

ETSI TS 138 133 V15.27.0 (2024-11)



**5G;
NR;
Requirements for support of radio resource management
(3GPP TS 38.133 version 15.27.0 Release 15)**



Reference

RTS/TSGR-0438133vfr0

Keywords

5G

ETSI

650 Route des Lucioles
F-06921 Sophia Antipolis Cedex - FRANCE

Tel.: +33 4 92 94 42 00 Fax: +33 4 93 65 47 16

Siret N° 348 623 562 00017 - APE 7112B
Association à but non lucratif enregistrée à la
Sous-Préfecture de Grasse (06) N° w061004871

Important notice

The present document can be downloaded from the
[ETSI Search & Browse Standards](#) application.

The present document may be made available in electronic versions and/or in print. The content of any electronic and/or print versions of the present document shall not be modified without the prior written authorization of ETSI. In case of any existing or perceived difference in contents between such versions and/or in print, the prevailing version of an ETSI deliverable is the one made publicly available in PDF format on [ETSI deliver](#).

Users should be aware that the present document may be revised or have its status changed,
this information is available in the [Milestones listing](#).

If you find errors in the present document, please send your comments to
the relevant service listed under [Committee Support Staff](#).

If you find a security vulnerability in the present document, please report it through our
[Coordinated Vulnerability Disclosure \(CVD\)](#) program.

Notice of disclaimer & limitation of liability

The information provided in the present deliverable is directed solely to professionals who have the appropriate degree of experience to understand and interpret its content in accordance with generally accepted engineering or other professional standard and applicable regulations.

No recommendation as to products and services or vendors is made or should be implied.

No representation or warranty is made that this deliverable is technically accurate or sufficient or conforms to any law and/or governmental rule and/or regulation and further, no representation or warranty is made of merchantability or fitness for any particular purpose or against infringement of intellectual property rights.

In no event shall ETSI be held liable for loss of profits or any other incidental or consequential damages.

Any software contained in this deliverable is provided "AS IS" with no warranties, express or implied, including but not limited to, the warranties of merchantability, fitness for a particular purpose and non-infringement of intellectual property rights and ETSI shall not be held liable in any event for any damages whatsoever (including, without limitation, damages for loss of profits, business interruption, loss of information, or any other pecuniary loss) arising out of or related to the use of or inability to use the software.

Copyright Notification

No part may be reproduced or utilized in any form or by any means, electronic or mechanical, including photocopying and microfilm except as authorized by written permission of ETSI.

The content of the PDF version shall not be modified without the written authorization of ETSI.

The copyright and the foregoing restriction extend to reproduction in all media.

© ETSI 2024.
All rights reserved.

Intellectual Property Rights

Essential patents

IPRs essential or potentially essential to normative deliverables may have been declared to ETSI. The declarations pertaining to these essential IPRs, if any, are publicly available for **ETSI members and non-members**, and can be found in ETSI SR 000 314: "*Intellectual Property Rights (IPRs); Essential, or potentially Essential, IPRs notified to ETSI in respect of ETSI standards*", which is available from the ETSI Secretariat. Latest updates are available on the [ETSI IPR online database](#).

Pursuant to the ETSI Directives including the ETSI IPR Policy, no investigation regarding the essentiality of IPRs, including IPR searches, has been carried out by ETSI. No guarantee can be given as to the existence of other IPRs not referenced in ETSI SR 000 314 (or the updates on the ETSI Web server) which are, or may be, or may become, essential to the present document.

Trademarks

The present document may include trademarks and/or tradenames which are asserted and/or registered by their owners. ETSI claims no ownership of these except for any which are indicated as being the property of ETSI, and conveys no right to use or reproduce any trademark and/or tradename. Mention of those trademarks in the present document does not constitute an endorsement by ETSI of products, services or organizations associated with those trademarks.

DECT™, **PLUGTESTS™**, **UMTS™** and the ETSI logo are trademarks of ETSI registered for the benefit of its Members. **3GPP™**, **LTE™** and **5G logo** are trademarks of ETSI registered for the benefit of its Members and of the 3GPP Organizational Partners. **oneM2M™** logo is a trademark of ETSI registered for the benefit of its Members and of the oneM2M Partners. **GSM®** and the GSM logo are trademarks registered and owned by the GSM Association.

Legal Notice

This Technical Specification (TS) has been produced by the ETSI 3rd Generation Partnership Project (3GPP).

The present document may refer to technical specifications or reports using their 3GPP identities. These shall be interpreted as being references to the corresponding ETSI deliverables.

The cross reference between 3GPP and ETSI identities can be found under <https://webapp.etsi.org/key/queryform.asp>.

Modal verbs terminology

In the present document "**shall**", "**shall not**", "**should**", "**should not**", "**may**", "**need not**", "**will**", "**will not**", "**can**" and "**cannot**" are to be interpreted as described in clause 3.2 of the [ETSI Drafting Rules](#) (Verbal forms for the expression of provisions).

"**must**" and "**must not**" are **NOT** allowed in ETSI deliverables except when used in direct citation.

Contents

Intellectual Property Rights	2
Legal Notice	2
Modal verbs terminology.....	2
Foreword.....	31
1 Scope	32
2 References	32
3 Definitions, symbols and abbreviations	33
3.1 Definitions	33
3.2 Symbols.....	34
3.3 Abbreviations	35
3.4 Test tolerances.....	37
3.5 Frequency bands grouping	37
3.5.1 Introduction.....	37
3.5.2 NR operating bands in FR1	37
3.5.3 NR operating bands in FR2	37
3.6 Applicability of requirements in this specification version	38
3.6.1 RRC connected state requirements in DRX.....	38
3.6.2 Number of serving carriers	39
3.6.2.1 Number of serving carriers for SA	39
3.6.2.2 Number of serving carriers for EN-DC.....	39
3.6.2.3 Number of serving carriers for NE-DC.....	39
3.6.2.4 Number of serving carriers for NR-DC.....	39
3.6.3 Applicability for intra-band FR2	39
3.6.4 Applicability for FR2 UE power classes.....	39
3.6.5 Applicability for SDL bands.....	40
3.6.6 Applicability of requirements for NGEN-DC operation.....	40
3.6.7 Applicability of QCL.....	40
4 SA: RRC_IDLE state mobility.....	40
4.1 Cell Selection	40
4.2 Cell Re-selection	40
4.2.1 Introduction.....	40
4.2.2 Requirements	40
4.2.2.1 UE measurement capability	40
4.2.2.2 Measurement and evaluation of serving cell.....	41
4.2.2.3 Measurements of intra-frequency NR cells.....	41
4.2.2.4 Measurements of inter-frequency NR cells.....	42
4.2.2.5 Measurements of inter-RAT E-UTRAN cells.....	44
4.2.2.6 Maximum interruption in paging reception.....	45
4.2.2.7 General requirements	45
5 SA: RRC_INACTIVE state mobility	46
5.1 Cell Re-selection	46
5.1.1 Introduction.....	46
5.1.2 Requirements	46
5.1.2.1 UE measurement capability	46
5.1.2.2 Measurement and evaluation of serving cell.....	46
5.1.2.3 Measurements of intra-frequency NR cells.....	46
5.1.2.4 Measurements of inter-frequency NR cells.....	46
5.1.2.5 Measurements of inter-RAT E-UTRAN cells.....	46
5.1.2.6 Maximum interruption in paging reception.....	46
5.1.2.7 General requirements	46
5.2 Void.....	47
6 RRC_CONNECTED state mobility	47

6.1	Handover	47
6.1.1	NR Handover	47
6.1.1.1	Introduction	47
6.1.1.2	NR FR1 - NR FR1 Handover	47
6.1.1.2.1	Handover delay	47
6.1.1.2.2	Interruption time	47
6.1.1.3	NR FR2- NR FR1 Handover	48
6.1.1.3.1	Handover delay	48
6.1.1.3.2	Interruption time	48
6.1.1.4	NR FR2- NR FR2 Handover	49
6.1.1.4.1	Handover delay	49
6.1.1.4.2	Interruption time	49
6.1.1.5	NR FR1- NR FR2 Handover	50
6.1.1.5.1	Handover delay	50
6.1.1.5.2	Interruption time	50
6.1.2	NR Handover to other RATs	51
6.1.2.1	NR – E-UTRAN Handover	51
6.1.2.1.1	Introduction	51
6.1.2.1.2	Handover delay	51
6.1.2.1.3	Interruption time	51
6.2	RRC Connection Mobility Control	52
6.2.1	SA: RRC Re-establishment	52
6.2.1.1	Introduction	52
6.2.1.2	Requirements	52
6.2.1.2.1	UE Re-establishment delay requirement	52
6.2.2	Random access	53
6.2.2.1	Introduction	53
6.2.2.2	Requirements	53
6.2.2.2.1	Contention based random access	54
6.2.2.2.2	Non-Contention based random access	55
6.2.2.2.3	UE behaviour when configured with supplementary UL	56
6.2.3	SA: RRC Connection Release with Redirection	56
6.2.3.1	Introduction	56
6.2.3.2	Requirements	56
6.2.3.2.1	RRC connection release with redirection to NR	56
6.2.3.2.2	RRC connection release with redirection to E-UTRAN	57
7	Timing	57
7.1	UE transmit timing	57
7.1.1	Introduction	57
7.1.2	Requirements	57
7.1.2.1	Gradual timing adjustment	58
7.1.2.2	Void	59
7.2	UE timer accuracy	59
7.2.1	Introduction	59
7.2.2	Requirements	59
7.3	Timing advance	59
7.3.1	Introduction	59
7.3.2	Requirements	60
7.3.2.1	Timing Advance adjustment delay	60
7.3.2.2	Timing Advance adjustment accuracy	60
7.4	Cell phase synchronization accuracy	60
7.4.1	Definition	60
7.4.2	Minimum requirements	60
7.5	Maximum Transmission Timing Difference	60
7.5.1	Introduction	60
7.5.2	Minimum Requirements for inter-band EN-DC	60
7.5.2.1	Minimum Requirements for inter-band synchronous EN-DC	61
7.5.3	Minimum Requirements for intra-band EN-DC	61
7.5.4	Minimum Requirements for NR Carrier Aggregation	62
7.5.5	Minimum Requirements for inter-band NE-DC	62
7.5.5.1	Minimum Requirements for inter-band synchronous NE-DC	62

7.5.6	Minimum Requirements for inter-band NR DC	63
7.6	Maximum Receive Timing Difference	63
7.6.1	Introduction	63
7.6.2	Minimum Requirements for inter-band EN-DC	63
7.6.2.1	Minimum Requirements for inter-band synchronous EN-DC	64
7.6.3	Minimum Requirements for intra-band EN-DC	64
7.6.4	Minimum Requirements for NR Carrier Aggregation	64
7.6.5	Minimum Requirements for inter-band NE-DC	65
7.6.5.1	Minimum Requirements for inter-band synchronous NE-DC	65
7.6.6	Minimum Requirements for inter-band NR DC	66
7.7	<i>deriveSSB-IndexFromCell</i> tolerance	66
7.7.1	Minimum requirements	66
7.8	Void	66
8	Signalling characteristics	66
8.1	Radio Link Monitoring	66
8.1.1	Introduction	66
8.1.2	Requirements for SSB based radio link monitoring	67
8.1.2.1	Introduction	67
8.1.2.2	Minimum requirement	68
8.1.2.3	Measurement restrictions for SSB based RLM	69
8.1.3	Requirements for CSI-RS based radio link monitoring	70
8.1.3.1	Introduction	70
8.1.3.2	Minimum requirement	71
8.1.3.3	Measurement restrictions for CSI-RS based RLM	73
8.1.4	Minimum requirement at transitions	73
8.1.5	Minimum requirement for UE turning off the transmitter	74
8.1.6	Minimum requirement for L1 indication	74
8.1.7	Scheduling availability of UE during radio link monitoring	74
8.1.7.1	Scheduling availability of UE performing radio link monitoring with a same subcarrier spacing as PDSCH/PDCCH on FR1	74
8.1.7.2	Scheduling availability of UE performing radio link monitoring with a different subcarrier spacing than PDSCH/PDCCH on FR1	74
8.1.7.3	Scheduling availability of UE performing radio link monitoring on FR2	75
8.1.7.4	Scheduling availability of UE performing radio link monitoring on FR1 or FR2 in case of FR1-FR2 inter-band CA and NR-DC	75
8.2	Interruption	75
8.2.1	EN-DC Interruption	75
8.2.1.1	Introduction	75
8.2.1.2	Requirements	76
8.2.1.2.1	Interruptions at transitions between active and non-active during DRX	76
8.2.1.2.2	Interruptions at transitions from non-DRX to DRX	76
8.2.1.2.3	Interruptions at SCell addition/release	76
8.2.1.2.4	Interruptions at SCell activation/deactivation	77
8.2.1.2.5	Interruptions during measurements on SCC	78
8.2.1.2.6	Interruptions at UL carrier RRC reconfiguration	79
8.2.1.2.7	Interruptions due to Active BWP switching Requirement	79
8.2.2	SA: Interruptions with Standalone NR Carrier Aggregation	80
8.2.2.1	Introduction	80
8.2.2.2	Requirements	81
8.2.2.2.1	Interruptions at SCell addition/release	81
8.2.2.2.2	Interruptions at SCell activation/deactivation	81
8.2.2.2.3	Interruptions during measurements on deactivated SCC	82
8.2.2.2.4	Interruptions at UL carrier RRC reconfiguration	83
8.2.2.2.5	Interruptions due to Active BWP switching Requirement	83
8.2.2.2.6	Interruptions at inter-frequency SFTD measurement	84
8.2.3	NE-DC Interruptions	85
8.2.3.1	Introduction	85
8.2.3.2	Requirements	85
8.2.3.2.1	Interruptions at transitions between active and non-active during DRX	85
8.2.3.2.2	Interruptions at transitions from non-DRX to DRX	86
8.2.3.2.3	Interruptions at PSCell/SCell addition/release	86

8.2.3.2.4	Interruptions at SCell activation/deactivation.....	87
8.2.3.2.5	Interruptions during measurements on SCC.....	88
8.2.3.2.6	Interruptions at UL carrier RRC reconfiguration	89
8.2.3.2.7	Interruptions due to Active BWP switching Requirement	89
8.2.4	NR-DC: Interruptions	89
8.2.4.1	Introduction.....	89
8.2.4.2	Requirements	90
8.2.4.2.1	Interruptions at PSCell/SCell addition/release	90
8.2.4.2.2	Interruptions at SCell activation/deactivation.....	90
8.2.4.2.3	Interruptions during measurements on SCC.....	91
8.2.4.2.4	Interruptions at UL carrier RRC reconfiguration	91
8.2.4.2.5	Interruptions due to Active BWP switching Requirement	92
8.2.4.2.6	Interruptions at transitions between active and non-active during DRX	92
8.2.4.2.7	Interruptions at transitions from non-DRX to DRX	92
8.3	SCell Activation and Deactivation Delay.....	92
8.3.1	Introduction.....	92
8.3.2	SCell Activation Delay Requirement for Deactivated SCell	93
8.3.3	SCell Deactivation Delay Requirement for Activated SCell	96
8.4	UE UL carrier RRC reconfiguration delay.....	97
8.4.1	Introduction.....	97
8.4.2	UE UL carrier configuration delay requirement	97
8.4.3	UE UL carrier deconfiguration delay requirement	97
8.5	Link Recovery Procedures	97
8.5.1	Introduction.....	97
8.5.2	Requirements for SSB based beam failure detection.....	98
8.5.2.1	Introduction.....	98
8.5.2.2	Minimum requirement	98
8.5.2.3	Measurement restriction for SSB based beam failure detection.....	100
8.5.3	Requirements for CSI-RS based beam failure detection.....	100
8.5.3.1	Introduction.....	100
8.5.3.2	Minimum requirement	101
8.5.3.3	Measurement restrictions for CSI-RS beam failure detection.....	102
8.5.4	Minimum requirement for L1 indication	103
8.5.5	Requirements for SSB based candidate beam detection	104
8.5.5.1	Introduction.....	104
8.5.5.2	Minimum requirement	104
8.5.5.3	Measurement restriction for SSB based candidate beam detection.....	105
8.5.6	Requirements for CSI-RS based candidate beam detection.....	106
8.5.6.1	Introduction.....	106
8.5.6.2	Minimum requirement	106
8.5.6.3	Measurement restriction for CSI-RS based candidate beam detection	108
8.5.7	Scheduling availability of UE during beam failure detection	108
8.5.7.1	Scheduling availability of UE performing beam failure detection with a same subcarrier spacing as PDSCH/PDCCH on FR1	108
8.5.7.2	Scheduling availability of UE performing beam failure detection with a different subcarrier spacing than PDSCH/PDCCH on FR1.....	108
8.5.7.3	Scheduling availability of UE performing beam failure detection on FR2	109
8.5.7.4	Scheduling availability of UE performing beam failure detection on FR1 or FR2 in case of FR1-FR2 inter-band CA and NR DC	109
8.5.8	Scheduling availability of UE during candidate beam detection	109
8.5.8.1	Scheduling availability of UE performing L1-RSRP measurement with a same subcarrier spacing as PDSCH/PDCCH on FR1	109
8.5.8.2	Scheduling availability of UE performing L1-RSRP measurement with a different subcarrier spacing than PDSCH/PDCCH on FR1.....	109
8.5.8.3	Scheduling availability of UE performing L1-RSRP measurement on FR2	110
8.5.8.4	Scheduling availability of UE performing L1-RSRP measurement on FR1 or FR2 in case of FR1-FR2 inter-band CA and NR-DC.....	110
8.5.9	Minimum requirement at transitions for beam failure detection.....	110
8.6	Active BWP switch delay.....	111
8.6.1	Introduction.....	111
8.6.2	DCI and timer based BWP switch delay.....	111
8.6.3	RRC based BWP switch delay.....	112

8.7	Void.....	112
8.8	NE-DC: E-UTRAN PSCell Addition and Release Delay	112
8.8.1	Introduction.....	112
8.8.2	E-UTRAN PSCell Addition Delay Requirement.....	112
8.8.3	E-UTRAN PSCell Release Delay Requirement	113
8.9	NR-DC: PSCell Addition and Release Delay.....	113
8.9.1	Introduction.....	113
8.9.2	PSCell Addition Delay Requirement	113
8.9.3	PSCell Release Delay Requirement.....	114
8.10	Active TCI state switching delay	114
8.10.6	Active TCI state list update delay.....	117
8.11	PSCell Change.....	117
9	Measurement Procedure	117
9.1	General measurement requirement.....	117
9.1.1	Introduction.....	117
9.1.2	Measurement gap	118
9.1.2.1	EN-DC: Measurement Gap Sharing.....	125
9.1.2.1a	SA: Measurement Gap Sharing.....	125
9.1.2.1b	NE-DC: Measurement Gap Sharing.....	126
9.1.2.1c	NR-DC: Measurement Gap Sharing	127
9.1.3	UE Measurement capability.....	128
9.1.3.1	EN-DC: Monitoring of multiple layers using gaps	128
9.1.3.1a	SA: Monitoring of multiple layers using gaps	128
9.1.3.1b	NE-DC: Monitoring of multiple layers using gaps	129
9.1.3.1c	NR-DC: Monitoring of multiple layers using gaps	129
9.1.3.2	EN-DC: Maximum allowed layers for multiple monitoring	129
9.1.3.2a	SA: Maximum allowed layers for multiple monitoring	130
9.1.3.2b	NE-DC: Maximum allowed layers for multiple monitoring	130
9.1.3.2c	NR-DC: Maximum allowed layers for multiple monitoring	131
9.1.4	Capabilities for Support of Event Triggering and Reporting Criteria.....	131
9.1.4.1	Introduction.....	131
9.1.4.2	Requirements	132
9.1.5	Carrier-specific scaling factor.....	133
9.1.5.1	Monitoring of multiple layers outside gaps.....	133
9.1.5.1.1	EN-DC mode: carrier-specific scaling factor for SSB-based measurements performed outside gaps.....	134
9.1.5.1.2	SA mode: carrier-specific scaling factor for SSB-based measurements performed outside gaps.....	134
9.1.5.1.3	NR-DC mode: carrier-specific scaling factor for SSB-based measurements performed outside gaps.....	135
9.1.5.1.4	NE-DC mode: carrier-specific scaling factor for SSB-based measurements performed outside gaps.....	135
9.1.5.2	Monitoring of multiple layers within gaps	136
9.1.5.2.1	EN-DC mode: carrier-specific scaling factor for SSB-based measurements performed within gaps.....	136
9.1.5.2.2	SA mode: carrier-specific scaling factor for SSB-based measurements performed within gaps.....	138
9.1.5.2.3	NE-DC: carrier-specific scaling factor for SSB-based measurements performed within gaps.....	139
9.1.5.2.4	NR-DC: carrier-specific scaling factor for SSB-based measurements performed within gaps	140
9.1.6	Minimum requirement at transitions.....	141
9.2	NR intra-frequency measurements	142
9.2.1	Introduction.....	142
9.2.2	Requirements applicability	142
9.2.3	Number of cells and number of SSB	143
9.2.3.1	Requirements for FR1	143
9.2.3.2	Requirements for FR2.....	143
9.2.4	Measurement Reporting Requirements.....	143
9.2.4.1	Periodic Reporting	143
9.2.4.2	Event-triggered Periodic Reporting.....	143
9.2.4.3	Event Triggered Reporting.....	143
9.2.5	Intrafrequency measurements without measurement gaps.....	144
9.2.5.1	Intrafrequency cell identification	144

9.2.5.2	Measurement period.....	146
9.2.5.3	Scheduling availability of UE during intra-frequency measurements.....	148
9.2.5.3.1	Scheduling availability of UE performing measurements in TDD bands on FR1	148
9.2.5.3.2	Scheduling availability of UE performing measurements with a different subcarrier spacing than PDSCH/PDCCH on FR1	148
9.2.5.3.3	Scheduling availability of UE performing measurements on FR2	149
9.2.5.3.4	Scheduling availability of UE performing measurements on FR1 or FR2 in case of FR1-FR2 inter-band CA	149
9.2.5.4	SFTD Measurements between PCell and PSCell.....	149
9.2.5.4.1	Introduction	149
9.2.5.4.2	SFTD Measurement delay	149
9.2.5.4.3	SFTD Measurement Reporting Delay	150
9.2.6	Intra-frequency measurements with measurement gaps	150
9.2.6.1	Void.....	150
9.2.6.2	Intra-frequency cell identification	150
9.2.6.3	Intra-frequency Measurement Period.....	152
9.3	NR inter-frequency measurements	152
9.3.1	Introduction.....	152
9.3.2	Requirements applicability	152
9.3.2.1	Void.....	153
9.3.2.2	Void.....	153
9.3.3	Number of cells and number of SSB	153
9.3.3.1	Requirements for FR1	153
9.3.3.2	Requirements for FR2	153
9.3.4	Inter-frequency cell identification.....	153
9.3.4.1	Void.....	155
9.3.4.2	Void.....	155
9.3.5	Inter-frequency measurements.....	155
9.3.5.1	Void.....	155
9.3.5.2	Void.....	155
9.3.5.3	Void.....	155
9.3.6	Inter-frequency measurements reporting requirements.....	155
9.3.6.1	Periodic Reporting	155
9.3.6.2	Event-triggered Periodic Reporting.....	155
9.3.6.3	Event-triggered Reporting.....	156
9.3.7	Void	156
9.3.8	Inter-frequency SFTD measurement requirements.....	156
9.3.8.1	Introduction.....	156
9.3.8.2	SFTD Measurement delay.....	156
9.3.8.3	SFTD Measurement reporting delay	157
9.4	Inter-RAT measurements	157
9.4.1	Introduction.....	157
9.4.2	NR – E-UTRAN FDD measurements	159
9.4.2.1	Introduction	159
9.4.2.2	Requirements when no DRX is used.....	159
9.4.2.3	Requirements when DRX is used.....	160
9.4.2.4	Measurement reporting requirements.....	160
9.4.2.4.1	Periodic Reporting.....	160
9.4.2.4.2	Event-Triggered Periodic Reporting.....	160
9.4.2.4.3	Event-Triggered Reporting.....	160
9.4.3	NR – E-UTRAN TDD measurements	161
9.4.3.1	Introduction.....	161
9.4.3.2	Requirements when no DRX is used.....	161
9.4.3.3	Requirements when DRX is used.....	162
9.4.3.4	Measurement reporting requirements.....	163
9.4.3.4.1	Periodic Reporting.....	163
9.4.3.4.2	Event-Triggered Periodic Reporting.....	163
9.4.3.4.3	Event-Triggered Reporting.....	163
9.4.4	Inter-RAT RSTD measurements.....	164
9.4.4.1	NR – E-UTRAN FDD RSTD measurements.....	164
9.4.4.1.1	Introduction	164
9.4.4.1.2	Requirements.....	164

9.4.4.2	NR – E-UTRAN TDD RSTD measurements	167
9.4.4.2.1	Introduction	167
9.4.4.2.2	Requirements	168
9.4.5	Inter-RAT E-CID measurements	171
9.4.5.1	NR–E-UTRAN FDD E-CID RSRP and RSRQ measurements	171
9.4.5.1.1	Introduction	171
9.4.5.1.2	Requirements	171
9.4.5.1.3	Measurement Reporting Delay	171
9.4.5.2	NR–E-UTRAN TDD E-CID RSRP and RSRQ measurements	171
9.4.5.2.1	Introduction	171
9.4.5.2.2	Requirements	172
9.4.5.2.3	Measurement Reporting Delay	172
9.5	L1-RSRP measurements for Reporting	172
9.5.1	Introduction.....	172
9.5.2	Requirements applicability	172
9.5.3	Measurement Reporting Requirements.....	173
9.5.3.1	Periodic Reporting	173
9.5.3.2	Semi-Persistent Reporting.....	173
9.5.3.3	Aperiodic Reporting.....	173
9.5.4	L1-RSRP measurement requirements	173
9.5.4.1	SSB based L1-RSRP Reporting	173
9.5.4.2	CSI-RS based L1-RSRP Reporting.....	175
9.5.5	Measurement restriction for CSI-RS and SSB for L1-RSRP measurement.....	177
9.5.5.1	Measurement restriction for SSB based L1-RSRP.....	178
9.5.5.2	Measurement restriction for CSI-RS based L1-RSRP	178
9.5.6	Scheduling availability of UE during L1-RSRP measurement	179
9.5.6.1	Scheduling availability of UE performing L1-RSRP measurement with a same subcarrier spacing as PDSCH/PDCCH on FR1	179
9.5.6.2	Scheduling availability of UE performing L1-RSRP measurement with a different subcarrier spacing than PDSCH/PDCCH on FR1	179
9.5.6.3	Scheduling availability of UE performing L1-RSRP measurement on FR2	179
9.5.6.4	Scheduling availability of UE performing L1-RSRP measurement on FR1 or FR2 in case of FR1-FR2 inter-band CA.....	180
9.6	NE-DC: Measurements	180
9.6.1	Introduction.....	180
9.6.2	SFTD Measurements	180
9.6.2.1	Introduction.....	180
9.6.2.2	SFTD Measurement requirements	180
10	Measurement Performance requirements	181
10.1	NR measurements.....	181
10.1.1	Introduction.....	181
10.1.2	Intra-frequency RSRP accuracy requirements for FR1.....	182
10.1.2.1	Intra-frequency SS-RSRP accuracy requirements.....	182
10.1.2.1.1	Absolute SS-RSRP Accuracy	182
10.1.2.1.2	Relative SS-RSRP Accuracy	182
10.1.2.2	Void.....	183
10.1.3	Intra-frequency RSRP accuracy requirements for FR2.....	183
10.1.3.1	Intra-frequency SS-RSRP accuracy requirements.....	183
10.1.3.1.1	Absolute SS-RSRP Accuracy	183
10.1.3.1.2	Relative SS-RSRP Accuracy	184
10.1.3.2	Void.....	184
10.1.4	Inter-frequency RSRP accuracy requirements for FR1.....	184
10.1.4.1	Inter-frequency SS-RSRP accuracy requirements.....	184
10.1.4.1.1	Absolute Accuracy of SS-RSRP in FR1	184
10.1.4.1.2	Relative Accuracy of SS-RSRP in FR1	185
10.1.4.2	Void.....	186
10.1.5	Inter-frequency RSRP accuracy requirements for FR2.....	186
10.1.5.1	Inter-frequency SS-RSRP accuracy requirements.....	186
10.1.5.1.1	Absolute SS-RSRP Accuracy	186
10.1.5.1.2	Relative SS-RSRP Accuracy	187
10.1.5.2	Void.....	187

10.1.6	RSRP Measurement Report Mapping.....	187
10.1.7	Intra-frequency RSRQ accuracy requirements for FR1	189
10.1.7.1	Intra-frequency SS-RSRQ accuracy requirements in FR1	189
10.1.7.1.1	Absolute SS-RSRQ Accuracy in FR1	189
10.1.8	Intra-frequency RSRQ accuracy requirements for FR2.....	190
10.1.8.1	Intra-frequency SS-RSRQ accuracy requirements in FR2	190
10.1.8.1.1	Absolute SS-RSRQ Accuracy in FR2	190
10.1.9	Inter-frequency RSRQ accuracy requirements for FR1	190
10.1.9.1	Inter-frequency SS-RSRQ accuracy requirements in FR1	190
10.1.9.1.1	Absolute Accuracy of SS-RSRQ in FR1	190
10.1.9.1.2	Relative Accuracy of SS-RSRQ in FR1	191
10.1.10	Inter-frequency RSRQ accuracy requirements for FR2.....	192
10.1.11	RSRQ report mapping	193
10.1.12	Intra-frequency SINR accuracy requirements for FR1	193
10.1.13	Intra-frequency SINR accuracy requirements for FR2	194
10.1.14	Inter-frequency SINR accuracy requirements for FR1	195
10.1.15	Inter-frequency SINR accuracy requirements for FR2	196
10.1.16	SINR report mapping.....	197
10.1.17	Power Headroom	198
10.1.18	$P_{\text{CMAX,c,f}}$	198
10.1.19	L1-RSRP accuracy requirements for FR1	199
10.1.20	L1-RSRP accuracy requirements for FR2	202
10.1.21	SFTD accuracy requirements.....	204
10.2	E-UTRAN measurements.....	208
10.2.1	Introduction.....	208
10.2.2	E-UTRAN RSRP measurements	208
10.2.3	E-UTRAN RSRQ measurements.....	209
10.2.4	E-UTRAN RSTD measurements	209
10.2.5	E-UTRAN RS-SINR measurements.....	209
11	Void.....	209
Annex A (normative): Test Cases		210
A.1	Purpose of annex	210
A.2	Requirement classification for statistical testing.....	210
A.2.1	Types of requirements in TS 38.133	210
A.2.1.1	Time and delay requirements on UE higher layer actions	210
A.2.1.2	Measurements of power levels, relative powers and time	211
A.2.1.3	Implementation requirements	211
A.2.1.4	Physical layer timing requirements.....	211
A.3	RRM test configurations	211
A.3.1	Reference measurement channels.....	211
A.3.1.1	PDSCH	211
A.3.1.1.1	FDD.....	211
A.3.1.1.2	TDD	212
A.3.1.2	CORESET for RMSI scheduling	215
A.3.1.2.1	FDD.....	215
A.3.1.2.2	TDD	216
A.3.1.3	CORESET for RMC scheduling	218
A.3.1.3.1	FDD.....	218
A.3.1.3.2	TDD	219
A.3.1.4	TDD UL/DL configuration	221
A.3.2	OFDMA channel noise generator (OCNG).....	222
A.3.2.1	Generic OFDMA Channel Noise Generator (OCNG)	222
A.3.2.1.1	OCNG pattern 1: Generic OCNG pattern for all unused REs	222
A.3.2.1.2	OCNG pattern 2: Generic OCNG pattern for all unused REs for 2AoA setup	222
A.3.2.1.3	OCNG pattern 3: Generic OCNG pattern for unused REs in the same bandwidth as CORESET	223
A.3.2.1.4	OCNG pattern 4: Generic OCNG pattern for all unused REs outside SSB slot(s).....	223
A.3.2.2	Void	225
A.3.3	Reference DRX configurations	225

A.3.3.1	DRX Configuration 1: DRX cycle = 40 ms and TAT = 500 ms.....	225
A.3.3.2	DRX Configuration 2: DRX cycle = 640 ms and TAT = 500 ms.....	225
A.3.3.3	DRX Configuration 3: DRX cycle = 40 ms and TAT = Infinity	225
A.3.3.4	DRX Configuration 4: DRX cycle = 160 ms and TAT = Infinity	226
A.3.3.5	DRX Configuration 5: DRX cycle = 320 ms and TAT = Infinity	226
A.3.3.6	DRX Configuration 6: DRX cycle = 320 ms and TAT = 500 ms.....	226
A.3.3.7	DRX Configuration 7: DRX cycle = 640 ms and TAT = Infinity	227
A.3.3.8	DRX Configuration 8: DRX cycle = 320 ms and TAT = Infinity	227
A.3.3.9	DRX Configuration 9: DRX cycle = 40 ms and TAT = 500 ms.....	227
A.3.3.10	DRX Configuration 10: DRX cycle = 640 ms and TAT = 500 ms.....	228
A.3.3.11	DRX Configuration 11: DRX cycle = 20 ms and TAT = Infinity	228
A.3.3.12	DRX Configuration 12: DRX cycle = 640 ms and TAT = Infinity	228
A.3.4	Test Cases with Different Channel Bandwidths.....	229
A.3.4.1	Test Cases with Different E-UTRA Channel Bandwidths.....	229
A.3.4.1.1	Introduction.....	229
A.3.4.1.2	Principle of testing	229
A.3.5	Test Cases for Synchronous and Asynchronous DC Operations.....	229
A.3.5.1	EN-DC Test Cases for Synchronous and Asynchronous EN-DC Operations	229
A.3.5.1.1	Introduction.....	229
A.3.5.1.2	Principle of Testing.....	229
A.3.6	Antenna configurations	229
A.3.6.1	Antenna configurations for FR1	229
A.3.6.1.1	Antenna connection for 4 Rx capable UEs	230
A.3.6.1.1.1	Introduction	230
A.3.6.1.1.2	Principle of testing.....	230
A.3.6.2	Antenna configurations for FR2	232
A.3.7	EN-DC test setup.....	232
A.3.7.1	Introduction.....	232
A.3.7.2	E-UTRAN Serving Cell Parameters	232
A.3.7.2.1	E-UTRAN Serving Cell Parameters for Tests with NR Cell(s) in FR1	232
A.3.7.2.2	E-UTRAN Serving Cell Parameters for Tests with NR Cell(s) in FR2	234
A.3.7A	NR FR1-FR2 test setup	235
A.3.7B	Void.....	235
A.3.7C	LTE-FR1/FR2 test setup	235
A.3.7D	NE-DC test setup.....	235
A.3.7D.1	Introduction.....	235
A.3.7D.2	E-UTRAN Serving Cell Parameters	235
A.3.7D.2.1	E-UTRAN Serving Cell Parameters for Tests with NR Cell(s) in FR1	235
A.3.7D.2.2	E-UTRAN Serving Cell Parameters for Tests with NR Cell(s) in FR2	235
A.3.8	PRACH configurations.....	235
A.3.8.1	Introduction.....	235
A.3.8.2	PRACH configurations in FR1	236
A.3.8.2.1	FR1 PRACH configuration 1	236
A.3.8.2.2	FR1 PRACH configuration 2	236
A.3.8.2.3	FR1 PRACH configuration 3	237
A.3.8.2.4	FR1 PRACH configuration 4	238
A.3.8.3	PRACH configurations in FR2	238
A.3.8.3.1	FR2 PRACH configuration 1	238
A.3.8.3.2	FR2 PRACH configuration 2	239
A.3.8.3.3	FR2 PRACH configuration 3	240
A.3.8.3.4	FR2 PRACH configuration 4	241
A.3.9	BWP configurations	241
A.3.9.1	Introduction.....	241
A.3.9.2	Downlink BWP configurations.....	241
A.3.9.2.1	Initial BWP	241
A.3.9.2.2	Dedicated BWP.....	242
A.3.9.3	Uplink BWP configurations.....	242
A.3.9.3.1	Initial BWP	242
A.3.9.3.2	Dedicated BWP.....	242
A.3.10	SSB Configurations	243
A.3.10.1	SSB Configurations for FR1	243
A.3.10.1.1	SSB pattern 1 in FR1: SSB allocation for SSB SCS=15 kHz in 10 MHz.....	243

A.3.10.1.2	SSB pattern 2 in FR1: SSB allocation for SSB SCS=30 kHz in 40 MHz	243
A.3.10.1.3	SSB pattern 3 in FR1: SSB allocation for SSB SCS=15 kHz in 10 MHz	244
A.3.10.1.4	SSB pattern 4 in FR1: SSB allocation for SSB SCS=30 kHz in 40 MHz	244
A.3.10.1.5	SSB pattern 5 in FR1: SSB allocation for SSB SCS=15 kHz starting from odd SFN in 10 MHz	245
A.3.10.1.6	SSB pattern 6 in FR1: SSB allocation for SSB SCS=30 kHz starting from odd SFN in 40 MHz	245
A.3.10.2	SSB Configurations for FR2	245
A.3.10.2.1	SSB pattern 1 in FR2: SSB allocation for SSB SCS=120 kHz in 100 MHz	245
A.3.10.2.2	SSB pattern 2 in FR2: SSB allocation for SSB SCS=240 kHz in 100 MHz	246
A.3.10.2.3	SSB pattern 3 in FR2: SSB allocation for SSB SCS=120 kHz in 100 MHz	246
A.3.10.2.4	SSB pattern 4 in FR2: SSB allocation for SSB SCS=240 kHz in 100 MHz	247
A.3.10.2.5	SSB pattern 5 in FR2: SSB allocation for SSB SCS=120 kHz in 100 MHz	247
A.3.10.2.6	SSB pattern 6 in FR2: SSB allocation for SSB SCS=240 kHz in 100 MHz	247
A.3.10.2.7	SSB pattern 7 in FR2: SSB allocation for SSB SCS=120 kHz in 100 MHz	248
A.3.10.2.8	SSB pattern 8 in FR2: SSB allocation for SSB SCS=240 kHz in 100 MHz	248
A.3.11	SMTC Configurations	249
A.3.11.1	SMTC pattern 1: SMTC period = 20 ms with SMTC duration = 1 ms	249
A.3.11.2	SMTC pattern 2: SMTC period = 20 ms with SMTC duration = 5 ms	249
A.3.11.3	SMTC pattern 3: SMTC period = 160 ms with SMTC duration = 1 ms	249
A.3.11.4	SMTC pattern 4: SMTC period = 20 ms with SMTC duration = 1 ms	249
A.3.11.5	SMTC pattern 5: SMTC period = 20 ms with SMTC duration = 5 ms	250
A.3.11.6	SMTC pattern 6: SMTC period = 20 ms with SMTC duration = 5 ms	250
A.3.12	Test Cases with Different CC Configurations	250
A.3.12.1	EN-DC Test Cases with Different EN-DC Configurations	250
A.3.12.1.1	Introduction	250
A.3.12.1.2	Principle of testing	250
A.3.12.2	Carrier Aggregation Test Cases with Different CA Configurations	250
A.3.12.2.1	Introduction	250
A.3.12.2.2	Principle of testing	251
A.3.13	Test Cases in SA and EN-DC Operations	251
A.3.13.1	Introduction	251
A.3.13.2	Principle of Testing	251
A.3.13A	Test Cases involving E-UTRA/FR1 and FR2 carriers	251
A.3.13A.1	Introduction	251
A.3.13A.2	Principle of Testing in EN-DC	251
A.3.13A.3	Principle of Testing in SA	252
A.3.13A.4	Principle of Testing in E-UTRA	252
A.3.13B	Test Cases for EN-DC and NE-DC Operations	253
A.3.13B.1	Active BWP switch Test Cases for EN-DC and NE-DC Operations	253
A.3.13B.1.1	Introduction	253
A.3.13B.1.2	Principle of Testing	253
A.3.13B.2	SFTD accuracy Test Cases for EN-DC and NE-DC Operations	253
A.3.13B.2.1	Introduction	253
A.3.13B.2.2	Principle of Testing	253
A.3.14	CSI-RS configurations	254
A.3.14.1	FDD	254
A.3.14.2	TDD	254
A.3.15	Angle of Arrival (AoA) for FR2 RRM test cases	257
A.3.15.1	Setup 1: Single AoA in Rx beam peak direction	257
A.3.15.2	Setup 2: Single AoA in non Rx beam peak direction	257
A.3.15.2.1	Setup 2a: Single AoA in non Rx beam peak direction without change in direction	257
A.3.15.2.2	Setup 2b: Single AoA in non Rx beam peak direction with change in direction	257
A.3.15.3	Setup 3: 2 AoAs	257
A.3.15.4	Setup 4: 2 AoAs, 1 AoA in Rx beam peak direction, 1 in non Rx beam peak	258
A.3.15.4.1	Setup 4a: 2 AoAs, 1 AoA in Rx beam peak direction, 1 in non Rx beam peak without change in direction	258
A.3.15.4.2	Setup 4b: 2 AoAs, 1 AoA in Rx beam peak direction, 1 in non Rx beam peak with change in direction	258
A.3.16	TCI State Configuration	258
A.3.16.1	Introduction	258
A.3.16.2	TCI states	259
A.3.17	Configurations of CSI-RS for tracking	259
A.3.17.1	Configuration of CSI-RS for tracking for FR1	259

A.3.17.1.1	FDD.....	259
A.3.17.1.2	TDD	260
A.3.17.2	Configuration of CSI-RS for tracking for FR2	261
A.3.17.2.1	TDD	261
A.3.18	Additional definitions related to OTA testing for FR2 RRM test cases	262
A.3.18.1	Introduction.....	262
A.3.18.2	PRACH Power Measurement	262
A.4	EN-DC tests with all NR cells in FR1	262
A.4.1	Void.....	262
A.4.2	Void.....	262
A.4.3	RRC_CONNECTED state mobility	262
A.4.3.1	Void	262
A.4.3.2	RRC Connection Mobility Control	262
A.4.3.2.1	Void.....	262
A.4.3.2.2	Random Access	262
A.4.3.2.2.1	Contention based random access test in FR1 for PSCell in EN-DC.....	262
A.4.3.2.2.1.1	Test Purpose and Environment.....	262
A.4.3.2.2.2	Non-contention based random access test in FR1 for PSCell in EN-DC	265
A.4.3.2.3	Void.....	269
A.4.4	Timing	269
A.4.4.1	UE transmit timing	269
A.4.4.1.1	NR UE Transmit Timing Test for FR1	269
A.4.4.1.1.1	Test Purpose and environment	269
A.4.4.1.1.2	Test requirements	271
A.4.4.2	UE timer accuracy	272
A.4.4.3	Timing advance	272
A.4.4.3.1	EN-DC FR1 timing advance adjustment accuracy.....	272
A.4.4.3.1.1	Test Purpose and Environment.....	272
A.4.4.3.1.2	Test Parameters	272
A.4.4.3.1.3	Test Requirements	275
A.4.5	Signaling characteristics	275
A.4.5.1	Radio link Monitoring	275
A.4.5.1.1	Radio Link Monitoring Out-of-sync Test for FR1 PSCell configured with SSB-based RLM RS in non-DRX mode	276
A.4.5.1.1.1	Test Purpose and Environment.....	276
A.4.5.1.1.2	Test Requirements	279
A.4.5.1.2	Radio Link Monitoring In-sync Test for FR1 PSCell configured with SSB-based RLM RS in non-DRX mode	279
A.4.5.1.2.2	Test Requirements	283
A.4.5.1.3	Radio Link Monitoring Out-of-sync Test for FR1 PSCell configured with SSB-based RLM RS in DRX mode	283
A.4.5.1.3.1	Test Purpose and Environment.....	283
A.4.5.1.3.2	Test Requirements	286
A.4.5.1.4	Radio Link Monitoring In-sync Test for FR1 PSCell configured with SSB-based RLM RS in DRX mode	287
A.4.5.1.4.1	Test Purpose and Environment.....	287
A.4.5.1.4.2	Test Requirements	290
A.4.5.1.5	EN-DC Radio Link Monitoring Out-of-sync Test for FR1 PSCell configured with CSI-RS-based RLM in non-DRX mode	290
A.4.5.1.5.1	Test Purpose and Environment.....	290
A.4.5.1.5.2	Test Requirements	294
A.4.5.1.6	EN-DC Radio Link Monitoring In-sync Test for FR1 PSCell configured with CSI-RS-based RLM in non-DRX mode	294
A.4.5.1.6.1	Test Purpose and Environment.....	294
A.4.5.1.6.2	Test Requirements	298
A.4.5.1.7	EN-DC Radio Link Monitoring Out-of-sync Test for FR1 PSCell configured with CSI-RS-based RLM in DRX mode.....	298
A.4.5.1.7.1	Test Purpose and Environment.....	298
A.4.5.1.7.2	Test Requirements	301
A.4.5.1.8	EN-DC Radio Link Monitoring In-sync Test for FR1 PSCell configured with CSI-RS-based RLM in DRX mode.....	301

A.4.5.1.8.1	Test Purpose and Environment.....	301
A.4.5.1.8.2	Test Requirements	305
A.4.5.2	Interruption	305
A.4.5.2.1	E-UTRAN – NR FR1 interruptions at transitions between active and non-active during DRX in synchronous EN-DC	305
A.4.5.2.1.1	Test Purpose and Environment.....	305
A.4.5.2.1.2	Test Requirements	308
A.4.5.2.2	E-UTRAN – NR FR1 interruptions at transitions between active and non-active during DRX in asynchronous EN-DC.....	308
A.4.5.2.2.1	Test Purpose and Environment.....	308
A.4.5.2.2.2	Test Requirements	311
A.4.5.2.3	E-UTRAN – NR FR1 interruptions during measurements on deactivated NR SCC in synchronous EN-DC	311
A.4.5.2.3.1	Test Purpose and Environment.....	311
A.4.5.2.3.2	Test Requirements	316
A.4.5.2.4	E-UTRAN – NR FR1 interruptions during measurements on deactivated NR SCC in asynchronous EN-DC.....	316
A.4.5.2.4.1	Test Purpose and Environment.....	316
A.4.5.2.4.2	Test Requirements	321
A.4.5.2.5	E-UTRAN – NR FR1 interruptions during measurements on deactivated E-UTRAN SCC in synchronous EN-DC	321
A.4.5.2.5.1	Test Purpose and Environment.....	321
A.4.5.2.5.2	Test Requirements	324
A.4.5.2.6	E-UTRAN – NR FR1 interruptions during measurements on deactivated E-UTRAN SCC in asynchronous EN-DC.....	324
A.4.5.2.6.1	Test Purpose and Environment.....	324
A.4.5.2.6.2	Test Requirements	327
A.4.5.2.7	Void.....	327
A.4.5.3.1	SCell Activation and deactivation of known SCell in FR1 for 160ms SCell measurement cycle	327
A.4.5.3.1.1	Test Purpose and Environment.....	327
A.4.5.3.1.2	Test Requirements	333
A.4.5.3.2	SCell Activation and deactivation of known SCell in FR1 for 640ms SCell measurement cycle	334
A.4.5.3.2.1	Test Purpose and Environment.....	334
A.4.5.3.2.2	Test Requirements	334
A.4.5.3.3	SCell Activation and deactivation of unknown SCell in FR1	334
A.4.5.3.3.1	Test Purpose and Environment.....	334
A.4.5.3.3.2	Test Requirements	335
A.4.5.4	UE UL carrier RRC reconfiguration Delay	335
A.4.5.4.1	UE UL carrier RRC reconfiguration Delay.....	335
A.4.5.4.1.1	Test Purpose and Environment.....	335
A.4.5.4.1.2	Test Requirements	342
A.4.5.5	Beam Failure Detection and Link recovery procedures.....	342
A.4.5.5.1	EN-DC Beam Failure Detection and Link Recovery Test for FR1 PSCell configured with SSB-based BFD and LR in non-DRX mode	342
A.4.5.5.1.1	Test Purpose and Environment.....	342
A.4.5.5.1.2	Test Requirements	346
A.4.5.5.2	EN-DC Beam Failure Detection and Link Recovery Test for FR1 PSCell configured with SSB-based BFD and LR in DRX mode.....	347
A.4.5.5.2.1	Test Purpose and Environment.....	347
A.4.5.5.2.2	Test Requirements	351
A.4.5.5.3	EN-DC Beam Failure Detection and Link Recovery Test for FR1 PSCell configured with CSI-RS-based BFD and LR in non-DRX mode	352
A.4.5.5.3.1	Test Purpose and Environment.....	352
A.4.5.5.3.2	Test Requirements	356
A.4.5.5.4	EN-DC Beam Failure Detection and Link Recovery Test for FR1 PSCell configured with CSI-RS-based BFD and LR in DRX mode.....	356
A.4.5.5.4.1	Test Purpose and Environment.....	356
A.4.5.5.4.2	Test Requirements	360
A.4.5.6.1	DCI-based and Timer-based Active BWP Switch	361
A.4.5.6.1.1	E-UTRAN – NR PSCell FR1 DL active BWP switch in non-DRX in synchronous EN-DC	361
A.4.5.6.1.1.1	Test Purpose and Environment	361
A.4.5.6.1.1.2	Test Requirements	364

A.4.5.6.1.2	E-UTRAN – NR PSCell FR1 DL active BWP switch with FR1 SCell in non-DRX in synchronous EN-DC.....	365
A.4.5.6.1.2.1	Test Purpose and Environment	365
A.4.5.6.1.2.2	Test Requirements	370
A.4.5.6.2	RRC-based Active BWP Switch	371
A.4.5.6.2.1.1	Test Purpose and Environment	371
A.4.5.6.2.1.2	Test Requirements	374
A.4.5.7	PSCell addition and release delay.....	375
A.4.5.7.1	Addition and Release Delay of known NR PSCell	375
A.4.5.7.1.1	Test purpose and environment.....	375
A.4.5.7.1.2	Test Requirements	378
A.4.6	Measurement procedure	379
A.4.6.1	Intra-frequency Measurements	379
A.4.6.1.1	EN-DC event triggered reporting tests without gap under non-DRX	379
A.4.6.1.1.1	Test purpose and Environment	379
A.4.6.1.1.2	Test parameters.....	379
A.4.6.1.1.3	Test Requirements	381
A.4.6.1.2	EN-DC event triggered reporting tests without gap under DRX.....	381
A.4.6.1.2.1	Test purpose and Environment	381
A.4.6.1.2.2	Test parameters.....	381
A.4.6.1.2.2	Test Requirements	384
A.4.6.1.3	EN-DC event triggered reporting tests with per-UE gaps under non-DRX	384
A.4.6.1.3.1	Test purpose and Environment	384
A.4.6.1.3.2	Test parameters.....	384
A.4.6.1.3.3	Test Requirements	387
A.4.6.1.4	EN-DC event triggered reporting tests with per-UE gaps under DRX	387
A.4.6.1.4.1	Test purpose and Environment	387
A.4.6.1.4.2	Test parameters.....	387
A.4.6.1.4.3	Test Requirements	390
A.4.6.1.5	EN-DC event triggered reporting tests without gap under non-DRX with SSB index reading	390
A.4.6.1.5.1	Test purpose and Environment	390
A.4.6.1.5.2	Test parameters.....	390
A.4.6.1.5.3	Test Requirements	392
A.4.6.1.6	EN-DC event triggered reporting tests with SSB index reading with per-UE gaps	392
A.4.6.1.6.1	Test purpose and Environment	392
A.4.6.1.6.2	Test parameters.....	392
A.4.6.1.6.3	Test Requirements	394
A.4.6.2	Inter-frequency Measurements	394
A.4.6.2.1	EN-DC event triggered reporting tests for FR1 cell without SSB time index detection when DRX is not used	394
A.4.6.2.1.1	Test Purpose and Environment.....	394
A.4.6.2.1.2	Test Requirements	397
A.4.6.2.2	EN-DC event triggered reporting tests for FR1 cell without SSB time index detection when DRX is used.....	398
A.4.6.2.2.1	Test Purpose and Environment.....	398
A.4.6.2.2.2	Test Requirements	401
A.4.6.2.3	Void.....	401
A.4.6.2.4	Void.....	401
A.4.6.2.5	EN-DC event triggered reporting tests for FR1 cell with SSB time index detection when DRX is not used	401
A.4.6.2.5.1	Test Purpose and Environment.....	401
A.4.6.2.5.2	Test Requirements	404
A.4.6.2.6	EN-DC event triggered reporting tests for FR1 cell with SSB time index detection when DRX is used	405
A.4.6.2.6.1	Test Purpose and Environment.....	405
A.4.6.2.6.2	Test Requirements	408
A.4.6.2.7	Void.....	408
A.4.6.2.8	Void.....	408
A.4.6.3	Void	408
A.4.6.4	L1-RSRP measurement for beam reporting	408
A.4.6.4.1	SSB based L1-RSRP measurement when DRX is not used	408
A.4.6.4.1.1	Test Purpose and Environment.....	408

A.4.6.4.1.2	Test parameters.....	409
A.4.6.4.1.3	Test Requirements	411
A.4.6.4.2	SSB based L1-RSRP measurement when DRX is used	411
A.4.6.4.2.1	Test Purpose and Environment.....	411
A.4.6.4.2.2	Test parameters.....	411
A.4.6.4.2.3	Test Requirements	413
A.4.6.4.3	CSI-RS based L1-RSRP measurement when DRX is not used.....	413
A.4.6.4.3.1	Test Purpose and Environment.....	413
A.4.6.4.3.2	Test parameters.....	414
A.4.6.4.3.3	Test Requirements	415
A.4.6.4.4	CSI-RS based L1-RSRP measurement when DRX is used.....	416
A.4.6.4.4.1	Test Purpose and Environment.....	416
A.4.6.4.4.2	Test parameters.....	416
A.4.6.4.4.3	Test Requirements	418
A.4.7	Measurement Performance requirements	418
A.4.7.1	SS-RSRP.....	418
A.4.7.1.1	EN-DC Intra-frequency measurement accuracy with FR1 serving cell and FR1 target cell.....	418
A.4.7.1.1.1	Test Purpose and Environment.....	418
A.4.7.1.1.2	Test parameters.....	419
A.4.7.1.1.3	Test Requirements	421
A.4.7.1.2	EN-DC inter-frequency measurement accuracy with FR1 serving cell and FR1 target cell	422
A.4.7.1.2.1	Test Purpose and Environment.....	422
A.4.7.1.2.2	Test parameters.....	422
A.4.7.1.2.3	Test Requirements	425
A.4.7.1.3	Void.....	425
A.4.7.2	SS-RSRQ.....	425
A.4.7.2.1	EN-DC Intra-frequency measurement accuracy with FR1 serving cell and FR1 target cell.....	425
A.4.7.2.1.1	Test Purpose and Environment.....	425
A.4.7.2.1.2	Test Parameters	425
A.4.7.2.1.3	Test Requirements	429
A.4.7.2.2	EN-DC Inter-frequency measurement accuracy with FR1 serving cell and FR1 target cell.....	429
A.4.7.2.2.1	Test Purpose and Environment.....	429
A.4.7.2.2.2	Test Parameters	429
A.4.7.2.2.3	Test Requirements	432
A.4.7.3	SS-SINR	432
A.4.7.3.1	EN-DC Intra-frequency measurement accuracy with FR1 serving cell and FR1 target cell.....	432
A.4.7.3.1.1	Test Purpose and Environment.....	432
A.4.7.3.1.2	Test Parameters	432
A.4.7.3.1.3	Test Requirements	435
A.4.7.3.2	EN-DC Inter-frequency measurement accuracy with FR1 serving cell and FR1 target cell.....	435
A.4.7.3.2.1	Test Purpose and Environment.....	435
A.4.7.3.2.2	Test Parameters	435
A.4.7.3.2.3	Test Requirements	439
A.4.7.4	L1-RSRP measurement for beam reporting.....	439
A.4.7.4.1	SSB based L1-RSRP measurement.....	439
A.4.7.4.1.1	Test Purpose and Environment.....	439
A.4.7.4.1.2	Test parameters.....	439
A.4.7.4.1.3	Test Requirements	442
A.4.7.4.2	CSI-RS based L1-RSRP measurement on resource set with repetition off.....	442
A.4.7.4.2.1	Test Purpose and Environment.....	442
A.4.7.4.2.2	Test parameters.....	442
A.4.7.4.2.3	Test Requirements	445
A.4.7.5	SFTD accuracy	446
A.4.7.5.1	SFTD accuracy.....	446
A.4.7.5.1.1	Test Purpose and Environment.....	446
A.4.7.5.1.2	Test Parameters	446
A.4.7.5.1.3	Test Requirements	448
A.4.7.5.2	Void.....	449
A.4.7.5.3	Void.....	449
A.4.8	Void.....	449
A.4A	NE-DC test with all NR cells in FR1	449

A.4A.1	Signaling characteristics	449
A.4A.1.1	E-UTRAN PSCell addition	449
A.4A.1.1.1	Test purpose and environment	449
A.4A.1.1.2	Test Requirements	453
A.4A.1.2	Active BWP switch	454
A.4A.1.2.1	E-UTRAN PSCell – NR PCell FR1 DCI-based and Timer-based DL active BWP switch in non-DRX in synchronous NE-DC	454
A.4A.1.2.1.1	Test Purpose and Environment	454
A.4A.2	Measurement performance	458
A.4A.2.1	SFTD accuracy	458
A.4A.2.1.1	SFTD accuracy	458
A.4A.2.1.1.1	Test Purpose	458
A.4A.2.1.1.2	Test Environment	458
A.4A.2.1.1.3	Test Requirements	461
A.5	EN-DC tests with one or more NR cells in FR2	462
A.5.1	Void	462
A.5.2	Void	462
A.5.3	RRC_CONNECTED state mobility	462
A.5.3.1	Void	462
A.5.3.2	RRC Connection Mobility Control	462
A.5.3.2.1	Void	462
A.5.3.2.2	Random Access	462
A.5.3.2.2.1	Contention based random access test in FR2 for PSCell/SCell in EN-DC	462
A.5.3.2.2.2	Non-contention based random access test in FR2 for PSCell/SCell in EN-DC	465
A.5.3.2.3	Void	469
A.5.4	Timing	469
A.5.4.1	UE transmit timing	469
A.5.4.1.1	NR UE Transmit Timing Test for FR2	469
A.5.4.1.1.1	Test Purpose and environment	469
A.5.4.1.1.2	Test requirements	472
A.5.4.2	UE timer accuracy	472
A.5.4.3	Timing advance	472
A.5.4.3.1	EN-DC FR2 timing advance adjustment accuracy	472
A.5.4.3.1.1	Test Purpose and Environment	472
A.5.4.3.1.2	Test Parameters	472
A.5.4.3.1.3	Test Requirements	475
A.5.5	Signaling characteristics	475
A.5.5.1	Radio link Monitoring	475
A.5.5.1.1	Radio Link Monitoring Out-of-sync Test for FR2 PSCell configured with SSB-based RLM RS in non-DRX mode	475
A.5.5.1.1.1	Test Purpose and Environment	475
A.5.5.1.1.2	Test Requirements	479
A.5.5.1.2	Radio Link Monitoring In-sync Test for FR2 PSCell configured with SSB-based RLM RS in non-DRX mode	479
A.5.5.1.2.1	Test Purpose and Environment	479
A.5.5.1.2.2	Test Requirements	483
A.5.5.1.3	Radio Link Monitoring Out-of-sync Test for FR2 PSCell configured with SSB-based RLM RS in DRX mode	483
A.5.5.1.3.1	Test Purpose and Environment	483
A.5.5.1.3.2	Test Requirements	486
A.5.5.1.4	Radio Link Monitoring In-sync Test for FR2 PSCell configured with SSB-based RLM RS in DRX mode	486
A.5.5.1.4.1	Test Purpose and Environment	486
A.5.5.1.4.2	Test Requirements	489
A.5.5.1.5	EN-DC Radio Link Monitoring Out-of-sync Test for FR2 PSCell configured with CSI-RS-based RLM in non-DRX mode	490
A.5.5.1.6	EN-DC Radio Link Monitoring In-sync Test for FR2 PSCell configured with CSI-RS-based RLM in non-DRX mode	493
A.5.5.1.6.1	Test Purpose and Environment	493
A.5.5.1.6.2	Test Requirements	497

A.5.5.1.7	EN-DC Radio Link Monitoring Out-of-sync Test for FR2 PSCell configured with CSI-RS-based RLM in DRX mode.....	497
A.5.5.1.7.1	Test Purpose and Environment.....	497
A.5.5.1.7.2	Test Requirements.....	501
A.5.5.1.8	EN-DC Radio Link Monitoring In-sync Test for FR2 PSCell configured with CSI-RS-based RLM in DRX mode.....	501
A.5.5.1.8.1	Test Purpose and Environment.....	501
A.5.5.1.8.2	Test Requirements.....	505
A.5.5.1.9	EN-DC Radio Link Monitoring UE Scheduling Restrictions on FR2	505
A.5.5.1.9.1	Test Purpose and Environment.....	505
A.5.5.1.9.2	Test Requirements.....	507
A.5.5.2	Interruption	508
A.5.5.2.1	E-UTRAN – NR FR2 interruptions at transitions between active and non-active during DRX in synchronous EN-DC	508
A.5.5.2.1.1	Test Purpose and Environment.....	508
A.5.5.2.1.2	Test Requirements.....	510
A.5.5.2.2	E-UTRAN – NR FR2 interruptions at transitions between active and non-active during DRX in asynchronous EN-DC.....	510
A.5.5.2.2.1	Test Purpose and Environment.....	510
A.5.5.2.2.2	Test Requirements.....	512
A.5.5.2.3	E-UTRAN – NR FR2 interruptions during measurements on deactivated NR SCC in synchronous EN-DC	513
A.5.5.2.3.1	Test Purpose and Environment.....	513
A.5.5.2.3.2	Test Requirements.....	515
A.5.5.2.4	E-UTRAN – NR FR2 interruptions during measurements on deactivated NR SCC in asynchronous EN-DC.....	516
A.5.5.2.4.1	Test Purpose and Environment.....	516
A.5.5.2.4.2	Test Requirements.....	518
A.5.5.2.5	E-UTRAN – NR FR2 interruptions during measurements on deactivated E-UTRAN SCC in synchronous EN-DC	519
A.5.5.2.5.1	Test Purpose and Environment.....	519
A.5.5.2.5.2	Test Requirements.....	521
A.5.5.2.6	E-UTRAN – NR FR2 interruptions during measurements on deactivated E-UTRAN SCC in asynchronous EN-DC.....	521
A.5.5.2.6.1	Test Purpose and Environment.....	521
A.5.5.2.6.2	Test Requirements.....	523
A.5.5.3.1	SCell Activation and deactivation of SCell in FR2 intra-band	524
A.5.5.3.1.1	Test Purpose and Environment.....	524
A.5.5.3.1.2	Test Requirements.....	526
A.5.5.3.2	SCell Activation and deactivation of known SCell in FR1 for 160ms SCell measurement cycle	526
A.5.5.3.2.1	Test Purpose and Environment.....	526
A.5.5.3.2.2	Test Requirements.....	528
A.5.5.3.3	Void.....	529
A.5.5.3.4	Void.....	529
A.5.5.3.5	SCell Activation and deactivation of SCell in FR2.....	529
A.5.5.3.5.1	Test Purpose and Environment.....	529
A.5.5.3.5.2	Test Requirements.....	532
A.5.5.4	Void	533
A.5.5.5	Beam Failure Detection and Link recovery procedures.....	533
A.5.5.5.1	EN-DC Beam Failure Detection and Link Recovery Test for FR2 PSCell configured with SSB-based BFD and LR in non-DRX mode	533
A.5.5.5.1.1	Test Purpose and Environment.....	533
A.5.5.5.1.2	Test Requirements.....	536
A.5.5.5.2	EN-DC Beam Failure Detection and Link Recovery Test for FR2 PSCell configured with SSB-based BFD and LR in DRX mode.....	537
A.5.5.5.2.1	Test Purpose and Environment.....	537
A.5.5.5.2.2	Test Requirements.....	540
A.5.5.5.3	EN-DC Beam Failure Detection and Link Recovery Test for FR2 PSCell configured with CSI-RS-based BFD and LR in non-DRX mode	541
A.5.5.5.3.1	Test Purpose and Environment.....	541
A.5.5.5.3.2	Test Requirements.....	544

A.5.5.5.4	EN-DC Beam Failure Detection and Link Recovery Test for FR2 PSCell configured with CSI-RS-based BFD and LR in DRX mode.....	545
A.5.5.5.4.1	Test Purpose and Environment.....	545
A.5.5.5.4.2	Test Requirements.....	548
A.5.5.5.5	EN-DC scheduling availability restriction during Beam Failure Detection and Link Recovery for FR2 PSCell configured with SSB-based BFD and LR in non-DRX mode.....	549
A.5.5.5.5.1	Test Purpose and Environment.....	549
A.5.5.5.5.2	Test Requirements.....	552
A.5.5.6	Active BWP switch.....	553
A.5.5.6.1	DCI-based and Timer-based Active BWP Switch.....	553
A.5.5.6.1.1	E-UTRAN – NR PSCell FR2 DL active BWP switch with non-DRX in synchronous EN-DC ...	553
A.5.5.6.1.1.1	Test Purpose and Environment.....	553
A.5.5.6.1.1.2	Test Requirements.....	556
A.5.5.6.1.2	E-UTRAN – NR PSCell FR2 with FR2 SCell DL active BWP switch in non-DRX in synchronous EN-DC.....	556
A.5.5.6.1.2.1	Test Purpose and Environment.....	556
A.5.5.6.1.2.2	Test Requirements.....	559
A.5.5.6.2	RRC-based Active BWP Switch.....	560
A.5.5.6.2.1	E-UTRAN – NR PSCell FR2 DL active BWP switch with non-DRX in synchronous EN-DC ...	560
A.5.5.6.2.1.1	Test Purpose and Environment.....	560
A.5.5.6.2.1.2	Test Requirements.....	563
A.5.5.7	PSCell addition and release delay.....	563
A.5.5.7.1	Addition and Release Delay of NR PSCell.....	563
A.5.5.7.1.1	Test purpose and environment.....	563
A.5.5.7.1.2	Test Requirements.....	566
A.5.5.8	Active TCI state switch delay.....	567
A.5.5.8.1	MAC-CE based active TCI state switch.....	567
A.5.5.8.1.1	E-UTRAN – NR PSCell FR2 active TCI state switch for a known TCI state.....	567
A.5.5.8.1.1.1	Test Purpose and Environment.....	567
A.5.5.8.1.1.2	Test Requirements.....	570
A.5.5.8.2	RRC based active TCI state switch.....	570
A.5.5.8.2.1	E-UTRAN – NR PSCell FR2 active TCI state switch for a known TCI state.....	570
A.5.5.8.2.1.1	Test Purpose and Environment.....	570
A.5.5.8.2.1.2	Test Requirements.....	574
A.5.6	Measurement procedure.....	574
A.5.6.1	Intra-frequency Measurements.....	574
A.5.6.1.1	EN-DC event triggered reporting test without gap under non-DRX.....	574
A.5.6.1.1.1	Test purpose and Environment.....	574
A.5.6.1.1.2	Test Requirements.....	577
A.5.6.1.2	EN-DC event triggered reporting test without gap under DRX.....	578
A.5.6.1.2.1	Test purpose and Environment.....	578
A.5.6.1.2.2	Test Requirements.....	580
A.5.6.1.3	EN-DC event triggered reporting test with per-UE gaps under non-DRX.....	580
A.5.6.1.3.1	Test purpose and Environment.....	580
A.5.6.1.3.2	Test Requirements.....	583
A.5.6.1.4	EN-DC event triggered reporting test with per-UE gaps under DRX.....	584
A.5.6.1.4.1	Test purpose and Environment.....	584
A.5.6.1.4.2	Test Requirements.....	586
A.5.6.2	Inter-frequency Measurements.....	587
A.5.6.2.1	EN-DC event triggered reporting tests for FR2 cell without SSB time index detection when DRX is not used.....	587
A.5.6.2.1.1	Test Purpose and Environment.....	587
A.5.6.2.1.2	Test Requirements.....	590
A.5.6.2.2	EN-DC event triggered reporting tests for FR2 cell without SSB time index detection when DRX is used.....	590
A.5.6.2.2.1	Test Purpose and Environment.....	590
A.5.6.2.2.2	Test Requirements.....	593
A.5.6.2.3	EN-DC event triggered reporting tests for FR2 cell with SSB time index detection when DRX is not used.....	593
A.5.6.2.3.1	Test Purpose and Environment.....	593
A.5.6.2.3.2	Test Requirements.....	596

A.5.6.2.4	EN-DC event triggered reporting tests for FR2 cell with SSB time index detection when DRX is used	596
A.5.6.2.4.1	Test Purpose and Environment.....	596
A.5.6.2.5	EN-DC event triggered reporting tests for FR2 cell without SSB time index detection when DRX is not used	600
A.5.6.2.5.1	Test Purpose and Environment.....	600
A.5.6.2.5.2	Test Requirements	603
A.5.6.2.6	EN-DC event triggered reporting tests for FR2 cell without SSB time index detection when DRX is used.....	604
A.5.6.2.6.1	Test Purpose and Environment.....	604
A.5.6.2.6.2	Test Requirements	607
A.5.6.2.7	EN-DC event triggered reporting tests for FR2 cell with SSB time index detection when DRX is not used	608
A.5.6.2.7.1	Test Purpose and Environment.....	608
A.5.6.2.7.2	Test Requirements	611
A.5.6.2.8	EN-DC event triggered reporting tests for FR2 cell with SSB time index detection when DRX is used	612
A.5.6.2.8.1	Test Purpose and Environment.....	612
A.5.6.2.8.2	Test Requirements	616
A.5.6.3	L1-RSRP measurement for beam reporting.....	616
A.5.6.3.1	SSB based L1-RSRP measurement when DRX is not used.....	616
A.5.6.3.1.1	Test Purpose and Environment.....	616
A.5.6.3.1.2	Test parameters.....	617
A.5.6.3.1.3	Test Requirements	618
A.5.6.3.1.3	Test Requirements	618
A.5.6.3.2	SSB based L1-RSRP measurement when DRX is used	619
A.5.6.3.2.1	Test Purpose and Environment.....	619
A.5.6.3.2.2	Test parameters.....	619
A.5.6.3.2.3	Test Requirements	621
A.5.6.3.3	CSI-RS based L1-RSRP measurement when DRX is not used.....	621
A.5.6.3.3.1	Test Purpose and Environment.....	621
A.5.6.3.3.2	Test parameters.....	621
A.5.6.3.3.3	Test Requirements	623
A.5.6.3.4	CSI-RS based L1-RSRP measurement when DRX is used.....	623
A.5.6.3.4.1	Test Purpose and Environment.....	623
A.5.6.3.4.2	Test parameters.....	624
A.5.6.3.4.3	Test Requirements	625
A.5.7	Measurement Performance requirements	626
A.5.7.1	SS-RSRP.....	626
A.5.7.1.1	EN-DC intra-frequency case measurement accuracy with FR2 serving cell and FR2 target cell	626
A.5.7.1.1.1	Test Purpose and Environment.....	626
A.5.7.1.1.2	Test parameters.....	626
A.5.7.1.1.3	Test Requirements	628
A.5.7.1.2	EN-DC inter-frequency case measurement accuracy with FR2 serving cell and FR2 target cell	629
A.5.7.1.2.1	Test Purpose and Environment.....	629
A.5.7.1.2.2	Test parameters.....	629
A.5.7.1.2.3	Test Requirements	632
A.5.7.1.3	EN-DC inter-frequency measurement accuracy with FR1 serving cell and FR2 target cell	633
A.5.7.1.3.1	Test Purpose and Environment.....	633
A.5.7.1.3.2	Test parameters.....	633
A.5.7.1.3.3	Test Requirements	635
A.5.7.2	SS-RSRQ	636
A.5.7.2.1	EN-DC Intra-frequency measurement accuracy with FR2 serving cell and FR2 TDD target cell.....	636
A.5.7.2.1.1	Test Purpose and Environment	636
A.5.7.2.1.2	Test Parameters	636
A.5.7.2.1.3	Test Requirements	638
A.5.7.2.2	EN-DC Inter-frequency measurement accuracy with FR2 serving cell and FR2 TDD target cell.....	638
A.5.7.2.2.1	Test Purpose and Environment.....	638
A.5.7.2.2.2	Test Parameters	638
A.5.7.2.2.3	Test Requirements	640
A.5.7.3	SS-SINR	640
A.5.7.3.1	EN-DC Intra-frequency measurement accuracy with FR2 serving cell and FR2 TDD target cell.....	640

A.5.7.3.1.1	Test Purpose and Environment.....	640
A.5.7.3.1.2	Test Parameters	640
A.5.7.3.1.3	Test Requirements	642
A.5.7.3.2	EN-DC Inter-frequency measurement accuracy with FR2 serving cell and FR2 TDD target cell.....	643
A.5.7.3.2.1	Test Purpose and Environment.....	643
A.5.7.3.2.2	Test Parameters	643
A.5.7.3.2.3	Test Requirements	645
A.5.7.4	L1-RSRP measurement for beam reporting.....	645
A.5.7.4.1	SSB based L1-RSRP measurement.....	645
A.5.7.4.1.1	Test Purpose and Environment.....	645
A.5.7.4.1.2	Test parameters.....	645
A.5.7.4.1.3	Test Requirements	647
A.5.7.4.2	CSI-RS based L1-RSRP measurement on resource set with repetition off.....	647
A.5.7.4.2.1	Test Purpose and Environment.....	647
A.5.7.4.2.2	Test parameters.....	648
A.5.7.4.2.3	Test Requirements	649
A.5.8	Void.....	650
A.6	NR standalone tests with all NR cells in FR1	651
A.6.1	SA: RRC_IDLE state mobility.....	651
A.6.1.1	Cell re-selection to NR	651
A.6.1.1.1	Cell reselection to FR1 intra-frequency NR case	651
A.6.1.1.1.1	Test Purpose and Environment.....	651
A.6.1.1.1.2	Test Parameters	651
A.6.1.1.1.3	Test Requirements	653
A.6.1.1.2	Cell reselection to FR1 inter-frequency NR case	654
A.6.1.1.2.1	Test Purpose and Environment.....	654
A.6.1.1.2.2	Test Parameters	654
A.6.1.1.2.3	Test Requirements	656
A.6.1.2.1	Cell reselection to higher priority E-UTRAN	657
A.6.1.2.1.1	Test Purpose and Environment.....	657
A.6.1.2.1.2	Test Parameters	657
A.6.1.2.1.3	Test Requirements	659
A.6.1.2.2	Cell reselection to lower priority E-UTRAN	660
A.6.1.2.2.1	Test Purpose and Environment.....	660
A.6.1.2.2.2	Test Parameters	660
A.6.1.2.2.3	Test Requirements	662
A.6.2	SA: RRC_INACTIVE state mobility	663
A.6.3	RRC_CONNECTED state mobility	663
A.6.3.1.1	Intra-frequency handover from FR1 to FR1; known target cell	663
A.6.3.1.1.1	Test Purpose and Environment.....	663
A.6.3.1.1.2	Test Parameters	663
A.6.3.1.1.3	Test Requirements	665
A.6.3.1.2	Intra-frequency handover from FR1 to FR1; unknown target cell	665
A.6.3.1.2.1	Test Purpose and Environment.....	665
A.6.3.1.2.2	Test Parameters	665
A.6.3.1.2.3	Test Requirements	667
A.6.3.1.3	Inter-frequency handover from FR1 to FR1; unknown target cell	667
A.6.3.1.3.1	Test Purpose and Environment.....	667
A.6.3.1.3.2	Test Parameters	668
A.6.3.1.3.3	Test Requirements	669
A.6.3.1.4	SA NR - E-UTRAN handover	670
A.6.3.1.4.1	Test Purpose and Environment.....	670
A.6.3.1.4.2	Test Requirements	673
A.6.3.1.5	SA NR - E-UTRAN handover with unknown target cell.....	673
A.6.3.1.5.1	Test Purpose and Environment.....	673
A.6.3.1.5.2	Test Requirements	676
A.6.3.2.1	SA: RRC Re-establishment.....	677
A.6.3.2.1.1	Intra-frequency RRC Re-establishment in FR1	677
A.6.3.2.1.2	Inter-frequency RRC Re-establishment in FR1	679
A.6.3.2.1.3	Intra-frequency RRC Re-establishment in FR1 without serving cell timing.....	682
A.6.3.2.2	Random Access.....	685

A.6.3.2.2.1	Contention based random access test in FR1 for NR standalone	685
A.6.3.2.2.2	Non-Contention based random access test in FR1 for NR standalone	688
A.6.3.2.3.1	Redirection from NR in FR1 to NR in FR1	691
A.6.3.2.3.2	Redirection from NR in FR1 to E-UTRAN.....	694
A.6.4	Timing	697
A.6.4.1.1	NR UE Transmit Timing Test for FR1	697
A.6.4.1.1.1	Test Purpose and environment	697
A.6.4.1.1.2	Test requirements	700
A.6.4.3.1	SA FR1 timing advance adjustment accuracy.....	701
A.6.4.3.1.1	Test Purpose and Environment.....	701
A.6.4.3.1.2	Test Parameters	701
A.6.4.3.1.3	Test Requirements	703
A.6.5	Signalling characteristics.....	704
A.6.5.1.1	Radio Link Monitoring Out-of-sync Test for FR1 PCell configured with SSB-based RLM RS in non-DRX mode	704
A.6.5.1.1.1	Test Purpose and Environment.....	704
A.6.5.1.1.2	Test Requirements	707
A.6.5.1.2	Radio Link Monitoring In-sync Test for FR1 PCell configured with SSB-based RLM RS in non-DRX mode	707
A.6.5.1.2.1	Test Purpose and Environment.....	707
A.6.5.1.2.2	Test Requirements	710
A.6.5.1.3	Radio Link Monitoring Out-of-sync Test for FR1 PCell configured with SSB-based RLM RS in DRX mode	711
A.6.5.1.3.1	Test Purpose and Environment.....	711
A.6.5.1.3.2	Test Requirements	714
A.6.5.1.4	Radio Link Monitoring In-sync Test for FR1 PCell configured with SSB-based RLM RS in DRX mode.....	714
A.6.5.1.4.1	Test Purpose and Environment.....	714
A.6.5.1.4.2	Test Requirements	717
A.6.5.1.5	Radio Link Monitoring Out-of-sync Test for FR1 PCell configured with CSI-RS-based RLM in non-DRX mode	718
A.6.5.1.5.1	Test Purpose and Environment.....	718
A.6.5.1.5.2	Test Requirements	721
A.6.5.1.6	Radio Link Monitoring In-sync Test for FR1 PCell configured with CSI-RS-based RLM in non-DRX mode	721
A.6.5.1.6.1	Test Purpose and Environment.....	721
A.6.5.1.6.2	Test Requirements	724
A.6.5.1.7	Radio Link Monitoring Out-of-sync Test for FR1 PCell configured with CSI-RS-based RLM in DRX mode	725
A.6.5.1.7.1	Test Purpose and Environment.....	725
A.6.5.1.7.2	Test Requirements	728
A.6.5.1.8	Radio Link Monitoring In-sync Test for FR1 PCell configured with CSI-RS-based RLM in DRX mode.....	728
A.6.5.1.8.1	Test Purpose and Environment.....	728
A.6.5.1.8.2	Test Requirements	731
A.6.5.2.1	Interruptions during measurements on deactivated NR SCC in FR1	731
A.6.5.3.1	SCell Activation and deactivation of known SCell in FR1 in non-DRX for 160ms SCell measurement cycle.....	736
A.6.5.3.1.1	Test Purpose and Environment.....	736
A.6.5.3.1.2	Test Requirements	741
A.6.5.3.2	SCell Activation and deactivation of known SCell in FR1 in non-DRX for 640 ms SCell measurement cycle.....	741
A.6.5.3.2.1	Test Purpose and Environment.....	741
A.6.5.3.2.2	Test Requirements	742
A.6.5.3.3	SCell Activation and deactivation of unknown SCell in FR1 in non-DRX	742
A.6.5.3.3.1	Test Purpose and Environment.....	742
A.6.5.3.3.2	Test Requirements	743
A.6.5.4.1	UE UL carrier RRC reconfiguration Delay.....	743
A.6.5.4.1.1	Test Purpose and Environment.....	743
A.6.5.4.1.2	Test Requirements	750
A.6.5.4.2	Void.....	751

A.6.5.5.1	Beam Failure Detection and Link Recovery Test for FR1 PCell configured with SSB-based BFD and LR in non-DRX mode	751
A.6.5.5.1.1	Test Purpose and Environment.....	751
A.6.5.5.1.2	Test Requirements	755
A.6.5.5.2	Beam Failure Detection and Link Recovery Test for FR1 PCell configured with SSB-based BFD and LR in DRX mode	755
A.6.5.5.2.1	Test Purpose and Environment.....	755
A.6.5.5.2.2	Test Requirements	760
A.6.5.5.3	Beam Failure Detection and Link Recovery Test for FR1 PCell configured with CSI-RS-based BFD and LR in non-DRX mode	760
A.6.5.5.3.1	Test Purpose and Environment.....	760
A.6.5.5.3.2	Test Requirements	764
A.6.5.5.4	Beam Failure Detection and Link Recovery Test for FR1 PCell configured with CSI-RS-based BFD and LR in DRX mode.....	764
A.6.5.5.4.1	Test Purpose and Environment.....	764
A.6.5.5.4.2	Test Requirements	768
A.6.5.6.1	DCI-based and Timer-based Active BWP Switch	769
A.6.5.6.1.1	NR FR1- NR FR1 DL active BWP switch of SCell with non-DRX in SA	769
A.6.5.6.1.2	NR FR1 DL active BWP switch with non-DRX in SA	774
A.6.5.6.2	RRC-based Active BWP Switch	777
A.6.5.6.2.1	NR FR1 DL active BWP switch of Cell with non-DRX in SA	777
A.6.6	Measurement procedure	780
A.6.6.1.1	SA event triggered reporting tests without gap under non-DRX	780
A.6.6.1.1.1	Test purpose and Environment	780
A.6.6.1.1.2	Test parameters.....	780
A.6.6.1.1.3	Test Requirements	782
A.6.6.1.2	SA event triggered reporting tests without gap under DRX.....	782
A.6.6.1.2.1	Test purpose and Environment	782
A.6.6.1.2.2	Test parameters.....	782
A.6.6.1.2.3	Test Requirements	784
A.6.6.1.3	SA event triggered reporting tests with per-UE gaps under non-DRX	785
A.6.6.1.3.1	Test purpose and Environment	785
A.6.6.1.3.2	Test parameters.....	785
A.6.6.1.3.3	Test Requirements	787
A.6.6.1.4	SA event triggered reporting tests with per-UE gaps under DRX.....	787
A.6.6.1.4.1	Test purpose and Environment	787
A.6.6.1.4.2	Test parameters.....	787
A.6.6.1.4.3	Test Requirements	789
A.6.6.1.5	SA event triggered reporting tests without gap under non-DRX with SSB index reading.....	790
A.6.6.1.5.1	Test purpose and Environment	790
A.6.6.1.5.2	Test parameters.....	790
A.6.6.1.5.3	Test Requirements	791
A.6.6.1.6	SA event triggered reporting tests with per-UE gaps under non-DRX with SSB index reading	791
A.6.6.1.6.1	Test purpose and Environment	791
A.6.6.1.6.2	Test parameters.....	792
A.6.6.1.6.3	Test Requirements	793
A.6.6.2.1	SA event triggered reporting tests for FR1 without SSB time index detection when DRX is not used	793
A.6.6.2.1.1	Test Purpose and Environment.....	793
A.6.6.2.1.2	Test Requirements	796
A.6.6.2.2	SA event triggered reporting tests for FR1 without SSB time index detection when DRX is used	796
A.6.6.2.2.1	Test Purpose and Environment.....	796
A.6.6.2.2.2	Test Requirements	799
A.6.6.2.3	Void.....	800
A.6.6.2.4	Void.....	800
A.6.6.2.5	SA event triggered reporting tests for FR1 with SSB time index detection when DRX is not used ...	800
A.6.6.2.5.1	Test Purpose and Environment.....	800
A.6.6.2.5.2	Test Requirements	802
A.6.6.2.6	SA event triggered reporting tests for FR1 with SSB time index detection when DRX is used	802
A.6.6.2.6.1	Test Purpose and Environment.....	802
A.6.6.2.6.2	Test Requirements	805
A.6.6.2.7	Void.....	805

A.6.6.2.8	Void.....	805
A.6.6.3	Inter-RAT Measurements	805
A.6.6.3.1	SA NR - E-UTRAN event-triggered reporting in non-DRX in FR1	805
A.6.6.3.1.1	Test Purpose and Environment.....	805
A.6.6.3.1.2	Test Requirements	809
A.6.6.3.2	SA NR - E-UTRAN event-triggered reporting in DRX in FR1	809
A.6.6.3.2.1	Test Purpose and Environment.....	809
A.6.6.3.2.2	Test Requirements	812
A.6.6.4	L1-RSRP measurement for beam reporting.....	813
A.6.6.4.1	SSB based L1-RSRP measurement when DRX is not used.....	813
A.6.6.4.1.1	Test Purpose and Environment.....	813
A.6.6.4.1.2	Test parameters.....	813
A.6.6.4.1.3	Test Requirements	815
A.6.6.4.2	SSB based L1-RSRP measurement when DRX is used	815
A.6.6.4.2.1	Test Purpose and Environment.....	815
A.6.6.4.2.2	Test parameters.....	815
A.6.6.4.2.3	Test Requirements	817
A.6.6.4.3	CSI-RS based L1-RSRP measurement when DRX is not used.....	817
A.6.6.4.3.1	Test Purpose and Environment.....	817
A.6.6.4.3.2	Test parameters.....	818
A.6.6.4.3.3	Test Requirements	820
A.6.6.4.4	CSI-RS based L1-RSRP measurement when DRX is used.....	820
A.6.6.4.4.1	Test Purpose and Environment.....	820
A.6.6.4.4.2	Test parameters.....	820
A.6.6.4.4.3	Test Requirements	822
A.6.7	Measurement Performance requirements	822
A.6.7.1.1	SA: intra-frequency case measurement accuracy with FR1 serving cell and FR1 target cell	823
A.6.7.1.1.1	Test Purpose and Environment.....	823
A.6.7.1.1.2	Test parameters.....	823
A.6.7.1.1.3	Test Requirements	826
A.6.7.1.2	SA inter-frequency case measurement accuracy with FR1 serving cell and FR1 target cell	826
A.6.7.1.2.1	Test Purpose and Environment.....	826
A.6.7.1.2.2	Test parameters.....	827
A.6.7.1.2.3	Test Requirements	829
A.6.7.1.3	Void.....	829
A.6.7.2	SS-RSRQ.....	829
A.6.7.2.1	SA: Intra-frequency measurement accuracy with FR1 serving cell and FR1 target cell.....	829
A.6.7.2.1.1	Test Purpose and Environment.....	829
A.6.7.2.1.2	Test Parameters	830
A.6.7.2.1.3	Test Requirements	833
A.6.7.2.2	SA Inter-frequency measurement accuracy with FR1 serving cell and FR1 target cell.....	833
A.6.7.2.2.1	Test Purpose and Environment.....	833
A.6.7.2.2.2	Test Parameters	834
A.6.7.2.2.3	Test Requirements	837
A.6.7.3.1	SA intra-frequency measurement accuracy with FR1 serving cell and FR1 target cell	837
A.6.7.3.1.1	Test Purpose and Environment.....	837
A.6.7.3.1.2	Test Parameters	837
A.6.7.3.1.3	Test Requirements	840
A.6.7.3.2	SA Inter-frequency measurement accuracy with FR1 serving cell and FR1 target cell.....	840
A.6.7.3.2.1	Test Purpose and Environment.....	840
A.6.7.3.2.2	Test Parameters	840
A.6.7.3.2.3	Test Requirements	844
A.6.7.4.1	SSB based L1-RSRP measurement.....	844
A.6.7.4.1.1	Test Purpose and Environment.....	844
A.6.7.4.1.2	Test parameters.....	844
A.6.7.4.1.3	Test Requirements	847
A.6.7.4.2	CSI-RS based L1-RSRP measurement on resource set with repetition off.....	847
A.6.7.4.2.1	Test Purpose and Environment.....	847
A.6.7.4.2.2	Test parameters.....	847
A.6.7.4.2.3	Test Requirements	850
A.6.7.5.1	SA: inter-RAT measurement accuracy with FR1 serving cell	850
A.6.7.5.1.1	Test Purpose and Environment.....	850

A.6.7.5.1.2	Test parameters.....	850
A.6.7.5.1.3	Test Requirements	853
A.6.7.6.1	SA: inter-RAT measurement accuracy with FR1 serving cell	853
A.6.7.6.1.1	Test Purpose and Environment.....	853
A.6.7.6.1.2	Test parameters.....	853
A.6.7.6.1.3	Test Requirements	857
A.6.7.7.1	SA: inter-RAT measurement accuracy with FR1 serving cell	857
A.6.7.7.1.1	Test Purpose and Environment.....	857
A.6.7.7.1.2	Test parameters.....	857
A.6.7.7.1.3	Test Requirements	860
A.7	NR standalone tests with one or more NR cells in FR2	861
A.7.1	SA: RRC_IDLE state mobility	861
A.7.1.1.1	Cell reselection to FR2 intra-frequency NR case	861
A.7.1.1.1.1	Test Purpose and Environment.....	861
A.7.1.1.1.2	Test Parameters	861
A.7.1.1.1.3	Test Requirements	863
A.7.1.1.2	Cell reselection to FR2 inter-frequency NR case	863
A.7.1.1.2.1	Test Purpose and Environment.....	863
A.7.1.1.2.2	Test Parameters	863
A.7.1.1.2.3	Test Requirements	865
A.7.2	SA: RRC_INACTIVE state mobility	866
A.7.3	RRC_CONNECTED state mobility	866
A.7.3.1	Handover	866
A.7.3.1.1	Inter-frequency handover from FR1 to FR2; unknown target cell	866
A.7.3.1.1.1	Test Purpose and Environment.....	866
A.7.3.1.1.2	Test Parameters	866
A.7.3.1.1.3	Test Requirements	869
A.7.3.1.2	Intra-frequency handover from FR2 to FR2; unknown target cell	869
A.7.3.1.2.1	Test Purpose and Environment.....	869
A.7.3.1.2.2	Test Parameters	869
A.7.3.1.2.3	Test Requirements	871
A.7.3.1.3	Inter-frequency handover from FR2 to FR2; unknown target cell	871
A.7.3.1.3.1	Test Purpose and Environment.....	871
A.7.3.1.3.2	Test Parameters	871
A.7.3.1.3.3	Test Requirements	873
A.7.3.2.1	SA: RRC Re-establishment.....	873
A.7.3.2.1.1	Intra-frequency RRC Re-establishment in FR2	873
A.7.3.2.1.2	Inter-frequency RRC Re-establishment in FR2	875
A.7.3.2.1.3	Intra-frequency RRC Re-establishment in FR2 without serving cell timing	878
A.7.3.2.1.3.1	Test Purpose and Environment	878
A.7.3.2.1.3.2	Test Requirements	879
A.7.3.2.2	Random Access.....	880
A.7.3.2.2.1	Contention based random access test in FR2 for NR Standalone.....	880
A.7.3.2.2.2	Non-contention based random access test in FR2 for NR Standalone.....	883
A.7.3.2.3	SA: RRC Connection Release with Redirection	887
A.7.3.2.3.1	Redirection from NR in FR2 to NR in FR2.....	887
A.7.4	Timing	889
A.7.4.1.1	NR UE Transmit Timing Test for FR2	889
A.7.4.1.1.1	Test Purpose and environment	889
A.7.4.1.1.2	Test requirements	892
A.7.4.3.1	SA FR2 timing advance adjustment accuracy.....	892
A.7.4.3.1.1	Test Purpose and Environment.....	892
A.7.4.3.1.2	Test Parameters	892
A.7.4.3.1.3	Test Requirements	895
A.7.5	Signaling characteristics	895
A.7.5.1.1	Radio Link Monitoring Out-of-sync Test for FR2 PCell configured with SSB-based RLM RS in non-DRX mode	895
A.7.5.1.1.1	Test Purpose and Environment.....	895
A.7.5.1.1.2	Test Requirements	898
A.7.5.1.2	Radio Link Monitoring In-sync Test for FR2 PCell configured with SSB-based RLM RS in non-DRX mode	899

A.7.5.1.2.1	Test Purpose and Environment.....	899
A.7.5.1.2.2	Test Requirements	902
A.7.5.1.3	Radio Link Monitoring Out-of-sync Test for FR2 PCell configured with SSB-based RLM RS in DRX mode	902
A.7.5.1.3.1	Test Purpose and Environment.....	902
A.7.5.1.3.2	Test Requirements	905
A.7.5.1.4	Radio Link Monitoring In-sync Test for FR2 PCell configured with SSB-based RLM RS in DRX mode.....	905
A.7.5.1.4.1	Test Purpose and Environment.....	905
A.7.5.1.4.2	Test Requirements	908
A.7.5.1.5	Radio Link Monitoring Out-of-sync Test for FR2 PCell configured with CSI-RS-based RLM in non-DRX mode	908
A.7.5.1.5.1	Test Purpose and Environment.....	908
A.7.5.1.5.2	Test Requirements	911
A.7.5.1.6	Radio Link Monitoring In-sync Test for FR2 PCell configured with CSI-RS-based RLM in non-DRX mode	911
A.7.5.1.6.1	Test Purpose and Environment.....	911
A.7.5.1.6.2	Test Requirements	914
A.7.5.1.7	Radio Link Monitoring Out-of-sync Test for FR2 PCell configured with CSI-RS-based RLM in DRX mode	915
A.7.5.1.7.1	Test Purpose and Environment.....	915
A.7.5.1.7.2	Test Requirements	917
A.7.5.1.8	Radio Link Monitoring In-sync Test for FR2 PCell configured with CSI-RS-based RLM in DRX mode.....	918
A.7.5.1.8.1	Test Purpose and Environment.....	918
A.7.5.1.8.2	Test Requirements	921
A.7.5.1.9	UE Radio Link Monitoring Scheduling Restrictions on FR2.....	921
A.7.5.1.9.1	Test Purpose and Environment.....	921
A.7.5.1.9.2	Test Requirements	923
A.7.5.2.1	Interruptions during measurements on deactivated NR SCC in FR2	923
A.7.5.3.1	SCell Activation and deactivation for SCell in FR2 intra-band in non-DRX	926
A.7.5.3.1.1	Test Purpose and Environment.....	926
A.7.5.3.1.2	Test Requirements	928
A.7.5.3.2	SCell Activation and deactivation for FR1+FR2 inter-band with target SCell in FR2	928
A.7.5.3.2.1	Test Purpose and Environment.....	928
A.7.5.3.2.2	Test Requirements	931
A.7.5.5.1	Beam Failure Detection and Link Recovery Test for FR2 PCell configured with SSB-based BFD and LR in non-DRX mode	932
A.7.5.5.1.1	Test Purpose and Environment.....	932
A.7.5.5.1.2	Test Requirements	935
A.7.5.5.2	Beam Failure Detection and Link Recovery Test for FR2 PCell configured with SSB-based BFD and LR in DRX mode	936
A.7.5.5.2.1	Test Purpose and Environment.....	936
A.7.5.5.2.2	Test Requirements	939
A.7.5.5.3	Beam Failure Detection and Link Recovery Test for FR2 PCell configured with CSI-RS-based BFD and LR in non-DRX mode	940
A.7.5.5.3.1	Test Purpose and Environment.....	940
A.7.5.5.3.2	Test Requirements	943
A.7.5.5.4	Beam Failure Detection and Link Recovery Test for FR2 PCell configured with CSI-RS-based BFD and LR in DRX mode.....	943
A.7.5.5.4.1	Test Purpose and Environment.....	943
A.7.5.5.4.2	Test Requirements	947
A.7.5.5.5	Scheduling availability restriction during Beam Failure Detection and Link Recovery for FR2 PCell configured with SSB-based BFD and LR in non-DRX mode	947
A.7.5.5.5.1	Test Purpose and Environment.....	947
A.7.5.5.5.2	Test Requirements	951
A.7.5.6.1	DCI-based and Timer-based Active BWP Switch	951
A.7.5.6.1.1	NR FR2- NR FR2 DL active BWP switch of SCell with non-DRX in SA	951
A.7.5.6.1.2	NR FR1- NR FR2 DL active BWP switch of SCell with non-DRX in SA	955
A.7.5.6.1.3	NR FR2 DL active BWP switch with non-DRX in SA	959
A.7.5.6.1.3.1	Test Purpose and Environment	959
A.7.5.6.1.3.2	Test Requirements	961

A.7.5.6.2	RRC-based Active BWP Switch	962
A.7.5.7.1	Addition and Release Delay of known NR PSCell	965
A.7.5.7.1.1	Test Purpose and Environment.....	965
A.7.5.7.2	Addition and Release Delay of unknown NR PSCell	968
A.7.5.7.2.1	Test Purpose and Environment.....	968
A.7.5.8.1	MAC-CE based active TCI state switch.....	970
A.7.5.8.2	RRC based active TCI state switch	974
A.7.6	Measurement procedure	978
A.7.6.1.1	SA event triggered reporting test without gap under non-DRX	978
A.7.6.1.1.1	Test purpose and Environment	978
A.7.6.1.1.2	Test Requirements	981
A.7.6.1.2	SA event triggered reporting test without gap under DRX	981
A.7.6.1.2.1	Test purpose and Environment	981
A.7.6.1.2.2	Test Requirements	984
A.7.6.1.3	SA event triggered reporting test with per-UE gaps under non-DRX	984
A.7.6.1.3.1	Test purpose and Environment	984
A.7.6.1.3.2	Test Requirements	987
A.7.6.1.4	SA event triggered reporting test with per-UE gaps under DRX	988
A.7.6.1.4.1	Test purpose and Environment	988
A.7.6.1.4.2	Test Requirements	990
A.7.6.2.1	SA event triggered reporting tests For FR2 without SSB time index detection when DRX is not used (PCell in FR2).....	991
A.7.6.2.1.1	Test Purpose and Environment.....	991
A.7.6.2.1.2	Test Requirements	993
A.7.6.2.2	SA event triggered reporting tests For FR2 without SSB time index detection when DRX is used (PCell in FR2)	993
A.7.6.2.2.1	Test Purpose and Environment.....	993
A.7.6.2.2.2	Test Requirements	996
A.7.6.2.3	SA event triggered reporting tests For FR2 with SSB time index detection when DRX is not used (PCell in FR2)	996
A.7.6.2.3.1	Test Purpose and Environment.....	996
A.7.6.2.3.2	Test Requirements	999
A.7.6.2.4	SA event triggered reporting tests For FR2 with SSB time index detection when DRX is used (PCell in FR2)	999
A.7.6.2.4.1	Test Purpose and Environment.....	999
A.7.6.2.4.2	Test Requirements	1002
A.7.6.2.5	SA event triggered reporting tests for FR2 without SSB time index detection when DRX is not used (PCell in FR1).....	1002
A.7.6.2.5.1	Test Purpose and Environment.....	1002
A.7.6.2.5.2	Test Requirements	1005
A.7.6.2.6	SA event triggered reporting tests for FR2 without SSB time index detection when DRX is used (PCell in FR1)	1006
A.7.6.2.6.1	Test Purpose and Environment.....	1006
A.7.6.2.6.2	Test Requirements	1009
A.7.6.2.7	SA event triggered reporting tests for FR2 with SSB time index detection when DRX is not used (PCell in FR1)	1009
A.7.6.2.7.1	Test Purpose and Environment.....	1009
A.7.6.2.7.2	Test Requirements	1012
A.7.6.2.8	SA event triggered reporting tests for FR2 with SSB time index detection when DRX is used (PCell in FR1)	1013
A.7.6.2.8.1	Test Purpose and Environment.....	1013
A.7.6.2.8.2	Test Requirements	1016
A.7.6.3	L1-RSRP measurement for beam reporting.....	1016
A.7.6.3.1	SSB based L1-RSRP measurement when DRX is not used	1016
A.7.6.3.1.1	Test Purpose and Environment.....	1016
A.7.6.3.1.2	Test parameters.....	1017
A.7.6.3.1.3	Test Requirements	1018
A.7.6.3.2	SSB based L1-RSRP measurement when DRX is used	1019
A.7.6.3.2.1	Test Purpose and Environment.....	1019
A.7.6.3.2.2	Test parameters.....	1019
A.7.6.3.2.3	Test Requirements	1021
A.7.6.3.3	CSI-RS based L1-RSRP measurement when DRX is not used.....	1021

A.7.6.3.3.1	Test Purpose and Environment.....	1021
A.7.6.3.3.2	Test parameters.....	1021
A.7.6.3.3.3	Test Requirements.....	1023
A.7.6.3.4	CSI-RS based L1-RSRP measurement when DRX is used.....	1023
A.7.6.3.4.1	Test Purpose and Environment.....	1023
A.7.6.3.4.2	Test parameters.....	1023
A.7.6.3.4.3	Test Requirements.....	1025
A.7.7	Measurement Performance requirements.....	1025
A.7.7.1.1	SA intra-frequency case measurement accuracy with FR2 serving cell and FR2 target cell.....	1026
A.7.7.1.1.1	Test Purpose and Environment.....	1026
A.7.7.1.1.2	Test parameters.....	1026
A.7.7.1.1.3	Test Requirements.....	1028
A.7.7.1.2	SA inter-frequency case measurement accuracy with FR2 serving cell and FR2 target cell.....	1029
A.7.7.1.2.1	Test Purpose and Environment.....	1029
A.7.7.1.2.2	Test parameters.....	1029
A.7.7.1.2.3	Test Requirements.....	1031
A.7.7.1.3	SA inter-frequency measurement accuracy with FR1 serving cell and FR2 target cell.....	1033
A.7.7.1.3.1	Test Purpose and Environment.....	1033
A.7.7.1.3.2	Test parameters.....	1033
A.7.7.1.3.3	Test Requirements.....	1035
A.7.7.2	SS-RSRQ.....	1036
A.7.7.2.1	SA intra-frequency measurement accuracy with FR2 serving cell and FR2 target cell.....	1036
A.7.7.2.1.1	Test Purpose and Environment.....	1036
A.7.7.2.1.2	Test Parameters.....	1036
A.7.7.2.1.3	Test Requirements.....	1037
A.7.7.2.2	SA Inter-frequency measurement accuracy with FR2 serving cell and FR2 TDD target cell.....	1038
A.7.7.2.2.1	Test Purpose and Environment.....	1038
A.7.7.2.2.2	Test Parameters.....	1038
A.7.7.2.2.3	Test Requirements.....	1039
A.7.7.3.1	SA intra-frequency case measurement accuracy with FR2 serving cell and FR2 target cell.....	1040
A.7.7.3.1.1	Test Purpose and Environment.....	1040
A.7.7.3.1.2	Test Parameters.....	1040
A.7.7.3.1.3	Test Requirements.....	1041
A.7.7.3.2	SA Inter-frequency measurement accuracy with FR2 serving cell and FR2 TDD target cell.....	1042
A.7.7.3.2.1	Test Purpose and Environment.....	1042
A.7.7.3.2.2	Test Parameters.....	1042
A.7.7.3.2.3	Test Requirements.....	1043
A.7.7.4.1	SSB based L1-RSRP measurement.....	1044
A.7.7.4.1.1	Test Purpose and Environment.....	1044
A.7.7.4.1.2	Test parameters.....	1044
A.7.7.4.1.3	Test Requirements.....	1045
A.7.7.4.2	CSI-RS based L1-RSRP measurement on resource set with repetition off.....	1046
A.7.7.4.2.1	Test Purpose and Environment.....	1046
A.7.7.4.2.2	Test parameters.....	1046
A.7.7.4.2.3	Test Requirements.....	1048
A.8	E-UTRA standalone tests for NR RRM.....	1048
A.8.1	Void.....	1049
A.8.2	RRC_IDLE state mobility.....	1049
A.8.2.1	Inter-RAT NR Cell re-selection.....	1049
A.8.2.1.1	E-UTRA Cell reselection to higher priority NR target Cell in FR1.....	1049
A.8.2.1.1.1	Test Purpose and Environment.....	1049
A.8.2.1.1.2	Test Requirements.....	1052
A.8.3	RRC_CONNECTED state mobility.....	1053
A.8.3.1	Handover.....	1053
A.8.3.1.1	E-UTRAN - NR handover in FR1.....	1053
A.8.3.1.1.1	Test Purpose and Environment.....	1053
A.8.3.1.1.2	Test Requirements.....	1056
A.8.4	Measurement procedure.....	1057
A.8.4.1.1	E-UTRA – NR Inter-RAT SFTD Measurement Delay in non-DRX.....	1057
A.8.4.1.1.1	Test Purpose and Environment.....	1057
A.8.4.1.1.2	Test Requirements.....	1059

A.8.4.1.2	E-UTRA – NR Inter-RAT SFTD Measurement Delay in DRX	1059
A.8.4.1.2.1	Test Purpose and Environment.....	1059
A.8.4.1.2.2	Test Requirements	1060
A.8.4.2	E-UTRA – NR Inter-RAT Measurements	1060
A.8.4.2.1	NR Inter-RAT event triggered reporting tests for FR1 without SSB time index detection when DRX is not used	1060
A.8.4.2.1.1	Test Purpose and Environment.....	1060
A.8.4.2.1.2	Test Requirements	1064
A.8.4.2.2	NR Inter-RAT event triggered reporting tests for FR1 without SSB time index detection when DRX is used	1064
A.8.4.2.2.1	Test Purpose and Environment.....	1064
A.8.4.2.2.2	Test Requirements	1067
A.8.4.2.3	NR Inter-RAT event triggered reporting tests for FR1 with SSB time index detection when DRX is not used	1068
A.8.4.2.3.1	Test Purpose and Environment.....	1068
A.8.4.2.3.2	Test Requirements	1071
A.8.4.2.4	NR Inter-RAT event triggered reporting tests for FR1 with SSB time index detection when DRX is used.....	1071
A.8.4.2.4.1	Test Purpose and Environment.....	1071
A.8.4.2.4.2	Test Requirements	1075
A.8.4.2.5	NR Inter-RAT event triggered reporting tests for FR2 without SSB time index detection when DRX is not used	1075
A.8.4.2.5.1	Test Purpose and Environment.....	1075
A.8.4.2.5.2	Test Requirements	1077
A.8.4.2.6	NR Inter-RAT event triggered reporting tests for FR2 without SSB time index detection when DRX is used	1077
A.8.4.2.6.1	Test Purpose and Environment.....	1077
A.8.4.2.6.2	Test Requirements	1079
A.8.4.2.7	NR Inter-RAT event triggered reporting tests for FR2 with SSB time index detection when DRX is not used	1080
A.8.4.2.7.1	Test Purpose and Environment.....	1080
A.8.4.2.7.2	Test Requirements	1082
A.8.4.2.8	NR Inter-RAT event triggered reporting tests for FR2 with SSB time index detection when DRX is used.....	1082
A.8.4.2.8.1	Test Purpose and Environment.....	1082
A.8.4.2.8.2	Test Requirements	1084
A.8.5	Measurement performance	1085
A.8.5.1.1	SFTD accuracy.....	1085
A.8.5.1.1.1	Test Purpose	1085
A.8.5.1.1.2	Test Environment	1085
A.8.5.1.1.3	Test Requirements	1089
A.8.5.2	E-UTRA – NR Inter-RAT Measurement Performance requirements.....	1089
A.8.5.2.1	SS-RSRP	1089
A.8.5.2.1.1	E-UTRAN – NR inter-RAT measurements with FR1 target cell	1089
A.8.5.2.1.2	E-UTRAN – NR inter-RAT measurements with FR2 target cell	1092
A.8.5.2.1.2.1	Test Purpose and Environment	1092
A.8.5.2.1.2.2	Test Parameters.....	1092
A.8.5.2.1.2.3	Test Requirements	1094
A.8.5.2.2	SS-RSRQ	1094
A.8.5.2.2.1	E-UTRAN – NR inter-RAT measurements with FR1 target cell	1094
A.8.5.2.2.2	E-UTRAN – NR inter-RAT measurements with FR2 target cell	1097
A.8.5.2.2.2.1	Test Purpose and Environment	1097
A.8.5.2.2.2.2	Test Parameters.....	1097
A.8.5.2.2.2.3	Test Requirements	1099
A.8.5.2.3	SS-SINR.....	1099
A.8.5.2.3.1	E-UTRAN – NR inter-RAT measurements with FR1 target cell	1099
A.8.5.2.3.2	E-UTRAN – NR inter-RAT measurements with FR2 target cell	1102
A.8.5.2.3.2.1	Test Purpose and Environment	1102
A.8.5.2.3.2.2	Test Parameters.....	1102
A.8.5.2.3.2.3	Test Requirements	1104

Annex B (normative): Conditions for RRM requirements applicability for operating bands .1105

B.1	Conditions for NR RRC_IDLE state mobility	1105
B.1.1	Introduction	1105
B.1.2	Conditions for measurements on NR intra-frequency cells for cell re-selection	1105
B.1.3	Conditions for measurements on NR inter-frequency cells for cell re-selection	1106
B.2	Conditions for UE measurements procedures and performance requirements in RRC_CONNECTED state	1106
B.2.1	Introduction	1106
B.2.1.1	General	1106
B.2.1.2	Derivation of Minimum SSB_RP values for FR1	1106
B.2.1.3	Derivation of Minimum SSB_RP values for FR2	1107
B.2.1.3.1	Minimum SSB_RP values for Rx Beam Peak angle of arrival	1107
B.2.1.4	Gain to SS-RSRP measurement point for FR1	1108
B.2.1.5	Gain to SS-RSRP measurement point for FR2	1108
B.2.1.5.1	Gain to SS-RSRP measurement point for Rx Beam Peak angle of arrival	1108
B.2.1.5.2	Gain to SS-RSRP measurement point for different frequency	1109
B.2.1.5.3	Alignment of Rough beam to Rx beam Peak	1109
B.2.2	Conditions for NR intra-frequency measurements	1110
B.2.3	Conditions for NR inter-frequency measurements	1111
B.2.4	Conditions for NR L1-RSRP reporting	1112
B.2.4.1	Conditions for SSB based L1-RSRP reporting	1112
B.2.4.2	Conditions for CSI-RS based L1-RSRP reporting	1113
B.2.5	Conditions for RRC connection release with redirection to NR	1114
B.2.6	Void	1115
B.2.6.1	Void	1115
B.2.6.2	Void	1115
B.3	RRM Requirements Exceptions	1115
B.3.1	Introduction	1115
B.3.2	Receiver sensitivity relaxation for CA	1115
B.3.2.1	Receiver sensitivity relaxation for UE supporting CA in FR1	1115
B.3.2.2	Receiver sensitivity relaxation for UE configured with CA in FR1	1115
B.3.2.2.1	Inter-band carrier aggregation	1115
B.3.2.2.2	Reference sensitivity exceptions due to UL harmonic interference for CA	1115
B.3.2.2.3	Reference sensitivity exceptions due to intermodulation interference due to 2UL CA	1116
B.3.2.3	Receiver sensitivity relaxation for UE supporting CA in FR2	1116
B.3.2.4	Receiver sensitivity relaxation for UE configured with CA in FR2	1116
B.3.2.4.1	Intra-band contiguous carrier aggregation	1116
B.3.2.4.2	Intra-band non-contiguous carrier aggregation	1116
B.3.3	Receiver sensitivity relaxation for DC	1116
B.3.3.1	Receiver sensitivity relaxation for EN-DC	1116
B.3.3.2	Receiver sensitivity relaxation for NE-DC	1116
B.3.4	Receiver sensitivity relaxation for SUL	1116
B.3.4.1	Receiver sensitivity relaxation for UE supporting SUL in FR1	1116
B.3.4.2	Receiver sensitivity relaxation for UE configured with SUL in FR1	1117
B.3.4.2.1	Reference sensitivity exceptions due to UL harmonic interference for SUL	1117
Annex C (informative):	Change history	1118
History		1127

Foreword

This Technical Specification has been produced by the 3rd Generation Partnership Project (3GPP).

The contents of the present document are subject to continuing work within the TSG and may change following formal TSG approval. Should the TSG modify the contents of the present document, it will be re-released by the TSG with an identifying change of release date and an increase in version number as follows:

Version x.y.z

where:

- x the first digit:
 - 1 presented to TSG for information;
 - 2 presented to TSG for approval;
 - 3 or greater indicates TSG approved document under change control.
- y the second digit is incremented for all changes of substance, i.e. technical enhancements, corrections, updates, etc.
- z the third digit is incremented when editorial only changes have been incorporated in the document.

1 Scope

The present document specifies requirements for support of Radio Resource Management for the FDD and TDD modes of New Radio (NR). These requirements include requirements on measurements in NR and the UE as well as requirements on node dynamical behaviour and interaction, in terms of delay and response characteristics.

2 References

The following documents contain provisions which, through reference in this text, constitute provisions of the present document.

- References are either specific (identified by date of publication, edition number, version number, etc.) or non-specific.
- For a specific reference, subsequent revisions do not apply.
- For a non-specific reference, the latest version applies. In the case of a reference to a 3GPP document (including a GSM document), a non-specific reference implicitly refers to the latest version of that document *in the same Release as the present document*.

- [1] 3GPP TS 38.304: "NR; User Equipment (UE) procedures in idle mode".
- [2] 3GPP TS 38.331: "NR; Radio Resource Control (RRC); Protocol specification".
- [3] 3GPP TS 38.213: "NR; Physical layer procedures for control".
- [4] 3GPP TS 38.215: "NR; Physical layer measurements".
- [5] 3GPP TS 38.533: "NR; User Equipment (UE) conformance specification; Radio Resource Management (RRM)".
- [6] 3GPP TS 38.211: "NR; Physical channels and modulation".
- [7] 3GPP TS 38.321: "NR; Medium Access Control (MAC) protocol specification".
- [8] 3GPP TS 38.212: "NR; Multiplexing and channel coding".
- [9] 3GPP TS 38.202: "NR; Physical layer services provided by the physical layer".
- [10] 3GPP TS 38.300: "NR; Overall description; Stage-2".
- [11] 3GPP TR 21.905: "Vocabulary for 3GPP Specifications".
- [12] 3GPP TS 38.423: "NG-RAN; Xn Application Protocol (XnAP)".
- [13] 3GPP TS 38.104: "NR; Base Station (BS) radio transmission and reception".
- [14] 3GPP TS 38.306: "NR; User Equipment (UE) radio access capabilities".
- [15] 3GPP TS 36.133: "Evolved Universal Terrestrial Radio Access (E-UTRA); Requirements for support of radio resource management".
- [16] 3GPP TS 36.331: "Evolved Universal Terrestrial Radio Access (E-UTRA); Radio Resource Control (RRC) protocol specification".
- [17] 3GPP TS 37.340: "Evolved Universal Terrestrial Radio Access (E-UTRA) and NR; Multi-connectivity", Stage 2.
- [18] 3GPP TS 38.101-1: "NR; User Equipment (UE) radio transmission and reception; Part 1: Range 1 Standalone".
- [19] 3GPP TS 38.101-2: "NR; User Equipment (UE) radio transmission and reception; Part 2: Range 2 Standalone".

- [20] 3GPP TS 38.101-3: "NR; User Equipment (UE) radio transmission and reception; Part 3: Range 1 and Range 2 Interworking operation with other radios".
- [21] 3GPP TS 38.101-4: "NR; User Equipment (UE) radio transmission and reception; Part 4: Performance requirements".
- [22] 3GPP TS 38.305: "NG Radio Access Network (NG-RAN); Stage 2 functional specification of User Equipment (UE) positioning in NG-RAN".
- [23] 3GPP TS 36.211: "Evolved Universal Terrestrial Radio Access (E-UTRA); Physical Channels and Modulation".
- [24] 3GPP TS 36.300: "Evolved Universal Terrestrial Radio Access (E-UTRA); Overall description".
- [25] 3GPP TS 36.101: "Technical Specification Group Radio Access Network; Evolved Universal Terrestrial Radio Access (E-UTRA); User Equipment (UE) radio transmission and reception".
- [26] 3GPP TS 38.214: "NR; Physical layer procedures for data".
- [27] 3GPP TS 36.355: "Evolved Universal Terrestrial Radio Access (E-UTRA); LTE Positioning Protocol (LPP)".
- [28] Void.
- [29] 3GPP TS 38.521-2: " NR; User Equipment (UE) conformance specification; Radio transmission and reception; Part 2: Range 2 Standalone".

3 Definitions, symbols and abbreviations

3.1 Definitions

For the purposes of the present document, the terms and definitions given in TR 21.905 [11] and the following apply. A term defined in the present document takes precedence over the definition of the same term, if any, in TR 21.905 [11].

Active DL BWP: Active DL bandwidth part as defined in TS 38.213 [3].

Blackbox Approach: Testing methodology, in which the UE internal implementation of certain specific UE functionality involved in the test, is unknown.

Control Resource Set: As defined in TS 38.213 [3].

DL BWP: DL bandwidth part as defined in TS 38.213 [3].

EN-DC: E-UTRA-NR Dual Connectivity as defined in clause 4.1.2 of TS 37.340 [17].

en-gNB: As defined in TS 37.340 [17].

FR1: Frequency range 1 as defined in clause 5.1 of TS 38.104 [13].

FR2: Frequency range 2 as defined in clause 5.1 of TS 38.104 [13].

gNB: as defined in TS 38.300 [10].

Master Cell Group: As defined in TS 38.331 [2].

Multi-Radio Dual Connectivity: Dual Connectivity between E-UTRA and NR nodes, or between two NR nodes, as defined in TS 37.340 [17].

ng-eNB: As defined in TS 38.300 [10].

NE-DC: NR-E-UTRA Dual Connectivity as defined in clause 4.1.3.2 of TS 37.340 [17].

NGEN-DC: NG-RAN E-UTRA-NR Dual Connectivity as defined in clause 4.1.3.1 of TS 37.340 [17].

NR-DC: NR-NR Dual Connectivity as defined in clause 4.1.3.3 of TS 37.340 [17].

Primary Cell: As defined in TS 38.331 [2].

Quasi Co-Location: As defined in TS 38.214 [26].

RLM-RS resource: A resource out of the set of resources configured for RLM by higher layer parameter RLM-RS-List [2] as defined in TS 38.213 [3].

SA operation mode: Operation mode when the UE is configured with at least PCell and not any MR-DC.

Secondary Cell: As defined in TS 38.331 [2].

Secondary Cell Group: As defined in TS 38.331 [2].

Serving Cell: As defined in TS 38.331 [2].

SMTC: An SSB-based measurement timing configuration configured by *SSB-MeasurementTimingConfiguration* as specified in TS 38.331 [2].

Special Cell: As defined in TS 38.331 [2].

SSB: SS/PBCH block as defined in clause 7.8.3 of TS 38.211 [6].

Timing Advance Group: As defined in TS 38.331 [2].

3.2 Symbols

For the purposes of the present document, the following symbols apply:

BW_{Channel}	Channel bandwidth, defined in TS 38.101-1, 38.101-2 and 38.101-3 subclause 3.2
\hat{E}_s	Received energy per RE (power normalized to the subcarrier spacing) during the useful part of the symbol, i.e. excluding the cyclic prefix, at the UE antenna connector or radiated interface boundary
F_c	<i>RF reference frequency</i> on the channel raster, given in table 5.4.2.2-1 in TS 38.101-1 and 38.101-2
$F_{c,\text{low}}$	The F_c of the lowest carrier, expressed in MHz
I_o	The total received power density, including signal and interference, as measured at the UE antenna connector or radiated interface boundary.
I_{oc}	The power spectral density (integrated in a noise bandwidth equal to the chip rate and normalized to the chip rate) of a band limited noise source (simulating interference from cells, which are not defined in a test procedure) as measured at the UE antenna connector or radiated interface boundary.
I_{ot}	The received power spectral density of the total noise and interference for a certain RE (power integrated over the RE and normalized to the subcarrier spacing) as measured at the UE antenna connector or radiated interface boundary
N_{oc}	The power spectral density of a white noise source (average power per RE normalised to the subcarrier spacing), simulating interference from cells that are not defined in a test procedure, as measured at the UE antenna connector or radiated interface boundary
n_{PRB}	Physical Resource Block number as defined in clause 3.2 in TS 38.211.
N_{TA}	Timing offset between uplink and downlink radio frames at the UE, as defined in clause 4.2 in TS 38.213.
$N_{TA\text{ offset}}$	Fixed timing advance offset, as defined in clause 7.1.2 in TS 38.133.
P_{CMAX}	Configured UE transmitted power as defined in clause 6.2.4 in TS 38.101-1, 38-101-2 and 38.101-3.
$P_{CMAX,c}$	Configured UE transmitted power on a serving cell c as defined in clause 6.2.4 in TS 38.101-1, 38-101-2 and 38.101-3
S	Cell Selection Criterion defined in TS 38.304, subclause 5.2.3.2 for NR
SSB_RP	Received (linear) average power of the resource elements that carry NR synchronisation burst, measured at the UE antenna connector or radiated interface boundary

Srxlev	Cell selection RX level, defined in TS 38.304, subclause 5.2.3.2
Squal	Cell selection quality, defined in TS 38.304, subclause 5.2.3.2
Sintrasearch	Defined in TS 38.304 , subclause 5.2.4.7 for E-UTRAN amd 38.304 subclause 5.2.4.7 for NR
Snonintrasearch	Defined in TS 38.304 , subclause 5.2.4.7
T _c	Basic time unit, defined in clause 4.1 of TS 38.211 [6].
T _{reselection}	Defined in TS 25.304, subclause 5.2.6.1.5
T _{reselectionRAT}	Defined in TS 36.304 , subclause 5.2.4.7
T _{reselectionEUTRA}	Defined in TS 36.304 , subclause 5.2.4.7
T _{reselectionUTRA}	Defined in TS 36.304 , subclause 5.2.4.7
T _{reselectionGERAN}	Defined in TS 36.304 , subclause 5.2.4.
Thresh _{x, high}	Defined in TS 38.304 , subclause 5.2.4.7
Thresh _{x, low}	Defined in TS 38.304 , subclause 5.2.4.7
Thresh _{servng, low}	Defined in TS 38.304 , subclause 5.2.4.7
T _s	Reference time unit, defined in clause 4.1 of TS 38.211 [6].
T _{UE_re-establish_delay}	Time between the moments when any of the conditions requiring RRC re-establishment as defined in clause 5.3.7 in TS 38.331 [2] is detected by the UE and when the UE sends PRACH to the target PCell.

3.3 Abbreviations

For the purposes of the present document, the abbreviations given in TR 21.905 [11] and the following apply. An abbreviation defined in the present document takes precedence over the definition of the same abbreviation, if any, in TR 21.905 [11].

BFD	Beam Failure Detection
BFD-RS	BFD Reference Signal
BLER	Block Error Rate
BM-RS	Beam Management Reference Signal
BWP	Bandwidth Part
CA	Carrier Aggregation
CBD	Candidate Beam Detection
CC	Component Carrier
CORESET	Control Resource Set
CP	Cyclic Prefix
CSI	Channel-State Information
CSI-RS	CSI Reference Signal
DC	Dual Connectivity
DCI	Downlink Control Information
DL	Downlink
DMRS	Demodulation Reference Signal
DRX	Discontinuous Reception
E-CID	Enhanced Cell ID
E-UTRA	Evolved UTRA
E-UTRAN	Evolved UTRAN
EN-DC	E-UTRA-NR Dual Connectivity
FDD	Frequency Division Duplex
FR	Frequency Range
HARQ	Hybrid Automatic Repeat Request
HO	Handover
L1-RSRP	Layer 1 RSRP
MAC	Medium Access Control
MCG	Master Cell Group
MG	Measurement Gap
MGL	Measurement Gap Length
MGRP	Measurement Gap Repetition Period
MIB	Master Information Block
MN	Master Node
MR-DC	Multi-Radio Dual Connectivity
NE-DC	NR-E-UTRA Dual Connectivity
NGEN-DC	NG-RAN E-UTRA-NR Dual Connectivity
NR	New Radio

NR-DC	NR-NR Dual Connectivity
OFDM	Orthogonal Frequency Division Multiplexing
OFDMA	Orthogonal Frequency Division Multiple Access
OTDOA	Observed Time Difference Of Arrival
PBCH	Physical Broadcast Channel
PCC	Primary Component Carrier
PCell	Primary Cell
PDCCH	Physical Downlink Control Channel
PDSCH	Physical Downlink Shared Channel
PLMN	Public Land Mobile Network
PRACH	Physical RACH
PSCell	Primary SCell
PSS	Primary Synchronization Signal
pTAG	Primary Timing Advance Group
PUCCH	Physical Uplink Control Channel
PUSCH	Physical Uplink Shared Channel
QCL	Quasi Co-Location
RACH	Random Access Channel
RAT	Radio Access Technology
RLM	Radio Link Monitoring
RLM-RS	Reference Signal for RLM
RMSI	Remaining Minimum System Information
RRC	Radio Resource Control
RRM	Radio Resource Management
RSSI	Received Signal Strength Indicator
RSTD	Reference Signal Time Difference
SA	Standalone operation mode
SCC	Secondary Component Carrier
SCell	Secondary Cell
SCG	Secondary Cell Group
SCS	Subcarrier Spacing
SCS _{SSB}	SSB subcarrier spacing
SDL	Supplementary Downlink
SFN	System Frame Number
SFTD	SFN and Frame Timing Difference
SI	System Information
SIB	System Information Block
SMTC	SSB-based Measurement Timing configuration
SpCell	Special Cell
SRS	Sounding Reference Signal
SS-RSRP	Synchronization Signal based Reference Signal Received Power
SS-RSRQ	Synchronization Signal based Reference Signal Received Quality
SS-SINR	Synchronization Signal based Signal to Noise and Interference Ratio
SSB	Synchronization Signal Block
SSB _{RP}	Received (linear) average power of the resource elements that carry NR SSB signals and channels, measured at the UE antenna connector or radiated interface boundary.
SSS	Secondary Synchronization Signal
sTAG	Secondary Timing Advance Group
SUL	Supplementary Uplink
TA	Timing Advance
TAG	Timing Advance Group
TCI	Transmission Configuration Indicator
TDD	Time Division Duplex
TTI	Transmission Time Interval
UE	User Equipment
UL	Uplink

3.4 Test tolerances

The requirements given in the present document make no allowance for measurement uncertainty. The test specification 38.533 [5] defines the test tolerances.

3.5 Frequency bands grouping

3.5.1 Introduction

The intention with the frequency band grouping below is to increase the readability of the specification.

The frequency bands grouping is derived based on UE REFSSENS requirements specified in [18, 19, 20] and assuming 0.5 dB step between the neighbour groups. The groups are defined in the order of increasing REFSSENS, i.e., the group A has the smallest REFSSENS among the groups. For the same SCS and a given bandwidth, the bands within the same group have the same I_o conditions in a corresponding requirement in this specification, provided the bands support this SCS. For different SCSs supported by a frequency band and the same bandwidth, different I_o conditions may apply for the frequency band in the requirements, while the band group is the same, based on the lowest REFSSENS requirement normalized by the number of subcarriers among its supported SCSs for this bandwidth. For the same SCS but different supported bandwidths, the group for a band is determined based on the lowest REFSSENS requirement normalized by the number of subcarriers among its supported bandwidths.

3.5.2 NR operating bands in FR1

NR frequency bands grouping for FR1 is specified in Table 3.5.2-1.

Table 3.5.2-1: NR frequency band groups for FR1

Group	NR FDD		NR TDD		NR SDL	
	Band group notation	Operating bands	Band group notation	Operating bands	Band group notation	Operating bands
A	NR_FDD_FR1_A	n1, n70, n74 ⁴	NR_TDD_FR1_A	n34, n38, n39, n40, n50, n51	NR_SDL_FR1_A	n75, n76
B	NR_FDD_FR1_B	n66, n74 ³	NR_TDD_FR1_B	-	NR_SDL_FR1_B	-
C	NR_FDD_FR1_C	-	NR_TDD_FR1_C	n77 ¹ , n78, n79	NR_SDL_FR1_C	-
D	NR_FDD_FR1_D	n28	NR_TDD_FR1_D	n77 ²	NR_SDL_FR1_D	-
E	NR_FDD_FR1_E	n2, n5, n7	NR_TDD_FR1_E	n41	NR_SDL_FR1_E	-
F	NR_FDD_FR1_F	-	NR_TDD_FR1_F	-	NR_SDL_FR1_F	-
G	NR_FDD_FR1_G	n3, n8, n12, n20, n71	NR_TDD_FR1_G	-	NR_SDL_FR1_G	-
H	NR_FDD_FR1_H	n25	NR_TDD_FR1_H	-	NR_SDL_FR1_H	-

NOTE 1: Except 3.8 GHz to 4.2 GHz.
NOTE 2: Only 3.8 GHz to 4.2 GHz.
NOTE 3: Except 1475.9 MHz to 1510.9 MHz.
NOTE 4: Only when the band is confined in 1475.9 MHz to 1510.9 MHz.
NOTE 5: These bands are used only in NR carrier aggregation with other NR bands according to NR CA band combinations specified in TS 38.101-1 [18] and TS 38.101-3 [20].

3.5.3 NR operating bands in FR2

NR frequency bands grouping for FR2 is specified in Table 3.5.3-1.

Table 3.5.3-1: NR frequency band groups for FR2

Group	Band group notation	Operating bands
A	NR_TDD_FR2_A	n257 ¹ , n258 ¹ , n261 ¹
B	NR_TDD_FR2_B	n257 ⁴ , n258 ⁴ , n261 ⁴
C	NR_TDD_FR2_C	
D	NR_TDD_FR2_D	
E	NR_TDD_FR2_E	
F	NR_TDD_FR2_F	n260 ⁴

G	NR_TDD_FR2_G	n260 ¹
H	NR_TDD_FR2_H	
I	NR_TDD_FR2_I	
J	NR_TDD_FR2_J	
K	NR_TDD_FR2_K	
L	NR_TDD_FR2_L	n257 ² , n258 ² , n261 ²
M	NR_TDD_FR2_M	
N	NR_TDD_FR2_N	
O	NR_TDD_FR2_O	
P	NR_TDD_FR2_P	
Q	NR_TDD_FR2_Q	
R	NR_TDD_FR2_R	
S	NR_TDD_FR2_S	
T	NR_TDD_FR2_T	n257 ³ , n258 ³ , n261 ³
U	NR_TDD_FR2_U	
V	NR_TDD_FR2_V	
W	NR_TDD_FR2_W	
X	NR_TDD_FR2_X	
Y	NR_TDD_FR2_Y	n260 ³
NOTE 1: UE power class 1. NOTE 2: UE power class 2. NOTE 3: UE power class 3. NOTE 4: UE power class 4.		

3.6 Applicability of requirements in this specification version

In this specification,

- ‘cell’, ‘PCell’, ‘PSCell’ and ‘SCell’ refer to NR cell, NR PCell, NR PSCell, and NR SCell,
- E-UTRA cells are referred to as ‘E-UTRA cell’, ‘E-UTRA PCell’, ‘E-UTRA PSCell’, and ‘E-UTRA SCell’,
- E-UTRA-NR dual connectivity where E-UTRA is the master is referred to as ‘E-UTRA-NR dual connectivity’ or ‘EN-DC’.
- NR-NR dual connectivity which involves two gNB acting as Master gNB and Secondary gNB is referred to as “NR-NR dual connectivity” or “NR-DC”. NR-DC in Rel-15 only includes the scenarios where all serving cells in MCG in FR1 and all serving cells in SCG in FR2.
- ‘active serving cell’ refers to PCell, PSCell and activated SCells

For UE configured with supplementary UL, the requirements in clause 7.1 and 7.3 shall also apply to uplink transmissions on supplementary UL.

3.6.1 RRC connected state requirements in DRX

For the requirements in RRC connected state specified in this version of the specification, the UE shall assume that no DRX is used provided the following conditions are met:

- DRX parameters are not configured or
- DRX parameters are configured and
 - *drx-InactivityTimer* is running or
 - *drx-RetransmissionTimerDL* is running or
 - *drx-RetransmissionTimerUL* is running or
 - *ra-ContentionResolutionTimer* is running or
 - a Scheduling Request sent on PUCCH is pending or

- a PDCCH indicating a new transmission addressed to the C-RNTI of the MAC entity has not been received after successful reception of a Random Access Response for the preamble not selected by the MAC entity

Otherwise the UE shall assume that DRX is used.

3.6.2 Number of serving carriers

3.6.2.1 Number of serving carriers for SA

Requirements for standalone NR with NR PCell are applicable for the UE configured with the following number of serving NR CCs:

- up to 8 NR DL CCs in total, with 1 UL (or 2 UL if SUL is configured) in PCell and up to 7 UL (or 8 UL if SUL is configured) in SCell.
- SUL may be configured together with one of the UL

3.6.2.2 Number of serving carriers for EN-DC

Requirements for EN-DC operation of E-UTRA and NR with E-UTRA PCell and NR PSCell are applicable for the UE configured with the following number of serving NR CCs:

- up to 8 NR DL CCs in total, with 1 UL (or 2 UL if SUL is configured) in PSCell and up to 1 UL (or 2 UL if SUL is configured) in SCell in different FR with PSCell.
- SUL may be configured together with one of the UL

The applicable number of E-UTRA CC for EN-DC in the MCG for both UL and DL is specified in TS 36.133 [15].

3.6.2.3 Number of serving carriers for NE-DC

Requirements for NE-DC operation of NR and E-UTRA with NR PCell and E-UTRA PSCell are applicable for the UE configured with the following number of serving NR CCs:

- up to 7 NR DL CCs in total, with 1 UL (or 2 UL if SUL is configured) in PCell and up to 1 UL (or 2 UL if SUL is configured) in SCell.
- SUL may be configured together with one of the UL

The applicable number of E-UTRA CC for NE-DC in the SCG for both UL and DL is specified in TS 36.133 [15].

3.6.2.4 Number of serving carriers for NR-DC

Requirements for NR-DC are applicable for the UE configured with the following number of serving NR CCs:

- up to 2 NR DL CCs in total in FR1, up to 8 NR DL CCs in total in FR2, with 1 UL in PCell, 1 UL in PSCell.

3.6.3 Applicability for intra-band FR2

For the requirements in RRC connected state specified in this version of the specification, UE shall assume that the transmitted signals from the serving cells should have the same downlink spatial domain transmission filter on one OFDM symbol in the same band in FR2. Otherwise, the UE is not supposed to satisfy any requirements for SCell.

3.6.4 Applicability for FR2 UE power classes

For the requirements of each FR2 power class specified in this version of the specification, certain UE types with specific device architectures are assumed. The UE types can be found in TS 38.101-2 [19].

3.6.5 Applicability for SDL bands

The measurements accuracy requirements for SDL bands in this version of specification in clause 10.1 shall apply for NR intra-frequency measurements on SCC (SS-RSRP, SS-RSRQ, SS-SINR, and L1-RSRP) and inter-frequency measurements (SS-RSRP, SS-RSRQ, and SS-SINR).

3.6.6 Applicability of requirements for NGEN-DC operation

All the requirements in this specification applicable for EN-DC are also applicable for NGEN-DC.

3.6.7 Applicability of QCL

For the requirements specified in this version of the specification, a reference signal is considered to be QCLed to another reference signal if it is in the same TCI chain as the other reference signal, provided that the number of Reference Signals in the chain is no more than 4. It is assumed there is single QCL type per TCI chain.

A TCI chain consists of an SSB, and one or more CSI-RS resources, and the TCI state of each Reference Signal includes another Reference Signal in the same TCI chain.

DMRS of PDCCH or PDSCH is QCLed with the reference signal in its active TCI state and any other reference signal that is QCLed, based on above criteria, with the reference signal in the active TCI state.

4 SA: RRC_IDLE state mobility

4.1 Cell Selection

After a UE has switched on and a PLMN has been selected, the cell selection process takes place, as described in TS 38.304 [1]. This process allows the UE to select a suitable cell where to camp on in order to access available services. In this process, the UE can use stored information (*Stored information cell selection*) or not (*Initial cell selection*).

4.2 Cell Re-selection

4.2.1 Introduction

The cell reselection procedure allows the UE to select a more suitable cell and camp on it.

When the UE is in either *Camped Normally* state or *Camped on Any Cell* state on a cell, the UE shall attempt to detect, synchronise, and monitor intra-frequency, inter-frequency and inter-RAT cells indicated by the serving cell. For intra-frequency and inter-frequency cells the serving cell may not provide explicit neighbour list but carrier frequency information and bandwidth information only. UE measurement activity is also controlled by measurement rules defined in TS 38.304 [1], allowing the UE to limit its measurement activity.

In the requirements of clause 4.2, the exceptions for side conditions apply as follows:

- for the UE capable of CA, the applicable exceptions for side conditions are specified in Annex B, clause B.3.2.1, B.3.2.3, or B.3.2.5 for UE supporting CA in FR1, CA in FR2 and CA between FR1 and FR2, respectively;
- for the UE capable of SUL, the applicable exceptions for side conditions are specified in Annex B, clause B.3.4.1 for UE supporting SUL in FR1.

4.2.2 Requirements

4.2.2.1 UE measurement capability

For idle mode cell re-selection purposes, the UE shall be capable of monitoring at least:

- Intra-frequency carrier, and
- Depending on UE capability, 7 NR inter-frequency carriers, and
- Depending on UE capability, 7 FDD E-UTRA inter-RAT carriers, and
- Depending on UE capability, 7 TDD E-UTRA inter-RAT carriers.

In addition to the requirements defined above, a UE supporting E-UTRA measurements in RRC_IDLE state shall be capable of monitoring a total of at least 14 carrier frequency layers, which includes serving layer, comprising of any above defined combination of E-UTRA FDD, E-UTRA TDD and NR layers.

4.2.2.2 Measurement and evaluation of serving cell

The UE shall measure the SS-RSRP and SS-RSRQ level of the serving cell and evaluate the cell selection criterion S defined in TS 38.304 [1] for the serving cell at least once every $M1 \cdot N1$ DRX cycle; where:

$M1=2$ if SMTC periodicity (T_{SMTC}) > 20 ms and DRX cycle \leq 0.64 second,
otherwise $M1=1$.

The UE shall filter the SS-RSRP and SS-RSRQ measurements of the serving cell using at least 2 measurements. Within the set of measurements used for the filtering, at least two measurements shall be spaced by, at least DRX cycle/2.

If the UE has evaluated according to Table 4.2.2.2-1 in N_{serv} consecutive DRX cycles that the serving cell does not fulfil the cell selection criterion S, the UE shall initiate the measurements of all neighbour cells indicated by the serving cell, regardless of the measurement rules currently limiting UE measurement activities.

If the UE in RRC_IDLE has not found any new suitable cell based on searches and measurements using the intra-frequency, inter-frequency and inter-RAT information indicated in the system information for 10 s, the UE shall initiate cell selection procedures for the selected PLMN as defined in TS 38.304 [1].

Table 4.2.2.2-1: N_{serv}

DRX cycle length [s]	Scaling Factor (N1)		N_{serv} [number of DRX cycles]
	FR1	FR2 ^{Note1}	
0.32	1	8	$M1 \cdot N1^4$
0.64		5	$M1 \cdot N1^4$
1.28		4	$N1^2$
2.56		3	$N1^2$
Note 1: Applies for UE supporting power class 2&3&4. For UE supporting power class 1, $N1 = 8$ for all DRX cycle length.			

4.2.2.3 Measurements of intra-frequency NR cells

The UE shall be able to identify new intra-frequency cells and perform SS-RSRP and SS-RSRQ measurements of the identified intra-frequency cells without an explicit intra-frequency neighbour list containing physical layer cell identities.

The UE shall be able to evaluate whether a newly detectable intra-frequency cell meets the reselection criteria defined in TS38.304[1] within T_{detect,NR_Intra} when that $T_{reselection} = 0$. An intra frequency cell is considered to be detectable according to the conditions defined in Annex B.1.2 for a corresponding Band.

The UE shall measure SS-RSRP and SS-RSRQ at least every $T_{measure,NR_Intra}$ (see table 4.2.2.3-1) for intra-frequency cells that are identified and measured according to the measurement rules.

The UE shall filter SS-RSRP and SS-RSRQ measurements of each measured intra-frequency cell using at least 2 measurements. Within the set of measurements used for the filtering, at least two measurements shall be spaced by at least $T_{measure,NR_Intra}/2$.

The UE shall not consider a NR neighbour cell in cell reselection, if it is indicated as not allowed in the measurement control system information of the serving cell.

For an intra-frequency cell that has been already detected, but that has not been reselected to, the filtering shall be such that the UE shall be capable of evaluating that the intra-frequency cell has met reselection criterion defined in TS38.304 [1] within $T_{\text{evaluate,NR_Intra}}$ when $T_{\text{reselection}} = 0$ as specified in table 4.2.2.3-1 provided that:

when *rangeToBestCell* is not configured:

- the cell is at least 3 dB better ranked in FR1 or 4.5 dB better ranked in FR2.

when *rangeToBestCell* is configured:

- the cell has the highest number of beams above the threshold *absThreshSS-BlocksConsolidation* among all detected cells whose cell-ranking criterion R value in TS38.304 [1] is within *rangeToBestCell* of the cell-ranking criterion R value of the highest ranked cell.
- if there are multiple such cells, the cell has the highest rank among them.
- the cell is at least 3dB better ranked in FR1 or 4.5dB better ranked in FR2 if the current serving cell is among them.

When evaluating cells for reselection, the SSB side conditions apply to both serving and non-serving intra-frequency cells.

If $T_{\text{reselection}}$ timer has a non zero value and the intra-frequency cell is satisfied with the reselection criteria which are defined in TS38.304 [1], the UE shall evaluate this intra-frequency cell for the $T_{\text{reselection}}$ time. If this cell remains satisfied with the reselection criteria within this duration, then the UE shall reselect that cell.

Table 4.2.2.3-1: $T_{\text{detect,NR_Intra}}$, $T_{\text{measure,NR_Intra}}$ and $T_{\text{evaluate,NR_Intra}}$

DRX cycle length [s]	Scaling Factor (N1)		$T_{\text{detect,NR_Intra}}$ [s] (number of DRX cycles)	$T_{\text{measure,NR_Intra}}$ [s] (number of DRX cycles)	$T_{\text{evaluate,NR_Intra}}$ [s] (number of DRX cycles)
	FR1	FR2 ^{Note1}			
0.32	1	8	$11.52 \times N1 \times M2$ (36 x N1 x M2)	$1.28 \times N1 \times M2$ (4 x N1 x M2)	$5.12 \times N1 \times M2$ (16 x N1 x M2)
0.64		5	$17.92 \times N1$ (28 x N1)	$1.28 \times N1$ (2 x N1)	$5.12 \times N1$ (8 x N1)
1.28		4	$32 \times N1$ (25 x N1)	$1.28 \times N1$ (1 x N1)	$6.4 \times N1$ (5 x N1)
2.56		3	$58.88 \times N1$ (23 x N1)	$2.56 \times N1$ (1 x N1)	$7.68 \times N1$ (3 x N1)
Note 1: Applies for UE supporting power class 2&3&4. For UE supporting power class 1, N1 = 8 for all DRX cycle length.					
Note 2: M2 = 1.5 if SMTC periodicity of measured intra-frequency cell > 20 ms; otherwise M2=1.					

4.2.2.4 Measurements of inter-frequency NR cells

The UE shall be able to identify new inter-frequency cells and perform SS-RSRP or SS-RSRQ measurements of identified inter-frequency cells if carrier frequency information is provided by the serving cell, even if no explicit neighbour list with physical layer cell identities is provided.

If $S_{\text{rxlev}} > S_{\text{nonIntraSearchP}}$ and $S_{\text{qual}} > S_{\text{nonIntraSearchQ}}$ then the UE shall search for inter-frequency layers of higher priority at least every $T_{\text{higher_priority_search}}$ where $T_{\text{higher_priority_search}}$ is described in clause 4.2.2.7.

If $S_{\text{rxlev}} \leq S_{\text{nonIntraSearchP}}$ or $S_{\text{qual}} \leq S_{\text{nonIntraSearchQ}}$ then the UE shall search for and measure inter-frequency layers of higher, equal or lower priority in preparation for possible reselection. In this scenario, the minimum rate at which the UE is required to search for and measure higher priority layers shall be the same as that defined below in this clause.

The UE shall be able to evaluate whether a newly detectable inter-frequency cell meets the reselection criteria defined in TS38.304 [1] within $K_{\text{carrier}} * T_{\text{detect,NR_Inter}}$ if at least carrier frequency information is provided for inter-frequency neighbour cells by the serving cells when $T_{\text{reselection}} = 0$ provided that the reselection criteria is met by a margin of at least 5 dB in FR1 or 6.5 dB in FR2 for reselections based on ranking or 6 dB in FR1 or 7.5 dB in FR2 for SS-RSRP reselections based on absolute priorities or 4 dB in FR1 and 4 dB in FR2 for SS-RSRQ reselections based on absolute priorities. The parameter K_{carrier} is the number of NR inter-frequency carriers indicated by the serving cell. An inter-frequency cell is considered to be detectable according to the conditions defined in Annex B.1.3 for a corresponding Band.

When higher priority cells are found by the higher priority search, they shall be measured at least every $T_{\text{measure,NR_Inter}}$. If, after detecting a cell in a higher priority search, it is determined that reselection has not occurred then the UE is not

required to continuously measure the detected cell to evaluate the ongoing possibility of reselection. However, the minimum measurement filtering requirements specified later in this clause shall still be met by the UE before it makes any determination that it may stop measuring the cell. If the UE detects on a NR carrier a cell whose physical identity is indicated as not allowed for that carrier in the measurement control system information of the serving cell, the UE is not required to perform measurements on that cell.

The UE shall measure SS-RSRP or SS-RSRQ at least every $K_{\text{carrier}} * T_{\text{measure,NR_Inter}}$ (see table 4.2.2.4-1) for identified lower or equal priority inter-frequency cells. If the UE detects on a NR carrier a cell whose physical identity is indicated as not allowed for that carrier in the measurement control system information of the serving cell, the UE is not required to perform measurements on that cell.

The UE shall filter SS-RSRP or SS-RSRQ measurements of each measured higher, lower and equal priority inter-frequency cell using at least 2 measurements. Within the set of measurements used for the filtering, at least two measurements shall be spaced by at least $T_{\text{measure,NR_Inter}}/2$.

The UE shall not consider a NR neighbour cell in cell reselection, if it is indicated as not allowed in the measurement control system information of the serving cell.

For an inter-frequency cell that has been already detected, but that has not been reselected to, the filtering shall be such that the UE shall be capable of evaluating that the inter-frequency cell has met reselection criterion defined TS 38.304 [1] within $K_{\text{carrier}} * T_{\text{evaluate,NR_Inter}}$ when $T_{\text{reselection}} = 0$ as specified in table 4.2.2.4-1 provided that the reselection criteria is met by

- the condition when performing equal priority reselection and when *rangeToBestCell* is not configured:
 - the cell is at least 5dB better ranked in FR1 or 6.5dB better ranked in FR2 or.
- when *rangeToBestCell* is configured:
 - the cell has the highest number of beams above the threshold *absThreshSS-BlocksConsolidation* among all detected cells whose cell-ranking criterion R value in TS38.304 [1] is within *rangeToBestCell* of the cell-ranking criterion R value of the highest ranked cell.
 - if there are multiple such cells, the cell has the highest rank among them
 - the cell is at least 5dB better ranked in FR1 or 6.5dB better ranked in FR2 if the current serving cell is among them. Or
 - 6dB in FR1 or 7.5dB in FR2 for SS-RSRP reselections based on absolute priorities or
 - 4dB in FR1 or 4dB in FR2 for SS-RSRQ reselections based on absolute priorities.

When evaluating cells for reselection, the SSB side conditions apply to both serving and inter-frequency cells.

If $T_{\text{reselection}}$ timer has a non zero value and the inter-frequency cell is satisfied with the reselection criteria, the UE shall evaluate this inter-frequency cell for the $T_{\text{reselection}}$ time. If this cell remains satisfied with the reselection criteria within this duration, then the UE shall reselect that cell.

The UE is not expected to meet the measurement requirements for an inter-frequency carrier under DRX cycle=320 ms defined in Table 4.2.2.4-1 under the following conditions:

- $T_{\text{SMTC_intra}} = T_{\text{SMTC_inter}} = 160$ ms; where $T_{\text{SMTC_intra}}$ and $T_{\text{SMTC_inter}}$ are periodicities of the SMTC occasions configured for the intra-frequency carrier and the inter-frequency carrier respectively, and
- SMTC occasions configured for the inter-frequency carrier occur up to 1 ms before the start or up to 1 ms after the end of the SMTC occasions configured for the intra-frequency carrier, and
- SMTC occasions configured for the intra-frequency carrier and for the inter-frequency carrier occur up to 1 ms before the start or up to 1 ms after the end of the paging occasion in TS38.304 [1].

Table 4.2.2.4-1: $T_{\text{detect,NR_Inter}}$, $T_{\text{measure,NR_Inter}}$ and $T_{\text{evaluate,NR_Inter}}$

	Scaling Factor (N1)		
--	----------------------------	--	--

DRX cycle length [s]	FR1	FR2 ^{Note1}	$T_{\text{detect,NR_Inter}}$ [s] (number of DRX cycles)	$T_{\text{measure,NR_Inter}}$ [s] (number of DRX cycles)	$T_{\text{evaluate,NR_Inter}}$ [s] (number of DRX cycles)
0.32	1	8	$11.52 \times N1 \times 1.5$ (36 x N1 x 1.5)	$1.28 \times N1 \times 1.5$ (4 x N1 x 1.5)	$5.12 \times N1 \times 1.5$ (16 x N1 x 1.5)
0.64		5	$17.92 \times N1$ (28 x N1)	$1.28 \times N1$ (2 x N1)	$5.12 \times N1$ (8 x N1)
1.28		4	$32 \times N1$ (25 x N1)	$1.28 \times N1$ (1 x N1)	$6.4 \times N1$ (5 x N1)
2.56		3	$58.88 \times N1$ (23 x N1)	$2.56 \times N1$ (1 x N1)	$7.68 \times N1$ (3 x N1)
Note 1: Applies for UE supporting power class 2&3&4. For UE supporting power class 1, N1 = 8 for all DRX cycle length.					

4.2.2.5 Measurements of inter-RAT E-UTRAN cells

If $S_{\text{rxlev}} > S_{\text{nonIntraSearchP}}$ and $S_{\text{qual}} > S_{\text{nonIntraSearchQ}}$ then the UE shall search for inter-RAT E-UTRAN layers of higher priority at least every $T_{\text{higher_priority_search}}$ where $T_{\text{higher_priority_search}}$ is described in clause 4.2.2

If $S_{\text{rxlev}} \leq S_{\text{nonIntraSearchP}}$ or $S_{\text{qual}} \leq S_{\text{nonIntraSearchQ}}$ then the UE shall search for and measure inter-RAT E-UTRAN layers of higher, lower priority in preparation for possible reselection. In this scenario, the minimum rate at which the UE is required to search for and measure higher priority inter-RAT E-UTRAN layers shall be the same as that defined below for lower priority RATs.

The requirements in this clause apply for inter-RAT E-UTRAN FDD measurements and E-UTRA TDD measurements. When the measurement rules indicate that inter-RAT E-UTRAN cells are to be measured, the UE shall measure RSRP and RSRQ of detected E-UTRA cells in the neighbour frequency list at the minimum measurement rate specified in this clause. The parameter $N_{\text{EUTRA_carrier}}$ is the total number of configured E-UTRA carriers in the neighbour frequency list. The UE shall filter RSRP and RSRQ measurements of each measured E-UTRA cell using at least 2 measurements. Within the set of measurements used for the filtering, at least two measurements shall be spaced by at least $T_{\text{measure,EUTRAN}}/2$.

An inter-RAT E-UTRA cell is considered to be detectable provided the following conditions are fulfilled:

- the same conditions as for inter-frequency RSRP measurements specified in TS 36.133 [15, Annex B.1.2] are fulfilled for a corresponding Band, and
- the same conditions as for inter-frequency RSRQ measurements specified in TS 36.133 [15, Annex B.1.2] are fulfilled for a corresponding Band.
- SCH conditions specified in TS 36.133 [15, Annex B.1.2] are fulfilled for a corresponding Band

The UE shall be able to evaluate whether a newly detectable inter-RAT E-UTRAN cell meets the reselection criteria defined in TS38.304 [1] within $(N_{\text{EUTRA_carrier}}) * T_{\text{detect,EUTRAN}}$ when $S_{\text{rxlev}} \leq S_{\text{nonIntraSearchP}}$ or $S_{\text{qual}} \leq S_{\text{nonIntraSearchQ}}$ when $T_{\text{reselction}} = 0$ provided that the reselection criteria is met by a margin of at least 6dB for RSRP reselections based on absolute priorities or 4dB for RSRQ reselections based on absolute priorities.

Cells which have been detected shall be measured at least every $(N_{\text{EUTRA_carrier}}) * T_{\text{measure,EUTRAN}}$ when $S_{\text{rxlev}} \leq S_{\text{nonIntraSearchP}}$ or $S_{\text{qual}} \leq S_{\text{nonIntraSearchQ}}$.

When higher priority cells are found by the higher priority search, they shall be measured at least every $T_{\text{measure,EUTRAN}}$. If, after detecting a cell in a higher priority search, it is determined that reselection has not occurred then the UE is not required to continuously measure the detected cell to evaluate the ongoing possibility of reselection. However, the minimum measurement filtering requirements specified later in this clause shall still be met by the UE before it makes any determination that it may stop measuring the cell.

If the UE detects on an inter-RAT E-UTRAN carrier a cell whose physical identity is indicated as not allowed for that carrier in the measurement control system information of the serving cell, the UE is not required to perform measurements on that cell.

The UE shall not consider an inter-RAT E-UTRA cell in cell reselection, if it is indicated as not allowed in the measurement control system information of the serving cell.

For a cell that has been already detected, but that has not been reselected to, the filtering shall be such that the UE shall be capable of evaluating that an already identified inter-RAT E-UTRA cell has met reselection criterion defined in TS 38.304 [1] within $(N_{\text{EUTRA_carrier}}) * T_{\text{evaluate,EUTRAN}}$ when $T_{\text{reselction}} = 0$ as specified in table 4.2.2.5-1 provided that the

reselection criteria is met by a margin of at least 6dB for RSRP reselections based on absolute priorities or 4dB for RSRQ reselections based on absolute priorities.

If $T_{\text{reselection}}$ timer has a non zero value and the inter-RAT E-UTRA cell is satisfied with the reselection criteria which are defined in TS 38.304 [1], the UE shall evaluate this E-UTRA cell for the $T_{\text{reselection}}$ time. If this cell remains satisfied with the reselection criteria within this duration, then the UE shall reselect that cell.

Table 4.2.2.5-1: $T_{\text{detect,EUTRAN}}$, $T_{\text{measure,EUTRAN}}$, and $T_{\text{evaluate,EUTRAN}}$

DRX cycle length [s]	$T_{\text{detect,EUTRAN}}$ [s] (number of DRX cycles)	$T_{\text{measure,EUTRAN}}$ [s] (number of DRX cycles)	$T_{\text{evaluate,EUTRAN}}$ [s] (number of DRX cycles)
0.32	11.52 (36)	1.28 (4)	5.12 (16)
0.64	17.92 (28)	1.28 (2)	5.12 (8)
1.28	32(25)	1.28 (1)	6.4 (5)
2.56	58.88 (23)	2.56 (1)	7.68 (3)

4.2.2.6 Maximum interruption in paging reception

UE shall perform the cell re-selection with minimum interruption in monitoring downlink channels for paging reception.

At intra-frequency and inter-frequency cell re-selection, the UE shall monitor the downlink of serving cell for paging reception until the UE is capable to start monitoring downlink channels of the target intra-frequency and inter-frequency cell for paging reception. The interruption time shall not exceed $T_{\text{SI-NR}} + 2 * T_{\text{target_cell_SMTC_period}}$ ms.

At inter-RAT cell re-selection, the UE shall monitor the downlink of serving cell for paging reception until the UE is capable to start monitoring downlink channels for paging reception of the target inter-RAT cell. For NR to E-UTRAN cell re-selection the interruption time must not exceed $T_{\text{SI-EUTRA}} + 55$ ms.

$T_{\text{SI-NR}}$ is the time required for receiving all the relevant system information data according to the reception procedure and the RRC procedure delay of system information blocks defined in TS 38.331 [2] for an NR cell.

$T_{\text{SI-EUTRA}}$ is the time required for receiving all the relevant system information data according to the reception procedure and the RRC procedure delay of system information blocks defined in TS 36.331 [16] for an E-UTRAN cell.

These requirements assume sufficient radio conditions, so that decoding of system information can be made without errors and does not take into account cell re-selection failure.

4.2.2.7 General requirements

The UE shall search every layer of higher priority at least every $T_{\text{higher_priority_search}} = (60 * N_{\text{layers}})$ seconds, where N_{layers} is the total number of higher priority NR and E-UTRA carrier frequencies broadcasted in system information.

5 SA: RRC_INACTIVE state mobility

5.1 Cell Re-selection

5.1.1 Introduction

The cell reselection procedure allows the UE to select a more suitable cell and camp on it.

When the UE is in *Camped Normally* state on a cell, the UE shall attempt to detect, synchronise, and monitor intra-frequency, inter-frequency and inter-RAT cells indicated by the serving cell. For intra-frequency and inter-frequency cells the serving cell may not provide explicit neighbour list but carrier frequency information and bandwidth information only. UE measurement activity is also controlled by measurement rules defined in TS38.304 [1], allowing the UE to limit its measurement activity.

5.1.2 Requirements

5.1.2.1 UE measurement capability

The requirements in sub-clause 4.2.2.1 shall apply.

5.1.2.2 Measurement and evaluation of serving cell

The requirements in sub-clause 4.2.2.2 shall apply.

5.1.2.3 Measurements of intra-frequency NR cells

The requirements in sub-clause 4.2.2.3 shall apply.

5.1.2.4 Measurements of inter-frequency NR cells

The requirements in sub-clause 4.2.2.4 shall apply.

5.1.2.5 Measurements of inter-RAT E-UTRAN cells

The requirements in sub-clause 4.2.2.5 shall apply.

5.1.2.6 Maximum interruption in paging reception

The requirements in sub-clause 4.2.2.6 shall apply.

5.1.2.7 General requirements

The requirements in sub-clause 4.2.2.7 shall apply.

5.2 Void

6 RRC_CONNECTED state mobility

6.1 Handover

6.1.1 NR Handover

6.1.1.1 Introduction

The purpose of NR handover is to change the NR PCell to another NR cell. The requirements in this clause are applicable to SA NR, NE-DC and NR-DC.

6.1.1.2 NR FR1 - NR FR1 Handover

The requirements in this clause are applicable to both intra-frequency and inter-frequency handovers from NR FR1 cell to NR FR1 cell.

6.1.1.2.1 Handover delay

When the UE receives a RRC message implying handover the UE shall be ready to start the transmission of the new uplink PRACH channel within D_{handover} msec from the end of the last TTI containing the RRC command.

Where:

D_{handover} equals the applicable RRC procedure delay defined in clause 12 in TS 38.331 [2] plus the interruption time stated in clause 6.1.1.2.2.

6.1.1.2.2 Interruption time

The interruption time is the time between end of the last TTI containing the RRC command on the old PDSCH and the time the UE starts transmission of the new PRACH, excluding the RRC procedure delay.

When intra-frequency or inter-frequency handover is commanded, the interruption time shall be less than $T_{\text{interrupt}}$

$$T_{\text{interrupt}} = T_{\text{search}} + T_{\text{IU}} + T_{\text{processing}} + T_{\Delta} + T_{\text{margin}} \text{ ms}$$

Where:

T_{search} is the time required to search the target cell when the target cell is not already known when the handover command is received by the UE. If the target cell is known, then $T_{\text{search}} = 0$ ms. If the target cell is an unknown intra-frequency cell and the target cell $E_s/I_{\text{ot}} \geq -2$ dB, then $T_{\text{search}} = T_{\text{rs}}$ ms. If the target cell is an unknown inter-frequency cell and the target cell $E_s/I_{\text{ot}} \geq -2$ dB, then $T_{\text{search}} = 3 * T_{\text{rs}}$ ms. Regardless of whether DRX is in use by the UE, T_{search} shall still be based on non-DRX target cell search times.

$T_{\text{processing}}$ is time for UE processing. $T_{\text{processing}}$ can be up to 20ms.

T_{margin} is time for SSB post-processing. T_{margin} can be up to 2ms.

T_{Δ} is time for fine time tracking and acquiring full timing information of the target cell. $T_{\Delta} = T_{\text{rs}}$ for both known and unknown target cell.

T_{IU} is the interruption uncertainty in acquiring the first available PRACH occasion in the new cell. T_{IU} can be up to the summation of SSB to PRACH occasion association period and 10 ms. SSB to PRACH occasion associated period is defined in the table 8.1-1 of TS 38.213 [3].

T_{rs} is the SMTC periodicity of the target NR cell if the UE has been provided with an SMTC configuration for the target cell in the handover command, otherwise T_{rs} is the SMTC configured in the `measObjectNR` having the

same SSB frequency and subcarrier spacing. If the measObjectNRs having the same SSB frequency and subcarrier spacing configured by MN and SN have different SMTC, T_{rs} is the periodicity of one of the SMTC which is up to UE implementation. If the UE is not provided SMTC configuration or measurement object on this frequency, the requirement in this clause is applied with $T_{rs}=5\text{ms}$ assuming the SSB transmission periodicity is 5ms. There is no requirement if the SSB transmission periodicity is not 5ms. If the UE has been provided with higher layer in TS 38.331 [2] signaling of *smtc2* prior to the handover command, T_{rs} follows *smtc1* or *smtc2* according to the physical cell ID of the target cell.

In the interruption requirement a cell is known if it has been meeting the relevant cell identification requirement during the last 5 seconds otherwise it is unknown. Relevant cell identification requirements are described in Clause 9.2.5 for intra-frequency handover and Clause 9.3.4 for inter-frequency handover.

6.1.1.3 NR FR2- NR FR1 Handover

The requirements in this clause are applicable to inter-frequency handovers from NR FR2 cell to NR FR1 cell.

6.1.1.3.1 Handover delay

When the UE receives a RRC message implying handover the UE shall be ready to start the transmission of the new uplink PRACH channel within D_{handover} ms from the end of the last TTI containing the RRC command.

Where:

D_{handover} equals the applicable RRC procedure delay defined in clause 12 in TS 38.331 [2] plus the interruption time stated in clause 6.1.1.3.2.

6.1.1.3.2 Interruption time

The interruption time is the time between the end of the last TTI containing the RRC command on the old PDSCH and the time the UE starts transmission of the new PRACH, excluding the RRC procedure delay.

When inter-frequency handover is commanded, the interruption time shall be less than $T_{\text{interrupt}}$

$$T_{\text{interrupt}} = T_{\text{search}} + T_{\text{IU}} + T_{\text{processing}} + T_{\Delta} + T_{\text{margin}} \text{ ms}$$

Where:

T_{search} is the time required to search the target cell when the target cell is not already known when the handover command is received by the UE. If the target cell is known, then $T_{\text{search}} = 0$ ms. If the target cell is an unknown inter-frequency cell and the target cell $E_s/I_{ot} \geq -2$ dB, then $T_{\text{search}} = 3 * T_{rs}$ ms. Regardless of whether DRX is in use by the UE, T_{search} shall still be based on non-DRX target cell search times.

T_{Δ} is time for fine time tracking and acquiring full timing information of the target cell. $T_{\Delta} = T_{rs}$ for both known and unknown target cell.

$T_{\text{processing}}$ is time for UE processing. $T_{\text{processing}}$ can be up to 40ms.

T_{margin} is time for SSB post-processing. T_{margin} can be up to 2ms.

T_{IU} is the interruption uncertainty in acquiring the first available PRACH occasion in the new cell. T_{IU} can be up to the summation of SSB to PRACH occasion association period and 10 ms. SSB to PRACH occasion associated period is defined in the table 8.1-1 of TS 38.213 [3].

T_{rs} is the SMTC periodicity of the target NR cell if the UE has been provided with an SMTC configuration for the target cell in the handover command, otherwise T_{rs} is the SMTC configured in the measObjectNR having the same SSB frequency and subcarrier spacing. If such measObjectNRs configured by MN and SN have different SMTC, T_{rs} is the periodicity of one of the SMTC which is up to UE implementation. If the UE is not provided SMTC configuration or measurement object on this frequency, the requirement in this clause is applied with $T_{rs}=5\text{ms}$ assuming the SSB transmission periodicity is 5ms. There is no requirement if the SSB transmission periodicity is not 5ms.

In the interruption requirement a cell is known if it has been meeting the relevant cell identification requirement during the last 5 seconds otherwise it is unknown. Relevant cell identification requirements are described in Clause 9.2.5 for intra-frequency handover and Clause 9.3.4 for inter-frequency handover.

6.1.1.4 NR FR2- NR FR2 Handover

The requirements in this clause are applicable to both intra-frequency and inter-frequency handovers from NR FR2 cell to NR FR2 cell.

6.1.1.4.1 Handover delay

When the UE receives a RRC message implying handover the UE shall be ready to start the transmission of the new uplink PRACH channel within D_{handover} ms from the end of the last TTI containing the RRC command.

Where:

D_{handover} equals the applicable RRC procedure delay defined in clause 12 in TS 38.331 [2] plus the interruption time stated in clause 6.1.1.4.2.

6.1.1.4.2 Interruption time

The interruption time is the time between end of the last TTI containing the RRC command on the old PDSCH and the time the UE starts transmission of the new PRACH, excluding the RRC procedure delay.

When intra-frequency or inter-frequency handover is commanded, the interruption time shall be less than $T_{\text{interrupt}}$

$$T_{\text{interrupt}} = T_{\text{search}} + T_{\text{IU}} + T_{\text{processing}} + T_{\Delta} + T_{\text{margin}} \text{ ms}$$

Where:

T_{search} is the time required to search the target cell when the handover command is received by the UE. If the target cell is a known cell, then $T_{\text{search}} = 0$ ms. If the target cell is an unknown intra-frequency cell and the target cell $E_s/I_{ot} \geq -2$ dB, then $T_{\text{search}} = 8 * T_{\text{rs}}$ ms. If the target cell is an unknown inter-frequency cell and the target cell $E_s/I_{ot} \geq -2$ dB, then $T_{\text{search}} = 8 * 3 * T_{\text{rs}}$ ms. Regardless of whether DRX is in use by the UE, T_{search} shall still be based on non-DRX target cell search times.

$T_{\text{processing}}$ is time for UE processing. $T_{\text{processing}}$ can be up to 20ms.

T_{margin} is time for SSB post-processing. T_{margin} can be up to 2ms.

T_{Δ} is time for fine time tracking and acquiring full timing information of the target cell. $T_{\Delta} = T_{\text{rs}}$ for both known and unknown target cell.

T_{IU} is the interruption uncertainty in acquiring the first available PRACH occasion in the new cell. T_{IU} can be up to the summation of SSB to PRACH occasion association period and 10 ms. SSB to PRACH occasion associated period is defined in the table 8.1-1 of TS 38.213 [3].

T_{rs} is the SMTC periodicity of the target NR cell if the UE has been provided with an SMTC configuration for the target cell in the handover command, otherwise T_{rs} is the SMTC configured in the measObjectNR having the same SSB frequency and subcarrier spacing. If such measObjectNRs configured by MN and SN have different SMTC, T_{rs} is the periodicity of one of the SMTC which is up to UE implementation. If the UE is not provided SMTC configuration or measurement object on this frequency, the requirement in this clause is applied with $T_{\text{rs}}=5$ ms assuming the SSB transmission periodicity is 5ms. There is no requirement if the SSB transmission periodicity is not 5ms. If the UE has been provided with higher layer in TS 38.331 [2] signaling of *smtc2* prior to the handover command, T_{rs} follows *smtc1* or *smtc2* according to the physical cell ID of the target cell.

In FR2, the target cell is known if it has been meeting the following conditions:

- During the last 5 seconds before the reception of the handover command:
 - the UE has sent a valid measurement report for the target cell and

- One of the SSBs measured from the NR target cell being configured remains detectable according to the cell identification conditions specified in clause 9.2 for intra-frequency cell and in clause 9.3 for inter-frequency cell,
- One of the SSBs measured from the target cell also remains detectable during the handover delay according to the cell identification conditions specified in clause 9.2 for intra-frequency cell and in clause 9.3 for inter-frequency cell.

otherwise it is unknown.

6.1.1.5 NR FR1- NR FR2 Handover

The requirements in this clause are applicable to inter-frequency handovers from NR FR1 cell to NR FR2 cell.

6.1.1.5.1 Handover delay

When the UE receives a RRC message implying handover the UE shall be ready to start the transmission of the new uplink PRACH channel within D_{handover} ms from the end of the last TTI containing the RRC command.

Where:

D_{handover} equals the applicable RRC procedure delay defined in clause 12 in TS 38.331 [2] plus the interruption time stated in clause 6.1.1.5.2.

6.1.1.5.2 Interruption time

The interruption time is the time between end of the last TTI containing the RRC command on the old PDSCH and the time the UE starts transmission of the new PRACH, excluding the RRC procedure delay.

When inter-frequency handover is commanded, the interruption time shall be less than $T_{\text{interrupt}}$

$$T_{\text{interrupt}} = T_{\text{search}} + T_{\text{IU}} + T_{\text{processing}} + T_{\Delta} + T_{\text{margin}} \text{ ms}$$

Where:

T_{search} is the time required to search the target cell when the handover command is received by the UE. If the target cell is a known cell, then $T_{\text{search}} = 0$ ms. . If the target cell is an unknown inter-frequency cell and the target cell $E_s/I_{ot} \geq -2$ dB, then $T_{\text{search}} = 8 \cdot 3 \cdot T_{\text{rs}}$ ms. Regardless of whether DRX is in use by the UE, T_{search} shall still be based on non-DRX target cell search times.

$T_{\text{processing}}$ is time for UE processing. $T_{\text{processing}}$ can be up to 40ms.

T_{margin} is time for SSB post-processing. T_{margin} can be up to 2ms.

T_{Δ} is time for fine time tracking and acquiring full timing information of the target cell. $T_{\Delta} = T_{\text{rs}}$ for both known and unknown target cell.

T_{IU} is the interruption uncertainty in acquiring the first available PRACH occasion in the new cell. T_{IU} can be up to the summation of SSB to PRACH occasion association period and 10 ms. SSB to PRACH occasion associated period is defined in the table 8.1-1 of TS 38.213 [3].

T_{rs} is the SMTC periodicity of the target NR cell if the UE has been provided with an SMTC configuration for the target cell in the handover command, otherwise T_{rs} is the SMTC configured in the measObjectNR having the same SSB frequency and subcarrier spacing. If such measObjectNRs configured by MN and SN have different SMTC, T_{rs} is the periodicity of one of the SMTC which is up to UE implementation. If the UE is not provided SMTC configuration or measurement object on this frequency, the requirement in this clause is applied with $T_{\text{rs}}=5$ ms assuming the SSB transmission periodicity is 5ms. There is no requirement if the SSB transmission periodicity is not 5ms.

In FR2, the target cell is known if it has been meeting the following conditions:

- During the last 5 seconds before the reception of the handover command:
- the UE has sent a valid measurement report for the target cell and

- One of the SSBs measured from the NR target cell being configured remains detectable according to the cell identification conditions specified in clause 9.3,
- One of the SSBs measured from the target cell also remains detectable during the handover delay according to the cell identification conditions specified in clause 9.3.

otherwise it is unknown.

6.1.2 NR Handover to other RATs

6.1.2.1 NR – E-UTRAN Handover

6.1.2.1.1 Introduction

The purpose of inter-RAT handover from NR to E-UTRAN is to change the radio access mode of PCell from NR to E-UTRAN. The handover procedure is initiated from NR with a RRC message that implies a handover as described in TS 38.331 [2]. The requirements in this clause are applicable to SA NR, NE-DC and NR-DC.

If PRACH occasion is configured in radio frames with even SFN and the relative time difference between radio frame i in the current cell and the target cell is not less than $153600 \cdot T_s$, the longer handover delay is expected.

6.1.2.1.2 Handover delay

When the UE receives a RRC message implying handover to E-UTRAN the UE shall be ready to start the transmission of the uplink PRACH channel in E-UTRA within D_{handover} ms from the end of the last TTI containing the RRC command. D_{handover} is defined as

$$D_{\text{handover}} = T_{\text{RRC_procedure_delay}} + T_{\text{interrupt}}$$

Where:

$T_{\text{RRC_procedure_delay}}$: it is the RRC procedure delay, which is 50ms

$T_{\text{interrupt}}$: it is the time between end of the last TTI containing the RRC command on the NR PDSCH and the time the UE starts transmission of the PRACH in E-UTRAN, excluding $T_{\text{RRC_procedure_delay}}$. $T_{\text{interrupt}}$ is defined in clause 6.1.2.1.3.

6.1.2.1.3 Interruption time

When the inter-RAT handover to E-UTRAN is commanded, the interruption time shall be less than $T_{\text{interrupt}}$

$$T_{\text{interrupt}} = T_{\text{search}} + T_{\text{IU}} + 20 \text{ ms}$$

Where:

T_{search} is the time required to search the target cell when the target cell is not already known when the handover command is received by the UE. If the target cell is known, then $T_{\text{search}} = 0$ ms. If the target cell is unknown and signal quality is sufficient for successful cell detection on the first attempt, then $T_{\text{search}} = 80$ ms. Regardless of whether DRX is in use by the UE, T_{search} shall still be based on non-DRX target cell search times.

T_{IU} is the interruption uncertainty in acquiring the first available PRACH occasion in the new cell. T_{IU} can be up to 30 ms.

NOTE: The actual value of T_{IU} shall depend upon the PRACH configuration used in the target cell.

In the interruption requirement a cell is known if it has been meeting the relevant cell identification requirement during the last 5 seconds otherwise it is unknown. Relevant E-UTRAN cell identification requirements are described in clause 9.4.1.

6.2 RRC Connection Mobility Control

6.2.1 SA: RRC Re-establishment

6.2.1.1 Introduction

This clause contains requirements on the UE regarding RRC connection re-establishment procedure. RRC connection re-establishment is initiated when a UE in RRC_CONNECTED state loses RRC connection due to any of failure cases, including radio link failure, handover failure, and RRC connection reconfiguration failure. The RRC connection re-establishment procedure is specified in clause 5.3.7 of TS 38.331 [2].

The requirements in this clause are applicable for RRC connection re-establishment to NR cell.

6.2.1.2 Requirements

In RRC_CONNECTED state the UE shall be capable of sending *RRCReestablishmentRequest* message within $T_{re-establish_delay}$ seconds from the moment it detects a loss in RRC connection. The total RRC connection delay ($T_{re-establish_delay}$) shall be less than:

$$T_{re-establish_delay} = T_{UE_re-establish_delay} + T_{UL_grant}$$

T_{UL_grant} : It is the time required to acquire and process uplink grant from the target PCell. The uplink grant is required to transmit *RRCReestablishmentRequest* message.

The UE re-establishment delay ($T_{UE_re-establish_delay}$) is specified in clause 6.2.1.2.1.

6.2.1.2.1 UE Re-establishment delay requirement

The UE re-establishment delay ($T_{UE_re-establish_delay}$) is the time between the moments when any of the conditions requiring RRC re-establishment as defined in clause 5.3.7 in TS 38.331 [2] is detected by the UE and when the UE sends PRACH to the target PCell. The UE re-establishment delay ($T_{UE_re-establish_delay}$) requirement shall be less than:

$$T_{UE_re-establish_delay} = 50 \text{ ms} + T_{identify_intra_NR} + \sum_{i=1}^{N_{freq}-1} T_{identify_inter_NR,i} + T_{SI-NR} + T_{PRACH}$$

The intra-frequency target NR cell shall be considered detectable if each relevant SSB can satisfy that:

- SS-RSRP related side conditions given in clause 10.1.2 and 10.1.3 are fulfilled for a corresponding NR Band for FR1 and FR2, respectively, and
- the conditions of SSB_{RP} and SSB \hat{E}_s/I_{ot} according to Annex B.2.2 for a corresponding NR Band are fulfilled.

The inter-frequency target NR cell shall be considered detectable when for each relevant SSB:

- SS-RSRP related side conditions given in clause 10.1.4 and 10.1.5 are fulfilled for a corresponding NR Band for FR1 and FR2, respectively, and
- the conditions of SSB_{RP} and SSB \hat{E}_s/I_{ot} according to Annex B.2.3 for a corresponding NR Band are fulfilled.

$T_{identify_intra_NR}$: It is the time to identify the target intra-frequency NR cell and it depends on whether the target NR cell is known cell or unknown cell and on the FR of the target NR cell. If the UE is not configured with intra-frequency NR carrier for RRC re-establishment then $T_{identify_intra_NR}=0$; otherwise $T_{identify_intra_NR}$ shall not exceed the values defined in Table 6.2.1.2.1-1.

$T_{identify_inter_NR,i}$: It is the time to identify the target inter-frequency NR cell on inter-frequency carrier i configured for RRC re-establishment and it depends on whether the target NR cell is known cell or unknown cell and on the FR of the target NR cell. $T_{identify_inter_NR,i}$ shall not exceed the values defined in Table 6.2.1.2.1-2.

T_{SMTC} : It is the periodicity of the SMTC occasion configured for the intra-frequency carrier. If the UE has been provided with higher layer in TS 38.331 [2] signaling of *smtc2*, T_{smtc} follows *smtc1* or *smtc2* according to the physical cell ID of the target cell.

$T_{\text{SMTC},i}$: It is the periodicity of the SMTC occasion configured for the inter-frequency carrier i . If it is not configured, the UE may assume that the target SSB periodicity is no larger than 20 ms.

$T_{\text{SI-NR}}$: It is the time required for receiving all the relevant system information according to the reception procedure and the RRC procedure delay of system information blocks defined in TS 38.331 [2] for the target NR cell.

T_{PRACH} : It is the delay uncertainty in acquiring the first available PRACH occasion in the target NR cell. T_{PRACH} can be up to the summation of SSB to PRACH occasion association period and 10 ms. SSB to PRACH occasion associated period is defined in the table 8.1-1 of TS 38.213 [3].

N_{freq} : It is the total number of NR frequencies to be monitored for RRC re-establishment; $N_{\text{freq}} = 1$ if the target intra-frequency NR cell is known, else $N_{\text{freq}} = 2$ and $T_{\text{identify_intra_NR}} = 0$ if the target inter-frequency NR cell is known.

There is no requirement if the target cell does not contain the UE context.

In the requirement defined in the below tables, the target FR1 cell is known if it has been meeting the relevant cell identification requirement during the last 5 seconds otherwise it is unknown.

Table 6.2.1.2.1-1: Time to identify target NR cell for RRC connection re-establishment to NR intra-frequency cell

Serving cell SSB \hat{E}_s/lot (dB)	FR of target NR cell	$T_{\text{identify_intra_NR}}$ [ms]	
		Known NR cell	Unknown NR cell
≥ -8	FR1	MAX (200 ms, $5 \times T_{\text{SMTC}}$)	MAX (800 ms, $10 \times T_{\text{SMTC}}$)
≥ -8	FR2	N/A	MAX (1000 ms, $80 \times T_{\text{SMTC}}$)
< -8	FR1	N/A	800 ^{Note1}
< -8	FR2	N/A	3520 ^{Note1}

Note 1: The UE is not required to successfully identify a cell on any NR frequency layer when $T_{\text{SMTC}} > 20$ ms and serving cell SSB $\hat{E}_s/\text{lot} < -8$ dB.

Table 6.2.1.2.1-2: Time to identify target NR cell for RRC connection re-establishment to NR inter-frequency cell

Serving cell SSB \hat{E}_s/lot (dB)	FR of target NR cell	$T_{\text{identify_inter_NR},i}$ [ms]	
		Known NR cell	Unknown NR cell
≥ -8	FR1	MAX (200 ms, $6 \times T_{\text{SMTC},i}$)	MAX (800 ms, $13 \times T_{\text{SMTC},i}$)
≥ -8	FR2	N/A	MAX (1000 ms, $104 \times T_{\text{SMTC},i}$)
< -8	FR1	N/A	800 ^{Note1}
< -8	FR2	N/A	4000 ^{Note1}

Note 1: The UE is not required to successfully identify a cell on any NR frequency layer when $T_{\text{SMTC},i} > 20$ ms and serving cell SSB $\hat{E}_s/\text{lot} < -8$ dB.

6.2.2 Random access

6.2.2.1 Introduction

This clause contains requirements on the UE regarding random access procedure. The random access procedure is initiated to establish uplink time synchronization for a UE which either has not acquired or has lost its uplink synchronization, or to convey UE's request Other SI, or for beam failure recovery. The random access is specified in clause 8 of TS 38.213 [3] and the control of the RACH transmission is specified in clause 5.1 of TS 38.321 [7].

6.2.2.2 Requirements

The UE shall have capability to calculate PRACH transmission power according to the PRACH power formula defined in TS 38.213 [3] and apply this power level at the first preamble or additional preambles. The absolute power applied to the first preamble shall have an accuracy as specified in Table 6.3.4.2-1 of TS 38.101-1 [18] for FR1 and in Table 6.3.4.2-1 of TS 38.101-2 [19] for FR2. The relative power applied to additional preambles shall have an accuracy as specified in Table 6.3.4.3-1 of TS 38.101-1 [18] for FR1 and clause 6.3.4.3 of TS 38.101-2 [19] for FR2.

The UE shall indicate a random access problem to upper layers if the maximum number of preamble transmission counter has been reached for the random access procedure on PCell or PSCell as specified in clause 5.1.4 in TS 38.321 [7].

The requirements in this clause apply for UE in SA operation mode or any MR-DC operation mode.

6.2.2.2.1 Contention based random access

6.2.2.2.1.1 Correct behaviour when transmitting Random Access Preamble

With the UE selected SSB with SS-RSRP above *rsrp-ThresholdSSB*, UE shall have the capability to select a Random Access Preamble randomly with equal probability from the Random Access Preambles associated with the selected SSB if the association between Random Access Preambles and SSB is configured, as specified in clause 5.1.2 in TS 38.321 [7].

With the UE selected SSB with SS-RSRP above *rsrp-ThresholdSSB*, UE shall have the capability to transmit Random Access Preamble on the next available PRACH occasion from the PRACH occasions corresponding to the selected SSB permitted by the restrictions given by the *ra-ssb-OccasionMaskIndex* if configured, if the association between PRACH occasions and SSBs is configured, and PRACH occasion shall be randomly selected with equal probability amongst the selected SSB associated PRACH occasions occurring simultaneously but on different subcarriers, as specified in clause 5.1.2 in TS 38.321 [7].

6.2.2.2.1.2 Correct behaviour when receiving Random Access Response

The UE may stop monitoring for Random Access Response(s) and shall transmit the msg3 if the Random Access Response contains a Random Access Preamble identifier corresponding to the transmitted Random Access Preamble.

The UE shall again perform the Random Access Resource selection procedure defined in clause 5.1.2 in TS 38.321 [7], and transmit with the calculated PRACH transmission power when the backoff time expires if all received Random Access Responses contain Random Access Preamble identifiers that do not match the transmitted Random Access Preamble.

6.2.2.2.1.3 Correct behaviour when not receiving Random Access Response

The UE shall again perform the Random Access Resource selection procedure defined in clause 5.1.2 in TS 38.321 [7], and transmit with the calculated PRACH transmission power when the backoff time expires if no Random Access Response is received within the RA Response window defined in clause 5.1.4 in TS 38.321 [7].

6.2.2.2.1.4 Correct behaviour when receiving an UL grant for msg3 retransmission

The UE shall re-transmit the msg3 upon the reception of an UL grant for msg3 retransmission.

6.2.2.2.1.5 SA: Correct behaviour when receiving a message over Temporary C-RNTI

The UE shall send ACK if the Contention Resolution is successful.

The UE shall again perform the Random Access Resource selection procedure defined in clause 5.1.2 in TS 38.321 [7], and transmit with the calculated PRACH transmission power when the backoff time expires unless the received message includes a UE Contention Resolution Identity MAC control element and the UE Contention Resolution Identity included in the MAC control element matches the CCCH SDU transmitted in the uplink message.

6.2.2.2.1.6 Correct behaviour when contention Resolution timer expires

The UE shall re-select a preamble and transmit with the calculated PRACH transmission power when the backoff time expires if the Contention Resolution Timer expires.

6.2.2.2.2 Non-Contention based random access

6.2.2.2.2.1 Correct behaviour when transmitting Random Access Preamble

If the contention-free Random Access Resources and the contention-free PRACH occasions associated with SSBs is configured, with the UE selected SSB with $SS\text{-RSRP}$ above $rsrp\text{-ThresholdSSB}$ amongst the associated SSBs, UE shall have the capability to select the Random Access Preamble corresponding to the selected SSB, and to transmit Random Access Preamble on the next available PRACH occasion from the PRACH occasions corresponding to the selected SSB permitted by the restrictions given by the $ra\text{-ssb}\text{-OccasionMaskIndex}$ if configured, and PRACH occasion shall be randomly selected with equal probability amongst the selected SSB associated PRACH occasions occurring simultaneously but on different subcarriers, as specified in clause 5.1.2 in TS 38.321 [7].

If the contention-free Random Access Resources and the contention-free PRACH occasions associated with CSI-RSs is configured, with the UE selected CSI-RS with $CSI\text{-RSRP}$ above $rsrp\text{-ThresholdCSI-RS}$ amongst the associated CSI-RSs, UE shall have the capability to select the Random Access Preamble corresponding to the selected CSI-RS, and to transmit Random Access Preamble on the next available PRACH occasion from the PRACH occasions in $ra\text{-OccasionList}$ corresponding to the selected CSI-RS, and PRACH occasion shall be randomly selected with equal probability amongst the selected CSI-RS associated PRACH occasions occurring simultaneously but on different subcarriers, as specified in clause 5.1.2 in TS 38.321 [7].

If the random access procedure is initialized for beam failure recovery and if the contention-free Random Access Resources and the contention-free PRACH occasions for beam failure recovery request associated with any of the SSBs and/or CSI-RSs is configured, UE shall have the capability to select the Random Access Preamble corresponding to the selected SSB with $SS\text{-RSRP}$ above $rsrp\text{-ThresholdSSB}$ amongst the associated SSBs or the selected CSI-RS with $CSI\text{-RSRP}$ above $rsrp\text{-ThresholdCSI-RS}$ amongst the associated CSI-RSs, and to transmit Random Access Preamble on the next available PRACH occasion from the PRACH occasions corresponding to the selected SSB permitted by the restrictions given by the $ra\text{-ssb}\text{-OccasionMaskIndex}$ if configured, or from the PRACH occasions in $ra\text{-OccasionList}$ corresponding to the selected CSI-RS, and PRACH occasion shall be randomly selected with equal probability amongst the selected SSB associated PRACH occasions or the selected CSI-RS associated PRACH occasions occurring simultaneously but on different subcarriers, as specified in clause 5.1.2 in TS 38.321 [7].

6.2.2.2.2.2 Correct behaviour when receiving Random Access Response

The UE may stop monitoring for Random Access Response(s), if the Random Access Response contains a Random Access Preamble identifier corresponding to the transmitted Random Access Preamble, unless the random access procedure is initialized for Other SI request from UE.

The UE may stop monitoring for Random Access Response(s) and shall monitor the Other SI transmission if the Random Access Response only contains a Random Access Preamble identifier which is corresponding to the transmitted Random Access Preamble and the random access procedure is initialized for SI request from UE, as specified in clause 5.1.4 in TS 38.321 [7].

The UE may stop monitoring for Random Access Response(s), if the contention-free Random Access Preamble for beam failure recovery request was transmitted and if the PDCCH addressed to UE's C-RNTI is received, as specified in clause 5.1.4 in TS 38.321 [7].

The UE shall again perform the Random Access Resource selection procedure defined in clause 5.1.2 in TS 38.321 [7] for the next available PRACH occasion, and transmit the preamble with the calculated PRACH transmission power if all received Random Access Responses contain Random Access Preamble identifiers that do not match the transmitted Random Access Preamble.

6.2.2.2.2.3 Correct behaviour when not receiving Random Access Response

The UE shall again perform the Random Access Resource selection procedure defined in clause 5.1.2 in TS 38.321 [7] for the next available PRACH occasion, and transmit the preamble with the calculated PRACH transmission power, if no Random Access Response is received within the RA Response window configured in $RACH\text{-ConfigCommon}$ or if no PDCCH addressed to UE's C-RNTI is received within the RA Response window configured in $BeamFailureRecoveryConfig$, as defined in clause 5.1.4 in TS 38.321 [7].

6.2.2.2.3 UE behaviour when configured with supplementary UL

In addition to the requirements defined in clause 6.2.2.2.1 and 6.2.2.2.2, a UE configured with supplementary UL carrier shall use RACH configuration for the supplementary UL carrier contained in RMSI and RRC dedicated signalling. If the cell for the random access procedure is configured with supplementary UL, the UE shall transmit or re-transmit PRACH preamble on the supplementary UL carrier if the SS-RSRP measured by the UE on the DL carrier is lower than the *rsrp-ThresholdSSB-SUL* as defined in TS 38.331 [2].

6.2.3 SA: RRC Connection Release with Redirection

6.2.3.1 Introduction

This clause contains requirements on the UE regarding RRC connection release with redirection procedure. RRC connection release with redirection is initiated by the *RRCRelease* message with redirection to E-UTRAN or NR from NR specified in TS 38.331 [2]. The RRC connection release with redirection procedure is specified in clause 5.3.8 of TS 38.331 [2].

6.2.3.2 Requirements

6.2.3.2.1 RRC connection release with redirection to NR

The UE shall be capable of performing the RRC connection release with redirection to the target NR cell within $T_{\text{connection_release_redirect_NR}}$.

The time delay ($T_{\text{connection_release_redirect_NR}}$) is the time between the end of the last slot containing the RRC command, “*RRCRelease*” (TS 38.331 [2]) on the NR PDSCH and the time the UE starts to send random access to the target NR cell. The time delay ($T_{\text{connection_release_redirect_NR}}$) shall be less than:

$$T_{\text{connection_release_redirect_NR}} = T_{\text{RRC_procedure_delay}} + T_{\text{identify-NR}} + T_{\text{SI-NR}} + T_{\text{RACH}}$$

The target NR cell shall be considered detectable when for each relevant SSB, the side conditions should be met that,

- the conditions of SSB_{RP} and SSB \hat{E}_s/I_{ot} according to Annex B.2.5 for a corresponding NR Band are fulfilled.

$T_{\text{RRC_procedure_delay}}$: It is the RRC procedure delay for processing the received message “*RRCRelease*” as defined in clause 6.2.2 of TS 38.331 [2].

$T_{\text{identify-NR}}$: It is the time to identify the target NR cell and depends on the FR of the target NR cell. It is defined in Table 6.2.3.2.1-1. Note that $T_{\text{identify-NR}} = T_{\text{PSS/SSS-sync}} + T_{\text{meas}}$, in which $T_{\text{PSS/SSS-sync}}$ is the cell search time and T_{meas} is the measurement time due to cell selection criteria evaluation.

$T_{\text{SI-NR}}$: It is the time required for acquiring all the relevant system information of the target NR cell. This time depends upon whether the UE is provided with the relevant system information of the target NR cell or not by the old NR cell before the RRC connection is released.

T_{RACH} : It is the delay uncertainty in acquiring the first available PRACH occasion in the target NR cell. T_{RACH} can be up to the summation of SSB to PRACH occasion association period and 10 ms. SSB to PRACH occasion associated period is defined in the table 8.1-1 of TS 38.213 [3].

T_{rs} is the SMTC periodicity of the target NR cell if the UE has been provided with an SMTC configuration for the target cell in the redirection command, otherwise T_{rs} is the SMTC periodicity configured in the *measObjectNR* having the same SSB frequency and subcarrier spacing configured for the RRC connection release with redirection. If the *measObjectNRs* having the same SSB frequency and subcarrier spacing configured by MN and SN have different SMTC, T_{rs} is the periodicity of one of the SMTC which is up to UE implementation. If the UE is not provided with SMTC configuration or measurement object for the frequency which is also configured for the RRC connection release with redirection then:

- the requirement in this clause is applied with $T_{\text{rs}} = 20$ ms if the SSB transmission periodicity is not larger than 20 ms; otherwise,
- there is no requirement if the SSB transmission periodicity is larger than 20ms.

Table 6.2.3.2.1-1: Time to identify target NR cell for RRC connection release with redirection to NR

FR of target NR cell	$T_{\text{identify-NR}}$
FR1	MAX (680 ms, $11 \times T_{\text{rs}}$)
FR2	MAX (880 ms, $8 \times 11 \times T_{\text{rs}}$)
Note:	If the UE has been provided with higher layer signaling of <i>smtc2</i> specified in TS 38.331 [2] prior to the redirection command, T_{rs} follows <i>smtc1</i> or <i>smtc2</i> according to the physical cell ID of the target cell.

6.2.3.2.2 RRC connection release with redirection to E-UTRAN

The UE shall be capable of performing the RRC connection release with redirection to the target E-UTRAN cell within $T_{\text{connection_release_redirect_E-UTRA}}$.

The time delay ($T_{\text{connection_release_redirect_E-UTRA}}$) is the time between the end of the last slot containing the RRC command, “*RRCRelease*” (TS 38.331 [2]) on the PDSCH and the time the UE starts to send random access to the target E-UTRAN cell. The time delay ($T_{\text{connection_release_redirect_E-UTRA}}$) shall be less than:

$$T_{\text{connection_release_redirect_E-UTRA}} = T_{\text{RRC_procedure_delay}} + T_{\text{identify-E-UTRA}} + T_{\text{SI-E-UTRA}} + T_{\text{RACH}}$$

The target E-UTRAN FDD or TDD cell shall be considered detectable provided the following conditions are fulfilled:

- the same conditions as for inter-frequency RSRP measurements specified in annex B.1.2 of TS 36.133 [15] are fulfilled for a corresponding Band, and
- the same conditions as for inter-frequency RSRQ measurements specified in annex B.1.2 of TS 36.133 [15] are fulfilled for a corresponding Band, and
- SCH conditions specified in annex B.1.2 of TS 36.133 [15] are fulfilled for a corresponding Band.

$T_{\text{RRC_procedure_delay}}$: It is the RRC procedure delay for processing the received message “*RRCRelease*” as defined in clause 6.2.2 of TS 38.331 [2].

$T_{\text{identify-E-UTRA}}$: It is the time to identify the target E-UTRAN cell. It shall be less than 320 ms.

$T_{\text{SI-E-UTRA}}$: It is the time required for acquiring all the relevant system information of the target E-UTRAN cell. This time depends upon whether the UE is provided with the relevant system information (SI) of the target E-UTRAN cell or not by the old NR cell before the RRC connection is released.

T_{RACH} : It is the delay caused due to the random access procedure when sending random access to the target E-UTRAN cell.

7 Timing

7.1 UE transmit timing

7.1.1 Introduction

The UE shall have capability to follow the frame timing change of the reference cell in connected state. The uplink frame transmission takes place $(N_{\text{TA}} + N_{\text{TA_offset}}) \times T_c$ before the reception of the first detected path (in time) of the corresponding downlink frame from the reference cell. For serving cell(s) in pTAG, UE shall use the SpCell as the reference cell for deriving the UE transmit timing for cells in the pTAG. For serving cell(s) in sTAG, UE shall use any of the activated SCells as the reference cell for deriving the UE transmit timing for the cells in the sTAG. UE initial transmit timing accuracy and gradual timing adjustment requirements are defined in the following requirements.

7.1.2 Requirements

The UE initial transmission timing error shall be less than or equal to $\pm T_e$ where the timing error limit value T_e is specified in Table 7.1.2-1. This requirement applies:

- when it is the first transmission in a DRX cycle for PUCCH, PUSCH and SRS or it is the PRACH transmission.

The UE shall meet the T_e requirement for an initial transmission provided that at least one SSB is available at the UE during the last 160 ms. The reference point for the UE initial transmit timing control requirement shall be the downlink timing of the reference cell minus $(N_{TA} + N_{TA\text{ offset}}) \times T_c$. The downlink timing is defined as the time when the first detected path (in time) of the corresponding downlink frame is received from the reference cell. N_{TA} for PRACH is defined as 0.

$(N_{TA} + N_{TA\text{ offset}}) \times T_c$ (in T_c units) for other channels is the difference between UE transmission timing and the downlink timing immediately after when the last timing advance in clause 7.3 was applied. N_{TA} for other channels is not changed until next timing advance is received. The value of $N_{TA\text{ offset}}$ depends on the duplex mode of the cell in which the uplink transmission takes place and the frequency range (FR). $N_{TA\text{ offset}}$ is defined in Table 7.1.2-2.

Table 7.1.2-1: T_e Timing Error Limit

Frequency Range	SCS of SSB signals (kHz)	SCS of uplink signals (kHz)	T_e
1	15	15	$12 \cdot 64 \cdot T_c$
		30	$10 \cdot 64 \cdot T_c$
		60	$10 \cdot 64 \cdot T_c$
	30	15	$8 \cdot 64 \cdot T_c$
		30	$8 \cdot 64 \cdot T_c$
		60	$7 \cdot 64 \cdot T_c$
2	120	60	$3.5 \cdot 64 \cdot T_c$
		120	$3.5 \cdot 64 \cdot T_c$
	240	60	$3 \cdot 64 \cdot T_c$
		120	$3 \cdot 64 \cdot T_c$

Note 1: T_c is the basic timing unit defined in TS 38.211 [6]

Table 7.1.2-2: The Value of $N_{TA\text{ offset}}$

Frequency range and band of cell used for uplink transmission	$N_{TA\text{ offset}}$ (Unit: T_c)
FR1 FDD band without LTE-NR coexistence case or FR1 TDD band without LTE-NR coexistence case	25600 (Note 1)
FR1 FDD band with LTE-NR coexistence case	0 (Note 1)
FR1 TDD band with LTE-NR coexistence case	39936 (Note 1)
FR2	13792

Note 1: The UE identifies $N_{TA\text{ offset}}$ based on the information n-TimingAdvanceOffset as specified in TS 38.331 [2]. If UE is not provided with the information n-TimingAdvanceOffset, the default value of $N_{TA\text{ offset}}$ is set as 25600 for FR1 band. In case of multiple UL carriers in the same TAG, UE expects that the same value of n-TimingAdvanceOffset is provided for all the UL carriers according to clause 4.2 in TS 38.213 [3] and the value 39936 of $N_{TA\text{ offset}}$ can also be provided for a FDD serving cell.

Note 2: Void

When it is not the first transmission in a DRX cycle or there is no DRX cycle, and when it is the transmission for PUCCH, PUSCH and SRS transmission, the UE shall be capable of changing the transmission timing according to the received downlink frame of the reference cell except when the timing advance in clause 7.3 is applied.

Table 7.1.2-3: void

7.1.2.1 Gradual timing adjustment

When the transmission timing error between the UE and the reference timing exceeds $\pm T_e$ then the UE shall adjust the timing such that timing error is within $\pm T_e$. The reference timing shall be $(N_{TA} + N_{TA\text{ offset}}) \times T_c$ before the downlink timing of the reference cell. All adjustments made to the UE uplink timing shall follow these rules:

- 1) The maximum amount of the magnitude of the timing change in one adjustment shall be T_q .

- 2) The minimum aggregate adjustment rate shall be T_p per second.
- 3) The maximum aggregate adjustment rate shall be T_q per 200 ms.

where the maximum autonomous time adjustment step T_q and the aggregate adjustment rate T_p are specified in Table 7.1.2.1-1.

Table 7.1.2.1-1: T_q Maximum Autonomous Time Adjustment Step and T_p Minimum Aggregate Adjustment rate

Frequency Range	SCS of uplink signals (kHz)	T_q	T_p
1	15	$5.5 \cdot 64 \cdot T_c$	$5.5 \cdot 64 \cdot T_c$
	30	$5.5 \cdot 64 \cdot T_c$	$5.5 \cdot 64 \cdot T_c$
	60	$5.5 \cdot 64 \cdot T_c$	$5.5 \cdot 64 \cdot T_c$
2	60	$2.5 \cdot 64 \cdot T_c$	$2.5 \cdot 64 \cdot T_c$
	120	$2.5 \cdot 64 \cdot T_c$	$2.5 \cdot 64 \cdot T_c$
NOTE: T_c is the basic timing unit defined in TS 38.211 [6]			

7.1.2.2 Void

Table 7.1.2.2-1: Void

7.2 UE timer accuracy

7.2.1 Introduction

UE timers are used in different protocol entities to control the UE behaviour.

7.2.2 Requirements

For UE timers specified in TS 38.331 [2], the UE shall comply with the timer accuracies according to Table 7.2.2-1.

The requirements are only related to the actual timing measurements internally in the UE. They do not include the following:

- Inaccuracy in the start and stop conditions of a timer (e.g. UE reaction time to detect that start and stop conditions of a timer is fulfilled), or
- Inaccuracies due to restrictions in observability of start and stop conditions of a UE timer (e.g. slot alignment when UE sends messages at timer expiry).

Table 7.2.2-1

Timer value [s]	Accuracy
timer value < 4	$\pm 0.1s$
timer value ≥ 4	$\pm 2.5\%$

7.3 Timing advance

7.3.1 Introduction

The timing advance is initiated from gNB to UE in EN-DC, NR-DC, NE-DC and NR SA operation modes, with MAC message that implies the adjustment of the timing advance, as defined in clause 5.2 of TS 38.321 [7].

7.3.2 Requirements

7.3.2.1 Timing Advance adjustment delay

UE shall adjust the timing of its uplink transmission timing at time slot $n+k+1$ for a timing advance command received in time slot n , and the value of k is defined in clause 4.2 in TS 38.213 [3]. The same requirement applies also when the UE is not able to transmit a configured uplink transmission due to the channel assessment procedure.

7.3.2.2 Timing Advance adjustment accuracy

The UE shall adjust the timing of its transmissions with a relative accuracy better than or equal to the UE Timing Advance adjustment accuracy requirement in Table 7.3.2.2-1, to the signalled timing advance value compared to the timing of preceding uplink transmission. The timing advance command step is defined in TS 38.213 [3].

Table 7.3.2.2-1: UE Timing Advance adjustment accuracy

UL Sub Carrier Spacing(kHz)	15	30	60	120
UE Timing Advance adjustment accuracy	$\pm 256 T_c$	$\pm 256 T_c$	$\pm 128 T_c$	$\pm 32 T_c$

7.4 Cell phase synchronization accuracy

7.4.1 Definition

Cell phase synchronization accuracy for TDD is defined as the maximum absolute deviation in frame start timing between any pair of cells on the same frequency that have overlapping coverage areas.

7.4.2 Minimum requirements

The cell phase synchronization accuracy measured at BS antenna connectors or radiated interface boundaries shall be better than 3 μ s.

7.5 Maximum Transmission Timing Difference

7.5.1 Introduction

A UE shall be capable of handling a relative transmission timing difference between subframe timing boundary of E-UTRA PCell and the closest slot timing boundary of PSCell to be aggregated for EN-DC operation.

A UE shall be capable of handling a relative transmission timing difference among the closest slot timing boundaries of different carriers to be aggregated in NR carrier aggregation.

A UE shall be capable of handling a relative transmission timing difference between slot timing boundary of PCell and subframe timing boundary of E-UTRA PSCell to be aggregated for NE-DC operation.

A UE shall be capable of handling a relative transmission timing difference between slot timing boundaries of PCell and the closest slot timing boundary of PSCell to be aggregated in NR DC operation.

7.5.2 Minimum Requirements for inter-band EN-DC

The UE shall be capable of handling a maximum uplink transmission timing difference between E-UTRA PCell and PSCell as shown in Table 7.5.2-1.

Table 7.5.2-1 Maximum uplink transmission timing difference requirement for asynchronous EN-DC

Sub-carrier spacing in E-UTRA PCell (kHz)	UL Sub-carrier spacing for data in PSCell (kHz)	Maximum uplink transmission timing difference (μ s)
15	15	500
15	30	250
15	60	125
15	120 ^{Note1}	62.5
NOTE 1: For E-UTRA FDD-NR FDD intra-band EN-DC, for which the requirement is defined in clause 7.5.3 and this Table 7.5.2-1 is also applicable, the scenario with 120kHz PSCell does not exist.		

Table 7.5.2-2 Void

7.5.2.1 Minimum Requirements for inter-band synchronous EN-DC

The requirements in this clause apply as a reference for inter-band synchronous EN-DC.

The UE shall be capable of handling a maximum uplink transmission timing difference between E-UTRA PCell and PSCell for inter-band synchronous EN-DC as shown in Table 7.5.2.1-1. The requirements for synchronous EN-DC are applicable for E-UTRA TDD-NR TDD, E-UTRA FDD-NR FDD, E-UTRA TDD-NR FDD and E-UTRA FDD-NR TDD inter-band EN-DC.

Table 7.5.2.1-1 Maximum uplink transmission timing difference requirement for inter-band synchronous EN-DC

Sub-carrier spacing in E-UTRA PCell (kHz)	UL Sub-carrier spacing for data in PSCell (kHz)	Maximum uplink transmission timing difference (μ s)
15	15	35.21
15	30	35.21
15	60	35.21
15	120	35.21

7.5.3 Minimum Requirements for intra-band EN-DC

For intra-band EN-DC, only co-located deployment is applied.

The UE shall be capable of handling a maximum uplink transmission timing difference between E-UTRA PCell and PSCell as shown in Table 7.5.2-1 for E-UTRA FDD-NR FDD intra-band EN-DC provided the UE indicates that it is capable of asynchronous EN-DC operation [2].

The UE shall be capable of handling a maximum uplink transmission timing difference between E-UTRA PCell and PSCell as shown in Table 7.5.3-1 for E-UTRA TDD-NR TDD and E-UTRA FDD-NR FDD intra-band EN-DC provided the UE does not indicate that it is capable of asynchronous FDD-FDD EN-DC operation [16].

Table 7.5.3-1: Maximum uplink transmission timing difference requirement for intra-band synchronous EN-DC

Sub-carrier spacing in E-UTRA PCell (kHz)	UL Sub-carrier spacing for data in PSCell (kHz)	Maximum uplink transmission timing difference (μ s)
15	15	5.21 ^{Note1, Note 2}
15	30	5.21 ^{Note 2}
15	60	5.21 ^{Note 2}
NOTE 1: This is not applicable for a UE which indicates the capability of only supporting single UL timing (<i>ul-TimingAlignmentEUTRA-NR</i> is signalled). Single UL timing for E-UTRA and NR cell is assumed for this UE.		

NOTE 2: If the transmission timing difference exceeds the cyclic prefix length of the UL Sub-carrier spacing for data in PSCell, NR UE Tx EVM degradation is expected for the symbol that is overlapping the LTE subframe boundary

7.5.4 Minimum Requirements for NR Carrier Aggregation

The UE shall be capable of handling at least a relative transmission timing difference between slot timing of all pairs of TAGs as shown in Table 7.5.4-1, provided that the UE is:

- configured with the pTAG and the sTAG for inter-band NR carrier aggregation in SA or NR-DC mode, or
- configured with more than one sTAG for inter-band NR carrier aggregation in EN-DC or NE-DC mode.

Table 7.5.4-1: Maximum uplink transmission timing difference requirement for inter-band NR carrier aggregation

Frequency Range of the pair of TAGs	Maximum uplink transmission timing difference (μ s)
FR1	34.6
FR2	8.5
Between FR1 and FR2	26.1

7.5.5 Minimum Requirements for inter-band NE-DC

The UE shall be capable of handling a maximum uplink transmission timing difference between PCell and E-UTRA PSCell as shown in Table 7.5.5-1 for inter-band asynchronous NE-DC.

Table 7.5.5-1: Maximum uplink transmission timing difference requirement for inter-band asynchronous NE-DC

Sub-carrier spacing in PCell (kHz)	UL Sub-carrier spacing for data in E-UTRA PSCell (kHz)	Maximum uplink transmission timing difference (μ s)
15	15	500
30	15	250
60	15	125
120	15	62.5
NOTE 1: Void		

Table 7.5.5-2: Void

7.5.5.1 Minimum Requirements for inter-band synchronous NE-DC

The requirements in this clause apply as a reference for inter-band synchronous NE-DC.

The UE shall be capable of handling a maximum uplink transmission timing difference between PCell and E-UTRA PSCell for inter-band synchronous NE-DC as shown in Table 7.5.5.1-1. The requirements for synchronous NE-DC are applicable for NR TDD- E-UTRA TDD, NR FDD- E-UTRA FDD, NR TDD- E-UTRA FDD and NR FDD- E-UTRA TDD inter-band NE-DC.

Table 7.5.5.1-1: Maximum uplink transmission timing difference requirement for inter-band synchronous NE-DC

Sub-carrier spacing in PCell (kHz)	UL Sub-carrier spacing for data in E-UTRA PSCell (kHz)	Maximum uplink transmission timing difference (μ s)
15	15	35.21

30	15	35.21
60	15	35.21
120	15	35.21

7.5.6 Minimum Requirements for inter-band NR DC

The UE shall be capable of handling a maximum uplink transmission timing difference between PCell and PSCell as shown in Table 7.5.6-1 provided that the UE indicates that it is capable of synchronous NR DC [16].

Table 7.5.6-1: Maximum uplink transmission timing difference requirement for inter-band synchronous NR DC

Frequency Range		Maximum uplink transmission timing difference (μ s)
PCell	PSCell	
FR1	FR2	34.1

7.6 Maximum Receive Timing Difference

7.6.1 Introduction

A UE shall be capable of handling a relative receive timing difference between subframe timing boundary of an E-UTRA cell belonging to the MCG and the closest slot timing boundary of a cell belonging to SCG to be aggregated for EN-DC operation.

A UE shall be capable of handling a relative receive timing difference between subframe timing boundary of an E-UTRA cell belonging to the SCG to be aggregated for NE-DC operation and the closest slot timing boundary of a cell belonging to MCG.

A UE shall be capable of handling a relative receive timing difference between slot timing boundary of a cell belonging to MCG and the closest slot timing boundary of a cell belonging to the SCG to be aggregated for NR DC operation. A UE shall be capable of handling a relative receive timing difference among the closest slot timing boundaries of different carriers to be aggregated in NR carrier aggregation.

7.6.2 Minimum Requirements for inter-band EN-DC

The UE shall be capable of handling at least a relative receive timing difference between subframe timing of signal from a E-UTRA cell belonging to the MCG and slot timing of signal from a cell belonging to SCG at the UE receiver as shown in Table 7.6.2-1.

Table 7.6.2-1: Maximum receive timing difference requirement for asynchronous EN-DC

Sub-carrier spacing of E-UTRA cell in MCG (kHz)	DL Sub-carrier spacing of cell in SCG (kHz) (Note 1)	Maximum receive timing difference (μ s)
15	15	500
15	30	250
15	60	125
15	120 ^{Note2}	62.5
NOTE 1: DL Sub-carrier spacing is $\min\{SCS_{SS}, SCS_{DATA}\}$.		
NOTE 2: For E-UTRA FDD-NR FDD intra-band EN-DC, for which the requirement is defined in clause 7.6.3 and this Table 7.6.2-1 is also applicable, the scenario with 120 kHz does not exit.		

Table 7.6.2-2: Void

Table 7.6.2-3 Void

7.6.2.1 Minimum Requirements for inter-band synchronous EN-DC

The requirements in this clause apply as a reference for inter-band synchronous EN-DC.

The UE shall be capable of handling at least a relative receive timing difference between subframe timing of signal from an E-UTRA cell belonging to the MCG and slot timing of signal from a cell belonging to SCG at the UE receiver for inter-band synchronous EN-DC as shown in Table 7.6.2.1-1. The requirements for synchronous EN-DC are applicable for E-UTRA TDD-NR TDD, E-UTRA FDD-NR FDD, E-UTRA TDD-NR FDD and E-UTRA FDD-NR TDD inter-band EN-DC.

Table 7.6.2.1-1: Maximum receive timing difference requirement for inter-band synchronous EN-DC

Sub-carrier spacing of E-UTRA cell in MCG (kHz)	DL Sub-carrier spacing of cell in SCG (kHz) (Note1)	Maximum receive timing difference (μ s)
15	15	33
15	30	
15	60	
15	120	
Note 1: DL Sub-carrier spacing is $\min\{SCS_{SS}, SCS_{DATA}\}$.		

7.6.3 Minimum Requirements for intra-band EN-DC

For intra-band EN-DC, only co-located deployment is applied.

The UE shall be capable of handling at least a relative receive timing difference between subframe timing of signal from a E-UTRA cell belonging to the MCG and slot timing of signal from a cell belonging to the SCG as shown in Table 7.6.2-1 for E-UTRA FDD-NR FDD intra-band EN-DC provided the UE indicates that it is capable of asynchronous EN-DC operation [2].

The UE shall be capable of handling at least a relative receive timing difference between subframe timing of signal from a E-UTRA cell belonging to the MCG and slot timing of signal from a cell belonging to the SCG as shown in Table 7.6.3-1 for E-UTRA FDD-NR FDD and E-UTRA TDD-NR TDD intra-band EN-DC provided the UE does not indicate that it is capable of asynchronous FDD-FDD EN-DC operation [16].

Table 7.6.3-1 Maximum receive timing difference requirement for intra-band synchronous EN-DC

Sub-carrier spacing of E-UTRA cell in MCG (kHz)	DL Sub-carrier spacing of cell in SCG (kHz) ^{Note1}	Maximum receive timing difference (μ s)
15	15	3
15	30	3
15	60	3
NOTE 1: DL Sub-carrier spacing is $\min\{SCS_{SS}, SCS_{DATA}\}$.		

Table 7.6.3-2 Void

7.6.4 Minimum Requirements for NR Carrier Aggregation

For intra-band CA, only co-located deployment is applied. For intra-band non-contiguous NR carrier aggregation, the UE shall be capable of handling at least a relative receive timing difference between slot timing of different carriers to be aggregated at the UE receiver as shown in Table 7.6.4-1 below.

Table 7.6.4-1: Maximum receive timing difference requirement for intra-band non-contiguous NR carrier aggregation

Frequency Range	Maximum receive timing difference (μs)
FR1	3 ¹
FR2	0.26
Note 1: In the case of different SCS on different CCs, if the receive time difference exceeds the cyclic prefix length of that SCS, demodulation performance degradation is expected for the first symbol of the slot.	

For inter-band NR carrier aggregation, the UE shall be capable of handling at least a relative receive timing difference between slot timing of all pairs of carriers to be aggregated at the UE receiver as shown in Table 7.6.4-2 below.

Table 7.6.4-2: Maximum receive timing difference requirement for inter-band NR carrier aggregation

Frequency Range of the pair of carriers	Maximum receive timing difference (μs)
FR1	33
FR2	8
Between FR1 and FR2	25

7.6.5 Minimum Requirements for inter-band NE-DC

The UE shall be capable of handling at least a relative receive timing difference between slot timing of signal from a cell belonging to the MCG and subframe timing of signal from an E-UTRA cell belonging to the SCG at the UE receiver for asynchronous NE-DC as shown in Table 7.6.5-1.

Table 7.6.5-1: Maximum receive timing difference requirement for asynchronous NE-DC

Sub-carrier spacing of cell in MCG (kHz)	DL Sub-carrier spacing of EUTRA cell in SCG (kHz) (Note 1)	Maximum receive timing difference (μs)
15	15	500
30	15	250
60	15	125
120	15	62.5
NOTE 1: DL Sub-carrier spacing is $\min\{\text{SCS}_{\text{SS}}, \text{SCS}_{\text{DATA}}\}$.		
NOTE 2: Void		

Table 7.6.5-2: Void

7.6.5.1 Minimum Requirements for inter-band synchronous NE-DC

The requirements in this clause apply as a reference for inter-band synchronous NE-DC.

The UE shall be capable of handling at least a relative receive timing difference between slot timing of signal from a cell belonging to the MCG and subframe timing of signal from an E-UTRA cell belonging to the SCG at the UE receiver for inter-band synchronous NE-DC as shown in Table 7.6.5.1-1. The requirements for synchronous NE-DC are applicable for NR TDD- E-UTRA TDD, NR FDD- E-UTRA FDD, NR TDD- E-UTRA FDD and NR FDD- E-UTRA TDD inter-band NE-DC.

Table 7.6.5.1-1: Maximum receive timing difference requirement for inter-band synchronous NE-DC

Sub-carrier spacing of cell in MCG (kHz)	DL Sub-carrier spacing of EUTRA cell in SCG (kHz) (Note1)	Maximum receive timing difference (μs)
--	---	---

15	15	33
30	15	
60	15	
120	15	

7.6.6 Minimum Requirements for inter-band NR DC

The UE shall be capable of handling at least a relative receive timing difference between slot timing of signal from a cell belonging to the MCG and slot timing of signal from a cell belonging to the SCG at the UE receiver as shown in Table 7.6.6-1 provided that the UE indicates that it is capable of synchronous NR DC [16].

Table 7.6.6-1: Maximum receive timing difference requirement for inter-band synchronous NR DC

Frequency Range		Maximum receive timing difference (μs)
Cell in MCG	Cell in SCG	
FR1	FR2	33

7.7 *deriveSSB-IndexFromCell* tolerance

7.7.1 Minimum requirements

When *deriveSSB-IndexFromCell* is enabled, the UE assumes frame boundary alignment (including half frame, subframe and slot boundary alignment) across cells on the same frequency carrier is within a tolerance not worse than $\min(2 \text{ SSB symbols}, 1 \text{ PDSCH symbol})$ and the SFNs of all cells on the same frequency carrier are the same.

7.8 Void

8 Signalling characteristics

8.1 Radio Link Monitoring

8.1.1 Introduction

The requirements in clause 8.1 apply for radio link monitoring on:

- PCell in SA NR, NR-DC and NE-DC operation mode,
- PSCell in NR-DC and EN-DC operation mode.

The UE shall monitor the downlink radio link quality based on the reference signal configured as RLM-RS resource(s) in order to detect the downlink radio link quality of the PCell and PSCell as specified in TS 38.213 [3]. The configured RLM-RS resources can be all SSBs, or all CSI-RSs, or a mix of SSBs and CSI-RSs. UE is not required to perform RLM outside the active DL BWP.

On each RLM-RS resource, the UE shall estimate the downlink radio link quality and compare it to the thresholds Q_{out} and Q_{in} for the purpose of monitoring downlink radio link quality of the cell.

The threshold Q_{out} is defined as the level at which the downlink radio link cannot be reliably received and shall correspond to the out-of-sync block error rate (BLER_{out}) as defined in Table 8.1.1-1. For SSB based radio link monitoring, $Q_{\text{out_SSB}}$ is derived based on the hypothetical PDCCH transmission parameters listed in Table 8.1.2.1-1. For CSI-RS based radio link monitoring, $Q_{\text{out_CSI-RS}}$ is derived based on the hypothetical PDCCH transmission parameters listed in Table 8.1.3.1-1.

The threshold Q_{in} is defined as the level at which the downlink radio link quality can be received with significantly higher reliability than at Q_{out} and shall correspond to the in-sync block error rate ($BLER_{in}$) as defined in Table 8.1.1-1. For SSB based radio link monitoring, Q_{in_SSB} is derived based on the hypothetical PDCCH transmission parameters listed in Table 8.1.2.1-2. For CSI-RS based radio link monitoring, Q_{in_CSI-RS} is derived based on the hypothetical PDCCH transmission parameters listed in Table 8.1.3.1-2.

The out-of-sync block error rate ($BLER_{out}$) and in-sync block error rate ($BLER_{in}$) are determined from the network configuration via parameter *rlmInSyncOutOfSyncThreshold* signalled by higher layers. When UE is not configured with *rlmInSyncOutOfSyncThreshold* from the network, UE determines out-of-sync and in-sync block error rates from Configuration #0 in Table 8.1.1-1 by default. All requirements in clause 8.1 are applicable for BLER Configuration #0 in Table 8.1.1-1.

Table 8.1.1-1: Out-of-sync and in-sync block error rates

Configuration	$BLER_{out}$	$BLER_{in}$
0	10%	2%

UE shall be able to monitor up to N_{RLM} RLM-RS resources of the same or different types in each corresponding carrier frequency range, depending on a maximum number L_{max} of SSBs per half frame according to TS 38.213 [3], where N_{RLM} is specified in Table 8.1.1-2 according to TS 38.213 [3], and meet the requirements as specified in clause 8.1. UE is not required to meet the requirements in clause 8.1 if RLM-RS is not configured and no TCI state for PDCCH is activated.

Table 8.1.1-2: Maximum number of RLM-RS resources N_{RLM}

Carrier frequency range of PCell/PSCell	L_{max}	Maximum number of RLM-RS resources, N_{RLM}
FR1, ≤ 3 GHz ^{Note}	4	2
FR1, > 3 GHz ^{Note}	8	4
FR2	64	8

NOTE: For unpaired spectrum operation with Case C - 30 kHz SCS, 3GHz is replaced by 1.88GHz, as specified in clause 4.1 in TS 38.213 [3].

8.1.2 Requirements for SSB based radio link monitoring

8.1.2.1 Introduction

The requirements in this clause apply for each SSB based RLM-RS resource configured for PCell or PSCell, provided that the SSB configured for RLM is actually transmitted within UE active DL BWP during the entire evaluation period specified in clause 8.1.2.2.

Table 8.1.2.1-1: PDCCH transmission parameters for out-of-sync evaluation

Attribute	Value for BLER Configuration #0
DCI format	1-0
Number of control OFDM symbols	2
Aggregation level (CCE)	8
Ratio of hypothetical PDCCH RE energy to average SSS RE energy	4dB
Ratio of hypothetical PDCCH DMRS energy to average SSS RE energy	4dB
Bandwidth (PRBs)	24
Sub-carrier spacing (kHz)	SCS of the active DL BWP
DMRS precoder granularity	REG bundle size
REG bundle size	6
CP length	Normal
Mapping from REG to CCE	Distributed

Table 8.1.2.1-2: PDCCH transmission parameters for in-sync evaluation

Attribute	Value for BLER Configuration #0
DCI payload size	1-0
Number of control OFDM symbols	2
Aggregation level (CCE)	4
Ratio of hypothetical PDCCH RE energy to average SSS RE energy	0dB
Ratio of hypothetical PDCCH DMRS energy to average SSS RE energy	0dB
Bandwidth (PRBs)	24
Sub-carrier spacing (kHz)	SCS of the active DL BWP
DMRS precoder granularity	REG bundle size
REG bundle size	6
CP length	Normal
Mapping from REG to CCE	Distributed

8.1.2.2 Minimum requirement

UE shall be able to evaluate whether the downlink radio link quality on the configured RLM-RS resource estimated over the last $T_{\text{Evaluate_out_SSB}}$ ms period becomes worse than the threshold $Q_{\text{out_SSB}}$ within $T_{\text{Evaluate_out_SSB}}$ [ms] evaluation period.

UE shall be able to evaluate whether the downlink radio link quality on the configured RLM-RS resource estimated over the last $T_{\text{Evaluate_in_SSB}}$ ms period becomes better than the threshold $Q_{\text{in_SSB}}$ within $T_{\text{Evaluate_in_SSB}}$ [ms] evaluation period.

$T_{\text{Evaluate_out_SSB}}$ and $T_{\text{Evaluate_in_SSB}}$ are defined in Table 8.1.2.2-1 for FR1.

$T_{\text{Evaluate_out_SSB}}$ and $T_{\text{Evaluate_in_SSB}}$ are defined in Table 8.1.2.2-2 for FR2 with scaling factor $N=8$.

For FR1,

- $P = \frac{1}{1 - \frac{T_{\text{SSB}}}{MGRP}}$, when in the monitored cell there are measurement gaps configured for intra-frequency, inter-frequency or inter-RAT measurements, and these measurement gaps are overlapping with some but not all occasions of the SSB; and
- $P = 1$ when in the monitored cell there are no measurement gaps overlapping with any occasion of the SSB.

For FR2,

- $P = \frac{1}{1 - \frac{T_{\text{SSB}}}{T_{\text{SMTCperiod}}}}$, when RLM-RS resource is not overlapped with measurement gap and the RLM-RS resource is partially overlapped with SMTC occasion ($T_{\text{SSB}} < T_{\text{SMTCperiod}}$).
- P is P_{sharing} factor, when the RLM-RS resource is not overlapped with measurement gap and RLM-RS resource is fully overlapped with SMTC period ($T_{\text{SSB}} = T_{\text{SMTCperiod}}$).
- $P = \frac{1}{1 - \frac{T_{\text{SSB}}}{MGRP} - \frac{T_{\text{SSB}}}{T_{\text{SMTCperiod}}}}$, when the RLM-RS resource is partially overlapped with measurement gap and the RLM-RS resource is partially overlapped with SMTC occasion ($T_{\text{SSB}} < T_{\text{SMTCperiod}}$) and SMTC occasion is not overlapped with measurement gap and
 - $T_{\text{SMTCperiod}} \neq MGRP$ or
 - $T_{\text{SMTCperiod}} = MGRP$ and $T_{\text{SSB}} < 0.5 \times T_{\text{SMTCperiod}}$

- $P = \frac{P_{\text{sharing factor}}}{1 - \frac{T_{\text{SSB}}}{MGRP}}$, when the RLM-RS is partially overlapped with measurement gap and the RLM-RS is partially overlapped with SMTC occasion ($T_{\text{SSB}} < T_{\text{SMTCperiod}}$) and SMTC occasion is not overlapped with measurement gap and $T_{\text{SMTCperiod}} = MGRP$ and $T_{\text{SSB}} = 0.5 \times T_{\text{SMTCperiod}}$
- $P = \frac{1}{1 - \frac{T_{\text{SSB}}}{\text{Min}(MGRP, T_{\text{SMTCperiod}})}}$, when the RLM-RS resource is partially overlapped with measurement gap and the RLM-RS resource is partially overlapped with SMTC occasion ($T_{\text{SSB}} < T_{\text{SMTCperiod}}$) and SMTC occasion is partially or fully overlapped with measurement gap
- $P = \frac{P_{\text{sharing factor}}}{1 - \frac{T_{\text{SSB}}}{MGRP}}$, when the RLM-RS resource is partially overlapped with measurement gap and the RLM-RS resource is fully overlapped with SMTC occasion ($T_{\text{SSB}} = T_{\text{SMTCperiod}}$) and SMTC occasion is partially overlapped with measurement gap ($T_{\text{SMTCperiod}} < MGRP$)
- $P_{\text{sharing factor}} = 1$, if the RLM-RS resource outside measurement gap is
 - not overlapped with the SSB symbols indicated by *SSB-ToMeasure* and 1 data symbol before each consecutive SSB symbols indicated by *SSB-ToMeasure* and 1 data symbol after each consecutive SSB symbols indicated by *SSB-ToMeasure*, given that *SSB-ToMeasure* is configured, where the *SSB-ToMeasure* is the union set of *SSB-ToMeasure* from all the configured measurement objects merged on the same serving carrier, and,
 - not overlapped by the RSSI symbols indicated by *ss-RSSI-Measurement* and 1 data symbol before each RSSI symbol indicated by *ss-RSSI-Measurement* and 1 data symbol after each RSSI symbol indicated by *ss-RSSI-Measurement*, given that *ss-RSSI-Measurement* is configured.
- $P_{\text{sharing factor}} = 3$, otherwise.

where,

If the high layer in TS 38.331 [2] signaling of *smtc2* is present, $T_{\text{SMTCperiod}}$ follows *smtc2*; Otherwise $T_{\text{SMTCperiod}}$ follows *smtc1*. $T_{\text{SMTCperiod}}$ is the shortest SMTC period among all CCs in the same FR2 band, provided the SMTC offset of all CCs in FR2 have the same offset.

Longer evaluation period would be expected if the combination of RLM-RS resource, SMTC occasion and measurement gap configurations does not meet previous conditions.

Table 8.1.2.2-1: Evaluation period $T_{\text{Evaluate_out_SSB}}$ and $T_{\text{Evaluate_in_SSB}}$ for FR1

Configuration	$T_{\text{Evaluate_out_SSB}}$ (ms)	$T_{\text{Evaluate_in_SSB}}$ (ms)
no DRX	$\text{Max}(200, \text{Ceil}(10 \times P) \times T_{\text{SSB}})$	$\text{Max}(100, \text{Ceil}(5 \times P) \times T_{\text{SSB}})$
DRX cycle ≤ 320 ms	$\text{Max}(200, \text{Ceil}(15 \times P) \times \text{Max}(T_{\text{DRX}}, T_{\text{SSB}}))$	$\text{Max}(100, \text{Ceil}(7.5 \times P) \times \text{Max}(T_{\text{DRX}}, T_{\text{SSB}}))$
DRX cycle > 320 ms	$\text{Ceil}(10 \times P) \times T_{\text{DRX}}$	$\text{Ceil}(5 \times P) \times T_{\text{DRX}}$
NOTE: T_{SSB} is the periodicity of the SSB configured for RLM. T_{DRX} is the DRX cycle length.		

Table 8.1.2.2-2: Evaluation period $T_{\text{Evaluate_out_SSB}}$ and $T_{\text{Evaluate_in_SSB}}$ for FR2

Configuration	$T_{\text{Evaluate_out_SSB}}$ (ms)	$T_{\text{Evaluate_in_SSB}}$ (ms)
no DRX	$\text{Max}(200, \text{Ceil}(10 \times P \times N) \times T_{\text{SSB}})$	$\text{Max}(100, \text{Ceil}(5 \times P \times N) \times T_{\text{SSB}})$
DRX cycle ≤ 320 ms	$\text{Max}(200, \text{Ceil}(15 \times P \times N) \times \text{Max}(T_{\text{DRX}}, T_{\text{SSB}}))$	$\text{Max}(100, \text{Ceil}(7.5 \times P \times N) \times \text{Max}(T_{\text{DRX}}, T_{\text{SSB}}))$
DRX cycle > 320 ms	$\text{Ceil}(10 \times P \times N) \times T_{\text{DRX}}$	$\text{Ceil}(5 \times P \times N) \times T_{\text{DRX}}$
NOTE: T_{SSB} is the periodicity of the SSB configured for RLM. T_{DRX} is the DRX cycle length.		

8.1.2.3 Measurement restrictions for SSB based RLM

The UE is required to be capable of measuring SSB for RLM without measurement gaps. The UE is required to perform the SSB measurements with measurement restrictions as described in the following clauses.

For FR1, when the SSB OFDM symbols used for RLM fully or partially overlap with CSI-RS for RLM, BFD, CBD or L1-RSRP measurement on the same CC or different CCs in the same band,

- If SSB and CSI-RS have same SCS, UE shall be able to measure the SSB for RLM without any restriction;
- If SSB and CSI-RS have different SCS,
 - If UE supports *simultaneousRxDataSSB-DiffNumerology*, UE shall be able to measure the SSB for RLM without any restriction;
 - If UE does not support *simultaneousRxDataSSB-DiffNumerology*, UE is required to measure one of but not both SSB for RLM and CSI-RS. Longer measurement period for SSB based RLM is expected, and no requirements are defined.

For FR2, when the SSB for RLM measurement on one CC is in the same OFDM symbol as CSI-RS for RLM, BFD, CBD or L1-RSRP measurement on the same CC or different CCs in the same band, UE is required to measure one of but not both SSB for RLM and CSI-RS. Longer measurement period for SSB based RLM is expected, and no requirements are defined.

8.1.3 Requirements for CSI-RS based radio link monitoring

8.1.3.1 Introduction

The requirements in this clause apply for each CSI-RS based RLM-RS resource configured for PCell or PSCell, provided that the CSI-RS configured for RLM is actually transmitted within UE active DL BWP during the entire evaluation period specified in clause 8.1.3.2. UE is not expected to perform radio link monitoring measurements on the CSI-RS configured as RLM-RS if the CSI-RS is not in the active TCI state of any CORESET configured in the UE active BWP.

Table 8.1.3.1-1: PDCCH transmission parameters for out-of-sync evaluation

Attribute	Value for BLER Configuration #0
DCI format	1-0
Number of control OFDM symbols	2
Aggregation level (CCE)	8
Ratio of hypothetical PDCCH RE energy to average CSI-RS RE energy	4dB
Ratio of hypothetical PDCCH DMRS energy to average CSI-RS RE energy	4dB
Bandwidth (PRBs)	48
Sub-carrier spacing (kHz)	SCS of the active DL BWP
DMRS precoder granularity	REG bundle size
REG bundle size	6
CP length	Normal
Mapping from REG to CCE	Distributed

Table 8.1.3.1-2: PDCCH transmission parameters for in-sync evaluation

Attribute	Value for BLER Configuration #0
DCI payload size	1-0
Number of control OFDM symbols	2
Aggregation level (CCE)	4
Ratio of hypothetical PDCCH RE energy to average CSI-RS RE energy	0dB
Ratio of hypothetical PDCCH DMRS energy to average CSI-RS RE energy	0dB
Bandwidth (PRBs)	48

Sub-carrier spacing (kHz)	SCS of the active DL BWP
DMRS precoder granularity	REG bundle size
REG bundle size	6
CP length	Normal
Mapping from REG to CCE	Distributed

8.1.3.2 Minimum requirement

UE shall be able to evaluate whether the downlink radio link quality on the configured RLM-RS resource estimated over the last $T_{\text{Evaluate_out_CSI-RS}}$ ms period becomes worse than the threshold $Q_{\text{out_CSI-RS}}$ within $T_{\text{Evaluate_out_CSI-RS}}$ [ms] evaluation period.

UE shall be able to evaluate whether the downlink radio link quality on the configured RLM-RS resource estimated over the last $T_{\text{Evaluate_in_CSI-RS}}$ ms period becomes better than the threshold $Q_{\text{in_CSI-RS}}$ within $T_{\text{Evaluate_in_CSI-RS}}$ [ms] evaluation period.

- $T_{\text{Evaluate_out_CSI-RS}}$ and $T_{\text{Evaluate_in_CSI-RS}}$ are defined in Table 8.1.3.2-1 for FR1.
- $T_{\text{Evaluate_out_CSI-RS}}$ and $T_{\text{Evaluate_in_CSI-RS}}$ are defined in Table 8.1.3.2-2 for FR2 with scaling factor $N=1$.

The requirements of $T_{\text{Evaluate_out_CSI-RS}}$ and $T_{\text{Evaluate_in_CSI-RS}}$ apply provided that the CSI-RS for RLM is not in a resource set configured with repetition ON. The requirements do not apply when the CSI-RS resource in the active TCI state of CORESET is the same CSI-RS resource for RLM and the TCI state information of the CSI-RS resource is not given, wherein the TCI state information means QCL Type-D to SSB for L1-RSRP or CSI-RS with repetition ON.

For FR1,

- $P = \frac{1}{1 - \frac{T_{\text{CSI-RS}}}{\text{MGRP}}}$, when in the monitored cell there are measurement gaps configured for intra-frequency, inter-frequency or inter-RAT measurements, and these measurement gaps are overlapping with some but not all occasions of the CSI-RS; and
- $P = 1$, when in the monitored cell there are no measurement gaps overlapping with any occasion of the CSI-RS.

For FR2,

- $P = 1$, when the RLM-RS resource is not overlapped with measurement gap and also not overlapped with SMTC occasion.
- $P = \frac{1}{1 - \frac{T_{\text{CSI-RS}}}{\text{MGRP}}}$, when the RLM-RS resource is partially overlapped with measurement gap and the RLM-RS resource is not overlapped with SMTC occasion ($T_{\text{CSI-RS}} < \text{MGRP}$)
- $P = \frac{1}{1 - \frac{T_{\text{CSI-RS}}}{T_{\text{SMTCperiod}}}}$, when the RLM-RS resource is not overlapped with measurement gap and the RLM-RS resource is partially overlapped with SMTC occasion ($T_{\text{CSI-RS}} < T_{\text{SMTCperiod}}$).
- $P = P_{\text{sharing factor}}$, when the RLM-RS resource is not overlapped with measurement gap and RLM-RS resource is fully overlapped with SMTC occasion ($T_{\text{CSI-RS}} = T_{\text{SMTCperiod}}$).
- $P = \frac{1}{1 - \frac{T_{\text{CSI-RS}}}{\text{MGRP}} - \frac{T_{\text{CSI-RS}}}{T_{\text{SMTCperiod}}}}$, when the RLM-RS resource is partially overlapped with measurement gap and the RLM-RS resource is partially overlapped with SMTC occasion ($T_{\text{CSI-RS}} < T_{\text{SMTCperiod}}$) and SMTC occasion is not overlapped with measurement gap and
 - $T_{\text{SMTCperiod}} \neq \text{MGRP}$ or
 - $T_{\text{SMTCperiod}} = \text{MGRP}$ and $T_{\text{CSI-RS}} < 0.5 \times T_{\text{SMTCperiod}}$
- $P = \frac{P_{\text{sharing factor}}}{1 - \frac{T_{\text{CSI-RS}}}{\text{MGRP}}}$, when the RLM-RS resource is partially overlapped with measurement gap and the RLM-RS resource is partially overlapped with SMTC occasion ($T_{\text{CSI-RS}} < T_{\text{SMTCperiod}}$) and SMTC occasion is not overlapped with measurement gap and $T_{\text{SMTCperiod}} = \text{MGRP}$ and $T_{\text{CSI-RS}} = 0.5 \times T_{\text{SMTCperiod}}$

- $P = \frac{1}{1 - \frac{T_{CSI-RS}}{\min(MGRP, T_{SMTCperiod})}}$, when the RLM-RS resource is partially overlapped with measurement gap and the RLM-RS resource is partially overlapped with SMTC occasion ($T_{CSI-RS} < T_{SMTCperiod}$) and SMTC occasion is partially or fully overlapped with measurement gap
- $P = \frac{P_{\text{sharing factor}}}{1 - \frac{T_{CSI-RS}}{MGRP}}$, when the RLM-RS resource is partially overlapped with measurement gap and the RLM-RS resource is fully overlapped with SMTC occasion ($T_{CSI-RS} = T_{SMTCperiod}$) and SMTC occasion is partially overlapped with measurement gap ($T_{SMTCperiod} < MGRP$)
- $P_{\text{sharing factor}} = 1$, if the RLM-RS resource outside measurement gap is
 - not overlapped with the SSB symbols indicated by *SSB-ToMeasure* and 1 data symbol before each consecutive SSB symbols indicated by *SSB-ToMeasure* and 1 data symbol after each consecutive SSB symbols indicated by *SSB-ToMeasure*, given that *SSB-ToMeasure* is configured, where the *SSB-ToMeasure* is the union set of *SSB-ToMeasure* from all the configured measurement objects merged on the same serving carrier, and,
 - not overlapped by the RSSI symbols indicated by *ss-RSSI-Measurement* and 1 data symbol before each RSSI symbol indicated by *ss-RSSI-Measurement* and 1 data symbol after each RSSI symbol indicated by *ss-RSSI-Measurement*, given that *ss-RSSI-Measurement* is configured.
- $P_{\text{sharing factor}} = 3$, otherwise.

where,

If the high layer in TS 38.331 [2] signaling of *smtc2* is present, $T_{SMTCperiod}$ follows *smtc2*; Otherwise $T_{SMTCperiod}$ follows *smtc1*. $T_{SMTCperiod}$ is the shortest SMTC period among all CCs in the same FR2 band, provided the SMTC offset of all CCs in FR2 have the same offset.

Note: The overlap between CSI-RS for RLM and SMTC means that CSI-RS based RLM is within the SMTC window duration.

Longer evaluation period would be expected if the combination of RLM-RS resource, SMTC occasion and measurement gap configurations does not meet previous conditions.

The values of M_{out} and M_{in} used in Table 8.1.3.2-1 and Table 8.1.3.2-2 are defined as:

- $M_{out} = 20$ and $M_{in} = 10$, if the CSI-RS resource configured for RLM is transmitted with higher layer CSI-RS parameter *density* [6, clause 7.4.1] set to 3 and over the bandwidth ≥ 24 PRBs.

Table 8.1.3.2-1: Evaluation period $T_{Evaluate_out_CSI-RS}$ and $T_{Evaluate_in_CSI-RS}$ for FR1

Configuration	$T_{Evaluate_out_CSI-RS}$ (ms)	$T_{Evaluate_in_CSI-RS}$ (ms)
no DRX	$\text{Max}(200, \text{Ceil}(M_{out} \times P) \times T_{CSI-RS})$	$\text{Max}(100, \text{Ceil}(M_{in} \times P) \times T_{CSI-RS})$
$DRX \leq 320\text{ms}$	$\text{Max}(200, \text{Ceil}(1.5 \times M_{out} \times P) \times \text{Max}(T_{DRX}, T_{CSI-RS}))$	$\text{Max}(100, \text{Ceil}(1.5 \times M_{in} \times P) \times \text{Max}(T_{DRX}, T_{CSI-RS}))$
$DRX > 320\text{ms}$	$\text{Ceil}(M_{out} \times P) \times T_{DRX}$	$\text{Ceil}(M_{in} \times P) \times T_{DRX}$

NOTE: T_{CSI-RS} is the periodicity of the CSI-RS resource configured for RLM. The requirements in this table apply for T_{CSI-RS} equal to 5 ms, 10ms, 20 ms or 40 ms. T_{DRX} is the DRX cycle length.

Table 8.1.3.2-2: Evaluation period $T_{Evaluate_out_CSI-RS}$ and $T_{Evaluate_in_CSI-RS}$ for FR2

Configuration	$T_{Evaluate_out_CSI-RS}$ (ms)	$T_{Evaluate_in_CSI-RS}$ (ms)
no DRX	$\text{Max}(200, \text{Ceil}(M_{out} \times P \times N) \times T_{CSI-RS})$	$\text{Max}(100, \text{Ceil}(M_{in} \times P \times N) \times T_{CSI-RS})$
$DRX \leq 320\text{ms}$	$\text{Max}(200, \text{Ceil}(1.5 \times M_{out} \times P \times N) \times \text{Max}(T_{DRX}, T_{CSI-RS}))$	$\text{Max}(100, \text{Ceil}(1.5 \times M_{in} \times P \times N) \times \text{Max}(T_{DRX}, T_{CSI-RS}))$
$DRX > 320\text{ms}$	$\text{Ceil}(M_{out} \times P \times N) \times T_{DRX}$	$\text{Ceil}(M_{in} \times P \times N) \times T_{DRX}$

NOTE: T_{CSI-RS} is the periodicity of the CSI-RS resource configured for RLM. The requirements in this table apply for T_{CSI-RS} equal to 5 ms, 10 ms, 20 ms or 40 ms. T_{DRX} is the DRX cycle length.

8.1.3.3 Measurement restrictions for CSI-RS based RLM

The UE is required to be capable of measuring CSI-RS for RLM without measurement gaps. The UE is required to perform the CSI-RS measurements with measurement restrictions as described in the following clauses.

For both FR1 and FR2, when the CSI-RS for RLM is in the same OFDM symbol as SSB for RLM, BFD, CBD or L1-RSRP measurement, UE is not required to receive CSI-RS for RLM in the PRBs that overlap with an SSB.

For FR1, when the SSB for RLM, BFD, CBD, or L1-RSRP measurement is within the active BWP and has same SCS than CSI-RS for RLM, the UE shall be able to perform CSI-RS measurement without restrictions.

For FR1, when the SSB for RLM, BFD, CBD or L1-RSRP measurement is within the active BWP and has different SCS than CSI-RS for RLM, the UE shall be able to perform CSI-RS measurement with restrictions according to its capabilities:

- If the UE supports *simultaneousRxDataSSB-DiffNumerology* the UE shall be able to perform CSI-RS for RLM measurement without restrictions.
- If the UE does not support *simultaneousRxDataSSB-DiffNumerology*, UE is required to measure one of but not both CSI-RS for RLM and SSB. Longer measurement period for CSI-RS based RLM is expected, and no requirements are defined.

For FR1, when the CSI-RS for RLM is in the same OFDM symbol as another CSI-RS for RLM, BFD, CBD or L1-RSRP measurement, UE shall be able to measure the CSI-RS for RLM without any restriction.

For FR2, when the CSI-RS for RLM measurement on one CC is in the same OFDM symbol as SSB for RLM, BFD, or L1-RSRP measurement on the same CC or different CCs in the same band, or in the same symbol as SSB for CBD measurement on the same CC or different CCs in the same band when beam failure is detected, UE is required to measure one of but not both CSI-RS for RLM and SSB. Longer measurement period for CSI-RS based RLM is expected, and no requirements are defined.

For FR2, when the CSI-RS for RLM measurement on one CC is in the same OFDM symbol as another CSI-RS for RLM, BFD, CBD or L1-RSRP measurement on the same CC or different CCs in the same band,

- In the following cases, UE is required to measure one of but not both CSI-RS for RLM and the other CSI-RS. Longer measurement period for CSI-RS based RLM is expected, and no requirements are defined.
 - The CSI-RS for RLM or the other CSI-RS in a resource set configured with repetition ON, or
 - The other CSI-RS is configured in q_1 and beam failure is detected, or
 - The two CSI-RS-es are not QCL-ed w.r.t. QCL-TypeD, or the QCL information is not known to UE,
- Otherwise, UE shall be able to measure the CSI-RS for RLM without any restriction.

8.1.4 Minimum requirement at transitions

When the UE transitions between DRX and no DRX or when DRX cycle periodicity changes, for each RLM-RS resource, for a duration of time equal to the evaluation period corresponding to the second mode after the transition occurs, the UE shall use an evaluation period that is no less than the minimum of evaluation period corresponding to the first mode and the second mode. Subsequent to this duration, the UE shall use an evaluation period corresponding to the second mode for each RLM-RS resource. This requirement shall be applied to both out-of-sync evaluation and in-sync evaluation of the monitored cell.

When the UE transitions from a first configuration of RLM resources to a second configuration of RLM resources that is different from the first configuration, for each RLM resource present in the second configuration, for a duration of time equal to the evaluation period corresponding to the second configuration after the transition occurs, the UE shall use an evaluation period that is no less than the minimum of evaluation periods corresponding to the first configuration and the second configuration. Subsequent to this duration, the UE shall use an evaluation period corresponding to the second configuration for each RLM resource present in the second configuration. This requirement shall be applied to both out-of-sync evaluation and in-sync evaluation of the monitored cell.

When the UE transitions from a first configuration of active TCI state of the CORESET to a second configuration of active TCI state of the CORESET, for each CSI-RS for RLM present in the second configuration, the UE shall use an

evaluation period corresponding to the second configuration from the time of transition. This requirement shall be applied to both out-of-sync evaluation and in-sync evaluation of the monitored cell.

8.1.5 Minimum requirement for UE turning off the transmitter

The transmitter power of the UE in the monitored cell shall be turned off within 40ms after expiry of T310 timer as specified in TS 38.331 [2].

8.1.6 Minimum requirement for L1 indication

When the downlink radio link quality on all the configured RLM-RS resources is worse than Q_{out} , layer 1 of the UE shall send an out-of-sync indication for the cell to the higher layers. A layer 3 filter shall be applied to the out-of-sync indications as specified in TS 38.331 [2].

When the downlink radio link quality on at least one of the configured RLM-RS resources is better than Q_{in} , layer 1 of the UE shall send an in-sync indication for the cell to the higher layers. A layer 3 filter shall be applied to the in-sync indications as specified in TS 38.331 [2].

The out-of-sync and in-sync evaluations for the configured RLM-RS resources shall be performed as specified in clause 5 in TS 38.213 [3]. Two successive indications from layer 1 shall be separated by at least $T_{Indication_interval}$.

When DRX is not used $T_{Indication_interval}$ is $\max(10\text{ms}, T_{RLM-RS,M})$, where $T_{RLM-RS,M}$ is the shortest periodicity of all configured RLM-RS resources for the monitored cell, which corresponds to T_{SSB} specified in clause 8.1.2 if the RLM-RS resource is SSB, or T_{CSI-RS} specified in clause 8.1.3 if the RLM-RS resource is CSI-RS.

In case DRX is used, $T_{Indication_interval}$ is $\text{Max}(10\text{ms}, 1.5 \times \text{DRX_cycle_length}, 1.5 \times T_{RLM-RS,M})$ if DRX cycle_length is less than or equal to 320ms, and $T_{Indication_interval}$ is DRX cycle_length if DRX cycle_length is greater than 320ms. Upon start of T310 timer as specified in TS 38.331 [2], the UE shall monitor the configured RLM-RS resources for recovery using the evaluation period and layer 1 indication interval corresponding to the no DRX mode until the expiry or stop of T310 timer.

8.1.7 Scheduling availability of UE during radio link monitoring

When the reference signal to be measured for RLM has different subcarrier spacing than PDSCH/PDCCH or is on frequency range 2, there are restrictions on the scheduling availability as described in the following clauses.

8.1.7.1 Scheduling availability of UE performing radio link monitoring with a same subcarrier spacing as PDSCH/PDCCH on FR1

There are no scheduling restrictions due to radio link monitoring performed with a same subcarrier spacing as PDSCH/PDCCH on FR1.

8.1.7.2 Scheduling availability of UE performing radio link monitoring with a different subcarrier spacing than PDSCH/PDCCH on FR1

For UEs which support *simultaneousRxDataSSB-DiffNumerology* [14] there are no restrictions on scheduling availability due to radio link monitoring based on SSB as RLM-RS. For UEs which do not support *simultaneousRxDataSSB-DiffNumerology* [14] the following restrictions apply due to radio link monitoring based on SSB as RLM-RS.

- The UE is not expected to transmit PUCCH, PUSCH or SRS or receive PDCCH, PDSCH or CSI-RS for tracking or CSI-RS for CQI on SSB symbols to be measured for radio link monitoring.

When intra-band carrier aggregation in FR1 is performed, the scheduling restrictions on FR1 serving PCell or PSCell applies to all serving cells in the same band on the symbols that fully or partially overlap with the restricted symbols. When inter-band carrier aggregation within FR1 is performed, there are no scheduling restrictions on FR1 serving cell(s) in the bands due to radio link monitoring performed on FR1 serving PCell or PSCell in different bands.

8.1.7.3 Scheduling availability of UE performing radio link monitoring on FR2

The following scheduling restriction applies due to radio link monitoring on an FR2 serving PCell and/or PSCell.

- If the RLM-RS is CSI-RS which is type-D QCLed with active TCI state for PDCCH or PDSCH, and the CSI-RS is not in a CSI-RS resource set with repetition ON,
 - There are no scheduling restrictions due to radio link monitoring based on the CSI-RS.
- Otherwise
 - The UE is not expected to transmit PUCCH, PUSCH or SRS or receive PDCCH, PDSCH or CSI-RS for tracking or CSI-RS for CQI on RLM-RS symbols to be measured for radio link monitoring.

When intra-band carrier aggregation in FR2 is performed, the scheduling restrictions on FR2 serving PCell or PSCell applies to all serving cells in the same band on the symbols that fully or partially overlap with restricted symbols.

For FR2, if following conditions are met,

- UE has been notified about system information update through paging,
- The gap between UE's reception of PDCCH that UE monitors in the Type2-PDCCH CSS set and that notifies system information update, and the PDCCH that UE monitors in the Type0-PDCCH CSS set, is greater than 2 slots,

For the SSB for RLM and CORESET for RMSI scheduling multiplexing patterns 3, UE is expected to receive the PDCCH that UE monitors in the Type0-PDCCH CSS set, and the corresponding PDSCH, on SSB symbols to be measured for RLM; and

For the SSB for RLM and CORESET for RMSI scheduling multiplexing patterns 2, UE is expected to receive PDSCH that corresponds to the PDCCH that UE monitors in the Type0-PDCCH CSS set, on SSB symbols to be measured for RLM.

8.1.7.4 Scheduling availability of UE performing radio link monitoring on FR1 or FR2 in case of FR1-FR2 inter-band CA and NR-DC

There are no scheduling restrictions on FR1 serving cell(s) due to radio link monitoring performed on FR2 serving PCell and/or PSCell.

There are no scheduling restrictions on FR2 serving cell(s) due to radio link monitoring performed on FR1 serving PCell and/or PSCell.

NR-DC in Rel-15 only includes the scenarios where all serving cells in MCG are in FR1 and all serving cells in SCG are in FR2.

8.2 Interruption

8.2.1 EN-DC Interruption

8.2.1.1 Introduction

This clause contains the requirements related to the interruptions on PSCell, and SCell, when

- E-UTRA PCell transitions between active and non-active during DRX, or
- E-UTRA PCell transitions from non-DRX to DRX, or
- E-UTRA SCell in MCG or SCell in SCG is added or released, or
- E-UTRA SCell in MCG or SCell in SCG is activated or deactivated, or
- measurements on SCC with deactivated SCell in either E-UTRA MCG or NR SCG, or

a supplementary UL carrier or an UL carrier is configured or de-configured, or
UL/DL BWP is switched on PSCell or SCell in SCG.

The requirements shall apply for E-UTRA-NR DC with an E-UTRA PCell.

This clause contains interruptions where victim cell is PSCell or SCell belonging to SCG. Requirements for interruptions requirements when the victim cell is E-UTRA PCell or E-UTRA SCell belonging to MCG are specified in TS 36.133 [15].

For a UE which does not support per-FR measurement gaps, interruptions to the PSCell or activated SCG SCells may be caused by EUTRA PCell, EUTRA SCells or SCells on any frequency range. For UE which support per-FR gaps, interruptions to the PSCell or activated SCG SCells may be caused by EUTRA PCell, EUTRA SCells or SCells on the same frequency range as the victim cell.

8.2.1.2 Requirements

8.2.1.2.1 Interruptions at transitions between active and non-active during DRX

Interruption on PSCell and the activated SCell if configured due to E-UTRA PCell transitions between active and non-active during DRX when PSCell or SCell is in non-DRX are allowed with up to 1% probability of missed ACK/NACK when the configured E-UTRA PCell DRX cycle is less than 640 ms, and 0.625% probability of missed ACK/NACK is allowed when the configured E-UTRA PCell DRX cycle is 640 ms or longer. Each interruption shall not exceed X slot as defined in table 8.2.1.2.1-1.

Table 8.2.1.2.1-1: Interruption length X at transition between active and non-active during DRX

μ	NR Slot length (ms)	Interruption length X (slots)	
		Sync	Async
0	1	1	2
1	0.5	1	2
2	0.25	3	
3	0.125	5	

When both E-UTRA PCell and PSCell are in DRX, no interruption is allowed.

8.2.1.2.2 Interruptions at transitions from non-DRX to DRX

Interruption on PSCell and the activated SCell if configured due to E-UTRA PCell transitions from non-DRX to DRX when PSCell or SCell is in non-DRX shall not exceed X slot as defined in table 8.2.1.2.1-1.

When PSCell and the activated SCell are in DRX, no interruption due to E-UTRA PCell transitions from non-DRX to DRX is allowed.

8.2.1.2.3 Interruptions at SCell addition/release

The requirements in this clause shall apply for the UE configured with PSCell.

When one E-UTRA SCell in MCG is added or released:

- the UE is allowed an interruption on any active serving cell in SCG:
- of up to X1 slot, if the active serving cell is not in the same band as the E-UTRA SCell being added or released, or
- of up to $\max\{Y1 \text{ slot} + T_{\text{SMTC_duration}}, 5\text{ms}\}$ if the active serving cells are in the same band as the E-UTRA SCell being added or released, provided the cell specific reference signals from the active serving cells and the E-UTRA SCell being added or released are available in the same slot, where $T_{\text{SMTC_duration}}$ is the longest SMTC duration among all above active serving cells in SCG;

Where X1 and Y1 are specified in Table 8.2.1.2.3-1.

When one SCell in SCG is added or released:

- the UE is allowed an interruption on any active serving cell in SCG:
 - of up to X1 slot, if the active serving cell is not in the same band as any of the SCells being added or released, or
 - of up to Y1 slot + T_{SMTC_duration} if the active serving cells are in the same band as any of the SCells being added or released, provided the cell specific reference signals from the active serving cells and the SCells being added or released are available in the same slot, where, T_{SMTC_duration} is
 - the longest SMTC duration among all above active serving cells in SCG and the SCell being added when one SCell is added. If SSB configuration (*absoluteFrequencySSB*) but no SMTC configuration is provided for the SCell being added, the SSB transmission periodicity is assumed to be 5ms and T_{SMTC_duration} for the SCell being added is x ms, where x = the number of consecutive subframes containing all SSBs in one SSB burst transmitted by the SCell being added. If no SSB configuration (*absoluteFrequencySSB*) nor SMTC configuration is provided for the SCell being added, T_{SMTC_duration} for the SCell being added is 0 ms;
 - the longest SMTC duration among all above active serving cells in SCG when one SCell is released.

Where X1 and Y1 are specified in Table 8.2.1.2.3-2.

Table 8.2.1.2.3-1: Interruption length X1 and Y1 at E-UTRA SCell addition/Release

μ	NR Slot length (ms)	Interruption length X1 (slots)		Interruption length Y1 (slots)	
		Sync	Async	Sync	Async
0	1	1	2	1	2
1	0.5	2	3	2	3
2	0.25	5		4	5
3	0.125	9		N/A	N/A

Table 8.2.1.2.3-2: Interruption length X1 and Y1 at SCell addition/Release

μ	NR Slot length (ms) of victim cell	Interruption length X1 (slots)		Interruption length Y1 (slots)
0	1	1		1
1	0.5	2		2
2	0.25	Both aggressor cell and victim cell are on FR2	4	4
		Either aggressor cell or victim cell is on FR1	5	
3	0.125	Aggressor cell is on FR2	8	8
		Aggressor cell is on FR1	9	

8.2.1.2.4 Interruptions at SCell activation/deactivation

The requirements in this clause shall apply for the UE configured with PSCell and one SCell.

When one E-UTRA SCell in MCG is activated or deactivated:

- the UE is allowed an interruption on any active serving cell in SCG:
 - of up to X2 slot, if the active serving cell is not in the same band as the E-UTRA SCell being activated or deactivated, or
 - of up to max{Y2 slot + T_{SMTC_duration}, 5ms} if the active serving cells are in the same band as the E-UTRA SCell being activated or deactivated, provided the cell specific reference signals from the active serving cells and the E-UTRA SCell being activated or deactivated are available in the same slot, where T_{SMTC_duration} is the longest SMTC duration among all above active serving cells in SCG.

Where X2 and Y2 are specified in Table 8.2.1.2.4-1.

When one SCell in SCG is activated or deactivated:

- an interruption on any active serving cell in SCG:
 - of up to X2 slot, if the active serving cell is not in the same band as the SCell being activated or deactivated, or
 - of up to Y2 slot + $T_{\text{SMTC_duration}}$ if the active serving cells are in the same band as the SCell being activated or deactivated, provided the cell specific reference signals from the active serving cells and the SCell being activated or deactivated are available in the same slot, where, $T_{\text{SMTC_duration}}$ is
 - the longest SMTC duration among all above active serving cells in SCG and the SCell being activated when one SCell is activated. If SSB configuration (*absoluteFrequencySSB*) but no SMTC configuration is provided for the SCell being activated, the SSB transmission periodicity is assumed to be 5ms and $T_{\text{SMTC_duration}}$ for the SCell being activated is x ms, where x = the number of consecutive subframes containing all SSBs in one SSB burst transmitted by the SCell being activated. If no SSB configuration (*absoluteFrequencySSB*) nor SMTC configuration is provided for the SCell being activated, $T_{\text{SMTC_duration}}$ for the SCell being activated is 0ms;
 - the longest SMTC duration among all above active serving cells in SCG when one SCell is deactivated.

Where X2 and Y2 are specified in Table 8.2.1.2.4-2.

Table 8.2.1.2.4-1: Interruption length X2 and Y2 at E-UTRA SCell activation/deactivation

μ	NR Slot length (ms)	Interruption length X2 (slots)		Interruption length Y2 (slots)	
		Sync	Async	Sync	Async
0	1	1	2	1	2
1	0.5	1	2	1	2
2	0.25	3		2	3
3	0.125	5		N/A	N/A

Table 8.2.1.2.4-2: Interruption length X2 and Y2 at SCell activation/deactivation

μ	NR Slot length (ms) of victim cell	Interruption length X2 (slots)		Interruption length Y2 (slots)
0	1	1		1
1	0.5	1		1
2	0.25	Both aggressor cell and victim cell are on FR2	2	2
		Either aggressor cell or victim cell is on FR1	3	
3	0.125	Aggressor cell is on FR2	4	4
		Aggressor cell is on FR1	5	

8.2.1.2.5 Interruptions during measurements on SCC

8.2.1.2.5.1 Interruptions during measurements on deactivated NR SCC

Interruption on PCell and other activated NR SCell(s) during measurement on the deactivated NR SCC shall meet requirements in clause 8.2.2.2.3, where the term PCell in clause 8.2.2.2.3 shall be deemed to be replaced with PSCell.

8.2.1.2.5.2 Interruptions during measurements on deactivated E-UTRAN SCC

When one E-UTRA SCell in MCG is deactivated, the UE is allowed due to measurements on the E-UTRA SCC with the deactivated E-UTRA SCell:

- an interruption on PSCell or any activated SCell with up to 0.5% probability of missed ACK/NACK when any of the configured *measCycleSCell* [15] for the deactivated E-UTRA SCells is 640 ms or longer.
- an interruption on PSCell or any activated SCell with up to 0.5% probability of missed ACK/NACK regardless of the configured *measCycleSCell* [15] for the deactivated E-UTRA SCells if indicated by the network using IE *allowInterruptions* [15].

Each interruption shall not exceed

- X3 slot, if the PSCell or activated SCell is not in the same band as the E-UTRA deactivated SCC being measured, or
- Y3 slot + SMTC duration, if the PSCell or activated SCell is in the same band as the E-UTRA deactivated SCC being measured, provided the cell specific reference signals from the PSCell or activated SCell and the E-UTRA deactivated SCC being measured are available in the same slot.

Table 8.2.1.2.5.2-1: Interruption length X3 and Y3 at measurements on deactivated E-UTRA SCC

μ	NR Slot length (ms)	Interruption length X3 (slots)		Interruption length Y3 (slots)	
		Sync	Async	Sync	Async
0	1	1	2	1	2
1	0.5	1	2	1	2
2	0.25	3		2	3
3	0.125	5		N/A	N/A

8.2.1.2.6 Interruptions at UL carrier RRC reconfiguration

The requirements in this clause shall apply when a supplementary UL carrier or an UL carrier is configured or de-configured in NR non-standalone operation as defined in TS 38.331 [2].

When an UL carrier or supplementary UL carrier is configured or de-configured, an interruption of up to X4 slot, is allowed during the RRC reconfiguration procedure [2] on E-UTRA PCell, all activated E-UTRA SCells, PSCell and all activated SCells within the same FR as the reconfigured uplink carrier. The interruption is for both uplink and downlink of E-UTRA PCell, all activated E-UTRA SCells, PSCell and all activated SCells within the same FR as the configured or de-configured UL.

Table 8.2.1.2.6-1: Interruption length X4 at UL carrier RRC reconfiguration

μ	NR Slot length (ms)	Interruption length X4 (slots)	
		Sync	Async
0	1	1	2
1	0.5	2	3
2	0.25	5	
3	0.125	9	

8.2.1.2.7 Interruptions due to Active BWP switching Requirement

The requirements for DCI-based and timer-based BWP switches in this clause only apply to the case that the BWP switch is performed on a single CC.

When UE receives a DCI indicating UE to switch its active BWP involving changes in any of the parameters listed in Table 8.2.1.2.7-2, the UE is allowed to cause interruption of up to X slot to other active serving cells if the UE is not capable of per-FR gap, or if the BWP switching involves SCS changing. When the BWP switch imposes changes in any of the parameters listed in Table 8.2.1.2.7-2 and the UE is capable of per-FR gap, the UE is allowed to cause interruption of up to X slot to other active serving cells in the same frequency range wherein the UE is performing BWP switching. X is defined in Table 8.2.1.2.7-1. The starting time of interruption is only allowed within the BWP switching delay $T_{\text{BWPswitchDelay}}$ as defined in clause 8.6.2. Interruptions are not allowed during BWP switch involving any other parameter change.

When a BWP timer *bwp-InactivityTimer* defined in TS 38.331 [2] expires, UE is allowed to cause interruption of up to X slot to other active serving cells due to switching its active BWP involving changes in any of the parameters listed in Table 8.2.1.2.7-2 if the UE is not capable of per-FR gap, or if the BWP switching involves SCS changing. When the BWP switch imposes changes in any of the parameters listed in Table 8.2.1.2.7-2 and the UE is capable of per-FR gap, the UE is allowed to cause interruption of up to X slot to other active serving cells in the same frequency range wherein the UE is performing BWP switching. X is defined in Table 8.2.1.2.7-1. The starting time of interruption is only allowed within the BWP switching delay $T_{\text{BWPswitchDelay}}$ as defined in clause 8.6.2. Interruptions are not allowed during BWP switch involving any other parameter change.

When UE receives an RRC reconfiguration that only requests UE to switch its active BWP on one single CC, the UE is allowed to cause interruption of up to X slot to other active serving cells due to switching its active BWP involving changes in any of the parameters listed in Table 8.2.1.2.7-2 if the UE is not capable of per-FR gap, or if the BWP switching involves SCS changing. When the BWP switch imposes changes in any of the parameters listed in Table 8.2.1.2.7-2 and the UE is capable of per-FR gap, the UE is allowed to cause interruption of up to X slot to other active serving cells in the same frequency range wherein the UE is performing BWP switching. X is defined in Table 8.2.1.2.7-1. The interruption is only allowed within the delay $T_{\text{RRCprocessingDelay}} + T_{\text{BWPswitchDelayRRC}}$ defined in clause 8.6.3.

Table 8.2.1.2.7-1: interruption length X

μ	NR Slot length (ms)	Interruption length X (slots)
0	1	1
1	0.5	1
2	0.25	3
3	0.125	5
Note1:	void	

Table 8.2.1.2.7-2: Parameters which cause interruption other than SCS

Parameters	Comment
<i>locationAndBandwidth</i>	From TS 38.331 [2]
<i>nrofSRS-Ports</i>	

8.2.2 SA: Interruptions with Standalone NR Carrier Aggregation

8.2.2.1 Introduction

This clause contains the requirements related to the interruptions on PCell and activated SCell if configured, when up to 7 SCells are configured, de-configured, activated or deactivated, or a supplementary UL carrier or an UL carrier is configured or de-configured, or measurements on SCC with deactivated SCell in NR SCG, or UL/DL BWP is switched on PCell or SCell.

Note: interruptions at SCell addition/release, activation/deactivation and during measurements on SCC may not be required by all UEs.

The interruptions shall not interrupt RRC signalling or ACK/NACKs related to RRC reconfiguration procedure [2] for SCell addition/release or MAC control signalling [17] for SCell activation/deactivation command.

This clause additionally contains requirements related to interruptions at inter-frequency SFTD between PCell in FR1 and neighbour cell in FR2.

For a UE which does not support per-FR measurement gap, interruptions to the PCell and activated SCell may be caused by SCells on any frequency range. For a UE which supports per-FR gap, interruptions to PCell and activated SCell may be caused by SCells on the same frequency range as the victim cell.

8.2.2.2 Requirements

8.2.2.2.1 Interruptions at SCell addition/release

When any number of SCells between one and 7 is added or released using the same *RRCConnectionReconfiguration* message as defined in TS 38.331 [2], the UE is allowed an interruption on any active serving cell during the RRC reconfiguration procedure as follows:

- an interruption on any active serving cell:
- of up to the duration shown in table 8.2.2.2.1-1, if the active serving cell is not in the same band as the SCell being added or released, or
- of up to the duration shown in table 8.2.2.2.1-2, if the active serving cells are in the same band as the SCell being added or released, provided the cell specific reference signals from the active serving cells and the SCell being added or released are available in the same slot.

Table 8.2.2.2.1-1: Interruption duration for SCell addition/release for inter-band CA

μ	NR Slot length (ms) of victim cell	Interruption length (slots)	
0	1	1	
1	0.5	2	
2	0.25	Both aggressor cell and victim cell are on FR2	4
		Either aggressor cell or victim cell is on FR1	5
3	0.125	Aggressor cell is on FR2	8
		Aggressor cell is on FR1	9

Table 8.2.2.2.1-2: Interruption duration for SCell addition/release for intra-band CA

μ	NR Slot length (ms)	Interruption length (slot)
0	1	$1 + T_{\text{SMTC_duration}} * N_{\text{slot}}^{\text{subframe},\mu}$
1	0.5	$2 + T_{\text{SMTC_duration}} * N_{\text{slot}}^{\text{subframe},\mu}$
2	0.25	$4 + T_{\text{SMTC_duration}} * N_{\text{slot}}^{\text{subframe},\mu}$
3	0.125	$8 + T_{\text{SMTC_duration}} * N_{\text{slot}}^{\text{subframe},\mu}$

NOTE 1: $T_{\text{SMTC_duration}}$ measured in subframes is

- the longest SMTC duration among all above active serving cells and the SCell being added when one SCell is added. If SSB configuration (*absoluteFrequencySSB*) but no SMTC configuration is provided for the SCell being added, the SSB transmission periodicity is assumed to be 5ms and $T_{\text{SMTC_duration}}$ for the SCell being added is x ms, where x = the number of consecutive subframes containing all SSBs in one SSB burst transmitted by the SCell being added. If no SSB configuration (*absoluteFrequencySSB*) nor SMTC configuration is provided for the SCell being added, $T_{\text{SMTC_duration}}$ for the SCell being added is 0ms;
- the longest SMTC duration among all active serving cells in the same band when one SCell is released.

NOTE 2: $N_{\text{slot}}^{\text{subframe},\mu}$ is as defined in TS 38.211 [6].

8.2.2.2.2 Interruptions at SCell activation/deactivation

When an SCell is activated or deactivated as defined in TS 37.340 [17], the UE is allowed

- an interruption on any active serving cell:
- of up to the duration shown in table 8.2.2.2.2-1, if the active serving cell is not in the same band as the SCell being activated or deactivated, or

- of up to the duration shown in table 8.2.2.2.2-2, if the active serving cells are in the same band as the SCell being activated or deactivated provided the cell specific reference signals from the active serving cells and the SCell being activated or deactivated are available in the same slot.

Table 8.2.2.2.2-1: Interruption duration for SCell activation/deactivation for inter-band CA

μ	NR Slot length (ms) of victim cell	Interruption length (slots)	
0	1		1
1	0.5		1
2	0.25	Both aggressor cell and victim cell are on FR2	2
		Either aggressor cell or victim cell is on FR1	3
3	0.125	Aggressor cell is on FR2	4
		Aggressor cell is on FR1	5

Table 8.2.2.2.2-2: Interruption duration for SCell activation/deactivation for intra-band CA

μ	NR Slot length (ms)	Interruption length (slots)
0	1	$1 + T_{\text{SMTC_duration}} * N_{\text{slot}}^{\text{subframe},\mu}$
1	0.5	$1 + T_{\text{SMTC_duration}} * N_{\text{slot}}^{\text{subframe},\mu}$
2	0.25	$2 + T_{\text{SMTC_duration}} * N_{\text{slot}}^{\text{subframe},\mu}$
3	0.125	$4 + T_{\text{SMTC_duration}} * N_{\text{slot}}^{\text{subframe},\mu}$

NOTE 1: $T_{\text{SMTC_duration}}$ measured in subframes is
 - the longest SMTC duration among all above active serving cells and the SCell being activated when one SCell is activated. If SSB configuration (*absoluteFrequencySSB*) but no SMTC configuration is provided for the SCell being activated, the SSB transmission periodicity is assumed to be 5ms and $T_{\text{SMTC_duration}}$ for the SCell being activated is x ms, where x = the number of consecutive subframes containing all SSBs in one SSB burst transmitted by the SCell being activated. If no SSB configuration (*absoluteFrequencySSB*) nor SMTC configuration is provided for the SCell being activated, $T_{\text{SMTC_duration}}$ for the SCell being activated is 0ms;
 - the longest SMTC duration among all active serving

NOTE 2: $N_{\text{slot}}^{\text{subframe},\mu}$ is as defined in TS 38.211 [6].

8.2.2.2.3 Interruptions during measurements on deactivated SCC

Interruptions on PCell or activated SCell(s) due to measurements when an SCell is deactivated are allowed with up to 0.5% probability of missed ACK/NACK when the configured *measCycleSCell* [2] is 640 ms or longer.

- If the PCell or activated SCell(s) is not in the same band as the deactivated SCell, the UE is only allowed to cause interruptions on PCell or activated SCell(s) immediately before and immediately after an SMTC. Each interruption shall not exceed requirement in Table 8.2.2.2.2-1.
- If the PCell or activated SCell(s) is in the same band as the deactivated SCell, the UE is only allowed to cause an interruption on PCell or activated SCell(s) no earlier than X slots before $T_{\text{SMTC_duration}}$ and no later than X slots after $T_{\text{SMTC_duration}}$, provided the cell specific reference signals from the active serving cells and the deactivated SCell are available in the same slot, where X and $T_{\text{SMTC_duration}}$ are given by Table 8.2.2.2.3-1. The interruption shall not exceed requirements in Table 8.2.2.2.3-1.

Table 8.2.2.2.3-1: Interruption duration for measurement on deactivated SCell for intra-band CA

μ	NR Slot length (ms)	X (slots)	Interruption length (slots)
0	1	1	$2 + T_{\text{SMTC_duration}} * N_{\text{slot}}^{\text{subframe},\mu}$
1	0.5	1	$2 + T_{\text{SMTC_duration}} * N_{\text{slot}}^{\text{subframe},\mu}$

2	0.25	2	$4 + T_{\text{SMTC_duration}} * N_{\text{slot}}^{\text{subframe},\mu}$
3	0.125	4	$8 + T_{\text{SMTC_duration}} * N_{\text{slot}}^{\text{subframe},\mu}$
NOTE 1: $T_{\text{SMTC_duration}}$ measured in subframes is the longest SMTC duration among all above active serving cells and the deactivated SCell to be measured;			
NOTE 2: $N_{\text{slot}}^{\text{subframe},\mu}$ is as defined in TS 38.211 [6].			

8.2.2.2.4 Interruptions at UL carrier RRC reconfiguration

The requirements in this clause shall apply when a supplementary UL carrier or an UL carrier is configured or de-configured in NR standalone carrier aggregation as defined in TS 38.331 [2].

When an UL carrier or supplementary UL carrier is configured or de-configured, an interruption of up to the duration shown in table 8.2.2.2.4-1, is allowed during the RRC reconfiguration procedure [2] on PCell and all activated SCells within the same FR as the reconfigured uplink carrier. The interruption is for both uplink and downlink of PCell and all the activated SCells within the same FR as the configured or de-configured UL.

Table 8.2.2.2.4-1: Interruption duration for UL carrier RRC reconfiguration

μ	NR Slot length (ms)	Interruption length (slots)
0	1	1
1	0.5	2
2	0.25	4
3	0.125	8

8.2.2.2.5 Interruptions due to Active BWP switching Requirement

The requirements for DCI-based and timer-based BWP switches in this clause only apply to the case that the BWP switch is performed on a single CC.

When UE receives a DCI indicating UE to switch its active BWP involving changes in any of the parameters listed in Table 8.2.2.2.5-2, the UE is allowed to cause interruption of up to X slot to other active serving cells if the UE is not capable of per-FR gap, or if the BWP switching involves SCS changing. When the BWP switch imposes changes in any of the parameters listed in Table 8.2.2.2.5-2 and the UE is capable of per-FR gap the UE is allowed to cause interruption of up to X slot to other active serving cells in the same frequency range wherein the UE is performing BWP switching. X is defined in Table 8.2.2.2.5-1. The starting time of interruption is only allowed within the BWP switching delay $T_{\text{BWPswitchDelay}}$ as defined in clause 8.6.2. Interruptions are not allowed during BWP switch involving any other parameter change.

When a BWP timer *bwp-InactivityTimer* defined in TS 38.331 [2] expires, UE is allowed to cause interruption of up to X slot to other active serving cells due to switching its active BWP involving changes in any of the parameters listed in Table 8.2.2.2.5-2 if the UE is not capable of per-FR gap, or if the BWP switching involves SCS changing. When the BWP switch imposes changes in any of the parameters listed in Table 8.2.2.2.5-2 and the UE is capable of per-FR gap, the UE is allowed to cause interruption of up to X slot to other active serving cells in the same frequency range wherein the UE is performing BWP switching. X is defined in Table 8.2.2.2.5-1. The starting time of interruption is only allowed within the BWP switching delay $T_{\text{BWPswitchDelay}}$ as defined in clause 8.6.2. Interruptions are not allowed during BWP switch involving any other parameter change.

When UE receives an RRC reconfiguration that only requests UE to switch its active BWP on one single CC, the UE is allowed to cause interruption of up to X slot to other active serving cells due to switching its active BWP involving changes in any of the parameters listed in Table 8.2.2.2.5-2 if the UE is not capable of per-FR gap, or if the BWP switching involves SCS changing. When the BWP switch imposes changes in any of the parameters listed in Table 8.2.2.2.5-2 and the UE is capable of per-FR gap, the UE is allowed to cause interruption of up to X slot to other active serving cells in the same frequency range wherein the UE is performing BWP switching. X is defined in Table 8.2.2.2.5-1. The interruption is only allowed within the delay $T_{\text{RRCprocessingDelay}} + T_{\text{BWPswitchDelayRRC}}$ defined in clause 8.6.3.

Table 8.2.2.2.5-1: Interruption length X

μ	NR Slot length (ms)	Interruption length X (slots)
0	1	1
1	0.5	1
2	0.25	3
3	0.125	5
Note1: void		

Table 8.2.2.2.5-2: Parameters which cause interruption other than SCS

Parameters	Comment
<i>locationAndBandwidth</i>	From TS 38.331 [2]
<i>nrofSRS-Ports</i>	

8.2.2.2.6 Interruptions at inter-frequency SFTD measurement

The requirements in this clause concern interruptions on PCell, as well as on activated SCells in MCG, when the UE is performing SFTD measurements on inter-frequency neighbour cell(s). The following requirements apply when no PSCell is configured.

For a UE with per-FR gap capability:

- for neighbour cell in FR1:
 - the percentage of interrupted slots on uplink and downlink on FR1 serving cells during the SFTD measurement period $T_{\text{measure_SFTD1}}$ specified in Clause 9.3.8 shall not exceed the percentages specified in Table 8.2.2.2.6-1. No interruption is allowed on FR2 serving cells.
 - the length of each interruption on FR1 serving cells shall not exceed the number of slots specified in Table 8.2.2.2.6-2.
- for neighbour cell in FR2:
 - the percentage of interrupted slots on uplink and downlink on FR2 serving cells during the SFTD measurement period $T_{\text{measure_SFTD1}}$ specified in Clause 9.3.8 shall not exceed the percentages specified in Table 8.2.2.2.6-1. No interruption is allowed on FR1 serving cells.
 - the length of each interruption on FR2 serving cells shall not exceed the number of slots specified in Table 8.2.2.2.6-2.

For a UE with per-UE gap capability:

- for neighbour cell in FR1 or FR2:
 - the percentage of interrupted slots on uplink and downlink on FR1 and FR2 serving cells during the SFTD measurement period $T_{\text{measure_SFTD1}}$ specified in Clause 9.3.8 shall not exceed the percentages specified in Table 8.2.2.2.6-1.
 - the length of each interruption on FR1 and FR2 serving cells shall not exceed the number of slots specified in Table 8.2.2.2.6-2.

Table 8.2.2.2.6-1: Requirements on maximum percentage of interrupted slots in serving cell in inter-frequency SFTD

SFTD configuration	Serving cell μ	Neighbour cell SMTC periodicity					
		5ms	10ms	20ms	40ms	80ms	160ms
With RSRP report	0	8.4%	6.3%	8.4%	6.3%	5.3%	4.7%
	1						
	2						
	3						

Without RSRP report	0	11.4%	8.6%	7.9%	6.8%	6.3%	6.0%
	1						
	2						
	3						

Table 8.2.2.2.6-2: Interruption duration for FR1 serving cell in inter-frequency SFTD with neighbour cell in FR1

μ	NR Slot length (ms)	Interruption length (slots)
0	1	1
1	0.5	2
2	0.25	4
3	0.125	8

Table 8.2.2.2.6-3: Void

Table 8.2.2.2.6-4: Void

8.2.3 NE-DC Interruptions

8.2.3.1 Introduction

This clause contains the requirements related to the interruptions on PCell and SCell, when

- E-UTRA PSCell transitions between active and non-active during DRX, or
- E-UTRA PSCell transitions from non-DRX to DRX, or
- E-UTRA PSCell/SCell in SCG or SCell in MCG is added or released, or
- E-UTRA PSCell/SCell in SCG or SCell in MCG is activated or deactivated, or
- measurements on SCC with deactivated SCell in either E-UTRA SCG or NR MCG or
- PUSCH/PUCCH carrier configuration and deconfiguration in NR MCG, or
- UL/DL BWP is switched on PCell or SCell in MCG.

The requirements shall apply for NE-DC with an NR PCell.

This clause contains interruptions where victim cell is PCell or SCell belonging to MCG. Requirements for interruptions requirements when the victim cell is E-UTRA PSCell or E-UTRA SCell belonging to SCG are specified in TS 36.133 [15].

For a UE which does not support per-FR measurement gap, interruptions to the PCell, E-UTRA PSCell or activated MCG SCells may be caused by EUTRA PSCell, EUTRA SCells or SCells on any frequency range. For UE which support per-FR gap, interruptions to the PCell, E-UTRA PSCell or activated MCG SCells may be caused by EUTRA PSCell, EUTRA SCells or SCells on the same frequency range as the victim cell.

8.2.3.2 Requirements

8.2.3.2.1 Interruptions at transitions between active and non-active during DRX

Interruption on PCell and the activated SCell if configured due to E-UTRA PSCell transitions between active and non-active during DRX when PCell or SCell is in non-DRX are allowed with up to 1% probability of missed ACK/NACK when the configured E-UTRA PSCell DRX cycle is less than 640 ms, and 0.625% probability of missed ACK/NACK is allowed when the configured E-UTRA PCell DRX cycle is 640 ms or longer. Each interruption shall not exceed X slot as defined in table 8.2.3.2.1-1.

Table 8.2.3.2.1-1: Interruption length X at transition between active and non-active during DRX

μ	NR slot length (ms)	Interruption length X (slots)	
		Sync	Async
0	1	1	2
1	0.5	1	2
2	0.25	3	
3	0.125	5	

When both PCell and E-UTRA PSCell are in DRX, no interruption is allowed.

8.2.3.2.2 Interruptions at transitions from non-DRX to DRX

Interruption on PCell and the activated SCell if configured due to E-UTRA PSCell transitions from non-DRX to DRX when PCell or SCell is in non-DRX shall not exceed X slot as defined in table 8.2.3.2.1-1.

8.2.3.2.3 Interruptions at PSCell/SCell addition/release

The requirements in this clause shall apply for the UE configured with E-UTRA PSCell.

When one E-UTRA PSCell/SCell in SCG is added or released:

- the UE is allowed an interruption on any active serving cell in MCG:
 - of up to X1 slots, if the active serving cell is not in the same band as the E-UTRA PSCell/SCell being added or released, or
 - of up to $\max\{Y1 \text{ slots} + T_{\text{SMTC_duration}}, 5\text{ms}\}$ if the active serving cells are in the same band as the E-UTRA PSCell/SCell being added or released, provided the cell specific reference signals from the active serving cells and the E-UTRA PSCell/SCell being added or released are available in the same slot, where $T_{\text{SMTC_duration}}$ is the longest SMTC duration among all above activated serving cells in MCG;

Where X1 and Y1 are specified in Table 8.2.3.2.3-1.

When one SCell in MCG is added or released:

- the UE is allowed an interruption on any activated serving cell in MCG:
 - of up to X1 slots, if the active serving cell is not in the same band as the SCell being added or released, or
 - of up to $Y1 \text{ slots} + T_{\text{SMTC_duration}}$ if the active serving cells are in the same band as the SCell being added or released, provided the cell specific reference signals from the active serving cells and the SCell being added or released are available in the same slot, where, $T_{\text{SMTC_duration}}$ is
 - the longest SMTC duration among all above active serving cells in MCG and the SCell being added when one SCell is added. If SSB configuration (*absoluteFrequencySSB*) but no SMTC configuration is provided for the SCell being added, the SSB transmission periodicity is assumed to be 5ms and $T_{\text{SMTC_duration}}$ for the SCell being added is x ms, where x = the number of consecutive subframes containing all SSBs in one SSB burst transmitted by the SCell being added. If no SSB configuration (*absoluteFrequencySSB*) nor SMTC configuration is provided for the SCell being added, $T_{\text{SMTC_duration}}$ for the SCell being added is 0ms;
 - the longest SMTC duration among all above active serving cells in MCG when one SCell is released.

Where X1 and Y1 are specified in Table 8.2.3.2.3-2.

Table 8.2.3.2.3-1: Interruption length X1 and Y1 at E-UTRA PSCell/SCell addition/release

μ	NR Slot length (ms)	Interruption length X1 (slots)		Interruption length Y1 (slots)	
		Sync	Async	Sync	Async
0	1	1	2	1	2
1	0.5	2	3	2	3

2	0.25	5	4	5
3	0.125	9	N/A	N/A

Table 8.2.3.2.3-2: Interruption length X1 and Y1 at SCell addition/Release

μ	NR Slot length (ms) of victim cell	Interruption length X1 (slots)		Interruption length Y1 (slots)
0	1	1		1
1	0.5	2		2
2	0.25	Both aggressor cell and victim cell are on FR2	4	4
		Either aggressor cell or victim cell is on FR1	5	
3	0.125	Aggressor cell is on FR2	8	8
		Aggressor cell is on FR1	9	

8.2.3.2.4 Interruptions at SCell activation/deactivation

The requirements in this clause shall apply for the UE configured with E-UTRA PSCell and one SCell.

When one E-UTRA SCell in SCG is activated or deactivated:

- the UE is allowed an interruption on any active serving cell in MCG:
 - of up to X2 slots, if the active serving cell is not in the same band as the E-UTRA SCell being activated or deactivated, or
 - of up to $\max\{Y2 \text{ slots} + T_{\text{SMTC_duration}}, 5\text{ms}\}$ if the active serving cells are in the same band as the E-UTRA SCell being activated or deactivated, provided the cell specific reference signals from the active serving cells and the E-UTRA SCell being activated or deactivated are available in the same slot, where $T_{\text{SMTC_duration}}$ is the longest SMTC duration among all above active serving cells in MCG.

Where X2 and Y2 are specified in Table 8.2.3.2.4-1.

When one SCell in MCG is activated or deactivated:

- the UE is allowed an interruption on any serving cell in MCG:
 - of up to X2 slots, if the active serving cell is not in the same band as the SCell being activated or deactivated, or
 - of up to $Y2 \text{ slots} + T_{\text{SMTC_duration}}$ if the active serving cells are in the same band as the SCell being activated or deactivated, provided the cell specific reference signals from the active serving cells and the SCell being activated or deactivated are available in the same slot, where, $T_{\text{SMTC_duration}}$ is
 - the longest SMTC duration among all above active serving cells in MCG and the SCell being activated when one SCell is activated, If SSB configuration (*absoluteFrequencySSB*) but no SMTC configuration is provided for the SCell being activated, the SSB transmission periodicity is assumed to be 5ms and $T_{\text{SMTC_duration}}$ for the SCell being activated is x ms, where x = the number of consecutive subframes containing all SSBs in one SSB burst transmitted by the SCell being activated. If no SSB configuration (*absoluteFrequencySSB*) nor SMTC configuration is provided for the SCell being activated, $T_{\text{SMTC_duration}}$ for the SCell being activated is 0ms;
 - the longest SMTC duration among all above active serving cells in MCG when one SCell is deactivated.

Where X2 and Y2 are specified in Table 8.2.3.2.4-2.

Table 8.2.3.2.4-1: Interruption length X2 and Y2 at E-UTRA SCell activation/deactivation

μ		Interruption length X2 (slots)	Interruption length Y2 (slots)
-------	--	--------------------------------	--------------------------------

	NR Slot length (ms)	Sync	Async	Sync	Async
0	1	1	2	1	2
1	0.5	1	2	1	2
2	0.25	3		2	3
3	0.125	5		N/A	N/A

Table 8.2.3.2.4-2: Interruption length X2 and Y2 at SCell activation/deactivation

μ	NR Slot length (ms) of victim cell	Interruption length X2 (slots)		Interruption length Y2 (slots)
0	1	1		1
1	0.5	1		1
2	0.25	Both aggressor cell and victim cell are on FR2	2	2
		Either aggressor cell or victim cell is on FR1	3	
3	0.125	Aggressor cell is on FR2	4	4
		Aggressor cell is on FR1	5	

8.2.3.2.5 Interruptions during measurements on SCC

8.2.3.2.5.1 Interruptions during measurements on deactivated NR SCC

Interruption on PCell and other activated SCell(s) during measurement on the deactivated NR SCC shall meet requirements in clause 8.2.2.2.3.

8.2.3.2.5.2 Interruptions during measurements on deactivated E-UTRAN SCC

When one E-UTRA SCell in SCG is deactivated, the UE is allowed due to measurements on the E-UTRA SCC with the deactivated E-UTRA SCell:

- an interruption on PCell or any activated SCell with up to 0.5% probability of missed ACK/NACK when any of the configured *measCycleSCell* [15] for the deactivated E-UTRA SCCells is 640 ms or longer.
- an interruption on PCell or any activated SCell with up to 0.5% probability of missed ACK/NACK regardless of the configured *measCycleSCell* [15] for the deactivated E-UTRA SCCells if indicated by the network using IE *allowInterruptions* [15].

Each interruption shall not exceed

- X3 slots, if the PCell or activated SCell is not in the same band as the E-UTRA deactivated SCC being measured, or
- Y3 slots + SMTC duration, if the PCell or activated SCell is in the same band as the E-UTRA deactivated SCC being measured, provided the cell specific reference signals from the PCell or activated SCell and the E-UTRA deactivated SCC being measured are available in the same slot.

Where X3 and Y3 are specified in Table 8.2.3.2.5-1

Table 8.2.3.2.5-1: Interruption length X3 and Y3 at measurements on deactivated E-UTRA SCC

μ	NR Slot length (ms)	Interruption length X3 (slots)		Interruption length Y3 (slot)	
		Sync	Async	Sync	Async
0	1	1	2	1	2
1	0.5	1	2	1	2
2	0.25	3		2	3

3	0.125	5	N/A	N/A
---	-------	---	-----	-----

8.2.3.2.6 Interruptions at UL carrier RRC reconfiguration

The requirements in this clause shall apply when a supplementary UL carrier or an UL carrier is configured or de-configured in NE-DC.

When an UL carrier or supplementary UL carrier is configured or deconfigured, an interruption of up to X4 slot as specified in Table 8.2.3.2.6-1, is allowed during the RRC reconfiguration procedure in TS 38.331 [2] on PCell, all activated SCells within the same FR as the reconfigured uplink carrier. The interruption is for both uplink and downlink of PCell, all activated E-UTRA SCells, E-UTRA PSCell and all activated SCells within the same FR as the configured or de-configured UL.

Table 8.2.3.2.6-1: Interruption length X4 at UL carrier RRC reconfiguration

μ	NR Slot length (ms)	Interruption length X4 (slots)	
		Sync	Async
0	1	1	2
1	0.5	2	3
2	0.25	5	
3	0.125	9	

8.2.3.2.7 Interruptions due to Active BWP switching Requirement

The requirements for DCI-based and timer-based BWP switches in this clause only apply to the case that the BWP switch is performed on a single CC.

When UE receives a DCI indicating the UE to switch its active BWP, or when a BWP timer *bwp-InactivityTimer* defined in TS 38.331 [2] expires, or when the UE receives an RRC command indicating the UE to switch its active BWP, the UE is allowed an interruption on PCell and any activated SCells as defined in clause 8.2.2.2.5.

8.2.4 NR-DC: Interruptions

8.2.4.1 Introduction

This clause contains the requirements related to the interruptions on PCell, PSCell and activated SCell if configured, when

SCells are configured, de-configured, activated or deactivated or,

a supplementary UL carrier or an UL carrier is configured or de-configured, or

measurements on SCC with deactivated SCell in NR SCG, or

UL/DL BWP is switched on PCell, PSCell or SCell. transitions between active and non-active during DRX, or transitions from non-DRX to DRX.

Note: interruptions at SCell addition/release, activation/deactivation and during measurements on SCC may not be required by all UEs.

The interruptions shall not interrupt RRC signalling or ACK/NACKs related to RRC reconfiguration procedure [2] for SCell addition/release or MAC control signalling [17] for SCell activation/deactivation command. How to specify this is FFS.

The requirements shall apply for NR-DC with an NR PCell, PSCell or SCell.

For a UE which does not support per-FR measurement gap, interruptions to the PCell and activated SCell may be caused by SCells on any frequency range. For a UE which supports per-FR gaps, interruptions to PCell, PSCell and activated SCell may be caused by SCells on the same frequency range as the victim cell.

8.2.4.2 Requirements

8.2.4.2.1 Interruptions at PSCell/SCell addition/release

When PSCell or one or more SCells is added or released using the same *RRCConnectionReconfiguration* message as defined in TS 38.331 [2], the UE is allowed an interruption on any activated serving cell during the RRC reconfiguration procedure as follows:

- an interruption on any active serving cell:
 - of up to the duration shown in table 8.2.4.2.1-1, if the active serving cell is not in the same band as the SCell being added or released, or
 - of up to the duration shown in table 8.2.4.2.1-2, if the active serving cells are in the same band as the SCell being added or released, provided the cell specific reference signals from the active serving cells and the SCell being added or released are available in the same slot.

Table 8.2.4.2.1-1: Interruption duration for PSCell/SCell addition/release for inter-band DC/CA

μ	NR Slot length (ms) of victim cell	Interruption length (slots)	
0	1	1	
1	0.5	2	
2	0.25	Both aggressor cell and victim cell are on FR2	4
		Either aggressor cell or victim cell is on FR1	5
3	0.125	Aggressor cell is on FR2	8
		Aggressor cell is on FR1	9

Table 8.2.4.2.1-2: Interruption duration for SCell addition/release for intra-band DC/CA

μ	NR Slot length (ms)	Interruption length (slots)
0	1	$1 + T_{\text{SMTC_duration}} * N_{\text{slot}}^{\text{subframe},\mu}$
1	0.5	$2 + T_{\text{SMTC_duration}} * N_{\text{slot}}^{\text{subframe},\mu}$
2	0.25	$4 + T_{\text{SMTC_duration}} * N_{\text{slot}}^{\text{subframe},\mu}$
3	0.125	$8 + T_{\text{SMTC_duration}} * N_{\text{slot}}^{\text{subframe},\mu}$

NOTE 1: $T_{\text{SMTC_duration}}$ measured in subframes is

- the longest SMTC duration among all above activeserving cells and the SCell being added when one SCell is added. If SSB configuration (*absoluteFrequencySSB*) but no SMTC configuration is provided for the SCell being added, the SSB transmission periodicity is assumed to be 5ms and $T_{\text{SMTC_duration}}$ for the SCell being added is x ms, where x = the number of consecutive subframes containing all SSBs in one SSB burst transmitted by the SCell being added. If no SSB configuration (*absoluteFrequencySSB*) nor SMTC configuration is provided for the SCell being added, $T_{\text{SMTC_duration}}$ for the SCell being added is 0ms;
- the longest SMTC duration among all active serving cells in the same band when one SCell is released.

NOTE 2: $N_{\text{slot}}^{\text{subframe},\mu}$ is as defined in TS 38.211 [6].

8.2.4.2.2 Interruptions at SCell activation/deactivation

When a SCell is activated or deactivated as defined in TS 37.340 [17], the UE is allowed

- an interruption on any active serving cell:
 - of up to the duration shown in table 8.2.4.2.2-1, if the active serving cell is not in the same band as the SCell being activated or deactivated, or

- of up to the duration shown in table 8.2.4.2.2-2, if the active serving cells are in the same band as the SCell being activated or deactivated provided the cell specific reference signals from the active serving cells and the SCell being activated or deactivated are available in the same slot.

Table 8.2.4.2.2-1: Interruption duration for SCell activation/deactivation for inter-band DC/CA

μ	NR Slot length (ms) of victim cell	Interruption length (slots)	
0	1	1	
1	0.5	1	
2	0.25	Both aggressor cell and victim cell are on FR2	2
		Either aggressor cell or victim cell is on FR1	3
3	0.125	Aggressor cell is on FR2	4
		Aggressor cell is on FR1	5

Table 8.2.4.2.2-2: Interruption duration for SCell activation/deactivation for intra-band DC/CA

μ	NR Slot length (ms)	Interruption length (slots)
0	1	$1 + T_{\text{SMTC_duration}} * N_{\text{slot}}^{\text{subframe}, \mu}$
1	0.5	$1 + T_{\text{SMTC_duration}} * N_{\text{slot}}^{\text{subframe}, \mu}$
2	0.25	$2 + T_{\text{SMTC_duration}} * N_{\text{slot}}^{\text{subframe}, \mu}$
3	0.125	$4 + T_{\text{SMTC_duration}} * N_{\text{slot}}^{\text{subframe}, \mu}$

NOTE 1: $T_{\text{SMTC_duration}}$ measured in subframes is

- the longest SMTC duration among all above active serving cells and the SCell being activated when one SCell is activated. If SSB configuration (*absoluteFrequencySSB*) but no SMTC configuration is provided for the SCell being activated, the SSB transmission periodicity is assumed to be 5ms and $T_{\text{SMTC_duration}}$ for the SCell being activated is x ms, where x = the number of consecutive subframes containing all SSBs in one SSB burst transmitted by the SCell being activated. If no SSB configuration (*absoluteFrequencySSB*) nor SMTC configuration is provided for the SCell being activated, $T_{\text{SMTC_duration}}$ for the SCell being activated is 0ms;
- the longest SMTC duration among all active serving cells in the same band when one SCell is deactivated.

NOTE 2: $N_{\text{slot}}^{\text{subframe}, \mu}$ is as defined in TS 38.211 [6].

8.2.4.2.3 Interruptions during measurements on SCC

Interruption on PCell, PSCell and other activated SCell(s) during measurement on the deactivated NR SCC shall meet requirements in clause 8.2.2.2.3, where the term PCell in clause 8.2.2.2.3 shall be deemed to be replaced with SpCell.

8.2.4.2.4 Interruptions at UL carrier RRC reconfiguration

The requirements in this clause shall apply when a supplementary UL carrier or an UL carrier is configured or de-configured in NR-DC as defined in TS 38.331 [2].

When an UL carrier or supplementary UL carrier is configured or de-configured, an interruption of up to the duration shown in table 8.2.4.2.4-1, is allowed during the RRC reconfiguration procedure in TS 38.331 [2] on all the other activated serving cells within the same FR as the reconfigured uplink carrier. The interruption is for both uplink and downlink of all the other serving cells within the same FR as the configured or de-configured UL.

Table 8.2.4.2.4-1: Interruption duration for UL carrier RRC reconfiguration

μ	NR Slot length (ms)	Interruption length (slots)
0	1	1

1	0.5	2
2	0.25	4
3	0.125	8

8.2.4.2.5 Interruptions due to Active BWP switching Requirement

The requirements for DCI-based and timer-based BWP switches in this clause only apply to the case that the BWP switch is performed on a single CC.

When UE receives a DCI indicating the UE to switch its active BWP, or when a BWP timer `bwp-InactivityTimer` defined in TS 38.331 [2] expires, or when the UE receives an RRC command indicating the UE to switch its active BWP, the UE is allowed to cause an interruption on any other serving cells as defined in clause 8.2.2.2.5.

8.2.4.2.6 Interruptions at transitions between active and non-active during DRX

When PCell is in non-DRX and PSCell is in DRX, interruptions on PCell and the activated SCell in MCG if configured due to transitions from active to non-active and from non-active to active during PSCell DRX are allowed with up to 1% probability of missed ACK/NACK when the configured PSCell DRX cycle is less than 640 ms, and 0.625% probability of missed ACK/NACK is allowed when the configured PSCell DRX cycle is 640 ms or longer. Each interruption shall not exceed X slot as defined in table 8.2.4.2.6-1.

When PSCell is in non-DRX and PCell is in DRX, interruptions on PSCell on the activated SCell in SCG if configured due to transitions from active to non-active and from non-active to active during PCell DRX are allowed with up to 1% probability of missed ACK/NACK when the configured PCell DRX cycle is less than 640 ms, and 0.625% probability of missed ACK/NACK is allowed when the configured PCell DRX cycle is 640 ms or longer. Each interruption shall not exceed X slot as defined in table 8.2.4.2.6-1.

Table 8.2.4.2.6-1: Interruption length X at transition between active and non-active during DRX

μ	NR Slot length (ms)	Interruption length X (slots)	
		Sync	Async
0	1	1	2
1	0.5	1	2
2	0.25	3	
3	0.125	5	

When both PCell and PSCell are in DRX, no interruption is allowed.

8.2.4.2.7 Interruptions at transitions from non-DRX to DRX

Interruption on PCell and the activated SCell in MCG if configured due to PSCell transitions from non-DRX to DRX when PCell is in non-DRX shall not exceed X slots as defined in table 8.2.4.2.6-1.

Interruption on PSCell and the activated SCell in SCG if configured due to PCell transitions from non-DRX to DRX when PSCell is in non-DRX shall not exceed X slots as defined in table 8.2.4.2.6-1.

8.3 SCell Activation and Deactivation Delay

8.3.1 Introduction

This clause defines requirements for the delay within which the UE shall be able to activate a deactivated SCell and deactivate an activated SCell in EN-DC, or in standalone NR carrier aggregation, or in NE-DC, or in NR-DC.

The requirements shall apply for EN-DC, standalone NR carrier aggregation, NE-DC, and NR-DC.

8.3.2 SCell Activation Delay Requirement for Deactivated SCell

The requirements in this clause shall apply for the UE configured with one downlink SCell in EN-DC, or in standalone NR carrier aggregation or in NE-DC or in NR-DC and when one SCell is being activated.

The delay within which the UE shall be able to activate the deactivated SCell depends upon the specified conditions.

Upon receiving SCell activation command in slot n , the UE shall be capable to transmit valid CSI report and apply actions related to the activation command for the SCell being activated no later than in slot $n +$

$\frac{T_{\text{HARQ}} + T_{\text{activation_time}} + T_{\text{CSI_Reporting}}}{\text{NR slot length}}$, where:

T_{HARQ} (in ms) is the timing between DL data transmission and acknowledgement as specified in TS 38.213 [3]

$T_{\text{activation_time}}$ is the SCell activation delay in millisecond.

If the SCell is known and belongs to FR1, $T_{\text{activation_time}}$ is:

- $T_{\text{FirstSSB}} + 5\text{ms}$, if the measurement period of the SCell being activated is equal to or smaller than 2400ms.
- $T_{\text{FirstSSB_MAX}} + T_{\text{rs}} + 5\text{ms}$, if the measurement period of the SCell being activated is larger than 2400ms.

If the SCell being activated belongs to FR1 and if there is at least one active serving cell contiguous to the SCell on that FR1 band, if the UE is not provided with SSB configuration (*absoluteFrequencySSB*) nor SMTC configuration for the target SCell, $T_{\text{activation_time}}$ is 3 ms for UE supporting *scellWithoutSSB*, provided

- The RTD between the target SCell and the contiguous active serving cell is within $\pm 260\text{ns}$, and
- The difference of the reception power with the contiguous active serving cell is $\leq 6\text{dB}$, and
- The RS(s) of SCell being activated is (are) QCL-TypeA with TRS(s) of the SCell being activated, and the TRS(s) of the SCell being activated is (are) further QCL-TypeC with SSB(s) of any active serving cell that is contiguous to the SCell being activated on that FR1 band.

If the SCell is unknown and belongs to FR1, provided that the side condition $\hat{E}_s/I_{\text{ot}} \geq -2\text{dB}$ is fulfilled, then $T_{\text{activation_time}}$ is:

- $T_{\text{FirstSSB_MAX}} + T_{\text{SMTC_MAX}} + 2 * T_{\text{rs}} + 5\text{ms}$

If the SCell being activated belongs to FR2 and if there is at least one active serving cell on that FR2 band, then $T_{\text{activation_time}}$ is $T_{\text{FirstSSB}} + 5\text{ms}$ provided:

- The UE is provided with SMTC for the target SCell, and
- The SSBs in the serving cell(s) and the SSBs in the SCell fulfil the condition defined in clause 3.6.3, and
- The parameter *ssb-PositionsInBurst* is same for the serving cell(s) and the SCell, and
- SSB is in the same half-frame on the SCell and the FR2 active serving cell.

If the SCell being activated belongs to FR2 and if there is at least one active serving cell on that FR2 band, if the UE supporting *scellWithoutSSB* is not provided with any SMTC for the target SCell, $T_{\text{activation_time}}$ is 3 ms, provided

- the RS (s) of SCell being activated is (are) QCL-TypeD with RS (s) of one active serving cell on that FR2 band.

If the SCell being activated belongs to FR2 and if there is no active serving cell on that FR2 band provided that PCell or PSCell is FR1:

If the target SCell is known to UE and semi-persistent CSI-RS is used for CSI reporting, then $T_{\text{activation_time}}$ is:

- $3\text{ms} + \max(T_{\text{uncertainty_MAC}} + T_{\text{FineTiming}} + 2\text{ms}, T_{\text{uncertainty_SP}})$, where $T_{\text{uncertainty_MAC}}=0$ and $T_{\text{uncertainty_SP}}=0$ if UE receives the SCell activation command, semi-persistent CSI-RS activation command and TCI state activation command at the same time.

If the target SCell is known to UE and periodic CSI-RS is used for CSI reporting, then $T_{\text{activation_time}}$ is:

- $\max(T_{\text{uncertainty_MAC}} + 5\text{ms} + T_{\text{FineTiming}}, T_{\text{uncertainty_RRC}} + T_{\text{RRC_delay}} - T_{\text{HARQ}})$, where $T_{\text{uncertainty_MAC}}=0$ if UE receives the SCell activation command and TCI state activation commands at the same time.

If the target SCell is unknown to UE and semi-persistent CSI-RS is used for CSI reporting, provided that the side condition $\hat{E}_s/I_{ot} \geq -2\text{dB}$ is fulfilled, then $T_{\text{activation_time}}$ is:

- $6\text{ms} + T_{\text{FirstSSB_MAX}} + 15 * T_{\text{SMTC_MAX}} + 8 * T_{\text{rs}} + T_{\text{L1-RSRP, measure}} + T_{\text{L1-RSRP, report}} + T_{\text{HARQ}} + \max(T_{\text{uncertainty_MAC}} + T_{\text{FineTiming}} + 2\text{ms}, T_{\text{uncertainty_SP}})$.

If the target SCell is unknown to UE and periodic CSI-RS is used for CSI reporting, provided that the side condition $\hat{E}_s/I_{ot} \geq -2\text{dB}$ is fulfilled, then $T_{\text{activation_time}}$ is:

- $3\text{ms} + T_{\text{FirstSSB_MAX}} + 15 * T_{\text{SMTC_MAX}} + 8 * T_{\text{rs}} + T_{\text{L1-RSRP, measure}} + T_{\text{L1-RSRP, report}} + \max\{(T_{\text{HARQ}} + T_{\text{uncertainty_MAC}} + 5\text{ms} + T_{\text{FineTiming}}), (T_{\text{uncertainty_RRC}} + T_{\text{RRC_delay}})\}$.

where,

$T_{\text{SMTC_MAX}}$:

- In FR1, in case of intra-band SCell activation, $T_{\text{SMTC_MAX}}$ is the longer SMTC periodicity between active serving cells and SCell being activated provided the cell specific reference signals from the active serving cells and the SCells being activated or released are available in the same slot; in case of inter-band SCell activation, $T_{\text{SMTC_MAX}}$ is the SMTC periodicity of SCell being activated.
- In FR2, $T_{\text{SMTC_MAX}}$ is the longer SMTC periodicity between active serving cells and SCell being activated provided that in Rel-15 only support FR2 intra-band CA.
- $T_{\text{SMTC_MAX}}$ is bounded to a minimum value of 10ms.

T_{rs} is the SMTC periodicity of the SCell being activated if the UE has been provided with an SMTC configuration for the SCell in SCell addition message, otherwise T_{rs} is the SMTC configured in the measObjectNR having the same SSB frequency and subcarrier spacing. If the measObjectNRs having the same SSB frequency and subcarrier spacing configured by MN and SN have different SMTC, T_{rs} is the periodicity of one of the SMTC which is up to UE implementation. If the UE is not provided SMTC configuration or measurement object on this frequency, the requirement which involves T_{rs} is applied with $T_{\text{rs}} = 5\text{ms}$ assuming the SSB transmission periodicity is 5ms. There are no requirements if the SSB transmission periodicity is not 5ms.

T_{FirstSSB} : is the time to the end of the first complete SSB burst indicated by the SMTC, or within 5ms if SMTC is not configured, after slot $n + \frac{T_{\text{HARQ}} + 3\text{ms}}{\text{NR slot length}}$.

$T_{\text{FirstSSB_MAX}}$: Is the time to the end of the first complete SSB burst indicated by the SMTC, or within 5ms if SMTC is not configured, after slot $n + \frac{T_{\text{HARQ}} + 3\text{ms}}{\text{NR slot length}}$, further fulfilling:

- In FR1, in case of intra-band SCell activation, the occasion when all active serving cells and SCells being activated or released are transmitting SSB bursts in the same slot; in case of inter-band SCell activation, the first occasion when the SCell being activated is transmitting SSB burst.
- In FR2, the occasion when all active serving cells and SCells being activated or released are transmitting SSB bursts in the same slot.

$T_{\text{FineTiming}}$ is the time period between UE finish processing the last activation command for PDCCH TCI, PDSCH TCI (when applicable) and the timing of first complete available SSB corresponding to the TCI state.

$T_{\text{L1-RSRP, measure}}$ is L1-RSRP measurement delay $T_{\text{L1-RSRP_Measurement_Period_SSB}}$ ms or $T_{\text{L1-RSRP_Measurement_Period_CSI-RS}}$ based on applicability as defined in clause 9.5 assuming $M=1$ and $T_{\text{Report}}=0$.

$T_{\text{L1-RSRP, report}}$ is delay of acquiring CSI reporting resources.

$T_{\text{uncertainty_MAC}}$ is the time period between reception of the last activation command for PDCCH TCI, PDSCH TCI (when applicable) relative to

- SCell activation command for known case;
- First valid L1-RSRP reporting for unknown case.

$T_{\text{uncertainty_SP}}$ is the time period between reception of the activation command for semi-persistent CSI-RS resource set for CQI reporting relative to

- SCell activation command for known case;
- First valid L1-RSRP reporting for unknown case.

$T_{\text{uncertainty_RRC}}$ is the time period between reception of the RRC configuration message for TCI of periodic CSI-RS for CQI reporting (when applicable) relative to

- SCell activation command for known case;
- First valid L1-RSRP reporting for unknown case.

$T_{\text{RRC_delay}}$ is the RRC procedure delay as specified in TS 38.331 [2].

Longer delays for RRM measurement requirements, and in case of FR2 also SSB based RLM/BFD/CBD/L1-RSRP measurement requirements, can be expected during the cell detection time for unknown SCell activation.

When *absoluteFrequencySSB* is not configured in *DownlinkConfigCommon* for target SCell but *SMTTC* for target SCell is configured, no requirement would be applied.

$T_{\text{CSI_reporting}}$ is the delay (in ms) including uncertainty in acquiring the first available downlink CSI reference resource, UE processing time for CSI reporting and uncertainty in acquiring the first available CSI reporting resources as specified in TS 38.331 [2].

SCell in FR1 is known if it has been meeting the following conditions:

- During the period equal to $\max(5 \cdot \text{measCycleSCell}, 5 \cdot \text{DRX cycles})$ for FR1 before the reception of the SCell activation command:
 - the UE has sent a valid measurement report for the SCell being activated and
 - the SSB measured remains detectable according to the cell identification conditions specified in clause 9.2 and 9.3.
- the SSB measured during the period equal to $\max(5 \cdot \text{measCycleSCell}, 5 \cdot \text{DRX cycles})$ also remains detectable during the SCell activation delay according to the cell identification conditions specified in clause 9.2 and 9.3.

Otherwise SCell in FR1 is unknown.

The requirements for FR1 unknown SCell activation specified in this clause apply when one of the following conditions is met

- 'ssb-PositionInBurst' indicates only one SSB is being actually transmitted, or
- 'ssb-PositionInBurst' indicates multiple SSBs and TCI indication is provided in same MAC PDU with SCell activation.

For the first SCell activation in FR2 bands, the SCell is known if it has been meeting the following conditions:

- During the period equal to 4s for UE supporting power class1 and 3s for UE supporting power class 2/3/4 before UE receives the last activation command for PDCCH TCI, PDSCH TCI (when applicable) and semi-persistent CSI-RS for CQI reporting (when applicable):
 - the UE has sent a valid L3-RSRP measurement report with SSB index, and
 - SCell activation command is received after L3-RSRP reporting and no later than the time when UE receives MAC-CE command for TCI activation

- During the period from L3-RSRP reporting to the valid CQI reporting, the reported SSBs with indexes remain detectable according to the cell identification conditions specified in clauses 9.2 and 9.3, and the TCI state is selected based on one of the latest reported SSB indexes.

Otherwise, the first SCell in FR2 band is unknown. The requirement for unknown SCell applies provided that the activation commands for PDCCH TCI, PDSCH TCI (when applicable), semi-persistent CSI-RS for CQI reporting (when applicable), and configuration message for TCI of periodic CSI-RS for CQI reporting (when applicable) are based on the latest valid L1-RSRP reporting.

If the UE has been provided with higher layer in TS 38.331 [2] signaling of *smtc2* prior to the activation command, $T_{\text{SMTc_Scell}}$ follows *smtc1* or *smtc2* according to the physical cell ID of the target cell being activated. $T_{\text{SMTc_MAX}}$ follows *smtc1* or *smtc2* according to the physical cell IDs of the target cells being activated and the active serving cells.

In addition to CSI reporting defined above, UE shall also apply other actions related to the activation command specified in TS 38.331 [2] for a SCell at the first opportunities for the corresponding actions once the SCell is activated.

The starting point of an interruption window on spCell or any activated SCell, as specified in clause 8.2, shall not occur before slot $n+1+\frac{T_{\text{HARQ}}}{\text{NR slot length}}$ and not occur after slot $n+1+\frac{T_{\text{HARQ}}+3\text{ms}+T_{\text{X}}}{\text{NR slot length}}$, where NR slot length is with respect to the numerology used in the SCell being activated, and T_{X} is:

- 0, if $T_{\text{activation_time}}$ is 3ms
- T_{FirstSSB} , for any scenario where $T_{\text{activation_time}}$ includes T_{FirstSSB} ;
- $T_{\text{FirstSSB_MAX}}$, for any scenario where $T_{\text{activation_time}}$ includes $T_{\text{FirstSSB_MAX}}$;
- $T_{\text{uncertainty_MAC}} + T_{\text{FineTiming}}$, for any scenario where $T_{\text{activation_time}}$ includes only $T_{\text{FineTiming}}$ - and no $T_{\text{FirstSSB_MAX}}$.

The length of the interruption window may be different for different victim cells, and depends on the applicable scenario and on the frequency band relation between the aggressor cell and the victim cell.

The requirements in this clause and requirements on interruption due to SCell activation in clause 8.2 apply provided that the SSB of the to-be-activated SCell is within the first active DL BWP of the SCell.

Starting from the slot specified in clause 4.3 of TS 38.213 [3] (timing for secondary Cell activation/deactivation) and until the UE has completed the SCell activation, the UE shall report out of range if the UE has available uplink resources to report CQI for the SCell.

Starting from the slot specified in clause 4.3 of TS 38.213 [3] (timing for secondary Cell activation/deactivation) and until the UE has completed a first L1-RSRP measurement, the UE shall report lowest valid L1 SS-RSRP range if the UE has available uplink resources to report L1-RSRP for the SCell.

8.3.3 SCell Deactivation Delay Requirement for Activated SCell

The requirements in this clause shall apply for the UE configured with one downlink SCell in EN-DC, or in standalone NR carrier aggregation, or in NE-DC, or in NR-DC.

Upon receiving SCell deactivation command in slot n , the UE shall accomplish the deactivation actions for the SCell being deactivated no later than in slot $n + \frac{T_{\text{HARQ}}+3\text{ms}}{\text{NR slot length}}$. The starting point of an interruption window on spCell or any activated SCell, as specified in clause 8.2, shall not occur before slot $n+1 + \frac{T_{\text{HARQ}}}{\text{NR slot length}}$ and not occur after slot $n+1 + \frac{T_{\text{HARQ}}+3\text{ms}}{\text{NR slot length}}$, where NR slot length is with respect to the numerology used in the SCell being deactivated.

Upon expiry of the *sCellDeactivationTimer* in slot n , the UE shall accomplish the deactivation actions for the SCell being deactivated no later than in slot $n + \frac{3\text{ms}}{\text{NR slot length}}$. The starting point of an interruption window on spCell or any activated SCell, as specified in clause 8.2, shall not occur before slot $n+1$ and not occur after slot $n+1 + \frac{3\text{ms}}{\text{NR slot length}}$, where NR slot length is with respect to the numerology used in the SCell being deactivated.

The length of the interruption window may be different for different victim cells, and depends on the applicable scenario and on the frequency band relation between the aggressor cell and the victim cell.

8.4 UE UL carrier RRC reconfiguration delay

8.4.1 Introduction

The requirements in this clause apply for a UE being configured or deconfigured with a supplementary UL carrier or NR UL carrier.

8.4.2 UE UL carrier configuration delay requirement

When the UE receives a RRC message implying NR UL or supplementary UL carrier configuration, the UE shall be ready to start transmission on the newly configured carrier within $T_{UL_carrier_config}$ from the end of the slot n .

Where

- Slot n is the last slot overlapping with the PDSCH containing the RRC command.
- $T_{UL_carrier_config}$ equals the maximum RRC procedure delay defined in clause 11.2 in TS 36.331 [16] if the corresponding RRC message is embedded in E-UTRA RRC message, otherwise it equals the maximum RRC procedure delay defined in clause 12 in TS 38.331 [2].

8.4.3 UE UL carrier deconfiguration delay requirement

When the UE receives a RRC message implying NR UL or supplementary UL carrier deconfiguration RRC signalling, the UE shall stop UL signalling on the deconfigured UL carrier within $T_{UL_carrier_deconfig}$ from the end of the slot n .

Where

- Slot n is the last slot overlapping with the PDSCH containing the RRC command.
- $T_{UL_carrier_deconfig}$ equals the maximum RRC procedure delay defined in clause 11.2 in TS 36.331 [16] if the corresponding RRC message is embedded in E-UTRA RRC message, otherwise it equals the maximum RRC procedure delay defined in clause 12 in TS 38.331 [2].

8.5 Link Recovery Procedures

8.5.1 Introduction

The UE shall assess the downlink radio link quality of a serving cell based on the reference signal in the set \bar{Q}_0 as specified in TS 38.213 [3] in order to detect beam failure on:

- PCell in SA, NR-DC, or NE-DC operation mode,
- PSCell in NR-DC and EN-DC operation mode.

The RS resource configurations in the set \bar{Q}_0 can be periodic CSI-RS resources and/or SSBs. UE is not required to perform beam failure detection outside the active DL BWP. UE is not required to meet the requirements in clause 8.5.2 and 8.5.3 if UE does not have set \bar{Q}_0 .

On each RS resource configuration in the set \bar{Q}_0 , the UE shall estimate the radio link quality and compare it to the threshold Q_{out_LR} for the purpose of accessing downlink radio link quality of the serving cell beams.

The threshold Q_{out_LR} is defined as the level at which the downlink radio level link of a given resource configuration on set \bar{Q}_0 cannot be reliably received and shall correspond to the $BLER_{out} = 10\%$ block error rate of a hypothetical PDCCH transmission. For SSB based beam failure detection, $Q_{out_LR_SSB}$ is derived based on the hypothetical PDCCH transmission parameters listed in Table 8.5.2.1-1. For CSI-RS based beam failure detection, $Q_{out_LR_CSI-RS}$ is derived based on the hypothetical PDCCH transmission parameters listed in Table 8.5.3.1-1.

Upon request the UE shall deliver configuration indexes from the set \bar{q}_1 as specified in TS 38.213 [3], to higher layers, and the corresponding L1-RSRP measurement provided that the measured L1-RSRP is equal to or better than the threshold Q_{in_LR} , which is indicated by higher layer parameter *rsrp-ThresholdSSB*. The UE applies the Q_{in_LR} threshold to the L1-RSRP measurement obtained from an SSB. The UE applies the Q_{in_LR} threshold to the L1-RSRP measurement obtained for a CSI-RS resource after scaling a respective CSI-RS reception power with a value provided by higher layer parameter *powerControlOffsetSS*. The RS resource configurations in the set \bar{q}_1 can be periodic CSI-RS resources or SSBs or both SSB and CSI-RS resources. UE is not required to perform candidate beam detection outside the active DL BWP.

8.5.2 Requirements for SSB based beam failure detection

8.5.2.1 Introduction

The requirements in this clause apply for each SSB resource in the set \bar{q}_0 configured for a serving cell, provided that the SSB configured for beam failure detection is actually transmitted within the UE active DL BWP during the entire evaluation period specified in clause 8.5.2.2.

Table 8.5.2.1-1: PDCCH transmission parameters for beam failure instance

Attribute	Value for BLER
DCI format	1-0
Number of control OFDM symbols	2
Aggregation level (CCE)	8
Ratio of hypothetical PDCCH RE energy to average SSS RE energy	0dB
Ratio of hypothetical PDCCH DMRS energy to average SSS RE energy	0dB
Bandwidth (PRBs)	24
Sub-carrier spacing (kHz)	Same as the SCS of RMSI CORESET
DMRS precoder granularity	REG bundle size
REG bundle size	6
CP length	Normal
Mapping from REG to CCE	Distributed

8.5.2.2 Minimum requirement

UE shall be able to evaluate whether the downlink radio link quality on the configured SSB resource in set \bar{q}_0 estimated over the last $T_{Evaluate_BFD_SSB}$ ms period becomes worse than the threshold $Q_{out_LR_SSB}$ within $T_{Evaluate_BFD_SSB}$ ms period.

The value of $T_{Evaluate_BFD_SSB}$ is defined in Table 8.5.2.2-1 for FR1.

The value of $T_{Evaluate_BFD_SSB}$ is defined in Table 8.5.2.2-2 for FR2 with scaling factor $N=8$

For FR1,

- $P = \frac{1}{1 - \frac{T_{SSB}}{MGRP}}$, when in the monitored cell there are measurement gaps configured for intra-frequency, inter-frequency or inter-RAT measurements, which are overlapping with some but not all occasions of the SSB.
- $P = 1$ when in the monitored cell there are no measurement gaps overlapping with any occasion of the SSB.

For FR2,

- $P = \frac{1}{1 - \frac{T_{SSB}}{T_{SMTCperiod}}}$, when BFD-RS resource is not overlapped with measurement gap and the BFD-RS resource is partially overlapped with SMTC occasion ($T_{SSB} < T_{SMTCperiod}$).
- $P = P_{\text{sharing factor}}$, when the BFD-RS resource is not overlapped with measurement gap and the BFD-RS resource is fully overlapped with SMTC period ($T_{SSB} = T_{SMTCperiod}$).
- $P = \frac{1}{1 - \frac{T_{SSB}}{MGRP} - \frac{T_{SSB}}{T_{SMTCperiod}}}$, when the BFD-RS resource is partially overlapped with measurement gap and the BFD-RS resource is partially overlapped with SMTC occasion ($T_{SSB} < T_{SMTCperiod}$) and SMTC occasion is not overlapped with measurement gap and
 - $T_{SMTCperiod} \neq MGRP$ or
 - $T_{SMTCperiod} = MGRP$ and $T_{SSB} < 0.5 \times T_{SMTCperiod}$
- $P = \frac{P_{\text{sharing factor}}}{1 - \frac{T_{SSB}}{MGRP}}$, when the BFD-RS resource is partially overlapped with measurement gap and the BFD-RS resource is partially overlapped with SMTC occasion ($T_{SSB} < T_{SMTCperiod}$) and SMTC occasion is not overlapped with measurement gap and $T_{SMTCperiod} = MGRP$ and $T_{SSB} = 0.5 \times T_{SMTCperiod}$
- $P = \frac{1}{1 - \frac{T_{SSB}}{\text{Min}(MGRP, T_{SMTCperiod})}}$, when the BFD-RS resource is partially overlapped with measurement gap ($T_{SSB} < MGRP$) and the BFD-RS resource is partially overlapped with SMTC occasion ($T_{SSB} < T_{SMTCperiod}$) and SMTC occasion is partially or fully overlapped with measurement gap.
- $P = \frac{P_{\text{sharing factor}}}{1 - \frac{T_{SSB}}{MGRP}}$, when the BFD-RS resource is partially overlapped with measurement gap and the BFD-RS resource is fully overlapped with SMTC occasion ($T_{SSB} = T_{SMTCperiod}$) and SMTC occasion is partially overlapped with measurement gap ($T_{SMTCperiod} < MGRP$)

$P_{\text{sharing factor}} = 1$, if the BFD-RS resource outside measurement gap is

- not overlapped with the SSB symbols indicated by *SSB-ToMeasure* and 1 data symbol before each consecutive SSB symbols indicated by *SSB-ToMeasure* and 1 data symbol after each consecutive SSB symbols indicated by *SSB-ToMeasure*, given that *SSB-ToMeasure* is configured, where the *SSB-ToMeasure* is the union set of *SSB-ToMeasure* from all the configured measurement objects merged on the same serving carrier, and;
- not overlapped with the RSSI symbols indicated by *ss-RSSI-Measurement* and 1 data symbol before each RSSI symbol indicated by *ss-RSSI-Measurement* and 1 data symbol after each RSSI symbol indicated by *ss-RSSI-Measurement*, given that *ss-RSSI-Measurement* is configured.
- $P_{\text{sharing factor}} = 3$, otherwise.

where,

If the high layer in TS 38.331 [2] signaling of *smtc2* is configured, $T_{SMTCperiod}$ corresponds to the value of higher layer parameter *smtc2*; Otherwise $T_{SMTCperiod}$ corresponds to the value of higher layer parameter *smtc1*. $T_{SMTCperiod}$ is the shortest SMTC period among all CCs in the same FR2 band, given the SMTC offset of all CCs in FR2 provided the same offset.

Longer evaluation period would be expected if the combination of BFD-RS resource, SMTC occasion and measurement gap configurations does not meet pervious conditions.

Table 8.5.2.2-1: Evaluation period $T_{\text{Evaluate_BFD_SSB}}$ for FR1

Configuration	$T_{\text{Evaluate_BFD_SSB}}$ (ms)
no DRX	$\text{Max}(50, \text{Ceil}(5 \times P) \times T_{SSB})$
DRX cycle ≤ 320 ms	$\text{Max}(50, \text{Ceil}(7.5 \times P) \times \text{Max}(T_{DRX}, T_{SSB}))$
DRX cycle > 320 ms	$\text{Ceil}(5 \times P) \times T_{DRX}$
Note: T_{SSB} is the periodicity of SSB in the set \bar{q}_0 . T_{DRX} is the DRX cycle length.	

Table 8.5.2.2-2: Evaluation period $T_{\text{Evaluate_BFD_SSB}}$ for FR2

Configuration	$T_{\text{Evaluate_BFD_SSB}}$ (ms)
no DRX	$\text{Max}(50, \text{Ceil}(5 \times P \times N) \times T_{\text{SSB}})$
DRX cycle $\leq 320\text{ms}$	$\text{Max}(50, \text{Ceil}(7.5 \times P \times N) \times \text{Max}(T_{\text{DRX}}, T_{\text{SSB}}))$
DRX cycle $> 320\text{ms}$	$\text{Ceil}(5 \times P \times N) \times T_{\text{DRX}}$
Note: T_{SSB} is the periodicity of SSB in the set \bar{q}_0 . T_{DRX} is the DRX cycle length.	

8.5.2.3 Measurement restriction for SSB based beam failure detection

The UE is required to be capable of measuring SSB for BFD without measurement gaps. The UE is required to perform the SSB measurements with measurement restrictions as described in the following clauses.

For FR1, when the SSB OFDM symbols used for BFD measurement fully or partially overlap with CSI-RS for RLM, BFD, CBD or L1-RSRP measurement on the same CC or different CCs in the same band,

- If SSB and CSI-RS have same SCS, UE shall be able to measure the SSB for BFD measurement without any restriction;
- If SSB and CSI-RS have different SCS,
 - If UE supports *simultaneousRxDataSSB-DiffNumerology*, UE shall be able to measure the SSB for BFD measurement without any restriction;
 - If UE does not support *simultaneousRxDataSSB-DiffNumerology*, UE is required to measure one of but not both SSB for BFD measurement and CSI-RS. Longer measurement period for SSB based BFD measurement is expected, and no requirements are defined.

For FR2, when the SSB for BFD measurement on one CC is in the same OFDM symbol as CSI-RS for RLM, BFD, CBD or L1-RSRP measurement on the same CC or different CCs in the same band, UE is required to measure one of but not both SSB for BFD measurement and CSI-RS. Longer measurement period for SSB based BFD measurement is expected, and no requirements are defined.

8.5.3 Requirements for CSI-RS based beam failure detection

8.5.3.1 Introduction

The requirements in this clause apply for each CSI-RS resource in the set \bar{q}_0 of resource configurations for a serving cell, provided that the CSI-RS resource(s) in set \bar{q}_0 for beam failure detection are actually transmitted within the UE active DL BWP during the entire evaluation period specified in clause 8.5.3.2. UE is not expected to perform beam failure detection measurements on the CSI-RS configured for BFD if the CSI-RS is not QCL-ed, with QCL-TypeD when applicable, with the RS in the active TCI state of any CORESET configured in the UE active BWP.

Table 8.5.3.1-1: PDCCH transmission parameters for beam failure instance

Attribute	Value for BLER
DCI format	1-0
Number of control OFDM symbols	2
Aggregation level (CCE)	8
Ratio of hypothetical PDCCH RE energy to average CSI-RS RE energy	0dB
Ratio of hypothetical PDCCH DMRS energy to average CSI-RS RE energy	0dB
Bandwidth (PRBs)	48
Sub-carrier spacing (kHz)	SCS of the active DL BWP
DMRS precoder granularity	REG bundle size
REG bundle size	6
CP length	Normal

Mapping from REG to CCE	Distributed
-------------------------	-------------

8.5.3.2 Minimum requirement

UE shall be able to evaluate whether the downlink radio link quality on the CSI-RS resource in set \bar{Q} estimated over the last $T_{\text{Evaluate_BFD_CSI-RS}}$ ms period becomes worse than the threshold $Q_{\text{out_LR_CSI-RS}}$ within $T_{\text{Evaluate_BFD_CSI-RS}}$ ms period.

The value of $T_{\text{Evaluate_BFD_CSI-RS}}$ is defined in Table 8.5.3.2-1 for FR1.

The value of $T_{\text{Evaluate_BFD_CSI-RS}}$ is defined in Table 8.5.3.2-2 for FR2 with $N=1$. The requirements of $T_{\text{Evaluate_BFD_CSI-RS}}$ apply provided that the CSI-RS for BFD is not in a resource set configured with repetition ON. The requirements shall not apply when the CSI-RS resource in the active TCI state of CORESET is the same CSI-RS resource for BFD and the TCI state information of the CSI-RS resource is not given, wherein the TCI state information means QCL Type-D to SSB for L1-RSRP or CSI-RS with repetition ON.

For FR1,

- $P = \frac{1}{1 - \frac{T_{\text{CSI-RS}}}{MGRP}}$, when in the monitored cell there are measurement gaps configured for intra-frequency, inter-frequency or inter-RAT measurements, which are overlapping with some but not all occasions of the CSI-RS.
- $P = 1$ when in the monitored cell there are no measurement gaps overlapping with any occasion of the CSI-RS.

For FR2,

- $P = 1$, when the BFD-RS resource is not overlapped with measurement gap and also not overlapped with SMTC occasion.
- $P = \frac{1}{1 - \frac{T_{\text{CSI-RS}}}{MGRP}}$, when the BFD-RS resource is partially overlapped with measurement gap and the BFD-RS resource is not overlapped with SMTC occasion ($T_{\text{CSI-RS}} < MGRP$)
- $P = \frac{1}{1 - \frac{T_{\text{CSI-RS}}}{T_{\text{SMTCperiod}}}}$, when the BFD-RS resource is not overlapped with measurement gap and the BFD-RS resource is partially overlapped with SMTC occasion ($T_{\text{CSI-RS}} < T_{\text{SMTCperiod}}$).
- $P = P_{\text{sharing factor}}$, when the BFD-RS resource is not overlapped with measurement gap and the BFD-RS resource is fully overlapped with SMTC occasion ($T_{\text{CSI-RS}} = T_{\text{SMTCperiod}}$).
- $P = \frac{1}{1 - \frac{T_{\text{CSI-RS}}}{MGRP} - \frac{T_{\text{CSI-RS}}}{T_{\text{SMTCperiod}}}}$, when the BFD-RS resource is partially overlapped with measurement gap and the BFD-RS resource is partially overlapped with SMTC occasion ($T_{\text{CSI-RS}} < T_{\text{SMTCperiod}}$) and SMTC occasion is not overlapped with measurement gap and
 - $T_{\text{SMTCperiod}} \neq MGRP$ or
 - $T_{\text{SMTCperiod}} = MGRP$ and $T_{\text{CSI-RS}} < 0.5 \times T_{\text{SMTCperiod}}$
- $P = \frac{P_{\text{sharing factor}}}{1 - \frac{T_{\text{CSI-RS}}}{MGRP}}$, when the BFD-RS resource is partially overlapped with measurement gap and the BFD-RS resource is partially overlapped with SMTC occasion ($T_{\text{CSI-RS}} < T_{\text{SMTCperiod}}$) and SMTC occasion is not overlapped with measurement gap and $T_{\text{SMTCperiod}} = MGRP$ and $T_{\text{CSI-RS}} = 0.5 \times T_{\text{SMTCperiod}}$
- $P = \frac{1}{1 - \frac{T_{\text{CSI-RS}}}{\text{Min}(MGRP, T_{\text{SMTCperiod}})}}$, when the BFD-RS resource is partially overlapped with measurement gap ($T_{\text{CSI-RS}} < MGRP$) and the BFD-RS resource is partially overlapped with SMTC occasion ($T_{\text{CSI-RS}} < T_{\text{SMTCperiod}}$) and SMTC occasion is partially or fully overlapped with measurement gap.
- $P = \frac{P_{\text{sharing factor}}}{1 - \frac{T_{\text{CSI-RS}}}{MGRP}}$, when the BFD-RS resource is partially overlapped with measurement gap and the BFD-RS resource is fully overlapped with SMTC occasion ($T_{\text{CSI-RS}} = T_{\text{SMTCperiod}}$) and SMTC occasion is partially overlapped with measurement gap ($T_{\text{SMTCperiod}} < MGRP$)

- $P_{\text{sharing factor}} = 1$, if the BFD-RS resource outside measurement gap is
 - not overlapped with the SSB symbols indicated by *SSB-ToMeasure* and 1 data symbol before each consecutive SSB symbols indicated by *SSB-ToMeasure* and 1 data symbol after each consecutive SSB symbols indicated by *SSB-ToMeasure*, given that *SSB-ToMeasure* is configured, where the *SSB-ToMeasure* is the union set of *SSB-ToMeasure* from all the configured measurement objects merged on the same serving carrier, and;
 - not overlapped with the RSSI symbols indicated by *ss-RSSI-Measurement* and 1 data symbol before each RSSI symbol indicated by *ss-RSSI-Measurement* and 1 data symbol after each RSSI symbol indicated by *ss-RSSI-Measurement*, given that *ss-RSSI-Measurement* is configured,
- $P_{\text{sharing factor}} = 3$, otherwise.

where,

If the high layer in TS 38.331 [2] signaling of *smtc2* is configured, $T_{\text{SMTCperiod}}$ corresponds to the value of higher layer parameter *smtc2*; Otherwise $T_{\text{SMTCperiod}}$ corresponds to the value of higher layer parameter *smtc1*. $T_{\text{SMTCperiod}}$ is the shortest SMTC period among all CCs in the same FR2 band, provided the SMTC offset of all CCs in FR2 have the same offset.

Note: The overlap between CSI-RS for BFD and SMTC means that CSI-RS for BFD is within the SMTC window duration.

Longer evaluation period would be expected if the combination of the BFD-RS resource, SMTC occasion and measurement gap configurations does not meet previous conditions.

The values of M_{BFD} used in Table 8.5.3.2-1 and Table 8.5.3.2-2 are defined as

- $M_{\text{BFD}} = 10$, if the CSI-RS resource(s) in set \bar{q}_0 used for BFD is transmitted with Density = 3 and over the bandwidth ≥ 24 PRBs.

Table 8.5.3.2-1: Evaluation period $T_{\text{Evaluate_BFD_CSI-RS}}$ for FR1

Configuration	$T_{\text{Evaluate_BFD_CSI-RS}}$ (ms)
no DRX	$\text{Max}(50, \text{Ceil}(M_{\text{BFD}} \times P) \times T_{\text{CSI-RS}})$
DRX cycle $\leq 320\text{ms}$	$\text{Max}(50, \text{Ceil}(1.5 \times M_{\text{BFD}} \times P) \times \text{Max}(T_{\text{DRX}}, T_{\text{CSI-RS}}))$
DRX cycle $> 320\text{ms}$	$\text{Ceil}(M_{\text{BFD}} \times P) \times T_{\text{DRX}}$
Note: $T_{\text{CSI-RS}}$ is the periodicity of CSI-RS resource in the set \bar{q}_0 . T_{DRX} is the DRX cycle length.	

Table 8.5.3.2-2: Evaluation period $T_{\text{Evaluate_BFD_CSI-RS}}$ for FR2

Configuration	$T_{\text{Evaluate_BFD_CSI-RS}}$ (ms)
no DRX	$\text{Max}(50, \text{Ceil}(M_{\text{BFD}} \times P \times N) \times T_{\text{CSI-RS}})$
DRX cycle $\leq 320\text{ms}$	$\text{Max}(50, \text{Ceil}(1.5 \times M_{\text{BFD}} \times P \times N) \times \text{Max}(T_{\text{DRX}}, T_{\text{CSI-RS}}))$
DRX cycle $> 320\text{ms}$	$\text{Ceil}(M_{\text{BFD}} \times P \times N) \times T_{\text{DRX}}$
Note: $T_{\text{CSI-RS}}$ is the periodicity of CSI-RS resource in the set \bar{q}_0 . T_{DRX} is the DRX cycle length.	

8.5.3.3 Measurement restrictions for CSI-RS beam failure detection

The UE is required to be capable of measuring CSI-RS for BFD without measurement gaps. The UE is required to perform the CSI-RS measurements with measurement restrictions as described in the following clauses.

For both FR1 and FR2, when the CSI-RS for BFD measurement is in the same OFDM symbol as SSB for RLM, BFD, CBD or L1-RSRP measurement, UE is not required to receive CSI-RS for BFD measurement in the PRBs that overlap with an SSB.

For FR1, when the SSB for RLM, BFD, CBD or L1-RSRP measurement is within the active BWP and has same SCS than CSI-RS for BFD measurement, the UE shall be able to perform CSI-RS measurement without restrictions.

For FR1, when the SSB for RLM, BFD, CBD or L1-RSRP measurement is within the active BWP and has different SCS than CSI-RS for BFD measurement, the UE shall be able to perform CSI-RS measurement with restrictions according to its capabilities:

- If the UE supports *simultaneousRxDataSSB-DiffNumerology* the UE shall be able to perform CSI-RS measurement without restrictions.
- If the UE does not support *simultaneousRxDataSSB-DiffNumerology*, UE is required to measure one of but not both CSI-RS for BFD measurement and SSB. Longer measurement period for CSI-RS based BFD measurement is expected, and no requirements are defined.

For FR1, when the CSI-RS for BFD measurement is in the same OFDM symbol as another CSI-RS for RLM, BFD, CBD or L1-RSRP measurement, UE shall be able to measure the CSI-RS for BFD measurement without any restriction.

For FR2, when the CSI-RS for BFD measurement on one CC is in the same OFDM symbol as SSB for RLM, BFD or L1-RSRP measurement on the same CC or different CCs in the same band, or in the same symbol as SSB for CBD measurement on the same CC or different CCs in the same band when beam failure is detected, UE is required to measure one of but not both CSI-RS for BFD measurement and SSB. Longer measurement period for CSI-RS based BFD measurement is expected, and no requirements are defined.

For FR2, when the CSI-RS for BFD measurement on one CC is in the same OFDM symbol as another CSI-RS for RLM, BFD, CBD or L1-RSRP measurement on the same CC or different CCs in the same band,

- In the following cases, UE is required to measure one of but not both CSI-RS for BFD measurement and the other CSI-RS. Longer measurement period for CSI-RS based BFD measurement is expected, and no requirements are defined.
 - The CSI-RS for BFD measurement or the other CSI-RS in a resource set configured with repetition ON, or
 - The other CSI-RS is configured in set \bar{q}_1 and beam failure is detected, or
 - The two CSI-RS-es are not QCL-ed w.r.t. QCL-TypeD, or the QCL information is not known to UE,
- Otherwise, UE shall be able to measure the CSI-RS for BFD measurement without any restriction.

8.5.4 Minimum requirement for L1 indication

When the radio link quality on all the RS resources in set \bar{q}_0 is worse than $Q_{\text{out_LR}}$, layer 1 of the UE shall send a beam failure instance indication to the higher layers.

The beam failure instance evaluation for the RS resources in set \bar{q}_0 shall be performed as specified in clause 6 in TS 38.213 [3]. Two successive indications from layer 1 shall be separated by at least $T_{\text{Indication_interval_BFD}}$.

When DRX is not used, $T_{\text{Indication_interval_BFD}}$ is $\max(2\text{ms}, T_{\text{SSB-RS,M}})$ or $\max(2\text{ms}, T_{\text{CSI-RS,M}})$, where $T_{\text{SSB-RS,M}}$ and $T_{\text{CSI-RS,M}}$ is the shortest periodicity of all RS resources in set \bar{q}_0 for the accessed cell, corresponding to either the shortest periodicity of the SSB in the set \bar{q}_0 or CSI-RS resource in the set \bar{q}_0 .

When DRX is used, for SSB based link quality measurement,

- $T_{\text{Indication_interval_BFD}} = \text{Max}(1.5 \times \text{DRX_cycle_length}, 1.5 \times T_{\text{SSB-RS,M}})$, if $\text{DRX_cycle_length} \leq 320\text{ms}$,
- $T_{\text{Indication_interval_BFD}} = \text{DRX_cycle_length}$, if $\text{DRX_cycle_length} > 320\text{ms}$.

When DRX is used, for CSI-RS based link quality measurement,

- $T_{\text{Indication_interval_BFD}} = \text{Max}(1.5 \times \text{DRX_cycle_length}, 1.5 \times T_{\text{CSI-RS,M}})$, if $\text{DRX_cycle_length} \leq 320\text{ms}$,
- $T_{\text{Indication_interval_BFD}} = \text{DRX_cycle_length}$, if $\text{DRX_cycle_length} > 320\text{ms}$.

8.5.5 Requirements for SSB based candidate beam detection

8.5.5.1 Introduction

The requirements in this clause apply for each SSB resource in the set \bar{q}_1 configured for a serving cell, provided that the SSBs configured for candidate beam detection are actually transmitted within UE active DL BWP during the entire evaluation period specified in clause 8.5.5.2.

8.5.5.2 Minimum requirement

Upon request the UE shall be able to evaluate whether the L1-RSRP measured on the configured SSB resource in set \bar{q}_1 estimated over the last $T_{\text{Evaluate_CBD_SSB}}$ ms period becomes better than the threshold $Q_{\text{in_LR}}$ provided SSB_RP and SSB \hat{E}_s/I_{ot} are according to Annex Table B.2.4.1 for a corresponding band.

The UE shall monitor the configured SSB resources using the evaluation period in table 8.5.5.2-1 and 8.5.5.2-2 corresponding to the non-DRX mode, if the configured DRX cycle ≤ 320 ms.

The value of $T_{\text{Evaluate_CBD_SSB}}$ is defined in Table 8.5.5.2-1 for FR1.

The value of $T_{\text{Evaluate_CBD_SSB}}$ is defined in Table 8.5.5.2-2 for FR2 with scaling factor $N=8$.

where,

For FR1,

- $P = \frac{1}{1 - \frac{T_{\text{SSB}}}{\text{MGRP}}}$, when in the monitored cell there are measurement gaps configured for intra-frequency, inter-frequency or inter-RAT measurements, which are overlapping with some but not all occasions of the SSB,
- $P = 1$ when in the monitored cell there are no measurement gaps overlapping with any occasion of the SSB.

For FR2,

- $P = \frac{1}{1 - \frac{T_{\text{SSB}}}{T_{\text{SMTCperiod}}}}$, when candidate beam detection RS is not overlapped with measurement gap and candidate beam detection RS is partially overlapped with SMTC occasion ($T_{\text{SSB}} < T_{\text{SMTCperiod}}$).
- P is $P_{\text{sharing factor}}$, when candidate beam detection RS is not overlapped with measurement gap and candidate beam detection RS is fully overlapped with SMTC period ($T_{\text{SSB}} = T_{\text{SMTCperiod}}$).
- $P = \frac{1}{1 - \frac{T_{\text{SSB}}}{\text{MGRP}} - \frac{T_{\text{SSB}}}{T_{\text{SMTCperiod}}}}$, when candidate beam detection RS is partially overlapped with measurement gap and candidate beam detection RS is partially overlapped with SMTC occasion ($T_{\text{SSB}} < T_{\text{SMTCperiod}}$) and SMTC occasion is not overlapped with measurement gap and
 - $T_{\text{SMTCperiod}} \neq \text{MGRP}$ or
 - $T_{\text{SMTCperiod}} = \text{MGRP}$ and $T_{\text{SSB}} < 0.5 \times T_{\text{SMTCperiod}}$
- $P = \frac{P_{\text{sharing factor}}}{1 - \frac{T_{\text{SSB}}}{\text{MGRP}}}$, when candidate beam detection RS is partially overlapped with measurement gap and candidate beam detection RS is partially overlapped with SMTC occasion ($T_{\text{SSB}} < T_{\text{SMTCperiod}}$) and SMTC occasion is not overlapped with measurement gap and $T_{\text{SMTCperiod}} = \text{MGRP}$ and $T_{\text{SSB}} = 0.5 \times T_{\text{SMTCperiod}}$
- $P = \frac{1}{1 - \frac{T_{\text{SSB}}}{\text{Min}(\text{MGRP}, T_{\text{SMTCperiod}})}}$, when candidate beam detection RS is partially overlapped with measurement gap and candidate beam detection RS is partially overlapped with SMTC occasion ($T_{\text{SSB}} < T_{\text{SMTCperiod}}$) and SMTC occasion is partially or fully overlapped with measurement gap
- $P = \frac{P_{\text{sharing factor}}}{1 - \frac{T_{\text{SSB}}}{\text{MGRP}}}$, when candidate beam detection RS is partially overlapped with measurement gap and candidate beam detection RS is fully overlapped with SMTC occasion ($T_{\text{SSB}} = T_{\text{SMTCperiod}}$) and SMTC occasion is partially overlapped with measurement gap ($T_{\text{SMTCperiod}} < \text{MGRP}$)

- $P_{\text{sharing factor}} = 1$, if the candidate beam detection RS outside measurement gap is
 - not overlapped with the SSB symbols indicated by SSB-ToMeasure and 1 data symbol before each consecutive SSB symbols indicated by SSB-ToMeasure and 1 data symbol after each consecutive SSB symbols indicated by SSB-ToMeasure, given that SSB-ToMeasure is configured, where the *SSB-ToMeasure* is the union set of *SSB-ToMeasure* from all the configured measurement objects merged on the same serving carrier, and;
 - not overlapped with the RSSI symbols indicated by ss-RSSI-Measurement and 1 data symbol before each RSSI symbol indicated by ss-RSSI-Measurement and 1 data symbol after each RSSI symbol indicated by ss-RSSI-Measurement, given that ss-RSSI-Measurement is configured
- $P_{\text{sharing factor}} = 3$, otherwise.

where,

If the high layer in TS 38.331 [2] signaling of *smtc2* is present, $T_{\text{SMTCperiod}}$ follows *smtc2*; Otherwise $T_{\text{SMTCperiod}}$ follows *smtc1*. $T_{\text{SMTCperiod}}$ is the shortest SMTC period among all CCs in the same FR2 band, provided the SMTC offset of all CCs in FR2 have the same offset.

Longer evaluation period would be expected if the combination of the CBD-RS resource, SMTC occasion and measurement gap configurations does not meet pervious conditions.

Table 8.5.5.2-1: Evaluation period $T_{\text{Evaluate_CBD_SSB}}$ for FR1

Configuration	$T_{\text{Evaluate_CBD_SSB}}$ (ms)
non-DRX, DRX cycle $\leq 320\text{ms}$	$\text{Max}(25, \text{Ceil}(3 \times P) \times T_{\text{SSB}})$
DRX cycle $> 320\text{ms}$	$\text{Ceil}(3 \times P) \times T_{\text{DRX}}$
Note:	T_{SSB} is the periodicity of SSB in the set \bar{q}_1 . T_{DRX} is the DRX cycle length.

Table 8.5.5.2-2: Evaluation period $T_{\text{Evaluate_CBD_SSB}}$ for FR2

Configuration	$T_{\text{Evaluate_CBD_SSB}}$ (ms)
non-DRX, DRX cycle $\leq 320\text{ms}$	$\text{Max}(25, \text{Ceil}(3 \times P \times N) \times T_{\text{SSB}})$
DRX cycle $> 320\text{ms}$	$\text{Ceil}(3 \times P \times N) \times T_{\text{DRX}}$
Note:	T_{SSB} is the periodicity of SSB in the set \bar{q}_1 . T_{DRX} is the DRX cycle length.

8.5.5.3 Measurement restriction for SSB based candidate beam detection

For FR1, when the SSB OFDM symbols used for CBD measurement fully or partially overlap with CSI-RS for RLM, BFD, CBD or L1-RSRP measurement on the same CC or different CCs in the same band,

- If SSB and CSI-RS have same SCS, UE shall be able to measure the SSB for CBD measurement without any restrictions;
- If SSB and CSI-RS have different SCS-es,
 - If UE supports *simultaneousRxDataSSB-DiffNumerology*, UE shall be able to measure the SSB for CBD measurement without any restriction;
 - If UE does not support *simultaneousRxDataSSB-DiffNumerology*, UE is required to measure one of but not both SSB for CBD measurement and CSI-RS. Longer measurement period for SSB based CBD measurement is expected, and no requirements are defined.

For FR2, when the SSB for CBD measurement on one CC is in the same OFDM symbol as CSI-RS for RLM, BFD, CBD or L1-RSRP measurement on the same CC or different CCs in the same band, UE is required to measure one of but not both SSB for CBD measurement and CSI-RS. Longer measurement period for SSB based CBD measurement is expected, and no requirements are defined.

8.5.6 Requirements for CSI-RS based candidate beam detection

8.5.6.1 Introduction

The requirements in this clause apply for each CSI-RS resource in the set \bar{q}_1 configured for a serving cell, provided that the CSI-RS resources configured for candidate beam detection are actually transmitted within UE active DL BWP during the entire evaluation period specified in clause 8.5.6.2.

8.5.6.2 Minimum requirement

Upon request the UE shall be able to evaluate whether the L1-RSRP measured on the configured CSI-RS resource in set \bar{q}_1 estimated over the last $T_{\text{Evaluate_CBD_CSI-RS}}$ [ms] period becomes better than the threshold $Q_{\text{in_LR}}$ within $T_{\text{Evaluate_CBD_CSI-RS}}$ [ms] period provided CSI-RS \hat{E}_s/I_{ot} is according to Annex Table B.2.4.2 for a corresponding band.

The UE shall monitor the configured CSI-RS resources using the evaluation period in table 8.5.6.2-1 and 8.5.6.2-2 corresponding to the non-DRX mode, if the configured DRX cycle ≤ 320 ms.

The value of $T_{\text{Evaluate_CBD_CSI-RS}}$ is defined in Table 8.5.6.2-1 for FR1.

The value of $T_{\text{Evaluate_CBD_CSI-RS}}$ is defined in Table 8.5.6.2-2 for FR2 with scaling factor $N=8$.

For FR1,

- $P = \frac{1}{1 - \frac{T_{\text{CSI-RS}}}{MGRP}}$, when in the monitored cell there are measurement gaps configured for intra-frequency, inter-frequency or inter-RAT measurements, which are overlapping with some but not all occasions of the CSI-RS; and
- $P = 1$ when in the monitored cell there are no measurement gaps overlapping with any occasion of the CSI-RS.

For FR2,

- $P = 1$, when candidate beam detection RS is not overlapped with measurement gap and also not overlapped with SMTC occasion.
- $P = \frac{1}{1 - \frac{T_{\text{CSI-RS}}}{MGRP}}$, when candidate beam detection RS is partially overlapped with measurement gap and candidate beam detection RS is not overlapped with SMTC occasion ($T_{\text{CSI-RS}} < MGRP$)
- $P = \frac{1}{1 - \frac{T_{\text{CSI-RS}}}{T_{\text{SMTCperiod}}}}$, when candidate beam detection RS is not overlapped with measurement gap and candidate beam detection RS is partially overlapped with SMTC occasion ($T_{\text{CSI-RS}} < T_{\text{SMTCperiod}}$).
- $P = P_{\text{sharing factor}}$, when candidate beam detection RS is not overlapped with measurement gap and candidate beam detection RS is fully overlapped with SMTC occasion ($T_{\text{CSI-RS}} = T_{\text{SMTCperiod}}$).
- $P = \frac{1}{1 - \frac{T_{\text{CSI-RS}}}{MGRP} - \frac{T_{\text{CSI-RS}}}{T_{\text{SMTCperiod}}}}$, when candidate beam detection RS is partially overlapped with measurement gap and candidate beam detection RS is partially overlapped with SMTC occasion ($T_{\text{CSI-RS}} < T_{\text{SMTCperiod}}$) and SMTC occasion is not overlapped with measurement gap and
 - $T_{\text{SMTCperiod}} \neq MGRP$ or
 - $T_{\text{SMTCperiod}} = MGRP$ and $T_{\text{CSI-RS}} < 0.5 \times T_{\text{SMTCperiod}}$
- $P = \frac{P_{\text{sharing factor}}}{1 - \frac{T_{\text{CSI-RS}}}{MGRP}}$, when candidate beam detection RS is partially overlapped with measurement gap and candidate beam detection RS is partially overlapped with SMTC occasion ($T_{\text{CSI-RS}} < T_{\text{SMTCperiod}}$) and SMTC occasion is not overlapped with measurement gap and $T_{\text{SMTCperiod}} = MGRP$ and $T_{\text{CSI-RS}} = 0.5 \times T_{\text{SMTCperiod}}$

- $P = \frac{1}{1 - \frac{T_{\text{CSI-RS}}}{\text{Min}(M_{\text{GRP}}, T_{\text{SMTCperiod}})}}$, when candidate beam detection RS is partially overlapped with measurement gap and candidate beam detection RS is partially overlapped with SMTC occasion ($T_{\text{CSI-RS}} < T_{\text{SMTCperiod}}$) and SMTC occasion is partially or fully overlapped with measurement gap
- $P = \frac{3}{1 - \frac{T_{\text{CSI-RS}}}{M_{\text{GRP}}}}$, when candidate beam detection RS is partially overlapped with measurement gap and candidate beam detection RS is fully overlapped with SMTC occasion ($T_{\text{CSI-RS}} = T_{\text{SMTCperiod}}$) and SMTC occasion is partially overlapped with measurement gap ($T_{\text{SMTCperiod}} < M_{\text{GRP}}$)
- $P_{\text{sharing factor}} = 1$, if the candidate beam detection RS outside measurement gap is
 - not overlapped with the SSB symbols indicated by *SSB-ToMeasure* and 1 data symbol before each consecutive SSB symbols indicated by *SSB-ToMeasure* and 1 data symbol after each consecutive SSB symbols indicated by *SSB-ToMeasure*, given that *SSB-ToMeasure* is configured, where the *SSB-ToMeasure* is the union set of *SSB-ToMeasure* from all the configured measurement objects merged on the same serving carrier, and;
 - not overlapped with the RSSI symbols indicated by *ss-RSSI-Measurement* and 1 data symbol before each RSSI symbol indicated by *ss-RSSI-Measurement* and 1 data symbol after each RSSI symbol indicated by *ss-RSSI-Measurement*, given that *ss-RSSI-Measurement* is configured.
- $P_{\text{sharing factor}} = 3$, otherwise.

where,

If the high layer in TS 38.331 [2] signaling of *smtc2* is present, $T_{\text{SMTCperiod}}$ follows *smtc2*; Otherwise $T_{\text{SMTCperiod}}$ follows *smtc1*. $T_{\text{SMTCperiod}}$ is the shortest SMTC period among all CCs in the same FR2 band, provided the SMTC offset of all CCs in FR2 have the same offset.

Note: The overlap between CSI-RS for CBD and SMTC means that CSI-RS for CBD is within the SMTC window duration.

Longer evaluation period would be expected if the combination of the CBD-RS resource, SMTC occasion and measurement gap configurations does not meet previous conditions.

Longer evaluation period would be expected if the CSI-RS is on the same OFDM symbols with RLM, BFD, BM-RS, or other CBD-RS, according to the measurement restrictions defined in clause 8.5.6.3.

The values of M_{CBD} used in Table 8.5.6.2-1 and Table 8.5.6.2-2 are defined as

- $M_{\text{CBD}} = 3$, if the CSI-RS resource configured in the set \bar{q}_1 is transmitted with Density = 3 and over the bandwidth ≥ 24 PRBs.

Table 8.5.6.2-1: Evaluation period $T_{\text{Evaluate_CBD_CSI-RS}}$ for FR1

Configuration	$T_{\text{EvaluateC_CBD_CSI-RS}}$ (ms)
non-DRX, DRX cycle $\leq 320\text{ms}$	$\text{Max}(25, \text{Ceil}(M_{\text{CBD}} \times P) \times T_{\text{CSI-RS}})$
DRX cycle $> 320\text{ms}$	$\text{Ceil}(M_{\text{CBD}} \times P) \times T_{\text{DRX}}$
Note:	$T_{\text{CSI-RS}}$ is the periodicity of CSI-RS resource in the set \bar{q}_1 . T_{DRX} is the DRX cycle length.

Table 8.5.6.2-2: Evaluation period $T_{\text{Evaluate_CBD_CSI-RS}}$ for FR2

Configuration	$T_{\text{Evaluate_CBD_CSI-RS}}$ (ms)
non-DRX, DRX cycle $\leq 320\text{ms}$	$\text{Max}(25, \text{Ceil}(M_{\text{CBD}} \times P \times N) \times T_{\text{CSI-RS}})$
DRX cycle $> 320\text{ms}$	$\text{Ceil}(M_{\text{CBD}} \times P \times N) \times T_{\text{DRX}}$
Note:	$T_{\text{CSI-RS}}$ is the periodicity of CSI-RS resource in the set \bar{q}_1 . T_{DRX} is the DRX cycle length.

8.5.6.3 Measurement restriction for CSI-RS based candidate beam detection

For both FR1 and FR2, when the CSI-RS for CBD measurement is in the same OFDM symbol as SSB for RLM, BFD, CBD or L1-RSRP measurement, UE is not required to receive CSI-RS for CBD measurement in the PRBs that overlap with an SSB.

For FR1, when the SSB for RLM, BFD, CBD or L1-RSRP measurement is within the active BWP and has same SCS than CSI-RS for CBD measurement, the UE shall be able to perform CSI-RS based CBD measurement without restrictions.

For FR1, when the SSB for RLM, BFD, CBD or L1-RSRP measurement is within the active BWP and has different SCS than CSI-RS for CBD measurement, the UE shall be able to perform CSI-RS based CBD measurement with restrictions according to its capabilities:

- If the UE supports *simultaneousRxDataSSB-DiffNumerology* the UE shall be able to perform CSI-RS based CBD measurement for without restrictions.
- If the UE does not support *simultaneousRxDataSSB-DiffNumerology*, UE is required to measure one of but not both CSI-RS for CBD measurement and SSB. Longer measurement period for CSI-RS based CBD measurement is expected, and no requirements are defined.

For FR1, when the CSI-RS for CBD measurement is in the same OFDM symbol as another CSI-RS for RLM, BFD, CBD or L1-RSRP measurement, UE shall be able to measure the CSI-RS for CBD measurement without any restriction.

For FR2, when the CSI-RS for CBD measurement on one CC is in the same OFDM symbol as SSB for RLM, BFD, CBD or L1-RSRP measurement on the same CC or different CCs in the same band, UE is required to measure one of but not both CSI-RS for CBD measurement and SSB. Longer evaluation period for CSI-RS based CBD measurement is expected, and no requirements are defined.

For FR2, when the CSI-RS for CBD measurement on one CC is in the same OFDM symbol as another CSI-RS for RLM, BFD, CBD or L1-RSRP measurement on the same CC or different CCs in the same band, UE is required to measure one of but not both CSI-RS for CBD measurement and the other CSI-RS. Longer evaluation period for CSI-RS based CBD measurement is expected, and no requirements are defined.

8.5.7 Scheduling availability of UE during beam failure detection

Scheduling availability restrictions when the UE is performing beam failure detection are described in the following clauses.

8.5.7.1 Scheduling availability of UE performing beam failure detection with a same subcarrier spacing as PDSCH/PDCCH on FR1

There are no scheduling restrictions due to beam failure detection performed on SSB and CSI-RS configured for BFD with the same SCS as PDSCH or PDCCH in FR1.

8.5.7.2 Scheduling availability of UE performing beam failure detection with a different subcarrier spacing than PDSCH/PDCCH on FR1

For UEs which support *simultaneousRxDataSSB-DiffNumerology* [14] there are no restrictions on scheduling availability due to beam failure detection when SSB is configured as BFD. For UEs which do not support *simultaneousRxDataSSB-DiffNumerology* [14] the following restrictions apply due to beam failure detection when SSB is configured as BFD.

- The UE is not expected to transmit PUCCH, PUSCH or SRS or receive PDCCH, PDSCH or CSI-RS for tracking or CSI-RS for CQI on SSB symbols to be measured for beam failure detection.

When intra-band carrier aggregation in FR1 is configured, the scheduling restrictions on FR1 serving PCell or PSCell apply to all serving cells in the same band on the symbols that fully or partially overlap with restricted symbols. When inter-band carrier aggregation within FR1 is configured, there are no scheduling restrictions on FR1 serving cell(s) configured in other bands than the bands in which PCell or PSCell is configured.

8.5.7.3 Scheduling availability of UE performing beam failure detection on FR2

The following scheduling restriction applies due to beam failure detection.

- For the case where no RSs are provided for BFD, or when CSI-RS is configured for BFD is explicitly configured and is type-D QCLed with active TCI state for PDCCH or PDSCH, and the CSI-RS is not in a CSI-RS resource set with repetition ON
 - There are no scheduling restrictions due to beam failure detection performed based on the CSI-RS.
- Otherwise
 - The UE is not expected to transmit PUCCH, PUSCH or SRS or receive PDCCH, PDSCH or CSI-RS for tracking or CSI-RS for CQI on BFD-RS resource symbols to be measured for beam failure detection.

When intra-band carrier aggregation in FR2 is performed, the scheduling restrictions on FR2 serving PCell or PSCell apply to all serving cells in the same band on the symbols that fully or partially overlap with restricted symbols.

For FR2, if following conditions are met,

- UE has been notified about system information update through paging,
- The gap between UE's reception of PDCCH that UE monitors in the Type2-PDCCH CSS set and that notifies system information update, and the PDCCH that UE monitors in the Type0-PDCCH CSS set, is greater than 2 slots,

For the SSB and CORESET for RMSI scheduling multiplexing patterns 3, UE is expected to receive the PDCCH that UE monitors in the Type0-PDCCH CSS set, and the corresponding PDSCH, on SSB symbols to be measured for BFD measurement; and

For the SSB and CORESET for RMSI scheduling multiplexing patterns 2, UE is expected to receive PDSCH that corresponds to the PDCCH that UE monitors in the Type0-PDCCH CSS set, on SSB symbols to be measured for BFD measurement.

8.5.7.4 Scheduling availability of UE performing beam failure detection on FR1 or FR2 in case of FR1-FR2 inter-band CA and NR DC

There are no scheduling restrictions on FR1 serving cell(s) due to beam failure detection performed on FR2 serving PCell and/or PSCell.

There are no scheduling restrictions on FR2 serving cell(s) due to beam failure detection performed on FR1 serving PCell and/or PSCell.

NR-DC in Rel-15 only includes the scenarios where all serving cells in MCG are in FR1 and all serving cells in SCG are in FR2.

8.5.8 Scheduling availability of UE during candidate beam detection

Scheduling availability restrictions when the UE is performing L1-RSRP measurement for candidate beam detection are described in the following clauses.

8.5.8.1 Scheduling availability of UE performing L1-RSRP measurement with a same subcarrier spacing as PDSCH/PDCCH on FR1

There are no scheduling restrictions due to L1-RSRP measurement performed on SSB and CSI-RS configured as link recovery detection resource with the same SCS as PDSCH or PDCCH in FR1.

8.5.8.2 Scheduling availability of UE performing L1-RSRP measurement with a different subcarrier spacing than PDSCH/PDCCH on FR1

For UEs which support *simultaneousRxDataSSB-DiffNumerology* [14] there are no restrictions on scheduling availability due to L1-RSRP measurement based on SSB as link recovery detection resource. For UEs which do not

support *simultaneousRxDataSSB-DiffNumerology* [14] the following restrictions apply due to L1-RSRP measurement based on SSB configured as link recovery detection resource.

- The UE is not expected to transmit PUCCH, PUSCH or SRS or receive PDCCH, PDSCH, TRS, CSI-RS for tracking or CSI-RS for CQI on SSB symbols to be measured for L1-RSRP.

When intra-band carrier aggregation in FR1 is configured, the scheduling restrictions on one serving cell apply to all other serving cells in the same band on the symbols that fully or partially overlap with the restricted symbols. When inter-band carrier aggregation within FR1 is configured, there are no scheduling restrictions on FR1 serving cell(s) configured in other bands.

8.5.8.3 Scheduling availability of UE performing L1-RSRP measurement on FR2

The following scheduling restriction applies due to candidate beam detection

- The UE is not expected to transmit PUCCH, PUSCH or SRS or receive PDCCH, PDSCH, CSI-RS for tracking or CSI-RS for CQI on reference symbols to be measured for candidate beam detection.

When intra-band carrier aggregation in FR2 is configured, the scheduling restrictions on to one serving cell apply to all serving cells in the same band on the symbols that fully or partially overlap with restricted symbols.

For FR2, if following conditions are met,

- UE has been notified about system information update through paging,
- The gap between UE's reception of PDCCH that UE monitors in the Type2-PDCCH CSS set and that notifies system information update, and the PDCCH that UE monitors in the Type0-PDCCH CSS set, is greater than 2 slots,

For the SSB and CORESET for RMSI scheduling multiplexing patterns 3, UE is expected to receive the PDCCH that UE monitors in the Type0-PDCCH CSS set, and the corresponding PDSCH, on SSB symbols to be measured for CBD measurement; and

For the SSB and CORESET for RMSI scheduling multiplexing patterns 2, UE is expected to receive PDSCH that corresponds to the PDCCH that UE monitors in the Type0-PDCCH CSS set, on SSB symbols to be measured for CBD measurement.

8.5.8.4 Scheduling availability of UE performing L1-RSRP measurement on FR1 or FR2 in case of FR1-FR2 inter-band CA and NR-DC

There are no scheduling restrictions on FR1 serving cell(s) due to L1-RSRP measurement performed on FR2 serving cell(s).

There are no scheduling restrictions on FR2 serving cell(s) due to L1-RSRP measurement performed on FR1 serving cell(s).

NR-DC in Rel-15 only includes the scenarios where all serving cells in MCG are in FR1 and all serving cells in SCG are in FR2.

8.5.9 Minimum requirement at transitions for beam failure detection

When the UE transitions between DRX and no DRX or when DRX cycle periodicity changes, for each BFD-RS resource, for a duration of time equal to the evaluation period corresponding to the second mode after the transition occurs, the UE shall use an evaluation period that is no less than the minimum of evaluation period corresponding to the first mode and the second mode. Subsequent to this duration, the UE shall use an evaluation period corresponding to the second mode for each BFD-RS resource.

When the UE transitions from a first configuration of BFD resources to a second configuration of BFD resources that is different from the first configuration, for each BFD resource present in the second configuration, for a duration of time equal to the evaluation period corresponding to the second configuration after the transition occurs, the UE shall use an evaluation period that is no less than the minimum of evaluation periods corresponding to the first configuration and the second configuration. Subsequent to this duration, the UE shall use an evaluation period corresponding to the second configuration for each BFD resource present in the second configuration.

When the UE transitions from a first configuration of active TCI state of the CORESET to a second configuration of active TCI state of the CORESET, for each CSI-RS for BFD present in the second configuration, the UE shall use an evaluation period corresponding to the second configuration from the time of transition.

8.6 Active BWP switch delay

8.6.1 Introduction

The requirements in this clause apply for a UE configured PCell or any activated SCell in standalone NR or NE-DC, PCell, PSCell or any activated SCell in MCG or SCG in NR-DC, or PSCell or any activated SCell in SCG in EN-DC. UE shall complete the switch of active DL and/or UL BWP within the delay defined in this clause.

8.6.2 DCI and timer based BWP switch delay

The requirements in this clause only apply to the case that the BWP switch is performed on a single CC with more than one BWP configurations configured.

For DCI based BWP switch, if the serving cell where UE receives DCI for BWP switch request is different from the serving cell on which BWP switch occurs, the UE is not required to follow the requirements specified in this clause.

For DCI-based BWP switch, after the UE receives BWP switching request at DL slot n on a serving cell, UE shall be able to receive PDSCH (for DL active BWP switch) or transmit PUSCH (for UL active BWP switch) on the new BWP on the serving cell on which BWP switch on the first DL or UL slot occurs right after a time duration of $T_{\text{BWPswitchDelay}}$ which starts from the beginning of DL slot n .

The UE is not required to transmit UL signals or receive DL signals until the first DL or UL slot occurs right after a time duration of $T_{\text{BWPswitchDelay}}$ which starts from the beginning of DL slot n except DCI triggering BWP switch on the cell where DCI-based BWP switch occurs. The UE is not required to follow the requirements defined in this clause when performing a DCI-based BWP switch between the BWPs in disjoint channel bandwidths or in partially overlapping channel bandwidths.

For timer-based BWP switch, the UE shall start BWP switch at DL slot n , where slot n is the first slot of a DL subframe (FR1) or DL half-subframe (FR2) immediately after a BWP-inactivity timer *bwp-InactivityTimer* [2] expires on a serving cell, and the UE shall be able to receive PDSCH (for DL active BWP switch) or transmit PUSCH (for UL active BWP switch) on the new BWP on the serving cell on which BWP switch on the first DL or UL slot occurs right after a time duration of $T_{\text{BWPswitchDelay}}$ which starts from the beginning of DL slot n .

The UE is not required to transmit UL signals or receive DL signals during time duration $T_{\text{BWPswitchDelay}}$ after *bwp-InactivityTimer* [2] expires on the cell where timer-based BWP switch occurs.

Depending on UE capability *bwp-SwitchingDelay* [2], UE shall finish BWP switch within the time duration $T_{\text{BWPswitchDelay}}$ defined in Table 8.6.2-1.

Table 8.6.2-1: BWP switch delay

μ	NR Slot length (ms)	BWP switch delay $T_{\text{BWPswitchDelay}}$ (slots)	
		Type 1 ^{Note 1}	Type 2 ^{Note 1}
0	1	1	3
1	0.5	2	5
2	0.25	3	9
3	0.125	6	18

Note 1: Depends on UE capability.
Note 2: If the BWP switch involves changing of SCS, the BWP switch delay is determined by the smaller SCS between the SCS before BWP switch and the SCS after BWP switch.

Provided the UE does not have the required TCI-state information to receive PDCCH and PDSCH in the new BWP, the UE shall use old TCI-states before the BWP switch until a new MAC CE updating the required TCI-state information for PDCCH and PDSCH is received after the BWP switch.

If UE has the information on the required TCI-state information to receive PDCCH and PDSCH in the new BWP,

- UE shall be able to receive PDCCH and PDSCH with old TCI-states before the delay as specified in Clause 8.10 in the new BWP.
- UE shall be able to receive PDCCH and PDSCH with new TCI-states after the delay as specified in Clause 8.10 in the new BWP

8.6.3 RRC based BWP switch delay

The requirements in this clause only apply to the case that the BWP switch is performed on a single CC with one or more than one BWP configuration(s) configured, with

- Active BWP switch or parameter change of its active BWPs for SpCell
- Parameter change of its active BWPs except parameter *firstActiveDownlinkBWP-Id* and *firstActiveUplinkBWP-Id* for SCell

For RRC-based BWP switch, after the UE receives RRC reconfiguration involving active BWP switching or parameter change of its active BWP, UE shall be able to receive PDSCH/PDCCH (for DL active BWP switch) or transmit PUSCH (for UL active BWP switch) on the new BWP on the serving cell on which BWP switch occurs on the first DL or UL slot right after a time duration of $\frac{T_{RRCprocessingDelay} + T_{BWPswitchDelayRRC}}{NR\ Slot\ length}$ slots which begins from the beginning of DL slot *n*, where

DL slot *n* is the last slot overlapping with the PDSCH containing the RRC command, and

NR Slot length is determined by the smaller SCS between the SCS before BWP switch and the SCS after BWP switch if the BWP switch involves changing of SCS.

$T_{RRCprocessingDelay}$ is the length of the RRC procedure delay in ms as defined in clause 11.2 in TS 36.331 [16] if the corresponding RRC message is embedded in E-UTRA RRC message, otherwise it is the length of the RRC procedure delay in ms as defined in clause 12 in TS 38.331 [2], and

$T_{BWPswitchDelayRRC} = 6ms$ is the time used by the UE to perform BWP switch.

The UE is not required to transmit UL signals or receive DL signals during the time defined by $T_{RRCprocessingDelay} + T_{BWPswitchDelayRRC}$ on the cell where RRC-based BWP switch occurs. When $T_{HARQ} > T_{RRCprocessingDelay}$ a longer switching delay is allowed. Where T_{HARQ} is the time between DL data transmission and acknowledgement as specified in TS 38.213 [3].

8.7 Void

8.8 NE-DC: E-UTRAN PSCell Addition and Release Delay

8.8.1 Introduction

This clause defines requirements for the delay within which the UE shall be able to configure an E-UTRAN PSCell in NR - E-UTRA dual connectivity. The requirements are applicable to an NR - E-UTRA dual connectivity capable UE.

8.8.2 E-UTRAN PSCell Addition Delay Requirement

The requirements in this clause shall apply for the UE, which is configured with PCell, and may also be configured with one or more SCells.

Upon receiving E-UTRAN PSCell addition in subframe n , the UE shall be capable to transmit PRACH preamble towards E-UTRAN PSCell no later than in subframe $n + T_{\text{config_E-UTRAN-PSCell}}$:

Where:

$$T_{\text{config_E-UTRAN-PSCell}} = T_{\text{RRC_delay}} + T_{\text{activation_time}} + 50\text{ms} + T_{\text{E-UTRAN-PSCell_DU}}$$

$T_{\text{RRC_delay}}$ is the RRC procedure delay as specified in TS 38.331 [2].

$T_{\text{activation_time}}$ is the E-UTRAN PSCell activation delay. If the E-UTRAN PSCell is known, then $T_{\text{activation_time}}$ is 20ms. If the E-UTRAN PSCell is unknown, then $T_{\text{activation_time}}$ is 30ms provided the E-UTRAN PSCell can be successfully detected on the first attempt.

$T_{\text{E-UTRAN-PSCell_DU}}$ is the delay uncertainty in acquiring the first available PRACH occasion in the E-UTRAN PSCell. $T_{\text{E-UTRAN-PSCell_DU}}$ is up to 30ms.

E-UTRAN PSCell is known if it has been meeting the following conditions:

- During the last 5 seconds before the reception of the E-UTRAN PSCell configuration command:
 - the UE has sent a valid measurement report for the E-UTRAN PSCell being configured and
 - the E-UTRAN PSCell being configured remains detectable according to the cell identification conditions specified in clause 8.8 of TS 36.133 [15],
- E-UTRAN PSCell being configured also remains detectable during the E-UTRAN PSCell configuration delay $T_{\text{config_E-UTRAN-PSCell}}$ according to the cell identification conditions specified in clause 8.8 of TS 36.133 [15].

otherwise it is unknown.

The PCell interruption specified in clause 8.2 is allowed only during the RRC reconfiguration procedure [2].

8.8.3 E-UTRAN PSCell Release Delay Requirement

The requirements in this clause shall apply for a UE which is configured with PCell and E-UTRAN PSCell and may also be configured with one or more SCells and/or E-UTRAN SCells.

Upon receiving E-UTRAN PSCell release in subframe n , the UE shall accomplish the release actions specified in TS 38.331 [2] no later than in subframe $n + T_{\text{RRC_delay}}$:

Where

$T_{\text{RRC_delay}}$ is the RRC procedure delay as specified in TS 38.331 [2].

The PCell interruption specified in clause 8.2 is allowed only during the RRC reconfiguration procedure [2].

8.9 NR-DC: PSCell Addition and Release Delay

8.9.1 Introduction

This clause defines requirements for the delay within which the UE shall be able to configure an PSCell in NR dual connectivity. The requirements are applicable to an NR dual connectivity capable UE.

8.9.2 PSCell Addition Delay Requirement

The requirements in this clause shall apply for the UE configured with only PCell in FR1.

Upon receiving PSCell addition in subframe n , the UE shall be capable to transmit PRACH preamble towards PSCell in FR2 no later than in slot $n + \frac{T_{\text{config_PSCell}}}{\text{NR slot length}}$.

where:

$$T_{\text{config_PSCell}} = T_{\text{RRC_delay}} + T_{\text{processing}} + T_{\text{search}} + T_{\Delta} + T_{\text{PSCell_DU}} + 2 \text{ ms}$$

$T_{\text{RRC_delay}}$ is the RRC procedure delay as specified in TS 38.331 [2].

$T_{\text{processing}}$ is the SW processing time needed by UE, including RF warm up period. $T_{\text{processing}} = 40 \text{ ms}$.

T_{search} is the time for AGC settling and PSS/SSS detection. If the target cell is known, $T_{\text{search}} = 0 \text{ ms}$. If the target cell is unknown and the target cell $\hat{E}_s/I_{ot} \geq -2\text{dB}$, $T_{\text{search}} = 24 * T_{\text{rs}} \text{ ms}$.

T_{Δ} is time for fine time tracking and acquiring full timing information of the target cell. $T_{\Delta} = 1 * T_{\text{rs}} \text{ ms}$ for a known or unknown PSCell.

$T_{\text{PSCell_DU}}$ is the delay uncertainty in acquiring the first available PRACH occasion in the PSCell. $T_{\text{PSCell_DU}}$ is up to the summation of SSB to PRACH occasion association period and 10 ms. SSB to PRACH occasion associated period is defined in Table 8.1-1 of TS 38.213 [3].

T_{rs} is the SMTC periodicity of the target cell if the UE has been provided with an SMTC configuration for the target cell in PSCell addition message, otherwise T_{rs} is the SMTC configured in the measObjectNR having the same SSB frequency and subcarrier spacing. If the UE is not provided SMTC configuration or measurement object on this frequency, the requirement in this clause is applied with $T_{\text{rs}} = 5 \text{ ms}$ assuming the SSB transmission periodicity is 5 ms. There is no requirement if the SSB transmission periodicity is not 5 ms.

In FR1 and FR2, the PSCell is known if it has been meeting the following conditions:

During the last 5 seconds before the reception of the PSCell configuration command:

- the UE has sent a valid measurement report for the PSCell being configured and
- One of the SSBs measured from the PSCell being configured remains detectable according to the cell identification conditions specified in clause 9.3.
- One of the SSBs measured from PSCell being configured also remains detectable during the PSCell configuration delay $T_{\text{config_PSCell}}$ according to the cell identification conditions specified in clause 9.3.

otherwise it is unknown.

The PCell interruption specified in clause 8.2 is allowed only during the RRC reconfiguration procedure [2].

8.9.3 PSCell Release Delay Requirement

The requirements in this clause shall apply for a UE which is configured with PCell and one PSCell.

Upon receiving PSCell release in subframe n , the UE shall accomplish the release actions specified in TS 38.331 [2] no later than in slot $n + \frac{T_{\text{RRC_delay}}}{NR \text{ slot length}}$.

where

$T_{\text{RRC_delay}}$ is the RRC procedure delay as specified in TS 38.331 [2].

The PCell interruption specified in clause 8.2 is allowed only during the RRC reconfiguration procedure [2].

8.10 Active TCI state switching delay

8.10.1 Introduction

The requirements in this clause apply for a UE configured with one or more TCI state configurations on serving cell in MR-DC or standalone NR. UE shall complete the switch of active TCI state within the delay defined in this clause.

8.10.2 Known conditions for TCI state

The TCI state is known if the following conditions are met:

- During the period from the last transmission of the RS resource used for the L1-RSRP measurement reporting for the target TCI state to the completion of active TCI state switch, where the RS resource for L1-RSRP measurement is the RS in target TCI state or QCLed to the target TCI state
 - TCI state switch command is received within 1280 ms upon the last transmission of the RS resource for beam reporting or measurement
 - The UE has sent at least 1 L1-RSRP report for the target TCI state before the TCI state switch command
 - The TCI state remain detectable during the TCI state switching period
 - The SSB associated with the TCI state remain detectable during the TCI switching period
 - SNR of the TCI state $\geq -3\text{dB}$

Otherwise, the TCI state is unknown.

8.10.3 MAC-CE based TCI state switch delay

If the target TCI state is known, upon receiving PDSCH carrying MAC-CE for indication of UE-specific PDCCH TCI state as defined in clause 6.1.3.15 of TS 38.321 [7] in slot n , UE shall be able to receive PDCCH with target TCI state of the serving cell on which TCI state switch occurs at the first slot that is after slot $n + T_{\text{HARQ}} + 3N_{\text{slot}}^{\text{subframe},\mu} + T_{\text{Ok}} \cdot (T_{\text{first-SSB}} + T_{\text{SSB-proc}}) / NR \text{ slot length}$. The UE shall be able to receive PDCCH with the old TCI state until slot $n + T_{\text{HARQ}} + 3N_{\text{slot}}^{\text{subframe},\mu}$.

Where T_{HARQ} is the timing between DL data transmission and acknowledgement as specified in TS 38.213 [3];

$T_{\text{first-SSB}}$ is time to first SSB transmission after MAC CE command is decoded by the UE;

$T_{\text{SSB-proc}} = 2 \text{ ms}$;

$T_{\text{Ok}} = 1$ if target TCI state is not in the active TCI state list for PDSCH, 0 otherwise.

If the target TCI state is unknown, upon receiving PDSCH carrying MAC-CE for indication of UE-specific PDCCH TCI state as defined in clause 6.1.3.15 of TS 38.321 [7] in slot n , UE shall be able to receive PDCCH with target TCI state of the serving cell on which TCI state switch occurs at the first slot that is after slot $n + T_{\text{HARQ}} + 3N_{\text{slot}}^{\text{subframe},\mu} + T_{\text{L1-RSRP}} + T_{\text{Ok}} \cdot (T_{\text{first-SSB}} + T_{\text{SSB-proc}}) / NR \text{ slot length}$. The UE shall be able to receive PDCCH with the old TCI state until slot $n + T_{\text{HARQ}} + 3N_{\text{slot}}^{\text{subframe},\mu}$.

Where

$T_{\text{L1-RSRP}} = 0$ in FR1 or when the TCI state switching not involving QCL-TypeD in FR2. Otherwise,

$T_{\text{L1-RSRP}}$ is the time for Rx beam refinement in FR2, defined as

- $T_{\text{L1-RSRP_Measurement_Period_SSB}}$ for SSB as specified in clause 9.5.4.1,
 - with the assumption of $M=1$
 - with $T_{\text{Report}} = 0$
- $T_{\text{L1-RSRP_Measurement_Period_CSI-RS}}$ for CSI-RS as specified in clause 9.5.4.2
 - configured with higher layer parameter *repetition* set to ON
 - with the assumption of $M=1$ for periodic CSI-RS
 - for aperiodic CSI-RS if number of resources in resource set at least equal to *MaxNumberRxBeam*
 - with $T_{\text{Report}} = 0$
- $T_{\text{Ok}} = 1$ for CSI-RS based L1-RSRP measurement, and 0 for SSB based L1-RSRP measurement when TCI state switching involves QCL-TypeD
- $T_{\text{Ok}} = 1$ when TCI state switching involves other QCL types only

- $T_{\text{first-SSB}}$ is time to first SSB transmission after L1-RSRP measurement when TCI state switching involves QCL-TypeD;
- $T_{\text{first-SSB}}$ is time to first SSB transmission after MAC CE command is decoded by the UE for other QCL types;
 - The SSB shall be the QCL-TypeA or QCL-TypeC to target TCI state

8.10.4 DCI based TCI state switch delay

If the target TCI state is known, when a UE is configured with the higher layer parameter *tcj-PresentInDCI* which is set as 'enabled' for the CORESET scheduling PDSCH at slot n , UE shall be able to receive PDSCH with target TCI state of the serving cell on which TCI state switch occurs at the first slot that is after slot $n + \text{timeDurationForQCL}$, where, *timeDurationForQCL* is the time required by the UE to perform PDCCH reception and applying spatial QCL information received in DCI for PDSCH processing as described in TS 38.214 [26], the value of *timeDurationForQCL* is defined in TS 38.331 [2].

The known condition for TCI state defined in clause 8.10.2 is applied.

8.10.5 RRC based TCI state switch delay

If the target TCI state is known, UE shall be able to receive PDCCH with target TCI state of the serving cell on which TCI state switch occurs at the first slot that is after slot $n + (T_{\text{RRC_processing}} + TO_k * (T_{\text{first-SSB}} + T_{\text{SSB-proc}})) / NR \text{ slot length}$, The UE is not required to receive PDCCH/PDSCH/CSI-RS or transmit PUCCH/PUSCH until the end of switching period.

Where

- Slot n is the last slot overlapping with the PDSCH carrying RRC activation command.
- $T_{\text{RRC_processing}}$ is the RRC processing delay defined in Clause 11.2 of TS 36.331 [16] if the corresponding RRC message is embedded in E-UTRA RRC message, otherwise it is the RRC processing delay defined in Clause 12 of TS 38.331 [2].
- $T_{\text{first-SSB}}$ is time to first SSB transmission after RRC processing by the UE; The SSB shall be the QCL-TypeA or QCL-TypeC to target TCI state.
- $T_{\text{SSB-proc}}$ and TO_k are defined in clause 8.10.3.

If the target TCI state is unknown, UE shall be able to receive PDCCH with target TCI state of the serving cell on which TCI state switch occurs at the first slot that is after slot $n + (T_{\text{RRC_processing}} + T_{\text{L1-RSRP}} + TO_{\text{uk}} * (T_{\text{first-SSB}} + T_{\text{SSB-proc}})) / NR \text{ slot length}$, The UE is not required to receive PDCCH/PDSCH/CSI-RS or transmit PUCCH/PUSCH until the end of switching period.

Where

- Slot n is the last slot overlapping with the PDSCH carrying RRC activation command.
- $T_{\text{RRC_processing}}$ is the RRC processing delay defined in Clause 11.2 of TS 36.331 [16] if the corresponding RRC message is embedded in E-UTRA RRC message, otherwise it is the RRC processing delay defined in Clause 12 of TS 38.331 [2].
- $T_{\text{first-SSB}}$ is time to first SSB transmission after L1-RSRP measurement when TCI state switching involves QCL-TypeD;
- $T_{\text{first-SSB}}$ is time to first SSB transmission after RRC processing time at the UE for other QCL types;
 - The SSB shall be the QCL-TypeA or QCL-TypeC to target TCI state
- $T_{\text{L1-RSRP}}$, TO_{uk} and $T_{\text{SSB-proc}}$ are defined in clause 8.10.3.

The requirements for RRC based TCI state switch delay apply when only 1 TCI state is configured in RRC TCI state list. When $T_{HARQ} > T_{RRC_processing}$ a longer switching delay is allowed. Where T_{HARQ} is the time between DL data transmission and acknowledgement as specified in TS 38.213 [3].

8.10.6 Active TCI state list update delay

If the target TCI state is known, upon receiving PDSCH carrying MAC-CE for activation/deactivation of UE-specific PDSCH TCI state as defined in clause 6.1.3.14 of TS 38.321 [7] at slot n , UE shall be able to receive PDSCH to schedule PDSCH with the new target TCI state at the first slot that is after $n + T_{HARQ} + 3N_{slot}^{subframe,\mu} + TO_k * (T_{first-SSB} + T_{SSB-proc}) / NR\ slot\ length$. Where T_{HARQ} , $T_{first-SSB}$, $T_{SSB-proc}$ and TO_k are defined in clause 8.10.3.

8.11 PSCell Change

This clause defines requirements for the delay within which the UE shall be able to change PSCell to other cell in EN-DC or NR-DC. The requirements in this clause are applicable to EN-DC and NR-DC.

The UE shall be capable of transmitting PRACH preamble towards the target PSCell no later than specified in clause 8.9.2 for the case of NR-DC and in TS 36.133 clause 7.31.2 for the case of EN-DC, where the following values for slot n , $T_{processing}$ and T_{RRC_delay} shall override the existing ones:

- Slot n is the last slot overlapping with the PDSCH containing PSCell change,
- $T_{processing} = 20$ ms when source and target cells are in the same FR,
- $T_{processing} = 40$ ms when source and target cells are in different FRs.
- T_{RRC_delay} is the RRC procedure delay as specified in TS 36.331 [16] if the corresponding RRC message is embedded in E-UTRA RRC message, otherwise it is the RRC procedure delay as specified in TS 38.331 [2].

If the SMTC periodicity of the target cell is not provided within the PSCell change message, and $measObjectNRs$ having the same SSB frequency and subcarrier spacing configured by MN and SN have different SMTC, T_{rs} is the periodicity of one of the SMTC which is up to UE implementation.

The target PSCell is known if it has been meeting the conditions in clause 8.9.2 for the case of NR-DC and in TS36.133 clause 7.31.2 for the case of EN-DC.

The interruption on PCell and other serving cells specified in TS36.133 clause 7.32.2.1 for EN-DC and in TS38.133 clause 8.2.4.2.1 for NR-DC is allowed only during the RRC reconfiguration procedure [2].

9 Measurement Procedure

9.1 General measurement requirement

9.1.1 Introduction

This clause contains general requirements on the UE regarding measurement reporting in RRC_CONNECTED state. The requirements are split in intra-frequency, inter-frequency, inter-RAT E-UTRAN FDD, inter-RAT E-UTRAN TDD, and L1-RSRP measurements requirements. These measurements may be used by the NG-RAN. The measurement quantities are defined in TS38.215 [4], the measurement model is defined in TS38.300 [10], TS37.340 [17] and measurement accuracies are specified in clause 10. Control of measurement reporting is specified in TS 38.331 [2].

In the requirements of clause 9, the exceptions for side conditions apply as follows:

- for the UE capable of CA but not configured with any SCell, the applicable exceptions for side conditions are specified in Annex B, clause B.3.2.1 for UE supporting CA in FR1, and clause B.3.2.3 for UE supporting CA in FR2, respectively;

- for the UE capable of CA and configured with at least one SCell, the applicable exceptions for side conditions are specified in Annex B, clause B.3.2.2 for UE configured with CA in FR1, and clause B.3.2.4 for UE supporting CA in FR2, respectively;
- for the UE capable of SUL but not configured with SUL, the applicable exceptions for side conditions are specified in Annex B, clause B.3.4.1 for UE supporting SUL in FR1;
- for the UE capable of SUL and configured with at least one SUL, the applicable exceptions for side conditions are specified in Annex B, clause B.3.4.2 for UE configured with SUL in FR1.

9.1.2 Measurement gap

If the UE requires measurement gaps to identify and measure intra-frequency cells and/or inter-frequency cells and/or inter-RAT E-UTRAN cells, and the UE does not support independent measurement gap patterns for different frequency ranges as specified in Table 5.1-1 in [18, 19, 20], in order for the requirements in the following clauses to apply the network must provide a single per-UE measurement gap pattern for concurrent monitoring of all frequency layers.

If the UE requires measurement gaps to identify and measure intra-frequency cells and/or inter-frequency cells and/or inter-RAT E-UTRAN cells, and the UE supports independent measurement gap patterns for different frequency ranges as specified in Table 5.1-1 in [18, 19, 20], in order for the requirements in the following clauses to apply the network must provide either per-FR measurement gap patterns for frequency range where UE requires per-FR measurement gap for concurrent monitoring of all frequency layers of each frequency range independently, or a single per-UE measurement gap pattern for concurrent monitoring of all frequency layers of all frequency ranges.

During the per-UE measurement gaps the UE:

- is not required to conduct reception/transmission from/to the corresponding E-UTRAN PCell, E-UTRAN SCell(s) and NR serving cells for E-UTRA-NR dual connectivity except the reception of signals used for RRM measurement(s) and the signals used for random access procedure according to TS38.321 [7].
- is not required to conduct reception/transmission from/to the corresponding NR serving cells for SA (with single carrier or CA configured) except the reception of signals used for RRM measurement(s) and the signals used for random access procedure according to TS38.321 [7].
- is not required to conduct reception/transmission from/to the corresponding PCell, SCell(s) and E-UTRAN serving cells for NR-E-UTRA dual connectivity except the reception of signals used for RRM measurement(s) and the signals used for random access procedure according to TS38.321 [7].
- is not required to conduct reception/transmission from/to the corresponding NR serving cells for NR-DC except the reception of signals used for RRM measurement(s) and the signals used for random access procedure according to TS38.321 [7].

During the per-FR measurement gaps the UE:

- is not required to conduct reception/transmission from/to the corresponding E-UTRAN PCell, E-UTRAN SCell(s) and NR serving cells in the corresponding frequency range for E-UTRA-NR dual connectivity except the reception of signals used for RRM measurement(s) and the signals used for random access procedure according to [7].
- is not required to conduct reception/transmission from/to the corresponding NR serving cells in the corresponding frequency range for SA (with single carrier or CA configured) except the reception of signals used for RRM measurement(s) and the signals used for random access procedure according to TS38.321 [7].
- is not required to conduct reception/transmission from/to the corresponding PCell, SCell(s) and E-UTRAN serving cells in the corresponding frequency range for NR-E-UTRA dual connectivity except the reception of signals used for RRM measurement(s) and the signals used for random access procedure according to TS38.321 [7].
- is not required to conduct reception/transmission from/to the corresponding NR serving cells in the corresponding frequency range for NR-DC except the reception of signals used for RRM measurement(s) and the signals used for random access procedure according to TS38.321 [7].

UEs shall support the measurement gap patterns listed in Table 9.1.2-1 based on the applicability specified in table 9.1.2-2 and 9.1.2-3. UE determines measurement gap timing based on gap offset configuration and measurement gap timing advance configuration provided by higher layer signalling as specified in TS 38.331 [2] and TS 36.331 [16].

Table 9.1.2-1: Gap Pattern Configurations

Gap Pattern Id	Measurement Gap Length (MGL, ms)	Measurement Gap Repetition Period (MGRP, ms)
0	6	40
1	6	80
2	3	40
3	3	80
4	6	20
5	6	160
6	4	20
7	4	40
8	4	80
9	4	160
10	3	20
11	3	160
12	5.5	20
13	5.5	40
14	5.5	80
15	5.5	160
16	3.5	20
17	3.5	40
18	3.5	80
19	3.5	160
20	1.5	20
21	1.5	40
22	1.5	80
23	1.5	160

Table 9.1.2-2: Applicability for Gap Pattern Configurations supported by the E-UTRA-NR dual connectivity UE or NR-E-UTRA dual connectivity UE

Measurement gap pattern configuration	Serving cell	Measurement Purpose	Applicable Gap Pattern Id
Per-UE measurement gap	E-UTRA + FR1, or E-UTRA + FR2, or E-UTRA + FR1 + FR2	non-NR RAT ^{Note1,2}	0,1,2,3
		FR1 and/or FR2	0-11
		non-NR RAT ^{Note1,2} and FR1 and/or FR2	0, 1, 2, 3, 4, 6, 7, 8,10
Per-FR measurement gap	E-UTRA and, FR1 if configured	non-NR RAT ^{Note1,2}	0,1,2,3
	FR2 if configured		No gap
	E-UTRA and, FR1 if configured	FR1 only	0-11
	FR2 if configured		No gap
	E-UTRA and, FR1 if configured	FR2 only	No gap
	FR2 if configured		12-23
	E-UTRA and, FR1 if configured	non-NR RAT ^{Note1,2} and FR1	0, 1, 2, 3, 4, 6, 7, 8,10
	FR2 if configured		No gap
	E-UTRA and, FR1 if configured	FR1 and FR2	0-11
	FR2 if configured		12-23
	E-UTRA and, FR1 if configured	non-NR RAT ^{Note1,2} and FR2	0, 1, 2, 3, 4, 6, 7, 8,10
FR2 if configured	12-23		

	E-UTRA and, FR1 if configured	non-NR RAT ^{Note1,2} and FR1 and FR2	0, 1, 2, 3, 4, 6, 7, 8,10
	FR2 if configured		12-23
Note:	In E-UTRA-NR dual connectivity mode, if GSM or UTRA TDD or UTRA FDD inter-RAT frequency layer is configured to be monitored, only measurement gap pattern #0 and #1 can be used for per-FR gap in E-UTRA and FR1 if configured, or for per-UE gap.		
NOTE 1:	In E-UTRA-NR dual connectivity mode, non-NR RAT includes E-UTRA, UTRA and/or GSM. In NR-E-UTRA dual connectivity mode, non-NR RAT means E-UTRA.		
NOTE 2:	Void		
NOTE 3:	When E-UTRA inter-frequency RSTD measurements are configured and the UE requires measurement gaps for performing such measurements, only Gap Pattern #0 can be used.		

In E-UTRA-NR dual connectivity mode,

- if per-UE measurement gap is configured with MG timing advance of T_{MG} ms, the measurement gap starts at time T_{MG} ms advanced to the end of the latest E-UTRA subframe occurring immediately before the configured measurement gap among MCG serving cells subframes.
- if per-FR measurement gap for FR1 is configured with MG timing advance of T_{MG} ms, the measurement gap for FR1 starts at time T_{MG} ms advanced to the end of the latest E-UTRA subframe occurring immediately before the configured measurement gap among MCG serving cells subframes.
- if per-FR measurement gap for FR2 is configured with MG timing advance of T_{MG} ms, the measurement gap for FR2 starts at time T_{MG} ms advanced to the end of the latest NR subframe occurring immediately before the configured measurement gap among SCG serving cells subframes in FR2.

In NR-E-UTRA dual connectivity mode,

- if per-UE measurement gap is configured with MG timing advance of T_{MG} ms, the measurement gap starts at time T_{MG} ms advanced to the end of the latest NR subframe occurring immediately before the configured measurement gap among MCG serving cells subframes.
- if per-FR measurement gap for FR1 is configured with MG timing advance of T_{MG} ms and UE has NR serving cell in FR1, the measurement gap for FR1 starts at time T_{MG} ms advanced to the end of the latest NR subframe occurring immediately before the configured measurement gap among MCG serving cells subframes in FR1.
- if per-FR measurement gap for FR1 is configured with MG timing advance of T_{MG} ms and UE doesn't have NR serving cell in FR1, the measurement gap for FR1 starts at time T_{MG} ms advanced to the end of the latest E-UTRA subframe occurring immediately before the configured measurement gap among SCG serving cells subframes.
- if per-FR measurement gap for FR2 is configured with MG timing advance of T_{MG} ms, the measurement gap for FR2 starts at time T_{MG} ms advanced to the end of the latest NR subframe occurring immediately before the configured measurement gap among MCG serving cells subframes in FR2.

In NR-NR dual connectivity mode,

- If per-UE measurement gap is configured with MG timing advance of T_{MG} ms, the measurement gap starts at time T_{MG} ms advanced to the end of the latest MCG subframe occurring immediately before the configured measurement gap among MCG serving cells subframes.
- If per-FR measurement gap for FR1 is configured with MG timing advance of T_{MG} ms, the measurement gap for FR1 starts at time T_{MG} ms advanced to the end of the latest MCG subframe occurring immediately before the configured measurement gap among MCG serving cells subframes.
- If per-FR measurement gap for FR2 is configured with MG timing advance of T_{MG} ms, the measurement gap for FR2 starts at time T_{MG} ms advanced to the end of the latest SCG subframe occurring immediately before the configured measurement gap among SCG serving cells subframes in FR2.

T_{MG} is the MG timing advance value provided in *mgta* according to TS38.331 [2].

In determining the measurement gap starting point, UE shall use the DL timing of the latest E-UTRA or NR subframe occurring immediately before the configured measurement gap among E-UTRA or NR serving cells.

NR-DC in Rel-15 only includes the scenarios where all serving cells in MCG in FR1 and all serving cells in SCG in FR2.

For per-FR measurement gap capable UE configured with E-UTRA-NR dual connectivity or NR-E-UTRA dual connectivity, when serving cells are in E-UTRA and FR1, measurement objects are in both E-UTRA/FR1 and FR2,

- If MN indicates UE that the measurement gap from MN applies to E-UTRA/FR1/FR2 serving cells, UE fulfils the per-UE measurement requirements for both E-UTRA/FR1 and FR2 measurement objects based on the measurement gap pattern configured by MN;
- If MN indicates UE that the measurement gap from MN applies to only LTE/FR1 serving cell(s),
 - UE fulfils the measurement requirements for FR1/LTE measurement objects based on the configured measurement gap pattern;
 - UE fulfils the requirements for FR2 measurement objects based on effective MGRP=20ms;

For per-FR measurement gap capable configured with E-UTRA-NR dual connectivity, NR-E-UTRA dual connectivity or NR-NR dual connectivity, when serving cells are in E-UTRA, FR1 and FR2, or in E-UTRA and FR2, or in FR1 and FR2, measurement objects are in both E-UTRA /FR1 and FR2,

- If MN indicates UE that the measurement gap from MN applies to E-UTRA/FR1/FR2 serving cells, UE fulfils the per-UE measurement requirements for both E-UTRA/FR1 and FR2 measurement objects based on the measurement gap pattern configured by MN.

Table 9.1.2-3: Applicability for Gap Pattern Configurations supported by the UE with NR standalone operation (with single carrier, NR CA and NR-DC configuration)

Measurement gap pattern configuration	Serving cell	Measurement Purpose ^{NOTE 2}	Applicable Gap Pattern Id	
Per-UE measurement gap	FR1 ^{NOTE5} , or FR1 + FR2	E-UTRA only ^{NOTE3}	0,1,2,3	
		FR1 and/or FR2	0-11	
		E-UTRAN and FR1 and/or FR2 ^{NOTE3}	0, 1, 2, 3, 4, 6, 7, 8,10	
	FR2 ^{NOTE5}	E-UTRA only ^{NOTE3}	0,1,2,3	
		FR1 only	0-11	
		FR1 and FR2	0-11	
		E-UTRAN and FR1 and/or FR2 ^{NOTE3}	0, 1, 2, 3, 4, 6, 7, 8,10	
		FR2 only	12-23	
	Per-FR measurement gap	FR1 if configured	E-UTRA only ^{NOTE3}	0,1,2,3
		FR2 if configured		No gap
FR1 if configured		FR1 only	0-11	
FR2 if configured			No gap	
FR1 if configured		FR2 only	No gap	
FR2 if configured			12-23	
FR1 if configured		E-UTRA and FR1 ^{NOTE3}	0, 1, 2, 3, 4, 6, 7, 8,10	
FR2 if configured			No gap	
FR1 if configured		FR1 and FR2	0-11	
FR2 if configured			12-23	
FR1 if configured		E-UTRA and FR2 ^{NOTE3}	0, 1, 2, 3, 4, 6, 7, 8,10	
FR2 if configured			12-23	
FR1 if configured		E-UTRA and FR1 and FR2 ^{NOTE3}	0, 1, 2, 3, 4, 6, 7, 8,10	
FR2 if configured			12-23	

NOTE 1: When E-UTRA inter-RAT RSTD measurements are configured and the UE requires measurement gaps for performing such measurements, only Gap Pattern #0 can be used.

NOTE 2: Measurement purpose which includes E-UTRA measurements includes also inter-RAT E-UTRA RSRP and RSRQ measurements for E-CID

NOTE 3: Void

NOTE4: If per-UE measurement gap is configured with MG timing advance of T_{MG} ms, the measurement gap starts at time T_{MG} ms advanced to the end of the latest subframe occurring immediately before the configured measurement gap among all serving cells subframes.
 If per-FR measurement gap for FR1 is configured with MG timing advance of T_{MG} ms, the measurement gap for FR1 starts at time T_{MG} ms advanced to the end of the latest subframe occurring immediately before the configured measurement gap among serving cells subframes in FR1.
 If per-FR measurement gap for FR2 is configured with MG timing advance of T_{MG} ms, the measurement gap for FR2 starts at time T_{MG} ms advanced to the end of the latest subframe occurring immediately before the configured measurement gap among serving cells subframes in FR2.
 T_{MG} is the MG timing advance value provided in *mgta* according to [2].
 In determining the measurement gap starting point, UE shall use the DL timing of the latest subframe occurring immediately before the configured measurement gap among serving cells.

NOTE 5: NR-DC in Rel-15 only includes the scenarios where all serving cells in MCG in FR1 and all serving cells in SCG in FR2.

For per-FR measurement gap capable UE in NR standalone operation (with single carrier, NR CA and NR-DC configuration), for per-FR gap based measurement, when there is no serving cell in a particular FR, where measurement objects are configured, regardless if explicit per-FR measurement gap is configured in this FR, the effective MGRP in this FR is used to determine requirements;

- 20 ms for FR2 NR measurements
- 40 ms for FR1 NR measurements
- 40 ms for LTE measurements
- 40 ms for FR1+LTE measurements

For per-FR measurement gap capable UE in NR standalone operation (with single carrier, NR CA and NR-DC configuration), when serving cells are in FR1 or FR2, measurement objects are in both E-UTRA /FR1 and FR2,

- If MN indicates UE that the measurement gap from MN applies to E-UTRA/FR1/FR2 serving cells, UE fulfils the per-UE measurement requirements for both E-UTRA/FR1 and FR2 measurement objects based on the measurement gap pattern configured by MN;

If measurement gap is configured in one FR but measurement object is not configured in the FR, the scheduling opportunity in the FR depends on the configured measurement gap pattern.

For E-UTRA-NR dual connectivity, if UE is not capable of per-FR-gap, total interruption time on SCG during MGL is defined only when $MGL(N) = 6ms, 4ms$ and $3ms$. And if UE is capable of per-FR-gap, total interruption time on FR1 serving cells in SCG during MGL is defined only when $MGL(N) = 6ms, 4ms$ and $3ms$, and total interruption time on FR2 serving cells in SCG during MGL is defined only when $MGL(N) = 5.5ms, 3.5ms$ and $1.5ms$.

For NR standalone operation (with single carrier, NR CA and NR-DC configuration), if UE is not capable of per-FR-gap, total interruption time on a serving cell during MGL is defined when $MGL(N) = 6ms, 5.5ms, 4ms, 3.5ms, 3ms$, and $1.5ms$. And if UE is capable of per-FR-gap, total interruption time on FR1 serving cells during MGL is defined only when $MGL(N) = 6ms, 4ms$ and $3ms$, and total interruption time on FR2 serving cells during MGL is defined only when $MGL(N) = 5.5ms, 3.5ms$ and $1.5ms$.

For NR-E-UTRA dual connectivity, if UE is not capable of per-FR-gap, total interruption time on MCG during MGL is defined only when $MGL(N) = 6ms, 4ms$ and $3ms$. And if UE is capable of per-FR-gap, total interruption time on FR1 serving cells in MCG during MGL is defined only when $MGL(N) = 6ms, 4ms$ and $3ms$, and total interruption time on FR2 serving cells in MCG during MGL is defined only when $MGL(N) = 5.5ms, 3.5ms$ and $1.5ms$.

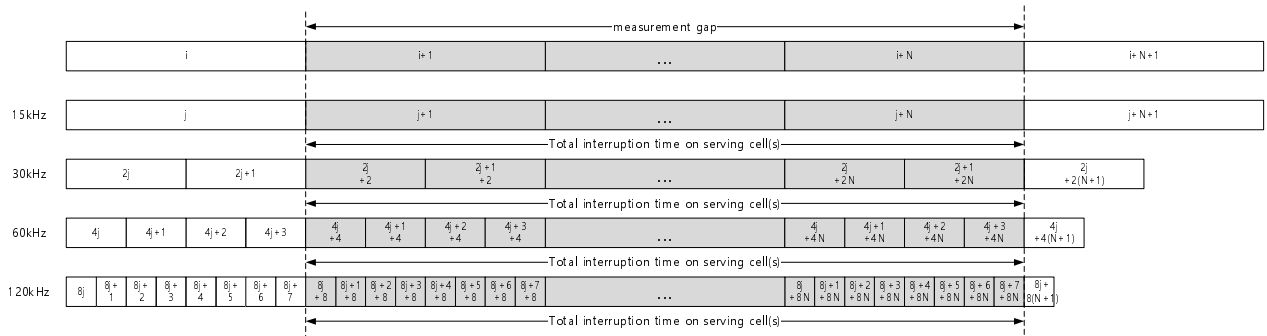

(a) Measurement gap with MGL = N(ms) with MG timing advance of 0ms for synchronous EN-DC, NR standalone operation (with single carrier, NR CA and NR-DC configuration) and synchronous NE-DC

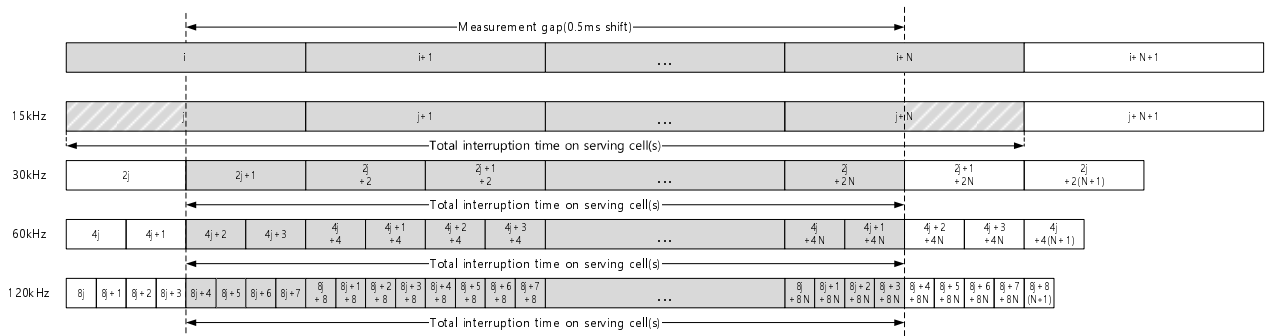

(b) Measurement gap with MGL = N(ms) with MG timing advance of 0.5ms for synchronous EN-DC, NR standalone operation (with single carrier, NR CA and NR-DC configuration) and synchronous NE-DC

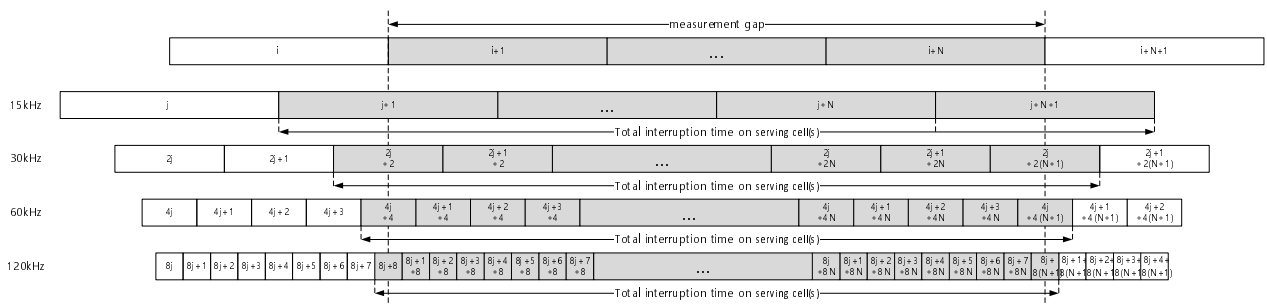

(c) Measurement gap with MGL = N(ms) with MG timing advance of 0ms for asynchronous EN-DC and asynchronous NE-DC

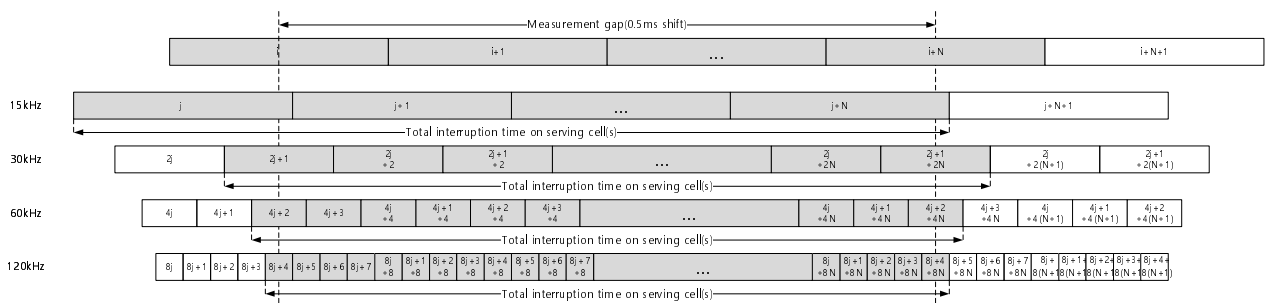

(d) Measurement gap with MGL = N(ms) with MG timing advance of 0.5ms for asynchronous EN-DC and asynchronous NE-DC

Figure 9.1.2-1: Measurement GAP and total interruption time on serving cells for EN-DC, NR standalone operation (with single carrier, NR CA and NR-DC configuration) and NE-DC

The corresponding total number of interrupted slots on serving cells is listed in Table 9.1.2-4 for synchronous EN-DC, NR standalone and NE-DC, and in Table 9.1.2-4a for asynchronous EN-DC respectively.

Table 9.1.2-4: Total number of interrupted slots on serving cells during MGL for Synchronous EN-DC, NR standalone operation (with single carrier, NR CA and NR-DC configuration) and NE-DC with per-UE measurement gap or per-FR measurement gap for FR1

NR SCS (kHz)	Total number of interrupted slots on serving cells					
	When MG timing advance of 0ms is applied			When MG timing advance of 0.5ms is applied		
	MGL=6ms	MGL=4ms	MGL=3ms	MGL=6ms	MGL=4ms	MGL=3ms
15	6	4	3	7 ^{Note3}	5 ^{Note3}	4 ^{Note3}
30	12	8	6	12	8	6
60	24	16	12	24	16	12
120	48	32	24	48	32	24
NOTE 1: Void						
NOTE 2: NR SCS of 120 kHz is only applicable to the case with per-UE measurement gap.						
NOTE 3: Non-overlapped half-slots occur before and after the measurement gap. Whether a Rel-15 UE can receive and/or transmit in those half-slots is up to UE implementation.						

Table 9.1.2-4a: Total number of interrupted slots on serving cells during MGL for Asynchronous EN-DC with per-UE measurement gap or per-FR measurement gap for FR1

NR SCS (kHz)	Total number of interrupted slots on serving cells					
	When MG timing advance of 0ms is applied			When MG timing advance of 0.5ms is applied		
	MGL=6ms	MGL=4ms	MGL=3ms	MGL=6ms	MGL=4ms	MGL=3ms
15	7	5	4	7	5	4
30	13	9	7	13	9	7
60	25	17	13	25	17	13
120	49	33	25	49	33	25
NOTE 1: Void						
NOTE 2: NR SCS of 120 kHz is only applicable to the case with per-UE measurement gap.						

In case that UE capable of per-FR measurement gap is configured with per-FR measurement gap for FR2 serving cells, total number of interrupted slots on FR2 serving cells during MGL is listed in Table 9.1.2-4b.

Table 9.1.2-4b: Total number of interrupted slots on FR2 serving cells during MGL for EN-DC, NR standalone operation (with single carrier, NR CA and NR-DC configuration) and NE-DC with per-UE measurement gap or per-FR measurement gap for FR2

NR SCS (kHz)	Total number of interrupted slots on FR2 serving cells					
	When MG timing advance of 0ms is applied			When MG timing advance of 0.25ms is applied		
	MGL=5.5ms	MGL=3.5ms	MGL=1.5ms	MGL=5.5ms	MGL=3.5ms	MGL=1.5ms
60	22	14	6	22	14	6
120	44	28	12	44	28	12
NOTE 1: The total number of interrupted slots is based on that SFN and subframe reference for per-FR gap in FR2 indicated by high layer parameter <i>refServCellIndicator</i> is an FR2 serving cell.						
NOTE 2: Slot occurs before or after the measurement gap may be interrupted additionally if SFN and subframe reference for per-FR gap in FR2 indicated by high layer parameter <i>refServCellIndicator</i> is an FR1 serving cell.						

It is up to UE implementation whether or not the UE is able to conduct transmission in the following slot(s),

- when MGTA is not applied, in the L consecutive UL slots with respect to the SCS of the UL carrier with the same slot indices as the DL slots occurring immediately after measurement gap
- when MGTA is applied and the SCS of the UL carrier is other than 15kHz, in the L consecutive UL slots with respect to the SCS of the UL carrier with the same slot indices as the DL slots occurring immediately after measurement gap

- when MGTA is applied and the SCS of the UL carrier is 15kHz, in the L consecutive UL slots with respect to the SCS of the UL carrier with the same slot indices as the DL slots occurring immediately after the slot partially overlapped with measurement gap

where UL slot denotes that all the symbols in the slot are uplink symbols, and $L=1$ if $(N_{TA} + N_{TA\text{ offset}}) \times T_c$ for the UL transmission is less than the length of one slot; $L=2$ otherwise.

Note: Network is supposed to take into account the possible difference between the estimated TA at network and actual TA at UE when scheduling UE in the above slot(s).

Table 9.1.2-5: (Void)

9.1.2.1 EN-DC: Measurement Gap Sharing

For E-UTRA-NR dual connectivity UE configured with per-UE measurement gap, measurement gap sharing shall be applies when UE requires measurement gaps to identify and measure cells on intra-frequency carriers or when SMTC configured for intra-frequency measurement are fully overlapping with per-UE measurement gaps, and when UE is configured to identify and measure cells on inter-frequency carriers, E-UTRA gap-needed inter-frequency carriers and inter-RAT UTRAN carriers and/or inter-RAT GSM carriers.

For E-UTRA-NR dual connectivity UE configured with per-FR1 measurement gap, measurement gap sharing shall be applied when UE requires measurement gaps to identify and measure cells on FR1 intra-frequency carriers or when SMTC configured for FR1 intra-frequency measurement are fully overlapping with per-FR1 measurement gaps, and when UE is configured to identify and measure cells on FR1 inter-frequency carriers, E-UTRA gap-needed inter-frequency carriers, inter-RAT UTRAN carriers and/or inter-RAT GSM carriers.

For E-UTRA-NR dual connectivity UE configured with per-FR2 measurement gap, measurement gap sharing shall be applied when UE requires measurement gaps to identify and measure cells on FR2 intra-frequency carriers or when SMTC configured for FR2 intra-frequency measurement are fully overlapping with per-FR2 measurement gaps, and when UE is configured to identify and measure cells on FR2 inter-frequency carriers.

When network signals “01”, “10” or “11” with RRC parameter *MeasGapSharingScheme* [2][16] and the value of X is defined as in Table 9.1.2.1-1, and

- $K_{\text{intra}} = 1 / X * 100$,
- $K_{\text{inter}} = 1 / (100 - X) * 100$,

When network signals “00” indicating equal splitting gap sharing, X is not applied.

The RRC parameter *MeasGapSharingScheme* shall be applied to the calculation of carrier specific scaling factor as specified in clause 9.1.5.2.1.

Table 9.1.2.1-1: Value of parameter X for EN-DC measurement gap sharing

measGapSharingScheme	Value of X (%)
‘00’	Equal splitting
‘01’	25
‘10’	50
‘11’	75
Note:	It is left to UE implementation to determine which measurement gap sharing scheme in the table <i>to be applied</i> , when <i>MeasGapSharingScheme</i> is absent and there is no stored value in the field.

9.1.2.1a SA: Measurement Gap Sharing

For NR standalone UE without NR-DC operation and configured with per-UE measurement gap, measurement gap sharing shall be applies when UE requires measurement gaps to identify and measure cells on intra-frequency carriers

or when SMTC configured for intra-frequency measurement are fully overlapping with per-UE measurement gaps, and when UE is configured to identify and measure cells on inter-frequency carriers, and/or inter-RAT E-UTRAN carriers.

For NR standalone UE without NR-DC operation and configured with per-FR1 measurement gap, measurement gap sharing shall be applied when UE requires measurement gaps to identify and measure cells on FR1 intra-frequency carriers or when SMTC configured for FR1 intra-frequency measurement are fully overlapping with per-FR1 measurement gaps, and when UE is configured to identify and measure cells on FR1 inter-frequency carriers and/or inter-RAT E-UTRAN carriers.

For NR standalone UE without NR-DC operation and configured with per-FR2 measurement gap, measurement gap sharing shall be applied when UE requires measurement gaps to identify and measure cells on FR2 intra-frequency carriers or when SMTC configured for FR2 intra-frequency measurement are fully overlapping with per-FR2 measurement gaps, and when UE is configured to identify and measure cells on FR2 inter-frequency carriers.

When network signals “01”, “10” or “11” with RRC parameter *MeasGapSharingScheme* [2] and the value of X is defined as in Table 9.1.2.1a-1, and

- $K_{\text{intra}} = 1 / X * 100$,
- $K_{\text{inter}} = 1 / (100 - X) * 100$,

When network signals “00” indicating equal splitting gap sharing, X is not applied.

The RRC parameter *MeasGapSharingScheme* shall be applied to the calculation of carrier specific scaling factor as specified in clause 9.1.5.2.2.

Table 9.1.2.1a-1: Value of parameter X for NR standalone measurement gap sharing

measGapSharingScheme	Value of X (%)
'00'	Equal splitting
'01'	25
'10'	50
'11'	75
Note:	It is left to UE implementation to determine which measurement gap sharing scheme in the table <i>to be applied</i> , when <i>MeasGapSharingScheme</i> is absent and there is no stored value in the field.

9.1.2.1b NE-DC: Measurement Gap Sharing

For NR-E-UTRA dual connectivity UE configured with per-UE measurement gap, measurement gap sharing shall be applied when UE requires measurement gaps to identify and measure cells on intra-frequency carriers or when SMTC configured for intra-frequency measurement are fully overlapping with per-UE measurement gaps, and when UE is configured to identify and measure cells on inter-frequency carriers, E-UTRA gap-needed inter-frequency carriers, and/or inter-RAT E-UTRA carriers.

For NR-E-UTRA dual connectivity UE configured with per-FR1 measurement gap, measurement gap sharing shall be applied when UE requires measurement gaps to identify and measure cells on FR1 intra-frequency carriers or when SMTC configured for FR1 intra-frequency measurement are fully overlapping with per-FR1 measurement gaps, and when UE is configured to identify and measure cells on inter-frequency carriers, E-UTRA gap-needed inter-frequency carriers, and/or inter-RAT E-UTRA carriers.

For NR-E-UTRA dual connectivity UE configured with per-FR2 measurement gap, measurement gap sharing shall be applied when UE requires measurement gaps to identify and measure cells on FR2 intra-frequency carriers or when SMTC configured for FR2 intra-frequency measurement are fully overlapping with per-FR2 measurement gaps, and when UE is configured to identify and measure cells on FR2 inter-frequency carriers.

When network signals “01”, “10” or “11” with RRC parameter *measGapSharingConfig* [2][16] and the value of X is defined as in Table 9.1.2.1b-1, and

- $K_{\text{intra}} = 1 / X * 100$,
- $K_{\text{inter}} = 1 / (100 - X) * 100$,

When network signals “00” indicating equal splitting gap sharing, X is not applied.

The RRC parameter *MeasGapSharingScheme* shall be applied to the calculation of carrier specific scaling factor as specified in clause 9.1.5.2.3.

Table 9.1.2.1b-1: Value of parameter X for NE-DC measurement gap sharing

<i>measGapSharingScheme</i>	Value of X (%)
'00'	Equal splitting
'01'	25
'10'	50
'11'	75
Note:	It is left to UE implementation to determine which measurement gap sharing scheme in the table <i>to be applied</i> , when <i>MeasGapSharingScheme</i> is absent and there is no stored value in the field.

9.1.2.1c NR-DC: Measurement Gap Sharing

For UE with NR-DC operation and configured with per-UE measurement gap, measurement gap sharing shall be applied when UE requires measurement gaps to identify and measure cells on intra-frequency carriers or when SMTC configured for intra-frequency measurement are fully overlapping with per-UE measurement gaps, and when UE is configured to identify and measure cells on inter-frequency carriers, and/or inter-RAT E-UTRAN carriers.

For UE with NR-DC operation and configured with per-FR1 measurement gap, measurement gap sharing shall be applied when UE requires measurement gaps to identify and measure cells on FR1 intra-frequency carriers or when SMTC configured for FR1 intra-frequency measurement are fully overlapping with per-FR1 measurement gaps, and when UE is configured to identify and measure cells on FR1 inter-frequency carriers and/or inter-RAT E-UTRAN carriers.

For UE with NR-DC operation and configured with per-FR2 measurement gap, measurement gap sharing shall be applied when UE requires measurement gaps to identify and measure cells on FR2 intra-frequency carriers or when SMTC configured for FR2 intra-frequency measurement are fully overlapping with per-FR2 measurement gaps, and when UE is configured to identify and measure cells on FR2 inter-frequency carriers.

When network signals “01”, “10” or “11” with RRC parameter *measGapSharingConfig* [2] and the value of X is defined as in Table 9.1.2.1c-1, and

- $K_{\text{intra}} = 1 / X * 100$,
- $K_{\text{inter}} = 1 / (100 - X) * 100$,

When network signals “00” indicating equal splitting gap sharing, X is not applied.

The RRC parameter *MeasGapSharingScheme* shall be applied to the calculation of carrier specific scaling factor as specified in clause 9.1.5.2.4.

Table 9.1.2.1c-1: Value of parameter X for NR-DC measurement gap sharing

<i>measGapSharingConfig</i>	Value of X (%)
'00'	Equal splitting
'01'	25
'10'	50
'11'	75
Note:	It is left to UE implementation to determine which measurement gap sharing scheme in the table <i>to be applied</i> , when <i>MeasGapSharingScheme</i> is absent and there is no stored value in the field.

9.1.3 UE Measurement capability

9.1.3.1 EN-DC: Monitoring of multiple layers using gaps

The requirements in this clause are applicable for UE capable of and configured with the EN-DC operation mode.

When monitoring of multiple inter-frequency E-UTRAN, inter-RAT NR, GSM, UTRA FDD and UTRA TDD carriers as configured by E-UTRA PCell, and inter-frequency NR carriers as configured by PSCell using gaps (or without using gaps provided the UE supports such capability or the effective MGRP is applied for per-FR measurement gap capable UE) is configured, the UE shall be capable of performing one measurement of the configured measurement type (SS-RSRP, SS-RSRQ, SS-SINR, SFTD, E-UTRAN RSRP, E-UTRAN RSRQ, E-UTRAN RS-SINR measurements, UTRAN TDD P-CCPCH RSCP, UTRAN FDD CPICH measurements, GSM carrier RSSI, etc.) of detected cells on all the layers.

For UE configured with the EN-DC operation, the effective total number of frequencies excluding the frequencies of the PSCell, SCells, E-UTRA PCell, and E-UTRA SCells being monitored is $N_{\text{freq, EN-DC}}$, which is defined as:

$$N_{\text{freq, EN-DC}} = N_{\text{freq, EN-DC, NR}} + N_{\text{freq, EN-DC, E-UTRA}} + N_{\text{freq, EN-DC, UTRA}} + M_{\text{EN-DC, GSM}},$$

where

$N_{\text{freq, EN-DC, E-UTRA}}$ is the number of E-UTRA inter-frequency carriers being monitored (FDD and TDD) as configured by E-UTRA PCell or via LPP [22],

$$N_{\text{freq, EN-DC, NR}} \leq N_{\text{freq, EN-DC, NR, inter-RAT}} + N_{\text{freq, EN-DC, NR, inter-freq}}$$

where

$N_{\text{freq, EN-DC, NR, inter-RAT}}$ is the number of NR inter-RAT carriers excluding NR serving carrier(s) being monitored as configured by E-UTRA PCell [15],

$N_{\text{freq, EN-DC, NR, inter-freq}}$ is the number of NR inter-frequency carriers being monitored as configured by PSCell,

$N_{\text{freq, EN-DC, UTRA}}$ is the number of UTRA inter-RAT carriers being monitored as configured by E-UTRA PCell (FDD and TDD).

$M_{\text{EN-DC, GSM}}$ is an integer which is a function of the number of GSM inter-RAT carriers as configured by E-UTRA PCell on which measurements are being performed. $M_{\text{EN-DC, GSM}}$ is equal to 0 if no GSM carrier is being monitored. For a MGRP of 40 ms, $M_{\text{EN-DC, GSM}}$ is equal to 1 if cells on up to 32 GSM carriers are being measured. For a MGRP of 80 ms, $M_{\text{EN-DC, GSM}}$ is equal to $\text{ceil}(N_{\text{carriers, GSM}}/20)$ where $N_{\text{carriers, GSM}}$ is the number of GSM carriers on which cells are being measured.

9.1.3.1a SA: Monitoring of multiple layers using gaps

The requirements in this clause are applicable for UE configured with SA NR operation mode.

When monitoring of multiple inter-RAT E-UTRAN carriers and inter-frequency NR carriers using gaps (or without using gaps provided the UE supports such capability or the effective MGRP is applied for per-FR measurement gap capable UE) is configured by PCell, the UE shall be capable of performing one measurement of the configured measurement type (SS-RSRP, SS-RSRQ, SS-SINR, E-UTRAN RSRP, E-UTRAN RSRQ, E-UTRAN RS-SINR measurements, etc.) of detected cells on all the layers.

For UE configured with the NR SA operation, the effective total number of frequencies, excluding the frequencies of the PCell, PSCell and SCells being monitored, is $N_{\text{freq, SA}}$, which is defined as:

$$N_{\text{freq, SA}} = N_{\text{freq, SA, NR}} + N_{\text{freq, SA, E-UTRA}},$$

where

$N_{\text{freq, SA, E-UTRA}}$ is the number of E-UTRA inter-RAT carriers being monitored (FDD and TDD) as configured by PCell or via LPP [22],

$N_{\text{freq, SA, NR}}$ is the number of NR inter-frequency carriers being monitored as configured by PCell.

9.1.3.1b NE-DC: Monitoring of multiple layers using gaps

The requirements in this clause are applicable for UE capable of and configured with the NE-DC operation mode.

When monitoring of multiple inter-frequency E-UTRAN carriers as configured by E-UTRA PSCell, inter-RAT E-UTRAN carriers as configured by PCell, and inter-frequency NR carriers as configured by PCell using gaps (or without using gaps provided the UE supports such capability or the effective MGRP is applied for per-FR measurement gap capable UE) is configured, the UE shall be capable of performing one measurement of the configured measurement type (SS-RSRP, SS-RSRQ, SS-SINR, SFTD, E-UTRAN RSRP, E-UTRAN RSRQ, and E-UTRAN RS-SINR measurements, etc.) of detected cells on all the layers.

For UE configured with the NE-DC operation, the effective total number of frequencies excluding the frequencies of the PCell, SCells, E-UTRA PSCell, and E-UTRA SCells being monitored is $N_{\text{freq, NE-DC}}$, which is defined as:

$$N_{\text{freq, NE-DC}} = N_{\text{freq, NE-DC, NR}} + N_{\text{freq, NE-DC, E-UTRA}},$$

where

$N_{\text{freq, NE-DC, NR}}$ is the number of NR inter-frequency carriers being monitored as configured by PCell,

$$N_{\text{freq, NE-DC, E-UTRA}} \leq N_{\text{freq, NE-DC, E-UTRA, inter-RAT}} + N_{\text{freq, NE-DC, E-UTRA, inter-freq}}$$

where

$N_{\text{freq, NE-DC, E-UTRA, inter-RAT}}$ is the number of E-UTRA inter-RAT carriers (FDD and TDD) excluding E-UTRA serving carrier(s) being monitored as configured by PCell or via LPP [22],

$N_{\text{freq, NE-DC, E-UTRA, inter-freq}}$ is the number of E-UTRA inter-frequency carriers (FDD and TDD) being monitored as configured by E-UTRA PSCell [15] or via LPP [22].

9.1.3.1c NR-DC: Monitoring of multiple layers using gaps

The requirements in this clause are applicable for UE configured with NR-DC operation mode.

When monitoring of multiple inter-RAT E-UTRAN carriers and inter-frequency NR carriers using gaps (or without using gaps provided the UE supports such capability) as configured by PCell, and inter-frequency NR carriers as configured by PSCell is configured, the UE shall be capable of performing one measurement of the configured measurement type (SS-RSRP, SS-RSRQ, SS-SINR, E-UTRAN RSRP, E-UTRAN RSRQ, E-UTRAN RS-SINR measurements, etc.) of detected cells on all the layers.

For UE configured with the NR-DC operation, the effective total number of frequencies, excluding the frequencies of the PCell, PSCell and SCells being monitored, is $N_{\text{freq, NR-DC}}$, which is defined as:

$$N_{\text{freq, NR-DC}} = N_{\text{freq, NR-DC, NR}} + N_{\text{freq, NR-DC, E-UTRA}},$$

where

$N_{\text{freq, NR-DC, E-UTRA}}$ is the number of E-UTRA inter-RAT carriers being monitored (FDD and TDD) as configured by PCell or via LPP [22].

$N_{\text{freq, NR-DC, NR}}$ is the number of NR inter-frequency carriers being monitored as configured by PCell and PSCell.

9.1.3.2 EN-DC: Maximum allowed layers for multiple monitoring

If a UE is configured with EN-DC operation, the UE shall be capable of monitoring at least:

- Depending on UE capability, 7 NR inter-frequency carriers configured by PSCell, and
- Depending on UE capability, 7 NR inter-RAT carriers excluding NR serving carrier(s) configured by E-UTRA PCell [15], and
- Depending on UE capability, 6 E-UTRA TDD inter-frequency carriers configured by E-UTRA PCell [15], and
- Depending on UE capability, 6 E-UTRA FDD inter-frequency carriers configured by E-UTRA PCell [15], and

- Depending on UE capability, 3 FDD UTRA carriers, and
- Depending on UE capability, 3 TDD UTRA carriers, and
- Depending on UE capability, 32 GSM carriers (one GSM layer corresponds to 32 carriers), and
- Depending on UE capability, 1 E-UTRA FDD inter-frequency carrier for RSTD measurements configured via LPP [22], and
- Depending on UE capability, 1 E-UTRA TDD inter-frequency carrier for RSTD measurements configured via LPP [22].

In addition to the requirements defined above, the UE shall be capable of monitoring a total of at least 13 effective carrier frequency layers comprising of any above defined combination of NR, E-UTRA FDD, E-UTRA TDD, UTRA FDD, UTRA TDD and GSM (one GSM layer corresponds to 32 carriers) layers. The UE shall be capable of monitoring a total of at least 7 effective NR carrier frequency layers excluding NR serving carrier(s), comprising of any above defined combination of NR inter-RAT carriers excluding NR serving carrier(s) configured by E-UTRA PCell and NR inter-frequency carriers configured by PSCell.

When the E-UTRA PCell and PSCell configures the same NR carrier frequency layer to be monitored by the UE in synchronous intra-band EN-DC, this layer shall be counted only once to the total number of effective carrier frequency layers provided that the SFN-s and slot boundaries are aligned, unless the configured NR carrier frequency layers to be monitored have

- different RSSI measurement resources or
- different *deriveSSB-IndexFromCell* indications or
- different SMTTC configurations.

Note 1: The E-UTRA-NR dual connectivity capable UE configured with PSCell shall fulfil the requirements defined in only one of clause 9.1.3.2 and clause 8.1.2.1.1b.1 of TS 36.133 [15].

9.1.3.2a SA: Maximum allowed layers for multiple monitoring

If a UE is configured with SA NR operation mode, the UE shall be capable of monitoring at least:

- Depending on UE capability, 7 NR inter-frequency carriers configured by PCell, and
- Depending on UE capability, 7 E-UTRA TDD inter-RAT carriers configured by PCell, and
- Depending on UE capability, 7 E-UTRA FDD inter-RAT carriers configured by PCell, and
- Depending on UE capability, 1 E-UTRA FDD inter-RAT carrier for RSTD measurements configured via LPP [22], and
- Depending on UE capability, 1 E-UTRA TDD inter-RAT carrier for RSTD measurements configured via LPP [22].

In addition to the requirements defined above, the UE shall be capable of monitoring a total of at least 13 effective carrier frequency layers comprising of any above defined combination of NR, E-UTRA FDD and E-UTRA TDD layers.

9.1.3.2b NE-DC: Maximum allowed layers for multiple monitoring

If a UE is configured with NE-DC operation mode, the UE shall be capable of monitoring at least:

- Depending on UE capability, 7 NR inter-frequency carriers configured by PCell, and
- Depending on UE capability, 6 E-UTRA TDD inter-RAT carriers excluding E-UTRA serving carriers configured by PCell, and
- Depending on UE capability, 6 E-UTRA FDD inter-RAT carriers excluding E-UTRA serving carriers configured by PCell, and
- Depending on UE capability, 6 E-UTRA TDD inter-frequency carriers configured by E-UTRA PSCell [15], and

- Depending on UE capability, 6 E-UTRA FDD inter-frequency carriers configured by E-UTRA PSCell [15], and
- Depending on UE capability, 1 E-UTRA FDD inter-frequency carrier for RSTD measurements configured via LPP [22], and
- Depending on UE capability, 1 E-UTRA TDD inter-frequency carrier for RSTD measurements configured via LPP [22].

In addition to the requirements defined above, the UE shall be capable of monitoring a total of at least 13 effective carrier frequency layers comprising of any above defined combination of NR, E-UTRA FDD, and E-UTRA TDD layers. The UE shall be capable of monitoring a total of at least 6 effective E-UTRA carrier frequency layers, excluding E-UTRA serving carrier(s), comprising of any above defined combination of E-UTRA inter-RAT carriers excluding E-UTRA serving carrier(s) configured by PCell and E-UTRA inter-frequency carriers configured by E-UTRA PSCell.

9.1.3.2c NR-DC: Maximum allowed layers for multiple monitoring

If a UE is configured with NR-DC operation, the UE shall be capable of monitoring at least:

- Depending on UE capability, 7 NR inter-frequency carriers configured by PCell, and
- Depending on UE capability, 7 NR inter-frequency carriers configured by PSCell, and
- Depending on UE capability, 7 E-UTRA TDD inter-RAT carriers configured by PCell, and
- Depending on UE capability, 7 E-UTRA FDD inter-RAT carriers configured by PCell, and
- Depending on UE capability, 1 E-UTRA FDD inter-RAT carrier for RSTD measurements configured via LPP [22], and
- Depending on UE capability, 1 E-UTRA TDD inter-RAT carrier for RSTD measurements configured via LPP [22].

In addition to the requirements defined above, the UE shall be capable of monitoring a total of at least 13 effective carrier frequency layers comprising of any above defined combination of NR, E-UTRA FDD and E-UTRA TDD layers. The UE shall be capable of monitoring a total of at least 7 effective NR carrier frequency layers excluding NR serving carrier(s), which are configured by PCell and PSCell.

When PCell and PSCell configures the same NR carrier frequency layer to be monitored by the UE in NR-DC, this layer shall be counted only once to the total number of effective carrier frequency layers provided that the SFN-s and slot boundaries are aligned, unless the configured NR carrier frequency layers to be monitored have

- different RSSI measurement resources or
- different *deriveSSB-IndexFromCell* indications or
- different SMTTC configurations.

9.1.4 Capabilities for Support of Event Triggering and Reporting Criteria

9.1.4.1 Introduction

This clause contains requirements on UE capabilities for support of event triggering and reporting criteria. As long as the measurement configuration does not exceed the requirements stated in clause 9.1.4.2, the UE shall meet all other performance requirements defined in clause 9 and clause 10.

The UE can be requested to make measurements under different measurement identities defined in TS 38.331 [2]. Each measurement identity corresponds to either event-based reporting, periodic reporting, or no reporting. In case of event-based reporting, each measurement identity is associated with an event triggering criterion. In case of periodic reporting, a measurement identity is associated with one periodic reporting criterion. In case of no reporting, a measurement identity is associated with one no reporting criterion.

The purpose of this clause is to set some limits on the number of different event triggering, periodic, and no reporting criteria the UE may be requested to track in parallel.

9.1.4.2 Requirements

In this clause a reporting criterion corresponds to either one event (in the case of event-based reporting), or one periodic reporting criterion (in case of periodic reporting), or one no reporting criterion (in case of no reporting). For event-based reporting, each instance of event, with the same or different event identities, is counted as separate reporting criterion in Table 9.1.4.2-1.

The UE shall be able to support in parallel per category up to E_{cat} reporting criteria according to Table 9.1.4.2-1. For the measurement categories belonging to intra-frequency, inter-frequency, and inter-RAT measurements (i.e. without counting other categories that the UE shall always support in parallel), the UE need not support more than the total number of reporting criteria as follows:

- For UE configured with EN-DC: $E_{cat,EN-DC,NR} + E_{cat,EN-DC,E-UTRA}$, where

$E_{cat,EN-DC,NR} = 10 + 9 \times n$ is the total number of NR reporting criteria configured by PSCell (NR intra- and inter-frequency reporting criteria) and by E-UTRA PCell on NR serving frequencies (NR intra-frequency reporting criteria) applicable for UE configured with EN-DC according to Table 9.1.4.2-1, and n is the number of configured NR serving frequencies, including PSCell and SCells carrier frequencies,

$E_{cat,EN-DC,E-UTRA}$ is the total number of reporting criteria configured by E-UTRA PCell except PSCell and SCells carrier frequencies, as specified in TS 36.133 [15] for UE configured with EN-DC.

- For UE configured with NE-DC: $E_{cat,NE-DC,NR} + E_{cat,NE-DC,E-UTRA}$, where

$E_{cat,NE-DC,NR} = 10 + 9 \times n$ is the total number of NR reporting criteria according to Table 9.1.4.2-1, and n is the number of configured NR serving frequencies, including PCell, and SCells carrier frequencies,

$E_{cat,NE-DC,E-UTRA} = E_{cat,NE-DC,E-UTRA,inter-RAT} + E_{cat,NE-DC,E-UTRA,intra-RAT}$, where

$E_{cat,NE-DC,E-UTRA,inter-RAT}$ is the total number of inter-RAT E-UTRA reporting criteria configured by PCell except E-UTRA PSCell and E-UTRA SCells carrier frequencies, according to Table 9.1.4.2-1,

$E_{cat,NE-DC,E-UTRA,intra-RAT}$ is the total number of E-UTRA reporting criteria including E-UTRA PSCell and E-UTRA SCells carrier frequencies as specified in TS 36.133 [15] for UE configured with NE-DC.

- For UE configured with SA operation mode: $E_{cat,SA,NR} + E_{cat,SA,E-UTRA}$, where

$E_{cat,SA,NR} = 10 + 9 \times n$ is the total number of NR reporting criteria according to Table 9.1.4.2-1, and n is the number of configured NR serving frequencies, including PCell, and SCells carrier frequencies,

$E_{cat,SA,E-UTRA}$ is the total number of inter-RAT E-UTRA reporting criteria according to Table 9.1.4.2-1.

- For UE configured with NR-DC: $E_{cat,NR-DC,NR} + E_{cat,NR-DC,E-UTRA}$, where

$E_{cat,NR-DC,NR} = 10 + 9 \times n$ is the total number of NR reporting criteria according to Table 9.1.4.2-1, and n is the number of configured NR serving frequencies, including PCell, PSCell and SCells carrier frequencies,

$E_{cat,NR-DC,E-UTRA}$ is the total number of inter-RAT E-UTRA reporting criteria according to Table 9.1.4.2-1.

Table 9.1.4.2-1: Requirements for reporting criteria per measurement category

Measurement category	E_{cat}	Note
Intra-frequency ^{Note 1,2,3,4,5}	9	Events for any one or a combination of intra-frequency SS-RSRP, SS-RSRQ, and SS-SINR for NG-RAN intra-frequency cells
Inter-frequency ^{Note 2,3,4,5}	10	Events for any one or a combination of inter-frequency SS-RSRP, SS-RSRQ, and SS-SINR for NG-RAN inter-frequency cells
Inter-RAT (E-UTRA FDD, E-UTRA TDD) ^{Note 2,4,5}	10	Only applicable for UE with this (inter-RAT) capability. These reporting criteria apply for any E-UTRA carrier frequencies other than the carrier frequency of the E-UTRA PSCell or E-UTRA SCell.

Inter-RAT (E-UTRA FDD, E-UTRA TDD) RSTD ^{Note 2,4,5}	1	Inter-RAT RSTD measurement reporting for UE supporting OTDOA; 1 report capable of minimum 16 inter-RAT cell measurements. Only applicable for UE with this (inter-RAT RSTD via LPP [22]) capability. These reporting criteria apply for any E-UTRA carrier frequencies other than the carrier frequency of the E-UTRA PSCell or E-UTRA SCell.
Inter-RAT (E-UTRA FDD, E-UTRA TDD) RSRP and RSRQ measurements for E-CID ^{Note 2,4,5}	1	Inter-RAT RSRP and RSRQ measurements for E-CID reported to E-SMLC via LPP [22]. One report capable of at least in total 10 inter-RAT RSRP and RSRQ measurements. Applicable to UE capable of reporting inter-RAT RSRP and RSRQ to E-SMLC via LPP. These reporting criteria apply for any E-UTRA carrier frequencies other than the carrier frequency of the E-UTRA PSCell or E-UTRA SCell.
<p>NOTE 1: When the UE is configured with PSCell and SCell carrier frequencies, E_{cat} for Intra-frequency is applied per corresponding NR serving frequency.</p> <p>NOTE 2: Applicable for UE configured with SA NR operation mode.</p> <p>NOTE 3: Applicable for UE configured with EN-DC operation mode.</p> <p>NOTE 4: Applicable for UE configured with NE-DC operation mode.</p> <p>NOTE 5: Applicable for UE configured with NR-DC operation mode.</p>		

9.1.5 Carrier-specific scaling factor

This clause specifies the derivation of carrier-specific scaling factor (CSSF) values, which scales the measurement delay requirements given in clause 9.2, 9.3 and 9.4 when UE is configured to monitor multiple measurement objects. The CSSF values are categorized into $CSSF_{outside_gap,i}$ and $CSSF_{within_gap,i}$, for the measurements conducted outside measurement gaps and within measurement gaps, respectively.

9.1.5.1 Monitoring of multiple layers outside gaps

The carrier-specific scaling factor $CSSF_{outside_gap,i}$ for measurement object i derived in this chapter is applied to following measurement types:

- Intra-frequency measurement with no measurement gap in clause 9.2.5, when none of the SMTC occasions of this intra-frequency measurement object are overlapped by the measurement gap.
- Intra-frequency measurement with no measurement gap in clause 9.2.5, when part of the SMTC occasions of this intra-frequency measurement object are overlapped by the measurement gap.
- For a UE in E-UTRA-NR dual connectivity operation, NR inter-RAT measurement object configured by the E-UTRAN PCell on an NR serving carrier
 - the SSB is completely contained in the active BWP of the UE, and
 - none or part of the SMTC occasions of this inter-RAT measurement object are overlapped by the measurement gap;

UE is expected to conduct the measurement of this measurement object i only outside the measurement gaps.

For a UE in E-UTRA-NR dual connectivity operation, if a measurement object configured by PSCell and an NR inter-RAT measurement object configured by E-UTRAN PCell are on the same serving carrier, they shall be counted as one intra-frequency measurement object, provided that they meet the measurement object merging conditions [in clause 9.1.3.2].

If the higher layer signaling in TS 38.331 [2] of *smtc2* is present and *smtc1* is fully overlapping with measurement gaps and *smtc2* is partially overlapping with measurement gaps, $CSSF_{outside_gap,i}$ and requirements derived from $CSSF_{outside_gap,i}$ are not specified.

The UE cell identification and measurement periods derived based on $CSSF_{outside_gap,i}$ in clauses 9.2.5.1, 9.2.5.2 may be extended for measurement objects of which the cell identification and measurement periods are overlapped with $T_{measure_SFTD1}$ specified in clause 9.3.8 when no measurement gaps are provided.

The requirements in this clause apply provided that

- The SMTC on all CCs in FR2 have the same offset, and one of following conditions is met
 - If *smtc2* is configured on any FR2 CC,
 - All CCs have the same configuration for *smtc1*, and
 - All CCs configured with *smtc2* have the same configuration for *smtc2*
 - If *smtc2* is not configured on any FR2 CC,
 - The total number of different SMTC periodicities on all serving CCs does not exceed 4

Note: Longer delays for cell identification and measurement periods derived based on $CSSF_{outside_gap,i}$ in clauses 9.2.5.1, 9.2.5.2, can be expected, if the UE is configured with more than 4 different SMTC periodicities on FR2 serving carriers. The longer delay applies for the FR2 intra-frequency measurement objects with the longest SMTC periodicity/periodicities.

9.1.5.1.1 EN-DC mode: carrier-specific scaling factor for SSB-based measurements performed outside gaps

For UE configured with the E-UTRA-NR dual connectivity operation, the carrier-specific scaling factor $CSSF_{outside_gap,i}$ for intra-frequency SSB-based measurements performed outside measurements gaps will be as specified in Table 9.1.5.1.1-1.

Table 9.1.5.1.1-1: $CSSF_{outside_gap,i}$ scaling factor for EN-DC mode

Scenario	$CSSF_{outside_gap,i}$ for FR1 PSCC	$CSSF_{outside_gap,i}$ for FR1 SCC	$CSSF_{outside_gap,i}$ for FR2 PSCC	$CSSF_{outside_gap,i}$ for FR2 SCC where neighbour cell measurement is required ^{Note 2}	$CSSF_{outside_gap,i}$ for FR2 SCC where neighbour cell measurement is not required
EN-DC with FR1 only CA	1	Number of configured FR1 SCell(s)	N/A	N/A	N/A
EN-DC with FR2 only intra band CA	N/A	N/A	1	N/A	Number of configured FR2 SCells
EN-DC with FR1 +FR2 CA (FR1 PSCell) ^{Note 1}	1	2x(Number of configured SCell(s)-1)	N/A	² Note 5	2x(Number of configured SCell(s)-1)
EN-DC with FR1 +FR2 CA (FR2 PSCell) ^{Note 1}	N/A	Number of configured SCell(s)	1	N/A	Number of configured SCell(s)
Note 1: Only one NR FR1 operating band and one NR FR2 operating band are included for FR1+FR2 inter-band EN-DC. Note 2: Selection of FR2 SCC where neighbour cell measurement is required follows clause 9.2.3.2. Note 3: Void Note 4: Void Note 5: $CSSF_{outside_gap,i} = 1$ if only one SCell is configured. Note 6: If a measurement object configured by PSCell and an NR inter-RAT measurement object configured by E-UTRAN PCell are on the same serving carrier, they shall be counted as one intra-frequency measurement object, provided that they meet the measurement object merging conditions [in clause 9.1.3.2], otherwise they are counted separately as two measurement objects.					

9.1.5.1.2 SA mode: carrier-specific scaling factor for SSB-based measurements performed outside gaps

For UE in SA operation mode, the carrier-specific scaling factor $CSSF_{outside_gap,i}$ for intra-frequency SSB-based measurements performed outside measurements gaps will be as specified in Table 9.1.5.1.2-1, which shall also be applied for a UE configured with NE-DC operation.

Table 9.1.5.1.2-1: $CSSF_{outside_gap,i}$ scaling factor for SA mode

Scenario	$CSSF_{outside_gap,i}$ for FR1 PCC	$CSSF_{outside_gap,i}$ for FR1 SCC	$CSSF_{outside_gap,i}$ for FR2 PCC	$CSSF_{outside_gap,i}$ for FR2 SCC where neighbour cell measurement is required	$CSSF_{outside_gap,i}$ for FR2 SCC where neighbour cell measurement is not required
FR1 only CA	1	Number of configured FR1 SCell(s)	N/A	N/A	N/A
FR2 only intra band CA	N/A	N/A	1	N/A	Number of configured FR2 SCell(s)
FR1 +FR2 CA (FR1 PCell) ^{Note 1}	1	2x(Number of configured SCell(s)-1)	N/A	² ^{Note 5}	2x(Number of configured SCell(s)-1)
FR1 +FR2 CA (FR2 PCell) ^{Note 1}	N/A	Number of configured SCell(s)	1	N/A	Number of configured SCell(s)

Note 1: Only one FR1 operating band and one FR2 operating band are included for FR1+FR2 inter-band CA.

Note 2: Selection of FR2 SCC where neighbour cell measurement is required follows clause 9.2.3.2.

Note 3: Void

Note 4: Void

Note 5: $CSSF_{outside_gap,i}=1$ if only one SCell is configured.

9.1.5.1.3 NR-DC mode: carrier-specific scaling factor for SSB-based measurements performed outside gaps

For UE configured with NR-DC operation, the carrier-specific scaling factor $CSSF_{outside_gap,i}$ for intra-frequency SSB-based measurements performed outside measurements gaps will be as specified in Table 9.1.5.1.3-1.

Table 9.1.5.1.3-1: $CSSF_{outside_gap,i}$ scaling factor for NR-DC mode

Scenario	$CSSF_{outside_gap,i}$ for FR1 PCC	$CSSF_{outside_gap,i}$ for FR1 SCC	$CSSF_{outside_gap,i}$ for FR2 PSCC	$CSSF_{outside_gap,i}$ for FR2 SCC where neighbour cell measurement is not required
FR1 + FR2 NR-DC (FR1 PCell and FR2 PScell) ^{Note 1}	1	2x(Number of configured SCell(s))	² ^{Note 3}	2x(Number of configured SCell(s))

Note 1: NR-DC in Rel-15 only includes the scenarios where all serving cells in MCG in FR1 and all serving cells in SCG in FR2.

Note 2: Void

Note 3: $CSSF_{outside_gap,i}=1$ if no SCell is configured.

9.1.5.1.4 NE-DC mode: carrier-specific scaling factor for SSB-based measurements performed outside gaps

For UE configured with NE-DC operation, the carrier-specific scaling factor $CSSF_{outside_gap,i}$ for intra-frequency SSB-based measurements performed outside measurements gaps will be as specified in Table 9.1.5.1.4-1.

Table 9.1.5.1.4-1: $CSSF_{outside_gap,i}$ scaling factor for NE-DC mode

Scenario	$CSSF_{outside_gap,i}$ for FR1 PCC	$CSSF_{outside_gap,i}$ for FR1 SCC	$CSSF_{outside_gap,i}$ for FR2 PCC	$CSSF_{outside_gap,i}$ for FR2 SCC where neighbour cell measurement is required	$CSSF_{outside_gap,i}$ for FR2 SCC where neighbour cell measurement is not required
NE-DC with FR1 only CA	1	Number of configured FR1 SCell(s)	N/A	N/A	N/A
NE-DC with FR2 only intra band CA	N/A	N/A	1	N/A	Number of configured FR2 SCell(s)

NE-DC with FR1 +FR2 CA (FR1 PCell) ^{Note 1}	1	2x(Number of configured SCell(s)-1)	N/A	2 ^{Note 3}	2x(Number of configured SCell(s)-1)
Note 1: Only one FR1 operating band and one FR2 operating band are included for FR1+FR2 inter-band CA.					
Note 2: Selection of FR2 SCC where neighbour cell measurement is required follows clause 9.2.3.2.					
Note 3: $CSSF_{outside_gap,i} = 1$ if only one SCell is configured.					

9.1.5.2 Monitoring of multiple layers within gaps

The carrier-specific scaling factor $CSSF_{within_gap,i}$ for measurement object i derived in this chapter is applied to following measurement types:

- Intra-frequency measurement object with no measurement gap in clause 9.2.5, when all of the SMTC occasions of this intra-frequency measurement object are overlapped by the measurement gap.
- Intra-frequency measurement object with measurement gap in clause 9.2.6.
- Inter-frequency measurement object in clause 9.3.
- E-UTRA Inter-RAT measurement object in clauses 9.4.2 and 9.4.3.
- E-UTRA Inter-RAT RSTD and E-CID measurements in clauses 9.4.4 and 9.4.5.
- For a UE in E-UTRA-NR dual connectivity operation, NR Inter-RAT measurement object configured by the E-UTRAN PCell (TS 36.133 [15] clause 8.17.4) on an NR serving carrier
 - the SSB is not completely contained in the active BWP of the UE, or
 - all of the SMTC occasions of this inter-RAT measurement object are overlapped by the measurement gap;
- NR Inter-RAT measurement object configured by the E-UTRAN PCell (TS 36.133 [15] clause 8.17.4) on an NR non-serving carrier.
- E-UTRAN Inter-frequency measurement object configured by the E-UTRAN PCell (TS 36.133 [15] clause 8.17.3) and by the E-UTRAN PSCell (TS 36.133 [15] clause 8.19.3).
- E-UTRAN Inter-frequency RSTD measurement configured by the E-UTRAN PCell (TS 36.133 [15] clause 8.17.15).
- UTRA Inter-RAT measurement object configured by the E-UTRAN PCell (TS 36.133 [15] clauses 8.17.5 to 8.17.12).
- GSM Inter-RAT measurements configured by the E-UTRAN PCell (TS 36.133 [15] clauses 8.17.13 and 8.17.14).

UE is expected to conduct the measurement of this measurement object i only within the measurement gaps.

If the higher layer signaling in TS 38.331 [2] of *smtc2* is present and *smtc1* is fully overlapping with measurement gaps and *smtc2* is partially overlapping with measurement gaps, $CSSF_{within_gap,i}$ and requirements derived from $CSSF_{outside_gap,i}$ are not specified.

9.1.5.2.1 EN-DC mode: carrier-specific scaling factor for SSB-based measurements performed within gaps

The scaling value $CSSF_{within_gap,i}$ below has been derived without considering GSM inter-RAT carriers.

For UE supporting per-FR gap, for each measurement object i that are measured based on effective MGRP as defined in clause 9.1.2, $CSSF_{within_gap,i}$ used for deriving the measurement requirements is defined as the total number of measurement objects in the same FR as measurement object i .

When one or more measurement objects are monitored within measurement gaps, the carrier specific scaling factor for a target measurement object with index i is designated as $CSSF_{within_gap,i}$ and is derived as described in this clause.

For a UE in E-UTRA-NR dual connectivity operation, if a measurement object configured by PSCell and an NR inter-RAT measurement object configured by E-UTRAN PCell are on the same carrier, they shall be counted as one measurement object in $M_{\text{tot},i,j}$, provided that they meet the measurement object merging conditions [in clause 9.1.3.2].

If measurement object i refers to an RSTD measurement with periodicity $T_{\text{prs}} > 160\text{ms}$ or with periodicity $T_{\text{prs}} = 160\text{ms}$ but *prs-MutingInfo-r9* is configured, $\text{CSSF}_{\text{within_gap},i} = 1$. Otherwise, the $\text{CSSF}_{\text{within_gap},i}$ for other measurement objects (including RSTD measurement with periodicity $T_{\text{prs}} = 160\text{ms}$) participate in the gap competition are derived as below.

For each measurement gap j not used for an RSTD measurement with periodicity $T_{\text{prs}} > 160\text{ms}$ or with periodicity $T_{\text{prs}} = 160\text{ms}$ but *prs-MutingInfo-r9* is configured within an arbitrary 160ms period, count the total number of intrafrequency measurement objects and interfrequency/interRAT measurement objects which are candidates to be measured within the gap j .

- An NR measurement object is a candidate to be measured in a gap if its SMTC duration is fully covered by the MGL excluding RF switching time. For intra-frequency NR carriers, if the higher layer in TS 38.331 [2] signaling of *smtc2* is configured, the assumed periodicity of SMTC occasions corresponds to the value of higher layer parameter *smtc2*; otherwise the assumed periodicity of SMTC occasions corresponds to the value of higher layer parameter *smtc1*
- An inter-RAT UTRA measurement object configured by E-UTRA PCell [15] is a candidate to be measured in all measurement gaps.
- An inter-frequency E-UTRA measurement object configured by E-UTRA PCell [15] is a candidate to be measured in all measurement gaps.
- For UEs which support and are configured with per FR gaps, the counting is done on a per FR basis, and for UEs which are configured with per UE gaps the counting is done on a per UE basis.
- $M_{\text{intra},i,j}$: Number of intra-frequency measurement objects which are candidates to be measured in gap j where the measurement object i is also a candidate. Otherwise $M_{\text{intra},i,j}$ equals 0.
- $M_{\text{inter},i,j}$: Number of NR inter-frequency measurement objects or NR inter-RAT measurement objects configured by E-UTRA PCell, EUTRA inter-frequency measurement objects configured by E-UTRA PCell, UTRA inter-RAT measurement objects configured by E-UTRA PCell which are candidates to be measured in gap j where the measurement object i is also a candidate. Otherwise $M_{\text{inter},i,j}$ equals 0.
- $M_{\text{tot},i,j} = M_{\text{intra},i,j} + M_{\text{inter},i,j}$: Total number of intra-frequency, inter-frequency and inter-RAT measurement objects which are candidates to be measured in gap j where the measurement object i is also a candidate. Otherwise $M_{\text{tot},i,j}$ equals 0.

For each measurement gap j used for an RSTD measurement with periodicity $T_{\text{prs}} > 160\text{ms}$ or with periodicity $T_{\text{prs}} = 160\text{ms}$ but *prs-MutingInfo-r9* is configured within an arbitrary 160ms period, $M_{\text{intra},i,j} = M_{\text{inter},i,j} = M_{\text{tot},i,j} = 0$.

The carrier specific scaling factor $\text{CSSF}_{\text{within_gap},i}$ is given by:

If *measGapSharingScheme* is equal sharing, $\text{CSSF}_{\text{within_gap},i} = \max(\text{ceil}(R_i \times M_{\text{tot},i,j}))$, where $j = 0 \dots (160/\text{MGRP}) - 1$

If *measGapSharingScheme* is not equal sharing and

- measurement object i is an intra-frequency measurement object, $\text{CSSF}_{\text{within_gap},i}$ is the maximum among
 - $\text{ceil}(R_i \times K_{\text{intra}} \times M_{\text{intra},i,j})$ in gaps where $M_{\text{inter},i,j} \neq 0$, where $j = 0 \dots (160/\text{MGRP}) - 1$
 - $\text{ceil}(R_i \times M_{\text{intra},i,j})$ in gaps where $M_{\text{inter},i,j} = 0$, where $j = 0 \dots (160/\text{MGRP}) - 1$
- measurement object i is an inter-frequency or inter-RAT measurement object, $\text{CSSF}_{\text{within_gap},i}$ is the maximum among
 - $\text{ceil}(R_i \times K_{\text{inter}} \times M_{\text{inter},i,j})$ in gaps where $M_{\text{intra},i,j} \neq 0$, where $j = 0 \dots (160/\text{MGRP}) - 1$

Where R_i is the maximal ratio of the number of measurement gap where measurement object i is a candidate to be measured over the number of measurement gap where measurement object i is a candidate and not used for RSTD measurement with periodicity $T_{\text{prs}} > 160\text{ms}$ or with periodicity $T_{\text{prs}} = 160\text{ms}$ but *prs-MutingInfo-r9* is configured within an arbitrary 1280ms period.

Note: In this release of specification, longer delays for cell identification and measurement periods derived based on $CSSF_{within_gap,i}$ can be expected, if the UE is configured with inter-RAT MO on NR serving CC by E-UTRAN PCell in EN-DC mode.

9.1.5.2.2 SA mode: carrier-specific scaling factor for SSB-based measurements performed within gaps

When one or more measurement objects are monitored within measurement gaps, the carrier specific scaling factor for a target measurement object with index i is designated as $CSSF_{within_gap,i}$ and is derived as described in this clause.

For UE supporting per-FR gap, for each measurement object i that are measured based on effective MGRP as defined in clause 9.1.2, $CSSF_{within_gap,i}$ used for deriving the measurement requirements is defined as the total number of measurement objects in the same FR as measurement object i .

If measurement object i refers to an RSTD measurement with periodicity $T_{prs} > 160ms$ or with periodicity $T_{prs} = 160ms$ but *prs-MutingInfo-r9* is configured, $CSSF_{within_gap,i} = 1$. Otherwise, the the $CSSF_{within_gap,i}$ for other measurement objects (including RSTD measurement with periodicity $T_{prs} = 160ms$) participate in the gap competition and the $CSSF_{within_gap,i}$ are derived as below.

For each measurement gap j not used for an RSTD measurement with periodicity $T_{prs} > 160ms$ or with periodicity $T_{prs} = 160ms$ but *prs-MutingInfo-r9* is configured within an arbitrary 160ms period, count the total number of intrafrequency measurement objects and interfrequency/interRAT measurement objects which are candidates to be measured within the gap j .

- An NR measurement object is a candidate to be measured in a gap if its SMTC duration is fully covered by the MGL excluding RF switching time. For intra-frequency NR measurement objects, if the higher layer in TS 38.331 [2] signaling of *smtc2* is configured, the assumed periodicity of SMTC occasions corresponds to the value of higher layer parameter *smtc2*; otherwise the assumed periodicity of SMTC occasions corresponds to the value of higher layer parameter *smtc1*.
- An inter-RAT measurement object is a candidate to be measured in all measurement gaps.
- An inter-frequency SFTD measurement object, if to be measured with measurement gaps, is a candidate to be measured in all measurement gaps.
- For UEs which support and are configured with per FR gaps, the counting is done on a per FR basis, and for UEs which are configured with per UE gaps the counting is done on a per UE basis.
- $M_{intra,i,j}$: Number of intra-frequency measurement objects which are candidates to be measured in gap j where the measurement object i is also a candidate. Otherwise $M_{intra,i,j}$ equals 0.
- $M_{inter,i,j}$: Number of NR inter-frequency and EUTRA inter-RAT measurement objects which are candidates to be measured in gap j where the measurement object i is also a candidate. Otherwise $M_{inter,i,j}$ equals 0.
- $M_{tot,i,j} = M_{intra,i,j} + M_{inter,i,j}$: Total number of intra-frequency, inter-frequency and inter-RAT measurement objects which are candidates to be measured in gap j where the measurement object i is also a candidate. Otherwise $M_{tot,i,j}$ equals 0.

For each measurement gap j used for an RSTD measurement with periodicity $T_{prs} > 160ms$ or with periodicity $T_{prs} = 160ms$ but *prs-MutingInfo-r9* is configured within an arbitrary 160ms period, $M_{intra,i,j} = M_{inter,i,j} = M_{tot,i,j} = 0$.

The carrier specific scaling factor $CSSF_{within_gap,i}$ is given by:

- If *measGapSharingScheme* is equal sharing, $CSSF_{within_gap,i} = \max(\text{ceil}(R_i \times M_{tot,i,j}))$, where $j = 0 \dots (160/MGRP) - 1$
- If *measGapSharingScheme* is not equal sharing and
 - measurement object i is an intra-frequency measurement object, $CSSF_{within_gap,i}$ is the maximum among
 - $\text{ceil}(R_i \times K_{intra} \times M_{intra,i,j})$ in gaps where $M_{inter,i,j} \neq 0$, where $j = 0 \dots (160/MGRP) - 1$
 - $\text{ceil}(R_i \times M_{intra,i,j})$ in gaps where $M_{inter,i,j} = 0$, where $j = 0 \dots (160/MGRP) - 1$
 - measurement object i is an inter-frequency or inter-RAT measurement object, $CSSF_{within_gap,i}$ is the maximum among

- $\text{ceil}(R_i \times K_{\text{inter}} \times M_{\text{inter},i,j})$ in gaps where $M_{\text{intra},i,j} \neq 0$, where $j=0 \dots (160/\text{MGRP})-1$
- $\text{ceil}(R_i \times M_{\text{inter},i,j})$ in gaps where $M_{\text{intra},i,j}=0$, where $j=0 \dots (160/\text{MGRP})-1$
- Where R_i is the maximal ratio of the number of measurement gap where measurement object i is a candidate to be measured over the number of measurement gap where measurement object i is a candidate and not used for RSTD measurement with periodicity $T_{\text{prs}} > 160\text{ms}$ or with periodicity $T_{\text{prs}} = 160\text{ms}$ but *prs-MutingInfo-r9* is configured within an arbitrary 1280ms period.

$\text{CSSF}_{\text{within_gap},k}=1$ during $T_{\text{Detect, E-UTRAN FDD}}$ specified in clause 9.4.4.1.2.2 and $T_{\text{Detect, E-UTRAN TDD}}$ specified in clause 9.4.4.2.2.2, where k is the carrier frequency where the UE is performing cell detection of the inter-RAT E-UTRA OTDOA assistance data reference cell when acquiring the subframe and slot timing of the cell according to clause 9.4.4. In this case, the UE cell identification and measurement periods derived based on $\text{CSSF}_{\text{within_gap},i}$ in clauses 9.2.5.1, 9.2.5.2, 9.2.6.2, 9.2.6.3, 9.3.4, 9.3.5, 9.4.2.2, and 9.4.2.3 may be extended for measurement objects of which the cell identification and measurement periods are overlapped with $T_{\text{Detect, E-UTRAN FDD}}$ and $T_{\text{Detect, E-UTRAN TDD}}$.

9.1.5.2.3 NE-DC: carrier-specific scaling factor for SSB-based measurements performed within gaps

When one or more measurement objects are monitored within measurement gaps, the carrier specific scaling factor for a target measurement object with index i is designated as $\text{CSSF}_{\text{within_gap},i}$ and is derived as described in this clause.

For UE supporting per-FR gap, for each measurement object i that are measured based on effective MGRP as defined in clause 9.1.2, $\text{CSSF}_{\text{within_gap},i}$ used for deriving the measurement requirements is defined as the total number of measurement objects in the same FR as measurement object i .

If measurement object i refers to an RSTD measurement with periodicity $T_{\text{prs}} > 160\text{ms}$ or with periodicity $T_{\text{prs}} = 160\text{ms}$ but *prs-MutingInfo-r9* is configured, $\text{CSSF}_{\text{within_gap},i}=1$. Otherwise, the $\text{CSSF}_{\text{within_gap},i}$ for other measurement objects (including RSTD measurement with periodicity $T_{\text{prs}} = 160\text{ms}$) participate in the gap competition are derived as below.

For each measurement gap j not used for an RSTD measurement with periodicity $T_{\text{prs}} > 160\text{ms}$ or with periodicity $T_{\text{prs}} = 160\text{ms}$ but *prs-MutingInfo-r9* is configured within an arbitrary 160ms period, count the total number of intrafrequency measurement objects and interfrequency/interRAT measurement objects which are candidates to be measured within the gap j .

- An NR measurement object is a candidate to be measured in a gap if its SMTC duration is fully covered by the MGL excluding RF switching time. For intra-frequency NR measurement objects, if the higher layer in TS 38.331 [2] signaling of *smtc2* is configured, the assumed periodicity of SMTC occasions corresponds to the value of higher layer parameter *smtc2*; otherwise the assumed periodicity of SMTC occasions corresponds to the value of higher layer parameter *smtc1*.
- An inter-RAT measurement object is a candidate to be measured in all measurement gaps.
- An inter-frequency E-UTRA measurement object is a candidate to be measured in all measurement gaps.
- For UEs which support and are configured with per FR gaps, the counting is done on a per FR basis, and for UEs which are configured with per UE gaps the counting is done on a per UE basis.
- If the number of configured inter-frequency and inter-RAT measurement objects is non-zero and the UE is configured with per UE gaps, or if the UE is configured with per FR gaps:
 - FR1 and FR2 intra-frequency measurement objects belong to group A
 - Inter-frequency and inter-RAT measurement objects belong to group B
 - $M_{\text{groupA},i,j}$: Sum of the number of FR1 intra-frequency measurement objects $M_{\text{intra-FR1},i,j}$ and the number of FR2 intra-frequency measurement objects $M_{\text{intra-FR2},i,j}$ which are candidates to be measured in gap j where the measurement object i is also a candidate. Otherwise $M_{\text{groupA},i,j}$ equals 0.
 - $M_{\text{groupB},i,j}$: Number of NR inter-frequency and EUTRA inter-RAT measurement objects which are candidates to be measured in gap j where the measurement object i is also a candidate. Otherwise $M_{\text{groupB},i,j}$ equals 0.
- If the number of configured inter-frequency and inter-RAT measurement objects is zero and the UE is configured with per UE gaps:

- FR1 intra-frequency measurement objects belong to group A
- FR2 intra-frequency measurement objects belong to group B
- $M_{\text{groupA},i,j}$: The number of FR1 intra-frequency measurement objects $M_{\text{intra-FR1},i,j}$ which are candidates to be measured in gap j where the measurement object i is also a candidate. Otherwise $M_{\text{groupA},i,j}$ equals 0.
- $M_{\text{groupB},i,j}$: The number of FR2 intra-frequency measurement objects $M_{\text{intra-FR2},i,j}$ which are candidates to be measured in gap j where the measurement object i is also a candidate. Otherwise $M_{\text{groupB},i,j}$ equals 0.
- $M_{\text{tot},i,j} = M_{\text{groupA},i,j} + M_{\text{groupB},i,j}$: Total number of group A and group B measurement objects which are candidates to be measured in gap j where the measurement object i is also a candidate. Otherwise $M_{\text{tot},i,j}$ equals 0.

For each measurement gap j used for an RSTD measurement with periodicity $T_{\text{prs}} > 160\text{ms}$ or with periodicity $T_{\text{prs}} = 160\text{ms}$ but *prs-MutingInfo-r9* is configured within an arbitrary 160ms period, $M_{\text{intra},i,j} = M_{\text{inter},i,j} = M_{\text{tot},i,j} = 0$.

- The carrier specific scaling factor $\text{CSSF}_{\text{within_gap},i}$ is given by:
 - If *measGapSharingScheme* is equal sharing, $\text{CSSF}_{\text{within_gap},i} = \max(\text{ceil}(R_i \times M_{\text{tot},i,j}))$, where $j = 0 \dots (160/\text{MGRP}) - 1$
 - If *measGapSharingScheme* is not equal sharing and
 - measurement object i is a group A measurement object, $\text{CSSF}_{\text{within_gap},i}$ is the maximum among
 - $\text{ceil}(R_i \times K_{\text{intra}} \times M_{\text{groupA},i,j})$ in gaps where $M_{\text{groupB},i,j} \neq 0$, where $j = 0 \dots (160/\text{MGRP}) - 1$
 - $\text{ceil}(R_i \times M_{\text{groupA},i,j})$ in gaps where $M_{\text{groupB},i,j} = 0$, where $j = 0 \dots (160/\text{MGRP}) - 1$
 - measurement object i is an group B measurement object, $\text{CSSF}_{\text{within_gap},i}$ is the maximum among
 - $\text{ceil}(R_i \times K_{\text{inter}} \times M_{\text{groupB},i,j})$ in gaps where $M_{\text{groupA},i,j} \neq 0$, where $j = 0 \dots (160/\text{MGRP}) - 1$
 - $\text{ceil}(R_i \times M_{\text{groupB},i,j})$ in gaps where $M_{\text{groupA},i,j} = 0$, where $j = 0 \dots (160/\text{MGRP}) - 1$
 - Where R_i is the maximal ratio of the number of measurement gap where measurement object i is a candidate to be measured over the number of measurement gap where measurement object i is a candidate and not used for RSTD measurement with periodicity $T_{\text{prs}} > 160\text{ms}$ or with periodicity $T_{\text{prs}} = 160\text{ms}$ but *prs-MutingInfo-r9* is configured within an arbitrary 1280ms period.

9.1.5.2.4 NR-DC: carrier-specific scaling factor for SSB-based measurements performed within gaps

When one or more measurement objects are monitored within measurement gaps, the carrier specific scaling factor for a target measurement object with index i is designated as $\text{CSSF}_{\text{within_gap},i}$ and is derived as described in this clause.

For UE supporting per-FR gap, for each measurement object i that are measured based on effective MGRP as defined in clause 9.1.2, $\text{CSSF}_{\text{within_gap},i}$ used for deriving the measurement requirements is defined as the total number of measurement objects in the same FR as measurement object i .

If measurement object i refers to an RSTD measurement with periodicity $T_{\text{prs}} > 160\text{ms}$ or with periodicity $T_{\text{prs}} = 160\text{ms}$ but *prs-MutingInfo-r9* is configured, $\text{CSSF}_{\text{within_gap},i} = 1$. Otherwise, the $\text{CSSF}_{\text{within_gap},i}$ for other measurement objects (including RSTD measurement with periodicity $T_{\text{prs}} = 160\text{ms}$) participate in the gap competition and the $\text{CSSF}_{\text{within_gap},i}$ are derived as below.

For each measurement gap j not used for an RSTD measurement with periodicity $T_{\text{prs}} > 160\text{ms}$ or with periodicity $T_{\text{prs}} = 160\text{ms}$ but *prs-MutingInfo-r9* is configured within an arbitrary 160ms period, count the total number of intra-frequency measurement objects and inter-frequency/interRAT measurement objects which are candidates to be measured within the gap j .

- An NR measurement object is a candidate to be measured in a gap if its SMTC duration is fully covered by the MGL excluding RF switching time. For intra-frequency NR measurement objects, if the higher layer in TS 38.331 [2] signaling of *smtc2* is configured, the assumed periodicity of SMTC occasions corresponds to the value of higher layer parameter *smtc2*; otherwise the assumed periodicity of SMTC occasions corresponds to the value of higher layer parameter *smtc1*.

- An inter-RAT measurement object is a candidate to be measured in all measurement gaps.

For UEs which support and are configured with per FR gaps, the counting is done on a per FR basis, and for UEs which are configured with per UE gaps the counting is done on a per UE basis.

If the number of configured inter-frequency and inter-RAT measurement objects is non-zero and the UE is configured with per UE gaps, or if the UE is configured with per FR gaps:

FR1 and FR2 intra-frequency measurement objects belong to group A

Inter-frequency and inter-RAT measurement objects belong to group B

$M_{\text{groupA},i,j}$: Sum of the number of FR1 intra-frequency measurement objects $M_{\text{intra-FR1},i,j}$ and the number of FR2 intra-frequency measurement objects $M_{\text{intra-FR2},i,j}$ which are candidates to be measured in gap j where the measurement object i is also a candidate. Otherwise $M_{\text{groupA},i,j}$ equals 0.

$M_{\text{groupB},i,j}$: Number of NR inter-frequency and EUTRA inter-RAT measurement objects which are candidates to be measured in gap j where the measurement object i is also a candidate. Otherwise $M_{\text{groupB},i,j}$ equals 0.

If the number of configured inter-frequency and inter-RAT measurement objects is zero and the UE is configured with per UE gaps:

FR1 intra-frequency measurement objects belong to group A

FR2 intra-frequency measurement objects belong to group B

$M_{\text{groupA},i,j}$: The number of FR1 intra-frequency measurement objects $M_{\text{intra-FR1},i,j}$ which are candidates to be measured in gap j where the measurement object i is also a candidate. Otherwise $M_{\text{groupA},i,j}$ equals 0.

$M_{\text{groupB},i,j}$: The number of FR2 intra-frequency measurement objects $M_{\text{intra-FR2},i,j}$ which are candidates to be measured in gap j where the measurement object i is also a candidate. Otherwise $M_{\text{groupB},i,j}$ equals 0.

$M_{\text{tot},i,j} = M_{\text{groupA},i,j} + M_{\text{groupB},i,j}$: Total number of group A and group B measurement objects which are candidates to be measured in gap j where the measurement object i is also a candidate. Otherwise $M_{\text{tot},i,j}$ equals 0.

For each measurement gap j used for an RSTD measurement with periodicity $T_{\text{prs}} > 160\text{ms}$ or with periodicity $T_{\text{prs}} = 160\text{ms}$ but *prs-MutingInfo-r9* is configured within an arbitrary 160ms period, $M_{\text{intra},i,j} = M_{\text{inter},i,j} = M_{\text{tot},i,j} = 0$.

The carrier specific scaling factor $\text{CSSF}_{\text{within_gap},i}$ is given by:

If *measGapSharingScheme* is equal sharing, $\text{CSSF}_{\text{within_gap},i} = \max(\text{ceil}(R_i \times M_{\text{tot},i,j}))$, where $j=0 \dots (160/\text{MGRP})-1$

If *measGapSharingScheme* is not equal sharing and

- measurement object i is a group A measurement object, $\text{CSSF}_{\text{within_gap},i}$ is the maximum among
 - $\text{ceil}(R_i \times K_{\text{intra}} \times M_{\text{groupA},i,j})$ in gaps where $M_{\text{groupB},i,j} \neq 0$, where $j=0 \dots (160/\text{MGRP})-1$
 - $\text{ceil}(R_i \times M_{\text{groupA},i,j})$ in gaps where $M_{\text{groupB},i,j} = 0$, where $j=0 \dots (160/\text{MGRP})-1$
- measurement object i is a group B measurement object, $\text{CSSF}_{\text{within_gap},i}$ is the maximum among
 - $\text{ceil}(R_i \times K_{\text{inter}} \times M_{\text{groupB},i,j})$ in gaps where $M_{\text{groupA},i,j} \neq 0$, where $j=0 \dots (160/\text{MGRP})-1$
 - $\text{ceil}(R_i \times M_{\text{groupB},i,j})$ in gaps where $M_{\text{groupA},i,j} = 0$, where $j=0 \dots (160/\text{MGRP})-1$

R_i is the maximal ratio of the number of measurement gap where measurement object i is a candidate to be measured over the number of measurement gap where measurement object i is a candidate and not used for RSTD measurement with periodicity $T_{\text{prs}} > 160\text{ms}$ or with periodicity $T_{\text{prs}} = 160\text{ms}$ but *prs-MutingInfo-r9* is configured within an arbitrary 1280ms period.

9.1.6 Minimum requirement at transitions

When the measurement on one intra-frequency measurement object transitions from measurements performed outside gaps to measurements performed within gaps or vice versa during one measurement period, the cell identification and measurement period requirements with the longer delay apply.

The carrier-specific scaling factor specified in clause 9.1.5 that applies to the other impacted measurement objects will also apply based on the longer measurement or cell identification delay before or after the transition.

When the UE transitions between DRX and non-DRX or when DRX cycle periodicity changes, the cell identification and measurement period requirements apply based on the longer delay before or after the transition.

Subsequent to this measurement period, the cell identification and measurement period requirements on each measurement object are corresponding to the second mode after transition.

9.2 NR intra-frequency measurements

9.2.1 Introduction

A measurement is defined as a SSB based intra-frequency measurement provided the centre frequency of the SSB of the serving cell indicated for measurement and the centre frequency of the SSB of the neighbour cell are the same, and the subcarrier spacing of the two SSBs are also the same.

The UE shall be able to identify new intra-frequency cells and perform SS-RSRP, SS-RSRQ, and SS-SINR measurements of identified intra-frequency cells if carrier frequency information is provided by PCell or the PSCell, even if no explicit neighbour list with physical layer cell identities is provided.

The UE can perform intra-frequency SSB based measurements without measurement gaps if

- the SSB is completely contained in the active BWP of the UE, or
- the active downlink BWP is initial BWP[3].

For intra-frequency SSB based measurements without measurement gaps, UE may cause scheduling restriction as specified in clause 9.2.5.3.

SSB based measurements are configured along with one or two measurement timing configuration(s) (SMTC(s)) which provides periodicity, duration and offset information on a window of up to 5ms where the measurements are to be performed. For intra-frequency connected mode measurements, up to two measurement window periodicities may be configured. A single measurement window offset and measurement duration are configured per intra-frequency measurement object.

When measurement gaps are needed, the UE is not expected to detect SSB and measure RSSI of RSRQ which start earlier than the gap starting time + switching time, nor detect SSB and measure RSSI of RSRQ which end later than the gap end – switching time. Switching time is 0.5ms for frequency range FR1 and 0.25ms for frequency range FR2.

9.2.2 Requirements applicability

The requirements in clause 9.2 apply, provided:

- The cell being identified or measured is detectable.

An intra-frequency cell shall be considered detectable when for each relevant SSB:

- SS-RSRP related side conditions given in clauses 10.1.2 and 10.1.3 for FR1 and FR2, respectively, for a corresponding Band,
- SS-RSRQ related side conditions given in clauses 10.1.7 and 10.1.8 for FR1 and FR2, respectively, for a corresponding Band,
- SS-SINR related side conditions given in clauses 10.1.12 and 10.1.13 for FR1 and FR2, respectively, for a corresponding Band,
- SSB_{RP} and SSB \hat{E}_s/I_{ot} according to Annex B.2.2 for a corresponding Band.

9.2.3 Number of cells and number of SSB

9.2.3.1 Requirements for FR1

For each intra-frequency layer, during each layer 1 measurement period, the UE shall be capable of performing SS-RSRP, SS-RSRQ, and SS-SINR measurements for at least:

- 8 identified cells, and
- 14 SSBs with different SSB index and/or PCI on the intra-frequency layer, where the number of SSBs in the serving cell (except for the SCell) is not smaller than the number of configured RLM-RS SSB resources.

9.2.3.2 Requirements for FR2

For one single intra-frequency layer in a band, during each layer 1 measurement period, the UE shall be capable of performing SS-RSRP, SS-RSRQ, and SS-SINR measurements for at least:

- 6 identified cells, and
- 24 SSBs with different SSB index and/or PCI,

where this single intra-frequency layer shall be:

- PCC when UE is configured with SA NR operation mode with PCC in the band; or
- PSCC when UE is configured with EN-DC with PSCC in the band; or
- PSCC when UE is configured with NR-DC with PSCC in the band; or
- One of the SCCs on which UE is configured to report SSB based measurements when neither PCC nor PSCC is in the same band, so that the selected SCC shall be an SCC where the UE is configured with SS-RSRP measurement reporting if such SCC exists, otherwise the selected SCC is determined by UE implementation.

The UE shall also be capable of performing SS-RSRP, SS-RSRQ, and SS-SINR measurements for at least 2 SSBs on serving cell for each of the other intra-frequency layer(s) in the same band.

9.2.4 Measurement Reporting Requirements

9.2.4.1 Periodic Reporting

Reported RSRP, RSRQ, and RS-SINR measurements contained in periodic measurement reports shall meet the requirements in clauses 10.1.2.1 (RSRP for FR1), 10.1.3.1 (RSRP for FR2), 10.1.7.1 (RSRQ for FR1), 10.1.8.1 (RSRQ for FR2), 10.1.12.1 (RS-SINR for FR1) and 10.1.13.1 (RS-SINR for FR2).

9.2.4.2 Event-triggered Periodic Reporting

Reported RSRP, RSRQ, and RS-SINR measurements contained in event-triggered periodic measurement reports shall meet the requirements in clauses 10.1.2.1 (RSRP for FR1), 10.1.3.1 (RSRP for FR2), 10.1.7.1 (RSRQ for FR1), 10.1.8.1 (RSRQ for FR2), 10.1.12.1 (RS-SINR for FR1) and 10.1.13.1 (RS-SINR for FR2).

The first report in event triggered periodic measurement reporting shall meet the requirements specified in clause 9.2.4.3.

9.2.4.3 Event Triggered Reporting

Reported RSRP, RSRQ, and RS-SINR measurements contained in event triggered measurement reports shall meet the requirements in clauses 10.1.2.1 (RSRP for FR1), 10.1.3.1 (RSRP for FR2), 10.1.7.1 (RSRQ for FR1), 10.1.8.1 (RSRQ for FR2), 10.1.12.1 (RS-SINR for FR1) and 10.1.13.1 (RS-SINR for FR2).

The UE shall not send any event triggered measurement reports as long as no reporting criteria is fulfilled.

The measurement reporting delay is defined as the time between an event that will trigger a measurement report and the point when the UE starts to transmit the measurement report over the air interface. This requirement assumes that the measurement report is not delayed by other RRC signalling on the DCCH. This measurement reporting delay excludes a delay uncertainty resulted when inserting the measurement report to the TTI of the uplink DCCH. The delay uncertainty is: $2 \times TTI_{DCCH}$. This measurement reporting delay excludes a delay which caused by no UL resources being available for UE to send the measurement report on.

The event triggered measurement reporting delay, measured without L3 filtering shall be less than $T_{\text{identify_intra_with_index}}$ Or $T_{\text{identify_intra_without_index}}$ defined in clause 9.2.5.1 or clause 9.2.6.2. When L3 filtering is used an additional delay can be expected.

A cell is detectable only if at least one SSBs measured from the Cell being configured remains detectable during the time period $T_{\text{identify_intra_without_index}}$ or $T_{\text{identify_intra_with_index}}$ as defined in clause 9.2.5.1 or clause 9.2.6.2. If a cell which has been detectable at least for the time period $T_{\text{identify_intra_without_index}}$ or $T_{\text{identify_intra_with_index}}$ defined in clause 9.2.5.1 or clause 9.2.6.2 becomes undetectable for a period ≤ 5 seconds and then the cell becomes detectable again with the same spatial reception parameter and triggers an event, the event triggered measurement reporting delay shall be less than $T_{SSB_measurement_period_intra}$ provided the timing to that cell has not changed more than $\pm 3200/2^\mu T_c$ while the measurement gap has not been available and L3 filtering has not been used, where μ is the SCS configuration as defined in clause 4.2 of TS 38.211 [3]. When L3 filtering is used, an additional delay can be expected.

9.2.5 Intrafrequency measurements without measurement gaps

9.2.5.1 Intrafrequency cell identification

The UE shall be able to identify a new detectable intra-frequency cell within $T_{\text{identify_intra_without_index}}$ if UE is not indicated to report SSB based RRM measurement result with the associated SSB index (*reportQuantityRsIndexes* or *maxNrofRSIndexesToReport* is not configured), or the UE is indicated that the neighbour cell is synchronous with the serving cell (*deriveSSB-IndexFromCell* is enabled). Otherwise UE shall be able to identify a new detectable intra frequency cell within $T_{\text{identify_intra_with_index}}$. The UE shall be able to identify a new detectable intra frequency SS block of an already detected cell within $T_{\text{identify_intra_without_index}}$. It is assumed that *deriveSSB-IndexFromCell* is always enabled for FR1 TDD and FR2.

$$T_{\text{identify_intra_without_index}} = (T_{\text{PSS/SSS_sync_intra}} + T_{\text{SSB_measurement_period_intra}}) \text{ ms}$$

$$T_{\text{identify_intra_with_index}} = (T_{\text{PSS/SSS_sync_intra}} + T_{\text{SSB_measurement_period_intra}} + T_{\text{SSB_time_index_intra}}) \text{ ms}$$

Where:

$T_{\text{PSS/SSS_sync_intra}}$: it is the time period used in PSS/SSS detection given in table 9.2.5.1-1, 9.2.5.1-2, 9.2.5.1-4 (deactivated SCell) or 9.2.5.1-5 (deactivated SCell)

$T_{\text{SSB_time_index_intra}}$: it is the time period used to acquire the index of the SSB being measured given in table 9.2.5.1-3 or 9.2.5.1-6 (deactivated SCell)

$T_{\text{SSB_measurement_period_intra}}$: equal to a measurement period of SSB based measurement given in table 9.2.5.2-1, table 9.2.5.2-2 table 9.2.5.2-3 (deactivated SCell) or 9.2.5.2-4(deactivated SCell)

$CSSF_{\text{intra}}$: it is a carrier specific scaling factor and is determined

according to $CSSF_{\text{outside_gap},i}$ in clause 9.1.5.1 for measurement conducted outside measurement gaps, i.e. when intra-frequency SMTC is fully non overlapping or partially overlapping with measurement gaps, or according to $CSSF_{\text{within_gap},i}$ in clause 9.1.5.2 for measurement conducted within measurement gaps, i.e. when intra-frequency SMTC is fully overlapping with measurement gaps.

if the high layer in TS 38.331 [2] signalling of *smtc2* is configured, the assumed periodicity of intra-frequency SMTC occasions corresponds to the value of higher layer parameter *smtc2*; Otherwise the assumed periodicity of intra-frequency SMTC occasions corresponds to the value of higher layer parameter *smtc1*.

$M_{\text{pss/sss_sync_w/o_gaps}}$: For a UE supporting FR2 power class 1, $M_{\text{pss/sss_sync_w/o_gaps}}=40$. For a UE supporting power class 2, $M_{\text{pss/sss_sync_w/o_gaps}}=24$. For a UE supporting FR2 power class 3, $M_{\text{pss/sss_sync_w/o_gaps}}=24$. For a UE supporting FR2 power class 4, $M_{\text{pss/sss_sync_w/o_gaps}}=24$

$M_{\text{meas_period_w/o_gaps}}$: For a UE supporting power class 1, $M_{\text{meas_period_w/o_gaps}} = 40$. For a UE supporting FR2 power class 2, $M_{\text{meas_period_w/o_gaps}} = 24$. For a UE supporting power class 3, $M_{\text{meas_period_w/o_gaps}} = 24$. For a UE supporting power class 4, $M_{\text{meas_period_w/o_gaps}} = 24$.

When intra-frequency SMTC is fully non overlapping with measurement gaps or intra-frequency SMTC is fully overlapping with MGs, $K_p = 1$

When intra-frequency SMTC is partially overlapping with measurement gaps, $K_p = 1 / (1 - (\text{SMTC period} / \text{MGRP}))$, where $\text{SMTC period} < \text{MGRP}$. For calculation of K_p , if the high layer signalling (TS 38.331 [2]) of *smtc2* is configured, for cells indicated in the *pci-List* parameter in *smtc2*, the SMTC periodicity corresponds to the value of higher layer parameter *smtc2*; for the other cells, the SMTC periodicity corresponds to the value of higher layer parameter *smtc1*.

If the higher layer signaling in TS38.331 [2] signalling of *smtc2* is present and *smtc1* is fully overlapping with measurement gaps and *smtc2* is partially overlapping with measurement gaps, requirements are not specified for $T_{\text{identify_intra_without_index}}$ Or $T_{\text{identify_intra_with_index}}$

For FR2,

$K_{\text{layer1_measurement}} = 1,$

- if all of the reference signals configured for RLM, BFD, CBD or L1-RSRP for beam reporting on any FR2 serving frequency in the same band outside measurement gap are not fully overlapped by intra-frequency SMTC occasions, or
- if all of the reference signal configured for RLM, BFD, CBD or L1-RSRP for beam reporting on any FR2 serving frequency in the same band outside measurement gap and fully-overlapped by intra-frequency SMTC occasions are not overlapped with any of the SSB symbols and the RSSI symbols, and 1 symbol before each consecutive SSB symbols and the RSSI symbols, and 1 symbol after each consecutive SSB symbols and the RSSI symbols, given that *SSB-ToMeasure* and *SS-RSSI-Measurement* are configured, where SSB symbols are indicated by the union set of *SSB-ToMeasure* from all the configured measurement objects on the same serving carrier which can be merged and RSSI symbols are indicated by *SS-RSSI-Measurement*;

$K_{\text{layer1_measurement}} = 1.5,$ otherwise.

If the above-mentioned reference signal configured for L1-RSRP measurement is aperiodic CSI-RS resource, longer cell identification delay would be expected.

If MCG DRX is in use, cell identification requirements for intra-frequency measurement in MCG specified in Table 9.2.5.1-1, Table 9.2.5.1-2, Table 9.2.5.1-3, Table 9.2.5.1-4, Table 9.2.5.1-5 and Table 9.2.5.1-6 shall depend on the MCG DRX cycle. If SCG DRX is in use, cell identification requirements for intra-frequency measurement in SCG specified in Table 9.2.5.1-1, Table 9.2.5.1-2, Table 9.2.5.1-3, Table 9.2.5.1-4, Table 9.2.5.1-5 and Table 9.2.5.1-6 shall depend on the SCG DRX cycle. Otherwise, the requirements for when DRX is not in use shall apply.

Table 9.2.5.1-1: Time period for PSS/SSS detection, (Frequency range FR1)

DRX cycle	$T_{\text{PSS/SSS_sync_intra}}$
No DRX	$\max(600\text{ms}, \text{ceil}(5 \times K_p) \times \text{SMTC period})^{\text{Note 1}} \times \text{CSSF}_{\text{intra}}$
$\text{DRX cycle} \leq 320\text{ms}$	$\max(600\text{ms}, \text{ceil}(1.5 \times 5 \times K_p) \times \max(\text{SMTC period}, \text{DRX cycle})) \times \text{CSSF}_{\text{intra}}$
$\text{DRX cycle} > 320\text{ms}$	$\text{ceil}(5) \times K_p \times \text{DRX cycle} \times \text{CSSF}_{\text{intra}}$

NOTE 1: If different SMTC periodicities are configured for different cells, the SMTC period in the requirement is the one used by the cell being identified

Table 9.2.5.1-2: Time period for PSS/SSS detection, (Frequency range FR2)

DRX cycle	$T_{\text{PSS/SSS_sync_intra}}$
No DRX	$\max(600\text{ms}, \text{ceil}(M_{\text{pss/sss_sync_w/o_gaps}} \times K_p \times K_{\text{layer1_measurement}}) \times \text{SMTC period})^{\text{Note 1}} \times \text{CSSF}_{\text{intra}}$

DRX cycle \leq 320ms	$\max(600\text{ms}, \text{ceil}(1.5 \times M_{\text{pss/sss_sync_w/o_gaps}} \times K_p \times K_{\text{layer1_measurement}}) \times \max(\text{SMTC period}, \text{DRX cycle})) \times \text{CSSF}_{\text{intra}}$
DRX cycle $>$ 320ms	$\text{ceil}(M_{\text{pss/sss_sync_w/o_gaps}} \times K_p \times K_{\text{layer1_measurement}}) \times \text{DRX cycle} \times \text{CSSF}_{\text{intra}}$
NOTE 1: If different SMTC periodicities are configured for different cells, the SMTC period in the requirement is the one used by the cell being identified	

Table 9.2.5.1-3: Time period for time index detection (FR1)

DRX cycle	T_{SSB_time_index_intra}
No DRX	$\max(120\text{ms}, \text{ceil}(3 \times K_p) \times \text{SMTC period})^{\text{Note 1}} \times \text{CSSF}_{\text{intra}}$
DRX cycle \leq 320ms	$\max(120\text{ms}, \text{ceil}(1.5 \times 3 \times K_p) \times \max(\text{SMTC period}, \text{DRX cycle})) \times \text{CSSF}_{\text{intra}}$
DRX cycle $>$ 320ms	$\text{Ceil}(3 \times K_p) \times \text{DRX cycle} \times \text{CSSF}_{\text{intra}}$
NOTE 1: If different SMTC periodicities are configured for different cells, the SMTC period in the requirement is the one used by the cell being identified	

Table 9.2.5.1-4: Time period for PSS/SSS detection, deactivated SCell (FR1)

DRX cycle	T_{PSS/SSS_sync_intra}
No DRX	$\text{Ceil}(5 \times K_p) \times \text{measCycleSCell} \times \text{CSSF}_{\text{intra}}$
DRX cycle \leq 320ms	$\text{Ceil}(5 \times K_p) \times \max(\text{measCycleSCell}, 1.5 \times \text{DRX cycle}) \times \text{CSSF}_{\text{intra}}$
DRX cycle $>$ 320ms	$\text{Ceil}(5 \times K_p) \times \max(\text{measCycleSCell}, \text{DRX cycle}) \times \text{CSSF}_{\text{intra}}$

Table 9.2.5.1-5: Time period for PSS/SSS detection, deactivated SCell (FR1)

DRX cycle	T_{PSS/SSS_sync_intra}
No DRX	$\text{Ceil}(M_{\text{pss/sss_sync_w/o_gaps}} \times K_p) \times \text{measCycleSCell} \times \text{CSSF}_{\text{intra}}$
DRX cycle \leq 320ms	$\text{Ceil}(M_{\text{pss/sss_sync_w/o_gaps}} \times K_p) \times \max(\text{measCycleSCell}, 1.5 \times \text{DRX cycle}) \times \text{CSSF}_{\text{intra}}$
DRX cycle $>$ 320ms	$\text{Ceil}(M_{\text{pss/sss_sync_w/o_gaps}} \times K_p) \times \max(\text{measCycleSCell}, \text{DRX cycle}) \times \text{CSSF}_{\text{intra}}$

Table 9.2.5.1-6: Time period for time index detection, deactivated SCell (FR1)

DRX cycle	T_{SSB_time_index_intra}
No DRX	$\text{Ceil}(3 \times K_p) \times \text{measCycleSCell} \times \text{CSSF}_{\text{intra}}$
DRX cycle \leq 320ms	$\text{Ceil}(3 \times K_p) \times \max(\text{measCycleSCell}, 1.5 \times \text{DRX cycle}) \times \text{CSSF}_{\text{intra}}$
DRX cycle $>$ 320ms	$\text{Ceil}(3 \times K_p) \times \max(\text{measCycleSCell}, \text{DRX cycle}) \times \text{CSSF}_{\text{intra}}$

Table 9.2.5.1-7: Void**Table 9.2.5.1-8: Void**

9.2.5.2 Measurement period

The measurement period for intrafrequency measurements without gaps is as shown in table 9.2.5.2-1, 9.2.5.2-2, 9.2.5.2-3 (deactivated SCell) or 9.2.5.2-4 (deactivated SCell). If the higher layer signaling in TS38.331 [2] signalling of *smtc2* is present and *smtc1* is fully overlapping with measurement gaps and *smtc2* is partially overlapping with measurement gaps, requirements are not specified for T_{SSB_measurement_period_intra}

If MCG DRX is in use, measurement period requirements for intra-frequency measurement in MCG specified in Table 9.2.5.2-1, Table 9.2.5.2-2, Table 9.2.5.2-3 and Table 9.2.5.2-4 shall depend on the MCG DRX cycle. If SCG DRX is in use, measurement period requirements for intra-frequency measurement in SCG specified in Table 9.2.5.2-1, Table 9.2.5.2-2, Table 9.2.5.2-3 and Table 9.2.5.2-4 shall depend on the SCG DRX cycle. Otherwise, the requirements for when DRX is not in use shall apply.

For FR2, a longer measurement period is allowed, if aperiodic CSI-RS resource is measured for L1-RSRP measurement on any FR2 serving frequency in the same band, and the CSI-RS resource is outside measurement gap and overlapped with any of the SSB symbols and the RSSI symbols, and 1 symbol before each consecutive SSB symbols and the RSSI symbols, and 1 symbol after each consecutive SSB symbols and the RSSI symbols. If *SSB-ToMeasure* or *SS-RSSI-Measurement* is configured, the SSB symbols are indicated by the union set of *SSB-ToMeasure* from all the configured measurement objects on the same band which can be merged and the RSSI symbols are indicated by *SS-RSSI-Measurement*.

Table 9.2.5.2-1: Measurement period for intrafrequency measurements without gaps(FR1)

DRX cycle	$T_{SSB_measurement_period_intra}$
No DRX	$\max(200\text{ms}, \text{ceil}(5 \times K_p) \times \text{SMTC period})^{\text{Note 1}} \times \text{CSSF}_{intra}$
DRX cycle $\leq 320\text{ms}$	$\max(200\text{ms}, \text{ceil}(1.5 \times 5 \times K_p) \times \max(\text{SMTC period}, \text{DRX cycle})) \times \text{CSSF}_{intra}$
DRX cycle $> 320\text{ms}$	$\text{ceil}(5 \times K_p) \times \text{DRX cycle} \times \text{CSSF}_{intra}$

NOTE 1: If different SMTC periodicities are configured for different cells, the SMTC period in the requirement is the one used by the cell being identified

Table 9.2.5.2-2: Measurement period for intra-frequency measurements without gaps(FR2)

DRX cycle	$T_{SSB_measurement_period_intra}$
No DRX	$\max(400\text{ms}, \text{ceil}(M_{meas_period_w/o_gaps} \times K_p \times K_{layer1_measurement}) \times \text{SMTC period})^{\text{Note 1}} \times \text{CSSF}_{intra}$
DRX cycle $\leq 320\text{ms}$	$\max(400\text{ms}, \text{ceil}(1.5 \times M_{meas_period_w/o_gaps} \times K_p \times K_{layer1_measurement}) \times \max(\text{SMTC period}, \text{DRX cycle})) \times \text{CSSF}_{intra}$
DRX cycle $> 320\text{ms}$	$\text{ceil}(M_{meas_period_w/o_gaps} \times K_p \times K_{layer1_measurement}) \times \text{DRX cycle} \times \text{CSSF}_{intra}$

NOTE 1: If different SMTC periodicities are configured for different cells, the SMTC period in the requirement is the one used by the cell being identified

Table 9.2.5.2-3: Measurement period for intra-frequency measurements without gaps (deactivated SCell) (FR1)

DRX cycle	$T_{SSB_measurement_period_intra}$
No DRX	$\text{Ceil}(5 \times K_p) \times \text{measCycleSCell} \times \text{CSSF}_{intra}$
DRX cycle $\leq 320\text{ms}$	$\text{Ceil}(5 \times K_p) \times \max(\text{measCycleSCell}, 1.5 \times \text{DRX cycle}) \times \text{CSSF}_{intra}$
DRX cycle $> 320\text{ms}$	$\text{Ceil}(5 \times K_p) \times \max(\text{measCycleSCell}, \text{DRX cycle}) \times \text{CSSF}_{intra}$

Table 9.2.5.2-4: Measurement period for intra-frequency measurements without gaps (deactivated SCell) FR2)

DRX cycle	$T_{SSB_measurement_period_intra}$
No DRX	$\text{Ceil}(M_{meas_period_w/o_gaps} \times K_p) \times \text{measCycleSCell} \times \text{CSSF}_{intra}$
DRX cycle $\leq 320\text{ms}$	$\text{Ceil}(M_{meas_period_w/o_gaps} \times K_p) \times \max(\text{measCycleSCell}, 1.5 \times \text{DRX cycle}) \times \text{CSSF}_{intra}$
DRX cycle $> 320\text{ms}$	$\text{Ceil}(M_{meas_period_w/o_gaps} \times K_p) \times \max(\text{measCycleSCell}, \text{DRX cycle}) \times \text{CSSF}_{intra}$

9.2.5.3 Scheduling availability of UE during intra-frequency measurements

UE are required to be capable of measuring without measurement gaps when the SSB is completely contained in the active bandwidth part of the UE. When any of the conditions in the following clauses is met, there are restrictions on the scheduling availability; otherwise, there is no scheduling restriction. Note that the SSB symbols to be measured in the following clauses are the SSB symbols indicated by the union set of *SSB-ToMeasure* from all the configured measurement objects on the same serving carrier which can be merged [2], if it is configured; otherwise, all *L* SSB symbols within SMTC window duration defined in clause 4.1 of TS 38.213 [3] are included.

9.2.5.3.1 Scheduling availability of UE performing measurements in TDD bands on FR1

When the UE performs intra-frequency measurements in a TDD band, the following restrictions apply due to SS-RSRP or SS-SINR measurement

- The UE is not expected to transmit PUCCH/PUSCH/SRS on SSB symbols to be measured, and on 1 data symbol before each consecutive SSB symbols to be measured and 1 data symbol after each consecutive SSB symbols to be measured within SMTC window duration. If the high layer in TS 38.331 [2] signalling of *smtc2* is configured, the SMTC periodicity follows *smtc2*; Otherwise SMTC periodicity follows *smtc1*.

When the UE performs intra-frequency measurements in a TDD band, the following restrictions apply due to SS-RSRQ measurement

- The UE is not expected to transmit PUCCH/PUSCH/SRS on SSB symbols to be measured, RSSI measurement symbols, and on 1 data symbol before each consecutive SSB to be measured/RSSI symbols and 1 data symbol after each consecutive SSB to be measured/RSSI symbols within SMTC window duration. If the high layer signalling of *smtc2* is configured in TS 38.331 [2], the SMTC periodicity follows *smtc2*; Otherwise the SMTC periodicity follows *smtc1*

When TDD intra-band carrier aggregation is performed, the scheduling restrictions due to a given serving cell should also apply to all other serving cells in the same band on the symbols that fully or partially overlap with aforementioned restricted symbols.

9.2.5.3.2 Scheduling availability of UE performing measurements with a different subcarrier spacing than PDSCH/PDCCH on FR1

For UE which do not support *simultaneousRxDataSSB-DiffNumerology* [14] the following restrictions apply due to SS-RSRP/RSRQ/SINR measurement

- If *deriveSSB_IndexFromCell* is enabled the UE is not expected to transmit PUCCH/PUSCH/SRS or receive PDCCH/PDSCH/TRS/CSI-RS for CQI on SSB symbols to be measured, and on 1 data symbol before each consecutive SSB symbols to be measured and 1 data symbol after each consecutive SSB symbols to be measured within SMTC window duration. If the high layer signalling of *smtc2* is configured in TS 38.331 [2], the SMTC periodicity follows *smtc2*; Otherwise the SMTC periodicity follows *smtc1*.
- If *deriveSSB_IndexFromCell* is not enabled the UE is not expected to transmit PUCCH/PUSCH/SRS or receive PDCCH/PDSCH/TRS/CSI-RS for CQI on all symbols within SMTC window duration. If the high layer signalling of *smtc2* is configured in TS 38.331 [2], the SMTC periodicity follows *smtc2*; Otherwise the SMTC periodicity follows *smtc1*.

If the following conditions are met:

- The UE has been notified about system information update through paging,
- The gap between the UE's reception of PDCCH that UE monitors in the Type 2-PDCCH CSS set that notifies system information update, and the PDCCH that UE monitors in the Type0-PDCCH CSS set, is greater than 2 slots

The UE is expected to receive the PDCCH that the UE monitors in the Type0-PDCCH CSS set, and/or the corresponding PDSCH, on SSB symbols to be measured.

When intra-band carrier aggregation is performed, the scheduling restrictions due to a given serving cell should also apply to all other serving cells in the same band on the symbols that fully or partially overlap with aforementioned restricted symbols.

9.2.5.3.3 Scheduling availability of UE performing measurements on FR2

The following scheduling restriction applies due to SS-RSRP or SS-SINR measurement on an FR2 intra-frequency cell

The UE is not expected to transmit PUCCH/PUSCH/SRS or receive PDCCH/PDSCH/TRS/CSI-RS for CQI on SSB symbols to be measured, and on 1 data symbol before each consecutive SSB symbols to be measured and 1 data symbol after each consecutive SSB symbols to be measured within SMTC window duration (The signaling *deriveSSB_IndexFromCell* is always enabled for FR2). If the high layer signalling of *smtc2* is configured in TS 38.331 [2], the SMTC periodicity follows *smtc2*; Otherwise the SMTC periodicity follows *smtc1*.

The following scheduling restriction applies to SS-RSRQ measurement on an FR2 intra-frequency cell

- The UE is not expected to transmit PUCCH/PUSCH/SRS or receive PDCCH/PDSCH/TRS/CSI-RS for CQI on SSB symbols to be measured, RSSI measurement symbols, and on 1 data symbol before each consecutive SSB to be measured/RSSI symbols and 1 data symbol after each consecutive SSB to be measured/RSSI symbols within SMTC window duration (The signaling *deriveSSB_IndexFromCell* is always enabled for FR2). If the high layer signalling of *smtc2* is configured in TS 38.331 [2], the SMTC periodicity follows *smtc2*; Otherwise the SMTC periodicity follows *smtc1*.

When intra-band carrier aggregation is performed, the scheduling restrictions due to a given serving cell should also apply to all other serving cells in the same band on the symbols that fully or partially overlap with aforementioned restricted symbols.

If following conditions are met:

- The UE has been notified about system information update through paging,
- The gap between the UE's reception of PDCCH that UE monitors in the Type 2-PDCCH CSS set that notifies system information update, and the PDCCH that UE monitors in the Type0-PDCCH CSS set, is greater than 2 slots,

For the SSB and CORESET for RMSI scheduling multiplexing patterns 3, the UE is expected to receive the PDCCH that the UE monitors in the Type0-PDCCH CSS set, and the corresponding PDSCH, on SSB symbols to be measured; and

For the SSB and CORESET for RMSI scheduling multiplexing patterns 2, the UE is expected to receive PDSCH that corresponds to the PDCCH that the UE monitors in the Type0-PDCCH CSS set, on SSB symbols to be measured.

9.2.5.3.4 Scheduling availability of UE performing measurements on FR1 or FR2 in case of FR1-FR2 inter-band CA

There are no scheduling restrictions on FR1 serving cell(s) due to measurements performed on FR2 serving cell frequency layer.

There are no scheduling restrictions on FR2 serving cell(s) due to measurements performed on FR1 serving cell frequency layer.

9.2.5.4 SFTD Measurements between PCell and PSCell

9.2.5.4.1 Introduction

This clause contains SFTD measurement requirements for UE which supports NR-DC and is configured with a PSCell in RRC_CONNECTED state. The UE shall perform SFTD measurement between PCell and PSCell, and report the SFTD result with/without SS-RSRP after the network requests with *reportType* for the associated *reportConfig* set to *reportSFTD*. The overall delay includes RRC procedure delay defined in clause 12 in TS 38.331 [2], and SFTD measurement reporting delay in clause 9.2.5.4.3.

9.2.5.4.2 SFTD Measurement delay

When no DRX is used in either of PCell and PSCell, the physical layer measurement period of the SFTD measurement shall be $T_{\text{measure_SFTD1}} = \max(200, 5 \times \text{SMTC period})$ ms, where the SMTC period refers to the maximum between the configured SMTC period in PCell and PSCell.

When DRX is used in either of the PCell or the PSCell, or in both PCell and PSCell, the physical layer measurement period ($T_{\text{measure_SFTD1}}$) of the SFTD measurement shall be as specified in Table 9.2.5.4.2-1.

Table 9.2.5.4.2-1: SFTD measurement requirement when DRX is used

DRX cycle length (s) ^{Note 3}	$T_{\text{measure_SFTD1}}$ (s)
≤ 0.04	max(0.2, 5 x SMTC period) (Note2)
$0.04 < \text{DRX cycle} \leq 0.32$	8 x max(DRX cycle, SMTC period)
$0.32 < \text{DRX cycle} \leq 10.24$	5 x DRX cycle
Note 1: SMTC period in this table refers to the maximum between the configured SMTC period in PCell and PSCell. Note 2: Number of DRX cycles depends upon the DRX cycle in use Note 3: DRX cycle length in this table refers to the DRX cycle length configured for PCell or PSCell. When DRX is used in both PCell and PSCell, DRX cycle length in this table refers to the longer of the DRX cycle lengths for PCell and PSCell.	

If PSCell is changed without changing carrier frequency of PSCell, while the UE is performing SFTD measurements, the UE shall still meet SFTD measurement and accuracy requirements for the new PSCell. In this case the UE shall restart the SFTD measurement, and the total physical layer measurement period shall not exceed $T_{\text{measure_SFTD2}}$ as defined by the following expression:

$$T_{\text{measure_SFTD2}} = (M+1) * (T_{\text{measure_SFTD1}}) + M * T_{\text{PSCell_change_NRDC}}$$

where:

M is the number of times the NR PSCell is changed over the measurement period ($T_{\text{measure_SFTD2}}$), and

$T_{\text{PSCell_change_NRDC}}$ is the time necessary to change the PSCell; it can be up to 25 ms.

If PCell is changed, or if PSCell is changed with different carrier frequency from PSCell, the UE shall terminate SFTD measurements.

The measurement accuracy for the SFTD measurement when DRX is used as well as when no DRX is used shall be as specified in the sub-clause 10.1.21.

9.2.5.4.3 SFTD Measurement Reporting Delay

The SFTD measurement reporting delay is defined as the time between a command that will trigger an SFTD measurement report and the point when the UE starts to transmit the measurement report over the air interface. This requirement assumes that the measurement report is not delayed by other RRC signalling on the DCCH. This measurement reporting delay excludes a delay uncertainty resulted when inserting the measurement report to the TTI of the uplink DCCH. The delay uncertainty is: $2 \times TTI_{\text{DCCH}}$. This measurement reporting delay excludes any delay caused by no UL resources available for UE to send the measurement report.

The SFTD measurement reporting delay shall be less than measurement period defined in clause 9.2.5.4.2 plus the RRC procedure delay defined in TS 38.331 [2].

9.2.6 Intra-frequency measurements with measurement gaps

9.2.6.1 Void

9.2.6.2 Intra-frequency cell identification

The UE shall be able to identify a new detectable intra-frequency cell within $T_{\text{identify_intra_without_index}}$ if UE is not indicated to report SSB based RRM measurement result with the associated SSB index (*reportQuantityRSIndexes* or *maxNrofRSIndexesToReport* is not configured), or the UE has been indicated that the neighbour cell is synchronous with the serving cell (*deriveSSB-IndexFromCell* is enabled). Otherwise UE shall be able to identify a new detectable intra frequency cell within $T_{\text{identify_intra_with_index}}$. The UE shall be able to identify a new detectable intra frequency SS block of an already detected cell within $T_{\text{identify_intra_without_index}}$. It is assumed that *deriveSSB-IndexFromCell* is always enabled for FR1 TDD and FR2.

$$T_{\text{identify_intra_without_index}} = T_{\text{PSS/SSS_sync_intra}} + T_{\text{SSB_measurement_period_intra}} \text{ ms}$$

$$T_{\text{identify_intra_with_index}} = T_{\text{PSS/SSS_sync_intra}} + T_{\text{SSB_measurement_period_intra}} + T_{\text{SSB_time_index_intra}}$$

Where:

$T_{\text{PSS/SSS_sync_intra}}$: it is the time period used in PSS/SSS detection given in table 9.2.6.2-1 or 9.2.6.2-2.

$T_{\text{SSB_time_index_intra}}$: it is the time period used to acquire the index of the SSB being measured given in table 9.2.6.2-3.

$T_{\text{SSB_measurement_period_intra}}$: equal to a measurement period of SSB based measurement given in table 9.2.6.3-1 or 9.2.6.3-2.

$\text{CSSF}_{\text{intra}}$: it is a carrier specific scaling factor and is determined according to $\text{CSSF}_{\text{within_gap},i}$ in clause 9.1.5.2 for measurement conducted within measurement gaps.

$M_{\text{pss/sss_sync_with_gaps}}$: For a UE supporting FR2 power class 1, $M_{\text{pss/sss_sync_with_gaps}}=40$. For a UE supporting FR2 power class 2, $M_{\text{pss/sss_sync_with_gaps}}=24$. For a UE supporting FR2 power class 3, $M_{\text{pss/sss_sync_with_gaps}}=24$. For a UE supporting power class 4, $M_{\text{pss/sss_sync_with_gaps}}=24$

$M_{\text{meas_period_with_gaps}}$: For a UE supporting power class 1, $M_{\text{meas_period_with_gaps}}=40$. For a UE supporting power class 2, $M_{\text{meas_period_with_gaps}}=24$. For a UE supporting power class 3, $M_{\text{meas_period_with_gaps}}=24$. For a UE supporting power class 4, $M_{\text{meas_period_with_gaps}}=24$.

If the higher layer signaling in TS 38.331 [2] of *smtc2* is present and *smtc1* is fully overlapping with measurement gaps and *smtc2* is partially overlapping with measurement gaps, requirements are not specified for $T_{\text{identify_intra_without_index}}$ OR $T_{\text{identify_intra_with_index}}$.

If MCG DRX is in use, cell identification requirements for intra-frequency measurement in MCG specified in Table 9.2.6.2-1, Table 9.2.6.2-2, and Table 9.2.6.2-3 shall depend on the MCG DRX cycle. If SCG DRX is in use, cell identification requirements for intra-frequency measurement in SCG specified in Table 9.2.6.2-1, Table 9.2.6.2-2, and Table 9.2.6.2-3 shall depend on the SCG DRX cycle. Otherwise, the requirements for when DRX is not in use shall apply.

Table 9.2.6.2-1: Time period for PSS/SSS detection (FR1)

DRX cycle	$T_{\text{PSS/SSS_sync_intra}}$
No DRX	$\max(600\text{ms}, 5 \times \max(\text{MGRP}, \text{SMTC period})) \times \text{CSSF}_{\text{intra}}$
$\text{DRX cycle} \leq 320\text{ms}$	$\max(600\text{ms}, \text{ceil}(1.5 \times 5) \times \max(\text{MGRP}, \text{SMTC period}, \text{DRX cycle})) \times \text{CSSF}_{\text{intra}}$
$\text{DRX cycle} > 320\text{ms}$	$5 \times \max(\text{MGRP}, \text{DRX cycle}) \times \text{CSSF}_{\text{intra}}$

Table 9.2.6.2-2: Time period for PSS/SSS detection (FR2)

DRX cycle	$T_{\text{PSS/SSS_sync_intra}}$
No DRX	$\max(600\text{ms}, M_{\text{pss/sss_sync_with_gaps}} \times \max(\text{MGRP}, \text{SMTC period})) \times \text{CSSF}_{\text{intra}}$
$\text{DRX cycle} \leq 320\text{ms}$	$\max(600\text{ms}, \text{ceil}(1.5 \times M_{\text{pss/sss_sync_with_gaps}}) \times \max(\text{MGRP}, \text{SMTC period}, \text{DRX cycle})) \times \text{CSSF}_{\text{intra}}$
$\text{DRX cycle} > 320\text{ms}$	$M_{\text{pss/sss_sync_with_gaps}} \times \max(\text{MGRP}, \text{DRX cycle}) \times \text{CSSF}_{\text{intra}}$

Table 9.2.6.2-3: Time period for time index detection (FR1)

DRX cycle	$T_{\text{SSB_time_index_intra}}$
No DRX	$\max(120\text{ms}, 3 \times \max(\text{MGRP}, \text{SMTC period})) \times \text{CSSF}_{\text{intra}}$
$\text{DRX cycle} \leq 320\text{ms}$	$\max(120\text{ms}, \text{ceil}(1.5 \times 3) \times \max(\text{MGRP}, \text{SMTC period}, \text{DRX cycle})) \times \text{CSSF}_{\text{intra}}$
$\text{DRX cycle} > 320\text{ms}$	$3 \times \max(\text{MGRP}, \text{DRX cycle}) \times \text{CSSF}_{\text{intra}}$

Table 9.2.6.2-7: Void**Table 9.2.6.2-8: Void**

9.2.6.3 Intra-frequency Measurement Period

The measurement period for FR1 intra-frequency measurements with gaps is as shown in table 9.2.6.3-1.

The measurement period for FR2 intra-frequency measurements with gaps is as shown in table 9.2.6.3-2.

If MCG DRX is in use, measurement period requirements for intra-frequency measurement in MCG specified in Table 9.2.6.3-1 and Table 9.2.6.3-2, shall depend on the MCG DRX cycle. If SCG DRX is in use, measurement period requirements for intra-frequency measurement in SCG specified in Table 9.2.6.3-1 and Table 9.2.6.3-2, shall depend on the SCG DRX cycle. Otherwise, the requirements for when DRX is not in use shall apply.

Table 9.2.6.3-1: Measurement period for intra-frequency measurements with gaps(FR1)

DRX cycle	$T_{SSB_measurement_period_intra}$
No DRX	$\max(200\text{ms}, 5 \times \max(\text{MGRP}, \text{SMTC period})) \times \text{CSSF}_{intra}$
DRX cycle $\leq 320\text{ms}$	$\max(200\text{ms}, \text{ceil}(1.5 \times 5) \times \max(\text{MGRP}, \text{SMTC period}, \text{DRX cycle})) \times \text{CSSF}_{intra}$
DRX cycle $> 320\text{ms}$	$5 \times \max(\text{MGRP}, \text{DRX cycle}) \times \text{CSSF}_{intra}$

Table 9.2.6.3-2: Measurement period for intra-frequency measurements with gaps(FR2)

DRX cycle	$T_{SSB_measurement_period_intra}$
No DRX	$\max(400\text{ms}, M_{meas_period\ with_gaps} \times \max(\text{MGRP}, \text{SMTC period})) \times \text{CSSF}_{intra}$
DRX cycle $\leq 320\text{ms}$	$\max(400\text{ms}, \text{ceil}(1.5 \times M_{meas_period\ with_gaps}) \times \max(\text{MGRP}, \text{SMTC period}, \text{DRX cycle})) \times \text{CSSF}_{intra}$ ^{Note 1}
DRX cycle $> 320\text{ms}$	$M_{meas_period\ with_gaps} \times \max(\text{MGRP}, \text{DRX cycle}) \times \text{CSSF}_{intra}$

9.3 NR inter-frequency measurements

9.3.1 Introduction

A measurement is defined as an SSB based inter-frequency measurement provided it is not defined as an intra-frequency measurement according to clause 9.2.

The UE shall be able to identify new inter-frequency cells and perform SS-RSRP, SS-RSRQ, and SS-SINR measurements of identified inter-frequency cells if carrier frequency information is provided by PCell or PSCell, even if no explicit neighbour list with physical layer cell identities is provided.

SSB based measurements are configured along with a measurement timing configuration (SMTC) per carrier, which provides periodicity, duration and offset information on a window of up to 5ms where the measurements on the configured inter-frequency carrier are to be performed. For inter-frequency connected mode measurements, one measurement window periodicity may be configured per inter-frequency measurement object.

When measurement gaps are needed, the UE is not expected to detect SSB and measure RSSI of RSRQ on an inter-frequency measurement object which starts earlier than the gap starting time + switching time, nor detect SSB and measure RSSI of RSRQ which ends later than the gap end – switching time. When the inter-frequency cells are in FR2 and the per-FR gap is configured to the UE in EN-DC, SA NR, NE-DC and NR-DC, or the serving cells are in FR2, the inter-frequency cells are in FR2 and the per-UE gap is configured to the UE in SA NR and NR-DC, the switching time is 0.25ms. Otherwise the switching time is 0.5ms.

9.3.2 Requirements applicability

The requirements in clause 9.3 apply, provided:

- The cell being identified or measured is detectable.

An inter-frequency cell shall be considered detectable when for each relevant SSB:

- SS-RSRP related side conditions given in clauses 10.1.4 and 10.1.5 for FR1 and FR2, respectively, for a corresponding Band,
- SS-RSRQ related side conditions given in clauses 10.1.9 and 10.1.10 for FR1 and FR2, respectively, for a corresponding Band,
- SS-SINR related side conditions given in clauses 10.1.14 and 10.1.15 for FR1 and FR2, respectively, for a corresponding Band,
- SSB_{RP} and SSB \hat{E}_s/I_{ot} according to Annex B.2.3 for a corresponding Band.

9.3.2.1 Void

9.3.2.2 Void

9.3.3 Number of cells and number of SSB

9.3.3.1 Requirements for FR1

For each inter-frequency layer, during each layer 1 measurement period, the UE shall be capable of performing SS-RSRP, SS-RSRQ, and SS-SINR measurements for at least:

- 4 identified cells, and
- 7 SSBs with different SSB index and/or PCI on the inter-frequency layer.

9.3.3.2 Requirements for FR2

For each inter-frequency layer, during each layer 1 measurement period, the UE shall be capable of performing SS-RSRP, SS-RSRQ, and SS-SINR measurements for at least:

- 4 identified cells, and
- 10 SSBs with different SSB index and/or PCI on the inter-frequency layer, and
- 1 SSB per identified cell.

9.3.4 Inter-frequency cell identification

When measurement gaps are provided, or the UE supports capability of conducting such measurements without gaps, the UE shall be able to identify a new detectable inter frequency cell within $T_{\text{identify_inter_without_index}}$ if UE is not indicated to report SSB based RRM measurement result with the associated SSB index (*reportQuantityRSIndexes* or *maxNrofRSIndexesToReport* is not configured). Otherwise UE shall be able to identify a new detectable inter frequency cell within $T_{\text{identify_inter_with_index}}$. The UE shall be able to identify a new detectable inter frequency SS block of an already detected cell within $T_{\text{identify_inter_without_index}}$.

$$T_{\text{identify_inter_without_index}} = (T_{\text{PSS/SSS_sync_inter}} + T_{\text{SSB_measurement_period_inter}}) \text{ ms}$$

$$T_{\text{identify_inter_with_index}} = (T_{\text{PSS/SSS_sync_inter}} + T_{\text{SSB_measurement_period_inter}} + T_{\text{SSB_time_index_inter}}) \text{ ms}$$

Where:

$T_{\text{PSS/SSS_sync_inter}}$: it is the time period used in PSS/SSS detection given in table 9.3.4-1 and table 9.3.4-2.

$T_{\text{SSB_time_index_inter}}$: it is the time period used to acquire the index of the SSB being measured given in table 9.3.4-3 and table 9.3.4-4.

$T_{SSB_measurement_period_inter}$: equal to a measurement period of SSB based measurement given in table 9.3.5-1 and table 9.3.5-2.

M_{pss/sss_sync_inter} : For a UE supporting FR2 power class 1, $M_{pss/sss_sync_inter} = 64$ samples. For a UE supporting FR2 power class 2, $M_{pss/sss_sync_inter} = 40$ samples. For a UE supporting FR2 power class 3, $M_{pss/sss_sync_inter} = 40$ samples. For a UE supporting FR2 power class 4, $M_{pss/sss_sync_inter} = 40$ samples.

$M_{SSB_index_inter}$: For a UE supporting FR2 power class 1, $M_{SSB_index_inter} = 40$ samples. For a UE supporting FR2 power class 2, $M_{SSB_index_inter} = 24$ samples. For a UE supporting FR2 power class 3, $M_{SSB_index_inter} = 24$ samples. For a UE supporting FR2 power class 4, $M_{SSB_index_inter} = 24$ samples.

$M_{meas_period_inter}$: For a UE supporting FR2 power class 1, $M_{meas_period_inter} = 64$ samples. For a UE supporting FR2 power class 2, $M_{meas_period_inter} = 40$ samples. For a UE supporting FR2 power class 3, $M_{meas_period_inter} = 40$ samples. For a UE supporting FR2 power class 4, $M_{meas_period_inter} = 40$ samples.

$CSSF_{inter}$: it is a carrier specific scaling factor and is determined according to $CSSF_{within_gap,i}$ in clause 9.1.5.2 for measurement conducted within measurement gaps.

Table 9.3.4-1: Time period for PSS/SSS detection, (Frequency range FR1)

Condition ^{NOTE1,2}	T_{pss/sss_sync_inter}
No DRX	$\text{Max}(600\text{ms}, 8 \times \text{Max}(\text{MGRP}, \text{SMTC period})) \times CSSF_{inter}$
DRX cycle $\leq 320\text{ms}$	$\text{Max}(600\text{ms}, \text{Ceil}(8 \times 1.5) \times \text{Max}(\text{MGRP}, \text{SMTC period}, \text{DRX cycle})) \times CSSF_{inter}$
DRX cycle $> 320\text{ms}$	$8 \times \text{DRX cycle} \times CSSF_{inter}$
NOTE 1: DRX or non DRX requirements apply according to the conditions described in clause 3.6.1	
NOTE 2: In EN-DC operation, the parameters, timers and scheduling requests referred to in clause 3.6.1 are for the secondary cell group. The DRX cycle is the DRX cycle of the secondary cell group.	

Table 9.3.4-2: Time period for PSS/SSS detection, (Frequency range FR2)

Condition ^{NOTE1,2}	T_{pss/sss_sync_inter}
No DRX	$\text{Max}(600\text{ms}, M_{pss/sss_sync_inter} \times \text{Max}(\text{MGRP}, \text{SMTC period})) \times CSSF_{inter}$
DRX cycle $\leq 320\text{ms}$	$\text{Max}(600\text{ms}, (1.5 \times M_{pss/sss_sync_inter}) \times \text{Max}(\text{MGRP}, \text{SMTC period}, \text{DRX cycle})) \times CSSF_{inter}$
DRX cycle $> 320\text{ms}$	$M_{pss/sss_sync_inter} \times \text{DRX cycle} \times CSSF_{inter}$
NOTE 1: DRX or non DRX requirements apply according to the conditions described in clause 3.6.1	
NOTE 2: In EN-DC operation, the parameters, timers and scheduling requests referred to in clause 3.6.1 are for the secondary cell group. The DRX cycle is the DRX cycle of the secondary cell group.	

Table 9.3.4-3: Time period for time index detection (Frequency range FR1)

Condition ^{NOTE1,2}	$T_{SSB_time_index_inter}$
No DRX	$\text{Max}(120\text{ms}, 3 \times \text{Max}(\text{MGRP}, \text{SMTC period})) \times CSSF_{inter}$
DRX cycle $\leq 320\text{ms}$	$\text{Max}(120\text{ms}, \text{Ceil}(3 \times 1.5) \times \text{Max}(\text{MGRP}, \text{SMTC period}, \text{DRX cycle})) \times CSSF_{inter}$
DRX cycle $> 320\text{ms}$	$3 \times \text{DRX cycle} \times CSSF_{inter}$
NOTE 1: DRX or non DRX requirements apply according to the conditions described in clause 3.6.1	
NOTE 2: In EN-DC operation, the parameters, timers and scheduling requests referred to in clause 3.6.1 are for the secondary cell group. The DRX cycle is the DRX cycle of the secondary cell group.	

Table 9.3.4-4: Time period for time index detection (Frequency range FR2)

Condition ^{NOTE1,2}	$T_{SSB_time_index_inter}$
No DRX	$\text{Max}(200\text{ms}, M_{SSB_index_inter} \times \text{Max}(\text{MGRP}, \text{SMTC period})) \times CSSF_{inter}$
DRX cycle $\leq 320\text{ms}$	$\text{Max}(200\text{ms}, (1.5 \times M_{SSB_index_inter}) \times \text{Max}(\text{MGRP}, \text{SMTC period}, \text{DRX cycle})) \times CSSF_{inter}$
DRX cycle $> 320\text{ms}$	$M_{SSB_index_inter} \times \text{DRX cycle} \times CSSF_{inter}$
NOTE 1: DRX or non DRX requirements apply according to the conditions described in clause 3.6.1	
NOTE 2: In EN-DC operation, the parameters, timers and scheduling requests referred to in clause 3.6.1 are for the secondary cell group. The DRX cycle is the DRX cycle of the secondary cell group.	

9.3.4.1 Void

9.3.4.2 Void

9.3.5 Inter-frequency measurements

When measurement gaps are provided for inter frequency measurements, or the UE supports capability of conducting such measurements without gaps, the UE physical layer shall be capable of reporting SS-RSRP, SS-RSRQ and SS-SINR measurements to higher layers with measurement accuracy as specified in sub-clauses 10.1.4, 10.1.5, 10.1.9, 10.1.10, 10.1.14 and 10.1.15, respectively, as shown in table 9.3.5-1 and 9.3.5-2:

Table 9.3.5-1: Measurement period for inter-frequency measurements with gaps (Frequency FR1)

Condition ^{NOTE1,2}	$T_{SSB_measurement_period_inter}$
No DRX	$\text{Max}(200\text{ms}, 8 \times \text{Max}(\text{MGRP}, \text{SMTC period})) \times \text{CSSF}_{inter}$
DRX cycle $\leq 320\text{ms}$	$\text{Max}(200\text{ms}, \text{Ceil}(8 \times 1.5) \times \text{Max}(\text{MGRP}, \text{SMTC period}, \text{DRX cycle})) \times \text{CSSF}_{inter}$
DRX cycle $> 320\text{ms}$	$8 \times \text{DRX cycle} \times \text{CSSF}_{inter}$
NOTE 1: DRX or non DRX requirements apply according to the conditions described in clause 3.6.1	
NOTE 2: In EN-DC operation, the parameters, timers and scheduling requests referred to in clause 3.6.1 are for the secondary cell group. The DRX cycle is the DRX cycle of the secondary cell group.	

Table 9.3.5-2: Measurement period for inter-frequency measurements with gaps (Frequency FR2)

Condition ^{NOTE1,2}	$T_{SSB_measurement_period_inter}$
No DRX	$\text{Max}(400\text{ms}, M_{meas_period_inter} \times \text{Max}(\text{MGRP}, \text{SMTC period})) \times \text{CSSF}_{inter}$
DRX cycle $\leq 320\text{ms}$	$\text{Max}(400\text{ms}, (1.5 \times M_{meas_period_inter}) \times \text{Max}(\text{MGRP}, \text{SMTC period}, \text{DRX cycle})) \times \text{CSSF}_{inter}$
DRX cycle $> 320\text{ms}$	$M_{meas_period_inter} \times \text{DRX cycle} \times \text{CSSF}_{inter}$
NOTE 1: DRX or non DRX requirements apply according to the conditions described in clause 3.6.1	
NOTE 2: In EN-DC operation, the parameters, timers and scheduling requests referred to in clause 3.6.1 are for the secondary cell group. The DRX cycle is the DRX cycle of the secondary cell group.	

9.3.5.1 Void

9.3.5.2 Void

9.3.5.3 Void

9.3.6 Inter-frequency measurements reporting requirements

9.3.6.1 Periodic Reporting

Reported SS-RSRP, SS-RSRQ, and SS-SINR measurements contained in periodically triggered measurement reports shall meet the requirements in clauses 10.1.4.1, 10.1.5.1, 10.1.9.1, 10.1.10.1, 10.1.14.1 and 10.1.15.1, respectively.

9.3.6.2 Event-triggered Periodic Reporting

Reported SS-RSRP, SS-RSRQ, and SS-SINR measurements contained in event triggered periodic measurement reports shall meet the requirements in clauses 10.1.4.1, 10.1.5.1, 10.1.9.1, 10.1.10.1, 10.1.14.1 and 10.1.15.1, respectively.

The first report in event triggered periodic measurement reporting shall meet the requirements specified in clause 9.3.6.3.

9.3.6.3 Event-triggered Reporting

Reported SS-RSRP, SS-RSRQ, and SS-SINR measurements contained in event triggered measurement reports shall meet the requirements in clauses 10.1.4.1, 10.1.5.1, 10.1.9.1, 10.1.10.1, 10.1.14.1 and 10.1.15.1, respectively.

The UE shall not send any event triggered measurement reports, as long as no reporting criteria are fulfilled.

The measurement reporting delay is defined as the time between an event that will trigger a measurement report and the point when the UE starts to transmit the measurement report over the air interface. This requirement assumes that the measurement report is not delayed by other RRC signalling on the DCCH. This measurement reporting delay excludes a delay uncertainty resulted when inserting the measurement report to the TTI of the uplink DCCH. The delay uncertainty is: $2 \times TTI_{DCCH}$. This measurement reporting delay excludes a delay which caused by no UL resources for UE to send the measurement report.

The event triggered measurement reporting delay, measured without L3 filtering shall be within $T_{\text{identify_inter_without_index}}$ if UE is not indicated to report SSB based RRM measurement result with the associated SSB index. Otherwise UE shall be able to identify a new detectable inter frequency cell within $T_{\text{identify_inter_with_index}}$. Both $T_{\text{identify_inter_without_index}}$ and $T_{\text{identify_inter_with_index}}$ are defined in clause 9.3.4. When L3 filtering is used an additional delay can be expected.

A cell is detectable only if at least one SSB measured from the cell being configured remains detectable during the time period $T_{\text{identify_inter_without_index}}$ or $T_{\text{identify_inter_with_index}}$ defined in clause 9.3.4. If a cell which has been detectable at least for the time period $T_{\text{identify_inter_without_index}}$ or $T_{\text{identify_inter_with_index}}$ defined in clause 9.3.4 becomes undetectable for a period ≤ 5 seconds and then the cell becomes detectable again with the same spatial reception parameter and then triggers the measurement report as per TS 38.331 [2], the event triggered measurement reporting delay shall be less than $T_{\text{SSB_measurement_period_inter}}$ defined in clause 9.3.5 provided the timing to that cell has not changed more than $\pm 3200/2^\mu$ Tc while measurement gap has not been available and the L3 filtering has not been used, where μ is the SCS configuration as defined in clause 4.2 of TS 38.211 [3]. When L3 filtering is used an additional delay can be expected.

9.3.7 Void

9.3.8 Inter-frequency SFTD measurement requirements

9.3.8.1 Introduction

This clause contains requirements for a UE supporting NR inter-frequency SFTD measurement and is applicable in RRC_CONNECTED state. The UE shall, depending on network request, perform inter-frequency SFTD measurement and report SFTD result with or without SS-RSRP. The overall delay includes RRC procedure delay defined in clause 12 in TS 38.331 [2] and SFTD measurement reporting delay in clause 9.3.8.3.

UE which fulfils the requirements in clause 9.3.8 is not supposed to fulfil the requirements defined in clause 9.2.5.4.

9.3.8.2 SFTD Measurement delay

The requirements on SFTD measurement delay defined in this clause are applicable under the side condition $SCH \hat{E}_s/I_{ot} \geq -3$ dB for the inter-frequency neighbour cell. Depending on configuration, the SFTD measurement may be carried out with or without the support of configured measurement gaps. In the current release, indication on whether to carry out the SFTD measurement with or without measurement gaps is implicit and depending on whether measurement gaps are configured.

The UE shall be able to detect, identify and measure SFTD of up to 3 of the strongest applicable inter-frequency neighbour cells on the carrier frequency provided in the SFTD measurement configuration. Further depending on the SFTD measurement configuration, the UE shall additionally report SS-RSRP for the one or more strongest cells. The UE may or may not be configured with *cellsForWhichToReportSFTD*. The UE does not expect *cellsForWhichToReportSFTD* to change during an ongoing SFTD measurement.

When no measurement gaps are provided, the UE shall be capable of finding the inter-frequency neighbour cell regardless of its SSB position in the SMTC period, provided that the carrier frequency where SFTD measurement is configured and the serving carrier(s) form a supported CA or NR-DC band combination of the UE. The SFTD measurement shall be conducted with sustained connection to the PCell and activated SCell(s) in MCG. Depending on capability, the UE may be allowed to cause a certain amount of interruptions for reconfiguration of the radio receiver, as specified in clause 8.2.2.2.6.

When measurement gaps are provided, the UE shall be capable of finding the inter-frequency neighbour cell under the additional condition that the SSB at least occasionally falls within the measurement gap.

When no DRX is used, the UE shall be capable of determining SFTD within a physical layer measurement period of $T_{\text{measure_SFTD1}}$ as follows:

- For SFTD measurements without measurement gaps, and without additional SS-RSRP reporting:
 - For carrier frequency in FR1: $T_{\text{measure_SFTD1}} = 14 \text{ SMTC periods}$
 - For carrier frequency in FR2: $T_{\text{measure_SFTD1}} = 112 \text{ SMTC periods}$
- For SFTD measurements in measurement gaps, and without additional SS-RSRP reporting:
 - For carrier frequency in FR1: $T_{\text{measure_SFTD1}} = \text{CSSF}_{\text{inter}} \times 8 \times \text{Max}(\text{MGRP}, \text{SMTC period})$
 - For carrier frequency in FR2: $T_{\text{measure_SFTD1}} = \text{CSSF}_{\text{inter}} \times 64 \times \text{Max}(\text{MGRP}, \text{SMTC period})$
- For SFTD measurements without measurement gaps, and with additional SS-RSRP reporting:
 - For carrier frequency in FR1: $T_{\text{measure_SFTD1}} = 19 \text{ SMTC periods}$
 - For carrier frequency in FR2: $T_{\text{measure_SFTD1}} = 152 \text{ SMTC periods}$
- For SFTD measurements in measurement gaps, and with additional SS-RSRP reporting:
 - For carrier frequency in FR1: $T_{\text{measure_SFTD1}} = \text{CSSF}_{\text{inter}} \times 13 \times \text{Max}(\text{MGRP}, \text{SMTC period})$
 - For carrier frequency in FR2: $T_{\text{measure_SFTD1}} = \text{CSSF}_{\text{inter}} \times 104 \times \text{Max}(\text{MGRP}, \text{SMTC period})$

where $\text{CSSF}_{\text{inter}}$ is a carrier specific scaling factor and is determined according to $\text{CSSF}_{\text{within_gap},i}$ in clause 9.1.5.2 for measurement conducted within measurement gaps.

When DRX is used, the same $T_{\text{measure_SFTD1}}$ as for non-DRX applies, but the reporting delay depends on the DRX cycle length in use.

In case PCell is changed due to handover, the UE shall terminate the inter-frequency SFTD measurement.

The measurement accuracy for the SFTD measurement shall fulfil the requirement in clause 10.1.21.3. The measurement accuracy for additionally reported SS-RSRP shall fulfil the requirement in clauses 10.1.4.1 and 10.1.5.1 for neighbour cell in FR1 and FR2, respectively.

9.3.8.3 SFTD Measurement reporting delay

The SFTD measurement reporting delay is defined as the time between a command that will trigger an SFTD measurement report and the point when the UE starts to transmit the measurement report over the air interface. This requirement assumes that the measurement report is not delayed by other RRC signalling on the DCCH. This measurement reporting delay excludes a delay uncertainty of $2 \times \text{TTI}_{\text{DCCH}}$ resulting when inserting the measurement report to the TTI of the uplink DCCH. This measurement reporting delay excludes any delay caused by lack of UL resources for UE to send the measurement report.

The SFTD measurement reporting delay shall be less than $T_{\text{measure_SFTD1}}$ defined in clause 9.3.8.2 plus the RRC procedure delay defined in TS 38.331 [2].

9.4 Inter-RAT measurements

9.4.1 Introduction

The requirements in this clause are specified for NR–E-UTRAN FDD and NR–E-UTRAN TDD measurements and are applicable without an explicit E-UTRAN neighbour cell list containing physical layer cell identities, for a UE:

- in RRC_CONNECTED state, and

- configured with SA or NR-DC operation mode or configured in NE-DC operation mode by PCell with NR-E-UTRAN FDD or TDD measurement (RSRP, RSRQ, RS-SINR, RSTD, or E-CID) on E-UTRA non-serving frequency carrier, and
- configured with an appropriate measurement gap pattern according to Table 9.1.2-3.

When the UE is in NE-DC operation mode and an NR-E-UTRAN FDD or TDD measurement (RSRP, RSRQ, RS-SINR, or E-CID RSRP and RSRQ) configured by NR PCell is on a E-UTRA serving frequency carrier, then the corresponding E-UTRA intra-frequency measurements requirements specified in clause 8.19 of TS 36.133 [15] shall apply.

Parameter $T_{\text{inter}1}$ used in inter-RAT requirements in clause 9.4 is specified in Table 9.4.1-1.

Table 9.4.1-1: Minimum available time for inter-RAT measurements

Gap Pattern Id	Measurement Gap Length (MGL, ms)	Measurement Gap Repetition Period (MGRP, ms)	Minimum available time for inter-frequency and inter-RAT measurements during 480 ms period ($T_{\text{inter}1}$, ms)
0	6	40	60
1	6	80	30
2	3	40	24 ^{Note 1}
3	3	80	12 ^{Note 1}
4	6	20	120 ^{Note 1}
6	4	20	72 ^{Note 1,3,6}
7	4	40	36 ^{Note 1,4,6}
8	4	80	18 ^{Note 1,5,6}
10	3	20	48 ^{Note 1}

NOTE 1: When determining UE requirements using $T_{\text{inter}1}$ for gap pattern IDs 2, 3, 4, 6, 7, 8, 10, $T_{\text{inter}1} = 60$ for gap pattern IDs 2, 4, 6, 7, 10, and $T_{\text{inter}1} = 30$ for gap pattern IDs 3 and 8 shall be used.

NOTE 2: Measurement gaps pattern configurations applicability is as specified in Table 9.1.2-1.

NOTE 3: When this gap pattern is used, the T_{inter} for E-UTRA inter-frequency measurements is 48 ms corresponding to the first 3 ms of the 4 ms gap.

NOTE 4: When this gap pattern is used, the T_{inter} for E-UTRA inter-frequency measurements is 24 ms corresponding to the first 3 ms of the 4 ms gap.

NOTE 5: When this gap pattern is used, the T_{inter} for E-UTRA inter-frequency measurements is 12 ms corresponding to the first 3 ms of the 4 ms gap.

NOTE 6: This gap pattern is applicable for E-UTRA inter-frequency measurements only if gap based NR measurements are also configured.

A UE configured with gap pattern ID 2, 3 or 10 shall be able to detect a target cell, provided that

- the E-UTRA subframe #0 or #5 of the target E-UTRAN cell begins not earlier than 500 μs from the start of the measurement gap, and
- the E-UTRA subframe #0 or #5 of the target E-UTRAN cell ends not later than 500 μs before the end of the measurement gap in case of FDD and not later than 750 μs before the end of measurement gap in case of TDD.

A UE configured with gap pattern ID 6, 7 or 8 shall be able to detect a target cell, provided that

- the E-UTRA subframe #0 or #5 of the target E-UTRAN cell begins not earlier than 500 μs from the start of the measurement gap, and
- the E-UTRA subframe #0 or #5 of the target E-UTRAN cell ends no later than 1500 μs before the end of the measurement gap in case of FDD and no later than 1750 μs before the end of measurement gap in case of TDD.

9.4.2 NR – E-UTRAN FDD measurements

9.4.2.1 Introduction

The requirements are applicable for NR–E-UTRAN FDD RSRP, RSRQ, and RS-SINR measurements.

In the requirements, an E-UTRAN FDD cell is considered to be detectable when:

- RSRP related conditions in the accuracy requirements in clause 10.2.2 are fulfilled for a corresponding Band, together with the corresponding side conditions in Annex B.2.3 and Annex B.3.3 of TS 36.133 [15],
- RSRQ related conditions in the accuracy requirements in clause 10.2.3 are fulfilled for a corresponding Band, together with the corresponding side conditions in Annex B.2.3 and Annex B.3.3 of TS 36.133 [15],
- RS-SINR related conditions in the accuracy requirements in clause 10.2.5 are fulfilled for a corresponding Band, together with the corresponding side conditions in Annex B.2.3 and Annex B.3.19 of TS 36.133 [15].

9.4.2.2 Requirements when no DRX is used

When the UE requires measurement gaps to identify and measure inter-RAT cells and an appropriate measurement gap pattern is scheduled, or the UE supports capability of conducting such measurements without gaps, the UE shall be able to identify a new detectable FDD cell within $T_{\text{Identify, E-UTRAN FDD}}$ according to the following expression:

$$T_{\text{Identify, E-UTRAN FDD}} = T_{\text{BasicIdentify}} \cdot \frac{480}{T_{\text{Inter1}}} \cdot \text{CSSF}_{\text{interRAT}} \quad \text{ms},$$

where:

$$T_{\text{BasicIdentify}} = 480 \text{ ms},$$

T_{Inter1} is defined in clause 9.4.1,

$\text{CSSF}_{\text{interRAT}} = \text{CSSF}_{\text{within_gap},i}$ is the scaling factor for the measured inter-RAT E-UTRA carrier i which is calculated as specified in clause 9.1.5.2.

Identification of a cell shall include detection of the cell and additionally performing a single measurement with measurement period of $T_{\text{Measure, E-UTRAN FDD}}$ defined in Table 9.4.2.2-1.

Table 9.4.2.2-1: Measurement period and measurement bandwidth

Configuration	Physical Layer Measurement period: $T_{\text{Measure, E-UTRAN FDD}}$ [ms]	Measurement bandwidth [RB]
0	$480 \times \text{CSSF}_{\text{interRAT}}$	6
1 (Note 1)	$240 \times \text{CSSF}_{\text{interRAT}}$	50
NOTE 1: This configuration is optional.		

When measurement gaps are scheduled for E-UTRAN FDD inter-RAT measurements, or the UE supports capability of conducting such measurements without gaps, the UE physical layer shall be capable of reporting RSRP, RSRQ, and RS-SINR measurements to higher layers with measurement period $T_{\text{Measure, E-UTRAN FDD}}$ given by table 9.4.2.2-1.

The UE shall be capable of identifying and performing NR – E-UTRAN FDD RSRP, RSRQ, and RS-SINR measurements of at least 4 identified E-UTRAN FDD cells per E-UTRA FDD carrier frequency layer during each layer 1 measurement period, for up to 7 E-UTRA FDD carrier frequency layers.

If higher layer filtering is used, an additional cell identification delay can be expected.

The NR – E-UTRAN FDD RSRP measurement accuracy for all measured cells shall be as specified in clause 10.2.2.

The NR – E-UTRAN FDD RSRQ measurement accuracy for all measured cells shall be as specified in clause 10.2.3.

The NR – E-UTRAN FDD RS-SINR measurement accuracy for all measured cells shall be as specified in clause 10.2.5.

9.4.2.3 Requirements when DRX is used

When DRX is in use and measurement gaps are configured, the UE shall be able to identify a new detectable E-UTRAN FDD cell within $T_{\text{Identify, E-UTRAN FDD}}$ specified in Table 9.4.2.3-1.

Table 9.4.2.3-1: Requirement to identify a newly detectable E-UTRAN FDD cell

DRX cycle length (s)	$T_{\text{Identify, E-UTRAN FDD}}$ (s) (DRX cycles)	
	Gap period = 40 ms, 20 ms	Gap period = 80 ms
≤ 0.16	Non-DRX requirements in clause 9.4.2.2 apply	Non-DRX requirements in clause 9.4.2.2 apply
0.256	$5.12^* \text{CSSF}_{\text{interRAT}}$ ($20^* \text{CSSF}_{\text{interRAT}}$)	$7.68^* \text{CSSF}_{\text{interRAT}}$ ($30^* \text{CSSF}_{\text{interRAT}}$)
0.32	$6.4^* \text{CSSF}_{\text{interRAT}}$ ($20^* \text{CSSF}_{\text{interRAT}}$)	$7.68^* \text{CSSF}_{\text{interRAT}}$ ($24^* \text{CSSF}_{\text{interRAT}}$)
$0.32 < \text{DRX-cycle} \leq 10.24$	Note1 ($20^* \text{CSSF}_{\text{interRAT}}$)	Note1 ($20^* \text{CSSF}_{\text{interRAT}}$)
NOTE 1: The time depends on the DRX cycle length. NOTE 2: $\text{CSSF}_{\text{interRAT}}$ is as defined in clause 9.4.2.2.		

When DRX is in use, the UE shall be capable of performing NR – E-UTRAN FDD RSRP, RSRQ, and RS-SINR measurements of at least 4 identified E-UTRAN FDD cells per E-UTRA FDD frequency layer during each layer 1 measurement period, for up to 7 E-UTRA FDD carrier frequency layers, and the UE physical layer shall be capable of reporting NR – E-UTRAN FDD RSRP, RSRQ, and RS-SINR measurements to higher layers with the measurement period $T_{\text{measure, E-UTRAN FDD}}$ specified in Table 9.4.2.3-2.

Table 9.4.2.3-2: Requirement to measure E-UTRAN FDD cells

DRX cycle length (s)	$T_{\text{measure, E-UTRAN FDD}}$ (s) (DRX cycles)
≤ 0.08	Non-DRX requirements in clause 9.4.2.2 apply
$0.08 < \text{DRX-cycle} \leq 10.24$	Note1 ($5^* \text{CSSF}_{\text{interRAT}}$)
NOTE 1: The time depends on the DRX cycle length. NOTE 2: $\text{CSSF}_{\text{interRAT}}$ is as defined in clause 9.4.2.2.	

If higher layer filtering is used, an additional cell identification delay can be expected.

The NR – E-UTRAN FDD RSRP measurement accuracy for all measured cells shall be as specified in clause 10.2.2.
The NR – E-UTRAN FDD RSRQ measurement accuracy for all measured cells shall be as specified in clause 10.2.3.
The NR – E-UTRAN FDD RS-SINR measurement accuracy for all measured cells shall be as specified in clause 10.2.5.

9.4.2.4 Measurement reporting requirements

9.4.2.4.1 Periodic Reporting

The reported NR – E-UTRAN FDD RSRP, RSRQ, and RS-SINR measurements contained in periodically triggered measurement reports shall meet the requirements in clauses 10.2.2, 10.2.3, and 10.2.5, respectively.

9.4.2.4.2 Event-Triggered Periodic Reporting

The reported NR – E-UTRAN FDD RSRP, RSRQ, and RS-SINR measurements contained in event-triggered periodic measurement reports shall meet the requirements in clauses 10.2.2, 10.2.3, and 10.2.5, respectively.

The first report in event-triggered periodic measurement reporting shall meet the requirements specified in clause 9.4.2.4.3.

9.4.2.4.3 Event-Triggered Reporting

The reported NR – E-UTRAN FDD RSRP, RSRQ, and RS-SINR measurements contained in event-triggered measurement reports shall meet the requirements in clauses 10.2.2, 10.2.3, and 10.2.5, respectively.

The UE shall not send any event-triggered measurement reports as long as no reporting criteria are fulfilled.

The measurement reporting delay is defined as the time between an event that will trigger a measurement report and the point when the UE starts to transmit the measurement report over the air interface. This requirement assumes that the measurement report is not delayed by other RRC signalling on the DCCH. This measurement reporting delay excludes a delay uncertainty resulted when inserting the measurement report to the TTI of the uplink DCCH. The delay uncertainty is: $2 \times T_{\text{TTI}_{\text{DCCH}}}$ where $T_{\text{TTI}_{\text{DCCH}}}$ is the duration of subframe or slot or subslot when the measurement report is transmitted on the PUSCH with subframe or slot or subslot duration. This measurement reporting delay excludes a delay which caused by no UL resources for UE to send the measurement report.

The event triggered measurement reporting delay, measured without L3 filtering shall be less than $T_{\text{Identify, E-UTRAN FDD}}$ defined in clauses 9.4.2.2 and 9.4.2.3 without DRX and with DRX, respectively. When L3 filtering is used, an additional delay can be expected.

If a cell which has been detectable at least for the time period $T_{\text{Identify, E-UTRAN FDD}}$ becomes undetectable for a period ≤ 5 seconds and then the cell becomes detectable again and triggers an event as per TS 38.331 [2], the event triggered measurement reporting delay shall be less than $T_{\text{Measure, E-UTRAN FDD}}$ provided the timing to that cell has not changed more than $\pm 50 T_s$ while measurement gap has not been available and the L3 filter has not been used.

9.4.3 NR – E-UTRAN TDD measurements

9.4.3.1 Introduction

The requirements are applicable for NR–E-UTRAN TDD RSRP, RSRQ, and RS-SINR measurements.

In the requirements, an E-UTRAN TDD cell is considered to be detectable when:

- RSRP related conditions in the accuracy requirements in clause 10.2.2 are fulfilled for a corresponding Band, together with the corresponding side conditions in Annex B.2.3 and Annex B.3.3 of TS 36.133 [15],
- RSRQ related conditions in the accuracy requirements in clause 10.2.3 are fulfilled for a corresponding Band, together with the corresponding side conditions in Annex B.2.3 and Annex B.3.3 of TS 36.133 [15],

RS-SINR related conditions in the accuracy requirements in clause 10.2.5 are fulfilled for a corresponding Band, together with the corresponding side conditions in Annex B.2.3 and Annex B.3.19 of TS 36.133 [15].

9.4.3.2 Requirements when no DRX is used

When the UE requires measurement gaps to identify and measure inter-RAT cells and an appropriate measurement gap pattern is scheduled, or the UE supports capability of conducting such measurements without gaps, the UE shall be able to identify a new detectable TDD cell within $T_{\text{Identify, E-UTRAN TDD}}$ according to the following expression:

- When configuration 0 or configuration 1 in Table 9.4.3.2-1 is applied,

$$T_{\text{Identify, E-UTRAN TDD}} = T_{\text{BasicIdentify}} \cdot \frac{480}{T_{\text{Inter1}}} \cdot \text{CSSF}_{\text{interRAT}} \quad \text{ms},$$

- When configuration 2 or configuration 3 in Table 9.4.3.2-1 is applied,

$$T_{\text{Identify, E-UTRAN TDD}} = T_{\text{BasicIdentify}} \cdot \frac{480}{T_{\text{Inter1}}} \cdot \text{CSSF}_{\text{interRAT}} + 240 \cdot \text{CSSF}_{\text{interRAT}} \quad \text{ms},$$

where:

$$T_{\text{BasicIdentify}} = 480 \text{ ms},$$

T_{Inter1} is defined in clause 9.4.1,

$\text{CSSF}_{\text{interRAT}} = \text{CSSF}_{\text{within_gap}, i}$ is the scaling factor for the measured inter-RAT E-UTRA carrier i which is calculated as specified in clause 9.1.5.2.

Identification of a cell shall include detection of the cell and additionally performing a single measurement with measurement period of $T_{\text{Measure, E-UTRAN TDD}}$ defined in Table 9.4.3.2-1.

Table 9.4.3.2-1: $T_{\text{Measure, E-UTRAN TDD}}$ for different configurations

Configuration	Measurement bandwidth (RB)	Number of UL/DL sub-frames per half frame (5 ms)		DwPTS		$T_{\text{Measure, E-UTRAN TDD}}$ (ms)
		DL	UL	Normal CP	Extended CP	
0	6	2	2	$19760 \cdot T_s$	$20480 \cdot T_s$	480 x $\text{CSSF}_{\text{interRAT}}$
1 (Note 1)	50	2	2	$19760 \cdot T_s$	$20480 \cdot T_s$	240 x $\text{CSSF}_{\text{interRAT}}$
2	6	1	3	$19760 \cdot T_s$	$20480 \cdot T_s$	720 x $\text{CSSF}_{\text{interRAT}}$
3 (Note 1)	50	1	3	$19760 \cdot T_s$	$20480 \cdot T_s$	480 x $\text{CSSF}_{\text{interRAT}}$

NOTE 1: This configuration is optional.
NOTE 2: Void

When measurement gaps are scheduled for E-UTRAN TDD inter-RAT measurements, or the UE supports capability of conducting such measurements without gaps, the UE physical layer shall be capable of reporting RSRP, RSRQ, and RS-SINR measurements to higher layers with measurement period $T_{\text{measure, E-UTRAN TDD}}$ given by table 9.4.3.2-1.

The UE shall be capable of identifying and performing NR – E-UTRAN TDD RSRP, RSRQ, and RS-SINR measurements of at least 4 identified E-UTRAN TDD cells per E-UTRA TDD carrier frequency layer during each layer 1 measurement period, for up to 7 E-UTRA TDD carrier frequency layers.

If higher layer filtering is used, an additional cell identification delay can be expected.

The NR – E-UTRAN TDD RSRP measurement accuracy for all measured cells shall be as specified in clause 10.2.2. The NR – E-UTRAN TDD RSRQ measurement accuracy for all measured cells shall be as specified in clause 10.2.3. The NR – E-UTRAN TDD RS-SINR measurement accuracy for all measured cells shall be as specified in clause 10.2.5.

9.4.3.3 Requirements when DRX is used

When DRX is in use and measurement gaps are configured, the UE shall be able to identify a new detectable E-UTRAN TDD cell within $T_{\text{Identify, E-UTRAN TDD}}$ specified in Table 9.4.3.3-1.

Table 9.4.3.3-1: Requirement to identify a newly detectable E-UTRAN TDD cell

DRX cycle length (s)	$T_{\text{Identify, E-UTRAN TDD}}$ (s) (DRX cycles)	
	Gap period = 40 ms, 20 ms	Gap period = 80 ms
≤ 0.16	Non-DRX requirements in clause 9.4.3.2 apply	Non-DRX requirements in clause 9.4.3.2 apply
0.256	$5.12^* \text{CSSF}_{\text{interRAT}}$ ($20^* \text{CSSF}_{\text{interRAT}}$)	$7.68^* \text{CSSF}_{\text{interRAT}}$ ($30^* \text{CSSF}_{\text{interRAT}}$)
0.32	$6.4^* \text{CSSF}_{\text{interRAT}}$ ($20^* \text{CSSF}_{\text{interRAT}}$)	$7.68^* \text{CSSF}_{\text{interRAT}}$ ($24^* \text{CSSF}_{\text{interRAT}}$)
$0.32 < \text{DRX-cycle} \leq 10.24$	Note1 ($20^* \text{CSSF}_{\text{interRAT}}$)	Note1 ($20^* \text{CSSF}_{\text{interRAT}}$)

NOTE 1: The time depends on the DRX cycle length.
NOTE 2: $\text{CSSF}_{\text{interRAT}}$ is as defined in clause 9.4.3.2.

When DRX is in use, the UE shall be capable of performing NR – E-UTRAN TDD RSRP, RSRQ, and RS-SINR measurements of at least 4 identified E-UTRAN TDD cells per E-UTRA TDD frequency layer during each layer 1 measurement period, for up to 7 E-UTRA TDD carrier frequency layers, and the UE physical layer shall be capable of reporting NR – E-UTRAN TDD RSRP, RSRQ, and RS-SINR measurements to higher layers with the measurement period $T_{\text{measure, E-UTRAN TDD}}$ specified in Table 9.4.3.3-2.

Table 9.4.3.3-2: Requirement to measure E-UTRAN TDD cells

DRX cycle length (s)	$T_{\text{measure, E-UTRAN TDD}}$ (s) (DRX cycles)
≤ 0.08	Non-DRX Requirements in clause 9.4.3.2 apply

0.128	For configuration 2 ^{Note3} , non-DRX requirements in clause 9.4.3.2 apply, Otherwise: Note1 ($5 \cdot \text{CSSF}_{\text{interRAT}}$)
$0.128 < \text{DRX-cycle} \leq 10.24$	Note1 ($5 \cdot \text{CSSF}_{\text{interRAT}}$)
NOTE 1: The time depends on the DRX cycle length. NOTE 2: $\text{CSSF}_{\text{interRAT}}$ is as defined in clause 9.4.3.2. NOTE 3: See Table 9.4.3.2-1.	

If higher layer filtering is used, an additional cell identification delay can be expected.

The NR – E-UTRAN TDD RSRP measurement accuracy for all measured cells shall be as specified in clause 10.2.2.
The NR – E-UTRAN TDD RSRQ measurement accuracy for all measured cells shall be as specified in clause 10.2.3.
The NR – E-UTRAN TDD RS-SINR measurement accuracy for all measured cells shall be as specified in clause 10.2.5.

9.4.3.4 Measurement reporting requirements

9.4.3.4.1 Periodic Reporting

The reported NR – E-UTRAN TDD RSRP, RSRQ, and RS-SINR measurements contained in periodically triggered measurement reports shall meet the requirements in clauses 10.2.2, 10.2.3, and 10.2.5, respectively.

9.4.3.4.2 Event-Triggered Periodic Reporting

The reported NR – E-UTRAN TDD RSRP, RSRQ, and RS-SINR measurements contained in event-triggered periodic measurement reports shall meet the requirements in clauses 10.2.2, 10.2.3, and 10.2.5, respectively.

The first report in event-triggered periodic measurement reporting shall meet the requirements specified in clause 9.4.3.4.3.

9.4.3.4.3 Event-Triggered Reporting

The reported NR – E-UTRAN TDD RSRP, RSRQ, and RS-SINR measurements contained in event-triggered measurement reports shall meet the requirements in clauses 10.2.2, 10.2.3, and 10.2.5, respectively.

The UE shall not send any event-triggered measurement reports as long as no reporting criteria are fulfilled.

The measurement reporting delay is defined as the time between an event that will trigger a measurement report and the point when the UE starts to transmit the measurement report over the air interface. This requirement assumes that that the measurement report is not delayed by other RRC signalling on the DCCH. This measurement reporting delay excludes a delay uncertainty resulted when inserting the measurement report to the TTI of the uplink DCCH. The delay uncertainty is: $2 \times \text{TTI}_{\text{DCCH}}$ where TTI_{DCCH} is the duration of subframe or slot or subslot when the measurement report is transmitted on the PUSCH with subframe or slot or subslot duration. This measurement reporting delay excludes a delay which caused by no UL resources for UE to send the measurement report.

The event triggered measurement reporting delay, measured without L3 filtering shall be less than $T_{\text{Identify, E-UTRAN TDD}}$ defined in clauses 9.4.3.2 and 9.4.3.3 without DRX and with DRX, respectively. When L3 filtering is used, an additional delay can be expected.

If a cell which has been detectable at least for the time period $T_{\text{Identify, E-UTRAN TDD}}$ becomes undetectable for a period ≤ 5 seconds and then the cell becomes detectable again and triggers an event as per TS 38.331 [2], the event triggered measurement reporting delay shall be less than $T_{\text{Measure, E-UTRAN TDD}}$ provided the timing to that cell has not changed more than $\pm 50 T_s$ while measurement gap has not been available and the L3 filter has not been used.

9.4.4 Inter-RAT RSTD measurements

9.4.4.1 NR – E-UTRAN FDD RSTD measurements

9.4.4.1.1 Introduction

The requirements are applicable for NR–E-UTRAN FDD RSTD measurements requested via LPP [22, 27].

When the UE is in NE-DC operation mode and an NR–E-UTRAN FDD RSTD measurement configured by NR PCell is on a E-UTRA serving frequency carrier, then the corresponding E-UTRA intra-frequency measurements requirements as follows shall apply.

- Measurements configured on E-UTRA PSCC shall meet E-UTRAN OTDOA intra-frequency measurements requirements in clause 8.1.2.5. The applicable measurement accuracy requirements are in clause 9.1.10.
- Measurements configured on E-UTRA SCC shall meet all applicable requirements in clause 8.4, except that the terms PCell and primary component carrier shall be deemed to be swapped with PSCell and PSCC. The applicable measurement accuracy requirements are in clause 9.1.12, except that the terms PCell and primary component carrier shall be deemed to be swapped with PSCell and PSCC.

The requirements in clause 9.4.4.1 apply when:

- the UE is provided with the LTE timing information via LPP [27], including both *nr-LTE-SFN-Offset* and *nr-LTE-fineTiming-Offset*, or
- the UE is not provided with *nr-LTE-SFN-Offset* or *nr-LTE-fineTiming-Offset*, or
- the UE is provided with *nr-LTE-SFN-Offset* but not with *nr-LTE-fineTiming-Offset*.

When the UE is not aware of the SFN of at least one LTE cell in the OTDOA assistance data, the UE may be using autonomous gaps to acquire SFN of the OTDOA assistance data reference cell prior to requesting measurement gaps for performing the requested E-UTRA RSTD measurements before the $T_{\text{RSTD InterRAT, E-UTRAN FDD}}$ time period starts while meeting all the requirements in clause 9.4.4.1.2, provided that the OTDOA assistance data is provided to allow sufficient time for the UE to acquire the SFN before the $T_{\text{RSTD InterRAT, E-UTRAN FDD}}$ starts.

When the UE is not aware of and cannot derive the subframe timing difference between the NR serving cell and the OTDOA assistance data reference cell, the UE may need to request measurement gaps to perform cell detection for the OTDOA assistance data reference cell prior to requesting measurement gaps for performing the requested E-UTRA RSTD measurements before the $T_{\text{RSTD InterRAT, E-UTRAN FDD}}$ time period starts while meeting all the requirements in clause 9.4.4.1.2, provided that the OTDOA assistance data is provided to allow sufficient time for the UE to detect the cell before the $T_{\text{RSTD InterRAT, E-UTRAN FDD}}$ starts.

9.4.4.1.2 Requirements

When the physical layer cell identities of neighbour cells together with the OTDOA assistance data are provided, the UE shall be able to detect and measure inter-RAT E-UTRAN FDD RSTD, specified in TS 38.215 [4], for at least $n=16$ cells, including the reference cell, within $T_{\text{RSTD InterRAT, E-UTRAN FDD}}$ ms as given below:

$$T_{\text{RSTD InterRAT, E-UTRAN FDD}} = T_{\text{PRS}} \cdot (M - 1) + \Delta \quad \text{ms},$$

where

$T_{\text{RSTD InterRAT, E-UTRAN FDD}}$ is the total time for detecting and measuring at least n cells,

T_{PRS} is the largest value of the cell-specific positioning subframe configuration period, defined in TS 36.211 [23], among the measured n cells including the reference cell,

M is the number of PRS positioning occasions as defined in Table 9.4.4.1.2-1, where each PRS positioning occasion comprises of N_{PRS} ($1 \leq N_{PRS} \leq 6$) consecutive downlink positioning subframes defined in TS 36.211 [23],

$CSSF_{interRAT} = CSSF_{within_gap,i}$ is the scaling factor determined by the gap sharing scheme for the RSTD measurements on the carrier frequency i as defined in clause 9.1.5.2,

$\Delta = 160 \cdot \left\lceil \frac{n}{M} \right\rceil$ ms is the measurement time for a single PRS positioning occasion which includes the sampling time and the processing time, and

the n cells are distributed on up to two E-UTRAN FDD carrier frequencies.

Table 9.4.4.1.2-1: Number of PRS positioning occasions within $T_{RSTD, InterRAT, E-UTRAN FDD}$

Positioning subframe configuration period T_{PRS}	Number of PRS positioning occasions M	
	f2 ^{Note1}	f1 and f2 ^{Note2}
160 ms	$16 \times CSSF_{interRAT}$	$32 \times CSSF_{interRAT}$
>160 ms	$8 \times CSSF_{interRAT}$	$16 \times CSSF_{interRAT}$
NOTE 1: When inter-RAT E-UTRAN FDD RSTD measurements are performed over the reference cell and neighbour cells, which belong to the E-UTRAN FDD carrier frequency f2.		
NOTE 2: When inter-RAT E-UTRAN FDD RSTD measurements are performed over the reference cell and the neighbour cells, which belong to the E-UTRAN FDD carrier frequency f1 and the E-UTRAN FDD carrier frequency f2 respectively.		

The UE physical layer shall be capable of reporting RSTD for the reference cell and all the neighbor cells i out of at least $(n-1)$ neighbor cells within $T_{RSTD, InterRAT, E-UTRAN FDD}$ provided:

$(PRS \hat{E}_s / Iot)_{ref} \geq -6$ dB for all Frequency Bands for the reference cell,

$(PRS \hat{E}_s / Iot)_i \geq -13$ dB for all Frequency Bands for neighbour cell i ,

$(PRS \hat{E}_s / Iot)_{ref}$ and $(PRS \hat{E}_s / Iot)_i$ conditions apply for all subframes of at least $L = \frac{M}{2}$ PRS positioning

occasions,

PRP 1,2_{dBm} according to TS 36.133 [15, Annex B.2.6] for a corresponding Band,

$PRS \hat{E}_s / Iot$ is defined as the ratio of the average received energy per PRS resource element during the useful part of the symbol to the average received power spectral density of the total noise and interference for this resource element, where the ratio is measured over all resource elements which carry PRS.

The time $T_{RSTD, InterRAT, E-UTRAN FDD}$ starts from the first subframe of the PRS positioning occasion closest in time after both the *OTDOA-RequestLocationInformation* message and the OTDOA assistance data in the *OTDOA-ProvideAssistanceData* message via LPP as specified in TS 38.305 [22], are delivered to the physical layer of the UE.

The RSTD measurement accuracy for all measured neighbor cells i shall be fulfilled according to the accuracy as specified in clause 10.2.4.

9.4.4.1.2.1 RSTD Measurement Reporting Delay

This requirement assumes that the measurement report is not delayed by other LPP signalling on the DCCH. This measurement reporting delay excludes a delay uncertainty resulted when inserting the measurement report to the TTI of the uplink DCCH. The delay uncertainty is: $2 \times TTI_{DCCH}$ where TTI_{DCCH} is the duration of subframe or slot or subslot when the measurement report is transmitted on the PUSCH with subframe or slot or subslot duration. This measurement reporting delay excludes any delay caused by no UL resources for UE to send the measurement report.

9.4.4.1.2.2 Requirements for acquiring the timing of the E-UTRA OTDOA reference cell

When the UE is not aware of the SFN of at least one LTE cell in the OTDOA assistance data, the UE supporting per-FR gaps may make autonomous gaps in downlink reception and uplink transmission of the PCell, PSCell, and each of the SCells in FR1 for acquiring SFN of the reference cell in the E-UTRA OTDOA assistance data, while no autonomous gaps in downlink reception or uplink transmission are allowed in any of the UE serving cells in FR2. The UE, which are only supporting per-UE gaps, may make autonomous gaps in downlink reception and uplink transmission of the PCell, PSCell, and each of the SCells for acquiring the SFN of the reference cell in the E-UTRA OTDOA assistance data.

When the UE is not aware of and cannot derive the subframe timing difference between the NR serving cell and the OTDOA assistance data reference cell, the UE may need to request measurement gaps while indicating *utra-FineTimingDetection* according to TS 38.331 [2] for detecting the reference cell in the E-UTRA OTDOA assistance data.

When the UE is performing one or both of SFN acquisition or cell detection as specified above, the UE shall be able to determine the timing of the E-UTRA OTDOA assistance data reference cell during the time period

$$T_{\text{RefCell,E-UTRAN}} = T_{\text{Detect, E-UTRAN FDD}} + T_{\text{MIB}} + T_{\text{ECGI}},$$

where

$T_{\text{Detect, E-UTRAN FDD}} = T_{\text{Identify, E-UTRAN FDD}} - T_{\text{measure, E-UTRAN FDD}}$ is according to clause 9.4.2 assuming $\text{CSSF}_{\text{interRAT}}=1$ and it is the time needed to detect the E-UTRA OTDOA assistance data reference cell when the UE needs to acquire the subframe and slot timing of the cell, provided the UE is configured with measurement gaps ($T_{\text{Detect, E-UTRAN FDD}}=0$ when both *nr-LTE-SFN-Offset* and *nr-LTE-fineTiming-Offset* are provided in the E-UTRA OTDOA assistance data or the E-UTRA OTDOA assistance data reference cell is known to the UE), and

$T_{\text{MIB}} = 50$ ms is the time required to acquire SFN and/or PHICH configuration of the E-UTRA OTDOA assistance data reference cell provided the OTDOA assistance data reference cell is decodable and at least all E-UTRA subframes #0 during T_{MIB} are available at the UE receiver ($T_{\text{MIB}}=0$ when *nr-LTE-SFN-Offset* is provided in the E-UTRA OTDOA assistance data and ECGI acquisition is not needed), and

$T_{\text{ECGI}} = 100$ ms is the time required to acquire ECGI of the E-UTRA OTDOA assistance data reference cell when *cellGlobalId* is included in *OTDOA-ReferenceCellInfo* and the UE is not aware of the ECGI of this cell ($T_{\text{ECGI}} = 0$ when *cellGlobalId* is not included in *OTDOA-ReferenceCellInfo* or the UE is aware of the ECGI of the E-UTRA OTDOA assistance data reference cell).

When detecting the E-UTRAN OTDOA reference cell, the requirements in this clause shall be met, provided the conditions for the detectable cell are fulfilled according to clause 9.4.2.1. In addition, the MIB of the E-UTRA OTDOA reference cell whose SFN is acquired shall be considered decodable by the UE provided the PBCH demodulation requirements are met according to TS 36.101 [25].

The requirement for acquiring the timing of the E-UTRA OTDOA reference cell within $T_{\text{RefCell,E-UTRAN}}$ is applicable when no DRX is used as well as when any of the DRX cycles specified in TS 38.331 [2] is used.

When $T_{\text{MIB}}>0$ and UE is using autonomous gaps during T_{MIB} , the UE shall transmit at least $N_{\text{ACK/NACK, MIB, FDD}}$ ACK/NACKs on PCell, PSCell, and each of activated SCell(s) in the frequency range where the autonomous gaps are created, specified in Table 9.4.4.1.2.2-1. When both $T_{\text{MIB}}>0$ and $T_{\text{ECGI}}>0$ and UE is using autonomous gaps during $T_{\text{MIB}}+T_{\text{ECGI}}$, the UE shall transmit on PCell, PSCell, and each of activated SCell(s) in the frequency range where autonomous gaps are created at least $N_{\text{ACK/NACK, MIB+ECGI, FDD}}$ ACK/NACKs specified in Table 9.4.4.1.2.2-3, provided the OTDOA reference cell bandwidth is configured in the OTDOA assistance data [22, 27]. The requirements in Tables 9.4.4.1.2.2-1, 9.4.4.1.2.2-2, and 9.4.4.1.2.2-3 apply, provided that:

- there is continuous DL data allocation,
- no DRX cycle is used,
- no measurement gaps are configured,
- only one code word is transmitted in each slot,
- 2 slot ACK/NACK feedback is configured,
- 20 ms SMTC period is configured,
- SSBs are transmitted in one slot within SMTC window.

Table 9.4.4.1.2.2-1: Number of ACK/NACKs transmitted by the UE during T_{MIB}

NACK/NACK, MIB, FDD	Configuration of the serving cell in which the transmitted ACK/NACKs are counted	
	Duplex mode configuration	SCS
15	FDD	15 kHz
39	FDD	30 kHz
85	FDD	60 kHz
0	TDD ^{Note 1}	15 kHz
4	TDD ^{Note 1}	30 kHz
12	TDD ^{Note 1}	60 kHz
46	TDD ^{Note 2}	60 kHz
104	TDD ^{Note 2}	120 kHz

NOTE 1: TDD UL-DL configuration is as specified in Table A.3.3.1-1 of TS 38.101-1 [18].
NOTE 2: TDD UL-DL configuration is as specified in Table A.3.3.1-1 of TS 38.101-2 [19].

Table 9.4.4.1.2.2-2: Void**Table 9.4.4.1.2.2-3: Number of ACK/NACKs transmitted by the UE during $T_{MIB}+T_{ECGI}$**

NACK/NACK, MIB+ECGI, FDD	Configuration of the serving cell in which the transmitted ACK/NACKs are counted	
	Duplex mode configuration	SCS
84	FDD	15 kHz
193	FDD	30 kHz
402	FDD	60 kHz
28	TDD ^{Note 1}	15 kHz
81	TDD ^{Note 1}	30 kHz
159	TDD ^{Note 1}	60 kHz
233	TDD ^{Note 2}	60 kHz
491	TDD ^{Note 2}	120 kHz

NOTE 1: TDD UL-DL configuration is as specified in Table A.3.3.1-1 of TS 38.101-1 [18].
NOTE 2: TDD UL-DL configuration is as specified in Table A.3.3.1-1 of TS 38.101-2 [19].

9.4.4.2 NR – E-UTRAN TDD RSTD measurements

9.4.4.2.1 Introduction

The requirements are applicable for NR–E-UTRAN TDD RSTD measurements requested via LPP [22, 27].

When the UE is in NE-DC operation mode and an NR–E-UTRAN TDD RSTD measurement configured by NR PCell is on a E-UTRA serving frequency carrier, then the corresponding E-UTRA intra-frequency measurements requirements as follows shall apply.

- Measurements configured on E-UTRA PSCC shall meet E-UTRAN OTDOA intra-frequency measurements requirements in clause 8.1.2.5. The applicable measurement accuracy requirements are in clause 9.1.10.
- Measurements configured on E-UTRA SCC shall meet all applicable requirements in clause 8.4, except that the terms PCell and primary component carrier shall be deemed to be swapped with PSCell and PSCC. The applicable measurement accuracy requirements are in clause 9.1.12, except that the terms PCell and primary component carrier shall be deemed to be swapped with PSCell and PSCC.

The requirements in clause 9.4.4.1 apply when:

- the UE is provided with the LTE timing information via LPP [27], including both *nr-LTE-SFN-Offset* and *nr-LTE-fineTiming-Offset*, or
- the UE is not provided with *nr-LTE-SFN-Offset* or *nr-LTE-fineTiming-Offset*, or

- the UE is provided with *nr-LTE-SFN-Offset* but not with *nr-LTE-fineTiming-Offset*.

When the UE is not aware of the SFN of at least one LTE cell in the OTDOA assistance data, the UE may be using autonomous gaps to acquire SFN of the OTDOA assistance data reference cell prior to requesting measurement gaps for performing the requested E-UTRA RSTD measurements before the $T_{\text{RSTD InterRAT,E-UTRAN TDD}}$ time period starts while meeting all the requirements in clause 9.4.4.2.2, provided that the OTDOA assistance data is provided to allow sufficient time for the UE to acquire the SFN before the $T_{\text{RSTD InterRAT,E-UTRAN TDD}}$ starts. When the UE is not aware of and cannot derive the subframe timing difference between the NR serving cell and the OTDOA assistance data reference cell, the UE may need to request measurement gaps to perform cell detection for the OTDOA assistance data reference cell prior to requesting measurement gaps for performing the requested E-UTRA RSTD measurements before the $T_{\text{RSTD InterRAT,E-UTRAN TDD}}$ time period starts while meeting all the requirements in clause 9.4.4.2.2, provided that the OTDOA assistance data is provided to allow sufficient time for the UE to detect the cell before the $T_{\text{RSTD InterRAT,E-UTRAN TDD}}$ starts.

9.4.4.2.2 Requirements

When the physical layer cell identities of neighbour cells together with the OTDOA assistance data are provided, the UE shall be able to detect and measure inter-RAT -UTRAN TDD RSTD, specified in TS 38.215 [4], for at least $n=16$ cells, including the reference cell, within $T_{\text{RSTD InterRAT,E-UTRAN TDD}}$ ms as given below:

$$T_{\text{RSTD InterRAT,E-UTRAN TDD}} = T_{\text{PRS}} \cdot (M - 1) + \Delta \quad \text{ms} \quad ,$$

where

$T_{\text{RSTD InterRAT,E-UTRAN TDD}}$ is the total time for detecting and measuring at least n cells,

T_{PRS} is the largest value of the cell-specific positioning subframe configuration period, defined in TS 36.211 [23], among the measured n cells including the reference cell,

M is the number of PRS positioning occasions as defined in Table 9.4.4.2.2-1, where a PRS positioning occasion is as defined in clause 9.4.4.1.2,

$\text{CSSF}_{\text{interRAT}} = \text{CSSF}_{\text{within_gap},i}$ is the scaling factor determined by the gap sharing scheme for the RSTD measurements on the carrier frequency i as defined in clause 9.1.5.2,

$\Delta = 160 \cdot \left\lceil \frac{n}{M} \right\rceil$ ms is the measurement time for a single PRS positioning occasion which includes the sampling time and the processing time, and

the n cells are distributed on up to two E-UTRAN TDD carrier frequencies.

Table 9.4.4.2.2-1: Number of PRS positioning occasions within $T_{\text{RSTD InterRAT,E-UTRAN TDD}}$

Positioning subframe configuration period T_{PRS}	Number of PRS positioning occasions M	
	f2 ^{Note1}	f1 and f2 ^{Note2}
160 ms	$16 \times \text{CSSF}_{\text{interRAT}}$	$32 \times \text{CSSF}_{\text{interRAT}}$
>160 ms	$8 \times \text{CSSF}_{\text{interRAT}}$	$16 \times \text{CSSF}_{\text{interRAT}}$
NOTE 1: When inter-RAT E-UTRAN TDD RSTD measurements are performed over the reference cell and neighbour cells, which belong to the E-UTRAN TDD carrier frequency f2.		
NOTE 2: When inter-RAT E-UTRAN TDD RSTD measurements are performed over the reference cell and the neighbour cells, which belong to the E-UTRAN TDD carrier frequency f1 and the E-UTRAN TDD carrier frequency f2 respectively.		

The requirements in this clause shall apply for all TDD special subframe configurations specified in TS 36.211 [23] and for the TDD uplink-downlink configurations as specified in Table 9.4.4.2.2-2 for UE requiring measurement gaps for these measurements. For UEs capable of performing inter-RAT RSTD measurements without measurement gaps, TDD uplink-downlink subframe configurations as specified in Table 9.4.4.2.2-3 shall apply.

Table 9.4.4.2.2-2: TDD uplink-downlink subframe configurations applicable for inter-RAT RSTD requirements

PRS Transmission Bandwidth (RB)	Applicable TDD uplink-downlink configurations
6, 15	3, 4 and 5
25	1, 2, 3, 4, 5 and 6
50, 75, 100	0, 1, 2, 3, 4, 5 and 6
NOTE 1: Uplink-downlink configurations are specified in Table 4.2-2 in TS 36.211 [23].	

Table 9.4.4.2.2-3: TDD uplink-downlink subframe configurations applicable for inter-RAT RSTD requirements without gaps

PRS Transmission Bandwidth (RB)	Applicable TDD uplink-downlink configurations
6, 15	1, 2, 3, 4 and 5
25, 50, 75, 100	0, 1, 2, 3, 4, 5 and 6
NOTE 1: Uplink-downlink configurations are specified in Table 4.2-2 in TS 36.211 [23].	

The UE physical layer shall be capable of reporting RSTD for the reference cell and all the neighbor cells i out of at least $(n-1)$ neighbor cells within $T_{\text{RSTD InterRAT,E-UTRAN TDD}}$ provided:

$(\text{PRS } \hat{E}_s / \text{Iot})_{\text{ref}} \geq -6$ dB for all Frequency Bands for the reference cell,

$(\text{PRS } \hat{E}_s / \text{Iot})_i \geq -13$ dB for all Frequency Bands for neighbour cell i ,

$(\text{PRS } \hat{E}_s / \text{Iot})_{\text{ref}}$ and $(\text{PRS } \hat{E}_s / \text{Iot})_i$ conditions apply for all subframes of at least $L = \frac{M}{2}$ PRS positioning

occasions,

PRP 1,2_{dBm} according to TS 36.133 [15, Annex B.2.6] for a corresponding Band,

$\text{PRS } \hat{E}_s / \text{Iot}$ is as defined in clause 9.4.4.1.2.

The time $T_{\text{RSTD InterRAT,E-UTRAN TDD}}$ starts from the first subframe of the PRS positioning occasion closest in time after both the OTDOA-RequestLocationInformation message and the OTDOA assistance data in the OTDOA-ProvideAssistanceData message via LPP as specified in TS 38.305 [22], are delivered to the physical layer of the UE.

The RSTD measurement accuracy for all measured neighbor cells i shall be fulfilled according to the accuracy as specified in clause 10.2.4.

9.4.4.2.2.1 RSTD Measurement Reporting Delay

This requirement assumes that the measurement report is not delayed by other LPP signalling on the DCCH. This measurement reporting delay excludes a delay uncertainty resulted when inserting the measurement report to the TTI of the uplink DCCH. The delay uncertainty is: $2 \times \text{TTI}_{\text{DCCH}}$ where TTI_{DCCH} is the duration of subframe or slot or subslot when the measurement report is transmitted on the PUSCH with subframe or slot or subslot duration. This measurement reporting delay excludes any delay caused by no UL resources for UE to send the measurement report.

9.4.4.2.2.2 Requirements for acquiring the timing of the E-UTRA OTDOA reference cell

When the UE is not aware of the SFN of at least one LTE cell in the OTDOA assistance data, the UE supporting per-FR gaps may make autonomous gaps in downlink reception and uplink transmission of the PCell, PSCell, and each of the SCells in FR1 for acquiring SFN of the reference cell in the E-UTRA OTDOA assistance data, while no autonomous gaps in downlink reception or uplink transmission are allowed in any of the UE serving cells in FR2. The UE, which are only supporting per-UE gaps, may make autonomous gaps in downlink reception and uplink transmission of the PCell, PSCell, and each of the SCells for acquiring the SFN of the reference cell in the E-UTRA OTDOA assistance data.

When the UE is not aware of and cannot derive the subframe timing difference between the NR serving cell and the OTDOA assistance data reference cell, the UE may need to request measurement gaps while indicating *eutra-*

FineTimingDetection according to TS 38.331 [2] for detecting the reference cell in the E-UTRA OTDOA assistance data.

When the UE is performing one or both of SFN acquisition or cell detection as specified above, the UE shall be able to determine the timing of the E-UTRA OTDOA assistance data reference cell during the time period

$$T_{\text{RefCell,E-UTRAN}} = T_{\text{Detect, E-UTRAN TDD}} + T_{\text{MIB}} + T_{\text{ECGI}},$$

where

$T_{\text{Detect, E-UTRAN TDD}} = T_{\text{Identify, E-UTRAN TDD}} - T_{\text{measure, E-UTRAN TDD}}$ is according to clause 9.4.3 assuming $\text{CSSF}_{\text{interRAT}}=1$ and it is the time needed to detect the E-UTRA OTDOA assistance data reference cell when the UE needs to acquire the subframe and slot timing of the cell, provided the UE is configured with measurement gaps ($T_{\text{Detect, E-UTRAN TDD}}=0$ when both *nr-LTE-SFN-Offset* and *nr-LTE-fineTiming-Offset* are provided in the E-UTRA OTDOA assistance data or the E-UTRA OTDOA assistance data reference cell is known to the UE), and

$T_{\text{MIB}} = 50$ ms is the time required to acquire SFN and/or PHICH configuration of the E-UTRA OTDOA assistance data reference cell provided the OTDOA assistance data reference cell is decodable and at least all E-UTRA subframes #0 during T_{MIB} are available at the UE receiver ($T_{\text{MIB}}=0$ when *nr-LTE-SFN-Offset* is provided in the E-UTRA OTDOA assistance data and ECGI acquisition is not needed), and

$T_{\text{ECGI}} = 100$ ms is the time required to acquire ECGI of the E-UTRA OTDOA assistance data reference cell when *cellGlobalId* is included in *OTDOA-ReferenceCellInfo* and the UE is not aware of the ECGI of this cell ($T_{\text{ECGI}} = 0$ when *cellGlobalId* is not included in *OTDOA-ReferenceCellInfo* or the UE is aware of the ECGI of the E-UTRA OTDOA assistance data reference cell).

When detecting the E-UTRAN OTDOA reference cell, the requirements in this clause shall be met, provided the conditions for the detectable cell are fulfilled according to clause 9.4.3.1. In addition, the MIB of the E-UTRA OTDOA reference cell whose SFN is acquired shall be considered decodable by the UE provided the PBCH demodulation requirements are met according to TS 36.101 [25].

The requirement for acquiring the timing of the E-UTRA OTDOA reference cell within $T_{\text{RefCell,E-UTRAN}}$ is applicable when no DRX is used as well as when any of the DRX cycles specified in TS 38.331 [2] is used.

When $T_{\text{MIB}}>0$ and UE is using autonomous gaps during T_{MIB} , the UE shall transmit at least $N_{\text{ACK/NACK, MIB, TDD}}$ ACK/NACKs on PCell, PSCell, and each of activated SCell(s) in the frequency range where the autonomous gaps are created, specified in Table 9.4.4.2.2.2-1. When both $T_{\text{MIB}}>0$ and $T_{\text{ECGI}}>0$ and UE is using autonomous gaps during $T_{\text{MIB}}+T_{\text{ECGI}}$, the UE shall transmit on PCell, PSCell, and each of activated SCell(s) in the frequency range where autonomous gaps are created at least $N_{\text{ACK/NACK, MIB+ECGI, TDD}}$ ACK/NACKs specified in Table 9.4.4.2.2.2-3, provided the OTDOA reference cell bandwidth is configured in the OTDOA assistance data [22, 27]. The requirements in Tables 9.4.4.2.2.2-1, 9.4.4.2.2.2-2 and 9.4.4.2.2.2-3 apply, provided that:

- there is continuous DL data allocation,
- no DRX cycle is used,
- no measurement gaps are configured,
- only one code word is transmitted in each slot,
- 2 slot ACK/NACK feedback is configured,
- 20 ms SMTC period is configured,
- SSBs are transmitted in one slot within SMTC window.

Table 9.4.4.2.2-1: Minimum number of ACK/NACKs transmitted by the UE during T_{MIB}

$N_{\text{ACK/NACK, MIB, TDD}}$	Configuration of the serving cell in which the transmitted ACK/NACKs are counted	
	Duplex mode configuration	SCS
15	FDD	15 kHz
39	FDD	30 kHz
85	FDD	60 kHz
0	TDD ^{Note 1}	15 kHz

4	TDD ^{Note 1}	30 kHz
12	TDD ^{Note 1}	60 kHz
46	TDD ^{Note 2}	60 kHz
104	TDD ^{Note 2}	120 kHz
NOTE 1: TDD UL-DL configuration is as specified in Table A.3.3.1-1 of TS 38.101-1 [18].		
NOTE 2: TDD UL-DL configuration is as specified in Table A.3.3.1-1 of TS 38.101-2 [19].		

Table 9.4.4.2.2-2: Void

Table 9.4.4.2.2-3: Minimum number of ACK/NACKs transmitted by the UE during $T_{MIB}+T_{ECGI}$

NACK/NACK, MIB+ECGI, TDD	Configuration of the serving cell in which the transmitted ACK/NACKs are counted	
	Duplex mode configuration	SCS
84	FDD	15 kHz
193	FDD	30 kHz
402	FDD	60 kHz
28	TDD ^{Note 1}	15 kHz
81	TDD ^{Note 1}	30 kHz
159	TDD ^{Note 1}	60 kHz
233	TDD ^{Note 2}	60 kHz
491	TDD ^{Note 2}	120 kHz
NOTE 1: TDD UL-DL configuration is as specified in Table A.3.3.1-1 of TS 38.101-1 [18].		
NOTE 2: TDD UL-DL configuration is as specified in Table A.3.3.1-1 of TS 38.101-2 [19].		

9.4.5 Inter-RAT E-CID measurements

9.4.5.1 NR–E-UTRAN FDD E-CID RSRP and RSRQ measurements

9.4.5.1.1 Introduction

The requirements in clause 9.4.5.1. shall apply provided the UE has received *ECID-RequestLocationInformation* message from LMF via LPP requesting the UE to report inter-RAT E-UTRAN FDD E-CID RSRP and RSRQ measurements [22, 27].

9.4.5.1.2 Requirements

The requirements in clause 9.4.2 also apply for this clause except the measurement reporting requirements. The measurement reporting requirements for E-CID RSRP and RSRQ are defined in clause 9.4.5.1.3.

9.4.5.1.3 Measurement Reporting Delay

This requirement assumes that the measurement report is not delayed by other LPP signalling on the DCCH. This measurement reporting delay excludes a delay uncertainty resulted when inserting the measurement report to the TTI of the uplink DCCH. The delay uncertainty is: $2 \times TTI_{DCCH}$ where TTI_{DCCH} is the duration of subframe or slot or subslot when the measurement report is transmitted on the PUSCH with subframe or slot or subslot duration. This measurement reporting delay excludes any delay caused by no UL resources for UE to send the measurement report.

Reported RSRP and RSRQ measurements contained in periodically triggered measurement reports shall meet the requirements in clauses 10.2.2 and 10.2.3, respectively.

9.4.5.2 NR–E-UTRAN TDD E-CID RSRP and RSRQ measurements

9.4.5.2.1 Introduction

The requirements in clause 9.4.5.2. shall apply provided the UE has received *ECID-RequestLocationInformation* message from LMF via LPP requesting the UE to report inter-RAT E-UTRAN TDD E-CID RSRP and RSRQ measurements [22, 27].

9.4.5.2.2 Requirements

The requirements in clause 9.4.3 also apply for this clause except the measurement reporting requirements. The measurement reporting requirements for E-CID RSRP and RSRQ are defined in clause 9.4.5.2.3.

9.4.5.2.3 Measurement Reporting Delay

This requirement assumes that the measurement report is not delayed by other LPP signalling on the DCCH. This measurement reporting delay excludes a delay uncertainty resulted when inserting the measurement report to the TTI of the uplink DCCH. The delay uncertainty is: $2 \times TTI_{DCCH}$ where TTI_{DCCH} is the duration of subframe or slot or subslot when the measurement report is transmitted on the PUSCH with subframe or slot or subslot duration. This measurement reporting delay excludes any delay caused by no UL resources for UE to send the measurement report.

Reported RSRP and RSRQ measurements contained in periodically triggered measurement reports shall meet the requirements in clauses 10.2.2 and 10.2.3, respectively.

9.5 L1-RSRP measurements for Reporting

9.5.1 Introduction

When configured by the network, the UE shall be able to perform L1-RSRP measurements of configured CSI-RS, SSB or CSI-RS and SSB resources for L1-RSRP. The measurements shall be performed for a serving cell, including PCell, PSCell, or SCell, on the resources configured for L1-RSRP measurements within the active BWP.

The UE shall be able to measure all CSI-RS resources and/or SSB resources of the *nzp-CSI-RS-ResourceSet* and/or *csi-SSB-ResourceSet* within the *CSI-ResourceConfig* settings configured for L1-RSRP for the active BWP, provided that the number of resources does not exceed the UE capability indicated by *beamManagementSSB-CSI-RS*.

The UE shall report the measurement quantity (*reportQuantity*) and send periodic, semi-persistent or aperiodic reports, according to the *reportConfigType* according to the CSI reporting configuration(s) (*CSI-ReportConfig*) for the active BWP.

9.5.2 Requirements applicability

The requirements in clause 9.5 apply, provided:

- The CSI-RS or SSB or CSI-RS and SSB resources configured for L1-RSRP measurements are measurable.

An SSB resource configured for L1-RSRP shall be considered measurable when for each relevant SSB the following conditions are met:

- L1-RSRP related side conditions given in clauses 10.1.19.1 and 10.1.20.1 for FR1 and FR2, respectively, for a corresponding band,
- SSB_{RP} and SSB \hat{E}_s/I_{ot} according to Annex B.2.4.1 for a corresponding band.

A CSI-RS resource configured for L1-RSRP shall be considered measurable when for each relevant CSI-RS the following conditions are met:

- L1-RSRP related side conditions given in clauses 10.1.19.2 and 10.1.20.2 for FR1 and FR2, respectively, for a corresponding band,
- CSI-RS_{RP} and CSI-RS \hat{E}_s/I_{ot} according to Annex B.2.4.2 for a corresponding band.

A CSI-RS and SSB resource configured for L1-RSRP shall be considered measurable when the measurable resource conditions are met for both CSI-RS resource and SSB resource.

Requirements are defined for periodic, semi-persistent and aperiodic resources.

9.5.3 Measurement Reporting Requirements

The UE shall send L1-RSRP reports only for report configurations configured for the active BWP.

The UE shall report the L1-RSRP value as a 7-bit value in the range [-140, -44] dBm with 1dB step size according to clause 10.1.19 for FR1 and 10.1.20 for FR2 if *nrofReportedRS* is configured to one. If *nrofReportedRS* is configured to be larger than one, or if *groupBasedBeamReporting* is enabled, the UE shall use differential L1-RSRP based reporting as defined in clause 10.1.19 for FR1 and 10.1.20 for FR2. The differential L1-RSRP is quantized to a 4-bit value with 2dB step size. The mapping between the reported L1-RSRP value and the measured quantity is described in 10.1.6.

9.5.3.1 Periodic Reporting

Reported L1-RSRP measurements contained in periodic L1-RSRP measurement reports shall meet the requirements in clauses 10.1.19 for FR1 and 10.1.20 for FR2, respectively.

The UE shall only send periodic L1-RSRP measurement reports for an active BWP.

The UE shall transmit the periodic L1-RSRP reporting on PUCCH over the air interface according to the periodicity defined in clause 5.2.1.4 in TS 38.214 [26].

9.5.3.2 Semi-Persistent Reporting

Reported L1-RSRP measurements contained in a Semi-Persistent L1-RSRP measurement report shall meet the requirements in clauses 10.1.19 for FR1 and 10.1.20 for FR2, respectively. This requirement applies for semi-persistent L1-RSRP reports send on PUSCH or PUCCH.

The UE shall only send semi-persistent L1-RSRP measurement reports on PUSCH, if a DCI request has been received.

The UE shall only send semi-persistent L1-RSRP measurement reports on PUCCH, if an activation command [7] has been received.

The UE shall transmit the semi-persistent L1-RSRP reporting on PUSCH or PUCCH over the air interface according to the periodicity defined in clause 5.2.1.4 in TS 38.214 [26].

9.5.3.3 Aperiodic Reporting

Reported L1-RSRP measurements contained in aperiodic triggered, aperiodic triggered periodic and aperiodic triggered semi-persistent L1-RSRP reports shall meet the requirements in clauses 10.1.19 for FR1 and 10.1.20 for FR2, respectively.

The UE shall only send aperiodic L1-RSRP measurement reports, if a DCI trigger has been received.

After the UE receives CSI request in DCI, the UE shall transmit the aperiodic L1-RSRP reporting on PUSCH over the air interface at the time specified according to clause 6.1.2.1 in TS 38.214 [26].

9.5.4 L1-RSRP measurement requirements

9.5.4.1 SSB based L1-RSRP Reporting

The UE shall be capable of performing L1-RSRP measurements based on the configured SSB resource for L1-RSRP computation, and the UE physical layer shall be capable of reporting L1-RSRP measured over the measurement period of $T_{L1-RSRP_Measurement_Period_SSB}$.

The value of $T_{L1-RSRP_Measurement_Period_SSB}$ is defined in Table 9.5.4.1-1 for FR1 and Table 9.5.4.1-2 for FR2, where

- $M=1$ if higher layer parameter *timeRestrictionForChannelMeasurement* is configured, and $M=3$ otherwise
- $N=8$.

For FR1,

- $P = \frac{1}{1 - \frac{T_{SSB}}{MGRP}}$, when in the monitored cell there are measurement gaps configured for intra-frequency, inter-frequency or inter-RAT measurements, which are overlapping with some but not all occasions of the SSB; and
- $P=1$ when in the monitored cell there are no measurement gaps overlapping with any occasion of the SSB.

For FR2,

- $P = \frac{1}{1 - \frac{T_{SSB}}{T_{SMTCperiod}}}$, when SSB is not overlapped with measurement gap and SSB is partially overlapped with SMTC occasion ($T_{SSB} < T_{SMTCperiod}$).
- P is $P_{sharing}$ factor, when SSB is not overlapped with measurement gap and SSB is fully overlapped with SMTC period ($T_{SSB} = T_{SMTCperiod}$).
- $P = \frac{1}{1 - \frac{T_{SSB}}{MGRP} \cdot \frac{T_{SSB}}{T_{SMTCperiod}}}$, when SSB is partially overlapped with measurement gap and SSB is partially overlapped with SMTC occasion ($T_{SSB} < T_{SMTCperiod}$) and SMTC occasion is not overlapped with measurement gap and
 - $T_{SMTCperiod} \neq MGRP$ or
 - $T_{SMTCperiod} = MGRP$ and $T_{SSB} < 0.5 * T_{SMTCperiod}$
- P is $\frac{1}{1 - \frac{T_{SSB}}{MGRP}} * P_{sharing}$ factor, when SSB is partially overlapped with measurement gap and SSB is partially overlapped with SMTC occasion ($T_{SSB} < T_{SMTCperiod}$) and SMTC occasion is not overlapped with measurement gap and $T_{SMTCperiod} = MGRP$ and $T_{SSB} = 0.5 * T_{SMTCperiod}$
- $P = \frac{1}{1 - \frac{T_{SSB}}{\min(T_{SMTCperiod}, MGRP)}}$, when SSB is partially overlapped with measurement gap ($T_{SSB} < MGRP$) and SSB is partially overlapped with SMTC occasion ($T_{SSB} < T_{SMTCperiod}$) and SMTC occasion is partially or fully overlapped with measurement gap.
- P is $\frac{1}{1 - \frac{T_{SSB}}{MGRP}} * P_{sharing}$ factor, when SSB is partially overlapped with measurement gap and SSB is fully overlapped with SMTC occasion ($T_{SSB} = T_{SMTCperiod}$) and SMTC occasion is partially overlapped with measurement gap ($T_{SMTCperiod} < MGRP$)
- P is $\frac{1}{1 - \frac{T_{SSB}}{MGRP}} * P_{sharing}$ factor, when SSB is partially overlapped with measurement gap and SSB is fully overlapped with SMTC occasion ($T_{SSB} = T_{SMTCperiod}$) and SMTC occasion is partially overlapped with measurement gap ($T_{SMTCperiod} < MGRP$) $P_{sharing}$ factor = 1
 - not overlapped with the SSB symbols indicated by SSB-ToMeasure and 1 data symbol before each consecutive SSB symbols indicated by SSB-ToMeasure and 1 data symbol after each consecutive SSB symbols indicated by SSB-ToMeasure, given that SSB-ToMeasure is configured, where the *SSB-ToMeasure* is the union set of *SSB-ToMeasure* from all the configured measurement objects merged on the same serving carrier, and,
 - not overlapped with the RSSI symbols indicated by ss-RSSI-Measurement and 1 data symbol before each RSSI symbol indicated by ss-RSSI-Measurement and 1 data symbol after each RSSI symbol indicated by ss-RSSI-Measurement, given that ss-RSSI-Measurement is configured,
- $P_{sharing}$ factor = 3, otherwise.

Where:

$T_{SSB} = \text{ssb-periodicityServingCell}$

$T_{SMTCperiod} = \text{the configured SMTC period}$

If the high layer in TS 38.331 [2] signaling of *smtc2* is configured, $T_{SMTCperiod}$ corresponds to the value of higher layer parameter *smtc2*; Otherwise $T_{SMTCperiod}$ corresponds to the value of higher layer parameter *smtc1*. $T_{SMTCperiod}$ is the shortest SMTC period among all CCs in the same FR2 band, provided the SMTC offset of all CCs in FR2 have the same offset.

Longer evaluation period would be expected if the combination of SSB, SMTC occasion and measurement gap configurations does not meet previous conditions.

Table 9.5.4.1-1: Measurement period $T_{L1-RSRP_Measurement_Period_SSB}$ for FR1

Configuration	$T_{L1-RSRP_Measurement_Period_SSB}$ (ms)
non-DRX	$\max(T_{Report}, \text{ceil}(M \cdot P) \cdot T_{SSB})$
DRX cycle ≤ 320 ms	$\max(T_{Report}, \text{ceil}(1.5 \cdot M \cdot P) \cdot \max(T_{DRX}, T_{SSB}))$
DRX cycle > 320 ms	$\text{ceil}(M \cdot P) \cdot T_{DRX}$
Note:	T_{SSB} = ssb-periodicityServingCell is the periodicity of the SSB-Index configured for L1-RSRP measurement. T_{DRX} is the DRX cycle length. T_{Report} is configured periodicity for reporting.

Table 9.5.4.1-2: Measurement period $T_{L1-RSRP_Measurement_Period_SSB}$ for FR2

Configuration	$T_{L1-RSRP_Measurement_Period_SSB}$ (ms)
non-DRX	$\max(T_{Report}, \text{ceil}(M \cdot P \cdot N) \cdot T_{SSB})$
DRX cycle ≤ 320 ms	$\max(T_{Report}, \text{ceil}(1.5 \cdot M \cdot P \cdot N) \cdot \max(T_{DRX}, T_{SSB}))$
DRX cycle > 320 ms	$\text{ceil}(1.5 \cdot M \cdot P \cdot N) \cdot T_{DRX}$
Note:	T_{SSB} = ssb-periodicityServingCell is the periodicity of the SSB-Index configured for L1-RSRP measurement. T_{DRX} is the DRX cycle length. T_{Report} is configured periodicity for reporting.

9.5.4.2 CSI-RS based L1-RSRP Reporting

The UE shall be capable of performing L1-RSRP measurements based on the configured CSI-RS resource for L1-RSRP computation, and the UE physical layer shall be capable of reporting L1-RSRP measured over the measurement period of $T_{L1-RSRP_Measurement_Period_CSI-RS}$.

The value of $T_{L1-RSRP_Measurement_Period_CSI-RS}$ is defined in Table 9.5.4.2-1 for FR1 and in Table 9.5.4.2-2 for FR2, where

- For periodic and semi-persistent CSI-RS resources, $M=1$ if higher layer parameter *timeRestrictionForChannelMeasurement* is configured, and $M=3$ otherwise
- For aperiodic CSI-RS resources $M=1$
- For periodic CSI-RS resources in a resource set configured with higher layer parameter *repetition* set to ON, $N=\text{ceil}(\text{maxNumberRxBeam} / N_{\text{res_per_set}})$, where $N_{\text{res_per_set}}$ is number of resources in the resource set. The requirements apply provided *qcl-InfoPeriodicCSI-RS* is configured for all resources in the resource set.
 - SSB for L1-RSRP measurement, or
 - another CSI-RS in resource set configured with repetition ON.
- For periodic CSI-RS resources in a resource set configured with higher layer parameter *repetition* set to ON, $N=\text{ceil}(\text{maxNumberRxBeam} / N_{\text{res_per_set}})$, where $N_{\text{res_per_set}}$ is number of resources in the resource set. The requirements apply provided *qcl-InfoPeriodicCSI-RS* is configured for with QCL-TypeD all resources in the resource set.
- For semi-persistent CSI-RS resources in a resource set configured with higher layer parameter *repetition* set to OFF, $N=1$. The requirements apply provided TCI state is provided for all resources in the resource set in the MAC CE activating the resource set and for each resource one RS has QCL-TypeD with
 - SSB for L1-RSRP measurement, or
 - another CSI-RS in resource set configured with repetition ON.
- For semi-persistent CSI-RS resources in a resource set configured with higher layer parameter *repetition* set to ON, $N=\text{ceil}(\text{maxNumberRxBeam} / N_{\text{res_per_set}})$, where $N_{\text{res_per_set}}$ is number of resources in the resource set. The requirements apply provided TCI state is provided with QCL-TypeD for all resources in the resource set in the MAC CE activating the resource set.

- For aperiodic CSI-RS resources in a resource set configured with higher layer parameter *repetition* set to OFF, $N=1$. The requirements apply provided *qcl-info* is configured for all resources in the resource set and for each resource one RS has QCL-TypeD with
 - SSB for L1-RSRP measurement, or
 - another CSI-RS in resource set configured with repetition ON.
- For aperiodic CSI-RS resources in a resource set configured with higher layer parameter *repetition* set to ON, $N=1$. UE is not required to meet the accuracy requirements in clause 10.1.19.2 and 10.1.20.2 if number of resources in the resource set is smaller than *maxNumberRxBeam*. The requirements apply provided *qcl-info* is configured with QCL-TypeD for all resources in the resource set.

For FR1,

- $P = \frac{1}{1 - \frac{T_{\text{CSI-RS}}}{\text{MGRP}}}$, when in the monitored cell there are measurement gaps configured for intra-frequency, inter-frequency or inter-RAT measurements, which are overlapping with some but not all occasions of the CSI-RS; and
- $P=1$ when in the monitored cell there are no measurement gaps overlapping with any occasion of the CSI-RS.

For FR2,

- $P=1$, when CSI-RS is not overlapped with measurement gap and also not overlapped with SMTC occasion.
- $P = \frac{1}{1 - \frac{T_{\text{CSI-RS}}}{\text{MGRP}}}$, when CSI-RS is partially overlapped with measurement gap and CSI-RS is not overlapped with SMTC occasion ($T_{\text{CSI-RS}} < \text{MGRP}$)
- $P = \frac{1}{1 - \frac{T_{\text{CSI-RS}}}{T_{\text{SMTCperiod}}}}$, when CSI-RS is not overlapped with measurement gap and CSI-RS is partially overlapped with SMTC occasion ($T_{\text{CSI-RS}} < T_{\text{SMTCperiod}}$).
- $P = P_{\text{sharing factor}}$, when CSI-RS is not overlapped with measurement gap and CSI-RS is fully overlapped with SMTC occasion ($T_{\text{CSI-RS}} = T_{\text{SMTCperiod}}$).
- $P=1$, when aperiodic CSI-RS resource is not overlapped with measurement gap.
- $P = \frac{1}{1 - \frac{T_{\text{CSI-RS}}}{\text{MGRP}} - \frac{T_{\text{CSI-RS}}}{T_{\text{SMTCperiod}}}}$, when CSI-RS is partially overlapped with measurement gap and CSI-RS is partially overlapped with SMTC occasion ($T_{\text{CSI-RS}} < T_{\text{SMTCperiod}}$) and SMTC occasion is not overlapped with measurement gap and
 - $T_{\text{SMTCperiod}} \neq \text{MGRP}$ or
 - $T_{\text{SMTCperiod}} = \text{MGRP}$ and $T_{\text{CSI-RS}} < 0.5 * T_{\text{SMTCperiod}}$
- $P = \frac{3}{1 - \frac{T_{\text{CSI-RS}}}{\text{MGRP}}}$, when CSI-RS is partially overlapped with measurement gap and CSI-RS is partially overlapped with SMTC occasion ($T_{\text{CSI-RS}} < T_{\text{SMTCperiod}}$) and SMTC occasion is not overlapped with measurement gap and $T_{\text{SMTCperiod}} = \text{MGRP}$ and $T_{\text{CSI-RS}} = 0.5 * T_{\text{SMTCperiod}}$
- $P = \frac{1}{1 - \frac{T_{\text{CSI-RS}}}{\min(T_{\text{SMTCperiod}}, \text{MGRP})}}$, when CSI-RS is partially overlapped with measurement gap ($T_{\text{CSI-RS}} < \text{MGRP}$) and CSI-RS is partially overlapped with SMTC occasion ($T_{\text{CSI-RS}} < T_{\text{SMTCperiod}}$) and SMTC occasion is partially or fully overlapped with measurement gap.
- $P = \frac{3}{1 - \frac{T_{\text{CSI-RS}}}{\text{MGRP}}}$, when CSI-RS is partially overlapped with measurement gap and CSI-RS is fully overlapped with SMTC occasion ($T_{\text{CSI-RS}} = T_{\text{SMTCperiod}}$) and SMTC occasion is partially overlapped with measurement gap ($T_{\text{SMTCperiod}} < \text{MGRP}$)
- $P_{\text{sharing factor}} = 1$, if the CSI-RS configured for L1-RSRP measurement outside measurement gap is

- not overlapped with the SSB symbols indicated by *SSB-ToMeasure* and 1 data symbol before each consecutive SSB symbols indicated by *SSB-ToMeasure* and 1 data symbol after each consecutive SSB symbols indicated by *SSB-ToMeasure*, given that *SSB-ToMeasure* is configured, where the *SSB-ToMeasure* is the union set of *SSB-ToMeasure* from all the configured measurement objects merged on the same serving carrier, and,
- not overlapped with the RSSI symbols indicated by *ss-RSSI-Measurement* and 1 data symbol before each RSSI symbol indicated by *ss-RSSI-Measurement* and 1 data symbol after each RSSI symbol indicated by *ss-RSSI-Measurement*, given that *ss-RSSI-Measurement* is configured
- $P_{\text{sharing factor}} = 3$, otherwise.

Where:

$T_{\text{SMTCperiod}}$ = the configured SMTC period.

$T_{\text{CSI-RS}}$ = the periodicity of CSI-RS configured for L1-RSRP measurement

If the high layer in TS 38.331 [2] signaling of *smtc2* is configured, $T_{\text{SMTCperiod}}$ corresponds to the value of higher layer parameter *smtc2*; Otherwise $T_{\text{SMTCperiod}}$ corresponds to the value of higher layer parameter *smtc1*. $T_{\text{SMTCperiod}}$ is the shortest SMTC period among all CCs in the same FR2 band, provided the SMTC offset of all CCs in FR2 have the same offset.

Note: The overlap between CSI-RS for L1-RSRP measurement and SMTC means that CSI-RS for L1-RSRP measurement is within the SMTC window duration.

Longer evaluation period would be expected if the combination of CSI-RS, SMTC occasion and measurement gap configurations does not meet pervious conditions.

Table 9.5.4.2-1: Measurement period $T_{\text{L1-RSRP_Measurement_Period_CSI-RS}}$ for FR1

Configuration	$T_{\text{L1-RSRP_Measurement_Period_CSI-RS}}$ (ms)
non-DRX	$\max(T_{\text{Report}}, \text{ceil}(M \cdot P) \cdot T_{\text{CSI-RS}})$
DRX cycle $\leq 320\text{ms}$	$\max(T_{\text{Report}}, \text{ceil}(1.5 \cdot M \cdot P) \cdot \max(T_{\text{DRX}}, T_{\text{CSI-RS}}))$
DRX cycle $> 320\text{ms}$	$\text{ceil}(M \cdot P) \cdot T_{\text{DRX}}$
Note 1:	$T_{\text{CSI-RS}}$ is the periodicity of CSI-RS configured for L1-RSRP measurement. T_{DRX} is the DRX cycle length. T_{Report} is configured periodicity for reporting.
Note 2:	the requirements are applicable provided that the CSI-RS resource configured for L1-RSRP measurement is transmitted with Density = 3.

Table 9.5.4.2-2: Measurement period $T_{\text{L1-RSRP_Measurement_Period_CSI-RS}}$ for FR2

Configuration	$T_{\text{L1-RSRP_Measurement_Period_CSI-RS}}$ (ms)
non-DRX	$\max(T_{\text{Report}}, \text{ceil}(M \cdot P \cdot N) \cdot T_{\text{CSI-RS}})$
DRX cycle $\leq 320\text{ms}$	$\max(T_{\text{Report}}, \text{ceil}(1.5 \cdot M \cdot P \cdot N) \cdot \max(T_{\text{DRX}}, T_{\text{CSI-RS}}))$
DRX cycle $> 320\text{ms}$	$\text{ceil}(M \cdot P \cdot N) \cdot T_{\text{DRX}}$
Note 1:	$T_{\text{CSI-RS}}$ is the periodicity of CSI-RS configured for L1-RSRP measurement. T_{DRX} is the DRX cycle length. T_{Report} is configured periodicity for reporting.
Note 2:	the requirements are applicable provided that the CSI-RS resource configured for L1-RSRP measurement is transmitted with Density = 3.

9.5.5 Measurement restriction for CSI-RS and SSB for L1-RSRP measurement

The UE is required to be capable of measuring SSB and CSI-RS for L1-RSRP without measurement gaps. The UE is required to perform the SSB and CSI-RS measurements with measurement restrictions as described in the following clauses.

9.5.5.1 Measurement restriction for SSB based L1-RSRP

For FR1, when the SSB for L1-RSRP measurement is in the same OFDM symbol as CSI-RS for RLM, BFD, CBD or L1-RSRP measurement,

- If SSB and CSI-RS have same SCS, UE shall be able to measure the SSB for L1-RSRP measurement without any restriction;
- If SSB and CSI-RS have different SCS,
 - If UE supports *simultaneousRxDataSSB-DiffNumerology*, UE shall be able to measure the SSB for L1-RSRP measurement without any restriction;
 - If UE does not support *simultaneousRxDataSSB-DiffNumerology*, UE is required to measure one of but not both SSB for L1-RSRP measurement and CSI-RS. Longer measurement period for SSB based L1-RSRP measurement is expected, and no requirements are defined.

For FR2, when the SSB for L1-RSRP measurement on one CC is in the same OFDM symbol as CSI-RS for RLM, BFD, CBD or L1-RSRP measurement on the same CC or different CCs in the same band, UE is required to measure one of but not both SSB for L1-RSRP measurement and CSI-RS. Longer measurement period for SSB based L1-RSRP measurement is expected, and no requirements are defined.

9.5.5.2 Measurement restriction for CSI-RS based L1-RSRP

For both FR1 and FR2, when the CSI-RS for L1-RSRP measurement is in the same OFDM symbol as SSB for RLM, BFD, CBD or L1-RSRP measurement, UE is not required to receive CSI-RS for L1-RSRP measurement in the PRBs that overlap with an SSB.

For FR1, when the SSB for RLM, BFD, CBD or L1-RSRP measurement is within the active BWP and has same SCS than CSI-RS for L1-RSRP measurement, the UE shall be able to perform CSI-RS measurement without restrictions.

For FR1, when the SSB for RLM, BFD, CBD or L1-RSRP measurement is within the active BWP and has different SCS than CSI-RS for L1-RSRP measurement, the UE shall be able to perform CSI-RS measurement with restrictions according to its capabilities:

- If the UE supports *simultaneousRxDataSSB-DiffNumerology* the UE shall be able to perform CSI-RS measurement without restrictions.
- If the UE does not support *simultaneousRxDataSSB-DiffNumerology*, UE is required to measure one of but not both CSI-RS for L1-RSRP measurement and SSB. Longer measurement period for CSI-RS based L1-RSRP measurement is expected, and no requirements are defined.

For FR1, when the CSI-RS for L1-RSRP measurement is in the same OFDM symbol as another CSI-RS for RLM, BFD, CBD or L1-RSRP measurement, UE shall be able to measure the CSI-RS for L1-RSRP measurement without any restriction.

For FR2, when the CSI-RS for L1-RSRP measurement on one CC is in the same OFDM symbol as SSB for RLM, BFD or L1-RSRP measurement on the same CC or different CCs in the same band, or in the same symbol as SSB for CBD measurement on the same CC or different CCs in the same band when beam failure is detected, UE is required to measure one of but not both CSI-RS for L1-RSRP measurement and SSB. Longer measurement period for CSI-RS based L1-RSRP measurement is expected, and no requirements are defined.

For FR2, when the CSI-RS for L1-RSRP measurement on one CC is in the same OFDM symbol as another CSI-RS for RLM, BFD, CBD or L1-RSRP measurement on the same CC or different CCs in the same band,

- In the following cases, UE is required to measure one of but not both CSI-RS for L1-RSRP measurement and the other CSI-RS. Longer measurement period for CSI-RS based L1-RSRP measurement is expected, and no requirements are defined.
 - The CSI-RS for L1-RSRP measurement or the other CSI-RS in a resource set configured with repetition ON, or
 - The other CSI-RS is configured in q1 and beam failure is detected, or
 - The two CSI-RS-es are not QCL-ed w.r.t. QCL-TypeD, or the QCL information is not known to UE,

- Otherwise, UE shall be able to measure the CSI-RS for L1-RSRP measurement without any restriction.

9.5.6 Scheduling availability of UE during L1-RSRP measurement

Scheduling availability restrictions when the UE is performing L1-RSRP measurement are described in the following clauses.

9.5.6.1 Scheduling availability of UE performing L1-RSRP measurement with a same subcarrier spacing as PDSCH/PDCCH on FR1

There are no scheduling restrictions due to L1-RSRP measurement performed on SSB and CSI-RS configured as RS for L1-RSRP measurement with the same SCS as PDSCH/PDCCH in FR1.

9.5.6.2 Scheduling availability of UE performing L1-RSRP measurement with a different subcarrier spacing than PDSCH/PDCCH on FR1

For UEs which support *simultaneousRxDataSSB-DiffNumerology* [14] there are no restrictions on scheduling availability due to L1-RSRP measurement based on SSB as RS for L1-RSRP measurement. For UEs which do not support *simultaneousRxDataSSB-DiffNumerology* [14] the following restrictions apply due to L1-RSRP measurement based on SSB configured for L1-RSRP measurement.

- The UE is not expected to transmit PUCCH/PUSCH/SRS or receive PDCCH/PDSCH/CSI-RS for tracking/CSI-RS for CQI on symbols corresponding to the SSB indexes configured for L1-RSRP measurement.

When intra-band carrier aggregation in FR1 is configured, the scheduling restrictions on serving cell where L1-RSRP measurement is performed apply to all serving cells in the same band on the symbols that fully or partially overlap with restricted symbols. When inter-band carrier aggregation within FR1 is configured, there are no scheduling restrictions on FR1 serving cell(s) configured in other bands than the bands in which the serving cell where L1-RSRP measurement is performed is configured.

9.5.6.3 Scheduling availability of UE performing L1-RSRP measurement on FR2

The following scheduling restriction applies due to L1-RSRP measurement.

- For the case where RS for L1-RSRP measurement is CSI-RS which is QCLed with active TCI state for PDCCH/PDSCH and not in a CSI-RS resource set with repetition ON, and N=1 applies as specified in clause 9.5.4.2
 - There are no scheduling restrictions due to L1-RSRP measurement performed based on the CSI-RS.
- Otherwise
 - The UE is not expected to transmit PUCCH/PUSCH/SRS or receive PDCCH/PDSCH/CSI-RS for tracking/CSI-RS for CQI on
 - symbols corresponding to the SSB indexes configured for L1-RSRP measurement, and/or
 - symbols corresponding to the periodic CSI-RS resource configured for L1-RSRP measurement, and/or
 - symbols corresponding to the semi-persistent CSI-RS resource configured for L1-RSRP measurement when the resource is activated, and/or
 - symbols corresponding to the aperiodic CSI-RS resource configured for L1-RSRP measurement when the reporting is triggered.

When intra-band carrier aggregation is performed, the scheduling restrictions on serving cell where L1-RSRP measurement is performed apply to all serving cells in the band on the symbols that fully or partially overlap with restricted symbols.

If following conditions are met,

- UE has been notified about system information update through paging,

- The gap between UE's reception of PDCCH that UE monitors in the Type 2-PDCCH CSS set and that notifies system information update, and the PDCCH that UE monitors in the Type0-PDCCH CSS set, is greater than 2 slots,

For the SSB and CORESET for RMSI scheduling multiplexing patterns 3, UE is expected to receive the PDCCH that UE monitors in the Type0-PDCCH CSS set, and the corresponding PDSCH, on SSB symbols to be measured for L1-RSRP measurement; and

For the SSB and CORESET for RMSI scheduling multiplexing patterns 2, UE is expected to receive PDSCH that corresponds to the PDCCH that UE monitors in the Type0-PDCCH CSS set, on SSB symbols to be measured for L1-RSRP measurement.

9.5.6.4 Scheduling availability of UE performing L1-RSRP measurement on FR1 or FR2 in case of FR1-FR2 inter-band CA

There are no scheduling restrictions on FR1 serving cell(s) due to L1-RSRP measurement performed on FR2 serving cell(s).

There are no scheduling restrictions on FR2 serving cell(s) due to L1-RSRP measurement performed on FR1 serving cell(s).

9.6 NE-DC: Measurements

9.6.1 Introduction

This clause contains requirements for UE supporting dual connectivity with NR PCell and E-UTRA FDD or TDD PSCell. The requirements apply to UEs that have been configured with NE-DC.

9.6.2 SFTD Measurements

9.6.2.1 Introduction

This clause contains requirements on UE capabilities for reporting of SFN and frame time difference between NR PCell and E-UTRA PSCell in RRC_CONNECTED state. The requirements comprise measurement reporting delay and measurement accuracy. The overall measurement reporting delay includes a RRC procedure delay specified in TS 38.331 [2], and the SFTD measurement reporting delay specified below.

9.6.2.2 SFTD Measurement requirements

When no DRX is used in either of the NR PCell and E-UTRA PSCell, the physical layer measurement period of the SFTD measurement shall be $T_{\text{measure_SFTD1}} = \max(0.2, 5 * \text{SMTC period})$ s.

When DRX is used in either of the NR PCell or the E-UTRA PSCell, or in both PCell and PSCell, the physical layer measurement period ($T_{\text{measure_SFTD1}}$) of the SFTD measurement shall be as specified in Table 9.6.2.2-1.

Table 9.6.2.2-1: SFTD measurement requirement when DRX is used

DRX cycle length (s) ^{Note2}	$T_{\text{measure_SFTD1}}$ (s)
DRX cycle ≤ 0.04	$\max(0.2, 5 \times \text{SMTC period})$ (Note1)
$0.04 < \text{DRX cycle} \leq 0.32$	$8 \times \max(\text{DRX cycle}, \text{SMTC period})$
$0.32 < \text{DRX cycle} \leq 10.24$	$5 \times \text{DRX cycle}$
Note1:	Number of DRX cycles depends upon the DRX cycle in use
Note2:	DRX cycle length in this table refers to the DRX cycle length configured for PCell or PSCell. When DRX is used in both PCell and PSCell, DRX cycle length in this table refers to the longer of the DRX cycle lengths for PCell and PSCell.

If PSCell is changed without changing carrier frequency of PSCell while the UE is performing SFTD measurements, the UE shall still meet SFTD measurement and accuracy requirements for the new PSCell. In this case the UE shall

restart the SFTD measurement, and the total physical layer measurement period shall not exceed $T_{\text{measure_SFTD2}}$ as defined by the following expression:

$$T_{\text{measure_SFTD2}} = (M+1) \cdot (T_{\text{measure_SFTD1}}) + M \cdot T_{\text{PSCell_change_NEDC}}$$

where:

M is the number of times the E-UTRA PSCell is changed over the measurement period ($T_{\text{measure_SFTD2}}$), and

$T_{\text{PSCell_change_NEDC}}$ is the time necessary to change the PSCell; it can be up to 25 ms.

If PCell is changed, or if PSCell is changed to a different carrier frequency, the UE shall terminate the SFTD measurement.

The measurement accuracy for the SFTD measurement when DRX is used as well as when no DRX is used shall be as specified in clause 10.1.21.1.

10 Measurement Performance requirements

10.1 NR measurements

10.1.1 Introduction

The requirements in clause 10.1 apply as follows:

- intra-frequency requirements apply for PCell measurements in SA, NR-DC, or NE-DC operation mode,
- intra-frequency requirements apply for PSCell measurements in NR-DC or EN-DC operation mode,
- intra-frequency requirements apply for SCell measurements in SA operation mode with NR CA or any MR-DC operation mode with NR CA,
- inter-frequency requirements apply for non-serving cell measurements on NR carrier frequencies,
- inter-frequency requirements apply for measurements from one cell on a frequency compared to the measurement from another cell on a different frequency.

In the requirements of clause 10.1, the exceptions for side conditions apply as follows:

- for the UE capable of CA but not configured with any SCell, the applicable exceptions for side conditions are specified in Annex B, clause B.3.2.1 for UE supporting CA in FR1, and clause B.3.2.3 for UE supporting CA in FR2, respectively;
- for the UE capable of CA and configured with at least one SCell, the applicable exceptions for side conditions are specified in Annex B, clause B.3.2.2 for UE configured with CA in FR1, and clause B.3.2.4 for UE supporting CA in FR2 respectively;
- for the UE capable of SUL but not configured with SUL, the applicable exceptions for side conditions are specified in Annex B, clause B.3.4.1 for UE supporting SUL in FR1;
- for the UE capable of SUL and configured with at least one SUL, the applicable exceptions for side conditions are specified in Annex B, clause B.3.4.2 for UE configured with SUL in FR1.

10.1.2 Intra-frequency RSRP accuracy requirements for FR1

10.1.2.1 Intra-frequency SS-RSRP accuracy requirements

10.1.2.1.1 Absolute SS-RSRP Accuracy

Unless otherwise specified, the requirements for absolute accuracy of SS-RSRP in this clause apply to a cell on the same frequency as that of the serving cell in FR1.

The accuracy requirements in Table 10.1.2.1.1-1 are valid under the following conditions:

- Conditions defined in clause 7.3 of TS 38.101-1 [18] for reference sensitivity are fulfilled.
- Conditions for intra-frequency measurements are fulfilled according to Annex B.2.2 for a corresponding Band for each relevant SSB.

Table 10.1.2.1.1-1: SS-RSRP Intra frequency absolute accuracy in FR1

Accuracy		Conditions					
Normal condition	Extreme condition	SSB \hat{E}_s/lot	I_o ^{Note 1} range				
			NR operating band groups <small>Note 2</small>	Minimum I_o		Maximum I_o	
dB	dB	dB		dBm / SCS_{SSB}		dBm/ BW_{Channel}	dBm/ BW_{Channel}
				$SCS_{SSB} = 15 \text{ kHz}$	$SCS_{SSB} = 30 \text{ kHz}$		
± 4.5	± 9	$\geq 6 \text{ dB}$	NR_FDD_FR1_A, NR_TDD_FR1_A, NR_SDL_FR1_A	-121	-118	N/A	-70
			NR_FDD_FR1_B	-120.5	-117.5	N/A	-70
			NR_TDD_FR1_C	-120	-117	N/A	-70
			NR_FDD_FR1_D, NR_TDD_FR1_D	-119.5	-116.5	N/A	-70
			NR_FDD_FR1_E, NR_TDD_FR1_E	-119	-116	N/A	-70
			NR_FDD_FR1_G	-118	-115	N/A	-70
			NR_FDD_FR1_H	-117.5	-114.5	N/A	-70
± 8	± 11	$\geq 6 \text{ dB}$	NR_FDD_FR1_A, NR_TDD_FR1_A, NR_SDL_FR1_A, NR_FDD_FR1_B, NR_TDD_FR1_C, NR_FDD_FR1_D, NR_TDD_FR1_D, NR_FDD_FR1_E, NR_TDD_FR1_E, NR_FDD_FR1_G, NR_FDD_FR1_H	N/A	N/A	-70	-50

NOTE 1: I_o is assumed to have constant EPRE across the bandwidth.
 NOTE 2: NR operating band groups in FR1 are as defined in clause 3.5.2.

10.1.2.1.2 Relative SS-RSRP Accuracy

The relative accuracy of SS-RSRP is defined as the SS-RSRP measured from one cell compared to the SS-RSRP measured from another cell on the same frequency, or between any two SS-RSRP levels measured on the same cell in FR1.

The accuracy requirements in Table 10.1.2.1.2-1 are valid under the following conditions:

- Conditions defined in clause 7.3 of TS 38.101-1 [18] for reference sensitivity are fulfilled.
- Conditions for intra-frequency measurements are fulfilled according to Annex B.2.2 for a corresponding Band for each relevant SSB.

Table 10.1.2.1.2-1: SS-RSRP Intra frequency relative accuracy in FR1

Accuracy		Conditions					
Normal condition	Extreme condition	SSB \hat{E}_s/lot Note 2	l_o Note 1 range				
			NR operating band groups Note 4	Minimum l_o		Maximum l_o	
dB	dB	dB		dBm / SCS_{SSB}			dBm/ BW_{Channel}
			$SCS_{SSB} = 15 \text{ kHz}$	$SCS_{SSB} = 30 \text{ kHz}$			
± 2	± 3	$\geq -3 \text{ dB}$	NR_FDD_FR1_A, NR_TDD_FR1_A, NR_SDL_FR1_A	-121	-118	N/A	-50
			NR_FDD_FR1_B	-120.5	-117.5	N/A	-50
			NR_TDD_FR1_C	-120	-117	N/A	-50
			NR_FDD_FR1_D, NR_TDD_FR1_D	-119.5	-116.5	N/A	-50
			NR_FDD_FR1_E, NR_TDD_FR1_E	-119	-116	N/A	-50
			NR_FDD_FR1_G	-118	-115	N/A	-50
			NR_FDD_FR1_H	-117.5	-114.5	N/A	-50
± 3	± 3	$\geq -6 \text{ dB}$	Note 3	Note 3	Note 3	N/A	Note 3

NOTE 1: l_o is assumed to have constant EPRE across the bandwidth.
 NOTE 2: The parameter SSB \hat{E}_s/lot is the minimum SSB \hat{E}_s/lot of the pair of cells to which the requirement applies.
 NOTE 3: The same bands and the same l_o conditions for each band apply for this requirement as for the corresponding highest accuracy requirement.
 NOTE 4: NR operating band groups in FR1 are as defined in clause 3.5.2.

10.1.2.2 Void

10.1.3 Intra-frequency RSRP accuracy requirements for FR2

10.1.3.1 Intra-frequency SS-RSRP accuracy requirements

10.1.3.1.1 Absolute SS-RSRP Accuracy

Unless otherwise specified, the requirements for absolute accuracy of SS-RSRP in this clause apply to a cell on the same frequency as that of the serving cell in FR2.

The accuracy requirements in Table 10.1.3.1.1-1 are valid under the following conditions:

- Conditions defined in clause 7.3 of TS 38.101-2 [19] for reference sensitivity are fulfilled.
- Conditions for intra-frequency measurements are fulfilled according to Annex B.2.2 for a corresponding Band for each relevant SSB.
- The measured signals are in the directions covered by the percentile EIS spherical coverage of the UE, defined in clause 7.3.4 of TS 38.101-2 [19].

Table 10.1.3.1.1-1: SS-RSRP Intra frequency absolute accuracy in FR2

Accuracy		Conditions				
Normal condition	Extreme condition	SSB \hat{E}_s/lot	l_o Note 2 range			
			Minimum l_o		Maximum l_o	
dB	dB	dB	dBm / SCS_{SSB} Note 1			dBm/ BW_{Channel}
			$SCS_{SSB} = 120\text{kHz}$	$SCS_{SSB} = 240\text{kHz}$		
± 6	± 9	≥ -6	Same value as SSB_RP in Table B.2.2-2, according to UE Power		N/A	-70

			class, operating band and angle of arrival		
±8	±11		N/A	-70	-50
<p>Note 1: Values based on Refsens and EIS spherical coverage as defined in clauses 7.3.2 and 7.3.4 of TS 38.101-2 [19]. Applicable side condition selected depending on angle of arrival.</p> <p>Note 2: I_0 specified at the Reference point, and assumed to have constant EPRE across the bandwidth.</p> <p>Note 3: In the test cases, the SSB \hat{E}_s/lot and related parameters may need to be adjusted to ensure \hat{E}_s/lot at UE baseband is above the value defined in this table.</p>					

10.1.3.1.2 Relative SS-RSRP Accuracy

The relative accuracy of SS-RSRP is defined as the SS-RSRP measured from one cell compared to the SS-RSRP measured from another cell on the same frequency, or between any two SS-RSRP levels measured on the same cell in FR2.

- Conditions defined in clause 7.3 of TS 38.101-2 [19] for reference sensitivity are fulfilled.
- Conditions for intra-frequency measurements are fulfilled according to Annex B.2.2 for a corresponding Band for each relevant SSB.
- The measured signals are in the directions covered by the percentile EIS spherical coverage of the UE, defined in clause 7.3.4 of TS 38.101-2 [19].

Table 10.1.3.1.2-1: SS-RSRP Intra frequency relative accuracy in FR2

Accuracy		Conditions		
Normal condition	Extreme condition	SSB \hat{E}_s/lot	I_0 ^{Note 2} range	
			Minimum I_0	
dB	dB	dB	dBm / SCS_{SSB} ^{Note 1}	
			$SCS_{SSB} = 120kHz$	$SCS_{SSB} = 240kHz$
			Maximum I_0	
			dBm/ $BW_{Channel}$	
±6	±9	≥-6	Same value as SSB_RP in Table B.2.2-2, according to UE Power class, operating band and angle of arrival	
<p>Note 1: Values based on Refsens and EIS spherical coverage as defined in clauses 7.3.2 and 7.3.4 of TS 38.101-2 [19]. Applicable side condition selected depending on angle of arrival.</p> <p>Note 2: I_0 specified at the Reference point, and assumed to have constant EPRE across the bandwidth.</p> <p>Note 3: In the test cases, the SSB \hat{E}_s/lot and related parameters may need to be adjusted to ensure \hat{E}_s/lot at UE baseband is above the value defined in this table.</p> <p>Note 4: The parameter SSB \hat{E}_s/lot is the minimum SSB \hat{E}_s/lot of the pair of cells to which the requirement applies.</p>				

10.1.3.2 Void

10.1.4 Inter-frequency RSRP accuracy requirements for FR1

10.1.4.1 Inter-frequency SS-RSRP accuracy requirements

10.1.4.1.1 Absolute Accuracy of SS-RSRP in FR1

The requirements for absolute accuracy of SS-RSRP in this clause apply to a cell on a frequency in FR1 that has different carrier frequency from the serving cell.

The accuracy requirements in Table 10.1.4.1.1-1 are valid under the following conditions:

- Conditions defined in clause 7.3 of TS 38.101-1 [18] for reference sensitivity are fulfilled.
- Conditions for inter-frequency measurements are fulfilled according to Annex B.2.3 for a corresponding Band for each relevant SSB.

Table 10.1.4.1.1-1: SS-RSRP Inter frequency Absolute accuracy in FR1

Accuracy		Conditions					
Normal condition	Extreme condition	SSB \hat{E}_s/lot Note 2	I_o ^{Note 1} range				
			NR operating band groups Note 3	Minimum I_o		Maximum I_o	
dB	dB	dB		dBm / SCS_{SSB}		dBm/ $BW_{Channel}$	dBm/ $BW_{Channel}$
			$SCS_{SSB} = 15 \text{ kHz}$	$SCS_{SSB} = 30 \text{ kHz}$			
± 4.5	± 9	$\geq -6 \text{ dB}$	NR_FDD_FR1_A, NR_TDD_FR1_A, NR_SDL_FR1_A	-121	-118	N/A	-70
			NR_FDD_FR1_B	-120.5	-117.5	N/A	-70
			NR_TDD_FR1_C	-120	-117	N/A	-70
			NR_FDD_FR1_D, NR_TDD_FR1_D	-119.5	-116.5	N/A	-70
			NR_FDD_FR1_E, NR_TDD_FR1_E	-119	-116	N/A	-70
			NR_FDD_FR1_G	-118	-115	N/A	-70
			NR_FDD_FR1_H	-117.5	-114.5	N/A	-70
± 8	± 11	$\geq -6 \text{ dB}$	NR_FDD_FR1_A, NR_TDD_FR1_A, NR_SDL_FR1_A, NR_FDD_FR1_B, NR_TDD_FR1_C, NR_FDD_FR1_D, NR_TDD_FR1_D, NR_FDD_FR1_E, NR_TDD_FR1_E, NR_FDD_FR1_G, NR_FDD_FR1_H	N/A	N/A	-70	-50

NOTE 1: I_o is assumed to have constant EPRE across the bandwidth.
 NOTE 2: Void
 NOTE 3: NR operating band groups in FR1 are as defined in clause 3.5.2.

10.1.4.1.2 Relative Accuracy of SS-RSRP in FR1

The relative accuracy of SS-RSRP in inter frequency case is defined as the RSRP measured from one cell on a frequency in FR1 compared to the RSRP measured from another cell on a different frequency in FR1.

The accuracy requirements in Table 10.1.4.1.2-1 are valid under the following conditions:

- Conditions defined in clause 7.3 of TS 38.101-1 [18] Clause 7.3 for reference sensitivity are fulfilled.
- Conditions for inter-frequency measurements are fulfilled according to Annex B.2.3 for a corresponding Band for each relevant SSB.
- $|SSB_RP1_{dBm} - SSB_RP2_{dBm}| \leq 27 \text{ dB}$
- $|Channel\ 1_I_o - Channel\ 2_I_o| \leq 20 \text{ dB}$

Table 10.1.4.1.2-1: SS-RSRP Inter frequency relative accuracy in FR1

Accuracy		Conditions			
Normal condition	Extreme condition	SSB \hat{E}_s/lot Note 2	I_o ^{Note 1} range		
			NR operating band groups Note 3	Minimum I_o	
dB	dB	dB		dBm / SCS_{SSB}	dBm/ $BW_{Channel}$

				SCS _{SSB} = 15 kHz	SCS _{SSB} = 30 kHz		
±4.5	±6	≥-6 dB	NR_FDD_FR1_A, NR_TDD_FR1_A, NR_SDL_FR1_A	-121	-118	N/A	-50
			NR_FDD_FR1_B	-120.5	-117.5	N/A	-50
			NR_TDD_FR1_C	-120	-117	N/A	-50
			NR_FDD_FR1_D, NR_TDD_FR1_D	-119.5	-116.5	N/A	-50
			NR_FDD_FR1_E, NR_TDD_FR1_E	-119	-116	N/A	-50
			NR_FDD_FR1_G	-118	-115	N/A	-50
			NR_FDD_FR1_H	-117.5	-114.5	N/A	-50

NOTE 1: I_o is assumed to have constant EPRE across the bandwidth.
 NOTE 2: The parameter SSB Ês/lot is the minimum SSB Ês/lot of the pair of cells to which the requirement applies.
 NOTE 3: NR operating band groups in FR1 are as defined in clause 3.5.2.

10.1.4.2 Void

10.1.5 Inter-frequency RSRP accuracy requirements for FR2

10.1.5.1 Inter-frequency SS-RSRP accuracy requirements

10.1.5.1.1 Absolute SS-RSRP Accuracy

Unless otherwise specified, the requirements for absolute accuracy of SS-RSRP in this clause apply to a cell on a frequency in FR2 that is on a different frequency than the serving cell.

The accuracy requirements in Table 10.1.5.1.1-1 are valid under the following conditions:

- Conditions defined in clause 7.3 of TS 38.101-2 [19] for reference sensitivity are fulfilled.
- Conditions for inter-frequency measurements are fulfilled according to Annex B.2.3 for a corresponding Band for each relevant SSB.
- The measured signals are in the directions covered by the percentile EIS spherical coverage of the UE, defined in clause 7.3.4 of TS 38.101-2 [19].

Table 10.1.5.1.1-1: SS-RSRP Inter frequency absolute accuracy in FR2

Accuracy		Conditions				
Normal condition	Extreme condition	SSB Ês/lot	I _o ^{Note 2} range			
			Minimum I _o		Maximum I _o	
dB	dB	dB	dBm / SCS _{SSB} ^{Note 1}		dBm/BW _{Channel}	
			SCS _{SSB} = 120kHz	SCS _{SSB} = 240kHz		dBm/BW _{Channel}
±6	±9	≥-4	Same value as SSB_RP in Table B.2.3-2, according to UE Power class, operating band and angle of arrival		N/A	-70
±8	±11		N/A		-70	-50

Note 1: Values based on Refsens and EIS spherical coverage as defined in clauses 7.3.2 and 7.3.4 of TS 38.101-2 [19]. Applicable side condition selected depending on angle of arrival.
 Note 2: I_o specified at the Reference point, and assumed to have constant EPRE across the bandwidth.
 Note 3: In the test cases, the SSB Ês/lot and related parameters may need to be adjusted to ensure Ês/lot at UE baseband is above the value defined in this table.

10.1.5.1.2 Relative SS-RSRP Accuracy

The relative accuracy of SS-RSRP is defined as the SS-RSRP measured from one cell on a frequency in FR2 compared to the SS-RSRP measured from another cell on another frequency in FR2.

The accuracy requirements in Table 10.1.5.1.2-1 are valid under the following conditions:

- Conditions defined in 38.101-2 [19] Clause 7.3 for reference sensitivity are fulfilled.
- Conditions for inter-frequency measurements are fulfilled according to Annex B.2.3 for a corresponding Band for each relevant SSB.
- $|\text{SSB_RP1}_{\text{dBm}} - \text{SSB_RP2}_{\text{dBm}}| \leq 27\text{dB}$
- $|\text{Channel 1_Io} - \text{Channel 2_Io}| \leq 20\text{ dB}$
- The measured signals are in the directions covered by the percentile EIS spherical coverage of the UE, defined in clause 7.3.4 of TS 38.101-2 [19].

Table 10.1.5.1.2-1: SS-RSRP Inter frequency relative accuracy in FR2

Accuracy		Conditions			
Normal condition	Extreme condition	SSB \hat{E}_s/lot	I_o ^{Note 2} range		Maximum I_o
			dBm / SCS_{SSB} ^{Note 1}		
dB	dB	dB	$\text{SCS}_{\text{SSB}} = 120\text{kHz}$	$\text{SCS}_{\text{SSB}} = 240\text{kHz}$	$\text{dBm}/\text{BW}_{\text{Channel}}$
± 6	± 9	≥ -4	Same value as SSB_RP in Table B.2.3-2, according to UE Power class, operating band and angle of arrival		-50
Note 1: Values based on Refsens and EIS spherical coverage as defined in clauses 7.3.2 and 7.3.4 of TS 38.101-2 [19]. Applicable side condition selected depending on angle of arrival. Note 2: I_o specified at the Reference point, and assumed to have constant EPRE across the bandwidth. Note 3: In the test cases, the SSB \hat{E}_s/lot and related parameters may need to be adjusted to ensure \hat{E}_s/lot at UE baseband is above the value defined in this table. Note 4: The parameter SSB \hat{E}_s/lot is the minimum SSB \hat{E}_s/lot of the pair of cells to which the requirement applies.					

10.1.5.2 Void

10.1.6 RSRP Measurement Report Mapping

The reporting range of SS-RSRP for L3 reporting is defined from -156 dBm to -31 dBm with 1 dB resolution. The reporting range of SS-RSRP and CSI-RSRP for L1 reporting is defined from -140 to -44 dBm with 1 dB resolution.

The mapping of measured quantity is defined in Table 10.1.6.1-1. The range in the signalling may be larger than the guaranteed accuracy range.

The reporting range of differential SS-RSRP and CSI-RSRP for L1 reporting is defined from 0 dBm to -30 dB with 2 dB resolution.

The mapping of measured quantity is defined in Table 10.1.6.1-2. The range in the signalling may be larger than the guaranteed accuracy range.

Table 10.1.6.1-1: SS-RSRP and CSI-RSRP measurement report mapping

Reported value	Measured quantity value (L3 SS-RSRP)	Measured quantity value (L1 SS-RSRP and CSI-RSRP)	Unit

RSRP_0	SS-RSRP<-156	Not valid	dBm
RSRP_1	-156 ≤ SS-RSRP<-155	Not valid	dBm
RSRP_2	-155 ≤ SS-RSRP<-154	Not valid	dBm
RSRP_3	-154 ≤ SS-RSRP<-153	Not valid	dBm
RSRP_4	-153 ≤ SS-RSRP<-152	Not valid	dBm
RSRP_5	-152 ≤ SS-RSRP<-151	Not valid	dBm
RSRP_6	-151 ≤ SS-RSRP<-150	Not valid	dBm
RSRP_7	-150 ≤ SS-RSRP<-149	Not valid	dBm
RSRP_8	-149 ≤ SS-RSRP<-148	Not valid	dBm
RSRP_9	-148 ≤ SS-RSRP<-147	Not valid	dBm
RSRP_10	-147 ≤ SS-RSRP<-146	Not valid	dBm
RSRP_11	-146 ≤ SS-RSRP<-145	Not valid	dBm
RSRP_12	-145 ≤ SS-RSRP<-144	Not valid	dBm
RSRP_13	-144 ≤ SS-RSRP<-143	Not valid	dBm
RSRP_14	-143 ≤ SS-RSRP<-142	Not valid	dBm
RSRP_15	-142 ≤ SS-RSRP<-141	Not valid	dBm
RSRP_16	-141 ≤ SS-RSRP<-140	RSRP<-140	dBm
RSRP_17	-140 ≤ SS-RSRP<-139	-140 ≤ RSRP<-139	dBm
RSRP_18	-139 ≤ SS-RSRP<-138	-139 ≤ RSRP<-138	dBm
...
RSRP_111	-46 ≤ SS-RSRP<-45	-46 ≤ RSRP<-45	dBm
RSRP_112	-45 ≤ SS-RSRP<-44	-45 ≤ RSRP<-44	dBm
RSRP_113	-44 ≤ SS-RSRP<-43	-44 ≤ RSRP	dBm
RSRP_114	-43 ≤ SS-RSRP<-42	Not valid	dBm
RSRP_115	-42 ≤ SS-RSRP<-41	Not valid	dBm
RSRP_116	-41 ≤ SS-RSRP<-40	Not valid	dBm
RSRP_117	-40 ≤ SS-RSRP<-39	Not valid	dBm
RSRP_118	-39 ≤ SS-RSRP<-38	Not valid	dBm
RSRP_119	-38 ≤ SS-RSRP<-37	Not valid	dBm
RSRP_120	-37 ≤ SS-RSRP<-36	Not valid	dBm
RSRP_121	-36 ≤ SS-RSRP<-35	Not valid	dBm
RSRP_122	-35 ≤ SS-RSRP<-34	Not valid	dBm
RSRP_123	-34 ≤ SS-RSRP<-33	Not valid	dBm
RSRP_124	-33 ≤ SS-RSRP<-32	Not valid	dBm
RSRP_125	-32 ≤ SS-RSRP<-31	Not valid	dBm
RSRP_126	-31 ≤ SS-RSRP	Not valid	dBm
RSRP_127 (Note)	Infinity	Infinity	dBm
Note:	The value of RSRP_127 is applicable for RSRP threshold configured by the network as defined in TS 38.331 [2], but not for the purpose of measurement reporting.		

Table 10.1.6.1-2: Differential SS-RSRP and CSI-RSRP measurement (for L1 reporting) report mapping

Reported value	Measured quantity value (difference in measured RSRP from strongest RSRP)	Unit
DIFFRSRP_0	$0 \geq \Delta \text{RSRP} > -2$	dB

DIFFRSRP_1	$-2 \geq \Delta \text{RSRP} > -4$	dB
DIFFRSRP_2	$-4 \geq \Delta \text{RSRP} > -6$	dB
DIFFRSRP_3	$-6 \geq \Delta \text{RSRP} > -8$	dB
DIFFRSRP_4	$-8 \geq \Delta \text{RSRP} > -10$	dB
DIFFRSRP_5	$-10 \geq \Delta \text{RSRP} > -12$	dB
DIFFRSRP_6	$-12 \geq \Delta \text{RSRP} > -14$	dB
DIFFRSRP_7	$-14 \geq \Delta \text{RSRP} > -16$	dB
DIFFRSRP_8	$-16 \geq \Delta \text{RSRP} > -18$	dB
DIFFRSRP_9	$-18 \geq \Delta \text{RSRP} > -20$	dB
DIFFRSRP_10	$-20 \geq \Delta \text{RSRP} > -22$	dB
DIFFRSRP_11	$-22 \geq \Delta \text{RSRP} > -24$	dB
DIFFRSRP_12	$-24 \geq \Delta \text{RSRP} > -26$	dB
DIFFRSRP_13	$-26 \geq \Delta \text{RSRP} > -28$	dB
DIFFRSRP_14	$-28 \geq \Delta \text{RSRP} > -30$	dB
DIFFRSRP_15	$-30 \geq \Delta \text{RSRP}$	dB

10.1.7 Intra-frequency RSRQ accuracy requirements for FR1

10.1.7.1 Intra-frequency SS-RSRQ accuracy requirements in FR1

10.1.7.1.1 Absolute SS-RSRQ Accuracy in FR1

Unless otherwise specified, the requirements for absolute accuracy of SS-RSRQ in this clause apply to a cell on the same frequency as that of the serving cell in FR1.

The accuracy requirements in Table 10.1.7.1.1-1 are valid under the following conditions:

- Conditions defined in clause 7.3 of TS 38.101-1 [18] for reference sensitivity are fulfilled.
- Conditions for intra-frequency measurements are fulfilled according to Annex B.2.2 for a corresponding Band for each relevant SSB.

Table 10.1.7.1.1-1: SS-RSRQ Intra frequency absolute accuracy in FR1

Accuracy		Conditions					
Normal condition	Extreme condition	SSB Es/lot	Io ^{Note 1} range				
			NR operating band groups ^{Note 3}	Minimum Io		Maximum Io	
dB	dB	dB		dBm / SCS _{SSB}			dBm/BW _{Channel}
			SCS _{SSB} = 15 kHz	SCS _{SSB} = 30 kHz	dBm/BW _{Channel}	dBm/BW _{Channel}	
±2.5	±4	≥3 dB	NR_FDD_FR1_A, NR_TDD_FR1_A, NR_SDL_FR1_A	-121	-118	N/A	-50
			NR_FDD_FR1_B	-120.5	-117.5	N/A	-50
			NR_TDD_FR1_C	-120	-117	N/A	-50
			NR_FDD_FR1_D, NR_TDD_FR1_D	-119.5	-116.5	N/A	-50
			NR_FDD_FR1_E, NR_TDD_FR1_E	-119	-116	N/A	-50
			NR_FDD_FR1_G	-118	-115	N/A	-50
			NR_FDD_FR1_H	-117.5	-114.5	N/A	-50
±3.5	±4	≥6 dB	Note 2	Note 2	Note 2	Note 2	Note 2

NOTE 1: Io is assumed to have constant EPRE across the bandwidth.
NOTE 2: The same bands and the same Io conditions for each band apply for this requirement as for the corresponding highest accuracy requirement.

NOTE 3: NR operating band groups in FR1 are as defined in clause 3.5.2.

10.1.8 Intra-frequency RSRQ accuracy requirements for FR2

10.1.8.1 Intra-frequency SS-RSRQ accuracy requirements in FR2

10.1.8.1.1 Absolute SS-RSRQ Accuracy in FR2

Unless otherwise specified, the requirements for absolute accuracy of SS-RSRQ in this clause apply to a cell on the same frequency as that of the serving cell in FR2.

The accuracy requirements in Table 10.1.8.1.1-1 are valid under the following conditions:

- Conditions defined in clause 7.3 of TS 38.101-2 [19] for reference sensitivity are fulfilled.
- Conditions for intra-frequency measurements are fulfilled according to Annex B.2.2 for a corresponding Band for each relevant SSB.
- The measured signals are in the directions covered by the percentile EIS spherical coverage of the UE, defined in clause 7.3.4 of TS 38.101-2 [19].

Table 10.1.8.1.1-1: SS-RSRQ Intra frequency absolute accuracy in FR2

Accuracy		Conditions			
Normal condition	Extreme condition	SSB $\hat{E}s/lot$	I_o ^{Note 2} range		Maximum I_o
			Minimum I_o		
dB	dB	dB	dBm / SCS_{SSB} ^{Note 1}		dBm/ $BW_{Channel}$
			$SCS_{SSB} = 120kHz$	$SCS_{SSB} = 240kHz$	
± 2.5	± 4	≥ -3	Same value as SSB_RP in Table B.2.2-2, according to UE Power class, operating band and angle of arrival		-50
± 3.5	± 4	≥ -6			
Note 1: Values based on Refsens and EIS spherical coverage as defined in clauses 7.3.2 and 7.3.4 of TS 38.101-2 [19]. Applicable side condition selected depending on angle of arrival. Note 2: I_o specified at the Reference point, and assumed to have constant EPRE across the bandwidth. Note 3: In the test cases, the SSB $\hat{E}s/lot$ and related parameters may need to be adjusted to ensure $\hat{E}s/lot$ at UE baseband is above the value defined in this table.					

10.1.9 Inter-frequency RSRQ accuracy requirements for FR1

10.1.9.1 Inter-frequency SS-RSRQ accuracy requirements in FR1

10.1.9.1.1 Absolute Accuracy of SS-RSRQ in FR1

The requirements for absolute accuracy of SS-RSRQ in this clause apply to a cell on a frequency in FR1 that has different carrier frequency from the serving cell.

The accuracy requirements in Table 10.1.9.1.1-1 are valid under the following conditions:

- Conditions defined in clause 7.3 of TS 38.101-1 [18] for reference sensitivity are fulfilled.
- Conditions for inter-frequency measurements are fulfilled according to Annex B.2.3 for a corresponding Band for each relevant SSB.

Table 10.1.9.1.1-1: SS-RSRQ Inter frequency absolute accuracy in FR1

Accuracy		Conditions	
		I_o ^{Note 1} range	

Normal condition	Extreme condition	SSB \hat{E}_s/lot dB	NR operating band groups <small>Note 3</small>	Minimum I_o			Maximum I_o
				dBm / SCS_{SSB}		dBm/ BW_{Channel}	dBm/ BW_{Channel}
				$SCS_{SSB} = 15 \text{ kHz}$	$SCS_{SSB} = 30 \text{ kHz}$		
± 2.5	± 4	$\geq -3 \text{ dB}$	NR_FDD_FR1_A, NR_TDD_FR1_A, NR_SDL_FR1_A	-121	-118	N/A	-50
			NR_FDD_FR1_B	-120.5	-117.5	N/A	-50
			NR_TDD_FR1_C	-120	-117	N/A	-50
			NR_FDD_FR1_D, NR_TDD_FR1_D	-119.5	-116.5	N/A	-50
			NR_FDD_FR1_E, NR_TDD_FR1_E	-119	-116	N/A	-50
			NR_FDD_FR1_G	-118	-115	N/A	-50
			NR_FDD_FR1_H	-117.5	-114.5	N/A	-50
± 3.5	± 4	$\geq -6 \text{ dB}$	Note 2	Note 2	Note 2	Note 2	Note 2

NOTE 1: I_o is assumed to have constant EPRE across the bandwidth.
 NOTE 2: The same bands and the same I_o conditions for each band apply for this requirement as for the corresponding highest accuracy requirement.
 NOTE 3: NR operating band groups in FR1 are as defined in clause 3.5.2.

10.1.9.1.2 Relative Accuracy of SS-RSRQ in FR1

The relative accuracy of SS-RSRQ in inter frequency case is defined as the RSRQ measured from one cell on a frequency in FR1 compared to the RSRP measured from another cell on a different frequency in FR1.

The accuracy requirements in Table 10.1.9.1.2-1 are valid under the following conditions:

- Conditions defined in clause 7.3 of TS 38.101-1 [18] for reference sensitivity are fulfilled.
- Conditions for inter-frequency measurements are fulfilled according to Annex B.2.3 for a corresponding Band for each relevant SSB.
- $|\text{SSB_RP1}_{\text{dBm}} - \text{SSB_RP2}_{\text{dBm}}| \leq 27 \text{ dB}$
- $|\text{Channel 1 } I_o - \text{Channel 2 } I_o| \leq 20 \text{ dB}$

Table 10.1.9.1.2-1: SS-RSRQ Inter frequency relative accuracy in FR1

Accuracy			Conditions				
Normal condition	Extreme condition	SSB \hat{E}_s/lot <small>Note 2</small>	NR operating band groups <small>Note 4</small>	I_o <small>Note 1</small> range			
				Minimum I_o		Maximum I_o	
				dBm / SCS_{SSB}		dBm/ BW_{Channel}	dBm/ BW_{Channel}
$SCS_{SSB} = 15 \text{ kHz}$	$SCS_{SSB} = 30 \text{ kHz}$						
± 3	± 4	$\geq -3 \text{ dB}$	NR_FDD_FR1_A, NR_TDD_FR1_A, NR_SDL_FR1_A	-121	-118	N/A	-50
			NR_FDD_FR1_B	-120.5	-117.5	N/A	-50
			NR_TDD_FR1_C	-120	-117	N/A	-50
			NR_FDD_FR1_D, NR_TDD_FR1_D	-119.5	-116.5	N/A	-50
			NR_FDD_FR1_E, NR_TDD_FR1_E	-119	-116	N/A	-50
			NR_FDD_FR1_G	-118	-115	N/A	-50
			NR_FDD_FR1_H	-117.5	-114.5	N/A	-50
± 4	± 4	$\geq -6 \text{ dB}$	Note 3	Note 3	Note 3	Note 3	Note 3

NOTE 1: I_o is assumed to have constant EPRE across the bandwidth.
 NOTE 2: The parameter SSB \hat{E}_s/lot is the minimum SSB \hat{E}_s/lot of the pair of cells to which the requirement applies.
 NOTE 3: The same bands and the same I_o conditions for each band apply for this requirement as for the corresponding highest accuracy requirement.

NOTE 4: NR operating band groups in FR1 are as defined in clause 3.5.2.

10.1.10 Inter-frequency RSRQ accuracy requirements for FR2

10.1.10.1 Inter-frequency SS-RSRQ accuracy requirements in FR2

10.1.10.1.1 Absolute Accuracy of SS-RSRQ in FR2

The requirements for absolute accuracy of SS-RSRQ in this clause apply to a cell on a frequency in FR2 that has different carrier frequency from the serving cell.

The accuracy requirements in Table 10.1.10.1.1-1 are valid under the following conditions:

- Conditions defined in clause 7.3 of TS 38.101-2 [19] for reference sensitivity are fulfilled.
- Conditions for inter-frequency measurements are fulfilled according to Annex B.2.3 for a corresponding Band for each relevant SSB.
- The measured signals are in the directions covered by the percentile EIS spherical coverage of the UE, defined in clause 7.3.4 of TS 38.101-2 [19].

Table 10.1.10.1.1-1: SS-RSRQ Inter frequency absolute accuracy in FR2

Accuracy		Conditions			
Normal condition	Extreme condition	SSB \hat{E}_s/lot	I_o ^{Note 2} range		Maximum I_o
			Minimum I_o		
dB	dB	dB	dBm / SCS_{SSB} ^{Note 1}		dBm/ BW_{Channel}
			$SCS_{SSB} = 120\text{kHz}$	$SCS_{SSB} = 240\text{kHz}$	
± 2.5	± 4	≥ -3	Same value as SSB_RP in Table B.2.2-2, according to UE Power class, operating band and angle of arrival		-50
± 3.5	± 4	≥ -4			
Note 1: Values based on Refsens and EIS spherical coverage as defined in clauses 7.3.2 and 7.3.4 of TS 38.101-2 [19]. Applicable side condition selected depending on angle of arrival. Note 2: I_o specified at the Reference point, and assumed to have constant EPRE across the bandwidth. Note 3: In the test cases, the SSB \hat{E}_s/lot and related parameters may need to be adjusted to ensure \hat{E}_s/lot at UE baseband is above the value defined in this table.					

10.1.10.1.2 Relative Accuracy of SS-RSRQ in FR2

The relative accuracy of SS-RSRQ in inter frequency case is defined as the RSRQ measured from one cell on a frequency in FR2 compared to the RSRP measured from another cell on a different frequency in FR2.

The accuracy requirements in Table 10.1.10.1.2-1 are valid under the following conditions:

- Conditions defined in clause 7.3 of TS 38.101-2 [19] for reference sensitivity are fulfilled.
- Conditions for inter-frequency measurements are fulfilled according to Annex B.2.3 for a corresponding Band for each relevant SSB.
- $|SSB_RP1_{\text{dBm}} - SSB_RP2_{\text{dBm}}| \leq 27 \text{ dB}$
- $| \text{Channel 1}_{I_o} - \text{Channel 2}_{I_o} | \leq 20 \text{ dB}$
- The measured signals are in the directions covered by the percentile EIS spherical coverage of the UE, defined in clause 7.3.4 of TS 38.101-2 [19].

Table 10.1.10.1.2-1: SS-RSRQ Inter frequency relative accuracy in FR2

Accuracy	Conditions
----------	------------

Normal condition	Extreme condition	SSB \hat{E}_s/lot	I_o ^{Note 2} range		
			Minimum I_o		Maximum I_o
			dBm / SCS_{SSB} ^{Note 1}		
dB	dB	dB	$SCS_{SSB} = 120\text{kHz}$	$SCS_{SSB} = 240\text{kHz}$	dBm/ BW_{Channel}
± 3	± 4	≥ -3	Same value as SSB_RP in Table B.2.2-2, according to UE Power class, operating band and angle of arrival		-50
± 4	± 4	≥ -4			
Note 1: Values based on Refsens and EIS spherical coverage as defined in clauses 7.3.2 and 7.3.4 of TS 38.101-2 [19]. Applicable side condition selected depending on angle of arrival. Note 2: I_o specified at the Reference point, and assumed to have constant EPRE across the bandwidth. Note 3: The parameter SSB \hat{E}_s/lot is the minimum SSB \hat{E}_s/lot of the pair of cells to which the requirement applies. Note 4: In the test cases, the SSB \hat{E}_s/lot and related parameters may need to be adjusted to ensure \hat{E}_s/lot at UE baseband is above the value defined in this table.					

10.1.11 RSRQ report mapping

10.1.11.1 SS-RSRQ measurement report mapping

The reporting range of SS-RSRQ is defined from -43 dB to 20 dB with 0.5 dB resolution. The mapping of measured quantity is defined in Table 10.1.11.1-1. The range in the signalling may be larger than the guaranteed accuracy range.

Table 10.1.11.1-1: SS-RSRQ measurement report mapping

Reported value	Measured quantity value	Unit
SS-RSRQ_0	$SS\text{-RSRQ} < -43$	dB
SS-RSRQ_1	$-43 \leq SS\text{-RSRQ} < -42.5$	dB
SS-RSRQ_2	$-42.5 \leq SS\text{-RSRQ} < -42$	dB
SS-RSRQ_3	$-42 \leq SS\text{-RSRQ} < -41.5$	dB
SS-RSRQ_4	$-41.5 \leq SS\text{-RSRQ} < -41$	dB
..
SS-RSRQ_122	$17.5 \leq SS\text{-RSRQ} < 18$	dB
SS-RSRQ_123	$18 \leq SS\text{-RSRQ} < 18.5$	dB
SS-RSRQ_124	$18.5 \leq SS\text{-RSRQ} < 19$	dB
SS-RSRQ_125	$19 \leq SS\text{-RSRQ} < 19.5$	dB
SS-RSRQ_126	$19.5 \leq SS\text{-RSRQ} < 20$	dB
SS-RSRQ_127	$20 \leq SS\text{-RSRQ}$	dB

10.1.12 Intra-frequency SINR accuracy requirements for FR1

10.1.12.1 Intra-frequency SS-SINR accuracy requirements in FR1

10.1.12.1.1 Absolute SS-SINR Accuracy in FR1

Unless otherwise specified, the requirements for absolute accuracy of SS-SINR in this clause apply to a cell on the same frequency as that of the serving cell in FR1.

The accuracy requirements in Table 10.1.12.1.1-1 are valid under the following conditions:

- Conditions defined in clause 7.3 of TS 38.101-1 [18] for reference sensitivity are fulfilled.
- Conditions for intra-frequency measurements are fulfilled according to Annex B.2.2 for a corresponding Band.

Table 10.1.12.1.1-1: SS-SINR Intra frequency absolute accuracy in FR1

Accuracy		Conditions					
Normal condition	Extreme condition	SSB \hat{E}_s/lot Note 3	NR operating band groups Note 4	I_o Note 1 range			
				Minimum I_o		Maximum I_o	
dB	dB	dB		dBm / SCS_{SSB}		dBm/ BW_{Channel}	dBm/ BW_{Channel}
				$SCS_{SSB} = 15 \text{ kHz}$	$SCS_{SSB} = 30 \text{ kHz}$		
± 3.0	± 4	$\geq -3 \text{ dB}$	NR_FDD_FR1_A, NR_TDD_FR1_A, NR_SDL_FR1_A	-121	-118	N/A	-50
			NR_FDD_FR1_B	-120.5	-117.5	N/A	-50
			NR_TDD_FR1_C	-120	-117	N/A	-50
			NR_FDD_FR1_D, NR_TDD_FR1_D	-119.5	-116.5	N/A	-50
			NR_FDD_FR1_E, NR_TDD_FR1_E	-119	-116	N/A	-50
			NR_FDD_FR1_G	-118	-115	N/A	-50
			NR_FDD_FR1_H	-117.5	-114.5	N/A	-50
± 3.5	± 4	$\geq -6 \text{ dB}$	Note 2	Note 2	Note 2	Note 2	Note 2

NOTE 1: I_o is assumed to have constant EPRE across the bandwidth.
 NOTE 2: The same bands and the same I_o conditions for each band apply for this requirement as for the corresponding highest accuracy requirement.
 NOTE 3: The requirements apply for SSB $\hat{E}_s/\text{lot} \leq 25 \text{ dB}$.
 NOTE 4: NR operating band groups in FR1 are as defined in clause 3.5.2.

10.1.13 Intra-frequency SINR accuracy requirements for FR2

10.1.13.1 Intra-frequency SS-SINR accuracy requirements in FR2

10.1.13.1.1 Absolute SS-SINR Accuracy in FR2

Unless otherwise specified, the requirements for absolute accuracy of SS-SINR in this clause apply to a cell on the same frequency as that of the serving cell in FR2.

The accuracy requirements in Table 10.1.13.1.1-1 are valid under the following conditions:

- Conditions defined in clause 7.3 of TS 38.101-2 [19] for reference sensitivity are fulfilled.
- Conditions for intra-frequency measurements are fulfilled according to Annex B.2.2 for a corresponding Band.
- The measured signals are in the directions covered by the percentile EIS spherical coverage of the UE, defined in clause 7.3.4 of TS 38.101-2 [19].

Table 10.1.13.1.1-1: SS-SINR Intra frequency absolute accuracy in FR2

Accuracy		Conditions			
Normal condition	Extreme condition	SSB \hat{E}_s/lot	I_o Note 2 range		
			Minimum I_o		Maximum I_o
dB	dB	dB	dBm / SCS_{SSB} Note 1		dBm/ BW_{Channel}
			$SCS_{SSB} = 120\text{kHz}$	$SCS_{SSB} = 240\text{kHz}$	
± 3	± 4	≥ -3	Same value as SSB_RP in Table B.2.2-2, according to UE Power class, operating band and angle of arrival		-50
± 3.5	± 4	≥ -6			

Note 1: Values based on Refsens and EIS spherical coverage as defined in clauses 7.3.2 and 7.3.4 of TS 38.101-2 [19]. Applicable side condition selected depending on angle of arrival.
 Note 2: I_o specified at the Reference point, and assumed to have constant EPRE across the bandwidth.
 Note 3: In the test cases, the SSB \hat{E}_s/lot and related parameters may need to be adjusted to ensure \hat{E}_s/lot at UE baseband is above the value defined in this table.

Note 4: The requirements apply for SSB $\hat{E}_s/\text{lot} \leq 25$ dB.

10.1.14 Inter-frequency SINR accuracy requirements for FR1

10.1.14.1 Inter-frequency SS-SINR accuracy requirements in FR1

10.1.14.1.1 Absolute Accuracy of SS-SINR in FR1

The requirements for absolute accuracy of SS-SINR in this clause apply to a cell on a frequency in FR1 that has different carrier frequency from the serving cell.

The accuracy requirements in Table 10.1.14.1.1-1 are valid under the following conditions:

- Conditions defined in clause 7.3 of TS 38.101-1 [18] for reference sensitivity are fulfilled.
- Conditions for inter-frequency measurements are fulfilled according to Annex B.2.3 for a corresponding Band.

Table 10.1.14.1.1-1: SS-SINR Inter frequency absolute accuracy in FR1

Accuracy		Conditions					
Normal condition	Extreme condition	SSB \hat{E}_s/lot Note 3	NR operating band groups Note 4	I_o Note 1 range			
				Minimum I_o		Maximum I_o	
dB	dB	dB		dBm / SCS_{SSB}		dBm/ $BW_{Channel}$	dBm/ $BW_{Channel}$
				$SCS_{SSB} = 15$ kHz	$SCS_{SSB} = 30$ kHz		
± 3.0	± 4	≥ 3 dB	NR_FDD_FR1_A, NR_TDD_FR1_A, NR_SDL_FR1_A	-121	-118	N/A	-50
			NR_FDD_FR1_B	-120.5	-117.5	N/A	-50
			NR_TDD_FR1_C	-120	-117	N/A	-50
			NR_FDD_FR1_D, NR_TDD_FR1_D	-119.5	-116.5	N/A	-50
			NR_FDD_FR1_E, NR_TDD_FR1_E	-119	-116	N/A	-50
			NR_FDD_FR1_G	-118	-115	N/A	-50
			NR_FDD_FR1_H	-117.5	-114.5	N/A	-50
± 3.5	± 4	≥ 6 dB	Note 2	Note 2	Note 2	Note 2	Note 2

NOTE 1: I_o is assumed to have constant EPRE across the bandwidth.
 NOTE 2: The same bands and the same I_o conditions for each band apply for this requirement as for the corresponding highest accuracy requirement.
 NOTE 3: The requirements apply for SSB $\hat{E}_s/\text{lot} \leq 25$ dB.
 NOTE 4: NR operating band groups in FR1 are as defined in clause 3.5.2.

10.1.14.1.2 Relative Accuracy of SS-SINR in FR1

The relative accuracy of SS-SINR in inter frequency case is defined as the SS-SINR measured from one cell on a frequency in FR1 compared to the SS-SINR measured from another cell on a different frequency in FR1.

The accuracy requirements in Table 10.1.14.1.2-1 are valid under the following conditions:

- Conditions defined in clause 7.3 of TS 38.101-1 [18] for reference sensitivity are fulfilled.
- Conditions for inter-frequency measurements are fulfilled according to Annex B.2.3 for a corresponding Band.
- $|SSB_RP1_{dBm} - SSB_RP2_{dBm}| \leq 27$ dB
- $|Channel\ 1_I_o - Channel\ 2_I_o| \leq 20$ dB

Table 10.1.14.1.2-1: SS-SINR Inter frequency relative accuracy in FR1

Accuracy		Conditions					
Normal condition	Extreme condition	SSB \hat{E}_s/lot Note 2,4	I_o ^{Note 1} range				
			NR operating band groups Note 5	Minimum I_o		Maximum I_o	
dB	dB	dB		dBm / SCS_{SSB}		dBm/ $BW_{Channel}$	dBm/ $BW_{Channel}$
			$SCS_{SSB} = 120 \text{ kHz}$	$SCS_{SSB} = 240 \text{ kHz}$			
±3.5	±4	≥-3 dB	NR_FDD_FR1_A, NR_TDD_FR1_A, NR_SDL_FR1_A	-121	-118	N/A	-50
			NR_FDD_FR1_B	-120.5	-117.5	N/A	-50
			NR_TDD_FR1_C	-120	-117	N/A	-50
			NR_FDD_FR1_D, NR_TDD_FR1_D	-119.5	-116.5	N/A	-50
			NR_FDD_FR1_E, NR_TDD_FR1_E	-119	-116	N/A	-50
			NR_FDD_FR1_G	-118	-115	N/A	-50
			NR_FDD_FR1_H	-117.5	-114.5	N/A	-50
±4	±4	≥-6 dB	Note 3	Note 3	Note 3	Note 3	Note 3

NOTE 1: I_o is assumed to have constant EPRE across the bandwidth.
 NOTE 2: The parameter SSB \hat{E}_s/lot is the minimum SSB \hat{E}_s/lot of the pair of cells to which the requirement applies.
 NOTE 3: The same bands and the same I_o conditions for each band apply for this requirement as for the corresponding highest accuracy requirement.
 NOTE 4: The requirements apply for SSB $\hat{E}_s/\text{lot} \leq 25 \text{ dB}$.
 NOTE 5: NR operating band groups in FR1 are as defined in clause 3.5.2.

10.1.15 Inter-frequency SINR accuracy requirements for FR2

10.1.15.1 Inter-frequency SS-SINR accuracy requirements in FR2

10.1.15.1.1 Absolute Accuracy of SS-SINR in FR2

The requirements for absolute accuracy of SS-SINR in this clause apply to a cell on a frequency in FR2 that has different carrier frequency from the serving cell.

The accuracy requirements in Table 10.1.15.1.1-1 are valid under the following conditions:

- Conditions defined in clause 7.3 of TS 38.101-2 [19] for reference sensitivity are fulfilled.
- Conditions for inter-frequency measurements are fulfilled according to Annex B.2.3 for a corresponding Band.
- The measured signals are in the directions covered by the percentile EIS spherical coverage of the UE, defined in clause 7.3.4 of TS 38.101-2 [19].

Table 10.1.15.1.1-1: SS-SINR Inter frequency absolute accuracy in FR2

Accuracy		Conditions			
Normal condition	Extreme condition	SSB \hat{E}_s/lot	I_o ^{Note 2} range		
			Minimum I_o		Maximum I_o
dB	dB	dB	dBm / SCS_{SSB} ^{Note 1}		dBm/ $BW_{Channel}$
			$SCS_{SSB} = 120\text{kHz}$	$SCS_{SSB} = 240\text{kHz}$	
±3	±4	≥-3	Same value as SSB_RP in Table B.2.2-2, according to UE Power class, operating band and angle of arrival		-50
±3.5	±4	≥-4			

Note 1: Values based on Refsens and EIS spherical coverage as defined in clauses 7.3.2 and 7.3.4 of TS 38.101-2 [19]. Applicable side condition selected depending on angle of arrival.
 Note 2: I_o specified at the Reference point, and assumed to have constant EPRE across the bandwidth.

Note 3: In the test cases, the SSB \hat{E}_s/lot and related parameters may need to be adjusted to ensure \hat{E}_s/lot at UE baseband is above the value defined in this table.
 Note 4: The requirements apply for SSB $\hat{E}_s/\text{lot} \leq 25$ dB.

10.1.15.1.2 Relative Accuracy of SS-SINR in FR2

The relative accuracy of SS-SINR in inter frequency case is defined as the SS-SINR measured from one cell on a frequency in FR2 compared to the SS-SINR measured from another cell on a different frequency in FR2.

The accuracy requirements in Table 10.1.15.1.2-1 are valid under the following conditions:

- Conditions defined in clause 7.3 of TS 38.101-2 [19] for reference sensitivity are fulfilled.
- Conditions for inter-frequency measurements are fulfilled according to Annex B.2.3 for a corresponding Band.
- $|\text{SSB_RP1}_{\text{dBm}} - \text{SSB_RP2}_{\text{dBm}}| \leq 27$ dB
- $|\text{Channel 1_Io} - \text{Channel 2_Io}| \leq 20$ dB
- The measured signals are in the directions covered by the percentile EIS spherical coverage of the UE, defined in clause 7.3.4 of TS 38.101-2 [19].

Table 10.1.15.1.2-1: SS-SINR Inter frequency relative accuracy in FR2

Accuracy		Conditions			
Normal condition	Extreme condition	SSB \hat{E}_s/lot	I_o ^{Note 2} range		Maximum I_o
			Minimum I_o		
dB	dB	dB	dBm / SCS_{SSB} ^{Note 1}		dBm/ $\text{BW}_{\text{Channel}}$
			$\text{SCS}_{\text{SSB}} = 120\text{kHz}$	$\text{SCS}_{\text{SSB}} = 240\text{kHz}$	
± 3.5	± 4	≥ -3	Same value as SSB_RP in Table B.2.2-2, according to UE Power class, operating band and angle of arrival		-50
± 4	± 4	≥ -6			
Note 1: Values based on Refsens and EIS spherical coverage as defined in clauses 7.3.2 and 7.3.4 of TS 38.101-2 [19]. Applicable side condition selected depending on angle of arrival. Note 2: I_o specified at the Reference point, and assumed to have constant EPRE across the bandwidth. Note 3: The parameter SSB \hat{E}_s/lot is the minimum SSB \hat{E}_s/lot of the pair of cells to which the requirement applies. Note 4: In the test cases, the SSB \hat{E}_s/lot and related parameters may need to be adjusted to ensure \hat{E}_s/lot at UE baseband is above the value defined in this table. Note 5: The requirements apply for SSB $\hat{E}_s/\text{lot} \leq 25$ dB.					

10.1.16 SINR report mapping

10.1.16.1 SS-SINR measurement report mapping

The reporting range of SS-SINR is defined from -23 dB to 40 dB with 0.5 dB resolution. The mapping of measured quantity is defined in Table 10.1.16.1-1. The range in the signalling may be larger than the guaranteed accuracy range.

Table 10.1.16.1-1: SS-SINR measurement report mapping

Reported value	Measured quantity value	Unit
SS-SINR_0	$\text{SS-SINR} < -23$	dB
SS-SINR_1	$-23 \leq \text{SS-SINR} < -22.5$	dB
SS-SINR_2	$-22.5 \leq \text{SS-SINR} < -22$	dB
SS-SINR_3	$-22 \leq \text{SS-SINR} < -21.5$	dB
SS-SINR_4	$-21.5 \leq \text{SS-SINR} < -21$	dB

..
SS-SINR_123	$38 \leq \text{SS-SINR} < 38.5$	dB
SS-SINR_124	$38.5 \leq \text{SS-SINR} < 39$	dB
SS-SINR_125	$39 \leq \text{SS-SINR} < 39.5$	dB
SS-SINR_126	$39.5 \leq \text{SS-SINR} < 40$	dB
SS-SINR_127	$40 \leq \text{SS-SINR}$	dB

10.1.17 Power Headroom

10.1.17.1 Power Headroom Report

10.1.17.1.1 Power Headroom Report Mapping

The power headroom reporting range is from -32 ...+38 dB. Table 10.1.17.1-1 defines the report mapping.

Table 10.1.17.1-1: Power headroom report mapping

Reported value	Measured quantity value (dB)
POWER_HEADROOM_0	$\text{PH} < -32$
POWER_HEADROOM_1	$-32 \leq \text{PH} < -31$
POWER_HEADROOM_2	$-31 \leq \text{PH} < -30$
POWER_HEADROOM_3	$-30 \leq \text{PH} < -29$
...	...
POWER_HEADROOM_53	$20 \leq \text{PH} < 21$
POWER_HEADROOM_54	$21 \leq \text{PH} < 22$
POWER_HEADROOM_55	$22 \leq \text{PH} < 24$
POWER_HEADROOM_56	$24 \leq \text{PH} < 26$
POWER_HEADROOM_57	$26 \leq \text{PH} < 28$
POWER_HEADROOM_58	$28 \leq \text{PH} < 30$
POWER_HEADROOM_59	$30 \leq \text{PH} < 32$
POWER_HEADROOM_60	$32 \leq \text{PH} < 34$
POWER_HEADROOM_61	$34 \leq \text{PH} < 36$
POWER_HEADROOM_62	$36 \leq \text{PH} < 38$
POWER_HEADROOM_63	$\text{PH} \geq 38$

10.1.18 $P_{\text{CMAX},c,f}$

The UE is required to report the UE configured maximum output power ($P_{\text{CMAX},c,f}$) together with the power headroom. This clause defines the requirements for the $P_{\text{CMAX},c,f}$ reporting.

10.1.18.1 Report Mapping

The $P_{\text{CMAX},c,f}$ reporting range is defined from -29 dBm to 33 dBm with 1 dB resolution. Table 10.1.18.1-1 defines the reporting mapping.

Table 10.1.18.1-1 Mapping of $P_{\text{CMAX},c,f}$

Reported value	Measured quantity value	Unit
PCMAX_C_00	$P_{\text{CMAX},c,f} < -29$	dBm
PCMAX_C_01	$-29 \leq P_{\text{CMAX},c,f} < -28$	dBm
PCMAX_C_02	$-28 \leq P_{\text{CMAX},c,f} < -27$	dBm
...
PCMAX_C_61	$31 \leq P_{\text{CMAX},c,f} < 32$	dBm
PCMAX_C_62	$32 \leq P_{\text{CMAX},c,f} < 33$	dBm
PCMAX_C_63	$33 \leq P_{\text{CMAX},c,f}$	dBm

10.1.19 L1-RSRP accuracy requirements for FR1

10.1.19.1 SSB based L1-RSRP accuracy requirements

10.1.19.1.1 Absolute Accuracy

Unless otherwise specified, the requirements for absolute accuracy of SSB based L1-RSRP in this clause apply to all SSBs of the serving cell configured for L1-RSRP measurement.

The accuracy requirements in Table 10.1.19.1.1-1 are valid under the following conditions:

- Conditions defined in clause 7.3 of TS 38.101-1 [18] for reference sensitivity are fulfilled.
- Conditions for L1-RSRP measurements are fulfilled according to Annex B.2.4.1 for a corresponding Band for each relevant SSB.

Table 10.1.19.1.1-1: SSB based L1-RSRP absolute accuracy in FR1

Accuracy		Conditions					
Normal condition	Extreme condition	SSB \hat{E}_s/lot	I_0 ^{Note 1} range				
			NR operating band groups ^{Note 2}	Minimum I_0		Maximum I_0	
dB	dB	dB		dBm / SCS_{SSB}		dBm/ BW_{Channel}	dBm/ BW_{Channel}
			$SCS_{SSB} = 15 \text{ kHz}$	$SCS_{SSB} = 30 \text{ kHz}$			
± 5.0	± 9.5	$\geq -3\text{dB}$	NR_FDD_FR1_A, NR_TDD_FR1_A, NR_SDL_FR1_A	-121	-118	N/A	-70
			NR_FDD_FR1_B	-120.5	-117.5	N/A	-70
			NR_TDD_FR1_C	-120	-117	N/A	-70
			NR_FDD_FR1_D, NR_TDD_FR1_D	-119.5	-116.5	N/A	-70
			NR_FDD_FR1_E, NR_TDD_FR1_E	-119	-116	N/A	-70
			NR_FDD_FR1_G	-118	-115	N/A	-70
			NR_FDD_FR1_H	-117.5	-114.5	N/A	-70
± 8.5	± 11.5	$\geq -3\text{dB}$	NR_FDD_FR1_A, NR_TDD_FR1_A, NR_SDL_FR1_A, NR_FDD_FR1_B, NR_TDD_FR1_C, NR_FDD_FR1_D, NR_TDD_FR1_D, NR_FDD_FR1_E, NR_TDD_FR1_E, NR_FDD_FR1_G, NR_FDD_FR1_H,	N/A	N/A	-70	-50

NOTE 1: I_0 is assumed to have constant EPRE across the bandwidth.
 NOTE 2: NR operating band groups in FR1 are as defined in clause 3.5.2.

10.1.19.1.2 Relative Accuracy

The relative accuracy of SSB based L1-RSRP is defined as the L1-RSRP measured from one SSB compared to the largest measured value of L1-RSRP among all SSBs of the serving cell.

The accuracy requirements in Table 10.1.19.1.2-1 are valid under the following conditions:

- Conditions defined in clause 7.3 of TS 38.101-1 [18] for reference sensitivity are fulfilled.
- Conditions for L1-RSRP measurements are fulfilled according to Annex B.2.4.1 for a corresponding Band for each relevant SSB.

Table 10.1.19.1.2-1: SSB based L1-RSRP relative accuracy in FR1

Accuracy		Conditions						
Normal condition	Extreme condition	SSB $\hat{E}s/lot$ Note 2	NR operating band groups Note 4	Io Note 1 range				
				Minimum Io			Maximum Io	
dB	dB	dB		dBm / SCS_{SSB}			dBm/ $BW_{Channel}$	dBm/ $BW_{Channel}$
				$SCS_{SSB} = 15$ kHz	$SCS_{SSB} = 30$ kHz			
± 3	± 4	≥ -3 dB	NR_FDD_FR1_A, NR_TDD_FR1_A, NR_SDL_FR1_A	-121	-118	N/A	-50	
			NR_FDD_FR1_B	-120.5	-117.5	N/A	-50	
			NR_TDD_FR1_C	-120	-117	N/A	-50	
			NR_FDD_FR1_D, NR_TDD_FR1_D	-119.5	-116.5	N/A	-50	
			NR_FDD_FR1_E, NR_TDD_FR1_E	-119	-116	N/A	-50	
			NR_FDD_FR1_G	-118	-115	N/A	-50	
			NR_FDD_FR1_H	-117.5	-114.5	N/A	-50	

NOTE 1: Io is assumed to have constant EPRE across the bandwidth.
NOTE 2: The parameter SSB $\hat{E}s/lot$ is the minimum SSB $\hat{E}s/lot$ of the pair of SSBs to which the requirement applies.
NOTE 3: Void
NOTE 4: NR operating band groups in FR1 are as defined in clause 3.5.2..

10.1.19.2 CSI-RS based L1-RSRP accuracy requirements

10.1.19.2.1 Absolute Accuracy

Unless otherwise specified, the requirements for absolute accuracy of CSI-RS based L1-RSRP in this clause apply to all CSI-RS resources of the serving cell configured for L1-RSRP measurement.

The accuracy requirements in Table 10.1.19.2.1-1 are valid under the following conditions:

- Conditions defined in clause 7.3 of TS 38.101-1 [18] for reference sensitivity are fulfilled.
- Conditions for L1-RSRP measurements are fulfilled according to Annex B.2.4.2 for a corresponding Band for each relevant CSI-RS.
- The bandwidth of CSI-RS is 48 PRBs and the density is 3.

The performance with larger bandwidth of CSI-RS is equal to or better than the accuracy requirements in Table 10.1.19.2.1-1.

Table 10.1.19.2.1-1: CSI-RS based L1-RSRP absolute accuracy in FR1

Accuracy		Conditions						
Normal condition	Extreme condition	CSI-RS $\hat{E}s/lot$	NR operating band groups Note 2	Io Note 1 range				
				Minimum Io			Maximum Io	
dB	dB	dB		dBm / SCS_{CSI-RS}			dBm/ $BW_{Channel}$	dBm/ $BW_{Channel}$
				$SCS_{CSI-RS} = 15$ kHz	$SCS_{CSI-RS} = 30$ kHz	$SCS_{CSI-RS} = 60$ kHz		
± 5.0	± 9.5	≥ -3 dB	NR_FDD_FR1_A, NR_TDD_FR1_A, NR_SDL_FR1_A	-121	-118	-115	N/A	-70
			NR_FDD_FR1_B	-120.5	-117.5	-114.5	N/A	-70
			NR_TDD_FR1_C	-120	-117	-114	N/A	-70
			NR_FDD_FR1_D, NR_TDD_FR1_D	-119.5	-116.5	-113.5	N/A	-70

			NR_FDD_FR1_E, NR_TDD_FR1_E	-119	-116	-113	N/A	-70
			NR_FDD_FR1_G	-118	-115	-112	N/A	-70
			NR_FDD_FR1_H	-117.5	-114.5	-111.5	N/A	-70
±8.5	±11.5	≥-3dB	NR_FDD_FR1_A, NR_TDD_FR1_A, NR_SDL_FR1_A, NR_FDD_FR1_B, NR_TDD_FR1_C, NR_FDD_FR1_D, NR_TDD_FR1_D, NR_FDD_FR1_E, NR_TDD_FR1_E, NR_FDD_FR1_G, NR_FDD_FR1_H	N/A	N/A	N/A	-70	-50

NOTE 1: I_0 is assumed to have constant EPRE across the bandwidth.
 NOTE 2: NR operating band groups in FR1 are as defined in clause 3.5.2.

10.1.19.2.2 Relative Accuracy

The relative accuracy of CSI-RS based L1-RSRP is defined as the L1-RSRP measured from one CSI-RS compared to the largest measured value of L1-RSRP among all CSI-RS resources of the serving cell.

The accuracy requirements in Table 10.1.19.2.2-1 are valid under the following conditions:

- Conditions defined in clause 7.3 of TS 38.101-1 [18] for reference sensitivity are fulfilled.
- Conditions for L1-RSRP measurements are fulfilled according to Annex B.2.4.2 for a corresponding Band for each relevant CSI-RS.
- The bandwidth of CSI-RS is 48 PRBs and the density is 3.

The performance with larger bandwidth of CSI-RS is equal to or better than the accuracy requirements in Table 10.1.19.2.2-1.

Table 10.1.19.2.2-1: CSI-RS based L1-RSRP relative accuracy in FR1

Accuracy		Conditions						
Normal condition	Extreme condition	CSI-RS \hat{E}_s/lot Note 2	NR operating band groups Note 4	I_0 Note 1 range			Maximum I_0	
				Minimum I_0				
dB	dB	dB		dBm / $SCS_{\text{CSI-RS}}$			dBm/ BW_{Channel}	dBm/ BW_{Channel}
				$SCS_{\text{CSI-RS}} = 15$ kHz	$SCS_{\text{CSI-RS}} = 30$ kHz	$SCS_{\text{CSI-RS}} = 60$ kHz		
±3	±4	≥-3dB	NR_FDD_FR1_A, NR_TDD_FR1_A, NR_SDL_FR1_A	-121	-118	-115	N/A	-50
			NR_FDD_FR1_B	-120.5	-117.5	-114.5	N/A	-50
			NR_TDD_FR1_C	-120	-117	-114	N/A	-50
			NR_FDD_FR1_D, NR_TDD_FR1_D	-119.5	-116.5	-113.5	N/A	-50
			NR_FDD_FR1_E, NR_TDD_FR1_E	-119	-116	-113	N/A	-50
			NR_FDD_FR1_G	-118	-115	-112	N/A	-50
			NR_FDD_FR1_H	-117.5	-114.5	-111.5	N/A	-50

NOTE 1: I_0 is assumed to have constant EPRE across the bandwidth.
 NOTE 2: The parameter CSI-RS \hat{E}_s/lot is the minimum CSI-RS \hat{E}_s/lot of the pair of CSI-RS resources to which the requirement applies.
 NOTE 3: Void
 NOTE 4: NR operating band groups in FR1 are as defined in clause 3.5.2.

10.1.20 L1-RSRP accuracy requirements for FR2

10.1.20.1 SSB based L1-RSRP accuracy requirements

10.1.20.1.1 Absolute Accuracy

Unless otherwise specified, the requirements for absolute accuracy of SSB based L1-RSRP in this clause apply to all SSBs of the serving cell configured for L1-RSRP measurement.

The accuracy requirements in Table 10.1.20.1.1-1 are valid under the following conditions:

- Conditions defined in clause 7.3 of TS 38.101-2 [19] for reference sensitivity are fulfilled.
- Conditions for L1-RSRP measurements are fulfilled according to Annex B.2.4.1 for a corresponding Band for each relevant SSB.
- The measured signals are in the directions covered by the percentile EIS spherical coverage of the UE, defined in clause 7.3.4 of TS 38.101-2 [19].

Table 10.1.20.1.1-1: SSB based L1-RSRP absolute accuracy in FR2

Accuracy		Conditions			
Normal condition	Extreme condition	SSB \hat{E}_s/lot	I_o ^{Note 1} range		
			Minimum I_o		Maximum I_o
dB	dB	dB	dBm / SCS_{SSB} ^{Note 2}		dBm/ $BW_{Channel}$
			$SCS_{SSB} = 120\text{kHz}$	$SCS_{SSB} = 240\text{kHz}$	
± 6.5	± 9.5	≥ -3	Same value as SSB_RP in Table B.2.4.1-2, according to UE Power class, operating band and angle of arrival		N/A
± 8.5	± 11.5	≥ -3	N/A		-70
NOTE 1: I_o specified at the Reference point, and assumed to have constant EPRE across the bandwidth.					
NOTE 2: Values based on Refsens and EIS spherical coverage as defined in clauses 7.3.2 and 7.3.4 of TS 38.101-2 [19]. Applicable side condition selected depending on angle of arrival.					
NOTE 3: In the test cases, the SSB \hat{E}_s/lot and related parameters may need to be adjusted to ensure \hat{E}_s/lot at UE baseband is above the value defined in this table.					

10.1.20.1.2 Relative Accuracy

The relative accuracy of SSB based L1-RSRP is defined as the L1-RSRP measured from one SSB compared to the largest measured value of L1-RSRP among all SSBs of the serving cell.

The accuracy requirements in Table 10.1.20.1.2-1 are valid under the following conditions:

- Conditions defined in clause 7.3 of TS 38.101-2 [19] for reference sensitivity are fulfilled.
- Conditions for L1-RSRP measurements are fulfilled according to Annex B.2.4.1 for a corresponding Band for each relevant SSB.
- The measured signals are in the directions covered by the percentile EIS spherical coverage of the UE, defined in clause 7.3.4 of TS 38.101-2 [19].

Table 10.1.20.1.2-1: SSB based L1-RSRP relative accuracy in FR2

Accuracy		Conditions			
Normal condition	Extreme condition	SSB \hat{E}_s/lot	I_o ^{Note 1} range		
			Minimum I_o		Maximum I_o
dB	dB	dB	dBm / SCS_{SSB} ^{Note 3}		dBm/ $BW_{Channel}$
			$SCS_{SSB} = 120\text{kHz}$	$SCS_{SSB} = 240\text{kHz}$	

±6.5	±9.5	≥-3	Same value as SSB_RP in Table B.2.4.1-2, according to UE Power class, operating band and angle of arrival	-50
<p>NOTE 1: I_0 specified at the Reference point, and assumed to have constant EPRE across the bandwidth.</p> <p>NOTE 2: The parameter SSB \hat{E}_s/lot is the minimum SSB \hat{E}_s/lot of the pair of SSBs to which the requirement applies.</p> <p>NOTE 3: Values based on Refsens and EIS spherical coverage as defined in clauses 7.3.2 and 7.3.4 of TS 38.101-2 [19]. Applicable side condition selected depending on angle of arrival.</p> <p>NOTE 4: In the test cases, the SSB \hat{E}_s/lot and related parameters may need to be adjusted to ensure \hat{E}_s/lot at UE baseband is above the value defined in this table.</p>				

10.1.20.2 CSI-RS based L1-RSRP accuracy requirements

10.1.20.2.1 Absolute Accuracy

Unless otherwise specified, the requirements for absolute accuracy of CSI-RS based L1-RSRP in this clause apply to all CSI-RS resources of the serving cell configured for L1-RSRP measurement.

The accuracy requirements in Table 10.1.20.2.1-1 are valid under the following conditions:

- Conditions defined in clause 7.3 of TS 38.101-2 [19] for reference sensitivity are fulfilled.
- Conditions for L1-RSRP measurements are fulfilled according to Annex B.2.4.2 for a corresponding Band for each relevant CSI-RS.
- The bandwidth of CSI-RS is 48 PRBs and the density is 3.
- The measured signals are in the directions covered by the percentile EIS spherical coverage of the UE, defined in clause 7.3.4 of TS 38.101-2 [19].

The performance with larger bandwidth of CSI-RS is equal to or better than the accuracy requirements in Table 10.1.20.2.1-1.

Table 10.1.20.2.1-1: CSI-RS based L1-RSRP absolute accuracy in FR2

Accuracy		Conditions			
Normal condition	Extreme condition	CSI-RS \hat{E}_s/lot	I_0 ^{Note 1} range		
			Minimum I_0		Maximum I_0
dB	dB	dB	dBm / $SCS_{\text{CSI-RS}}$ ^{Note 2}		dBm/ BW_{Channel}
			$SCS_{\text{CSI-RS}} = 60\text{kHz}$	$SCS_{\text{CSI-RS}} = 120\text{kHz}$	
±6.5	±9.5	≥-3	Same value as CSI-RS_RP in Table B.2.4.2-2, according to UE Power class, operating band and angle of arrival		-70
±8.5	±11.5	≥-3	N/A		-50

NOTE 1: I_0 specified at the Reference point, and assumed to have constant EPRE across the bandwidth.
 NOTE 2: Values based on Refsens and EIS spherical coverage as defined in clauses 7.3.2 and 7.3.4 of TS 38.101-2 [19]. Applicable side condition selected depending on angle of arrival.
 NOTE 3: In the test cases, the CSI-RS \hat{E}_s/lot and related parameters may need to be adjusted to ensure \hat{E}_s/lot at UE baseband is above the value defined in this table.

10.1.20.2.2 Relative Accuracy

The relative accuracy of CSI-RS based L1-RSRP is defined as the L1-RSRP measured from one CSI-RS compared to the largest measured value of L1-RSRP among all CSI-RS resources of the serving cell.

The accuracy requirements in Table 10.1.20.2.2-1 are valid under the following conditions:

- Conditions defined in clause 7.3 of TS 38.101-2 [19] for reference sensitivity are fulfilled.
- Conditions for L1-RSRP measurements are fulfilled according to Annex B.2.4.2 for a corresponding Band for each relevant CSI-RS.
- The bandwidth of CSI-RS is 48 PRBs and the density is 3.
- The measured signals are in the directions covered by the percentile EIS spherical coverage of the UE, defined in clause 7.3.4 of TS 38.101-2 [19].

The performance with larger bandwidth of CSI-RS is equal to or better than the accuracy requirements in Table 10.1.20.2.2-1.

Table 10.1.20.2.2-1: CSI-RS based L1-RSRP relative accuracy in FR2

Accuracy		Conditions			
Normal condition	Extreme condition	CSI-RS $\hat{E}s/lot$	I_o ^{Note 1} range		Maximum I_o
			dBm / SCS_{CSI-RS}		
dB	dB	dB	Minimum I_o		dBm/ $BW_{Channel}$
			$SCS_{CSI-RS} = 60kHz$	$SCS_{CSI-RS} = 120kHz$	
±6.5	±9.5	≥-3	Same value as CSI-RS RP in Table B.2.4.2-2, according to UE Power class, operating band and angle of arrival		-50
NOTE 1: I_o specified at the Reference point, and assumed to have constant EPRE across the bandwidth.					
NOTE 2: The parameter CSI-RS $\hat{E}s/lot$ is the minimum CSI-RS $\hat{E}s/lot$ of the pair of CSI-RS resources to which the requirement applies.					
NOTE 3: Values based on Refsens and EIS spherical coverage as defined in clauses 7.3.2 and 7.3.4 of TS 38.101-2 [19]. Applicable side condition selected depending on angle of arrival.					
NOTE 4: In the test cases, the CSI-RS $\hat{E}s/lot$ and related parameters may need to be adjusted to ensure $\hat{E}s/lot$ at UE baseband is above the value defined in this table.					

10.1.21 SFTD accuracy requirements

10.1.21.1 SFTD accuracy requirements for NE-DC

The SFN and frame timing difference (SFTD) is measured between PCell and E-UTRAN PCell under NE-DC.

The accuracy requirements in Table 10.1.21.1-4 are applicable under the following conditions:

For FR1 PCell SFN and frame timing measurement:

- Conditions defined in clause 7.3 of TS 38.101-1 [18] for reference sensitivity are fulfilled.
- I_o range defined in Table 10.1.21.1-1.

Table 10.1.21.1-1: PCell I_o range conditions in FR1

Parameter	I_o ^{Note 1} range			
	NR operating band groups ^{Note 4, 5}	Minimum I_o ^{Note 2, 3}		Maximum I_o
		dBm/ SCS_{SSB}		
Conditions		$SCS_{SSB} = 15 kHz$	$SCS_{SSB} = 30 kHz$	dBm/ $BW_{Channel}$
		NR_FDD_FR1_A, NR_TDD_FR1_A	-121	-118
	NR_FDD_FR1_B	-120.5	-117.5	-50
	NR_TDD_FR1_C	-120	-117	-50
	NR_FDD_FR1_D, NR_TDD_FR1_D	-119.5	-116.5	-50

	NR_FDD_FR1_E, NR_TDD_FR1_E	-119	-116	-50
	NR_FDD_FR1_G	-118	-115	-50
	NR_FDD_FR1_H	-117.5	-114.5	-50
<p>NOTE 1: I_0 is assumed to have constant EPRE across the bandwidth.</p> <p>NOTE 2: The condition level is increased by $\Delta R_{IB,c}$ as defined in clause 7.3B in TS 38.101-3 [20], depending on E-UTRA – NR band combination.</p> <p>NOTE 3: The condition level is increased by MSD as defined in clause 7.3B in TS 38.101-3 [20], if applicable depending on E-UTRA – NR band combination.</p> <p>NOTE 4: NR operating band groups are as defined in clause 3.5.</p> <p>NOTE 5: Only NR bands within EN-DC band combinations as specified in clause 5.5B in TS 38.101-3 [20] are applicable.</p>				

For FR2 PCell SFN and frame timing measurement:

- Conditions defined in clause 7.3 of TS 38.101-2 [19] for reference sensitivity are fulfilled.
- I_0 range defined in Table 10.1.21.1-2.

Table 10.1.21.1-2: PCell I_0 range conditions in FR2

Parameter	I_0 ^{Note 1} range		
	Minimum I_0 ^{Note 2, 3}		Maximum I_0
	dBm/ SCS _{SSB}		dBm/BW _{Channel}
	SCS _{SSB} = 15 kHz	SCS _{SSB} = 30 kHz	
Conditions	Same value as SSB_RP in Table B.2.4.1-2, according to UE Power class, operating band and angle of arrival	Same value as SSB_RP in Table B.2.4.1-2, according to UE Power class, operating band and angle of arrival	-50
<p>NOTE 1: I_0 is assumed to have constant EPRE across the bandwidth and specified at the Reference point.</p> <p>NOTE 2: Values based on Refsens and EIS spherical coverage as defined in clauses 7.3.2 and 7.3.4 of TS 38.101-2 [19]. Applicable side condition selected depending on angle of arrival.</p> <p>NOTE 3: In the test cases, the SSB \hat{E}_s/I_0 and related parameters may need to be adjusted to ensure \hat{E}_s/I_0 at UE baseband is above the value defined in this table.</p>			

For E-UTRA PSCell SFN and frame timing measurement:

- Cell specific reference signals are transmitted either from one, two or four antenna ports.
- Conditions defined in TS 36.101 [25] Clause 7.3 for reference sensitivity are fulfilled.
- No changes to the uplink transmission timing are applied during the measurement period.
- RSRP_{dBm} according to Annex B.3.5 in TS 36.101 [25] for a corresponding Band.
- I_0 range defined in Table 10.1.21.1-3.

Table 10.1.21.1-3: E-UTRA PSCell I_0 range conditions

Parameter	I_0 ^{Note 1} range		
	E-UTRA operating band groups ^{Note 3}	Minimum I_0	Maximum I_0
		dBm/15kHz ^{Note 2}	dBm/BW _{Channel}
Conditions	FDD_A, TDD_A	-121	-50
	FDD_C, TDD_C	-120	-50
	FDD_D	-119.5	-50
	FDD_E, TDD_E	-119	-50
	FDD_F	-118.5	-50
	FDD_G	-118	-50
	FDD_H	-117.5	-50
	FDD_N	-114.5	-50
<p>NOTE 1: When in dBm/15kHz, the minimum I_0 condition is expressed as the average I_0 per RE over all REs in that symbol. I_0 may be different in different symbols within a subframe.</p> <p>NOTE 2: The condition level is increased by $\Delta > 0$, when applicable, as described in clauses B.4.2 and B.4.3 in TS36.133 [15].</p> <p>NOTE 3: E-UTRA operating band groups are as defined in clause 3.5 in TS 36.133 [15].</p>			

Table 10.1.21.1-4: SFTD measurement accuracy

Accuracy	Conditions	
	\hat{E}_s/lot ^{Note 2}	Frequency range
T_s ^{Note 1}	dB	
$40 \cdot 64 \cdot T_c$	≥ -3 dB	FR1
$40 \cdot 64 \cdot T_c$		FR2
NOTE 1: T_c is the basic timing unit defined in TS 38.211 [6].		
NOTE 2: The parameter \hat{E}_s/lot is the minimum \hat{E}_s/lot of the pair of cells to which the requirement applies.		

10.1.21.2 SFTD accuracy requirements for NR-DC

The SFN and frame timing difference (SFTD) is measured between PCell in FR1 and PSCell in FR2 under NR dual connectivity.

The accuracy requirements in Table 10.1.21.2-3 are applicable under the following conditions:

For FR1 PCell SFN and frame timing measurement:

- Conditions defined in clause 7.3 of TS 38.101-1 [18] for reference sensitivity are fulfilled.
- I_o range defined in Table 10.1.21.2-1.

Table 10.1.21.2-1: PCell I_o range conditions in FR1

Parameter	I_o ^{Note 1} range			
	NR operating band groups ^{Note 2}	Minimum I_o		Maximum I_o
		dBm/ SCS_{SSB}		
Conditions		$SCS_{SSB} = 15$ kHz	$SCS_{SSB} = 30$ kHz	dBm/ $BW_{Channel}$
	NR_FDD_FR1_A, NR_TDD_FR1_A	-121	-118	-50
	NR_FDD_FR1_B	-120.5	-117.5	-50
	NR_TDD_FR1_C	-120	-117	-50
	NR_FDD_FR1_D, NR_TDD_FR1_D	-119.5	-116.5	-50
	NR_FDD_FR1_E, NR_TDD_FR1_E	-119	-116	-50
	NR_FDD_FR1_G	-118	-115	-50
	NR_FDD_FR1_H	-117.5	-114.5	-50
NOTE 1: I_o is assumed to have constant EPRE across the bandwidth.				
NOTE 2: NR operating band groups are as defined in clause 3.5.2.				

For FR2 PSCell SFN and frame timing measurement:

- Conditions defined in clause 7.3 of TS 38.101-2 [19] for reference sensitivity are fulfilled.
- I_o range defined in Table 10.1.21.2-2.
- The measured signals are in the directions covered by the percentile EIS spherical coverage of the UE, defined in clause 7.3.4 of TS 38.101-2 [19].

Table 10.1.21.2-2: PSCell I_o range conditions in FR2

Parameter	I_o ^{Note 1} range		
	Minimum I_o ^{Note 2, 3}		Maximum I_o
	dBm/ SCS_{SSB}		
	$SCS_{SSB} = 15$ kHz	$SCS_{SSB} = 30$ kHz	dBm/ $BW_{Channel}$

Conditions	Same value as SSB_RP in Table B.2.4.1-2, according to UE Power class, operating band and angle of arrival	Same value as SSB_RP in Table B.2.4.1-2, according to UE Power class, operating band and angle of arrival	-50
NOTE 1: I_o is assumed to have constant EPRE across the bandwidth and specified at the Reference point.			
NOTE 2: Values based on Refsens and EIS spherical coverage as defined in clauses 7.3.2 and 7.3.4 of TS 38.101-2 [19]. Applicable side condition selected depending on angle of arrival.			
NOTE 3: In the test cases, the SSB \hat{E}_s/lot and related parameters may need to be adjusted to ensure \hat{E}_s/lot at UE baseband is above the value defined in this table.			

Table 10.1.21.2-3: SFTD measurement accuracy

Accuracy	Conditions	
	\hat{E}_s/lot ^{Note 2}	Frequency range
T_s ^{Note 1}	dB	
40*64*T _c	≥ -3 dB	Between FR1 and FR2
NOTE 1: T _c is the basic timing unit defined in TS 38.211 [6].		
NOTE 2: The parameter \hat{E}_s/lot is the minimum \hat{E}_s/lot of the pair of cells to which the requirement applies.		

10.1.21.3 Inter frequency SFTD accuracy requirements

The SFN and frame timing difference (SFTD) is measured between PCell and inter-frequency neighbour cell.

The accuracy requirements in Table 10.1.21.3-3 are applicable under the following conditions:

For FR1 PCell, inter frequency neighbour cell SFN and frame timing measurement:

- Conditions defined in clause 7.3 of TS 38.101-1 [18] for reference sensitivity are fulfilled.
- I_o range defined in Table 10.1.21.3-1.

Table 10.1.21.3-1: PCell, inter frequency neighbour cell I_o range conditions in FR1

Parameter	I_o ^{Note 1} range			
	NR operating band groups ^{Note 2}	Minimum I_o		Maximum I_o
		dBm/ SCS _{SSB}		
		SCS _{SSB} = 15 kHz	SCS _{SSB} = 30 kHz	dBm/BW _{Channel}
Conditions	NR_FDD_FR1_A, NR_TDD_FR1_A	-121	-118	-50
	NR_FDD_FR1_B	-120.5	-117.5	-50
	NR_TDD_FR1_C	-120	-117	-50
	NR_FDD_FR1_D, NR_TDD_FR1_D	-119.5	-116.5	-50
	NR_FDD_FR1_E, NR_TDD_FR1_E	-119	-116	-50
	NR_FDD_FR1_G	-118	-115	-50
	NR_FDD_FR1_H	-117.5	-114.5	-50
NOTE 1: I_o is assumed to have constant EPRE across the bandwidth.				
NOTE 2: NR operating band groups are as defined in clause 3.5.2.				

For FR2 PCell, inter frequency neighbour cell SFN and frame timing measurement:

- Conditions defined in clause 7.3 of TS 38.101-2 [19] for reference sensitivity are fulfilled.
- I_o range defined in Table 10.1.21.3-2.
- The measured signals are in the directions covered by the percentile EIS spherical coverage of the UE, defined in clause 7.3.4 of TS 38.101-2 [19].

Table 10.1.21.3-2: PCell, inter frequency neighbour cell I_o range conditions in FR2

Parameter	I_o ^{Note 1} range
-----------	-------------------------------

	Minimum I_o ^{Note 2, 3}		Maximum I_o
	dBm/ SCS_{SSB}		dBm/BW _{Channel}
	$SCS_{SSB} = 15$ kHz	$SCS_{SSB} = 30$ kHz	
Conditions	Same value as SSB_RP in Table B.2.4.1-2, according to UE Power class, operating band and angle of arrival	Same value as SSB_RP in Table B.2.4.1-2, according to UE Power class, operating band and angle of arrival	-50
NOTE 1: I_o is assumed to have constant EPRE across the bandwidth and specified at the Reference point.			
NOTE 2: Values based on Refsens and EIS spherical coverage as defined in clauses 7.3.2 and 7.3.4 of TS 38.101-2 [19]. Applicable side condition selected depending on angle of arrival.			
NOTE 3: In the test cases, the SSB \hat{E}_s/I_{ot} and related parameters may need to be adjusted to ensure \hat{E}_s/I_{ot} at UE baseband is above the value defined in this table.			

Table 10.1.21.3-3: Inter frequency SFTD measurement accuracy

Accuracy	Conditions	
	\hat{E}_s/I_{ot} ^{Note 2}	Frequency range
T_s ^{Note 1}	dB	
$40 \cdot 64 \cdot T_c$	≥ -3 dB	FR1, FR2
NOTE 1: T_c is the basic timing unit defined in TS 38.211 [6].		
NOTE 2: The parameter \hat{E}_s/I_{ot} is the minimum \hat{E}_s/I_{ot} of the pair of cells to which the requirement applies.		

10.2 E-UTRAN measurements

10.2.1 Introduction

Accuracy requirements for measurements on E-UTRAN carrier frequencies are specified in clause 10.2 and apply for UE in SA or NR-DC or NE-DC operation mode.

The requirements in clause 10.2 are applicable for a UE:

- in RRC_CONNECTED state
- performing measurements with appropriate measurement gaps according to clause 9.1.2.
- that is synchronised to the cell that is measured.

The reported measurement result after layer 1 filtering shall be an estimate of the average value of the measured quantity over the measurement period. The reference point for the measurement result after layer 1 filtering is referred to as point B in the measurement model described in TS 36.300 [24].

The accuracy requirements of E-UTRA measurements in this clause are valid for the reported measurement result after layer 1 filtering. The accuracy requirements are verified from the measurement report at point D in the measurement model having the layer 3 filtering disabled.

If the UE needs measurement gaps to perform the inter-RAT NR — E-UTRAN FDD and NR — E-UTRAN TDD measurements, the relevant measurement procedure and measurement gap patterns stated in clause 9.1.2 shall apply.

10.2.2 E-UTRAN RSRP measurements

NOTE: This measurement is for handover between NR and E-UTRAN.

The measurement period of E-UTRA RSRP in RRC_CONNECTED state is specified in clause 9.4.2 and 9.4.3.

The accuracy requirements of E-UTRA RSRP measurements in RRC_CONNECTED state and the corresponding side conditions shall be the same as the inter-frequency RSRP Accuracy Requirements in clause 9.1.3 of TS 36.133 [15].

The reporting range and mapping specified for RSRP measurements in clause 9.1.4 of TS 36.133 [15] shall apply.

10.2.3 E-UTRAN RSRQ measurements

NOTE: This measurement is for handover between NR and E-UTRAN.

The measurement period of E-UTRA RSRQ in RRC_CONNECTED state is specified in clause 9.4.2 and 9.4.3.

The accuracy requirements of E-UTRA RSRQ measurements in RRC_CONNECTED state and the corresponding side conditions shall be the same as the inter-frequency RSRQ Accuracy Requirements in clause 9.1.6 of TS 36.133 [15].

The requirements for accuracy of E-UTRA RSRQ measurements in RRC_CONNECTED state and the corresponding side conditions shall be the same as the inter-frequency RSRQ Accuracy Requirements in clause 9.1.6 of TS 36.133 [15].

The reporting range and mapping specified for RSRQ measurements in clause 9.1.7 of TS 36.133 [15] shall apply.

10.2.4 E-UTRAN RSTD measurements

The requirements in this clause are valid for UE supporting this capability.

The measurement period is specified in clauses 9.4.4.1 and 9.4.4.2 for inter-RAT NR — E-UTRAN FDD and inter-RAT NR — E-UTRAN TDD RSTD measurements, respectively.

The accuracy requirements and the corresponding side conditions shall be the same as the inter-frequency measurement accuracy requirements for RSTD measurements in RRC_CONNECTED in clause 9.1.10.2 of TS 36.133 [15].

If the UE needs measurement gaps to perform the inter-RAT NR — E-UTRAN FDD and NR — E-UTRAN TDD RSTD measurements, the relevant measurement procedure and measurement gap patterns stated in clause 9.1.2 shall apply.

The reporting range and mapping for the inter-RAT NR — E-UTRAN FDD and NR — E-UTRAN TDD RSTD measurements is the same as specified for RSTD measurements in TS 36.133 [15, clauses 9.1.10.3 and 9.1.10.4].

10.2.5 E-UTRAN RS-SINR measurements

NOTE: This measurement is for handover between NR and E-UTRAN.

The measurement period of E-UTRA RS-SINR in RRC_CONNECTED state is specified in clause 9.4.2 and 9.4.3.

The accuracy requirements of E-UTRA RS-SINR measurements in RRC_CONNECTED state and the corresponding side conditions shall be the same as the inter-frequency RS-SINR Accuracy Requirements in clause 9.1.17.3 of TS 36.133 [15].

The reporting range and mapping for E-UTRA RS-SINR measurements shall be the same as specified for RS-SINR measurements in clause 9.1.17.1 of TS 36.133 [15].

11 Void

Annex A (normative): Test Cases

A.1 Purpose of annex

A.2 Requirement classification for statistical testing

Requirements in this specification are either expressed as absolute requirements with a single value stating the requirement, or expressed as a success rate. There are no provisions for the statistical variations that will occur when the parameter is tested.

Annex A outlines the tests in more detail and lists the test parameters needed. The test will result in an outcome of a test variable value for the device under test (DUT) inside or outside the test limit. Overall, the probability of a "good" DUT being inside the test limit(s) and the probability of a "bad" DUT being outside the test limit(s) should be as high as possible. For this reason, when selecting the test variable and the test limit(s), the statistical nature of the test is accounted for.

The statistical nature depends on the type of requirement. Some have large statistical variations, while others are not statistical in nature at all. When testing a parameter with a statistical nature, a confidence level is set. This establishes the probability that a DUT passing the test actually meets the requirements and determines how many times a test has to be repeated and what the pass and fail criteria are. Those aspects are not covered by TS 38.133. The details of the tests on how many times to run it and how to establish confidence in the tests are described in TS 38.533 [5]. This Annex establishes the variable to be used in the test and whether it can be viewed as statistical in nature or not.

A.2.1 Types of requirements in TS 38.133

A.2.1.1 Time and delay requirements on UE higher layer actions

A very large part of the RRM requirements are delay requirements:

- In RRC_IDLE state mobility (clause A.6.1 and A.7.1) there is cell re-selection delay.
- In RRC_CONNECTED state mobility (clauses A.4.3, A.4.6, A.5.3, A.5.6, A.6.3, A.6.6, A.7.3 and A.7.6) there is handover delay, cell search delay and measurement reporting delay.
- In RRC Connection Control (clauses A.4.3.2, A.5.3.2, A.6.3.2 and A.7.3.2) there is RRC re-establishment delay.

All have in common that the UE is required to perform an action observable in higher layers (e.g. camp on the correct cell) within a certain time after a specific event (e.g. when a new strong pilot or reference signal appears). The delay time is statistical in nature for several reasons, among others that several of the measurements are performed by the UE in a fading radio environment.

The variations make a strict limit unsuitable for a test. Instead there is a condition set for a correct action by the UE, e.g. that the UE shall camp on the correct cell within X seconds. Then the rate of correct events is observed during repeated tests and a limit is set on the rate of correct events, usually 90% correct events are required. How the limit is applied in the test depends on the confidence required, further detailed are in TS 38.533 [5].

A.2.1.2 Measurements of power levels, relative powers and time

A very large number of requirements are on measurements that the UE performs:

- In RRC_CONNECTED state mobility (clauses A.4.3, A.5.3, A.6.3 and A.7.3) there are measurement reports.
- In Measurement Performance Requirements (clauses A.4.7, A.5.7, A.6.7 and A.7.7) there are requirements for all type of measurements.

The accuracy requirements on measurements are expressed in this specification as a fixed limit (e.g. +/-X dB), but the measurement error will have a distribution that is not easily confined in fixed limits. Assuming a Gaussian distribution of the error, the limits will have to be set at $\pm 3.29\sigma$ if the probability of failing a "good DUT" in a single test is to be kept at 0.1%. It is more reasonable to set the limit tighter and test the DUT by counting the rate of measurements that are within the limits, in a way similar to the requirements on delay.

A.2.1.3 Implementation requirements

A few requirements are strict actions the UE should take or capabilities the UE should have, without any allowance for deviations. These requirements are absolute and should be tested as such. Examples are:

- "Event triggered report rate" in RRC_CONNECTED state mobility (clauses A.4.3, A.4.6, A.5.3, A.5.6, A.6.3, A.6.6, A.7.3 and A.7.6)
- "Correct behaviour at time-out" in RRC connection control (clauses A.4.3.2, A.5.3.2, A.6.3.2 and A.7.3.2)

A.2.1.4 Physical layer timing requirements

There are requirements on Timing (clauses A.4.4, A.5.4, A.6.4 and A.7.4). There are both absolute and relative limits on timing accuracy depending upon the type of requirement. Examples are:

- Initial Transmit Timing (clauses A.4.4.1, A.5.4.1, A.6.4.1 and A.7.4.1) has an absolute limit on timing accuracy.
- Timing Advance (clauses A.4.4.2, A.5.4.2, A.6.4.2 and A.7.4.2) has a relative limit on timing accuracy.

A.3 RRM test configurations

A.3.1 Reference measurement channels

A.3.1.1 PDSCH

A.3.1.1.1 FDD

Table A.3.1.1.1-1: PDSCH Reference Measurement Channels for SCS=15kHz

Parameter	Unit	Value						
Reference channel		SR.1.1 FDD						
Channel bandwidth	MHz	Defined in test case						
Number of transmitter antennas		1						

Allocated resource blocks for PDSCH ^{Note 1}		24						
Allocated slots per Radio Frame		10						
Radio frame containing SSB	slots	Note 5						
Radio frame not containing SSB	slots	10						
MCS index		4						
Modulation		QPSK						
Target Coding Rate		1/3						
Number of control symbols		2						
PDSCH mapping type		Type A						
Information Bit Payload								
For slots with RMSI ^{Note 2}	bits	1608						
For slots without RMSI	bits	1864						
Number of Code Blocks per slot		1						
Binary Channel Bits Per slot								
For slots with RMSI ^{Note 2, Note 4}	bits	5184						
For slots without RMSI ^{Note 6}	bits	6048						
<p>Note 1: Allocated outside the SMTc duration in time and in resource blocks which do not overlap with the resource blocks allocated for SS/PBCH block.</p> <p>Note 2: PDSCH is scheduled on the slots with RMSI.</p> <p>Note 3: If necessary the information bit payload size can be adjusted to facilitate the test implementation. The payload sizes are defined in TS 38.213 [3].</p> <p>Note 4: Derived based on the PDSCH DMRS assumption: dmrs-TypeA-Position=2, dmrs-Type=1, dmrs-AdditionalPositions=2, maxLength=1, Antenna port index: 1000, and Number of PDSCH DMRS CDM group(s) without data: 2.</p> <p>Note 5: PDSCH is not scheduled in slots containing SSB according to the SSB configuration used in the test. SSB configurations are defined in clause A.3.10.</p> <p>Note 6: When DRX is configured, PDCCH can be scheduled both for downlink assignment and/or UL grant only during ([10]ms - drx-InactivityTimer) from timing when drx-onDurationTimer starts, unless otherwise specified in the test case</p>								

A.3.1.1.2 TDD

Table A.3.1.1.2-1: PDSCH Reference Measurement Channels for SCS=15kHz

Parameter	Unit	Value						
Reference channel		SR.1.1 TDD	SR.1.2 TDD					
Channel bandwidth	MHz	Defined in test case	Defined in test case					
Number of transmitter antennas		1	1					
Allocated resource blocks for PDSCH ^{Note 1}		24	24					
Allocated slots per Radio Frame								
Radio frame containing SSB	slots	Note 5	Note 5					
Radio frame not containing SSB	slots	4	6					

MCS table		64QAM	64QAM					
MCS index		4	4					
Modulation		QPSK	QPSK					
Target Coding Rate		1/3	1/3					
Number of control symbols		2	2					
PDSCH mapping type		Type A	Type A					
Information Bit Payload								
For slots with RMSI ^{Note 2}	bits	1608	1608					
For slots without RMSI	bits	1864	1864					
For special slots	bits	N/A	1128					
Number of Code Blocks per slot		1	1					
Binary Channel Bits Per slot								
For slots with RMSI ^{Note 2, Note 4}	bits	5184	5184					
For slots without RMSI ^{Note 6}	bits	6048	6048					
For special slots ^{Note 6}	bits	-	3744					
<p>Note 1: Allocated outside the SMTC duration in time and in resource blocks which do not overlap with the resource blocks allocated for SS/PBCH block.</p> <p>Note 2: PDSCH is scheduled on the slots with RMSI.</p> <p>Note 3: If necessary the information bit payload size can be adjusted to facilitate the test implementation. The payload sizes are defined in TS 38.213 [3].</p> <p>Note 4: Derived based on the PDSCH DMRS assumption: dmrs-TypeA-Position=2, dmrs-Type=1, dmrs-AdditionalPositions=2, maxLength=1, Antenna port index: 1000, and Number of PDSCH DMRS CDM group(s) without data: 2.</p> <p>Note 5: PDSCH is not scheduled in slots containing SSB according to the SSB configuration used in the test. SSB configurations are defined in clause A.3.10.</p> <p>Note 6: Derived based on the PDSCH DMRS assumption: dmrs-TypeA-Position=2, dmrs-Type=1, dmrs-AdditionalPositions=2, maxLength=1, Antenna port index: 1000, and Number of PDSCH DMRS CDM group(s) without data: 1.</p> <p>Note 7: When DRX is configured, PDCCH can be scheduled both for downlink assignment and/or UL grant only during ($[10]ms - drx-InactivityTimer$) from timing when $drx-onDurationTimer$ starts, unless otherwise specified in the test case</p>								

Table A.3.1.1.2-2: PDSCH Reference Measurement Channels for SCS=30kHz

Parameter	Unit	Value						
Reference channel		SR.2.1 TDD						
Channel bandwidth	MHz	Defined in test case						
Number of transmitter antennas		1						
Allocated resource blocks for PDSCH ^{Note 1}		24						
Allocated slots per Radio Frame								
Radio frame containing SSB	slots	Note 5						
Radio frame not containing SSB	slots	10						
MCS table		64QAM						
MCS index		4						
Modulation		QPSK						
Target Coding Rate		1/3						

Number of control symbols		2					
PDSCH mapping type		Type A					
Information Bit Payload							
For slots with RMSI ^{Note 2}	bits	1608					
For slots without RMSI	bits	1864					
Number of Code Blocks per slot		1					
Binary Channel Bits Per slot							
For slots with RMSI ^{Note 2, Note 4}	bits	6048					
<p>Note 1: Allocated outside the SMTC duration in time and in resource blocks which do not overlap with the resource blocks allocated for SS/PBCH block.</p> <p>Note 2: PDSCH is scheduled on the slots with RMSI.</p> <p>Note 3: If necessary the information bit payload size can be adjusted to facilitate the test implementation. The payload sizes are defined in TS 38.213 [3].</p> <p>Note 4: Derived based on the PDSCH DMRS assumption: dmrs-TypeA-Position=2, dmrs-Type=1, dmrs-AdditionalPositions=2, maxLength=1, Antenna port index: 1000, and Number of PDSCH DMRS CDM group(s) without data: 2.</p> <p>Note 5: PDSCH is not scheduled in slots containing SSB according to the SSB configuration used in the test. SSB configurations are defined in clause A.3.10.</p> <p>Note 6: Derived based on the PDSCH DMRS assumption: dmrs-TypeA-Position=2, dmrs-Type=1, dmrs-AdditionalPositions=2, maxLength=1, Antenna port index: 1000, and Number of PDSCH DMRS CDM group(s) without data: 1.</p> <p>Note 7: When DRX is configured, PDCCH can be scheduled both for downlink assignment and/or UL grant only during ([10]ms - drx-InactivityTimer) from timing when drx-onDurationTimer starts, unless otherwise specified in the test case</p>							

Table A.3.1.1.2-3: PDSCH Reference Measurement Channels for SCS=120kHz

Parameter	Unit	Value				
Reference channel		SR.3.1 TDD	SR.3.2 TDD	SR.3.3 TDD		
Channel bandwidth	MHz	100	100	100		
Number of transmitter antennas		1	1	1		
Allocated resource blocks for PDSCH		24 ^{Note 1}	24 ^{Note 7}	48 ^{Note 7}		
Allocated slots per Radio Frame						
Radio frame containing SSB	slots	Note 5	Note 5	Note 5		
Radio frame not containing SSB	slots	48	48	48		
MCS table		64QAM	64QAM	64QAM		
MCS index		4	4	4		
Modulation		QPSK	QPSK	QPSK		
Target Coding Rate		1/3	1/3	1/3		
Number of control symbols		2	2	2		
PDSCH mapping type		Type A	Type A	Type A		
Information Bit Payload						
For slots with RMSI	bits	1608	1608	3104		
For slots without RMSI	bits	1864	1864	3624		
Number of Code Blocks per slot		1	1	1		
Binary Channel Bits Per slot						

For slots with RMSI ^{Note 4}	bits	5184	5184	10368				
For slots without RMSI ^{Note 6}	bits	6048	6048	12096				
<p>Note 1: Allocated in resource blocks which do not overlap with the resource blocks allocated for SS/PBCH block</p> <p>Note 2: Void</p> <p>Note 3: If necessary the information bit payload size can be adjusted to facilitate the test implementation. The payload sizes are defined in TS 38.213 [3].</p> <p>Note 4: Derived based on the PDSCH DMRS assumption: dmrs-TypeA-Position=2, dmrs-Type=1, dmrs-AdditionalPositions=2, maxLength=1, Antenna port index: 1000, and Number of PDSCH DMRS CDM group(s) without data: 2.</p> <p>Note 5: PDSCH is not scheduled in slots containing SSB according to the SSB configuration used in the test. SSB configurations are defined in clause A.3.10.</p> <p>Note 6: Derived based on the PDSCH DMRS assumption: dmrs-TypeA-Position=2, dmrs-Type=1, dmrs-AdditionalPositions=2, maxLength=1, Antenna port index: 1000, and Number of PDSCH DMRS CDM group(s) without data: 1.</p> <p>Note 7: Allocated in the same resource blocks as the CORESET.</p> <p>Note 8: When DRX is configured, PDSCH is scheduled only while <i>drx-onDurationTimer</i> is running, unless otherwise specified in the test case.</p>								

A.3.1.2 CORESET for RMSI scheduling

A.3.1.2.1 FDD

Table A.3.1.2.1-1: RMSI CORESET Reference Channel for FDD with SCS=15KHz

Parameter	Unit	Value						
Reference channel		CR.1.1 FDD						
Channel bandwidth	MHz	Defined in test case						
Subcarrier spacing for RMSI CORESET	kHz	15						
Allocated resource blocks for RMSI CORESET ^{Note 7}		24						
Subcarrier spacing for SSB	kHz	15						
SSB and RMSI CORESET multiplexing configuration ^{Note 7}		Pattern 1						
Offset between SSB and RMSI CORESET ^{Note 3, 7}	RB	0 (Note8)						
Configuration of PDCCH monitoring occasions for RMSI CORESET ^{Note 4}		Index 4						
Number of transmitter antennas		1						
Duration of RMSI CORESET ^{Note 7}	symbols	2						
DCI Format ^{Note 1}		Note 2						
Aggregation level	CCE	8						
DMRS precoder granularity		6						
REG bundle size		6						
Mapping from REG to CCE		Distributed						
Cell ID		Note 5						
Payload (without CRC)	bits	Note 6						
Note 1: DCI formats are defined in TS 38.212.								

Note 2:	DCI format shall depend upon the test configuration.
Note 3:	The offset is defined with respect to the subcarrier spacing of the CORESET from the smallest RB index of RMSI CORESET to the smallest RB index of the common RB overlapping with the first RB of the SS/PBCH block.
Note 4:	The configuration of PDCCH monitoring occasions for RMSI CORESET is defined in Table 13-11 in TS 38.213 [3].
Note 5:	Cell ID shall depend upon the test configuration.
Note 6:	Payload size shall depend upon the test configuration.
Note 7:	The configuration of set of resource blocks and slot symbols of control resource set for Type0-PDCCH search space corresponds to index 0 in Table 13-1 in TS 38.213 [3]
Note 8:	Other values can be used to align with GSCN [13] as long as SSB does not overlap the RMC.

A.3.1.2.2 TDD

Table A.3.1.2.2-1: RMSI CORESET Reference Channel for TDD with SCS=15KHz

Parameter	Unit	Value						
Reference channel		CR.1.1 TDD						
Channel bandwidth	MHz	Defined in test case						
Subcarrier spacing	kHz	15						
Allocated resource blocks for RMSI CORESET ^{Note 7}		24						
SSB and RMSI CORESET multiplexing configuration ^{Note 7}		Pattern 1						
Offset between SSB and RMSI CORESET ^{Note 3, 7}	RB	0 (Note 8)						
Configuration of PDCCH monitoring occasions for RMSI CORESET ^{Note 4}		Index 4						
Number of transmitter antennas		1						
Duration of RMSI CORESET ^{Note 7}	symbols	2						
DCI Format ^{Note 1}		Note 2						
Aggregation level	CCE	8						
DMRS precoder granularity		6						
REG bundle size		6						
Mapping from REG to CCE		Distributed						
Cell ID		Note 5						
Payload (without CRC)	bits	Note 6						
Note 1:	DCI formats are defined in TS 38.212.							
Note 2:	DCI format shall depend upon the test configuration.							
Note 3:	The offset is defined with respect to the subcarrier spacing of the CORESET from the smallest RB index of RMSI CORESET to the smallest RB index of the common RB overlapping with the first RB of the SS/PBCH block.							
Note 4:	The configuration of PDCCH monitoring occasions for RMSI CORESET is defined in Table 13-11 in TS 38.213 [3].							
Note 5:	Cell ID shall depend upon the test configuration.							
Note 6:	Payload size shall depend upon the test configuration.							
Note 7:	The configuration of set of resource blocks and slot symbols of control resource set for Type0-PDCCH search space corresponds to index 0 in Table 13-1 in TS 38.213 [3].							
Note 8:	Other values can be used to align with GSCN [13] as long as SSB does not overlap the RMC.							

Table A.3.1.2.2-2: RMSI CORESET Reference Channel for TDD with SCS=30KHz

Parameter	Unit	Value					
Reference channel		CR.2.1 TDD					
Channel bandwidth	MHz	Defined in test case					
Subcarrier spacing	kHz	30					
Allocated resource blocks for RMSI CORESET ^{Note 7}		24					
SSB and RMSI CORESET multiplexing configuration ^{Note 7}		Pattern 1					
Offset between SSB and RMSI CORESET ^{Note 3, 7}	RB	0 (Note 8)					
Configuration of PDCCH monitoring occasions for RMSI CORESET ^{Note 4}		Index 4					
Number of transmitter antennas		1					
Duration of RMSI CORESET ^{Note 7}	symbols	2					
DCI Format ^{Note 1}		Note 2					
Aggregation level	CCE	8					
DMRS precoder granularity		6					
REG bundle size		6					
Mapping from REG to CCE		Distributed					
Cell ID		Note 5					
Payload (without CRC)	bits	Note 6					
<p>Note 1: DCI formats are defined in TS 38.212.</p> <p>Note 2: DCI format shall depend upon the test configuration.</p> <p>Note 3: The offset is defined with respect to the subcarrier spacing of the CORESET from the smallest RB index of RMSI CORESET to the smallest RB index of the common RB overlapping with the first RB of the SS/PBCH block.</p> <p>Note 4: The configuration of PDCCH monitoring occasions for RMSI CORESET is defined in Table 13-11 in TS 38.213 [3].</p> <p>Note 5: Cell ID shall depend upon the test configuration.</p> <p>Note 6: Payload size shall depend upon the test configuration.</p> <p>Note 7: The configuration of set of resource blocks and slot symbols of control resource set for Type0-PDCCH search space corresponds to index 0 in Table 13-6 in TS 38.213 [3].</p> <p>Note 8: Other values can be used to align with GSCN [13] as long as SSB does not overlap the RMC.</p>							

Table A.3.1.2.2-3: RMSI CORESET Reference Channel for TDD with SCS=120KHz

Parameter	Unit	Value					
Reference channel		CR.3.1 TDD	CR.3.2 TDD				
Channel bandwidth	MHz	100	100				
Subcarrier spacing	kHz	120	120				
Allocated resource blocks for RMSI CORESET		24 ^{Note 7}	48 ^{Note 9}				
SSB and RMSI CORESET multiplexing configuration		Pattern 1 ^{Note 7}	Pattern 1 ^{Note 9}				
Offset between SSB and RMSI CORESET ^{Note 3}	RB	0 (Note 8) ^{Note 7}	0 (Note 8) ^{Note 9}				

Configuration of PDCCH monitoring occasions for RMSI CORESET ^{Note 4}		Index 4	Index 4					
Number of transmitter antennas		1	1					
Duration of RMSI CORESET	symbols	2 ^{Note 7}	2 ^{Note 9}					
DCI Format ^{Note 1}		Note 2	Note 2					
Aggregation level	CCE	8	8					
DMRS precoder granularity		6	6					
REG bundle size		6	6					
Mapping from REG to CCE		Distributed	Distributed					
Cell ID		Note 5	Note 5					
Payload (without CRC)	bits	Note 6	Note 6					
<p>Note 1: DCI formats are defined in TS 38.212.</p> <p>Note 2: DCI format shall depend upon the test configuration.</p> <p>Note 3: The offset is defined with respect to the subcarrier spacing of the CORESET from the smallest RB index of RMSI CORESET to the smallest RB index of the common RB overlapping with the first RB of the SS/PBCH block.</p> <p>Note 4: The configuration of PDCCH monitoring occasions for RMSI CORESET is defined in Table 13-12 in TS 38.213 [3].</p> <p>Note 5: Cell ID shall depend upon the test configuration.</p> <p>Note 6: Payload size shall depend upon the test configuration.</p> <p>Note 7: The configuration of set of resource blocks and slot symbols of control resource set for Type0-PDCCH search space corresponds to index 0 in Table 13-8 in TS 38.213 [3].</p> <p>Note 8: Other values can be used to align with GSCN [13] as long as SSB does not overlap the RMC.</p> <p>Note 9: The configuration of set of resource blocks and slot symbols of control resource set for Type0-PDCCH search space corresponds to index 2 in Table 13-10 in TS 38.213 [3].</p>								

A.3.1.3 CORESET for RMC scheduling

A.3.1.3.1 FDD

Table A.3.1.3.1-1: Control Channel RMC for FDD with SCS=15KHz

Parameter	Unit	Value					
		CCR.1.1 FDD	CCR.1.2 FDD	CCR.1.3 FDD	CCR.1.4 FDD		
Reference channel		Defined in test case	Defined in test case	Defined in test case	Defined in test case		
Channel bandwidth	MHz	15	15	15	15		
Subcarrier spacing	kHz	24	18	24	18		
Allocated resource blocks for CORESET ^{Note 3}		1	1	1	1		
Number of transmitter antennas		2	2	2	2		
Duration of CORESET monitoringSymbolsWithinSlot	symbols	1000000 0000000	1000000 0000000	1000000 0000000	1000000 0000000		
REG bundle size		6	6	6	6		
DMRS precoder granularity		Same as REG bundle size	Same as REG bundle size	Same as REG bundle size	Same as REG bundle size		
CCE to REG mapping		Interleaved	Interleaved	Interleaved	Interleaved		
Interleave n_shift		0	0	0	0		
Interleave size		2	2	2	2		

Beamforming Pre-Coder		N/A	N/A	N/A	N/A			
Aggregation level	CCE	4	2	8	4			
DCI formats		Note 1	Note 1	Note 1	Note 1			
Payload size (without CRC)	bits	Note 2	Note 2	Note 2	Note 2			
Note 1: DCI format shall depend upon the test configuration. Note 2: Payload size shall depend upon the test configuration Note 3: Allocated in the resource blocks where the associated RMC is scheduled.								

A.3.1.3.2 TDD

Table A.3.1.3.2-1: Control Channel RMC for TDD with SCS=15KHz

Parameter	Unit	Value						
		CCR.1.1 TDD	CCR.1.2 TDD	CCR.1.3 TDD	CCR.1.4 TDD			
Reference channel		Defined in test case	Defined in test case	Defined in test case	Defined in test case			
Channel bandwidth	MHz	15	15	15	15			
Subcarrier spacing	kHz	24	18	24	18			
Allocated resource blocks for CORESET <small>Note 3</small>		1	1	1	1			
Number of transmitter antennas		2	2	2	2			
Duration of CORESET monitoringSymbolsWithinSlot	symbols	1000000 0000000	1000000 0000000	1000000 0000000	1000000 0000000			
REG bundle size		6	6	6	6			
DMRS precoder granularity		Same as REG bundle size	Same as REG bundle size	Same as REG bundle size	Same as REG bundle size			
CCE to REG mapping		Interleaved	Interleaved	Interleaved	Interleaved			
Interleave n_shift		0	0	0	0			
Interleave size		2	2	2	2			
Beamforming Pre-Coder		N/A	N/A	N/A	N/A			
Aggregation level	CCE	4	2	8	4			
DCI formats		Note 1	Note 1	Note 1	Note 1			
Payload size (without CRC)	bits	Note 2	Note 2	Note 2	Note 2			
Note 1: DCI format shall depend upon the test configuration. Note 2: Payload size shall depend upon the test configuration Note 3: Allocated in the resource blocks where the associated RMC is scheduled.								

Table A.3.1.3.2-2: Control Channel RMC for TDD with SCS=30KHz

Parameter	Unit	Value			
		CCR.2.1 TDD	CCR.2.2 TDD	CCR.2.3 TDD	CCR.2.4 TDD
Reference channel		Defined in test case	Defined in test case	Defined in test case	Defined in test case
Channel bandwidth	MHz	30	30	30	30
Subcarrier spacing	kHz	24	24	18	18
Allocated resource blocks for CORESET <small>Note 3</small>		1	1	1	1
Number of transmitter antennas		2	2	2	2
Duration of CORESET	symbols	6	6	6	6
REG bundle size		6	6	6	6

DMRS precoder granularity		Same as REG bundle size	Same as REG bundle size	Same as REG bundle size	Same as REG bundle size			
CCE to REG mapping		Interleaved	Interleaved	Interleaved	Interleaved			
Interleave n_shift		0	0	0	0			
Interleave size		2	2	2	2			
Beamforming Pre-Coder		N/A	N/A	N/A	N/A			
Aggregation level	CCE	4	8	4	2			
DCI formats		Note 1	Note 1	Note 1	Note 1			
Payload size (without CRC)	bits	Note 2	Note 2	Note 2	Note 2			
<p>Note 1: DCI format shall depend upon the test configuration.</p> <p>Note 2: Payload size shall depend upon the test configuration.</p> <p>Note 3: Allocated in the same resource blocks where the associated RMC is scheduled.</p>								

Table A.3.1.3.2-3: Control Channel RMC for TDD with SCS=120KHz

Parameter	Unit	Value						
		CCR.3.1 TDD	CCR.3.2 TDD	CCR.3.3 TDD	CCR.3.4 TDD	CCR.3.5 TDD	CCR.3.6 TDD	CCR.3.7 TDD
Reference channel								
Channel bandwidth	MHz	100	100	100	100	100	100	100
Subcarrier spacing	kHz	120	120	120	120	120	120	120
Allocated resource blocks for CORESET ^{Note 3}		24	24	24	24	24	24	48
Number of transmitter antennas		1	1	1	1	1	1	1
monitoringSlotPeriodicityAndOffset ^{Note 4}		sl160 0	sl160 0	sl160 80	sl160 0	sl160 0	sl160 80	sl160 0
monitoringSymbolsWithinSlot		1100000 0000000	0011000 0000000	1100000 0000000	1000000 0000000	0010000 0000000	1000000 0000000	1100000 0000000
Duration of CORESET	slot	1	1	1	2	2	2	1
REG bundle size		6	6	6	6	6	6	6
DMRS precoder granularity		Same as REG bundle size	Same as REG bundle size	Same as REG bundle size	Same as REG bundle size	Same as REG bundle size	Same as REG bundle size	Same as REG bundle size
CCE to REG mapping		Interleaved	Interleaved	Interleaved	Interleaved	Interleaved	Interleaved	Interleaved
Interleave n_shift		0	0	0	0	0	0	0
Interleave size		2	2	2	2	2	2	2
Beamforming Pre-Coder		N/A	N/A	N/A	N/A	N/A	N/A	N/A
Aggregation level	CCE	4	4	4	8	8	8	4
DCI formats		Note 1	Note 1	Note 1	Note 1	Note 1	Note 1	Note 1
Payload size (without CRC)	bits	Note 2	Note 2	Note 2	Note 2	Note 2	Note 2	Note 2
<p>Note 1: DCI format shall depend upon the test configuration.</p> <p>Note 2: Payload size shall depend upon the test configuration.</p> <p>Note 3: Allocated in the same resource blocks where the associated PDSCH RMC is scheduled.</p> <p>Note 4: <i>monitoringSlotPeriodicityAndOffset</i> is set to "sl1 0" if it is specifically stated that cell(s) configured with one of the control channel RMCs above shall transmit PDCCHs continuously.</p>								

A.3.1.4 TDD UL/DL configuration

Table A.3.1.4-1: TDD UL/DL configuration for SCS=15kHz

Parameter	Unit	Value	
Reference channel		TDDConf.1.1	
<i>referenceSubcarrierSpacing</i>	kHz	15	
TDD UL/DL pattern 1 ^{Note 2}		'DSUU' S='10DL:2GP:2UL'	
<i>dl-UL-TransmissionPeriodicity</i>	ms	4	
<i>nrofDownlinkSlots</i>		1	
<i>nrofDownlinkSymbols</i>		10	
<i>nrofUplinkSlot</i>		2	
<i>nrofUplinkSymbols</i>		2	
TDD UL/DL pattern 2 ^{Note 2}		'D'	
<i>dl-UL-TransmissionPeriodicity</i>	ms	1	
<i>nrofDownlinkSlots</i>		1	
<i>nrofDownlinkSymbols</i>		0	
<i>nrofUplinkSlot</i>		0	
<i>nrofUplinkSymbols</i>		0	
Note 1: As specified in TS 38.213 [3] and TS 38.331 [2].			
Note 2: For information			

Table A.3.1.4-2: TDD UL/DL configuration for SCS=30kHz

Parameter	Unit	Value	
Reference channel		TDDConf.2.1	
<i>referenceSubcarrierSpacing</i>	kHz	30	
TDD UL/DL pattern 1 ^{Note 2}		'3D1S4U' S='6DL:4GP:4UL'	
<i>dl-UL-TransmissionPeriodicity</i>	ms	4	
<i>nrofDownlinkSlots</i>		3	
<i>nrofDownlinkSymbols</i>		6	
<i>nrofUplinkSlot</i>		4	
<i>nrofUplinkSymbols</i>		4	
TDD UL/DL pattern 2 ^{Note 2}		'DD'	
<i>dl-UL-TransmissionPeriodicity</i>	ms	1	
<i>nrofDownlinkSlots</i>		2	
<i>nrofDownlinkSymbols</i>		0	
<i>nrofUplinkSlot</i>		0	
<i>nrofUplinkSymbols</i>		0	
Note 1: As specified in TS 38.213 [3] and TS 38.331 [2].			
Note 2: For information			

Table A.3.1.4-3: TDD UL/DL configuration for SCS=120kHz

Parameter	Unit	Value	
Reference channel		TDDConf.3.1	
<i>referenceSubcarrierSpacing</i>	kHz	120	
TDD UL/DL pattern 1 ^{Note 2}		'DDDSU'	

		S='10DL:2GP:2UL'	
<i>dl-UL-TransmissionPeriodicity</i>	ms	0.625	
<i>nrofDownlinkSlots</i>		3	
<i>nrofDownlinkSymbols</i>		10	
<i>nrofUplinkSlot</i>		1	
<i>nrofUplinkSymbols</i>		2	
TDD UL/DL pattern 2 ^{Note 2}		Not configured	
<i>dl-UL-TransmissionPeriodicity</i>	ms	Not configured	
<i>nrofDownlinkSlots</i>		Not configured	
<i>nrofDownlinkSymbols</i>		Not configured	
<i>nrofUplinkSlot</i>		Not configured	
<i>nrofUplinkSymbols</i>		Not configured	
Note 1:	As specified in TS 38.213 [3] and TS 38.331 [2].		
Note 2:	For information		

A.3.2 OFDMA channel noise generator (OCNG)

A.3.2.1 Generic OFDMA Channel Noise Generator (OCNG)

The OCNG pattern is used in a test for modelling allocations of unused resources in the channel bandwidth to virtual UEs (which are not under test). The OCNG pattern comprises PDCCH and PDSCH transmissions to the virtual UEs.

A.3.2.1.1 OCNG pattern 1: Generic OCNG pattern for all unused REs

Table A.3.2.1.1-1: OP.1: Generic OCNG pattern for all unused REs

OCNG Parameters	Control Region	Data Region
Resource allocation	Unused REs (Note 1)	Unused REs (Note 2)
Channel	PDCCH	PDSCH
Contents	Virtual UE IDs	Uncorrelated pseudo random QPSK modulated data
Antenna transmission scheme	Same as used in PDCCH RMC	Same as used in PDSCH RMC
Subcarrier spacing	Same as used in PDCCH RMC	Same as used in PDSCH RMC
Aggregation level	Same as used in PDCCH RMC	N/A
Code rate	Same as used in PDCCH RMC	Same as used in PDSCH RMC
Transmit Power	Same as used in PDCCH RMC	Same as used in PDSCH RMC
CP length	Same as used in PDCCH RMC	Same as used in PDSCH RMC
Note 1:	REs not used in the active CORESETs where PDCCH is scheduled for the UE under test.	
Note 2:	REs not allocated to any physical channels, CORESET, SSB or any other reference signal within the channel bandwidth of the cell, confined to $BW_{occupied}$ where specified in the test case.	

A.3.2.1.2 OCNG pattern 2: Generic OCNG pattern for all unused REs for 2AoA setup

Table A.3.2.1.2-2: OP.2: Generic OCNG pattern for all unused REs for 2AoA setup

OCNG Parameters	Control Region	Data Region
Probe	Transmitting the serving beam	

Resource allocation	Unused REs (Note 1) in the symbols where SSB/CSI-RS are not transmitted from both the serving beam probe and non-serving beam probe.	Unused REs (Note 2) in the symbols where SSB/CSI-RS are not transmitted from both the serving beam probe and non-serving beam probe.
Channel	PDCCH	PDSCH
Contents	Virtual UE IDs	Uncorrelated pseudo random QPSK modulated data
Antenna transmission scheme	Same as used in PDCCH RMC	Same as used in PDSCH RMC
Subcarrier spacing	Same as used in PDCCH RMC	Same as used in PDSCH RMC
Aggregation level	Same as used in PDCCH RMC	N/A
Code rate	Same as used in PDCCH RMC	Same as used in PDSCH RMC
Transmit Power	Same as used in PDCCH RMC	Same as used in PDSCH RMC
CP length	Same as used in PDCCH RMC	Same as used in PDSCH RMC
Note 1:	REs not used in the active CORESETs where PDCCH is scheduled for the UE under test.	
Note 2:	REs not allocated to any physical channels, CORESET, SSB or any other reference signal within the channel bandwidth of the cell, confined to $BW_{occupied}$ where specified in the test case	
Note 3:	No OCNG is transmitted from the probe transmitting non-serving beam.	

A.3.2.1.3 OCNG pattern 3: Generic OCNG pattern for unused REs in the same bandwidth as CORESET

Table A.3.2.1.3-1: OP.3: Generic OCNG pattern for unused REs in the same BW as CORESET

OCNG Parameters	Control Region	Data Region
Resource allocation	Unused REs (Note 1)	Unused REs (Note 2)
Channel	PDCCH	PDSCH
Contents	Virtual UE IDs	Uncorrelated pseudo random QPSK modulated data
Antenna transmission scheme	Same as used in PDCCH RMC	Same as used in PDSCH RMC
Subcarrier spacing	Same as used in PDCCH RMC	Same as used in PDSCH RMC
Aggregation level	Same as used in PDCCH RMC	N/A
Code rate	Same as used in PDCCH RMC	Same as used in PDSCH RMC
Transmit Power	Same as used in PDCCH RMC	Same as used in PDSCH RMC
CP length	Same as used in PDCCH RMC	Same as used in PDSCH RMC
Note 1:	REs not used in the active CORESETs where PDCCH is scheduled for the UE under test. REs for OCNG shall not be allocated outside the allocated bandwidth of the CORESET of the serving cell.	
Note 2:	REs not allocated to any physical channels, CORESET, SSB or any other reference signal within the allocated bandwidth of the CORESET of the serving cell. REs for OCNG shall not be allocated outside the allocated bandwidth of the CORESET of the serving cell.	

A.3.2.1.4 OCNG pattern 4: Generic OCNG pattern for all unused REs outside SSB slot(s)

Table A.3.2.1.4-1: OP.4: Generic OCNG pattern for all unused REs outside SSB slot(s)

OCNG Parameters	Control Region	Data Region
Resource allocation	Unused REs (Note 1)	Unused REs (Note 2)
Channel	PDCCH	PDSCH
Contents	Virtual UE IDs	Uncorrelated pseudo random QPSK modulated data

Antenna transmission scheme	Same as used in PDCCH RMC	Same as used in PDSCH RMC
Subcarrier spacing	Same as used in PDCCH RMC	Same as used in PDSCH RMC
Aggregation level	Same as used in PDCCH RMC	N/A
Code rate	Same as used in PDCCH RMC	Same as used in PDSCH RMC
Transmit Power	Same as used in PDCCH RMC	Same as used in PDSCH RMC
CP length	Same as used in PDCCH RMC	Same as used in PDSCH RMC
Note 1:	REs not used in the active CORESETs where PDCCH is scheduled for the UE under test. REs for OCNG shall not be allocated in the slot(s) containing SSB of the respective cell.	
Note 2:	REs not allocated to any physical channels, CORESET, SSB or any other reference signal within the channel bandwidth of the cell. REs for OCNG shall not be allocated in the slot(s) containing SSB of the respective cell.	

A.3.2.1.5 OCNG pattern 5: Generic OCNG pattern for unused REs in the same bandwidth as CORESET for 2AoA setup

Table A.3.2.1.5-1: OP.5: Generic OCNG pattern for unused REs in the same BW as CORESET for 2AoA setup

OCNG Parameters	Control Region	Data Region
Probe	Transmitting the serving beam	
Resource allocation	Unused REs (Note 1) in the symbols where SSB/CSI-RS are not transmitted from both the serving beam probe and non-serving beam probe.	Unused REs (Note 2) in the symbols where SSB/CSI-RS are not transmitted from both the serving beam probe and non-serving beam probe.
Channel	PDCCH	PDSCH
Contents	Virtual UE IDs	Uncorrelated pseudo random QPSK modulated data
Antenna transmission scheme	Same as used in PDCCH RMC	Same as used in PDSCH RMC
Subcarrier spacing	Same as used in PDCCH RMC	Same as used in PDSCH RMC
Aggregation level	Same as used in PDCCH RMC	N/A
Code rate	Same as used in PDCCH RMC	Same as used in PDSCH RMC
Transmit Power	Same as used in PDCCH RMC	Same as used in PDSCH RMC
CP length	Same as used in PDCCH RMC	Same as used in PDSCH RMC
Note 1:	REs not used in the active CORESETs where PDCCH is scheduled for the UE under test. REs for OCNG shall not be allocated outside the allocated bandwidth of the CORESET of the serving cell.	
Note 2:	REs not allocated to any physical channels, CORESET, SSB or any other reference signal within the allocated bandwidth of the CORESET of the serving cell. REs for OCNG shall not be allocated outside the allocated bandwidth of the CORESET of the serving cell.	
Note 3:	No OCNG is transmitted from the probe transmitting non-serving beam.	

A.3.2.2 Void

A.3.3 Reference DRX configurations

A.3.3.1 DRX Configuration 1: DRX cycle = 40 ms and TAT = 500 ms

Table A.3.3.1-1: DRX.1: DRX cycle = 40 ms and time alignment timer (TAT) = 500 ms

Field	Value
drx-onDurationTimer	1 ms
drx-InactivityTimer	1 ms
drx-RetransmissionTimerDL	1 slot
drx-RetransmissionTimerUL	1 slot
drx-LongCycleStartOffset	40 ms
shortDRX	disable
TimeAlignmentTimer	500 ms
Note:	This DRX configuration is applicable for NR serving cell. The DRX cycle and time alignment timer parameters are specified in clause 6.3.2 in TS 38.331 [2]

A.3.3.2 DRX Configuration 2: DRX cycle = 640 ms and TAT = 500 ms

Table A.3.3.2-1: DRX.2: DRX cycle = 640 ms and time alignment timer (TAT) = 500 ms

Field	Value
drx-onDurationTimer	1 ms
drx-InactivityTimer	1 ms
drx-RetransmissionTimerDL	1 slot
drx-RetransmissionTimerUL	1 slot
drx-LongCycleStartOffset	640 ms
shortDRX	disable
TimeAlignmentTimer	500 ms
Note:	This DRX configuration is applicable for NR serving cell. The DRX cycle and time alignment timer parameters are specified in clause 6.3.2 in TS 38.331 [2]

A.3.3.3 DRX Configuration 3: DRX cycle = 40 ms and TAT = Infinity

Table A.3.3.3-1: DRX.3: DRX cycle = 40 ms and time alignment timer (TAT) = Infinity

Field	Value
drx-onDurationTimer	6 ms
drx-InactivityTimer	1 ms
drx-RetransmissionTimerDL	1 slot
drx-RetransmissionTimerUL	1 slot
drx-LongCycleStartOffset	40 ms
shortDRX	disable
TimeAlignmentTimer	Infinity
Note:	This DRX configuration is applicable for NR serving cell. The DRX cycle and time alignment timer parameters are specified in clause 6.3.2 in TS 38.331 [2]

A.3.3.4 DRX Configuration 4: DRX cycle = 160 ms and TAT = Infinity

Table A.3.3.4-1: DRX.4: DRX cycle = 160 ms and time alignment timer (TAT) = Infinity

Field	Value
drx-onDurationTimer	psf2
drx-InactivityTimer	psf2
drx-RetransmissionTimer	Psf16
longDRX-CycleStartOffset	sf160, 0
shortDRX	disable
TimeAlignmentTimer	Infinity
Note:	This DRX configuration is applicable for E-UTRA serving cell. For further information see clause 6.3.2 in TS 36.331 [16].

A.3.3.5 DRX Configuration 5: DRX cycle = 320 ms and TAT = Infinity

Table A.3.3.5-1: DRX.5: DRX cycle = 320 ms and time alignment timer (TAT) = Infinity

Field	Value
drx-onDurationTimer	psf6
drx-InactivityTimer	psf1920
drx-RetransmissionTimer	psf16
longDRX-CycleStartOffset	sf320, 0
shortDRX	disable
TimeAlignmentTimer	Infinity
Note:	This DRX configuration is applicable for E-UTRA serving cell. For further information see clause 6.3.2 in TS 36.331 [16].

A.3.3.6 DRX Configuration 6: DRX cycle = 320 ms and TAT = 500 ms

Table A.3.3.6-1: DRX.6: DRX cycle = 320 ms and time alignment timer (TAT) = 500 ms

Field	Value
drx-onDurationTimer	1 ms
drx-InactivityTimer	1 ms
drx-RetransmissionTimerDL	1 slot
drx-RetransmissionTimerUL	1 slot
drx-LongCycleStartOffset	320 ms
shortDRX	disable
TimeAlignmentTimer	500 ms
Note:	This DRX configuration is applicable for NR serving cell. The DRX cycle and time alignment timer parameters are specified in clause 6.3.2 in TS 38.331 [2]

A.3.3.7 DRX Configuration 7: DRX cycle = 640 ms and TAT = Infinity

Table A.3.3.7-1: DRX.7: DRX cycle = 640 ms and time alignment timer (TAT) = Infinity

Field	Value
drx-onDurationTimer	6 ms
drx-InactivityTimer	1 ms
drx-RetransmissionTimerDL	1 slot
drx-RetransmissionTimerUL	1 slot
drx-LongCycleStartOffset	640 ms
shortDRX	disable
TimeAlignmentTimer	Infinity
Note:	This DRX configuration is applicable for NR serving cell. The DRX cycle and time alignment timer parameters are specified in clause 6.3.2 in TS 38.331 [2]

A.3.3.8 DRX Configuration 8: DRX cycle = 320 ms and TAT = Infinity

Table A.3.3.8-1: DRX.8: DRX cycle = 320 ms and time alignment timer (TAT) = Infinity

Field	Value
drx-onDurationTimer	6 ms
drx-InactivityTimer	1 ms
drx-RetransmissionTimerDL	1 slot
drx-RetransmissionTimerUL	1 slot
drx-LongCycleStartOffset	320 ms
shortDRX	disable
TimeAlignmentTimer	Infinity
Note:	This DRX configuration is applicable for NR serving cell. The DRX cycle and time alignment timer parameters are specified in clause 6.3.2 in TS 38.331 [2]

A.3.3.9 DRX Configuration 9: DRX cycle = 40 ms and TAT = 500 ms

Table A.3.3.9-1: DRX.9: DRX cycle = 40 ms and time alignment timer (TAT) = 500 ms

Field	Value
drx-onDurationTimer	psf2
drx-InactivityTimer	psf2
drx-RetransmissionTimer	psf16
longDRX-CycleStartOffset	sf40, 0
shortDRX	disable
TimeAlignmentTimer	500 ms
Note:	This DRX configuration is applicable for E-UTRA serving cell. For further information see clause 6.3.2 in TS 36.331 [16].

A.3.3.10 DRX Configuration 10: DRX cycle = 640 ms and TAT = 500 ms

Table A.3.3.10-1: DRX.10: DRX cycle = 640 ms and time alignment timer (TAT) = 500 ms

Field	Value
drx-onDurationTimer	psf6
drx-InactivityTimer	psf2
drx-RetransmissionTimer	psf16
longDRX-CycleStartOffset	sf640, 0
shortDRX	disable
TimeAlignmentTimer	500 ms
Note:	This DRX configuration is applicable for E-UTRA serving cell. For further information see clause 6.3.2 in TS 36.331 [16].

A.3.3.11 DRX Configuration 11: DRX cycle = 20 ms and TAT = Infinity

Table A.3.3.11-1: DRX.11: DRX cycle = 20 ms and time alignment timer (TAT) = Infinity

Field	Value
drx-onDurationTimer	6 ms
drx-InactivityTimer	1 ms
drx-RetransmissionTimerDL	1 slot
drx-RetransmissionTimerUL	1 slot
drx-LongCycleStartOffset	20 ms
shortDRX	disable
TimeAlignmentTimer	Infinity
Note:	This DRX configuration is applicable for NR serving cell. The DRX cycle and time alignment timer parameters are specified in clause 6.3.2 in TS 38.331 [2].

A.3.3.12 DRX Configuration 12: DRX cycle = 640 ms and TAT = Infinity

Table A.3.3.12-1: DRX.12: DRX cycle = 640 ms and time alignment timer (TAT) = Infinity

Field	Value
drx-onDurationTimer	psf6
drx-InactivityTimer	psf2
drx-RetransmissionTimer	psf16
longDRX-CycleStartOffset	sf640, 0
shortDRX	disable
TimeAlignmentTimer	Infinity
Note:	This DRX configuration is applicable for E-UTRA serving cell. For further information see clause 6.3.2 in TS 36.331 [16].

A.3.4 Test Cases with Different Channel Bandwidths

A.3.4.1 Test Cases with Different E-UTRA Channel Bandwidths

A.3.4.1.1 Introduction

In Annex A test cases involving E-UTRA cell(s) may be defined with different E-UTRA channel bandwidths to verify the same type of RRM requirement.

A.3.4.1.2 Principle of testing

If multiple test cases involving E-UTRA cell(s) are defined with different E-UTRA channel bandwidths to verify the same type of RRM requirement that is E-UTRA channel bandwidth independent, then the UE needs to be tested with only one channel bandwidth in each E-UTRA cell and with the same bandwidth in all the E-UTRA cells used in the test case.

A.3.5 Test Cases for Synchronous and Asynchronous DC Operations

A.3.5.1 EN-DC Test Cases for Synchronous and Asynchronous EN-DC Operations

A.3.5.1.1 Introduction

This clause defines a principle which is applicable to test cases verifying RRM requirements for EN-DC operation in synchronous and asynchronous scenarios.

In Annex A test cases may be defined in both synchronous EN-DC and asynchronous EN-DC scenarios to verify the same type of RRM requirement.

A.3.5.1.2 Principle of Testing

If EN-DC test cases are defined in both synchronous and asynchronous EN-DC scenarios to verify the same type of RRM requirement then the UE capable of both synchronous and asynchronous EN-DC operations needs to be tested with one of the tests in either synchronous or asynchronous EN-DC scenarios.

A.3.6 Antenna configurations

A.3.6.1 Antenna configurations for FR1

Unless otherwise specified, NR FDD or NR TDD cells in all RRM Test cases in AWGN propagation condition are configured with Antenna Configuration 1x2.

A.3.6.1.1 Antenna connection for 4 Rx capable UEs

A.3.6.1.1.1 Introduction

All tests in clause A.4 and A.6 are specified for UEs supporting 2RX. In this clause, the antenna connection method for applying 2RX tests to UEs supporting 4RX antenna ports is specified. No tests are currently specified in clause A.4 or A.6 which are applicable only to 4RX antenna ports, so 4RX capable UEs are always tested by reusing tests which were originally specified for 2RX UEs.

A.3.6.1.1.2 Principle of testing

A.3.6.1.1.2.1 Single carrier tests

For 4RX capable UEs supporting at least one band where 2RX is supported and 4RX is not supported, all single carrier tests specified in clause A.4 and A.6 except those in A.4.7 and A.6.7 shall be tested on any band where 2RX is supported and 4RX is not supported with the antenna connection specified in A.3.6.1.1.2.4. For single carrier tests specified in clause A.4.7 or A.6.7, all tests shall be tested with the antenna connection specified in A.3.6.1.1.2.4 for bands where 2RX is supported and 4RX is not supported, and the antenna connection specified in A.3.6.1.1.2.5 for bands where 4RX is supported.

For 4RX capable UEs which do not support any band where 2RX is supported and 4RX is not supported, all tests specified in clauses A.4 and A.6 shall be tested using the antenna connection specified in clause A.3.6.1.1.2.5. For radio link monitoring tests, the SNR levels are modified according to table A.3.6.1.1.2.1-1 and table A.3.6.1.1.2.1-2. For beam failure detection and link recovery tests, the SNR levels are modified according to table A.3.6.1.1.2.1-3.

Table A.3.6.1.1.2.1-1: Modified parameters for RLM out of sync testing with 4 RX antenna connection

Test case	SNR during T3 (dB)			
	Test 1	Test 2	Test 3	Test 4
A.4.5.1.1	-18	N/A	N/A	N/A
A.4.5.1.3	-18	N/A	N/A	N/A
A.4.5.1.5	-18	N/A	N/A	N/A
A.4.5.1.7	-18	N/A	N/A	N/A
A.5.5.1.1	-18	N/A	N/A	N/A
A.5.5.1.3	-18	N/A	N/A	N/A
A.5.5.1.5	-18	N/A	N/A	N/A
A.5.5.1.7	-18	N/A	N/A	N/A
A.6.5.1.1	-18	N/A	N/A	N/A
A.6.5.1.3	-18	N/A	N/A	N/A
A.6.5.1.5	-18	N/A	N/A	N/A
A.6.5.1.7	-18	N/A	N/A	N/A
A.7.5.1.1	-18	N/A	N/A	N/A
A.7.5.1.3	-18	N/A	N/A	N/A
A.7.5.1.5	-18	N/A	N/A	N/A
A.7.5.1.7	-18	N/A	N/A	N/A

Table A.3.6.1.1.2.1-2: Modified parameters for RLM in sync single carrier testing with 4 RX antenna connection

Test case	SNR during T3 (dB)		SNR during T4 (dB)	
	Test 1	Test 2	Test 1	Test 2
A.4.5.1.2	-18	N/A	-8	N/A
A.4.5.1.4	-18	N/A	-8	N/A

A.4.5.1.6	-18	N/A	-8	N/A
A.4.5.1.8	-18	N/A	-8	N/A
A.5.5.1.2	-18	N/A	-8	N/A
A.5.5.1.4	-18	N/A	-8	N/A
A.5.5.1.6	-18	N/A	-8	N/A
A.5.5.1.8	-18	N/A	-8	N/A
A.6.5.1.2	-18	N/A	-8	N/A
A.6.5.1.4	-18	N/A	-8	N/A
A.6.5.1.6	-18	N/A	-8	N/A
A.6.5.1.8	-18	N/A	-8	N/A
A.7.5.1.2	-18	N/A	-8	N/A
A.7.5.1.4	-18	N/A	-8	N/A
A.7.5.1.6	-18	N/A	-8	N/A
A.7.5.1.8	-18	N/A	-8	N/A

Table A.3.6.1.1.2.1-3: Modified parameters for Beam Failure Detection and Link Recovery testing with 4 RX antenna connection

Test case	SNR for RS in set q_0 during T3, T4 and T5 (dB)
	Test 1
A.4.5.5.1	-15
A.4.5.5.2	-15
A.4.5.5.3	-15
A.4.5.5.4	-15
A.5.5.5.1	-15
A.5.5.5.2	-15
A.5.5.5.3	-15
A.5.5.5.4	-15
A.6.5.5.1	-15
A.6.5.5.2	-15
A.6.5.5.3	-15
A.6.5.5.4	-15
A.7.5.5.1	-15
A.7.5.5.2	-15
A.7.5.5.3	-15
A.7.5.5.4	-15

A.3.6.1.1.2.2 Carrier aggregation tests

All carrier aggregation tests are performed using the antenna connection in clause A.3.6.1.1.2.4 for the PCell antenna connection if the PCell is on a band where 2RX is supported and 4RX is not supported, or using the antenna connection in A.3.6.1.1.2.5 for the PCell antenna connection if the PCell is on a band where 4RX is supported.

All carrier aggregation tests are performed using the antenna connection in clause A.3.6.1.1.2.4 for the SCell antenna connection if an SCell is on band where 2RX is supported and 4RX is not supported, or using the antenna connection in A.3.6.1.1.2.5 for the SCell antenna connection if an SCell is on a band where 4RX is supported.

A.3.6.1.1.2.3 EN-DC tests

All EN-DC tests are performed using the antenna connection in clause A.3.6.1.1.2.6 for the PCell antenna connection if the PCell is on a band where 2RX is supported and 4RX is not supported, or using the antenna connection in A.3.6.1.1.2.7 for the PCell antenna connection if the PCell is on a band where 4RX is supported.

All EN-DC tests are performed using the antenna connection in clause A.3.6.1.1.2.4 for the PSCell or SCell antenna connection if an SCell is on band where 2RX is supported and 4RX is not supported, or using the antenna

connection in A.3.6.1.1.2.5 for the SCell antenna connection if an SCell or PSCell is on a band where 4RX is supported.

A.3.6.1.1.2.4 Antenna connection for bands where 2RX is supported

For bands where 2RX is supported and 4RX is not supported, it is left to the UE declaration and antenna port configuration to decide which 2 of the 4 Rx ports are connected with data source from system simulator. The remaining 2 RX ports shall be connected with zero input. No test parameters or requirements are modified.

A.3.6.1.1.2.5 Antenna connection for bands where 4RX is supported

For bands where 4RX is supported, all 4 RX antennas are connected with data source from system simulator. The system simulator shall provide independent noise and fading (low correlation) for each antenna port. Except for the modifications to radio link monitoring thresholds and beam failure detection thresholds described in clauses A.3.6.1.1.2.1, no test parameters or requirements are modified.

A.3.6.1.1.2.6 EN-DC LTE Antenna connection for bands where 2RX is supported

For E-UTRAN bands where 2RX is supported and 4RX is not supported, it is left to the UE declaration and antenna port configuration to decide which 2 of the 4 Rx ports are connected with data source from system simulator. The remaining 2 RX ports shall be connected with zero input. No test parameters or requirements are modified.

A.3.6.1.1.2.7 EN-DC LTE Antenna connection for bands where 4RX is supported

For E-UTRAN bands where 4RX is supported, all 4 RX antennas are connected with data source from system simulator. The system simulator shall provide independent noise and fading (low correlation) for each antenna port. Except for the modifications to radio link monitoring thresholds described in clauses A.3.8.1.2.1 and A.3.8.1.2.2 of TS 36.133 [15], no test parameters or requirements are modified.

A.3.6.2 Antenna configurations for FR2

Unless otherwise specified, the default Downlink Antenna Configuration for NR FR2 cells is 1x2.

In case of Downlink Antenna Configuration 2x2 for NR FR2 cells, unless otherwise specified, the downlink signal is transmitted over the two polarizations (V and H) of the dual polarized antenna of the test equipment.

In both cases, the downlink signal is received assuming 2 UE baseband receivers. As the UE is tested following the Blackbox Approach with regard to the UE Rx antennas, the exact UE Rx antenna configuration is not relevant for the test configuration and has no impact on the test implementation.

A.3.7 EN-DC test setup

A.3.7.1 Introduction

A.3.7.2 E-UTRAN Serving Cell Parameters

A.3.7.2.1 E-UTRAN Serving Cell Parameters for Tests with NR Cell(s) in FR1

Table A.3.7.2.1-1 defines cell specific test parameters for E-UTRAN cell which can be used in EN-DC test cases or in any test case comprising at least one E-UTRA serving cell with all NR cells in FR1. Unless otherwise stated within the test, all measurements in Annex A.4 and A.5 are performed only on the NR carrier. The E-UTRA serving cell shall be configured to not interfere with NR operation and the E-UTRA serving cell signal power shall not be critical to the test purpose.

Table A.3.7.2.1-1: E-UTRAN cell specific test parameters for tests with all NR cells in FR1

Parameter	Unit	E-UTRAN Cell	
Duplex mode		FDD or TDD	
TDD special subframe configuration ^{Note1}		6	
TDD uplink-downlink configuration ^{Note1}		1	
$BW_{channel}$		5 MHz: $N_{RB,c} = 25$ 10 MHz: $N_{RB,c} = 50$ 20 MHz: $N_{RB,c} = 100$	
PDSCH parameters: DL Reference Measurement Channel ^{Note2}		5 MHz: R.7 FDD 10 MHz: R.3 FDD 20 MHz: R.6 FDD 5 MHz: R.4 TDD 10 MHz: R.0 TDD 20 MHz: R.3 TDD	
PCFICH/PDCCH/PHICH parameters: DL Reference Measurement Channel ^{Note2}		5 MHz: R.11 FDD 10 MHz: R.6 FDD 20 MHz: R.10 FDD 5 MHz: R.11 TDD 10 MHz: R.6 TDD 20 MHz: R.10 TDD	
OCNG Patterns ^{Note2}		5 MHz: OP.20 FDD 10 MHz: OP.10 FDD 20 MHz: OP.17 FDD 5 MHz: OP.9 TDD 10 MHz: OP.1 TDD 20 MHz: OP.7 TDD	
PBCH_RA	dB	0	
PBCH_RB	dB		
PSS_RA	dB		
SSS_RA	dB		
PCFICH_RB	dB		
PHICH_RA	dB		
PHICH_RB	dB		
PDCCH_RA	dB		
PDCCH_RB	dB		
PDSCH_RA	dB		
PDSCH_RB	dB		
OCNG_RA ^{Note3}	dB		
OCNG_RB ^{Note3}	dB		
N_{oc} ^{Note4}	dBm/15 kHz		-104
\bar{E}_s/N_{oc}	dB		17
\bar{E}_s/I_{ot}	dB	17	
RSRP ^{Note5}	dBm/15 kHz	-87	
SCH_RP ^{Note5}	dBm/15 kHz	-87	
I_o ^{Note5}	dBm/Ch BW	$-59.13+10\log(N_{RB,c}/50)$	
Propagation Condition		AWGN	
Antenna Configuration		1x2	
<p>Note 1: Special subframe and uplink-downlink configurations are specified in table 4.2-1 in TS 36.211.</p> <p>Note 2: DL RMCs and OCNG patterns are specified in clauses A 3.1 and A 3.2 of TS 36.133 respectively.</p> <p>Note 3: OCNG shall be used such that all cells are fully allocated and a constant total transmitted power spectral density is achieved for all OFDM symbols.</p> <p>Note 4: Interference from other cells and noise sources not specified in the test is assumed to be constant over subcarriers and time and shall be modelled as AWGN of appropriate power for N_{oc} to be fulfilled.</p> <p>Note 5: \bar{E}_s/I_{ot}, RSRP, SCH_RP and I_o levels have been derived from other parameters for information purposes. They are not settable parameters themselves.</p>			

A.3.7.2.2 E-UTRAN Serving Cell Parameters for Tests with NR Cell(s) in FR2

Table A.3.7.2.2-1 defines cell specific test parameters for E-UTRAN cell which can be used in EN-DC test cases or in any test case comprising at least one E-UTRA serving cell with one or more NR cells in FR2.

Table A.3.7.2.2-1: E-UTRAN cell specific test parameters for tests with one or more NR cells in FR2

Parameter	Unit	E-UTRAN Cell
Duplex mode		FDD or TDD
TDD special subframe configuration ^{Note1}		6
TDD uplink-downlink configuration ^{Note1}		1
BW _{channel}	MHz	5 MHz: N _{RB,c} = 25 10 MHz: N _{RB,c} = 50 20 MHz: N _{RB,c} = 100
PDSCH parameters: DL Reference Measurement Channel ^{Note2}		5 MHz: R.7 FDD 10 MHz: R.3 FDD 20 MHz: R.6 FDD 5 MHz: R.4 TDD 10 MHz: R.0 TDD 20 MHz: R.3 TDD
PCFICH/PDCCH/PHICH parameters: DL Reference Measurement Channel ^{Note2}		5 MHz: R.11 FDD 10 MHz: R.6 FDD 20 MHz: R.10 FDD 5 MHz: R.11 TDD 10 MHz: R.6 TDD 20 MHz: R.10 TDD
OCNG Patterns ^{Note2}		5 MHz: OP.20 FDD 10 MHz: OP.10 FDD 20 MHz: OP.17 FDD 5 MHz: OP.9 TDD 10 MHz: OP.1 TDD 20 MHz: OP.7 TDD
PBCH_RA	dB	0
PBCH_RB	dB	
PSS_RA	dB	
SSS_RA	dB	
PCFICH_RB	dB	
PHICH_RA	dB	
PHICH_RB	dB	
PDCCH_RA	dB	
PDCCH_RB	dB	
PDSCH_RA	dB	
PDSCH_RB	dB	
OCNG_RA ^{Note3}	dB	
OCNG_RB ^{Note3}	dB	
Note 1:	Special subframe and uplink-downlink configurations are specified in table 4.2-1 in TS 36.211.	
Note 2:	DL RMCs and OCNG patterns are specified in clauses A 3.1 and A 3.2 of TS 36.133 respectively.	
Note 3:	OCNG shall be used such that all cells are fully allocated and a constant total transmitted power spectral density is achieved for all OFDM symbols.	
Note 4:	The E-UTRA signal is required only to ensure the E-UTRA link to the DUT in the EN-DC operation. The Test System shall provide a stable and noise-free E-UTRA signal without need of precise propagation modelling, path loss and polarization control. Further details of the E-UTRA signal configuration are not defined as part of the cell specific test parameters, since the E-UTRA link is not under performance verification and shall not affect the test result unless otherwise specifically stated in the test case.	

A.3.7A NR FR1-FR2 test setup

Some Test cases in clause A.7 have NR cells in both FR1 and FR2. Unless otherwise stated within the test, the NR FR1 Cell signal is required only to provide a link to the UE under test. The Test System shall provide a stable and noise-free NR FR1 signal without need of precise propagation modelling, path loss and polarization control. Further details of the NR FR1 signal configuration are not defined as part of the cell specific test parameters, since the NR FR1 link is not under performance verification and shall not affect the test result unless otherwise specifically stated in the test case.

A.3.7B Void

A.3.7C LTE-FR1/FR2 test setup

Some Test cases in clause A.5 have LTE and FR2 NR cells. Unless otherwise stated within the test, the LTE Cell signal is required only to provide a link to the UE under test. The Test System shall provide a stable and noise-free LTE signal without need of precise propagation modelling, path loss and polarization control. Further details of the LTE signal configuration are not defined as part of the cell specific test parameters, since the LTE link is not under performance verification and shall not affect the test result unless otherwise specifically stated in the test case.

A.3.7D NE-DC test setup

A.3.7D.1 Introduction

A.3.7D.2 E-UTRAN Serving Cell Parameters

A.3.7D.2.1 E-UTRAN Serving Cell Parameters for Tests with NR Cell(s) in FR1

The parameters are same as as specified in clause A.3.7.2.1.

A.3.7D.2.2 E-UTRAN Serving Cell Parameters for Tests with NR Cell(s) in FR2

The parameters are same as as specified in clause A.3.7.2.2.

A.3.8 PRACH configurations

A.3.8.1 Introduction

This clause provides the typical PRACH configurations used for RRM test cases defined in Annex A. To note that for other parameters not listed in this clause, either it can be derived from the set up of each test or it is subjected to RAN5 specifications.

A.3.8.2 PRACH configurations in FR1

A.3.8.2.1 FR1 PRACH configuration 1

FR1 PRACH configuration 1 in this clause provides the typical PRACH configuration for SSB-based contention based random access in FR1.

Table A.3.8.2.1-1: Parameters for FR1 PRACH configuration 1

Field	Value	Comment
prach-ConfigurationIndex	102	10ms PRACH periodicity, and other detailed configuration defined in table 6.3.3.2-2 and table 6.3.3.2-3 in TS 38.211 [6].
msg1-SubcarrierSpacing	Same as UL carrier SCS	
totalNumberOfRA-Preambles	48	Total number of preambles used for contention based and contention free random access
numberOfRA-PreamblesGroupA	48	No group B.
prach-RootSequenceIndex	0	Logic sequence index = 0, resulting in root sequence = 1.
ssb-perRACH-OccasionAndCB-PreamblesPerSSB	oneFourth, n48	OneFourth: 1 SSB associated with 4 RACH occasions n48: 48 contention based preambles per SSB
msg1-FDM	One	One PRACH transmission occasions FDMed in one time instance.
rsrp-ThresholdSSB	RSRP_51	The actual value of the threshold is -105dBm, as defined in TS 38.331 [2].
ra-ContentionResolutionTimer	sf48	48 sub-frames
powerRampingStep	dB2	
preambleReceivedTargetPower	dBm-120	
preambleTransMax	n6	Max number of RA preamble transmission performed before declaring a failure is 6
ra-ResponseWindow	sl10	10 slots
zeroCorrelationZoneConfig	11	N-CS configuration, N _{cs} = 23
Backoff Parameter Index	2	20ms, as defined in table 7.2-1 in TS 38.321 [7].
Note:	For further information see clause 6.3.2 in TS 38.331 [2].	

A.3.8.2.2 FR1 PRACH configuration 2

FR1 PRACH configuration 2 in this clause provides the typical PRACH configuration for SSB based non-contention based random access in FR1.

Table A.3.8.2.2-1: Parameters for FR1 PRACH configuration 2

Field	Value	Comment
prach-ConfigurationIndex	102	10ms PRACH periodicity, and other detailed configuration defined in table 6.3.3.2-2 and table 6.3.3.2-3 in TS 38.211 [6].
msg1-SubcarrierSpacing	Same as UL carrier SCS	
totalNumberOfRA-Preambles	48	Total number of preambles used for contention based and contention free random access
numberOfRA-PreamblesGroupA	48	No group B.
prach-RootSequenceIndex	0	Logic sequence index = 0, resulting in root sequence = 1.

ssb-perRACH-Occasion	oneFourth	OneFourth: 1 SSB associated with 4 RACH occasions
msg1-FDM	One	One PRACH transmission occasions FDMed in one time instance.
powerRampingStep	dB2	
preambleReceivedTargetPower	dBm-120	
preambleTransMax	n6	Max number of RA preamble transmission performed before declaring a failure is 6
ra-ResponseWindow	sl10	10 slots
zeroCorrelationZoneConfig	11	N-CS configuration, N _{cs} = 23
Backoff Parameter Index	2	20ms, as defined in table 7.2-1 in TS 38.321 [7].
<i>ssb-ResourceList</i>	ra-PreambleIndex = 40	Associated with SSB index 0. UE doesn't use <i>ssb-ResourceList</i> and BFR-SSB-Resource IEs at the same time. UE doesn't use this field if is transmitting CFRA to convey BFR.
<i>BFR-SSB-Resource</i>	ra-PreambleIndex = 40	Associated with SSB index 0. UE doesn't use <i>ssb-ResourceList</i> and BFR-SSB-Resource IEs at the same time. UE uses this field only if is transmitting CFRA to convey BFR
ra-ssb-OccasionMaskIndex	1	PRACH occasion index 1 is allowed
rsrp-ThresholdSSB	RSRP_51	The actual value of the threshold is -105dBm, as defined in TS 38.331 [2].
Note: For further information see clause 6.3.2 in TS 38.331 [2].		

A.3.8.2.3 FR1 PRACH configuration 3

FR1 PRACH configuration 3 in this clause provides the typical PRACH configuration for CSI-RS based non-contention based random access in FR1.

Table A.3.8.2.3-1: Parameters for FR1 PRACH configuration 3

Field	Value	Comment
<i>prach-ConfigurationIndex</i>	102	10ms PRACH periodicity, and other detailed configuration defined in table 6.3.3.2-2 and table 6.3.3.2-3 in TS 38.211 [6].
msg1-SubcarrierSpacing	Same as UL carrier SCS	
totalNumberOfRA-Preambles	48	Total number of preambles used for contention based and contention free random access
numberOfRA-PreamblesGroupA	48	No group B.
prach-RootSequenceIndex	0	Logic sequence index = 0, resulting in root sequence = 1.
ssb-perRACH-Occasion	oneFourth	OneFourth: 1 SSB associated with 4 RACH occasions
msg1-FDM	One	One PRACH transmission occasions FDMed in one time instance.
powerRampingStep	dB2	
preambleReceivedTargetPower	dBm-120	
preambleTransMax	n6	Max number of RA preamble transmission performed before declaring a failure is 6
ra-ResponseWindow	sl10	10 slots
zeroCorrelationZoneConfig	11	N-CS configuration, N _{cs} = 23
Backoff Parameter Index	2	20ms, as defined in table 7.2-1 in TS 38.321 [7].

csirs-ResourceList	ra-PreambleIndex = 40	Associated with CSI-RS configured
ra-OccasionList	1	RA occasions allowed corresponding to CSI-RS
rsrp-ThresholdCSI-RS	RSRP_51	The actual value of the threshold is -105dBm, as defined in TS 38.331 [2].
Note: For further information see clause 6.3.2 in TS 38.331 [2].		

A.3.8.2.4 FR1 PRACH configuration 4

FR1 PRACH configuration 4 in this clause provides the PRACH configuration for CSI-RS based non-contention based random access in FR1 to convey BFR.

Table A.3.8.2.4-1: Parameters for FR1 PRACH configuration 4

Field	Value	Comment
prach-ConfigurationIndex	102	10ms PRACH periodicity, and other detailed configuration defined in table 6.3.3.2-2 and table 6.3.3.2-3 in TS 38.211 [6].
totalNumberOfRA-Preambles	48	Total number of preambles used for contention based and contention free random access
numberOfRA-PreamblesGroupA	48	No group B.
prach-RootSequenceIndex	0	Logic sequence index = 0, resulting in root sequence = 1.
ssb-perRACH-Occasion	oneFourth	OneFourth: 1 SSB associated with 4 RACH occasions
msg1-FDM	One	One PRACH transmission occasions FDMed in one time instance.
powerRampingStep	dB2	
preambleReceivedTargetPower	dBm-120	
preambleTransMax	n200	Max number of RA preamble transmission performed before declaring a failure is 200
ra-ResponseWindow	sl1	1 slot
zeroCorrelationZoneConfig	11	N-CS configuration, $N_{CS} = 93$
Backoff Parameter Index	2	20ms, as defined in table 7.2-1 in TS 38.321 [7].
BFR-CSIRS-Resource	ra-PreambleIndex = 40	Associated with CSI-RS configured
ra-OccasionList	1	RA occasions allowed corresponding to CSI-RS
rsrp-ThresholdSSB	RSRP_51	The actual value of the threshold is -105dBm, as defined in TS 38.331 [2].
Note: For further information see clause 6.3.2 in TS 38.331 [2].		

A.3.8.3 PRACH configurations in FR2

A.3.8.3.1 FR2 PRACH configuration 1

FR2 PRACH configuration 1 in this clause provides the typical PRACH configuration for SSB-based contention based random access in FR2.

Table A.3.8.3.1-1: Parameters for FR2 PRACH configuration 1

Field	Value	Comment
-------	-------	---------

prach-ConfigurationIndex	190	Preamble Format C2, with 10ms PRACH periodicity, and other detailed configuration defined in table 6.3.3.2-4 in TS 38.211 [6].
msg1-SubcarrierSpacing	Same as UL carrier SCS	
totalNumberOfRA-Preambles	48	Total number of preambles used for contention based and contention free random access
numberOfRA-PreamblesGroupA	48	No group B.
prach-RootSequenceIndex	0	Logic sequence index = 0, resulting in root sequence = 1.
ssb-perRACH-OccasionAndCB-PreamblesPerSSB	oneFourth, n48	OneFourth: 1 SSB associated with 4 RACH occasions n48: 48 contention based preambles per SSB
msg1-FDM	One	One PRACH transmission occasions FDMed in one time instance.
rsrp-ThresholdSSB	RSRP_51	The actual value of the threshold is -105dBm, as defined in TS 38.331 [2].
ra-ContentionResolutionTimer	sf48	48 sub-frames
powerRampingStep	dB2	
preambleReceivedTargetPower	dBm-120	
preambleTransMax	n6	Max number of RA preamble transmission performed before declaring a failure is 6
ra-ResponseWindow	sl10	10 slots
zeroCorrelationZoneConfig	11	N-CS configuration, N _{CS} = 23
Backoff Parameter Index	2	20 ms, as defined in table 7.2-1 in TS 38.321 [7].
Note: For further information see clause 6.3.2 in TS 38.331 [2].		

A.3.8.3.2 FR2 PRACH configuration 2

FR2 PRACH configuration 2 in this clause provides the typical PRACH configuration for SSB based non-contention based random access in FR2.

Table A.3.8.3.2-1: Parameters for FR2 PRACH configuration 2

Field	Value	Comment
prach-ConfigurationIndex	190	Preamble Format C2, with 10ms PRACH periodicity, and other detailed configuration defined in table 6.3.3.2-4 in TS 38.211 [6].
msg1-SubcarrierSpacing	Same as UL carrier SCS	
totalNumberOfRA-Preambles	48	Total number of preambles used for contention based and contention free random access
numberOfRA-PreamblesGroupA	48	No group B.
prach-RootSequenceIndex	0	Logic sequence index = 0, resulting in root sequence = 1.
ssb-perRACH-Occasion	oneFourth	OneFourth: 1 SSB associated with 4 RACH occasions
msg1-FDM	One	One PRACH transmission occasions FDMed in one time instance.
powerRampingStep	dB2	
preambleReceivedTargetPower	dBm-120	
preambleTransMax	n6	Max number of RA preamble transmission performed before declaring a failure is 6
ra-ResponseWindow	sl10	10 slots
zeroCorrelationZoneConfig	11	N-CS configuration, N _{CS} = 23
Backoff Parameter Index	2	20 ms, as defined in table 7.2-1 in TS 38.321 [7].

<i>ssb-ResourceList</i>	ra-PreambleIndex = 40	Associated with SSB index 0. UE doesn't use <i>ssb-ResourceList</i> and BFR-SSB-Resource IEs at the same time. UE doesn't use this field if is transmitting CFRA to convey BFR.
<i>BFR-SSB-Resource</i>	ra-PreambleIndex = 40	Associated with SSB index 0. UE doesn't use <i>ssb-ResourceList</i> and BFR-SSB-Resource IEs at the same time. UE uses this field only if is transmitting CFRA to convey BFR
ra-ssb-OccasionMaskIndex	1	PRACH occasion index 1 is allowed
rsrp-ThresholdSSB	RSRP_51	The actual value of the threshold is -105dBm, as defined in TS 38.331 [2].
Note: For further information see clause 6.3.2 in TS 38.331 [2].		

A.3.8.3.3 FR2 PRACH configuration 3

FR2 PRACH configuration 3 in this clause provides the typical PRACH configuration for CSI-RS based non-contention based random access in FR2.

Table A.3.8.3.3-1: Parameters for FR2 PRACH configuration 3

Field	Value	Comment
prach-ConfigurationIndex	190	Preamble Format C2, with 10ms PRACH periodicity, and other detailed configuration defined in table 6.3.3.2-4 in TS 38.211 [6].
msg1-SubcarrierSpacing	Same as UL carrier SCS	
totalNumberOfRA-Preambles	48	Total number of preambles used for contention based and contention free random access
numberOfRA-PreamblesGroupA	48	No group B.
prach-RootSequenceIndex	0	Logic sequence index = 0, resulting in root sequence = 1.
ssb-perRACH-Occasion	oneFourth	OneFourth: 1 SSB associated with 4 RACH occasions
msg1-FDM	One	One PRACH transmission occasions FDMed in one time instance.
powerRampingStep	dB2	
preambleReceivedTargetPower	dBm-120	
preambleTransMax	n6	Max number of RA preamble transmission performed before declaring a failure is 6
ra-ResponseWindow	sl10	10 slots
zeroCorrelationZoneConfig	11	N-CS configuration, N _{cs} = 23
Backoff Parameter Index	2	20 ms, as defined in table 7.2-1 in TS 38.321 [7].
csirs-ResourceList	ra-PreambleIndex = 40	Associated with CSI-RS configured
ra-OccasionList	1	RA occasions allowed corresponding to CSI-RS
rsrp-ThresholdCSI-RS	RSRP_51	The actual value of the threshold is -105dBm, as defined in TS 38.331 [2].
Note: For further information see clause 6.3.2 in TS 38.331 [2].		

A.3.8.3.4 FR2 PRACH configuration 4

FR2 PRACH configuration 4 in this clause provides the PRACH configuration for CSI-RS based non-contention based random access in FR2 to convey BFR.

Table A.3.8.3.4-1: Parameters for FR2 PRACH configuration 4

Field	Value	Comment
prach-ConfigurationIndex	190	Preamble Format C2, with 10ms PRACH periodicity, and other detailed configuration defined in table 6.3.3.2-4 in TS 38.211 [6].
msg1-SubcarrierSpacing	Same as UL carrier SCS	
totalNumberOfRA-Preambles	48	Total number of preambles used for contention based and contention free random access
numberOfRA-PreamblesGroupA	48	No group B.
prach-RootSequenceIndex	0	Logic sequence index = 0, resulting in root sequence = 1.
ssb-perRACH-Occasion	oneFourth	OneFourth: 1 SSB associated with 4 RACH occasions
msg1-FDM	One	One PRACH transmission occasions FDMed in one time instance.
powerRampingStep	dB2	
preambleReceivedTargetPower	dBm-120	
preambleTransMax	n200	Max number of RA preamble transmission performed before declaring a failure is 200.
ra-ResponseWindow	sl40	40 slots
zeroCorrelationZoneConfig	11	N-CS configuration, $N_{CS} = 23$
Backoff Parameter Index	2	20 ms, as defined in table 7.2-1 in TS 38.321 [7].
BFR-CSIRS-Resource	ra-PreambleIndex = 40	Associated with CSI-RS configured
ra-OccasionList	1	RA occasions allowed corresponding to CSI-RS
rsrp-ThresholdSSB	RSRP_51	The actual value of the threshold is -105dBm, as defined in TS 38.331 [2].
Note:	For further information see clause 6.3.2 in TS 38.331 [2].	

A.3.9 BWP configurations

A.3.9.1 Introduction

This clause provides the typical BWP configurations used for RRM test cases defined in Annex A. For downlink BWP, both initial BWP and dedicated BWP configurations are specified in clause A.3.9.2 and for uplink BWP, both initial BWP and dedicated BWP configurations are specified in clause A.3.9.3. To note that for other parameters not listed in this clause, either it can be derived from the set up of each test or it is subjected to RAN5 specifications.

A.3.9.2 Downlink BWP configurations

A.3.9.2.1 Initial BWP

Table A.3.9.2.1-1: Downlink BWP patterns for initial BWP configuration

BWP Parameters	Unit	Values	
Reference BWP		DLBWP.0.1	DLBWP.0.2

Starting PRB index		0	RB_c ^{Note 1}	
Bandwidth	RB	Same as RF channel defined in each test	same as RMSI CORESET (CORESET #0) defined in each test	
Note 1: RB_c is the lowest PRB index to guarantee the BWP including CORESET #0 which is defined in Clause A.3.1.2.				

A.3.9.2.2 Dedicated BWP

Table A.3.9.2.2-1: Downlink BWP patterns for dedicated BWP configuration

BWP Parameters	Unit	Values				
		DLBWP.1.1	DLBWP.1.2	DLBWP.1.3	DLBWP.1.4	DLBWP.1.7
Reference BWP						
Starting PRB index		0	RB_b ^{Note 1}	RB_a ^{Note 2}	0	RB_c ^{Note 3}
Bandwidth	RB	Same as RF channel defined in each test	25 for SSB SCS = 15KHz, 51 for SSB SCS = 30KHz, 32 for SSB SCS = 120KHz 48 for SSB SCS = 240KHz	25 for SSB SCS = 15KHz, 51 for SSB SCS = 30KHz, 32 for SSB SCS = 120KHz 48 for SSB SCS = 240KHz	24 for SSB SCS = 120KHz 24 for SSB SCS = 240KHz	25 for SSB SCS = 15KHz, 51 for SSB SCS = 30KHz, 32 for SSB SCS = 120KHz 48 for SSB SCS = 240KHz
Note 1: RB_b is the lowest PRB index to guarantee the BWP not fully overlapped with SSB PRB index ($RB_J, RB_{J+1}, \dots, RB_{J+19}$) which is defined in Clause A.3.10.						
Note 2: RB_a is the lowest PRB index to guarantee the BWP including SSB PRB index ($RB_J, RB_{J+1}, \dots, RB_{J+19}$) which is defined in Clause A.3.10.						
Note 3: RB_c is the PRB index having an offset of 6 PRBs with respect to the start of SSB PRB index ($RB_J, RB_{J+1}, \dots, RB_{J+19}$) which is defined in Clause A.3.10.						

A.3.9.3 Uplink BWP configurations

A.3.9.3.1 Initial BWP

Table A.3.9.3.1-1: Uplink BWP patterns for initial BWP configuration

BWP Parameters	Unit	Values	
		ULBWP.0.1	ULBWP.0.2
Reference BWP			
Starting PRB index		0	RB_c ^{Note 1}
Bandwidth	RB	Same as RF channel defined in each test	same as RMSI CORESET (CORESET #0) defined in each test
Note 1: RB_c is same as RB_c for DLBWP.0.2 as defined in Table A.3.9.2.1-1.			

A.3.9.3.2 Dedicated BWP

Table A.3.9.3.2-1: Uplink BWP patterns for dedicated BWP configuration

BWP Parameters	Unit	Values				
		ULBWP.1.1	ULBWP.1.2	ULBWP.1.3	ULBWP.1.4	ULBWP.1.7
Reference BWP						

Starting PRB index		0	RB _b ^{Note 1}	RB _a ^{Note 2}	0	RB _c ^{Note 3}
Bandwidth	RB	Same as RF channel defined in each test	25 for SSB SCS = 15KHz, 51 for SSB SCS = 30KHz, 32 for SSB SCS = 120KHz 48 for SSB SCS = 240KHz	25 for SSB SCS = 15KHz, 51 for SSB SCS = 30KHz, 32 for SSB SCS = 120KHz 48 for SSB SCS = 240KHz	24 for SSB SCS = 120KHz 24 for SSB SCS = 240KHz	25 for SSB SCS = 15KHz, 51 for SSB SCS = 30KHz, 32 for SSB SCS = 120KHz 48 for SSB SCS = 240KHz
Note 1: RB _b is same as RB _b for DLBWP.1.2 as defined in Table A.3.9.2.2-1.						
Note 2: RB _a is same as RB _a for DLBWP.1.3 as defined in Table A.3.9.2.2-1.						
Note 3: RB _c is same as RB _c for DLBWP.1.7 as defined in Table A.3.9.2.2-1.						

A.3.10 SSB Configurations

A.3.10.1 SSB Configurations for FR1

A.3.10.1.1 SSB pattern 1 in FR1: SSB allocation for SSB SCS=15 kHz in 10 MHz

Table A.3.10.1.1-1: SSB.1 FR1: SSB Pattern 1 for SSB SCS=15 kHz in 10 MHz channel

SSB Parameters	Values
Channel bandwidth	10 MHz
SSB SCS	15 kHz
SSB periodicity (T _{SSB})	20 ms
Number of SSBs per SS-burst	1
SS/PBCH block index	0
Symbol numbers containing SSB ^{Note 2}	2-5
Slot numbers containing SSB ^{Note 2}	0
SFN containing SSB	SFN mod (max(T _{SSB} ,10ms)/10ms) = 0
RB numbers containing SSB within channel BW	(RB _J , RB _{J+1} , ..., RB _{J+19}) ^{Note 1}
Note 1:	RBs containing SSB can be configured in any frequency location within the cell bandwidth according to the allowed synchronization raster defined in TS 38.104 [13].
Note 2:	These values have been derived from other parameters for information purposes (as per TS 38.213 [3]). They are not settable parameters themselves.

A.3.10.1.2 SSB pattern 2 in FR1: SSB allocation for SSB SCS=30 kHz in 40 MHz

Table A.3.10.1.2-1: SSB.2 FR1: SSB Pattern 2 for SSB SCS=30 kHz in 40 MHz channel

SSB Parameters	Values
Channel bandwidth	40 MHz
SSB SCS	30 kHz
SSB periodicity (T _{SSB})	20 ms
Number of SSBs per SS-burst	1
SS/PBCH block index	0
Symbol numbers containing SSB ^{Note 3}	4-7 or 2-5 ^{Note 2}
Slot numbers containing SSB ^{Note 3}	0
SFN containing SSB	SFN mod (max(T _{SSB} ,10ms)/10ms) = 0
RB numbers containing SSB within channel BW	(RB _J , RB _{J+1} , ..., RB _{J+19}) ^{Note 1}
Note 1:	RBs containing SSB can be configured in any frequency location within the cell bandwidth according to the allowed synchronization raster defined in TS 38.104 [13].

Note 2:	Symbols 4-7 is chosen, if the SSB pattern Case B should be used for the current band as indicated by Table 5.4.3.3-1 of TS 38.104 [13]; Otherwise, symbol 2-5 is chosen.
Note 3:	These values have been derived from other parameters for information purposes (as per TS 38.213 [3]). They are not settable parameters themselves.

A.3.10.1.3 SSB pattern 3 in FR1: SSB allocation for SSB SCS=15 kHz in 10 MHz

Table A.3.10.1.3-1: SSB.3 FR1: SSB Pattern 3 for SSB SCS=15 kHz in 10 MHz channel

SSB Parameters	Values	
Channel bandwidth	10 MHz	
SSB SCS	15 kHz	
SSB periodicity (T_{SSB})	20 ms	
Number of SSBs per SS-burst	2	
SS/PBCH block index	0	1
Symbol numbers containing SSB ^{Note 2}	2-5	8-11
Slot numbers containing SSB ^{Note 2}	0	0
SFN containing SSB	SFN mod ($\max(T_{SSB}, 10\text{ms})/10\text{ms}$) = 0	
RB numbers containing SSB within channel BW	$(RB_J, RB_{J+1}, \dots, RB_{J+19})^{\text{Note 1}}$	
Note 1:	RBs containing SSB can be configured in any frequency location within the cell bandwidth according to the allowed synchronization raster defined in TS 38.104 [13].	
Note 2:	These values have been derived from other parameters for information purposes (as per TS 38.213 [3]). They are not settable parameters themselves.	

A.3.10.1.4 SSB pattern 4 in FR1: SSB allocation for SSB SCS=30 kHz in 40 MHz

Table A.3.10.1.4-1: SSB.4 FR1: SSB Pattern 4 for SSB SCS=30 kHz in 40 MHz channel

SSB Parameters	Values	
Channel bandwidth	40 MHz	
SSB SCS	30 kHz	
SSB periodicity (T_{SSB})	20 ms	
Number of SSBs per SS-burst	2	
SS/PBCH block index	0	1
Symbol numbers containing SSB ^{Note 3}	4-7 or 2-5 ^{Note 2}	8-11
Slot numbers containing SSB ^{Note 3}	0	0
SFN containing SSB	SFN mod ($\max(T_{SSB}, 10\text{ms})/10\text{ms}$) = 0	
RB numbers containing SSB within channel BW	$(RB_J, RB_{J+1}, \dots, RB_{J+19})^{\text{Note 1}}$	
Note 1:	RBs containing SSB can be configured in any frequency location within the cell bandwidth according to the allowed synchronization raster defined in TS 38.104 [13].	
Note 2:	Symbols 4-7 is chosen, if the SSB pattern Case B should be used for the current band as indicated by Table 5.4.3.3-1 of TS 38.104 [13]; Otherwise, symbol 2-5 is chosen.	
Note 3:	These values have been derived from other parameters for information purposes (as per TS 38.213 [3]). They are not settable parameters themselves.	

A.3.10.1.5 SSB pattern 5 in FR1: SSB allocation for SSB SCS=15 kHz starting from odd SFN in 10 MHz

Table A.3.10.1.5-1: SSB.5 FR1: SSB Pattern 5 for SSB SCS=15 kHz in 10 MHz channel

SSB Parameters	Values
Channel bandwidth	10 MHz
SSB SCS	15 kHz
SSB periodicity (T_{SSB})	20 ms
Number of SSBs per SS-burst	1
SS/PBCH block index	0
Symbol numbers containing SSB ^{Note 2}	2-5
Slot numbers containing SSB ^{Note 2}	0
SFN containing SSB	$SFN \bmod (\max(T_{SSB}, 10\text{ms})/10\text{ms}) = 1$
RB numbers containing SSB within channel BW	$(RB_J, RB_{J+1}, \dots, RB_{J+19})^{\text{Note 1}}$
Note 1:	RBs containing SSB can be configured in any frequency location within the cell bandwidth according to the allowed synchronization raster defined in TS 38.104 [13].
Note 2:	These values have been derived from other parameters for information purposes (as per TS 38.213 [3]). They are not settable parameters themselves.

A.3.10.1.6 SSB pattern 6 in FR1: SSB allocation for SSB SCS=30 kHz starting from odd SFN in 40 MHz

Table A.3.10.1.6-1: SSB.6 FR1: SSB Pattern 6 for SSB SCS=30 kHz in 40 MHz channel

SSB Parameters	Values
Channel bandwidth	40 MHz
SSB SCS	30 kHz
SSB periodicity (T_{SSB})	20 ms
Number of SSBs per SS-burst	1
SS/PBCH block index	0
Symbol numbers containing SSB ^{Note 3}	4-7 or 2-5 ^{Note 2}
Slot numbers containing SSB ^{Note 3}	0
SFN containing SSB	$SFN \bmod (\max(T_{SSB}, 10\text{ms})/10\text{ms}) = 1$
RB numbers containing SSB within channel BW	$(RB_J, RB_{J+1}, \dots, RB_{J+19})^{\text{Note 1}}$
Note 1:	RBs containing SSB can be configured in any frequency location within the cell bandwidth according to the allowed synchronization raster defined in TS 38.104 [13].
Note 2:	Symbols 4-7 is chosen, if the SSB pattern Case B should be used for the current band as indicated by Table 5.4.3.3-1 of TS 38.104 [13]; Otherwise, symbol 2-5 is chosen.
Note 3:	These values have been derived from other parameters for information purposes (as per TS 38.213 [3]). They are not settable parameters themselves.

A.3.10.2 SSB Configurations for FR2

A.3.10.2.1 SSB pattern 1 in FR2: SSB allocation for SSB SCS=120 kHz in 100 MHz

Table A.3.10.2.1-1: SSB.1 FR2: SSB Pattern 1 for SSB SCS = 120 kHz in 100 MHz channel with 2 SSBs per SS-burst

SSB Parameters	Values
Channel bandwidth	100 MHz

SSB SCS	120 kHz	
SSB periodicity (T_{SSB})	20 ms	
Number of SSBs per SS-burst	2	
SS/PBCH block index	0	1
Symbol numbers containing SSBs ^{Note 2}	4-7	8-11
Slot numbers containing SSB ^{Note 2}	0	0
SFN containing SSB	SFN mod ($\max(T_{SSB}, 10\text{ms})/10\text{ms}$) = 0	
RB numbers containing SSBs within channel BW	$(RB_J, RB_{J+1}, \dots, RB_{J+19})$ ^{Note 1}	
Note 1:	RBs containing SSB can be configured in any frequency location within the cell bandwidth according to the allowed synchronization raster defined in TS 38.104 [13].	
Note 2:	These values have been derived from other parameters for information purposes (as per TS 38.213 [3]). They are not settable parameters themselves.	

A.3.10.2.2 SSB pattern 2 in FR2: SSB allocation for SSB SCS=240 kHz in 100 MHz

Table A.3.10.2.2-1: SSB.2 FR2: SSB Pattern 2 for SSB SCS = 240 kHz in 100 MHz channel with 2 SSBs per SS-burst

SSB Parameters	Values		
Channel bandwidth	100 MHz		
SSB SCS	240 kHz		
SSB periodicity (T_{SSB})	20 ms		
Number of SSBs per SS-burst	2		
SS/PBCH block index	0	1	
Symbol numbers containing SSBs ^{Note 2}	8-11	12-13	0-1
Slot numbers containing SSB ^{Note 2}	0	0	1
SFN containing SSB	SFN mod ($\max(T_{SSB}, 10\text{ms})/10\text{ms}$) = 0		
RB numbers containing SSBs within channel BW	$(RB_J, RB_{J+1}, \dots, RB_{J+39})$ ^{Note 1}		
Note 1:	RBs containing SSB can be configured in any frequency location within the cell bandwidth according to the allowed synchronization raster defined in TS 38.104 [13].		
Note 2:	These values have been derived from other parameters for information purposes (as per TS 38.213 [3]). They are not settable parameters themselves.		

A.3.10.2.3 SSB pattern 3 in FR2: SSB allocation for SSB SCS=120 kHz in 100 MHz

Table A.3.10.2.3-1: SSB.3 FR2: SSB Pattern 3 for SSB SCS = 120 kHz in 100 MHz channel with 1 SSB per SS-burst

SSB Parameters	Values		
Channel bandwidth	100 MHz		
SSB SCS	120 kHz		
SSB periodicity (T_{SSB})	20 ms		
Number of SSBs per SS-burst	1		
SS/PBCH block index	0		
Symbol numbers containing SSBs ^{Note 2}	4-7		
Slot numbers containing SSB ^{Note 2}	0		
SFN containing SSB	SFN mod ($\max(T_{SSB}, 10\text{ms})/10\text{ms}$) = 0		
RB numbers containing SSBs within channel BW	$(RB_J, RB_{J+1}, \dots, RB_{J+19})$ ^{Note 1}		
Note 1:	RBs containing SSB can be configured in any frequency location within the cell bandwidth according to the allowed synchronization raster defined in TS 38.104 [13].		
Note 2:	These values have been derived from other parameters for information purposes (as per TS 38.213 [3]). They are not settable parameters themselves.		

A.3.10.2.4 SSB pattern 4 in FR2: SSB allocation for SSB SCS=240 kHz in 100 MHz

Table A.3.10.2.4-1: SSB.4 FR2: SSB Pattern 4 for SSB SCS = 240 kHz in 100 MHz channel with 1 SSB per SS-burst

SSB Parameters	Values
Channel bandwidth	100 MHz
SSB SCS	240 kHz
SSB periodicity (T_{SSB})	20 ms
Number of SSBs per SS-burst	1
SS/PBCH block index	0
Symbol numbers containing SSBs ^{Note 2}	8-11
Slot numbers containing SSB ^{Note 2}	0
SFN containing SSB	$SFN \bmod (\max(T_{SSB}, 10\text{ms})/10\text{ms}) = 0$
RB numbers containing SSBs within channel BW	$(RB_J, RB_{J+1}, \dots, RB_{J+39})$ ^{Note 1}
Note 1:	RBs containing SSB can be configured in any frequency location within the cell bandwidth according to the allowed synchronization raster defined in TS 38.104 [13].
Note 2:	These values have been derived from other parameters for information purposes (as per TS 38.213 [3]). They are not settable parameters themselves.

A.3.10.2.5 SSB pattern 5 in FR2: SSB allocation for SSB SCS=120 kHz in 100 MHz

Table A.3.10.2.5-1: SSB.5 FR2: SSB Pattern 5 for SSB SCS = 120 kHz in 100 MHz channel with 2 SSBs per SS-burst

SSB Parameters	Values	
Channel bandwidth	100 MHz	
SSB SCS	120 kHz	
SSB periodicity (T_{SSB})	20 ms	
Number of SSBs per SS-burst	2	
SS/PBCH block index	2	3
Symbol numbers containing SSBs ^{Note 2}	2-5	6-9
Slot numbers containing SSB ^{Note 2}	1	1
SFN containing SSB	$SFN \bmod (\max(T_{SSB}, 10\text{ms})/10\text{ms}) = 0$	
RB numbers containing SSBs within channel BW	$(RB_J, RB_{J+1}, \dots, RB_{J+19})$ ^{Note 1}	
Note 1:	RBs containing SSB can be configured in any frequency location within the cell bandwidth according to the allowed synchronization raster defined in TS 38.104 [13].	
Note 2:	These values have been derived from other parameters for information purposes (as per TS 38.213 [3]). They are not settable parameters themselves.	

A.3.10.2.6 SSB pattern 6 in FR2: SSB allocation for SSB SCS=240 kHz in 100 MHz

Table A.3.10.2.6-1: SSB.6 FR2: SSB Pattern 6 for SSB SCS = 240 kHz in 100 MHz channel with 2 SSBs per SS-burst

SSB Parameters	Values	
Channel bandwidth	100 MHz	
SSB SCS	240 kHz	
SSB periodicity (T_{SSB})	20 ms	
Number of SSBs per SS-burst	2	
SS/PBCH block index	2	3
Symbol numbers containing SSBs ^{Note 2}	2-5	6-9
Slot numbers containing SSB ^{Note 2}	1	1
SFN containing SSB	$SFN \bmod (\max(T_{SSB}, 10\text{ms})/10\text{ms}) = 0$	

RB numbers containing SSBs within channel BW	$(RB_J, RB_{J+1}, \dots, RB_{J+39})$ ^{Note 1}
Note 1: RBs containing SSB can be configured in any frequency location within the cell bandwidth according to the allowed synchronization raster defined in TS 38.104 [13].	
Note 2: These values have been derived from other parameters for information purposes (as per TS 38.213 [3]). They are not settable parameters themselves.	

A.3.10.2.7 SSB pattern 7 in FR2: SSB allocation for SSB SCS=120 kHz in 100 MHz

Table A.3.10.2.7-1: SSB.7 FR2: SSB Pattern 7 for SSB SCS = 120 kHz in 100 MHz channel with 1 SSB per SS-burst

SSB Parameters	Values
Channel bandwidth	100 MHz
SSB SCS	120 kHz
SSB periodicity (T_{SSB})	20 ms
Number of SSBs per SS-burst	1
SS/PBCH block index	1
Symbol numbers containing SSBs ^{Note 2}	8-11
Slot numbers containing SSB ^{Note 2}	0
SFN containing SSB	$SFN \bmod (\max(T_{SSB}, 10\text{ms})/10\text{ms}) = 0$
RB numbers containing SSBs within channel BW	$(RB_J, RB_{J+1}, \dots, RB_{J+19})$ ^{Note 1}
Note 1: RBs containing SSB can be configured in any frequency location within the cell bandwidth according to the allowed synchronization raster defined in TS 38.104 [13].	
Note 2: These values have been derived from other parameters for information purposes (as per TS 38.213 [3]). They are not settable parameters themselves.	

A.3.10.2.8 SSB pattern 8 in FR2: SSB allocation for SSB SCS=240 kHz in 100 MHz

Table A.3.10.2.8-1: SSB.8 FR2: SSB Pattern 8 for SSB SCS = 240 kHz in 100 MHz channel with 1 SSB per SS-burst

SSB Parameters	Values
Channel bandwidth	100 MHz
SSB SCS	240 kHz
SSB periodicity (T_{SSB})	20 ms
Number of SSBs per SS-burst	1
SS/PBCH block index	1
Symbol numbers containing SSBs ^{Note 2}	12-13
Slot numbers containing SSB ^{Note 2}	0
SFN containing SSB	$SFN \bmod (\max(T_{SSB}, 10\text{ms})/10\text{ms}) = 0$
RB numbers containing SSBs within channel BW	$(RB_J, RB_{J+1}, \dots, RB_{J+39})$ ^{Note 1}
Note 1: RBs containing SSB can be configured in any frequency location within the cell bandwidth according to the allowed synchronization raster defined in TS 38.104 [13].	
Note 2: These values have been derived from other parameters for information purposes (as per TS 38.213 [3]). They are not settable parameters themselves.	

A.3.11 SMTC Configurations

A.3.11.1 SMTC pattern 1: SMTC period = 20 ms with SMTC duration = 1 ms

Table A.3.11.1-1: SMTC.1: SMTC Pattern 1 for SMTC period = 20 ms and duration = 1 ms

SMTC Parameters	Values
SMTC periodicity	20 ms
SMTC offset	0 ms
SMTC duration	1 ms

A.3.11.2 SMTC pattern 2: SMTC period = 20 ms with SMTC duration = 5 ms

Table A.3.11.2-1: SMTC.2: SMTC Pattern 2 for SMTC period = 20 ms and duration = 5 ms

SMTC Parameters	Values
SMTC periodicity	20 ms
SMTC offset	0 ms
SMTC duration	5 ms

A.3.11.3 SMTC pattern 3: SMTC period = 160 ms with SMTC duration = 1 ms

Table A.3.11.3-1: SMTC.3: SMTC Pattern 3 for SMTC period = 160 ms and duration = 1 ms

SMTC Parameters	Values
SMTC periodicity	160 ms
SMTC offset	0 ms
SMTC duration	1 ms

A.3.11.4 SMTC pattern 4: SMTC period = 20 ms with SMTC duration = 1 ms

Table A.3.11.4-1: SMTC.4: SMTC Pattern 4 for SMTC period = 20 ms and duration = 1 ms

SMTC Parameters	Values
SMTC periodicity	20 ms
SMTC offset	10 ms
SMTC duration	1 ms

A.3.11.5 SMTC pattern 5: SMTC period = 20 ms with SMTC duration = 5 ms

Table A.3.11.5-1: SMTC.5: SMTC Pattern 5 for SMTC period = 20 ms and duration = 5 ms

SMTC Parameters	Values
SMTC periodicity	20 ms
SMTC offset	10 ms
SMTC duration	5 ms

A.3.11.6 SMTC pattern 6: SMTC period = 20 ms with SMTC duration = 5 ms

Table A.3.11.6-1: SMTC.6: SMTC Pattern 6 for SMTC period = 20 ms and duration = 5 ms

SMTC Parameters	Values
SMTC periodicity	20 ms
SMTC offset	17 ms
SMTC duration	5 ms

A.3.12 Test Cases with Different CC Configurations

A.3.12.1 EN-DC Test Cases with Different EN-DC Configurations

A.3.12.1.1 Introduction

In Annex A EN-DC test cases may be defined for two component carriers (CCs) as well as for more than two CCs to verify the same RRM requirement.

A.3.12.1.2 Principle of testing

If multiple EN-DC test cases are defined for two CCs as well as for more than two CCs to verify the same type of RRM requirement, which depends on the number of CCs, then from the UE performance point of view the test coverage can be considered fulfilled by executing only the EN-DC test cases with the maximum number of CCs in EN-DC supported by the UE. Otherwise if the same type of RRM requirement is independent of the number of CCs then from the UE performance point of view the test coverage can be considered fulfilled by executing only the EN-DC test cases with two CCs in EN-DC supported by the UE.

Editor's: The maximum number of CCs that can be used in FR2 tests in EN-DC would depend on the test equipment capability.

A.3.12.2 Carrier Aggregation Test Cases with Different CA Configurations

A.3.12.2.1 Introduction

In Annex A carrier aggregation test cases may be defined for two CCs as well as for more than two CCs to verify the same RRM requirement.

A.3.12.2.2 Principle of testing

If multiple carrier aggregation test cases are defined for two CCs as well as for more than two CCs to verify the same RRM requirement, which depends on the number of CCs, then from the UE performance point of view the test coverage can be considered fulfilled by executing only the CA test cases with the maximum number of CCs in CA supported by the UE. Otherwise if the same type of RRM requirement is independent of the number of CCs then from the UE performance point of view the test coverage can be considered fulfilled by executing only the CA test cases with at least two CCs in CA supported by the UE.

Editor's: The maximum number of CCs that can be used in FR2 tests in CA would depend on the test equipment capability.

A.3.13 Test Cases in SA and EN-DC Operations

A.3.13.1 Introduction

This clause defines a principle which is applicable to test cases verifying RRM requirements in standalone (SA) or EN-DC operations.

In Annex A test cases may be defined in SA and EN-DC operations to verify the same RRM requirement.

Editor's note: this clause may need to define further for NE-DC and NR-DC test cases, which subjects to the test cases defined in the future.

A.3.13.2 Principle of Testing

If test cases are defined in both SA and EN-DC operations to verify the same RRM requirement then the UE capable of both SA and EN-DC operations needs to verify that RRM requirement by performing test case(s) in either SA operation or in EN-DC operation.

If test cases are defined in both SA and EN-DC operations to verify at least one common RRM requirement then the UE capable of both SA and EN-DC operations needs to verify RRM requirements by performing test case(s) in either SA operation or in EN-DC operation provided that the performed test case(s):

- verifies the largest number of RRM requirements and
- verifies at least all RRM requirements covered in the test case(s), which is not performed.

A.3.13A Test Cases involving E-UTRA/FR1 and FR2 carriers

A.3.13A.1 Introduction

The following applies to UE compliant to this version of the specification when undergoing tests with a mix of E-UTRA/NR FR1 and NR FR2 carriers in clauses A.5, A.7 and A.8.

A.3.13A.2 Principle of Testing in EN-DC

For test cases in clause A.5 listed in Table A.3.13A.2-1, the following applies:

- UE does not have to pass the test case

Table A.3.13A.2-1: Test cases UE does not have to pass in current version of specification (EN-DC)

Clause	Test case slogan
A.5.5.3.2	SCell Activation and deactivation of known SCell in FR1 for 160ms SCell measurement cycle
A.5.5.3.5	SCell Activation and deactivation of SCell in FR2
A.5.5.6.1.2	E-UTRAN – NR PSCell FR2 with FR2 SCell DL active BWP switch in non-DRX in synchronous EN-DC
A.5.6.2.5	EN-DC event triggered reporting tests for FR2 cell without SSB time index detection when DRX is not used
A.5.6.2.6	EN-DC event triggered reporting tests for FR2 cell without SSB time index detection when DRX is used
A.5.6.2.7	EN-DC event triggered reporting tests for FR2 cell with SSB time index detection when DRX is not used
A.5.6.2.8	EN-DC event triggered reporting tests for FR2 cell with SSB time index detection when DRX is used
A.5.7.1.3	EN-DC inter-frequency measurement accuracy with FR1 serving cell and FR2 target cell

A.3.13A.3 Principle of Testing in SA

For test cases in clause A.7 listed in Table A.3.13A.3-1, the following applies:

- UE does not have to pass the test case

Table A.3.13A.3-1: Test cases UE does not have to pass in current version of specification (SA)

Clause	Test case slogan
A.7.3.1.1	Inter-frequency handover from FR1 to FR2; unknown target cell
A.7.5.3.2	SCell Activation and deactivation for FR1+FR2 inter-band with target SCell in FR2
A.7.5.6.1.2	NR FR1- NR FR2 DL active BWP switch of PCell with non-DRX in SA
A.7.5.7.1	Addition and Release Delay of known NR PSCell
A.7.5.7.2	Addition and Release Delay of unknown NR PSCell
A.7.6.2.5	SA event triggered reporting tests for FR2 without SSB time index detection when DRX is not used (PCell in FR1)
A.7.6.2.6	SA event triggered reporting tests for FR2 without SSB time index detection when DRX is used (PCell in FR1)
A.7.6.2.7	SA event triggered reporting tests for FR2 with SSB time index detection when DRX is not used (PCell in FR1)
A.7.6.2.8	SA event triggered reporting tests for FR2 with SSB time index detection when DRX is used (PCell in FR1)
A.7.7.1.3	SA inter-frequency measurement accuracy with FR1 serving cell and FR2 target cell

A.3.13A.4 Principle of Testing in E-UTRA

For test cases in clause A.8 listed in Table A.3.13A.4-1, the following applies:

- UE does not have to pass the test case.

Table A.3.13A.4-1: Test cases UE does not have to pass in current version of specification (E-UTRA)

Clause	Test case slogan
A.8.4.2.5	NR Inter-RAT event triggered reporting tests for FR2 without SSB time index detection when DRX is not used
A.8.4.2.6	NR Inter-RAT event triggered reporting tests for FR2 without SSB time index detection when DRX is used
A.8.4.2.7	NR Inter-RAT event triggered reporting tests for FR2 with SSB time index detection when DRX is not used
A.8.4.2.8	NR Inter-RAT event triggered reporting tests for FR2 with SSB time index detection when DRX is used

A.3.13B Test Cases for EN-DC and NE-DC Operations

A.3.13B.1 Active BWP switch Test Cases for EN-DC and NE-DC Operations

A.3.13B.1.1 Introduction

This clause defines a principle which is applicable to test cases verifying active BWP switch requirements for EN-DC and NE-DC operations.

In Annex A test cases are defined for both EN-DC and NE-DC operations to verify the same type of RRM requirement.

A.3.13B.1.2 Principle of Testing

UE capable of both EN-DC and NE-DC operations needs to be tested with one of the tests in either EN-DC or NE-DC operations.

A.3.13B.2 SFTD accuracy Test Cases for EN-DC and NE-DC Operations

A.3.13B.2.1 Introduction

This clause defines a principle which is applicable to test cases verifying SFTD accuracy requirements for EN-DC and NE-DC operations.

In Annex A test cases are defined for both EN-DC and NE-DC operations to verify the same type of RRM requirement.

A.3.13B.2.2 Principle of Testing

UE capable of both EN-DC and NE-DC operations needs to be tested with one of the tests in either EN-DC or NE-DC operations.

A.3.14 CSI-RS configurations

A.3.14.1 FDD

Table A.3.14.1-1: CSI-RS Reference Measurement Channels for SCS=15kHz

	CSI-RS.1.1 FDD	CSI-RS.1.2 FDD	CSI-RS.1.3 FDD	CSI-RS.1.4 FDD
Resource Type	periodic	periodic	aperiodic	aperiodic
Resource Set Config				
nzp-CSI-ResourceSetId	0	0	0	0
repetition	n.a.	off	off	on
aperiodicTriggeringOffset	n.a.	n.a.	0	0
trs-Info	n.a.	n.a.	n.a.	n.a.
Resource Config				
nzp-CSI-RS-ResourceId	0 for resource #0	0 for resource #0	0 for resource #0	0 for resource #0
				1 for resource #1
				2 for resource #2
				3 for resource #3
	1 for resource #1	1 for resource #1	4 for resource #4	
			5 for resource #5	
			6 for resource #6	
			7 for resource #7	
powerControlOffset	0	0	0	0
powerControlOffsetSS	db0	db0	db0	db0
scramblingID	0	0	0	0
Period (slots)	slot5	slot10	n.a.	n.a.
Offset	1	1	n.a.	n.a.
qcl-InfoPeriodicCSI-RS	TCI.State.0	TCI.State.0 TCI.State.1	n.a.	n.a.
frequencyDomainAllocation	000001	0001	0001	0001
nrofPorts	2	1	1	1
firstOFDMsymbolInTimeDomain	4 for resource #0	6 for resource #0	6 for resource #0	0 for resource #0
				1 for resource #1
				2 for resource #2
				3 for resource #3
	10 for resource #1	10 for resource #1	4 for resource #4	
			5 for resource #5	
			6 for resource #6	
			7 for resource #7	
cdm-Type	FD-CDM2	noCDM	noCDM	noCDM
density	1	3	3	3
startingRB	0	0	0	0
nrofRBs	276 (Note 1)	276 (Note 1)	276 (Note 1)	276 (Note 1)
Note 1: If the configured value of PRBs is larger than the width of the corresponding BWP relevant for the test case, the Test Equipment shall implement CSI-RS only in the width of that BWP.				

A.3.14.2 TDD

Table A.3.14.2-1: CSI-RS Reference Measurement Channels for SCS=15kHz

	CSI-RS.1.1 TDD	CSI-RS.1.2 TDD	CSI-RS.1.3 TDD	CSI-RS.1.4 TDD
Resource Type	periodic	periodic	aperiodic	aperiodic
Resource Set Config				
nzp-CSI-ResourceSetId	0	0	0	0
repetition	n.a.	off	off	on

aperiodicTriggeringOffset	n.a.	n.a.	0	0
trs-Info	n.a.	n.a.	n.a.	n.a.
Resource Config				
nzp-CSI-RS-ResourceId	0 for resource #0	0 for resource #0	0 for resource #0	0 for resource #0 1 for resource #1 2 for resource #2 3 for resource #3
		1 for resource #1	1 for resource #1	4 for resource #4 5 for resource #5 6 for resource #6 7 for resource #7
powerControlOffset	0	0	0	0
powerControlOffsetSS	db0	db0	db0	db0
scramblingID	0	0	0	0
Period (slots)	slot5	slot10	n.a.	n.a.
Offset	1	1	n.a.	n.a.
qcl-InfoPeriodicCSI-RS	TCI.State.0	TCI.State.0 TCI.State.1	n.a.	n.a.
frequencyDomainAllocation	000001	0001	0001	0001
nrofPorts	2	1	1	1
firstOFDMSymbolInTimeDomain	4 for resource #0	6 for resource #0	6 for resource #0	0 for resource #0 1 for resource #1 2 for resource #2 3 for resource #3
		10 for resource #1	10 for resource #1	4 for resource #4 5 for resource #5 6 for resource #6 7 for resource #7
cdm-Type	FD-CDM2	noCDM	noCDM	noCDM
density	1	3	3	3
startingRB	0	0	0	0
nrofRBs	276 (Note 1)	276 (Note 1)	276 (Note 1)	276 (Note 1)
Note 1: If the configured value of PRBs is larger than the width of the corresponding BWP relevant for the test case, the Test Equipment shall implement CSI-RS only in the width of that BWP.				

Table A.3.14.2-2: CSI-RS Reference Measurement Channels for SCS=30kHz

	CSI-RS.2.1 TDD	CSI-RS.2.2 TDD	CSI-RS.2.3 TDD	CSI-RS.2.4 TDD
Resource Type	periodic	periodic	aperiodic	aperiodic
Resource Set Config				
nzp-CSI-RS-ResourceSetId	0	0	0	0
repetition	n.a.	off	off	on
aperiodicTriggeringOffset	n.a.	n.a.	0	0
trs-Info	n.a.	n.a.	n.a.	n.a.
Resource Config				
nzp-CSI-RS-ResourceId	0 for resource #0	0 for resource #0	0 for resource #0	0 for resource #0 1 for resource #1 2 for resource #2 3 for resource #3
		1 for resource #1	1 for resource #1	4 for resource #4 5 for resource #5 6 for resource #6 7 for resource #7
powerControlOffset	0	0	0	0
powerControlOffsetSS	db0	db0	db0	db0
scramblingID	0	0	0	0
Period (slots)	slot10	slot20	n.a.	n.a.

Offset	2	2	n.a.	n.a.
qcl-InfoPeriodicCSI-RS	TCI.State.0	TCI.State.0 TCI.State.1	n.a.	n.a.
frequencyDomainAllocation	000001	0001	0001	0001
nrofPorts	2	1	1	1
firstOFDMSymbolInTimeDomain	5 for resource #0	6 for resource #0 10 for resource #1	6 for resource #0 10 for resource #1	0 for resource #0 1 for resource #1 2 for resource #2 3 for resource #3 4 for resource #4 5 for resource #5 6 for resource #6 7 for resource #7
cdm-Type	FD-CDM2	noCDM	noCDM	noCDM
density	1	3	3	3
startingRB	0	0	0	0
nrofRBs	276 (Note 1)	276 (Note 1)	276 (Note 1)	276 (Note 1)
Note 1:	If the configured value of PRBs is larger than the width of the corresponding BWP relevant for the test case, the Test Equipment shall implement CSI-RS only in the width of that BWP.			

Table A.3.14.2-3: CSI-RS Reference Measurement Channels for SCS=120kHz

	CSI-RS.3.1 TDD	CSI-RS.3.2 TDD	CSI-RS.3.3 TDD	CSI-RS.3.4 TDD
Resource Type	periodic	periodic	aperiodic	aperiodic
Resource Set Config				
nzp-CSI-ResourceSetId	0	0	0	0
repetition	n.a.	off	off	on
aperiodicTriggeringOffset	n.a.	n.a.	4	4
trs-Info	n.a.	n.a.	n.a.	n.a.
Resource Config				
nzp-CSI-RS-ResourceId	0 for resource #0	0 for resource #0 1 for resource #1	0 for resource #0 1 for resource #1	0 for resource #0 1 for resource #1 2 for resource #2 3 for resource #3 4 for resource #4 5 for resource #5 6 for resource #6 7 for resource #7
powerControlOffset	0	0	0	0
powerControlOffsetSS	db0	db0	db0	db0
scramblingID	0	0	0	0
Period (slots)	slot40	slot80	n.a.	n.a.
Offset	8	16	n.a.	n.a.
qcl-InfoPeriodicCSI-RS	TCI.State.0	TCI.State.0 TCI.State.1	n.a.	n.a.
frequencyDomainAllocation	000001	0001	0001	0001
nrofPorts	2	1	1	1
firstOFDMSymbolInTimeDomain	5 for resource #0	6 for resource #0	6 for resource #0	0 for resource #0

				1 for resource #1
				2 for resource #2
				3 for resource #3
		10 for resource #1	10 for resource #1	4 for resource #4
				5 for resource #5
				6 for resource #6
				7 for resource #7
cdm-Type	FD-CDM2	noCDM	noCDM	noCDM
density	1	3	3	3
startingRB	0	0	0	0
nrofRBs	276 (Note 1)	276 (Note 1)	276 (Note 1)	276 (Note 1)
Note 1:	If the configured value of PRBs is larger than the width of the corresponding BWP relevant for the test case, the Test Equipment shall implement CSI-RS only in the width of that BWP.			

A.3.15 Angle of Arrival (AoA) for FR2 RRM test cases

This clause specifies the AoA setups for FR2 RRM test cases in clause A.5 and A.7. The applicable AoA setup is defined in each test case in clause A.5 and A.7.

A.3.15.1 Setup 1: Single AoA in Rx beam peak direction

There is only one active probe in the test. The DL signals, and noise if applicable, transmitted from the probe, are aligned to the UE Rx beam peak direction (as defined in TS 38.101-2 [19]).

A.3.15.2 Setup 2: Single AoA in non Rx beam peak direction

A.3.15.2.1 Setup 2a: Single AoA in non Rx beam peak direction without change in direction

There is only one active probe in the test. The DL signals, and noise if applicable, transmitted from the probe, align to a direction (AoA) which is from the set of directions corresponding to the EIS spherical coverage percentile of the DUT as defined in clause 7.3.4 of TS 38.101-2 [19] for each UE power class. The direction (AoA) of the signals shall not be changed between test iterations.

A.3.15.2.2 Setup 2b: Single AoA in non Rx beam peak direction with change in direction

There is only one active probe in the test. The DL signals, and noise if applicable, transmitted from the probe, align to a direction (AoA) which is from the set of directions corresponding to the EIS spherical coverage percentile of the DUT as defined in clause 7.3.4 of TS 38.101-2 [19] for each UE power class. For UE power class 3, the direction (AoA) of the signals shall be changed for each test iteration (for UE power classes other than 3, this is FFS).

A.3.15.3 Setup 3: 2 AoAs

There are 2 active probes in the test. The DL signals, and noise if applicable, transmitted from the two active probes, align to directions (AoAs) which are from the set of directions corresponding to the EIS spherical coverage

percentile of the DUT as defined in clause 7.3.4 of TS 38.101-2 [19] for each UE power class. The relative angular offset between the directions (AoAs) of the 2 active probes, shall be changed for each test iteration. The applicable set of relative angular offsets between the 2 active probes is given in Table 3.15.3-1 for each UE power class.

Editor Note: If RAN5 finds the changing of angular offset between the directions (AoAs) of the 2 active probes per test iteration to be infeasible from the perspectives of EIS spherical coverage and other impacts, e.g.: testing time, then the test setup will be revised.

Table A.3.15.3-1: Set of relative angular offsets between active probes for each power class

UE Power class	Relative angular offset between active probes
1	30°, 60°, 90° and 120°
2	FFS
3	30°, 60°, 90°, 120° and 150°
4	FFS

A.3.15.4 Setup 4: 2 AoAs, 1 AoA in Rx beam peak direction, 1 in non Rx beam peak

A.3.15.4.1 Setup 4a: 2 AoAs, 1 AoA in Rx beam peak direction, 1 in non Rx beam peak without change in direction

There are 2 active probes in the test. The DL signals, and noise if applicable, are transmitted from the two active probes. One probe is aligned to the UE Rx beam peak direction as defined in TS 38.101-2 [19]. The second is aligned to a direction (AoA) which is from the set of directions corresponding to the EIS spherical coverage percentile of the DUT as defined in clause 7.3.4 of TS 38.101-2 [19] for each UE power class. The direction (AoA) of the non Rx beam peak signal shall not be changed between test iterations.

A.3.15.4.2 Setup 4b: 2 AoAs, 1 AoA in Rx beam peak direction, 1 in non Rx beam peak with change in direction

There are 2 active probes in the test. The DL signals, and noise if applicable, are transmitted from the two active probes. One probe is aligned to the UE Rx beam peak direction as defined in TS 38.101-2 [19]. The second is aligned to a direction (AoA) which is from the set of directions corresponding to the EIS spherical coverage percentile of the DUT as defined in clause 7.3.4 of TS 38.101-2 [19] for each UE power class.

For UE power class 3, the relative angular offset between the directions (AoAs) of the 2 active probes shall be changed for each test iteration, within the probe alignment described above. The applicable set of relative angular offsets between the 2 active probes is given in Table 3.15.3-1 for each UE power class.

A.3.16 TCI State Configuration

A.3.16.1 Introduction

This clause provides the configurations for TCI states towards either SSB or CSI-RS. The TCI states defined in this clause are configured in each test when applicable to indicate that certain DL signals are QCL'ed with the referenceSignal configured in the TCI states.

A.3.16.2 TCI states

Table A.3.16.2-1: TCI States

Parameter	TCI.State.0	TCI.State.1	TCI.State.2	TCI.State.3
tcid-StateId	Id0	Id1	Id2	Id3
qcl-Type1	typeC	typeC	typeA	typeA
qcl-Type2 ^{Note1}	typeD	typeD	typeD	typeD
referenceSignal	SSB0	SSB1	Resource #4 in TRS resource set 1 ^{Note3}	Resource #4 in TRS resource set 2 ^{Note3}
Note 1: qcl-Type2 of typeD only where applicable. For RRM test cases, this will be only in FR2 Note 2: referenceSignal configurations towards which the TCI states are configured are defined in a test-specific manner. Note 3: Reference TRS resource sets are defined in A.3.17, and the applicable TRS resource set(s) are specified in each test case. When a single TRS resource set is configured in a test case, it is considered as resource set 1.				

Table A.3.16.2-2: Void

A.3.17 Configurations of CSI-RS for tracking

A.3.17.1 Configuration of CSI-RS for tracking for FR1

A.3.17.1.1 FDD

Table A.3.17.1.1-1: CSI-RS for tracking for SCS=15kHz

Parameter	Unit	Value
Reference channel		TRS.1.1 FDD
Bandwidth		BW of Active BWP ^{Note 1}
SCS	kHz	15
First subcarrier index in the PRB used for CSI-RS		$k_0=0$ for CSI-RS resource 1,2,3,4
First OFDM symbol in the slot used for CSI-RS		$l_0 = 5$ for CSI-RS resource 1 and 3 $l_0 = 9$ for CSI-RS resource 2 and 4
Number of CSI-RS ports (X)		1 for CSI-RS resource 1,2,3,4
CDM Type		'No CDM' for CSI-RS resource 1,2,3,4
Density (ρ)		3 for CSI-RS resource 1,2,3,4
CSI-RS periodicity	slots	20 for CSI-RS resource 1,2,3,4
CSI-RS offset	slots	10 for CSI-RS resource 1 and 2 11 for CSI-RS resource 3 and 4
EPRE ratio to SSS	dB	0 ^{Note 2}
TCI state		TCI.State.0
Note 1: BW of TRS is configured same as the BW size of UE active BWP in the RRM test cases Note 2: Unless otherwise specified in the test case		

Table A.3.17.1.1-2: CSI-RS for tracking for SCS=30kHz

Parameter	Unit	Value
Reference channel		TRS.1.2 FDD

Bandwidth		BW of Active BWP ^{Note 1}
SCS	kHz	30
First subcarrier index in the PRB used for CSI-RS		$k_0=0$ for CSI-RS resource 1,2,3,4
First OFDM symbol in the slot used for CSI-RS		$l_0 = 5$ for CSI-RS resource 1 and 3 $l_0 = 9$ for CSI-RS resource 2 and 4
Number of CSI-RS ports (X)		1 for CSI-RS resource 1,2,3,4
CDM Type		'No CDM' for CSI-RS resource 1,2,3,4
Density (ρ)		3 for CSI-RS resource 1,2,3,4
CSI-RS periodicity	slots	40 for CSI-RS resource 1,2,3,4
CSI-RS offset	slots	20 for CSI-RS resource 1 and 2 21 for CSI-RS resource 3 and 4
EPRE ratio to SSS	dB	0 ^{Note 2}
TCI state		TCI.State.0
Note 1: BW of TRS is configured same as the BW size of UE active BWP in the RRM test cases		
Note 2: Unless otherwise specified in the test case		

A.3.17.1.2 TDD

Table A.3.17.1.2-1: CSI-RS for tracking for SCS=15kHz

Parameter	Unit	Value
Reference channel		TRS.1.1 TDD
Bandwidth		BW of Active BWP ^{Note 1}
SCS	kHz	15
First subcarrier index in the PRB used for CSI-RS		$k_0=0$ for CSI-RS resource 1,2,3,4
First OFDM symbol in the slot used for CSI-RS		$l_0 = 5$ for CSI-RS resource 1 and 3 $l_0 = 9$ for CSI-RS resource 2 and 4
Number of CSI-RS ports (X)		1 for CSI-RS resource 1,2,3,4
CDM Type		'No CDM' for CSI-RS resource 1,2,3,4
Density (ρ)		3 for CSI-RS resource 1,2,3,4
CSI-RS periodicity	slots	20 for CSI-RS resource 1,2,3,4
CSI-RS offset	slots	10 for CSI-RS resource 1 and 2 11 for CSI-RS resource 3 and 4
EPRE ratio to SSS	dB	0 ^{Note 2}
TCI state		TCI.State.0
Note 1: BW of TRS is configured same as the BW size of UE active BWP in the RRM test cases		
Note 2: Unless otherwise specified in the test case		

Table A.3.17.1.2-2: CSI-RS for tracking for SCS=30kHz

Parameter	Unit	Value
Reference channel		TRS.1.2 TDD
Bandwidth		BW of Active BWP ^{Note 1}
SCS	kHz	30
First subcarrier index in the PRB used for CSI-RS		$k_0=0$ for CSI-RS resource 1,2,3,4
First OFDM symbol in the slot used for CSI-RS		$l_0 = 5$ for CSI-RS resource 1 and 3 $l_0 = 9$ for CSI-RS resource 2 and 4
Number of CSI-RS ports (X)		1 for CSI-RS resource 1,2,3,4
CDM Type		'No CDM' for CSI-RS resource 1,2,3,4

Density (ρ)		3 for CSI-RS resource 1,2,3,4
CSI-RS periodicity	slots	40 for CSI-RS resource 1,2,3,4
CSI-RS offset	slots	20 for CSI-RS resource 1 and 2 21 for CSI-RS resource 3 and 4
EPRE ratio to SSS	dB	0 ^{Note 2}
TCI state		TCI.State.0
Note 1: BW of TRS is configured same as the BW size of UE active BWP in the RRM test cases		
Note 2: Unless otherwise specified in the test case		

A.3.17.2 Configuration of CSI-RS for tracking for FR2

A.3.17.2.1 TDD

Table A.3.17.2.1-1: CSI-RS for tracking for SCS=120kHz Set 1

Parameter	Unit	Value
Reference channel		TRS.2.1 TDD
Bandwidth		BW of Active BWP ^{Note 1, 3}
SCS	kHz	120
First subcarrier index in the PRB used for CSI-RS		$k_0=0$ for CSI-RS resource 1,2,3,4
First OFDM symbol in the slot used for CSI-RS		$l_0 = 1$ for CSI-RS resource 1 and 3 $l_0 = 5$ for CSI-RS resource 2 and 4
Number of CSI-RS ports (X)		1 for CSI-RS resource 1,2,3,4
CDM Type		'No CDM' for CSI-RS resource 1,2,3,4
Density (ρ)		3 for CSI-RS resource 1,2,3,4
CSI-RS periodicity	slots	80 for CSI-RS resource 1,2,3,4
CSI-RS offset	slots	40 for CSI-RS resource 1 and 2 41 for CSI-RS resource 3 and 4
EPRE ratio to SSS	dB	0 ^{Note 2}
TCI state		TCI.State.0
Note 1: BW of TRS is configured same as the BW size of UE active BWP in the RRM test cases		
Note 2: Unless otherwise specified in the test case		
Note 3: If active BWP is larger than 52RBs, BW of TRS is configured as 52RBs. Otherwise, same as active BWP size.		

Table A.3.17.2.1-2: CSI-RS for tracking for SCS=120kHz Set 2

Parameter	Unit	Value
Reference channel		TRS.2.2 TDD
Bandwidth		BW of Active BWP ^{Note 1, 3}
SCS	kHz	120
First subcarrier index in the PRB used for CSI-RS		$k_0=0$ for CSI-RS resource 1,2,3,4
First OFDM symbol in the slot used for CSI-RS		$l_0 = 2$ for CSI-RS resource 1 and 3 $l_0 = 6$ for CSI-RS resource 2 and 4
Number of CSI-RS ports (X)		1 for CSI-RS resource 1,2,3,4
CDM Type		'No CDM' for CSI-RS resource 1,2,3,4
Density (ρ)		3 for CSI-RS resource 1,2,3,4
CSI-RS periodicity	slots	80 for CSI-RS resource 1,2,3,4
CSI-RS offset	slots	40 for CSI-RS resource 1 and 2 41 for CSI-RS resource 3 and 4

EPRE ratio to SSS	dB	0 ^{Note 2}
TCI state		TCI.State.1
Note 1: BW of TRS is configured same as the BW size of UE active BWP in the RRM test cases		
Note 2: Unless otherwise specified in the test case		
Note 3: If active BWP is larger than 52RBs, BW of TRS is configured as 52RBs. Otherwise, same as active BWP size.		

A.3.18 Additional definitions related to OTA testing for FR2 RRM test cases

A.3.18.1 Introduction

FR2 RRM test cases are performed over the air (OTA). This clause provides additional definitions and clarifications on the OTA measurements and metrics defined or referred in the test cases.

A.3.18.2 PRACH Power Measurement

PRACH power is measured as EIRP(Link=Link angle, Meas=Link angle) as defined in clause 3.1 of TS 38.101-2 [19].

A.4 EN-DC tests with all NR cells in FR1

A.4.1 Void

A.4.2 Void

A.4.3 RRC_CONNECTED state mobility

A.4.3.1 Void

A.4.3.2 RRC Connection Mobility Control

A.4.3.2.1 Void

A.4.3.2.2 Random Access

A.4.3.2.2.1 Contention based random access test in FR1 for PSCell in EN-DC

A.4.3.2.2.1.1 Test Purpose and Environment

The purpose of this test is to verify that the behavior of the random access procedure is according to the requirements and that the PRACH power settings and timing are within specified limits. This test will verify the requirements in clause 6.2.2.2 and clause 7.1.2 in an AWGN model.

For this test two cells are used, with the configuration of Cell 1 (E-UTRA PCell) specified in clause A.3.7.2.1 and Cell 2 configured as PSCell in FR1. Supported test parameters are shown in Table A.4.3.2.2.1.1-1. UE capable of EN-DC with PSCell in FR1 needs to be tested by using the parameters in Table A.4.3.2.2.1.1-2.

Table A.4.3.2.2.1.1-1: Supported test configurations for contention based random access test in FR1 for PSCell in EN-DC

Config	Description
1	LTE FDD, NR 15 kHz SSB SCS, 10 MHz bandwidth, FDD duplex mode
2	LTE TDD, NR 15 kHz SSB SCS, 10 MHz bandwidth, FDD duplex mode
3	LTE FDD, NR 30 kHz SSB SCS, 40 MHz bandwidth, TDD duplex mode
4	LTE TDD, NR 30 kHz SSB SCS, 40 MHz bandwidth, TDD duplex mode
Note:	The UE is only required to be tested in one of the supported test configurations depending on UE capability

Table A.4.3.2.2.1.1-2: General test parameters for contention based random access test in FR1 for PSCell in EN-DC

Parameter	Unit	Test-1	Comments	
SSB Configuration	Config 1,2	SSB pattern 3 in FR1	As defined in A.3.10	
	Config 3,4	SSB pattern 4 in FR1		
Duplex Mode for Cell 2	Config 1,2	FDD		
	Config 3,4	TDD		
TDD Configuration	Config 3,4	TDDConf.2.1		
OCNG Pattern ^{Note 1}		OCNG pattern 1	As defined in A.3.2.1.	
PDSCH parameters ^{Note 4}	Config 1,2	SR.1.1 FDD	As defined in A.3.1.1.	
	Config 3,4	SR.2.1 TDD		
RMSI CORESET Reference Channel	Config 1,2		CR.1.1 FDD	
	Config 3,4		CR.2.1 TDD	
Dedicated CORESET Reference Channel	Config 1,2		CCR.1.1 FDD	
	Config 3,4		CCR.2.1 TDD	
NR RF Channel Number		1		
EPRE ratio of PSS to SSS	dB	0		
EPRE ratio of PBCH_DMRS to SSS	dB			
EPRE ratio of PBCH to PBCH_DMRS	dB			
EPRE ratio of PDCCH_DMRS to SSS	dB			
EPRE ratio of PDCCH to PDCCH_DMRS	dB			
EPRE ratio of PDSCH_DMRS to SSS	dB			
EPRE ratio of PDSCH to PDSCH_DMRS	dB			
EPRE ratio of PDSCH to PDSCH_DMRS	dB			
SSB with index 0	\hat{E}_s / I_{ot}	dB	3	Power of SSB with index 0 is set to be above configured <i>rsrp-ThresholdSSB</i>
	N_{oc}	Config 1,2	-98	
		Config 3,4	-101	
	\hat{E}_s / N_{oc}	dB	3	
SS-RSRP ^{Note 3}	dBm/ SCS	-95		
SSB with index 1	\hat{E}_s / I_{ot}	dB	-17	Power of SSB with index 1 is set to be below configured <i>rsrp-ThresholdSSB</i>
	N_{oc}	Config 1,2	-98	
		Config 3,4	-101	
	\hat{E}_s / N_{oc}	dB	-17	
SS-RSRP ^{Note 3}	dBm/ SCS	-115		

I ₀ ^{Note 2}	Config 1,2	dBm	-65.3/9.36MHz	For symbols without SSB index 1
	Config 3,4		-62.2/38.16MHz	
ss-PBCH-BlockPower		dBm/ SCS	-5	As defined in clause 6.3.2 in TS 38.331 [2].
Configured UE transmitted power ($P_{CMAX, f,c}$)		dBm	23	As defined in clause 6.2.4 in TS 38.101-1.
PRACH Configuration			FR1 PRACH configuration 1	As defined in A.3.8.2.
Propagation Condition		-	AWGN	
Note 1:	OCNG shall be used such that the cell is fully allocated and a constant total transmitted power spectral density is achieved for all OFDM symbols. The OCNG pattern is chosen during the test according to the presence of a DL reference measurement channel.			
Note 2:	SS-RSRP, Es/lot and I ₀ levels have been derived from other parameters for information purpose. They are not settable parameters.			
Note 3:	Void			
Note 4:	The DL PDSCH reference measurement channel is used in the test only when a downlink transmission dedicated to the UE under test is required.			

A.4.3.2.2.1.2 Test Requirements

Contention based random access is triggered by *not* explicitly assigning a random access preamble via dedicated signalling in the downlink.

A.4.3.2.2.1.2.1 Random Access Preamble Transmission

To test the UE behavior specified in Clause 6.2.2.2.1.1 the System Simulator shall receive the Random Access Preamble which belongs to one of the Random Access Preambles associated with the SSB with index 0, which has SS-RSRP above the configured *rsrp-ThresholdSSB*.

In addition, the power applied to all preambles shall be in accordance with what is specified in Clause 6.2.2.2. The power of the first preamble shall be -22 dBm with an accuracy specified in clause 6.3.4.2 of TS 38.101-1 [18]. The relative power applied to additional preambles shall have an accuracy specified in clause 6.3.4.3 of TS 38.101-1 [18].

The transmit timing of all PRACH transmissions shall be within the accuracy specified in Clause 7.1.2.

A.4.3.2.2.1.2.2 Random Access Response Reception

To test the UE behavior specified in Clause 6.2.2.2.1.2 the System Simulator shall transmit a Random Access Response containing a Random Access Preamble identifier corresponding to the transmitted Random Access Preamble after 5 preambles have been received by the System Simulator. In response to the first 4 preambles, the System Simulator shall transmit a Random Access Response *not* corresponding to the transmitted Random Access Preamble.

The UE may stop monitoring for Random Access Response(s) and shall transmit the msg3 if the Random Access Response contains a Random Access Preamble identifier corresponding to the transmitted Random Access Preamble.

The UE shall again perform the Random Access Resource selection procedure specified in clause 5.1.2 in TS38.321 [7], and transmit with the calculated PRACH transmission power when the backoff time expires if all received Random Access Responses contain Random Access Preamble identifiers that do not match the transmitted Random Access Preamble.

In addition, the power applied to all preambles shall be in accordance with what is specified in Clause 6.2.2.2. The power of the first preamble shall be -22 dBm with an accuracy specified in clause 6.3.4.2 of TS 38.101-1 [18]. The

relative power applied to additional preambles shall have an accuracy specified in clause 6.3.4.3 of TS 38.101-1 [18].

The transmit timing of all PRACH transmissions shall be within the accuracy specified in Clause 7.1.2.

A.4.3.2.2.1.2.3 No Random Access Response Reception

To test the UE behavior specified in clause 6.2.2.2.1.3 the System Simulator shall transmit a Random Access Response containing a Random Access Preamble identifier corresponding to the transmitted Random Access Preamble after 5 preambles have been received by the System Simulator. The System Simulator shall *not* respond to the first 4 preambles.

The UE shall again perform the Random Access Resource selection procedure specified in clause 5.1.2 in TS38.321 [7], and transmit with the calculated PRACH transmission power when the backoff time expires if no Random Access Response is received within the RA Response window.

In addition, the power applied to all preambles shall be in accordance with what is specified in Clause 6.2.2.2. The power of the first preamble shall be -22 dBm with an accuracy specified in clause 6.3.4.2 of TS 38.101-1 [18]. The relative power applied to additional preambles shall have an accuracy specified in clause 6.3.4.3 of TS 38.101-1 [18].

The transmit timing of all PRACH transmissions shall be within the accuracy specified in Clause 7.1.2.

A.4.3.2.2.1.2.4 Receiving an UL grant for msg3 retransmission

To test the UE behavior specified in clause 6.2.2.2.1.4, the System Simulator shall provide an UL grant for msg3 retransmission following a successful Random Access Response.

The UE shall re-transmit the msg3 upon the reception of an UL grant for msg3 retransmission..

A.4.3.2.2.1.2.5 void

A.4.3.2.2.1.2.6 void

A.4.3.2.2.1.2.7 Contention Resolution Timer expiry

To test the UE behavior specified in Clause 6.2.2.2.1.6 the System Simulator shall *not* send a response to a msg3.

The UE shall again perform the Random Access Resource selection procedure specified in clause 5.1.2 in TS38.321 [7], and transmit with the calculated PRACH transmission power when the backoff time expires if the Contention Resolution Timer expires.

A.4.3.2.2.2 Non-contention based random access test in FR1 for PSCell in EN-DC

A.4.3.2.2.2.1 Test Purpose and Environment

The purpose of this test is to verify that the behavior of the random access procedure is according to the requirements and that the PRACH power settings and timing are within specified limits. This test will verify the requirements in clause 6.2.2.2 and clause 7.1.2 in an AWGN model.

For this test two cells are used, with the configuration of Cell 1 (E-UTRA PCell) specified in clause A.3.7.2.1 and Cell 2 configured as PCell in FR1. Supported test parameters are shown in Table A.4.3.2.2.1-1. UE capable of EN-DC with PCell in FR1 needs to be tested by using the parameters in Table A.4.3.2.2.1-2 for SSB-based non-contention based random access test (Test 1) and CSI-RS-based non-contention based random access test (Test 2). Test 2 is only applicable to UE which supports csi-RSRP-AndRSRQ-MeasWithSSB or csi-RSRP-AndRSRQ-MeasWithoutSSB.

Table A.4.3.2.2.1-1: Supported test configurations for non-contention based random access test in FR1 for PCell in EN-DC

Config	Description
1	LTE FDD, NR 15 kHz SSB SCS, 10 MHz bandwidth, FDD duplex mode
2	LTE TDD, NR 15 kHz SSB SCS, 10 MHz bandwidth, FDD duplex mode
3	LTE FDD, NR 30 kHz SSB SCS, 40 MHz bandwidth, TDD duplex mode
4	LTE TDD, NR 30 kHz SSB SCS, 40 MHz bandwidth, TDD duplex mode
Note:	The UE is only required to be tested in one of the supported test configurations depending on UE capability

Table A.4.3.2.2.1-2: General test parameters for non-contention based random access test in FR1 for PCell in EN-DC

Parameter		Unit	Test-1	Test-2	Comments
SSB Configuration	Config 1,2		SSB pattern 3 in FR1	SSB pattern 3 in FR1	As defined in A.3.10
	Config 3,4		SSB pattern 4 in FR1	SSB pattern 4 in FR1	
CSI-RS Configuration	Config 1,2		N/A	CSI-RS.1.1 FDD	As defined in A.3.1.4
	Config 3,4			CSI-RS.2.1 TDD	
Duplex Mode for Cell 2	Config 1,2		FDD	FDD	
	Config 3,4		TDD	TDD	
TDD Configuration	Config 3,4		TDDConf.2.1	TDDConf.2.1	
OCNG Pattern ^{Note 1}			OCNG pattern 1	OCNG pattern 1	As defined in A.3.2.1.
PDSCH parameters ^{Note 4}	Config 1,2		SR.1.1 FDD	SR.1.1 FDD	As defined in A.3.1.1.
	Config 3,4		SR.2.1 TDD	SR.2.1 TDD	
RMSI CORESET Reference Channel	Config 1,2		CR.1.1 TDD	CR.1.1 TDD	
	Config 3,4		CR.2.1 TDD	CR.2.1 TDD	
Dedicated CORESET Reference Channel	Config 1,2		CCR.1.1 TDD	CCR.1.1 TDD	
	Config 3,4		CCR.2.1 TDD	CCR.2.1 TDD	
NR RF Channel Number			1	1	
EPRE ratio of PSS to SSS		dB	0	0	
EPRE ratio of PBCH_DMRS to SSS		dB			
EPRE ratio of PBCH to PBCH_DMRS		dB			
EPRE ratio of PDCCH_DMRS to SSS		dB			
EPRE ratio of PDCCH to PDCCH_DMRS		dB			
EPRE ratio of PDSCH_DMRS to SSS		dB			
EPRE ratio of PDSCH to PDSCH_DMRS		dB			
SSB with index 0	\hat{E}_s / I_{ot}	dB			3
	N_{oc}	Config 1,2	-98	-98	
		Config 3,4	-101	-101	
	\hat{E}_s / N_{oc}	dB	3	3	

	SS-RSRP ^{Note 3}		dBm/ SCS	-95	-95	
SSB with index 1	\hat{E}_s / I_{ot}		dB	-17	-17	Power of SSB with index 1 is set to be below configured <i>rsrp-ThresholdSSB</i>
	N_{oc}	Config 1,2	dBm/15kHz	-98	-98	
		Config 3,4		-101	-101	
	\hat{E}_s / N_{oc}		dB	-17	-17	
SS-RSRP ^{Note 3}			dBm/ SCS	-115	-115	
I_o ^{Note 2}	Config 1,2		dBm	-65.3/9.36MHz	-65.3/9.36MHz	For symbols without SSB index 1
	Config 3,4			-62.2/38.16MHz	-62.2/38.16MHz	
ss-PBCH-BlockPower			dBm/ SCS	-5	-5	As defined in clause 6.3.2 in TS 38.331 [2].
Configured UE transmitted power ($P_{CMAX, f,c}$)			dBm	23	23	As defined in clause 6.2.4 in TS 38.101-1.
PRACH Configuration				FR1 PRACH configuration 2	FR1 PRACH configuration 3	As defined in A.3.8.2.
Propagation Condition			-	AWGN	AWGN	
<p>Note 1: OCNG shall be used such that the cell is fully allocated and a constant total transmitted power spectral density is achieved for all OFDM symbols. The OCNG pattern is chosen during the test according to the presence of a DL reference measurement channel.</p> <p>Note 2: SS-RSRP, E_s/I_{ot} and I_o levels have been derived from other parameters for information purpose. They are not settable parameters.</p> <p>Note 3: Void</p> <p>Note 4: The DL PDSCH reference measurement channel is used in the test only when a downlink transmission dedicated to the UE under test is required.</p>						

A.4.3.2.2.2.2 Test Requirements

Non-Contention based random access is triggered by explicitly assigning a random access preamble via dedicated signalling in the downlink. In the test, the non-contention based random access procedure is not initialized for Other SI requested from UE or beam failure recovery.

A.4.3.2.2.2.2.1 SSB-based Random Access Preamble Transmission

In Test-1, to test the UE behavior specified in Clause 6.2.2.2.1 for SSB-based Random Access Preamble transmission, with the contention-free Random Access Resources and the contention-free PRACH occasions associated with SSBs configured, the System Simulator shall receive the Random Access Preamble which has the Preamble Index associated with the SSB with index 0.

In addition, the System Simulator shall receive the Random Access Preamble on the PRACH occasion which belongs to the PRACH occasions corresponding to the SSB with index 0, and the selected PRACH occasion shall belong to the PRACH occasions permitted by the restrictions given by the *ra-ssb-OccasionMaskIndex*.

In addition, the power applied to all preambles shall be in accordance with what is specified in Clause 6.2.2.2. The power of the first preamble shall be -22 dBm with an accuracy specified in clause 6.3.4.2 of TS 38.101-1 [18]. The relative power applied to additional preambles shall have an accuracy specified in clause 6.3.4.3 of TS 38.101-1 [18].

The transmit timing of all PRACH transmissions shall be within the accuracy specified in Clause 7.1.2.

A.4.3.2.2.2.2.2 CSI-RS-based Random Access Preamble Transmission

In Test-2, to test the UE behavior specified in Clause 6.2.2.2.1 for CSI-RS-based Random Access Preamble transmission, with the contention-free Random Access Resources and the contention-free PRACH occasions

associated with CSI-RSs configured, the System Simulator shall receive the Random Access Preamble which has the Preamble Index associated with the CSI-RS configured.

In addition, the System Simulator shall receive the Random Access Preamble on the PRACH occasion which belongs to the PRACH occasions corresponding to the CSI-RS configured, and the selected PRACH occasion shall belong to the PRACH occasions permitted by the restrictions given by the *ra-OccasionList*.

In addition, the power applied to all preambles shall be in accordance with what is specified in Clause 6.2.2.2. The power of the first preamble shall be -22 dBm with an accuracy specified in clause 6.3.4.2 of TS 38.101-1 [18]. The relative power applied to additional preambles shall have an accuracy specified in clause 6.3.4.3 of TS 38.101-1 [18].

The transmit timing of all PRACH transmissions shall be within the accuracy specified in Clause 7.1.2.

A.4.3.2.2.2.3 Random Access Response Reception

To test the UE behavior specified in Clause 6.2.2.2.2 the System Simulator shall transmit a Random Access Response containing a Random Access Preamble identifier corresponding to the transmitted Random Access Preamble after 5 preambles have been received by the System Simulator. In response to the first 4 preambles, the System Simulator shall transmit a Random Access Response *not* corresponding to the transmitted Random Access Preamble.

The UE may stop monitoring for Random Access Response(s) if the Random Access Response contains a Random Access Preamble identifier corresponding to the transmitted Random Access Preamble.

The UE shall again perform the Random Access Resource selection procedure specified in clause 5.1.2 in TS38.321 [7], and transmit with the calculated PRACH transmission power if all received Random Access Responses contain Random Access Preamble identifiers that do not match the transmitted Random Access Preamble.

In addition, the power applied to all preambles shall be in accordance with what is specified in Clause 6.2.2.2. The power of the first preamble shall be -22 dBm with an accuracy specified in clause 6.3.4.2 of TS 38.101-1 [18]. The relative power applied to additional preambles shall have an accuracy specified in clause 6.3.4.3 of TS 38.101-1 [18].

The transmit timing of all PRACH transmissions shall be within the accuracy specified in Clause 7.1.2.

A.4.3.2.2.2.4 No Random Access Response Reception

To test the UE behavior specified in clause 6.2.2.2.2.3 the System Simulator shall transmit a Random Access Response containing a Random Access Preamble identifier corresponding to the transmitted Random Access Preamble after 5 preambles have been received by the System Simulator. The System Simulator shall *not* respond to the first 4 preambles.

The UE shall again perform the Random Access Resource selection procedure specified in clause 5.1.2 in TS38.321 [7], and transmit with the calculated PRACH transmission power when the backoff time expires if no Random Access Response is received within the RA Response window configured in *RACH-ConfigCommon*.

In addition, the power applied to all preambles shall be in accordance with what is specified in Clause 6.2.2.2. The power of the first preamble shall be -22 dBm with an accuracy specified in clause 6.3.4.2 of TS 38.101-1 [18]. The relative power applied to additional preambles shall have an accuracy specified in clause 6.3.4.3 of TS 38.101-1 [18].

The transmit timing of all PRACH transmissions shall be within the accuracy specified in Clause 7.1.2.

A.4.3.2.3 Void

A.4.4 Timing

A.4.4.1 UE transmit timing

A.4.4.1.1 NR UE Transmit Timing Test for FR1

A.4.4.1.1.1 Test Purpose and environment

The purpose of this test is to verify that the UE can follow frame timing change of the connected gNodeB and that the UE initial transmit timing accuracy, maximum amount of timing change in one adjustment, minimum and maximum adjustment rate are within the specified limits. This test will verify the requirements in clause 7.1.2. Supported test configurations are shown in Table 4.4.1.1.1-1.

Table A.4.4.1.1.1-1: Supported test configurations for FR1 PSCell

Configuration	Description
1	LTE FDD, NR FDD, SSB SCS 15 kHz, data SCS 15 kHz, BW 10 MHz
2	LTE FDD, NR TDD, SSB SCS 15 kHz, data SCS 15 kHz, BW 10 MHz
3	LTE FDD, NR TDD, SSB SCS 30 kHz, data SCS 30 kHz, BW 40 MHz
4	LTE TDD, NR FDD, SSB SCS 15 kHz, data SCS 15 kHz, BW 10 MHz
5	LTE TDD, NR TDD, SSB SCS 15 kHz, data SCS 15 kHz, BW 10 MHz
6	LTE TDD, NR TDD, SSB SCS 30 kHz, data SCS 30 kHz, BW 40 MHz
Note:	The UE is only required to be tested in one of the supported test configurations

The test consists of E-UTRA PCell and NR PSCell. The configuration for E-UTRA is given in A.3.7.2.1. Table A.4.4.1.1.1-2 defines the parameters to be configured and strength of the transmitted signals. The transmit timing is verified by the UE transmitting SRS using the configuration defined in Table A.4.4.1.1.1-3.

Table A.4.4.1.1.1-2: Cell Specific Test Parameters for UL Transmit Timing test

Parameter	Unit	Config	Test1	Test2	Band Group
SSB ARFCN		1,2,3,4,5,6	Freq1	Freq1	
Duplex Mode		1,4	FDD		
		2,3,5,6	TDD		
TDD configuration		1,4	Not Applicable		
		2,5	TDDConf.1.1		
		3,6	TDDConf.2.1		
BW _{channel}	MHz	1,4	10: N _{RB,c} = 52		
		2,5	10: N _{RB,c} = 52		
		3,6	40: N _{RB,c} = 106		
Initial BWP Configuration		1,2,3,4,5,6	DLBWP.0.1 ULBWP.0.1		
Dedicated BWP Configuration		1,2,3,4,5,6	DLBWP.1.1 ULBWP.1.1		
DRx Cycle	ms	1,2,3,4,5,6	N/A	DRX.8 ^{Note5}	
PDSCH Reference measurement channel		1,4	SR.1.1 FDD		
		2,5	SR.1.1 TDD		

		3,6	SR.2.1 TDD		
RMSI CORESET Reference Channel		1,4	CR.1.1 FDD		
		2,5	CR.1.1 TDD		
		3,6	CR.2.1 TDD		
Dedicated CORESET Reference Channel		1,4	CCR.1.1 FDD		
		2,5	CCR.1.1 TDD		
		3,6	CCR.2.1 TDD		
OCNG Patterns		1,2,3,4,5,6	OP.1		
SSB configuration		1,4	SSB.1 FR1		
		2,5	SSB.1 FR1		
		3,6	SSB.2 FR1		
SMTC configuration		1,2,3,4,5,6	SMTC.2		
TRS configuration		1,4	TRS.1.1 FDD		
		2,5	TRS.1.1 TDD		
		3,6	TRS.1.2 TDD		
PDSCH/PDCCH subcarrier spacing	kHz	1,2,4,5	15		
		3,6	30		
EPRE ratio of PSS to SSS	dB	1,2,3,4,5,6	0	0	
EPRE ratio of PBCH DMRS to SSS					
EPRE ratio of PBCH to PBCH DMRS					
EPRE ratio of PDCCH DMRS to SSS					
EPRE ratio of PDCCH to PDCCH DMRS					
EPRE ratio of PDSCH DMRS to SSS					
EPRE ratio of PDSCH to PDSCH					
EPRE ratio of OCNG DMRS to SSS(Note 1)					
EPRE ratio of OCNG to OCNG DMRS (Note 1)					
N_{oc}^{Note2}					dBm/15 kHz
N_{oc}^{Note2}	dBm/SCS	1,2,4,5	-98	-98	
		3,6	-95	-95	
\hat{E}_s / I_{ot}		1,2,3,4,5,6	3	3	
\hat{E}_s / N_{oc}		1,2,3,4,5,6	3	3	
SS-RSRP ^{Note3}	dBm/SCS	1,2,4,5	-95	-95	
		3,6	-92	-92	
I_o^{Note3}	dBm/9.36MHz	1,2,4,5	-65.2	-65.2	
	dBm/38.1MHz	3,6	-59.2	-59.2	
Propagation condition		1,2,3,4,5,6	AWGN		
SRS Config		1,2,4,5	SRSCConf.1 ^{Note6}	SRSCConf.3 ^{Note6}	
		3, 6	SRSCConf.1 ^{Note6}	SRSCConf.2 ^{Note6}	

Note 1:	OCNG shall be used such that both cells are fully allocated and a constant total transmitted power spectral density is achieved for all OFDM symbols.
Note 2:	Interference from other cells and noise sources not specified in the test is assumed to be constant over subcarriers and time and shall be modelled as AWGN of appropriate power for N_{oc} to be fulfilled.
Note 3:	SS-RSRP and I_0 levels have been derived from other parameters for information purposes. They are not settable parameters themselves.
Note 4:	SS-RSRP minimum requirements are specified assuming independent interference and noise at each receiver antenna port.
Note 5:	DRx related parameters are given in Table A.3.3.8-1
Note 6:	SRS configs are given in Table A.4.4.1.1-3

Table A.4.4.1.1-3: SRS Configuration for Timing Accuracy Test

	Field	SRSCConf.1	SRSCConf.2	SRSCConf.3	Comments
SRS-ResourceSet	srs-ResourceSetId	0	0	0	
	srs-ResourceIdList	0	0	0	
	resourceType	Periodic	Periodic	Periodic	
	Usage	Codebook	Codebook	Codebook	
SRS-Resource	SRS-ResourceId	0	0	0	
	nrofSRS-Ports	Port1	Port1	Port1	
	transmissionComb	n2	n2	n2	
	combOffset-n2	0	0	0	
	cyclicShift-n2	0	0	0	
	resourceMapping startPosition	0	0	0	
	resourceMapping nrofSymbols	n1	n1	n1	
	resourceMapping repetitionFactor	n1	n1	n1	
	freqDomainPosition	0	0	0	
	freqDomainShift	0	0	0	
	freqHopping c-SRS	14 for test configuration 1,2,4,5 25 for test configuration 3,6	25	14	Matches $N_{RB,c}$
	freqHopping b-SRS	0	0	0	
	freqHopping b-hop	0	0	0	
	groupOrSequenceHopping	Neither	Neither	Neither	
	resourceType	Periodic	Periodic	Periodic	
	periodicityAndOffset-p	sl1, 0	sl640, 5	sl320, 3	Offset to align with DRx periodicity
sequencId	0	0	0	Any 10 bit number	

A.4.4.1.1.2 Test requirements

The test sequence shall be carried out in RRC_CONNECTED for every test case.

Following will be the test sequence for this test

- 1) Set up E-UTRA PCell according to parameters given in Table A.3.7.2.1-1 and setup NR PSCell according to parameters given in Table A.4.4.1.1.1-1.
- 2) After connection set up with the cell, the test equipment will verify that the timing of the NR cell is within $(N_{TA} + N_{TA_offset}) \times T_c \pm T_e$ of the first detected path of DL SSB.
 - a. The N_{TA} offset value (in T_c units) is 25600
 - b. The T_e values depend on the DL and UL SCS for which the test is being run and are given in Table 7.1.2-1
- 3) The test system shall adjust the timing of the DL path by values given in Table A.4.4.1.1.2-1

Table A.4.4.1.1.2-1: Adjustment Value for DL Timing

SCS of SSB signals (kHz)	Adjustment Value	
	Test1	Test2
15	+64*64T _c	+32*64T _c
30	+32*64T _c	+16*64T _c

- 4) The test system shall verify that the adjustment step size and the adjustment rate shall be according to requirements specified in Clause 7.1.2 Table 7.1.2.1-1 until the UE transmit timing offset is within $(N_{TA} + N_{TA_offset}) \times T_c \pm T_e$ respective to the first detected path (in time) of DL SSB. Skip this step for test 2 with DRX configured.
- 5) The test system shall verify that the UE transmit timing offset stays within $(N_{TA} + N_{TA_offset}) \times T_c \pm T_e$ of the first detected path of DL SSB. For Test 2 the UE transmit timing offset shall be verified for the first transmission in the DRX cycle immediately after DL timing adjustment.

A.4.4.2 UE timer accuracy

A.4.4.3 Timing advance

A.4.4.3.1 EN-DC FR1 timing advance adjustment accuracy

A.4.4.3.1.1 Test Purpose and Environment

The purpose of the test is to verify UE Timing Advance adjustment delay and accuracy requirement defined in clause 7.3.

A.4.4.3.1.2 Test Parameters

Supported test configurations are shown in table A.4.4.3.1.2-1. Both timing advance adjustment delay and accuracy are tested by using the parameters in table A.4.4.3.1.2-2, A.4.4.3.1.2-3 and A.4.4.3.1.2-4. The configuration of Cell 1 (LTE PCell) is specified in clause A.3.7.2.1.

In all test cases, two cells are used. Cell 1 is the PCell in the primary Timing Advance Group (pTAG) and cell 2 is the PSCell in the secondary Timing Advance Group (sTAG). Each test consists of two successive time periods, with time duration of T1 and T2 respectively. In each time period, timing advance commands for sTAG are sent to the UE and Sounding Reference Signals (SRS), as specified in table A.4.4.3.1.2-3, are sent from the UE and received by the test equipment. By measuring the reception of the SRS, the transmit timing, and hence the timing advance adjustment accuracy, can be measured for PSCell in sTAG.

During time period T1, the test equipment shall send one message with a Timing Advance Command MAC Control Element for sTAG, as specified in clause 6.1.3.4 in TS 38.321 [7]. The Timing Advance Command value shall be set to 31, which according to clause 4.2 in TS 38.213 [3] results in zero adjustment of the Timing Advance. In this way, a reference value for the timing advance for sTAG used by the UE is established.

During time period T2, the test equipment shall send a sequence of messages with Timing Advance Command MAC Control Elements for sTAG, with Timing Advance Command value specified in table A.4.4.3.1.2-2. This value shall result in changes of the timing advance for sTAG used by the UE, and the accuracy of the change shall then be measured, using the SRS sent from the UE.

As specified in clause 7.3.2.1, the UE adjusts its uplink timing at slot $n+k$ for a timing advance command received in slot n . This delay must be taken into account when measuring the timing advance adjustment accuracy, via the SRS sent from the UE.

The UE Time Alignment Timer, described in clause 5.2 in TS 38.321, shall be configured so that it does not expire in the duration of the test.

Table A.4.4.3.1.2-1: Timing advance supported test configurations

Config	Description
1	LTE FDD, NR 15 kHz SSB SCS, 10 MHz bandwidth, FDD duplex mode
2	LTE FDD, NR 15 kHz SSB SCS, 10 MHz bandwidth, TDD duplex mode
3	LTE FDD, NR 30 kHz SSB SCS, 40 MHz bandwidth, TDD duplex mode
4	LTE TDD, NR 15 kHz SSB SCS, 10 MHz bandwidth, FDD duplex mode
5	LTE TDD, NR 15 kHz SSB SCS, 10 MHz bandwidth, TDD duplex mode
6	LTE TDD, NR 30 kHz SSB SCS, 40 MHz bandwidth, TDD duplex mode

Note: The UE is only required to be tested in one of the supported test configurations

Table A.4.4.3.1.2-2: General test parameters for timing advance

Parameter	Unit	Value	Comment
RF channel number		Cell 1: 1 Cell 2: 2	1 for E-UTRAN PCell 2 for NR PSCell
Initial DL BWP		DLBWP.0.1	As specified in Table A.3.9.2.1-1
Dedicated DL BWP		DLBWP.1.1	As specified in Table A.3.9.2.2-1
Initial UL BWP		ULBWP.0.1	As specified in Table A.3.9.3.1-1
Dedicated UL BWP		ULBWP.1.1	As specified in Table A.3.9.3.2-1
Timing Advance Command (T_A) value during T1		31	$N_{TA_new} = N_{TA_old}$ for the purpose of establishing a reference value from which the timing advance adjustment accuracy can be measured during T2
Timing Advance Command (T_A) value during T2		39	For 15 kHz SCS $N_{TA_new} = N_{TA_old} + 8192 * T_c$ For 30 kHz SCS $N_{TA_new} = N_{TA_old} + 4096 * T_c$ (based on equation in clause 4.2 of TS 38.213 [3])
T1	s	5	
T2	s	5	

Table A.4.4.3.1.2-3: Cell specific test parameters for timing advance

Parameter		Unit	Test1	
			T1	T2
Duplex mode	Config 1,4		FDD	

	Config 2,3,5,6		TDD
TDD configuration	Config 1,4		Not Applicable
	Config 2,5		TDDConf.1.1
	Config 3,6		TDDConf.2.1
BW_{channel}	Config 1,4	MHz	10: $N_{RB,c} = 52$
	Config 2,5		10: $N_{RB,c} = 52$
	Config 3,6		40: $N_{RB,c} = 106$
BWP BW	Config 1,4	MHz	10: $N_{RB,c} = 52$
	Config 2,5		10: $N_{RB,c} = 52$
	Config 3,6		40: $N_{RB,c} = 106$
DRx Cycle		ms	Not Applicable
PDSCH Reference measurement channel	Config 1,4		SR.1.1 FDD
	Config 2,5		SR.1.1 TDD
	Config 3,6		SR2.1 TDD
RMSI CORESET Reference Channel	Config 1,4		CR.1.1 FDD
	Config 2,5		CR.1.1 TDD
	Config 3,6		CR2.1 TDD
Dedicated CORESET Reference Channel	Config 1,4		CCR.1.1 FDD
	Config 2,5		CCR.1.1 TDD
	Config 3,6		CCR.2.1 TDD
TRS configuration	Config 1,4		TRS.1.1 FDD
	Config 2,5		TRS.1.1 TDD
	Config 3,6		TRS.1.2 TDD
OCNG Patterns			OCNG pattern 1
SSB Configuration	Config 1,2,4,5		SSB.1 FR1
	Config 3,6		SSB.2 FR1
SMTTC configuration	Config 1,2,4,5		SMTTC.1 FR1
	Config 3,6		SMTTC.2 FR1
PDSCH/PDCCH subcarrier spacing	Config 1,2,4,5	kHz	15 kHz
	Config 3,6		30 kHz
PUCCH/PUSCH subcarrier spacing	Config 1,2,4,5	kHz	15 kHz
	Config 3,6		30 kHz
EPRE ratio of PSS to SSS		dB	0
EPRE ratio of PBCH DMRS to SSS			
EPRE ratio of PBCH to PBCH DMRS			
EPRE ratio of PDCCH DMRS to SSS			
EPRE ratio of PDCCH to PDCCH DMRS			
EPRE ratio of PDSCH DMRS to SSS			
EPRE ratio of PDSCH to PDSCH			
EPRE ratio of OCNG DMRS to SSS(Note 1)			
EPRE ratio of OCNG to OCNG DMRS (Note 1)			
N_{oc} ^{Note2}		dBm/15kHz	-98
N_{oc} ^{Note2}	Config 1,2,4,5		-98
	Config 3,6	dBm/SCS	-95
\hat{E}_s / I_{ot}		dB	3
\hat{E}_s / N_{oc}		dB	3
I_o ^{Note3}	Config 1,2,4,5	dBm/9.36MHz	-67.57
	Config 3,6	dBm/38.16MHz	-62.58
Propagation condition		-	AWGN

Note 1:	OCNG shall be used such that both cells are fully allocated and a constant total transmitted power spectral density is achieved for all OFDM symbols.
Note 2:	Interference from other cells and noise sources not specified in the test is assumed to be constant over subcarriers and time and shall be modelled as AWGN of appropriate power for N_{oc} to be fulfilled.
Note 3:	lo levels have been derived from other parameters for information purposes. They are not settable parameters themselves.

Table A.4.4.3.1.2-4: Sounding Reference Symbol Configuration for timing advance

Field		Value	Comment
c-SRS	Config 1,2,4,5	12	Frequency hopping is disabled
	Config 3,6	24	
b-SRS		0	
b-hop		0	
freqDomainPosition		0	Frequency domain position of SRS
freqDomainShift		0	
groupOrSequenceHopping		neither	No group or sequence hopping
SRS-PeriodicityAndOffset		sl5=2 for SCS 15kHz sl5=4 for SCS 30kHz	Once every 5 slots
pathlossReferenceRS		ssb-Index=0	SSB #0 is used for SRS path loss estimation
usage		Codebook	Codebook based UL transmission
startPosition		0	resourceMapping setting. SRS on last symbol of slot, and 1symbols for SRS without repetition.
nrofSymbols		n1	
repetitionFactor		n1	transmissionComb setting
combOffset-n2		0	
cyclicShift-n2		0	
nrofSRS-Ports		port1	Number of antenna ports used for SRS transmission
Note: For further information see clause 6.3.2 in TS 38.331 [2].			

A.4.4.3.1.3 Test Requirements

The UE shall apply the signalled Timing Advance value for PSCell in sTAG to the transmission timing at the designated activation time i.e. $k+l$ slots after the reception of the timing advance command, where $k=5$.

The Timing Advance adjustment accuracy for PSCell in sTAG shall be within the limits specified in clause 7.3.2.2.

The rate of correct Timing Advance adjustments observed during repeated tests shall be at least 90%.

A.4.5 Signaling characteristics

A.4.5.1 Radio link Monitoring

In the following clause, any uplink signal transmitted by the UE is used for detecting the In-/Out-of-Sync state of the UE. In terms of measurement, the uplink signal is verified on the basis of the UE output power:

For intra-band contiguous carrier aggregation, transmit OFF power is measured as the mean power per component carrier.

For UE with multiple transmit antennas, transmit OFF power is measured as the mean power at each transmit connector.

- UE output power higher than Transmit OFF power -50 dBm (as defined in TS 38.101-3 [20]) means uplink signal
- UE output power equal to or less than Transmit OFF power -50 dBm (as defined in TS 38.101-3 [20]) means no uplink signal.

A.4.5.1.1 Radio Link Monitoring Out-of-sync Test for FR1 PSCell configured with SSB-based RLM RS in non-DRX mode

A.4.5.1.1.1 Test Purpose and Environment

The purpose of this test is to verify that the UE properly detects the out of sync and in sync for the purpose of monitoring downlink radio link quality of the PSCell. This test will partly verify the FR1 PSCell radio link monitoring requirements in clause 8.1.

In the test, UE is configured to perform RLM on SSB, with *detectionResource* included in *RadioLinkMonitoringRS* set to SSB#0, and *purpose* set to 'rlf'. Supported test configurations are shown in table A.4.5.1.1.1-1. The test parameters are given in Tables A.4.5.1.1.1-2, A.4.5.1.1.1-3, and A.4.5.1.1.1-4 below. There are two cells, Cell 1 is the E-UTRAN PCell, and Cell 2 is the PSCell, in the test. The E-UTRAN PCell setting refers to Table A.3.7.2.1-1. The test consists of three successive time periods, with time duration of T1, T2 and T3 respectively. Figure A.4.5.1.1.1-1 shows the variation of the downlink SNR in the active Cell 2 to emulate out-of-sync and in-sync states. Prior to the start of the time duration T1, the UE shall be fully synchronized to Cell 1 and Cell 2. The UE shall be configured for periodic CSI reporting with a reporting periodicity of 5 ms. The UE is configured to perform inter-frequency measurements using Gap Pattern ID #0 (40ms) in test 1.

Table A.4.5.1.1.1-1: Supported test configurations for FR1 PSCell

Configuration	Description
1	LTE FDD, NR 15 kHz SSB SCS, 10 MHz bandwidth, FDD duplex mode
2	LTE FDD, NR 15 kHz SSB SCS, 10 MHz bandwidth, TDD duplex mode
3	LTE FDD, NR 30 kHz SSB SCS, 40 MHz bandwidth, TDD duplex mode
4	LTE TDD, NR 15 kHz SSB SCS, 10 MHz bandwidth, FDD duplex mode
5	LTE TDD, NR 15 kHz SSB SCS, 10 MHz bandwidth, TDD duplex mode
6	LTE TDD, NR 30 kHz SSB SCS, 40 MHz bandwidth, TDD duplex mode
Note: The UE is only required to pass in one of the supported test configurations in FR1	

Table A.4.5.1.1.1-2: General test parameters for FR1 out-of-sync testing in non-DRX mode

Parameter		Unit	Value
			Test 1
Active E-UTRA PCell			Cell 1
E-UTRA RF Channel Number			1
Active PSCell			Cell 2
RF Channel Number			2
Duplex mode	Config 1, 4		FDD
	Config 2, 3, 5, 6		TDD
BW _{channel}	Config 1, 4	MHz	10: N _{RB,c} = 52
	Config 2, 5		10: N _{RB,c} = 52
	Config 3, 6		40: N _{RB,c} = 106
DL initial BWP configuration	Config 1, 2, 3, 4, 5, 6		DLBWP.0.1

DL dedicated BWP configuration	Config 1, 2, 3, 4, 5, 6		DLBWP.1.1
UL initial BWP configuration	Config 1, 2, 3, 4, 5, 6		ULBWP.0.1
UL dedicated BWP configuration	Config 1, 2, 3, 4, 5, 6		ULBWP.1.1
TDD Configuration	Config 1, 4		Not Applicable
	Config 2, 5		TDDConf.1.1
	Config 3, 6		TDDConf.2.1
RMSI CORESET Reference Channel	Config 1, 4		CR.1.1 FDD
	Config 2, 5		CR.1.1 TDD
	Config 3, 6		CR.2.1 TDD
Dedicated CORESET Reference Channel	Config 1, 4		CCR.1.3 FDD
	Config 2, 5		CCR.1.3 TDD
	Config 3, 6		CCR.2.2 TDD
SSB Configuration	Config 1, 4		SSB.1 FR1
	Config 2, 5		SSB.1 FR1
	Config 3, 6		SSB.2 FR1
SMTC Configuration	Config 1, 2, 4, 5		SMTC.1
	Config 3, 6		SMTC.1
PDSCH/PDCCH subcarrier spacing	Config 1, 2, 4, 5		15 kHz
	Config 3, 6		30 kHz
PRACH Configuration	Config 1, 2, 4, 5		Table A.3.8.2.1-1
	Config 3, 6		Table A.3.8.2.1-1
SSB index assigned as RLM RS			0
OCNG parameters			OP.1
CP length			Normal
Correlation Matrix and Antenna Configuration			2x2 Low
Out of sync transmission parameters	DCI format		1-0
	Number of Control OFDM symbols		2
	Aggregation level	CCE	8
	Ratio of hypothetical PDCCH RE energy to average SSS RE energy	dB	4
	Ratio of hypothetical PDCCH DMRS energy to average SSS RE energy	dB	4
	DMRS precoder granularity		REG bundle size
	REG bundle size		6
DRX			OFF
Gap pattern ID			gp0
Layer 3 filtering			Enabled
T310 timer		ms	0
T311 timer		ms	1000
N310			1
N311			1
CSI-RS for CSI reporting	Config 1, 4		CSI-RS.1.1 FDD
	Config 2, 5		CSI-RS.1.1 TDD
	Config 3, 6		CSI-RS.2.1 TDD

CSI-RS for tracking	Config 1, 4		TRS.1.1 FDD
	Config 2, 5		TRS.1.1 TDD
	Config 3, 6		TRS.1.2 TDD
T1		s	0.2
T2		s	0.48
T3		s	0.48
D1		s	0.44
Note 1: All configurations are assigned to the UE prior to the start of time period T1.			
Note 2: UE-specific PDCCH is not transmitted after T1 starts.			
Note 3: E-UTRAN is in non-DRX mode under test.			

Table A.4.5.1.1.1-3: Cell specific test parameters for FR1 (Cell 2) for out-of-sync radio link monitoring tests in non-DRX mode

Parameter		Unit	Test 1		
			T1	T2	T3
EPRE ratio of PDCCH DMRS to SSS		dB	4		
EPRE ratio of PDCCH to PDCCH DMRS		dB	0		
EPRE ratio of PBCH DMRS to SSS		dB	0		
EPRE ratio of PBCH to PBCH DMRS		dB			
EPRE ratio of PSS to SSS		dB			
EPRE ratio of PDSCH DMRS to SSS		dB			
EPRE ratio of PDSCH to PDSCH DMRS		dB			
EPRE ratio of OCNG DMRS to SSS		dB			
EPRE ratio of OCNG to OCNG DMRS		dB			
SNR on RLM-RS	Config 1, 4	dB	1	-7	-15
	Config 2, 5		1	-7	-15
	Config 3, 6		1	-7	-15
N_{oc}	Config 1, 4	dBm/15 kHz	-98		
	Config 2, 5		-98		
	Config 3, 6		-98		
N_{oc}	Config 1, 4	dBm/SCS	-98		
	Config 2, 5		-98		
	Config 3, 6		-95		
Propagation condition			TDL-C 300ns 100Hz		
Note 1: OCNG shall be used such that the resources in Cell 2 are fully allocated and a constant total transmitted power spectral density is achieved for all OFDM symbols.					
Note 2: The signal contains PDCCH for UEs other than the device under test as part of OCNG.					
Note 3: SNR levels correspond to the signal to noise ratio over the SSS REs.					

Table A.4.5.1.1.1-4: Measurement gap configuration for out-of-sync tests in non-DRX mode

Field	Test 1
	Value
gapOffset	0

Note 1: E-UTRAN PCell and PSCell are SFN-synchronous and frame boundary aligned. (Ensure that RLM RS is partially overlapped with measurement gap).

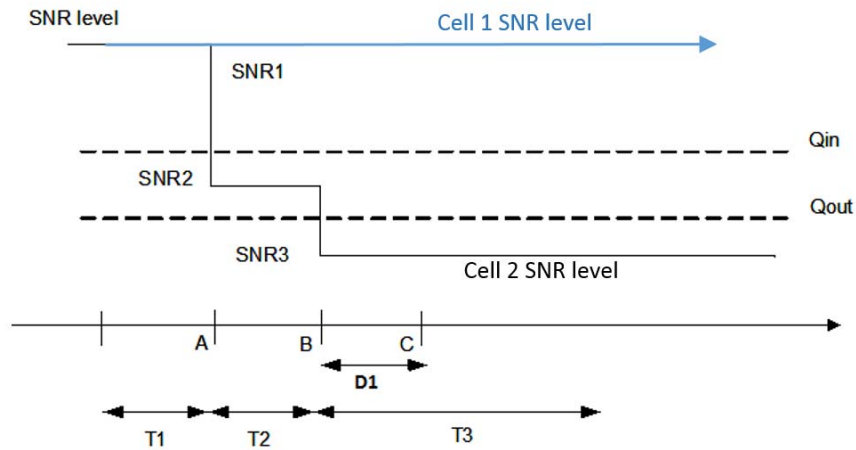

Figure A.4.5.1.1.1-1: SNR variation for out-of-sync testing

A.4.5.1.1.2 Test Requirements

The UE behaviour in each test during time durations T1, T2 and T3 shall be as follows:

During the period from time point A to time point B the UE shall transmit uplink signal at least in all uplink slots configured for CSI transmission according to the configured periodic CSI reporting.

The UE shall stop transmitting uplink signal in Cell 2 no later than time point C (D1 second after the start of the time duration T3).

The rate of correct events observed during repeated tests shall be at least 90%.

A.4.5.1.2 Radio Link Monitoring In-sync Test for FR1 PSCell configured with SSB-based RLM RS in non-DRX mode

A.4.5.1.2.1 Test Purpose and Environment

The purpose of this test is to verify that the UE properly detects the out of sync and in sync for the purpose of monitoring downlink radio link quality of the PSCell. This test will partly verify the FR1 PSCell radio link monitoring requirements in clause 8.1.

In the test, UE is configured to perform RLM on SSB, with *detectionResource* included in *RadioLinkMonitoringRS* set to SSB#0, and *purpose* set to 'rlf'. Supported test configurations are shown in table A.4.5.1.2.1-1. The test parameters are given in Tables A.4.5.1.2.1-2, and A.4.5.1.2.1-3 below. There are two cells, Cell 1 is the E-UTRAN PCell, and Cell 2 is the PSCell, in the test. The E-UTRAN PCell setting refers to Table A.3.7.2.1-1. The test consists of five successive time periods, with time duration of T1, T2, T3, T4 and T5 respectively. Figure A.4.5.1.2.1-1 shows the variation of the downlink SNR in the active Cell 2 to emulate out-of-sync and in-sync states. Prior to the

start of the time duration T1, the UE shall be fully synchronized to Cell 1 and Cell 2. The UE shall be configured for periodic CSI reporting with a reporting periodicity of 5 ms.

Table A.4.5.1.2.1-1: Supported test configurations for FR1 PSCell

Configuration	Description
1	LTE FDD, NR 15 kHz SSB SCS, 10 MHz bandwidth, FDD duplex mode
2	LTE FDD, NR 15 kHz SSB SCS, 10 MHz bandwidth, TDD duplex mode
3	LTE FDD, NR 30 kHz SSB SCS, 40 MHz bandwidth, TDD duplex mode
4	LTE TDD, NR 15 kHz SSB SCS, 10 MHz bandwidth, FDD duplex mode
5	LTE TDD, NR 15 kHz SSB SCS, 10 MHz bandwidth, TDD duplex mode
6	LTE TDD, NR 30 kHz SSB SCS, 40 MHz bandwidth, TDD duplex mode
Note:	The UE is only required to pass in one of the supported test configurations in FR1

Table A.4.5.1.2.1-2: General test parameters for FR1 in-sync testing in non-DRX mode

Parameter		Unit	Value
			Test 1
Active E-UTRA PCell			Cell 1
E-UTRA RF Channel Number			1
Active PSCell			Cell 2
RF Channel Number			2
Duplex mode	Config 1, 4		FDD
	Config 2, 3, 5, 6		TDD
BW _{channel}	Config 1, 4	MHz	10: N _{RB,c} = 52
	Config 2, 5		10: N _{RB,c} = 52
	Config 3, 6		40: N _{RB,c} = 106
DL initial BWP configuration	Config 1, 2, 3, 4, 5, 6		DLBWP.0.1
DL dedicated BWP configuration	Config 1, 2, 3, 4, 5, 6		DLBWP.1.1
UL initial BWP configuration	Config 1, 2, 3, 4, 5, 6		ULBWP.0.1
UL dedicated BWP configuration	Config 1, 2, 3, 4, 5, 6		ULBWP.1.1
TDD Configuration	Config 1, 4		Not Applicable
	Config 2, 5		TDDConf.1.1
	Config 3, 6		TDDConf.2.1
RMSI CORESET Reference Channel	Config 1, 4		CR.1.1 FDD
	Config 2, 5		CR.1.1 TDD
	Config 3, 6		CR.2.1 TDD
Dedicated CORESET Reference Channel	Config 1, 4		CCR.1.1 FDD
	Config 2, 5		CCR.1.1 TDD
	Config 3, 6		CCR.2.1 TDD
SSB Configuration	Config 1, 4		SSB.1 FR1
	Config 2, 5		SSB.1 FR1
	Config 3, 6		SSB.2 FR1
SMTc Configuration	Config 1, 2, 4, 5		SMTc.1
	Config 3, 6		SMTc.1
PDSCH/PDCCH subcarrier spacing	Config 1, 2, 4, 5		15 kHz
	Config 3, 6		30 kHz

PRACH Configuration	Config 1, 2, 4, 5		Table A.3.8.2.1-1
	Config 3, 6		Table A.3.8.2.1-1
SSB index assigned as RLM RS			0
OCNG parameters			OP.1
CP length			Normal
Correlation Matrix and Antenna Configuration			2x2 Low
In sync transmission parameters	DCI format		1-0
	Number of Control OFDM symbols		2
	Aggregation level	CCE	4
	Ratio of hypothetical PDCCH RE energy to average SSS RE energy	dB	0
	Ratio of hypothetical PDCCH DMRS energy to average SSS RE energy	dB	0
	DMRS precoder granularity		REG bundle size
	REG bundle size		6
Out of sync transmission parameters	DCI format		1-0
	Number of Control OFDM symbols		2
	Aggregation level	CCE	8
	Ratio of hypothetical PDCCH RE energy to average SSS RE energy	dB	4
	Ratio of hypothetical PDCCH DMRS energy to average SSS RE energy	dB	4
	DMRS precoder granularity		REG bundle size
	REG bundle size		6
DRX			<i>OFF</i>
Gap pattern ID			N.A.
Layer 3 filtering			<i>Enabled</i>
T310 timer		ms	1000
T311 timer		ms	1000
N310			1
N311			1

CSI-RS for CSI reporting	Config 1, 4		CSI-RS.1.1 FDD
	Config 2, 5		CSI-RS.1.1 TDD
	Config 3, 6		CSI-RS.2.1 TDD
CSI-RS for tracking	Config 1, 4		TRS.1.1 FDD
	Config 2, 5		TRS.1.1 TDD
	Config 3, 6		TRS.1.2 TDD
T1		s	0.2
T2		s	0.2
T3		s	0.24
T4		s	0.2
T5		s	0.88
D1		s	0.84
Note 1: All configurations are assigned to the UE prior to the start of time period T1.			
Note 2: UE-specific PDCCH is not transmitted after T1 starts.			
Note 3: E-UTRAN is in non-DRX mode under test.			

Table A.4.5.1.2.1-3: Cell specific test parameters for FR1 (Cell 2) for in-sync radio link monitoring tests in non-DRX mode

Parameter		Unit	Test 1				
			T1	T2	T3	T4	T5
EPRE ratio of PDCCH DMRS to SSS		dB	0				
EPRE ratio of PDCCH to PDCCH DMRS		dB	0				
EPRE ratio of PBCH DMRS to SSS		dB	0				
EPRE ratio of PBCH to PBCH DMRS		dB					
EPRE ratio of PSS to SSS		dB					
EPRE ratio of PDSCH DMRS to SSS		dB					
EPRE ratio of PDSCH to PDSCH DMRS		dB					
EPRE ratio of OCNG DMRS to SSS		dB					
EPRE ratio of OCNG to OCNG DMRS		dB					
SNR on RLM-RS	Config 1, 4	dB	1	-7	-15	-4.5	1
	Config 2, 5		1	-7	-15	-4.5	1
	Config 3, 6		1	-7	-15	-4.5	1
N_{oc}	Config 1, 4	dBm/15 kHz	-98				
	Config 2, 5		-98				
	Config 3, 6		-98				
N_{oc}	Config 1, 4	dBm/SCS	-98				
	Config 2, 5		-98				
	Config 3, 6		-95				
Propagation condition			TDL-C 300ns 100Hz				
Note 1: OCNG shall be used such that the resources in Cell 2 are fully allocated and a constant total transmitted power spectral density is achieved for all OFDM symbols.							
Note 2: The signal contains PDCCH for UEs other than the device under test as part of OCNG.							
Note 3: SNR levels correspond to the signal to noise ratio over the SSS REs.							
Note 4: The SNR in time periods T1, T2, T3, T4 and T5 is denoted as SNR1, SNR2, SNR3, SNR4 and SNR5 respectively in Figure A.4.5.1.2.1-1.							
Note 5: The SNR values are specified for testing a UE which supports 2RX on at least one band. For testing of a UE which supports 4RX on all bands, the SNR during T3 and T4 is modified as specified in clause A.3.6.							

Table A.4.5.1.2.1-4: Void

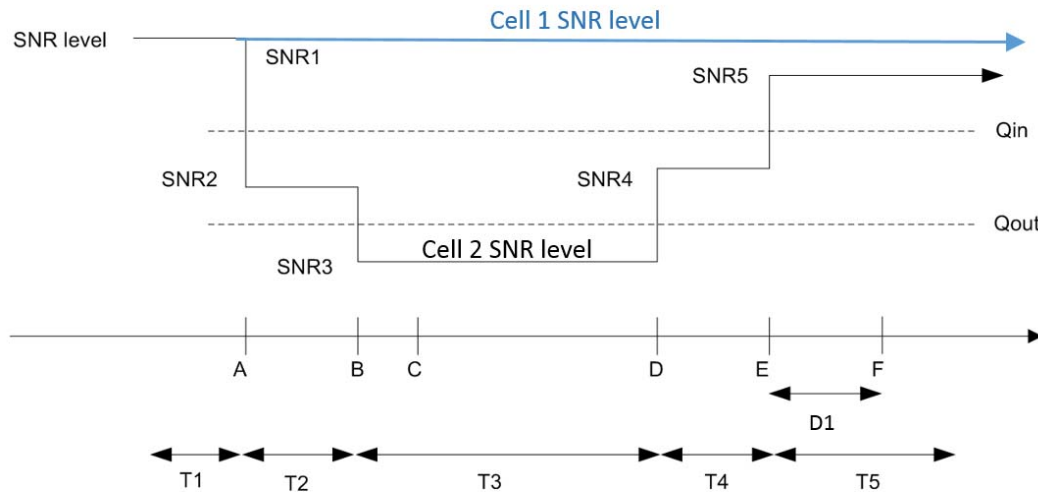

Figure A.4.5.1.2.1-1: SNR variation for in-sync testing

A.4.5.1.2.2 Test Requirements

The UE behaviour in each test during time durations T1, T2, T3, T4 and T5 shall be as follows:

During the period from time point A to time point F (D1 second after the start of time duration T5) the UE shall transmit uplink signal at least in all uplink slots configured for CSI transmission according to the configured periodic CSI reporting.

The rate of correct events observed during repeated tests shall be at least 90%.

A.4.5.1.3 Radio Link Monitoring Out-of-sync Test for FR1 PSCell configured with SSB-based RLM RS in DRX mode

A.4.5.1.3.1 Test Purpose and Environment

The purpose of this test is to verify that the UE properly detects the out of sync and in sync for the purpose of monitoring downlink radio link quality of the PSCell when DRX is used. This test will partly verify the FR1 radio link monitoring requirements in clause 8.1.

In the test, UE is configured to perform RLM on SSB, with *detectionResource* included in *RadioLinkMonitoringRS* set to SSB#0, and *purpose* set to 'rlf'. Supported test configurations are shown in table A.4.5.1.3.1-1. The test parameters are given in Tables A.4.5.1.3.1-2 and A.4.5.1.3.1-3. There are two cells, Cell 1 is the E-UTRAN PCell, and Cell 2 is the PSCell, in the test. The E-UTRAN PCell setting refers to Table A.3.7.2.1-1. The test consists of three successive time periods, with time duration of T1, T2 and T3 respectively. Figure A.4.5.1.3.1-1 shows the variation of the downlink SNR in the active Cell 2 to emulate out-of-sync and in-sync states. Prior to the start of the time duration T1, the UE shall be fully synchronized to Cell 1 and Cell 2. The UE shall be configured for periodic CSI reporting with a reporting periodicity of 5 ms. In the test, DRX configuration is enabled and DRX inactivity timer has already been expired, i.e. UE tries to decode PDCCH and to send periodic CSI during the period when On-

duration timer is running. Time alignment timers shall be set to “infinity” so that UL timing alignment is maintained during the test.

Table A.4.5.1.3.1-1: Supported test configurations for FR1 PSCell

Configuration	Description
1	LTE FDD, NR 15 kHz SSB SCS, 10 MHz bandwidth, FDD duplex mode
2	LTE FDD, NR 15 kHz SSB SCS, 10 MHz bandwidth, TDD duplex mode
3	LTE FDD, NR 30 kHz SSB SCS, 40 MHz bandwidth, TDD duplex mode
4	LTE TDD, NR 15 kHz SSB SCS, 10 MHz bandwidth, FDD duplex mode
5	LTE TDD, NR 15 kHz SSB SCS, 10 MHz bandwidth, TDD duplex mode
6	LTE TDD, NR 30 kHz SSB SCS, 40 MHz bandwidth, TDD duplex mode
Note:	The UE is only required to pass in one of the supported test configurations in FR1

Table A.4.5.1.3.1-2: General test parameters for FR1 out-of-sync testing in DRX mode

Parameter		Unit	Value Test 1
Active E-UTRA PCell			Cell 1
E-UTRA RF Channel Number			1
Active PSCell			Cell 2
RF Channel Number			2
Duplex mode	Config 1, 4		FDD
	Config 2, 3, 5, 6		TDD
BW _{channel}	Config 1, 4	MHz	10: N _{RB,c} = 52
	Config 2, 5		10: N _{RB,c} = 52
	Config 3, 6		40: N _{RB,c} = 106
DL initial BWP configuration	Config 1, 2, 3, 4, 5, 6		DLBWP.0.1
DL dedicated BWP configuration	Config 1, 2, 3, 4, 5, 6		DLBWP.1.1
UL initial BWP configuration	Config 1, 2, 3, 4, 5, 6		ULBWP.0.1
UL dedicated BWP configuration	Config 1, 2, 3, 4, 5, 6		ULBWP.1.1
TDD Configuration	Config 1, 4		Not Applicable
	Config 2, 5		TDDConf.1.1
	Config 3, 6		TDDConf.2.1
RMSI CORESET Reference Channel	Config 1, 4		CR.1.1 FDD
	Config 2, 5		CR.1.1 TDD
	Config 3, 6		CR.2.1 TDD
Dedicated CORESET Reference Channel	Config 1, 4		CCR.1.3 FDD
	Config 2, 5		CCR.1.3 TDD
	Config 3, 6		CCR.2.2 TDD
SSB Configuration	Config 1, 4		SSB.1 FR1
	Config 2, 5		SSB.1 FR1
	Config 3, 6		SSB.2 FR1
SMTC Configuration	Config 1, 2, 4, 5		SMTC.1
	Config 3, 6		SMTC.1
PDSCH/PDCCH subcarrier spacing	Config 1, 2, 4, 5		15 kHz
	Config 3, 6		30 kHz
PRACH Configuration	Config 1, 2, 4, 5		Table A.3.8.2.1-1
	Config 3, 6		Table A.3.8.2.1-1

SSB index assigned as RLM RS			0
OCNG parameters			OP.1
CP length			Normal
Correlation Matrix and Antenna Configuration			2x2 Low
Out of sync transmission parameters	DCI format		1-0
	Number of Control OFDM symbols		2
	Aggregation level	CCE	8
	Ratio of hypothetical PDCCH RE energy to average SSS RE energy	dB	4
	Ratio of hypothetical PDCCH DMRS energy to average SSS RE energy	dB	4
	DMRS precoder granularity		REG bundle size
	REG bundle size		6
DRX Configuration			DRX.3
Gap pattern ID			N.A.
Layer 3 filtering			Enabled
T310 timer	ms		0
T311 timer	ms		1000
N310			1
N311			1
CSI-RS for CSI reporting	Config 1, 4		CSI-RS.1.1 FDD
	Config 2, 5		CSI-RS.1.1 TDD
	Config 3, 6		CSI-RS.2.1 TDD
CSI-RS for tracking	Config 1, 4		TRS.1.1 FDD
	Config 2, 5		TRS.1.1 TDD
	Config 3, 6		TRS.1.2 TDD
T1	s		0.2
T2	s		0.68
T3	s		0.68
D1	s		0.64
Note 1: All configurations are assigned to the UE prior to the start of time period T1.			
Note 2: UE-specific PDCCH is not transmitted after T1 starts.			
Note 3: E-UTRAN is in non-DRX mode under test.			

Table A.4.5.1.3.1-3: Cell specific test parameters for FR1 (Cell 2) for out-of-sync radio link monitoring tests in DRX mode

Parameter	Unit	Test 1		
		T1	T2	T3
EPRE ratio of PDCCH DMRS to SSS	dB	4		
EPRE ratio of PDCCH to PDCCH DMRS	dB	0		
EPRE ratio of PBCH DMRS to SSS	dB	0		
EPRE ratio of PBCH to PBCH DMRS	dB			
EPRE ratio of PSS to SSS	dB			
EPRE ratio of PDSCH DMRS to SSS	dB			
EPRE ratio of PDSCH to PDSCH DMRS	dB			
EPRE ratio of OCNG DMRS to SSS	dB			
EPRE ratio of OCNG to OCNG DMRS	dB			
SNR on RLM-RS	Config 1, 4	1	-7	-15
	Config 2, 5	1	-7	-15
	Config 3, 6	1	-7	-15

N_{oc}	Config 1, 4	dBm/15k Hz	-98
	Config 2, 5		-98
	Config 3, 6		-98
N_{oc}	Config 1, 4	dBm/SCS	-98
	Config 2, 5		-98
	Config 3, 6		-95
Propagation condition			TDL-C 300ns 100Hz
<p>Note 1: OCNG shall be used such that the resources in Cell 2 are fully allocated and a constant total transmitted power spectral density is achieved for all OFDM symbols.</p> <p>Note 2: The signal contains PDCCH for UEs other than the device under test as part of OCNG.</p> <p>Note 3: SNR levels correspond to the signal to noise ratio over the SSS REs.</p> <p>Note 4: The SNR in time periods T1, T2 and T3 is denoted as SNR1, SNR2 and SNR3 respectively in Figure A.4.5.1.3.1-1.</p> <p>Note 5: The SNR values are specified for testing a UE which supports 2RX on at least one band. For testing of a UE which supports 4RX on all bands, the SNR during T3 is A.3.6.</p>			

Table A.4.5.1.3.1-4: Void

Table A.4.5.1.3.1-5: Void

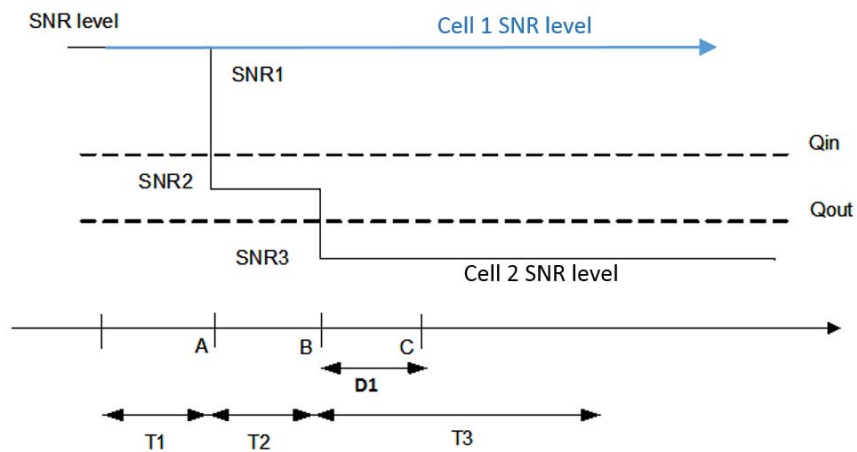

Figure A.4.5.1.3.1-1: SNR variation for out-of-sync testing

A.4.5.1.3.2 Test Requirements

The UE behaviour in each test during time durations T1, T2 and T3 shall be as follows:

During the period from time point A to time point B the UE shall transmit uplink signal at least in all uplink slots configured for CSI transmission according to the configured periodic CSI reporting.

The UE shall stop transmitting uplink signal in Cell 2 no later than time point C (D1 second after the start of the time duration T3).

The rate of correct events observed during repeated tests shall be at least 90%.

A.4.5.1.4 Radio Link Monitoring In-sync Test for FR1 PSCell configured with SSB-based RLM RS in DRX mode

A.4.5.1.4.1 Test Purpose and Environment

The purpose of this test is to verify that the UE properly detects the out of sync and in sync for the purpose of monitoring downlink radio link quality of the PSCell when DRX is used. This test will partly verify the FR1 radio link monitoring requirements in clause 8.1.

In the test, UE is configured to perform RLM on SSB, with *detectionResource* included in *RadioLinkMonitoringRS* set to SSB#0, and *purpose* set to 'rlf'. Supported test configurations are shown in table A.4.5.1.4.1-1. The test parameters are given in Tables A.4.5.1.4.1-2, and A.4.5.1.4.1-3. There are two cells, Cell 1 is the E-UTRAN PCell, and Cell 2 is the PSCell, in the test. The E-UTRAN PCell setting refers to Table A.3.7.2.1-1. The test consists of five successive time periods, with time duration of T1, T2, T3, T4 and T5 respectively. Figure A.4.5.1.4.1-1 shows the variation of the downlink SNR in the active Cell 2 to emulate out-of-sync and in-sync states. Prior to the start of the time duration T1, the UE shall be fully synchronized to Cell 1 and Cell 2. The UE shall be configured for periodic CSI reporting with a reporting periodicity of 5 ms. In the test, DRX configuration is enabled and DRX inactivity timer has already been expired, i.e. UE tries to decode PDCCH and to send periodic CSI during the period when On-duration timer is running. Time alignment timers shall be set to "infinity" so that UL timing alignment is maintained during the test.

Table A.4.5.1.4.1-1: Supported test configurations for FR1 PSCell

Configuration	Description
1	LTE FDD, NR 15 kHz SSB SCS, 10 MHz bandwidth, FDD duplex mode
2	LTE FDD, NR 15 kHz SSB SCS, 10 MHz bandwidth, TDD duplex mode
3	LTE FDD, NR 30 kHz SSB SCS, 40 MHz bandwidth, TDD duplex mode
4	LTE TDD, NR 15 kHz SSB SCS, 10 MHz bandwidth, FDD duplex mode
5	LTE TDD, NR 15 kHz SSB SCS, 10 MHz bandwidth, TDD duplex mode
6	LTE TDD, NR 30 kHz SSB SCS, 40 MHz bandwidth, TDD duplex mode
Note:	The UE is only required to pass in one of the supported test configurations in FR1

Table A.4.5.1.4.1-2: General test parameters for FR1 in-sync testing in DRX mode

Parameter		Unit	Value
			Test 1
Active E-UTRA PCell			Cell 1
E-UTRA RF Channel Number			1
Active PSCell			Cell 2
RF Channel Number			2
Duplex mode	Config 1, 4		FDD
	Config 2, 3, 5, 6		TDD
BW _{channel}	Config 1, 4	MHz	10: N _{RB,c} = 52
	Config 2, 5		10: N _{RB,c} = 52
	Config 3, 6		40: N _{RB,c} = 106
DL initial BWP configuration	Config 1, 2, 3, 4, 5, 6		DLBWP.0.1
DL dedicated BWP configuration	Config 1, 2, 3, 4, 5, 6		DLBWP.1.1
UL initial BWP configuration	Config 1, 2, 3, 4, 5, 6		ULBWP.0.1
UL dedicated BWP configuration	Config 1, 2, 3, 4, 5, 6		ULBWP.1.1

TDD Configuration	Config 1, 4		Not Applicable
	Config 2, 5		TDDConf.1.1
	Config 3, 6		TDDConf.2.1
RMSI CORESET Reference Channel	Config 1, 4		CR.1.1 FDD
	Config 2, 5		CR.1.1 TDD
	Config 3, 6		CR.2.1 TDD
Dedicated CORESET Reference Channel	Config 1, 4		CCR.1.1 FDD
	Config 2, 5		CCR.1.1 TDD
	Config 3, 6		CCR.2.1 TDD
SSB Configuration	Config 1, 4		SSB.1 FR1
	Config 2, 5		SSB.1 FR1
	Config 3, 6		SSB.2 FR1
SMTC Configuration	Config 1, 2, 4, 5		SMTC.1
	Config 3, 6		SMTC.1
PDSCH/PDCCH subcarrier spacing	Config 1, 2, 4, 5		15 kHz
	Config 3, 6		30 kHz
PRACH Configuration	Config 1, 2, 4, 5		Table A.3.8.2.1-1
	Config 3, 6		Table A.3.8.2.1-1
SSB index assigned as RLM RS			0
OCNG parameters			OP.1
CP length			Normal
Correlation Matrix and Antenna Configuration			2x2 Low
In sync transmission parameters	DCI format		1-0
	Number of Control OFDM symbols		2
	Aggregation level	CCE	4
	Ratio of hypothetical PDCCH RE energy to average SSS RE energy	dB	0
	Ratio of hypothetical PDCCH DMRS energy to average SSS RE energy	dB	0
	DMRS precoder granularity		REG bundle size
	REG bundle size		6
Out of sync transmission parameters	DCI format		1-0
	Number of Control OFDM symbols		2
	Aggregation level	CCE	8
	Ratio of hypothetical PDCCH RE energy to average SSS RE energy	dB	4
	Ratio of hypothetical PDCCH DMRS energy to average SSS RE energy	dB	4
	DMRS precoder granularity		REG bundle size
	REG bundle size		6

DRX Configuration		DRX.3
Gap pattern ID		N.A.
Layer 3 filtering		<i>Enabled</i>
T310 timer	ms	1000
T311 timer	ms	1000
N310		1
N311		1
CSI-RS for CSI reporting	Config 1, 4	CSI-RS.1.1 FDD
	Config 2, 5	CSI-RS.1.1 TDD
	Config 3, 6	CSI-RS.2.1 TDD
CSI-RS for tracking	Config 1, 4	TRS.1.1 FDD
	Config 2, 5	TRS.1.1 TDD
	Config 3, 6	TRS.1.2 TDD
T1	s	0.2
T2	s	0.2
T3	s	0.64
T4	s	0.2
T5	s	0.88
D1	s	0.84
Note 1: All configurations are assigned to the UE prior to the start of time period T1.		
Note 2: UE-specific PDCCH is not transmitted after T1 starts.		
Note 3: E-UTRAN is in non-DRX mode under test.		

Table A.4.5.1.4.1-3: Cell specific test parameters for FR1 (Cell 2) for in-sync radio link monitoring tests in DRX mode

Parameter		Unit	Test 1				
			T1	T2	T3	T4	T5
EPRE ratio of PDCCH DMRS to SSS		dB	0				
EPRE ratio of PDCCH to PDCCH DMRS		dB	0				
EPRE ratio of PBCH DMRS to SSS		dB	0				
EPRE ratio of PBCH to PBCH DMRS		dB					
EPRE ratio of PSS to SSS		dB					
EPRE ratio of PDSCH DMRS to SSS		dB					
EPRE ratio of PDSCH to PDSCH DMRS		dB					
EPRE ratio of OCNG DMRS to SSS		dB					
EPRE ratio of OCNG to OCNG DMRS		dB					
SNR on RLM-RS	Config 1, 4	dB	1	-7	-15	-4.5	1
	Config 2, 5		1	-7	-15	-4.5	1
	Config 3, 6		1	-7	-15	-4.5	1
N_{oc}	Config 1, 4	dBm/15 kHz	-98				
	Config 2, 5		-98				
	Config 3, 6		-98				
N_{oc}	Config 1, 4	dBm/SCS	-98				
	Config 2, 5		-98				
	Config 3, 6		-95				
Propagation condition			TDL-C 300ns 100Hz				
Note 1: OCNG shall be used such that the resources in Cell 2 are fully allocated and a constant total transmitted power spectral density is achieved for all OFDM symbols.							
Note 2: The signal contains PDCCH for UEs other than the device under test as part of OCNG.							
Note 3: SNR levels correspond to the signal to noise ratio over the SSS REs.							
Note 4: The SNR in time periods T1, T2, T3, T4 and T5 is denoted as SNR1, SNR2, SNR3, SNR4 and SNR5 respectively in Figure A.4.5.1.4.1-1.							
Note 5: The SNR values are specified for testing a UE which supports 2RX on at least one band. For testing of a UE which supports 4RX on all bands, the SNR during T3 and T4 is modified as specified in clause A.3.6.							

Table A.4.5.1.4.1-4: Void

Table A.4.5.1.4.1-5: Void

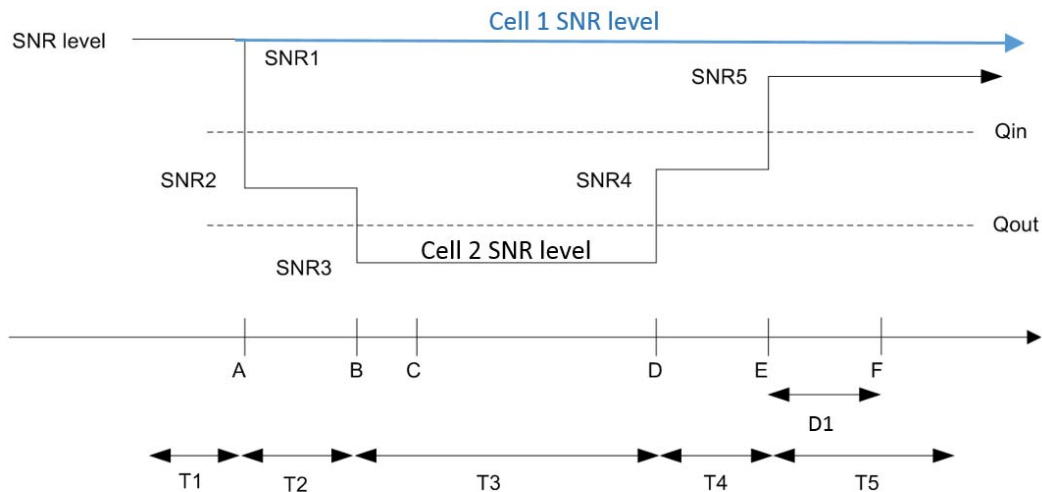

Figure A.4.5.1.4.1-1: SNR variation for in-sync testing

A.4.5.1.4.2 Test Requirements

The UE behaviour in each test during time durations T1, T2, T3, T4 and T5 shall be as follows:

During the period from time point A to time point F ($D1$ second after the start of time duration T5) the UE shall transmit uplink signal at least in all uplink slots configured for CSI transmission according to the configured periodic CSI reporting.

The rate of correct events observed during repeated tests shall be at least 90%.

A.4.5.1.5 EN-DC Radio Link Monitoring Out-of-sync Test for FR1 PSCell configured with CSI-RS-based RLM in non-DRX mode

A.4.5.1.5.1 Test Purpose and Environment

The purpose of this test is to verify that the UE properly detects the out of sync for the purpose of monitoring downlink CSI-RS based radio link quality of the PSCell when no DRX is used. This test will partly verify the FR1 PSCell CSI-RS Out-of-sync radio link monitoring requirements in clause 8.1.

The test parameters are given in Tables A.4.5.1.5.1-1, A.4.5.1.5.1-2, A.4.5.1.5.1-3, and A.4.5.1.5.1-3A below. There are two cells, cell 1 is the E-UTRAN PCell, and cell 2 is the PSCell, in the test. The test consists of three successive time periods, with time duration of T1, T2 and T3 respectively. Figure A.4.5.1.5.1-1 shows the variation of the downlink SNR in the E-UTRAN PCell and the PSCell to emulate out-of-sync and in-sync states. Prior to the start of the time duration T1, the UE shall be fully synchronized to cell 1 and cell 2. The UE shall be configured for periodic CSI reporting with a reporting periodicity of 5ms. In the test, DRX configuration is not enabled. The UE is

configured to perform inter-frequency measurements using GP ID #0 (40ms). In the test, SSB0 is configured as the BFD-RS.

Table A.4.5.1.5.1-1: Supported test configurations for FR1 PSCell

Configuration	Description
1	LTE FDD, NR 15 kHz SSB SCS, 10 MHz bandwidth, FDD duplex mode
2	LTE FDD, NR 15 kHz SSB SCS, 10 MHz bandwidth, TDD duplex mode
3	LTE FDD, NR 30 kHz SSB SCS, 40 MHz bandwidth, TDD duplex mode
4	LTE TDD, NR 15 kHz SSB SCS, 10 MHz bandwidth, FDD duplex mode
5	LTE TDD, NR 15 kHz SSB SCS, 10 MHz bandwidth, TDD duplex mode
6	LTE TDD, NR 30 kHz SSB SCS, 40 MHz bandwidth, TDD duplex mode
Note:	The UE is only required to pass in one of the supported test configurations in FR1

Table A.4.5.1.5.1-2: General test parameters for FR1 PSCell for CSI-RS out-of-sync testing in non-DRX mode

Parameter		Unit	Value Test 1
Active E-UTRA PCell			Cell 1
E-UTRA RF Channel Number			1
Active PSCell			Cell 2
RF Channel Number			2
Duplex mode	Config 1, 4		FDD
	Config 2, 3, 5, 6		TDD
TDD Configuration	Config 1, 4		Not Applicable
	Config 2, 5		TDDConf.1.1
	Config 3, 6		TDDConf.2.1
DL initial BWP configuration	Config 1, 2, 3, 4, 5, 6		DLBWP.0.1
DL dedicated BWP configuration	Config 1, 2, 3, 4, 5, 6		DLBWP.1.1
UL initial BWP configuration	Config 1, 2, 3, 4, 5, 6		ULBWP.0.1
UL dedicated BWP configuration	Config 1, 2, 3, 4, 5, 6		ULBWP.1.1
RMSI CORESET Reference Channel	Config 1, 4		CR.1.1 FDD
	Config 2, 5		CR.1.1 TDD
	Config 3, 6		CR.2.1 TDD
Dedicated CORESET Reference Channel	Config 1, 4		CCR.1.3 FDD
	Config 2, 5		CCR.1.3 TDD
	Config 3, 6		CCR.2.2 TDD
SSB Configuration	Config 1, 4		SSB.1 FR1
	Config 2, 5		SSB.1 FR1
	Config 3, 6		SSB.2 FR1
SMTTC Configuration	Config 1, 2, 4, 5		SMTTC.1
	Config 3, 6		SMTTC.1
PDSCH/PDCCH subcarrier spacing	Config 1, 2, 4, 5		15 KHz
	Config 3, 6		30 KHz
TRS configuration	Config 1, 4		TRS.1.1 FDD
	Config 2, 5		TRS.1.1 TDD
	Config 3, 6		TRS.1.2 TDD
CSI-RS for RLM	Config 1, 4		Resource #4 in TRS.1.1 FDD
	Config 2, 5		Resource #4 in TRS.1.1 TDD

	Config 3, 6		Resource #4 in TRS.1.2 TDD
TCI configuration for PDCCH/PDSCH			TCI.State.2
OCNG parameters			OP.1
CP length			Normal
Correlation Matrix and Antenna Configuration			2x2 Low
Out of sync transmission parameters	DCI format		1-0
	Number of Control OFDM symbols		2
	Aggregation level	CCE	8
	Ratio of hypothetical PDCCH RE energy to average CSI-RS RE energy	dB	4
	Ratio of hypothetical PDCCH DMRS energy to average CSI-RS RE energy	dB	4
	DMRS precoder granularity		REG bundle size
	REG bundle size		6
DRX			OFF
Gap pattern ID			gp0
Layer 3 filtering			Enabled
T310 timer		ms	0
T311 timer		ms	1000
N310			1
N311			1
CSI-RS for reporting	Config 1, 4		CSI-RS1.1 FDD
	Config 2, 5		CSI-RS.1.1 TDD
	Config 3, 6		CSI-RS.2.1 TDD
T1		s	0.2
T2		s	0.48
T3		s	0.48
D1		s	0.44
Note 1: UE-specific PDCCH is not transmitted after T1 starts.			
Note 2: E-UTRAN is in non-DRX mode under test.			

Table A.4.5.1.5.1-3: Cell specific test parameters for FR1 for CSI-RS out-of-sync radio link monitoring in non-DRX mode

Parameter	Unit	Test 1		
		T1	T2	T3
EPRE ratio of PDCCH DMRS to SSS	dB	4		
EPRE ratio of PDCCH to PDCCH DMRS	dB	0		
EPRE ratio of PBCH to PBCH DMRS	dB			
EPRE ratio of PSS to SSS	dB			
EPRE ratio of PBCH DMRS to SSS	dB			
EPRE ratio of PDSCH to PDSCH DMRS	dB			
EPRE ratio of PDSCH DMRS to SSS	dB			

EPRE ratio of OCNG DMRS to SSS		dB			
EPRE ratio of OCNG to OCNG DMRS		dB			
SNR on RLM-RS	Config 1, 4	dB	1	-7	-15
	Config 2, 5		1	-7	-15
	Config 3, 6		1	-7	-15
N_{oc}	Config 1, 4	dBm/15K	-98		
	Config 2, 5	Hz	-98		
	Config 3, 6		-98		
Propagation condition		TDL-C 300ns 100Hz			
<p>Note 1: OCNG shall be used such that the resources in Cell 2 are fully allocated and a constant total transmitted power spectral density is achieved for all OFDM symbols.</p> <p>Note 2: The uplink resources for CSI reporting are assigned to the UE prior to the start of time period T1.</p> <p>Note 3: NZP CSI-RS resource set configuration for CSI reporting are assigned to the UE prior to the start of time period T1.</p> <p>Note 4: Measurement gap configuration is assigned to the UE prior to the start of time period T1.</p> <p>Note 5: The timers and layer 3 filtering related parameters are configured prior to the start of time period T1.</p> <p>Note 6: The signal contains PDCCH for UEs other than the device under test as part of OCNG.</p> <p>Note 7: SNR levels correspond to the signal to noise ratio over the SSS REs.</p> <p>Note 8: The SNR in time periods T1, T2 and T3 is denoted as SNR1, SNR2 and SNR3 respectively in figure A.4.5.1.5.1-1.</p> <p>Note 9: The SNR values are specified for testing a UE which supports 2RX on at least one band. For testing of a UE which supports 4RX on all bands, the SNR during T3 is specified in section A.3.6.1.1.</p>					

Table A.4.5.1.5.1-3A: Measurement gap configuration for FR1 CSI-RS out-of-sync radio link monitoring in non-DRX mode

Field	Test 1
	Value
gapOffset	0
Note 1: E-UTRAN PCell and PSCell are SFN-synchronous and frame boundary aligned.	

Table A.4.5.1.5.1-4: Void

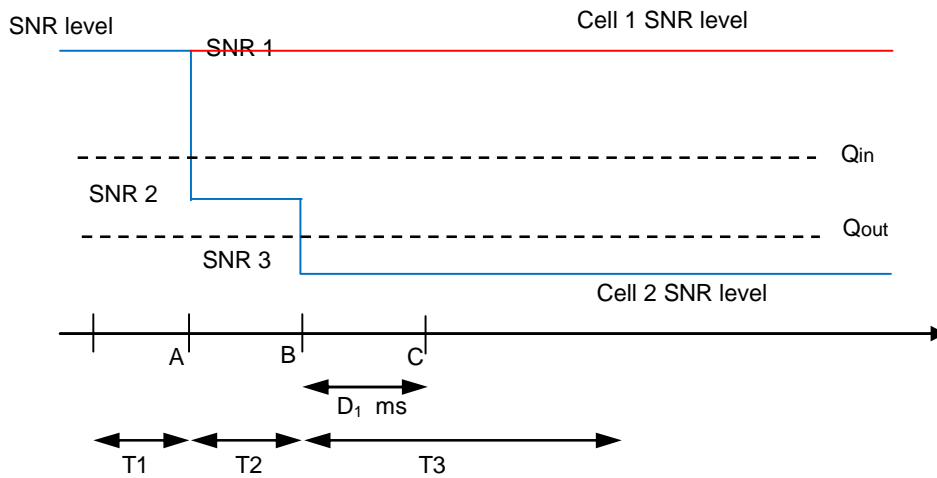

Figure A.4.5.1.5.1-1: SNR variation for CSI-RS out-of-sync testing

A.4.5.1.5.2 Test Requirements

The UE behaviour during time durations T1, T2, and T3 shall be as follows:

During the period from time point A to time point B the UE shall transmit uplink signal in Cell 2 (PSCell) at least in all uplink slots configured for CSI transmission according to the configured periodic CSI reporting for Cell 2.

The UE shall stop transmitting uplink signal in Cell 2 (PSCell) no later than time point C (D_1 after the start of the time duration T3) on the PSCell.

The rate of correct events observed during repeated tests shall be at least 90%.

A.4.5.1.6 EN-DC Radio Link Monitoring In-sync Test for FR1 PSCell configured with CSI-RS-based RLM in non-DRX mode

A.4.5.1.6.1 Test Purpose and Environment

The purpose of this test is to verify that the UE properly detects the in sync for the purpose of monitoring downlink CSI-RS based radio link quality of the PSCell when no DRX is used. This test will partly verify the FR1 PSCell CSI-RS In-sync radio link monitoring requirements in clause 8.1.

The test parameters are given in Tables A.4.5.1.6.1-1, A.4.5.1.6.1-2, and A.4.5.1.6.1-3 below. There are two cells, cell 1 which is the E-UTRAN PCell, and cell 2 is the PSCell, in the test. The test consists of five successive time periods, with time duration of T1, T2, T3, T4 and T5 respectively. Figure A.4.5.1.6.1-1 shows the variation of the downlink SNR in the PSCell to emulate out-of-sync and in-sync states. Prior to the start of the time duration T1, the UE shall be fully synchronized to cell 1 and cell 2. The UE shall be configured for periodic CSI reporting with a reporting periodicity of 5ms. In the test, DRX configuration is not enabled. In the test, SSB0 is configured as the BFD-RS.

Table A.4.5.1.6.1-1: Supported test configurations for FR1 PSCell

Configuration	Description
1	LTE FDD, NR 15 kHz SSB SCS, 10 MHz bandwidth, FDD duplex mode

2	LTE FDD, NR 15 kHz SSB SCS, 10 MHz bandwidth, TDD duplex mode
3	LTE FDD, NR 30 kHz SSB SCS, 40 MHz bandwidth, TDD duplex mode
4	LTE TDD, NR 15 kHz SSB SCS, 10 MHz bandwidth, FDD duplex mode
5	LTE TDD, NR 15 kHz SSB SCS, 10 MHz bandwidth, TDD duplex mode
6	LTE TDD, NR 30 kHz SSB SCS, 40 MHz bandwidth, TDD duplex mode
Note: The UE is only required to pass in one of the supported test configurations in FR1	

Table A.4.5.1.6.1-2: General test parameters for FR1 PSCell for CSI-RS in-sync testing in non-DRX mode

Parameter		Unit	Value
			Test 1
Active E-UTRA PCell			Cell 1
E-UTRA RF Channel Number			1
Active PSCell			Cell 2
RF Channel Number			2
Duplex mode	Config 1, 4		FDD
	Config 2, 3, 5, 6		TDD
TDD Configuration	Config 1, 4		Not Applicable
	Config 2, 5		TDDConf.1.1
	Config 3, 6		TDDConf.2.1
DL initial BWP configuration	Config 1, 2, 3, 4, 5, 6		DLBWP.0.1
DL dedicated BWP configuration	Config 1, 2, 3, 4, 5, 6		DLBWP.1.1
UL initial BWP configuration	Config 1, 2, 3, 4, 5, 6		ULBWP.0.1
UL dedicated BWP configuration	Config 1, 2, 3, 4, 5, 6		ULBWP.1.1
RMSI CORESET Reference Channel	Config 1, 4		CR.1.1 FDD
	Config 2, 5		CR.1.1 TDD
	Config 3, 6		CR.2.1 TDD
Dedicated CORESET Reference Channel	Config 1, 4		CCR.1.1 FDD
	Config 2, 5		CCR.1.1 TDD
	Config 3, 6		CCR.2.1 TDD
SSB Configuration	Config 1, 4		SSB.1 FR1
	Config 2, 5		SSB.1 FR1
	Config 3, 6		SSB.2 FR1
SMTc Configuration	Config 1, 2, 4, 5		SMTc.1
	Config 3, 6		SMTc.1
PDSCH/PDCCH subcarrier spacing	Config 1, 2, 4, 5		15 KHz
	Config 3, 6		30 KHz
TRS configuration	Config 1, 4		TRS.1.1 FDD
	Config 2, 5		TRS.1.1 TDD
	Config 3, 6		TRS.1.2 TDD
CSI-RS for RLM	Config 1, 4		Resource #4 in TRS.1.1 FDD
	Config 2, 5		Resource #4 in TRS.1.1 TDD
	Config 3, 6		Resource #4 in TRS.1.2 TDD
TCI configuration for PDCCH/PDSCH			TCI.State.2
OCNG parameters			OP.1
CP length			Normal
Correlation Matrix and Antenna Configuration			2x2 Low
	DCI format		1-0
	Number of Control OFDM symbols		2

Out of sync transmission parameters	Aggregation level	CCE	8
	Ratio of hypothetical PDCCH RE energy to average CSI-RS RE energy	dB	4
	Ratio of hypothetical PDCCH DMRS energy to average CSI-RS RE energy	dB	4
	DMRS precoder granularity		REG bundle size
In sync transmission parameters	REG bundle size		6
	DCI format		1-0
	Number of Control OFDM symbols		2
	Aggregation level	CCE	4
	Ratio of hypothetical PDCCH RE energy to average CSI-RS RE energy	dB	0
	Ratio of hypothetical PDCCH DMRS energy to average CSI-RS RE energy	dB	0
	DMRS precoder granularity		REG bundle size
	REG bundle size		6
DRX			OFF
Gap pattern ID			N.A.
Layer 3 filtering			Enabled
T310 timer	ms		1000
T311 timer	ms		1000
N310			1
N311			1
CSI-RS for reporting	Config 1, 4		CSI-RS.1.1 FDD
	Config 2, 5		CSI-RS.1.1 TDD
	Config 3, 6		CSI-RS.2.1 TDD
T1	s		0.2
T2	s		0.2
T3	s		0.44
T4	s		0.2
T5	s		0.88
T6	s		0.84
Note 1: UE-specific PDCCH is not transmitted after T1 starts.			
Note 2: E-UTRAN is in non-DRX mode under test.			

Table A.4.5.1.6.1-3: Cell specific test parameters for FR1 for CSI-RS in-sync radio link monitoring in non-DRX mode

Parameter	Unit	Test 1				
		T1	T2	T3	T4	T5
EPRE ratio of PDCCH DMRS to SSS	dB	0				
EPRE ratio of PDCCH to PDCCH DMRS	dB	0				
EPRE ratio of PBCH DMRS to SSS	dB					
EPRE ratio of PSS to SSS	dB					
EPRE ratio of PBCH to PBCH DMRS	dB					

EPRE ratio of PDSCH to PDSCH DMRS		dB					
EPRE ratio of PDSCH DMRS to SSS		dB					
EPRE ratio of OCNG DMRS to SSS		dB					
EPRE ratio of OCNG to OCNG DMRS		dB					
SNR on RLM-RS	Config 1, 4	dB	1	-7	-15	-4.5	1
	Config 2, 5		1	-7	-15	-4.5	1
	Config 3, 6		1	-7	-15	-4.5	1
N_{oc}	Config 1, 4	dBm/15KHz	-98				
	Config 2, 5		-98				
	Config 3, 6		-98				
Propagation condition		TDL-C 300ns 100Hz					
<p>Note 1: OCNG shall be used such that the resources in Cell 2 are fully allocated and a constant total transmitted power spectral density is achieved for all OFDM symbols.</p> <p>Note 2: The uplink resources for CSI reporting are assigned to the UE prior to the start of time period T1.</p> <p>Note 3: NZP CSI-RS resource set configuration for CSI reporting are assigned to the UE prior to the start of time period T1.</p> <p>Note 4: Measurement gap configuration is assigned to the UE prior to the start of time period T1.</p> <p>Note 5: The timers and layer 3 filtering related parameters are configured prior to the start of time period T1.</p> <p>Note 6: The signal contains PDCCH for UEs other than the device under test as part of OCNG.</p> <p>Note 7: SNR levels correspond to the signal to noise ratio over the SSS REs.</p> <p>Note 8: The SNR in time periods T1, T2, T3, T4 and T5 is denoted as SNR1, SNR2, SNR3, SNR4 and SNR5 respectively in figure A.4.5.1.6.1-1.</p> <p>Note 9: The SNR values are specified for testing a UE which supports 2RX on at least one band. For testing of a UE which supports 4RX on all bands, the SNR during T3 is specified in section A.3.6.1.1.</p>							

Table A.4.5.1.6.1-3A: Void

Table A.4.5.1.6.1-4: Void

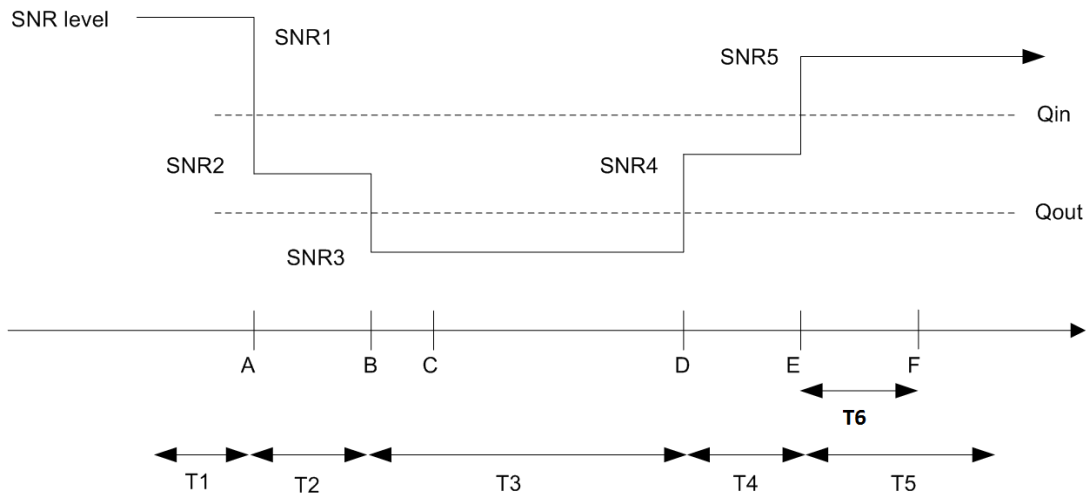

Figure A.4.5.1.6.1-1: SNR variation for CSI-RS in-sync testing

A.4.5.1.6.2 Test Requirements

The UE behaviour in each test during time durations T1, T2, T3, T4 and T5 shall be as follows:

During the period from time point A to time point F (T6 second after the start of time duration T5) the UE shall transmit uplink signal at least in all uplink slots configured for CSI transmission according to the configured periodic CSI reporting on the PSCell.

The rate of correct events observed during repeated tests shall be at least 90%.

A.4.5.1.7 EN-DC Radio Link Monitoring Out-of-sync Test for FR1 PSCell configured with CSI-RS-based RLM in DRX mode

A.4.5.1.7.1 Test Purpose and Environment

The purpose of this test is to verify that the UE properly detects the out of sync for the purpose of monitoring downlink CSI-RS based radio link quality of the PSCell when no DRX is used. This test will partly verify the FR1 PSCell CSI-RS Out-of-sync radio link monitoring requirements in clause 8.1.

The test parameters are given in Tables A.4.5.1.7.1-1, A.4.5.1.7.1-2, and A.4.5.1.7.1-3 below. There are two cells, cell 1 is the E-UTRAN PCell, and cell 2 is the PSCell, in the test. The test consists of three successive time periods, with time duration of T1, T2 and T3 respectively. Figure A.4.5.1.7.1-1 shows the variation of the downlink SNR in the E-UTRAN PCell and the PSCell to emulate out-of-sync and in-sync states. Prior to the start of the time duration T1, the UE shall be fully synchronized to cell 1 and cell 2. The UE shall be configured for periodic CSI reporting with a reporting periodicity of 5ms. In the test, DRX configuration is enabled in PSCell and DRX inactivity timer has already been expired, i.e. UE tries to decode PDCCH and to send periodic CQI during the period when On-duration timer is running. Time alignment timers shall be set to “infinity” so that UL timing alignment is maintained during the test. In the test, SSB0 is configured as the BFD-RS.

Table A.4.5.1.7.1-1: Supported test configurations for FR1 PSCell

Configuration	Description
1	LTE FDD, NR 15 kHz SSB SCS, 10 MHz bandwidth, FDD duplex mode
2	LTE FDD, NR 15 kHz SSB SCS, 10 MHz bandwidth, TDD duplex mode
3	LTE FDD, NR 30 kHz SSB SCS, 40 MHz bandwidth, TDD duplex mode
4	LTE TDD, NR 15 kHz SSB SCS, 10 MHz bandwidth, FDD duplex mode
5	LTE TDD, NR 15 kHz SSB SCS, 10 MHz bandwidth, TDD duplex mode
6	LTE TDD, NR 30 kHz SSB SCS, 40 MHz bandwidth, TDD duplex mode
Note:	The UE is only required to pass in one of the supported test configurations in FR1

Table A.4.5.1.7.1-2: General test parameters for FR1 PSCell for CSI-RS out-of-sync testing in DRX mode

Parameter	Unit	Value
		Test 1
Active E-UTRA PCell		Cell 1
E-UTRA RF Channel Number		1
Active PSCell		Cell 2
RF Channel Number		2
Duplex mode	Config 1, 4	FDD
	Config 2, 3, 5, 6	TDD
TDD Configuration	Config 1, 4	Not Applicable
	Config 2, 5	TDDConf.1.1

	Config 3, 6		TDDConf.2.1
DL initial BWP configuration	Config 1, 2, 3, 4, 5, 6		DLBWP.0.1
DL dedicated BWP configuration	Config 1, 2, 3, 4, 5, 6		DLBWP.1.1
UL initial BWP configuration	Config 1, 2, 3, 4, 5, 6		ULBWP.0.1
UL dedicated BWP configuration	Config 1, 2, 3, 4, 5, 6		ULBWP.1.1
RMSI CORESET Reference Channel	Config 1, 4		CR.1.1 FDD
	Config 2, 5		CR.1.1 TDD
	Config 3, 6		CR.2.1 TDD
Dedicated CORESET Reference Channel	Config 1, 4		CCR.1.3 FDD
	Config 2, 5		CCR.1.3 TDD
	Config 3, 6		CCR.2.2 TDD
SSB Configuration	Config 1, 4		SSB.1 FR1
	Config 2, 5		SSB.1 FR1
	Config 3, 6		SSB.2 FR1
SMTTC Configuration	Config 1, 2, 4, 5		SMTTC.1
	Config 3, 6		SMTTC.1
PDSCH/PDCCH subcarrier spacing	Config 1, 2, 4, 5		15 KHz
	Config 3, 6		30 KHz
TRS configuration	Config 1, 4		TRS.1.1 FDD
	Config 2, 5		TRS.1.1 TDD
	Config 3, 6		TRS.1.2 TDD
CSI-RS for RLM	Config 1, 4		Resource #4 in TRS.1.1 FDD
	Config 2, 5		Resource #4 in TRS.1.1 TDD
	Config 3, 6		Resource #4 in TRS.1.2 TDD
TCI configuration for PDCCH/PDSCH			TCI.State.2
OCNG parameters			OP.1
CP length			Normal
Correlation Matrix and Antenna Configuration			2x2 Low
Out of sync transmission parameters	DCI format		1-0
	Number of Control OFDM symbols		2
	Aggregation level	CCE	8
	Ratio of hypothetical PDCCH RE energy to average CSI-RS RE energy	dB	4
	Ratio of hypothetical PDCCH DMRS energy to average CSI-RS RE energy	dB	4
	DMRS precoder granularity		REG bundle size
	REG bundle size		6
DRX			DRX.3
Gap pattern ID			N.A.
Layer 3 filtering			Enabled
T310 timer		ms	0
T311 timer		ms	1000
N310			1
N311			1
CSI-RS for reporting	Config 1, 4		CSI-RS.1.1 FDD
	Config 2, 5		CSI-RS.1.1 TDD

	Config 3, 6		CSI-RS.2.1 TDD
T1		s	0.2
T2		s	1.28
T3		s	1.28
D1		s	1.24
Note 1: UE-specific PDCCH is not transmitted after T1 starts.			
Note 2: E-UTRAN is in non-DRX mode under test.			

Table A.4.5.1.7.1-3: Cell specific test parameters for FR1 for CSI-RS out-of-sync radio link monitoring in DRX mode

Parameter	Unit	Test 1			
		T1	T2	T3	
EPRE ratio of PDCCH DMRS to SSS	dB	4			
EPRE ratio of PDCCH to PDCCH DMRS	dB	0			
EPRE ratio of PBCH DMRS to SSS	dB				
EPRE ratio of PBCH to PBCH DMRS	dB				
EPRE ratio of PBCH to PBCH DMRS	dB				
EPRE ratio of PDSCH DMRS to SSS	dB				
EPRE ratio of PDSCH to PDSCH DMRS	dB				
EPRE ratio of OCNG DMRS to SSS	dB				
EPRE ratio of OCNG to OCNG DMRS	dB				
SNR	Config 1, 4	dB	1	-7	-15
	Config 2, 5		1	-7	-15
	Config 3, 6		1	-7	-15
N_{oc}	Config 1, 4	dBm/15KHz	-98		
	Config 2, 5		-98		
	Config 3, 6		-98		
Propagation condition			TDL-C 300ns 100Hz		
Note 1: OCNG shall be used such that the resources in Cell 2 are fully allocated and a constant total transmitted power spectral density is achieved for all OFDM symbols.					
Note 2: The uplink resources for CSI reporting are assigned to the UE prior to the start of time period T1.					
Note 3: NZP CSI-RS resource set configuration for CSI reporting are assigned to the UE prior to the start of time period T1.					
Note 4: Measurement gap configuration is assigned to the UE prior to the start of time period T1.					
Note 5: The timers and layer 3 filtering related parameters are configured prior to the start of time period T1.					
Note 6: The signal contains PDCCH for UEs other than the device under test as part of OCNG.					
Note 7: SNR levels correspond to the signal to noise ratio over the SSS REs.					
Note 8: The SNR in time periods T1, T2 and T3 is denoted as SNR1, SNR2 and SNR3 respectively in figure A.4.5.1.7.1-1.					
Note 9: The SNR values are specified for testing a UE which supports 2RX on at least one band. For testing of a UE which supports 4RX on all bands, the SNR during T3 is specified in section A.3.6.1.1.					

Table A.4.5.1.7.1-3A: Void

Table A.4.5.1.7.1-4: Void

Table A.4.5.1.7.1-5: Void

Table A.4.5.1.7.1-6: Void

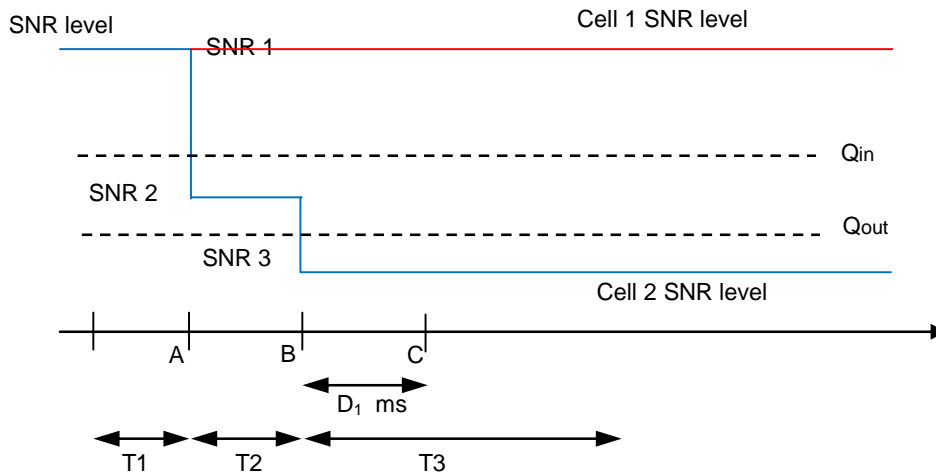

Figure A.4.5.1.7.1-1: SNR variation for CSI-RS out-of-sync testing

A.4.5.1.7.2 Test Requirements

The UE behaviour during time durations T1, T2, and T3 shall be as follows:

During the period from time point A to time point B the UE shall transmit uplink signal in Cell 2 (PSCell) at least in all uplink slots configured for CSI transmission according to the configured periodic CSI reporting for Cell 2.

The UE shall stop transmitting uplink signal in Cell 2 (PSCell) no later than time point C (D_1 after the start of the time duration T3) on the PSCell.

The rate of correct events observed during repeated tests shall be at least 90%.

A.4.5.1.8 EN-DC Radio Link Monitoring In-sync Test for FR1 PSCell configured with CSI-RS-based RLM in DRX mode

A.4.5.1.8.1 Test Purpose and Environment

The purpose of this test is to verify that the UE properly detects the in sync for the purpose of monitoring downlink CSI-RS based radio link quality of the PSCell when no DRX is used. This test will partly verify the FR1 PSCell CSI-RS In-sync radio link monitoring requirements in clause 8.1.

The test parameters are given in Tables A.4.5.1.8.1-1, A.4.5.1.8.1-2, A.4.5.1.8.1-3 and A.4.5.1.8.1-3A below. There are two cells, cell 1 which is the E-UTRAN PCell, and cell 2 is the NR PSCell, in the test. The test consists of five successive time periods, with time duration of T1, T2, T3, T4 and T5 respectively. Figure A.4.5.1.8.1-1 shows the

variation of the downlink SNR in the PSCell to emulate out-of-sync and in-sync states. Prior to the start of the time duration T1, the UE shall be fully synchronized to cell 1 and cell 2. The UE shall be configured for periodic CSI reporting with a reporting periodicity defined in CSI-RS configuration. In the test, DRX configuration is not enabled. The UE is configured to perform inter-frequency measurements using GP ID #0 (40ms). In the test, SSB0 is configured as the BFD-RS.

Table A.4.5.1.8.1-1: Supported test configurations for FR1 PSCell

Configuration	Description
1	LTE FDD, NR 15 kHz SSB SCS, 10 MHz bandwidth, FDD duplex mode
2	LTE FDD, NR 15 kHz SSB SCS, 10 MHz bandwidth, TDD duplex mode
3	LTE FDD, NR 30 kHz SSB SCS, 40 MHz bandwidth, TDD duplex mode
4	LTE TDD, NR 15 kHz SSB SCS, 10 MHz bandwidth, FDD duplex mode
5	LTE TDD, NR 15 kHz SSB SCS, 10 MHz bandwidth, TDD duplex mode
6	LTE TDD, NR 30 kHz SSB SCS, 40 MHz bandwidth, TDD duplex mode

Note: The UE is only required to pass in one of the supported test configurations in FR1

Table A.4.5.1.8.1-2: General test parameters for FR1 PSCell for CSI-RS in-sync testing in DRX mode

Parameter	Unit	Value
		Test 1
Active E-UTRA PCell		Cell 1
E-UTRA RF Channel Number		1
Active PSCell		Cell 2
RF Channel Number		2
Duplex mode	Config 1, 4	FDD
	Config 2, 3, 5, 6	TDD
TDD Configuration	Config 1, 4	Not Applicable
	Config 2, 5	TDDConf.1.1
	Config 3, 6	TDDConf.2.1
DL initial BWP configuration	Config 1, 2, 3, 4, 5, 6	DLBWP.0.1
DL dedicated BWP configuration	Config 1, 2, 3, 4, 5, 6	DLBWP.1.1
UL initial BWP configuration	Config 1, 2, 3, 4, 5, 6	ULBWP.0.1
UL dedicated BWP configuration	Config 1, 2, 3, 4, 5, 6	ULBWP.1.1
RMSI CORESET Reference Channel	Config 1, 4	CR.1.1 FDD
	Config 2, 5	CR.1.1 TDD
	Config 3, 6	CR.2.1 TDD
Dedicated CORESET Reference Channel	Config 1, 4	CCR.1.1 FDD
	Config 2, 5	CCR.1.1 TDD
	Config 3, 6	CCR.2.1 TDD
SSB Configuration	Config 1, 4	SSB.1 FR1
	Config 2, 5	SSB.1 FR1
	Config 3, 6	SSB.2 FR1
SMTc Configuration	Config 1, 2, 4, 5	SMTc.1
	Config 3, 6	SMTc.1
PDSCH/PDCCH subcarrier spacing	Config 1, 2, 4, 5	15 KHz
	Config 3, 6	30 KHz
TRS configuration	Config 1, 4	TRS.1.1 FDD
	Config 2, 5	TRS.1.1 TDD

	Config 3, 6		TRS.1.2 TDD
CSI-RS for RLM	Config 1, 4		Resource #4 in TRS.1.1 FDD
	Config 2, 5		Resource #4 in TRS.1.1 TDD
	Config 3, 6		Resource #4 in TRS.1.2 TDD
TCI configuration for PDCCH/PDSCH			TCI.State.2
OCNG parameters			OP.1
CP length			Normal
Correlation Matrix and Antenna Configuration			2x2 Low
Out of sync transmission parameters	DCI format		1-0
	Number of Control OFDM symbols		2
	Aggregation level	CCE	8
	Ratio of hypothetical PDCCH RE energy to average CSI-RS RE energy	dB	4
	Ratio of hypothetical PDCCH DMRS energy to average CSI-RS RE energy	dB	4
	DMRS precoder granularity		REG bundle size
	REG bundle size		6
In sync transmission parameters	DCI format		1-0
	Number of Control OFDM symbols		2
	Aggregation level	CCE	4
	Ratio of hypothetical PDCCH RE energy to average CSI-RS RE energy	dB	0
	Ratio of hypothetical PDCCH DMRS energy to average CSI-RS RE energy	dB	0
	DMRS precoder granularity		REG bundle size
	REG bundle size		6
DRX			DRX.3
Gap pattern ID			gp0
Layer 3 filtering			Enabled
T310 timer		ms	2000
T311 timer		ms	1000
N310			1
N311			1
CSI-RS for reporting	Config 1, 4		CSI-RS.1.1 FDD
	Config 2, 5		CSI-RS.1.1 TDD
	Config 3, 6		CSI-RS.2.1 TDD
T1		s	0.2
T2		s	0.2
T3		s	1.24
T4		s	0.2
T5		s	1.88
T6		s	1.84
Note 1: UE-specific PDCCH is not transmitted after T1 starts.			
Note 2: E-UTRAN is in non-DRX mode under test.			

Table A.4.5.1.8.1-3: Cell specific test parameters for FR1 for CSI-RS in-sync radio link monitoring in DRX mode

Parameter	Unit	Test 1				
		T1	T2	T3	T4	T5
EPRE ratio of PDCCH DMRS to SSS	dB	0				
EPRE ratio of PDCCH to PDCCH DMRS	dB	0				
EPRE ratio of PBCH DMRS to SSS	dB					
EPRE ratio of PBCH to PBCH DMRS	dB					
EPRE ratio of PSS to SSS	dB					
EPRE ratio of PDSCH DMRS to SSS	dB					
EPRE ratio of PDSCH to PDSCH DMRS	dB					
EPRE ratio of OCNG DMRS to SSS	dB					
EPRE ratio of OCNG to OCNG DMRS	dB					
SNR on RLM-RS	Config 1, 4					
	Config 2, 5	1	-7	-15	-4.5	1
	Config 3, 6	1	-7	-15	-4.5	1
N_{oc}	Config 1, 4	-98				
	Config 2, 5	-98				
	Config 3, 6	-98				
Propagation condition		TDL-C 300ns 100Hz				
Note 1:	OCNG shall be used such that the resources in Cell 2 are fully allocated and a constant total transmitted power spectral density is achieved for all OFDM symbols.					
Note 2:	The uplink resources for CSI reporting are assigned to the UE prior to the start of time period T1.					
Note 3:	NZP CSI-RS resource set configuration for CSI reporting are assigned to the UE prior to the start of time period T1.					
Note 4:	Measurement gap configuration is assigned to the UE prior to the start of time period T1.					
Note 5:	The timers and layer 3 filtering related parameters are configured prior to the start of time period T1.					
Note 6:	The signal contains PDCCH for UEs other than the device under test as part of OCNG.					
Note 7:	SNR levels correspond to the signal to noise ratio over the SSS REs.					
Note 8:	The SNR in time periods T1, T2, T3, T4 and T5 is denoted as SNR1, SNR2, SNR3, SNR4 and SNR5 respectively in figure A.4.5.1.8.1-1.					
Note 9:	The SNR values are specified for testing a UE which supports 2RX on at least one band. For testing of a UE which supports 4RX on all bands, the SNR during T3 is specified in section A.3.6.1.1.					

Table A.4.5.1.8.1-3A: Measurement gap configuration for FR1 CSI-RS in-sync radio link monitoring in DRX mode

Field	Test 1
	Value
gapOffset	0
Note 1:	E-UTRAN PCell and PSCell are SFN-synchronous and frame boundary aligned.

Table A.4.5.1.8.1-4: Void

Table A.4.5.1.8.1-5: Void

Table A.4.5.1.8.1-6: Void

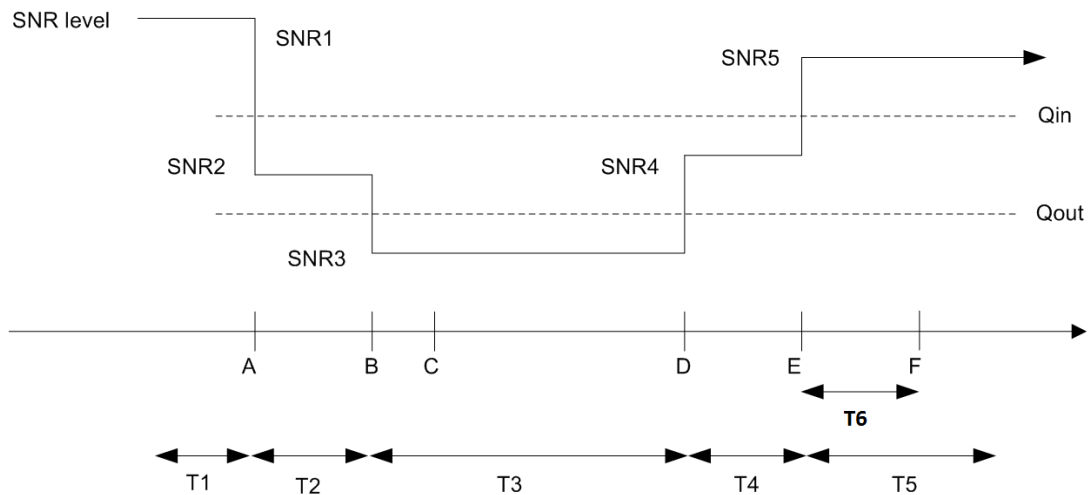

Figure A.4.5.1.8.1-1: SNR variation for CSI-RS in-sync testing

A.4.5.1.8.2 Test Requirements

The UE behaviour in each test during time durations T1, T2, T3, T4 and T5 shall be as follows:

During the period from time point A to time point F (T6 second after the start of time duration T5) the UE shall transmit uplink signal at least in all uplink slots configured for CSI transmission according to the configured periodic CSI reporting on the PSCell.

The rate of correct events observed during repeated tests shall be at least 90%.

A.4.5.2 Interruption

A.4.5.2.1 E-UTRAN – NR FR1 interruptions at transitions between active and non-active during DRX in synchronous EN-DC

A.4.5.2.1.1 Test Purpose and Environment

The purpose of this test is to verify that when LTE PCell is in DRX and NR PSCell is in non-DRX, NR PSCell interruptions due to transitions from active to non-active and from non-active to active during LTE PCell DRX the UE missed ACK/NACK does not exceed the limits. This test will verify the missed ACK/NACK rate for NR PSCell in EN-DC specified in TS38.133 clause 8. 2.1.2. Supported test configurations are shown in table A.4.5.2.1.1-1.

The general test parameters and NR cell specific test parameters are given in Table A.4.5.2.1.1-2 and A.4.5.2.1.1-3. The E-UTRAN PCell DRX configuration parameters are given in Table A.4.5.2.1.1-4 below. And the E-UTRAN

cell specific test parameters can refer to Table A.3.7.2.1-1. In the test there are two cells: Cell1 and Cell2. Cell1 is LTE PCell and Cell2 is NR FR1 PSCell. The test consists of one time period, with duration of T1. During T1, NR PSCell is continuously scheduled in DL while LTE PCell is not scheduled and has DRX configured. Prior to the start of the time duration T1, the UE shall be fully synchronized to Cell1 and Cell2. Cell1 shall be configured as LTE PCell and Cell2 shall be configured as NR PSCell. Prior to start of T1 the DRX inactivity timer for the LTE PCell has already expired. During T1 the UE shall be continuously scheduled on NR PSCell while not scheduled on LTE PCell. CORESET indicating a new transmission on PSCell shall be sent continuously during the entire time duration to ensure UE would not enter DRX state on PSCell.

Table A.4.5.2.1.1-1: Interruption at transitions between active and non-active during DRX supported test configurations

Config	Description
1	LTE FDD, NR 15 kHz SSB SCS, 10 MHz bandwidth, FDD duplex mode
2	LTE FDD, NR 15 kHz SSB SCS, 10 MHz bandwidth, TDD duplex mode
3	LTE FDD, NR 30 kHz SSB SCS, 40 MHz bandwidth, TDD duplex mode
4	LTE TDD, NR 15 kHz SSB SCS, 10 MHz bandwidth, FDD duplex mode
5	LTE TDD, NR 15 kHz SSB SCS, 10 MHz bandwidth, TDD duplex mode
6	LTE TDD, NR 30 kHz SSB SCS, 40 MHz bandwidth, TDD duplex mode

Note: The UE is only required to be tested in one of the supported test configurations

Table A.4.5.2.1.1-2: General test parameters for E-UTRAN – NR FR1 interruptions at transitions between active and non-active during DRX in synchronous EN-DC

Parameter	Unit	Value	Comment
RF Channel Number		1, 2	One is E-UTRAN RF channel and the other is NR RF channel
Active PCell		Cell1	PCell on E-UTRAN RF channel number 1.
Configured PSCell		Cell2	PSCell on NR RF channel number 2.
CP length		Normal	Applicable to Cell1 and Cell2
DRX		DRX.4	DRX related parameters are defined in Table A.3.3.4-1
Measurement gap pattern Id		OFF	
T1	s	10	

Table A.4.5.2.1.1-3: NR cell specific test parameters for E-UTRAN – NR FR1 interruptions at transitions between active and non-active during DRX in synchronous EN-DC

Parameter	Unit	Cell2
Frequency Range		FR1
Duplex mode	Config 1,4	FDD
	Config 2,3,5,6	TDD
TDD configuration	Config 1,4	Not Applicable
	Config 2,5	TDDConf.1.1
	Config 3,6	TDDConf.2.1
BW _{channel}	Config 1,4	10: N _{RB,c} = 52
	Config 2,5	10: N _{RB,c} = 52
	Config 3,6	40: N _{RB,c} = 106
Initial DL BWP Configuration	Config 1,4	DLBWP.0.1
	Config 2,5	DLBWP.0.1
	Config 3,6	DLBWP.0.1

Dedicated DL BWP Configuration	Config 1,4		DLBWP.1.1
	Config 2,5		DLBWP.1.1
	Config 3,6		DLBWP.1.1
Initial UL BWP Configuration	Config 1,4		ULBWP.0.1
	Config 2,5		ULBWP.0.1
	Config 3,6		ULBWP.0.1
Dedicated UL BWP Configuration	Config 1,4		ULBWP.1.1
	Config 2,5		ULBWP.1.1
	Config 3,6		ULBWP.1.1
PDSCH Reference measurement channel	Config 1,4		SR.1.1 FDD
	Config 2,5		SR.1.1 TDD
	Config 3,6		SR.2.1 TDD
RMSI CORESET parameters	Config 1,4		CR.1.1 FDD
	Config 2,5		CR.1.1 TDD
	Config 3,6		CR.2.1 TDD
PDCCH CORESET parameters	Config 1,4		CCR.1.1 FDD
	Config 2,5		CCR.1.1 TDD
	Config 3,6		CCR.2.1 TDD
OCNG Patterns			OP.1
SMTTC Configuration			SMTTC.1
TRS configuration	Config 1,4		TRS.1.1 FDD
	Config 2,5		TRS.1.1 TDD
	Config 3,6		TRS.1.2 TDD
SSB Configuration	Config 1,2,4,5		SSB.1 FR1
	Config 3,6		SSB.2 FR1
Correlation Matrix and Antenna Configuration			1x2 Low
EPRE ratio of PSS to SSS		dB	0
EPRE ratio of PBCH DMRS to SSS			
EPRE ratio of PBCH to PBCH DMRS			
EPRE ratio of PDCCH DMRS to SSS			
EPRE ratio of PDCCH to PDCCH DMRS			
EPRE ratio of PDSCH DMRS to SSS			
EPRE ratio of PDSCH to PDSCH			
EPRE ratio of OCNG DMRS to SSS(Note 1)			
EPRE ratio of OCNG to OCNG DMRS (Note 1)			
N_{oc} ^{Note 2}		dBm/15 kHz	-104
SS-RSRP ^{Note 3}		dBm/15 kHz	-87
\hat{E}_s/I_{ot}		dB	17
\hat{E}_s/N_{oc}		dB	17
I_o ^{Note 3}	Config 1,2,4,5	dBm/9.36MHz	-58.96
	Config 3,6	dBm/38.16MHz	-52.86
Time offset to Cell1 ^{Note 4}		μ s	3 for intra-band EN-DC, 33 for inter-band EN-DC
Propagation Condition			AWGN

Note 1:	OCNG shall be used such that both cells are fully allocated and a constant total transmitted power spectral density is achieved for all OFDM symbols.
Note 2:	Interference from other cells and noise sources not specified in the test is assumed to be constant over subcarriers and time and shall be modeled as AWGN of appropriate power for N_{oc} to be fulfilled.
Note 3:	SS-RSRP and I_0 levels have been derived from other parameters for information purposes. They are not settable parameters themselves.
Note 4:	Receive time difference of signals received between subframe timing boundary of E-UTRA PCell and slot timing boundary of PSCell at the UE antenna connector including time alignment error between the two cells

Table A.4.5.2.1.1-4: Void

A.4.5.2.1.2 Test Requirements

The UE shall be continuously scheduled in NR PSCell during the entire length of T1. UE shall not be scheduled in LTE PCell during T1. During the time duration T1 the UE shall transmit at least 99% of ACK/NACK on NR PSCell.

Interruption on NR PSCell shall not exceed X as defined in Table A.4.5.2.1.2-1.

Table A.4.5.2.1.2-1: Interruption length X at transition between active and non-active during DRX

μ	NR Slot length (ms)	Interruption length X
		Sync
0	1	1
1	0.5	1

The rate of correct events observed during repeated tests shall be at least 90%.

A.4.5.2.2 E-UTRAN – NR FR1 interruptions at transitions between active and non-active during DRX in asynchronous EN-DC

A.4.5.2.2.1 Test Purpose and Environment

The purpose of this test is to verify that when LTE PCell is in DRX and NR PSCell is in non-DRX, NR PSCell interruptions due to transitions from active to non-active and from non-active to active during LTE PCell DRX the UE missed ACK/NACK does not exceed the limits. This test will verify the missed ACK/NACK rate for NR PSCell in EN-DC specified in TS 38.133 clause 8.2.1.2. Supported test configurations are shown in table A.4.5.2.2.1-1.

The general test parameters and NR cell specific test parameters are given in Table A.4.5.2.2.1-2 and A.4.5.2.2.1-3. The E-UTRAN PCell DRX configuration parameters are given in Table A.4.5.2.2.1-4 below. And the E-UTRAN cell specific test parameters can refer to Table A.3.7.2.1-1. In the test there are two cells: Cell1 and Cell2. Cell1 is LTE PCell and Cell2 is NR FR1 PSCell. The test consists of one time period, with duration of T1. During T1, NR PSCell is continuously scheduled in DL while LTE PCell is not scheduled and has DRX configured. Prior to the start of the time duration T1, Cell1 shall be configured as LTE PCell and Cell2 shall be configured as NR PSCell. Prior to start of T1 the DRX inactivity timer for the LTE PCell has already expired. During T1 the UE shall be continuously scheduled on NR PSCell while not scheduled on LTE PCell. PDCCH indicating a new transmission on PSCell shall be sent continuously during the entire time duration to ensure UE would not enter DRX state on PSCell.

Table A.4.5.2.2.1-1: Interruption at transitions between active and non-active during DRX supported test configurations

Config	Description
1	LTE FDD, NR 15 kHz SSB SCS, 10 MHz bandwidth, FDD duplex mode
2	LTE FDD, NR 15 kHz SSB SCS, 10 MHz bandwidth, TDD duplex mode
3	LTE FDD, NR 30 kHz SSB SCS, 40 MHz bandwidth, TDD duplex mode
4	LTE TDD, NR 15 kHz SSB SCS, 10 MHz bandwidth, FDD duplex mode
5	LTE TDD, NR 15 kHz SSB SCS, 10 MHz bandwidth, TDD duplex mode
6	LTE TDD, NR 30 kHz SSB SCS, 40 MHz bandwidth, TDD duplex mode
Note: The UE is only required to be tested in one of the supported test configurations	

Table A.4.5.2.2.1-2: General test parameters for E-UTRAN – NR FR1 interruptions at transitions between active and non-active during DRX in asynchronous EN-DC

Parameter	Unit	Value	Comment
RF Channel Number		1, 2	One is E-UTRAN RF channel and the other is NR RF channel
Active PCell		Cell1	PCell on E-UTRAN RF channel number 1.
Configured PSCell		Cell2	PSCell on NR RF channel number 2.
CP length		Normal	Applicable to Cell1 and Cell2
DRX		DRX.4	DRX related parameters are defined in Table A.3.3.4-1
Measurement gap pattern Id		OFF	
T1	s	10	

Table A.4.5.2.2.1-3: NR cell specific test parameters for E-UTRAN – NR FR1 interruptions at transitions between active and non-active during DRX in asynchronous EN-DC

Parameter	Unit	Cell2
Frequency Range		FR1
Duplex mode	Config 1,4	FDD
	Config 2,3,5,6	TDD
TDD configuration	Config 1,4	Not Applicable
	Config 2,5	TDDConf.1.1
	Config 3,6	TDDConf.2.1
BW _{channel}	Config 1,4	10: N _{RB,c} = 52
	Config 2,5	10: N _{RB,c} = 52
	Config 3,6	40: N _{RB,c} = 106
Initial DL BWP Configuration	Config 1,4	DLBWP.0.1
	Config 2,5	DLBWP.0.1
	Config 3,6	DLBWP.0.1
Dedicated DL BWP Configuration	Config 1,4	DLBWP.1.1
	Config 2,5	DLBWP.1.1
	Config 3,6	DLBWP.1.1
Initial UL BWP Configuration	Config 1,4	ULBWP.0.1
	Config 2,5	ULBWP.0.1
	Config 3,6	ULBWP.0.1
Dedicated UL BWP Configuration	Config 1,4	ULBWP.1.1
	Config 2,5	ULBWP.1.1
	Config 3,6	ULBWP.1.1
	Config 1,4	SR.1.1 FDD

PDSCH Reference measurement channel	Config 2,5		SR.1.1 TDD
	Config 3,6		SR.2.1 TDD
RMSI CORESET parameters	Config 1,4		CR.1.1 FDD
	Config 2,5		CR.1.1 TDD
	Config 3,6		CR.2.1 TDD
PDCCH CORESET parameters	Config 1,4		CCR.1.1 FDD
	Config 2,5		CCR.1.1 TDD
	Config 3,6		CCR.2.1 TDD
OCNG Patterns			OP.1
SMTTC Configuration			SMTTC.1
TRS configuration	Config 1,4		TRS.1.1 FDD
	Config 2,5		TRS.1.1 TDD
	Config 3,6		TRS.1.2 TDD
SSB Configuration	Config 1,2,4,5		SSB.1 FR1
	Config 3,6		SSB.2 FR1
Correlation Matrix and Antenna Configuration			1x2 Low
EPRE ratio of PSS to SSS		dB	0
EPRE ratio of PBCH DMRS to SSS			
EPRE ratio of PBCH to PBCH DMRS			
EPRE ratio of PDCCH DMRS to SSS			
EPRE ratio of PDCCH to PDCCH DMRS			
EPRE ratio of PDSCH DMRS to SSS			
EPRE ratio of PDSCH to PDSCH			
EPRE ratio of OCNG DMRS to SSS(Note 1)			
EPRE ratio of OCNG to OCNG DMRS (Note 1)			
N_{oc} ^{Note 2}		dBm/15 kHz	-104
SS-RSRP ^{Note 3}		dBm/15 kHz	-87
\hat{E}_s/I_{ot}		dB	17
\hat{E}_s/N_{oc}		dB	17
I_o ^{Note3}	Config 1,2,4,5	dBm/9.36MHz	-58.96
	Config 3,6	dBm/38.16MHz	-52.86
Time offset to Cell1 ^{Note 4}	Config 1,2,4,5	μ s	500
	Config 3,6		250
Propagation Condition			AWGN
<p>Note 1: OCNG shall be used such that both cells are fully allocated and a constant total transmitted power spectral density is achieved for all OFDM symbols.</p> <p>Note 2: Interference from other cells and noise sources not specified in the test is assumed to be constant over subcarriers and time and shall be modeled as AWGN of appropriate power for N_{oc} to be fulfilled.</p> <p>Note 3: SS-RSRP and I_o levels have been derived from other parameters for information purposes. They are not settable parameters themselves.</p> <p>Note 4: Receive time difference of signals received between subframe timing boundary of E-UTRA PCell and slot timing boundary of PSCell at the UE antenna connector including time alignment error between the two cells</p>			

Table A.4.5.2.2.1-4: Void**A.4.5.2.2.2 Test Requirements**

The UE shall be continuously scheduled in NR PSCell during the entire length of T1. UE shall not be scheduled in LTE PCell during T1. During the time duration T1 the UE shall transmit at least 99% of ACK/NACK on NR PSCell.

Interruption on NR PSCell shall not exceed X as defined in Table A.4.5.2.2.2-1.

Table A.4.5.2.2.2-1: Interruption length X at transition between active and non-active during DRX

μ	NR Slot length (ms)	Interruption length X
		Async
0	1	2
1	0.5	2

The rate of correct events observed during repeated tests shall be at least 90%.

A.4.5.2.3 E-UTRAN – NR FR1 interruptions during measurements on deactivated NR SCC in synchronous EN-DC**A.4.5.2.3.1 Test Purpose and Environment**

The purpose of this test is to verify E-UTRAN PCell and NR PSCell interruptions during the measurement on the deactivated NR SCC, the UE missed ACK/NACK does not exceed the limits. This test will verify the missed ACK/NACK rate for E-UTRAN PCell and NR PSCell in EN-DC specified in TS 38.133 clause 8.2.1.2. Supported test configurations for LTE PCell and NR PSCell are shown in table A.4.5.2.3.1-1. Supported test configurations for NR SCell are shown in table A.4.5.2.3.1-1A. Test configuration for LTE PCell and NR PSCell and test configuration for NR SCell are chosen independently.

The general test parameters and NR cell specific test parameters are given in Table A.4.5.2.3.1-2, A.4.5.2.3.1-3 and A.4.5.2.3.1-4 below. And the E-UTRAN cell specific test parameters can refer to Table A.3.7.2.1-1. In the test there are three cells: Cell1, Cell2 and Cell3. Cell1 is LTE PCell, Cell2 and Cell3 is NR PSCell and NR deactivated SCell. Cell1 shall be configured as LTE PCell and Cell2 shall be configured as NR PSCell. The test consists of one time period, with duration of T1. Prior to the start of the time duration T1, the UE is connected to Cell1 and Cell2 and the RRC message including *measCycleSCell* or *allowInterruptions* for the deactivated NR SCells is received at the UE antenna connector. During T1, LTE PCell and NR PSCell are continuously scheduled in DL.

Table A.4.5.2.3.1-1: Interruptions during measurements on deactivated NR SCC supported test configurations for LTE PCell and NR PSCell

Config	Description
1	LTE FDD, NR 15 kHz SSB SCS, ≥ 10 MHz bandwidth, FDD duplex mode
2	LTE FDD, NR 15 kHz SSB SCS, ≥ 10 MHz bandwidth, TDD duplex mode
3	LTE FDD, NR 30 kHz SSB SCS, ≥ 40 MHz bandwidth, TDD duplex mode
4	LTE TDD, NR 15 kHz SSB SCS, ≥ 10 MHz bandwidth, FDD duplex mode
5	LTE TDD, NR 15 kHz SSB SCS, ≥ 10 MHz bandwidth, TDD duplex mode
6	LTE TDD, NR 30 kHz SSB SCS, ≥ 40 MHz bandwidth, TDD duplex mode
Note 1:	The UE is only required to be tested in one of the supported test configurations
Note 2:	The UE is only required to be tested in one with smallest aggregated channel bandwidth from supported band combinations which is composed of CCs \geq the bandwidth ($BW_{channel}$) defined in each test configuration,

Table A.4.5.2.3.1-1A: Interruptions during measurements on deactivated NR SCC supported test configurations for NR SCell

Config _{SCell}	Description
1	NR 15 kHz SSB SCS, ≥10 MHz bandwidth, FDD duplex mode
2	NR 15 kHz SSB SCS, ≥10 MHz bandwidth, TDD duplex mode
3	NR 30 kHz SSB SCS, ≥40 MHz bandwidth, TDD duplex mode
Note 1:	The UE is only required to be tested in one of the supported test configurations
Note 2:	The UE is only required to be tested in one with smallest aggregated channel bandwidth from supported band combinations which is composed of CCs ≥ the bandwidth (BW _{channel}) defined in each test configuration

Table A.4.5.2.3.1-2: General test parameters for E-UTRAN – NR interruptions during measurements on deactivated NR SCC in synchronous EN-DC

Parameter	Unit	Value	Comment
RF Channel Number		1, 2, 3	One is E-UTRAN RF channel and the other two are NR RF channels
Active PCell		Cell1	PCell on E-UTRAN RF channel number 1.
Active PSCell		Cell2	PSCell on NR RF channel number 2.
Configured deactivated SCell		Cell3	Deactivated SCell on NR RF channel number 3.
CP length		Normal	Applicable to Cell1, Cell2 and Cell3
DRX		OFF	
Measurement gap pattern Id		OFF	
SCell measurement cycle (measCycleSCell)	ms	640	
T1	s	10	

Table A.4.5.2.3.1-3: NR cell specific test parameters for NR PSCell for E-UTRAN – NR interruptions during measurements on deactivated NR SCC in synchronous EN-DC

Parameter	Unit	Cell2
Frequency Range		FR1
Duplex mode	Config 1,4	FDD
	Config 2,3,5,6	TDD
TDD configuration	Config 1,4	Not Applicable
	Config 2,5	TDDConf.1.1
	Config 3,6	TDDConf.2.1
BW _{channel}	Config 1,4	Note 8
	Config 2,5	Note 8
	Config 3,6	Note 8
BW _{occupied}	Config 1,4	52 ^{Note 6}
	Config 2,5	52 ^{Note 6}
	Config 3,6	106 ^{Note 7}
Initial DL BWP Configuration	Config 1,4	DLBWP.0.1
	Config 2,5	DLBWP.0.1
	Config 3,6	DLBWP.0.1
Dedicated DL BWP Configuration	Config 1,4	DLBWP.1.1
	Config 2,5	DLBWP.1.1
	Config 3,6	DLBWP.1.1
Initial UL BWP Configuration	Config 1,4	ULBWP.0.1
	Config 2,5	ULBWP.0.1

	Config 3,6		ULBWP.0.1
Dedicated UL BWP Configuration	Config 1,4		ULBWP.1.1
	Config 2,5		ULBWP.1.1
	Config 3,6		ULBWP.1.1
	Config 3,6		ULBWP.1.1
PDSCH Reference measurement channel	Config 1,4		SR.1.1 FDD
	Config 2,5		SR.1.1 TDD
	Config 3,6		SR.2.1 TDD
RMSI CORESET parameters	Config 1,4		CR.1.1 FDD
	Config 2,5		CR.1.1 TDD
	Config 3,6		CR.2.1 TDD
PDCCH CORESET parameters	Config 1,4		CCR.1.1 FDD
	Config 2,5		CCR.1.1 TDD
	Config 3,6		CCR.2.1 TDD
TRS configuration	Config 1,4		TRS.1.1 FDD
	Config 2,5		TRS.1.1 TDD
	Config 3,6		TRS.1.2 TDD
OCNG Patterns	Config 1,2,4,5		OP.1 ^{Note 6}
	Config 3,6		OP.1 ^{Note 7}
SMTTC Configuration			SMTTC.1
TCI state			TCI.State.0
SSB Configuration	Config 1,2,4,5		SSB.1 FR1
	Config 3,6		SSB.2 FR1
Correlation Matrix and Antenna Configuration			1x2 Low
EPRE ratio of PSS to SSS		dB	0
EPRE ratio of PBCH DMRS to SSS			
EPRE ratio of PBCH to PBCH DMRS			
EPRE ratio of PDCCH DMRS to SSS			
EPRE ratio of PDCCH to PDCCH DMRS			
EPRE ratio of PDSCH DMRS to SSS			
EPRE ratio of PDSCH to PDSCH			
EPRE ratio of OCNG DMRS to SSS ^{Note 1}			
EPRE ratio of OCNG to OCNG DMRS ^{Note 1}			
N_{oc} ^{Note 2}		dBm/15 kHz	-104
SS-RSRP ^{Note 3}		dBm/15 kHz	-87
\hat{E}_s/I_{ot}		dB	17
\hat{E}_s/N_{oc}		dB	17
I_o ^{Note 3}	Config 1,2,4,5	dBm/9.36MHz	-58.96
	Config 3,6	dBm/38.16MHz	-52.86
Time offset to Cell1 ^{Note 4}		μ s	3 for intra-band EN-DC, 33 for inter-band EN-DC
Time offset to Cell2 ^{Note 5}		μ s	-
Propagation Condition			AWGN

Note 1:	OCNG shall be used such that both cells are fully allocated and a constant total transmitted power spectral density is achieved for all OFDM symbols.
Note 2:	Interference from other cells and noise sources not specified in the test is assumed to be constant over subcarriers and time and shall be modeled as AWGN of appropriate power for N_{oc} to be fulfilled within $BW_{occupied}$.
Note 3:	SS-RSRP and I_0 levels have been derived from other parameters for information purposes. They are not settable parameters themselves.
Note 4:	Receive time difference of signals received between subframe timing boundary of E-UTRA PCell and slot timing boundary of PSCell at the UE antenna connector including time alignment error between the two cells
Note 5:	Receive time difference between slot boundaries of signals received from the two cells at the UE antenna connector including time alignment error between the two cells.
Note 6:	All UL/DL transmission shall be confined within $BW_{occupied}$ (i.e. 10 MHz, 52 RBs) from $F_{C,low}$, and I_0 is independent of the $BW_{channel}$ configured.
Note 7:	All UL/DL transmission shall be confined within $BW_{occupied}$ (i.e. 40 MHz, 106 RBs) from $F_{C,low}$, and I_0 is independent of the $BW_{channel}$ configured.
Note 8:	$N_{RB,c}$ is derived from Table 5.3.2-1 in TS38.101-1[2] with configured $BW_{channel}$.

Table A.4.5.2.3.1-4: NR cell specific test parameters for NR SCell for E-UTRAN – NR interruptions during measurements on deactivated NR SCC in synchronous EN-DC

Parameter		Unit	Cell3
Frequency Range			FR1
Duplex mode	Config _{SCell} 1		FDD
	Config _{SCell} 2,3		TDD
TDD configuration	Config _{SCell} 1		Not Applicable
	Config _{SCell} 2		TDDConf.1.1
	Config _{SCell} 3		TDDConf.2.1
$BW_{channel}$	Config _{SCell} 1		Note 8
	Config _{SCell} 2		Note 8
	Config _{SCell} 3		Note 8
$BW_{occupied}$	Config _{SCell} 1	RB	52 ^{Note 6}
	Config _{SCell} 2		52 ^{Note 6}
	Config _{SCell} 3		106 ^{Note 7}
Initial DL BWP Configuration	Config _{SCell} 1		DLBWP.0.1
	Config _{SCell} 2		DLBWP.0.1
	Config _{SCell} 3		DLBWP.0.1
Dedicated DL BWP Configuration	Config _{SCell} 1		DLBWP.1.1
	Config _{SCell} 2		DLBWP.1.1
	Config _{SCell} 3		DLBWP.1.1
Initial UL BWP Configuration	Config _{SCell} 1		ULBWP.0.1
	Config _{SCell} 2		ULBWP.0.1
	Config _{SCell} 3		ULBWP.0.1
Dedicated UL BWP Configuration	Config _{SCell} 1		ULBWP.1.1
	Config _{SCell} 2		ULBWP.1.1
	Config _{SCell} 3		ULBWP.1.1
PDSCH Reference measurement channel	Config _{SCell} 1		-
	Config _{SCell} 2		-
	Config _{SCell} 3		-
RMSI CORESET parameters	Config _{SCell} 1		CR.1.1 FDD
	Config _{SCell} 2		CR.1.1 TDD

	Config _{SCell} 3		CR.2.1 TDD
PDCCH CORESET parameters	Config _{SCell} 1		CCR.1.1 FDD
	Config _{SCell} 2		CCR.1.1 TDD
	Config _{SCell} 3		CCR.2.1 TDD
TRS configuration	Config _{SCell} 1		TRS.1.1 FDD
	Config _{SCell} 2		TRS.1.1 TDD
	Config _{SCell} 3		TRS.1.2 TDD
OCNG Patterns	Config _{SCell} 1,2		OP.1 ^{Note 6}
	Config _{SCell} 3		OP.1 ^{Note 7}
SMTC Configuration			SMTC.1
TCI state			TCI.State.0
SSB Configuration	Config _{SCell} 1,2		SSB.1 FR1
	Config _{SCell} 3		SSB.2 FR1
Correlation Matrix and Antenna Configuration			1x2 Low
EPRE ratio of PSS to SSS		dB	0
EPRE ratio of PBCH DMRS to SSS			
EPRE ratio of PBCH to PBCH DMRS			
EPRE ratio of PDCCH DMRS to SSS			
EPRE ratio of PDCCH to PDCCH DMRS			
EPRE ratio of PDSCH DMRS to SSS			
EPRE ratio of PDSCH to PDSCH			
EPRE ratio of OCNG DMRS to SSS ^{Note 1}			
EPRE ratio of OCNG to OCNG DMRS ^{Note 1}			
N _{oc} ^{Note 2}		dBm/15 kHz	-104
SS-RSRP ^{Note 3}		dBm/15 kHz	-87
\bar{E}_s/I_{ot}		dB	17
\bar{E}_s/N_{oc}		dB	17
I _o ^{Note 3}	Config _{SCell} 1,2	dBm/9.36MHz	-58.96
	Config _{SCell} 3	dBm/38.16MHz	-52.86
Time offset to Cell1 ^{Note 4}		μs	3 + Time offset to Cell2 for intra-band EN-DC, 33 + Time offset to Cell2 for inter-band EN-DC
Time offset to Cell2 ^{Note 5}		μs	3
Propagation Condition			AWGN
Note 1: OCNG shall be used such that both cells are fully allocated and a constant total transmitted power spectral density is achieved for all OFDM symbols.			
Note 2: Interference from other cells and noise sources not specified in the test is assumed to be constant over subcarriers and time and shall be modeled as AWGN of appropriate power for N _{oc} to be fulfilled within BW _{occupied} .			
Note 3: SS-RSRP and I _o levels have been derived from other parameters for information purposes. They are not settable parameters themselves.			
Note 4: Receive time difference of signals received between subframe timing boundary of E-UTRA PCell and slot timing boundary of PSCell at the UE antenna connector including time alignment error between the two cells			
Note 5: Receive time difference between slot boundaries of signals received from the two cells at the UE antenna connector including time alignment error between the two cells.			
Note 6: All UL/DL transmission shall be confined within BW _{occupied} (i.e. 10 MHz, 52 RBs) from F _{C,low} , and I _o is independent of the BW _{channel} configured.			
Note 7: All UL/DL transmission shall be confined within BW _{occupied} (i.e. 40 MHz, 106 RBs) from F _{C,low} , and I _o is independent of the BW _{channel} configured.			
Note 8: N _{RB,c} is derived from Table 5.3.2-1 in TS38.101-1[2] with configured BW _{channel} .			

A.4.5.2.3.2 Test Requirements

The UE shall be continuously scheduled in LTE PCell and NR PSCell during the entire length of T1. During the time duration T1 the UE shall transmit at least 99.5% of ACK/NACK on NR PSCell.

If the NR PSCell is not in the same band as the deactivated SCell, the UE is only allowed to cause interruptions on NR PSCell immediately before and immediately after an SMTC. Each interruption on NR PSCell shall not exceed the value defined in Table A.4.5.2.3.2-1.

If the NR PSCell is in the same band as the deactivated SCell, the UE is only allowed to cause an interruption on PSCell no earlier than 1 slot before an SMTC and no later than 1 slot after the SMTC. the interruption on NR PSCell shall not exceed the value defined in Table A.4.5.2.3.2-2.

Table A.4.5.2.3.2-1: Interruption duration if the NR PSCell is not in the same band as the deactivated SCell

μ	NR Slot length (ms)	Interruption length
0	1	1
1	0.5	1

Table A.4.5.2.3.2-2: Interruption duration if the NR PSCell is in the same band as the deactivated SCell

μ	NR Slot length (ms)	Interruption length
0	1	2 + SMTC duration
1	0.5	2 + SMTC duration

For synchronous inter-band EN-DC, the UE is only allowed to cause interruptions on E-UTRA PCell immediately before and immediately after an SMTC. Each interruption on E-UTRA PCell shall not exceed 1 subframe.

For synchronous intra-band EN-DC, the UE is only allowed to cause an interruption on E-UTRA PCell no earlier than 1 subframe before an SMTC and no later than 1 subframe after the SMTC. The interruption on E-UTRA PCell shall not exceed SMTC duration + 2 subframes.

The rate of correct events observed during repeated tests shall be at least 90%.

A.4.5.2.4 E-UTRAN – NR FR1 interruptions during measurements on deactivated NR SCC in asynchronous EN-DC

A.4.5.2.4.1 Test Purpose and Environment

The purpose of this test is to verify E-UTRAN PCell and NR PSCell interruptions during the measurement on the deactivated NR SCC, the UE missed ACK/NACK does not exceed the limits. This test will verify the missed ACK/NACK rate for E-UTRAN PCell and NR PSCell in EN-DC specified in TS 38.133 clause 8.2.1. Supported test configurations for LTE PCell and NR PSCell are shown in table A.4.5.2.4.1-1. Supported test configurations for NR SCell are shown in table A.4.5.2.4.1-1. Test configuration for LTE PCell and NR PSCell and test configuration for NR SCell are chosen independently.

The general test parameters and NR cell specific test parameters are given in Table A.4.5.2.4.1-2, A.4.5.2.4.1-3 and A.4.5.2.4.1-4 below. And the E-UTRAN cell specific test parameters can refer to Table A.3.7.2.1-1. In the test there are three cells: Cell1, Cell2 and Cell3. Cell1 is LTE PCell, Cell2 and Cell3 is NR PSCell and NR deactivated SCell. Cell1 shall be configured as LTE PCell and Cell2 shall be configured as NR PSCell. The test consists of one time period, with duration of T1. Prior to the start of the time duration T1, the UE is connected to Cell1 and Cell2 and the RRC message including *measCycleSCell* or *allowInterruptions* for the deactivated NR SCCells is received at the UE antenna connector. During T1, LTE PCell and NR PSCell are continuously scheduled in DL.

Table A.4.5.2.4.1-1: Interruptions during measurements on deactivated NR SCC supported test configurations for LTE PCell and NR PSCell

Config	Description
1	LTE FDD, NR 15 kHz SSB SCS, ≥ 10 MHz bandwidth, FDD duplex mode
2	LTE FDD, NR 15 kHz SSB SCS, ≥ 10 MHz bandwidth, TDD duplex mode
3	LTE FDD, NR 30 kHz SSB SCS, ≥ 40 MHz bandwidth, TDD duplex mode
4	LTE TDD, NR 15 kHz SSB SCS, ≥ 10 MHz bandwidth, FDD duplex mode
5	LTE TDD, NR 15 kHz SSB SCS, ≥ 10 MHz bandwidth, TDD duplex mode
6	LTE TDD, NR 30 kHz SSB SCS, ≥ 40 MHz bandwidth, TDD duplex mode
Note 1:	The UE is only required to be tested in one of the supported test configurations
Note 2:	The UE is only required to be tested in one with smallest aggregated channel bandwidth from supported band combinations which is composed of CCs \geq the bandwidth ($BW_{channel}$) defined in each test configuration,

Table A.4.5.2.4.1-1A: Interruptions during measurements on deactivated NR SCC supported test configurations for NR SCell

Config _{SCell}	Description
1	NR 15 kHz SSB SCS, ≥ 10 MHz bandwidth, FDD duplex mode
2	NR 15 kHz SSB SCS, ≥ 10 MHz bandwidth, TDD duplex mode
3	NR 30 kHz SSB SCS, ≥ 40 MHz bandwidth, TDD duplex mode
Note 1:	The UE is only required to be tested in one of the supported test configurations
Note 2:	The UE is only required to be tested in one with smallest aggregated channel bandwidth from supported band combinations which is composed of CCs \geq the bandwidth ($BW_{channel}$) defined in each test configuration

Table A.4.5.2.4.1-2: General test parameters for E-UTRAN – NR interruptions during measurements on deactivated NR SCC in asynchronous EN-DC

Parameter	Unit	Value	Comment
RF Channel Number		1, 2, 3	One is E-UTRAN RF channel and the other two are NR RF channels
Active PCell		Cell1	PCell on E-UTRAN RF channel number 1.
Configured PSCell		Cell2	PSCell on NR RF channel number 2.
Configured deactivated SCell		Cell3	Deactivated SCell on NR RF channel number 3.
CP length		Normal	Applicable to Cell1, Cell2 and Cell3
DRX		OFF	
Measurement gap pattern Id		OFF	
SCell measurement cycle (<i>measCycleSCell</i>)	ms	640	
T1	s	10	

Table A.4.5.2.4.1-3: NR cell specific test parameters for NR PSCell for E-UTRAN – NR interruptions during measurements on deactivated NR SCC in asynchronous EN-DC

Parameter		Unit	Cell2
Frequency Range			FR1
Duplex mode	Config 1,4		FDD
	Config 2,3,5,6		TDD
TDD configuration	Config 1,4		Not Applicable
	Config 2,5		TDDConf.1.1
	Config 3,6		TDDConf.2.1
BW _{channel}	Config 1,4		Note 8
	Config 2,5		Note 8
	Config 3,6		Note 8
BW _{occupied}	Config 1,4	RB	52 ^{Note 6}
	Config 2,5		52 ^{Note 6}
	Config 3,6		106 ^{Note 7}
Initial BWP Configuration	Config 1,4		DLBWP.0.1
	Config 2,5		DLBWP.0.1
	Config 3,6		DLBWP.0.1
Dedicated DL BWP Configuration	Config 1,4		DLBWP.1.1
	Config 2,5		DLBWP.1.1
	Config 3,6		DLBWP.1.1
Initial UL BWP Configuration	Config 1,4		ULBWP.0.1
	Config 2,5		ULBWP.0.1
	Config 3,6		ULBWP.0.1
Dedicated UL BWP Configuration	Config 1,4		ULBWP.1.1
	Config 2,5		ULBWP.1.1
	Config 3,6		ULBWP.1.1
PDSCH Reference measurement channel	Config 1,4		SR.1.1 FDD
	Config 2,5		SR.1.1 TDD
	Config 3,6		SR.2.1 TDD
RMSI CORESET parameters	Config 1,4		CR.1.1 FDD
	Config 2,5		CR.1.1 TDD
	Config 3,6		CR.2.1 TDD
PDCCH CORESET parameters	Config 1,4		CCR.1.1 FDD
	Config 2,5		CCR.1.1 TDD
	Config 3,6		CCR.2.1 TDD
TRS configuration	Config 1,4		TRS.1.1 FDD
	Config 2,5		TRS.1.1 TDD
	Config 3,6		TRS.1.2 TDD
OCNG Patterns	Config 1,2,4,5		OP.1 ^{Note 6}
	Config 3,6		OP.1 ^{Note 7}
SSB Configuration	Config 1,2,4,5		SSB.1 FR1
	Config 3,6		SSB.2 FR1
SMTc Configuration			SMTc.1
TCI state			TCI.State.0
Correlation Matrix and Antenna Configuration			1x2 Low
EPRE ratio of PSS to SSS		dB	0
EPRE ratio of PBCH DMRS to SSS			
EPRE ratio of PBCH to PBCH DMRS			
EPRE ratio of PDCCH DMRS to SSS			
EPRE ratio of PDCCH to PDCCH DMRS			
EPRE ratio of PDSCH DMRS to SSS			
EPRE ratio of PDSCH to PDSCH			
EPRE ratio of OCNG DMRS to SSS ^{Note 1}			
EPRE ratio of OCNG to OCNG DMRS ^{Note 1}			
N _{oc} ^{Note 2}		dBm/15 Hz	-104
SS-RSRP ^{Note 3}		dBm/15 kHz	-87

\hat{E}_s/I_{ot}		dB	17
\hat{E}_s/N_{oc}		dB	17
I_o ^{Note3}	Config 1,2,4,5	dBm/9.36MHz	-58.96
	Config 3,6	dBm/38.16MHz	-52.86
Time offset to Cell1 ^{Note 4}	Config 1,2,4,5	μ s	500
	Config 3,6		250
Time offset to Cell2 ^{Note 5}		μ s	-
Propagation Condition			AWGN
Note 1:	OCNG shall be used such that both cells are fully allocated and a constant total transmitted power spectral density is achieved for all OFDM symbols.		
Note 2:	Interference from other cells and noise sources not specified in the test is assumed to be constant over subcarriers and time and shall be modeled as AWGN of appropriate power for N_{oc} to be fulfilled within $BW_{occupied}$.		
Note 3:	SS-RSRP and I_o levels have been derived from other parameters for information purposes. They are not settable parameters themselves.		
Note 4:	Receive time difference of signals received between subframe timing boundary of E-UTRA PCell and slot timing boundary of PSCell at the UE antenna connector including time alignment error between the two cells		
Note 5:	Receive time difference between slot boundaries of signals received from the two cells at the UE antenna connector including time alignment error between the two cells.		
Note 6:	All UL/DL transmission shall be confined within $BW_{occupied}$ (i.e. 10 MHz, 52 RBs) from $F_{C,low}$, and I_o is independent of the $BW_{channel}$ configured.		
Note 7:	All UL/DL transmission shall be confined within $BW_{occupied}$ (i.e. 40 MHz, 106 RBs) from $F_{C,low}$, and I_o is independent of the $BW_{channel}$ configured.		
Note 8:	$N_{RB,C}$ is derived from Table 5.3.2-1 in TS38.101-1[2] with configured $BW_{channel}$.		

Table A.4.5.2.4.1-4: NR cell specific test parameters for NR SCell for E-UTRAN – NR interruptions during measurements on deactivated NR SCC in asynchronous EN-DC

Parameter		Unit	Cell3
Frequency Range			FR1
Duplex mode	Config _{SCell} 1		FDD
	Config _{SCell} 2,3		TDD
TDD configuration	Config _{SCell} 1		Not Applicable
	Config _{SCell} 2		TDDConf.1.1
	Config _{SCell} 3		TDDConf.2.1
$BW_{channel}$	Config _{SCell} 1		Note 8
	Config _{SCell} 2		Note 8
	Config _{SCell} 3		Note 8
$BW_{occupied}$	Config _{SCell} 1	RB	52 ^{Note 6}
	Config _{SCell} 2		52 ^{Note 6}
	Config _{SCell} 3		106 ^{Note 7}
Initial BWP Configuration	Config _{SCell} 1		DLBWP.0.1
	Config _{SCell} 2		DLBWP.0.1
	Config _{SCell} 3		DLBWP.0.1
Dedicated DL BWP Configuration	Config _{SCell} 1		DLBWP.1.1
	Config _{SCell} 2		DLBWP.1.1
	Config _{SCell} 3		DLBWP.1.1
Initial UL BWP Configuration	Config _{SCell} 1		ULBWP.0.1
	Config _{SCell} 2		ULBWP.0.1
	Config _{SCell} 3		ULBWP.0.1
Dedicated UL BWP Configuration	Config _{SCell} 1		ULBWP.1.1
	Config _{SCell} 2		ULBWP.1.1
	Config _{SCell} 3		ULBWP.1.1
PDSCH Reference measurement channel	Config _{SCell} 1		-
	Config _{SCell} 2		-
	Config _{SCell} 3		-

RMSI CORESET parameters	Config _{SCell} 1		CR.1.1 FDD
	Config _{SCell} 2		CR.1.1 TDD
	Config _{SCell} 3		CR.2.1 TDD
PDCCH CORESET parameters	Config _{SCell} 1		CCR.1.1 FDD
	Config _{SCell} 2		CCR.1.1 TDD
	Config _{SCell} 3		CCR.2.1 TDD
TRS configuration	Config _{SCell} 1		TRS.1.1 FDD
	Config _{SCell} 2		TRS.1.1 TDD
	Config _{SCell} 3		TRS.1.2 TDD
OCNG Patterns	Config _{SCell} 1,2		OP.1 ^{Note 6}
	Config _{SCell} 3		OP.1 ^{Note 7}
SSB Configuration	Config _{SCell} 1,2		SSB.1 FR1
	Config _{SCell} 3		SSB.2 FR1
SMTC Configuration			SMTC.1
TCI state			TCI.State.0
Correlation Matrix and Antenna Configuration			1x2 Low
EPRE ratio of PSS to SSS		dB	0
EPRE ratio of PBCH DMRS to SSS			
EPRE ratio of PBCH to PBCH DMRS			
EPRE ratio of PDCCH DMRS to SSS			
EPRE ratio of PDCCH to PDCCH DMRS			
EPRE ratio of PDSCH DMRS to SSS			
EPRE ratio of PDSCH to PDSCH			
EPRE ratio of OCNG DMRS to SSS ^{Note 1}			
EPRE ratio of OCNG to OCNG DMRS ^{Note 1}			
N _{oc} ^{Note 2}		dBm/15 kHz	-104
SS-RSRP ^{Note 3}		dBm/15 kHz	-87
\bar{E}_s/I_{ot}		dB	17
\bar{E}_s/N_{oc}		dB	17
I _o ^{Note 3}	Config _{SCell} 1,2	dBm/ 9.36MHz	-58.96
	Config _{SCell} 3	dBm/ 38.16MHz	-52.86
Time offset to Cell1 ^{Note 4}	Config _{SCell} 1,2	μs	500 + Time offset to Cell2
	Config _{SCell} 3		250 + Time offset to Cell2
Time offset to Cell2 ^{Note 5}		μs	3
Propagation Condition			AWGN
Note 1: OCNG shall be used such that both cells are fully allocated and a constant total transmitted power spectral density is achieved for all OFDM symbols.			
Note 2: Interference from other cells and noise sources not specified in the test is assumed to be constant over subcarriers and time and shall be modeled as AWGN of appropriate power for N _{oc} to be fulfilled within BW _{occupied} .			
Note 3: SS-RSRP and I _o levels have been derived from other parameters for information purposes. They are not settable parameters themselves.			
Note 4: Receive time difference of signals received between subframe timing boundary of E-UTRA PCell and slot timing boundary of PSCell at the UE antenna connector including time alignment error between the two cells			
Note 5: Receive time difference between slot boundaries of signals received from the two cells at the UE antenna connector including time alignment error between the two cells.			
Note 6: All UL/DL transmission shall be confined within BW _{occupied} (i.e. 10 MHz, 52 RBs) from F _{C,low} , and I _o is independent of the BW _{channel} configured.			
Note 7: All UL/DL transmission shall be confined within BW _{occupied} (i.e. 40 MHz, 106 RBs) from F _{C,low} , and I _o is independent of the BW _{channel} configured.			
Note 8: N _{RB,c} is derived from Table 5.3.2-1 in TS38.101-1[2] with configured BW _{channel} .			

A.4.5.2.4.2 Test Requirements

The UE shall be continuously scheduled in LTE PCell and NR PSCell during the entire length of T1. During the time duration T1 the UE shall transmit at least 99.5% of ACK/NACK on NR PSCell.

If the NR PSCell is not in the same band as the deactivated SCell, the UE is only allowed to cause interruptions on NR PSCell immediately before and immediately after an SMTC. Each interruption on NR PSCell shall not exceed the value defined in Table A.4.5.2.4.2-1.

If the NR PSCell is in the same band as the deactivated SCell, the UE is only allowed to cause an interruption on PSCell no earlier than 1 slot before an SMTC and no later than 1 slot after the SMTC. the interruption on NR PSCell shall not exceed the value defined in Table A.4.5.2.4.2-2.

Table A.4.5.2.4.2-1: Interruption duration if the NR PSCell is not in the same band as the deactivated SCell

μ	NR Slot length (ms)	Interruption length
0	1	1
1	0.5	1

Table A.4.5.2.4.2-2: Interruption duration if the NR PSCell is in the same band as the deactivated SCell

μ	NR Slot length (ms)	Interruption length
0	1	2 + SMTC duration
1	0.5	2 + SMTC duration

For asynchronous inter-band EN-DC, the UE is only allowed to cause interruptions on E-UTRA PCell immediately before and immediately after an SMTC. Each interruption on E-UTRA PCell shall not exceed 2 subframe.

The rate of correct events observed during repeated tests shall be at least 90%.

A.4.5.2.5 E-UTRAN – NR FR1 interruptions during measurements on deactivated E-UTRAN SCC in synchronous EN-DC

A.4.5.2.5.1 Test Purpose and Environment

The purpose of this test is to verify E-UTRAN PCell and NR PSCell interruptions during the measurement on the deactivated E-UTRAN SCC, the UE missed ACK/NACK does not exceed the limits. This test will verify the missed ACK/NACK rate for E-UTRAN PCell and NR PSCell in EN-DC specified in TS38.133 clause 8. 2.1.2. Supported test configurations are shown in table A.4.5.2.5.1-1.

The general test parameters and NR cell specific test parameters are given in Table A.4.5.2.5.1-2 and A.4.5.2.5.1-3 below. And the E-UTRAN cell specific test parameters can refer to Table A.3.7.2.1-1. In the test there are three cells: Cell1, Cell2 and Cell3. Cell1 and Cell3 is E-UTRAN PCell and E-UTRAN deactivated SCell, Cell2 is NR FR1 PSCell. Cell1 shall be configured as LTE PCell and Cell2 shall be configured as NR PSCell. The test consists of one time period, with duration of T1. Prior to the start of the time duration T1, the UE is connected to Cell1 and Cell2 and the RRC message including *measCycleSCell* or *allowInterruptions* for the deactivated E-UTRAN SCells is received at the UE antenna connector. During T1, LTE PCell and NR PSCell are continuously scheduled in DL.

Table A.4.5.2.5.1-1: Interruptions during measurements on deactivated E-UTRAN SCC supported test configurations

Config	Description
	LTE PCell + NR PSCell ^{Note 2}
1	LTE FDD, NR 15 kHz SSB SCS, 10 MHz bandwidth, FDD duplex mode
2	LTE FDD, NR 15 kHz SSB SCS, 10 MHz bandwidth, TDD duplex mode
3	LTE FDD, NR 30 kHz SSB SCS, 40 MHz bandwidth, TDD duplex mode
4	LTE TDD, NR 15 kHz SSB SCS, 10 MHz bandwidth, FDD duplex mode
5	LTE TDD, NR 15 kHz SSB SCS, 10 MHz bandwidth, TDD duplex mode
6	LTE TDD, NR 30 kHz SSB SCS, 40 MHz bandwidth, TDD duplex mode

Note 1: The UE is only required to be tested in one of the supported test configurations
Note 2: The duplex mode of the LTE SCell is determined based on the band combination to be tested.

Table A.4.5.2.5.1-2: General test parameters for E-UTRAN – NR interruptions during measurements on deactivated E-UTRAN SCC in synchronous EN-DC

Parameter	Unit	Value	Comment
RF Channel Number		1, 2	One is E-UTRAN RF channel and the other is NR RF channel
Active PCell		Cell1	PCell on E-UTRAN RF channel number 1.
Active PSCell		Cell2	PSCell on NR RF channel number 2.
Configured deactivated SCell		Cell3	Deactivated SCell on E-UTRAN RF channel number 1.
CP length		Normal	Applicable to Cell1, Cell2 and Cell3
DRX		OFF	
Measurement gap pattern Id		OFF	
SCell measurement cycle (measCycleSCell)	ms	640	
T1	s	10	

Table A.4.5.2.5.1-3: NR cell specific test parameters for E-UTRAN – NR interruptions during measurements on deactivated E-UTRAN SCC in synchronous EN-DC

Parameter	Unit	Cell2
Frequency Range		FR1
Duplex mode	Config 1,4	FDD
	Config 2,3,5,6	TDD
TDD configuration	Config 1,4	Not Applicable
	Config 2,5	TDDConf.1.1
	Config 3,6	TDDConf.2.1
BW _{channel}	Config 1,4	10: N _{RB,c} = 52
	Config 2,5	10: N _{RB,c} = 52
	Config 3,6	40: N _{RB,c} = 106
Initial DL BWP Configuration	Config 1,4	DLBWP.0.1
	Config 2,5	DLBWP.0.1
	Config 3,6	DLBWP.0.1
Dedicated DL BWP Configuration	Config 1,4	DLBWP.1.1
	Config 2,5	DLBWP.1.1
	Config 3,6	DLBWP.1.1
Initial UL BWP Configuration	Config 1,4	ULBWP.0.1
	Config 2,5	ULBWP.0.1
	Config 3,6	ULBWP.0.1

Dedicated UL BWP Configuration	Config 1,4		ULBWP.1.1
	Config 2,5		ULBWP.1.1
	Config 3,6		ULBWP.1.1
PDSCH Reference measurement channel	Config 1,4		SR.1.1 FDD
	Config 2,5		SR.1.1 TDD
	Config 3,6		SR.2.1 TDD
RMSI CORESET parameters	Config 1,4		CR.1.1 FDD
	Config 2,5		CR.1.1 TDD
	Config 3,6		CR.2.1 TDD
PDCCH CORESET parameters	Config 1,4		CCR.1.1 FDD
	Config 2,5		CCR.1.1 TDD
	Config 3,6		CCR.2.1 TDD
TRS configuration	Config 1,4		TRS.1.1 FDD
	Config 2,5		TRS.1.1 TDD
	Config 3,6		TRS.1.2 TDD
OCNG Patterns			OP.1
SMTTC Configuration			SMTTC.1
TCI state			TCI.State.0
SSB Configuration	Config 1,2,4,5		SSB.1 FR1
	Config 3,6		SSB.2 FR1
Correlation Matrix and Antenna Configuration			1x2 Low
EPRE ratio of PSS to SSS		dB	0
EPRE ratio of PBCH DMRS to SSS			
EPRE ratio of PBCH to PBCH DMRS			
EPRE ratio of PDCCH DMRS to SSS			
EPRE ratio of PDCCH to PDCCH DMRS			
EPRE ratio of PDSCH DMRS to SSS			
EPRE ratio of PDSCH to PDSCH			
EPRE ratio of OCNG DMRS to SSS(Note 1)			
EPRE ratio of OCNG to OCNG DMRS (Note 1)			
N_{oc} ^{Note 2}		dBm/15 kHz	-104
SS-RSRP ^{Note 3}		dBm/15 kHz	-87
\hat{E}_s/I_{ot}		dB	17
\hat{E}_s/N_{oc}		dB	17
I_0 ^{Note3}	Config 1,2,4,5	dBm/9.36MHz	-58.96
	Config 3,6	dBm/38.16MHz	-52.86
Time offset to Cell1 ^{Note 4}		μ s	3 for intra-band EN-DC, 33 for inter-band EN-DC
Propagation Condition			AWGN

Note 1:	OCNG shall be used such that both cells are fully allocated and a constant total transmitted power spectral density is achieved for all OFDM symbols.
Note 2:	Interference from other cells and noise sources not specified in the test is assumed to be constant over subcarriers and time and shall be modeled as AWGN of appropriate power for N_{oc} to be fulfilled.
Note 3:	SS-RSRP and I_0 levels have been derived from other parameters for information purposes. They are not settable parameters themselves.
Note 4:	Receive time difference of signals received between subframe timing boundary of E-UTRA PCell and slot timing boundary of PSCell at the UE antenna connector including time alignment error between the two cells

A.4.5.2.5.2 Test Requirements

The UE shall be continuously scheduled in LTE PCell and NR PSCell during the entire length of T1. During the time duration T1 the UE shall transmit at least 99.5% of ACK/NACK on NR PSCell. The UE is only allowed to cause one interruption on PCell and one interruption on PSCell. Each interruption on NR PSCell shall not exceed X defined in Table A.4.5.2.5.2-1 if the NR PSCell is not in the same band as the E-UTRAN deactivated SCell or Y in Table A.4.5.2.3.2-1 if the NR PSCell is in the same band as the E-UTRAN deactivated SCell.

Table A.4.5.2.5.2-1: Interruption length X and Y at measurements on deactivated E-UTRA SCC

μ	NR Slot length (ms)	Interruption length X slot	Interruption length Y slot
		Sync	
0	1	1	1+SMTC duration
1	0.5	1	1+SMTC duration

Each interruption on E-UTRAN PCell shall not exceed 1 subframe if the PCell is not in the same band as the deactivated SCell, or 5 subframes if the PCell is in the same band as the deactivated SCell.

The rate of correct events observed during repeated tests shall be at least 90%.

A.4.5.2.6 E-UTRAN – NR FR1 interruptions during measurements on deactivated E-UTRAN SCC in asynchronous EN-DC

A.4.5.2.6.1 Test Purpose and Environment

The purpose of this test is to verify E-UTRAN PCell and NR PSCell interruptions during the measurement on the deactivated NR SCC, the UE missed ACK/NACK does not exceed the limits. This test will verify the missed ACK/NACK rate for E-UTRAN PCell and NR PSCell in EN-DC specified in TS 38.133 clause 8.2.1. Supported test configurations are shown in table A.4.5.2.6.1-1.

The general test parameters and NR cell specific test parameters are given in Table A.4.5.2.6.1-1 and A.4.5.2.6.1-2 below. And the E-UTRAN cell specific test parameters can refer to Table A.3.7.2.1-1. In the test there are three cells: Cell1, Cell2 and Cell3. Cell1 and Cell3 is E-UTRAN PCell and E-UTRAN deactivated SCell, Cell2 is NR FR1 PSCell. Cell1 shall be configured as LTE PCell and Cell2 shall be configured as NR PSCell. The test consists of one time period, with duration of T1. Prior to the start of the time duration T1, the UE is connected to Cell1 and Cell2 and the RRC message including *measCycleSCell* or *allowInterruptions* for the deactivated NR SCells is received at the UE antenna connector. During T1, LTE PCell and NR PSCell are continuously scheduled in DL.

Table A.4.5.2.6.1-1: Interruptions during measurements on deactivated E-UTRAN SCC supported test configurations

Config	Description
	LTE PCell + NR PSCell ^{Note 2}

1	LTE FDD, NR 15 kHz SSB SCS, 10 MHz bandwidth, FDD duplex mode
2	LTE FDD, NR 15 kHz SSB SCS, 10 MHz bandwidth, TDD duplex mode
3	LTE FDD, NR 30 kHz SSB SCS, 40 MHz bandwidth, TDD duplex mode
4	LTE TDD, NR 15 kHz SSB SCS, 10 MHz bandwidth, FDD duplex mode
5	LTE TDD, NR 15 kHz SSB SCS, 10 MHz bandwidth, TDD duplex mode
6	LTE TDD, NR 30 kHz SSB SCS, 40 MHz bandwidth, TDD duplex mode
Note 1: The UE is only required to be tested in one of the supported test configurations	
Note 2: The duplex mode of the LTE SCell is determined based on the band combination to be tested.	

Table A.4.5.2.6.1-2: General test parameters for E-UTRAN – NR interruptions during measurements on deactivated E-UTRAN SCC in asynchronous EN-DC

Parameter	Unit	Value	Comment
RF Channel Number		1, 2, 3	One is NR RF channel and the other two are E-UTRAN RF channels
Active PCell		Cell1	PCell on E-UTRAN RF channel number 1.
Configured PSCell		Cell2	PSCell on NR RF channel number 2.
Configured deactivated SCell		Cell3	Deactivated SCell on E-UTRAN RF channel number 3.
CP length		Normal	Applicable to Cell1, Cell2 and Cell3
DRX		OFF	
Measurement gap pattern Id		OFF	
SCell measurement cycle (measCycleSCell)	ms	640	
T1	s	10	

Table A.4.5.2.6.1-3: NR cell specific test parameters for E-UTRAN – NR interruptions during measurements on deactivated E-UTRAN SCC in asynchronous EN-DC

Parameter	Unit	Cell2
Frequency Range		FR1
Duplex mode	Config 1,4	FDD
	Config 2,3,5,6	TDD
TDD configuration	Config 1,4	Not Applicable
	Config 2,5	TDDConf.1.1
	Config 3,6	TDDConf.2.1
BW _{channel}	Config 1,4	10: N _{RB,c} = 52
	Config 2,5	10: N _{RB,c} = 52
	Config 3,6	40: N _{RB,c} = 106
Initial DL BWP Configuration	Config 1,4	DLBWP.0.1
	Config 2,5	DLBWP.0.1
	Config 3,6	DLBWP.0.1
Dedicated DL BWP Configuration	Config 1,4	DLBWP.1.1
	Config 2,5	DLBWP.1.1
	Config 3,6	DLBWP.1.1
Initial UL BWP Configuration	Config 1,4	ULBWP.0.1
	Config 2,5	ULBWP.0.1
	Config 3,6	ULBWP.0.1
Dedicated UL BWP Configuration	Config 1,4	ULBWP.1.1
	Config 2,5	ULBWP.1.1
	Config 3,6	ULBWP.1.1
PDSCH Reference measurement channel	Config 1,4	SR.1.1 FDD
	Config 2,5	SR.1.1 TDD

	Config 3,6		SR.2.1 TDD
RMSI CORESET parameters	Config 1,4		CR.1.1 FDD
	Config 2,5		CR.1.1 TDD
	Config 3,6		CR.2.1 TDD
PDCCH CORESET parameters	Config 1,4		CCR.1.1 FDD
	Config 2,5		CCR.1.1 TDD
	Config 3,6		CCR.2.1 TDD
TRS configuration	Config 1,4		TRS.1.1 FDD
	Config 2,5		TRS.1.1 TDD
	Config 3,6		TRS.1.2 TDD
OCNG Patterns			OP.1
SMTc Configuration			SMTc.1
TCI state			TCI.State.0
SSB Configuration	Config 1,2,4,5		SSB.1 FR1
	Config 3,6		SSB.2 FR1
Correlation Matrix and Antenna Configuration			1x2 Low
EPRE ratio of PSS to SSS		dB	0
EPRE ratio of PBCH DMRS to SSS			
EPRE ratio of PBCH to PBCH DMRS			
EPRE ratio of PDCCH DMRS to SSS			
EPRE ratio of PDCCH to PDCCH DMRS			
EPRE ratio of PDSCH DMRS to SSS			
EPRE ratio of PDSCH to PDSCH			
EPRE ratio of OCNG DMRS to SSS(Note 1)			
EPRE ratio of OCNG to OCNG DMRS (Note 1)			
N_{oc} ^{Note 2}		dBm/15 kHz	-104
SS-RSRP ^{Note 3}		dBm/15 kHz	-87
\hat{E}_s/I_{ot}		dB	17
\hat{E}_s/N_{oc}		dB	17
I_o ^{Note3}	Config 1,2,4,5	dBm/9.36MHz	-58.96
	Config 3,6	dBm/38.16MHz	-52.86
Time offset to Cell1 ^{Note 4}	Config 1,2,4,5	μ s	500
	Config 3,6		250
Propagation Condition			AWGN
<p>Note 1: OCNG shall be used such that both cells are fully allocated and a constant total transmitted power spectral density is achieved for all OFDM symbols.</p> <p>Note 2: Interference from other cells and noise sources not specified in the test is assumed to be constant over subcarriers and time and shall be modeled as AWGN of appropriate power for N_{oc} to be fulfilled.</p> <p>Note 3: SS-RSRP and I_o levels have been derived from other parameters for information purposes. They are not settable parameters themselves.</p> <p>Note 4: Receive time difference of signals received between subframe timing boundary of E-UTRA PCell and slot timing boundary of PSCell at the UE antenna connector including time alignment error between the two cells</p>			

A.4.5.2.6.2 Test Requirements

The UE shall be continuously scheduled in LTE PCell and NR PSCell during the entire length of T1. During the time duration T1 the UE shall transmit at least 99.5% of ACK/NACK on E-UTRAN PCell and NR PSCell. The UE is only allowed to cause one interruption on PCell and one interruption on PSCell. Each interruption on NR PSCell shall not exceed the value defined in Table A.4.5.2.4.2-1 and Table A.4.5.2.4.2-2.

Table A.4.5.2.6.2-1: Interruption duration if the NR PSCell is not in the same band as the E-UTRAN deactivated SCell

μ	NR Slot length (ms)	Interruption length
0	1	2
1	0.5	2

Table A.4.5.2.6.2-2: Interruption duration if the NR PSCell is in the same band as the E-UTRAN deactivated SCell

μ	NR Slot length (ms)	Interruption length
0	1	2 + SMTC duration
1	0.5	2 + SMTC duration

Each interruption on E-UTRAN PCell shall not exceed 1 subframe if the PCell is not in the same band as the deactivated SCell, or 5 subframes if the PCell is in the same band as the deactivated SCell.

The rate of correct events observed during repeated tests shall be at least 90%.

A.4.5.2.7 Void

A.4.5.3 SCell Activation and Deactivation Delay

A.4.5.3.1 SCell Activation and deactivation of known SCell in FR1 for 160ms SCell measurement cycle

A.4.5.3.1.1 Test Purpose and Environment

The purpose of this test is to verify that the SCell activation and deactivation times are within the requirements stated in clause 8.3, when the SCell in FR1 is known by the UE at the time of activation.

The supported test configurations for LTE PCell and NR PSCell are shown in table A.4.5.3.1.1-1 below. Supported test configurations for NR SCell are shown in table A.4.5.3.1.1-1A below. Test configuration for LTE PCell and NR PSCell and test configuration for NR SCell are chosen independently. The test parameters are given in Tables A.4.5.3.1.1-2 and cell-specific parameters in A.4.5.3.1.1-3 and A.4.5.3.1.1-4 below. The test consists of three successive time periods, with duration of T1, T2 and T3, respectively. There are three carriers, E-UTRA has one cell, NR has two cells. All cells have constant signal levels throughout the test. Before the test starts the UE is connected to Cell 1 (PCell) on E-UTRA and Cell 2 (PSCell) on NR, but is not aware of Cell 3 (SCell) on NR. The UE is monitoring the PCell and PSCell. The UE shall be continuously scheduled in the PCell and PSCell throughout the whole test.

At the beginning of T1 the UE receives an RRC message by which the SCell (Cell 3) becomes configured on NR. The UE now starts monitoring the SCell. The test equipment sends a MAC message for activation of the SCell.

The point in time at which the MAC message is received at the UE antenna connector, in a slot # denoted m, defines the start of time period T2. The UE shall be able to report valid CSI in PSCell for the activated SCell at latest in slot

$m + \frac{T_{\text{HARQ}} + T_{\text{activation_time}} + T_{\text{CSI_Reporting}}}{\text{NR slot length}}$, as defined in clause 8.3. The UE shall start reporting CSI in PSCell after at least one CSI-RS transmission occasion for channel measurement plus $n_{\text{CSI_ref}}$ slots, as defined in 5.2.2.5 in [26], and reporting after slot $(m+k)$ and shall report CQI index 0 (out-of-range) until the SCell activation has been completed. Any PSCell interruption due to activation of SCell shall occur in the slot $m + 1 + \frac{T_{\text{HARQ}}}{\text{NR slot length}}$ to slot $m + 1 + \frac{T_{\text{HARQ}} + 3\text{ms} + T_X}{\text{NR slot length}} + N_{\text{interruption}}$, as defined in clause 8.3, where $N_{\text{interruption}}$ is the interruption length given in section 8.2. Any E-UTRA PCell interruption due to activation of SCell shall occur in the subframe $m_1 + 1 + \frac{T_{\text{HARQ}}}{\text{EUTRA slot length}}$ to subframe $m_2 + 1 + \frac{T_{\text{HARQ}} + 3\text{ms} + T_X}{\text{EUTRA slot length}} + N_{\text{interruption}}$, where m_1 and m_2 are the index of the first and last subframe of E-UTRA PCell which overlaps with slot m , and $N_{\text{interruption}}$ is the interruption length given in TS 36.133 [14] section 7.32.

Time period T3 starts when a MAC message for deactivation of SCell, sent from the test equipment to the UE in a slot # denoted n , is received at the UE antenna connector. The UE shall carry out deactivation of the SCell in a slot $n + \frac{T_{\text{HARQ}} + 3\text{ms}}{\text{NR slot length}}$, as defined in clause 8.3. The starting point of any PSCell interruption due to the deactivation shall occur in the slot $n + 1 + \frac{T_{\text{HARQ}}}{\text{NR slot length}}$ to $n + 1 + \frac{T_{\text{HARQ}} + 3\text{ms}}{\text{NR slot length}}$, as defined in clause 8.3. The starting point of any E-UTRA PCell interruption due to the deactivation shall occur in the subframe $n_1 + 1 + \frac{T_{\text{HARQ}}}{\text{EUTRA subframe length}}$ to subframe $n_2 + 1 + \frac{T_{\text{HARQ}} + 3\text{ms}}{\text{EUTRA subframe length}}$, where n_1 and n_2 are the index of the first and last subframe of E-UTRA PCell which overlaps with slot n .

The test equipment verifies that potential interruption is carried out in the correct time span by monitoring ACK/NACK sent in PSCell during activation and deactivation of SCell, respectively.

The test equipment verifies the activation time by counting the slots from the time when the SCell activation command is sent until a CSI report with other than CQI index 0 is received.

The test equipment verifies the deactivation time by counting the slots from the time when the SCell deactivation command is sent until CSI reporting for SCell is discontinued.

Table A.4.5.3.1.1-1: known FR1 SCell activation in non-DRX for 160ms SCell measurement cycle supported test configurations for LTE PCell and NR PSCell

Config	Description
1	LTE FDD, NR 15 kHz SSB SCS, ≥ 10 MHz bandwidth, FDD duplex mode
2	LTE FDD, NR 15 kHz SSB SCS, ≥ 10 MHz bandwidth, TDD duplex mode
3	LTE FDD, NR 30 kHz SSB SCS, ≥ 40 MHz bandwidth, TDD duplex mode
4	LTE TDD, NR 15 kHz SSB SCS, ≥ 10 MHz bandwidth, FDD duplex mode
5	LTE TDD, NR 15 kHz SSB SCS, ≥ 10 MHz bandwidth, TDD duplex mode
6	LTE TDD, NR 30 kHz SSB SCS, ≥ 40 MHz bandwidth, TDD duplex mode
Note 1:	The UE is only required to be tested in one of the supported test configurations
Note 2:	The UE is only required to be tested in one with smallest aggregated channel bandwidth from supported band combinations which is composed of CCs \geq the bandwidth (BW_{channel}) defined in each test configuration,

Table A.4.5.3.1.1-1A: known FR1 SCell activation in non-DRX for 160ms SCell measurement cycle supported test configurations for NR SCell

Configs _{Cell}	Description
1	NR 15 kHz SSB SCS, ≥ 10 MHz bandwidth, FDD duplex mode
2	NR 15 kHz SSB SCS, ≥ 10 MHz bandwidth, TDD duplex mode
3	NR 30 kHz SSB SCS, ≥ 40 MHz bandwidth, TDD duplex mode
Note 1:	The UE is only required to be tested in one of the supported test configurations

Note 2: The UE is only required to be tested in one with smallest aggregated channel bandwidth from supported band combinations which is composed of CCs \geq the bandwidth (BW_{channel}) defined in each test configuration,

Table A.4.5.3.1.1-2: General test parameters for known FR1 SCell activation case, 160ms SCell measurement cycle

Parameter	Unit	Value	Comment
RF Channel Number		1,2,3	One E-UTRAN radio channel (1) and two NR radio channel (2,3) are used for this test
Active PCell		Cell 1	Primary cell on E-UTRAN RF channel number 1. As specified in clause A.3.7.2.1
Active PSCell		Cell 2	Primary secondary cell on NR RF channel number 2.
Configured deactivated SCell		Cell 3	Configured deactivated secondary cell on NR RF channel number 3
CP length		Normal	
DRX		OFF	Continuous monitoring of primary cell
Cell-individual offset for cells on E-UTRA RF channel number	dB	0	Individual offset for cells on primary component carrier.
Cell-individual offset for cells on NR channel number	dB	0	Individual offset for cells on secondary component carrier.
SCell measurement cycle (measCycleSCell)	ms	160	
Cell3 timing offset to cell2	μs	0	
Time alignment error between cell3 and cell2	μs	\leq Time alignment error as specified in TS 38.104 [13] clause 6.5.3.1.	The value of time alignment error depends upon the type of carrier aggregation.
T1	s	7	During this time the PSCell shall be known and the SCell configured and detected.
T2	s	1	During this time the UE shall activate the SCell.
T3	s	1	During this time the UE shall deactivate the SCell.
T_{HARQ}	ms	$k_1 \times \text{NR slot length}$	k_1 is a number of slots indicated by the PDSCH-to-HARQ_feedback timing indicator field in a corresponding DCI format or provided by <i>dl-DataToUL-ACK</i> if the PDSCH-to-HARQ feedback timing field is not present in the DCI format, the value is defined in 38.213 [3]
$T_{\text{CSI_Reporting}}$	ms	15	The delay (in ms) including uncertainty in acquiring the first available downlink CSI reference resource, UE processing time for CSI reporting (clause 5.2.2.5 in TS 38.214) and uncertainty in acquiring the first available CSI reporting resources as specified in TS 38.331 [2]
k	slot	$k_1 + 3 \cdot N_{\text{slot}}^{\text{subframe}, \mu} + 1$	As specified in clause 4.3 of TS 38.213 [3]

Table A.4.5.3.1-3: Cell specific test parameters for NR PSCell for known FR1 SCell activation case, 160ms SCell measurement cycle

Parameter		Unit	Cell 2		
			T1	T2	T3
SSB ARFCN			freq1		
Duplex mode	Config 1,4		FDD		
	Config 2,3,5,6		TDD		
TDD configuration	Config 1,4		Not Applicable		
	Config 2,5		TDDConf.1.1		
	Config 3,6		TDDConf.2.1		
BW _{channel}	Config 1,4	MHz	Note 7		
	Config 2,5		Note 7		
	Config 3,6		Note 7		
BW _{occupied}	Config 1,4	RB	52 ^{Note 5}		
	Config 2,5		52 ^{Note 5}		
	Config 3,6		106 ^{Note 6}		
DL initial BWP configuration	Config 1, 2, 3, 4, 5, 6		DLBWP.0.1		
DL dedicated BWP configuration	Config 1, 2, 3, 4, 5, 6		DLBWP.1.1		
UL initial BWP configuration	Config 1, 2, 3, 4, 5, 6		ULBWP.0.1		
UL dedicated BWP configuration	Config 1, 2, 3, 4, 5, 6		ULBWP.1.1		
DRX Cycle		ms	Not Applicable		
PDSCH Reference measurement channel	Config 1,4		SR.1.1 FDD		
	Config 2,5		SR.1.1 TDD		
	Config 3,6		SR.2.1 TDD		
RMSI CORESET Reference Channel	Config 1,4		CR.1.1 FDD		
	Config 2,5		CR.1.1 TDD		
	Config 3,6		CR.2.1 TDD		
RMC CORESET Reference Channel	Config 1,4		CCR.1.1 FDD		
	Config 2,5		CCR.1.1 TDD		
	Config 3,6		CCR.2.1 TDD		
TRS configuration	Config 1,4		TRS.1.1 FDD		
	Config 2,5		TRS.1.1 TDD		
	Config 3,6		TRS.1.2 TDD		
OCNG Patterns	Config 1,2,4,5		OP.1 ^{Note 5}		
	Config 3,6		OP.1 ^{Note 6}		
SMTC configuration			SMTC.1		
SSB configuration	Config 1,2,4,5		SSB.1 FR1		
	Config 3,6		SSB.2 FR1		
CSI-RS configuration for CSI reporting	Config 1,4		CSI-RS.1.1 FDD		
	Config 2,5		CSI-RS.1.1 TDD		
	Config 3,6		CSI-RS.2.1 TDD		
PDSCH/PDCCH subcarrier spacing	Config 1,2,4,5	kHz	15		
	Config 3,6		30		
reportConfigType	Config 1-6		periodic		
reportQuantity	Config 1-6		cri-RI-PMI-CQI		
CSI reporting periodicity	Config 1,2,4,5	slot	5		
	Config 3,6		10		
CSI reporting offset	Config 1,2,4,5	slot	2		
	Config 3,6		4		
EPRE ratio of PSS to SSS		dB	0		

EPRE ratio of PBCH DMRS to SSS			
EPRE ratio of PBCH to PBCH DMRS			
EPRE ratio of PDCCH DMRS to SSS			
EPRE ratio of PDCCH to PDCCH DMRS			
EPRE ratio of PDSCH DMRS to SSS			
EPRE ratio of PDSCH to PDSCH			
EPRE ratio of OCNG DMRS to SSS ^{Note 1}			
EPRE ratio of OCNG to OCNG DMRS ^{Note 1}			
N_{oc} ^{Note2}		dBm/15kHz	-104
N_{oc} ^{Note2}	Config 1,2,4,5	dBm/SCS	-104
	Config 3,6		-101
\hat{E}_s/I_{ot}		dB	17
\hat{E}_s/N_{oc}		dB	17
SS-RSRP ^{Note3}	Config 1,2,4,5	dBm/SCS	-87
	Config 3,6		-84
SCH_RP ^{Note 3}		dBm/15 kHz	-87
I_o ^{Note3}	Config 1,2,4,5	dBm/9.36MHz	-58.96
	Config 3,6	dBm/38.16MHz	-52.87
Propagation condition		-	AWGN
Correlation Matrix and Antenna Configuration		-	2x2 Low
<p>Note 1: OCNG shall be used such that both cells are fully allocated and a constant total transmitted power spectral density is achieved for all OFDM symbols.</p> <p>Note 2: Interference from other cells and noise sources not specified in the test is assumed to be constant over subcarriers and time and shall be modelled as AWGN of appropriate power for N_{oc} to be fulfilled within $BW_{occupied}$.</p> <p>Note 3: SS-RSRP, I_o and SCH_RP levels have been derived from other parameters for information purposes. They are not settable parameters themselves.</p> <p>Note 4: The uplink resources for CSI reporting are assigned to the UE prior to the start of time period T2.]</p> <p>Note 5: All UL/DL transmission shall be confined within $BW_{channel_actual-occupied}$ (i.e. 10 MHz, 52 RBs) from $F_{C,low}$, and I_o is independent of the $BW_{channel}$ configured.</p> <p>Note 6: All UL/DL transmission shall be confined within $BW_{channel_actual-occupied}$ (i.e. 40 MHz, 106 RBs) from $F_{C,low}$, and I_o is independent of the $BW_{channel}$ configured.</p> <p>Note 7: $N_{RB,c}$ is derived from Table 5.3.2-1 in TS38.101-1[2] with configured $BW_{channel}$.</p>			

Table A.4.5.3.1-4: Cell specific test parameters for NR SCell for known FR1 SCell activation case, 160ms SCell measurement cycle

Parameter		Unit	Cell 3		
			T1	T2	T3
SSB ARFCN			freq2		
Duplex mode	Config _{SCell} 1		FDD		
	Config _{SCell} 2,3		TDD		
TDD configuration	Config _{SCell} 1		Not Applicable		
	Config _{SCell} 2		TDDConf.1.1		
	Config _{SCell} 3		TDDConf.2.1		
$BW_{channel}$	Config _{SCell} 1	MHz	Note 7		
	Config _{SCell} 2		Note 7		
	Config _{SCell} 3		Note 7		
$BW_{occupied}$	Config _{SCell} 1	RB	52 ^{Note 5}		

	Config _{SCell} 2		52 ^{Note 5}
	Config _{SCell} 3		106 ^{Note 6}
DL initial BWP configuration	Config _{SCell} 1-3		DLBWP.0.1
DL dedicated BWP configuration	Config _{SCell} 1-3		DLBWP.1.1
UL initial BWP configuration	Config _{SCell} 1-3		ULBWP.0.1
UL dedicated BWP configuration	Config _{SCell} 1-3		ULBWP.1.1
DRX Cycle		ms	Not Applicable
PDSCH Reference measurement channel	Config _{SCell} 1		SR.1.1 FDD
	Config _{SCell} 2		SR.1.1 TDD
	Config _{SCell} 3		SR.2.1 TDD
RMSI CORESET Reference Channel	Config _{SCell} 1		CR.1.1 FDD
	Config _{SCell} 2		CR.1.1 TDD
	Config _{SCell} 3		CR.2.1 TDD
RMC CORESET Reference Channel	Config _{SCell} 1		CCR.1.1 FDD
	Config _{SCell} 2		CCR.1.1 TDD
	Config _{SCell} 3		CCR.2.1 TDD
TRS configuration	Config _{SCell} 1		TRS.1.1 FDD
	Config _{SCell} 2		TRS.1.1 TDD
	Config _{SCell} 3		TRS.1.2 TDD
OCNG Patterns	Config _{SCell} 1,2		OP.1 ^{Note 5}
	Config _{SCell} 3		OP.1 ^{Note 6}
SMTTC configuration			SMTTC.1
SSB configuration	Config _{SCell} 1,2		SSB.1 FR1
	Config _{SCell} 3		SSB.2 FR1
CSI-RS configuration for CSI reporting	Config _{SCell} 1		CSI-RS.1.1 FDD
	Config _{SCell} 2		CSI-RS.1.1 TDD
	Config _{SCell} 3		CSI-RS.2.1 TDD
PDSCH/PDCCH subcarrier spacing	Config _{SCell} 1,2	kHz	15
	Config _{SCell} 3		30
reportConfigType	Config _{SCell} 1-3		periodic
reportQuantity	Config _{SCell} 1-3		cri-RI-PMI-CQI
CSI reporting periodicity	Config _{SCell} 1,2	slot	5
	Config _{SCell} 3		10
CSI reporting offset	Config _{SCell} 1,2	slot	2
	Config _{SCell} 3		4
EPRE ratio of PSS to SSS		dB	0
EPRE ratio of PBCH DMRS to SSS			
EPRE ratio of PBCH to PBCH DMRS			
EPRE ratio of PDCCH DMRS to SSS			
EPRE ratio of PDCCH to PDCCH DMRS			
EPRE ratio of PDSCH DMRS to SSS			
EPRE ratio of PDSCH to PDSCH			
EPRE ratio of OCNG DMRS to SSS ^{Note 1}			
EPRE ratio of OCNG to OCNG DMRS ^{Note 1}			
N_{oc} ^{Note 2}			
N_{oc} ^{Note 2}	Config _{SCell} 1,2	dBm/SCS	-104
	Config _{SCell} 3		-101
\hat{E}_s/I_{ot}		dB	17
\hat{E}_s/N_{oc}		dB	17
SS-RSRP ^{Note 3}	Config _{SCell} 1,2	dBm/SCS	-87

	Config _{SCell} 3		-84
SCH_RP ^{Note 3}		dBm/15 kHz	-87
I _o ^{Note3}	Config _{SCell} 1,2	dBm/9.36MHz	-58.96
	Config _{SCell} 3	dBm/38.16MHz	-52.87
Propagation condition		-	AWGN
Correlation Matrix and Antenna Configuration		-	2x2 Low
Note 1: OCNG shall be used such that both cells are fully allocated and a constant total transmitted power spectral density is achieved for all OFDM symbols.			
Note 2: Interference from other cells and noise sources not specified in the test is assumed to be constant over subcarriers and time and shall be modelled as AWGN of appropriate power for N_{oc} to be fulfilled within $BW_{occupied}$.			
Note 3: SS-RSRP, I _o and SCH_RP levels have been derived from other parameters for information purposes. They are not settable parameters themselves.			
Note 4: The uplink resources for CSI reporting are assigned to the UE prior to the start of time period T2.]			
Note 5: All UL/DL transmission shall be confined within $BW_{channel_actual-occupied}$ (i.e. 10 MHz, 52 RBs) from $F_{C,low}$, and I _o is independent of the $BW_{channel}$ configured.			
Note 6: All UL/DL transmission shall be confined within $BW_{channel_actual-occupied}$ (i.e. 40 MHz, 106 RBs) from $F_{C,low}$, and I _o is independent of the $BW_{channel}$ configured.			
Note 7: $N_{RB,c}$ is derived from Table 5.3.2-1 in TS38.101-1[2] with configured $BW_{channel}$.			

A.4.5.3.1.2 Test Requirements

During T2 the UE shall start sending CSI reports for SCell with non-zero CQI index at latest in a slot $m + \frac{T_{HARQ} + T_{activation_time} + T_{CSI_Reporting}}{NR\ slot\ length}$, $T_{activation_time} = T_{FirstSSB} + 5\text{ms}$, as defined in clause 8.3.

During T3 the UE shall stop sending CSI reports for SCell at latest in a slot $n + \frac{T_{HARQ} + 3\text{ms}}{NR\ slot\ length}$, as defined in clause 8.3.

During T2 interruption of PSCell during SCell activation shall not happen outside the slot $m + 1 + \frac{T_{HARQ}}{NR\ slot\ length}$ to $m + 1 + \frac{T_{HARQ} + 3\text{ms} + T_X}{NR\ slot\ length} + N_{interruption}$, and interruption of E-UTRA PCell during SCell activation shall not happen outside the subframe $m_1 + 1 + \frac{T_{HARQ}}{EUTRA\ slot\ length}$ to subframe $m_2 + 1 + \frac{T_{HARQ} + 3\text{ms} + T_X}{EUTRA\ slot\ length} + N_{interruption}$, as defined in clause 8.3.

During T3 the starting point of interruption of PSCell during SCell deactivation shall not happen outside the slot $n + 1 + \frac{T_{HARQ}}{NR\ slot\ length}$ to $n + 1 + \frac{T_{HARQ} + 3\text{ms}}{NR\ slot\ length}$, as defined in clause 8.3 and the starting point of interruption of E-UTRA PCell during SCell deactivation shall not happen outside the subframe $n_1 + 1 + \frac{T_{HARQ}}{EUTRA\ subframe\ length}$ to subframe $n_2 + 1 + \frac{T_{HARQ} + 3\text{ms}}{EUTRA\ subframe\ length}$.

The interruption of PSCell shall not be more than the values specified for EN-DC in Clause 8.2.1.2.4.

All of the above test requirements shall be fulfilled in order for the observed SCell activation delay and SCell deactivation delay to be counted as correct. The rate of correct observed SCell activation delay and SCell deactivation delay during repeated tests shall be at least 90%.

NOTE: During T2 if there are no uplink resources for reporting the valid CSI in a slot $m + \frac{T_{HARQ} + T_{activation_time} + T_{CSI_Reporting}}{NR\ slot\ length}$ as defined in clause 8.3 then the UE shall use the next available uplink resource for reporting the corresponding valid CSI.

A.4.5.3.2 SCell Activation and deactivation of known SCell in FR1 for 640ms SCell measurement cycle

A.4.5.3.2.1 Test Purpose and Environment

The purpose of this test case is the same as for the test defined in clause A.4.5.3.1.1. The supported test configurations are the same as defined in clause A.4.5.3.1.1. The test parameters are the same except those described in the following clause. The listed parameter values in Tables A.4.5.3.2.1-1 will replace the values of corresponding parameters in Tables A.4.5.3.1.1-2.

Table A.4.5.3.2.1-1: General test parameters for known FR1 SCell activation case, 640ms SCell measurement cycle

Parameter	Unit	Value	Comment
SCell measurement cycle (measCycleSCell)	ms	640	

A.4.5.3.2.2 Test Requirements

The test requirements defined in clause A.4.5.3.1.2 shall apply to this test case, except $T_{\text{activation_time}}$ will be replaced with the value $T_{\text{FirstSSB_MAX}} + T_{\text{rs}} + 5\text{ms}$.

A.4.5.3.3 SCell Activation and deactivation of unknown SCell in FR1

A.4.5.3.3.1 Test Purpose and Environment

The purpose of this test is to verify that the SCell activation and deactivation times are within the requirements stated in clause 8.3, when the SCell in FR1 is unknown by the UE at the time of activation.

The supported test configurations are defined in clause A.4.5.3.1.1. The test parameters are the same except those described in the following clause. The listed parameter values in Tables A.4.5.3.3.1-1 will replace the values of corresponding parameters in Tables A.4.5.3.1.1-2. The test consists of three successive time periods, with duration of T1, T2 and T3, respectively. There are three carriers, E-UTRA has one cell, NR has two cells. Cell 1 and Cell 2 have constant signal levels throughout the test. Before the test starts the UE is connected to Cell 1 (PCell) on E-UTRA and Cell 2 (PSCell) on NR, but is not aware of Cell 3 (SCell) on NR. The UE is monitoring the PCell and PSCell. The UE shall be continuously scheduled in the PCell and PSCell throughout the whole test.

At the beginning of T1 the UE receives an RRC message by which the SCell (Cell 3) becomes configured on NR. During T1 the SCell is powered off and UE is not aware of SCell.

A MAC message for activation of SCell is sent by the test equipment 100ms after the RRC message, in a slot # denoted m . The point in time at which the MAC message for activation of SCell is received at the UE antenna connector defines the start of time period T2. The UE shall be able to report valid CSI for the activated SCell at latest in slot $m + \frac{T_{\text{HARQ}} + T_{\text{activation_time}} + T_{\text{CSI_Reporting}}}{\text{NR slot length}}$ as defined in clause 8.3 provided the SCell can be successfully detected on the first attempt. The UE shall start reporting CSI after at least one CSI-RS transmission occasion for channel measurement plus $n_{\text{CSI_ref}}$ slots, as defined in 5.2.2.5 in [26], and reporting after slot $(m+k)$ and shall report CQI index 0 (out-of-range) until the SCell activation has been completed. Any PSCell interruption due to activation of SCell shall occur in the slot $m + 1 + \frac{T_{\text{HARQ}}}{\text{NR slot length}}$ to slot $m + 1 + \frac{T_{\text{HARQ}} + 3\text{ms} + T_{\text{X}}}{\text{NR slot length}} + N_{\text{interruption}}$, as defined in clause 8.3, where $N_{\text{interruption}}$ is the interruption length given in section 8.2. Any E-UTRA PCell interruption due to activation of SCell shall occur in the subframe $m_1 + 1 + \frac{T_{\text{HARQ}}}{\text{EUTRA slot length}}$ to subframe $m_2 + 1 + \frac{T_{\text{HARQ}} + 3\text{ms} + T_{\text{X}}}{\text{EUTRA slot length}} + N_{\text{interruption}}$, where m_1 and m_2 are the index of the first and last subframe of E-UTRA PCell which overlaps with slot m , and $N_{\text{interruption}}$ is the interruption length given in TS 36.133 [14] section 7.32.

Time period T3 starts when a MAC message for deactivation of the SCell, sent from the test equipment to the UE in a slot # denoted n, is received at the UE antenna connector. The UE shall carry out deactivation of the SCell at latest in slot $n + \frac{T_{\text{HARQ}} + 3\text{ms}}{\text{NR slot length}}$ as defined in clause 8.3. The starting point of any PSCell interruption due to the deactivation shall occur in the slot $n + 1 + \frac{T_{\text{HARQ}}}{\text{NR slot length}}$ to $n + 1 + \frac{T_{\text{HARQ}} + 3\text{ms}}{\text{NR slot length}}$, as defined in clause 8.3. The starting point of any E-UTRA PCell interruption due to the deactivation shall occur in the subframe $n_1 + 1 + \frac{T_{\text{HARQ}}}{\text{EUTRA subframe length}}$ to subframe $n_2 + 1 + \frac{T_{\text{HARQ}} + 3\text{ms}}{\text{EUTRA subframe length}}$, where n_1 and n_2 are the index of the first and last subframe of E-UTRA PCell which overlaps with slot n.

The test equipment verifies that potential interruption is carried out in the correct time span by monitoring ACK/NACK sent in PSCell during activation of SCell, respectively.

The test equipment verifies the activation time by counting the slots from the time when the SCell activation command is sent until a CSI report with other than CQI index 0 is received.

The test equipment verifies the deactivation time by counting the slots from the time when the SCell1 deactivation command is sent until CSI reporting for SCell1 is discontinued.

Table A.4.5.3.3.1-1: General test parameters for unknown FR1 SCell activation case, 160ms SCell measurement cycle

Parameter	Unit	Value	Comment
T1	ms	100	During this time the PSCell shall be known and the SCell configured, but not detected.

A.4.5.3.3.2 Test Requirements

The test requirements defined in clause A.4.5.3.1.2 shall apply to this test case, except $T_{\text{activation_time}}$ will be replaced with the value $T_{\text{FirstSSB_MAX}} + T_{\text{SMTc_MAX}} + 2 * T_{\text{rs}} + 5\text{ms}$ as defined in clause 8.3.

A.4.5.4 UE UL carrier RRC reconfiguration Delay

A.4.5.4.1 UE UL carrier RRC reconfiguration Delay

Table A.4.5.4.1-1 - Table A.4.5.4.1-4 : Void

A.4.5.4.1.1 Test Purpose and Environment

The purpose of this test is to verify that when the UE receives a RRC message implying NR UL or Supplementary UL carrier configuration, the UE shall be ready to start transmission on the newly configured carrier within the time limits specified in clause 8.4.2 and 8.4.3 for configuring and deconfiguring, respectively.

There are three cells: E-UTRAN PCell (Cell 1), FR1 PSCell (Cell 2) and FR1 SCell (Cell 3). For SCell, both NR uplink and supplementary uplink are broadcast by *ServingCellConfigCommonSIB*. The test parameters for PSCell and SCell are given in Table A. 4.5.4.1.1-1, Table A. 4.5.4.1.1-2, Table A. 4.5.4.1.1-3 and Table A. 4.5.4.1.1-4 below. The test parameters and applicability for E-UTRAN PCell are defined in A.3.7.2. The test consists two tests. The test consists of three time periods, with duration of T1, T2 and T3 respectively. During time duration T1, NR uplink of cell 3 is configured to UE. At the start of T2, a supplementary uplink of cell3 is configured to UE through *RRCReconfiguration*, then UE shall start transmission on the supplementary uplink. At the start of T3, the supplementary uplink is released through *RRCReconfiguration*.

Table A.4.5.4.1.1-1: Supported test configurations

Configuration	PSCell (Cell2)	SCell (Cell3)
1	15 kHz SSB SCS, ≥ 10 MHz bandwidth, FDD duplex mode	DL and UL: 15kHz SSB SCS, ≥ 10 MHz bandwidth, FDD duplex mode; SUL: 15kHz SCS, ≥ 10 MHz bandwidth, SUL duplex mode
2	15 kHz SSB SCS, ≥ 10 MHz bandwidth, FDD duplex mode	DL and UL: 15kHz SSB SCS, ≥ 10 MHz bandwidth, TDD duplex mode; SUL: 15kHz SCS, ≥ 10 MHz bandwidth, SUL duplex mode
3	15 kHz SSB SCS, ≥ 10 MHz bandwidth, FDD duplex mode	DL and UL: 30kHz SSB SCS, ≥ 40 MHz bandwidth, TDD duplex mode; SUL: 30kHz SCS, ≥ 40 MHz bandwidth, SUL duplex mode
4	15 kHz SSB SCS, ≥ 10 MHz bandwidth, TDD duplex mode	DL and UL: 15kHz SSB SCS, ≥ 10 MHz bandwidth, FDD duplex mode; SUL: 15kHz SCS, ≥ 10 MHz bandwidth, SUL duplex mode
5	15 kHz SSB SCS, ≥ 10 MHz bandwidth, TDD duplex mode	DL and UL: 15kHz SSB SCS, ≥ 10 MHz bandwidth, TDD duplex mode; SUL: 15kHz SCS, ≥ 10 MHz bandwidth, SUL duplex mode
6	15 kHz SSB SCS, ≥ 10 MHz bandwidth, TDD duplex mode	DL and UL: 30kHz SSB SCS, ≥ 40 MHz bandwidth, TDD duplex mode; SUL: 30kHz SCS, ≥ 40 MHz bandwidth, SUL duplex mode
7	30 kHz SSB SCS, ≥ 40 MHz bandwidth, TDD duplex mode	DL and UL: 15kHz SSB SCS, 10 MHz bandwidth, FDD duplex mode; SUL: 15kHz SCS, 10 MHz bandwidth, SUL duplex mode
8	30 kHz SSB SCS, ≥ 40 MHz bandwidth, TDD duplex mode	DL and UL: 15kHz SSB SCS, ≥ 10 MHz bandwidth, TDD duplex mode; SUL: 15kHz SCS, ≥ 10 MHz bandwidth, SUL duplex mode
9	30 kHz SSB SCS, ≥ 40 MHz bandwidth, TDD duplex mode	DL and UL: 30kHz SSB SCS, ≥ 40 MHz bandwidth, TDD duplex mode; SUL: 30kHz SCS, ≥ 40 MHz bandwidth, SUL duplex mode
Note 1:	The UE is only required to be tested in one of the supported test configurations	
Note 2:	The UE is only required to be tested in one with smallest aggregated channel bandwidth from supported band combinations which is composed of CCs \geq the bandwidth ($BW_{channel}$) defined in each test configuration,	

Table A.4.5.4.1.1-2: General test parameters for EN-DC UE UL carrier RRC reconfiguration Delay

Parameter	Unit	Test configuration	Value	Comment
RF Channel Number		Config 1,2,3, 4, 5, 6, 7, 8, 9	1, 2, 3	Three radio channels are used for this test.
Active cell		Config 1,2,3, 4, 5, 6, 7, 8, 9	Cell 1: E-UTRAN PCell Cell 2: FR1 PSCell Cell 3: FR1 SCell	E-UTRAN PCell on RF channel number 1 FR1 PSCell on RF channel number 2 FR1 SCell on RF channel number 3
CP length		Config 1,2,3, 4, 5, 6, 7, 8, 9	Normal	
DRX		Config 1,2,3, 4, 5, 6, 7, 8, 9	OFF	

Measurement gap pattern Id		Config 1,2,3, 4, 5, 6, 7, 8, 9	OFF	
Filter coefficient		Config 1,2,3, 4, 5, 6, 7, 8, 9	0	L3 filtering is not used
T1	s	Config 1,2,3, 4, 5, 6, 7, 8, 9	5	
T2	s	Config 1,2,3, 4, 5, 6, 7, 8, 9	5	
T3	s	Config 1,2,3, 4, 5, 6, 7, 8, 9	5	

Table A.4.5.4.1.1-3: NR Cell specific test parameters for EN-DC UE UL carrier RRC reconfiguration Delay on PSCell (Cell 2)

Parameter	Unit	Test Configuration	Test 1		
			T1	T2	T3
Channel number		Conf 1, 2, 3, 4, 5, 6, 7, 8, 9	2		
TDD configuration		Conf 1, 2, 3	N/A		
		Conf 4, 5, 6	TDD Conf.1.1		
		Conf 7, 8, 9	TDD Conf.2.1		
BW _{channel}	MHz	Conf 1, 2, 3	Note 6		
		Conf 4, 5, 6	Note 6		
		Conf 7, 8, 9	Note 6		
BW _{occupied}	RB	Conf 1, 2, 3	52 ^{Note 4}		
		Conf 4, 5, 6	52 ^{Note 4}		
		Conf 7, 8, 9	106 ^{Note 5}		
PDSCH reference measurement channel as defined in A.3.1.1		Conf 1, 2, 3	SR.1.1 FDD		
		Conf 4, 5, 6	SR.1.1 TDD		
		Conf 7, 8, 9	SR 2.1 TDD		
RMSI CORESET reference measurement channel as defined in A.3.1.2		Conf 1, 2, 3	CR.1.1 FDD		
		Conf 4, 5, 6	CR.1.1 TDD		
		Conf 7, 8, 9	CR.2.1 TDD		
RMC CORESET reference measurement channel as defined in A.3.1.3		Conf 1, 2, 3	CCR.1.1 FDD		
		Conf 4, 5, 6	CCR.1.1 TDD		
		Conf 7, 8, 9	CCR.2.1 TDD		
OCNG Pattern ^{Note 1}		Conf 1, 2, 3, 4, 5, 6	OP.1 ^{Note 4}		
		Config 7, 8, 9	OP.1 ^{Note 5}		
SSB configuration		Conf 1, 2, 3, 4, 5, 6	SSB.1 FR1		
		Conf 7, 8, 9	SSB.2 FR1		
SMTc configuration		Conf 1, 2, 3, 4, 5, 6, 7, 8, 9	SMTc.1		
CSI-RS for tracking		Conf 1	TRS.1.1 FDD		
		Conf 2	TRS.1.1 FDD		
		Conf 3	TRS.1.1 FDD		
		Conf 4	TRS.1.1 TDD		
		Conf 5	TRS.1.1 TDD		
		Conf 6	TRS.1.1 TDD		
		Conf 7	TRS.1.2 TDD		
		Conf 8	TRS.1.2 TDD		
		Conf 9	TRS.1.2 TDD		

DL initial BWP configuration		Conf 1, 2, 3, 4, 5, 6, 7, 8, 9	DLBWP.0.1		
DL dedicated BWP configuration		Conf 1, 2, 3, 4, 5, 6, 7, 8, 9	DLBWP.1.1		
UL dedicated BWP configuration		Conf 1, 2, 3, 4, 5, 6, 7, 8, 9	ULBWP.1.1		
EPRE ratio of PSS to SSS	dB	Conf 1, 2, 3, 4, 5, 6, 7, 8, 9	0		
EPRE ratio of PBCH_DMRS to SSS					
EPRE ratio of PBCH to PBCH_DMRS					
EPRE ratio of PDCCH_DMRS to SSS					
EPRE ratio of PDCCH to PDCCH_DMRS					
EPRE ratio of PDSCH_DMRS to SSS					
EPRE ratio of PDSCH to PDSCH_DMRS					
EPRE ratio of OCNG DMRS to SSS					
EPRE ratio of OCNG to OCNG DMRS					
N_{oc} ^{Note 2}					
	dBm/SCS	Conf 1,2,3,4,5,6	-102		
		Conf 7,8,9	-99		
\hat{E}_s / N_{oc}	dB	Conf 1, 2, 3, 4, 5, 6, 7, 8, 9	16	16	16
\hat{E}_s / I_{ot} ^{Note 3}	dB	Conf 1, 2, 3, 4, 5, 6, 7, 8, 9	16	16	16
SS-RSRP ^{Note 3}	dBm/SCS	Conf 1,2,3,4,5,6	-86	-86	-86
		Conf 7,8,9	-83	-83	-83
I_o ^{Note 3}	dBm/9.36 MHz	Conf 1,2,3,4,5,6	-57.9	-57.9	-57.9
	dBm/38.16 MHz	Conf 7,8,9	-51.8	-51.8	-51.8
Propagation Condition		Conf 1, 2, 3, 4, 5, 6, 7, 8, 9	AWGN		
Antenna configuration		Conf 1, 2, 3, 4, 5, 6, 7, 8, 9	1 x 2		

NOTE 1: OCNG shall be used such that both cells are fully allocated, and a constant total transmitted power spectral density is achieved for all OFDM symbols.

NOTE 2: Interference from other cells and noise sources not specified in the test is assumed to be constant over subcarriers and time and shall be modelled as AWGN of appropriate power for N_{oc} to be fulfilled within $BW_{occupied}$.

NOTE 3: \hat{E}_s/I_{ot} , I_o , and SS-RSRP levels have been derived from other parameters for information purposes. They are not settable parameters themselves.

NOTE 4: All UL/DL transmission shall be confined within $BW_{occupied}$ (i.e. 10 MHz, 52 RBs) from $F_{C,low}$, and I_o is independent of the $BW_{channel}$ configured.

NOTE 5: All UL/DL transmission shall be confined within $BW_{occupied}$ (i.e. 40 MHz, 106 RBs) from $F_{C,low}$, and I_o is independent of the $BW_{channel}$ configured.

NOTE 6: $N_{RB,C}$ is derived from Table 5.3.2-1 in TS38.101-1[2] with configured $BW_{channel}$.

Table A.4.5.4.1.1-4: NR Cell specific test parameters for EN-DC UE UL carrier RRC reconfiguration Delay on SCell (Cell 3)

Parameter	Unit	Test Configuration	Test 1		
			T1	T2	T3
Channel number		Conf 1, 2, 3, 4, 5, 6, 7, 8, 9	3		
TDD configuration		Conf 1, 4, 7	N/A		
		Conf 2, 5, 8	TDDConf.1.1		
		Conf 3, 6, 9	TDDConf.2.1		
$BW_{channel}$	MHz	Conf 1, 4, 7	Note 6		
		Conf 2, 5, 8	Note 6		
		Conf 3, 6, 9	Note 6		
$BW_{occupied}$	RB	Conf 1, 4, 7	52 ^{Note 4}		
		Conf 2, 5, 8	52 ^{Note 4}		
		Conf 3, 6, 9	106 ^{Note 5}		
PUSCH parameters for NR UL carrier		Conf 1, 4, 7	G-FR1-A3-10 in [13]	G-FR1-A3-10 in [13]	G-FR1-A3-10 in [13]
		Conf 2, 5, 8	G-FR1-A3-10 in [13]	G-FR1-A3-10 in [13]	G-FR1-A3-10 in [13]
		Conf 3, 6, 9	G-FR1-A3-14 in [13]	G-FR1-A3-14 in [13]	G-FR1-A3-14 in [13]
PUCCH parameters For NR UL carrier		Conf 1, 4, 7	Table 8.3.3.1.2-1 in [13]	Table 8.3.3.1.2-1 in [13]	Table 8.3.3.1.2-1 in [13]
		Conf 2, 5, 8	Table 8.3.3.1.2-1 in [13]	Table 8.3.3.1.2-1 in [13]	Table 8.3.3.1.2-1 in [13]
		Conf 3, 6, 9	Table 8.3.3.1.2-2 in [13]	Table 8.3.3.1.2-2 in [13]	Table 8.3.3.1.2-2 in [13]

PUSCH parameters for supplementary UL		Conf 1, 4, 7	N/A	G-FR1-A3-10 in [13]	N/A
		Conf 2, 5, 8	N/A	G-FR1-A3-10 in [13]	N/A
		Conf 3, 6, 9	N/A	G-FR1-A3-14 in [13]	N/A
PUCCH parameters for supplementary UL		Conf 1, 4, 7	N/A	N/A	N/A
		Conf 2, 5, 8	N/A	N/A	N/A
		Conf 3, 6, 9	N/A	N/A	N/A
PDSCH reference measurement channel as defined in A.3.1.1		Conf 1, 4, 7		SR.1.1 FDD	
		Conf 2, 5, 8		SR.1.1 TDD	
		Conf 3, 6, 9		SR.2.1 TDD	
RMSI CORESET reference measurement channel as defined in A.3.1.2		Conf 1, 4, 7		CR.1.1 FDD	
		Conf 2, 5, 8		CR.1.1 TDD	
		Conf 3, 6, 9		CR.2.1 TDD	
RMC CORESET reference measurement channel as defined in A.3.1.3		Conf 1, 4, 7		CCR.1.1 FDD	
		Conf 2, 5, 8		CCR.1.1 TDD	
		Conf 3, 6, 9		CCR.2.1 TDD	
OCNG Pattern ^{Note 1}		Conf 1, 2, 4, 5, 7, 8		OP.1 ^{Note 4}	
		Conf 3, 6, 9		OP.1 ^{Note 5}	
SSB configuration		Conf 1, 2, 4, 5, 7, 8		SSB.1 FR1	
		Conf 3, 6, 9		SSB.2 FR1	
SMTC configuration		Conf 1, 2, 3, 4, 5, 6, 7, 8, 9		SMTC.1	
CSI-RS for tracking		Conf 1		TRS.1.1 FDD	
		Conf 2		TRS.1.1 TDD	
		Conf 3		TRS.1.2 TDD	
		Conf 4		TRS.1.1 FDD	
		Conf 5		TRS.1.1 TDD	
		Conf 6		TRS.1.2 TDD	
		Conf 7		TRS.1.1 FDD	
		Conf 8		TRS.1.1 TDD	
		Conf 9		TRS.1.2 TDD	
DL initial BWP configuration		Conf 1, 2, 3, 4, 5, 6, 7, 8, 9		DLBWP.0.1	
DL dedicated BWP configuration		Conf 1, 2, 3, 4, 5, 6, 7, 8, 9		DLBWP.1.1	
UL dedicated BWP configuration		Conf 1, 2, 3, 4, 5, 6, 7, 8, 9		ULBWP.1.1	
EPRE ratio of PSS to SSS	dB	Conf 1, 2, 3, 4, 5, 6, 7, 8, 9		0	
EPRE ratio of PBCH_DMRS to SSS					
EPRE ratio of PBCH to PBCH_DMRS					
EPRE ratio of PDCCH_DMRS to SSS					

EPRE ratio of PDCCH to PDCCH_DMRS					
EPRE ratio of PDSCH_DMRS to SSS					
EPRE ratio of PDSCH to PDSCH_DMRS					
EPRE ratio of OCNG DMRS to SSS					
EPRE ratio of OCNG to OCNG DMRS					
N_{oc} ^{Note 2}	dBm / 15kHz	Conf 1, 2, 3, 4, 5, 6, 7, 8, 9	-102		
	dBm/SCS	Conf 1, 2, 4, 5, 7, 8	-102		
		Conf 3, 6, 9	-99		
\hat{E}_s / N_{oc}	dB	Conf 1, 2, 3, 4, 5, 6, 7, 8, 9	16	16	16
\hat{E}_s / I_{ot} ^{Note 3}	dB	Conf 1, 2, 3, 4, 5, 6, 7, 8, 9	16	16	16
SS-RSRP ^{Note 3}	dBm/SCS	Conf 1, 2, 4, 5, 7, 8	-86	-86	-86
		Conf 3, 6, 9	-83	-83	-83
I_o ^{Note 3}	dBm/9.36 MHz	Conf 1, 2, 4, 5, 7, 8	-57.9	-57.9	-57.9
	dBm/38.16 MHz	Conf 3, 6, 9	-51.8	-51.8	-51.8
Propagation Condition		Conf 1, 2, 3, 4, 5, 6, 7, 8, 9	AWGN		
Antenna configuration		Conf 1, 2, 3, 4, 5, 6, 7, 8, 9	1 x 2		
SUL RSRP threshold (<i>rsrp-ThresholdSSB-SUL</i>)	dBm	Conf 1,2,3,4,5,6	-75		
		Conf 7,8,9	-72		
<p>NOTE 1: OCNG shall be used such that both cells are fully allocated, and a constant total transmitted power spectral density is achieved for all OFDM symbols.</p> <p>NOTE 2: Interference from other cells and noise sources not specified in the test is assumed to be constant over subcarriers and time and shall be modelled as AWGN of appropriate power for N_{oc} to be fulfilled within $BW_{occupied}$.</p> <p>NOTE 3: \hat{E}_s / I_{ot}, I_o, and SS-RSRP levels have been derived from other parameters for information purposes. They are not settable parameters themselves.</p> <p>NOTE 4: All UL/DL transmission shall be confined within $BW_{occupied}$ (i.e. 10 MHz, 52 RBs) from $F_{C,low}$, and I_o is independent of the $BW_{channel}$ configured.</p> <p>NOTE 5: All UL/DL transmission shall be confined within $BW_{occupied}$ (i.e. 40 MHz, 106 RBs) from $F_{C,low}$, and I_o is independent of the $BW_{channel}$ configured.</p> <p>NOTE 6: $N_{RB,c}$ is derived from Table 5.3.2-1 in TS38.101-1[2] with configured $BW_{channel}$.</p>					

A.4.5.4.1.2 Test Requirements

The UE shall be ready to start transmission on the supplementary uplink carrier on SCell within 20ms from the start of T2.

The UE shall stop the transmission on the supplementary uplink carrier on SCell within 20ms from the start of T3.

All of the above test requirements shall be fulfilled in order for the observed UE UL carrier configuration delay and UE UL carrier release delay to be counted as correct. The rate of correct observed UE UL carrier configuration delay and UE UL carrier release delay during repeated tests shall be at least 90%.

A.4.5.5 Beam Failure Detection and Link recovery procedures

A.4.5.5.1 EN-DC Beam Failure Detection and Link Recovery Test for FR1 PSCell configured with SSB-based BFD and LR in non-DRX mode

A.4.5.5.1.1 Test Purpose and Environment

The purpose of this test is to verify that the UE properly detects SSB-based beam failure in the set q_0 configured for a serving PSCell and that the UE performs correct SSB-based link recovery based on beam candidate set q_1 . The purpose is to test the downlink monitoring for beam failure detection within the UEs active DL BWP of the PSCell, during the evaluation period, and link recovery, when no DRX is used. This test will partly verify the SSB based beam failure detection and link recovery for an FR1 serving cell requirements in clause 8.5.

The test parameters are given in Tables A.4.5.5.1.1-1, A.4.5.5.1.1-2, A.4.5.5.1.1-3 and A.4.5.5.1.1-4 below. There are two cells, cell 1 is the E-UTRAN PCell, and cell 2 is the PSCell, in the test. The test consists of five successive time periods, with time duration of T1, T2, T3, T4 and T5 respectively. Figure A.4.5.5.1.1-1 shows the variation of the downlink SNR of the PCell and the SNR of the SSB in set q_0 in the active PSCell to emulate SSB based beam failure. Figure A.4.5.5.1.1-2 shows the variation of the downlink L1-RSRP of the SSB in set q_1 of the candidate beam used for link recovery. Prior to the start of the time duration T1, the UE shall be fully synchronized to cell 1 and cell 2. The UE shall be configured for periodic CSI reporting with a reporting periodicity of 5 ms. In the test, DRX configuration is not enabled. The UE is configured to perform inter-frequency measurements using GP ID #0 (40ms) in test 1.

Table A.4.5.5.1.1-1: Supported test configurations for FR1 PCell

Configuration	Description
1	LTE FDD, NR 15 kHz SSB SCS, 10 MHz bandwidth, FDD duplex mode
2	LTE FDD, NR 15 kHz SSB SCS, 10 MHz bandwidth, TDD duplex mode
3	LTE FDD, NR 30 kHz SSB SCS, 40 MHz bandwidth, TDD duplex mode
4	LTE TDD, NR 15 kHz SSB SCS, 10 MHz bandwidth, FDD duplex mode
5	LTE TDD, NR 15 kHz SSB SCS, 10 MHz bandwidth, TDD duplex mode
6	LTE TDD, NR 30 kHz SSB SCS, 40 MHz bandwidth, TDD duplex mode
Note:	The UE is only required to pass in one of the supported test configurations in FR1

Table A.4.5.5.1.1-2: General test parameters for FR1 PSCell for SSB-based beam failure detection and link recovery testing in non-DRX mode

Parameter	Unit	Value	Comment
		Test 1	
Active E-UTRA PCell		Cell 1	

E-UTRA RF Channel Number			1	
Active PSCell			Cell 2	
RF Channel Number			2	
Duplex mode	Config 1, 4		FDD	
	Config 2, 3, 5, 6		TDD	
BWchannel	Config 1, 4	MHz	10: NRB,c = 52	
	Config 2, 5		10: NRB,c = 52	
	Config 3, 6		40: NRB,c = 106	
DL initial BWP configuration	Config 1, 2, 3, 4, 5, 6		DLBWP.0.1	
DL dedicated BWP configuration	Config 1, 2, 3, 4, 5, 6		DLBWP.1.1	
UL initial BWP configuration	Config 1, 2, 3, 4, 5, 6		ULBWP.0.1	
UL dedicated BWP configuration	Config 1, 2, 3, 4, 5, 6		ULBWP.1.1	
TDD Configuration	Config 1, 4		Not Applicable	
	Config 2, 5		TDDConf.1.1	
	Config 3, 6		TDDConf.2.1	
RMSI CORESET Reference Channel	Config 1, 4		CR.1.1 FDD	
	Config 2, 5		CR.1.1 TDD	
	Config 3, 6		CR.2.1 TDD	
Dedicated CORESET Reference Channel	Config 1, 4		CCR.1.1 FDD	
	Config 2, 5		CCR.1.1 TDD	
	Config 3, 6		CCR.2.1 TDD	
SSB Configuration	Config 1, 4		SSB.3 FR1	
	Config 2, 5		SSB.3 FR1	
	Config 3, 6		SSB.4 FR1	
SMTTC Configuration	Config 1, 2, 4, 5		SMTTC.1	
	Config 3, 6		SMTTC.1	
PDSCH/PDCCH subcarrier spacing	Config 1, 2, 4, 5		15 KHz	
	Config 3, 6		30 KHz	
PRACH Configuration	Config 1, 2, 4, 5		Table A.3.8.2.2-1	
	Config 3, 6		Table A.3.8.2.2-1	
SSB Index assigned as BFD RS (q_0)			0	
SSB Index assigned as CBD RS (q_i)			1	
OCNG parameters			OP.1	
CP length			Normal	
Correlation Matrix and Antenna Configuration			2x2 Low	
Beam failure	DCI format		1-0	

detection transmission parameters	Number of Control OFDM symbols		2	
	Aggregation level	CCE	8	
	Ratio of hypothetical PDCCH RE energy to average SSS RE energy	dB	0	
	Ratio of hypothetical PDCCH DMRS energy to average SSS RE energy	dB	0	
	DMRS precoder granularity		REG bundle size	
	REG bundle size		6	
DRX			OFF	
Gap pattern ID			gp0	
gapOffset			0	
rInSyncOutOfSyncThreshold			absent	When the field is absent, the UE applies the value 0. (Table 8.1.1-1).
rsrp-ThresholdSSB	Config 1, 2, 4, 5	dBm/SCS kHz	-98	Threshold used for $Q_{in_LR_SSB}$
	Config 3, 6		-95	
powerControlOffsetSS			db0	Used for deriving rsrp-ThresholdCSI-RS
beamFailureInstanceMaxCount			n1	see TS 38.321 [7], clause 5.17
beamFailureDetectionTimer			pbfd4	see TS 38.321 [7], clause 5.17
CSI-RS configuration for CSI reporting	Config 1, 4		CSI-RS.1.1 FDD	
	Config 2, 5		CSI-RS.1.1 TDD	
	Config 3, 6		CSI-RS.2.1 TDD	
CSI-RS for tracking	Config 1, 4		TRS.1.1 FDD	
	Config 2, 5		TRS.1.1 TDD	
	Config 3, 6		TRS.1.2 TDD	
SSB Index assigned as RLM RS			0,1	
T310 timer		ms	1000	
N310			2	
T1		s	0.2	During this time the the UE shall be

			fully synchronized to cell 1
T2	s	0.37	
T3	s	0.24	
T4	s	0	
T5	s	0.17	
D1	s	0.14	
Note 1: All configurations are assigned to the UE prior to the start of time period T1.			
Note 2: UE-specific PDCCH is not transmitted after T1 starts.			
Note 3: E-UTRAN is in non-DRX mode under test.			

Table A.4.5.1.1-3: Cell specific test parameters for FR1 PSCell for SSB-based beam failure detection and link recovery testing in non-DRX mode

Parameter		Unit	Test 1				
			T1	T2	T3	T4	T5
EPRE ratio of PDCCH DMRS to SSS		dB	0				
EPRE ratio of PDCCH to PDCCH DMRS							
EPRE ratio of PBCH DMRS to SSS							
EPRE ratio of PBCH to PBCH DMRS							
EPRE ratio of PSS to SSS							
EPRE ratio of PDSCH DMRS to SSS							
EPRE ratio of PDSCH to PDSCH DMRS							
EPRE ratio of OCNG DMRS to SSS							
EPRE ratio of OCNG to OCNG DMRS							
SNR_SSB of set q_0	Config 1, 4	dB	5	-3	-12	-12	-12
	Config 2, 5		5	-3	-12	-12	-12
	Config 3, 6		5	-3	-12	-12	-12
SNR_SSB of set q_1	Config 1, 4	dB	-10	-10	10	10	10
	Config 2, 5		-10	-10	10	10	10
	Config 3, 6		-10	-10	10	10	10
SSB_RP of set q_1	Config 1, 4	dBm/ SCS kHz	-108	-108	-88	-88	-88
	Config 2, 5		-108	-108	-88	-88	-88
	Config 3, 6		-105	-105	-85	-85	-85
N_{oc}	Config 1, 4	dBm/15 KHz	-98				
	Config 2, 5		-98				
	Config 3, 6		-98				
Propagation condition			TDL-C 300ns 100Hz				
Note 1:		OCNG shall be used such that the resources in Cell 1 are fully allocated and a constant total transmitted power spectral density is achieved for all OFDM symbols.					
Note 2:		The uplink resources for CSI reporting are assigned to the UE prior to the start of time period T1.					
Note 3:		NZP CSI-RS resource set configuration for CSI reporting are assigned to the UE prior to the start of time period T1.					
Note 4:		Measurement gap configuration is assigned to the UE prior to the start of time period T1.					
Note 5:		The timers and layer 3 filtering related parameters are configured prior to the start of time period T1.					
Note 6:		The signal contains PDCCH for UEs other than the device under test as part of OCNG.					
Note 7:		SNR levels correspond to the signal to noise ratio over the SSS REs.					
Note 8:		The SNR in time periods T1, T2, T3, T4 and T5 is denoted as SNR1, SNR2 and SNR3 respectively in figure A.4.5.1.1-1.					
Note 9:		The SNR values are specified for testing a UE which supports 2RX on at least one band. For testing of a UE which supports 4RX on all bands, the SNR during T3 is modified as specified in clause A.3.6.					

Table A.4.5.5.1.1-4: Void

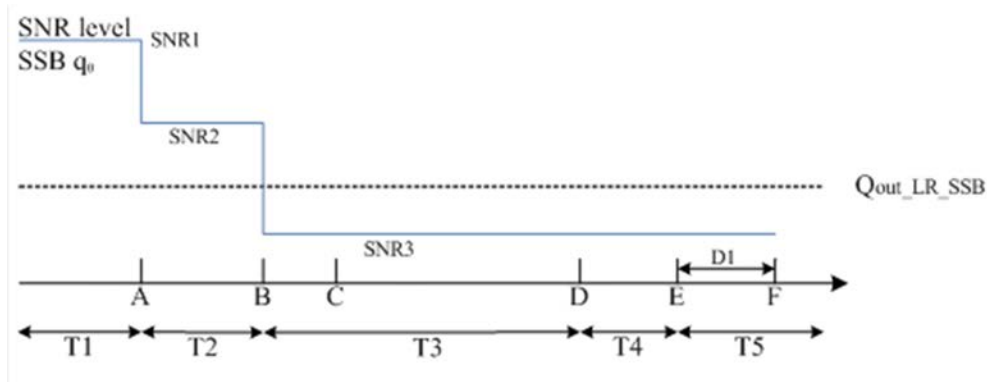

Figure A.4.5.5.1.1-1: SNR variation for SSB-based beam failure detection and link recovery testing in non-DRX mode

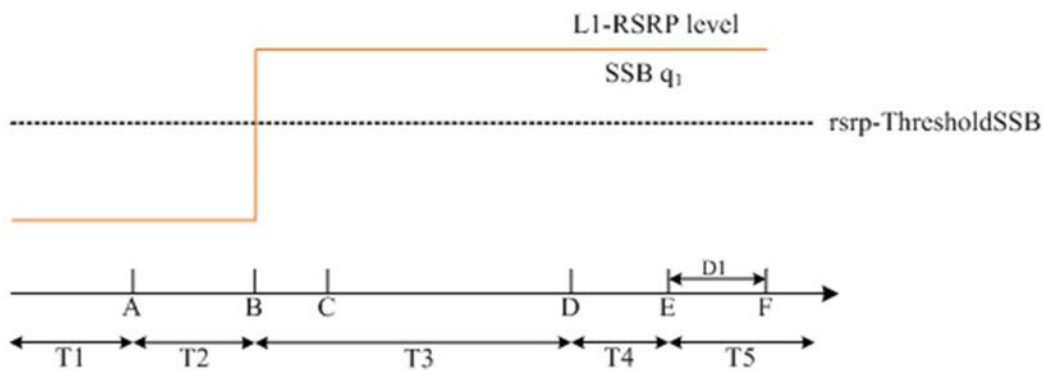

Figure A.4.5.5.1.1-2: L1-RSRP level variation for SSB-based beam failure detection and link recovery testing in non-DRX mode

A.4.5.5.1.2 Test Requirements

The UE behaviour during time durations T1, T2, T3, T4 and T5 shall be as follows:

During the time duration T1 and T2, the UE shall transmit uplink signal at least in all subframes configured for CSI transmission on Cell 1.

During the period from time point A to time point B the UE shall transmit uplink signal in Cell 1 in all uplink slots configured for CSI transmission according to the configured periodic CSI reporting for Cell 1.

During T3 the UE shall detect beam failure and initiate link recovery. During T4 and T5 the UE measures and evaluate beam candidate from beam candidate set q_1 .

No later than time point F occurring no later than $D1 = 120+20$ ms after the start of T5, the UE shall transmit preamble on a beam associated with the candidate beam set q_1 . The UE shall not transmit preamble on a beam associated with the candidate beam set q_1 earlier than time point B.

Test is concluded once the test equipment has received the initial preamble transmission from the UE. The rate of correct events observed during repeated tests shall be at least 90%.

A.4.5.5.2 EN-DC Beam Failure Detection and Link Recovery Test for FR1 PSCell configured with SSB-based BFD and LR in DRX mode

A.4.5.5.2.1 Test Purpose and Environment

The purpose of this test is to verify that the UE properly detects SSB-based beam failure in the set q_0 configured for a serving PSCell and that the UE performs correct SSB-based link recovery based on beam candidate set q_1 . The purpose is to test the downlink monitoring for beam failure detection within the UEs active DL BWP of the PSCell, during the evaluation period, and link recovery, when DRX is used. This test will partly verify the SSB based beam failure detection and link recovery for an FR1 serving cell requirements in clause 8.5.

The test parameters are given in Tables A.4.5.5.2.1-1, A.4.5.5.2.1-2, A.4.5.5.2.1-3, A.4.5.5.2.1-4 and A.4.5.5.2.1-5 below. There are two cells, cell 1 is the E-UTRAN PCell, and cell 2 is the PSCell, in the test. The test consists of five successive time periods, with time duration of T1, T2, T3, T4 and T5 respectively. Figure A.4.5.5.2.1-1 shows the variation of the downlink SNR of the PCell and the SNR of the SSB in set q_0 in the active PSCell to emulate SSB based beam failure. Figure A.4.5.5.2.1-2 shows the variation of the downlink L1-RSRP of the SSB in set q_1 of the candidate beam used for link recovery. Prior to the start of the time duration T1, the UE shall be fully synchronized to cell 1 and cell 2. The UE shall be configured for periodic CSI reporting with a reporting periodicity of 5 ms. In the test, DRX configuration is enabled in PSCell and DRX inactivity timer has already been expired, i.e. UE tries to decode PDCCH and to send periodic CQI during the period when On-duration timer is running. Time alignment timers shall be set to "infinity" so that UL timing alignment is maintained during the test.

Table A.4.5.5.2.1-1: Supported test configurations for FR1 PCell

Configuration	Description
1	LTE FDD, NR 15 kHz SSB SCS, 10 MHz bandwidth, FDD duplex mode
2	LTE FDD, NR 15 kHz SSB SCS, 10 MHz bandwidth, TDD duplex mode
3	LTE FDD, NR 30 kHz SSB SCS, 40 MHz bandwidth, TDD duplex mode
4	LTE TDD, NR 15 kHz SSB SCS, 10 MHz bandwidth, FDD duplex mode
5	LTE TDD, NR 15 kHz SSB SCS, 10 MHz bandwidth, TDD duplex mode
6	LTE TDD, NR 30 kHz SSB SCS, 40 MHz bandwidth, TDD duplex mode
Note:	The UE is only required to pass in one of the supported test configurations in FR1

Table A.4.5.5.2.1-2: General test parameters for FR1 PCell for SSB-based beam failure detection and link recovery testing in DRX mode

Parameter		Unit	Value	Comment
			Test 1	
Active E-UTRA PCell			Cell 1	
E-UTRA RF Channel Number			1	
Active PSCell			Cell 2	
RF Channel Number			2	
Duplex mode	Config 1, 4		FDD	
	Config 2, 3, 5, 6		TDD	

BWchannel	Config 1, 4	MHz	10: NRB,c = 52	
	Config 2, 5		10: NRB,c = 52	
	Config 3, 6		40: NRB,c = 106	
DL initial BWP configuration	Config 1, 2, 3, 4, 5, 6		DLBWP.0.1	
DL dedicated BWP configuration	Config 1, 2, 3, 4, 5, 6		DLBWP.1.1	
UL initial BWP configuration	Config 1, 2, 3, 4, 5, 6		ULBWP.0.1	
UL dedicated BWP configuration	Config 1, 2, 3, 4, 5, 6		ULBWP.1.1	
TDD Configuration	Config 1, 4		Not Applicable	
	Config 2, 5		TDDConf.1.1	
	Config 3, 6		TDDConf.2.1	
RMSI CORESET Reference Channel	Config 1, 4		CR.1.1 FDD	
	Config 2, 5		CR.1.1 TDD	
	Config 3, 6		CR.2.1 TDD	
Dedicated CORESET Reference Channel	Config 1, 4		CCR.1.1 FDD	
	Config 2, 5		CCR.1.1 TDD	
	Config 3, 6		CCR.2.1 TDD	
SSB Configuration	Config 1, 4		SSB.3 FR1	
	Config 2, 5		SSB.3 FR1	
	Config 3, 6		SSB.4 FR1	
SMTC Configuration	Config 1, 2, 4, 5		SMTC.1	
	Config 3, 6		SMTC.1	
PDSCH/PDCCH subcarrier spacing	Config 1, 2, 4, 5		15 KHz	
	Config 3, 6		30 KHz	
PRACH Configuration	Config 1, 2, 4, 5		Table A.3.8.2.2-1	
	Config 3, 6		Table A.3.8.2.2-1	
SSB Index assigned as BFD RS (q_0)			0	
SSB Index assigned as CBD RS (q_1)			1	
OCNG parameters			OP.1	
CP length			Normal	

Correlation Matrix and Antenna Configuration			2x2 Low	
Beam failure detection transmission parameters	DCI format		1-0	
	Number of Control OFDM symbols		2	
	Aggregation level	CCE	8	
	Ratio of hypothetical PDCCH RE energy to average SSS RE energy	dB	0	
	Ratio of hypothetical PDCCH DMRS energy to average SSS RE energy	dB	0	
	DMRS precoder granularity		REG bundle size	
	REG bundle size		6	
DRX			DRX.7	A.3.3.7
Gap pattern ID			N.A.	
rimInSyncOutOfSyncThreshold			absent	When the field is absent, the UE applies the value 0. (Table 8.1.1-1).
rsrp-ThresholdSSB	Config 1, 2, 4, 5	dBm/SCS kHz	-98	Threshold used for $Q_{in_LR_SSB}$
	Config 3, 6		-95	
powerControlOffsetSS			db0	Used for deriving rsrp-ThresholdCSI-RS
beamFailureInstanceMaxCount			n1	see TS 38.321 [7], clause 5.17
beamFailureDetectionTimer			pbfd4	see TS 38.321 [7], clause 5.17
CSI-RS configuration for CSI reporting	Config 1, 4		CSI-RS.1.1 FDD	
	Config 2, 5		CSI-RS.1.1 TDD	
	Config 3, 6		CSI-RS.2.1 TDD	
CSI-RS for tracking	Config 1, 4		TRS.1.1 FDD	
	Config 2, 5		TRS.1.1 TDD	
	Config 3, 6		TRS.1.2 TDD	
SSB Index assigned as RLM RS			0,1	
T310 Timer		ms	1000	
N310			2	
T1		s	1	During this time the the UE shall

			be fully synchronized to cell 1
T2	s	5.17	
T3	s	3.24	
T4	s	0	
T5	s	1.97	
D1	s	1.94	
Note 1: All configurations are assigned to the UE prior to the start of time period T1.			
Note 2: UE-specific PDCCH is not transmitted after T1 starts.			
Note 3: E-UTRAN is in non-DRX mode under test.			

Table A.4.5.5.2.1-3: Cell specific test parameters for FR1 PSCell for SSB-based beam failure detection and link recovery testing in DRX mode

Parameter		Unit	Test 1				
			T1	T2	T3	T4	T5
EPRE ratio of PDCCH DMRS to SSS		dB	0				
EPRE ratio of PDCCH to PDCCH DMRS							
EPRE ratio of PBCH DMRS to SSS							
EPRE ratio of PBCH to PBCH DMRS							
EPRE ratio of PSS to SSS							
EPRE ratio of PDSCH DMRS to SSS							
EPRE ratio of PDSCH to PDSCH DMRS							
EPRE ratio of OCNG DMRS to SSS							
EPRE ratio of OCNG to OCNG DMRS							
SNR_SSB of set q_0	Config 1, 4	dB	5	-3	-12	-12	-12
	Config 2, 5		5	-3	-12	-12	-12
	Config 3, 6		5	-3	-12	-12	-12
SNR_SSB of set q_1	Config 1, 4	dB	-10	-10	10	10	10
	Config 2, 5		-10	-10	10	10	10
	Config 3, 6		-10	-10	10	10	10
SSB_RP of set q_1	Config 1, 4	dBm/ SCS kHz	-108	-108	-88	-88	-88
	Config 2, 5		-108	-108	-88	-88	-88
	Config 3, 6		-105	-105	-85	-85	-85
N_{oc}	Config 1, 4	dBm/15 KHz	-98				
	Config 2, 5		-98				
	Config 3, 6		-98				
Propagation condition			TDL-C 300ns 100Hz				
Note 1: OCNG shall be used such that the resources in Cell 1 are fully allocated and a constant total transmitted power spectral density is achieved for all OFDM symbols.							
Note 2: The uplink resources for CSI reporting are assigned to the UE prior to the start of time period T1.							
Note 3: NZP CSI-RS resource set configuration for CSI reporting are assigned to the UE prior to the start of time period T1.							
Note 4: Void							
Note 5: The timers and layer 3 filtering related parameters are configured prior to the start of time period T1.							
Note 6: The signal contains PDCCH for UEs other than the device under test as part of OCNG.							
Note 7: SNR levels correspond to the signal to noise ratio over the SSS REs.							
Note 8: The SNR in time periods T1, T2, T3, T4 and T5 is denoted as SNR1, SNR2 and SNR3 respectively in figure A.4.5.5.1.1-1.							
Note 9: The SNR values are specified for testing a UE which supports 2RX on at least one band. For testing of a UE which supports 4RX on all bands, the SNR during T3 is modified as specified in clause A.3.6.							

Table A.4.5.5.2.1-4: Void

Table A.4.5.5.2.1-5: Void

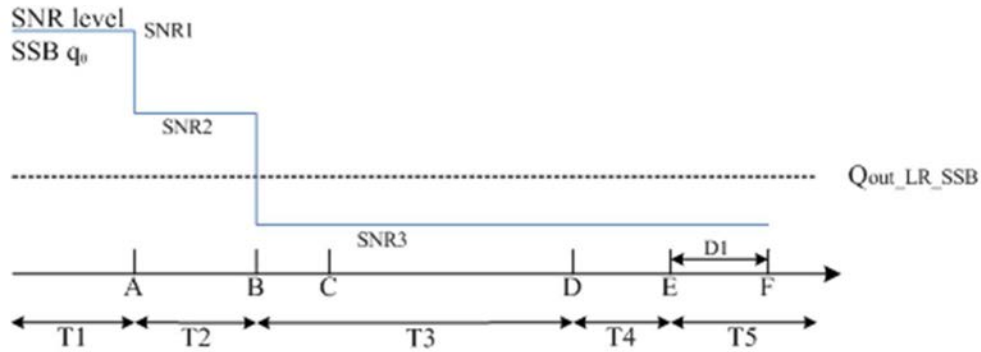

Figure A.4.5.5.2.1-1: SNR variation for SSB-based beam failure detection and link recovery testing in DRX mode

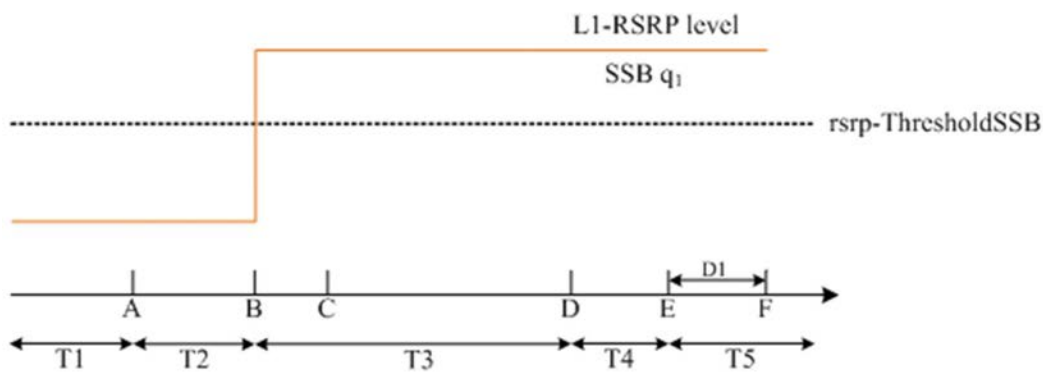

Figure A.4.5.5.2.1-2: L1-RSRP level variation for SSB-based beam failure detection and link recovery testing in DRX mode

A.4.5.5.2.2 Test Requirements

The UE behaviour during time durations T1, T2, T3, T4 and T5 shall be as follows:

During the time duration T1 and T2, the UE shall transmit uplink signal at least in all subframes configured for CSI transmission on Cell 1.

During the period from time point A to time point B the UE shall transmit uplink signal in Cell 1 in all uplink slots configured for CSI transmission according to the configured periodic CSI reporting for Cell 1.

During T3 the UE shall detect beam failure and initiate link recovery. During T4 and T5 the UE measures and evaluates beam candidate from beam candidate set q_1 .

No later than time point F occurring no later than $D1 = 1920 + 20$ ms after the start of T5, the UE shall transmit preamble on a beam associated with the candidate beam set q_1 . The UE shall not transmit preamble on a beam associated with the candidate beam set q_1 earlier than time point B.

Test is concluded once the test equipment has received the initial preamble transmission from the UE. The rate of correct events observed during repeated tests shall be at least 90%.

A.4.5.5.3 EN-DC Beam Failure Detection and Link Recovery Test for FR1 PSCell configured with CSI-RS-based BFD and LR in non-DRX mode

A.4.5.5.3.1 Test Purpose and Environment

The purpose of this test is to verify that the UE properly detects CSI-RS-based beam failure in the set q_0 configured for a serving PSCell and that the UE performs correct CSI-RS-based link recovery based on beam candidate set q_1 . The purpose is to test the downlink monitoring for beam failure detection within the UEs active DL BWP of the PSCell, during the evaluation period, and link recovery, when no DRX is used. This test will partly verify the CSI-RS based beam failure detection and link recovery for an FR1 serving cell requirements in clause 8.5.

The test parameters are given in Tables A.4.5.5.3.1-1, A.4.5.5.3.1-2, and A.4.5.5.3.1-3 below. There are two cells, cell 1 is the E-UTRAN PCell, and cell 2 is the PSCell, in the test. The test consists of five successive time periods, with time duration of T1, T2, T3, T4 and T5 respectively. Figure A.4.5.5.3.1-1 shows the variation of the downlink SNR of the PSCell and the SNR of the CSI-RS in set q_0 in the active PSCell to emulate CSI-RS based beam failure. Figure A.4.5.5.3.1-2 shows the variation of the downlink L1-RSRP of the CSI-RS in set q_1 of the candidate beam used for link recovery. Prior to the start of the time duration T1, the UE shall be fully synchronized to cell 1 and cell 2. The UE shall be configured for periodic CSI reporting with a reporting periodicity of 5 ms. In the test, DRX configuration is not enabled.

Table A.4.5.5.3.1-1: Supported test configurations for FR1 PSCell

Configuration	Description
1	LTE FDD, NR 15 kHz SSB SCS, 10 MHz bandwidth, FDD duplex mode
2	LTE FDD, NR 15 kHz SSB SCS, 10 MHz bandwidth, TDD duplex mode
3	LTE FDD, NR 30 kHz SSB SCS, 40 MHz bandwidth, TDD duplex mode
4	LTE TDD, NR 15 kHz SSB SCS, 10 MHz bandwidth, FDD duplex mode
5	LTE TDD, NR 15 kHz SSB SCS, 10 MHz bandwidth, TDD duplex mode
6	LTE TDD, NR 30 kHz SSB SCS, 40 MHz bandwidth, TDD duplex mode

Note: The UE is only required to pass in one of the supported test configurations in FR1

Table A.4.5.5.3.1-2: General test parameters for FR1 PSCell for CSI-RS-based beam failure detection and link recovery testing in non-DRX mode

Parameter	Unit	Value	Comment
		Test 1	
Active PCell		Cell 1	
RF Channel Number		1	
Active PSCell		Cell 2	
RF Channel Number		2	
Duplex mode	Config 1, 4	FDD	
	Config 2, 3, 5, 6	TDD	
BWchannel	Config 1, 4	10: NRB,c = 52	
	Config 2, 5	10: NRB,c = 52	
	Config 3, 6	40: NRB,c = 106	
DL initial BWP configuration	Config 1, 2, 3, 4, 5, 6	DLBWP.0.1	
DL dedicated BWP configuration	Config 1, 2, 3, 4, 5, 6	DLBWP.1.1	

UL initial BWP configuration	Config 1, 2, 3, 4, 5, 6		ULBWP.0.1	
UL dedicated BWP configuration	Config 1, 2, 3, 4, 5, 6		ULBWP.1.1	
TDD Configuration	Config 1, 4		Not Applicable	
	Config 2, 5		TDDConf.1.1	
	Config 3, 6		TDDConf.2.1	
RMSI CORESET Reference Channel	Config 1, 4		CR.1.1 FDD	A.3.1.2
	Config 2, 5		CR.1.1 TDD	
	Config 3, 6		CR.2.1 TDD	
Dedicated CORESET Reference Channel	Config 1, 4		CCR.1.1 FDD	A.3.1.3
	Config 2, 5		CCR.1.1 TDD	
	Config 3, 6		CCR.2.1 TDD	
SSB Configuration	Config 1, 4		SSB.3 FR1	A.3.10
	Config 2, 5		SSB.3 FR1	
	Config 3, 6		SSB.4 FR1	
SMTC Configuration	Config 1, 2, 4, 5		SMTC.1	A.3.11
	Config 3, 6		SMTC.1	
PDSCH/PDCCH subcarrier spacing	Config 1, 2, 4, 5		15 KHz	
	Config 3, 6		30 KHz	
PRACH Configuration	Config 1, 2, 4, 5		FR1 PRACH configuration 4	A.3.8.2
	Config 3, 6		FR1 PRACH configuration 4	A.3.8.2
csi-RS-Index assigned as beam failure detection RS in set q_0			0	
OCNG parameters			OP.1	A.3.2.1
CP length			Normal	
Correlation Matrix and Antenna Configuration			2x2 Low	
Beam failure detection transmission parameters	DCI format		1-0	
	Number of Control OFDM symbols		2	
	Aggregation level	CCE	8	
	Ratio of hypothetical PDCCH RE energy to average CSI-RS RE energy	dB	0	
	Ratio of hypothetical PDCCH DMRS energy to average CSI-RS RE energy	dB	0	
	DMRS precoder granularity		REG bundle size	
	REG bundle size		6	

DRX			OFF	
Gap pattern ID			N.A.	
csi-RS-Index assigned as candidate beam detection RS in set q_1			1	
rlmInSyncOutOfSyncThreshold			absent	When the field is absent, the UE applies the value 0. (Table 8.1.1-1).
rsrp-ThresholdCSI-RS	Config 1, 2, 4, 5	dBm/SCS kHz	-98	Threshold used for $Q_{in_LR_CSI-RS}$
	Config 3, 6		-95	
powerControlOffsetSS			db0	Used for deriving rsrp-ThresholdCSI-RS
beamFailureInstanceMaxCount			n1	see TS 38.321 [7], clause 5.17
beamFailureDetectionTimer			pbfd4	see TS 38.321 [7], clause 5.17
CSI-RS configuration for q_0 and q_1	Config 1, 4		CSI-RS.1.2 FDD	A.3.14
	Config 2, 5		CSI-RS.1.2 TDD	
	Config 3, 6		CSI-RS.2.2 TDD	
CSI-RS configuration for CSI reporting	Config 1, 4		CSI-RS.1.1 FDD	A.3.14
	Config 2, 5		CSI-RS.1.1 TDD	
	Config 3, 6		CSI-RS.2.1 TDD	
TRS configuration	Config 1, 4		TRS.1.1 FDD	
	Config 2, 5		TRS.1.1 TDD	
	Config 3, 6		TRS.1.2 TDD	
csi-RS-Index assigned as RLM RS	Config 1, 4		CSI-RS.1.2 FDD	A.3.14
	Config 2, 5		CSI-RS.1.2 TDD	
	Config 3, 6		CSI-RS.2.2 TDD	
T310 Timer		ms	1000	
N310			2	
T1		s	1	During this time the the UE shall be fully synchronized to cell 1
T2		s	0.18	
T3		s	0.14	
T4		s	0	
T5		s	0.08	
D1		s	0.05	
Note 1: UE-specific PDCCH is not transmitted after T1 starts.				

Table A.4.5.5.3.1-3: Cell specific test parameters for FR1 PSCell for CSI-RS-based beam failure detection and link recovery testing in non-DRX mode

Parameter	Unit	Test 1				
		T1	T2	T3	T4	T5
EPRE ratio of PDCCH DMRS to SSS	dB	0				
EPRE ratio of PDCCH to PDCCH DMRS	dB					
EPRE ratio of PBCH DMRS to SSS	dB					
EPRE ratio of PBCH to PBCH DMRS	dB					
EPRE ratio of PSS to SSS	dB					
EPRE ratio of PDSCH DMRS to SSS	dB					
EPRE ratio of PDSCH to PDSCH DMRS	dB					
EPRE ratio of OCNG DMRS to SSS	dB					

EPRE ratio of OCNG to OCNG DMRS		dB					
SNR_CSI-RS of set q_0	Config 1, 4	dB	5	-3	-12	-12	-12
	Config 2, 5		5	-3	-12	-12	-12
	Config 3, 6		5	-3	-12	-12	-12
SNR_CSI-RS of set q_1	Config 1, 4	dB	-10	-10	10	10	10
	Config 2, 5		-10	-10	10	10	10
	Config 3, 6		-10	-10	10	10	10
CSI-RS_RP of set q_1	Config 1, 4	dBm/ SCS kHz	-108	-108	-88	-88	-88
	Config 2, 5		-108	-108	-88	-88	-88
	Config 3, 6		-105	-105	-85	-85	-85
N_{oc}	Config 1, 4	dBm/15 KHz	-98				
	Config 2, 5		-98				
	Config 3, 6		-98				
Propagation condition			TDL-C 300ns 100Hz				
<p>Note 1: OCNG shall be used such that the resources in Cell 1 are fully allocated and a constant total transmitted power spectral density is achieved for all OFDM symbols.</p> <p>Note 2: The uplink resources for CSI reporting are assigned to the UE prior to the start of time period T1.</p> <p>Note 3: NZP CSI-RS resource set configuration for CSI reporting are assigned to the UE prior to the start of time period T1.</p> <p>Note 4: Void</p> <p>Note 5: The timers and layer 3 filtering related parameters are configured prior to the start of time period T1.</p> <p>Note 6: The signal contains PDCCH for UEs other than the device under test as part of OCNG.</p> <p>Note 7: SNR levels correspond to the signal to noise ratio over the REs carrying CSI-RS. Note 8: The SNR in time periods T1, T2, T3, T4 and T5 is denoted as SNR1, SNR2 and SNR3 respectively in figure A.4.5.5.1.1-1.</p> <p>Note 9: The SNR values are specified for testing a UE which supports 2RX on at least one band. For testing of a UE which supports 4RX on all bands, the SNR during T3 is modified as specified in clause A.3.6.</p>							

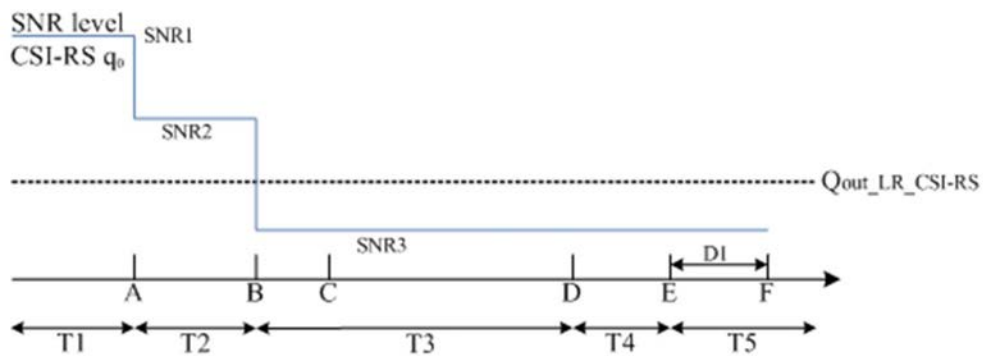

Figure A.4.5.5.3.1-1: SNR variation for CSI-RS-based beam failure detection and link recovery testing in non-DRX mode

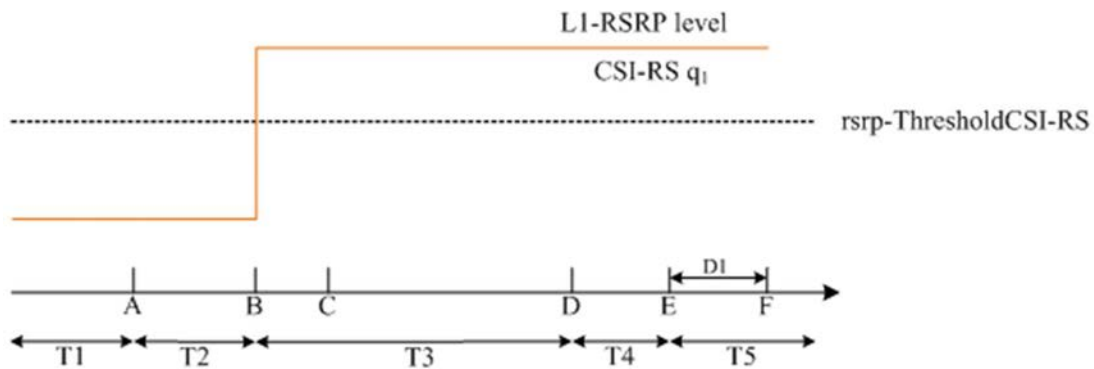

Figure A.4.5.5.3.1-2: L1-RSRP level variation for CSI-RS based beam failure detection and link recovery testing in non-DRX mode

A.4.5.5.3.2 Test Requirements

The UE behaviour during time durations T1, T2, T3, T4 and T5 shall be as follows:

During the time duration T1 and T2, the UE shall transmit uplink signal at least in all subframes configured for CSI transmission on Cell 1.

During the period from time point A to time point B the UE shall transmit uplink signal in Cell 1 in all uplink slots configured for CSI transmission according to the configured periodic CSI reporting for Cell 1.

During T3 the UE shall detect beam failure and initiate link recovery. During T4 and T5 the UE measures and evaluate beam candidate from beam candidate set q_1 .

No later than time point F occurring no later than $D1 = 30+20$ ms after the start of T5, the UE shall transmit preamble on a beam associated with the candidate beam set q_1 . The UE shall not transmit preamble on a beam associated with the candidate beam set q_1 earlier than time point B.

Test is concluded once the test equipment has received the initial preamble transmission from the UE. The rate of correct events observed during repeated tests shall be at least 90%.

A.4.5.5.4 EN-DC Beam Failure Detection and Link Recovery Test for FR1 PSCell configured with CSI-RS-based BFD and LR in DRX mode

A.4.5.5.4.1 Test Purpose and Environment

The purpose of this test is to verify that the UE properly detects CSI-RS-based beam failure in the set q_0 configured for a serving PSCell and that the UE performs correct CSI-RS-based link recovery based on beam candidate set q_1 . The purpose is to test the downlink monitoring for beam failure detection within the UEs active DL BWP of the PSCell, during the evaluation period, and link recovery, when DRX is used. This test will partly verify the CSI-RS based beam failure detection and link recovery for an FR1 serving cell requirements in clause 8.5.

The test parameters are given in Tables A.4.5.5.4.1-1, A.4.5.5.4.1-2, A.4.5.5.4.1-3, and A.4.5.5.4.1-4 below. There are two cells, cell 1 is the E-UTRAN PCell, and cell 2 is the PSCell, in the test. The test consists of five successive time periods, with time duration of T1, T2, T3, T4 and T5 respectively. Figure A.4.5.5.4.1-1 shows the variation of the downlink SNR of the PSCell and the SNR of the CSI-RS in set q_0 in the active PSCell to emulate CSI-RS based beam failure. Figure A.4.5.5.4.1-2 shows the variation of the downlink L1-RSRP of the CSI-RS in set q_1 of the candidate beam used for link recovery. Prior to the start of the time duration T1, the UE shall be fully synchronized to cell 1 and cell 2. The UE shall be configured for periodic CSI reporting with a reporting periodicity of 5 ms. In the test, DRX configuration is enabled in PSCell and DRX inactivity timer has already been expired, i.e. UE tries to

decode PDCCH and to send periodic CQI during the period when On-duration timer is running. Time alignment timers shall be set to “infinity” so that UL timing alignment is maintained during the test.

Table A.4.5.5.4.1-1: Supported test configurations for FR1 PSCell

Configuration	Description
1	LTE FDD, NR 15 kHz SSB SCS, 10 MHz bandwidth, FDD duplex mode
2	LTE FDD, NR 15 kHz SSB SCS, 10 MHz bandwidth, TDD duplex mode
3	LTE FDD, NR 30 kHz SSB SCS, 40 MHz bandwidth, TDD duplex mode
4	LTE TDD, NR 15 kHz SSB SCS, 10 MHz bandwidth, FDD duplex mode
5	LTE TDD, NR 15 kHz SSB SCS, 10 MHz bandwidth, TDD duplex mode
6	LTE TDD, NR 30 kHz SSB SCS, 40 MHz bandwidth, TDD duplex mode
Note:	The UE is only required to pass in one of the supported test configurations in FR1

Table A.4.5.5.4.1-2: General test parameters for FR1 PSCell for CSI-RS-based beam failure detection and link recovery testing in DRX mode

Parameter	Unit	Value	Comment
		Test 1	
Active PCell		Cell 1	
RF Channel Number		1	
Active PSCell		Cell 2	
RF Channel Number		2	
Duplex mode	Config 1, 4	FDD	
	Config 2, 3, 5, 6	TDD	
BWchannel	Config 1, 4	MHz	10: NRB,c = 52
	Config 2, 5		10: NRB,c = 52
	Config 3, 6		40: NRB,c = 106
DL initial BWP configuration	Config 1, 2, 3, 4, 5, 6		DLBWP.0.1
DL dedicated BWP configuration	Config 1, 2, 3, 4, 5, 6		DLBWP.1.1
UL initial BWP configuration	Config 1, 2, 3, 4, 5, 6		ULBWP.0.1
UL dedicated BWP configuration	Config 1, 2, 3, 4, 5, 6		ULBWP.1.1
TDD Configuration	Config 1, 4		Not Applicable
	Config 2, 5		TDDConf.1.1
	Config 3, 6		TDDConf.2.1
RMSI CORESET Reference Channel	Config 1, 4		CR.1.1 FDD
	Config 2, 5		CR.1.1 TDD
	Config 3, 6		CR.2.1 TDD
Dedicated CORESET Reference Channel	Config 1, 4		CCR.1.1 FDD
	Config 2, 5		CCR.1.1 TDD
	Config 3, 6		CCR.2.1 TDD
SSB Configuration	Config 1, 4		SSB.3 FR1
	Config 2, 5		SSB.3 FR1
	Config 3, 6		SSB.4 FR1
SMTC Configuration	Config 1, 2, 4, 5		SMTC.1
	Config 3, 6		SMTC.1
PDSCH/PDCCH subcarrier spacing	Config 1, 2, 4, 5		15 KHz
	Config 3, 6		30 KHz

PRACH Configuration	Config 1, 2, 4, 5		FR1 PRACH configuration 4	A.3.8.2
	Config 3, 6		FR1 PRACH configuration 4	A.3.8.2
csi-RS-Index assigned as beam failure detection RS in set q_0			0	
OCNG parameters			OP.1	A.3.2.1
CP length			Normal	
Correlation Matrix and Antenna Configuration			2x2 Low	
Beam failure detection transmission parameters	DCI format		1-0	
	Number of Control OFDM symbols		2	
	Aggregation level	CCE	8	
	Ratio of hypothetical PDCCH RE energy to average CSI-RS RE energy	dB	0	
	Ratio of hypothetical PDCCH DMRS energy to average CSI-RS RE energy	dB	0	
	DMRS precoder granularity		REG bundle size	
	REG bundle size		6	
DRX			DRX.7	A.3.3.7
Gap pattern ID			N.A.	
csi-RS-Index assigned as candidate beam detection RS in set q_1			1	
rlmInSyncOutOfSyncThreshold			absent	When the field is absent, the UE applies the value 0. (Table 8.1.1-1).
rsrp-ThresholdCSI-RS		dBm	-98	Threshold used for $Q_{in_LR_CSI-RS}$
powerControlOffsetSS			db0	Used for deriving rsrp-ThresholdCSI-RS
beamFailureInstanceMaxCount			n1	see TS 38.321 [7], clause 5.17
beamFailureDetectionTimer			pbfd4	see TS 38.321 [7], clause 5.17
CSI-RS configuration for q_0 and q_1	Config 1, 4		CSI-RS.1.2 FDD	A.3.14
	Config 2, 5		CSI-RS.1.2 TDD	
	Config 3, 6		CSI-RS.2.2 TDD	
CSI-RS configuration for CSI reporting	Config 1, 4		CSI-RS.1.1 FDD	A.3.14
	Config 2, 5		CSI-RS.1.1 TDD	
	Config 3, 6		CSI-RS.2.1 TDD	
TRS configuration	Config 1, 4		TRS.1.1 FDD	
	Config 2, 5		TRS.1.1 TDD	
	Config 3, 6		TRS.1.2 TDD	
csi-RS-Index assigned as RLM RS	Config 1, 4		CSI-RS.1.2 FDD	A.3.14
	Config 2, 5		CSI-RS.1.2 TDD	
	Config 3, 6		CSI-RS.2.2 TDD	

T310 Timer	ms	1000	
N310		2	
T1	s	1	During this time the the UE shall be fully synchronized to cell 1
T2	s	8.37	
T3	s	6.44	
T4	s	0	
T5	s	1.97	
D1	s	1.94	
Note 1: UE-specific PDCCH is not transmitted after T1 starts.			

Table A.4.5.5.4.1-3: Cell specific test parameters for FR1 PSCell for CSI-RS-based beam failure detection and link recovery testing in DRX mode

Parameter	Unit	Test 1				
		T1	T2	T3	T4	T5
EPRE ratio of PDCCH DMRS to SSS	dB	0				
EPRE ratio of PDCCH to PDCCH DMRS						
EPRE ratio of PBCH DMRS to SSS						
EPRE ratio of PBCH to PBCH DMRS						
EPRE ratio of PSS to SSS						
EPRE ratio of PDSCH DMRS to SSS						
EPRE ratio of PDSCH to PDSCH DMRS						
EPRE ratio of OCNG DMRS to SSS						
EPRE ratio of OCNG to OCNG DMRS						
SNR_CSI-RS of set q_0	Config 1, 4	5	-3	-12	-12	-12
	Config 2, 5	5	-3	-12	-12	-12
	Config 3, 6	5	-3	-12	-12	-12
SNR_CSI-RS of set q_1	Config 1, 4	-10	-10	10	10	10
	Config 2, 5	-10	-10	10	10	10
	Config 3, 6	-10	-10	10	10	10
CSI-RS_RP of set q_1	Config 1, 4	-108	-108	-88	-88	-88
	Config 2, 5	-108	-108	-88	-88	-88
	Config 3, 6	-105	-105	-85	-85	-85
N_{oc}	Config 1, 4	-98				
	Config 2, 5	-98				
	Config 3, 6	-98				
Propagation condition		TDL-C 300ns 100Hz				
<p>Note 1: OCNG shall be used such that the resources in Cell 1 are fully allocated and a constant total transmitted power spectral density is achieved for all OFDM symbols.</p> <p>Note 2: The uplink resources for CSI reporting are assigned to the UE prior to the start of time period T1.</p> <p>Note 3: NZP CSI-RS resource set configuration for CSI reporting are assigned to the UE prior to the start of time period T1.</p> <p>Note 4: Void</p> <p>Note 5: The timers and layer 3 filtering related parameters are configured prior to the start of time period T1.</p> <p>Note 6: The signal contains PDCCH for UEs other than the device under test as part of OCNG.</p> <p>Note 7: SNR levels correspond to the signal to noise ratio over the REs carrying CSI-RS.</p> <p>Note 8: The SNR in time periods T1, T2, T3, T4 and T5 is denoted as SNR1, SNR2 and SNR3 respectively in figure A.4.5.5.1.1-1.</p> <p>Note 9: The SNR values are specified for testing a UE which supports 2RX on at least one band. For testing of a UE which supports 4RX on all bands, the SNR during T3 is modified as specified in clause A.3.6.</p>						

Table A.4.5.5.4.1-4: Void

Table A.4.5.5.4.1-5: Void

Table A.4.5.5.4.1-6: Void

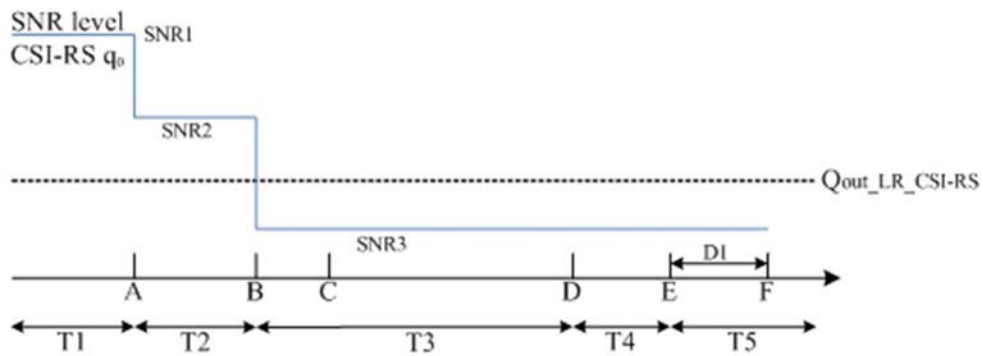

Figure A.4.5.5.4.1-1: SNR variation for CSI-RS-based beam failure detection and link recovery testing in DRX mode

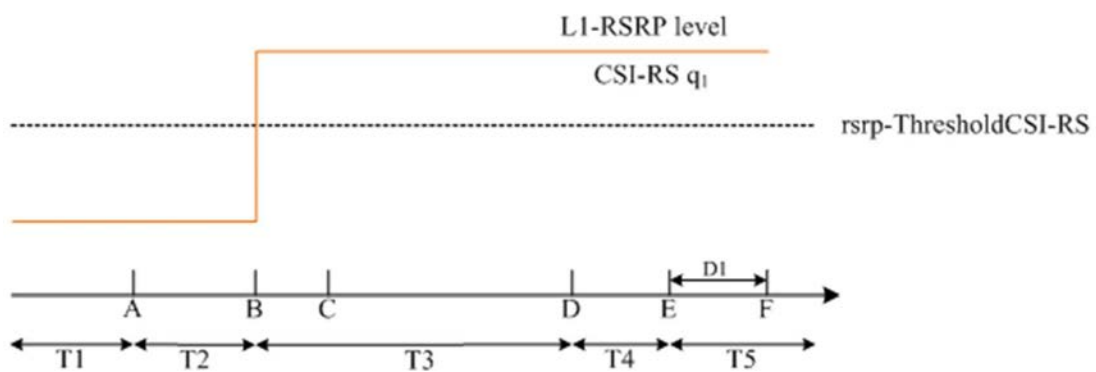

Figure A.4.5.5.4.1-2: L1-RSRP level variation for CSI-RS based beam failure detection and link recovery testing in DRX mode

A.4.5.5.4.2 Test Requirements

The UE behaviour during time durations T1, T2, T3, T4 and T5 shall be as follows:

During the time duration T1 and T2, the UE shall transmit uplink signal at least in all subframes configured for CSI transmission on Cell 1.

During the period from time point A to time point B the UE shall transmit uplink signal in Cell 1 in all uplink slots configured for CSI transmission according to the configured periodic CSI reporting for Cell 1.

During T3 the UE shall detect beam failure and initiate link recovery. During T4 and T5 the UE measures and evaluates beam candidate from beam candidate set q_1 .

No later than time point F occurring no later than $D1 = 1920 + 20$ ms after the start of T5, the UE shall transmit preamble on a beam associated with the candidate beam set q_1 . The UE shall not transmit preamble on a beam associated with the candidate beam set q_1 earlier than time point B.

Test is concluded once the test equipment has received the initial preamble transmission from the UE. The rate of correct events observed during repeated tests shall be at least 90%.

A.4.5.6 Active BWP switch

A.4.5.6.1 DCI-based and Timer-based Active BWP Switch

A.4.5.6.1.1 E-UTRAN – NR PSCell FR1 DL active BWP switch in non-DRX in synchronous EN-DC

A.4.5.6.1.1.1 Test Purpose and Environment

The purpose of this test is to verify the DL BWP switch delay requirement defined in TS38.133 clause 8.6, and interruption requirement for E-UTRA victim cell defined in TS36.133 clause 7.32.2.7. Supported test configurations are shown in Table A.4.5.6.1.1.1-1.

The test scenario comprises of one E-UTRA PCell (Cell 1), and one PSCell (Cell 2) as given in Table A.4.5.6.1.1.1-2. Cell-specific parameters of E-UTRA PCell are specified in Table A.3.7.2.1-1 and Cell-specific parameters of PSCell is specified in Table A.4.5.6.1.1.1-3 below.

PDCCHs indicating new transmissions shall be sent continuously on E-UTRA PCell (Cell 1) to ensure that the UE will have ACK/NACK sending.

PDCCHs indicating new transmissions shall be sent continuously on PSCell (Cell 2) to ensure that the UE would have ACK/NACK sending except for the time duration when BWP is switching on Cell 2 and the time duration of T2.

Before the test starts,

- UE is connected to Cell 1 (E-UTRA PCell) on radio channel 1 (PCC), and Cell 2 (PSCell) on radio channel 2 (PSCC).
- UE is configured with 2 different UE-specific downlink bandwidth parts for PSCell, BWP-1 and BWP-2, in Cell 2 before starting the test. BWP-1 and BWP-2 always include bandwidth of the initial DL BWP and SSB.
- UE is indicated in *firstActiveDownlinkBWP-Id* that the active DL BWP is BWP-1 in PSCell.
- UE is configured with a *bwp-InactivityTimer* timer value for PSCell.

All cells have constant signal levels throughout the test.

The test consists of 3 successive time periods, with durations of T1, T2, and T3, respectively.

During T1,

Time period T1 starts when a DCI format 1_1 command for PSCell DL BWP switch, sent from the test equipment to the UE, is received at the UE side in PSCell's slot # denoted i . The UE shall switch its bandwidth part from BWP-1 to BWP-2.

The UE shall be able to receive PDSCH on the first DL slot that occurs after the beginning of PSCell's DL slot ($i + T_{BWPswitchDelay}$) as defined in clause 8.6 and starts to report valid ACK/NACK for the PSCell no later than the first UL slot that occurs after the beginning of DL slot ($i + T_{BWPswitchDelay} + kI$). The UE shall be continuously scheduled on PSCell's BWP-2 starting from the first DL slot that occurs after the beginning of DL slot ($i + T_{BWPswitchDelay}$).

The starting time of E-UTRA PCell (Cell 1) interruption due to BWP switch on PSCell shall occur within the BWP switch delay.

During T2, the test equipment won't transmit DCI format for PDSCH reception on PSCell(Cell 2).

During T3,

The time period T3 starts from the slot # j , where j is the first slot of the subframe immediately after the *bwp-InactivityTimer* timer expires. The UE shall switch its bandwidth part from BWP-2 back to the default bandwidth part – BWP-1.

The UE shall be able to receive PDSCH on the first DL slot that occurs after the beginning of PSCell's DL slot ($j+T_{BWPswitchDelay}$) as defined in clause 8.6 and starts to report valid ACK/NACK for the PSCell at latest on the first UL slot that occurs after the beginning of DL slot ($j+T_{BWPswitchDelay}+kI$). The UE shall be continuously scheduled on PSCell's BWP-1 starting from the first DL slot that occurs after the beginning of DL slot ($j+T_{BWPswitchDelay}$).

The starting time of E-UTRA PCell (Cell 1) interruption due to BWP switch of PSCell shall occur within the BWP switch delay.

The test equipment verifies the DL BWP switch time in PSCell by counting the slots from the time when the BWP switch command is received or *bwp-InactivityTimer* timer expires till an ACK/NACK is received.

The test equipment verifies that potential interruption to E-UTRA PCell is carried out in the correct time span by monitoring ACK/NACK sent in E-UTRA PCell during BWP switch of PSCell, respectively.

Table A.4.5.6.1.1-1: DL BWP switch supported test configurations

Config	Description
1	LTE FDD, NR 15 kHz SSB SCS, 10 MHz bandwidth, FDD duplex mode
2	LTE FDD, NR 15 kHz SSB SCS, 10 MHz bandwidth, TDD duplex mode
3	LTE FDD, NR 30 kHz SSB SCS, 40 MHz bandwidth, TDD duplex mode
4	LTE TDD, NR 15 kHz SSB SCS, 10 MHz bandwidth, FDD duplex mode
5	LTE TDD, NR 15 kHz SSB SCS, 10 MHz bandwidth, TDD duplex mode
6	LTE TDD, NR 30 kHz SSB SCS, 40 MHz bandwidth, TDD duplex mode
Note 1: The UE is only required to be tested in one of the supported test configurations.	
Note 2: A UE which fulfils the requirements in test case A.4.5.6.1.2 can skip the test cases in A.4.5.6.1.1.	

Table A.4.5.6.1.1-2: General test parameters for DL BWP switch in synchronous EN-DC

Parameter	Unit	Value	Comment
E-UTRA RF Channel Number		1	One E-UTRA radio channel is used for this test
NR RF Channel Number		2	One NR radio channel is used for this test
Active PCell		Cell 1	PCell on RF channel number 1.
Active PSCell		Cell 2	PSCell on RF channel number 2.
CP length		Normal	
DRX		OFF	For both PCell and PSCell
<i>bwp-InactivityTimer</i>	ms	200	
PDCCH and PDSCH maximum number of HARQ transmission		1	For both PCell and PSCell
Cell-individual offset for cells on RF channel number 1	dB	0	Individual offset for cells on PCC.
Cell-individual offset for cells on RF channel number 2	dB	0	Individual offset for cells on PSCC.
Cell2 timing offset to cell1	µs	3	Synchronous EN-DC

T1	s	0.2	
T2	s	0.2	
T3	s	0.2	

Table A.4.5.6.1.1.1-3: NR Cell specific test parameters for DL BWP switch in synchronous EN-DC

Parameter		Unit	Cell 2
Frequency Range			FR1
Duplex mode	Config 1,4		FDD
	Config 2,3,5,6		TDD
TDD configuration	Config 1,4		Not Applicable
	Config 2,5		TDDConf.1.1
	Config 3,6		TDDConf.2.1
BW _{channel}	Config 1,4		10 MHz: N _{RB,c} = 52
	Config 2,5		10 MHz: N _{RB,c} = 52
	Config 3,6		40 MHz: N _{RB,c} = 106
Active BWP ID			1, 2
Initial DL BWP Configuration	Config 1,4		DLBWP.0.2 ^{Note 4}
	Config 2,5		
	Config 3,6		
Active DL BWP-1 Configuration	Config 1,4		DLBWP.1.1 ^{Note 4}
	Config 2,5		
	Config 3,6		
Active DL BWP-2 Configuration	Config 1,4		DLBWP.1.3 ^{Note 4}
	Config 2,5		
	Config 3,6		
Initial UL BWP Configuration	Config 1,4		ULBWP.0.2 ^{Note 4}
	Config 2,5		
	Config 3,6		
Active UL BWP-1 Configuration	Config 1,4		ULBWP.1.1 ^{Note 4}
	Config 2,5		
	Config 3,6		
Active UL BWP-2 Configuration	Config 1,4		N/A
	Config 2,5		
	Config 3,6		
PDSCH Reference measurement channel	Config 1,4		SR.1.1 FDD
	Config 2,5		SR.1.1 TDD
	Config 3,6		SR.2.1 TDD
RMSI CORESET parameters	Config 1,4		CR.1.1 FDD
	Config 2,5		CR.1.1 TDD
	Config 3,6		CR.2.1 TDD
Dedicated CORESET parameters	Config 1,4		CCR.1.2 FDD
	Config 2,5		CCR.1.2 TDD
	Config 3,6		CCR.2.4 TDD
OCNG Patterns			OP.1
SSB Configuration	Config 1,2,4,5		SSB.1 FR1
	Config 3,6		SSB.2 FR1
SMTC Configuration			SMTC.1
Correlation Matrix and Antenna Configuration			1x2 Low

TRS Configuration	Config 1,4		TRS.1.1 FDD
	Config 2,5		TRS.1.1 TDD
	Config 3,6		TRS.1.2 TDD
EPRE ratio of PSS to SSS		dB	0
EPRE ratio of PBCH DMRS to SSS			
EPRE ratio of PBCH to PBCH DMRS			
EPRE ratio of PDCCH DMRS to SSS			
EPRE ratio of PDCCH to PDCCH DMRS			
EPRE ratio of PDSCH DMRS to SSS			
EPRE ratio of PDSCH to PDSCH			
EPRE ratio of OCNG DMRS to SSS(Note 1)			
EPRE ratio of OCNG to OCNG DMRS (Note 1)			
N_{oc} ^{Note 2}	Config 1,2,4,5		
	Config 3,6	-101	
N_{oc} ^{Note 2}		dBm/15kHz	-104
SS-RSRP ^{Note 3}	Config 1,2,4,5	dBm/SCS	-87
	Config 3,6		-84
\bar{E}_s/I_{ot}		dB	17
\bar{E}_s/N_{oc}		dB	17
I_o ^{Note 3}	Config 1,2,4,5	dBm/9.36MHz	-58.96
	Config 3,6	dBm/38.16MHz	-52.86
Propagation Condition			AWGN
<p>Note 1: OCNG shall be used such that both cells are fully allocated and a constant total transmitted power spectral density is achieved for all OFDM symbols.</p> <p>Note 2: Interference from other cells and noise sources not specified in the test is assumed to be constant over subcarriers and time and shall be modelled as AWGN of appropriate power for N_{oc} to be fulfilled.</p> <p>Note 3: SS-RSRP and I_o levels have been derived from other parameters for information purposes. They are not settable parameters themselves.</p> <p>Note 4: For unpaired spectrum, a DL BWP is linked with an UL BWP. DLBWP.0.2 is linked with ULBWP.0.2; DLBWP.1.1 is linked with ULBWP.1.1; DLBWP.1.3 is linked with ULBWP.1.3 defined in clause 12 of TS 38.213 [3].</p>			

A.4.5.6.1.1.2 Test Requirements

During T1, the UE shall start to send the ACK/NACK for PSCell from the first UL slot that occurs after the beginning of DL slot ($i+T_{BWPswitchDelay}+kI$).

During T3, the UE shall start to send the ACK/NACK for PSCell from the first UL slot that occurs after the beginning of DL slot ($j+T_{BWPswitchDelay}+kI$).

Where, kI is the timing between DL data receiving and acknowledgement as specified in [7].

Depending on UE capability *bwp-SwitchingDelay* [2], UE shall finish BWP switch within the time duration $T_{BWPswitchDelay}$ defined in Table 8.6.2-1.

All of the above test requirements shall be fulfilled in order for the observed PSCell active BWP switch delay to be counted as correct.

The rate of correct events observed during repeated tests shall be at least 90%.

During T1, the start time of E-UTRA PCell interruption during PSCell active BWP switch shall not happen outside the BWP switch delay.

During T3, the start time of E-UTRA PCell interruption of during PSCell active BWP switch shall not happen outside the BWP switch delay.

The interruption of E-UTRA PCell shall not be longer than the interruption duration specified for active BWP switch in TS36.133 Clause 7.32.2.7.

All of the above test requirements shall be fulfilled in order for the observed E-UTRA PCell active BWP switch interruption to be counted as correct.

The rate of correct events observed during repeated tests shall be at least 90%.

NOTE: During T1, T3 if there are no uplink resources for reporting the ACK/NACK in the first UL slot that occurs after the beginning of DL slot ($i+T_{BWPswitchDelay+kI}$), ($j+T_{BWPswitchDelay+kI}$), then the UE shall use the next available uplink resource for reporting the corresponding ACK/NACK.

A.4.5.6.1.2 E-UTRAN – NR PSCell FR1 DL active BWP switch with FR1 SCell in non-DRX in synchronous EN-DC

A.4.5.6.1.2.1 Test Purpose and Environment

The purpose of this test is to verify the DL BWP switch delay requirement defined in clause 8.6, and interruption requirements for NR victim cell defined in clause 8.2.1.2.7 and interruption requirement for E-UTRA victim cell defined in clause 7.32.2.7 of TS 36.133 [15]. Supported test configurations for LTE PCell and NR PSCell are shown in Table A.4.5.6.1.2.1-1. Supported test configurations for NR SCell are shown in table A.4.5.6.1.2.1-1A. Test configuration for LTE PCell and NR PSCell and test configuration for NR SCell are chosen independently.

The test scenario comprises of one E-UTRA PCell (Cell 1), one PSCell (Cell 2) and one SCell (Cell 3) as given in Table A.4.5.6.1.2.1-2. Cell-specific parameters of E-UTRA PCell are specified in Table A.3.7.2.1-1 and Cell-specific parameters of PSCell and SCell are specified in Table A.4.5.6.1.2.1-3 and Table A.4.5.6.1.2.1-4 below.

PDCCHs indicating new transmissions shall be sent continuously on E-UTRA PCell (Cell 1) and PSCell (Cell 2) to ensure that the UE will have ACK/NACK sending.

PDCCHs indicating new transmissions shall be sent continuously on SCell (Cell 3) to ensure that the UE would have ACK/NACK sending except for the time duration when BWP is switching on Cell 3 and the time duration of T2.

Before the test starts,

- UE is connected to Cell 1 (E-UTRA PCell) on radio channel 1 (PCC), Cell 2 (PSCell) on radio channel 2 (PSCC) and Cell 3 (SCell) on radio channel 3 (SCC).
- UE is configured with 2 different UE-specific downlink bandwidth parts for SCell, BWP-1 and BWP-2, in Cell 3 before starting the test. BWP-1 and BWP-2 always include bandwidth of the initial DL BWP and SSB.
- UE is configured with 1 UE-specific downlink bandwidth parts the same as initial BWP for PSCell, BWP-0 in Cell 2 before starting the test.
- UE is indicated in *firstActiveDownlinkBWP-Id* that the active DL BWP is BWP-1 in SCell.
- UE is indicated in *firstActiveDownlinkBWP-Id* that the active DL BWP is BWP-0 in PSCell.
- UE is configured with a *bwp-InactivityTimer* timer value for SCell.

All cells have constant signal levels throughout the test.

The test consists of 3 successive time periods, with durations of T1, T2, and T3, respectively.

During T1,

Time period T1 starts when a DCI format 1_1 command for SCell DL BWP switch, sent from the test equipment to the UE, is received at the UE side in SCell's slot # denoted i . The UE shall switch its bandwidth part from BWP-1 to BWP-2.

The UE shall be able to receive PDSCH on the first DL slot that occurs after the beginning of SCell's DL slot ($i+T_{\text{BWPswitchDelay}}$) as defined in clause 8.6 and starts to report valid ACK/NACK for the SCell on PSCell no later than on the first UL slot that occurs after the beginning of slot ($i+T_{\text{BWPswitchDelay}}+k_1$). The UE shall be continuously scheduled on SCell's BWP-2 starting from the first DL slot that occurs after the beginning of slot ($i+T_{\text{BWPswitchDelay}}$).

E-UTRA PCell(Cell 1) interruption due to BWP switch on PSCell shall occur within the BWP switch delay.

PSCell(Cell 2) interruption due to BWP switch on SCell shall occur within the BWP switch delay.

During T2, the test equipment won't transmit DCI format for PDSCH reception on SCell(Cell 3).

During T3,

The time period T3 starts from the slot # j , where j is the first slot of the subframe immediately after *bwp-InactivityTimer* timer expires. The UE shall switch its bandwidth part from BWP-2 back to the default bandwidth part – BWP-1.

The UE shall be able to receive PDSCH on the first DL slot that occurs after the beginning of SCell's DL slot ($j+T_{\text{BWPswitchDelay}}$) as defined in clause 8.6 and starts to report valid ACK/NACK for the SCell on PSCell no later than on the first UL slot that occurs after the beginning of slot ($j+T_{\text{BWPswitchDelay}}+k_1$). The UE shall be continuously scheduled on SCell's BWP-1 starting from the first DL slot that occurs after the beginning of slot ($j+T_{\text{BWPswitchDelay}}$).

E-UTRA PCell(Cell 1) interruption due to BWP switch of SCell shall occur within the BWP switch delay.

PSCell(Cell 2) interruption due to BWP switch of SCell shall occur within the BWP switch delay.

The test equipment verifies the DL BWP switch time in SCell by counting the slots from the time when the BWP switch command is received or *bwp-InactivityTimer* timer expires till an ACK/NACK is received.

The test equipment verifies that potential interruption to E-UTRA PCell and NR PSCell is carried out in the correct time span by monitoring ACK/NACK sent in E-UTRA PCell and PSCell during BWP switch of SCell, respectively.

Table A.4.5.6.1.2.1-1: DL BWP switch supported test configurations for LTE PCell and NR PSCell

Config	Description
1	LTE FDD, NR 15 kHz SSB SCS, ≥ 10 MHz bandwidth, FDD duplex mode
2	LTE FDD, NR 15 kHz SSB SCS, ≥ 10 MHz bandwidth, TDD duplex mode
3	LTE FDD, NR 30 kHz SSB SCS, ≥ 40 MHz bandwidth, TDD duplex mode
4	LTE TDD, NR 15 kHz SSB SCS, ≥ 10 MHz bandwidth, FDD duplex mode
5	LTE TDD, NR 15 kHz SSB SCS, ≥ 10 MHz bandwidth, TDD duplex mode
6	LTE TDD, NR 30 kHz SSB SCS, ≥ 40 MHz bandwidth, TDD duplex mode
Note 1:	The UE is only required to be tested in one of the supported test configurations
Note 2:	A UE which fulfils the requirements in test case A.4.5.6.1.2 can skip the test cases in A.4.5.6.1.1.
Note 3:	Void
Note 4:	The UE is only required to be tested in one with smallest aggregated channel bandwidth from supported band combinations which is composed of CCs \geq the bandwidth (BW_{channel}) defined in each test configuration

Table A.4.5.6.1.2.1-1A: DL BWP switch supported test configurations for NR SCell

Config _{SCell}	Description
1	NR 15 kHz SSB SCS, ≥10 MHz bandwidth, FDD duplex mode
2	NR 15 kHz SSB SCS, ≥10 MHz bandwidth, TDD duplex mode
3	NR 30 kHz SSB SCS, ≥40 MHz bandwidth, TDD duplex mode
Note 1:	The UE is only required to be tested in one of the supported test configurations
Note 2:	A UE which fulfils the requirements in test case A.4.5.6.1.2 can skip the test cases in A.4.5.6.1.1.
Note 3:	The UE is only required to be tested in one with smallest aggregated channel bandwidth from supported band combinations which is composed of CCs ≥ the bandwidth (BW _{channel}) defined in each test configuration

Table A.4.5.6.1.2.1-2: General test parameters for DL BWP switch in synchronous EN-DC

Parameter	Unit	Value	Comment
E-UTRA RF Channel Number		1	One E-UTRA radio channel is used for this test
NR RF Channel Number		2, 3	Two NR radio channels are used for this test
Active PCell		Cell 1	PCell on RF channel number 1.
Active PSCell		Cell 2	PSCell on RF channel number 2.
Active SCell		Cell 3	SCell on RF channel number 3.
CP length		Normal	
DRX		OFF	
<i>bwp-InactivityTimer</i>	ms	200	
PDCCH and PDSCH maximum number of HARQ transmission		1	For PCell, PSCell and SCell
Cell-individual offset for cells on RF channel number 1	dB	0	Individual offset for cells on PCC.
Cell-individual offset for cells on RF channel number 2	dB	0	Individual offset for cells on PSCC.
Cell-individual offset for cells on RF channel number 3	dB	0	Individual offset for cells on SCC.
Cell2 timing offset to cell1	μs	3	Synchronous EN-DC
Cell3 timing offset to cell2	μs	3	Synchronous cells
T1	s	0.2	
T2	s	0.2	
T3	s	0.2	

Table A.4.5.6.1.2.1-3: NR Cell specific test parameters for NR PSCell for DL BWP switch in synchronous EN-DC

Parameter	Unit	Cell 2
Frequency Range		FR1
Duplex mode	Config 1,4	FDD
	Config 2,3,5,6	TDD
TDD configuration	Config 1,4	Not Applicable
	Config 2,5	TDDConf.1.1
	Config 3,6	TDDConf.2.1
BW _{channel}	Config 1,2,3,4,5,6	Note 7
BW _{occupied}	Config 1,2,4,5	52 ^{Note 5}
	Config 3,6	106 ^{Note 6}
Active BWP ID		0

Initial DL BWP Configuration	Config 1,2,3,4,5,6		DLBWP.0.2
Active DL BWP-0 Configuration	Config 1,2,3,4,5,6		DLBWP.0.2
Active DL BWP-1 Configuration	Config 1,2,3,4,5,6		N.A.
Active DL BWP-2 Configuration	Config 1,2,3,4,5,6		N.A.
Initial UL BWP Configuration	Config 1,2,3,4,5,6		ULBWP.0.2
Active UL BWP-0 Configuration	Config 1,2,3,4,5,6		ULBWP.0.2
Active UL BWP-1 Configuration	Config 1,2,3,4,5,6		N.A.
Active UL BWP-2 Configuration	Config 1,2,3,4,5,6		N.A.
PDSCH Reference measurement channel	Config 1,4		SR.1.1 FDD
	Config 2,5		SR.1.1 TDD
	Config 3,6		SR.2.1 TDD
RMSI CORESET parameters	Config 1,4		CR.1.1 FDD
	Config 2,5		CR.1.1 TDD
	Config 3,6		CR.2.1 TDD
Dedicated CORESET parameters	Config 1,4		CCR.1.2 FDD
	Config 2,5		CCR.1.2 TDD
	Config 3,6		CCR.2.4 TDD
OCNG Patterns	Config 1,2,4,5		OP.1 ^{Note 5}
	Config 3,6		OP.1 ^{Note 6}
SSB Configuration	Config 1,2,4,5		SSB.1 FR1
	Config 3,6		SSB.2 FR1
SMTc Configuration			SMTc.1
TRS Configuration	Config 1,4		TRS.1.1 FDD
	Config 2,5		TRS.1.1 TDD
	Config 3,6		TRS.1.2 TDD
Antenna Configuration			1x2
Propagation Condition			AWGN
EPRE ratio of PSS to SSS		dB	0
EPRE ratio of PBCH DMRS to SSS			
EPRE ratio of PBCH to PBCH DMRS			
EPRE ratio of PDCCH DMRS to SSS			
EPRE ratio of PDCCH to PDCCH DMRS			
EPRE ratio of PDSCH DMRS to SSS			
EPRE ratio of PDSCH to PDSCH			
EPRE ratio of OCNG DMRS to SSS ^{Note 1}			
EPRE ratio of OCNG to OCNG DMRS ^{Note 1}			
N_{oc} ^{Note 2}			
SS-RSRP ^{Note 3}		dBm/15 kHz	-87
\bar{E}_s/I_{ot}		dB	17
\bar{E}_s/N_{oc}		dB	17
I_o ^{Note 3}	Config 1,2,4,5	dBm/9.36MHz	-58.96
	Config 3,6	dBm/38.16MHz	-52.86

Note 1:	OCNG shall be used such that both cells are fully allocated and a constant total transmitted power spectral density is achieved for all OFDM symbols.
Note 2:	Interference from other cells and noise sources not specified in the test is assumed to be constant over subcarriers and time and shall be modelled as AWGN of appropriate power for N_{oc} to be fulfilled within $BW_{occupied}$.
Note 3:	SS-RSRP and I_o levels have been derived from other parameters for information purposes. They are not settable parameters themselves.
Note 4:	For unpaired spectrum, a DL BWP is linked with an UL BWP. DLBWP.0.2 is linked with ULBWP.0.2; DLBWP.1.1 is linked with ULBWP.1.1; DLBWP.1.3 is linked with ULBWP.1.3 defined in clause 12 of TS 38.213 [3].
Note 5:	All UL/DL transmission shall be confined within $BW_{occupied}$ (i.e. 10 MHz, 52 RBs) from $F_{C,low}$, and I_o is independent of the $BW_{channel}$ configured.
Note 6:	All UL/DL transmission shall be confined within $BW_{occupied}$ (i.e. 40 MHz, 106 RBs) from $F_{C,low}$, and I_o is independent of the $BW_{channel}$ configured.
Note 7:	NRB_{c} is derived from Table 5.3.2-1 in TS38.101-1[2] with configured $BW_{channel}$.

Table A.4.5.6.1.2.1-4: NR Cell specific test parameters for NR SCell for DL BWP switch in synchronous EN-DC

Parameter		Unit	Cell 3
Frequency Range			FR1
Duplex mode	Config _{SCell} 1		FDD
	Config _{SCell} 2,3		TDD
TDD configuration	Config _{SCell} 1		Not Applicable
	Config _{SCell} 2		TDDConf.1.1
	Config _{SCell} 3		TDDConf.2.1
$BW_{channel}$	Config _{SCell} 1,2,3		Note 7
$BW_{occupied}$	Config _{SCell} 1,2	RB	52 ^{Note 5}
	Config _{SCell} 3		106 ^{Note 6}
Active BWP ID			1,2
Initial DL BWP Configuration	Config _{SCell} 1,2,3		DLBWP.0.2
Active DL BWP-0 Configuration	Config _{SCell} 1,2,3		N.A.
Active DL BWP-1 Configuration	Config _{SCell} 1,2,3		DLBWP.1.3
Active DL BWP-2 Configuration	Config _{SCell} 1,2,3		DLBWP.1.1
Initial UL BWP Configuration	Config _{SCell} 1,2,3		N.A.
Active UL BWP-0 Configuration	Config _{SCell} 1,2,3		N.A.
Active UL BWP-1 Configuration	Config _{SCell} 1,2,3		N.A.
Active UL BWP-2 Configuration	Config _{SCell} 1,2,3		N.A.
PDSCH Reference measurement channel	Config _{SCell} 1		SR.1.1 FDD
	Config _{SCell} 2		SR.1.1 TDD
	Config _{SCell} 3		SR.2.1 TDD
RMSI CORESET parameters	Config _{SCell} 1		CR.1.1 FDD
	Config _{SCell} 2		CR.1.1 TDD
	Config _{SCell} 3		CR.2.1 TDD
Dedicated CORESET parameters	Config _{SCell} 1		CCR.1.2 FDD
	Config _{SCell} 2		CCR.1.2 TDD
	Config _{SCell} 3		CCR.2.4 TDD
OCNG Patterns	Config _{SCell} 1,2		OP.1 ^{Note 5}

	Config _{SCell} 3		OP.1 ^{Note 6}
SSB Configuration	Config _{SCell} 1,2		SSB.1 FR1
	Config _{SCell} 3		SSB.2 FR1
SMTC Configuration			SMTC.1
TRS Configuration	Config _{SCell} 1		TRS.1.1 FDD
	Config _{SCell} 2		TRS.1.1 TDD
	Config _{SCell} 3		TRS.1.2 TDD
Antenna Configuration			1x2
Propagation Condition			AWGN
EPRE ratio of PSS to SSS		dB	0
EPRE ratio of PBCH DMRS to SSS			
EPRE ratio of PBCH to PBCH DMRS			
EPRE ratio of PDCCH DMRS to SSS			
EPRE ratio of PDCCH to PDCCH DMRS			
EPRE ratio of PDSCH DMRS to SSS			
EPRE ratio of PDSCH to PDSCH			
EPRE ratio of OCNG DMRS to SSS ^{Note 1}			
EPRE ratio of OCNG to OCNG DMRS ^{Note 1}			
N _{oc} ^{Note 2}			
SS-RSRP ^{Note 3}		dBm/15 kHz	-87
\hat{E}_s/I_{ot}		dB	17
\hat{E}_s/N_{oc}		dB	17
I _o ^{Note 3}	Config _{SCell} 1,2	dBm/9.36MHz	-58.96
	Config _{SCell} 3	dBm/38.16MHz	-52.86
Note 1:	OCNG shall be used such that both cells are fully allocated and a constant total transmitted power spectral density is achieved for all OFDM symbols.		
Note 2:	Interference from other cells and noise sources not specified in the test is assumed to be constant over subcarriers and time and shall be modelled as AWGN of appropriate power for N _{oc} to be fulfilled within BW _{occupied} .		
Note 3:	SS-RSRP and I _o levels have been derived from other parameters for information purposes. They are not settable parameters themselves.		
Note 4:	For unpaired spectrum, a DL BWP is linked with an UL BWP. DLBWP.0.2 is linked with ULBWP.0.2; DLBWP.1.1 is linked with ULBWP.1.1; DLBWP.1.3 is linked with ULBWP.1.3 defined in clause 12 of TS 38.213 [3].		
Note 5:	All UL/DL transmission shall be confined within BW _{occupied} (i.e. 10 MHz, 52 RBs) from F _{C,low} , and I _o is independent of the BW _{channel} configured.		
Note 6:	All UL/DL transmission shall be confined within BW _{occupied} (i.e. 40 MHz, 106 RBs) from F _{C,low} , and I _o is independent of the BW _{channel} configured.		
Note 7:	NRB _c is derived from Table 5.3.2-1 in TS38.101-1[2] with configured BW _{channel} .		

A.4.5.6.1.2.2 Test Requirements

During T1, the UE shall start to send the ACK/NACK for SCell on PSCell from the first UL slot that occurs after the beginning of DL slot ($i + T_{BWPswitchDelay} + k_1$).

During T3, the UE shall start to send the ACK/NACK for SCell on PSCell from the first UL slot that occurs after the beginning of DL slot ($j + T_{BWPswitchDelay} + k_1$).

Where, k_1 is the timing between DL data receiving and acknowledgement as specified in [7].

Depending on UE capability *bwp-SwitchingDelay* [2], UE shall finish BWP switch within the time duration $T_{BWPswitchDelay}$ defined in Table 8.6.2-1.

All of the above test requirements shall be fulfilled in order for the observed SCell active BWP switch delay to be counted as correct.

The rate of correct events observed during repeated tests shall be at least 90%.

During T1, the start of the interruption of E-UTRA PCell during SCell active BWP switch shall not happen outside the BWP switch delay.

During T3, the start of the interruption of E-UTRA PCell during SCell active BWP switch shall not happen outside the BWP switch delay.

The interruption of E-UTRA PCell shall not be longer than the interruption duration specified for active BWP switch in clause 7.32.2.7 of TS 36.133 [15].

During T1, the start of the interruption of PSCell during SCell active BWP switch shall not happen outside the BWP switch delay.

During T3, the start of the interruption of PSCell during SCell active BWP switch shall not happen outside the BWP switch delay.

The interruption of PSCell shall not be longer than the interruption duration specified for active BWP switch in clause 8.6.2.

All of the above test requirements shall be fulfilled in order for the observed E-UTRA PCell and PSCell active BWP switch interruption to be counted as correct.

The rate of correct events observed during repeated tests shall be at least 90%.

NOTE: During T1, T3 if there are no uplink resources for reporting the ACK/NACK in the first UL slot that occurs after the beginning of DL slot ($i+T_{\text{BWPswitchDelay}}+k_1$), ($j+T_{\text{BWPswitchDelay}}+k_1$), then the UE shall use the next available uplink resource for reporting the corresponding ACK/NACK.

A.4.5.6.2 RRC-based Active BWP Switch

A.4.5.6.2.1 E-UTRAN – NR PSCell FR1 DL active BWP switch in non-DRX in synchronous EN-DC

A.4.5.6.2.1.1 Test Purpose and Environment

The purpose of this test is to verify the DL BWP switch delay requirement for RRC-based BWP switch defined in clause 8.6.3. Supported test configurations are shown in Table A.4.5.6.2.1.1-1.

The test scenario comprises of one E-UTRA PCell (Cell 1) and one PSCell (Cell 2) as given in Table A.4.5.6.2.1.1-2. Cell-specific parameters of E-UTRA PCell are specified in Table A.3.7.2.1-1 and Cell-specific parameters of PSCell are specified in Table A.4.5.6.2.1.1-3 below.

PDCCHs indicating new transmissions shall be sent continuously on E-UTRA PCell (Cell 1) to ensure that the UE will have ACK/NACK sending.

PDCCHs indicating new transmissions shall be sent continuously on PSCell (Cell 2) to ensure that the UE would have ACK/NACK sending except for the time duration when BWP is switching on Cell 2.

Before the test starts,

- UE is connected to Cell 1 (E-UTRA PCell) on radio channel 1 (PCC) and to Cell 2 (PSCell) on radio channel 2 (PSCC).
- UE has bandwidth part BWP-1 in its RRC-configuration for Cell 1 (PSCell).
- UE is indicated in *firstActiveDownlinkBWP-Id* that the active DL BWP is BWP-1 of initial condition in PSCell.

All cells have constant signal levels throughout the test.

The test consists of 1 time period, with duration of T1.

During T1,

Time period T1 starts when a *RRCReconfiguration* with updated bandwidth part configuration, sent from the test equipment to the UE, is completely received at the UE side in PSCell's slot # denoted *i*. The UE shall reconfigure its bandwidth part with the updated bandwidth part BWP-1 of final condition.

The UE shall be able to receive PDSCH on PSCell from on the first DL slot that occurs after PSCell's DL slot *i* + $\frac{T_{RRCprocessingDelay} + T_{BWPswitchDelayRRC}}{NR\ Slot\ length}$ as defined in clause 8.6.3 and starts to report valid ACK/NACK

for the PSCell from the first UL slot that occurs after the beginning of DL slot *i* +

$\frac{T_{RRCprocessingDelay} + T_{BWPswitchDelayRRC}}{NR\ Slot\ length} + k1$. The UE shall be continuously scheduled on PSCell's BWP-1

starting from the first DL slot occurs after the beginning of DL slot *i* + $\frac{T_{RRCprocessingDelay} + T_{BWPswitchDelayRRC}}{NR\ Slot\ length}$.

$T_{RRCprocessingDelay}$ and $T_{BWPswitchDelayRRC}$ are defined in clause 8.6.3.

The test equipment verifies the DL BWP switch time in PSCell by counting the time from the time when the *RRCReconfiguration* message including updated BWP configuration is sent till the time when a valid ACK/NACK is received.

Table A.4.5.6.2.1.1-1: DL BWP switch supported test configurations

Config	Description
1	LTE FDD, NR 15 kHz SSB SCS, 10 MHz bandwidth, FDD duplex mode
2	LTE FDD, NR 15 kHz SSB SCS, 10 MHz bandwidth, TDD duplex mode
3	LTE FDD, NR 30 kHz SSB SCS, 40 MHz bandwidth, TDD duplex mode
4	LTE TDD, NR 15 kHz SSB SCS, 10 MHz bandwidth, FDD duplex mode
5	LTE TDD, NR 15 kHz SSB SCS, 10 MHz bandwidth, TDD duplex mode
6	LTE TDD, NR 30 kHz SSB SCS, 40 MHz bandwidth, TDD duplex mode
Note 1: The UE is only required to be tested in one of the supported test configurations	

Table A.4.5.6.2.1.1-2: General test parameters for DL BWP switch in synchronous EN-DC

Parameter	Unit	Value	Comment
E-UTRA RF Channel Number		1	One E-UTRA radio channel is used for this test
NR RF Channel Number		2	One NR radio channel is used for this test
Active PCell		Cell 1	PCell on RF channel number 1.
Active PSCell		Cell 2	PSCell on RF channel number 2.
CP length		Normal	
DRX		OFF	
PDCCH and PDSCH maximum number of HARQ transmission		1	For both PCell and PSCell
Cell-individual offset for cells on RF channel number 1	dB	0	Individual offset for cells on PCC.
Cell-individual offset for cells on RF channel number 2	dB	0	Individual offset for cells on PSCC.
Cell2 timing offset to cell1	µs	3	Synchronous EN-DC
T1	s	0.2	

Table A.4.5.6.2.1.1-3: NR Cell specific test parameters for DL BWP switch in synchronous EN-DC

Parameter		Unit	Cell 2	
Frequency Range			FR1	
Duplex mode	Config 1,4		FDD	
	Config 2,3,5,6		TDD	
TDD configuration	Config 1,4		Not Applicable	
	Config 2,5		TDDConf.1.1	
	Config 3,6		TDDConf.2.1	
BW _{channel}	Config 1,4		10 MHz: N _{RB,c} = 52	
	Config 2,5		10 MHz: N _{RB,c} = 52	
	Config 3,6		40 MHz: N _{RB,c} = 106	
Active DL BWP ID			1	
Initial DL BWP Configuration	Config 1,4		DLBWP.0.2	
	Config 2,5			
	Config 3,6			
Initial UL BWP Configuration	Config 1,4		ULBWP.0.2	
	Config 2,5			
	Config 3,6			
Initial Condition	Active DL BWP-1 Configuration	Config 1,4	DLBWP.1.3	
		Config 2,5		
		Config 3,6		
	Active UL BWP-1 Configuration	Config 1,4		ULBWP.1.3
		Config 2,5		
		Config 3,6		
Final Condition	Active DL BWP-1 Configuration	Config 1,4	DLBWP.1.1	
		Config 2,5		
		Config 3,6		
	Active UL BWP-1 Configuration	Config 1,4		ULBWP.1.1
		Config 2,5		
		Config 3,6		
PDSCH Reference measurement channel	Config 1,4		SR.1.1 FDD	
	Config 2,5		SR.1.1 TDD	
	Config 3,6		SR.2.1 TDD	
RMSI CORESET parameters	Config 1,4		CR.1.1 FDD	
	Config 2,5		CR.1.1 TDD	
	Config 3,6		CR.2.1 TDD	
Dedicated CORESET parameters	Config 1,4		CCR.1.2 FDD	
	Config 2,5		CCR.1.2 TDD	
	Config 3,6		CCR.2.4 TDD	
OCNG Patterns			OP.1	
SSB Configuration	Config 1,2,4,5		SSB.1 FR1	
	Config 3,6		SSB.2 FR1	
SMTC Configuration			SMTC.1	

TRS Configuration	Config 1,4		TRS.1.1 FDD
	Config 2,5		TRS.1.1 TDD
	Config 3,6		TRS.1.2 TDD
Antenna Configuration			1x2
Propagation Condition			AWGN
EPRE ratio of PSS to SSS		dB	0
EPRE ratio of PBCH DMRS to SSS			
EPRE ratio of PBCH to PBCH DMRS			
EPRE ratio of PDCCH DMRS to SSS			
EPRE ratio of PDCCH to PDCCH DMRS			
EPRE ratio of PDSCH DMRS to SSS			
EPRE ratio of PDSCH to PDSCH			
EPRE ratio of OCNG DMRS to SSS(Note 1)			
EPRE ratio of OCNG to OCNG DMRS (Note 1)			
N_{oc} ^{Note 2}		dBm/15 kHz	-104
SS-RSRP ^{Note 3}		dBm/15 kHz	-87
\bar{E}_s/I_{ot}		dB	17
\bar{E}_s/N_{oc}		dB	17
I_o ^{Note3}	Config 1,2,4,5	dBm/9.36MHz	-58.96
	Config 3,6	dBm/38.16MHz	-52.86
<p>Note 1: OCNG shall be used such that both cells are fully allocated and a constant total transmitted power spectral density is achieved for all OFDM symbols.</p> <p>Note 2: Interference from other cells and noise sources not specified in the test is assumed to be constant over subcarriers and time and shall be modelled as AWGN of appropriate power for N_{oc} to be fulfilled.</p> <p>Note 3: SS-RSRP and I_o levels have been derived from other parameters for information purposes. They are not settable parameters themselves.</p> <p>Note 4: For unpaired spectrum, a DL BWP is linked with an UL BWP. DLBWP.0.2 is linked with ULBWP.0.2; DLBWP.1.1 is linked with ULBWP.1.1; DLBWP.1.3 is linked with ULBWP.1.3 defined in clause 12 of TS 38.213 [3].</p>			

A.4.5.6.2.1.2 Test Requirements

During T1, the UE shall be ready for the reception of uplink grant on PSCell from the first DL slot occurs after the beginning of DL slot $i + \frac{T_{RRCPprocessingDelay} + T_{BWPswitchDelayRRC}}{NR\ Slot\ length}$, and starts to report valid ACK/NACK for the PSCell from the first UL slot that occurs after the beginning of DL slot $i + \frac{T_{RRCPprocessingDelay} + T_{BWPswitchDelayRRC}}{NR\ Slot\ length} + k1$

Where, $k1$ is the timing between DL data receiving and acknowledgement as specified in [7].

All of the above test requirements shall be fulfilled in order for the observed PSCell active BWP switch delay to be counted as correct.

The rate of correct events observed during repeated tests shall be at least 90%.

A.4.5.7 PSCell addition and release delay

A.4.5.7.1 Addition and Release Delay of known NR PSCell

A.4.5.7.1.1 Test purpose and environment

The purpose of this test is to verify that the NR PSCell addition and release delays under EN-DC are within the requirements stated in clause 7.31.2 [15] for the case when the PSCell is known by the UE at the time of addition.

Supported test configurations are shown in A.4.5.7.1.1-1. The test parameters for the E-UTRA cell are given in Table A.3.7.2.1-1. The E-UTRA cell once set up is not changed across time.

The test parameters for NR cell are given in Tables A.4.5.7.1.1-2 and cell-specific parameters in A.4.5.7.1.1-3 below. The test consists of six successive time periods with duration of T1, T2, T3, T4, T5 and T6 respectively. There are two carriers each with one cell. Before the test starts the UE is connected to Cell 1 (E-UTRA PCell) on radio channel 1 (PCC) but is not aware of Cell 2 (NR PSCell) on radio channel 2. The UE is only monitoring the PCC. During T1 only Cell1 is known to the UE.

Before the start of T2, the UE in the measurement control information that event-triggered reporting with Event B1 is configured for neighbour cell (Cell2). Before the start of T2 the UE is configured with the measurement gaps (gap pattern Id # 0). The Cell2 becomes known to the UE during T2. Therefore, during T2 the UE shall report Event B1. The point in time at which the RRC message to release measurement gap is transmitted from the test system defines the start of period T3. During T3, after measurement gap is released, the test system transmits the RRC message to the UE to add PSCell on radio channel 2.

The RRC message (to add PSCell) also includes a request for the UE to start periodic CSI reporting for the PSCell after the PSCell has been successfully added. The point in time at which the RRC message to add PSCell (Cell2) is received at the UE antenna connector defines the start of period T4.

The test system shall observe the periodic reporting of CSI for PSCell during T5. The point in time at which the UE has sent PRACH to the PSCell (Cell 2) defines the start of period T5.

The test system shall send a RRC message to the UE to release PSCell (Cell 2) on radio channel 2. The RRC message to release PSCell (Cell2) shall be sent to the UE during period T5, after the UE has sent at least one CQI report with non-zero CQI index for PSCell (Cell 2). The point in time at which the RRC message to release PSCell (Cell2) is received at the UE antenna connector defines the start of period T6.

Table A.4.5.7.1.1-1: Supported test configurations for FR1 PSCell

Configuration	Description
1	LTE FDD, NR SCS 15 kHz, BW 10 MHz, FDD
2	LTE FDD, NR SCS 15 kHz, BW 10 MHz, TDD
3	LTE FDD, NR SCS 30 kHz, BW 40 MHz, TDD
4	LTE TDD, NR SCS 15 kHz, BW 10 MHz, FDD
5	LTE TDD, NR SCS 15 kHz, BW 10 MHz, TDD
6	LTE TDD, NR SCS 30 kHz, BW 40 MHz, TDD
Note:	The UE is only required to pass in one of the supported test configurations in FR1

Table A.4.5.7.1.1-2: General Test Parameters for PSCell Addition and Release

Parameter	Unit	Value	Comment
RF Channel Number		1, 2	Two radio channels are used for this test. One for E-UTRA cell and second for NR Cell

Initial Condition	Active PCell		Cell1	PCell on RF channel number 1.
	Neighbour cell		Cell2	Neighbour cell on RF channel number 2.
Final Condition	Active PCell		Cell1	PCell on RF channel number 1.
	Neighbour Cell		Cell2	PSCell released on RF channel number 2.
B1	Hysteresis	dB	0	Hysteresis for evaluation of event B1.
	Threshold RSRP (Config 1,2,4,5)	dBm	-96	Actual RSRP threshold for event B1. Needs to take absolute accuracy tolerance in clause 9.11.1 of TS 36.133 [15] into account plus margin.
	Threshold RSRP (Config 3,6)	dBm	-93	Actual RSRP threshold for event B1. Needs to take absolute accuracy tolerance in clause 9.11.1 of TS 36.133 [15] into account plus margin.
	Time to Trigger	S	0	
DRX			OFF	Continuous monitoring of primary cell
Measurement gap pattern Id			0	Gaps are configured before T2 and released before T3.
PRACH configuration on cell2			FR1 PRACH configuration 1	Captured in A.3.8.2.1
Cell-individual offset for cells on RF channel number 1		dB	0	Individual offset for cells on primary component carrier.
Cell-individual offset for cells on RF channel number 2		dB	0	Individual offset for cells on carrier frequency of cell2.
T1		s	1	During this time the PCell shall be known and cell2 shall be unknown.
T2		s	1.5	During this time the UE shall identify neighbour cell (cell2) and report event B1.
T3		s	3	During this time the test system transmits the RRC messages to release measurement gap and add PSCell.
T4		s	0.5	During this time the UE adds the PSCell.
T5		s	0.5	During this time the UE sends CSI reports for PSCell.
T6		s	0.5	During this time the UE releases the PSCell.

Table A.4.5.7.1.1-3: Cell Specific Parameters for PSCell Addition and Release

Parameter	Unit	Config	Test					
			T1	T2	T3	T4	T5	T6
E-UTRA RF Channel Number		1,2,3,4,5,6	1					
NR RF Channel Number		1,2,3,4,5,6	2					
TDD configuration		1,4	Not Applicable					
		2,5	TDDConf.1.1					
		3,6	TDDConf.2.1					
BW _{channel}	MHz	1,4	10: N _{RB,c} = 52					
		2,5	10: N _{RB,c} = 52					
		3,6	40: N _{RB,c} = 106					
Initial BWP Configuration		1,2,3	DLBWP.0.1 ULBWP.0.1					
Dedicated BWP Configuration		1,2,3	DLBWP.1.1 ULBWP.1.1					

PDSCH Reference measurement channel		1,4	SR.1.1 FDD	
		2,5	SR.1.1 TDD	
		3,6	SR.2.1 TDD	
RMSI CORESET Reference Channel		1,4	CR.1.1 FDD	
		2,5	CR.1.1 TDD	
		3,6	CR.2.1 TDD	
Dedicated CORESET Reference Channel		1,4	CCR.1.1 FDD	
		2,5	CCR.1.1 TDD	
		3,6	CCR.2.1 TDD	
OCNG Patterns		1,2,3,4,5,6	OP.1	
SSB configuration		1,2,4,5	SSB.1 FR1	
		3,6	SSB.2 FR1	
SMTc configuration		1,2,4,5	SMTc.1	
		3,6	SMTc.1	
TRS Configuration		1,4	TRS.1.1 FDD	
		2,5	TRS.1.1 TDD	
		3,6	TRS.1.2 TDD	
CSI-RS configuration for CSI reporting		1,4	CSI-RS.1.1 FDD	
		2,5	CSI-RS.1.1 TDD	
		3,6	CSI-RS.2.1 TDD	
reportConfigType		1,2,3,4,5,6	periodic	
reportQuantity		1,2,3,4,5,6	cri-RI-PMI-CQI	
CSI reporting periodicity	slot	1,2,4,5	5	
		3,6	10	
CSI reporting offset	slot	1,2,4,5	2	
		3,6	4	
EPRE ratio of PSS to SSS	dB	1,2,3,4,5,6	0	
EPRE ratio of PBCH DMRS to SSS				
EPRE ratio of PBCH to PBCH DMRS				
EPRE ratio of PDCCH DMRS to SSS				
EPRE ratio of PDCCH to PDCCH DMRS				
EPRE ratio of PDSCH DMRS to SSS				
EPRE ratio of PDSCH to PDSCH				
EPRE ratio of OCNG DMRS to SSS(Note 1)				
EPRE ratio of OCNG to OCNG DMRS (Note 1)				
N_{oc} ^{Note2}	dBm/15 kHz	1,2,3,4,5,6	N/A	-88

N_{oc} ^{Note2}	dBm/SCS	1,2,4,5	N/A	-88
		3,6	N/A	-85
\hat{E}_s/I_{ot}		1,2,3,4,5,6	-infinity	0
\hat{E}_s/N_{oc}		1,2,3,4,5,6	-infinity	0
SS-RSRP ^{Note3}	dBm/SCS	1,2,4,5	-infinity	-88
		3,6	-infinity	-85
I _o ^{Note3}	dBm/9.36MHz	1,2,4,5	N/A	-57
	dBm/38.1MHz	3,6	N/A	-51
Propagation condition		1,2,3,4,5,6	AWGN	
<p>Note 1: OCNG shall be used such that both cells are fully allocated and a constant total transmitted power spectral density is achieved for all OFDM symbols.</p> <p>Note 2: Interference from other cells and noise sources not specified in the test is assumed to be constant over subcarriers and time and shall be modelled as AWGN of appropriate power for N_{oc} to be fulfilled.</p> <p>Note 3: SS-RSRP and I_o levels have been derived from other parameters for information purposes. They are not settable parameters themselves.</p> <p>Note 4: SS-RSRP minimum requirements are specified assuming independent interference and noise at each receiver antenna port.</p>				

A.4.5.7.1.2 Test Requirements

The UE shall transmit the PRACH to PSCell no later than 82 ms^{Note1} from the start of T4.

The UE shall send at least one CSI report for PSCell with non-zero CQI index during T5.

The UE shall periodically send CSI reports for PSCell after the UE has sent first CQI report with non-zero CQI index during T5

The UE shall stop sending CSI reports for PSCell no later than 20ms from the start of T6.

All the above test requirements shall be fulfilled in order for the observed PSCell addition delay and PSCell release delay to be counted as correct. The rate of correct observed PSCell addition delay and PSCell release delay during repeated tests shall be at least 90%.

Note1: The PSCell addition delay can be expressed as follows as specified in clause 7.31.2 [15]:

$$T_{\text{config_PSCell}} = T_{\text{RRC_delay}} + T_{\text{processing}} + T_{\text{search}} + T_{\Delta} + T_{\text{PSCell_DU}} + 2\text{ms}$$

Where:

$$T_{\text{RRC_delay}} = 20\text{ms}$$

$$T_{\text{processing}} = 20\text{ms}$$

$$T_{\text{search}} = 0$$

$$T_{\Delta} = 20\text{ms}$$

$$T_{\text{PSCell_DU}} = 1 \cdot 10 + 10 = 20\text{ms}$$

A.4.6 Measurement procedure

A.4.6.1 Intra-frequency Measurements

A.4.6.1.1 EN-DC event triggered reporting tests without gap under non-DRX

A.4.6.1.1.1 Test purpose and Environment

The purpose of this test is to verify that the UE makes correct reporting of an event. This test will partly verify the intra-frequency cell search requirements in clause 9.2.5.1 and 9.2.5.2.

A.4.6.1.1.2 Test parameters

Three cells are deployed in the test, which are E-UTRAN PCell (Cell 1), FR1 PSCell (Cell 2) and a FR1 neighbour cell (Cell 3) on the same frequency as the PSCell. The test parameters for PSCell are given in Table A.4.6.1.1.2-1, A.4.6.1.1.2-2, A.4.6.1.1.2-3 below and the test parameters and applicability for the E-UTRAN cell are defined in A.3.7.2. In the measurement control information, a measurement object is configured for the frequency of the PSCell, and it is indicated to the UE that event-triggered reporting with Event A3 is used. The test consists of two successive time periods, with time duration of T1, and T2 respectively. During time duration T1, the UE shall not have any timing information of cell 3.

Table A.4.6.1.1.2-1: Supported test configurations

Config	Description
1	LTE FDD, NR 15 kHz SSB SCS, 10 MHz bandwidth, FDD duplex mode
2	LTE FDD, NR 15 kHz SSB SCS, 10 MHz bandwidth, TDD duplex mode
3	LTE FDD, NR 30 kHz SSB SCS, 40 MHz bandwidth, TDD duplex mode
4	LTE TDD, NR 15 kHz SSB SCS, 10 MHz bandwidth, FDD duplex mode
5	LTE TDD, NR 15 kHz SSB SCS, 10 MHz bandwidth, TDD duplex mode
6	LTE TDD, NR 30 kHz SSB SCS, 40 MHz bandwidth, TDD duplex mode

Note 1: The UE is only required to be tested in one of the supported test configurations
Note 2: Target NR Cell 3 has the same SCS, BW and duplex mode as NR serving Cell 2

Table A.4.6.1.1.2-2: General test parameters for EN-DC intra-frequency event triggered reporting without gap for PSCell in FR1

Parameter	Unit	Test configuration	Value	Comment
Active cell		1, 2, 3, 4, 5, 6	E-UTRAN Cell 1 and NR Cell 2	
Neighbour cell		1, 2, 3, 4, 5, 6	NR Cell 3	Cell to be identified.
RF Channel Number		1, 2, 3, 4, 5, 6	1: Cell 1 2: Cell 2 and Cell 3	
SSB configuration		1, 4	SSB.1 FR1	
		2, 5	SSB.1 FR1	
		3, 6	SSB.2 FR1	
SMTC configuration		1, 4	SMTC.2	
		2, 5	SMTC.1	
		3, 6	SMTC.1	
A3-Offset	dB	1, 2, 3, 4, 5, 6	-4.5	

CP length		1, 2, 3, 4, 5, 6	Normal	
Hysteresis	dB	1, 2, 3, 4, 5, 6	0	
Time To Trigger	s	1, 2, 3, 4, 5, 6	0	
Filter coefficient		1, 2, 3, 4, 5, 6	0	L3 filtering is not used
DRX		1, 2, 3, 4, 5, 6	N/A	OFF
Time offset between PCell and PSCell		1, 2, 3, 4, 5, 6	3 μ s	Synchronous EN-DC
Time offset between serving and neighbour cells		1, 4	3 ms	Asynchronous cells. The timing of Cell 3 is 3ms later than the timing of Cell 2.
		2, 5	3 μ s	Synchronous cells
		3, 6	3 μ s	Synchronous cells
T1	s	1, 2, 3, 4, 5, 6	5	
T2	s	1, 2, 3, 4, 5, 6	5	

Table A.4.6.1.1.2-3: NR Cell specific test parameters for EN-DC intra-frequency event triggered reporting without gap for PSCell in FR1

Parameter	Unit	Test configuration	Cell 2		Cell 3	
			T1	T2	T1	T2
TDD configuration		1, 4	N/A		N/A	
		2, 5	TDDConf.1.1		TDDConf.1.1	
		3, 6	TDDConf.2.1		TDDConf.2.1	
PDSCH RMC configuration		1, 4	SR.1.1 FDD		N/A	
		2, 5	SR.1.1 TDD			
		3, 6	SR.2.1 TDD			
RMSI CORESET RMC configuration		1, 4	CR.1.1 FDD		N/A	
		2, 5	CR.1.1 TDD		N/A	
		3, 6	CR.2.1 TDD		N/A	
Dedicated CORESET RMC configuration		1, 4	CCR.1.1 FDD		N/A	
		2, 5	CCR.1.1 TDD		N/A	
		3, 6	CCR.2.1 TDD		N/A	
OCNG Patterns		1, 2, 3, 4, 5, 6	OP.1		OP.1	
TRS configuration		1, 4	TRS.1.1 FDD		N/A	
		2, 5	TRS.1.1 TDD		N/A	
		3, 6	TRS.1.2 TDD		N/A	
Initial BWP configuration		1, 2, 3, 4, 5, 6	DLBWP.0.1 ULBWP.0.1		DLBWP.0.1 ULBWP.0.1	
Active DL BWP configuration		1, 2, 3, 4, 5, 6	DLBWP.1.1		DLBWP.1.1	
Active UL BWP configuration		1, 2, 3, 4, 5, 6	ULBWP.1.1		ULBWP.1.1	
RLM-RS		1, 2, 3, 4, 5, 6	SSB		SSB	
N_{oc} <small>Note 2</small>	dBm/SCS	1, 4	-98			
		2, 5	-98			
		3, 6	-95			

N_{oc} Note 2	dBm/15 kHz	1, 4	-98			
		2, 5				
		3, 6				
\hat{E}_s/I_{ot}	dB	1, 4	4	-1.46	-Infinity	-1.46
		2, 5				
		3, 6				
\hat{E}_s/N_{oc}	dB	1, 4	4	4	-Infinity	4
		2, 5				
		3, 6				
SS-RSRP Note 3	dBm/SCS kHz	1, 4	-94	-94	-Infinity	-94
		2, 5	-94	-94	-Infinity	-94
		3, 6	-91	-91	-Infinity	-91
Io	dBm/9.36 MHz	1, 4	-64.60	-62.25	-64.60	-62.25
	dBm/9.36 MHz	2, 5	-64.60	-62.25	-64.60	-62.25
	dBm/38.16 MHz	3, 6	-58.50	-56.16	-58.50	-56.16
Propagation Condition		1, 2, 3, 4, 5, 6	AWGN			
<p>Note 1: The resources for uplink transmission are assigned to the UE prior to the start of time period T2.</p> <p>Note 2: Interference from other cells and noise sources not specified in the test is assumed to be constant over subcarriers and time and shall be modelled as AWGN of appropriate power for N_{oc} to be fulfilled.</p> <p>Note 3: SS-RSRP levels have been derived from other parameters for information purposes. They are not settable parameters themselves.</p>						

A.4.6.1.1.3 Test Requirements

The UE shall send one Event A3 triggered measurement report, with a measurement reporting delay less than 800 ms from the beginning of time period T2. The UE is not required to read the neighbour cell SSB index in this test.

The UE shall not send event triggered measurement reports, as long as the reporting criteria are not fulfilled.

The rate of correct events observed during repeated tests shall be at least 90%.

NOTE: The actual overall delays measured in the test may be up to $2xTTI_{DCC}$ higher than the measurement reporting delays above because of TTI insertion uncertainty of the measurement report in DCC.

A.4.6.1.2 EN-DC event triggered reporting tests without gap under DRX

A.4.6.1.2.1 Test purpose and Environment

The purpose of this test is to verify that the UE makes correct reporting of an event. This test will partly verify the TDD intra-frequency cell search requirements in clause 9.2.5.1 and 9.2.5.2.

A.4.6.1.2.2 Test parameters

Three cells are deployed in the test, which are E-UTRAN PCell (Cell 1), FR1 PSCell (Cell 2) and a FR1 neighbour cell (Cell 3) on the same frequency as the PSCell. The test parameters for PSCell are given in Table A.4.6.1.2.1-1, A.4.6.1.2.1-2, A.4.6.1.2.1-3 and A.4.6.1.2.1-4 below and the test parameters and applicability for the E-UTRAN cell are defined in A.3.7.2. In the measurement control information, a measurement object is configured for the frequency of the PSCell, and it is indicated to the UE that event-triggered reporting with Event A3 is used. The test

consists of two successive time periods, with time duration of T1, and T2 respectively. During time duration T1, the UE shall not have any timing information of cell 3.

UE needs to be provided with new Timing Advance Command MAC control element at least once during each time alignment timer period to maintain uplink time alignment. Furthermore UE is allocated with PUSCH resource at every DRX cycle.

Table A.4.6.1.2.2-1: Supported test configurations

Config	Description
1	LTE FDD, NR 15 kHz SSB SCS, 10 MHz bandwidth, FDD duplex mode
2	LTE FDD, NR 15 kHz SSB SCS, 10 MHz bandwidth, TDD duplex mode
3	LTE FDD, NR 30 kHz SSB SCS, 40 MHz bandwidth, TDD duplex mode
4	LTE TDD, NR 15 kHz SSB SCS, 10 MHz bandwidth, FDD duplex mode
5	LTE TDD, NR 15 kHz SSB SCS, 10 MHz bandwidth, TDD duplex mode
6	LTE TDD, NR 30 kHz SSB SCS, 40 MHz bandwidth, TDD duplex mode
Note 1:	The UE is only required to be tested in one of the supported test configurations
Note 2:	Target NR Cell 3 has the same SCS, BW and duplex mode as NR serving Cell 2

Table A.4.6.1.2.2-2: General test parameters for EN-DC intra-frequency event triggered reporting without gap for PSCell in FR1 with DRX

Parameter	Unit	Test configuration	Value		Comment
			Test 1	Test 2	
Active cell		1, 2, 3, 4, 5, 6	E-UTRAN Cell 1 and NR Cell 2		
Neighbour cell		1, 2, 3, 4, 5, 6	NR Cell 3		Cell to be identified.
RF Channel Number		1, 2, 3, 4, 5, 6	1: Cell 1 2: Cell 2 and Cell 3		
SSB configuration		1, 4	SSB.1 FR1		
		2, 5	SSB.1 FR1		
		3, 6	SSB.2 FR1		
SMTC configuration		1, 4	SMTC.2		
		2, 5	SMTC.1		
		3, 6	SMTC.1		
A3-Offset	dB	1, 2, 3, 4, 5, 6	-4.5		
CP length		1, 2, 3, 4, 5, 6	Normal		
Hysteresis	dB	1, 2, 3, 4, 5, 6	0		
Time To Trigger	s	1, 2, 3, 4, 5, 6	0		
Filter coefficient		1, 2, 3, 4, 5, 6	0		L3 filtering is not used
DRX		1, 2, 3, 4, 5, 6	DRX.1	DRX.7	
Time offset between PCell and PSCell		1, 2, 3, 4, 5, 6	3 μ s		Synchronous EN-DC
Time offset between serving and neighbour cells		1, 4	3 ms		Asynchronous cells. The timing of Cell 3 is 3ms later than the timing of Cell 2.

		2, 5	3 μs		Synchronous cells
		3, 6	3 μs		Synchronous cells
T1	s	1, 2, 3, 4, 5, 6	5		
T2	s	1, 2, 3, 4, 5, 6	5	10	

Table A.4.6.1.2.2-3: NR Cell specific test parameters for EN-DC intra-frequency event triggered reporting without gap for PSCell in FR1 with DRX

Parameter	Unit	Test configuration	Cell 2		Cell 3	
			T1	T2	T1	T2
TDD configuration		1, 4	N/A		N/A	
		2, 5	TDDConf.1.1		TDDConf.1.1	
		3, 6	TDDConf.2.1		TDDConf.2.1	
PDSCH RMC configuration		1, 4	SR.1.1 FDD		N/A	
		2, 5	SR.1.1 TDD			
		3, 6	SR.2.1 TDD			
RMSI CORESET RMC configuration		1, 4	CR.1.1 FDD		N/A	
		2, 5	CR.1.1 TDD		N/A	
		3, 6	CR.2.1 TDD		N/A	
Dedicated CORESET RMC configuration		1, 4	CCR.1.1 FDD		N/A	
		2, 5	CCR.1.1 TDD		N/A	
		3, 6	CCR.2.1 TDD		N/A	
OCNG Patterns		1, 2, 3, 4, 5, 6	OP.1		OP.1	
TRS configuration		1, 4	TRS.1.1 FDD		N/A	
		2, 5	TRS.1.1 TDD		N/A	
		3, 6	TRS.1.2 TDD		N/A	
Initial BWP configuration		1, 2, 3, 4, 5, 6	DLBWP.0.1 ULBWP.0.1		DLBWP.0.1 ULBWP.0.1	
Active DL BWP configuration		1, 2, 3, 4, 5, 6	DLBWP.1.1		DLBWP.1.1	
Active UL BWP configuration		1, 2, 3, 4, 5, 6	ULBWP.1.1		ULBWP.1.1	
RLM-RS		1, 2, 3, 4, 5, 6	SSB		SSB	
N_{oc} <small>Note 2</small>	dBm/SCS	1, 4	-98			
		2, 5	-98			
		3, 6	-95			
N_{oc} <small>Note 2</small>	dBm/15 kHz	1, 4	-98			
		2, 5				
		3, 6				
\hat{E}_s/I_{ot}	dB	1, 4	4	-1.46	-Infinity	-1.46
		2, 5				
		3, 6				
\hat{E}_s/N_{oc}	dB	1, 4	4	4	-Infinity	4
		2, 5				
		3, 6				
SS-RSRP <small>Note 3</small>	dBm/SCS kHz	1, 4	-94	-94	-Infinity	-94
		2, 5	-94	-94	-Infinity	-94
		3, 6	-91	-91	-Infinity	-91
I _o	dBm/9.36 MHz	1, 4	-64.60	-62.25	-64.60	-62.25
		2, 5	-64.60	-62.25	-64.60	-62.25

	dBm/38.16 MHz	3, 6	-58.50	-56.16	-58.50	-56.16
Propagation Condition		1, 2, 3, 4, 5, 6	AWGN			
Note 1:	The resources for uplink transmission are assigned to the UE prior to the start of time period T2.					
Note 2:	Interference from other cells and noise sources not specified in the test is assumed to be constant over subcarriers and time and shall be modelled as AWGN of appropriate power for N_{oc} to be fulfilled.					
Note 3:	SS-RSRP levels have been derived from other parameters for information purposes. They are not settable parameters themselves.					

A.4.6.1.2.2 Test Requirements

In test 1, the UE shall send one Event A3 triggered measurement report, with a measurement reporting delay less than 920 ms from the beginning of time period T2. The UE is not required to read the neighbour cell SSB index in this test.

In test 2, the UE shall send one Event A3 triggered measurement report, with a measurement reporting delay less than 6400 ms from the beginning of time period T2. The UE is not required to read the neighbour cell SSB index in this test.

The UE shall not send event triggered measurement reports, as long as the reporting criteria are not fulfilled.

The rate of correct events observed during repeated tests shall be at least 90%.

NOTE: The actual overall delays measured in the test may be up to $2 \times TTI_{DCCH}$ higher than the measurement reporting delays above because of TTI insertion uncertainty of the measurement report in DCCH.

A.4.6.1.3 EN-DC event triggered reporting tests with per-UE gaps under non-DRX

A.4.6.1.3.1 Test purpose and Environment

The purpose of this test is to verify that the UE makes correct reporting of an event. This test will partly verify the TDD intra-frequency cell search requirements in clause 9.2.6.2 and 9.2.6.3.

A.4.6.1.3.2 Test parameters

Three cells are deployed in the test, which are E-UTRAN PCell (Cell 1), FR1 PSCell (Cell 2) and a FR1 neighbour cell (Cell 3) on the same frequency as the PSCell. The test parameters for PSCell are given in Table A.4.6.1.3.1-1 and A.4.6.1.3.1-2 below and the test parameters and applicability for the E-UTRAN cell are defined in A.3.7.2. In the measurement control information, a measurement object is configured for the frequency of the PSCell, and it is indicated to the UE that event-triggered reporting with Event A3 is used. The test consists of two successive time periods, with time duration of T1, and T2 respectively. During time duration T1, the UE shall not have any timing information of cell 3.

There are two BWPs configured in Cell 2, BWP1 which contains the cell defining SSB, and BWP2 which does not contain any SSB of Cell 2. During the whole test, BWP2 is always scheduled as the active BWP for the UE.

Table A.4.6.1.3.2-1: Supported test configurations

Config	Description
1	LTE FDD, NR 15 kHz SSB SCS, 10 MHz bandwidth, FDD duplex mode
2	LTE FDD, NR 15 kHz SSB SCS, 10 MHz bandwidth, TDD duplex mode
3	LTE FDD, NR 30 kHz SSB SCS, 40 MHz bandwidth, TDD duplex mode
4	LTE TDD, NR 15 kHz SSB SCS, 10 MHz bandwidth, FDD duplex mode

5	LTE TDD, NR 15 kHz SSB SCS, 10 MHz bandwidth, TDD duplex mode
6	LTE TDD, NR 30 kHz SSB SCS, 40 MHz bandwidth, TDD duplex mode
Note 1: The UE is only required to be tested in one of the supported test configurations	
Note 2: Target NR Cell 3 has the same SCS, BW and duplex mode as NR serving Cell 2	

Table A.4.6.1.3.2-2: General test parameters for EN-DC intra-frequency event triggered reporting with per-UE gaps for PSCell in FR1

Parameter	Unit	Test configuration	Value	Comment
Active cell		1, 2, 3, 4, 5, 6	E-UTRAN Cell 1 and NR Cell 2	
Neighbour cell		1, 2, 3, 4, 5, 6	NR Cell 3	Cell to be identified.
RF Channel Number		1, 2, 3, 4, 5, 6	1: Cell 1 2: Cell 2 and Cell 3	
Measurement gap type		1, 2, 3, 4, 5, 6	Per-UE gaps	
Measurement gap repetition periodicity	ms	1, 2, 3, 4, 5, 6	40	
Measurement gap length	ms	1, 2, 3, 4, 5, 6	6	
Measurement gap offset	ms	1, 2, 3, 4, 5, 6	39	
SSB configuration		1, 4	SSB.1 FR1	
		2, 5	SSB.1 FR1	
		3, 6	SSB.2 FR1	
SMTC configuration		1, 4	SMTC.2	
		2, 5	SMTC.1	
		3, 6	SMTC.1	
CSI-RS parameters		1, 4	CSI-RS.1.2 FDD resource #0	
		2, 5	CSI-RS.1.2 TDD resource #0	
		3, 6	CSI-RS.2.2 TDD resource #0	
A3-Offset	dB	1, 2, 3, 4, 5, 6	-4.5	
CP length		1, 2, 3, 4, 5, 6	Normal	
Hysteresis	dB	1, 2, 3, 4, 5, 6	0	
Time To Trigger	s	1, 2, 3, 4, 5, 6	0	
Filter coefficient		1, 2, 3, 4, 5, 6	0	L3 filtering is not used
DRX		1, 2, 3, 4, 5, 6	N/A	OFF
Time offset between PCell and PSCell		1, 2, 3, 4, 5, 6	3 μ s	Synchronous EN-DC
Time offset between serving and neighbour cells		1, 4	3 ms	Asynchronous cells. The timing of Cell 3 is 3ms later than the timing of Cell 2.
		2, 5	3 μ s	Synchronous cells
		3, 6	3 μ s	Synchronous cells
T1	s	1, 2, 3, 4, 5, 6	5	
T2	s	1, 2, 3, 4, 5, 6	5	

Table A.4.6.1.3.2-3: NR Cell specific test parameters for EN-DC intra-frequency event triggered reporting with per-UE gaps for PSCell in FR1

Parameter	Unit	Test configuration	Cell 2		Cell 3	
			T1	T2	T1	T2
TDD configuration		1, 4	N/A		N/A	
		2, 5	TDDConf.1.1		TDDConf.1.1	
		3, 6	TDDConf.2.1		TDDConf.2.1	
PDSCH RMC configuration		1, 4	SR.1.1 FDD		N/A	
		2, 5	SR.1.1 TDD			
		3, 6	SR.2.1 TDD			
RMSI CORESET RMC configuration		1, 4	CR.1.1 FDD		N/A	
		2, 5	CR.1.1 TDD		N/A	
		3, 6	CR.2.1 TDD		N/A	
Dedicated CORESET RMC configuration		1, 4	CCR.1.2 FDD		N/A	
		2, 5	CCR.1.2 TDD		N/A	
		3, 6	CCR.2.1 TDD		N/A	
OCNG Patterns		1, 2, 3, 4, 5, 6	OP.1		OP.1	
TRS configuration		1, 4	TRS.1.1 FDD		N/A	
		2, 5	TRS.1.1 TDD		N/A	
		3, 6	TRS.1.2 TDD		N/A	
Initial BWP configuration		1, 2, 3, 4, 5, 6	DLBWP.0.1 ULBWP.0.1		DLBWP.0.1 ULBWP.0.1	
Active DL BWP configuration		1, 2, 3, 4, 5, 6	DLBWP.1.2		DLBWP.1.1	
Active UL BWP configuration		1, 2, 3, 4, 5, 6	ULBWP.1.2		ULBWP.1.1	
RLM-RS		1, 2, 3, 4, 5, 6	CSI-RS		SSB	
N_{oc} ^{Note 2}	dBm/SCS	1, 4	-98			
		2, 5	-98			
		3, 6	-95			
N_{oc} ^{Note 2}	dBm/15 kHz	1, 4	-98			
		2, 5				
		3, 6				
\hat{E}_s/I_{ot}	dB	1, 4	4	-1.46	-Infinity	-1.46
		2, 5				
		3, 6				
\hat{E}_s/N_{oc}	dB	1, 4	4	4	-Infinity	4
		2, 5				
		3, 6				
SS-RSRP ^{Note 3}	dBm/SCS kHz	1, 4	-94	-94	-Infinity	-94
		2, 5	-94	-94	-Infinity	-94
		3, 6	-91	-91	-Infinity	-91
I _o	dBm/9.36 MHz	1, 4	-64.60	-62.25	-64.60	-62.25
	dBm/9.36 MHz	2, 5	-64.60	-62.25	-64.60	-62.25
	dBm/38.16 MHz	3, 6	-58.50	-56.16	-58.50	-56.16
Propagation Condition		1, 2, 3, 4, 5, 6	AWGN			

Note 1:	The resources for uplink transmission are assigned to the UE prior to the start of time period T2.
Note 2:	Interference from other cells and noise sources not specified in the test is assumed to be constant over subcarriers and time and shall be modelled as AWGN of appropriate power for N_{oc} to be fulfilled.
Note 3:	SS-RSRP levels have been derived from other parameters for information purposes. They are not settable parameters themselves.

A.4.6.1.3.3 Test Requirements

The UE shall send one Event A3 triggered measurement report, with a measurement reporting delay less than 800 ms from the beginning of time period T2. The UE is not required to read the neighbour cell SSB index in this test.

The UE shall not send event triggered measurement reports, as long as the reporting criteria are not fulfilled.

The rate of correct events observed during repeated tests shall be at least 90%.

NOTE: The actual overall delays measured in the test may be up to $2 \times TTI_{DCCH}$ higher than the measurement reporting delays above because of TTI insertion uncertainty of the measurement report in DCCH.

A.4.6.1.4 EN-DC event triggered reporting tests with per-UE gaps under DRX

A.4.6.1.4.1 Test purpose and Environment

The purpose of this test is to verify that the UE makes correct reporting of an event. This test will partly verify the intra-frequency cell search requirements in clause 9.2.6.2 and 9.2.6.3.

A.4.6.1.4.2 Test parameters

Three cells are deployed in the test, which are E-UTRAN PCell (Cell 1), FR1 PSCell (Cell 2) and a FR1 neighbour cell (Cell 3) on the same frequency as the PSCell. The test parameters for PSCell are given in Table A.4.6.1.4.2-1, A.4.6.1.4.2-2, A.4.6.1.4.2-3 A.4.6.1.4.2-4 and A.4.6.1.4.2-5 below and the test parameters and applicability for the E-UTRAN cell are defined in A.3.7.2. In the measurement control information, a measurement object is configured for the frequency of the PSCell, and it is indicated to the UE that event-triggered reporting with Event A3 is used. The test consists of two successive time periods, with time duration of T1, and T2 respectively. During time duration T1, the UE shall not have any timing information of cell 3.

There are two BWPs configured in Cell 2, BWP1 which contains the cell defining SSB, and BWP2 which does not contain any SSB of Cell 2. During the whole test, BWP2 is always scheduled as the active BWP for the UE.

UE needs to be provided with new Timing Advance Command MAC control element at least once during each time alignment timer period to maintain uplink time alignment. Furthermore UE is allocated with PUSCH resource at every DRX cycle.

Table A.4.6.1.4.2-1: Supported test configurations

Config	Description
1	LTE FDD, NR 15 kHz SSB SCS, 10 MHz bandwidth, FDD duplex mode
2	LTE FDD, NR 15 kHz SSB SCS, 10 MHz bandwidth, TDD duplex mode
3	LTE FDD, NR 30 kHz SSB SCS, 40 MHz bandwidth, TDD duplex mode
4	LTE TDD, NR 15 kHz SSB SCS, 10 MHz bandwidth, FDD duplex mode
5	LTE TDD, NR 15 kHz SSB SCS, 10 MHz bandwidth, TDD duplex mode
6	LTE TDD, NR 30 kHz SSB SCS, 40 MHz bandwidth, TDD duplex mode

Note 1: The UE is only required to be tested in one of the supported test configurations
 Note 2: Target NR Cell 3 has the same SCS, BW and duplex mode as NR serving Cell 2

Table A.4.6.1.4.2-2: General test parameters for EN-DC intra-frequency event triggered reporting with per-UE gaps for PSCell in FR1 with DRX

Parameter	Unit	Test configuration	Value		Comment
			Test 1	Test 2	
Active cell		1, 2, 3, 4, 5, 6	E-UTRAN Cell 1 and NR Cell 2		
Neighbour cell		1, 2, 3, 4, 5, 6	NR Cell 3		Cell to be identified.
RF Channel Number		1, 2, 3, 4, 5, 6	1: Cell 1 2: Cell 2 and Cell 3		
Measurement gap type		1, 2, 3, 4, 5, 6	Per-UE gaps		
Measurement gap repetition periodicity	ms	1, 2, 3, 4, 5, 6	40		
Measurement gap length	ms	1, 2, 3, 4, 5, 6	6		
Measurement gap offset	ms	1, 2, 3, 4, 5, 6	39		
SSB configuration		1, 4	SSB.1 FR1		
		2, 5	SSB.1 FR1		
		3, 6	SSB.2 FR1		
SMTC configuration		1, 4	SMTC.2		
		2, 5	SMTC.1		
		3, 6	SMTC.1		
CSI-RS parameters		1, 4	CSI-RS.1.2 FDD resource #0		
		2, 5	CSI-RS.1.2 TDD resource #0		
		3, 6	CSI-RS.2.2 TDD resource #0		
A3-Offset	dB	1, 2, 3, 4, 5, 6	-4.5		
CP length		1, 2, 3, 4, 5, 6	Normal		
Hysteresis	dB	1, 2, 3, 4, 5, 6	0		
Time To Trigger	s	1, 2, 3, 4, 5, 6	0		
Filter coefficient		1, 2, 3, 4, 5, 6	0		L3 filtering is not used
DRX		1, 2, 3, 4, 5, 6	DRX.1	DRX.7	
Time offset between PCell and PSCell		1, 2, 3, 4, 5, 6	3 μ s		Synchronous EN-DC
Time offset between serving and neighbour cells		1, 4	3 ms		Asynchronous cells. The timing of Cell 3 is 3ms later than the timing of Cell 2.
		2, 5	3 μ s		Synchronous cells
		3, 6	3 μ s		Synchronous cells
T1	s	1, 2, 3, 4, 5, 6	5		
T2	s	1, 2, 3, 4, 5, 6	5	10	

Table A.4.6.1.4.2-3: NR Cell specific test parameters for EN-DC intra-frequency event triggered reporting with per-UE gaps for PSCell in FR1 with DRX

Parameter	Unit	Test configuration	Cell 2		Cell 3	
			T1	T2	T1	T2
TDD configuration		1, 4	N/A		N/A	
		2, 5	TDDConf.1.1		TDDConf.1.1	
		3, 6	TDDConf.2.1		TDDConf.2.1	
PDSCH RMC configuration		1, 4	SR.1.1 FDD		N/A	
		2, 5	SR.1.1 TDD			
		3, 6	SR.2.1 TDD			
RMSI CORESET RMC configuration		1, 4	CR.1.1 FDD		N/A	
		2, 5	CR.1.1 TDD		N/A	
		3, 6	CR.2.1 TDD		N/A	
Dedicated CORESET RMC configuration		1, 4	CCR.1.2 FDD		N/A	
		2, 5	CCR.1.2 TDD		N/A	
		3, 6	CCR.2.1 TDD		N/A	
OCNG Patterns		1, 2, 3, 4, 5, 6	OP.1		OP.1	
TRS configuration		1, 4	TRS.1.1 FDD		N/A	
		2, 5	TRS.1.1 TDD		N/A	
		3, 6	TRS.1.2 TDD		N/A	
Initial BWP configuration		1, 2, 3, 4, 5, 6	DLBWP.0.1 ULBWP.0.1		DLBWP.0.1 ULBWP.0.1	
Active DL BWP configuration		1, 2, 3, 4, 5, 6	DLBWP.1.2		DLBWP.1.1	
Active UL BWP configuration		1, 2, 3, 4, 5, 6	ULBWP.1.2		ULBWP.1.1	
RLM-RS		1, 2, 3, 4, 5, 6	CSI-RS		SSB	
N_{oc} ^{Note 2}	dBm/SCS	1, 4	-98			
		2, 5	-98			
		3, 6	-95			
N_{oc} ^{Note 2}	dBm/15 KHz	1, 4	-98			
		2, 5				
		3, 6				
\hat{E}_s/I_{ot}	dB	1, 4	4	-1.46	-Infinity	-1.46
		2, 5				
		3, 6				
\hat{E}_s/N_{oc}	dB	1, 4	4	4	-Infinity	4
		2, 5				
		3, 6				
SS-RSRP ^{Note 3}	dBm/SCS KHz	1, 4	-94	-94	-Infinity	-94
		2, 5	-94	-94	-Infinity	-94
		3, 6	-91	-91	-Infinity	-91
I _o	dBm/9.36 MHz	1, 4	-64.60	-62.25	-64.60	-62.25
	dBm/9.36 MHz	2, 5	-64.60	-62.25	-64.60	-62.25
	dBm/38.16 MHz	3, 6	-58.50	-56.16	-58.50	-56.16
Propagation Condition		1, 2, 3, 4, 5, 6	AWGN			

Note 1:	The resources for uplink transmission are assigned to the UE prior to the start of time period T2.
Note 2:	Interference from other cells and noise sources not specified in the test is assumed to be constant over subcarriers and time and shall be modelled as AWGN of appropriate power for N_{oc} to be fulfilled.
Note 3:	SS-RSRP levels have been derived from other parameters for information purposes. They are not settable parameters themselves.

A.4.6.1.4.3 Test Requirements

In test 1, the UE shall send one Event A3 triggered measurement report, with a measurement reporting delay less than 920 ms from the beginning of time period T2. The UE is not required to read the neighbour cell SSB index in this test.

In test 2, the UE shall send one Event A3 triggered measurement report, with a measurement reporting delay less than 6400 ms from the beginning of time period T2. The UE is not required to read the neighbour cell SSB index in this test.

The UE shall not send event triggered measurement reports, as long as the reporting criteria are not fulfilled.

The rate of correct events observed during repeated tests shall be at least 90%.

NOTE: The actual overall delays measured in the test may be up to $2 \times TTI_{DCCH}$ higher than the measurement reporting delays above because of TTI insertion uncertainty of the measurement report in DCCH.

A.4.6.1.5 EN-DC event triggered reporting tests without gap under non-DRX with SSB index reading

A.4.6.1.5.1 Test purpose and Environment

The purpose of this test is to verify that the UE makes correct reporting of an event. This test will partly verify the FDD intra-frequency cell search requirements in clause 9.2.5.1 and 9.2.5.2.

A.4.6.1.5.2 Test parameters

Three cells are deployed in the test, which are E-UTRAN PCell (Cell 1), FR1 PSCell (Cell 2) and a FR1 neighbour cell (Cell 3) on the same frequency as the PSCell. The test parameters for FDD PSCell are given in Table A.4.6.1.5.1-1 and A.4.6.1.5.1-2 below and the test parameters and applicability for the E-UTRAN cell are defined in A.3.7.2. In the measurement control information, a measurement object is configured for the frequency of the PSCell, and it is indicated to the UE that event-triggered reporting with Event A3 is used. The test consists of two successive time periods, with time duration of T1, and T2 respectively. During time duration T1, the UE shall not have any timing information of cell 3.

Table A.4.6.1.5.2-1: Supported test configurations

Config	Description
1	LTE FDD, NR 15 kHz SSB SCS, 10 MHz bandwidth, FDD duplex mode
2	LTE TDD, NR 15 kHz SSB SCS, 10 MHz bandwidth, FDD duplex mode
Note 1:	The UE is only required to be tested in one of the supported test configurations
Note 2:	Target NR Cell 3 has the same SCS, BW and duplex mode as NR serving Cell 2

Table A.4.6.1.5.2-2: General test parameters for EN-DC intra-frequency event triggered reporting without gap for FDD PSCell in FR1 with SSB index reading

Parameter	Unit	Test configuration	Value	Comment
Active cell		1, 2	E-UTRAN Cell 1 and NR Cell 2	
Neighbour cell		1, 2	NR Cell 3	Cell to be identified.
RF Channel Number		1, 2	1: Cell 1 2: Cell 2 and Cell 3	
SSB configuration		1, 2	SSB.1 FR1	
SMTC configuration		1, 2	SMTC.2	
A3-Offset	dB	1, 2	-4.5	
CP length		1, 2	Normal	
Hysteresis	dB	1, 2	0	
Time To Trigger	s	1, 2	0	
Filter coefficient		1, 2	0	L3 filtering is not used
DRX		1, 2	N/A	OFF
Time offset between PCell and PSCell		1, 2	3 μ s	Synchronous EN-DC
Time offset between serving and neighbour cells		1, 2	3 ms	Asynchronous cells. The timing of Cell 3 is 3ms later than the timing of Cell 2.
T1	s	1, 2	5	
T2	s	1, 2	5	

Table A.4.6.1.5.1-3: NR Cell specific test parameters for EN-DC intra-frequency event triggered reporting without gap for FDD PSCell in FR1 with SSB index reading

Parameter	Unit	Test configuration	Cell 2		Cell 3	
			T1	T2	T1	T2
TDD configuration		1, 2	N/A		N/A	
PDSCH RMC configuration		1, 2	SR.1.1 FDD		N/A	
RMSI CORESET RMC configuration		1, 2	CR.1.1 FDD		N/A	
Dedicated CORESET RMC configuration		1, 2	CCR.1.1 FDD		N/A	
OCNG Patterns		1, 2	OP.1		OP.1	
TRS configuration		1, 2	TRS.1.1 FDD		N/A	
Initial BWP configuration		1, 2	DLBWP.0.1 ULBWP.0.1		DLBWP.0.1 ULBWP.0.1	
Active DL BWP configuration		1, 2	DLBWP.1.1		DLBWP.1.1	
Active UL BWP configuration		1, 2	ULBWP.1.1		ULBWP.1.1	
RLM-RS		1, 2	SSB		SSB	
N_{oc} Note 2	dBm/SCS	1, 2	-98			
N_{oc} Note 2	dBm/15 kHz	1, 2	-98			
\hat{E}_s/I_{ot}	dB	1, 2	4	-1.46	-Infinity	-1.46
\hat{E}_s/N_{oc}	dB	1, 2	4	4	-Infinity	4

SS-RSRP ^{Note 3}	dBm/SCS kHz	1, 2	-94	-94	-Infinity	-94
Io	dBm/9.36 MHz	1, 2	-64.60	-62.25	-64.60	-62.25
Propagation Condition		1, 2	AWGN			
Note 1:	The resources for uplink transmission are assigned to the UE prior to the start of time period T2.					
Note 2:	Interference from other cells and noise sources not specified in the test is assumed to be constant over subcarriers and time and shall be modelled as AWGN of appropriate power for N_{oc} to be fulfilled.					
Note 3:	SS-RSRP levels have been derived from other parameters for information purposes. They are not settable parameters themselves.					

A.4.6.1.5.3 Test Requirements

The UE shall send one Event A3 triggered measurement report, with a measurement reporting delay less than 920 ms from the beginning of time period T2. The UE is required to read the neighbour cell SSB index and report the acquired SSB index in this test.

The UE shall not send event triggered measurement reports, as long as the reporting criteria are not fulfilled.

The rate of correct events observed during repeated tests shall be at least 90%.

NOTE: The actual overall delays measured in the test may be up to $2xTTI_{DCCH}$ higher than the measurement reporting delays above because of TTI insertion uncertainty of the measurement report in DCCH.

A.4.6.1.6 EN-DC event triggered reporting tests with SSB index reading with per-UE gaps

A.4.6.1.6.1 Test purpose and Environment

The purpose of this test is to verify that the UE makes correct reporting of an event. This test will partly verify the intra-frequency cell search requirements in clause 9.2.6.2 and 9.2.6.3.

A.4.6.1.6.2 Test parameters

Three cells are deployed in the test, which are E-UTRAN PCell (Cell 1), FR1 PSCell (Cell 2) and a FR1 neighbour cell (Cell 3) on the same frequency as the PSCell. The test parameters for PSCell are given in Table A.4.6.1.6.2-1 A.4.6.1.6.2-2 and A.4.6.1.6.2-3 below and the test parameters and applicability for the E-UTRAN cell are defined in A.3.7.2. In the measurement control information, a measurement object is configured for the frequency of the PSCell, and it is indicated to the UE that event-triggered reporting with Event A3 is used. The test consists of two successive time periods, with time duration of T1, and T2 respectively. During time duration T1, the UE shall not have any timing information of cell 3.

There are two BWPs configured in Cell 2, BWP1 which contains the cell defining SSB, and BWP2 which does not contain any SSB of Cell 2. During the whole test, BWP2 is always scheduled as the active BWP for the UE.

Table A.4.6.1.6.2-1: Supported test configurations

Config	Description
1	LTE FDD, NR 15 kHz SSB SCS, 10 MHz bandwidth, FDD duplex mode
2	LTE TDD, NR 15 kHz SSB SCS, 10 MHz bandwidth, FDD duplex mode
Note 1:	The UE is only required to be tested in one of the supported test configurations
Note 2:	Target NR Cell 3 has the same SCS, BW and duplex mode as NR serving Cell 2

Table A.4.6.1.6.2-2: General test parameters for EN-DC intra-frequency event triggered reporting with gap for PSCell in FR1 with SSB index reading

Parameter	Unit	Test configuration	Value	Comment
Active cell		1, 2	E-UTRAN Cell 1 and NR Cell 2	
Neighbour cell		1, 2	NR Cell 3	Cell to be identified.
RF Channel Number		1, 2	1: Cell 1 2: Cell 2 and Cell 3	
Measurement gap type		1, 2	Per-UE gaps	
Measurement gap repetition periodicity	ms	1, 2	40	
Measurement gap length	ms	1, 2	6	
Measurement gap offset	ms	1, 2	39	
SSB configuration		1, 2	SSB.1 FR1	
SMTC configuration		1, 2	SMTC.2	
CSI-RS parameters		1, 2	CSI-RS.1.2 FDD resource #0	
A3-Offset	dB	1, 2	-4.5	
CP length		1, 2	Normal	
Hysteresis	dB	1, 2	0	
Time To Trigger	s	1, 2	0	
Filter coefficient		1, 2	0	L3 filtering is not used
DRX		1, 2	N/A	OFF
Time offset between PCell and PSCell		1, 2	3 μ s	Synchronous EN-DC
Time offset between serving and neighbour cells		1, 2	3 ms	Asynchronous cells. The timing of Cell 3 is 3ms later than the timing of Cell 2.
T1	s	1, 2	5	
T2	s	1, 2	5	

Table A.4.6.1.6.2-3: NR Cell specific test parameters for EN-DC intra-frequency event triggered reporting with gap for PSCell in FR1 with SSB index reading

Parameter	Unit	Test configuration	Cell 2		Cell 3	
			T1	T2	T1	T2
TDD configuration		1, 2	N/A		N/A	
PDSCH RMC configuration		1, 2	SR.1.1 FDD		N/A	
RMSI CORESET RMC configuration		1, 2	CR.1.1 FDD		N/A	
Dedicated CORESET RMC configuration		1, 2	CCR.1.2 FDD		N/A	
OCNG Patterns		1, 2	OP.1		OP.1	
TRS configuration		1, 2	TRS.1.1 FDD		N/A	
Initial BWP configuration		1, 2	DLBWP.0.1 ULBWP.0.1		DLBWP.0.1 ULBWP.0.1	
Active DL BWP configuration		1, 2	DLBWP.1.2		DLBWP.1.1	
Active UL BWP configuration		1, 2	ULBWP.1.2		ULBWP.1.1	
RLM-RS		1, 2	CSI-RS		SSB	
N_{oc} Note 2	dBm/SCS	1, 2	-98			

N_{oc} Note 2	dBm/15 kHz	1, 2	-98			
\hat{E}_s/I_{ot}	dB	1, 2	4	-1.46	-Infinity	-1.46
\hat{E}_s/N_{oc}	dB	1, 2	4	4	-Infinity	4
SS-RSRP Note 3	dBm/SCS kHz	1, 2	-94	-94	-Infinity	-94
I_o	dBm/9.36 MHz	1, 2	-64.60	-62.25	-64.60	-62.25
Propagation Condition		1, 2	AWGN			
<p>Note 1: The resources for uplink transmission are assigned to the UE prior to the start of time period T2.</p> <p>Note 2: Interference from other cells and noise sources not specified in the test is assumed to be constant over subcarriers and time and shall be modelled as AWGN of appropriate power for N_{oc} to be fulfilled.</p> <p>Note 3: SS-RSRP levels have been derived from other parameters for information purposes. They are not settable parameters themselves.</p>						

A.4.6.1.6.3 Test Requirements

The UE shall send one Event A3 triggered measurement report, with a measurement reporting delay less than 920 ms from the beginning of time period T2. The UE is required to read the neighbour cell SSB index and report the acquired SSB index in this test.

The UE shall not send event triggered measurement reports, as long as the reporting criteria are not fulfilled.

The rate of correct events observed during repeated tests shall be at least 90%.

NOTE: The actual overall delays measured in the test may be up to $2xTTI_{DCCH}$ higher than the measurement reporting delays above because of TTI insertion uncertainty of the measurement report in DCCH.

A.4.6.2 Inter-frequency Measurements

A.4.6.2.1 EN-DC event triggered reporting tests for FR1 cell without SSB time index detection when DRX is not used

A.4.6.2.1.1 Test Purpose and Environment

The purpose of this test is to verify that the UE makes correct reporting of an event. This test will partly verify the EN-DC inter-frequency NR cell search requirements in clause 9.3.4.

In this test, there are three cells: LTE cell 1 as PCell on E-UTRA RF channel 1, NR cell 2 as PSCell in FR1 on NR RF channel 1 and NR cell 3 as neighbour cell in FR1 on NR RF channel 2. The test parameters and configurations are given in Tables A.4.6.2.1.1-1, A.4.6.2.1.1-2, and A.4.6.2.1.1-3.

Measurement gap pattern configuration is defined in Table A.4.6.2.1.1-2.

In the measurement control information, it is indicated to the UE that event-triggered reporting with Event A3 is used. The test consists of two successive time periods, with time duration of T1, and T2 respectively. During time duration T1, the UE shall not have any timing information of NR cell 3.

The configuration of LTE cell 1 is defined in table A.3.7.2.1-1. Supported test configurations are shown in table A.4.6.2.1.1-1.

Table A.4.6.2.1.1-1: EN-DC event triggered reporting tests without SSB index reading for FR1-FR1

Config	Description
1	LTE FDD, NR 15 kHz SSB SCS, 10 MHz bandwidth, FDD duplex mode
2	LTE FDD, NR 15 kHz SSB SCS, 10 MHz bandwidth, TDD duplex mode
3	LTE FDD, NR 30 kHz SSB SCS, 40 MHz bandwidth, TDD duplex mode
4	LTE TDD, NR 15 kHz SSB SCS, 10 MHz bandwidth, FDD duplex mode
5	LTE TDD, NR 15 kHz SSB SCS, 10 MHz bandwidth, TDD duplex mode
6	LTE TDD, NR 30 kHz SSB SCS, 40 MHz bandwidth, TDD duplex mode
Note 1:	The UE is only required to be tested in one of the supported test configurations
Note 2:	target NR cell3 has the same SCS, BW and duplex mode as NR serving cell2

Table A.4.6.2.1.1-2: General test parameters for EN-DC inter-frequency event triggered reporting without SSB time index detection

Parameter	Unit	Test configuration	Value	Comment
E-UTRA RF Channel Number		Config 1,2,3,4,5,6	1	One E-UTRAN carrier frequencies is used.
NR RF Channel Number		Config 1,2,3,4,5,6	1, 2	Two FR1 NR carrier frequencies is used.
Active cell		Config 1,2,3,4,5,6	LTE Cell 1 (PCell) and NR cell 2 (PScell)	LTE Cell 1 is on E-UTRA RF channel number 1. NR Cell 2 is on NR RF channel number 1.
Neighbour cell		Config 1,2,3,4,5,6	NR cell 3	NR cell 3 is on NR RF channel number 2.
Gap Pattern Id		Config 1,2,3,4,5,6	0	As specified in clause 9.1.2-1.
Measurement gap offset		Config 1,2,3,4,5,6	9	
A3-Offset	dB	Config 1,2,3,4,5,6	-6	
Hysteresis	dB	Config 1,2,3,4,5,6	0	
CP length		Config 1,2,3,4,5,6	Normal	
TimeToTrigger	s	Config 1,2,3,4,5,6	0	
Filter coefficient		Config 1,2,3,4,5,6	0	L3 filtering is not used
DRX		Config 1,2,3,4,5,6	OFF	DRX is not used
Time offset between PCell and PScell		Config 1,2,3,4,5,6	3 μ s	Synchronous EN-DC
Time offset between serving and neighbour cells		Config 1,4	3 ms	Asynchronous cells. The timing of Cell 3 is 3ms later than the timing of Cell 2.
		Config 2,3,5,6	3 μ s	Synchronous cells.
T1	s	Config 1,2,3,4,5,6	5	
T2	s	Config 1,2,3,4,5,6	1	

Table A.4.6.2.1.1-3: Cell specific test parameters for EN-DC inter-frequency event triggered reporting without SSB time index detection

Parameter	Unit	Test configuration	Cell 2		Cell 3	
			T1	T2	T1	T2
NR RF Channel Number		Config 1,2,3,4,5,6	1		2	
Duplex mode		Config 1,4	FDD			
		Config 2,3,5,6	TDD			
BW _{channel}	MHz	Config 1,4	10: N _{RB,c} = 52			
		Config 2,5	10: N _{RB,c} = 52			
		Config 3,6	40: N _{RB,c} = 106			
BWP BW	MHz	Config 1,4	10: N _{RB,c} = 52			
		Config 2,5	10: N _{RB,c} = 52			
		Config 3,6	40: N _{RB,c} = 106			
TDD configuration		Config 2,5	TDDConf.1.1	TDDConf.1.1		
		Config 3,6	TDDConf.2.1	TDDConf.2.1		
Initial DL BWP		Config 1,2,3,4,5,6	DLBWP.0.1	NA		
Initial UL BWP		Config 1,2,3,4,5,6	ULBWP.0.1	NA		
Dedicated DL BWP		Config 1,2,3,4,5,6	DLBWP.1.1	NA		
Dedicated UL BWP		Config 1,2,3,4,5,6	ULBWP.1.1	NA		
TRS configuration		Config 1,4	TRS.1.1 FDD	NA		
		Config 2,5	TRS.1.1 TDD	NA		
		Config 3,6	TRS.1.2 TDD	NA		
OCNG Patterns defined in A.3.2.1.1 (OP.1)		Config 1,2,3,4,5,6	OP.1	OP.1		
PDSCH Reference measurement channel		Config 1,4	SR.1.1 FDD			
		Config 2,5	SR.1.1 TDD			
		Config 3,6	SR2.1 TDD			
RMSI CORESET Reference Channel		Config 1,4	CR.1.1 FDD	-		
		Config 2,5	CR.1.1 TDD			
		Config 3,6	CR2.1 TDD			
Dedicated CORESET Reference Channel		Config 1,4	CCR.1.1 FDD			
		Config 2,5	CCR.1.1 TDD			
		Config 3,6	CCR.2.1 TDD			
SSB parameters		Config 1,4	SSB.1 FR1	SSB.5 FR1		
		Config 2,5	SSB.1 FR1	SSB.5 FR1		
		Config 3,6	SSB.2 FR1	SSB.6 FR1		
SMTC configuration defined in A.3.11		Config 1,4	SMTC.2	SMTC.5		
		Config 2,3,5,6	SMTC.1	SMTC.4		
PDSCH/PDCCH subcarrier spacing	kHz	Config 1,2,4,5	15			
		Config 3,6	30			
EPRE ratio of PSS to SSS		Config 1,2,3,4,5,6	0		0	
EPRE ratio of PBCH DMRS to SSS						
EPRE ratio of PBCH to PBCH DMRS						

EPRE ratio of PDCCH DMRS to SSS						
EPRE ratio of PDCCH to PDCCH DMRS						
EPRE ratio of PDSCH DMRS to SSS						
EPRE ratio of PDSCH to PDSCH						
EPRE ratio of OCNG DMRS to SSS(Note 1)						
EPRE ratio of OCNG to OCNG DMRS (Note 1)						
N_{oc}^{Note2}	dBm/15 kHz			-98		-98
N_{oc}^{Note2}	dBm/S CS	Config 1,2,4,5		-98		-98
		Config 3,6		-95		-95
SS-RSRP ^{Note 3}	dBm/S CS	Config 1,2,4,5	-94	-94	-Infinity	-91
		Config 3,6	-91	-91	-Infinity	-88
\hat{E}_s / I_{ca}	dB	Config 1,2,3,4,5,6	4	4	-Infinity	7
\hat{E}_s / N_{oc}	dB	Config 1,2,3,4,5,6	4	4	-Infinity	7
I_o^{Note3}	dBm/9.36MHz	Config 1,2,4,5	-64.59	-64.59	-70.05	-62.26
	dBm/38.16MHz	Config 3,6	-58.49	-58.49	-63.94	-56.15
Propagation Condition		Config 1,2,3,4,5,6	AWGN			
<p>Note 1: OCNG shall be used such that both cells are fully allocated and a constant total transmitted power spectral density is achieved for all OFDM symbols.</p> <p>Note 2: Interference from other cells and noise sources not specified in the test is assumed to be constant over subcarriers and time and shall be modelled as AWGN of appropriate power for N_{oc} to be fulfilled.</p> <p>Note 3: SS-RSRP and I_o levels have been derived from other parameters for information purposes. They are not settable parameters themselves.</p> <p>Note 4: SS-RSRP minimum requirements are specified assuming independent interference and noise at each receiver antenna port.</p>						

A.4.6.2.1.2 Test Requirements

The UE shall send one Event A3 triggered measurement report, with a measurement reporting delay less than 920 ms from the beginning of time period T2. The UE shall not send event triggered measurement reports, as long as the reporting criteria are not fulfilled. The rate of correct events observed during repeated tests shall be at least 90%.

UE is not required to report SSB time index.

NOTE: The actual overall delays measured in the test may be up to $2xTTI_{DCCH}$ higher than the measurement reporting delays above because of TTI insertion uncertainty of the measurement report in DCCH.

A.4.6.2.2 EN-DC event triggered reporting tests for FR1 cell without SSB time index detection when DRX is used

A.4.6.2.2.1 Test Purpose and Environment

The purpose of this test is to verify that the UE makes correct reporting of an event. This test will partly verify the EN-DC inter-frequency NR cell search requirements in clause 9.3.4.

In this test, there are three cells: LTE cell 1 as PCell on E-UTRA RF channel 1, NR cell 2 as PSCell in FR1 on NR RF channel 1 and NR cell 3 as neighbour cell in FR1 on NR RF channel 2. The test parameters and configurations are given in Tables A.4.6.2.2.1-1, A.4.6.2.2.1-2, and A.4.6.2.2.1-3.

Measurement gap pattern configuration is defined in Table A.4.6.2.2.1-2.

In the measurement control information, it is indicated to the UE that event-triggered reporting with Event A3 is used. The test consists of two successive time periods, with time duration of T1, and T2 respectively. During time duration T1, the UE shall not have any timing information of NR cell 3.

The configuration of LTE cell 1 is defined in table A.3.7.2.1-1. Supported test configurations are shown in table A.4.6.2.2.1-1.

UE needs to be provided with new Timing Advance Command MAC control element at least once during each time alignment timer period to maintain uplink time alignment. Furthermore, UE is allocated with PUSCH resource at every DRX cycle.

Table A.4.6.2.2.1-1: EN-DC event triggered reporting tests without SSB index reading for FR1-FR1

Config	Description
1	LTE FDD, NR 15 kHz SSB SCS, 10 MHz bandwidth, FDD duplex mode
2	LTE FDD, NR 15 kHz SSB SCS, 10 MHz bandwidth, TDD duplex mode
3	LTE FDD, NR 30 kHz SSB SCS, 40 MHz bandwidth, TDD duplex mode
4	LTE TDD, NR 15 kHz SSB SCS, 10 MHz bandwidth, FDD duplex mode
5	LTE TDD, NR 15 kHz SSB SCS, 10 MHz bandwidth, TDD duplex mode
6	LTE TDD, NR 30 kHz SSB SCS, 40 MHz bandwidth, TDD duplex mode
Note 1:	The UE is only required to be tested in one of the supported test configurations
Note 2:	target NR cell3 has the same SCS, BW and duplex mode as NR serving cell2

Table A.4.6.2.2.1-2: General test parameters for EN-DC inter-frequency event triggered reporting without SSB time index detection

Parameter	Unit	Test configuration	Value		Comment
			Test 1	Test 2	
E-UTRA RF Channel Number		Config 1,2,3,4,5,6	1		One E-UTRAN carrier frequencies is used.
NR RF Channel Number		Config 1,2,3,4,5,6	1, 2		Two FR1 NR carrier frequencies is used.
Active cell		Config 1,2,3,4,5,6	LTE Cell 1 (PCell) and NR cell 2 (PScell)		LTE Cell 1 is on E-UTRA RF channel number 1. NR Cell 2 is on NR RF channel number 1.
Neighbour cell		Config 1,2,3,4,5,6	NR cell 3		NR cell 3 is on NR RF channel number 2.

Gap Pattern Id		Config 1,2,3,4,5,6	0		As specified in clause 9.1.2-1.
Measurement gap offset		Config 1,2,3,4,5,6	39		
A3-Offset	dB	Config 1,2,3,4,5,6	-6		
Hysteresis	dB	Config 1,2,3,4,5,6	0		
CP length		Config 1,2,3,4,5,6	Normal		
TimeToTrigger	s	Config 1,2,3,4,5,6	0		
Filter coefficient		Config 1,2,3,4,5,6	0		L3 filtering is not used
DRX	ms	Config 1,2,3,4,5,6	DRX.1	DRX.7	As specified in clause A.3.3
Time offset between PCell and PSCell		Config 1,2,3,4,5,6	3 μ s		Synchronous EN-DC
Time offset between serving and neighbour cells		Config 1,4	3ms		Asynchronous cells. The timing of Cell 3 is 3ms later than the timing of Cell 2.
		Config 2,3,5,6	3 μ s		Synchronous cells.
T1	s	Config 1,2,3,4,5,6	5		
T2	s	Config 1,2,3,4,5,6	1.1	11	

Table A.4.6.2.2.1-3: Cell specific test parameters for EN-DC inter-frequency event triggered reporting without SSB time index detection

Parameter	Unit	Test configuration	Cell 2		Cell 3	
			T1	T2	T1	T2
NR RF Channel Number		Config 1,2,3,4,5,6	1		2	
Duplex mode		Config 1,4	FDD			
		Config 2,3,5,6	TDD			
BW _{channel}	MHz	Config 1,4	10: N _{RB,c} = 52			
		Config 2,5	10: N _{RB,c} = 52			
		Config 3,6	40: N _{RB,c} = 106			
BWP BW	MHz	Config 1,4	10: N _{RB,c} = 52			
		Config 2,5	10: N _{RB,c} = 52			
		Config 3,6	40: N _{RB,c} = 106			
TDD configuration		Config 2,5	TDDConf.1.1		TDDConf.1.1	
		Config 3,6	TDDConf.2.1		TDDConf.2.1	
Initial DL BWP		Config 1,2,3,4,5,6	DLBWP.0.1		NA	
Initial UL BWP		Config 1,2,3,4,5,6	ULBWP.0.1		NA	
Dedicated DL BWP		Config 1,2,3,4,5,6	DLBWP.1.1		NA	
Dedicated UL BWP		Config 1,2,3,4,5,6	ULBWP.1.1		NA	

TRS configuration		Config 1,4	TRS.1.1 FDD	NA		
		Config 2,5	TRS.1.1 TDD	NA		
		Config 3,6	TRS.1.2 TDD	NA		
OCNG Patterns defined in A.3.2.1.1 (OP.1)		Config 1,2,3,4,5,6	OP.1	OP.1		
PDSCH Reference measurement channel		Config 1,4	SR.1.1 FDD			
		Config 2,5	SR.1.1 TDD			
		Config 3,6	SR2.1 TDD			
RMSI CORESET Reference Channel		Config 1,4	CR.1.1 FDD	-		
		Config 2,5	CR.1.1 TDD			
		Config 3,6	CR2.1 TDD			
Dedicated CORESET Reference Channel		Config 1,4	CCR.1.1 FDD			
		Config 2,5	CCR.1.1 TDD			
		Config 3,6	CCR.2.1 TDD			
SSB parameters		Config 1,4	SSB.1 FR1	SSB.5 FR1		
		Config 2,5	SSB.1 FR1	SSB.5 FR1		
		Config 3,6	SSB.2 FR1	SSB.6 FR1		
SMTC configuration defined in A.3.11		Config 1,4	SMTC.2	SMTC.5		
		Config 2,3,5,6	SMTC.1	SMTC.4		
PDSCH/PDCCH subcarrier spacing	kHz	Config 1,2,4,5	15			
		Config 3,6	30			
EPRE ratio of PSS to SSS		Config 1,2,3,4,5,6	0	0		
EPRE ratio of PBCH DMRS to SSS						
EPRE ratio of PBCH to PBCH DMRS						
EPRE ratio of PDCCH DMRS to SSS						
EPRE ratio of PDCCH to PDCCH DMRS						
EPRE ratio of PDSCH DMRS to SSS						
EPRE ratio of PDSCH to PDSCH						
EPRE ratio of OCNG DMRS to SSS(Note 1)						
EPRE ratio of OCNG to OCNG DMRS (Note 1)						
N_{oc}^{Note2}	dBm/15 kHz		-98	-98		
N_{oc}^{Note2}	dBm/S CS	Config 1,2,4,5	-98	-98		
		Config 3,6	-95	-95		
SS-RSRP Note 3	dBm/S CS	Config 1,2,4,5	-94	-94	-Infinity	-91
		Config 3,6	-91	-91	-Infinity	-88
\hat{E}_s / I_{oc}	dB	Config 1,2,3,4,5,6	4	4	-Infinity	7
\hat{E}_s / N_{oc}	dB	Config 1,2,3,4,5,6	4	4	-Infinity	7
I_o^{Note3}	dBm/9.36MHz	Config 1,2,4,5	-64.59	-64.59	-70.05	-62.26
	dBm/38.16MHz	Config 3,6	-58.49	-58.49	-63.94	-56.15

Propagation Condition		Config 1,2,3,4,5,6	AWGN
Note 1:	OCNG shall be used such that both cells are fully allocated and a constant total transmitted power spectral density is achieved for all OFDM symbols.		
Note 2:	Interference from other cells and noise sources not specified in the test is assumed to be constant over subcarriers and time and shall be modelled as AWGN of appropriate power for N_{oc} to be fulfilled.		
Note 3:	SS-RSRP and I_0 levels have been derived from other parameters for information purposes. They are not settable parameters themselves.		
Note 4:	SS-RSRP minimum requirements are specified assuming independent interference and noise at each receiver antenna port.		

A.4.6.2.2.2 Test Requirements

In test 1 with per-UE gap, the UE shall send one Event A3 triggered measurement report, with a measurement reporting delay less than 1080 ms from the beginning of time period T2. The UE shall not send event triggered measurement reports, as long as the reporting criteria are not fulfilled. The rate of correct events observed during repeated tests shall be at least 90%.

In test 2 with per-UE gap, the UE shall send one Event A3 triggered measurement report, with a measurement reporting delay less than 10240 ms from the beginning of time period T2. The UE shall not send event triggered measurement reports, as long as the reporting criteria are not fulfilled. The rate of correct events observed during repeated tests shall be at least 90%.

In test 1 and 2, UE is not required to report SSB time index.

NOTE: The actual overall delays measured in the test may be up to $2 \times TTI_{DCCH}$ higher than the measurement reporting delays above because of TTI insertion uncertainty of the measurement report in DCCH.

A.4.6.2.3 Void

A.4.6.2.4 Void

A.4.6.2.5 EN-DC event triggered reporting tests for FR1 cell with SSB time index detection when DRX is not used

A.4.6.2.5.1 Test Purpose and Environment

The purpose of this test is to verify that the UE makes correct reporting of an event. This test will partly verify the EN-DC inter-frequency NR cell search requirements in clause 9.3.4.

In this test, there are three cells: LTE cell 1 as PCell on E-UTRA RF channel 1, NR cell 2 as PSCell in FR1 on NR RF channel 1 and NR cell 3 as neighbour cell in FR1 on NR RF channel 2. The test parameters and configurations are given in Tables A.4.6.2.5.1-1, A.4.6.2.5.1-2, and A.4.6.2.5.1-3.

Measurement gap pattern configuration is defined in Table A.4.6.2.5.1-2.

In the measurement control information, it is indicated to the UE that event-triggered reporting with Event A3 is used. The test consists of two successive time periods, with time duration of T1, and T2 respectively. During time duration T1, the UE shall not have any timing information of NR cell 3.

The configuration of LTE cell 1 is defined in table A.3.7.2.1-1. Supported test configurations are shown in table A.4.6.2.5.1-1.

Table A.4.6.2.5.1-1: EN-DC event triggered reporting tests without SSB index reading for FR1-FR1

Config	Description
1	LTE FDD, NR 15 kHz SSB SCS, 10 MHz bandwidth, FDD duplex mode
2	LTE FDD, NR 15 kHz SSB SCS, 10 MHz bandwidth, TDD duplex mode
3	LTE FDD, NR 30 kHz SSB SCS, 40 MHz bandwidth, TDD duplex mode
4	LTE TDD, NR 15 kHz SSB SCS, 10 MHz bandwidth, FDD duplex mode
5	LTE TDD, NR 15 kHz SSB SCS, 10 MHz bandwidth, TDD duplex mode
6	LTE TDD, NR 30 kHz SSB SCS, 40 MHz bandwidth, TDD duplex mode
Note 1:	The UE is only required to be tested in one of the supported test configurations
Note 2:	target NR cell3 has the same SCS, BW and duplex mode as NR serving cell2

Table A.4.6.2.5.1-2: General test parameters for EN-DC inter-frequency event triggered reporting with SSB time index detection

Parameter	Unit	Test configuration	Value	Comment
E-UTRA RF Channel Number		Config 1,2,3,4,5,6	1	One E-UTRAN carrier frequencies is used.
NR RF Channel Number		Config 1,2,3,4,5,6	1, 2	Two FR1 NR carrier frequencies is used.
Active cell		Config 1,2,3,4,5,6	LTE Cell 1 (PCell) and NR cell 2 (PScell)	LTE Cell 1 is on E-UTRA RF channel number 1. NR Cell 2 is on NR RF channel number 1.
Neighbour cell		Config 1,2,3,4,5,6	NR cell 3	NR cell 3 is on NR RF channel number 2.
Gap Pattern Id		Config 1,2,3,4,5,6	0	As specified in clause 9.1.2-1.
Measurement gap offset		Config 1,2,3,4,5,6	9	
A3-Offset	dB	Config 1,2,3,4,5,6	-6	
Hysteresis	dB	Config 1,2,3,4,5,6	0	
CP length		Config 1,2,3,4,5,6	Normal	
TimeToTrigger	s	Config 1,2,3,4,5,6	0	
Filter coefficient		Config 1,2,3,4,5,6	0	L3 filtering is not used
DRX		Config 1,2,3,4,5,6	OFF	DRX is not used
Time offset between PCell and PScell		Config 1,2,3,4,5,6	3 μ s	Synchronous EN-DC
Time offset between serving and neighbour cells		Config 1,4	3ms	Asynchronous cells. The timing of Cell 3 is 3ms later than the timing of Cell 2.
		Config 2,3,5,6	3 μ s	Synchronous cells.
T1	s	Config 1,2,3,4,5,6	5	
T2	s	Config 1,2,3,4,5,6	1.1	

Table A.4.6.2.5.1-3: Cell specific test parameters for EN-DC inter-frequency event triggered reporting with SSB time index detection

Parameter	Unit	Test configuration	Cell 2		Cell 3	
			T1	T2	T1	T2
NR RF Channel Number		Config 1,2,3,4,5,6	1		2	
Duplex mode		Config 1,4	FDD			
		Config 2,3,5,6	TDD			
BW _{channel}	MHz	Config 1,4	10: N _{RB,c} = 52			
		Config 2,5	10: N _{RB,c} = 52			
		Config 3,6	40: N _{RB,c} = 106			
BWP BW	MHz	Config 1,4	10: N _{RB,c} = 52			
		Config 2,5	10: N _{RB,c} = 52			
		Config 3,6	40: N _{RB,c} = 106			
TDD configuration		Config 2,5	TDDConf.1.1		TDDConf.1.1	
		Config 3,6	TDDConf.2.1		TDDConf.2.1	
Initial DL BWP		Config 1,2,3,4,5,6	DLBWP.0.1		NA	
Initial UL BWP		Config 1,2,3,4,5,6	ULBWP.0.1		NA	
Dedicated DL BWP		Config 1,2,3,4,5,6	DLBWP.1.1		NA	
Dedicated UL BWP		Config 1,2,3,4,5,6	ULBWP.1.1		NA	
TRS configuration		Config 1,4	TRS.1.1 FDD		NA	
		Config 2,5	TRS.1.1 TDD		NA	
		Config 3,6	TRS.1.2 TDD		NA	
OCNG Patterns defined in A.3.2.1.1 (OP.1)		Config 1,2,3,4,5,6	OP.1		OP.1	
PDSCH Reference measurement channel		Config 1,4	SR.1.1 FDD			
		Config 2,5	SR.1.1 TDD			
		Config 3,6	SR2.1 TDD			
RMSI CORESET Reference Channel		Config 1,4	CR.1.1 FDD		-	
		Config 2,5	CR.1.1 TDD			
		Config 3,6	CR2.1 TDD			
Dedicated CORESET Reference Channel		Config 1,4	CCR.1.1 FDD			
		Config 2,5	CCR.1.1 TDD			
		Config 3,6	CCR.2.1 TDD			
SSB parameters		Config 1,4	SSB.1 FR1		SSB.5 FR1	
		Config 2,5	SSB.1 FR1		SSB.5 FR1	
		Config 3,6	SSB.2 FR1		SSB.6 FR1	
SMTC configuration defined in A.3.11		Config 1,4	SMTC.2		SMTC.5	
		Config 2,3,5,6	SMTC.1		SMTC.4	
PDSCH/PDCCH subcarrier spacing	kHz	Config 1,2,4,5	15			
		Config 3,6	30			
EPRE ratio of PSS to SSS		Config 1,2,3,4,5,6	0		0	
EPRE ratio of PBCH DMRS to SSS						

EPRE ratio of PBCH to PBCH DMRS						
EPRE ratio of PDCCH DMRS to SSS						
EPRE ratio of PDCCH to PDCCH DMRS						
EPRE ratio of PDSCH DMRS to SSS						
EPRE ratio of PDSCH to PDSCH						
EPRE ratio of OCNG DMRS to SSS(Note 1)						
EPRE ratio of OCNG to OCNG DMRS (Note 1)						
N_{oc}^{Note2}	dBm/15 kHz			-98		-98
N_{oc}^{Note2}	dBm/S CS	Config 1,2,4,5		-98		-98
		Config 3,6		-95		-95
SS-RSRP ^{Note 3}	dBm/S CS	Config 1,2,4,5	-94	-94	-Infinity	-91
		Config 3,6	-91	-91	-Infinity	-88
\hat{E}_s / I_{α}	dB	Config 1,2,3,4,5,6	4	4	-Infinity	7
\hat{E}_s / N_{oc}	dB	Config 1,2,3,4,5,6	4	4	-Infinity	7
I_o^{Note3}	dBm/9.36MHz	Config 1,2,4,5	-64.59	-64.59	-70.05	-62.26
	dBm/38.16MHz	Config 3,6	-58.49	-58.49	-63.94	-56.15
Propagation Condition		Config 1,2,3,4,5,6	AWGN			
<p>Note 1: OCNG shall be used such that both cells are fully allocated and a constant total transmitted power spectral density is achieved for all OFDM symbols.</p> <p>Note 2: Interference from other cells and noise sources not specified in the test is assumed to be constant over subcarriers and time and shall be modelled as AWGN of appropriate power for N_{oc} to be fulfilled.</p> <p>Note 3: SS-RSRP and I_o levels have been derived from other parameters for information purposes. They are not settable parameters themselves.</p> <p>Note 4: SS-RSRP minimum requirements are specified assuming independent interference and noise at each receiver antenna port.</p>						

A.4.6.2.5.2 Test Requirements

The UE shall send one Event A3 triggered measurement report, with a measurement reporting delay less than 1040 ms from the beginning of time period T2. The UE shall not send event triggered measurement reports, as long as the reporting criteria are not fulfilled. The rate of correct events observed during repeated tests shall be at least 90%.

UE is required to report SSB time index.

NOTE: The actual overall delays measured in the test may be up to $2 \times TTI_{DCCH}$ higher than the measurement reporting delays above because of TTI insertion uncertainty of the measurement report in DCCH.

A.4.6.2.6 EN-DC event triggered reporting tests for FR1 cell with SSB time index detection when DRX is used

A.4.6.2.6.1 Test Purpose and Environment

The purpose of this test is to verify that the UE makes correct reporting of an event. This test will partly verify the EN-DC inter-frequency NR cell search requirements in clause 9.3.4.

In this test, there are three cells: LTE cell 1 as PCell on E-UTRA RF channel 1, NR cell 2 as PSCell in FR1 on NR RF channel 1 and NR cell 3 as neighbour cell in FR1 on NR RF channel 2. The test parameters and configurations are given in Tables A.4.6.2.6.1-1, A.4.6.2.6.1-2, and A.4.6.2.6.1-3.

Measurement gap pattern configuration is defined in Table A.4.6.2.6.1-2.

In the measurement control information, it is indicated to the UE that event-triggered reporting with Event A3 is used. The test consists of two successive time periods, with time duration of T1, and T2 respectively. During time duration T1, the UE shall not have any timing information of NR cell 3.

The configuration of LTE cell 1 is defined in table A.3.7.2.1-1. Supported test configurations are shown in table A.4.6.2.6.1-1.

UE needs to be provided with new Timing Advance Command MAC control element at least once during each time alignment timer period to maintain uplink time alignment. Furthermore, UE is allocated with PUSCH resource at every DRX cycle.

Table A.4.6.2.6.1-1: EN-DC event triggered reporting tests without SSB index reading for FR1-FR1

Config	Description
1	LTE FDD, NR 15 kHz SSB SCS, 10 MHz bandwidth, FDD duplex mode
2	LTE FDD, NR 15 kHz SSB SCS, 10 MHz bandwidth, TDD duplex mode
3	LTE FDD, NR 30 kHz SSB SCS, 40 MHz bandwidth, TDD duplex mode
4	LTE TDD, NR 15 kHz SSB SCS, 10 MHz bandwidth, FDD duplex mode
5	LTE TDD, NR 15 kHz SSB SCS, 10 MHz bandwidth, TDD duplex mode
6	LTE TDD, NR 30 kHz SSB SCS, 40 MHz bandwidth, TDD duplex mode

Note 1: The UE is only required to be tested in one of the supported test configurations
Note 2: target NR cell3 has the same SCS, BW and duplex mode as NR serving cell2

Table A.4.6.2.6.1-2: General test parameters for EN-DC inter-frequency event triggered reporting with SSB time index detection

Parameter	Unit	Test configuration	Value		Comment
			Test 1	Test 2	
E-UTRA RF Channel Number		Config 1,2,3,4,5,6	1		One E-UTRAN carrier frequencies is used.
NR RF Channel Number		Config 1,2,3,4,5,6	1, 2		Two FR1 NR carrier frequencies is used.
Active cell		Config 1,2,3,4,5,6	LTE Cell 1 (PCell) and NR cell 2 (PScell)		LTE Cell 1 is on E-UTRA RF channel number 1. NR Cell 2 is on NR RF channel number 1.
Neighbour cell		Config 1,2,3,4,5,6	NR cell 3		NR cell 3 is on NR RF channel number 2.

Gap Pattern Id		Config 1,2,3,4,5,6	0		As specified in clause 9.1.2-1.
Measurement gap offset		Config 1,2,3,4,5,6	9		
A3-Offset	dB	Config 1,2,3,4,5,6	-6		
Hysteresis	dB	Config 1,2,3,4,5,6	0		
CP length		Config 1,2,3,4,5,6	Normal		
TimeToTrigger	s	Config 1,2,3,4,5,6	0		
Filter coefficient		Config 1,2,3,4,5,6	0		L3 filtering is not used
DRX	ms	Config 1,2,3,4,5,6	DRX.1	DRX.7	As specified in clause A.3.3
Time offset between PCell and PSCell		Config 1,2,3,4,5,6	3 μ s		Synchronous EN-DC
Time offset between serving and neighbour cells		Config 1,4	3ms		Asynchronous cells. The timing of Cell 3 is 3ms later than the timing of Cell 2.
		Config 2,3,5,6	3 μ s		Synchronous cells.
T1	s	Config 1,2,3,4,5,6	5		
T2	s	Config 1,2,3,4,5,6	1.3	13.5	

Table A.4.6.2.6.1-3: Cell specific test parameters for EN-DC inter-frequency event triggered reporting with SSB time index detection

Parameter	Unit	Test configuration	Cell 2		Cell 3	
			T1	T2	T1	T2
NR RF Channel Number		Config 1,2,3,4,5,6	1		2	
Duplex mode		Config 1,4	FDD			
		Config 2,3,5,6	TDD			
BW _{channel}	MHz	Config 1,4	10: N _{RB,c} = 52			
		Config 2,5	10: N _{RB,c} = 52			
		Config 3,6	40: N _{RB,c} = 106			
BWP BW	MHz	Config 1,4	10: N _{RB,c} = 52			
		Config 2,5	10: N _{RB,c} = 52			
		Config 3,6	40: N _{RB,c} = 106			
OCNG Patterns defined in A.3.2.1.1 (OP.1)		Config 1,2,3,4,5,6	OP.1		OP.1	
PDSCH Reference measurement channel		Config 1,4	SR.1.1 FDD		-	
		Config 2,5	SR.1.1 TDD			
		Config 3,6	SR.2.1 TDD			
RMSI CORESET Reference Channel		Config 1,4	CR.1.1 FDD		-	
		Config 2,5	CR.1.1 TDD			
		Config 3,6	CR.2.1 TDD			
Dedicated CORESET Reference Channel		Config 1,4	CCR.1.1 FDD			
		Config 2,5	CCR.1.1 TDD			
		Config 3,6	CCR.2.1 TDD			

TDD configuration		Config 2,5	TDDConf.1.1				
		Config 3,6	TDDConf.2.1				
Initial DL BWP		Config 1,2,3,4,5,6	DLBWP.0.1				
TRS configuration		Config 1,4	TRS.1.1 FDD	N/A			
		Config 2,5	TRS.1.1 TDD	N/A			
		Config 3,6	TRS.1.2 TDD	N/A			
Initial UL BWP		Config 1,2,3,4,5,6	ULBWP.0.1				
Dedicated DL BWP		Config 1,2,3,4,5,6	DLBWP.1.1				
Dedicated UL BWP		Config 1,2,3,4,5,6	ULBWP.1.1				
SSB parameters		Config 1,4	SSB.1 FR1	SSB.5 FR1			
		Config 2,5	SSB.1 FR1	SSB.5 FR1			
		Config 3,6	SSB.2 FR1	SSB.6 FR1			
SMTC configuration defined in A.3.11		Config 1,4	SMTC.2	SMTC.5			
		Config 2,3,5,6	SMTC.1	SMTC.4			
PDSCH/PDCCH subcarrier spacing	kHz	Config 1,2,4,5	15				
		Config 3,6	30				
EPRE ratio of PSS to SSS		Config 1,2,3,4,5,6	0	0			
EPRE ratio of PBCH DMRS to SSS							
EPRE ratio of PBCH to PBCH DMRS							
EPRE ratio of PDCCH DMRS to SSS							
EPRE ratio of PDCCH to PDCCH DMRS							
EPRE ratio of PDSCH DMRS to SSS							
EPRE ratio of PDSCH to PDSCH							
EPRE ratio of OCNG DMRS to SSS(Note 1)							
EPRE ratio of OCNG to OCNG DMRS (Note 1)							
N_{oc} Note2	dBm/15 kHz		-98				-98
N_{oc} Note2	dBm/S CS	Config 1,2,4,5	-98				-98
		Config 3,6	-95				-95
SS-RSRP Note 3	dBm/S CS	Config 1,2,4,5	-94	-94	-Infinity	-91	
		Config 3,6	-91	-91	-Infinity	-88	
\hat{E}_s/I_{ot}	dB	Config 1,2,3,4,5,6	4	4	-Infinity	7	
\hat{E}_s/N_{oc}	dB	Config 1,2,3,4,5,6	4	4	-Infinity	7	

I _o ^{Note3}	dBm/9.36MHz	Config 1,2,4,5	-64.59	-64.59	-70.05	-62.26
	dBm/38.16MHz	Config 3,6	-58.49	-58.49	-63.94	-56.15
Propagation Condition		Config 1,2,3,4,5,6	AWGN			
Note 1:	OCNG shall be used such that both cells are fully allocated and a constant total transmitted power spectral density is achieved for all OFDM symbols.					
Note 2:	Interference from other cells and noise sources not specified in the test is assumed to be constant over subcarriers and time and shall be modelled as AWGN of appropriate power for N_{oc} to be fulfilled.					
Note 3:	SS-RSRP and I _o levels have been derived from other parameters for information purposes. They are not settable parameters themselves.					
Note 4:	SS-RSRP minimum requirements are specified assuming independent interference and noise at each receiver antenna port.					

A.4.6.2.6.2 Test Requirements

In test 1 with per-UE gap, the UE shall send one Event A3 triggered measurement report, with a measurement reporting delay less than 1280 ms from the beginning of time period T2. The UE shall not send event triggered measurement reports, as long as the reporting criteria are not fulfilled. The rate of correct events observed during repeated tests shall be at least 90%.

In test 2 with per-UE gap, the UE shall send one Event A3 triggered measurement report, with a measurement reporting delay less than 12160 ms from the beginning of time period T2. The UE shall not send event triggered measurement reports, as long as the reporting criteria are not fulfilled. The rate of correct events observed during repeated tests shall be at least 90%.

In test 1 and 2, UE is required to report SSB time index.

NOTE: The actual overall delays measured in the test may be up to $2 \times TTI_{DCC}$ higher than the measurement reporting delays above because of TTI insertion uncertainty of the measurement report in DCC.

A.4.6.2.7 Void

A.4.6.2.8 Void

A.4.6.3 Void

A.4.6.4 L1-RSRP measurement for beam reporting

A.4.6.4.1 SSB based L1-RSRP measurement when DRX is not used

A.4.6.4.1.1 Test Purpose and Environment

The purpose of this test is to verify that the UE makes correct reporting of L1-RSRP measurement. This test will partly verify the L1-RSRP measurement requirements in clause 9.5.4.1, with the testing configurations for NR cells in Table A.4.6.4.1.1-1.

Table A.4.6.4.1.1-1: Applicable NR configurations for FR1 SSB based L1-RSRP test

Config	Description
1	LTE FDD, NR 15 kHz SSB SCS, 10 MHz bandwidth, FDD duplex mode

2	LTE FDD, NR 15 kHz SSB SCS, 10 MHz bandwidth, TDD duplex mode
3	LTE FDD, NR 30 kHz SSB SCS, 40 MHz bandwidth, TDD duplex mode
4	LTE TDD, NR 15 kHz SSB SCS, 10 MHz bandwidth, FDD duplex mode
5	LTE TDD, NR 15 kHz SSB SCS, 10 MHz bandwidth, TDD duplex mode
6	LTE TDD, NR 30 kHz SSB SCS, 40 MHz bandwidth, TDD duplex mode
Note:	The UE is only required to be tested in one of the supported test configurations

A.4.6.4.1.2 Test parameters

There are two cells in the test, E-UTRAN PCell (Cell 1) and FR1 PSCell (Cell 2). The test parameters and applicability for Cell 1 are defined in A.3.7.2. The test parameters for the Cell 2 are given in Table A.4.6.4.1.2-1 and Table A.4.6.4.1.2-2 below.

In CSI measurement configuration, UE is indicated to perform L1-RSRP measurement on the SSBs and report periodically. The test consists of two successive time periods, with time duration of T1 and T2 respectively. The test has higher layer parameter *timeRestrictionForChannelMeasurements* configured.

There is no measurement gap configured in the test. Before the test, UE is configured to perform RLM, BFD and L1-RSRP measurement based on the SSBs.

Table A.4.6.4.1.2-1: General test parameters

Parameter	Config	Unit	Value
SSB GSCN	1~6		freq1
Duplex mode	1,4		FDD
	2,5		TDD
	3,6		TDD
TDD Configuration	1,4		N/A
	2,5		TDDConf.1.1
	3,6		TDDConf.2.1
BW _{channel}	1,4	MHz	10: N _{RB,c} = 52
	2,5		10: N _{RB,c} = 52
	3,6		40: N _{RB,c} = 106
PDSCH Reference measurement channel	1,4		SR.1.1 FDD
	2,5		SR.1.1 TDD
	3,6		SR.2.1 TDD
RMSI CORESET Reference Channel	1,4		CR.1.1 FDD
	2,5		CR.1.1 TDD
	3,6		CR.2.1 TDD
Dedicated CORESET Reference Channel	1,4		CCR.1.1 FDD
	2,5		CCR.1.1 TDD
	3,6		CCR.2.1 TDD
SSB configuration	1,4		SSB.3 FR1
	2,5		SSB.3 FR1
	3,6		SSB.4 FR1
OCNG Patterns	1~6		OP.1
Initial BWP Configuration	1~6		DLBWP.0.1 ULBWP.0.1
Dedicated BWP configuration	1~6		DLBWP.1.1 ULBWP.1.1
SMTTC configuration	1~6		SMTTC.1
TRS Configuration	1,4		TRS.1.1 FDD
	2,5		TRS.1.1 TDD
	3,6		TRS.1.2 TDD

DRX configuration	1~6		Off
reportConfigType	1~6		periodic
reportQuantity	1~6		ssb-Index-RSRP
Number of reported RS	1~6		2
L1-RSRP reporting period	1~6	slot	80
T1	1~6	s	5
T2	1~6	s	1
EPRE ratio of PSS to SSS	1~6	dB	0
EPRE ratio of PBCH DMRS to SSS			
EPRE ratio of PBCH to PBCH DMRS			
EPRE ratio of PDCCH DMRS to SSS			
EPRE ratio of PDCCH to PDCCH DMRS			
EPRE ratio of PDSCH DMRS to SSS			
EPRE ratio of PDSCH to PDSCH DMRS			
EPRE ratio of OCNG DMRS to SSS ^{Note 1}			
EPRE ratio of OCNG to OCNG DMRS ^{Note 1}			
Propagation condition	1~6		AWGN
Note 1: OCNG shall be used such that both cells are fully allocated and a constant total transmitted power spectral density is achieved for all OFDM symbols.			

Table A.4.6.4.1.2-2: SSB specific test parameters

Parameter	Config	Unit	SSB#0		SSB#1	
			T1	T2	T1	T2
N_{oc} ^{Note2}	1~6	dBm/15kHz	-94.65			
N_{oc} ^{Note2}	1,2,4,5	dBm/SSB SCS	-94.65			
	3,6		-91.65			
\hat{E}_s / I_{ot}	1~6	dB	0	0	-Infinity	3
SSB RSRP ^{Note3}	1,2,4,5	dBm/SSB SCS	-94.65	-94.65	-Infinity	-91.65
	3,6		-91.65	-91.65	-Infinity	-88.65
I_o ^{Note3}	1,2,4,5	dBm/9.36 MHz	-63.69	-63.69	-66.70	-61.93
	3,6	dBm/38.16 MHz	-57.59	-57.59	-60.61	-55.84
\hat{E}_s / N_{oc}	1~6	dB	0	0	-Infinity	3
<p>Note 1: The resources for uplink transmission are assigned to the UE prior to the start of time period T2.</p> <p>Note 2: Interference from other cells and noise sources not specified in the test is assumed to be constant over subcarriers and time and shall be modelled as AWGN of appropriate power for N_{oc} to be fulfilled.</p> <p>Note 3: SS-RSRP and I_o levels have been derived from other parameters for information purposes. They are not settable parameters themselves.</p>						

A.4.6.4.1.3 Test Requirements

The UE shall send L1-RSRP report every 80 slots. No later than 640ms plus 80 slots from the beginning of time period T2, UE shall send L1-RSRP report including results of both SSB0 and SSB1 while meeting the absolute accuracy requirement in clause 10.1.19.1.1 and relative accuracy requirement in clause 10.1.19.1.2. The rate of correct events observed during repeated tests shall be at least 90%.

NOTE: The actual overall delays measured in the test may be up to $2 \times TTI_{DCCH}$ higher than the measurement reporting delays above because of TTI insertion uncertainty of the measurement report in DCCH.

A.4.6.4.2 SSB based L1-RSRP measurement when DRX is used

A.4.6.4.2.1 Test Purpose and Environment

The purpose of this test is to verify that the UE makes correct reporting of L1-RSRP measurement. This test will partly verify the L1-RSRP measurement requirements in clause 9.5.4.1, with the testing configurations for NR cells in Table A.4.6.4.2.1-1.

Table A.4.6.4.2.1-1: Applicable NR configurations for FR1 SSB based L1-RSRP test

Config	Description
1	LTE FDD, NR 15 kHz SSB SCS, 10 MHz bandwidth, FDD duplex mode
2	LTE FDD, NR 15 kHz SSB SCS, 10 MHz bandwidth, TDD duplex mode
3	LTE FDD, NR 30 kHz SSB SCS, 40 MHz bandwidth, TDD duplex mode
4	LTE TDD, NR 15 kHz SSB SCS, 10 MHz bandwidth, FDD duplex mode
5	LTE TDD, NR 15 kHz SSB SCS, 10 MHz bandwidth, TDD duplex mode
6	LTE TDD, NR 30 kHz SSB SCS, 40 MHz bandwidth, TDD duplex mode

Note: The UE is only required to be tested in one of the supported test configurations

A.4.6.4.2.2 Test parameters

There are two cells in the test, E-UTRAN PCell (Cell 1) and FR1 PSCell (Cell 2). The test parameters and applicability for Cell 1 are defined in A.3.7.2. The test parameters for the Cell 2 are given in Table A.4.6.4.2.2-1 and Table A.4.6.4.2.2-2 below.

In CSI measurement configuration, UE is indicated to perform L1-RSRP measurement on the SSBs and report periodically. The test consists of two successive time periods, with time duration of T1 and T2 respectively. The test has higher layer parameter *timeRestrictionForChannelMeasurements* configured.

There is no measurement gap configured in the test. Before the test, UE is configured to perform RLM, BFD and L1-RSRP measurement based on the SSBs.

Table A.4.6.4.2.2-1: General test parameters

Parameter	Config	Unit	Value
SSB GSCN	1~6		freq1
Duplex mode	1,4		FDD
	2,5		TDD
	3,6		TDD
TDD Configuration	1,4		N/A
	2,5		TDDConf.1.1
	3,6		TDDConf.2.1
BW _{channel}	1,4	MHz	10: N _{RB,c} = 52
	2,5		10: N _{RB,c} = 52

	3,6		40: $N_{RB,c} = 106$
PDSCH Reference measurement channel	1,4		SR.1.1 FDD
	2,5		SR.1.1 TDD
	3,6		SR.2.1 TDD
RMSI CORESET Reference Channel	1,4		CR.1.1 FDD
	2,5		CR.1.1 TDD
	3,6		CR.2.1 TDD
Dedicated CORESET Reference Channel	1,4		CCR.1.1 FDD
	2,5		CCR.1.1 TDD
	3,6		CCR.2.1 TDD
SSB configuration	1,4		SSB.3 FR1
	2,5		SSB.3 FR1
	3,6		SSB.4 FR1
OCNG Patterns	1~6		OP.1
Initial BWP Configuration	1~6		DLBWP.0.1 ULBWP.0.1
Dedicated BWP configuration	1~6		DLBWP.1.1 ULBWP.1.1
SMTC configuration	1~6		SMTC.1
TRS Configuration	1,4		TRS.1.1 FDD
	2,5		TRS.1.1 TDD
	3,6		TRS.1.2 TDD
DRX configuration	1~6		DRX.3
reportConfigType	1~6		periodic
reportQuantity	1~6		ssb-Index-RSRP
Number of reported RS	1~6		2
L1-RSRP reporting period	1~6	slot	80
T1	1~6	s	5
T2	1~6	s	1
EPRE ratio of PSS to SSS	1~6	dB	0
EPRE ratio of PBCH DMRS to SSS			
EPRE ratio of PBCH to PBCH DMRS			
EPRE ratio of PDCCH DMRS to SSS			
EPRE ratio of PDCCH to PDCCH DMRS			
EPRE ratio of PDSCH DMRS to SSS			
EPRE ratio of PDSCH to PDSCH DMRS			
EPRE ratio of OCNG DMRS to SSS ^{Note 1}			
EPRE ratio of OCNG to OCNG DMRS ^{Note 1}			
Propagation condition			
Note 1: OCNG shall be used such that both cells are fully allocated and a constant total transmitted power spectral density is achieved for all OFDM symbols.			

Table A.4.6.4.2.2-2: SSB specific test parameters

Parameter	Config	Unit	SSB#0		SSB#1	
			T1	T2	T1	T2
N_{oc} ^{Note2}	1~6	dBm/15kHz	-94.65			
	1,2,4,5	dBm/SSB SCS	-94.65			

N_{oc} ^{Note2}	3,6		-91.65			
\hat{E}_s/I_{ot}	1~6	dB	0	0	-Infinity	3
SSB RSRP ^{Note3}	1,2,4,5	dBm/SSB SCS	-94.65	-94.65	-Infinity	-91.65
	3,6		-91.65	-91.65	-Infinity	-88.65
I_o ^{Note3}	1,2,4,5	dBm/9.36 MHz	-63.69	-63.69	-66.70	-61.93
	3,6	dBm/38.16 MHz	-57.59	-57.59	-60.61	-55.84
\hat{E}_s/N_{oc}	1~6	dB	0	0	-Infinity	3
<p>Note 1: The resources for uplink transmission are assigned to the UE prior to the start of time period T2.</p> <p>Note 2: Interference from other cells and noise sources not specified in the test is assumed to be constant over subcarriers and time and shall be modelled as AWGN of appropriate power for N_{oc} to be fulfilled.</p> <p>Note 3: SS-RSRP and I_o levels have been derived from other parameters for information purposes. They are not settable parameters themselves.</p>						

A.4.6.4.2.3 Test Requirements

The UE shall send L1-RSRP report every 80 slots. No later than 640ms plus 80 slots from the beginning of time period T2, UE shall send L1-RSRP report including results of both SSB0 and SSB1 while meeting absolute accuracy requirement in clause 10.1.19.1.1 and relative accuracy requirement in clause 10.1.19.1.2. The rate of correct events observed during repeated tests shall be at least 90%.

NOTE: The actual overall delays measured in the test may be up to $2xTTI_{DCCH}$ higher than the measurement reporting delays above because of TTI insertion uncertainty of the measurement report in DCCH.

A.4.6.4.3 CSI-RS based L1-RSRP measurement when DRX is not used

A.4.6.4.3.1 Test Purpose and Environment

The purpose of this test is to verify that the UE makes correct reporting of L1-RSRP measurement. This test will partly verify the L1-RSRP measurement requirements in clause 9.5.4.2, with the testing configurations for NR cells in Table A.4.6.4.3.1-1.

Table A.4.6.4.3.1-1: Applicable NR configurations for FR1 CSI-RS based L1-RSRP test

Config	Description
1	LTE FDD, NR 15 kHz SSB SCS, 10 MHz bandwidth, FDD duplex mode
2	LTE FDD, NR 15 kHz SSB SCS, 10 MHz bandwidth, TDD duplex mode
3	LTE FDD, NR 30 kHz SSB SCS, 40 MHz bandwidth, TDD duplex mode
4	LTE TDD, NR 15 kHz SSB SCS, 10 MHz bandwidth, FDD duplex mode
5	LTE TDD, NR 15 kHz SSB SCS, 10 MHz bandwidth, TDD duplex mode
6	LTE TDD, NR 30 kHz SSB SCS, 40 MHz bandwidth, TDD duplex mode
Note:	The UE is only required to be tested in one of the supported test configurations

A.4.6.4.3.2 Test parameters

There are two cells in the test, E-UTRAN PCell (Cell 1) and FR1 PSCell (Cell 2). The test parameters and applicability for Cell 1 are defined in A.3.7.2. The test parameters for the Cell 2 are given in Table A.4.6.4.3.2-1 and Table A.4.6.4.3.2-2 below.

In CSI measurement configuration, UE is indicated to perform L1-RSRP measurement on the CSI-RS and report aperiodically. The test consists of a single time period T1, during which the UE is triggered via DCI to report L1-RSRP on aperiodic CSI-RS resources. UE is also configured to measure L1-RSRP based on SSB. After 80ms from the beginning of the test, the DCI trigger comes in slot n (0 for Config 1,2,4,5 and 8 for Config 3,6) of a frame and UE provides the report back based on the reporting configuration as defined in Table A.4.6.4.3.2-1.

There is no measurement gap configured in the test. Before the test, UE is configured to perform RLM and BFD based on the SSBs.

Table A.4.6.4.3.2-1: General test parameters

Parameter	Config	Unit	Value
SSB GSCN	1~6		freq1
Duplex mode	1,4		FDD
	2,5		TDD
	3,6		TDD
TDD Configuration	1,4		N/A
	2,5		TDDConf.1.1
	3,6		TDDConf.2.1
BW _{channel}	1,4	MHz	10: N _{RB,c} = 52
	2,5		10: N _{RB,c} = 52
	3,6		40: N _{RB,c} = 106
PDSCH Reference measurement channel	1,4		SR.1.1 FDD
	2,5		SR.1.1 TDD
	3,6		SR.2.1 TDD
RMSI CORESET Reference Channel	1,4		CR.1.1 FDD
	2,5		CR.1.1 TDD
	3,6		CR.2.1 TDD
Dedicated CORESET Reference Channel	1,4		CCR.1.1 FDD
	2,5		CCR.1.1 TDD
	3,6		CCR.2.1 TDD
SSB configuration	1,4		SSB.3 FR1
	2,5		SSB.3 FR1
	3,6		SSB.4 FR1
CSI-RS configuration	1,4		CSI-RS 1.3 FDD
	2,5		CSI-RS 1.3 TDD
	3,6		CSI-RS 2.3 TDD
OCNG Patterns	1~6		OP.1
TRS Configuration	1,4		TRS.1.1 FDD
	2,5		TRS.1.1 TDD
	3,6		TRS.1.2 TDD
Initial BWP Configuration	1~6		DLBWP.0.1 ULBWP.0.1
Dedicated BWP configuration	1~6		DLBWP.1.1 ULBWP.1.1
SMTc configuration	1~6		SMTc.1
DRX configuration	1~6		Off
reportConfigType	1~6		aperiodic
reportQuantity	1~6		cri-RSRP

Number of reported RS	1~6		2
qcl-Info	1~6		SSB#0 for resource#0 SSB#1 for resource#1
reportSlotOffsetList	1~6	slots	8
T1	1~6	s	5
EPRE ratio of PSS to SSS	1~6	dB	0
EPRE ratio of PBCH DMRS to SSS			
EPRE ratio of PBCH to PBCH DMRS			
EPRE ratio of PDCCH DMRS to SSS			
EPRE ratio of PDCCH to PDCCH DMRS			
EPRE ratio of PDSCH DMRS to SSS			
EPRE ratio of PDSCH to PDSCH DMRS			
EPRE ratio of OCNG DMRS to SSS ^{Note 1}			
EPRE ratio of OCNG to OCNG DMRS ^{Note 1}			
Propagation condition	1~6		AWGN
Note 1: OCNG shall be used such that both cells are fully allocated and a constant total transmitted power spectral density is achieved for all OFDM symbols.			

Table A.4.6.4.3.2-2: CSI-RS specific test parameters

Parameter	Config	Unit	CSI-RS#0	CSI-RS#1
N_{oc} ^{Note1}	1~6	dBm/15kHz	-94.65	
N_{oc} ^{Note1}	1,2,4,5	dBm/SSB SCS	-94.65	
	3,6		-91.65	
\hat{E}_s / I_{ot}	1~6	dB	0	3
CSI-RS RSRP ^{Note2}	1,2,4,5	dBm/SSB SCS	-94.65	-91.65
	3,6		-91.65	-88.65
I_o ^{Note2}	1,2,4,5	dBm/9.36 MHz	-63.69	-61.93
	3,6	dBm/38.16 MHz	-57.59	-55.84
\hat{E}_s / N_{oc}	1~6	dB	0	3
Note 2: Interference from other cells and noise sources not specified in the test is assumed to be constant over subcarriers and time and shall be modelled as AWGN of appropriate power for N_{oc} to be fulfilled.				
Note 3: CSI-RS RSRP and I_o levels have been derived from other parameters for information purposes. They are not settable parameters themselves.				

A.4.6.4.3.3 Test Requirements

After 80ms from the beginning of the test, the UE shall send L1-RSRP report at slot 8 from the reception of DCI triggering the L1-RSRP measurement. The L1-RSRP report shall include the results for both CSI-RS#0 and CSI-

RS#1 while meeting the absolute accuracy requirement in clause 10.1.20.1.1 and relative accuracy requirement in clause 10.1.20.1.2.

The rate of correct events observed during repeated tests shall be at least 90%.

NOTE: The actual overall delays measured in the test may be up to $2 \times TTI_{DCCH}$ higher than the measurement reporting delays above because of TTI insertion uncertainty of the measurement report in DCCH.

A.4.6.4.4 CSI-RS based L1-RSRP measurement when DRX is used

A.4.6.4.4.1 Test Purpose and Environment

The purpose of this test is to verify that the UE makes correct reporting of L1-RSRP measurement. This test will partly verify the L1-RSRP measurement requirements in clause 9.5.4.2, with the testing configurations for NR cells in Table A.4.6.4.4.1-1.

Table A.4.6.4.4.1-1: Applicable NR configurations for FR1 CSI-RS based L1-RSRP test

Config	Description
1	LTE FDD, NR 15 kHz SSB SCS, 10 MHz bandwidth, FDD duplex mode
2	LTE FDD, NR 15 kHz SSB SCS, 10 MHz bandwidth, TDD duplex mode
3	LTE FDD, NR 30 kHz SSB SCS, 40 MHz bandwidth, TDD duplex mode
4	LTE TDD, NR 15 kHz SSB SCS, 10 MHz bandwidth, FDD duplex mode
5	LTE TDD, NR 15 kHz SSB SCS, 10 MHz bandwidth, TDD duplex mode
6	LTE TDD, NR 30 kHz SSB SCS, 40 MHz bandwidth, TDD duplex mode

Note: The UE is only required to be tested in one of the supported test configurations

A.4.6.4.4.2 Test parameters

There are two cells in the test, E-UTRAN PCell (Cell 1) and FR1 PSCell (Cell 2). The test parameters and applicability for Cell 1 are defined in A.3.7.2. The test parameters for the Cell 2 are given in Table A.4.6.4.4.2-1 and Table A.4.6.4.4.2-2 below.

In CSI measurement configuration, UE is indicated to perform L1-RSRP measurement on the CSI-RS and report aperiodically. The test consists of a single time period T1, during which the UE is triggered via DCI to report L1-RSRP on aperiodic CSI-RS resources. UE is also configured to measure L1-RSRP based on SSB. After 80ms from the beginning of the test, the DCI trigger comes in slot n (0 for Config 1,2,4,5 and 8 for Config 3,6) of a frame and UE provides the report back based on the reporting configuration as defined in Table A.4.6.4.4.2-1.

There is no measurement gap configured in the test. Before the test, UE is configured to perform RLM and BFD based on the SSBs.

Table A.4.6.4.4.2-1: General test parameters

Parameter	Config	Unit	Value
SSB GSCN	1~6		freq1
Duplex mode	1,4		FDD
	2,5		TDD
	3,6		TDD
TDD Configuration	1,4		N/A
	2,5		TDDConf.1.1
	3,6		TDDConf.2.1
BW _{channel}	1,4	MHz	10: N _{RB,c} = 52
	2,5		10: N _{RB,c} = 52
	3,6		40: N _{RB,c} = 106

PDSCH Reference measurement channel	1,4		SR.1.1 FDD
	2,5		SR.1.1 TDD
	3,6		SR.2.1 TDD
RMSI CORESET Reference Channel	1,4		CR.1.1 FDD
	2,5		CR.1.1 TDD
	3,6		CR.2.1 TDD
Dedicated CORESET Reference Channel	1,4		CCR.1.1 FDD
	2,5		CCR.1.1 TDD
	3,6		CCR.2.1 TDD
SSB configuration	1,4		SSB.3 FR1
	2,5		SSB.3 FR1
	3,6		SSB.4 FR1
CSI-RS configuration	1,4		CSI-RS 1.3 FDD
	2,5		CSI-RS 1.3 TDD
	3,6		CSI-RS 2.3 TDD
OCNG Patterns	1~6		OP.1
TRS Configuration	1,4		TRS.1.1 FDD
	2,5		TRS.1.1 TDD
	3,6		TRS.1.2 TDD
Initial BWP Configuration	1~6		DLBWP.0.1 ULBWP.0.1
Dedicated BWP configuration	1~6		DLBWP.1.1 ULBWP.1.1
SMTTC configuration	1~6		SMTTC.1
DRX configuration	1~6		DRX.3
reportConfigType	1~6		aperiodic
reportQuantity	1~6		cri-RSRP
Number of reported RS	1~6		2
qcl-Info	1~6		SSB#0 for resource#0
			SSB#1 for resource#1
reportSlotOffsetList	1~6	slots	8
T1	1~6	s	5
EPRE ratio of PSS to SSS	1~6	dB	0
EPRE ratio of PBCH DMRS to SSS			
EPRE ratio of PBCH to PBCH DMRS			
EPRE ratio of PDCCH DMRS to SSS			
EPRE ratio of PDCCH to PDCCH DMRS			
EPRE ratio of PDSCH DMRS to SSS			
EPRE ratio of PDSCH to PDSCH DMRS			
EPRE ratio of OCNG DMRS to SSS ^{Note 1}			
EPRE ratio of OCNG to OCNG DMRS ^{Note 1}			
Propagation condition	1~6		AWGN
Note 1: OCNG shall be used such that both cells are fully allocated and a constant total transmitted power spectral density is achieved for all OFDM symbols.			

Table A.4.6.4.2-2: CSI-RS specific test parameters

Parameter	Config	Unit	CSI-RS#0	CSI-RS#1
N_{oc} ^{Note1}	1~6	dBm/15kHz	-94.65	
N_{oc} ^{Note1}	1,2,4,5	dBm/SSB SCS	-94.65	
	3,6		-91.65	

\hat{E}_s / I_{ot}	1~6	dB	0	3
CSI-RS RSRP <small>Note2</small>	1,2,4,5	dBm/SSB SCS	-94.65	-91.65
	3,6		-91.65	-88.65
I_o <small>Note2</small>	1,2,4,5	dBm/9.36 MHz	-63.69	-61.93
	3,6	dBm/38.16 MHz	-57.59	-55.84
\hat{E}_s / N_{oc}	1~6	dB	0	3
<p>Note 2: Interference from other cells and noise sources not specified in the test is assumed to be constant over subcarriers and time and shall be modelled as AWGN of appropriate power for N_{oc} to be fulfilled.</p> <p>Note 3: CSI-RS RSRP and I_o levels have been derived from other parameters for information purposes. They are not settable parameters themselves.</p>				

A.4.6.4.4.3 Test Requirements

After 80ms from the beginning of the test, the UE shall send L1-RSRP report at slot 8 from the reception of DCI triggering the L1-RSRP measurement. The L1-RSRP report shall include the results for both CSI-RS#0 and CSI-RS#1 while meeting absolute accuracy requirement in clause 10.1.20.1.1 and relative accuracy requirement in clause 10.1.20.1.2.

The rate of correct events observed during repeated tests shall be at least 90%.

NOTE: The actual overall delays measured in the test may be up to $2 \times TTI_{DCCH}$ higher than the measurement reporting delays above because of TTI insertion uncertainty of the measurement report in DCCH.

A.4.7 Measurement Performance requirements

Unless explicitly stated otherwise:

- Reported measurements shall be within defined range of accuracy limits defined in Clause 10 for at least 90 % of the reported cases. If multiple measurement performance requirements are verified in the same test, the reported measurements for each requirement shall be within defined range of accuracy limits of the corresponding requirement defined in Clause 10 for at least 90% of the reported cases.
- Measurements are performed in RRC_CONNECTED state.
- The reference channels assume transmission of PDSCH with a maximum number of 5 HARQ transmissions unless otherwise specified.

A.4.7.1 SS-RSRP

A.4.7.1.1 EN-DC Intra-frequency measurement accuracy with FR1 serving cell and FR1 target cell

A.4.7.1.1.1 Test Purpose and Environment

The purpose of this test is to verify that the SS-RSRP measurement accuracy is within the specified limits. This test will verify the requirements in Clauses 10.1.2.1.1 and 10.1.2.1.2 for intra-frequency measurements.

A.4.7.1.1.2 Test parameters

In this set of test cases all NR cells are on the same carrier frequency. Supported test configurations are shown in table A.4.7.1.1.2-1. Both absolute and relative accuracy of SS-RSRP intra-frequency measurements are tested by using the parameters in A.4.7.1.1.2-2. The configuration of cell 1 (E-UTRA PCell) is specified in clause A.3.7.2.1 In all test cases, Cell 2 is the PSCell, and Cell 3 is the target cell.

Table A.4.7.1.1.2-1: SS-RSRP Intra frequency SS-RSRP supported test configurations

Config	Description
1	LTE FDD, NR 15 kHz SSB SCS, 10 MHz bandwidth, FDD duplex mode
2	LTE FDD, NR 15 kHz SSB SCS, 10 MHz bandwidth, TDD duplex mode
3	LTE FDD, NR 30kHz SSB SCS, 40 MHz bandwidth, TDD duplex mode
4	LTE TDD, NR 15 kHz SSB SCS, 10 MHz bandwidth, FDD duplex mode
5	LTE TDD, NR 15 kHz SSB SCS, 10 MHz bandwidth, TDD duplex mode
6	LTE TDD, NR 30kHz SSB SCS, 40 MHz bandwidth, TDD duplex mode

Note: The UE is only required to be tested in one of the supported test configurations for each supported band

Table A.4.7.1.1.2-2: SS-RSRP Intra frequency test parameters

Parameter	Unit	Test 1		Test 2		Test 3	
		Cell 2	Cell 3	Cell 2	Cell 3	Cell 2	Cell 3
Physical cell ID		489	0	489	0	489	0
SSB ARFCN		freq1		freq1		freq1	
Duplex mode	Config 1,4	FDD					
	Config 2,3,5,6	TDD					
TDD configuration	Config 1,4	Not Applicable					
	Config 2,5	TDDConf.1.1					
	Config 3,6	TDDConf.2.1					
BW _{channel}	Config 1,4	10: N _{RB,c} = 52					
	Config 2,5	10: N _{RB,c} = 52					
	Config 3,6	40: N _{RB,c} = 106					
Downlink initial BWP configuration		DLBWP.0.1					
Downlink dedicated BWP configuration		DLBWP.1.1					
Uplink initial BWP configuration		ULBWP.0.1					
Uplink dedicated BWP configuration		ULBWP.1.1					
TRS configuration	Config 1,4	TRS.1.1 FDD	NA	TRS.1.1 FDD	NA	TRS.1.1 FDD	NA
	Config 2,5	TRS.1.1 TDD	NA	TRS.1.1 TDD	NA	TRS.1.1 TDD	NA
	Config 3,6	TRS.1.2 TDD	NA	TRS.1.2 TDD	NA	TRS.1.2 TDD	NA
DRX Cycle	ms	Not Applicable					
PDSCH Reference measurement channel	Config 1,4	SR.1.1 FDD	-	SR.1.1 FDD	-	SR.1.1 FDD	-
	Config 2,5	SR.1.1 TDD	-	SR.1.1 TDD	-	SR.1.1 TDD	-
	Config 3,6	SR2.1 TDD	-	SR2.1 TDD	-	SR2.1 TDD	-
RMSI CORESET Reference Channel	Config 1,4	CR.1.1 FDD	-	CR.1.1 FDD	-	CR.1.1 FDD	-
	Config 2,5	CR.1.1 TDD	-	CR.1.1 TDD	-	CR.1.1 TDD	-
	Config 3,6	CR2.1 TDD	-	CR2.1 TDD	-	CR2.1 TDD	-
Control Channel RMC	Config 1,4	CCR.1.1 FDD	-	CCR.1.1 FDD	-	CCR.1.1 FDD	-
	Config 2,5	CCR.1.1 TDD	-	CCR.1.1 TDD	-	CCR.1.1 TDD	-
	Config 3,6	CCR2.1 TDD	-	CCR2.1 TDD	-	CCR2.1 TDD	-
SSB configuration	Config 1,4	SSB.1 FR1	SSB.1 FR1	SSB.1 FR1	SSB.1 FR1	SSB.1 FR1	SSB.1 FR1

	Config 2,5		SSB.1 FR1	SSB.1 FR1	SSB.1 FR1	SSB.1 FR1	SSB.1 FR1	SSB.1 FR1	
	Config 3,6		SSB.2 FR1	SSB.2 FR1	SSB.2 FR1	SSB.2 FR1	SSB.2 FR1	SSB.2 FR1	
Time offset with Cell 2	Config 1,4	ms	-	3	-	3	-	3	
	Config 2,3,5,6	μs	-	3	-	3	-	3	
SMTC configuration	Config 1,4		SMTC.2						
	Config 2,3,5,6		SMTC.1						
OCNG Patterns			OP.1						
PDSCH/PDCCH subcarrier spacing	Config 1,2,4,5	kHz	15 kHz						
	Config 3,6		30kHz						
EPRE ratio of PSS to SSS		dB	0	0	0	0	0	0	
EPRE ratio of PBCH DMRS to SSS									
EPRE ratio of PBCH to PBCH DMRS									
EPRE ratio of PDCCH DMRS to SSS									
EPRE ratio of PDCCH to PDCCH DMRS									
EPRE ratio of PDSCH DMRS to SSS									
EPRE ratio of PDSCH to PDSCH									
EPRE ratio of OCNG DMRS to SSS(Note 1)									
EPRE ratio of OCNG to OCNG DMRS (Note 1)									
N_{oc} ^{Note2}	Config 1,2,4,5	NR_FDD_FR1_A, NR_TDD_FR1_A <small>NOTE 6</small>	-106			-88		-114	
		NR_FDD_FR1_B						-113.5	
		NR_TDD_FR1_C						-113	
		NR_FDD_FR1_D, NR_TDD_FR1_D						-112.5	
		NR_FDD_FR1_E, NR_TDD_FR1_E						-112	
		NR_FDD_FR1_G						-111	
		NR_FDD_FR1_H						-110.5	
	Config 3,6	NR_FDD_FR1_A, NR_TDD_FR1_A <small>NOTE 6</small>	Not applicable ^{Note 5}			-94		-114	
		NR_FDD_FR1_B						-113.5	
		NR_TDD_FR1_C						-113	
		NR_FDD_FR1_D, NR_TDD_FR1_D						-112.5	
		NR_FDD_FR1_E, NR_TDD_FR1_E						-112	
		NR_FDD_FR1_G						-111	
		NR_FDD_FR1_H						-110.5	
N_{oc} ^{Note2}	Config 1,2,4,5		-106			-88	Same as Noc/15kHz		
	Config 3,6	NR_FDD_FR1_A, NR_TDD_FR1_A <small>NOTE 6</small>	Not applicable ^{Note 5}			-91	-111		
		NR_FDD_FR1_B					-110.5		
		NR_TDD_FR1_C					-110		
		NR_FDD_FR1_D, NR_TDD_FR1_D					-109.5		
		NR_FDD_FR1_E, NR_TDD_FR1_E					-109		
		NR_FDD_FR1_G					-108		
		NR_FDD_FR1_H					-107.5		
							-0.01	-4.76	
SS- RSRP ^{Note3}	Config 1,2,4,5	NR_FDD_FR1_A, NR_TDD_FR1_A <small>NOTE 6</small>	dBm/SCS	-100	-105	-82	-87	-111.00	-114.00
		NR_FDD_FR1_B						-110.50	-113.50
		NR_TDD_FR1_C						-110.00	-113.00
		NR_FDD_FR1_D, NR_TDD_FR1_D						-109.50	-112.50

		NR_FDD_FR1_E, NR_TDD_FR1_E						-109.00	-112.00	
		NR_FDD_FR1_G						-108.00	-111.00	
		NR_FDD_FR1_H						-107.50	-110.50	
	Config 3,6		NR_FDD_FR1_A, NR_TDD_FR1_A NOTE 6						-108.00	-111.00
			NR_FDD_FR1_B						-107.50	-110.50
			NR_TDD_FR1_C						-107.00	-110.00
			NR_FDD_FR1_D, NR_TDD_FR1_D		- Not applicable ^{Note 5}	Not applicable ^{Note 5}	-85	-90	-106.50	-109.50
			NR_FDD_FR1_E, NR_TDD_FR1_E						-106.00	-109.00
			NR_FDD_FR1_G						-105.00	-108.00
			NR_FDD_FR1_H						-104.50	-107.50
Io ^{Note3}	Config 1,2,4,5	NR_FDD_FR1_A, NR_TDD_FR1_A NOTE 6	dBm/ 9.36MHz					-80.03		
		NR_FDD_FR1_B						-79.53		
		NR_TDD_FR1_C						-79.03		
		NR_FDD_FR1_D, NR_TDD_FR1_D						-78.53		
		NR_FDD_FR1_E, NR_TDD_FR1_E						-78.03		
		NR_FDD_FR1_G						-77.03		
		NR_FDD_FR1_H						-76.53		
	Config 3,6		NR_FDD_FR1_A, NR_TDD_FR1_A NOTE 6	dBm/ 38.16MHz	Not applicable ^{Note 5}				-73.94	
			NR_FDD_FR1_B						-73.44	
			NR_TDD_FR1_C						-72.94	
			NR_FDD_FR1_D, NR_TDD_FR1_D						-72.44	
			NR_FDD_FR1_E, NR_TDD_FR1_E						-71.94	
			NR_FDD_FR1_G						-70.94	
			NR_FDD_FR1_H						-70.44	
Propagation condition			-	AWGN						
Antenna configuration			1x2							
<p>Note 1: OCNG shall be used such that both cells are fully allocated and a constant total transmitted power spectral density is achieved for all OFDM symbols.</p> <p>Note 2: Interference from other cells and noise sources not specified in the test is assumed to be constant over subcarriers and time and shall be modelled as AWGN of appropriate power for N_{oc} to be fulfilled.</p> <p>Note 3: SS-RSRP and Io levels have been derived from other parameters for information purposes. They are not settable parameters themselves.</p> <p>Note 4: SS-RSRP minimum requirements are specified assuming independent interference and noise at each receiver antenna port.</p> <p>Note 5: Subtest 1 is not used when testing with 30kHz SSB SCS</p> <p>Note 6: The test configuration excludes support for band n51 and it is not required to run this test on band n51 in this release of the specification</p>										

A.4.7.1.1.3 Test Requirements

The SS-RSRP measurement accuracy for cell 2 and cell 3 shall fulfil absolute requirement in clause 10.1.2.1.1 and relative requirement in clause 10.1.2.1.2.

A.4.7.1.2 EN-DC inter-frequency measurement accuracy with FR1 serving cell and FR1 target cell

A.4.7.1.2.1 Test Purpose and Environment

The purpose of this test is to verify that the SS-RSRP measurement accuracy is within the specified limits. This test will verify the requirements in Clauses 10.1.4.1.1 and 10.1.4.1.2 for inter-frequency measurements with the testing configurations in Table A.4.7.1.2.1-1.

Table A.4.7.1.2.1-1: Applicable NR configurations for FR1 inter-frequency SS-RSRP accuracy test

Config	Description
1	LTE FDD, NR 15 kHz SSB SCS, 10 MHz bandwidth, FDD duplex mode
2	LTE FDD, NR 15 kHz SSB SCS, 10 MHz bandwidth, TDD duplex mode
3	LTE FDD, NR 30 kHz SSB SCS, 40 MHz bandwidth, TDD duplex mode
4	LTE TDD, NR 15 kHz SSB SCS, 10 MHz bandwidth, FDD duplex mode
5	LTE TDD, NR 15 kHz SSB SCS, 10 MHz bandwidth, TDD duplex mode
6	LTE TDD, NR 30 kHz SSB SCS, 40 MHz bandwidth, TDD duplex mode

Note: The UE is only required to be tested in one of the supported test configurations on each supported band

A.4.7.1.2.2 Test parameters

In this set of test cases there are three cells in the test, E-UTRAN PCell (Cell 1), FR1 PSCell (Cell 2) and a FR1 neighbour cell (Cell 3) on a different frequency than the PSCell. The test parameters and applicability for Cell 1 are defined in A.3.7.2. The test parameters for the Cell 2 and Cell 3 are given in Table A.4.7.1.2.2-1 below. Both absolute and relative accuracy of RSRP inter-frequency measurements are tested by using the parameters in Table A.4.7.1.2.2-1. The inter-frequency measurements are supported by a measurement gap.

Table A.4.7.1.2.2-1: SS-RSRP inter-frequency test parameters

Parameter	Config	Unit	Test 1		Test 2	
			Cell 2 freq1	Cell 3 freq2	Cell 2 freq1	Cell 3 freq2
SSB ARFCN	1~6					
BW _{channel}	1,4	MHz	10: N _{RB,c} = 52		10: N _{RB,c} = 52	
	2,5		10: N _{RB,c} = 52		10: N _{RB,c} = 52	
	3,6		40: N _{RB,c} = 106		40: N _{RB,c} = 106	
Gap pattern ID			0		0	
Duplex mode	1,4		FDD		FDD	
	2,5		TDD		TDD	
	3,6		TDD		TDD	
TDD configuration	1,4		N/A		N/A	
	2,5		TDDConf.1.1		TDDConf.1.1	
	3,6		TDDConf.2.1		TDDConf.2.1	
PDSCH Reference measurement channel	1,4		SR.1.1 FDD	-	SR.1.1 FDD	-
	2,5		SR.1.1 TDD		SR.1.1 TDD	
	3,6		SR.2.1 FDD		SR.2.1 FDD	
RMSI CORESET Reference Channel	1,4		CR.1.1 FDD	-	CR.1.1 FDD	-
	2,5		CR.1.1 TDD		CR.1.1 TDD	
	3,6		CR.2.1 FDD		CR.2.1 FDD	
Dedicated CORESET Reference Channel	1,4		CCR.1.1 FDD	-	CCR.1.1 FDD	-
	2,5		CCR.1.1 TDD		CCR.1.1 TDD	

	3,6		CCR.2.1 TDD	-	CCR.2.1 TDD	-	
SSB configuration	1,4		SSB.1 FR1		SSB.1 FR1		
	2,5		SSB.1 FR1		SSB.1 FR1		
	3,6		SSB.2 FR1		SSB.2 FR1		
OCNG Patterns	1~6		OP.1		OP.1		
TRS configuration	1,4		TRS.1.1 FDD		TRS.1.1 FDD		
	2,5		TRS.1.1 TDD	-	TRS.1.1 TDD	-	
	3,6		TRS.1.2 TDD		TRS.1.2 TDD		
Initial BWP Configuration	1~6		DLBWP.0.1 ULBWP.0.1		DLBWP.0.1 ULBWP.0.1		
Dedicated BWP configuration	1~6		DLBWP.1.1 ULBWP.1.1		DLBWP.1.1 ULBWP.1.1		
Time offset with Cell 2	1,4	ms	-	3	-	3	
	2,3,5,6	µs	-	3	-	3	
SMTC configuration	1,4		SMTC.2		SMTC.2		
	2,3,5,6		SMTC.1		SMTC.1		
EPRE ratio of PSS to SSS	1~6	dB	0	0	0	0	
EPRE ratio of PBCH DMRS to SSS							
EPRE ratio of PBCH to PBCH DMRS							
EPRE ratio of PDCCH DMRS to SSS							
EPRE ratio of PDCCH to PDCCH DMRS							
EPRE ratio of PDSCH DMRS to SSS							
EPRE ratio of PDSCH to PDSCH DMRS							
EPRE ratio of OCNG DMRS to SSS ^{Note 1}							
EPRE ratio of OCNG to OCNG DMRS ^{Note 1}							
N_{oc} ^{Note2}							NR_FDD_FR1_A, NR_TDD_FR1_A <small>NOTE 5</small>
	NR_FDD_FR1_B	-114.5					
	NR_TDD_FR1_C	-114					
	NR_FDD_FR1_D, NR_TDD_FR1_D	-113.5					
	NR_FDD_FR1_E, NR_TDD_FR1_E	-113					
	NR_FDD_FR1_G	-112					
	NR_FDD_FR1_H	-111.5					
	N_{oc} ^{Note2}	NR_FDD_FR1_A, NR_TDD_FR1_A <small>NOTE 5</small>	1,2,4,5	dBm/SS B SCS	-94.65	$(N_{oc}$ for Cell 3 +8dB)	-115
NR_FDD_FR1_B		-114.5					
NR_TDD_FR1_C		-114					
NR_FDD_FR1_D, NR_TDD_FR1_D		-113.5					
NR_FDD_FR1_E, NR_TDD_FR1_E		-113					
NR_FDD_FR1_G		-112					
NR_FDD_FR1_H		-111.5					
NR_FDD_FR1_A, NR_TDD_FR1_A <small>NOTE 5</small>		3,6				$(N_{oc}$ for C 3 +8dB)	-112.00
NR_FDD_FR1_B							-111.50
NR_TDD_FR1_C							-111.00

	NR_FDD_FR1_D, NR_TDD_FR1_D						-110.50	
	NR_FDD_FR1_E, NR_TDD_FR1_E						-110.00	
	NR_FDD_FR1_G						-109.00	
	NR_FDD_FR1_H						-108.50	
	\hat{E}_s / I_{ot}	1~6	dB	10	10	13	-3	
SS- RSRP ^{Note3}	NR_FDD_FR1_A, NR_TDD_FR1_A <small>NOTE 5,</small>	1,2,4,5	dBm/SC S	-84.65	(RSRP for Cell 3 +25dB)		-118.00	
	NR_FDD_FR1_B						-117.50	
	NR_TDD_FR1_C						-117.00	
	NR_FDD_FR1_D, NR_TDD_FR1_D						-116.50	
	NR_FDD_FR1_E, NR_TDD_FR1_E						-116.00	
	NR_FDD_FR1_G						-115.00	
	NR_FDD_FR1_H	-114.50						
	NR_FDD_FR1_A, NR_TDD_FR1_A <small>NOTE 5,</small>	3,6		-81.65	(RSRP for Cell 3 +25dB)		-115.00	
	NR_FDD_FR1_B						-114.50	
	NR_TDD_FR1_C						-114.00	
	NR_FDD_FR1_D, NR_TDD_FR1_D						-113.50	
	NR_FDD_FR1_E, NR_TDD_FR1_E						-113.00	
	NR_FDD_FR1_G						-112.00	
	NR_FDD_FR1_H	-111.50						
I _o ^{Note3}	NR_FDD_FR1_A, NR_TDD_FR1_A <small>NOTE 6,</small>	1,2,4,5	dBm/ 9.36MH z	-56.28	(I _o for Channel 3 +19.75dB)		-85.28	
	NR_FDD_FR1_B						-84.78	
	NR_TDD_FR1_C						-84.28	
	NR_FDD_FR1_D, NR_TDD_FR1_D						-83.78	
	NR_FDD_FR1_E, NR_TDD_FR1_E						-83.28	
	NR_FDD_FR1_G						-82.28	
	NR_FDD_FR1_H	-81.78						
	NR_FDD_FR1_A, NR_TDD_FR1_A <small>NOTE 6,</small>	3,6		dBm/ 38.16M Hz	-50.19	(I _o for Channel 3 +19.75dB)		-79.19
	NR_FDD_FR1_B							-78.69
	NR_TDD_FR1_C							-78.19
	NR_FDD_FR1_D, NR_TDD_FR1_D							-77.69
	NR_FDD_FR1_E, NR_TDD_FR1_E							-77.19
	NR_FDD_FR1_G							-76.19
	NR_FDD_FR1_H	-75.69						
	\hat{E}_s / N_{oc}	1~6	dB	10	10	13	-3	
	Propagation condition	1~6	-	AWGN		AWGN		
	Antenna configuration			1x2		1x2		
<p>Note 1: OCNG shall be used such that both cells are fully allocated and a constant total transmitted power spectral density is achieved for all OFDM symbols.</p> <p>Note 2: Interference from other cells and noise sources not specified in the test is assumed to be constant over subcarriers and time and shall be modelled as AWGN of appropriate power for N_{oc} to be fulfilled.</p>								

Note 3:	RSRP and Io levels have been derived from other parameters for information purposes. They are not settable parameters themselves.
Note 4:	RSRP minimum requirements are specified assuming independent interference and noise at each receiver antenna port.
Note 5:	The test configuration excludes support for band n51 and it is not required to run this test on band n51 in this release of the specification

A.4.7.1.2.3 Test Requirements

The SS-RSRP measurement accuracy for Cell 2 and Cell 3 shall fulfil the Absolute requirement in clause 10.1.4.1.1 and Relative requirement in clause 10.1.4.1.2.

A.4.7.1.3 Void

A.4.7.2 SS-RSRQ

A.4.7.2.1 EN-DC Intra-frequency measurement accuracy with FR1 serving cell and FR1 target cell

A.4.7.2.1.1 Test Purpose and Environment

The purpose of this test is to verify that the SS-RSRQ measurement accuracy is within the specified limits. This test will verify the requirements in Clause 10.1.7.1.1.

A.4.7.2.1.2 Test Parameters

In this test case all cells are on the same carrier frequency. Supported test configuration are shown in Table A.4.7.2.1.2-1. The absolute accuracy of SS-RSRQ intra-frequency measurement is test by using the parameters in Table A.4.7.2.1.2-2. The configuration of cell 1 (E-UTRA PCell) is specified in clause A.3.7.2.1. In all test cases, Cell 2 is the PCell and Cell 3 is the target cell.

Table A.4.7.2.1.2-1: SS-RSRQ Intra frequency SS-RSRQ supported test configurations

Config	Description
1	LTE FDD, NR 15 kHz SSB SCS, 10MHz bandwidth, FDD duplex mode
2	LTE FDD, NR 15 kHz SSB SCS, 10MHz bandwidth, TDD duplex mode
3	LTE FDD, NR 30kHz SSB SCS, 40MHz bandwidth, TDD duplex mode
4	LTE TDD, NR 15 kHz SSB SCS, 10MHz bandwidth, FDD duplex mode
5	LTE TDD, NR 15 kHz SSB SCS, 10MHz bandwidth, TDD duplex mode
6	LTE TDD, NR 30kHz SSB SCS, 40MHz bandwidth, TDD duplex mode

Note: The UE is only required to be tested in one of the supported test configurations in each supported band

Table A.4.7.2.1.2-2: SS-RSRQ Intra frequency test parameters

Parameter	Unit	Test 1		Test 2		Test 3	
		Cell 2	Cell 3	Cell 2	Cell 3	Cell 2	Cell 3
Cell ID		489	0	489	0	489	0
SSB ARFCN		freq1		freq1		freq1	
Duplex mode	Config 1,4	FDD					
	Config 2,3,5,6	TDD					
TDD configuration	Config 1,4	Not Applicable					
	Config 2,5	TDDConf.1.1					
	Config 3,6	TDDConf.2.1					

BW _{channel}	Config 1,4	MHz	10: N _{RB,c} = 52					
	Config 2,5		10: N _{RB,c} = 52					
	Config 3,6		40: N _{RB,c} = 106					
BWP configuration	Initial DL BWP		DLBWP.0.1					
	Dedicated DL BWP		DLBWP.1.1					
	Initial UL BWP		ULBWP.0.1					
	Dedicated UL BWP		ULBWP.1.1					
DRX Cycle		ms	Not Applicable					
PDSCH Reference measurement channel	Config 1,4		SR.1.1 FDD	-	SR.1.1 FDD	-	SR.1.1 FDD	-
	Config 2,5		SR.1.1 TDD		SR.1.1 TDD		SR.1.1 TDD	
	Config 3,6		SR2.1 TDD		SR2.1 TDD		SR2.1 TDD	
RMSI CORESET Reference Channel	Config 1,4		CR.1.1 FDD	-	CR.1.1 FDD	-	CR.1.1 FDD	-
	Config 2,5		CR.1.1 TDD		CR.1.1 TDD		CR.1.1 TDD	
	Config 3,6		CR.2.1 TDD		CR.2.1 TDD		CR.2.1 TDD	
Control Channel RMC	Config 1,4		CCR.1.1 FDD	-	CCR.1.1 FDD	-	CCR.1.1 FDD	-
	Config 2,5		CCR.1.1 TDD		CCR.1.1 TDD		CCR.1.1 TDD	
	Config 3,6		CCR.2.1 TDD		CCR.2.1 TDD		CCR.2.1 TDD	
TRS configuration	Config 1,4		TRS.1.1 FDD	-	TRS.1.1 FDD	-	TRS.1.1 FDD	-
	Config 2,5		TRS.1.1 TDD		TRS.1.1 TDD		TRS.1.1 TDD	
	Config 3,6		TRS.1.2 TDD		TRS.1.2 TDD		TRS.1.2 TDD	
OCNG Patterns			OP. 1					
SS-RSSI-Measurement			Not Applicable					
Time offset with Cell 2	Config 1,4	ms	-	3	-	3	-	3
	Config 2,3,5,6	µs	-	3	-	3	-	3
SMTc configuration	Config 1,4	SMTc.2						
	Config 2,3,5,6	SMTc.1						
SSB configuration	Config 1,2,4,5	SSB.1 FR1						
	Config 3,6	SSB.2 FR1						
PDSCH/PDCCH subcarrier spacing	Config 1,2,4,5	kHz	15 kHz					
	Config 3,6		30kHz					
EPRE ratio of PSS to SSS		dB	0	0	0	0	0	0
EPRE ratio of PBCH DMRS to SSS								
EPRE ratio of PBCH to PBCH DMRS								
EPRE ratio of PDCCH DMRS to SSS								
EPRE ratio of PDCCH to PDCCH DMRS								
EPRE ratio of PDSCH DMRS to SSS								
EPRE ratio of PDSCH to PDSCH								
EPRE ratio of OCNG DMRS to SSS(Note 1)								
EPRE ratio of OCNG to OCNG DMRS (Note 1)								
N _{oc} Note2	Config 1,2,4,5	dBm/15k Hz	-85		-101			-114
								-113.5
								-113
								-112.5

		NR_FDD_FR1_E, NR_TDD_FR1_E					-112									
		NR_FDD_FR1_G					-111									
		NR_FDD_FR1_H					-110.5									
	Config 3,6	NR_FDD_FR1_A, NR_TDD_FR1_A NOTE 7					-114									
		NR_FDD_FR1_B					-113.5									
		NR_TDD_FR1_C					-113									
		NR_FDD_FR1_D, NR_TDD_FR1_D					-112.5									
		NR_FDD_FR1_E, NR_TDD_FR1_E					-112									
		NR_FDD_FR1_G					-111									
		NR_FDD_FR1_H					-110.5									
N_{oc} Note2	Config 1,2,4,5	NR_FDD_FR1_A, NR_TDD_FR1_A NOTE 7	dBm/SC S				-114									
		NR_FDD_FR1_B					-113.5									
		NR_TDD_FR1_C					-113									
		NR_FDD_FR1_D, NR_TDD_FR1_D					-112.5									
		NR_FDD_FR1_E, NR_TDD_FR1_E					-112									
		NR_FDD_FR1_G					-111									
		NR_FDD_FR1_H					-110.5									
	Config 3,6	NR_FDD_FR1_A, NR_TDD_FR1_A NOTE 7					-111									
		NR_FDD_FR1_B					-110.5									
		NR_TDD_FR1_C					-110									
		NR_FDD_FR1_D, NR_TDD_FR1_D					-109.5									
		NR_FDD_FR1_E, NR_TDD_FR1_E					-109									
		NR_FDD_FR1_G					-108									
		NR_FDD_FR1_H					-107.5									
\hat{E}_s/I_{ot}			dB		-1.76		-4.7		-5.46		-5.46					
\hat{E}_s/N_{oc}			dB		3		3		-2.9		-2.9		-4		-4	
SS- RSRP Note3	Config 1,2,4,5	NR_FDD_FR1_A, NR_TDD_FR1_A NOTE 7	dBm/SC S						-118		-118					
		NR_FDD_FR1_B							-117.5		-117.5					
		NR_TDD_FR1_C							-117		-117					
		NR_FDD_FR1_D, NR_TDD_FR1_D							-116.5		-116.5					
		NR_FDD_FR1_E, NR_TDD_FR1_E							-116		-116					
		NR_FDD_FR1_G							-115		-115					
		NR_FDD_FR1_H							-114.5		-114.5					
	Config 3,6	NR_FDD_FR1_A, NR_TDD_FR1_A NOTE 7							-115		-115					
		NR_FDD_FR1_B							-114.5		-114.5					
		NR_TDD_FR1_C							-114		-114					

		NR_FDD_FR1_D, NR_TDD_FR1_D						-113.5	-113.5
		NR_FDD_FR1_E, NR_TDD_FR1_E						-113	-113
		NR_FDD_FR1_G						-112	-112
		NR_FDD_FR1_H						-111.5	-111.5
SS-RSRQ	Note3	NR_FDD_FR1_A, NR_TDD_FR1_A NOTE 7	dB	-14.77	-14.77	-16.76	-16.76	-17.34	-17.34
		NR_FDD_FR1_B							
		NR_TDD_FR1_C							
		NR_FDD_FR1_D, NR_TDD_FR1_D							
		NR_FDD_FR1_E, NR_TDD_FR1_E							
		NR_FDD_FR1_G NR_FDD_FR1_H							
I _o	Note3	NR_FDD_FR1_A, NR_TDD_FR1_A NOTE 7	dBm/ 9.36MHz z	-50		-70			-83.5
		NR_FDD_FR1_B							-83
		NR_TDD_FR1_C							-82.5
		NR_FDD_FR1_D, NR_TDD_FR1_D							-82
		NR_FDD_FR1_E, NR_TDD_FR1_E							-81.5
		NR_FDD_FR1_G							-80.5
		NR_FDD_FR1_H							-80
	Config 3,6	NR_FDD_FR1_A, NR_TDD_FR1_A NOTE 7	dBm/ 38.16M Hz	-50					-77.4
		NR_FDD_FR1_B							-76.9
		NR_TDD_FR1_C							-76.4
		NR_FDD_FR1_D, NR_TDD_FR1_D							-75.9
		NR_FDD_FR1_E, NR_TDD_FR1_E							-75.4
		NR_FDD_FR1_G							-74.4
		NR_FDD_FR1_H							-73.9
Propagation condition			-	AWGN	AWGN	AWGN	AWGN	AWGN	AWGN
Antenna configuration				1x2	1x2	1x2	1x2	1x2	1x2
<p>Note 1: OCNG shall be used such that both cells are fully allocated and a constant total transmitted power spectral density is achieved for all OFDM symbols.</p> <p>Note 2: Interference from other cells and noise sources not specified in the test is assumed to be constant over subcarriers and time and shall be modelled as AWGN of appropriate power for N_{oc} to be fulfilled.</p> <p>Note 3: SS-RSRQ, SS-RSRP, and I_o levels have been derived from other parameters for information purposes. They are not settable parameters themselves.</p> <p>Note 4: SS-RSRQ, SS-RSRP minimum requirements are specified assuming independent interference and noise at each receiver antenna port.</p> <p>Note 5: NR operating band groups are as defined in Clause 3.5.2.</p> <p>Note 6: Subtest 2 is not used when testing with 30kHz SSB SCS.</p> <p>Note 7: The test configuration excludes support for band n51 and it is not required to run this test on band n51 in this release of the specification.</p>									

A.4.7.2.1.3 Test Requirements

The SS-RSRQ measurement accuracy shall fulfil the requirements in clause 10.1.7.1.1.

A.4.7.2.2 EN-DC Inter-frequency measurement accuracy with FR1 serving cell and FR1 target cell

A.4.7.2.2.1 Test Purpose and Environment

The purpose of this test is to verify that the SS-RSRQ measurement accuracy is within the specified limits. This test will verify the requirements in clause 10.1.9.1.1 and 10.1.9.1.2 for inter frequency measurement.

A.4.7.2.2.2 Test Parameters

In this test case the two NR cells (i.e., Cell 2 and Cell 3) are on different carrier frequencies and measurement gaps are provided. Supported test configurations are shown in Table A.4.7.2.2.2-1. Both absolute accuracy and relative accuracy requirements of SS-RSRQ inter-frequency measurement are tested by using test parameters in Table A.4.7.2.2.2-2. In all test cases, Cell 2 is the PCell and Cell 3 is target cell. Cell 1 is the E-UTRA cell which specific test parameters for this test case are specified in Table A.3.7.2.1-1.

Table A.4.7.2.2.2-1: SS-RSRQ Inter frequency SS-RSRQ supported test configurations

Config	Description
1	LTE FDD, NR 15 kHz SSB SCS, 10 MHz bandwidth, FDD duplex mode
2	LTE FDD, NR 15 kHz SSB SCS, 10 MHz bandwidth, TDD duplex mode
3	LTE FDD, NR 30 kHz SSB SCS, 40 MHz bandwidth, TDD duplex mode
4	LTE TDD, NR 15 kHz SSB SCS, 10 MHz bandwidth, FDD duplex mode
5	LTE TDD, NR 15 kHz SSB SCS, 10 MHz bandwidth, TDD duplex mode
6	LTE TDD, NR 30 kHz SSB SCS, 40 MHz bandwidth, TDD duplex mode

Note: The UE is only required to be tested in one of the supported test configurations

Table A.4.7.2.2.2-2: SS-RSRQ Inter frequency test parameters

Parameter		Unit	Test 1		Test 2		Test 3	
			Cell 2	Cell 3	Cell 2	Cell 3	Cell 2	Cell 3
SSB ARFCN			freq1	freq2	freq1	freq2	freq1	freq2
Duplex mode	Config 1,4		FDD					
	Config 2,3,5,6		TDD					
TDD configuration	Config 1,4		Not Applicable					
	Config 2,5		TDDConf.1.1					
	Config 3,6		TDDConf.2.1					
BW _{channel}	Config 1,4	MHz	10: N _{RB,c} = 52					
	Config 2,5		10: N _{RB,c} = 52					
	Config 3,6		40: N _{RB,c} = 106					
BWP BW	Config 1,4	MHz	10: N _{RB,c} = 52					
	Config 2,5		10: N _{RB,c} = 52					
	Config 3,6		40: N _{RB,c} = 106					
DRX Cycle		ms	Not Applicable					
PDSCH Reference measurement channel	Config 1,4		SR.1.1 FDD	-	SR.1.1 FDD	-	SR.1.1 FDD	-
	Config 2,5		SR.1.1 TDD	-	SR.1.1 TDD	-	SR.1.1 TDD	-

		Config 3,6		SR.2.1 TDD		SR.2.1 TDD		SR.2.1 TDD	
RMSI CORESET Reference Channel		Config 1,4		CR.1.1 FDD		CR.1.1 FDD		CR.1.1 FDD	
		Config 2,5		CR.1.1 TDD	-	CR.1.1 TDD	-	CR.1.1 TDD	-
		Config 3,6		CR.2.1 TDD		CR.2.1 TDD		CR.2.1 TDD	
Dedicated CORESET Reference Channel		Config 1,4		CCR.1.1 FDD		CCR.1.1 FDD		CCR.1.1 FDD	
		Config 2,5		CCR.1.1 TDD	-	CCR.1.1 TDD	-	CCR.1.1 TDD	-
		Config 3,6		CCR.2.1 TDD		CCR.2.1 TDD		CCR.2.1 TDD	
TRS configuration		Config 1,4		TRS.1.1 FDD	-	TRS.1.1 FDD	-	TRS.1.1 FDD	-
		Config 2,5		TRS.1.1 TDD		TRS.1.1 TDD		TRS.1.1 TDD	
		Config 3,6		TRS.1.2 TDD		TRS.1.2 TDD		TRS.1.2 TDD	
OCNG Patterns				OCNG pattern 1					
Time offset with Cell 2		Config 1,4	ms	-	3	-	3	-	3
		Config 2,3,5,6	µs	-	3	-	3	-	3
SMTc configuration		Config 1,4		SMTc pattern 2					
		Config 2,3,5,6		SMTc pattern 1					
SSB configuration		Config 1,2,4,5		SSB pattern 1 in FR1					
		Config 3,6		SSB pattern 2 in FR1					
PDSCH/PDCCH subcarrier spacing		Config 1,2,4,5		15 kHz					
		Config 3,6	kHz	30 kHz					
EPRE ratio of PSS to SSS									
EPRE ratio of PBCH DMRS to SSS									
EPRE ratio of PBCH to PBCH DMRS									
EPRE ratio of PDCCH DMRS to SSS									
EPRE ratio of PDCCH to PDCCH DMRS									
EPRE ratio of PDSCH DMRS to SSS				0	0	0	0	0	0
EPRE ratio of PDSCH to PDSCH									
EPRE ratio of OCNG DMRS to SSS(Note 1)									
EPRE ratio of OCNG to OCNG DMRS (Note 1)									
N_{oc} ^{Note2}	Config 1,2,4,5	NR_FDD_FR1_A	dBm/ 15kHz	-80.18	-80.18	-106	-106	-116	-116
		NR_TDD_FR1_A						-115.5	-115.5
		NR_SDL_FR1_A						-115	-115
		NR_FDD_FR1_B						-114.5	-114.5
		NR_TDD_FR1_C						-114	-114
		NR_FDD_FR1_D						-113	-113
		NR_TDD_FR1_D						-112.5	-112.5
		NR_FDD_FR1_E						-112.5	-112.5
	Config 3,6	NR_TDD_FR1_E	dBm/ 15kHz	-86.27	-86.27	-113	-113	-116	-116
		NR_FDD_FR1_F						-115.5	-115.5
		NR_TDD_FR1_G						-115	-115
		NR_FDD_FR1_G						-114.5	-114.5
		NR_TDD_FR1_H						-114	-114
		NR_FDD_FR1_H						-112.5	-112.5

Config 3,6	NR_TDD_FR1_D	dBm/ 38.16MHz	-50	-50	-76.73	-76.73		
	NR_FDD_FR1_E						-81.28	-83.83
	NR_TDD_FR1_E							
	NR_FDD_FR1_G						-80.28	-82.83
	NR_FDD_FR1_H						-79.78	-82.33
	NR_FDD_FR1_A						-77.19	-79.73
	NR_TDD_FR1_A							
	NR_SDL_FR1_A							
	NR_FDD_FR1_B						-76.69	-79.23
	NR_TDD_FR1_C						-76.19	-78.73
	NR_FDD_FR1_D						-75.69	-78.23
	NR_TDD_FR1_D							
	NR_FDD_FR1_E						-75.19	-77.73
NR_TDD_FR1_E								
NR_FDD_FR1_G	-74.19	-76.73						
NR_FDD_FR1_H	-73.69	-76.53						
Propagation condition			AWGN	AWGN	AWGN	AWGN	AWGN	AWGN
<p>Note 1: OCNG shall be used such that both cells are fully allocated and a constant total transmitted power spectral density is achieved for all OFDM symbols.</p> <p>Note 2: Interference from other cells and noise sources not specified in the test is assumed to be constant over subcarriers and time and shall be modelled as AWGN of appropriate power for N_{oc} to be fulfilled.</p> <p>Note 3: SS-RSRQ, SS-RSRP, and I_o levels have been derived from other parameters for information purposes. They are not settable parameters themselves.</p> <p>Note 4: SS-RSRQ, SS-RSRP minimum requirements are specified assuming independent interference and noise at each receiver antenna port.</p> <p>Note 5: NR operating band groups are as defined in Section 3.5.2.</p>								

A.4.7.2.2.3 Test Requirements

The SS-RSRQ measurement accuracy shall fulfil the requirements in section 10.1.9.1.1 and 10.1.9.1.2.

A.4.7.3 SS-SINR

A.4.7.3.1 EN-DC Intra-frequency measurement accuracy with FR1 serving cell and FR1 target cell

A.4.7.3.1.1 Test Purpose and Environment

The purpose of this test is to verify that the SS-SINR measurement accuracy is within the specified limits. This test will verify the requirements in clause 10.1.12.1.1.

A.4.7.3.1.2 Test Parameters

In this test case all cells are on the same carrier frequency. Supported test configuration are shown in Table A.4.7.3.1.2-1. The absolute accuracy of SS-SINR intra-frequency measurement is tested by using the parameters in Table A.4.7.3.1.2-2. The configuration of cell 1 (E-UTRA PCell) is specified in clause A.3.7.2.1. In all test cases, Cell 2 is the PCell and Cell 3 is the target cell.

Table A.4.7.3.1.2-1: SS-SINR Intra frequency SS-SINR supported test configurations

Config	Description
1	LTE FDD, NR 15 kHz SSB SCS, 10 MHz bandwidth, FDD duplex mode
2	LTE FDD, NR 15 kHz SSB SCS, 10 MHz bandwidth, TDD duplex mode
3	LTE FDD, NR 30 kHz SSB SCS, 40 MHz bandwidth, TDD duplex mode
4	LTE TDD, NR 15 kHz SSB SCS, 10 MHz bandwidth, FDD duplex mode
5	LTE TDD, NR 15 kHz SSB SCS, 10 MHz bandwidth, TDD duplex mode
6	LTE TDD, NR 30 kHz SSB SCS, 40 MHz bandwidth, TDD duplex mode

Note: The UE is only required to be tested in one of the supported test configurations
--

Table A.4.7.3.1.2-2: SS-SINR Intra frequency test parameters

Parameter		Unit	Test 1		Test 2	
			Cell 2	Cell 3	Cell 2	Cell 3
Cell ID			489	0	489	0
SSB ARFCN			freq1		freq1	
Duplex mode	Config 1,4		FDD			
	Config 2,3,5,6		TDD			
TDD configuration	Config 1,4		Not Applicable			
	Config 2,5		TDDConf.1.1			
	Config 3,6		TDDConf.2.1			
Downlink initial BWP configuration			DLBWP.0.1			
Downlink dedicated BWP configuration			DLBWP.1.1			
Uplink initial BWP configuration			ULBWP.0.1			
Uplink dedicated BWP configuration			ULBWP.1.1			
DRX Cycle configuration		ms	Not Applicable			
TRS Configuration	Config 1,4		TRS.1.1 FDD		TRS.1.1 FDD	
	Config 2,5		TRS.1.1 TDD	-	TRS.1.1 TDD	-
	Config 3,6		TRS.1.2 TDD		TRS.1.2 TDD	
PDSCH Reference measurement channel	Config 1,4		SR.1.1 FDD		SR.1.1 FDD	
	Config 2,5		SR.1.1 TDD	-	SR.1.1 TDD	-
	Config 3,6		SR.2.1 TDD		SR.2.1 TDD	
RMSI CORESET Reference Channel	Config 1,4		CR.1.1 FDD		CR.1.1 FDD	
	Config 2,5		CR.1.1 TDD	-	CR.1.1 TDD	-
	Config 3,6		CR.2.1 TDD		CR.2.1 TDD	
Dedicated CORESET Reference Channel	Config 1,4		CCR.1.1 FDD		CCR.1.1 FDD	
	Config 2,5		CCR.1.1 TDD	-	CCR.1.1 TDD	-
	Config 3,6		CCR.2.1 TDD		CCR.2.1 TDD	
OCNG Patterns			OP.1			
SS-RSSI-Measurement			Not Applicable			
Time offset with Cell 2	Config 1,4	ms	-	3	-	3
	Config 2,3,5,6	µs	-	3	-	3
SMTC configuration	Config 1,4		SMTC.2			
	Config 2,3,5,6		SMTC.1			
SSB configuration	Config 1,2,4,5		SSB.1 FR1			
	Config 3,6		SSB.2 FR1			
PDSCH/PDCCH subcarrier spacing	Config 1,2,4,5		15			
	Config 3,6	kHz	30			
EPRE ratio of PSS to SSS						
EPRE ratio of PBCH DMRS to SSS						
EPRE ratio of PBCH to PBCH DMRS						
EPRE ratio of PDCCH DMRS to SSS						
EPRE ratio of PDCCH to PDCCH DMRS						
EPRE ratio of PDSCH DMRS to SSS						
EPRE ratio of PDSCH to PDSCH						
EPRE ratio of OCNG DMRS to SSS(Note 1)						
EPRE ratio of OCNG to OCNG DMRS (Note 1)						
		dB	0	0	0	0

N_{oc} ^{Note2}	NR_FDD_FR1_A, NR_TDD_FR1_A NOTE 6		dBm/15kHz z	-93	-116		
	NR_FDD_FR1_B				-115.5		
	NR_TDD_FR1_C				-115		
	NR_FDD_FR1_D, NR_TDD_FR1_D				-114.5		
	NR_FDD_FR1_E, NR_TDD_FR1_E				-114		
	NR_FDD_FR1_G				-113		
	NR_FDD_FR1_H				-112.5		
N_{oc} ^{Note2}	Config 1,2,4,5		dBm/SCS	-93	Same as Noc for 15kHz		
	Config 3,6	NR_FDD_FR1_A, NR_TDD_FR1_A NOTE 6			-113		
		NR_FDD_FR1_B			-112.5		
		NR_TDD_FR1_C			-112		
		NR_FDD_FR1_D, NR_TDD_FR1_D			-111.5		
		NR_FDD_FR1_E, NR_TDD_FR1_E			-111		
		NR_FDD_FR1_G			-110		
NR_FDD_FR1_H		-109.5					
\hat{E}_s / I_{ot}			dB	0	-3.19	-5.46	-5.46
\hat{E}_s / N_{oc}			dB	4.54	2.66	-4	-4
SS-RSRP ^{Note3}	Config 1,2,4,5	NR_FDD_FR1_A, NR_TDD_FR1_A NOTE 6		-88.46	-90.34	-120	-120
		NR_FDD_FR1_B				-119.5	-119.5
		NR_TDD_FR1_C				-119	-119
		NR_FDD_FR1_D, NR_TDD_FR1_D				-118.5	-118.5
		NR_FDD_FR1_E, NR_TDD_FR1_E				-118	-118
		NR_FDD_FR1_G				-117	-117
	NR_FDD_FR1_H		-116.5	-116.5			
	Config 3,6	NR_FDD_FR1_A, NR_TDD_FR1_A NOTE 6		-85.46	-87.34	-117	-117
		NR_FDD_FR1_B				-116.5	-116.5
		NR_TDD_FR1_C				-116	-116
		NR_FDD_FR1_D, NR_TDD_FR1_D				-115.5	-115.5
		NR_FDD_FR1_E, NR_TDD_FR1_E				-115	-115
		NR_FDD_FR1_G				-114	-114
NR_FDD_FR1_H		-113.5	-113.5				
SS-SINR ^{Note3}	NR_FDD_FR1_A, NR_TDD_FR1_A NOTE 6		dB	0	-3.19	-5.46	-5.46
	NR_FDD_FR1_B						
	NR_TDD_FR1_C						
	NR_FDD_FR1_D, NR_TDD_FR1_D						
	NR_FDD_FR1_E, NR_TDD_FR1_E						
	NR_FDD_FR1_G						
NR_FDD_FR1_H							

Io ^{Note3}	Config 1,2,4,5	NR_FDD_FR1_A, NR_TDD_FR1_A NOTE 6	dBm/ 9.36MHz	-57.5	-85.51
		NR_FDD_FR1_B			-85.01
		NR_TDD_FR1_C			-84.51
		NR_FDD_FR1_D, NR_TDD_FR1_D			-84.01
		NR_FDD_FR1_E, NR_TDD_FR1_E			-83.51
		NR_FDD_FR1_G			-82.51
		NR_FDD_FR1_H			-82.01
	Config 3,6	NR_FDD_FR1_A, NR_TDD_FR1_A NOTE 6	dBm/ 38.16MHz	-51.41	-79.41
		NR_FDD_FR1_B			-78.91
		NR_TDD_FR1_C			-78.41
		NR_FDD_FR1_D, NR_TDD_FR1_D			-77.91
		NR_FDD_FR1_E, NR_TDD_FR1_E			-77.41
		NR_FDD_FR1_G			-76.41
		NR_FDD_FR1_H			-75.91
Propagation condition		-	AWGN		
Antenna configuration		-	1x2		
<p>Note 1: OCNG shall be used such that both cells are fully allocated and a constant total transmitted power spectral density is achieved for all OFDM symbols.</p> <p>Note 2: Interference from other cells and noise sources not specified in the test is assumed to be constant over subcarriers and time and shall be modelled as AWGN of appropriate power for N_{oc} to be fulfilled.</p> <p>Note 3: SS-SINR, SS-RSRP, and Io levels have been derived from other parameters for information purposes. They are not settable parameters themselves.</p> <p>Note 4: SS-SINR, SS-RSRP minimum requirements are specified assuming independent interference and noise at each receiver antenna port.</p> <p>Note 5: NR operating band groups are as defined in Clause 3.5.2.</p> <p>Note 6: The test configuration excludes support for band n51 and it is not required to run this test on band n51 in this release of the specification.</p>					

A.4.7.3.1.3 Test Requirements

The SS-SINR measurement accuracy shall fulfil the requirements in clause 10.1.12.1.1.

A.4.7.3.2 EN-DC Inter-frequency measurement accuracy with FR1 serving cell and FR1 target cell

A.4.7.3.2.1 Test Purpose and Environment

The purpose of this test is to verify that the SS-SINR measurement accuracy is within the specified limits. This test will verify the requirements in clause 10.1.14.1.1 and 10.1.14.1.2 for interfrequency measurement.

A.4.7.3.2.2 Test Parameters

In this test case the two NR cells (i.e., Cell 2 and Cell 3) are on different carrier frequencies and measurement gaps are provided. Supported test configurations are shown in Table A.4.7.3.2.2-1. Both absolute accuracy and relative accuracy requirements of SS-SINR inter-frequency measurement are tested by using test parameters in Table A.4.7.3.2.2-2. In all test cases, Cell 2 is the PSCell and Cell 3 is target cell. Cell 1 is the E-UTRA cell of which specific test parameters for this test case are specified in Table A.3.7.2.1-1.

Table A.4.7.3.2.2-1: SS-SINR Inter frequency SS-SINR supported test configurations

Config	Description
1	LTE FDD, NR 15 kHz SSB SCS, 10 MHz bandwidth, FDD duplex mode
2	LTE FDD, NR 15 kHz SSB SCS, 10 MHz bandwidth, TDD duplex mode
3	LTE FDD, NR 30 kHz SSB SCS, 40 MHz bandwidth, TDD duplex mode
4	LTE TDD, NR 15 kHz SSB SCS, 10 MHz bandwidth, FDD duplex mode
5	LTE TDD, NR 15 kHz SSB SCS, 10 MHz bandwidth, TDD duplex mode
6	LTE TDD, NR 30 kHz SSB SCS, 40 MHz bandwidth, TDD duplex mode

Note: The UE is only required to be tested in one of the supported test configurations

Table A.4.7.3.2.2-2: SS-SINR Inter frequency test parameters

Parameter		Unit	Test 1		Test 2		Test 3	
			Cell 2	Cell 3	Cell 2	Cell 3	Cell 2	Cell 3
SSB ARFCN			freq1	freq2	freq1	freq2	freq1	freq2
Duplex mode	Config 1,4		FDD					
	Config 2,3,5,6		TDD					
TDD configuration	Config 1,4		Not Applicable					
	Config 2,5		TDDConf.1.1					
	Config 3,6		TDDConf.2.1					
Downlink initial BWP configuration			DLBWP.0.1					
Downlink dedicated BWP configuration			DLBWP.1.1					
Uplink initial BWP configuration			ULBWP.0.1					
Uplink dedicated BWP configuration			ULBWP.1.1					
DRX Cycle configuration		ms	Not Applicable					
Gap pattern ID			0	-	0	-	0	-
TRS Configuration	Config 1,4		TRS.1.1 FDD		TRS.1.1 FDD		TRS.1.1 FDD	
	Config 2,5		TRS.1.1 TDD	-	TRS.1.1 TDD	-	TRS.1.1 TDD	-
	Config 3,6		TRS.1.2 TDD		TRS.1.2 TDD		TRS.1.2 TDD	
PDSCH Reference measurement channel	Config 1,4		SR.1.1 FDD		SR.1.1 FDD		SR.1.1 FDD	
	Config 2,5		SR.1.1 TDD	-	SR.1.1 TDD	-	SR.1.1 TDD	-
	Config 3,6		SR.2.1 TDD		SR.2.1 TDD		SR.2.1 TDD	
RMSI CORESET Reference Channel	Config 1,4		CR.1.1 FDD		CR.1.1 FDD		CR.1.1 FDD	
	Config 2,5		CR.1.1 TDD	-	CR.1.1 TDD	-	CR.1.1 TDD	-
	Config 3,6		CR.2.1 TDD		CR.2.1 TDD		CR.2.1 TDD	
Dedicated CORESET Reference Channel	Config 1,4		CCR.1.1 FDD		CCR.1.1 FDD		CCR.1.1 FDD	
	Config 2,5		CCR.1.1 TDD	-	CCR.1.1 TDD	-	CCR.1.1 TDD	-

		Config 3,6		CCR.2. 1 TDD		CCR.2. 1 TDD		CCR.2. 1 TDD	
OCNG Patterns				OP.1					
SS-RSSI-Measurement				Not Applicable					
SMTC configuration				SMTC.1					
Time offset with Cell 2	Config 1,4		ms	-	3	-	3	-	3
	Config 2,3,5,6		µs	-	3	-	3	-	3
SMTC configuration	Config 1,4			SMTC.2					
	Config 2,3,5,6			SMTC.1					
SSB configuration	Config 1,2,4,5			SSB.1 FR1					
	Config 3,6			SSB.2 FR1					
PDSCH/PDCCH subcarrier spacing	Config 1,2,4,5		kHz	15					
	Config 3,6			30					
EPRE ratio of PSS to SSS			dB	0	0	0	0	0	0
EPRE ratio of PBCH DMRS to SSS									
EPRE ratio of PBCH to PBCH DMRS									
EPRE ratio of PDCCH DMRS to SSS									
EPRE ratio of PDCCH to PDCCH DMRS									
EPRE ratio of PDSCH DMRS to SSS									
EPRE ratio of PDSCH to PDSCH									
EPRE ratio of OCNG DMRS to SSS(Note 1)									
EPRE ratio of OCNG to OCNG DMRS (Note 1)									
N_{oc} ^{Note2}	Config 1,2,4,5	NR_FDD_FR1_A NR_TDD_FR1_A NOTE 6	dBm/15k Hz	-88	-108.5				-119.5
		NR_FDD_FR1_B							-119
		NR_TDD_FR1_C							-118.5
		NR_FDD_FR1_D NR_TDD_FR1_D							-118
		NR_FDD_FR1_E NR_TDD_FR1_E							-117.5
		NR_FDD_FR1_G							-116.5
		NR_FDD_FR1_H							-116
N_{oc} ^{Note2}	Config 1,2,4,5		dBm/SC S	-88	-108.5				Same as Noc for 15kHz
	Config 3,6	NR_FDD_FR1_A NR_TDD_FR1_A NOTE 6							-116.5
		NR_FDD_FR1_B							-116
		NR_TDD_FR1_C							-115.5
		NR_FDD_FR1_D NR_TDD_FR1_D							-115
		NR_FDD_FR1_E NR_TDD_FR1_E							-114.5
		NR_FDD_FR1_G							-114.5
NR_FDD_FR1_H	-113								
\hat{E}_s / I_{ot}			dB	-1.75	20	-4.0			
\hat{E}_s / N_{oc}			dB	-1.75	20	-4.0			
SS-RSRP ^{Not e3}	Config 1,2,4,5	NR_FDD_FR1_A NR_TDD_FR1_A NOTE 6	dBm/SC S	-89.75	-88.5				-123.5
		NR_FDD_FR1_B							-123
		NR_TDD_FR1_C							-122.5

		NR_FDD_FR1_D				-122				
		NR_TDD_FR1_D				-121.5				
		NR_FDD_FR1_E				-120.5				
		NR_TDD_FR1_E				-120				
	Config 3,6	NOTE 6				NR_FDD_FR1_A	-86.75	-85.5	-120.5	
						NR_TDD_FR1_A			-120	
						NR_FDD_FR1_B			-119.5	
						NR_TDD_FR1_C			-119	
						NR_FDD_FR1_D			-118.5	
						NR_TDD_FR1_D			-117.5	
						NR_FDD_FR1_E			-117	
						NR_TDD_FR1_E				
SS-SINR ^{Note3}	NOTE 6	NR_FDD_FR1_A	dB	-1.75	20	-4.0				
		NR_TDD_FR1_A								
		NR_FDD_FR1_B								
		NR_TDD_FR1_C								
		NR_FDD_FR1_D								
		NR_TDD_FR1_D								
		NR_FDD_FR1_E								
NR_TDD_FR1_E										
I_o ^{Note3}	Config 1,2,4,5	NOTE 6	dBm/ 9.36MHz	-57.83	-60.5	-90.09				
						NR_FDD_FR1_B	-89.59			
						NR_TDD_FR1_C	-89.09			
						NR_FDD_FR1_D	-88.59			
						NR_TDD_FR1_D	-88.09			
						NR_FDD_FR1_E	-87.09			
						NR_TDD_FR1_E	-86.59			
	Config 3,6	NOTE 6				38.16MHz	-51.73	-54.41	-84	
									NR_FDD_FR1_B	-83.5
									NR_TDD_FR1_C	-83
									NR_FDD_FR1_D	-82.5
									NR_TDD_FR1_D	-82
									NR_FDD_FR1_E	-81
									NR_TDD_FR1_E	-80.5
Propagation condition			-	AWGN						
Antenna configuration			-	1x2						
<p>Note 1: OCNG shall be used such that both cells are fully allocated and a constant total transmitted power spectral density is achieved for all OFDM symbols.</p> <p>Note 2: Interference from other cells and noise sources not specified in the test is assumed to be constant over subcarriers and time and shall be modelled as AWGN of appropriate power for N_{oc} to be fulfilled.</p>										

Note 3:	SS-SINR, SS-RSRP, and Io levels have been derived from other parameters for information purposes. They are not settable parameters themselves.
Note 4:	SS-SINR, SS-RSRP minimum requirements are specified assuming independent interference and noise at each receiver antenna port.
Note 5:	NR operating band groups are as defined in Clause 3.5.2.
Note 6:	The test configuration excludes support for band n51 and it is not required to run this test on band n51 in this release of the specification.

A.4.7.3.2.3 Test Requirements

The SS-SINR measurement accuracy shall fulfil the requirements in clause 10.1.14.1.1 and 10.1.14.1.2.

A.4.7.4 L1-RSRP measurement for beam reporting

A.4.7.4.1 SSB based L1-RSRP measurement

A.4.7.4.1.1 Test Purpose and Environment

The purpose of this test is to verify that the L1-RSRP measurement accuracy is within the specified limits. This test will verify the requirements in Clauses 9.5.2 and clause 10.1.19.1 for L1-RSRP measurements based on SSB with the testing configurations for NR cells in Table A.4.7.4.1.1-1.

Table A.4.7.4.1.1-1: Applicable NR configurations for FR1 SSB based L1-RSRP test

Config	Description
1	LTE FDD, NR 15 kHz SSB SCS, 10 MHz bandwidth, FDD duplex mode
2	LTE FDD, NR 15 kHz SSB SCS, 10 MHz bandwidth, TDD duplex mode
3	LTE FDD, NR 30kHz SSB SCS, 40 MHz bandwidth, TDD duplex mode
4	LTE TDD, NR 15 kHz SSB SCS, 10 MHz bandwidth, FDD duplex mode
5	LTE TDD, NR 15 kHz SSB SCS, 10 MHz bandwidth, TDD duplex mode
6	LTE TDD, NR 30kHz SSB SCS, 40 MHz bandwidth, TDD duplex mode
Note:	The UE is only required to be tested in one of the supported test configurations in each supported band

A.4.7.4.1.2 Test parameters

In this set of test cases there are two cells in the test, E-UTRAN PCell (Cell 1), FR1 PSCell (Cell 2). The test parameters and applicability for Cell 1 are defined in A.3.7.2. The test parameters for the Cell 2 are given in Table A.4.7.4.1.2-1 below. The absolute and relative accuracy of L1-RSRP measurements are tested by using the parameters in Table A.4.7.4.1.2-1.

There is no measurement gap configured in the test. Before the test, UE is configured one SSB resource set with two SSB resources. UE is configured to perform RLM, BFD and L1-RSRP measurement based on the SSB resources 0 and 1.

Table A.4.7.4.1.2-1: FR1 SSB based L1-RSRP test parameters

Parameter	Config	Unit	Test 1	Test 2
SSB GSCN	1~6		freq1	freq1
Duplex mode	1,4		FDD	FDD
	2,5		TDD	TDD
	3,6		TDD	TDD
TDD Configuration	1,4		N/A	N/A
	2,5		TDDConf.1.1	TDDConf.1.1

	3,6		TDDConf.2.1	TDDConf.2.1	
BW _{channel}	1,4	MHz	10: N _{RB,c} = 52	10: N _{RB,c} = 52	
	2,5		10: N _{RB,c} = 52	10: N _{RB,c} = 52	
	3,6		40: N _{RB,c} = 106	40: N _{RB,c} = 106	
PDSCH Reference measurement channel	1,4		SR.1.1 FDD	SR.1.1 FDD	
	2,5		SR.1.1 TDD	SR.1.1 TDD	
	3,6		SR.2.1 TDD	SR.2.1 TDD	
RMSI CORESET Reference Channel	1,4		CR.1.1 FDD	CR.1.1 FDD	
	2,5		CR.1.1 TDD	CR.1.1 TDD	
	3,6		CR.2.1 TDD	CR.2.1 TDD	
Dedicated CORESET Reference Channel	1,4		CCR.1.1 FDD	CCR.1.1 FDD	
	2,5		CCR.1.1 TDD	CCR.1.1 TDD	
	3,6		CCR.2.1 TDD	CCR.2.1 TDD	
SSB configuration	1,4		SSB.3 FR1	SSB.3 FR1	
	2,5		SSB.3 FR1	SSB.3 FR1	
	3,6		SSB.4 FR1	SSB.4 FR1	
OCNG Patterns	1~6		OP.1	OP.1	
TRS configuration	1,4		TRS.1.1 FDD	TRS.1.1 FDD	
	2,5		TRS.1.1 TDD	TRS.1.1 TDD	
	3,6		TRS.1.2 TDD	TRS.1.2 TDD	
Initial BWP Configuration	1~6		DLBWP.0.1 ULBWP.0.1	DLBWP.0.1 ULBWP.0.1	
Dedicated BWP configuration	1~6		DLBWP.1.1 ULBWP.1.1	DLBWP.1.1 ULBWP.1.1	
SMTC configuration	1~6		SMTC.1	SMTC.1	
reportConfigType	1~6		periodic	periodic	
reportQuantity	1~6		ssb-Index-RSRP	ssb-Index-RSRP	
Number of reported RS	1~6		2	2	
L1-RSRP reporting period	1~6		slot80	slot80	
EPRE ratio of PSS to SSS	1~6	dB	0	0	
EPRE ratio of PBCH DMRS to SSS					
EPRE ratio of PBCH to PBCH DMRS					
EPRE ratio of PDCCH DMRS to SSS					
EPRE ratio of PDCCH to PDCCH DMRS					
EPRE ratio of PDSCH DMRS to SSS					
EPRE ratio of PDSCH to PDSCH DMRS					
EPRE ratio of OCNG DMRS to SSS ^{Note 1}					
EPRE ratio of OCNG to OCNG DMRS ^{Note 1}					
N _{oc} Note2					1~6
	NR_FDD_FR1_B	-116.5			
	NR_TDD_FR1_C	-116			
	NR_FDD_FR1_D, NR_TDD_FR1_D	-115.5			
	NR_FDD_FR1_E, NR_TDD_FR1_E	-115			
	NR_FDD_FR1_G	-114			
	NR_FDD_FR1_H	-113.5			
N _{oc} Note2	1,2,4,5	dBm/SSB SCS	-94.65	NR_FDD_FR1_A, NR_TDD_FR1_A NOTE 5	-117
				NR_FDD_FR1_B	-116.5

	NR_TDD_FR1_C	3,6		-91.65	-116	
	NR_FDD_FR1_D, NR_TDD_FR1_D				-115.5	
	NR_FDD_FR1_E, NR_TDD_FR1_E				-115	
	NR_FDD_FR1_G				-114	
	NR_FDD_FR1_H				-113.5	
	NR_FDD_FR1_A, NR_TDD_FR1_A NOTE 5				-114	
	NR_FDD_FR1_B				-113.5	
	NR_TDD_FR1_C				-114	
	NR_FDD_FR1_D, NR_TDD_FR1_D				-112.5	
	NR_FDD_FR1_E, NR_TDD_FR1_E				-112	
	NR_FDD_FR1_G				-111	
	NR_FDD_FR1_H				-110.5	
\hat{E}_s / I_{ot}		1~6	dB	10	-3	
SSB RSRP Note3	NR_FDD_FR1_A, NR_TDD_FR1_A NOTE 5	1,2,4,5	dBm/SSB SCS	-84.65	-120	
	NR_FDD_FR1_B				-119.5	
	NR_TDD_FR1_C				-119	
	NR_FDD_FR1_D, NR_TDD_FR1_D				-118.5	
	NR_FDD_FR1_E, NR_TDD_FR1_E				-118	
	NR_FDD_FR1_G				-117	
	NR_FDD_FR1_H	-116.5				
	NR_FDD_FR1_A, NR_TDD_FR1_A NOTE 5	3,6		-81.65	-117	
	NR_FDD_FR1_B				-116.5	
	NR_TDD_FR1_C				-116	
	NR_FDD_FR1_D, NR_TDD_FR1_D				-115.5	
	NR_FDD_FR1_E, NR_TDD_FR1_E				-115	
	NR_FDD_FR1_G				-114	
	NR_FDD_FR1_H				-113.5	
I _o Note3	NR_FDD_FR1_A, NR_TDD_FR1_A NOTE 5	1,2,4,5	dBm/9.36 MHz	-56.28	-87.28	
	NR_FDD_FR1_B				-86.78	
	NR_TDD_FR1_C				-86.28	
	NR_FDD_FR1_D, NR_TDD_FR1_D				-85.78	
	NR_FDD_FR1_E, NR_TDD_FR1_E				-85.28	
	NR_FDD_FR1_G				-84.28	
	NR_FDD_FR1_H	-83.78				
	NR_FDD_FR1_A, NR_TDD_FR1_A NOTE 5	3,6		dBm/38.16 MHz	-50.19	-81.19
	NR_FDD_FR1_B					-80.69

	NR_TDD_FR1_C				-80.19
	NR_FDD_FR1_D, NR_TDD_FR1_D				-79.69
	NR_FDD_FR1_E, NR_TDD_FR1_E				-79.19
	NR_FDD_FR1_G				-78.19
	NR_FDD_FR1_H				-77.69
	\hat{E}_s / N_{oc}	1~6	dB	10	-3
	Propagation condition	1~6		AWGN	AWGN
	Antenna configuration	1~6		1x2	1x2
Note 1:	OCNG shall be used such that both cells are fully allocated and a constant total transmitted power spectral density is achieved for all OFDM symbols.				
Note 2:	Interference from other cells and noise sources not specified in the test is assumed to be constant over subcarriers and time and shall be modelled as AWGN of appropriate power for N_{oc} to be fulfilled.				
Note 3:	RSRP and I_0 levels have been derived from other parameters for information purposes. They are not settable parameters themselves.				
Note 4:	RSRP minimum requirements are specified assuming independent interference and noise at each receiver antenna port.				
Note 5:	The test configuration excludes support for band n51 and it is not required to run this test on band n51 in this release of the specification.				

A.4.7.4.1.3 Test Requirements

The L1-RSRP measurement accuracy for SSB resource reported by UE in L1-RSRP report (SSB#0 or SSB#1) of Cell 2 shall fulfil the requirements in clauses 10.1.19.1.

A.4.7.4.2 CSI-RS based L1-RSRP measurement on resource set with repetition off

A.4.7.4.2.1 Test Purpose and Environment

The purpose of this test is to verify that the L1-RSRP measurement accuracy is within the specified limits. This test will verify the requirements in Clauses 9.5.3 and clause 10.1.19.2 for L1-RSRP measurements based on CSI-RS with the testing configurations for NR cells in Table A.4.7.4.2.1-1.

Table A.4.7.4.2.1-1: Applicable NR configurations for FR1 CSI-RS based L1-RSRP test

Config	Description
1	LTE FDD, NR 15 kHz CSI-RS SCS, 10 MHz bandwidth, FDD duplex mode
2	LTE FDD, NR 15 kHz CSI-RS SCS, 10 MHz bandwidth, TDD duplex mode
3	LTE FDD, NR 30kHz CSI-RS SCS, 40 MHz bandwidth, TDD duplex mode
4	LTE TDD, NR 15 kHz CSI-RS SCS, 10 MHz bandwidth, FDD duplex mode
5	LTE TDD, NR 15 kHz CSI-RS SCS, 10 MHz bandwidth, TDD duplex mode
6	LTE TDD, NR 30kHz CSI-RS SCS, 40 MHz bandwidth, TDD duplex mode
Note:	The UE is only required to be tested in one of the supported test configurations in each supported band

A.4.7.4.2.2 Test parameters

In this set of test cases there are two cells in the test, E-UTRAN PCell (Cell 1), FR1 PSCell (Cell 2). The test parameters and applicability for Cell 1 are defined in A.3.7.2. The test parameters for the Cell 2 are given in Table

A.4.7.4.2.2-1 below. The absolute and relative accuracy of L1-RSRP measurements are tested by using the parameters in Table A.4.7.4.2.2-1.

There is no measurement gap configured in the test. Before the test, UE is configured one CSI-RS resource set with two CSI-RS resources. UE is configured to perform RLM and BFD based on SSB 0 and 1. CSI-RS is not transmitted in the same OFDM symbols as SSB.

Table A.4.7.4.2.2-1: FR1 CSI-RS based L1-RSRP test parameters

Parameter	Config	Unit	Test 1	Test 2
SSB GSCN	1~6		freq1	freq1
Duplex mode	1,4		FDD	FDD
	2,5		TDD	TDD
	3,6		TDD	TDD
TDD Configuration	1,4		N/A	N/A
	2,5		TDDConf.1.1	TDDConf.1.1
	3,6		TDDConf.2.1	TDDConf.2.1
BW _{channel}	1,4	MHz	10: N _{RB,c} = 52	10: N _{RB,c} = 52
	2,5		10: N _{RB,c} = 52	10: N _{RB,c} = 52
	3,6		40: N _{RB,c} = 106	40: N _{RB,c} = 106
PDSCH Reference measurement channel	1,4		SR.1.1 FDD	SR.1.1 FDD
	2,5		SR.1.1 TDD	SR.1.1 TDD
	3,6		SR.2.1 TDD	SR.2.1 TDD
RMSI CORESET Reference Channel	1,4		CR.1.1 FDD	CR.1.1 FDD
	2,5		CR.1.1 TDD	CR.1.1 TDD
	3,6		CR.2.1 TDD	CR.2.1 TDD
Dedicated CORESET Reference Channel	1,4		CCR.1.1 FDD	CCR.1.1 FDD
	2,5		CCR.1.1 TDD	CCR.1.1 TDD
	3,6		CCR.2.1 TDD	CCR.2.1 TDD
SSB configuration	1,4		SSB.3 FR1	SSB.3 FR1
	2,5		SSB.3 FR1	SSB.3 FR1
	3,6		SSB.4 FR1	SSB.4 FR1
OCNG Patterns	1~6		OP.1	OP.1
TRS configuration	1,4		TRS.1.1 FDD	TRS.1.1 FDD
	2,5		TRS.1.1 TDD	TRS.1.1 TDD
	3,6		TRS.1.2 TDD	TRS.1.2 TDD
Initial BWP Configuration	1~6		DLBWP.0.1 ULBWP.0.1	DLBWP.0.1 ULBWP.0.1
Dedicated BWP configuration	1~6		DLBWP.1.1 ULBWP.1.1	DLBWP.1.1 ULBWP.1.1
SMTc configuration	1~6		SMTc.1	SMTc.1
CSI-RS	1,4		CSI-RS 1.2 FDD	CSI-RS 1.2 FDD
	2,5		CSI-RS 1.2 TDD	CSI-RS 1.2 TDD
	3,6		CSI-RS 2.2 TDD	CSI-RS 2.2 FDD
reportConfigType	1~6		periodic	periodic
reportQuantity	1~6		cri-RSRP	cri-RSRP
Number of reported RS	1~6		2	2
L1-RSRP reporting period	1~6		slot80	slot80
EPRE ratio of PSS to SSS	1~6	dB	0	0
EPRE ratio of PBCH DMRS to SSS				
EPRE ratio of PBCH to PBCH DMRS				
EPRE ratio of PDCCH DMRS to SSS				
EPRE ratio of PDCCH to PDCCH DMRS				
EPRE ratio of PDSCH DMRS to SSS				

EPRE ratio of PDSCH to PDSCH DMRS					
EPRE ratio of OCNG DMRS to SSS ^{Note 1}					
EPRE ratio of OCNG to OCNG DMRS ^{Note 1}					
N_{oc} Note2	NR_FDD_FR1_A, NR_TDD_FR1_A NOTE 5	1~6	dBm/15kHz	-94.65	-117
	NR_FDD_FR1_B				-116.5
	NR_TDD_FR1_C				-116
	NR_FDD_FR1_D, NR_TDD_FR1_D				-115.5
	NR_FDD_FR1_E, NR_TDD_FR1_E				-115
	NR_FDD_FR1_G				-114
	NR_FDD_FR1_H				-113.5
N_{oc} Note2	NR_FDD_FR1_A, NR_TDD_FR1_A NOTE 5	1,2,4,5	dBm/CSI-RS SCS	-94.65	-117
	NR_FDD_FR1_B				-116.5
	NR_TDD_FR1_C				-116
	NR_FDD_FR1_D, NR_TDD_FR1_D				-115.5
	NR_FDD_FR1_E, NR_TDD_FR1_E				-115
	NR_FDD_FR1_G				-114
	NR_FDD_FR1_H				-113.5
	NR_FDD_FR1_A, NR_TDD_FR1_A NOTE 5	3,6	-91.65	-114	
	NR_FDD_FR1_B			-113.5	
	NR_TDD_FR1_C			-114	
	NR_FDD_FR1_D, NR_TDD_FR1_D			-112.5	
	NR_FDD_FR1_E, NR_TDD_FR1_E			-112	
	NR_FDD_FR1_G			-111	
	NR_FDD_FR1_H			-110.5	
\hat{E}_s/I_{ot}		1~6	dB	10	10
CSI-RS RSRP Note3	NR_FDD_FR1_A, NR_TDD_FR1_A NOTE 5	1,2,4,5	dBm/CSI-RS SCS	-84.65	-120
	NR_FDD_FR1_B				-119.5
	NR_TDD_FR1_C				-119
	NR_FDD_FR1_D, NR_TDD_FR1_D				-118.5
	NR_FDD_FR1_E, NR_TDD_FR1_E				-118
	NR_FDD_FR1_G				-117
	NR_FDD_FR1_H				-116.5
	NR_FDD_FR1_A, NR_TDD_FR1_A NOTE 5	3,6	-81.65	-117	
	NR_FDD_FR1_B			-116.5	
	NR_TDD_FR1_C			-116	

	NR_FDD_FR1_D, NR_TDD_FR1_D				-115.5
	NR_FDD_FR1_E, NR_TDD_FR1_E				-115
	NR_FDD_FR1_G				-114
	NR_FDD_FR1_H				-113.5
I _o <small>Note3</small>	NR_FDD_FR1_A, NR_TDD_FR1_A <small>NOTE 5</small>	1,2,4,5	dBm/9.36 MHz	-56.28	-87.28
	NR_FDD_FR1_B				-86.78
	NR_TDD_FR1_C				-86.28
	NR_FDD_FR1_D, NR_TDD_FR1_D				-85.78
	NR_FDD_FR1_E, NR_TDD_FR1_E				-85.28
	NR_FDD_FR1_G				-84.28
	NR_FDD_FR1_H	-83.78			
	NR_FDD_FR1_A, NR_TDD_FR1_A <small>NOTE 5</small>	3,6	dBm/38.16 MHz	-50.19	-81.19
	NR_FDD_FR1_B				-80.69
	NR_TDD_FR1_C				-80.19
	NR_FDD_FR1_D, NR_TDD_FR1_D				-79.69
	NR_FDD_FR1_E, NR_TDD_FR1_E				-79.19
	NR_FDD_FR1_G				-78.19
	NR_FDD_FR1_H	-77.69			
\hat{E}_s / N_{oc}	1~6	dB	10	-3	
Propagation condition	1~6		AWGN	AWGN	
Antenna configuration	1~6		1x2	1x2	
<p>Note 1: OCNG shall be used such that both cells are fully allocated and a constant total transmitted power spectral density is achieved for all OFDM symbols.</p> <p>Note 2: Interference from other cells and noise sources not specified in the test is assumed to be constant over subcarriers and time and shall be modelled as AWGN of appropriate power for N_{oc} to be fulfilled.</p> <p>Note 3: RSRP and I_o levels have been derived from other parameters for information purposes. They are not settable parameters themselves.</p> <p>Note 4: RSRP minimum requirements are specified assuming independent interference and noise at each receiver antenna port.</p> <p>Note 5: The test configuration excludes support for band n51 and it is not required to run this test on band n51 in this release of the specification.</p>					

A.4.7.4.2.3 Test Requirements

The L1-RSRP measurement accuracy for CSI-RS resource reported by UE in L1-RSRP report (CSI-RS#0 or CSI-RS#1) of Cell 2 shall fulfil the requirements in clauses 10.1.19.2.

A.4.7.5 SFTD accuracy

A.4.7.5.1 SFTD accuracy

A.4.7.5.1.1 Test Purpose and Environment

The purpose of this set of tests is to verify that the SFTD measurement accuracy is within the specified limits. This test will verify the requirements as specified in clause 9.1.27 in TS 36.133 [15] for EN-DC SFTD measurements.

A.4.7.5.1.2 Test Parameters

Supported test configurations are shown in Table A.4.7.5.1.2-1. In this set of test cases there are two cells on different carriers. Cell 1 is E-UTRAN PCell and Cell 2 is NR FR1 PSCell. The test parameters of cell 1 are given in clause A.3.7.2.1. The test parameters of cell 2 are given in Table A.4.7.5.1.2-2. The SFTD between PCell and PSCell shall be set by the test equipment to one of the time differences in Table A.4.7.5.1.2-3.

Table A.4.7.5.1.2-1: Supported test configurations for SFTD accuracy

Configuration	Description
1	NR 15 kHz SSB SCS, 10 MHz bandwidth, FDD duplex mode, LTE FDD
2	NR 15 kHz SSB SCS, 10 MHz bandwidth, TDD duplex mode, LTE FDD
3	NR 30 kHz SSB SCS, 40 MHz bandwidth, TDD duplex mode, LTE FDD
4	NR 15 kHz SSB SCS, 10 MHz bandwidth, FDD duplex mode, LTE TDD
5	NR 15 kHz SSB SCS, 10 MHz bandwidth, TDD duplex mode, LTE TDD
6	NR 30kHz SSB SCS, 40 MHz bandwidth, TDD duplex mode, LTE TDD

Note: The UE is only required to be tested in one of the supported test configurations

Table A.4.7.5.1.2-2: Test parameters for SFTD accuracy

Parameter	Config	Unit	Test 1
SSB GSCN	1~6		freq1
Duplex mode	1,4		FDD
	2,5		TDD
	3,6		TDD
TDD Configuration	1,4		N/A
	2,5		TDDConf.1.1
	3,6		TDDConf.2.1
BW _{channel}	1,4	MHz	10: N _{RB,c} = 52
	2,5		10: N _{RB,c} = 52
	3,6		40: N _{RB,c} = 106
PDSCH Reference measurement channel	1,4		SR.1.1 FDD
	2,5		SR.1.1 TDD
	3,6		SR.2.1 TDD
RMSI CORESET Reference Channel	1,4		CR.1.1 FDD
	2,5		CR.1.1 TDD
	3,6		CR.2.1 TDD
RMC CORESET Reference Channel	1,4		CCR.1.1 FDD
	2,5		CCR.1.1 TDD
	3,6		CCR.2.1 TDD
SSB configuration	1,4		SSB.1 FR1
	2,5		SSB.1 FR1
	3,6		SSB.2 FR1
SMTc configuration	1~6		SMTc.1
DL BWP configuration	1~6		DLBWP.1.1
UL BWP configuration	1~6		ULBWP.1.1
	1,4		TRS.1.1 FDD

CSI-RS for tracking		2,5		TRS.1.1 TDD
		3,6		TRS.1.2 TDD
OCNG Patterns		1~6		OP.1
EPRE ratio of PSS to SSS		1~6	dB	0
EPRE ratio of PBCH DMRS to SSS				
EPRE ratio of PBCH to PBCH DMRS				
EPRE ratio of PDCCH DMRS to SSS				
EPRE ratio of PDCCH to PDCCH DMRS				
EPRE ratio of PDSCH DMRS to SSS				
EPRE ratio of PDSCH to PDSCH DMRS				
EPRE ratio of OCNG DMRS to SSS ^{Note 1}				
EPRE ratio of OCNG to OCNG DMRS ^{Note 1}				
N_{oc} ^{Note2}	NR_FDD_FR1_A, NR_TDD_FR1_A ^{NOTE 5}	1~6	dBm/15kHz	-104
	NR_FDD_FR1_B			
	NR_TDD_FR1_C			
	NR_FDD_FR1_D, NR_TDD_FR1_D			
	NR_FDD_FR1_E, NR_TDD_FR1_E			
	NR_FDD_FR1_G			
	NR_FDD_FR1_H			
N_{oc} ^{Note2}	NR_FDD_FR1_A, NR_TDD_FR1_A ^{NOTE 5}	1,2,4,5	dBm/SSB SCS	-104
	NR_FDD_FR1_B			
	NR_TDD_FR1_C			
	NR_FDD_FR1_D, NR_TDD_FR1_D			
	NR_FDD_FR1_E, NR_TDD_FR1_E			
	NR_FDD_FR1_G			
	NR_FDD_FR1_H			
	NR_FDD_FR1_A, NR_TDD_FR1_A ^{NOTE 5}	3,6		-101
	NR_FDD_FR1_B			
	NR_TDD_FR1_C			
	NR_FDD_FR1_D, NR_TDD_FR1_D			
	NR_FDD_FR1_E, NR_TDD_FR1_E			
	NR_FDD_FR1_G			
	NR_FDD_FR1_H			
\hat{E}_s / I_{ot}		1~6	dB	-3
\hat{E}_s / N_{oc}		1~6	dB	-3
SS-RSRP ^{Note3}	NR_FDD_FR1_A, NR_TDD_FR1_A ^{NOTE 5}	1,2,4,5	dBm/SCS	-107
	NR_FDD_FR1_B			
	NR_TDD_FR1_C			
	NR_FDD_FR1_D, NR_TDD_FR1_D			
	NR_FDD_FR1_E, NR_TDD_FR1_E			
	NR_FDD_FR1_G			
	NR_FDD_FR1_H			
	NR_FDD_FR1_A, NR_TDD_FR1_A ^{NOTE 5}	3,6		-104
	NR_FDD_FR1_B			
	NR_TDD_FR1_C			
	NR_FDD_FR1_D, NR_TDD_FR1_D			
	NR_FDD_FR1_E, NR_TDD_FR1_E			
	NR_FDD_FR1_G			
	NR_FDD_FR1_H			

	NR_FDD_FR1_G			
	NR_FDD_FR1_H			
Io Note3	NR_FDD_FR1_A, NR_TDD_FR1_A ^{NOTE 5}	1,2,4,5	dBm/9.36 MHz	-74.28
	NR_FDD_FR1_B			
	NR_TDD_FR1_C			
	NR_FDD_FR1_D, NR_TDD_FR1_D			
	NR_FDD_FR1_E, NR_TDD_FR1_E			
	NR_FDD_FR1_G			
	NR_FDD_FR1_H	3,6	dBm/38.16 MHz	-68.18
	NR_FDD_FR1_A, NR_TDD_FR1_A ^{NOTE 5}			
	NR_FDD_FR1_B			
	NR_TDD_FR1_C			
	NR_FDD_FR1_D, NR_TDD_FR1_D			
	NR_FDD_FR1_E, NR_TDD_FR1_E			
	NR_FDD_FR1_G			
	NR_FDD_FR1_H			
Propagation condition	1~6		AWGN	
Antenna configuration	1~6		1x2	
<p>Note 1: OCNG shall be used such that both cells are fully allocated and a constant total transmitted power spectral density is achieved for all OFDM symbols.</p> <p>Note 2: Interference from other cells and noise sources not specified in the test is assumed to be constant over subcarriers and time and shall be modelled as AWGN of appropriate power for N_{oc} to be fulfilled.</p> <p>Note 3: SS-RSRP and Io levels have been derived from other parameters for information purposes. They are not settable parameters themselves.</p> <p>Note 4: SS-RSRP minimum requirements are specified assuming independent interference and noise at each receiver antenna port.</p> <p>Note 5: The test configuration excludes support for band n51 and it is not required to run this test on band n51 in this release of the specification.</p>				

Table A.4.7.5.1.2-3: Timing offsets for SFTD accuracy test

Condition	SFN offset between PCell and PSCell	Frame boundary offset between PCell and PSCell (Ts)
1	100	-122000
2	300	-60540
3	500	1000
4	700	62540
5	900	124000

A.4.7.5.1.3 Test Requirements

The SFTD reported by the UE consists of 2 elements, SFN offset and frame boundary offset between PCell and PSCell. The reported SFTD accuracy shall fulfil the requirement in clause 9.1.27 in TS 36.133 [15].

A.4.7.5.2 Void

A.4.7.5.3 Void

A.4.8 Void

A.4A NE-DC test with all NR cells in FR1

A.4A.1 Signaling characteristics

A.4A.1.1 E-UTRAN PSCell addition

A.4A.1.1.1 Test purpose and environment

The purpose of this test is to verify that the LTE PSCell addition/release delay and interruption under NE-DC are within the requirements stated in clause 8.8 and clause 8.2.3.2.3 for the case when the PSCell is known by the UE at the time of addition.

Supported test configurations are shown in A.4A.1.1.1-1. The test parameters for the E-UTRA cell are given in Table A.3.7.2.1-1.

The test parameters for NR cell are given in Tables A.4A.1.1.1-2 and cell-specific parameters in A.4A.1.1.1-3 below. The test consists of six successive time periods with duration of T1, T2, T3, T4, T5 and T6 respectively. There are two carriers each with one cell. Before the test starts the UE is connected to Cell 1 (NR PCell) on radio channel 1 (PCC) but is not aware of Cell 2 (E-UTRAN PSCell) on radio channel 2. The UE is only monitoring the PCC. During T1 only Cell1 is known to the UE.

Before the start of T2, the UE in the measurement control information that event-triggered reporting with Event B1 is configured for neighbour cell (Cell2). Before the start of T2 the UE is configured with the measurement gaps (gap pattern Id # 0). The Cell2 becomes known to the UE during T2. Therefore, during T2 the UE shall report Event B1. The point in time at which the RRC message to release measurement gap is transmitted from the test system defines the start of period T3. During T3, after measurement gap is released, the test system transmits the RRC message to the UE to add PSCell on radio channel 2.

The RRC message (to add PSCell) also includes a request for the UE to start periodic CSI reporting for the PSCell after the PSCell has been successfully added. The point in time at which the RRC message to add PSCell (Cell2) is received at the UE antenna connector defines the start of period T4.

The test system shall observe the periodic reporting of CSI for PSCell during T5. The point in time at which the UE has sent PRACH to the PSCell (Cell 2) defines the start of period T5.

The test system shall send a RRC message to the UE to release PSCell (Cell 2) on radio channel 2. The RRC message to release PSCell (Cell2) shall be sent to the UE during period T5, after the UE has sent at least one CQI report with non-zero CQI index for PSCell (Cell 2). The point in time at which the RRC message to release PSCell (Cell2) is received at the UE antenna connector defines the start of period T6.

Table A.4A.1.1.1-1: Applicable E-UTRA and NR configurations for NE-DC PSCell addition and Release test

Config	Description
1	LTE FDD, NR 15 kHz SSB SCS, 10 MHz bandwidth, FDD duplex mode
2	LTE FDD, NR 15 kHz SSB SCS, 10 MHz bandwidth, TDD duplex mode
3	LTE FDD, NR 30 kHz SSB SCS, 40 MHz bandwidth, TDD duplex mode
4	LTE TDD, NR 15 kHz SSB SCS, 10 MHz bandwidth, FDD duplex mode
5	LTE TDD, NR 15 kHz SSB SCS, 10 MHz bandwidth, TDD duplex mode
6	LTE TDD, NR 30 kHz SSB SCS, 40 MHz bandwidth, TDD duplex mode
Note: The UE is only required to be tested in one of the supported test configurations	

Table A.4A.1.1.1-2: General Test Parameters for PSCell Addition and Release

Parameter	Unit	Value	Comment	
RF Channel Number		1, 2	Two radio channels are used for this test. One for NR cell and second for E-UTRAN Cell	
Initial	Active PCell	Cell1	PCell on RF channel number 1.	
	Neighbour cell	Cell2	Neighbour cell on RF channel number 2.	
Final Condition	Active PCell	Cell1	PCell on RF channel number 1.	
	Neighbour Cell	Cell2	PSCell released on RF channel number 2.	
B1	Hysteresis	dB	0	Hysteresis for evaluation of event B1.
	Threshold RSRP (Config 1,2,4,5)	dBm	-96	Actual RSRP threshold for event B1.
	Threshold RSRP (Config 3,6)	dBm	-93	Actual RSRP threshold for event B1.
	Time to Trigger	s	0	
DRX		OFF	Continuous monitoring of primary cell	
Measurement gap pattern Id		0	Gaps are configured before T2 and released before T3.	
Cell-individual offset for cells on RF channel number 1	dB	0	Individual offset for cells on primary component carrier.	
Cell-individual offset for cells on RF channel number 2	dB	0	Individual offset for cells on carrier frequency of cell2.	
T1	s	1	During this time the PCell shall be known and cell2 shall be unknown.	
T2	s	1	During this time the UE shall identify neighbour cell (cell2) and report event B1.	
T3	s	3.5	During this time the test system transmits the RRC messages to release measurement gap and add PSCell.	
T4	s	0.5	During this time the UE adds the PSCell.	
T5	s	0.5	During this time the UE sends CSI reports for PSCell.	
T6	s	0.5	During this time the UE releases the PSCell.	

Table A.4A.1.1.1-3: NR Cell Specific Parameters for PSCell Addition and Release

Parameter	Unit	Config	Test
NR RF Channel Number		1,2,3,4,5,6	1
E-UTRA RF Channel Number		1,2,3,4,5,6	2
TDD configuration		1,4	Not Applicable
		2,5	TDDConf.1.1
		3,6	TDDConf.2.1

BW_{channel}	MHz	1,4	10: $N_{RB,c} = 52$
		2,5	10: $N_{RB,c} = 52$
		3,6	40: $N_{RB,c} = 106$
Initial BWP Configuration		1,2,3	DLBWP.0.1 ULBWP.0.1
Dedicated BWP Configuration		1,2,3	DLBWP.1.1 ULBWP.1.1
PDSCH Reference measurement channel		1,4	SR.1.1 FDD
		2,5	SR.1.1 TDD
		3,6	SR.2.1 TDD
RMSI CORESET Reference Channel		1,4	CR.1.1 FDD
		2,5	CR.1.1 TDD
		3,6	CR.2.1 TDD
Dedicated CORESET Reference Channel		1,4	CCR.1.1 FDD
		2,5	CCR.1.1 TDD
		3,6	CCR.2.1 TDD
OCNG Patterns		1,2,3,4,5,6	OP.1
SSB configuration		1,2,4,5	SSB.1 FR1
		3,6	SSB.2 FR1
SMTC configuration		1,2,4,5	SMTC.1
		3,6	SMTC.1
TRS Configuration		1,4	TRS.1.1 FDD
		2,5	TRS.1.1 TDD
		3,6	TRS.1.2 TDD
CSI-RS configuration for CSI reporting		1,4	CSI-RS.1.1 FDD
		2,5	CSI-RS.1.1 TDD
		3,6	CSI-RS.2.1 TDD
reportConfigType		1,2,3,4,5,6	periodic
reportQuantity		1,2,3,4,5,6	cri-RI-PMI-CQI
CSI reporting periodicity	slot	1,2,4,5	5
		3,6	10
CSI reporting offset	slot	1,2,4,5	2
		3,6	4
EPRE ratio of PSS to SSS	dB	1,2,3,4,5,6	0
EPRE ratio of PBCH DMRS to SSS			
EPRE ratio of PBCH to PBCH DMRS			
EPRE ratio of PDCCH DMRS to SSS			
EPRE ratio of PDCCH to PDCCH DMRS			
EPRE ratio of PDSCH DMRS to SSS			
EPRE ratio of PDSCH to PDSCH DMRS			
EPRE ratio of OCNG DMRS to SSS(Note 1)			
EPRE ratio of OCNG to OCNG DMRS (Note 1)			
N_{oc} ^{Note2}	dBm/15 kHz	1,2,3,4,5,6	-88
N_{oc} ^{Note2}	dBm/SCS	1,2,4,5	-88
		3,6	-85
\hat{E}_s/I_{ot}		1,2,3,4,5,6	0

\hat{E}_s / N_{oc}		1,2,3,4,5,6	0
SS-RSRP ^{Note3}	dBm/SCS	1,2,4,5	-88
		3,6	-85
I _o ^{Note3}	dBm/9.36MHz	1,2,4,5	-57
		3,6	-51
Propagation condition		1,2,3,4,5,6	AWGN
<p>Note 1: OCNG shall be used such that both cells are fully allocated and a constant total transmitted power spectral density is achieved for all OFDM symbols.</p> <p>Note 2: Interference from other cells and noise sources not specified in the test is assumed to be constant over subcarriers and time and shall be modelled as AWGN of appropriate power for N_{oc} to be fulfilled.</p> <p>Note 3: SS-RSRP and I_o levels have been derived from other parameters for information purposes. They are not settable parameters themselves.</p> <p>Note 4: SS-RSRP minimum requirements are specified assuming independent interference and noise at each receiver antenna port.</p>			

Table A.4A.1.1.1-4: E-UTRAN cell specific test parameters for PSCell Addition and Release tests

Parameter	Unit	E-UTRAN Cell					
		T1	T2	T3	T4	T5	T6
Duplex mode		FDD or TDD					
TDD special subframe configuration ^{Note1}		6					
TDD uplink-downlink configuration ^{Note1}		1					
BW _{channel}		5 MHz: N _{RB,c} = 25 10 MHz: N _{RB,c} = 50 20 MHz: N _{RB,c} = 100					
PDSCH parameters: DL Reference Measurement Channel ^{Note2}		5 MHz: R.7 FDD 10 MHz: R.3 FDD 20 MHz: R.6 FDD 5 MHz: R.4 TDD 10 MHz: R.0 TDD 20 MHz: R.3 TDD					
PCFICH/PDCCH/PHICH parameters: DL Reference Measurement Channel ^{Note2}		5 MHz: R.11 FDD 10 MHz: R.6 FDD 20 MHz: R.10 FDD 5 MHz: R.11 TDD 10 MHz: R.6 TDD 20 MHz: R.10 TDD					
OCNG Patterns ^{Note2}		5 MHz: OP.20 FDD 10 MHz: OP.10 FDD 20 MHz: OP.17 FDD 5 MHz: OP.9 TDD 10 MHz: OP.1 TDD 20 MHz: OP.7 TDD					
PBCH_RA	dB	0					
PBCH_RB	dB						
PSS_RA	dB						
SSS_RA	dB						
PCFICH_RB	dB						
PHICH_RA	dB						
PHICH_RB	dB						
PDCCH_RA	dB						
PDCCH_RB	dB						
PDSCH_RA	dB						
PDSCH_RB	dB						
OCNG_RA ^{Note3}	dB						

OCNG_RB ^{Note3}	dB		
N _{oc} ^{Note4}	dBm/15 kHz	N/A	-104
\bar{E}_s/N_{oc}	dB	-infinite	17
\bar{E}_s/I_{ot}	dB	-infinite	17
RSRP ^{Note5}	dBm/15 kHz	-infinite	-87
SCH_RP ^{Note5}	dBm/15 kHz	-infinite	-87
I _o ^{Note5}	dBm/Ch BW	N/A	-59.13+10log(N _{RB,c} /50)
Propagation Condition			AWGN
Antenna Configuration			1x2
<p>Note 1: Special subframe and uplink-downlink configurations are specified in table 4.2-1 in TS 36.211.</p> <p>Note 2: DL RMCs and OCNG patterns are specified in clauses A 3.1 and A 3.2 of TS 36.133 respectively.</p> <p>Note 3: OCNG shall be used such that all cells are fully allocated and a constant total transmitted power spectral density is achieved for all OFDM symbols.</p> <p>Note 4: Interference from other cells and noise sources not specified in the test is assumed to be constant over subcarriers and time and shall be modelled as AWGN of appropriate power for N_{oc} to be fulfilled.</p> <p>Note 5: E_s/I_{ot}, RSRP, SCH_RP and I_o levels have been derived from other parameters for information purposes. They are not settable parameters themselves.</p>			

A.4A.1.1.2 Test Requirements

The UE shall transmit the PRACH to PSCell at latest 120 ms^{Note1} into T4.

The UE shall send at least one CSI report for PSCell with non-zero CQI index during T5.

The UE shall periodically send CSI reports for PSCell after the UE has sent first CQI report with non-zero CQI index during T5

The UE shall stop sending CSI reports for PSCell in at latest 20ms into T6.

Interruption on PCell during PSCell addition and release shall not exceed the values specified for NE-DC in Clause 8.2.3.2.3.

All the above test requirements shall be fulfilled in order for the observed PSCell addition delay and PSCell release delay to be counted as correct. The rate of correct observed PSCell addition delay and PSCell release delay during repeated tests shall be at least 90%.

Note1: The PSCell addition delay can be expressed as follows as specified in clause 8.8 [15]:

$$T_{\text{config_EUTRAN-PSCell}} = 20\text{ms} + T_{\text{activation_time}} + 50\text{ms} + T_{\text{PCell_DU}} + T_{\text{E-UTRAN-PSCell_DU}}$$

Where:

$$T_{\text{activation_time}} = 20\text{ms}$$

$$T_{\text{PCell_DU}} = 0\text{ms}$$

$$T_{\text{E-UTRAN-PSCell_DU}} = 30\text{ms}$$

A.4A.1.2 Active BWP switch

A.4A.1.2.1 E-UTRAN PSCell – NR PCell FR1 DCI-based and Timer-based DL active BWP switch in non-DRX in synchronous NE-DC

A.4A.1.2.1.1 Test Purpose and Environment

The purpose of this test is to verify the DL BWP switch delay requirement defined in TS38.133 clause 8.6, and interruption requirement for E-UTRA victim cell defined in TS36.133 clause 7.36.2.6. Supported test configurations are shown in Table A.4A.1.2.1.1-1.

The test scenario comprises of one NR PCell (Cell 1), and one E-UTRA PSCell (Cell 2) as given in Table A.4A.1.2.1.1-2. Cell-specific parameters of NR PCell is specified in Table A.4A.1.2.1.1-3. below, and cell-specific parameters of E-UTRA PSCell are specified in Table A.3.7.2.1-1.

PDCCHs indicating new transmissions shall be sent continuously on PCell (Cell 1) to ensure that the UE would have ACK/NACK sending except for the time duration when BWP is switching on Cell 1 and the time duration of T2.

PDCCHs indicating new transmissions shall be sent continuously on PSCell (Cell 2) to ensure that the UE will have ACK/NACK sending.

Before the test starts,

- UE is connected to Cell 1 (PCell) on radio channel 1 (PCC), and Cell 2 (PSCell) on radio channel 2 (PSCC).
- UE is configured with 2 different UE-specific downlink bandwidth parts for PCell, BWP-1 and BWP-2, in Cell 1 before starting the test. BWP-1 and BWP-2 always include bandwidth of the initial DL BWP and SSB.
- UE is indicated in *firstActiveDownlinkBWP-Id* that the active DL BWP is BWP-1 in PCell.
- UE is configured with a *bwp-InactivityTimer* timer value for PCell.

All cells have constant signal levels throughout the test.

The test consists of 3 successive time periods, with durations of T1, T2, and T3, respectively.

During T1,

Time period T1 starts when a DCI format 1_1 command for PCell DL BWP switch, sent from the test equipment to the UE, is received at the UE side in PCell's slot # denoted i . The UE shall switch its bandwidth part from BWP-1 to BWP-2.

The UE shall be able to receive PDSCH at the beginning of the DL slot right after PCell's DL slot ($i + T_{BWPswitchDelay}$) as defined in clause 8.6 and starts to report valid ACK/NACK for the PCell no later than at the beginning of the DL slot right after DL slot ($i + T_{BWPswitchDelay} + kI$). The UE shall be continuously scheduled on PCell's BWP-2 starting from the beginning of the DL slot right after DL slot ($i + T_{BWPswitchDelay}$).

The starting time of PSCell(Cell 2) interruption due to BWP switch on PCell shall occur within the BWP switch delay.

During T2, the test equipment won't transmit DCI format for PDSCH reception on PCell(Cell 1).

During T3,

The time period T3 starts from the slot # j , where j is the beginning slot of the DL subframe immediately after the *bwp-InactivityTimer* timer expires. The UE shall switch its bandwidth part from BWP-2 back to the default bandwidth part – BWP-1.

The UE shall be able to receive PDSCH at the beginning of the DL slot right after PCell's DL slot ($j+T_{BWPswitchDelay}$) as defined in clause 8.6 and starts to report valid ACK/NACK for the PCell at latest at the beginning of the DL slot right after DL slot ($j+T_{BWPswitchDelay}+kI$). The UE shall be continuously scheduled on PCell's BWP-1 starting from the beginning of the DL slot right after DL slot ($j+T_{BWPswitchDelay}$).

The starting time of PSCell(Cell 2) interruption due to BWP switch of PCell shall occur within the BWP switch delay.

The test equipment verifies the DL BWP switch time in PCell by counting the slots from the time when the BWP switch command is received or *bwp-InactivityTimer* timer expires till an ACK is received.

The test equipment verifies that potential interruption to E-UTRA PSCell is carried out in the correct time span by monitoring ACK/NACK sent in PSCell during BWP switch of PCell, respectively.

Table A.4A.1.2.1.1-1: DL BWP switch supported test configurations

Config	Description
1	LTE FDD, NR 15 kHz SSB SCS, 10 MHz bandwidth, FDD duplex mode
2	LTE FDD, NR 15 kHz SSB SCS, 10 MHz bandwidth, TDD duplex mode
3	LTE FDD, NR 30kHz SSB SCS, 40 MHz bandwidth, TDD duplex mode
4	LTE TDD, NR 15 kHz SSB SCS, 10 MHz bandwidth, FDD duplex mode
5	LTE TDD, NR 15 kHz SSB SCS, 10 MHz bandwidth, TDD duplex mode
6	LTE TDD, NR 30kHz SSB SCS, 40 MHz bandwidth, TDD duplex mode

Note 1: The UE is only required to be tested in one of the supported test configurations.

Table A.4A.1.2.1.1-2: General test parameters for DL BWP switch in synchronous NE-DC

Parameter	Unit	Value	Comment
NR RF Channel Number		1	One NR radio channel is used for this test
E-UTRA RF Channel Number		2	One E-UTRA radio channel is used for this test
Active PCell		Cell 1	PCell on RF channel number 1.
Active PSCell		Cell 2	PSCell on RF channel number 2.
CP length		Normal	
DRX		OFF	For both PCell and PSCell
<i>bwp-InactivityTimer</i>	ms	[200]	
Cell-individual offset for cells on RF channel number 1	dB	0	Individual offset for cells on PCC.
Cell-individual offset for cells on RF channel number 2	dB	0	Individual offset for cells on PSCC.
Cell2 timing offset to cell1	μs	3	Synchronous NE-DC
T1	s	[0.2]	
T2	s	[0.2]	
T3	s	[0.2]	

Table A.4A.1.2.1.1-3: NR Cell specific test parameters for DL BWP switch in synchronous NE-DC

Parameter	Unit	Cell 1
Frequency Range		FR1
Duplex mode	Config 1,4	FDD
	Config 2,3,5,6	TDD
TDD configuration	Config 1,4	Not Applicable
	Config 2,5	TDDConf.1.1
	Config 3,6	TDDConf.2.1
$BW_{channel}$	Config 1,4	10 MHz: $N_{RB,c} = 52$
	Config 2,5	10 MHz: $N_{RB,c} = 52$

	Config 3,6		40 MHz: $N_{RB,c} = 106$
Active BWP ID			1, 2
Initial DL BWP Configuration	Config 1,4		DLBWP.0.2 ^{Note 4}
	Config 2,5		
	Config 3,6		
Active DL BWP-1 Configuration	Config 1,4		DLBWP.1.1 ^{Note 4}
	Config 2,5		
	Config 3,6		
Active DL BWP-2 Configuration	Config 1,4		DLBWP.1.3 ^{Note 4}
	Config 2,5		
	Config 3,6		
Initial UL BWP Configuration	Config 1,4		ULBWP.0.2 ^{Note 4}
	Config 2,5		
	Config 3,6		
Active UL BWP-1 Configuration	Config 1,4		ULBWP.1.1 ^{Note 4}
	Config 2,5		
	Config 3,6		
Active UL BWP-2 Configuration	Config 1,4		ULBWP.1.3 ^{Note 4}
	Config 2,5		
	Config 3,6		
PDSCH Reference measurement channel	Config 1,4		SR.1.1 FDD
	Config 2,5		SR.1.1 TDD
	Config 3,6		SR.2.1 TDD
RMSI CORESET parameters	Config 1,4		CR.1.1 FDD
	Config 2,5		CR.1.1 TDD
	Config 3,6		CR.2.1 TDD
Dedicated CORESET parameters	Config 1,4		CCR.1.1 FDD
	Config 2,5		CCR.1.1 TDD
	Config 3,6		CCR.2.3 TDD
OCNG Patterns			OP.1
SSB Configuration	Config 1,2,4,5		SSB.1 FR1
	Config 3,6		SSB.2 FR1
SMTc Configuration			SMTc.1
Correlation Matrix and Antenna Configuration			1x2 Low
TRS Configuration	Config 1,4		TRS.1.1 FDD
	Config 2,5		TRS.1.1 TDD
	Config 3,6		TRS.1.2 TDD
EPRE ratio of PSS to SSS		dB	0
EPRE ratio of PBCH DMRS to SSS			
EPRE ratio of PBCH to PBCH DMRS			
EPRE ratio of PDCCH DMRS to SSS			
EPRE ratio of PDCCH to PDCCH DMRS			
EPRE ratio of PDSCH DMRS to SSS			
EPRE ratio of PDSCH to PDSCH			
EPRE ratio of OCNG DMRS to SSS (Note 1)			
EPRE ratio of OCNG to OCNG DMRS (Note 1)			
N_{oc} ^{Note 2}	Config 1,2,4,5	dBm/SCS	[-104]
	Config 3,6		[-101]
N_{oc} ^{Note 2}		dBm/15kHz	-104
SS-RSRP ^{Note 3}	Config 1,2,4,5	dBm/SCS	[-87]
	Config 3,6		[-90]
\hat{E}_s/I_{ot}		dB	17
\hat{E}_s/N_{oc}		dB	17
I_o ^{Note 3}	Config 1,2,4,5	dBm/9.36MHz	[-59]
	Config 3,6	dBm/38.16MHz	[-61.9]
Propagation Condition			AWGN

Note 1:	OCNG shall be used such that both cells are fully allocated and a constant total transmitted power spectral density is achieved for all OFDM symbols.
Note 2:	Interference from other cells and noise sources not specified in the test is assumed to be constant over subcarriers and time and shall be modelled as AWGN of appropriate power for N_{oc} to be fulfilled.
Note 3:	SS-RSRP and I_{o} levels have been derived from other parameters for information purposes. They are not settable parameters themselves.
Note 4:	For unpaired spectrum, a DL BWP is linked with an UL BWP. DLBWP.0.2 is linked with ULBWP.0.2; DLBWP.1.1 is linked with ULBWP.1.1; DLBWP.1.3 is linked with ULBWP.1.3 defined in clause 12 of TS 38.213 [3].

A.4A.1.2.1.2 Test Requirements

During T1, the UE shall start to send the ACK for PCell in the DL slot right after DL slot $(i+T_{BWPswitchDelay}+kI)$.

During T3, the UE shall start to send the ACK for PCell in the DL slot right after DL slot $(j+T_{BWPswitchDelay}+kI)$.

Where, kI is the timing between DL data receiving and acknowledgement as specified in [7].

Depending on UE capability *bwp-SwitchingDelay* [2], UE shall finish BWP switch within the time duration $T_{BWPswitchDelay}$ defined in Table 8.6.2-1.

All of the above test requirements shall be fulfilled in order for the observed PCell active BWP switch delay to be counted as correct.

The rate of correct events observed during repeated tests shall be at least 90%.

During T1, the start time of PSCell interruption during PCell active BWP switch shall not happen outside the BWP switch delay.

During T3, the start time of PSCell interruption of during PCell active BWP switch shall not happen outside the BWP switch delay.

The interruption of PSCell shall not be longer than the interruption duration specified for active BWP switch in TS36.133 Clause 7.36.2.6.

All of the above test requirements shall be fulfilled in order for the observed PSCell active BWP switch interruption to be counted as correct.

The rate of correct events observed during repeated tests shall be at least 90%.

NOTE: During T1, T3 if there are no uplink resources for reporting the ACK in the DL slot right after DL slot $(i+T_{BWPswitchDelay}+kI)$, $(j+T_{BWPswitchDelay}+kI)$, then the UE shall use the next available uplink resource for reporting the corresponding ACK.

A.4A.2 Measurement performance

A.4A.2.1 SFTD accuracy

A.4A.2.1.1 SFTD accuracy

A.4A.2.1.1.1 Test Purpose

The purpose of this set of tests is to verify that the SFTD measurement accuracy is within the specified limits. This test will verify the requirements as specified in clause 10.21.1.1 for NE-DC SFTD measurements.

A.4A.2.1.1.2 Test Environment

Supported test configurations are shown in Table A.4A.2.1.1.2-1. In this set of test cases there are two cells on different carriers. Cell 1 is NR FR1 PCell and Cell 2 is E-UTRAN target cell. The test parameters of cell 1 are given in clause A.4A.2.1.1.2-2. The test parameters of cell 2 are given in Table A.3.7.2.1. The SFTD between PCell and target cell shall be set by the test equipment to one of the time differences in Table A.4A.2.1.1.2-3.

Table A.4A.2.1.1.2-1: Supported test configurations for SFTD accuracy

Configuration	Description
1	NR 15 kHz SSB SCS, 10 MHz bandwidth, FDD duplex mode, LTE FDD
2	NR 15 kHz SSB SCS, 10 MHz bandwidth, TDD duplex mode, LTE FDD
3	NR 30 kHz SSB SCS, 40 MHz bandwidth, TDD duplex mode, LTE FDD
4	NR 15 kHz SSB SCS, 10 MHz bandwidth, FDD duplex mode, LTE TDD
5	NR 15 kHz SSB SCS, 10 MHz bandwidth, TDD duplex mode, LTE TDD
6	NR 30kHz SSB SCS, 40 MHz bandwidth, TDD duplex mode, LTE TDD

Note 1: The UE is only required to be tested in one of the supported test configurations
Note 2: A UE which fulfils the requirements in test case A.4A.1.1 can skip the test cases in A.4.7.5.1

Table A.4A.2.1.1.2-2: Test parameters for SFTD accuracy (Cell 1)

Parameter	Config	Unit	Test 1
SSB GSCN	1~6		freq1
Duplex mode	1,4		FDD
	2,5		TDD
	3,6		TDD
TDD Configuration	1,4		N/A
	2,5		TDDConf.1.1
	3,6		TDDConf.2.1
BW _{channel}	1,4	MHz	10: N _{RB,c} = 52
	2,5		10: N _{RB,c} = 52
	3,6		40: N _{RB,c} = 106
PDSCH Reference measurement channel	1,4		SR.1.1 FDD
	2,5		SR.1.1 TDD
	3,6		SR.2.1 TDD
RMSI CORESET Reference Channel	1,4		CR.1.1 FDD
	2,5		CR.1.1 TDD
	3,6		CR.2.1 TDD
RMC CORESET Reference Channel	1,4		CCR.1.1 FDD
	2,5		CCR.1.1 TDD
	3,6		CCR.2.1 TDD

SSB configuration		1,4		SSB.1 FR1			
		2,5		SSB.1 FR1			
		3,6		SSB.2 FR1			
SMTC configuration		1~6		SMTC.1			
DL BWP configuration		1~6		DLBWP.1.1			
UL BWP configuration		1~6		ULBWP.1.1			
OCNG Patterns		1~6		OP.1			
EPRE ratio of PSS to SSS		1~6	dB	0			
EPRE ratio of PBCH DMRS to SSS							
EPRE ratio of PBCH to PBCH DMRS							
EPRE ratio of PDCCH DMRS to SSS							
EPRE ratio of PDCCH to PDCCH DMRS							
EPRE ratio of PDSCH DMRS to SSS							
EPRE ratio of PDSCH to PDSCH DMRS							
EPRE ratio of OCNG DMRS to SSS ^{Note 1}							
EPRE ratio of OCNG to OCNG DMRS ^{Note 1}							
N_{oc} ^{Note2}	NR_FDD_FR1_A, NR_TDD_FR1_A ^{NOTE 5}				1~6	dBm/15kHz	-104
	NR_FDD_FR1_B						
	NR_TDD_FR1_C						
	NR_FDD_FR1_D, NR_TDD_FR1_D						
	NR_FDD_FR1_E, NR_TDD_FR1_E						
	NR_FDD_FR1_F						
	NR_FDD_FR1_G						
	NR_FDD_FR1_H						
N_{oc} ^{Note2}	NR_FDD_FR1_A, NR_TDD_FR1_A ^{NOTE 5}	1,2,4,5	dBm/SSB SCS	-104			
	NR_FDD_FR1_B						
	NR_TDD_FR1_C						
	NR_FDD_FR1_D, NR_TDD_FR1_D						
	NR_FDD_FR1_E, NR_TDD_FR1_E						
	NR_FDD_FR1_F						
	NR_FDD_FR1_G						
	NR_FDD_FR1_H						
	NR_FDD_FR1_A, NR_TDD_FR1_A ^{NOTE 5}	3,6		-101			
	NR_FDD_FR1_B						
	NR_TDD_FR1_C						
	NR_FDD_FR1_D, NR_TDD_FR1_D						
	NR_FDD_FR1_E, NR_TDD_FR1_E						
	NR_FDD_FR1_F						
	NR_FDD_FR1_G						
	NR_FDD_FR1_H						

\hat{E}_s / I_{ot}		1~6	dB	-3		
\hat{E}_s / N_{oc}		1~6	dB	-3		
SS-RSRP Note3	NR_FDD_FR1_A, NR_TDD_FR1_A NOTE 5	1,2,4,5	dBm/SCS	-107		
	NR_FDD_FR1_B					
	NR_TDD_FR1_C					
	NR_FDD_FR1_D, NR_TDD_FR1_D					
	NR_FDD_FR1_E, NR_TDD_FR1_E					
	NR_FDD_FR1_F					
	NR_FDD_FR1_G					
	NR_FDD_FR1_H					
	NR_FDD_FR1_A, NR_TDD_FR1_A NOTE 5	3,6		-104		
	NR_FDD_FR1_B					
	NR_TDD_FR1_C					
	NR_FDD_FR1_D, NR_TDD_FR1_D					
	NR_FDD_FR1_E, NR_TDD_FR1_E					
	NR_FDD_FR1_F					
	NR_FDD_FR1_G					
	NR_FDD_FR1_H					
	I _o Note3	NR_FDD_FR1_A, NR_TDD_FR1_A NOTE 5		1,2,4,5	dBm/9.36 MHz	-74.28
		NR_FDD_FR1_B				
NR_TDD_FR1_C						
NR_FDD_FR1_D, NR_TDD_FR1_D						
NR_FDD_FR1_E, NR_TDD_FR1_E						
NR_FDD_FR1_F						
NR_FDD_FR1_G						
NR_FDD_FR1_H						
NR_FDD_FR1_A, NR_TDD_FR1_A NOTE 5		3,6	dBm/38.16 MHz	-68.18		
NR_FDD_FR1_B						
NR_TDD_FR1_C						
NR_FDD_FR1_D, NR_TDD_FR1_D						
NR_FDD_FR1_E, NR_TDD_FR1_E						
NR_FDD_FR1_F						
NR_FDD_FR1_G						
NR_FDD_FR1_H						
Propagation condition		1~6		AWGN		
Antenna configuration		1~6		1x2		

Note 1:	OCNG shall be used such that both cells are fully allocated and a constant total transmitted power spectral density is achieved for all OFDM symbols.
Note 2:	Interference from other cells and noise sources not specified in the test is assumed to be constant over subcarriers and time and shall be modelled as AWGN of appropriate power for N_{oc} to be fulfilled.
Note 3:	SS-RSRP and I_0 levels have been derived from other parameters for information purposes. They are not settable parameters themselves.
Note 4:	SS-RSRP minimum requirements are specified assuming independent interference and noise at each receiver antenna port.
Note 5:	The test configuration excludes support for band n51 and it is not required to run this test on band n51 in this release of the specification

Table A.4A.2.1.1.2-3: Timing offsets for SFTD accuracy test

Configuration	SFN offset between PCell and PSCell	Frame boundary offset between PCell and PSCell (Ts)
1	100	-122000
2	300	-60540
3	500	1000
4	700	62540
5	900	124000

A.4A.2.1.1.3 Test Requirements

The SFTD reported by the UE consists of 2 elements, SFN offset and frame boundary offset between PCell and E-UTRAN target cell. The reported SFTD accuracy shall fulfil the requirement in clause 10.1.21.1.

A.5 EN-DC tests with one or more NR cells in FR2

A.5.1 Void

A.5.2 Void

A.5.3 RRC_CONNECTED state mobility

A.5.3.1 Void

A.5.3.2 RRC Connection Mobility Control

A.5.3.2.1 Void

A.5.3.2.2 Random Access

A.5.3.2.2.1 Contention based random access test in FR2 for PSCell/SCell in EN-DC

A.5.3.2.2.1.1 Test Purpose and Environment

The purpose of this test is to verify that the behavior of the random access procedure is according to the requirements and that the PRACH power settings and timing are within specified limits. This test will verify the requirements in clause 6.2.2.2 and clause 7.1.2 in an AWGN model.

For this test two cells are used, with the configuration of Cell 1 (E-UTRA PCell) specified in clause A.3.7.2.1 and Cell 2 configured as PSCell or SCell in FR2. Supported test parameters are shown in Table A.5.3.2.2.1.1-1. UE capable of EN-DC with PSCell or SCell in FR2 needs to be tested by using the parameters in Table A.5.3.2.2.1.1-2 and Table A.5.3.2.2.1.1-3.

Table A.5.3.2.2.1.1-1: Supported test configurations for non-contention based random access test in FR2 for PSCell/SCell in EN-DC

Config	Description
1	LTE FDD, NR PSCell/SCell 120 kHz SSB SCS, 100 MHz bandwidth, TDD duplex mode
2	LTE TDD, NR PSCell/SCell 120 kHz SSB SCS, 100 MHz bandwidth, TDD duplex mode
Note:	The UE is only required to be tested in one of the supported test configurations depending on UE capability

Table A.5.3.2.2.1.1-2: General test parameters for contention based random access test in FR2 for PSCell/SCell in EN-DC

Parameter	Unit	Test-1	Comments
SSB Configuration	Config 1,2	SSB.1 FR2	As defined in A.3.10
CSI-RS for tracking	Config 1,2	TRS.2.1 TDD	
Duplex Mode for Cell 2	Config 1,2	TDD	

TDD Configuration	Config 1,2		TDDConf.3.1	
BW _{channel}	Config 1	MHz	100: N _{RB,C} = 24	
OCNG Pattern ^{Note 1}			OP.3	As defined in A.3.2.1.
PDSCH Reference Channel ^{Note 2}	Config 1,2		SR.3.1 TDD	As defined in A.3.1.1.
RMSI CORESET Reference Channel	Config 1,2		CR.3.1 TDD	As defined in A.3.1.2
Dedicated CORESET Reference Channel	Config 1,2		CCR.3.1 TDD	
NR RF Channel Number			1	
EPRE ratio of PSS to SSS		dB	0	
EPRE ratio of PBCH_DMRS to SSS		dB		
EPRE ratio of PBCH to PBCH_DMRS		dB		
EPRE ratio of PDCCH_DMRS to SSS		dB		
EPRE ratio of PDCCH to PDCCH_DMRS		dB		
EPRE ratio of PDSCH_DMRS to SSS		dB		
EPRE ratio of PDSCH to PDSCH_DMRS		dB		
<i>ss-PBCH-BlockPower</i>		dBm/ SCS		+20 + Δ_{UL}
Configured UE transmitted power ($P_{C_{MAX, f,c}}$)		dBm	maximum value configurable for certain power class	As defined in clause 6.2.4 in TS 38.101-2 [19]
PRACH Configuration			FR2 PRACH configuration 1	As defined in A.3.8.3, with exceptions as defined below.
<i>rsrp-ThresholdSSB</i>		dBm	RSRP_69 + Δ_{DL}	RSRP_69 corresponds to -88dBm. Δ_{DL} is derived from the downlink calibration process ^{Note 4}
<i>preambleReceivedTargetPower</i>		dBm	-100	As defined in TS 38.331 [2].
Note 1:	OCNG shall be used such that a constant total transmitted power spectral density is achieved for all OFDM symbols. The OCNG pattern is chosen during the test according to the presence of a DL reference measurement channel.			
Note 2:	The DL PDSCH reference measurement channel is used in the test only when a downlink transmission dedicated to the UE under test is required.			
Note 3:	The Δ_{UL} value is calculated as $-\text{ROUND}(\text{PPRACH0} - 1)$, where PPRACH0 is the measured first PRACH power with -80.6dBm/SCS applied, <i>preambleReceivedTargetPower</i> = -100dBm and <i>ss-PBCH-BlockPower</i> = 20dBm. These values are used during the uplink calibration process carried out before the test case is run, with the UE configured to send PRACH.			
Note 4:	The Δ_{DL} value is calculated as $(\text{RSRP}_{\text{REP}} - \text{RSRP}_{76})$, where RSRP _{REP} is the SS-RSRP Reported value in Table 10.1.6.1-1 with -80.6dBm/SCS applied. These values are used during the downlink calibration process carried out before the test case is run, with the UE configured to report SS-RSRP. For a Reported value RSRP _x , x is treated as a positive integer value.			

Table A.5.3.2.2.1.1-3: OTA-related test parameters for contention based random access test in FR2 for PSCell/SCell in EN-DC

Parameter	Unit	Test-1	Comments	
AoA setup		Setup 1	As defined in A.3.15.1	
Assumption for UE beams ^{Note 3}		Rough		
SSB with index 0	E_s ^{Note 1}	dBm/SCS	-80.6	Power of SSB with index 0 is set to be above configured <i>rsrp-ThresholdSSB</i>
	SSB _{RP}	dBm/SCS	-80.6	
	E_s/I_{otBB}	dB	21.09	

	lo	dBm/95.04 MHz	-56.01	lo in symbols containing SSB index 0
SSB with index 1	Es ^{Note1}	dBm/SCS	-95.0	Power of SSB with index 1 is set to be below configured <i>rsrp-ThresholdSSB</i>
	SSB_RP	dBm/SCS	-95.0	
	Es/Iot _{BB}	dB	6.69	
	lo	dBm/95.04 MHz	-70.41	lo in symbols containing SSB index 1
Propagation Condition		-	No external noise (Note 4)	
<p>Note 1: No artificial noise is applied in this test.</p> <p>Note 2: Void.</p> <p>Note 3: Information about types of UE beam is given in B.2.1.3, and does not limit UE implementation or test system implementation</p> <p>Note 4: The downlink connection between the System Simulator and the UE is without Additive White Gaussian Noise, and has no fading or multipath effects as specified in TS 38.521-2 B.0 [29].</p>				

A.5.3.2.2.1.2 Test Requirements

Contention based random access is triggered by *not* explicitly assigning a random access preamble via dedicated signalling in the downlink.

A.5.3.2.2.1.2.1 Random Access Preamble Transmission

To test the UE behavior specified in Clause 6.2.2.2.1.1 the System Simulator shall receive the Random Access Preamble which belongs to one of the Random Access Preambles associated with the SSB with index 0, which has SS-RSRP above the configured *rsrp-ThresholdSSB*.

In addition, the power applied to all preambles shall be in accordance with what is specified in Clause 6.2.2.2. The power of the first preamble shall be 0.6 dBm to be received at TE with an accuracy specified in clause 6.3.4.2 of TS 38.101-2 [19]. The relative power applied to additional preambles shall have an accuracy specified in clause 6.3.4.3 of TS 38.101-2 [19].

The transmit timing of all PRACH transmissions shall be within the accuracy specified in Clause 7.1.2.

A.5.3.2.2.1.2.2 Random Access Response Reception

To test the UE behavior specified in Clause 6.2.2.2.1.2 the System Simulator shall transmit a Random Access Response containing a Random Access Preamble identifier corresponding to the transmitted Random Access Preamble after 3 preambles have been received by the System Simulator. In response to the first 2 preambles, the System Simulator shall transmit a Random Access Response *not* corresponding to the transmitted Random Access Preamble.

The UE may stop monitoring for Random Access Response(s) and shall transmit the msg3 if the Random Access Response contains a Random Access Preamble identifier corresponding to the transmitted Random Access Preamble.

The UE shall again perform the Random Access Resource selection procedure specified in clause 5.1.2 in TS38.321 [7], and transmit with the calculated PRACH transmission power when the backoff time expires if all received Random Access Responses contain Random Access Preamble identifiers that do not match the transmitted Random Access Preamble.

In addition, the power applied to all preambles shall be in accordance with what is specified in Clause 6.2.2.2. The power of the first preamble shall be 0.6 dBm to be received at TE with an accuracy specified in clause 6.3.4.2 of TS 38.101-2 [19]. The relative power applied to additional preambles shall have an accuracy specified in clause 6.3.4.3 of TS 38.101-2 [19].

The transmit timing of all PRACH transmissions shall be within the accuracy specified in Clause 7.1.2.

A.5.3.2.2.1.2.3 No Random Access Response Reception

To test the UE behavior specified in clause 6.2.2.2.1.3 the System Simulator shall transmit a Random Access Response containing a Random Access Preamble identifier corresponding to the transmitted Random Access Preamble after 3 preambles have been received by the System Simulator. The System Simulator shall *not* respond to the first 2 preambles.

The UE shall again perform the Random Access Resource selection procedure specified in clause 5.1.2 in TS38.321 [7], and transmit with the calculated PRACH transmission power when the backoff time expires if no Random Access Response is received within the RA Response window.

In addition, the power applied to all preambles shall be in accordance with what is specified in Clause 6.2.2.2. The power of the first preamble shall be 0.6 dBm to be received at TE with an accuracy specified in clause 6.3.4.2 of TS 38.101-2 [19]. The relative power applied to additional preambles shall have an accuracy specified in clause 6.3.4.3 of TS 38.101-2 [19].

The transmit timing of all PRACH transmissions shall be within the accuracy specified in Clause 7.1.2.

A.5.3.2.2.1.2.4 Receiving an UL grant for msg3 retransmission

To test the UE behavior specified in clause 6.2.2.2.1.4 the System Simulator shall provide an UL grant for msg3 retransmission following a successful Random Access Response.

The UE shall re-transmit the msg3 upon the reception of an UL grant for msg3 retransmission.

A.5.3.2.2.1.2.5 Void

A.5.3.2.2.1.2.6 Void

A.5.3.2.2.1.2.7 Contention Resolution Timer expiry

To test the UE behavior specified in Clause 6.2.2.2.1.6 the System Simulator shall *not* send a response to a msg3.

The UE shall again perform the Random Access Resource selection procedure specified in clause 5.1.2 in TS38.321 [7], and transmit with the calculated PRACH transmission power when the backoff time expires if the Contention Resolution Timer expires.

A.5.3.2.2.2 Non-contention based random access test in FR2 for PSCell/SCell in EN-DC

A.5.3.2.2.2.1 Test Purpose and Environment

The purpose of this test is to verify that the behavior of the random access procedure is according to the requirements and that the PRACH power settings and timing are within specified limits. This test will verify the requirements in clause 6.2.2.2 and clause 7.1.2 in an AWGN model.

For this test two cells are used, with the configuration of Cell 1 (E-UTRA PCell) specified in clause A.3.7.2.1 and Cell 2 configured as PSCell or SCell in FR2. Supported test parameters are shown in Table A.5.3.2.2.2.1-1. UE capable of EN-DC with PSCell or SCell in FR2 needs to be tested by using the parameters in Table A.5.3.2.2.2.1-2 and Table A.5.3.2.2.2.1-3 for SSB-based non-contention based random access test (Test 1) and CSI-RS-based non-

contention based random access test (Test 2). Test 2 is only applicable to UE which supports csi-RSRP-AndRSRQ-MeasWithSSB or csi-RSRP-AndRSRQ-MeasWithoutSSB.

Table A.5.3.2.2.1-1: Supported test configurations for non-contention based random access test in FR2 for PSCell/SCell in EN-DC

Config	Description
1	LTE FDD, NR PSCell/SCell 120 kHz SSB SCS, 100 MHz bandwidth, TDD duplex mode
2	LTE TDD, NR PSCell/SCell 120 kHz SSB SCS, 100 MHz bandwidth, TDD duplex mode
Note:	The UE is only required to be tested in one of the supported test configurations depending on UE capability

Table A.5.3.2.2.1-2: General test parameters for non-contention based random access test in FR2 for PSCell/SCell in EN-DC

Parameter	Unit	Test-1	Test-2	Comments
SSB Configuration	Config 1,2	SSB.1 FR2	SSB.1 FR2	As defined in A.3.10
CSI-RS Configuration	Config 1,2	N/A	CSI-RS.3.1 TDD	As defined in A.3.1.4
CSI-RS for tracking	Config 1,2	TRS.2.1 TDD	TRS.2.1 TDD	
Duplex Mode for Cell 2	Config 1,2	TDD	TDD	
TDD Configuration	Config 1,2	TDDConf.3.1	TDDConf.3.1	
BW _{channel}	Config 1,2	MHz	100: N _{RB,c} = 24	100: N _{RB,c} = 24
OCNG Pattern ^{Note 1}		OP.3	OP.3	As defined in A.3.2.1.
PDSCH Reference Channel ^{Note 2}	Config 1,2	SR3.1 TDD	SR3.1 TDD	As defined in A.3.1.1.
RMSI CORESET Reference Channel	Config 1,2	CR.3.1 TDD	CR.3.1 TDD	As defined in A.3.1.2
Dedicated CORESET Reference Channel	Config 1,2	CCR.3.1 TDD	CCR.3.1 TDD	
NR RF Channel Number		1	1	
EPRE ratio of PSS to SSS	dB	0	0	
EPRE ratio of PBCH_DMRS to SSS	dB			
EPRE ratio of PBCH to PBCH_DMRS	dB			
EPRE ratio of PDCCH_DMRS to SSS	dB			
EPRE ratio of PDCCH to PDCCH_DMRS	dB			
EPRE ratio of PDSCH_DMRS to SSS	dB			
EPRE ratio of PDSCH to PDSCH_DMRS	dB			
ss-PBCH-BlockPower	dBm/ SCS	+20 +Δ _{UL}	+20 +Δ _{UL}	As defined in TS 38.331 [2]. Δ _{UL} is derived from the uplink calibration process ^{Note 3}
Configured UE transmitted power (P _{MAX, f,c})	dBm	maximum value configurable for certain power class	maximum value configurable for certain power class	As defined in clause 6.2.4 in TS 38.101-2 [19]

PRACH Configuration		FR2 PRACH configuration 2	FR2 PRACH configuration 3	As defined in A.3.8.3, with exceptions as defined below
<i>rsrp-ThresholdSSB</i>	dBm	RSRP ₆₉ + Δ_{DL}	RSRP ₆₉ + Δ_{DL}	RSRP ₆₉ corresponds to -88dBm. Δ_{DL} is derived from the downlink calibration process ^{Note 4}
<i>preambleReceivedTargetPower</i>	dBm	-100	-100	As defined in TS 38.331 [2]
Note 1:	OCNG shall be used such that a constant total transmitted power spectral density is achieved for all OFDM symbols. The OCNG pattern is chosen during the test according to the presence of a DL reference measurement channel.			
Note 2:	The DL PDSCH reference measurement channel is used in the test only when a downlink transmission dedicated to the UE under test is required.			
Note 3:	The Δ_{UL} value is calculated as $-\text{ROUND}(\text{PPRACH}_0 - 1)$, where PPRACH ₀ is the measured first PRACH power with -80.6dBm/SCS applied, <i>preambleReceivedTargetPower</i> = -100dBm and <i>ss-PBCH-BlockPower</i> = 20dBm. These values are used during the uplink calibration process carried out before the test case is run, with the UE configured to send PRACH.			
Note 4:	The Δ_{DL} value is calculated as $(\text{RSRP}_{\text{REP}} - \text{RSRP}_{76})$, where RSRP _{REP} is the SS-RSRP Reported value in Table 10.1.6.1-1 with -80.6dBm/SCS applied. These values are used during the downlink calibration process carried out before the test case is run, with the UE configured to report SS-RSRP. For a Reported value RSRP _x , x is treated as a positive integer value.			

Table A.5.3.2.2.1-3: OTA-related test parameters for non-contention based random access test in FR2 for PSCell/SCell in EN-DC

Parameter		Unit	Test-1	Test-2	Comments
AoA setup			Setup 1	Setup 1	As defined in A.3.15.1
Assumption for UE beams ^{Note 3}			Rough	Rough	
SSB with index 0	Es ^{Note1}	dBm/SCS	-80.6	-80.6	Power of SSB with index 0 is set to be above configured <i>rsrp-ThresholdSSB</i>
	SSB_RP	dBm/SCS	-80.6	-80.6	
	Es/lot _{BB}	dB	21.09	21.09	
	lo	dBm/95.04 MHz	-56.01	-56.01	lo in symbols containing SSB index 0
SSB with index 1	Es ^{Note1}	dBm/SCS	-95.0	-95.0	Power of SSB with index 1 is set to be below configured <i>rsrp-ThresholdSSB</i>
	SSB_RP	dBm/SCS	-95.0	-95.0	
	Es/lot _{BB}	dB	6.69	6.69	
	lo	dBm/95.04 MHz	-70.41	-70.41	lo in symbols containing SSB index 1
Propagation Condition		-	No external noise (Note 4)	No external noise (Note 4)	
Note 1:	No artificial noise is applied in this test.				
Note 2:	void.				
Note 3:	Information about types of UE beam is given in B.2.1.3, and does not limit UE implementation or test system implementation				
Note 4:	The downlink connection between the System Simulator and the UE is without Additive White Gaussian Noise, and has no fading or multipath effects as specified in TS 38.521-2 B.0 [29].				

A.5.3.2.2.2.2 Test Requirements

Non-Contention based random access is triggered by explicitly assigning a random access preamble via dedicated signalling in the downlink. In the test, the non-contention based random access procedure is not initialized for Other SI requested from UE or beam failure recovery.

A.5.3.2.2.2.2.1 SSB-based Random Access Preamble Transmission

In Test-1, to test the UE behavior specified in Clause 6.2.2.2.2.1 for SSB-based Random Access Preamble transmission, with the contention-free Random Access Resources and the contention-free PRACH occasions associated with SSBs configured, the System Simulator shall receive the Random Access Preamble which has the Preamble Index associated with the SSB with index 0.

In addition, the System Simulator shall receive the Random Access Preamble on the PRACH occasion which belongs to the PRACH occasions corresponding to the SSB with index 0, and the selected PRACH occasion shall belong to the PRACH occasions permitted by the restrictions given by the *ra-ssb-OccasionMaskIndex*.

In addition, the power applied to all preambles shall be in accordance with what is specified in Clause 6.2.2.2. The power of the first preamble shall be -60 dBm to be received at TE with an accuracy specified in clause 6.3.4.2 of TS 38.101-2 [19]. The relative power applied to additional preambles shall have an accuracy specified in clause 6.3.4.3 of TS 38.101-2 [19].

The transmit timing of all PRACH transmissions shall be within the accuracy specified in Clause 7.1.2.

A.5.3.2.2.2.2.2 CSI-RS-based Random Access Preamble Transmission

In Test-2, to test the UE behavior specified in Clause 6.2.2.2.2.1 for CSI-RS-based Random Access Preamble transmission, with the contention-free Random Access Resources and the contention-free PRACH occasions associated with CSI-RSs configured, the System Simulator shall receive the Random Access Preamble which has the Preamble Index associated with the CSI-RS configured.

In addition, the System Simulator shall receive the Random Access Preamble on the PRACH occasion which belongs to the PRACH occasions corresponding to the CSI-RS configured, and the selected PRACH occasion shall belong to the PRACH occasions permitted by the restrictions given by the *ra-OccasionList*.

In addition, the power applied to all preambles shall be in accordance with what is specified in Clause 6.2.2.2. The power of the first preamble shall be -60 dBm to be received at TE with an accuracy specified in clause 6.3.4.2 of TS 38.101-2 [19]. The relative power applied to additional preambles shall have an accuracy specified in clause 6.3.4.3 of TS 38.101-2 [19].

The transmit timing of all PRACH transmissions shall be within the accuracy specified in Clause 7.1.2.

A.5.3.2.2.2.2.3 Random Access Response Reception

To test the UE behavior specified in Clause 6.2.2.2.2.2 the System Simulator shall transmit a Random Access Response containing a Random Access Preamble identifier corresponding to the transmitted Random Access Preamble after 5 preambles have been received by the System Simulator. In response to the first 4 preambles, the System Simulator shall transmit a Random Access Response *not* corresponding to the transmitted Random Access Preamble.

The UE may stop monitoring for Random Access Response(s) if the Random Access Response contains a Random Access Preamble identifier corresponding to the transmitted Random Access Preamble.

The UE shall again perform the Random Access Resource selection procedure specified in clause 5.1.2 in TS38.321 [7], and transmit with the calculated PRACH transmission power if all received Random Access Responses contain Random Access Preamble identifiers that do not match the transmitted Random Access Preamble.

In addition, the power applied to all preambles shall be in accordance with what is specified in Clause 6.2.2.2. The power of the first preamble shall be -60 dBm to be received at TE with an accuracy specified in clause 6.3.4.2 of TS 38.101-2 [19]. The relative power applied to additional preambles shall have an accuracy specified in clause 6.3.4.3 of TS 38.101-2 [19].

The transmit timing of all PRACH transmissions shall be within the accuracy specified in Clause 7.1.2.

A.5.3.2.2.2.4 No Random Access Response Reception

To test the UE behavior specified in clause 6.2.2.2.3 the System Simulator shall transmit a Random Access Response containing a Random Access Preamble identifier corresponding to the transmitted Random Access Preamble after 5 preambles have been received by the System Simulator. The System Simulator shall *not* respond to the first 4 preambles.

The UE shall again perform the Random Access Resource selection procedure specified in clause 5.1.2 in TS38.321 [7], and transmit with the calculated PRACH transmission power when the backoff time expires if no Random Access Response is received within the RA Response window configured in *RACH-ConfigCommon*.

In addition, the power applied to all preambles shall be in accordance with what is specified in Clause 6.2.2.2. The power of the first preamble shall be -60 dBm to be received at TE with an accuracy specified in clause 6.3.4.2 of TS 38.101-2 [19]. The relative power applied to additional preambles shall have an accuracy specified in clause 6.3.4.3 of TS 38.101-2 [19].

The transmit timing of all PRACH transmissions shall be within the accuracy specified in Clause 7.1.2.

A.5.3.2.3 Void

A.5.4 Timing

A.5.4.1 UE transmit timing

A.5.4.1.1 NR UE Transmit Timing Test for FR2

A.5.4.1.1.1 Test Purpose and environment

The purpose of this test is to verify that the UE can follow frame timing change of the connected gNodeB and that the UE initial transmit timing accuracy, maximum amount of timing change in one adjustment, minimum and maximum adjustment rate are within the specified limits. This test will verify the requirements in clause 7.1.2.

Supported test configurations are shown in Table 5.4.1.1.1-1.

Table A.5.4.1.1.1-1: Supported test configurations for FR2 PSCell

Configuration	Description
1	LTE FDD, NR TDD, SSB SCS 240 kHz, data SCS 120 kHz, BW 100 MHz
2	LTE TDD, NR TDD, SSB SCS 240 kHz, data SCS 120 kHz, BW 100 MHz

The test consists of E-UTRA PCell and NR PSCell. The configuration for E-UTRA is given in A.3.7.2.1. Tables A.5.4.1.1.1-2 and A.5.4.1.1.1-2A define the parameters to be configured and strength of the transmitted signals. The transmit timing is verified by the UE transmitting SRS using the configuration defined in Table A.5.4.1.1.1-3.

Table A.5.4.1.1.1-2: Cell Specific Test Parameters for UL Transmit Timing test

Parameter	Unit	Config	Test1	Test2	Band Group
SSB ARFCN		1,2	Freq1	Freq1	
Duplex Mode		1,2	TDD		
TDD configuration		1,2	TDDConf.3.1		
BW _{channel}	MHz	1,2	100: N _{RB,c} = 66		
Data RBs allocated		1,2	66		
Initial BWP Configuration		1,2	DLBWP.0.1 ULBWP.0.1		
Dedicated BWP Configuration		1,2	DLBWP.1.1 ULBWP.1.1		
TRS Configuration		1,2	TRS.2.1 TDD		
PDSCH/PDCCH TCI state		1,2	TCI.State.2		
DRx Cycle	ms	1,2	N/A	DRX.8 ^{Note5}	
PDSCH Reference measurement channel		1,2	SR.3.3 TDD		
RMSI CORESET Reference Channel		1,2	CR.3.2 TDD		
Dedicated CORESET Reference Channel		1,2	CCR.3.7 TDD		
OCNG Patterns		1,2	OP.1		
SSB Configuration		1,2	SSB.4 FR2		
SMTC Configuration		1,2	SMTC.1		
PDSCH/PDCCH subcarrier spacing	kHz	1,2	120		
EPRE ratio of PSS to SSS	dB	1,2	0	0	
EPRE ratio of PBCH DMRS to SSS					
EPRE ratio of PBCH to PBCH DMRS					
EPRE ratio of PDCCH DMRS to SSS					
EPRE ratio of PDCCH to PDCCH DMRS					
EPRE ratio of PDSCH DMRS to SSS					
EPRE ratio of PDSCH to PDSCH					
EPRE ratio of OCNG DMRS to SSS(Note 1)					
EPRE ratio of OCNG to OCNG DMRS (Note 1)					
Propagation condition					
SRS Config		1,2	SRSCConf.1 ^{Note6}	SRSCConf.2 ^{Note6}	
<p>Note 1: OCNG shall be used such that both cells are fully allocated and a constant total transmitted power spectral density is achieved for all OFDM symbols.</p> <p>Note 2: Void</p> <p>Note 3: Void</p> <p>Note 4: Void</p> <p>Note 5: DRx related parameters are given in Table A.3.3.8-1</p> <p>Note 6: SRS configs are given in Table A.5.4.1.1.1-3</p>					

Table A.5.4.1.1.1-2A: OTA related test parameters

Parameter	Unit	Test 1	Test 2
Angle of arrival configuration		Setup 1 according to clause A.3.15.1	

Assumption for UE beams ^{Note 6}		Fine
N_{oc} ^{Note1}	dBm/15kHz ^{Note4}	-112
N_{oc} ^{Note1}	dBm/SCS ^{Note3}	-100
\hat{E}_s/N_{oc}	dB	4
SSB_RP ^{Note2}	dBm/SCS ^{Note4}	-96
\hat{E}_s/I_{ot}	dB	4
I_o ^{Note2}	dBm/95.04 MHz ^{Note4}	-68.5
Note 1:	Interference from other cells and noise sources not specified in the test is assumed to be constant over subcarriers and time and shall be modelled as AWGN of appropriate power for N_{oc} to be fulfilled.	
Note 2:	SSB_RP and I_o levels have been derived from other parameters for information purposes. They are not settable parameters themselves.	
Note 3:	Void	
Note 4:	Equivalent power received by an antenna with 0dBi gain at the centre of the quiet zone	
Note 5:	As observed with 0dBi gain antenna at the centre of the quiet zone	
Note 6:	Information about types of UE beam is given in B.2.1.3, and does not limit UE implementation or test system implementation	

Table A.5.4.1.1-3: SRS Configuration for Timing Accuracy Test

	Field	SRSCnf.1	SRSCnf.2	Comments
SRS-ResourceSet	srs-ResourceSetId	0	0	
	srs-ResourceCldList	0	0	
	resourceType	Periodic	Periodic	
	Usage	Codebook	Codebook	
SRS-Resource	SRS-ResourceCld	0	0	
	nrofSRS-Ports	Port1	Port1	
	transmissionComb	n2	n2	
	combOffset-n2	0	0	
	cyclicShift-n2	0	0	
	resourceMapping startPosition	0	0	
	resourceMapping nrofSymbols	n1	n1	
	resourceMapping repetitionFactor	n1	n1	
	freqDomainPosition	0	0	
	freqDomainShift	0	0	
	freqHopping c-SRS	17	17	Matches $N_{RB,c}$
	freqHopping b-SRS	0	0	
	freqHopping b-hop	0	0	
	groupOrSequenceHopping	Neither	Neither	
	resourceType	Periodic	Periodic	
	periodicityAndOffset-p	sl1,0	sl2560,4	Offset to align with DRx periodicity
	sequenceCld	0	0	Any 10 bit number

Table A.5.4.1.1.1-4: Void**A.5.4.1.1.2 Test requirements**

The test sequence shall be carried out in RRC_CONNECTED for every test case.

Following will be the test sequence for this test

- 1) Set up E-UTRA PCell according to parameters given in Table A.3.7.2.2-1 and setup NR PSCell according to parameters given in Table A.5.4.1.1.1-1.
- 2) After connection set up with the cell, the test equipment will verify that the timing of the NR cell is within $(N_{TA} + N_{TA_offset}) \times T_c \pm T_e$ of the first detected path of DL SSB.
 - a. The N_{TA} offset value (in T_c units) is 13792
 - b. The T_e values depend on the DL and UL SCS for which the test is being run and are given in Table 7.1.2-1
- 3) The test system shall adjust the timing of the DL path by values given in Table A.5.4.1.1.2-1

Table A.5.4.1.1.2-1 Adjustment Value for DL Timing

SCS of SSB signals (kHz)	Adjustment Value	
	Test1	Test2
240	$+8*64T_c$	$+4*64T_c$

- 4) The test system shall verify that the adjustment step size and the adjustment rate shall be according to requirements specified in Clause 7.1.2 Table 7.1.2.1-1 until the UE transmit timing offset is within $(N_{TA} + N_{TA_offset}) \times T_c \pm T_e$ respective to the first detected path (in time) of DL SSB. Skip this step for test 2 with DRX configured.
- 5) The test system shall verify that the UE transmit timing offset stays within $(N_{TA} + N_{TA_offset}) \times T_c \pm T_e$ of the first detected path of DL SSB. For Test 2 the UE transmit timing offset shall be verified for the first transmission in the DRX cycle immediately after DL timing adjustment

A.5.4.2 UE timer accuracy**A.5.4.3 Timing advance****A.5.4.3.1 EN-DC FR2 timing advance adjustment accuracy****A.5.4.3.1.1 Test Purpose and Environment**

The purpose of the test is to verify UE Timing Advance adjustment delay and accuracy requirement defined in clause 7.3.

A.5.4.3.1.2 Test Parameters

Supported test configurations are shown in table A.5.4.3.1.2-1. Both timing advance adjustment delay and accuracy are tested by using the parameters in table A.5.4.3.1.2-2, A.5.4.3.1.2-3, A.5.4.3.1.2-3A and A.5.4.3.1.2-4. The configuration of Cell 1 (LTE PCell) is specified in clause A.3.7.2.1.

In all test cases, two cells are used. Cell 1 is the PCell in the primary Timing Advance Group (pTAG) and cell 2 is the PSCell in the secondary Timing Advance Group (sTAG). Each test consists of two successive time periods, with time duration of T1 and T2 respectively. In each time period, timing advance commands for sTAG are sent to the UE and Sounding Reference Signals (SRS), as specified in table A.5.4.3.1.2-3, are sent from the UE and received by the test equipment. By measuring the reception of the SRS, the transmit timing, and hence the timing advance adjustment accuracy, can be measured for PSCell in sTAG.

During time period T1, the test equipment shall send one message with a Timing Advance Command MAC Control Element for sTAG, as specified in clause 6.1.3.4 in TS 38.321 [7]. The Timing Advance Command value shall be set to 31, which according to clause 4.2 in TS 38.213 [3] results in zero adjustment of the Timing Advance. In this way, a reference value for the timing advance for sTAG used by the UE is established.

During time period T2, the test equipment shall send a sequence of messages with Timing Advance Command MAC Control Elements for sTAG, with Timing Advance Command value specified in table A.5.4.3.1.2-2. This value shall result in changes of the timing advance for sTAG used by the UE, and the accuracy of the change shall then be measured, using the SRS sent from the UE.

As specified in clause 7.3.2.1, the UE adjusts its uplink timing at slot $n+k$ for a timing advance command received in slot n . This delay must be taken into account when measuring the timing advance adjustment accuracy, via the SRS sent from the UE.

The UE Time Alignment Timer, described in clause 5.2 in TS 38.321, shall be configured so that it does not expire in the duration of the test.

Table A.5.4.3.1.2-1: Timing advance supported test configurations

Config	Description
1	LTE FDD, NR 120 kHz SSB SCS, 100 MHz bandwidth, TDD duplex mode
2	LTE TDD, NR 120 kHz SSB SCS, 100 MHz bandwidth, TDD duplex mode
Note: The UE is only required to be tested in one of the supported test configurations	

Table A.5.4.3.1.2-2: General test parameters for timing advance

Parameter	Unit	Value	Comment
RF channel number		Cell 1: 1 Cell 2: 2	1 for E-UTRAN PCell 2 for NR PSCell
Initial DL BWP		DLBWP.0.1	As specified in Table A.3.9.2.1-1
Dedicated DL BWP		DLBWP.1.1	As specified in Table A.3.9.2.2-1
Initial UL BWP		ULBWP.0.1	As specified in Table A.3.9.3.1-1
Dedicated UL BWP		ULBWP.1.1	As specified in Table A.3.9.3.2-1
Timing Advance Command (T_A) value during T1		31	$N_{TA_new} = N_{TA_old}$ for the purpose of establishing a reference value from which the timing advance adjustment accuracy can be measured during T2
Timing Advance Command (T_A) value during T2		39	For 120 kHz SCS $N_{TA_new} = N_{TA_old} + 1024 * T_c$ (based on equation in clause 4.2 of TS 38.213 [3])
T1	s	5	
T2	s	5	

Table A.5.4.3.1.2-3: Cell specific test parameters for timing advance

Parameter	Unit	Test1	
		T1	T2
Duplex mode		TDD	
TDD configuration		TDDConf.3.1	
$BW_{channel}$	MHz	100: $N_{RB,c} = 66$	

BWP BW	MHz	100: $N_{RB,c} = 66$
DRx Cycle	ms	Not Applicable
PDSCH Reference measurement channel		SR.3.1 TDD
RMSI CORESET Reference Channel		CR.3.1 TDD
Dedicated CORESET Reference Channel		CCR.3.1 TDD
TRS configuration		TRS.2.1 TDD
PDSCH/PDCCH TCI state		TCI.State.2
OCNG Patterns		OCNG pattern 1
SMTTC configuration		SMTTC.1
SSB configuration		SSB.3 FR2
PDSCH/PDCCH subcarrier spacing	kHz	120 kHz
PUCCH/PUSCH subcarrier spacing	kHz	120 kHz
EPRE ratio of PSS to SSS	dB	0
EPRE ratio of PBCH DMRS to SSS		
EPRE ratio of PBCH to PBCH DMRS		
EPRE ratio of PDCCH DMRS to SSS		
EPRE ratio of PDCCH to PDCCH DMRS		
EPRE ratio of PDSCH DMRS to SSS		
EPRE ratio of PDSCH to PDSCH		
EPRE ratio of OCNG DMRS to SSS(Note 1)		
EPRE ratio of OCNG to OCNG DMRS (Note 1)		
Propagation condition		
Note 1: OCNG shall be used such that both cells are fully allocated and a constant total transmitted power spectral density is achieved for all OFDM symbols.		

Table A.5.4.3.1.2-3A: OTA related test parameters

Parameter	Unit	Test 1	
		T1	T2
Angle of arrival configuration		Setup 1 according to clause A.3.15.1	
Assumption for UE beams ^{Note 6}		Fine	
N_{oc} ^{Note1}	dBm/15kHz ^{Note4}	-112	
N_{oc} ^{Note1}	dBm/SCS ^{Note3}	-103	
\hat{E}_s / N_{oc}	dB	4	
SS-RSRP ^{Note2}	dBm/SCS ^{Note4}	-99	
\hat{E}_s / I_{ot}	dB	4	
I_o ^{Note2}	dBm/95.04 MHz ^{Note4}	-68.5	
<p>Note 1: Interference from other cells and noise sources not specified in the test is assumed to be constant over subcarriers and time and shall be modelled as AWGN of appropriate power for N_{oc} to be fulfilled.</p> <p>Note 2: SS-RSRP and I_o levels have been derived from other parameters for information purposes. They are not settable parameters themselves.</p> <p>Note 3: SS-RSRP minimum requirements are specified assuming independent interference and noise at each receiver antenna port.</p> <p>Note 4: Equivalent power received by an antenna with 0dBi gain at the centre of the quiet zone</p> <p>Note 5: As observed with 0dBi gain antenna at the centre of the quiet zone</p> <p>Note 6: Information about types of UE beam is given in B.2.1.3, and does not limit UE implementation or test system implementation</p>			

Table A.5.4.3.1.2-4: Sounding Reference Symbol Configuration for timing advance

Field	Value	Comment
c-SRS	16	Frequency hopping is disabled
b-SRS	0	
b-hop	0	
freqDomainPosition	0	Frequency domain position of SRS
freqDomainShift	0	
groupOrSequenceHopping	neither	No group or sequence hopping
SRS-PeriodicityAndOffset	sl5=4	Once every 5 slots
pathlossReferenceRS	ssb-Index=0	SSB #0 is used for SRS path loss estimation
usage	Codebook	Codebook based UL transmission
startPosition	0	resourceMapping setting. SRS on last symbol of slot, and 1symbols for SRS without repetition.
nrofSymbols	n1	
repetitionFactor	n1	
combOffset-n2	0	transmissionComb setting
cyclicShift-n2	0	
nrofSRS-Ports	port1	Number of antenna ports used for SRS transmission
Note: For further information see clause 6.3.2 in TS 38.331 [2].		

A.5.4.3.1.3 Test Requirements

The UE shall apply the signalled Timing Advance value for PSCell in sTAG to the transmission timing at the designated activation time i.e. $k+1$ slots after the reception of the timing advance command, where $k = 11$.

The Timing Advance adjustment accuracy for PSCell in sTAG shall be within the limits specified in clause 7.3.2.2.

The rate of correct Timing Advance adjustments observed during repeated tests shall be at least 90%.

A.5.5 Signaling characteristics

A.5.5.1 Radio link Monitoring

In the following clause, any uplink signal transmitted by the UE is used for detecting the In-/Out-of-Sync state of the UE. In terms of measurement, the uplink signal is verified on the basis of the UE output power:

Editor note: The metric for the detection of the UE UL transmitted signal by the TE is FFS.

A.5.5.1.1 Radio Link Monitoring Out-of-sync Test for FR2 PSCell configured with SSB-based RLM RS in non-DRX mode

A.5.5.1.1.1 Test Purpose and Environment

The purpose of this test is to verify that the UE properly detects the out of sync and in sync for the purpose of monitoring downlink radio link quality of the PSCell. This test will partly verify the FR2 radio link monitoring requirements in clause 8.1.

In the test, UE is configured to perform RLM on SSB, with *detectionResource* included in *RadioLinkMonitoringRS* set to SSB#0 and SSB#1, and *purpose* set to 'rlf'. Supported test configurations are shown in table A.5.5.1.1.1-1. The test parameters are given in Tables A.5.5.1.1.1-2, A.5.5.1.1.1-3, and A.5.5.1.1.1-4 below. There are two cells, Cell 1 is the E-UTRAN PCell, and Cell 2 is the PSCell, in the test. The E-UTRAN PCell setting refers to Table A.3.7.2.1-2. The test consists of three successive time periods, with time duration of T1, T2 and T3 respectively. Figure A.5.5.1.1.1-1 shows the variation of the downlink SNR in the active cell to emulate out-of-sync and in-sync states, and Figure A.5.5.1.1.1-2 shows the Time multiplexed downlink transmissions from each Angle of Arrival. Prior to the start of the time duration T1, the UE shall be fully synchronized to Cell 1 and Cell 2. The UE shall be configured for periodic CSI reporting with a reporting periodicity of 5 ms. In addition to RLM-RS radio link monitoring using SSB index 0 and SSB index 1, the UE is configured to perform inter-frequency measurements using Gap Pattern ID #0 (40ms) in test 1.

Table A.5.5.1.1.1-1: Supported test configurations for FR2 PSCell

Configuration	Description
1	FDD LTE PCell, NR 120 KHz SSB SCS, 100 MHz bandwidth, TDD duplex mode
2	TDD LTE PCell, NR 120 KHz SSB SCS, 100 MHz bandwidth, TDD duplex mode
Note: The UE is only required to pass in one of the supported test configurations in FR2	

Table A.5.5.1.1.1-2: General test parameters for FR2 out-of-sync testing in non-DRX mode

Parameter		Unit	Value
			Test 1
Active E-UTRA PCell			Cell 1
E-UTRA RF Channel Number			1
Active PSCell			Cell 2
RF Channel Number			2
Duplex mode	Config 1, 2		TDD
BW _{channel}	Config 1, 2		100: N _{RB,c} = 66
Data RBs allocated	Config 1, 2		24
DL initial BWP configuration	Config 1, 2		DLBWP.0.1
DL dedicated BWP configuration	Config 1, 2		DLBWP.1.1
UL initial BWP configuration	Config 1, 2		ULBWP.0.1
UL dedicated BWP configuration	Config 1, 2		ULBWP.1.1
TDD Configuration	Config 1, 2		TDDConf.3.1
RMSI CORESET Reference Channel	Config 1, 2		CR.3.1 TDD
Dedicated CORESET Reference Channel	Config 1, 2		CCR.3.4 TDD
SSB Configuration	Config 1, 2		SSB.1 FR2
SMTC Configuration	Config 1, 2		SMTC.1
PDSCH/PDCCH subcarrier spacing	Config 1, 2		120 KHz
PRACH Configuration	Config 1, 2		Table A.3.8.3.1
SSB index assigned as RLM RS	Config 1, 2		0,1
OCNG parameters			OP.5
CP length			Normal
Out of sync transmission parameters	DCI format		1-0
	Number of Control OFDM symbols		2
	Aggregation level	CCE	8

	Ratio of hypothetical PDCCH RE energy to average SSS RE energy	dB	4
	Ratio of hypothetical PDCCH DMRS energy to average SSS RE energy	dB	4
	DMRS precoder granularity		REG bundle size
	REG bundle size		6
DRX			OFF
Gap pattern ID			gp0
Layer 3 filtering			Enabled
T310 timer		ms	0
T311 timer		ms	1000
N310			1
N311			1
CSI-RS for CSI reporting	Config 1, 2		CSI-RS.3.1 TDD
reportConfigType			periodic
reportQuantity			cri-RI-PMI-CQI
CSI reporting periodicity		slot	40
CSI reporting offset		slot	4
TCI states for PDCCH/PDSCH			TCI.State.2
CSI-RS for tracking	Config 1, 2		TRS.2.1 TDD
T1		s	0.2
T2		s	9.68
T3		s	9.68
D1		s	9.64
Note 1: All configurations are assigned to the UE prior to the start of time period T1. Note 2: UE-specific PDCCH is not transmitted after T1 starts. Note 3: E-UTRAN is in non-DRX mode under test.			

Table A.5.5.1.1-3: OTA related cell specific test parameters for FR2 (Cell 2) for out-of-sync radio link monitoring tests in non-DRX mode

Parameter	Unit	Test 1						
		T1	T2	T3	T1	T2	T3	
AoA setup		Setup 3 defined in A.3.15						
		AoA1			AoA2			
Assumption for UE beams ^{Note 5}		Rough			Rough			
EPRE ratio of PDCCH DMRS to SSS	dB	4			Not sent			
EPRE ratio of PDCCH to PDCCH DMRS	dB	0						
EPRE ratio of PBCH DMRS to SSS	dB							
EPRE ratio of PBCH to PBCH DMRS	dB							
EPRE ratio of PSS to SSS	dB							
EPRE ratio of PDSCH DMRS to SSS	dB							
EPRE ratio of PDSCH to PDSCH DMRS	dB							
EPRE ratio of OCNG DMRS to SSS	dB							
EPRE ratio of OCNG to OCNG DMRS	dB							
ssb-Index 0 SNR	Config 1, 2	dB	2 ^{Note 6}	-6 ^{Note 6}	-15			
ssb-Index 1 SNR	Config 1, 2	dB	Not sent			2 ^{Note 6}	-15	-15
N_{oc}	Config 1, 2	dBm/15kHz	-92.1			-92.1		
Time multiplexing of the downlink transmissions from each AoA			Defined in Figure A.5.5.1.1-2					
Propagation condition			TDL-A 30ns 75Hz			TDL-A 30ns 75Hz		

- Note 1: OCNG shall be used such that a constant total transmitted power spectral density is achieved for all OFDM symbols.
- Note 2: The signal contains PDCCH for UEs other than the device under test as part of OCNG.
- Note 3: SNR levels correspond to the signal to noise ratio over the SSS REs.
- Note 4: The SNR values are specified for testing a UE which supports 2RX on at least one band. For testing of a UE which supports 4RX on all bands, the SNR during T3 is A.3.6.
- Note 5: Information about types of UE beam is given in B.2.1.3, and does not limit UE implementation or test system implementation
- Note 6: This value allows up to 1dB degradation from applied SNR to UE baseband

Table A.5.5.1.1.1-4: Measurement gap configuration for out-of-sync tests in non-DRX mode

Field	Test 1
	Value
gapOffset	0
Note 1: E-UTRAN PCell and PSCell are SFN-synchronous and frame boundary aligned. (Ensure that RLM RS is partially overlapped with measurement gap).	

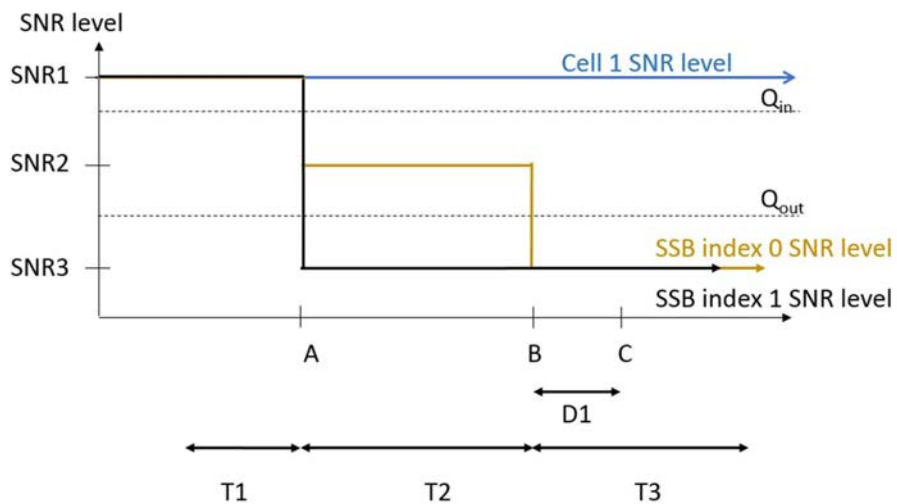

Figure A.5.5.1.1.1-1: SNR variation for out-of-sync testing

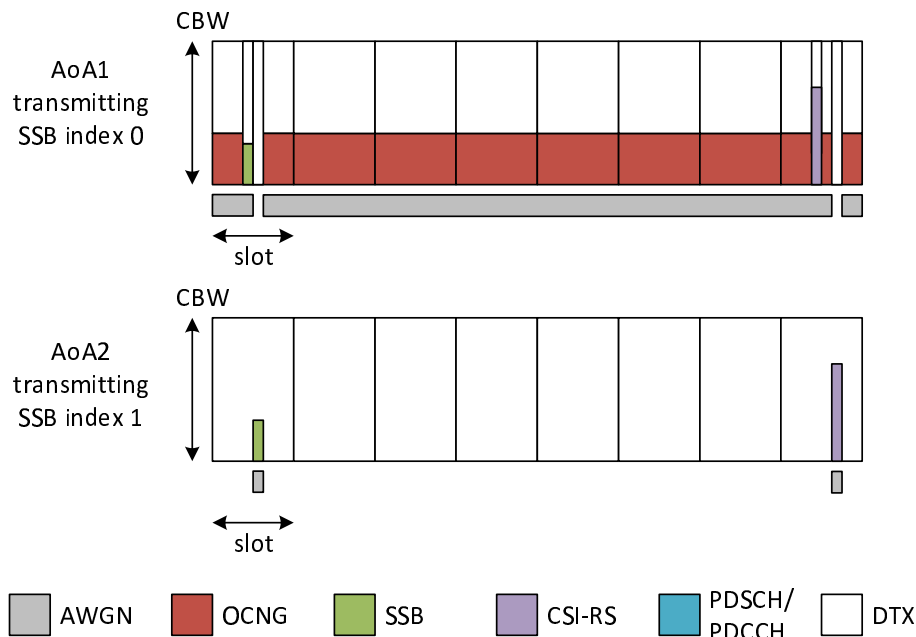

Figure A.5.5.1.1.1-2: Time multiplexed downlink transmissions

A.5.5.1.1.2 Test Requirements

The UE behavior in each test during time durations T1, T2 and T3 shall be as follows:

During the period from time point A to time point B the UE shall transmit uplink signal at least in all uplink slots configured for CSI transmission according to the configured periodic CSI reporting.

The UE shall stop transmitting uplink signal in Cell 2 no later than time point C (D1 second after the start of the time duration T3).

The rate of correct events observed during repeated tests shall be at least 90%.

A.5.5.1.2 Radio Link Monitoring In-sync Test for FR2 PSCell configured with SSB-based RLM RS in non-DRX mode

A.5.5.1.2.1 Test Purpose and Environment

The purpose of this test is to verify that the UE properly detects the out of sync and in sync for the purpose of monitoring downlink radio link quality of the PSCell. This test will partly verify the FR2 radio link monitoring requirements in clause 8.1.

In the test, UE is configured to perform RLM on SSB, with *detectionResource* included in *RadioLinkMonitoringRS* set to SSB#0 and SSB#1, and *purpose* set to 'rlf'. Supported test configurations are shown in table A.5.5.1.2.1-1. The test parameters are given in Tables A.5.5.1.2.1-2, and A.5.5.1.2.1-3 below. There are two cells, Cell 1 is the E-UTRAN PCell, and Cell 2 is the PSCell, in the test. The E-UTRAN PCell setting refers to Table A.3.7.2.1-2. The test consists of five successive time periods, with time duration of T1, T2, T3, T4 and T5 respectively. Figure A.5.5.1.2.1-1 shows the variation of the downlink SNR in the active cell to emulate out-of-sync and in-sync states, and Figure A.5.5.1.2.1-2 shows the Time multiplexed downlink transmissions from each Angle of Arrival. Prior to the start of the time duration T1, the UE shall be fully synchronized to Cell 1 and Cell 2. The UE shall be configured for periodic CSI reporting with a reporting periodicity of 5ms.

Table A.5.5.1.2.1-1: Supported test configurations for FR2 PSCell

Configuration	Description
1	FDD LTE PCell, NR 120 KHz SSB SCS, 100 MHz bandwidth, TDD duplex mode
2	TDD LTE PCell, NR 120 KHz SSB SCS, 100 MHz bandwidth, TDD duplex mode
Note: The UE is only required to pass in one of the supported test configurations in FR2	

Table A.5.5.1.2.1-2: General test parameters for FR2 in-sync testing in non-DRX mode

Parameter		Unit	Value Test 1
Active E-UTRA PCell			Cell 1
E-UTRA RF Channel Number			1
Active PSCell			Cell 2
RF Channel Number			2
Duplex mode	Config 1, 2		TDD
BW _{channel}	Config 1, 2		100: N _{RB,c} = 66
Data RBs allocated	Config 1, 2		24
DL initial BWP configuration	Config 1, 2		DLBWP.0.1
DL dedicated BWP configuration	Config 1, 2		DLBWP.1.1
UL initial BWP configuration	Config 1, 2		ULBWP.0.1
UL dedicated BWP configuration	Config 1, 2		ULBWP.1.1
TDD Configuration	Config 1, 2		TDDConf.3.1
RMSI CORESET Reference Channel	Config 1, 2		CR.3.1 TDD
Dedicated CORESET Reference Channel	Config 1, 2		CCR.3.1 TDD
SSB Configuration	Config 1, 2		SSB.1 FR2
SMTTC Configuration	Config 1, 2		SMTTC.3
PDSCH/PDCCH subcarrier spacing	Config 1, 2		120 KHz
PRACH Configuration	Config 1, 2		Table A.3.8.3.1
SSB index assigned as RLM RS	Config 1, 2		0,1
OCNG parameters			OP.5
CP length			Normal
In sync transmission parameters	DCI format		1-0
	Number of Control OFDM symbols		2
	Aggregation level	CCE	4
	Ratio of hypothetical PDCCH RE energy to average SSS RE energy	dB	0
	Ratio of hypothetical PDCCH DMRS energy to average SSS RE energy	dB	0
	DMRS precoder granularity		REG bundle size
	REG bundle size		6
Out of sync transmission parameters	DCI format		1-0
	Number of Control OFDM symbols		2
	Aggregation level	CCE	8
	Ratio of hypothetical PDCCH RE energy to average SSS RE energy	dB	4
	Ratio of hypothetical PDCCH DMRS energy to average SSS RE energy	dB	4
	DMRS precoder granularity		REG bundle size

	REG bundle size		6
DRX			OFF
Gap pattern ID			N.A.
Layer 3 filtering			Enabled
T310 timer		ms	4000
T311 timer		ms	1000
N310			1
N311			1
CSI-RS for CSI reporting	Config 1, 2		CSI-RS.3.1 TDD
reportConfigType			periodic
reportQuantity			cri-RI-PMI-CQI
CSI reporting periodicity		slot	40
CSI reporting offset		slot	4
TCI states for PDCCH/PDSCH			TCI.State.2
CSI-RS for tracking	Config 1, 2		TRS.2.1 TDD
T1		s	0.2
T2		s	0.2
T3		s	1.88
T4		s	0.2
T5		s	3.84
D1		s	3.8
Note 1: All configurations are assigned to the UE prior to the start of time period T1.			
Note 2: UE-specific PDCCH is not transmitted after T1 starts.			
Note 3: E-UTRAN is in non-DRX mode under test.			

Table A.5.5.1.2.1-3: OTA related cell specific test parameters for FR2 (Cell 2) for in-sync radio link monitoring tests in non-DRX mode

Parameter	Unit	Test 1										
		T1	T2	T3	T4	T5	T1	T2	T3	T4	T5	
AoA setup		Setup 3 defined in A.3.15										
		AoA1					AoA2					
Assumption for UE beams ^{Note 5}		Rough					Rough					
EPRE ratio of PDCCH DMRS to SSS	dB	0					Not sent					
EPRE ratio of PDCCH to PDCCH DMRS	dB	0										
EPRE ratio of PBCH DMRS to SSS	dB											
EPRE ratio of PBCH to PBCH DMRS	dB											
EPRE ratio of PSS to SSS	dB											
EPRE ratio of PDSCH DMRS to SSS	dB											
EPRE ratio of PDSCH to PDSCH DMRS	dB											
EPRE ratio of OCNG DMRS to SSS	dB											
EPRE ratio of OCNG to OCNG DMRS	dB											
ssb-Index 0 SNR	Config 1, 2	dB	² Note 6	- ⁶ Note 6	-15	-15	-15					
ssb-Index 1 SNR	Config 1, 2		Not sent					² Note 6	-15	-15	-4.5	² Note 6
N_{oc}	Config 1, 2	dBm/ 15kHz	-92.1					-92.1				

Time multiplexing of the downlink transmissions from each AoA		Defined in Figure A.5.5.1.2.1-2	
Propagation condition		TDL-A 30ns 75Hz	TDL-A 30ns 75Hz
Note 1:	OCNG shall be used such that a constant total transmitted power spectral density is achieved for all OFDM symbols.		
Note 2:	The signal contains PDCCH for UEs other than the device under test as part of OCNG.		
Note 3:	SNR levels correspond to the signal to noise ratio over the SSS REs.		
Note 4:	The SNR values are specified for testing a UE which supports 2RX on at least one band. For testing of a UE which supports 4RX on all bands, the SNR during T3 is A.3.6.		
Note 5:	Information about types of UE beam is given in B.2.1.3, and does not limit UE implementation or test system implementation		
Note 6:	This value allows up to 1dB degradation from applied SNR to UE baseband		

Table A.5.5.1.2.1-4: Void

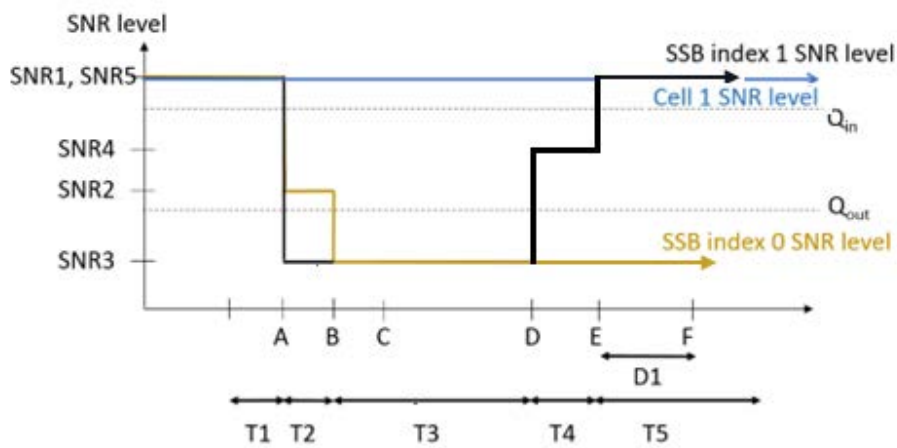

Figure A.5.5.1.2.1-1: SNR variation for in-sync testing

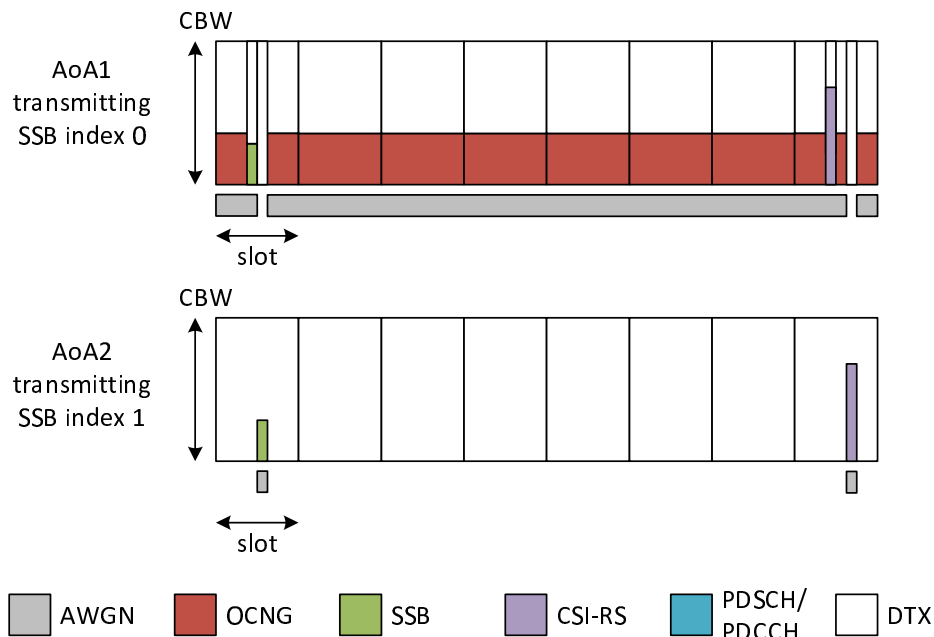

Figure A.5.5.1.2.1-2: Time multiplexed downlink transmissions

A.5.5.1.2.2 Test Requirements

The UE behaviour in each test during time durations T1, T2, T3, T4 and T5 shall be as follows:

During the period from time point A to time point F (D1 second after the start of time duration T5) the UE shall transmit uplink signal at least in all uplink slots configured for CSI transmission according to the configured periodic CSI reporting.

The rate of correct events observed during repeated tests shall be at least 90%.

A.5.5.1.3 Radio Link Monitoring Out-of-sync Test for FR2 PSCell configured with SSB-based RLM RS in DRX mode

A.5.5.1.3.1 Test Purpose and Environment

The purpose of this test is to verify that the UE properly detects the out of sync and in sync for the purpose of monitoring downlink radio link quality of the PSCell when DRX is used. This test will partly verify the FR2 radio link monitoring requirements in clause 8.1.

In the test, UE is configured to perform RLM on SSB, with *detectionResource* included in *RadioLinkMonitoringRS* set to SSB#0 and SSB#1, and *purpose* set to 'rlf'. Supported test configurations are shown in table A.5.5.1.3.1-1. The test parameters are given in Tables A.5.5.1.3.1-2, and A.5.5.1.3.1-3. There are two cells, Cell 1 is the E-UTRAN PCell, and Cell 2 is the PSCell, in the test. The E-UTRAN PCell setting refers to Table A.3.7.2.1-2. The test consists of three successive time periods, with time duration of T1, T2 and T3 respectively. Figure A.5.5.1.3.1-1 shows the variation of the downlink SNR in the active cell to emulate out-of-sync and in-sync states. Prior to the start of the time duration T1, the UE shall be fully synchronized to Cell 1 and Cell 2. The UE shall be configured for periodic CSI reporting with a reporting periodicity of 5 ms. In the test, DRX configuration is enabled and DRX inactivity timer has already been expired, i.e. UE tries to decode PDCCH and to send periodic CSI during the period when On-duration timer is running. Time alignment timers shall be set to "infinity" so that UL timing alignment is maintained during the test.

Table A.5.5.1.3.1-1: Supported test configurations for FR2 PSCell

Configuration	Description
1	FDD LTE PCell, NR 120 KHz SSB SCS, 100 MHz bandwidth, TDD duplex mode
2	TDD LTE PCell, NR 120 KHz SSB SCS, 100 MHz bandwidth, TDD duplex mode
Note: The UE is only required to pass in one of the supported test configurations in FR2	

Table A.5.5.1.3.1-2: General test parameters for FR2 out-of-sync testing in DRX mode

Parameter		Unit	Value
			Test 1
Active E-UTRA PCell			Cell 1
E-UTRA RF Channel Number			1
Active PSCell			Cell 2
RF Channel Number			2
Duplex mode	Config 1, 2		TDD
BW _{channel}	Config 1, 2		100: N _{RB,c} = 66
Data RBs allocated	Config 1, 2		66
DL initial BWP configuration	Config 1, 2		DLBWP.0.1
DL dedicated BWP configuration	Config 1, 2		DLBWP.1.1
UL initial BWP configuration	Config 1, 2		ULBWP.0.1
UL dedicated BWP configuration	Config 1, 2		ULBWP.1.1
TDD Configuration	Config 1, 2		TDDConf.3.1
RMSI CORESET Reference Channel	Config 1, 2		CR.3.1 TDD
Dedicated CORESET Reference Channel	Config 1, 2		CCR.3.4 TDD
SSB Configuration	Config 1, 2		SSB.1 FR2
SMTC Configuration	Config 1, 2		SMTC.1
PDSCH/PDCCH subcarrier spacing	Config 1, 2		120 KHz
PRACH Configuration	Config 1, 2		Table A.3.8.3.1
SSB index assigned as RLM RS	Config 1, 2		0,1
OCNG parameters			OP.1
CP length			Normal
Out of sync transmission parameters	DCI format		1-0
	Number of Control OFDM symbols		2
	Aggregation level	CCE	8
	Ratio of hypothetical PDCCH RE energy to average SSS RE energy	dB	4
	Ratio of hypothetical PDCCH DMRS energy to average SSS RE energy	dB	4
	DMRS precoder granularity		REG bundle size
REG bundle size			6
DRX Configuration			DRX.3
Gap pattern ID			N.A.
Layer 3 filtering			Enabled
T310 timer		ms	0
T311 timer		ms	1000
N310			1
N311			1
CSI-RS for CSI reporting	Config 1, 2		CSI-RS.3.1 TDD
reportConfigType			periodic
reportQuantity			cri-RI-PMI-CQI

CSI reporting periodicity	slot	40
CSI reporting offset	slot	4
TCI states for PDCCH/PDSCH		TCI.State.2
CSI-RS for tracking	Config 1, 2	TRS.2.1 TDD
T1	s	0.2
T2	s	14.48
T3	s	14.48
D1	s	14.44
Note 1: All configurations are assigned to the UE prior to the start of time period T1.		
Note 2: UE-specific PDCCH is not transmitted after T1 starts.		
Note 3: E-UTRAN is in non-DRX mode under test.		

Table A.5.5.1.3.1-3: OTA related cell specific test parameters for FR2 (Cell 2) for out-of-sync radio link monitoring tests in DRX mode

Parameter	Unit	Test 1			
		T1	T2	T3	
AoA setup		Setup 1 defined in A.3.15			
Assumption for UE beams ^{Note 5}		Rough			
EPRE ratio of PDCCH DMRS to SSS	dB	4			
EPRE ratio of PDCCH to PDCCH DMRS	dB	0			
EPRE ratio of PBCH DMRS to SSS	dB	0			
EPRE ratio of PBCH to PBCH DMRS	dB				
EPRE ratio of PSS to SSS	dB				
EPRE ratio of PDSCH DMRS to SSS	dB				
EPRE ratio of PDSCH to PDSCH DMRS	dB				
EPRE ratio of OCNG DMRS to SSS	dB				
EPRE ratio of OCNG to OCNG DMRS	dB				
ssb-Index 0 SNR	Config 1, 2	dB	² Note 6	⁻⁶ Note 6	-15
ssb-Index 1 SNR	Config 1, 2	dB	² Note 6	-15	-15
N_{oc}	Config 1, 2	dBm/15K Hz	-104.7dBm		
Propagation condition		TDL-A 30ns 75Hz			
Note 1: OCNG shall be used such that the resources in Cell 2 are fully allocated and a constant total transmitted power spectral density is achieved for all OFDM symbols.					
Note 2: The signal contains PDCCH for UEs other than the device under test as part of OCNG.					
Note 3: SNR levels correspond to the signal to noise ratio over the SSS REs.					
Note 4: The SNR values are specified for testing a UE which supports 2RX on at least one band. For testing of a UE which supports 4RX on all bands, the SNR during T3 is A.3.6.					
Note 5: Information about types of UE beam is given in B.2.1.3, and does not limit UE implementation or test system implementation					
Note 6: This value allows up to 1dB degradation from applied SNR to UE baseband					

Table A.5.5.1.3.1-4: Void

Table A.5.5.1.3.1-5: Void

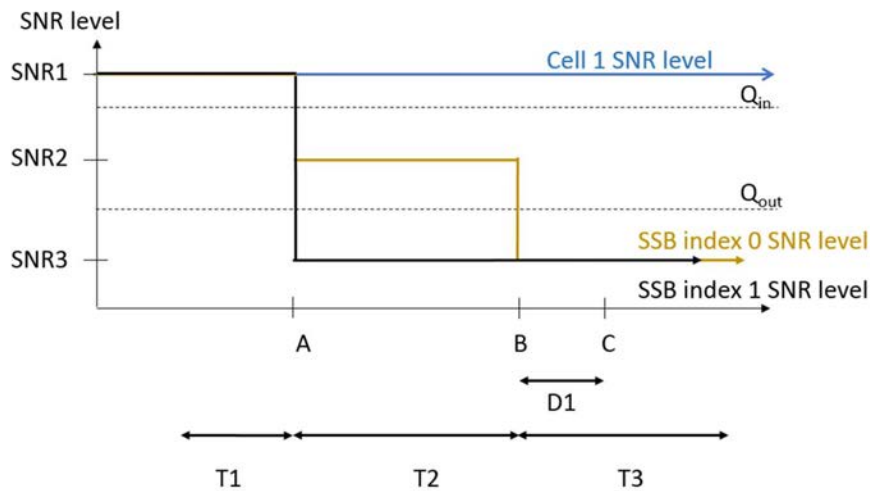

Figure A.5.5.1.3.1-1: SNR variation for out-of-sync testing

A.5.5.1.3.2 Test Requirements

The UE behavior in each test during time durations T1, T2 and T3 shall be as follows:

During the period from time point A to time point B the UE shall transmit uplink signal at least in all uplink slots configured for CSI transmission according to the configured periodic CSI reporting.

The UE shall stop transmitting uplink signal in Cell 2 no later than time point C (D1 second after the start of the time duration T3).

The rate of correct events observed during repeated tests shall be at least 90%.

A.5.5.1.4 Radio Link Monitoring In-sync Test for FR2 PSCell configured with SSB-based RLM RS in DRX mode

A.5.5.1.4.1 Test Purpose and Environment

The purpose of this test is to verify that the UE properly detects the out of sync and in sync for the purpose of monitoring downlink radio link quality of the PSCell when DRX is used. This test will partly verify the FR2 radio link monitoring requirements in clause 8.1.

In the test, UE is configured to perform RLM on SSB, with *detectionResource* included in *RadioLinkMonitoringRS* set to SSB#0 and SSB#1, and *purpose* set to 'rlf'. Supported test configurations are shown in table A.5.5.1.4.1-1. The test parameters are given in Tables A.5.5.1.4.1-2, and A.5.5.1.4.1-3. There are two cells, Cell 1 is the E-UTRAN PCell, and Cell 2 is the PSCell, in the test. The E-UTRAN PCell setting refers to Table A.3.7.2.1-2. The test consists of five successive time periods, with time duration of T1, T2, T3, T4 and T5 respectively. Figure A.5.5.1.4.1-1 shows the variation of the downlink SNR in the active cell to emulate out-of-sync and in-sync states. Prior to the start of the time duration T1, the UE shall be fully synchronized to Cell 1 and Cell 2. The UE shall be configured for periodic CSI reporting with a reporting periodicity of 5 ms. In the test, DRX configuration is enabled and DRX inactivity timer has already been expired, i.e. UE tries to decode PDCCH and to send periodic CSI during the period when On-duration timer is running. Time alignment timers shall be set to "infinity" so that UL timing alignment is maintained during the test.

Table A.5.5.1.4.1-1: Supported test configurations for FR2 PSCell

Configuration	Description
1	FDD LTE PCell, NR 120 KHz SSB SCS, 100 MHz bandwidth, TDD duplex mode
2	TDD LTE PCell, NR 120 KHz SSB SCS, 100 MHz bandwidth, TDD duplex mode
Note: The UE is only required to pass in one of the supported test configurations in FR2	

Table A.5.5.1.4.1-2: General test parameters for FR2 in-sync testing in DRX mode

Parameter		Unit	Value Test 1
Active E-UTRA PCell			Cell 1
E-UTRA RF Channel Number			1
Active PSCell			Cell 2
RF Channel Number			2
Duplex mode	Config 1, 2		TDD
BW _{channel}	Config 1, 2		100: N _{RB,c} = 66
Data RBs allocated	Config 1, 2		66
DL initial BWP configuration	Config 1, 2		DLBWP.0.1
DL dedicated BWP configuration	Config 1, 2		DLBWP.1.1
UL initial BWP configuration	Config 1, 2		ULBWP.0.1
UL dedicated BWP configuration	Config 1, 2		ULBWP.1.1
TDD Configuration	Config 1, 2		TDDConf.3.1
RMSI CORESET Reference Channel	Config 1, 2		CR.3.1 TDD
Dedicated CORESET Reference Channel	Config 1, 2		CCR.3.1 TDD
SSB Configuration	Config 1, 2		SSB.1 FR2
SMTTC Configuration	Config 1, 2		SMTTC.3
PDSCH/PDCCH subcarrier spacing	Config 1, 2		120 KHz
PRACH Configuration	Config 1, 2		Table A.3.8.3.1
SSB index assigned as RLM RS	Config 1, 2		0,1
OCNG parameters			OP.1
CP length			Normal
In sync transmission parameters	DCI format		1-0
	Number of Control OFDM symbols		2
	Aggregation level	CCE	4
	Ratio of hypothetical PDCCH RE energy to average SSS RE energy	dB	0
	Ratio of hypothetical PDCCH DMRS energy to average SSS RE energy	dB	0
	DMRS precoder granularity		REG bundle size
	REG bundle size		6
Out of sync transmission parameters	DCI format		1-0
	Number of Control OFDM symbols		2
	Aggregation level	CCE	8
	Ratio of hypothetical PDCCH RE energy to average SSS RE energy	dB	4
	Ratio of hypothetical PDCCH DMRS energy to average SSS RE energy	dB	4

	DMRS precoder granularity		REG bundle size
	REG bundle size		6
DRX Configuration			DRX.11
Gap pattern ID			N.A.
Layer 3 filtering			Enabled
T310 timer		ms	4000
T311 timer		ms	1000
N310			1
N311			1
CSI-RS for CSI reporting	Config 1, 2		CSI-RS.3.1 TDD
reportConfigType			periodic
reportQuantity			cri-RI-PMI-CQI
CSI reporting periodicity		slot	40
CSI reporting offset		slot	4
TCI states for PDCCH/PDSCH			TCI.State.2
CSI-RS for tracking	Config 1, 2		TRS.2.1 TDD
T1		s	0.2
T2		s	0.2
T3		s	2.8
T4		s	0.2
T5		s	3.88
D1		s	3.84
Note 1: All configurations are assigned to the UE prior to the start of time period T1.			
Note 2: UE-specific PDCCH is not transmitted after T1 starts.			
Note 3: E-UTRAN is in non-DRX mode under test.			

Table A.5.5.1.4.1-3: OTA related cell specific test parameters for FR2 (Cell 2) for in-sync radio link monitoring test in DRX mode

Parameter		Unit	Test 1				
			T1	T2	T3	T4	T5
AoA setup			Setup 1 defined in A.3.15				
Assumption for UE beams ^{Note 5}			Rough				
EPRE ratio of PDCCH DMRS to SSS		dB	0				
EPRE ratio of PDCCH to PDCCH DMRS		dB	0				
EPRE ratio of PBCH DMRS to SSS		dB	0				
EPRE ratio of PBCH to PBCH DMRS		dB					
EPRE ratio of PSS to SSS		dB					
EPRE ratio of PDSCH DMRS to SSS		dB					
EPRE ratio of PDSCH to PDSCH DMRS		dB					
EPRE ratio of OCNG DMRS to SSS		dB					
EPRE ratio of OCNG to OCNG DMRS		dB					
ssb-Index 0 SNR	Config 1, 2	dB	2 ^{Note 6}	-6 ^{Note 6}	-15	-4.5	2 ^{Note 6}
ssb-Index 1 SNR	Config 1, 2		2 ^{Note 6}	-15	-15	-15	-15
N_{oc}	Config 1, 2	dBm/1 5KHz	-104.7dBm				
Propagation condition			TDL-A 30ns 75Hz				

Note 1:	OCNG shall be used such that the resources in Cell 2 are fully allocated and a constant total transmitted power spectral density is achieved for all OFDM symbols.
Note 2:	The signal contains PDCCH for UEs other than the device under test as part of OCNG.3
Note 3:	SNR levels correspond to the signal to noise ratio over the SSS REs.
Note 4:	The SNR values are specified for testing a UE which supports 2RX on at least one band. For testing of a UE which supports 4RX on all bands, the SNR during T3 is A.3.6.
Note 5:	Information about types of UE beam is given in B.2.1.3, and does not limit UE implementation or test system implementation
Note 6:	This value allows up to 1dB degradation from applied SNR to UE baseband

Table A.5.5.1.4.1-4: Void

Table A.5.5.1.4.1-5: Void

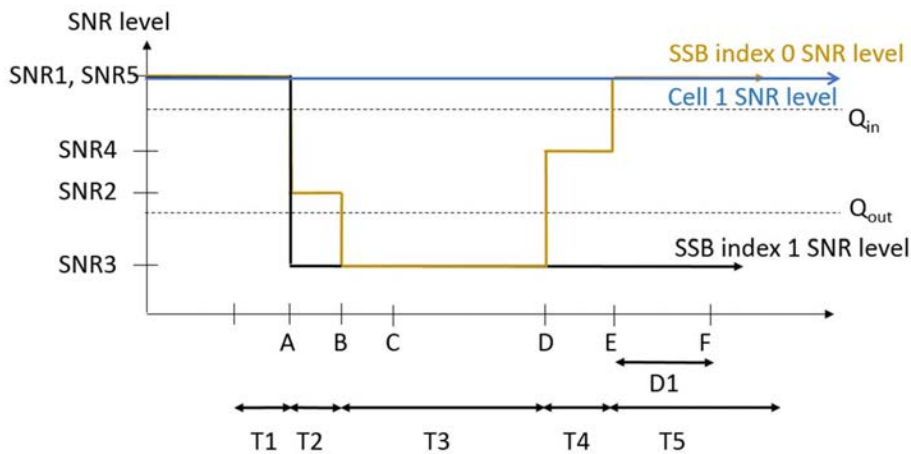

Figure A.5.5.1.4.1-1: SNR variation for in-sync testing.

A.5.5.1.4.2 Test Requirements

The UE behaviour in each test during time durations T1, T2, T3, T4 and T5 shall be as follows:

During the period from time point A to time point F (D1 second after the start of time duration T5) the UE shall transmit uplink signal at least in all uplink slots configured for CSI transmission according to the configured periodic CSI reporting.

The rate of correct events observed during repeated tests shall be at least 90%.

A.5.5.1.5 EN-DC Radio Link Monitoring Out-of-sync Test for FR2 PSCell configured with CSI-RS-based RLM in non-DRX mode

A.5.5.1.5.1 Test Purpose and Environment

The purpose of this test is to verify that the UE properly detects the out of sync for the purpose of monitoring downlink CSI-RS based radio link quality of the PSCell when no DRX is used. This test will partly verify the FR2 TDD PSCell CSI-RS Out-of-sync radio link monitoring requirements in clause 8.1.

The test parameters are given in Tables A.5.5.1.5.1-1, A.5.5.1.5.1-2, A.5.5.1.5.1-3 and A.5.5.1.5.1-3A below. There are two cells, cell 1 is the E-UTRAN PCell, and cell 2 is the PSCell, in the test. The test consists of three successive time periods, with time duration of T1, T2 and T3 respectively. Figure A.5.5.1.5.1-1 shows the variation of the downlink SNR in the E-UTRAN PCell and the PSCell to emulate out-of-sync and in-sync states. Prior to the start of the time duration T1, the UE shall be fully synchronized to cell 1 and cell 2. The UE shall be configured for periodic CSI reporting with a reporting periodicity of 5ms. In the test, DRX configuration is not enabled. The UE is configured to perform inter-frequency measurements using GP ID #0 (40ms). In the test, SSB0 and SSB1 are configured as BFD-RS.

Table A.5.5.1.5.1-1: Supported test configurations for FR2 PSCell

Configuration	Description
1	LTE FDD, NR 120 kHz SSB SCS, 100 MHz bandwidth, TDD duplex mode
2	LTE TDD, NR 120 kHz SSB SCS, 100 MHz bandwidth, TDD duplex mode
Note: The UE is only required to pass in one of the supported test configurations in FR2	

Table A.5.5.1.5.1-2: General test parameters for FR2 PSCell for CSI-RS out-of-sync testing in non-DRX mode

Parameter		Unit	Value Test 1
Active E-UTRA PCell			Cell 1
E-UTRA RF Channel Number			1
Active PSCell			Cell 2
RF Channel Number			2
Duplex Mode			TDD
$BW_{channel}$	Config 1, 2		100: $N_{RB,c} = 66$
Data RBs allocated	Config 1, 2		24
$BW_{occupied}$	Config 1, 2		24
TDD Configuration	Config 1		TDDConf.3.1
	Config 2		TDDConf.3.1
DL initial BWP configuration	Config 1, 2		DLBWP.0.1
DL dedicated BWP configuration	Config 1, 2		DLBWP.1.4
UL initial BWP configuration	Config 1, 2		ULBWP.0.1
UL dedicated BWP configuration	Config 1, 2		ULBWP.1.4
RMSI CORESET Reference Channel	Config 1		CR.3.1 TDD
	Config 2		CR.3.1 TDD
Dedicated CORESET Reference Channel	Config 1		CCR.3.4 TDD CCR.3.6 TDD
	Config 2		CCR.3.4 TDD

SSB Configuration	Config 1		CCR.3.6 TDD
	Config 2		SSB.1 FR2
SMTC Configuration	Config 1		SSB.1 FR2
	Config 2		SMTC.1
PDSCH/PDCCH subcarrier spacing	Config 1		SMTC.1
	Config 2		120 KHz
CSI-RS for RLM	Config 1, 2		120 KHz
TRS configuration			Resource #4 in TRS.2.1 TDD Resource #4 in TRS.2.2 TDD
TCI configuration for PDCCH#1/PDSCH			TRS.2.1 TDD
TCI configuration for PDCCH#2			TRS.2.2 TDD
OCNG parameters			TCI.State.2
CP length			TCI.State.3
Out of sync transmission parameters	DCI format		OP.5
	Number of Control OFDM symbols		Normal
	Aggregation level	CCE	1-0
	Ratio of hypothetical PDCCH RE energy to average CSI-RS RE energy	dB	2
	Ratio of hypothetical PDCCH DMRS energy to average CSI-RS RE energy	dB	8
	DMRS precoder granularity		4
	REG bundle size		REG bundle size
DRX			6
Gap pattern ID			OFF
Layer 3 filtering			gp0
T310 timer	ms		Enabled
T311 timer	ms		0
N310			1000
N311			1
CSI-RS for CSI reporting	Config 1		1
	Config 2		1
reportConfigType			CSI-RS.3.1 TDD
reportQuantity			CSI-RS.3.1 TDD
CSI reporting periodicity	slot		periodic
CSI reporting offset	slot		cri-RI-PMI-CQI
T1	s		40
T2	s		4
T3	s		0.2
D1	s		0.35
Note 1: UE-specific PDCCH is not transmitted after T1 starts.			
Note 2: E-UTRAN is in non-DRX mode under test.			

Table A.5.5.1.5.1-3: Cell specific test parameters for FR2 for CSI-RS out-of-sync radio link monitoring in non-DRX mode

Parameter	Unit	Test 1					
		T1	T2	T3	T1	T2	T3

AoA setup		Setup 3 defined in A.3.15					
		AoA1		AoA2			
Assumption for UE beams ^{Note 10}			Rough		Rough		
EPRE ratio of PDCCH DMRS to SSS	dB	4		Not sent			
EPRE ratio of PDCCH to PDCCH DMRS	dB	0					
EPRE ratio of PBCH DMRS to SSS	dB						
EPRE ratio of PBCH to PBCH DMRS	dB						
EPRE ratio of PSS to SSS	dB						
EPRE ratio of PDSCH DMRS to SSS	dB						
EPRE ratio of PDSCH to PDSCH DMRS	dB						
EPRE ratio of OCNG DMRS to SSS	dB						
EPRE ratio of OCNG to OCNG DMRS	dB						
SNR on RLM-RS1	Config 1, 2	dB	2 ^{Note 11}	-6 ^{Note 11}	-15		
SNR on RLM-RS2	Config 1, 2	dB	Not sent		2 ^{Note 11}	-15	-15
N_{oc}	Config 1, 2	dBm/15kHz	-92.1		-92.1		
Propagation condition			TDL-A 30ns 75Hz		TDL-A 30ns 75Hz		
<p>Note 1: OCNG shall be used such that the resources in Cell 2 are fully allocated and a constant total transmitted power spectral density is achieved for all OFDM symbols.</p> <p>Note 2: The uplink resources for CSI reporting are assigned to the UE prior to the start of time period T1.</p> <p>Note 3: NZP CSI-RS resource set configuration for CSI reporting are assigned to the UE prior to the start of time period T1.</p> <p>Note 4: Measurement gap configuration is assigned to the UE prior to the start of time period T1.</p> <p>Note 5: The timers and layer 3 filtering related parameters are configured prior to the start of time period T1.</p> <p>Note 6: The signal contains PDCCH for UEs other than the device under test as part of OCNG.</p> <p>Note 7: SNR levels correspond to the signal to noise ratio over the SSS REs.</p> <p>Note 8: The SNR in time periods T1, T2 and T3 is denoted as SNR1, SNR2 and SNR3 respectively in figure A.5.5.1.5.1-1.</p> <p>Note 9: The SNR values are specified for testing a UE which supports 2RX on at least one band. For testing of a UE which supports 4RX on all bands, the SNR during T3 is A.3.6.</p> <p>Note 10: Information about types of UE beam is given in B.2.1.3, and does not limit UE implementation or test system implementation</p> <p>Note 11: This value allows up to 1dB degradation from applied SNR to UE baseband</p>							

Table A.5.5.1.5.1-3A: Measurement gap configuration for FR2 CSI-RS out-of-sync radio link monitoring in non-DRX mode

Field	Test 1
	Value
gapOffset	0
<p>Note 1: E-UTRAN PCell and PSCell are SFN-synchronous and frame boundary aligned. (Ensure that RLM RS is partially overlapped with measurement gap)</p>	

Table A.5.5.1.5.1-4: Void

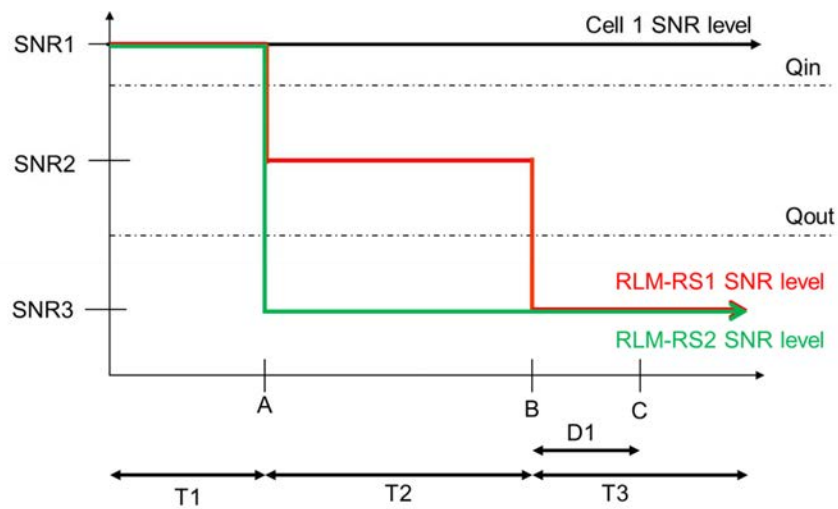

Figure A.5.5.1.5.1-1: SNR variation for CSI-RS out-of-sync testing

A.5.5.1.5.2 Test Requirements

The UE behaviour during time durations T1, T2, and T3 shall be as follows:

During the period from time point A to time point B the UE shall transmit uplink signal in Cell 2 (PSCell) at least in all uplink slots configured for CSI transmission according to the configured periodic CSI reporting for Cell 2.

The UE shall stop transmitting uplink signal in Cell 2 (PSCell) no later than time point C (D_1 after the start of the time duration T3) on the PSCell.

The rate of correct events observed during repeated tests shall be at least 90%.

A.5.5.1.6 EN-DC Radio Link Monitoring In-sync Test for FR2 PSCell configured with CSI-RS-based RLM in non-DRX mode

A.5.5.1.6.1 Test Purpose and Environment

The purpose of this test is to verify that the UE properly detects the in sync for the purpose of monitoring downlink CSI-RS based radio link quality of the PSCell when no DRX is used. This test will partly verify the FR2 TDD PSCell CSI-RS In-sync radio link monitoring requirements in clause 8.1.

The test parameters are given in Tables A.5.5.1.6.1-1, A.5.5.1.6.1-2, and A.5.5.1.6.1-3 below. There are two cells, cell 1 which is the E-UTRAN PCell, and cell 2 is the PSCell, in the test. The test consists of five successive time periods, with time duration of T1, T2, T3, T4 and T5 respectively. Figure A.5.5.1.6.1-1 shows the variation of the downlink SNR in the PSCell to emulate out-of-sync and in-sync states. Prior to the start of the time duration T1, the UE shall be fully synchronized to cell 1 and cell 2. The UE shall be configured for periodic CSI reporting with a reporting periodicity of 5ms. In the test, DRX configuration is not enabled. In the test, SSB0 and SSB1 are configured as BFD-RS.

Table A.5.5.1.6.1-1: Supported test configurations for FR2 PSCell

Configuration	Description
1	LTE FDD, NR 120 kHz SSB SCS, 100 MHz bandwidth, TDD duplex mode
2	LTE TDD, NR 120 kHz SSB SCS, 100 MHz bandwidth, TDD duplex mode
Note: The UE is only required to pass in one of the supported test configurations in FR2	

Table A.5.5.1.6.1-2: General test parameters for FR2 PSCell for CSI-RS in-sync testing in non-DRX mode

Parameter		Unit	Value
			Test 1
Active E-UTRA PCell			Cell 1
E-UTRA RF Channel Number			1
Active PSCell			Cell 2
RF Channel Number			2
Duplex Mode			TDD
BW _{channel}	Config 1, 2		100: N _{RB,c} = 66
Data RBs allocated	Config 1, 2		24
BW _{occupied}	Config 1, 2		24
TDD Configuration	Config 1		TDDConf.3.1
	Config 2		TDDConf.3.1
DL initial BWP configuration	Config 1, 2		DLBWP.0.1
DL dedicated BWP configuration	Config 1, 2		DLBWP.1.4
UL initial BWP configuration	Config 1, 2		ULBWP.0.1
UL dedicated BWP configuration	Config 1, 2		ULBWP.1.4
RMSI CORESET Reference Channel	Config 1		CR.3.1 TDD
	Config 2		CR.3.1 TDD
Dedicated CORESET Reference Channel	Config 1		CCR.3.1 TDD CCR.3.3 TDD
	Config 2		CCR.3.1 TDD CCR.3.3 TDD
SSB Configuration	Config 1		SSB.1 FR2
	Config 2		SSB.1 FR2
SMTc Configuration	Config 1		SMTc.1
	Config 2		SMTc.1
PDSCH/PDCCH subcarrier spacing	Config 1		120 KHz
	Config 2		120 KHz
CSI-RS for RLM	Config 1, 2		Resource #4 in TRS.2.1 TDD Resource #4 in TRS.2.2 TDD
OCNG parameters			OP.5
TRS configuration			TRS.2.1 TDD TRS.2.2 TDD
TCI configuration for PDCCH#1/PDSCH			TCI.State.2
TCI configuration for PDCCH#2			TCI.State.3

CP length			Normal
Out of sync transmission parameters	DCI format		1-0
	Number of Control OFDM symbols		2
	Aggregation level	CCE	8
	Ratio of hypothetical PDCCH RE energy to average CSI-RS RE energy	dB	4
	Ratio of hypothetical PDCCH DMRS energy to average CSI-RS RE energy	dB	4
	DMRS precoder granularity		REG bundle size
	REG bundle size		6
In sync transmission parameters	DCI format		1-0
	Number of Control OFDM symbols		2
	Aggregation level	CCE	4
	Ratio of hypothetical PDCCH RE energy to average CSI-RS RE energy	dB	0
	Ratio of hypothetical PDCCH DMRS energy to average CSI-RS RE energy	dB	0
	DMRS precoder granularity		REG bundle size
	REG bundle size		6
DRX			<i>OFF</i>
Gap pattern ID			N.A.
Layer 3 filtering			<i>Enabled</i>
T310 timer	ms		1000
T311 timer	ms		1000
N310			1
N311			1
CSI-RS for CSI reporting	Config 1		CSI-RS.3.1 TDD
	Config 2		CSI-RS.3.1 TDD
reportConfigType			periodic
reportQuantity			cri-RI-PMI-CQI
CSI reporting periodicity	slot		40
CSI reporting offset	slot		4
T1	s		0.2
T2	s		0.2
T3	s		0.24
T4	s		0.2
T5	s		0.88
D1	s		0.84
Note 1: UE-specific PDCCH is not transmitted after T1 starts.			
Note 2: E-UTRAN is in non-DRX mode under test.			

Table A.5.5.1.6.1-3: Cell specific test parameters for FR2 for CSI-RS in-sync radio link monitoring in non-DRX mode

Parameter		Unit	Test 1									
			T1	T2	T3	T4	T5	T1	T2	T3	T4	T5
AoA setup			Setup 3 defined in A.3.15									
			AoA1					AoA2				
Assumption for UE beams ^{Note 10}			Rough					Rough				
EPRE ratio of PDCCH DMRS to SSS		dB	0					Not sent				
EPRE ratio of PDCCH to PDCCH DMRS		dB	0									
EPRE ratio of PBCH DMRS to SSS		dB										
EPRE ratio of PBCH to PBCH DMRS		dB										
EPRE ratio of PSS to SSS		dB										
EPRE ratio of PDSCH DMRS to SSS		dB										
EPRE ratio of PDSCH to PDSCH DMRS		dB										
EPRE ratio of OCNG DMRS to SSS		dB										
EPRE ratio of OCNG to OCNG DMRS		dB										
SNR on RLM-RS1	Config 1, 2	dB										
SNR on RLM-RS2	Config 1, 2	dB	Not sent					² Note 11	-15	-15	-4.5	² Note 6
N_{oc}	Config 1, 2	dBm/15KHz	-92.1					-92.1				
Propagation condition			TDL-A 30ns 75Hz					TDL-A 30ns 75Hz				
<p>Note 1: OCNG shall be used such that the resources in Cell 2 are fully allocated and a constant total transmitted power spectral density is achieved for all OFDM symbols.</p> <p>Note 2: The uplink resources for CSI reporting are assigned to the UE prior to the start of time period T1.</p> <p>Note 3: NZP CSI-RS resource set configuration for CSI reporting are assigned to the UE prior to the start of time period T1.</p> <p>Note 4: Measurement gap configuration is assigned to the UE prior to the start of time period T1.</p> <p>Note 5: The timers and layer 3 filtering related parameters are configured prior to the start of time period T1.</p> <p>Note 6: The signal contains PDCCH for UEs other than the device under test as part of OCNG.</p> <p>Note 7: SNR levels correspond to the signal to noise ratio over the SSS REs.</p> <p>Note 8: The SNR in time periods T1, T2, T3, T4 and T5 is denoted as SNR1, SNR2, SNR3, SNR4 and SNR5 respectively in figure A.5.5.1.6.1-1.</p> <p>Note 9: The SNR values are specified for testing a UE which supports 2RX on at least one band. For testing of a UE which supports 4RX on all bands, the SNR during T3 is A.3.6.</p> <p>Note 10: Information about types of UE beam is given in B.2.1.3, and does not limit UE implementation or test system implementation</p> <p>Note 11: This value allows up to 1dB degradation from applied SNR to UE baseband</p>												

Table A.5.5.1.6.1-3A: Void

Table A.5.5.1.6.1-4: Void

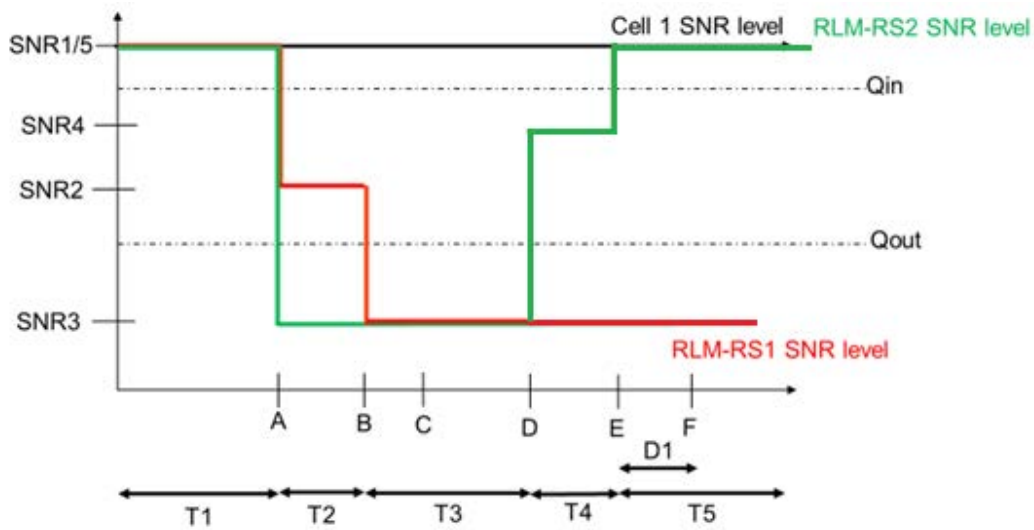

Figure A.5.5.1.6.1-1: SNR variation for CSI-RS in-sync testing

A.5.5.1.6.2 Test Requirements

The UE behaviour in each test during time durations T1, T2, T3, T4 and T5 shall be as follows:

During the period from time point A to time point F (D1 second after the start of time duration T5) the UE shall transmit uplink signal at least in all uplink slots configured for CSI transmission according to the configured periodic CSI reporting on the PSCell.

The rate of correct events observed during repeated tests shall be at least 90%.

A.5.5.1.7 EN-DC Radio Link Monitoring Out-of-sync Test for FR2 PSCell configured with CSI-RS-based RLM in DRX mode

A.5.5.1.7.1 Test Purpose and Environment

The purpose of this test is to verify that the UE properly detects the out of sync for the purpose of monitoring downlink CSI-RS based radio link quality of the PSCell when DRX is used. This test will partly verify the FR2 TDD PSCell CSI-RS Out-of-sync radio link monitoring requirements in clause 8.1.

The test parameters are given in Tables A.5.5.1.7.1-1, A.5.5.1.7.1-2, and A.5.5.1.7.1-3 below. There are two cells, cell 1 is the E-UTRAN PCell, and cell 2 is the PSCell, in the test. The test consists of three successive time periods, with time duration of T1, T2 and T3 respectively. Figure A.5.5.1.7.1-1 shows the variation of the downlink SNR in the E-UTRAN PCell and the PSCell to emulate out-of-sync and in-sync states. Prior to the start of the time duration T1, the UE shall be fully synchronized to cell 1 and cell 2. The UE shall be configured for periodic CSI reporting with a reporting periodicity of 5ms. In the test, DRX configuration is enabled in PSCell and DRX inactivity timer has already been expired, i.e. UE tries to decode PDCCH and to send periodic CQI during the period when On-duration timer is running. Time alignment timers shall be set to “infinity” so that UL timing alignment is maintained during the test. In the test, SSB0 and SSB1 are configured as BFD-RS and are not same as RLM-RS to avoid triggering the beam failure during the RLM test.

Table A.5.5.1.7.1-1: Supported test configurations for FR2 PSCell

Configuration	Description
1	LTE FDD, NR 120 kHz SSB SCS, 100 MHz bandwidth, TDD duplex mode
2	LTE TDD, NR 120 kHz SSB SCS, 100 MHz bandwidth, TDD duplex mode
Note: The UE is only required to pass in one of the supported test configurations in FR2	

Table A.5.5.1.7.1-2: General test parameters for FR2 PSCell for CSI-RS out-of-sync testing in DRX mode

Parameter		Unit	Value
			Test 1
Active E-UTRA PCell			Cell 1
E-UTRA RF Channel Number			1
Active PSCell			Cell 2
RF Channel Number			2
Duplex Mode			TDD
TDD Configuration	Config 1		TDDConf.3.1
	Config 2		TDDConf.3.1
DL initial BWP configuration	Config 1, 2		DLBWP.0.1
DL dedicated BWP configuration	Config 1, 2		DLBWP.1.1
UL initial BWP configuration	Config 1, 2		ULBWP.0.1
UL dedicated BWP configuration	Config 1, 2		ULBWP.1.1
RMSI CORESET Reference Channel	Config 1		CR. 3.1 TDD
	Config 2		CR. 3.1 TDD
Dedicated CORESET Reference Channel	Config 1		CCR. 3.4 TDD CCR.3.6 TDD
	Config 2		CCR. 3.4 TDD CCR.3.6 TDD
SSB Configuration	Config 1		SSB.1 FR2
	Config 2		SSB.1 FR2
SMT C Configuration	Config 1		SMT C.1
	Config 2		SMT C.1
PDSCH/PDCC H subcarrier spacing	Config 1		120 KHz
	Config 2		120 KHz
CSI-RS for RLM	Config 1, 2		Resource #4 in TRS.2.1 TDD Resource #4 in TRS.2.2 TDD
SSB index for BFD-RS	Config 1, 2		0, 1
TRS configuration			TRS.2.1 TDD TRS.2.2 TDD
TCI configuration for PDCCH#1/PDSCH			TCI.State.2
TCI configuration for PDCCH#2			TCI.State.3
OCNG parameters			OP.1
CP length			Normal
	DCI format		1-0

Out of sync transmission parameters	Number of Control OFDM symbols		2
	Aggregation level	CCE	8
	Ratio of hypothetical PDCCH RE energy to average CSI-RS RE energy	dB	4
	Ratio of hypothetical PDCCH DMRS energy to average CSI-RS RE energy	dB	4
	DMRS precoder granularity		REG bundle size
	REG bundle size		6
DRX			DRX.3
Gap pattern ID			N.A.
Layer 3 filtering			<i>Enabled</i>
T310 timer		ms	0
T311 timer		ms	1000
N310			1
N311			1
CSI-RS for CSI reporting	Config 1		CSI-RS.3.1 TDD
	Config 2		CSI-RS.3.1 TDD
reportConfigType			periodic
reportQuantity			cri-RI-PMI-CQI
CSI reporting periodicity		slot	40
CSI reporting offset		slot	4
T1		s	0.2
T2		s	1.28
T3		s	1.28
D1		s	1.24
Note 1: UE-specific PDCCH is not transmitted after T1 starts.			
Note 2: E-UTRAN is in non-DRX mode under test.			

Table A.5.1.7.1-3: Cell specific test parameters for FR2 for CSI-RS out-of-sync radio link monitoring in DRX mode

Parameter	Unit	Test 1		
		T1	T2	T3
AoA setup		Setup 1 defined in A.3.15		
Assumption for UE beams ^{Note 10}		Rough		
EPRE ratio of PDCCH DMRS to SSS	dB	4		
EPRE ratio of PDCCH to PDCCH DMRS	dB	0		
EPRE ratio of PBCH DMRS to SSS	dB			
EPRE ratio of PBCH to PBCH DMRS	dB			
EPRE ratio of PSS to SSS	dB			
EPRE ratio of PDSCH DMRS to SSS	dB			
EPRE ratio of PDSCH to PDSCH DMRS	dB			
EPRE ratio of OCNG DMRS to SSS	dB			
EPRE ratio of OCNG to OCNG DMRS	dB			

SNR on RLM-RS1	Config 1, 2	dB	2 ^{Note 11}	-6 ^{Note 11}	-15
SNR on RLM-RS2	Config 1, 2		2 ^{Note 11}	-15	-15
N_{oc}	Config 1	dBm/15KHz	-104.7		
	Config 2		-104.7		
Propagation condition			TDL-A 30ns 75Hz		
<p>Note 1: OCNG shall be used such that the resources in Cell 2 are fully allocated and a constant total transmitted power spectral density is achieved for all OFDM symbols.</p> <p>Note 2: The uplink resources for CSI reporting are assigned to the UE prior to the start of time period T1.</p> <p>Note 3: NZP CSI-RS resource set configuration for CSI reporting are assigned to the UE prior to the start of time period T1.</p> <p>Note 4: Void</p> <p>Note 5: The timers and layer 3 filtering related parameters are configured prior to the start of time period T1.</p> <p>Note 6: The signal contains PDCCH for UEs other than the device under test as part of OCNG.</p> <p>Note 7: SNR levels correspond to the signal to noise ratio over the SSS REs.</p> <p>Note 8: The SNR in time periods T1, T2 and T3 is denoted as SNR1, SNR2 and SNR3 respectively in figure A.5.5.1.7.1-1.</p> <p>Note 9: The SNR values are specified for testing a UE which supports 2RX on at least one band. For testing of a UE which supports 4RX on all bands, the SNR during T3 is A.3.6.</p> <p>Note 10: Information about types of UE beam is given in B.2.1.3, and does not limit UE implementation or test system implementation</p> <p>Note 11: This value allows up to 1dB degradation from applied SNR to UE baseband</p>					

Table A.5.5.1.7.1-3A: Void

Table A.5.5.1.7.1-4: Void

Table A.5.5.1.7.1-5: Void

Table A.5.5.1.7.1-6: Void

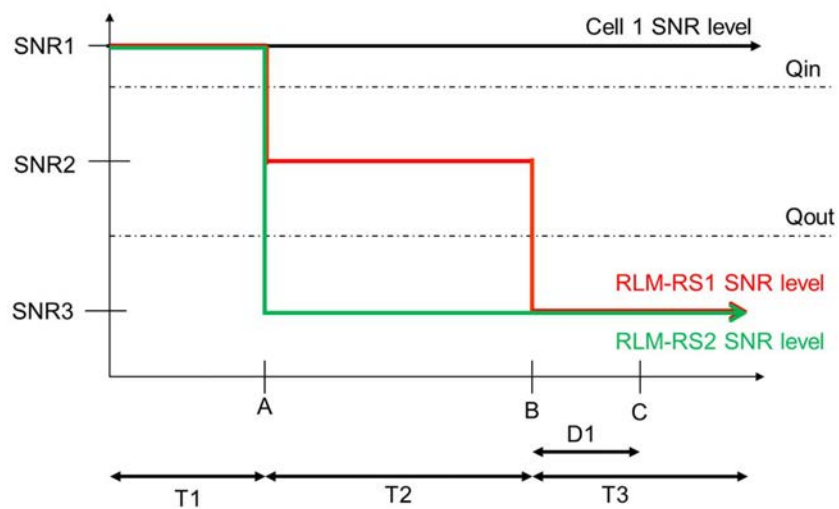

Figure A.5.5.1.7.1-1: SNR variation for CSI-RS out-of-sync testing

A.5.5.1.7.2 Test Requirements

The UE behaviour during time durations T1, T2, and T3 shall be as follows:

During the period from time point A to time point B the UE shall transmit uplink signal in Cell 2 (PSCell) at least in all uplink slots configured for CSI transmission according to the configured periodic CSI reporting for Cell 2.

The UE shall stop transmitting uplink signal in Cell 2 (PSCell) no later than time point C (D_1 after the start of the time duration T3) on the PSCell.

The rate of correct events observed during repeated tests shall be at least 90%.

A.5.5.1.8 EN-DC Radio Link Monitoring In-sync Test for FR2 PSCell configured with CSI-RS-based RLM in DRX mode

A.5.5.1.8.1 Test Purpose and Environment

The purpose of this test is to verify that the UE properly detects the in sync for the purpose of monitoring downlink CSI-RS based radio link quality of the PSCell when DRX is used. This test will partly verify the FR2 TDD PSCell CSI-RS In-sync radio link monitoring requirements in clause 8.1.

The test parameters are given in Tables A.5.5.1.8.1-1, A.5.5.1.8.1-2, A.5.5.1.8.1-3 and A.5.5.1.8.1-3A below. There are two cells, cell 1 which is the E-UTRAN PCell, and cell 2 is the NR PSCell, in the test. The test consists of five successive time periods, with time duration of T1, T2, T3, T4 and T5 respectively. Figure A.5.5.1.8.1-1 shows the variation of the downlink SNR in the PSCell to emulate out-of-sync and in-sync states. Prior to the start of the time duration T1, the UE shall be fully synchronized to cell 1 and cell 2. The UE shall be configured for periodic CSI reporting with a reporting periodicity of 5ms. In the test, DRX configuration is enabled. The UE is configured to perform inter-frequency measurements using GP ID #0 (40ms). In the test, SSB0 and SSB1 are configured as BFD-RS and are not same with RLM-RS to avoid triggering the beam failure during the RLM test.

Table A.5.5.1.8.1-1: Supported test configurations for FR2 PSCell

Configuration	Description
1	LTE FDD, NR 120 kHz SSB SCS, 100 MHz bandwidth, TDD duplex mode
2	LTE TDD, NR 120 kHz SSB SCS, 100 MHz bandwidth, TDD duplex mode
Note: The UE is only required to pass in one of the supported test configurations in FR2	

Table A.5.5.1.8.1-2: General test parameters for FR2 PSCell for CSI-RS in-sync testing in non-DRX mode

Parameter		Unit	Value Test 1
Active E-UTRA PCell			Cell 1
E-UTRA RF Channel Number			1
Active PSCell			Cell 2
RF Channel Number			2
Duplex Mode			TDD
TDD Configuratio n	Config 1		TDDConf.3.1
	Config 2		TDDConf.3.1

DL initial BWP configuration	Config 1, 2		DLBWP.0.1
DL dedicated BWP configuration	Config 1, 2		DLBWP.1.1
UL initial BWP configuration	Config 1, 2		ULBWP.0.1
UL dedicated BWP configuration	Config 1, 2		ULBWP.1.1
RMSI CORESET Reference Channel	Config 1		CR.3.1 TDD
	Config 2		CR.3.1 TDD
Dedicated CORESET Reference Channel	Config 1		CCR.3.1 TDD CCR.3.3 TDD
	Config 2		CCR.3.1 TDD CCR.3.3 TDD
SSB Configuration	Config 1		SSB.1 FR2
	Config 2		SSB.1 FR2
SMTTC Configuration	Config 1		SMTTC.1
	Config 2		SMTTC.1
PDSCH/PDCCH subcarrier spacing	Config 1		120 KHz
	Config 2		120 KHz
CSI-RS for RLM	Config 1, 2		Resource #4 in TRS.2.1 TDD Resource #4 in TRS.2.2 TDD
SSB index for BFD-RS	Config 1, 2		0, 1
TRS configuration			TRS.2.1 TDD TRS.2.2 TDD
TCI configuration for PDCCH#1/PDSCH			TCI.State.2
TCI configuration for PDCCH#2			TCI.State.3
OCNG parameters			OP.1
CP length			Normal
Out of sync transmission parameters	DCI format		1-0
	Number of Control OFDM symbols		2
	Aggregation level	CCE	8
	Ratio of hypothetical PDCCH RE energy to average CSI-RS RE energy	dB	4
	Ratio of hypothetical PDCCH DMRS energy to average CSI-RS RE energy	dB	4
	DMRS precoder granularity		REG bundle size
	REG bundle size		6
	DCI format		1-0

In sync transmission parameters	Number of Control OFDM symbols		2
	Aggregation level	CCE	4
	Ratio of hypothetical PDCCH RE energy to average CSI-RS RE energy	dB	0
	Ratio of hypothetical PDCCH DMRS energy to average CSI-RS RE energy	dB	0
	DMRS precoder granularity		REG bundle size
	REG bundle size		6
DRX			DRX.3
Gap pattern ID			<i>gp0</i>
Layer 3 filtering			<i>Enabled</i>
T310 timer		ms	2000
T311 timer		ms	1000
N310			1
N311			1
CSI-RS for CSI reporting	Config 1		CSI-RS.3.1 TDD
	Config 2		CSI-RS.3.1 TDD
reportConfigType			periodic
reportQuantity			cri-RI-PMI-CQI
CSI reporting periodicity		slot	40
CSI reporting offset		slot	4
T1		s	0.2
T2		s	0.2
T3		s	1.64
T4		s	0.2
T5		s	1.88
D1		s	1.84
Note 1: UE-specific PDCCH is not transmitted after T1 starts.			
Note 2: E-UTRAN is in non-DRX mode under test.			

Table A.5.5.1.8.1-3: Cell specific test parameters for FR2 for CSI-RS in-sync radio link monitoring in DRX mode

Parameter	Unit	Test 1				
		T1	T2	T3	T4	T5
AoA setup		Setup 1 defined in A.3.15				
Assumption for UE beams ^{Note 10}		Rough				
EPRE ratio of PDCCH DMRS to SSS	dB	0				
EPRE ratio of PDCCH to PDCCH DMRS	dB	0				
EPRE ratio of PBCH DMRS to SSS	dB					
EPRE ratio of PBCH to PBCH DMRS	dB					
EPRE ratio of PSS to SSS	dB					
EPRE ratio of PDSCH DMRS to SSS	dB					
EPRE ratio of PDSCH to PDSCH DMRS	dB					

EPRE ratio of OCNG DMRS to SSS		dB					
EPRE ratio of OCNG to OCNG DMRS		dB					
SNR on RLM-RS1	Config 1, 2	dB	$2^{\text{Note 11}}$	$-6^{\text{Note 11}}$	-15	-4.5	$2^{\text{Note 11}}$
SNR on RLM-RS2	Config 1, 2	dB	$2^{\text{Note 11}}$	-15	-15	-15	-15
N_{oc}	Config 1, 2	dBm/15KHz	-104.7				
Propagation condition			TDL-A 30ns 75Hz				
<p>Note 1: OCNG shall be used such that the resources in Cell 2 are fully allocated and a constant total transmitted power spectral density is achieved for all OFDM symbols.</p> <p>Note 2: The uplink resources for CSI reporting are assigned to the UE prior to the start of time period T1.</p> <p>Note 3: NZP CSI-RS resource set configuration for CSI reporting are assigned to the UE prior to the start of time period T1.</p> <p>Note 4: Measurement gap configuration is assigned to the UE prior to the start of time period T1.</p> <p>Note 5: The timers and layer 3 filtering related parameters are configured prior to the start of time period T1.</p> <p>Note 6: The signal contains PDCCH for UEs other than the device under test as part of OCNG.</p> <p>Note 7: SNR levels correspond to the signal to noise ratio over the SSS REs.</p> <p>Note 8: The SNR in time periods T1, T2, T3, T4 and T5 is denoted as SNR1, SNR2, SNR3, SNR4 and SNR5 respectively in figure A.5.5.1.8.1-1.</p> <p>Note 9: The SNR values are specified for testing a UE which supports 2RX on at least one band. For testing of a UE which supports 4RX on all bands, the SNR during T3 is A.3.6.</p> <p>Note 10: Information about types of UE beam is given in B.2.1.3, and does not limit UE implementation or test system implementation</p> <p>Note 11: This value allows up to 1dB degradation from applied SNR to UE baseband</p>							

Table A.5.5.1.8.1-3A: Measurement gap configuration for FR2 CSI-RS in-sync radio link monitoring in DRX mode

Field	Test 1
	Value
gapOffset	0
<p>Note 1: E-UTRAN PCell and PSCell are SFN-synchronous and frame boundary aligned. (Ensure that RLM RS is partially overlapped with measurement gap)</p>	

Table A.5.5.1.8.1-4: Void

Table A.5.5.1.8.1-5: Void

Table A.5.5.1.8.1-6: Void

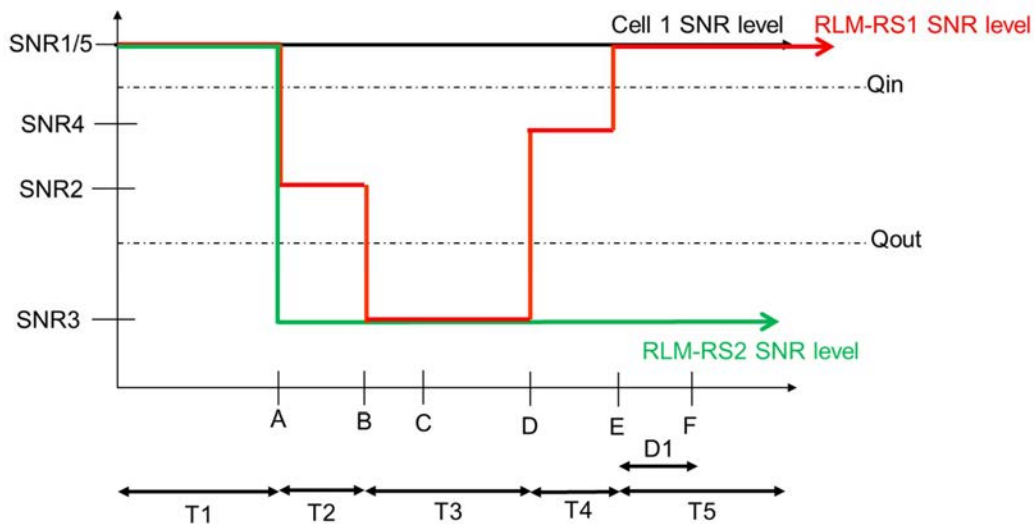

Figure A.5.5.1.8.1-1: SNR variation for CSI-RS in-sync testing

A.5.5.1.8.2 Test Requirements

The UE behaviour in each test during time durations T1, T2, T3, T4 and T5 shall be as follows:

During the period from time point A to time point F (D1 second after the start of time duration T5) the UE shall transmit uplink signal at least in all uplink slots configured for CSI transmission according to the configured periodic CSI reporting on the PSCell.

The rate of correct events observed during repeated tests shall be at least 90%.

A.5.5.1.9 EN-DC Radio Link Monitoring UE Scheduling Restrictions on FR2

A.5.5.1.9.1 Test Purpose and Environment

The purpose is to verify that the NR UE correctly follows the RLM scheduling restrictions requirements defined in clause 8.1.7. This test verifies that the UE correctly receive the PDCCH scheduled on the symbols right before the RLM SSB symbols without overlap so that it sends ACK/NACK correctly. The test case is only applicable to UE which supports `pdccch-MonitoringAnyOccasions` or `pdccch-MonitoringAnyOccasionsWithSpanGap`.

Two cells are deployed in the test, which are E-UTRAN PCell (Cell 1) and NR FR2 PSCell (Cell 2). The test parameters for NR PSCell are given in table A.5.5.1.9.1-1, table A.5.5.1.9.1-2 and table A.5.5.1.9.1-3 below and the parameters and applicability for the E-UTRAN cell are defined in A.3.7.2. The UE is required during time period T1 to transmit ACK/NACK correctly upon scheduling of PDSCH.

Table A.5.5.1.9.1-1: Supported test configurations

Configuration	Description
1	FDD LTE, 120 kHz SSB SCS, 120 kHz RMC SCS, 100 MHz bandwidth, TDD duplex mode
2	TDD LTE, 120 kHz SSB SCS, 120 kHz RMC SCS, 100 MHz bandwidth, TDD duplex mode
Note: The UE is only required to be tested in one of the supported test configurations.	

Table A.5.5.1.9.1-2: General test parameters for RLM scheduling restriction test case in FR2

Parameter	Unit	Test configuration	Value	Comment
RF Channel Number		1, 2	1 and 2	1 for NR PSCell and 2 for LTE PCell
SSB configuration		1, 2	SSB.1 FR2	
SMTC configuration		1, 2	SMTC pattern 1	
DRX cycle length	s	1, 2	OFF	
T1	s	1, 2	5	During T1 the UE is required to correctly transmit ACK/NACK

Table A.5.5.1.9.1-3: Cell specific test parameters for RLM scheduling restriction test case in FR2

Parameter	Unit	Test configuration	Cell 2	
AoA setup		1, 2	Setup 3 defined in A.3.15.3	
			AoA1	AoA2
Assumption for UE beams ^{Note 1}			Rough	Rough
TDD configuration		1, 2	TDDConf.3.1	
BW _{channel}	MHz	1, 2	100: N _{RB,c} = 66	
Data RBs allocated		1, 2	24	
PDSCH Reference measurement channel		1, 2	SR.3.2 TDD	Not sent
RMSI CORESET RMC configuration		1, 2	CR.3.1 TDD	Not sent
Dedicated CORESET RMC configuration		1, 2	CCR.3.2 TDD	Not sent
TRS configuration		1, 2	TRS.2.1 TDD	TRS.2.2 TDD
PDCCH/PDSCH TCI state		1, 2	TCI.State.2	Not sent
OCNG Pattern		1, 2	OP.5 defined in A.3.2.1	Not sent
Initial DL BWP configuration		1, 2	DLBWP.0.1	
Initial UL BWP configuration		1, 2	ULBWP.0.1	
RLM-RS		1, 2	SSB with index 0	SSB with index 1
N _{oc}	dBm/15kHz	1, 2	-92.1	-92.1
N _{oc} ^{Note2}	dBm/SCS	1, 2	-83.1	-83.1

\hat{E}_s / N_{oc}	dB	1, 2	2	2
$\hat{E}_s / I_{ot_{BB}}$ Note 4	dB	1, 2	1	1
SSB_RP Note3	dBm/SCS	1, 2	-81.1	-81.1
I_o	dBm/95.04 MHz	1, 2	-54.35	-54.35
Time multiplexing of the downlink transmissions from each AoA		1, 2	Defined in Figure A.5.5.1.9.1-1	
Propagation Condition		1, 2	AWGN	AWGN
<p>Note 1: Information about types of UE beam is given in B.2.1.3, and does not limit UE implementation or test system implementation</p> <p>Note 2: Interference from other cells and noise sources not specified in the test is assumed to be constant over subcarriers and time and shall be modelled as AWGN of appropriate power for N_{oc} to be fulfilled.</p> <p>Note 3: E_s/I_{ot}, SSB_RP and I_o levels have been derived from other parameters for information purposes. They are not settable parameters themselves.</p> <p>Note 4: Calculation of $E_s/I_{ot_{BB}}$ includes the effect of UE internal noise up to the value assumed for the associated Refsens requirement in clause 7.3.2 of TS 38.101-2 [19], and an allowance of 1dB for UE multi-band relaxation factor ΔMB_s from TS 38.101-2 [19] Table 6.2.1.3-4.</p>				

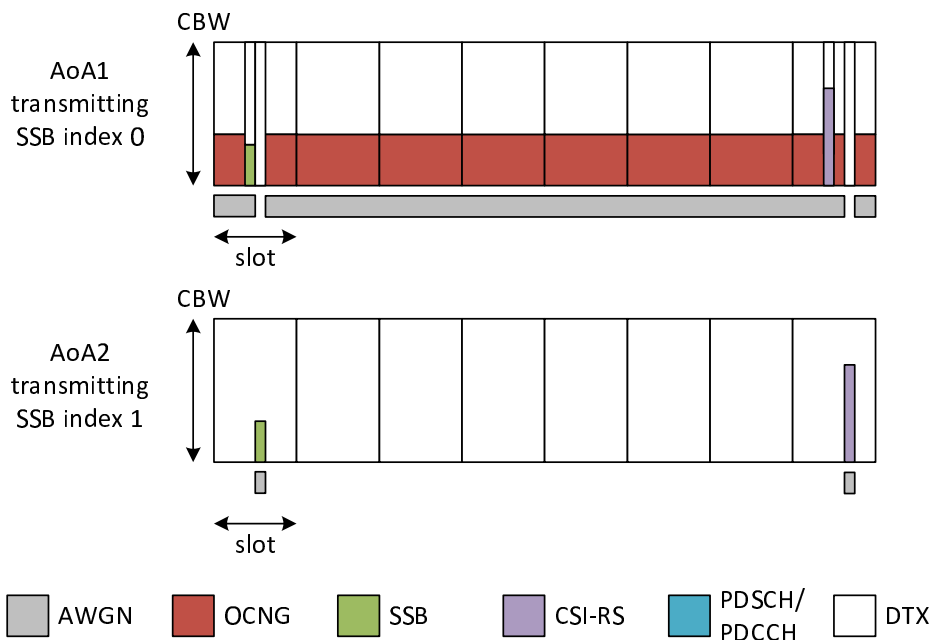

Figure A.5.5.1.9.1-1: Time multiplexed downlink transmissions

A.5.5.1.9.2 Test Requirements

The UE behaviour follows the requirements defined in clause 8.1.7.3.

A.5.5.2 Interruption

A.5.5.2.1 E-UTRAN – NR FR2 interruptions at transitions between active and non-active during DRX in synchronous EN-DC

A.5.5.2.1.1 Test Purpose and Environment

The purpose of this test is to verify that when E-UTRA PCell is in DRX and NR PSCell is in non-DRX, NR PSCell interruptions due to transitions from active to non-active and from non-active to active during LTE PCell DRX the UE missed ACK/NACK does not exceed the limits. This test will verify the missed ACK/NACK rate for NR PSCell in EN-DC specified in clause 8. 2.1.2. Supported test configurations are shown in table A.5.5.2.1.1-1.

The general test parameters are given in Table A.5.5.2.1.1-2, and NR cell specific test parameters are given in Table A.5.5.2.1.1-3 and A.5.5.2.1.1-4. The E-UTRAN PCell DRX configuration parameters are given in Table A.5.5.2.1.1-5 below. And the E-UTRAN cell specific test parameters can refer to Table A.3.7.2.2-1. In the test there are two cells: Cell1 and Cell2. Cell1 is LTE PCell on and Cell2 is NR FR2 PSCell. The test consists of one time period, with duration of T1. During T1, NR PSCell is continuously scheduled in DL while LTE PCell is not scheduled and has DRX configured. Prior to the start of the time duration T1, Cell1 shall be configured as LTE PCell and Cell2 shall be configured as NR PSCell. Prior to start of T1 the DRX inactivity timer for the LTE PCell has already expired. During T1 the UE shall be continuously scheduled on NR PSCell while not scheduled on LTE PCell. PDCCH indicating a new transmission on PSCell shall be sent continuously during the entire time duration to ensure UE would not enter DRX state on PSCell.

Table A.5.5.2.1.1-1: Interruption at transitions between active and non-active during DRX supported test configurations

Config	Description
1	LTE FDD, NR 120 kHz SSB SCS, 100 MHz bandwidth, TDD duplex mode
2	LTE TDD, NR 120 kHz SSB SCS, 100 MHz bandwidth, TDD duplex mode
Note: The UE is only required to be tested in one of the supported test configurations	

Table A.5.5.2.1.1-2: General test parameters for E-UTRAN – NR FR2 interruptions at transitions between active and non-active during DRX in synchronous EN-DC

Parameter	Unit	Value	Comment
RF Channel Number		1, 2	One is E-UTRAN RF channel and the other is NR RF channel
Active PCell		Cell1	PCell on E-UTRAN RF channel number 1.
Configured PSCell		Cell2	PSCell on NR RF channel number 2.
CP length		Normal	Applicable to cell1 and cell 2
DRX		DRX.4	DRX related parameters are defined in Table A.3.3.4-1
Measurement gap pattern Id		OFF	
T1	s	6.25	

Table A.5.5.2.1.1-3: NR cell specific test parameters for E-UTRAN – NR FR2 interruptions at transitions between active and non-active during DRX in synchronous EN-DC

Parameter		Unit	Cell 2
Frequency Range			FR2
Duplex mode	Config 1,2		TDD
TDD configuration	Config 1,2		TDDConf.3.1
BW _{channel}	Config 1,2	MHz	100: N _{RB,c} = 66

Data RBs allocated	Config 1,2		66
Downlink initial BWP Configuration	Config 1,2		DLBWP.0.1
Downlink dedicated BWP Configuration	Config 1,2		DLBWP.1.1
Uplink initial BWP configuration	Config 1,2		ULBWP.0.1
Uplink dedicated BWP configuration	Config 1,2		ULBWP.1.1
TRS configuration	Config 1,2		TRS.2.1 TDD
TCI state	Config 1,2		TCI.State.0
PDSCH Reference measurement channel	Config 1,2		SR.3.1 TDD
RMSI CORESET Reference Channel	Config 1,2		CR.3.1 TDD
RMC CORESET Reference Channel	Config 1,2		CCR.3.1 TDD
OCNG Patterns			OP.1
SSB Configuration			SSB.3 FR2
SMTC Configuration	Config 1,2		SMTC.1
EPRE ratio of PSS to SSS		dB	0
EPRE ratio of PBCH DMRS to SSS			
EPRE ratio of PBCH to PBCH DMRS			
EPRE ratio of PDCCH DMRS to SSS			
EPRE ratio of PDCCH to PDCCH DMRS			
EPRE ratio of PDSCH DMRS to SSS			
EPRE ratio of PDSCH to PDSCH			
EPRE ratio of OCNG DMRS to SSS(Note 1)			
EPRE ratio of OCNG to OCNG DMRS (Note 1)			
\hat{E}_s/N_{oc}			
Propagation Condition			AWGN
Time offset to cell1 ^{Note 2}		μ s	3
Note 1: OCNG shall be used such that both cells are fully allocated and a constant total transmitted power spectral density is achieved for all OFDM symbols.			
Note 2: Receive time difference of signals received between subframe timing boundary of E-UTRA PCell and slot timing boundary of PSCell including time alignment error between the two cells			

Table A.5.5.2.1.1-4: NR cell specific OTA related test parameters for E-UTRAN – NR FR2 interruptions at transitions between active and non-active during DRX in synchronous EN-DC

Parameter	Unit	Cell2
Angle of arrival configuration		Setup 1 according to clause A.3.15.1
Assumption for UE beams ^{Note 6}		Fine
N_{oc} ^{Note1}	dBm/15kHz ^{Note4}	-112
N_{oc} ^{Note1}	dBm/SCS ^{Note3}	-102.97
\hat{E}_s/N_{oc}	dB	17
SSB RP ^{Note2}	dBm/SCS ^{Note4}	-85.97
\hat{E}_s/I_{ot} ^{Note2}	dB	17
I_{o} ^{Note2}	dBm/95.04 MHz ^{Note4}	-56.90

Note 1:	Interference from other cells and noise sources not specified in the test is assumed to be constant over subcarriers and time and shall be modelled as AWGN of appropriate power for N_{oc} to be fulfilled.
Note 2:	SSB_RP and I_0 levels have been derived from other parameters for information purposes. They are not settable parameters themselves.
Note 3:	SS-RSRP minimum requirements are specified assuming independent interference and noise at each receiver antenna port.
Note 4:	Equivalent power received by an antenna with 0dBi gain at the centre of the quiet zone
Note 5:	As observed with 0dBi gain antenna at the centre of the quiet zone
Note 6:	Information about types of UE beam is given in B.2.1.3, and does not limit UE implementation or test system implementation

Table A.5.5.2.1.1-5: Void

A.5.5.2.1.2 Test Requirements

The UE shall be continuously scheduled in NR PSCell during the entire length of T1. UE shall not be scheduled in LTE PCell during T1. During the time duration T1 the UE shall transmit at least 99% of ACK/NACK on NR PSCell.

Interruption on NR PSCell shall not exceed 0.625ms (5 slots) as defined in clause 8. 2.1.

The rate of correct events observed during repeated tests shall be at least 90%.

A.5.5.2.2 E-UTRAN – NR FR2 interruptions at transitions between active and non-active during DRX in asynchronous EN-DC

A.5.5.2.2.1 Test Purpose and Environment

The purpose of this test is to verify that when LTE PCell is in DRX and NR PSCell is in non-DRX, NR PSCell interruptions due to transitions from active to non-active and from non-active to active during LTE PCell DRX the UE missed ACK/NACK does not exceed the limits. This test will verify the missed ACK/NACK rate for NR PSCell in EN-DC specified in clause 8. 2.1.2. Supported test configurations are shown in table A.5.5.2.2.1-1.

The general test parameters are given in Table A.5.5.2.2.1-2, and NR cell specific test parameters are given in Table A.5.5.2.2.1-3 and A.5.5.2.2.1-4. The E-UTRAN PCell DRX configuration parameters are given in Table A.5.5.2.2.1-5 below. And the E-UTRAN cell specific test parameters can refer to Table A.3.7.2.2-1. In the test there are two cells: Cell1 and Cell2. Cell1 is LTE PCell and Cell2 is NR PSCell. The test consists of one time period, with duration of T1. During T1, NR PSCell is continuously scheduled in DL while LTE PCell is not scheduled and has DRX configured. Prior to the start of the time duration T1, Cell1 shall be configured as LTE PCell and Cell2 shall be configured as NR PSCell. Prior to start of T1 the DRX inactivity timer for the LTE PCell has already expired. During T1 the UE shall be continuously scheduled on NR PSCell while not scheduled on LTE PCell. PDCCCH indicating a new transmission on PSCell shall be sent continuously during the entire time duration to ensure UE would not enter DRX state on PSCell.

Table A.5.5.2.2.1-1: Interruption at transitions between active and non-active during DRX supported test configurations

Config	Description
1	LTE FDD, NR 120 kHz SSB SCS, 100 MHz bandwidth, TDD duplex mode
2	LTE TDD, NR 120 kHz SSB SCS, 100 MHz bandwidth, TDD duplex mode
Note:	The UE is only required to be tested in one of the supported test configurations

Table A.5.5.2.2.1-2: General test parameters for E-UTRAN – NR FR2 interruptions at transitions between active and non-active during DRX in asynchronous EN-DC

Parameter	Unit	Value	Comment
RF Channel Number		1, 2	One is E-UTRAN RF channel and the other is NR RF channel
Active PCell		Cell1	PCell on E-UTRAN RF channel number 1.
Configured PSCell		Cell2	PSCell on NR RF channel number 2.
CP length		Normal	Applicable to cell1 and cell 2
DRX		DRX.6	DRX related parameters are defined in Table A.3.3.6-1
Measurement gap pattern Id		OFF	
T1	s	6.25	

Table A.5.5.2.2.1-3: NR cell specific test parameters for E-UTRAN – NR FR2 interruptions at transitions between active and non-active during DRX in asynchronous EN-DC

Parameter		Unit	Cell 2
Frequency Range			FR2
Duplex mode	Config 1,2		TDD
TDD configuration	Config 1,2		TDDConf.3.1
BW _{channel}	Config 1,2	MHz	100: N _{RB,c} = 66
Data RBs allocated	Config 1,2		66
Downlink initial BWP Configuration	Config 1,2		DLBWP.0.1
Downlink dedicated BWP Configuration	Config 1,2		DLBWP.1.1
Uplink initial BWP configuration	Config 1,2		ULBWP.0.1
Uplink dedicated BWP configuration	Config 1,2		ULBWP.1.1
TRS configuration	Config 1,2		TRS.2.1 TDD
TCI state	Config 1,2		TCI.State.0
PDSCH Reference measurement channel	Config 1,2		SR.3.1 TDD
RMSI CORESET Reference Channel	Config 1,2		CR.3.1 TDD
RMC CORESET Reference Channel	Config 1,2		CCR.3.1 TDD
OCNG Patterns			OP.1
SSB Configuration			SSB.3 FR2
SMTTC Configuration	Config 1,2		SMTTC.1
EPRE ratio of PSS to SSS		dB	0
EPRE ratio of PBCH DMRS to SSS			
EPRE ratio of PBCH to PBCH DMRS			
EPRE ratio of PDCCH DMRS to SSS			
EPRE ratio of PDCCH to PDCCH DMRS			
EPRE ratio of PDSCH DMRS to SSS			
EPRE ratio of PDSCH to PDSCH			
EPRE ratio of OCNG DMRS to SSS(Note 1)			
EPRE ratio of OCNG to OCNG DMRS (Note 1)			
\tilde{E}_s/N_{oc}		dB	17
Propagation Condition			AWGN
Time offset to cell1 ^{Note 2}		μ s	62.5
Note 1: OCNG shall be used such that both cells are fully allocated and a constant total transmitted power spectral density is achieved for all OFDM symbols.			
Note 2: Receive time difference of signals received between subframe timing boundary of E-UTRA PCell and slot timing boundary of PSCell including time alignment error between the two cells			

Table A.5.5.2.2.1-4: NR cell specific OTA related test parameters for E-UTRAN – NR FR2 interruptions at transitions between active and non-active during DRX in asynchronous EN-DC

Parameter	Unit	Cell2
Angle of arrival configuration		Setup 1 according to clause A.3.15.1
Assumption for UE beams ^{Note 6}		Fine
N_{oc} ^{Note1}	dBm/15kHz ^{Note4}	-112
N_{oc} ^{Note1}	dBm/SCS ^{Note3}	-102.97
\hat{E}_s / N_{oc}	dB	17
SSB_RP ^{Note2}	dBm/SCS ^{Note4}	-85.97
\hat{E}_s / I_{ot}	dB	17
I_o ^{Note2}	dBm/95.04 MHz ^{Note4}	-56.90
<p>Note 1: Interference from other cells and noise sources not specified in the test is assumed to be constant over subcarriers and time and shall be modelled as AWGN of appropriate power for N_{oc} to be fulfilled.</p> <p>Note 2: SSB_RP and I_o levels have been derived from other parameters for information purposes. They are not settable parameters themselves.</p> <p>Note 3: SS-RSRP minimum requirements are specified assuming independent interference and noise at each receiver antenna port.</p> <p>Note 4: Equivalent power received by an antenna with 0dBi gain at the centre of the quiet zone</p> <p>Note 5: As observed with 0dBi gain antenna at the centre of the quiet zone</p> <p>Note 6: Information about types of UE beam is given in B.2.1.3, and does not limit UE implementation or test system implementation</p>		

Table A.5.5.2.2.1-5: Void

A.5.5.2.2.2 Test Requirements

The UE shall be continuously scheduled in NR PSCell during the entire length of T1. UE shall not be scheduled in LTE PCell during T1. During the time duration T1 the UE shall transmit at least 99% of ACK/NACK on NR PSCell.

Interruption on NR PSCell shall not exceed 0.625ms (5 slots) as defined in clause 8. 2.1.

The rate of correct events observed during repeated tests shall be at least 90%.

A.5.5.2.3 E-UTRAN – NR FR2 interruptions during measurements on deactivated NR SCC in synchronous EN-DC

A.5.5.2.3.1 Test Purpose and Environment

The purpose of this test is to verify that for NR PSCell interruptions during the measurement on the deactivated NR SCC, the UE missed ACK/NACK does not exceed the limits. This test will verify the missed ACK/NACK rate for NR PSCell in EN-DC specified in clause 8. 2.1.2. Supported test configurations are shown in table A.5.5.2.3.1-1.

The general test parameters are given in Table A.5.5.2.3.1-2, and NR cell specific test parameters are given in Table A.5.5.2.3.1-3 and A.5.5.2.3.1-4 below. The E-UTRAN cell specific test parameters can be found in Table A.3.7.2.1-2. In the test there are three cells: Cell1, Cell2 and Cell3. Cell1 is LTE PCell, Cell2 and Cell 3 are NR FR2 PSCell and NR FR2 deactivated SCell, respectively. Cell1 shall be configured as LTE PCell and Cell2 shall be configured as NR PSCell. The test consists of one time period, with duration of T1. Prior to the start of the time duration T1, the UE is connected to Cell1 and Cell2. The point in time at which the RRC message including *measCycleSCell* for the deactivated NR SCells is received by the UE, defines the start of time period T1. During T1, LTE PCell and NR PSCell are continuously scheduled in DL.

Table A.5.5.2.3.1-1: Interruption during measurements on deactivated NR SCC supported test configurations

Config	Description
1	LTE FDD, NR 120 kHz SSB SCS, 100 MHz bandwidth, TDD duplex mode
2	LTE TDD, NR 120 kHz SSB SCS, 100 MHz bandwidth, TDD duplex mode
Note:	The UE is only required to be tested in one of the supported test configurations

Table A.5.5.2.3.1-2: General test parameters for E-UTRAN – NR FR2 interruptions during measurements on deactivated NR SCC in synchronous EN-DC

Parameter	Unit	Value	Comment
RF Channel Number		1, 2, 3	One is E-UTRAN RF channel and the other two are NR RF channels
Active PCell		Cell1	PCell on E-UTRAN RF channel number 1.
Configured PSCell		Cell2	PSCell on NR RF channel number 2.
Configured deactivated SCell		Cell3	Deactivated SCell on NR RF channel number 3.
CP length		Normal	Applicable to cell1, cell 2 and cell3
AoA number		1	Applicable to cell2 and cell3
DRX		OFF	
Measurement gap pattern Id		OFF	
SCell measurement cycle (<i>measCycleSCell</i>)	ms	640	

Table A.5.5.2.3.1-3: NR cell specific test parameters for E-UTRAN – NR FR2 interruptions during measurements on deactivated NR SCC in synchronous EN-DC

Parameter		Unit	Cell 2	Cell 3
Frequency Range			FR2	FR2
Duplex mode	Config 1,2		TDD	TDD
TDD configuration	Config 1,2		TDDConf.3.1	TDDConf.3.1
BW _{channel}	Config 1,2	MHz	100: N _{RB,c} = 66	100: N _{RB,c} = 66
Data RBs allocated	Config 1,2		66	66
Downlink initial BWP Configuration	Config 1,2		DLBWP.0.1	DLBWP.0.1

Downlink dedicated BWP Configuration	Config 1,2		DLBWP.1.1	DLBWP.1.1
Uplink initial BWP configuration	Config 1,2		ULBWP.0.1	ULBWP.0.1
Uplink dedicated BWP configuration	Config 1,2		ULBWP.1.1	ULBWP.1.1
PDSCH Reference measurement channel	Config 1,2		SR.3.1 TDD	-
RMSI CORESET Reference Channel	Config 1,2		CR.3.1 TDD	CR.3.1 TDD
PDCCH CORESET parameters	Config 1,2		CCR 3.1 TDD	CCR 3.1 TDD
OCNG Patterns			OP.1	OP.1
SSB Configuration	Config 1,2		SSB.1 FR2	SSB.1 FR2
SMTc Configuration	Config 1,2		SMTc.1	SMTc.1
TRS configuration	Config 1,2		TRS.2.1 TDD	TRS.2.1 TDD
TCI state	Config 1,2		TCI.State.0	TCI.State.0
EPRE ratio of PSS to SSS		dB	0	0
EPRE ratio of PBCH DMRS to SSS				
EPRE ratio of PBCH to PBCH DMRS				
EPRE ratio of PDCCH DMRS to SSS				
EPRE ratio of PDCCH to PDCCH DMRS				
EPRE ratio of PDSCH DMRS to SSS				
EPRE ratio of PDSCH to PDSCH				
EPRE ratio of OCNG DMRS to SSS(Note 1)				
EPRE ratio of OCNG to OCNG DMRS (Note 1)				
Propagation Condition			AWGN	AWGN
Time offset to cell1 ^{Note 2}		µs	3	3+ Time offset to cell2
Time offset to cell2 ^{Note 3}		µs	-	3
<p>Note 1: OCNG shall be used such that both cells are fully allocated and a constant total transmitted power spectral density is achieved for all OFDM symbols.</p> <p>Note 2: Receive time difference of signals received between subframe timing boundary of E-UTRA PCell and slot timing boundary of PSCell including time alignment error between the two cells</p> <p>Note 3: Receive time difference of signals received between slot timing boundary from two NR Cells including time alignment error between the two cells</p>				

Table A.5.5.2.3.1-4: NR cell specific OTA related test parameters for E-UTRAN – NR FR2 interruptions during measurements on deactivated NR SCC in synchronous EN-DC

Parameter		Unit	Cell 2	Cell 3
Angle of arrival configuration			Setup 1 defined in clause A.3.15.1	
Assumption for UE beams ^{Note 6}			Fine	Rough
N_{oc} ^{Note1}	NR_TDD_FR2_A	dBm/15kHz	-111.7	-104.7
	NR_TDD_FR2_B			
	NR_TDD_FR2_F			
	NR_TDD_FR2_G			
	NR_TDD_FR2_T			
N_{oc} ^{Note1}	NR_TDD_FR2_A	dBm/SCS ^{Note 3}	-102.7	-95.7
	NR_TDD_FR2_B			
	NR_TDD_FR2_F			
	NR_TDD_FR2_G			
	NR_TDD_FR2_T			
SSB_RP ^{Note2}	NR_TDD_FR2_A	dBm/SCS ^{Note4}	-90.7	-90.7
	NR_TDD_FR2_B			
	NR_TDD_FR2_F			

	NR_TDD_FR2_G			
	NR_TDD_FR2_T			
	NR_TDD_FR2_Y			
\hat{E}_s/I_{ot}	NR_TDD_FR2_A	dB	12	5
	NR_TDD_FR2_B			
	NR_TDD_FR2_F			
	NR_TDD_FR2_G			
	NR_TDD_FR2_T			
	NR_TDD_FR2_Y			
\hat{E}_s/N_{oc}	NR_TDD_FR2_A	dB	12	5
	NR_TDD_FR2_B			
	NR_TDD_FR2_F			
	NR_TDD_FR2_G			
	NR_TDD_FR2_T			
	NR_TDD_FR2_Y			
I_{o}^{Note2}	NR_TDD_FR2_A	dBm/95.04 MHz ^{Note4}	-61.45	-60.52
	NR_TDD_FR2_B			
	NR_TDD_FR2_F			
	NR_TDD_FR2_G			
	NR_TDD_FR2_T			
	NR_TDD_FR2_Y			
<p>Note 1: Interference from other cells and noise sources not specified in the test is assumed to be constant over subcarriers and time and shall be modelled as AWGN of appropriate power for N_{oc} to be fulfilled.</p> <p>Note 2: SSB_RP and I_o levels have been derived from other parameters for information purposes. They are not settable parameters themselves.</p> <p>Note 3: SS-RSRP minimum requirements are specified assuming independent interference and noise at each receiver antenna port.</p> <p>Note 4: Equivalent power received by an antenna with 0dBi gain at the centre of the quiet zone</p> <p>Note 5: As observed with 0dBi gain antenna at the centre of the quiet zone</p> <p>Note 6: Information about types of UE beam is given in B.2.1.3, and does not limit UE implementation or test system implementation</p>				

A.5.5.2.3.2 Test Requirements

The UE shall be continuously scheduled in LTE PCell and NR PSCell during the entire length of T1. During the time duration T1 the UE shall transmit at least 99.5% of ACK/NACK on NR PSCell.

If the NR PSCell is not in the same band as the deactivated SCell, the UE is only allowed to cause interruptions on NR PSCell immediately before and immediately after an SMTC. Each interruption on NR PSCell shall not exceed the value defined in Table A.5.5.2.3.2-1.

If the NR PSCell is in the same band as the deactivated SCell, the UE is only allowed to cause an interruption on PSCell no earlier than 4 slot before an SMTC and no later than 4 slot after the SMTC. the interruption on NR PSCell shall not exceed the value defined in Table A.5.5.2.3.2-2.

Table A.5.5.2.3.2-1: Interruption duration if the NR PSCell is not in the same band as the deactivated SCell

μ	NR Slot length (ms)	Interruption length (slot)
3	0.125	4

Table A.5.5.2.3.2-2: Interruption duration if the NR PSCell is in the same band as the deactivated SCell

μ	NR Slot length (ms)	Interruption length (slot)
3	0.125	8 + SMTC duration

The rate of correct events observed during repeated tests shall be at least 90%.

A.5.5.2.4 E-UTRAN – NR FR2 interruptions during measurements on deactivated NR SCC in asynchronous EN-DC

A.5.5.2.4.1 Test Purpose and Environment

The purpose of this test is to verify that for NR PSCell interruptions during the measurement on the deactivated NR SCC, the UE missed ACK/NACK does not exceed the limits. This test will verify the missed ACK/NACK rate for NR PSCell in EN-DC specified in clause 8. 2.1.2. Supported test configurations are shown in table A.5.5.2.4.1-1.

The general test parameters are given in Table A.5.5.2.4.1-2, and NR cell specific test parameters are given in Table A.5.5.2.4.1-3 and A.5.5.2.4.1-4 below. The E-UTRAN cell specific test parameters can be found in Table A.3.7.2.1-2. In the test there are three cells: Cell1, Cell2 and Cell3. Cell1 is LTE PCell, Cell2 and Cell 3 are NR FR2 PSCell and NR FR2 deactivated SCell, respectively. Cell1 shall be configured as LTE PCell and Cell2 shall be configured as NR PSCell. The test consists of one time period, with duration of T1. Prior to the start of the time duration T1, the UE is connected to Cell1 and Cell2. The point in time at which the RRC message including *measCycleSCell* for the deactivated NR SCells is received by the UE, defines the start of time period T1. During T1, LTE PCell and NR PSCell are continuously scheduled in DL.

Table A.5.5.2.4.1-1: Interruption during measurements on deactivated NR SCC supported test configurations

Config	Description
1	LTE FDD, NR 120 kHz SSB SCS, 100 MHz bandwidth, TDD duplex mode
2	LTE TDD, NR 120 kHz SSB SCS, 100 MHz bandwidth, TDD duplex mode
Note:	The UE is only required to be tested in one of the supported test configurations

Table A.5.5.2.4.1-2: General test parameters for E-UTRAN – NR interruptions during measurements on deactivated NR SCC in asynchronous EN-DC

Parameter	Unit	Value	Comment
RF Channel Number		1, 2	One is E-UTRAN RF channel and the other two are NR RF channel
Active PCell		Cell1	PCell on E-UTRAN RF channel number 1.
Configured PSCell		Cell2	PSCell on NR RF channel number 2.
Configured deactivated SCell		Cell3	Deactivated SCell on NR RF channel number 2.
CP length		Normal	Applicable to cell1, cell 2 and cell3
AoA number		1	Applicable to cell2 and cell3
DRX		OFF	
Measurement gap pattern Id		OFF	
SCell measurement cycle (<i>measCycleSCell</i>)	ms	640	
T1	s	10	

Table A.5.5.2.4.1-3: NR cell specific test parameters for E-UTRAN – NR interruptions during measurements on deactivated NR SCC in asynchronous EN-DC

Parameter		Unit	Cell 2	Cell 3
Frequency Range			FR2	FR2
Duplex mode	Config 1,2		TDD	TDD
TDD configuration	Config 1,2		TDDConf.3.1	TDDConf.3.1
$BW_{channel}$	Config 1,2	MHz	100: $N_{RB,c} = 66$	100: $N_{RB,c} = 66$
Data RBs allocated	Config 1,2		66	66
Downlink initial BWP Configuration	Config 1,2		DLBWP.0.1	
Downlink dedicated BWP Configuration	Config 1,2		DLBWP.1.1	
Uplink initial BWP configuration	Config 1,2		ULBWP.0.1	
Uplink dedicated BWP configuration	Config 1,2		ULBWP.1.1	
PDSCH Reference measurement channel	Config 1,2		SR.3.1 TDD	-
RMSI CORESET Reference Channel	Config 1,2		CR.3.1 TDD	CR.3.1 TDD
PDCCH CORESET parameters	Config 1,2		CCR.3.1 TDD	CCR.3.1 TDD
OCNG Patterns			OP.1	OP.1
SSB Configuration			SSB.1 FR2	SSB.1 FR2
SMTTC Configuration		Config 1,2	SMTTC.1	SMTTC.1
TRS configuration		Config 1,2	TRS.2.1 TDD	TRS.2.1 TDD
TCI state		Config 1,2	TCI.State.0	TCI.State.0
EPRE ratio of PSS to SSS		dB	0	0
EPRE ratio of PBCH DMRS to SSS				
EPRE ratio of PBCH to PBCH DMRS				
EPRE ratio of PDCCH DMRS to SSS				
EPRE ratio of PDCCH to PDCCH DMRS				
EPRE ratio of PDSCH DMRS to SSS				
EPRE ratio of PDSCH to PDSCH				
EPRE ratio of OCNG DMRS to SSS(Note 1)				
EPRE ratio of OCNG to OCNG DMRS (Note 1)				
Propagation Condition				
Time offset to cell1 ^{Note 2}		μ s	62.5	62.5+ Time offset to cell2
Time offset to cell2 ^{Note 3}		μ s	-	3
Note 1: OCNG shall be used such that both cells are fully allocated and a constant total transmitted power spectral density is achieved for all OFDM symbols.				
Note 2: Receive time difference of signals received between subframe timing boundary of E-UTRA PCell and slot timing boundary of PSCell including time alignment error between the two cells				
Note 3: Receive time difference of signals received between slot timing boundary from two NR Cells including time alignment error between the two cells				

Table A.5.5.2.4.1-4: NR cell specific OTA related test parameters for E-UTRAN – NR FR2 interruptions during measurements on deactivated NR SCC in asynchronous EN-DC

Parameter		Unit	Cell 2	Cell 3
Angle of arrival configuration			Setup 1 defined in clause A.3.15.1	
Assumption for UE beams ^{Note 6}			Fine	Rough
N_{oc} ^{Note1}	NR_TDD_FR2_A	dBm/15kHz	-111.7	-104.7
	NR_TDD_FR2_B			
	NR_TDD_FR2_F			
	NR_TDD_FR2_G			
	NR_TDD_FR2_T			
NR_TDD_FR2_Y				

N_{oc} ^{Note1}	NR_TDD_FR2_A	dBm/SCS ^{Note3}	-102.7	-95.7
	NR_TDD_FR2_B			
	NR_TDD_FR2_F			
	NR_TDD_FR2_G			
	NR_TDD_FR2_T			
NR_TDD_FR2_Y				
SSB_RP ^{Note2}	NR_TDD_FR2_A	dBm/SCS ^{Note4}	-90.7	-90.7
	NR_TDD_FR2_B			
	NR_TDD_FR2_F			
	NR_TDD_FR2_G			
	NR_TDD_FR2_T			
NR_TDD_FR2_Y				
\hat{E}_s/I_{ot}		dB	12	5
\hat{E}_s/N_{oc}		dB	12	5
I_o ^{Note2}	NR_TDD_FR2_A	dBm/95.04 MHz ^{Note4}	-61.45	-60.52
	NR_TDD_FR2_B			
	NR_TDD_FR2_F			
	NR_TDD_FR2_G			
	NR_TDD_FR2_T			
NR_TDD_FR2_Y				
<p>Note 1: Interference from other cells and noise sources not specified in the test is assumed to be constant over subcarriers and time and shall be modelled as AWGN of appropriate power for N_{oc} to be fulfilled.</p> <p>Note 2: SSB_RP and I_o levels have been derived from other parameters for information purposes. They are not settable parameters themselves.</p> <p>Note 3: SS-RSRP minimum requirements are specified assuming independent interference and noise at each receiver antenna port.</p> <p>Note 4: Equivalent power received by an antenna with 0dBi gain at the centre of the quiet zone</p> <p>Note 5: As observed with 0dBi gain antenna at the centre of the quiet zone</p> <p>Note 6: Information about types of UE beam is given in B.2.1.3, and does not limit UE implementation or test system implementation</p>				

A.5.5.2.4.2 Test Requirements

The UE shall be continuously scheduled in LTE PCell and NR PSCell during the entire length of T1. During the time duration T1 the UE shall transmit at least 99.5% of ACK/NACK on NR PSCell.

If the NR PSCell is not in the same band as the deactivated SCell, the UE is only allowed to cause interruptions on NR PSCell immediately before and immediately after an SMTC. Each interruption on NR PSCell shall not exceed the value defined in Table A.5.5.2.4.2-1.

If the NR PSCell is in the same band as the deactivated SCell, the UE is only allowed to cause an interruption on PSCell no earlier than 4 slot before an SMTC and no later than 4 slot after the SMTC. the interruption on NR PSCell shall not exceed the value defined in Table A.5.5.2.4.2-2.

Table A.5.5.2.4.2-1: Interruption duration if the NR PSCell is not in the same band as the deactivated SCell

μ	NR Slot length (ms)	Interruption length (slot)
3	0.125	4

Table A.5.5.2.4.2-2: Interruption duration if the NR PSCell is in the same band as the deactivated SCell

μ	NR Slot length (ms)	Interruption length (slot)
3	0.125	8 + SMTC duration

The rate of correct events observed during repeated tests shall be at least 90%.

A.5.5.2.5 E-UTRAN – NR FR2 interruptions during measurements on deactivated E-UTRAN SCC in synchronous EN-DC

A.5.5.2.5.1 Test Purpose and Environment

The purpose of this test is to verify that for NR PSCell interruptions during the measurement on the deactivated E-UTRAN SCC, the UE missed ACK/NACK does not exceed the limits. This test will verify the missed ACK/NACK rate for NR PSCell in EN-DC specified in clause 8.2.1.2. Supported test configurations are shown in table A.5.5.2.5.1-1.

The general test parameters are given in Table A.5.5.2.5.1-2, and NR cell specific test parameters are given in Table A.5.5.2.5.1-3 and A.5.5.2.5.1-4 below. The E-UTRAN cell specific test parameters can be found in Table A.3.7.2.1-2. In the test there are three cells: Cell1, Cell2 and Cell3. Cell1 and Cell3 are LTE PCell and LTE deactivated SCell, respectively, and Cell2 is NR FR2 PSCell. Cell1 shall be configured as LTE PCell and Cell2 shall be configured as NR PSCell. The test consists of one time period, with duration of T1. Prior to the start of the time duration T1, the UE is connected to Cell1 and Cell2. The point in time at which the RRC message including *measCycleSCell* or *allowInterruptions* for the deactivated E-UTRA SCell is received by the UE, defines the start of time period T1. During T1, LTE PCell and NR PSCell are continuously scheduled in DL.

Table A.5.5.2.5.1-1: Interruption during measurements on deactivated E-UTRAN SCC supported test configurations

Config	Description
1	LTE FDD, NR 120 kHz SSB SCS, 100 MHz bandwidth, TDD duplex mode
2	LTE TDD, NR 120 kHz SSB SCS, 100 MHz bandwidth, TDD duplex mode

Note: The UE is only required to be tested in one of the supported test configurations

Table A.5.5.2.5.1-2: General test parameters for E-UTRAN – NR FR2 interruptions during measurements on deactivated E-UTRAN SCC in synchronous EN-DC

Parameter	Unit	Value	Comment
RF Channel Number		1, 2, 3	One is NR RF channel and two are E-UTRAN RF channels
Active PCell		Cell1	PCell on E-UTRAN RF channel number 1.
Configured PSCell		Cell2	PSCell on NR RF channel number 2.
Configured deactivated SCell		Cell3	Deactivated SCell on E-UTRAN RF channel number 3.
CP length		Normal	Applicable to cell1, cell 2 and cell3
DRX		OFF	
Measurement gap pattern Id		OFF	
SCell measurement cycle (<i>measCycleSCell</i>)	ms	640	
T1	s	10	

Table A.5.5.2.5.1-3: NR cell specific test parameters for E-UTRAN – NR FR2 interruptions during measurements on deactivated E_UTRAN SCC in synchronous EN-DC

Parameter		Unit	Cell 2
Frequency Range			FR2
Duplex mode	Config 1,2		TDD
TDD configuration	Config 1,2		TDDConf.3.1
BW _{channel}	Config 1,2	MHz	100: N _{RB,c} = 66
Data RBs allocated	Config 1,2		66
Downlink initial BWP Configuration	Config 1,2		DLBWP.0.1
Downlink dedicated BWP Configuration	Config 1,2		DLBWP.1.1
Uplink initial BWP configuration	Config 1,2		ULBWP.0.1
Uplink dedicated BWP configuration	Config 1,2		ULBWP.1.1
PDSCH Reference measurement channel	Config 1,2		SR.3.1 TDD
RMSI CORESET Reference Channel	Config 1,2		CR.3.1 TDD
PDCCH CORESET parameters	Config 1,2		CCR.3.1 TDD
OCNG Patterns			OP.1
SMTTC Configuration	Config 1,2		SMTTC.1
SSB Configuration	Config 1,2		SSB.1 FR2
TRS configuration	Config 1,2		TRS.2.1 TDD
TCI state	Config 1,2		TCI.State.0
EPRE ratio of PSS to SSS		dB	0
EPRE ratio of PBCH DMRS to SSS			
EPRE ratio of PBCH to PBCH DMRS			
EPRE ratio of PDCCH DMRS to SSS			
EPRE ratio of PDCCH to PDCCH DMRS			
EPRE ratio of PDSCH DMRS to SSS			
EPRE ratio of PDSCH to PDSCH			
EPRE ratio of OCNG DMRS to SSS(Note 1)			
EPRE ratio of OCNG to OCNG DMRS (Note 1)			
Propagation Condition			AWGN
Time offset to cell1 ^{Note 2}		μs	3
Note 1: OCNG shall be used such that both cells are fully allocated and a constant total transmitted power spectral density is achieved for all OFDM symbols.			
Note 2: Receive time difference of signals received between subframe timing boundary of E-UTRA PCell and slot timing boundary of PSCell including time alignment error between the two cells			

Table A.5.5.2.5.1-4: NR cell specific OTA related test parameters for E-UTRAN – NR FR2 interruptions during measurements on deactivated E_UTRAN SCC in synchronous EN-DC

Parameter	Unit	Cell2
Angle of arrival configuration		Setup 1 according to clause A.3.15.1
Assumption for UE beams ^{Note 6}		Fine
N_{oc} ^{Note1}	dBm/15kHz ^{Note4}	-112
N_{oc} ^{Note1}	dBm/SCS ^{Note3}	-102.97

\hat{E}_s / N_{oc}	dB	17
SSB_RP ^{Note2}	dBm/SCS ^{Note4}	-85.97
\hat{E}_s / I_{ot}	dB	17
I_o ^{Note2}	dBm/95.04 MHz ^{Note4}	-56.90
<p>Note 1: Interference from other cells and noise sources not specified in the test is assumed to be constant over subcarriers and time and shall be modelled as AWGN of appropriate power for N_{oc} to be fulfilled.</p> <p>Note 2: SSB_RP and I_o levels have been derived from other parameters for information purposes. They are not settable parameters themselves.</p> <p>Note 3: SS-RSRP minimum requirements are specified assuming independent interference and noise at each receiver antenna port.</p> <p>Note 4: Equivalent power received by an antenna with 0dBi gain at the centre of the quiet zone</p> <p>Note 5: As observed with 0dBi gain antenna at the centre of the quiet zone</p> <p>Note 6: Information about types of UE beam is given in B.2.1.3, and does not limit UE implementation or test system implementation</p>		

A.5.5.2.5.2 Test Requirements

The UE shall be continuously scheduled in LTE PCell and NR PSCell during the entire length of T1. During the time duration T1 the UE shall transmit at least 99.5% of ACK/NACK on NR PSCell. The UE is only allowed to cause interruptions immediately before and immediately after an SMTC. Each interruption on NR PSCell shall not exceed the value defined in Table A.5.5.2.5.2-1.

Table A.5.5.2.5.2-1: Interruption duration if the NR PSCell is not in the same band as the deactivated SCell

μ	NR Slot length (ms)	Interruption length (slot)
3	0.125	5

Table A.5.5.2.5.2-2: Void

The rate of correct events observed during repeated tests shall be at least 90%.

A.5.5.2.6 E-UTRAN – NR FR2 interruptions during measurements on deactivated E-UTRAN SCC in asynchronous EN-DC

A.5.5.2.6.1 Test Purpose and Environment

The purpose of this test is to verify that for NR PSCell interruptions during the measurement on the deactivated E-UTRAN SCC, the UE missed ACK/NACK does not exceed the limits. This test will verify the missed ACK/NACK rate for NR PSCell in EN-DC specified in clause 8. 2.1.2. Supported test configurations are shown in table A.5.5.2.6.1-1.

The general test parameters are given in Table A.5.5.2.6.1-2, and NR cell specific test parameters are given in Table A.5.5.2.6.1-3 and A.5.5.2.6.1-4 below. The E-UTRAN cell specific test parameters can be found in Table A.3.7.2.1-2. In the test there are three cells: Cell1, Cell2 and Cell3. Cell1 and Cell3 are LTE PCell and LTE deactivated SCell, respectively, and Cell2 is NR FR2 PSCell. Cell1 shall be configured as LTE PCell and Cell2 shall be configured as

NR PSCell. The test consists of one time period, with duration of T1. Prior to the start of the time duration T1, the UE is connected to Cell1 and Cell2. The point in time at which the RRC message including *measCycleSCell* or *allowInterruptions* for the deactivated E-UTRA SCell is received by the UE, defines the start of time period T1. During T1, LTE PCell and NR PSCell are continuously scheduled in DL.

Table A.5.5.2.6.1-1: Interruption during measurements on deactivated E-UTRAN SCC supported test configurations

Config	Description
1	LTE FDD, NR 120 kHz SSB SCS, 100 MHz bandwidth, TDD duplex mode
2	LTE TDD, NR 120 kHz SSB SCS, 100 MHz bandwidth, TDD duplex mode

Note: The UE is only required to be tested in one of the supported test configurations

Table A.5.5.2.6.1-2: General test parameters for E-UTRAN – NR FR2 interruptions during measurements on deactivated E_UTRAN SCC in asynchronous EN-DC

Parameter	Unit	Value	Comment
RF Channel Number		1, 2, 3	One is NR RF channel and two are E-UTRAN RF channels
Active PCell		Cell1	PCell on E-UTRAN RF channel number 1.
Configured PSCell		Cell2	PSCell on NR RF channel number 2.
Configured deactivated SCell		Cell3	Deactivated SCell on E-UTRAN RF channel number 3.
CP length		Normal	Applicable to cell1, cell 2 and cell3
DRX		OFF	
Measurement gap pattern Id		OFF	
SCell measurement cycle (<i>measCycleSCell</i>)	ms	640	
T1	s	10	

Table A.5.5.2.6.1-3: NR cell specific test parameters for E-UTRAN – NR FR2 interruptions during measurements on deactivated E_UTRAN SCC in asynchronous EN-DC

Parameter	Unit	Cell 2
Frequency Range		FR2
Duplex mode	Config 1,2	TDD
TDD configuration	Config 1,2	TDDConf.3.1
BW _{channel}	Config 1,2	100: N _{RB,c} = 66
Data RBs allocated	Config 1,2	66
Downlink initial BWP Configuration	Config 1,2	DLBWP.0.1
Downlink dedicated BWP Configuration	Config 1,2	DLBWP.1.1
Uplink initial BWP configuration	Config 1,2	ULBWP.0.1
Uplink dedicated BWP configuration	Config 1,2	ULBWP.1.1
PDSCH Reference measurement channel	Config 1,2	SR.3.1 TDD
RMSI CORESET Reference Channel	Config 1,2	CR.3.1 TDD
PDCCH CORESET parameters	Config 1,2	CCR.3.1 TDD
OCNG Patterns		OP.1
SMTc Configuration	Config 1,2	SMTc.1
SSB Configuration	Config 1,2	SSB.1 FR2

TRS configuration	Config 1,2		TRS.2.1 TDD
TCI state	Config 1,2		TCI.State.0
EPRE ratio of PSS to SSS		dB	0
EPRE ratio of PBCH DMRS to SSS			
EPRE ratio of PBCH to PBCH DMRS			
EPRE ratio of PDCCH DMRS to SSS			
EPRE ratio of PDCCH to PDCCH DMRS			
EPRE ratio of PDSCH DMRS to SSS			
EPRE ratio of PDSCH to PDSCH			
EPRE ratio of OCNB DMRS to SSS(Note 1)			
EPRE ratio of OCNB to OCNB DMRS (Note 1)			
Propagation Condition			AWGN
Time offset to cell1 ^{Note 2}		μ s	62.5
Note 1: OCNB shall be used such that both cells are fully allocated and a constant total transmitted power spectral density is achieved for all OFDM symbols.			
Note 2: Receive time difference of signals received between subframe timing boundary of E-UTRA PCell and slot timing boundary of PSCell including time alignment error between the two cells			

Table A.5.5.2.6.1-4: NR cell specific OTA related test parameters for E-UTRAN – NR FR2 interruptions during measurements on deactivated E_UTRAN SCC in asynchronous EN-DC

Parameter	Unit	Cell2
Angle of arrival configuration		Setup 1 according to clause A.3.15.1
Assumption for UE beams ^{Note 6}		Fine
N_{oc} ^{Note1}	dBm/15kHz ^{Note4}	-112
N_{oc} ^{Note1}	dBm/SCS ^{Note3}	-102.97
\hat{E}_s / N_{oc}	dB	17
SSB_RP ^{Note2}	dBm/SCS ^{Note4}	-85.97
\hat{E}_s / I_{ot}	dB	17
I_o ^{Note2}	dBm/95.04 MHz ^{Note4}	-56.90
<p>Note 1: Interference from other cells and noise sources not specified in the test is assumed to be constant over subcarriers and time and shall be modelled as AWGN of appropriate power for N_{oc} to be fulfilled.</p> <p>Note 2: SSB_RP and I_o levels have been derived from other parameters for information purposes. They are not settable parameters themselves.</p> <p>Note 3: SS-RSRP minimum requirements are specified assuming independent interference and noise at each receiver antenna port.</p> <p>Note 4: Equivalent power received by an antenna with 0dBi gain at the centre of the quiet zone</p> <p>Note 5: As observed with 0dBi gain antenna at the centre of the quiet zone</p> <p>Note 6: Information about types of UE beam is given in B.2.1.3, and does not limit UE implementation or test system implementation.</p>		

A.5.5.2.6.2 Test Requirements

The UE shall be continuously scheduled in LTE PCell and NR PSCell during the entire length of T1. During the time duration T1 the UE shall transmit at least 99.5% of ACK/NACK on NR PSCell. The UE is only allowed to

cause interruptions immediately before and immediately after an SMTTC. Each interruption on NR PSCell shall not exceed the value defined in Table A.5.5.2.6.2-1.

Table A.5.5.2.6.2-1: Interruption duration if the NR PSCell is not in the same band as the deactivated SCell

μ	NR Slot length (ms)	Interruption length (slot)
3	0.125	5

Table A.5.5.2.6.2-2: Void

The rate of correct events observed during repeated tests shall be at least 90%.

A.5.5.3 SCell Activation and Deactivation Delay

A.5.5.3.1 SCell Activation and deactivation of SCell in FR2 intra-band

A.5.5.3.1.1 Test Purpose and Environment

The purpose of this test case is the same as for the test defined in clause A.4.5.3.1.1 except the SCell is in FR2 intra-band.

The supported test configurations are shown in table A.5.5.3.1.1-1 below. The general and cell specific test parameters are the same except those described in the following clause. The listed parameter values in Tables A.5.5.3.1.1-2 and A.5.5.3.1.1-3 will replace the values of corresponding parameters in Tables A.4.5.3.1.1-2 and A.4.5.3.1.1-3. In this case, OTA related test parameters are shown in table A.5.5.3.1.1-4 below.

In this test it is assumed that the UE is receiving RRC messages pertaining to the SCell in SCG via signaling on SRB3.

Table A.5.5.3.1.1-1: Supported test configurations for FR2 SCell activation case with FR2 PSCell

Configuration	Description
1	FDD LTE PCell, Cell 2&3 120 kHz SSB SCS, 100 MHz bandwidth, TDD duplex mode
2	TDD LTE PCell, Cell 2&3 120 kHz SSB SCS, 100 MHz bandwidth, TDD duplex mode

Note: The UE is only required to pass in one of the supported test configurations

Table A.5.5.3.1.1-2: General test parameters for FR2 SCell activation case with FR2 PSCell

Parameter	Unit	Value	Comment
Active PCell		Cell 1	Primary cell on E-UTRAN RF channel number 1. As specified in clause A.3.7.2.2

Table A.5.5.3.1.1-3: Cell specific test parameters for FR2 SCell activation case with FR2 PSCell

Parameter ^{Note 5}	Unit	Cell 2			Cell 3		
		T1	T2	T3	T1	T2	T3

SSB ARFCN		freq1	freq2
Duplex mode		TDD	TDD
TDD configuration		TDDConf.3.1	TDDConf.3.1
BW _{channel}	MHz	100: N _{RB,c} = 66	100: N _{RB,c} = 66
Data RBs allocated		66	66
PDSCH Reference measurement channel		SR.3.1 TDD	SR.3.1 TDD
RMSI CORESET Reference Channel		CR.3.1 TDD	CR.3.1 TDD
RMC CORESET Reference Channel		CCR.3.1 TDD	CCR.3.1 TDD
DL initial BWP configuration			DLBWP.0.1
DL dedicated BWP configuration			DLBWP.1.1
UL initial BWP configuration			ULBWP.0.1
UL dedicated BWP configuration			ULBWP.1.1
OCNG Patterns			OP.1
SMTc configuration			SMTc.1
SSB configuration			SSB.1 FR2
TCI state			TCI.State.0
TRS configuration			TRS.2.1 TDD
CSI-RS configuration for CSI reporting			CSI-RS.3.1 TDD
reportConfigType		periodic	N/A
reportQuantity		cri-RI-PMI-CQI	N/A
CSI reporting periodicity	slot	40	N/A
CSI reporting offset	slot	4	N/A
PDSCH/PDCCH subcarrier spacing	kHz		120
EPRE ratio of PSS to SSS	dB		0
EPRE ratio of PBCH_DMRS to SSS			
EPRE ratio of PBCH to PBCH_DMRS			
EPRE ratio of PDCCH_DMRS to SSS			
EPRE ratio of PDCCH to PDCCH_DMRS			
EPRE ratio of PDSCH_DMRS to SSS			
EPRE ratio of PDSCH to PDSCH_DMRS			
EPRE ratio of OCNG DMRS to SSS ^{Note 1}			
EPRE ratio of OCNG to OCNG DMRS ^{Note 1}			
Propagation conditions			AWGN
<p>Note 1: OCNG shall be used such that both cells are fully allocated and a constant total transmitted power spectral density is achieved for all OFDM symbols.</p> <p>Note 2: Void</p> <p>Note 3: Void</p> <p>Note 4: Void</p> <p>Note 5: All parameters apply for configuration 1 and 2</p>			

Table A.5.5.3.1.1-4: OTA related test parameters for FR2 SCell activation case with FR2 PSCell

Parameter ^{Note 6}	Unit	Cell 2			Cell 3		
		T1	T2	T3	T1	T2	T3
Angle of arrival configuration		Setup 1 according to A.3.15.1					
Assumption for UE beams ^{Note 7}		Rough			Rough		
N_{oc} ^{Note1}	$\text{dBm}/15\text{kHz}$ ^{Note4}	-104.7			-104.7		
N_{oc} ^{Note1}	dBm/SCS ^{Note3}	-95.7			-95.7		
\hat{E}_s/N_{oc}	dB	7			7		
SSB_RP ^{Note2}	dBm/SCS ^{Note4}	-88.7			-88.7		

\hat{E}_s / I_{ot}	dB	7	7
I_o ^{Note2}	dBm/95.04 MHz ^{Note4}	-58.92	-58.92
<p>Note 1: Interference from other cells and noise sources not specified in the test is assumed to be constant over subcarriers and time and shall be modelled as AWGN of appropriate power for N_{oc} to be fulfilled.</p> <p>Note 2: E_s/I_{ot}, SSB_RP and I_o levels have been derived from other parameters for information purposes. They are not settable parameters themselves.</p> <p>Note 3: Void</p> <p>Note 4: Equivalent power received by an antenna with 0dBi gain at the centre of the quiet zone</p> <p>Note 5: Void</p> <p>Note 6: All parameters apply for configuration 1 and 2</p> <p>Note 7: Information about types of UE beam is given in B.2.1.3, and does not limit UE implementation or test system implementation</p>			

A.5.5.3.1.2 Test Requirements

The test requirements defined in clause A.4.5.3.1.2 shall apply to this test case.

A.5.5.3.2 SCell Activation and deactivation of known SCell in FR1 for 160ms SCell measurement cycle

A.5.5.3.2.1 Test Purpose and Environment

The purpose of this test case is the same as for the test defined in clause A.4.5.3.1.1, except PSCell is in FR2.

The supported test configurations are shown in table A.5.5.3.2.1-1 below. The general test parameters are the same in Tables A.4.5.3.1.1-2. The cell specific test parameters are given in Tables A.5.5.3.2.1-2. In this case, OTA related test parameters are the same as in table A.5.5.3.2.1-3.

Table A.5.5.3.2.1-1: Supported test configurations for FR1 SCell activation case with PSCell is FR2

Configuration	Description
1	FDD LTE PCell, Cell 2 NR 120 kHz SSB SCS, 100 MHz bandwidth, TDD duplex mode Cell 3 NR 15 kHz SSB SCS, 10 MHz bandwidth, FDD duplex mode
2	FDD LTE PCell, Cell 2 NR 120 kHz SSB SCS, 100 MHz bandwidth, TDD duplex mode Cell 3 NR 15 kHz SSB SCS, 10 MHz bandwidth, TDD duplex mode
3	FDD LTE PCell, Cell 2 NR 120 kHz SSB SCS, 100 MHz bandwidth, TDD duplex mode Cell 3 NR 30 kHz SSB SCS, 40 MHz bandwidth, TDD duplex mode
4	TDD LTE PCell, Cell 2 NR 120 kHz SSB SCS, 100 MHz bandwidth, TDD duplex mode Cell 3 NR 15 kHz SSB SCS, 10 MHz bandwidth, FDD duplex mode
5	TDD LTE PCell, Cell 2 NR 120 kHz SSB SCS, 100 MHz bandwidth, TDD duplex mode Cell 3 NR 15 kHz SSB SCS, 10 MHz bandwidth, TDD duplex mode
6	TDD LTE PCell, Cell 2 NR 120 kHz SSB SCS, 100 MHz bandwidth, TDD duplex mode Cell 3 NR 30 kHz SSB SCS, 40 MHz bandwidth, TDD duplex mode
Note:	The UE is only required to pass in one of the supported test configurations

Table A.5.5.3.2.1-2: Cell specific test parameters for FR1 SCell activation case with FR2 PSCell

Parameter	Unit	Cell 2			Cell 3		
		T1	T2	T3	T1	T2	T3
SSB ARFCN		freq2			freq1		
Duplex mode	Config 1,4	TDD			FDD		
	Config 2,3,5,6	TDD			TDD		

TDD configuration	Config 1,4		TDDConf.3.1	Not Applicable
	Config 2,5			TDDConf.1.1
	Config 3,6			TDDConf.2.1
BW _{channel}	Config 1,4	MHz	100: N _{RB,c} = 66	10: N _{RB,c} = 52
	Config 2,5			10: N _{RB,c} = 52
	Config 3,6			40: N _{RB,c} = 106
Data RBs allocated	Config 1,4		66	52
	Config 2,5			52
	Config 3,6			106
DL initial BWP configuration	Config 1,2,3,4,5,6			DLBWP.0.1
DL dedicated BWP configuration	Config 1,2,3,4,5,6			DLBWP.1.1
UL initial BWP configuration	Config 1,2,3,4,5,6			ULBWP.0.1
UL dedicated BWP configuration	Config 1,2,3,4,5,6			ULBWP.1.1
DRX Cycle		ms		Not Applicable
PDSCH Reference measurement channel	Config 1,4		SR.3.1 TDD	SR.1.1 FDD
	Config 2,5			SR.1.1 TDD
	Config 3,6			SR.2.1 TDD
RMSI CORESET Reference Channel	Config 1,4		CR.3.1 TDD	CR.1.1 FDD
	Config 2,5			CR.1.1 TDD
	Config 3,6			CR.2.1 TDD
RMC CORESET Reference Channel	Config 1,4		CCR.3.1 TDD	CCR.1.1 FDD
	Config 2,5			CCR.1.1 TDD
	Config 3,6			CCR.2.1 TDD
OCNG Patterns				OP.1
SMTTC configuration				SMTTC.1
TCI state			TCI.State.0	NA
TRS configuration	Config 1,4		TRS.2.1 TDD	TRS.1.1 FDD
	Config 2,5			TRS.1.1 TDD
	Config 3,6			TRS.1.2 TDD
SSB configuration	Config 1,2,4,5		SSB.1 FR2	SSB.1 FR1
	Config 3,6			SSB.2 FR1
CSI-RS configuration for CSI reporting	Config 1,4		CSI-RS.3.1 TDD	CSI-RS.1.1 FDD
	Config 2,5			CSI-RS.1.1 TDD
	Config 3,6			CSI-RS.2.1 TDD
PDSCH/PDCCH subcarrier spacing	Config 1,2,4,5	kHz	120kHz	15kHz
	Config 3,6			30kHz
reportConfigType	Config 1-6		periodic	N/A
reportQuantity	Config 1-6		cri-RI-PMI-CQI	N/A
CSI reporting periodicity	Config 1,2,3,4,5,6	slot	40	N/A
CSI reporting offset	Config 1,2,3,4,5,6	slot	4	N/A
EPRE ratio of PSS to SSS		dB		0
EPRE ratio of PBCH DMRS to SSS				
EPRE ratio of PBCH to PBCH DMRS				
EPRE ratio of PDCCH DMRS to SSS				
EPRE ratio of PDCCH to PDCCH DMRS				
EPRE ratio of PDSCH DMRS to SSS				
EPRE ratio of PDSCH to PDSCH				
EPRE ratio of OCNG DMRS to SSS(Note 1)				
EPRE ratio of OCNG to OCNG DMRS (Note 1)				
Propagation condition		-	AWGN	NA

			Link only, see clause A.3.7A
Note 1:	OCNG shall be used such that both cells are fully allocated and a constant total transmitted power spectral density is achieved for all OFDM symbols.		
Note 2:	Void		
Note 3:	Void		
Note 4:	The uplink resources for CSI reporting are assigned to the UE prior to the start of time period T2.]		

Table A.5.5.3.2.1-3: OTA related test parameters for FR1 SCell activation case with FR2 PSCell

Parameter	Unit	Cell 2			Cell 3					
		T1	T2	T3	T1	T2	T3			
Angle of arrival configuration		Setup 1 according to clause A.3.15.1			NA Link only, see clause A.3.7A					
Assumption for UE beams ^{Note 7}		Rough								
N_{oc} ^{Note1}	dBm/15kHz	-104.7								
N_{oc} ^{Note1}	Config 1,2,4,5	dBm/SCS						-95.7		
	Config 3,6									
SSB_RP ^{Note2}	Config 1,2,4,5	dBm/SCS ^{Note3}						-88.7		
	Config 3,6									
\hat{E}_s/N_{oc}	Config 1,2,3,4,5,6	dB						7		
\hat{E}_s/I_{ot}		dB			7					
I_o ^{Note2}	Config 1,2,4,5	dBm/ChBw ^{Note4,Note6}			-58.92					
	Config 3,6									

Note 1: Interference from other cells and noise sources not specified in the test is assumed to be constant over subcarriers and time and shall be modelled as AWGN of appropriate power for N_{oc} to be fulfilled.
 Note 2: E_s/I_{ot} , SSB_RP and I_o levels have been derived from other parameters for information purposes. They are not settable parameters themselves.
 Note 3: Void
 Note 4: Equivalent power received by an antenna with 0dBi gain at the centre of the quiet zone
 Note 5: Void
 Note 6: ChBW is 95.04 MHz for Cell2, 9.36 MHz for Cell 3 in configurations 1,2,4,5, 38.1 MHz in configurations 3,6
 Note 7: Information about types of UE beam is given in B.2.1.3, and does not limit UE implementation or test system implementation

A.5.5.3.2.2 Test Requirements

The test requirements defined in clause A.4.5.3.1.2 shall apply to this test case, with the following exceptions:

- Placement of interruptions is only verified in NR PSCell.

A.5.5.3.3 Void

A.5.5.3.4 Void

A.5.5.3.5 SCell Activation and deactivation of SCell in FR2

A.5.5.3.5.1 Test Purpose and Environment

The purpose of this test is to verify that the SCell activation and deactivation times are within the requirements stated in clause 8.3, when the SCell is in FR2.

The supported test configurations are shown in table A.5.5.3.5.1-1 below. The test parameters are the same as in clause A.4.5.3.3.1 except those described in the following clause. The listed parameter values in Tables A.5.5.3.5.1-2 will replace the values of corresponding parameters in Tables A.4.5.3.3.1-2. The listed parameter values in Tables A.5.5.3.5.1-3 will replace the values of corresponding parameters in Tables A.4.5.3.3.1-3. In this case, OTA related test parameters are shown in table A.5.5.3.5.1-4 below.

The test consists of three successive time periods, with duration of T1, T2 and T3, respectively. There are three carriers, E-UTRA has one cell (Cell 1), NR has two cells, PSCell (Cell 2) in FR1 and SCell (Cell 3) in FR2. Cell 1 and Cell 2 have constant signal levels throughout the test. Before the test starts the UE is connected to Cell 1 (PCell) on E-UTRAN and Cell 2 (PSCell) on NR, but is not aware of Cell 3 (SCell) on NR. The UE is monitoring the PCell and PSCell. The UE shall be continuously scheduled in the PCell and PSCell throughout the whole test.

At the beginning of T1 the UE receives an RRC message by which the SCell (Cell 3) becomes configured on NR. During T1 the SCell is powered off and UE is not aware of SCell.

A MAC message for activation of SCell is sent by the test equipment 100ms after the RRC message, in a slot # denoted m. The point in time at which the MAC message for activation of SCell is received at the UE antenna connector defines the start of time period T2.

During T2, the test equipment monitors the L1-RSRP measurement reporting for the SCell. The time when test equipment receives a valid L1-RSRP report is denoted as slot $m+T_{L1-RSRP}$. In the next DL slot after slot $m+T_{L1-RSRP}$, the test equipment sends a MAC message for the activation of the TCI state of the RMC CORESET of the SCell. In the same slot, the test equipment also sends an RRC message to configure the CSI-RS resources for SCell.

Time period T3 starts when a MAC message for deactivation of the SCell, sent from the test equipment to the UE in a slot # denoted n, is received at the UE antenna connector.

The test equipment verifies that potential interruption is carried out in the correct time span by monitoring ACK/NACK sent in PCell and PSCell during activation of SCell, respectively.

The test equipment verifies the activation time by counting the slots from the time when the SCell activation command is sent until a CSI report with other than CQI index 0 is received.

The test equipment verifies the deactivation time by counting the slots from the time when the SCell1 deactivation command is sent until CSI reporting for SCell1 is discontinued.

Table A.5.5.3.5.1-1: FR2 SCell activation in non-DRX test configurations with FR1 PSCell

Configuration	Description
1	LTE FDD PCell, Cell 2 NR 15 kHz SSB SCS, 10 MHz bandwidth, FDD duplex mode Cell 3 NR 120 kHz SSB SCS, 100 MHz bandwidth, TDD duplex mode
2	LTE FDD PCell, Cell 2 NR 15 kHz SSB SCS, 10 MHz bandwidth, TDD duplex mode Cell 3 NR 120 kHz SSB SCS, 100 MHz bandwidth, TDD duplex mode
3	LTE FDD PCell, Cell 2 NR 30 kHz SSB SCS, 40 MHz bandwidth, TDD duplex mode Cell 3 NR 120 kHz SSB SCS, 100 MHz bandwidth, TDD duplex mode
4	LTE TDD PCell, Cell 2 NR 15 kHz SSB SCS, 10 MHz bandwidth, FDD duplex mode

	Cell 3 NR 120 kHz SSB SCS, 100 MHz bandwidth, TDD duplex mode
5	LTE TDD PCell, Cell 2 NR 15 kHz SSB SCS, 10 MHz bandwidth, TDD duplex mode Cell 3 NR 120 kHz SSB SCS, 100 MHz bandwidth, TDD duplex mode
6	LTE TDD PCell, Cell 2 NR 30 kHz SSB SCS, 40 MHz bandwidth, TDD duplex mode Cell 3 NR 120 kHz SSB SCS, 100 MHz bandwidth, TDD duplex mode
Note: The UE is only required to be tested in one of the supported test configurations	

Table A.5.5.3.5.1-2: General test parameters for FR2 SCell activation case with FR1 PCell

Parameter	Unit	Value	Comment
Active PCell		Cell 1	Primary cell on E-UTRAN RF channel number 1. As specified in clause A.3.7.2.2
T2	s	2	During this time the UE shall activate the SCell.

Table A.5.5.3.5.1-3: Cell specific test parameters for FR2 SCell activation case with FR1 PCell

Parameter		Unit	Cell 2			Cell 3		
			T1	T2	T3	T1	T2	T3
SSB ARFCN			freq1			freq2		
Duplex mode	Config 1,4		FDD			TDD		
	Config 2,3,5,6		TDD			TDD		
TDD configuration	Config 1,4		Not Applicable			TDDConf.3.1		
	Config 2,5		TDDConf.1.1					
	Config 3,6		TDDConf.2.1					
BW _{channel}	Config 1,4	MHz	10: N _{RB,c} = 52			100: N _{RB,c} = 66		
	Config 2,5		10: N _{RB,c} = 52					
	Config 3,6		40: N _{RB,c} = 106					
Data RBs allocated	Config 1,4		52			66		
	Config 2,5		52					
	Config 3,6		106					
BWP BW	Config 1,4		10: N _{RB,c} = 52			100: N _{RB,c} = 66		
	Config 2,5		10: N _{RB,c} = 52					
	Config 3,6		40: N _{RB,c} = 106					
DRx Cycle		ms	Not Applicable					
PDSCH Reference measurement channel	Config 1,4		SR.1.1 FDD			SR.3.1 TDD		
	Config 2,5		SR.1.1 TDD					
	Config 3,6		SR.2.1 TDD					
RMSI CORESET Reference Channel	Config 1,4		CR.1.1 FDD			CR.3.1 TDD		
	Config 2,5		CR.1.1 TDD					
	Config 3,6		CR.2.1 TDD					
RMC CORESET Reference Channel	Config 1,4		CCR.1.1 FDD			CCR.3.1 TDD		
	Config 2,5		CCR.1.1 TDD					
	Config 3,6		CCR.2.1 TDD					
OCNG Patterns			OP.1					
SMTC configuration			SMTC.1					
TCI state			NA			TCI.State.0		
TRS configuration	Config 1,4		TRS.2.1 TDD			TRS.2.1 TDD		
	Config 2,5		TRS.1.1 TDD					
	Config 3,6		TRS.1.2 TDD					
SSB configuration	Config 1,2,4,5		SSB.1 FR1			SSB.1 FR2		
	Config 3,6		SSB.2 FR1					

PDSCH/PDCCH subcarrier spacing	Config 1,2,4,5	kHz	15 kHz	120 kHz	
	Config 3,6		30 kHz		
CSI-RS configuration	Config 1~6		NA	NA	CSI-RS.3.1 TDD Note 5
reportConfigType	Config 1~6		periodic	NA	
reportQuantity	Config 1~6		cri-RI-PMI-CQI	NA	
CSI reporting periodicity Note 6	Config 1~6	slot	40	NA	
CSI reporting offset	Config 1~6	slot	4	NA	
EPRE ratio of PSS to SSS		dB	0		
EPRE ratio of PBCH DMRS to SSS					
EPRE ratio of PBCH to PBCH DMRS					
EPRE ratio of PDCCH DMRS to SSS					
EPRE ratio of PDCCH to PDCCH DMRS					
EPRE ratio of PDSCH DMRS to SSS					
EPRE ratio of PDSCH to PDSCH					
EPRE ratio of OCNG DMRS to SSS(Note 1)					
EPRE ratio of OCNG to OCNG DMRS (Note 1)					
Propagation condition					
<p>Note 1: OCNG shall be used such that both cells are fully allocated and a constant total transmitted power spectral density is achieved for all OFDM symbols.</p> <p>Note 2: Void</p> <p>Note 3: Void</p> <p>Note 4: The uplink resources for CSI reporting are assigned to the UE prior to the start of time period T2.</p> <p>Note 5: CSI-RS for CSI measurement is (re)configured in the next DL slot after slot $m+T_{L1-RSRP}$ during T2.</p> <p>Note 6: L1-RSRP measurement and reporting are configured to the the UE prior to the start of time period T1.</p>					

Table A.5.5.3.5.1-4: OTA related test parameters for FR2 SCell activation case with FR1 PSCell

Parameter	Unit	Cell 2			Cell 3					
		T1	T2	T3	T1	T2	T3			
Angle of arrival configuration		NA			Setup 1 according to clause A.3.15.1					
Assumption for UE beams ^{Note 7}		NA			Rough					
N_{oc} ^{Note1}	dBm/15kHz	Link only, see clause A.3.7A			-104.7					
N_{oc} ^{Note1}	Config 1,2,4,5				-95.7					
	Config 3,6									
SSB_RP ^{Note2}	Config 1,2,4,5				-∞			-88.7	-88.7	
	Config 3,6									
\hat{E}_s/N_{oc}	Config 1,2,3,4,5,6				dB			-∞	7	7
\hat{E}_s/I_{ot}					dB			-∞	7	7
I_o ^{Note2, Note 4}	Config 1,2,4,5	dBm/95.04 MHz			-66.68	-58.92	-58.92			
	Config 3,6									
<p>Note 1: Interference from other cells and noise sources not specified in the test is assumed to be constant over subcarriers and time and shall be modelled as AWGN of appropriate power for N_{oc} to be fulfilled.</p> <p>Note 2: E_s/I_{ot}, SSB_RP and I_o levels have been derived from other parameters for information purposes. They are not settable parameters themselves.</p> <p>Note 3: Void</p> <p>Note 4: Equivalent power received by an antenna with 0dBi gain at the centre of the quiet zone</p> <p>Note 5: Void</p> <p>Note 6: Void</p>										

Note 7: Information about types of UE beam is given in B.2.1.3, and does not limit UE implementation or test system implementation.

A.5.5.3.5.2 Test Requirements

During T2 the UE shall send the first CSI report for SCell in the first available uplink resource after slot $(m+k)$. UE is allowed to postpone CSI report to next available UL resource if an available uplink resource is subject to interruption. Whether CSI report in a slot was interrupted is checked by monitoring ACK/NACK sent in PCell in the slot.

During T2 the UE shall start sending valid L1-RSRP report for the SCell in the configured slots for CSI reporting after slot $(m+T_{L1-RSRP})$, where $T_{L1-RSRP}$ is no larger than

$$3\text{ms} + T_{\text{FirstSSB_MAX}} + 15 * T_{\text{SMTc_MAX}} + 8 * T_{\text{rs}} + T_{L1-RSRP, \text{measure}} + T_{L1-RSRP, \text{report}}$$

as defined in clause 8.3.2. For this test case, $T_{\text{FirstSSB_MAX}}=T_{\text{SMTc_MAX}}=T_{\text{rs}}=20\text{ms}$; $T_{L1-RSRP, \text{measure}}=480\text{ms}$ and $T_{L1-RSRP, \text{report}}=5\text{ms}$, which allows $T_{L1-RSRP}$ 1000ms.

During T2 the UE shall start sending CSI reports for the SCell with non-zero CQI index in the configured slots for CSI reporting no later than slot $m + \frac{T_{\text{HARQ}} + T_{\text{activation_time}} + T_{\text{CSI_Reporting}}}{NR \text{ slot length}}$, where

- T_{HARQ} is defined in Table A.5.5.3.1.1-2

- $T_{\text{activation_time}} = 3\text{ms} + T_{\text{FirstSSB_MAX}} + 15 * T_{\text{SMTc_MAX}} + 8 * T_{\text{rs}} + T_{L1-RSRP, \text{measure}} + T_{L1-RSRP, \text{report}} + \max \{ (T_{\text{HARQ}} + T_{\text{uncertainty_MAC}} + 5\text{ms} + T_{\text{FineTiming}}), (T_{\text{uncertainty_RRC}} + T_{\text{RRC_delay}}) \}$, which allows 1030ms

- $T_{\text{CSI_Reporting}} = 10\text{ms}$

- NR slot length is 0.125ms for this test case.

During T3 the UE shall stop sending CSI reports for both SCells no later than slot $n + \frac{T_{\text{HARQ}} + 3\text{ms}}{NR \text{ slot length}}$, as defined in clause 8.3.

During T2 interruption of PCell during SCell activation shall not happen outside the slot $m + 1 + \frac{T_{\text{HARQ}}}{NR \text{ slot length}}$ to $m + 1 + \frac{T_{\text{HARQ}} + 3\text{ms} + T_{\text{X}}}{NR \text{ slot length}}$, and interruption of E-UTRA PCell during SCell activation shall not happen outside the subframe $m_1 + 1 + \frac{T_{\text{HARQ}}}{EUTRA \text{ slot length}}$ to subframe $m_2 + 1 + \frac{T_{\text{HARQ}} + 3\text{ms} + T_{\text{X}}}{EUTRA \text{ slot length}}$, as defined in clause 8.3, where $T_{\text{X}} = 20\text{ms}$, and m_1 and m_2 are the index of the first and last subframe of E-UTRA PCell which overlaps with slot m .

During T3 the starting point of interruption of PCell during SCell deactivation shall not happen outside the slot $n + 1 + \frac{T_{\text{HARQ}}}{NR \text{ slot length}}$ to $n + 1 + \frac{T_{\text{HARQ}} + 3\text{ms}}{NR \text{ slot length}}$, as defined in clause 8.3 and the starting point of interruption of E-UTRA PCell during SCell deactivation shall not happen outside the subframe $n_1 + 1 + \frac{T_{\text{HARQ}}}{EUTRA \text{ subframe length}}$ to subframe $n_2 + 1 + \frac{T_{\text{HARQ}} + 3\text{ms}}{EUTRA \text{ subframe length}}$, where n_1 and n_2 are the index of the first and last subframe of E-UTRA PCell which overlaps with slot n .

The interruption of PCell due to activation of SCell1 and SCell2 shall not be more than the values specified for EN-DC in Clause 8.2.1.2.10.

The interruption of PCell due to activation of SCell1 and SCell2 shall not be more than the values specified for EN-DC in Clause 7.32.2.5 of TS 36.133 [50].

A.5.5.4 Void

A.5.5.5 Beam Failure Detection and Link recovery procedures

A.5.5.5.1 EN-DC Beam Failure Detection and Link Recovery Test for FR2 PSCell configured with SSB-based BFD and LR in non-DRX mode

A.5.5.5.1.1 Test Purpose and Environment

The purpose of this test is to verify that the UE properly detects SSB-based beam failure in the set q_0 configured for a serving PSCell and that the UE performs correct SSB-based link recovery based on beam candidate set q_1 . The purpose is to test the downlink monitoring for beam failure detection within the UEs active DL BWP of the PSCell, during the evaluation period, and link recovery, when no DRX is used. This test will partly verify the SSB based beam failure detection and link recovery for an FR2 serving cell requirements in clause 8.5.

The test parameters are given in Tables A.5.5.5.1.1-1, A.5.5.5.1.1-2, A.5.5.5.1.1-3 and A.5.5.5.1.1-4 below. There are two cells, cell 1 is the E-UTRAN PCell, and cell 2 is the PSCell, in the test. The test consists of five successive time periods, with time duration of T1, T2, T3, T4 and T5 respectively. Figure A.5.5.5.1.1-1 shows the variation of the downlink SNR of the PCell and the SNR of the SSB in set q_0 in the active PSCell to emulate SSB based beam failure. Figure A.5.5.5.1.1-2 shows the variation of the downlink L1-RSRP of the SSB in set q_1 of the candidate beam used for link recovery. Prior to the start of the time duration T1, the UE shall be fully synchronized to cell 1 and cell 2. The UE shall be configured for periodic CSI reporting with a reporting periodicity of 5 ms. In the test, DRX configuration is not enabled. The UE is configured to perform inter-frequency measurements using GP ID #0 (40ms) in test 1.

Table A.5.5.5.1.1-1: Supported test configurations for FR2 PSCell

Configuration	Description
1	LTE FDD, TDD duplex mode, 120 kHz SSB SCS, 100 MHz bandwidth
2	LTE TDD, TDD duplex mode, 120 kHz SSB SCS, 100 MHz bandwidth
3	LTE FDD, TDD duplex mode, 240 kHz SSB SCS, 100 MHz bandwidth
4	LTE TDD, TDD duplex mode, 240 kHz SSB SCS, 100 MHz bandwidth
Note:	The UE is only required to pass in one of the supported test configurations in FR2

Table A.5.5.5.1.1-2: General test parameters for FR2 PCell for SSB-based beam failure detection and link recovery testing in non-DRX mode

Parameter	Test Config.	Unit	Value	Comment
			Test 1	
Active E-UTRA PCell	1-4		Cell 1	
E-UTRA RF Channel Number	1-4		1	
Active PCell	1-4		Cell 2	
RF Channel Number	1-4		2	
Duplex mode	1-4		TDD	
TDD Configuration	1-4		TDDConf.3.1	
BW _{channel}	1-4	MHz	100: N _{RB,c} = 66	
Data RBs allocated	1-4		66	
PDSCH/PDCCH subcarrier spacing	1-4	kHz	120	
DL initial BWP configuration	1-4		DLBWP.0.1	
DL dedicated BWP configuration	1-4		DLBWP.1.1	
UL initial BWP configuration	1-4		ULBWP.0.1	

UL dedicated BWP configuration	1-4		ULBWP.1.1	
PDSCH Reference Channel	1-2		SR.3.2 TDD	
	3-4		SR.3.3 TDD	
RMSI CORESET Reference Channel	1-2		CR.3.1 TDD	
	3-4		CR.3.2 TDD	
Dedicated CORESET Reference Channel	1-2		CCR.3.1 TDD	
	3-4		CCR.3.7 TDD	
OCNG parameters	1-4		OP.1	
CP length	1-4		Normal	
PDSCH/PDCCH TCI state	1-4		TCI.State.0	
CSI-RS for tracking	1-4		TRS.2.1 TDD	
SSB Configuration	1-2		SSB.1 FR2	
	3-4		SSB.2 FR2	
SMTC Configuration	1-4		SMTC.3	
PRACH Configuration	1-4		FR2 PRACH configuration 2	A.3.8.3.2
DRX configuration	1-4		OFF	
SSB index assigned as BFD RS (q_0)	1-4		0	
SSB index assigned as CBD RS (q_1)	1-4		1	
SSB index assigned as RLM RS	1-4		0,1	
Beam failure detection transmission parameters	DCI format	1-4	1-0	
	Number of Control OFDM symbols	1-4	2	
	Aggregation level	1-4	CCE	8
	Ratio of hypothetical PDCCH RE energy to average SSS RE energy	1-4	dB	0
	Ratio of hypothetical PDCCH DMRS energy to average SSS RE energy	1-4	dB	0
	DMRS precoder granularity	1-4		REG bundle size
	REG bundle size	1-4		6
Gap pattern ID	1-4		gp0	
gapOffset	1-4	ms	0	
rlmInSyncOutOfSyncThreshold	1-4		absent	Value 0 is applied. (Table 8.1.1-1).
rsrp-ThresholdSSB	1-2	dBm/SCS	-95	Threshold used for $Q_{in_LR_SSB}$
	3-4		-92	
powerControlOffsetSS	1-4		db0	Used for deriving rsrp-ThresholdCSI-RS
beamFailureInstanceMaxCount	1-4		n1	see TS 38.321 [7], clause 5.17
beamFailureDetectionTimer	1-4		pbfd4	see TS 38.321 [7], clause 5.17
CSI-RS configuration for CSI reporting	1-4		CSI-RS.3.1 TDD	
reportConfigType	1-4		periodic	
reportQuantity	1-4		cri-RI-PMI-CQI	
CSI reporting periodicity	1-4	slot	40	
CSI reporting offset	1-4	slot	4	
T310	1-4	ms	1000	
N310	1-4		2	
T1	1-4	s	1	The UE shall be fully synchronized to cell 1 during T1
T2	1-4	s	2.61	

T3	1-4	s	1.64	
T4	1-4	s	0	
T5	1-4	s	1.01	
D1	1-4	s	0.97	
Note 1: All configurations are assigned to the UE prior to the start of time period T1.				
Note 2: UE-specific PDCCH is not transmitted after T1 starts.				

Table A.5.5.1.1-3: Cell specific test parameters for FR2 PSCell for SSB-based beam failure detection and link recovery testing in non-DRX mode

Parameter		Unit	Test 1				
			T1	T2	T3	T4	T5
AoA setup			Setup 1 defined in A.3.15				
Assumption for UE beams ^{Note 10}			Rough				
EPRE ratio of PDCCH DMRS to SSS		dB	0				
EPRE ratio of PDCCH to PDCCH DMRS		dB					
EPRE ratio of PBCH DMRS to SSS		dB					
EPRE ratio of PBCH to PBCH DMRS		dB					
EPRE ratio of PSS to SSS		dB					
EPRE ratio of PDSCH DMRS to SSS		dB					
EPRE ratio of PDSCH to PDSCH DMRS		dB					
EPRE ratio of OCNG DMRS to SSS		dB					
EPRE ratio of OCNG to OCNG DMRS		dB					
SNR_SSB of set q_0	Config 1-4	dB	5 ^{Note 11}	-3 ^{Note 11}	-12	-12	-12
SNR_SSB of set q_1	Config 1-4	dB	0.2	0.2	20.2	20.2	20.2
SSB_RP of set q_1	Config 1-2	dBm/SCS	-104.5	-104.5	-84.5	-84.5	-84.5
	Config 3-4		-101.5	-101.5	-81.5	-81.5	-81.5
N_{oc}	Config 1-4	dBm/120 KHz	-104.7				
Propagation condition			TDL-A 30ns 75Hz				
Note 1: OCNG shall be used such that the resources in Cell 1 are fully allocated and a constant total transmitted power spectral density is achieved for all OFDM symbols.							
Note 2: The uplink resources for CSI reporting are assigned to the UE prior to the start of time period T1.							
Note 3: NZP CSI-RS resource set configuration for CSI reporting are assigned to the UE prior to the start of time period T1.							
Note 4: Measurement gap configuration is assigned to the UE prior to the start of time period T1.							
Note 5: The timers and layer 3 filtering related parameters are configured prior to the start of time period T1.							
Note 6: The signal contains PDCCH for UEs other than the device under test as part of OCNG.							
Note 7: SNR levels correspond to the signal to noise ratio over the SSS REs.							
Note 8: The SNR in time periods T1, T2, T3, T4 and T5 is denoted as SNR1, SNR2 and SNR3 respectively in figure A.5.5.1.1-1.							
Note 9: The SNR values are specified for testing a UE which supports 2RX on at least one band. For testing of a UE which supports 4RX on all bands, the SNR during T3 is modified as specified in clause A.3.6.							
Note 10: Information about types of UE beam is given in B.2.1.3, and does not limit UE implementation or test system implementation							
Note 11: This value allows up to 1dB degradation from applied SNR to UE baseband							

Table A.5.5.1.1-4: Void

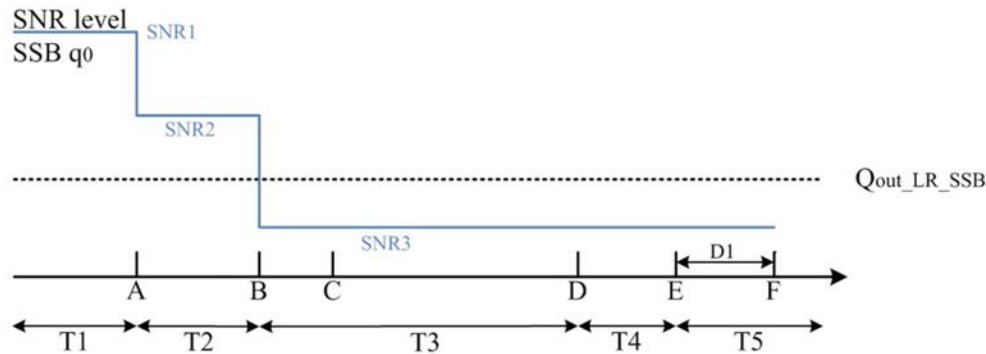

Figure A.5.5.1.1-1: SNR variation for SSB-based beam failure detection and link recovery testing in non-DRX mode

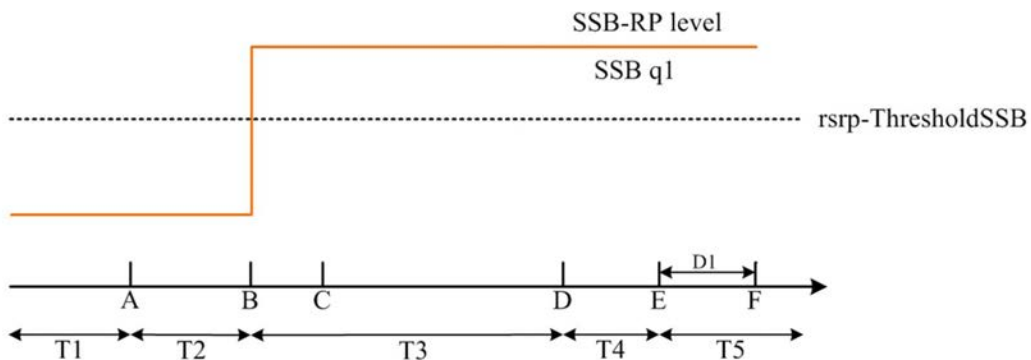

Figure A.5.5.1.1-2: SSB_RP level variation for SSB-based beam failure detection and link recovery testing in non-DRX mode

A.5.5.1.2 Test Requirements

The UE behaviour during time durations T1, T2, T3, T4 and T5 shall be as follows:

During the time duration T1 and T2, the UE shall transmit uplink signal at least in all subframes configured for CSI transmission on Cell 1.

During the period from time point A to time point B the UE shall transmit uplink signal in Cell 1 in all uplink slots configured for CSI transmission according to the configured periodic CSI reporting for Cell 1.

During T3 the UE shall detect beam failure and initiate link recovery. During T4 and T5 the UE measures and evaluate beam candidate from beam candidate set q_1 .

No later than time point F occurring no later than $D1 = 960 + 10$ ms after the start of T5, the UE shall transmit preamble on a beam associated with the candidate beam set q_1 . The UE shall not transmit preamble on a beam associated with the candidate beam set q_1 earlier than time point B.

Test is concluded once the test equipment has received the initial preamble transmission from the UE. The rate of correct events observed during repeated tests shall be at least 90%.

A.5.5.5.2 EN-DC Beam Failure Detection and Link Recovery Test for FR2 PSCell configured with SSB-based BFD and LR in DRX mode

A.5.5.5.2.1 Test Purpose and Environment

The purpose of this test is to verify that the UE properly detects SSB-based beam failure in the set q_0 configured for a serving PSCell and that the UE performs correct SSB-based link recovery based on beam candidate set q_1 . The purpose is to test the downlink monitoring for beam failure detection within the UEs active DL BWP of the PSCell, during the evaluation period, and link recovery, when DRX is used. This test will partly verify the SSB based beam failure detection and link recovery for an FR2 serving cell requirements in clause 8.5.

The test parameters are given in Tables A.5.5.5.2.1-1, A.5.5.5.2.1-2, A.5.5.5.2.1-3, A.5.5.5.2.1-4 and A.5.5.5.2.1-5 below. There are two cells, cell 1 is the E-UTRAN PCell, and cell 2 is the PSCell, in the test. The test consists of five successive time periods, with time duration of T1, T2, T3, T4 and T5 respectively. Figure A.5.5.5.2.1-1 shows the variation of the downlink SNR of the PCell and the SNR of the SSB in set q_0 in the active PSCell to emulate SSB based beam failure. Figure A.5.5.5.2.1-2 shows the variation of the downlink L1-RSRP of the SSB in set q_1 of the candidate beam used for link recovery. Prior to the start of the time duration T1, the UE shall be fully synchronized to cell 1 and cell 2. The UE shall be configured for periodic CSI reporting with a reporting periodicity of 5 ms. In the test, DRX configuration is enabled in PCell and DRX inactivity timer has already been expired, i.e. UE tries to decode PDCCH and to send periodic CQI during the period when On-duration timer is running. Time alignment timers shall be set to "infinity" so that UL timing alignment is maintained during the test.

Table A.5.5.5.2.1-1: Supported test configurations for FR2 PSCell

Configuration	Description
1	LTE FDD, TDD duplex mode, 120 kHz SSB SCS, 100 MHz bandwidth
2	LTE TDD, TDD duplex mode, 240 kHz SSB SCS, 100 MHz bandwidth
3	LTE FDD, TDD duplex mode, 240 kHz SSB SCS, 100 MHz bandwidth
4	LTE TDD, TDD duplex mode, 240 kHz SSB SCS, 100 MHz bandwidth
Note:	The UE is only required to pass in one of the supported test configurations in FR2

Table A.5.5.5.2.1-2: General test parameters for FR2 PSCell for SSB-based beam failure detection and link recovery testing in DRX mode

Parameter	Test Config.	Unit	Value	Comment
			Test 1	
Active E-UTRA PCell	1-4		Cell 1	
E-UTRA RF Channel Number	1-4		1	
Active PCell	1-4		Cell 2	
RF Channel Number	1-4		2	
Duplex mode	1-4		TDD	
TDD Configuration	1-4		TDDConf.3.1	
BW _{channel}	1-4	MHz	100: N _{RB,c} = 66	
Data RBs allocated	1-4		66	
PDSCH/PDCCH subcarrier spacing	1-4	kHz	120	
DL initial BWP configuration	1-4		DLBWP.0.1	

DL dedicated BWP configuration		1-4		DLBWP.1.1	
UL initial BWP configuration		1-4		ULBWP.0.1	
UL dedicated BWP configuration		1-4		ULBWP.1.1	
PDSCH Reference Channel		1-2		SR.3.2 TDD	
		3-4		SR.3.3 TDD	
RMSI CORESET Reference Channel		1-2		CR.3.1 TDD	
		3-4		CR.3.2 TDD	
Dedicated CORESET Reference Channel		1-2		CCR.3.1 TDD	
		3-4		CCR.3.7 TDD	
OCNG parameters		1-4		OP.1	
CP length		1-4		Normal	
PDSCH/PDCCH TCI state		1-4		TCI.State.0	
CSI-RS for tracking		1-4		TRS.2.1 TDD	
SSB Configuration		1-2		SSB.1 FR2	
		3-4		SSB.2 FR2	
SMTC Configuration		1-4		SMTC.3	
PRACH Configuration		1-4		FR2 PRACH configuration 2	A.3.8.3.2
DRX configuration		1-4		DRX.3	A.3.3.3
SSB index assigned as BFD RS (q_0)		1-4		0	
SSB index assigned as CBD RS (q_1)		1-4		1	
SSB index assigned as RLM RS		1-4		0,1	
Beam failure detection transmission parameters	DCI format	1-4		1-0	
	Number of Control OFDM symbols	1-4		2	
	Aggregation level	1-4	CCE	8	
	Ratio of hypothetical PDCCH RE energy to average SSS RE energy	1-4	dB	0	
	Ratio of hypothetical PDCCH DMRS energy to average SSS RE energy	1-4	dB	0	
	DMRS precoder granularity	1-4		REG bundle size	
REG bundle size		1-4		6	
Gap pattern ID		1-4		N/A	
rlmInSyncOutOfSyncThreshold		1-4		absent	Value 0 is applied. (Table 8.1.1-1).
rsrp-ThresholdSSB		1-2	dBm/SCS	-95	Threshold used for $Q_{in_LR_SSB}$
		3-4		-92	
powerControlOffsetSS		1-4		db0	Used for deriving rsrp-ThresholdCSI-RS
beamFailureInstanceMaxCount		1-4		n1	see TS 38.321 [7], clause 5.17
beamFailureDetectionTimer		1-4		pbfd4	see TS 38.321 [7], clause 5.17
CSI-RS configuration for CSI reporting		1-4		CSI-RS.3.1 TDD	
reportConfigType		1-4		periodic	
reportQuantity		1-4		cri-RI-PMI-CQI	
CSI reporting periodicity		1-4	slot	40	
CSI reporting offset		1-4	slot	4	
T310		1-4	ms	1000	
N310		1-4		2	
T1		1-4	s	1	The UE shall be fully synchronized to cell 1 during T1

T2	1-4	s	3.37	
T3	1-4	s	2.8	
T4	1-4	s	0	
T5	1-4	s	0.61	
D1	1-4	s	0.57	
Note 1: UE-specific PDCCH is not transmitted after T1 starts.				

Table A.5.5.2.1-3: Cell specific test parameters for FR2 PSCell for SSB-based beam failure detection and link recovery testing in DRX mode

Parameter		Unit	Test 1				
			T1	T2	T3	T4	T5
AoA setup			Setup 1 defined in A.3.15				
Assumption for UE beams ^{Note 10}			Rough				
EPRE ratio of PDCCH DMRS to SSS		dB	0				
EPRE ratio of PDCCH to PDCCH DMRS							
EPRE ratio of PBCH DMRS to SSS							
EPRE ratio of PBCH to PBCH DMRS							
EPRE ratio of PSS to SSS							
EPRE ratio of PDSCH DMRS to SSS							
EPRE ratio of PDSCH to PDSCH DMRS							
EPRE ratio of OCNG DMRS to SSS							
EPRE ratio of OCNG to OCNG DMRS							
SNR_SSB of set q ₀	Config 1-4	dB	⁵ Note 11	⁻³ Note 11	-12	-12	-12
SNR_SSB of set q ₁	Config 1-4		0.2	0.2	20.2	20.2	20.2
SSB_RP of set q ₁	Config 1-2		-104.5	-104.5	-84.5	-84.5	-84.5
	Config 3-4	-101.5	-101.5	-81.5	-81.5	-81.5	
N _{oc}	Config 1-4	dBm/120 KHz	-104.7				
Propagation condition			TDL-A 30ns 75Hz				
<p>Note 1: OCNG shall be used such that the resources in Cell 1 are fully allocated and a constant total transmitted power spectral density is achieved for all OFDM symbols.</p> <p>Note 2: The uplink resources for CSI reporting are assigned to the UE prior to the start of time period T1.</p> <p>Note 3: NZP CSI-RS resource set configuration for CSI reporting are assigned to the UE prior to the start of time period T1.</p> <p>Note 4: Void</p> <p>Note 5: The timers and layer 3 filtering related parameters are configured prior to the start of time period T1.</p> <p>Note 6: The signal contains PDCCH for UEs other than the device under test as part of OCNG.</p> <p>Note 7: SNR levels correspond to the signal to noise ratio over the SSS REs.</p> <p>Note 8: The SNR in time periods T1, T2, T3, T4 and T5 is denoted as SNR1, SNR2 and SNR3 respectively in figure A.5.5.2.1-1.</p> <p>Note 9: The SNR values are specified for testing a UE which supports 2RX on at least one band. For testing of a UE which supports 4RX on all bands, the SNR during T3 is modified as specified in clause A.3.6.</p> <p>Note 10: Information about types of UE beam is given in B.2.1.3, and does not limit UE implementation or test system implementation</p> <p>Note 11: This value allows up to 1dB degradation from applied SNR to UE baseband</p>							

Table A.5.5.2.1-4: Void

Table A.5.5.2.1-5: Void

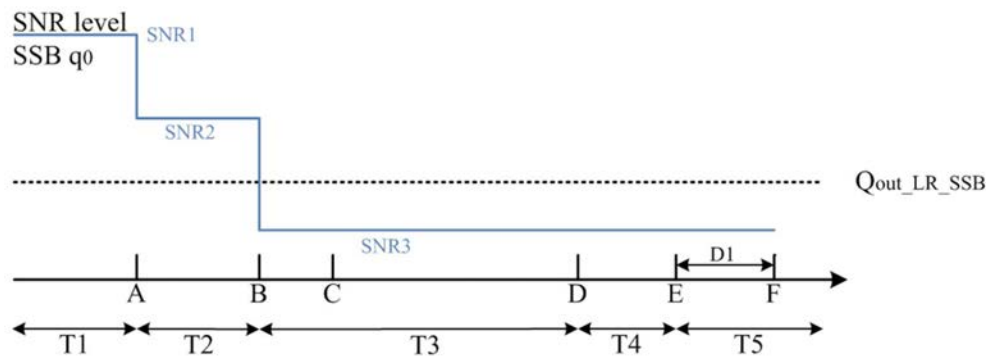

Figure A.5.5.5.2.1-1: SNR variation for SSB-based beam failure detection and link recovery testing in DRX mode

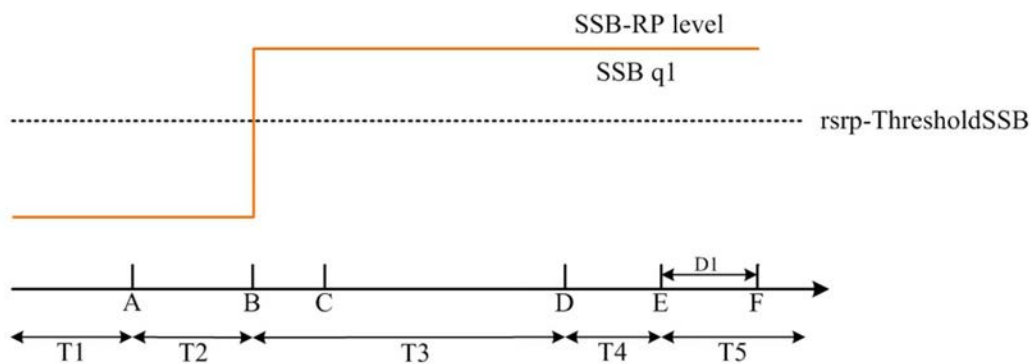

Figure A.5.5.5.2.1-2: SSB_RP level variation for SSB-based beam failure detection and link recovery testing in DRX mode

A.5.5.5.2.2 Test Requirements

The UE behaviour during time durations T1, T2, T3, T4 and T5 shall be as follows:

During the time duration T1 and T2, the UE shall transmit uplink signal at least in all subframes configured for CSI transmission on Cell 1.

During the period from time point A to time point B the UE shall transmit uplink signal in Cell 1 in all uplink slots configured for CSI transmission according to the configured periodic CSI reporting for Cell 1.

During T3 the UE shall detect beam failure and initiate link recovery. During T4 and T5 the UE measures and evaluate beam candidate from beam candidate set q_1 .

No later than time point F occurring no later than $D1 = 560 + 10$ ms after the start of T5, the UE shall transmit preamble on a beam associated with the candidate beam set q_1 . The UE shall not transmit preamble on a beam associated with the candidate beam set q_1 earlier than time point B.

Test is concluded once the test equipment has received the initial preamble transmission from the UE. The rate of correct events observed during repeated tests shall be at least 90%.

A.5.5.5.3 EN-DC Beam Failure Detection and Link Recovery Test for FR2 PSCell configured with CSI-RS-based BFD and LR in non-DRX mode

A.5.5.5.3.1 Test Purpose and Environment

The purpose of this test is to verify that the UE properly detects CSI-RS-based beam failure in the set q_0 configured for a serving PSCell and that the UE performs correct CSI-RS-based link recovery based on beam candidate set q_1 . The purpose is to test the downlink monitoring for beam failure detection within the UEs active DL BWP of the PSCell, during the evaluation period, and link recovery, when no DRX is used. This test will partly verify the CSI-RS based beam failure detection and link recovery for an FR2 serving cell requirements in clause 8.5.

The test parameters are given in Tables A.5.5.5.3.1-1, A.5.5.5.3.1-2, and A.5.5.5.3.1-3 below. There are two cells, cell 1 is the E-UTRAN PCell, and cell 2 is the PSCell, in the test. The test consists of five successive time periods, with time duration of T1, T2, T3, T4 and T5 respectively. Figure A.5.5.5.3.1-1 shows the variation of the downlink SNR of the PCell and the SNR of the CSI-RS in set q_0 in the active PSCell to emulate CSI-RS based beam failure. Figure A.5.5.5.3.1-2 shows the variation of the downlink L1-RSRP of the CSI-RS in set q_1 of the candidate beam used for link recovery. Prior to the start of the time duration T1, the UE shall be fully synchronized to cell 1 and cell 2. The UE shall be configured for periodic CSI reporting with a reporting periodicity of 5 ms. In the test, DRX configuration is not enabled.

Table A.5.5.5.3.1-1: Supported test configurations for FR2 PSCell

Configuration	Description
1	LTE FDD, TDD duplex mode, 120 kHz SSB SCS, 100 MHz bandwidth
2	LTE TDD, TDD duplex mode, 120 kHz SSB SCS, 100 MHz bandwidth

Table A.5.5.5.3.1-2: General test parameters for FR2 PSCell for CSI-RS-based beam failure detection and link recovery testing in non-DRX mode

Parameter	Test Config.	Unit	Value	Comment
			Test 1	
Active E-UTRA PCell	1-2		Cell 1	
E-UTRA RF Channel Number	1-2		1	
Active PCell	1-2		Cell 2	
RF Channel Number	1-2		2	
Duplex mode	1-2		TDD	
TDD Configuration	1-2		TDDConf.3.1	
$BW_{channel}$	1-2		100: $N_{RB,c} = 66$	
Data RBs allocated	1-2		66	
PDSCH/PDCCH subcarrier spacing	1-2	kHz	120	
DL initial BWP configuration	1-2		DLBWP.0.1	
DL dedicated BWP configuration	1-2		DLBWP.1.1	
UL initial BWP configuration	1-2		ULBWP.0.1	
UL dedicated BWP configuration	1-2		ULBWP.1.1	
PDSCH Reference Channel	1-2		SR.3.2 TDD	
RMSI CORESET Reference Channel	1-2		CR.3.1 TDD	
Dedicated CORESET Reference Channel	1-2		CCR.3.1 TDD	
OCNG parameters	1-2		OP.1	
CP length	1-2		Normal	
PDSCH/PDCCH TCI state	1-2		TCI.State.0	
CSI-RS for tracking	1-2		TRS.2.1 TDD	

SSB Configuration	1-2		SSB.1 FR2		
SMTC Configuration	1-2		SMTC.3		
PRACH Configuration	1-2		FR2 PRACH configuration 4	A.3.8.3.4	
DRX configuration	1-2		OFF		
CSI-RS configuration for BFD/CBD/RLM	1-2		CSI-RS.3.2 TDD	A.3.14.2	
CSI-RS index assigned as BFD RS (q_0)	1-2		0		
CSI-RS index assigned as CBD RS (q_1)	1-2		1		
CSI-RS index assigned as RLM RS	1-2		0,1		
Beam failure detection transmission parameters	DCI format	1-2	1-0		
	Number of Control OFDM symbols	1-2	2		
	Aggregation level	1-2	CCE	8	
	Ratio of hypothetical PDCCH RE energy to average SSS RE energy	1-2	dB	0	
	Ratio of hypothetical PDCCH DMRS energy to average SSS RE energy	1-2	dB	0	
	DMRS precoder granularity	1-2		REG bundle size	
	REG bundle size	1-2		6	
Gap pattern ID	1-2		N/A		
rlmInSyncOutOfSyncThreshold	1-2		absent	Value 0 is applied. (Table 8.1.1-1).	
rsrp-ThresholdSSB	1-2	dBm/SCS	-95	Threshold used for $Q_{in_LR_SSB}$	
powerControlOffsetSS	1-2		db0	Used for deriving rsrp-ThresholdCSI-RS	
beamFailureInstanceMaxCount	1-2		n1	see TS 38.321 [7], clause 5.17	
beamFailureDetectionTimer	1-2		pbfd4	see TS 38.321 [7], clause 5.17	
CSI-RS configuration for CSI reporting	1-2		CSI-RS.3.1 TDD	A.3.14.2	
reportConfigType	1-2		periodic		
reportQuantity	1-2		cri-RI-PMI-CQI		
CSI reporting periodicity	1-2	slot	40		
CSI reporting offset	1-2	slot	4		
T310	1-2	ms	1000		
N310	1-2		2		
T1	1-2	s	1	The UE shall be fully synchronized to cell 1 during T1	
T2	1-2	s	1.17		
T3	1-2	s	0.9		
T4	1-2	s	0		
T5	1-2	s	0.31		
D1	1-2	s	0.27		
Note 1: UE-specific PDCCH is not transmitted after T1 starts.					

Table A.5.5.3.1-3: Cell specific test parameters for FR2 PSCell for CSI-RS-based beam failure detection and link recovery testing in non-DRX mode

Parameter	Unit	Test 1
-----------	------	--------

			T1	T2	T3	T4	T5
AoA setup			Setup 1 defined in A.3.15				
Assumption for UE beams ^{Note 10}			Rough				
EPRE ratio of PDCCH DMRS to SSS		dB	0				
EPRE ratio of PDCCH to PDCCH DMRS		dB					
EPRE ratio of PBCH DMRS to SSS		dB					
EPRE ratio of PBCH to PBCH DMRS		dB					
EPRE ratio of PSS to SSS		dB					
EPRE ratio of PDSCH DMRS to SSS		dB					
EPRE ratio of PDSCH to PDSCH DMRS		dB					
EPRE ratio of OCNG DMRS to SSS		dB					
EPRE ratio of OCNG to OCNG DMRS		dB					
SNR_CSI-RS of set q_0	Config 1-2	dB	5 ^{Note 11}	-3 ^{Note 11}	-12	-12	-12
SNR_CSI-RS of set q_1	Config 1-2	dB	0.2	0.2	20.2	20.2	20.2
CSI-RS_RP of set q_1	Config 1-2	dBm/S CS	-104.5	-104.5	-84.5	-84.5	-84.5
N_{oc}	Config 1-2	dBm/12 0 KHz	-104.7				
Propagation condition			TDL-A 30ns 75Hz				
<p>Note 1: OCNG shall be used such that the resources in Cell 1 are fully allocated and a constant total transmitted power spectral density is achieved for all OFDM symbols.</p> <p>Note 2: The uplink resources for CSI reporting are assigned to the UE prior to the start of time period T1.</p> <p>Note 3: NZP CSI-RS resource set configuration for CSI reporting are assigned to the UE prior to the start of time period T1.</p> <p>Note 4: Void</p> <p>Note 5: The timers and layer 3 filtering related parameters are configured prior to the start of time period T1.</p> <p>Note 6: The signal contains PDCCH for UEs other than the device under test as part of OCNG.</p> <p>Note 7: SNR levels correspond to the signal to noise ratio over the REs carrying CSI-RS. Note 8: The SNR in time periods T1, T2, T3, T4 and T5 is denoted as SNR1, SNR2 and SNR3 respectively in figure A.5.5.5.3.1-1.</p> <p>Note 9: The SNR values are specified for testing a UE which supports 2RX on at least one band. For testing of a UE which supports 4RX on all bands, the SNR during T3 is modified as specified in clause A.3.6.</p> <p>Note 10: Information about types of UE beam is given in B.2.1.3, and does not limit UE implementation or test system implementation</p> <p>Note 11: This value allows up to 1dB degradation from applied SNR to UE baseband</p>							

Table A.5.5.5.3.1-4: Void

Table A.5.5.5.3.1-5: Void

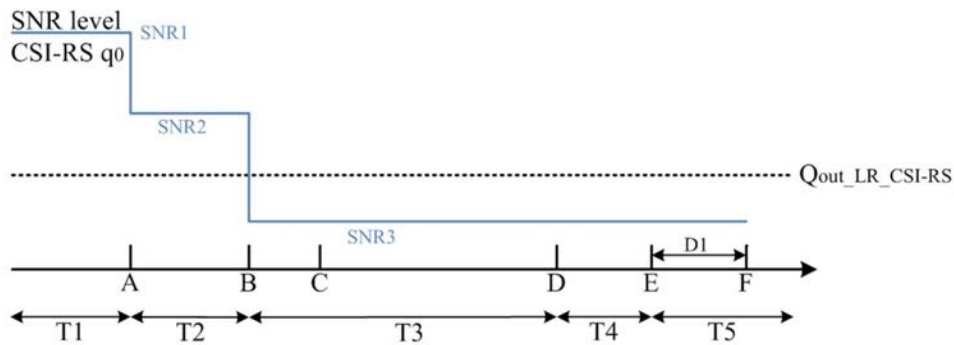

Figure A.5.5.5.3.1-1: SNR variation for CSI-RS based beam failure detection and link recovery testing in non-DRX mode

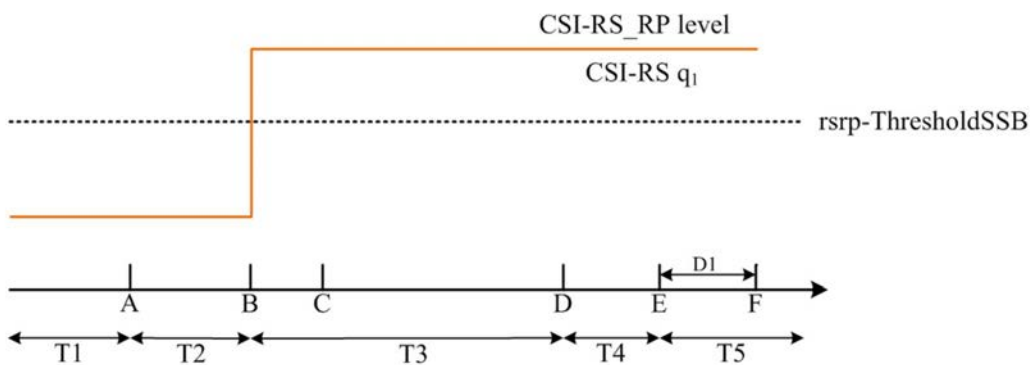

Figure A.5.5.5.3.1-2: CSI-RS_RP level variation for CSI-RS based beam failure detection and link recovery testing in non-DRX mode

A.5.5.5.3.2 Test Requirements

The UE behaviour during time durations T1, T2, T3, T4 and T5 shall be as follows:

During the time duration T1 and T2, the UE shall transmit uplink signal at least in all subframes configured for CSI transmission on Cell 1.

During the period from time point A to time point B the UE shall transmit uplink signal in Cell 1 in all uplink slots configured for CSI transmission according to the configured periodic CSI reporting for Cell 1.

During T3 the UE shall detect beam failure and initiate link recovery. During T4 and T5 the UE measures and evaluates beam candidate from beam candidate set q_1 .

No later than time point F occurring no later than $D1 = 260 + 10$ ms after the start of T5, the UE shall transmit preamble on a beam associated with the candidate beam set q_1 . The UE shall not transmit preamble on a beam associated with the candidate beam set q_1 earlier than time point B.

Test is concluded once the test equipment has received the initial preamble transmission from the UE. The rate of correct events observed during repeated tests shall be at least 90%.

A.5.5.5.4 EN-DC Beam Failure Detection and Link Recovery Test for FR2 PSCell configured with CSI-RS-based BFD and LR in DRX mode

A.5.5.5.4.1 Test Purpose and Environment

The purpose of this test is to verify that the UE properly detects CSI-RS-based beam failure in the set q_0 configured for a serving PSCell and that the UE performs correct CSI-RS-based link recovery based on beam candidate set q_1 . The purpose is to test the downlink monitoring for beam failure detection within the UEs active DL BWP of the PSCell, during the evaluation period, and link recovery, when DRX is used. This test will partly verify the CSI-RS based beam failure detection and link recovery for an FR2 serving cell requirements in clause 8.5.

The test parameters are given in Tables A.5.5.5.4.1-1, A.5.5.5.4.1-2, A.5.5.5.4.1-3, and A.5.5.5.4.1-4 below. There are two cells, cell 1 is the E-UTRAN PCell, and cell 2 is the PSCell, in the test. The test consists of five successive time periods, with time duration of T1, T2, T3, T4 and T5 respectively. Figure A.5.5.5.4.1-1 shows the variation of the downlink SNR of the PCell and the SNR of the CSI-RS in set q_0 in the active PSCell to emulate CSI-RS based beam failure. Figure A.5.5.5.4.1-2 shows the variation of the downlink L1-RSRP of the CSI-RS in set q_1 of the candidate beam used for link recovery. Prior to the start of the time duration T1, the UE shall be fully synchronized to cell 1 and cell 2. The UE shall be configured for periodic CSI reporting with a reporting periodicity of 5 ms. In the test, DRX configuration is enabled in PCell and DRX inactivity timer has already been expired, i.e. UE tries to decode PDCCH and to send periodic CQI during the period when On-duration timer is running. Time alignment timers shall be set to "infinity" so that UL timing alignment is maintained during the test.

Table A.5.5.5.4.1-1: Supported test configurations for FR2 PSCell

Configuration	Description
1	LTE FDD, TDD duplex mode, 120 kHz SSB SCS, 100 MHz bandwidth
2	LTE TDD, FDD duplex mode, 120 kHz SSB SCS, 100 MHz bandwidth

Table A.5.5.5.4.1-2: General test parameters for FR2 PSCell for CSI-RS-based beam failure detection and link recovery testing in DRX mode

Parameter	Test Config.	Unit	Value	Comment
			Test 1	
Active E-UTRA PCell	1-2		Cell 1	
E-UTRA RF Channel Number	1-2		1	
Active PCell	1-2		Cell 2	
RF Channel Number	1-2		2	
Duplex mode	1-2		TDD	
TDD Configuration	1-2		TDDConf.3.1	
$BW_{channel}$	1-2		100: $N_{RB,c} = 66$	
Data RBs allocated	1-2		66	
PDSCH/PDCCH subcarrier spacing	1-2	kHz	120	
DL initial BWP configuration	1-2		DLBWP.0.1	
DL dedicated BWP configuration	1-2		DLBWP.1.1	
UL initial BWP configuration	1-2		ULBWP.0.1	
UL dedicated BWP configuration	1-2		ULBWP.1.1	

PDSCH Reference Channel	1-2		SR.3.2 TDD		
RMSI CORESET Reference Channel	1-2		CR.3.1 TDD		
Dedicated CORESET Reference Channel	1-2		CCR.3.1 TDD		
OCNG parameters	1-2		OP.1		
CP length	1-2		Normal		
PDSCH/PDCCH TCI state	1-2		TCI.State.0		
CSI-RS for tracking	1-2		TRS.2.1 TDD		
SSB Configuration	1-2		SSB.1 FR2		
SMTC Configuration	1-2		SMTC.3		
PRACH Configuration	1-2		FR2 PRACH configuration 4	A.3.8.3.4	
DRX configuration	1-2		DRX.3	A.3.3.3	
CSI-RS configuration for BFD/CBD/RLM	1-2		CSI-RS.3.2 TDD	A.3.14.2	
CSI-RS index assigned as BFD RS (q_0)	1-2		0		
CSI-RS index assigned as CBD RS (q_1)	1-2		1		
CSI-RS index assigned as RLM RS	1-2		0,1		
Beam failure detection transmission parameters	DCI format	1-2	1-0		
	Number of Control OFDM symbols	1-2	2		
	Aggregation level	1-2	CCE	8	
	Ratio of hypothetical PDCCH RE energy to average SSS RE energy	1-2	dB	0	
	Ratio of hypothetical PDCCH DMRS energy to average SSS RE energy	1-2	dB	0	
	DMRS precoder granularity	1-2		REG bundle size	
REG bundle size	1-2		6		
Gap pattern ID	1-2		N/A		
rlmInSyncOutOfSyncThreshold	1-2		absent	Value 0 is applied. (Table 8.1.1-1).	
rsrp-ThresholdSSB	1-2	dBm/SCS	-95	Threshold used for $Q_{in_LR_SSB}$	
powerControlOffsetSS	1-2		db0	Used for deriving rsrp-ThresholdCSI-RS	
beamFailureInstanceMaxCount	1-2		n1	see TS 38.321 [7], clause 5.17	
beamFailureDetectionTimer	1-2		pbfd4	see TS 38.321 [7], clause 5.17	
CSI-RS configuration for CSI reporting	1-2		CSI-RS.3.1 TDD	A.3.14.2	
reportConfigType	1-2		periodic		
reportQuantity	1-2		cri-RI-PMI-CQI		
CSI reporting periodicity	1-2	slot	40		
CSI reporting offset	1-2	slot	4		
T310	1-2	ms	1000		
N310	1-2		2		
T1	1-2	s	1	The UE shall be fully synchronized to cell 1 during T1	
T2	1-2	s	5.43		
T3	1-2	s	5.16		
T4	1-2	s	0		
T5	1-2	s	0.31		
D1	1-2	s	0.27		
Note 1: UE-specific PDCCH is not transmitted after T1 starts.					

Table A.5.5.4.1-3: Cell specific test parameters for FR2 PSCell for CSI-RS-based beam failure detection and link recovery testing in DRX mode

Parameter		Unit	Test 1				
			T1	T2	T3	T4	T5
AoA setup			Setup 1 defined in A.3.15				
Assumption for UE beams ^{Note 10}			Rough				
EPRE ratio of PDCCH DMRS to SSS		dB	0				
EPRE ratio of PDCCH to PDCCH DMRS							
EPRE ratio of PBCH DMRS to SSS							
EPRE ratio of PBCH to PBCH DMRS							
EPRE ratio of PSS to SSS							
EPRE ratio of PDSCH DMRS to SSS							
EPRE ratio of PDSCH to PDSCH DMRS							
EPRE ratio of OCNG DMRS to SSS							
EPRE ratio of OCNG to OCNG DMRS							
SNR_CSI-RS of set q_0	Config 1-2						
SNR_CSI-RS of set q_1	Config 1-2	0.2	0.2	20.2	20.2	20.2	
CSI-RS_RP of set q_1	Config 1-2	dBm/S CS	-104.5	-104.5	-84.5	-84.5	-84.5
N_{oc}	Config 1-2	dBm/12 0 KHz	-104.7				
Propagation condition			TDL-A 30ns 75Hz				
<p>Note 1: OCNG shall be used such that the resources in Cell 1 are fully allocated and a constant total transmitted power spectral density is achieved for all OFDM symbols.</p> <p>Note 2: The uplink resources for CSI reporting are assigned to the UE prior to the start of time period T1.</p> <p>Note 3: NZP CSI-RS resource set configuration for CSI reporting are assigned to the UE prior to the start of time period T1.</p> <p>Note 4: Void</p> <p>Note 5: The timers and layer 3 filtering related parameters are configured prior to the start of time period T1.</p> <p>Note 6: The signal contains PDCCH for UEs other than the device under test as part of OCNG.</p> <p>Note 7: SNR levels correspond to the signal to noise ratio over the REs carrying CSI-RS.</p> <p>Note 8: The SNR in time periods T1, T2, T3, T4 and T5 is denoted as SNR1, SNR2 and SNR3 respectively in figure A.5.5.4.1-1.</p> <p>Note 9: The SNR values are specified for testing a UE which supports 2RX on at least one band. For testing of a UE which supports 4RX on all bands, the SNR during T3 is modified as specified in clause A.3.6.</p> <p>Note 10: Information about types of UE beam is given in B.2.1.3, and does not limit UE implementation or test system implementation</p> <p>Note 11: This value allows up to 1dB degradation from applied SNR to UE baseband</p>							

Table A.5.5.5.4.1-4: Void

Table A.5.5.5.4.1-5: Void

Table A.5.5.5.4.1-6: Void

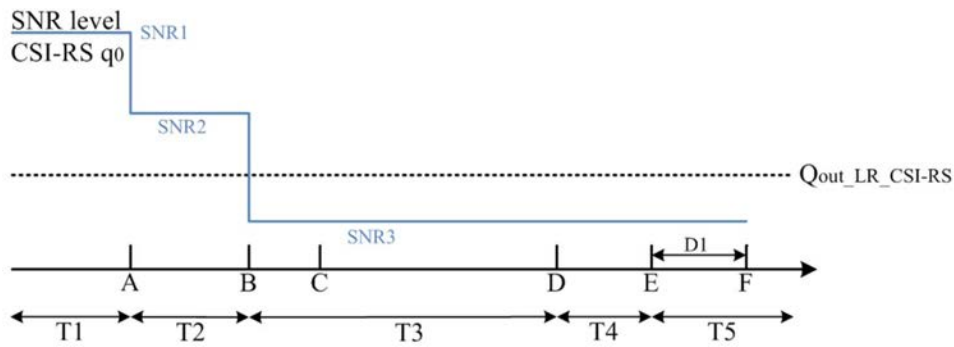

Figure A.5.5.5.4.1-1: SNR variation for CSI-RS-based beam failure detection and link recovery testing in DRX mode

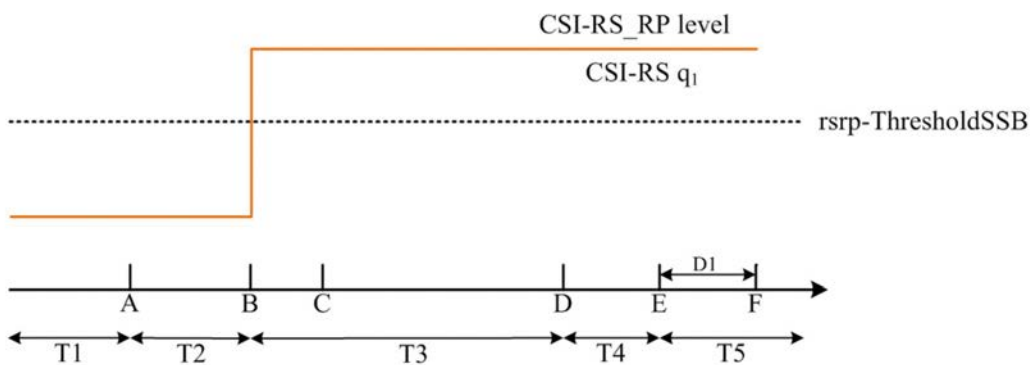

Figure A.5.5.5.4.1-2: CSI-RS_RP level variation for CSI-RS based beam failure detection and link recovery testing in DRX mode

A.5.5.5.4.2 Test Requirements

The UE behaviour during time durations T1, T2, T3, T4 and T5 shall be as follows:

During the time duration T1 and T2, the UE shall transmit uplink signal at least in all subframes configured for CSI transmission on Cell 1.

During the period from time point A to time point B the UE shall transmit uplink signal in Cell 1 in all uplink slots configured for CSI transmission according to the configured periodic CSI reporting for Cell 1.

During T3 the UE shall detect beam failure and initiate link recovery. During T4 and T5 the UE measures and evaluates beam candidate from beam candidate set q_1 .

No later than time point F occurring no later than $D1 = 260 + 10$ ms after the start of T5, the UE shall transmit preamble on a beam associated with the candidate beam set q_1 . The UE shall not transmit preamble on a beam associated with the candidate beam set q_1 earlier than time point B.

Test is concluded once the test equipment has received the initial preamble transmission from the UE. The rate of correct events observed during repeated tests shall be at least 90%.

A.5.5.5.5 EN-DC scheduling availability restriction during Beam Failure Detection and Link Recovery for FR2 PSCell configured with SSB-based BFD and LR in non-DRX mode

A.5.5.5.5.1 Test Purpose and Environment

The purpose is to test scheduling availability restrictions when the UE is performing beam failure detection or when the UE is performing L1-RSRP measurement for candidate beam detection, when no DRX is used. This test will verify the scheduling availability restriction requirements for SSB based beam failure detection and link recovery for an FR2 serving cell in clause 8.5.7 and 8.5.8.

The test parameters are given in Tables A.5.5.5.5.1-1, A.5.5.5.5.1-2 and A.5.5.5.5.1-3 below. There are two cells, cell 1 is the E-UTRAN PCell, and cell 2 is the PSCell, in the test. The test consists of five successive time periods, with time duration of T1, T2, T3, T4 and T5 respectively. Figure A.5.5.5.5.1-1 shows the variation of the downlink SNR of the PCell and the SNR of the SSB in set q_0 in the active PSCell to emulate SSB based beam failure. Figure A.5.5.5.5.1-2 shows the variation of the downlink L1-RSRP of the SSB in set q_1 of the candidate beam used for link recovery. Prior to the start of the time duration T1, the UE shall be fully synchronized to cell 1 and cell 2. The UE shall be configured for periodic CSI reporting with a reporting periodicity of 5ms. This test will focus on the scheduling availability during beam failure detection and candidate beam detection. In the test, DRX configuration is not enabled. Test is to test the scheduling availability restriction of UE performing beam failure detection and candidate beam detection when SSB RS configured for Beam failure detection and candidate beam detection. During the test the UE is scheduled to transmit continuously in UL.

Table A.5.5.5.5.1-1: Supported test configurations for FR2 PSCell

Configuration	Description
1	LTE FDD, NR 120 kHz SSB SCS, 100MHz bandwidth, TDD duplex mode
2	LTE TDD, NR 120 kHz SSB SCS, 100MHz bandwidth, TDD duplex mode
3	LTE FDD, NR 240 kHz SSB SCS, 100MHz bandwidth, TDD duplex mode
4	LTE TDD, NR 240 kHz SSB SCS, 100MHz bandwidth, TDD duplex mode
Note:	The UE is only required to be tested in one of the supported test configurations

Table A.5.5.5.5.1-2: General test parameters for FR2 PSCell for SSB-based beam failure detection and link recovery testing in non-DRX mode

Parameter	Test Config.	Unit	Value	Comment
			Test 1	
Active E-UTRA PCell	1-4		Cell 1	
E-UTRA RF Channel Number	1-4		1	
Active PCell	1-4		Cell 2	
RF Channel Number	1-4		2	
Duplex mode	1-4		TDD	
TDD Configuration	1-4		TDDConf.3.1	
BW _{channel}	1-4		100: N _{RB,c} = 66	

Data RBs allocated	1-4		66		
PDSCH/PDCCH subcarrier spacing	1-4	kHz	120		
DL initial BWP configuration	1-4		DLBWP.0.1		
DL dedicated BWP configuration	1-4		DLBWP.1.1		
UL initial BWP configuration	1-4		ULBWP.0.1		
UL dedicated BWP configuration	1-4		ULBWP.1.1		
PDSCH Reference Channel	1-2		SR.3.2 TDD		
	3-4		SR.3.3 TDD		
RMSI CORESET Reference Channel	1-2		CR.3.1 TDD		
	3-4		CR.3.2 TDD		
Dedicated CORESET Reference Channel	1-2		CCR.3.1 TDD		
	3-4		CCR.3.7 TDD		
OCNG parameters	1-4		OP.1		
CP length	1-4		Normal		
PDSCH/PDCCH TCI state	1-4		TCI.State.0		
CSI-RS for tracking	1-4		TRS.2.1 TDD		
SSB Configuration	1-2		SSB.1 FR2		
	3-4		SSB.2 FR2		
SMTTC Configuration	1-4		SMTTC.1		
PRACH Configuration	1-4		FR2 PRACH configuration 2	A.3.8.3.2	
DRX configuration	1-4		OFF		
SSB index assigned as BFD RS (q_0)	1-4		0		
SSB index assigned as CBD RS (q_1)	1-4		1		
Beam failure detection transmission parameters	DCI format	1-4	1-0		
	Number of Control OFDM symbols	1-4	2		
	Aggregation level	1-4	CCE	8	
	Ratio of hypothetical PDCCH RE energy to average SSS RE energy	1-4	dB	0	
	Ratio of hypothetical PDCCH DMRS energy to average SSS RE energy	1-4	dB	0	
	DMRS precoder granularity	1-4		REG bundle size	
REG bundle size	1-4		6		
Gap pattern ID	1-4		N/A	No measurement gap is configured	
rlmInSyncOutOfSyncThreshold	1-4		absent	Value 0 is applied. (Table 8.1.1-1).	
rsrp-ThresholdSSB	1-2	dBm/SCS	-95	Threshold used for $Q_{in_LR_SSB}$	
	3-4		-92		
powerControlOffsetSS	1-4		db0	Used for deriving rsrp-ThresholdCSI-RS	
beamFailureInstanceMaxCount	1-4		n1	see TS 38.321 [7], clause 5.17	
beamFailureDetectionTimer	1-4		pbfd4	see TS 38.321 [7], clause 5.17	
CSI-RS configuration for CSI reporting	1-4		CSI-RS.3.1 TDD		
reportConfigType	1-4		periodic		
reportQuantity	1-4		cri-RI-PMI-CQI		
CSI reporting periodicity	1-4	slot	40		
CSI reporting offset	1-4	slot	4		
T310	1-4	ms	1000		
N310	1-4		2		

T1	1-4	s	1	The UE shall be fully synchronized to cell 1 during T1
T2	1-4	s	2.6	
T3	1-4	s	1.64	
T4	1-4	s	0	
T5	1-4	s	1.01	
D1	1-4	s	0.97	
Note 1: All configurations are assigned to the UE prior to the start of time period T1.				
Note 2: UE-specific PDCCH is not transmitted after T1 starts.				

Table A.5.5.5.1-3: Cell specific test parameters for FR2 PSCell for SSB-based beam failure detection and link recovery testing in non-DRX mode

Parameter		Unit	Test 1				
			T1	T2	T3	T4	T5
AoA setup			Setup 1 defined in A.3.15				
Assumption for UE beams ^{Note 10}			Rough				
EPRE ratio of PDCCH DMRS to SSS		dB	0				
EPRE ratio of PDCCH to PDCCH DMRS		dB					
EPRE ratio of PBCH DMRS to SSS		dB					
EPRE ratio of PBCH to PBCH DMRS		dB					
EPRE ratio of PSS to SSS		dB					
EPRE ratio of PDSCH DMRS to SSS		dB					
EPRE ratio of PDSCH to PDSCH DMRS		dB					
EPRE ratio of OCNG DMRS to SSS		dB					
EPRE ratio of OCNG to OCNG DMRS		dB					
SNR_SSB of set q_0	Config 1-4	dB	5 ^{Note 11}	-3 ^{Note 11}	-12	-12	-12
SNR_SSB of set q_1 SSB_RP of set q_1	Config 1-4	dB	0.2	0.2	20.2	20.2	20.2
	Config 1-2	dBm/	-104.5	-104.5	-84.5	-84.5	-84.5
	Config 3-4	SCS	-101.5	-101.5	-81.5	-81.5	-81.5
N_{oc}	Config 1-4	dBm/120 kHz	-104.7				
Propagation condition			TDL-A 30ns 75Hz				
<p>Note 1: OCNG shall be used such that the resources in Cell 1 are fully allocated and a constant total transmitted power spectral density is achieved for all OFDM symbols.</p> <p>Note 2: The uplink resources for CSI reporting are assigned to the UE prior to the start of time period T1.</p> <p>Note 3: NZP CSI-RS resource set configuration for CSI reporting are assigned to the UE prior to the start of time period T1.</p> <p>Note 4: Void</p> <p>Note 5: The timers and layer 3 filtering related parameters are configured prior to the start of time period T1.</p> <p>Note 6: The signal contains PDCCH for UEs other than the device under test as part of OCNG.</p> <p>Note 7: SNR levels correspond to the signal to noise ratio over the SSS REs.</p> <p>Note 8: The SNR in time periods T1, T2, T3, T4 and T5 is denoted as SNR1, SNR2 and SNR3 respectively in figure A.5.5.5.1-1.</p> <p>Note 9: The SNR values are specified for testing a UE which supports 2RX on at least one band. For testing of a UE which supports 4RX on all bands, the SNR during T3 is modified as specified in clause A.3.6.</p> <p>Note 10: Information about types of UE beam is given in B.2.1.3, and does not limit UE implementation or test system implementation</p> <p>Note 11: This value allows up to 1dB degradation from applied SNR to UE baseband</p>							

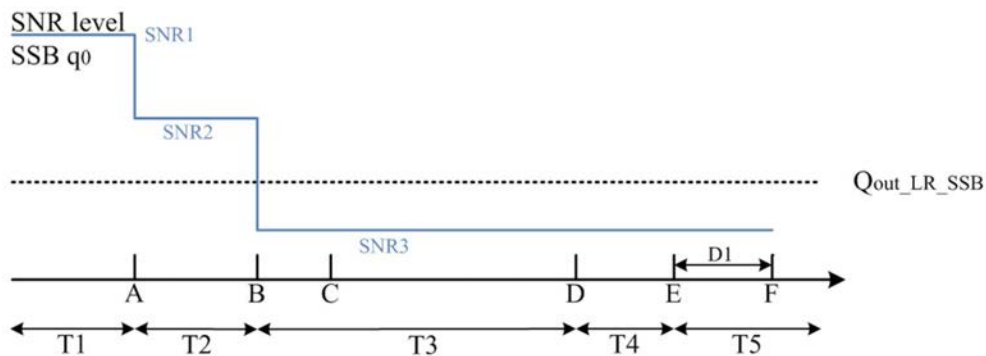

Figure A.5.5.5.1-1: SNR variation for SSB-based beam failure detection and link recovery testing in non-DRX mode

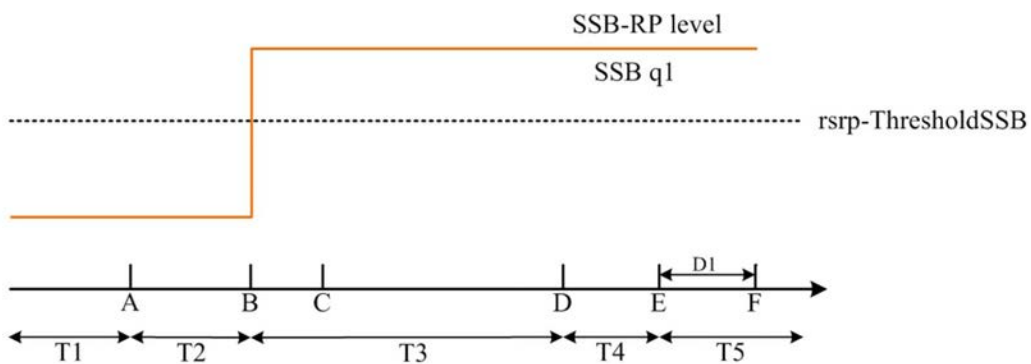

Figure A.5.5.5.1-2: SSB_RP level variation for SSB-based beam failure detection and link recovery testing in non-DRX mode

A.5.5.5.5.2 Test Requirements

The UE behaviour during time duration T3 follows the requirements defined in clause 8.5.7.3:

- The UE is not expected to transmit PUCCH/PUSCH/SRS or receive PDCCH/PDSCH/CSI-RS for tracking/CSI-RS for CQI on BFD-RS symbols to be measured for beam failure detection.

The UE behaviour during time durations T4 and T5 follows the requirements defined in clause 8.5.8.3:

- The UE is not expected to transmit PUCCH/PUSCH or receive PDCCH/PDSCH on reference symbols to be measured for candidate beam detection.

A.5.5.6 Active BWP switch

A.5.5.6.1 DCI-based and Timer-based Active BWP Switch

A.5.5.6.1.1 E-UTRAN – NR PSCell FR2 DL active BWP switch with non-DRX in synchronous EN-DC

A.5.5.6.1.1.1 Test Purpose and Environment

The purpose of this test is to verify the DL BWP switch delay requirement defined in clause 8.6. Supported test configurations are shown in Table A.5.5.6.1.1.1-1.

The test scenario comprises of one E-UTRA PCell (Cell 1), and one PSCell (Cell 2) as given in Table A.5.5.6.1.1.1-2. Cell-specific parameters of E-UTRA PCell are specified in Table A.3.7.2.1-1 and Cell-specific parameters of PSCell is specified in Table A.5.5.6.1.1.1-3 below. The OTA related test parameters for FR2 is shown in Table A.5.5.6.1.1.1-4.

PDCCHs indicating new transmissions shall be sent continuously on E-UTRA PCell (Cell 1) to ensure that the UE will have ACK/NACK sending.

PDCCHs indicating new transmissions shall be sent continuously on PSCell (Cell 2) to ensure that the UE would have ACK/NACK sending except for the time duration when BWP is switching on Cell 2 and the time duration of T2.

Before the test starts,

- UE is connected to Cell 1 (E-UTRA PCell) on radio channel 1 (PCC), and Cell 2 (PSCell) on radio channel 2 (PSCC).
- UE is configured with 2 different UE-specific downlink bandwidth parts for PSCell, BWP-1 and BWP-2, in Cell 2 before starting the test. BWP-1 and BWP-2 always include bandwidth of the initial DL BWP and SSB.
- UE is indicated in *firstActiveDownlinkBWP-Id* that the active DL BWP is BWP-1 in PSCell.
- UE is configured with a *bwp-InactivityTimer* timer value for PSCell.

All cells have constant signal levels throughout the test.

The test consists of 3 successive time periods, with durations of T1, T2, and T3, respectively.

During T1,

Time period T1 starts when a DCI format 1_1 command for PSCell DL BWP switch, sent from the test equipment to the UE, is received at the UE side in PSCell's slot # denoted i . The UE should switch its bandwidth part from BWP-1 to BWP-2.

The UE shall be able to receive PDSCH on the first DL slot that occurs after the beginning of PSCell's DL slot ($i+T_{BWPswitchDelay}$) as defined in clause 8.6 and starts to report valid ACK/NACK for the PSCell no later than the first UL slot that occurs after the beginning of slot ($i+T_{BWPswitchDelay}+kI$). The UE shall be continuously scheduled on PSCell's BWP-2 starting from the first DL slot that occurs after the beginning of slot ($i+T_{BWPswitchDelay}$).

During T2, the test equipment won't transmit DCI format for PDSCH reception on PSCell(Cell 2).

During T3,

The time period T3 starts from the slot # j , where j is the first slot of the half subframe immediately after the slot wherein *bwp-InactivityTimer* timer expires. The UE should switch its bandwidth part from BWP-2 back to the default bandwidth part – BWP-1.

The UE shall be able to receive PDSCH on the first DL slot that occurs after the beginning of PSCell's DL slot ($j+T_{BWPswitchDelay}$) as defined in clause 8.6 and starts to report valid ACK/NACK for the PSCell at latest on the first UL slot that occurs after the beginning of slot ($j+T_{BWPswitchDelay}+kI$). The UE shall be continuously scheduled on PSCell's BWP-1 starting from the first DL slot that occurs after the beginning of slot ($j+T_{BWPswitchDelay}$).

The test equipment verifies the DL BWP switch time in PSCell by counting the slots from the time when the BWP switch command is received or *bwp-InactivityTimer* timer expires till an ACK/NACK is received.

Table A.5.5.6.1.1-1: DL BWP switch supported test configurations

Config	Description
1	LTE FDD, NR 120 kHz SSB SCS, 100 MHz bandwidth, TDD duplex mode
2	LTE TDD, NR 120 kHz SSB SCS, 100 MHz bandwidth, TDD duplex mode
Note 1:	The UE is only required to be tested in one of the supported test configurations
Note 2:	A UE which fulfils the requirements in test case A.5.5.2.2 can skip the test cases in A.5.5.2.1.

Table A.5.5.6.1.1-2: General test parameters for DL BWP switch in synchronous EN-DC

Parameter	Unit	Value	Comment
E-UTRA RF Channel Number		1	One E-UTRA radio channel is used for this test
NR RF Channel Number		2	One NR radio channel is used for this test
Active PCell		Cell 1	PCell on RF channel number 1.
Active PSCell		Cell 2	PSCell on RF channel number 2.
CP length		Normal	
DRX		OFF	For both PCell and PSCell
<i>bwp-InactivityTimer</i>	ms	200	
PDCCH and PDSCH maximum number of HARQ transmission		1	For both PCell and PSCell
Cell-individual offset for cells on RF channel number 1	dB	0	Individual offset for cells on PCC.
Cell-individual offset for cells on RF channel number 2	dB	0	Individual offset for cells on PSCC.
Cell2 timing offset to cell1	μs	3	Synchronous EN-DC
T1	s	0.2	
T2	s	0.2	
T3	s	0.2	

Table A.5.5.6.1.1-3: NR Cell specific test parameters for DL BWP switch in synchronous EN-DC

Parameter	Unit	Cell 2
Frequency Range		FR2
Duplex mode		TDD
TDD configuration		TDDConf.3.1
$BW_{channel}$		100 MHz: $N_{RB,c} = 66$
Active BWP ID		1, 2
Initial DL BWP Configuration		DLBWP.0.2 ^{Note 2}
Active DL BWP-1 Configuration		DLBWP.1.1 ^{Note 2}
Active DL BWP-2 Configuration		DLBWP.1.3 ^{Note 2}
Initial UL BWP Configuration		ULBWP.0.2 ^{Note 2}

Active UL BWP-1 Configuration		ULBWP.1.1 ^{Note 2}
Active UL BWP-2 Configuration		ULBWP.1.3 ^{Note 2}
PDSCH Reference measurement channel		SR.3.1 TDD
RMSI CORESET parameters		CR.3.1 TDD
Dedicated CORESET parameters		CCR.3.1 TDD
OCNG Patterns		OP.1
SSB Configuration		SSB.1 FR2
SMTC Configuration		SMTC.1
TCI State		TCI.State.0
TRS Configuration		TRS.2.1 TDD
Correlation Matrix and Antenna Configuration		1x2 Low
EPRE ratio of PSS to SSS	dB	0
EPRE ratio of PBCH DMRS to SSS		
EPRE ratio of PBCH to PBCH DMRS		
EPRE ratio of PDCCH DMRS to SSS		
EPRE ratio of PDCCH to PDCCH DMRS		
EPRE ratio of PDSCH DMRS to SSS		
EPRE ratio of PDSCH to PDSCH		
EPRE ratio of OCNG DMRS to SSS (Note 1)		
EPRE ratio of OCNG to OCNG DMRS (Note 1)		
Propagation Condition		AWGN
<p>Note 1: OCNG shall be used such that both cells are fully allocated and a constant total transmitted power spectral density is achieved for all OFDM symbols.</p> <p>Note 2: For unpaired spectrum, a DL BWP is linked with an UL BWP. DLBWP.0.2 is linked with ULBWP.0.2; DLBWP.1.1 is linked with ULBWP.1.1; DLBWP.1.3 is linked with ULBWP.1.3 defined in clause 12 of TS 38.213 [3].</p>		

Table A.5.5.6.1.1-4: OTA related test parameters for DL BWP switch in synchronous EN-DC

Parameter	Unit	Cell 2
Angle of arrival configuration		Setup 1 according to clause A.3.15.1
Assumption for UE beams ^{Note 6}		Fine
N_{oc} ^{Note 1}	dBm/15 kHz	-112
N_{oc} ^{Note 1}	dBm/SCS	-103
SS-RSRP ^{Note 2}	dBm/120 kHz ^{Note 3}	-85
\bar{E}_s/I_{ot}	dB	18
I_o ^{Note 2}	dBm/95.04 MHz ^{Note 4}	-55.94
<p>Note 1: Interference from other cells and noise sources not specified in the test is assumed to be constant over subcarriers and time and shall be modelled as AWGN of appropriate power for N_{oc} to be fulfilled.</p> <p>Note 2: SS-RSRP and I_o levels have been derived from other parameters for information purposes. They are not settable parameters themselves.</p> <p>Note 3: SS-RSRP minimum requirements are specified assuming independent interference and noise at each receiver antenna port.</p> <p>Note 4: Equivalent power received by an antenna with 0 dBi gain at the centre of the quiet zone</p> <p>Note 5: As observed with 0dBi gain antenna at the centre of the quiet zone.</p> <p>Note 6: Information about types of UE beam is given in B.2.1.3, and does not limit UE implementation or test system implementation</p>		

A.5.5.6.1.1.2 Test Requirements

During T1, the UE shall start to send the ACK/NACK for PSCell from the first UL slot that occurs after the beginning of DL slot $(i + T_{BWPswitchDelay} + kI)$.

During T3, the UE shall start to send the ACK/NACK for PSCell from the first UL slot that occurs after the beginning of DL slot $(j + T_{BWPswitchDelay} + kI)$.

Where, kI is the timing between DL data receiving and acknowledgement as specified in [7].

Depending on UE capability *bwp-SwitchingDelay* [2], UE shall finish BWP switch within the time duration $T_{BWPswitchDelay}$ defined in Table 8.6.2-1.

All of the above test requirements shall be fulfilled in order for the observed PSCell active BWP switch delay to be counted as correct.

The rate of correct events observed during repeated tests shall be at least 90%.

NOTE: During T1, T3 if there are no uplink resources for reporting the ACK/NACK in the first UL slot that occurs after the beginning of DL slot $(i + T_{BWPswitchDelay} + kI)$, $(j + T_{BWPswitchDelay} + kI)$, then the UE shall use the next available uplink resource for reporting the corresponding ACK/NACK.

A.5.5.6.1.2 E-UTRAN – NR PSCell FR2 with FR2 SCell DL active BWP switch in non-DRX in synchronous EN-DC

A.5.5.6.1.2.1 Test Purpose and Environment

The purpose of this test is to verify the DL BWP switch delay requirement defined in clause 8.6.2, and interruption requirements for NR victim cell defined in clause 8.2.1.2. 7. Supported test configurations are shown in Table A.5.5.6.1.2.1-1.

The test scenario comprises of one E-UTRA PCell (Cell 1), one PSCell (Cell 2) and one SCell (Cell 3) as given in Table A.5.5.6.1.2.1-2. Cell-specific parameters of E-UTRA PCell are specified in Table A.3.7.2.1-1 and Cell-specific parameters of PSCell and SCell are specified in Table A.5.5.6.1.2.1-3 below.

PDCCHs indicating new transmissions shall be sent continuously on E-UTRA PCell (Cell 1) to ensure that the UE will have ACK/NACK sending.

PDCCHs indicating new transmissions shall be sent continuously on PSCell (Cell 2) and SCell (Cell 3) to ensure that the UE would have ACK/NACK sending except for the time duration when BWP is switching on Cell 3 and the time duration of T2.

Before the test starts,

- UE is connected to Cell 1 (E-UTRA PCell) on radio channel 1 (PCC), Cell 2 (PSCell) on radio channel 2 (PSCC) and Cell 3 (SCell) on radio channel 3 (SCC).
- UE is configured with 2 different UE-specific downlink bandwidth parts for SCell, BWP-1 and BWP-2, in Cell 3 before starting the test. BWP-1 and BWP-2 always include bandwidth of the initial DL BWP and SSB.
- UE is configured with 1 UE-specific downlink bandwidth parts the same as initial BWP for PSCell, BWP-0 in Cell 2 before starting the test.
- UE is indicated in *firstActiveDownlinkBWP-Id* that the active DL BWP is BWP-1 in SCell.
- UE is indicated in *firstActiveDownlinkBWP-Id* that the active DL BWP is BWP-0 in PSCell.

- UE is configured with a *bwp-InactivityTimer* timer value for SCell.

All cells have constant signal levels throughout the test.

The test consists of 3 successive time periods, with durations of T1, T2, and T3, respectively.

During T1,

Time period T1 starts when a DCI format 1_1 command for SCell DL BWP switch, sent from the test equipment to the UE, is received at the UE side in SCell's slot # denoted i . The UE shall switch its bandwidth part from BWP-1 to BWP-2.

The UE shall be able to receive PDSCH on the first DL slot that occurs after the beginning of SCell's DL slot ($i+T_{BWPswitchDelay}$) as defined in clause 8.6 and starts to report valid ACK/NACK for the SCell on PSCell no later than the first UL slot that occurs after the beginning of slot ($i+T_{BWPswitchDelay}+k_1$). The UE shall be continuously scheduled on SCell's BWP-2 starting from the first DL slot that occurs after the beginning of slot ($i+T_{BWPswitchDelay}$).

PSCell(Cell 2) interruption due to BWP switch on SCell shall occur within the BWP switch delay.

During T2, the test equipment won't transmit DCI format for PDSCH reception on SCell(Cell 3).

During T3,

The time period T3 starts from the slot # j , where j is the first slot of the half subframe immediately after *bwp-InactivityTimer* timer expires. The UE shall switch its bandwidth part from BWP-2 back to the default bandwidth part – BWP-1.

The UE shall be able to receive PDSCH on the first DL slot that occurs after the beginning of SCell's DL slot ($j+T_{BWPswitchDelay}$) as defined in clause 8.6 and starts to report valid ACK/NACK for the SCell on PSCell at latest on the first UL slot that occurs after the beginning of slot ($j+T_{BWPswitchDelay}+k_1$). The UE shall be continuously scheduled on SCell's BWP-1 starting from the first DL slot that occurs after the beginning of slot ($j+T_{BWPswitchDelay}$).

PSCell(Cell 2) interruption due to BWP switch of SCell shall occur within the BWP switch delay.

The test equipment verifies the DL BWP switch time in SCell by counting the slots from the time when the BWP switch command is received or *bwp-InactivityTimer* timer expires till an ACK/NACK is received.

The test equipment verifies that potential interruption to NR PSCell is carried out in the correct time span by monitoring ACK/NACK sent in PSCell during BWP switch of SCell.

Table A.5.5.6.1.2.1-1: DL BWP switch supported test configurations

Config	Description
1	LTE FDD, NR 120 kHz SSB SCS, 100 MHz bandwidth, TDD duplex mode
2	LTE TDD, NR 120 kHz SSB SCS, 100 MHz bandwidth, TDD duplex mode
Note 1: The UE is only required to be tested in one of the supported test configurations	
Note 2: A UE which fulfils the requirements in test case A.5.5.6.1.2 can skip the test cases in A.5.5.6.1.1.	
Note 3: NR configuration is the same for PSCell and SCells.	

Table A.5.5.6.1.2.1-2: General test parameters for DL BWP switch in synchronous EN-DC

Parameter	Unit	Value	Comment
E-UTRA RF Channel Number		1	One E-UTRA radio channel is used for this test

NR RF Channel Number		2, 3	Two NR radio channels are used for this test
Active PCell		Cell 1	PCell on RF channel number 1.
Active PSCell		Cell 2	PSCell on RF channel number 2.
Active SCell		Cell 3	SCell on RF channel number 3.
CP length		Normal	
DRX		OFF	
<i>bwp-InactivityTimer</i>	ms	200	
PDCCH and PDSCH maximum number of HARQ transmission		1	For PCell, PSCell and SCell
Cell-individual offset for cells on RF channel number 1	dB	0	Individual offset for cells on PCC.
Cell-individual offset for cells on RF channel number 2	dB	0	Individual offset for cells on PSCC.
Cell-individual offset for cells on RF channel number 3	dB	0	Individual offset for cells on SCC.
Cell2 timing offset to cell1	μs	3	Synchronous EN-DC
Cell3 timing offset to cell2	μs	3	Synchronous cells
T1	s	0.2	
T2	s	0.2	
T3	s	0.2	

Table A.5.5.6.1.2.1-3: NR Cell specific test parameters for DL BWP switch in synchronous EN-DC

Parameter	Unit	Cell 2	Cell 3
Frequency Range		FR2	
Duplex mode		TDD	
TDD configuration		TDDConf.3.1	
BW _{channel}		100 MHz: N _{RB,G} = 66	
Active BWP ID		0	1,2
Initial DL BWP Configuration		DLBWP.0.2	DLBWP.0.2
Active DL BWP-0 Configuration		DLBWP.0.2	N.A.
Active DL BWP-1 Configuration		N.A.	DLBWP.1.3
Active DL BWP-2 Configuration		N.A.	DLBWP.1.1
Initial UL BWP Configuration		ULBWP.0.2	N.A.
Active UL BWP-0 Configuration		ULBWP.0.2	N.A.
Active UL BWP-1 Configuration		N.A.	N.A.
Active UL BWP-2 Configuration		N.A.	N.A.
PDSCH Reference measurement channel		SR.3.1 TDD	
RMSI CORESET parameters		CR.3.1 TDD	
Dedicated CORESET parameters		CCR.3.1 TDD	
OCNG Patterns		OP.1	
SSB Configuration		SSB.1 FR2	
SMTC Configuration		SMTC.1	
TCI State		TRS.2.1 TDD	
TRS Configuration		TCI.State.0	
Antenna Configuration		1x2	
Propagation Condition		AWGN	
EPRE ratio of PSS to SSS	dB	0	0
EPRE ratio of PBCH DMRS to SSS			
EPRE ratio of PBCH to PBCH DMRS			
EPRE ratio of PDCCH DMRS to SSS			
EPRE ratio of PDCCH to PDCCH DMRS			
EPRE ratio of PDSCH DMRS to SSS			

EPRE ratio of PDSCH to PDSCH			
EPRE ratio of OCNG DMRS to SSS(Note 1)			
EPRE ratio of OCNG to OCNG DMRS (Note 1)			
<p>Note 1: OCNG shall be used such that both cells are fully allocated and a constant total transmitted power spectral density is achieved for all OFDM symbols.</p> <p>Note 2: Interference from other cells and noise sources not specified in the test is assumed to be constant over subcarriers and time and shall be modelled as AWGN of appropriate power for N_{oc} to be fulfilled.</p> <p>Note 3: SS-RSRP and I_o levels have been derived from other parameters for information purposes. They are not settable parameters themselves.</p> <p>Note 4: For unpaired spectrum, a DL BWP is linked with an UL BWP. DLBWP.0.2 is linked with ULBWP.0.2; DLBWP.1.1 is linked with ULBWP.1.1; DLBWP.1.3 is linked with ULBWP.1.3.</p>			

Table A.5.5.6.1.2.1-4: OTA related test parameters for DL BWP switch in synchronous EN-DC

Parameter	Unit	Cell 2	Cell 3
Angle of arrival configuration		Setup 1 according to clause A.3.15	
Assumption for UE beams ^{Note 6}		Fine	
N_{oc} ^{Note 1}	dBm/15 kHz	-112	-112
SS-RSRP ^{Note 2}	dBm/120 kHz ^{Note 3}	-85	-85
\bar{E}_s/I_{ot}	dB	18	18
I_o ^{Note 2}	dBm/95.04 MHz ^{Note 4}	-55.94	-55.94
<p>Note 1: Interference from other cells and noise sources not specified in the test is assumed to be constant over subcarriers and time and shall be modelled as AWGN of appropriate power for N_{oc} to be fulfilled.</p> <p>Note 2: SS-RSRP and I_o levels have been derived from other parameters for information purposes. They are not settable parameters themselves.</p> <p>Note 3: SS-RSRP minimum requirements are specified assuming independent interference and noise at each receiver antenna port.</p> <p>Note 4: Equivalent power received by an antenna with 0dBi gain at the centre of the quiet zone</p> <p>Note 5: As observed with 0dBi gain antenna at the centre of the quiet zone.</p> <p>Note 6: Information about types of UE beam is given in B.2.1.3, and does not limit UE implementation or test system implementation</p>			

A.5.5.6.1.2.2 Test Requirements

During T1, the UE shall start to send the ACK/NACK for SCell from the first UL slot that occurs after the beginning of DL slot ($i+T_{BWPswitchDelay}+k_1$).

During T3, the UE shall start to send the ACK/NACK for SCell from the first UL slot that occurs after the beginning of DL slot ($j+T_{BWPswitchDelay}+k_1$).

Where, k_1 is the timing between DL data receiving and acknowledgement as specified in [7].

Depending on UE capability *bwp-SwitchingDelay* [2], UE shall finish BWP switch within the time duration $T_{BWPswitchDelay}$ defined in Table 8.6.2-1.

All of the above test requirements shall be fulfilled in order for the observed SCell active BWP switch delay to be counted as correct.

The rate of correct events observed during repeated tests shall be at least 90%.

During T1, the start of the interruption of PSCell during SCell active BWP switch shall not happen outside the BWP switch delay.

During T3, the start of the interruption of PSCell during SCell active BWP switch shall not happen outside the BWP switch delay.

The interruption of PSCell shall not be longer than the interruption duration specified for active BWP switch in Clause 8.6.2.

All of the above test requirements shall be fulfilled in order for the observed active BWP switch interruption to be counted as correct.

The rate of correct events observed during repeated tests shall be at least 90%.

NOTE: During T1, T3 if there are no uplink resources for reporting the ACK/NACK in the first UL slot that occurs after the beginning of DL slot ($i+T_{\text{BWPswitchDelay}+k_1}$), ($j+T_{\text{BWPswitchDelay}+k_1}$), then the UE shall use the next available uplink resource for reporting the corresponding ACK/NACK.

A.5.5.6.2 RRC-based Active BWP Switch

A.5.5.6.2.1 E-UTRAN – NR PSCell FR2 DL active BWP switch with non-DRX in synchronous EN-DC

A.5.5.6.2.1.1 Test Purpose and Environment

The purpose of this test is to verify the DL BWP switch delay requirement for RRC-based BWP switch defined in clause 8.6.3. Supported test configurations are shown in Table A.5.5.6.2.1.1-1.

The test scenario comprises of one E-UTRA PCell (Cell 1) and one PSCell (Cell 2) as given in Table A.5.5.6.2.1.1-2. Cell-specific parameters of E-UTRA PCell are specified in Table A.3.7.2.1-1 and Cell-specific parameters of PSCell are specified in Table A.5.5.6.2.1.1-3 below.

PDCCHs indicating new transmissions shall be sent continuously on E-UTRA PCell (Cell 1) to ensure that the UE will have ACK/NACK sending.

PDCCHs indicating new transmissions shall be sent continuously on PSCell (Cell 2) to ensure that the UE would have ACK/NACK sending except for the time duration when BWP is switching on Cell 2.

Before the test starts,

- UE is connected to Cell 1 (E-UTRA PCell) on radio channel 1 (PCC) and to Cell 2 (PSCell) on radio channel 2 (PSCC).
- UE has bandwidth part BWP-1 in its RRC-configuration for Cell 2 (PSCell).
- UE is indicated in *firstActiveDownlinkBWP-Id* that the active DL BWP is BWP-1 of initial condition in PSCell.

All cells have constant signal levels throughout the test.

The test consists of 1 time period, with duration of T1.

During T1,

If the *RRCReconfiguration* is embedded in E-UTRA RRC message, time period T1 starts when a E-UTRA RRC message *RRCConnectionReconfiguration* with updated bandwidth part configuration, sent from the test equipment to the UE, is completely received at the UE side from PCell in PSCell's slot # denoted *i*. Otherwise, i.e., if the *RRCReconfiguration* is not embedded in E-UTRA RRC message, time period T1 starts

when a *RRCReconfiguration* with updated bandwidth part configuration, sent from the test equipment to the UE, is completely received at the UE side in from PSCell in PSCell's slot # denoted i . The UE shall reconfigure its bandwidth part with the updated bandwidth part BWP-1 of final condition.

The UE shall be able to completely receive PDSCH on PSCell from the first DL slot occurs right after the beginning of PSCell's DL slot $i + \frac{T_{RRCprocessingDelay} + T_{BWPswitchDelayRRC}}{NR\ Slot\ length}$ as defined in clause 8.6.3 and starts to report valid ACK/NACK for the PSCell from the first UL slot that occurs after the beginning of DL slot $i + \frac{T_{RRCprocessingDelay} + T_{BWPswitchDelayRRC}}{NR\ Slot\ length} + k1..$ The UE shall be continuously scheduled on PSCell's BWP-1 starting from the first DL slot that occurs right after the beginning of DL slot $i + \frac{T_{RRCprocessingDelay} + T_{BWPswitchDelayRRC}}{NR\ Slot\ length}$.

$T_{RRCprocessingDelay}$ and $T_{BWPswitchDelayRRC}$ are defined in clause 8.6.3.

The test equipment verifies the DL BWP switch time in PSCell by counting the time from the time when the *RRCReconfiguration* message including updated BWP configuration is sent till the time when a valid ACK/NACK is received.

Table A.5.5.6.2.1.1-1: DL BWP switch supported test configurations

Config	Description
1	LTE FDD, NR 120 kHz SSB SCS, 100 MHz bandwidth, TDD duplex mode
2	LTE TDD, NR 120 kHz SSB SCS, 100 MHz bandwidth, TDD duplex mode
Note 1: The UE is only required to be tested in one of the supported test configurations	

Table A.5.5.6.2.1.1-2: General test parameters for DL BWP switch in synchronous EN-DC

Parameter	Unit	Value	Comment
E-UTRA RF Channel Number		1	One E-UTRA radio channel is used for this test
NR RF Channel Number		2	One NR radio channel is used for this test
Active PCell		Cell 1	PCell on RF channel number 1.
Active PSCell		Cell 2	PSCell on RF channel number 2.
CP length		Normal	
DRX		OFF	
PDCCH and PDSCH maximum number of HARQ transmission		1	For both PCell and PSCell
Cell-individual offset for cells on RF channel number 1	dB	0	Individual offset for cells on PCC.
Cell-individual offset for cells on RF channel number 2	dB	0	Individual offset for cells on PSCC.
Cell2 timing offset to cell1	μs	3	Synchronous EN-DC
T1	s	0.2	

Table A.5.5.6.2.1.1-3: NR Cell specific test parameters for DL BWP switch in synchronous EN-DC

Parameter	Unit	Cell 2
Frequency Range		FR2
Duplex mode		TDD
TDD configuration		TDDConf.3.1
BW _{channel}		100 MHz: N _{RB,c} = 66
Active BWP ID		1, 2

Initial DL BWP Configuration			DLBWP.0.2
Initial UL BWP Configuration			ULBWP.0.2
Initial Condition	Active DL BWP-1 Configuration		DLBWP.1.3
	Active UL BWP-1 Configuration		ULBWP.1.3
Final Condition	Active DL BWP-1 Configuration		DLBWP.1.1
	Active UL BWP-1 Configuration		ULBWP.1.1
PDSCH Reference measurement channel			SR.3.1 TDD
RMSI CORESET parameters			CR.3.1 TDD
Dedicated CORESET parameters			CCR.3.1 TDD
OCNG Patterns			OP.1
SSB Configuration			SSB.1 FR2
SMTC Configuration			SMTC.1
TCI State			TCI.State.0
TRS Configuration			TRS.2.1 TDD
Antenna Configuration			1x2
Propagation Condition			AWGN
EPRE ratio of PSS to SSS		dB	0
EPRE ratio of PBCH DMRS to SSS			
EPRE ratio of PBCH to PBCH DMRS			
EPRE ratio of PDCCH DMRS to SSS			
EPRE ratio of PDCCH to PDCCH DMRS			
EPRE ratio of PDSCH DMRS to SSS			
EPRE ratio of PDSCH to PDSCH			
EPRE ratio of OCNG DMRS to SSS(Note 1)			
EPRE ratio of OCNG to OCNG DMRS (Note 1)			
<p>Note 1: OCNG shall be used such that both cells are fully allocated and a constant total transmitted power spectral density is achieved for all OFDM symbols.</p> <p>Note 2: Interference from other cells and noise sources not specified in the test is assumed to be constant over subcarriers and time and shall be modelled as AWGN of appropriate power for N_{oc} to be fulfilled.</p> <p>Note 3: SS-RSRP and I_o levels have been derived from other parameters for information purposes. They are not settable parameters themselves.</p> <p>Note 4: For unpaired spectrum, a DL BWP is linked with an UL BWP. DLBWP.0.2 is linked with ULBWP.0.2; DLBWP.1.1 is linked with ULBWP.1.1; DLBWP.1.3 is linked with ULBWP.1.3 defined in clause 12 of TS 38.213 [3].</p>			

Table A.5.5.6.2.1.1-4: OTA related test parameters for BWP switching test case

Parameter		Unit	Cell 2
Angle of arrival configuration			Setup 1 according to A.3.15
Assumption for UE beams ^{Note 5}			Fine
N_{oc} ^{Note1}	NR_TDD_FR2_A	dBm/15kHz	-112
	NR_TDD_FR2_B		
	NR_TDD_FR2_F		
	NR_TDD_FR2_G		
	NR_TDD_FR2_T		
N_{oc} ^{Note1}	NR_TDD_FR2_Y	dBm/SCS	-103
	NR_TDD_FR2_A		
	NR_TDD_FR2_B		
	NR_TDD_FR2_F		
	NR_TDD_FR2_G		

	NR_TDD_FR2_T		
	NR_TDD_FR2_Y		
SS-RSRP ^{Note2}	NR_TDD_FR2_A	dBm/SCS ^{Note3}	-85
	NR_TDD_FR2_B		
	NR_TDD_FR2_F		
	NR_TDD_FR2_G		
	NR_TDD_FR2_T		
	NR_TDD_FR2_Y		
\hat{E}_s/I_{ot}		dB	18
I _o ^{Note2}	NR_TDD_FR2_A	dBm/95.04 MHz ^{Note4}	-55.94
	NR_TDD_FR2_B		
	NR_TDD_FR2_F		
	NR_TDD_FR2_G		
	NR_TDD_FR2_T		
	NR_TDD_FR2_Y		
<p>Note 1: Interference from other cells and noise sources not specified in the test is assumed to be constant over subcarriers and time and shall be modelled as AWGN of appropriate power for N_{oc} to be fulfilled.</p> <p>Note 2: SS-RSRP and I_o levels have been derived from other parameters for information purposes. They are not settable parameters themselves.</p> <p>Note 3: SS-RSRP minimum requirements are specified assuming independent interference and noise at each receiver antenna port.</p> <p>Note 4: Equivalent power received by an antenna with 0dBi gain at the centre of the quiet zone</p> <p>Note 5: Information about types of UE beam is given in B.2.1.3, and does not limit UE implementation or test system implementation</p>			

A.5.5.6.2.1.2 Test Requirements

During T1, the UE shall be ready for the reception of uplink grant for PSCell from the first DL slot that occurs right after the beginning of DL slot $i + \frac{T_{RRCprocessingDelay} + T_{BWPswitchDelayRRC}}{NR\ Slot\ length}$ and starts to report valid ACK/NACK for the PSCell from the first UL slot that occurs after the beginning of DL slot $i + \frac{T_{RRCprocessingDelay} + T_{BWPswitchDelayRRC}}{NR\ Slot\ length} + k1$.

Where, $k1$ is the timing between DL data receiving and acknowledgement as specified in [7].

All of the above test requirements shall be fulfilled in order for the observed PSCell active BWP switch delay to be counted as correct.

The rate of correct events observed during repeated tests shall be at least 90%.

A.5.5.7 PSCell addition and release delay

A.5.5.7.1 Addition and Release Delay of NR PSCell

A.5.5.7.1.1 Test purpose and environment

The purpose of this test is to verify that the NR PSCell addition and release delays under EN-DC are within the requirements stated in clause 7.31.2 of TS 36.133 [15] for the case when the PSCell is unknown by the UE at the time of addition.

Supported test configurations are shown in A.5.5.7.1.1-1. The test parameters for the E-UTRA cell are given in Table A.3.7.2.2-1. The E-UTRA cell once set up is not changed across time.

The test parameters for NR cell are given in Tables A.5.5.7.1.1-2, cell-specific parameters in A.5.5.7.1.1-3 and OTA parameters in A.5.5.7.1.1-4 below. The test consists of four successive time periods with duration of T1, T2, T3 and T4. There are two carriers each with one cell. Before the test starts the UE is connected to Cell 1 (E-UTRA PCell) on radio channel 1 (PCC) but is not aware of Cell 2 (NR PSCell) on radio channel 2. The UE is only monitoring the PCC. During T1 only Cell1 is known to the UE.

The test system shall send a RRC message to the UE to add PSCell (Cell 2) on radio channel 2. The RRC message (to add PSCell) also includes a request for the UE to start periodic CSI reporting for the PSCell after the PSCell has been successfully added. The RRC message to add PSCell shall be sent to the UE during period T1. The point in time at which the RRC message to add PSCell (Cell2) is received at the UE antenna connector defines the start of period T2.

The test system shall observe the periodic reporting of CSI for PSCell during T3. The point in time at which the UE has sent PRACH to the PSCell (Cell 2) defines the start of period T3.

The test system shall send a RRC message to the UE to release PSCell (Cell 2) on radio channel 2. The RRC message to release PSCell (Cell2) shall be sent to the UE during period T3, after the UE has sent at least one CQI report with non-zero CQI index for PSCell (Cell 2). The point in time at which the RRC message to release PSCell (Cell2) is received at the UE antenna connector defines the start of period T4.

Table A.5.5.7.1.1-1: Supported test configurations for FR2 PSCell

Configuration	Description
1	LTE FDD, NR TDD, SSB SCS 240 kHz, data SCS 120 kHz, BW 100 MHz
2	LTE TDD, NR TDD, SSB SCS 240 kHz, data SCS 120 kHz, BW 100 MHz
Note:	The UE is only required to be tested in one of the supported test configurations

Table A.5.5.7.1.1-2: General Test Parameters for PSCell Addition and Release

Parameter	Unit	Value	Comment	
RF Channel Number		1, 2	Two radio channels are used for this test. One for E-UTRA cell and second for NR Cell	
Initial Condition	Active PCell	Cell1	PCell on RF channel number 1.	
	Neighbour cell	Cell2	Neighbour cell on RF channel number 2.	
Final Condition	Active PCell	Cell1	PCell on RF channel number 1.	
	Neighbour Cell	Cell2	PSCell released on RF channel number 2.	
B1	Hysteresis	dB	0	Hysteresis for evaluation of event B1.
	Threshold RSRP	dBm	-118	Actual RSRP threshold for event B1. Needs to take absolute accuracy tolerance in clause 9.1.11.1 into account plus margin.
	Time to Trigger	s	0	
DRX		OFF	Continuous monitoring of primary cell	
PRACH configuration on cell2		FR2 configuration 2	Captured in A.3.8.3.2	
Cell-individual offset for cells on RF channel number 1	dB	0	Individual offset for cells on primary component carrier.	
Cell-individual offset for cells on RF channel number 2	dB	0	Individual offset for cells on carrier frequency of cell2.	
T1	s	1	During this time the PCell shall be known and cell2 shall be unknown.	
T2	s	1	During this time the UE adds the PSCell.	
T3	s	1	During this time the UE sends CSI reports for PSCell.	
T4	s	1	During this time the UE releases the PSCell.	

Table A.5.5.7.1.1-3: Cell Specific Parameters for PSCell Addition and Release

Parameter	Unit	Config	Test			
			T1	T2	T3	T4
E-UTRA Channel Number		1,2	1			
NR Channel Number		1,2	2			
Duplex Mode		1,2	TDD			
TDD configuration		1,2	TDDConf.3.1			
BW _{channel}	MHz	1,2	100: NRB,c = 66			
Data RBs allocated		1,2	48			
Initial BWP Configuration		1,2	DLBWP.0.1 ULBWP.0.1			
Dedicated BWP Configuration		1,2	DLBWP.1.1 ULBWP.1.1			
TRS Configuration		1	TRS.2.1 TDD			
PDSCH/PDCCH TCI state		1	TCI.State.2			
PDSCH Reference measurement channel		1,2	SR.3.3 TDD			
RMSI CORESET Reference Channel		1,2	CR.3.2 TDD			
Dedicated CORESET Reference Channel		1,2	CCR.3.7 TDD			
OCNG Patterns		1,2	OP.3			
SSB configuration		1,2	SSB.2 FR2			
SMTC configuration		1,2	SMTC.2			
PDSCH/PDCCH subcarrier spacing	kHz	1,2	120			
TRS Configuration		1,2	TRS.2.1 TDD			
CSI-RS configuration for CSI reporting		1,2	CSI-RS.3.1 TDD			
reportConfigType		1,2	periodic			
reportQuantity		1,2	cri-RI-PMI-CQI			
CSI reporting periodicity	slot	1,2	40			
CSI reporting offset	slot	1,2	4			
EPRE ratio of PSS to SSS	dB	1,2	0			
EPRE ratio of PBCH DMRS to SSS						
EPRE ratio of PBCH to PBCH DMRS						
EPRE ratio of PDCCH DMRS to SSS						
EPRE ratio of PDCCH to PDCCH DMRS						
EPRE ratio of PDSCH DMRS to SSS						
EPRE ratio of PDSCH to PDSCH						
EPRE ratio of OCNG DMRS to SSS(Note 1)						
EPRE ratio of OCNG to OCNG DMRS (Note 1)						
Propagation condition						
Note 1: The downlink connection between the System Simulator and the UE is without Additive White Gaussian Noise, and has no fading or multipath effects as specified in TS 38.521-2 B.0 [29].						

Table A.5.5.7.1.1-4: OTA related test parameters

Parameter	Unit	Cell 2			
		T1	T2	T3	T4
Angle of arrival configuration		Setup 2a according to clause A.3.15.2.1			
Assumption for UE beams ^{Note 6}		Rough			
\hat{E}_s ^{Note 2}	dBm/SCS	$-\infty$		-81	
SSB_RP ^{Note 2, Note 4}	dBm/SCS	$-\infty$		-81	
$\hat{E}_s / I_{ot\ BB}$ ^{Note 2, Note 7}	dB	$-\infty$		4.88	
I_o ^{Note 2, Note 4}	dBm/95.04 MHz	N/A		-56.41	
<p>Note 1: Void</p> <p>Note 2: E_s/lot, SSB_RP and I_o levels have been derived from other parameters for information purposes. They are not settable parameters themselves.</p> <p>Note 3: Void</p> <p>Note 4: Equivalent power received by an antenna with 0dBi gain at the centre of the quiet zone</p> <p>Note 5: Void</p> <p>Note 6: Information about types of UE beam is given in B.2.1.3, and does not limit UE implementation or test system implementation.</p> <p>Note 7: Calculation of E_s/lot_{BB} includes the effect of UE internal noise up to the value assumed for the associated Refsens requirement in clause 7.3.2 of TS 38.101-2 [19], and an allowance of 1dB for UE multi-band relaxation factor ΔMB_S from TS 38.101-2 [19] Table 6.2.1.3-4.</p>					

A.5.5.7.1.2 Test Requirements

The UE shall transmit the PRACH to PSCell at latest 582 ms^{Note1} into T2.

The UE shall send at least one CSI report for PSCell with non-zero CQI index during T3.

The UE shall periodically send CSI reports for PSCell after the UE has sent first CQI report with non-zero CQI index during T3.

The UE shall stop sending CSI reports for PSCell in at latest 20 ms into T4.

All the above test requirements shall be fulfilled for the observed PSCell addition delay and PSCell release delay to be counted as correct. The rate of correct observed PSCell addition delay and PSCell release delay during repeated tests shall be at least 90%.

Note1: The PSCell addition delay can be expressed as follows as specified in clause 7.31.2 of TS 36.133 [15]:

$$T_{\text{config_PSCell}} = T_{\text{RRC_delay}} + T_{\text{processing}} + T_{\text{search}} + T_{\Delta} + T_{\text{PSCell_DU}} + 2\text{ms}$$

Where:

$$T_{\text{RRC_delay}} = 20\text{ms}$$

$$T_{\text{processing}} = 40\text{ms}$$

$$T_{\text{search}} = 8 * 3 * 20 = 480 \text{ ms}$$

$$T_{\Delta} = 20\text{ms}$$

$$T_{\text{PSCell_DU}} = 1 * 10 + 10 = 20 \text{ ms}$$

A.5.5.8 Active TCI state switch delay

A.5.5.8.1 MAC-CE based active TCI state switch

A.5.5.8.1.1 E-UTRAN – NR PSCell FR2 active TCI state switch for a known TCI state

A.5.5.8.1.1.1 Test Purpose and Environment

The purpose of this test is to verify the active TCI state switch delay requirement defined in clause 8.10.3. Supported test configurations are shown in Table A.5.5.8.1.1.1-1.

The test scenario comprises of one E-UTRA PCell (Cell 1), and one NR PSCell (Cell 2) as given in Table A.5.5.8.1.1.1-2. Cell-specific parameters of E-UTRA PCell are specified in Table A.3.7.2.1-1 and Cell-specific parameters of NR PSCell is specified in Table A.5.5.8.1.1.1-3 below. The OTA related test parameters for FR2 is shown in Table A.5.5.8.1.1.1-4.

PDCCHs indicating new transmissions shall be sent continuously on PSCell (Cell 2) to ensure that the UE would have ACK/NACK sending.

Before the test starts,

- UE is connected to Cell 1 (PCell) on radio channel 1 (PCC), and Cell 2 (PSCell) on radio channel 2 (PSCC).
- UE is configured with 2 different TCI states for PSCell, PDCCH TCI state 0 (QCL'd to SSB0) and TCIstate 1 (QCL'd to SSB1), in Cell 2 before starting the test.
- UE is indicated in TCI state 0 as the active PDCCH TCI state

The test consists of two time periods, T1 and T2. Figure A.5.5.8.1.1.1-1 and Figure A.5.5.8.1.1.1-2 show the Time multiplexed (allocation in Frequency is symbolic) downlink transmissions from each Angle of Arrival. During T1 only SSB to which PDCCH-TCI-state0 is QCL'd is transmitted. At the beginning of T2, the SSB corresponding to TCI state 1 starts transmitting. The UE is configured to provide periodic L1-RSRP reports. In slot n which is within 1280ms of UE providing L1-RSRP report with results for both SSB0 and SSB1, UE receives a MAC-CE command indicating a switch to TCI state 1. *tci-PresentInDCI* is not configured in the PDSCH configuration, i.e. TCI state for the PDSCH is identical to the PDCCH TCI state.

The test equipment verifies that UE can be scheduled on PSCell on TCI state 0 till slot $n + T_{\text{HARQ}} + 3N_{\text{slot}}^{\text{subframe},\mu}$. The test equipment also verifies the TCI state switch time in PSCell by scheduling the UE on TCI state 1 after slot $n + T_{\text{HARQ}} + 3N_{\text{slot}}^{\text{subframe},\mu} + (T_{\text{first-SSB}} + T_{\text{SSB-proc}})/\text{NR slot length}$.

Table A.5.5.8.1.1.1-1: Supported test configurations

Config	Description
1	LTE FDD, NR 120 kHz SSB SCS, 100 MHz bandwidth, TDD duplex mode
2	LTE TDD, NR 120 kHz SSB SCS, 100 MHz bandwidth, TDD duplex mode
Note 1: The UE is only required to be tested in one of the supported test configurations	

Table A.5.5.8.1.1.1-2: General test parameters for TCI state switch

Parameter	Unit	Value	Comment
E-UTRA RF Channel Number		1	One E-UTRA radio channel is used for this test
NR RF Channel Number		2	One NR radio channel is used for this test
Active PCell		Cell 1	PCell on RF channel number 1.
Active PSCell		Cell 2	PSCell on RF channel number 2.
CP length		Normal	

DRX		OFF	For both PCell and PSCell
Cell-individual offset for cells on RF channel number 1	dB	0	Individual offset for cells on PCC.
Cell-individual offset for cells on RF channel number 2	dB	0	Individual offset for cells on PSCC.
Cell2 timing offset to cell1	µs	3	Synchronous EN-DC
T1	s	0.2	
T2	s	0.2	

Table A.5.5.8.1.1.1-3: NR Cell specific test parameters for TCI state switch

Parameter	Unit	Cell 2
Frequency Range		FR2
Duplex mode		TDD
TDD configuration		TDDConf.3.1
BW _{channel}		100 MHz: N _{RB,C} = 66
Data RBs allocated		24
Initial DL BWP Configuration		DLBWP.0.2
Dedicated DL BWP Configuration		DLBWP.1.1
Initial UL BWP Configuration		ULBWP.0.2
Dedicated UL BWP Configuration		ULBWP.1.1
PDSCH Reference measurement channel		SR.3.2 TDD
RMSI CORESET parameters		CR.3.1 TDD
Dedicated CORESET parameters		CCR.3.1 TDD
OCNG Patterns		OP.5
SSB Configuration		SSB.1 FR2
SMTTC Configuration		SMTTC.1
TCI State 0		TCI.State.2
TCI State 1		TCI.State.3
TRS Configuration		TRS.2.1 TDD TRS.2.2 TDD
Correlation Matrix and Antenna Configuration		1x2 Low
EPRE ratio of PSS to SSS	dB	0
EPRE ratio of PBCH DMRS to SSS		
EPRE ratio of PBCH to PBCH DMRS		
EPRE ratio of PDCCH DMRS to SSS		
EPRE ratio of PDCCH to PDCCH DMRS		
EPRE ratio of PDSCH DMRS to SSS		
EPRE ratio of PDSCH to PDSCH		
EPRE ratio of OCNG DMRS to SSS(Note 1)		
EPRE ratio of OCNG to OCNG DMRS (Note 1)		
Propagation Condition		
Note 1: OCNG shall be used such that a constant total transmitted power spectral density is achieved for all OFDM symbols.		
Note 2: The downlink connection between the System Simulator and the UE is without Additive White Gaussian Noise, and has no fading or multipath effects as specified in TS 38.521-2 B.0 [29].		

Table A.5.5.8.1.1.1-4: OTA related test parameters for TCI state switch

Parameter	Unit	Cell 2			
		SSB0		SSB1	
		T1	T2	T1	T2
Angle of arrival configuration		Setup 3 according to clause A.3.15.3			
		AoA1		AoA2	

Assumption for UE beams ^{Note 6}		Rough		Rough	
\bar{E}_s	dBm/SCS	-80.6	-80.6	-Infinity	-80.6
SSB-RP ^{Note 2}	dBm/SCS	-80.6	-80.6	-Infinity	-80.6
\bar{E}_s/I_{ot_BB} ^{Note 7}	dB	8.3	8.3	-Infinity	8.3
I_o ^{Note 2}	dBm/95.04 MHz ^{Note 4}	-55.41	-55.41	- Infinity	-55.41

Note 1: Void
 Note 2: SSB-RP and I_o levels have been derived from other parameters for information purposes. They are not settable parameters themselves.
 Note 3: Void
 Note 4: Equivalent power received by an antenna with 0 dBi gain at the centre of the quiet zone
 Note 5: As observed with 0dBi gain antenna at the center of the quiet zone.
 Note 6: Information about types of UE beam is given in B.2.1.3 and does not limit UE implementation or test system implementation.
 Note 7: Calculation of E_s/I_{ot_BB} includes the effect of UE internal noise up to the value assumed for the associated Refsens requirement in clause 7.3.2 of TS 38.101-2 [19], and an allowance of 1dB for UE multi-band relaxation factor ΔMB_P from TS 38.101-2 [19] Table 6.2.1.3-4.

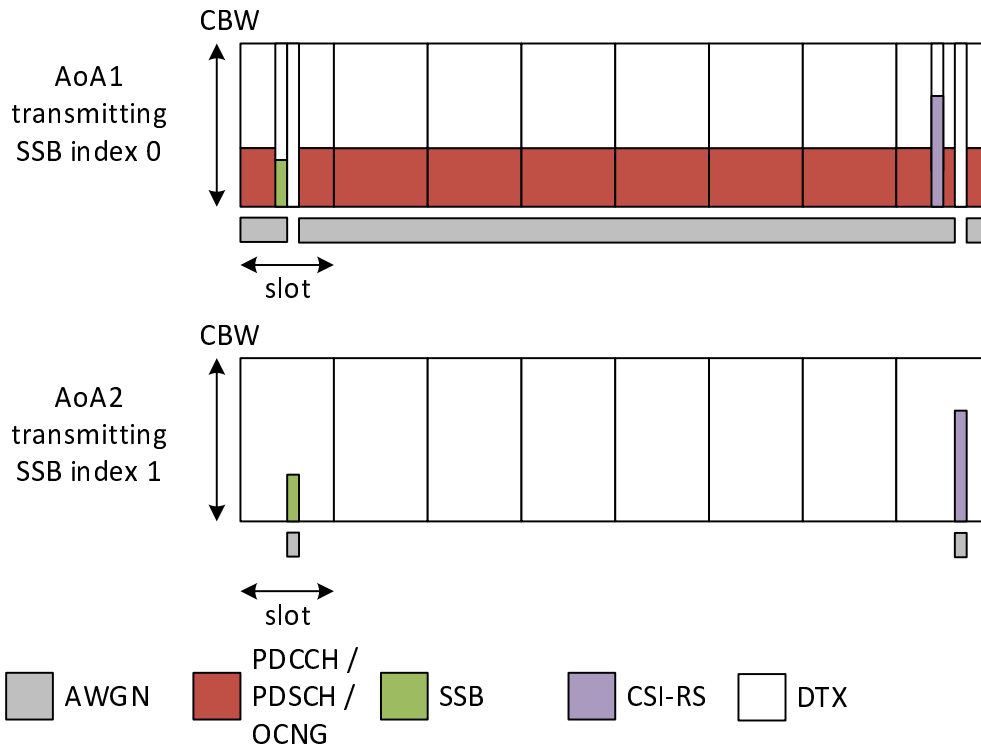

Figure A.5.5.8.1.1-1: Time multiplexed downlink transmissions during T1

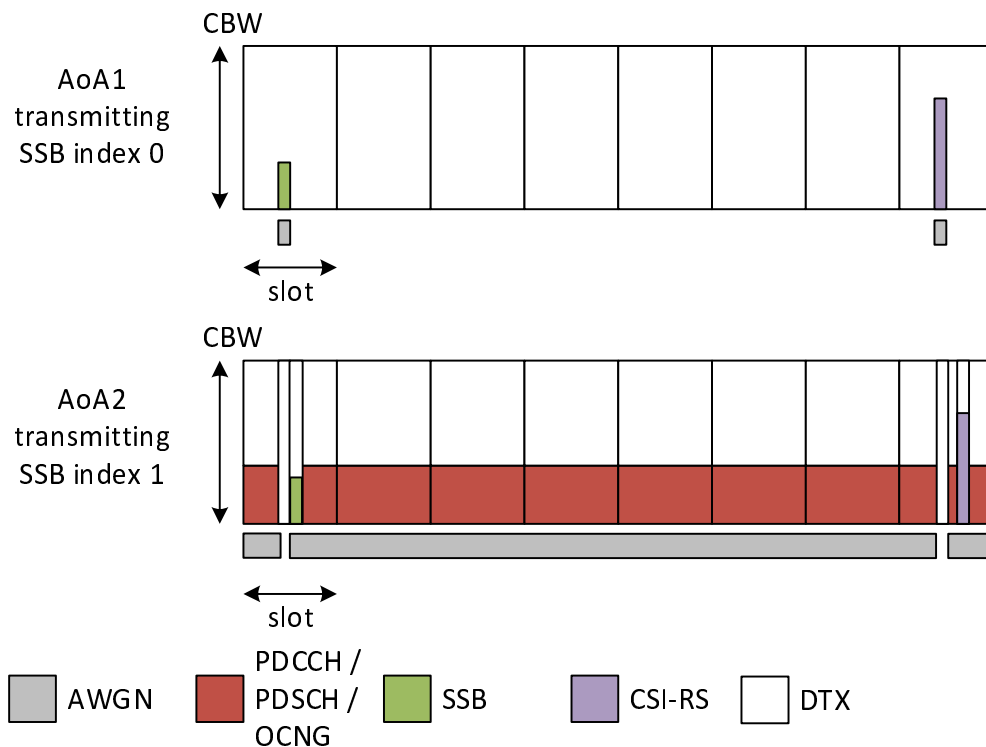

Figure A.5.5.8.1.1-2: Time multiplexed downlink transmissions during T2

A.5.5.8.1.1.2 Test Requirements

During T2, UE shall send L1-RSRP report with results for both SSB0 and SSB1.

After receiving MAC-CE command in slot n , UE shall:

- be able to continue to receive on TCI state 0 till slot $n + T_{\text{HARQ}} + 3N_{\text{slot}}^{\text{subframe},\mu}$
- be able to start receiving on TCI state 1 after slot $n + T_{\text{HARQ}} + 5N_{\text{slot}}^{\text{subframe},\mu} + T_{\text{first-SSB}}/\text{NR slot length}$

The rate of correct events observed during repeated tests shall be at least 90%.

A.5.5.8.2 RRC based active TCI state switch

A.5.5.8.2.1 E-UTRAN – NR PSCell FR2 active TCI state switch for a known TCI state

A.5.5.8.2.1.1 Test Purpose and Environment

The purpose of this test is to verify the active TCI state switch delay requirement defined in clause 8.10.5. Supported test configurations are shown in Table A.5.5.8.2.1.1-1.

The test scenario comprises of one E-UTRA PCell (Cell 1), and one NR PSCell (Cell 2) as given in Table A.5.5.8.2.1.1-2. Cell-specific parameters of E-UTRA PCell are specified in Table A.3.7.2.1-1 and Cell-specific parameters of NR PSCell is specified in Table A.5.5.8.2.1.1-3 below. The OTA related test parameters for FR2 is shown in Table A.5.5.8.2.1.1-4.

PDCCHs indicating new transmissions shall be sent continuously on PSCell (Cell 2) to ensure that the UE would have ACK/NACK sending.

Before the test starts,

- UE is connected to Cell 1 (PCell) on radio channel 1 (PCC), and Cell 2 (PSCell) on radio channel 2 (PSCC).
- UE is configured with 1 TCI state for PSCell, PDCCH-TCI-state0 (QCL'd to SSB0)
- UE is indicated in TCI state0 as the active TCI state

The test consists of two time periods, T1 and T2. Figure A.5.5.8.2.1.1-1 and Figure A.5.5.8.2.1.1-2 show the Time multiplexed (allocation in Frequency is symbolic) downlink transmissions from each Angle of Arrival. During T1 only SSB to which TCI-state0 is QCL'd is transmitted. At the beginning of T2, the SSB corresponding to TCI-state1 starts transmitting. The UE is configured to provide periodic L1-RSRP reports. In slot n which is within 1280 ms of UE providing L1-RSRP report with results for both SSB0 and SSB1, UE receives a RRC command indicating a switch to TCI-state1.

The test equipment verifies the TCI state switch time in PSCell by scheduling the UE on TCI state 1 after slot $n + (T_{\text{RRC_processing}} + T_{\text{first-SSB}}) / NR \text{ slot length} + 2N_{\text{slot}}^{\text{subframe},\mu}$.

Table A.5.5.8.2.1.1-1: Supported test configurations

Config	Description
1	LTE FDD, NR 120 kHz SSB SCS, 100 MHz bandwidth, TDD duplex mode
2	LTE TDD, NR 120 kHz SSB SCS, 100 MHz bandwidth, TDD duplex mode

Note 1: The UE is only required to be tested in one of the supported test configurations

Table A.5.5.8.2.1.1-2: General test parameters for TCI state switch

Parameter	Unit	Value	Comment
E-UTRA RF Channel Number		1	One E-UTRA radio channel is used for this test
NR RF Channel Number		2	One NR radio channel is used for this test
Active PCell		Cell 1	PCell on RF channel number 1.
Active PSCell		Cell 2	PSCell on RF channel number 2.
CP length		Normal	
DRX		OFF	For both PCell and PSCell
Cell-individual offset for cells on RF channel number 1	dB	0	Individual offset for cells on PCC.
Cell-individual offset for cells on RF channel number 2	dB	0	Individual offset for cells on PSCC.
Cell2 timing offset to cell1	μs	3	Synchronous EN-DC
T1	s	0.2	
T2	s	2	

Table A.5.5.8.2.1.1-3: NR Cell specific test parameters for TCI state switch

Parameter	Unit	Cell 2
Frequency Range		FR2
Duplex mode		TDD
TDD configuration		TDDConf.3.1
BW _{channel}		100 MHz: N _{RB,C} = 66
Data RBs allocated		24
Initial DL BWP Configuration		DLBWP.0.2
Dedicated DL BWP Configuration		DLBWP.1.1

Initial UL BWP Configuration		ULBWP.0.2
Dedicated UL BWP Configuration		ULBWP.1.1
PDSCH Reference measurement channel		SR.3.2 TDD
RMSI CORESET parameters		CR.3.1 TDD
Dedicated CORESET parameters		CCR.3.1 TDD
OCNG Patterns		OP.5
SSB Configuration		SSB.1 FR2
SMTC Configuration		SMTC.1
TCI State 0		TC.State.2
TCI State 1		TCI.State.3
TRS Configuration		TRS.2.1 TDD TRS.2.2 TDD
reportConfigType		ssb-Index-RSRP
reportConfigType		periodic
Number of reported RS		2
L1-RSRP reporting period	slot	640
timeRestrictionForChannelMeasurements		configured
Correlation Matrix and Antenna Configuration		1x2 Low
EPRE ratio of PSS to SSS	dB	0
EPRE ratio of PBCH DMRS to SSS		
EPRE ratio of PBCH to PBCH DMRS		
EPRE ratio of PDCCH DMRS to SSS		
EPRE ratio of PDCCH to PDCCH DMRS		
EPRE ratio of PDSCH DMRS to SSS		
EPRE ratio of PDSCH to PDSCH		
EPRE ratio of OCNG DMRS to SSS(Note 1)		
EPRE ratio of OCNG to OCNG DMRS (Note 1)		
Propagation Condition		No external noise (Note 2)
Note 1: OCNG shall be used such that a constant total transmitted power spectral density is achieved for all OFDM symbols.		
Note 2: The downlink connection between the System Simulator and the UE is without Additive White Gaussian Noise, and has no fading or multipath effects as specified in TS 38.521-2 B.0 [29].		

Table A.5.5.8.2.1.1-4: OTA related test parameters for TCI state switch

Parameter	Unit	Cell 2			
		SSB0		SSB1	
		T1	T2	T1	T2
Angle of arrival configuration		Setup 3 according to clause A.3.15.3			
		AoA1		AoA2	
Assumption for UE beams ^{Note 6}		Rough		Rough	
\hat{E}_s	dBm/SCS	-80.6	-80.6	-Infinity	-80.6
SSB-RP ^{Note 2}	dBm/SCS	-80.6	-80.6	-Infinity	-80.6
$\hat{E}_s/I_{ot, BB}$ ^{Note 7}	dB	8.3	8.3	-Infinity	8.3
I_o ^{Note 2}	dBm/95.04 MHz ^{Note 4}	-55.41	-55.41	-Infinity	-55.41

- Note 1: Void
- Note 2: SSB-RP and I_0 levels have been derived from other parameters for information purposes. They are not settable parameters themselves.
- Note 3: Void
- Note 4: Equivalent power received by an antenna with 0 dBi gain at the centre of the quiet zone
- Note 5: As observed with 0dBi gain antenna at the center of the quiet zone.
- Note 6: Information about types of UE beam is given in B.2.1.3, and does not limit UE implementation or test system implementation
- Note 7: Calculation of $E_s/I_{0\text{BB}}$ includes the effect of UE internal noise up to the value assumed for the associated Refsens requirement in clause 7.3.2 of TS 38.101-2 [19], and an allowance of 1dB for UE multi-band relaxation factor ΔMB_P from TS 38.101-2 [19] Table 6.2.1.3-4.

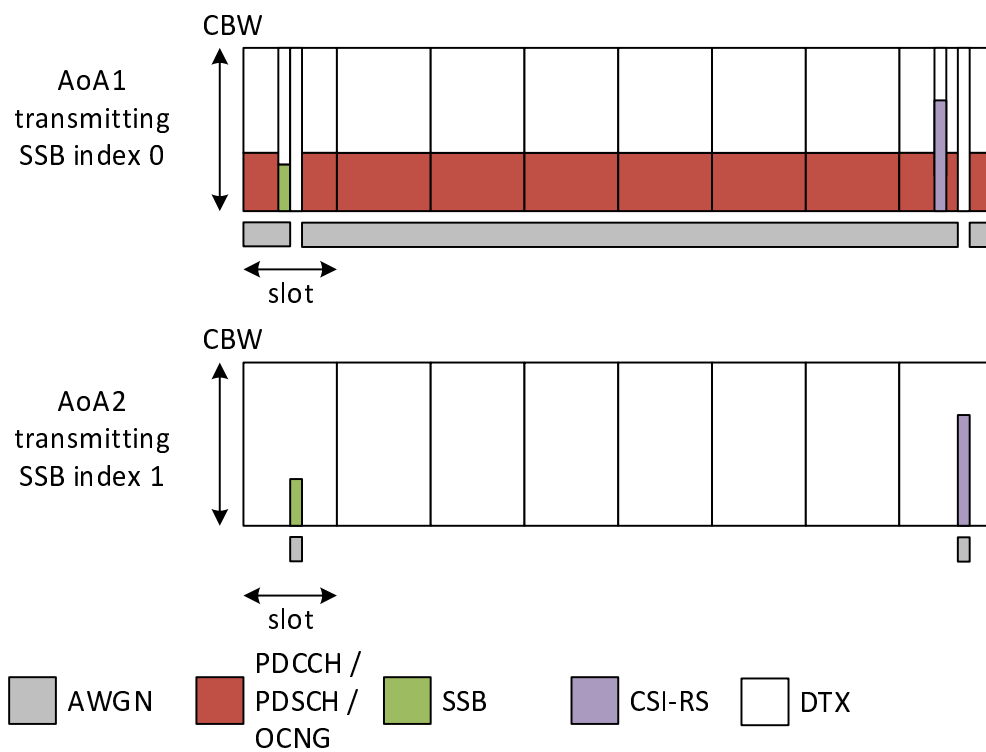

Figure A.5.5.8.2.1.1-1: Time multiplexed downlink transmissions during T1

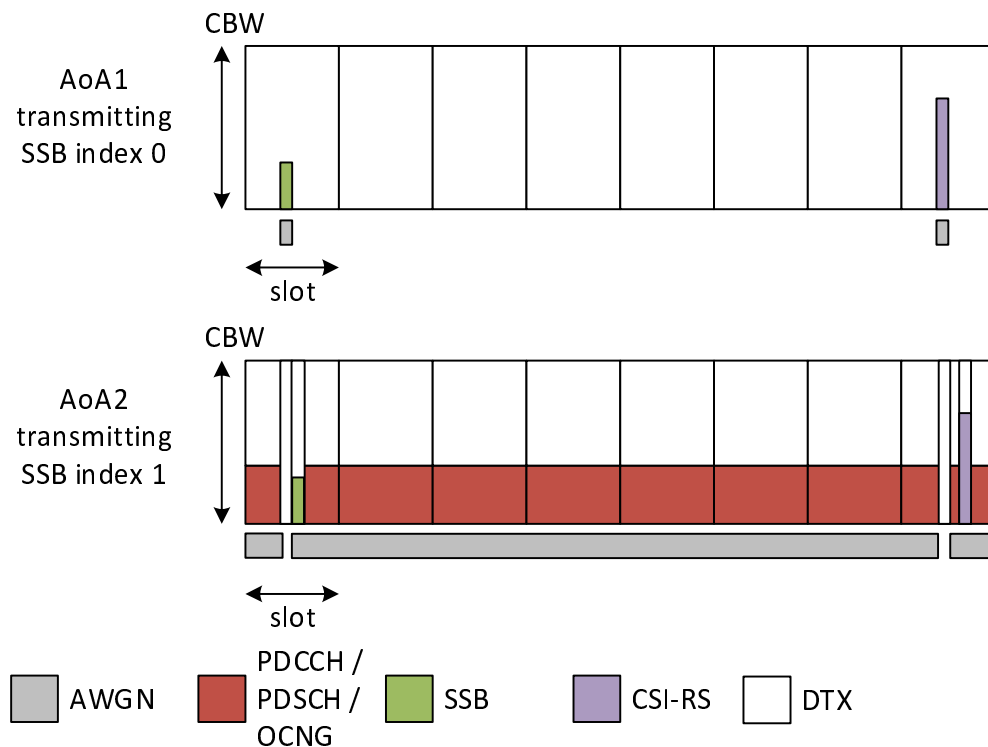

Figure A.5.5.8.2.1.1-2: Time multiplexed downlink transmissions during T2

A.5.5.8.2.1.2 Test Requirements

During T2, UE shall send L1-RSRP report with both SSB0 and SSB1.

After receiving RRC command in slot n , UE shall be able to start receiving on TCI state 1 after slot $n + (T_{\text{RRC_processing}} + T_{\text{first-SSB}}) / \text{NR slot length} + 2N_{\text{slot}}^{\text{subframe}, \mu}$.

The rate of correct events observed during repeated tests shall be at least 90%.

A.5.6 Measurement procedure

A.5.6.1 Intra-frequency Measurements

A.5.6.1.1 EN-DC event triggered reporting test without gap under non-DRX

A.5.6.1.1.1 Test purpose and Environment

The purpose of this test is to verify that the UE makes correct reporting of an event. This test will partly verify the TDD intra-frequency cell search requirements in clause 9.2.5.1 and 9.2.5.2. Supported test configurations are shown in table A.5.6.1.1.1-1.

Table A.5.6.1.1.1-1: supported test configurations

Configuration	Description
1	LTE FDD, 120 kHz SSB SCS, 100 MHz bandwidth, TDD duplex mode
2	LTE TDD, 120 kHz SSB SCS, 100 MHz bandwidth, TDD duplex mode
3	LTE FDD, 240 kHz SSB SCS, 100 MHz bandwidth, TDD duplex mode
4	LTE TDD, 240 kHz SSB SCS, 100 MHz bandwidth, TDD duplex mode
Note:	The UE is only required to be tested in one of the supported test configurations.

There are three cells in the test, E-UTRAN PCell (Cell 1), FR2 PSCell (Cell 2) and a FR2 neighbour cell (Cell 3) on the same frequency as the PSCell. The test parameters and applicability for Cell 1 are defined in A.3.7.2. The test parameters for the Cell 2 and Cell 3 are given in Table A.5.6.1.1.1-2, A.5.6.1.1.1-3 and A.5.6.1.1.1-4 below.

In the measurement control information, a measurement object is configured for the frequency of the PSCell, and it is indicated to the UE that event-triggered reporting with Event A3 is used.

The test consists of two successive time periods, with time duration of T1, and T2 respectively. During time duration T1, the UE shall not have any timing information of cell 3.

Table A.5.6.1.1.1-2: General test parameters for intra-frequency event triggered reporting for EN-DC with TDD PSCell in FR2 without gap without DRX

Parameter	Unit	Config	Value	Comment
Active cell		1~4	E-UTRAN PCell (Cell 1) PSCell (Cell 2)	
Neighbour cell		1~4	Cell 3	Cell to be identified.
RF Channel Number		1~4	1: Cell 1 2: Cell 2 and Cell 3	One TDD carrier frequency is used for the NR cells and one TDD or FDD carrier frequency is used for E-UTRAN cell.
SMTC configuration		1~4	SMTC.1	
A3-Offset	dB	1~4	-11	
CP length		1~4	Normal	
Hysteresis	dB	1~4	0	
Time To Trigger	s	1~4	0	
Filter coefficient		1~4	0	L3 filtering is not used
DRX		1~4	OFF	
Time offset between Cell 1 and Cell 2		1~4	3 μ s	Synchronous EN-DC
Time offset between Cell 2 and Cell 3		1~4	3 μ s	Synchronous cells
T1	s	1~4	5	
T2	s	1~4	5	

Table A.5.6.1.1.1-3: NR Cell specific test parameters for intra-frequency event triggered reporting for EN-DC with TDD PSCell in FR2 without gap without DRX

Parameter	Unit	Config	Cell 2		Cell 3	
			T1	T2	T1	T2
TDD configuration		1~4	TDDConf.3.1		TDDConf.3.1	
BW _{channel}	MHz	1~4	100: N _{RB,c} = 66		100: N _{RB,c} = 66	
Data RBs allocated		1,2	24		24	

		3,4	48	48
Initial BWP configuration		1~4	DLBWP.0.1 ULBWP.0.1	DLBWP.0.1 ULBWP.0.1
Active DL BWP configuration		1~4	DLBWP.1.1	DLBWP.1.1
Active UL BWP configuration		1~4	ULBWP.1.1	ULBWP.1.1
RLM-RS		1~4	SSB	SSB
PDSCH RMC configuration		1,2	SR.3.2 TDD	N/A
		3,4	SR.3.3 TDD	
RMSI CORESET RMC configuration		1,2	CR.3.1 TDD	N/A
		3,4	CR.3.2 TDD	N/A
Dedicated CORESET RMC configuration		1,2	CCR.3.1 TDD	N/A
		3,4	CCR.3.7 TDD	N/A
PDSCH/PDCCH subcarrier spacing	kHz	1~4	120	120
OCNG Patterns		1~4	OP.5	N/A
TRS configuration		1~4	TRS.2.1 TDD	N/A
PDSCH/PDCCH TCI state		1~4	TCI.State.2	N/A
cellIndividualOffset	dB	1~4	N/A	16
SSB configuration		1, 2	SSB.3 FR2	SSB.7 FR2
		3, 4	SSB.4 FR2	SSB.8 FR2
Propagation Condition		1~4	No external noise (Note 1)	No external noise (Note 1)
Note 1: The downlink connection between the System Simulator and the UE is without Additive White Gaussian Noise, and has no fading or multipath effects as specified in TS 38.521-2 B.0 [29].				

Table A.5.6.1.1.1-4: NR OTA Cell specific test parameters for intra-frequency event triggered reporting for EN-DC with TDD PSCell in FR2 without gap without DRX

Parameter	Unit	Config	Cell 2		Cell 3	
			T1	T2	T1	T2
AoA setup		1~4	Setup 3 defined in A.3.15.3			
			AoA1		AoA2	
Assumption for UE beams ^{Note 4}		1~4	Rough		Rough	
E_s	dBm/SCS	1, 2	-89	-89	-Infinity	-89
		3, 4	-86	-86	-Infinity	-86
\hat{E}_s / I_{ot_BB} ^{Note 5}	dB	1~4	-0.12	-0.12	-Infinity	-0.12
SSB_RP	dBm/SCS	1, 2	-89	-89	-Infinity	-89
		3, 4	-86	-86	-Infinity	-86
I_o	dBm/95.04MHz	1,2	-64.41	-64.41	-Infinity	-64.41
		3,4	-61.41	-61.41	-Infinity	-61.41
Time multiplexing of the downlink transmissions from each AoA		1~4	Defined in Figure A.5.6.1.1.1-1			

Note 1:	The resources for uplink transmission are assigned to the UE prior to the start of time period T2.
Note 2:	Void
Note 3:	Es/lot, SSB_RP and Io levels have been derived from other parameters for information purposes. They are not settable parameters themselves.
Note 4:	Information about types of UE beam is given in B.2.1.3, and does not limit UE implementation or test system implementation.
Note 5:	Calculation of Es/lot _{BB} includes the effect of UE internal noise up to the value assumed for the associated Refsens requirement in clause 7.3.2 of TS 38.101-2 [19], and an allowance of 1dB for UE multi-band relaxation factor ΔMB_P from TS 38.101-2 [19] Table 6.2.1.3-4.

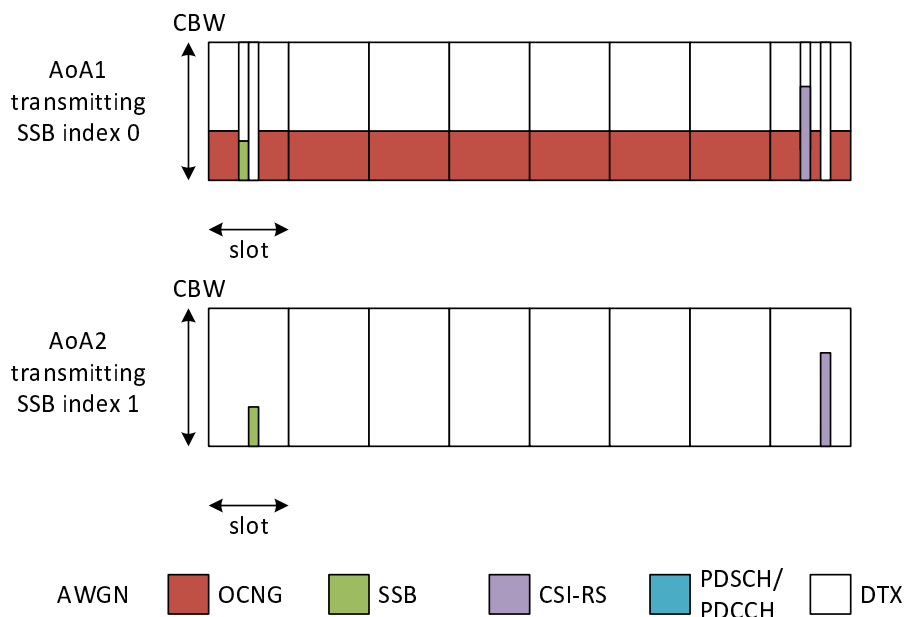

Figure A.5.6.1.1.1-1: Time multiplexed downlink transmissions (Config 1,2 example)

A.5.6.1.1.2 Test Requirements

In the test, the UE shall send one Event A3 triggered measurement report, with a measurement reporting delay less than X ms from the beginning of time period T2, where X is

- 2.4s for a UE supporting power class 1,
- 1.44s for a UE supporting power class 2, 3 and 4

The UE is not required to read the neighbour cell SSB index in this test.

The UE shall not send event triggered measurement reports, as long as the reporting criteria are not fulfilled.

The rate of correct events observed during repeated tests shall be at least 90%.

NOTE: The actual overall delays measured in the test may be up to $2xTTIDCCH$ higher than the measurement reporting delays above because of TTI insertion uncertainty of the measurement report in DCCH.

A.5.6.1.2 EN-DC event triggered reporting test without gap under DRX

A.5.6.1.2.1 Test purpose and Environment

The purpose of this test is to verify that the UE makes correct reporting of an event. This test will partly verify the TDD intra-frequency cell search requirements in clause 9.2.5.1 and 9.2.5.2. Supported test configurations are shown in table A.5.6.1.2.1-1.

Table A.5.6.1.2.1-1: supported test configurations

Configuration	Description
1	LTE FDD, 120 kHz SSB SCS, 100 MHz bandwidth, TDD duplex mode
2	LTE TDD, 120 kHz SSB SCS, 100 MHz bandwidth, TDD duplex mode
3	LTE FDD, 240 kHz SSB SCS, 100 MHz bandwidth, TDD duplex mode
4	LTE TDD, 240 kHz SSB SCS, 100 MHz bandwidth, TDD duplex mode
Note:	The UE is only required to be tested in one of the supported test configurations.

There are three cells in the test, E-UTRAN PCell (Cell 1), FR2 PCell (Cell 2) and a FR2 neighbour cell (Cell 3) on the same frequency as the PCell. The test parameters and applicability for Cell 1 are defined in A.3.7.2. The test parameters for the Cell 2 and Cell 3 are given in Table A.5.6.1.2.1-2 ~ Table A.5.6.1.2.1-6 below.

In the measurement control information, a measurement object is configured for the frequency of the PCell, and it is indicated to the UE that event-triggered reporting with Event A3 is used.

The test consists of two successive time periods, with time duration of T1, and T2 respectively. During time duration T1, the UE shall not have any timing information of cell 3.

UE needs to be provided with new Timing Advance Command MAC control element at least once during each time alignment timer period to maintain uplink time alignment. Furthermore UE is allocated with PUSCH resource at every DRX cycle.

Table A.5.6.1.2.1-2: General test parameters for intra-frequency event triggered reporting for EN-DC with TDD PCell in FR2 without gap with DRX

Parameter	Unit	Config	Value		Comment
			Test 1	Test 2	
Active cell		1~4	E-UTRAN PCell (Cell 1) PCell (Cell 2)		
Neighbour cell		1~4	Cell 3		Cell to be identified.
RF Channel Number		1~4	1: Cell 1 2: Cell 2 and Cell 3		One TDD carrier frequency is used for the NR cells and one TDD or FDD carrier frequency is used for E-UTRAN cell.
SMTC configuration		1~4	SMTC.1		
A3-Offset	dB	1~4	-6		
CP length		1~4	Normal		
Hysteresis	dB	1~4	0		
Time To Trigger	s	1~4	0		
Filter coefficient		1~4	0		L3 filtering is not used
DRX		1~4	DRX.1	DRX.7	DRX related parameters are defined in Table A.5.6.1.2.1-4
Time offset between Cell 1 and Cell 2		1~4	3 μ s		Synchronous EN-DC
Time offset between Cell 2 and Cell 3		1~4	3 μ s		Synchronous cells

T1	s	1~4	5	
T2	s	1~4	10	52

Table A.5.6.1.2.1-3: NR Cell specific test parameters for intra-frequency event triggered reporting for EN-DC with TDD PSCell in FR2 without gap with DRX

Parameter	Unit	Config	Cell 2		Cell 3	
			T1	T2	T1	T2
TDD configuration		1~4	TDDConf.3.1		TDDConf.3.1	
BW_{channel}	MHz	1~4	100: $N_{RB,c} = 66$		100: $N_{RB,c} = 66$	
Data RBs allocated		1~4	66		66	
Initial BWP configuration		1~4	DLBWP.0.1 ULBWP.0.1		DLBWP.0.1 ULBWP.0.1	
Active DL BWP configuration		1~4	DLBWP.1.1		DLBWP.1.1	
Active UL BWP configuration		1~4	ULBWP.1.1		ULBWP.1.1	
RLM-RS		1~4	SSB		SSB	
PDSCH RMC configuration		1,2	SR.3.2 TDD		N/A	
		3,4	SR.3.3 TDD			
RMSI CORESET RMC configuration		1,2	CR.3.1 TDD		N/A	
		3,4	CR.3.2 TDD		N/A	
Dedicated CORESET RMC configuration		1,2	CCR.3.1 TDD		N/A	
		3,4	CCR.3.7 TDD		N/A	
PDSCH/PDCCH subcarrier spacing	kHz	1~4	120		120	
OCNG Patterns		1~4	OP.1		OP.1	
PDSCH/PDCCH TCI state		1~4	TCI.State.2		N/A	
CSI-RS for tracking			TRS.2.1 TDD		N/A	
			TRS.2.1 TDD		N/A	
SSB configuration		1, 2	SSB.3 FR2		SSB.3 FR2	
		3, 4	SSB.4 FR2		SSB.4 FR2	
Propagation Condition		1~4	AWGN		AWGN	

Table A.5.6.1.2.1-4: NR OTA Cell specific test parameters for intra-frequency event triggered reporting for EN-DC with TDD PSCell in FR2 without gap with DRX

Parameter	Unit	Config	Cell 2		Cell 3	
			T1	T2	T1	T2
AoA setup		1~4	Setup 1 defined in A.3.15.1			
Assumption for UE beams ^{Note 4}		1~4	Rough			
$\hat{E}_s / I_{\text{ot}}$ ^{BB Note 5}	dB	1~4	3.77	-1.52	-Infinity	-1.52
N_{oc} ^{Note 2}	dBm/15 KHz	1~4	-98			
N_{oc} ^{Note 2}	dBm/SCS	1, 2	-89			
		3, 4	-86			

SSB_RP	dBm/SCS	1, 2	-85	-85	-Infinity	-85
		3, 4	-82	-82	-Infinity	-82
\hat{E}_s/N_{oc}	dB	1~4	4	4	-Infinity	4
I_o	dBm/95.04MHz	1~4	-54.53	-52.18	See Cell 2 columns	
<p>Note 1: The resources for uplink transmission are assigned to the UE prior to the start of time period T2.</p> <p>Note 2: Interference from other cells and noise sources not specified in the test is assumed to be constant over subcarriers and time and shall be modelled as AWGN of appropriate power for N_{oc} to be fulfilled.</p> <p>Note 3: E_s/I_{ot}, SSB_RP and I_o levels have been derived from other parameters for information purposes. They are not settable parameters themselves.</p> <p>Note 4: Information about types of UE beam is given in B.2.1.3, and does not limit UE implementation or test system implementation.</p> <p>Note 5: Calculation of $E_s/I_{ot_{BB}}$ includes the effect of UE internal noise up to the value assumed for the associated Refsens requirement in clause 7.3.2 of TS 38.101-2 [19], and an allowance of 1dB for UE multi-band relaxation factor ΔMB_P from TS 38.101-2 [19] Table 6.2.1.3-4.</p>						

A.5.6.1.2.2 Test Requirements

In test 1, the UE shall send one Event A3 triggered measurement report, with a measurement reporting delay less than X ms from the beginning of time period T2, where X is

- 7.2s for a UE supporting power class 1,
- 4.32s for a UE supporting power class 2, 3 and 4

In test 2, the UE shall send one Event A3 triggered measurement report, with a measurement reporting delay less than X ms from the beginning of time period T2, where X is

- 51.2s for a UE supporting power class 1,
- 30.72s for a UE supporting power class 2, 3 and 4

The UE is not required to read the neighbour cell SSB index in this test.

The UE shall not send event triggered measurement reports, as long as the reporting criteria are not fulfilled.

The rate of correct events observed during repeated tests shall be at least 90%.

NOTE: The actual overall delays measured in the test may be up to $2 \times TTI_{DCCCH}$ higher than the measurement reporting delays above because of TTI insertion uncertainty of the measurement report in DCCCH.

A.5.6.1.3 EN-DC event triggered reporting test with per-UE gaps under non-DRX

A.5.6.1.3.1 Test purpose and Environment

The purpose of this test is to verify that the UE makes correct reporting of an event. This test will partly verify the TDD intra-frequency cell search requirements in clause 9.2.5.1 and 9.2.5.2. Supported test configurations are shown in table A.5.6.1.3.1-1.

Table A.5.6.1.3.1-1: supported test configurations

Configuration	Description
1	LTE FDD, 120 kHz SSB SCS, 100 MHz bandwidth, TDD duplex mode
2	LTE TDD, 120 kHz SSB SCS, 100 MHz bandwidth, TDD duplex mode

3	LTE FDD, 240 kHz SSB SCS, 100 MHz bandwidth, TDD duplex mode
4	LTE TDD, 240 kHz SSB SCS, 100 MHz bandwidth, TDD duplex mode
Note: The UE is only required to be tested in one of the supported test configurations.	

There are three cells in the test, E-UTRAN PCell (Cell 1), FR2 PCell (Cell 2) and a FR2 neighbour cell (Cell 3) on the same frequency as the PCell. The test parameters and applicability for Cell 1 are defined in A.3.7.2. The test parameters for the Cell 2 and Cell 3 are given in Table A.5.6.1.3.1-2 ~ 4 below.

There are two BWPs configured in Cell 2, BWP1 which contains the cell defining SSB, and BWP2 which does not contain any SSB of Cell 2. During the whole test, BWP2 is always scheduled as the active BWP for the UE.

In the measurement control information, a measurement object is configured for the frequency of the PCell, and it is indicated to the UE that event-triggered reporting with Event A3 is used.

The test consists of two successive time periods, with time duration of T1, and T2 respectively. During time duration T1, the UE shall not have any timing information of cell 3.

Table A.5.6.1.3.1-2: General test parameters for intra-frequency event triggered reporting for EN-DC with TDD PCell in FR2 with per-UE gaps without DRX

Parameter	Unit	Config	Value	Comment
Active cell		1~4	E-UTRAN PCell (Cell 1) PCell (Cell 2)	
Neighbour cell		1~4	Cell 3	Cell to be identified.
RF Channel Number		1~4	1: Cell 1 2: Cell 2 and Cell 3	One TDD carrier frequency is used for the NR cells and one TDD or FDD carrier frequency is used for E-UTRAN cell.
Gap type		1~4	Per-UE gaps	
Measurement gap repetition periodicity	ms	1~4	40	
Measurement gap length	ms	1~4	6	
Measurement gap offset	ms	1~4	39	
SMTC configuration		1~4	SMTC.1	
CSI-RS parameters		1~4	CSI-RS.3.2 TDD resource #0	Resource #1 is not used
A3-Offset	dB	1~4	-11	
CP length		1~4	Normal	
Hysteresis	dB	1~4	0	
Time To Trigger	s	1~4	0	
Filter coefficient		1~4	0	L3 filtering is not used
DRX		1~4	OFF	
Time offset between Cell 1 and Cell 2		1~4	3 μ s	Synchronous EN-DC
Time offset between Cell 2 and Cell 3		1~4	3 μ s	Synchronous cells
T1	s	1~4	5	
T2	s	1~4	5	

Table A.5.6.1.3.1-3: NR Cell specific test parameters for intra-frequency event triggered reporting for EN-DC with TDD PSCell in FR2 with per-UE gaps without DRX

Parameter	Unit	Config	Cell 2		Cell 3	
			T1	T2	T1	T2
TDD configuration		1~4	TDDConf.3.1		TDDConf.3.1	
BW _{channel}	MHz	1~4	100: N _{RB,c} = 66		100: N _{RB,c} = 66	
Data RBs allocated		1,2	24		24	
		3,4	48		48	
Initial BWP configuration		1~4	DLBWP.0.1 ULBWP.0.1		DLBWP.0.1 ULBWP.0.1	
Active DL BWP configuration		1,2	DLBWP.1.2		DLBWP.1.1	
		3,4	DLBWP.1.7		DLBWP.1.1	
Active UL BWP configuration		1,2	ULBWP.1.2		ULBWP.1.1	
		3,4	ULBWP.1.7		ULBWP.1.1	
RLM-RS		1~4	CSI-RS		SSB	
PDSCH RMC configuration		1,2	SR.3.2 TDD		N/A	
		3,4	SR.3.3 TDD			
RMSI CORESET RMC configuration		1,2	CR.3.1 TDD		N/A	
		3,4	CR.3.2 TDD		N/A	
Dedicated CORESET RMC configuration		1,2	CCR.3.1 TDD		N/A	
		3,4	CCR.3.7 TDD		N/A	
TRS configuration		1~4	TRS.2.1 TDD		N/A	
PDSCH/PDCCH TCI state		1~4	TCI.State.2		N/A	
PDSCH/PDCCH subcarrier spacing	kHz	1~4	120		120	
OCNG Patterns		1~4	OP.5		N/A	
cellIndividualOffset	dB	1~4	N/A		16	
SSB		1, 2	SSB.3 FR2		SSB.7 FR2	
		3, 4	SSB.4 FR2		SSB.8 FR2	
Propagation Condition		1~4	No external noise (Note 1)		No external noise (Note 1)	
Note 1: The downlink connection between the System Simulator and the UE is without Additive White Gaussian Noise, and has no fading or multipath effects as specified in TS 38.521-2 B.0 [29].						

Table A.5.6.1.3.1-4: NR OTA Cell specific test parameters for intra-frequency event triggered reporting for EN-DC with TDD PSCell in FR2 with per-UE gaps without DRX

Parameter	Unit	Config	Cell 2		Cell 3	
			T1	T2	T1	T2
AoA setup		1~4	Setup 3 defined in A.3.15.3			
			AoA1		AoA2	
Assumption for UE beams ^{Note 4}		1~4	Rough		Rough	
E _s	dBm/SCS	1, 2	-89	-89	-Infinity	-89
		3, 4	-86	-86	-Infinity	-86
\hat{E}_s / I_{ot_BB} ^{Note 5}	dB	1~4	-0.12	-0.12	-Infinity	-0.12
SSB _{RP}	dBm/SCS	1, 2	-89	-89	-Infinity	-89
		3, 4	-86	-86	-Infinity	-86
I _o	dBm/95.04MHz	1,2	-64.41	-64.41	-Infinity	-64.41
		3,4	-61.41	-61.41	-Infinity	-61.41

Time multiplexing of the downlink transmissions from each AoA	1~4	Defined in Figure A.5.6.1.3.1-1
Note 1:	The resources for uplink transmission are assigned to the UE prior to the start of time period T2.	
Note 2:	Void	
Note 3:	Es/Iot, SSB_RP and Io levels have been derived from other parameters for information purposes. They are not settable parameters themselves.	
Note 4:	Information about types of UE beam is given in B.2.1.3, and does not limit UE implementation or test system implementation.	
Note 5:	Calculation of Es/Iot _{BB} includes the effect of UE internal noise up to the value assumed for the associated Refsens requirement in clause 7.3.2 of TS 38.101-2 [19], and an allowance of 1dB for UE multi-band relaxation factor ΔMB _P from TS 38.101-2 [19] Table 6.2.1.3-4.	

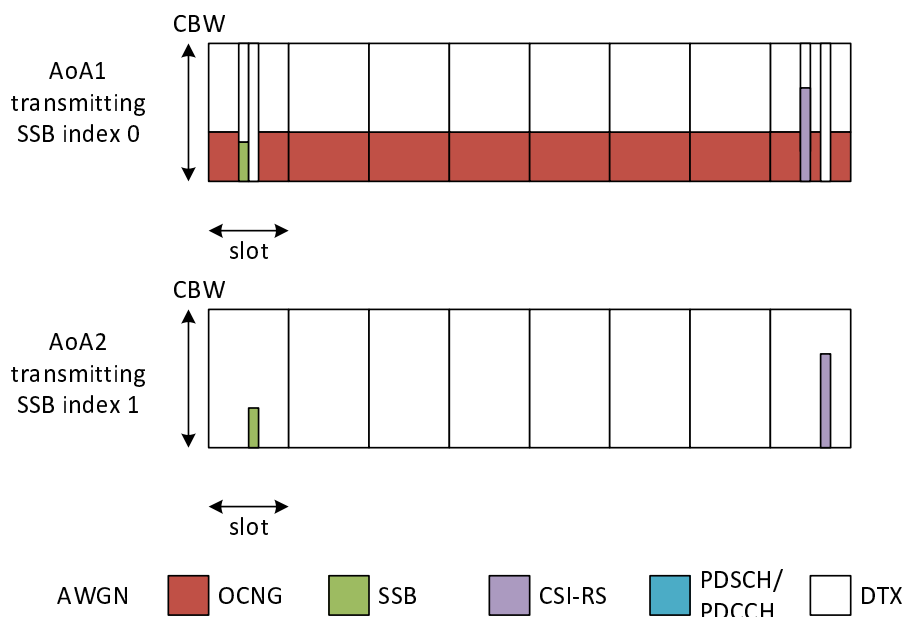

Figure A.5.6.1.3.1-1: Time multiplexed downlink transmissions (Config 1,2 example)

A.5.6.1.3.2 Test Requirements

In the test, the UE shall send one Event A3 triggered measurement report, with a measurement reporting delay less than X ms from the beginning of time period T2, where X is

- 3.2s for a UE supporting power class 1,
- 1.92s for a UE supporting power class 2, 3 and 4

The UE is not required to read the neighbour cell SSB index in this test.

The UE shall not send event triggered measurement reports, as long as the reporting criteria are not fulfilled.

The rate of correct events observed during repeated tests shall be at least 90%.

NOTE: The actual overall delays measured in the test may be up to $2xTTI_{DCCH}$ higher than the measurement reporting delays above because of TTI insertion uncertainty of the measurement report in DCCH.

A.5.6.1.4 EN-DC event triggered reporting test with per-UE gaps under DRX

A.5.6.1.4.1 Test purpose and Environment

The purpose of this test is to verify that the UE makes correct reporting of an event. This test will partly verify the TDD intra-frequency cell search requirements in clause 9.2.5.1 and 9.2.5.2. Supported test configurations are shown in table A.5.6.1.4.1-1.

Table A.5.6.1.4.1-1: supported test configurations

Configuration	Description
1	LTE FDD, 120 kHz SSB SCS, 100 MHz bandwidth, TDD duplex mode
2	LTE TDD, 120 kHz SSB SCS, 100 MHz bandwidth, TDD duplex mode
3	LTE FDD, 240 kHz SSB SCS, 100 MHz bandwidth, TDD duplex mode
4	LTE TDD, 240 kHz SSB SCS, 100 MHz bandwidth, TDD duplex mode
Note:	The UE is only required to be tested in one of the supported test configurations.

There are three cells in the test, E-UTRAN PCell (Cell 1), FR2 PSCell (Cell 2) and a FR2 neighbour cell (Cell 3) on the same frequency as the PSCell. The test parameters and applicability for Cell 1 are defined in A.3.7.2. The test parameters for the Cell 2 and Cell 3 are given in Table A.5.6.1.4.1-2 ~ 6.

During the test, Cell 2 and Cell 3 are transmitted from the direction determined according to A3.8.

There are two BWPs configured in Cell 2, BWP1 which contains the cell defining SSB, and BWP2 which does not contain any SSB of Cell 2. During the whole test, BWP2 is always scheduled as the active BWP for the UE.

In the measurement control information, a measurement object is configured for the frequency of the PSCell, and it is indicated to the UE that event-triggered reporting with Event A3 is used.

The test consists of two successive time periods, with time duration of T1, and T2 respectively. During time duration T1, the UE shall not have any timing information of cell 3.

UE needs to be provided with new Timing Advance Command MAC control element at least once during each time alignment timer period to maintain uplink time alignment. Furthermore UE is allocated with PUSCH resource at every DRX cycle.

Table A.5.6.1.4.1-2: General test parameters for intra-frequency event triggered reporting for EN-DC with TDD PSCell in FR2 with per-UE gaps with DRX

Parameter	Unit	Config	Value		Comment
			Test 1	Test 2	
Active cell		1~4	E-UTRAN PCell (Cell 1) PSCell (Cell 2)		
Neighbour cell		1~4	Cell 3		Cell to be identified.
RF Channel Number		1~4	1: Cell 1 2: Cell 2 and Cell 3		One TDD carrier frequency is used for the NR cells and one TDD or FDD carrier frequency is used for E-UTRAN cell.
Gap type		1~4	Per-UE gaps		
Measurement gap repetition periodicity	ms	1~4	40		

Measurement gap length	ms	1~4	6		
Measurement gap offset	ms	1~4	39		
SMTC configuration		1~4	SMTC.1		
CSI-RS parameters		1~4	CSI-RS.3.2 TDD resource #0		Resource #1 is not used
A3-Offset	dB	1~4	-6		
CP length		1~4	Normal		
Hysteresis	dB	1~4	0		
Time To Trigger	s	1~4	0		
Filter coefficient		1~4	0		L3 filtering is not used
DRX		1~4	DRX.1	DRX.7	DRX related parameters are defined in Table A.5.6.1.4.1-5
Time offset between Cell 1 and Cell 2		1~4	3 μ s		Synchronous EN-DC
Time offset between Cell 2 and Cell 3		1~4	3 μ s		Synchronous cells
T1	s	1~4	5		
T2	s	1~4	10	52	

Table A.5.6.1.4.1-3: NR Cell specific test parameters for intra-frequency event triggered reporting for EN-DC with TDD PSCell in FR2 with per-UE gaps with DRX

Parameter	Unit	Config	Cell 2		Cell 3	
			T1	T2	T1	T2
TDD configuration		1~4	TDDConf.3.1		TDDConf.3.1	
BW _{channel}	MHz	1~4	100: N _{RB,c} = 66		100: N _{RB,c} = 66	
Data RBs allocated		1~4	66		66	
Initial BWP configuration		1~4	DLBWP.0.1 ULBWP.0.1		DLBWP.0.1 ULBWP.0.1	
Active DL BWP configuration		1,2	DLBWP.1.2		DLBWP.1.1	
		3,4	DLBWP.1.7		DLBWP.1.1	
Active UL BWP configuration		1,2	ULBWP.1.2		ULBWP.1.1	
		3,4	ULBWP.1.7		ULBWP.1.1	
RLM-RS		1~4	CSI-RS		SSB	
PDSCH RMC configuration		1,2	SR.3.2 TDD		N/A	
		3,4	SR.3.3 TDD			
RMSI CORESET RMC configuration		1,2	CR.3.1 TDD		N/A	
		3,4	CR.3.2 TDD		N/A	
Dedicated CORESET RMC configuration		1,2	CCR.3.1 TDD		N/A	
		3,4	CCR.3.7 TDD		N/A	
TRS configuration		1~4	TRS.2.1 TDD		N/A	
PDSCH/PDCCH TCI state		1~4	TCI.State.2		N/A	
PDSCH/PDCCH subcarrier spacing	kHz	1~4	120		120	
OCNG Patterns		1~4	OP.1		OP.1	
SSB		1, 2	SSB.3 FR2		SSB.3 FR2	
		3, 4	SSB.4 FR2		SSB.4 FR2	

Propagation Condition		1~4	AWGN	AWGN
-----------------------	--	-----	------	------

Table A.5.6.1.4.1-4: NR Cell specific test parameters for intra-frequency event triggered reporting for EN-DC with TDD PSCell in FR2 with per-UE gaps with DRX

Parameter	Unit	Config	Cell 2		Cell 3	
			T1	T2	T1	T2
AoA setup		1~4	Setup 1 defined in A.3.15.1			
Assumption for UE beams ^{Note 4}		1~4	Rough		Rough	
\hat{E}_s/I_{ot} ^{BB Note 5}	dB	1~4	3.77	-1.52	-Infinity	-1.52
N_{oc} ^{Note 2}	dBm/15 KHz	1~4	-98			
N_{oc} ^{Note 2}	dBm/SCS	1, 2	-89			
		3, 4	-86			
SSB_RP	dBm/SCS	1, 2	-85	-85	-Infinity	-85
		3, 4	-82	-82	-Infinity	-82
\hat{E}_s/N_{oc}	dB	1~4	4	4	-Infinity	4
I_o	dBm/95.04MHz	1~4	-54.53	-52.18	See Cell 2 columns	
<p>Note 1: The resources for uplink transmission are assigned to the UE prior to the start of time period T2.</p> <p>Note 2: Interference from other cells and noise sources not specified in the test is assumed to be constant over subcarriers and time and shall be modelled as AWGN of appropriate power for N_{oc} to be fulfilled.</p> <p>Note 3: E_s/I_{ot}, SSB_RP and I_o levels have been derived from other parameters for information purposes. They are not settable parameters themselves.</p> <p>Note 4: Information about types of UE beam is given in B.2.1.3, and does not limit UE implementation or test system implementation.</p> <p>Note 5: Calculation of E_s/I_{ot} includes the effect of UE internal noise up to the value assumed for the associated Refsens requirement in clause 7.3.2 of TS 38.101-2 [19], and an allowance of 1dB for UE multi-band relaxation factor ΔMB_P from TS 38.101-2 [19] Table 6.2.1.3-4.</p>						

Table A.5.6.1.4.1-5: Void

Table A.5.6.1.4.1-6: Void

A.5.6.1.4.2 Test Requirements

In test 1, the UE shall send one Event A3 triggered measurement report, with a measurement reporting delay less than X ms from the beginning of time period T2, where X is

- 7.2s for a UE supporting power class 1,
- 4.32s for a UE supporting power class 2, 3 and 4

In test 2, the UE shall send one Event A3 triggered measurement report, with a measurement reporting delay less than X ms from the beginning of time period T2, where X is

- 51.20s for a UE supporting power class 1,
- 30.72s for a UE supporting power class 2, 3 and 4

The UE is not required to read the neighbour cell SSB index in this test.

The UE shall not send event triggered measurement reports, as long as the reporting criteria are not fulfilled.

The rate of correct events observed during repeated tests shall be at least 90%.

NOTE: The actual overall delays measured in the test may be up to $2xTTI_{DCCCH}$ higher than the measurement reporting delays above because of TTI insertion uncertainty of the measurement report in DCCCH.

A.5.6.2 Inter-frequency Measurements

A.5.6.2.1 EN-DC event triggered reporting tests for FR2 cell without SSB time index detection when DRX is not used

A.5.6.2.1.1 Test Purpose and Environment

The purpose of this test is to verify that the UE makes correct reporting of an event. This test will partly verify the EN-DC inter-frequency NR cell search requirements in clause 9.3.4.

In this test, there are three cells: LTE cell 1 as PCell on E-UTRA RF channel 1, NR cell 2 as PSCell in FR2 on NR RF channel 1 and NR cell 3 as neighbour cell in FR2 on NR RF channel 2. The test parameters and configurations are given in Tables A.5.6.2.1.1-1, A.5.6.2.1.1-2, and A.5.6.2.1.1-3.

In test 1 measurement gap pattern configuration # 0 as defined in Table A.5.6.2.1.1-2 is provided for UE that does not support per-FR gap and in test 2 measurement gap pattern configuration #13 as defined in Table A.5.6.2.1.1-2 is provided for UE that supports per-FR gap. If a UE supports per-FR gap and gap pattern configuration #4, it is only required to pass test 2. Otherwise it is only required to pass test 1.

In the measurement control information, it is indicated to the UE that event-triggered reporting with Event A3 is used. The test consists of two successive time periods, with time duration of T1, and T2 respectively. During time duration T1, the UE shall not have any timing information of NR cell 3.

The configuration of LTE cell 1 is defined in table A.3.7.2.2-1. Supported test configurations are shown in table A.5.6.2.1.1-1.

Table A.5.6.2.1.1-1 EN-DC event triggered reporting tests without SSB index reading for FR2-FR2

Config	Description
1	LTE FDD, 120 kHz SSB SCS, 100 MHz bandwidth, TDD duplex mode
2	LTE TDD, 120 kHz SSB SCS, 100 MHz bandwidth, TDD duplex mode
Note 1: The UE is only required to be tested in one of the supported test configurations	
Note 2: target NR cell has the same SCS, BW and duplex mode as NR serving cell	

Table A.5.6.2.1.1-2: General test parameters for EN-DC inter-frequency event triggered reporting without SSB time index detection

Parameter	Unit	Test configuration	Value		Comment
			Test 1	Test 2	
E-UTRA RF Channel Number		Config 1,2	1		One E-UTRAN TDD carrier frequency is used.
NR RF Channel Number		Config 1,2	1, 2		Two FR2 NR carrier frequencies are used.

Active cell		Config 1,2	LTE Cell 1 (PCell) and NR cell 2 (PScell)		LTE Cell 1 is on E-UTRA RF channel number 1. NR Cell 2 is on NR RF channel number 1.
Neighbour cell		Config 1,2	NR cell 3		NR cell 3 is on NR RF channel number 2.
Gap Pattern Id		Config 1,2	0	13	As specified in clause 9.1.2-1.
Measurement gap offset		Config 1,2	39	39	
SMTTC-SSB parameters		Config 1,2	SSB.3 FR2		As specified in clause A.3.10.2
offsetMO	dB	Config 1,2	16		Applied to NR Cell 3 measurement object
A3-Offset	dB	Config 1,2	-11		
Hysteresis	dB	Config 1,2	0		
CP length		Config 1,2	Normal		
TimeToTrigger	s	Config 1,2	0		
Filter coefficient		Config 1,2	0		L3 filtering is not used
DRX		Config 1,2	OFF		DRX is not used
Time offset between PCell and PScell		Config 1,2	3 μ s		Synchronous EN-DC
Time offset between serving and neighbour cells		Config 1,2	3 μ s		Synchronous cells.
T1	s	Config 1,2	5		
T2	s	Config 1,2	5.2 for PC1; 3.5 for other PC	5.2 for PC1; 3.5 for other PC	

Table A.5.6.2.1.1-3: Cell specific test parameters for EN-DC inter-frequency event triggered reporting without SSB time index detection

Parameter	Unit	Test configuration	Cell 2		Cell 3	
			T1	T2	T1	T2
AoA setup		Config 1,2	Setup 3 as specified in clause A.3.15			
			AoA1		AoA2	
Assumption for UE beams ^{Note 7}		Config 1,2	Rough		Rough	
NR RF Channel Number		Config 1,2	1		2	
Duplex mode		Config 1,2	TDD		TDD	
BW _{channel}	MHz	Config 1,2	100: N _{RB,c} = 66		100: N _{RB,c} = 66	
Data RBs allocated		Config 1,2	66		66	
BWP BW	MHz	Config 1,2	100: N _{RB,c} = 66		100: N _{RB,c} = 66	
TDD configuration		Config 1,2	TDDConf.3.1		TDDConf.3.1	
Initial DL BWP		Config 1,2	DLBWP.0.1		NA	
Initial UL BWP		Config 1,2	ULBWP.0.1		NA	
Dedicated DL BWP		Config 1,2	DLBWP.1.1		NA	
Dedicated UL BWP		Config 1,2	ULBWP.1.1		NA	
OCNG Patterns defined in A.3.2.1.1		Config 1,2	OP.1		OP.1	

TRS configuration		Config 1,2	TRS.2.1 TDD		NA	
PDSCH/PDCCH TCI state		Config 1,2	TCI.State.2		NA	
PDSCH Reference measurement channel		Config 1,2	SR.3.1 TDD		-	
RMSI CORESET Reference Channel		Config 1,2	CR.3.1 TDD		-	
Dedicated CORESET Reference Channel		Config 1,2	CCR.3.1 TDD		-	
SMTC configuration defined in A.3.11		Config 1,2	SMTC.1		SMTC.1	
PDSCH/PDCCH subcarrier spacing	kHz	Config 1,2	120		120	
EPRE ratio of PSS to SSS		Config 1,2	0		0	
EPRE ratio of PBCH DMRS to SSS						
EPRE ratio of PBCH to PBCH DMRS						
EPRE ratio of PDCCH DMRS to SSS						
EPRE ratio of PDCCH to PDCCH DMRS						
EPRE ratio of PDSCH DMRS to SSS						
EPRE ratio of PDSCH to PDSCH						
EPRE ratio of OCNG DMRS to SSS(Note 1)						
EPRE ratio of OCNG to OCNG DMRS (Note 1)						
\hat{E}_s	dBm/S CS	Config 1,2	-87	-87	-Infinity	-87
SSB_RP ^{Note 3}	dBm/S CS ^{Note5}	Config 1,2	-87	-87	-Infinity	-87
\hat{E}_s / I_{ot_BB} ^{Note 8}	dB	Config 1,2	1.89	1.89	-Infinity	1.89
I_o ^{Note3}	dBm/95 .04 MHz ^{Note5}	Config 1,2	-58.01	-58.01	-Infinity	-58.01
Propagation Condition		Config 1,2	No external noise (Note 9)		No external noise (Note 9)	
<p>Note 1: OCNG shall be used such that both cells are fully allocated and a constant total transmitted power spectral density is achieved for all OFDM symbols.</p> <p>Note 2: Void</p> <p>Note 3: SSB-RP, E_s/I_{ot} and I_o levels have been derived from other parameters for information purposes. They are not settable parameters themselves.</p> <p>Note 4: Void</p> <p>Note 5: Equivalent power received by an antenna with 0dBi gain at the centre of the quiet zone</p> <p>Note 6: As observed with 0dBi gain antenna at the centre of the quiet zone</p> <p>Note 7: Information about types of UE beam is given in B.2.1.3, and does not limit UE implementation or test system implementation</p> <p>Note 8: Calculation of E_s/I_{ot_BB} includes the effect of UE internal noise up to the value assumed for the associated Refsens requirement in clause 7.3.2 of TS 38.101-2 [19], and an allowance of 1dB for UE multi-band relaxation factor ΔMB_s from TS 38.101-2 [19] Table 6.2.1.3-4.</p> <p>Note 9: The downlink connection between the System Simulator and the UE is without Additive White Gaussian Noise, and has no fading or multipath effects as specified in TS 38.521-2 B.0 [29].</p>						

A.5.6.2.1.2 Test Requirements

In test 1 with per-UE gap and in test 2 with per-FR gap, the UE shall send one Event A3 triggered measurement report, with a measurement reporting delay less than X ms from the beginning of time period T2, where X is

5120 for UE supporting power class 1, or

3200 for UE supporting other power class.

In test 1 and 2 UE is not required to report SSB time index. The UE shall not send event triggered measurement reports, as long as the reporting criteria are not fulfilled. The rate of correct events observed during repeated tests shall be at least 90%.

NOTE: The actual overall delays measured in the test may be up to $2xTTI_{DCCH}$ higher than the measurement reporting delays above because of TTI insertion uncertainty of the measurement report in DCCH.

A.5.6.2.2 EN-DC event triggered reporting tests for FR2 cell without SSB time index detection when DRX is used

A.5.6.2.2.1 Test Purpose and Environment

The purpose of this test is to verify that the UE makes correct reporting of an event. This test will partly verify the EN-DC inter-frequency NR cell search requirements in clause 9.3.4.

In this test, there are three cells: LTE cell 1 as PCell on E-UTRA RF channel 1, NR cell 2 as PSCell in FR2 on NR RF channel 1 and NR cell 3 as neighbour cell in FR2 on NR RF channel 2. The test parameters and configurations are given in Tables A.5.6.2.2.1-1, A.5.6.2.2.1-2, and A.5.6.2.2.1-3.

In test 1&2 measurement gap pattern configuration # 0 as defined in Table A.5.6.2.2.1-2 is provided for UE that does not support per-FR gap and in test 3&4 measurement gap pattern configuration #13 as defined in Table A.5.6.2.2.1-2 is provided for UE that supports per-FR gap. If a UE supports per-FR gap and gap pattern configuration #13, it is only required to pass test 3&4. Otherwise it is only required to pass test 1&2.

In the measurement control information, it is indicated to the UE that event-triggered reporting with Event A3 is used. The test consists of two successive time periods, with time duration of T1, and T2 respectively. During time duration T1, the UE shall not have any timing information of NR cell 3.

The configuration of LTE cell 1 is defined in table A.3.7.2.2-1. Supported test configurations are shown in table A.5.6.2.2.1-1.

UE needs to be provided with new Timing Advance Command MAC control element at least once during each time alignment timer period to maintain uplink time alignment. Furthermore UE is allocated with PUSCH resource at every DRX cycle.

Table A.5.6.2.2.1-1 EN-DC event triggered reporting tests without SSB index reading for FR2-FR2

Config	Description
1	LTE FDD, 120 kHz SSB SCS, 100 MHz bandwidth, TDD duplex mode
2	LTE TDD, 120 kHz SSB SCS, 100 MHz bandwidth, TDD duplex mode
Note 1:	The UE is only required to be tested in one of the supported test configurations
Note 2:	target NR cell has the same SCS, BW and duplex mode as NR serving cell

Table A.5.6.2.1-2: General test parameters for EN-DC inter-frequency event triggered reporting without SSB time index detection

Parameter	Unit	Test configuration	Value				Comment
			Test 1	Test 2	Test 3	Test 4	
E-UTRA RF Channel Number		Config 1,2	1				One E-UTRAN TDD carrier frequency is used.
NR RF Channel Number		Config 1,2	1, 2				Two FR2 NR carrier frequencies are used.
Active cell		Config 1,2	LTE Cell 1 (PCell) and NR cell 2 (PScell)				LTE Cell 1 is on E-UTRA RF channel number 1. NR Cell 2 is on NR RF channel number 1.
Neighbour cell		Config 1,2	NR cell 3				NR cell 3 is on NR RF channel number 2.
Gap Pattern Id		Config 1,2	0		13		As specified in clause 9.1.2-1.
Measurement gap offset		Config 1,2	39		39		
SMTC-SSB parameters		Config 1,2	SSB.3 FR2				As specified in clause A.3.10.2
A3-Offset	dB	Config 1,2	-6				
Hysteresis	dB	Config 1,2	0				
CP length		Config 1,2	Normal				
TimeToTrigger	s	Config 1,2	0				
Filter coefficient		Config 1,2	0				L3 filtering is not used
DRX		Config 1,2	DRX .1	DRX .7	DRX .1	DRX .7	As specified in clause A.3.3
Time offset between PCell and PSCell		Config 1,2	3 μs				Synchronous EN-DC
Time offset between serving and neighbour cells		Config 1,2	3μs				Synchronous cells.
T1	s	Config 1,2	5				
T2	s	Config 1,2	8 for PC1; 5 for other PC	82 for PC1; 52 for other PC	8 for PC1; 5 for other PC	82 for PC1; 52 for other PC	

Table A.5.6.2.1-3: Cell specific test parameters for EN-DC inter-frequency event triggered reporting without SSB time index detection

Parameter	Unit	Test configuration	Cell 2		Cell 3	
			T1	T2	T1	T2
AoA setup		Config 1,2	Setup 1 as specified in clause A.3.15			
Assumption for UE beams ^{Note 7}		Config 1,2	Rough		Rough	
NR RF Channel Number		Config 1,2	1		2	
Duplex mode		Config 1,2	TDD		TDD	
BW _{channel}	MHz	Config 1,2	100: N _{RB,c} = 66		100: N _{RB,c} = 66	
Data RBs allocated		Config 1,2	66		66	
BWP BW	MHz	Config 1,2	100: N _{RB,c} = 66		100: N _{RB,c} = 66	

TDD configuration		Config 1,2	TDDConf.3.1		TDDConf.3.1	
Initial DL BWP		Config 1,2	DLBWP.0.1		NA	
Initial UL BWP		Config 1,2	ULBWP.0.1			
Dedicated DL BWP		Config 1,2	DLBWP.1.1		NA	
Dedicated UL BWP		Config 1,2	ULBWP.1.1		NA	
OCNG Patterns defined in A.3.2.1.1 (OP.1)		Config 1,2	OP.1		OP.1	
TRS configuration		Config 1,2	TRS.2.1 TDD		NA	
PDSCH/PDCCH TCI state		Config 1,2	TCI.State.2		NA	
PDSCH Reference measurement channel		Config 1,2	SR.3.1 TDD		-	
RMSI CORESET Reference Channel		Config 1,2	CR.3.1 TDD		-	
Dedicated CORESET Reference Channel		Config 1,2	CCR.3.1 TDD		-	
SMTTC configuration defined in A.3.11		Config 1,2	SMTTC.1		SMTTC.1	
PDSCH/PDCCH subcarrier spacing	kHz	Config 1,2	120		120	
EPRE ratio of PSS to SSS		Config 1,2	0		0	
EPRE ratio of PBCH DMRS to SSS						
EPRE ratio of PBCH to PBCH DMRS						
EPRE ratio of PDCCH DMRS to SSS						
EPRE ratio of PDCCH to PDCCH DMRS						
EPRE ratio of PDSCH DMRS to SSS						
EPRE ratio of PDSCH to PDSCH						
EPRE ratio of OCNG DMRS to SSS(Note 1)						
EPRE ratio of OCNG to OCNG DMRS (Note 1)						
N_{oc} ^{Note2}	dBm/15 kHz Note5		-104.7		-104.7	
N_{oc} ^{Note2}	dBm/S CS Note4	Config 1,2	-95.7		-95.7	
SSB_RP ^{Note 3}	dBm/S CS Note5	Config 1,2	-89.7	-89.7	-Infinity	-86.7
\hat{E}_s / I_{ot}	dB	Config 1,2	6	6	-Infinity	9
\hat{E}_s / N_{oc}	dB	Config 1,2	6	6	-Infinity	9

I_{o} ^{Note3}	dBm/95 .04 MHz Note5	Config 1,2	-59.7	-59.7	-66.7	-57.2
Propagation Condition		Config 1,2	AWGN		AWGN	
Note 1:	OCNG shall be used such that both cells are fully allocated and a constant total transmitted power spectral density is achieved for all OFDM symbols.					
Note 2:	Interference from other cells and noise sources not specified in the test is assumed to be constant over subcarriers and time and shall be modelled as AWGN of appropriate power for N_{oc} to be fulfilled.					
Note 3:	SSB_RP and I_o levels have been derived from other parameters for information purposes. They are not settable parameters themselves.					
Note 4:	Void					
Note 5:	Equivalent power received by an antenna with 0 dBi gain at the centre of the quiet zone					
Note 6:	As observed with 0 dBi gain antenna at the centre of the quiet zone					
Note 7:	Information about types of UE beam is given in B.2.1.3, and does not limit UE implementation or test system implementation.					

A.5.6.2.2.2 Test Requirements

In test 1 with per-UE gap and in test 3 with per-FR gap, the UE shall send one Event A3 triggered measurement report, with a measurement reporting delay less than $X1$ ms from the beginning of time period T2, where $X1$ is

7680 for UE supporting power class 1, or

4800 for UE supporting other power class.

In test 2 with per-UE gap and in test 4 with per-FR gap, the UE shall send one Event A3 triggered measurement report, with a measurement reporting delay less than $X2$ ms from the beginning of time period T2, where $X2$ is

81920 for UE supporting power class 1, or

51200 for UE supporting other power class.

In test 1, 2, 3 and 4 UE is not required to report SSB time index. The UE shall not send event triggered measurement reports, as long as the reporting criteria are not fulfilled. The rate of correct events observed during repeated tests shall be at least 90%.

NOTE: The actual overall delays measured in the test may be up to $2 \times TTI_{DCC}$ higher than the measurement reporting delays above because of TTI insertion uncertainty of the measurement report in DCC.

A.5.6.2.3 EN-DC event triggered reporting tests for FR2 cell with SSB time index detection when DRX is not used

A.5.6.2.3.1 Test Purpose and Environment

The purpose of this test is to verify that the UE makes correct reporting of an event. This test will partly verify the EN-DC inter-frequency NR cell search requirements in clause 9.3.4.

In this test, there are three cells: LTE cell 1 as PCell on E-UTRA RF channel 1, NR cell 2 as PSCell in FR2 on NR RF channel 1 and NR cell 3 as neighbour cell in FR2 on NR RF channel 2. The test parameters and configurations are given in Tables A.5.6.2.3.1-1, A.5.6.2.3.1-2, and A.5.6.2.3.1-3.

In test 1 measurement gap pattern configuration # 0 as defined in Table A.5.6.2.3.1-1 is provided for UE that does not support per-FR gap and in test 2 measurement gap pattern configuration #13 as defined in Table A.5.6.2.3.1-1 is provided for UE that supports per-FR gap. If a UE supports per-FR gap and gap pattern configuration #13, it is only required to pass test 2. Otherwise it is only required to pass test 1.

In the measurement control information, it is indicated to the UE that event-triggered reporting with Event A3 is used. The test consists of two successive time periods, with time duration of T1, and T2 respectively. During time duration T1, the UE shall not have any timing information of NR cell 3.

The configuration of LTE cell 1 is defined in table A.3.7.2.2-1. Supported test configurations are shown in table A.5.6.2.3.1-1.

Table A.5.6.2.3.1-1 EN-DC event triggered reporting tests with SSB index reading for FR2-FR2

Config	Description
1	LTE FDD, 120 kHz SSB SCS, 100 MHz bandwidth, TDD duplex mode
2	LTE TDD, 120 kHz SSB SCS, 100 MHz bandwidth, TDD duplex mode
Note 1: The UE is only required to be tested in one of the supported test configurations	
Note 2: target NR cell has the same SCS, BW and duplex mode as NR serving cell	

Table A.5.6.2.3.1-2: General test parameters for EN-DC inter-frequency event triggered reporting with SSB time index detection

Parameter	Unit	Test configuration	Value		Comment
			Test 1	Test 2	
E-UTRA RF Channel Number		Config 1,2	1		One E-UTRAN TDD carrier frequency is used.
NR RF Channel Number		Config 1,2	1, 2		Two FR2 NR carrier frequencies are used.
Active cell		Config 1,2	LTE Cell 1 (PCell) and NR cell 2 (PScell)		LTE Cell 1 is on E-UTRA RF channel number 1. NR Cell 2 is on NR RF channel number 1.
Neighbour cell		Config 1,2	NR cell 3		NR cell 3 is on NR RF channel number 2.
Gap Pattern Id		Config 1,2	0	13	As specified in clause 9.1.2-1.
Measurement gap offset		Config 1,2	39	39	
SMTC-SSB parameters		Config 1,2	SSB.3 FR2		As specified in clause A.3.10.2
offsetMO	dB	Config 1,2	16		Applied to NR Cell 3 measurement object
A3-Offset	dB	Config 1,2	-11		
Hysteresis	dB	Config 1,2	0		
CP length		Config 1,2	Normal		
TimeToTrigger	s	Config 1,2	0		
Filter coefficient		Config 1,2	0		L3 filtering is not used
DRX		Config 1,2	OFF		DRX is not used
Time offset between PCell and PScell		Config 1,2	3 μs		Synchronous EN-DC
Time offset between serving and neighbour cells		Config 1,2	3μs		Synchronous cells.
T1	s	Config 1,2	5		
T2	s	Config 1,2	7 for PC1; 4.5 for other PC	7 for PC1; 4.5 for other PC	

Table A.5.6.2.3.1-3: Cell specific test parameters for EN-DC inter-frequency event triggered reporting with SSB time index detection

Parameter	Unit	Test configuration	Cell 2		Cell 3	
			T1	T2	T1	T2
AoA setup		Config 1,2	Setup 3 as specified in clause A.3.15			
			AoA1		AoA2	
Assumption for UE beams ^{Note 7}		Config 1,2	Rough		Rough	
NR RF Channel Number		Config 1,2	1		2	
Duplex mode		Config 1,2	TDD		TDD	
BW _{channel}	MHz	Config 1,2	100: N _{RB,c} = 66		100: N _{RB,c} = 66	
Data RBs allocated		Config 1,2	66		66	
BWP BW	MHz	Config 1,2	100: N _{RB,c} = 66		100: N _{RB,c} = 66	
TDD configuration		Config 1,2	TDDConf.3.1		TDDConf.3.1	
Initial DL BWP		Config 1,2	DLBWP.0.1		NA	
Initial UL BWP		Config 1,2	DLBWP.0.1		N/A	
Dedicated DL BWP		Config 1,2	DLBWP.1.1		NA	
Dedicated UL BWP		Config 1,2	ULBWP.1.1		NA	
OCNG Patterns defined in A.3.2.1.1		Config 1,2	OP.1		OP.1	
PDSCH Reference measurement channel		Config 1,2	SR.3.1 TDD		-	
RMSI CORESET Reference Channel		Config 1,2	CR.3.1 TDD		-	
Dedicated CORESET Reference Channel		Config 1,2	CCR.3.1 TDD		-	
TRS configuration		Config 1,2	TRS.2.1 TDD		NA	
PDSCH/PDCCH TCI state		Config 1,2	TCI.State.2		NA	
SMTC configuration defined in A.3.11		Config 1,2	SMTC.1		SMTC.1	
PDSCH/PDCCH subcarrier spacing	kHz	Config 1,2	120		120	
EPRE ratio of PSS to SSS		Config 1,2	0	0		
EPRE ratio of PBCH DMRS to SSS						
EPRE ratio of PBCH to PBCH DMRS						
EPRE ratio of PDCCH DMRS to SSS						
EPRE ratio of PDCCH to PDCCH DMRS						
EPRE ratio of PDSCH DMRS to SSS						
EPRE ratio of PDSCH to PDSCH						

EPRE ratio of OCNG DMRS to SSS(Note 1)						
EPRE ratio of OCNG to OCNG DMRS (Note 1)						
\hat{E}_s	dBm/S CS	Config 1	-87	-87	-Infinity	-87
SSB_RP ^{Note 3}	dBm/S CS ^{Note5}	Config 1,2	-87	-87	-Infinity	-87
\hat{E}_s / I_{ot} ^{BB Note 8}	dB	Config 1,2	1.89	1.89	-Infinity	1.89
I_o ^{Note3}	dBm/95 .04 MHz ^{Note5}	Config 1,2	-58.01	-58.01	-Infinity	-58.01
Propagation Condition		Config 1,2	No external noise (Note 9)		No external noise (Note 9)	
<p>Note 1: OCNG shall be used such that both cells are fully allocated and a constant total transmitted power spectral density is achieved for all OFDM symbols.</p> <p>Note 2: Void</p> <p>Note 3: SSB-RP, E_s/I_{ot} and I_o levels have been derived from other parameters for information purposes. They are not settable parameters themselves.</p> <p>Note 4: Void</p> <p>Note 5: Equivalent power received by an antenna with 0dBi gain at the centre of the quiet zone</p> <p>Note 6: As observed with 0dBi gain antenna at the centre of the quiet zone</p> <p>Note 7: Information about types of UE beam is given in B.2.1.3, and does not limit UE implementation or test system implementation</p> <p>Note 8: Calculation of $E_s/I_{ot_{BB}}$ includes the effect of UE internal noise up to the value assumed for the associated Refsens requirement in clause 7.3.2 of TS 38.101-2 [19], and an allowance of 1dB for UE multi-band relaxation factor ΔMBs from TS 38.101-2 [19] Table 6.2.1.3-4.</p> <p>Note 9: The downlink connection between the System Simulator and the UE is without Additive White Gaussian Noise, and has no fading or multipath effects as specified in TS 38.521-2 B.0 [29].</p>						

A.5.6.2.3.2 Test Requirements

In test 1 with per-UE gap and in test 2 with per-FR gap, the UE shall send one Event A3 triggered measurement report, with a measurement reporting delay less than X ms from the beginning of time period T2, where X is

6720 for UE supporting power class 1, or

4160 for UE supporting other power class.

In test 1 and 2 UE is required to report SSB time index. The UE shall not send event triggered measurement reports, as long as the reporting criteria are not fulfilled. The rate of correct events observed during repeated tests shall be at least 90%.

NOTE: The actual overall delays measured in the test may be up to $2xTTI_{DCC}$ higher than the measurement reporting delays above because of TTI insertion uncertainty of the measurement report in DCC.

A.5.6.2.4 EN-DC event triggered reporting tests for FR2 cell with SSB time index detection when DRX is used

A.5.6.2.4.1 Test Purpose and Environment

The purpose of this test is to verify that the UE makes correct reporting of an event. This test will partly verify the EN-DC inter-frequency NR cell search requirements in clause 9.3.4.

In this test, there are three cells: LTE cell 1 as PCell on E-UTRA RF channel 1, NR cell 2 as PSCell in FR2 on NR RF channel 1 and NR cell 3 as neighbour cell in FR2 on NR RF channel 2. The test parameters and configurations are given in Tables A.5.6.2.4.1-1, A.5.6.2.4.1-2, and A.5.6.2.4.1-3.

In test 1&2 measurement gap pattern configuration # 0 as defined in Table A.5.6.2.4.1-2 is provided for UE that does not support per-FR gap and in test 3&4 measurement gap pattern configuration #13 as defined in Table A.5.6.2.4.1-2 is provided for UE that supports per-FR gap. If a UE supports per-FR gap and gap pattern configuration #13, it is only required to pass test 3&4. Otherwise it is only required to pass test 1&2.

In the measurement control information, it is indicated to the UE that event-triggered reporting with Event A3 is used. The test consists of two successive time periods, with time duration of T1, and T2 respectively. During time duration T1, the UE shall not have any timing information of NR cell 3.

The configuration of LTE cell 1 is defined in table A.3.7.2.2-1. Supported test configurations are shown in table A.5.6.2.4.1-1.

UE needs to be provided with new Timing Advance Command MAC control element at least once during each time alignment timer period to maintain uplink time alignment. Furthermore UE is allocated with PUSCH resource at every DRX cycle.

Table A.5.6.2.4.1-1: EN-DC event triggered reporting tests with SSB index reading for FR2-FR2

Config	Description
1	LTE FDD, 120 kHz SSB SCS, 100 MHz bandwidth, TDD duplex mode
2	LTE TDD, 120 kHz SSB SCS, 100 MHz bandwidth, TDD duplex mode
Note 1: The UE is only required to be tested in one of the supported test configurations	
Note 2: target NR cell has the same SCS, BW and duplex mode as NR serving cell	

Table A.5.6.2.4.1-2: General test parameters for EN-DC inter-frequency event triggered reporting with SSB time index detection

Parameter	Unit	Test configuration	Value				Comment
			Test 1	Test 2	Test 3	Test 4	
E-UTRA RF Channel Number		Config 1,2	1				One E-UTRAN TDD carrier frequency is used.
NR RF Channel Number		Config 1,2	1, 2				Two FR2 NR carrier frequencies are used.
Active cell		Config 1,2	LTE Cell 1 (PCell) and NR cell 2 (PScell)				LTE Cell 1 is on E-UTRA RF channel number 1. NR Cell 2 is on NR RF channel number 1.
Neighbour cell		Config 1,2	NR cell 3				NR cell 3 is on NR RF channel number 2.
Gap Pattern Id		Config 1,2	0		13		As specified in clause 9.1.2-1.
Measurement gap offset		Config 1,2	39		39		
SMTC-SSB parameters		Config 1,2	SSB.3 FR2				As specified in clause A.3.10.2
A3-Offset	dB	Config 1,2	-6				
Hysteresis	dB	Config 1,2	0				
CP length		Config 1,2	Normal				
TimeToTrigger	s	Config 1,2	0				
Filter coefficient		Config 1,2	0				L3 filtering is not used

DRX		Config 1,2	DRX .1	DRX .7	DRX .1	DRX .7	As specified in clause A.3.3
Time offset between PCell and PSCell		Config 1,2	3 μ s				Synchronous EN-DC
Time offset between serving and neighbour cells		Config 1,2	3 μ s				Synchronous cells.
T1	s	Config 1,2	5				
T2	s	Config 1,2	11 for PC1; 6.5 for other PC	108 for PC1; 67 for other PC	11 for PC1; 6.5 for other PC	108 for PC1; 67 for other PC	

Table A.5.6.2.4.1-3: Cell specific test parameters for EN-DC inter-frequency event triggered reporting with SSB time index detection

Parameter	Unit	Test configuration	Cell 2		Cell 3	
			T1	T2	T1	T2
AoA setup		Config 1,2	Setup 1 as specified in clause A.3.15			
Assumption for UE beams ^{Note 7}		Config 1,2	Rough		Rough	
NR RF Channel Number		Config 1,2	1		2	
Duplex mode		Config 1,2	TDD		TDD	
BW _{channel}	MHz	Config 1,2	100: N _{RB,c} = 66		100: N _{RB,c} = 66	
Data RBs allocated		Config 1,2	66		66	
BWP BW	MHz	Config 1,2	100: N _{RB,c} = 66		100: N _{RB,c} = 66	
TDD configuration		Config 1,2	TDDConf.3.1		TDDConf.3.1	
Initial DL BWP		Config 1,2	DLBWP.0.1		NA	
Initial UL BWP		Config 1,2	ULBWP.0.1			
Dedicated DL BWP		Config 1,2	DLBWP.1.1		NA	
Dedicated UL BWP		Config 1,2	ULBWP.1.1		NA	
OCNG Patterns defined in A.3.2.1.1		Config 1,2	OP.1		OP.1	
PDSCH Reference measurement channel		Config 1,2	SR.3.1 TDD		-	
RMSI CORESET Reference Channel		Config 1,2	CR.3.1 TDD		-	
Dedicated CORESET Reference Channel		Config 1,2	CCR.3.1 TDD		-	
TRS configuration		Config 1,2	TRS.2.1 TDD		NA	
PDSCH/PDCCH TCI state		Config 1,2	TCI.State.2		NA	
SMTTC configuration defined in A.3.11		Config 1,2	SMTTC.1		SMTTC.1	

PDSCH/PDCCH subcarrier spacing	kHz	Config 1,2	120		120	
EPRE ratio of PSS to SSS		Config 1,2	0		0	
EPRE ratio of PBCH DMRS to SSS						
EPRE ratio of PBCH to PBCH DMRS						
EPRE ratio of PDCCH DMRS to SSS						
EPRE ratio of PDCCH to PDCCH DMRS						
EPRE ratio of PDSCH DMRS to SSS						
EPRE ratio of PDSCH to PDSCH						
EPRE ratio of OCNG DMRS to SSS(Note 1)						
EPRE ratio of OCNG to OCNG DMRS (Note 1)						
N_{oc} Note2	dBm/15 kHz Note5		-104.7		-104.7	
N_{oc} Note2	dBm/S CS Note4	Config 1,2	-95.7		-95.7	
SSB_RP Note 3	dBm/S CS Note5	Config 1,2	-89.7	-89.7	-Infinity	-86.7
\hat{E}_s / I_{ot}	dB	Config 1,2	6	6	-Infinity	9
\hat{E}_s / N_{oc}	dB	Config 1,2	6	6	-Infinity	9
I_o Note3	dBm/95 .04 MHz Note5	Config 1,2	-59.7	-59.7	-66.7	-57.2
Propagation Condition		Config 1,2	AWGN		AWGN	
<p>Note 1: OCNG shall be used such that both cells are fully allocated and a constant total transmitted power spectral density is achieved for all OFDM symbols.</p> <p>Note 2: Interference from other cells and noise sources not specified in the test is assumed to be constant over subcarriers and time and shall be modelled as AWGN of appropriate power for N_{oc} to be fulfilled.</p> <p>Note 3: SSB_RP and I_o levels have been derived from other parameters for information purposes. They are not settable parameters themselves.</p> <p>Note 4: Void</p> <p>Note 5: Equivalent power received by an antenna with 0dBi gain at the centre of the quiet zone</p> <p>Note 6: As observed with 0dBi gain antenna at the centre of the quiet zone</p> <p>Note 7: Information about types of UE beam is given in B.2.1.3, and does not limit UE implementation or test system implementation.</p>						

A.5.6.2.4.2 Test Requirements

In test 1 with per-UE gap and in test 3 with per-FR gap, the UE shall send one Event A3 triggered measurement report, with a measurement reporting delay less than $X1$ ms from the beginning of time period T2, where $X1$ is

10080 for UE supporting power class 1, or

6240 for UE supporting other power class.

In test 2 with per-UE gap and in test 4 with per-FR gap, the UE shall send one Event A3 triggered measurement report, with a measurement reporting delay less than $X2$ ms from the beginning of time period T2, where $X2$ is

107520 for UE supporting power class 1, or

66560 for UE supporting other power class.

In test 1, 2, 3 and 4 UE is required to report SSB time index. The UE shall not send event triggered measurement reports, as long as the reporting criteria are not fulfilled. The rate of correct events observed during repeated tests shall be at least 90%.

NOTE: The actual overall delays measured in the test may be up to $2xTTI_{DCCCH}$ higher than the measurement reporting delays above because of TTI insertion uncertainty of the measurement report in DCCCH.

A.5.6.2.5 EN-DC event triggered reporting tests for FR2 cell without SSB time index detection when DRX is not used

A.5.6.2.5.1 Test Purpose and Environment

The purpose of this test is to verify that the UE makes correct reporting of an event. This test will partly verify the EN-DC inter-frequency NR cell search requirements in clause 9.3.4.

In this test, there are three cells: LTE cell 1 as PCell on E-UTRA RF channel 1, NR cell 2 as PSCell in FR1 on NR RF channel 1 and NR cell 3 as neighbour cell in FR2 on NR RF channel 2. The test parameters and configurations are given in Tables A.5.6.2.5.1-1, A.5.6.2.5.1-2, and A.5.6.2.5.1-3.

In test 1 measurement gap pattern configuration # 0 as defined in Table A.5.6.2.5.1-2 is provided for a UE that does not support per-FR gap and in test 2 measurement gap pattern configuration #13 as defined in Table A.5.6.2.5.1-2 is provided for UE that support per-FR gap. If a UE supports per-FR gap and gap pattern configuration #13, it is only required to pass test 2. Otherwise it is only required to pass test 1.

In the measurement control information, it is indicated to the UE that event-triggered reporting with Event A4 is used. The test consists of two successive time periods, with time duration of T1, and T2 respectively. During time duration T1, the UE shall not have any timing information of NR cell 3.

The configuration of LTE cell 1 is defined in table A.3.7.2.1-1. Supported test configurations are shown in table A.5.6.2.5.1-1.

Table A.5.6.2.5.1-1: EN-DC event triggered reporting tests without SSB index reading for FR1-FR2

Config	Description of serving cell	Description of target cell
1	LTE FDD, NR 15 kHz SSB SCS, 10 MHz bandwidth, FDD duplex mode	120 kHz SSB SCS, 100 MHz bandwidth, TDD duplex mode
2	LTE FDD, NR 15 kHz SSB SCS, 10 MHz bandwidth, TDD duplex mode	
3	LTE FDD, NR 30 kHz SSB SCS, 40 MHz bandwidth, TDD duplex mode	
4	LTE TDD, NR 15 kHz SSB SCS, 10 MHz bandwidth, FDD duplex mode	
5	LTE TDD, NR 15 kHz SSB SCS, 10 MHz bandwidth, TDD duplex mode	
6	LTE TDD, NR 30 kHz SSB SCS, 40 MHz bandwidth, TDD duplex mode	
Note: The UE is only required to be tested in one of the supported test configurations		

Table A.5.6.2.5.1-2: General test parameters for EN-DC inter-frequency event triggered reporting without SSB time index detection

Parameter	Unit	Test configuration	Value		Comment
			Test 1	Test 2	
E-UTRA RF Channel Number		Config 1,2,3,4,5,6	1		One E-UTRAN TDD carrier frequency is used.
NR RF Channel Number		Config 1,2,3,4,5,6	1, 2		One FR1 and one FR2 NR carrier frequency is used.
Active cell		Config 1,2,3,4,5,6	LTE Cell 1 (PCell) and NR cell 2 (PScell)		LTE Cell 1 is on E-UTRA RF channel number 1. NR Cell 2 is on NR RF channel number 1.
Neighbour cell		Config 1,2,3,4,5,6	NR cell 3		NR cell 3 is on NR RF channel number 2.
Gap Pattern Id		Config 1,2,3,4,5,6	0	13	As specified in clause 9.1.2-1.
Measurement gap offset		Config 1,2,3,4,5,6	39	39	
SMTC-SSB parameters on NR RF Channel 1		Config 1,4	SSB.1 FR1		As specified in clause A.3.10.1
		Config 2,5	SSB.1 FR1		As specified in clause A.3.10.1
		Config 3,6	SSB.2 FR1		As specified in clause A.3.10.1
SMTC-SSB parameters on NR RF Channel 2		Config 1,2,3,4,5,6	SSB.3 FR2		As specified in clause A.3.10.2
CSI-RS for tracking		Config 1,4	TRS.1.1 FDD		
		Config 2,5	TRS.1.1 TDD		
		Config 3,6	TRS.1.2 TDD		
<i>offsetMO</i>	dB	Config 1,2,3,4,5,6	6		
Hysteresis	dB	Config 1,2,3,4,5,6	0		
<i>a4-Threshold</i>	dBm	Config 1,2,3,4,5,6	-105		
CP length		Config 1,2,3,4,5,6	Normal		
TimeToTrigger	s	Config 1,2,3,4,5,6	0		
Filter coefficient		Config 1,2,3,4,5,6	0		L3 filtering is not used
DRX		Config 1,2,3,4,5,6	OFF		DRX is not used
Time offset between PCell and PScell		Config 1,2,3,4,5,6	3 μ s		Synchronous EN-DC
Time offset between serving and neighbour cells		Config 1,4	3ms		Asynchronous cells. The timing of Cell 3 is 3ms later than the timing of Cell 2.
		Config 2,3,5,6	3 μ s		Synchronous cells.
T1	s	Config 1,2,3,4,5,6	5		
T2	s	Config 1,2,3,4,5,6	5.2 for PC1; 3.5 for other PC	5.2 for PC1; 3.5 for other PC	

Table A.5.6.2.5.1-3: Cell specific test parameters for EN-DC inter-frequency event triggered reporting without SSB time index detection

Parameter	Unit	Test configuration	Cell 2		Cell 3	
			T1	T2	T1	T2
AoA setup		Config 1,2,3,4,5,6	N/A		Setup 1 as specified in clause A.3.15	
Assumption for UE beams ^{Note 7}		Config 1,2,3,4,5,6	N/A		Rough	
NR RF Channel Number		Config 1,2,3,4,5,6	1		2	
Duplex mode		Config 1,4	FDD		TDD	
		Config 2,3,5,6	TDD		TDD	
BW _{channel}	MHz	Config 1,4	10: N _{RB,c} = 52		100: N _{RB,c} = 66	
		Config 2,5	10: N _{RB,c} = 52		100: N _{RB,c} = 66	
		Config 3,6	40: N _{RB,c} = 106		100: N _{RB,c} = 66	
BWP BW	MHz	Config 1,4	10: N _{RB,c} = 52		100: N _{RB,c} = 66	
		Config 2,5	10: N _{RB,c} = 52		100: N _{RB,c} = 66	
		Config 3,6	40: N _{RB,c} = 106		100: N _{RB,c} = 66	
Data RBs allocated		Config 1,4	52		66	
		Config 2,5	52		66	
		Config 3,6	106		66	
TDD configuration		Config 2,5	TDDConf.1.1		TDDConf.3.1	
		Config 3,6	TDDConf.2.1		TDDConf.3.1	
Initial DL BWP		Config 1,2,3,4,5,6	DLBWP.0.1		NA	
Initial UL BWP		Config 1,2,3,4,5,6	ULBWP.0.1		NA	
Dedicated DL BWP		Config 1,2,3,4,5,6	DLBWP.1.1		NA	
Dedicated UL BWP		Config 1,2,3,4,5,6	ULBWP.1.1		NA	
OCNG Patterns defined in A.3.2.1.1 (OP.1)		Config 1,2,3,4,5,6	OP.1		OP.1	
PDSCH Reference measurement channel		Config 1,4	SR.1.1 FDD		-	
		Config 2,5	SR.1.1 TDD			
		Config 3,6	SR2.1 TDD			
RMSI CORESET Reference Channel		Config 1,4	CR.1.1 FDD		-	
		Config 2,5	CR.1.1 TDD			
		Config 3,6	CR2.1 TDD			
Dedicated CORESET Reference Channel		Config 1,4	CCR.1.1 FDD		-	
		Config 2,5	CCR.1.1 TDD			
		Config 3,6	CCR.2.1 TDD			
SMTC configuration defined in A.3.11		Config 1,4	SMTC.2		SMTC.2	
		Config 2,3,5,6	SMTC.1		SMTC.1	
PDSCH/PDCCH subcarrier spacing	kHz	Config 1,2,4,5	15		120	
		Config 3,6	30		120	

EPRE ratio of PSS to SSS		Config 1,2,3,4,5,6	0	0	
EPRE ratio of PBCH DMRS to SSS					
EPRE ratio of PBCH to PBCH DMRS					
EPRE ratio of PDCCH DMRS to SSS					
EPRE ratio of PDCCH to PDCCH DMRS					
EPRE ratio of PDSCH DMRS to SSS					
EPRE ratio of PDSCH to PDSCH					
EPRE ratio of OCNG DMRS to SSS(Note 1)					
EPRE ratio of OCNG to OCNG DMRS (Note 1)					
\hat{E}_s	dBm/S CS	Config 1,2,3,4,5,6	Link only, see clause A.3.7A	-Infinity	-87
SSB_RP ^{Note 3}	dBm/S CS Note5	Config 1,2,3,4,5,6		-Infinity	-87
$\hat{E}_s / I_{ot\ BB}$ ^{Note 8}	dB	Config 1,2,3,4,5,6		-Infinity	14.69
I_o ^{Note3}	dBm/95 .04 MHz Note5	Config 1,2,3,4,5,6		-Infinity	-58.01
Propagation Condition		Config 1,2,3,4,5,6		No external noise (Note 9)	
<p>Note 1: OCNG shall be used such that both cells are fully allocated and a constant total transmitted power spectral density is achieved for all OFDM symbols.</p> <p>Note 2: Void</p> <p>Note 3: SSB_RP, E_s/I_{ot} and I_o levels have been derived from other parameters for information purposes. They are not settable parameters themselves.</p> <p>Note 4: Void.</p> <p>Note 5: Equivalent power received by an antenna with 0dBi gain at the centre of the quiet zone</p> <p>Note 6: As observed with 0dBi gain antenna at the centre of the quiet zone</p> <p>Note 7: Information about types of UE beam is given in B.2.1.3, and does not limit UE implementation or test system implementation</p> <p>Note 8: Calculation of $E_s/I_{ot\ BB}$ includes the effect of UE internal noise up to the value assumed for the associated Refsens requirement in clause 7.3.2 of TS 38.101-2 [19], and an allowance of 1dB for UE multi-band relaxation factor ΔMB_s from TS 38.101-2 [19] Table 6.2.1.3-4.</p> <p>Note 9: The downlink connection between the System Simulator and the UE is without Additive White Gaussian Noise, and has no fading or multipath effects as specified in TS 38.521-2 B.0 [29].</p>					

A.5.6.2.5.2 Test Requirements

In test 1 with per-UE gap and in test 2 with per-FR gap, the UE shall send one Event A4 triggered measurement report, with a measurement reporting delay less than X ms from the beginning of time period T2, where X is

5120 for UE supporting power class 1, or

3200 for UE supporting other power class.

In test 1 and 2 UE is not required to report SSB time index. The UE shall not send event triggered measurement reports, as long as the reporting criteria are not fulfilled. The rate of correct events observed during repeated tests shall be at least 90%.

NOTE: The actual overall delays measured in the test may be up to $2xTTI_{DCC}$ higher than the measurement reporting delays above because of TTI insertion uncertainty of the measurement report in DCC.

A.5.6.2.6 EN-DC event triggered reporting tests for FR2 cell without SSB time index detection when DRX is used

A.5.6.2.6.1 Test Purpose and Environment

The purpose of this test is to verify that the UE makes correct reporting of an event. This test will partly verify the EN-DC inter-frequency NR cell search requirements in clause 9.3.4.

In this test, there are three cells: LTE cell 1 as PCell on E-UTRA RF channel 1, NR cell 2 as PSCell in FR1 on NR RF channel 1 and NR cell 3 as neighbour cell in FR2 on NR RF channel 2. The test parameters and configurations are given in Tables A.5.6.2.6.1-1, A.5.6.2.6.1-2, and A.5.6.2.6.1-3.

In test 1&2 measurement gap pattern configuration # 0 as defined in Table A.5.6.2.6.1-2 is provided for a UE that does not support per-FR gap and in test 3&4 measurement gap pattern configuration #13 as defined in Table A.5.6.2.6.1-2 is provided for UE that support per-FR gap. If a UE supports per-FR gap and gap pattern configuration #13, it is only required to pass test 3&4. Otherwise it is only required to pass test 1&2.

In the measurement control information, it is indicated to the UE that event-triggered reporting with Event A4 is used. The test consists of two successive time periods, with time duration of T1, and T2 respectively. During time duration T1, the UE shall not have any timing information of NR cell 3.

The configuration of LTE cell 1 is defined in table A.3.7.2.1-1. Supported test configurations are shown in table A.5.6.2.6.1-1.

UE needs to be provided with new Timing Advance Command MAC control element at least once during each time alignment timer period to maintain uplink time alignment. Furthermore UE is allocated with PUSCH resource at every DRX cycle.

Table A.5.6.2.6.1-1: EN-DC event triggered reporting tests without SSB index reading for FR1-FR2

Config	Description of serving cell	Description of target cell
1	LTE FDD, NR 15 kHz SSB SCS, 10 MHz bandwidth, FDD duplex mode	120 kHz SSB SCS, 100 MHz bandwidth, TDD duplex mode
2	LTE FDD, NR 15 kHz SSB SCS, 10 MHz bandwidth, TDD duplex mode	
3	LTE FDD, NR 30 kHz SSB SCS, 40 MHz bandwidth, TDD duplex mode	
4	LTE TDD, NR 15 kHz SSB SCS, 10 MHz bandwidth, FDD duplex mode	
5	LTE TDD, NR 15 kHz SSB SCS, 10 MHz bandwidth, TDD duplex mode	
6	LTE TDD, NR 30 kHz SSB SCS, 40 MHz bandwidth, TDD duplex mode	
Note: The UE is only required to be tested in one of the supported test configurations		

Table A.5.6.2.6.1-2: General test parameters for EN-DC inter-frequency event triggered reporting without SSB time index detection

Parameter	Unit	Test configuration	Value				Comment
			Test 1	Test 2	Test 3	Test 4	

E-UTRA RF Channel Number		Config 1,2,3,4,5,6	1				One E-UTRAN TDD carrier frequency is used.
NR RF Channel Number		Config 1,2,3,4,5,6	1, 2				One FR1 and one FR2 NR carrier frequency is used.
Active cell		Config 1,2,3,4,5,6	LTE Cell 1 (PCell) and NR cell 2 (PScell)				LTE Cell 1 is on E-UTRA RF channel number 1. NR Cell 2 is on NR RF channel number 1.
Neighbour cell		Config 1,2,3,4,5,6	NR cell 3				NR cell 3 is on NR RF channel number 2.
Gap Pattern Id		Config 1,2,3,4,5,6	0	13			As specified in clause 9.1.2-1.
Measurement gap offset		Config 1,2,3,4,5,6	39	39			
SMTC-SSB parameters on NR RF Channel 1		Config 1,4	SSB.1 FR1				As specified in clause A.3.10.1
		Config 2,5	SSB.1 FR1				As specified in clause A.3.10.1
		Config 3,6	SSB.2 FR1				As specified in clause A.3.10.1
SMTC-SSB parameters on NR RF Channel 2		Config 1,2,3,4,5,6	SSB.3 FR2				As specified in clause A.3.10.2
CSI-RS for tracking		Config 1,4	TRS.1.1 FDD				
		Config 2,5	TRS.1.1 TDD				
		Config 3,6	TRS.1.2 TDD				
<i>offsetMO</i>	dB	Config 1,2,3,4,5,6	6				
Hysteresis	dB	Config 1,2,3,4,5,6	0				
<i>a4-Threshold</i>	dBm	Config 1,2,3,4,5,6	-105				
CP length		Config 1,2,3,4,5,6	Normal				
TimeToTrigger	s	Config 1,2,3,4,5,6	0				
Filter coefficient		Config 1,2,3,4,5,6	0				L3 filtering is not used
DRX		Config 1,2,3,4,5,6	DRX .1	DRX .7	DRX .1	DRX .7	As specified in clause A.3.3
Time offset between PCell and PScell		Config 1,2,3,4,5,6	3 μs				Synchronous EN-DC
Time offset between serving and neighbour cells		Config 1,4	3ms				Asynchronous cells. The timing of Cell 3 is 3ms later than the timing of Cell 2.
		Config 2,3,5,6	3μs				Synchronous cells.
T1	s	Config 1,2,3,4,5,6	5				
T2	s	Config 1,2,3,4,5,6	8 for PC1; 5 for other PC	82 for PC1; 52 for other PC	8 for PC1; 5 for other PC	82 for PC1; 52 for other PC	

Table A.5.6.2.6.1-3: Cell specific test parameters for EN-DC inter-frequency event triggered reporting without SSB time index detection

Parameter	Unit	Test configuration	Cell 2		Cell 3	
			T1	T2	T1	T2
AoA setup		Config 1,2,3,4,5,6	N/A		Setup 1 as specified in clause A.3.15	
Assumption for UE beams ^{Note 7}		Config 1,2,3,4,5,6	N/A		Rough	
NR RF Channel Number		Config 1,2,3,4,5,6	1		2	
Duplex mode		Config 1,4	FDD		TDD	
		Config 2,3,5,6	TDD		TDD	
BW _{channel}	MHz	Config 1,4	10: N _{RB,c} = 52		100: N _{RB,c} = 66	
		Config 2,5	10: N _{RB,c} = 52		100: N _{RB,c} = 66	
		Config 3,6	40: N _{RB,c} = 106		100: N _{RB,c} = 66	
BWP BW	MHz	Config 1,4	10: N _{RB,c} = 52		100: N _{RB,c} = 66	
		Config 2,5	10: N _{RB,c} = 52		100: N _{RB,c} = 66	
		Config 3,6	40: N _{RB,c} = 106		100: N _{RB,c} = 66	
Data RBs allocated		Config 1,4	52		66	
		Config 2,5	52		66	
		Config 3,6	106		66	
TDD configuration		Config 2,5	TDDConf.1.1		TDDConf.3.1	
		Config 3,6	TDDConf.2.1		TDDConf.3.1	
Initial DL BWP		Config 1,2,3,4,5,6	DLBWP.0.1		NA	
Initial UL BWP		Config 1,2,3,4,5,6	ULBWP.0.1		NA	
Dedicated DL BWP		Config 1,2,3,4,5,6	DLBWP.1.1		NA	
Dedicated UL BWP		Config 1,2,3,4,5,6	ULBWP.1.1		NA	
OCNG Patterns defined in A.3.2.1.1 (OP.1)		Config 1,2,3,4,5,6	OP.1		OP.1	
PDSCH Reference measurement channel		Config 1,4	SR.1.1 FDD		-	
		Config 2,5	SR.1.1 TDD			
		Config 3,6	SR2.1 TDD			
RMSI CORESET Reference Channel		Config 1,4	CR.1.1 FDD		-	
		Config 2,5	CR.1.1 TDD			
		Config 3,6	CR2.1 TDD			
Dedicated CORESET Reference Channel		Config 1,4	CCR.1.1 FDD		-	
		Config 2,5	CCR.1.1 TDD			
		Config 3,6	CCR.2.1 TDD			
SMTC configuration defined in A.3.11		Config 1,4	SMTC.2		SMTC.2	
		Config 2,3,5,6	SMTC.1		SMTC.1	
PDSCH/PDCCH subcarrier spacing	kHz	Config 1,2,4,5	15		120	
		Config 3,6	30		120	
EPRE ratio of PSS to SSS			0		0	

EPRE ratio of PBCH DMRS to SSS		Config 1,2,3,4,5,6			
EPRE ratio of PBCH to PBCH DMRS					
EPRE ratio of PDCCH DMRS to SSS					
EPRE ratio of PDCCH to PDCCH DMRS					
EPRE ratio of PDSCH DMRS to SSS					
EPRE ratio of PDSCH to PDSCH					
EPRE ratio of OCNG DMRS to SSS(Note 1)					
EPRE ratio of OCNG to OCNG DMRS (Note 1)					
N_{oc} ^{Note2}	dBm/15 kHz Note5		N/A Link only, see clause A.3.7A	-104.7	
N_{oc} ^{Note2}	dBm/S CS Note4	Config 1,2,4,5 Config 3,6		-95.7	
SSB_RP ^{Note3}	dBm/S CS Note5	Config 1,2,4,5		-Infinity	-86.7
		Config 3,6		-Infinity	-86.7
\hat{E}_s / I_{ot}	dB	Config 1,2,3,4,5,6		-Infinity	9
\hat{E}_s / N_{oc}	dB	Config 1,2,3,4,5,6		-Infinity	9
I_o ^{Note3}	dBm/9.36MHz	Config 1,2,4,5		-	-
	dBm/38.16MHz	Config 3,6		-	-
	dBm/95.04 MHz Note5	Config 1,2,3,4,5,6		-66.7	-57.2
Propagation Condition		Config 1,2,3,4,5,6		AWGN	
<p>Note 1: OCNG shall be used such that both cells are fully allocated and a constant total transmitted power spectral density is achieved for all OFDM symbols.</p> <p>Note 2: Interference from other cells and noise sources not specified in the test is assumed to be constant over subcarriers and time and shall be modelled as AWGN of appropriate power for N_{oc} to be fulfilled.</p> <p>Note 3: SSB_RP and I_o levels have been derived from other parameters for information purposes. They are not settable parameters themselves.</p> <p>Note 4: SSB_RP minimum requirements are specified assuming independent interference and noise at each receiver antenna port.</p> <p>Note 5: Equivalent power received by an antenna with 0 dBi gain at the centre of the quiet zone</p> <p>Note 6: As observed with 0 dBi gain antenna at the centre of the quiet zone</p> <p>Note 7: Information about types of UE beam is given in B.2.1.3, and does not limit UE implementation or test system implementation</p>					

A.5.6.2.6.2 Test Requirements

In test 1 with per-UE gap and in test 3 with per-FR gap, the UE shall send one Event A4 triggered measurement report, with a measurement reporting delay less than X1 ms from the beginning of time period T2, where X1 is

7680 for UE supporting power class 1, or

4800 for UE supporting other power class.

In test 2 with per-UE gap and in test 4 with per-FR gap, the UE shall send one Event A4 triggered measurement report, with a measurement reporting delay less than X2 ms from the beginning of time period T2, where X2 is

81920 for UE supporting power class 1, or

51200 for UE supporting other power class.

In test 1, 2, 3 and 4 UE is not required to report SSB time index. The UE shall not send event triggered measurement reports, as long as the reporting criteria are not fulfilled. The rate of correct events observed during repeated tests shall be at least 90%.

NOTE: The actual overall delays measured in the test may be up to $2 \times TTI_{DCCH}$ higher than the measurement reporting delays above because of TTI insertion uncertainty of the measurement report in DCCH.

A.5.6.2.7 EN-DC event triggered reporting tests for FR2 cell with SSB time index detection when DRX is not used

A.5.6.2.7.1 Test Purpose and Environment

The purpose of this test is to verify that the UE makes correct reporting of an event. This test will partly verify the EN-DC inter-frequency NR cell search requirements in clause 9.3.4.

In this test, there are three cells: LTE cell 1 as PCell on E-UTRA RF channel 1, NR cell 2 as PSCell in FR1 on NR RF channel 1 and NR cell 3 as neighbour cell in FR2 on NR RF channel 2. The test parameters and configurations are given in Tables A.5.6.2.7.1-1, A.5.6.2.7.1-2, and A.5.6.2.7.1-3.

In test 1 measurement gap pattern configuration # 0 as defined in Table A.5.6.2.7.1-2 is provided for a UE that does not support per-FR gap and in test 2 measurement gap pattern configuration #13 as defined in Table A.5.6.2.7.1-2 is provided for UE that support per-FR gap. If a UE supports per-FR gap and gap pattern configuration #13, it is only required to pass test 2. Otherwise it is only required to pass test 1.

In the measurement control information, it is indicated to the UE that event-triggered reporting with Event A4 is used. The test consists of two successive time periods, with time duration of T1, and T2 respectively. During time duration T1, the UE shall not have any timing information of NR cell 3.

The configuration of LTE cell 1 is defined in table A.3.7.2.1-1. Supported test configurations are shown in table A.5.6.2.7.1-1.

Table A.5.6.2.7.1-1: EN-DC event triggered reporting tests with SSB index reading for FR1-FR2

Config	Description of serving cell	Description of target cell
1	LTE FDD, NR 15 kHz SSB SCS, 10 MHz bandwidth, FDD duplex mode	120 kHz SSB SCS, 100 MHz bandwidth, TDD duplex mode
2	LTE FDD, NR 15 kHz SSB SCS, 10 MHz bandwidth, TDD duplex mode	
3	LTE FDD, NR 30 kHz SSB SCS, 40 MHz bandwidth, TDD duplex mode	
4	LTE TDD, NR 15 kHz SSB SCS, 10 MHz bandwidth, FDD duplex mode	
5	LTE TDD, NR 15 kHz SSB SCS, 10 MHz bandwidth, TDD duplex mode	
6	LTE TDD, NR 30 kHz SSB SCS, 40 MHz bandwidth, TDD duplex mode	
Note: The UE is only required to be tested in one of the supported test configurations		

Table A.5.6.2.7.1-2: General test parameters for EN-DC inter-frequency event triggered reporting with SSB time index detection

Parameter	Unit	Test configuration	Value		Comment
			Test 1	Test 2	
E-UTRA RF Channel Number		Config 1,2,3,4,5,6	1		One E-UTRAN TDD carrier frequency is used.
NR RF Channel Number		Config 1,2,3,4,5,6	1, 2		One FR1 and one FR2 NR carrier frequency is used.
Active cell		Config 1,2,3,4,5,6	LTE Cell 1 (PCell) and NR cell 2 (PScell)		LTE Cell 1 is on E-UTRA RF channel number 1. NR Cell 2 is on NR RF channel number 1.
Neighbour cell		Config 1,2,3,4,5,6	NR cell 3		NR cell 3 is on NR RF channel number 2.
Gap Pattern Id		Config 1,2,3,4,5,6	0	13	As specified in clause 9.1.2-1.
Measurement gap offset		Config 1,2,3,4,5,6	39	39	
SMTC-SSB parameters on NR RF Channel 1		Config 1,4	SSB.1 FR1		As specified in clause A.3.10.1
		Config 2,5	SSB.1 FR1		As specified in clause A.3.10.1
		Config 3,6	SSB.2 FR1		As specified in clause A.3.10.1
SMTC-SSB parameters on NR RF Channel 2		Config 1,2,3,4,5,6	SSB.3 FR2		As specified in clause A.3.10.2
CSI-RS for tracking		Config 1,4	TRS.1.1 FDD		
		Config 2,5	TRS.1.1 TDD		
		Config 3,6	TRS.1.2 TDD		
<i>offsetMO</i>	dB	Config 1,2,3,4,5,6	6		
Hysteresis	dB	Config 1,2,3,4,5,6	0		
<i>a4-Threshold</i>	dBm	Config 1,2,3,4,5,6	-105		
CP length		Config 1,2,3,4,5,6	Normal		
TimeToTrigger	s	Config 1,2,3,4,5,6	0		
Filter coefficient		Config 1,2,3,4,5,6	0		L3 filtering is not used
DRX		Config 1,2,3,4,5,6	OFF		DRX is not used
Time offset between PCell and PScell		Config 1,2,3,4,5,6	3 μ s		Synchronous EN-DC
Time offset between serving and neighbour cells		Config 1,4	3ms		Asynchronous cells. The timing of Cell 3 is 3ms later than the timing of Cell 2.
		Config 2,3,5,6	3 μ s		Synchronous cells.
T1	s	Config 1,2,3,4,5,6	5		

T2	s	Config 1,2,3,4,5,6	7 for PC1; 4.5 for other PC	7 for PC1; 4.5 for other PC	
----	---	--------------------	-----------------------------	-----------------------------	--

Table A.5.6.2.7.1-3: Cell specific test parameters for EN-DC inter-frequency event triggered reporting with SSB time index detection

Parameter	Unit	Test configuration	Cell 2		Cell 3	
			T1	T2	T1	T2
AoA setup		Config 1,2,3,4,5,6	N/A		Setup 1 as specified in clause A.3.15	
Assumption for UE beams ^{Note 7}		Config 1,2,3,4,5,6	N/A		Rough	
NR RF Channel Number		Config 1,2,3,4,5,6	1		2	
Duplex mode		Config 1,4	FDD		TDD	
		Config 2,3,5,6	TDD		TDD	
BW _{channel}	MHz	Config 1,4	10: N _{RB,c} = 52		100: N _{RB,c} = 66	
		Config 2,5	10: N _{RB,c} = 52		100: N _{RB,c} = 66	
		Config 3,6	40: N _{RB,c} = 106		100: N _{RB,c} = 66	
BWP BW	MHz	Config 1,4	10: N _{RB,c} = 52		100: N _{RB,c} = 66	
		Config 2,5	10: N _{RB,c} = 52		100: N _{RB,c} = 66	
		Config 3,6	40: N _{RB,c} = 106		100: N _{RB,c} = 66	
Data RBs allocated		Config 1,4	52		66	
		Config 2,5	52		66	
		Config 3,6	106		66	
OCNG Patterns defined in A.3.2.1.1 (OP.1)		Config 1,2,3,4,5,6	OP.1		OP.1	
PDSCH Reference measurement channel		Config 1,4	SR.1.1 FDD		-	
		Config 2,5	SR.1.1 TDD			
		Config 3,6	SR2.1 TDD			
RMSI CORESET Reference Channel		Config 1,4	CR.1.1 FDD		-	
		Config 2,5	CR.1.1 TDD			
		Config 3,6	CR2.1 TDD			
Dedicated CORESET Reference Channel		Config 1,4	CCR.1.1 FDD		-	
		Config 2,5	CCR.1.1 TDD			
		Config 3,6	CCR.2.1 TDD			
TDD configuration		Config 2,5	TDDConf.1.1		TDDConf.3.1	
		Config 3,6	TDDConf.2.1		TDDConf.3.1	
Initial DL BWP		Config 1,2,3,4,5,6	DLBWP.0.1		NA	
Initial UL BWP		Config 1,2,3,4,5,6	ULBWP.0.1		NA	
Dedicated DL BWP		Config 1,2,3,4,5,6	DLBWP.1.1		NA	
Dedicated UL BWP		Config 1,2,3,4,5,6	ULBWP.1.1		NA	
SMTC configuration defined in A.3.11		Config 1,4	SMTC.2		SMTC.2	

		Config 2,3,5,6	SMTC.1	SMTC.1	
PDSCH/PDCCH subcarrier spacing	kHz	Config 1,2,4,5	15	120	
		Config 3,6	30	120	
EPRE ratio of PSS to SSS		Config 1,2,3,4,5,6	0	0	
EPRE ratio of PBCH DMRS to SSS					
EPRE ratio of PBCH to PBCH DMRS					
EPRE ratio of PDCCH DMRS to SSS					
EPRE ratio of PDCCH to PDCCH DMRS					
EPRE ratio of PDSCH DMRS to SSS					
EPRE ratio of PDSCH to PDSCH					
EPRE ratio of OCNG DMRS to SSS(Note 1)					
EPRE ratio of OCNG to OCNG DMRS (Note 1)					
\hat{E}_s	dBm/S CS	Config 1,2,3,4,5,6	Link only, see clause A.3.7A	-Infinity	-87
SSB_RP ^{Note 3}	dBm/S CS Note5	Config 1,2,3,4,5,6		-Infinity	-87
$\hat{E}_s / I_{ot, BB}$ ^{Note 8}	dB	Config 1,2,3,4,5,6		-Infinity	14.69
I_o ^{Note3}	dBm/95 .04 MHz Note5	Config 1,2,3,4,5,6		-Infinity	-58.01
Propagation Condition		Config 1,2,3,4,5,6		No external noise (Note 9)	
<p>Note 1: OCNG shall be used such that both cells are fully allocated and a constant total transmitted power spectral density is achieved for all OFDM symbols.</p> <p>Note 2: Void</p> <p>Note 3: SS-RP, E_s/I_o and I_o levels have been derived from other parameters for information purposes. They are not settable parameters themselves.</p> <p>Note 4: Void</p> <p>Note 5: Equivalent power received by an antenna with 0dBi gain at the centre of the quiet zone</p> <p>Note 6: As observed with 0dBi gain antenna at the centre of the quiet zone</p> <p>Note 7: Information about types of UE beam is given in B.2.1.3, and does not limit UE implementation or test system implementation</p> <p>Note 8: Calculation of $E_s/I_{ot, BB}$ includes the effect of UE internal noise up to the value assumed for the associated Refsens requirement in clause 7.3.2 of TS 38.101-2 [19], and an allowance of 1dB for UE multi-band relaxation factor ΔMBs from TS 38.101-2 [19] Table 6.2.1.3-4.</p> <p>Note 9: The downlink connection between the System Simulator and the UE is without Additive White Gaussian Noise, and has no fading or multipath effects as specified in TS 38.521-2 B.0 [29].</p>					

A.5.6.2.7.2 Test Requirements

In test 1 with per-UE gap and in test 2 with per-FR gap, the UE shall send one Event A4 triggered measurement report, with a measurement reporting delay less than X ms from the beginning of time period T2, where X is

6720 for UE supporting power class 1, or

4160 for UE supporting other power class.

In test 1 and 2 UE is required to report SSB time index. The UE shall not send event triggered measurement reports, as long as the reporting criteria are not fulfilled. The rate of correct events observed during repeated tests shall be at least 90%.

NOTE: The actual overall delays measured in the test may be up to $2 \times TTI_{DCCH}$ higher than the measurement reporting delays above because of TTI insertion uncertainty of the measurement report in DCCH.

A.5.6.2.8 EN-DC event triggered reporting tests for FR2 cell with SSB time index detection when DRX is used

A.5.6.2.8.1 Test Purpose and Environment

The purpose of this test is to verify that the UE makes correct reporting of an event. This test will partly verify the EN-DC inter-frequency NR cell search requirements in clause 9.3.4.

In this test, there are three cells: LTE cell 1 as PCell on E-UTRA RF channel 1, NR cell 2 as PSCell in FR1 on NR RF channel 1 and NR cell 3 as neighbour cell in FR2 on NR RF channel 2. The test parameters and configurations are given in Tables A.5.6.2.8.1-1, A.5.6.2.8.1-2, and A.5.6.2.8.1-3.

In test 1&2 measurement gap pattern configuration # 0 as defined in Table A.5.6.2.8.1-2 is provided for a UE that does not support per-FR gap and in test 3&4 measurement gap pattern configuration #13 as defined in Table A.5.6.2.8.1-2 is provided for UE that support per-FR gap. If a UE supports per-FR gap and gap pattern configuration #13, it is only required to pass test 3&4. Otherwise it is only required to pass test 1&2.

In the measurement control information, it is indicated to the UE that event-triggered reporting with Event A4 is used. The test consists of two successive time periods, with time duration of T1, and T2 respectively. During time duration T1, the UE shall not have any timing information of NR cell 3.

The configuration of LTE cell 1 is defined in table A.3.7.2.1-1. Supported test configurations are shown in table A.5.6.2.8.1-1.

UE needs to be provided with new Timing Advance Command MAC control element at least once during each time alignment timer period to maintain uplink time alignment. Furthermore UE is allocated with PUSCH resource at every DRX cycle.

Table A.5.6.2.8.1-1: EN-DC event triggered reporting tests without SSB index reading for FR1-FR2

Config	Description of serving cell	Description of target cell
1	LTE FDD, NR 15 kHz SSB SCS, 10 MHz bandwidth, FDD duplex mode	120 kHz SSB SCS, 100 MHz bandwidth, TDD duplex mode
2	LTE FDD, NR 15 kHz SSB SCS, 10 MHz bandwidth, TDD duplex mode	
3	LTE FDD, NR 30 kHz SSB SCS, 40 MHz bandwidth, TDD duplex mode	
4	LTE TDD, NR 15 kHz SSB SCS, 10 MHz bandwidth, FDD duplex mode	
5	LTE TDD, NR 15 kHz SSB SCS, 10 MHz bandwidth, TDD duplex mode	
6	LTE TDD, NR 30 kHz SSB SCS, 40 MHz bandwidth, TDD duplex mode	
Note: The UE is only required to be tested in one of the supported test configurations		

Table A.5.6.2.8.1-2: General test parameters for EN-DC inter-frequency event triggered reporting with SSB time index detection

Parameter	Unit	Test configuration	Value				Comment
			Test 1	Test 2	Test 3	Test 4	
E-UTRA RF Channel Number		Config 1,2,3,4,5,6	1				One E-UTRAN TDD carrier frequency is used.
NR RF Channel Number		Config 1,2,3,4,5,6	1, 2				One FR1 and one FR2 NR carrier frequency is used.
Active cell		Config 1,2,3,4,5,6	LTE Cell 1 (PCell) and NR cell 2 (PScell)				LTE Cell 1 is on E-UTRA RF channel number 1. NR Cell 2 is on NR RF channel number 1.
Neighbour cell		Config 1,2,3,4,5,6	NR cell 3				NR cell 3 is on NR RF channel number 2.
Gap Pattern Id		Config 1,2,3,4,5,6	0		13		As specified in clause 9.1.2-1.
Measurement gap offset		Config 1,2,3,4,5,6	39		39		
SMTC-SSB parameters on NR RF Channel 1		Config 1,4	SSB.1 FR1				As specified in clause A.3.10.1
		Config 2,5	SSB.1 FR1				As specified in clause A.3.10.1
		Config 3,6	SSB.2 FR1				As specified in clause A.3.10.1
SMTC-SSB parameters on NR RF Channel 2		Config 1,2,3,4,5,6	SSB.3 FR2				As specified in clause A.3.10.2
CSI-RS for tracking		Config 1,4	TRS.1.1 FDD				
		Config 2,5	TRS.1.1 TDD				
		Config 3,6	TRS.1.2 TDD				
<i>offsetMO</i>	dB	Config 1,2,3,4,5,6	6				
Hysteresis	dB	Config 1,2,3,4,5,6	0				
<i>a4-Threshold</i>	dBm	Config 1,2,3,4,5,6	-105				
CP length		Config 1,2,3,4,5,6	Normal				
TimeToTrigger	s	Config 1,2,3,4,5,6	0				
Filter coefficient		Config 1,2,3,4,5,6	0				L3 filtering is not used
DRX		Config 1,2,3,4,5,6	DRX .1	DRX .7	DRX .1	DRX .7	As specified in clause A.3.3
Time offset between PCell and PScell		Config 1,2,3,4,5,6	3 μs				Synchronous EN-DC
Time offset between serving and neighbour cells		Config 1,4	3ms				Asynchronous cells. The timing of Cell 3 is 3ms later than the timing of Cell 2.
		Config 2,3,5,6	3μs				Synchronous cells.
T1	s	Config 1,2,3,4,5,6	5				

T2	s	Config 1,2,3,4,5,6	11 for PC1; 6.5 for other PC	108 for PC1; 67 for other PC	11 for PC1; 6.5 for other PC	108 for PC1; 67 for other PC	
----	---	--------------------	------------------------------	------------------------------	------------------------------	------------------------------	--

Table A.5.6.2.8.1-3: Cell specific test parameters for EN-DC inter-frequency event triggered reporting with SSB time index detection

Parameter	Unit	Test configuration	Cell 2		Cell 3	
			T1	T2	T1	T2
AoA setup		Config 1,2,3,4,5,6	N/A		Setup 1 as specified in clause A.3.15	
Assumption for UE beams ^{Note 7}		Config 1,2,3,4,5,6	N/A		Rough	
NR RF Channel Number		Config 1,2,3,4,5,6	1		2	
Duplex mode		Config 1,4	FDD		TDD	
		Config 2,3,5,6	TDD		TDD	
BW _{channel}	MHz	Config 1,4	10: N _{RB,c} = 52		100: N _{RB,c} = 66	
		Config 2,5	10: N _{RB,c} = 52		100: N _{RB,c} = 66	
		Config 3,6	40: N _{RB,c} = 106		100: N _{RB,c} = 66	
BWP BW	MHz	Config 1,4	10: N _{RB,c} = 52		100: N _{RB,c} = 66	
		Config 2,5	10: N _{RB,c} = 52		100: N _{RB,c} = 66	
		Config 3,6	40: N _{RB,c} = 106		100: N _{RB,c} = 66	
Data RBs allocated		Config 1,4	52		66	
		Config 2,5	52		66	
		Config 3,6	106		66	
OCNG Patterns defined in A.3.2.1.1 (OP.1)		Config 1,2,3,4,5,6	OP.1		OP.1	
PDSCH Reference measurement channel		Config 1,4	SR.1.1 FDD		-	
		Config 2,5	SR.1.1 TDD			
		Config 3,6	SR2.1 TDD			
RMSI CORESET Reference Channel		Config 1,4	CR.1.1 FDD		-	
		Config 2,5	CR.1.1 TDD			
		Config 3,6	CR2.1 TDD			
Dedicated CORESET Reference Channel		Config 1,4	CCR.1.1 FDD		-	
		Config 2,5	CCR.1.1 TDD			
		Config 3,6	CCR.2.1 TDD			
TDD configuration		Config 2,5	TDDConf.1.1		TDDConf.3.1	
		Config 3,6	TDDConf.2.1		TDDConf.3.1	
Initial DL BWP		Config 1,2,3,4,5,6	DLBWP.0.1		NA	
Initial UL BWP		Config 1,2,3,4,5,6	ULBWP.0.1		NA	
Dedicated DL BWP		Config 1,2,3,4,5,6	DLBWP.1.1		NA	

Dedicated UL BWP		Config 1,2,3,4,5,6	ULBWP.1.1	NA	
SMTC configuration defined in A.3.11		Config 1,4	SMTC.2	SMTC.2	
		Config 2,3,5,6	SMTC.1	SMTC.1	
PDSCH/PDCCH subcarrier spacing	kHz	Config 1,2,4,5	15	120	
		Config 3,6	30	120	
EPRE ratio of PSS to SSS		Config 1,2,3,4,5,6	0	0	
EPRE ratio of PBCH DMRS to SSS					
EPRE ratio of PBCH to PBCH DMRS					
EPRE ratio of PDCCH DMRS to SSS					
EPRE ratio of PDCCH to PDCCH DMRS					
EPRE ratio of PDSCH DMRS to SSS					
EPRE ratio of PDSCH to PDSCH					
EPRE ratio of OCNG DMRS to SSS(Note 1)					
EPRE ratio of OCNG to OCNG DMRS (Note 1)					
N_{oc} ^{Note2}	dBm/15 kHz ^{Note5}		N/A Link only, see clause A.3.7A	-104.7	
N_{oc} ^{Note2}	dBm/S CS ^{Note4}	Config 1,2,4,5		-95.7	
		Config 3,6		-95.7	
SSB_RP ^{Note 3}	dBm/S CS ^{Note5}	Config 1,2,4,5		-Infinity	-86.7
		Config 3,6		-Infinity	-86.7
\hat{E}_s / I_{ot}	dB	Config 1,2,3,4,5,6		-Infinity	9
\hat{E}_s / N_{oc}	dB	Config 1,2,3,4,5,6		-Infinity	9
I_o ^{Note3}	dBm/9.36MHz	Config 1,2,4,5		-	-
	dBm/38.16MHz	Config 3,6		-	-
	dBm/95.04 MHz ^{Note5}	Config 1,2,3,4,5,6		-66.7	-57.2
Propagation Condition		Config 1,2,3,4,5,6	AWGN		

Note 1:	OCNG shall be used such that both cells are fully allocated and a constant total transmitted power spectral density is achieved for all OFDM symbols.
Note 2:	Interference from other cells and noise sources not specified in the test is assumed to be constant over subcarriers and time and shall be modelled as AWGN of appropriate power for N_{oc} to be fulfilled.
Note 3:	SSB_RP and lo levels have been derived from other parameters for information purposes. They are not settable parameters themselves.
Note 4:	SSB_RP minimum requirements are specified assuming independent interference and noise at each receiver antenna port.
Note 5:	Equivalent power received by an antenna with 0dBi gain at the centre of the quiet zone
Note 6:	As observed with 0dBi gain antenna at the centre of the quiet zone
Note 7:	Information about types of UE beam is given in B.2.1.3, and does not limit UE implementation or test system implementation

A.5.6.2.8.2 Test Requirements

In test 1 with per-UE gap and in test 3 with per-FR gap, the UE shall send one Event A4 triggered measurement report, with a measurement reporting delay less than X1 ms from the beginning of time period T2, where X1 is

10080 for UE supporting power class 1, or

6240 for UE supporting other power class.

In test 2 with per-UE gap and in test 4 with per-FR gap, the UE shall send one Event A4 triggered measurement report, with a measurement reporting delay less than X2 ms from the beginning of time period T2, where X2 is

107520 for UE supporting power class 1, or

66560 for UE supporting other power class.

In test 1, 2, 3 and 4 UE is required to report SSB time index. The UE shall not send event triggered measurement reports, as long as the reporting criteria are not fulfilled. The rate of correct events observed during repeated tests shall be at least 90%.

NOTE: The actual overall delays measured in the test may be up to $2xTTI_{DCCCH}$ higher than the measurement reporting delays above because of TTI insertion uncertainty of the measurement report in DCCCH.

A.5.6.3 L1-RSRP measurement for beam reporting

A.5.6.3.1 SSB based L1-RSRP measurement when DRX is not used

A.5.6.3.1.1 Test Purpose and Environment

The purpose of this test is to verify that the UE makes correct reporting of L1-RSRP measurement. This test will partly verify the L1-RSRP measurement requirements in clause 9.5.4.1, with the testing configurations for NR cells in Table A.5.6.3.1.1-1.

The AoA setup for this test is Setup 1 as defined in clause A.3.15

Table A.5.6.3.1.1-1: Applicable NR configurations for FR2 SSB based L1-RSRP test

Config	Description
1	LTE FDD, NR 120 kHz SSB SCS, 100 MHz bandwidth, TDD duplex mode
2	LTE TDD, NR 120 kHz SSB SCS, 100 MHz bandwidth, TDD duplex mode
3	LTE FDD, NR 240 kHz SSB SCS, 100 MHz bandwidth, TDD duplex mode
4	LTE TDD, NR 240 kHz SSB SCS, 100 MHz bandwidth, TDD duplex mode

Note: The UE is only required to be tested in one of the supported test configurations
--

A.5.6.3.1.2 Test parameters

There are two cells in the test, E-UTRAN PCell (Cell 1) and FR2 PCell (Cell 2). The test parameters and applicability for Cell 1 are defined in A.3.7.2. The test parameters for the Cell 2 are given in Table A.5.6.3.1.2-1 and Table A.5.6.3.1.2-2 below.

In CSI measurement configuration, UE is indicated to perform L1-RSRP measurement on the SSBs and report periodically. The test consists of two successive time periods, with time duration of T1 and T2 respectively. The test has higher layer parameter *timeRestrictionForChannelMeasurements* configured.

There is no measurement gap configured in the test. Before the test, UE is configured to perform RLM, BFD and L1-RSRP measurement based on the SSBs.

Table A.5.6.3.1.2-1: General test parameters

Parameter	Config	Unit	Value
SSB GSCN	1~4		freq1
Duplex mode	1~4		TDD
TDD Configuration	1~4		TDDConf.3.1
BW _{channel}	1~4	MHz	100: N _{RB,c} = 66
Data RBs allocated	1~4		66
PDSCH Reference measurement channel	1,2		SR.3.2 TDD
	3,4		SR.3.3 TDD
RMSI CORESET Reference Channel	1,2		CR.3.1 TDD
	3,4		CR.3.2 TDD
Dedicated CORESET Reference Channel	1~4		CCR.3.1 TDD
	3,4		CCR.3.7 TDD
SSB configuration	1,2		SSB.1 FR2
	3,4		SSB.2 FR2
OCNG Patterns	1~4		OP.1
Initial BWP Configuration	1~4		DLBWP.0.1
			ULBWP.0.1
Dedicated BWP configuration	1~4		DLBWP.1.3
			ULBWP.1.3
SMTc configuration	1~4		SMTc.1
TRS Configuration	1~4		TRS.2.1 TDD
PDCCH/PDSCH TCI Configuration	1~4		TCI.State.2
DRX configuration	1~4		Off
reportConfigType	1~4		periodic
reportQuantity	1~4		ssb-Index-RSRP
Number of reported RS	1~4		2
L1-RSRP reporting period	1~4	slot	320
T1	1~4	s	5
T2	1~4	s	2
EPRE ratio of PSS to SSS	1~4	dB	0
EPRE ratio of PBCH DMRS to SSS			
EPRE ratio of PBCH to PBCH DMRS			
EPRE ratio of PDCCH DMRS to SSS			
EPRE ratio of PDCCH to PDCCH DMRS			
EPRE ratio of PDSCH DMRS to SSS			
EPRE ratio of PDSCH to PDSCH DMRS			
EPRE ratio of OCNG DMRS to SSS ^{Note 1}			

EPRE ratio of OCNG to OCNG DMRS ^{Note 1}			
Propagation condition	1~4		AWGN
Note 1: OCNG shall be used such that both cells are fully allocated and a constant total transmitted power spectral density is achieved for all OFDM symbols.			

Table A.5.6.3.1.2-2: SSB specific test parameters

Parameter	Config	Unit	SSB#0		SSB#1	
			T1	T2	T1	T2
Angle of arrival configuration			Setup 1 according to A.3.15.1			
Assumption for UE beams ^{Note 4}	1~4		Rough			
N_{oc} ^{Note2}	1~4	dBm/15kHz	-105			
N_{oc} ^{Note2}	1,2	dBm/SSB SCS	-96			
	3,4		-93			
\hat{E}_s / I_{ot}	1~4	dB	0	0	-Infinity	9
SSB_RP ^{Note3}	1,2	dBm/SSB SCS	-96	-96	-Infinity	-87
	3,4		-93	-93	-Infinity	-84
I_o ^{Note3}	1,2	dBm/95.04MHz	-63.97	-63.97	-66.98	-57.47
	3,4		-63.97	-63.97	-66.98	-57.47
\hat{E}_s / N_{oc}	1~4	dB	0	0	-Infinity	9
<p>Note 1: The resources for uplink transmission are assigned to the UE prior to the start of time period T2.</p> <p>Note 2: Interference from other cells and noise sources not specified in the test is assumed to be constant over subcarriers and time and shall be modelled as AWGN of appropriate power for N_{oc} to be fulfilled.</p> <p>Note 3: SSB_RP and I_o levels have been derived from other parameters for information purposes. They are not settable parameters themselves.</p> <p>Note 4: Information about types of UE beam is given in B.2.1.3, and does not limit UE implementation or test system implementation</p>						

A.5.6.3.1.3 Test Requirements

A.5.6.3.1.3 Test Requirements

The UE shall send L1-RSRP report every 320 slots. No later than X ms plus 320 slots from the beginning of time period T2, UE shall send L1-RSRP report including the results for both SSB#0 and SSB#1 while meeting the accuracy requirements defined in clause 10.1.20.1, where X is

- 1680 for UE supporting power class 1
- 1200 for UE supporting power class 2,3 or 4.

The reported L1-RSRP value shall include the Rx antenna gain in the range of -10 to +20 dB.

The rate of correct events observed during repeated tests shall be at least 90%.

A.5.6.3.2 SSB based L1-RSRP measurement when DRX is used

A.5.6.3.2.1 Test Purpose and Environment

The purpose of this test is to verify that the UE makes correct reporting of L1-RSRP measurement. This test will partly verify the L1-RSRP measurement requirements in clause 9.5.4.1, with the testing configurations for NR cells in Table A.5.6.3.2.1-1.

The AoA setup for this test is Setup 1 as defined in clause A.3.15

Table A.5.6.3.2.1-1: Applicable NR configurations for FR2 SSB based L1-RSRP test

Config	Description
1	LTE FDD, NR 120 kHz SSB SCS, 100 MHz bandwidth, TDD duplex mode
2	LTE TDD, NR 120 kHz SSB SCS, 100 MHz bandwidth, TDD duplex mode
3	LTE FDD, NR 240 kHz SSB SCS, 100 MHz bandwidth, TDD duplex mode
4	LTE TDD, NR 240 kHz SSB SCS, 100 MHz bandwidth, TDD duplex mode
Note:	The UE is only required to be tested in one of the supported test configurations

A.5.6.3.2.2 Test parameters

There are two cells in the test, E-UTRAN PCell (Cell 1) and FR2 PSCell (Cell 2). The test parameters and applicability for Cell 1 are defined in A.3.7.2. The test parameters for the Cell 2 are given in Table A.5.6.3.2.2-1 and Table A.5.6.3.2.2-2 below.

In CSI measurement configuration, UE is indicated to perform L1-RSRP measurement on the SSBs and report periodically. The test consists of two successive time periods, with time duration of T1 and T2 respectively. The test has higher layer parameter *timeRestrictionForChannelMeasurements* configured.

There is no measurement gap configured in the test. Before the test, UE is configured to perform RLM, BFD and L1-RSRP measurement based on the SSBs.

Table A.5.6.3.2.2-1: General test parameters

Parameter	Config	Unit	Value
SSB GSCN	1~4		freq1
Duplex mode	1~4		TDD
TDD Configuration	1~4		TDDConf.3.1
BW _{channel}	1~4	MHz	100: N _{RB,c} = 66
Data RBs allocated	1~4		66
PDSCH Reference measurement channel	1,2		SR.3.2 TDD
	3,4		SR.3.3 TDD
RMSI CORESET Reference Channel	1,2		CR.3.1 TDD
	3,4		CR.3.2 TDD
Dedicated CORESET Reference Channel	1,2		CCR.3.1 TDD
	3,4		CCR.3.7 TDD
SSB configuration	1,2		SSB.1 FR2
	3,4		SSB.2 FR2
OCNG Patterns	1~4		OP.1
Initial BWP Configuration	1~4		DLBWP.0.1
			ULBWP.0.1
Dedicated BWP configuration	1~4		DLBWP.1.3
			ULBWP.1.3
SMTc configuration	1~4		SMTc.1
TRS Configuration	1~4		TRS.2.1 TDD

PDCCH/PDSCH TCI Configuration	1~4		TCI.State.2
DRX configuration	1~4		DRX.3
reportConfigType	1~4		periodic
reportQuantity	1~4		ssb-Index-RSRP
Number of reported RS	1~4		2
L1-RSRP reporting period	1~4	slot	320
T1	1~4	s	5
T2	1~4	s	3
EPRE ratio of PSS to SSS	1~4	dB	0
EPRE ratio of PBCH DMRS to SSS			
EPRE ratio of PBCH to PBCH DMRS			
EPRE ratio of PDCCH DMRS to SSS			
EPRE ratio of PDCCH to PDCCH DMRS			
EPRE ratio of PDSCH DMRS to SSS			
EPRE ratio of PDSCH to PDSCH DMRS			
EPRE ratio of OCNG DMRS to SSS ^{Note 1}			
EPRE ratio of OCNG to OCNG DMRS ^{Note 1}			
Propagation condition			
Note 1: OCNG shall be used such that both cells are fully allocated and a constant total transmitted power spectral density is achieved for all OFDM symbols.			

Table A.5.6.3.2.2-2: SSB specific test parameters

Parameter	Config	Unit	SSB#0		SSB#1	
			T1	T2	T1	T2
Angle of arrival configuration			Setup 1 according to A.3.15.1			
Assumption for UE beams ^{Note 4}	1~4		Rough			
N_{oc} ^{Note2}	1~4	dBm/15kHz	-105			
N_{oc} ^{Note2}	1,2	dBm/SSB SCS	-96			
	3,4		-93			
\hat{E}_s / I_{ot}	1~4	dB	0	0	-Infinity	9
SSB_RP ^{Note3}	1,2	dBm/SSB SCS	-96	-96	-Infinity	-87
	3,4		-93	-93	-Infinity	-84
I_o ^{Note3}	1,2	dBm/95.04MHz	-63.97	-63.97	-66.98	-57.47
	3,4		-63.97	-63.97	-66.98	-57.47
\hat{E}_s / N_{oc}	1~4	dB	0	0	-Infinity	9
<p>Note 1: The resources for uplink transmission are assigned to the UE prior to the start of time period T2.</p> <p>Note 2: Interference from other cells and noise sources not specified in the test is assumed to be constant over subcarriers and time and shall be modelled as AWGN of appropriate power for N_{oc} to be fulfilled.</p> <p>Note 3: SSB_RP and I_o levels have been derived from other parameters for information purposes. They are not settable parameters themselves.</p> <p>Note 4: Information about types of UE beam is given in B.2.1.3, and does not limit UE implementation or test system implementation</p>						

A.5.6.3.2.3 Test Requirements

The UE shall send L1-RSRP report every 320 slots. No later than X ms plus 320 slots from the beginning of time period T2, UE shall send L1-RSRP report including the results for both SSB#0 and SSB#1 while meeting the accuracy requirements defined in clause 10.1.20.1, where X is

- 2880 for UE supporting power class 1
- 1920 for UE supporting power class 2,3 or 4.

The reported L1-RSRP value shall include the Rx antenna gain in the range of -10 to +20 dB.

The rate of correct events observed during repeated tests shall be at least 90%.

A.5.6.3.3 CSI-RS based L1-RSRP measurement when DRX is not used

A.5.6.3.3.1 Test Purpose and Environment

The purpose of this test is to verify that the UE makes correct reporting of L1-RSRP measurement. This test will partly verify the L1-RSRP measurement requirements in clause 9.5.4.2, with the testing configurations for NR cells in Table A.5.6.3.3.1-1.

Table A.5.6.3.3.1-1: Applicable NR configurations for FR2 CSI-RS based L1-RSRP test

Config	Description
1	LTE FDD, NR 120 kHz SSB SCS, 100 MHz bandwidth, TDD duplex mode
2	LTE TDD, NR 120 kHz SSB SCS, 100 MHz bandwidth, TDD duplex mode
Note:	The UE is only required to be tested in one of the supported test configurations

A.5.6.3.3.2 Test parameters

There are two cells in the test, E-UTRAN PCell (Cell 1) and FR1 PSCell (Cell 2). The test parameters and applicability for Cell 1 are defined in A.3.7.2. The test parameters for the Cell 2 are given in Table A.5.6.3.3.2-1 and Table A.5.6.3.3.2-2 below.

In CSI measurement configuration, UE is indicated to perform L1-RSRP measurement on the CSI-RS and report aperiodically. The test consists of a single time period T1, during which the UE is triggered via DCI to report L1-RSRP on aperiodic CSI-RS resources. UE is also configured to measure L1-RSRP based on SSB. After 480ms from the beginning of the test, the DCI trigger comes in slot 1 of a frame and UE provides the report back based on the reporting configuration as defined in Table A.5.6.3.3.2-1.

There is no measurement gap configured in the test. Before the test, UE is configured to perform RLM and BFD based on the SSBs.

Table A.5.6.3.3.2-1: General test parameters

Parameter	Config	Unit	Value
SSB GSCN	1~2		freq1
Duplex mode	1~2		TDD
TDD Configuration	1~2		TDDConf.3.1
BW _{channel}	1~2	MHz	100: N _{RB,c} = 66
Data RBs allocated	1~2		66
PDSCH Reference measurement channel	1~2		SR.3.3 TDD

RMSI CORESET Reference Channel	1~2		CR.3.2 TDD
Dedicated CORESET Reference Channel	1~2		CCR.3.7 TDD
SSB configuration	1~2		SSB.1 FR2
CSI-RS configuration	1~2		CSI-RS.3.3 TDD
OCNG Patterns	1~2		OP.1
Initial BWP Configuration	1~2		DLBWP.0.1 ULBWP.0.1
Dedicated BWP configuration	1~2		DLBWP.1.1 ULBWP.1.1
SMTC configuration	1~2		SMTC.1
TRS Configuration	1~2		TRS.2.1 TDD
PDCCH/PDSCH TCI Configuration	1~2		TCI.State.2
DRX configuration	1~2		Off
reportConfigType	1~2		aperiodic
reportQuantity	1~2		cri-RSRP
Number of reported RS	1~2		2
qcl-Info	1~2		SSB#0 for resource#0
			SSB#1 for resource#1
reportSlotOffsetList	1~2		8
Propagation condition	1~2		AWGN
T1	1~2	s	5
EPRE ratio of PSS to SSS	1~2	dB	0
EPRE ratio of PBCH DMRS to SSS			
EPRE ratio of PBCH to PBCH DMRS			
EPRE ratio of PDCCH DMRS to SSS			
EPRE ratio of PDCCH to PDCCH DMRS			
EPRE ratio of PDSCH DMRS to SSS			
EPRE ratio of PDSCH to PDSCH DMRS			
EPRE ratio of OCNG DMRS to SSS ^{Note 1}			
EPRE ratio of OCNG to OCNG DMRS ^{Note 1}			
Note 1: OCNG shall be used such that both cells are fully allocated and a constant total transmitted power spectral density is achieved for all OFDM symbols.			

Table A.5.6.3.3.2-1: CSI-RS specific test parameters

Parameter	Config	Unit	CSI-RS#0	CSI-RS#1
Angle of arrival configuration	1~2		Setup 1 according to A.3.15.1	
Assumption for UE beams ^{Note 4}	1~2		Rough	
N_{oc} ^{Note1}	1~2	dBm/15kHz	-105	
N_{oc} ^{Note1}	1~2	dBm/SSB SCS	-95.97	
\hat{E}_s / I_{ot}	1~2	dB	0	9
CSI-RS RSRP ^{Note2}	1~2	dBm/SSB SCS	-95.97	-86.97

I_o ^{Note2}	1~2	dBm/95.04MHz	-63.97	-57.47
\hat{E}_s / N_{oc}	1~2	dB	0	9
<p>Note 2: Interference from other cells and noise sources not specified in the test is assumed to be constant over subcarriers and time and shall be modelled as AWGN of appropriate power for N_{oc} to be fulfilled.</p> <p>Note 3: CSI-RS RSRP and I_o levels have been derived from other parameters for information purposes. They are not settable parameters themselves.</p> <p>Note 4: Information about types of UE beam is given in B.2.1.3, and does not limit UE implementation or test system implementation</p>				

A.5.6.3.3.3 Test Requirements

After 480ms from the beginning of the test, the UE shall send L1-RSRP report at slot 8 from the reception of DCI triggering the L1-RSRP measurement. The L1-RSRP report shall include the results for both CSI-RS#0 and CSI-RS#1 while meeting the accuracy requirements defined in clause 10.1.20.1. The reported L1-RSRP value shall include the Rx antenna gain in the range of -10 to +20 dB.

For absolute accuracy of CSI-RS0 and absolute accuracy of CSI-RS1, the UE is deemed to meet the requirement if the reported L1-RSRP is in the range shown in Table A.5.6.3.3.3-1.

For relative accuracy of CSI-RS0 compared with CSI-RS1, the UE is deemed to meet the requirement if the difference in reported L1-RSRP meets the requirements in Table 10.1.20.2.2-1.

Table A.5.6.3.3.3-1: L1-RSRP absolute accuracy test requirement

	Test requirement ^{Notes1,2,3}
CSI-RS0	$CSI-RS_RP0 - \delta + G_{min} \leq \text{Reported RSRP(dBm)} \leq CSI-RS_RP0 + \delta + G_{max}$
CSI-RS1	$CSI-RS_RP1 - \delta + G_{min} \leq \text{Reported RSRP(dBm)} \leq CSI-RS_RP1 + \delta + G_{max}$
Note 1:	CSI-RS_RPn is the equivalent power received by an antenna with 0dBi gain at the centre of the quiet zone configured in the test for the CSI-RS n under consideration
Note 2:	δ is the RSRP absolute accuracy requirement from Table 10.1.20.2.1-1, selected according to the I_o used in the test
Note 3:	G_{min} and G_{max} are the minimum and maximum UE gain values from Table B.2.1.5.1-1, selected according to the UE power class

The rate of correct events observed during repeated tests shall be at least 90%.

A.5.6.3.4 CSI-RS based L1-RSRP measurement when DRX is used

A.5.6.3.4.1 Test Purpose and Environment

The purpose of this test is to verify that the UE makes correct reporting of L1-RSRP measurement. This test will partly verify the L1-RSRP measurement requirements in clause 9.5.4.2, with the testing configurations for NR cells in Table A.5.6.3.4.1-1.

Table A.5.6.3.4.1-1: Applicable NR configurations for FR2 CSI-RS based L1-RSRP test

Config	Description
1	LTE FDD, NR 120 kHz SSB SCS, 100 MHz bandwidth, TDD duplex mode
2	LTE TDD, NR 120 kHz SSB SCS, 100 MHz bandwidth, TDD duplex mode
Note:	The UE is only required to be tested in one of the supported test configurations

A.5.6.3.4.2 Test parameters

There are two cells in the test, E-UTRAN PCell (Cell 1) and FR1 PCell (Cell 2). The test parameters and applicability for Cell 1 are defined in A.3.7.2. The test parameters for the Cell 2 are given in Table A.5.6.3.4.2-1 and Table A.5.6.3.4.2-2 below.

In CSI measurement configuration, UE is indicated to perform L1-RSRP measurement on the CSI-RS and report aperiodically. The test consists of a single time period T1, during which the UE is triggered via DCI to report L1-RSRP on aperiodic CSI-RS resources. UE is also configured to measure L1-RSRP based on SSB. After 1440ms from the beginning of the test, the DCI trigger comes in slot 1 of a frame and UE provides the report back based on the reporting configuration as defined in Table A.5.6.3.4.2-1.

There is no measurement gap configured in the test. Before the test, UE is configured to perform RLM and BFD based on the SSBs.

Table A.5.6.3.4.2-1: General test parameters

Parameter	Config	Unit	Value
SSB GSCN	1~2		freq1
Duplex mode	1~2		TDD
TDD Configuration	1~2		TDDConf.3.1
BW _{channel}	1~2	MHz	100: N _{RB,c} = 66
Data RBs allocated	1~2		66
PDSCH Reference measurement channel	1~2		SR.3.3 TDD
RMSI CORESET Reference Channel	1~2		CR.3.2 TDD
Dedicated CORESET Reference Channel	1~2		CCR.3.7 TDD
SSB configuration	1~2		SSB.1 FR2
CSI-RS configuration	1~2		CSI-RS.3.3 TDD
OCNG Patterns	1~2		OP.1
Initial BWP Configuration	1~2		DLBWP.0.1 ULBWP.0.1
Dedicated BWP configuration	1~2		DLBWP.1.1 ULBWP.1.1
SMTc configuration	1~2		SMTc.1
TRS Configuration	1~2		TRS.2.1 TDD
PDCCH/PDSCH TCI Configuration	1~2		TCI.State.2
DRX configuration	1~2		DRX.3
reportConfigType	1~2		aperiodic
reportQuantity	1~2		cri-RSRP
Number of reported RS	1~2		2
qcl-Info	1~2		SSB#0 for resource#0 SSB#1 for resource#1
reportSlotOffsetList	1~2		8
Propagation condition	1~2		AWGN
T1	1~2	s	5
EPRE ratio of PSS to SSS	1~2	dB	0
EPRE ratio of PBCH DMRS to SSS			
EPRE ratio of PBCH to PBCH DMRS			
EPRE ratio of PDCCH DMRS to SSS			

EPRE ratio of PDCCH to PDCCH DMRS			
EPRE ratio of PDSCH DMRS to SSS			
EPRE ratio of PDSCH to PDSCH DMRS			
EPRE ratio of OCNG DMRS to SSS ^{Note 1}			
EPRE ratio of OCNG to OCNG DMRS ^{Note 1}			
Note 1: OCNG shall be used such that both cells are fully allocated and a constant total transmitted power spectral density is achieved for all OFDM symbols.			

Table A.5.6.3.4.2-1: CSI-RS specific test parameters

Parameter	Config	Unit	CSI-RS#0	CSI-RS#1
Angle of arrival configuration	1~2		Setup 1 according to A.3.15.1	
Assumption for UE beams ^{Note 4}	1~2		Rough	
N_{oc} ^{Note1}	1~2	dBm/15kHz	-105	
N_{oc} ^{Note1}	1~2	dBm/SSB SCS	-95.97	
\hat{E}_s / I_{ot}	1~2	dB	0	9
CSI-RS RSRP ^{Note2}	1~2	dBm/SSB SCS	-95.97	-86.97
I_o ^{Note2}	1~2	dBm/95.04MHz	-63.97	-57.47
\hat{E}_s / N_{oc}	1~2	dB	0	9
<p>Note 2: Interference from other cells and noise sources not specified in the test is assumed to be constant over subcarriers and time and shall be modelled as AWGN of appropriate power for N_{oc} to be fulfilled.</p> <p>Note 3: CSI-RS RSRP and I_o levels have been derived from other parameters for information purposes. They are not settable parameters themselves.</p> <p>Note 4: Information about types of UE beam is given in B.2.1.3, and does not limit UE implementation or test system implementation</p>				

A.5.6.3.4.3 Test Requirements

After 1440ms from the beginning of the test, the UE shall send L1-RSRP report at slot 8 from the reception of DCI triggering the L1-RSRP measurement. The L1-RSRP report shall include the results for both CSI-RS#0 and CSI-RS#1 while meeting the accuracy requirements defined in clause 10.1.20.1.

For absolute accuracy of CSI-RS0 and absolute accuracy of CSI-RS1, the UE is deemed to meet the requirement if the reported L1-RSRP is in the range shown in Table A.5.6.3.4.3-1.

For relative accuracy of CSI-RS0 compared with CSI-RS1, the UE is deemed to meet the requirement if the difference in reported L1-RSRP meets the requirements in Table 10.1.20.2.2-1.

Table A.5.6.3.4.3-1: L1-RSRP absolute accuracy test requirement

	Test requirement ^{Notes1,2,3}
CSI-RS0	$CSI-RS_RP0 - \delta + G_{min} \leq \text{Reported RSRP(dBm)} \leq CSI-RS_RP0 + \delta + G_{max}$

CSI-RS1	$CSI-RS_RP1 - \delta + G_{min} \leq \text{Reported RSRP(dBm)} \leq CSI-RS_RP1 + \delta + G_{max}$
Note 1:	CSI-RS_RPn is the equivalent power received by an antenna with 0dBi gain at the centre of the quiet zone configured in the test for the CSI-RS n under consideration
Note 2:	δ is the RSRP absolute accuracy requirement from Table 10.1.20.2.1-1, selected according to the l_0 used in the test
Note 3:	G_{min} and G_{max} are the minimum and maximum UE gain values from Table B.2.1.5.1-1, selected according to the UE power class

The rate of correct events observed during repeated tests shall be at least 90%.

A.5.7 Measurement Performance requirements

Unless explicitly stated otherwise:

- Reported measurements shall be within defined range of accuracy limits defined in Clause 10 for at least 90 % of the reported cases. If multiple measurement performance requirements are verified in the same test, the reported measurements for each requirement shall be within defined range of accuracy limits of the corresponding requirement defined in Clause 10 for at least 90% of the reported cases.
- Measurements are performed in RRC_CONNECTED state.
- The reference channels assume transmission of PDSCH with a maximum number of 5 HARQ transmissions unless otherwise specified.

A.5.7.1 SS-RSRP

A.5.7.1.1 EN-DC intra-frequency case measurement accuracy with FR2 serving cell and FR2 target cell

A.5.7.1.1.1 Test Purpose and Environment

The purpose of this test is to verify that the SS-RSRP measurement accuracy is within the specified limits. This test will verify the requirements in Clauses 10.1.3.1.1 and 10.1.3.1.2 for intra-frequency measurements.

A.5.7.1.1.2 Test parameters

In this set of test cases, all NR cells are on the same carrier frequency. Supported test configurations are shown in Table A.5.7.1.1.2-1. Both absolute and relative accuracy of SS-RSRP intra-frequency measurements are tested by using the parameters in Table A.5.7.1.1.2-2 and A.5.7.1.1.2-3. The E-UTRA PCell is configured as specified in clause A.3.7.2.2. In all test cases, Cell 1 is the PCell, cell 2 is the PSCell and Cell 3 is the target cell. The test consists of two time phases T1 and T2.

Table A.5.7.1.1.2-1: SS-RSRP Intra frequency SS-RSRP supported test configurations

Configuration	Description
1	FDD LTE PCell, Cell 2&3 120 kHz SSB SCS, 100 MHz bandwidth, TDD duplex mode
2	TDD LTE PCell, Cell 2&3 120 kHz SSB SCS, 100 MHz bandwidth, TDD duplex mode
Note:	The UE is only required to pass in one of the supported test configurations

Table A.5.7.1.1.2-2: SS-RSRP Intra frequency general test parameters

Parameter ^{Note 5}	Unit	T1		T2	
		Cell 2	Cell 3	Cell 2	Cell 3
Physical cell ID		489	0	489	0
SSB ARFCN		freq1		freq1	
Duplex mode		TDD		TDD	
TDD configuration		TDDConf.3.1		TDDConf.3.1	
BW _{channel}	MHz	100: N _{RB,c} = 66		100: N _{RB,c} = 66	
Data RBs allocated		24		24	
BWP configuration	Initial DL BWP	DLBWP.0.1			
	Dedicated DL BWP	DLBWP.1.1			
	Initial UL BWP	ULBWP.0.1			
	Dedicated UL BWP	ULBWP.1.1			
TRS configuration		TRS.2.1 TDD	-	TRS.2.1 TDD	-
TCI state		TCI.State.0	-	TCI.State.0	-
PDSCH Reference measurement channel		SR.3.2 TDD	-	SR.3.2 TDD	-
RMSI CORESET Reference Channel		CR.3.1 TDD	-	CR.3.1 TDD	-
Dedicated CORESET Reference Channel		CCR.3.1 TDD	-	CCR.3.1 TDD	-
OCNG Patterns		OP.3	OP.3	OP.3	OP.3
SSB configuration		SSB.3 FR2	SSB.3 FR2	SSB.3 FR2	SSB.3 FR2
SMTC configuration		SMTC.1	SMTC.1	SMTC.1	SMTC.1
Time offset with Cell 2	µs	-	3	-	3
PDSCH/PDCCH subcarrier spacing	kHz	120	120	120	120
EPRE ratio of PSS to SSS	dB	0	0	0	0
EPRE ratio of PBCH_DMRS to SSS					
EPRE ratio of PBCH to PBCH_DMRS					
EPRE ratio of PDCCH_DMRS to SSS					
EPRE ratio of PDCCH to PDCCH_DMRS					
EPRE ratio of PDSCH_DMRS to SSS					
EPRE ratio of PDSCH to PDSCH_DMRS					
EPRE ratio of OCNG DMRS to SSS ^{Note 1}					
EPRE ratio of OCNG to OCNG DMRS ^{Note 1}					
Propagation conditions		AWGN		AWGN	
Antenna configuration		1x2	1x2	1x2	1x2
<p>Note 1: OCNG shall be used such that both cells are fully allocated and a constant total transmitted power spectral density is achieved for all OFDM symbols.</p> <p>Note 2: Void</p> <p>Note 3: Void</p> <p>Note 4: Void</p> <p>Note 5: All parameters apply for configuration 1 and 2</p> <p>Note 6: Void</p>					

Table A.5.7.1.1.2-3: SS-RSRP Intra frequency OTA related test parameters

Parameter	Unit	T1	T2
-----------	------	----	----

		Cell 2	Cell 3	Cell 2	Cell 3
Angle of arrival configuration		Setup 1 according to clause A.3.15.1			
Assumption for UE beams ^{Note 8}		Rough			
N_{oc} ^{Note1}	dBm/15kHz z ^{Note4}	-91.6		N/A	
N_{oc} ^{Note1}	dBm/SCS ^{Note4}	-82.6		N/A	
\hat{E}_s/N_{oc}	dB	6.0	1.0	N/A	N/A
E_s	dBm/SCS ^{Note4}	-76.6	-81.6	(Table B.2.2-2 Rx Beam Peak +2.1dB)	(Table B.2.2-2 Rx Beam Peak +2.1dB)
SSB_RP ^{Note2}	dBm/SCS	-76.6	-81.6	(Table B.2.2-2 Rx Beam Peak +2.1dB)	(Table B.2.2-2 Rx Beam Peak +2.1dB)
$\hat{E}_s/I_{ot\ BB}$ ^{Note6}	dB	2.44	-5.98	-5.98	-5.98
I_o ^{Note2}	dBm/95.04 MHz ^{Note4}	-50.05		(Table B.2.2-2 Rx Beam Peak +29.70dB)	
Note 1:	Where used, interference from other cells and noise sources not specified in the test is assumed to be constant over subcarriers and time and shall be modelled as AWGN of appropriate power for N_{oc} to be fulfilled.				
Note 2:	SSB_RP, E_s/I_{ot} , E_s in test 1 and I_o levels have been derived from other parameters for information purposes. They are not settable parameters themselves.				
Note 3:	Void				
Note 4:	Equivalent power received by an antenna with 0 dBi gain at the centre of the quiet zone				
Note 5:	Void				
Note 6:	Calculation of $E_s/I_{ot\ BB}$ includes the effect of UE internal noise up to the value assumed for the associated Refsens requirement in clause 7.3.2 of TS 38.101-2 [19], and an allowance of 1dB for UE multi-band relaxation factor ΔMB_P from TS 38.101-2 [19] Table 6.2.1.3-4.				
Note 7:	All parameters apply for configurations 1 and 2				
Note 8:	Information about types of UE beam is given in B.2.1.3, and does not limit UE implementation or test system implementation				

A.5.7.1.1.3 Test Requirements

The SS-RSRP measurement accuracy shall fulfil the absolute accuracy requirements in clauses 10.1.3.1.1 and relative accuracy requirements in clause 10.1.3.1.2. The following requirements are to be verified:

During T1:

Absolute accuracy of Cell 2 and absolute accuracy of Cell 3. The UE is deemed to meet the requirement if the reported SS-RSRP is in the range shown in table A.5.7.1.1.3-1.

Relative accuracy of Cell 3 compared with Cell 2. The UE is deemed to meet the requirement if the difference in reported SS-RSRP meets the requirements in Table 10.1.3.1.2-1.

During T2:

Absolute accuracy of Cell 2 and absolute accuracy of Cell 3. The UE is deemed to meet the requirement if the reported SS-RSRP is in the range shown in table A.5.7.1.1.3-1.

Relative accuracy of Cell 3 compared with Cell 2. The UE is deemed to meet the requirement if the difference in reported SS-RSRP meets the requirements in Table 10.1.3.1.2-1.

During T1 and T2:

Relative accuracy of Cell 2 during T2 compared with Cell 2 during T1. The UE is deemed to meet the requirement if the difference in reported SS-RSRP meets the requirements in Table 10.1.3.1.2-1

Relative accuracy of Cell 3 during T2 compared with Cell 3 during T1. The UE is deemed to meet the requirement if the difference in reported SS-RSRP meets the requirements in Table 10.1.3.1.2-1.

Table A.5.7.1.1.3-1: SS-RSRP absolute accuracy test requirement

	Test requirement ^{Notes1,2,3}
Cell 2	$SSB_RP2 - \delta + G_{min} \leq \text{Reported RSRP(dBm)} \leq SSB_RP2 + \delta + G_{max}$
Cell 3	$SSB_RP3 - \delta + G_{min} \leq \text{Reported RSRP(dBm)} \leq SSB_RP3 + \delta + G_{max}$
Note 1:	SSB_RPn is the equivalent power received by an antenna with 0dBi gain at the centre of the quiet zone configured in the test for the cell n under consideration
Note 2:	δ is the RSRP absolute accuracy requirement from Table 10.1.3.1.1-1, selected according to the l_0 used in the test
Note 3:	G_{min} and G_{max} are the minimum and maximum UE gain values from Table B.2.1.5.1-1, selected according to the UE power class

A.5.7.1.2 EN-DC inter-frequency case measurement accuracy with FR2 serving cell and FR2 target cell

A.5.7.1.2.1 Test Purpose and Environment

The purpose of this test is to verify that the SS-RSRP measurement accuracy is within the specified limits. This test will verify the requirements in Clauses 10.1.5.1.1 and 10.1.5.1.2 for inter-frequency measurements with the testing configurations for NR cells in Table A.5.7.1.2.1-1.

Table A.5.7.1.2.1-1: Applicable NR configurations for FR2 inter-frequency SS-RSRP accuracy test

Configuration	Description
1	FDD LTE PCell, cells 2&3 120 kHz SSB SCS, 100 MHz bandwidth, TDD duplex mode
2	TDD LTE PCell, cells 2&3 120 kHz SSB SCS, 100 MHz bandwidth, TDD duplex mode
3	FDD LTE PCell, cells 2&3 240 kHz SSB SCS, 100 MHz bandwidth, TDD duplex mode
4	TDD LTE PCell, cells 2&3 240 kHz SSB SCS, 100 MHz bandwidth, TDD duplex mode

A.5.7.1.2.2 Test parameters

In this set of test cases, there are three cells in the test, E-UTRAN PCell (Cell 1), FR2 PSCell (Cell 2) and a FR2 neighbour cell (Cell 3) on a different frequency than the PSCell. The test parameters and applicability for Cell 1 are defined in A.3.7.2. The test parameters for the Cell 2 and Cell 3 are given in Table A.5.7.1.2.2-1 and Table A.5.7.1.2.2-2 below. Both absolute and relative accuracy of RSRP intrer-frequency measurements are tested by

using the parameters in Table A.5.7.1.2.2-1 and Table A.5.7.1.2.2-2. The inter-frequency measurements are supported by a measurement gap.

Table A.5.7.1.2.2-1: SS-RSRP inter-frequency test parameters

Parameter	Config	Unit	Test 1		Test 2	
			Cell 2	Cell 3	Cell 2	Cell 3
SSB ARFCN	1~4		freq1	freq2	freq1	freq2
BW _{channel}	1~4		100: NRB,c = 66		100: NRB,c = 66	
Data RBs allocated	1,2 3,4		24 48		24 48	
Duplex mode	1~4		TDD		TDD	
TDD configuration	1~4		TDDConf.3.1		TDDConf.3.1	
PDSCH Reference measurement channel	1,2		SR.3.2 TDD	-	SR.3.2 TDD	-
	3,4		SR.3.3 TDD		SR.3.3 TDD	
RMSI CORESET Reference Channel	1,2		CR.3.1 TDD	-	CR.3.1 TDD	-
	3,4		CR.3.2 TDD		CR.3.2 TDD	
Dedicated CORESET Reference Channel	1,2		CCR.3.1 TDD	-	CCR.3.1 TDD	-
	3,4		CCR.3.7 TDD		CCR.3.7 TDD	
SSB configuration	1,2		SSB.3 FR2		SSB.3 FR2	
	3,4		SSB.4 FR2		SSB.4 FR2	
PDSCH/PDCCH subcarrier spacing	1~4	kHz	120		120	
OCNG Patterns	1~4		OP.3		OP.3	
Initial BWP Configuration	1~4		DLBWP.0.1 ULBWP.0.1		DLBWP.0.1 ULBWP.0.1	
Dedicated BWP configuration	1~4		DLBWP.1.3 ULBWP.1.3		DLBWP.1.3 ULBWP.1.3	
TRS Configuration	1~4		TRS.2.1 TDD		TRS.2.1 TDD	
PDCCH/PDSCH TCI Configuration	1~4		TCI.State.2		TCI.State.2	
SMTTC configuration	1~4		SMTTC.1		SMTTC.1	
Time offset between Cell 2 and Cell 3	1~4	µs	3		3	
EPRE ratio of PSS to SSS	1~4	dB	0	0	0	0
EPRE ratio of PBCH DMRS to SSS						
EPRE ratio of PBCH to PBCH DMRS						
EPRE ratio of PDCCH DMRS to SSS						
EPRE ratio of PDCCH to PDCCH DMRS						
EPRE ratio of PDSCH DMRS to SSS						
EPRE ratio of PDSCH to PDSCH DMRS						
EPRE ratio of OCNG DMRS to SSS ^{Note 1}						
EPRE ratio of OCNG to OCNG DMRS ^{Note 1}						
Propagation condition						
Antenna configuration	1~4	-	1x2	1x2	1x2	1x2
Note 1: OCNG shall be used such that a constant total transmitted power spectral density is achieved for all OFDM symbols.						
Note 2: Void						

Table A.5.7.1.2.2-2: SS-RSRP inter-frequency OTA related test parameters

Parameter	Config	Unit	Test 1		Test 2	
			Cell 2	Cell 3	Cell 2	Cell 3
Angle of arrival configuration	1~4		Setup 4b according to clause A.3.15.4.2		Setup 4b according to clause A.3.15.4.2	
			AoA1 Spherical coverage	AoA2 Rx Beam Peak	AoA1 Spherical coverage	AoA2 Rx Beam Peak
Assumption for UE beams ^{Note 7}	1~4		Rough		Rough	
N_{oc} ^{Note1}	1, 2	dBm/15kHz z ^{Note4}	-90.6	-90.6	(Table B.2.3-2 Rx Beam Peak ^{Note 8} +1.97dB)	(Table B.2.3-2 Rx Beam Peak ^{Note 8} -3.03dB)
	3, 4		-93.7	-93.7		
N_{oc} ^{Note1}	1, 2	dBm/SCS ^{Note4}	-81.6	-81.6	(Table B.2.3-2 Rx Beam Peak ^{Note 8} +11.0dB)	(Table B.2.3-2 Rx Beam Peak ^{Note 8} +6.0dB)
	3, 4		-81.7	-81.7	(Table B.2.3-2 Rx Beam Peak ^{Note 8} +14.0dB)	(Table B.2.3-2 Rx Beam Peak ^{Note 8} +9.0dB)
\hat{E}_s/N_{oc}	1~4	dB	6.0	6.0	17.0	-1.0
SSB_RP ^{Note2}	1, 2	dBm/SCS	-75.6	-75.6	(Table B.2.3-2 Rx Beam Peak ^{Note 8} +28.0dB)	(Table B.2.3-2 Rx Beam Peak ^{Note 8} +5.0dB)
	3, 4		-75.7	-75.7	(Table B.2.3-2 Rx Beam Peak ^{Note 8} +31.0dB)	(Table B.2.3-2 Rx Beam Peak ^{Note 8} +8.0dB)
(SSB_RP _{Cell 2} – SSB_RP _{Cell 3})	1~4	dB	0		23.00	
$\hat{E}_s/I_{ot\ BB}$ ^{Note6}	1, 2	dB	5.26	5.96	9.53	-3.46
	3, 4		4.61	5.91		
I_{o} ^{Note2}	1, 2	dBm/95.04 MHz ^{Note4}	-50.00	-50.00	(Table B.2.3-2 Rx Beam Peak ^{Note 8} +52.68dB)	(Table B.2.3-2 Rx Beam Peak ^{Note 8} +33.13dB)
	3, 4		-50.09	-50.09	(Table B.2.3-2 Rx Beam Peak ^{Note 8} +55.69dB)	(Table B.2.3-2 Rx Beam Peak ^{Note 8} +36.14dB)
($I_{o\ freq\ 1} - I_{o\ freq\ 2}$)	1~4	dB	0		19.55	
<p>Note 1: Where used, interference from other cells and noise sources not specified in the test is assumed to be constant over subcarriers and time and shall be modelled as AWGN of appropriate power for N_{oc} to be fulfilled.</p>						

Note 2:	SSB _{RP} , Es/lot, lo, (SSB _{RP} _{Cell 3} – SSB _{RP} _{Cell 2}) and (I _{ofreq 2} – I _{ofreq 1}) levels have been derived from other parameters for information purposes. They are not settable parameters themselves.
Note 3:	Void
Note 4:	Equivalent power received by an antenna with 0 dBi gain at the centre of the quiet zone
Note 5:	Void
Note 6:	Calculation of Es/lot _{BB} includes the effect of UE internal noise up to the value assumed for the associated Refsens requirement in clause 7.3.2 of TS 38.101-2 [19], and an allowance of 1dB for UE multi-band relaxation factor ΔMB _P or ΔMB _S from TS 38.101-2 [19] Table 6.2.1.3-4.
Note 7:	Information about types of UE beam is given in B.2.1.3, and does not limit UE implementation or test system implementation
Note 8:	The value in Table B.2.3-2 is the Minimum SSB _{RP} for SCS _{SSB} = 120 kHz, selected according to the operating band of cell 3 and UE power class, without ΔMB _{P,n} adjustment.

A.5.7.1.2.3 Test Requirements

The SS-RSRP measurement accuracy for Cell 2 and Cell 3 shall fulfil the absolute requirements in clause 10.1.5.1.1 and the relative requirements in clause 10.1.5.1.2.

Test 1:

Absolute accuracy of Cell 2 and absolute accuracy of Cell 3. The UE is deemed to meet the requirement if the reported SS-RSRP is in the range shown in Table A.5.7.1.2.3-1.

Relative accuracy of Cell 3 compared with Cell 2. The UE is deemed to meet the requirement if the difference in reported SS-RSRP meets the requirements in A.5.7.1.2.3-2.

Test 2:

Absolute accuracy of Cell 2 and absolute accuracy of Cell 3. The UE is deemed to meet the requirement if the reported SS-RSRP is in the range shown in Table A.5.7.1.2.3-1.

Relative accuracy of Cell 3 compared with Cell 2. The UE is deemed to meet the requirement if the difference in reported SS-RSRP meets the requirements in A.5.7.1.2.3-2.

Table A.5.7.1.2.3-1: SS-RSRP absolute accuracy test requirement

	Test requirement ^{Notes 1,2,3,4}
Cell 2	$SSB_RP2 - \delta + G_{min} + X \leq \text{Reported RSRP(dBm)} \leq SSB_RP2 + \delta + G_{max}$
Cell 3	$SSB_RP3 - \delta + G_{min} \leq \text{Reported RSRP(dBm)} \leq SSB_RP3 + \delta + G_{max}$
Note 1:	SSB _{RPn} is the equivalent power received by an antenna with 0dBi gain at the centre of the quiet zone configured in the test for the cell n under consideration
Note 2:	δ is the RSRP absolute accuracy requirement from Table 10.1.5.1.1-1, selected according to the lo used in the test
Note 3:	G _{min} and G _{max} are the minimum and maximum UE gain values from Table B.2.1.5.1-1, selected according to the UE power class
Note 4:	X is the Spherical coverage gain difference in dB, derived as (UE Refsens - UE Spherical coverage) from TS 38.101-2 [19] clauses 7.3.2 and 7.3.4, selected according to the UE power class and operating band. X is always a negative value.

Table A.5.7.1.2.3-2: SS-RSRP relative accuracy test requirement

	Test requirement ^{Notes 1,2,3,4, 5, 6, 7}
--	--

Cell 3 – Cell 2	$SSB_RP3 - SSB_RP2 - \delta - D - G_{inter} \leq \text{Reported RSRP(dB)} \leq SSB_RP3 - SSB_RP2 + \delta + G_{inter} - (X) + E$
Note 1:	SSB_RPn is the equivalent power received by an antenna with 0dBi gain at the centre of the quiet zone configured in the test for the cell n under consideration
Note 2:	δ is the RSRP relative accuracy requirement from Table 10.1.5.1.2-1
Note 3:	Void
Note 4:	X is the Spherical coverage gain difference in dB, derived as (UE Refsens - UE Spherical coverage) from TS 38.101-2 [19] clauses 7.3.2 and 7.3.4, selected according to the UE power class and operating band. X is always a negative value.
Note 5:	D is the margin due to mis-alignment between fine beam and rough beam. D is the Rough Beam gain reduction in Rx beam peak direction from Table B.2.1.5.3-1, selected according to the UE power class. D is always a positive value.
Note 6:	G_{inter} is the margin due to different antenna gain caused by frequency separation. G_{inter} is from Table B.2.1.5.2-1, selected according to the UE power class, and is always a positive value.
Note 7:	E = 3 (dB) is an additional margin to account for the actual gain difference between peak direction and spherical coverage using rough beams.

A.5.7.1.3 EN-DC inter-frequency measurement accuracy with FR1 serving cell and FR2 target cell

A.5.7.1.3.1 Test Purpose and Environment

The purpose of this test is to verify that the SS-RSRP measurement accuracy is within the specified limits. This test will verify the requirements in Clauses 10.1.5.1.1 for inter-frequency measurements with the testing configurations in Table A.5.7.1.3.1-1.

Table A.5.7.1.3.1-1: Applicable NR configurations for FR2 inter-frequency SS-RSRP accuracy test

Config	Description of serving cell	Description of target cell
1	LTE FDD, NR 15 kHz SSB SCS, 10 MHz bandwidth, FDD duplex mode	120 kHz SSB SCS, 100 MHz bandwidth, TDD duplex mode
2	LTE FDD, NR 15 kHz SSB SCS, 10 MHz bandwidth, TDD duplex mode	
3	LTE FDD, NR 30 kHz SSB SCS, 40 MHz bandwidth, TDD duplex mode	
4	LTE TDD, NR 15 kHz SSB SCS, 10 MHz bandwidth, FDD duplex mode	
5	LTE TDD, NR 15 kHz SSB SCS, 10 MHz bandwidth, TDD duplex mode	
6	LTE TDD, NR 30 kHz SSB SCS, 40 MHz bandwidth, TDD duplex mode	
Note:	The UE is only required to be tested in one of the supported test configurations	

A.5.7.1.3.2 Test parameters

In this set of test cases there are three cells in the test, E-UTRAN PCell (Cell 1), FR1 PSCell (Cell 2) and a FR2 neighbour cell (Cell 3) on a different frequency than the PSCell. The test parameters and applicability for Cell 1 are defined in A.3.7.2. The test parameters for the Cell 2 and Cell 3 are given in Table A.5.7.1.3.2-1 and Table A.5.7.1.3.2-2 below. Absolute accuracy of RSRP inter-frequency measurements are tested by using the parameters in Table A.5.7.1.3.2-1 and Table A.5.7.1.3.2-2. The inter-frequency measurements are supported by a measurement gap.

Table A.5.7.1.3.2-1: SS-RSRP inter-frequency test parameters

Parameter	Config	Unit	Test 1	Test 2
-----------	--------	------	--------	--------

			Cell 2	Cell 3	Cell 2	Cell 3
SSB ARFCN	1~6		freq1	freq2	freq1	freq2
BW _{channel}	1,4	MHz	10: N _{RB,c} = 52	100: N _{RB,c} = 66	10: N _{RB,c} = 52	100: N _{RB,c} = 66
	2,5		10: N _{RB,c} = 52		10: N _{RB,c} = 52	
	3,6		40: N _{RB,c} = 106		40: N _{RB,c} = 106	
Data RBs allocated	1,2,4,5		52	24	52	66
	3,6		106		106	
Gap pattern ID			0		0	
Duplex mode	1,4		FDD	TDD	FDD	TDD
	2,5		TDD		TDD	
	3,6		TDD		TDD	
TDD configuration	1,4		N/A	TDDConf. 3.1	N/A	TDDConf. 3.1
	2,5		TDDConf. 1.1		TDDConf. 1.1	
	3,6		TDDConf. 2.1		TDDConf. 2.1	
PDSCH Reference measurement channel	1,4		SR.1.1 FDD	-	SR.1.1 FDD	-
	2,5		SR.1.1 TDD		SR.1.1 TDD	
	3,6		SR.2.1 FDD		SR.2.1 FDD	
RMSI CORESET Reference Channel	1,4		CR.1.1 FDD	-	CR.1.1 FDD	-
	2,5		CR.1.1 TDD	-	CR.1.1 TDD	-
	3,6		CR.2.1 FDD	-	CR.2.1 FDD	-
Dedicated CORESET Reference Channel	1,4		CCR.1.1 FDD	-	CCR.1.1 FDD	-
	2,5		CCR.1.1 TDD	-	CCR.1.1 TDD	-
	3,6		CCR.2.1 TDD	-	CCR.2.1 TDD	-
SSB configuration	1,4		SSB.1 FR1	SSB.3 FR2	SSB.1 FR1	SSB.3 FR2
	2,5		SSB.1 FR1		SSB.1 FR1	
	3,6		SSB.2 FR1		SSB.2 FR1	
OCNG Patterns	1~6		OP.1	OP.3	OP.1	OP.1
Initial BWP Configuration	1~6		DLBWP.0.1 ULBWP.0.1		DLBWP.0.1 ULBWP.0.1	
Dedicated BWP configuration	1~6		DLBWP.1.3 ULBWP.1.3		DLBWP.1.3 ULBWP.1.3	
TRS Configuration	1~6		TRS.2.1 TDD		TRS.2.1 TDD	
PDCCH/PDSCH TCI Configuration	1~6		TCI.State.2		TCI.State.2	
SMTTC configuration	1~6		SMTTC.1		SMTTC.1	
Time offset between Cell 2 and Cell 3	1~6	μs	3		3	
EPRE ratio of PSS to SSS	1~6	dB	0	0	0	0
EPRE ratio of PBCH DMRS to SSS						
EPRE ratio of PBCH to PBCH DMRS						
EPRE ratio of PDCCH DMRS to SSS						
EPRE ratio of PDCCH to PDCCH DMRS						
EPRE ratio of PDSCH DMRS to SSS						
EPRE ratio of PDSCH to PDSCH DMRS						
EPRE ratio of OCNG DMRS to SSS ^{Note 1}						
EPRE ratio of OCNG to OCNG DMRS ^{Note 1}						

Propagation condition	1~6	-	NA	AWGN	NA	AWGN
Antenna configuration	1~6	-	Link only, see clause A.3.7A	1x2	Link only, see clause A.3.7A	1x2
Note 1:	OCNG shall be used such that both cells are fully allocated and a constant total transmitted power spectral density is achieved for all OFDM symbols.					
Note 2:	Void					

Table A.5.7.1.3.2-2: SS-RSRP inter-frequency OTA related test parameters

Parameter	Config	Unit	Test 1		Test 2 ^{NOTE 3}	
			Cell 2	Cell 3	Cell 2	Cell 3
Angle of arrival configuration according to clause A.3.15			NA	Setup 2b	NA	Setup 2b
Assumption for UE beams ^{Note 4}			N/A	Rough	N/A	Rough
N_{oc}	1~6	dBm/15 kHz	NA Link only, see clause A.3.7A	-90	NA Link only, see clause A.3.7A	NA
N_{oc}	1~6	dBm/SSB SCS		-80.97		NA
\hat{E}_s/N_{oc}	1~6	dB		5		NA
E_s	1~6	dBm/SCS				(Table B.2.3-2 Spherical coverage +1dB)
SSB_RP ^{Note1}	1~6	dBm/SCS		-76.0		(Table B.2.3-2 Spherical coverage +1dB)
\hat{E}_s/I_{otBB} ^{Note6}	1~6	dB		4.35		-3.81
I_o ^{Note1}	1~6	dBm/95.04MHz		-50.18		SSB_RP+28.98
Note 1:	Es/Iot, SSB_RP and Io levels have been derived from other parameters for information purposes. They are not settable parameters themselves.					
Note 2:	Void					
Note 3:	No additional noise is added by the test system in Test 2.					
Note 4:	Information about types of UE beam is given in B.2.1.3, and does not limit UE implementation or test system implementation.					
Note 5:	Where used, interference from other cells and noise sources not specified in the test is assumed to be constant over subcarriers and time and shall be modelled as AWGN of appropriate power for N_{oc} to be fulfilled.					
Note 6:	Calculation of Es/IotBB includes the effect of UE internal noise up to the value assumed for the associated Refsens requirement in clause 7.3.2 of TS 38.101-2 [19], and an allowance of 1dB for UE multi-band relaxation factor ΔMB_s from TS 38.101-2 [19] Table 6.2.1.3-4.					

A.5.7.1.3.3 Test Requirements

The SS-RSRP measurement accuracy for Cell 3 shall fulfil the Absolute requirement in clause 10.1.5.1.1.

Test 1:

Absolute accuracy of Cell 3. The UE is deemed to meet the requirement if the reported SS-RSRP is in the range shown in Table A.5.7.1.3.3.

Test 2:

Absolute accuracy of Cell 3. The UE is deemed to meet the requirement if the reported SS-RSRP is in the range shown in Table A.5.7.1.3.3.

Table A.5.7.1.3.3: SS-RSRP absolute accuracy test requirement

	Test requirement ^{Notes1,2,3,4}
Cell 3	$SSB_RP2 - \delta + G_{min} + X \leq \text{Reported RSRP(dBm)} \leq SSB_RP2 + \delta + G_{max}$
Note 1:	SSB_RPn is the equivalent power received by an antenna with 0dBi gain at the centre of the quiet zone configured in the test for the cell n under consideration
Note 2:	δ is the RSRP absolute accuracy requirement from Table 10.1.5.1.1-1, selected according to the I_o used in the test
Note 3:	G_{min} and G_{max} are the minimum and maximum UE gain values from Table B.2.1.5.1-1, selected according to the UE power class
Note 4:	X is the Spherical coverage gain difference in dB, derived as (UE Refsens - UE Spherical coverage) from TS 38.101-2 [19] clauses 7.3.2 and 7.3.4, selected according to the UE power class and operating band. X is always a negative value.

A.5.7.2 SS-RSRQ

A.5.7.2.1 EN-DC Intra-frequency measurement accuracy with FR2 serving cell and FR2 TDD target cell

A.5.7.2.1.1 Test Purpose and Environment

The purpose of this test is to verify that the SS-RSRQ measurement accuracy is within the specified limits. This test will verify the requirements in clause 10.1.8.1.1.

A.5.7.2.1.2 Test Parameters

In this test case all cells are on the same carrier frequency. Supported test configurations are shown in Table A.5.7.2.1.2-1. The absolute accuracy of SS-RSRQ intra-frequency measurement is test by using the parameters in Table A.5.7.2.1.2-2 and Table A.5.7.2.1.2-3. The configuration of cell 1 (E-UTRA PCell) is specified in clause A.3.7.2.1. In all test cases, Cell 2 is the PSCell and Cell 3 is the target cell.

Table A.5.7.2.1.2-1: SS-RSRQ Intra frequency SS-RSRQ supported test configurations

Configuration	Description
1	FDD LTE PCell, Cell 2&3 120 kHz SSB SCS, 100 MHz bandwidth, TDD duplex mode
2	TDD LTE PCell, Cell 2&3 120 kHz SSB SCS, 100 MHz bandwidth, TDD duplex mode
Note:	The UE is only required to pass in one of the supported test configurations

Table A.5.7.2.1.2-2: SS-RSRQ Intra frequency test parameters

Parameter	Unit	Test 1		Test 2	
		Cell 2	Cell 3	Cell 2	Cell 3
Cell ID		489	0	489	0
SSB ARFCN		freq1		freq1	

Duplex mode		TDD		TDD	
TDD configuration		TDDConf.3.1		TDDConf.3.1	
BW _{channel}		MHz		100: N _{RB,c} = 66	
Data RBs allocated		66		66	
BWP configuration	Initial DL BWP	DLBWP.0.1			
	Dedicated DL BWP	DLBWP.1.1			
	Initial UL BWP	ULBWP.0.1			
	Dedicated UL BWP	ULBWP.1.1			
TRS configuration		TRS.2.1 TDD		TRS.2.1 TDD	
TCI state		TCI.State .0		TCI.State .0	
PDSCH Reference measurement channel		SR.3.1 TDD		SR.3.1 TDD	
RMSI CORESET Reference Channel		CR.3.1 TDD	-	CR.3.1 TDD	-
Control channel RMC		CCR.3.1 TDD	-	CCR.3.1 TDD	-
OCNG Patterns		OP.1	OP.1	OP.1	OP.1
SMTC configuration		SMTC.1			
SSB configuration		SSB.3 FR2	SSB.3 FR2	SSB.3 FR2	SSB.3 FR2
PDSCH/PDCCH subcarrier spacing		kHz		120	120
SS-RSSI-Measurement		Not Applicable			
EPRE ratio of PSS to SSS		dB	0	0	0
EPRE ratio of PBCH_DMRS to SSS					
EPRE ratio of PBCH to PBCH_DMRS					
EPRE ratio of PDCCH_DMRS to SSS					
EPRE ratio of PDCCH to PDCCH_DMRS					
EPRE ratio of PDSCH_DMRS to SSS					
EPRE ratio of PDSCH to PDSCH_DMRS					
EPRE ratio of OCNG DMRS to SSS ^{Note 1}					
EPRE ratio of OCNG to OCNG DMRS ^{Note 1}					
Propagation condition		AWGN		AWGN	
Antenna Configuration		1x2	1x2	1x2	1x2
<p>Note 1: OCNG shall be used such that both cells are fully allocated and a constant total transmitted power spectral density is achieved for all OFDM symbols.</p> <p>Note 2: Void</p> <p>Note 3: Void</p> <p>Note 4: Void</p> <p>Note 5: Void</p>					

Table A.5.7.2.1.2-3: SS-RSRQ Intra frequency OTA related test parameters

Parameter	Unit	Test 1		Test 2	
		Cell 2	Cell 3	Cell 2	Cell 3
Angle of arrival configuration		Setup 1 according to clause A.3.15.1		Setup 1 according to clause A.3.15.1	
Assumption for UE beams ^{Note 9}		Rough			
N_{oc} ^{Note1}	$\text{dBm}/15\text{kHz}$ ^{Note4}	-95		-95	
N_{oc} ^{Note1}	dBm/SCS ^{Note3}	-86		-86	
\hat{E}_s / N_{oc}	dB	3	3	-3	-3

SSB_RP ^{Note2}	dBm/SCS ^{Note4}	-83	-83	-89	-89
SS-RSRQ ^{Note2}	dB	-14.77	-14.77	-16.81	-16.81
\hat{E}_s/I_{ot}	dB	-1.76	-1.76	-4.76	-4.76
I_o ^{Note2}	dBm/95.04 MHz ^{Note4}	-50		--54	
<p>Note 1: Interference from other cells and noise sources not specified in the test is assumed to be constant over subcarriers and time and shall be modelled as AWGN of appropriate power for N_{oc} to be fulfilled.</p> <p>Note 2: SS-RSRQ, SSB_RP, and I_o levels have been derived from other parameters for information purposes. They are not settable parameters themselves.</p> <p>Note 3: SS-RSRQ and SS-RSRP minimum requirements are specified assuming independent interference and noise at each receiver antenna port.</p> <p>Note 4: Equivalent power received by an antenna with 0dBi gain at the centre of the quiet zone</p> <p>Note 5: As observed with 0dBi gain antenna at the centre of the quiet zone</p> <p>Note 6: Void</p> <p>Note 7: Void</p> <p>Note 8: Void</p> <p>Note 9: Information about types of UE beam is given in B.2.1.3, and does not limit UE implementation or test system implementation</p>					

A.5.7.2.1.3 Test Requirements

The SS-RSRQ absolute measurement accuracy in test 1 shall be within the range Nominal SS-RSRQ+2.5dB to Nominal SS-RSRQ -2.5dB and the SS-RSRQ measurement accuracy in test 2 shall be within the range Nominal SS-RSRQ +3.5dB to Nominal SS-RSRQ -3.5dB according to the requirements in clause 10.1.8.1.1. Nominal SS-RSRQ is the value shown in table A.5.7.2.1.2-3.

A.5.7.2.2 EN-DC Inter-frequency measurement accuracy with FR2 serving cell and FR2 TDD target cell

A.5.7.2.2.1 Test Purpose and Environment

The purpose of this test is to verify that the SS-RSRQ measurement accuracy is within the specified limits. This test will verify the requirements in clause 10.1.9.1.1 and 10.1.9.1.2 for inter-frequency measurement.

A.5.7.2.2.2 Test Parameters

In this test case the two NR cells (i.e., Cell 2 and Cell 3) are on different carrier frequencies and measurement gaps are provided. Supported test configurations are shown in Table A.5.7.2.2.2-1. Both absolute accuracy and relative accuracy requirements of SS-RSRQ inter-frequency measurement are tested by using test setup in Table A.5.7.2.2.2-2 and Table A.5.7.2.2.2-3. In all test cases, Cell 2 is the PSCell and Cell 3 is target cell. Cell 1 is the E-UTRA cell which specific test parameters for this test case are specified in Table A.3.7.2.1-1.

Table A.5.7.2.2.2-1: SS-RSRQ Inter frequency SS-RSRQ supported test configurations

Configuration	Description
1	LTE FDD, NR 120 kHz SSB SCS, 100 MHz bandwidth, TDD duplex mode
2	LTE TDD, NR 120 kHz SSB SCS, 100 MHz bandwidth, TDD duplex mode

Table A.5.7.2.2-2: SS-RSRQ Inter frequency general test parameters

Parameter	Unit	Test 1		Test 2	
		Cell 2	Cell 3	Cell 2	Cell 3
SSB ARFCN		Freq1	freq2	freq1	Freq2
Duplex mode		TDD		TDD	
TDD configuration		TDDConf.3.1		TDDConf.3.1	
$BW_{channel}$	MHz	100: $N_{RB,c} = 66$		100: $N_{RB,c} = 66$	
Data RBs allocated		66		66	
BWP configuration	Initial DL BWP	DLBWP.0.1			
	Dedicated DL BWP	DLBWP.1.1			
	Initial UL BWP	ULBWP.0.1			
	Dedicated UL BWP	ULBWP.1.1			
TRS configuration		TRS.2.1 TDD	-	TRS.2.1 TDD	-
TCI state		TCI.State.0	-	TCI.State.0	-
PDSCH Reference measurement channel		SR.3.1 TDD	-	SR.3.1 TDD	-
RMSI CORESET Reference Channel		CR.3.1 TDD	-	CR.3.1 TDD	-
OCNG Patterns		OP.1	OP.1	OP.1	OP.1
SSB configuration		SSB.3 FR2	SSB.3 FR2	SSB.3 FR2	SSB.3 FR2
SMTTC configuration		SMTTC.1	SMTTC.1	SMTTC.1	SMTTC.1
PDSCH/PDCCH subcarrier spacing	kHz	120	120	120	120
EPRE ratio of PSS to SSS	dB	0	0	0	0
EPRE ratio of PBCH_DMRS to SSS					
EPRE ratio of PBCH to PBCH_DMRS					
EPRE ratio of PDCCH_DMRS to SSS					
EPRE ratio of PDCCH to PDCCH_DMRS					
EPRE ratio of PDSCH_DMRS to SSS					
EPRE ratio of PDSCH to PDSCH_DMRS					
EPRE ratio of OCNG DMRS to SSS ^{Note 1}					
EPRE ratio of OCNG to OCNG DMRS ^{Note 1}					
Propagation conditions		AWGN	AWGN	AWGN	AWGN
Antenna configuration		1x2	1x2	1x2	1x2
Note 1: OCNG shall be used such that both cells are fully allocated and a constant total transmitted power spectral density is achieved for all OFDM symbols.					
Note 2: Void					
Note 3: Void					
Note 4: Void					

Table A.5.7.2.2-3: SS-RSRQ Inter frequency OTA related test parameters

Parameter	Unit	Test 1		Test 2	
		Cell 2	Cell 3	Cell 2	Cell 3
AoA setup		Setup 1 in clause in clause A.3.15		Setup 1 in clause in clause A.3.15	
Assumption for UE beams ^{Note 8}		Rough		Rough	
N_{oc} ^{Note 1}	$\text{dBm}/15\text{kHz}^{\text{ote4}}$	-94.03	-94.03	-94.03	-94.03

N_{oc} ^{Note1}	dBm/SCS ₃ ^{Note}	-85.0	-85.0	-85.0	-85.0
\hat{E}_s / N_{oc}	dB	-1.75	-1.75	-3	-3
SSB_RP ^{Note2}	dBm/SCS _{Note4}	-86.75	-86.75	-88	-88
SS-RSRQ ^{Note2}	dB	-14.75	-14.75	-15.56	-15.56
\hat{E}_s / I_{ot}	dB	-1.75	-1.75	-3	-3
I_o ^{Note2}	dBm/95.04 MHz ^{Note4}	-53.8	-53.8	-54.25	-54.25
<p>Note 1: Interference from other cells and noise sources not specified in the test is assumed to be constant over subcarriers and time and shall be modelled as AWGN of appropriate power for N_{oc} to be fulfilled.</p> <p>Note 2: SS-RSRQ, SSB_RP, and I_o levels have been derived from other parameters for information purposes. They are not settable parameters themselves.</p> <p>Note 3: SS-RSRQ and SS-RSRP minimum requirements are specified assuming independent interference and noise at each receiver antenna port.</p> <p>Note 4: Equivalent power received by an antenna with 0dBi gain at the centre of the quiet zone</p> <p>Note 5: As observed with 0dBi gain antenna at the centre of the quiet zone</p> <p>Note 6: Void</p> <p>Note 7: Void</p> <p>Note 8: Information about types of UE beam is given in B.2.1.3, and does not limit UE implementation or test system implementation</p>					

A.5.7.2.2.3 Test Requirements

The SS-RSRQ absolute measurement accuracy in test 1 shall be within the range Nominal SS-RSRQ+2.5dB to Nominal SS-RSRQ-2.5dB and the SS-RSRQ measurement accuracy in test 2 shall be within the range Nominal SS-RSRQ+3.5dB to Nominal SS-RSRQ-3.5dB according to the requirements in clause 10.1.10.1.1.

The SS-RSRQ relative measurement accuracy shall fulfil the requirements in clause 10.1.10.1.2.

A.5.7.3 SS-SINR

A.5.7.3.1 EN-DC Intra-frequency measurement accuracy with FR2 serving cell and FR2 TDD target cell

A.5.7.3.1.1 Test Purpose and Environment

The purpose of this test is to verify that the SS-SINR measurement accuracy is within the specified limits. This test will verify the requirements in clause 10.1.13.1.1.

A.5.7.3.1.2 Test Parameters

In this test case all cells are on the same carrier frequency. Supported test configurations are shown in Table A.5.7.3.1.2-1. The absolute accuracy of SS-SINR intra-frequency measurement is test by using the parameters in Table A.5.7.3.1.2-2 and Table A.5.7.3.1.2-3. The configuration of cell 1 (E-UTRA PCell) is specified in clause A.3.7.2.1. In all test cases, Cell 2 is the PCell and Cell 3 is the target cell.

Table A.5.7.3.1.2-1: SS-SINR Intra frequency SS-SINR supported test configurations

Configuration	Description
1	FDD LTE PCell, Cell 2&3 120 kHz SSB SCS, 100 MHz bandwidth, TDD duplex mode
2	TDD LTE PCell, Cell 2&3 120 kHz SSB SCS, 100 MHz bandwidth, TDD duplex mode
Note: The UE is only required to pass in one of the supported test configurations	

Table A.5.7.3.1.2-2: SS-SINR Intra frequency test parameters

Parameter	Unit	Test 1		Test 2	
		Cell 2	Cell 3	Cell 2	Cell 3
Cell ID		489	0	489	0
SSB ARFCN		freq2		freq2	
Duplex mode		TDD		TDD	
TDD configuration		TDDConf.3.1		TDDConf.3.1	
BW _{channel}	MHz	100: N _{RB,c} = 66		100: N _{RB,c} = 66	
Data RBs allocated		66		66	
Downlink initial BWP configuration		DLBWP.0.1			
Downlink dedicated BWP configuration		DLBWP.1.1			
Uplink initial BWP configuration		ULBWP.0.1			
Uplink dedicated BWP configuration		ULBWP.1.1			
DRX cycle configuration	ms	Not applicable			
TRS configuration		TRS.2.1 TDD			
TCI state		TCI.State.0			
PDSCH Reference measurement channel		SR.3.1 TDD		SR.3.1 TDD	
RMSI CORESET Reference Channel		CR.3.1 TDD	-	CR.3.1 TDD	-
Dedicated RMSI CORESET Reference Channel		CCR.3. 1 TDD	-	CCR.3. 1 TDD	-
OCNG Patterns		OP.1	OP.1	OP.1	OP.1
SMTTC configuration		SMTTC.1			
SSB configuration		SSB.1 FR2	SSB.1 FR2	SSB.1 FR2	SSB.1 FR2
PDSCH/PDCCH subcarrier spacing	kHz	120	120	120	120
SS-RSSI-Measurement		Not Applicable			
EPRE ratio of PSS to SSS	dB	0	0	0	0
EPRE ratio of PBCH_DMRS to SSS					
EPRE ratio of PBCH to PBCH_DMRS					
EPRE ratio of PDCCH_DMRS to SSS					
EPRE ratio of PDCCH to PDCCH_DMRS					
EPRE ratio of PDSCH_DMRS to SSS					
EPRE ratio of PDSCH to PDSCH_DMRS					
EPRE ratio of OCNG DMRS to SSS ^{Note 1}					
EPRE ratio of OCNG to OCNG DMRS ^{Note 1}					
Propagation conditions		AWGN		AWGN	
Antenna configuration		1x2	1x2	1x2	1x2
Note 1: OCNG shall be used such that both cells are fully allocated and a constant total transmitted power spectral density is achieved for all OFDM symbols.					
Note 2: Void					
Note 3: Void					
Note 4: Void					

Table A.5.7.3.1.2-3: SS-SINR Intra frequency OTA related test parameters

Parameter	Unit	Test 1		Test 2	
		Cell 2	Cell 3	Cell 2	Cell 3
Angle of arrival configuration		Setup 1 according to clause A.3.15.1		Setup 1 according to clause A.3.15.1	
Assumption for UE beams ^{Note 9}		Rough		Rough	
N_{oc} ^{Note1}	dBm/15kHz ^{Note4}	-105		-105	
N_{oc} ^{Note1}	dBm/SCS ^{Note3}	-96		-96	
\hat{E}_s / N_{oc}	dB	4.54	2.66	-3	-3
SS-RSRP ^{Note2}	dBm/SCS ^{Note4}	-91.46	-93.34	-99	-99
SS-SINR ^{Note2}	dB	0	-3.2	-4.76	-4.76
\hat{E}_s / I_{ot}	dB	0	-3.2	-4.76	-4.76
I_o ^{Note2}	dBm/95.04 MHz ^{Note4}	59.43		-64	
<p>Note 1: Interference from other cells and noise sources not specified in the test is assumed to be constant over subcarriers and time and shall be modelled as AWGN of appropriate power for N_{oc} to be fulfilled.</p> <p>Note 2: SS-SINR, SSB_RP, and I_o levels have been derived from other parameters for information purposes. They are not settable parameters themselves.</p> <p>Note 3: SS-SINR and SS-RSRP minimum requirements are specified assuming independent interference and noise at each receiver antenna port.</p> <p>Note 4: Equivalent power received by an antenna with 0dBi gain at the centre of the quiet zone</p> <p>Note 5: As observed with 0dBi gain antenna at the centre of the quiet zone</p> <p>Note 6: Void</p> <p>Note 7: Void</p> <p>Note 8: Void</p> <p>Note 9: Information about types of UE beam is given in B.2.1.3, and does not limit UE implementation or test system implementation</p>					

A.5.7.3.1.3 Test Requirements

The SS-SINR absolute measurement accuracy in test 1 shall be within the range Nominal SS-SINR+3B to Nominal SS-SINR -3dB and the SS-SINR measurement accuracy in test 2 shall be within the range Nominal SS-SINR +3.5dB to Nominal SS-SINR -3.5dB according to the requirements in clause 10.1.10.13.1. Nominal SS-SINR is the value shown in table A.5.7.3.1.2-3.

A.5.7.3.2 EN-DC Inter-frequency measurement accuracy with FR2 serving cell and FR2 TDD target cell

A.5.7.3.2.1 Test Purpose and Environment

The purpose of this test is to verify that the SS-SINR measurement accuracy is within the specified limits. This test will verify the requirements in clause 10.1.15.1.1 and 10.1.15.1.2 for inter-frequency measurement.

A.5.7.3.2.2 Test Parameters

In this test case the two NR cells (i.e., Cell 2 and Cell 3) are on different carrier frequencies and measurement gaps are provided. Supported test configurations are shown in Table A.5.7.3.2.2-1. Both absolute accuracy and relative accuracy requirements of SS-SINR inter-frequency measurement are tested by using test setup in Table A.5.7.3.2.2-2 and Table A.5.7.3.2.2-3. In all test cases, Cell 2 is the PSCell and Cell 3 is target cell. Cell 1 is the E-UTRA cell which specific test parameters for this test case are specified in Table A.3.7.2.1-1. The TCI status for Cell 1 is defined in Table A.3.16.2-1 and TRS configuration for Cell 1 is defined in Table A.3.17.2.1-1.

Table A.5.7.3.2.2-2: SS-SINR Inter frequency SS-SINR supported test configurations

Configuration	Description
1	LTE FDD, NR 120 kHz SSB SCS, 100 MHz bandwidth, TDD duplex mode
2	LTE TDD, NR 120 kHz SSB SCS, 100 MHz bandwidth, TDD duplex mode

Table A. 5.7.3.2.2-2: SS-SINR Inter frequency general test parameters

Parameter	Unit	Test 1		Test 2		Test 3	
		Cell 2	Cell 3	Cell 2	Cell 3	Cell 2	Cell 3
SSB ARFCN		Freq1	freq2	freq1	Freq2	freq1	Freq2
Duplex mode		TDD		TDD		TDD	
TDD configuration		TDDConf.3.1		TDDConf.3.1		TDDConf.3.1	
BW _{channel}	MHz	100: N _{RB,c} = 66		100: N _{RB,c} = 66		100: N _{RB,c} = 66	
Data RBs allocated		66		66		66	
Downlink initial BWP configuration		DLBWP.0.1					
Downlink dedicated BWP configuration		DLBWP.1.1					
Uplink initial BWP configuration		ULBWP.0.1					
Uplink dedicated BWP configuration		ULBWP.1.1					
DRX cycle configuration	ms	Not applicable					
TRS configuration		TRS.2.1 TDD					
TCI state		TCI.State.0					
PDSCH Reference measurement channel		SR.3.1 TDD	-	SR.3.1 TDD	-	SR.3.1 TDD	-
RMSI CORESET Reference Channel		CR.3.1 TDD	-	CR.3.1 TDD	-	CR.3.1 TDD	-
OCNG Patterns		OP.1	OP.1	OP.1	OP.1	OP.1	OP.1
SMTTC configuration		SMTTC. 1	SMTTC. 1	SMTTC. 1	SMTTC. 1	SMTTC. 1	SMTTC. 1
SSB configuration		SSB.3 FR2	SSB.3 FR2	SSB.3 FR2	SSB.3 FR2	SSB.3 FR2	SSB.3 FR2
PDSCH/PDCCH subcarrier spacing	kHz	120	120	120	120	120	120
EPRE ratio of PSS to SSS	dB	0	0	0	0	0	0
EPRE ratio of PBCH_DMRS to SSS							
EPRE ratio of PBCH to PBCH_DMRS							

EPRE ratio of PDCCH_DMRS to SSS							
EPRE ratio of PDCCH to PDCCH_DMRS							
EPRE ratio of PDSCH_DMRS to SSS							
EPRE ratio of PDSCH to PDSCH_DMRS							
EPRE ratio of OCNG DMRS to SSS ^{Note 1}							
EPRE ratio of OCNG to OCNG DMRS ^{Note 1}							
Propagation conditions		AWGN	AWGN	AWGN	AWGN	AWGN	AWGN
Antenna configuration		1x2	1x2	1x2	1x2	1x2	1x2
Note 1: OCNG shall be used such that both cells are fully allocated and a constant total transmitted power spectral density is achieved for all OFDM symbols.							
Note 2: Void							
Note 3: Void							
Note 4: Void							

Table A.5.7.3.2.2-3: SS-SINR Inter frequency OTA related test parameters

Parameter	Unit	Test 1		Test 2		Test 3	
		Cell 2	Cell 3	Cell 2	Cell 3	Cell 2	Cell 3
Angle of arrival configuration	degrees	Setup 1 according to A.3.15.1		Setup 1 according to A.3.15.1		Setup 1 according to A.3.15.1	
Assumption for UE beams ^{Note 10}		Rough		Rough		Rough	
N_{oc} ^{Note1}	dBm/15kHz ^{Note4}	-105	-105	-105	-105	-105	-105
N_{oc} ^{Note1}	dBm/SCS ^{Note3}	-96	-96	-96	-96	-96	-96
\hat{E}_s / N_{oc}	dB	-0.5	-0.5	11	11	-3.0	-3.0
SS-RSRP ^{Note2}	dBm/SCS ^{Note4}	-96.5	-96.5	-85	-85	-99	-99
SS-SINR ^{Note2}	dB	-0.5	-0.5	11	11	-3.0	-3.0
\hat{E}_s / I_{ot}	dB	-0.5	-0.5	11	11	-3.0	-3.0
I_o ^{Note2}	dBm/95.04 MHz ^{Note4}	-69.3	-69.3	-55.4	-55.4	-65.24	-65.24
Note 1: Interference from other cells and noise sources not specified in the test is assumed to be constant over subcarriers and time and shall be modelled as AWGN of appropriate power for N_{oc} to be fulfilled.							
Note 2: SS-SINR, SSB_RP, and I_o levels have been derived from other parameters for information purposes. They are not settable parameters themselves.							
Note 3: SS-SINR and SS-RSRP minimum requirements are specified assuming independent interference and noise at each receiver antenna port.							
Note 4: Equivalent power received by an antenna with 0dBi gain at the centre of the quiet zone							
Note 5: As observed with 0dBi gain antenna at the centre of the quiet zone							
Note 6: Void							
Note 7: Void							
Note 8: Void							
Note 9: Void							
Note 10: Information about types of UE beam is given in B.2.1.3, and does not limit UE implementation or test system implementation.							

A.5.7.3.2.3 Test Requirements

The SS-SINR absolute measurement accuracy in test 1 shall be within the range Nominal SS-SINR+3dB to Nominal SS-SINR -3dB and the SS-SINR measurement accuracy in test 2 shall be within the range Nominal SS-SINR+3.5dB to Nominal SS-SINR -3.5dB according to the requirements in clause 10.1.15.1.1. Nominal SS-SINR is the value shown in table A.5.7.2.2.2-3

The SS-SINR relative measurement accuracy shall fulfil the requirements in clause 10.1.15.1.2.

A.5.7.4 L1-RSRP measurement for beam reporting

A.5.7.4.1 SSB based L1-RSRP measurement

A.5.7.4.1.1 Test Purpose and Environment

The purpose of this test is to verify that the L1-RSRP measurement accuracy is within the specified limits. This test will verify the requirements in Clauses 9.5.2 and clause 10.1.20.1 for L1-RSRP measurements based on SSB with the testing configurations for NR cells in Table A.5.7.4.1.1-1.

The AoA setup for this test is Setup 1 as defined in clause A.3.15.

Table A.5.7.4.1.1-1: Applicable NR configurations for FR2 SSB based L1-RSRP test

Config	Description
1	LTE FDD, NR 120 kHz SSB SCS, 100 MHz bandwidth, TDD duplex mode
2	LTE TDD, NR 120 kHz SSB SCS, 100 MHz bandwidth, TDD duplex mode
3	LTE FDD, NR 240 kHz SSB SCS, 100 MHz bandwidth, TDD duplex mode
4	LTE TDD, NR 240 kHz SSB SCS, 100 MHz bandwidth, TDD duplex mode
Note:	The UE is only required to be tested in one of the supported test configurations in each supported band

A.5.7.4.1.2 Test parameters

In this set of test cases there are two cells in the test, E-UTRAN PCell (Cell 1), FR2 PSCell (Cell 2). The test parameters and applicability for Cell 1 are defined in A.3.7.2. The test parameters for the Cell 2 are given in Table A.5.7.4.1.2-1 and Table A.5.7.4.1.2-2 below. The absolute and relative accuracy of L1-RSRP measurements are tested by using the parameters in Table A.5.7.4.1.2-1 and Table A.5.7.4.1.2-2.

There is no measurement gap configured in the test. Before the test, UE is configured one SSB resource set with two SSB resources. UE is configured to perform RLM, BFD and L1-RSRP measurement based on the SSB resources 0 and 1.

Table A.5.7.4.1.2-1: FR2 SSB based L1-RSRP general test parameters

Parameter	Config	Unit	Test 1	Test 2
SSB GSCN	1~4		freq1	freq1
Duplex mode	1~4		TDD	TDD
TDD Configuration	1~4		TDDConf.3.1	TDDConf.3.1
BW _{channel}	1~4	MHz	100: N _{RB,c} = 66	100: N _{RB,c} = 66
Data RBs allocated	1~4		66	66
PDSCH Reference measurement channel	1,2		SR.3.2 TDD	SR.3.2 TDD
	3,4		SR.3.3 TDD	SR.3.3 TDD

RMSI CORESET Reference Channel	1,2		CR.3.1 TDD	CR.3.1 TDD
	3,4		CR.3.2 TDD	CR.3.2 TDD
Dedicated CORESET Reference Channel	1,2		CCR.3.1 TDD	CCR.3.1 TDD
	3,4		CCR.3.7 TDD	CCR.3.7 TDD
SSB configuration	1,2		SSB.1 FR2	SSB.1 FR2
	3,4		SSB.2 FR2	SSB.2 FR2
OCNG Patterns	1~4		OP.1	OP.1
Initial BWP Configuration	1~4		DLBWP.0.1 ULBWP.0.1	DLBWP.0.1 ULBWP.0.1
Dedicated BWP configuration	1~4		DLBWP.1.3 ULBWP.1.3	DLBWP.1.3 ULBWP.1.3
TRS Configuration	1~4		TRS.2.1 TDD	TRS.2.1 TDD
PDCCH/PDSCH TCI Configuration	1~4		TCI.State.2	TCI.State.2
SMTC configuration	1~4		SMTC.1	SMTC.1
reportConfigType	1~4		periodic	periodic
reportQuantity	1~4		ssb-Index-RSRP	ssb-Index-RSRP
Number of reported RS	1~4		2	2
L1-RSRP reporting period	1~4		slot320	slot320
Propagation condition	1~4		AWGN	AWGN
Antenna configuration			1x2	1x2
EPRE ratio of PSS to SSS	1~4	dB	0	0
EPRE ratio of PBCH DMRS to SSS				
EPRE ratio of PBCH to PBCH DMRS				
EPRE ratio of PDCCH DMRS to SSS				
EPRE ratio of PDCCH to PDCCH DMRS				
EPRE ratio of PDSCH DMRS to SSS				
EPRE ratio of PDSCH to PDSCH DMRS				
EPRE ratio of OCNG DMRS to SSS ^{Note 1}				
EPRE ratio of OCNG to OCNG DMRS ^{Note 1}				
<p>Note 1: OCNG shall be used such that both cells are fully allocated and a constant total transmitted power spectral density is achieved for all OFDM symbols.</p> <p>Note 2: Interference from other cells and noise sources not specified in the test is assumed to be constant over subcarriers and time and shall be modelled as AWGN of appropriate power for N_{oc} to be fulfilled.</p>				

Table A.5.7.4.1.2-2: FR2 SSB based L1-RSRP OTA related test parameters

Parameter	Config	Unit	Test 1		Test 2 ^{NOTE 3}	
			SSB0	SSB1	SSB0	SSB1
Angle of arrival configuration			Setup 1 according to A.3.15.1		Setup 1 according to A.3.15.1	
Assumption for UE beams ^{Note 4}			Rough		Rough	
N_{oc}	1~4	dBm/15 kHz	-100		n.a.	
N_{oc}	1,2	dBm/SS	-91		n.a.	
	3,4	B SCS	-88		n.a.	
\hat{E}_s/I_{ot}	1~4	dB	10	-2	n.a.	
SSB_RP ^{Note1}	1,2	dBm/SC	-81	-93	As in Table B.2.4-2	
	3,4	S	-78	-90	As in Table B.2.4-2	
I_o ^{Note1}	1~4	dBm/95.04M Hz	-51.57		SSB_RP+28.98	

\hat{E}_s/N_{oc}	1~4	dB	10	-2	n.a.
Note 1:	SSB_RP and l_0 levels have been derived from other parameters for information purposes. They are not settable parameters themselves.				
Note 2:	Void				
Note 3:	No additional noise is added by the test system in Test 2.				
Note 4:	Information about types of UE beam is given in B.2.1.3, and does not limit UE implementation or test system implementation.				

A.5.7.4.1.3 Test Requirements

After 320ms from the beginning of the test, the L1-RSRP measurement accuracy for SSB#0 and SSB#1 of Cell 2 shall fulfil the requirements in clauses 10.1.20.1. The following requirements are to be verified:

For Test 1:

Absolute accuracy of SSB0. The UE is deemed to meet the requirement if the reported L1-RSRP is in the range shown in Table A.5.7.4.1.3-1.

Relative accuracy of SSB0 compared with SSB1. The UE is deemed to meet the requirement if the difference in reported L1-RSRP meets the requirements in Table 10.1.20.1.2-1.

For Test 2:

Absolute accuracy of SSB resource reported by UE in L1-RSRP report (SSB0 or SSB1). The UE is deemed to meet the requirement if the reported L1-RSRP is in the range shown in Table A.5.7.4.1.3-1.

Relative accuracy of SSB0 compared with SSB1. The UE is deemed to meet the requirement if the difference in reported L1-RSRP meets the requirements in Table 10.1.20.1.2-1.

Table A.5.7.4.1.3-1: L1-RSRP absolute accuracy test requirement

	Test requirement ^{Notes1,2,3}
SSB0	$SSB_RP0 - \delta + G_{min} \leq \text{Reported RSRP(dBm)} \leq SSB_RP0 + \delta + G_{max}$
SSB1	$SSB_RP1 - \delta + G_{min} \leq \text{Reported RSRP(dBm)} \leq SSB_RP1 + \delta + G_{max}$
Note 1:	SSB_RPn is the equivalent power received by an antenna with 0dBi gain at the centre of the quiet zone configured in the test for the SSB n under consideration
Note 2:	δ is the RSRP absolute accuracy requirement from Table 10.1.20.1.1-1, selected according to the l_0 used in the test
Note 3:	G_{min} and G_{max} are the minimum and maximum UE gain values from Table B.2.1.5.1-1, selected according to the UE power class

A.5.7.4.2 CSI-RS based L1-RSRP measurement on resource set with repetition off

A.5.7.4.2.1 Test Purpose and Environment

The purpose of this test is to verify that the L1-RSRP measurement accuracy is within the specified limits. This test will verify the requirements in Clauses 9.5.3 and clause 10.1.20.2 for L1-RSRP measurements based on CSI-RS with the testing configurations for NR cells in Table A.5.7.4.2.1-1.

The AoA setup for this test is Setup 1 as defined in clause A.3.15.

Table A.5.7.4.2.1-1: Applicable NR configurations for FR2 CSI-RS based L1-RSRP test

Config	Description
1	LTE FDD, NR 120 kHz CSI-RS SCS, 100 MHz bandwidth, TDD duplex mode

2	LTE TDD, NR 120 kHz CSI-RS SCS, 100 MHz bandwidth, TDD duplex mode
Note:	The UE is only required to be tested in one of the supported test configurations in each supported band

A.5.7.4.2.2 Test parameters

In this set of test cases there are two cells in the test, E-UTRAN PCell (Cell 1), FR1 PCell (Cell 2). The test parameters and applicability for Cell 1 are defined in A.3.7.2. The test parameters for the Cell 2 are given in Table A.5.7.4.2.2-1 and Table A.5.7.4.2.2-2 below. The absolute and relative accuracy of L1-RSRP measurements are tested by using the parameters in Table A.5.7.4.2.2-1 and Table A.5.7.4.2.2-2.

There is no measurement gap configured in the test. Before the test, UE is configured one CSI-RS resource set with two CSI-RS resources. UE is configured to perform RLM and BFD based on SSB 0 and 1. CSI-RS is not transmitted in the same OFDM symbols as SSB.

Table A.5.7.4.2.2-1: FR2 CSI-RS based L1-RSRP general test parameters

Parameter	Config	Unit	Test 1	Test 2
SSB GSCN	1~2		freq1	freq1
Duplex mode	1~2		TDD	TDD
TDD Configuration	1~2		TDDConf.3.1	TDDConf.3.1
BW _{channel}	1~2	MHz	100: N _{RB,c} = 66	100: N _{RB,c} = 66
PDSCH Reference measurement channel	1~2		SR.3.1 TDD	SR.3.1 TDD
RMSI CORESET Reference Channel	1~2		CR.3.1 TDD	CR.3.1 TDD
Dedicated CORESET Reference Channel	1~2		CCR.3.1 TDD	CCR.3.1 TDD
SSB configuration	1~2		SSB.1 FR2	SSB.1 FR2
OCNG Patterns	1~2		OP.1	OP.1
Initial BWP Configuration	1~2		DLBWP.0.1 ULBWP.0.1	DLBWP.0.1 ULBWP.0.1
Dedicated BWP configuration	1~2		DLBWP.1.1 ULBWP.1.1	DLBWP.1.1 ULBWP.1.1
TRS Configuration	1~2		TRS.2.1 TDD	TRS.2.1 TDD
PDCCH/PDSCH TCI Configuration	1~2		TCI.State.2	TCI.State.2
SMTC configuration	1~2		SMTC.1	SMTC.1
CSI-RS	1~2		CSI-RS.3.2 TDD	CSI-RS.3.2 TDD
reportConfigType	1~2		periodic	periodic
reportQuantity	1~2		cri-RSRP	cri-RSRP
Number of reported RS	1~2		2	2
L1-RSRP reporting period	1~2		slot320	slot320
Propagation condition	1~2		AWGN	AWGN
Antenna configuration	1~2		1x2	1x2
EPRE ratio of PSS to SSS	1~2	dB	0	0
EPRE ratio of PBCH DMRS to SSS				
EPRE ratio of PBCH to PBCH DMRS				
EPRE ratio of PDCCH DMRS to SSS				
EPRE ratio of PDCCH to PDCCH DMRS				
EPRE ratio of PDSCH DMRS to SSS				
EPRE ratio of PDSCH to PDSCH DMRS				
EPRE ratio of OCNG DMRS to SSS ^{Note 1}				
EPRE ratio of OCNG to OCNG ^{Note 1}				

Note 1:	OCNG shall be used such that both cells are fully allocated and a constant total transmitted power spectral density is achieved for all OFDM symbols.
Note 2:	Interference from other cells and noise sources not specified in the test is assumed to be constant over subcarriers and time and shall be modelled as AWGN of appropriate power for N_{oc} to be fulfilled.

Table A.5.7.4.2.2-2: FR2 CSI-RS based L1-RSRP OTA related test parameters

Parameter	Config	Unit	Test 1		Test 2 ^{NOTE 3}	
			CSI-RS0	CSI-RS1	CSI-RS0	CSI-RS1
Angle of arrival configuration			Setup 1 according to A.3.15.1		Setup 1 according to A.3.15.1	
Assumption for UE beams ^{Note 4}			Rough		Rough	
N_{oc}	1~2	dBm/15 kHz	-100		n.a.	
N_{oc}	1~2	dBm/SS B SCS	-91		n.a. n.a.	
\hat{E}_s/I_{ot}	1~2	dB	10	-2	n.a.	
CSI-RS-RSRP ^{Note 1}	1~2	dBm/SC S	-81	-93	As in Table B.2.4-2	
Io ^{Note 1}	1~2	dBm/95.04M Hz	-59.86		SS-RSRP+28.98	
\hat{E}_s/N_{oc}	1~2	dB	-51.57	-2	n.a.	
Note 1:	RSRP and Io levels have been derived from other parameters for information purposes. They are not settable parameters themselves.					
Note 2:	RSRP minimum requirements are specified assuming independent interference and noise at each receiver antenna port.					
Note 3:	No additional noise is added by the test system in Test 2.					
Note 4:	Information about types of UE beam is given in B.2.1.3, and does not limit UE implementation or test system implementation					

A.5.7.4.2.3 Test Requirements

After 320ms from the beginning of the test, the L1-RSRP measurement accuracy for CSI-RS#0 and CSI-RS#1 of Cell 2 shall fulfil the requirements in clauses 10.1.20.2. The following requirements are to be verified:

For Test 1:

Absolute accuracy of CSI-RS0. The UE is deemed to meet the requirement if the reported L1-RSRP is in the range shown in Table A.5.7.4.2.3-1.

Relative accuracy of CSI-RS0 compared with CSI-RS1. The UE is deemed to meet the requirement if the difference in reported L1-RSRP meets the requirements in Table 10.1.20.2.2-1.

For Test 2:

Absolute accuracy of CSI-RS resource reported by UE in L1-RSRP report (CSI-RS0 or CSI-RS1). The UE is deemed to meet the requirement if the reported L1-RSRP is in the range shown in Table A.5.7.4.2.3-1.

Relative accuracy of CSI-RS0 compared with CSI-RS1. The UE is deemed to meet the requirement if the difference in reported L1-RSRP meets the requirements in Table 10.1.20.2.2-1.

Table A.5.7.4.2.3-1: L1-RSRP absolute accuracy test requirement

	Test requirement ^{Notes1,2,3}
CSI-RS0	$\text{CSI-RS_RP0} - \delta + G_{\min} \leq \text{Reported RSRP(dBm)} \leq \text{CSI-RS_RP0} + \delta + G_{\max}$
CSI-RS1	$\text{CSI-RS_RP1} - \delta + G_{\min} \leq \text{Reported RSRP(dBm)} \leq \text{CSI-RS_RP1} + \delta + G_{\max}$
Note 1:	CSI-RS_RPn is the equivalent power received by an antenna with 0dBi gain at the centre of the quiet zone configured in the test for the CSI-RS n under consideration
Note 2:	δ is the RSRP absolute accuracy requirement from Table 10.1.20.2.1-1, selected according to the I_0 used in the test
Note 3:	G_{\min} and G_{\max} are the minimum and maximum UE gain values from Table B.2.1.5.1-1, selected according to the UE power class

A.5.8 Void

A.6 NR standalone tests with all NR cells in FR1

A.6.1 SA: RRC_IDLE state mobility

A.6.1.1 Cell re-selection to NR

A.6.1.1.1 Cell reselection to FR1 intra-frequency NR case

A.6.1.1.1.1 Test Purpose and Environment

This test is to verify the requirement for the intra frequency NR cell reselection requirements specified in clause 4.2.2.3.

A.6.1.1.1.2 Test Parameters

The test scenario comprises of 1 NR carrier and 2 cells as given in tables A.6.1.1.1.2-1, A.6.1.1.1.2-2 and A.6.1.1.1.2-3. The test consists of three successive time periods, with time duration of T1, T2, and T3 respectively. Only cell 1 is already identified by the UE prior to the start of the test. Cell 1 and cell 2 belong to different tracking areas. Furthermore, UE has not registered with network for the tracking area containing cell 2.

Table A.6.1.1.1.2-1: Supported test configurations

Configuration	Description
1	15 kHz SSB SCS, 10 MHz bandwidth, FDD duplex mode
2	15 kHz SSB SCS, 10 MHz bandwidth, TDD duplex mode
3	30 kHz SSB SCS, 40 MHz bandwidth, TDD duplex mode
Note: The UE is only required to be tested in one of the supported test configurations.	

Table A.6.1.1.1.2-2: General test parameters for intra frequency NR cell re-selection test case

Parameter		Unit	Test configuration	Value	Comment
Initial condition	Active cell		1, 2, 3	Cell1	
T2 end condition	Active cell		1, 2, 3	Cell2	
	Neighbour cells		1, 2, 3	Cell1	
Final condition	Active cell		1, 2, 3	Cell1	
	Neighbour cells		1, 2, 3	Cell2	
RF Channel Number			1, 2, 3	1	
Time offset between cells			1	3 ms	Asynchronous cells
			2	3 μ s	Synchronous cells
			3	3 μ s	Synchronous cells
Access Barring Information		-	1, 2, 3	Not Sent	No additional delays in random access procedure.
SSB configuration			1	SSB.1 FR1	
			2	SSB.1 FR1	
			3	SSB.2 FR1	
SMTC configuration			1	SMTC.2	Configured in SIB2 of Cell 1
				SMTC.6	Configured in SIB2 of Cell 2
			2	SMTC.1	
	3	SMTC.1			
DRX cycle length		s	1, 2, 3	1.28	The value shall be used for all cells in the test.
PRACH configuration index			1, 2, 3	102	The detailed configuration is specified in TS 38.211 clause 6.3.3.2

rangeToBestCell		1, 2, 3	Not configured	
T1	s	1, 2, 3	>7	During T1, Cell 2 shall be powered off, and during the off time the physical cell identity shall be changed, The intention is to ensure that Cell 2 has not been detected by the UE prior to the start of period T2
T2	s	1, 2, 3	40	T2 needs to be defined so that cell re-selection reaction time is taken into account.
T3	s	1, 2, 3	15	T3 needs to be defined so that cell re-selection reaction time is taken into account.

Table A.6.1.1.2-3: Cell specific test parameters for intra frequency NR cell re-selection test case in AWGN

Parameter	Unit	Test configuration	Cell 1			Cell 2		
			T1	T2	T3	T1	T2	T3
TDD configuration		1	N/A			N/A		
		2	TDDConf.1.1			TDDConf.1.1		
		3	TDDConf.2.1			TDDConf.2.1		
PDSCH RMC configuration		1	SR.1.1 FDD			SR.1.1 FDD		
		2	SR.1.1 TDD			SR.1.1 TDD		
		3	SR.2.1 TDD			SR.2.1 TDD		
RMSI CORESET RMC configuration		1	CR.1.1 FDD			CR.1.1 FDD		
		2	CR.1.1 TDD			CR.1.1 TDD		
		3	CR.2.1 TDD			CR.2.1 TDD		
Dedicated CORESET RMC configuration		1	CCR.1.1 FDD			CCR.1.1 FDD		
		2	CCR.1.1 TDD			CCR.1.1 TDD		
		3	CCR.2.1 TDD			CCR.2.1 TDD		
OCNG Pattern		1, 2, 3	OP.1 defined in A.3.2.1			OP.1 defined in A.3.2.1		
Initial DL BWP configuration		1, 2, 3	DLBWP.0.1			DLBWP.0.1		
Initial UL BWP configuration		1, 2, 3	ULBWP.0.1			ULBWP.0.1		
RLM-RS		1, 2, 3	SSB			SSB		
Qrxlevmin	dBm/SCS	1, 2	-130			-130		
		3	-127			-127		
Pcompensation	dB	1, 2, 3	0			0		
Qhysts	dB	1, 2, 3	0			0		
Qoffsets _{s,n}	dB	1, 2, 3	0			0		
Cell_selection_and_reselection_quality_measurement		1, 2, 3	SS-RSRP			SS-RSRP		
\hat{E}_s / I_{n}	dB	1	16	-3.11	2.79	-infinity	2.79	-3.11
		2						
		3						
N_{oc} <small>Note2</small>	dBm/SCS	1	-98					
		2	-98					
		3	-95					
N_{oc} <small>Note2</small>	dBm/15 kHz	1	-98					
		2						
		3						
\hat{E}_s / N_{oc}	dB	1	16	13	16	-infinity	16	13
		2						

SS-RSRP ^{Note3}	dBm/SCS	3						
		1	-82	-85	-82	-infinity	-82	-85
		2	-82	-85	-82	-infinity	-82	-85
		3	-79	-82	-79	-infinity	-79	-82
Io	dBm/9.36 MHz	1	-53.94	-52.21	-52.21	Same as parameters specified in Cell 1 columns		
	dBm/9.36 MHz	2	-53.94	-52.21	-52.21			
	dBm/38.16 MHz	3	-47.85	-46.12	-46.12			
Treselection	s	1, 2, 3	0	0	0	0	0	0
Sintrasearch	dB	1, 2, 3	60			60		
Propagation Condition		1, 2, 3	AWGN					
<p>Note 1: OCNB shall be used such that both cells are fully allocated and a constant total transmitted power spectral density is achieved for all OFDM symbols.</p> <p>Note 2: Interference from other cells and noise sources not specified in the test is assumed to be constant over subcarriers and time and shall be modelled as AWGN of appropriate power for N_{oc} to be fulfilled.</p> <p>Note 3: SS-RSRP levels have been derived from other parameters for information purposes. They are not settable parameters themselves.</p>								

A.6.1.1.1.3 Test Requirements

The cell reselection delay to a newly detectable cell is defined as the time from the beginning of time period T2, to the moment when the UE camps on Cell 2, and starts to send preambles on the PRACH for sending the *RRCSetupRequest* message to perform a Registration procedure for mobility and periodic registration update on Cell 2.

The cell re-selection delay to a newly detectable cell shall be less than 34 s.

The cell reselection delay to an already detected cell is defined as the time from the beginning of time period T3, to the moment when the UE camps on cell 1, and starts to send preambles on the PRACH for sending the *RRCSetupRequest* message to perform a Registration procedure for mobility and periodic registration update on cell 1.

The cell re-selection delay to an already detected cell shall be less than 8 s.

The rate of correct cell reselections observed during repeated tests shall be at least 90%.

NOTE: The cell re-selection delay to a newly detectable cell can be expressed as: $T_{\text{detect, NR_Intra}} + T_{\text{SI-NR}}$, and to an already detected cell can be expressed as: $T_{\text{evaluate, NR_intra}} + T_{\text{SI-NR}}$,

Where:

$T_{\text{detect, NR_Intra}}$ See Table 4.2.2.3-1 in clause 4.2.2.3

$T_{\text{evaluate, NR_intra}}$ See Table 4.2.2.3-1 in clause 4.2.2.3

$T_{\text{SI-NR}}$ Maximum repetition period of relevant system info blocks that needs to be received by the UE to camp on a cell; 1280ms is assumed in this test case.

This gives a total of 33.28 s, allow 34 s for the cell re-selection delay to a newly detectable cell and 7.68 s for the cell re-selection delay to an already detected cell in the test case, which we allow 8 s.

A.6.1.1.2 Cell reselection to FR1 inter-frequency NR case

A.6.1.1.2.1 Test Purpose and Environment

This test is to verify the requirement for the inter frequency NR cell reselection requirements specified in clause 4.2.2.4.

A.6.1.1.2.2 Test Parameters

The test scenario comprises of 2 cells on 2 different NR carriers respectively as given in tables A.6.1.1.2.2-1, A.6.1.1.2.2-2 and A.6.1.1.2.2-3. The test consists of three successive time periods, with time duration of T1, T2, and T3 respectively. Both cell 1 and cell 2 are already identified by the UE prior to the start of the test. Cell 1 and cell 2 belong to different tracking areas and cell 2 is of higher priority than cell 1.

Table A.6.1.1.2.2-1: Supported test configurations

Configuration	Description of serving cell	Description of target cell
1	15 kHz SSB SCS, 10 MHz bandwidth, FDD duplex mode	15 kHz SSB SCS, 10 MHz bandwidth, FDD duplex mode
2	15 kHz SSB SCS, 10 MHz bandwidth, TDD duplex mode	15 kHz SSB SCS, 10 MHz bandwidth, TDD duplex mode
3	30 kHz SSB SCS, 40 MHz bandwidth, TDD duplex mode	30 kHz SSB SCS, 40 MHz bandwidth, TDD duplex mode

Note: The UE is only required to be tested in one of the supported test configurations.

Table A.6.1.1.2.2-2: General test parameters for FR1 inter frequency NR cell re-selection test case

Parameter		Unit	Test configuration	Value	Comment
Initial condition	Active cell		1, 2, 3	Cell 2	The UE camps on cell 2 in the initial phase and during T1 period the UE reselects to cell 1
	Neighbour cell		1, 2, 3	Cell 1	
T1 end condition	Active cell		1, 2, 3	Cell1	The UE shall perform reselection to cell 1 during T1
	Neighbour cells		1, 2, 3	Cell2	
T3 end condition	Active cell		1, 2, 3	Cell2	The UE shall perform reselection to cell 2 with higher priority during T3
	Neighbour cell		1, 2, 3	Cell 1	
RF Channel Number			1, 2, 3	1, 2	
Time offset between cells			1	3 ms	Asynchronous cells
			2	3 μ s	Synchronous cells
			3	3 μ s	Synchronous cells
Access Barring Information		-	1, 2, 3	Not Sent	No additional delays in random access procedure.
SSB configuration			1	SSB.1 FR1	
			2	SSB.1 FR1	
			3	SSB.2 FR1	
SMTC configuration			1	SMTC.2	Configured in SIB4 of Cell 1
				SMTC.6	Configured in SIB4 of Cell 2
			2	SMTC.1	
	3	SMTC.1			
DRX cycle length		s	1, 2, 3	1.28	The value shall be used for all cells in the test.
PRACH configuration index			1, 2, 3	102	The detailed configuration is specified in TS 38.211 clause 6.3.3.2
rangeToBestCell			1, 2, 3	Not configured	
T1		s	1, 2, 3	15	T1 needs to be defined so that cell re-selection reaction time is taken into account.

T2	s	1, 2, 3	>7	During T2, cell 2 shall be powered off, and during the off time the physical cell identity shall be changed. The intention is to ensure that cell 2 has not been detected by the UE prior to the start of period T3.
T3	s	1, 2, 3	75	T3 needs to be defined so that cell re-selection reaction time is taken into account.

Table A.6.1.1.2.2-3: Cell specific test parameters for FR1 inter frequency NR cell re-selection test case in AWGN

Parameter	Unit	Test configuration	Cell 1			Cell 2		
			T1	T2	T3	T1	T2	T3
TDD configuration		1	N/A			N/A		
		2	TDDConf.1.1			TDDConf.1.1		
		3	TDDConf.2.1			TDDConf.2.1		
PDSCH RMC configuration		1	SR.1.1 FDD			SR.1.1 FDD		
		2	SR.1.1 TDD			SR.1.1 TDD		
		3	SR.2.1 TDD			SR.2.1 TDD		
RMSI CORESET RMC configuration		1	CR.1.1 FDD			CR.1.1 FDD		
		2	CR.1.1 TDD			CR.1.1 TDD		
		3	CR.2.1 TDD			CR.2.1 TDD		
Dedicated CORESET RMC configuration		1	CCR.1.1 FDD			CCR.1.1 FDD		
		2	CCR.1.1 TDD			CCR.1.1 TDD		
		3	CCR.2.1 TDD			CCR.2.1 TDD		
OCNG Pattern		1, 2, 3	OP.1 defined in A.3.2.1			OP.1 defined in A.3.2.1		
Initial DL BWP configuration		1, 2, 3	DLBWP.0.1			DLBWP.0.1		
Initial UL BWP configuration		1, 2, 3	ULBWP.0.1			ULBWP.0.1		
RLM-RS		1, 2, 3	SSB			SSB		
Qrxlevmin	dBm/SCS	1, 2	-140			-140		
		3	-137			-137		
Pcompensation	dB	1, 2, 3	0			0		
Cell_selection_and_reselection_quality_measurement		1, 2, 3	SS-RSRP			SS-RSRP		
\hat{E}_s / I_{α}	dB	1	14	14	14	-4	-infinity	12
		2						
		3						
N_{oc} ^{Note2}	dBm/SCS	1	-98					
		2	-98					
		3	-95					
N_{oc} ^{Note2}	dBm/15 kHz	1	-98					
		2						
		3						
\hat{E}_s / N_{oc}	dB	1	14	14	14	-4	-infinity	12
		2						
		3						
SS-RSRP ^{Note3}	dBm/SCS	1	-84	-84	-84	-102	-infinity	-86
		2	-84	-84	-84	-102	-infinity	-86
		3	-81	-81	-81	-99	-infinity	-83

Io	dBm/9.36 MHz	1	-55.88	-55.88	-55.88	-68.60	-70.05	-57.78
	dBm/9.36 MHz	2	-55.88	-55.88	-55.88	-68.60	-70.05	-57.78
	dBm/38.16 MHz	3	-49.79	-49.79	-49.79	-62.50	-63.96	-51.69
Treselection	s	1, 2, 3	0	0	0	0	0	0
SnonintrasearchP	dB	1, 2, 3	50			50		
Thresh _{x, highP}	dB	1, 2, 3	48			48		
Thresh _{nserving, lowP}	dB	1, 2, 3	44			44		
Thresh _{x, lowP}	dB	1, 2, 3	50			50		
Propagation Condition		1, 2, 3	AWGN					
Note 1:	OCNG shall be used such that both cells are fully allocated and a constant total transmitted power spectral density is achieved for all OFDM symbols.							
Note 2:	Interference from other cells and noise sources not specified in the test is assumed to be constant over subcarriers and time and shall be modelled as AWGN of appropriate power for N_{oc} to be fulfilled.							
Note 3:	SS-RSRP levels have been derived from other parameters for information purposes. They are not settable parameters themselves.							

A.6.1.1.2.3 Test Requirements

The cell reselection delay to a higher priority cell is defined as the time from the beginning of time period T3, to the moment when the UE camps again on cell 2, and starts to send preambles on the PRACH for sending the *RRCSetupRequest* message to perform a Registration procedure for mobility and periodic registration update on cell 2.

The cell re-selection delay to a higher priority cell shall be less than 68 s.

The cell reselection delay to a lower priority cell is defined as the time from the beginning of time period T1, to the moment when the UE camps on cell 1, and starts to send preambles on the PRACH for sending the *RRCSetupRequest* message to perform a Registration procedure for mobility and periodic registration update on cell 1.

The cell re-selection delay to a lower priority cell shall be less than 8 s.

The rate of correct cell reselections observed during repeated tests shall be at least 90%.

NOTE: The cell re-selection delay to a higher priority cell can be expressed as: $T_{\text{higher_priority_search}} + T_{\text{evaluate, NR_inter}} + T_{\text{SI-NR}}$, and to a lower priority cell can be expressed as: $T_{\text{evaluate, NR_inter}} + T_{\text{SI-NR}}$.

Where:

$T_{\text{higher_priority_search}}$ See clause 4.2.2.7

$T_{\text{evaluate, NR_inter}}$ See Table 4.2.2.4-1 in clause 4.2.2.4

$T_{\text{SI-NR}}$ Maximum repetition period of relevant system info blocks that needs to be received by the UE to camp on a cell; 1280 ms is assumed in this test case.

This gives a total of 67.68 s, allow 68 s for the cell re-selection delay to a higher priority cell and 7.68 s for the cell re-selection delay to a lower priority cell in the test case, which we allow 8 s.

A.6.1.2 Inter-RAT E-UTRAN cell re-selection

A.6.1.2.1 Cell reselection to higher priority E-UTRAN

A.6.1.2.1.1 Test Purpose and Environment

This test is to verify the requirement for the NR to E-UTRAN inter-RAT cell reselection requirements specified in clause 4.2.2.5 when the E-UTRAN cell is of higher priority.

A.6.1.2.1.2 Test Parameters

The test scenario comprises of one NR cell and one E-UTRAN cell as given in tables A.6.1.2.1.2-1, A.6.1.2.1.2-2, A.6.1.2.1.2-3 and A.6.1.2.1.2-4. The test consists of three successive time periods, with time duration of T1, T2, and T3 respectively. NR cell 1 is already identified by the UE prior to the start of the test. E-UTRAN cell 2 is of higher priority than cell 1.

Table A.6.1.2.1.2-1: Supported test configurations

Configuration	Description of serving cell	Description of target cell
1	NR 15 kHz SSB SCS, 10 MHz bandwidth, FDD duplex mode	LTE 10 MHz bandwidth, TDD duplex mode
2	NR 15 kHz SSB SCS, 10 MHz bandwidth, TDD duplex mode	LTE 10 MHz bandwidth, TDD duplex mode
3	NR 30 kHz SSB SCS, 40 MHz bandwidth, TDD duplex mode	LTE 10 MHz bandwidth, TDD duplex mode
4	NR 15 kHz SSB SCS, 10 MHz bandwidth, FDD duplex mode	LTE 10 MHz bandwidth, FDD duplex mode
5	NR 15 kHz SSB SCS, 10 MHz bandwidth, TDD duplex mode	LTE 10 MHz bandwidth, FDD duplex mode
6	NR 30 kHz SSB SCS, 40 MHz bandwidth, TDD duplex mode	LTE 10 MHz bandwidth, FDD duplex mode

Note: The UE is only required to be tested in one of the supported test configurations.

Table A.6.1.2.1.2-2: General test parameters for NR to E-UTRAN cell re-selection test case

Parameter		Unit	Test configuration	Value	Comment
Initial condition	Active cell		1, 2, 3, 4, 5, 6	Cell1	The UE camps on cell 1 in the initial phase and during T2 period the UE reselects to cell 2.
T2 end condition	Active cell		1, 2, 3, 4, 5, 6	Cell2	The UE shall perform reselection to cell 2 during T2.
	Neighbour cell		1, 2, 3, 4, 5, 6	Cell1	
T3 end condition	Active cell		1, 2, 3, 4, 5, 6	Cell1	The UE shall perform reselection to cell 1 during T3 for iteration of the tests.
	Neighbour cell		1, 2, 3, 4, 5, 6	Cell2	
Access Barring Information		-	1, 2, 3, 4, 5, 6	Not Sent	No additional delays in random access procedure.
DRX cycle length		s	1, 2, 3, 4, 5, 6	1.28	The value shall be used for all cells in the test.
NR PRACH configuration index			1, 2, 3, 4, 5, 6	102	The detailed configuration is specified in TS 38.211 clause 6.3.3.2
E-UTRAN PRACH configuration index			1, 2, 3	53	As specified in table 5.7.1-2 in TS 36.211 [23]
			4, 5, 6	4	
T1		s	1, 2, 3, 4, 5, 6	>7	During T1, cell 2 shall be powered off, and during the off time the physical cell identity shall be changed. The intention is to ensure that cell 2 has not been detected by the UE prior to the start of period T2.

T2	s	1, 2, 3, 4, 5, 6	75	T2 needs to be defined so that cell re-selection reaction time is taken into account.
T3	s	1, 2, 3, 4, 5, 6	15	T3 needs to be defined so that cell re-selection reaction time is taken into account.

Table A.6.1.2.1.2-3: Cell specific test parameters for NR cell 1

Parameter	Unit	Test configuration	Cell 1		
			T1	T2	T3
TDD configuration		1, 4	N/A		
		2, 5	TDDConf.1.1		
		3, 6	TDDConf.2.1		
PDSCH parameters		1, 4	SR.1.1 FDD		
		2, 5	SR.1.1 TDD		
		3, 6	SR.2.1 TDD		
RMSI CORESET parameters		1, 4	CR.1.1 FDD		
		2, 5	CR.1.1 TDD		
		3, 6	CR.2.1 TDD		
Dedicated CORESET parameters		1, 4	CCR.1.1 FDD		
		2, 5	CCR.1.1 TDD		
		3, 6	CCR.2.1 TDD		
SSB parameters		1, 4	SSB.1 FR1		
		2, 5	SSB.1 FR1		
		3, 6	SSB.2 FR1		
NR SMTc parameters		1, 4	SMTc.2		
		2, 5	SMTc.1		
		3, 6	SMTc.1		
OCNG Pattern		1, 2, 3, 4, 5, 6	OP.1 defined in A.3.2.1		
Initial DL BWP configuration		1, 2, 3, 4, 5, 6	DLBWP.0.1		
Initial UL BWP configuration		1, 2, 3, 4, 5, 6	ULBWP.0.1		
RLM-RS		1, 2, 3, 4, 5, 6	SSB		
Qrxlevmin	dBm/SCS	1, 2, 4, 5	-140		
		3, 6	-137		
N_{oc}	dBm/SCS	1, 4	-98		
		2, 5	-98		
		3, 6	-95		
N_{oc}	dBm/15 kHz	1, 2, 3, 4, 5, 6	-98		
SS-RSRP	dBm/SCS	1, 4	-84	-84	-84
		2, 5	-84	-84	-84
		3, 6	-81	-81	-81
\hat{E}_s / I_{ot}	dB	1, 4	14	14	14
		2, 5			
		3, 6			
\hat{E}_s / N_{oc}	dB	1, 4	14	14	14
		2, 5			
		3, 6			
Io	dBm/9.36 MHz	1, 4	-55.88	-55.88	-55.88
	dBm/9.36 MHz	2, 5	-55.88	-55.88	-55.88
	dBm/38.16 MHz	3, 6	-49.79	-49.79	-49.79
Treselection	S	1, 2, 3, 4, 5, 6	0		
SnonintrasearchP	dB	1, 2, 3, 4, 5, 6	50		
Thresh _{x, highP} (Note 2)	dB	1, 2, 3, 4, 5, 6	48		
Thresh _{serv, lowP}	dB	1, 2, 3, 4, 5, 6	44		
Thresh _{x, lowP}	dB	1, 2, 3, 4, 5, 6	50		
Propagation Condition		1, 2, 3, 4, 5, 6	AWGN		

Note 1:	OCNG shall be used such that both cells are fully allocated and a constant total transmitted power spectral density is achieved for all OFDM symbols.
Note 2:	This refers to the value of $\text{Thresh}_{x, \text{high}}$ which is included in NR system information, and is a threshold for the E-UTRA target cell

Table A.6.1.2.1.2-4: Cell specific test parameters for E-UTRA cell 2

Parameter	Unit	Cell 2		
		T1	T2	T3
E-UTRA RF Channel number		1		
BW_{channel}	MHz	10		
OCNG Patterns defined in TS 36.133 [15] clause A.3.2		OP.2 TDD for test configuration 1, 2, 3; OP.2 FDD for test configuration 4, 5, 6		
PBCH_RA	dB	0		
PBCH_RB	dB			
PSS_RA	dB			
SSS_RA	dB			
PCFICH_RB	dB			
PHICH_RA	dB			
PHICH_RB	dB			
PDCCH_RA	dB			
PDCCH_RB	dB			
PDSCH_RA	dB			
PDSCH_RB	dB			
OCNG_RA ^{Note 1}	dB			
OCNG_RB ^{Note 1}	dB			
$Q_{rxlevmin}$	dBm			
N_{oc}	dBm/15 kHz	-98		
RSRP	dBm/15 KHz	-infinity	-86	-102
\hat{E}_s / I_{ot}	dB	-infinity	12	-4
\hat{E}_s / N_{oc}	dB	-infinity	12	-4
$\text{Treselection}_{EUTRAN}$	S	0		
SnonintrasearchP	dB	Not sent		
$\text{Thresh}_{x, \text{highP}}$	dB	48		
$\text{Thresh}_{\text{serv}, \text{lowP}}$	dB	44		
$\text{Thresh}_{x, \text{lowP}}$ (Note 2)	dB	50		
Propagation Condition		AWGN		
Note 1:	OCNG shall be used such that both cells are fully allocated and a constant total transmitted power spectral density is achieved for all OFDM symbols.			
Note 2:	This refers to the value of $\text{Thresh}_{x, \text{Low}}$ which is included in E-UTRA system information, and is a threshold for the NR target cell			

A.6.1.2.1.3 Test Requirements

The cell reselection delay to a higher priority E-UTRAN cell is defined as the time from the beginning of time period T2, to the moment when the UE camps on cell 2, and starts to send preambles on the PRACH for sending the *RRCSetupRequest* message to perform a Tracking Area Update procedure on cell 2.

The cell re-selection delay to a higher priority cell shall be less than 68 s.

The rate of correct cell reselections observed during repeated tests shall be at least 90%.

NOTE: The cell re-selection delay to a higher priority cell can be expressed as: $T_{\text{higher_priority_search}} + T_{\text{evaluate, E-UTRAN}} + T_{\text{SI-E-UTRA}}$,

Where:

$T_{\text{higher_priority_search}}$ See clause 4.2.2.7

$T_{\text{evaluate, E-UTRAN}}$ See Table 4.2.2.5-1 in clause 4.2.2.5

$T_{\text{SI-E-UTRA}}$ Maximum repetition period of relevant system info blocks that needs to be received by the UE to camp on a cell; 1280 ms is assumed in this test case.

This gives a total of 67.68 s, allow 68 s for the cell re-selection delay to a higher priority E-UTRAN cell.

A.6.1.2.2 Cell reselection to lower priority E-UTRAN

A.6.1.2.2.1 Test Purpose and Environment

This test is to verify the requirement for the NR to E-UTRAN inter-RAT cell reselection requirements specified in clause 4.2.2.5 when the E-UTRAN cell is of lower priority.

A.6.1.2.2.2 Test Parameters

The test scenario comprises of one NR cell and one E-UTRAN cell as given in tables A.6.1.2.2.2-1, A.6.1.2.2.2-2, A.6.1.2.2.2-3 and A.6.1.2.2.2-4. The test consists of two successive time periods, with time duration of T1 and T2 respectively. Both NR cell 1 and E-UTRAN cell 2 are already identified by the UE prior to the start of the test. E-UTRAN cell 2 is of lower priority than cell 1.

Table A.6.1.2.2.2-1: Supported test configurations

Configuration	Description of serving cell	Description of target cell
1	NR 15 kHz SSB SCS, 10 MHz bandwidth, FDD duplex mode	LTE 10 MHz bandwidth, TDD duplex mode
2	NR 15 kHz SSB SCS, 10 MHz bandwidth, TDD duplex mode	LTE 10 MHz bandwidth, TDD duplex mode
3	NR 30 kHz SSB SCS, 40 MHz bandwidth, TDD duplex mode	LTE 10 MHz bandwidth, TDD duplex mode
4	NR 15 kHz SSB SCS, 10 MHz bandwidth, FDD duplex mode	LTE 10 MHz bandwidth, FDD duplex mode
5	NR 15 kHz SSB SCS, 10 MHz bandwidth, TDD duplex mode	LTE 10 MHz bandwidth, FDD duplex mode
6	NR 30 kHz SSB SCS, 40 MHz bandwidth, TDD duplex mode	LTE 10 MHz bandwidth, FDD duplex mode

Note: The UE is only required to be tested in one of the supported test configurations.

Table A.6.1.2.2.2-2: General test parameters for NR to E-UTRAN cell re-selection test case

Parameter		Unit	Test configuration	Value	Comment
Initial condition	Active cell		1, 2, 3, 4, 5, 6	Cell1	The UE camps on cell 1 in the initial phase.
	Neighbour cell		1, 2, 3, 4, 5, 6	Cell2	
T1 end condition	Active cell		1, 2, 3, 4, 5, 6	Cell2	The UE shall perform reselection to cell 2 during T1.
	Neighbour cell		1, 2, 3, 4, 5, 6	Cell1	
T2 end condition	Active cell		1, 2, 3, 4, 5, 6	Cell1	The UE shall perform reselection to cell 1 during T2 for iteration of the tests.
	Neighbour cell		1, 2, 3, 4, 5, 6	Cell2	
Access Barring Information		-	1, 2, 3, 4, 5, 6	Not Sent	No additional delays in random access procedure.
DRX cycle length		s	1, 2, 3, 4, 5, 6	1.28	The value shall be used for all cells in the test.

NR PRACH configuration index		1, 2, 3, 4, 5, 6	102	The detailed configuration is specified in TS 38.211 clause 6.3.3.2
E-UTRAN PRACH configuration index		1, 2, 3	53	As specified in table 5.7.1-2 in TS 36.211 [23]
		4, 5, 6	4	
T1	s	1, 2, 3, 4, 5, 6	15	T1 needs to be defined so that cell re-selection reaction time is taken into account.
T2	s	1, 2, 3, 4, 5, 6	75	T2 needs to be defined so that cell re-selection reaction time is taken into account.

Table A.6.1.2.2.2-3: Cell specific test parameters for NR cell 1

Parameter	Unit	Test configuration	Cell 1	
			T1	T2
TDD configuration		1, 4	N/A	
		2, 5	TDDConf.1.1	
		3, 6	TDDConf.2.1	
PDSCH RMC configuration		1, 4	SR.1.1 FDD	
		2, 5	SR.1.1 TDD	
		3, 6	SR.2.1 TDD	
RMSI CORESET RMC configuration		1, 4	CR.1.1 FDD	
		2, 5	CR.1.1 TDD	
		3, 6	CR.2.1 TDD	
Dedicated CORESET RMC configuration		1, 4	CCR.1.1 FDD	
		2, 5	CCR.1.1 TDD	
		3, 6	CCR.2.1 TDD	
SSB configuration		1, 4	SSB.1 FR1	
		2, 5	SSB.1 FR1	
		3, 6	SSB.2 FR1	
SMTTC configuration		1, 4	SMTTC.2	
		2, 5	SMTTC.1	
		3, 6	SMTTC.1	
OCNG Pattern		1, 2, 3, 4, 5, 6	OP.1 defined in A.3.2.1	
Initial DL BWP configuration		1, 2, 3, 4, 5, 6	DLBWP.0.1	
Initial UL BWP configuration		1, 2, 3, 4, 5, 6	ULBWP.0.1	
RLM-RS		1, 2, 3, 4, 5, 6	SSB	
Qrxlevmin	dBm/SCS	1, 2, 4, 5	-140	
		3, 6	-137	
N_{oc}	dBm/SCS	1, 4	-98	
		2, 5	-98	
		3, 6	-95	
N_{oc}	dBm/15 kHz	1, 2, 3, 4, 5, 6	-98	
SS-RSRP	dBm/SCS	1, 4	-102	-86
		2, 5	-102	-86
		3, 6	-99	-83
$\hat{E}_s / I_{\text{off}}$	dB	1, 4	-4	12
		2, 5		
		3, 6		
\hat{E}_s / N_{oc}	dB	1, 4	-4	12
		2, 5		
		3, 6		
Io	dBm/9.36 MHz	1, 4	-68.60	-57.78
	dBm/9.36 MHz	2, 5	-68.60	-57.78
	dBm/38.16 MHz	3, 6	-62.50	-51.69
Treselection	S	1, 2, 3, 4, 5, 6	0	
SnonintrasearchP	dB	1, 2, 3, 4, 5, 6	Not sent	

Thresh _{x, highP}	dB	1, 2, 3, 4, 5, 6	48
Thresh _{-serving, lowP}	dB	1, 2, 3, 4, 5, 6	44
Thresh _{x, lowP} (Note 2)	dB	1, 2, 3, 4, 5, 6	50
Propagation Condition		1, 2, 3, 4, 5, 6	AWGN
Note 1: OCNG shall be used such that both cells are fully allocated and a constant total transmitted power spectral density is achieved for all OFDM symbols.			
Note 2: This refers to the value of Thresh _{x, Low} which is included in NR system information, and is a threshold for the E-UTRA target cell			

Table A.6.1.2.2-4: Cell specific test parameters for E-UTRA cell 2

Parameter	Unit	Cell 2	
		T1	T2
E-UTRA RF Channel number		1	
BW _{channel}	MHz	10	
OCNG Patterns defined in TS 36.133 [15] clause A.3.2		OP.2 TDD for test configuration 1, 2, 3; OP.2 FDD for test configuration 4, 5, 6	
PBCH_RA	dB	0	
PBCH_RB	dB		
PSS_RA	dB		
SSS_RA	dB		
PCFICH_RB	dB		
PHICH_RA	dB		
PHICH_RB	dB		
PDCCH_RA	dB		
PDCCH_RB	dB		
PDSCH_RA	dB		
PDSCH_RB	dB		
OCNG_RA ^{Note 1}	dB		
OCNG_RB ^{Note 1}	dB		
Qrxlevmin	dBm		
N_{oc}	dBm/15 kHz	-98	
RSRP	dBm/15 KHz	-84	-84
\hat{E}_s / I_{ot}	dB	14	14
\hat{E}_s / N_{oc}	dB	14	14
Treselection _{EUTRAN}	S	0	
SnonintrasearchP	dB	Not sent	
Thresh _{x, highP} (Note 2)	dB	48	
Thresh _{-serving, lowP}	dB	44	
Thresh _{x, lowP}	dB	50	
Propagation Condition		AWGN	
Note 1: OCNG shall be used such that both cells are fully allocated and a constant total transmitted power spectral density is achieved for all OFDM symbols.			
Note 2: This refers to the value of Thresh _{x, high} which is included in E-UTRA system information, and is a threshold for the NR target cell			

A.6.1.2.2.3 Test Requirements

The cell reselection delay to a lower priority E-UTRAN cell is defined as the time from the beginning of time period T1, to the moment when the UE camps on cell 2, and starts to send preambles on the PRACH for sending the *RRCSetupRequest* message to perform a Tracking Area Update procedure on cell 2.

The cell re-selection delay to a lower priority cell shall be less than 8 s.

The rate of correct cell reselections observed during repeated tests shall be at least 90%.

NOTE: The cell re-selection delay to a lower priority cell can be expressed as: $T_{\text{evaluate, E-UTRAN}} + T_{\text{SI-E-UTRA}}$,

Where:

$T_{\text{evaluate, E-UTRAN}}$ See Table 4.2.2.5-1 in clause 4.2.2.5

$T_{\text{SI-E-UTRA}}$ Maximum repetition period of relevant system info blocks that needs to be received by the UE to camp on a cell; 1280 ms is assumed in this test case.

This gives a total of 7.68 s, allow 8 s for the cell re-selection delay to a lower priority E-UTRAN cell.

A.6.2 SA: RRC_INACTIVE state mobility

A.6.3 RRC_CONNECTED state mobility

A.6.3.1 Handover

A.6.3.1.1 Intra-frequency handover from FR1 to FR1; known target cell

A.6.3.1.1.1 Test Purpose and Environment

This test is to verify the requirement for the NR FR1-NR FR1 intra frequency handover requirements specified in clause 6.1.1.2.

A.6.3.1.1.2 Test Parameters

Supported test configurations are shown in table A.6.3.1.1.2-1. Both handover delay and interruption length are tested by using the parameters in table A.6.3.1.1.2-2, and A.6.3.1.1.2-3.

The test consists of three successive time periods, with time durations of T1, T2 and T3 respectively. At the start of time duration T1, the UE may not have any timing information of cell 2.

NR shall send a RRC message implying handover to cell 2. The RRC message implying handover shall be sent to the UE during period T2, after the UE has reported Event A3. T3 is defined as the end of the last TTI containing the RRC message implying handover.

Table A.6.3.1.1.2-1: Intra-frequency handover from FR1 to FR1 test configurations

Config	Description
1	Source cell: NR 15 kHz SSB SCS, 10 MHz bandwidth, FDD duplex mode Target cell: NR 15 kHz SSB SCS, 10 MHz bandwidth, FDD duplex mode
2	Source cell: NR 15 kHz SSB SCS, 10 MHz bandwidth, TDD duplex mode Target cell: NR 15 kHz SSB SCS, 10 MHz bandwidth, TDD duplex mode
3	Source cell: NR 30 kHz SSB SCS, 40 MHz bandwidth, TDD duplex mode Target cell: NR 30 kHz SSB SCS, 40 MHz bandwidth, TDD duplex mode
Note:	The UE is only required to be tested in one of the supported test configurations

Table A.6.3.1.1.2-2: General test parameters Intra-frequency handover from FR1 to FR1

Parameter	Unit	Value	Comment
Initial conditions	Active cell	Cell 1	
	Neighbouring cell	Cell 2	
Final condition	Active cell	Cell 2	
A3-Offset	dB	0	

Hysteresis	dB	0	
Time To Trigger	s	0	
Filter coefficient		0	L3 filtering is not used
Access Barring Information	-	Not Sent	No additional delays in random access procedure.
Time offset between cells		3 μ s	Synchronous cells
T1	s	5	
T2	s	≤ 5	
T3	s	1	

Table A.6.3.1.1.2-3: Cell specific test parameters for NR FR1-FR1 Intra frequency handover test case

Parameter		Unit	Cell 1			Cell 2		
			T1	T2	T3	T1	T2	T3
NR RF Channel Number			1			1		
Duplex mode	Config 1		FDD					
	Config 2,3		TDD					
TDD configuration	Config 1		Not Applicable					
	Config 2		TDDConf.1.1					
	Config 3		TDDConf.2.1					
BW _{channel}	Config 1	MHz	10: N _{RB,c} = 52					
	Config 2		10: N _{RB,c} = 52					
	Config 3		40: N _{RB,c} = 106					
BWP BW	Config 1	MHz	10: N _{RB,c} = 52					
	Config 2		10: N _{RB,c} = 52					
	Config 3		40: N _{RB,c} = 106					
DRx Cycle		ms	Not Applicable					
PDSCH Reference measurement channel	Config 1		SR.1.1 FDD					
	Config 2		SR.1.1 TDD					
	Config 3		SR2.1 TDD					
CORESET Reference Channel	Config 1		CR.1.1 FDD					
	Config 2		CR.1.1 TDD					
	Config 3		CR2.1 TDD					
TRS configuration	Config 1		TRS.1.1 FDD					
	Config 2		TRS.1.1 TDD					
	Config 3		TRS.1.2 TDD					
OCNG Patterns			OP.1					
SMTTC Configuration			SMTTC.1					
SSB Configuration	Config 1,2		SSB.1 FR1					
	Config 3		SSB.2 FR1					
PDSCH/PDCCH subcarrier spacing	Config 1,2	kHz	15 kHz					
	Config 3		30 kHz					
PUCCH/PUSCH subcarrier spacing	Config 1,2	kHz	15 kHz					
	Config 3		30 kHz					
PRACH configuration			FR1 PRACH configuration 1					
BWP configuraiton	Initial DL BWP		DLBWP.0.1					
	Dedicated DL BWP		DLBWP.1.1					
	Initial UL BWP		ULBWP.0.1					
	Dedicated UL BWP		ULBWP.1.1					
EPRE ratio of PSS to SSS		dB	0					
EPRE ratio of PBCH DMRS to SSS								
EPRE ratio of PBCH to PBCH DMRS								
EPRE ratio of PDCCH DMRS to SSS								
EPRE ratio of PDCCH to PDCCH DMRS								
EPRE ratio of PDSCH DMRS to SSS								
EPRE ratio of PDSCH to PDSCH								

EPRE ratio of OCNG DMRS to SSS(Note 1)								
EPRE ratio of OCNG to OCNG DMRS (Note 1)								
N_{oc} ^{Note2}		dBm/15kHz	-98					
N_{oc} ^{Note2}	Config 1,2		-98					
	Config 3	dBm/SCS	-95					
$\hat{E}_s / 1_{oc}$		dB	8	-3.3	-3.3	-	2.36	2.36
\hat{E}_s / N_{oc}		dB	8	8	8	-	11	11
SSB_RP	Config 1,2	dBm/SCS	-90	-90	-90	-	-87	-87
	Config 3	dBm/SCS	-87	-87	-87	-	-84	-84
I_o ^{Note3}	Config 1,2	dBm/ 9.36MHz	-61.41	-57.06	-57.06	-61.41	-57.06	-57.06
	Config 3	dBm/ 38.16MHz	-55.31	-50.96	-50.96	-55.31	-50.96	-50.96
Propagation condition		-	AWGN			AWGN		
Note 1: OCNG shall be used such that both cells are fully allocated and a constant total transmitted power spectral density is achieved for all OFDM symbols.								
Note 2: Interference from other cells and noise sources not specified in the test is assumed to be constant over subcarriers and time and shall be modelled as AWGN of appropriate power for N_{oc} to be fulfilled.								
Note 3: I_o levels have been derived from other parameters for information purposes. They are not settable parameters themselves.								

A.6.3.1.1.3 Test Requirements

The UE shall start to transmit the PRACH to Cell 2 less than 72 ms from the beginning of time period T3. The rate of correct handovers observed during repeated tests shall be at least 90%.

NOTE: The handover delay can be expressed as: RRC procedure delay + $T_{interrupt}$, where:

RRC procedure delay = 10 ms and is specified in clause 12 in TS 38.331 [2].

$T_{interrupt}$ = 62 ms in the test. $T_{interrupt}$ is defined in clause 6.1.1.2.2.

This gives a total of 72 ms.

A.6.3.1.2 Intra-frequency handover from FR1 to FR1; unknown target cell

A.6.3.1.2.1 Test Purpose and Environment

This test is to verify the requirement for the NR FR1-NR FR1 intra frequency handover requirements specified in clause 6.1.1.2.

A.6.3.1.2.2 Test Parameters

Supported test configurations are shown in table A.6.3.1.2.2-1. Both handover delay and interruption length are tested by using the parameters in table A.6.3.1.2.2-2, and A.6.3.1.2.2-3.

The test scenario comprises of two cells on one carrier. No gap patterns are configured in the test case. The test consists of two successive time periods, with time durations of T1, T2 respectively. At the start of time duration T1, the UE does not have any timing information of cell 2. Starting T2, cell 2 becomes detectable and the UE receives a RRC handover command from the network. The start of T2 is the instant when the last TTI containing the RRC message implying handover is sent to the UE.

Table A.6.3.1.2.2-1: Intra-frequency handover from FR1 to FR1 test configurations

Config	Description
1	Source cell: NR 15 kHz SSB SCS, 10 MHz bandwidth, FDD duplex mode Target cell: NR 15 kHz SSB SCS, 10 MHz bandwidth, FDD duplex mode
2	Source cell: NR 15 kHz SSB SCS, 10 MHz bandwidth, TDD duplex mode Target cell: NR 15 kHz SSB SCS, 10 MHz bandwidth, TDD duplex mode
3	Source cell: NR 30 kHz SSB SCS, 40 MHz bandwidth, TDD duplex mode Target cell: NR 30 kHz SSB SCS, 40 MHz bandwidth, TDD duplex mode
Note: The UE is only required to be tested in one of the supported test configurations	

Table A.6.3.1.2.2-2: General test parameters Intra-frequency handover from FR1 to FR1

Parameter	Unit	Value	Comment
Initial conditions	Active cell	Cell 1	
	Neighbouring cell	Cell 2	
Final condition	Active cell	Cell 2	
Access Barring Information	-	Not Sent	No additional delays in random access procedure.
Time offset between cells		3 μ s	Synchronous cells
T1	s	5	
T2	s	≤ 5	

Table A.6.3.1.2.2-3: Cell specific test parameters for NR FR1-FR1 Intra frequency handover test case

Parameter	Unit	Cell 1		Cell 2	
		T1	T2	T1	T2
NR RF Channel Number		1		1	
Duplex mode	Config 1	FDD			
	Config 2,3	TDD			
TDD configuration	Config 1	Not Applicable			
	Config 2	TDDConf. 1.1			
	Config 3	TDDConf. 2.1			
BW _{channel}	Config 1	10: N _{RB,c} = 52			
	Config 2	10: N _{RB,c} = 52			
	Config 3	40: N _{RB,c} = 106			
BWP BW	Config 1	10: N _{RB,c} = 52			
	Config 2	10: N _{RB,c} = 52			
	Config 3	40: N _{RB,c} = 106			
DRx Cycle	ms	Not Applicable			
PDSCH Reference measurement channel	Config 1	SR.1.1 FDD			
	Config 2	SR.1.1 TDD			
	Config 3	SR2.1 TDD			
CORESET Reference Channel	Config 1	CR.1.1 FDD			
	Config 2	CR.1.1 TDD			
	Config 3	CR2.1 TDD			
TRS configuration	Config 1	TRS.1.1 FDD			
	Config 2	TRS.1.1 TDD			
	Config 3	TRS.1.2 TDD			
OCNG Patterns		OP.1			
SMTC Configuration		SMTC.1			
SSB Configuration	Config 1,2	SSB.1 FR1			
	Config 3	SSB.2 FR1			
PDSCH/PDCCH subcarrier spacing	Config 1,2	15 kHz			
	Config 3	30 kHz			
PUCCH/PUSCH subcarrier spacing	Config 1,2	15 kHz			
	Config 3	30 kHz			

PRACH configuration			FR1 PRACH configuration 1			
BWP configuration	Initial DL BWP		DLBWP.0.1			
	Dedicated DL BWP		DLBWP.1.1			
	Initial UL BWP		ULBWP.0.1			
	Dedicated UL BWP		ULBWP.1.1			
EPRE ratio of PSS to SSS		dB	0			
EPRE ratio of PBCH DMRS to SSS						
EPRE ratio of PBCH to PBCH DMRS						
EPRE ratio of PDCCH DMRS to SSS						
EPRE ratio of PDCCH to PDCCH DMRS						
EPRE ratio of PDSCH DMRS to SSS						
EPRE ratio of PDSCH to PDSCH						
EPRE ratio of OCNG DMRS to SSS(Note 1)						
EPRE ratio of OCNG to OCNG DMRS (Note 1)						
N_{oc} ^{Note2}		dBm/15kHz	-98			
N_{oc} ^{Note2}	Config 1,2	dBm/SCS	-98			
	Config 3		-95			
\hat{E}_s / I_{ca}		dB	8	-0.64	-Infinity	-0.64
\hat{E}_s / N_{oc}		dB	8	8	-Infinity	8
SSB_RP	Config 1,2	dBm/SCS	-90	-90	-Infinity	-90
	Config 3	dBm/SCS	-87	-87	-Infinity	-87
I_o ^{Note3}	Config 1,2	dBm/9.36MHz	-61.41	-58.71	-61.41	-58.71
	Config 3	dBm/38.16MHz	-55.31	-52.60	-55.31	-52.60
Propagation condition		-	AWGN		AWGN	
<p>Note 1: OCNG shall be used such that both cells are fully allocated and a constant total transmitted power spectral density is achieved for all OFDM symbols.</p> <p>Note 2: Interference from other cells and noise sources not specified in the test is assumed to be constant over subcarriers and time and shall be modelled as AWGN of appropriate power for N_{oc} to be fulfilled.</p> <p>Note 3: I_o levels have been derived from other parameters for information purposes. They are not settable parameters themselves.</p>						

A.6.3.1.2.3 Test Requirements

The UE shall start to transmit the PRACH to Cell 2 less than 92 ms from the beginning of time period T2. The rate of correct handovers observed during repeated tests shall be at least 90%.

NOTE: The handover delay can be expressed as: RRC procedure delay + $T_{interrupt}$, where:

RRC procedure delay = 10 ms and is specified in clause 12 in TS 38.331 [2].

$T_{interrupt}$ = 82 ms in the test. $T_{interrupt}$ is defined in clause 6.1.1.2.2.

This gives a total of 92 ms.

A.6.3.1.3 Inter-frequency handover from FR1 to FR1; unknown target cell

A.6.3.1.3.1 Test Purpose and Environment

This test is to verify the requirement for the NR FR1-NR FR1 inter frequency handover requirements specified in clause 6.1.1.2.

A.6.3.1.3.2 Test Parameters

Supported test configurations are shown in table A.6.3.1.3.2-1. Both handover delay and interruption length are tested by using the parameters in table A.6.3.1.3.2-2, and A.6.3.1.3.2-3.

The test scenario comprises of two carriers and one cell on each carrier. No gap patterns are configured in the test case. The test consists of two successive time periods, with time durations of T1, T2 respectively. At the start of time duration T1, the UE does not have any timing information of cell 2. Starting T2, cell 2 becomes detectable and the UE receives a RRC handover command from the network. The start of T2 is the instant when the last TTI containing the RRC message implying handover is sent to the UE.

Table A.6.3.1.3.2-1: Inter-frequency handover from FR1 to FR1 test configurations

Config	Description
1	Source cell: NR 15 kHz SSB SCS, 10 MHz bandwidth, FDD duplex mode Target cell: NR 15 kHz SSB SCS, 10 MHz bandwidth, FDD duplex mode
2	Source cell: NR 15 kHz SSB SCS, 10 MHz bandwidth, TDD duplex mode Target cell: NR 15 kHz SSB SCS, 10 MHz bandwidth, TDD duplex mode
3	Source cell: NR 30 kHz SSB SCS, 40 MHz bandwidth, TDD duplex mode Target cell: NR 30 kHz SSB SCS, 40 MHz bandwidth, TDD duplex mode
Note: The UE is only required to be tested in one of the supported test configurations	

Table A.6.3.1.3.2-2: General test parameters Inter-frequency handover from FR1 to FR1

Parameter	Unit	Value	Comment
Initial conditions	Active cell	Cell 1	
	Neighbouring cell	Cell 2	
Final condition	Active cell	Cell 2	
Access Barring Information	-	Not Sent	No additional delays in random access procedure.
T1	s	5	
T2	s	≤5	

Table A.6.3.1.3.2-3: Cell specific test parameters for NR FR1-FR1 Inter frequency handover test case

Parameter	Unit	Cell 1		Cell 2	
		T1	T2	T1	T2
NR RF Channel Number		1		2	
Duplex mode	Config 1	FDD			
	Config 2,3	TDD			
TDD configuration	Config 1	Not Applicable			
	Config 2	TDDConf.1.1			
	Config 3	TDDConf.2.1			
BW _{channel}	Config 1	10: N _{RB,c} = 52			
	Config 2	10: N _{RB,c} = 52			
	Config 3	40: N _{RB,c} = 106			
BWP BW	Config 1	10: N _{RB,c} = 52			
	Config 2	10: N _{RB,c} = 52			
	Config 3	40: N _{RB,c} = 106			
TRS configuration	Config 1	TRS.1.1 FDD			
	Config 2	TRS.1.1 TDD			
	Config 3	TRS.1.2 TDD			
DRx Cycle	ms	Not Applicable			
PDSCH Reference measurement channel	Config 1	SR.1.1 FDD			
	Config 2	SR.1.1 TDD			
	Config 3	SR2.1 TDD			
		CR.1.1 FDD			

CORESET Reference Channel	Config 2		CR.1.1 TDD			
	Config 3		CR2.1 TDD			
OCNG Patterns			OP.1			
SMTC Configuration			SMTC.1			
SSB Configuration	Config 1,2		SSB.1 FR1			
	Config 3		SSB.2 FR1			
PDSCH/PDCCH subcarrier spacing	Config 1,2	kHz	15 kHz			
	Config 3		30 kHz			
PUCCH/PUSCH subcarrier spacing	Config 1,2	kHz	15 kHz			
	Config 3		30 kHz			
PRACH configuration			FR1 PRACH configuration 1			
BWP	Initial DL BWP		DLBWP.0.1			
	Dedicated DL BWP		DLBWP.1.1			
	Initial UL BWP		ULBWP.0.1			
	Dedicated UL BWP		ULBWP.1.1			
EPRE ratio of PSS to SSS		dB	0			
EPRE ratio of PBCH DMRS to SSS						
EPRE ratio of PBCH to PBCH DMRS						
EPRE ratio of PDCCH DMRS to SSS						
EPRE ratio of PDCCH to PDCCH DMRS						
EPRE ratio of PDSCH DMRS to SSS						
EPRE ratio of PDSCH to PDSCH						
EPRE ratio of OCNG DMRS to SSS(Note 1)						
EPRE ratio of OCNG to OCNG DMRS (Note 1)						
N_{oc}^{Note2}						
N_{oc}^{Note2}	Config 1,2	dBm/SCS	-98		-98	
	Config 3		-95		-95	
\hat{E}_s / I_{ot}		dB	4	4	-Infinity	5
\hat{E}_s / N_{oc}		dB	4	4	-Infinity	5
SSB_RP	Config 1,2	dBm/SCS	-94	-94	-Infinity	-93
	Config 3	dBm/SCS	-91	-91	-Infinity	-90
I_o^{Note3}	Config 1,2	dBm/9.36MHz	-64.59	-64.59	-70.05	-63.85
	Config 3	dBm/38.16MHz	-58.49	-58.49	-63.94	-57.75
Propagation condition		-	AWGN		AWGN	
<p>Note 1: OCNG shall be used such that both cells are fully allocated and a constant total transmitted power spectral density is achieved for all OFDM symbols.</p> <p>Note 2: Interference from other cells and noise sources not specified in the test is assumed to be constant over subcarriers and time and shall be modelled as AWGN of appropriate power for N_{oc} to be fulfilled.</p> <p>Note 3: I_o levels have been derived from other parameters for information purposes. They are not settable parameters themselves.</p>						

A.6.3.1.3.3 Test Requirements

The UE shall start to transmit the PRACH to Cell 2 less than 132 ms from the beginning of time period T2. The rate of correct handovers observed during repeated tests shall be at least 90%.

NOTE: The handover delay can be expressed as: RRC procedure delay + $T_{interrupt}$, where:

RRC procedure delay = 10 ms and is specified in clause 12 in TS 38.331 [2].

$T_{interrupt}$ = 122 ms in the test. $T_{interrupt}$ is defined in clause 6.1.1.2.2.

This gives a total of 132 ms.

A.6.3.1.4 SA NR - E-UTRAN handover

A.6.3.1.4.1 Test Purpose and Environment

The purpose of this set of tests is to verify that the UE can make correct inter-RAT E-UTRAN handover when operating in standalone (SA) operation with PCell in FR1. This test shall verify the NR to E-UTRAN handover requirements as specified in clause 6.1.2.1.

The test comprises of one NR carrier and one E-UTRA carrier. There are two cells and one cell on each carrier. Cell 1 is the NR PCell and Cell 2 is an inter-RAT E-UTRAN neighbour cell. The test consists of three successive time periods, with time durations of T1, T2 and T3 respectively. At the start of time duration T1, the UE does not have any timing information of Cell 2. Starting T2, Cell 2 becomes detectable and the UE is expected to detect and send a measurement report. Gap pattern configuration with id #0 as specified in Table 9.1.2-1 is configured before T2 begins to enable inter-RAT frequency monitoring.

A RRC message implying handover shall be sent to the UE during period T2 after the UE has reported Event B2. The start of T3 is the next instant after the last TTI containing the RRC message implying handover is sent to the UE. The handover message shall contain Cell 2 as the target cell.

Supported test configurations are shown in table A.6.3.1.4-1. General test parameters are provided in Table A.6.3.1.4-2. Cell specific test parameters for Cell 1 and Cell 2 are provided in Tables A.6.3.1.4-3 and A.6.3.1.4-4 respectively.

Table A.6.3.1.4-1: Supported test configurations for SA inter-RAT E-UTRAN handover tests

Configuration	Description
1	NR 15 kHz SSB SCS, 10 MHz bandwidth, FDD duplex mode, LTE FDD
2	NR 15 kHz SSB SCS, 10 MHz bandwidth, TDD duplex mode, LTE FDD
3	NR 30 kHz SSB SCS, 40 MHz bandwidth, TDD duplex mode, LTE FDD
4	NR 15 kHz SSB SCS, 10 MHz bandwidth, FDD duplex mode, LTE TDD
5	NR 15 kHz SSB SCS, 10 MHz bandwidth, TDD duplex mode, LTE TDD
6	NR 30 kHz SSB SCS, 40 MHz bandwidth, TDD duplex mode, LTE TDD

Note: The UE is only required to be tested in one of the supported test configurations

Table A.6.3.1.4-2: General test parameters for SA inter-RAT E-UTRAN handover

Parameter	Unit	Value	Comment
NR RF Channel Number		1	1 NR carrier frequency is used in the test
LTE RF Channel Number		2	1 E-UTRAN carrier frequency is used in the test
Initial conditions	Active cell	Cell 1	NR cell
	Neighbouring cell	Cell 2	E-UTRAN cell
Final condition	Active cell	Cell 2	
NR measurement quantity		SS-RSRP	
E-UTRAN measurement quantity		RSRP	
b2-Threshold1	dBm	As specified in Table A.6.3.1.4-3	Absolute NR SS-RSRP threshold for event B2
b2-Threshold2EUTRAN	dBm	-98	Absolute E-UTRAN RSRP threshold for event B2
Hysteresis	dB	0	
TimeToTrigger	s	0	
Filter coefficient		0	L3 filtering is not used
DRX		OFF	Non-DRX test
Access Barring Information	-	Not sent	No additional delays in random access procedure
Time offset between cells		3 ms	Asynchronous cells

Gap pattern configuration Id		0	As specified in Table 9.1.2-1 started before T2 starts
T1	s	5	
T2	s	≤5	
T3	s	1	

Table A.6.3.1.4-3: Cell specific test parameters for SA inter-RAT E-UTRA handover (Cell 1)

Parameter	Unit	Configuration	Cell 1							
			T1	T2	T3					
RF channel number		1, 2, 3, 4, 5, 6	1							
Duplex mode		1, 4	FDD							
		2, 3, 5, 6	TDD							
TDD Configuration		2, 5	TDDConf.1.1							
		3, 6	TDDConf.2.1							
BW _{channel}	MHz	1, 4	10: N _{RB,c} = 52 (FDD)							
		2, 5	10: N _{RB,c} = 52 (TDD)							
		3, 6	40: N _{RB,c} = 106 (TDD)							
PDSCH reference measurement channel		1, 4	SR.1.1 FDD							
		2, 5	SR.1.1 TDD							
		3, 6	SR.2.1 TDD							
CORSET reference channel		1, 4	CR.1.1 FDD							
		2, 5	CR.1.1 TDD							
		3, 6	CR.2.1 TDD							
TRS configuration		1, 4	TRS.1.1 FDD							
		2, 5	TRS.1.1 TDD							
		3, 6	TRS.1.2 TDD							
OCNG pattern ^{Note1}		1, 2, 3, 4, 5, 6	OP.1							
BWP	Initial DL BWP Dedicated DL BWP	1, 2, 3, 4, 5, 6	DLBWP.0.1							
			DLBWP.1.1							
	Initial UL BWP Dedicated UL BWP		ULBWP.0.1							
			ULBWP.1.1							
SMTc configuration		1, 2, 3, 4, 5, 6	SMTc.1							
SSB configuration		1, 2, 4, 5	SSB.1 FR1							
		3, 6	SSB.2 FR1							
b2-Threshold1	dBm	1, 2, 4, 5	-96							
		3, 6	-93							
EPRE ratio of PSS to SSS	dB	1, 2, 3, 4, 5, 6	0							
EPRE ratio of PBCH_DMRS to SSS										
EPRE ratio of PBCH to PBCH_DMRS										
EPRE ratio of PDCCH_DMRS to SSS										
EPRE ratio of PDCCH to PDCCH_DMRS										
EPRE ratio of PDSCH_DMRS to SSS										
EPRE ratio of PDSCH to PDSCH_DMRS										
EPRE ratio of OCNG DMRS to SSS										
EPRE ratio of OCNG to OCNG DMRS										
N _{oc} ^{Note2}						dBm/15 KHz	1, 2, 3, 4, 5, 6	-100	-104	-100
N _{oc} ^{Note2}						dBm/SCS	1, 2, 4, 5	-100	-104	-100
	3, 6	-97	-101	-97						
\hat{E}_s/N_{oc}	dB	1, 2, 3, 4, 5, 6	12	0	0					
\hat{E}_s/I_{ot} ^{Note3}	dB	1, 2, 3, 4, 5, 6	12	0	0					

SS-RSRP ^{Note3}	dBm/SCS	1, 2, 4, 5	-88	-104	-104
		3, 6	-85	-101	-101
I _o ^{Note3}	dBm/9.36 MHz	1, 2, 4, 5	-59.78	-73.04	-69.04
	dBm/38.16 MHz	3, 6	-53.68	-66.9448	-64.19
Propagation condition		1, 2, 3, 4, 5, 6	AWGN		
Antenna Configuration and Correlation Matrix		1, 2, 3, 4, 5, 6	1x2 Low		
<p>Note 1: OCNG shall be used such that both cells are fully allocated and a constant total transmitted power spectral density is achieved for all OFDM symbols.</p> <p>Note 2: Interference from other cells and noise sources not specified in the test is assumed to be constant over subcarriers and time and shall be modelled as AWGN of appropriate power for N_{oc} to be fulfilled.</p> <p>Note 3: \hat{E}_s/I_{ot}, SS-RSRP, and I_o levels have been derived from other parameters for information purposes. They are not settable parameters themselves.</p>					

Table A.6.3.1.4-4: Cell specific test parameters for SA inter-RAT E-UTRA handover (Cell 2)

Parameter	Unit	Configuration	Cell 2		
			T1	T2	T3
RF channel number		1, 2, 3, 4, 5, 6	2		
Duplex mode		1, 2, 3	FDD		
		4, 5, 6	TDD		
TDD special subframe configuration ^{Note1}		4, 5, 6	6		
TDD uplink-downlink configuration ^{Note1}		4, 5, 6	1		
BW _{channel}	MHz	1, 2, 3, 4, 5, 6	5 MHz: N _{RB,c} = 25 10 MHz: N _{RB,c} = 50 20 MHz: N _{RB,c} = 100		
PRACH Configuration ^{Note2}		1, 2, 3	4		
		4, 5, 6	53		
PDSCH parameters: DL Reference Measurement Channel ^{Note3}		1, 2, 3	5 MHz: R.7 FDD 10 MHz: R.3 FDD 20 MHz: R.6 FDD		
		4, 5, 6	5 MHz: R.4 TDD 10 MHz: R.0 TDD 20 MHz: R.3 TDD		
PCFICH/PDCCH/PHICH parameters: DL Reference Measurement Channel ^{Note3}		1, 2, 3	5 MHz: R.11 FDD 10 MHz: R.6 FDD 20 MHz: R.10 FDD		
		4, 5, 6	5 MHz: R.11 TDD 10 MHz: R.6 TDD 20 MHz: R.10 TDD		
OCNG Patterns ^{Note3}		1, 2, 3	5 MHz: OP.20 FDD 10 MHz: OP.10 FDD 20 MHz: OP.17 FDD		
		4, 5, 6	5 MHz: OP.9 TDD 10 MHz: OP.1 TDD 20 MHz: OP.7 TDD		
PBCH_RA	dB	1, 2, 3, 4, 5, 6	0		
PBCH_RB					
PSS_RA					
SSS_RA					
PCFICH_RB					
PHICH_RA					
PHICH_RB					
PDCCH_RA					

PDCCH_RB					
PDSCH_RA					
PDSCH_RB					
OCNG_RA ^{Note4}					
OCNG_RB ^{Note4}					
N_{oc} ^{Note5}	dBm/15kHz	1, 2, 3, 4, 5, 6		-98	
\hat{E}_s/N_{oc}	dB	1, 2, 3, 4, 5, 6	-Infinity	8	78
\hat{E}_s/I_{ot} ^{Note6}	dB	1, 2, 3, 4, 5, 6	-Infinity	78	78
RSRP ^{Note6}	dBm/15kHz	1, 2, 3, 4, 5, 6	-Infinity	-90	-90
SCH_RP ^{Note6}	dBm/15kHz	1, 2, 3, 4, 5, 6	-Infinity	-90	-90
I_o ^{Note6}	dBm/9MHz	1, 2, 3, 4, 5, 6	-67.21 +10log($N_{RB,c}/100$)	-58.57 +10log($N_{RB,c}/100$)	-58.57 +10log($N_{RB,c}/100$)
Propagation Condition		1, 2, 3, 4, 5, 6		AWGN	
Antenna Configuration and Correlation Matrix ^{Note7}		1, 2, 3, 4, 5, 6		1x2 Low	
<p>Note 1: Special subframe and uplink-downlink configurations are specified in table 4.2-1 in TS 36.211 [23].</p> <p>Note 2: PRACH configurations are specified in table 5.7.1-2 and table 5.7.1-3 in TS 36.211 [23].</p> <p>Note 3: DL RMCs and OCNG patterns are specified in clauses A 3.1 and A 3.2 of TS 36.133 [15] respectively.</p> <p>Note 4: OCNG shall be used such that all cells are fully allocated and a constant total transmitted power spectral density is achieved for all OFDM symbols.</p> <p>Note 5: Interference from other cells and noise sources not specified in the test is assumed to be constant over subcarriers and time and shall be modelled as AWGN of appropriate power for N_{oc} to be fulfilled.</p> <p>Note 6: \hat{E}_s/I_{ot}, RSRP, SCH_RP and I_o levels have been derived from other parameters for information purposes. They are not settable parameters themselves.</p> <p>Note 7: Propagation condition and correlation matrix are defined in clause B.2 in TS 36.101 [25].</p>					

A.6.3.1.4.2 Test Requirements

The UE shall start to transmit the PRACH to Cell 2 less than 85 ms from the beginning of time period T3.

The rate of correct handovers observed during repeated tests shall be at least 90%.

NOTE: The handover delay can be expressed as: RRC procedure delay + $T_{interrupt}$, where:

RRC procedure delay = 50 ms and is specified in clause 6.1.2.1.

$T_{interrupt}$ = 35 ms in the test; $T_{interrupt}$ is defined in clause 6.1.2.1.

This gives a total of 85 ms.

A.6.3.1.5 SA NR - E-UTRAN handover with unknown target cell

A.6.3.1.5.1 Test Purpose and Environment

The purpose of this set of tests is to verify that the UE can make correct inter-RAT E-UTRAN handover when operating in standalone (SA) operation with PCell in FR1. This test shall verify the NR to E-UTRAN handover requirements for the case when the target E-UTRAN cell is unknown as specified in clause 6.1.2.1.

The test comprises of one NR carrier and one E-UTRA carrier. There are two cells and one cell on each carrier. Cell 1 is the NR PCell and Cell 2 is an inter-RAT E-UTRAN neighbour cell. The test consists of two successive time periods, with time durations of T1 and T2 respectively. At the start of time duration T1, the UE does not have any timing information of Cell 2. Starting T2, Cell 2 becomes detectable. No Gap pattern shall be configured.

A RRC message implying handover shall be sent to the UE during period T1. The start of T2 is the instant when the last TTI containing the RRC message implying handover is sent to the UE. The handover message shall contain Cell 2 as the target cell.

Supported test configurations are shown in table A.6.3.1.5-1. General test parameters are provided in Table A.6.3.1.5-2. Cell specific test parameters for Cell 1 and Cell 2 are provided in Tables A.6.3.1.5-3 and A.6.3.1.5-4 respectively.

Table A.6.3.1.5-1: Supported test configurations for SA inter-RAT E-UTRAN handover tests

Configuration	Description
1	NR 15 kHz SSB SCS, 10 MHz bandwidth, FDD duplex mode, LTE FDD
2	NR 15 kHz SSB SCS, 10 MHz bandwidth, TDD duplex mode, LTE FDD
3	NR 30 kHz SSB SCS, 40 MHz bandwidth, TDD duplex mode, LTE FDD
4	NR 15 kHz SSB SCS, 10 MHz bandwidth, FDD duplex mode, LTE TDD
5	NR 15 kHz SSB SCS, 10 MHz bandwidth, TDD duplex mode, LTE TDD
6	NR 30kHz SSB SCS, 40 MHz bandwidth, TDD duplex mode, LTE TDD
Note:	The UE is only required to be tested in one of the supported test configurations

Table A.6.3.1.5-2: General test parameters for SA inter-RAT E-UTRAN handover

Parameter	Unit	Value	Comment
NR RF Channel Number		1	1 NR carrier frequency is used in the test
LTE RF Channel Number		2	1 E-UTRAN carrier frequency is used in the test
Initial conditions	Active cell	Cell 1	NR cell
	Neighbouring cell	Cell 2	E-UTRAN cell
Final condition	Active cell	Cell 2	
NR measurement quantity		SS-RSRP	
DRX		OFF	Non-DRX test
Access Barring Information	-	Not sent	No additional delays in random access procedure
Time offset between cells		3 ms	Asynchronous cells
T1	s	≤5	
T2	s	1	

Table A.6.3.1.5-3: Cell specific test parameters for SA inter-RAT E-UTRA handover (Cell 1)

Parameter	Unit	Configuration	Cell 1	
			T1	T2
RF channel number		1, 2, 3, 4, 5, 6	1	
Duplex mode		1, 4	FDD	
		2, 3, 5, 6	TDD	
TDD Configuration		2, 5	TDDConf.1.1	
		3, 6	TDDConf.2.1	
BW _{channel}	MHz	1, 4	10: N _{RB,c} = 52 (FDD)	
		2, 5	10: N _{RB,c} = 52 (TDD)	
		3, 6	40: N _{RB,c} = 106 (TDD)	
PDSCH reference measurement channel		1, 4	SR.1.1 FDD	
		2, 5	SR.1.1 TDD	
		3, 6	SR.2.1 TDD	
CORSET reference channel		1, 4	CR.1.1 FDD	
		2, 5	CR.1.1 TDD	
		3, 6	CR.2.1 TDD	
TRS configuration		1, 4	TRS.1.1 FDD	
		2, 5	TRS.1.1 TDD	
		3, 6	TRS.1.2 TDD	
OCNG pattern ^{Note1}		1, 2, 3, 4, 5, 6	OP.1	
BWP	Initial DL BWP	1, 2, 3, 4, 5, 6	DLBWP.0.1	
	Dedicated DL BWP		DLBWP.1.1	

	Initial UL BWP			ULBWP.0.1	
	Dedicated UL BWP			ULBWP.1.1	
SMTC configuration			1, 2, 3, 4, 5, 6	SMTC.1	
SSB configuration			1, 2, 4, 5	SSB.1 FR1	
			3, 6	SSB.2 FR1	
EPRE ratio of PSS to SSS		dB	1, 2, 3, 4, 5, 6	0	
EPRE ratio of PBCH_DMRS to SSS					
EPRE ratio of PBCH to PBCH_DMRS					
EPRE ratio of PDCCH_DMRS to SSS					
EPRE ratio of PDCCH to PDCCH_DMRS					
EPRE ratio of PDSCH_DMRS to SSS					
EPRE ratio of PDSCH to PDSCH_DMRS					
EPRE ratio of OCNG DMRS to SSS					
EPRE ratio of OCNG to OCNG DMRS					
N_{oc} ^{Note2}	dBm/15 KHz				
N_{oc} ^{Note2}	dBm/SCS		1, 2, 4, 5	-98	
			3, 6	-95	
\hat{E}_s/N_{oc}	dB		1, 2, 3, 4, 5, 6	0	0
\hat{E}_s/I_{ot} ^{Note3}	dB		1, 2, 3, 4, 5, 6	0	0
SS-RSRP ^{Note3}	dBm/SCS		1, 2, 4, 5	-98	-98
			3, 6	-95	-95
I_o ^{Note3}	dBm/9.36 MHz		1, 2, 4, 5	-67.04	-67.04
	dBm/38.16 MHz		3, 6	-60.94	-60.94
Propagation condition			1, 2, 3, 4, 5, 6	AWGN	
Antenna Configuration and Correlation Matrix			1, 2, 3, 4, 5, 6	1x2 Low	
<p>Note 1: OCNG shall be used such that both cells are fully allocated and a constant total transmitted power spectral density is achieved for all OFDM symbols.</p> <p>Note 2: Interference from other cells and noise sources not specified in the test is assumed to be constant over subcarriers and time and shall be modelled as AWGN of appropriate power for N_{oc} to be fulfilled.</p> <p>Note 3: \hat{E}_s/I_{ot}, SS-RSRP, and I_o levels have been derived from other parameters for information purposes. They are not settable parameters themselves.</p>					

Table A.6.3.1.5-4: Cell specific test parameters for SA inter-RAT E-UTRA handover (Cell 2)

Parameter	Unit	Configuration	Cell 2	
			T1	T2
RF channel number		1, 2, 3, 4, 5, 6	2	
Duplex mode		1, 2, 3	FDD	
		4, 5, 6	TDD	
TDD special subframe configuration ^{Note1}		4, 5, 6	6	
TDD uplink-downlink configuration ^{Note1}		4, 5, 6	1	
BW _{channel}	MHz	1, 2, 3, 4, 5, 6	5 MHz: $N_{RB,c} = 25$ 10 MHz: $N_{RB,c} = 50$	

PRACH Configuration ^{Note2}		1, 2, 3	20 MHz: $N_{RB,c} = 100$	
		4, 5, 6	4	
PDSCH parameters: DL Reference Measurement Channel ^{Note3}		1, 2, 3	5 MHz: R.7 FDD 10 MHz: R.3 FDD 20 MHz: R.6 FDD	
		4, 5, 6	5 MHz: R.4 TDD 10 MHz: R.0 TDD 20 MHz: R.3 TDD	
PCFICH/PDCCH/PHICH parameters: DL Reference Measurement Channel ^{Note3}		1, 2, 3	5 MHz: R.11 FDD 10 MHz: R.6 FDD 20 MHz: R.10 FDD	
		4, 5, 6	5 MHz: R.11 TDD 10 MHz: R.6 TDD 20 MHz: R.10 TDD	
OCNG Patterns ^{Note3}		1, 2, 3	5 MHz: OP.20 FDD 10 MHz: OP.10 FDD 20 MHz: OP.17 FDD	
		4, 5, 6	5 MHz: OP.9 TDD 10 MHz: OP.1 TDD 20 MHz: OP.7 TDD	
PBCH_RA	dB	1, 2, 3, 4, 5, 6	0	
PBCH_RB				
PSS_RA				
SSS_RA				
PCFICH_RB				
PHICH_RA				
PHICH_RB				
PDCCH_RA				
PDCCH_RB				
PDSCH_RA				
PDSCH_RB				
OCNG_RA ^{Note4}				
OCNG_RB ^{Note4}				
N_{oc} ^{Note5}				
\hat{E}_s/N_{oc}	dB	1, 2, 3, 4, 5, 6	-Infinity	7
\hat{E}_s/I_{ot} ^{Note6}	dB	1, 2, 3, 4, 5, 6	-Infinity	7
RSRP ^{Note6}	dBm/15kHz	1, 2, 3, 4, 5, 6	-Infinity	-91
SCH_RP ^{Note6}	dBm/15kHz	1, 2, 3, 4, 5, 6	-Infinity	-91
I_o ^{Note6}	dBm/9MHz	1, 2, 3, 4, 5, 6	-70.22	-62.43
Propagation Condition		1, 2, 3, 4, 5, 6	AWGN	
Antenna Configuration and Correlation Matrix ^{Note7}		1, 2, 3, 4, 5, 6	1x2 Low	
<p>Note 1: Special subframe and uplink-downlink configurations are specified in table 4.2-1 in TS 36.211 [23].</p> <p>Note 2: PRACH configurations are specified in table 5.7.1-2 and table 5.7.1-3 in TS 36.211 [23].</p> <p>Note 3: DL RMCs and OCNG patterns are specified in clauses A 3.1 and A 3.2 of TS 36.133 [15] respectively.</p> <p>Note 4: OCNG shall be used such that all cells are fully allocated and a constant total transmitted power spectral density is achieved for all OFDM symbols.</p> <p>Note 5: Interference from other cells and noise sources not specified in the test is assumed to be constant over subcarriers and time and shall be modelled as AWGN of appropriate power for N_{oc} to be fulfilled.</p> <p>Note 6: \hat{E}_s/I_{ot}, RSRP, SCH_RP and I_o levels have been derived from other parameters for information purposes. They are not settable parameters themselves.</p> <p>Note 7: Propagation condition and correlation matrix are defined in clause B.2 in TS 36.101 [25].</p>				

A.6.3.1.5.2 Test Requirements

The UE shall start to transmit the PRACH to Cell 2 less than 165 ms from the beginning of time period T2.

The rate of correct handovers observed during repeated tests shall be at least 90%.

NOTE: The handover delay can be expressed as: RRC procedure delay + $T_{\text{interrupt}}$, where:

RRC procedure delay = 50 ms and is specified in clause 6.1.2.1.

$T_{\text{interrupt}}$ = 115 ms in the test; $T_{\text{interrupt}}$ is defined in clause 6.1.2.1.

This gives a total of 165 ms.

A.6.3.2 RRC Connection Mobility Control

A.6.3.2.1 SA: RRC Re-establishment

A.6.3.2.1.1 Intra-frequency RRC Re-establishment in FR1

A.6.3.2.1.1.1 Test Purpose and Environment

The purpose is to verify that the NR intra-frequency RRC re-establishment delay in FR1 with known target cell is within the specified limits. These tests will verify the requirements in clause 6.2.1.

The test parameters are given in table A.6.3.2.1.1.1-1, table A.6.3.2.1.1.1-2 and table A.6.3.2.1.1.1-3 below. The test consists of 3 successive time periods, with time duration of T1, T2 and T3 respectively. At the start of time period T2, cell 1, which is the active cell, is deactivated. The time period T3 starts after the occurrence of the radio link failure.

Table A.6.3.2.1.1.1-1: Supported test configurations

Configuration	Description
1	15 kHz SSB SCS, 10 MHz bandwidth, FDD duplex mode
2	15 kHz SSB SCS, 10 MHz bandwidth, TDD duplex mode
3	30 kHz SSB SCS, 40 MHz bandwidth, TDD duplex mode

Note: The UE is only required to be tested in one of the supported test configurations.

Table A.6.3.2.1.1.1-2: General test parameters for NR intra-frequency RRC Re-establishment test case in FR1

Parameter		Unit	Test configuration	Value	Comment
Initial condition	Active cell		1, 2, 3	Cell1	
	Neighbour cells		1, 2, 3	Cell2	
Final condition	Active cell		1, 2, 3	Cell2	
RF Channel Number			1, 2, 3	1	
Time offset between cells			1	3 ms	Asynchronous cells
			2	3 μ s	Synchronous cells
			3	3 μ s	Synchronous cells
N310		-	1, 2, 3	1	Maximum consecutive out-of-sync indications from lower layers
N311		-	1, 2, 3	1	Minimum consecutive in-sync indications from lower layers
T310		ms	1, 2, 3	0	Radio link failure timer;
T311		ms	1, 2, 3	3000	RRC re-establishment timer
Access Barring Information		-	1, 2, 3	Not Sent	No additional delays in random access procedure.
SSB configuration			1	SSB.1 FR1	
			2	SSB.1 FR1	
			3	SSB.2 FR1	
SMTC configuration			1	SMTC.2	

		2	SMTC.1	
		3	SMTC.1	
DRX cycle length	s	1, 2, 3	OFF	
PRACH configuration		1, 2, 3	FR1 PRACH configuration 1	Table A.3.8.2.1-1
T1	s	1, 2, 3	5	
T2	ms	1, 2, 3	240	Time for the UE to detect RLF (Summation of $T_{Evaluate_out_SSB}$ defined in clause 8.1 in TS 38.133, T310 and the period for UE turns off transmitter defined in clause 8.1.5 in TS 38.133)
T3	s	1, 2, 3	2	

Table A.6.3.2.1.1-3: Cell specific test parameters for NR intra-frequency RRC Re-establishment test case in FR1

Parameter	Unit	Test configuration	Cell 1			Cell 2		
			T1	T2	T3	T1	T2	T3
TDD configuration		1	N/A			N/A		
		2	TDDConf.1.1			TDDConf.1.1		
		3	TDDConf.2.1			TDDConf.2.1		
PDSCH RMC configuration		1	SR.1.1 FDD			SR.1.1 FDD		
		2	SR.1.1 TDD			SR.1.1 TDD		
		3	SR.2.1 TDD			SR.2.1 TDD		
RMSI CORESET RMC configuration		1	CR.1.1 FDD			CR.1.1 FDD		
		2	CR.1.1 TDD			CR.1.1 TDD		
		3	CR.2.1 TDD			CR.2.1 TDD		
Dedicated CORESET RMC configuration		1	CCR.1.1 FDD			CCR.1.1 FDD		
		2	CCR.1.1 TDD			CCR.1.1 TDD		
		3	CCR.2.1 TDD			CCR.2.1 TDD		
OCNG Pattern		1, 2, 3	OP.1 defined in A.3.2.1			OP.1 defined in A.3.2.1		
TRS configuration		1	TRS.1.1 FDD			TRS.1.1 FDD		
		2	TRS.1.1 TDD			TRS.1.1 TDD		
		3	TRS.1.2 TDD			TRS.1.2 TDD		
Initial DL BWP configuration		1, 2, 3	DLBWP.0.1			DLBWP.0.1		
Initial UL BWP configuration		1, 2, 3	ULBWP.0.1			ULBWP.0.1		
Active DL BWP configuration		1, 2, 3	DLBWP.1.1	N/A	N/A	N/A	N/A	DLBWP.1.1
Active UL BWP configuration		1, 2, 3	ULBWP.1.1	N/A	N/A	N/A	N/A	ULBWP.1.1
RLM-RS		1, 2, 3	SSB			SSB		
\hat{E}_s / I_{ot}	dB	1	1.54	-infinity	-infinity	-3.79	4	4
		2						
		3						
N_{oc} Note2	dBm/SCS	1	-98					
		2	-98					
		3	-95					
N_{oc} Note2	dBm/15 kHz	1	-98					
		2						
		3						
\hat{E}_s / N_{oc}	dB	1	7	-infinity	-infinity	4	4	4
		2						
		3						
SS-RSRP Note3	dBm/SCS	1	-91	-infinity	-infinity	-94	-94	-94

		2	-91	-infinity	-infinity	-94	-94	-94
		3	-88	-infinity	-infinity	-91	-91	-91
Io	dBm/9.36 MHz	1	-60.74	-64.59	-64.59	-60.74	-64.59	-64.59
	dBm/9.36 MHz	2	-60.74	-64.59	-64.59	-60.74	-64.59	-64.59
	dBm/38.16 MHz	3	-54.65	-58.50	-58.50	-54.65	-58.50	-58.50
Propagation Condition		1, 2, 3	AWGN					
Note 1:	OCNG shall be used such that both cells are fully allocated and a constant total transmitted power spectral density is achieved for all OFDM symbols.							
Note 2:	Interference from other cells and noise sources not specified in the test is assumed to be constant over subcarriers and time and shall be modelled as AWGN of appropriate power for N_{oc} to be fulfilled.							
Note 3:	SS-RSRP levels have been derived from other parameters for information purposes. They are not settable parameters themselves.							

A.6.3.2.1.1.2 Test Requirements

The RRC re-establishment delay is defined as the time from the moment UE declares RLF, to the moment when the UE starts to send PRACH preambles to cell 2 for sending the *RRCReestablishmentRequest* message to cell 2.

The RRC re-establishment delay to a known NR intra frequency cell shall be less than 1.6 s.

The rate of correct RRC re-establishments observed during repeated tests shall be at least 90%.

NOTE: The RRC re-establishment delay in the test is derived from the following expression:

$$T_{\text{re-establish_delay}} = T_{\text{UL_grant}} + T_{\text{UE_re-establish_delay}}$$

Where:

$T_{\text{UL_grant}}$ = It is the time required to acquire and process uplink grant from the target cell. The PRACH reception at the system simulator is used as a trigger for the completion of the test; hence $T_{\text{UL_grant}}$ is not used.

$$T_{\text{UE_re-establish_delay}} = 50 \text{ ms} + T_{\text{identify_intra_NR}} + \sum_{i=1}^{N_{\text{freq}}-1} T_{\text{identify_inter_NR},i} + T_{\text{SI-NR}} + T_{\text{PRACH}}$$

$$N_{\text{freq}} = 1$$

$$T_{\text{identify_intra_NR}} = 200 \text{ ms}$$

$T_{\text{SI}} = 1280 \text{ ms}$; it is the time required for receiving all the relevant system information as defined in TS 38.331 for the target intra-frequency NR cell.

$T_{\text{PRACH}} = 15 \text{ ms}$; it is the additional delay caused by the random access procedure.

This gives a total of 1545 ms for RRC re-establishment delay, allow 1840 ms (240 ms + 1.6 s) from the beginning of T2 in the test case.

A.6.3.2.1.2 Inter-frequency RRC Re-establishment in FR1

A.6.3.2.1.2.1 Test Purpose and Environment

The purpose is to verify that the NR inter-frequency RRC re-establishment delay in FR1 without known target cell is within the specified limits. These tests will verify the requirements in clause 6.2.1.

The test parameters are given in table A.6.3.2.1.2.1-1, table A.6.3.2.1.2.1-2 and table A.6.3.2.1.2.1-3 below. The test consists of 3 successive time periods, with time duration of T1, T2 and T3 respectively. At the start of time period T2, cell 1, which is the active cell, becomes inactive. The time period T3 starts after the occurrence of the radio link failure. During T1, the UE shall be configured with the carrier frequency of cell 2 (with RF Channel Number #2) to ensure that the UE has the context of the carrier frequency of cell 2 by the end of T1.

Table A.6.3.2.1.2.1-1: Supported test configurations

Configuration	Description of serving cell	Description of target cell
1	15 kHz SSB SCS, 10 MHz bandwidth, FDD duplex mode	15 kHz SSB SCS, 10 MHz bandwidth, FDD duplex mode
2	15 kHz SSB SCS, 10 MHz bandwidth, TDD duplex mode	15 kHz SSB SCS, 10 MHz bandwidth, TDD duplex mode
3	30 kHz SSB SCS, 40 MHz bandwidth, TDD duplex mode	30 kHz SSB SCS, 40 MHz bandwidth, TDD duplex mode
Note: The UE is only required to be tested in one of the supported test configurations.		

Table A.6.3.2.1.2.1-2: General test parameters for NR inter-frequency RRC Re-establishment test case in FR1

Parameter		Unit	Test configuration	Value	Comment
Initial condition	Active cell		1, 2, 3	Cell1	
	Neighbour cells		1, 2, 3	Cell2	
Final condition	Active cell		1, 2, 3	Cell2	
RF Channel Number			1, 2, 3	1, 2	
Time offset between cells			1	3 ms	Asynchronous cells
			2	3 μ s	Synchronous cells
			3	3 μ s	Synchronous cells
N310		-	1, 2, 3	1	Maximum consecutive out-of-sync indications from lower layers
N311		-	1, 2, 3	1	Minimum consecutive in-sync indications from lower layers
T310		ms	1, 2, 3	0	Radio link failure timer;
T311		ms	1, 2, 3	5000	RRC re-establishment timer
Access Barring Information		-	1, 2, 3	Not Sent	No additional delays in random access procedure.
SSB configuration			1	SSB.1 FR1	
			2	SSB.1 FR1	
			3	SSB.2 FR1	
SMTC configuration			1	SMTC.2	
			2	SMTC.1	
			3	SMTC.1	
DRX cycle length		s	1, 2, 3	OFF	
PRACH configuration			1, 2, 3	FR1 PRACH configuration 1	Table A.3.8.2.1-1
T1		s	1, 2, 3	5	
T2		ms	1, 2, 3	240	Time for the UE to detect RLF (Summation of T _{Evaluate_out_SSB} defined in clause 8.1 in TS 38.133, T310 and the period for UE turns off transmitter defined in clause 8.1.5 in TS 38.133)
T3		s	1, 2, 3	5	

Table A.6.3.2.1.2.1-3: Cell specific test parameters for NR inter-frequency RRC Re-establishment test case in FR1

Parameter	Unit	Test configuration	Cell 1			Cell 2		
			T1	T2	T3	T1	T2	T3
RF Channel Number		1, 2, 3	1			2		

TDD configuration		1	N/A			N/A		
		2	TDDConf.1.1			TDDConf.1.1		
		3	TDDConf.2.1			TDDConf.2.1		
PDSCH RMC configuration		1	SR.1.1 FDD			SR.1.1 FDD		
		2	SR.1.1 TDD			SR.1.1 TDD		
		3	SR.2.1 TDD			SR.2.1 TDD		
RMSI CORESET RMC configuration		1	CR.1.1 FDD			CR.1.1 FDD		
		2	CR.1.1 TDD			CR.1.1 TDD		
		3	CR.2.1 TDD			CR.2.1 TDD		
Dedicated CORESET RMC configuration		1	CCR.1.1 FDD			CCR.1.1 FDD		
		2	CCR.1.1 TDD			CCR.1.1 TDD		
		3	CCR.2.1 TDD			CCR.2.1 TDD		
OCNG Pattern		1, 2, 3	OP.1 defined in A.3.2.1			OP.1 defined in A.3.2.1		
TRS configuration		1	TRS.1.1 FDD			TRS.1.1 FDD		
		2	TRS.1.1 TDD			TRS.1.1 TDD		
		3	TRS.1.2 TDD			TRS.1.2 TDD		
Initial DL BWP configuration		1, 2, 3	DLBWP.0.1			DLBWP.0.1		
Initial UL BWP configuration		1, 2, 3	ULBWP.0.1			ULBWP.0.1		
Active DL BWP configuration		1, 2, 3	DLBWP.1.1	N/A	N/A	N/A	N/A	DLBWP.1.1
Active UL BWP configuration		1, 2, 3	ULBWP.1.1	N/A	N/A	N/A	N/A	ULBWP.1.1
RLM-RS		1, 2, 3	SSB			SSB		
\hat{E}_s / I_{oc}	dB	1	4	-infinity	-infinity	-infinity	-infinity	7
		2						
		3						
N_{oc} Note2	dBm/SCS	1	-98					
		2	-98					
		3	-95					
N_{oc} Note2	dBm/15 kHz	1	-98					
		2						
		3						
\hat{E}_s / N_{oc}	dB	1	4	-infinity	-infinity	-infinity	-infinity	7
		2						
		3						
SS-RSRP Note3	dBm/SCS	1	-94	-infinity	-infinity	-infinity	-infinity	-91
		2	-94	-infinity	-infinity	-infinity	-infinity	-91
		3	-91	-infinity	-infinity	-infinity	-infinity	-88
I _o	dBm/9.36 MHz	1	-64.59	-70.05	-70.05	-70.05	-70.05	-62.26
	dBm/9.36 MHz	2	-64.59	-70.05	-70.05	-70.05	-70.05	-62.26
	dBm/38.16 MHz	3	-58.50	-63.94	-63.94	-63.94	-63.94	-56.15
Propagation Condition		1, 2, 3	AWGN					
<p>Note 1: OCNG shall be used such that both cells are fully allocated and a constant total transmitted power spectral density is achieved for all OFDM symbols.</p> <p>Note 2: Interference from other cells and noise sources not specified in the test is assumed to be constant over subcarriers and time and shall be modelled as AWGN of appropriate power for N_{oc} to be fulfilled.</p> <p>Note 3: SS-RSRP levels have been derived from other parameters for information purposes. They are not settable parameters themselves.</p>								

A.6.3.2.1.2.2 Test Requirements

The RRC re-establishment delay is defined as the time from the start of time period T3, to the moment when the UE starts to send PRACH preambles to cell 2 for sending the *RRCReestablishmentRequest* message to cell 2.

The RRC re-establishment delay to an unknown NR inter frequency cell shall be less than 3 s.

The rate of correct RRC re-establishments observed during repeated tests shall be at least 90%.

NOTE: The RRC re-establishment delay in the test is derived from the following expression:

$$T_{\text{re-establish_delay}} = T_{\text{UL_grant}} + T_{\text{UE_re-establish_delay}}$$

Where:

$T_{\text{UL_grant}}$ = It is the time required to acquire and process uplink grant from the target cell. The PRACH reception at the system simulator is used as a trigger for the completion of the test; hence $T_{\text{UL_grant}}$ is not used.

$$T_{\text{UE_re-establish_delay}} = 50 \text{ ms} + T_{\text{identify_intra_NR}} + \sum_{i=1}^{N_{\text{freq}}-1} T_{\text{identify_inter_NR},i} + T_{\text{SI-NR}} + T_{\text{PRACH}}$$

$$N_{\text{freq}} = 2$$

$$T_{\text{identify_intra_NR}} = 800 \text{ ms}$$

$$T_{\text{identify_inter_NR}} = 800 \text{ ms}$$

$T_{\text{SI}} = 1280 \text{ ms}$; it is the time required for receiving all the relevant system information as defined in TS 38.331 for the target inter-frequency NR cell.

$T_{\text{PRACH}} = 15 \text{ ms}$; it is the additional delay caused by the random access procedure.

This gives a total of 2945 ms, allow 3 s in the test case.

A.6.3.2.1.3 Intra-frequency RRC Re-establishment in FR1 without serving cell timing

A.6.3.2.1.3.1 Test Purpose and Environment

The purpose is to verify that the NR intra-frequency RRC re-establishment delay in FR1 without serving cell timing is within the specified limits. These tests will verify the requirements in clause 6.2.1.

The test parameters are given in table A.6.3.2.1.3.1-1, table A.6.3.2.1.3.1-2 and table A.6.3.2.1.3.1-3 below. The test consists of 3 successive time periods, with time duration of T1, T2 and T3 respectively. At the start of time period T2, cell 1, which is the active cell, is deactivated. The time period T3 starts after the occurrence of the radio link failure.

Table A.6.3.2.1.3.1-1: Supported test configurations

Configuration	Description
1	15 kHz SSB SCS, 10 MHz bandwidth, FDD duplex mode
2	15 kHz SSB SCS, 10 MHz bandwidth, TDD duplex mode
3	30 kHz SSB SCS, 40 MHz bandwidth, TDD duplex mode
Note: The UE is only required to be tested in one of the supported test configurations.	

Table A.6.3.2.1.3.1-2: General test parameters for NR intra-frequency RRC Re-establishment test case in FR1

Parameter		Unit	Test configuration	Value	Comment
Initial condition	Active cell		1, 2, 3	Cell1	
	Neighbour cells		1, 2, 3	Cell2	

Final condition	Active cell		1, 2, 3	Cell2	
RF Channel Number			1, 2, 3	1	
Time offset between cells			1	3 ms	Asynchronous cells
			2	3 μ s	Synchronous cells
			3	3 μ s	Synchronous cells
N310	-		1, 2, 3	1	Maximum consecutive out-of-sync indications from lower layers
N311	-		1, 2, 3	1	Minimum consecutive in-sync indications from lower layers
T310	ms		1, 2, 3	6000	Radio link failure timer configured by <i>RLF-TimersAndConstants</i>
T311	ms		1, 2, 3	3000	RRC re-establishment timer
Access Barring Information	-		1, 2, 3	Not Sent	No additional delays in random access procedure.
SSB configuration			1	SSB.1 FR1	
			2	SSB.1 FR1	
			3	SSB.2 FR1	
SMTC configuration			1	SMTC.2	
			2	SMTC.1	
			3	SMTC.1	
DRX cycle length	s		1, 2, 3	OFF	
PRACH configuration			1, 2, 3	FR1 PRACH configuration 1	Table A.3.8.2.1-1
T1	s		1, 2, 3	5	
T2	s		1, 2, 3	6.24	Time for the UE to detect RLF (Summation of T _{Evaluate_out_SSB} defined in clause 8.1 in TS 38.133, T310 and the period for UE turns off transmitter defined in clause 8.1.5 in TS 38.133)
T3	s		1, 2, 3	3	

Table A.6.3.2.1.3.1-3: Cell specific test parameters for NR intra-frequency RRC Re-establishment test case in FR1

Parameter	Unit	Test configuration	Cell 1			Cell 2		
			T1	T2	T3	T1	T2	T3
TDD configuration		1	N/A			N/A		
		2	TDDConf.1.1			TDDConf.1.1		
		3	TDDConf.2.1			TDDConf.2.1		
PDSCH RMC configuration		1	SR.1.1 FDD			SR.1.1 FDD		
		2	SR.1.1 TDD			SR.1.1 TDD		
		3	SR.2.1 TDD			SR.2.1 TDD		
RMSI CORESET RMC configuration		1	CR.1.1 FDD			CR.1.1 FDD		
		2	CR.1.1 TDD			CR.1.1 TDD		
		3	CR.2.1 TDD			CR.2.1 TDD		
Dedicated CORESET RMC configuration		1	CCR.1.1 FDD			CCR.1.1 FDD		
		2	CCR.1.1 TDD			CCR.1.1 TDD		
		3	CCR.2.1 TDD			CCR.2.1 TDD		
OCNG Pattern		1, 2, 3	OP.1 defined in A.3.2.1			OP.1 defined in A.3.2.1		
TRS Configuration		1	TRS.1.1 FDD			TRS.1.1 FDD		
		2	TRS.1.1 TDD			TRS.1.1 TDD		
		3	TRS.1.2 TDD			TRS.1.2 TDD		
Initial DL BWP configuration		1, 2, 3	DLBWP.0.1			DLBWP.0.1		

Initial UL BWP configuration		1, 2, 3	ULBWP.0.1			ULBWP.0.1		
RLM-RS		1, 2, 3	SSB			SSB		
\hat{E}_s / I_{ca}	dB	1	4	-infinity	-infinity	-infinity	-infinity	4
		2						
		3						
N_{oc} Note2	dBm/SCS	1	-98					
		2	-98					
		3	-95					
N_{oc} Note2	dBm/15 kHz	1	-98					
		2						
		3						
\hat{E}_s / N_{oc}	dB	1	4	-infinity	-infinity	-infinity	-infinity	4
		2						
		3						
SS-RSRP Note3	dBm/SCS	1	-94	-infinity	-infinity	-infinity	-infinity	-94
		2	-94	-infinity	-infinity	-infinity	-infinity	-94
		3	-91	-infinity	-infinity	-infinity	-infinity	-91
Io	dBm/9.36 MHz	1	-64.59	-infinity	-infinity	-infinity	-infinity	-64.59
	dBm/9.36 MHz	2	-64.59	-infinity	-infinity	-infinity	-infinity	-64.59
	dBm/38.16 MHz	3	-58.50	-infinity	-infinity	-infinity	-infinity	-58.50
Propagation Condition		1, 2, 3	AWGN					
Note 1:	OCNG shall be used such that both cells are fully allocated and a constant total transmitted power spectral density is achieved for all OFDM symbols.							
Note 2:	Interference from other cells and noise sources not specified in the test is assumed to be constant over subcarriers and time and shall be modelled as AWGN of appropriate power for N_{oc} to be fulfilled.							
Note 3:	SS-RSRP levels have been derived from other parameters for information purposes. They are not settable parameters themselves.							

A.6.3.2.1.3.2 Test Requirements

The RRC re-establishment delay is defined as the time from the start of time period T3, to the moment when the UE starts to send PRACH preambles to cell 2 for sending the *RRCReestablishmentRequest* message to cell 2.

The RRC re-establishment delay to an unknown NR intra frequency cell without serving cell timing shall be less than 2.2 s.

The rate of correct RRC re-establishments observed during repeated tests shall be at least 90%.

NOTE: The RRC re-establishment delay in the test is derived from the following expression:

$$T_{re-establish_delay} = T_{UL_grant} + T_{UE_re-establish_delay}$$

Where:

T_{UL_grant} = It is the time required to acquire and process uplink grant from the target cell. The PRACH reception at the system simulator is used as a trigger for the completion of the test; hence T_{UL_grant} is not used.

$$T_{UE_re-establish_delay} = 50 \text{ ms} + T_{identify_intra_NR} + \sum_{i=1}^{N_{freq}-1} T_{identify_inter_NR,i} + T_{SI-NR} + T_{PRACH}$$

$$N_{freq} = 1$$

$$T_{identify_intra_NR} = 800 \text{ ms}$$

$T_{SI} = 1280$ ms; it is the time required for receiving all the relevant system information as defined in TS 38.331 [2] for the target intra-frequency NR cell.

$T_{PRACH} = 15$ ms; it is the additional delay caused by the random access procedure.

This gives a total of 2145 ms, allow 2.2 s in the test case.

A.6.3.2.2 Random Access

A.6.3.2.2.1 Contention based random access test in FR1 for NR standalone

A.6.3.2.2.1.1 Test Purpose and Environment

The purpose of this test is to verify that the behavior of the random access procedure is according to the requirements and that the PRACH power settings and timing are within specified limits. This test will verify the requirements in Clause 6.2.2.2 and Clause 7.1.2 in an AWGN model.

For this test one cell is used and configured as PCell in FR1. Supported test parameters are shown in Table A.6.3.2.2.1.1-1. UE capable of SA with PCell in FR1 needs to be tested by using the parameters in Table A.6.3.2.2.1.1-2.

Table A.6.3.2.2.1.1-1: Supported test configurations for contention based random access test in FR1 for NR standalone

Config	Description
1	NR 15 kHz SSB SCS, 10 MHz bandwidth, FDD duplex mode
2	NR 30 kHz SSB SCS, 40 MHz bandwidth, TDD duplex mode
Note:	The UE is only required to be tested in one of the supported test configurations depending on UE capability

Table A.6.3.2.2.1.1-2: General test parameters for contention based random access test in FR1 for NR Standalone

Parameter	Unit	Test-1	Comments
SSB Configuration	Config 1	SSB pattern 1 in FR1	As defined in A.3.10, except for number of SSBs per SS-burst and SS/PBCH block index as below
	Config 2	SSB pattern 2 in FR1	
Number of SSBs per SS-burst		2	Different from the definition in A.3.10
SS/PBCH block index		0,1	Different from the definition in A.3.10
Duplex Mode for Cell 1	Config 1	FDD	
	Config 2	TDD	
TDD Configuration	Config 2	TDDConf.2.1	
CSI-RS for tracking	Config 1	TRS.1.1 FDD	
	Config 2	TRS.1.2 TDD	
OCNG Pattern ^{Note 1}		OP.1	As defined in A.3.2.1.
PDSCH parameters ^{Note 4}	Config 1	SR.1.1 FDD	As defined in A.3.1.1.
	Config 2	SR.2.1 TDD	
RMSI CORESET Reference Channel	Config 1	CR.1.1 FDD	
	Config 2	CR.2.1 TDD	
Dedicated CORESET Reference Channel	Config 1	CCR.1.1 FDD	
	Config 2	CCR.2.1 TDD	

NR RF Channel Number			1		
EPRE ratio of PSS to SSS		dB			
EPRE ratio of PBCH_DMRS to SSS		dB			
EPRE ratio of PBCH to PBCH_DMRS		dB			
EPRE ratio of PDCCH_DMRS to SSS		dB	0		
EPRE ratio of PDCCH to PDCCH_DMRS		dB			
EPRE ratio of PDSCH_DMRS to SSS		dB			
EPRE ratio of PDSCH to PDSCH_DMRS		dB			
SSB with index 0	\hat{E}_s / I_{ot}	dB	3	Power of SSB with index 0 is set to be above configured <i>rsrp-ThresholdSSB</i>	
	N_{oc}	Config 1	dBm/15kHz		-98
		Config 2			-101
	\hat{E}_s / N_{oc}	dB	3		
SS-RSRP ^{Note 3}		dBm/SCS	-95		
SSB with index 1	\hat{E}_s / I_{ot}	dB	-17	Power of SSB with index 1 is set to be below configured <i>rsrp-ThresholdSSB</i>	
	N_{oc}	Config 1	dBm/15kHz		-98
		Config 2			-101
	\hat{E}_s / N_{oc}	dB	-17		
SS-RSRP ^{Note 3}		dBm/SCS	-115		
I_o ^{Note 2}	Config 1	dBm	-65.3/9.36MHz	For symbols without SSB index 1	
	Config 2		-62.2/38.16MHz		
ss-PBCH-BlockPower		dBm/SCS	-5	As defined in clause 6.3.2 in TS 38.331 [2].	
Configured UE transmitted power ($P_{CMAX, f, c}$)		dBm	23	As defined in clause 6.2.4 in TS 38.101-1.	
PRACH Configuration			FR1 PRACH configuration 1	As defined in A.3. 8.	
Propagation Condition		-	AWGN		
<p>Note 1: OCNG shall be used such that the cell is fully allocated and a constant total transmitted power spectral density is achieved for all OFDM symbols. The OCNG pattern is chosen during the test according to the presence of a DL reference measurement channel.</p> <p>Note 2: SS-RSRP, E_s/I_{ot} and I_o levels have been derived from other parameters for information purpose. They are not settable parameters.</p> <p>Note 3: Void</p> <p>Note 4: The DL PDSCH reference measurement channel is used in the test only when a downlink transmission dedicated to the UE under test is required.</p>					

A.6.3.2.2.1.2 Test Requirements

Contention based random access is triggered by *not* explicitly assigning a random access preamble via dedicated signalling in the downlink.

A.6.3.2.2.1.2.1 Random Access Preamble Transmission

To test the UE behavior specified in Clause 6.2.2.2.1.1 the System Simulator shall receive the Random Access Preamble which belongs to one of the Random Access Preambles associated with the SSB with index 0, which has SS-RSRP above the configured *rsrp-ThresholdSSB*.

In addition, the power applied to all preambles shall be in accordance with what is specified in Clause 6.2.2.2. The power of the first preamble shall be -22 dBm with an accuracy specified in clause 6.3.4.2 of TS 38.101-1 [18]. The relative power applied to additional preambles shall have an accuracy specified in clause 6.3.4.3 of TS 38.101-1 [18].

The transmit timing of all PRACH transmissions shall be within the accuracy specified in Clause 7.1.2.

A.6.3.2.2.1.2.2 Random Access Response Reception

To test the UE behavior specified in Clause 6.2.2.2.1.2 the System Simulator shall transmit a Random Access Response containing a Random Access Preamble identifier corresponding to the transmitted Random Access Preamble after 5 preambles have been received by the System Simulator. In response to the first 4 preambles, the System Simulator shall transmit a Random Access Response *not* corresponding to the transmitted Random Access Preamble.

The UE may stop monitoring for Random Access Response(s) and shall transmit the msg3 if the Random Access Response contains a Random Access Preamble identifier corresponding to the transmitted Random Access Preamble.

The UE shall again perform the Random Access Resource selection procedure specified in clause 5.1.2 in TS 38.321 [7], and transmit with the calculated PRACH transmission power when the backoff time expires if all received Random Access Responses contain Random Access Preamble identifiers that do not match the transmitted Random Access Preamble.

In addition, the power applied to all preambles shall be in accordance with what is specified in Clause 6.2.2.2. The power of the first preamble shall be -22 dBm with an accuracy specified in clause 6.3.4.2 of TS 38.101-1 [18]. The relative power applied to additional preambles shall have an accuracy specified in clause 6.3.4.3 of TS 38.101-1 [18].

The transmit timing of all PRACH transmissions shall be within the accuracy specified in Clause 7.1.2.

A.6.3.2.2.1.2.3 No Random Access Response Reception

To test the UE behavior specified in clause 6.2.2.2.1.3 the System Simulator shall transmit a Random Access Response containing a Random Access Preamble identifier corresponding to the transmitted Random Access Preamble after 5 preambles have been received by the System Simulator. The System Simulator shall *not* respond to the first 4 preambles.

The UE shall again perform the Random Access Resource selection procedure specified in clause 5.1.2 in TS 38.321 [7], and transmit with the calculated PRACH transmission power when the backoff time expires if no Random Access Response is received within the RA Response window.

In addition, the power applied to all preambles shall be in accordance with what is specified in Clause 6.2.2.2. The power of the first preamble shall be -22 dBm with an accuracy specified in clause 6.3.4.2 of TS 38.101-1 [18]. The relative power applied to additional preambles shall have an accuracy specified in clause 6.3.4.3 of TS 38.101-1 [18].

The transmit timing of all PRACH transmissions shall be within the accuracy specified in Clause 7.1.2.

A.6.3.2.2.1.2.4 Receiving an UL grant for msg3 retransmission

To test the UE behavior specified in clause 6.2.2.2.1.4 the System Simulator shall provide an UL grant for msg3 retransmission following a successful Random Access Response.

The UE shall re-transmit the msg3 upon the reception of an UL grant for msg3 retransmission.

A.6.3.2.2.1.2.5 Reception of an Incorrect Message over Temporary C-RNTI

To test the UE behavior specified in Clause 6.2.2.2.1.5 the System Simulator shall send a message addressed to the temporary C-RNTI with a UE Contention Resolution Identity included in the MAC control element *not* matching the CCCH SDU transmitted in msg3 uplink message.

The UE shall again perform the Random Access Resource selection procedure specified in clause 5.1.2 in TS 38.321 [7], and transmit with the calculated PRACH transmission power when the backoff time expires unless the received message includes a UE Contention Resolution Identity MAC control element and the UE Contention

Resolution Identity included in the MAC control element matches the CCCH SDU transmitted in the uplink message.

A.6.3.2.2.1.2.6 Reception of a Correct Message over Temporary C-RNTI

To test the UE behavior specified in Clause 6.2.2.2.1.5 the System Simulator shall send a message addressed to the temporary C-RNTI with a UE Contention Resolution Identity included in the MAC control element matching the CCCH SDU transmitted in the msg3 uplink message.

The UE shall send ACK if the Contention Resolution is successful.

A.6.3.2.2.1.2.7 Contention Resolution Timer expiry

To test the UE behavior specified in Clause 6.2.2.2.1.6 the System Simulator shall *not* send a response to a msg3.

The UE shall again perform the Random Access Resource selection procedure specified in clause 5.1.2 in TS 38.321 [7], and transmit with the calculated PRACH transmission power when the backoff time expires if the Contention Resolution Timer expires.

A.6.3.2.2.2 Non-Contention based random access test in FR1 for NR standalone

A.6.3.2.2.2.1 Test Purpose and Environment

The purpose of this test is to verify that the behavior of the random access procedure is according to the requirements and that the PRACH power settings and timing are within specified limits. This test will verify the requirements in Clause 6.2.2.2 and Clause 7.1.2 in an AWGN model.

For this test one cell is used and configured as PCell in FR1. Supported test parameters are shown in Table A.6.3.2.2.2.1-1. UE capable of SA with PCell in FR1 needs to be tested by using the parameters in Table A.6.3.2.2.2.1-2 for SSB-based non-contention based random access test (Test 1) and CSI-RS-based non-contention based random access test (Test 2). Test 2 is only applicable to UE which supports csi-RSRP-AndRSRQ-MeasWithSSB or csi-RSRP-AndRSRQ-MeasWithoutSSB.

Table A.6.3.2.2.2.1-1: Supported test configurations for non-contention based random access test in FR1 for NR standalone

Config	Description
1	NR 15 kHz SSB SCS, 10 MHz bandwidth, FDD duplex mode
2	NR 30 kHz SSB SCS, 40 MHz bandwidth, TDD duplex mode
Note:	The UE is only required to be tested in one of the supported test configurations depending on UE capability

Table A.6.3.2.2.2.1-2: General test parameters for non-contention based random access test in FR1 for NR Standalone

Parameter		Unit	Test-1	Test-2	Comments
SSB Configuration	Config 1		SSB pattern 1 in FR1	SSB pattern 1 in FR1	As defined in A.3.10, except for number of SSBs per SS-burst and SS/PBCH block index as below
	Config 2		SSB pattern 2 in FR1	SSB pattern 2 in FR1	
Number of SSBs per SS-burst			2	2	Different from the definition in A.3.10
SS/PBCH block index			0,1	0,1	Different from the definition in A.3.10
CSI-RS Configuration	Config 1		N/A	CSI-RS.1.1 FDD	As defined in A.3.1.4
	Config 2			CSI-RS.2.1 TDD	
Duplex Mode for Cell 1	Config 1		FDD	FDD	

	Config 2		TDD	TDD	
TDD Configuration	Config 2		TDDConf.2.1	TDDConf.2.1	
CSI-RS for tracking	Config 1		TRS.1.1 FDD	TRS.1.1 FDD	
	Config 2		TRS.1.2 TDD	TRS.1.2 TDD	
OCNG Pattern ^{Note 1}			OP.1	OP.1	As defined in A.3.2.1.
RMSI CORESET Reference Channel	Config 1		CR.1.1 TDD	CR.1.1 TDD	
	Config 2		CR.2.1 TDD	CR.2.1 TDD	
Dedicated CORESET Reference Channel	Config 1		CCR.1.1 TDD	CCR.1.1 TDD	
	Config 2		CCR.2.1 TDD	CCR.2.1 TDD	
PDSCH parameters ^{Note 4}	Config 1		SR.1.1 FDD	SR.1.1 FDD	As defined in A.3.1.1.
	Config 2		SR.2.1 TDD	SR.2.1 TDD	
NR RF Channel Number			1	1	
EPRE ratio of PSS to SSS		dB			
EPRE ratio of PBCH_DMRS to SSS		dB			
EPRE ratio of PBCH to PBCH_DMRS		dB			
EPRE ratio of PDCCH_DMRS to SSS		dB	0	0	
EPRE ratio of PDCCH to PDCCH_DMRS		dB			
EPRE ratio of PDSCH_DMRS to SSS		dB			
EPRE ratio of PDSCH to PDSCH_DMRS		dB			
SSB with index 0	\hat{E}_s / I_{ot}		dB	3	Power of SSB with index 0 is set to be above configured <i>rsrp-ThresholdSSB</i>
	N_{oc}	Config 1	dBm/15kHz	-98	
		Config 2		-101	
	\hat{E}_s / N_{oc}		dB	3	
SS-RSRP ^{Note 3}		dBm/SCS	-95	-95	
SSB with index 1	\hat{E}_s / I_{ot}		dB	-17	Power of SSB with index 1 is set to be below configured <i>rsrp-ThresholdSSB</i>
	N_{oc}	Config 1	dBm/15kHz	-98	
		Config 2		-101	
	\hat{E}_s / N_{oc}		dB	-17	
SS-RSRP ^{Note 3}		dBm/SCS	-115	-115	
I_o ^{Note 2}	Config 1	dBm	-65.3/9.36MHz	-65.3/9.36MHz	For symbols without SSB index 1
	Config 2		-62.2/38.16MHz	-62.2/38.16MHz	
ss-PBCH-BlockPower		dBm/SCS	-5	-5	As defined in clause 6.3.2 in TS 38.331 [2].
Configured UE transmitted power ($P_{CMAX, \epsilon, c}$)		dBm	23	23	As defined in clause 6.2.4 in TS 38.101-1.
PRACH Configuration			FR1 PRACH configuration 2	FR1 PRACH configuration 3	As defined in A.3.8.2.
Propagation Condition		-	AWGN	AWGN	
<p>Note 1: OCNG shall be used such that the cell is fully allocated and a constant total transmitted power spectral density is achieved for all OFDM symbols. The OCNG pattern is chosen during the test according to the presence of a DL reference measurement channel.</p> <p>Note 2: SS-RSRP, E_s/I_{ot} and I_o levels have been derived from other parameters for information purpose. They are not settable parameters.</p> <p>Note 3: Void</p> <p>Note 4: The DL PDSCH reference measurement channel is used in the test only when a downlink transmission dedicated to the UE under test is required.</p>					

A.6.3.2.2.2.2 Test Requirements

Non-Contention based random access is triggered by explicitly assigning a random access preamble via dedicated signalling in the downlink. In the test, the non-contention based random access procedure is not initialized for Other SI requested from UE or beam failure recovery.

A.6.3.2.2.2.2.1 SSB-based Random Access Preamble Transmission

In Test-1, to test the UE behavior specified in Clause 6.2.2.2.2.1 for SSB-based Random Access Preamble transmission, with the contention-free Random Access Resources and the contention-free PRACH occasions associated with SSBs configured, the System Simulator shall receive the Random Access Preamble which has the Preamble Index associated with the SSB with index 0.

In addition, the System Simulator shall receive the Random Access Preamble on the PRACH occasion which belongs to the PRACH occasions corresponding to the SSB with index 0, and the selected PRACH occasion shall belong to the PRACH occasions permitted by the restrictions given by the *ra-ssb-OccasionMaskIndex*.

In addition, the power applied to all preambles shall be in accordance with what is specified in Clause 6.2.2.2. The power of the first preamble shall be -22 dBm with an accuracy specified in clause 6.3.4.2 of TS 38.101-1 [18]. The relative power applied to additional preambles shall have an accuracy specified in clause 6.3.4.3 of TS 38.101-1 [18].

The transmit timing of all PRACH transmissions shall be within the accuracy specified in Clause 7.1.2.

A.6.3.2.2.2.2.2 CSI-RS-based Random Access Preamble Transmission

In Test-2, to test the UE behavior specified in Clause 6.2.2.2.2.1 for CSI-RS-based Random Access Preamble transmission, with the contention-free Random Access Resources and the contention-free PRACH occasions associated with CSI-RSs configured, the System Simulator shall receive the Random Access Preamble which has the Preamble Index associated with the CSI-RS configured.

In addition, the System Simulator shall receive the Random Access Preamble on the PRACH occasion which belongs to the PRACH occasions corresponding to the CSI-RS configured, and the selected PRACH occasion shall belong to the PRACH occasions permitted by the restrictions given by the *ra-OccasionList*.

In addition, the power applied to all preambles shall be in accordance with what is specified in Clause 6.2.2.2. The power of the first preamble shall be -22 dBm with an accuracy specified in clause 6.3.4.2 of TS 38.101-1 [18]. The relative power applied to additional preambles shall have an accuracy specified in clause 6.3.4.3 of TS 38.101-1 [18].

The transmit timing of all PRACH transmissions shall be within the accuracy specified in Clause 7.1.2.

A.6.3.2.2.2.2.3 Random Access Response Reception

To test the UE behavior specified in Clause 6.2.2.2.2.2 the System Simulator shall transmit a Random Access Response containing a Random Access Preamble identifier corresponding to the transmitted Random Access Preamble after 5 preambles have been received by the System Simulator. In response to the first 4 preambles, the System Simulator shall transmit a Random Access Response *not* corresponding to the transmitted Random Access Preamble.

The UE may stop monitoring for Random Access Response(s) if the Random Access Response contains a Random Access Preamble identifier corresponding to the transmitted Random Access Preamble.

The UE shall again perform the Random Access Resource selection procedure specified in clause 5.1.2 in TS 38.321 [7], and transmit with the calculated PRACH transmission power if all received Random Access Responses contain Random Access Preamble identifiers that do not match the transmitted Random Access Preamble.

In addition, the power applied to all preambles shall be in accordance with what is specified in Clause 6.2.2.2. The power of the first preamble shall be -22 dBm with an accuracy specified in clause 6.3.4.2 of TS 38.101-1 [18]. The relative power applied to additional preambles shall have an accuracy specified in clause 6.3.4.3 of TS 38.101-1 [18].

The transmit timing of all PRACH transmissions shall be within the accuracy specified in Clause 7.1.2.

A.6.3.2.2.2.4 No Random Access Response Reception

To test the UE behavior specified in clause 6.2.2.2.3 the System Simulator shall transmit a Random Access Response containing a Random Access Preamble identifier corresponding to the transmitted Random Access Preamble after 5 preambles have been received by the System Simulator. The System Simulator shall *not* respond to the first 4 preambles.

The UE shall again perform the Random Access Resource selection procedure specified in clause 5.1.2 in TS 38.321 [7], and transmit with the calculated PRACH transmission power when the backoff time expires if no Random Access Response is received within the RA Response window configured in *RACH-ConfigCommon*.

In addition, the power applied to all preambles shall be in accordance with what is specified in Clause 6.2.2.2. The power of the first preamble shall be -22 dBm with an accuracy specified in clause 6.3.4.2 of TS 38.101-1 [18]. The relative power applied to additional preambles shall have an accuracy specified in clause 6.3.4.3 of TS 38.101-1 [18].

The transmit timing of all PRACH transmissions shall be within the accuracy specified in Clause 7.1.2.

A.6.3.2.3 SA: RRC Connection Release with Redirection

A.6.3.2.3.1 Redirection from NR in FR1 to NR in FR1

A.6.3.2.3.1.1 Test Purpose and Environment

This test is to verify RRC connection release with redirection from NR to NR requirements specified in clause 6.2.3.2.1.

A.6.3.2.3.1.2 Test Parameters

Supported test configurations are shown in table A.6.3.2.3.1.2-1. The time delay is tested by using the parameters in table A.6.3.2.3.1.2-2, and A.6.3.2.3.1.2-3.

The test consists of two successive time periods, with time duration of T1, and T2 respectively. The *RRCRelease* message shall be sent to the UE during period T1 and the start of T2 is the instant when the last TTI containing the RRC message is sent to the UE. Prior to time duration T2, the UE shall not have any timing information of Cell 2. Cell 2 is powered up at the beginning of the T2. Cell 1 and Cell 2 belong to different tracking areas.

Table A.6.3.2.3.1.2-1: Redirection from NR to NR test configurations

Config	Description
1	Source cell: NR 15 kHz SSB SCS, 10 MHz bandwidth, FDD duplex mode Target cell: NR 15 kHz SSB SCS, 10 MHz bandwidth, FDD duplex mode
2	Source cell: NR 15 kHz SSB SCS, 10 MHz bandwidth, TDD duplex mode Target cell: NR 15 kHz SSB SCS, 10 MHz bandwidth, TDD duplex mode
3	Source cell: NR 30 kHz SSB SCS, 40 MHz bandwidth, TDD duplex mode Target cell: NR 30 kHz SSB SCS, 40 MHz bandwidth, TDD duplex mode
Note:	The UE is only required to be tested in one of the supported test configurations

Table A.6.3.2.3.1.2-2: General test parameters for Redirection from NR to NR test case

Parameter	Unit	Value	Comment
Initial conditions	Active cell	Cell 1	

	Neighbouring cell		Cell 2	
Final condition	Active cell		Cell 2	
Filter coefficient			0	L3 filtering is not used
Access Barring Information	-		Not Sent	No additional delays in random access procedure.
Time offset between cells			3 μ s	Synchronous cells
T1	s		5	
T2	s		2.3	

Table A.6.3.2.3.1.2-3: Cell specific test parameters for Redirection from NR to NR test case

Parameter		Unit	Cell 1		Cell 2	
			T1	T2	T1	T2
NR RF Channel Number			1		2	
Duplex mode	Config 1		FDD			
	Config 2,3		TDD			
SSB Configuration	Config 1		SSB.1 FR1			
	Config 2		SSB.1 FR1			
	Config 3		SSB.2 FR1			
CSI-RS for tracking	Config 1		TRS.1.1 FDD			
	Config 2		TRS.1.1 TDD			
	Config 3		TRS.1.2 TDD			
TDD configuration	Config 1		Not Applicable			
	Config 2		TDDConf.1.1			
	Config 3		TDDConf.2.1			
BW _{channel}	Config 1	MHz	10: N _{RB,c} = 52			
	Config 2		10: N _{RB,c} = 52			
	Config 3		40: N _{RB,c} = 106			
BWP BW	Config 1	MHz	10: N _{RB,c} = 52			
	Config 2		10: N _{RB,c} = 52			
	Config 3		40: N _{RB,c} = 106			
DRx Cycle		ms	Not Applicable			
PDSCH Reference measurement channel	Config 1		SR.1.1 FDD			
	Config 2		SR.1.1 TDD			
	Config 3		SR2.1 TDD			
CORESET Reference Channel	Config 1		CR.1.1 FDD			
	Config 2		CR.1.1 TDD			
	Config 3		CR2.1 TDD			
OCNG Patterns			OCNG pattern 1			
SMTC configuration	Config 1,2		SMTC.1 FR1			
	Config 3		SMTC.2 FR1			
PDSCH/PDCCH subcarrier spacing	Config 1,2	kHz	15 kHz			
	Config 3		30 kHz			
	Config 1,2	kHz	15 kHz			

PUCCH/PUSCH subcarrier spacing	Config 3		30 kHz			
PRACH configuration			FR1 PRACH configuration 1			
BWP configuraiton	Initial DL BWP		DLBWP.0.1			
	Dedicated DL BWP		DLBWP.1.1			
	Initial UL BWP		ULBWP.0.1			
	Dedicated UL BWP		ULBWP.1.1			
EPRE ratio of PSS to SSS		dB	0			
EPRE ratio of PBCH DMRS to SSS						
EPRE ratio of PBCH to PBCH DMRS						
EPRE ratio of PDCCH DMRS to SSS						
EPRE ratio of PDCCH to PDCCH DMRS						
EPRE ratio of PDSCH DMRS to SSS						
EPRE ratio of PDSCH to PDSCH						
EPRE ratio of OCNG DMRS to SSS(Note 1)						
EPRE ratio of OCNG to OCNG DMRS (Note 1)						
N_{oc} ^{Note2}						
N_{oc} ^{Note2}	Config 1,2		-98			
	Config 3	dBm/SCS	-95			
\hat{E}_s / I_{ot}		dB	4	4	-infinity	4
\hat{E}_s / N_{oc}		dB	4	4	-infinity	4
I_o ^{Note3}	Config 1,2	dBm/9.36MHz	-64.59	-64.59	-70.05	-64.59
	Config 3	dBm/38.16MHz	-58.49	-58.49	-63.94	-58.49
Propagation condition		-	AWGN			
<p>Note 1: OCNG shall be used such that both cells are fully allocated and a constant total transmitted power spectral density is achieved for all OFDM symbols.</p> <p>Note 2: Interference from other cells and noise sources not specified in the test is assumed to be constant over subcarriers and time and shall be modelled as AWGN of appropriate power for N_{oc} to be fulfilled.</p> <p>Note 3: I_o levels have been derived from other parameters for information purposes. They are not settable parameters themselves.</p>						

A.6.3.2.3.1.3 Test Requirements

The UE shall start to transmit the PRACH to Cell 2 less than 2240 ms from the beginning of time period T2. The rate of correct RRC connection release redirection to NR observed during repeated tests shall be at least 90%.

NOTE: The redirection delay can be expressed as:

$$T_{\text{connection_release_redirect_NR}} = T_{\text{RRC_procedure_delay}} + T_{\text{identify-NR}} + T_{\text{SI-NR}} + T_{\text{RACH}}$$

where:

$T_{\text{RRC_procedure_delay}} = 110$ ms in the test.

$T_{\text{identify-NR}} = 680$ ms in the test.

$T_{\text{SI-NR}} = 1280$ ms, it is the time required for receiving all the relevant system information as defined in TS 38.331 for the target NR cell.

$T_{\text{RACH}} = 170$ ms in the test.

This gives a total of 2240 ms.

A.6.3.2.3.2 Redirection from NR in FR1 to E-UTRAN

A.6.3.2.3.2.1 Test Purpose and Environment

This test is to verify RRC connection release with redirection from NR to E-UTRAN requirements specified in clause 6.2.3.2.2.

A.6.3.2.3.2.2 Test Parameters

Supported test configurations are shown in table A.6.3.2.3.2.2-1. The time delay is tested by using the parameters in table A.6.3.2.3.2.2-2, A.6.3.2.3.2.2-3 and A.6.3.2.3.2.2-4.

The test consists of two successive time periods, with time duration of T1, and T2 respectively. The *RRCRelease* message shall be sent to the UE during period T1 and the start of T2 is the instant when the last TTI containing the RRC message is sent to the UE. Prior to time duration T2, the UE shall not have any timing information of Cell 2. Cell 2 is powered up at the beginning of the T2.

Table A.6.3.2.3.2.2-1: Redirection from NR to E-UTRAN test configurations

Configuration	Description
1	NR 15 kHz SSB SCS, 10 MHz bandwidth, FDD duplex mode, LTE FDD
2	NR 15 kHz SSB SCS, 10 MHz bandwidth, TDD duplex mode, LTE FDD
3	NR 30 kHz SSB SCS, 40 MHz bandwidth, TDD duplex mode, LTE FDD
4	NR 15 kHz SSB SCS, 10 MHz bandwidth, FDD duplex mode, LTE TDD
5	NR 15 kHz SSB SCS, 10 MHz bandwidth, TDD duplex mode, LTE TDD
6	NR 30kHz SSB SCS, 40 MHz bandwidth, TDD duplex mode, LTE TDD
Note:	The UE is only required to be tested in one of the supported test configurations

Table A.6.3.2.3.2.2-2: General test parameters for Redirection from NR to E-UTRAN test case

Parameter	Unit	Value	Comment
Initial conditions	Active cell		Cell 1
	Neighbouring cell		Cell 2
Final condition	Active cell		Cell 2
Filter coefficient		0	L3 filtering is not used
Access Barring Information	-	Not Sent	No additional delays in random access procedure.
Time offset between cells		3 μ s	Synchronous cells
T1	s	5	
T2	s	2.3	

Table A.6.3.2.3.2.2-3: Cell specific test parameters for Redirection from NR to E-UTRAN (cell 1)

Parameter	Unit	Cell 1	
		T1	T2
RF Channel Number		1	
Duplex mode	Config 1,4	FDD	
	Config 2,3,5,6	TDD	
SSB Configuration	Config 1,4	SSB.1 FR1	
	Config 2,5	SSB.1 FR1	
	Config 3,6	SSB.2 FR1	
CSI-RS for tracking	Config 1,4	TRS.1.1 FDD	
	Config 2,5	TRS.1.1 TDD	
	Config 3,6	TRS.1.2 TDD	
TDD configuration	Config 1,4	Not Applicable	
	Config 2,5	TDDConf.1.1	

	Config 3,6		TDDConf.2.1	
$BW_{channel}$	Config 1,4	MHz	10: $N_{RB,c} = 52$	
	Config 2,5		10: $N_{RB,c} = 52$	
	Config 3,6		40: $N_{RB,c} = 106$	
BWP BW	Config 1,4	MHz	10: $N_{RB,c} = 52$	
	Config 2,5		10: $N_{RB,c} = 52$	
	Config 3,6		40: $N_{RB,c} = 106$	
DRx Cycle		ms	Not Applicable	
PDSCH Reference measurement channel	Config 1,4		SR.1.1 FDD	
	Config 2,5		SR.1.1 TDD	
	Config 3,6		SR2.1 TDD	
CORESET Reference Channel	Config 1,4		CR.1.1 FDD	
	Config 2,5		CR.1.1 TDD	
	Config 3,6		CR2.1 TDD	
OCNG Patterns			OCNG pattern 1	
SMTc configuration	Config 1,2,4,5		SMTc.1 FR1	
	Config 3,6		SMTc.2 FR1	
PDSCH/PDCCH subcarrier spacing	Config 1,2,4,5	kHz	15 kHz	
	Config 3,6		30 kHz	
PUCCH/PUSCH subcarrier spacing	Config 1,2,4,5	kHz	15 kHz	
	Config 3,6		30 kHz	
PRACH configuration			FR1 PRACH configuration 1	
BWP configuraiton	Initial DL BWP		DLBWP.0.1	
	Dedicated DL BWP		DLBWP.1.1	
	Initial UL BWP		ULBWP.0.1	
	Dedicated UL BWP		ULBWP.1.1	
EPRE ratio of PSS to SSS		dB	0	
EPRE ratio of PBCH DMRS to SSS				
EPRE ratio of PBCH to PBCH DMRS				
EPRE ratio of PDCCH DMRS to SSS				
EPRE ratio of PDCCH to PDCCH DMRS				
EPRE ratio of PDSCH DMRS to SSS				
EPRE ratio of PDSCH to PDSCH				
EPRE ratio of OCNG DMRS to SSS(Note 1)				
EPRE ratio of OCNG to OCNG DMRS (Note 1)				
N_{oc} ^{Note2}		dBm/15kHz	-98	
N_{oc} ^{Note2}	Config 1,2,4,5	dBm/SCS	-98	
	Config 3,6		-95	
\hat{E}_s/I_{ot}		dB	4	4

\hat{E}_s/N_{oc}		dB	4	4
I_o ^{Note3}	Config 1,2,4,5	dBm/ 9.36MHz	-64.59	-64.59
	Config 3,6	dBm/ 38.16MHz	-58.49	-58.49
Propagation condition		-	AWGN	
Note 1: OCNG shall be used such that both cells are fully allocated and a constant total transmitted power spectral density is achieved for all OFDM symbols.				
Note 2: Interference from other cells and noise sources not specified in the test is assumed to be constant over subcarriers and time and shall be modelled as AWGN of appropriate power for N_{oc} to be fulfilled.				
Note 3: I_o levels have been derived from other parameters for information purposes. They are not settable parameters themselves.				

Table A.6.3.2.3.2.2-4: Cell specific test parameters for Redirection from NR to E-UTRAN (cell 2)

Parameter	Unit	Configuration	Cell 2	
			T1	T2
RF channel number		1, 2, 3, 4, 5, 6	2	
Duplex mode		1, 2, 3	FDD	
		4, 5, 6	TDD	
TDD special subframe configuration ^{Note1}		4, 5, 6	6	
TDD uplink-downlink configuration ^{Note1}		4, 5, 6	1	
$BW_{channel}$	MHz	1, 2, 3, 4, 5, 6	5 MHz: $N_{RB,c} = 25$ 10 MHz: $N_{RB,c} = 50$ 20 MHz: $N_{RB,c} = 100$	
PRACH Configuration ^{Note2}		1, 2, 3	4	
		4, 5, 6	53	
PDSCH parameters: DL Reference Measurement Channel ^{Note3}		1, 2, 3	5 MHz: R.7 FDD 10 MHz: R.3 FDD 20 MHz: R.6 FDD	
		4, 5, 6	5 MHz: R.4 TDD 10 MHz: R.0 TDD 20 MHz: R.3 TDD	
PCFICH/PDCCH/PHICH parameters: DL Reference Measurement Channel ^{Note3}		1, 2, 3	5 MHz: R.11 FDD 10 MHz: R.6 FDD 20 MHz: R.10 FDD	
		4, 5, 6	5 MHz: R.11 TDD 10 MHz: R.6 TDD 20 MHz: R.10 TDD	
OCNG Patterns ^{Note3}		1, 2, 3	5 MHz: OP.20 FDD 10 MHz: OP.10 FDD 20 MHz: OP.17 FDD	
		4, 5, 6	5 MHz: OP.9 TDD 10 MHz: OP.1 TDD 20 MHz: OP.7 TDD	
PBCH_RA	dB	1, 2, 3, 4, 5, 6	0	
PBCH_RB				
PSS_RA				
SSS_RA				
PCFICH_RB				
PHICH_RA				
PHICH_RB				
PDCCH_RA				
PDCCH_RB				
PDSCH_RA				

PDSCH_RB				
OCNG_RA ^{Note4}				
OCNG_RB ^{Note4}				
N _{oc} ^{Note5}	dBm/15kHz	1, 2, 3, 4, 5, 6	-98	
\hat{E}_s/N_{oc}	dB	1, 2, 3, 4, 5, 6	-Infinity	4
\hat{E}_s/I_{ot} ^{Note6}	dB	1, 2, 3, 4, 5, 6	-Infinity	4
RSRP ^{Note6}	dBm/15kHz	1, 2, 3, 4, 5, 6	-Infinity	-94
SCH_RP ^{Note6}	dBm/15kHz	1, 2, 3, 4, 5, 6	-Infinity	-94
I _o ^{Note6}	dBm/9MHz	1, 2, 3, 4, 5, 6	-70.22	-64.76
Propagation Condition		1, 2, 3, 4, 5, 6	AWGN	
<p>Note 1: Special subframe and uplink-downlink configurations are specified in table 4.2-1 in TS 36.211 [23].</p> <p>Note 2: PRACH configurations are specified in table 5.7.1-2 and table 5.7.1-3 in TS 36.211 [23].</p> <p>Note 3: DL RMCs and OCNG patterns are specified in clauses A 3.1 and A 3.2 of TS 36.133 [15] respectively.</p> <p>Note 4: OCNG shall be used such that all cells are fully allocated and a constant total transmitted power spectral density is achieved for all OFDM symbols.</p> <p>Note 5: Interference from other cells and noise sources not specified in the test is assumed to be constant over subcarriers and time and shall be modelled as AWGN of appropriate power for N_{oc} to be fulfilled.</p> <p>Note 6: \hat{E}_s/I_{ot}, RSRP, SCH_RP and I_o levels have been derived from other parameters for information purposes. They are not settable parameters themselves.</p> <p>Note 7: Propagation condition and correlation matrix are defined in clause B.2 in TS 36.101 [25].</p>				

A.6.3.2.3.2.3 Test Requirements

The UE shall start to transmit the PRACH to Cell 2 less than 2205 ms from the beginning of time period T2. The rate of correct RRC connection release redirection to E-UTRAN observed during repeated tests shall be at least 90%.

NOTE: The redirection delay can be expressed as:

$$T_{\text{connection_release_redirect_E-UTRA}} = T_{\text{RRC_procedure_delay}} + T_{\text{identify-E-UTRA}} + T_{\text{SI-E-UTRA}} + T_{\text{RACH}},$$

where:

$T_{\text{RRC_procedure_delay}} = 110$ ms in the test.

$T_{\text{identify-E-UTRA}} = 800$ ms in the test.

$T_{\text{SI-E-UTRA}} = 1280$ ms, it is the time required for receiving all the relevant system information as defined in TS 36.331 for the target E-UTRA cell.

$T_{\text{RACH}} = 15$ ms in the test.

This gives a total of 2205 ms.

A.6.4 Timing

A.6.4.1 UE transmit timing

A.6.4.1.1 NR UE Transmit Timing Test for FR1

A.6.4.1.1.1 Test Purpose and environment

The purpose of this test is to verify that the UE can follow frame timing change of the connected gNodeb and that the UE initial transmit timing accuracy, maximum amount of timing change in one adjustment, minimum and maximum adjustment rate are within the specified limits. This test will verify the requirements in clause 7.1.2.

Supported test configurations are shown in Table A.6.4.1.1.1-1.

Table A.6.4.1.1.1-1: Supported test configurations for FR1 PCell

Configuration	Description
1	NR FDD, SSB SCS 15 kHz, data SCS 15 kHz, BW 10 MHz
2	NR TDD, SSB SCS 15 kHz, data SCS 15 kHz, BW 10 MHz
3	NR TDD, SSB SCS 30 kHz, data SCS 30 kHz, BW 40 MHz
Note:	The UE is only required to be tested in one of the supported test configurations

For this test a single NR cell is used. Table A.6.4.1.1.1-2 defines the parameters to be configured and strength of the transmitted signals. The transmit timing is verified by the UE transmitting SRS using the configuration defined in Table A.6.4.1.1.1-3.

Table A.6.4.1.1.1-2: Cell Specific Test Parameters for UL Transmit Timing test

Parameter	Unit	Config	Test1	Test2
SSB ARFCN		1,2,3	1	1
TDD configuration		1	Not Applicable	
		2	TDDConf.1.1	
		3	TDDConf.2.1	
BW _{channel}	MHz	1	10: N _{RB,c} = 52	
		2	10: N _{RB,c} = 52	
		3	40: N _{RB,c} = 106	
Initial BWP Configuration		1,2,3	DLBWP.0.1 ULBWP.0.1	
Dedicated BWP Configuration		1,2,3	DLBWP.1.1 ULBWP.1.1	
DRx Cycle	ms	1,2,3	N/A	DRX.8 ^{Note5}
PDSCH Reference measurement channel		1	SR.1.1 FDD	
		2	SR.1.1 TDD	
		3	SR.2.1 TDD	
RMSI CORESET Reference Channel		1	CR.1.1 FDD	
		2	CR.1.1 TDD	
		3	CR.2.1 TDD	
Dedicated CORESET Reference Channel		1	CCR.1.1 FDD	
		2	CCR.1.1 TDD	
		3	CCR.2.1 TDD	
OCNG Patterns		1,2,3	OP.1	
SSB configuration		1,2	SSB.1 FR1	
		3	SSB.2 FR1	
SMTc Configuration		1,2	SMTc.1	
		3	SMTc.2	
TRS configuration		1	TRS.1.1 FDD	
		2	TRS.1.1 TDD	
		3	TRS.1.2 TDD	
EPRE ratio of PSS to SSS	dB	1,2,3	0	0
EPRE ratio of PBCH DMRS to SSS				
EPRE ratio of PBCH to PBCH DMRS				
EPRE ratio of PDCCH DMRS to SSS				

EPRE ratio of PDCCH to PDCCH DMRS				
EPRE ratio of PDSCH DMRS to SSS				
EPRE ratio of PDSCH to PDSCH				
EPRE ratio of OCNG DMRS to SSS(Note 1)				
EPRE ratio of OCNG to OCNG DMRS (Note 1)				
N_{oc} ^{Note2}	dBm/15 kHz	1,2,3	-98	-98
N_{oc} ^{Note2}	dBm/SCS	1,2	-98	-98
		3	-95	-95
\hat{E}_s / I_{ot}		1,2,3	3	3
\hat{E}_s / N_{oc}		1,2,3	3	3
SS-RSRP ^{Note3}	dBm/SCS	1,2	-95	-95
		3	-92	-92
I_o ^{Note3}	dBm/9.36MHz	1,2	-65.2	-65.2
	dBm/38.1MHz	3	-59.2	-59.2
Propagation condition		1,2,3	AWGN	
SRS Config		1,2	SRSCConf.1 ^{Note6}	SRSCConf.3 ^{Note6}
		3	SRSCConf.1 ^{Note6}	SRSCConf.2 ^{Note6}
<p>Note 1: OCNG shall be used such that both cells are fully allocated and a constant total transmitted power spectral density is achieved for all OFDM symbols.</p> <p>Note 2: Interference from other cells and noise sources not specified in the test is assumed to be constant over subcarriers and time and shall be modelled as AWGN of appropriate power for N_{oc} to be fulfilled.</p> <p>Note 3: SS-RSRP and I_o levels have been derived from other parameters for information purposes. They are not settable parameters themselves.</p> <p>Note 4: SS-RSRP minimum requirements are specified assuming independent interference and noise at each receiver antenna port.</p> <p>Note 5: DRx related parameters are given in Table A.3.3.8-1</p> <p>Note 6: SRS configs are given in Table A.6.4.1.1.1-3</p>				

Table A.6.4.1.1.1-3: SRS Configuration for Timing Accuracy Test

	Field	SRSCConf.1	SRSCConf.2	SRSCConf.3	Comments
SRS-ResourceSet	srs-ResourceSetId	0	0	0	
	srs-ResourceIdList	0	0	0	
	resourceType	Periodic	Periodic	Periodic	
	Usage	Codebook	Codebook	Codebook	
SRS-Resource	SRS-ResourceId	0	0	0	
	nrofSRS-Ports	Port1	Port1	Port1	
	transmissionComb	n2	n2	n2	
	combOffset-n2	0	0	0	
	cyclicShift-n2	0	0	0	
	resourceMapping startPosition	0	0	0	
	resourceMapping nrofSymbols	n1	n1	n1	
	resourceMapping repetitionFactor	n1	n1	n1	
	freqDomainPosition	0	0	0	
	freqDomainShift	0	0	0	
	freqHopping c-SRS	14 for test configuration 1,2 25 for test configuration 3	25	14	Matches $N_{RB,c}$

freqHopping b-SRS	0	0	0	
freqHopping b-hop	0	0	0	
groupOrSequenceHopping	Neither	Neither	Neither	
resourceType	Periodic	Periodic	Periodic	
periodicityAndOffset-p	sl1, 0	sl640, 5	sl320, 3	Offset to align with DRX periodicity
sequenceId	0	0	0	Any 10 bit number

Table A.6.4.1.1.1-4: Void**A.6.4.1.1.2 Test requirements**

The test sequence shall be carried out in RRC_CONNECTED for every test case.

Following will be the test sequence for this test

- 1) Setup NR PCell according to parameters given in Table A.6.4.1.1.1-1.
- 2) After connection set up with the cell, the test equipment will verify that the timing of the NR cell is within $(N_{TA} + N_{TA_offset}) \times T_c \pm T_e$ of the first detected path of DL SSB.
 - a. The N_{TA} offset value (in T_c units) is 25600
 - b. The T_e values depend on the DL and UL SCS for which the test is being run and are given in Table 7.1.2-1
- 3) The test system shall adjust the timing of the DL path by values given in Table A.6.4.1.1.2-1

Table A.6.4.1.1.2-1: Adjustment Value for DL Timing

SCS of SSB signals (KHz)	Adjustment Value	
	Test1	Test2
15	$+64 \times 64 T_c$	$+32 \times 64 T_c$
30	$+32 \times 64 T_c$	$+16 \times 64 T_c$

- 4) The test system shall verify that the adjustment step size and the adjustment rate shall be according to requirements specified in clause 7.1.2 Table 7.1.2.1-1 until the UE transmit timing offset is within $(N_{TA} + N_{TA_offset}) \times T_c \pm T_e$ respective to the first detected path (in time) of DL SSB. Skip this step for test 2 with DRX configured.
- 5) The test system shall verify that the UE transmit timing offset stays within $(N_{TA} + N_{TA_offset}) \times T_c \pm T_e$ of the first detected path of DL SSB. For Test 2 the UE transmit timing offset shall be verified for the first transmission in the DRX cycle immediately after DL timing adjustment

A.6.4.2 UE timer accuracy

A.6.4.3 Timing advance

A.6.4.3.1 SA FR1 timing advance adjustment accuracy

A.6.4.3.1.1 Test Purpose and Environment

The purpose of the test is to verify UE Timing Advance adjustment delay and accuracy requirement defined in clause 7.3.

A.6.4.3.1.2 Test Parameters

Supported test configurations are shown in table A.6.4.3.1.2-1. Both timing advance adjustment delay and accuracy are tested by using the parameters in table A.6.4.3.1.2-2, A.6.4.3.1.2-3 and A.6.4.3.1.2-4.

In all test cases, single cell is used. Each test consists of two successive time periods, with time duration of T1 and T2 respectively. In each time period, timing advance commands are sent to the UE and Sounding Reference Signals (SRS), as specified in table A.6.4.3.1.2-3, are sent from the UE and received by the test equipment. By measuring the reception of the SRS, the transmit timing, and hence the timing advance adjustment accuracy, can be measured.

During time period T1, the test equipment shall send one message with a Timing Advance Command MAC Control Element, as specified in Clause 6.1.3.4 in TS 38.321 [7]. The Timing Advance Command value shall be set to 31, which according to Clause 4.2 in TS 38.213 [3] results in zero adjustment of the Timing Advance. In this way, a reference value for the timing advance used by the UE is established.

During time period T2, the test equipment shall send a sequence of messages with Timing Advance Command MAC Control Elements, with Timing Advance Command value specified in table A.6.4.3.1.2-2. This value shall result in changes of the timing advance used by the UE, and the accuracy of the change shall then be measured, using the SRS sent from the UE.

As specified in Clause 7.3.2.1, the UE adjusts its uplink timing at slot $n+k+1$ for a timing advance command received in slot n . This delay must be taken into account when measuring the timing advance adjustment accuracy, via the SRS sent from the UE.

The UE Time Alignment Timer, described in Clause 5.2 in TS 38.321 [7], shall be configured so that it does not expire in the duration of the test.

Table A.6.4.3.1.2-1: Timing advance supported test configurations

Config	Description
1	NR 15 kHz SSB SCS, 10 MHz bandwidth, FDD duplex mode
2	NR 15 kHz SSB SCS, 10 MHz bandwidth, TDD duplex mode
3	NR 30 kHz SSB SCS, 40 MHz bandwidth, TDD duplex mode
Note:	The UE is only required to be tested in one of the supported test configurations

Table A.6.4.3.1.2-2: General test parameters for timing advance

Parameter	Unit	Value	Comment
RF channel number		1	
Initial DL BWP		DLBWP.0.1	As specified in Table A.3.9.2.1-1
Dedicated DL BWP		DLBWP.1.1	As specified in Table A.3.9.2.2-1
Initial UL BWP		ULBWP.0.1	As specified in Table A.3.9.3.1-1
Dedicated UL BWP		ULBWP.1.1	As specified in Table A.3.9.3.2-1
Timing Advance Command (T_A) value during T1		31	$N_{TA_new} = N_{TA_old}$ for the purpose of establishing a reference value from which the timing advance adjustment accuracy can be measured during T2

Timing Advance Command (T_A) value during T2		39	For 15 kHz SCS $N_{TA_new} = N_{TA_old} + 8192 * T_c$ For 30 kHz SCS $N_{TA_new} = N_{TA_old} + 4096 * T_c$ (based on equation in clause 4.2 of TS 38.213 [3])
T1	s	5	
T2	s	5	

Table A.6.4.3.1.2-3: Cell specific test parameters for timing advance

Parameter		Unit	Test1	
			T1	T2
Duplex mode	Config 1		FDD	
	Config 2,3		TDD	
TDD configuration	Config 1		Not Applicable	
	Config 2		TDDConf.1.1	
	Config 3		TDDConf.2.1	
$BW_{channel}$	Config 1	MHz	10: $N_{RB,c} = 52$	
	Config 2		10: $N_{RB,c} = 52$	
	Config 3		40: $N_{RB,c} = 106$	
BWP BW	Config 1	MHz	10: $N_{RB,c} = 52$	
	Config 2		10: $N_{RB,c} = 52$	
	Config 3		40: $N_{RB,c} = 106$	
DRx Cycle		ms	Not Applicable	
PDSCH Reference measurement channel	Config 1		SR.1.1 FDD	
	Config 2		SR.1.1 TDD	
	Config 3		SR.2.1 TDD	
RMSI CORESET Reference Channel	Config 1		CR.1.1 FDD	
	Config 2		CR.1.1 TDD	
	Config 3		CR.2.1 TDD	
Dedicated CORESET Reference Channel	Config 1		CCR.1.1 FDD	
	Config 2		CCR.1.1 TDD	
	Config 3		CCR.2.1 TDD	
TRS configuration	Config 1		TRS.1.1 FDD	
	Config 2		TRS.1.1 TDD	
	Config 3		TRS.1.2 TDD	
OCNG Patterns			OCNG pattern 1	
SMTC configuration	Config 1,2		SMTC.1 FR1	
	Config 3		SMTC.2 FR1	
SSB configuration	Config 1,2		SSB.1 FR1	
	Config 3		SSB.2 FR1	
PDSCH/PDCCH subcarrier spacing	Config 1,2	kHz	15 kHz	
	Config 3		30 kHz	
PUCCH/PUSCH subcarrier spacing	Config 1,2	kHz	15 kHz	
	Config 3		30 kHz	
EPRE ratio of PSS to SSS		dB	0	
EPRE ratio of PBCH DMRS to SSS				
EPRE ratio of PBCH to PBCH DMRS				
EPRE ratio of PDCCH DMRS to SSS				
EPRE ratio of PDCCH to PDCCH DMRS				
EPRE ratio of PDSCH DMRS to SSS				
EPRE ratio of PDSCH to PDSCH				
EPRE ratio of OCNG DMRS to SSS(Note 1)				
EPRE ratio of OCNG to OCNG DMRS (Note 1)				

N_{oc} Note2		dBm/15kHz	-98
N_{oc} Note2	Config 1,2	dBm/SCS	-98
	Config 3		-95
$\hat{E}_s / 1_{sc}$		dB	3
\hat{E}_s / N_{oc}		dB	3
I_0 Note3	Config 1,2	dBm/ 9.36MHz	-67.57
	Config 3	dBm/ 38.16MHz	-62.58
Propagation condition		-	AWGN
<p>Note 1: OCNG shall be used such that both cells are fully allocated and a constant total transmitted power spectral density is achieved for all OFDM symbols.</p> <p>Note 2: Interference from other cells and noise sources not specified in the test is assumed to be constant over subcarriers and time and shall be modelled as AWGN of appropriate power for N_{oc} to be fulfilled.</p> <p>Note 3: I_0 levels have been derived from other parameters for information purposes. They are not settable parameters themselves.</p>			

Table A.6.4.3.1.2-4: Sounding Reference Symbol Configuration for timing advance

Field		Value	Comment
c-SRS	Config 1,2	12	Frequency hopping is disabled
	Config 3	24	
b-SRS		0	
b-hop		0	
freqDomainPosition		0	Frequency domain position of SRS
freqDomainShift		0	
groupOrSequenceHopping		neither	No group or sequence hopping
SRS-PeriodicityAndOffset		sl5=2 for SCS 15kHz sl5=4 for SCS 30kHz	Once every 5 slots
pathlossReferenceRS		ssb-Index=0	SSB #0 is used for SRS path loss estimation
usage		Codebook	Codebook based UL transmission
startPosition		0	resourceMapping setting. SRS on last symbol of slot, and 1symbols for SRS without repetition.
nrofSymbols		n1	
repetitionFactor		n1	transmissionComb setting
combOffset-n2		0	
cyclicShift-n2		0	
nrofSRS-Ports		port1	Number of antenna ports used for SRS transmission
Note: For further information see clause 6.3.2 in TS 38.331 [2].			

A.6.4.3.1.3 Test Requirements

The UE shall apply the signalled Timing Advance value to the transmission timing at the designated activation time i.e. $k+1$ slots after the reception of the timing advance command, where $k=5$.

The Timing Advance adjustment accuracy shall be within the limits specified in clause 7.3.2.2.

The rate of correct Timing Advance adjustments observed during repeated tests shall be at least 90%.

A.6.5 Signalling characteristics

A.6.5.1 Radio link Monitoring

In the following clause, any uplink signal transmitted by the UE is used for detecting the In-/Out-of-Sync state of the UE. In terms of measurement, the uplink signal is verified on the basis of the UE output power:

For intra-band contiguous carrier aggregation, transmit OFF power is measured as the mean power per component carrier.

For UE with multiple transmit antennas, transmit OFF power is measured as the mean power at each transmit connector.

- UE output power higher than Transmit OFF power -50 dBm (as defined in TS 38.101-1 [18]) means uplink signal
- UE output power equal to or less than Transmit OFF power -50 dBm (as defined in TS 38.101-1 [18]) means no uplink signal.

A.6.5.1.1 Radio Link Monitoring Out-of-sync Test for FR1 PCell configured with SSB-based RLM RS in non-DRX mode

A.6.5.1.1.1 Test Purpose and Environment

The purpose of this test is to verify that the UE properly detects the out of sync and in sync for the purpose of monitoring downlink radio link quality of the PCell. This test will partly verify the FR1 radio link monitoring requirements in clause 8.1.

In the test, UE is configured to perform RLM on SSB, with *detectionResource* included in *RadioLinkMonitoringRS* set to SSB#0, and *purpose* set to 'rlf'. Supported test configurations are shown in table A.6.5.1.1.1-1. The test parameters are given in Tables A.6.5.1.1.1-2, A.6.5.1.1.1-3, and A.6.5.1.1.1-4 below. There is one cell (Cell 1), which is the active NR cell, in the test. The test consists of three successive time periods, with time duration of T1, T2 and T3 respectively. Figure A.6.5.1.1.1-1 shows the variation of the downlink SNR in the active cell to emulate out-of-sync and in-sync states. Prior to the start of the time duration T1, the UE shall be fully synchronized to Cell 1. The UE shall be configured for periodic CSI reporting with a reporting periodicity of 5 ms. The UE is configured to perform inter-frequency measurements using Gap Pattern ID #0 (40ms) in test 1.

Table A.6.5.1.1.1-1: Supported test configurations for FR1 PCell

Configuration	Description
1	FDD, SSB SCS 15 kHz, data SCS 15 kHz, BW 10 MHz
2	TDD, SSB SCS 15 kHz, data SCS 15 kHz, BW 10 MHz
3	TDD, SSB SCS 30 kHz, data SCS 30 kHz, BW 40 MHz
Note:	The UE is only required to pass in one of the supported test configurations in FR1

Table A.6.5.1.1.1-2: General test parameters for FR1 out-of-sync testing in non-DRX mode

Parameter	Unit	Value	
		Test 1	
Active PCell		Cell 1	
RF Channel Number		1	
Duplex mode	Config 1	FDD	
	Config 2, 3	TDD	
BW _{channel}	Config 1	MHz	10: N _{RB,C} = 52

	Config 2		10: $N_{RB,c} = 52$
	Config 3		40: $N_{RB,c} = 106$
DL initial BWP configuration	Config 1, 2, 3		DLBWP.0.1
DL dedicated BWP configuration	Config 1, 2, 3		DLBWP.1.1
UL initial BWP configuration	Config 1, 2, 3		ULBWP.0.1
UL dedicated BWP configuration	Config 1, 2, 3		ULBWP.1.1
TDD Configuration	Config 1		Not Applicable
	Config 2		TDDConf.1.1
	Config 3		TDDConf.2.1
RMSI CORESET Reference Channel	Config 1		CR.1.1 FDD
	Config 2		CR.1.1 TDD
	Config 3		CR.2.1 TDD
Dedicated CORESET Reference Channel	Config 1		CCR.1.3 FDD
	Config 2		CCR.1.3 TDD
	Config 3		CCR.2.2 TDD
SSB Configuration	Config 1		SSB.1 FR1
	Config 2		SSB.1 FR1
	Config 3		SSB.2 FR1
SMTC Configuration	Config 1, 2		SMTC.1
	Config 3		SMTC.1
PDSCH/PDCCH subcarrier spacing	Config 1, 2		15 kHz
	Config 3		30 kHz
PRACH Configuration	Config 1, 2		Table A.3.8.2.1-1
	Config 3		Table A.3.8.2.1-1
SSB index assigned as RLM RS			0
OCNG parameters			OP.1
CP length			Normal
Correlation Matrix and Antenna Configuration			2x2 Low
Out of sync transmission parameters	DCI format		1-0
	Number of Control OFDM symbols		2
	Aggregation level	CCE	8
	Ratio of hypothetical PDCCH RE energy to average SSS RE energy	dB	4
	Ratio of hypothetical PDCCH DMRS energy to average SSS RE energy	dB	4
	DMRS precoder granularity		REG bundle size
	REG bundle size		6
DRX			OFF
Gap pattern ID			gp0
Layer 3 filtering			Enabled
T310 timer		ms	0
T311 timer		ms	1000
N310			1
N311			1
	Config 1		CSI-RS.1.1 FDD
	Config 2		CSI-RS.1.1 TDD

CSI-RS configuration for CSI reporting	Config 3		CSI-RS.2.1 TDD
CSI-RS for tracking	Config 1		TRS.1.1 FDD
	Config 2		TRS.1.1 TDD
	Config 3		TRS.1.2 TDD
T1		s	0.2
T2		s	0.48
T3		s	0.48
D1		s	0.44
Note 1: All configurations are assigned to the UE prior to the start of time period T1.			
Note 2: UE-specific PDCCH is not transmitted after T1 starts.			

Table A.6.5.1.1.1-3: Cell specific test parameters for FR1 (Cell 1) for out-of-sync radio link monitoring tests in non-DRX mode

Parameter		Unit	Test 1		
			T1	T2	T3
EPRE ratio of PDCCH DMRS to SSS		dB	4		
EPRE ratio of PDCCH to PDCCH DMRS		dB	0		
EPRE ratio of PBCH DMRS to SSS		dB	0		
EPRE ratio of PBCH to PBCH DMRS		dB			
EPRE ratio of PSS to SSS		dB			
EPRE ratio of PDSCH DMRS to SSS		dB			
EPRE ratio of PDSCH to PDSCH DMRS		dB			
EPRE ratio of OCNG DMRS to SSS		dB			
EPRE ratio of OCNG to OCNG DMRS		dB			
SNR on RLM-RS	Config 1	dB			
	Config 2		1	-7	-15
	Config 3		1	-7	-15
N_{oc}	Config 1	dBm/ 15kHz z	-98		
	Config 2		-98		
	Config 3		-98		
N_{oc}	Config 1	dBm/ SCS	-98		
	Config 2		-98		
	Config 3		-95		
Propagation condition			TDL-C 300ns 100Hz		
Note 1: OCNG shall be used such that the resources in Cell 1 are fully allocated and a constant total transmitted power spectral density is achieved for all OFDM symbols.					
Note 2: The signal contains PDCCH for UEs other than the device under test as part of OCNG.					
Note 3: SNR levels correspond to the signal to noise ratio over the SSS REs.					
Note 4: The SNR in time periods T1, T2 and T3 is denoted as SNR1, SNR2 and SNR3 respectively in Figure A.6.5.1.1.1-1.					
Note 5: The SNR values are specified for testing a UE which supports 2RX on at least one band. For testing of a UE which supports 4RX on all bands, the SNR during T3 is A.3.6.					

Table A.6.5.1.1.1-4: Measurement gap configuration for out-of-sync tests in non-DRX mode

Field	Test 1
	Value
gapOffset	0
Note: Ensure that RLM RS is partially overlapped with measurement gap	

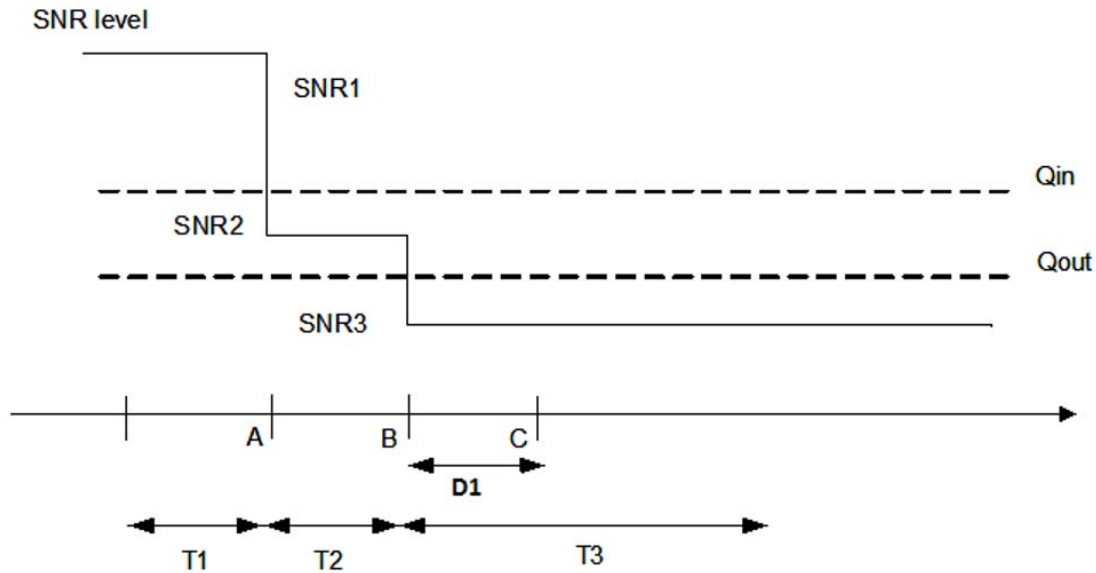

Figure A.6.5.1.1.1-1: SNR variation for out-of-sync testing

A.6.5.1.1.2 Test Requirements

The UE behaviour in each test during time durations T1, T2 and T3 shall be as follows:

During the period from time point A to time point B the UE shall transmit uplink signal at least in all uplink slots configured for CSI transmission according to the configured periodic CSI reporting.

The UE shall stop transmitting uplink signal no later than time point C (D1 second after the start of the time duration T3).

The rate of correct events observed during repeated tests shall be at least 90%.

A.6.5.1.2 Radio Link Monitoring In-sync Test for FR1 PCell configured with SSB-based RLM RS in non-DRX mode

A.6.5.1.2.1 Test Purpose and Environment

The purpose of this test is to verify that the UE properly detects the out of sync and in sync for the purpose of monitoring downlink radio link quality of the PCell. This test will partly verify the FR1 radio link monitoring requirements in clause 8.1.

In the test, UE is configured to perform RLM on SSB, with *detectionResource* included in *RadioLinkMonitoringRS* set to SSB#0, and *purpose* set to 'rlf'. Supported test configurations are shown in table A.6.5.1.2.1-1. The test parameters are given in Tables A.6.5.1.2.1-2, and A.6.5.1.2.1-3 below. There is one cell (Cell 1), which is the active cell, in the test. The test consists of five successive time periods, with time duration of T1, T2, T3, T4 and T5 respectively. Figure A.6.5.1.2.1-1 shows the variation of the downlink SNR in the active cell to emulate out-of-sync and in-sync states. Prior to the start of the time duration T1, the UE shall be fully synchronized to Cell 1. Prior to the start of the time duration T1, the UE shall be fully synchronized to Cell 1. The UE shall be configured for periodic CSI reporting with a reporting periodicity of 5 ms.

Table A.6.5.1.2.1-1: Supported test configurations for FR1 PCell

Configuration	Description
1	FDD, SSB SCS 15 kHz, data SCS 15 kHz, BW 10 MHz
2	TDD, SSB SCS 15 kHz, data SCS 15 kHz, BW 10 MHz
3	TDD, SSB SCS 30 kHz, data SCS 30 kHz, BW 40 MHz
Note:	The UE is only required to pass in one of the supported test configurations in FR1

Table A.6.5.1.2.1-2: General test parameters for FR1 in-sync testing in non-DRX mode

Parameter		Unit	Value
Active PCell			Test 1
RF Channel Number			Cell 1
RF Channel Number			1
Duplex mode	Config 1		FDD
	Config 2, 3		TDD
BW _{channel}	Config 1	MHz	10: N _{RB,c} = 52
	Config 2		10: N _{RB,c} = 52
	Config 3		40: N _{RB,c} = 106
DL initial BWP configuration	Config 1, 2, 3		DLBWP.0.1
DL dedicated BWP configuration	Config 1, 2, 3		DLBWP.1.1
UL initial BWP configuration	Config 1, 2, 3		ULBWP.0.1
UL dedicated BWP configuration	Config 1, 2, 3		ULBWP.1.1
TDD Configuration	Config 1		Not Applicable
	Config 2		TDDConf.1.1
	Config 3		TDDConf.2.1
RMSI CORESET Reference Channel	Config 1		CR.1.1 FDD
	Config 2		CR.1.1 TDD
	Config 3		CR.2.1 TDD
Dedicated CORESET Reference Channel	Config 1		CCR.1.1 FDD
	Config 2		CCR.1.1 TDD
	Config 3		CCR.2.1 TDD
SSB Configuration	Config 1		SSB.1 FR1
	Config 2		SSB.1 FR1
	Config 3		SSB.2 FR1
SMTTC Configuration	Config 1, 2		SMTTC.1
	Config 3		SMTTC.1
PDSCH/PDCCH subcarrier spacing	Config 1, 2		15 kHz
	Config 3		30 kHz
PRACH Configuration	Config 1, 2		Table A.3.8.2.1-1
	Config 3		Table A.3.8.2.1-1
SSB index assigned as RLM RS			0
OCNG parameters			OP.1
CP length			Normal
Correlation Matrix and Antenna Configuration			2x2 Low
n sync transmission parameters	DCI format		1-0
	Number of Control OFDM symbols		2

	Aggregation level	CCE	4
	Ratio of hypothetical PDCCH RE energy to average SSS RE energy	dB	0
	Ratio of hypothetical PDCCH DMRS energy to average SSS RE energy	dB	0
	DMRS precoder granularity		REG bundle size
	REG bundle size		6
Out of sync transmission parameters	DCI format		1-0
	Number of Control OFDM symbols		2
	Aggregation level	CCE	8
	Ratio of hypothetical PDCCH RE energy to average SSS RE energy	dB	4
	Ratio of hypothetical PDCCH DMRS energy to average SSS RE energy	dB	4
	DMRS precoder granularity		REG bundle size
	REG bundle size		6
DRX			OFF
Gap pattern ID			N.A.
Layer 3 filtering			Enabled
T310 timer		ms	1000
T311 timer		ms	1000
N310			1
N311			1
CSI-RS configuration for CSI reporting	Config 1		CSI-RS.1.1 FDD
	Config 2		CSI-RS.1.1 TDD
	Config 3		CSI-RS.2.1 TDD
CSI-RS for tracking	Config 1, 4		TRS.1.1 FDD
	Config 2, 5		TRS.1.1 TDD
	Config 3, 6		TRS.1.2 TDD
T1	s	0.2	
T2	s	0.2	
T3	s	0.24	
T4	s	0.2	
T5	s	0.88	
D1	s	0.84	
Note 1: All configurations are assigned to the UE prior to the start of time period T1.			
Note 2: UE-specific PDCCH is not transmitted after T1 starts.			

Table A.6.5.1.2.1-3: Cell specific test parameters for FR1 (Cell 1) for in-sync radio link monitoring tests in non-DRX mode

Parameter	Unit	Test 1				
		T1	T2	T3	T4	T5
EPRE ratio of PDCCH DMRS to SSS	dB	0				
EPRE ratio of PDCCH to PDCCH DMRS	dB	0				

EPRE ratio of PBCH DMRS to SSS		dB	0				
EPRE ratio of PBCH to PBCH DMRS		dB					
EPRE ratio of PSS to SSS		dB					
EPRE ratio of PDSCH DMRS to SSS		dB					
EPRE ratio of PDSCH to PDSCH DMRS		dB					
EPRE ratio of OCNG DMRS to SSS		dB					
EPRE ratio of OCNG to OCNG DMRS		dB					
SNR on RLM-RS	Config 1	dB	1	-7	-15	-4.5	1
	Config 2		1	-7	-15	-4.5	1
	Config 3		1	-7	-15	-4.5	1
N_{oc}	Config 1	dBm/ 15 kHz	-98				
	Config 2		-98				
	Config 3		-98				
N_{oc}	Config 1	dBm/ SCS	-98				
	Config 2		-98				
	Config 3		-95				
Propagation condition			TDL-C 300ns 100Hz				
<p>Note 1: OCNG shall be used such that the resources in Cell 1 are fully allocated and a constant total transmitted power spectral density is achieved for all OFDM symbols.</p> <p>Note 2: The signal contains PDCCH for UEs other than the device under test as part of OCNG.</p> <p>Note 3: SNR levels correspond to the signal to noise ratio over the SSS REs.</p> <p>Note 4: The SNR in time periods T1, T2, T3, T4 and T5 is denoted as SNR1, SNR2, SNR3, SNR4 and SNR5 respectively in Figure A.6.5.1.2.1-1.</p> <p>Note 5: The SNR values are specified for testing a UE which supports 2RX on at least one band. For testing of a UE which supports 4RX on all bands, the SNR during T3 and T4 is modified as specified in clause A.3.6.</p>							

Table A.6.5.1.2.1-4: Void

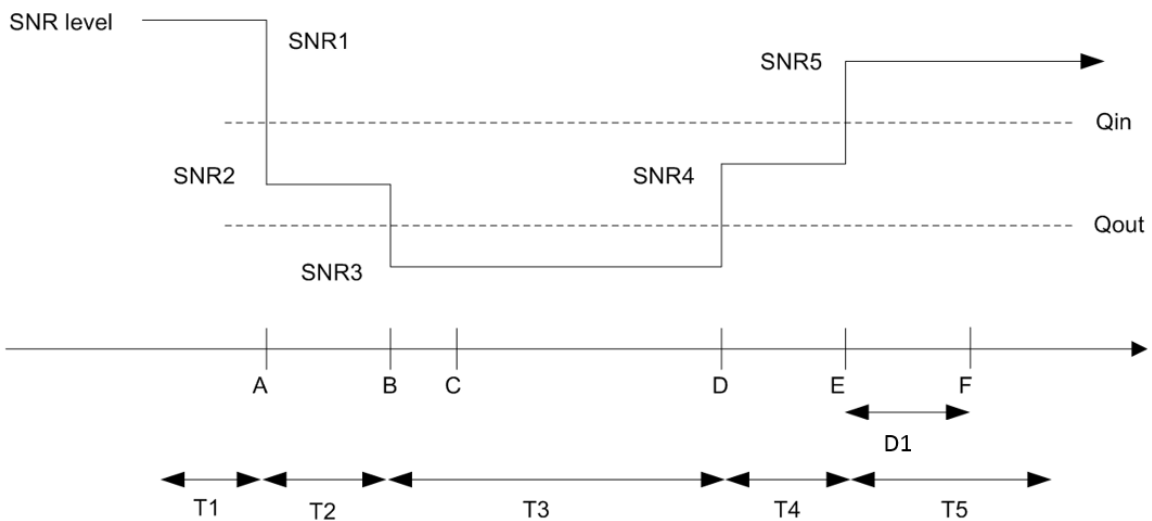

Figure A.6.5.1.2.1-1: SNR variation for in-sync testing

A.6.5.1.2.2 Test Requirements

The UE behaviour in each test during time durations T1, T2, T3, T4 and T5 shall be as follows:

During the period from time point A to time point F (D1 second after the start of time duration T5) the UE shall transmit uplink signal at least in all uplink slots configured for CSI transmission according to the configured periodic CSI reporting.

The rate of correct events observed during repeated tests shall be at least 90%.

A.6.5.1.3 Radio Link Monitoring Out-of-sync Test for FR1 PCell configured with SSB-based RLM RS in DRX mode

A.6.5.1.3.1 Test Purpose and Environment

The purpose of this test is to verify that the UE properly detects the out of sync and in sync for the purpose of monitoring downlink radio link quality of the PCell when DRX is used. This test will partly verify the FR1 radio link monitoring requirements in clause 8.1.

In the test, UE is configured to perform RLM on SSB, with *detectionResource* included in *RadioLinkMonitoringRS* set to SSB#0, and *purpose* set to ‘*rlf*’. Supported test configurations are shown in table A.6.5.1.3.1-1. The test parameters are given in Tables A.6.5.1.3.1-2, and A.6.5.1.3.1-3. There is one cell (Cell 1), which is the active NR cell, in the test. The test consists of three successive time periods, with time duration of T1, T2 and T3 respectively. Figure A.6.5.1.3.1-1 shows the variation of the downlink SNR in the active cell to emulate out-of-sync and in-sync states. Prior to the start of the time duration T1, the UE shall be fully synchronized to Cell 1. The UE shall be configured for periodic CSI reporting with a reporting periodicity of 5 ms. In the test, DRX configuration is enabled and DRX inactivity timer has already been expired, i.e. UE tries to decode PDCCH and to send periodic CSI during the period when On-duration timer is running. Time alignment timers shall be set to “infinity” so that UL timing alignment is maintained during the test.

Table A.6.5.1.3.1-1: Supported test configurations for FR1 PCell

Configuration	Description
1	FDD, SSB SCS 15 kHz, data SCS 15 kHz, BW 10 MHz
2	TDD, SSB SCS 15 kHz, data SCS 15 kHz, BW 10 MHz
3	TDD, SSB SCS 30 kHz, data SCS 30 kHz, BW 40 MHz
Note:	The UE is only required to pass in one of the supported test configurations in FR1

Table A.6.5.1.3.1-2: General test parameters for FR1 out-of-sync testing in DRX mode

Parameter	Unit	Value
		Test 1
Active PCell		Cell 1
RF Channel Number		1
Duplex mode	Config 1	FDD
	Config 2, 3	TDD
BW _{channel}	Config 1	10: N _{RB,c} = 52
	Config 2	10: N _{RB,c} = 52
	Config 3	40: N _{RB,c} = 106
DL initial BWP configuration	Config 1, 2, 3	DLBWP.0.1
DL dedicated BWP configuration	Config 1, 2, 3	DLBWP.1.1
UL initial BWP configuration	Config 1, 2, 3	ULBWP.0.1

UL dedicated BWP configuration	Config 1, 2, 3		ULBWP.1.1
TDD Configuration	Config 1		Not Applicable
	Config 2		TDDConf.1.1
	Config 3		TDDConf.2.1
RMSI CORESET Reference Channel	Config 1		CR.1.1 FDD
	Config 2		CR.1.1 TDD
	Config 3		CR.2.1 TDD
Dedicated CORESET Reference Channel	Config 1		CCR.1.3 FDD
	Config 2		CCR.1.3 TDD
	Config 3		CCR.2.2 TDD
SSB Configuration	Config 1		SSB.1 FR1
	Config 2		SSB.1 FR1
	Config 3		SSB.2 FR1
SMTC Configuration	Config 1, 2		SMTC.1
	Config 3		SMTC.1
PDSCH/PDCCH subcarrier spacing	Config 1, 2		15 kHz
	Config 3		30 kHz
PRACH Configuration	Config 1, 2		Table A.3.8.2.1-1
	Config 3		Table A.3.8.2.1-1
SSB index assigned as RLM RS			0
OCNG parameters			OP.1
CP length			Normal
Correlation Matrix and Antenna Configuration			2x2 Low
Out of sync transmission parameters	DCI format		1-0
	Number of Control OFDM symbols		2
	Aggregation level	CCE	8
	Ratio of hypothetical PDCCH RE energy to average SSS RE energy	dB	4
	Ratio of hypothetical PDCCH DMRS energy to average SSS RE energy	dB	4
	DMRS precoder granularity		REG bundle size
	REG bundle size		6
DRX Configuration			DRX.3
Gap pattern ID			N.A.
Layer 3 filtering			<i>Enabled</i>
T310 timer		ms	0
T311 timer		ms	1000
N310			1
N311			1
CSI-RS configuration for CSI reporting	Config 1		CSI-RS.1.1 FDD
	Config 2		CSI-RS.1.1 TDD
	Config 3		CSI-RS.2.1 TDD
CSI-RS for tracking	Config 1		TRS.1.1 FDD
	Config 2		TRS.1.1 TDD

	Config 3		TRS.1.2 TDD
T1		s	0.2
T2		s	0.68
T3		s	0.68
D1		s	0.64
Note 1: All configurations are assigned to the UE prior to the start of time period T1.			
Note 2: UE-specific PDCCH is not transmitted after T1 starts.			

Table A.6.5.1.3.1-3: Cell specific test parameters for FR1 (Cell 1) for out-of-sync radio link monitoring tests in DRX mode

Parameter		Unit	Test 1		
			T1	T2	T3
EPRE ratio of PDCCH DMRS to SSS		dB	4		
EPRE ratio of PDCCH to PDCCH DMRS		dB	0		
EPRE ratio of PBCH DMRS to SSS		dB	0		
EPRE ratio of PBCH to PBCH DMRS		dB			
EPRE ratio of PSS to SSS		dB			
EPRE ratio of PDSCH DMRS to SSS		dB			
EPRE ratio of PDSCH to PDSCH DMRS		dB			
EPRE ratio of OCNG DMRS to SSS		dB			
EPRE ratio of OCNG to OCNG DMRS		dB			
SNR on RLM-RS		dB			
Config 1			1	-7	-15
Config 2			1	-7	-15
Config 3					
N_o	Config 1	dBm/15 kHz	-98		
	Config 2		-98		
	Config 3		-98		
N_{oc}	Config 1	dBm/S	-98		
	Config 2		-98		
	Config 3		-95		
Propagation condition			TDL-C 300ns 100Hz		
Note 1: OCNG shall be used such that the resources in Cell 1 are fully allocated and a constant total transmitted power spectral density is achieved for all OFDM symbols.					
Note 2: The signal contains PDCCH for UEs other than the device under test as part of OCNG.					
Note 3: SNR levels correspond to the signal to noise ratio over the SSS REs.					
Note 4: The SNR in time periods T1, T2 and T3 is denoted as SNR1, SNR2 and SNR3 respectively in Figure A.6.5.1.3.1-1.					
Note 5: The SNR values are specified for testing a UE which supports 2RX on at least one band. For testing of a UE which supports 4RX on all bands, the SNR during T3 is A.3.6.					

Table A.6.5.1.3.1-4: Void

Table A.6.5.1.3.1-5: Void

Table A.6.5.1.3.1-6: Void

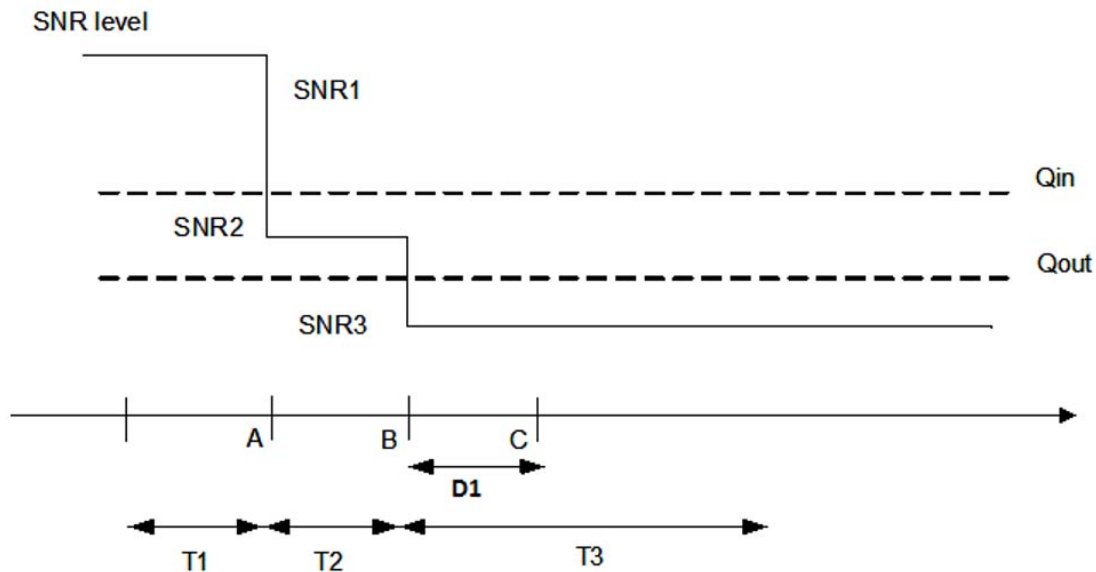

Figure A.6.5.1.3.1-1: SNR variation for out-of-sync testing

A.6.5.1.3.2 Test Requirements

The UE behaviour in each test during time durations T1, T2 and T3 shall be as follows:

During the period from time point A to time point B the UE shall transmit uplink signal at least in all uplink slots configured for CSI transmission according to the configured periodic CSI reporting.

The UE shall stop transmitting uplink signal no later than time point C (D1 second after the start of the time duration T3).

The rate of correct events observed during repeated tests shall be at least 90%.

A.6.5.1.4 Radio Link Monitoring In-sync Test for FR1 PCell configured with SSB-based RLM RS in DRX mode

A.6.5.1.4.1 Test Purpose and Environment

The purpose of this test is to verify that the UE properly detects the out of sync and in sync for the purpose of monitoring downlink radio link quality of the PCell when DRX is used. This test will partly verify the FR1 radio link monitoring requirements in clause 8.1.

In the test, UE is configured to perform RLM on SSB, with *detectionResource* included in *RadioLinkMonitoringRS* set to SSB#0, and *purpose* set to 'rlf'. Supported test configurations are shown in table A.6.5.1.4.1-1. The test parameters are given in Tables A.6.5.1.4.1-2, and A.6.5.1.4.1-3. There is one cell (Cell 1), which is the active NR cell, in the test. The test consists of five successive time periods, with time duration of T1, T2, T3, T4 and T5 respectively. Figure A.6.5.1.4.1-1 shows the variation of the downlink SNR in the active cell to emulate out-of-sync and in-sync states. Prior to the start of the time duration T1, the UE shall be fully synchronized to Cell 1. The UE shall be configured for periodic CSI reporting with a reporting periodicity of 5 ms. In the test, DRX configuration is enabled and DRX inactivity timer has already been expired, i.e. UE tries to decode PDCCH and to send periodic CSI during the period when On-duration timer is running. Time alignment timers shall be set to "infinity" so that UL timing alignment is maintained during the test.

Table A.6.5.1.4.1-1: Supported test configurations for FR1 PCell

Configuration	Description
1	FDD, SSB SCS 15 kHz, data SCS 15 kHz, BW 10 MHz
2	TDD, SSB SCS 15 kHz, data SCS 15 kHz, BW 10 MHz
3	TDD, SSB SCS 30 kHz, data SCS 30 kHz, BW 40 MHz
Note:	The UE is only required to pass in one of the supported test configurations in FR1

Table A.6.5.1.4.1-2: General test parameters for FR1 in-sync testing in DRX mode

Parameter		Unit	Value Test 1
Active PCell			Cell 1
RF Channel Number			1
Duplex mode	Config 1		FDD
	Config 2, 3		TDD
BW _{channel}	Config 1	MHz	10: N _{RB,c} = 52
	Config 2		10: N _{RB,c} = 52
	Config 3		40: N _{RB,c} = 106
DL initial BWP configuration	Config 1, 2, 3		DLBWP.0.1
DL dedicated BWP configuration	Config 1, 2, 3		DLBWP.1.1
UL initial BWP configuration	Config 1, 2, 3		ULBWP.0.1
UL dedicated BWP configuration	Config 1, 2, 3		ULBWP.1.1
TDD Configuration	Config 1		Not Applicable
	Config 2		TDDConf.1.1
	Config 3		TDDConf.2.1
RMSI CORESET Reference Channel	Config 1		CR.1.1 FDD
	Config 2		CR.1.1 TDD
	Config 3		CR.2.1 TDD
Dedicated CORESET Reference Channel	Config 1		CCR.1.1 FDD
	Config 2		CCR.1.1 TDD
	Config 3		CCR.2.1 TDD
SSB Configuration	Config 1		SSB.1 FR1
	Config 2		SSB.1 FR1
	Config 3		SSB.2 FR1
SMTTC Configuration	Config 1, 2		SMTTC.1
	Config 3		SMTTC.1
PDSCH/PDCCH subcarrier spacing	Config 1, 2		15 kHz
	Config 3		30 kHz
PRACH Configuration	Config 1, 2		Table A.3.8.2.1-1
	Config 3		Table A.3.8.2.1-1
SSB index assigned as RLM RS			0
OCNG parameters			OP.1
CP length			Normal
Correlation Matrix and Antenna Configuration			2x2 Low
In sync transmission parameters	DCI format		1-0
	Number of Control OFDM symbols		2

	Aggregation level	CCE	4
	Ratio of hypothetical PDCCH RE energy to average SSS RE energy	dB	0
	Ratio of hypothetical PDCCH DMRS energy to average SSS RE energy	dB	0
	DMRS precoder granularity		REG bundle size
	REG bundle size		6
Out of sync transmission parameters	DCI format		1-0
	Number of Control OFDM symbols		2
	Aggregation level	CCE	8
	Ratio of hypothetical PDCCH RE energy to average SSS RE energy	dB	4
	Ratio of hypothetical PDCCH DMRS energy to average SSS RE energy	dB	4
	DMRS precoder granularity		REG bundle size
	REG bundle size		6
DRX Configuration			DRX.3
Gap pattern ID			N.A.
Layer 3 filtering			<i>Enabled</i>
T310 timer		ms	2000
T311 timer		ms	1000
N310			1
N311			1
CSI-RS configuration for CSI reporting	Config 1		CSI-RS.1.1 FDD
	Config 2		CSI-RS.1.1 TDD
	Config 3		CSI-RS.2.1 TDD
CSI-RS for tracking	Config 1		TRS.1.1 FDD
	Config 2		TRS.1.1 TDD
	Config 3		TRS.1.2 TDD
T1	s	0.2	
T2	s	0.2	
T3	s	0.64	
T4	s	0.2	
T5	s	0.88	
D1	s	0.84	
Note 1: All configurations are assigned to the UE prior to the start of time period T1.			
Note 2: UE-specific PDCCH is not transmitted after T1 starts.			

Table A.6.5.1.4.1-3: Cell specific test parameters for FR1 (Cell 1) for in-sync radio link monitoring tests in DRX mode

Parameter	Unit	Test 1				
		T1	T2	T3	T4	T5
EPRE ratio of PDCCH DMRS to SSS	dB	0				
EPRE ratio of PDCCH to PDCCH DMRS	dB	0				
EPRE ratio of PBCH DMRS to SSS	dB					

EPRE ratio of PBCH to PBCH DMRS		dB	0				
EPRE ratio of PSS to SSS		dB					
EPRE ratio of PDSCH DMRS to SSS		dB					
EPRE ratio of PDSCH to PDSCH DMRS		dB					
EPRE ratio of OCNG DMRS to SSS		dB					
EPRE ratio of OCNG to OCNG DMRS		dB					
SNR on RLM-RS	Config 1	dB	1	-7	-15	-4.5	1
	Config 2		1	-7	-15	-4.5	1
	Config 3		1	-7	-15	-4.5	1
N_{oc}	Config 1	dBm/15 kHz	-98				
	Config 2		-98				
	Config 3		-98				
N_{oc}	Config 1	dBm/S CS	-98				
	Config 2		-98				
	Config 3		-95				
Propagation condition			TDL-C 300ns 100Hz				
<p>Note 1: OCNG shall be used such that the resources in Cell 1 are fully allocated and a constant total transmitted power spectral density is achieved for all OFDM symbols.</p> <p>Note 2: The signal contains PDCCH for UEs other than the device under test as part of OCNG.</p> <p>Note 3: SNR levels correspond to the signal to noise ratio over the SSS REs.</p> <p>Note 4: The SNR in time periods T1, T2, T3, T4 and T5 is denoted as SNR1, SNR2, SNR3, SNR4 and SNR5 respectively in Figure A.6.5.1.4.1-1.</p> <p>Note 5: The SNR values are specified for testing a UE which supports 2RX on at least one band. For testing of a UE which supports 4RX on all bands, the SNR during T3 and T4 is modified as specified in clause A.3.6.</p>							

Table A.6.5.1.4.1-4: Void

Table A.6.5.1.4.1-5: Void

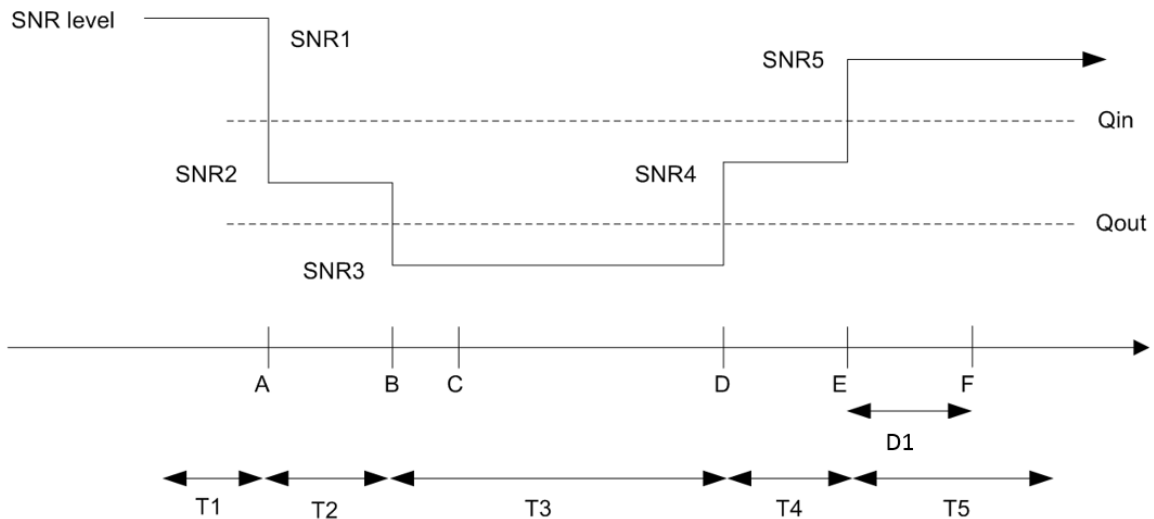

Figure A.6.5.1.4.1-1: SNR variation for in-sync testing.

A.6.5.1.4.2 Test Requirements

The UE behaviour in each test during time durations T1, T2, T3, T4 and T5 shall be as follows:

During the period from time point A to time point F (D1 second after the start of time duration T5) the UE shall transmit uplink signal at least in all uplink slots configured for CSI transmission according to the configured periodic CSI reporting.

The rate of correct events observed during repeated tests shall be at least 90%.

A.6.5.1.5 Radio Link Monitoring Out-of-sync Test for FR1 PCell configured with CSI-RS-based RLM in non-DRX mode

A.6.5.1.5.1 Test Purpose and Environment

The purpose of this test is to verify that the UE properly detects the out of sync for the purpose of monitoring downlink CSI-RS based radio link quality of the PCell when no DRX is used. This test will partly verify the FR1 PCell CSI-RS Out-of-sync radio link monitoring requirements in clause 8.1.

The test parameters are given in Tables A.6.5.1.5.1-1, A.6.5.1.5.1-2, A.6.5.1.5.1-3, and A.6.5.1.5.1-3A below. There is one cell, cell 1 which is the PCell, in the test. The test consists of three successive time periods, with time duration of T1, T2 and T3 respectively. Figure A.6.5.1.5.1-1 shows the variation of the downlink SNR in the PCell to emulate out-of-sync and in-sync states. Prior to the start of the time duration T1, the UE shall be fully synchronized to cell 1. The UE shall be configured for periodic CSI reporting of 5ms. In the test, DRX configuration is not enabled. The UE is configured to perform inter-frequency measurements using GP ID #0 (40ms) in test. In the test, SSB0 is configured as the BFD-RS.

Table A.6.5.1.5.1-1: Supported test configurations for FR1 PCell

Configuration	Description
1	FDD duplex mode, 15 kHz SSB SCS, 10 MHz bandwidth
2	TDD duplex mode, 15 kHz SSB SCS, 10 MHz bandwidth
3	TDD duplex mode, 30 kHz SSB SCS, 40 MHz bandwidth
Note: The UE is only required to pass in one of the supported test configurations in FR1	

Table A.6.5.1.5.1-2: General test parameters for FR1 PCell for CSI-RS out-of-sync testing in non-DRX mode

Parameter	Unit	Value
		Test 1
Active PCell		Cell 1
RF Channel Number		1
Duplex mode	Config 1	FDD
	Config 2, 3	TDD
TDD Configuration	Config 1	Not Applicable
	Config 2	TDDConf.1.1
	Config 3	TDDConf.2.1
DL initial BWP configuration	Config 1, 2, 3	DLBWP.0.1
DL dedicated BWP configuration	Config 1, 2, 3	DLBWP.1.1
UL initial BWP configuration	Config 1, 2, 3	ULBWP.0.1
UL dedicated BWP configuration	Config 1, 2, 3	ULBWP.1.1
RMSI CORESET Reference Channel	Config 1	CR.1.1 FDD
	Config 2	CR.1.1 TDD
	Config 3	CR.2.1 TDD
Dedicated CORESET Reference Channel	Config 1	CCR.1.3 FDD

	Config 2		CCR.1.3 TDD
	Config 3		CCR.2.2 TDD
SSB Configuration	Config 1		SSB.1 FR1
	Config 2		SSB.1 FR1
	Config 3		SSB.2 FR1
SMTC Configuration	Config 1, 2		SMTC.1
	Config 3		SMTC.1
PDSCH/PDCCH subcarrier spacing	Config 1, 2		15 kHz
	Config 3		30 kHz
TRS configuration	Config 1		TRS.1.1 FDD
	Config 2		TRS.1.1 TDD
	Config 3		TRS.1.2 TDD
CSI-RS for RLM	Config 1		Resource #4 in TRS.1.1 FDD
	Config 2		Resource #4 in TRS.1.1 TDD
	Config 3		Resource #4 in TRS.1.2 TDD
TCI configuration for PDCCH/PDSCH			TCI.State.2
OCNG parameters			OP.1
CP length			Normal
Correlation Matrix and Antenna Configuration			2x2 Low
Out of sync transmission parameters	DCI format		1-0
	Number of Control OFDM symbols		2
	Aggregation level	CCE	8
	Ratio of hypothetical PDCCH RE energy to average CSI-RS RE energy	dB	4
	Ratio of hypothetical PDCCH DMRS energy to average CSI-RS RE energy	dB	4
	DMRS precoder granularity		REG bundle size
	REG bundle size		6
DRX			OFF
Gap pattern ID			gp0
Layer 3 filtering			Enabled
T310 timer	ms		0
T311 timer	ms		1000
N310			1
N311			1
CSI-RS configuration for CSI reporting	Config 1		CSI-RS.1.1 FDD
	Config 2		CSI-RS.1.1 TDD
	Config 3		CSI-RS.2.1 TDD
T1	s		0.2
T2	s		0.88
T3	s		0.88
D1	s		0.84
Note 1: UE-specific PDCCH is not transmitted after T1 starts.			

Table A.6.5.1.5.1-3: Cell specific test parameters for FR1 for CSI-RS out-of-sync radio link monitoring in non-DRX mode

Parameter	Unit	Test 1		
		T1	T2	T3
EPRE ratio of PDCCH DMRS to SSS	dB		4	

EPRE ratio of PDCCH to PDCCH DMRS		dB	0		
EPRE ratio of PBCH DMRS to SSS		dB			
EPRE ratio of PBCH to PBCH DMRS		dB			
EPRE ratio of PSS to SSS		dB			
EPRE ratio of PDSCH DMRS to SSS		dB			
EPRE ratio of PDSCH to PDSCH DMRS		dB			
EPRE ratio of OCNG DMRS to SSS		dB			
EPRE ratio of OCNG to OCNG DMRS		dB			
SNR on RLM-RS	Config 1	dB	1	-7	-15
	Config 2		1	-7	-15
	Config 3		1	-7	-15
N_{oc}	Config 1	dBm/15kHz	-98		
	Config 2		-98		
	Config 3		-98		
Propagation condition			TDL-C 300ns 100Hz		
<p>Note 1: OCNG shall be used such that the resources in Cell 1 are fully allocated and a constant total transmitted power spectral density is achieved for all OFDM symbols.</p> <p>Note 2: The uplink resources for CSI reporting are assigned to the UE prior to the start of time period T1.</p> <p>Note 3: NZP CSI-RS resource set configuration for CSI reporting are assigned to the UE prior to the start of time period T1.</p> <p>Note 4: Measurement gap configuration is assigned to the UE prior to the start of time period T1.</p> <p>Note 5: The timers and layer 3 filtering related parameters are configured prior to the start of time period T1.</p> <p>Note 6: The signal contains PDCCH for UEs other than the device under test as part of OCNG.</p> <p>Note 7: SNR levels correspond to the signal to noise ratio over the SSS REs.</p> <p>Note 8: The SNR in time periods T1, T2 and T3 is denoted as SNR1, SNR2 and SNR3 respectively in figure A.6.5.1.5.1-1.</p> <p>Note 9: The SNR values are specified for testing a UE which supports 2RX on at least one band. For testing of a UE which supports 4RX on all bands, the SNR during T3 is [A.3.6].</p>					

Table A.6.5.1.5.1-3A: Measurement gap configuration for FR1 CSI-RS out-of-sync radio link monitoring in non-DRX mode

Field	Test 1
	Value
gapOffset	0
Note 1: Void	

Table A.6.5.1.5.1-4: Void

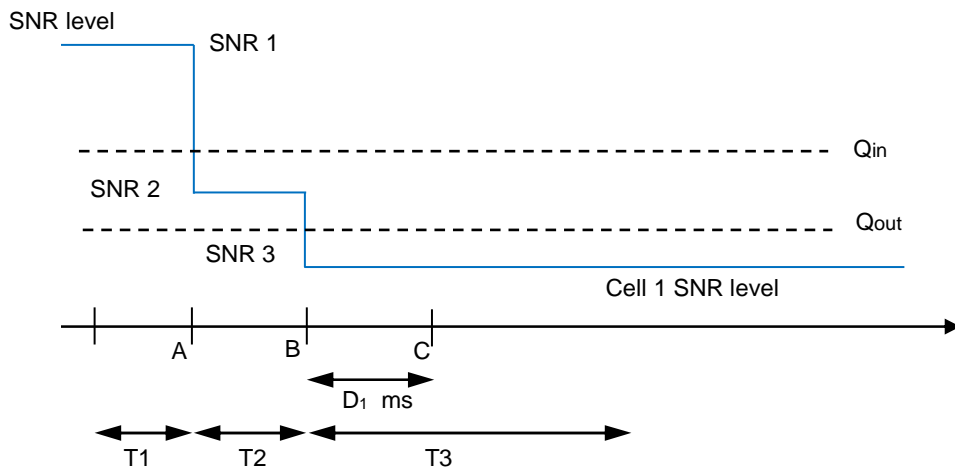

Figure A.6.5.1.5.1-1: SNR variation for CSI-RS out-of-sync testing

A.6.5.1.5.2 Test Requirements

The UE behaviour during time durations T1, T2, and T3 shall be as follows:

During the period from time point A to time point B the UE shall transmit uplink signal in Cell 1 at least in all uplink slots configured for CSI transmission according to the configured periodic CSI reporting for Cell 1.

The UE shall stop transmitting uplink signal in Cell 1 no later than time point C (D_1 ms after the start of the time duration T3) on the PCell.

The rate of correct events observed during repeated tests shall be at least 90%.

A.6.5.1.6 Radio Link Monitoring In-sync Test for FR1 PCell configured with CSI-RS-based RLM in non-DRX mode

A.6.5.1.6.1 Test Purpose and Environment

The purpose of this test is to verify that the UE properly detects the in sync for the purpose of monitoring downlink CSI-RS based radio link quality of the PCell when no DRX is used. This test will partly verify the FR1 PCell CSI-RS In-sync radio link monitoring requirements in clause 8.1.

The test parameters are given in Tables A.6.5.1.6.1-1, A.6.5.1.6.1-2, and A.6.5.1.6.1-3 below. There is one cells, cell 1 which is the PCell, in the test. The test consists of five successive time periods, with time duration of T1, T2, T3, T4 and T5 respectively. Figure A.6.5.1.6.1-1 shows the variation of the downlink SNR in the PCell to emulate out-of-sync and in-sync states. Prior to the start of the time duration T1, the UE shall be fully synchronized to cell 1. The UE shall be configured for periodic CSI reporting with a reporting periodicity of 5ms. In the test, DRX configuration is not enabled. In the test, SSB0 is configured as the BFD-RS.

Table A.6.5.1.6.1-1: Supported test configurations for FR1 PCell

Configuration	Description
1	FDD duplex mode, 15 kHz SSB SCS, 10 MHz bandwidth
2	TDD duplex mode, 15 kHz SSB SCS, 10 MHz bandwidth
3	TDD duplex mode, 30kHz SSB SCS, 40 MHz bandwidth
Note:	The UE is only required to pass in one of the supported test configurations in FR1

Table A.6.5.1.6.1-2: General test parameters for FR1 PCell for CSI-RS in-sync testing in non-DRX mode

Parameter		Unit	Value
			Test 1
Active PCell			Cell 1
RF Channel Number			1
Duplex mode	Config 1		FDD
	Config 2, 3		TDD
TDD Configuration	Config 1		Not Applicable
	Config 2		TDDConf.1.1
	Config 3		TDDConf.2.1
DL initial BWP configuration	Config 1, 2, 3		DLBWP.0.1
DL dedicated BWP configuration	Config 1, 2, 3		DLBWP.1.1
UL initial BWP configuration	Config 1, 2, 3		ULBWP.0.1
UL dedicated BWP configuration	Config 1, 2, 3		ULBWP.1.1
RMSI CORESET Reference Channel	Config 1		CR.1.1 FDD
	Config 2		CR.1.1 TDD
	Config 3		CR.2.1 TDD
Dedicated CORESET Reference Channel	Config 1		CCR.1.1 FDD
	Config 2		CCR.1.1 TDD
	Config 3		CCR.2.1 TDD
SSB Configuration	Config 1		SSB.1 FR1
	Config 2		SSB.1 FR1
	Config 3		SSB.2 FR1
SMTTC Configuration	Config 1, 2		SMTTC.1
	Config 3		SMTTC.1
PDSCH/PDCCH subcarrier spacing	Config 1, 2		15 kHz
	Config 3		30 kHz
TRS configuration	Config 1		TRS.1.1 FDD
	Config 2		TRS.1.1 TDD
	Config 3		TRS.1.2 TDD
CSI-RS for RLM	Config 1		Resource #4 in TRS.1.1 FDD
	Config 2		Resource #4 in TRS.1.1 TDD
	Config 3		Resource #4 in TRS.1.2 TDD
TCI configuration for PDCCH/PDSCH			TCI.State.0
OCNG parameters			OP.1
CP length			Normal
Correlation Matrix and Antenna Configuration			2x2 Low
Out of sync transmission parameters	DCI format		1-0
	Number of Control OFDM symbols		2
	Aggregation level	CCE	8
	Ratio of hypothetical PDCCH RE energy to average CSI-RS RE energy	dB	4

	Ratio of hypothetical PDCCH DMRS energy to average CSI-RS RE energy	dB	4
	DMRS precoder granularity		REG bundle size
	REG bundle size		6
In sync transmission parameters	DCI format		1-0
	Number of Control OFDM symbols		2
	Aggregation level	CCE	4
	Ratio of hypothetical PDCCH RE energy to average CSI-RS RE energy	dB	0
	Ratio of hypothetical PDCCH DMRS energy to average CSI-RS RE energy	dB	0
	DMRS precoder granularity		REG bundle size
	REG bundle size		6
DRX			OFF
Gap pattern ID			N.A.
Layer 3 filtering			Enabled
T310 timer	ms		1000
T311 timer	ms		1000
N310			1
N311			1
CSI-RS configuration for CSI reporting	Config 1		CSI-RS.1.1 FDD
	Config 2		CSI-RS.1.1 TDD
	Config 3		CSI-RS.2.1 TDD
T1	s		0.2
T2	s		0.2
T3	s		0.44
T4	s		0.2
T5	s		0.88
T6	S		0.84
Note 1: UE-specific PDCCH is not transmitted after T1 starts.			

Table A.6.5.1.6.1-3: Cell specific test parameters for FR1 for CSI-RS in-sync radio link monitoring in non-DRX mode

Parameter	Unit	Test 1					
		T1	T2	T3	T4	T5	
EPRE ratio of PDCCH DMRS to SSS	dB	0					
EPRE ratio of PDCCH to PDCCH DMRS	dB						
EPRE ratio of PBCH DMRS to SSS	dB						
EPRE ratio of PBCH to PBCH DMRS	dB						0
EPRE ratio of PSS to SSS	dB						
EPRE ratio of PDSCH DMRS to SSS	dB						
EPRE ratio of PDSCH to PDSCH DMRS	dB						
EPRE ratio of OCNG DMRS to SSS	dB						
EPRE ratio of OCNG to OCNG DMRS	dB						
SNR on RLM-RS	dB						1
Config 1		1	-7	-15	-4.5	1	
Config 2							

N_{oc}	Config 3	dBm/15kHz	1	-7	-15	-4.5	1
	Config 1		-98				
	Config 2		-98				
	Config 3		-98				
Propagation condition		TDL-C 300ns 100Hz					
<p>Note 1: OCNG shall be used such that the resources in Cell 1 are fully allocated and a constant total transmitted power spectral density is achieved for all OFDM symbols.</p> <p>Note 2: The uplink resources for CSI reporting are assigned to the UE prior to the start of time period T1.</p> <p>Note 3: NZP CSI-RS resource set configuration for CSI reporting are assigned to the UE prior to the start of time period T1.</p> <p>Note 4: Measurement gap configuration is assigned to the UE prior to the start of time period T1.</p> <p>Note 5: The timers and layer 3 filtering related parameters are configured prior to the start of time period T1.</p> <p>Note 6: The signal contains PDCCH for UEs other than the device under test as part of OCNG.</p> <p>Note 7: SNR levels correspond to the signal to noise ratio over the SSS REs.</p> <p>Note 8: The SNR in time periods T1, T2, T3, T4 and T5 is denoted as SNR1, SNR2, SNR3, SNR4 and SNR5 respectively in figure A.6.5.1.6.1-1.</p> <p>Note 9: The SNR values are specified for testing a UE which supports 2RX on at least one band. For testing of a UE which supports 4RX on all bands, the SNR during T3 is specified in section A.3.6.1.1.</p>							

Table A.6.5.1.6.1-4: Void

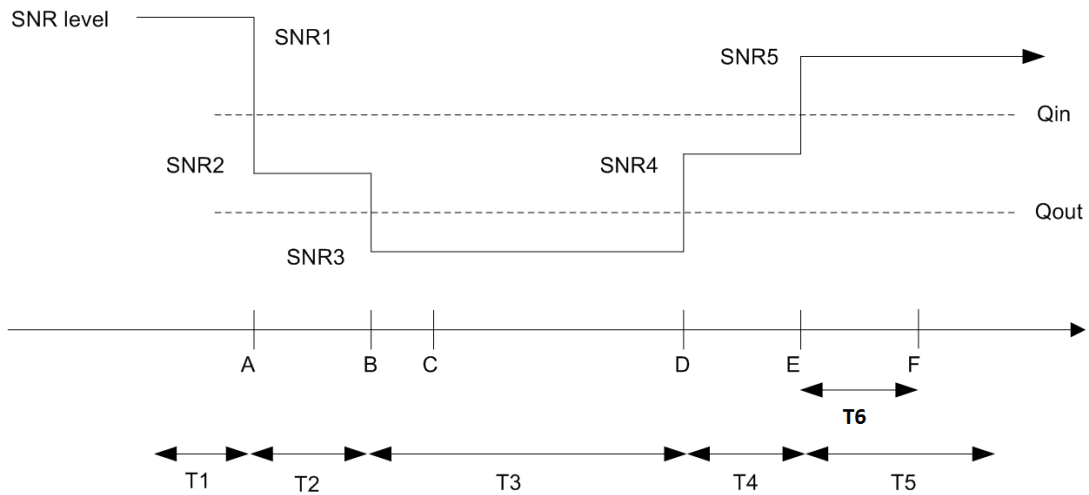

Figure A.6.5.1.6.1-1: SNR variation for CSI-RS in-sync testing

A.6.5.1.6.2 Test Requirements

The UE behaviour in each test during time durations T1, T2, T3, T4 and T5 shall be as follows:

During the period from time point A to time point F (T6 second after the start of time duration T5) the UE shall transmit uplink signal at least in all uplink slots configured for CSI transmission according to the configured periodic CSI reporting on the PCell.

The rate of correct events observed during repeated tests shall be at least 90%.

A.6.5.1.7 Radio Link Monitoring Out-of-sync Test for FR1 PCell configured with CSI-RS-based RLM in DRX mode

A.6.5.1.7.1 Test Purpose and Environment

The purpose of this test is to verify that the UE properly detects the out of sync for the purpose of monitoring downlink CSI-RS based radio link quality of the PCell when DRX is used. This test will partly verify the FR1 PCell CSI-RS Out-of-sync radio link monitoring requirements in clause 8.1.

The test parameters are given in Tables A.6.5.1.7.1-1, A.6.5.1.7.1-2, and A.6.5.1.7.1-3 below. There is one cell, cell 1 is the PCell, in the test. The test consists of three successive time periods, with time duration of T1, T2 and T3 respectively. Figure A.6.5.1.7.1-1 shows the variation of the downlink SNR in the PCell to emulate out-of-sync and in-sync states. Prior to the start of the time duration T1, the UE shall be fully synchronized to cell 1. The UE shall be configured for periodic CSI reporting with a reporting periodicity of 5ms. In the test, DRX configuration is enabled in PCell and DRX inactivity timer has already been expired, i.e. UE tries to decode PDCCH and to send periodic CQI during the period when On-duration timer is running. Time alignment timers shall be set to “infinity” so that UL timing alignment is maintained during the test. In the test, SSB0 is configured as the BFD-RS.

Table A.6.5.1.7.1-1: Supported test configurations for FR1 PCell

Configuration	Description
1	FDD duplex mode, 15 kHz SSB SCS, 10 MHz bandwidth
2	TDD duplex mode, 15 kHz SSB SCS, 10 MHz bandwidth
3	TDD duplex mode, 30 kHz SSB SCS, 40 MHz bandwidth
Note: The UE is only required to pass in one of the supported test configurations in FR1	

Table A.6.5.1.7.1-2: General test parameters for FR1 PCell for CSI-RS out-of-sync testing in DRX mode

Parameter		Unit	Value
			Test 1
Active PCell			Cell 1
RF Channel Number			1
Duplex mode	Config 1		FDD
	Config 2, 3		TDD
TDD Configuration	Config 1		Not Applicable
	Config 2		TDDConf.1.1
	Config 3		TDDConf.2.1
DL initial BWP configuration	Config 1, 2, 3		DLBWP.0.1
DL dedicated BWP configuration	Config 1, 2, 3		DLBWP.1.1
UL initial BWP configuration	Config 1, 2, 3		ULBWP.0.1
UL dedicated BWP configuration	Config 1, 2, 3		ULBWP.1.1
RMSI CORESET Reference Channel	Config 1		CR.1.1 FDD
	Config 2		CR.1.1 TDD
	Config 3		CR.2.1 TDD
Dedicated CORESET Reference Channel	Config 1		CCR.1.3 FDD
	Config 2		CCR.1.3 TDD
	Config 3		CCR.2.2 TDD
SSB Configuration	Config 1		SSB.1 FR1
	Config 2		SSB.1 FR1
	Config 3		SSB.2 FR1

SMTC Configuration	Config 1, 2		SMTC.1
	Config 3		SMTC.1
PDSCH/PDCCH subcarrier spacing	Config 1, 2		15 kHz
	Config 3		30 kHz
TRS configuration	Config 1		TRS.1.1 FDD
	Config 2		TRS.1.1 TDD
	Config 3		TRS.1.2 TDD
CSI-RS for RLM	Config 1		Resource #4 in TRS.1.1 FDD
	Config 2		Resource #4 in TRS.1.1 TDD
	Config 3		Resource #4 in TRS.1.2 TDD
TCI configuration for PDCCH/PDSCH			TCI.State.0
OCNG parameters			OP.1
CP length			Normal
Correlation Matrix and Antenna Configuration			2x2 Low
Out of sync transmission parameters	DCI format		1-0
	Number of Control OFDM symbols		2
	Aggregation level	CCE	8
	Ratio of hypothetical PDCCH RE energy to average CSI-RS RE energy	dB	4
	Ratio of hypothetical PDCCH DMRS energy to average CSI-RS RE energy	dB	4
	DMRS precoder granularity		REG bundle size
REG bundle size			6
DRX			DRX.3
Gap pattern ID			N.A.
Layer 3 filtering			Enabled
T310 timer	ms		0
T311 timer	ms		1000
N310			1
N311			1
CSI-RS configuration for CSI reporting	Config 1		CSI-RS.1.1 FDD
	Config 2		CSI-RS.1.1 TDD
	Config 3		CSI-RS.2.1 TDD
T1	s		0.2
T2	s		1.28
T3	s		1.28
D1	s		1.24
Note 1: UE-specific PDCCH is not transmitted after T1 starts.			

Table A.6.5.1.7.1-3: Cell specific test parameters for FR1 for CSI-RS out-of-sync radio link monitoring in DRX mode

Parameter	Unit	Test 1		
		T1	T2	T3
EPRE ratio of PDCCH DMRS to SSS	dB	4		
EPRE ratio of PDCCH to PDCCH DMRS	dB	0		
EPRE ratio of PBCH DMRS to SSS	dB			
EPRE ratio of PBCH to PBCH DMRS	dB			

EPRE ratio of PSS to SSS		dB			
EPRE ratio of PDSCH DMRS to SSS		dB			
EPRE ratio of PDSCH to PDSCH DMRS		dB			
EPRE ratio of OCNG DMRS to SSS		dB			
EPRE ratio of OCNG to OCNG DMRS		dB			
SNR on RLM-RS	Config 1	dB	1	-7	-15
	Config 2		1	-7	-15
	Config 3		1	-7	-15
N_{oc}	Config 1	dBm/15kHz	-98		
	Config 2		-98		
	Config 3		-98		
Propagation condition			TDL-C 300ns 100Hz		
<p>Note 1: OCNG shall be used such that the resources in Cell 1 are fully allocated and a constant total transmitted power spectral density is achieved for all OFDM symbols.</p> <p>Note 2: The uplink resources for CSI reporting are assigned to the UE prior to the start of time period T1.</p> <p>Note 3: NZP CSI-RS resource set configuration for CSI reporting are assigned to the UE prior to the start of time period T1.</p> <p>Note 4: Measurement gap configuration is assigned to the UE prior to the start of time period T1.</p> <p>Note 5: The timers and layer 3 filtering related parameters are configured prior to the start of time period T1.</p> <p>Note 6: The signal contains PDCCH for UEs other than the device under test as part of OCNG.</p> <p>Note 7: SNR levels correspond to the signal to noise ratio over the SSS REs.</p> <p>Note 8: The SNR in time periods T1, T2 and T3 is denoted as SNR1, SNR2 and SNR3 respectively in figure A.6.5.1.7.1-1.</p> <p>Note 9: The SNR values are specified for testing a UE which supports 2RX on at least one band. For testing of a UE which supports 4RX on all bands, the SNR during T3 is specified in section A.3.6.1.1.</p>					

Table A.6.5.1.7.1-4: Void

Table A.6.5.1.7.1-5: Void

Table A.6.5.1.7.1-6: Void

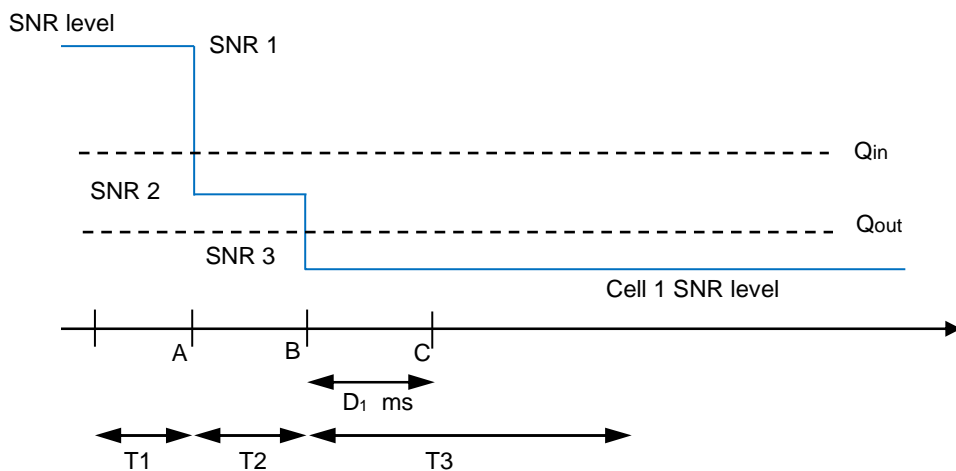

Figure A.6.5.1.7.1-1: SNR variation for CSI-RS out-of-sync testing

A.6.5.1.7.2 Test Requirements

The UE behaviour during time durations T1, T2, and T3 shall be as follows:

During the period from time point A to time point B the UE shall transmit uplink signal in Cell 1 (PCell) at least in all uplink slots configured for CSI transmission according to the configured periodic CSI reporting for Cell 1.

The UE shall stop transmitting uplink signal in Cell 1 (PCell) no later than time point C (D_1 ms after the start of the time duration T3) on the PCell.

The rate of correct events observed during repeated tests shall be at least 90%.

A.6.5.1.8 Radio Link Monitoring In-sync Test for FR1 PCell configured with CSI-RS-based RLM in DRX mode

A.6.5.1.8.1 Test Purpose and Environment

The purpose of this test is to verify that the UE properly detects the in sync for the purpose of monitoring downlink CSI-RS based radio link quality of the PCell when DRX is used. This test will partly verify the FR1 PCell CSI-RS In-sync radio link monitoring requirements in clause 8.1.

The test parameters are given in Tables A.6.5.1.8.1-1, A.6.5.1.8.1-2, A.6.5.1.8.1-3 and A.6.5.1.8.1-3A below. There is one cells, cell 1 which is the PCell, in the test. The test consists of five successive time periods, with time duration of T1, T2, T3, T4 and T5 respectively. Figure A.6.5.1.8.1-1 shows the variation of the downlink SNR in the PCell to emulate out-of-sync and in-sync states. Prior to the start of the time duration T1, the UE shall be fully synchronized to cell 1. The UE shall be configured for periodic CSI reporting with a reporting periodicity of 5ms. The UE is configured to perform inter-frequency measurements using GP ID #0 (40ms) in test. In the test, SSB0 is configured as the BFD-RS.

Table A.6.5.1.8.1-1: Supported test configurations for FR1 PCell

Configuration	Description
1	FDD duplex mode, 15 kHz SSB SCS, 10 MHz bandwidth
2	TDD duplex mode, 15 kHz SSB SCS, 10 MHz bandwidth
3	TDD duplex mode, 30kHz SSB SCS, 40 MHz bandwidth
Note:	The UE is only required to pass in one of the supported test configurations in FR1

Table A.6.5.1.8.1-2: General test parameters for FR1 PCell for CSI-RS in-sync testing in non-DRX mode

Parameter	Unit	Value
		Test 1
Active PCell		Cell 1
RF Channel Number		1
Duplex mode	Config 1	FDD
	Config 2, 3	TDD
TDD Configuration	Config 1	Not Applicable
	Config 2	TDDConf.1.1
	Config 3	TDDConf.2.1
DL initial BWP configuration	Config 1, 2, 3	DLBWP.0.1
DL dedicated BWP configuration	Config 1, 2, 3	DLBWP.1.1
UL initial BWP configuration	Config 1, 2, 3	ULBWP.0.1
UL dedicated BWP configuration	Config 1, 2, 3	ULBWP.1.1

RMSI CORESET Reference Channel	Config 1		CR.1.1 FDD
	Config 2		CR.1.1 TDD
	Config 3		CR.2.1 TDD
Dedicated CORESET Reference Channel	Config 1		CCR.1.1 FDD
	Config 2		CCR.1.1 TDD
	Config 3		CCR.2.1 TDD
SSB Configuration	Config 1		SSB.1 FR1
	Config 2		SSB.1 FR1
	Config 3		SSB.2 FR1
SMTTC Configuration	Config 1, 2		SMTTC.1
	Config 3		SMTTC.1
PDSCH/PDCCH subcarrier spacing	Config 1, 2		15 kHz
	Config 3		30 kHz
TRS configuration	Config 1		TRS.1.1 FDD
	Config 2		TRS.1.1 TDD
	Config 3		TRS.1.2 TDD
CSI-RS for RLM	Config 1		Resource #4 in TRS.1.1 FDD
	Config 2		Resource #4 in TRS.1.1 TDD
	Config 3		Resource #4 in TRS.1.2 TDD
TCI configuration for PDCCH/PDSCH			TCI.State.0
OCNG parameters			OP.1
CP length			Normal
Correlation Matrix and Antenna Configuration			2x2 Low
Out of sync transmission parameters	DCI format		1-0
	Number of Control OFDM symbols		2
	Aggregation level	CCE	8
	Ratio of hypothetical PDCCH RE energy to average CSI-RS RE energy	dB	4
	Ratio of hypothetical PDCCH DMRS energy to average CSI-RS RE energy	dB	4
	DMRS precoder granularity		REG bundle size
	REG bundle size		6
In sync transmission parameters	DCI format		1-0
	Number of Control OFDM symbols		2
	Aggregation level	CCE	4
	Ratio of hypothetical PDCCH RE energy to average CSI-RS RE energy	dB	0
	Ratio of hypothetical PDCCH DMRS energy to average CSI-RS RE energy	dB	0
	DMRS precoder granularity		REG bundle size
	REG bundle size		6
DRX			DRX.3
Gap pattern ID			gp0
Layer 3 filtering			Enabled
T310 timer	ms		4000
T311 timer	ms		1000
N310			1
N311			1

CSI-RS configuration for CSI reporting	Config 1		CSI-RS.1.1 FDD
	Config 2		CSI-RS.1.1 TDD
	Config 3		CSI-RS.2.1 TDD
T1		s	0.2
T2		s	0.2
T3		s	1.24
T4		s	0.2
T5		s	4
T6		s	3.88
Note 1: UE-specific PDCCH is not transmitted after T1 starts.			

Table A.6.5.1.8.1-3: Cell specific test parameters for FR1 for CSI-RS in-sync radio link monitoring in non-DRX mode

Parameter		Unit	Test 1				
			T1	T2	T3	T4	T5
EPRE ratio of PDCCH DMRS to SSS		dB	0				
EPRE ratio of PDCCH to PDCCH DMRS		dB	0				
EPRE ratio of PBCH DMRS to SSS		dB					
EPRE ratio of PBCH to PBCH DMRS		dB					
EPRE ratio of PSS to SSS		dB					
EPRE ratio of PDSCH DMRS to SSS		dB					
EPRE ratio of PDSCH to PDSCH DMRS		dB					
EPRE ratio of OCNG DMRS to SSS		dB					
EPRE ratio of OCNG to OCNG DMRS		dB					
SNR on RLM-RS	Config 1	dB	1	-7	-15	-4.5	1
	Config 2		1	-7	-15	-4.5	1
	Config 3		1	-7	-15	-4.5	1
N_{oc}	Config 1	dBm/15kHz	-98				
	Config 2		-98				
	Config 3		-98				
Propagation condition			TDL-C 300ns 100Hz				
Note 1: OCNG shall be used such that the resources in Cell 1 are fully allocated and a constant total transmitted power spectral density is achieved for all OFDM symbols.							
Note 2: The uplink resources for CSI reporting are assigned to the UE prior to the start of time period T1.							
Note 3: NZP CSI-RS resource set configuration for CSI reporting are assigned to the UE prior to the start of time period T1.							
Note 4: Measurement gap configuration is assigned to the UE prior to the start of time period T1.							
Note 5: The timers and layer 3 filtering related parameters are configured prior to the start of time period T1.							
Note 6: The signal contains PDCCH for UEs other than the device under test as part of OCNG.							
Note 7: SNR levels correspond to the signal to noise ratio over the SSS REs.							
Note 8: The SNR in time periods T1, T2, T3, T4 and T5 is denoted as SNR1, SNR2, SNR3, SNR4 and SNR5 respectively in figure A.6.5.1.8.1-1.							
Note 9: The SNR values are specified for testing a UE which supports 2RX on at least one band. For testing of a UE which supports 4RX on all bands, the SNR during T3 is specified in section A.3.6.1.1[A.3.6].							

Table A.6.5.1.8.1-3A: Measurement gap configuration for FR1 CSI-RS in-sync radio link monitoring in non-DRX mode

Field	Test 1
-------	--------

	Value
gapOffset	0
Note 1:	Void

Table A.6.5.1.8.1-4: Void

Table A.6.5.1.8.1-5: Void

Table A.6.5.1.8.1-6: Void

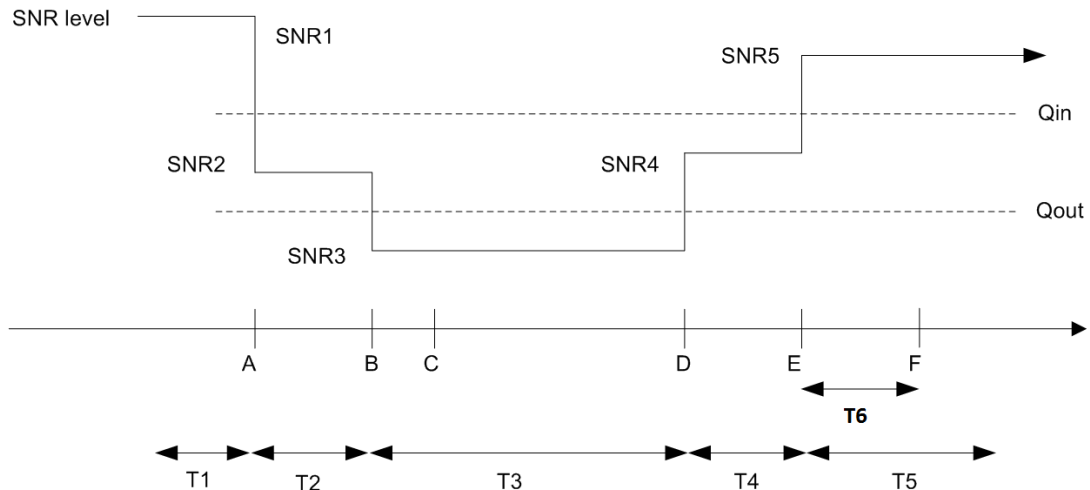

Figure A.6.5.1.8.1-1: SNR variation for CSI-RS in-sync testing

A.6.5.1.8.2 Test Requirements

The UE behaviour in each test during time durations T1, T2, T3, T4 and T5 shall be as follows:

During the period from time point A to time point F (T6 second after the start of time duration T5) the UE shall transmit uplink signal at least in all uplink slots configured for CSI transmission according to the configured periodic CSI reporting on the PCell.

The rate of correct events observed during repeated tests shall be at least 90%.

A.6.5.2 Interruption

A.6.5.2.1 Interruptions during measurements on deactivated NR SCC in FR1

A.6.5.2.1.1 Test Purpose and Environment

The purpose of this test is to verify that the UE missed ACK/NACK rate does not exceed the limits at NR PSCell interruptions during the measurement on the deactivated NR SCC. This test will verify the missed ACK/NACK rate for PCell in standalone NR specified in clause 8.2.2.2. Supported test configurations for NR PCell are shown in table A.6.5.2.1.1-1. Supported test configurations for NR SCell are shown in table A.6.5.2.1.1-1A. Test configuration for NR PCell and test configuration for NR SCell are chosen independently.

The general test parameters and NR cell specific test parameters are given in Table A.6.5.2.1.1-2, A.6.5.2.1.1-3 and A.6.5.2.1.1-4 below. In the test there are two cells: Cell1 and Cell2. Cell1 is PCell, Cell2 is an NR deactivated SCell. Cell1 shall be configured as PCell and Cell2 shall be configured as SCell.

The test consists of one time period, with duration of T1. Prior to the start of the time duration T1, the UE is connected to Cell1 and Cell2 and the RRC message including *measCycleSCell* or *allowInterruptions* for the deactivated NR SCells is received at the UE antenna connector. During T1, PCell is continuously scheduled in DL.

Table A.6.5.2.1.1-1: Interruptions during measurements on deactivated NR SCC supported test configurations for NR PCell

Config	Description
1	NR 15 kHz SSB SCS, ≥ 10 MHz bandwidth, FDD duplex mode
2	NR 15 kHz SSB SCS, ≥ 10 MHz bandwidth, TDD duplex mode
3	NR 30 kHz SSB SCS, ≥ 40 MHz bandwidth, TDD duplex mode
Note 1:	The UE is only required to be tested in one of the supported test configurations
Note 2:	The UE is only required to be tested in one with smallest aggregated channel bandwidth from supported band combinations which is composed of CCs \geq the bandwidth ($BW_{channel}$) defined in each test configuration,

Table A.6.5.2.1.1-1A: Interruptions during measurements on deactivated NR SCC supported test configurations for NR SCell

Config _{SCell}	Description
1	NR 15 kHz SSB SCS, ≥ 10 MHz bandwidth, FDD duplex mode
2	NR 15 kHz SSB SCS, ≥ 10 MHz bandwidth, TDD duplex mode
3	NR 30 kHz SSB SCS, ≥ 40 MHz bandwidth, TDD duplex mode
Note 1:	The UE is only required to be tested in one of the supported test configurations
Note 2:	The UE is only required to be tested in one with smallest aggregated channel bandwidth from supported band combinations which is composed of CCs \geq the bandwidth ($BW_{channel}$) defined in each test configuration,

Table A.6.5.2.1.1-2: General test parameters for interruptions during measurements on deactivated NR SCC in standalone NR

Parameter	Unit	Value	Comment
RF Channel Number		1, 2	Two NR RF channels
Active PCell		Cell1	PCell on NR RF channel number 1.
Configured deactivated SCell		Cell2	Deactivated SCell on NR RF channel number 2.
CP length		Normal	Applicable to Cell1 and Cell2
DRX		OFF	
Measurement gap pattern Id		OFF	
SCell measurement cycle (<i>measCycleSCell</i>)	ms	640	
T1	s	10	

Table A.6.5.2.1.1-3: NR cell specific test parameters for NR PCell for interruptions during measurements on deactivated NR SCC in standalone NR

Parameter	Unit	Cell1
Frequency Range		FR1
Duplex mode	Config 1	FDD
	Config 2,3	TDD
TDD configuration	Config 1	Not Applicable
	Config 2	TDDConf.1.1

BW _{channel}	Config 3		TDDConf.2.1
	Config 1,2		Note 9
	Config 3		Note 9
BW _{occupied}	Config 1,2	RB	52 ^{Note 7}
	Config 3		106 ^{Note 8}
Initial DL BWP Configuration	Config 1,2,3		DLBWP.0.1
Dedicated DL BWP Configuration	Config 1,2,3		DLBWP.1.1
Initial UL BWP Configuration	Config 1,2,3		ULBWP.0.1
Dedicated UL BWP Configuration	Config 1,2,3		ULBWP.1.1
PDSCH Reference measurement channel	Config 1		SR.1.1 FDD
	Config 2		SR.1.2 TDD
	Config 3		SR.2.1 TDD
CSI-RS for tracking	Config 1		TRS.1.1 FDD
	Config 2		TRS.1.1 TDD
	Config 3		TRS.1.2 TDD
RMSI CORESET parameters	Config 1		CR.1.1 FDD
	Config 2		CR.1.1 TDD
	Config 3		CR.2.1 TDD
Dedicated CORESET parameters	Config 1		CCR.1.1 FDD
	Config 2		CCR.1.1 TDD
	Config 3		CCR.2.1 TDD
OCNG Patterns	Config 1,2		OP.1 ^{Note 7}
	Config 3		OP.1 ^{Note 8}
SMTTC Configuration			SMTTC.1
SSB Configuration	Config 1,2		SSB.1 FR1
	Config 3		SSB.2 FR1
Correlation Matrix and Antenna Configuration			1x2 Low
EPRE ratio of PSS to SSS		dB	0
EPRE ratio of PBCH DMRS to SSS			
EPRE ratio of PBCH to PBCH DMRS			
EPRE ratio of PDCCH DMRS to SSS			
EPRE ratio of PDCCH to PDCCH DMRS			
EPRE ratio of PDSCH DMRS to SSS			
EPRE ratio of PDSCH to PDSCH			
EPRE ratio of OCNG DMRS to SSS ^{Note 1}			
EPRE ratio of OCNG to OCNG DMRS ^{Note 1}			
N _{oc} ^{Note 2}			
SS-RSRP ^{Note 3}		dBm/15 kHz	-87
\bar{E}_s/I_{ot}		dB	17
\bar{E}_s/N_{oc}		dB	17
N _{oc} ^{Note 2}	Config 1,2	dBm/SCS	-104
	Config 3		-101
I _Q ^{Note 3}	Config 1,2	dBm/9.36MHz	-58.96
	Config 3	dBm/38.16MHz	-52.86
Time offset to Cell1 ^{Note 5}		μs	-
Propagation Condition			AWGN

Note 1:	OCNG shall be used such that both cells are fully allocated and a constant total transmitted power spectral density is achieved for all OFDM symbols.
Note 2:	Interference from other cells and noise sources not specified in the test is assumed to be constant over subcarriers and time and shall be modeled as AWGN of appropriate power for N_{oc} to be fulfilled within $BW_{occupied}$.
Note 3:	SS-RSRP and I_o levels have been derived from other parameters for information purposes. They are not settable parameters themselves.
Note 4:	Void
Note 5:	Receive time difference between slot boundaries of signals received from the two cells at the UE antenna connector including time alignment error between the two cells.
Note 6:	For unpaired spectrum, a DL BWP is linked with an UL BWP. DLBWP.0.2 is linked with ULBWP.0.2 defined in clause 12 of TS 38.213 [3].
Note 7:	All UL/DL transmission shall be confined within $BW_{occupied}$ (i.e. 10 MHz, 52 RBs) from $F_{C,low}$, and I_o is independent of the $BW_{channel}$ configured.
Note 8:	All UL/DL transmission shall be confined within $BW_{occupied}$ (i.e. 40 MHz, 106 RBs) from $F_{C,low}$, and I_o is independent of the $BW_{channel}$ configured.
Note 9:	$N_{RB,c}$ is derived from Table 5.3.2-1 in TS38.101-1[2] with configured $BW_{channel}$.

Table A.6.5.2.1.1-4: NR cell specific test parameters for NR SCell for interruptions during measurements on deactivated NR SCC in standalone NR

Parameter		Unit	Cell2
Frequency Range			FR1
Duplex mode	Config _{SCell} 1		FDD
	Config _{SCell} 2,3		TDD
TDD configuration	Config _{SCell} 1		Not Applicable
	Config _{SCell} 2		TDDConf.1.1
	Config _{SCell} 3		TDDConf.2.1
$BW_{channel}$	Config _{SCell} 1,2		Note 9
	Config _{SCell} 3		Note 9
$BW_{occupied}$	Config _{SCell} 1,2	RB	52 ^{Note 7}
	Config _{SCell} 3		106 ^{Note 8}
Initial DL BWP Configuration	Config _{SCell} 1,2,3		DLBWP.0.1
Dedicated DL BWP Configuration	Config _{SCell} 1,2,3		DLBWP.1.1
Initial UL BWP Configuration	Config _{SCell} 1,2,3		N/A
Dedicated UL BWP Configuration	Config 1,2,3		N/A
PDSCH Reference measurement channel	Config _{SCell} 1		SR.1.1 FDD
	Config _{SCell} 2		SR.1.2 TDD
	Config _{SCell} 3		SR.2.1 TDD
CSI-RS for tracking	Config _{SCell} 1		TRS.1.1 FDD
	Config _{SCell} 2		TRS.1.1 TDD
	Config _{SCell} 3		TRS.1.2 TDD
RMSI CORESET parameters	Config _{SCell} 1		CR.1.1 FDD
	Config _{SCell} 2		CR.1.1 TDD
	Config _{SCell} 3		CR.2.1 TDD
Dedicated CORESET parameters	Config _{SCell} 1		CCR.1.1 FDD
	Config _{SCell} 2		CCR.1.1 TDD
	Config _{SCell} 3		CCR.2.1 TDD
OCNG Patterns	Config _{SCell} 1,2		OP.1 ^{Note 7}
	Config _{SCell} 3		OP.1 ^{Note 8}
SMTC Configuration			SMTC.4
SSB Configuration	Config _{SCell} 1,2		SSB.5 FR1
	Config _{SCell} 3		SSB.6 FR1
Correlation Matrix and Antenna Configuration			1x2 Low
EPRE ratio of PSS to SSS		dB	0

EPRE ratio of PBCH DMRS to SSS			
EPRE ratio of PBCH to PBCH DMRS			
EPRE ratio of PDCCH DMRS to SSS			
EPRE ratio of PDCCH to PDCCH DMRS			
EPRE ratio of PDSCH DMRS to SSS			
EPRE ratio of PDSCH to PDSCH			
EPRE ratio of OCNG DMRS to SSS ^{Note 1}			
EPRE ratio of OCNG to OCNG DMRS ^{Note 1}			
N_{oc} ^{Note 2}	dBm/15 kHz	-104	
SS-RSRP ^{Note 3}	dBm/15 kHz	-87	
\bar{E}_s/I_{ot}	dB	17	
\bar{E}_s/N_{oc}	dB	17	
N_{oc} ^{Note 2}	Config _{SCell} 1,2	dBm/SCS	-104
	Config _{SCell} 3		-101
I_o ^{Note 3}	Config _{SCell} 1,2	dBm/9.36MHz	-58.96
	Config _{SCell} 3	dBm/38.16MHz	-52.86
Time offset to Cell1 ^{Note 5}	μ s	3	
Propagation Condition		AWGN	
Note 1: OCNG shall be used such that both cells are fully allocated and a constant total transmitted power spectral density is achieved for all OFDM symbols.			
Note 2: Interference from other cells and noise sources not specified in the test is assumed to be constant over subcarriers and time and shall be modeled as AWGN of appropriate power for N_{oc} to be fulfilled within $BW_{occupied}$.			
Note 3: SS-RSRP and I_o levels have been derived from other parameters for information purposes. They are not settable parameters themselves.			
Note 4: Void			
Note 5: Receive time difference between slot boundaries of signals received from the two cells at the UE antenna connector including time alignment error between the two cells.			
Note 6: For unpaired spectrum, a DL BWP is linked with an UL BWP. DLBWP.0.2 is linked with ULBWP.0.2 defined in clause 12 of TS 38.213 [3].			
Note 7: All UL/DL transmission shall be confined within $BW_{occupied}$ (i.e. 10 MHz, 52 RBs) from $F_{C,low}$, and I_o is independent of the $BW_{channel}$ configured.			
Note 8: All UL/DL transmission shall be confined within $BW_{occupied}$ (i.e. 40 MHz, 106 RBs) from $F_{C,low}$, and I_o is independent of the $BW_{channel}$ configured.			
Note 9: $N_{RB,c}$ is derived from Table 5.3.2-1 in TS38.101-1[2] with configured $BW_{channel}$.			

A.6.5.2.1.2 Test Requirements

If the NR PCell is not in the same band as the deactivated SCell, the UE is only allowed to cause interruptions on NR PCell immediately before and immediately after an SMTC. Each interruption on NR PCell shall not exceed the value defined in Table A.6.5.2.1.2-1.

If the NR PCell is in the same band as the deactivated SCell, the UE is only allowed to cause an interruption on PCell no earlier than 1 slot before an SMTC and no later than 1 slot after the SMTC. the interruption on NR PCell shall not exceed the value defined in Table A.6.5.2.1.2-2.

Table A.6.5.2.1.2-1: Interruption duration if the PCell is not in the same band as the deactivated SCell

μ	NR Slot length (ms)	Interruption length
0	1	1
1	0.5	1

Table A.6.5.2.1.2-2: Interruption duration if the PCell is in the same band as the deactivated SCell

μ	NR Slot length (ms)	Interruption length
0	1	2 + SMTC duration
1	0.5	2 + SMTC duration

The rate of correct events observed during repeated tests shall be at least 90%.

A.6.5.3 SCell Activation and Deactivation Delay

A.6.5.3.1 SCell Activation and deactivation of known SCell in FR1 in non-DRX for 160ms SCell measurement cycle

A.6.5.3.1.1 Test Purpose and Environment

The purpose of this test is to verify that the SCell activation and deactivation times are within the requirements stated in clause 8.3, when the SCell in FR1 is known by the UE at the time of activation.

The supported test configurations for NR PCell are shown in table A.6.5.3.1.1-1 below. Supported test configurations for NR SCell are shown in table A.6.5.3.1.1-1A. Test configuration for NR PCell and test configuration for NR SCell are chosen independently. The test parameters are given in Tables A.6.5.3.1.1-2 and cell-specific parameters in A.6.5.3.1.1-3 and A.6.5.3.1.1-4 below. The test consists of three successive time periods, with duration of T1, T2 and T3, respectively. There are two NR carriers, each with one cell. Both cells have constant signal levels throughout the test. Before the test starts the UE is connected to Cell 1, but is not aware of Cell2. The UE is only monitoring the PCC. The UE shall be continuously scheduled in the PCell throughout the whole test.

At the beginning of T1 the UE receives an RRC message by which the SCell (Cell 2) becomes configured on radio channel 2. The UE now starts monitoring the SCC. The test equipment sends a MAC message for activation of the SCell.

The point in time at which the MAC message is received at the UE antenna connector, in slot # denoted n , defines the start of time period T2. The UE shall be able to report valid CSI in PCell for the activated SCell at latest in slot $n + \frac{T_{\text{HARQ}} + T_{\text{activation_time}} + T_{\text{CSI_Reporting}}}{\text{NR slot length}}$, as defined in clause 8.3. The UE shall start reporting CSI in PCell after at least one CSI-RS transmission occasion for channel measurement plus $n_{\text{CSI_ref}}$ slots, as defined in 5.2.2.5 in [26], and reporting after slot $n + \frac{T_{\text{HARQ}} + 3\text{ms}}{\text{NR slot length}}$ and shall report CQI index 0 (out-of-range) until the SCell activation has been completed. Any PCell interruption due to activation of SCell shall occur in the slot $n + 1 + \frac{T_{\text{HARQ}}}{\text{NR slot length}}$ to $n + 1 + \frac{T_{\text{HARQ}} + 3\text{ms} + T_x}{\text{NR slot length}} + N_{\text{interruption}}$, as defined in clause 8.3, where $N_{\text{interruption}}$ is the interruption length given in section 8.2.

Time period T3 starts when a MAC message for deactivation of SCell, sent from the test equipment to the UE in a slot # denoted m , is received at the UE antenna connector. The UE shall carry out deactivation of the SCell in a slot $m + \frac{T_{\text{HARQ}} + 3\text{ms}}{\text{NR slot length}}$, as defined in clause 8.3, and The starting point of any PCell interruption due to the deactivation shall occur in the slot $m + 1 + \frac{T_{\text{HARQ}}}{\text{NR slot length}}$ to $m + 1 + \frac{T_{\text{HARQ}} + 3\text{ms}}{\text{NR slot length}}$, as defined in clause 8.3.

The test equipment verifies that potential interruption is carried out in the correct time span by monitoring ACK/NACK sent in PCell during activation and deactivation of SCell, respectively.

The test equipment verifies the activation time by counting the slots from the time when the SCell activation command is sent until a CSI report with other than CQI index 0 is received.

The test equipment verifies the deactivation time by counting the slots from the time when the SCell deactivation command is sent until CQI reporting for SCell is discontinued.

Table A.6.5.3.1.1-1: known FR1 SCell activation in non-DRX for 160ms SCell measurement cycle supported test configurations for NR PCell

Config	Description
1	NR 15 kHz SSB SCS, ≥ 10 MHz bandwidth, FDD duplex mode
2	NR 15 kHz SSB SCS, ≥ 10 MHz bandwidth, TDD duplex mode
3	NR 30kHz SSB SCS, ≥ 40 MHz bandwidth, TDD duplex mode
Note 1: The UE is only required to be tested in one of the supported test configurations	
Note 2: The UE is only required to be tested in one with smallest aggregated channel bandwidth from supported band combinations which is composed of CCs \geq the bandwidth (BW_{channel}) defined in each test configuration,	

Table A.6.5.3.1.1-1A: known FR1 SCell activation in non-DRX for 160ms SCell measurement cycle supported test configurations for NR SCell

Configs _{SCell}	Description
1	NR 15 kHz SSB SCS, ≥ 10 MHz bandwidth, FDD duplex mode
2	NR 15 kHz SSB SCS, ≥ 10 MHz bandwidth, TDD duplex mode
3	NR 30kHz SSB SCS, ≥ 40 MHz bandwidth, TDD duplex mode
Note 1: The UE is only required to be tested in one of the supported test configurations	
Note 2: The UE is only required to be tested in one with smallest aggregated channel bandwidth from supported band combinations which is composed of CCs \geq the bandwidth (BW_{channel}) defined in each test configuration,	

Table A.6.5.3.1.1-2: General test parameters for known FR1 SCell activation case, 160ms SCell measurement cycle

Parameter	Unit	Value	Comment
RF Channel Number		1,2	Two NR radio channel (1, 2) are used for this test
Active PCell		Cell 1	Primary cell on NR RF channel number 1.
Configured deactivated SCell		Cell 2	Configured deactivated secondary cell on NR RF channel number 2
CP length		Normal	
DRX		OFF	Continuous monitoring of primary cell
Cell-individual offset for cells on NR channel number	dB	0	Individual offset for cells on primary component carrier.
SCell measurement cycle (measCycleSCell)	ms	160	
Cell2 timing offset to cell1	μs	0	
Time alignment error between cell2 and cell1	μs	\leq Time alignment error as specified in TS 38.104 [13] clause 6.5.3.1.	The value of time alignment error depends upon the type of carrier aggregation.
T1	s	7	During this time the PCell shall be known and the SCell configured and detected.
T2	s	1	During this time the UE shall activate the SCell.
T3	s	1	During this time the UE shall deactivate the SCell.

T_{HARQ}	ms	Config 1: 2 Config 2: 3 Config 3: 2.5	$k_1 \times \text{NR slot length}$ k_1 is a number of slots and is indicated by the PDSCH-to-HARQ-timing-indicator field in the DCI format, if present, or provided by <i>dl-DataToUL-ACK</i> , the value of k should be the minimum value defined in TS 38.213 [3] that will meet the timing constraints of this test case.
$T_{CSI_Reporting}$	ms	15	The delay (in ms) including uncertainty in acquiring the first available downlink CSI reference resource, UE processing time for CSI reporting (clause 5.2.2.5 in TS 38.214) and uncertainty in acquiring the first available CSI reporting resources as specified in TS 38.331 [2]

Table A.6.5.3.1.1-3: Cell specific test parameters for NR PCell for known FR1 SCell activation case, 160ms SCell measurement cycle

Parameter		Unit	Cell 1		
			T1	T2	T3
Duplex mode	Config 1		FDD		
	Config 2,3		TDD		
TDD configuration	Config 1		Not applicable		
	Config 2		TDDConf.1.1		
	Config 3		TDDConf.2.1		
$BW_{channel}$	Config 1,2	MHz	Note 7		
	Config 3		Note 7		
$BW_{occupied}$	Config 1,2	RB	52 ^{Note 5}		
	Config 3		106 ^{Note 6}		
Initial BWP configuration			DLBWP.0.1		
TCI state			TCI.State.0		
TRS Configuration	Config 1		TRS.1.1 FDD		
	Config 2		TRS.1.1 TDD		
	Config 3		TRS.1.2 TDD		
PDSCH Reference measurement channel	Config 1		SR.1.1 FDD		
	Config 2		SR.1.1 TDD		
	Config 3		SR.2.1 TDD		
Dedicated CORESET parameters	Config 1		CCR.1.1 FDD		
	Config 2		CCR.1.1 TDD		
	Config 3		CCR.2.1 TDD		
RMSI CORESET parameters	Config 1		CR.1.1 FDD		
	Config 2		CR.1.1 TDD		
	Config 3		CR.2.1 TDD		
OCNG Patterns	Config 1,2		OP.1 ^{Note 5}		
	Config 3,		OP.1 ^{Note 6}		
SSB Configuration	Config 1,2		SSB.1 FR1		
	Config 3		SSB.2 FR1		
CSI-RS configuration for CSI reporting (Note 8)	Config 1		CSI-RS.1.1 FDD		
	Config 2		CSI-RS.1.1 TDD		
	Config 3		CSI-RS.2.1 TDD		
SMTC configuration			SMTC.1		
reportConfigType			periodic		
reportQuantity			cri-RI-PMI-CQI		
CSI reporting periodicity	Config 1,2	slot	5		
	Config 3		10		

CSI reporting offset	Config 1,2	slot	3
	Config 3		5
EPRE ratio of PSS to SSS		dB	0
EPRE ratio of PBCH DMRS to SSS			
EPRE ratio of PBCH to PBCH DMRS			
EPRE ratio of PDCCH DMRS to SSS			
EPRE ratio of PDCCH to PDCCH DMRS			
EPRE ratio of PDSCH DMRS to SSS			
EPRE ratio of PDSCH to PDSCH			
EPRE ratio of OCNG DMRS to SSS ^{Note 1}			
EPRE ratio of OCNG to OCNG DMRS ^{Note 1}			
N_{oc} ^{Note2}	Config 1,2	dBm/SCS	-104
	Config 3		-101
\hat{E}_s/I_{ot}		dB	17
\hat{E}_s/N_{oc}		dB	17
SS-RSRP ^{Note3}	Config 1,2	dBm/SCS	-87
	Config 3		-84
SCH_RP ^{Note 3}		dBm/15 kHz	-87
I_o ^{Note3}	Config 1,2	dBm/ 9.36MHz	-58.96
	Config 3	dBm/ 38.16MHz	-52.87
Propagation condition		-	AWGN
Correlation Matrix and Antenna Configuration		-	2x2 Low
<p>Note 1: OCNG shall be used such that both cells are fully allocated and a constant total transmitted power spectral density is achieved for all OFDM symbols.</p> <p>Note 2: Interference from other cells and noise sources not specified in the test is assumed to be constant over subcarriers and time and shall be modelled as AWGN of appropriate power for N_{oc} to be fulfilled within $BW_{occupied}$.</p> <p>Note 3: SS-RSRP and SCH_RP levels have been derived from other parameters for information purposes. They are not settable parameters themselves.</p> <p>Note 4: The uplink resources for CSI reporting are assigned to the UE prior to the start of time period T2.</p> <p>Note 5: All UL/DL transmission shall be confined within $BW_{occupied}$ (i.e. 10 MHz, 52 RBs) from $F_{C,low}$, and I_o is independent of the $BW_{channel}$ configured.</p> <p>Note 6: All UL/DL transmission shall be confined within $BW_{occupied}$ (i.e. 40 MHz, 106 RBs) from $F_{C,low}$, and I_o is independent of the $BW_{channel}$ configured.</p> <p>Note 7: $N_{RB,c}$ is derived from Table 5.3.2-1 in TS38.101-1[2] with configured $BW_{channel}$.</p> <p>Note 8: On top of the reference configurations, CSI-RS offset should be set to meet the CSI reference resource timing definition in TS 38.214 cl. 5.2.2.5.</p>			

Table A.6.5.3.1.1-4: Cell specific test parameters for NR SCell for known FR1 SCell activation case, 160ms SCell measurement cycle

Parameter		Unit	Cell 2		
			T1	T2	T3
Duplex mode	Config _{SCell 1}		FDD		
	Config _{SCell 2,3}		TDD		
TDD configuration	Config _{SCell 1}		Not applicable		
	Config _{SCell 2}		TDDConf.1.1		
	Config _{SCell 3}		TDDConf.2.1		
$BW_{channel}$	Config _{SCell 1,2}	MHz	Note 7		
	Config _{SCell 3}		Note 7		
$BW_{occupied}$	Config _{SCell 1,2}	RB	52 ^{Note 5}		
	Config _{SCell 3}		106 ^{Note 6}		
Initial BWP configuration			DLBWP.0.1		

TCI state			TCI.State.0
TRS Configuration	Config _{SCell} 1		TRS.1.1 FDD
	Config _{SCell} 2		TRS.1.1 TDD
	Config _{SCell} 3		TRS.1.2 TDD
PDSCH Reference measurement channel	Config _{SCell} 1		N/A
	Config _{SCell} 2		N/A
	Config _{SCell} 3		N/A
Dedicated CORESET parameters	Config _{SCell} 1		N/A
	Config _{SCell} 2		N/A
	Config _{SCell} 3		N/A
RMSI CORESET parameters	Config _{SCell} 1		N/A
	Config _{SCell} 2		N/A
	Config _{SCell} 3		N/A
OCNG Patterns	Config _{SCell} 1,2		OP.1 ^{Note 5}
	Config _{SCell} 3,		OP.1 ^{Note 6}
SSB Configuration	Config _{SCell} 1,2		SSB.1 FR1
	Config _{SCell} 3		SSB.2 FR1
CSI-RS configuration for CSI reporting ^{Note 8}	Config _{SCell} 1		CSI-RS.1.1 FDD
	Config _{SCell} 2		CSI-RS.1.1 TDD
	Config _{SCell} 3		CSI-RS.2.1 TDD
SMTC configuration			SMTC.1
reportConfigType			N/A
reportQuantity			N/A
CSI reporting periodicity	Config _{SCell} 1,2	slot	N/A
	Config _{SCell} 3		N/A
CSI reporting offset	Config _{SCell} 1,2	slot	N/A
	Config _{SCell} 3		N/A
EPRE ratio of PSS to SSS		dB	0
EPRE ratio of PBCH DMRS to SSS			
EPRE ratio of PBCH to PBCH DMRS			
EPRE ratio of PDCCH DMRS to SSS			
EPRE ratio of PDCCH to PDCCH DMRS			
EPRE ratio of PDSCH DMRS to SSS			
EPRE ratio of PDSCH to PDSCH			
EPRE ratio of OCNG DMRS to SSS ^{Note 1}			
EPRE ratio of OCNG to OCNG DMRS ^{Note 1}			
N_{oc} ^{Note2}	Config _{SCell} 1,2	dBm/SCS	-104
	Config _{SCell} 3		-101
\hat{E}_s/I_{ot}		dB	17
\hat{E}_s/N_{oc}		dB	17
SS-RSRP ^{Note3}	Config _{SCell} 1,2	dBm/SCS	-87
	Config _{SCell} 3		-84
SCH_RP ^{Note 3}		dBm/15 kHz	-87
I_o ^{Note3}	Config _{SCell} 1,2	dBm/ 9.36MHz	-58.96
	Config _{SCell} 3	dBm/ 38.16MHz	-52.87
Propagation condition		-	AWGN
Correlation Matrix and Antenna Configuration			2x2 Low
<p>Note 1: OCNG shall be used such that both cells are fully allocated and a constant total transmitted power spectral density is achieved for all OFDM symbols.</p> <p>Note 2: Interference from other cells and noise sources not specified in the test is assumed to be constant over subcarriers and time and shall be modelled as AWGN of appropriate power for N_{oc} to be fulfilled within $BW_{occupied}$.</p>			

Note 3:	SS-RSRP and SCH_RP levels have been derived from other parameters for information purposes. They are not settable parameters themselves.
Note 4:	The uplink resources for CSI reporting are assigned to the UE prior to the start of time period T2.
Note 5:	All UL/DL transmission shall be confined within $BW_{occupied}$ (i.e. 10 MHz, 52 RBs) from $F_{C,low}$, and l_0 is independent of the $BW_{channel}$ configured.
Note 6:	All UL/DL transmission shall be confined within $BW_{occupied}$ (i.e. 40 MHz, 106 RBs) from $F_{C,low}$, and l_0 is independent of the $BW_{channel}$ configured.
Note 7:	$N_{RB,c}$ is derived from Table 5.3.2-1 in TS38.101-1[2] with configured $BW_{channel}$.
Note 8:	On top of the reference configurations, CSI-RS offset should be set to meet the CSI reference resource timing definition in TS 38.214 cl. 5.2.2.5.

A.6.5.3.1.2 Test Requirements

During T2 the UE shall send the first CSI report for SCell in the first available uplink resource after at least one CSI-RS transmission occasion for channel measurement plus n_{CSI_ref} slots, as defined in 5.2.2.5 in [26], and reporting after slot $(n + 1 + \frac{T_{HARQ} + 3ms}{NR\ slot\ length})$. UE is allowed to postpone CSI report to next available UL resource if an available uplink resource is subject to interruption. During T2 the UE shall start sending CSI reports for SCell with non-zero CQI index at latest in a slot $n + \frac{T_{HARQ} + T_{activation_time} + T_{CSI_Reporting}}{NR\ slot\ length}$, $T_{activation_time} = T_{FirstSSB} + 5ms$, as defined in clause 8.3.

During T3 the UE shall stop sending CSI reports for SCell at latest in a slot $m + \frac{T_{HARQ} + 3ms}{NR\ slot\ length}$, as defined in clause 8.3.

During T2 interruption of PCell during SCell activation shall not happen outside the slot $n + 1 + \frac{T_{HARQ}}{NR\ slot\ length}$ to $n + 1 + \frac{T_{HARQ} + 3ms + T_X}{NR\ slot\ length} + N_{interruption}$, as defined in clause 8.3.

During T3 the starting point of interruption of PCell during SCell deactivation shall not happen outside the slot $m + 1 + \frac{T_{HARQ}}{NR\ slot\ length}$ to $m + 1 + \frac{T_{HARQ} + 3ms}{NR\ slot\ length}$, as defined in clause 8.3.

The interruption on any activated serving cell shall not be more than the values specified for SA in clause 8.2.2.2.2.

All of the above test requirements shall be fulfilled in order for the observed SCell activation delay and SCell deactivation delay to be counted as correct. The rate of correct observed SCell activation delay and SCell deactivation delay during repeated tests shall be at least 90%.

NOTE: During T2 if there are no uplink resources for reporting the valid CSI in a slot $\frac{T_{HARQ} + T_{activation_time} + T_{CSI_Reporting}}{NR\ slot\ length}$ as defined in clause 8.3 then the UE shall use the next available uplink resource for reporting the corresponding valid CSI.

A.6.5.3.2 SCell Activation and deactivation of known SCell in FR1 in non-DRX for 640 ms SCell measurement cycle

A.6.5.3.2.1 Test Purpose and Environment

The purpose of this test case is the same as for the test defined in clause A.6.5.3.1.1. The supported test configurations are the same as defined in clause A.6.5.3.1.1. The test parameters are the same except those described in the following clause. The listed parameter values in Tables A.6.5.3.2.1-1 will replace the values of corresponding parameters in Tables A.4.5.3.1.1-1.

Table A.6.5.3.2.1-1: General test parameters for known FR1 SCell activation case, 640 ms SCell measurement cycle

Parameter	Unit	Value	Comment
SCell measurement cycle (measCycleSCell)	ms	640	

A.6.5.3.2.2 Test Requirements

The test requirements defined in clause A.6.5.3.1.2 shall apply to this test case, except $T_{\text{activation_time}}$ will be replaced with the value $T_{\text{FirstSSB_MAX}} + T_{\text{rs}} + 5\text{ms}$.

A.6.5.3.3 SCell Activation and deactivation of unknown SCell in FR1 in non-DRX

A.6.5.3.3.1 Test Purpose and Environment

The purpose of this test is to verify that the SCell activation and deactivation times are within the requirements stated in clause 8.3, when the SCell in FR1 is unknown by the UE at the time of activation.

The supported test configurations are the same as defined in clause A.6.5.3.1.1. The test parameters are the same except those described in the following clause. The listed parameter values in Tables A.6.5.3.3.1-1 will replace the values of corresponding parameters in Tables A.6.5.3.1.1-1. The test consists of three successive time periods, with duration of T1, T2 and T3, respectively. There are two NR carriers, each with one cell. Both cells have constant signal levels throughout the test. Before the test starts the UE is connected to Cell 1, but is not aware of Cell2. The UE is only monitoring the PCC. The UE shall be continuously scheduled in the PCell throughout the whole test.

At the beginning of T1 the UE receives an RRC message by which the SCell (Cell 2) becomes configured on radio channel 2. The UE now starts monitoring the SCC. The test equipment sends a MAC message for activation of the SCell.

The point in time at which the MAC message is received at the UE antenna connector, in slot # denoted n , defines the start of time period T2. The UE shall be able to report valid CSI in PCell for the activated SCell at latest in slot $\frac{T_{\text{HARQ}} + T_{\text{activation_time}} + T_{\text{CSI_Reporting}}}{\text{NR slot length}}$, as defined in clause 8.3. The UE shall start reporting CSI in PCell after at least one CSI-RS transmission occasion for channel measurement plus $n_{\text{CSI_ref}}$ slots, as defined in 5.2.2.5 in [26], and reporting after slot $n + 1 + \frac{T_{\text{HARQ}} + 3\text{ms}}{\text{NR slot length}}$ and shall report CQI index 0 (out-of-range) until the SCell activation has been completed. Any PCell interruption due to activation of SCell shall occur in the slot $n + 1 + \frac{T_{\text{HARQ}}}{\text{NR slot length}}$ to $m + 1 + \frac{T_{\text{HARQ}} + 3\text{ms} + T_{\text{x}}}{\text{NR slot length}} + N_{\text{interruption}}$, as defined in clause 8.3, where $N_{\text{interruption}}$ is the interruption length given in section 8.2.

Time period T3 starts when a MAC message for deactivation of SCell, sent from the test equipment to the UE in a slot # denoted m , is received at the UE antenna connector. The UE shall carry out deactivation of the SCell in a slot $n + \frac{T_{\text{HARQ}} + 3\text{ms}}{\text{NR slot length}}$, as defined in clause 8.3, and the starting point of any PCell interruption due to the deactivation shall occur in the slot $n + 1 + \frac{T_{\text{HARQ}}}{\text{NR slot length}}$ to $n + 1 + \frac{T_{\text{HARQ}} + 3\text{ms}}{\text{NR slot length}}$, as defined in clause 8.3.

The test equipment verifies that potential interruption is carried out in the correct time span by monitoring ACK/NACK sent in PCell during activation and deactivation of SCell, respectively.

The test equipment verifies the activation time by counting the slots from the time when the SCell activation command is sent until a CSI report with other than CQI index 0 is received.

The test equipment verifies the deactivation time by counting the slots from the time when the SCell deactivation command is sent until CQI reporting for SCell is discontinued.

Table A.6.5.3.1-1: General test parameters for unknown FR1 SCell activation case, 160ms SCell measurement cycle

Parameter	Unit	Value	Comment
T1	ms	100	During this time the PCell shall be known and the SCell configured, but not detected.

A.6.5.3.3.2 Test Requirements

The test requirements defined in clause A.6.5.3.1.2 shall apply to this test case, except $T_{\text{activation_time}}$ will be replaced with the value $T_{\text{FirstSSB_MAX}} + T_{\text{SMTC_MAX}} + 2 * T_{\text{RS}} + 5\text{ms}$ as defined in clause 8.3.

A.6.5.4 UE UL carrier RRC reconfiguration Delay

A.6.5.4.1 UE UL carrier RRC reconfiguration Delay

Table A.6.5.4.1-1 - Table A.6.5.4.1-4 : Void

A.6.5.4.1.1 Test Purpose and Environment

The purpose of this test is to verify that when the UE receives a RRC message implying NR UL or Supplementary UL carrier configuration, the UE shall be ready to start transmission on the newly configured carrier within the time limits specified in clause 8.4.2 and 8.4.3 for configuring and deconfiguring, respectively.

There are two cells: FR1 PCell (cell 1) and FR1 SCell (cell 2). Both NR uplink and supplementary uplink are broadcast by *ServingCellConfigCommonSIB*. The test parameters for PCell and SCell are given in Table A.6.5.4.1.1-1, Table A.6.5.4.1.1-2, Table A.6.5.4.1.1-3 and Table A.6.5.4.1.1-4 below. The test consists of three time periods, with duration of T1, T2 and T3 respectively. During time duration T1, NR uplink of cell 2 is configured to UE. At the start of T2, a supplementary uplink of cell 2 is configured to UE through *RRCReconfiguration*, then UE shall start transmission on the supplementary uplink. At the start of T3, the supplementary uplink is released through *RRCReconfiguration*.

Table A.6.5.4.1.1-1: Supported test configurations

Configuration	PCell (Cell 1)	SCell (Cell 2)
1	15 kHz SSB SCS, ≥ 10 MHz bandwidth, FDD duplex mode	DL and UL: 15 kHz SSB SCS, ≥ 10 MHz bandwidth, FDD duplex mode; SUL: 15 kHz SCS, ≥ 10 MHz bandwidth, SUL duplex mode
2	15 kHz SSB SCS, ≥ 10 MHz bandwidth, FDD duplex mode	DL and UL: 15 kHz SSB SCS, ≥ 10 MHz bandwidth, TDD duplex mode; SUL: 15 kHz SCS, ≥ 10 MHz bandwidth, SUL duplex mode
3	15 kHz SSB SCS, ≥ 10 MHz bandwidth, FDD duplex mode	DL and UL: 30kHz SSB SCS, ≥ 40 MHz bandwidth, TDD duplex mode; SUL: 30kHz SCS, ≥ 40 MHz bandwidth, SUL duplex mode
4	15 kHz SSB SCS, ≥ 10 MHz bandwidth, TDD duplex mode	DL and UL: 15 kHz SSB SCS, ≥ 10 MHz bandwidth, FDD duplex mode; SUL: 15 kHz SCS, ≥ 10 MHz bandwidth, SUL duplex mode
5	15 kHz SSB SCS, ≥ 10 MHz bandwidth, TDD duplex mode	DL and UL: 15 kHz SSB SCS, ≥ 10 MHz bandwidth, TDD duplex mode; SUL: 15 kHz SCS, ≥ 10 MHz bandwidth, SUL duplex mode
6	15 kHz SSB SCS, ≥ 10 MHz bandwidth, TDD duplex mode	DL and UL: 30kHz SSB SCS, ≥ 40 MHz bandwidth, TDD duplex mode;

		SUL: 30kHz SCS, ≥ 40 MHz bandwidth, SUL duplex mode
7	30 kHz SSB SCS, ≥ 40 MHz bandwidth, TDD duplex mode	DL and UL: 15 kHz SSB SCS, ≥ 10 MHz bandwidth, FDD duplex mode; SUL: 15 kHz SCS, ≥ 10 MHz bandwidth, SUL duplex mode
8	30 kHz SSB SCS, ≥ 40 MHz bandwidth, TDD duplex mode	DL and UL: 15 kHz SSB SCS, ≥ 10 MHz bandwidth, TDD duplex mode; SUL: 15 kHz SCS, ≥ 10 MHz bandwidth, SUL duplex mode
9	30 kHz SSB SCS, ≥ 40 MHz bandwidth, TDD duplex mode	DL and UL: 30kHz SSB SCS, ≥ 40 MHz bandwidth, TDD duplex mode; SUL: 30kHz SCS, ≥ 40 MHz bandwidth, SUL duplex mode
Note 1: The UE is only required to be tested in one of the supported test configurations		
Note 2: The UE is only required to be tested in one with smallest aggregated channel bandwidth from supported band combinations which is composed of CCs \geq the bandwidth ($BW_{channel}$) defined in each test configuration,		

Table A.6.5.4.1.1-2: General test parameters for NR standalone UE UL carrier RRC reconfiguration Delay on Pcell

Parameter	Unit	Test configuration	Value	Comment
RF Channel Number		Config 1,2,3, 4, 5, 6, 7, 8, 9	1, 2	Two radio channels are used for this test.
Active cell		Config 1,2,3, 4, 5, 6, 7, 8, 9	Cell 1: FR1 PCell Cell 2: FR1 SCell	PCell on RF channel number 1 FR1 SCell on RF channel number 2
CP length		Config 1,2,3, 4, 5, 6, 7, 8, 9	Normal	
DRX		Config 1,2,3, 4, 5, 6, 7, 8, 9	OFF	
Measurement gap pattern Id		Config 1,2,3, 4, 5, 6, 7, 8, 9	OFF	
Filter coefficient		Config 1,2,3, 4, 5, 6, 7, 8, 9	0	L3 filtering is not used
T1	s	Config 1,2,3, 4, 5, 6, 7, 8, 9	5	
T2	s	Config 1,2,3, 4, 5, 6, 7, 8, 9	5	
T3	s	Config 1,2,3, 4, 5, 6, 7, 8, 9	5	

Table A.6.5.4.1.1-3: NR Cell specific test parameters for NR standalone UE UL carrier RRC reconfiguration Delay on PCell (Cell 1)

Parameter	Unit	Test Configuration	Test 1		
			T1	T2	T3
Channel number		Conf 1, 2, 3, 4, 5, 6, 7, 8, 9	2		
TDD configuration		Conf 1, 4, 7	N/A		
		Conf 2, 5, 8	TDDConf.1.1		
		Conf 3, 6, 9	TDDConf.2.1		
BW _{channel}	MHz	Conf 1, 4, 7	Note 6		
		Conf 2, 5, 8	Note 6		
		Conf 3, 6, 9	Note 6		
BW _{occupied}	RB	Conf 1, 4, 7	52 ^{Note 4}		
		Conf 2, 5, 8	52 ^{Note 4}		
		Conf 3, 6, 9	106 ^{Note 5}		
PUSCH parameters for NR UL carrier		Conf 1, 4, 7	G-FR1-A3-10 in [13]	G-FR1-A3-10 in [13]	G-FR1-A3-10 in [13]
		Conf 2, 5, 8	G-FR1-A3-10 in [13]	G-FR1-A3-10 in [13]	G-FR1-A3-10 in [13]
		Conf 3, 6, 9	G-FR1-A3-14 in [13]	G-FR1-A3-14 in [13]	G-FR1-A3-14 in [13]
PUCCH parameters For NR UL carrier		Conf 1, 4, 7	Table 8.3.3.1.2-1 in [13]	Table 8.3.3.1.2-1 in [13]	Table 8.3.3.1.2-1 in [13]
		Conf 2, 5, 8	Table 8.3.3.1.2-1 in [13]	Table 8.3.3.1.2-1 in [13]	Table 8.3.3.1.2-1 in [13]
		Conf 3, 6, 9	Table 8.3.3.1.2-2 in [13]	Table 8.3.3.1.2-2 in [13]	Table 8.3.3.1.2-2 in [13]
PUSCH parameters for supplementary UL		Conf 1, 4, 7	N/A	G-FR1-A3-10 in [13]	N/A
		Conf 2, 5, 8	N/A	G-FR1-A3-10 in [13]	N/A
		Conf 3, 6, 9	N/A	G-FR1-A3-14 in [13]	N/A
PUCCH parameters for supplementary UL		Conf 1, 4, 7	N/A	N/A	N/A
		Conf 2, 5, 8	N/A	N/A	N/A
		Conf 3, 6, 9	N/A	N/A	N/A
PDSCH reference measurement channel as defined in A.3.1.1		Conf 1, 4, 7	SR.1.1 FDD		
		Conf 2, 5, 8	SR.1.1 TDD		
		Conf 3, 6, 9	SR 2.1 TDD		
RMSI CORESET reference		Conf 1, 4, 7	CR.1.1 FDD		
		Conf 2, 5, 8	CR.1.1 TDD		

measurement channel as defined in A.3.1.2		Conf 3, 6, 9	CR.2.1 TDD
RMC CORESET reference measurement channel as defined in A.3.1.3		Conf 1, 4, 7	CCR.1.1 FDD
		Conf 2, 5, 8	CCR.1.1 TDD
		Conf 3, 6, 9	CCR.2.1 TDD
OCNG Pattern ^{Note 1}		Conf 1, 2, 4, 5, 7, 8	OP.1 ^{Note 4}
		Conf 3, 6, 9	OP.1 ^{Note 5}
SSB configuration		Conf 1, 2, 4, 5, 7, 8	SSB.1 FR1
		Conf 3, 6, 9	SSB.2 FR1
SMTC configuration		Conf 1, 2, 3, 4, 5, 6, 7, 8, 9	SMTC.1
CSI-RS for tracking			Conf 1
			Conf 2
			Conf 3
			Conf 4
			Conf 5
			Conf 6
			Conf 7
			Conf 8
			Conf 9
DL initial BWP configuration		Conf 1, 2, 3, 4, 5, 6, 7, 8, 9	DLBWP.0.1
DL dedicated BWP configuration		Conf 1, 2, 3, 4, 5, 6, 7, 8, 9	DLBWP.1.1
UL dedicated BWP configuration		Conf 1, 2, 3, 4, 5, 6, 7, 8, 9	ULBWP.1.1
EPRE ratio of PSS to SSS	dB	Conf 1, 2, 3, 4, 5, 6, 7, 8, 9	0
EPRE ratio of PBCH_DMRS to SSS			
EPRE ratio of PBCH to PBCH_DMRS			
EPRE ratio of PDCCH_DMRS to SSS			
EPRE ratio of PDCCH to PDCCH_DMRS			
EPRE ratio of PDSCH_DMRS to SSS			
EPRE ratio of PDSCH to PDSCH_DMRS			
EPRE ratio of OCNG DMRS to SSS			
EPRE ratio of OCNG to OCNG DMRS			
N_{oc} ^{Note 2}			
	dBm/SCS	Conf 1, 2, 4, 5, 7, 8	-102
		Conf 3, 6, 9	-99

\hat{E}_s / N_{oc}	dB	Conf 1, 2, 3, 4, 5, 6, 7, 8, 9	16	16	16
\hat{E}_s / I_{ot} ^{Note 3}	dB	Conf 1, 2, 3, 4, 5, 6, 7, 8, 9	16	16	16
SS-RSRP ^{Note 3}	dBm/ SCS	Conf 1, 2, 4, 5, 7, 8	-86	-86	-86
		Conf 3, 6, 9	-83	-83	-83
I_o ^{Note 3}	dBm/ 9.36 MHz	Conf 1, 2, 4, 5, 7, 8	-57.9	-57.9	-57.9
	dBm/ 38.16 MHz	Conf 3, 6, 9	-51.8	-51.8	-51.8
Propagation Condition		Conf 1, 2, 3, 4, 5, 6, 7, 8, 9	AWGN		
Antenna configuration		Conf 1, 2, 3, 4, 5, 6, 7, 8, 9	1 x 2		
<p>NOTE 1: OCNG shall be used such that both cells are fully allocated, and a constant total transmitted power spectral density is achieved for all OFDM symbols.</p> <p>NOTE 2: Interference from other cells and noise sources not specified in the test is assumed to be constant over subcarriers and time and shall be modelled as AWGN of appropriate power for N_{oc} to be fulfilled within $BW_{occupied}$.</p> <p>NOTE 3: \hat{E}_s / I_{ot}, I_o, and SS-RSRP levels have been derived from other parameters for information purposes. They are not settable parameters themselves.</p> <p>NOTE 4: All UL/DL transmission shall be confined within $BW_{occupied}$ (i.e. 10 MHz, 52 RBs) from $F_{C,low}$, and I_o is independent of the $BW_{channel}$ configured.</p> <p>NOTE 5: All UL/DL transmission shall be confined within $BW_{occupied}$ (i.e. 40 MHz, 106 RBs) from $F_{C,low}$, and I_o is independent of the $BW_{channel}$ configured.</p> <p>NOTE 6: $N_{RB,c}$ is derived from Table 5.3.2-1 in TS38.101-1[2] with configured $BW_{channel}$.</p>					

Table A.6.5.4.1.1-4: NR Cell specific test parameters for NR standalone UE UL carrier RRC reconfiguration Delay on SCell (Cell 2)

Parameter	Unit	Test Configuration	Test 1		
			T1	T2	T3
Channel number		Conf 1, 2, 3, 4, 5, 6, 7, 8, 9	2		
TDD configuration		Conf 1, 4, 7	N/A		
		Conf 2, 5, 8	TDDConf.1.1		
		Conf 3, 6, 9	TDDConf.2.1		
BW _{channel}	MHz	Conf 1, 4, 7	Note 6		
		Conf 2, 5, 8	Note 6		
		Conf 3, 6, 9	Note 6		
BW _{occupied}	RB	Conf 1, 4, 7	52 ^{Note 4}		
		Conf 2, 5, 8	52 ^{Note 4}		
		Conf 3, 6, 9	106 ^{Note 5}		
PUSCH parameters for NR UL carrier		Conf 1, 4, 7	G-FR1-A3-10 in [13]	G-FR1-A3-10 in [13]	G-FR1-A3-10 in [13]
		Conf 2, 5, 8	G-FR1-A3-10 in [13]	G-FR1-A3-10 in [13]	G-FR1-A3-10 in [13]
		Conf 3, 6, 9	G-FR1-A3-14 in [13]	G-FR1-A3-14 in [13]	G-FR1-A3-14 in [13]
PUCCH parameters For NR UL carrier		Conf 1, 4, 7	Table 8.3.3.1.2-1 in [13]	Table 8.3.3.1.2-1 in [13]	Table 8.3.3.1.2-1 in [13]
		Conf 2, 5, 8	Table 8.3.3.1.2-1 in [13]	Table 8.3.3.1.2-1 in [13]	Table 8.3.3.1.2-1 in [13]
		Conf 3, 6, 9	Table 8.3.3.1.2-2 in [13]	Table 8.3.3.1.2-2 in [13]	Table 8.3.3.1.2-2 in [13]
PUSCH parameters for supplementary UL		Conf 1, 4, 7	N/A	G-FR1-A3-10 in [13]	N/A
		Conf 2, 5, 8	N/A	G-FR1-A3-10 in [13]	N/A
		Conf 3, 6, 9	N/A	G-FR1-A3-14 in [13]	N/A
PUCCH parameters for supplementary UL		Conf 1, 4, 7	N/A	N/A	N/A
		Conf 2, 5, 8	N/A	N/A	N/A
		Conf 3, 6, 9	N/A	N/A	N/A
PDSCH reference measurement channel as defined in A.3.1.1		Conf 1, 4, 7	SR.1.1 FDD		
		Conf 2, 5, 8	SR.1.1 TDD		
		Conf 3, 6, 9	SR 2.1 TDD		
RMSI CORESET reference measurement channel as defined in A.3.1.2		Conf 1, 4, 7	CR.1.1 FDD		
		Conf 2, 5, 8	CR.1.1 TDD		
		Conf 3, 6, 9	CR.2.1 TDD		

RMC CORESET reference measurement channel as defined in A.3.1.3		Conf 1, 4, 7	CCR.1.1 FDD		
		Conf 2, 5, 8	CCR.1.1 TDD		
		Conf 3, 6, 9	CCR.2.1 TDD		
OCNG Pattern ^{Note 1}		Conf 1, 2, 4, 5, 7, 8	OP.1 ^{Note 4}		
		Conf 3, 6, 9	OP.1 ^{Note 5}		
SSB configuration		Conf 1, 2, 4, 5, 7, 8	SSB.1 FR1		
		Conf 3, 6, 9	SSB.2 FR1		
SMTC configuration		Conf 1, 2, 3, 4, 5, 6, 7, 8, 9	SMTC.1		
CSI-RS for tracking		Conf 1	TRS.1.1 FDD		
		Conf 2	TRS.1.1 FDD		
		Conf 3	TRS.1.2 FDD		
		Conf 4	TRS.1.1 TDD		
		Conf 5	TRS.1.1 TDD		
		Conf 6	TRS.1.2 TDD		
		Conf 7	TRS.1.1 TDD		
		Conf 8	TRS.1.1 TDD		
		Conf 9	TRS.1.2 TDD		
DL initial BWP configuration		Conf 1, 2, 3, 4, 5, 6, 7, 8, 9	DLBWP.0.1		
DL dedicated BWP configuration		Conf 1, 2, 3, 4, 5, 6, 7, 8, 9	DLBWP.1.1		
UL dedicated BWP configuration		Conf 1, 2, 3, 4, 5, 6, 7, 8, 9	ULBWP.1.1		
EPRE ratio of PSS to SSS	dB	Conf 1, 2, 3, 4, 5, 6, 7, 8, 9	0		
EPRE ratio of PBCH_DMRS to SSS					
EPRE ratio of PBCH to PBCH_DMRS					
EPRE ratio of PDCCH_DMRS to SSS					
EPRE ratio of PDCCH to PDCCH_DMRS					
EPRE ratio of PDSCH_DMRS to SSS					
EPRE ratio of PDSCH to PDSCH_DMRS					
EPRE ratio of OCNG DMRS to SSS					
EPRE ratio of OCNG to OCNG DMRS					
N_{oc} ^{Note 2}					
	dBm/SCS	Conf 1, 2, 4, 5, 7, 8	-102		
		Conf 3, 6, 9	-99		
\hat{E}_s / N_{oc}	dB	Conf 1, 2, 3, 4, 5, 6, 7, 8, 9	16	16	16

\hat{E}_s/I_{ot} Note 3	dB	Conf 1, 2, 3, 4, 5, 6, 7, 8, 9	16	16	16
SS-RSRP Note 3	dBm/SCS	Conf 1, 2, 4, 5, 7, 8	-86	-86	-86
		Conf 3, 6, 9	-83	-83	-83
I_o Note 3	dBm/9.36 MHz	Conf 1, 2, 4, 5, 7, 8	-57.9	-57.9	-57.9
	dBm/38.16 MHz	Conf 3, 6, 9	-51.8	-51.8	-51.8
Propagation Condition		Conf 1, 2, 3, 4, 5, 6, 7, 8, 9	AWGN		
Antenna configuration		Conf 1, 2, 3, 4, 5, 6, 7, 8, 9	1 x 2		
SUL RSRP threshold (rsrp-ThresholdSSB-SUL)	dBm	Conf 1,2,3,4,5,6	-75		
		Conf 7,8,9	-72		
<p>NOTE 1: OCNB shall be used such that both cells are fully allocated, and a constant total transmitted power spectral density is achieved for all OFDM symbols.</p> <p>NOTE 2: Interference from other cells and noise sources not specified in the test is assumed to be constant over subcarriers and time and shall be modelled as AWGN of appropriate power for N_{oc} to be fulfilled within $BW_{occupied}$.</p> <p>NOTE 3: \hat{E}_s/I_{ot}, I_o, and SS-RSRP levels have been derived from other parameters for information purposes. They are not settable parameters themselves.</p> <p>NOTE 4: All UL/DL transmission shall be confined within $BW_{occupied}$ (i.e. 10 MHz, 52 RBs) from $F_{C,low}$, and I_o is independent of the $BW_{channel}$ configured.</p> <p>NOTE 5: All UL/DL transmission shall be confined within $BW_{occupied}$ (i.e. 40 MHz, 106 RBs) from $F_{C,low}$, and I_o is independent of the $BW_{channel}$ configured.</p> <p>NOTE 6: $N_{RB,c}$ is derived from Table 5.3.2-1 in TS38.101-1[2] with configured $BW_{channel}$.</p>					

A.6.5.4.1.2 Test Requirements

The UE shall be ready to start transmission on the supplementary uplink carrier on SCell within 20ms from the start of T2.

The UE shall stop the transmission on the supplementary uplink carrier on SCell within 20ms from the start of T3.

All of the above test requirements shall be fulfilled in order for the observed UE UL carrier configuration delay and UE UL carrier release delay to be counted as correct. The rate of correct observed UE UL carrier configuration delay and UE UL carrier release delay during repeated tests shall be at least 90%.

A.6.5.4.2 Void

A.6.5.5 Beam Failure Detection and Link recovery procedures

A.6.5.5.1 Beam Failure Detection and Link Recovery Test for FR1 PCell configured with SSB-based BFD and LR in non-DRX mode

A.6.5.5.1.1 Test Purpose and Environment

The purpose of this test is to verify that the UE properly detects SSB-based beam failure in the set q_0 configured for a serving cell and that the UE performs correct SSB-based link recovery based on beam candidate set q_1 . The purpose is to test the downlink monitoring for beam failure detection within the UEs active DL BWP, during the evaluation period, and link recovery, when no DRX is used. This test will partly verify the SSB based beam failure detection and link recovery for an FR1 serving cell requirements in clause 8.5.

The test parameters are given in Tables A.6.5.5.1.1-1, A.6.5.5.1.1-2, A.6.5.5.1.1-3 and A.6.5.5.1.1-4 below. There is one cell, cell 1 which is the active cell, in the test. The test consists of five successive time periods, with time duration of T1, T2, T3, T4 and T5 respectively. Figure A.6.5.5.1.1-1 shows the variation of the downlink SNR of the SSB in set q_0 in the active cell to emulate SSB based beam failure. Figure A.6.5.5.1.1-2 shows the variation of the downlink L1-RSRP of the SSB in set q_1 of the candidate beam used for link recovery. Prior to the start of the time duration T1, the UE shall be fully synchronized to cell 1. The UE shall be configured for periodic CSI reporting with a reporting periodicity of 5 ms. In the test, DRX configuration is not enabled. The UE is configured to perform inter-frequency measurements using GP ID #0 (40ms) in test 1.

Table A.6.5.5.1.1-1: Supported test configurations for FR1 PCell

Configuration	Description
1	FDD duplex mode, 15 kHz SSB SCS, 10 MHz bandwidth
2	TDD duplex mode, 15 kHz SSB SCS, 10 MHz bandwidth
3	TDD duplex mode, 30 kHz SSB SCS, 40 MHz bandwidth
Note:	The UE is only required to pass in one of the supported test configurations in FR1

Table A.6.5.5.1.1-2: General test parameters for FR1 PCell for SSB-based beam failure detection and link recovery testing in non-DRX mode

Parameter	Unit	Value	Comment
		Test 1	
Active PSCell		Cell 1	
RF Channel Number		1	
Duplex mode	Config 1	FDD	
	Config 2, 3	TDD	
BWchannel	Config 1	MHz	10: NRB,c = 52
	Config 2		10: NRB,c = 52
	Config 3		40: NRB,c = 106
DL initial BWP configuration	Config 1, 2, 3		DLBWP.0.1
DL dedicated BWP configuration	Config 1, 2, 3		DLBWP.1.1

UL initial BWP configuration	Config 1, 2, 3		ULBWP.0.1	
UL dedicated BWP configuration	Config 1, 2, 3		ULBWP.1.1	
TDD Configuration	Config 1		Not Applicable	
	Config 2		TDDConf.1.1	
	Config 3		TDDConf.2.1	
RMSI CORESET Reference Channel	Config 1		CR.1.1 FDD	
	Config 2		CR.1.1 TDD	
	Config 3		CR.2.1 TDD	
Dedicated CORESET Reference Channel	Config 1		CCR.1.1 FDD	
	Config 2		CCR.1.1 TDD	
	Config 3		CCR.2.1 TDD	
SSB Configuration	Config 1		SSB.3 FR1	
	Config 2		SSB.3 FR1	
	Config 3		SSB.4 FR1	
SMTC Configuration	Config 1, 2		SMTC.1	
	Config 3		SMTC.1	
PDSCH/PDCCH subcarrier spacing	Config 1, 2		15 KHz	
	Config 3		30 KHz	
PRACH Configuration	Config 1, 2		Table A.3.8.2.2-1	
	Config 3		Table A.3.8.2.2-1	
SSB Index assigned as BFD RS (q_0)			0	
SSB Index assigned as CBD RS (q_1)			1	
OCNG parameters			OP.1	
CP length			Normal	
Correlation Matrix and Antenna Configuration			2x2 Low	
Beam failure detection transmission parameters	DCI format		1-0	
	Number of Control OFDM symbols		2	
	Aggregation level	CCE	8	
	Ratio of hypothetical PDCCH RE energy to average SSS RE energy	dB	0	
	Ratio of hypothetical PDCCH DMRS energy to average SSS RE energy	dB	0	
	DMRS precoder granularity		REG bundle size	
	REG bundle size		6	
DRX			OFF	
Gap pattern ID			gp0	

gapOffset			0	
rimInSyncOutOfSyncThreshold			absent	When the field is absent, the UE applies the value 0. (Table 8.1.1-1).
rsrp-ThresholdSSB	Config 1, 2	dBm/	-98	Threshold used for $Q_{in_LR_SSB}$
	Config 3	SCS kHz	-95	
powerControlOffsetSS			db0	Used for deriving rsrp-ThresholdCSI-RS
beamFailureInstanceMaxCount			n1	see clause 5.17 of TS 38.321 [7]
beamFailureDetectionTimer			pbfd4	see clause 5.17 of TS 38.321 [7]
CSI-RS configuration for CSI reporting	Config 1		CSI-RS.1.1 FDD	
	Config 2		CSI-RS.1.1 TDD	
	Config 3		CSI-RS.2.1 TDD	
CSI-RS for tracking	Config 1		TRS.1.1 FDD	
	Config 2		TRS.1.1 TDD	
	Config 3		TRS.1.2 TDD	
SSB Index assigned as RLM RS			0, 1	
T310 Timer		ms	1000	
N310			2	
T1		s	0.2	During this time the the UE shall be fully synchronized to cell 1
T2		s	0.37	
T3		s	0.24	
T4		s	0	
T5		s	0.17	
D1		s	0.14	
Note 1: All configurations are assigned to the UE prior to the start of time period T1.				
Note 2: UE-specific PDCCH is not transmitted after T1 starts.				

Table A.6.5.1.1-3: Cell specific test parameters for FR1 PCell for SSB-based beam failure detection and link recovery testing in non-DRX mode

Parameter	Unit	Test 1				
		T1	T2	T3	T4	T5
EPRE ratio of PDCCH DMRS to SSS	dB	0				

EPRE ratio of PDCCH to PDCCH DMRS		dB					
EPRE ratio of PBCH DMRS to SSS		dB					
EPRE ratio of PBCH to PBCH DMRS		dB					
EPRE ratio of PSS to SSS		dB					
EPRE ratio of PDSCH DMRS to SSS		dB					
EPRE ratio of PDSCH to PDSCH DMRS		dB					
EPRE ratio of OCNG DMRS to SSS		dB					
EPRE ratio of OCNG to OCNG DMRS		dB					
SNR_SSB of set q_0	Config 1	dB	5	-3	-12	-12	-12
	Config 2		5	-3	-12	-12	-12
	Config 3		5	-3	-12	-12	-12
SNR_SSB of set q_1	Config 1	dB	-10	-10	10	10	10
	Config 2		-10	-10	10	10	10
	Config 3		-10	-10	10	10	10
SSB_RP of set q_1	Config 1	dBm/ SCS kHz	-108	-108	-88	-88	-88
	Config 2		-108	-108	-88	-88	-88
	Config 3		-105	-105	-85	-85	-85
N_{oc}	Config 1	dBm/15 KHz	-98				
	Config 2		-98				
	Config 3		-98				
Propagation condition			TDL-C 300ns 100Hz				
<p>Note 1: OCNG shall be used such that the resources in Cell 1 are fully allocated and a constant total transmitted power spectral density is achieved for all OFDM symbols.</p> <p>Note 2: The uplink resources for CSI reporting are assigned to the UE prior to the start of time period T1.</p> <p>Note 3: NZP CSI-RS resource set configuration for CSI reporting are assigned to the UE prior to the start of time period T1.</p> <p>Note 4: Measurement gap configuration is assigned to the UE prior to the start of time period T1.</p> <p>Note 5: The timers and layer 3 filtering related parameters are configured prior to the start of time period T1.</p> <p>Note 6: The signal contains PDCCH for UEs other than the device under test as part of OCNG.</p> <p>Note 7: SNR levels correspond to the signal to noise ratio over the SSS REs.</p> <p>Note 8: The SNR in time periods T1, T2, T3, T4 and T5 is denoted as SNR1, SNR2 and SNR3 respectively in figure A.4.5.5.1.1-1.</p> <p>Note 9: The SNR values are specified for testing a UE which supports 2RX on at least one band. For testing of a UE which supports 4RX on all bands, the SNR during T3 is modified as specified in clause A.3.6.</p>							

Table A.6.5.5.1.1-4: Void

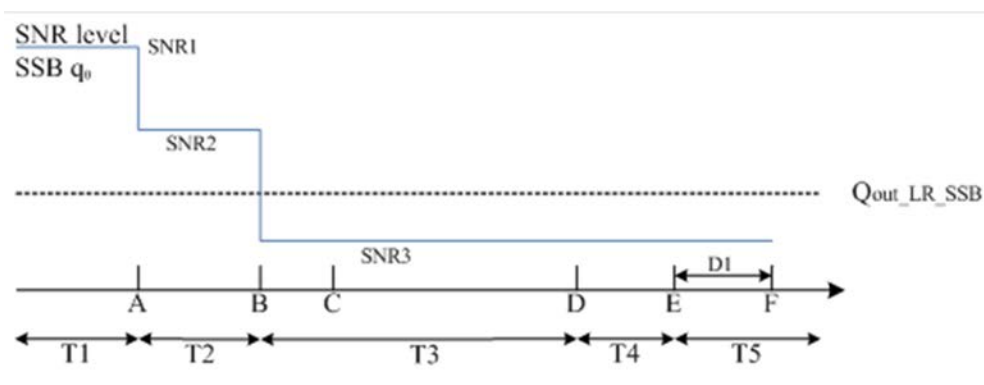

Figure A.6.5.5.1.1-1: SNR variation for SSB-based beam failure detection and link recovery testing in non-DRX mode

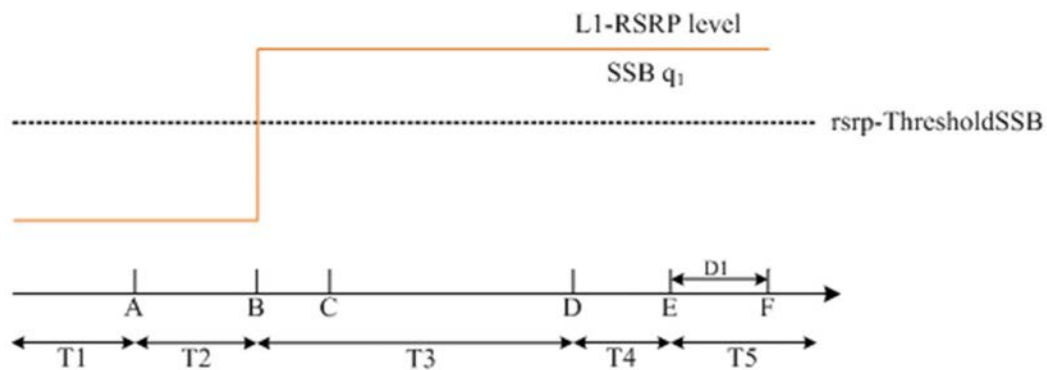

Figure A.6.5.5.1.1-2: L1-RSRP level variation for SSB-based beam failure detection and link recovery testing in non-DRX mode

A.6.5.5.1.2 Test Requirements

The UE behaviour during time durations T1, T2, T3, T4 and T5 shall be as follows:

During the time duration T1 and T2, the UE shall transmit uplink signal at least in all subframes configured for CSI transmission on Cell 1.

During the period from time point A to time point B the UE shall transmit uplink signal in Cell 1 in all uplink slots configured for CSI transmission according to the configured periodic CSI reporting for Cell 1.

During T3 the UE shall detect beam failure and initiate link recovery. During T4 and T5 the UE measures and evaluate beam candidate from beam candidate set q_1 .

No later than time point F occurring no later than $D1 = 120+20$ ms after the start of T5, the UE shall transmit preamble on a beam associated with the candidate beam set q_1 . The UE shall not transmit preamble on a beam associated with the candidate beam set q_1 earlier than time point B.

Test is concluded once the test equipment has received the initial preamble transmission from the UE. The rate of correct events observed during repeated tests shall be at least 90%.

A.6.5.5.2 Beam Failure Detection and Link Recovery Test for FR1 PCell configured with SSB-based BFD and LR in DRX mode

A.6.5.5.2.1 Test Purpose and Environment

The purpose of this test is to verify that the UE properly detects SSB-based beam failure in the set q_0 configured for a serving cell and that the UE performs correct SSB-based link recovery based on beam candidate set q_1 . The purpose is to test the downlink monitoring for beam failure detection within the UEs active DL BWP, during the evaluation period, and link recovery, when DRX is used. This test will partly verify the SSB based beam failure detection and link recovery for an FR1 serving cell requirements in clause 8.5.

The test parameters are given in Tables A.6.5.5.2.1-1, A.6.5.5.2.1-2, A.6.5.5.2.1-3, A.6.5.5.2.1-4 and A.6.5.5.2.1-5 below. There is one cell, cell 1 which is the active cell, in the test. The test consists of five successive time periods, with time duration of T1, T2, T3, T4 and T5 respectively. Figure A.6.5.5.2.1-1 shows the variation of the downlink SNR of the SSB in set q_0 in the active cell to emulate SSB based beam failure. Figure A.6.5.5.2.1-2 shows the variation of the downlink L1-RSRP of the SSB in set q_1 of the candidate beam used for link recovery. Prior to the start of the time duration T1, the UE shall be fully synchronized to cell 1. The UE shall be configured for periodic CSI reporting with a reporting periodicity of 5 ms. In the test, DRX configuration is enabled in PCell and DRX inactivity timer has already been expired, i.e. UE tries to decode PDCCH and to send periodic CQI during the period

when On-duration timer is running. Time alignment timers shall be set to “infinity” so that UL timing alignment is maintained during the test.

Table A.6.5.5.2.1-1: Supported test configurations for FR1 PCell

Configuration	Description
1	FDD duplex mode, 15 kHz SSB SCS, 10 MHz bandwidth
2	TDD duplex mode, 15 kHz SSB SCS, 10 MHz bandwidth
3	TDD duplex mode, 30 kHz SSB SCS, 40 MHz bandwidth
Note:	The UE is only required to pass in one of the supported test configurations in FR1

Table A.6.5.5.2.1-2: General test parameters for FR1 PCell for SSB-based beam failure detection and link recovery testing in DRX mode

Parameter	Unit	Value	Comment
			Test 1
Active PSCell		Cell 1	
RF Channel Number		1	
Duplex mode	Config 1	FDD	
	Config 2, 3	TDD	
BWchannel	Config 1	MHz	10: NRBC,c = 52
	Config 2		10: NRBC,c = 52
	Config 3		40: NRBC,c = 106
DL initial BWP configuration	Config 1, 2, 3		DLBWP.0.1
DL dedicated BWP configuration	Config 1, 2, 3		DLBWP.1.1
UL initial BWP configuration	Config 1, 2, 3		ULBWP.0.1
UL dedicated BWP configuration	Config 1, 2, 3		ULBWP.1.1
TDD Configuration	Config 1		Not Applicable
	Config 2		TDDConf.1.1
	Config 3		TDDConf.2.1
RMSI CORESET Reference Channel	Config 1		CR.1.1 FDD
	Config 2		CR.1.1 TDD
	Config 3		CR.2.1 TDD
Dedicated CORESET Reference Channel	Config 1		CCR.1.1 FDD
	Config 2		CCR.1.1 TDD
	Config 3		CCR.2.1 TDD
SSB Configuration	Config 1		SSB.3 FR1
	Config 2		SSB.3 FR1
	Config 3		SSB.4 FR1
SMTTC Configuration	Config 1, 2		SMTTC.1

	Config 3		SMTc.1	
PDSCH/PDCCH subcarrier spacing	Config 1, 2		15 KHz	
	Config 3		30 KHz	
PRACH Configuration	Config 1, 2		Table A.3.8.2.2-1	
	Config 3		Table A.3.8.2.2-1	
SSB Index assigned as BFD RS (q_0)			0	
SSB Index assigned as CBD RS (q_1)			1	
OCNG parameters			OP.1	
CP length			Normal	
Correlation Matrix and Antenna Configuration			2x2 Low	
Beam failure detection transmission parameters	DCI format		1-0	
	Number of Control OFDM symbols		2	
	Aggregation level	CCE	8	
	Ratio of hypothetical PDCCH RE energy to average SSS RE energy	dB	0	
	Ratio of hypothetical PDCCH DMRS energy to average SSS RE energy	dB	0	
	DMRS precoder granularity		REG bundle size	
	REG bundle size		6	
DRX			DRX.7	A.3.3.7
Gap pattern ID			N.A.	
rimInSyncOutOfSyncThreshold			Absent	When the field is absent, the UE applies the value 0. (Table 8.1.1-1).
rsrp-ThresholdSSB	Config 1, 2	dBm/S CS kHz	-98	Threshold used for $Q_{in_LR_SSB}$
	Config 3		-95	
powerControlOffsetSS			db0	Used for deriving rsrp-ThresholdCSI-RS
beamFailureInstanceMaxCount			n1	see clause 5.17

				of TS 38.321 [7]
beamFailureDetectionTimer			pbfd4	see clause 5.17 of TS 38.321 [7]
CSI-RS configuration for CSI reporting	Config 1		CSI-RS.1.1 FDD	
	Config 2		CSI-RS.1.1 TDD	
	Config 3		CSI-RS.2.1 TDD	
CSI-RS for tracking	Config 1		TRS.1.1 FDD	
	Config 2		TRS.1.1 TDD	
	Config 3		TRS.1.2 TDD	
SSB Index assigned as RLM RS			0, 1	
T310 Timer		ms	1000	
N310			2	
T1		s	1	During this time the the UE shall be fully synchronized to cell 1
T2		s	5.17	
T3		s	3.24	
T4		s	0	
T5		s	1.97	
D1		s	1.94	
Note 1: All configurations are assigned to the UE prior to the start of time period T1. Note 2: UE-specific PDCCH is not transmitted after T1 starts.				

Table A.6.5.5.2.1-3: Cell specific test parameters for FR1 PCell for SSB-based beam failure detection and link recovery testing in DRX mode

Parameter	Unit	Test 1					
		T1	T2	T3	T4	T5	
EPRE ratio of PDCCH DMRS to SSS	dB	0					
EPRE ratio of PDCCH to PDCCH DMRS	dB						
EPRE ratio of PBCH DMRS to SSS	dB						
EPRE ratio of PBCH to PBCH DMRS	dB						
EPRE ratio of PSS to SSS	dB						
EPRE ratio of PDSCH DMRS to SSS	dB						
EPRE ratio of PDSCH to PDSCH DMRS	dB						
EPRE ratio of OCNG DMRS to SSS	dB						
EPRE ratio of OCNG to OCNG DMRS	dB						
SNR_SSB of set q_0	Config 1	dB	5	-3	-12	-12	-12

	Config 2		5	-3	-12	-12	-12
	Config 3		5	-3	-12	-12	-12
SNR_SSB of set q_1	Config 1	dB	-10	-10	10	10	10
	Config 2		-10	-10	10	10	10
	Config 3		-10	-10	10	10	10
SSB_RP of set q_1	Config 1	dBm/ SCS kHz	-108	-108	-88	-88	-88
	Config 2		-108	-108	-88	-88	-88
	Config 3		-105	-105	-85	-85	-85
N_{oc}	Config 1	dBm/15 KHz	-98				
	Config 2		-98				
	Config 3		-98				
Propagation condition			TDL-C 300ns 100Hz				
<p>Note 1: OCNG shall be used such that the resources in Cell 1 are fully allocated and a constant total transmitted power spectral density is achieved for all OFDM symbols.</p> <p>Note 2: The uplink resources for CSI reporting are assigned to the UE prior to the start of time period T1.</p> <p>Note 3: NZP CSI-RS resource set configuration for CSI reporting are assigned to the UE prior to the start of time period T1.</p> <p>Note 4: Void</p> <p>Note 5: The timers and layer 3 filtering related parameters are configured prior to the start of time period T1.</p> <p>Note 6: The signal contains PDCCH for UEs other than the device under test as part of OCNG.</p> <p>Note 7: SNR levels correspond to the signal to noise ratio over the SSS REs.</p> <p>Note 8: The SNR in time periods T1, T2, T3, T4 and T5 is denoted as SNR1, SNR2 and SNR3 respectively in figure A.4.5.5.1.1-1.</p> <p>Note 9: The SNR values are specified for testing a UE which supports 2RX on at least one band. For testing of a UE which supports 4RX on all bands, the SNR during T3 is modified as specified in clause A.3.6.</p>							

Table A.6.5.5.2.1-4: Void

Table A.6.5.5.2.1-5: Void

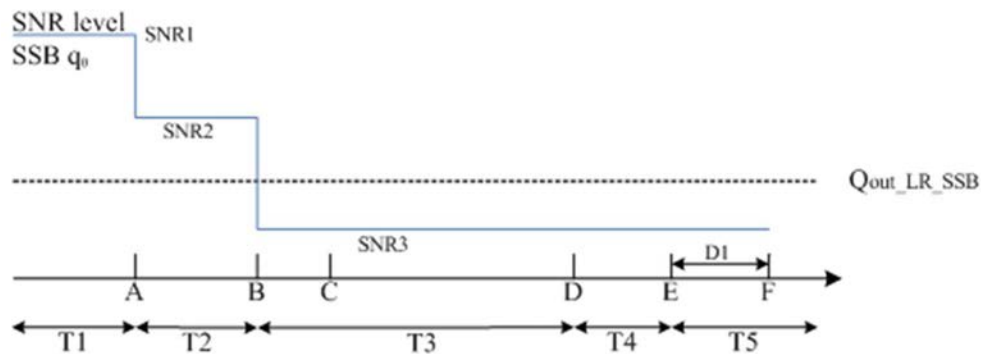

Figure A.6.5.5.2.1-1: SNR variation for SSB-based beam failure detection and link recovery testing in DRX mode

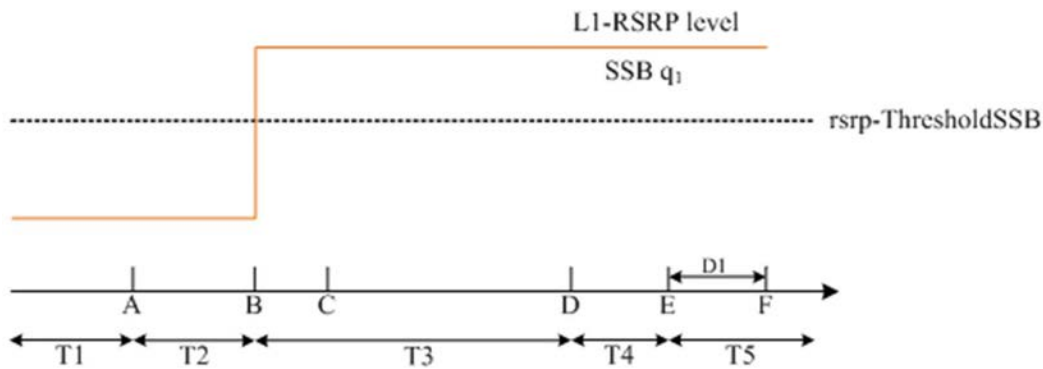

Figure A.6.5.5.2.1-2: L1-RSRP level variation for SSB-based beam failure detection and link recovery testing in DRX mode

A.6.5.5.2.2 Test Requirements

The UE behaviour during time durations T1, T2, T3, T4 and T5 shall be as follows:

During the time duration T1 and T2, the UE shall transmit uplink signal at least in all subframes configured for CSI transmission on Cell 1.

During the period from time point A to time point B the UE shall transmit uplink signal in Cell 1 in all uplink slots configured for CSI transmission according to the configured periodic CSI reporting for Cell 1.

During T3 the UE shall detect beam failure and initiate link recovery. During T4 and T5 the UE measures and evaluate beam candidate from beam candidate set q_1 .

No later than time point F occurring no later than $D1 = 1920 + 20$ ms after the start of T5, the UE shall transmit preamble on a beam associated with the candidate beam set q_1 . The UE shall not transmit preamble on a beam associated with the candidate beam set q_1 earlier than time point B.

Test is concluded once the test equipment has received the initial preamble transmission from the UE. The rate of correct events observed during repeated tests shall be at least 90%.

A.6.5.5.3 Beam Failure Detection and Link Recovery Test for FR1 PCell configured with CSI-RS-based BFD and LR in non-DRX mode

A.6.5.5.3.1 Test Purpose and Environment

The purpose of this test is to verify that the UE properly detects CSI-RS-based beam failure in the set q_0 configured for a serving cell and that the UE performs correct CSI-RS-based link recovery based on beam candidate set q_1 . The purpose is to test the downlink monitoring for beam failure detection within the UEs active DL BWP, during the evaluation period, and link recovery, when no DRX is used. This test will partly verify the CSI-RS based beam failure detection and link recovery for an FR1 serving cell requirements in clause 8.5.

The test parameters are given in Tables A.6.5.5.3.1-1, A.6.5.5.3.1-2, and below. There is one cell, cell 1 which is the active cell, in the test. The test consists of five successive time periods, with time duration of T1, T2, T3, T4 and T5 respectively. Figure A.6.5.5.3.1-1 shows the variation of the downlink SNR of the CSI-RS in set q_0 in the active cell to emulate CSI-RS based beam failure. Figure A.6.5.5.3.1-2 shows the variation of the downlink L1-RSRP of the CSI-RS in set q_1 of the candidate beam used for link recovery. Prior to the start of the time duration T1, the UE shall be fully synchronized to cell 1. The UE shall be configured for periodic CSI reporting with a reporting periodicity of 5 ms. In the test, DRX configuration is not enabled.

Table A.6.5.5.3.1-1: Supported test configurations for FR1 PCell

Configuration	Description
1	FDD duplex mode, 15 kHz SSB SCS, 10 MHz bandwidth
2	TDD duplex mode, 15 kHz SSB SCS, 10 MHz bandwidth
3	TDD duplex mode, 30 kHz SSB SCS, 40 MHz bandwidth
Note:	The UE is only required to pass in one of the supported test configurations in FR1

Table A.6.5.5.3.1-2: General test parameters for FR1 PCell for CSI-RS-based beam failure detection and link recovery testing in non-DRX mode

Parameter		Unit	Value Test 1	Comment
Active PCell			Cell 1	
RF Channel Number			1	
Duplex mode	Config 1		FDD	
	Config 2, 3		TDD	
TDD Configuration	Config 1		Not Applicable	
	Config 2		TDDConf.1.1	
	Config 3		TDDConf.2.1	
RMSI CORESET Reference Channel	Config 1		CR.1.1 FDD	A.3.1.2
	Config 2		CR.1.1 TDD	
	Config 3		CR.2.1 TDD	
Dedicated CORESET Reference Channel	Config 1		CCR.1.1 FDD	A.3.1.3
	Config 2		CCR.1.1 TDD	
	Config 3		CCR.2.1 TDD	
SSB Configuration	Config 1		SSB.3 FR1	A.3.10
	Config 2		SSB.3 FR1	
	Config 3		SSB.4 FR1	
SMTC Configuration	Config 1, 2		SMTC.1	A.3.11
	Config 3		SMTC.1	
PDSCH/PDC CH subcarrier spacing	Config 1, 2		15 KHz	
	Config 3		30 KHz	
PRACH Configuration	Config 1, 2, 3		FR1 PRACH configuration 4	A.3.8.2
csi-RS-Index assigned as beam failure detection RS in set q_0			0	
OCNG parameters			OP.1	A.3.2.1
CP length			Normal	
Correlation Matrix and Antenna Configuration			2x2 Low	
Beam failure detection transmission parameters	DCI format		1-0	
	Number of Control OFDM symbols		2	
	Aggregation level	CCE	8	
	Ratio of hypothetical PDCCH RE energy to average CSI-RS RE energy	dB	0	

	Ratio of hypothetical PDCCH DMRS energy to average CSI-RS RE energy	dB	0	
	DMRS precoder granularity		REG bundle size	
	REG bundle size		6	
DRX			OFF	
Gap pattern ID			N.A.	
csi-RS-Index assigned as candidate beam detection RS in set q ₁			1	N
rInSyncOutOfSyncThreshold			absent	When the field is absent, the UE applies the value 0. (Table 8.1.1-1).
rsrp-ThresholdCSI-RS	Config 1, 2	dBm/SCS kHz	-98	Threshold used for Q _{in_LR_CSI-RS}
	Config 3		-95	
powerControlOffsetSS			db0	Used for deriving rsrp-ThresholdCSI-RS
beamFailureInstanceMaxCount			n1	see clause 5.17 of TS 38.321 [7]
beamFailureDetectionTimer			pbfd4	see clause 5.17 of TS 38.321 [7]
CSI-RS configuration for q ₀ and q ₁	Config 1		CSI-RS.1.2 FDD	A.3.14
	Config 2		CSI-RS.1.2 TDD	
	Config 3		CSI-RS.2.2 TDD	
CSI-RS configuration for CSI reporting	Config 1		CSI-RS.1.1 FDD	A.3.14
	Config 2		CSI-RS.1.1 TDD	
	Config 3		CSI-RS.2.1 TDD	
TRS configuration	Config 1		TRS.1.1 FDD	
	Config 2		TRS.1.1 TDD	
	Config 3		TRS.1.2 TDD	
CSI-RS-Index assigned as RLM RS	Config 1		CSI-RS.1.2 FDD	A.3.14
	Config 2		CSI-RS.1.2 TDD	
	Config 3		CSI-RS.2.2 TDD	
T310 Timer		ms	1000	
N310			2	
T1		s	0.2	During this time the the UE shall be fully synchronized to cell 1
T2		s	0.18	
T3		s	0.14	
T4		s	0	
T5		s	0.08	
D1		s	0.05	
Note 1: UE-specific PDCCH is not transmitted after T1 starts.				

Table A.6.5.3.1-3: Cell specific test parameters for FR1 PCell for CSI-RS-based beam failure detection and link recovery testing in non-DRX mode

Parameter	Unit	Test 1				
		T1	T2	T3	T4	T5
EPRE ratio of PDCCH DMRS to SSS	dB	0				
EPRE ratio of PDCCH to PDCCH DMRS	dB					

EPRE ratio of PBCH DMRS to SSS		dB					
EPRE ratio of PBCH to PBCH DMRS		dB					
EPRE ratio of PSS to SSS		dB					
EPRE ratio of PDSCH DMRS to SSS		dB					
EPRE ratio of PDSCH to PDSCH DMRS		dB					
EPRE ratio of OCNG DMRS to SSS		dB					
EPRE ratio of OCNG to OCNG DMRS		dB					
SNR_CSI-RS of set q_0	Config 1	dB	5	-3	-12	-12	-12
	Config 2		5	-3	-12	-12	-12
	Config 3		5	-3	-12	-12	-12
SNR_CSI-RS of set q_1	Config 1	dB	-10	-10	10	10	10
	Config 2		-10	-10	10	10	10
	Config 3		-10	-10	10	10	10
CSI-RS_RP of set q_1	Config 1	dBm/ SCS kHz	-108	-108	-88	-88	-88
	Config 2		-108	-108	-88	-88	-88
	Config 3		-105	-105	-85	-85	-85
N_{oc}	Config 1	dBm/15 KHz	-98				
	Config 2		-98				
	Config 3		-98				
Propagation condition			TDL-C 300ns 100Hz				
<p>Note 1: OCNG shall be used such that the resources in Cell 1 are fully allocated and a constant total transmitted power spectral density is achieved for all OFDM symbols.</p> <p>Note 2: The uplink resources for CSI reporting are assigned to the UE prior to the start of time period T1.</p> <p>Note 3: NZP CSI-RS resource set configuration for CSI reporting are assigned to the UE prior to the start of time period T1.</p> <p>Note 4: Void</p> <p>Note 5: The timers and layer 3 filtering related parameters are configured prior to the start of time period T1.</p> <p>Note 6: The signal contains PDCCH for UEs other than the device under test as part of OCNG.</p> <p>Note 7: SNR levels correspond to the signal to noise ratio over the REs carrying CSI-RS.</p> <p>Note 8: The SNR in time periods T1, T2, T3, T4 and T5 is denoted as SNR1, SNR2 and SNR3 respectively in figure A.4.5.5.1.1-1.</p> <p>Note 9: The SNR values are specified for testing a UE which supports 2RX on at least one band. For testing of a UE which supports 4RX on all bands, the SNR during T3 is modified as specified in clause A.3.6.</p>							

Table A.6.5.5.3.1-4: Void

Table A.6.5.5.3.1-5: Void

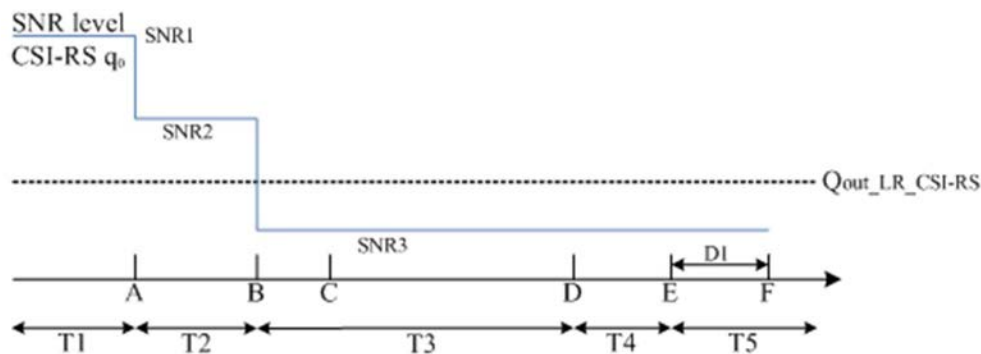

Figure A.6.5.5.3.1-1: SNR variation for CSI-RS-based beam failure detection and link recovery testing in non-DRX mode

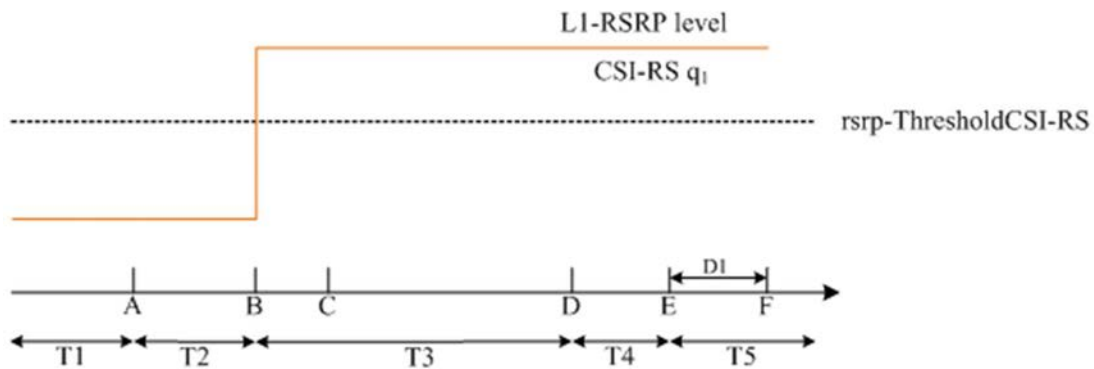

Figure A.6.5.5.3.1-2: L1-RSRP level variation for CSI-RS based beam failure detection and link recovery testing in non-DRX mode

A.6.5.5.3.2 Test Requirements

The UE behaviour during time durations T1, T2, T3, T4 and T5 shall be as follows:

During the time duration T1 and T2, the UE shall transmit uplink signal at least in all subframes configured for CSI transmission on Cell 1.

During the period from time point A to time point B the UE shall transmit uplink signal in Cell 1 in all uplink slots configured for CSI transmission according to the configured periodic CSI reporting for Cell 1.

During T3 the UE shall detect beam failure and initiate link recovery. During T4 and T5 the UE measures and evaluates beam candidate from beam candidate set q_1 .

No later than time point F occurring no later than $D1 = 30+20$ ms after the start of T5, the UE shall transmit preamble on a beam associated with the candidate beam set q_1 . The UE shall not transmit preamble on a beam associated with the candidate beam set q_1 earlier than time point B.

Test is concluded once the test equipment has received the initial preamble transmission from the UE. The rate of correct events observed during repeated tests shall be at least 90%.

A.6.5.5.4 Beam Failure Detection and Link Recovery Test for FR1 PCell configured with CSI-RS-based BFD and LR in DRX mode

A.6.5.5.4.1 Test Purpose and Environment

The purpose of this test is to verify that the UE properly detects CSI-RS-based beam failure in the set q_0 configured for a serving cell and that the UE performs correct CSI-RS-based link recovery based on beam candidate set q_1 . The purpose is to test the downlink monitoring for beam failure detection within the UE's active DL BWP, during the evaluation period, and link recovery, when DRX is used. This test will partly verify the CSI-RS based beam failure detection and link recovery for an FR1 serving cell requirements in clause 8.5.

The test parameters are given in Tables A.6.5.5.4.1-1, A.6.5.5.4.1-2, A.6.5.5.4.1-3, and A.6.5.5.4.1-4 below. There is one cell, cell 1 which is the active cell, in the test. The test consists of five successive time periods, with time duration of T1, T2, T3, T4 and T5 respectively. Figure A.6.5.5.4.1-1 shows the variation of the downlink SNR of the CSI-RS in set q_0 in the active cell to emulate CSI-RS based beam failure. Figure A.6.5.5.4.1-2 shows the variation of the downlink L1-RSRP of the CSI-RS in set q_1 of the candidate beam used for link recovery. Prior to the start of the time duration T1, the UE shall be fully synchronized to cell 1. The UE shall be configured for periodic CSI reporting with a reporting periodicity of 5 ms. In the test, DRX configuration is enabled in PCell and DRX inactivity timer has already been expired, i.e. UE tries to decode PDCCH and to send periodic CQI during the period when On-duration timer is running. Time alignment timers shall be set to "infinity" so that UL timing alignment is maintained during the test.

Table A.6.5.5.4.1-1: Supported test configurations for FR1 PCell

Configuration	Description
1	FDD duplex mode, 15 kHz SSB SCS, 10 MHz bandwidth
2	TDD duplex mode, 15 kHz SSB SCS, 10 MHz bandwidth
3	TDD duplex mode, 30 kHz SSB SCS, 40 MHz bandwidth
Note:	The UE is only required to pass in one of the supported test configurations in FR1

Table A.6.5.5.4.1-2: General test parameters for FR1 PCell for CSI-RS-based beam failure detection and link recovery testing in DRX mode

Parameter		Unit	Value	Comment
			Test 1	
Active PCell			Cell 1	
RF Channel Number			1	
Duplex mode	Config 1		FDD	
	Config 2, 3		TDD	
TDD Configuration	Config 1		Not Applicable	
	Config 2		TDDConf.1.1	
	Config 3		TDDConf..21	
RMSI CORESET Reference Channel	Config 1		CR.1.1 FDD	A.3.1.2
	Config 2		CR.1.1 TDD	
	Config 3		CR.2.1 TDD	
Dedicated CORESET Reference Channel	Config 1		CCR.1.1 FDD	A.3.1.3
	Config 2		CCR.1.1 TDD	
	Config 3		CCR.2.1 TDD	
SSB Configuration	Config 1		SSB.3 FR1	A.3.10
	Config 2		SSB.3 FR1	
	Config 3		SSB.4 FR1	
SMTC Configuration	Config 1, 2		SMTC.1	A.3.11
	Config 3		SMTC.1	
PDSCH/PDCC H subcarrier spacing	Config 1, 2		15 KHz	
	Config 3		30 KHz	
PRACH Configuration	Config 1, 2, 3		FR1 PRACH configuration 4	A.3.8.2
csi-RS-Index assigned as beam failure detection RS in set q_0			0	
OCNG parameters			OP.1	A.3.2.1
CP length			Normal	
Correlation Matrix and Antenna Configuration			2x2 Low	
Beam failure detection transmission parameters	DCI format		1-0	
	Number of Control OFDM symbols		2	
	Aggregation level	CCE	8	
	Ratio of hypothetical PDCCH RE energy to average CSI-RS RE energy	dB	0	

	Ratio of hypothetical PDCCH DMRS energy to average CSI-RS RE energy	dB	0	
	DMRS precoder granularity		REG bundle size	
	REG bundle size		6	
DRX			DRX.7	A.3.3.7
Gap pattern ID			N.A.	
csi-RS-Index assigned as candidate beam detection RS in set q_1			1	
rlmInSyncOutOfSyncThreshold			absent	When the field is absent, the UE applies the value 0. (Table 8.1.1-1).
rsrp-ThresholdCSI-RS	Config 1, 2	dBm/	-98	Threshold used for $Q_{in_LR_CSI-RS}$
	Config 3	SCS kHz	-95	
powerControlOffsetSS			db0	Used for deriving rsrp-ThresholdCSI-RS
beamFailureInstanceMaxCount			n1	see clause 5.17 of TS 38.321 [7]
beamFailureDetectionTimer			pbfd4	see clause 5.17 of TS 38.321 [7]
CSI-RS configuration for q_0 and q_1	Config 1		CSI-RS.1.2 FDD	A.3.14.1
	Config 2		CSI-RS.1.2 TDD	
	Config 3		CSI-RS.2.2 TDD	
CSI-RS configuration for CSI reporting	Config 1		CSI-RS.1.1 FDD	A.3.14.1
	Config 2		CSI-RS.1.1 TDD	
	Config 3		CSI-RS.2.1 TDD	
TRS configuration	Config 1		TRS.1.1 FDD	
	Config 2		TRS.1.1 TDD	
	Config 3		TRS.1.2 TDD	
CSI-RS-Index assigned as RLM RS	Config 1		CSI-RS.1.2 FDD	
	Config 2		CSI-RS.1.2 TDD	
	Config 3		CSI-RS.2.2 TDD	
T310 Timer		ms	1000	
N310			2	
T1		s	1	During this time the the UE shall be fully synchronized to cell 1
T2		s	8.37	
T3		s	6.44	
T4		s	0	
T5		s	1.97	
D1		s	1.94	
Note 1: UE-specific PDCCH is not transmitted after T1 starts.				

Table A.6.5.5.4.1-3: Cell specific test parameters for FR1 PCell for CSI-RS-based beam failure detection and link recovery testing in DRX mode

Parameter		Unit	Test 1				
			T1	T2	T3	T4	T5
EPRE ratio of PDCCH DMRS to SSS		dB	0				
EPRE ratio of PDCCH to PDCCH DMRS		dB					
EPRE ratio of PBCH DMRS to SSS		dB					
EPRE ratio of PBCH to PBCH DMRS		dB					
EPRE ratio of PSS to SSS		dB					
EPRE ratio of PDSCH DMRS to SSS		dB					
EPRE ratio of PDSCH to PDSCH DMRS		dB					
EPRE ratio of OCNG DMRS to SSS		dB					
EPRE ratio of OCNG to OCNG DMRS		dB					
SNR_CSI-RS of set q_0	Config 1	dB	5	-3	-12	-12	-12
	Config 2		5	-3	-12	-12	-12
	Config 3		5	-3	-12	-12	-12
SNR_CSI-RS of set q_1	Config 1	dB	-10	-10	10	10	10
	Config 2		-10	-10	10	10	10
	Config 3		-10	-10	10	10	10
CSI-RS_RP of set q_1	Config 1	dB/ SCS kHz	-108	-108	-88	-88	-88
	Config 2		-108	-108	-88	-88	-88
	Config 3		-105	-105	-85	-85	-85
N_{oc}	Config 1	dBm/15 KHz	-98				
	Config 2		-98				
	Config 3		-98				
Propagation condition			TDL-C 300ns 100Hz				
<p>Note 1: OCNG shall be used such that the resources in Cell 1 are fully allocated and a constant total transmitted power spectral density is achieved for all OFDM symbols.</p> <p>Note 2: The uplink resources for CSI reporting are assigned to the UE prior to the start of time period T1.</p> <p>Note 3: NZP CSI-RS resource set configuration for CSI reporting are assigned to the UE prior to the start of time period T1.</p> <p>Note 4: Void</p> <p>Note 5: The timers and layer 3 filtering related parameters are configured prior to the start of time period T1.</p> <p>Note 6: The signal contains PDCCH for UEs other than the device under test as part of OCNG.</p> <p>Note 7: SNR levels correspond to the signal to noise ratio over the REs carrying CSI-RS.</p> <p>Note 8: The SNR in time periods T1, T2, T3, T4 and T5 is denoted as SNR1, SNR2 and SNR3 respectively in figure A.4.5.5.1.1-1.</p> <p>Note 9: The SNR values are specified for testing a UE which supports 2RX on at least one band. For testing of a UE which supports 4RX on all bands, the SNR during T3 is modified as specified in clause A.3.6.</p>							

Table A.6.5.5.4.1-4: Void**Table A.6.5.5.4.1-5: Void****Table A.6.5.5.4.1-6: Void**

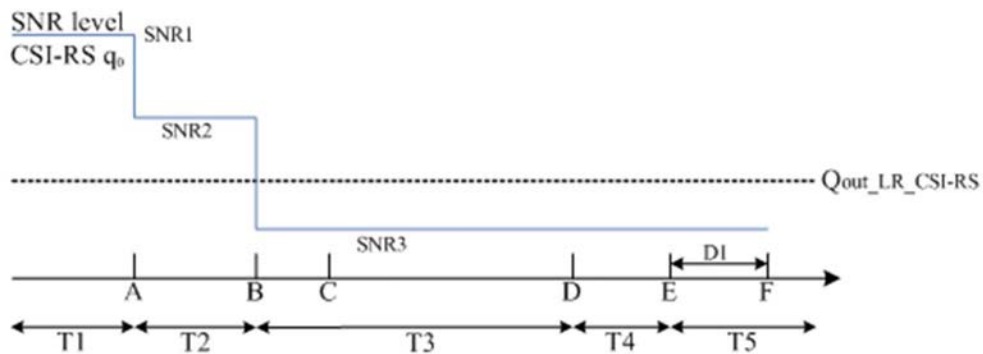

Figure A.6.5.5.4.1-1: SNR variation for CSI-RS-based beam failure detection and link recovery testing in DRX mode

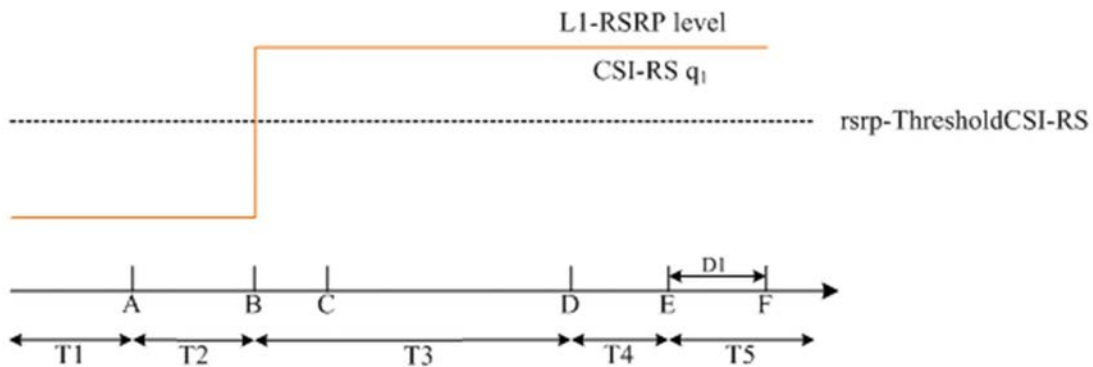

Figure A.6.5.5.4.1-2: L1-RSRP level variation for CSI-RS based beam failure detection and link recovery testing in DRX mode

A.6.5.5.4.2 Test Requirements

The UE behaviour during time durations T1, T2, T3, T4 and T5 shall be as follows:

During the time duration T1 and T2, the UE shall transmit uplink signal at least in all subframes configured for CSI transmission on Cell 1.

During the period from time point A to time point B the UE shall transmit uplink signal in Cell 1 in all uplink slots configured for CSI transmission according to the configured periodic CSI reporting for Cell 1.

During T3 the UE shall detect beam failure and initiate link recovery. During T4 and T5 the UE measures and evaluates beam candidate from beam candidate set q_1 .

No later than time point F occurring no later than $D1 = 1920 + 20$ ms after the start of T5, the UE shall transmit preamble on a beam associated with the candidate beam set q_1 . The UE shall not transmit preamble on a beam associated with the candidate beam set q_1 earlier than time point B.

Test is concluded once the test equipment has received the initial preamble transmission from the UE. The rate of correct events observed during repeated tests shall be at least 90%.

A.6.5.6 Active BWP switch

A.6.5.6.1 DCI-based and Timer-based Active BWP Switch

A.6.5.6.1.1 NR FR1- NR FR1 DL active BWP switch of SCell with non-DRX in SA

A.6.5.6.1.1.1 Test Purpose and Environment

The purpose of this test is to verify the DL BWP switch delay requirement defined in clause 8.6, and interruption requirement on other active serving cell defined in clause 8.2.2.2.5.

The supported test configurations for PCell are shown in Table A.6.5.6.1.1.1-1 below. Supported test configurations for NR SCell are shown in table A.6.5.6.1.1.1-1A below. Test configuration for NR PCell and test configuration for NR SCell are chosen independently. The test scenario comprises of one NR PCell (Cell 1) and one SCell (Cell 2) as given in Table A.6.5.6.1.1.1-2. NR Cell-specific parameters are specified in Table A.6.5.6.1.1.1-3 and Table A.6.5.6.1.1.1-4 below.

PDCCHs indicating new transmissions shall be sent continuously on SCell (Cell 2) to ensure that the UE would have ACK/NACK sending except for the time duration when BWP is switching on Cell 2 and the time duration of T2.

PDCCHs indicating new transmissions shall be sent continuously on PCell (Cell 1) to ensure that the UE will have ACK/NACK sending.

Before the test starts,

- UE is connected to Cell 1 (PCell) on radio channel 1 (PCC), and Cell 2 (SCell) on radio channel 2 (SCC).
- UE is configured with 2 different UE-specific downlink bandwidth parts for SCell, BWP-1 and BWP-2, in Cell 2 before starting the test. BWP-1 and BWP-2 always include bandwidth of the initial DL BWP and SSB.
- UE is configured with 1 UE-specific downlink bandwidth parts the same as initial BWP for PCell, BWP-0 in Cell 1 before starting the test.
- UE is indicated in *firstActiveDownlinkBWP-Id* that the active DL BWP is BWP-1 in SCell.
- UE is indicated in *firstActiveDownlinkBWP-Id* that the active DL BWP is BWP-0 in PCell.
- UE is configured with a *bwp-InactivityTimer* timer value for SCell.

All cells have constant signal levels throughout the test.

The test consists of 3 successive time periods, with durations of T1, T2, and T3, respectively.

During T1,

Time period T1 starts when a DCI format 1_1 command for SCell DL BWP switch, sent from the test equipment to the UE, is received at the UE side in SCell's slot # denoted i . The UE shall switch its bandwidth part from BWP-1 to BWP-2.

The UE shall be able to receive PDSCH no later than the first DL slot that occurs after the beginning of SCell's DL slot ($i+T_{\text{BWPswitchDelay}}$) as defined in clause 8.6 and starts to report valid ACK/NACK for the SCell on PCell no later than the first UL slot that occurs after the beginning of slot ($i+T_{\text{BWPswitchDelay}}+k_1$). The UE shall be continuously scheduled on SCell's BWP-2 no later than the first DL slot that occurs after the beginning of slot ($i+T_{\text{BWPswitchDelay}}$).

The starting time of PCell (Cell 1) interruption due to BWP switch on SCell shall occur within the BWP switch delay.

During T2, the test equipment won't transmit DCI format for PDSCH reception on SCell (Cell 2).

During T3,

The time period T3 starts from the slot # j , where j is the first slot of the subframe immediately after *bwp-InactivityTimer* expires. The UE should switch its bandwidth part from BWP-2 back to the default bandwidth part – BWP-1.

The UE shall be able to receive PDSCH no later than the first DL slot that occurs after the beginning of SCell's slot ($j+T_{\text{BWPswitchDelay}}$) as defined in clause 8.6 and starts to report valid ACK/NACK for the SCell on PCell at latest on the first UL slot that occurs after the beginning of slot ($j+T_{\text{BWPswitchDelay}}+k_1$). The UE shall be continuously scheduled on SCell's BWP-1 no later than the first DL slot that occurs after the beginning of slot ($j+T_{\text{BWPswitchDelay}}$).

The starting time of PCell (Cell 1) interruption due to BWP switch of SCell shall occur within the BWP switch delay.

The test equipment verifies the DL BWP switch time in SCell by counting the slots from the time when the BWP switch command is received or *bwp-InactivityTimer* expires till an ACK/NACK is received.

The test equipment verifies that potential interruption to PCell is carried out in the correct time span by monitoring ACK/NACK sent in PCell during BWP switch of SCell, respectively.

Table A.6.5.6.1.1-1: DL BWP switch supported test configurations for NR PCell

Config	Description
1	NR 15 kHz SSB SCS, ≥ 10 MHz bandwidth, FDD duplex mode
2	NR 15 kHz SSB SCS, ≥ 10 MHz bandwidth, TDD duplex mode
3	NR 30 kHz SSB SCS, ≥ 40 MHz bandwidth, TDD duplex mode
Note 1:	The UE is only required to be tested in one of the supported test configurations
Note 2:	The UE is only required to be tested in one with smallest aggregated channel bandwidth from supported band combinations which is composed of CCs \geq the bandwidth (BW_{channel}) defined in each test configuration,

Table A.6.5.6.1.1-1A: DL BWP switch supported test configurations for NR SCell

Config _{SCell}	Description
1	NR 15 kHz SSB SCS, ≥ 10 MHz bandwidth, FDD duplex mode
2	NR 15 kHz SSB SCS, ≥ 10 MHz bandwidth, TDD duplex mode
3	NR 30 kHz SSB SCS, ≥ 40 MHz bandwidth, TDD duplex mode
Note 1:	The UE is only required to be tested in one of the supported test configurations
Note 2:	The UE is only required to be tested in one with smallest aggregated channel bandwidth from supported band combinations which is composed of CCs \geq the bandwidth (BW_{channel}) defined in each test configuration,

Table A.6.5.6.1.1-2: General test parameters for DL BWP switch in SA

Parameter	Unit	Value	Comment
NR RF Channel Number		1, 2	Two NR radio channels are used for this test
Active PCell		Cell 1	PCell on RF channel number 1.
Active SCell		Cell 2	SCell on RF channel number 2.
CP length		Normal	
DRX		OFF	For both PCell and SCell
<i>bwp-InactivityTimer</i>	ms	200	
PDCCH and PDSCH maximum number of HARQ transmission		1	For both PCell and SCell
Cell-individual offset for cells on RF channel number 1	dB	0	Individual offset for cells on PCC.

Cell-individual offset for cells on RF channel number 2	dB	0	Individual offset for cells on SCC.
Cell2 timing offset to cell1	μs	3	Time alignment error as specified in TS 38.104 [13] clause 6.5.3.1.
T1	s	0.2	
T2	s	0.2	
T3	s	0.2	

Table A.6.5.6.1.1-3: NR Cell specific test parameters for NR PCell for DL BWP switch in SA

Parameter		Unit	Cell 1
Frequency Range			FR1
Duplex mode	Config 1		FDD
	Config 2,3		TDD
TDD configuration	Config 1		Not Applicable
	Config 2		TDDConf.1.1
	Config 3		TDDConf.1.2
BW _{channel}	Config 1,2		Note 7
	Config 3		Note 7
BW _{occupied}	Config 1,2	RB	52 ^{Note 5}
	Config 3		106 ^{Note 6}
Active BWP ID			0
Initial DL BWP Configuration			DLBWP.0.2 ^{Note4}
Initial UL BWP Configuration			ULBWP.0.2 ^{Note4}
Active DL BWP-0 Configuration			DLBWP.0.2 ^{Note4}
Active DL BWP-1 Configuration			N.A.
Active DL BWP-2 Configuration			N.A.
Active UL BWP-0 Configuration			ULBWP.0.2 ^{Note4}
Active UL BWP-1 Configuration			N.A.
Active UL BWP-2 Configuration			N.A.
PDSCH Reference measurement channel	Config 1		SR.1.1 FDD
	Config 2		SR.1.1 TDD
	Config 3		SR.2.1 TDD
RMSI CORESET parameters	Config 1		CR.1.1 FDD
	Config 2		CR.1.1 TDD
	Config 3		CR.2.1 TDD
Dedicated CORESET parameters	Config 1		CCR.1.2 FDD
	Config 2		CCR.1.2 TDD
	Config 3		CCR.2.4 TDD
TRS Configuration	Config 1		TRS.1.1 FDD
	Config 2		TRS.1.1 TDD
	Config 3		TRS.1.2 TDD
OCNG Patterns	Config 1,2		OP.1 ^{Note 5}
	Config 3		OP.1 ^{Note 6}
SSB Configuration	Config 1,2		SSB.1 FR1
	Config 3		SSB.2 FR1
SMTC Configuration			SMTC.1
Correlation Matrix and Antenna Configuration			1x2 Low
EPRE ratio of PSS to SSS		dB	0
EPRE ratio of PBCH DMRS to SSS			
EPRE ratio of PBCH to PBCH DMRS			
EPRE ratio of PDCCH DMRS to SSS			
EPRE ratio of PDCCH to PDCCH DMRS			
EPRE ratio of PDSCH DMRS to SSS			

EPRE ratio of PDSCH to PDSCH			
EPRE ratio of OCNG DMRS to SSS(Note 1)			
EPRE ratio of OCNG to OCNG DMRS (Note 1)			
N_{oc} ^{Note 2}	Config 1,2	dBm/SCS	-104
	Config 3		-101
N_{oc} ^{Note 2}		dBm/15KHz	-104
SS-RSRP ^{Note 3}	Config 1,2	dBm/SCS	-87
	Config 3		-84
\dot{E}_s/I_{ot}		dB	17
\dot{E}_s/N_{oc}		dB	17
I_o ^{Note3}	Config 1,2	dBm/ 9.36MHz	-58.96
	Config 3	dBm/ 38.16MHz	-52.86
Propagation Condition			AWGN
<p>Note 1: OCNG shall be used such that both cells are fully allocated and a constant total transmitted power spectral density is achieved for all OFDM symbols.</p> <p>Note 2: Interference from other cells and noise sources not specified in the test is assumed to be constant over subcarriers and time and shall be modelled as AWGN of appropriate power for N_{oc} to be fulfilled within $BW_{occupied}$.</p> <p>Note 3: SS-RSRP and I_o levels have been derived from other parameters for information purposes. They are not settable parameters themselves.</p> <p>Note 4: For unpaired spectrum, a DL BWP is linked with an UL BWP. DLBWP.0.2 is linked with ULBWP.0.2; DLBWP.1.1 is linked with ULBWP.1.1; DLBWP.1.3 is linked with ULBWP.1.3 defined in clause 12 of TS 38.213 [3].</p> <p>Note 5: All UL/DL transmission shall be confined within $BW_{occupied}$ (i.e. 10 MHz, 52 RBs) from $F_{C,low}$, and I_o is independent of the $BW_{channel}$ configured.</p> <p>Note 6: All UL/DL transmission shall be confined within $BW_{occupied}$ (i.e. 40 MHz, 106 RBs) from $F_{C,low}$, and I_o is independent of the $BW_{channel}$ configured.</p> <p>Note 7: $N_{RB,c}$ is derived from Table 5.3.2-1 in TS38.101-1[2] with configured $BW_{channel}$.</p>			

Table A.6.5.6.1.1-4: NR Cell specific test parameters for NR SCell for DL BWP switch in SA

Parameter		Unit	Cell2
Frequency Range			FR1
Duplex mode	Config _{SCell} 1		FDD
	Config _{SCell} 2,3		TDD
TDD configuration	Config _{SCell} 1		Not Applicable
	Config _{SCell} 2		TDDConf.1.1
	Config _{SCell} 3		TDDConf.1.2
$BW_{channel}$	Config _{SCell} 1,2		Note 7
	Config _{SCell} 3		Note 7
$BW_{occupied}$	Config _{SCell} 1,2	RB	52 ^{Note 5}
	Config _{SCell} 3		106 ^{Note 6}
Active BWP ID			1, 2
Initial DL BWP Configuration			DLBWP.0.2 ^{Note4}
Initial UL BWP Configuration			N.A.
Active DL BWP-0 Configuration			N.A.
Active DL BWP-1 Configuration			DLBWP.1.1 ^{Note4}
Active DL BWP-2 Configuration			DLBWP.1.3 ^{Note4}
Active UL BWP-0 Configuration			N.A.
Active UL BWP-1 Configuration			N.A.
Active UL BWP-2 Configuration			N.A.

PDSCH Reference measurement channel	Config _{SCell} 1		SR.1.1 FDD
	Config _{SCell} 2		SR.1.1 TDD
	Config _{SCell} 3		SR.2.1 TDD
RMSI CORESET parameters	Config _{SCell} 1		CR.1.1 FDD
	Config _{SCell} 2		CR.1.1 TDD
	Config _{SCell} 3		CR.2.1 TDD
Dedicated CORESET parameters	Config _{SCell} 1		CCR.1.2 FDD
	Config _{SCell} 2		CCR.1.2 TDD
	Config _{SCell} 3		CCR.2.4 TDD
TRS Configuration	Config _{SCell} 1		TRS.1.1 FDD
	Config _{SCell} 2		TRS.1.1 TDD
	Config _{SCell} 3		TRS.1.2 TDD
OCNG Patterns	Config _{SCell} 1,2		OP.1 ^{Note 5}
	Config _{SCell} 3		OP.1 ^{Note 6}
SSB Configuration	Config _{SCell} 1,2		SSB.1 FR1
	Config _{SCell} 3		SSB.2 FR1
SMT C Configuration			SMT C.1
Correlation Matrix and Antenna Configuration			1x2 Low
EPRE ratio of PSS to SSS		dB	0
EPRE ratio of PBCH DMRS to SSS			
EPRE ratio of PBCH to PBCH DMRS			
EPRE ratio of PDCCH DMRS to SSS			
EPRE ratio of PDCCH to PDCCH DMRS			
EPRE ratio of PDSCH DMRS to SSS			
EPRE ratio of PDSCH to PDSCH			
EPRE ratio of OCNG DMRS to SSS ^{Note 1}			
EPRE ratio of OCNG to OCNG DMRS ^{Note 1}			
N _{oc} ^{Note 2}	Config _{SCell} 1,2	dBm/SCS	-104
	Config _{SCell} 3		-101
N _{oc} ^{Note 2}		dBm/15KHz	-104
SS-RSRP ^{Note 3}	Config _{SCell} 1,2	dBm/SCS	-87
	Config _{SCell} 3		-84
\dot{E}_s/I_{ot}		dB	17
\dot{E}_s/N_{oc}		dB	17
I _o ^{Note 3}	Config _{SCell} 1,2	dBm/ 9.36MHz	-58.96
	Config _{SCell} 3		-52.86
Propagation Condition			AWGN
Note 1:	OCNG shall be used such that both cells are fully allocated and a constant total transmitted power spectral density is achieved for all OFDM symbols.		
Note 2:	Interference from other cells and noise sources not specified in the test is assumed to be constant over subcarriers and time and shall be modelled as AWGN of appropriate power for N _{oc} to be fulfilled within BW _{occupied} .		
Note 3:	SS-RSRP and I _o levels have been derived from other parameters for information purposes. They are not settable parameters themselves.		
Note 4:	For unpaired spectrum, a DL BWP is linked with an UL BWP. DLBWP.0.2 is linked with ULBWP.0.2; DLBWP.1.1 is linked with ULBWP.1.1; DLBWP.1.3 is linked with ULBWP.1.3 defined in clause 12 of TS 38.213 [3].		
Note 5:	All UL/DL transmission shall be confined within BW _{occupied} (i.e. 10 MHz, 52 RBs) from F _{C,low} , and I _o is independent of the BW _{channel} configured.		
Note 6:	All UL/DL transmission shall be confined within BW _{occupied} (i.e. 40 MHz, 106 RBs) from F _{C,low} , and I _o is independent of the BW _{channel} configured.		
Note 7:	N _{RB,c} is derived from Table 5.3.2-1 in TS38.101-1[2] with configured BW _{channel} .		

A.6.5.6.1.1.2 Test Requirements

During T1, the UE shall start to send the ACK/NACK for SCell on PCell from the first UL slot that occurs after the beginning of DL slot ($i + T_{\text{BWPswitchDelay}} + k_1$).

During T3, the UE shall start to send the ACK/NACK for SCell on PCell from the first UL slot that occurs after the beginning of DL slot ($j + T_{\text{BWPswitchDelay}} + k_1$).

Where, k_1 is the timing between DL data receiving and acknowledgement as specified in [7].

Depending on UE capability *bwp-SwitchingDelay* [2], UE shall finish BWP switch within the time duration $T_{\text{BWPswitchDelay}}$ defined in Table 8.6.2-1.

All of the above test requirements shall be fulfilled in order for the observed SCell active BWP switch delay to be counted as correct.

The rate of correct events observed during repeated tests shall be at least 90%.

During T1 and T3, the start time of PCell interruption during SCell active BWP switch shall not happen outside the BWP switch delay.

The interruption of PCell shall not be longer than the interruption duration specified for active BWP switch in clause 8.2.2.2.5.

All of the above test requirements shall be fulfilled in order for the observed SCell active BWP switch interruption to be counted as correct.

The rate of correct events observed during repeated tests shall be at least 90%.

NOTE: During T1, T3 if there are no uplink resources for reporting the ACK/NACK in the first UL slot that occurs after the beginning of DL slot ($i + T_{\text{BWPswitchDelay}} + k_1$), ($j + T_{\text{BWPswitchDelay}} + k_1$), then the UE shall use the next available uplink resource for reporting the corresponding ACK/NACK.

A.6.5.6.1.2 NR FR1 DL active BWP switch with non-DRX in SA

A.6.5.6.1.2.1 Test Purpose and Environment

The purpose of this test is to verify the DL BWP switch delay requirement defined in clause 8.6.

The supported test configurations are shown in Table A.6.5.6.1.2.1-1. The test scenario comprises of one cell (Cell 1) as given in Table A.6.5.6.1.2.1-2. Cell-specific parameters of the cell are specified in Table A.6.5.6.1.2.1-3 below.

PDCCHs indicating new transmissions shall be sent continuously on Cell 1 to ensure that the UE will have ACK/NACK sending.

Before the test starts,

- UE is connected to Cell 1 on radio channel 1.
- UE is configured with 2 different UE-specific downlink bandwidth parts, BWP-1 and BWP-2 before starting the test. BWP-1 and BWP-2 always include bandwidth of the initial DL BWP and SSB.
- UE is indicated in *firstActiveDownlinkBWP-Id* that the active DL BWP is BWP-1.
- UE is configured with a *bwp-InactivityTimer* timer value for Cell1.

The cell has constant signal levels throughout the test.

The test consists of 3 successive time periods, with durations of T1, T2, and T3, respectively.

During T1,

Time period T1 starts when a DCI format 1_1 command for DL BWP switch, sent from the test equipment to the UE, is received at the UE side in Cell1's slot # denoted i . The UE shall switch its bandwidth part from BWP-1 to BWP-2.

The UE shall be able to receive PDSCH on the first DL slot that occurs after the beginning of Cell1's DL slot ($i+T_{BWPswitchDelay}$) as defined in clause 8.6 and starts to report valid ACK/NACK for the Cell1 no later than the first UL slot that occurs after the beginning of slot ($i+T_{BWPswitchDelay}+kI$). The UE shall be continuously scheduled on Cell1's BWP-2 starting from the first DL slot that occurs after the beginning of slot ($i+T_{BWPswitchDelay}$).

During T2, the test equipment won't transmit DCI format for PDSCH reception on Cell1.

During T3,

The time period T3 starts from the slot # j , where j is the first slot of the subframe immediately after *bwp-InactivityTimer* timer expires. The UE shall switch its bandwidth part from BWP-2 back to the default bandwidth part – BWP-1.

The UE shall be able to receive PDSCH on the first DL slot that occurs after the beginning of Cell1's slot ($j+T_{BWPswitchDelay}$) as defined in clause 8.6 and starts to report valid ACK/NACK for the Cell1 at latest on the first UL slot that occurs after the beginning of slot ($j+T_{BWPswitchDelay}+kI$). The UE shall be continuously scheduled on Cell1's BWP-1 starting from the first DL slot that occurs after the beginning of slot ($j+T_{BWPswitchDelay}$).

The test equipment verifies the DL BWP switch time by counting the slots from the time when the BWP switch command is received or *bwp-InactivityTimer* timer expires till an ACK/NACK is received.

Table A.6.5.6.1.2.1-1: DL BWP switch supported test configurations

Config	Description
1	NR 15 kHz SSB SCS, 10 MHz bandwidth, FDD duplex mode
2	NR 15 kHz SSB SCS, 10 MHz bandwidth, TDD duplex mode
3	NR 30 kHz SSB SCS, 40 MHz bandwidth, TDD duplex mode
Note 1:	The UE is only required to be tested in one of the supported test configurations.
Note 2:	A UE which fulfils the requirements in test case A.6.5.6.1.1 can skip the test cases in A.6.5.6.1.2.

Table A.6.5.6.1.2.1-2: General test parameters for DL BWP switch in SA

Parameter	Unit	Value	Comment
NR RF Channel Number		1	One NR radio channel is used for this test
Active Cell		Cell 1	Cell1 on RF channel number 1.
CP length		Normal	
DRX		OFF	
<i>bwp-InactivityTimer</i>	ms	200	
PDCCH and PDSCH maximum number of HARQ transmission		1	
T1	s	0.2	
T2	s	0.2	
T3	s	0.2	

Table A.6.5.6.1.2.1-3: NR Cell specific test parameters for DL BWP switch in SA

Parameter	Unit	Cell 1
Frequency Range		FR1
Duplex mode	Config 1	FDD
	Config 2,3	TDD
TDD configuration	Config 1	Not Applicable

	Config 2		TDDConf.1.1
	Config 3		TDDConf.2.1
BW _{channel}	Config 1		10 MHz: N _{RB,c} = 52
	Config 2		10 MHz: N _{RB,c} = 52
	Config 3		40 MHz: N _{RB,c} = 106
Active BWP ID			1, 2
Initial DL BWP Configuration	Config 1,2,3		DLBWP.0.2 ^{Note 4}
Active DL BWP-1 Configuration	Config 1,2,3		DLBWP.1.1 ^{Note 4}
Active DL BWP-2 Configuration	Config 1,2,3		DLBWP.1.3 ^{Note 4}
Initial UL BWP Configuration	Config 1,2,3		ULBWP.0.2 ^{Note 4}
Active UL BWP-1 Configuration	Config 1,2,3		ULBWP.1.1 ^{Note 4}
Active UL BWP-2 Configuration	Config 1		N/A
	Config 2,3		ULBWP.1.3 ^{Note 4}
PDSCH Reference measurement channel	Config 1		SR.1.1 FDD
	Config 2		SR.1.1 TDD
	Config 3		SR.2.1 TDD
RMSI CORESET parameters	Config 1		CR.1.1 FDD
	Config 2		CR.1.1 TDD
	Config 3		CR.2.1 TDD
Dedicated CORESET parameters	Config 1		CCR.1.2 FDD
	Config 2		CCR.1.2 TDD
	Config 3		CCR.2.4 TDD
OCNG Patterns			OP.1
SSB Configuration	Config 1,2		SSB.1 FR1
	Config 3		SSB.2 FR1
SMTC Configuration			SMTC.1
Correlation Matrix and Antenna Configuration			1x2 Low
TRS Configuration	Config 1,4		TRS.1.1 FDD
	Config 2,5		TRS.1.1 TDD
	Config 3,6		TRS.1.2 TDD
EPRE ratio of PSS to SSS		dB	0
EPRE ratio of PBCH DMRS to SSS			
EPRE ratio of PBCH to PBCH DMRS			
EPRE ratio of PDCCH DMRS to SSS			
EPRE ratio of PDCCH to PDCCH DMRS			
EPRE ratio of PDSCH DMRS to SSS			
EPRE ratio of PDSCH to PDSCH			
EPRE ratio of OCNG DMRS to SSS(Note 1)			
EPRE ratio of OCNG to OCNG DMRS (Note 1)			
N _{oc} ^{Note 2}	Config 1,2	dBm/SCS	-104
	Config 3		-101
N _{oc} ^{Note 2}		dBm/15kHz	-104
SS-RSRP ^{Note 3}	Config 1,2	dBm/SCS	-87
	Config 3		-84
\hat{E}_s/I_{ot}		dB	17
\hat{E}_s/N_{oc}		dB	17
I _o ^{Note3}	Config 1,2	dBm/9.36MHz	-58.96

	Config 3	dBm/ 38.16MHz	-52.86
Propagation Condition			AWGN
Note 1:	OCNG shall be used such that both cells are fully allocated and a constant total transmitted power spectral density is achieved for all OFDM symbols.		
Note 2:	Interference from other cells and noise sources not specified in the test is assumed to be constant over subcarriers and time and shall be modelled as AWGN of appropriate power for N_{oc} to be fulfilled.		
Note 3:	SS-RSRP and I_{o} levels have been derived from other parameters for information purposes. They are not settable parameters themselves.		
Note 4:	For unpaired spectrum, a DL BWP is linked with an UL BWP. DLBWP.0.2 is linked with ULBWP.0.2; DLBWP.1.1 is linked with ULBWP.1.1; DLBWP.1.3 is linked with ULBWP.1.3 defined in clause 12 of TS 38.213 [3].		

A.6.5.6.1.2.2 Test Requirements

During T1, the UE shall start to send the ACK/NACK for PCell from the first UL slot that occurs after the beginning of DL slot $(i+T_{BWPswitchDelay}+kI)$.

During T3, the UE shall start to send the ACK/NACK for PCell from the first UL slot that occurs after the beginning of DL slot $(j+T_{BWPswitchDelay}+kI)$.

Where, kI is the timing between DL data receiving and acknowledgement as specified in [7].

Depending on UE capability *bwp-SwitchingDelay* [2], UE shall finish BWP switch within the time duration $T_{BWPswitchDelay}$ defined in Table 8.6.2-1.

All of the above test requirements shall be fulfilled in order for the observed Cell1 active BWP switch delay to be counted as correct.

The rate of correct events observed during repeated tests shall be at least 90%.

NOTE: During T1, T3 if there are no uplink resources for reporting the ACK/NACK in the first UL slot that occurs after beginning of DL slot $(i+T_{BWPswitchDelay}+kI)$, $(j+T_{BWPswitchDelay}+kI)$, then the UE shall use the next available uplink resource for reporting the corresponding ACK/NACK.

A.6.5.6.2 RRC-based Active BWP Switch

A.6.5.6.2.1 NR FR1 DL active BWP switch of Cell with non-DRX in SA

A.6.5.6.2.1.1 Test Purpose and Environment

The purpose of this test is to verify the DL BWP switch delay requirement for RRC-based BWP switch defined in clause 8.6.

The supported test configurations are shown in Table A.6.5.6.2.1.1-1. The test scenario comprises of one Cell (Cell 1) as given in Table A.6.5.6.2.1.1-2. Cell-specific parameters of Cell are specified in Table A.6.5.6.2.1.1-3 below.

PDCCHs indicating new transmissions shall be sent continuously on Cell 1 to ensure that the UE will have ACK/NACK sending.

Before the test starts,

- UE is connected to Cell 1 on radio channel 1.
- UE has bandwidth part BWP-1 in its RRC-configuration for Cell 1.
- UE is indicated in *firstActiveDownlinkBWP-Id* that the active DL BWP is BWP-1 of initial condition in Cell 1.

All cells have constant signal levels throughout the test.

The test consists of 1 time period, with duration of T1.

During T1,

Time period T1 starts when a *RRCReconfiguration* with updated bandwidth part configuration, sent from the test equipment to the UE, is completely received at the UE side in Cell's slot # denoted *i*. The UE shall reconfigure its bandwidth part with the updated bandwidth part BWP-1 of final condition.

The UE shall be able to receive PDSCH on PCell from the first DL slot that occurs after the beginning of DL slot *i* + $\frac{T_{RRCprocessingDelay} + T_{BWPswitchDelayRRC}}{NR\ Slot\ length}$ as defined in clause 8.6.3 and starts to report valid ACK/NACK for the PCell from the first UL slot that occurs after the beginning of DL slot *i* + $\frac{T_{RRCprocessingDelay} + T_{BWPswitchDelayRRC}}{NR\ Slot\ length} + k1$ on BWP-1 of final condition. The UE shall be continuously scheduled on PCell's BWP-1 starting from the the first DL slot that occurs after the beginning of DL slot *i* + $\frac{T_{RRCprocessingDelay} + T_{BWPswitchDelayRRC}}{NR\ Slot\ length}$.

$T_{RRCprocessingDelay}$ and $T_{BWPswitchDelayRRC}$ are defined in clause 8.6.3.

The test equipment verifies the DL BWP switch time in PCell by counting the time from the time when the RRC Reconfiguration message including updated BWP configuration is sent till the time when a valid ACK/NACK is received.

Table A.6.5.6.2.1.1-1: DL BWP switch supported test configurations in SA scenario

Config	Description
1	NR 15 kHz SSB SCS, 10 MHz bandwidth, FDD duplex mode
2	NR 15 kHz SSB SCS, 10 MHz bandwidth, TDD duplex mode
3	NR 30 kHz SSB SCS, 40 MHz bandwidth, TDD duplex mode
Note 1: The UE is only required to be tested in one of the supported test configurations	

Table A.6.5.6.2.1.1-2: General test parameters for DL BWP switch in SA scenario

Parameter	Unit	Value	Comment
NR RF Channel Number		1	One NR radio channel is used for this test
Active Cell		Cell 1	Cell on RF channel number 1.
CP length		Normal	
DRX		OFF	
PDCCH and PDSCH maximum number of HARQ transmission		1	
T1	s	0.2	

Table A.6.5.6.2.1.1-3: NR Cell specific test parameters for DL BWP switch in SA scenario

Parameter	Unit	Cell 1
Frequency Range		FR1
Duplex mode	Config 1	FDD
	Config 2,3	TDD
TDD configuration	Config 1	Not Applicable
	Config 2	TDDConf.1.1
	Config 3	TDDConf.2.1
BW _{channel}	Config 1	10 MHz: N _{RB,c} = 52
	Config 2	10 MHz: N _{RB,c} = 52
	Config 3	40 MHz: N _{RB,c} = 106
Active BWP ID		1

Initial DL BWP Configuration		Config 1, 2, 3		DLBWP.0.2
Initial UL BWP Configuration		Config 1, 2, 3		ULBWP.0.2
Initial Condition	Active DL BWP-1 Configuration	Config 1, 2, 3		DLBWP.1.3
	Active UL BWP-1 Configuration	Config 1, 2, 3		ULBWP.1.3
Final Condition	Active DL BWP-1 Configuration	Config 1, 2, 3		DLBWP.1.1
	Active UL BWP-1 Configuration	Config 1, 2, 3		ULBWP.1.1
PDSCH Reference measurement channel		Config 1		SR.1.1 FDD
		Config 2		SR.1.1 TDD
		Config 3		SR2.1 TDD
RMSI CORESET parameters		Config 1		CR.1.1 FDD
		Config 2		CR.1.1 TDD
		Config 3		CR2.1 TDD
Dedicated CORESET parameters		Config 1		CCR.1.2 FDD
		Config 2		CCR.1.2 TDD
		Config 3		CCR.2.4 TDD
OCNG Patterns				OP.1
SSB Configuration		Config 1,2		SSB.1 FR1
		Config 3		SSB.2 FR1
SMTTC Configuration				SMTTC.1
TRS Configuration		Config 1		TRS.1.1 FDD
		Config 2		TRS.1.1 TDD
		Config 3		TRS.1.2 TDD
Antenna Configuration				1x2 Low
Propagation Condition				AWGN
EPRE ratio of PSS to SSS		dB		0
EPRE ratio of PBCH DMRS to SSS				
EPRE ratio of PBCH to PBCH DMRS				
EPRE ratio of PDCCH DMRS to SSS				
EPRE ratio of PDCCH to PDCCH DMRS				
EPRE ratio of PDSCH DMRS to SSS				
EPRE ratio of PDSCH to PDSCH				
EPRE ratio of OCNG DMRS to SSS ^(Note 1)				
EPRE ratio of OCNG to OCNG DMRS ^(Note 1)				
N_{oc} ^{Note 2}		Config 1,2	dBm/SCS	-104
		Config 3		-101
SS-RSRP ^{Note 3}		Config 1,2	dBm/SCS	-87
		Config 3		-84
\bar{E}_s/I_{ot}			dB	17
\bar{E}_s/N_{oc}			dB	17
I_{o} ^{Note3}		Config 1,2	dBm/ 9.36MHz	-58.96
		Config 3	dBm/ 38.16MHz	-52.86

Note 1:	OCNG shall be used such that both cells are fully allocated and a constant total transmitted power spectral density is achieved for all OFDM symbols.
Note 2:	Interference from other cells and noise sources not specified in the test is assumed to be constant over subcarriers and time and shall be modelled as AWGN of appropriate power for N_{oc} to be fulfilled.
Note 3:	SS-RSRP and I_0 levels have been derived from other parameters for information purposes. They are not settable parameters themselves.
Note 4:	For unpaired spectrum, a DL BWP is linked with an UL BWP. DLBWP.0.2 is linked with ULBWP.0.2; DLBWP.1.1 is linked with ULBWP.1.1; DLBWP.1.3 is linked with ULBWP.1.3 defined in clause 12 of TS 38.213 [3].

A.6.5.6.2.1.2 Test Requirements

During T1, the UE shall be ready for the reception of uplink grant for the PCell from the first DL slot that occurs right after the beginning of slot $i + \frac{T_{RRCprocessingDelay} + T_{BWPswitchDelayRRC}}{NR\ Slot\ length}$ and starts to report valid ACK/NACK for PCell from the first UL slot that occurs after the beginning of DL slot $i + \frac{T_{RRCprocessingDelay} + T_{BWPswitchDelayRRC}}{NR\ Slot\ length} + k1$.

Where, $k1$ is the timing between DL data receiving and acknowledgement as specified in [7].

All of the above test requirements shall be fulfilled in order for the observed Cell active BWP switch delay to be counted as correct.

The rate of correct events observed during repeated tests shall be at least 90%.

A.6.6 Measurement procedure

A.6.6.1 Intra-frequency Measurements

A.6.6.1.1 SA event triggered reporting tests without gap under non-DRX

A.6.6.1.1.1 Test purpose and Environment

The purpose of this test is to verify that the UE makes correct reporting of an event. This test will partly verify the intra-frequency cell search requirements in clauses 9.2.5.1 and 9.2.5.2.

A.6.6.1.1.2 Test parameters

Two cells are deployed in the test, which are FR1 PCell (Cell 1) and a FR1 neighbour cell (Cell 2) on the same frequency as the PCell. The test parameters for PCell and neighbour cell are given in Table A.6.6.1.1.1-1 and A.6.6.1.1.1-2 below. In the measurement control information, a measurement object is configured for the frequency of the PCell, and it is indicated to the UE that event-triggered reporting with Event A3 is used. The test consists of two successive time periods, with time duration of T1, and T2 respectively. During time duration T1, the UE shall not have any timing information of Cell 2.

Table A.6.6.1.1.2-1: Supported test configurations

Configuration	Description
1	15 kHz SSB SCS, 10 MHz bandwidth, FDD duplex mode
2	15 kHz SSB SCS, 10 MHz bandwidth, TDD duplex mode
3	30 kHz SSB SCS, 40 MHz bandwidth, TDD duplex mode
Note:	The UE is only required to be tested in one of the supported test configurations.

Table A.6.6.1.1.2-2: General test parameters for SA intra-frequency event triggered reporting without gap for FR1

Parameter	Unit	Test configuration	Value	Comment
Active cell		1, 2, 3	Cell 1	
Neighbour cell		1, 2, 3	Cell 2	Cell to be identified.
RF Channel Number		1, 2, 3	1: Cell 1 and Cell 2	
SSB configuration		1	SSB.1 FR1	
		2	SSB.1 FR1	
		3	SSB.2 FR1	
SMTC configuration		1	SMTC.2	
		2	SMTC.1	
		3	SMTC.1	
A3-Offset	dB	1, 2, 3	-4.5	
CP length		1, 2, 3	Normal	
Hysteresis	dB	1, 2, 3	0	
Time To Trigger	s	1, 2, 3	0	
Filter coefficient		1, 2, 3	0	L3 filtering is not used
DRX		1, 2, 3		OFF
Time offset between serving and neighbour cells		1	3 ms	Asynchronous cells. The timing of Cell 2 is 3ms later than the timing of Cell 1.
		2	3 μ s	Synchronous cells
		3	3 μ s	Synchronous cells
T1	s	1, 2, 3	5	
T2	s	1, 2, 3	5	

Table A.6.6.1.1.2-3: NR Cell specific test parameters for SA intra-frequency event triggered reporting without gap for FR1

Parameter	Unit	Test configuration	Cell 1		Cell 2	
			T1	T2	T1	T2
TDD configuration		1	TN/A		TN/A	
		2	TDDConf.1.1		TDDConf.1.1	
		3	TDDConf.2.1		TDDConf.2.1	
PDSCH RMC configuration		1	SR.1.1 FDD		N/A	
		2	SR.1.1 TDD			
		3	SR.2.1 TDD			
RMSI CORESET RMC configuration		1	CR.1.1 FDD		N/A	
		2	CR.1.1 TDD		N/A	
		3	CR.2.1 TDD		N/A	
Dedicated CORESET RMC configuration		1	CCR.1.1 FDD		N/A	
		2	CCR.1.1 TDD		N/A	
		3	CCR.2.1 TDD		N/A	
OCNG Patterns		1, 2, 3	OP.1		OP.1	
TRS Configuration		1	TRS.1.1 FDD		N/A	
		2	TRS.1.1 TDD		N/A	
		3	TRS.1.2 TDD		N/A	
Initial BWP configuration		1, 2, 3	DLBWP.0.1 ULBWP.0.1		DLBWP.0.1 ULBWP.0.1	
Active DL BWP configuration		1, 2, 3	DLBWP.1.1		DLBWP.1.1	
Active UL BWP configuration		1, 2, 3	ULBWP.1.1		ULBWP.1.1	
RLM-RS		1, 2, 3	SSB		SSB	

N_{oc} Note 2	dBm/SCS	1	-98			
		2	-98			
		3	-95			
N_{oc} Note 2	dBm/15 kHz	1	-98			
		2				
		3				
\hat{E}_s/I_{ot}	dB	1	4	-1.46	-Infinity	-1.46
		2				
		3				
\hat{E}_s/N_{oc}	dB	1	4	4	-Infinity	4
		2				
		3				
SS-RSRP Note 3	dBm/SCS kHz	1	-94	-94	-Infinity	-94
		2	-94	-94	-Infinity	-94
		3	-91	-91	-Infinity	-91
Io	dBm/9.36 MHz	1	-64.60	-62.25	--64.60	-62.25
	dBm/9.36 MHz	2	-64.60	-62.25	--64.60	-62.25
	dBm/38.16 MHz	3	-58.50	-56.16	--58.50	-56.16
Propagation Condition		1, 2, 3	AWGN			
<p>Note 1: The resources for uplink transmission are assigned to the UE prior to the start of time period T2.</p> <p>Note 2: Interference from other cells and noise sources not specified in the test is assumed to be constant over subcarriers and time and shall be modelled as AWGN of appropriate power for N_{oc} to be fulfilled.</p> <p>Note 3: SS-RSRP levels have been derived from other parameters for information purposes. They are not settable parameters themselves.</p>						

A.6.6.1.1.3 Test Requirements

The UE shall send one Event A3 triggered measurement report, with a measurement reporting delay less than 800 ms from the beginning of time period T2. The UE is not required to read the neighbour cell SSB index in this test.

The UE shall not send event triggered measurement reports, as long as the reporting criteria are not fulfilled.

The rate of correct events observed during repeated tests shall be at least 90%.

NOTE: The actual overall delays measured in the test may be up to $2xTTI_{DCCH}$ higher than the measurement reporting delays above because of TTI insertion uncertainty of the measurement report in DCCH.

A.6.6.1.2 SA event triggered reporting tests without gap under DRX

A.6.6.1.2.1 Test purpose and Environment

The purpose of this test is to verify that the UE makes correct reporting of an event. This test will partly verify the intra-frequency cell search requirements in clauses 9.2.5.1 and 9.2.5.2.

A.6.6.1.2.2 Test parameters

Two cells are deployed in the test, which are FR1 PCell (Cell 1) and a FR1 neighbour cell (Cell 2) on the same frequency as the PCell. The test parameters for PCell are given in Table A.6.6.1.2.2-1, A.6.6.1.2.2-2 and A.6.6.1.2.2-3 below. In the measurement control information, a measurement object is configured for the frequency of the PCell, and it is indicated to the UE that event-triggered reporting with Event A3 is used. The test consists of two successive time periods, with time duration of T1, and T2 respectively. During time duration T1, the UE shall not have any timing information of Cell 2.

UE needs to be provided with new Timing Advance Command MAC control element at least once during each time alignment timer period to maintain uplink time alignment. Furthermore UE is allocated with PUSCH resource at every DRX cycle.

Table A.6.6.1.2.2-1: Supported test configurations

Configuration	Description
1	15 kHz SSB SCS, 10 MHz bandwidth, FDD duplex mode
2	15 kHz SSB SCS, 10 MHz bandwidth, TDD duplex mode
3	30 kHz SSB SCS, 40 MHz bandwidth, TDD duplex mode
Note:	The UE is only required to be tested in one of the supported test configurations.

Table A.6.6.1.2.2-2: General test parameters for SA intra-frequency event triggered reporting without gap for PCell in FR1 with DRX

Parameter	Unit	Test configuration	Value		Comment
			Test 1	Test 2	
Active cell		1, 2, 3	Cell 1		
Neighbour cell		1, 2, 3	Cell 2		Cell to be identified.
RF Channel Number		1, 2, 3	1: Cell 1 and Cell 2		
SSB configuration		1	SSB.1 FR1		
		2	SSB.1 FR1		
		3	SSB.2 FR1		
SMTC configuration		1	SMTC.2		
		2	SMTC.1		
		3	SMTC.1		
A3-Offset	dB	1, 2, 3	-4.5		
CP length		1, 2, 3	Normal		
Hysteresis	dB	1, 2, 3	0		
Time To Trigger	s	1, 2, 3	0		
Filter coefficient		1, 2, 3	0		L3 filtering is not used
DRX		1, 2, 3	DRX.1	DRX.7	
Time offset between serving and neighbour cells		1	3 ms		Asynchronous cells. The timing of Cell 2 is 3ms later than the timing of Cell 1.
		2	3 μ s		Synchronous cells
		3	3 μ s		Synchronous cells
T1	s	1, 2, 3	5		
T2	s	1, 2, 3	5	10	

Table A.6.6.1.2.2-3: NR Cell specific test parameters for SA intra-frequency event triggered reporting without gap for PCell in FR1 with DRX

Parameter	Unit	Test configuration	Cell 1		Cell 2	
			T1	T2	T1	T2
TDD configuration		1	TN/A		TN/A	
		2	TDDConf.1.1		TDDConf.1.1	
		3	TDDConf.2.1		TDDConf.2.1	
PDSCH RMC configuration		1	SR.1.1 FDD		N/A	
		2	SR.1.1 TDD			
		3	SR.2.1 TDD			
		1	CR.1.1 FDD		N/A	
		2	CR.1.1 TDD		N/A	

RMSI CORESET RMC configuration		3	CR.2.1 TDD	N/A		
Dedicated CORESET RMC configuration		1	CCR.1.1 FDD	N/A		
		2	CCR.1.1 TDD	N/A		
		3	CCR.2.1 TDD	N/A		
OCNG Patterns		1, 2, 3	OP.1	OP.1		
TRS configuration		1	TRS.1.1 FDD	N/A		
		2	TRS.1.1 TDD	N/A		
		3	TRS.1.2 TDD	N/A		
Initial BWP configuration		1, 2, 3	DLBWP.0.1 ULBWP.0.1	DLBWP.0.1 ULBWP.0.1		
Active DL BWP configuration		1, 2, 3	DLBWP.1.1	DLBWP.1.1		
Active UL BWP configuration		1, 2, 3	ULBWP.1.1	ULBWP.1.1		
RLM-RS		1, 2, 3	SSB	SSB		
N_{oc} Note 2	dBm/SCS	1	-98			
		2	-98			
		3	-95			
N_{oc} Note 2	dBm/15 kHz	1	-98			
		2				
		3				
\hat{E}_s/I_{ot}	dB	1	4	-1.46	-Infinity	-1.46
		2				
		3				
\hat{E}_s/N_{oc}	dB	1	4	4	-Infinity	4
		2				
		3				
SS-RSRP Note 3	dBm/SCS kHz	1	-94	-94	-Infinity	-94
		2	-94	-94	-Infinity	-94
		3	-91	-91	-Infinity	-91
Io	dBm/9.36 MHz	1	-64.60	-62.25	--64.60	-62.25
	dBm/9.36 MHz	2	-64.60	-62.25	--64.60	-62.25
	dBm/38.16 MHz	3	-58.50	-56.16	--58.50	-56.16
Propagation Condition		1, 2, 3	AWGN			
Note 1:	The resources for uplink transmission are assigned to the UE prior to the start of time period T2.					
Note 2:	Interference from other cells and noise sources not specified in the test is assumed to be constant over subcarriers and time and shall be modelled as AWGN of appropriate power for N_{oc} to be fulfilled.					
Note 3:	SS-RSRP levels have been derived from other parameters for information purposes. They are not settable parameters themselves.					

A.6.6.1.2.3 Test Requirements

In test 1, the UE shall send one Event A3 triggered measurement report, with a measurement reporting delay less than 920 ms from the beginning of time period T2. The UE is not required to read the neighbour cell SSB index in this test.

In test 2, the UE shall send one Event A3 triggered measurement report, with a measurement reporting delay less than 6400 ms from the beginning of time period T2. The UE is not required to read the neighbour cell SSB index in this test.

The UE shall not send event triggered measurement reports, as long as the reporting criteria are not fulfilled.

The rate of correct events observed during repeated tests shall be at least 90%.

NOTE: The actual overall delays measured in the test may be up to $2xTTI_{DCCH}$ higher than the measurement reporting delays above because of TTI insertion uncertainty of the measurement report in DCCH.

A.6.6.1.3 SA event triggered reporting tests with per-UE gaps under non-DRX

A.6.6.1.3.1 Test purpose and Environment

The purpose of this test is to verify that the UE makes correct reporting of an event. This test will partly verify the intra-frequency cell search requirements in clause 9.2.6.2 and 9.2.6.3.

A.6.6.1.3.2 Test parameters

Two cells are deployed in the test, which are FR1 PCell (Cell 1) and a FR1 neighbour cell (Cell 2) on the same frequency as the PCell. The test parameters for PCell are given in Table A.6.6.1.3.1-1 and A.6.6.1.3.1-2 below. In the measurement control information, a measurement object is configured for the frequency of the PCell, and it is indicated to the UE that event-triggered reporting with Event A3 is used. The test consists of two successive time periods, with time duration of T1, and T2 respectively. During time duration T1, the UE shall not have any timing information of Cell 2.

There are two BWPs configured in Cell 1, BWP1 which contains the cell defining SSB, and BWP2 which does not contain any SSB of Cell 1. During the whole test, BWP2 is always scheduled as the active BWP for the UE.

Table A.6.6.1.3.2-1: Supported test configurations

Configuration	Description
1	15 kHz SSB SCS, 10 MHz bandwidth, FDD duplex mode
2	15 kHz SSB SCS, 10 MHz bandwidth, TDD duplex mode
3	30 kHz SSB SCS, 40 MHz bandwidth, TDD duplex mode
Note:	The UE is only required to be tested in one of the supported test configurations.

Table A.6.6.1.3.2-2: General test parameters for SA intra-frequency event triggered reporting with per-UE gaps for PCell in FR1

Parameter	Unit	Test configuration	Value	Comment
Active cell		1, 2, 3	Cell 1	
Neighbour cell		1, 2, 3	Cell 2	Cell to be identified.
RF Channel Number		1, 2, 3	1: Cell 1 and Cell 2	
Measurement gap type		1, 2, 3	Per-UE gaps	
Measurement gap repetition periodicity	ms	1, 2, 3	40	
Measurement gap length	ms	1, 2, 3	6	
Measurement gap offset	ms	1, 2, 3	39	
SSB configuration		1	SSB.1 FR1	
		2	SSB.1 FR1	
		3	SSB.2 FR1	
SMTC configuration		1	SMTC.2	
		2	SMTC.1	
		3	SMTC.1	
CSI-RS parameters		1	CSI-RS.1.2 FDD resource #0	
		2	CSI-RS.1.2 TDD resource #0	
		3	CSI-RS.2.2 TDD resource #0	
A3-Offset	dB	1, 2, 3	-4.5	
CP length		1, 2, 3	Normal	
Hysteresis	dB	1, 2, 3	0	
Time To Trigger	s	1, 2, 3	0	
Filter coefficient		1, 2, 3	0	L3 filtering is not used

DRX	ms	1, 2, 3		OFF
Time offset between serving and neighbour cells		1	3 ms	Asynchronous cells. The timing of Cell 2 is 3ms later than the timing of Cell 1.
		2	3 μ s	Synchronous cells
		3	3 μ s	Synchronous cells
T1	s	1, 2, 3	5	
T2	s	1, 2, 3	5	

Table A.6.6.1.3.2-3: NR Cell specific test parameters for SA intra-frequency event triggered reporting with per-UE gaps for PCell in FR1

Parameter	Unit	Test configuration	Cell 1		Cell 2	
			T1	T2	T1	T2
TDD configuration		1	TN/A		TN/A	
		2	TDDConf.1.1		TDDConf.1.1	
		3	TDDConf.2.1		TDDConf.2.1	
PDSCH RMC configuration		1	SR.1.1 FDD		N/A	
		2	SR.1.1 TDD			
		3	SR.2.1 TDD			
RMSI CORESET RMC configuration		1	CR.1.1 FDD		N/A	
		2	CR.1.1 TDD		N/A	
		3	CR.2.1 TDD		N/A	
Dedicated CORESET RMC configuration		1	CCR.1.1 FDD		N/A	
		2	CCR.1.1 TDD		N/A	
		3	CCR.2.1 TDD		N/A	
OCNG Patterns		1, 2, 3	OP.1		OP.1	
TRS configuration		1	TRS.1.1 FDD		N/A	
		2	TRS.1.1 TDD		N/A	
		3	TRS.1.2 TDD		N/A	
Initial BWP configuration		1, 2, 3	DLBWP.0.1 ULBWP.0.1		DLBWP.0.1 ULBWP.0.1	
Active DL BWP configuration		1, 2, 3	DLBWP.1.2		DLBWP.1.1	
Active UL BWP configuration		1, 2, 3	ULBWP.1.2		ULBWP.1.1	
RLM-RS		1, 2, 3	CSI-RS		SSB	
N_{oc} ^{Note 2}	dBm/SCS	1	-98			
		2	-98			
		3	-95			
N_{oc} ^{Note 2}	dBm/15 kHz	1	-98			
		2				
		3				
\hat{E}_s/I_{ot}	dB	1	4	-1.46	-Infinity	-1.46
		2				
		3				
\hat{E}_s/N_{oc}	dB	1	4	4	-Infinity	4
		2				
		3				
SS-RSRP ^{Note 3}	dBm/SCS kHz	1	-94	-94	-Infinity	-94
		2	-94	-94	-Infinity	-94
		3	-91	-91	-Infinity	-91
I _o	dBm/9.36 MHz	1	-64.60	-62.25	-64.60	-62.25
		2	-64.60	-62.25	-64.60	-62.25

	dBm/38.16 MHz	3	-58.50	-56.16	--58.50	-56.16
Propagation Condition		1, 2, 3	AWGN			
Note 1:	The resources for uplink transmission are assigned to the UE prior to the start of time period T2.					
Note 2:	Interference from other cells and noise sources not specified in the test is assumed to be constant over subcarriers and time and shall be modelled as AWGN of appropriate power for N_{oc} to be fulfilled.					
Note 3:	SS-RSRP levels have been derived from other parameters for information purposes. They are not settable parameters themselves.					

A.6.6.1.3.3 Test Requirements

The UE shall send one Event A3 triggered measurement report, with a measurement reporting delay less than 800 ms from the beginning of time period T2. The UE is not required to read the neighbour cell SSB index in this test.

The UE shall not send event triggered measurement reports, as long as the reporting criteria are not fulfilled.

The rate of correct events observed during repeated tests shall be at least 90%.

NOTE: The actual overall delays measured in the test may be up to $2xTTI_{DCCH}$ higher than the measurement reporting delays above because of TTI insertion uncertainty of the measurement report in DCCH.

A.6.6.1.4 SA event triggered reporting tests with per-UE gaps under DRX

A.6.6.1.4.1 Test purpose and Environment

The purpose of this test is to verify that the UE makes correct reporting of an event. This test will partly verify the intra-frequency cell search requirements in clause 9.2.6.2 and 9.2.6.3.

A.6.6.1.4.2 Test parameters

Two cells are deployed in the test, which are FR1 PCell (Cell 1) and a FR1 neighbour cell (Cell 2) on the same frequency as the PCell. The test parameters for PCell are given in Table A.6.6.1.4.2-1, A.6.6.1.4.2-2 and A.6.6.1.4.2-3 below. In the measurement control information, a measurement object is configured for the frequency of the PCell, and it is indicated to the UE that event-triggered reporting with Event A3 is used. The test consists of two successive time periods, with time duration of T1, and T2 respectively. During time duration T1, the UE shall not have any timing information of Cell 2.

There are two BWPs configured in Cell 1, BWP1 which contains the cell defining SSB, and BWP2 which does not contain any SSB of Cell 1. During the whole test, BWP2 is always scheduled as the active BWP for the UE.

UE needs to be provided with new Timing Advance Command MAC control element at least once during each time alignment timer period to maintain uplink time alignment. Furthermore UE is allocated with PUSCH resource at every DRX cycle.

Table A.6.6.1.4.2-1: Supported test configurations

Configuration	Description
1	15 kHz SSB SCS, 10 MHz bandwidth, FDD duplex mode
2	15 kHz SSB SCS, 10 MHz bandwidth, TDD duplex mode
3	30 kHz SSB SCS, 40 MHz bandwidth, TDD duplex mode
Note:	The UE is only required to be tested in one of the supported test configurations.

Table A.6.6.1.4.2-2: General test parameters for SA intra-frequency event triggered reporting with per-UE gaps for PCell in FR1 with DRX

Parameter	Unit	Test configuration	Value		Comment
			Test 1	Test 2	
Active cell		1, 2, 3	Cell 1		
Neighbour cell		1, 2, 3	Cell 2		Cell to be identified.
RF Channel Number		1, 2, 3	1: Cell 1 and Cell 2		
Measurement gap type		1, 2, 3	Per-UE gaps		
Measurement gap repetition periodicity	ms	1, 2, 3	40		
Measurement gap length	ms	1, 2, 3	6		
Measurement gap offset	ms	1, 2, 3	39		
SSB configuration		1	SSB.1 FR1		
		2	SSB.1 FR1		
		3	SSB.2 FR1		
SMTC configuration		1	SMTC.2		
		2	SMTC.1		
		3	SMTC.1		
CSI-RS parameters		1	CSI-RS.1.2 FDD resource #0		
		2	CSI-RS.1.2 TDD resource #0		
		3	CSI-RS.2.2 TDD resource #0		
A3-Offset	dB	1, 2, 3	-4.5		
CP length		1, 2, 3	Normal		
Hysteresis	dB	1, 2, 3	0		
Time To Trigger	s	1, 2, 3	0		
Filter coefficient		1, 2, 3	0		L3 filtering is not used
DRX		1, 2, 3	DRX.1	DRX.7	
Time offset between serving and neighbour cells		1	3 ms		Asynchronous cells. The timing of Cell 2 is 3ms later than the timing of Cell 1.
		2	3 μ s		Synchronous cells
		3	3 μ s		Synchronous cells
T1	s	1, 2, 3	5		
T2	s	1, 2, 3	5	10	

Table A.6.6.1.4.2-3: NR Cell specific test parameters for SA intra-frequency event triggered reporting with per-UE gaps for PCell in FR1 with DRX

Parameter	Unit	Test configuration	Cell 1		Cell 2	
			T1	T2	T1	T2
TDD configuration		1	TN/A		TN/A	
		2	TDDConf.1.1		TDDConf.1.1	
		3	TDDConf.2.1		TDDConf.2.1	
PDSCH RMC configuration		1	SR.1.1 FDD		N/A	
		2	SR.1.1 TDD			
		3	SR.2.1 TDD			
RMSI CORESET RMC configuration		1	CR.1.1 FDD		N/A	
		2	CR.1.1 TDD		N/A	
		3	CR.2.1 TDD		N/A	
Dedicated CORESET RMC configuration		1	CCR.1.2 FDD		N/A	
		2	CCR.1.2 TDD		N/A	
		3	CCR.2.1 TDD		N/A	
OCNG Patterns		1, 2, 3	OP.1		OP.1	

TRS configuration		1	TRS.1.1 FDD	N/A		
		2	TRS.1.1 TDD	N/A		
		3	TRS.1.2 TDD	N/A		
Initial BWP configuration		1, 2, 3	DLBWP.0.1 ULBWP.0.1	DLBWP.0.1 ULBWP.0.1		
Active DL BWP configuration		1, 2, 3	DLBWP.1.2	DLBWP.1.1		
Active UL BWP configuration		1, 2, 3	ULBWP.1.2	ULBWP.1.1		
RLM-RS		1, 2, 3	CSI-RS	SSB		
N_{oc} Note 2	dBm/SCS	1	-98			
		2	-98			
		3	-95			
N_{oc} Note 2	dBm/15 kHz	1	-98			
		2				
		3				
\hat{E}_s / I_{ot}	dB	1	4	-1.46	-Infinity	-1.46
		2				
		3				
\hat{E}_s / N_{oc}	dB	1	4	4	-Infinity	4
		2				
		3				
SS-RSRP Note 3	dBm/SCS kHz	1	-94	-94	-Infinity	-94
		2	-94	-94	-Infinity	-94
		3	-91	-91	-Infinity	-91
Io	dBm/9.36 MHz	1	-64.60	-62.25	-64.60	-62.25
	dBm/9.36 MHz	2	-64.60	-62.25	-64.60	-62.25
	dBm/38.16 MHz	3	-58.50	-56.16	-58.50	-56.16
Propagation Condition		1, 2, 3	AWGN			
<p>Note 1: Table A.6.6.1.4.2-1 The resources for uplink transmission are assigned to the UE prior to the start of time period T2.</p> <p>Note 2: Table A.6.6.1.4.2-1 Interference from other cells and noise sources not specified in the test is assumed to be constant over subcarriers and time and shall be modelled as AWGN of appropriate power for N_{oc} to be fulfilled.</p> <p>Note 3: Table A.6.6.1.4.2-1 SS-RSRP levels have been derived from other parameters for information purposes. They are not settable parameters themselves.</p>						

Table A.6.6.1.4.2-4: Void

Table A.6.6.1.4.2-5: Void

A.6.6.1.4.3 Test Requirements

In test 1, the UE shall send one Event A3 triggered measurement report, with a measurement reporting delay less than 920 ms from the beginning of time period T2. The UE is not required to read the neighbour cell SSB index in this test.

In test 2, the UE shall send one Event A3 triggered measurement report, with a measurement reporting delay less than 6400 ms from the beginning of time period T2. The UE is not required to read the neighbour cell SSB index in this test.

The UE shall not send event triggered measurement reports, as long as the reporting criteria are not fulfilled.

The rate of correct events observed during repeated tests shall be at least 90%.

NOTE: The actual overall delays measured in the test may be up to $2 \times TTI_{DCCH}$ higher than the measurement reporting delays above because of TTI insertion uncertainty of the measurement report in DCCH.

A.6.6.1.5 SA event triggered reporting tests without gap under non-DRX with SSB index reading

A.6.6.1.5.1 Test purpose and Environment

The purpose of this test is to verify that the UE makes correct reporting of an event. This test will partly verify the FDD intra-frequency cell search requirements in clause 9.2.5.1 and 9.2.5.2.

A.6.6.1.5.2 Test parameters

Two cells are deployed in the test, which are FR1 PCell (Cell 1) and a FR1 neighbour cell (Cell 2) on the same frequency as the PCell. The test parameters for FDD PCell and neighbour cell are given in Table A.6.6.1.5.2-1 and A.6.6.1.5.2-2 below. In the measurement control information, a measurement object is configured for the frequency of the PCell, and it is indicated to the UE that event-triggered reporting with Event A3 is used. The test consists of two successive time periods, with time duration of T1, and T2 respectively. During time duration T1, the UE shall not have any timing information of Cell 2.

Table A.6.6.1.5.2-1: Supported test configurations

Configuration	Description
1	15 kHz SSB SCS, 10 MHz bandwidth, FDD duplex mode

Table A.6.6.1.5.2-2: General test parameters for SA intra-frequency event triggered reporting without gap for FDD PCell in FR1 with SSB index reading

Parameter	Unit	Test configuration	Value	Comment
Active cell		1	Cell 1	
Neighbour cell		1	Cell 2	Cell to be identified.
RF Channel Number		1	1: Cell 1 and Cell 2	
SSB configuration		1	SSB.1 FR1	
SMTC configuration		1	SMTC.2	
A3-Offset	dB	1	-4.5	
CP length		1	Normal	
Hysteresis	dB	1	0	
Time To Trigger	s	1	0	
Filter coefficient		1	0	L3 filtering is not used
DRX	ms	1		OFF
Time offset between serving and neighbour cells		1	3 ms	Asynchronous cells. The timing of Cell 2 is 3ms later than the timing of Cell 1.
T1	s	1	5	
T2	s	1	5	

Table A.6.6.1.5.2-3: NR Cell specific test parameters for SA intra-frequency event triggered reporting without gap for FDD PCell in FR1 with SSB index reading

Parameter	Unit	Test configuration	Cell 1		Cell 2	
			T1	T2	T1	T2
TDD configuration		1	N/A		N/A	

PDSCH RMC configuration		1	SR.1.1 FDD	N/A		
RMSI CORESET RMC configuration		1	CR.1.1 FDD	N/A		
Dedicated CORESET RMC configuration		1	CCR.1.1 FDD	N/A		
OCNG Patterns		1	OP.1	OP.1		
TRS configuration		1	TRS.1.1 FDD	N/A		
Initial BWP configuration		1	DLBWP.0.1 ULBWP.0.1	DLBWP.0.1 ULBWP.0.1		
Active DL BWP configuration		1	DLBWP.1.1	DLBWP.1.1		
Active UL BWP configuration		1	ULBWP.1.1	ULBWP.1.1		
RLM-RS		1	SSB	SSB		
N_{oc} Note 2	dBm/SCS	1	-98			
N_{oc} Note 2	dBm/15 kHz	1	-98			
\hat{E}_s/I_{ot}	dB	1	4	-1.46	-Infinity	-1.46
\hat{E}_s/N_{oc}	dB	1	4	4	-Infinity	4
SS-RSRP Note 3	dBm/SCS kHz	1	-94	-94	-Infinity	-94
l_o	dBm/9.36 MHz	1	-64.60	-62.25	-64.60	-62.25
Propagation Condition		1	AWGN			
Note 1:	The resources for uplink transmission are assigned to the UE prior to the start of time period T2.					
Note 2:	Interference from other cells and noise sources not specified in the test is assumed to be constant over subcarriers and time and shall be modelled as AWGN of appropriate power for N_{oc} to be fulfilled.					
Note 3:	SS-RSRP levels have been derived from other parameters for information purposes. They are not settable parameters themselves.					

A.6.6.1.5.3 Test Requirements

The UE shall send one Event A3 triggered measurement report, with a measurement reporting delay less than 920 ms from the beginning of time period T2. The UE is required to read the neighbour cell SSB index and report the acquired SSB index in this test.

The UE shall not send event triggered measurement reports, as long as the reporting criteria are not fulfilled.

The rate of correct events observed during repeated tests shall be at least 90%.

NOTE: The actual overall delays measured in the test may be up to $2xTTI_{DCCH}$ higher than the measurement reporting delays above because of TTI insertion uncertainty of the measurement report in DCCH.

A.6.6.1.6 SA event triggered reporting tests with per-UE gaps under non-DRX with SSB index reading

A.6.6.1.6.1 Test purpose and Environment

The purpose of this test is to verify that the UE makes correct reporting of an event. This test will partly verify the FDD intra-frequency cell search requirements in clause 9.2.6.2 and 9.2.6.3.

A.6.6.1.6.2 Test parameters

Two cells are deployed in the test, which are FR1 PCell (Cell 1) and a FR1 neighbour cell (Cell 2) on the same frequency as the PCell. The test parameters for FDD PCell and neighbour cell are given in Table A.6.6.1.6.2-1 and A.6.6.1.6.2-2 below. In the measurement control information, a measurement object is configured for the frequency of the PCell, and it is indicated to the UE that event-triggered reporting with Event A3 is used. The test consists of two successive time periods, with time duration of T1, and T2 respectively. During time duration T1, the UE shall not have any timing information of Cell 2.

There are two BWPs configured in Cell 1, BWP1 which contains the cell defining SSB, and BWP2 which does not contain any SSB of Cell 1. During the whole test, BWP2 is always scheduled as the active BWP for the UE.

Table A.6.6.1.6.2-1: Supported test configurations

Configuration	Description
1	15 kHz SSB SCS, 10 MHz bandwidth, FDD duplex mode

Table A.6.6.1.6.2-2: General test parameters for SA intra-frequency event triggered reporting with gap for FDD PCell in FR1 with SSB index reading

Parameter	Unit	Test configuration	Value	Comment
Active cell		1	Cell 1	
Neighbour cell		1	Cell 2	Cell to be identified.
RF Channel Number		1	1: Cell 1 and Cell 2	
Measurement gap type		1	Per-UE gaps	
Measurement gap repetition periodicity	ms	1	40	
Measurement gap length	ms	1	6	
Measurement gap offset	ms	1	39	
SSB configuration		1	SSB.1 FR1	
SMTC configuration		1	SMTC.2	
CSI-RS parameters		1	CSI-RS.1.2 FDD resource #0	
A3-Offset	dB	1	-4.5	
CP length		1	Normal	
Hysteresis	dB	1	0	
Time To Trigger	s	1	0	
Filter coefficient		1	0	L3 filtering is not used
DRX	ms	1		OFF
Time offset between serving and neighbour cells		1	3 ms	Asynchronous cells. The timing of Cell 2 is 3ms later than the timing of Cell 1.
T1	s	1	5	
T2	s	1	5	

Table A.6.6.1.6.2-3: NR Cell specific test parameters for SA intra-frequency event triggered reporting with gap for FDD PCell in FR1 with SSB index reading

Parameter	Unit	Test configuration	Cell 1		Cell 2	
			T1	T2	T1	T2
TDD configuration		1	N/A		N/A	
PDSCH RMC configuration		1	SR.1.1 FDD		N/A	
RMSI CORESET RMC configuration		1	CR.1.1 FDD		N/A	

Dedicated CORESET RMC configuration		1	CCR.1.2 FDD			N/A
OCNG Patterns		1	OP.1			OP.1
TRS configuration		1	TRS.1.1 FDD			N/A
Initial BWP configuration		1	DLBWP.0.1 ULBWP.0.1		DLBWP.0.1 ULBWP.0.1	
Active DL BWP configuration		1	DLBWP.1.2		DLBWP.1.1	
Active UL BWP configuration		1	ULBWP.1.2		ULBWP.1.1	
RLM-RS		1	CSI-RS		SSB	
N_{oc} Note 2	dBm/SCS	1	-98			
N_{oc} Note 2	dBm/15 kHz	1	-98			
\hat{E}_s/I_{ot}	dB	1	4	-1.46	-Infinity	-1.46
\hat{E}_s/N_{oc}	dB	1	4	4	-Infinity	4
SS-RSRP Note 3	dBm/SCS kHz	1	-94	-94	-Infinity	-94
I_o	dBm/9.36 MHz	1	-64.60	-62.25	--64.60	-62.25
Propagation Condition		1	AWGN			
<p>Note 1: The resources for uplink transmission are assigned to the UE prior to the start of time period T2.</p> <p>Note 2: Interference from other cells and noise sources not specified in the test is assumed to be constant over subcarriers and time and shall be modelled as AWGN of appropriate power for N_{oc} to be fulfilled.</p> <p>Note 3: SS-RSRP levels have been derived from other parameters for information purposes. They are not settable parameters themselves.</p>						

A.6.6.1.6.3 Test Requirements

The UE shall send one Event A3 triggered measurement report, with a measurement reporting delay less than 920 ms from the beginning of time period T2. The UE is required to read the neighbour cell SSB index and report the acquired SSB index in this test.

The UE shall not send event triggered measurement reports, as long as the reporting criteria are not fulfilled.

The rate of correct events observed during repeated tests shall be at least 90%.

NOTE: The actual overall delays measured in the test may be up to $2 \times TTI_{DCC}$ higher than the measurement reporting delays above because of TTI insertion uncertainty of the measurement report in DCC.

A.6.6.2 Inter-frequency Measurements

A.6.6.2.1 SA event triggered reporting tests for FR1 without SSB time index detection when DRX is not used

A.6.6.2.1.1 Test Purpose and Environment

The purpose of this test is to verify that the UE makes correct reporting of an event. This test will partly verify the SA inter-frequency NR cell search requirements in clause 9.3.4.

In this test, there are two cells: NR cell 1 as PCell in FR1 on NR RF channel 1 and NR cell 2 as neighbour cell in FR1 on NR RF channel 2. The test parameters are given in Tables A.6.6.2.1.1-1, A.6.6.2.1.1-2 and A.6.6.2.1.1-3.

Measurement gap pattern configuration is defined in Table A.6.6.2.1.1-2.

In the measurement control information, it is indicated to the UE that event-triggered reporting with Event A3 is used. The test consists of two successive time periods, with time duration of T1, and T2 respectively. During time duration T1, the UE shall not have any timing information of NR cell 2.

Table A.6.6.2.1.1-1: SA event triggered reporting tests without SSB index reading for FR1-FR1

Config	Description
1	NR 15 kHz SSB SCS, 10 MHz bandwidth, FDD duplex mode
2	NR 15 kHz SSB SCS, 10 MHz bandwidth, TDD duplex mode
3	NR 30 kHz SSB SCS, 40 MHz bandwidth, TDD duplex mode
Note 1:	The UE is only required to be tested in one of the supported test configurations
Note 2:	target NR cell has the same SCS, BW and duplex mode as NR serving cell

Table A.6.6.2.1.1-2: General test parameters for SA inter-frequency event triggered reporting for FR1 without SSB time index detection

Parameter	Unit	Test configuration	Value	Comment
NR RF Channel Number		Config 1,2,3	1, 2	Two FR1 NR carrier frequencies is used.
Active cell		Config 1,2,3	NR cell 1 (Pcell)	NR Cell 1 is on NR RF channel number 1.
Neighbour cell		Config 1,2,3	NR cell2	NR cell 2 is on NR RF channel number 2.
Gap Pattern Id		Config 1,2,3	0	As specified in clause 9.1.2-1.
Measurement gap offset		Config 1,2,3	9	
A3-Offset	dB	Config 1,2,3	-6	
Hysteresis	dB	Config 1,2,3	0	
CP length		Config 1,2,3	Normal	
TimeToTrigger	s	Config 1,2,3	0	
Filter coefficient		Config 1,2,3	0	L3 filtering is not used
DRX		Config 1,2,3	OFF	DRX is not used
Time offset between serving and neighbour cells		Config 1	3ms	Asynchronous cells. The timing of Cell 2 is 3ms later than the timing of Cell 1.
		Config 2,3	3μs	Synchronous cells.
T1	s	Config 1,2,3	5	
T2	s	Config 1,2,3	1	

Table A.6.6.2.1.1-3: Cell specific test parameters for SA inter-frequency event triggered reporting for FR1 without SSB time index detection

Parameter	Unit	Test configuration	Cell 1		Cell 2	
			T1	T2	T1	T2
NR RF Channel Number		Config 1,2,3	1		2	
Duplex mode		Config 1	FDD			
		Config 2,3	TDD			

TDD configuration			Config 1	Not Applicable	
			Config 2	TDDConf.1.1	
			Config 3	TDDConf.2.1	
BW _{channel}		MHz	Config 1,2	10: N _{RB,c} = 52	
			Config 3	40: N _{RB,c} = 106	
BWP BW		MHz	Config 1,2	10: N _{RB,c} = 52	
			Config 3	40: N _{RB,c} = 106	
BWP configuration	Initial DL BWP		Config 1, 2, 3	DLBWP.0.1	NA
	Initial UL BWP			ULBWP.0.1	NA
	Dedicated DL BWP			DLBWP.1.1	NA
	Dedicated UL BWP			ULBWP.1.1	NA
TRS configuration			Config 1	TRS.1.1 FDD	NA
			Config 2	TRS.1.1 TDD	NA
			Config 3	TRS.1.2 TDD	NA
OCNG Patterns defined in A.3.2.1.1 (OP.1)			Config 1,2,3	OP.1	OP.1
PDSCH Reference measurement channel			Config 1	SR.1.1 FDD	-
			Config 2	SR.1.1 TDD	
			Config 3	SR.2.1 TDD	
RMSI CORESET Reference Channel			Config 1	CR.1.1 FDD	-
			Config 2	CR.1.1 TDD	
			Config 3	CR.2.1 TDD	
Dedicated CORESET Reference Channel			Config 1	CCR.1.1 FDD	
			Config 2	CCR.1.1 TDD	
			Config 3	CCR.2.1 TDD	
SSB parameters			Config 1	SSB.1 FR1	SSB.5 FR1
			Config 2	SSB.1 FR1	SSB.5 FR1
			Config 3	SSB.2 FR1	SSB.6 FR1
SMTC configuration defined in A.3.11			Config 1	SMTC.2	SMTC.5
			Config 2, 3	SMTC.1	SMTC.4
PDSCH/PDCCH subcarrier spacing		kHz	Config 1,2	15	
			Config 3	30	
EPRE ratio of PSS to SSS			Config 1,2,3	0	0
EPRE ratio of PBCH DMRS to SSS					
EPRE ratio of PBCH to PBCH DMRS					
EPRE ratio of PDCCH DMRS to SSS					
EPRE ratio of PDCCH to PDCCH DMRS					
EPRE ratio of PDSCH DMRS to SSS					
EPRE ratio of PDSCH to PDSCH					
EPRE ratio of OCNG DMRS to SSS(Note 1)					
EPRE ratio of OCNG to OCNG DMRS (Note 1)					
N_{oc} ^{Note2}	dBm/15 kHz				
N_{oc} ^{Note2}	dBm/S CS		Config 1,2	-98	-98
			Config 3	-95	-95

SS-RSRP ^{Note 3}	dBm/S CS	Config 1,2	-94	-94	-Infinity	-91
		Config 3	-91	-91	-Infinity	-88
$\hat{E}_s / I_{\text{ot}}$	dB	Config 1,2,3,4,5,6	4	4	-Infinity	7
$\hat{E}_s / N_{\text{oc}}$	dB	Config 1,2,3	4	4	-Infinity	7
I _o ^{Note 3}	dBm/9. 36MHz	Config 1,2	-64.59	-64.59	-70.05	-62.26
	dBm/38 .16MHz	Config 3	-58.49	-58.49	-63.94	-56.15
Propagation Condition		Config 1,2,3	AWGN		AWGN	
<p>Note 1: OCNG shall be used such that both cells are fully allocated and a constant total transmitted power spectral density is achieved for all OFDM symbols.</p> <p>Note 2: Interference from other cells and noise sources not specified in the test is assumed to be constant over subcarriers and time and shall be modelled as AWGN of appropriate power for N_{oc} to be fulfilled.</p> <p>Note 3: SS-RSRP and I_o levels have been derived from other parameters for information purposes. They are not settable parameters themselves.</p> <p>Note 4: SS-RSRP minimum requirements are specified assuming independent interference and noise at each receiver antenna port.</p>						

A.6.6.2.1.2 Test Requirements

The UE shall send one Event A3 triggered measurement report, with a measurement reporting delay less than 920 ms from the beginning of time period T2. The UE shall not send event triggered measurement reports, as long as the reporting criteria are not fulfilled. The rate of correct events observed during repeated tests shall be at least 90%.

UE is not required to report SSB time index.

NOTE: The actual overall delays measured in the test may be up to $2 \times \text{TTI}_{\text{DCCCH}}$ higher than the measurement reporting delays above because of TTI insertion uncertainty of the measurement report in DCCCH.

A.6.6.2.2 SA event triggered reporting tests for FR1 without SSB time index detection when DRX is used

A.6.6.2.2.1 Test Purpose and Environment

The purpose of this test is to verify that the UE makes correct reporting of an event. This test will partly verify the SA inter-frequency NR cell search requirements in clause 9.3.4.

In this test, there are two cells: NR cell 1 as PCell in FR1 on NR RF channel 1 and NR cell 2 as neighbour cell in FR1 on NR RF channel 2. The test parameters are given in Tables A.6.6.2.2.1-1, A.6.6.2.2.1-2 and A.6.6.2.2.1-3.

Measurement gap pattern configuration is defined in Table A.6.6.2.2.1-2.

In the measurement control information, it is indicated to the UE that event-triggered reporting with Event A3 is used. The test consists of two successive time periods, with time duration of T1, and T2 respectively. During time duration T1, the UE shall not have any timing information of NR cell 2.

UE needs to be provided with new Timing Advance Command MAC control element at least once during each time alignment timer period to maintain uplink time alignment. Furthermore, UE is allocated with PUSCH resource at every DRX cycle.

Table A.6.6.2.2.1-1: SA event triggered reporting tests without SSB index reading for FR1-FR1

Config	Description
1	NR 15 kHz SSB SCS, 10 MHz bandwidth, FDD duplex mode
2	NR 15 kHz SSB SCS, 10 MHz bandwidth, TDD duplex mode

3	NR 30 kHz SSB SCS, 40 MHz bandwidth, TDD duplex mode
Note 1:	The UE is only required to be tested in one of the supported test configurations
Note 2:	target NR cell has the same SCS, BW and duplex mode as NR serving cell

Table A.6.6.2.2.1-2: General test parameters for SA inter-frequency event triggered reporting for FR1 without SSB time index detection

Parameter	Unit	Test configuration	Value		Comment
			Test 1	Test 2	
NR RF Channel Number		Config 1,2,3	1, 2		Two FR1 NR carrier frequencies is used.
Active cell		Config 1,2,3	NR cell 1 (Pcell)		NR Cell 1 is on NR RF channel number 1.
Neighbour cell		Config 1,2,3	NR cell2		NR cell 2 is on NR RF channel number 2.
Gap Pattern Id		Config 1,2,3	0		As specified in clause 9.1.2-1.
Measurement gap offset		Config 1,2,3	39		
A3-Offset	dB	Config 1,2,3	-6		
Hysteresis	dB	Config 1,2,3	0		
CP length		Config 1,2,3	Normal		
TimeToTrigger	s	Config 1,2,3	0		
Filter coefficient		Config 1,2,3	0		L3 filtering is not used
DRX		Config 1,2,3	DRX.1	DRX.7	As specified in clause A.3.3
Time offset between serving and neighbour cells		Config 1	3ms		Asynchronous cells. The timing of Cell 2 is 3ms later than the timing of Cell 1.
		Config 2,3	3μs		Synchronous cells.
T1	s	Config 1,2,3	5		
T2	s	Config 1,2,3	1.1	11	

Table A.6.6.2.2.1-3: Cell specific test parameters for SA inter-frequency event triggered reporting for FR1 without SSB time index detection

Parameter		Unit	Test configuration	Cell 1		Cell 2	
				T1	T2	T1	T2
NR RF Channel Number			Config 1,2,3	1		2	
Duplex mode			Config 1	FDD			
			Config 2,3	TDD			
TDD configuration			Config 1	Not Applicable			
			Config 2	TDDConf.1.1			
			Config 3	TDDConf.2.1			
BW _{channel}		MHz	Config 1,2	10: N _{RB,c} = 52			
			Config 3	40: N _{RB,c} = 106			
BWP BW		MHz	Config 1,2	10: N _{RB,c} = 52			
			Config 3	40: N _{RB,c} = 106			
BWP configuration	Initial DL BWP		Config 1, 2, 3	DLBWP.0.1		NA	
	Initial UL BWP		Config 1, 2, 3	ULBWP.0.1		NA	

	Dedicated DL BWP			DLBWP.1.1	NA		
	Dedicated UL BWP			ULBWP.1.1	NA		
TRS configuration			Config 1	TRS.1.1 FDD	NA		
			Config 2	TRS.1.1 TDD	NA		
			Config 3	TRS.1.2 TDD	NA		
OCNG Patterns defined in A.3.2.1.1 (OP.1)			Config 1,2,3	OP.1	OP.1		
PDSCH Reference measurement channel			Config 1	SR.1.1 FDD	-		
			Config 2	SR.1.1 TDD			
			Config 3	SR.2.1 TDD			
RMSI CORESET Reference Channel			Config 1	CR.1.1 FDD	-		
			Config 2	CR.1.1 TDD			
			Config 3	CR.2.1 TDD			
Dedicated CORESET Reference Channel			Config 1	CCR.1.1 FDD	-		
			Config 2	CCR.1.1 TDD			
			Config 3	CCR.2.1 TDD			
SSB parameters			Config 1	SSB.1 FR1	SSB.5 FR1		
			Config 2	SSB.1 FR1	SSB.5 FR1		
			Config 3	SSB.2 FR1	SSB.6 FR1		
SMTC configuration defined in A.3.11			Config 1	SMTC.2	SMTC.5		
			Config 2, 3	SMTC.1	SMTC.4		
PDSCH/PDCCH subcarrier spacing	kHz		Config 1,2	15			
			Config 3	30			
EPRE ratio of PSS to SSS		Config 1,2,3					
EPRE ratio of PBCH DMRS to SSS							
EPRE ratio of PBCH to PBCH DMRS							
EPRE ratio of PDCCH DMRS to SSS							
EPRE ratio of PDCCH to PDCCH DMRS				0		0	
EPRE ratio of PDSCH DMRS to SSS							
EPRE ratio of PDSCH to PDSCH							
EPRE ratio of OCNG DMRS to SSS(Note 1)							
EPRE ratio of OCNG to OCNG DMRS (Note 1)							
N_{oc} ^{Note2}	dBm/15 kHz		Config 1,2,3	-98	-98		
N_{oc} ^{Note2}	dBm/S CS		Config 1,2	-98	-98		
			Config 3	-95	-95		
SS-RSRP ^{Note 3}	dBm/S CS		Config 1,2	-94	-94	-Infinity	-91
			Config 3	-91	-91	-Infinity	-88
\hat{E}_s/I_{ot}	dB		Config 1,2,3,4,5,6	4	4	-Infinity	7
\hat{E}_s/N_{oc}	dB		Config 1,2,3	4	4	-Infinity	7
I_o ^{Note3}	dBm/9.36MHz		Config 1,2	-64.59	-64.59	-70.05	-62.2

	dBm/38 .16MHz	Config 3	-58.49	-58.49	-63.94	-56.15
Propagation Condition		Config 1,2,3	AWGN		AWGN	
Note 1:	OCNG shall be used such that both cells are fully allocated and a constant total transmitted power spectral density is achieved for all OFDM symbols.					
Note 2:	Interference from other cells and noise sources not specified in the test is assumed to be constant over subcarriers and time and shall be modelled as AWGN of appropriate power for N_{oc} to be fulfilled.					
Note 3:	SS-RSRP and I_o levels have been derived from other parameters for information purposes. They are not settable parameters themselves.					
Note 4:	SS-RSRP minimum requirements are specified assuming independent interference and noise at each receiver antenna port.					

Table A.6.6.2.2.1-4: DRX-Configuration for SA inter-frequency event triggered reporting without SSB time index detection

Field	Test1&3	Test2&4	Comment
	Value	Value	
drx-onDurationTimer	ms1	ms1	As specified in clause 6.3.2 in TS 38.331 [2]
drx-InactivityTimer	ms1	ms1	
drx-RetransmissionTimerDL	sl1	sl1	
drx-RetransmissionTimerUL	sl1	sl1	
drx-LongCycleStartOffset	ms40	Ms640	
shortDRX	disable	disable	

Table A.6.6.2.2.1-5: TimeAlignmentTimer -Configuration SA inter-frequency event triggered reporting without SSB time index detection

Field	Value	Comment
TimeAlignmentTimer	ms500	As specified in clause 6.3.2 in TS 38.331 [2]

A.6.6.2.2.2 Test Requirements

In test 1 with per-UE gap, the UE shall send one Event A3 triggered measurement report, with a measurement reporting delay less than 1080 ms from the beginning of time period T2. The UE shall not send event triggered measurement reports, as long as the reporting criteria are not fulfilled. The rate of correct events observed during repeated tests shall be at least 90%.

In test 2 with per-UE gap, the UE shall send one Event A3 triggered measurement report, with a measurement reporting delay less than 10240 ms from the beginning of time period T2. The UE shall not send event triggered measurement reports, as long as the reporting criteria are not fulfilled. The rate of correct events observed during repeated tests shall be at least 90%.

In test 1 and 2, UE is not required to report SSB time index.

NOTE: The actual overall delays measured in the test may be up to $2 \times TTI_{DCCH}$ higher than the measurement reporting delays above because of TTI insertion uncertainty of the measurement report in DCCH.

A.6.6.2.3 Void

A.6.6.2.4 Void

A.6.6.2.5 SA event triggered reporting tests for FR1 with SSB time index detection when DRX is not used

A.6.6.2.5.1 Test Purpose and Environment

The purpose of this test is to verify that the UE makes correct reporting of an event. This test will partly verify the SA inter-frequency NR cell search requirements in clause 9.3.4.

In this test, there are two cells: NR cell 1 as PCell in FR1 on NR RF channel 1 and NR cell 2 as neighbour cell in FR1 on NR RF channel 2. The test parameters are given in Tables A.6.6.2.5.1-1, A.6.6.2.5.1-2 and A.6.6.2.5.1-3.

Measurement gap pattern configuration is defined in Table A.6.6.2.5.1-2.

In the measurement control information, it is indicated to the UE that event-triggered reporting with Event A3 is used. The test consists of two successive time periods, with time duration of T1, and T2 respectively. During time duration T1, the UE shall not have any timing information of NR cell 2.

Table A.6.6.2.5.1-1: SA event triggered reporting tests with SSB index reading for FR1-FR1

Config	Description
1	NR 15 kHz SSB SCS, 10 MHz bandwidth, FDD duplex mode
2	NR 15 kHz SSB SCS, 10 MHz bandwidth, TDD duplex mode
3	NR 30 kHz SSB SCS, 40 MHz bandwidth, TDD duplex mode
Note 1:	The UE is only required to be tested in one of the supported test configurations
Note 2:	target NR cell has the same SCS, BW and duplex mode as NR serving cell

Table A.6.6.2.5.1-2: General test parameters for SA inter-frequency event triggered reporting for FR1 with SSB time index detection

Parameter	Unit	Test configuration	Value	Comment
NR RF Channel Number		Config 1,2,3	1, 2	Two FR1 NR carrier frequencies is used.
Active cell		Config 1,2,3	NR cell 1 (Pcell)	NR Cell 1 is on NR RF channel number 1.
Neighbour cell		Config 1,2,3	NR cell2	NR cell 2 is on NR RF channel number 2.
Gap Pattern Id		Config 1,2,3	0	As specified in clause 9.1.2-1.
Measurement gap offset		Config 1,2,3	9	
A3-Offset	dB	Config 1,2,3	-6	
Hysteresis	dB	Config 1,2,3	0	
CP length		Config 1,2,3	Normal	
TimeToTrigger	s	Config 1,2,3	0	
Filter coefficient		Config 1,2,3	0	L3 filtering is not used
DRX		Config 1,2,3	OFF	DRX is not used
Time offset between serving and neighbour cells		Config 1	3ms	Asynchronous cells. The timing of Cell 2 is 3ms later than the timing of Cell 1.
		Config 2,3	3μs	Synchronous cells.
T1	s	Config 1,2,3	5	

T2	s	Config 1,2,3	1.1	
----	---	--------------	-----	--

Table A.6.6.2.5.1-3: Cell specific test parameters for SA inter-frequency event triggered reporting for FR1 with SSB time index detection

Parameter		Unit	Test configuration	Cell 1		Cell 2	
				T1	T2	T1	T2
NR RF Channel Number			Config 1,2,3	1		2	
Duplex mode			Config 1	FDD			
			Config 2,3	TDD			
TDD configuration			Config 1	Not Applicable			
			Config 2	TDDConf.1.1			
			Config 3	TDDConf.2.1			
BW _{channel}		MHz	Config 1,2	10: N _{RB,c} = 52			
			Config 3	40: N _{RB,c} = 106			
BWP BW		MHz	Config 1,2	10: N _{RB,c} = 52			
			Config 3	40: N _{RB,c} = 106			
BWP configuration	Initial DL BWP		Config 1, 2, 3	DLBWP.0.1		NA	
	Initial UL BWP			ULBWP.0.1		NA	
	Dedicated DL BWP			DLBWP.1.1		NA	
	Dedicated UL BWP			ULBWP.1.1		NA	
TRS configuration			Config 1	TRS.1.1 FDD		NA	
			Config 2	TRS.1.1 TDD		NA	
			Config 3	TRS.1.2 TDD		NA	
OCNG Patterns defined in A.3.2.1.1 (OP.1)			Config 1,2,3	OP.1		OP.1	
PDSCH Reference measurement channel			Config 1	SR.1.1 FDD		-	
			Config 2	SR.1.1 TDD			
			Config 3	SR.2.1 TDD			
RMSI CORESET Reference Channel			Config 1	CR.1.1 FDD		-	
			Config 2	CR.1.1 TDD			
			Config 3	CR.2.1 TDD			
Dedicated CORESET Reference Channel			Config 1	CCR.1.1 FDD		-	
			Config 2	CCR.1.1 TDD			
			Config 3	CCR.2.1 TDD			
SSB parameters			Config 1	SSB.1 FR1		SSB.5 FR1	
			Config 2	SSB.1 FR1		SSB.5 FR1	
			Config 3	SSB.2 FR1		SSB.6 FR1	
SMTC configuration defined in A.3.11			Config 1	SMTC.2		SMTC.5	
			Config 2, 3	SMTC.1		SMTC.4	
PDSCH/PDCCH subcarrier spacing		kHz	Config 1,2	15			
			Config 3	30			
EPRE ratio of PSS to SSS			Config 1,2,3	0		0	
EPRE ratio of PBCH DMRS to SSS							
EPRE ratio of PBCH to PBCH DMRS							
EPRE ratio of PDCCH DMRS to SSS							
EPRE ratio of PDCCH to PDCCH DMRS							
EPRE ratio of PDSCH DMRS to SSS							

EPRE ratio of PDSCH to PDSCH						
EPRE ratio of OCNG DMRS to SSS(Note 1)						
EPRE ratio of OCNG to OCNG DMRS (Note 1)						
N_{oc} ^{Note2}	dBm/15 kHz			-98		-98
N_{oc} ^{Note2}	dBm/S CS	Config 1,2		-98		-98
		Config 3		-95		-95
SS-RSRP ^{Note 3}	dBm/S CS	Config 1,2	-94	-94	-Infinity	-91
		Config 3	-91	-91	-Infinity	-88
\hat{E}_s / I_{ca}	dB	Config 1,2,3	4	4	-Infinity	7
\hat{E}_s / N_{oc}	dB	Config 1,2,3	4	4	-Infinity	7
I_o ^{Note3}	dBm/9.36MHz	Config 1,2	-64.59	-64.59	-70.05	-62.2
	dBm/38.16MHz	Config 3	-58.4	-58.49	-63.94	-56.15
Propagation Condition		Config 1,2,3	AWGN		AWGN	
<p>Note 1: OCNG shall be used such that both cells are fully allocated and a constant total transmitted power spectral density is achieved for all OFDM symbols.</p> <p>Note 2: Interference from other cells and noise sources not specified in the test is assumed to be constant over subcarriers and time and shall be modelled as AWGN of appropriate power for N_{oc} to be fulfilled.</p> <p>Note 3: SS-RSRP and I_o levels have been derived from other parameters for information purposes. They are not settable parameters themselves.</p> <p>Note 4: SS-RSRP minimum requirements are specified assuming independent interference and noise at each receiver antenna port.</p>						

A.6.6.2.5.2 Test Requirements

The UE shall send one Event A3 triggered measurement report, with a measurement reporting delay less than 1040 ms from the beginning of time period T2. The UE shall not send event triggered measurement reports, as long as the reporting criteria are not fulfilled. The rate of correct events observed during repeated tests shall be at least 90%.

UE is required to report SSB time index.

NOTE: The actual overall delays measured in the test may be up to $2 \times TTI_{DCCH}$ higher than the measurement reporting delays above because of TTI insertion uncertainty of the measurement report in DCCH.

A.6.6.2.6 SA event triggered reporting tests for FR1 with SSB time index detection when DRX is used

A.6.6.2.6.1 Test Purpose and Environment

The purpose of this test is to verify that the UE makes correct reporting of an event. This test will partly verify the SA inter-frequency NR cell search requirements in clause 9.3.4.

In this test, there are two cells: NR cell 1 as PCell in FR1 on NR RF channel 1 and NR cell 2 as neighbour cell in FR1 on NR RF channel 2. The test parameters are given in Tables A.6.6.2.6.1-1, A.6.6.2.6.1-2 and A.6.6.2.6.1-3.

Measurement gap pattern configuration is defined in Table A.6.6.2.6.1-2.

In the measurement control information, it is indicated to the UE that event-triggered reporting with Event A3 is used. The test consists of two successive time periods, with time duration of T1, and T2 respectively. During time duration T1, the UE shall not have any timing information of NR cell 2.

UE needs to be provided with new Timing Advance Command MAC control element at least once during each time alignment timer period to maintain uplink time alignment. Furthermore, UE is allocated with PUSCH resource at every DRX cycle.

Table A.6.6.2.6.1-1: SA event triggered reporting tests with SSB index reading for FR1-FR1

Config	Description
1	NR 15 kHz SSB SCS, 10 MHz bandwidth, FDD duplex mode
2	NR 15 kHz SSB SCS, 10 MHz bandwidth, TDD duplex mode
3	NR 30 kHz SSB SCS, 40 MHz bandwidth, TDD duplex mode
Note 1: The UE is only required to be tested in one of the supported test configurations	
Note 2: target NR cell has the same SCS, BW and duplex mode as NR serving cell	

Table A.6.6.2.6.1-2: General test parameters for SA inter-frequency event triggered reporting for FR1 with SSB time index detection

Parameter	Unit	Test configuration	Value		Comment
			Test 1	Test 2	
NR RF Channel Number		Config 1,2,3	1, 2		Two FR1 NR carrier frequencies is used.
Active cell		Config 1,2,3	NR cell 1 (Pcell)		NR Cell 1 is on NR RF channel number 1.
Neighbour cell		Config 1,2,3	NR cell2		NR cell 2 is on NR RF channel number 2.
Gap Pattern Id		Config 1,2,3	0		As specified in clause 9.1.2-1.
Measurement gap offset		Config 1,2,3	39		
A3-Offset	dB	Config 1,2,3	-6		
Hysteresis	dB	Config 1,2,3	0		
CP length		Config 1,2,3	Normal		
TimeToTrigger	s	Config 1,2,3	0		
Filter coefficient		Config 1,2,3	0		L3 filtering is not used
DRX		Config 1,2,3	DRX.1	DRX.7	As specified in clause A.3.3
Time offset between serving and neighbour cells		Config 1	3 ms		Asynchronous cells. The timing of Cell 2 is 3ms later than the timing of Cell 1.
		Config 2,3	3 μ s		Synchronous cells.
T1	s	Config 1,2,3	5		
T2	s	Config 1,2,3	1.3	13.5	

Table A.6.6.2.6.1-3: Cell specific test parameters for SA inter-frequency event triggered reporting for FR1 with SSB time index detection

Parameter	Unit	Test configuration	Cell 1		Cell 2	
			T1	T2	T1	T2
NR RF Channel Number		Config 1,2,3	1		2	
Duplex mode		Config 1	FDD			
		Config 2,3	TDD			
TDD configuration		Config 1	Not Applicable			
		Config 2	TDDConf.1.1			

BW _{channel}	MHz	Config 3	TDDConf.2.1			
		Config 1,2	10: N _{RB,c} = 52			
BWP BW	MHz	Config 3	40: N _{RB,c} = 106			
		Config 1,2	10: N _{RB,c} = 52			
BWP configuration	Initial DL BWP	Config 1, 2, 3	DLBWP.0.1		NA	
	Initial UL BWP		ULBWP.0.1		NA	
	Dedicated DL BWP		DLBWP.1.1		NA	
	Dedicated UL BWP		ULBWP.1.1		NA	
TRS configuration		Config 1	TRS.1.1 FDD		NA	
		Config 2	TRS.1.1 TDD		NA	
		Config 3	TRS.1.2 TDD		NA	
OCNG Patterns defined in A.3.2.1.1 (OP.1)		Config 1,2,3	OP.1		OP.1	
PDSCH Reference measurement channel		Config 1	SR.1.1 FDD		-	
		Config 2	SR.1.1 TDD			
		Config 3	SR2.1 TDD			
RMSI CORESET Reference Channel		Config 1	CR.1.1 FDD		-	
		Config 2	CR.1.1 TDD			
		Config 3	CR2.1 TDD			
Dedicated CORESET Reference Channel		Config 1	CCR.1.1 FDD		-	
		Config 2	CCR.1.1 TDD			
		Config 3	CCR.2.1 TDD			
SSB parameters		Config 1	SSB.1 FR1		SSB.5 FR1	
		Config 2	SSB.1 FR1		SSB.5 FR1	
		Config 3	SSB.2 FR1		SSB.6 FR1	
SMTC configuration defined in A.3.11		Config 1	SMTC.2		SMTC.5	
		Config 2, 3	SMTC.1		SMTC.4	
PDSCH/PDCCH subcarrier spacing	kHz	Config 1,2	15			
		Config 3	30			
EPRE ratio of PSS to SSS		Config 1,2,3	0		0	
EPRE ratio of PBCH DMRS to SSS						
EPRE ratio of PBCH to PBCH DMRS						
EPRE ratio of PDCCH DMRS to SSS						
EPRE ratio of PDCCH to PDCCH DMRS						
EPRE ratio of PDSCH DMRS to SSS						
EPRE ratio of PDSCH to PDSCH						
EPRE ratio of OCNG DMRS to SSS(Note 1)						
EPRE ratio of OCNG to OCNG DMRS (Note 1)						
N_{oc}^{Note2}	dBm/15 kHz		-98		-98	
N_{oc}^{Note2}	dBm/S CS	Config 1,2	-98		-98	
		Config 3	-95		-95	
SS-RSRP ^{Note 3}	dBm/S CS	Config 1,2	-94	-94	-Infinity	-91
		Config 3	-91	-91	-Infinity	-88
\hat{E}_s / I_{ot}	dB	Config 1,2,3	4	4	-Infinity	7

\hat{E}_s / N_{oc}	dB	Config 1,2,3	4	4	-Infinity	7
I_o ^{Note3}	dBm/9.36MHz	Config 1,2	-64.59	-64.59	-70.05	-62.26
	dBm/38.16MHz	Config 3	-58.49	-58.49	-63.94	-56.15
Propagation Condition		Config 1,2,3	AWGN		AWGN	
Note 1:	OCNG shall be used such that both cells are fully allocated and a constant total transmitted power spectral density is achieved for all OFDM symbols.					
Note 2:	Interference from other cells and noise sources not specified in the test is assumed to be constant over subcarriers and time and shall be modelled as AWGN of appropriate power for N_{oc} to be fulfilled.					
Note 3:	SS-RSRP and I_o levels have been derived from other parameters for information purposes. They are not settable parameters themselves.					
Note 4:	SS-RSRP minimum requirements are specified assuming independent interference and noise at each receiver antenna port.					

A.6.6.2.6.2 Test Requirements

In test 1 with per-UE gap, the UE shall send one Event A3 triggered measurement report, with a measurement reporting delay less than 1280 ms from the beginning of time period T2. The UE shall not send event triggered measurement reports, as long as the reporting criteria are not fulfilled. The rate of correct events observed during repeated tests shall be at least 90%.

In test 2 with per-UE gap, the UE shall send one Event A3 triggered measurement report, with a measurement reporting delay less than 12160ms from the beginning of time period T2. The UE shall not send event triggered measurement reports, as long as the reporting criteria are not fulfilled. The rate of correct events observed during repeated tests shall be at least 90%.

In test 1 and 2, UE is required to report SSB time index.

NOTE: The actual overall delays measured in the test may be up to $2 \times TTI_{DCC}$ higher than the measurement reporting delays above because of TTI insertion uncertainty of the measurement report in DCC.

A.6.6.2.7 Void

A.6.6.2.8 Void

A.6.6.3 Inter-RAT Measurements

A.6.6.3.1 SA NR - E-UTRAN event-triggered reporting in non-DRX in FR1

A.6.6.3.1.1 Test Purpose and Environment

The purpose of this set of tests is to verify that the UE makes correct event-triggered reporting of inter-RAT E-UTRAN measurements when operating in standalone (SA) operation with PCell in FR1. This test shall partly verify the cell search and measurement requirements in Clauses 9.4.2 and 9.4.3.

In each test there are two cells: Cell 1 and Cell 2. Cell 1 is the NR PCell and Cell 2 is an inter-RAT E-UTRAN inter-RAT neighbour cell. In the measurement control information from the PCell it is indicated to the UE that event-triggered reporting with Event B2 (PCell becomes worse than threshold1 and inter RAT neighbour becomes better than threshold2) is to be used. Each test consists of two consecutive time periods, with durations T1 and T2, respectively. Prior to the start of time duration T1, the UE shall be fully synchronized to Cell 1. During T1, the UE shall not have any information on Cell 2.

Supported test configurations are shown in table A.6.6.3.1.1-1. General test parameters are provided in Table A.6.6.3.1.1-2 below. Test parameters for Cell 1 and Cell 2, valid for both time duration T1 and T2, are provided in Tables A.6.6.3.1.1-3 and A.6.6.3.1.1-4, respectively.

Table A.6.6.3.1.1-1: Supported test configurations in SA inter-RAT E-UTRAN event triggered reporting in non-DRX with PCell in FR1

Configuration	Description
1	NR 15 kHz SSB SCS, 10 MHz bandwidth, FDD duplex mode, LTE FDD
2	NR 15 kHz SSB SCS, 10 MHz bandwidth, TDD duplex mode, LTE FDD
3	NR 30 kHz SSB SCS, 40 MHz bandwidth, TDD duplex mode, LTE FDD
4	NR 15 kHz SSB SCS, 10 MHz bandwidth, FDD duplex mode, LTE TDD
5	NR 15 kHz SSB SCS, 10 MHz bandwidth, TDD duplex mode, LTE TDD
6	NR 30 kHz SSB SCS, 40 MHz bandwidth, TDD duplex mode, LTE TDD
Note:	The UE is only required to be tested in one of the supported test configurations

Table A.6.6.3.1.1-2: General test parameters for SA inter-RAT E-UTRAN event triggered reporting in non-DRX with PCell in FR1

Parameter	Unit	Value	Comment
NR RF Channel Number		1	1 NR carrier frequency is used in the test
LTE RF Channel Number		1	1 LTE carrier frequency is used in the test
Channel Bandwidth	MHz	As specified in Tables A.6.6.3.1.1-2 and A.6.6.3.1.1-3.	
Active cell		Cell 1	Cell 1 is on RF channel number 1
Neighbour cell		Cell 2	Cell 2 is on RF channel number 2
Gap Pattern Id		0	As specified in Clause Table 9.1.2-1. Per-UE gap pattern.
NR measurement quantity		SS-RSRP	Measurement quantity for Cell 1
Inter-RAT E-UTRAN measurement quantity		RSRP	Measurement quantity for Cell 2
b2-Threshold1	dBm	Note 1	SS-RSRP threshold for SS-RSRP measurement on cell1 for event B2
b2-Threshold2EUTRA	dBm	-97	E-UTRAN RSRP threshold for SS-RSRP measurement on cell1 for event B2
Hysteresis	dB	0	
TimeToTrigger	s	0	
Filter coefficient		0	L3 filtering is not used
DRX		OFF	OFF
T1	s	5	
T2	s	5	
Note 1: Values are defined in Table A.6.6.3.1.1-3			

Table A.6.6.3.1.1-3: PCell specific test parameters for SA inter-RAT E-UTRA event triggered reporting in non-DRX with PCell in FR1

Parameter		Unit	Configuration	Cell 1	
				T1	T2
RF channel number			1, 2, 3, 4, 5, 6	1	
Duplex mode			1, 2, 3	FDD	
			4, 5, 6	TDD	
TDD Configuration	SCS=15 KHz		2, 5	TDDConf.1.1	
	SCS=30 KHz		3, 6	TDDConf.2.1	
BW _{channel}		MHz	1, 4	10: N _{RB,c} = 52 (FDD)	
			2, 5	10: N _{RB,c} = 52 (TDD)	
			3, 6	40: N _{RB,c} = 106 (TDD)	
			1, 4	SR.1.1 FDD	

PDSCH reference measurement channel			2, 5	SR.1.1 TDD	
			3, 6	SR.2.1 TDD	
RMSI CORSET reference channel			1, 4	CR.1.1 FDD	
			2, 5	CR.1.1 TDD	
			3, 6	CR.2.1 TDD	
Dedicated CORSET reference channel			1, 4	CCR.1.1 FDD	
			2, 5	CCR.1.1 TDD	
			3, 6	CCR.2.1 TDD	
BWP configurations	Initial DL BWP		1, 2, 3, 4, 5, 6	DLBWP.0.1	
	Dedicated DL BWP		1, 2, 3, 4, 5, 6	DLBWP.1.1	
	Initial UL BWP		1, 2, 3, 4, 5, 6	ULBWP.0.1	
	Dedicated UL BWP		1, 2, 3, 4, 5, 6	ULBWP.1.1	
OCNG pattern ^{Note1}			1, 2, 3, 4, 5, 6	OP.1	
SMTTC configuration			1, 2, 3, 4, 5, 6	SMTTC.1	
SSB configuration			1, 2, 4, 5	SSB.1 FR1	
			3, 6	SSB.2 FR1	
CSI-RS for tracking			1, 4	TRS.1.1 FDD	
			2, 5	TRS.1.1 TDD	
			3, 6	TRS.1.2 TDD	
b2-Threshold1	dBm		1, 2, 4, 5	-96	
			3, 6	-93	
EPRE ratio of PSS to SSS		dB	1, 2, 3, 4, 5, 6	0	
EPRE ratio of PBCH_DMRS to SSS					
EPRE ratio of PBCH to PBCH_DMRS					
EPRE ratio of PDCCH_DMRS to SSS					
EPRE ratio of PDCCH to PDCCH_DMRS					
EPRE ratio of PDSCH_DMRS to SSS					
EPRE ratio of PDSCH to PDSCH_DMRS					
EPRE ratio of OCNG DMRS to SSS					
EPRE ratio of OCNG to OCNG DMRS					
N_{oc} ^{Note2}	dBm/15 KHz		1, 2, 3, 4, 5, 6	-104	
N_{oc} ^{Note2}	dBm/SCS		1, 2, 4, 5	-104	
			3, 6	-101	
\hat{E}_s/N_{oc}	dB		1, 2, 3, 4, 5, 6	16	0
\hat{E}_s/I_{ot} ^{Note3}	dB		1, 2, 3, 4, 5, 6	16	0
SS-RSRP ^{Note3}	dBm/SCS		1, 2, 4, 5	-88	-104
			3, 6	-85	-101
SSB_RP ^{Note3}	dBm/SCS		1, 2, 4, 5	-88	-104
			3, 6	-85	-101
I_o ^{Note3}	dBm/9.36 MHz		1, 2, 4, 5	-59.94	-73.04
	dBm/38.16 MHz		3, 6	-53.84	-66.93
Propagation condition			1, 2, 3, 4, 5, 6	AWGN	
Antenna Configuration and Correlation Matrix			1, 2, 3, 4, 5, 6	1x2	
<p>Note 1: OCNG shall be used such that both cells are fully allocated and a constant total transmitted power spectral density is achieved for all OFDM symbols.</p> <p>Note 2: Interference from other cells and noise sources not specified in the test is assumed to be constant over subcarriers and time and shall be modelled as AWGN of appropriate power for N_{oc} to be fulfilled.</p> <p>Note 3: \hat{E}_s/I_{ot}, SS-RSRP, SSB_RP and I_o levels have been derived from other parameters for information purposes. They are not settable parameters themselves.</p>					

Table A.6.6.3.1.1-4: E-UTRAN neighbour cell specific test parameters for SA inter-RAT E-UTRAN event triggered reporting in non-DRX with PCell in FR1

Parameter	Unit	Configuration	Cell 2	
			T1	T2
RF channel number		1, 2, 3, 4, 5, 6	1	
Duplex mode		1, 2, 3	FDD	
		4, 5, 6	TDD	
TDD special subframe configuration ^{Note1}		4, 5, 6	6	
TDD uplink-downlink configuration ^{Note1}		4, 5, 6	1	
BW _{channel}	MHz	1, 2, 3, 4, 5, 6	5 MHz: N _{RB,c} = 25 10 MHz: N _{RB,c} = 50 20 MHz: N _{RB,c} = 100	
PDSCH parameters: DL Reference Measurement Channel ^{Note2}		1, 2, 3	5 MHz: R.7 FDD 10 MHz: R.3 FDD 20 MHz: R.6 FDD	
		4, 5, 6	5 MHz: R.4 TDD 10 MHz: R.0 TDD 20 MHz: R.3 TDD	
PCFICH/PDCCH/PHICH parameters: DL Reference Measurement Channel ^{Note2}		1, 2, 3	5 MHz: R.11 FDD 10 MHz: R.6 FDD 20 MHz: R.10 FDD	
		4, 5, 6	5 MHz: R.11 TDD 10 MHz: R.6 TDD 20 MHz: R.10 TDD	
OCNG Patterns ^{Note2}		1, 2, 3	5 MHz: OP.20 FDD 10 MHz: OP.10 FDD 20 MHz: OP.17 FDD	
		4, 5, 6	5 MHz: OP.9 TDD 10 MHz: OP.1 TDD 20 MHz: OP.7 TDD	
PBCH_RA	dB	1, 2, 3, 4, 5, 6	0	
PBCH_RB				
PSS_RA				
SSS_RA				
PCFICH_RB				
PHICH_RA				
PHICH_RB				
PDCCH_RA				
PDCCH_RB				
PDSCH_RA				
PDSCH_RB				
OCNG_RA ^{Note3}				
OCNG_RB ^{Note3}				
N _{oc} ^{Note4}				
\bar{E}_s/N_{oc}	dB	1, 2, 3, 4, 5, 6	-Infinity	19
\bar{E}_s/I_{ot} ^{Note5}	dB	1, 2, 3, 4, 5, 6	-Infinity	19
RSRP ^{Note5}	dBm/15kHz	1, 2, 3, 4, 5, 6	-Infinity	-87
SCH_RP ^{Note5}	dBm/15kHz	1, 2, 3, 4, 5, 6	-Infinity	-87
I _o ^{Note5}	dBm/9MHz	1, 2, 3, 4, 5, 6	$-73.21+10\log(N_{RB,c}/50)$	$-56.12+10\log(N_{RB,c}/50)$
Propagation Condition		1, 2, 3, 4, 5, 6	AWGN	
Antenna Configuration and Correlation Matrix		1, 2, 3, 4, 5, 6	1x2	
Note 1: Special subframe and uplink-downlink configurations are specified in table 4.2-1 in TS 36.211 [23].				
Note 2: DL RMCs and OCNG patterns are specified in clauses A 3.1 and A 3.2 of TS 36.133 [15] respectively.				

Note 3:	OCNG shall be used such that all cells are fully allocated and a constant total transmitted power spectral density is achieved for all OFDM symbols.
Note 4:	Interference from other cells and noise sources not specified in the test is assumed to be constant over subcarriers and time and shall be modelled as AWGN of appropriate power for N_{oc} to be fulfilled.
Note 5:	\hat{E}_s/I_{ot} , RSRP, SCH_RP and I_o levels have been derived from other parameters for information purposes. They are not settable parameters themselves.

A.6.6.3.1.2 Test Requirements

The UE shall send one Event B2 triggered measurement report for Cell 2 to the PCell, with a measurement reporting delay less than 3.84s from the start of period T2. The measurement reporting delay is defined as the time from the beginning of time period T2 to the moment when the UE sends the measurement report on PUSCH.

The UE shall not send event-triggered measurement reports as long as the reporting criteria is not fulfilled.

The rate of correct events observed during repeated tests shall be at least 90%.

A.6.6.3.2 SA NR - E-UTRAN event-triggered reporting in DRX in FR1

A.6.6.3.2.1 Test Purpose and Environment

The purpose of this set of tests is to verify that the UE makes correct event-triggered reporting of inter-RAT E-UTRAN measurements when operating in standalone (SA) operation with PCell in FR1 when DRX is used. This test shall partly verify the cell search and measurement requirements in Clauses 9.4.2 and 9.4.3. There are two test cases. In test 1 the UE shall be configured with DRX cycle of 40 ms. In test 2 the UE shall be configured with DRX cycle of 640 ms.

In each test there are two cells: Cell 1 and Cell 2. Cell 1 is the NR PCell and Cell 2 is an inter-RAT E-UTRAN inter-RAT neighbour cell. In the measurement control information from the PCell it is indicated to the UE that event-triggered reporting with Event B2 (PCell becomes worse than threshold1 and inter RAT neighbour becomes better than threshold2) is to be used. Each test consists of two consecutive time periods, with durations T1 and T2, respectively. Prior to the start of time duration T1, the UE shall be fully synchronized to Cell 1. During T1, the UE shall not have any information on Cell 2.

In each test the UE shall be provided with new Timing Advance Command MAC control element at least once during each time alignment timer period to maintain uplink time alignment. Furthermore the UE shall be allocated with PUSCH resource at every DRX cycle

Supported test configurations are shown in table A.6.6.3.2.1-1. General test parameters are provided in Table A.6.6.3.2.1-2 below. Test parameters for Cell 1 and Cell 2, valid for both time duration T1 and T2, are provided in Tables A.6.6.3.2.1-3 and A.6.6.3.2.1-4, respectively.

Table A.6.6.3.2.1-1: Supported test configurations in SA inter-RAT E-UTRAN event triggered reporting in DRX with PCell in FR1

Configuration	Description
1	NR 15 kHz SSB SCS, 10 MHz bandwidth, FDD duplex mode, LTE FDD
2	NR 15 kHz SSB SCS, 10 MHz bandwidth, TDD duplex mode, LTE FDD
3	NR 30 kHz SSB SCS, 40 MHz bandwidth, TDD duplex mode, LTE FDD
4	NR 15 kHz SSB SCS, 10 MHz bandwidth, FDD duplex mode, LTE TDD
5	NR 15 kHz SSB SCS, 10 MHz bandwidth, TDD duplex mode, LTE TDD
6	NR 30 kHz SSB SCS, 40 MHz bandwidth, TDD duplex mode, LTE TDD
Note:	The UE is only required to be tested in one of the supported test configurations

Table A.6.6.3.2.1-2: General test parameters for SA inter-RAT E-UTRAN event triggered reporting in DRX with PCell in FR1

Parameter	Unit	Test 1	Test 2	Comment
		Value		
NR RF Channel Number		1		1 NR carrier frequency is used in the test
LTE RF Channel Number		2		1 LTE carrier frequency is used in the test
Channel Bandwidth	MHz	As specified in Tables A.6.6.3.2.1-2 and A.6.6.3.2.1-3.		
Active cell		Cell 1		Cell 1 is on RF channel number 1
Neighbour cell		Cell 2		Cell 2 is on RF channel number 2
Gap Pattern Id		0		As specified in Clause Table 9.1.2-1. Per-UE gap pattern.
NR measurement quantity		SS-RSRP		Measurement quantity for Cell 1
Inter-RAT E-UTRAN measurement quantity		RSRP		Measurement quantity for Cell 2
b2-Threshold1	dBm	Note 1		SS-RSRP threshold for SS-RSRP measurement on cell1 for event B2
b2-Threshold2EUTRA	dBm	-97		E-UTRAN RSRP threshold for SS-RSRP measurement on cell1 for event B2
Hysteresis	dB	0		
TimeToTrigger	s	0		
Filter coefficient		0		L3 filtering is not used
DRX		DRX.1	DRX.7	DRX cycle configurations DRX.1 and DRX.7 are defined in Table A.3.3.1-1 and Table A.3.3.7-1 respectively.
T1	s	5		
T2	s	5	15	

Note 1: Values are defined in Table A.6.6.3.2.1-3

Table A.6.6.3.2.1-3: PCell specific test parameters for SA inter-RAT E-UTRA event triggered reporting in DRX with PCell in FR1

Parameter		Unit	Configuration	Cell 1	
				T1	T2
RF channel number			1, 2, 3, 4, 5, 6	1	
Duplex mode			1, 2, 3	FDD	
			4, 5, 6	TDD	
TDD Configuration	SCS=15 KHz		2, 5	TDDConf.1.1	
	SCS=30 KHz		3, 6	TDDConf.2.1	
BW _{channel}		MHz	1, 4	10: N _{RB,c} = 52 (FDD)	
			2, 5	10: N _{RB,c} = 52 (TDD)	
			3, 6	40: N _{RB,c} = 106 (TDD)	
PDSCH reference measurement channel			1, 4	SR.1.1 FDD	
			2, 5	SR.1.1 TDD	
			3, 6	SR.2.1 TDD	
RMSI CORSET reference channel			1, 4	CR.1.1 FDD	
			2, 5	CR.1.1 TDD	
			3, 6	CR.2.1 TDD	
Dedicated CORSET reference channel			1, 4	CCR.1.1 FDD	
			2, 5	CCR.1.1 TDD	
			3, 6	CCR.2.1 TDD	
BWP configurations	Initial DL BWP		1, 2, 3, 4, 5, 6	DLBWP.0.1	
	Dedicated DL BWP		1, 2, 3, 4, 5, 6	DLBWP.1.1	
	Initial UL BWP		1, 2, 3, 4, 5, 6	ULBWP.0.1	
	Dedicated UL BWP		1, 2, 3, 4, 5, 6	ULBWP.1.1	
OCNG pattern ^{Note1}			1, 2, 3, 4, 5, 6	OP.1	
SMTTC configuration			1, 2, 3, 4, 5, 6	SMTTC.1	

SSB configuration		1, 2, 4, 5	SSB.1 FR1	
		3, 6	SSB.2 FR1	
CSI-RS for tracking		1, 4	TRS.1.1 FDD	
		2, 5	TRS.1.1 TDD	
		3, 6	TRS.1.2 TDD	
b2-Threshold1	dBm	1, 2, 4, 5	-96	
		3, 6	-93	
EPRE ratio of PSS to SSS	dB	1, 2, 3, 4, 5, 6	0	
EPRE ratio of PBCH_DMRS to SSS				
EPRE ratio of PBCH to PBCH_DMRS				
EPRE ratio of PDCCH_DMRS to SSS				
EPRE ratio of PDCCH to PDCCH_DMRS				
EPRE ratio of PDSCH_DMRS to SSS				
EPRE ratio of PDSCH to PDSCH_DMRS				
EPRE ratio of OCNG DMRS to SSS				
EPRE ratio of OCNG to OCNG DMRS				
N_{oc}^{Note2}	dBm/15 KHz	1, 2, 3, 4, 5, 6	-104	
N_{oc}^{Note2}	dBm/SCS	1, 2, 4, 5	-104	
		3, 6	-101	
\hat{E}_s/N_{oc}	dB	1, 2, 3, 4, 5, 6	16	0
\hat{E}_s/I_{ot}^{Note3}	dB	1, 2, 3, 4, 5, 6	16	0
SS-RSRP ^{Note3}	dBm/SCS	1, 2, 4, 5	-88	-104
		3, 6	-85	-101
SSB_RP ^{Note3}	dBm/SCS	1, 2, 4, 5	-88	-104
		3, 6	-85	-101
I_o^{Note3}	dBm/9.36 MHz	1, 2, 4, 5	-59.94	-73.04
	dBm/38.16 MHz	3, 6	-53.84	-66.93
Propagation condition		1, 2, 3, 4, 5, 6	AWGN	
Antenna Configuration and Correlation Matrix		1, 2, 3, 4, 5, 6	1x2	
<p>Note 1: OCNG shall be used such that both cells are fully allocated and a constant total transmitted power spectral density is achieved for all OFDM symbols.</p> <p>Note 2: Interference from other cells and noise sources not specified in the test is assumed to be constant over subcarriers and time and shall be modelled as AWGN of appropriate power for N_{oc} to be fulfilled.</p> <p>Note 3: \hat{E}_s/I_{ot}, SS-RSRP, SSB_RP and I_o levels have been derived from other parameters for information purposes. They are not settable parameters themselves.</p>				

Table A.6.6.3.2.1-4: E-UTRAN neighbour cell specific test parameters for SA inter-RAT E-UTRAN event triggered reporting in DRX with PCell in FR1

Parameter	Unit	Configuration	Cell 2	
			T1	T2
RF channel number		1, 2, 3, 4, 5, 6	2	
Duplex mode		1, 2, 3	FDD	
		4, 5, 6	TDD	
TDD special subframe configuration ^{Note1}		4, 5, 6	6	
TDD uplink-downlink configuration ^{Note1}		4, 5, 6	1	
BW _{channel}	MHz	1, 2, 3, 4, 5, 6	5 MHz: $N_{RB,c} = 25$ 10 MHz: $N_{RB,c} = 50$ 20 MHz: $N_{RB,c} = 100$	

PDSCH parameters: DL Reference Measurement Channel ^{Note2}		1, 2, 3	5 MHz: R.7 FDD 10 MHz: R.3 FDD 20 MHz: R.6 FDD
		4, 5, 6	5 MHz: R.4 TDD 10 MHz: R.0 TDD 20 MHz: R.3 TDD
PCFICH/PDCCH/PHICH parameters: DL Reference Measurement Channel ^{Note2}		1, 2, 3	5 MHz: R.11 FDD 10 MHz: R.6 FDD 20 MHz: R.10 FDD
		4, 5, 6	5 MHz: R.11 TDD 10 MHz: R.6 TDD 20 MHz: R.10 TDD
OCNG Patterns ^{Note2}		1, 2, 3	5 MHz: OP.20 FDD 10 MHz: OP.10 FDD 20 MHz: OP.17 FDD
		4, 5, 6	5 MHz: OP.9 TDD 10 MHz: OP.1 TDD 20 MHz: OP.7 TDD
PBCH_RA	dB	1, 2, 3, 4, 5, 6	0
PBCH_RB			
PSS_RA			
SSS_RA			
PCFICH_RB			
PHICH_RA			
PHICH_RB			
PDCCH_RA			
PDCCH_RB			
PDSCH_RA			
PDSCH_RB			
OCNG_RA ^{Note3}			
OCNG_RB ^{Note3}			
N_{oc} ^{Note4}	dBm/15kHz	1, 2, 3, 4, 5, 6	-104
\bar{E}_s/N_{oc}	dB	1, 2, 3, 4, 5, 6	-Infinity 17
\bar{E}_s/I_{ot} ^{Note5}	dB	1, 2, 3, 4, 5, 6	-Infinity 17
RSRP ^{Note5}	dBm/15kHz	1, 2, 3, 4, 5, 6	-Infinity -87
SCH_RP ^{Note5}	dBm/15kHz	1, 2, 3, 4, 5, 6	-Infinity -87
I_o ^{Note5}	dBm/9MHz	1, 2, 3, 4, 5, 6	$-73.21+10\log(N_{RB,c}/50)$ $-56.12+10\log(N_{RB,c}/50)$
Propagation Condition ^{Note6}		1, 2, 3, 4, 5, 6	AWGN
Antenna Configuration and Correlation Matrix ^{Note6}		1, 2, 3, 4, 5, 6	1x2
<p>Note 1: Special subframe and uplink-downlink configurations are specified in table 4.2-1 in TS 36.211 [23].</p> <p>Note 2: DL RMCs and OCNG patterns are specified in clauses A 3.1 and A 3.2 of TS 36.133 [15] respectively.</p> <p>Note 3: OCNG shall be used such that all cells are fully allocated and a constant total transmitted power spectral density is achieved for all OFDM symbols.</p> <p>Note 4: Interference from other cells and noise sources not specified in the test is assumed to be constant over subcarriers and time and shall be modelled as AWGN of appropriate power for N_{oc} to be fulfilled.</p> <p>Note 5: \bar{E}_s/I_{ot}, RSRP, SCH_RP and I_o levels have been derived from other parameters for information purposes. They are not settable parameters themselves.</p> <p>Note 6: Propagation condition and correlation matrix are defined in clause B.2 in TS 36.101 [25].</p>			

A.6.6.3.2.2 Test Requirements

In test 1, the UE shall send one Event B2 triggered measurement report for Cell 2 to the PCell, with a measurement reporting delay less than 3.84s from the start of period T2. The measurement reporting delay is defined as the time from the beginning of time period T2 to the moment when the UE sends the measurement report on PUSCH.

In test 2, the UE shall send one Event B2 triggered measurement report for Cell 2 to the PCell, with a measurement reporting delay less than 12.8s from the start of period T2. The measurement reporting delay is defined as the time from the beginning of time period T2 to the moment when the UE sends the measurement report on PUSCH.

The UE shall not send event-triggered measurement reports as long as the reporting criteria is not fulfilled.

The rate of correct events observed during repeated tests shall be at least 90%.

A.6.6.4 L1-RSRP measurement for beam reporting

A.6.6.4.1 SSB based L1-RSRP measurement when DRX is not used

A.6.6.4.1.1 Test Purpose and Environment

The purpose of this test is to verify that the UE makes correct reporting of L1-RSRP measurement. This test will partly verify the L1-RSRP measurement requirements in clause 9.5.4.1, with the testing configurations for NR cells in Table A.6.6.4.1.1-1.

Table A.6.6.4.1.1-1: Applicable NR configurations for FR1 SSB based L1-RSRP test

Config	Description
1	NR 15 kHz SSB SCS, 10 MHz bandwidth, FDD duplex mode
2	NR 15 kHz SSB SCS, 10 MHz bandwidth, TDD duplex mode
3	NR 30 kHz SSB SCS, 40 MHz bandwidth, TDD duplex mode
Note:	The UE is only required to be tested in one of the supported test configurations

A.6.6.4.1.2 Test parameters

There is one cells in the test, the FR1 PCell (Cell 1). The test parameters for the Cell 1 are given in Table A.6.6.4.1.2-1 and Table A.6.6.4.1.2-2 below.

In CSI measurement configuration, UE is indicated to perform L1-RSRP measurement on the SSBs and report periodically. The test consists of two successive time periods, with time duration of T1 and T2 respectively. The test has higher layer parameter *timeRestrictionForChannelMeasurements* configured.

There is no measurement gap configured in the test. Before the test, UE is configured to perform RLM, BFD and L1-RSRP measurement based on the SSBs.

Table A.6.6.4.1.2-1: General test parameters

Parameter	Config	Unit	Value
SSB GSCN	1~3		freq1
Duplex mode	1		FDD
	2		TDD
	3		TDD
TDD Configuration	1		N/A
	2		TDDConf.1.1
	3		TDDConf.2.1
BW _{channel}	1	MHz	10: N _{RB,c} = 52
	2		10: N _{RB,c} = 52
	3		40: N _{RB,c} = 106
PDSCH Reference measurement channel	1		SR.1.1 FDD
	2		SR.1.1 TDD
	3		SR.2.1 TDD
	1		CR.1.1 FDD

RMSI CORESET Reference Channel	2		CR.1.1 TDD
	3		CR.2.1 TDD
Dedicated CORESET Reference Channel	1		CCR.1.1 FDD
	2		CCR.1.1 TDD
	3		CCR.2.1 TDD
SSB configuration	1		SSB.3 FR1
	2		SSB.3 FR1
	3		SSB.4 FR1
OCNG Patterns	1~3		OP.1
Initial BWP Configuration	1~3		DLBWP.0.1 ULBWP.0.1
Dedicated BWP configuration	1~3		DLBWP.1.1 ULBWP.1.1
SMTC configuration	1~3		SMTC.1
TRS Configuration	1		TRS.1.1 FDD
	2		TRS.1.1 TDD
	3		TRS.1.2 TDD
DRX configuration	1~3		Off
reportConfigType	1~3		periodic
reportQuantity	1~3		ssb-Index-RSRP
Number of reported RS	1~3		2
L1-RSRP reporting period	1~3	slot	80
T1	1~3	s	5
T2	1~3	s	1
EPRE ratio of PSS to SSS	1~3	dB	0
EPRE ratio of PBCH DMRS to SSS			
EPRE ratio of PBCH to PBCH DMRS			
EPRE ratio of PDCCH DMRS to SSS			
EPRE ratio of PDCCH to PDCCH DMRS			
EPRE ratio of PDSCH DMRS to SSS			
EPRE ratio of PDSCH to PDSCH DMRS			
EPRE ratio of OCNG DMRS to SSS ^{Note 1}			
EPRE ratio of OCNG to OCNG DMRS ^{Note 1}			
Propagation condition			
Note 1: OCNG shall be used such that the resources in Cell 1 are fully allocated and a constant total transmitted power spectral density is achieved for all OFDM symbols.			

Table A.6.6.4.1.2-2: SSB specific test parameters

Parameter	Config	Unit	SSB#0		SSB#1	
			T1	T2	T1	T2
N_{oc} ^{Note2}	1~3	dBm/15kHz	-94.65			
N_{oc} ^{Note2}	1,2	dBm/SSB SCS	-94.65			
	3		-91.65			
\hat{E}_s/I_{ot}	1~3	dB	0	0	-Infinity	3

SSB RSRP ^{Note3}	1,2	dBm/SSB SCS	-94.65	-94.65	-Infinity	-91.65
	3		-91.65	-91.65	-Infinity	-88.65
I _o ^{Note3}	1,2	dBm/9.36 MHz	-63.69	-63.69	-66.70	-61.93
	3	dBm/38.16 MHz	-57.59	-57.59	-60.61	-55.84
\hat{E}_s / N_{oc}	1~3	dB	0	0	-Infinity	3
<p>Note 1: The resources for uplink transmission are assigned to the UE prior to the start of time period T2.</p> <p>Note 2: Interference from other cells and noise sources not specified in the test is assumed to be constant over subcarriers and time and shall be modelled as AWGN of appropriate power for N_{oc} to be fulfilled.</p> <p>Note 3: SS-RSRP and I_o levels have been derived from other parameters for information purposes. They are not settable parameters themselves.</p>						

A.6.6.4.1.3 Test Requirements

The UE shall send L1-RSRP report every 80 slots. No later than 640ms plus 80 slots from the beginning of time period T2, UE shall send L1-RSRP report including results of both SSB0 and SSB1 while meeting the absolute accuracy requirement in clause 10.1.19.1.1 and relative accuracy requirement in clause 10.1.19.1.2. The rate of correct events observed during repeated tests shall be at least 90%.

NOTE: The actual overall delays measured in the test may be up to $2xTTI_{DCCCH}$ higher than the measurement reporting delays above because of TTI insertion uncertainty of the measurement report in DCCCH.

A.6.6.4.2 SSB based L1-RSRP measurement when DRX is used

A.6.6.4.2.1 Test Purpose and Environment

The purpose of this test is to verify that the UE makes correct reporting of L1-RSRP measurement. This test will partly verify the L1-RSRP measurement requirements in clause 9.5.4.1, with the testing configurations for NR cells in Table A.6.6.4.2.1-1.

Table A.6.6.4.2.1-1: Applicable NR configurations for FR1 SSB based L1-RSRP test

Config	Description
1	NR 15 kHz SSB SCS, 10 MHz bandwidth, FDD duplex mode
2	NR 15 kHz SSB SCS, 10 MHz bandwidth, TDD duplex mode
3	NR 30 kHz SSB SCS, 40 MHz bandwidth, TDD duplex mode
Note:	The UE is only required to be tested in one of the supported test configurations

A.6.6.4.2.2 Test parameters

There is one cells in the test, the FR1 PCell (Cell 1). The test parameters for the Cell 1 are given in Table A.6.6.4.2.2-1 and Table A.6.6.4.2.2-2 below.

In CSI measurement configuration, UE is indicated to perform L1-RSRP measurement on the SSBs and report periodically. The test consists of two successive time periods, with time duration of T1 and T2 respectively. The test has higher layer parameter *timeRestrictionForChannelMeasurements* configured.

There is no measurement gap configured in the test. Before the test, UE is configured to perform RLM, BFD and L1-RSRP measurement based on the SSBs.

Table A.6.6.4.2.2-1: General test parameters

Parameter	Config	Unit	Value
SSB GSCN	1~3		freq1
Duplex mode	1		FDD
	2		TDD
	3		TDD
TDD Configuration	1		N/A
	2		TDDConf.1.1
	3		TDDConf.2.1
BW_{channel}	1	MHz	10: $N_{RB,c} = 52$
	2		10: $N_{RB,c} = 52$
	3		40: $N_{RB,c} = 106$
PDSCH Reference measurement channel	1		SR.1.1 FDD
	2		SR.1.1 TDD
	3		SR.2.1 TDD
RMSI CORESET Reference Channel	1		CR.1.1 FDD
	2		CR.1.1 TDD
	3		CR.2.1 TDD
Dedicated CORESET Reference Channel	1		CCR.1.1 FDD
	2		CCR.1.1 TDD
	3		CCR.2.1 TDD
SSB configuration	1		SSB.3 FR1
	2		SSB.3 FR1
	3		SSB.4 FR1
OCNG Patterns	1~3		OP.1
Initial BWP Configuration	1~3		DLBWP.0.1 ULBWP.0.1
Dedicated BWP configuration	1~3		DLBWP.1.1 ULBWP.1.1
SMTc configuration	1~3		SMTc.1
TRS Configuration	1		TRS.1.1 FDD
	2		TRS.1.1 TDD
	3		TRS.1.2 TDD
DRX configuration	1~3		DRX.3
reportConfigType	1~3		periodic
reportQuantity	1~3		ssb-Index-RSRP
Number of reported RS	1~3		2
L1-RSRP reporting period	1~3	slot	80
T1	1~3	s	5
T2	1~3	s	1
EPRE ratio of PSS to SSS	1~3	dB	0
EPRE ratio of PBCH DMRS to SSS			
EPRE ratio of PBCH to PBCH DMRS			
EPRE ratio of PDCCH DMRS to SSS			
EPRE ratio of PDCCH to PDCCH DMRS			
EPRE ratio of PDSCH DMRS to SSS			
EPRE ratio of PDSCH to PDSCH DMRS			
EPRE ratio of OCNG DMRS to SSS ^{Note 1}			

EPRE ratio of OCNG to OCNG DMRS ^{Note 1}			
Propagation condition	1~3		AWGN
Note 1: OCNG shall be used such that the resources in Cell 1 are fully allocated and a constant total transmitted power spectral density is achieved for all OFDM symbols.			

Table A.6.6.4.2.2-2: SSB specific test parameters

Parameter	Config	Unit	SSB#0		SSB#1	
			T1	T2	T1	T2
N_{oc} ^{Note2}	1~3	dBm/15kHz	-94.65			
N_{oc} ^{Note2}	1,2	dBm/SSB SCS	-94.65			
	3		-91.65			
\hat{E}_s/I_{ot}	1~3	dB	0	0	-Infinity	3
SSB RSRP ^{Note3}	1,2	dBm/SSB SCS	-94.65	-94.65	-Infinity	-91.65
	3		-91.65	-91.65	-Infinity	-88.65
I_o ^{Note3}	1,2	dBm/9.36 MHz	-63.69	-63.69	-66.70	-61.93
	3	dBm/38.16 MHz	-57.59	-57.59	-60.61	-55.84
\hat{E}_s/N_{oc}	1~3	dB	0	0	-Infinity	3
<p>Note 1: The resources for uplink transmission are assigned to the UE prior to the start of time period T2.</p> <p>Note 2: Interference from other cells and noise sources not specified in the test is assumed to be constant over subcarriers and time and shall be modelled as AWGN of appropriate power for N_{oc} to be fulfilled.</p> <p>Note 3: SS-RSRP and I_o levels have been derived from other parameters for information purposes. They are not settable parameters themselves.</p>						

A.6.6.4.2.3 Test Requirements

The UE shall send L1-RSRP report every 80 slots. No later than 640ms plus 80 slots from the beginning of time period T2, UE shall send L1-RSRP report including results of both SSB0 and SSB1 while meeting the absolute accuracy requirement in clause 10.1.19.1.1 and relative accuracy requirement in clause 10.1.19.1.2. The rate of correct events observed during repeated tests shall be at least 90%.

NOTE: The actual overall delays measured in the test may be up to $2xTTI_{DCCH}$ higher than the measurement reporting delays above because of TTI insertion uncertainty of the measurement report in DCCH.

A.6.6.4.3 CSI-RS based L1-RSRP measurement when DRX is not used

A.6.6.4.3.1 Test Purpose and Environment

The purpose of this test is to verify that the UE makes correct reporting of L1-RSRP measurement. This test will partly verify the L1-RSRP measurement requirements in clause 9.5.4.2, with the testing configurations for NR cells in Table A.6.6.4.3.1-1.

Table A.6.6.4.3.1-1: Applicable NR configurations for FR1 CSI-RS based L1-RSRP test

Config	Description
1	NR 15 kHz SSB SCS, 10 MHz bandwidth, FDD duplex mode
2	NR 15 kHz SSB SCS, 10 MHz bandwidth, TDD duplex mode
3	NR 30 kHz SSB SCS, 40 MHz bandwidth, TDD duplex mode
Note:	The UE is only required to be tested in one of the supported test configurations

A.6.6.4.3.2 Test parameters

There is one cells in the test, the FR1 PCell (Cell 1). The test parameters for the Cell 1 are given in Table A.6.6.4.3.2-1 and Table A.6.6.4.3.2-2 below.

In CSI measurement configuration, UE is indicated to perform L1-RSRP measurement on the CSI-RS and report aperiodically. The test consists of a single time period T1, during which the UE is triggered via DCI to report L1-RSRP on aperiodic CSI-RS resources. UE is also configured to measure L1-RSRP based on SSB. After 80ms from the beginning of the test, the DCI trigger comes in slot n (0 for Config 1,2 and 8 for Config 3) of a frame and UE provides the report back based on the reporting configuration as defined in Table A.6.6.4.3.2-1.

There is no measurement gap configured in the test. Before the test, UE is configured to perform RLM and BFD based on the SSBs.

Table A.6.6.4.3.2-1: General test parameters

Parameter	Config	Unit	Value
SSB GSCN	1~3		freq1
Duplex mode	1		FDD
	2		TDD
	3		TDD
TDD Configuration	1		N/A
	2		TDDConf.1.1
	3		TDDConf.2.1
BW _{channel}	1	MHz	10: N _{RB,c} = 52
	2		10: N _{RB,c} = 52
	3		40: N _{RB,c} = 106
PDSCH Reference measurement channel	1		SR.1.1 FDD
	2		SR.1.1 TDD
	3		SR.2.1 TDD
RMSI CORESET Reference Channel	1		CR.1.1 FDD
	2		CR.1.1 TDD
	3		CR.2.1 TDD
Dedicated CORESET Reference Channel	1		CCR.1.1 FDD
	2		CCR.1.1 TDD
	3		CCR.2.1 TDD
SSB configuration	1		SSB.3 FR1
	2		SSB.3 FR1
	3		SSB.4 FR1
CSI-RS configuration	1		CSI-RS 1.3 FDD
	2		CSI-RS 1.3 TDD
	3		CSI-RS 2.3 TDD
OCNG Patterns	1~3		OP.1
TRS Configuration	1		TRS.1.1 FDD
	2		TRS.1.1 TDD
	3		TRS.1.2 TDD
Initial BWP Configuration	1~3		DLBWP.0.1

			ULBWP.0.1
Dedicated BWP configuration	1~3		DLBWP.1.1 ULBWP.1.1
SMTTC configuration	1~3		SMTTC.1
DRX configuration	1~3		Off
reportConfigType	1~3		aperiodic
reportQuantity	1~3		cri-RSRP
Number of reported RS	1~3		2
qcl-Info	1~3		SSB#0 for resource#0 SSB#1 for resource#1
reportSlotOffsetList	1~3	slots	8
T1	1~3	s	5
EPRE ratio of PSS to SSS	1~3	dB	0
EPRE ratio of PBCH DMRS to SSS			
EPRE ratio of PBCH to PBCH DMRS			
EPRE ratio of PDCCH DMRS to SSS			
EPRE ratio of PDCCH to PDCCH DMRS			
EPRE ratio of PDSCH DMRS to SSS			
EPRE ratio of PDSCH to PDSCH DMRS			
EPRE ratio of OCNG DMRS to SSS ^{Note 1}			
EPRE ratio of OCNG to OCNG DMRS ^{Note 1}			
Propagation condition	1~3		AWGN
Note 1: OCNG shall be used such that the resources in Cell 1 are fully allocated and a constant total transmitted power spectral density is achieved for all OFDM symbols.			

Table A.6.6.4.3.2-2: CSI-RS specific test parameters

Parameter	Config	Unit	CSI-RS#0	CSI-RS#1
N_{oc} ^{Note1}	1~3	dBm/15kHz	-94.65	
N_{oc} ^{Note1}	1,2	dBm/SSB SCS	-94.65	
	3		-91.65	
\hat{E}_s / I_{ot}	1~3	dB	0	3
CSI-RS RSRP ^{Note2}	1,2	dBm/SSB SCS	-94.65	-91.65
	3		-91.65	-88.65
I_o ^{Note2}	1,2	dBm/9.36 MHz	-63.69	-61.93
	3	dBm/38.16 MHz	-57.59	-55.84
\hat{E}_s / N_{oc}	1~3	dB	0	3
Note 2: Interference from other cells and noise sources not specified in the test is assumed to be constant over subcarriers and time and shall be modelled as AWGN of appropriate power for N_{oc} to be fulfilled.				

Note 3: CSI-RS RSRP and Io levels have been derived from other parameters for information purposes. They are not settable parameters themselves.

A.6.6.4.3.3 Test Requirements

After 80ms from the beginning of the test, the UE shall send L1-RSRP report at slot 8 from the reception of DCI triggering the L1-RSRP measurement. The L1-RSRP report shall include the results for both CSI-RS#0 and CSI-RS#1 while meeting the absolute accuracy requirement in clause 10.1.20.1.1 and relative accuracy requirement in clause 10.1.20.1.2.

The rate of correct events observed during repeated tests shall be at least 90%.

NOTE: The actual overall delays measured in the test may be up to $2 \times TTI_{DCCH}$ higher than the measurement reporting delays above because of TTI insertion uncertainty of the measurement report in DCCH.

A.6.6.4.4 CSI-RS based L1-RSRP measurement when DRX is used

A.6.6.4.4.1 Test Purpose and Environment

The purpose of this test is to verify that the UE makes correct reporting of L1-RSRP measurement. This test will partly verify the L1-RSRP measurement requirements in clause 9.5.4.2, with the testing configurations for NR cells in Table A.6.6.4.4.1-1.

Table A.6.6.4.4.1-1: Applicable NR configurations for FR1 CSI-RS based L1-RSRP test

Config	Description
1	NR 15 kHz SSB SCS, 10 MHz bandwidth, FDD duplex mode
2	NR 15 kHz SSB SCS, 10 MHz bandwidth, TDD duplex mode
3	NR 30 kHz SSB SCS, 40 MHz bandwidth, TDD duplex mode
Note: The UE is only required to be tested in one of the supported test configurations	

A.6.6.4.4.2 Test parameters

There is one cells in the test, the FR1 PCell (Cell 1). The test parameters for the Cell 1 are given in Table A.6.6.4.4.2-1 and Table A.6.6.4.4.2-2 below.

In CSI measurement configuration, UE is indicated to perform L1-RSRP measurement on the CSI-RS and report aperiodically. The test consists of a single time period T1, during which the UE is triggered via DCI to report L1-RSRP on aperiodic CSI-RS resources. UE is also configured to measure L1-RSRP based on SSB. After 80ms from the beginning of the test, the DCI trigger comes in slot n (0 for Config 1,2 and 8 for Config 3) of a frame and UE provides the report back based on the reporting configuration as defined in Table A.6.6.4.4.2-1.

There is no measurement gap configured in the test. Before the test, UE is configured to perform RLM and BFD based on the SSBs.

Table A.6.6.4.4.2-1: General test parameters

Parameter	Config	Unit	Value
SSB GSCN	1~3		freq1
Duplex mode	1		FDD
	2		TDD
	3		TDD
TDD Configuration	1		N/A
	2		TDDConf.1.1
	3		TDDConf.2.1

BW _{channel}	1	MHz	10: N _{RB,c} = 52
	2		10: N _{RB,c} = 52
	3		40: N _{RB,c} = 106
PDSCH Reference measurement channel	1		SR.1.1 FDD
	2		SR.1.1 TDD
	3		SR.2.1 TDD
RMSI CORESET Reference Channel	1		CR.1.1 FDD
	2		CR.1.1 TDD
	3		CR.2.1 TDD
Dedicated CORESET Reference Channel	1		CCR.1.1 FDD
	2		CCR.1.1 TDD
	3		CCR.2.1 TDD
SSB configuration	1		SSB.3 FR1
	2		SSB.3 FR1
	3		SSB.4 FR1
CSI-RS configuration	1		CSI-RS 1.3 FDD
	2		CSI-RS 1.3 TDD
	3		CSI-RS 2.3 TDD
OCNG Patterns	1~3		OP.1
TRS Configuration	1		TRS.1.1 FDD
	2		TRS.1.1 TDD
	3		TRS.1.2 TDD
Initial BWP Configuration	1~3		DLBWP.0.1 ULBWP.0.1
Dedicated BWP configuration	1~3		DLBWP.1.1 ULBWP.1.1
SMTC configuration	1~3		SMTC.1
DRX configuration	1~3		DRX.3
reportConfigType	1~3		aperiodic
reportQuantity	1~3		cri-RSRP
Number of reported RS	1~3		2
qcl-Info	1~3		SSB#0 for resource#0
			SSB#1 for resource#1
reportSlotOffsetList	1~3	slots	8
T1	1~3	s	5
EPRE ratio of PSS to SSS	1~3	dB	0
EPRE ratio of PBCH DMRS to SSS			
EPRE ratio of PBCH to PBCH DMRS			
EPRE ratio of PDCCH DMRS to SSS			
EPRE ratio of PDCCH to PDCCH DMRS			
EPRE ratio of PDSCH DMRS to SSS			
EPRE ratio of PDSCH to PDSCH DMRS			
EPRE ratio of OCNG DMRS to SSS ^{Note 1}			
EPRE ratio of OCNG to OCNG DMRS ^{Note 1}			
Propagation condition	1~3		AWGN
Note 1: OCNG shall be used such that the resources in Cell 1 are fully allocated and a constant total transmitted power spectral density is achieved for all OFDM symbols.			

Table A.6.6.4.4.2-2: CSI-RS specific test parameters

Parameter	Config	Unit	CSI-RS#0	CSI-RS#1
N_{oc} ^{Note1}	1~3	dBm/15kHz	-94.65	
N_{oc} ^{Note1}	1,2	dBm/SSB SCS	-94.65	
	3		-91.65	
\hat{E}_s/I_{ot}	1~3	dB	0	3
CSI-RS RSRP ^{Note2}	1,2	dBm/SSB SCS	-94.65	-91.65
	3		-91.65	-88.65
I_o ^{Note2}	1,2	dBm/9.36 MHz	-63.69	-61.93
	3	dBm/38.16 MHz	-57.59	-55.84
\hat{E}_s/N_{oc}	1~3	dB	0	3
<p>Note 1: Interference from other cells and noise sources not specified in the test is assumed to be constant over subcarriers and time and shall be modelled as AWGN of appropriate power for N_{oc} to be fulfilled.</p> <p>Note 2: CSI-RS RSRP and I_o levels have been derived from other parameters for information purposes. They are not settable parameters themselves.</p>				

A.6.6.4.4.3 Test Requirements

After 80ms from the beginning of the test, the UE shall send L1-RSRP report at slot 8 from the reception of DCI triggering the L1-RSRP measurement. The L1-RSRP report shall include the results for both CSI-RS#0 and CSI-RS#1 while meeting the absolute accuracy requirement in clause 10.1.20.1.1 and relative accuracy requirement in clause 10.1.20.1.2.

The rate of correct events observed during repeated tests shall be at least 90%.

NOTE: The actual overall delays measured in the test may be up to $2 \times TTI_{DCCH}$ higher than the measurement reporting delays above because of TTI insertion uncertainty of the measurement report in DCCH.

A.6.7 Measurement Performance requirements

Unless explicitly stated otherwise:

- Reported measurements shall be within defined range of accuracy limits defined in Clause 10 for at least 90 % of the reported cases. If multiple measurement performance requirements are verified in the same test, the reported measurements for each requirement shall be within defined range of accuracy limits of the corresponding requirement defined in Clause 10 for at least 90% of the reported cases.
- Measurements are performed in RRC_CONNECTED state.
- The reference channels assume transmission of PDSCH with a maximum number of 5 HARQ transmissions unless otherwise specified.

A.6.7.1 SS-RSRP

A.6.7.1.1 SA: intra-frequency case measurement accuracy with FR1 serving cell and FR1 target cell

A.6.7.1.1.1 Test Purpose and Environment

The purpose of this test is to verify that the SS-RSRP measurement accuracy is within the specified limits. This test will verify the requirements in clauses 10.1.2.1.1 and 10.1.2.1.2 for intra-frequency measurements.

A.6.7.1.1.2 Test parameters

In this set of test cases all cells are on the same carrier frequency. Supported test configurations are shown in table A.6.7.1.1.2-1. Both absolute and relative accuracy of SS-RSRP intra-frequency measurements are tested by using the parameters in A.6.7.1.1.2-2. In all test cases, Cell 1 is the PCell, and Cell 2 is the target cell.

Table A.6.7.1.1.2-1: SS-RSRP Intra frequency SS-RSRP supported test configurations

Config	Description
1	NR 15 kHz SSB SCS, 10 MHz bandwidth, FDD duplex mode
2	NR 15 kHz SSB SCS, 10 MHz bandwidth, TDD duplex mode
3	NR 30kHz SSB SCS, 40 MHz bandwidth, TDD duplex mode
Note:	The UE is only required to be tested in one of the supported test configurations in each supported band

Table A.6.7.1.1.2-2: SS-RSRP Intra frequency test parameters

Parameter		Unit	Test 1		Test 2		Test 3	
			Cell 1	Cell 2	Cell 1	Cell 2	Cell 1	Cell 2
Cell ID			489	0	489	0	489	0
SSB ARFCN			freq1		freq1		freq1	
Duplex mode	Config 1		FDD					
	Config 2,3		TDD					
TDD configuration	Config 1		Not Applicable					
	Config 2		TDDConf.1.1					
	Config 3		TDDConf.2.1					
BW _{channel}	Config 1	MHz	10: N _{RB,c} = 52					
	Config 2		10: N _{RB,c} = 52					
	Config 3		40: N _{RB,c} = 106					
BWP BW	Config 1		10: N _{RB,c} = 52					
	Config 2		10: N _{RB,c} = 52					
	Config 3		40: N _{RB,c} = 106					
Downlink initial BWP configuration			DLBWP.0.1					
Downlink dedicated BWP configuration			DLBWP.1.1					
Uplink initial BWP configuration			ULBWP.0.1					
Uplink dedicated BWP configuration			ULBWP.1.1					
TRS configuration	Config 1		TRS.1. 1 FDD	NA	TRS.1 .1 FDD	NA	TRS.1. 1 FDD	NA
	Config 2		TRS.1. 1 TDD	NA	TRS.1 .1 TDD	NA	TRS.1. 1 TDD	NA
	Config 3		TRS.1. 2 TDD	NA	TRS.1 .2 TDD	NA	TRS.1. 2 TDD	NA

DRX Cycle		ms	Not Applicable						
PDSCH Reference measurement channel	Config 1		SR.1.1 FDD	-	SR.1.1 FDD	-	SR.1.1 FDD	-	
	Config 2		SR.1.1 TDD	-	SR.1.1 TDD	-	SR.1.1 TDD	-	
	Config 3		SR2.1 TDD	-	SR2.1 TDD	-	SR2.1 TDD	-	
RMSI CORESET Reference Channel	Config 1		CR.1.1 FDD	-	CR.1.1 FDD	-	CR.1.1 FDD	-	
	Config 2		CR.1.1 TDD	-	CR.1.1 TDD	-	CR.1.1 TDD	-	
	Config 3		CR2.1 TDD	-	CR2.1 TDD	-	CR2.1 TDD	-	
Control channel RMC	Config 1		CCR.1.1 FDD	-	CCR.1.1 FDD	-	CCR.1.1 FDD	-	
	Config 2		CCR.1.1 TDD	-	CCR.1.1 TDD	-	CCR.1.1 TDD	-	
	Config 3		CCR2.1 TDD	-	CCR2.1 TDD	-	CCR2.1 TDD	-	
SSB configuration	Config 1		SSB.1 FR1	SSB.1 FR1	SSB.1 FR1	SSB.1 FR1	SSB.1 FR1	SSB.1 FR1	
	Config 2		SSB.1 FR1	SSB.1 FR1	SSB.1 FR1	SSB.1 FR1	SSB.1 FR1	SSB.1 FR1	
	Config 3		SSB.2 FR1	SSB.2 FR1	SSB.2 FR1	SSB.2 FR1	SSB.2 FR1	SSB.2 FR1	
Time offset with Cell 1	Config 1	ms	-	3	-	3	-	3	
	Config 2,3	µs	-	3	-	3	-	3	
SMTC configuration	Config 1		SMTC.2						
	Config 2,3		SMTC.1						
OCNG Patterns			OCNG pattern 1						
PDSCH/PDCCH subcarrier spacing	Config 1,2	kHz	15 kHz						
	Config 3		30kHz						
EPRE ratio of PSS to SSS		dB	0	0	0	0	0	0	
EPRE ratio of PBCH DMRS to SSS									
EPRE ratio of PBCH to PBCH DMRS									
EPRE ratio of PDCCH DMRS to SSS									
EPRE ratio of PDCCH to PDCCH DMRS									
EPRE ratio of PDSCH DMRS to SSS									
EPRE ratio of PDSCH to PDSCH									
EPRE ratio of OCNG DMRS to SSS(Note 1)									
EPRE ratio of OCNG to OCNG DMRS (Note 1)									
N_{oc} Note2	Config 1,2	NR_FDD_FR1_A, NR_TDD_FR1_A NOTE 6	dBm/15KHz		-106		-88		-114
		NR_FDD_FR1_B							-113.5

		NR_TDD_FR1_C	dBm/SCS						-113						
		NR_FDD_FR1_D, NR_TDD_FR1_D							-112.5						
		NR_FDD_FR1_E, NR_TDD_FR1_E							-112						
		NR_FDD_FR1_G							-111						
		NR_FDD_FR1_H							-110.5						
	Config 3	NR_FDD_FR1_A, NR_TDD_FR1_A NOTE 6							Not applicable ^{Note 5}	-94	-114				
		NR_FDD_FR1_B									-113.5				
		NR_TDD_FR1_C									-113				
		NR_FDD_FR1_D, NR_TDD_FR1_D									-112.5				
		NR_FDD_FR1_E, NR_TDD_FR1_E									-112				
		NR_FDD_FR1_G NR_FDD_FR1_H									-111 -110.5				
N_{oc} ^{Note2}	Config 1,2		dBm/SCS	Not applicable ^{Note 5}	-88	-106	-91	Same as Noc/15kHz							
	Config 3	NR_FDD_FR1_A, NR_TDD_FR1_A NOTE 6						-111							
		NR_FDD_FR1_B						-110.5							
		NR_TDD_FR1_C						-110							
		NR_FDD_FR1_D, NR_TDD_FR1_D						-109.5							
		NR_FDD_FR1_E, NR_TDD_FR1_E						-109							
		NR_FDD_FR1_G NR_FDD_FR1_H						-108 -107.5							
	\hat{E}_s/I_{ot}							dB	2.46	-5.97	2.46	-5.97	-0.01	-4.76	
	\hat{E}_s/N_{oc}							dB	6	1	6	1	3	0	
	SS- RSRP ^{Note 3}	Config 1,2						NR_FDD_FR1_A, NR_TDD_FR1_A NOTE 6	dBm/SCS	-100	-105	-82	-87	-	-
NR_FDD_FR1_B			111.00	114.00											
NR_TDD_FR1_C			110.50	113.50											
NR_FDD_FR1_D, NR_TDD_FR1_D			110.00	113.00											
NR_FDD_FR1_E, NR_TDD_FR1_E			109.50	112.50											
NR_FDD_FR1_G			109.00	112.00											
NR_FDD_FR1_H			108.00	111.00											
Config 3		NR_FDD_FR1_A, NR_TDD_FR1_A NOTE 6	107.50	110.50											
		NR_FDD_FR1_B	108.00	111.00											
		NR_TDD_FR1_C	107.50	110.50											
		NR_FDD_FR1_D, NR_TDD_FR1_D	107.00	110.00											
		NR_FDD_FR1_E, NR_TDD_FR1_E	106.50	109.50											
		NR_FDD_FR1_G	106.00	109.00											
		NR_FDD_FR1_H	105.50	108.50											

		NR_FDD_FR1_E, NR_TDD_FR1_E						- 106.00	- 109.00
		NR_FDD_FR1_G						- 105.00	- 108.00
		NR_FDD_FR1_H						- 104.50	- 107.50
I _o Note3	Config 1,2	NR_FDD_FR1_A, NR_TDD_FR1_A NOTE 6	dBm/ 9.36MHz	-70.09	-52.09	-80.03			
		NR_FDD_FR1_B				-79.53			
		NR_TDD_FR1_C				-79.03			
		NR_FDD_FR1_D, NR_TDD_FR1_D				-78.53			
		NR_FDD_FR1_E, NR_TDD_FR1_E				-78.03			
		NR_FDD_FR1_G				-77.03			
		NR_FDD_FR1_H				-76.53			
	Config 3	NR_FDD_FR1_A, NR_TDD_FR1_A NOTE 6	dBm/ 38.16MHz	Not applicable ^{Note 5,}	-51.99	-73.94			
		NR_FDD_FR1_B				-73.44			
		NR_TDD_FR1_C				-72.94			
		NR_FDD_FR1_D, NR_TDD_FR1_D				-72.44			
		NR_FDD_FR1_E, NR_TDD_FR1_E				-71.94			
		NR_FDD_FR1_G				-70.94			
		NR_FDD_FR1_H				-70.44			
Propagation condition			-	AWGN					
Antenna configuration				1x2					
<p>Note 1: OCNG shall be used such that both cells are fully allocated and a constant total transmitted power spectral density is achieved for all OFDM symbols.</p> <p>Note 2: Interference from other cells and noise sources not specified in the test is assumed to be constant over subcarriers and time and shall be modelled as AWGN of appropriate power for N_{oc} to be fulfilled.</p> <p>Note 3: SS-RSRP and I_o levels have been derived from other parameters for information purposes. They are not settable parameters themselves.</p> <p>Note 4: SS-RSRP minimum requirements are specified assuming independent interference and noise at each receiver antenna port.</p> <p>Note 5: Subtest 1 is not used when testing with 30kHz SSB SCS.</p> <p>Note 6: The test configuration excludes support for band n51 and it is not required to run this test on band n51 in this release of the specification</p>									

A.6.7.1.1.3 Test Requirements

The SS-RSRP measurement accuracy for cell 1 and cell 2 shall fulfil absolute requirement in clause 10.1.2.1.1 and relative requirement in clause 10.1.2.1.2.

A.6.7.1.2 SA inter-frequency case measurement accuracy with FR1 serving cell and FR1 target cell

A.6.7.1.2.1 Test Purpose and Environment

The purpose of this test is to verify that the SS-RSRP measurement accuracy is within the specified limits. This test will verify the requirements in clauses 10.1.4.1.1 and 10.1.4.1.2 for inter-frequency measurements with the testing configurations for NR cells in Table A.6.7.1.2.1-1.

Table A.6.7.1.2.1-1: Applicable NR configurations for FR1 inter-frequency SS-RSRP accuracy test

Config	Description
1	NR 15 kHz SSB SCS, 10 MHz bandwidth, FDD duplex mode
2	NR 15 kHz SSB SCS, 10 MHz bandwidth, TDD duplex mode
3	NR 30kHz SSB SCS, 40 MHz bandwidth, TDD duplex mode
Note: The UE is only required to be tested in one of the supported test configurations in each supported band	

A.6.7.1.2.2 Test parameters

In this set of test cases there are two cells in the test, PCell (Cell 1) and a FR1 neighbour cell (Cell 2) on a different frequency than the PCell. The test parameters for the Cell 1 and Cell 2 are given in Table A.6.7.1.2.2-1 below. Both absolute and relative accuracy of RSRP inter-frequency measurements are tested by using the parameters in Table A.6.7.1.2.2-1. The inter-frequency measurements are supported by a measurement gap.

Table A.6.7.1.2.2-1: SS-RSRP inter-frequency test parameters

Parameter	Config	Unit	Test 1		Test 2	
			Cell 1	Cell 2	Cell 1	Cell 2
SSB ARFCN	1~3		freq1	freq2	freq1	freq2
BW _{channel}	1	MHz	10: N _{RB,c} = 52		10: N _{RB,c} = 52	
	2		10: N _{RB,c} = 52		10: N _{RB,c} = 52	
	3		40: N _{RB,c} = 106		40: N _{RB,c} = 106	
Duplex mode	1		FDD		FDD	
	2		TDD		TDD	
	3		TDD		TDD	
TDD configuration	1		N/A		N/A	
	2		TDDConf.1.1		TDDConf.1.1	
	3		TDDConf.2.1		TDDConf.2.1	
PDSCH Reference measurement channel	1		SR.1.1 FDD	-	SR.1.1 FDD	-
	2		SR.1.1 TDD		SR.1.1 TDD	
	3		SR.2.1 TDD		SR.2.1 TDD	
RMSI CORESET Reference Channel	1		CR.1.1 FDD	-	CR.1.1 FDD	-
	2		CR.1.1 TDD		CR.1.1 TDD	
	3		CR.2.1 TDD		CR.2.1 TDD	
Dedicated CORESET Reference Channel	1		CCR.1.1 FDD	-	CCR.1.1 FDD	-
	2		CCR.1.1 TDD		CCR.1.1 TDD	
	3		CCR.2.1 TDD		CCR.2.1 TDD	
SSB configuration	1		SSB.1 FR1		SSB.1 FR1	
	2		SSB.1 FR1		SSB.1 FR1	
	3		SSB.2 FR1		SSB.2 FR1	
OCNG Patterns	1~3		OP.1		OP.1	
TRS configuration	1		TRS.1.1 FDD	-	TRS.1.1 FDD	
	2		TRS.1.1 TDD		TRS.1.1 TDD	
	3		TRS.1.2 TDD		TRS.1.2 TDD	
Initial BWP Configuration	1~3		DLBWP.0.1 ULBWP.0.1		DLBWP.0.1 ULBWP.0.1	
Dedicated BWP configuration	1~3		DLBWP.1.1 ULBWP.1.1		DLBWP.1.1 ULBWP.1.1	
Time offset with Cell 1	1	ms	-	3	-	3
	2,3	µs	-	3	-	3
SMTTC configuration	1		SMTTC.2		SMTTC.2	
	2,3		SMTTC.1		SMTTC.1	
EPRE ratio of PSS to SSS	1~3	dB	0	0	0	0

EPRE ratio of PBCH DMRS to SSS							
EPRE ratio of PBCH to PBCH DMRS							
EPRE ratio of PDCCH DMRS to SSS							
EPRE ratio of PDCCH to PDCCH DMRS							
EPRE ratio of PDSCH DMRS to SSS							
EPRE ratio of PDSCH to PDSCH DMRS							
EPRE ratio of OCNG DMRS to SSS ^{Note 1}							
EPRE ratio of OCNG to OCNG DMRS ^{Note 1}							
N_{oc} ^{Note2}	NR_FDD_FR1_A, NR_TDD_FR1_A <small>NOTE 5</small>	1~3	dBm/15 kHz	-94.65	$(N_{oc}$ for Channel 2 +8dB)	-115	
	NR_FDD_FR1_B					-114.5	
	NR_TDD_FR1_C					-114	
	NR_FDD_FR1_D, NR_TDD_FR1_D					-113.5	
	NR_FDD_FR1_E, NR_TDD_FR1_E					-113	
	NR_FDD_FR1_G					-112	
	NR_FDD_FR1_H					-111.5	
N_{oc} ^{Note2}	NR_FDD_FR1_A, NR_TDD_FR1_A <small>NOTE 5</small>	1,2	dBm/SS B SCS	-94.65	$(N_{oc}$ for Channel 2 +8dB)	-115	
	NR_FDD_FR1_B					-114.5	
	NR_TDD_FR1_C					-114	
	NR_FDD_FR1_D, NR_TDD_FR1_D					-113.5	
	NR_FDD_FR1_E, NR_TDD_FR1_E					-113	
	NR_FDD_FR1_G					-112	
	NR_FDD_FR1_H	-111.5					
	NR_FDD_FR1_A, NR_TDD_FR1_A <small>NOTE 5</small>	3	dBm/SS B SCS	-91.65	$(N_{oc}$ for Channel 2 +8dB)	-112.00	
	NR_FDD_FR1_B					-111.50	
	NR_TDD_FR1_C					-111.00	
	NR_FDD_FR1_D, NR_TDD_FR1_D					-110.50	
	NR_FDD_FR1_E, NR_TDD_FR1_E					-110.00	
	NR_FDD_FR1_G					-109.00	
	NR_FDD_FR1_H					-108.50	
\hat{E}_s/I_{ot}		1~3	dB	10	10	13	-3
SS-RSRP ^{Note3}	NR_FDD_FR1_A, NR_TDD_FR1_A <small>NOTE 5</small>	1,2,4,5	dBm/SC S	-84.65	(RSRP for Cell 2 +25dB)	-118.00	
	NR_FDD_FR1_B					-117.50	
	NR_TDD_FR1_C					-117.00	
	NR_FDD_FR1_D, NR_TDD_FR1_D					-116.50	
	NR_FDD_FR1_E, NR_TDD_FR1_E					-116.00	
	NR_FDD_FR1_G					-115.00	
	NR_FDD_FR1_H					-114.50	
	NR_FDD_FR1_A, NR_TDD_FR1_A <small>NOTE 5</small>	3	dBm/SC S	-81.65	(RSRP for Cell 2 +25dB)	-115.00	
	NR_FDD_FR1_B					-114.50	
	NR_TDD_FR1_C					-114.00	

	NR_FDD_FR1_D, NR_TDD_FR1_D						-113.50
	NR_FDD_FR1_E, NR_TDD_FR1_E						-113.00
	NR_FDD_FR1_G						-112.00
	NR_FDD_FR1_H						-111.50
I _o Note3	NR_FDD_FR1_A, NR_TDD_FR1_A NOTE 5	1,2	dBm/ 9.36MH z	-56.28	(I _o for Channel 2 +19.75dB)		-85.28
	NR_FDD_FR1_B						-84.78
	NR_TDD_FR1_C						-84.28
	NR_FDD_FR1_D, NR_TDD_FR1_D						-83.78
	NR_FDD_FR1_E, NR_TDD_FR1_E						-83.28
	NR_FDD_FR1_G						-82.28
	NR_FDD_FR1_H	-81.78					
	NR_FDD_FR1_A, NR_TDD_FR1_A NOTE 5	3	dBm/ 38.16M Hz	-50.19	(I _o for Channel 2 +19.75dB)		-79.19
	NR_FDD_FR1_B						-78.69
	NR_TDD_FR1_C						-78.19
	NR_FDD_FR1_D, NR_TDD_FR1_D						-77.69
	NR_FDD_FR1_E, NR_TDD_FR1_E						-77.19
	NR_FDD_FR1_G						-76.19
	NR_FDD_FR1_H	-75.69					
\hat{E}_s / N_{oc}	1~3	dB	10	10	13	-3	
Propagation condition	1~3	-	AWGN		AWGN		
Antenna configuration	1~3		1x2		1x2		
<p>Note 1: OCNG shall be used such that both cells are fully allocated and a constant total transmitted power spectral density is achieved for all OFDM symbols.</p> <p>Note 2: Interference from other cells and noise sources not specified in the test is assumed to be constant over subcarriers and time and shall be modelled as AWGN of appropriate power for N_{oc} to be fulfilled.</p> <p>Note 3: RSRP and I_o levels have been derived from other parameters for information purposes. They are not settable parameters themselves.</p> <p>Note 4: RSRP minimum requirements are specified assuming independent interference and noise at each receiver antenna port.</p> <p>Note 5: The test configuration excludes support for band n51 and it is not required to run this test on band n51 in this release of the specification</p>							

A.6.7.1.2.3 Test Requirements

The SS-RSRP measurement accuracy for Cell 1 and Cell 2 shall fulfil the absolute requirement in clause 10.1.4.1.1 and relative requirement in clause 10.1.4.1.2.

A.6.7.1.3 Void

A.6.7.2 SS-RSRQ

A.6.7.2.1 SA: Intra-frequency measurement accuracy with FR1 serving cell and FR1 target cell

A.6.7.2.1.1 Test Purpose and Environment

The purpose of this test is to verify that the SS-RSRQ measurement accuracy is within the specified limits. This test will verify the requirements in Clause 10.1.7.1.1.

A.6.7.2.1.2 Test Parameters

In this test case all cells are on the same carrier frequency. Supported test configuration are shown in Table A.6.7.2.1.2-1. The absolute accuracy of SS-RSRQ intra-frequency measurement is tested by using the parameters in Table A.6.7.2.1.2-2. In all test cases, Cell 1 is the PCell and Cell 2 is the target cell.

Table A.6.7.2.1.2-1: SS-RSRQ Intra frequency SS-RSRQ supported test configurations

Config	Description
1	NR 15 kHz SSB SCS, 10 MHz bandwidth, FDD duplex mode
2	NR 15 kHz SSB SCS, 10 MHz bandwidth, TDD duplex mode
3	NR 30 kHz SSB SCS, 40 MHz bandwidth, TDD duplex mode
Note: The UE is only required to be tested in one of the supported test configurations	

Table A.6.7.2.1.2-2: SS-RSRQ Intra frequency test parameters

Parameter		Unit	Test 1		Test 2		Test 3	
			Cell 1	Cell 2	Cell 1	Cell 2	Cell 1	Cell 2
Cell ID			489	0	489	0	489	0
SSB ARFCN			freq1		freq1		freq1	
Duplex mode	Config 1		FDD					
	Config 2,3		TDD					
TDD configuration	Config 1		Not Applicable					
	Config 2		TDDConf.1.1					
	Config 3		TDDConf.2.1					
BW _{channel}	Config 1	MHz	10: N _{RB,c} = 52					
	Config 2		10: N _{RB,c} = 52					
	Config 3		40: N _{RB,c} = 106					
BWP configuration	Initial DL BWP		DLBWP.0.1					
	Dedicated DL BWP		DLBWP.1.1					
	Initial UL BWP		ULBWP.0.1					
	Dedicated UL BWP		ULBWP.1.1					
DRX Cycle		ms	Not Applicable					
PDSCH Reference measurement channel	Config 1		SR.1.1 FDD	-	SR.1.1 FDD	-	SR.1.1 FDD	-
	Config 2		SR.1.1 TDD	-	SR.1.1 TDD	-	SR.1.1 TDD	-
	Config 3		SR2.1 TDD	-	SR2.1 TDD	-	SR2.1 TDD	-
RMSI CORESET Reference Channel	Config 1		CR.1.1 FDD	-	CR.1.1 FDD	-	CR.1.1 FDD	-
	Config 2		CR.1.1 TDD	-	CR.1.1 TDD	-	CR.1.1 TDD	-
	Config 3		CR.2.1 TDD	-	CR.2.1 TDD	-	CR.2.1 TDD	-
Control Channel RMC	Config 1		CCR.1.1 FDD	-	CCR.1.1 FDD	-	CCR.1.1 FDD	-

	Config 2		CCR.1.1 TDD		CCR.1.1 TDD		CCR.1.1 TDD	
	Config 3		CCR.2.1 TDD		CCR.2.1 TDD		CCR.2.1 TDD	
TRS Configuration	Config 1		TRS.1.1 FDD		TRS.1.1 FDD		TRS.1.1 FDD	
	Config 2		TRS.1.1 TDD	-	TRS.1.1 TDD	-	TRS.1.1 TDD	-
	Config 3		TRS.1.2 TDD		TRS.1.2 TDD		TRS.1.2 TDD	
OCNG Patterns			OP. 1					
SS-RSSI-Measurement			Not Applicable					
Time offset with Cell 1	Config 1	ms	-	3	-	3	-	3
	Config 2,3	µs	-	3	-	3	-	3
SMTC configuration	Config 1		SMTC.2					
	Config 2,3		SMTC.1					
SSB configuration	Config 1,2		SSB.1 FR1					
	Config 3		SSB.2 FR1					
CSI-RS for tracking	Config 1		TRS.1.1 FDD					
	Config 2		TRS.1.1 TDD					
	Config 3		TRS.1.2 TDD					
PDSCH/PDCCH subcarrier spacing	Config 1,2	kHz	15 kHz					
	Config 3		30kHz					
EPRE ratio of PSS to SSS		dB	0	0	0	0	0	0
EPRE ratio of PBCH DMRS to SSS								
EPRE ratio of PBCH to PBCH DMRS								
EPRE ratio of PDCCH DMRS to SSS								
EPRE ratio of PDCCH to PDCCH DMRS								
EPRE ratio of PDSCH DMRS to SSS								
EPRE ratio of PDSCH to PDSCH								
EPRE ratio of OCNG DMRS to SSS(Note 1)								
EPRE ratio of OCNG to OCNG DMRS (Note 1)								
N_{oc} Note2	Config 1,2							
		NR_FDD_FR1_B	-113.5					
		NR_TDD_FR1_C	-113					
		NR_FDD_FR1_D, NR_TDD_FR1_D	-112.5					
		NR_FDD_FR1_E, NR_TDD_FR1_E	-112					
		NR_FDD_FR1_G	-111					
		NR_FDD_FR1_H	-110.5					
	Config 3	NR_FDD_FR1_A, NR_TDD_FR1_A NOTE 6	-91		-			-114
		NR_FDD_FR1_B						-113.5
		NR_TDD_FR1_C						-113
		NR_FDD_FR1_D, NR_TDD_FR1_D						-112.5

		NR_FDD_FR1_E, NR_TDD_FR1_E						-112					
		NR_FDD_FR1_G						-111					
		NR_FDD_FR1_H						-110.5					
N_{oc}	Config 1,2	NR_FDD_FR1_A, NR_TDD_FR1_A NOTE 6	dBm/SCS	-85	-101			-114					
		NR_FDD_FR1_B						-113.5					
		NR_TDD_FR1_C						-113					
		NR_FDD_FR1_D, NR_TDD_FR1_D						-112.5					
		NR_FDD_FR1_E, NR_TDD_FR1_E						-112					
		NR_FDD_FR1_G						-111					
	NR_FDD_FR1_H	-110.5											
	Config 3	NR_FDD_FR1_A, NR_TDD_FR1_A NOTE 6		-88	-				-111				
		NR_FDD_FR1_B							-110.5				
		NR_TDD_FR1_C							-110				
		NR_FDD_FR1_D, NR_TDD_FR1_D							-109.5				
		NR_FDD_FR1_E, NR_TDD_FR1_E							-109				
		NR_FDD_FR1_G							-108				
		NR_FDD_FR1_H							-107.5				
$\hat{E}_s/1_{oc}$			dB		-1.76		-4.7		-5.46	-5.46			
\hat{E}_s/N_{oc}			dB		3		3		-2.9	-2.9	-4	-4	
SS- RSRP ^{Note 3}	Config 1,2	NR_FDD_FR1_A, NR_TDD_FR1_A NOTE 6	dBm/SCS	-82	-82	-103.9	-103.9	-118	-118				
		NR_FDD_FR1_B						-	-117.5				
		NR_TDD_FR1_C						-117	-117				
		NR_FDD_FR1_D, NR_TDD_FR1_D						-	-116.5				
		NR_FDD_FR1_E, NR_TDD_FR1_E						-116	-116				
		NR_FDD_FR1_G						-115	-115				
	NR_FDD_FR1_H	-		-114.5									
	Config 3	NR_FDD_FR1_A, NR_TDD_FR1_A NOTE 6		-85	-85	-	-		-115	-115			
		NR_FDD_FR1_B							-	-114.5			
		NR_TDD_FR1_C							-114	-114			
		NR_FDD_FR1_D, NR_TDD_FR1_D							-	-113.5			
		NR_FDD_FR1_E, NR_TDD_FR1_E							-113	-113			
		NR_FDD_FR1_G							-112	-112			
		NR_FDD_FR1_H							-	-111.5			
SS-RSRQ ^{Note 3}		NR_FDD_FR1_A, NR_TDD_FR1_A NOTE 6	dB		-14.77		-14.77		-16.76	-16.76	-	17.34	-17.34
		NR_FDD_FR1_B											
		NR_TDD_FR1_C											

		NR_FDD_FR1_D, NR_TDD_FR1_D								
		NR_FDD_FR1_E, NR_TDD_FR1_E								
		NR_FDD_FR1_G								
		NR_FDD_FR1_H								
I _o Note3	Config 1,2	NR_FDD_FR1_A, NR_TDD_FR1_A NOTE 6	dBm/ 9.36MHz	-50	-70				-83.5	
		NR_FDD_FR1_B							-83	
		NR_TDD_FR1_C							-82.5	
		NR_FDD_FR1_D, NR_TDD_FR1_D							-82	
		NR_FDD_FR1_E, NR_TDD_FR1_E							-81.5	
		NR_FDD_FR1_G							-80.5	
		NR_FDD_FR1_H							-80	
	Config 3	NR_FDD_FR1_A, NR_TDD_FR1_A NOTE 6	dBm/ 38.16MHz	-50	-					-77.4
		NR_FDD_FR1_B								-76.9
		NR_TDD_FR1_C								-76.4
		NR_FDD_FR1_D, NR_TDD_FR1_D								-75.9
		NR_FDD_FR1_E, NR_TDD_FR1_E								-75.4
		NR_FDD_FR1_G								-74.4
		NR_FDD_FR1_H								-73.9
Propagation condition			-	AWGN	AWGN	AWGN	AWGN	AWGN	AWGN	
Antenna configuration				1x2	1x2	1x2	1x2	1x2	1x2	
<p>Note 1: OCNG shall be used such that both cells are fully allocated and a constant total transmitted power spectral density is achieved for all OFDM symbols.</p> <p>Note 2: Interference from other cells and noise sources not specified in the test is assumed to be constant over subcarriers and time and shall be modelled as AWGN of appropriate power for N_{oc} to be fulfilled.</p> <p>Note 3: SS-RSRQ, SS-RSRP, and I_o levels have been derived from other parameters for information purposes. They are not settable parameters themselves.</p> <p>Note 4: SS-RSRQ, SS-RSRP minimum requirements are specified assuming independent interference and noise at each receiver antenna port.</p> <p>Note 5: NR operating band groups are as defined in clause 3.5.2.</p> <p>Note 6: The test configuration excludes support for band n51 and it is not required to run this test on band n51 in this release of the specification</p>										

A.6.7.2.1.3 Test Requirements

The SS-RSRQ measurement accuracy shall fulfil the requirements in clause 10.1.7.1.1.

A.6.7.2.2 SA Inter-frequency measurement accuracy with FR1 serving cell and FR1 target cell

A.6.7.2.2.1 Test Purpose and Environment

The purpose of this test is to verify that the SS-RSRQ measurement accuracy is within the specified limits. This test will verify the requirements in Clause 10.1.9.1.1 and 10.1.9.1.2.

A.6.7.2.2.2 Test Parameters

In this test case the two cells (i.e., Cell 1 and Cell 2) are on different carrier frequencies and measurement gaps are provided. Supported test configurations are shown in Table A.6.7.2.2.2-1. Both absolute accuracy and relative accuracy requirements of SS-RSRQ inter-frequency measurement are tested by using test parameters in Table A.6.7.2.2.2-2. In all test cases, Cell 1 is the PCell and Cell 2 is target cell.

Table A.6.7.2.2-1: SS-RSRQ Inter frequency SS-RSRQ supported test configurations

Config	Description
1	NR 15 kHz SSB SCS, 10 MHz bandwidth, FDD duplex mode
2	NR 15 kHz SSB SCS, 10 MHz bandwidth, TDD duplex mode
3	NR 30 kHz SSB SCS, 40 MHz bandwidth, TDD duplex mode
Note: The UE is only required to be tested in one of the supported test configurations	

Table A.6.7.2.2-2: SS-RSRQ Inter frequency test parameters

Parameter		Unit	Test 1		Test 2		Test 3	
			Cell 1	Cell 2	Cell 1	Cell 2	Cell 1	Cell 2
SSB ARFCN			freq1	freq2	freq1	freq2	freq1	freq2
Duplex mode	Config 1		FDD					
	Config 2,3		TDD					
TDD configuration	Config 1		Not Applicable					
	Config 2		TDDConf.1.1					
	Config 3		TDDConf.2.1					
BW _{channel}	Config 1	MHz	10: N _{RB,c} = 52					
	Config 2		10: N _{RB,c} = 52					
	Config 3		40: N _{RB,c} = 106					
Gap pattern ID	Config 1,2,3		0					
BWP BW	Config 1		10: N _{RB,c} = 52					
	Config 2		10: N _{RB,c} = 52					
	Config 3		40: N _{RB,c} = 106					
DRX Cycle		ms	Not Applicable					
PDSCH Reference measurement channel	Config 1		SR.1.1 FDD	-	SR.1.1 FDD	-	SR.1.1 FDD	-
	Config 2		SR.1.1 TDD		SR.1.1 TDD		SR.1.1 TDD	
	Config 3		SR2.1 TDD		SR2.1 TDD		SR2.1 TDD	
RMSI CORESET Reference Channel	Config 1		CR.1.1 FDD	-	R.1.1 FDD	-	CR.1.1 FDD	
	Config 2		CR.1.1 TDD		CR.1.1 TDD		CR.1.1 TDD	
	Config 3		CR2.1 TDD		CR2.1 TDD		CR2.1 TDD	
Dedicated CORESET Reference Channel	Config 1		CCR.1.1 FDD	-	CCR.1.1 FDD	-	CCR.1.1 FDD	-
	Config 2		CCR.1.1 TDD		CCR.1.1 TDD		CCR.1.1 TDD	
	Config 3		CCR2.1 TDD		CCR2.1 TDD		CCR2.1 TDD	

TRS Configuration	Config 1		TRS.1.1 FDD		TRS.1.1 FDD		TRS.1.1 FDD	
	Config 2		TRS.1.1 TDD	-	TRS.1.1 TDD	-	TRS.1.1 TDD	-
	Config 3		TRS.1.2 TDD		TRS.1.2 TDD		TRS.1.2 TDD	
OCNG Patterns			OCNG pattern 1					
Time offset with Cell 1	Config 1	ms	-	3	-	3	-	3
	Config 2,3	µs	-	3	-	3	-	3
SMTC configuration	Config 1		SMTC pattern 2					
	Config 2,3		SMTC pattern 1					
SSB configuration	Config 1,2		SSB pattern 1 in FR1					
	Config 3		SSB pattern 2 in FR1					
CSI-RS for tracking	Config 1		TRS.1.1 FDD					
	Config 2		TRS.1.1 TDD					
	Config 3		TRS.1.2 TDD					
PDSCH/PDCCH subcarrier spacing	Config 1,2	kHz	15 kHz					
	Config 3		30 kHz					
EPRE ratio of PSS to SSS		dB	0	0	0	0	0	0
EPRE ratio of PBCH DMRS to SSS								
EPRE ratio of PBCH to PBCH DMRS								
EPRE ratio of PDCCH DMRS to SSS								
EPRE ratio of PDCCH to PDCCH DMRS								
EPRE ratio of PDSCH DMRS to SSS								
EPRE ratio of PDSCH to PDSCH								
EPRE ratio of OCNG DMRS to SSS(Note 1)								
EPRE ratio of OCNG to OCNG DMRS (Note 1)								
N_{oc} Note2	Config 1,2	NR_FDD_FR1_A NR_TDD_FR1_A NOTE 6	dBm/ 15kHz	-80.18	-106			-116
		NR_FDD_FR1_B						-115.5
		NR_TDD_FR1_C						-115
		NR_FDD_FR1_D NR_TDD_FR1_D						-114.5
		NR_FDD_FR1_E NR_TDD_FR1_E						-114
		NR_FDD_FR1_G						-113
		NR_FDD_FR1_H						-112.5
		N_{oc} Note2						Config 3
NR_FDD_FR1_B	-115.5							
NR_TDD_FR1_C	-115							
NR_FDD_FR1_D NR_TDD_FR1_D	-114.5							
NR_FDD_FR1_E NR_TDD_FR1_E	-114							
NR_FDD_FR1_G	-113							
NR_FDD_FR1_H	-112.5							
N_{oc} Note2	Config 1,2		NR_FDD_FR1_A NR_TDD_FR1_A NOTE 6	dBm/ 15kHz	-80.18	-106		
		NR_FDD_FR1_B	-115.5					
		NR_TDD_FR1_C	-115					
		NR_FDD_FR1_D NR_TDD_FR1_D	-114.5					
		NR_FDD_FR1_D	-114.5					

	Config 3	NR_FDD_FR1_E							-114
		NR_TDD_FR1_E							-113
		NR_FDD_FR1_G							-112.5
		NR_FDD_FR1_H							-113
		NR_FDD_FR1_A							-112.5
		NR_TDD_FR1_A							-112
		NOTE 6							-111.5
		NR_FDD_FR1_B							-111
		NR_TDD_FR1_C							-110
		NR_FDD_FR1_D							-109.5
NR_TDD_FR1_D									
NR_FDD_FR1_E									
NR_TDD_FR1_E									
NR_FDD_FR1_G									
NR_FDD_FR1_H									
\hat{E}_s / I_{ot}			dB	-1.75	-1.75	3	-1.75		
\hat{E}_s / N_{oc}			dB	-1.75	-1.75	3	-1.75		
SS- RSRP ^{Not e3}	Config 1,2	NR_FDD_FR1_A	dBm/ SCS	-81.93	-81.93	-107.75	-107.75	-113	-117.75
		NR_TDD_FR1_A						-112.5	-117.25
		NOTE 6						-112	-116.75
		NR_FDD_FR1_B						-111.5	-116.25
		NR_TDD_FR1_C						-111	-115.75
		NR_FDD_FR1_D						-110	-114.75
	NR_TDD_FR1_D	-109.5		-114.25					
	NR_FDD_FR1_E								
	NR_TDD_FR1_E								
	NR_FDD_FR1_G								
	NR_FDD_FR1_H								
	Config 3	NR_FDD_FR1_A		-85.02	-85.02	-111.75	-111.75	-110	-114.75
		NR_TDD_FR1_A						-109.5	-114.25
		NOTE 6						-109	-113.75
		NR_FDD_FR1_B						-108.5	-113.25
		NR_TDD_FR1_C						-108	-112.75
NR_FDD_FR1_D		-107	-111.75						
NR_TDD_FR1_D	-106.5	-111.25							
NR_FDD_FR1_E									
NR_TDD_FR1_E									
NR_FDD_FR1_G									
NR_FDD_FR1_H									
SS-RSRQ ^{Note3}		NR_FDD_FR1_A	dB	-14.77	-14.77	-14.77	-14.77	-12.56	-14.76
		NR_TDD_FR1_A							
		NOTE 6							
		NR_FDD_FR1_B							
		NR_TDD_FR1_C							
		NR_FDD_FR1_D							
NR_TDD_FR1_D									
NR_FDD_FR1_E									
NR_TDD_FR1_E									
NR_FDD_FR1_G									
NR_FDD_FR1_H									
I _o ^{Note3}	Config 1,2	NR_FDD_FR1_A	dBm/ SCS	-50			-75.83	-83.28	-85.83
		NR_TDD_FR1_A						-82.78	-85.33
		NOTE 6						-82.28	-84.83
		NR_FDD_FR1_B						-81.78	-84.33
		NR_TDD_FR1_C						-81.28	-83.83
		NR_FDD_FR1_D						-80.28	-82.83
NR_TDD_FR1_D									
NR_FDD_FR1_E									
NR_TDD_FR1_E									
NR_FDD_FR1_G									

Config 3	NR_FDD_FR1_H	-50	-76.73	-79.78	-82.33			
	NR_FDD_FR1_A NR_TDD_FR1_A NOTE 6			-77.19	-79.73			
	NR_FDD_FR1_B			-76.69	-79.23			
	NR_TDD_FR1_C			-76.19	-78.73			
	NR_FDD_FR1_D NR_TDD_FR1_D			-75.69	-78.23			
	NR_FDD_FR1_E NR_TDD_FR1_E			-75.19	-77.73			
	NR_FDD_FR1_G			-74.19	-76.73			
	NR_FDD_FR1_H			-73.69	-76.53			
Propagation condition		-	AWGN	AWGN	AWGN	AWGN	AWGN	AWGN
Antenna configuration			1x2	1x2	1x2	1x2	1x2	1x2
<p>Note 1: OCNG shall be used such that both cells are fully allocated and a constant total transmitted power spectral density is achieved for all OFDM symbols.</p> <p>Note 2: Interference from other cells and noise sources not specified in the test is assumed to be constant over subcarriers and time and shall be modelled as AWGN of appropriate power for N_{oc} to be fulfilled.</p> <p>Note 3: SS-RSRQ, SS-RSRP, and I_o levels have been derived from other parameters for information purposes. They are not settable parameters themselves.</p> <p>Note 4: SS-RSRQ, SS-RSRP minimum requirements are specified assuming independent interference and noise at each receiver antenna port.</p> <p>Note 5: NR operating band groups are as defined in clause 3.5.2.</p> <p>Note 6: The test configuration excludes support for band n51 and it is not required to run this test on band n51 in this release of the specification</p>								

A.6.7.2.2.3 Test Requirements

The SS-RSRQ measurement accuracy shall fulfil the requirements in clause 10.1.9.1.1 and 10.1.9.1.2.

A.6.7.3 SS-SINR

A.6.7.3.1 SA intra-frequency measurement accuracy with FR1 serving cell and FR1 target cell

A.6.7.3.1.1 Test Purpose and Environment

The purpose of this test is to verify that the SS-SINR measurement accuracy is within the specified limits. This test will verify the requirements in clause 10.1.12.1.1.

A.6.7.3.1.2 Test Parameters

In this test case all cells are on the same carrier frequency. Supported test configuration are shown in Table A.6.7.3.1.2-1. The absolute accuracy of SS-SINR intra-frequency measurement is tested by using the parameters in Table A.6.7.3.1.2-2. In all test cases, Cell 1 is the PCell and Cell 2 is the target cell.

Table A.6.7.3.1.2-1: SS-SINR Intra frequency SS-SINR supported test configurations

Config	Description
1	NR 15 kHz SSB SCS, 10 MHz bandwidth, FDD duplex mode
2	NR 15 kHz SSB SCS, 10 MHz bandwidth, TDD duplex mode
3	NR 30 kHz SSB SCS, 40 MHz bandwidth, TDD duplex mode
Note: The UE is only required to be tested in one of the supported test configurations	

Table A.6.7.3.1.2-2: SS-SINR Intra frequency test parameters

Parameter	Unit	Test 1	Test 2
-----------	------	--------	--------

Cell ID		Cell 1	Cell 2	Cell 1	Cell 2	
Cell ID		489	0	489	0	
SSB ARFCN		freq1		freq1		
Duplex mode	Config 1	FDD				
	Config 2,3	TDD				
TDD configuration	Config 1	Not Applicable				
	Config 2	TDDConf.1.1				
	Config 3	TDDConf.2.1				
Downlink initial BWP configuration		DLBWP.0.1				
Downlink dedicated BWP configuration		DLBWP.1.1				
Uplink initial BWP configuration		ULBWP.0.1				
Uplink dedicated BWP configuration		ULBWP.1.1				
DRX Cycle configuration		ms	Not Applicable			
TRS configuration	Config 1	TRS.1.1 FDD	-	TRS.1.1 FDD	-	
	Config 2	TRS.1.1 TDD		TRS.1.1 TDD		
	Config 3	TRS.1.2 TDD		TRS.1.2 TDD		
PDSCH Reference measurement channel	Config 1	SR.1.1 FDD	-	SR.1.1 FDD	-	
	Config 2	SR.1.1 TDD		SR.1.1 TDD		
	Config 3	SR.2.1 TDD		SR.2.1 TDD		
RMSI CORESET Reference Channel	Config 1	CR.1.1 FDD	-	CR.1.1 FDD	-	
	Config 2	CR.1.1 TDD		CR.1.1 TDD		
	Config 3	CR.2.1 TDD		CR.2.1 TDD		
Dedicated CORESET Reference Channel	Config 1	CCR.1.1 FDD	-	CCR.1.1 FDD	-	
	Config 2	CCR.1.1 TDD		CCR.1.1 TDD		
	Config 3	CCR.2.1 TDD		CCR.2.1 TDD		
OCNG Patterns		OP.1				
SS-RSSI-Measurement		Not Applicable				
Time offset with Cell 1	Config 1	ms	-	3	-	3
	Config 2,3	µs	-	3	-	3
SMTC configuration	Config 1	SMTC.2				
	Config 2,3	SMTC.1				
SSB configuration	Config 1,2	SSB.1 FR1				
	Config 3	SSB.2 FR1				
PDSCH/PDCCH subcarrier spacing	Config 1,2	kHz	15			
	Config 3		30			
EPRE ratio of PSS to SSS		dB	0	0	0	
EPRE ratio of PBCH DMRS to SSS						
EPRE ratio of PBCH to PBCH DMRS						
EPRE ratio of PDCCH DMRS to SSS						

EPRE ratio of PDCCH to PDCCH DMRS							
EPRE ratio of PDSCH DMRS to SSS							
EPRE ratio of PDSCH to PDSCH							
EPRE ratio of OCNG DMRS to SSS(Note 1)							
EPRE ratio of OCNG to OCNG DMRS (Note 1)							
N_{oc} Note2		NR_FDD_FR1_A, NR_TDD_FR1_A NOTE 6	dBm/15kHz z	-93	-116		
		NR_FDD_FR1_B			-115.5		
		NR_TDD_FR1_C			-115		
		NR_FDD_FR1_D, NR_TDD_FR1_D			-114.5		
		NR_FDD_FR1_E, NR_TDD_FR1_E			-114		
		NR_FDD_FR1_G			-113		
		NR_FDD_FR1_H			-112.5		
N_{oc} Note2	Config 1,2		dBm/SCS	-90	Same as Noc for 15 kHz		
	Config 3	NR_FDD_FR1_A, NR_TDD_FR1_A NOTE 6			-113		
		NR_FDD_FR1_B			-112.5		
		NR_TDD_FR1_C			-112		
		NR_FDD_FR1_D, NR_TDD_FR1_D			-111.5		
		NR_FDD_FR1_E, NR_TDD_FR1_E			-111		
		NR_FDD_FR1_G			-110		
		NR_FDD_FR1_H			-109.5		
\hat{E}_s / I_{ot}							
\hat{E}_s / N_{oc}							
SS- RSRP ^{Note3}	Config 1,2	NR_FDD_FR1_A, NR_TDD_FR1_A NOTE 6	dBm/SCS	-88.46	-90.34	-120	-120
		NR_FDD_FR1_B				-119.5	-119.5
		NR_TDD_FR1_C				-119	-119
		NR_FDD_FR1_D, NR_TDD_FR1_D				-118.5	-118.5
		NR_FDD_FR1_E, NR_TDD_FR1_E				-118	-118
		NR_FDD_FR1_G				-117	-117
		NR_FDD_FR1_H				-116.5	-116.5
	Config 3	NR_FDD_FR1_A, NR_TDD_FR1_A NOTE 6		-85.46	-87.34	-117	-117
		NR_FDD_FR1_B				-116.5	-116.5
		NR_TDD_FR1_C				-116	-116
		NR_FDD_FR1_D, NR_TDD_FR1_D				-115.5	-115.5
		NR_FDD_FR1_E, NR_TDD_FR1_E				-115	-115
		NR_FDD_FR1_G				-114	-114
		NR_FDD_FR1_H				-113.5	-113.5
SS-SINR ^{Note3}		NR_FDD_FR1_A, NR_TDD_FR1_A NOTE 6	dB	0	-3.19	-5.46	-5.46
		NR_FDD_FR1_B					
		NR_TDD_FR1_C					
		NR_FDD_FR1_D, NR_TDD_FR1_D					

		NR_FDD_FR1_E, NR_TDD_FR1_E				
		NR_FDD_FR1_G				
		NR_FDD_FR1_H				
Io ^{Note3}	Config 1,2	NR_FDD_FR1_A, NR_TDD_FR1_A NOTE 6	dBm/ 9.36MHz	-57.5		-85.51
		NR_FDD_FR1_B				-85.01
		NR_TDD_FR1_C				-84.51
		NR_FDD_FR1_D, NR_TDD_FR1_D				-84.01
		NR_FDD_FR1_E, NR_TDD_FR1_E				-83.51
		NR_FDD_FR1_G				-82.51
		NR_FDD_FR1_H				-82.01
	Config 3	NR_FDD_FR1_A, NR_TDD_FR1_A NOTE 6	dBm/ 38.16MHz	-51.41		-79.41
		NR_FDD_FR1_B				-78.91
		NR_TDD_FR1_C				-78.41
		NR_FDD_FR1_D, NR_TDD_FR1_D				-77.91
		NR_FDD_FR1_E, NR_TDD_FR1_E				-77.41
		NR_FDD_FR1_G				-76.41
		NR_FDD_FR1_H				-75.91
Propagation condition			-	AWGN		
Antenna configuration			-	1x2		
<p>Note 1: OCNG shall be used such that both cells are fully allocated and a constant total transmitted power spectral density is achieved for all OFDM symbols.</p> <p>Note 2: Interference from other cells and noise sources not specified in the test is assumed to be constant over subcarriers and time and shall be modelled as AWGN of appropriate power for N_{oc} to be fulfilled.</p> <p>Note 3: SS-SINR, SS-RSRP, and Io levels have been derived from other parameters for information purposes. They are not settable parameters themselves.</p> <p>Note 4: SS-SINR, SS-RSRP minimum requirements are specified assuming independent interference and noise at each receiver antenna port.</p> <p>Note 5: NR operating band groups are as defined in clause 3.5.2.</p> <p>Note 6: The test configuration excludes support for band n51 and it is not required to run this test on band n51 in this release of the specification</p>						

A.6.7.3.1.3 Test Requirements

The SS-SINR measurement accuracy shall fulfil the requirements in clause 10.1.12.1.1.

A.6.7.3.2 SA Inter-frequency measurement accuracy with FR1 serving cell and FR1 target cell

A.6.7.3.2.1 Test Purpose and Environment

The purpose of this test is to verify that the SS-SINR measurement accuracy is within the specified limits. This test will verify the requirements in clauses 10.1.14.1.1 and 10.1.14.1.2.

A.6.7.3.2.2 Test Parameters

In this test case the two cells (i.e., Cell 1 and Cell 2) are on different carrier frequencies and measurement gaps are provided. Supported test configurations are shown in Table A.6.7.3.2.2-1. Both absolute accuracy and relative

accuracy requirements of SS-SINR inter-frequency measurement are tested by using test parameters in Table A.6.7.3.2.2-2. In all test cases, Cell 1 is the PCell and Cell 2 is target cell.

Table A.6.7.3.2.2-1: SS-SINR Inter frequency SS-SINR supported test configurations

Config	Description
1	NR 15 kHz SSB SCS, 10 MHz bandwidth, FDD duplex mode
2	NR 15 kHz SSB SCS, 10 MHz bandwidth, TDD duplex mode
3	NR 30 kHz SSB SCS, 40 MHz bandwidth, TDD duplex mode
Note: The UE is only required to be tested in one of the supported test configurations	

Table A.6.7.3.2.2-2: SS-SINR Inter frequency test parameters

Parameter		Unit	Test 1		Test 2		Test 3	
			Cell 1	Cell 2	Cell 1	Cell 2	Cell 1	Cell 2
SSB ARFCN			freq1	freq2	freq1	freq2	freq1	freq2
Duplex mode	Config 1		FDD					
	Config 2,3		TDD					
TDD configuration	Config 1		Not Applicable					
	Config 2		TDDConf.1.1					
	Config 3		TDDConf.2.1					
Downlink initial BWP configuration			DLBWP.0.1					
Downlink dedicated BWP configuration			DLBWP.1.1					
Uplink initial BWP configuration			ULBWP.0.1					
Uplink dedicated BWP configuration			ULBWP.1.1					
DRX Cycle configuration		ms	Not Applicable					
Gap pattern ID			0	-	0	-	0	-
TRS Configuration	Config 1		TRS.1.1 FDD	-	TRS.1.1 FDD	-	TRS.1.1 FDD	-
	Config 2		TRS.1.1 TDD	-	TRS.1.1 TDD	-	TRS.1.1 TDD	-
	Config 3		TRS.1.2 TDD	-	TRS.1.2 TDD	-	TRS.1.2 TDD	-
PDSCH Reference measurement channel	Config 1		SR.1.1 FDD	-	SR.1.1 FDD	-	SR.1.1 FDD	-
	Config 2		SR.1.1 TDD	-	SR.1.1 TDD	-	SR.1.1 TDD	-
	Config 3		SR2.1 TDD	-	SR2.1 TDD	-	SR2.1 TDD	-
RMSI CORESET Reference Channel	Config 1		CR.1.1 FDD	-	CR.1.1 FDD	-	CR.1.1 FDD	-
	Config 2		CR.1.1 TDD	-	CR.1.1 TDD	-	CR.1.1 TDD	-
	Config 3		CR2.1 TDD	-	CR2.1 TDD	-	CR2.1 TDD	-
Dedicated CORESET Reference Channel	Config 1		CCR.1.1 FDD	-	CCR.1.1 FDD	-	CCR.1.1 FDD	-
	Config 2		CCR.1.1 TDD	-	CCR.1.1 TDD	-	CCR.1.1 TDD	-
	Config 3		CCR2.1 TDD	-	CCR2.1 TDD	-	CCR2.1 TDD	-
OCNG Patterns			OP.1					

SS-RSSI-Measurement			Not Applicable							
Time offset with Cell 1	Config 1	ms	-	3	-	3	-	3		
	Config 2,3	μs	-	3	-	3	-	3		
SMTC configuration	Config 1		SMTC pattern 2							
	Config 2,3		SMTC pattern 1							
SSB configuration	Config 1,2		SSB.1 FR1							
	Config 3		SSB.2 FR1							
PDSCH/PDCCH subcarrier spacing	Config 1,2	kHz	15							
	Config 3		30							
EPRE ratio of PSS to SSS			dB	0	0	0	0	0		
EPRE ratio of PBCH DMRS to SSS										
EPRE ratio of PBCH to PBCH DMRS										
EPRE ratio of PDCCH DMRS to SSS										
EPRE ratio of PDCCH to PDCCH DMRS										
EPRE ratio of PDSCH DMRS to SSS										
EPRE ratio of PDSCH to PDSCH										
EPRE ratio of OCNB DMRS to SSS(Note 1)										
EPRE ratio of OCNB to OCNB DMRS (Note 1)										
N_{oc} Note2	Config 1,2	NR_FDD_FR1_A NR_TDD_FR1_A NOTE 6							dBm/15kHz	-88
		NR_FDD_FR1_B NR_TDD_FR1_C	-119							
		NR_FDD_FR1_D NR_TDD_FR1_D	-118.5							
		NR_FDD_FR1_E NR_TDD_FR1_E	-118							
		NR_FDD_FR1_G NR_TDD_FR1_H	-117.5							
			-116.5							
			-116							
N_{oc} Note2	Config 1,2		dBm/SCS	-88	-108.5			Same as N_{oc} for 15kHz		
									Config 3	
	NR_FDD_FR1_A NR_TDD_FR1_A NOTE 6	-116								
	NR_FDD_FR1_B NR_TDD_FR1_C	-115.5								
	NR_FDD_FR1_D NR_TDD_FR1_D	-115								
	NR_FDD_FR1_E NR_TDD_FR1_E	-114.5								
	NR_FDD_FR1_G NR_TDD_FR1_H	-114.5								
		-113								
	\hat{E}_s / I_{ot}			dB	-1.75	-1.75	20	20	-4.0	-4.0
	\hat{E}_s / N_{oc}			dB	-1.75		20		-4.0	
	SS-RSRP Note3	Config 1,2	NR_FDD_FR1_A NR_TDD_FR1_A NOTE 6	dBm/SCS	-89.75	-88.5			-123.5	
			NR_FDD_FR1_B						-123	
			NR_TDD_FR1_C						-122.5	

		NR_FDD_FR1_D				-122			
		NR_TDD_FR1_D				-121.5			
		NR_FDD_FR1_E				-120.5			
		NR_TDD_FR1_E				-120			
	Config 3	NR_FDD_FR1_G				-120.5			
		NR_FDD_FR1_H				-120			
		NR_FDD_FR1_A				-86.75	-85.5	-120.5	
		NR_TDD_FR1_A						-120	
		NOTE 6						-119.5	
		NR_FDD_FR1_B						-119	
		NR_TDD_FR1_C						-118.5	
		NR_FDD_FR1_D						-117.5	
	NR_TDD_FR1_D	-117							
	NR_FDD_FR1_E	-117.5							
NR_TDD_FR1_E	-117								
NR_FDD_FR1_G	-117.5								
NR_FDD_FR1_H	-117								
SS-SINR ^{Note3}	NR_FDD_FR1_A	dB	-1.75	20	-4.0				
	NR_TDD_FR1_A								
	NOTE 6								
	NR_FDD_FR1_B								
	NR_TDD_FR1_C								
	NR_FDD_FR1_D								
	NR_TDD_FR1_D								
NR_FDD_FR1_E									
NR_TDD_FR1_E									
NR_FDD_FR1_G									
NR_FDD_FR1_H									
I _o ^{Note3}	Config 1,2	NR_FDD_FR1_A	dBm/ 9.36MHz	-57.83	-60.5	-90.09			
		NR_TDD_FR1_A				-89.59			
		NOTE 6				-89.09			
		NR_FDD_FR1_B				-88.59			
		NR_TDD_FR1_C				-88.09			
		NR_FDD_FR1_D				-87.09			
		NR_TDD_FR1_D				-86.59			
	NR_FDD_FR1_E	-84							
	NR_TDD_FR1_E	-83.5							
	NR_FDD_FR1_G	-83							
	NR_FDD_FR1_H	-82.5							
	Config 3	NR_FDD_FR1_A				dBm/ 38.16MHz	-51.73	-54.41	-82
		NR_TDD_FR1_A							-81
		NOTE 6							-80.5
NR_FDD_FR1_B		-80.5							
NR_TDD_FR1_C		-80.5							
NR_FDD_FR1_D		-80.5							
NR_TDD_FR1_D		-80.5							
NR_FDD_FR1_E	-80.5								
NR_TDD_FR1_E	-80.5								
NR_FDD_FR1_G	-80.5								
NR_FDD_FR1_H	-80.5								
Propagation condition			-	AWGN					
Antenna configuration			-	1x2					
<p>Note 1: OCNG shall be used such that both cells are fully allocated and a constant total transmitted power spectral density is achieved for all OFDM symbols.</p> <p>Note 2: Interference from other cells and noise sources not specified in the test is assumed to be constant over subcarriers and time and shall be modelled as AWGN of appropriate power for N_{oc} to be fulfilled.</p> <p>Note 3: SS-SINR, SS-RSRP, and I_o levels have been derived from other parameters for information purposes. They are not settable parameters themselves.</p>									

Note 4:	SS-SINR, SS-RSRP minimum requirements are specified assuming independent interference and noise at each receiver antenna port.
Note 5:	NR operating band groups are as defined in clause 3.5.2.
Note 6:	The test configuration excludes support for band n51 and it is not required to run this test on band n51 in this release of the specification

A.6.7.3.2.3 Test Requirements

The SS-SINR measurement accuracy shall fulfil the requirements in clause 10.1.14.1.1 and 10.1.14.1.2.

A.6.7.4 L1-RSRP measurement for beam reporting

A.6.7.4.1 SSB based L1-RSRP measurement

A.6.7.4.1.1 Test Purpose and Environment

The purpose of this test is to verify that the L1-RSRP measurement accuracy is within the specified limits. This test will verify the requirements in clause 9.5.2 and clause 10.1.19.1 for L1-RSRP measurements based on SSB with the testing configurations for NR cells in Table A.6.7.4.1.1-1.

Table A.6.7.4.1.1-1: Applicable NR configurations for FR1 SSB based L1-RSRP test

Config	Description
1	NR 15 kHz SSB SCS, 10 MHz bandwidth, FDD duplex mode
2	NR 15 kHz SSB SCS, 10 MHz bandwidth, TDD duplex mode
3	NR 30kHz SSB SCS, 40 MHz bandwidth, TDD duplex mode
Note:	The UE is only required to be tested in one of the supported test configurations in each supported band

A.6.7.4.1.2 Test parameters

In this set of test cases there one cell in the test, PCell (Cell 1). The test parameters for the Cell 1 are given in Table A.6.7.4.1.2-1 below. The absolute and relative accuracy of L1-RSRP measurements are tested by using the parameters in Table A.6.7.4.1.2-1.

There is no measurement gap configured in the test. Before the test, UE is configured one SSB resource set with two SSB resources. UE is configured to perform RLM, BFD and L1-RSRP measurement based on the SSB resources 0 and 1.

Table A.6.7.4.1.2-1: FR1 SSB based L1-RSRP test parameters

Parameter	Config	Unit	Test 1	Test 2
SSB GSCN	1~3		freq1	freq1
Duplex mode	1		FDD	FDD
	2		TDD	TDD
	3		TDD	TDD
TDD Configuration	1		N/A	N/A
	2		TDDConf.1.1	TDDConf.1.1
	3		TDDConf.2.1	TDDConf.2.1
BW _{channel}	1	MHz	10: N _{RB,c} = 52	10: N _{RB,c} = 52
	2		10: N _{RB,c} = 52	10: N _{RB,c} = 52
	3		40: N _{RB,c} = 106	40: N _{RB,c} = 106
PDSCH Reference measurement channel	1		SR.1.1 FDD	SR.1.1 FDD
	2		SR.1.1 TDD	SR.1.1 TDD
	3		SR.2.1 TDD	SR.2.1 TDD
RMSI CORESET Reference Channel	1		CR.1.1 FDD	CR.1.1 FDD
	2		CR.1.1 TDD	CR.1.1 TDD

	3		CR.2.1 TDD	CR.2.1 TDD		
Dedicated CORESET Reference Channel	1		CCR.1.1 FDD	CCR.1.1 FDD		
	2		CCR.1.1 TDD	CCR.1.1 TDD		
	3		CCR.2.1 TDD	CCR.2.1 TDD		
SSB configuration	1		SSB.3 FR1	SSB.3 FR1		
	2		SSB.3 FR1	SSB.3 FR1		
	3		SSB.4 FR1	SSB.4 FR1		
OCNG Patterns	1~3		OP.1	OP.1		
Initial BWP Configuration	1~3		DLBWP.0.1 ULBWP.0.1	DLBWP.0.1 ULBWP.0.1		
TRS configuration	1		TRS.1.1 FDD	TRS.1.1 FDD		
	2		TRS.1.1 TDD	TRS.1.1 TDD		
	3		TRS.1.2 TDD	TRS.1.2 TDD		
Dedicated BWP configuration	1~3		DLBWP.1.1 ULBWP.1.1	DLBWP.1.1 ULBWP.1.1		
SMTC configuration	1~3		SMTC.1	SMTC.1		
reportConfigType	1~3		periodic	periodic		
reportQuantity	1~3		ssb-Index-RSRP	ssb-Index-RSRP		
Number of reported RS	1~3		2	2		
L1-RSRP reporting period	1~3		slot80	slot80		
EPRE ratio of PSS to SSS	1~3	dB	0	0		
EPRE ratio of PBCH DMRS to SSS						
EPRE ratio of PBCH to PBCH DMRS						
EPRE ratio of PDCCH DMRS to SSS						
EPRE ratio of PDCCH to PDCCH DMRS						
EPRE ratio of PDSCH DMRS to SSS						
EPRE ratio of PDSCH to PDSCH DMRS						
EPRE ratio of OCNG DMRS to SSS ^{Note 1}						
EPRE ratio of OCNG to OCNG DMRS ^{Note 1}						
N_{oc} ^{Note2}					1~3	dBm/15kHz
	NR_FDD_FR1_B	-116.5				
	NR_TDD_FR1_C	-116				
	NR_FDD_FR1_D, NR_TDD_FR1_D	-115.5				
	NR_FDD_FR1_E, NR_TDD_FR1_E	-115				
	NR_FDD_FR1_G	-114				
	NR_FDD_FR1_H	-113.5				
N_{oc} ^{Note2}	1,2	dBm/SSB SCS	-94.65	NR_FDD_FR1_A, NR_TDD_FR1_A ^{NOTE 5}	-117	
				NR_FDD_FR1_B	-116.5	
				NR_TDD_FR1_C	-116	
				NR_FDD_FR1_D, NR_TDD_FR1_D	-115.5	
				NR_FDD_FR1_E, NR_TDD_FR1_E	-115	
				NR_FDD_FR1_G	-114	
	NR_FDD_FR1_H	-113.5				
	3			-91.65	NR_FDD_FR1_A, NR_TDD_FR1_A ^{NOTE 5}	-114
					NR_FDD_FR1_B	-113.5
					NR_TDD_FR1_C	-114
NR_FDD_FR1_D, NR_TDD_FR1_D					-112.5	

	NR_FDD_FR1_E, NR_TDD_FR1_E				-112	
	NR_FDD_FR1_G				-111	
	NR_FDD_FR1_H				-110.5	
	\hat{E}_s/I_{ot}	1~3	dB	10	-3	
SSB RSRP Note3	NR_FDD_FR1_A, NR_TDD_FR1_A NOTE 5	1,2	dBm/SSB SCS	-84.65	-120	
	NR_FDD_FR1_B				-119.5	
	NR_TDD_FR1_C				-119	
	NR_FDD_FR1_D, NR_TDD_FR1_D				-118.5	
	NR_FDD_FR1_E, NR_TDD_FR1_E				-118	
	NR_FDD_FR1_G				-117	
	NR_FDD_FR1_H	-116.5				
	NR_FDD_FR1_A, NR_TDD_FR1_A NOTE 5	3		-81.65	-117	
	NR_FDD_FR1_B				-116.5	
	NR_TDD_FR1_C				-116	
	NR_FDD_FR1_D, NR_TDD_FR1_D				-115.5	
	NR_FDD_FR1_E, NR_TDD_FR1_E				-115	
	NR_FDD_FR1_G				-114	
	NR_FDD_FR1_H	-113.5				
I _o Note3	NR_FDD_FR1_A, NR_TDD_FR1_A NOTE 5	1,2	dBm/9.36 MHz	-56.28	-87.28	
	NR_FDD_FR1_B				-86.78	
	NR_TDD_FR1_C				-86.28	
	NR_FDD_FR1_D, NR_TDD_FR1_D				-85.78	
	NR_FDD_FR1_E, NR_TDD_FR1_E				-85.28	
	NR_FDD_FR1_G				-84.28	
	NR_FDD_FR1_H	-83.78				
	NR_FDD_FR1_A, NR_TDD_FR1_A NOTE 5	3		dBm/38.16 MHz	-50.19	-81.19
	NR_FDD_FR1_B					-80.69
	NR_TDD_FR1_C					-80.19
	NR_FDD_FR1_D, NR_TDD_FR1_D					-79.69
	NR_FDD_FR1_E, NR_TDD_FR1_E					-79.19
	NR_FDD_FR1_G					-78.19
	NR_FDD_FR1_H	-77.69				
	\hat{E}_s/N_{oc}	1~3	dB	10	-3	
	Propagation condition	1~3		AWGN	AWGN	
	Antenna configuration	1~3		1x2	1x2	
<p>Note 1: OCNG shall be used such that both cells are fully allocated and a constant total transmitted power spectral density is achieved for all OFDM symbols.</p> <p>Note 2: Interference from other cells and noise sources not specified in the test is assumed to be constant over subcarriers and time and shall be modelled as AWGN of appropriate power for N_{oc} to be fulfilled.</p>						

Note 3:	RSRP and I_0 levels have been derived from other parameters for information purposes. They are not settable parameters themselves.
Note 4:	RSRP minimum requirements are specified assuming independent interference and noise at each receiver antenna port.
Note 5:	The test configuration excludes support for band n51 and it is not required to run this test on band n51 in this release of the specification.

A.6.7.4.1.3 Test Requirements

The L1-RSRP measurement accuracy for SSB resource reported by UE in L1-RSRP report (SSB#0 or SSB#1) of Cell 2 shall fulfil the requirements in clauses 10.1.19.1.

A.6.7.4.2 CSI-RS based L1-RSRP measurement on resource set with repetition off

A.6.7.4.2.1 Test Purpose and Environment

The purpose of this test is to verify that the L1-RSRP measurement accuracy is within the specified limits. This test will verify the requirements in clause 9.5.3 and clause 10.1.19.2 for L1-RSRP measurements based on CSI-RS with the testing configurations for NR cells in Table A.6.7.4.2.1-1.

Table A.6.7.4.2.1-1: Applicable NR configurations for FR1 CSI-RS based L1-RSRP test

Config	Description
1	NR 15 kHz CSI-RS SCS, 10 MHz bandwidth, FDD duplex mode
2	NR 15 kHz CSI-RS SCS, 10 MHz bandwidth, TDD duplex mode
3	NR 30kHz CSI-RS SCS, 40 MHz bandwidth, TDD duplex mode
Note:	The UE is only required to be tested in one of the supported test configurations in each supported band

A.6.7.4.2.2 Test parameters

In this set of test cases there are one cell in the test, PCell (Cell 1). The test parameters for the Cell 1 are given in Table A.6.7.4.2.2-1 below. The absolute and relative accuracy of L1-RSRP measurements are tested by using the parameters in Table A.6.7.4.2.2-1.

There is no measurement gap configured in the test. Before the test, UE is configured one CSI-RS resource set with two CSI-RS resources. UE is configured to perform RLM and BFD based on SSB 0 and 1. CSI-RS is not transmitted in the same OFDM symbols as SSB.

Table A.6.7.4.2.2-1: FR1 CSI-RS based L1-RSRP test parameters

Parameter	Config	Unit	Test 1	Test 2
SSB GSCN	1~3		freq1	freq1
Duplex mode	1		FDD	FDD
	2		TDD	TDD
	3		TDD	TDD
TDD Configuration	1		N/A	N/A
	2		TDDConf.1.1	TDDConf.1.1
	3		TDDConf.2.1	TDDConf.2.1
BW_{channel}	1	MHz	10: $N_{RB,c} = 52$	10: $N_{RB,c} = 52$
	2		10: $N_{RB,c} = 52$	10: $N_{RB,c} = 52$
	3		40: $N_{RB,c} = 106$	40: $N_{RB,c} = 106$
PDSCH Reference measurement channel	1		SR.1.1 FDD	SR.1.1 FDD
	2		SR.1.1 TDD	SR.1.1 TDD
	3		SR.2.1 TDD	SR.2.1 TDD
RMSI CORESET Reference Channel	1		CR.1.1 FDD	CR.1.1 FDD
	2		CR.1.1 TDD	CR.1.1 TDD

	3		CR.2.1 TDD	CR.2.1 TDD	
Dedicated CORESET Reference Channel	1		CCR.1.1 FDD	CCR.1.1 FDD	
	2		CCR.1.1 TDD	CCR.1.1 TDD	
	3		CCR.2.1 TDD	CCR.2.1 TDD	
SSB configuration	1		SSB.3 FR1	SSB.3 FR1	
	2		SSB.3 FR1	SSB.3 FR1	
	3		SSB.4 FR1	SSB.4 FR1	
OCNG Patterns	1~3		OP.1	OP.1	
TRS configuration	1		TRS.1.1 FDD	TRS.1.1 FDD	
	2		TRS.1.1 TDD	TRS.1.1 TDD	
	3		TRS.1.2 TDD	TRS.1.2 TDD	
Initial BWP Configuration	1~3		DLBWP.0.1 ULBWP.0.1	DLBWP.0.1 ULBWP.0.1	
Dedicated BWP configuration	1~3		DLBWP.1.1 ULBWP.1.1	DLBWP.1.1 ULBWP.1.1	
SMTC configuration	1~3		SMTC.1	SMTC.1	
CSI-RS	1		CSI-RS 1.2 FDD	CSI-RS 1.2 FDD	
	2		CSI-RS 1.2 TDD	CSI-RS 1.2 TDD	
	3		CSI-RS 2.2 TDD	CSI-RS 2.2 FDD	
reportConfigType	1~3		periodic	periodic	
reportQuantity	1~3		cri-RSRP	cri-RSRP	
Number of reported RS	1~3		2	2	
L1-RSRP reporting period	1~3		slot80	slot80	
EPRE ratio of PSS to SSS					
EPRE ratio of PBCH DMRS to SSS					
EPRE ratio of PBCH to PBCH DMRS					
EPRE ratio of PDCCH DMRS to SSS					
EPRE ratio of PDCCH to PDCCH DMRS					
EPRE ratio of PDSCH DMRS to SSS	1~3	dB	0	0	
EPRE ratio of PDSCH to PDSCH DMRS					
EPRE ratio of OCNG DMRS to SSS ^{Note 1}					
EPRE ratio of OCNG to OCNG DMRS ^{Note 1}					
N_{oc} Note2	NR_FDD_FR1_A, NR_TDD_FR1_A NOTE 5	1~3	dBm/15kHz	-94.65	-117
	NR_FDD_FR1_B				-116.5
	NR_TDD_FR1_C				-116
	NR_FDD_FR1_D, NR_TDD_FR1_D				-115.5
	NR_FDD_FR1_E, NR_TDD_FR1_E				-115
	NR_FDD_FR1_G				-114
	NR_FDD_FR1_H				-113.5
N_{oc} Note2	NR_FDD_FR1_A, NR_TDD_FR1_A NOTE 5	1,2	dBm/CSI-RS SCS	-94.65	-117
	NR_FDD_FR1_B				-116.5
	NR_TDD_FR1_C				-116
	NR_FDD_FR1_D, NR_TDD_FR1_D				-115.5
	NR_FDD_FR1_E, NR_TDD_FR1_E				-115
	NR_FDD_FR1_G				-114
	NR_FDD_FR1_H	-113.5			
	NR_FDD_FR1_A, NR_TDD_FR1_A NOTE 5	3		-91.65	-114
NR_FDD_FR1_B				-113.5	

	NR_TDD_FR1_C				-114	
	NR_FDD_FR1_D, NR_TDD_FR1_D				-112.5	
	NR_FDD_FR1_E, NR_TDD_FR1_E				-112	
	NR_FDD_FR1_G				-111	
	NR_FDD_FR1_H				-110.5	
\hat{E}_s/I_{ot}		1~3	dB	10	-3	
CSI-RS RSRP Note3	NR_FDD_FR1_A, NR_TDD_FR1_A NOTE 5	1,2	dBm/CSI-RS SCS	-84.65	-120	
	NR_FDD_FR1_B				-119.5	
	NR_TDD_FR1_C				-119	
	NR_FDD_FR1_D, NR_TDD_FR1_D				-118.5	
	NR_FDD_FR1_E, NR_TDD_FR1_E				-118	
	NR_FDD_FR1_G				-117	
	NR_FDD_FR1_H	-116.5				
	NR_FDD_FR1_A, NR_TDD_FR1_A NOTE 5	3		-81.65	-117	
	NR_FDD_FR1_B				-116.5	
	NR_TDD_FR1_C				-116	
	NR_FDD_FR1_D, NR_TDD_FR1_D				-115.5	
	NR_FDD_FR1_E, NR_TDD_FR1_E				-115	
	NR_FDD_FR1_G				-114	
	NR_FDD_FR1_H				-113.5	
I_o Note3	NR_FDD_FR1_A, NR_TDD_FR1_A NOTE 5	1,2	dBm/9.36 MHz	-56.28	-87.28	
	NR_FDD_FR1_B				-86.78	
	NR_TDD_FR1_C				-86.28	
	NR_FDD_FR1_D, NR_TDD_FR1_D				-85.78	
	NR_FDD_FR1_E, NR_TDD_FR1_E				-85.28	
	NR_FDD_FR1_G				-84.28	
	NR_FDD_FR1_H	-83.78				
	NR_FDD_FR1_A, NR_TDD_FR1_A NOTE 5	3		dBm/38.16 MHz	-50.19	-81.19
	NR_FDD_FR1_B					-80.69
	NR_TDD_FR1_C					-80.19
	NR_FDD_FR1_D, NR_TDD_FR1_D					-79.69
	NR_FDD_FR1_E, NR_TDD_FR1_E					-79.19
	NR_FDD_FR1_G					-78.19
	NR_FDD_FR1_H					-77.69
\hat{E}_s/N_{oc}		1~3	dB	10	-3	
Propagation condition		1~3		AWGN	AWGN	
Antenna configuration		1~3		1x2	1x2	
Note 1: OCNG shall be used such that both cells are fully allocated and a constant total transmitted power spectral density is achieved for all OFDM symbols.						

Note 2:	Interference from other cells and noise sources not specified in the test is assumed to be constant over subcarriers and time and shall be modelled as AWGN of appropriate power for N_{oc} to be fulfilled.
Note 3:	RSRP and I_0 levels have been derived from other parameters for information purposes. They are not settable parameters themselves.
Note 4:	RSRP minimum requirements are specified assuming independent interference and noise at each receiver antenna port.
Note 5:	The test configuration excludes support for band n51 and it is not required to run this test on band n51 in this release of the specification.

A.6.7.4.2.3 Test Requirements

The L1-RSRP measurement accuracy for CSI-RS resource reported by UE in L1-RSRP report (CSI-RS#0 or CSI-RS#1) of Cell 1 shall fulfil the requirements in clause 10.1.19.2.

A.6.7.5 E-UTRAN RSRP

A.6.7.5.1 SA: inter-RAT measurement accuracy with FR1 serving cell

A.6.7.5.1.1 Test Purpose and Environment

The purpose of this test is to verify that the E-UTRAN RSRP measurement accuracy is within the specified limits. This test will verify the requirements in clause 10.2.2 for SA inter-RAT E-UTRAN RSRP measurements.

A.6.7.5.1.2 Test parameters

In each test there are two cells: Cell 1 and Cell 2. Cell 1 is the NR PCell and Cell 2 is an E-UTRAN inter-RAT neighbour cell. Supported test configurations are shown in table A.6.7.5.1.2-1. The measurement accuracy of SA inter-RAT E-UTRAN RSRP are tested by using the parameters in A.6.7.5.1.2-2 and A.6.7.5.1.2-3.

Table A.6.7.5.1.2-1: Inter-RAT E-UTRAN RSRP supported test configurations with FR1 serving cell

Configuration	Description
1	NR 15 kHz SSB SCS, 10 MHz bandwidth, FDD duplex mode, E-UTRAN FDD
2	NR 15 kHz SSB SCS, 10 MHz bandwidth, TDD duplex mode, E-UTRAN FDD
3	NR 30 kHz SSB SCS, 40 MHz bandwidth, TDD duplex mode, E-UTRAN FDD
4	NR 15 kHz SSB SCS, 10 MHz bandwidth, FDD duplex mode, E-UTRAN TDD
5	NR 15 kHz SSB SCS, 10 MHz bandwidth, TDD duplex mode, E-UTRAN TDD
6	NR 30 kHz SSB SCS, 40 MHz bandwidth, TDD duplex mode, E-UTRAN TDD

Note: The UE is only required to be tested in one of the supported test configurations

Table A.6.7.5.1.2-2: NR Cell specific test parameters for SA Inter-RAT E-UTRAN RSRP test parameters

Parameter	Unit	Cell 1
NR RF channel number		1
Duplex mode	Config 1, 4	FDD
	Config 2, 3, 5, 6	TDD
TDD Configuration	Config 1, 4	N/A
	Config 2, 5	TDDConf.1.1
	Config 3, 6	TDDConf.2.1
$BW_{channel}$	Config 1, 4	10: $N_{RB,c} = 52$ (FDD)
	Config 2, 5	10: $N_{RB,c} = 52$ (TDD)
	Config 3, 6	40: $N_{RB,c} = 106$ (TDD)
Gap pattern Id		0
PDSCH reference measurement channel	Config 1, 4	SR.1.1 FDD
	Config 2, 5	SR.1.1 TDD

RMSI CORSET reference channel	Config 3, 6		SR.2.1 TDD
	Config 1, 4		CR.1.1 FDD
	Config 2, 5		CR.1.1 TDD
	Config 3, 6		CR.2.1 TDD
Dedicated CORSET reference channel	Config 1, 4		CCR.1.1 FDD
	Config 2, 5		CCR.1.1 TDD
	Config 3, 6		CCR.2.1 TDD
CSI-RS for tracking	Config 1, 4		TRS.1.1 FDD
	Config 2, 5		TRS.1.1 TDD
	Config 3, 6		TRS.1.2 TDD
BWP configurations	Initial DL BWP		DLBWP.0.1
	Dedicated DL BWP		DLBWP.1.1
	Initial UL BWP		ULBWP.0.1
	Dedicated UL BWP		ULBWP.1.1
OCNG pattern ^{Note1}			OP.1
SMTC configuration			SMTC.1
SSB configuration	Config 1, 2, 4, 5		SSB.1 FR1
	Config 3, 6		SSB.2 FR1
EPRE ratio of PSS to SSS		dB	0
EPRE ratio of PBCH_DMRS to SSS			
EPRE ratio of PBCH to PBCH_DMRS			
EPRE ratio of PDCCH_DMRS to SSS			
EPRE ratio of PDCCH to PDCCH_DMRS			
EPRE ratio of PDSCH_DMRS to SSS			
EPRE ratio of PDSCH to PDSCH_DMRS			
EPRE ratio of OCNG DMRS to SSS			
EPRE ratio of OCNG to OCNG DMRS			
N_{oc} ^{Note2}		dBm/15 kHz	-104
N_{oc} ^{Note2}	Config 1, 2, 4, 5	dBm/SCS	-104
	Config 3, 6		-101
\hat{E}_s/N_{oc}		dB	17
\hat{E}_s/I_{ot} ^{Note3}		dB	17
SS-RSRP ^{Note3}	Config 1, 2, 4, 5	dBm/SCS	-87
	Config 3, 6		-84
SSB_RP ^{Note3}	Config 1, 2, 4, 5	dBm/SCS	-87
	Config 3, 6		-84
I_o ^{Note3}	Config 1, 2, 4, 5	dBm/9.36 MHz	-58.96
	Config 3, 6	dBm/38.16 MHz	-52.87
Propagation condition			AWGN
Antenna Configuration and Correlation Matrix			1x2
<p>Note 1: OCNG shall be used such that both cells are fully allocated and a constant total transmitted power spectral density is achieved for all OFDM symbols.</p> <p>Note 2: Interference from other cells and noise sources not specified in the test is assumed to be constant over subcarriers and time and shall be modelled as AWGN of appropriate power for N_{oc} to be fulfilled.</p> <p>Note 3: \hat{E}_s/I_{ot}, SS-RSRP, SSB_RP and I_o levels have been derived from other parameters for information purposes. They are not settable parameters themselves.</p>			

Table A.6.7.5.1.2-3: E-UTRAN Cell specific test parameters for SA Inter-RAT E-UTRAN RSRP test parameters

Parameter	Unit	Cell 2	
		Test 1	Test 2
E-UTRA RF channel number		1	
Duplex mode	Config 1, 2, 3	FDD	
	Config 4, 5, 6	TDD	
TDD special subframe configuration ^{Note1}	Config 1, 2, 3	N/A	
	Config 4, 5, 6	6	

TDD uplink-downlink configuration ^{Note1}	Config 1, 2, 3		N/A	
	Config 4, 5, 6		1	
BW _{channel}		MHz	5 MHz: N _{RB,c} = 25 10 MHz: N _{RB,c} = 50 20 MHz: N _{RB,c} = 100	
PDSCH parameters: DL Reference Measurement Channel ^{Note2}			-	
PCFICH/PDCCH/PHICH parameters: DL Reference Measurement Channel ^{Note2}	Config 1, 2, 3		5 MHz: R.11 FDD 10 MHz: R.6 FDD 20 MHz: R.10 FDD	
	Config 4, 5, 6		5 MHz: R.11 TDD 10 MHz: R.6 TDD 20 MHz: R.10 TDD	
OCNG Patterns ^{Note2}	Config 1, 2, 3		5 MHz: OP.19 FDD 10 MHz: OP.6 FDD 20 MHz: OP.14 FDD	
	Config 4, 5, 6		5 MHz: OP.10 TDD 10 MHz: OP.2 TDD 20 MHz: OP.8 TDD	
PBCH_RA		dB	0	
PBCH_RB				
PSS_RA				
SSS_RA				
PCFICH_RB				
PHICH_RA				
PHICH_RB				
PDCCH_RA				
PDCCH_RB				
PDSCH_RA				
PDSCH_RB				
OCNG_RA ^{Note3}				
OCNG_RB ^{Note3}				
N _{oc} ^{Note4}	Bands FDD_A ^{Note 9} , TDD_A	dBm/15kHz	-91.65	-117
	Bands FDD_B1, FDD_B2 ^{Note 10}			-116.5
	Bands FDD_C, TDD_C			-116
	Bands FDD_D			-115.5
	Bands FDD_E, FDD_F ^{Note 7} , TDD_E			-115
	Bands FDD_G ^{Note 8}			-114
	Bands FDD_H			-113.5
\bar{E}_s/N_{oc}		dB	10	-4
\bar{E}_s/I_{ot} ^{Note5}		dB	10	-4
RSRP ^{Note5}	Bands FDD_A ^{Note 9} , TDD_A	dBm/15kHz	-81.65	-121
	Bands FDD_B1, FDD_B2 ^{Note 10}			-120.5
	Bands FDD_C, TDD_C			-120
	Bands FDD_D			-119.5
	Bands FDD_E, FDD_F ^{Note 7} , TDD_E			-119
	Bands FDD_G ^{Note 8}			-118
	Bands FDD_H			-117.5
SCH_RP ^{Note5}	Bands FDD_A ^{Note 9} , TDD_A	dBm/15kHz	-81.65	-121
	Bands FDD_B1, FDD_B2 ^{Note 10}			-120.5
	Bands FDD_C, TDD_C			-120
	Bands FDD_D			-119.5

	Bands FDD_E, FDD_F Note 7, TDD_E			-119
	Bands FDD_G Note 8			-118
	Bands FDD_H			-117.5
I _o Note5	Bands FDD_A Note 9, TDD_A	dBm/Ch BW	-53.45 + 10log(N _{RB,c} /50)	-87.76 + 10log(N _{RB,c} /50)
	Bands FDD_B1, FDD_B2 Note 10			-87.26 + 10log(N _{RB,c} /50)
	Bands FDD_C, TDD_C			-86.76 + 10log(N _{RB,c} /50)
	Bands FDD_D			-86.26 + 10log(N _{RB,c} /50)
	Bands FDD_E, FDD_F Note 7, TDD_E			-85.76 + 10log(N _{RB,c} /50)
	Bands FDD_G Note 8			-84.76 + 10log(N _{RB,c} /50)
	Bands FDD_H			-84.26 + 10log(N _{RB,c} /50)
Propagation Condition			AWGN	
Antenna Configuration and Correlation Matrix			1x2	
<p>Note 1: Special subframe and uplink-downlink configurations are specified in table 4.2-1 in TS 36.211 [23].</p> <p>Note 2: DL RMCs and OCN patterns are specified in clauses A 3.1 and A 3.2 of TS 36.133 [15] respectively.</p> <p>Note 3: OCN shall be used such that all cells are fully allocated and a constant total transmitted power spectral density is achieved for all OFDM symbols.</p> <p>Note 4: Interference from other cells and noise sources not specified in the test is assumed to be constant over subcarriers and time and shall be modelled as AWGN of appropriate power for N_{oc} to be fulfilled.</p> <p>Note 5: \hat{E}_s/I_{ot}, RSRP, SCH_RP and I_o levels have been derived from other parameters for information purposes. They are not settable parameters themselves.</p> <p>Note 6: E-UTRA operating band groups are as defined in clause 3.5 of TS 36.133 [15].</p> <p>Note 7: For Band 26, the tests shall be performed with the carrier frequency of assigned E-UTRA channel bandwidth within 865-894 MHz.</p> <p>Note 8: Except Band 29.</p> <p>Note 9: Except Band 32, Band 75 and Band 76.</p> <p>Note 10: For Band 74, the tests shall be performed with the carrier frequency of the assigned E-UTRA channel bandwidth within 1475.9-1510.9 MHz.</p>				

A.6.7.5.1.3 Test Requirements

The SA inter-RAT E-UTRAN RSRP measurement accuracy for cell 2 shall fulfil absolute requirement in clause 10.2.2.

A.6.7.6 E-UTRAN RSRQ

A.6.7.6.1 SA: inter-RAT measurement accuracy with FR1 serving cell

A.6.7.6.1.1 Test Purpose and Environment

The purpose of this test is to verify that the E-UTRAN RSRQ measurement accuracy is within the specified limits. This test will verify the requirements in clause 10.2.3 for SA inter-RAT E-UTRAN RSRQ measurements.

A.6.7.6.1.2 Test parameters

In each test there are two cells: Cell 1 and Cell 2. Cell 1 is the NR PCell and Cell 2 is an E-UTRAN inter-RAT neighbour cell. Supported test configurations are shown in table A.6.7.6.1.2-1. The measurement accuracy of SA inter-RAT E-UTRAN RSRQ are tested by using the parameters in A.6.7.6.1.2-2 and A.6.7.6.1.2-3.

Table A.6.7.6.1.2-1: Inter-RAT E-UTRAN RSRQ supported test configurations with FR1 serving cell

Configuration	Description
---------------	-------------

1	NR 15 kHz SSB SCS, 10 MHz bandwidth, FDD duplex mode, E-UTRAN FDD
2	NR 15 kHz SSB SCS, 10 MHz bandwidth, TDD duplex mode, E-UTRAN FDD
3	NR 30 kHz SSB SCS, 40 MHz bandwidth, TDD duplex mode, E-UTRAN FDD
4	NR 15 kHz SSB SCS, 10 MHz bandwidth, FDD duplex mode, E-UTRAN TDD
5	NR 15 kHz SSB SCS, 10 MHz bandwidth, TDD duplex mode, E-UTRAN TDD
6	NR 30 kHz SSB SCS, 40 MHz bandwidth, TDD duplex mode, E-UTRAN TDD
Note: The UE is only required to be tested in one of the supported test configurations	

Table A.6.7.6.1.2-2: NR Cell specific test parameters for SA Inter-RAT E-UTRAN RSRQ test parameters

Parameter		Unit	Cell 1
NR RF channel number			1
Duplex mode	Config 1, 4		FDD
	Config 2, 3, 5, 6		TDD
TDD Configuration	Config 1, 4		N/A
	Config 2, 5		TDDConf.1.1
	Config 3, 6		TDDConf.1.2
BW _{channel}	Config 1, 4	MHz	10: N _{RB,c} = 52 (FDD)
	Config 2, 5		10: N _{RB,c} = 52 (TDD)
	Config 3, 6		40: N _{RB,c} = 106 (TDD)
Gap pattern Id			0
PDSCH reference measurement channel	Config 1, 4		SR.1.1 FDD
	Config 2, 5		SR.1.1 TDD
	Config 3, 6		SR.2.1 TDD
RMSI CORSET reference channel	Config 1, 4		CR.1.1 FDD
	Config 2, 5		CR.1.1 TDD
	Config 3, 6		CR.2.1 TDD
Dedicated CORSET reference channel	Config 1, 4		CCR.1.1 FDD
	Config 2, 5		CCR.1.1 TDD
	Config 3, 6		CCR.2.1 TDD
CSI-RS for tracking	Config 1, 4		TRS.1.1 FDD
	Config 2, 5		TRS.1.1 TDD
	Config 3, 6		TRS.1.2 TDD
BWP configurations	Initial DL BWP		DLBWP.0.1
	Dedicated DL BWP		DLBWP.1.1
	Initial UL BWP		ULBWP.0.1
	Dedicated UL BWP		ULBWP.1.1
OCNG pattern ^{Note1}			OP.1
SMTc configuration			SMTc.1
SSB configuration	Config 1, 2, 4, 5		SSB.1 FR1
	Config 3, 6		SSB.2 FR1
EPRE ratio of PSS to SSS		dB	0
EPRE ratio of PBCH_DMRS to SSS			
EPRE ratio of PBCH to PBCH_DMRS			
EPRE ratio of PDCCH_DMRS to SSS			
EPRE ratio of PDCCH to PDCCH_DMRS			
EPRE ratio of PDSCH_DMRS to SSS			
EPRE ratio of PDSCH to PDSCH_DMRS			
EPRE ratio of OCNG DMRS to SSS			
EPRE ratio of OCNG to OCNG DMRS			
N _{oc} ^{Note2}		dBm/15 kHz	-104
N _{oc} ^{Note2}	Config 1, 2, 4, 5	dBm/SCS	-104
	Config 3, 6		-101
Ē _s /N _{oc}		dB	17
Ē _s /I _{ot} ^{Note3}		dB	17
SS-RSRQ ^{Note3}	Config 1, 2, 4, 5	dBm/SCS	-87
	Config 3, 6		-84

SSB_RP ^{Note3}	Config 1, 2, 4, 5	dBm/SCS	-87
	Config 3, 6		-84
I _o ^{Note3}	Config 1, 2, 4, 5	dBm/9.36 MHz	-58.96
	Config 3, 6	dBm/38.16 MHz	-52.87
Propagation condition			AWGN
Antenna Configuration and Correlation Matrix			1x2
<p>Note 1: OCNG shall be used such that both cells are fully allocated and a constant total transmitted power spectral density is achieved for all OFDM symbols.</p> <p>Note 2: Interference from other cells and noise sources not specified in the test is assumed to be constant over subcarriers and time and shall be modelled as AWGN of appropriate power for N_{oc} to be fulfilled.</p> <p>Note 3: \hat{E}_s/I_{ot}, SS-RSRQ, SSB_RP and I_o levels have been derived from other parameters for information purposes. They are not settable parameters themselves.</p>			

Table A.6.7.6.1.2-3: E-UTRAN Cell specific test parameters for SA Inter-RAT E-UTRAN RSRQ test parameters

Parameter		Unit	Cell 2		
			Test 1	Test 2	Test 3
E-UTRA RF channel number			1		
Duplex mode	Config 1, 2, 3		FDD		
	Config 4, 5, 6		TDD		
TDD special subframe configuration ^{Note1}	Config 1, 2, 3		N/A		
	Config 4, 5, 6		6		
TDD uplink-downlink configuration ^{Note1}	Config 1, 2, 3		N/A		
	Config 4, 5, 6		1		
BW _{channel}		MHz	5 MHz: N _{RB,c} = 25 10 MHz: N _{RB,c} = 50 20 MHz: N _{RB,c} = 100		
PDSCH parameters: DL Reference Measurement Channel ^{Note2}			-		
PCFICH/PDCCH/PHICH parameters: DL Reference Measurement Channel ^{Note2}	Config 1, 2, 3		5 MHz: R.11 FDD 10 MHz: R.6 FDD 20 MHz: R.10 FDD		
	Config 4, 5, 6		5 MHz: R.11 TDD 10 MHz: R.6 TDD 20 MHz: R.10 TDD		
OCNG Patterns ^{Note2}	Config 1, 2, 3		5 MHz: OP.19 FDD 10 MHz: OP.6 FDD 20 MHz: OP.14 FDD		
	Config 4, 5, 6		5 MHz: OP.10 TDD 10 MHz: OP.2 TDD 20 MHz: OP.8 TDD		
PBCH_RA		dB	0		
PBCH_RB					
PSS_RA					
SSS_RA					
PCFICH_RB					
PHICH_RA					
PHICH_RB					
PDCCH_RA					
PDCCH_RB					
PDSCH_RA					
PDSCH_RB					
OCNG_RA ^{Note3}					
OCNG_RB ^{Note3}					
N _{oc} ^{Note4}	Bands FDD_A ^{Note9} , TDD_A	dBm/15kHz	-83	-104.70	-119.5

	Bands FDD_B1, FDD_B2 ^{Note 10}				-119
	Bands FDD_C, TDD_C				-118.5
	Bands FDD_D				-118
	Bands FDD_E, FDD_F ^{Note 7} , TDD_E				-117.5
	Bands FDD_G ^{Note 8}				-116.5
	Bands FDD_H				-116
\hat{E}_s/N_{oc}		dB	-1.75	-4.0	-4.0
\hat{E}_s/I_{ot} ^{Note 5}		dB	-1.75	-4.0	-4.0
RSRP ^{Note 5}	Bands FDD_A ^{Note 9} , TDD_A	dBm/15kHz	-84.75	-108.70	-123.5
	Bands FDD_B1, FDD_B2 ^{Note 10}				-123
	Bands FDD_C, TDD_C				-122.5
	Bands FDD_D				-122
	Bands FDD_E, FDD_F ^{Note 7} , TDD_E				-121.5
	Bands FDD_G ^{Note 8}				-120.5
	Bands FDD_H				-120
RSRQ ^{Note 5}	Bands FDD_A ^{Note 9} , TDD_A	dB	-14.76	-16.25	-16.25
	Bands FDD_B1, FDD_B2 ^{Note 10}				
	Bands FDD_C, TDD_C				
	Bands FDD_D				
	Bands FDD_E, FDD_F ^{Note 7} , TDD_E				
	Bands FDD_G ^{Note 8}				
	Bands FDD_H				
I _o ^{Note 5}	Bands FDD_A ^{Note 9} , TDD_A	dBm/Ch BW	-53 + 10log(N _{RB,c} /50)	-75.46 + 10log(N _{RB,c} /50)	-90.26 + 10log(N _{RB,c} /50)
	Bands FDD_B1, FDD_B2 ^{Note 10}				-89.76 + 10log(N _{RB,c} /50)
	Bands FDD_C, TDD_C				-89.26 + 10log(N _{RB,c} /50)
	Bands FDD_D				-88.76 + 10log(N _{RB,c} /50)
	Bands FDD_E, FDD_F ^{Note 7} , TDD_E				-88.26 + 10log(N _{RB,c} /50)
	Bands FDD_G ^{Note 8}				-87.26 + 10log(N _{RB,c} /50)
	Bands FDD_H				-86.76 + 10log(N _{RB,c} /50)
Propagation Condition			AWGN		
Antenna Configuration and Correlation Matrix			1x2		
<p>Note 1: Special subframe and uplink-downlink configurations are specified in table 4.2-1 in TS 36.211 [23].</p> <p>Note 2: DL RMCs and OCNG patterns are specified in clauses A 3.1 and A 3.2 of TS 36.133 [15] respectively.</p> <p>Note 3: OCNG shall be used such that all cells are fully allocated and a constant total transmitted power spectral density is achieved for all OFDM symbols.</p> <p>Note 4: Interference from other cells and noise sources not specified in the test is assumed to be constant over subcarriers and time and shall be modelled as AWGN of appropriate power for N_{oc} to be fulfilled.</p> <p>Note 5: \hat{E}_s/I_{ot}, RSRP, RSRQ and I_o levels have been derived from other parameters for information purposes. They are not settable parameters themselves.</p>					

Note 6:	E-UTRA operating band groups are as defined in clause 3.5 of TS 36.133 [15].
Note 7:	For Band 26, the tests shall be performed with the carrier frequency of assigned E-UTRA channel bandwidth within 865-894 MHz.
Note 8:	Except Band 29.
Note 9:	Except Band 32, Band 75 and Band 76.
Note 10:	For Band 74, the tests shall be performed with the carrier frequency of the assigned E-UTRA channel bandwidth within 1475.9-1510.9 MHz.

A.6.7.6.1.3 Test Requirements

The SA inter-RAT E-UTRAN RSRQ measurement accuracy for cell 2 shall fulfil absolute requirement in clause 10.2.3.

A.6.7.7 E-UTRAN RS-SINR

A.6.7.7.1 SA: inter-RAT measurement accuracy with FR1 serving cell

A.6.7.7.1.1 Test Purpose and Environment

The purpose of this test is to verify that the E-UTRAN RS-SINR measurement accuracy is within the specified limits. This test will verify the requirements in clause 10.2.4 for SA inter-RAT E-UTRAN RS-SINR measurements.

A.6.7.7.1.2 Test parameters

In each test there are two cells: Cell 1 and Cell 2. Cell 1 is the NR PCell and Cell 2 is an E-UTRAN inter-RAT neighbour cell. Supported test configurations are shown in table A.6.7.7.1.2-1. The measurement accuracy of SA inter-RAT E-UTRAN RS-SINR are tested by using the parameters in A.6.7.7.1.2-2 and A.6.7.7.1.2-3.

Table A.6.7.7.1.2-1: Inter-RAT E-UTRAN RS-SINR supported test configurations with FR1 serving cell

Configuration	Description
1	NR 15 kHz SSB SCS, 10 MHz bandwidth, FDD duplex mode, E-UTRAN FDD
2	NR 15 kHz SSB SCS, 10 MHz bandwidth, TDD duplex mode, E-UTRAN FDD
3	NR 30 kHz SSB SCS, 40 MHz bandwidth, TDD duplex mode, E-UTRAN FDD
4	NR 15 kHz SSB SCS, 10 MHz bandwidth, FDD duplex mode, E-UTRAN TDD
5	NR 15 kHz SSB SCS, 10 MHz bandwidth, TDD duplex mode, E-UTRAN TDD
6	NR 30 kHz SSB SCS, 40 MHz bandwidth, TDD duplex mode, E-UTRAN TDD
Note:	The UE is only required to be tested in one of the supported test configurations

Table A.6.7.7.1.2-2: NR Cell specific test parameters for SA Inter-RAT E-UTRAN RS-SINR test parameters

Parameter	Unit	Cell 1
NR RF channel number		1
Duplex mode	Config 1, 4	FDD
	Config 2, 3, 5, 6	TDD
TDD Configuration	Config 1, 4	N/A
	Config 2, 5	TDDConf.1.1
	Config 3, 6	TDDConf.2.1
BW _{channel}	Config 1, 4	10: N _{RB,c} = 52 (FDD)
	Config 2, 5	10: N _{RB,c} = 52 (TDD)
	Config 3, 6	40: N _{RB,c} = 106 (TDD)
Gap pattern Id		0
PDSCH reference measurement channel	Config 1, 4	SR.1.1 FDD
	Config 2, 5	SR.1.1 TDD
	Config 3, 6	SR.2.1 TDD

RMSI CORSET reference channel	Config 1, 4		CR.1.1 FDD
	Config 2, 5		CR.1.1 TDD
	Config 3, 6		CR.2.1 TDD
Dedicated CORSET reference channel	Config 1, 4		CCR.1.1 FDD
	Config 2, 5		CCR.1.1 TDD
	Config 3, 6		CCR.2.1 TDD
CSI-RS for tracking	Config 1, 4		TRS.1.1 FDD
	Config 2, 5		TRS.1.1 TDD
	Config 3, 6		TRS.1.2 TDD
BWP configurations	Initial DL BWP		DLBWP.0.1
	Dedicated DL BWP		DLBWP.1.1
	Initial UL BWP		ULBWP.0.1
	Dedicated UL BWP		ULBWP.1.1
OCNG pattern ^{Note1}			OP.1
SMTC configuration			SMTC.1
SSB configuration	Config 1, 2, 4, 5		SSB.1 FR1
	Config 3, 6		SSB.2 FR1
EPRE ratio of PSS to SSS		dB	0
EPRE ratio of PBCH_DMRS to SSS			
EPRE ratio of PBCH to PBCH_DMRS			
EPRE ratio of PDCCH_DMRS to SSS			
EPRE ratio of PDCCH to PDCCH_DMRS			
EPRE ratio of PDSCH_DMRS to SSS			
EPRE ratio of PDSCH to PDSCH_DMRS			
EPRE ratio of OCNG DMRS to SSS			
EPRE ratio of OCNG to OCNG DMRS			
N_{oc} ^{Note2}		dBm/15 kHz	-104
N_{oc} ^{Note2}	Config 1, 2, 4, 5	dBm/SCS	-104
	Config 3, 6		-101
\hat{E}_s/N_{oc}		dB	17
\hat{E}_s/I_{ot} ^{Note3}		dB	17
SS-RS-SINR ^{Note3}	Config 1, 2, 4, 5	dBm/SCS	-87
	Config 3, 6		-84
SSB_RP ^{Note3}	Config 1, 2, 4, 5	dBm/SCS	-87
	Config 3, 6		-84
I_o ^{Note3}	Config 1, 2, 4, 5	dBm/9.36 MHz	-58.96
	Config 3, 6	dBm/38.16 MHz	-52.87
Propagation condition			AWGN
Antenna Configuration and Correlation Matrix			1x2
<p>Note 1: OCNG shall be used such that both cells are fully allocated and a constant total transmitted power spectral density is achieved for all OFDM symbols.</p> <p>Note 2: Interference from other cells and noise sources not specified in the test is assumed to be constant over subcarriers and time and shall be modelled as AWGN of appropriate power for N_{oc} to be fulfilled.</p> <p>Note 3: \hat{E}_s/I_{ot}, SS-RS-SINR, SSB_RP and I_o levels have been derived from other parameters for information purposes. They are not settable parameters themselves.</p>			

Table A.6.7.7.1.2-3: E-UTRAN Cell specific test parameters for SA Inter-RAT E-UTRAN RS-SINR test parameters

Parameter		Unit	Cell 2		
			Test 1	Test 2	Test 3
E-UTRA RF channel number				1	
Duplex mode	Config 1, 2, 3		FDD		
	Config 4, 5, 6		TDD		
TDD special subframe configuration ^{Note1}	Config 1, 2, 3		N/A		
	Config 4, 5, 6		6		
	Config 1, 2, 3		N/A		

TDD uplink-downlink configuration ^{Note1}	Config 4, 5, 6		1		
BW _{channel}		MHz	5 MHz: N _{RB,c} = 25 10 MHz: N _{RB,c} = 50 20 MHz: N _{RB,c} = 100		
PDSCH parameters: DL Reference Measurement Channel ^{Note2}			-		
PCFICH/PDCCH/PHICH parameters: DL Reference Measurement Channel ^{Note2}	Config 1, 2, 3		5 MHz: R.11 FDD 10 MHz: R.6 FDD 20 MHz: R.10 FDD		
	Config 4, 5, 6		5 MHz: R.11 TDD 10 MHz: R.6 TDD 20 MHz: R.10 TDD		
OCNG Patterns ^{Note2}	Config 1, 2, 3		5 MHz: OP.19 FDD 10 MHz: OP.6 FDD 20 MHz: OP.14 FDD		
	Config 4, 5, 6		5 MHz: OP.10 TDD 10 MHz: OP.2 TDD 20 MHz: OP.8 TDD		
PBCH_RA		dB	0		
PBCH_RB					
PSS_RA					
SSS_RA					
PCFICH_RB					
PHICH_RA					
PHICH_RB					
PDCCH_RA					
PDCCH_RB					
PDSCH_RA					
PDSCH_RB					
OCNG_RA ^{Note3}					
OCNG_RB ^{Note3}					
N _{oc} ^{Note4}	Bands FDD_A ^{Note 9} , TDD_A	dBm/15kHz	-88	-108.50	-119.5
	Bands FDD_B1, FDD_B2 ^{Note 10}				-119
	Bands FDD_C, TDD_C				-118.5
	Bands FDD_D				-118
	Bands FDD_E, FDD_F ^{Note 7} , TDD_E				-117.5
	Bands FDD_G ^{Note 8}				-116.5
Bands FDD_H	-116				
CRS E _s /N _{oc} ¹		dB	-1.75	20.0	-4.0
CRS E _s /I _{ot} ^{Note5}		dB	-1.75	20.0	-4.0
RSRP ^{Note5}	Bands FDD_A ^{Note 9} , TDD_A	dBm/15kHz	-89.75	-88.50	-123.5
	Bands FDD_B1, FDD_B2 ^{Note 10}				-123
	Bands FDD_C, TDD_C				-122.5
	Bands FDD_D				-122
	Bands FDD_E, FDD_F ^{Note 7} , TDD_E				-121.5
	Bands FDD_G ^{Note 8}				-120.5
Bands FDD_H	-120				
RS-SINR ^{Note5}	Bands FDD_A ^{Note 9} , TDD_A	dB	-1.75	20	-4.0
	Bands FDD_B1, FDD_B2 ^{Note 10}				
	Bands FDD_C, TDD_C				
	Bands FDD_D				

	Bands FDD_E, FDD_F Note 7, TDD_E				
	Bands FDD_G Note 8				
	Bands FDD_H				
I _o Note5	Bands FDD_A Note 9, TDD_A	dBm/Ch BW	-53.79 + 10log(N _{RB,c} /50)	-60.56 + 10log(N _{RB,c} /50)	-93.48 + 10log(N _{RB,c} /50)
	Bands FDD_B1, FDD_B2 Note 10				-92.98 + 10log(N _{RB,c} /50)
	Bands FDD_C, TDD_C				-92.48 + 10log(N _{RB,c} /50)
	Bands FDD_D				-91.98 + 10log(N _{RB,c} /50)
	Bands FDD_E, FDD_F Note 7, TDD_E				-91.48 + 10log(N _{RB,c} /50)
	Bands FDD_G Note 8				-90.48 + 10log(N _{RB,c} /50)
	Bands FDD_H				-89.98 + 10log(N _{RB,c} /50)
Propagation Condition			AWGN		
Antenna Configuration and Correlation Matrix			1x2		
<p>Note 1: Special subframe and uplink-downlink configurations are specified in table 4.2-1 in TS 36.211 [23].</p> <p>Note 2: DL RMCs and OCN patterns are specified in clauses A 3.1 and A 3.2 of TS 36.133 [15] respectively.</p> <p>Note 3: OCN shall be used such that all cells are fully allocated and a constant total transmitted power spectral density is achieved for all OFDM symbols.</p> <p>Note 4: Interference from other cells and noise sources not specified in the test is assumed to be constant over CRS subcarriers and time and shall be modelled as AWGN of appropriate power for N_{oc1} to be fulfilled.</p> <p>Note 4a: Void.</p> <p>Note 5: CRS Ê_s/I_{ot}, RSRP, RS-SINR and I_o levels have been derived from other parameters for information purposes. They are not settable parameters themselves.</p> <p>Note 6: E-UTRA operating band groups are as defined in clause 3.5 of TS 36.133 [15].</p> <p>Note 7: For Band 26, the tests shall be performed with the carrier frequency of assigned E-UTRA channel bandwidth within 865-894 MHz.</p> <p>Note 8: Except Band 29.</p> <p>Note 9: Except Band 32, Band 75 and Band 76.</p> <p>Note 10: For Band 74, the tests shall be performed with the carrier frequency of the assigned E-UTRA channel bandwidth within 1475.9-1510.9 MHz.</p>					

A.6.7.7.1.3 Test Requirements

The SA inter-RAT E-UTRAN RS-SINR measurement accuracy for cell 2 shall fulfil absolute requirement in clause 10.2.4.

A.7 NR standalone tests with one or more NR cells in FR2

A.7.1 SA: RRC_IDLE state mobility

A.7.1.1 Cell re-selection to NR

A.7.1.1.1 Cell reselection to FR2 intra-frequency NR case

A.7.1.1.1.1 Test Purpose and Environment

This test is to verify the requirement for the intra frequency NR cell reselection requirements specified in clause 4.2.2.3.

A.7.1.1.1.2 Test Parameters

The test scenario comprises of 1 NR carrier and 2 cells as given in tables A.7.1.1.1.2-1, A.7.1.1.1.2-2 and A.7.1.1.1.2-3. The test consists of three successive time periods, with time duration of T1, T2, and T3 respectively. Only cell 1 is already identified by the UE prior to the start of the test. Cell 1 and cell 2 belong to different tracking areas. Furthermore, UE has not registered with network for the tracking area containing cell 2.

Table A.7.1.1.1.2-1: Supported test configurations

Configuration	Description
1	120 kHz SSB SCS, 100 MHz bandwidth, TDD duplex mode
2	240 kHz SSB SCS, 100 MHz bandwidth, TDD duplex mode
Note:	The UE is only required to be tested in one of the supported test configurations.

Table A.7.1.1.1.2-2: General test parameters for intra frequency NR cell re-selection test case

Parameter		Unit	Test configuration	Value	Comment
Initial condition	Active cell		1, 2	Cell1	
T2 end condition	Active cell		1, 2	Cell2	
	Neighbour cells		1, 2	Cell1	
Final condition	Active cell		1, 2	Cell1	
	Neighbour cell		1, 2	Cell2	
RF Channel Number			1, 2	1	
Time offset between cells			1, 2	3 μ s	Synchronous cells
Access Barring Information		-	1, 2	Not Sent	No additional delays in random access procedure.
SMTC configuration			1, 2	SMTC.1	
DRX cycle length		s	1, 2	1.28	The value shall be used for all cells in the test.
PRACH configuration index			1, 2	190	The detailed configuration is specified in TS 38.211 clause 6.3.3.2
rangeToBestCell			1, 2	Not configured	
T1		s	1, 2	>7	During T1, Cell 2 shall be powered off, and during the off time the physical cell identity shall be changed, The intention is to ensure that Cell 2 has not been detected by the UE prior to the start of period T2

T2	s	1, 2	135	T2 needs to be defined so that cell re-selection reaction time is taken into account.
T3	s	1, 2	35	T3 needs to be defined so that cell re-selection reaction time is taken into account.

Table A.7.1.1.1.2-3: Cell specific test parameters for intra frequency NR cell re-selection test case in AWGN

Parameter	Unit	Test configuration	Cell 1			Cell 2		
			T1	T2	T3	T1	T2	T3
TDD configuration		1, 2	TDDConf.3.1			TDDConf.3.1		
PDSCH RMC configuration		1	SR.3.1 TDD			SR.3.1 TDD		
		2	SR.3.1 TDD			SR.3.1 TDD		
RMSI CORESET RMC configuration		1	CR.3.1 TDD			CR.3.1 TDD		
		2	CR.3.1 TDD			CR.3.1 TDD		
Dedicated CORESET RMC configuration		1	CCR.3.1 TDD			CCR.3.1 TDD		
		2	CCR.3.1 TDD			CCR.3.1 TDD		
SSB configuration		1	SSB.3 FR2			SSB.7 FR2		
		2	SSB.4 FR2			SSB.8 FR2		
OCNG Pattern		1, 2	OP.4			OP.4		
BW _{channel}	MHz	1, 2	100: N _{RB,C} = 66			100: N _{RB,C} = 66		
Data RBs allocated		1, 2	66			66		
Initial DL BWP configuration		1, 2	DLBWP.0.1			DLBWP.0.1		
Initial UL BWP configuration		1, 2	ULBWP.0.1			ULBWP.0.1		
RLM-RS		1, 2	SSB			SSB		
Qrxlevmin	dBm/SCS	1	-138			-138		
		2	-135			-135		
Pcompensation	dB	1, 2	0			0		
Qhysts	dB	1, 2	0			0		
Qoffset _{s,n}	dB	1, 2	0			0		
Cell_selection_and_reselection_quality_measurement		1, 2	SS-RSRP			SS-RSRP		
AoA setup		1, 2	Setup 1 defined in A.3.15.1			Setup 1 defined in A.3.15.1		
Beam assumption ^{Note 4}		1,2	Rough			Rough		
$\hat{E}_s / I_{ot\ BB}$ ^{Note 5}	dB	1	7.45	-3.55	0.95	-infinity	0.95	-3.55
		2						
N_{oc} ^{Note2}	dBm/SCS	1	-93					
		2	-90					
N_{oc} ^{Note2}	dBm/15 kHz	1	-102					
		2						
\hat{E}_s / N_{oc}	dB	1	8	-3	1.5	-infinity	1.5	-3
		2						
SS-RSRP ^{Note3}	dBm/SCS	1	-85	-96	-91.5	-infinity	-91.5	-96
		2	-82	-93	-88.5	-infinity	-88.5	-93
Io on SSB symbols of each cell	dBm/95.04 MHz	1	-60.53	-67.40	-65.34	-69.17	-65.34	-67.40
		2	-57.52	-64.39	-62.33	-66.16	-62.33	-64.39
Treselection	s	1, 2	0	0	0	0	0	0
SintrasearchP	dB	1, 2	50			50		
Propagation Condition		1, 2	AWGN					

Note 1:	OCNG shall be used such that both cells are fully allocated and a constant total transmitted power spectral density is achieved for all OFDM symbols.
Note 2:	Interference from other cells and noise sources not specified in the test is assumed to be constant over
Note 3:	subcarriers and time and shall be modelled as AWGN of appropriate power for N_{oc} to be fulfilled. SS-RSRP levels have been derived from other parameters for information purposes. They are not settable parameters themselves.
Note 4:	Information about types of UE beam is given in B.2.1.3, and does not limit UE implementation or test system implementation
Note 5:	Calculation of E_s/lot_{BB} includes the effect of UE internal noise up to the value assumed for the associated Refsens requirement in clause 7.3.2 of TS 38.101-2 [19], and an allowance of 1dB for UE multi-band relaxation factor ΔMB_P from TS 38.101-2 [19] Table 6.2.1.3-4.

A.7.1.1.1.3 Test Requirements

The cell reselection delay to a newly detectable cell is defined as the time from the beginning of time period T2, to the moment when the UE camps on Cell 2, and starts to send preambles on the PRACH for sending the *RRCSetupRequest* message to perform a Registration procedure for mobility and periodic registration update on Cell 2.

The cell re-selection delay to a newly detectable cell shall be less than 130 s.

The cell reselection delay to an already detected cell is defined as the time from the beginning of time period T3, to the moment when the UE camps on cell 1, and starts to send preambles on the PRACH for sending the *RRCSetupRequest* message to perform a Registration procedure for mobility and periodic registration update on cell 1.

The cell re-selection delay to an already detected cell shall be less than 27 s.

The rate of correct cell reselections observed during repeated tests shall be at least 90%.

NOTE: The cell re-selection delay to a newly detectable cell can be expressed as: $T_{\text{detect, NR_Intra}} + T_{\text{SI-NR}}$, and to an already detected cell can be expressed as: $T_{\text{evaluate, NR_intra}} + T_{\text{SI-NR}}$,

Where:

$T_{\text{detect, NR_Intra}}$	See Table 4.2.2.3-1 in clause 4.2.2.3
$T_{\text{evaluate, NR_intra}}$	See Table 4.2.2.3-1 in clause 4.2.2.3
$T_{\text{SI-NR}}$	Maximum repetition period of relevant system info blocks that needs to be received by the UE to camp on a cell; 1280 ms is assumed in this test case.

This gives a total of 129.28 s, allow 130 s for the cell re-selection delay to a newly detectable cell and 26.88 s for the cell re-selection delay to an already detected cell in the test case, which we allow 27 s.

A.7.1.1.2 Cell reselection to FR2 inter-frequency NR case

A.7.1.1.2.1 Test Purpose and Environment

This test is to verify the requirement for the inter frequency NR cell reselection requirements specified in clause 4.2.2.4.

A.7.1.1.2.2 Test Parameters

The test scenario comprises of 2 cells on 2 different NR carriers respectively as given in tables A.7.1.1.2.2-1, A.7.1.1.2.2-2 and A.7.1.1.2.2-3. The test consists of three successive time periods, with time duration of T1, T2, and T3 respectively. Both cell 1 and cell 2 are already identified by the UE prior to the start of the test. Cell 1 and cell 2

belong to different tracking areas and cell 2 is of higher priority than cell 1. Furthermore, UE has not registered with network for the tracking area containing cell 2.

Table A.7.1.1.2.2-1: Supported test configurations

Configuration	Description for serving cell	Description for target cell
1	120 kHz SSB SCS, 100 MHz bandwidth, TDD duplex mode	120 kHz SSB SCS, 100 MHz bandwidth, TDD duplex mode
2	240 kHz SSB SCS, 100 MHz bandwidth, TDD duplex mode	240 kHz SSB SCS, 100 MHz bandwidth, TDD duplex mode
Note: The UE is only required to be tested in one of the supported test configurations.		

Table A.7.1.1.2.2-2: General test parameters for FR2 inter frequency NR cell re-selection test case

Parameter		Unit	Test configuration	Value	Comment
Initial condition	Active cell		1, 2	Cell2	The UE camps on cell 2 in the initial phase and during T1 period the UE reselects to cell 1
	Neighbour cell		1, 2	Cell1	
T1 end condition	Active cell		1, 2	Cell1	The UE shall perform reselection to cell 1 during T1
	Neighbour cells		1, 2	Cell2	
T3 end condition	Active cell		1, 2	Cell2	The UE shall perform reselection to cell 2 with higher priority during T3
	Neighbour cell		1, 2	Cell1	
RF Channel Number			1, 2	1, 2	
Time offset between cells			1, 2	3 μ s	Synchronous cells
Access Barring Information		-	1, 2	Not Sent	No additional delays in random access procedure.
SSB configuration			1	SSB.1 FR2	
			2	SSB.2 FR2	
SMTC configuration			1, 2	SMTC.1	
DRX cycle length		s	1, 2	1.28	The value shall be used for all cells in the test.
PRACH configuration index			1, 2	190	The detailed configuration is specified in TS 38.211 clause 6.3.3.2
rangeToBestCell			1, 2	Not configured	
T1		s	1, 2	35	T1 needs to be defined so that cell re-selection reaction time is taken into account.
T2		s	1, 2	>7	During T2, cell 2 shall be powered off, and during the off time the physical cell identity shall be changed. The intention is to ensure that cell 2 has not been detected by the UE prior to the start of period T3.
T3		s	1, 2	95	T3 needs to be defined so that cell re-selection reaction time is taken into account.

Table A.7.1.1.2.2-3: Cell specific test parameters for FR2 inter frequency NR cell re-selection test case in AWGN

Parameter	Unit	Test configuration	Cell 1			Cell 2		
			T1	T2	T3	T1	T2	T3
TDD configuration		1, 2	TDDConf.3.1			TDDConf.3.1		
PDSCH RMC configuration		1, 2	SR.3.1 TDD			SR.3.1 TDD		

RMSI CORESET parameters		1, 2	CR.3.1 TDD			CR.3.1 TDD		
RMSI CORESET RMC configuration		1, 2	CCR.3.1 TDD			CCR.3.1 TDD		
OCNG Pattern		1, 2	OP.1 defined in A.3.2.1			OP.1 defined in A.3.2.1		
Initial DL BWP configuration		1, 2	DLBWP.0.1			DLBWP.0.1		
Initial UL BWP configuration		1, 2	ULBWP.0.1			ULBWP.0.1		
RLM-RS		1, 2	SSB			SSB		
Qrxlevmin	dBm/SCS	1	-140			-140		
		2	-137			-137		
Pcompensation	dB	1, 2	0			0		
Qhysts	dB	1, 2	0			0		
Qoffsets _{s, n}	dB	1, 2	0			0		
Cell_selection_and_reselection_quality_measurement		1, 2	SS-RSRP			SS-RSRP		
AoA setup		1, 2	Setup 1 defined in A.3.15.1			Setup 1 defined in A.3.15.1		
Beam assumption ^{Note 4}		1, 2	Rough			Rough		
$\hat{E}_s / I_{ot\ BB}$ ^{Note 5}	dB	1	9.95	9.95	7.45	-11.05	-infinity	7.95
		2						
N_{oc} ^{Note 2}	dBm/SCS	1	-93			-93		
		2	-90			-90		
N_{oc} ^{Note 2}	dBm/15 kHz	1	-102			-102		
		2						
\hat{E}_s / N_{oc}	dB	1	10.5	10.5	8	-10.5	-infinity	8.5
		2						
SS-RSRP ^{Note 3}	dBm/SCS	1	-82.5	-82.5	-85	-103.5	-infinity	-84.5
		2	-79.5	-79.5	-82	-100.5	-infinity	-81.5
Io	dBm/95.04 MHz	1, 2	-53.11	-53.11	-55.34	-63.61	-63.98	-54.91
Treselection	s	1, 2	0	0	0	0	0	0
SnonintrasearchP	dB	1, 2	50			50		
Thresh _{x, highP}	dB	1, 2	48			48		
Thresh _{servicing, lowP}	dB	1, 2	44			44		
Thresh _{x, lowP}	dB	1, 2	50			50		
Propagation Condition		1, 2	AWGN			AWGN		
<p>Note 1: OCNG shall be used such that both cells are fully allocated and a constant total transmitted power spectral density is achieved for all OFDM symbols.</p> <p>Note 2: Interference from other cells and noise sources not specified in the test is assumed to be constant over subcarriers and time and shall be modelled as AWGN of appropriate power for N_{oc} to be fulfilled.</p> <p>Note 3: SS-RSRP levels have been derived from other parameters for information purposes. They are not settable parameters themselves.</p> <p>Note 4: Information about types of UE beam is given in B.2.1.3, and does not limit UE implementation or test system implementation</p> <p>Note 5: Calculation of $E_s/I_{ot\ BB}$ includes the effect of UE internal noise up to the value assumed for the associated Refsens requirement in clause 7.3.2 of TS 38.101-2 [19], and an allowance of 1dB for UE multi-band relaxation factor ΔMB_P from TS 38.101-2 [19] Table 6.2.1.3-4.</p>								

A.7.1.1.2.3 Test Requirements

The cell reselection delay to a higher priority cell is defined as the time from the beginning of time period T3, to the moment when the UE camps on cell 2, and starts to send preambles on the PRACH for sending the *RRCSetupRequest* message to perform a Registration procedure for mobility and periodic registration update on cell 2.

The cell re-selection delay to a higher priority cell shall be less than 87 s.

The cell reselection delay to a lower priority cell is defined as the time from the beginning of time period T1, to the moment when the UE camps on cell 1, and starts to send preambles on the PRACH for sending the *RRCSetupRequest* message to perform a Tracking Area Update procedure on cell 1.

The cell re-selection delay to a lower priority cell shall be less than 27 s.

The rate of correct cell reselections observed during repeated tests shall be at least 90%.

NOTE: The cell re-selection delay to a higher priority cell can be expressed as: $T_{\text{higher_priority_search}} + T_{\text{evaluate, NR_inter}} + T_{\text{SI-NR}}$, and to a lower priority cell can be expressed as: $T_{\text{evaluate, NR_inter}} + T_{\text{SI-NR}}$.

Where:

$T_{\text{higher_priority_search}}$ See clause 4.2.2.7

$T_{\text{evaluate, NR_inter}}$ See Table 4.2.2.4-1 in clause 4.2.2.4

$T_{\text{SI-NR}}$ Maximum repetition period of relevant system info blocks that needs to be received by the UE to camp on a cell; 1280 ms is assumed in this test case.

This gives a total of 86.88 s, allow 87 s for the cell re-selection delay to a higher priority cell and 26.88 s for the cell re-selection delay to a lower priority cell in the test case, which we allow 27 s.

A.7.2 SA: RRC_INACTIVE state mobility

A.7.3 RRC_CONNECTED state mobility

A.7.3.1 Handover

A.7.3.1.1 Inter-frequency handover from FR1 to FR2; unknown target cell

A.7.3.1.1.1 Test Purpose and Environment

This test is to verify the requirement for the NR FR1-NR FR2 inter frequency handover requirements specified in clause 6.1.1.5.

A.7.3.1.1.2 Test Parameters

Supported test configurations are shown in table A.7.3.1.2.2-1. Both handover delay and interruption length are tested by using the parameters in table A.7.3.1.1.2-2, and A.7.3.1.1.2-3.

The test scenario comprises of two carriers and one cell on each carrier. No gap patterns are configured in the test case. The test consists of two successive time periods, with time durations of T1, T2 respectively. At the start of time duration T1, the UE does not have any timing information of cell 2. Starting T2, cell 2 becomes detectable and the UE receives a RRC handover command from the network. The start of T2 is the instant when the last TTI containing the RRC message implying handover is sent to the UE.

Table A.7.3.1.1.2-1: Inter-frequency handover from FR1 to FR2 test configurations

Config	Description
1	Source cell: NR 15 kHz SSB SCS, 10 MHz bandwidth, FDD duplex mode Target cell: NR 120 kHz SSB SCS, 100 MHz bandwidth, TDD duplex mode
2	Source cell: NR 15 kHz SSB SCS, 10 MHz bandwidth, TDD duplex mode Target cell: NR 120 kHz SSB SCS, 100 MHz bandwidth, TDD duplex mode
3	Source cell: NR 30 kHz SSB SCS, 40 MHz bandwidth, TDD duplex mode Target cell: NR 120 kHz SSB SCS, 100 MHz bandwidth, TDD duplex mode
Note:	The UE is only required to be tested in one of the supported test configurations

Table A.7.3.1.1.2-2: General test parameters Inter-frequency handover from FR1 to FR2

Parameter		Unit	Value	Comment
Initial conditions	Active cell		Cell 1	
	Neighbouring cell		Cell 2	
Final condition	Active cell		Cell 2	
Access Barring Information		-	Not Sent	No additional delays in random access procedure.
Time offset between cells			3 μ s	Synchronous cells
T1		s	5	
T2		s	≤ 10	

Table A.7.3.1.1.2-3: Cell specific test parameters for NR FR1-FR2 Inter frequency handover test case

Parameter		Unit	Cell 1		Cell 2	
			T1	T2	T1	T2
Assumption for UE beams ^{Note 6}			N/A		Rough	
AoA setup			NA		Setup 1 as defined in A.3.15	
NR RF Channel Number			1		2	
Duplex mode	Config 1		FDD		TDD	
	Config 2,3		TDD		TDD	
TDD configuration	Config 1		Not Applicable		TDDConf.3.1	
	Config 2		TDDConf.1.1		TDDConf.3.1	
	Config 3		TDDConf.2.1		TDDConf.3.1	
BW _{channel}	Config 1	MHz	10: N _{RB,c} = 52		100: N _{RB,c} = 66	
	Config 2		10: N _{RB,c} = 52		100: N _{RB,c} = 66	
	Config 3		40: N _{RB,c} = 106		100: N _{RB,c} = 66	
BWP BW	Config 1	MHz	10: N _{RB,c} = 52		100: N _{RB,c} = 66	
	Config 2		10: N _{RB,c} = 52		100: N _{RB,c} = 66	
	Config 3		40: N _{RB,c} = 106		100: N _{RB,c} = 66	
Data RBs allocated	Config 1		52		66	
	Config 2		52		66	
	Config 3		106		66	
DRx Cycle		ms	Not Applicable			
PDSCH Reference measurement channel	Config 1		SR.1.1 FDD		SR.3.1 TDD	
	Config 2		SR.1.1 TDD		SR.3.1 TDD	
	Config 3		SR2.1 TDD		SR.3.1 TDD	
RMSI CORESET Reference Channel	Config 1		CR.1.1 FDD		CR.3.1 TDD	
	Config 2		CR.1.1 TDD		CR.3.1 TDD	
	Config 3		CR2.1 TDD		CR.3.1 TDD	

Control Channel RMC	Config 1		CCR.1.1 FDD	CCR.3.1 TDD	
	Config 2		CCR.1.1 TDD	CCR.3.1 TDD	
	Config 3		CCR.2.1 TDD	CCR.3.1 TDD	
OCNG Patterns			OP.1		
SSB configuration	Config 1,2		SSB.1 FR1	SSB.3 FR2	
	Config 3		SSB.2 FR1	SSB.3 FR2	
SSB configuration	Config 1,2		SSB.1 FR1	SSB.3 FR2	
	Config 3		SSB.2 FR1	SSB.3 FR2	
SMTC configuration	Config 1,2		SMTC.1	SMTC.1	
	Config 3		SMTC.2	SMTC.1	
PDSCH/PDCCH subcarrier spacing	Config 1,2	kHz	15 kHz	120 kHz	
	Config 3		30 kHz	120 kHz	
PUCCH/PUSCH subcarrier spacing	Config 1,2	kHz	15 kHz	120 kHz	
	Config 3		30 kHz	120 kHz	
PRACH configuration			FR1 PRACH configuration 1	FR2 PRACH configuration 1	
TRS configuration	Config 1		TRS.1.1 FDD	TRS.2.1 TDD	
	Config 2		TRS.1.1 TDD	TRS.2.1 TDD	
	Config 3		TRS.1.2 TDD	TRS.2.1 TDD	
PDSCH/PDCCH TCI state			N/A	TCI.State.2	
BWP configuraiton	Initial DL BWP		DLBWP.0.1	DLBWP.0.1	
	Dedicated DL BWP		DLBWP.1.1	DLBWP.1.1	
	Initial UL BWP		ULBWP.0.1	ULBWP.0.1	
	Dedicated UL BWP		ULBWP.1.1	ULBWP.1.1	
EPRE ratio of PSS to SSS		dB	0	0	
EPRE ratio of PBCH DMRS to SSS					
EPRE ratio of PBCH to PBCH DMRS					
EPRE ratio of PDCCH DMRS to SSS					
EPRE ratio of PDCCH to PDCCH DMRS					
EPRE ratio of PDSCH DMRS to SSS					
EPRE ratio of PDSCH to PDSCH					
EPRE ratio of OCNG DMRS to SSS(Note 1)					
EPRE ratio of OCNG to OCNG DMRS (Note 1)					
Note2 N_{oc}		dBm/15kHz	Link only, see clause A.3.7A	-104.7	
N_{oc} Note2	Config 1,2	dBm/SCS		-95.7	
	Config 3			-95.7	
\hat{E}_s / I_{oc}		dB		-Infinity	10
\hat{E}_s / N_{oc}		dB		-Infinity	10
I_o Note3	Config 1,2	dBm/BW		-66.7	-56.3
	Config 3	dBm/BW		-66.7	-56.3
Propagation condition		-		AWGN	

Note 1:	OCNG shall be used such that both cells are fully allocated and a constant total transmitted power spectral density is achieved for all OFDM symbols.
Note 2:	Interference from other cells and noise sources not specified in the test is assumed to be constant over subcarriers and time and shall be modelled as AWGN of appropriate power for N_{sc} to be fulfilled.
Note 3:	Io levels have been derived from other parameters for information purposes. They are not settable parameters themselves.
Note 4:	Equivalent power received by an antenna with 0 dBi gain at the centre of the quiet zone
Note 5:	As observed with 0 dBi gain antenna at the centre of the quiet zone
Note 6:	Information about types of UE beam is given in B.2.1.3, and does not limit UE implementation or test system implementation

A.7.3.1.1.3 Test Requirements

The UE shall start to transmit the PRACH to Cell 2 less than 572 ms from the beginning of time period T2. The rate of correct handovers observed during repeated tests shall be at least 90%.

NOTE: The handover delay can be expressed as: RRC procedure delay + $T_{\text{interrupt}}$, where:

RRC procedure delay = 10 ms and is specified in clause 12 in TS 38.331 [2].

$T_{\text{interrupt}}$ = 562 ms in the test. $T_{\text{interrupt}}$ is defined in clause 6.1.1.5.2.

This gives a total of 572 ms.

A.7.3.1.2 Intra-frequency handover from FR2 to FR2; unknown target cell

A.7.3.1.2.1 Test Purpose and Environment

This test is to verify the requirement for the NR FR2-NR FR2 intra frequency handover requirements specified in clause 6.1.1.4.

A.7.3.1.2.2 Test Parameters

Supported test configurations are shown in table A.7.3.1.2.2-1. Both handover delay and interruption length are tested by using the parameters in table A.7.3.1.2.2-2, and A.7.3.1.2.2-3.

The test scenario comprises of two cells on same carrier. No gap patterns are configured in the test case. The test consists of two successive time periods, with time durations of T1, T2 respectively. At the start of time duration T1, the UE does not have any timing information of cell 2. Starting T2, cell 2 becomes detectable and the UE receives a RRC handover command from the network. The start of T2 is the instant when the last TTI containing the RRC message implying handover is sent to the UE.

Table A.7.3.1.2.2-1: Intra-frequency handover from FR2 to FR2 test configurations

Config	Description
1	Source cell: NR 120 kHz SSB SCS, 100 MHz bandwidth, TDD duplex mode Target cell: NR 120 kHz SSB SCS, 100 MHz bandwidth, TDD duplex mode

Table A.7.3.1.2.2-2: General test parameters Intra-frequency handover from FR2 to FR2

Parameter	Unit	Value	Comment
Initial conditions	Active cell	Cell 1	
	Neighbouring cell	Cell 2	
Final condition	Active cell	Cell 2	
Access Barring Information	-	Not Sent	No additional delays in random access procedure.
Time offset between cells		3 μ s	Synchronous cells
T1	s	5	

T2	s	≤10
----	---	-----

Table A.7.3.1.2.2-3: Cell specific test parameters for NR FR2-FR2 Intra frequency handover test case

Parameter	Unit	Cell 1		Cell 2	
		T1	T2	T1	T2
Assumption for UE beams ^{Note 6}		Rough		Rough	
AoA setup		Setup 1 as defined in A.3.15			
NR RF Channel Number		1		1	
Duplex mode		TDD			
TDD configuration		TDDConf.3.1			
BW _{channel}	MHz	100: N _{RB,c} = 66			
BWP BW	MHz	100: N _{RB,c} = 66			
Data RBs allocated		66			
DRx Cycle	ms	Not Applicable			
PDSCH Reference measurement channel		SR.3.1 TDD			
RMSI CORESET Reference Channel		CR.3.1 TDD			
Control Channel RMC		CCR.3.1 TDD			
OCNG Patterns		OP.1			
SMTc Configuration		SMTc pattern 1			
SSB Configuration		SSB.3 FR2			
PDSCH/PDCCH subcarrier spacing	kHz	120 kHz			
PUCCH/PUSCH subcarrier spacing	kHz	120 kHz			
PRACH configuration		FR2 PRACH configuration 1			
TRS configuration		TRS.2.1 TDD			
PDSCH/PDCCH TCI state		TCI.State.2			
BWP configuraiton	Initial DL BWP	DLBWP.0.1			
	Dedicated DL BWP	DLBWP.1.1			
	Initial UL BWP	ULBWP.0.1			
	Dedicated UL BWP	ULBWP.1.1			
EPRE ratio of PSS to SSS	dB	0		0	
EPRE ratio of PBCH DMRS to SSS					
EPRE ratio of PBCH to PBCH DMRS					
EPRE ratio of PDCCH DMRS to SSS					
EPRE ratio of PDCCH to PDCCH DMRS					
EPRE ratio of PDSCH DMRS to SSS					
EPRE ratio of PDSCH to PDSCH					
EPRE ratio of OCNG DMRS to SSS(Note 1)					
EPRE ratio of OCNG to OCNG DMRS (Note 1)					
^{Note2} N _{oc}	dBm/15kHz z	-104.7			
^{Note2} N _{oc}	dBm/SCS	-95.7			
\hat{E}_s / I_{α}	dB	6	-1.8	-Infinity	0
\hat{E}_s / N_{oc}	dB	6	6	-Infinity	7
I _o ^{Note3}	dBm/ BW	-59.7	-56.7	-59.7	-56.7
Propagation condition	-	AWGN		AWGN	

Note 1:	OCNG shall be used such that both cells are fully allocated and a constant total transmitted power spectral density is achieved for all OFDM symbols.
Note 2:	Interference from other cells and noise sources not specified in the test is assumed to be constant over subcarriers and time and shall be modelled as AWGN of appropriate power for N_{sc} to be fulfilled.
Note 3:	Io levels have been derived from other parameters for information purposes. They are not settable parameters themselves.
Note 4:	Equivalent power received by an antenna with 0 dBi gain at the centre of the quiet zone
Note 5:	As observed with 0 dBi gain antenna at the centre of the quiet zone
Note 6:	Information about types of UE beam is given in B.2.1.3, and does not limit UE implementation or test system implementation

A.7.3.1.2.3 Test Requirements

The UE shall start to transmit the PRACH to Cell 2 less than 232 ms from the beginning of time period T2.

The rate of correct handovers observed during repeated tests shall be at least 90%.

NOTE: The handover delay can be expressed as: RRC procedure delay + $T_{\text{interrupt}}$, where:

RRC procedure delay = 10 ms and is specified in clause 12 in TS 38.331 [2].

$T_{\text{interrupt}} = 222$ ms in the test. $T_{\text{interrupt}}$ is defined in clause 6.1.1.4.2.

This gives a total of 232 ms.

A.7.3.1.3 Inter-frequency handover from FR2 to FR2; unknown target cell

A.7.3.1.3.1 Test Purpose and Environment

This test is to verify the requirement for the NR FR2-NR FR2 inter frequency handover requirements specified in clause 6.1.1.4.

A.7.3.1.3.2 Test Parameters

Supported test configurations are shown in table A.7.3.1.3.2-1. Both handover delay and interruption length are tested by using the parameters in table A.7.3.1.3.2-2, and A.7.3.1.3.2-3.

The test scenario comprises of two carriers and one cell on each carrier. No gap patterns are configured in the test case. The test consists of two successive time periods, with time durations of T1, T2 respectively. At the start of time duration T1, the UE does not have any timing information of cell 2. Starting T2, cell 2 becomes detectable and the UE receives a RRC handover command from the network. The start of T2 is the instant when the last TTI containing the RRC message implying handover is sent to the UE.

Table A.7.3.1.3.2-1: Inter-frequency handover from FR2 to FR2 test configurations

Config	Description
1	Source cell: NR 120 kHz SSB SCS, 100 MHz bandwidth, TDD duplex mode Target cell: NR 120 kHz SSB SCS, 100 MHz bandwidth, TDD duplex mode

Table A.7.3.1.3.2-2: General test parameters Inter-frequency handover from FR2 to FR2

Parameter	Unit	Value	Comment
Initial conditions	Active cell	Cell 1	
	Neighbouring cell	Cell 2	
Final condition	Active cell	Cell 2	
Access Barring Information	-	Not Sent	No additional delays in random access procedure.
Time offset between cells		3 μ s	Synchronous cells

T1	s	5	
T2	s	≤10	

Table A.7.3.1.3.2-3: Cell specific test parameters for NR FR2-FR2 Inter frequency handover test case

Parameter	Unit	Cell 1		Cell 2	
		T1	T2	T1	T2
Assumption for UE beams ^{Note 6}		Rough		Rough	
AoA setup		Setup 1 as defined in A.3.15			
NR RF Channel Number		1		2	
Duplex mode		TDD			
TDD configuration		TDDConf.3.1			
BW _{channel}	MHz	100: N _{RB,c} = 66			
BWP BW	MHz	100: N _{RB,c} = 66			
Data RBs allocated		66			
DRx Cycle	ms	Not Applicable			
PDSCH Reference measurement channel		SR.3.1 TDD			
RMSI CORESET Reference Channel		CR.3.1 TDD			
Control Channel RMC		CCR.3.1 TDD			
OCNG Patterns		OP.1			
SMTc Configuration		SMTc pattern 1			
SSB Configuration		SSB.3 FR2			
PDSCH/PDCCH subcarrier spacing	kHz	120 kHz			
PUCCH/PUSCH subcarrier spacing	kHz	120 kHz			
PRACH configuration		FR2 PRACH configuration 1			
TRS configuration		TRS.2.1 TDD			
PDSCH/PDCCH TCI state		TCI.State.2			
BWP configuraiton	Initial DL BWP	DLBWP.0.1			
	Dedicated DL BWP	DLBWP.1.1			
	Initial UL BWP	ULBWP.0.1			
	Dedicated UL BWP	ULBWP.1.1			
EPRE ratio of PSS to SSS	dB	0		0	
EPRE ratio of PBCH DMRS to SSS					
EPRE ratio of PBCH to PBCH DMRS					
EPRE ratio of PDCCH DMRS to SSS					
EPRE ratio of PDCCH to PDCCH DMRS					
EPRE ratio of PDSCH DMRS to SSS					
EPRE ratio of PDSCH to PDSCH					
EPRE ratio of OCNG DMRS to SSS(Note 1)					
EPRE ratio of OCNG to OCNG DMRS (Note 1)					
N_{oc}^{Note2}	dBm/15kHz	-104.7		-104.7	
N_{oc}^{Note2}	dBm/SCS	-95.7		-95.7	
\hat{E}_s / I_{oc}	dB	5	5	-Infinity	5
\hat{E}_s / N_{oc}	dB	5	5	-Infinity	5
I_o^{Note3}	dBm/BW	-60.5	-60.5	-66.7	-60.5
Propagation condition	-	AWGN		AWGN	
Note 1: OCNG shall be used such that both cells are fully allocated and a constant total transmitted power spectral density is achieved for all OFDM symbols.					

Note 2:	Interference from other cells and noise sources not specified in the test is assumed to be constant over subcarriers and time and shall be modelled as AWGN of appropriate power for N_{oc} to be fulfilled.
Note 3:	Io levels have been derived from other parameters for information purposes. They are not settable parameters themselves.
Note 4:	Equivalent power received by an antenna with 0 dBi gain at the centre of the quiet zone
Note 5:	As observed with 0 dBi gain antenna at the centre of the quiet zone
Note 6:	Information about types of UE beam is given in B.2.1.3, and does not limit UE implementation or test system implementation

A.7.3.1.3.3 Test Requirements

The UE shall start to transmit the PRACH to Cell 2 less than 552 ms from the beginning of time period T2.

The rate of correct handovers observed during repeated tests shall be at least 90%.

NOTE: The handover delay can be expressed as: RRC procedure delay + $T_{interrupt}$, where:

RRC procedure delay = 10 ms and is specified in clause 12 in TS 38.331 [2].

$T_{interrupt}$ = 542 ms in the test. $T_{interrupt}$ is defined in clause 6.1.1.4.2.

This gives a total of 552 ms.

A.7.3.2 RRC Connection Mobility Control

A.7.3.2.1 SA: RRC Re-establishment

A.7.3.2.1.1 Intra-frequency RRC Re-establishment in FR2

A.7.3.2.1.1.1 Test Purpose and Environment

The purpose is to verify that the NR intra-frequency RRC re-establishment delay in FR2 without known target cell is within the specified limits. These tests will verify the requirements in clause 6.2.1.

The test parameters are given in table A.7.3.2.1.1.1-1, table A.7.3.2.1.1.1-2 and table A.7.3.2.1.1.1-3 below. The test consists of 3 successive time periods, with time duration of T1, T2 and T3 respectively. At the start of time period T2, cell 1, which is the active cell, becomes inactive. The time period T3 starts after the occurrence of the radio link failure.

Table A.7.3.2.1.1.1-1: Supported test configurations

Config	Description
1	NR 120 kHz SSB SCS, 100 MHz bandwidth, TDD duplex mode

Table A.7.3.2.1.1.1-2: General test parameters for NR intra-frequency RRC Re-establishment test case in FR2

Parameter	Unit	Test configuration	Value	Comment
Initial condition	Active cell	1	Cell1	
	Neighbour cells	1	Cell2	
Final condition	Active cell	1	Cell2	
RF Channel Number		1	1	
Time offset between cells		1	3 μ s	Synchronous cells

N310	-	1	1	Maximum consecutive out-of-sync indications from lower layers
N311	-	1	1	Minimum consecutive in-sync indications from lower layers
T310	ms	1	0	Radio link failure timer; T310 is disabled
T311	ms	1	5000	RRC re-establishment timer
Access Barring Information	-	1	Not Sent	No additional delays in random access procedure.
SSB configuration		1	SSB.1 FR2	
SMTC configuration		1	SMTC pattern 1	
DRX cycle length	s	1	OFF	
PRACH configuration		1	FR2 PRACH configuration 1	Table A.3.8.3.1-1
T1	s	1	5	
T2	s	1	4.84	Time for the UE to detect RLF (Summation of $T_{Evaluate_out_SSB}$ defined in clause 8.1 in TS 38.133, T310 and the period for UE turns off transmitter defined in clause 8.1.5 in TS 38.133)
T3	s	1	5	

Table A.7.3.2.1.1-3: Cell specific test parameters for NR intra-frequency RRC Re-establishment test case in FR2

Parameter	Unit	Test configuration	Cell 1			Cell 2		
			T1	T2	T3	T1	T2	T3
Assumption for UE beams ^{Note 4}			Rough			Rough		
TDD configuration		1	TDDConf.3.1			TDDConf.3.1		
BW _{channel}	MHz	1	100: N _{RB,c} = 66			100: N _{RB,c} = 66		
Data RBs allocated		1	24			24		
PDSCH RMC configuration		1	SR.3.1 TDD			N/A		
RMSI CORESET RMC configuration		1	CR.3.1 TDD			CR.3.1 TDD		
Dedicated CORESET RMC configuration		1	CCR.3.1 TDD			CCR.3.1 TDD		
TRS configuration		1	TRS.2.1 TDD			N/A		
PDSCH/PDCCH TCI state		1	TCI.State.2			N/A		
OCNG Pattern		1	OP.1 defined in A.3.2.1			OP.1 defined in A.3.2.1		
Initial DL BWP configuration		1	DLBWP.0.1			DLBWP.0.1		
Initial UL BWP configuration		1	ULBWP.0.1			ULBWP.0.1		
RLM-RS		1	SSB			SSB		
AoA setup		1	Setup 1 defined in A.3.15.1			Setup 1 defined in A.3.15.1		
\hat{E}_s / I_{oc}	dB	1	-0.12	-infinity	-infinity	-3.46	2	2
N_{oc} ^{Note2}	dBm/15 kHz	1	-104.7					
N_{oc} ^{Note2}	dBm/SCS	1	-95.7					
\hat{E}_s / N_{oc}	dB	1	4	-infinity	-infinity	2	2	2
SS-RSRP ^{Note3}	dBm/SCS	1	-91.7	-infinity	-infinity	-93.7	-93.7	-93.7
Io	dBm/95.04 MHz	1	-59.64	-62.59	-62.59	-59.94	-62.59	-62.59

Propagation Condition		1	AWGN
Note 1:	OCNG shall be used such that both cells are fully allocated and a constant total transmitted power spectral density is achieved for all OFDM symbols.		
Note 2:	Interference from other cells and noise sources not specified in the test is assumed to be constant over subcarriers and time and shall be modelled as AWGN of appropriate power for N_{oc} to be fulfilled.		
Note 3:	SS-RSRP levels have been derived from other parameters for information purposes. They are not settable parameters themselves.		
Note 4:	Information about types of UE beam is given in B.2.1.3, and does not limit UE implementation or test system implementation		

A.7.3.2.1.1.2 Test Requirements

The RRC re-establishment delay is defined as the time from the moment UE declares RLF, to the moment when the UE starts to send PRACH preambles to cell 2 for sending the *RRCReestablishmentRequest* message to cell 2.

The RRC re-establishment delay to an unknown NR intra frequency cell shall be less than 5 s.

The rate of correct RRC re-establishments observed during repeated tests shall be at least 90%.

NOTE: The RRC re-establishment delay in the test is derived from the following expression:

$$T_{\text{re-establish_delay}} = T_{\text{UL_grant}} + T_{\text{UE_re-establish_delay}}$$

Where:

$T_{\text{UL_grant}}$ = It is the time required to acquire and process uplink grant from the target cell. The PRACH reception at the system simulator is used as a trigger for the completion of the test; hence $T_{\text{UL_grant}}$ is not used.

$$T_{\text{UE_re-establish_delay}} = 50 \text{ ms} + T_{\text{identify_intra_NR}} + \sum_{i=1}^{N_{\text{freq}}-1} T_{\text{identify_inter_NR},i} + T_{\text{SI-NR}} + T_{\text{PRACH}}$$

$$N_{\text{freq}} = 1$$

$$T_{\text{identify_intra_NR}} = 3250 \text{ ms}$$

$T_{\text{SI}} = 1280 \text{ ms}$; it is the time required for receiving all the relevant system information as defined in TS 38.331 for the target intra-frequency NR cell.

$T_{\text{PRACH}} = 15 \text{ ms}$; it is the additional delay caused by the random access procedure.

This gives a total of 4865 ms for RRC re-establishment delay, allow 9.84 s (4.84 s + 5 s) from the beginning of T2 in the test case.

A.7.3.2.1.2 Inter-frequency RRC Re-establishment in FR2

A.7.3.2.1.2.1 Test Purpose and Environment

The purpose is to verify that the NR inter-frequency RRC re-establishment delay in FR2 without known target cell is within the specified limits. These tests will verify the requirements in clause 6.2.1.

The test parameters are given in table A.7.3.2.1.2.1-1, table A.7.3.2.1.2.1-2 and table A.7.3.2.1.2.1-3 below. The test consists of 3 successive time periods, with time duration of T1, T2 and T3 respectively. At the start of time period T2, cell 1, which is the active cell, becomes inactive. The time period T3 starts after the occurrence of the radio link failure. During T1, the UE shall be configured with the carrier frequency of cell 2 (with RF Channel Number #2) to ensure that the UE has the context of the carrier frequency of cell 2 by the end of T1.

Table A.7.3.2.1.2.1-1: Supported test configurations

Config	Description
1	NR 120 kHz SSB SCS, 100 MHz bandwidth, TDD duplex mode

Table A.7.3.2.1.2.1-2: General test parameters for NR inter-frequency RRC Re-establishment test case in FR2

Parameter		Unit	Test configuration	Value	Comment
Initial condition	Active cell		1	Cell1	
	Neighbour cells		1	Cell2	
Final condition	Active cell		1	Cell2	
RF Channel Number			1	1, 2	
Time offset between cells			1	3 μ s	Synchronous cells
N310		-	1	1	Maximum consecutive out-of-sync indications from lower layers
N311		-	1	1	Minimum consecutive in-sync indications from lower layers
T310		ms	1	0	Radio link failure timer; T310 is disabled
T311		ms	1	5000	RRC re-establishment timer
Access Barring Information		-	1	Not Sent	No additional delays in random access procedure.
SSB configuration			1	SSB.1 FR2	
SMTTC configuration			1	SMTTC pattern 1	
DRX cycle length		s	1	OFF	
PRACH configuration			1	FR2 PRACH configuration 1	Table A.3.8.3.1-1
T1		s	1	5	
T2		s	1	4.84	Time for the UE to detect RLF (Summation of T _{Evaluate_out_SSB} defined in clause 8.1 in TS 38.133, T310 and the period for UE turns off transmitter defined in clause 8.1.5 in TS 38.133)
T3		s	1	6	

Table A.7.3.2.1.2.1-3: Cell specific test parameters for NR inter-frequency RRC Re-establishment test case in FR2

Parameter	Unit	Test configuration	Cell 1			Cell 2		
			T1	T2	T3	T1	T2	T3
Assumption for UE beams ^{Note 4}			Rough			Rough		
AoA setup		1	Setup 3 as specified in clause A.3.15			AoA2		
TDD configuration		1	TDDConf.3.1			TDDConf.3.1		
BW _{channel}	MHz	1	100: N _{RB,c} = 66			100: N _{RB,c} = 66		
Data RBs allocated		1	24			24		
PDSCH RMC configuration		1	SR.3.2 TDD			N/A		
RMSI CORESET RMC configuration		1	CR.3.1 TDD			CR.3.1 TDD		

Dedicated CORESET RMC configuration		1	CCR.3.1 TDD			CCR.3.1 TDD		
TRS configuration		1	TRS.2.1 TDD			N/A		
PDSCH/PDCCH TCI state		1	TCI.State.2			N/A		
OCNG Pattern		1	OP.3 defined in A.3.2.1			OP.3 defined in A.3.2.1		
Initial DL BWP configuration		1	DLBWP.0.1			DLBWP.0.1		
Initial UL BWP configuration		1	ULBWP.0.1			ULBWP.0.1		
RLM-RS		1	SSB			SSB		
N_{oc} Note2	dBm/15 kHz	1	-92.1			-92.1		
N_{oc} Note2	dBm/SCS	1	-83.1			-83.1		
\hat{E}_s / N_{oc}	dB	1	0	-infinity	-infinity	-infinity	-infinity	0
\hat{E}_s / I_{ot_BB} Note 5	dB	1	-1.01	-infinity	-infinity	-infinity	-infinity	-1.01
SSB_RP Note3	dBm/SCS	1	-83.1	-infinity	-infinity	-infinity	-infinity	-83.1
Io	dBm/95.04 MHz	1	-55.46	-58.51	-58.51	-58.51	-58.51	-55.46
Propagation Condition		1	AWGN			AWGN		
<p>Note 1: OCNG shall be used such that a constant total transmitted power is achieved for all OFDM symbols.</p> <p>Note 2: Interference from other cells and noise sources not specified in the test is assumed to be constant over subcarriers and time and shall be modelled as AWGN of appropriate power for N_{oc} to be fulfilled.</p> <p>Note 3: E_s/I_{ot}, SSB_RP and Io levels have been derived from other parameters for information purposes. They are not settable parameters themselves.</p> <p>Note 4: Information about types of UE beam is given in B.2.1.3, and does not limit UE implementation or test system implementation</p> <p>Note 5: Calculation of E_s/I_{ot_BB} includes the effect of UE internal noise up to the value assumed for the associated Refsens requirement in clause 7.3.2 of TS 38.101-2 [19], and an allowance of 1dB for UE multi-band relaxation factor ΔMBs from TS 38.101-2 [19] Table 6.2.1.3-4.</p>								

A.7.3.2.1.2.2 Test Requirements

The RRC re-establishment delay is defined as the time from the start of time period T3, to the moment when the UE starts to send PRACH preambles to cell 2 for sending the *RRCReestablishmentRequest* message to cell 2.

The RRC re-establishment delay to an unknown NR inter frequency cell shall be less than 6 s.

The rate of correct RRC re-establishments observed during repeated tests shall be at least 90%.

NOTE: The RRC re-establishment delay in the test is derived from the following expression:

$$T_{\text{re-establish_delay}} = T_{\text{UL_grant}} + T_{\text{UE_re-establish_delay}}$$

Where:

$T_{\text{UL_grant}}$ = It is the time required to acquire and process uplink grant from the target cell. The PRACH reception at the system simulator is used as a trigger for the completion of the test; hence $T_{\text{UL_grant}}$ is not used.

$$T_{\text{UE_re-establish_delay}} = 50 \text{ ms} + T_{\text{identify_intra_NR}} + \sum_{i=1}^{N_{\text{freq}}-1} T_{\text{identify_inter_NR},i} + T_{\text{SI-NR}} + T_{\text{PRACH}}$$

$$N_{\text{freq}} = 2$$

$T_{\text{identify_intra_NR}} = 1600 \text{ ms}$

$T_{\text{identify_inter_NR}} = 2080 \text{ ms}$

$T_{\text{SI}} = 1280 \text{ ms}$; it is the time required for receiving all the relevant system information as defined in TS 38.331 for the target inter-frequency NR cell.

$T_{\text{PRACH}} = 15 \text{ ms}$; it is the additional delay caused by the random access procedure.

This gives a total of 5025 ms, allow 6 s in the test case.

A.7.3.2.1.3 Intra-frequency RRC Re-establishment in FR2 without serving cell timing

A.7.3.2.1.3.1 Test Purpose and Environment

The purpose is to verify that the NR intra-frequency RRC re-establishment delay in FR2 without serving cell timing is within the specified limits. These tests will verify the requirements in clause 6.2.1.

The test parameters are given in table A.7.3.2.1.3.1-1, table A.7.3.2.1.3.1-2 and table A.7.3.2.1.3.1-3 below. The test consists of 3 successive time periods, with time duration of T1, T2 and T3 respectively. At the start of time period T2, cell 1, which is the active cell, is deactivated. The time period T3 starts after the occurrence of the radio link failure.

Table A.7.3.2.1.3.1-1: Supported test configurations

Configuration	Description
1	120 kHz SSB SCS, 100 MHz bandwidth, TDD duplex mode

Table A.7.3.2.1.3.1-2: General test parameters for NR intra-frequency RRC Re-establishment test case in FR2

Parameter		Unit	Test configuration	Value	Comment
Initial condition	Active cell		1	Cell1	
	Neighbour cells		1	Cell2	
Final condition	Active cell		1	Cell2	
RF Channel Number			1	1	
Time offset between cells			1	3 μs	Synchronous cells
N310		-	1	1	Maximum consecutive out-of-sync indications from lower layers
N311		-	1	1	Minimum consecutive in-sync indications from lower layers
T310		ms	1	6000	Radio link failure timer configured by <i>RLF-TimersAndConstants</i>
T311		ms	1	5000	RRC re-establishment timer
Access Barring Information		-	1	Not Sent	No additional delays in random access procedure.
SSB configuration			1	SSB.1 FR2	
SMTC configuration			1	SMTC pattern 1	
DRX cycle length		s	1	OFF	
PRACH configuration			1	FR2 PRACH configuration on 1	Table A.3.8.3.1-1
T1		s	1	5	

T2	s	1	10.84	Time for the UE to detect RLF (Summation of $T_{Evaluate_out_SSB}$ defined in clause 8.1 in TS 38.133, T310 and the period for UE turns off transmitter defined in clause 8.1.5 in TS 38.133)
T3	s	1	5	

Table A.7.3.2.1.3.1-3: Cell specific test parameters for NR intra-frequency RRC Re-establishment test case in FR2

Parameter	Unit	Test configuration	Cell 1			Cell 2		
			T1	T2	T3	T1	T2	T3
Assumption for UE beams ^{Note 4}			Rough			Rough		
TDD configuration		1	TDDConf.3.1			TDDConf.3.1		
PDSCH RMC configuration		1	SR.3.1 TDD			N/A		
RMSI CORESET RMC configuration		1	CR.3.1 FDD			CR.3.1 FDD		
Dedicated CORESET RMC configuration		1	CCR.3.1 FDD			CCR.3.1 FDD		
TRS configuration		1	TRS.2.1 TDD			N/A		
PDSCH/PDCCH TCI state		1	TCI.State.2			N/A		
OCNG Pattern		1	OP.1 defined in A.3.2.1			OP.1 defined in A.3.2.1		
Initial DL BWP configuration		1	DLBWP.0.1			DLBWP.0.1		
Initial UL BWP configuration		1	ULBWP.0.1			ULBWP.0.1		
RLM-RS		1	SSB			SSB		
AoA setup		1	Setup 1 defined in A.3.15.1			Setup 1 defined in A.3.15.1		
\hat{E}_s / I_{oc}	dB	1	5	-infinity	-infinity	-infinity	-infinity	5
N_{oc} ^{Note2}	dBm/15kHz	1	-104.7					
N_{oc} ^{Note2}	dBm/SCS	1	-95.7					
\hat{E}_s / N_{oc}	dB	1	5	-infinity	-infinity	-infinity	-infinity	5
SS-RSRP ^{Note3}	dBm/SCS	1	-90.7	-infinity	-infinity	-infinity	-infinity	-90.7
Io	dBm/95.04 MHz	1	-60.52	-66.71	-60.52	-60.52	-66.71	-60.52
Propagation Condition		1	AWGN					
Note 1:	OCNG shall be used such that both cells are fully allocated and a constant total transmitted power spectral density is achieved for all OFDM symbols.							
Note 2:	Interference from other cells and noise sources not specified in the test is assumed to be constant over subcarriers and time and shall be modelled as AWGN of appropriate power for N_{oc} to be fulfilled.							
Note 3:	SS-RSRP levels have been derived from other parameters for information purposes. They are not settable parameters themselves.							
Note 4:	Information about types of UE beam is given in B.2.1.3, and does not limit UE implementation or test system implementation							

A.7.3.2.1.3.2 Test Requirements

The RRC re-establishment delay is defined as the time from the start of time period T3, to the moment when the UE starts to send PRACH preambles to cell 2 for sending the *RRCReestablishmentRequest* message to cell 2.

The RRC re-establishment delay to an unknown NR intra frequency cell without serving cell timing shall be less than 5 s.

The rate of correct RRC re-establishments observed during repeated tests shall be at least 90%.

NOTE: The RRC re-establishment delay in the test is derived from the following expression:

$$T_{\text{re-establish_delay}} = T_{\text{UL_grant}} + T_{\text{UE_re-establish_delay}}$$

Where:

$T_{\text{UL_grant}}$ = It is the time required to acquire and process uplink grant from the target cell. The PRACH reception at the system simulator is used as a trigger for the completion of the test; hence $T_{\text{UL_grant}}$ is not used.

$$T_{\text{UE_re-establish_delay}} = 50 \text{ ms} + T_{\text{identify_intra_NR}} + \sum_{i=1}^{N_{\text{freq}}-1} T_{\text{identify_inter_NR},i} + T_{\text{SI-NR}} + T_{\text{PRACH}}$$

$$N_{\text{freq}} = 1$$

$$T_{\text{identify_intra_NR}} = 3520 \text{ ms}$$

$T_{\text{SI}} = 1280 \text{ ms}$; it is the time required for receiving all the relevant system information as defined in TS 38.331 [2] for the target intra-frequency NR cell.

$T_{\text{PRACH}} = 15 \text{ ms}$; it is the additional delay caused by the random access procedure.

This gives a total of 4865 ms, allow 5 s in the test case.

A.7.3.2.2 Random Access

A.7.3.2.2.1 Contention based random access test in FR2 for NR Standalone

A.7.3.2.2.1.1 Test Purpose and Environment

The purpose of this test is to verify that the behavior of the random access procedure is according to the requirements and that the PRACH power settings and timing are within specified limits. This test will verify the requirements in Clause 6.2.2.2 and Clause 7.1.2 in an AWGN model.

For this test one cell is used, with the configuration of Cell 1 configured as PCell or SCell in FR2. Supported test parameters are shown in Table A.7.3.2.2.1.1-1. UE capable of SA with PCell or SCell in FR2 needs to be tested by using the parameters in Table A.7.3.2.2.1.1-2 and Table A.7.3.2.2.1.1-3.

Table A.7.3.2.2.1.1-1: Supported test configurations for contention based random access test in FR2 for NR Standalone

Config	Description
1	NR PSCell/SCell 120 kHz SSB SCS, 100 MHz bandwidth, TDD duplex mode

Table A.7.3.2.2.1.1-2: General test parameters for contention based random access test in FR2 for NR Standalone

Parameter	Unit	Test-1	Comments
SSB Configuration	Config 1	SSB.1 FR2	As defined in A.3.10
CSI-RS for tracking	Config 1	TRS.2.1 TDD	
Duplex Mode for Cell 1	Config 1	TDD	
TDD Configuration	Config 1	TDDConf.3.1	As defined in A.3.1.4
BW_{channel}	Config 1	MHz	100: $N_{\text{RB,C}} = 66$
Data RBs allocated	Config 1		24
OCNG Pattern ^{Note 1}			OP.3
PDSCH Reference Channel ^{Note 2}	Config 1		SR.3.1 TDD
			As defined in A.3.1.1.

RMSI CORESET Reference Channel	Config 1		CR.3.1 TDD	As defined in A.3.1.2
NR RF Channel Number			1	
EPRE ratio of PSS to SSS		dB	0	
EPRE ratio of PBCH_DMRS to SSS		dB		
EPRE ratio of PBCH to PBCH_DMRS		dB		
EPRE ratio of PDCCH_DMRS to SSS		dB		
EPRE ratio of PDCCH to PDCCH_DMRS		dB		
EPRE ratio of PDSCH_DMRS to SSS		dB		
EPRE ratio of PDSCH to PDSCH_DMRS		dB		
<i>ss-PBCH-BlockPower</i>		dBm/SCS		+20 + Δ_{UL}
Configured UE transmitted power ($P_{CMAX, f, c}$)		dBm	maximum value configurable for certain power class	As defined in clause 6.2.4 in TS 38.101-2 [19]
PRACH Configuration			FR2 PRACH configuration 1	As defined in A.3.8.3, with exceptions as defined below
<i>rsrp-ThresholdSSB</i>		dBm	RSRP_69 + Δ_{DL}	RSRP_69 corresponds to -88dBm. Δ_{DL} is derived from the downlink calibration process Note 4
<i>preambleReceivedTargetPower</i>		dBm	-100	As defined in TS 38.331 [2]
<p>Note 1: OCNG shall be used such that a constant total transmitted power spectral density is achieved for all OFDM symbols. The OCNG pattern is chosen during the test according to the presence of a DL reference measurement channel.</p> <p>Note 2: The DL PDSCH reference measurement channel is used in the test only when a downlink transmission dedicated to the UE under test is required.</p> <p>Note 3: The Δ_{UL} value is calculated as $-\text{ROUND}(\text{PPRACH}_0 - 1)$, where PPRACH₀ is the measured first PRACH power with -80.6dBm/SCS applied, <i>preambleReceivedTargetPower</i> = -100dBm and <i>ss-PBCH-BlockPower</i> = 20dBm. These values are used during the uplink calibration process carried out before the test case is run, with the UE configured to send PRACH.</p> <p>Note 4: The Δ_{DL} value is calculated as $(\text{RSRP}_{\text{REP}} - \text{RSRP}_{76})$, where RSRP_{REP} is the SS-RSRP Reported value in Table 10.1.6.1-1 with -80.6dBm/SCS applied. These values are used during the downlink calibration process carried out before the test case is run, with the UE configured to report SS-RSRP. For a Reported value RSRP_x, x is treated as a positive integer value.</p>				

Table A.7.3.2.2.1.1-3: OTA-related test parameters for contention based random access test in FR2 for NR Standalone

Parameter		Unit	Test-1	Comments
AoA setup			Setup 1	As defined in A.3.15.1
Assumption for UE beams ^{Note 3}			Rough	
SSB with index 0	E_s ^{Note1}	dBm/SCS	-80.6	Power of SSB with index 0 is set to be above configured <i>rsrp-ThresholdSSB</i>
	SSB_RP	dBm/SCS	-80.6	
	$E_s/\text{lot}_{\text{BB}}$	dB	21.09	
	lo	dBm/95.04 MHz	-56.01	lo in symbols containing SSB index 0
SSB with index 1	E_s ^{Note1}	dBm/SCS	-95.0	Power of SSB with index 1 is set to be below configured <i>rsrp-ThresholdSSB</i>
	SSB_RP	dBm/SCS	-95.0	
	$E_s/\text{lot}_{\text{BB}}$	dB	6.69	

	lo	dBm/95.04 MHz	-70.41	lo in symbols containing SSB index 1
Propagation Condition		-	No external noise (Note 4)	
Note 1: No artificial noise is applied in this test. Note 2: Void. Note 3: Information about types of UE beam is given in B.2.1.3, and does not limit UE implementation or test system implementation Note 4: The downlink connection between the System Simulator and the UE is without Additive White Gaussian Noise, and has no fading or multipath effects as specified in TS 38.521-2 B.0 [29].				

A.7.3.2.2.1.2 Test Requirements

Contention based random access is triggered by *not* explicitly assigning a random access preamble via dedicated signalling in the downlink.

A.7.3.2.2.1.2.1 Random Access Preamble Transmission

To test the UE behavior specified in Clause 6.2.2.2.1.1 the System Simulator shall receive the Random Access Preamble which belongs to one of the Random Access Preambles associated with the SSB with index 0, which has SS-RSRP above the configured *rsrp-ThresholdSSB*.

In addition, the power applied to all preambles shall be in accordance with what is specified in Clause 6.2.2.2. The power of the first preamble shall be 0.6 dBm to be received at TE with an accuracy specified in clause 6.3.4.2 of TS 38.101-2 [19]. The relative power applied to additional preambles shall have an accuracy specified in clause 6.3.4.3 of TS 38.101-2 [19].

The transmit timing of all PRACH transmissions shall be within the accuracy specified in Clause 7.1.2.

A.7.3.2.2.1.2.2 Random Access Response Reception

To test the UE behavior specified in Clause 6.2.2.2.1.2 the System Simulator shall transmit a Random Access Response containing a Random Access Preamble identifier corresponding to the transmitted Random Access Preamble after 3 preambles have been received by the System Simulator. In response to the first 2 preambles, the System Simulator shall transmit a Random Access Response *not* corresponding to the transmitted Random Access Preamble.

The UE may stop monitoring for Random Access Response(s) and shall transmit the msg3 if the Random Access Response contains a Random Access Preamble identifier corresponding to the transmitted Random Access Preamble.

The UE shall again perform the Random Access Resource selection procedure specified in clause 5.1.2 in TS 38.321 [7], and transmit with the calculated PRACH transmission power when the backoff time expires if all received Random Access Responses contain Random Access Preamble identifiers that do not match the transmitted Random Access Preamble.

In addition, the power applied to all preambles shall be in accordance with what is specified in Clause 6.2.2.2. The power of the first preamble shall be 0.6 dBm to be received at TE with an accuracy specified in clause 6.3.4.2 of TS 38.101-2 [19]. The relative power applied to additional preambles shall have an accuracy specified in clause 6.3.4.3 of TS 38.101-2 [19].

The transmit timing of all PRACH transmissions shall be within the accuracy specified in Clause 7.1.2.

A.7.3.2.2.1.2.3 No Random Access Response Reception

To test the UE behavior specified in clause 6.2.2.2.1.3 the System Simulator shall transmit a Random Access Response containing a Random Access Preamble identifier corresponding to the transmitted Random Access Preamble after 3 preambles have been received by the System Simulator. The System Simulator shall *not* respond to the first 2 preambles.

The UE shall again perform the Random Access Resource selection procedure specified in clause 5.1.2 in TS 38.321 [7], and transmit with the calculated PRACH transmission power when the backoff time expires if no Random Access Response is received within the RA Response window.

In addition, the power applied to all preambles shall be in accordance with what is specified in Clause 6.2.2.2. The power of the first preamble shall be 0.6 dBm to be received at TE with an accuracy specified in clause 6.3.4.2 of TS 38.101-2 [19]. The relative power applied to additional preambles shall have an accuracy specified in clause 6.3.4.3 of TS 38.101-2 [19].

The transmit timing of all PRACH transmissions shall be within the accuracy specified in Clause 7.1.2.

A.7.3.2.2.1.2.4 Receiving an UL grant for msg3 retransmission

To test the UE behavior specified in clause 6.2.2.2.1.4 the System Simulator shall provide an UL grant for msg3 retransmission following a successful Random Access Response.

The UE shall re-transmit the msg3 upon the reception of an UL grant for msg3 retransmission.

A.7.3.2.2.1.2.5 Reception of an Incorrect Message over Temporary C-RNTI

To test the UE behavior specified in Clause 6.2.2.2.1.5 the System Simulator shall send a message addressed to the temporary C-RNTI with a UE Contention Resolution Identity included in the MAC control element *not* matching the CCCH SDU transmitted in msg3 uplink message.

The UE shall again perform the Random Access Resource selection procedure specified in clause 5.1.2 in TS 38.321 [7], and transmit with the calculated PRACH transmission power when the backoff time expires unless the received message includes a UE Contention Resolution Identity MAC control element and the UE Contention Resolution Identity included in the MAC control element matches the CCCH SDU transmitted in the uplink message.

A.7.3.2.2.1.2.6 Reception of a Correct Message over Temporary C-RNTI

To test the UE behavior specified in Clause 6.2.2.2.1.5 the System Simulator shall send a message addressed to the temporary C-RNTI with a UE Contention Resolution Identity included in the MAC control element matching the CCCH SDU transmitted in the msg3 uplink message.

The UE shall send ACK if the Contention Resolution is successful.

A.7.3.2.2.1.2.7 Contention Resolution Timer expiry

To test the UE behavior specified in Clause 6.2.2.2.1.6 the System Simulator shall *not* send a response to a msg3.

The UE shall again perform the Random Access Resource selection procedure specified in clause 5.1.2 in TS 38.321 [7], and transmit with the calculated PRACH transmission power when the backoff time expires if the Contention Resolution Timer expires.

A.7.3.2.2.2 Non-contention based random access test in FR2 for NR Standalone

A.7.3.2.2.2.1 Test Purpose and Environment

The purpose of this test is to verify that the behavior of the random access procedure is according to the requirements and that the PRACH power settings and timing are within specified limits. This test will verify the requirements in Clause 6.2.2.2 and Clause 7.1.2 in an AWGN model.

For this test one cell is used, with the configuration of Cell 1 configured as PCell or SCell in FR2. Supported test parameters are shown in Table A.7.3.2.2.2.1-1. UE capable of SA with PCell or SCell in FR2 needs to be tested by using the parameters in Table A.7.3.2.2.2.1-2 and Table A.7.3.2.2.2.1-3 for SSB-based non-contention based random access test (Test 1) and CSI-RS-based non-contention based random access test (Test 2). Test 2 is only applicable to UE which supports `csi-RSRP-AndRSRQ-MeasWithSSB` or `csi-RSRP-AndRSRQ-MeasWithoutSSB`.

Table A.7.3.2.2.1-1: Supported test configurations for non-contention based random access test in FR2 for NR Standalone

Config	Description
1	NR PSCell/SCell 120 kHz SSB SCS, 100 MHz bandwidth, TDD duplex mode

Table A.7.3.2.2.1-2: General test parameters for non-contention based random access test in FR2 for NR Standalone

Parameter	Unit	Test-1	Test-2	Comments
SSB Configuration	Config 1	SSB.1 FR2	SSB.1 FR2	As defined in A.3.10
CSI-RS for tracking	Config 1	TRS.2.1 TDD	TRS.2.1 TDD	
CSI-RS Configuration	Config 1	N/A	CSI-RS.3.1 TDD	As defined in A.3.1.4
Duplex Mode for Cell 1	Config 1	TDD	TDD	
TDD Configuration	Config 1	TDDConf.3.1	TDDConf.3.1	
$BW_{channel}$	Config 1	MHz	100: $N_{RB,c} = 66$	100: $N_{RB,c} = 66$
Data RBs allocated	Config 1		24	24
OCNG Pattern ^{Note 1}			OP.3	OP.3
PDSCH Reference Channel ^{Note 2}	Config 1		SR3.1 TDD	SR3.1 TDD
RMSI CORESET Reference Channel	Config 1			CR.3.1 TDD
NR RF Channel Number			1	1
EPRE ratio of PSS to SSS	dB			
EPRE ratio of PBCH_DMRS to SSS	dB			
EPRE ratio of PBCH to PBCH_DMRS	dB			
EPRE ratio of PDCCH_DMRS to SSS	dB			
EPRE ratio of PDCCH to PDCCH_DMRS	dB	0	0	
EPRE ratio of PDSCH_DMRS to SSS	dB			
EPRE ratio of PDSCH to PDSCH_DMRS	dB			
<i>ss-PBCH-BlockPower</i>	dBm/ SCS	+20 + Δ_{UL}	+20 + Δ_{UL}	As defined in TS 38.331 [2]. Δ_{UL} is derived from the uplink calibration process ^{Note 3}
Configured UE transmitted power ($P_{CMAX, f, c}$)	dBm	maximum value configurable for certain power class	maximum value configurable for certain power class	As defined in clause 6.2.4 in TS 38.101-2 [19]
PRACH Configuration		FR2 PRACH configuration 2	FR2 PRACH configuration 3	As defined in A.3.8.3, with exceptions as defined below.
<i>rsrp-ThresholdSSB</i>	dBm	RSRP_69 + Δ_{DL}	RSRP_69 + Δ_{DL}	RSRP_69 corresponds to -88dBm. Δ_{DL} is derived from the downlink calibration process ^{Note 4}
<i>preambleReceivedTargetPower</i>	dBm	-100	-100	As defined in TS 38.331 [2]

Note 1:	OCNG shall be used such that a constant total transmitted power spectral density is achieved for all OFDM symbols. The OCNG pattern is chosen during the test according to the presence of a DL reference measurement channel.
Note 2:	The DL PDSCH reference measurement channel is used in the test only when a downlink transmission dedicated to the UE under test is required.
Note 3:	The Δ_{UL} value is calculated as $-\text{ROUND}(\text{PPRACH0} - 1)$, where PPRACH0 is the measured first PRACH power with -80.6dBm/SCS applied, $\text{preambleReceivedTargetPower} = -100\text{dBm}$ and $\text{ss-PBCH-BlockPower} = 20\text{dBm}$. These values are used during the uplink calibration process carried out before the test case is run, with the UE configured to send PRACH.
Note 4:	The Δ_{DL} value is calculated as $(\text{RSRP}_{\text{REP}} - \text{RSRP}_{76})$, where RSRP_{REP} is the SS-RSRP Reported value in Table 10.1.6.1-1 with -80.6dBm/SCS applied. These values are used during the downlink calibration process carried out before the test case is run, with the UE configured to report SS-RSRP. For a Reported value RSRP_x , x is treated as a positive integer value.

Table A.7.3.2.2.1-3: OTA-related test parameters for non-contention based random access test in FR2 for NR Standalone

Parameter		Unit	Test-1	Test-2	Comments
AoA setup			Setup 1	Setup 1	As defined in A.3.15.1
Assumption for UE beams ^{Note 3}			Rough	Rough	
SSB with index 0	E_s ^{Note1}	dBm/SCS	-80.6	-80.6	Power of SSB with index 0 is set to be above configured rsrp-ThresholdSSB
	SSB_RP	dBm/SCS	-80.6	-80.6	
	E_s/I_{otBB}	dB	21.09	21.09	
	I_o	dBm/95.04 MHz	-56.01	-56.01	I_o in symbols containing SSB index 0
SSB with index 1	E_s ^{Note1}	dBm/SCS	-95.0	-95.0	Power of SSB with index 1 is set to be below configured rsrp-ThresholdSSB
	SSB_RP	dBm/SCS	-95.0	-95.0	
	E_s/I_{otBB}	dB	6.69	6.69	
	I_o	dBm/95.04 MHz	-70.41	-70.41	I_o in symbols containing SSB index 1
Propagation Condition		-	No external noise (Note 4)	No external noise (Note 4)	
<p>Note 1: No artificial noise is applied in this test.</p> <p>Note 2: void.</p> <p>Note 3: Information about types of UE beam is given in B.2.1.3, and does not limit UE implementation or test system implementation</p> <p>Note 4: The downlink connection between the System Simulator and the UE is without Additive White Gaussian Noise, and has no fading or multipath effects as specified in TS 38.521-2 B.0 [29].</p>					

A.7.3.2.2.2.2 Test Requirements

Non-Contention based random access is triggered by explicitly assigning a random access preamble via dedicated signalling in the downlink. In the test, the non-contention based random access procedure is not initialized for Other SI requested from UE or beam failure recovery.

A.7.3.2.2.2.1 SSB-based Random Access Preamble Transmission

In Test-1, to test the UE behavior specified in Clause 6.2.2.2.1 for SSB-based Random Access Preamble transmission, with the contention-free Random Access Resources and the contention-free PRACH occasions associated with SSBs configured, the System Simulator shall receive the Random Access Preamble which has the Preamble Index associated with the SSB with index 0.

In addition, the System Simulator shall receive the Random Access Preamble on the PRACH occasion which belongs to the PRACH occasions corresponding to the SSB with index 0, and the selected PRACH occasion shall belong to the PRACH occasions permitted by the restrictions given by the *ra-ssb-OccasionMaskIndex*.

In addition, the power applied to all preambles shall be in accordance with what is specified in Clause 6.2.2.2. The power of the first preamble shall be 0.6 dBm to be received at TE with an accuracy specified in clause 6.3.4.2 of TS 38.101-2 [19]. The relative power applied to additional preambles shall have an accuracy specified in clause 6.3.4.3 of TS 38.101-2 [19].

The transmit timing of all PRACH transmissions shall be within the accuracy specified in Clause 7.1.2.

A.7.3.2.2.2.2 CSI-RS-based Random Access Preamble Transmission

In Test-1, to test the UE behavior specified in Clause 6.2.2.2.2.1 for CSI-RS-based Random Access Preamble transmission, with the contention-free Random Access Resources and the contention-free PRACH occasions associated with CSI-RSs configured, the System Simulator shall receive the Random Access Preamble which has the Preamble Index associated with the CSI-RS configured.

In addition, the System Simulator shall receive the Random Access Preamble on the PRACH occasion which belongs to the PRACH occasions corresponding to the CSI-RS configured, and the selected PRACH occasion shall belong to the PRACH occasions permitted by the restrictions given by the *ra-OccasionList*.

In addition, the power applied to all preambles shall be in accordance with what is specified in Clause 6.2.2.2. The power of the first preamble shall be 0.6 dBm to be received at TE with an accuracy specified in clause 6.3.4.2 of TS 38.101-2 [19]. The relative power applied to additional preambles shall have an accuracy specified in clause 6.3.4.3 of TS 38.101-2 [19].

The transmit timing of all PRACH transmissions shall be within the accuracy specified in Clause 7.1.2.

A.7.3.2.2.2.3 Random Access Response Reception

To test the UE behavior specified in Clause 6.2.2.2.2.2 the System Simulator shall transmit a Random Access Response containing a Random Access Preamble identifier corresponding to the transmitted Random Access Preamble after 3 preambles have been received by the System Simulator. In response to the first 2 preambles, the System Simulator shall transmit a Random Access Response *not* corresponding to the transmitted Random Access Preamble.

The UE may stop monitoring for Random Access Response(s) if the Random Access Response contains a Random Access Preamble identifier corresponding to the transmitted Random Access Preamble.

The UE shall again perform the Random Access Resource selection procedure specified in clause 5.1.2 in TS 38.321 [7], and transmit with the calculated PRACH transmission power if all received Random Access Responses contain Random Access Preamble identifiers that do not match the transmitted Random Access Preamble.

In addition, the power applied to all preambles shall be in accordance with what is specified in Clause 6.2.2.2. The power of the first preamble shall be 0.6 dBm to be received at TE with an accuracy specified in clause 6.3.4.2 of TS 38.101-2 [19]. The relative power applied to additional preambles shall have an accuracy specified in clause 6.3.4.3 of TS 38.101-2 [19].

The transmit timing of all PRACH transmissions shall be within the accuracy specified in Clause 7.1.2.

A.7.3.2.2.2.4 No Random Access Response Reception

To test the UE behavior specified in clause 6.2.2.2.2.3 the System Simulator shall transmit a Random Access Response containing a Random Access Preamble identifier corresponding to the transmitted Random Access Preamble after 3 preambles have been received by the System Simulator. The System Simulator shall *not* respond to the first 2 preambles.

The UE shall again perform the Random Access Resource selection procedure specified in clause 5.1.2 in TS 38.321 [7], and transmit with the calculated PRACH transmission power when the backoff time expires if no Random Access Response is received within the RA Response window configured in *RACH-ConfigCommon*.

In addition, the power applied to all preambles shall be in accordance with what is specified in Clause 6.2.2.2. The power of the first preamble shall be 0.6 dBm to be received at TE with an accuracy specified in clause 6.3.4.2 of TS 38.101-2 [19]. The relative power applied to additional preambles shall have an accuracy specified in clause 6.3.4.3 of TS 38.101-2 [19].

The transmit timing of all PRACH transmissions shall be within the accuracy specified in Clause 7.1.2.

A.7.3.2.3 SA: RRC Connection Release with Redirection

A.7.3.2.3.1 Redirection from NR in FR2 to NR in FR2

A.7.3.2.3.1.1 Test Purpose and Environment

This test is to verify RRC connection release with redirection from NR to NR requirements specified in clause 6.2.3.2.1.

A.7.3.2.3.1.2 Test Parameters

Supported test configurations are shown in table A.7.3.2.3.1.2-1. The time delay is tested by using the parameters in table A.7.3.2.3.1.2-2, and A.7.3.2.3.1.2-3.

The test consists of two successive time periods, with time duration of T1, and T2 respectively. The *RRCRelease* message shall be sent to the UE during period T1 and the start of T2 is the instant when the last TTI containing the RRC message is sent to the UE. Prior to time duration T2, the UE shall not have any timing information of Cell 2. Cell 2 is powered up at the beginning of the T2.

Table A.7.3.2.3.1.2-1: Redirection from NR to NR test configurations

Config	Description
1	Source cell: NR 120 kHz SSB SCS, 100 MHz bandwidth, TDD duplex mode Target cell: NR 120 kHz SSB SCS, 100 MHz bandwidth, TDD duplex mode

Table A.7.3.2.3.1.2-2: General test parameters for Redirection from NR to NR test case

Parameter	Unit	Value	Comment
Initial conditions		Cell 1	
		Cell 2	
Final condition		Cell 2	
Filter coefficient		0	L3 filtering is not used
Access Barring Information	-	Not Sent	No additional delays in random access procedure.
Time offset between cells		3 μ s	Synchronous cells
T1	s	5	
T2	s	3.2	

Table A.7.3.2.3.1.2-3: Cell specific test parameters for Redirection from NR to NR test case

Parameter	Unit	Cell 1		Cell 2	
		T1	T2	T1	T2
Assumption for UE beams ^{Note 6}		Rough		Rough	
AoA setup		Setup 1 as defined in A.3.15			
NR RF Channel Number		1		2	
Duplex mode		TDD			
TDD configuration		TDDConf.3.1			

BW _{channel}		MHz	100: N _{RB,c} = 66			
BWP BW		MHz	100: N _{RB,c} = 66			
Data RBs allocated			66			
DRx Cycle		ms	Not Applicable			
PDSCH Reference measurement channel			SR.3.1 TDD			
RMSI CORESET Reference Channel			CR.3.1 TDD			
Control Channel RMC			CCR.3.1 TDD			
OCNG Patterns			OP.1			
SMTc configuration			SMTc.1			
SSB Configuration			SSB.3 FR2			
PDSCH/PDCCH subcarrier spacing		kHz	120 kHz			
PUCCH/PUSCH subcarrier spacing		kHz	120 kHz			
PRACH configuration			FR2 PRACH configuration 1			
TRS configuration			TRS.2.1 TDD			
PDSCH/PDCCH TCI state			TCI.State.2			
BWP configuraiton	Initial DL BWP		DLBWP.0.1			
	Dedicated DL BWP		DLBWP.1.1			
	Initial UL BWP		ULBWP.0.1			
	Dedicated UL BWP		ULBWP.1.1			
EPRE ratio of PSS to SSS		dB	0		0	
EPRE ratio of PBCH DMRS to SSS						
EPRE ratio of PBCH to PBCH DMRS						
EPRE ratio of PDCCH DMRS to SSS						
EPRE ratio of PDCCH to PDCCH DMRS						
EPRE ratio of PDSCH DMRS to SSS						
EPRE ratio of PDSCH to PDSCH						
EPRE ratio of OCNG DMRS to SSS(Note 1)						
EPRE ratio of OCNG to OCNG DMRS (Note 1)						
N_{oc}^{Note2}	dBm/15kHz		-104.7		-104.7	
N_{oc}^{Note2}	dBm/SCS		-95.7		-95.7	
\hat{E}_s/I_{ot}	dB	5	5	-Infinity	5	
\hat{E}_s/N_{oc}	dB	5	5	-Infinity	5	
I_o^{Note3}	dBm/BW	-60.5	-60.5	-66.7	-60.5	
Propagation condition		-	AWGN		AWGN	
<p>Note 1: OCNG shall be used such that both cells are fully allocated and a constant total transmitted power spectral density is achieved for all OFDM symbols.</p> <p>Note 2: Interference from other cells and noise sources not specified in the test is assumed to be constant over subcarriers and time and shall be modelled as AWGN of appropriate power for N_{oc} to be fulfilled.</p> <p>Note 3: I_o levels have been derived from other parameters for information purposes. They are not settable parameters themselves.</p> <p>Note 4: Equivalent power received by an antenna with 0 dBi gain at the centre of the quiet zone</p> <p>Note 5: As observed with 0 dBi gain antenna at the centre of the quiet zone</p> <p>Note 6: Information about types of UE beam is given in B.2.1.3, and does not limit UE implementation or test system implementation</p>						

A.7.3.2.3.1.3 Test Requirements

The UE shall start to transmit the PRACH to Cell 2 less than 3160 ms from the beginning of time period T2.

The rate of correct RRC connection release redirection to NR observed during repeated tests shall be at least 90%.

NOTE: The redirection delay can be expressed as:

$$T_{\text{connection_release_redirect_NR}} = T_{\text{RRC_procedure_delay}} + T_{\text{identify-NR}} + T_{\text{SI-NR}} + T_{\text{RACH}}$$

where:

$T_{\text{RRC_procedure_delay}} = 110$ ms in the test.

$T_{\text{identify-NR}} = 1760$ ms in the test.

$T_{\text{SI-NR}} = 1280$ ms, it is the time required for receiving all the relevant system information as defined in TS 38.331 for the target NR cell.

$T_{\text{RACH}} = 10$ ms in the test.

This gives a total of 3160 ms.

A.7.4 Timing

A.7.4.1 UE transmit timing

A.7.4.1.1 NR UE Transmit Timing Test for FR2

A.7.4.1.1.1 Test Purpose and environment

The purpose of this test is to verify that the UE can follow frame timing change of the connected gNodeB and that the UE initial transmit timing accuracy, maximum amount of timing change in one adjustment, minimum and maximum adjustment rate are within the specified limits. This test will verify the requirements in clause 7.1.2.

Supported test configurations are shown in Table 7.4.1.1.1-1.

Table A.7.4.1.1.1-1: Supported test configurations for FR2 PCell

Configuration	Description
1	NR TDD, SSB SCS 240 kHz, data SCS 120 kHz, BW 100 MHz

For this test a single NR cell is used. Tables A.7.4.1.1.1-2 and A.7.4.1.1.1-2A define the parameters to be configured and strength of the transmitted signals. The transmit timing is verified by the UE transmitting SRS using the configuration defined in Table A.7.4.1.1.1-3.

Table A.7.4.1.1.1-2: Cell Specific Test Parameters for UL Transmit Timing test

Parameter	Unit	Config	Test1	Test2
SSB ARFCN		1	Freq1	Freq1
TDD configuration		1	TDDConf.3.1	
BW _{channel}	MHz	1	100: N _{RB,c} = 66	
Data RBs allocated		1	66	

Initial BWP Configuration		1	DLBWP.0.1 ULBWP.0.1	
Dedicated BWP Configuration		1	DLBWP.1.1 ULBWP.1.1	
TRS Configuration		1	TRS.2.1 TDD	
PDSCH/PDCCH TCI state		1	TCI.State.2	
DRx Cycle	ms	1	N/A	DRX.8 ^{Note5}
PDSCH Reference measurement channel		1	SR.3.3 TDD	
RMSI CORESET Reference Channel		1	CR.3.2 TDD	
Dedicated CORESET Reference Channel		1	CCR.3.7 TDD	
OCNG Patterns		1	OP.1	
SSB Configuration		1	SSB.4 FR2	
SMTc Configuration		1	SMTc.1	
PDSCH/PDCCH subcarrier spacing	kHz	1	120	
EPRE ratio of PSS to SSS	dB	1	0	0
EPRE ratio of PBCH DMRS to SSS				
EPRE ratio of PBCH to PBCH DMRS				
EPRE ratio of PDCCH DMRS to SSS				
EPRE ratio of PDCCH to PDCCH DMRS				
EPRE ratio of PDSCH DMRS to SSS				
EPRE ratio of PDSCH to PDSCH				
EPRE ratio of OCNG DMRS to SSS(Note 1)				
EPRE ratio of OCNG to OCNG DMRS (Note 1)				
Propagation condition		1	AWGN	
SRS Config		1	SRSCConf.1 ^{Note6}	SRSCConf.2 ^{Note6}
<p>Note 1: OCNG shall be used such that both cells are fully allocated and a constant total transmitted power spectral density is achieved for all OFDM symbols.</p> <p>Note 2: Void</p> <p>Note 3: Void</p> <p>Note 4: Void</p> <p>Note 5: DRx related parameters are given in Table A.3.3.8-1</p> <p>Note 6: SRS configs are given in Table A.7.4.1.1.1-3</p>				

Table A.7.4.1.1.1-2A: OTA related test parameters

Parameter	Unit	Test 1	Test 2
-----------	------	--------	--------

Angle of arrival configuration		Setup 1 according to clause A.3.15.1
Assumption for UE beams ^{Note 6}		Fine
N_{oc} ^{Note1}	dBm/15kHz ^{Note4}	-112
N_{oc} ^{Note1}	dBm/SCS ^{Note3}	-100
\hat{E}_s / N_{oc}	dB	4
SSB_RP ^{Note2}	dBm/SCS ^{Note4}	-96
\hat{E}_s / I_{sa}	dB	4
I_o ^{Note2}	dBm/95.04 MHz ^{Note4}	-68.5
Note 1:	Interference from other cells and noise sources not specified in the test is assumed to be constant over subcarriers and time and shall be modelled as AWGN of appropriate power for N_{oc} to be fulfilled.	
Note 2:	SSB_RP and I_o levels have been derived from other parameters for information purposes. They are not settable parameters themselves.	
Note 3:	Void	
Note 4:	Equivalent power received by an antenna with 0dBi gain at the centre of the quiet zone	
Note 5:	As observed with 0dBi gain antenna at the centre of the quiet zone	
Note 6:	Information about types of UE beam is given in B.2.1.3, and does not limit UE implementation or test system implementation	

Table A.7.4.1.1.1-3: SRS Configuration for Timing Accuracy Test

	Field	SRSCnf.1	SRSCnf.2	Comments
SRS-ResourceSet	srs-ResourceSetId	0	0	
	srs-ResourceSetList	0	0	
	resourceType	Periodic	Periodic	
	usage	Codebook	Codebook	
SRS-Resource	SRS-ResourceSetId	0	0	
	nrofSRS-Ports	Port1	Port1	
	transmissionComb	n2	n2	
	combOffset-n2	0	0	
	cyclicShift-n2	0	0	
	resourceMapping	0	0	
	startPosition			
	resourceMapping	n1	n1	
	nrofSymbols			
	resourceMapping	n1	n1	
	repetitionFactor			
	freqDomainPosition	0	0	
	freqDomainShift	0	0	
	freqHopping	17	17	Matches $N_{RB,c}$
	c-SRS			
	freqHopping	0	0	
b-SRS				
freqHopping	0	0		
b-hop				
groupOrSequenceHopping	Neither	Neither		
resourceType	Periodic	Periodic		
periodicityAndOffset-p	sl1, 0	sl2560, 4	Offset to align with DRx periodicity	
sequenceId	0	0	Any 10 bit number	

Table A.7.4.1.1.1-4: Void**A.7.4.1.1.2 Test requirements**

The test sequence shall be carried out in RRC_CONNECTED for every test case.

Following will be the test sequence for this test:

- 1) Setup NR PCell according to parameters given in Table A.7.4.1.1.1-1.
- 2) After connection set up with the cell, the test equipment will verify that the timing of the NR cell is within $(N_{TA} + N_{TA_offset}) \times T_c \pm T_e$ of the first detected path of DL SSB.
 - a. The N_{TA} offset value (in T_c units) is 13792
 - b. The T_e values depend on the DL and UL SCS for which the test is being run and are given in Table 7.1.2-1
- 3) The test system shall adjust the timing of the DL path by values given in Table A.7.4.1.1.2-1

Table A.7.4.1.1.2-1 Adjustment Value for DL Timing

SCS of SSB signals (kHz)	Adjustment Value	
	Test1	Test2
240	+8*64T _c	+4*64T _c

- 4) The test system shall verify that the adjustment step size and the adjustment rate shall be according to requirements specified in clause 7.1.2 Table 7.1.2.1-1 until the UE transmit timing offset is within $(N_{TA} + N_{TA_offset}) \times T_c \pm T_e$ respective to the first detected path (in time) of DL SSB. Skip this step for test 2 with DRX configured.
- 5) The test system shall verify that the UE transmit timing offset stays within $(N_{TA} + N_{TA_offset}) \times T_c \pm T_e$ of the first detected path of DL SSB. For Test 2 the UE transmit timing offset shall be verified for the first transmission in the DRX cycle immediately after DL timing adjustment.

A.7.4.2 UE timer accuracy**A.7.4.3 Timing advance****A.7.4.3.1 SA FR2 timing advance adjustment accuracy****A.7.4.3.1.1 Test Purpose and Environment**

The purpose of the test is to verify UE Timing Advance adjustment delay and accuracy requirement defined in clause 7.3.

A.7.4.3.1.2 Test Parameters

Supported test configurations are shown in table A.7.4.3.1.2-1. Both timing advance adjustment delay and accuracy are tested by using the parameters in table A.7.4.3.1.2-2, A.7.4.3.1.2-3 and A.7.4.3.1.2-4.

In all test cases, single cell is used. Each test consists of two successive time periods, with time duration of T1 and T2 respectively. In each time period, timing advance commands are sent to the UE and Sounding Reference Signals (SRS), as specified in table A.7.4.3.1.2-3, are sent from the UE and received by the test equipment. By measuring the reception of the SRS, the transmit timing, and hence the timing advance adjustment accuracy, can be measured.

During time period T1, the test equipment shall send one message with a Timing Advance Command MAC Control Element, as specified in clause 6.1.3.4 in TS 38.321 [7]. The Timing Advance Command value shall be set to 31, which according to clause 4.2 in TS 38.213 [3] results in zero adjustment of the Timing Advance. In this way, a reference value for the timing advance used by the UE is established.

During time period T2, the test equipment shall send a sequence of messages with Timing Advance Command MAC Control Elements, with Timing Advance Command value specified in table A.7.4.3.1.2-2. This value shall result in changes of the timing advance used by the UE, and the accuracy of the change shall then be measured, using the SRS sent from the UE.

As specified in Clause 7.3.2.1, the UE adjusts its uplink timing at slot $n+k+1$ for a timing advance command received in slot n . This delay must be taken into account when measuring the timing advance adjustment accuracy, via the SRS sent from the UE.

The UE Time Alignment Timer, described in Clause 5.2 in TS 38.321 [7], shall be configured so that it does not expire in the duration of the test.

Table A.7.4.3.1.2-1: Timing advance supported test configurations

Config	Description
1	NR 120 kHz SSB SCS, 100 MHz bandwidth, TDD duplex mode

Table A.7.4.3.1.2-2: General test parameters for timing advance

Parameter	Unit	Value	Comment
RF channel number		1	
Initial DL BWP		DLBWP.0.1	As specified in Table A.3.9.2.1-1
Dedicated DL BWP		DLBWP.1.1	As specified in Table A.3.9.2.2-1
Initial UL BWP		ULBWP.0.1	As specified in Table A.3.9.3.1-1
Dedicated UL BWP		ULBWP.1.1	As specified in Table A.3.9.3.2-1
Timing Advance Command (T_A) value during T1		31	$N_{TA_new} = N_{TA_old}$ for the purpose of establishing a reference value from which the timing advance adjustment accuracy can be measured during T2
Timing Advance Command (T_A) value during T2		39	For 120 kHz SCS $N_{TA_new} = N_{TA_old} + 1024 * T_c$ (based on equation in clause 4.2 of TS 38.213 [3])
T1	s	5	
T2	s	5	

Table A.7.4.3.1.2-3: Cell specific test parameters for timing advance

Parameter	Unit	Test1	
		T1	T2
Duplex mode		TDD	
TDD configuration		TDDConf.3.1	
$BW_{channel}$	MHz	100: $N_{RB,c} = 66$	
BWP BW	MHz	100: $N_{RB,c} = 66$	
DRx Cycle	ms	Not Applicable	
PDSCH Reference measurement channel		SR.3.1 TDD	
CORESET Reference Channel		CR.3.1 TDD	
OCNG Patterns		OCNG pattern 1	
TRS configuration		TRS.2.1 TDD	
PDSCH/PDCCH TCI state		TCI.State.2	
SMTc configuration		SMTc.1	
SSB Configuration		SSB.3 FR2	

PDSCH/PDCCH subcarrier spacing	kHz	120 kHz
PUCCH/PUSCH subcarrier spacing	kHz	120 kHz
EPRE ratio of PSS to SSS	dB	0
EPRE ratio of PBCH DMRS to SSS		
EPRE ratio of PBCH to PBCH DMRS		
EPRE ratio of PDCCH DMRS to SSS		
EPRE ratio of PDCCH to PDCCH DMRS		
EPRE ratio of PDSCH DMRS to SSS		
EPRE ratio of PDSCH to PDSCH		
EPRE ratio of OCNG DMRS to SSS(Note 1)		
EPRE ratio of OCNG to OCNG DMRS (Note 1)		
Propagation condition		
Note 1: OCNG shall be used such that the resources in the cell in this test are fully allocated and a constant total transmitted power spectral density is achieved for all OFDM symbols.		
Note 2: Interference from other cells and noise sources not specified in the test is assumed to be constant over subcarriers and time and shall be modelled as AWGN of appropriate power for N_{oc} to be fulfilled.		
Note 3: I_o levels have been derived from other parameters for information purposes. They are not settable parameters themselves.		
Note 4: Equivalent power received by an antenna with 0 dBi gain at the centre of the quiet zone		
Note 5: As observed with 0 dBi gain antenna at the centre of the quiet zone		

Table A.7.4.3.1.2-3A: OTA related test parameters

Parameter	Unit	Test 1	
		T1	T2
Angle of arrival configuration		Setup 1 according to clause A.3.15.1	
Assumption for UE beams ^{Note 6}		Fine	
N_{oc} ^{Note 1}	dBm/15kHz ^{Note 4}	-112	
N_{oc} ^{Note 1}	dBm/SCS ^{Note 3}	-103	
\hat{E}_s/N_{oc}	dB	4	
SS-RSRP ^{Note 2}	dBm/SCS ^{Note 4}	-99	
\hat{E}_s/I_{ot}	dB	4	
I_o ^{Note 2}	dBm/95.04 MHz ^{Note 4}	-68.5	
Note 1: Interference from other cells and noise sources not specified in the test is assumed to be constant over subcarriers and time and shall be modelled as AWGN of appropriate power for N_{oc} to be fulfilled.			
Note 2: SS-RSRP and I_o levels have been derived from other parameters for information purposes. They are not settable parameters themselves.			
Note 3: SS-RSRP minimum requirements are specified assuming independent interference and noise at each receiver antenna port.			
Note 4: Equivalent power received by an antenna with 0dBi gain at the centre of the quiet zone			
Note 5: As observed with 0dBi gain antenna at the centre of the quiet zone			
Note 6: Information about types of UE beam is given in B.2.1.3, and does not limit UE implementation or test system implementation			

Table A.7.4.3.1.2-4: Sounding Reference Symbol Configuration for timing advance

Field	Value	Comment
c-SRS	16	Frequency hopping is disabled
b-SRS	0	
b-hop	0	
freqDomainPosition	0	Frequency domain position of SRS
freqDomainShift	0	
groupOrSequenceHopping	neither	No group or sequence hopping
SRS-PeriodicityAndOffset	sl5=4	Once every 5 slots
pathlossReferenceRS	ssb-Index=0	SSB #0 is used for SRS path loss estimation
usage	Codebook	Codebook based UL transmission
startPosition	0	resourceMapping setting. SRS on last symbol of slot, and 1symbols for SRS without repetition.
nrofSymbols	n1	
repetitionFactor	n1	
combOffset-n2	0	transmissionComb setting
cyclicShift-n2	0	
nrofSRS-Ports	port1	Number of antenna ports used for SRS transmission
Note:	For further information see clause 6.3.2 in TS 38.331 [2].	

A.7.4.3.1.3 Test Requirements

The UE shall apply the signalled Timing Advance value to the transmission timing at the designated activation time i.e. $k+1$ slots after the reception of the timing advance command, where $k = 11$.

The Timing Advance adjustment accuracy shall be within the limits specified in clause 7.3.2.2.

The rate of correct Timing Advance adjustments observed during repeated tests shall be at least 90%.

A.7.5 Signaling characteristics

A.7.5.1 Radio link Monitoring

In the following clause, any uplink signal transmitted by the UE is used for detecting the In-/Out-of-Sync state of the UE. In terms of measurement, the uplink signal is verified on the basis of the UE output power:

Editor note: The metric for the detection of the UE UL transmitted signal by the TE is FFS.

A.7.5.1.1 Radio Link Monitoring Out-of-sync Test for FR2 PCell configured with SSB-based RLM RS in non-DRX mode

A.7.5.1.1.1 Test Purpose and Environment

The purpose of this test is to verify that the UE properly detects the out of sync and in sync for the purpose of monitoring downlink radio link quality of the PCell. This test will partly verify the FR2 radio link monitoring requirements in clause 8.1.

In the test, UE is configured to perform RLM on SSB, with *detectionResource* included in *RadioLinkMonitoringRS* set to SSB#0 and SSB#1, and *purpose* set to 'rlf'. Supported test configurations are shown in table A.7.5.1.1.1-1. The test parameters are given in Tables A.7.5.1.1.1-2, A.7.5.1.1.1-3, and A.7.5.1.1.1-4 below. There is one cell (Cell 1), which is the active NR cell, in the test. The test consists of three successive time periods, with time duration of T1, T2 and T3 respectively. Figure A.7.5.1.1.1-1 shows the variation of the downlink SNR in the active cell to

emulate out-of-sync and in-sync states, and Figure A.7.5.1.1.1-2 shows the Time multiplexed downlink transmissions from each Angle of Arrival. Prior to the start of the time duration T1, the UE shall be fully synchronized to Cell 1. The UE shall be configured for periodic CSI reporting with a reporting periodicity of 5 ms. In addition to RLM-RS radio link monitoring using SSB index 0 and SSB index 1, the UE is configured to perform inter-frequency measurements using Gap Pattern ID #0 (40ms) in test 1.

Table A.7.5.1.1.1-1: Supported test configurations for FR2 PCell

Configuration	Description
1	TDD, SSB SCS 120 KHz, data SCS 120KHz, BW 100 MHz

Table A.7.5.1.1.1-2: General test parameters for FR2 out-of-sync testing in non-DRX mode

Parameter		Unit	Value Test 1
Active PCell			Cell 1
RF Channel Number			1
Duplex mode	Config 1		TDD
BW _{channel}	Config 1		100: N _{RB,c} = 66
Data RBs allocated	Config 1		24
DL initial BWP configuration	Config 1		DLBWP.0.1
DL dedicated BWP configuration	Config 1		DLBWP.1.1
UL initial BWP configuration	Config 1		ULBWP.0.1
UL dedicated BWP configuration	Config 1		ULBWP.1.1
TDD Configuration	Config 1		TDDConf.3.1
RMSI CORESET Reference Channel	Config 1		CR.3.1 TDD
Dedicated CORESET Reference Channel	Config 1		CCR.3.4 TDD
SSB Configuration	Config 1		SSB.1 FR2
SMTC Configuration	Config 1		SMTC.1
PDSCH/PDCCH subcarrier spacing	Config 1		120 KHz
PRACH Configuration	Config 1		Table A.3.8.3.1
SSB index assigned as RLM RS	Config 1		0,1
OCNG parameters			OP.5
CP length			Normal
Out of sync transmission parameters	DCI format		1-0
	Number of Control OFDM symbols		2
	Aggregation level	CCE	8
	Ratio of hypothetical PDCCH RE energy to average SSS RE energy	dB	4
	Ratio of hypothetical PDCCH DMRS energy to average SSS RE energy	dB	4
	DMRS precoder granularity		REG bundle size
REG bundle size			6
DRX			OFF
Gap pattern ID			gp0
Layer 3 filtering			Enabled
T310 timer		ms	0
T311 timer		ms	1000
N310			1
N311			1
CSI-RS for CSI reporting	Config 1		CSI-RS.3.1 TDD
reportConfigType			periodic
reportQuantity			cri-RI-PMI-CQI

CSI reporting periodicity	slot	40
CSI reporting offset	slot	4
TCI states for PDCCH/PDSCH		TCI.State.2
CSI-RS for tracking	Config 1	TRS.2.1 TDD
T1	s	0.2
T2	s	9.68
T3	s	9.68
D1	s	9.64
Note 1: All configurations are assigned to the UE prior to the start of time period T1.		
Note 2: UE-specific PDCCH is not transmitted after T1 starts.		

Table A.7.5.1.1.1-3: OTA related cell specific test parameters for FR2 (Cell 1) for out-of-sync radio link monitoring tests in non-DRX mode

Parameter	Unit	Test 1						
		T1	T2	T3	T1	T2	T3	
AoA setup		Setup 3 defined in A.3.15						
		AoA1			AoA2			
Assumption for UE beams ^{Note 5}		Rough			Rough			
EPRE ratio of PDCCH DMRS to SSS	dB	4			Not sent			
EPRE ratio of PDCCH to PDCCH DMRS	dB	0						
EPRE ratio of PBCH DMRS to SSS	dB							
EPRE ratio of PBCH to PBCH DMRS	dB							
EPRE ratio of PSS to SSS	dB							
EPRE ratio of PDSCH DMRS to SSS	dB							
EPRE ratio of PDSCH to PDSCH DMRS	dB							
EPRE ratio of OCNG DMRS to SSS	dB							
EPRE ratio of OCNG to OCNG DMRS	dB							
ssb-Index 0 SNR	Config 1	dB	2 ^{Note 6}	-6 ^{Note 6}				-15
ssb-Index 1 SNR	Config 1		Not sent			2 ^{Note 6}	-15	-15
N_{oc}	Config 1	dBm/ 15kHz	-92.1			-92.1		
Time multiplexing of the downlink transmissions from each AoA			Defined in Figure A.7.5.1.1.1-2					
Propagation condition			TDL-A 30ns 75Hz			TDL-A 30ns 75Hz		
Note 1: OCNG shall be used such that a constant total transmitted power spectral density is achieved for all OFDM symbols.								
Note 2: The signal contains PDCCH for UEs other than the device under test as part of OCNG.								
Note 3: SNR levels correspond to the signal to noise ratio over the SSS REs.								
Note 4: The SNR values are specified for testing a UE which supports 2RX on at least one band. For testing of a UE which supports 4RX on all bands, the SNR during T3 is A.3.6.								
Note 5: Information about types of UE beam is given in B.2.1.3 and does not limit UE implementation or test system implementation.								
Note 6: This value allows up to 1dB degradation from applied SNR to UE baseband								

Table A.7.5.1.1.1-4: Measurement gap configuration for out-of-sync tests in non-DRX mode

Field	Test 1
	Value
gapOffset	0

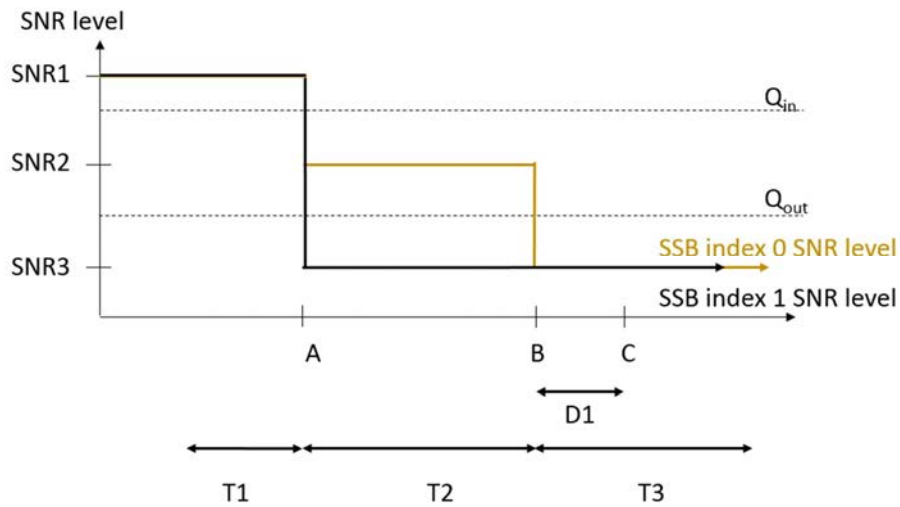

Figure A.7.5.1.1.1-1: SNR variation for out-of-sync testing

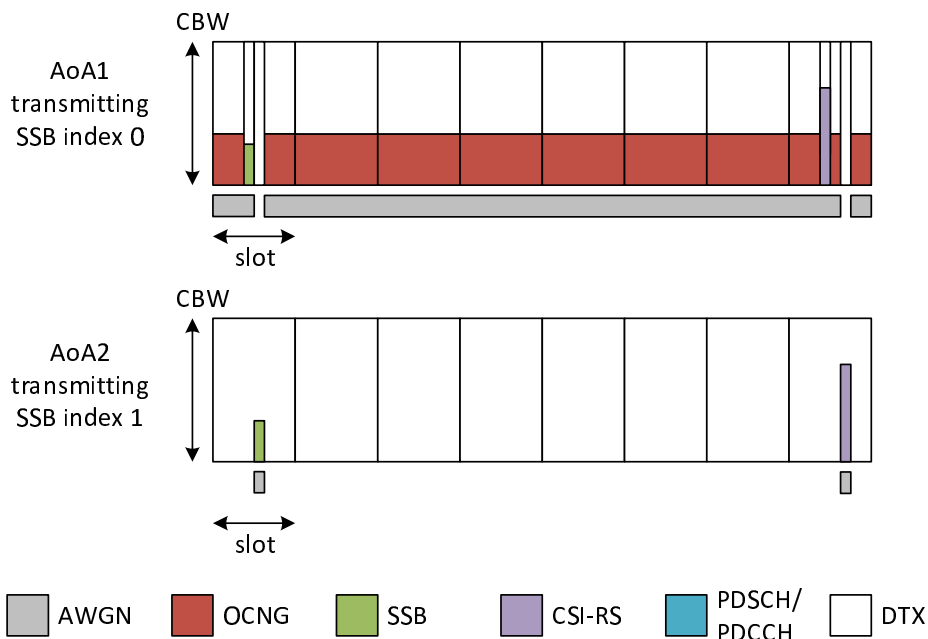

Figure A.7.5.1.1.1-2: Time multiplexed downlink transmissions

A.7.5.1.1.2 Test Requirements

The UE behavior in each test during time durations T1, T2 and T3 shall be as follows:

During the period from time point A to time point B the UE shall transmit uplink signal at least in all uplink slots configured for CSI transmission according to the configured periodic CSI reporting.

The UE shall stop transmitting uplink signal no later than time point C (D1 second after the start of the time duration T3).

The rate of correct events observed during repeated tests shall be at least 90%.

A.7.5.1.2 Radio Link Monitoring In-sync Test for FR2 PCell configured with SSB-based RLM RS in non-DRX mode

A.7.5.1.2.1 Test Purpose and Environment

The purpose of this test is to verify that the UE properly detects the out of sync and in sync for the purpose of monitoring downlink radio link quality of the PCell. This test will partly verify the FR2 radio link monitoring requirements in clause 8.1.

In the test, UE is configured to perform RLM on SSB, with *detectionResource* included in *RadioLinkMonitoringRS* set to SSB#0 and SSB#1, and *purpose* set to 'rlf'. Supported test configurations are shown in table A.7.5.1.2.1-1. The test parameters are given in Tables A.7.5.1.2.1-2, and A.7.5.1.2.1-3 below. There is one cell (Cell 1), which is the active cell, in the test. The test consists of five successive time periods, with time duration of T1, T2, T3, T4 and T5 respectively. Figure A.7.5.1.2.1-1 shows the variation of the downlink SNR in the active cell to emulate out-of-sync and in-sync states, and Figure A.7.5.1.2.1-2 shows the Time multiplexed downlink transmissions from each Angle of Arrival. Prior to the start of the time duration T1, the UE shall be fully synchronized to Cell 1. Prior to the start of the time duration T1, the UE shall be fully synchronized to Cell 1. The UE shall be configured for periodic CSI reporting with a reporting periodicity of 5 ms.

Table A.7.5.1.2.1-1: Supported test configurations for FR2 PCell

Configuration	Description
1	TDD, SSB SCS 120 KHz, data SCS 120KHz, BW 100 MHz

Table A.7.5.1.2.1-2: General test parameters for FR2 in-sync testing in non-DRX mode

Parameter		Unit	Value
			Test 1
Active PCell			Cell 1
RF Channel Number			1
Duplex mode	Config 1		TDD
BW _{channel}	Config 1		100: N _{RB,c} = 66
Data RBs allocated	Config 1		24
DL initial BWP configuration	Config 1		DLBWP.0.1
DL dedicated BWP configuration	Config 1		DLBWP.1.1
UL initial BWP configuration	Config 1		ULBWP.0.1
UL dedicated BWP configuration	Config 1		ULBWP.1.1
TDD Configuration	Config 1		TDDConf.3.1
RMSI CORESET Reference Channel	Config 1		CR.3.1 TDD
Dedicated CORESET Reference Channel	Config 1		CCR.3.1 TDD
SSB Configuration	Config 1		SSB.1 FR2
SMTc Configuration	Config 1		SMTc.3
PDSCH/PDCCH subcarrier spacing	Config 1		120 KHz
PRACH Configuration	Config 1		Table A.3.8.3.1
SSB index assigned as RLM RS	Config 1		0,1
OCNG parameters			OP.5
CP length			Normal
	DCI format		1-0
	Number of Control OFDM symbols		2

In sync transmission parameters	Aggregation level	CCE	4
	Ratio of hypothetical PDCCH RE energy to average SSS RE energy	dB	0
	Ratio of hypothetical PDCCH DMRS energy to average SSS RE energy	dB	0
	DMRS precoder granularity		REG bundle size
	REG bundle size		6
Out of sync transmission parameters	DCI format		1-0
	Number of Control OFDM symbols		2
	Aggregation level	CCE	8
	Ratio of hypothetical PDCCH RE energy to average SSS RE energy	dB	4
	Ratio of hypothetical PDCCH DMRS energy to average SSS RE energy	dB	4
	DMRS precoder granularity		REG bundle size
	REG bundle size		6
DRX			OFF
Gap pattern ID			N.A.
Layer 3 filtering			Enabled
T310 timer	ms		4000
T311 timer	ms		1000
N310			1
N311			1
CSI-RS for CSI reporting	Config 1		CSI-RS.3.1 TDD
reportConfigType			periodic
reportQuantity			cri-RI-PMI-CQI
CSI reporting periodicity	slot		40
CSI reporting offset	slot		4
TCI states for PDCCH/PDSCH			TCI.State.2
CSI-RS for tracking	Config 1		TRS.2.1 TDD
T1	s		0.2
T2	s		0.2
T3	s		1.88
T4	s		0.2
T5	s		3.84
D1	s		3.8
Note 1: All configurations are assigned to the UE prior to the start of time period T1.			
Note 2: UE-specific PDCCH is not transmitted after T1 starts.			

Table A.7.5.1.2.1-3: OTA related cell specific test parameters for FR2 (Cell 1) for in-sync radio link monitoring tests in non-DRX mode

Parameter	Unit	Test 1									
		T1	T2	T3	T4	T5	T1	T2	T3	T4	T5
AoA setup		Setup 3 defined in A.3.15									
Assumption for UE beams ^{Note 5}		AoA1					AoA2				
EPRE ratio of PDCCH DMRS to SSS	dB	0					Not sent				
EPRE ratio of PDCCH to PDCCH DMRS	dB	0									
EPRE ratio of PBCH DMRS to SSS	dB										
EPRE ratio of PBCH to PBCH DMRS	dB										
EPRE ratio of PSS to SSS	dB										
EPRE ratio of PDSCH DMRS to SSS	dB										

EPRE ratio of PDSCH to PDSCH DMRS	dB													
EPRE ratio of OCNG DMRS to SSS	dB													
EPRE ratio of OCNG to OCNG DMRS	dB													
ssb-Index 0 SNR	Config 1	dB	2 ^{Note 6}	-6 ^{Note 6}	-15	-15	-15							
ssb-Index 1 SNR	Config 1		Not sent						2 ^{Note 6}	-15	-15	-4.5	2 ^{Note 6}	
N_{oc}	Config 1	dBm/ 15kHz	-92.1						-92.1					
Time multiplexing of the downlink transmissions from each AoA			Defined in Figure A.7.5.1.2.1-2											
Propagation condition			TDL-A 30ns 75Hz						TDL-A 30ns 75Hz					

- Note 1: OCNG shall be used such that a constant total transmitted power spectral density is achieved for all OFDM symbols.
- Note 2: The signal contains PDCCH for UEs other than the device under test as part of OCNG.
- Note 3: SNR levels correspond to the signal to noise ratio over the SSS REs.
- Note 4: The SNR values are specified for testing a UE which supports 2RX on at least one band. For testing of a UE which supports 4RX on all bands, the SNR during T3 is A.3.6.
- Note 5: Information about types of UE beam is given in B.2.1.3 and does not limit UE implementation or test system implementation.
- Note 6: This value allows up to 1dB degradation from applied SNR to UE baseband

Table A.7.5.1.2.1-4: Void

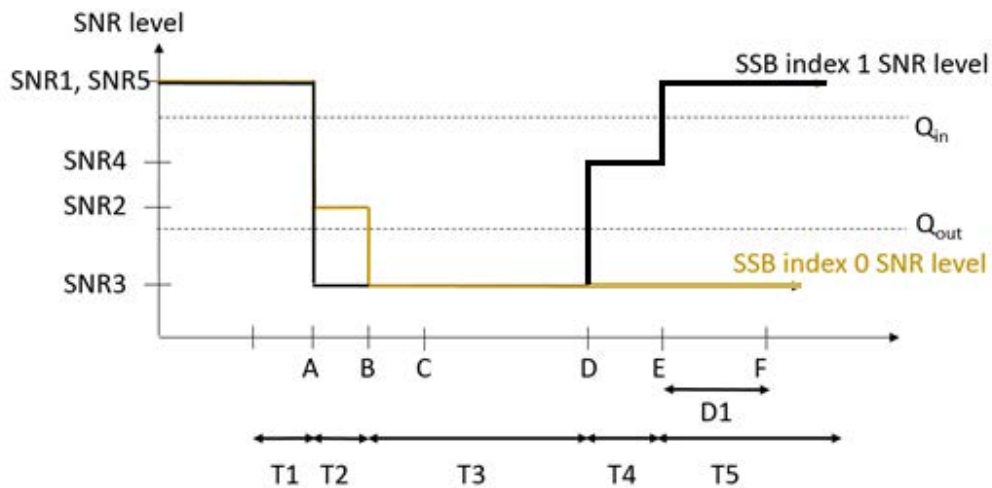

Figure A.7.5.1.2.1-1: SNR variation for in-sync testing

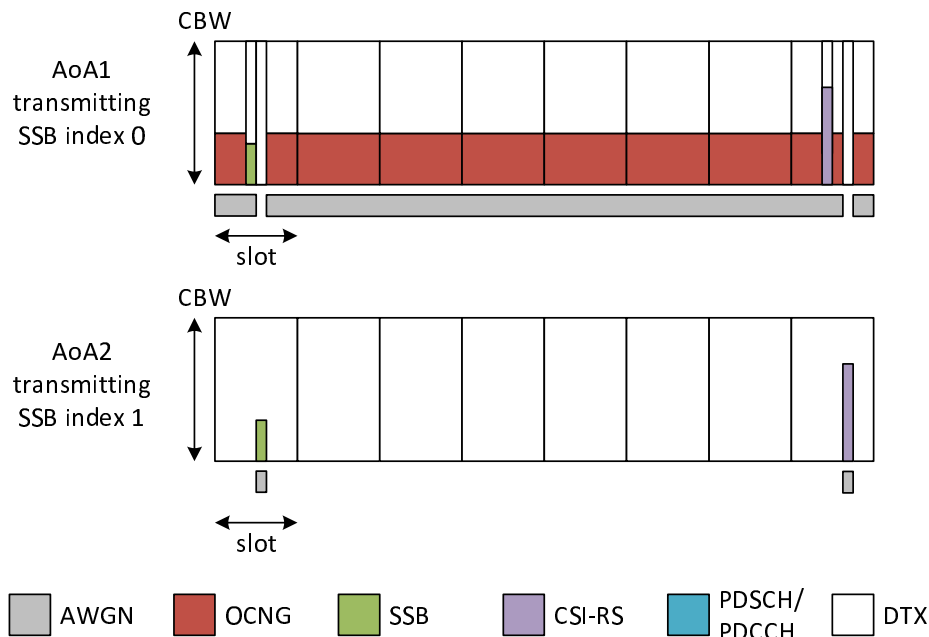

Figure A.7.5.1.2.1-2: Time multiplexed downlink transmissions

A.7.5.1.2.2 Test Requirements

The UE behaviour in each test during time durations T1, T2, T3, T4 and T5 shall be as follows:

During the period from time point A to time point F (D1 second after the start of time duration T5) the UE shall transmit uplink signal at least in all uplink slots configured for CSI transmission according to the configured periodic CSI reporting.

The rate of correct events observed during repeated tests shall be at least 90%.

A.7.5.1.3 Radio Link Monitoring Out-of-sync Test for FR2 PCell configured with SSB-based RLM RS in DRX mode

A.7.5.1.3.1 Test Purpose and Environment

The purpose of this test is to verify that the UE properly detects the out of sync and in sync for the purpose of monitoring downlink radio link quality of the PCell when DRX is used. This test will partly verify the FR2 radio link monitoring requirements in clause 8.1.

In the test, UE is configured to perform RLM on SSB, with *detectionResource* included in *RadioLinkMonitoringRS* set to SSB#0 and SSB#1, and *purpose* set to *'rlf'*. Supported test configurations are shown in table A.7.5.1.3.1-1. The test parameters are given in Tables A.7.5.1.3.1-2, and A.7.5.1.3.1-3. There is one cell (Cell 1), which is the active NR cell, in the test. The test consists of three successive time periods, with time duration of T1, T2 and T3 respectively. Figure A.7.5.1.3.1-1 shows the variation of the downlink SNR in the active cell to emulate out-of-sync and in-sync states. Prior to the start of the time duration T1, the UE shall be fully synchronized to Cell 1. The UE shall be configured for periodic CSI reporting with a reporting periodicity of 5 ms. In the test, DRX configuration is enabled and DRX inactivity timer has already been expired, i.e. UE tries to decode PDCCH and to send periodic CSI during the period when On-duration timer is running. Time alignment timers shall be set to “infinity” so that UL timing alignment is maintained during the test.

Table A.7.5.1.3.1-1: Supported test configurations for FR2 PCell

Configuration	Description
1	TDD, SSB SCS 120 KHz, data SCS 120KHz, BW 100 MHz

Table A.7.5.1.3.1-2: General test parameters for FR2 out-of-sync testing in DRX mode

Parameter		Unit	Value Test 1
Active PCell			Cell 1
RF Channel Number			1
Duplex mode	Config 1		TDD
BW _{channel}	Config 1		100: N _{RB,C} = 66
Data RBs allocated	Config 1		66
DL initial BWP configuration	Config 1		DLBWP.0.1
DL dedicated BWP configuration	Config 1		DLBWP.1.1
UL initial BWP configuration	Config 1		ULBWP.0.1
UL dedicated BWP configuration	Config 1		ULBWP.1.1
TDD Configuration	Config 1		TDDConf.3.1
RMSI CORESET Reference Channel	Config 1		CR.3.1 TDD
Dedicated CORESET Reference Channel	Config 1		CCR.3.4 TDD
SSB Configuration	Config 1		SSB.1 FR2
SMTTC Configuration	Config 1		SMTTC.1
PDSCH/PDCCH subcarrier spacing	Config 1		120 KHz
PRACH Configuration	Config 1		Table A.3.8.3.1
SSB index assigned as RLM RS	Config 1		0,1
OCNG parameters			OP.1
CP length			Normal
Out of sync transmission parameters	DCI format		1-0
	Number of Control OFDM symbols		2
	Aggregation level	CCE	8
	Ratio of hypothetical PDCCH RE energy to average SSS RE energy	dB	4
	Ratio of hypothetical PDCCH DMRS energy to average SSS RE energy	dB	4
	DMRS precoder granularity		REG bundle size
	REG bundle size		6
DRX Configuration			DRX.3
Gap pattern ID			N.A.
Layer 3 filtering			<i>Enabled</i>
T310 timer		ms	0
T311 timer		ms	1000
N310			1
N311			1
CSI-RS for CSI reporting	Config 1		CSI-RS.3.1 TDD
reportConfigType			periodic
reportQuantity			cri-RI-PMI-CQI
CSI reporting periodicity		slot	40
CSI reporting offset		slot	4
TCI states for PDCCH/PDSCH			TCI.State.2

CSI-RS for tracking	Config 1		TRS.2.1 TDD
T1		s	0.2
T2		s	14.48
T3		s	14.48
D1		s	14.44
Note 1: All configurations are assigned to the UE prior to the start of time period T1.			
Note 2: UE-specific PDCCH is not transmitted after T1 starts.			

Table A.7.5.1.3.1-3: OTA related cell specific test parameters for FR2 (Cell 1) for out-of-sync radio link monitoring tests in DRX mode

Parameter		Unit	Test 1		
			T1	T2	T3
AoA setup			Setup 1 defined in A.3.15		
Assumption for UE beams ^{Note 5}			Rough		
EPRE ratio of PDCCH DMRS to SSS		dB	4		
EPRE ratio of PDCCH to PDCCH DMRS		dB	0		
EPRE ratio of PBCH DMRS to SSS		dB	0		
EPRE ratio of PBCH to PBCH DMRS		dB			
EPRE ratio of PSS to SSS		dB			
EPRE ratio of PDSCH DMRS to SSS		dB			
EPRE ratio of PDSCH to PDSCH DMRS		dB			
EPRE ratio of OCNG DMRS to SSS		dB			
EPRE ratio of OCNG to OCNG DMRS		dB			
ssb-Index 0 SNR	Config 1	dB	² Note 6	⁻⁶ Note 6	-15
ssb-Index 1 SNR	Config 1		² Note 6	-15	-15
N_{oc}	Config 1	dBm/15K Hz	-104.7dBm		
Propagation condition			TDL-A 30ns 75Hz		
Note 1: OCNG shall be used such that the resources in Cell 1 are fully allocated and a constant total transmitted power spectral density is achieved for all OFDM symbols.					
Note 2: The signal contains PDCCH for UEs other than the device under test as part of OCNG.					
Note 3: SNR levels correspond to the signal to noise ratio over the SSS REs.					
Note 4: The SNR values are specified for testing a UE which supports 2RX on at least one band. For testing of a UE which supports 4RX on all bands, the SNR during T3 is A.3.6.					
Note 5: Information about types of UE beams is given in B.2.1.3 and does not limit UE implementation or test system implementation.					
Note 6: This value allows up to 1dB degradation from applied SNR to UE baseband					

Table A.7.5.1.3.1-4: Void

Table A.7.5.1.3.1-5: Void

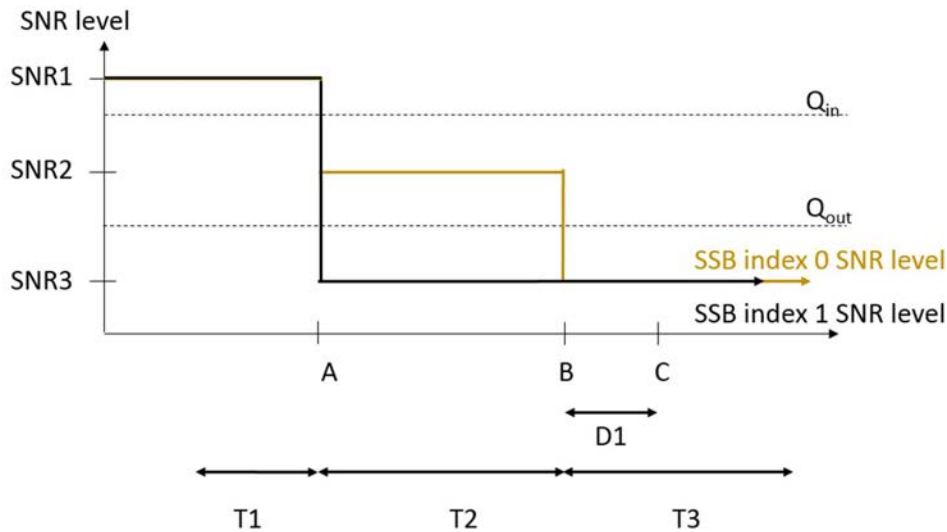

Figure A.7.5.1.3.1-1: SNR variation for out-of-sync testing

A.7.5.1.3.2 Test Requirements

The UE behavior in each test during time durations T1, T2 and T3 shall be as follows:

During the period from time point A to time point B the UE shall transmit uplink signal at least in all uplink slots configured for CSI transmission according to the configured periodic CSI reporting.

The UE shall stop transmitting uplink signal no later than time point C (D1 second after the start of the time duration T3).

The rate of correct events observed during repeated tests shall be at least 90%.

A.7.5.1.4 Radio Link Monitoring In-sync Test for FR2 PCell configured with SSB-based RLM RS in DRX mode

A.7.5.1.4.1 Test Purpose and Environment

The purpose of this test is to verify that the UE properly detects the out of sync and in sync for the purpose of monitoring downlink radio link quality of the PCell when DRX is used. This test will partly verify the FR2 radio link monitoring requirements in clause 8.1.

In the test, UE is configured to perform RLM on SSB, with *detectionResource* included in *RadioLinkMonitoringRS* set to SSB#0 and SSB#1, and *purpose* set to 'rlf'. Supported test configurations are shown in table A.7.5.1.4.1-1. The test parameters are given in Tables A.7.5.1.4.1-2, and A.7.5.1.4.1-3. There is one cell (Cell 1), which is the active NR cell, in the test. The test consists of five successive time periods, with time duration of T1, T2, T3, T4 and T5 respectively. Figure A.7.5.1.4.1-1 shows the variation of the downlink SNR in the active cell to emulate out-of-sync and in-sync states. Prior to the start of the time duration T1, the UE shall be fully synchronized to Cell 1. The UE shall be configured for periodic CSI reporting with a reporting periodicity of 5 ms. In the test, DRX configuration is enabled and DRX inactivity timer has already been expired, i.e. UE tries to decode PDCCH and to send periodic CSI during the period when On-duration timer is running. Time alignment timers shall be set to "infinity" so that UL timing alignment is maintained during the test.

Table A.7.5.1.4.1-1: Supported test configurations for FR2 PCell

Configuration	Description
---------------	-------------

1	TDD, SSB SCS 120 KHz, data SCS 120KHz, BW 100 MHz
---	---

Table A.7.5.1.4.1-2: General test parameters for FR2 in-sync testing in DRX mode

Parameter		Unit	Value
			Test 1
Active PCell			Cell 1
RF Channel Number			1
Duplex mode	Config 1		TDD
BW _{channel}	Config 1		100: N _{RB,c} = 66
Data RBs allocated	Config 1		66
DL initial BWP configuration	Config 1		DLBWP.0.1
DL dedicated BWP configuration	Config 1		DLBWP.1.1
UL initial BWP configuration	Config 1		ULBWP.0.1
UL dedicated BWP configuration	Config 1		ULBWP.1.1
TDD Configuration	Config 1		TDDConf.3.1
RMSI CORESET Reference Channel	Config 1		CR.3.1 TDD
Dedicated CORESET Reference Channel	Config 1		CCR.3.1 TDD
SSB Configuration	Config 1		SSB.1 FR2
SMTC Configuration	Config 1		SMTC.3
PDSCH/PDCCH subcarrier spacing	Config 1		120 KHz
PRACH Configuration	Config 1		Table A.3.8.3.1
SSB index assigned as RLM RS	Config 1		0,1
OCNG parameters			OP.1
CP length			Normal
In sync transmission parameters	DCI format		1-0
	Number of Control OFDM symbols		2
	Aggregation level	CCE	4
	Ratio of hypothetical PDCCH RE energy to average SSS RE energy	dB	0
	Ratio of hypothetical PDCCH DMRS energy to average SSS RE energy	dB	0
	DMRS precoder granularity		REG bundle size
	REG bundle size		6
Out of sync transmission parameters	DCI format		1-0
	Number of Control OFDM symbols		2
	Aggregation level	CCE	8
	Ratio of hypothetical PDCCH RE energy to average SSS RE energy	dB	4
	Ratio of hypothetical PDCCH DMRS energy to average SSS RE energy	dB	4
	DMRS precoder granularity		REG bundle size
	REG bundle size		6
DRX Configuration			DRX.11
Gap pattern ID			N.A.
Layer 3 filtering			Enabled
T310 timer		ms	4000
T311 timer		ms	1000
N310			1
N311			1

CSI-RS for CSI reporting	Config 1		CSI-RS.3.1 TDD
reportConfigType			periodic
reportQuantity			cri-RI-PMI-CQI
CSI reporting periodicity		slot	40
CSI reporting offset		slot	4
TCI states for PDCCH/PDSCH			TCI.State.2
CSI-RS for tracking	Config 1		TRS.2.1 TDD
T1		s	0.2
T2		s	0.2
T3		s	2.8
T4		s	0.2
T5		s	3.88
D1		s	3.84
Note 1: All configurations are assigned to the UE prior to the start of time period T1.			
Note 2: UE-specific PDCCH is not transmitted after T1 starts.			

Table A.7.5.1.4.1-3: OTA related cell specific test parameters for FR2 (Cell 1) for in-sync radio link monitoring test in DRX mode

Parameter		Unit	Test 1				
			T1	T2	T3	T4	T5
AoA setup			Setup 1 defined in A.3.15				
Assumption for UE beams ^{Note 5}			Rough				
EPRE ratio of PDCCH DMRS to SSS		dB	0				
EPRE ratio of PDCCH to PDCCH DMRS		dB	0				
EPRE ratio of PBCH DMRS to SSS		dB	0				
EPRE ratio of PBCH to PBCH DMRS		dB					
EPRE ratio of PSS to SSS		dB					
EPRE ratio of PDSCH DMRS to SSS		dB					
EPRE ratio of PDSCH to PDSCH DMRS		dB					
EPRE ratio of OCNG DMRS to SSS		dB					
EPRE ratio of OCNG to OCNG DMRS		dB					
ssb-Index 0 SNR	Config 1	dB	² Note 6	- ⁶ Note 6	-15	-4.5	² Note 6
ssb-Index 1 SNR	Config 1		² Note 6	-15	-15	-15	-15
N_{oc}	Config 1	dBm/15KHz	-104.7dBm				
Propagation condition			TDL-A 30ns 75Hz				
<p>Note 1: OCNG shall be used such that the resources in Cell 1 are fully allocated and a constant total transmitted power spectral density is achieved for all OFDM symbols.</p> <p>Note 2: The signal contains PDCCH for UEs other than the device under test as part of OCNG.3</p> <p>Note 3: SNR levels correspond to the signal to noise ratio over the SSS REs.</p> <p>Note 4: The SNR values are specified for testing a UE which supports 2RX on at least one band. For testing of a UE which supports 4RX on all bands, the SNR during T3 is A.3.6.</p> <p>Note 5: Information about types of UE beam is given in B.2.1.3 and does not limit UE implementation or test system implementation.</p> <p>Note 6: This value allows up to 1dB degradation from applied SNR to UE baseband</p>							

Table A.7.5.1.4.1-4: Void

Table A.7.5.1.4.1-5: Void

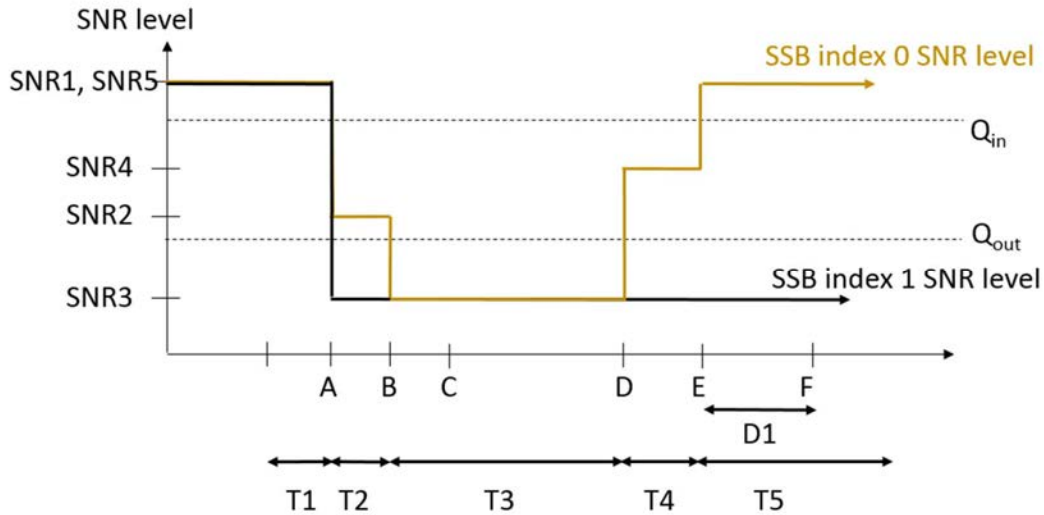

Figure A.7.5.1.4.1-1: SNR variation for in-sync testing

A.7.5.1.4.2 Test Requirements

The UE behaviour in each test during time durations T1, T2, T3, T4 and T5 shall be as follows:

During the period from time point A to time point F (D1 second after the start of time duration T5) the UE shall transmit uplink signal at least in all uplink slots configured for CSI transmission according to the configured periodic CSI reporting.

The rate of correct events observed during repeated tests shall be at least 90%.

A.7.5.1.5 Radio Link Monitoring Out-of-sync Test for FR2 PCell configured with CSI-RS-based RLM in non-DRX mode

A.7.5.1.5.1 Test Purpose and Environment

The purpose of this test is to verify that the UE properly detects the out of sync for the purpose of monitoring downlink CSI-RS based radio link quality of the PCell when no DRX is used. This test will partly verify the FR2 PCell CSI-RS Out-of-sync radio link monitoring requirements in clause 8.1.

The test parameters are given in Tables A.7.5.1.5.1-1, A.7.5.1.5.1-2, A.7.5.1.5.1-3 and A.7.5.1.5.1-4 below. There is one cell, cell 1 which is the PCell, in the test. The test consists of three successive time periods, with time duration of T1, T2 and T3 respectively. Figure A.7.5.1.5.1-1 shows the variation of the downlink SNR in the PCell to emulate out-of-sync and in-sync states. Prior to the start of the time duration T1, the UE shall be fully synchronized to cell 1. The UE shall be configured for periodic CSI reporting with a reporting periodicity of 10 ms. In the test, DRX configuration is not enabled. The UE is configured to perform inter-frequency measurements using GP ID #0 (40ms) in test. In the test, SSB0 and SSB1 are configured as BFD-RS.

Table A.7.5.1.5.1-1: Supported test configurations for FR2 PCell

Configuration	Description
---------------	-------------

1	TDD duplex mode, 120 kHz SSB SCS, 100 MHz bandwidth
---	---

Table A.7.5.1.5.1-2: General test parameters for FR2 PCell for CSI-RS out-of-sync testing in non-DRX mode

Parameter		Unit	Value
			Test 1
Active PCell			Cell 1
RF Channel Number			1
Duplex mode	Config 1		TDD
TDD Configuration	Config 1		TDDConf.3.1
$BW_{channel}$	Config 1		100: $N_{RB,c} = 66$
Data RBs allocated	Config 1		24
$BW_{occupied}$	Config 1		24
DL initial BWP configuration	Config 1		DLBWP.0.1
DL dedicated BWP configuration	Config 1		DLBWP.1.4
UL initial BWP configuration	Config 1		ULBWP.0.1
UL dedicated BWP configuration	Config 1		ULBWP.1.4
RMSI CORESET Reference Channel	Config 1		CR.3.1 TDD
Dedicated CORESET Reference Channel	Config 1		CCR.3.4 TDD CCR.3.6 TDD
SSB Configuration	Config 1		SSB.1 FR2
SMTC Configuration	Config 1		SMTC.1
PDSCH/PDCCH subcarrier spacing	Config 1		120 KHz
CSI-RS for RLM	Config 1		Resource #4 in TRS.2.1 TDD Resource #4 in TRS.2.2 TDD
TRS configuration			TRS.2.1 TDD TRS.2.2 TDD
TCI configuration for PDCCH#1/PDSCH			TCI.State.2
TCI configuration for PDCCH#2			TCI.State.3
OCNG parameters			OP.5
CP length			Normal
Out of sync transmission parameters	DCI format		1-0
	Number of Control OFDM symbols		2
	Aggregation level	CCE	8
	Ratio of hypothetical PDCCH RE energy to average CSI-RS RE energy	dB	4
	Ratio of hypothetical PDCCH DMRS energy to average CSI-RS RE energy	dB	4
	DMRS precoder granularity		REG bundle size
REG bundle size			6
DRX			OFF
Gap pattern ID			*gp0
Layer 3 filtering			Enabled
T310 timer		ms	0
T311 timer		ms	1000
N310			1
N311			1

CSI-RS for CSI reporting	Config 1		CSI-RS.3.1 TDD
reportConfigType			periodic
reportQuantity			cri-RI-PMI-CQI
CSI reporting periodicity		slot	40
CSI reporting offset		slot	4
T1		s	0.2
T2		s	0.35
T3		s	0.35
D1		s	0.31
Note 1: UE-specific PDCCH is not transmitted after T1 starts.			

Table A.7.5.1.5.1-3: Cell specific test parameters for FR2 for CSI-RS out-of-sync radio link monitoring in non-DRX mode

Parameter	Unit	Test 1						
		T1	T2	T3	T1	T2	T3	
AoA setup		Setup 3 defined in A.3.15						
		AoA1			AoA2			
Assumption for UE beams ^{Note 10}		Rough			Rough			
EPRE ratio of PDCCH DMRS to SSS	dB	4			Not sent			
EPRE ratio of PDCCH to PDCCH DMRS	dB	0						
EPRE ratio of PBCH DMRS to SSS	dB							
EPRE ratio of PBCH to PBCH DMRS	dB							
EPRE ratio of PSS to SSS	dB							
EPRE ratio of PDSCH DMRS to SSS	dB							
EPRE ratio of PDSCH to PDSCH DMRS	dB							
EPRE ratio of OCNG DMRS to SSS	dB							
EPRE ratio of OCNG to OCNG DMRS	dB							
SNR on RLM-RS1	Config 1	dB	2 ^{Note 11}	-6 ^{Note 11}	-15			
SNR on RLM-RS2	Config 1	dB	Not sent			2 ^{Note 11}	-15	-15
N_{oc}	Config 1	dBm/15kHz	-92.1			-92.1		
Propagation condition			TDL-C 300ns 100Hz			TDL-C 300ns 100Hz		
<p>Note 1: OCNG shall be used such that the resources in Cell 1 are fully allocated and a constant total transmitted power spectral density is achieved for all OFDM symbols.</p> <p>Note 2: The uplink resources for CSI reporting are assigned to the UE prior to the start of time period T1.</p> <p>Note 3: NZP CSI-RS resource set configuration for CSI reporting are assigned to the UE prior to the start of time period T1.</p> <p>Note 4: Measurement gap configuration is assigned to the UE prior to the start of time period T1.</p> <p>Note 5: The timers and layer 3 filtering related parameters are configured prior to the start of time period T1.</p> <p>Note 6: The signal contains PDCCH for UEs other than the device under test as part of OCNG.</p> <p>Note 7: SNR levels correspond to the signal to noise ratio over the SSS REs.</p> <p>Note 8: The SNR in time periods T1, T2 and T3 is denoted as SNR1, SNR2 and SNR3 respectively in figure A.7.5.1.5.1-1.</p> <p>Note 9: The SNR values are specified for testing a UE which supports 2RX on at least one band. For testing of a UE which supports 4RX on all bands, the SNR during T3 is A.3.6.</p> <p>Note 10: Information about types of UE beams is given in B.2.1.3 and does not limit UE implementation or test system implementation.</p> <p>Note 11: This value allows up to 1dB degradation from applied SNR to UE baseband.</p>								

Table A.7.5.1.5.1-4: Measurement gap configuration for FR2 CSI-RS out-of-sync radio link monitoring in non-DRX mode

Field	Test 1
	Value
gapOffset	0
Note 1: RLM RS is partially overlapped with measurement gap	

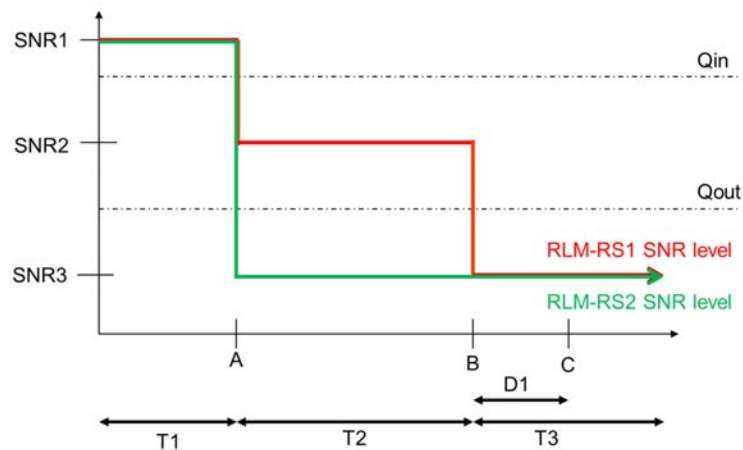

Figure A.7.5.1.5.1-1: SNR variation for CSI-RS out-of-sync testing

A.7.5.1.5.2 Test Requirements

The UE behaviour during time durations T1, T2, and T3 shall be as follows:

During the period from time point A to time point B the UE shall transmit uplink signal in Cell 1 at least in all uplink slots configured for CSI transmission according to the configured periodic CSI reporting for Cell 1.

The UE shall stop transmitting uplink signal in Cell 1 no later than time point C (D_1 second after the start of the time duration T3) on the PCell.

The rate of correct events observed during repeated tests shall be at least 90%.

A.7.5.1.6 Radio Link Monitoring In-sync Test for FR2 PCell configured with CSI-RS-based RLM in non-DRX mode

A.7.5.1.6.1 Test Purpose and Environment

The purpose of this test is to verify that the UE properly detects the in sync for the purpose of monitoring downlink CSI-RS based radio link quality of the PCell when no DRX is used. This test will partly verify the FR2 PCell CSI-RS In-sync radio link monitoring requirements in clause 8.1.

The test parameters are given in Tables A.7.5.1.6.1-1, A.7.5.1.6.1-2 and A.7.5.1.6.1-3 below. There is one cells, cell 1 which is the PCell, in the test. The test consists of five successive time periods, with time duration of T1, T2, T3, T4 and T5 respectively. Figure A.7.5.1.6.1-1 shows the variation of the downlink SNR in the PCell to emulate out-of-sync and in-sync states. Prior to the start of the time duration T1, the UE shall be fully synchronized to cell 1. The UE shall be configured for periodic CSI reporting with a reporting periodicity of 10 ms. In the test, DRX configuration is not enabled. In the test, SSB0 and SSB1 are configured as BFD-RS.

Table A.7.5.1.6.1-1: Supported test configurations for FR2 PCell

Configuration	Description
1	TDD duplex mode, 120 kHz SSB SCS, 100 MHz bandwidth

Table A.7.5.1.6.1-2: General test parameters for FR2 PCell for CSI-RS in-sync testing in non-DRX mode

Parameter		Unit	Value
			Test 1
Active PCell			Cell 1
RF Channel Number			1
Duplex mode	Config 1		TDD
TDD Configuration	Config 1		TDDConf.3.1
$BW_{channel}$	Config 1		100: $N_{RB,c} = 66$
Data RBs allocated	Config 1		24
$BW_{occupied}$	Config 1		24
DL initial BWP configuration	Config 1		DLBWP.0.1
DL dedicated BWP configuration	Config 1		DLBWP.1.4
UL initial BWP configuration	Config 1		ULBWP.0.1
UL dedicated BWP configuration	Config 1		ULBWP.1.4
RMSI CORESET Reference Channel	Config 1		CR.3.1 TDD
Dedicated CORESET Reference Channel	Config 1		CCR.3.1 TDD CCR.3.3 TDD
SSB Configuration	Config 1		SSB.1 FR2
SMTTC Configuration	Config 1		SMTTC.1
PDSCH/PDCCH subcarrier spacing	Config 1		120 KHz
CSI-RS for RLM	Config 1		Resource #4 in TRS.2.1 TDD Resource #4 in TRS.2.2 TDD
TRS configuration			TRS.2.1 TDD TRS.2.2 TDD
TCI configuration for PDCCH#1/PDSCH			TCI.State.2
TCI configuration for PDCCH#2			TCI.State.3
OCNG parameters			OP.5
CP length			Normal
Out of sync transmission parameters	DCI format		1-0
	Number of Control OFDM symbols		2
	Aggregation level	CCE	8
	Ratio of hypothetical PDCCH RE energy to average CSI-RS RE energy	dB	4
	Ratio of hypothetical PDCCH DMRS energy to average CSI-RS RE energy	dB	4
	DMRS precoder granularity		REG bundle size
	REG bundle size		6
In sync transmission parameters	DCI format		1-0
	Number of Control OFDM symbols		2
	Aggregation level	CCE	4

	Ratio of hypothetical PDCCH RE energy to average CSI-RS RE energy	dB	0
	Ratio of hypothetical PDCCH DMRS energy to average CSI-RS RE energy	dB	0
	DMRS precoder granularity		REG bundle size
	REG bundle size		6
DRX			OFF
Gap pattern ID			N.A.
Layer 3 filtering			<i>Enabled</i>
T310 timer		ms	1000
T311 timer		ms	1000
N310			1
N311			1
CSI-RS for CSI reporting	Config 1		CSI-RS.3.1 TDD
reportConfigType			periodic
reportQuantity			cri-RI-PMI-CQI
CSI reporting periodicity		slot	40
CSI reporting offset		slot	4
T1		s	0.2
T2		s	0.2
T3		s	0.24
T4		s	0.2
T5		s	0.88
D1		s	0.84
Note 1: UE-specific PDCCH is not transmitted after T1 starts.			

Table A.7.5.1.6.1-3: Cell specific test parameters for FR2 for CSI-RS in-sync radio link monitoring in non-DRX mode

Parameter	Unit	Test 1									
		T1	T2	T3	T4	T5	T1	T2	T3	T4	T5
AoA setup		Setup 3 defined in A.3.15									
		AoA1					AoA2				
Assumption for UE beams <small>Note 10</small>		Rough					Rough				
EPRE ratio of PDCCH DMRS to SSS	dB	0					Not sent				
EPRE ratio of PDCCH to PDCCH DMRS	dB	0									
EPRE ratio of PBCH DMRS to SSS	dB										
EPRE ratio of PBCH to PBCH DMRS	dB										
EPRE ratio of PSS to SSS	dB										
EPRE ratio of PDSCH DMRS to SSS	dB										
EPRE ratio of PDSCH to PDSCH DMRS	dB										
EPRE ratio of OCNG DMRS to SSS	dB										
EPRE ratio of OCNG to OCNG DMRS	dB										

SNR on RLM-RS1	Config 1	dB	2 ^{Note 11}	-6 ^{Note 11}	-15	-15	-15				
SNR on RLM-RS2	Config 1	dB	Not sent				2 ^{Note 11}	-15	-15	-4.5	2 ^{Note 11}
N_{oc}	Config 1	dBm/15KHz	-92.1				-92.1				
Propagation condition			TDL-C 300ns 100Hz				TDL-C 300ns 100Hz				
<p>Note 1: OCNG shall be used such that the resources in Cell 1 are fully allocated and a constant total transmitted power spectral density is achieved for all OFDM symbols.</p> <p>Note 2: The uplink resources for CSI reporting are assigned to the UE prior to the start of time period T1.</p> <p>Note 3: NZP CSI-RS resource set configuration for CSI reporting are assigned to the UE prior to the start of time period T1.</p> <p>Note 4: Measurement gap configuration is assigned to the UE prior to the start of time period T1.</p> <p>Note 5: The timers and layer 3 filtering related parameters are configured prior to the start of time period T1.</p> <p>Note 6: The signal contains PDCCH for UEs other than the device under test as part of OCNG.</p> <p>Note 7: SNR levels correspond to the signal to noise ratio over the SSS REs.</p> <p>Note 8: The SNR in time periods T1, T2, T3, T4 and T5 is denoted as SNR1, SNR2, SNR3, SNR4 and SNR5 respectively in figure A.7.5.1.6.1-1.</p> <p>Note 9: The SNR values are specified for testing a UE which supports 2RX on at least one band. For testing of a UE which supports 4RX on all bands, the SNR during T3 is A.3.6.</p> <p>Note 10: Information about types of UE beam is given in B.2.1.3 and does not limit UE implementation or test system implementation.</p> <p>Note 11: This value allows up to 1dB degradation from applied SNR to UE baseband</p>											

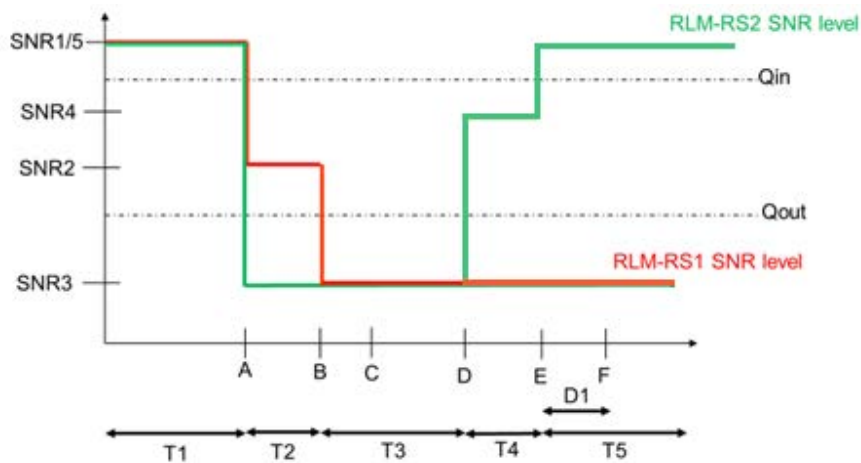

Figure A.7.5.1.6.1-1: SNR variation for CSI-RS in-sync testing

A.7.5.1.6.2 Test Requirements

The UE behaviour in each test during time durations T1, T2, T3, T4 and T5 shall be as follows:

During the period from time point A to time point F (D1 second after the start of time duration T5) the UE shall transmit uplink signal at least in all uplink slots configured for CSI transmission according to the configured periodic CSI reporting on the PCell.

The rate of correct events observed during repeated tests shall be at least 90%.

A.7.5.1.7 Radio Link Monitoring Out-of-sync Test for FR2 PCell configured with CSI-RS-based RLM in DRX mode

A.7.5.1.7.1 Test Purpose and Environment

The purpose of this test is to verify that the UE properly detects the out of sync for the purpose of monitoring downlink CSI-RS based radio link quality of the PCell when DRX is used. This test will partly verify the FR2 PCell CSI-RS Out-of-sync radio link monitoring requirements in clause 8.1.

The test parameters are given in Tables A.7.5.1.7.1-1, A.7.5.1.7.1-2, and A.7.5.1.7.1-3 below. There is one cell, cell 1 is the PCell, in the test. The test consists of three successive time periods, with time duration of T1, T2 and T3 respectively. Figure A.7.5.1.7.1-1 shows the variation of the downlink SNR in the PCell to emulate out-of-sync and in-sync states. Prior to the start of the time duration T1, the UE shall be fully synchronized to cell 1. The UE shall be configured for periodic CSI reporting with a reporting periodicity of 10 ms. In the test, DRX configuration is enabled in PCell and DRX inactivity timer has already been expired, i.e. UE tries to decode PDCCH and to send periodic CQI during the period when On-duration timer is running. Time alignment timers shall be set to “infinity” so that UL timing alignment is maintained during the test. In the test, SSB0 and SSB1 are configured as BFD-RS.

Table A.7.5.1.7.1-1: Supported test configurations for FR2 PCell

Configuration	Description
1	TDD duplex mode, 120 kHz SSB SCS, 100 MHz bandwidth

Table A.7.5.1.7.1-2: General test parameters for FR2 PCell for CSI-RS out-of-sync testing in DRX mode

Parameter		Unit	Value
			Test 1
Active PCell			Cell 1
RF Channel Number			1
Duplex mode	Config 1		TDD
TDD Configuration	Config 1		TDDConf.3.1
DL initial BWP configuration	Config 1		DLBWP.0.1
DL dedicated BWP configuration	Config 1		DLBWP.1.1
UL initial BWP configuration	Config 1		ULBWP.0.1
UL dedicated BWP configuration	Config 1		ULBWP.1.1
RMSI CORESET Reference Channel	Config 1		CR.3.1 TDD
Dedicated CORESET Reference Channel	Config 1		CCR.3.4 TDD CCR.3.6 TDD
SSB Configuration	Config 1		SSB.1 FR2
SMTTC Configuration	Config 1		SMTTC.1
PDSCH/PDCCH subcarrier spacing	Config 1		120 KHz
CSI-RS for RLM	Config 1		Resource #4 in TRS.2.1 TDD Resource #4 in TRS.2.2 TDD
TRS configuration			TRS.2.1 TDD TRS.2.2 TDD
TCI configuration for PDCCH#1/PDSCH			TCI.State.2
TCI configuration for PDCCH#2			TCI.State.3
OCNG parameters			OP.1
CP length			Normal
	DCI format		1-0

Out of sync transmission parameters	Number of Control OFDM symbols		2
	Aggregation level	CCE	8
	Ratio of hypothetical PDCCH RE energy to average CSI-RS RE energy	dB	4
	Ratio of hypothetical PDCCH DMRS energy to average CSI-RS RE energy	dB	4
	DMRS precoder granularity		REG bundle size
	REG bundle size		6
DRX			DRX,3
Gap pattern ID			N.A.
Layer 3 filtering			<i>Enabled</i>
T310 timer		ms	0
T311 timer		ms	1000
N310			1
N311			1
CSI-RS for CSI reporting	Config 1		CSI-RS.3.1 TDD
reportConfigType			periodic
reportQuantity			cri-RI-PMI-CQI
CSI reporting periodicity		slot	40
CSI reporting offset		slot	4
T1		s	0.2
T2		s	1.28
T3		s	1.28
D1		s	1.24
Note 1: UE-specific PDCCH is not transmitted after T1 starts.			

Table A.7.5.1.7.1-3: Cell specific test parameters for FR2 for CSI-RS out-of-sync radio link monitoring in DRX mode

Parameter		Unit	Test 1		
			T1	T2	T3
AoA setup		dB	Setup 1 defined in A.3.15		
Assumption for UE beams ^{Note 10}			Rough		
EPRE ratio of PDCCH DMRS to SSS		dB	4		
EPRE ratio of PDCCH to PDCCH DMRS		dB	0		
EPRE ratio of PBCH DMRS to SSS		dB			
EPRE ratio of PBCH to PBCH DMRS		dB			
EPRE ratio of PSS to SSS		dB			
EPRE ratio of PDSCH DMRS to SSS		dB			
EPRE ratio of PDSCH to PDSCH DMRS		dB			
EPRE ratio of OCNG DMRS to SSS		dB			
EPRE ratio of OCNG to OCNG DMRS		dB			
SNR on RLM-RS1	Config 1	dB	2 ^{Note 11}	-6 ^{Note 11}	-15

SNR on RLM-RS2	Config 1	dB	$2^{Note\ 11}$	-15	-15
N_{oc}	Config 1	dBm/15KHz	-104.7		
Propagation condition		TDL-C 300ns 100Hz			
<p>Note 1: OCNG shall be used such that the resources in Cell 1 are fully allocated and a constant total transmitted power spectral density is achieved for all OFDM symbols.</p> <p>Note 2: The uplink resources for CSI reporting are assigned to the UE prior to the start of time period T1.</p> <p>Note 3: NZP CSI-RS resource set configuration for CSI reporting are assigned to the UE prior to the start of time period T1.</p> <p>Note 4: Measurement gap configuration is assigned to the UE prior to the start of time period T1.</p> <p>Note 5: The timers and layer 3 filtering related parameters are configured prior to the start of time period T1.</p> <p>Note 6: The signal contains PDCCH for UEs other than the device under test as part of OCNG.</p> <p>Note 7: SNR levels correspond to the signal to noise ratio over the SSS REs.</p> <p>Note 8: The SNR in time periods T1, T2 and T3 is denoted as SNR1, SNR2 and SNR3 respectively in figure A.7.5.1.7.1-1.</p> <p>Note 9: The SNR values are specified for testing a UE which supports 2RX on at least one band. For testing of a UE which supports 4RX on all bands, the SNR during T3 is specified in section A.3.6.1.</p> <p>Note 10: Information about types of UE beam is given in B.2.1.3 and does not limit UE implementation or test system implementation.</p> <p>Note 11: This value allows up to 1dB degradation from applied SNR to UE baseband</p>					

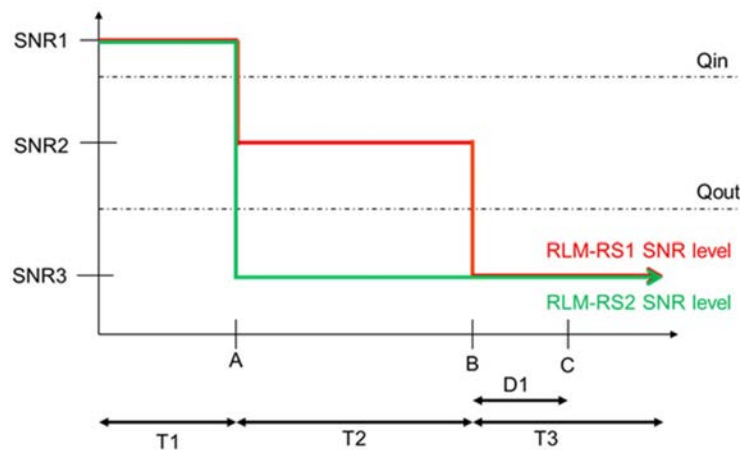

Figure A.7.5.1.7.1-1: SNR variation for CSI-RS out-of-sync testing

A.7.5.1.7.2 Test Requirements

The UE behaviour during time durations T1, T2, and T3 shall be as follows:

During the period from time point A to time point B the UE shall transmit uplink signal in Cell 1 (PCell) at least in all uplink slots configured for CSI transmission according to the configured periodic CSI reporting for Cell 1.

The UE shall stop transmitting uplink signal in Cell 1 (PCell) no later than time point C (D_1 seconds after the start of the time duration T3) on the PCell.

The rate of correct events observed during repeated tests shall be at least 90%.

A.7.5.1.8 Radio Link Monitoring In-sync Test for FR2 PCell configured with CSI-RS-based RLM in DRX mode

A.7.5.1.8.1 Test Purpose and Environment

The purpose of this test is to verify that the UE properly detects the in sync for the purpose of monitoring downlink CSI-RS based radio link quality of the PCell when DRX is used. This test will partly verify the FR2 PCell CSI-RS In-sync radio link monitoring requirements in clause 8.1.

The test parameters are given in Tables A.7.5.1.8.1-1, A.7.5.1.8.1-2, A.7.5.1.8.1-3 and A.7.5.1.8.1-4 below. There is one cells, cell 1 which is the PCell, in the test. The test consists of five successive time periods, with time duration of T1, T2, T3, T4 and T5 respectively. Figure A.7.5.1.8.1-1 shows the variation of the downlink SNR in the PCell to emulate out-of-sync and in-sync states. Prior to the start of the time duration T1, the UE shall be fully synchronized to cell 1. The UE shall be configured for periodic CSI reporting with a reporting periodicity of 10 ms. The UE is configured to perform inter-frequency measurements using GP ID #0 (40ms) in test. In the test, SSB0 and SSB1 are configured as BFD-RS.

Table A.7.5.1.8.1-1: Supported test configurations for FR2 PSCell

Configuration	Description
1	TDD duplex mode, 120 kHz SSB SCS, 100 MHz bandwidth

Table A.7.5.1.8.1-2: General test parameters for FR2 PCell for CSI-RS in-sync testing in non-DRX mode

Parameter		Unit	Value
			Test 1
Active PCell			Cell 1
RF Channel Number			1
Duplex mode	Config 1		TDD
TDD Configuration	Config 1		TDDConf.3.1
DL initial BWP configuration	Config 1		DLBWP.0.1
DL dedicated BWP configuration	Config 1		DLBWP.1.1
UL initial BWP configuration	Config 1		ULBWP.0.1
UL dedicated BWP configuration	Config 1		ULBWP.1.1
RMSI CORESET Reference Channel	Config 1		CR.3.1 TDD
Dedicated CORESET Reference Channel	Config 1		CCR.3.1 TDD CCR.3.3 TDD
SSB Configuration	Config 1		SSB.1 FR2
SMTTC Configuration	Config 1		SMTTC.1
PDSCH/PDCCH subcarrier spacing	Config 1		120 KHz
CSI-RS for RLM	Config 1		Resource #4 in TRS.2.1 TDD Resource #4 in TRS.2.2 TDD
TRS configuration			TRS.2.1 TDD TRS.2.2 TDD
TCI configuration for PDCCH#1/PDSCH			TCI.State.2
TCI configuration for PDCCH#2			TCI.State.3
OCNG parameters			OP.1
CP length			Normal
	DCI format		1-0

Out of sync transmission parameters	Number of Control OFDM symbols		2
	Aggregation level	CCE	8
	Ratio of hypothetical PDCCH RE energy to average CSI-RS RE energy	dB	4
	Ratio of hypothetical PDCCH DMRS energy to average CSI-RS RE energy	dB	4
	DMRS precoder granularity		REG bundle size
	REG bundle size		6
In sync transmission parameters	DCI format		1-0
	Number of Control OFDM symbols		2
	Aggregation level	CCE	4
	Ratio of hypothetical PDCCH RE energy to average CSI-RS RE energy	dB	0
	Ratio of hypothetical PDCCH DMRS energy to average CSI-RS RE energy	dB	0
	DMRS precoder granularity		REG bundle size
	REG bundle size		6
DRX			DRX.3
Gap pattern ID			*gp0
Layer 3 filtering			Enabled
T310 timer	ms		2000
T311 timer	ms		1000
N310			1
N311			1
CSI-RS for CSI reporting	Config 1		CSI-RS.3.1 TDD
reportConfigType			periodic
reportQuantity			cri-RI-PMI-CQI
CSI reporting periodicity	slot		40
CSI reporting offset	slot		4
T1	s		0.2
T2	s		0.2
T3	s		1.64
T4	s		0.2
T5	s		1.88
D1	s		1.84
Note 1: UE-specific PDCCH is not transmitted after T1 starts.			

Table A.7.5.1.8.1-3: Cell specific test parameters for FR2 for CSI-RS in-sync radio link monitoring in non-DRX mode

Parameter	Unit	Test 1				
		T1	T2	T3	T4	T5
AoA setup	dB	Setup 1 defined in A.3.15				
Assumption for UE beams ^{Note 10}		Rough				
EPRE ratio of PDCCH DMRS to SSS	dB	0				
EPRE ratio of PDCCH to PDCCH DMRS	dB	0				
EPRE ratio of PBCH DMRS to SSS	dB					
EPRE ratio of PBCH to PBCH DMRS	dB					

EPRE ratio of PSS to SSS		dB					
EPRE ratio of PDSCH DMRS to SSS		dB					
EPRE ratio of PDSCH to PDSCH DMRS		dB					
EPRE ratio of OCNG DMRS to SSS		dB					
EPRE ratio of OCNG to OCNG DMRS		dB					
SNR on RLM-RS1	Config 1	dB	2 ^{Note 11}	-6 ^{Note 11}	-15	-4.5	2 ^{Note 11}
SNR on RLM-RS2	Config 1	dB	2 ^{Note 11}	-15	-15	-15	-15
N_{oc}	Config 1	dBm/15KHz	-104.7				
Propagation condition		TDL-C 300ns 100Hz					
<p>Note 1: OCNG shall be used such that the resources in Cell 1 are fully allocated and a constant total transmitted power spectral density is achieved for all OFDM symbols.</p> <p>Note 2: The uplink resources for CSI reporting are assigned to the UE prior to the start of time period T1.</p> <p>Note 3: NZP CSI-RS resource set configuration for CSI reporting are assigned to the UE prior to the start of time period T1.</p> <p>Note 4: Measurement gap configuration is assigned to the UE prior to the start of time period T1.</p> <p>Note 5: The timers and layer 3 filtering related parameters are configured prior to the start of time period T1.</p> <p>Note 6: The signal contains PDCCH for UEs other than the device under test as part of OCNG.</p> <p>Note 7: SNR levels correspond to the signal to noise ratio over the SSS REs.</p> <p>Note 8: The SNR in time periods T1, T2, T3, T4 and T5 is denoted as SNR1, SNR2, SNR3, SNR4 and SNR5 respectively in figure A.7.5.1.8.1-1.</p> <p>Note 9: The SNR values are specified for testing a UE which supports 2RX on at least one band. For testing of a UE which supports 4RX on all bands, the SNR during T3 is A.3.6.</p> <p>Note 10: Information about types of UE beams is given in B.2.1.3 and does not limit UE implementation or test system implementation.</p> <p>Note 11: This value allows up to 1dB degradation from applied SNR to UE baseband.</p>							

Table A.7.5.1.8.1-4: Measurement gap configuration for FR2 CSI-RS in-sync radio link monitoring in non-DRX mode

Field	Test 1
	Value
gapOffset	0
Note 1: RLM RS is partially overlapped with measurement gap	

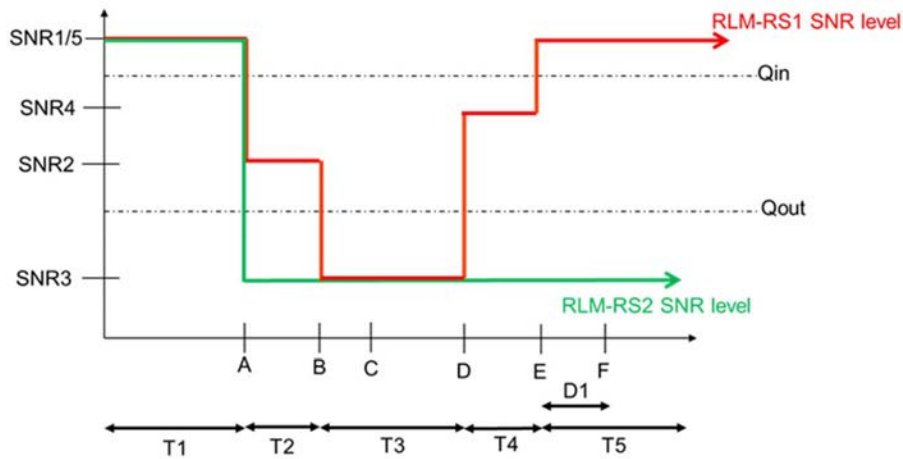

Figure A.7.5.1.8.1-1: SNR variation for CSI-RS in-sync testing

A.7.5.1.8.2 Test Requirements

The UE behaviour in each test during time durations T1, T2, T3, T4 and T5 shall be as follows:

During the period from time point A to time point F (D1 second after the start of time duration T5) the UE shall transmit uplink signal at least in all uplink slots configured for CSI transmission according to the configured periodic CSI reporting on the PCell.

The rate of correct events observed during repeated tests shall be at least 90%.

A.7.5.1.9 UE Radio Link Monitoring Scheduling Restrictions on FR2

A.7.5.1.9.1 Test Purpose and Environment

The purpose is to verify that the NR UE correctly follows the RLM scheduling restrictions requirements defined in clause 8.1.7. This test verifies that the UE correctly receive the PDCCH scheduled on the symbols right before the RLM SSB symbols without overlap so that it sends ACK/NACK correctly. The test case is only applicable to UE which supports pdccch-MonitoringAnyOccasions or pdccch-MonitoringAnyOccasionsWithSpanGap.

The test parameters are given in table A.7.5.1.9.1-1, table A.7.5.1.9.1-2 and table A.7.5.1.9.1-3 below. The UE is required during time period T1 to transmit ACK/NACK correctly upon scheduling of PDSCH.

Table A.7.5.1.9.1-1: Supported test configurations

Configuration	Description
1	120 kHz SSB SCS, 120 kHz RMC SCS, 100 MHz bandwidth, TDD duplex mode

Table A.7.5.1.9.1-2: General test parameters for NR RLM scheduling restriction test case in FR2

Parameter	Unit	Test configuration	Value	Comment
RF Channel Number		1	1	
SSB configuration		1	SSB.1 FR2	
SMTC configuration		1	SMTC pattern 1	
DRX cycle length	s	1	OFF	

T1	s	1	5	During T1 the UE is required to correctly transmit ACK/NACK
----	---	---	---	---

Table A.7.5.1.9.1-3: Cell specific test parameters for NR RLM scheduling restriction test case in FR2

Parameter	Unit	Test configuration	Cell 1	
AoA setup		1	Setup 3 defined in A.3.15.3	
Assumption for UE beams ^{Note 1}			AoA1	AoA2
			Rough	Rough
TDD configuration		1	TDDConf.3.1	
BW _{channel}	MHz	1	100: N _{RB,c} = 66	
Data RBs allocated		1	24	
PDSCH Reference measurement channel		1	SR.3.2 TDD	Not sent
RMSI CORESET RMC configuration		1	CR.3.1 TDD	Not sent
Dedicated CORESET RMC configuration		1	CCR.3.2 TDD	Not sent
TRS configuration		1	TRS.2.1 TDD	TRS.2.2 TDD
PDCCH/PDSCH TCI state		1	TCI.State.2	N/A
OCNG Pattern		1	OP.5 defined in A.3.2.1	Not sent
Initial DL BWP configuration		1	DLBWP.0.1	
Initial UL BWP configuration		1	ULBWP.0.1	
RLM-RS		1	SSB with index 0	SSB with index 1
N_{oc}	dBm/15kHz	1	-92.1	-92.1
N_{oc} ^{Note2}	dBm/SCS	1	-83.1	-83.1
\hat{E}_s / N_{oc}	dB	1	2	2
$\hat{E}_s / I_{\alpha_{BB}}$ ^{Note 4}	dB	1	1	1
SSB_RP ^{Note3}	dBm/SCS	1	-81.1	-81.1
Io	dBm/95.04 MHz	1	-54.35	-54.35
Time multiplexing of the downlink transmissions from each AoA		1	Defined in Figure A.7.5.1.9.1-1	
Propagation Condition		1	AWGN	AWGN
<p>Note 1: Information about types of UE beam is given in B.2.1.3 and does not limit UE implementation or test system implementation.</p> <p>Note 2: Interference from other cells and noise sources not specified in the test is assumed to be constant over subcarriers and time and shall be modelled as AWGN of appropriate power for N_{oc} to be fulfilled.</p> <p>Note 3: Es/I_{ot}, SSB_RP and Io levels have been derived from other parameters for information purposes. They are not settable parameters themselves.</p> <p>Note 4: Calculation of Es/I_{otBB} includes the effect of UE internal noise up to the value assumed for the associated Refsens requirement in clause 7.3.2 of TS 38.101-2 [19], and an allowance of 1dB for UE multi-band relaxation factor ΔM_{Bs} from TS 38.101-2 [19] Table 6.2.1.3-4.</p>				

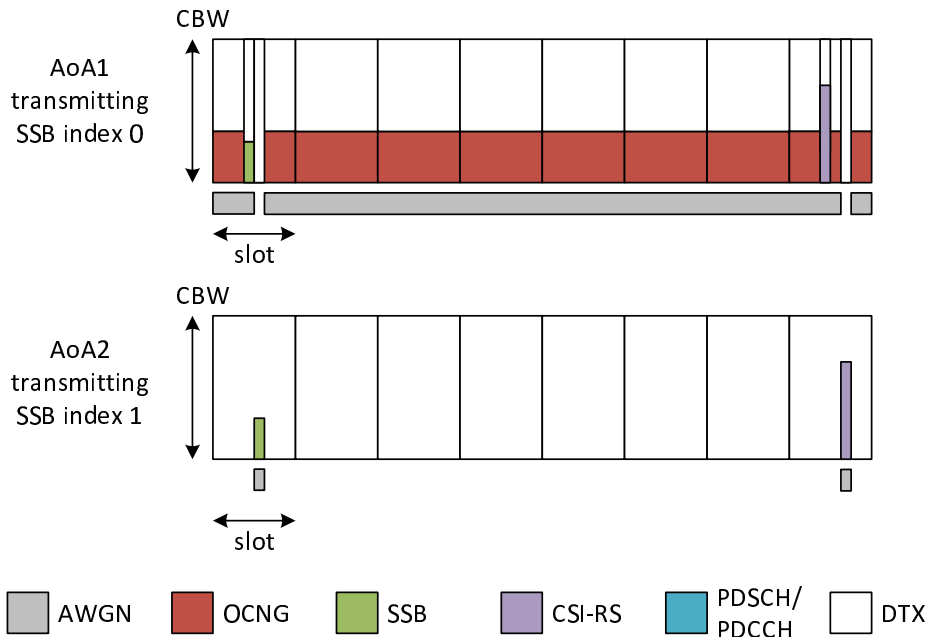

Figure A.7.5.1.9.1-1: Time multiplexed downlink transmissions

A.7.5.1.9.2 Test Requirements

The UE behaviour follows the requirements defined in clause 8.1.7.3.

A.7.5.2 Interruption

A.7.5.2.1 Interruptions during measurements on deactivated NR SCC in FR2

A.7.5.2.1.1 Test Purpose and Environment

The purpose of this test is to verify that the UE missed ACK/NACK rate does not exceed the limits at NR PSCell interruptions during the measurement on the deactivated NR SCC. This test will verify the missed ACK/NACK rate for PCell in standalone NR specified in clause 8.2.2.2. Supported test configurations are shown in table A.7.5.2.1.1-1.

The general test parameters and NR cell specific test parameters are given in Table A.7.5.2.1.1-2 and A.7.5.2.1.1-3 below. In the test there are two cells: Cell1 and Cell2. Cell1 is PCell, Cell2 is an NR deactivated SCell. Cell1 shall be configured as PCell and Cell2 shall be configured as SCell.

The test consists of one time period, with duration of T1. Prior to the start of the time duration T1, the UE is connected to Cell1 and Cell2. The point in time at which the RRC message including *measCycleSCell* or *allowInterruptions* for the deactivated NR SCells is received at the UE antenna connector, defines the start of time period T1. During T1, PCell is continuously scheduled in DL.

Table A.7.5.2.1.1-1: Interruptions during measurements on deactivated NR SCC supported test configurations

Config	Description
1	NR 120 kHz SSB SCS, 100 MHz bandwidth, TDD – TDD duplex mode

Table A.7.5.2.1.1-2: General test parameters for interruptions during measurements on deactivated NR SCC in standalone NR

Parameter	Unit	Value	Comment
RF Channel Number		1, 2	Two NR RF channels
Active PCell		Cell1	PCell on NR RF channel number 1.
Configured deactivated SCell		Cell2	Deactivated SCell on NR RF channel number 2.
CP length		Normal	Applicable to Cell1 and Cell2
DRX		OFF	
Measurement gap pattern Id		OFF	
SCell measurement cycle (measCycleSCell)	ms	640	
T1	s	10	

Table A.7.5.2.1.1-3: NR cell specific test parameters for interruptions during measurements on deactivated NR SCC in standalone NR

Parameter	Unit	Cell1	Cell2
Frequency Range			FR2
Duplex mode			TDD
TDD configuration			TDDConf.3.1
BW _{channel}			100 MHz: N _{RB,c} = 66
Data RBs allocated			66
Initial DL BWP Configuration			DLBWP.0.2 ^{Note4}
Initial UL BWP Configuration			ULBWP.0.2 ^{Note6}
Downlink dedicated BWP Configuration			DLBWP.1.1
Uplink dedicated BWP configuration			ULBWP.1.1
PDSCH Reference measurement channel			SR.3.1 TDD
RMSI CORESET parameters			CR.3.1 TDD
Dedicated CORESET parameters			CCR.3.1 TDD
OCNG Patterns			OP.1
SMTTC Configuration			SMTTC.1
SSB Configuration			SSB.1 FR2
TCI State			TCI.State.0
TRS Configuration			TRS.2.1 TDD
Correlation Matrix and Antenna Configuration			1x2 Low
EPRE ratio of PSS to SSS	dB	0	0
EPRE ratio of PBCH DMRS to SSS			
EPRE ratio of PBCH to PBCH DMRS			
EPRE ratio of PDCCH DMRS to SSS			
EPRE ratio of PDCCH to PDCCH DMRS			
EPRE ratio of PDSCH DMRS to SSS			
EPRE ratio of PDSCH to PDSCH			

EPRE ratio of OCNG DMRS to SSS(Note 1)			
EPRE ratio of OCNG to OCNG DMRS (Note 1)			
Time offset to Cell1 ^{Note 3}	μs	-	3
Propagation Condition		AWGN	
Note 1: OCNG shall be used such that both cells are fully allocated and a constant total transmitted power spectral density is achieved for all OFDM symbols.			
Note 2: Void			
Note 3: Receive time difference between slot boundaries of signals received from the two cells at the UE antenna connector including time alignment error between the two cells.			
Note 4: For unpaired spectrum, a DL BWP is linked with an UL BWP. DLBWP.0.2 is linked with ULBWP.0.2 defined in clause 12 of of TS 38.213 [3].			

Table A.7.5.2.1.1-4: OTA related test parameters for interruptions during measurements on deactivated NR SCC in standalone NR

Parameter		Unit	Cell 1	Cell 2
Angle of arrival configuration			Setup1 according to table A.3.15.1	Setup 1 according to table A.3.15.1
Assumption for UE beams ^{Note 6}			Rough	Rough
N_{oc} ^{Note1}	NR_TDD_FR2_A	dBm/15kHz	-104.7	-104.7
	NR_TDD_FR2_B			
	NR_TDD_FR2_F			
	NR_TDD_FR2_G			
	NR_TDD_FR2_T			
N_{oc} ^{Note1}	NR_TDD_FR2_A	dBm/SCS	-95.7	-95.7
	NR_TDD_FR2_B			
	NR_TDD_FR2_F			
	NR_TDD_FR2_G			
	NR_TDD_FR2_T			
SS-RSRP ^{Note2}	NR_TDD_FR2_A	dBm/120KH z ^{Note3}	-88.7	-88.7
	NR_TDD_FR2_B			
	NR_TDD_FR2_F			
	NR_TDD_FR2_G			
	NR_TDD_FR2_T			
\hat{E}_s/N_{oc}		dB	7	7
\hat{E}_s/I_{ot}		dB	7	7
I_o ^{Note2}	NR_TDD_FR2_A	dBm/95.04 MHz ^{Note4}	-58.92	-58.92
	NR_TDD_FR2_B			
	NR_TDD_FR2_F			
	NR_TDD_FR2_G			
	NR_TDD_FR2_T			
Note 1: Interference from other cells and noise sources not specified in the test is assumed to be constant over subcarriers and time and shall be modelled as AWGN of appropriate power for N_{oc} to be fulfilled.				
Note 2: SS-RSRP and I_o levels have been derived from other parameters for information purposes. They are not settable parameters themselves.				
Note 3: SS-RSRP minimum requirements are specified assuming independent interference and noise at each receiver antenna port.				
Note 4: Equivalent power received by an antenna with 0 dBi gain at the centre of the quiet zone				
Note 5: As observed with 0 dBi gain antenna at the centre of the quiet zone				

Note 6: Information about types of UE beams is given in B.2.1.3 and does not limit UE implementation or test system implementation.

A.7.5.2.1.2 Test Requirements

The UE shall be continuously scheduled on PCell during the entire length of T1. During the time duration T1 the UE shall transmit at least 99.5% of ACK/NACK on PCell.

If the NR PCell is not in the same band as the deactivated SCell, the UE is only allowed to cause interruptions on NR PCell immediately before and immediately after an SMTC. Each interruption on NR PCell shall not exceed the value defined in Table A.7.5.2.1.2-1.

If the NR PCell is in the same band as the deactivated SCell, the UE is only allowed to cause an interruption on PCell no earlier than 4 slots before an SMTC and no later than 4 slots after the SMTC. The interruption on NR PCell shall not exceed the value defined in Table A.7.5.2.1.2-2.

Table A.7.5.2.1.2-1: Interruption duration if the PCell is not in the same band as the deactivated SCell

μ	NR Slot length (ms)	Interruption length (slot)
3	0.125	4

Table A.7.5.2.1.2-2: Interruption duration if the PCell is in the same band as the deactivated SCell

μ	NR Slot length (ms)	Interruption length (slot)
3	0.125	8 + SMTC duration

The rate of correct events observed during repeated tests shall be at least 90%.

A.7.5.3 SCell Activation and Deactivation Delay

A.7.5.3.1 SCell Activation and deactivation for SCell in FR2 intra-band in non-DRX

A.7.5.3.1.1 Test Purpose and Environment

The purpose of this test case is the same as for the test defined in clause A.6.5.3.1.1 except the PCell and SCell are in FR2 intra-band.

The supported test configurations are shown in table A.7.5.3.1.1-1 below. The general test parameters are the same as defined in Table A.6.5.3.1.1-2 except those described in Tables A.7.5.3.1.1-2, and cell specific test parameters are described in Tables A.7.5.3.1.1-3. OTA related test parameters are shown in table A.7.5.3.1.1-4 below.

Table A.7.5.3.1.1-1: Supported test configurations for FR2 SCell activation case

Configuration	Description
1	NR 120 kHz SSB SCS, 100MHz bandwidth, TDD duplex mode

Table A.7.5.3.1.1-2: General test parameters for FR2 SCell activation case

Parameter	Unit	Value	Comment
-----------	------	-------	---------

RF Channel Number		1,2	Two NR radio channels are used for this test, cell 1 and cell2 use RF channel 1 and 2, respectively.
-------------------	--	-----	--

Table A.7.5.3.1.1-3: Cell specific test parameters for FR2 SCell activation case

Parameter ^{Note 5}	Unit	Cell 1			Cell 2		
		T1	T2	T3	T1	T2	T3
SSB ARFCN		freq1			freq2		
Duplex mode		TDD					
TDD configuration		TDDConf.3.1					
Downlink initial BWP Configuration		DLBWP.0.1					
Downlink dedicated BWP Configuration		DLBWP.1.1					
Uplink initial BWP configuration		ULBWP.0.1					
Uplink dedicated BWP configuration		ULBWP.1.1					
TRS configuration		TRS.2.1 TDD					
TCI state		TCI.State.0					
BW _{channel}	MHz	100: N _{RB,c} = 66					
Data RBs allocated		66			66		
PDSCH Reference measurement channel		SR.3.1 TDD			-		
RMSI CORESET Parameters		CR.3.1 TDD			-		
Dedicated CORESET Parameters		CCR.3.1 TDD			-		
OCNG Patterns		OP.1					
SSB Configuration		SSB.1 FR2					
SMTc Configuration		SMTc.1					
CSI-RS configuration for CSI reporting		CSI-RS.3.1 TDD					
reportConfigType		periodic			N/A		
reportQuantity		cri-RI-PMI-CQI			N/A		
CSI reporting periodicity	slot	40			N/A		
CSI reporting offset	slot	4			N/A		
EPRE ratio of PSS to SSS	dB	0					
EPRE ratio of PBCH_DMRS to SSS							
EPRE ratio of PBCH to PBCH_DMRS							
EPRE ratio of PDCCH_DMRS to SSS							
EPRE ratio of PDCCH to PDCCH_DMRS							
EPRE ratio of PDSCH_DMRS to SSS							
EPRE ratio of PDSCH to PDSCH_DMRS							
EPRE ratio of OCNG DMRS to SSS ^{Note 1}							
EPRE ratio of OCNG to OCNG DMRS ^{Note 1}							
Propagation conditions		AWGN					
<p>Note 1: OCNG shall be used such that both cells are fully allocated and a constant total transmitted power spectral density is achieved for all OFDM symbols.</p> <p>Note 2: Void</p> <p>Note 3: Void</p> <p>Note 4: Void</p> <p>Note 5: Void</p>							

Table A.7.5.3.1.1-4: OTA related test parameters for FR2 SCell activation case

Parameter	Unit	Cell 1			Cell 2		
		T1	T2	T3	T1	T2	T3
Angle of arrival configuration		Setup 1 according to table A.3.15.1			Setup 1 according to table A.3.15.1		
Assumption for UE beams ^{Note 7}		Rough			Rough		
N_{ec} ^{Note1}	$\text{dBm}/15\text{kHz}^{\text{ote4}}$	-104.7			-104.7		

N_{oc} ^{Note1}	dBm/SCS ₃ ^{Note3}	-95.7	-95.7
\hat{E}_s/N_{oc}	dB	7	7
SSB_RP ^{Note2}	dBm/SCS _{Note4}	-88.7	-88.7
\hat{E}_s/I_{ot}	dB	7	7
I_o ^{Note2}	dBm/95.04 MHz _{Note4}	-58.92	-58.92
<p>Note 1: Interference from other cells and noise sources not specified in the test is assumed to be constant over subcarriers and time and shall be modelled as AWGN of appropriate power for N_{oc} to be fulfilled.</p> <p>Note 2: E_s/I_{ot}, SSB_RP and I_o levels have been derived from other parameters for information purposes. They are not settable parameters themselves.</p> <p>Note 3: Void</p> <p>Note 4: Equivalent power received by an antenna with 0dBi gain at the centre of the quiet zone</p> <p>Note 5: Void</p> <p>Note 6: Void</p> <p>Note 7: Implementation about types of UE beam is given in B.2.1.3 and does not limit UE implementation or test system implementation.</p>			

A.7.5.3.1.2 Test Requirements

The test requirements defined in clause A.6.5.3.1.2 shall apply to this test case, except $T_{activation_time}$ will be replaced with the value $T_{FirstSSB} + 5ms$ as defined in clause 8.3.

A.7.5.3.2 SCell Activation and deactivation for FR1+FR2 inter-band with target SCell in FR2

A.7.5.3.2.1 Test Purpose and Environment

The purpose of this test case is the same as for the test defined in clause A.7.5.3.1.1 except the PCell is in FR1 and SCell is in FR2.

The supported test configurations are defined in Table A.7.5.3.2.1-1. The general test parameters are the same as defined in Table A.6.5.3.1.1-2 except that the length of T2 is 2s. And cell specific test parameters are described in Tables A.7.5.3.2.1-2. OTA related test parameters are defined in Table A.7.5.3.2.1-3.

At the beginning of T1 the UE receives an RRC message by which the SCell (Cell 2) becomes configured on NR. During T1 the SCell is powered off and UE is not aware of SCell.

A MAC message for activation of SCell is sent by the test equipment 100ms after the RRC message, in a slot # denoted m. The point in time at which the MAC message for activation of SCell is received at the UE antenna connector defines the start of time period T2.

During T2, the test equipment monitors the L1-RSRP measurement reporting for the SCell. The time when test equipment receives a valid L1-RSRP report is denoted as slot $m+T_{L1-RSRP}$. In the next DL slot after slot $m+T_{L1-RSRP}$, the test equipment sends a MAC message for the activation of the TCI state of the RMC CORESET of the SCell. In the same slot, the test equipment also sends an RRC message to configure the CSI-RS resources for SCell.

Time period T3 starts when a MAC message for deactivation of the SCell, sent from the test equipment to the UE in a slot # denoted n, is received at the UE antenna connector.

The test equipment verifies that potential interruption is carried out in the correct time span by monitoring ACK/NACK sent in PCell and PCell during activation of SCell, respectively.

The test equipment verifies the activation time by counting the slots from the time when the SCell activation command is sent until a CSI report with other than CQI index 0 is received.

The test equipment verifies the deactivation time by counting the slots from the time when the SCell1 deactivation command is sent until CSI reporting for SCell1 is discontinued.

Table A.7.5.3.2.1-1: Supported test configurations for FR2 SCell activation case

Configuration	Description
1	PCell: 15 kHz SSB SCS, 10MHz bandwidth, FDD duplex mode Target SCell: 120 kHz SSB SCS, 100MHz bandwidth, TDD duplex mode
2	PCell: 15 kHz SSB SCS, 10MHz bandwidth, TDD duplex mode Target SCell: 120 kHz SSB SCS, 100MHz bandwidth, TDD duplex mode
3	PCell: 30kHz SSB SCS, 40MHz bandwidth, TDD duplex mode Target SCell: 120 kHz SSB SCS, 100MHz bandwidth, TDD duplex mode
Note: The UE is only required to pass in one of the supported test configurations	

Table A.7.5.3.2.1-2: Cell specific test parameters for FR2 SCell activation case

Parameter ^{Note 5}	Unit	Cell 1			Cell 2		
		T1	T2	T3	T1	T2	T3
SSB ARFCN		Freq1			Freq2		
Duplex mode	Config 1	FDD			TDD		
	Config 2,3	TDD					
TDD configuration	Config 1	Not Applicable			TDDConf.3.1		
	Config 2	TDDConf.1.1					
	Config 3	TDDConf.2.1					
Downlink initial BWP Configuration	Config 1,2,3	DLBWP.0.1					
Downlink dedicated BWP Configuration	Config 1,2,3	DLBWP.1.1					
Uplink initial BWP configuration	Config 1,2,3	ULBWP.0.1					
Uplink dedicated BWP configuration	Config 1,2,3	ULBWP.1.1					
TRS configuration	Config 1,2,3	N/A			TRS.2.1 TDD		
TCI state	Config 1,2,3	TCI.State.0					
BW _{channel}	Config 1,2	10: N _{RB,c} = 52			100: N _{RB,c} = 66		
	Config 3	40: N _{RB,c} = 106					
Data RBs allocated	Config 1,2	52	66	52	66	52	66
	Config 3	106		106		106	
PDSCH Reference measurement channel	Config 1	SR.1.1 FDD			-		
	Config 2	SR.1.1 TDD					
	Config 3	SR.2.1 TDD					
RMSI CORESET Parameters	Config 1	CR.1.1 FDD			-		
	Config 2	CR.1.1 TDD					
	Config 3	CR.2.1 TDD					
Dedicated CORESET Parameters	Config 1	CCR.1.1 FDD			-		
	Config 2	CCR.1.1 TDD					
	Config 3	CCR.2.1 TDD					
OCNG Patterns		OP.1					
SSB configuration	Config 1,2	SSB.1 FR1			SSB.3 FR2		
	Config 3	SSB.2 FR1					
CSI-RS configuration for CSI reporting	Config 1~3	N/A			N/A	CSI-RS.3.1 TDD ^{Note 6}	CSI-RS.3.1 TDD
reportConfigType for CSI reporting		periodic			N/A		
reportConfigType for L1-RSRP		periodic			N/A		

reportQuantity for CSI reporting			cri-RI-PMI-CQI	N/A
reportQuantity for L1-RSRP			ssb-Index-RSRP	N/A
CSI reporting periodicity	Config 1,2	slot	5	N/A
	Config 3		10	
L1-RSRP reporting periodicity ^{Note 7}	Config 1,2	slot	5	N/A
	Config 3		10	
CSI reporting offset	Config 1,2	slot	2	N/A
	Config 3		4	
L1-RSRP reporting offset	Config 1,2	slot	2	N/A
	Config 3		4	
SMTC configuration			SMTC.1	
EPRE ratio of PSS to SSS		dB	0	
EPRE ratio of PBCH_DMRS to SSS				
EPRE ratio of PBCH to PBCH_DMRS				
EPRE ratio of PDCCH_DMRS to SSS				
EPRE ratio of PDCCH to PDCCH_DMRS				
EPRE ratio of PDSCH_DMRS to SSS				
EPRE ratio of PDSCH to PDSCH_DMRS				
EPRE ratio of OCNG DMRS to SSS ^{Note 1}				
EPRE ratio of OCNG to OCNG DMRS ^{Note 1}				
Propagation conditions			N/A Link only, see clause A.3.7A	AWGN
<p>Note 1: OCNG shall be used such that both cells are fully allocated and a constant total transmitted power spectral density is achieved for all OFDM symbols.</p> <p>Note 2: Void</p> <p>Note 3: Void</p> <p>Note 4: Void</p> <p>Note 5: All parameters apply for configuration 1 and 2.</p> <p>Note 6: CSI-RS for CSI measurement is (re)configured in the next DL slot after slot $m+T_{L1-RSRP}$ during T2.</p> <p>Note 7: L1-RSRP measurement and reporting are configured to the the UE prior to the start of time period T1.</p>				

Table A.7.5.3.2.1-3: OTA related test parameters for FR1 PCell activation case with FR2 SCell

Parameter	Unit	Cell 1			Cell 2			
		T1	T2	T3	T1	T2	T3	
Angle of arrival configuration		N/A			According to clause A.3.15.1			
Assumption for UE beams ^{Note 7}		N/A			Rough			
N_{oc} ^{Note 1}	Config 1,2,3	dBm/15kHz	Link only, see clause A.3.7A			-104.7		
N_{oc} ^{Note 1}	Config 1,2,3					-95.7		
\hat{E}_s/N_{oc}	Config 1,2,3					-∞	7	7
$\epsilon_{s, \text{max}}$	Config 1,2,3					-∞	7	7
SSB_RP ^{Note 2, Note 4}	Config 1,2,3					-∞	-88.7	-88.7
I_o ^{Note 2, Note 4}	Config 1,2,3					-66.68	-58.92	-58.92
<p>Note 1: Interference from other cells and noise sources not specified in the test is assumed to be constant over subcarriers and time and shall be modelled as AWGN of appropriate power for N_{oc} to be fulfilled.</p> <p>Note 2: E_s/lot, SSB_RP and I_o levels have been derived from other parameters for information purposes. They are not settable parameters themselves.</p>								

Note 3:	Void
Note 4:	Equivalent power received by an antenna with 0dBi gain at the centre of the quiet zone
Note 5:	Void
Note 6:	Void
Note 7:	Information about types of UE beam is given in B.2.1.3 and does not limit UE implementation or test system implementation.

A.7.5.3.2.2 Test Requirements

During T2 the UE shall send the first CSI report for SCell in the first available uplink resource after at least one CSI-RS transmission occasion for channel measurement plus n_{CSI_ref} slots, as defined in 5.2.2.5 in [26], and reporting after slot $(m+k)$. UE is allowed to postpone CSI report to next available UL resource if an available uplink resource is subject to interruption. Whether CSI report in a slot was interrupted is checked by monitoring ACK/NACK sent in PCell in the slot.

During T2 the UE shall start sending valid L1-RSRP report for the SCell in the configured slots for CSI reporting after slot $(m+T_{L1-RSRP})$, where $T_{L1-RSRP}$ is no larger than

$$3\text{ms} + T_{\text{FirstSSB_MAX}} + 15 * T_{\text{SMTC_MAX}} + 8 * T_{\text{TS}} + T_{L1-RSRP, \text{measure}} + T_{L1-RSRP, \text{report}}$$

as defined in clause 8.3.2. For this test case, $T_{\text{FirstSSB_MAX}}=T_{\text{SMTC_MAX}}=T_{\text{TS}}=20\text{ms}$; $T_{L1-RSRP, \text{measure}}=160\text{ms}$ and $T_{L1-RSRP, \text{report}}=5\text{ms}$, which allows $T_{L1-RSRP}$ 680 ms.

During T2 the UE shall start sending CSI reports for the SCell with non-zero CQI index in the configured slots for CSI reporting no later than slot $m + \frac{T_{\text{HARQ}} + T_{\text{activation_time}} + T_{\text{CSI_Reporting}}}{NR \text{ slot length}}$, where

- T_{HARQ} is defined in Table A.5.5.3.1.1-2

- $T_{\text{activation_time}} = 3\text{ms} + T_{\text{FirstSSB_MAX}} + 15 * T_{\text{SMTC_MAX}} + 8 * T_{\text{TS}} + T_{L1-RSRP, \text{measure}} + T_{L1-RSRP, \text{report}} + \max \{ (T_{\text{HARQ}} + T_{\text{uncertainty_MAC}} + 5\text{ms} + T_{\text{FineTiming}}), (T_{\text{uncertainty_RRC}} + T_{\text{RRC_delay}}) \}$, which allows 710 ms

- $T_{\text{CSI_Reporting}} = 10\text{ms}$

- NR slot length is 0.125ms for this test case.

During T3 the UE shall stop sending CSI reports for both SCells no later than slot $n + \frac{T_{\text{HARQ}} + 3\text{ms}}{NR \text{ slot length}}$, as defined in clause 8.3.

During T2 interruption of PCell during SCell activation shall not happen outside the slot $m + 1 + \frac{T_{\text{HARQ}}}{NR \text{ slot length}}$ to $m + 1 + \frac{T_{\text{HARQ}} + 3\text{ms} + T_X}{NR \text{ slot length}}$, as defined in clause 8.3, where $T_X=20\text{ms}$.

During T3 the starting point of interruption of PCell during SCell deactivation shall not happen outside the slot $n + 1 + \frac{T_{\text{HARQ}}}{NR \text{ slot length}}$ to $n + 1 + \frac{T_{\text{HARQ}} + 3\text{ms}}{NR \text{ slot length}}$, as defined in clause 8.3.

The interruption of PCell due to activation of SCell shall not be more than the values specified for SA in Clause 8.2.2.2.7.

A.7.5.4 Void

A.7.5.5 Beam Failure Detection and Link recovery procedures

A.7.5.5.1 Beam Failure Detection and Link Recovery Test for FR2 PCell configured with SSB-based BFD and LR in non-DRX mode

A.7.5.5.1.1 Test Purpose and Environment

The purpose of this test is to verify that the UE properly detects SSB-based beam failure in the set q_0 configured for a serving cell and that the UE performs correct SSB-based link recovery based on beam candidate set q_1 . The purpose is to test the downlink monitoring for beam failure detection within the UEs active DL BWP, during the evaluation period, and link recovery, when no DRX is used. This test will partly verify the SSB based beam failure detection and link recovery for an FR2 serving cell requirements in clause 8.5.

The test parameters are given in Tables A.7.5.5.1.1-1, A.7.5.5.1.1-2, A.7.5.5.1.1-3 and A.7.5.5.1.1-4 below. There is one cell, cell 1 which is the active cell, in the test. The test consists of five successive time periods, with time duration of T1, T2, T3, T4 and T5 respectively. Figure A.7.5.5.1.1-1 shows the variation of the downlink SNR of the SSB in set q_0 in the active cell to emulate SSB based beam failure. Figure A.7.5.5.1.1-2 shows the variation of the downlink L1-RSRP of the SSB in set q_1 of the candidate beam used for link recovery. Prior to the start of the time duration T1, the UE shall be fully synchronized to cell 1. The UE shall be configured for periodic CSI reporting with a reporting periodicity of 5 ms. In the test, DRX configuration is not enabled. The UE is configured to perform inter-frequency measurements using GP ID #0 (40ms) in test 1.

Table A.7.5.5.1.1-1: Supported test configurations for FR2 PCell

Configuration	Description
1	TDD duplex mode, 120 kHz SSB SCS, 100 MHz bandwidth
2	TDD duplex mode, 240 kHz SSB SCS, 100 MHz bandwidth
Note:	The UE is only required to pass in one of the supported test configurations in FR2

Table A.7.5.5.1.1-2: General test parameters for FR2 PCell for SSB-based beam failure detection and link recovery testing in non-DRX mode

Parameter	Test Config.	Unit	Value	Comment
			Test 1	
Active PCell	1-2		Cell 1	
RF Channel Number	1-2		1	
Duplex mode	1-2		TDD	
TDD Configuration	1-2		TDDConf.3.1	
$BW_{channel}$	1-2		100: $N_{RB,c} = 66$	
Data RBs allocated	1-2		66	
PDSCH/PDCCH subcarrier spacing	1-2	kHz	120	
DL initial BWP configuration	1-2		DLBWP.0.1	
DL dedicated BWP configuration	1-2		DLBWP.1.1	
UL initial BWP configuration	1-2		ULBWP.0.1	
UL dedicated BWP configuration	1-2		ULBWP.1.1	
PDSCH Reference Channel	1		SR.3.2 TDD	
	2		SR.3.3 TDD	
RMSI CORESET Reference Channel	1		CR.3.1 TDD	
	2		CR.3.2 TDD	
Dedicated CORESET Reference Channel	1		CCR.3.1 TDD	
	2		CCR.3.7 TDD	
OCNG parameters	1-2		OP.1	

CP length	1-2		Normal		
PDSCH/PDCCH TCI state	1-2		TCI.State.0		
CSI-RS for tracking	1-2		TRS.2.1 TDD		
SSB Configuration	1		SSB.1 FR2		
	2		SSB.2 FR2		
SMTC Configuration	1-2		SMTC.3		
PRACH Configuration	1-2		FR2 PRACH configuration 2	A.3.8.3.2	
DRX configuration	1-2		OFF		
SSB index assigned as BFD RS (q_0)	1-2		0		
SSB index assigned as CBD RS (q_1)	1-2		1		
SSB index assigned as RLM RS	1-2		0,1		
Beam failure detection transmission parameters	DCI format	1-2	1-0		
	Number of Control OFDM symbols	1-2	2		
	Aggregation level	1-2	CCE	8	
	Ratio of hypothetical PDCCH RE energy to average SSS RE energy	1-2	dB	0	
	Ratio of hypothetical PDCCH DMRS energy to average SSS RE energy	1-2	dB	0	
	DMRS precoder granularity	1-2		REG bundle size	
	REG bundle size	1-2		6	
Gap pattern ID	1-2		gp0		
gapOffset	1-2	ms	0		
rlmInSyncOutOfSyncThreshold	1-2		absent	Value 0 is applied. (Table 8.1.1-1).	
rsrp-ThresholdSSB	1	dBm/SCS	-95	Threshold used for $Q_{in_LR_SSB}$	
	2		-92		
powerControlOffsetSS	1-2		db0	Used for deriving rsrp-ThresholdCSI-RS	
beamFailureInstanceMaxCount	1-2		n1	see TS 38.321 [7], clause 5.17	
beamFailureDetectionTimer	1-2		pbfd4	see TS 38.321 [7], clause 5.17	
CSI-RS configuration for CSI reporting	1-2		CSI-RS.3.1 TDD		
reportConfigType	1-2		periodic		
reportQuantity	1-2		cri-RI-PMI-CQI		
CSI reporting periodicity	1-2	slot	40		
CSI reporting offset	1-2	slot	4		
T310	1-2	ms	1000		
N310	1-2		2		
T1	1-2	s	1	The UE shall be fully synchronized to cell 1 during T1	
T2	1-2	s	2.61		
T3	1-2	s	1.64		
T4	1-2	s	0		
T5	1-2	s	1.01		
D1	1-2	s	0.97		
Note 1: All configurations are assigned to the UE prior to the start of time period T1.					
Note 2: UE-specific PDCCH is not transmitted after T1 starts.					

Table A.7.5.5.1.1-3: Cell specific test parameters for FR2 PCell for SSB-based beam failure detection and link recovery testing in non-DRX mode

Parameter		Unit	Test 1				
			T1	T2	T3	T4	T5
AoA setup			Setup 1 defined in A.3.15				
Assumption for UE beams ^{Note 10}			Rough				
EPRE ratio of PDCCH DMRS to SSS		dB	0				
EPRE ratio of PDCCH to PDCCH DMRS		dB					
EPRE ratio of PBCH DMRS to SSS		dB					
EPRE ratio of PBCH to PBCH DMRS		dB					
EPRE ratio of PSS to SSS		dB					
EPRE ratio of PDSCH DMRS to SSS		dB					
EPRE ratio of PDSCH to PDSCH DMRS		dB					
EPRE ratio of OCNG DMRS to SSS		dB					
EPRE ratio of OCNG to OCNG DMRS		dB					
SNR_SSB of set q_0	Config 1-2	dB	5 ^{Note 11}	-3 ^{Note 11}	-12	-12	-12
SNR_SSB of set q_1	Config 1-2	dB	0.2	0.2	20.2	20.2	20.2
SSB_RP of set q_1	Config 1	dBm/SCS	-104.5	-104.5	-84.5	-84.5	-84.5
	Config 2	SCS	-101.5	-101.5	-81.5	-81.5	-81.5
N_{oc}	Config 1,2	dBm/120 KHz	-104.7				
Propagation condition			TDL-A 30ns 75Hz				
<p>Note 1: OCNG shall be used such that the resources in Cell 1 are fully allocated and a constant total transmitted power spectral density is achieved for all OFDM symbols.</p> <p>Note 2: The uplink resources for CSI reporting are assigned to the UE prior to the start of time period T1.</p> <p>Note 3: NZP CSI-RS resource set configuration for CSI reporting are assigned to the UE prior to the start of time period T1.</p> <p>Note 4: Measurement gap configuration is assigned to the UE prior to the start of time period T1.</p> <p>Note 5: The timers and layer 3 filtering related parameters are configured prior to the start of time period T1.</p> <p>Note 6: The signal contains PDCCH for UEs other than the device under test as part of OCNG.</p> <p>Note 7: SNR levels correspond to the signal to noise ratio over the SSS REs.</p> <p>Note 8: The SNR in time periods T1, T2, T3, T4 and T5 is denoted as SNR1, SNR2 and SNR3 respectively in figure A.7.5.5.1.1-1.</p> <p>Note 9: The SNR values are specified for testing a UE which supports 2RX on at least one band. For testing of a UE which supports 4RX on all bands, the SNR during T3 is modified as specified in clause A.3.6.</p> <p>Note 10: Information about types of UE beam is given in B.2.1.3 and does not limit UE implementation or test system implementation.</p> <p>Note 11: This value allows up to 1dB degradation from applied SNR to UE baseband</p>							

Table A.7.5.5.1.1-4: Void

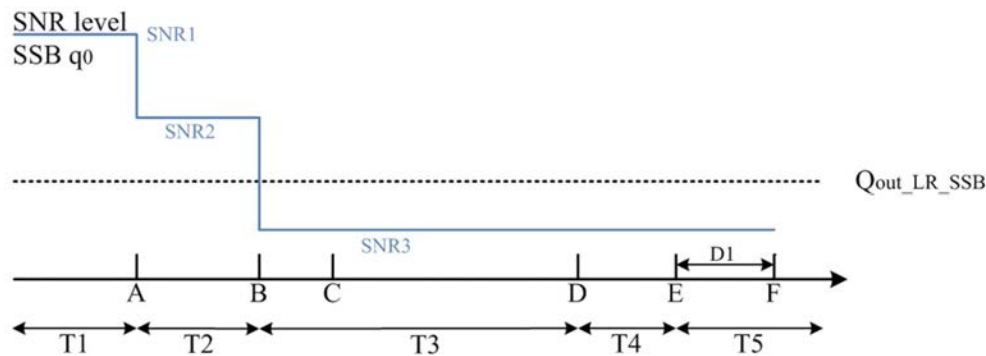

Figure A.7.5.5.1.1-1: SNR variation for SSB-based beam failure detection and link recovery testing in non-DRX mode

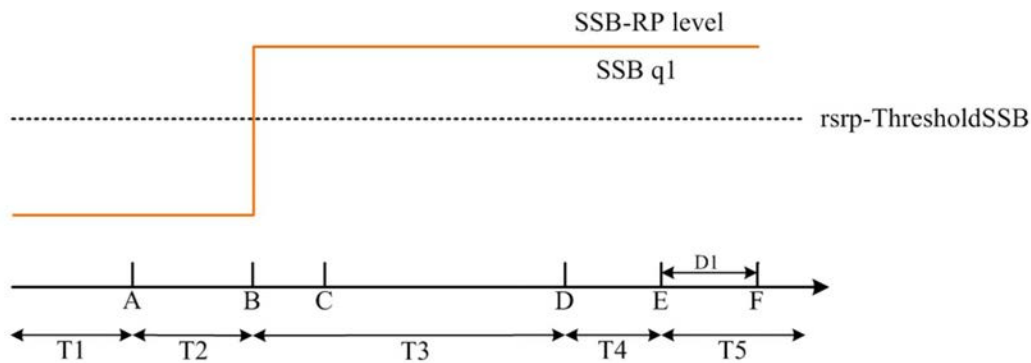

Figure A.7.5.5.1.1-2: SSB_RP level variation for SSB-based beam failure detection and link recovery testing in non-DRX mode

A.7.5.5.1.2 Test Requirements

The UE behaviour during time durations T1, T2, T3, T4 and T5 shall be as follows:

During the time duration T1 and T2, the UE shall transmit uplink signal at least in all subframes configured for CSI transmission on Cell 1.

During the period from time point A to time point B the UE shall transmit uplink signal in Cell 1 in all uplink slots configured for CSI transmission according to the configured periodic CSI reporting for Cell 1.

During T3 the UE shall detect beam failure and initiate link recovery. During T4 and T5 the UE measures and evaluate beam candidate from beam candidate set q_1 .

No later than time point F occurring no later than $D1 = 960 + 10$ ms after the start of T5, the UE shall transmit preamble on a beam associated with the candidate beam set q_1 . The UE shall not transmit preamble on a beam associated with the candidate beam set q_1 earlier than time point B.

Test is concluded once the test equipment has received the initial preamble transmission from the UE. The rate of correct events observed during repeated tests shall be at least 90%.

A.7.5.5.2 Beam Failure Detection and Link Recovery Test for FR2 PCell configured with SSB-based BFD and LR in DRX mode

A.7.5.5.2.1 Test Purpose and Environment

The purpose of this test is to verify that the UE properly detects SSB-based beam failure in the set q_0 configured for a serving cell and that the UE performs correct SSB-based link recovery based on beam candidate set q_1 . The purpose is to test the downlink monitoring for beam failure detection within the UEs active DL BWP, during the evaluation period, and link recovery, when DRX is used. This test will partly verify the SSB based beam failure detection and link recovery for an FR2 serving cell requirements in clause 8.5.

The test parameters are given in Tables A.7.5.5.2.1-1, A.7.5.5.2.1-2, A.7.5.5.2.1-3, A.7.5.5.2.1-4 and A.7.5.5.2.1-5 below. There is one cell, cell 1 which is the active cell, in the test. The test consists of five successive time periods, with time duration of T1, T2, T3, T4 and T5 respectively. Figure A.7.5.5.2.1-1 shows the variation of the downlink SNR of the SSB in set q_0 in the active cell to emulate SSB based beam failure. Figure A.7.5.5.2.1-2 shows the variation of the downlink L1-RSRP of the SSB in set q_1 of the candidate beam used for link recovery. Prior to the start of the time duration T1, the UE shall be fully synchronized to cell 1. The UE shall be configured for periodic CSI reporting with a reporting periodicity of 5 ms. In the test, DRX configuration is enabled in PCell and DRX inactivity timer has already been expired, i.e. UE tries to decode PDCCH and to send periodic CQI during the period when On-duration timer is running. Time alignment timers shall be set to “infinity” so that UL timing alignment is maintained during the test.

Table A.7.5.5.2.1-1: Supported test configurations for FR2 PCell

Configuration	Description
1	TDD duplex mode, 120 kHz SSB SCS, 100 MHz bandwidth
2	TDD duplex mode, 240 kHz SSB SCS, 100 MHz bandwidth
Note: The UE is only required to pass in one of the supported test configurations in FR2	

Table A.7.5.5.2.1-2: General test parameters for FR2 PCell for SSB-based beam failure detection and link recovery testing in DRX mode

Parameter	Test Config.	Unit	Value	Comment
			Test 1	
Active PCell	1-2		Cell 1	
RF Channel Number	1-2		1	
Duplex mode	1-2		TDD	
TDD Configuration	1-2		TDDConf.3.1	
BW _{channel}	1-2		100: N _{RB,c} = 66	
Data RBs allocated	1-2		66	
PDSCH/PDCCH subcarrier spacing	1-2	kHz	120	
DL initial BWP configuration	1-2		DLBWP.0.1	
DL dedicated BWP configuration	1-2		DLBWP.1.1	
UL initial BWP configuration	1-2		ULBWP.0.1	
UL dedicated BWP configuration	1-2		ULBWP.1.1	
PDSCH Reference Channel	1		SR.3.2 TDD	
	2		SR.3.3 TDD	
RMSI CORESET Reference Channel	1		CR.3.1 TDD	
	2		CR.3.2 TDD	
Dedicated CORESET Reference Channel	1		CCR.3.1 TDD	
	2		CCR.3.7 TDD	
OCNG parameters	1-2		OP.1	

CP length	1-2		Normal		
PDSCH/PDCCH TCI state	1-2		TCI.State.0		
CSI-RS for tracking	1-2		TRS.2.1 TDD		
SSB Configuration	1		SSB.1 FR2		
	2		SSB.2 FR2		
SMTC Configuration	1-2		SMTC.3		
PRACH Configuration	1-2		FR2 PRACH configuration 2	A.3.8.3.2	
DRX configuration	1-2		DRX.3	A.3.3.3	
SSB index assigned as BFD RS (q_0)	1-2		0		
SSB index assigned as CBD RS (q_1)	1-2		1		
SSB index assigned as RLM RS	1-2		0,1		
Beam failure detection transmission parameters	DCI format	1-2	1-0		
	Number of Control OFDM symbols	1-2	2		
	Aggregation level	1-2	CCE	8	
	Ratio of hypothetical PDCCH RE energy to average SSS RE energy	1-2	dB	0	
	Ratio of hypothetical PDCCH DMRS energy to average SSS RE energy	1-2	dB	0	
	DMRS precoder granularity	1-2		REG bundle size	
	REG bundle size	1-2		6	
Gap pattern ID	1-2		N/A		
rlmInSyncOutOfSyncThreshold	1-2		absent	Value 0 is applied. (Table 8.1.1-1).	
rsrp-ThresholdSSB	1	dBm/SCS	-95	Threshold used for $Q_{in_LR_SSB}$	
	2		-92		
powerControlOffsetSS	1-2		db0	Used for deriving rsrp-ThresholdCSI-RS	
beamFailureInstanceMaxCount	1-2		n1	see TS 38.321 [7], clause 5.17	
beamFailureDetectionTimer	1-2		pbfd4	see TS 38.321 [7], clause 5.17	
CSI-RS configuration for CSI reporting	1-2		CSI-RS.3.1 TDD		
reportConfigType	1-2		periodic		
reportQuantity	1-2		cri-RI-PMI-CQI		
CSI reporting periodicity	1-2	slot	40		
CSI reporting offset	1-2	slot	4		
T310	1-2	ms	1000		
N310	1-2		2		
T1	1-2	s	1	The UE shall be fully synchronized to cell 1 during T1	
T2	1-2	s	3.37		
T3	1-2	s	2.8		
T4	1-2	s	0		
T5	1-2	s	0.61		
D1	1-2	s	0.57		
Note 1: All configurations are assigned to the UE prior to the start of time period T1.					
Note 2: UE-specific PDCCH is not transmitted after T1 starts.					

Table A.7.5.5.2.1-3: Cell specific test parameters for FR2 PCell for SSB-based beam failure detection and link recovery testing in DRX mode

Parameter		Unit	Test 1				
			T1	T2	T3	T4	T5
AoA setup			Setup 1 defined in A.3.15				
Assumption for UE beams ^{Note 10}			Rough				
EPRE ratio of PDCCH DMRS to SSS		dB	0				
EPRE ratio of PDCCH to PDCCH DMRS		dB					
EPRE ratio of PBCH DMRS to SSS		dB					
EPRE ratio of PBCH to PBCH DMRS		dB					
EPRE ratio of PSS to SSS		dB					
EPRE ratio of PDSCH DMRS to SSS		dB					
EPRE ratio of PDSCH to PDSCH DMRS		dB					
EPRE ratio of OCNG DMRS to SSS		dB					
EPRE ratio of OCNG to OCNG DMRS		dB					
SNR_SSB of set q_0	Config 1,2	dB	5 ^{Note 11}	-3 ^{Note 11}	-12	-12	-12
SNR_SSB of set q_1	Config 1-2	dB	0.2	0.2	20.2	20.2	20.2
SSB_RP of set q_1	Config 1	dBm/SCS	-104.5	-104.5	-84.5	-84.5	-84.5
	Config 2		-101.5	-101.5	-81.5	-81.5	-81.5
N_{oc}	Config 1-2	dBm/120 KHz	-104.7				
Propagation condition			TDL-A 30ns 75Hz				
<p>Note 1: OCNG shall be used such that the resources in Cell 1 are fully allocated and a constant total transmitted power spectral density is achieved for all OFDM symbols.</p> <p>Note 2: The uplink resources for CSI reporting are assigned to the UE prior to the start of time period T1.</p> <p>Note 3: NZP CSI-RS resource set configuration for CSI reporting are assigned to the UE prior to the start of time period T1.</p> <p>Note 4: Void</p> <p>Note 5: The timers and layer 3 filtering related parameters are configured prior to the start of time period T1.</p> <p>Note 6: The signal contains PDCCH for UEs other than the device under test as part of OCNG.</p> <p>Note 7: SNR levels correspond to the signal to noise ratio over the SSS REs.</p> <p>Note 8: The SNR in time periods T1, T2, T3, T4 and T5 is denoted as SNR1, SNR2 and SNR3 respectively in figure A.7.5.5.1.1-1.</p> <p>Note 9: The SNR values are specified for testing a UE which supports 2RX on at least one band. For testing of a UE which supports 4RX on all bands, the SNR during T3 is modified as specified in clause A.3.6.</p> <p>Note 10: Information about types of UE beam is given in B.2.1.3 and does not limit UE implementation or test system implementation.</p> <p>Note 11: This value allows up to 1dB degradation from applied SNR to UE baseband.</p>							

Table A.7.5.5.2.1-4: Void

Table A.7.5.5.2.1-5: Void

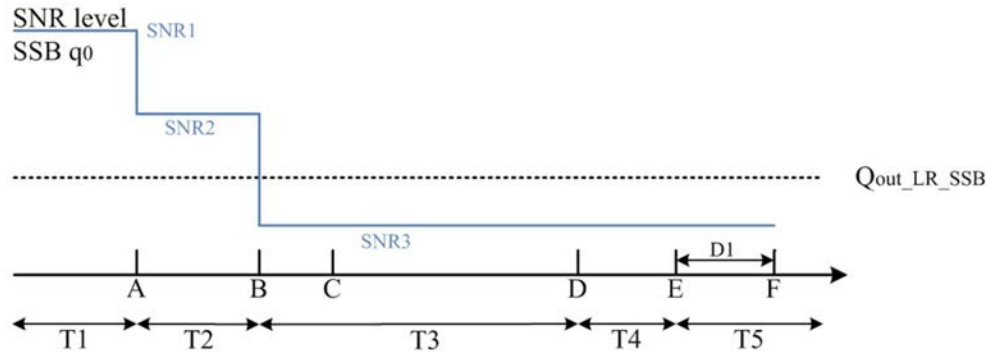

Figure A.7.5.5.2.1-1: SNR variation for SSB-based beam failure detection and link recovery testing in DRX mode

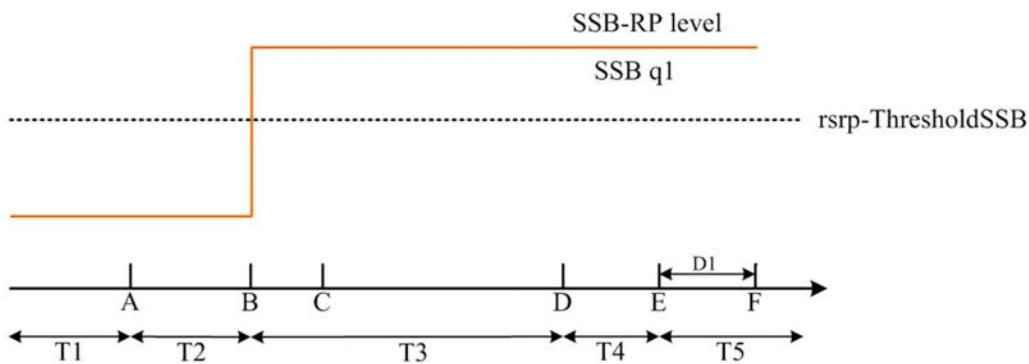

Figure A.7.5.5.2.1-2: SSB_RP level variation for SSB-based beam failure detection and link recovery testing in DRX mode

A.7.5.5.2.2 Test Requirements

The UE behaviour during time durations T1, T2, T3, T4 and T5 shall be as follows:

During the time duration T1 and T2, the UE shall transmit uplink signal at least in all subframes configured for CSI transmission on Cell 1.

During the period from time point A to time point B the UE shall transmit uplink signal in Cell 1 in all uplink slots configured for CSI transmission according to the configured periodic CSI reporting for Cell 1.

During T3 the UE shall detect beam failure and initiate link recovery. During T4 and T5 the UE measures and evaluate beam candidate from beam candidate set q_1 .

No later than time point F occurring no later than $D1 = 560 + 10$ ms after the start of T5, the UE shall transmit preamble on a beam associated with the candidate beam set q_1 . The UE shall not transmit preamble on a beam associated with the candidate beam set q_1 earlier than time point B.

Test is concluded once the test equipment has received the initial preamble transmission from the UE. The rate of correct events observed during repeated tests shall be at least 90%.

A.7.5.5.3 Beam Failure Detection and Link Recovery Test for FR2 PCell configured with CSI-RS-based BFD and LR in non-DRX mode

A.7.5.5.3.1 Test Purpose and Environment

The purpose of this test is to verify that the UE properly detects CSI-RS-based beam failure in the set q_0 configured for a serving cell and that the UE performs correct CSI-RS-based link recovery based on beam candidate set q_1 . The purpose is to test the downlink monitoring for beam failure detection within the UEs active DL BWP, during the evaluation period, and link recovery, when no DRX is used. This test will partly verify the CSI-RS based beam failure detection and link recovery for an FR2 serving cell requirements in clause 8.5.

The test parameters are given in Tables A.7.5.5.3.1-1, A.7.5.5.3.1-2, and A.7.5.5.3.1-3 below. There is one cell, cell 1 which is the active cell, in the test. The test consists of five successive time periods, with time duration of T1, T2, T3, T4 and T5 respectively. Figure A.7.5.5.3.1-1 shows the variation of the downlink SNR of the CSI-RS in set q_0 in the active cell to emulate CSI-RS based beam failure. Figure A.7.5.5.3.1-2 shows the variation of the downlink L1-RSRP of the CSI-RS in set q_1 of the candidate beam used for link recovery. Prior to the start of the time duration T1, the UE shall be fully synchronized to cell 1. The UE shall be configured for periodic CSI reporting with a reporting periodicity of 5 ms. In the test, DRX configuration is not enabled.

Table A.7.5.5.3.1-1: Supported test configurations for FR2 PCell

Configuration	Description
1	TDD duplex mode, 120 kHz SSB SCS, 100 MHz bandwidth

Table A.7.5.5.3.1-2: General test parameters for FR2 PCell for CSI-RS-based beam failure detection and link recovery testing in non-DRX mode

Parameter	Test Config.	Unit	Value	Comment
			Test 1	
Active PCell	1		Cell 1	
RF Channel Number	1		1	
Duplex mode	1		TDD	
TDD Configuration	1		TDDConf.3.1	
BW _{channel}	1		100: N _{RB,c} = 66	
Data RBs allocated	1		66	
PDSCH/PDCCH subcarrier spacing	1	kHz	120	
DL initial BWP configuration	1		DLBWP.0.1	
DL dedicated BWP configuration	1		DLBWP.1.1	
UL initial BWP configuration	1		ULBWP.0.1	
UL dedicated BWP configuration	1		ULBWP.1.1	
PDSCH Reference Channel	1		SR.3.2 TDD	
RMSI CORESET Reference Channel	1		CR.3.1 TDD	
Dedicated CORESET Reference Channel	1		CCR.3.1 TDD	
OCNG parameters	1		OP.1	
CP length	1		Normal	
PDSCH/PDCCH TCI state	1		TCI.State.0	
CSI-RS for tracking	1		TRS.2.1 TDD	
SSB Configuration	1		SSB.1 FR2	
SMTC Configuration	1		SMTC.3	
PRACH Configuration	1		FR2 PRACH configuration 4	A.3.8.3.4
DRX configuration	1		OFF	

CSI-RS configuration for BFD/CBD/RLM		1		CSI-RS.3.2 TDD	A.3.14.2
CSI-RS index assigned as BFD RS (q_0)		1		0	
CSI-RS index assigned as CBD RS (q_1)		1		1	
CSI-RS index assigned as RLM RS		1		0,1	
Beam failure detection transmission parameters	DCI format	1		1-0	
	Number of Control OFDM symbols	1		2	
	Aggregation level	1	CCE	8	
	Ratio of hypothetical PDCCH RE energy to average SSS RE energy	1	dB	0	
	Ratio of hypothetical PDCCH DMRS energy to average SSS RE energy	1	dB	0	
	DMRS precoder granularity	1		REG bundle size	
	REG bundle size	1		6	
Gap pattern ID		1		N/A	
rlmInSyncOutOfSyncThreshold		1		absent	Value 0 is applied. (Table 8.1.1-1).
rsrp-ThresholdSSB		1	dBm/SCS	-95	Threshold used for $Q_{in_LR_SSB}$
powerControlOffsetSS		1		db0	Used for deriving rsrp-ThresholdCSI- RS
beamFailureInstanceMaxCount		1		n1	see TS 38.321 [7], clause 5.17
beamFailureDetectionTimer		1		pbfd4	see TS 38.321 [7], clause 5.17
CSI-RS configuration for CSI reporting		1		CSI-RS.3.1 TDD	A.3.14.2
reportConfigType		1		periodic	
reportQuantity		1		cri-RI-PMI-CQI	
CSI reporting periodicity		1	slot	40	
CSI reporting offset		1	slot	4	
T310		1	ms	1000	
N310		1		2	
T1		1	s	1	The UE shall be fully synchronized to cell 1 during T1
T2		1	s	1.17	
T3		1	s	0.9	
T4		1	s	0	
T5		1	s	0.31	
D1		1	s	0.27	
Note 1: UE-specific PDCCH is not transmitted after T1 starts.					

Table A.7.5.5.3.1-3: Cell specific test parameters for FR2 PCell for CSI-RS-based beam failure detection and link recovery testing in non-DRX mode

Parameter	Unit	Test 1				
		T1	T2	T3	T4	T5
AoA setup		Setup 1 defined in A.3.15				
Assumption for UE beams <small>Note 10</small>		Rough				

EPRE ratio of PDCCH DMRS to SSS	dB	0					
EPRE ratio of PDCCH to PDCCH DMRS	dB						
EPRE ratio of PBCH DMRS to SSS	dB						
EPRE ratio of PBCH to PBCH DMRS	dB						
EPRE ratio of PSS to SSS	dB						
EPRE ratio of PDSCH DMRS to SSS	dB						
EPRE ratio of PDSCH to PDSCH DMRS	dB						
EPRE ratio of OCNG DMRS to SSS	dB						
EPRE ratio of OCNG to OCNG DMRS	dB						
SNR_CSI-RS of set q_0	Config 1	dB	5 ^{Note 11}	-3 ^{Note 11}	-12	-12	-12
SNR_CSI-RS of set q_1	Config 1	dB	0.2	0.2	20.2	20.2	20.2
CSI-RS_RP of set q_1	Config 1	dBm/S CS	-104.5	-104.5	-84.5	-84.5	-84.5
N_{oc}	Config 1	dBm/12 0 KHz	-104.7				
Propagation condition			TDL-A 30ns 75Hz				
<p>Note 1: OCNG shall be used such that the resources in Cell 1 are fully allocated and a constant total transmitted power spectral density is achieved for all OFDM symbols.</p> <p>Note 2: The uplink resources for CSI reporting are assigned to the UE prior to the start of time period T1.</p> <p>Note 3: NZP CSI-RS resource set configuration for CSI reporting are assigned to the UE prior to the start of time period T1.</p> <p>Note 4: Void</p> <p>Note 5: The timers and layer 3 filtering related parameters are configured prior to the start of time period T1.</p> <p>Note 6: The signal contains PDCCH for UEs other than the device under test as part of OCNG.</p> <p>Note 7: SNR levels correspond to the signal to noise ratio over the REs carrying CSI-RS.</p> <p>Note 8: The SNR in time periods T1, T2, T3, T4 and T5 is denoted as SNR1, SNR2 and SNR3 respectively in figure A.7.5.5.3.1-1.</p> <p>Note 9: The SNR values are specified for testing a UE which supports 2RX on at least one band. For testing of a UE which supports 4RX on all bands, the SNR during T3 is modified as specified in clause A.3.6.</p> <p>Note 10: Information about types of UE beam is given in B.2.1.3 and does not limit UE implementation or test system implementation.</p> <p>Note 11: This value allows up to 1dB degradation from applied SNR to UE baseband.</p>							

Table A.7.5.5.3.1-4: Void

Table A.7.5.5.3.1-5: Void

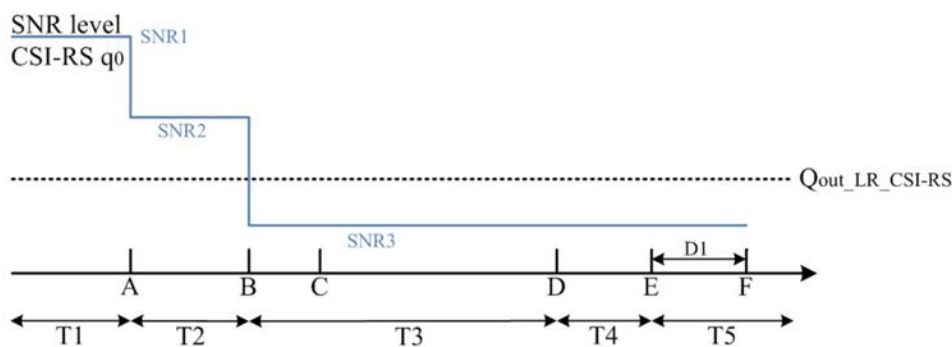

Figure A.7.5.5.3.1-1: SNR variation for CSI-RS based beam failure detection and link recovery testing in non-DRX mode

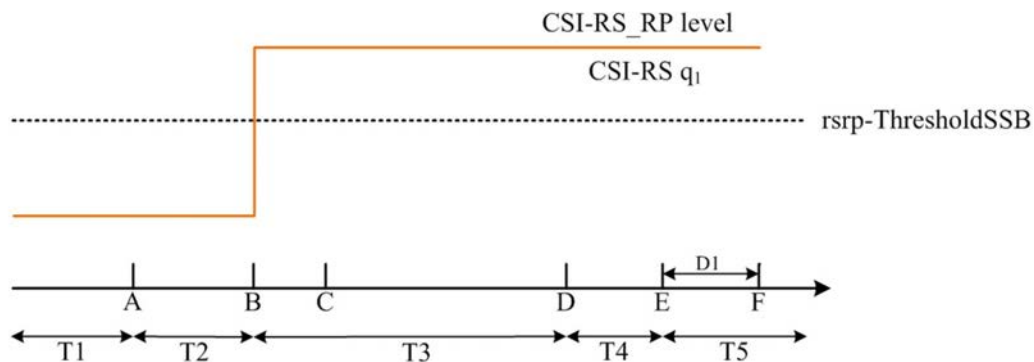

Figure A.7.5.5.3.1-2: CSI-RS_RP level variation for CSI-RS based beam failure detection and link recovery testing in non-DRX mode

A.7.5.5.3.2 Test Requirements

The UE behaviour during time durations T1, T2, T3, T4 and T5 shall be as follows:

During the time duration T1 and T2, the UE shall transmit uplink signal at least in all subframes configured for CSI transmission on Cell 1.

During the period from time point A to time point B the UE shall transmit uplink signal in Cell 1 in all uplink slots configured for CSI transmission according to the configured periodic CSI reporting for Cell 1.

During T3 the shall detect beam failure and initiate link recovery. During T4 and T5 the UE measures and evaluate beam candidate from beam candidate set q_1 .

No later than time point F occurring no later than $D1 = 260 + 10$ ms after the start of T5, the UE shall transmit preamble on a beam associated with the candidate beam set q_1 . The UE shall not transmit preamble on a beam associated with the candidate beam set q_1 earlier than time point B.

Test is concluded once the test equipment has received the initial preamble transmission from the UE. The rate of correct events observed during repeated tests shall be at least 90%.

A.7.5.5.4 Beam Failure Detection and Link Recovery Test for FR2 PCell configured with CSI-RS-based BFD and LR in DRX mode

A.7.5.5.4.1 Test Purpose and Environment

The purpose of this test is to verify that the UE properly detects CSI-RS-based beam failure in the set q_0 configured for a serving cell and that the UE performs correct CSI-RS-based link recovery based on beam candidate set q_1 . The purpose is to test the downlink monitoring for beam failure detection within the UE's active DL BWP, during the evaluation period, and link recovery, when DRX is used. This test will partly verify the CSI-RS based beam failure detection and link recovery for an FR2 serving cell requirements in clause 8.5.

The test parameters are given in Tables A.7.5.5.4.1-1, A.7.5.5.4.1-2, A.7.5.5.4.1-3, and A.7.5.5.4.1-4 below. There is one cell, cell 1 which is the active cell, in the test. The test consists of five successive time periods, with time duration of T1, T2, T3, T4 and T5 respectively. Figure A.7.5.5.4.1-1 shows the variation of the downlink SNR of the CSI-RS in set q_0 in the active cell to emulate CSI-RS based beam failure. Figure A.7.5.5.4.1-2 shows the variation of the downlink L1-RSRP of the CSI-RS in set q_1 of the candidate beam used for link recovery. Prior to the start of the time duration T1, the UE shall be fully synchronized to cell 1. The UE shall be configured for periodic CSI reporting with a reporting periodicity of 5 ms. In the test, DRX configuration is enabled in PCell and DRX inactivity timer has already been expired, i.e. UE tries to decode PDCCH and to send periodic CQI during the period when On-duration

timer is running. Time alignment timers shall be set to “infinity” so that UL timing alignment is maintained during the test.

Table A.7.5.5.4.1-1: Supported test configurations for FR2 PCell

Configuration	Description
1	TDD duplex mode, 120 kHz SSB SCS, 100 MHz bandwidth

Table A.7.5.5.4.1-2: General test parameters for FR2 PCell for CSI-RS-based beam failure detection and link recovery testing in DRX mode

Parameter	Test Config.	Unit	Value	Comment	
			Test 1		
Active PCell	1		Cell 1		
RF Channel Number	1		1		
Duplex mode	1		TDD		
TDD Configuration	1		TDDConf.3.1		
BW _{channel}	1		100: N _{RB,c} = 66		
Data RBs allocated	1		66		
PDSCH/PDCCH subcarrier spacing	1	kHz	120		
DL initial BWP configuration	1		DLBWP.0.1		
DL dedicated BWP configuration	1		DLBWP.1.1		
UL initial BWP configuration	1		ULBWP.0.1		
UL dedicated BWP configuration	1		ULBWP.1.1		
PDSCH Reference Channel	1		SR.3.2 TDD		
RMSI CORESET Reference Channel	1		CR.3.1 TDD		
Dedicated CORESET Reference Channel	1		CCR.3.1 TDD		
OCNG parameters	1		OP.1		
CP length	1		Normal		
PDSCH/PDCCH TCI state	1		TCI.State.0		
CSI-RS for tracking	1		TRS.2.1 TDD		
SSB Configuration	1		SSB.1 FR2		
SMTTC Configuration	1		SMTTC.3		
PRACH Configuration	1		FR2 PRACH configuration 4	A.3.8.3.4	
DRX configuration	1		DRX.3	A.3.3.3	
CSI-RS configuration for BFD/CBD/RLM	1		CSI-RS.3.2 TDD	A.3.14.2	
CSI-RS index assigned as BFD RS (q ₀)	1		0		
CSI-RS index assigned as CBD RS (q ₁)	1		1		
CSI-RS index assigned as RLM RS	1		0,1		
Beam failure detection transmission parameters	DCI format	1	1-0		
	Number of Control OFDM symbols	1	2		
	Aggregation level	1	CCE	8	
	Ratio of hypothetical PDCCH RE energy to average SSS RE energy	1	dB	0	
	Ratio of hypothetical PDCCH DMRS energy to average SSS RE energy	1	dB	0	
	DMRS precoder granularity	1		REG bundle size	
	REG bundle size	1	6		
Gap pattern ID	1		N/A		

rlmInSyncOutOfSyncThreshold	1		absent	Value 0 is applied. (Table 8.1.1-1).
rsrp-ThresholdSSB	1	dBm/SCS	-95	Threshold used for $Q_{in_LR_SSB}$
powerControlOffsetSS	1		db0	Used for deriving rsrp-ThresholdCSI-RS
beamFailureInstanceMaxCount	1		n1	see TS 38.321 [7], clause 5.17
beamFailureDetectionTimer	1		pbfd4	see TS 38.321 [7], clause 5.17
CSI-RS configuration for CSI reporting	1		CSI-RS.3.1 TDD	A.3.14.2
reportConfigType	1		periodic	
reportQuantity	1		cri-RI-PMI-CQI	
CSI reporting periodicity	1	slot	40	
CSI reporting offset	1	slot	4	
T310	1	ms	1000	
N310	1		2	
T1	1	s	1	The UE shall be fully synchronized to cell 1 during T1
T2	1	s	5.43	
T3	1	s	5.16	
T4	1	s	0	
T5	1	s	0.31	
D1	1	s	0.27	
Note 1: UE-specific PDCCH is not transmitted after T1 starts.				

Table A.7.5.5.4.1-3: Cell specific test parameters for FR2 PCell for CSI-RS-based beam failure detection and link recovery testing in DRX mode

Parameter	Unit	Test 1					
		T1	T2	T3	T4	T5	
AoA setup		Setup 1 defined in A.3.15					
Assumption for UE beams <small>Note 10</small>		Rough					
EPRE ratio of PDCCH DMRS to SSS	dB	0					
EPRE ratio of PDCCH to PDCCH DMRS	dB						
EPRE ratio of PBCH DMRS to SSS	dB						
EPRE ratio of PBCH to PBCH DMRS	dB						
EPRE ratio of PSS to SSS	dB						
EPRE ratio of PDSCH DMRS to SSS	dB						
EPRE ratio of PDSCH to PDSCH DMRS	dB						
EPRE ratio of OCNG DMRS to SSS	dB						
EPRE ratio of OCNG to OCNG DMRS	dB						
SNR_CSI-RS of set q_0	Config 1	5 <small>Note 11</small>	-3 <small>Note 11</small>	-12	-12	-12	
SNR_CSI-RS of set q_1	Config 1	0.2	0.2	20.2	20.2	20.2	
CSI-RS_RP of set q_1	Config 1	dBm/S CS	-104.5	-104.5	-84.5	-84.5	-84.5
N_{oc}	Config 1	dBm/120 KHz	-104.7				
Propagation condition			TDL-A 30ns 75Hz				

- Note 1: OCNG shall be used such that the resources in Cell 1 are fully allocated and a constant total transmitted power spectral density is achieved for all OFDM symbols.
- Note 2: The uplink resources for CSI reporting are assigned to the UE prior to the start of time period T1.
- Note 3: NZP CSI-RS resource set configuration for CSI reporting are assigned to the UE prior to the start of time period T1.
- Note 4: Void
- Note 5: The timers and layer 3 filtering related parameters are configured prior to the start of time period T1.
- Note 6: The signal contains PDCCH for UEs other than the device under test as part of OCNG.
- Note 7: SNR levels correspond to the signal to noise ratio over the REs carrying CSI-RS.
- Note 8: The SNR in time periods T1, T2, T3, T4 and T5 is denoted as SNR1, SNR2 and SNR3 respectively in figure A.7.5.5.4.1-1.
- Note 9: The SNR values are specified for testing a UE which supports 2RX on at least one band. For testing of a UE which supports 4RX on all bands, the SNR during T3 is modified as specified in clause A.3.6.
- Note 10: Information about types of UE beam is given in B.2.1.3 and does not limit UE implementation or test system implementation.
- Note 11: This value allows up to 1dB degradation from applied SNR to UE baseband.

Table A.7.5.5.4.1-4: Void

Table A.7.5.5.4.1-5: Void

Table A.7.5.5.4.1-6: Void

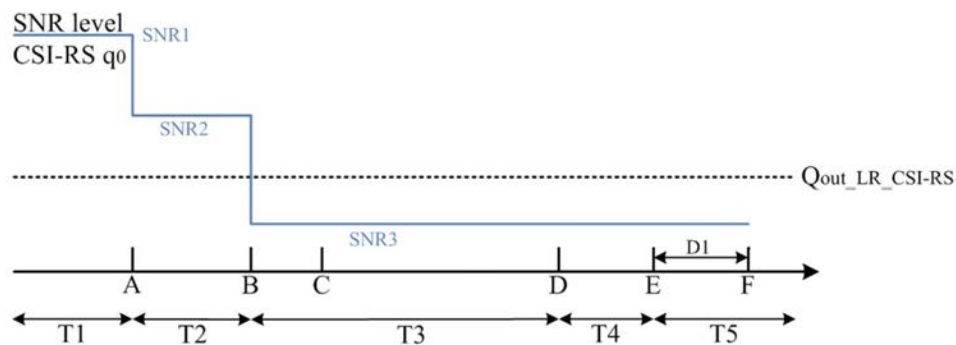

Figure A.7.5.5.4.1-1: SNR variation for CSI-RS-based beam failure detection and link recovery testing in DRX mode

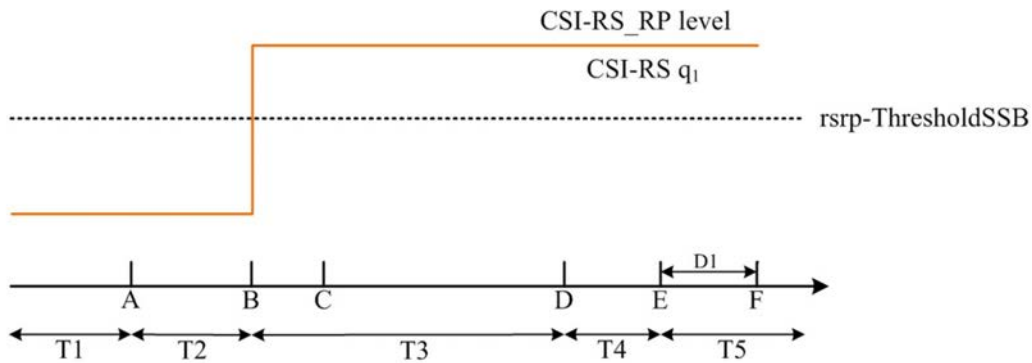

Figure A.7.5.5.4.1-2: CSI-RS_RP level variation for CSI-RS based beam failure detection and link recovery testing in DRX mode

A.7.5.5.4.2 Test Requirements

The UE behaviour during time durations T1, T2, T3, T4 and T5 shall be as follows:

During the time duration T1 and T2, the UE shall transmit uplink signal at least in all subframes configured for CSI transmission on Cell 1.

During the period from time point A to time point B the UE shall transmit uplink signal in Cell 1 in all uplink slots configured for CSI transmission according to the configured periodic CSI reporting for Cell 1.

During T3 the UE shall detect beam failure and initiate link recovery. During T4 and T5 the UE measures and evaluates beam candidate from beam candidate set q_1 .

No later than time point F occurring no later than $D1 = 260 + 10$ ms after the start of T5, the UE shall transmit preamble on a beam associated with the candidate beam set q_1 . The UE shall not transmit preamble on a beam associated with the candidate beam set q_1 earlier than time point B.

Test is concluded once the test equipment has received the initial preamble transmission from the UE. The rate of correct events observed during repeated tests shall be at least 90%.

A.7.5.5.5 Scheduling availability restriction during Beam Failure Detection and Link Recovery for FR2 PCell configured with SSB-based BFD and LR in non-DRX mode

A.7.5.5.5.1 Test Purpose and Environment

The purpose is to test scheduling availability restrictions when the UE is performing beam failure detection or when the UE is performing L1-RSRP measurement for candidate beam detection, when no DRX is used. This test will verify the scheduling availability restriction requirements in clause 8.5.7 and 8.5.8.

The test parameters are given in Tables A.7.5.5.5.1-1, A.7.5.5.5.1-2 and A.7.5.5.5.1-3 below. There is one cell, cell 1 which is the active cell, in the test. The test consists of five successive time periods, with time duration of T1, T2, T3, T4 and T5 respectively. Figure A.7.5.5.5.1-1 shows the variation of the downlink SNR of the SSB index 0 in the active cell to emulate SSB based beam failure. Figure A.7.5.5.5.1-2 shows the variation of the downlink L1-RSRP of the SSB index 1 used for link recovery. Prior to the start of the time duration T1, the UE shall be fully synchronized to cell 1. The UE shall be configured for periodic CSI reporting with a reporting periodicity of 5ms. This test will focus on the scheduling availability during beam failure detection) and candidate beam detection. In the test, DRX configuration is not enabled. Test is to test the scheduling availability restriction of UE performing

beam failure detection and candidate beam detection when SSB RS configured for Beam failure detection and candidate beam detection. During the test the UE is scheduled to transmit continuously in UL.

Table A.7.5.5.1-1: Supported test configurations for FR2 PCell

Configuration	Description
1	NR 120 kHz SSB SCS, 100MHz bandwidth, TDD duplex mode
2	NR 240 kHz SSB SCS, 100MHz bandwidth, TDD duplex mode
Note: The UE is only required to be tested in one of the supported test configurations	

Table A.7.5.5.1-2: General test parameters for FR2 PCell for SSB-based beam failure detection and link recovery testing in non-DRX mode

Parameter	Test Config.	Unit	Value	Comment	
			Test 1		
Active PCell	1-2		Cell 1		
RF Channel Number	1-2		1		
Duplex mode	1-2		TDD		
TDD Configuration	1-2		TDDConf.3.1		
BW _{channel}	1-2		100: N _{RB,c} = 66		
Data RBs allocated	1-2		66		
PDSCH/PDCCH subcarrier spacing	1-2	kHz	120		
DL initial BWP configuration	1-2		DLBWP.0.1		
DL dedicated BWP configuration	1-2		DLBWP.1.1		
UL initial BWP configuration	1-2		ULBWP.0.1		
UL dedicated BWP configuration	1-2		ULBWP.1.1		
PDSCH Reference Channel	1		SR.3.2 TDD		
	2		SR.3.3 TDD		
RMSI CORESET Reference Channel	1		CR.3.1 TDD		
	2		CR.3.2 TDD		
Dedicated CORESET Reference Channel	1		CCR.3.1 TDD		
	2		CCR.3.7 TDD		
OCNG parameters	1-2		OP.1		
CP length	1-2		Normal		
PDSCH/PDCCH TCI state	1-2		TCI.State.0		
CSI-RS for tracking	1-2		TRS.2.1 TDD		
SSB Configuration	1		SSB.1 FR2		
	2		SSB.2 FR2		
SMTC Configuration	1-2		SMTC.1		
PRACH Configuration	1-2		FR2 PRACH configuration 2	A.3.8.3.2	
DRX configuration	1-2		OFF		
Beam failure detection transmission parameters	DCI format	1-2	1-0		
	Number of Control OFDM symbols	1-2	2		
	Aggregation level	1-2	CCE	8	
	Ratio of hypothetical PDCCH RE energy to average SSS RE energy	1-2	dB	0	
	Ratio of hypothetical PDCCH DMRS energy to average SSS RE energy	1-2	dB	0	
	DMRS precoder granularity	1-2		REG bundle size	
REG bundle size	1-2		6		

Gap pattern ID	1-2		N/A	
rlmInSyncOutOfSyncThreshold	1-2		absent	Value 0 is applied. (Table 8.1.1-1).
rsrp-ThresholdSSB	1	dBm/SCS	-95	Threshold used for $Q_{in_LR_SSB}$
	2		-92	
powerControlOffsetSS	1-2		db0	Used for deriving rsrp-ThresholdCSI-RS
beamFailureInstanceMaxCount	1-2		n1	see TS 38.321 [7], clause 5.17
beamFailureDetectionTimer	1-2		pbfd4	see TS 38.321 [7], clause 5.17
CSI-RS configuration for CSI reporting	1-2		CSI-RS.3.1 TDD	
reportConfigType	1-2		periodic	
reportQuantity	1-2		cri-RI-PMI-CQI	
CSI reporting periodicity	1-2	slot	40	
CSI reporting offset	1-2	slot	4	
T310	1-2	ms	1000	
N310	1-2		2	
T1	1-2	s	1	The UE shall be fully synchronized to cell 1 during T1
T2	1-2	s	2.6	
T3	1-2	s	1.64	
T4	1-2	s	0	
T5	1-2	s	1.01	
D1	1-2	s	0.97	
Note 1: All configurations are assigned to the UE prior to the start of time period T1.				
Note 2: UE-specific PDCCH is not transmitted after T1 starts.				

Table A.7.5.5.1-3: Cell specific test parameters for FR2 PCell for SSB-based beam failure detection and link recovery testing in non-DRX mode

Parameter		Unit	Test 1				
			T1	T2	T3	T4	T5
AoA Setup			Setup1 defined in A.3.15.1				
Assumption for UE beams ^{Note 10}			Rough				
EPRE ratio of PDCCH DMRS to SSS		dB	0				
EPRE ratio of PDCCH to PDCCH DMRS		dB					
EPRE ratio of PBCH DMRS to SSS		dB					
EPRE ratio of PBCH to PBCH DMRS		dB					
EPRE ratio of PSS to SSS		dB					
EPRE ratio of PDSCH DMRS to SSS		dB					
EPRE ratio of PDSCH to PDSCH DMRS		dB					
EPRE ratio of OCNG DMRS to SSS		dB					
EPRE ratio of OCNG to OCNG DMRS		dB					
SSB index assigned as BFD RS (q_0)	Config 1-4		0	0	Note 12		
SSB index assigned as CBD RS (q_1)	Config 1-4		1	1	1	1	1
SNR of SSB index 0	Config 1-2	dB	⁵ Note 11	⁻³ Note 11	-12	-12	-12
SNR of SSB index 1	Config 1-2	dB	0.2	0.2	20.2	20.2	20.2
SSB_RP of SSB index 1	Config 1	dBm/S	-104.5	-104.5	-84.5	-84.5	-84.5
	Config 2	CS	-101.5	-101.5	-81.5	-81.5	-81.5

N_{oc}	Config 1-2	dBm/12 0 kHz	-104.7
Propagation condition		TDL-A 30ns 75Hz	
<p>Note 1: OCNG shall be used such that the resources in Cell 1 are fully allocated and a constant total transmitted power spectral density is achieved for all OFDM symbols.</p> <p>Note 2: The uplink resources for CSI reporting are assigned to the UE prior to the start of time period T1.</p> <p>Note 3: NZP CSI-RS resource set configuration for CSI reporting are assigned to the UE prior to the start of time period T1.</p> <p>Note 4: Void</p> <p>Note 5: The timers and layer 3 filtering related parameters are configured prior to the start of time period T1.</p> <p>Note 6: The signal contains PDCCH for UEs other than the device under test as part of OCNG.</p> <p>Note 7: SNR levels correspond to the signal to noise ratio over the SSS REs.</p> <p>Note 8: The SNR in time periods T1, T2, T3, T4 and T5 is denoted as SNR1, SNR2 and SNR3 respectively in figure A.7.5.5.1-1.</p> <p>Note 9: The SNR values are specified for testing a UE which supports 2RX on at least one band. For testing of a UE which supports 4RX on all bands, the SNR during T3 is modified as specified in clause A.3.6.</p> <p>Note 10: Information about types of UE beam given in B.2.1.3 and does not limit UE implementation or test system implementation</p> <p>Note 11: This value allows up to 1dB degradation from applied SNR to UE baseband.</p> <p>Note 12: BFD RS (q_0) is configured as SSB index 0 at the start of T3, and it is reconfigured by RRC as SSB index 1 after the UE transmits the preamble on a beam associated with the candidate beam set q_1.</p>			

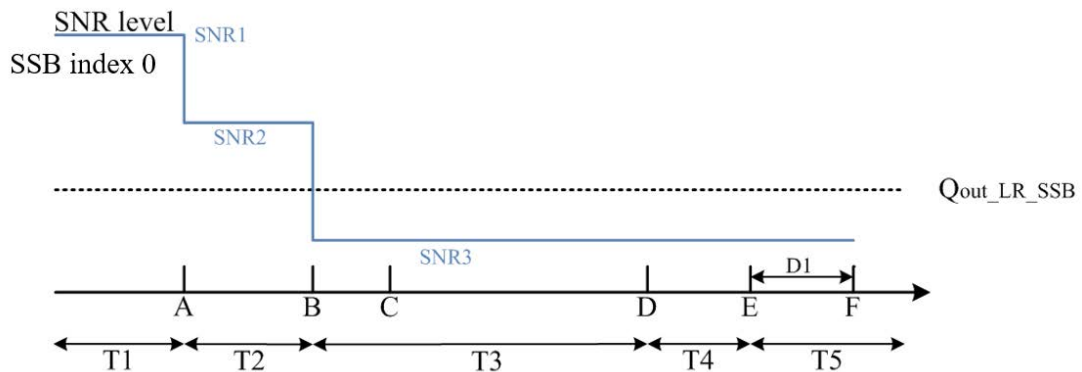

Figure A.7.5.5.1-1: SNR variation for SSB-based beam failure detection and link recovery testing in non-DRX mode

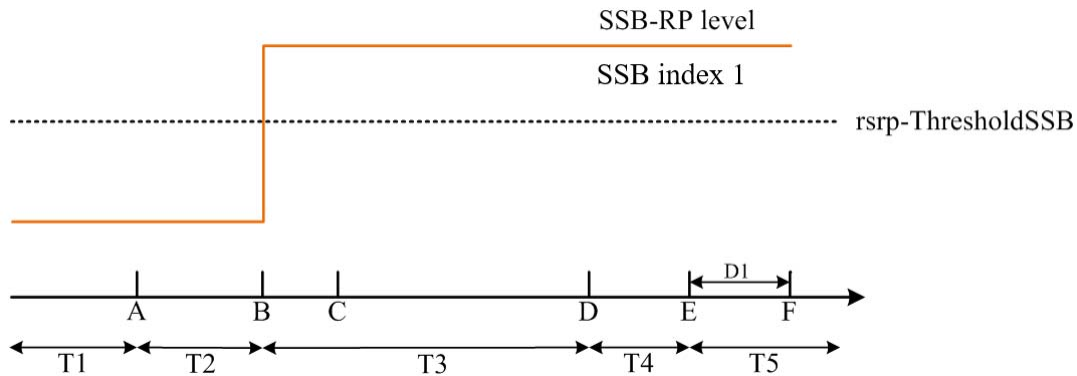

Figure A.7.5.5.1-2: SSB_RP level variation for SSB-based beam failure detection and link recovery testing in non-DRX mode

A.7.5.5.5.2 Test Requirements

The UE behaviour during time duration T3 follows the requirements defined in clause 8.5.7.3:

- The UE is not expected to transmit PUCCH/PUSCH/SRS or receive PDCCH/PDSCH/CSI-RS for tracking/CSI-RS for CQI on BFD-RS symbols to be measured for beam failure detection.

The UE behaviour during time durations T4 and T5 follows the requirements defined in clause 8.5.8.3:

- The UE is not expected to transmit PUCCH/PUSCH or receive PDCCH/PDSCH on reference symbols to be measured for candidate beam detection.

A.7.5.6 Active BWP switch

A.7.5.6.1 DCI-based and Timer-based Active BWP Switch

A.7.5.6.1.1 NR FR2- NR FR2 DL active BWP switch of SCell with non-DRX in SA

A.7.5.6.1.1.1 Test Purpose and Environment

The purpose of this test is to verify the DL BWP switch delay requirement defined in clause 8.6, and interruption requirement on other active serving cell defined in clause 8.2.2.2.5.

The supported test configurations are shown in Table A.7.5.6.1.1.1-1 below. The test scenario comprises of one PCell (Cell 1) and one SCell (Cell 2) as given in Table A.7.5.6.1.1.1-2. NR Cell-specific parameters are specified in Table A.7.5.6.1.1.1-3 below. OTA related test parameters are shown in table A.7.5.6.1.1.1-4 below.

PDCCHs indicating new transmissions shall be sent continuously on SCell (Cell 2) to ensure that the UE would have ACK/NACK sending except for the time duration when BWP is switching on Cell 2 and the time duration of T2.

PDCCHs indicating new transmissions shall be sent continuously on PCell (Cell 1) to ensure that the UE will have ACK/NACK sending.

Before the test starts,

UE is connected to Cell 1 (PCell) on radio channel 1 (PCC), and Cell 2 (SCell) on radio channel 2 (SCC).

UE is configured with 2 different UE-specific downlink bandwidth parts for SCell, BWP-1 and BWP-2, in Cell 2 before starting the test. BWP-1 and BWP-2 always include bandwidth of the initial DL BWP and SSB.

UE is configured with 1 UE-specific downlink bandwidth parts the same as initial BWP for PSCell, BWP-0 in Cell 1 before starting the test.

UE is indicated in *firstActiveDownlinkBWP-Id* that the active DL BWP is BWP-1 in SCell.

UE is indicated in *firstActiveDownlinkBWP-Id* that the active DL BWP is BWP-0 in PCell.

UE is configured with a *bwp-InactivityTimer* timer value for SCell.

All cells have constant signal levels throughout the test.

The test consists of 3 successive time periods, with durations of T1, T2, and T3, respectively.

During T1,

Time period T1 starts when a DCI format 1_1 command for SCell DL BWP switch, sent from the test equipment to the UE, is received at the UE side in SCell's slot # denoted i . The UE shall switch its bandwidth part from BWP-1 to BWP-2.

The UE shall be able to receive PDSCH no later than the first DL slot that occurs after the beginning of SCell's DL slot ($i+T_{\text{BWPswitchDelay}}$) as defined in clause 8.6 and starts to report valid ACK/NACK for the SCell on PCell no later than the first UL slot that occurs after the beginning of slot ($i+T_{\text{BWPswitchDelay}}+k_1$). The UE shall be continuously scheduled on SCell's BWP-2 no later than the first DL slot that occurs after the beginning of slot ($i+T_{\text{BWPswitchDelay}}$).

The starting time of PCell (Cell 1) interruption due to BWP switch on SCell shall occur within the BWP switch delay.

During T2, the test equipment won't transmit DCI format for PDSCH reception on SCell (Cell 2).

During T3,

The time period T3 starts from the slot # j , where j is the first slot of the half subframe immediately after *bwp-InactivityTimer* timer expires. The UE should switch its bandwidth part from BWP-2 back to the default bandwidth part – BWP-1.

The UE shall be able to receive PDSCH no later than the first DL slot that occurs after the beginning of SCell's DL slot ($j+T_{\text{BWPswitchDelay}}$) as defined in clause 8.6 and starts to report valid ACK/NACK for the SCell on PCell at latest on the first UL slot that occurs after the beginning of slot ($j+T_{\text{BWPswitchDelay}}+k_1$). The UE shall be continuously scheduled on SCell's BWP-1 no later than the first DL slot that occurs after the beginning of slot ($j+T_{\text{BWPswitchDelay}}$).

The starting time of PCell (Cell 1) interruption due to BWP switch of SCell shall occur within the BWP switch delay.

The test equipment verifies the DL BWP switch time in SCell by counting the slots from the time when the BWP switch command is received or *bwp-InactivityTimer* timer expires till an ACK/NACK is received.

The test equipment verifies that potential interruption to PCell is carried out in the correct time span by monitoring ACK/NACK sent in PCell during BWP switch of SCell, respectively.

Table A.7.5.6.1.1.1-1: DL BWP switch supported test configurations

Config	Description
1	NR 120 kHz SSB SCS, 100 MHz bandwidth, TDD -TDD duplex mode

Table A.7.5.6.1.1.1-2: General test parameters for DL BWP switch in SA

Parameter	Unit	Value	Comment
-----------	------	-------	---------

NR RF Channel Number		1, 2	Two NR radio channels are used for this test
Active PCell		Cell 1	PCell on RF channel number 1.
Active SCell		Cell 2	SCell on RF channel number 2.
CP length		Normal	
DRX		OFF	For both PCell and SCell
<i>bwp-InactivityTimer</i>	ms	200	
Cell-individual offset for cells on RF channel number 1	dB	0	Individual offset for cells on PCC.
Cell-individual offset for cells on RF channel number 2	dB	0	Individual offset for cells on PSCC.
Cell2 timing offset to cell1	μs	3	Time alignment error as specified in TS 38.104 [13] clause 6.5.3.1.
T1	s	0.2	
T2	s	0.2	
T3	s	0.2	

Table A.7.5.6.1.1-3: NR Cell specific test parameters for DL BWP switch in SA

Parameter	Unit	Cell 1	Cell2
Frequency Range		FR2	FR2
Duplex mode		TDD	
TDD configuration		TDDConf.3.1	
BW _{channel}		100 MHz: N _{RB,c} = 66	
Active BWP ID		0	1, 2
Downlink initial BWP Configuration		DLBWP.0.2	
Uplink initial BWP Configuration		ULBWP.0.2	N.A.
Downlink active BWP-0 Configuration		DLBWP.0.2	-
Downlink active BWP-1 Configuration		N.A.	DLBWP.1.1
Downlink active BWP-2 Configuration		N.A.	DLBWP.1.3
Uplink active BWP-0 Configuration		ULBWP.0.2	N.A.
Uplink active BWP-1 Configuration		N.A.	N.A.
Uplink active BWP-2 Configuration		N.A.	N.A.
PDSCH Reference measurement channel		SR.3.1 TDD	
TRS configuration		TRS.2.1 TDD	
TCI state		TCI.State.0	
RMSI CORESET parameters		CR.3.1 TDD	
Dedicated CORESET parameters		CCR.3.1 TDD	
OCNG Patterns		OP.1	
SSB Configuration		SSB.1 FR2	
SMTc Configuration		SMTc.1	
Correlation Matrix and Antenna Configuration		1x2 Low	
EPRE ratio of PSS to SSS	dB	0	0
EPRE ratio of PBCH DMRS to SSS			
EPRE ratio of PBCH to PBCH DMRS			
EPRE ratio of PDCCH DMRS to SSS			
EPRE ratio of PDCCH to PDCCH DMRS			
EPRE ratio of PDSCH DMRS to SSS			
EPRE ratio of PDSCH to PDSCH			
EPRE ratio of OCNG DMRS to SSS(Note 1)			
EPRE ratio of OCNG to OCNG DMRS (Note 1)			

Propagation Condition		AWGN	AWGN
Note 1: OCNG shall be used such that both cells are fully allocated and a constant total transmitted power spectral density is achieved for all OFDM symbols.			

Table A.7.5.6.1.1.1-4: OTA related test parameters for BWP switching test case

Parameter	Unit	Cell 1	Cell 2
Angle of arrival configuration		Setup 1 defined in clause A.3.15.1	
Assumption for UE beams ^{Note 6}		Fine	Fine
N_{oc} ^{Note1}	dBm/15kHz	-112	-112
N_{oc} ^{Note1}	dBm/SCS	-103	-103
SS-RSRP ^{Note2}	dBm/SCS ^{Note3}	-85	-85
\hat{E}_s / I_{ot}	dB	18	18
I_o ^{Note4}	dBm/95.04 MHz ^{Note4}	-56	-56
<p>Note 1: Interference from other cells and noise sources not specified in the test is assumed to be constant over subcarriers and time and shall be modelled as AWGN of appropriate power for N_{oc} to be fulfilled.</p> <p>Note 2: SS-RSRP and I_o levels have been derived from other parameters for information purposes. They are not settable parameters themselves.</p> <p>Note 3: SS-RSRP minimum requirements are specified assuming independent interference and noise at each receiver antenna port.</p> <p>Note 4: Equivalent power received by an antenna with 0 dBi gain at the centre of the quiet zone</p> <p>Note 5: As observed with 0 dBi gain antenna at the centre of the quiet zone.</p> <p>Note 6: Information about types of UE beam is given in B.2.1.3 and does not limit UE implementation or test system implementation.</p>			

A.7.5.6.1.1.2 Test Requirements

During T1, the UE shall start to send the ACK/NACK for SCell on PCell from the first UL slot that occurs after the beginning of DL slot ($i + T_{BWPswitchDelay} + k_1$).

During T3, the UE shall start to send the ACK/NACK for SCell on PCell from the first UL slot that occurs after the beginning of DL slot ($j + T_{BWPswitchDelay} + k_1$).

Where, k_j is the timing between DL data receiving and acknowledgement as specified in [7].

Depending on UE capability *bwp-SwitchingDelay* [2], UE shall finish BWP switch within the time duration $T_{BWPswitchDelay}$ defined in Table 8.6.2-1.

All of the above test requirements shall be fulfilled in order for the observed SCell active BWP switch delay to be counted as correct.

The rate of correct events observed during repeated tests shall be at least 90%.

During T1 and T3, the start time of PCell interruption during SCell active BWP switch shall not happen outside the BWP switch delay.

The interruption of PCell shall not be longer than the interruption duration specified for active BWP switch in clause 8.2.2.2.5.

All of the above test requirements shall be fulfilled in order for the observed SCell active BWP switch interruption to be counted as correct.

The rate of correct events observed during repeated tests shall be at least 90%.

NOTE: During T1, T3 if there are no uplink resources for reporting the ACK in the first UL slot that occurs after the beginning of DL slot ($i + T_{\text{BWPswitchDelay}} + k_1$), ($j + T_{\text{BWPswitchDelay}} + k_1$), then the UE shall use the next available uplink resource for reporting the corresponding ACK.

A.7.5.6.1.2 NR FR1- NR FR2 DL active BWP switch of SCell with non-DRX in SA

A.7.5.6.1.2.1 Test Purpose and Environment

The purpose of this test is to verify the DL BWP switch delay requirement defined in clause 8.6, and interruption requirement on other active serving cell defined in clause 8.2.2.2.5.

The supported test configurations are shown in Table A.7.5.6.1.2.1-1 below. The test scenario comprises of one NR PCell (Cell 1) and one NR SCell (Cell 2). The general parameters are given in Table A.7.5.6.1.2.1-2. NR Cell-specific parameters are specified in Table A.7.5.6.1.2.1-3 below. OTA related test parameters are shown in table A.7.5.6.1.2.1-4 below.

PDCCHs indicating new transmissions shall be sent continuously on SCell (Cell 2) to ensure that the UE would have ACK/NACK sending except for the time duration when BWP is switching on Cell 2 and the time duration of T2.

PDCCHs indicating new transmissions shall be sent continuously on PCell (Cell 1) to ensure that the UE will have ACK/NACK sending.

Before the test starts,

UE is connected to Cell 1 (PCell) on radio channel 1 (PCC), and Cell 2 (SCell) on radio channel 2 (SCC).

UE is configured with 2 different UE-specific downlink bandwidth parts for SCell, BWP-1 and BWP-2, in Cell 2 before starting the test. BWP-1 and BWP-2 always include bandwidth of the initial DL BWP and SSB.

UE is configured with 1 UE-specific downlink bandwidth parts the same as initial BWP for PCell, BWP-0 in Cell 1 before starting the test.

UE is indicated in firstActiveDownlinkBWP-Id that the active DL BWP is BWP-1 in SCell.

UE is indicated in firstActiveDownlinkBWP-Id that the active DL BWP is BWP-0 in PCell.

UE is configured with a bwp-InactivityTimer timer value for SCell.

All cells have constant signal levels throughout the test.

The test consists of 3 successive time periods, with durations of T1, T2, and T3, respectively.

During T1,

Time period T1 starts when a DCI format 1_1 command for SCell DL BWP switch, sent from the test equipment to the UE, is received at the UE side in SCell's slot # denoted i . The UE shall switch its bandwidth part from BWP-1 to BWP-2.

The UE shall be able to receive PDSCH no later than the first DL slot that occurs after the beginning of SCell's DL slot ($i + T_{\text{BWPswitchDelay}}$) as defined in clause 8.6 and starts to report valid ACK/NACK for the SCell on PCell no later than the first UL slot that occurs after the beginning of slot ($i + T_{\text{BWPswitchDelay}} + k_1$). The UE shall be continuously scheduled on SCell's BWP-2 no later than the first DL slot that occurs after the beginning of slot ($i + T_{\text{BWPswitchDelay}}$).

The starting time of PCell (Cell 1) interruption due to BWP switch on SCell shall occur within the BWP switch delay if the UE doesn't support per-FR gap, otherwise no interruption due to BWP switch on PCell is allowed.

During T2, the test equipment won't transmit DCI format for PDSCH reception on SCell (Cell 2).

During T3,

The time period T3 starts from the slot # j , where j is the first slot of the half subframe immediately after *bwp-InactivityTimer* timer expires. The UE should switch its bandwidth part from BWP-2 back to the default bandwidth part – BWP-1.

The UE shall be able to receive PDSCH no later than the first DL slot that occurs after the beginning of SCell's DL slot ($j+T_{\text{BWPswitchDelay}}$) as defined in clause 8.6 and starts to report valid ACK/NACK for the SCell on PCell at latest on the first UL slot that occurs after the beginning of slot ($j+T_{\text{BWPswitchDelay}}+k_1$). The UE shall be continuously scheduled on SCell's BWP-1 no later than the first DL slot that occurs after the beginning of slot ($j+T_{\text{BWPswitchDelay}}$).

The starting time of PCell (Cell 1) interruption due to BWP switch of SCell shall occur within the BWP switch delay if the UE doesn't support per-FR gap, otherwise no interruption due to BWP switch on PCell is allowed.

The test equipment verifies the DL BWP switch time in SCell by counting the slots from the time when the BWP switch command is received or *bwp-InactivityTimer* timer expires till an ACK/NACK is received.

The test equipment verifies that potential interruption to PCell is carried out in the correct time span by monitoring ACK/NACK sent in PCell during BWP switch of SCell, respectively.

Table A.7.5.6.1.2.1-1: DL BWP switch supported test configurations

Config	Description
1	PCell: NR 15 kHz SSB SCS, 10 MHz bandwidth, FDD duplex mode SCell: NR 120 kHz SSB SCS, 100 MHz bandwidth, TDD duplex mode
2	PCell: NR 15 kHz SSB SCS, 10 MHz bandwidth, TDD duplex mode SCell: NR 120 kHz SSB SCS, 100 MHz bandwidth, TDD duplex mode
3	PCell: NR 30 kHz SSB SCS, 10 MHz bandwidth, TDD duplex mode SCell: NR 120 kHz SSB SCS, 100 MHz bandwidth, TDD duplex mode
Note 1: The UE is only required to be tested in one of the supported test configurations	

Table A.7.5.6.1.2.1-2: General test parameters for DL BWP switch in SA

Parameter	Unit	Value	Comment
NR RF Channel Number		2	Two NR radio channel is used for this test
Active PCell		Cell 1	PCell on RF channel number 1.
Active SCell		Cell 2	SCell on RF channel number 2.
CP length		Normal	
DRX		OFF	For both PCell and SCell
<i>bwp-InactivityTimer</i>	ms	200	
Cell-individual offset for cells on RF channel number 2	dB	0	Individual offset for cells on SCC.
Cell-individual offset for cells on RF channel number 2	dB	0	Individual offset for cells on PSCC.
Cell2 timing offset to cell1	μs	3	Time alignment error as specified in TS 38.104 [13] clause 6.5.3.1.
T1	s	0.2	
T2	s	0.2	
T3	s	0.2	

Table A.7.5.6.1.2.1-3: NR Cell specific test parameters for DL BWP switch in SA

Parameter		Unit	Cell 1	Cell2
Frequency Range			FR1	FR2
Duplex mode	Config 1		FDD	TDD
	Config 2,3		TDD	
TDD configuration	Config 1		Not Applicable	TDDConf.3.1
	Config 2		TDDConf.1.1	
	Config 3		TDDConf.2.1	
BW _{channel}	Config 1,2	MHz	10 MHz: N _{RB,c} = 52	100 MHz: N _{RB,c} = 66
	Config 3		40 MHz: N _{RB,c} = 106	
Active BWP ID			0	1, 2
Downlink initial BWP Configuration			DLBWP.0.2	
Uplink initial BWP Configuration			ULBWP.0.2	N.A.
Downlink active BWP-0 Configuration			DLBWP.0.2	-
Downlink active BWP-1 Configuration			-	DLBWP.1.1
Downlink active BWP-2 Configuration			-	DLBWP.1.3
Uplink active BWP-0 Configuration			ULBWP.0.2	-
Uplink active BWP-1 Configuration			-	N.A.
Uplink active BWP-2 Configuration			-	N.A.
PDSCH Reference measurement channel	Config 1		SR.1.1 FDD	SR.3.1 TDD
	Config 2		SR.1.1 TDD	
	Config 3		SR.2.1 TDD	
RMSI CORESET parameters	Config 1		CR.1.1 FDD	CR.3.1 TDD
	Config 2		CR.1.1 TDD	
	Config 3		CR.2.1 TDD	
Dedicated CORESET parameters	Config 1		CCR.1.1 FDD	CCR.3.1 TDD
	Config 2		CCR.1.1 TDD	
	Config 3		CCR.2.1 TDD	
OCNG Patterns			OP.1	
SSB Configuration	Config 1,2		SSB.1 FR1	SSB.1 FR2
	Config 3		SSB.2 FR1	
TRS configuration	Config 1,2,3		-	TRS.2.1 TDD
TCI state	Config 1,2,3		TCI.State.0	TCI.State.0
SMTc Configuration			SMTc.1	
Correlation Matrix and Antenna Configuration			NA Link only, see clause A.3.7A	1x2 Low
EPRE ratio of PSS to SSS		dB	0	0
EPRE ratio of PBCH DMRS to SSS				
EPRE ratio of PBCH to PBCH DMRS				
EPRE ratio of PDCCH DMRS to SSS				
EPRE ratio of PDCCH to PDCCH DMRS				
EPRE ratio of PDSCH DMRS to SSS				
EPRE ratio of PDSCH to PDSCH				
EPRE ratio of OCNG DMRS to SSS(Note 1)				
EPRE ratio of OCNG to OCNG DMRS (Note 1)				
Propagation Condition				
<p>Note 1: OCNG shall be used such that both cells are fully allocated and a constant total transmitted power spectral density is achieved for all OFDM symbols.</p> <p>Note 2: Interference from other cells and noise sources not specified in the test is assumed to be constant over subcarriers and time and shall be modelled as AWGN of appropriate power for N_{oc} to be fulfilled.</p> <p>Note 3: SS-RSRP and SCH_RP levels have been derived from other parameters for information purposes. They are not settable parameters themselves.</p>				

Table A.7.5.6.1.2.1-4: OTA related test parameters for BWP switching test case

Parameter	Unit	Cell 1	Cell 2
Angle of arrival configuration		NA Link only, see clause A.3.7A	Setup 1 defined in clause A.3.15.1
Assumption for UE beams ^{Note 6}			Fine
N_{oc} ^{Note1}	dBm/15kHz		-112
N_{oc} ^{Note1}	dBm/SCS		-103
SS-RSRP ^{Note2}	dBm/SCS ^{Note3}		-85
\hat{E}_s/I_{ot}	dB		18
I_o ^{Note4}	dBm/95.04 MHz ^{Note4}		-56
<p>Note 1: Interference from other cells and noise sources not specified in the test is assumed to be constant over subcarriers and time and shall be modelled as AWGN of appropriate power for N_{oc} to be fulfilled.</p> <p>Note 2: SS-RSRP and I_o levels have been derived from other parameters for information purposes. They are not settable parameters themselves.</p> <p>Note 3: SS-RSRP minimum requirements are specified assuming independent interference and noise at each receiver antenna port.</p> <p>Note 4: Equivalent power received by an antenna with 0 dBi gain at the centre of the quiet zone</p> <p>Note 5: As observed with 0 dBi gain antenna at the centre of the quiet zone.</p> <p>Note 6: Information about types of UE beam is given in B.2.1.3 and does not limit UE implementation or test system implementation.</p>			

A.7.5.6.1.2.2 Test Requirements

During T1, the UE shall start to send the ACK/NACK for PCell from the first UL slot that occurs after the beginning of DL slot $(i + T_{BWPswitchDelay} + kI)$.

During T3, the UE shall start to send the ACK/NACK for PCell from the first UL slot that occurs after the beginning of DL slot $(j + T_{BWPswitchDelay} + kI)$.

Where, kI is the timing between DL data receiving and acknowledgement as specified in [7].

Depending on UE capability *bwp-SwitchingDelay* [2], UE shall finish BWP switch within the time duration $T_{BWPswitchDelay}$ defined in Table 8.6.2-1.

All of the above test requirements shall be fulfilled in order for the observed PCell active BWP switch delay to be counted as correct.

The rate of correct events observed during repeated tests shall be at least 90%.

If the UE doesn't support per-FR gap,

During T1 and T3, the start time of SCell interruption during PCell active BWP switch shall not happen outside the BWP switch delay.

The interruption of SCell shall not be longer than the interruption duration specified for active BWP switch in clause 8.2.2.2.5.

Otherwise no interruption due to BWP switch on SCell is allowed.

All of the above test requirements shall be fulfilled in order for the observed SCell active BWP switch interruption to be counted as correct.

The rate of correct events observed during repeated tests shall be at least 90%.

NOTE: During T1, T3 if there are no uplink resources for reporting the ACK/NACK in the first UL slot that occurs after the beginning of DL slot $(i + T_{BWPswitchDelay} + kI)$, $(j + T_{BWPswitchDelay} + kI)$, then the UE shall use the next available uplink resource for reporting the corresponding ACK/NACK.

A.7.5.6.1.3 NR FR2 DL active BWP switch with non-DRX in SA

A.7.5.6.1.3.1 Test Purpose and Environment

The purpose of this test is to verify the DL BWP switch delay requirement defined in clause 8.6. Supported test configurations are shown in Table A.7.5.6.1.3.1-1.

The test scenario comprises of one cell (Cell 1) as given in Table A.7.5.6.1.3.1-2. Cell-specific parameters of NR PCell is specified in Table A.7.5.6.1.3.1-3 below. The OTA related test parameters for FR2 is shown in Table A.7.5.6.1.3.1-4.

PDCCHs indicating new transmissions shall be sent continuously on PCell (Cell 1) to ensure that the UE will have ACK/NACK sending.

Before the test starts,

- UE is connected to Cell 1 on radio channel 1.
- UE is configured with 2 different UE-specific downlink bandwidth parts, BWP-1 and BWP-2 before starting the test. BWP-1 and BWP-2 always include bandwidth of the initial DL BWP and SSB.
- UE is indicated in *firstActiveDownlinkBWP-Id* that the active DL BWP is BWP-1.
- UE is configured with a *bwp-InactivityTimer* timer value for Cell1.

All cells have constant signal levels throughout the test.

The test consists of 3 successive time periods, with durations of T1, T2, and T3, respectively.

During T1,

Time period T1 starts when a DCI format 1_1 command for DL BWP switch, sent from the test equipment to the UE, is received at the UE side in Cell 1's slot # denoted i . The UE should switch its bandwidth part from BWP-1 to BWP-2.

The UE shall be able to receive PDSCH on the first DL slot that occurs after the beginning of Cell 1's DL slot $(i + T_{BWPswitchDelay})$ as defined in clause 8.6 and starts to report valid ACK/NACK for the Cell 1 no later than the first UL slot that occurs after the beginning of slot $(i + T_{BWPswitchDelay} + kI)$. The UE shall be continuously scheduled on Cell 1's BWP-2 starting from the first DL slot that occurs after the beginning of slot $(i + T_{BWPswitchDelay})$.

During T2, the test equipment won't transmit DCI format for PDSCH reception on Cell 1.

During T3,

The time period T3 starts from the slot # j , where j is the first slot of the half subframe immediately after *bwp-InactivityTimer* timer expires. The UE should switch its bandwidth part from BWP-2 back to the default bandwidth part – BWP-1.

The UE shall be able to receive PDSCH on the first DL slot that occurs after the beginning of Cell 1's DL slot $(j + T_{BWPswitchDelay})$ as defined in clause 8.6 and starts to report valid ACK/NACK for the Cell 1 at latest on

the first UL slot that occurs after the beginning of slot $(j+T_{BWPswitchDelay}+kI)$. The UE shall be continuously scheduled on Cell 1's BWP-1 starting from the first DL slot that occurs after the beginning of slot $(j+T_{BWPswitchDelay})$.

The test equipment verifies the DL BWP switch time by counting the slots from the time when the BWP switch command is received or *bwp-InactivityTimer* timer expires till an ACK is received.

Table A.7.5.6.1.3.1-1: DL BWP switch supported test configurations

Config	Description
1	NR 120 kHz SSB SCS, 100 MHz bandwidth, TDD duplex mode
Note 1:	Void.
Note 2:	A UE which fulfils the requirements in test case A.7.5.6.1.1 or A.7.5.6.1.2 can skip the test cases in A.7.5.6.1.3.

Table A.7.5.6.1.3.1-2: General test parameters for DL BWP switch in SA

Parameter	Unit	Value	Comment
NR RF Channel Number		1	One NR radio channel is used for this test
Active Cell		Cell 1	Cell on RF channel number 1.
CP length		Normal	
DRX		OFF	For both PCell and PSCell
<i>bwp-InactivityTimer</i>	ms	200	
T1	s	0.2	
T2	s	0.2	
T3	s	0.2	

Table A.7.5.6.1.3.1-3: NR Cell specific test parameters for DL BWP switch in SA

Parameter	Unit	Cell 1
Frequency Range		FR2
Duplex mode		TDD
TDD configuration		TDDConf.3.1
BW _{channel}		100 MHz: N _{RB,c} = 66
Active BWP ID		1, 2
Initial DL BWP Configuration		DLBWP.0.2 ^{Note 2}
Active DL BWP-1 Configuration		DLBWP.1.1 ^{Note 2}
Active DL BWP-2 Configuration		DLBWP.1.3 ^{Note 2}
Initial UL BWP Configuration		ULBWP.0.2 ^{Note 2}
Active UL BWP-1 Configuration		ULBWP.1.1 ^{Note 2}
Active UL BWP-2 Configuration		ULBWP.1.3 ^{Note 2}
PDSCH Reference measurement channel		SR.3.1 TDD
RMSI CORESET parameters		CR.3.1 TDD
Dedicated CORESET parameters		CCR.3.1 TDD
OCNG Patterns		OP.1
SSB Configuration		SSB.1 FR2
SMTTC Configuration		SMTTC.1
TCI State		TCI.State.0
TRS Configuration		TRS.2.1 TDD
Correlation Matrix and Antenna Configuration		1x2 Low
EPRE ratio of PSS to SSS	dB	0
EPRE ratio of PBCH DMRS to SSS		
EPRE ratio of PBCH to PBCH DMRS		
EPRE ratio of PDCCH DMRS to SSS		
EPRE ratio of PDCCH to PDCCH DMRS		
EPRE ratio of PDSCH DMRS to SSS		

EPRE ratio of PDSCH to PDSCH		
EPRE ratio of OCNG DMRS to SSS(Note 1)		
EPRE ratio of OCNG to OCNG DMRS (Note 1)		
Propagation Condition		AWGN
Note 1:	OCNG shall be used such that the cell is fully allocated and a constant total transmitted power spectral density is achieved for all OFDM symbols.	
Note 2:	For unpaired spectrum, a DL BWP is linked with an UL BWP. DLBWP.0.2 is linked with ULBWP.0.2; DLBWP.1.1 is linked with ULBWP.1.1; DLBWP.1.3 is linked with ULBWP.1.3 defined in clause 12 of TS 38.213 [3].	

Table A.7.5.6.1.3.1-4: OTA related test parameters for DL BWP switch in SA

Parameter	Unit	Cell 2
Angle of arrival configuration		Setup 1 defined in clause A.3.15.1
Assumption for UE beams ^{Note 6}		Fine
N_{oc} ^{Note 1}	dBm/15 kHz	-112
N_{oc} ^{Note 1}	dBm/SCS	-103
SS-RSRP ^{Note 2}	dBm/120 kHz ^{Note 3}	-85
\dot{E}_s/I_{ot}	dB	18
\dot{E}_s/N_{oc} ^{Note 5}	dB	18
I_o ^{Note 2}	dBm/95.04 MHz ^{Note 4}	-56
Note 1:	Interference from other cells and noise sources not specified in the test is assumed to be constant over subcarriers and time and shall be modelled as AWGN of appropriate power for N_{oc} to be fulfilled.	
Note 2:	SS-RSRP and I_o levels have been derived from other parameters for information purposes. They are not settable parameters themselves.	
Note 3:	SS-RSRP minimum requirements are specified assuming independent interference and noise at each receiver antenna port.	
Note 4:	Equivalent power received by an antenna with 0 dBi gain at the centre of the quiet zone	
Note 5:	As observed with 0 dBi gain antenna at the centre of the quiet zone.	
Note 6:	Information about types of UE beam is given in B.2.1.3 and does not limit UE implementation or test system implementation.	

A.7.5.6.1.3.2 Test Requirements

During T1, the UE shall start to send the ACK/NACK for PCell from the first UL slot that occurs after the beginning of DL slot ($i+T_{BWPswitchDelay}+kI$).

During T3, the UE shall start to send the ACK/NACK for PCell from the first UL slot that occurs after the beginning of DL slot ($j+T_{BWPswitchDelay}+kI$).

Where, kI is the timing between DL data receiving and acknowledgement as specified in [7].

Depending on UE capability *bwp-SwitchingDelay* [2], UE shall finish BWP switch within the time duration $T_{BWPswitchDelay}$ defined in Table 8.6.2-1.

All of the above test requirements shall be fulfilled in order for the observed PCell active BWP switch delay to be counted as correct.

The rate of correct events observed during repeated tests shall be at least 90%.

NOTE: During T1, T3 if there are no uplink resources for reporting the ACK/NACK in the first UL slot that occurs after the beginning of DL slot $(i + T_{BWPswitchDelay} + kI)$, $(j + T_{BWPswitchDelay} + kI)$, then the UE shall use the next available uplink resource for reporting the corresponding ACK/NACK.

A.7.5.6.2 RRC-based Active BWP Switch

A.7.5.6.2.1 NR FR2 DL active BWP switch of PCell with non-DRX in SA

A.7.5.6.2.1.1 Test Purpose and Environment

The purpose of this test is to verify the DL BWP switch delay requirement for RRC-based BWP switch defined in clause 8.6.3. Supported test configurations are shown in Table A.7.5.6.2.1.1-1.

The test scenario comprises of one PCell (Cell 1) as given in Table A.7.5.6.2.1.1-2. Cell-specific parameters of PCell are specified in Table A.7.5.6.2.1.1-3 below.

PDCCHs indicating new transmissions shall be sent continuously on PCell (Cell 1) to ensure that the UE will have ACK/NACK sending.

Before the test starts,

- UE is connected to Cell 1 (PCell) on radio channel 1 (PCC).
- UE has bandwidth part BWP-1 in its RRC-configuration for Cell 1 (PCell).
- UE is indicated in *firstActiveDownlinkBWP-Id* that the active DL BWP is BWP-1 of initial condition in PCell.

All cells have constant signal levels throughout the test.

The test consists of 1 time period, with duration of T1.

During T1,

Time period T1 starts when a *RRCReconfiguration* with updated bandwidth part configuration, sent from the test equipment to the UE, is received at the UE side in PCell's slot # denoted i . The UE shall reconfigure its bandwidth part with the updated bandwidth part BWP-1 of final condition.

The UE shall be able to completely receive PDSCH on PCell from the first DL slot that occurs after the beginning of DL slot $i + \frac{T_{RRCprocessingDelay} + T_{BWPswitchDelayRRC}}{NR\ Slot\ length}$ as defined in clause 8.6.3 and starts to report valid ACK/NACK for the PCell from the first UL slot that occurs after the beginning of DL slot $i + \frac{T_{RRCprocessingDelay} + T_{BWPswitchDelayRRC}}{NR\ Slot\ length} + k1$. The UE shall be continuously scheduled on PCell's BWP-1 starting from the first DL slot that occurs after the beginning of DL slot $i + \frac{T_{RRCprocessingDelay} + T_{BWPswitchDelayRRC}}{NR\ Slot\ length}$.

$T_{RRCprocessingDelay}$ and $T_{BWPswitchDelayRRC}$ are defined in clause 8.6.3.

The test equipment verifies the DL BWP switch time in PCell by counting the time from the time when the RRC Reconfiguration message including updated BWP configuration is sent till the time when RRC Reconfiguration Complete message is received.

Table A.7.5.6.2.1.1-1: DL BWP switch supported test configurations

Config	Description
1	NR 120 kHz SSB SCS, 100 MHz bandwidth, TDD duplex mode

Table A.7.5.6.2.1.1-2: General test parameters for DL BWP switch in SA

Parameter	Unit	Value	Comment
NR RF Channel Number		1	One NR radio channel is used for this test
Active PCell		Cell 1	PCell on RF channel number 1.
CP length		Normal	
DRX		OFF	
Cell-individual offset for cells on RF channel number 1	dB	0	Individual offset for cells on PCC.
T1	s	0.2	

Table A.7.5.6.2.1.1-3: NR Cell specific test parameters for DL BWP switch in SA

Parameter		Unit	Cell 1
Frequency Range			FR2
Duplex mode			TDD
TDD configuration			TDDConf.3.1
BW _{channel}			100 MHz: N _{RB,C} = 66
Active BWP ID			1
Initial DL BWP Configuration			DLBWP.0.2
Initial UL BWP Configuration			ULBWP.0.2
Initial Condition	Active DL BWP-1 Configuration		DLBWP.1.3
	Active UL BWP-1 Configuration		ULBWP.1.3
Final Condition	Active DL BWP-1 Configuration		DLBWP.1.1
	Active UL BWP-1 Configuration		ULBWP.1.1
PDSCH Reference measurement channel			SR.3.1 TDD
RMSI CORESET parameters			CR.3.1 TDD
Dedicated CORESET parameters			CCR.3.1 TDD
OCNG Patterns			OP.1
SSB Configuration			SSB.1 FR2
SMTC Configuration			SMTC.1
TCI State			TCI.State.0
TRS Configuration			TRS.2.1 TDD
Antenna Configuration			1x2
Propagation Condition			AWGN
EPRE ratio of PSS to SSS		dB	0
EPRE ratio of PBCH DMRS to SSS			
EPRE ratio of PBCH to PBCH DMRS			
EPRE ratio of PDCCH DMRS to SSS			
EPRE ratio of PDCCH to PDCCH DMRS			
EPRE ratio of PDSCH DMRS to SSS			
EPRE ratio of PDSCH to PDSCH			
EPRE ratio of OCNG DMRS to SSS(Note 1)			
EPRE ratio of OCNG to OCNG DMRS (Note 1)			

Note 1:	OCNG shall be used such that the resources in Cell 1 are fully allocated and a constant total transmitted power spectral density is achieved for all OFDM symbols.
Note 2:	Interference from other cells and noise sources not specified in the test is assumed to be constant over subcarriers and time and shall be modelled as AWGN of appropriate power for N_{oc} to be fulfilled.
Note 3:	SS-RSRP and I_o levels have been derived from other parameters for information purposes. They are not settable parameters themselves.
Note 4:	For unpaired spectrum, a DL BWP is linked with an UL BWP. DLBWP.0.2 is linked with ULBWP.0.2; DLBWP.1.1 is linked with ULBWP.1.1; DLBWP.1.3 is linked with ULBWP.1.3 defined in clause 12 of TS 38.213 [3].

Table A.7.5.6.2.1.1-4: OTA related test parameters for BWP switching test case

Parameter		Unit	Cell 1
Angle of arrival configuration			Setup 1 according to table A.3.15
Assumption for UE beams ^{Note 5}			Fine
N_{oc} ^{Note1}	NR_TDD_FR2_A	dBm/15kHz	-112
	NR_TDD_FR2_B		
	NR_TDD_FR2_F		
	NR_TDD_FR2_G		
	NR_TDD_FR2_T		
	NR_TDD_FR2_Y		
N_{oc} ^{Note1}	NR_TDD_FR2_A	dBm/SCS	-103
	NR_TDD_FR2_B		
	NR_TDD_FR2_F		
	NR_TDD_FR2_G		
	NR_TDD_FR2_T		
	NR_TDD_FR2_Y		
SS-RSRP ^{Note2}	NR_TDD_FR2_A	dBm/SCS ^{Note3}	-85
	NR_TDD_FR2_B		
	NR_TDD_FR2_F		
	NR_TDD_FR2_G		
	NR_TDD_FR2_T		
	NR_TDD_FR2_Y		
\hat{E}_s/I_{ot}		dB	18
I_o ^{Note2}	NR_TDD_FR2_A	dBm/95.04 MHz ^{Note4}	-56
	NR_TDD_FR2_B		
	NR_TDD_FR2_F		
	NR_TDD_FR2_G		
	NR_TDD_FR2_T		
	NR_TDD_FR2_Y		
Note 1:	Interference from other cells and noise sources not specified in the test is assumed to be constant over subcarriers and time and shall be modelled as AWGN of appropriate power for N_{oc} to be fulfilled.		
Note 2:	SS-RSRP and I_o levels have been derived from other parameters for information purposes. They are not settable parameters themselves.		
Note 3:	SS-RSRP minimum requirements are specified assuming independent interference and noise at each receiver antenna port.		
Note 4:	Equivalent power received by an antenna with 0 dBi gain at the centre of the quiet zone		
Note 5:	Information about types of UE beam is given in B.2.1.3 and does not limit UE implementation or test system implementation.		

A.7.5.6.2.1.2 Test Requirements

During T1, the UE shall be ready for the reception of uplink grant for PCell from the first DL slot that occurs after the beginning of slot $i + \frac{T_{\text{RRCprocessingDelay}} + T_{\text{BWPswitchDelayRRC}}}{\text{NR Slot length}}$ and starts to report valid ACK/NACK for the PCell from the first UL slot that occurs after the beginning of DL slot $i + \frac{T_{\text{RRCprocessingDelay}} + T_{\text{BWPswitchDelayRRC}}}{\text{NR Slot length}} + k1$.

Where, $k1$ is the timing between DL data receiving and acknowledgement as specified in [7].

All of the above test requirements shall be fulfilled in order for the observed PCell active BWP switch delay to be counted as correct.

The rate of correct events observed during repeated tests shall be at least 90%.

A.7.5.7 PSCell addition and release delay

A.7.5.7.1 Addition and Release Delay of known NR PSCell

A.7.5.7.1.1 Test Purpose and Environment

The purpose of this test is to verify the PSCell addition and release delay requirements defined in clauses 8.9.2 and 8.9.3, respectively, for the case where the PSCell is known to the UE at the time of addition.

The supported test configurations are given in Table A.7.5.7.1.1-1. The test scenario comprises two NR cells, Cell 1 and Cell 2, on radio channel 1 in FR1 and radio channel 2 in FR2, respectively. Test parameters are given in Tables A.7.5.7.1.1-2, A.7.5.7.1.1-3 and A.7.5.7.1.1-4 below. The test consists of six time periods with durations T1, T2, T3, T4, T5 and T6, respectively.

At the start of T1, the UE shall be connected to Cell 1 (PCell) on radio channel 1 (PCC) and shall only monitor PCC and hence be unaware of Cell 2 (PSCell-to-be) on radio channel 2. Before the start of T2, the test system shall send measurement control information including measurement gap configuration and event-triggered reporting configuration for measurements on radio channel 2.

During T2, the Cell2 becomes known to the UE. Therefore, during T2 the UE shall report Event triggered report.

The point in time at which the RRC message to release measurement gap is transmitted from the test system defines the start of period T3. During T3, after measurement gap is released, the test system transmits the RRC message to the UE to add PSCell on radio channel 2. The RRC message (to add PSCell) also includes a request for the UE to start periodic CSI reporting for the PSCell after the PSCell has been successfully added.

The point in time at which the RRC message to add PSCell (Cell2) is received at the UE antenna connector defines the start of period T4.

During T4, the UE shall carry out random access towards the PSCell. Reception by the test system of the PRACH preamble defines the start of T5.

During T5, the UE shall send periodic CSI reports in PSCell. After having received at least one such report, the test system shall send a RRC message instructing the UE to release the PSCell. Reception by the UE of the RRC message defines the start of T6.

During T6, the UE shall release the PSCell.

Table A.7.5.7.1.1-1: Supported test configurations for FR2 PSCell

Config	Description
1	FR1 FDD SSB SCS 15kHz BW 10MHz – FR2 TDD SSB SCS 240kHz BW 100MHz
2	FR1 TDD SSB SCS 15kHz BW 10MHz – FR2 TDD SSB SCS 240kHz BW 100MHz
3	FR1 TDD SSB SCS 30kHz BW 40MHz – FR2 TDD SSB SCS 240kHz BW 100MHz
Note 1: The UE is only required to be tested in one of the supported test configurations	

Table A.7.5.7.1.1-2: General test parameters for PSCell addition and release delay

Parameter		Unit	Value	Comment
RF Channel Number			1, 2	Two radio channels are used for this test
Active PCell			Cell 1	PCell on RF channel number 1 in FR1
Neighbour cell			Cell 2	Neighbour cell (PSCell-to-be) on RF channel number 2 in FR2
A4	Hysteresis	dB	0	Hysteresis for event A4
	Threshold RSRP	dBm	-118	Threshold for event A4
	Time to Trigger	S	0	Time to trigger for event A4
DRX			OFF	For both PCell and PSCell once activated
Measurement gap pattern ID			0	Gaps are configured before T2 and released before T3.
PRACH configuration in Cell 2			FR2 PRACH configuration 2	PRACH configuration as specified in Clause A.3.8.3.2.
CSI reporting periodicity and offset configuration for Cell 2		ms	2	
T1		s	5	During this time the PCell is known and Cell 2 is unknown.
T2		s	1	During this time the UE shall identify neighbour cell 2 and report event B1.
T3		s	3.5	During this time the test system transmits the RRC messages to release measurement gap and add PSCell.
T4		s	1	During this time the UE adds the PSCell.
T5		s	1	During this time the UE sends CSI reports for PSCell.
T6		s	1	During this time the UE releases the PSCell.

Table A.7.5.7.1.1-3: NR Cell specific test parameters for PSCell addition and release delay

Parameter	Unit	Config	Cell 1	Cell2					
				T1	T2	T3	T4	T5	T6
Frequency Range		1,2,3	FR1	FR2					
Duplex mode		1	FDD	TDD					
		2,3	TDD						
TDD configuration		1	–	TDDConf.3.1					
		2	TDDConf.1.1						
		3	TDDConf.2.1						
BW _{channel}	MHz	1,2	10: N _{RB,c} = 52	100: N _{RB,c} = 66					
		3	40: N _{RB,c} = 106						
Data RBs allocated		1,2	52	48					
		3	106						
Initial Downlink BWP configuration		1,2,3	DLBWP.0.1	DLBWP.0.1					
Initial Uplink BWP configuration		1,2,3	ULBWP.0.1	ULBWP.0.1					
Dedicated Downlink BWP configuration		1,2,3	DLBWP.1.1	DLBWP.1.1					
Dedicated Uplink BWP configuration		1,2,3	ULBWP.1.1	ULBWP.1.1					

PDSCH Reference Measurement Channel		1	SR.1.1 FDD	SR.3.3 TDD
		2	SR.1.1 TDD	
		3	SR.2.1 TDD	
TRS configuration		1,2,3	–	TRS.2.1 TDD
TCI state		1,2,3	–	TCI.State.0
RMSI CORESET parameters		1	CR.1.1 FDD	CR.3.2 TDD
		2	CR.1.1 TDD	
		3	CR.2.1 TDD	
Dedicated CORESET parameters		1	CCR.1.1 FDD	CCR.3.7 TDD
		2	CCR.1.1 TDD	
		3	CCR.2.1 TDD	
OCNG Patterns ^{Note1}		1,2,3	OP.1	OP.3
SSB configuration		1,2	SSB.1 FR1	SSB.2 FR2
		3	SSB.2 FR1	
SMTC configuration		1,2,3	SMTC.2	SMTC.1
PDSCH/PDCCH subcarrier spacing	kHz	1,2	15	120
		3	30	
EPRE ratio of PSS to SSS	dB	1,2,3	0	0
EPRE ratio of PBCH DMRS to SSS				
EPRE ratio of PBCH to PBCH DMRS				
EPRE ratio of PDCCH DMRS to SSS				
EPRE ratio of PDCCH to PDCCH DMRS				
EPRE ratio of PDSCH DMRS to SSS				
EPRE ratio of PDSCH to PDSCH				
EPRE ratio of OCNG DMRS to SSS				
EPRE ratio of OCNG to OCNG DMRS				
Propagation Condition		1,2,3	N/A	No external noise (Note 6)
<p>Note 1: OCNG shall be used such that a constant total transmitted power spectral density is achieved for all OFDM symbols.</p> <p>Note 2: Void</p> <p>Note 3: Void</p> <p>Note 4: Void</p> <p>Note 5: Void</p> <p>Note 6: The downlink connection between the System Simulator and the UE is without Additive White Gaussian Noise, and has no fading or multipath effects as specified in TS 38.521-2 B.0 [29].</p>				

Table A.7.5.7.1.1-4: OTA related test parameters for PSCell addition and release delay

Parameter	Unit	Config	Cell 1	Cell 2					
				T1	T2	T3	T4	T5	T6
Angle of arrival configuration		1,2,3	Link only, see clause A.3.7A	Setup 2a according to clause A.3.15.2.1					
Assumption for UE beams ^{Note 3}				Rough					
\hat{E}_s	dBm/SCS	1,2,3		–∞	–81				
SSB_RP ^{Note1, Note2}	dBm/SCS	1,2,3		–∞	–81				
$\hat{E}_s / I_{ot\ BB}$ ^{Note1, Note 4}	dB	1,2,3		–∞	4.88				
I_o ^{Note 1, Note2}	dBm/95.04 MHz	1,2,3		N/A	–56.41				
<p>Note 1: E_s/I_{ot}, SSB_RP and I_o levels have been derived from other parameters for information purposes. They are not settable parameters themselves.</p> <p>Note 2: Equivalent power received by an antenna with 0dBi gain at the centre of the quiet zone.</p> <p>Note 3: Information about types of UE beam is given in B.2.1.3 and does not limit UE implementation or test system implementation.</p> <p>Note 4: Calculation of $E_s/I_{ot\ BB}$ includes the effect of UE internal noise up to the value assumed for the associated Refsens requirement in clause 7.3.2 of TS 38.101-2 [19], and an allowance of 1dB for UE multi-band relaxation factor ΔMB_s from TS 38.101-2 [19] Table 6.2.1.3-4.</p>									

A.7.5.7.1.2 Test Requirements

The UE shall transmit the PRACH preamble to PSCell at latest 112 ms into T4.

The UE shall transmit at least one periodic CSI report for PSCell during T5.

The UE shall stop transmitting CSI reports for PSCell at latest 20 ms into T6.

All of the above test requirements shall be fulfilled in order for the observed PSCell addition and release delay to be counted as correct. The rate of correct events observed during repeated tests shall be at least 90%.

A.7.5.7.2 Addition and Release Delay of unknown NR PSCell

A.7.5.7.2.1 Test Purpose and Environment

The purpose of this test is to verify the PSCell addition and release delay requirements defined in clauses 8.9.2 and 8.9.3, respectively, for the case where the PSCell is unknown to the UE at the time of addition.

The supported test configurations are given in Table A.7.5.7.2.1-1. The test scenario comprises two NR cells, Cell 1 and Cell 2, on radio channel 1 in FR1 and radio channel 2 in FR2, respectively. Test parameters are given in Tables A.7.5.7.2.1-2, A.7.5.7.2.1-3 and A.7.5.7.2.1-4 below. The test consists of four time periods with durations T1, T2, T3 and T4, respectively.

At the start of T1, the UE shall be connected to Cell 1 (PCell) on radio channel 1 (PCC) and shall only monitor PCC and hence be unaware of Cell 2 (PSCell-to-be) on radio channel 2. At the end of T1, the test system shall send a RRC message instructing the UE to add PSCell (Cell 2), and further instructing the UE to report CSI periodically in the PSCell once it has been added. Reception by the UE of this RRC message defines the start of T2.

During T2, the UE shall identify PSCell and carry out random access towards the PSCell. Reception by the test system of the PRACH preamble defines the start of T3.

During T3, the UE shall send periodic CSI reports in PSCell. After having received at least one such report, the test system shall send a RRC message instructing the UE to release the PSCell. Reception by the UE of the RRC message defines the start of T4.

During T4, the UE shall release the PSCell.

Table A.7.5.7.2.1-1: Supported test configurations for FR2 PSCell

Config	Description
1	FR1 FDD SSB SCS 15kHz BW 10MHz – FR2 TDD SSB SCS 240kHz BW 100MHz
2	FR1 TDD SSB SCS 15kHz BW 10MHz – FR2 TDD SSB SCS 240kHz BW 100MHz
3	FR1 TDD SSB SCS 30kHz BW 40MHz – FR2 TDD SSB SCS 240kHz BW 100MHz
Note 1: The UE is only required to be tested in one of the supported test configurations	

Table A.7.5.7.2.1-2: General test parameters for PSCell addition and release delay

Parameter	Unit	Value	Comment
RF Channel Number		1, 2	Two radio channels are used for this test
Active PCell		Cell 1	PCell on RF channel number 1 in FR1
Neighbour cell		Cell 2	Neighbour cell (PSCell-to-be) on RF channel number 2 in FR2
DRX		OFF	For both PCell and PSCell once activated

PRACH configuration in Cell 2		FR2 PRACH configuration 2	PRACH configuration as specified in Clause A.3.8.3.2.
CSI reporting periodicity and offset configuration for Cell 2	ms	[2]	
T1	s	5	During this time the PCell is known and Cell 2 is unknown.
T2	s	1	During this time the UE adds the PSCell.
T3	s	1	During this time the UE sends CSI reports for PSCell.
T4	s	1	During this time the UE releases the PSCell.

Table A.7.5.7.2.1-3: NR Cell specific test parameters for PSCell addition and release delay

Parameter	Unit	Config	Cell 1	Cell2			
				T1	T2	T3	T4
Frequency Range		1,2,3	FR1	FR2			
Duplex mode		1	FDD	TDD			
		2,3	TDD				
TDD configuration		1	–	TDDConf.3.1			
		2	TDDConf.1.1				
		3	TDDConf.2.1				
BW _{channel}	MHz	1,2	10: N _{RB,c} = 52	100: N _{RB,c} = 66			
		3	40: N _{RB,c} = 106				
Data RBs allocated		1,2	52	48			
		3	106				
Initial Downlink BWP configuration		1,2,3	DLBWP.0.1	DLBWP.0.1			
Initial Uplink BWP configuration		1,2,3	ULBWP.0.1	ULBWP.0.1			
Dedicated Downlink BWP configuration		1,2,3	DLBWP.1.1	DLBWP.1.1			
Dedicated Uplink BWP configuration		1,2,3	ULBWP.1.1	ULBWP.1.1			
PDSCH Reference Measurement Channel		1	SR.1.1 FDD	SR.3.3 TDD			
		2	SR.1.1 TDD				
		3	SR.2.1 TDD				
TRS configuration		1,2,3	–	TRS.2.1 TDD			
TCI state		1,2,3	–	TCI.State.0			
RMSI CORESET parameters		1	CR.1.1 FDD	CR.3.2 TDD			
		2	CR.1.1 TDD				
		3	CR.2.1 TDD				
Dedicated CORESET parameters		1	CCR.1.1 FDD	CCR.3.7 TDD			
		2	CCR.1.1 TDD				
		3	CCR.2.1 TDD				
OCNG Patterns ^{Note1}		1,2,3	OP.1	OP.3			
SSB configuration		1,2	SSB.1 FR1	SSB.2 FR2			
		3	SSB.2 FR1				
SMTC configuration		1,2,3	SMTC.2	SMTC.1			
PDSCH/PDCCH subcarrier spacing	kHz	1,2	15	120			
		3	30				
EPRE ratio of PSS to SSS	dB	1,2,3	0	0			
EPRE ratio of PBCH DMRS to SSS							
EPRE ratio of PBCH to PBCH DMRS							
EPRE ratio of PDCCH DMRS to SSS							
EPRE ratio of PDCCH to PDCCH DMRS							
EPRE ratio of PDSCH DMRS to SSS							
EPRE ratio of PDSCH to PDSCH							
EPRE ratio of OCNG DMRS to SSS							
EPRE ratio of OCNG to OCNG DMRS							
Propagation Condition		1,2,3	AWGN	No external noise (Note 6)			

Note 1:	OCNG shall be used such that and a constant total transmitted power spectral density is achieved for all OFDM symbols.
Note 2:	Void
Note 3:	Void
Note 4:	Void
Note 5:	Void
Note 6:	The downlink connection between the System Simulator and the UE is without Additive White Gaussian Noise, and has no fading or multipath effects as specified in TS 38.521-2 B.0 [29].

Table A.7.5.7.2.1-4: OTA related test parameters for PSCell addition and release delay

Parameter	Unit	Config	Cell 1	Cell 2			
				T1	T2	T3	T4
Angle of arrival configuration		1,2,3	Link only, see clause A.3.7A	Setup 2a according to clause A.3.15.2.1			
Assumption for UE beams ^{Note 3}				Rough			
\hat{E}_s	dBm/SCS	1,2,3		$-\infty$	-81		
SSB_RP ^{Note 1, Note 2}	dBm/SCS	1,2,3		$-\infty$	-81		
$\hat{E}_s/I_{ot\ BB}$ ^{Note 1, Note 4}	dB	1,2,3		$-\infty$	4.88		
I_o ^{Note 1, Note 2}	dBm/95.04 MHz	1,2,3	N/A	-56.41			
Note 1:	Es/lot, SSB_RP and Io levels have been derived from other parameters for information purposes. They are not settable parameters themselves.						
Note 2:	Equivalent power received by an antenna with 0dBi gain at the centre of the quiet zone.						
Note 3:	Information about types of UE beam is given in B.2.1.3 and does not limit UE implementation or test system implementation.						
Note 4:	Calculation of Es/Iot _{BB} includes the effect of UE internal noise up to the value assumed for the associated Refsens requirement in clause 7.3.2 of TS 38.101-2 [19], and an allowance of 1dB for UE multi-band relaxation factor ΔMB_s from TS 38.101-2 [19] Table 6.2.1.3-4.						

A.7.5.7.2.2 Test Requirements

The UE shall transmit the PRACH preamble to PSCell at latest 572 ms into T2.

The UE shall transmit at least one periodic CSI report for PSCell during T3.

The UE shall stop transmitting CSI reports for PSCell at latest 20 ms into T4.

All of the above test requirements shall be fulfilled in order for the observed PSCell addition and release delay to be counted as correct. The rate of correct events observed during repeated tests shall be at least 90%.

A.7.5.8 Active TCI state switch delay

A.7.5.8.1 MAC-CE based active TCI state switch

A.7.5.8.1.1 NR PCell FR2 active TCI state switch for a known TCI state

A.7.5.8.1.1.1 Test Purpose and Environment

The purpose of this test is to verify the active TCI state switch delay requirement defined in clause 8.10.3. Supported test configuration is shown in Table A.7.5.8.1.1.1-1.

The test scenario comprises of one NR PCell (Cell 1) as given in Table A.7.5.8.1.1.1-2. Cell-specific parameters of NR PCell are specified in Table A.7.5.8.1.1.1-3 below. The OTA related test parameters for FR2 are shown in Table A.7.5.8.1.1.1-4.

PDCCHs indicating new transmissions shall be sent continuously on PCell to ensure that the UE would have ACK/NACK sending.

Before the test starts,

- UE is connected to Cell 1 (PCell) on radio channel 1 (PCC).
- UE is configured with 2 different TCI states for PCell, PDCCH TCI state 0 (QCL'd to SSB0) and TCI state 1 (QCL'd to SSB1), in Cell 1 before starting the test.
- UE is indicated in TCI state 0 as the active PDCCH TCI state
- Target TCI state is not in the active TCI state list.

The test consists of two time periods, T1 and T2. Figure A.7.5.8.1.1.1-1 and Figure A.7.5.8.1.1.1-2 show the Time multiplexed (allocation in Frequency is symbolic) downlink transmissions from each Angle of Arrival. During T1 only SSB to which PDCCH-TCI-state0 is QCL'd is transmitted. At the beginning of T2, the SSB corresponding to TCI state 1 starts transmitting. The UE is configured to provide periodic L1-RSRP reports with a periodicity of 1280ms or less. In slot n which is within 1280ms of the last transmission of the RS resource for beam reporting or measurements, and UE providing L1-RSRP report with results for both SSB0 and SSB1, UE receives a MAC-CE command indicating a switch to TCI state 1. *tcj-PresentInDCI* is not configured in the PDSCH configuration, i.e. TCI state for the PDSCH is identical to the PDCCH TCI state.

The test equipment verifies that UE can be scheduled on PCell on TCI state 0 till slot $n + T_{\text{HARQ}} + 3N_{\text{slot}}^{\text{subframe},\mu}$. The test equipment also verifies the TCI state switch time in PCell by scheduling the UE on TCI state 1 after slot $n + T_{\text{HARQ}} + 3N_{\text{slot}}^{\text{subframe},\mu} + (T_{\text{first-SSB}} + T_{\text{SSB-proc}})/NR \text{ slot length}$.

Table A.7.5.8.1.1-1: Supported test configurations

Config	Description
1	NR 120 kHz SSB SCS, 100 MHz bandwidth, TDD duplex mode

Table A.7.5.8.1.1-2: General test parameters for TCI state switch

Parameter	Unit	Value	Comment
NR RF Channel Number		1	One NR radio channel is used for this test
Active PCell		Cell 1	PCell on RF channel number 1.
CP length		Normal	
DRX		OFF	
T1	s	0.2	
T2	s	0.2	

Table A.7.5.8.1.1-3: NR Cell specific test parameters for TCI state switch

Parameter	Unit	Cell 1
Frequency Range		FR2
Duplex mode		TDD
TDD configuration		TDDConf.3.1
BW _{channel}		100 MHz: N _{RB,c} = 66
Data RBs allocated		24
Initial DL BWP Configuration		DLBWP.0.2
Dedicated DL BWP Configuration		DLBWP.1.1
Initial UL BWP Configuration		ULBWP.0.2
Dedicated UL BWP Configuration		ULBWP.1.1
PDSCH Reference measurement channel		SR.3.2 TDD

RMSI CORESET parameters		CR.3.1 TDD
Dedicated CORESET parameters		CCR.3.1 TDD
OCNG Patterns		OP.5
SSB Configuration		SSB.1 FR2
SMTC Configuration		SMTC.1
TCI State 0		TC.State.2
TCI State 1		TCI.State.3
TRS Configuration		TRS.2.1 TDD TRS.2.2 TDD
Correlation Matrix and Antenna Configuration		1x2 Low
EPRE ratio of PSS to SSS	dB	0
EPRE ratio of PBCH DMRS to SSS		
EPRE ratio of PBCH to PBCH DMRS		
EPRE ratio of PDCCH DMRS to SSS		
EPRE ratio of PDCCH to PDCCH DMRS		
EPRE ratio of PDSCH DMRS to SSS		
EPRE ratio of PDSCH to PDSCH		
EPRE ratio of OCNG DMRS to SSS(Note 1)		
EPRE ratio of OCNG to OCNG DMRS (Note 1)		
Propagation Condition		
Note 1: OCNG shall be used such that a constant total transmitted power spectral density is achieved for all OFDM symbols.		
Note 2: The downlink connection between the System Simulator and the UE is without Additive White Gaussian Noise, and has no fading or multipath effects as specified in TS 38.521-2 B.0 [29].		

Table A.7.5.8.1.1-4: OTA related test parameters for TCI state switch

Parameter	Unit	Cell 1			
		SSB0		SSB1	
		T1	T2	T1	T2
Angle of arrival configuration		Setup 3 According to clause A.3.15.3			
		AoA1		AoA2	
Assumption for UE beams ^{Note 6}		Rough		Rough	
\hat{E}_s	dBm/SCS	-80.6	-80.6	-Infinity	-80.6
SSB-RP ^{Note 2}	dBm/SCS	-80.6	-80.6	-Infinity	-80.6
\hat{E}_s/I_{BB} ^{Note 7}	dB	8.3	8.3	-Infinity	8.3
I_0 ^{Note 2}	dBm/95.04 MHz ^{Note 4}	-55.41	-55.41	-Infinity	-55.41
Note 1: Void					
Note 2: SSB-RP and I_0 levels have been derived from other parameters for information purposes. They are not settable parameters themselves.					
Note 3: Void					
Note 4: Equivalent power received by an antenna with 0 dBi gain at the centre of the quiet zone					
Note 5: As observed with 0dBi gain antenna at the center of the quiet zone.					
Note 6: Information about types of UE beam is given in B.2.1.3 and does not limit UE implementation or test system implementation.					
Note 7: Calculation of E_s/I_{BB} includes the effect of UE internal noise up to the value assumed for the associated Refsens requirement in clause 7.3.2 of TS 38.101-2 [19], and an allowance of 1dB for UE multi-band relaxation factor ΔMB_P from TS 38.101-2 [19] Table 6.2.1.3-4.					

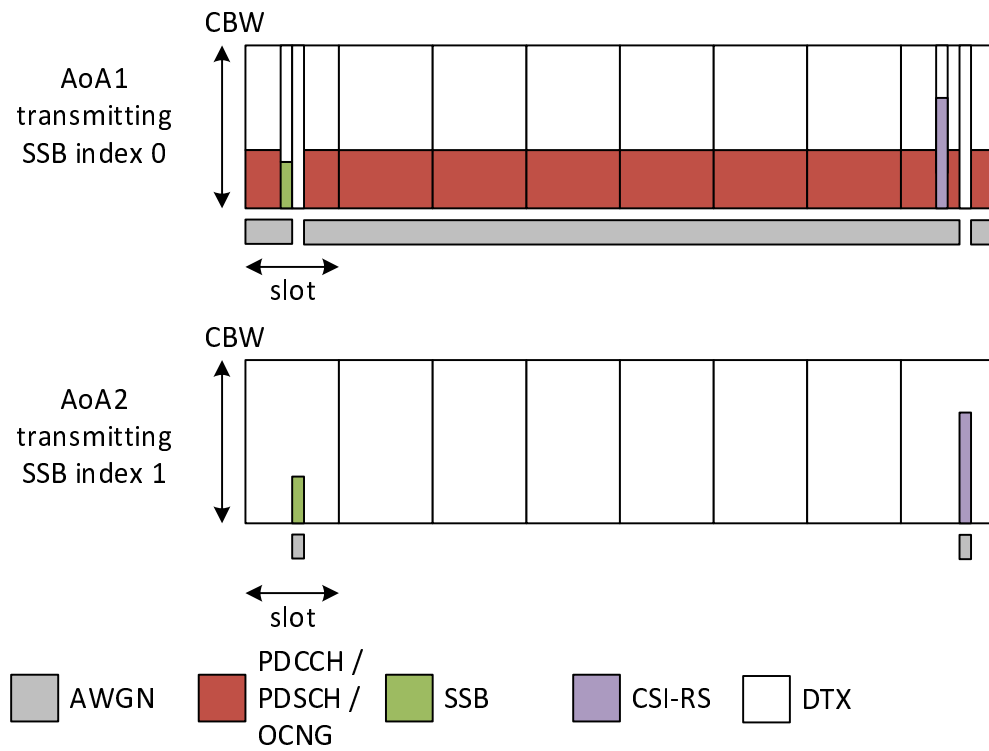

Figure A.7.5.8.1.1.1-1: Time multiplexed downlink transmissions during T1

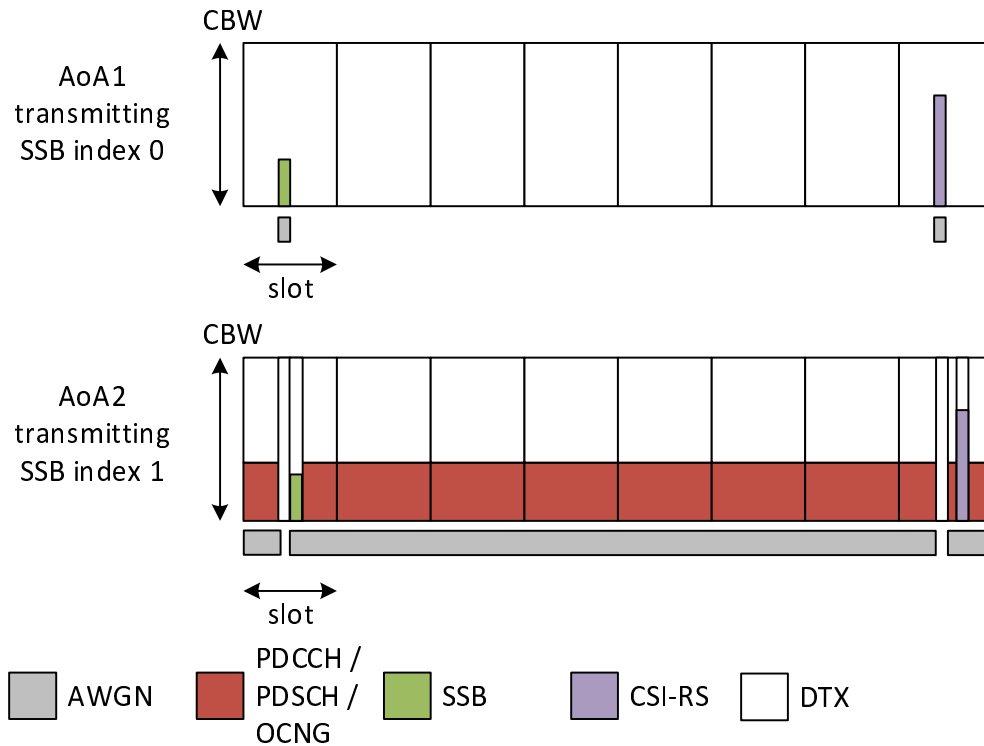

Figure A.7.5.8.1.1-2: Time multiplexed downlink transmissions during T2

A.7.5.8.1.1.2 Test Requirements

During T2, UE shall send L1-RSRP report with results for both SSB0 and SSB1.

After receiving MAC-CE command in slot n, UE shall:

- be able to continue to receive on TCI state 0 till slot $n + T_{HARQ} + 3N_{slot}^{subframe,\mu}$
- be able to start receiving on TCI state 1 after slot $n + T_{HARQ} + 5N_{slot}^{subframe,\mu} + T_{first-SSB/NR\ slot\ length}$

The rate of correct events observed during repeated tests shall be at least 90%.

A.7.5.8.2 RRC based active TCI state switch

A.7.5.8.2.1 NR PCell FR2 active TCI state switch for a known TCI state

A.7.5.8.2.1.1 Test Purpose and Environment

The purpose of this test is to verify the active TCI state switch delay requirement defined in clause 8.10.5. Supported test configuration is shown in Table A.7.5.8.2.1.1-1.

The test scenario comprises of one NR PCell as given in Table A.7.5.8.2.1.1-2. Cell-specific parameters of NR PCell is specified in Table A.7.5.8.2.1.1-3 below. The OTA related test parameters for FR2 is shown in Table A.7.5.8.2.1.1-4.

PDCCHs indicating new transmissions shall be sent continuously on PCell to ensure that the UE would have ACK/NACK sending.

Before the test starts,

- UE is connected to Cell 1 (PCell) on radio channel 1 (PCC).
- UE is configured with 1 TCI state for PCell, PDCCH-TCI-state0 (QCL'd to SSB0)
- UE is indicated in TCI state0 as the active TCI state

The test consists of two time periods, T1 and T2. Figure A.7.5.8.2.1.1-1 and Figure A.7.5.8.2.1.1-2 show the Time multiplexed (allocation in Frequency is symbolic) downlink transmissions from each Angle of Arrival. During T1 only SSB to which TCI-state0 is QCL'd is transmitted. At the beginning of T2, the SSB corresponding to TCI-state1 starts transmitting. The UE is configured to provide periodic L1-RSRP reports. In slot n which is within 1280 ms of UE providing L1-RSRP report with results for both SSB0 and SSB1, UE receives a RRC command indicating a switch to TCI-state1.

The test equipment verifies the TCI state switch time in PCell by scheduling the UE on TCI state 1 after slot $n + (T_{\text{RRC_processing}} + T_{\text{first-SSB}}) / \text{NR slot length} + 2N_{\text{slot}}^{\text{subframe}, \mu}$.

Table A.7.5.8.2.1.1-1: Supported test configurations

Config	Description
1	NR 120 kHz SSB SCS, 100 MHz bandwidth, TDD duplex mode

Table A.7.5.8.2.1.1-2: General test parameters for TCI state switch

Parameter	Unit	Value	Comment
NR RF Channel Number		1	One NR radio channel is used for this test
Active PCell		Cell 1	PCell on RF channel number 1.
CP length		Normal	
DRX		OFF	
T1	s	0.2	
T2	s	0.2	

Table A.7.5.8.2.1.1-3: NR Cell specific test parameters for TCI state switch

Parameter	Unit	Cell 1
Frequency Range		FR2
Duplex mode		TDD
TDD configuration		TDDConf.3.1
BW_{channel}		100 MHz: $N_{\text{RB},c} = 66$
Data RBs allocated		24
Initial DL BWP Configuration		DLBWP.0.2
Dedicated DL BWP Configuration		DLBWP.1.1
Initial UL BWP Configuration		ULBWP.0.2
Dedicated UL BWP Configuration		ULBWP.1.1
PDSCH Reference measurement channel		SR.3.2 TDD
RMSI CORESET parameters		CR.3.1 TDD
Dedicated CORESET parameters		CCR.3.1 TDD
OCNG Patterns		OP.5
SSB Configuration		SSB.1 FR2
SMTTC Configuration		SMTTC.1
TCI State 0		TC. State.2

TCI State 1		TCI.State.3
reportConfigType		ssb-Index-RSRP
reportConfigType		periodic
Number of reported RS		2
L1-RSRP reporting period	slot	640
timeRestrictionForChannelMeasurements		configured
TRS Configuration		TRS.2.1 TDD TRS.2.2 TDD
Correlation Matrix and Antenna Configuration		1x2 Low
EPRE ratio of PSS to SSS	dB	0
EPRE ratio of PBCH DMRS to SSS		
EPRE ratio of PBCH to PBCH DMRS		
EPRE ratio of PDCCH DMRS to SSS		
EPRE ratio of PDCCH to PDCCH DMRS		
EPRE ratio of PDSCH DMRS to SSS		
EPRE ratio of PDSCH to PDSCH		
EPRE ratio of OCNG DMRS to SSS(Note 1)		
EPRE ratio of OCNG to OCNG DMRS (Note 1)		
Propagation Condition		
Note 1: OCNG shall be used such that the resources in Cell 1 are fully allocated and a constant total transmitted power spectral density is achieved for all OFDM symbols.		
Note 2: The downlink connection between the System Simulator and the UE is without Additive White Gaussian Noise, and has no fading or multipath effects as specified in TS 38.521-2 B.0 [29].		

Table A.7.5.8.2.1.1-4: OTA related test parameters for TCI state switch

Parameter	Unit	Cell 1			
		SSB0		SSB1	
		T1	T2	T1	T2
Angle of arrival configuration		Setup 3 According to clause A.3.15.3			
		AoA1		AoA2	
Assumption for UE beams ^{Note 6}		Rough		Rough	
\hat{E}_s ^{Note 2}	dBm/SCS	-80.6	-80.6	-Infinity	-80.6
SSB-RP ^{Note 2}	dBm/SCS	-80.6	-80.6	-Infinity	-80.6
$\hat{E}_s/I_{e, BB}$ ^{Note 7}	dB	8.3	8.3	-Infinity	8.3
I_o ^{Note 2}	dBm/95.04 MHz ^{Note 4}	-55.41	-55.41	-Infinity	-55.41
Note 1: Void					
Note 2: SSB-RP and I_o levels have been derived from other parameters for information purposes. They are not settable parameters themselves.					
Note 3: Void					
Note 4: Equivalent power received by an antenna with 0 dBi gain at the centre of the quiet zone					
Note 5: As observed with 0dBi gain antenna at the center of the quiet zone.					
Note 6: Information about types of UE beam is given in B.2.1.3 and does not limit UE implementation or test system implementation.					
Note 7: Calculation of $E_s/I_{e, BB}$ includes the effect of UE internal noise up to the value assumed for the associated Refsens requirement in clause 7.3.2 of TS 38.101-2 [19], and an allowance of 1dB for UE multi-band relaxation factor ΔMB_P from TS 38.101-2 [19] Table 6.2.1.3-4.					

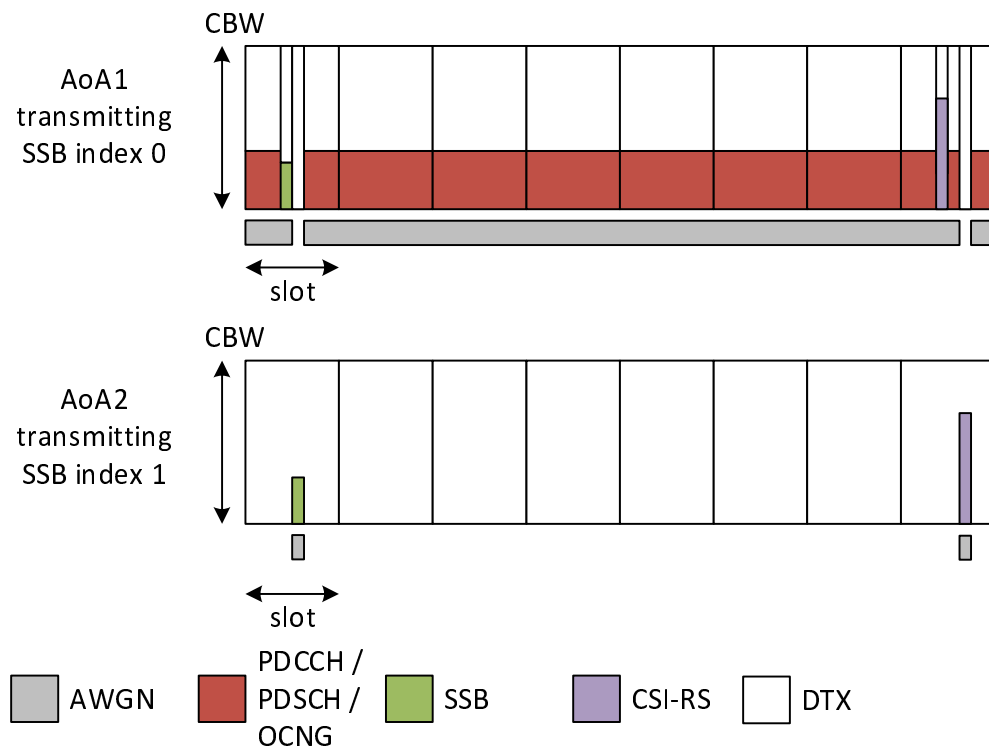

Figure A.7.5.8.2.1.1-1: Time multiplexed downlink transmissions during T1

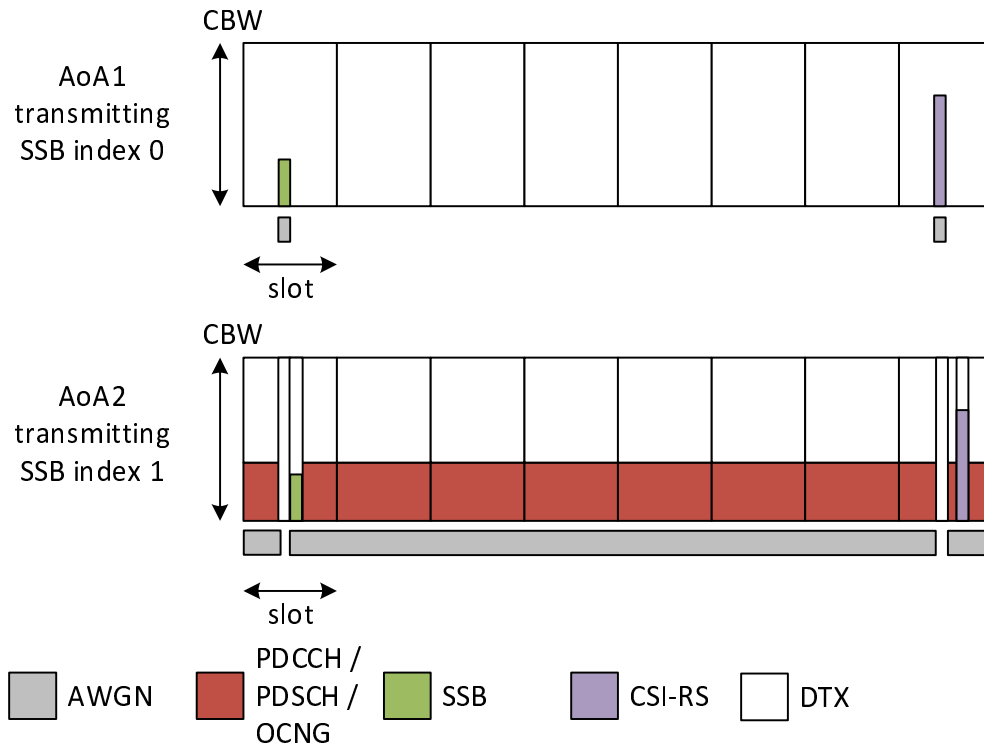

Figure A.7.5.8.2.1.1-2: Time multiplexed downlink transmissions during T2

A.7.5.8.2.1.2 Test Requirements

During T2, UE shall send L1-RSRP report with both SSB0 and SSB1.

After receiving RRC command in slot n , UE shall be able to start receiving on TCI state 1 after slot $n + (T_{RRC_processing} + T_{first-SSB}) / NR\ slot\ length + 2N_{slot}^{subframe,\mu}$.

The rate of correct events observed during repeated tests shall be at least 90%.

A.7.6 Measurement procedure

A.7.6.1 Intra-frequency Measurements

A.7.6.1.1 SA event triggered reporting test without gap under non-DRX

A.7.6.1.1.1 Test purpose and Environment

The purpose of this test is to verify that the UE makes correct reporting of an event. This test will partly verify the TDD intra-frequency cell search requirements in clause 9.2.5.1 and 9.2.5.2. Supported test configurations are shown in table A.7.6.1.1.1-1.

Table A.7.6.1.1.1-1: supported test configurations

Configuration	Description
---------------	-------------

1	120 kHz SSB SCS, 100 MHz bandwidth, TDD duplex mode
2	240 kHz SSB SCS, 100 MHz bandwidth, TDD duplex mode
Note:	The UE is only required to be tested in one of the supported test configurations.

There are two cells in the test, PCell (Cell 1) and a FR2 neighbour cell (Cell 2) on the same frequency as the PCell. The test parameters for the Cell 1 and Cell 2 are given in Table A.7.6.1.1.1-2, A.7.6.1.1.1-3 and A.7.6.1.1.1-4 below.

In the measurement control information, a measurement object is configured for the frequency of the PCell, and it is indicated to the UE that event-triggered reporting with Event A3 is used.

The test consists of two successive time periods, with time duration of T1, and T2 respectively. During time duration T1, the UE shall not have any timing information of Cell 2.

Table A.7.6.1.1.1-2: General test parameters for intra-frequency event triggered reporting for SA with TDD PCell in FR2 without gap without DRX

Parameter	Unit	Config	Value	Comment
Active cell		1, 2	PCell (Cell 1)	
Neighbour cell		1, 2	Cell 2	Cell to be identified.
RF Channel Number		1, 2	1: Cell 1 and Cell 2	One TDD carrier frequency is used for the NR cells.
SMTC configuration		1, 2	SMTC.1	
A3-Offset	dB	1, 2	-11	
CP length		1, 2	Normal	
Hysteresis	dB	1, 2	0	
Time To Trigger	s	1, 2	0	
Filter coefficient		1, 2	0	L3 filtering is not used
DRX		1, 2	OFF	
Time offset between Cell 1 and Cell 2		1, 2	3 μ s	Synchronous cells
T1	s	1, 2	5	
T2	s	1, 2	5	

Table A.7.6.1.1.1-3: NR Cell specific test parameters for intra-frequency event triggered reporting for SA with TDD PCell in FR2 without gap without DRX

Parameter	Unit	Config	Cell 1		Cell 2	
			T1	T2	T1	T2
TDD configuration		1, 2	TDDConf.3.1		TDDConf.3.1	
BW _{channel}	MHz	1, 2	100: N _{RB,c} = 66		100: N _{RB,c} = 66	
Data RBs allocated		1	24		24	
		2	48		48	
Initial BWP configuration		1, 2	DLBWP.0.1	DLBWP.0.1	DLBWP.0.1	DLBWP.0.1
Active DL BWP configuration		1, 2	DLBWP.1.1	DLBWP.1.1	DLBWP.1.1	DLBWP.1.1
Active UL BWP configuration		1, 2	ULBWP.1.1	ULBWP.1.1	ULBWP.1.1	ULBWP.1.1
RLM-RS		1, 2	SSB		SSB	
PDSCH RMC configuration		1	SR.3.2 TDD		N/A	
		2	SR.3.3 TDD		N/A	
RMSI CORESET RMC configuration		1	CR.3.1 TDD		N/A	
		2	CR.3.2 TDD		N/A	
		1	CCR.3.1 TDD		N/A	

Dedicated CORESET RMC configuration		2	CCR.3.7 TDD	N/A
TRS configuration		1, 2	TRS.2.1 TDD	N/A
PDSCH/PDCCH TCI states		1, 2	TCI.State.2	N/A
PDSCH/PDCCH subcarrier spacing	kHz	1, 2	120	120
OCNG Patterns		1, 2	OP.5	N/A
cellIndividualOffset	dB	1~2	N/A	16
SSB		1	SSB.3 FR2	SSB.7 FR2
		2	SSB.4 FR2	SSB.8 FR2
Propagation Condition		1, 2	No external noise (Note 1)	No external noise (Note 1)
Note 1: The downlink connection between the System Simulator and the UE is without Additive White Gaussian Noise, and has no fading or multipath effects as specified in TS 38.521-2 B.0 [29].				

Table A.7.6.1.1-4: NR OTA Cell specific test parameters for intra-frequency event triggered reporting for SA with TDD PCell in FR2 without gap without DRX

Parameter	Unit	Config	Cell 1		Cell 2	
			T1	T2	T1	T2
AoA setup		1, 2	Setup 3 defined in A.3.15.3			
Beam assumption ^{Note 4}		1,2	AoA1		AoA2	
			Rough		Rough	
E_s	dBm/SCS	1	-89	-89	-Infinity	-89
		2	-86	-86	-Infinity	-86
\hat{E}_s/I_{ot_BB} ^{Note 5}	dB	1, 2	-0.12	-0.12	-Infinity	-0.12
SSB_RP	dBm/SCS	1	-89	-89	-Infinity	-89
		2	-86	-86	-Infinity	-86
I_o	dBm/95.04MHz	1	-64.41	-64.41	-Infinity	-64.41
		2	-61.41	-61.41	-Infinity	-61.41
Time multiplexing of the downlink transmissions from each AoA		1, 2	Defined in Figure A.7.6.1.1-1			
<p>Note 1: The resources for uplink transmission are assigned to the UE prior to the start of time period T2.</p> <p>Note 2: Void</p> <p>Note 3: E_s/I_{ot}, SSB_RP and I_o levels have been derived from other parameters for information purposes. They are not settable parameters themselves.</p> <p>Note 4: Information about types of UE beam is given in B.2.1.3, and does not limit UE implementation or test system implementation</p> <p>Note 5: Calculation of E_s/I_{ot_BB} includes the effect of UE internal noise up to the value assumed for the associated Refsens requirement in clause 7.3.2 of TS 38.101-2 [19], and an allowance of 1dB for UE multi-band relaxation factor ΔMB_P from TS 38.101-2 [19] Table 6.2.1.3-4.</p>						

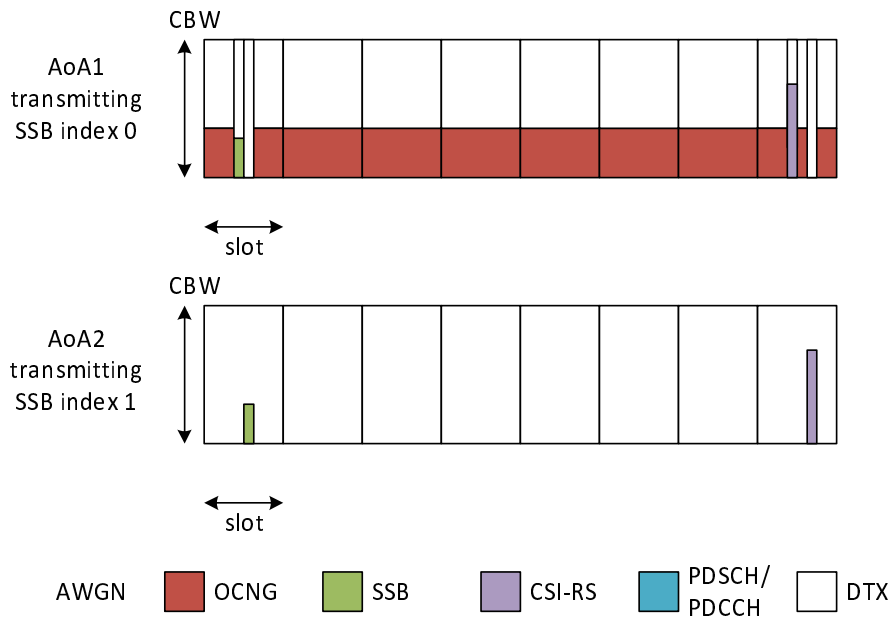

Figure A.7.6.1.1.1-1: Time multiplexed downlink transmissions (Config 1 example)

A.7.6.1.1.2 Test Requirements

In the test, the UE shall send one Event A3 triggered measurement report, with a measurement reporting delay less than X ms from the beginning of time period T2, where X is

- 2.4s for a UE supporting power class 1,
- 1.44s for a UE supporting power class 2, 3 and 4

The UE is not required to read the neighbour cell SSB index in this test.

The UE shall not send event triggered measurement reports, as long as the reporting criteria are not fulfilled.

The rate of correct events observed during repeated tests shall be at least 90%.

NOTE: The actual overall delays measured in the test may be up to $2 \times TTI_{DCCH}$ higher than the measurement reporting delays above because of TTI insertion uncertainty of the measurement report in DCCH.

A.7.6.1.2 SA event triggered reporting test without gap under DRX

A.7.6.1.2.1 Test purpose and Environment

The purpose of this test is to verify that the UE makes correct reporting of an event. This test will partly verify the TDD intra-frequency cell search requirements in clause 9.2.5.1 and 9.2.5.2. Supported test configurations are shown in table A.7.6.1.2.1-1.

Table A.7.6.1.2.1-1: supported test configurations

Configuration	Description
1	120 kHz SSB SCS, 100 MHz bandwidth, TDD duplex mode
2	240 kHz SSB SCS, 100 MHz bandwidth, TDD duplex mode
Note:	The UE is only required to be tested in one of the supported test configurations.

There are two cells in the test, PCell (Cell 1) and a FR2 neighbour cell (Cell 2) on the same frequency as the PCell. The test parameters for the Cell 1 and Cell 2 are given in Table A.7.6.1.2.1-2 ~ 6.

In the measurement control information, a measurement object is configured for the frequency of the PCell, and it is indicated to the UE that event-triggered reporting with Event A3 is used.

The test consists of two successive time periods, with time duration of T1, and T2 respectively. During time duration T1, the UE shall not have any timing information of Cell 2.

UE needs to be provided with new Timing Advance Command MAC control element at least once during each time alignment timer period to maintain uplink time alignment. Furthermore UE is allocated with PUSCH resource at every DRX cycle.

Table A.7.6.1.2.1-2: General test parameters for intra-frequency event triggered reporting for SA with TDD PCell in FR2 without gap with DRX

Parameter	Unit	Config	Value		Comment
			Test 1	Test 2	
Active cell		1, 2	PCell (Cell 1)		
Neighbour cell		1, 2	Cell 2		Cell to be identified.
RF Channel Number		1, 2	1: Cell 1 and Cell 2		One TDD carrier frequency is used for the NR cells.
SMTC configuration		1, 2	SMTC.1		
A3-Offset	dB	1, 2	-6		
CP length		1, 2	Normal		
Hysteresis	dB	1, 2	0		
Time To Trigger	s	1, 2	0		
Filter coefficient		1, 2	0		L3 filtering is not used
DRX		1, 2	DRX.1	DRX.7	DRX related parameters are defined in Table A.7.6.1.2.1-5
Time offset between Cell 1 and Cell 2		1, 2	3 μ s		Synchronous cells
T1	s	1, 2	5		
T2	s	1, 2	10	52	

Table A.7.6.1.2.1-3: NR Cell specific test parameters for intra-frequency event triggered reporting for SA with TDD PCell in FR2 without gap with DRX

Parameter	Unit	Config	Cell 1		Cell 2	
			T1	T2	T1	T2
TDD configuration		1, 2	TDDConf.3.1		TDDConf.3.1	
BW _{channel}	MHz	1, 2	100: N _{RB,c} = 66		100: N _{RB,c} = 66	
Data RBs allocated		1, 2	66		66	
Initial BWP configuration		1, 2	DLBWP.0.1 ULBWP.0.1		DLBWP.0.1 ULBWP.0.1	
Active DL BWP configuration		1, 2	DLBWP.1.1		DLBWP.1.1	
Active UL BWP configuration		1, 2	ULBWP.1.1		ULBWP.1.1	
RLM-RS		1, 2	SSB		SSB	
PDSCH RMC configuration		1	SR.3.2 TDD		N/A	
		2	SR.3.3 TDD			
RMSI CORESET RMC configuration		1	CR.3.1 TDD		N/A	
		2	CR.3.2 TDD		N/A	
Dedicated CORESET RMC configuration		1	CCR.3.1 TDD		N/A	
		2	CCR.3.7 TDD		N/A	
TRS configuration		1, 2	TRS.2.1 TDD		N/A	
PDSCH/PDCCH TCI states		1, 2	TCI.State.2		N/A	
PDSCH/PDCCH subcarrier spacing	kHz	1, 2	120		120	
OCNG Patterns		1, 2	OP.1		OP.1	
SSB		1	SSB.3 FR2		SSB.3 FR2	
		2	SSB.4 FR2		SSB.4 FR2	
Propagation Condition		1, 2	AWGN		AWGN	

Table A.7.6.1.2.1-4: NR OTA Cell specific test parameters for intra-frequency event triggered reporting for SA with TDD PCell in FR2 without gap with DRX

Parameter	Unit	Config	Cell 1		Cell 2	
			T1	T2	T1	T2
AoA setup		1, 2	Setup 1 defined in A.3.15.1			
Beam assumption ^{Note 4}		1,2	Rough			
\hat{E}_s/I_{ot} ^{BB Note 5}	dB	1, 2	3.77	-1.52	-Infinity	-1.52
N_{oc} ^{Note 2}	dBm/15 KHz	1, 2	-98			
N_{oc} ^{Note 2}	dBm/SCS	1	-89			
		2	-86			
SSB_RP	dBm/SCS	1	-85	-85	-Infinity	-85
		2	-82	-82	-Infinity	-82

\hat{E}_s/N_{oc}	dB	1, 2	4	4	-Infinity	4
I_o	dBm/95.04MHz	1, 2	-54.53	-52.18	See Cell 1 columns	
<p>Note 1: The resources for uplink transmission are assigned to the UE prior to the start of time period T2.</p> <p>Note 2: Interference from other cells and noise sources not specified in the test is assumed to be constant over subcarriers and time and shall be modelled as AWGN of appropriate power for N_{oc} to be fulfilled.</p> <p>Note 3: E_s/I_{ot}, SSB_RP and I_o levels have been derived from other parameters for information purposes. They are not settable parameters themselves.</p> <p>Note 4: Information about types of UE beam is given in B.2.1.3, and does not limit UE implementation or test system implementation</p> <p>Note 5: Calculation of $E_s/I_{ot_{BB}}$ includes the effect of UE internal noise up to the value assumed for the associated Refsens requirement in clause 7.3.2 of TS 38.101-2 [19], and an allowance of 1dB for UE multi-band relaxation factor ΔMB_P from TS 38.101-2 [19] Table 6.2.1.3-4.</p>						

Table A.7.6.1.2.1-5: Void**Table A.7.6.1.2.1-6: Void**

A.7.6.1.2.2 Test Requirements

In test 1, the UE shall send one Event A3 triggered measurement report, with a measurement reporting delay less than X ms from the beginning of time period T2, where X is

- 7.2s for a UE supporting power class 1,
- 4.32s for a UE supporting power class 2, 3 and 4

In test 2, the UE shall send one Event A3 triggered measurement report, with a measurement reporting delay less than X ms from the beginning of time period T2, where X is

- 51.2s for a UE supporting power class 1,
- 30.72s for a UE supporting power class 2, 3 and 4

The UE is not required to read the neighbour cell SSB index in this test.

The UE shall not send event triggered measurement reports, as long as the reporting criteria are not fulfilled.

The rate of correct events observed during repeated tests shall be at least 90%.

NOTE: The actual overall delays measured in the test may be up to $2xTTI_{DCCH}$ higher than the measurement reporting delays above because of TTI insertion uncertainty of the measurement report in DCCH.

A.7.6.1.3 SA event triggered reporting test with per-UE gaps under non-DRX

A.7.6.1.3.1 Test purpose and Environment

The purpose of this test is to verify that the UE makes correct reporting of an event. This test will partly verify the TDD intra-frequency cell search requirements in clause 9.2.5.1 and 9.2.5.2. Supported test configurations are shown in table A.7.6.1.3.1-1.

Table A.7.6.1.3.1-1: supported test configurations

Configuration	Description
---------------	-------------

1	120 kHz SSB SCS, 100 MHz bandwidth, TDD duplex mode
2	240 kHz SSB SCS, 100 MHz bandwidth, TDD duplex mode
Note:	The UE is only required to be tested in one of the supported test configurations.

There are two cells in the test, PCell (Cell 1) and a FR2 neighbour cell (Cell 2) on the same frequency as the PCell. The test parameters for the Cell 1 and Cell 2 are given in Table A.7.6.1.3.1-2 ~ 4 below.

There are two BWPs configured in Cell 1, BWP1 which contains the cell defining SSB, and BWP2 which does not contain any SSB of Cell 1. During the whole test, BWP2 is always scheduled as the active BWP for the UE.

In the measurement control information, a measurement object is configured for the frequency of the PCell, and it is indicated to the UE that event-triggered reporting with Event A3 is used.

The test consists of two successive time periods, with time duration of T1, and T2 respectively. During time duration T1, the UE shall not have any timing information of Cell 2.

Table A.7.6.1.3.1-2: General test parameters for intra-frequency event triggered reporting for SA with TDD PCell in FR2 with per-UE gaps without DRX

Parameter	Unit	Config	Value	Comment
Active cell		1, 2	PCell (Cell 1)	
Neighbour cell		1, 2	Cell 2	Cell to be identified.
RF Channel Number		1, 2	1: Cell 1 and Cell 2	One TDD carrier frequency is used for the NR cells.
Gap type		1, 2	Per-UE gaps	
Measurement gap repetition periodicity	ms	1, 2	40	
Measurement gap length	ms	1, 2	6	
Measurement gap offset	ms	1, 2	39	
SMTC configuration		1, 2	SMTC.1	
CSI-RS parameters		1, 2	CSI-RS.3.2 TDD resource #0	Resource #1 is not used
A3-Offset	dB	1, 2	-11	
CP length		1, 2	Normal	
Hysteresis	dB	1, 2	0	
Time To Trigger	s	1, 2	0	
Filter coefficient		1, 2	0	L3 filtering is not used
DRX		1, 2	OFF	
Time offset between Cell 1 and Cell 2		1, 2	3 μ s	Synchronous cells
T1	s	1, 2	5	
T2	s	1, 2	5	

Table A.7.6.1.3.1-3: NR Cell specific test parameters for intra-frequency event triggered reporting for SA with TDD PCell in FR2 with per-UE gaps without DRX

Parameter	Unit	Config	Cell 1		Cell 2	
			T1	T2	T1	T2
TDD configuration		1, 2	TDDConf.3.1		TDDConf.3.1	
BW _{channel}	MHz	1, 2	100: N _{RB,c} = 66		100: N _{RB,c} = 66	
Data RBs allocated		1	24		24	
		2	48		48	

Initial BWP configuration		1, 2	DLBWP.0.1 ULBWP.0.1	DLBWP.0.1 ULBWP.0.1
Active DL BWP configuration		1, 2	DLBWP.1.2	DLBWP.1.1
Active UL BWP configuration		1, 2	ULBWP.1.2	ULBWP.1.1
RLM-RS		1, 2	CSI-RS	SSB
PDSCH RMC configuration		1	SR.3.2 TDD	N/A
		2	SR.3.3 TDD	
RMSI CORESET RMC configuration		1	CR.3.1 TDD	N/A
		2	CR.3.2 TDD	N/A
Dedicated CORESET RMC configuration		1	CCR.3.1 TDD	N/A
		2	CCR.3.7 TDD	N/A
TRS configuration		1, 2	TRS.2.1 TDD	N/A
PDSCH/PDCCH TCI states		1, 2	TCI.State.2	N/A
PDSCH/PDCCH subcarrier spacing	kHz	1, 2	120	120
OCNG Patterns		1, 2	OP.5	N/A
cellIndividualOffset	dB	1~2	N/A	16
SSB		1	SSB.3 FR2	SSB.7 FR2
		2	SSB.4 FR2	SSB.8 FR2
Propagation Condition		1, 2	No external noise (Note 1)	No external noise (Note 1)
Note 1: The downlink connection between the System Simulator and the UE is without Additive White Gaussian Noise, and has no fading or multipath effects as specified in TS 38.521-2 B.0 [29].				

Table A.7.6.1.3.1-4: NR OTA Cell specific test parameters for intra-frequency event triggered reporting for SA with TDD PCell in FR2 with per-UE gaps without DRX

Parameter	Unit	Config	Cell 1		Cell 2	
			T1	T2	T1	T2
AoA setup		1, 2	Setup 3 defined in A.3.15.3			
			AoA1		AoA2	
Beam Assumption ^{Note 4}		1,2	Rough		Rough	
E_s	dBm/SCS	1	-89	-89	-Infinity	-89
		2	-86	-86	-Infinity	-86
\hat{E}_s / I_{ot} ^{BB Note 5}	dB	1, 2	-0.12	-0.12	-Infinity	-0.12
SSB_RP	dBm/SCS	1	-89	-89	-Infinity	-89
		2	-86	-86	-Infinity	-86
I_o	dBm/95.04MHz	1	-64.41	-64.41	-Infinity	-64.41
		2	-61.41	-61.41	-Infinity	-61.41
Time multiplexing of the downlink transmissions from each AoA		1	Defined in Figure A.7.6.1.3.1-1			

Note 1:	The resources for uplink transmission are assigned to the UE prior to the start of time period T2.
Note 2:	Void
Note 3:	Es/lot, SSB_RP and Io levels have been derived from other parameters for information purposes. They are not settable parameters themselves.
Note 4:	Information about types of UE beam is given in B.2.1.3, and does not limit UE implementation or test system implementation
Note 5:	Calculation of Es/lot _{BB} includes the effect of UE internal noise up to the value assumed for the associated Refsens requirement in clause 7.3.2 of TS 38.101-2 [19], and an allowance of 1dB for UE multi-band relaxation factor ΔMB_P from TS 38.101-2 [19] Table 6.2.1.3-4.

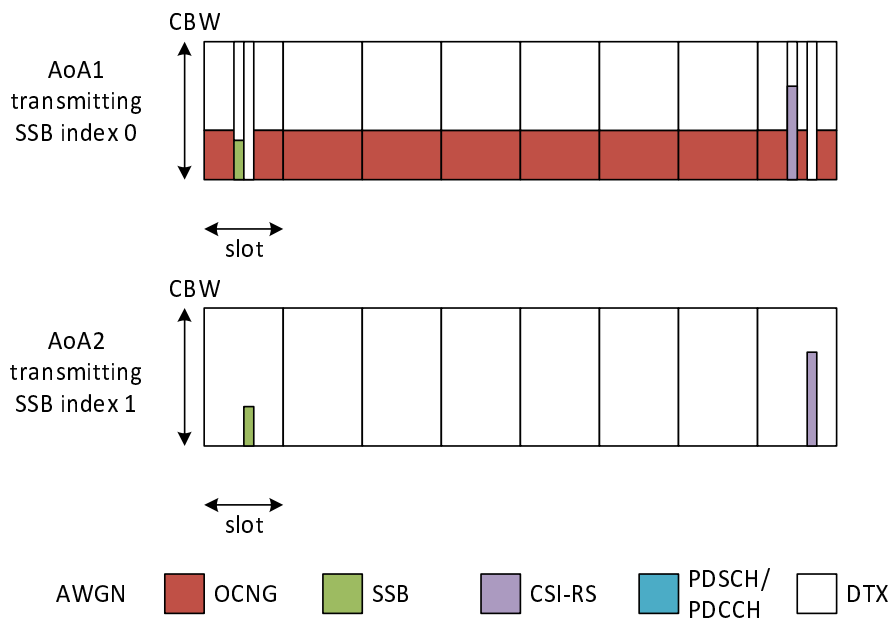

Figure A.7.6.1.3.1-1: Time multiplexed downlink transmissions (Config 1 example)

A.7.6.1.3.2 Test Requirements

In the test, the UE shall send one Event A3 triggered measurement report, with a measurement reporting delay less than X ms from the beginning of time period T2, where X is

- 3.2s for a UE supporting power class 1,
- 1.92s for a UE supporting power class 2, 3 and 4

The UE is not required to read the neighbour cell SSB index in this test.

The UE shall not send event triggered measurement reports, as long as the reporting criteria are not fulfilled.

The rate of correct events observed during repeated tests shall be at least 90%.

NOTE: The actual overall delays measured in the test may be up to $2 \times TTI_{DCCH}$ higher than the measurement reporting delays above because of TTI insertion uncertainty of the measurement report in DCCH.

A.7.6.1.4 SA event triggered reporting test with per-UE gaps under DRX

A.7.6.1.4.1 Test purpose and Environment

The purpose of this test is to verify that the UE makes correct reporting of an event. This test will partly verify the TDD intra-frequency cell search requirements in clause 9.2.5.1 and 9.2.5.2. Supported test configurations are shown in table A.7.6.1.4.1-1.

Table A.7.6.1.4.1-1: supported test configurations

Configuration	Description
1	120 kHz SSB SCS, 100 MHz bandwidth, TDD duplex mode
2	240 kHz SSB SCS, 100 MHz bandwidth, TDD duplex mode
Note:	The UE is only required to be tested in one of the supported test configurations.

There are two cells in the test, PCell (Cell 1) and a FR2 neighbour cell (Cell 2) on the same frequency as the PCell. The test parameters for the Cell 1 and Cell 2 are given in Table A.7.6.1.4.1-2, A.7.6.1.4.1-3 and A.7.6.1.4.1-4 below.

There are two BWPs configured in Cell 1, BWP1 which contains the cell defining SSB, and BWP2 which does not contain any SSB of Cell 1. During the whole test, BWP2 is always scheduled as the active BWP for the UE.

In the measurement control information, a measurement object is configured for the frequency of the PCell, and it is indicated to the UE that event-triggered reporting with Event A3 is used.

The test consists of two successive time periods, with time duration of T1, and T2 respectively. During time duration T1, the UE shall not have any timing information of Cell 2.

UE needs to be provided with new Timing Advance Command MAC control element at least once during each time alignment timer period to maintain uplink time alignment. Furthermore UE is allocated with PUSCH resource at every DRX cycle.

Table A.7.6.1.4.1-2: General test parameters for intra-frequency event triggered reporting for SA with TDD PCell in FR2 with per-UE gaps with DRX

Parameter	Unit	Config	Value		Comment
			Test 1	Test 2	
Active cell		1, 2	PCell (Cell 1)		
Neighbour cell		1, 2	Cell 2		Cell to be identified.
RF Channel Number		1, 2	1: Cell 1 and Cell 2		One TDD carrier frequency is used for the NR cells.
Gap type		1, 2	Per-UE gaps		
Measurement gap repetition periodicity	ms	1, 2	40		
Measurement gap length	ms	1, 2	6		
Measurement gap offset	ms	1, 2	39		
SMTC configuration		1, 2	SMTC.1		
CSI-RS parameters		1, 2	CSI-RS.3.2 TDD resource #0		Resource #1 is not used
A3-Offset	dB	1, 2	-6		
CP length		1, 2	Normal		
Hysteresis	dB	1, 2	0		
Time To Trigger	s	1, 2	0		
Filter coefficient		1, 2	0		L3 filtering is not used
DRX		1, 2	DRX.1	DRX.7	DRX related parameters are defined in Table A.7.6.1.2.1-5

Time offset between Cell 1 and Cell 2		1, 2	3 μ s		Synchronous cells
T1	s	1, 2	5		
T2	s	1, 2	10	52	

Table A.7.6.1.4.1-3: NR Cell specific test parameters for intra-frequency event triggered reporting for SA with TDD PCell in FR2 with per-UE gaps with DRX

Parameter	Unit	Config	Cell 1		Cell 2	
			T1	T2	T1	T2
TDD configuration		1, 2	TDDConf.3.1		TDDConf.3.1	
BW _{channel}	MHz	1, 2	100: N _{RB,c} = 66		100: N _{RB,c} = 66	
Data RBs allocated		1, 2	66		66	
Initial BWP configuration		1, 2	DLBWP.0.1 ULBWP.0.1		DLBWP.0.1 ULBWP.0.1	
Active DL BWP configuration		1, 2	DLBWP.1.2		DLBWP.1.1	
Active UL BWP configuration		1, 2	ULBWP.1.2		ULBWP.1.1	
RLM-RS		1, 2	SCSI-RS		SSB	
PDSCH RMC configuration		1	SR.3.2 TDD		N/A	
		2	SR.3.3 TDD			
RMSI CORESET RMC configuration		1	CR.3.1 TDD		N/A	
		2	CR.3.2 TDD		N/A	
Dedicated CORESET RMC configuration		1	CCR.3.1 TDD		N/A	
		2	CCR.3.7 TDD		N/A	
TRS configuration		1, 2	TRS.2.1 TDD		N/A	
PDSCH/PDCCH TCI state		1, 2	TCI.State.2		N/A	
PDSCH/PDCCH subcarrier spacing	kHz	1, 2	120		120	
OCNG Patterns		1, 2	OP.1		OP.1	
SSB		1	SSB.3 FR2		SSB.3 FR2	
		2	SSB.4 FR2		SSB.4 FR2	
Propagation Condition		1, 2	AWGN		AWGN	

Table A.7.6.1.4.1-4: NR OTA Cell specific test parameters for intra-frequency event triggered reporting for SA with TDD PCell in FR2 with per-UE gaps with DRX

Parameter	Unit	Config	Cell 1		Cell 2	
			T1	T2	T1	T2
AoA setup		1, 2	Setup 1 defined in A.3.15.1			
Beam Assumption ^{Note 4}		1,2	Rough			
\hat{E}_s / I_{ot} ^{BB Note 5}	dB	1, 2	3.77	-1.52	-Infinity	-1.52

N_{oc} <small>Note 2</small>	dBm/15 KHz	1, 2	-98			
N_{oc} <small>Note 2</small>	dBm/SCS	1	-89			
		2	-86			
SSB_RP	dBm/SCS	1	-85	-85	-Infinity	-85
		2	-82	-82	-Infinity	-82
\hat{E}_s/N_{oc}	dB	1, 2	4	4	-Infinity	4
I_o	dBm/95.04MHz	1, 2	-54.53	-52.18	See Cell 2 columns	
<p>Note 1: The resources for uplink transmission are assigned to the UE prior to the start of time period T2.</p> <p>Note 2: Interference from other cells and noise sources not specified in the test is assumed to be constant over subcarriers and time and shall be modelled as AWGN of appropriate power for N_{oc} to be fulfilled.</p> <p>Note 3: E_s/lot, SSB_RP and I_o levels have been derived from other parameters for information purposes. They are not settable parameters themselves.</p> <p>Note 4: Information about types of UE beam is given in B.2.1.3, and does not limit UE implementation or test system implementation</p> <p>Note 5: Calculation of E_s/lot_{BB} includes the effect of UE internal noise up to the value assumed for the associated Refsens requirement in clause 7.3.2 of TS 38.101-2 [19], and an allowance of 1dB for UE multi-band relaxation factor ΔMB_P from TS 38.101-2 [19] Table 6.2.1.3-4.</p>						

Table A.7.6.1.4.1-5: Void

Table A.7.6.1.4.1-6: Void

A.7.6.1.4.2 Test Requirements

In test 1, the UE shall send one Event A3 triggered measurement report, with a measurement reporting delay less than X ms from the beginning of time period T2, where X is

- 7.2s for a UE supporting power class 1,
- 4.32s for a UE supporting power class 2, 3 and 4

In test 2, the UE shall send one Event A3 triggered measurement report, with a measurement reporting delay less than X ms from the beginning of time period T2, where X is

- 51.2s for a UE supporting power class 1,
- 30.72s for a UE supporting power class 2, 3 and 4

The UE is not required to read the neighbour cell SSB index in this test.

The UE shall not send event triggered measurement reports, as long as the reporting criteria are not fulfilled.

The rate of correct events observed during repeated tests shall be at least 90%.

NOTE: The actual overall delays measured in the test may be up to $2 \times TTI_{DCCH}$ higher than the measurement reporting delays above because of TTI insertion uncertainty of the measurement report in DCCH.

A.7.6.2 Inter-frequency Measurements

A.7.6.2.1 SA event triggered reporting tests For FR2 without SSB time index detection when DRX is not used (PCell in FR2)

A.7.6.2.1.1 Test Purpose and Environment

The purpose of this test is to verify that the UE makes correct reporting of an event. This test will partly verify the SA inter-frequency NR cell search requirements in clause 9.3.4.

In this test, there are two cells: NR cell 1 as PCell in FR2 on NR RF channel 1 and NR cell 2 as neighbour cell in FR2 on NR RF channel 2. The test parameters and configurations are given in Tables A.7.6.2.1.1-1, A.7.6.2.1.1-2, and A.7.6.2.1.1-3.

Measurement gap pattern configuration defined in Table A.7.6.2.1.1-2 is provided for a UE that does not support per-FR gap, and no gap pattern (Gap Pattern Id and Measurement gap offset) is configured for a UE capable of per-FR gap.

In the measurement control information, it is indicated to the UE that event-triggered reporting with Event A3 is used. The test consists of two successive time periods, with time duration of T1, and T2 respectively. During time duration T1, the UE shall not have any timing information of NR cell 2.

Supported test configurations are shown in table A.7.6.2.1.1-1.

Table A.7.6.2.1.1-1 SA event triggered reporting tests without SSB index reading for FR2-FR2

Config	Description
1	120 kHz SSB SCS, 100 MHz bandwidth, TDD duplex mode
Note 1: Void.	

Table A.7.6.2.1.1-2: General test parameters for SA inter-frequency event triggered reporting for FR2 without SSB time index detection

Parameter	Unit	Test configuration	Value	Comment
NR RF Channel Number		Config 1	1, 2	Two FR2 NR carrier frequencies is used.
Active cell		Config 1	NR cell 1 (Pcell)	NR Cell 1 is on NR RF channel number 1.
Neighbour cell		Config 1	NR cell 2	NR cell 2 is on NR RF channel number 2.
Gap Pattern Id		Config 1	13	As specified in clause 9.1.2-1.
Measurement gap offset		Config 1	39	
SMTC-SSB parameters		Config 1	SSB.3 FR2	As specified in clause A.3.10.2
offsetMO	dB	Config 1	16	Applied to NR Cell 2 measurement object
A3-Offset	dB	Config 1	-11	
Hysteresis	dB	Config 1	0	
CP length		Config 1	Normal	
TimeToTrigger	s	Config 1	0	
Filter coefficient		Config 1	0	L3 filtering is not used

DRX		Config 1	OFF	DRX is not used
Time offset between serving and neighbour cells		Config 1	3 μ s	Synchronous cells.
T1	s	Config 1	5	
T2	s	Config 1	5.2 for PC1; 3.5 for other PC	

Table A.7.6.2.1.1-3: Cell specific test parameters for SA inter-frequency event triggered reporting for FR2 without SSB time index detection

Parameter		Unit	Test configuration	Cell 1		Cell 2	
				T1	T2	T1	T2
AoA setup			Config 1	Setup 3 as specified in clause A.3.15			
				AoA1		AoA2	
Beam Assumption ^{Note 7}			1,2	Rough		Rough	
NR RF Channel Number			Config 1	1		2	
Duplex mode			Config 1	TDD		TDD	
TDD configuration			Config 1	TDDConf.3.1		TDDConf.3.1	
BW _{channel}		MHz	Config 1	100: N _{RB,c} = 66		100: N _{RB,c} = 66	
Data RBs allocated			Config 1	66		66	
BWP BW		MHz	Config 1	100: N _{RB,c} = 66		100: N _{RB,c} = 66	
BWP configuration	Initial DL BWP		Config 1	DLBWP.0.1		N/A	
	Initial UL BWP			ULBWP.0.1		N/A	
	Dedicated DL BWP			DLBWP.1.1		N/A	
	Dedicated UL BWP			ULBWP.1.1		N/A	
OCNG Patterns defined in A.3.2.1.1 (OP.1)			Config 1	OP.1		OP.1	
PDSCH Reference measurement channel			Config 1	SR.3.1 TDD		-	
CORESET Reference Channel			Config 1	CR.3.1 TDD		-	
SMTC configuration defined in A.3.11.1 and A.3.11.2			Config 1	SMTC.1		SMTC.1	
PDSCH/PDCCH subcarrier spacing		kHz	Config 1	120		120	
TRS configuration			Config 1	TRS.2.1 TDD		N/A	
PDSCH/PDCCH TCI state			Config 1	TCI.State.2		N/A	
EPRE ratio of PSS to SSS			Config 1	0		0	
EPRE ratio of PBCH DMRS to SSS							
EPRE ratio of PBCH to PBCH DMRS							
EPRE ratio of PDCCH DMRS to SSS							
EPRE ratio of PDCCH to PDCCH DMRS							
EPRE ratio of PDSCH DMRS to SSS							
EPRE ratio of PDSCH to PDSCH							

EPRE ratio of OCNG DMRS to SSS(Note 1)						
EPRE ratio of OCNG to OCNG DMRS (Note 1)						
\hat{E}_s	dBm/S CS	Config 1	-87	-87	-Infinity	-87
SSB_RP ^{Note 3}	dBm/S CS ^{Note5}	Config 1	-87	-87	-Infinity	-87
$\hat{E}_s / I_{ot\ BB}$ ^{Note 8}	dB	Config 1	1.89	1.89	-Infinity	1.89
I_o ^{Note3}	dBm/95 .04 MHz ^{Note5}	Config 1	-58.01	-58.01	-Infinity	-58.01
Propagation Condition		Config 1	No external noise (Note 9)		No external noise (Note 9)	
<p>Note 1: OCNG shall be used such that both cells are fully allocated and a constant total transmitted power spectral density is achieved for all OFDM symbols.</p> <p>Note 2: Void</p> <p>Note 3: SSB-RP, E_s/I_{ot} and I_o levels have been derived from other parameters for information purposes. They are not settable parameters themselves.</p> <p>Note 4: Void</p> <p>Note 5: Equivalent power received by an antenna with 0 dBi gain at the centre of the quiet zone</p> <p>Note 6: As observed with 0 dBi gain antenna at the centre of the quiet zone</p> <p>Note 7: Information about types of UE beam is given in B.2.1.3, and does not limit UE implementation or test system implementation</p> <p>Note 8: Calculation of $E_s/I_{ot\ BB}$ includes the effect of UE internal noise up to the value assumed for the associated Refsens requirement in clause 7.3.2 of TS 38.101-2 [19], and an allowance of 1dB for UE multi-band relaxation factor ΔMB_s from TS 38.101-2 [19] Table 6.2.1.3-4.</p> <p>Note 9: The downlink connection between the System Simulator and the UE is without Additive White Gaussian Noise, and has no fading or multipath effects as specified in TS 38.521-2 B.0 [29].</p>						

A.7.6.2.1.2 Test Requirements

The UE shall send one Event A3 triggered measurement report, with a measurement reporting delay less than X ms from the beginning of time period T2, where X is

5120 for UE supporting power class 1, or

3200 for UE supporting other power class.

The UE is not required to report SSB time index. The UE shall not send event triggered measurement reports, as long as the reporting criteria are not fulfilled. The rate of correct events observed during repeated tests shall be at least 90%.

NOTE: The actual overall delays measured in the test may be up to $2xTTI_{DCCH}$ higher than the measurement reporting delays above because of TTI insertion uncertainty of the measurement report in DCCH.

A.7.6.2.2 SA event triggered reporting tests For FR2 without SSB time index detection when DRX is used (PCell in FR2)

A.7.6.2.2.1 Test Purpose and Environment

The purpose of this test is to verify that the UE makes correct reporting of an event. This test will partly verify the SA inter-frequency NR cell search requirements in clause 9.3.4.

In this test, there are two cells: NR cell 1 as PCell in FR2 on NR RF channel 1 and NR cell 2 as neighbour cell in FR2 on NR RF channel 2. The test parameters and configurations are given in Tables A.7.6.2.2.1-1, A.7.6.2.2.1-2, and A.7.6.2.2.1-3.

Measurement gap pattern configuration defined in Table A.7.6.2.2.1-2 is provided for a UE that does not support per-FR gap, and no gap pattern (Gap Pattern Id and Measurement gap offset) is configured for a UE capable of per-FR gap.

In the measurement control information, it is indicated to the UE that event-triggered reporting with Event A3 is used. The test consists of two successive time periods, with time duration of T1, and T2 respectively. During time duration T1, the UE shall not have any timing information of NR cell 2.

Supported test configurations are shown in table A.7.6.2.2.1-1.

UE needs to be provided at least once every 500ms with new Timing Advance Command MAC control element to restart the Time alignment timer to keep UE uplink time alignment. Furthermore UE is allocated with PUSCH resource at every DRX cycle.

UE needs to be provided with new Timing Advance Command MAC control element at least once during each time alignment timer period to maintain uplink time alignment. Furthermore UE is allocated with PUSCH resource at every DRX cycle.

Table A.7.6.2.2.1-1: SA event triggered reporting tests without SSB index reading for FR2-FR2

Config	Description
1	120 kHz SSB SCS, 100 MHz bandwidth, TDD duplex mode
Note 1: Void.	

Table A.7.6.2.2.1-2: General test parameters for SA inter-frequency event triggered reporting for FR2 without SSB time index detection

Parameter	Unit	Test configuration	Value		Comment
			Test 1	Test 2	
NR RF Channel Number		Config 1	1, 2		Two FR2 NR carrier frequencies is used.
Active cell		Config 1	NR cell 1 (Pcell)		NR Cell 1 is on NR RF channel number 1.
Neighbour cell		Config 1	NR cell 2		NR cell 2 is on NR RF channel number 2.
Gap Pattern Id		Config 1	13		As specified in clause 9.1.2-1.
Measurement gap offset		Config 1	39		
SMTC-SSB parameters		Config 1	SSB.3 FR2		As specified in clause A.3.10.2
A3-Offset	dB	Config 1	-6		
Hysteresis	dB	Config 1	0		
CP length		Config 1	Normal		
TimeToTrigger	s	Config 1	0		
Filter coefficient		Config 1	0		L3 filtering is not used
DRX		Config 1	DRX.1	DRX.7	As specified in clause A.3.3
Time offset between serving and neighbour cells		Config 1	3μs		Synchronous cells.
T1	s	Config 1	5		
T2	s	Config 1	8 for PC1; 5 for other PC	82 for PC1; 52 for other PC	

Table A.7.6.2.2.1-3: Cell specific test parameters for CA inter-frequency event triggered reporting without SSB time index detection

Parameter		Unit	Test configuration	Cell 1		Cell 2	
				T1	T2	T1	T2
AoA setup			Config 1	Setup 1 as specified in clause A.3.15			
Beam Assumption ^{Note 7}			Config 1	Rough			
NR RF Channel Number			Config 1	1		2	
TDD configuration			Config 1	TDDConf.3.1		TDDConf.3.1	
Duplex mode			Config 1	TDD		TDD	
$BW_{channel}$		MHz	Config 1	100: $N_{RB,c} = 66$		100: $N_{RB,c} = 66$	
Data RBs allocated			Config 1	66		66	
BWP BW		MHz	Config 1	100: $N_{RB,c} = 66$		100: $N_{RB,c} = 66$	
BWP configuration	Initial DL BWP		Config 1	DLBWP.0.1		N/A	
	Initial UL BWP			ULBWP.0.1		N/A	
	Dedicated DL BWP			DLBWP.1.1		N/A	
	Dedicated UL BWP			ULBWP.1.1		N/A	
OCNG Patterns defined in A.3.2.1.1			Config 1	OP.1		OP.1	
PDSCH Reference measurement channel			Config 1	SR.3.1 TDD		-	
CORESET Reference Channel			Config 1	CR.3.1 TDD		-	
SMTTC configuration defined in A.3.11.1 and A.3.11.2			Config 1	SMTTC.1		SMTTC.1	
PDSCH/PDCCH subcarrier spacing		kHz	Config 1	120		120	
TRS configuration			Config 1	TRS.2.1 TDD		N/A	
PDSCH/PDCCH TCI state			Config 1	TCI.State.2		N/A	
EPRE ratio of PSS to SSS			Config 1	0		0	
EPRE ratio of PBCH DMRS to SSS							
EPRE ratio of PBCH to PBCH DMRS							
EPRE ratio of PDCCH DMRS to SSS							
EPRE ratio of PDCCH to PDCCH DMRS							
EPRE ratio of PDSCH DMRS to SSS							
EPRE ratio of PDSCH to PDSCH							
EPRE ratio of OCNG DMRS to SSS(Note 1)							
EPRE ratio of OCNG to OCNG DMRS (Note 1)							
N_{oc} ^{Note2}	dBm/15 kHz Note5			-104.7		-104.7	
N_{oc} ^{Note2}	dBm/CS Note4	Config 1		-95.7		-95.7	

SSB_RP ^{Note 3}	dBm/S CS Note5	Config 1	-89.7	-89.7	-Infinity	-86.7
\hat{E}_s / I_{ot}	dB	Config 1	6	6	-Infinity	9
\hat{E}_s / N_{oc}	dB	Config 1	6	6	-Infinity	9
I_o ^{Note3}	dBm/95 .04 MHz Note5	Config 1	-59.7	-59.7	-66.7	-57.2
Propagation Condition		Config 1	AWGN		AWGN	
<p>Note 1: OCNG shall be used such that both cells are fully allocated and a constant total transmitted power spectral density is achieved for all OFDM symbols.</p> <p>Note 2: Interference from other cells and noise sources not specified in the test is assumed to be constant over subcarriers and time and shall be modelled as AWGN of appropriate power for N_{oc} to be fulfilled.</p> <p>Note 3: SSB_RP and I_o levels have been derived from other parameters for information purposes. They are not settable parameters themselves.</p> <p>Note 4: Void</p> <p>Note 5: Equivalent power received by an antenna with 0 dBi gain at the centre of the quiet zone</p> <p>Note 6: As observed with 0 dBi gain antenna at the centre of the quiet zone</p> <p>Note 7: Information about types of UE beam is given in B.2.1.3, and does not limit UE implementation or test system implementation</p>						

A.7.6.2.2.2 Test Requirements

In test 1 the UE shall send one Event A3 triggered measurement report, with a measurement reporting delay less than X1 ms from the beginning of time period T2, where X1 is

7680 for UE supporting power class 1, or

4800 for UE supporting other power class.

In test 2 the UE shall send one Event A3 triggered measurement report, with a measurement reporting delay less than X2 ms from the beginning of time period T2, where X2 is

81920 for UE supporting power class 1, or

51200 for UE supporting other power class.

In test 1 and 2 UE is not required to report SSB time index. The UE shall not send event triggered measurement reports, as long as the reporting criteria are not fulfilled. The rate of correct events observed during repeated tests shall be at least 90%.

NOTE: The actual overall delays measured in the test may be up to $2xTTI_{DCCH}$ higher than the measurement reporting delays above because of TTI insertion uncertainty of the measurement report in DCCH.

A.7.6.2.3 SA event triggered reporting tests For FR2 with SSB time index detection when DRX is not used (PCell in FR2)

A.7.6.2.3.1 Test Purpose and Environment

The purpose of this test is to verify that the UE makes correct reporting of an event. This test will partly verify the SA inter-frequency NR cell search requirements in clause 9.3.4.

In this test, there are two cells: NR cell 1 as PCell in FR2 on NR RF channel 1 and NR cell 2 as neighbour cell in FR2 on NR RF channel 2. The test parameters and configurations are given in Tables A.7.6.2.3.1-1, A.7.6.2.3.1-2, and A.7.6.2.3.1-3.

Measurement gap pattern configuration defined in Table A.7.6.2.3.1-2 is provided for a UE that does not support per-FR gap, and no gap pattern (Gap Pattern Id and Measurement gap offset) is configured for a UE capable of per-FR gap.

In the measurement control information, it is indicated to the UE that event-triggered reporting with Event A3 is used. The test consists of two successive time periods, with time duration of T1, and T2 respectively. During time duration T1, the UE shall not have any timing information of NR cell 2.

Supported test configurations are shown in table A.7.6.2.3.1-1.

Table A.7.6.2.3.1-1: SA event triggered reporting tests with SSB index reading for FR2-FR2

Config	Description
1	120 kHz SSB SCS, 100 MHz bandwidth, TDD duplex mode
Note 1:	Void.

Table A.7.6.2.3.1-2: General test parameters for SA inter-frequency event triggered reporting for FR2 with SSB time index detection

Parameter	Unit	Test configuration	Value	Comment
NR RF Channel Number		Config 1	1, 2	Two FR2 NR carrier frequencies is used.
Active cell		Config 1	NR cell 1 (Pcell)	NR Cell 1 is on NR RF channel number 1.
Neighbour cell		Config 1	NR cell 2	NR cell 2 is on NR RF channel number 2.
Gap Pattern Id		Config 1	13	As specified in clause 9.1.2-1.
Measurement gap offset		Config 1	39	
SMTCS-SSB parameters		Config 1	SSB.3 FR2	As specified in clause A.3.10.2
offsetMO	dB	Config 1	16	Applied to NR Cell 2 measurement object
A3-Offset	dB	Config 1	-11	
Hysteresis	dB	Config 1	0	
CP length		Config 1	Normal	
TimeToTrigger	s	Config 1	0	
Filter coefficient		Config 1	0	L3 filtering is not used
DRX		Config 1	OFF	DRX is not used
Time offset between serving and neighbour cells		Config 1	3µs	Synchronous cells.
T1	s	Config 1	5	
T2	s	Config 1	7 for PC1; 4.5 for other PC	

Table A.7.6.2.3.1-3: Cell specific test parameters for SA inter-frequency event triggered reporting for FR2 with SSB time index detection

Parameter	Unit	Test configuration	Cell 1		Cell 2	
			T1	T2	T1	T2
AoA setup		Config 1	Setup 3 as specified in clause A.3.15			
			AoA1		AoA2	
Beam Assumption ^{Note 7}		Config 1	Rough		Rough	
NR RF Channel Number		Config 1	1		2	
Duplex mode		Config 1	TDD		TDD	

TDD configuration			Config 1	TDDConf.3.1		TDDConf.3.1	
BW _{channel}		MHz	Config 1	100: N _{RB,c} = 66		100: N _{RB,c} = 66	
Data RBs allocated			Config 1	66		66	
BWP BW		MHz	Config 1	100: N _{RB,c} = 66		100: N _{RB,c} = 66	
BWP configuration	Initial DL BWP		Config 1	DLBWP.0.1		N/A	
	Initial UL BWP			ULBWP.0.1		N/A	
	Dedicated DL BWP			DLBWP.1.1		N/A	
	Dedicated UL BWP			ULBWP.1.1		N/A	
OCNG Patterns defined in A.3.2.1.1			Config 1	OP.1		OP.1	
PDSCH Reference measurement channel			Config 1	SR.3.1 TDD		-	
CORESET Reference Channel			Config 1	CR.3.1 TDD		-	
SMTC configuration defined in A.3.11.1 and A.3.11.2			Config 1	SMTC.1		SMTC.1	
PDSCH/PDCCH subcarrier spacing		kHz	Config 1	120		120	
TRS configuration			Config 1	TRS.2.1 TDD		N/A	
PDSCH/PDCCH TCI state			Config 1	TCI.State.2		N/A	
EPRE ratio of PSS to SSS			Config 1	0		0	
EPRE ratio of PBCH DMRS to SSS							
EPRE ratio of PBCH to PBCH DMRS							
EPRE ratio of PDCCH DMRS to SSS							
EPRE ratio of PDCCH to PDCCH DMRS							
EPRE ratio of PDSCH DMRS to SSS							
EPRE ratio of PDSCH to PDSCH							
EPRE ratio of OCNG DMRS to SSS(Note 1)							
EPRE ratio of OCNG to OCNG DMRS (Note 1)							
\hat{E}_s	dBm/S CS	Config 1	-87	-87	-Infinity	-87	
SSB _{RP} ^{Note 3}	dBm/S CS ^{Note5}	Config 1	-87	-87	-Infinity	-87	
\hat{E}_s / I_{ot_BB} ^{Note 8}	dB	Config 1	1.89	1.89	-Infinity	1.89	
I_o ^{Note3}	dBm/95 .04 MHz ^{Note5}	Config 1	-58.01	-58.01	-Infinity	-58.01	
Propagation Condition			Config 1	No external noise (Note 9)		No external noise (Note 9)	

Note 1:	OCNG shall be used such that both cells are fully allocated and a constant total transmitted power spectral density is achieved for all OFDM symbols.
Note 2:	Void
Note 3:	SSB-RP, Es/lot and Io levels have been derived from other parameters for information purposes. They are not settable parameters themselves.
Note 4:	Void
Note 5:	Equivalent power received by an antenna with 0 dBi gain at the centre of the quiet zone
Note 6:	As observed with 0 dBi gain antenna at the centre of the quiet zone
Note 7:	Information about types of UE beam is given in B.2.1.3, and does not limit UE implementation or test system implementation
Note 8:	Calculation of Es/lot _{BB} includes the effect of UE internal noise up to the value assumed for the associated Refsens requirement in clause 7.3.2 of TS 38.101-2 [19], and an allowance of 1dB for UE multi-band relaxation factor ΔMBs from TS 38.101-2 [19] Table 6.2.1.3-4.
Note 9:	The downlink connection between the System Simulator and the UE is without Additive White Gaussian Noise, and has no fading or multipath effects as specified in TS 38.521-2 B.0 [29].

A.7.6.2.3.2 Test Requirements

The UE shall send one Event A3 triggered measurement report, with a measurement reporting delay less than X ms from the beginning of time period T2, where X is

6720 for UE supporting power class 1, or

4160 for UE supporting other power class.

The UE is required to report SSB time index. The UE shall not send event triggered measurement reports, as long as the reporting criteria are not fulfilled. The rate of correct events observed during repeated tests shall be at least 90%.

NOTE: The actual overall delays measured in the test may be up to $2xTTI_{DCCCH}$ higher than the measurement reporting delays above because of TTI insertion uncertainty of the measurement report in DCCCH.

A.7.6.2.4 SA event triggered reporting tests For FR2 with SSB time index detection when DRX is used (PCell in FR2)

A.7.6.2.4.1 Test Purpose and Environment

The purpose of this test is to verify that the UE makes correct reporting of an event. This test will partly verify the SA inter-frequency NR cell search requirements in clause 9.3.4.

In this test, there are two cells: NR cell 1 as PCell in FR2 on NR RF channel 1 and NR cell 2 as neighbour cell in FR2 on NR RF channel 2. The test parameters and configurations are given in Tables A.7.6.2.4.1-1, A.7.6.2.4.1-2, and A.7.6.2.4.1-3.

Measurement gap pattern configuration defined in Table A.7.6.2.4.1-2 is provided for a UE that does not support per-FR gap, and no gap pattern (Gap Pattern Id and Measurement gap offset) is configured for a UE capable of per-FR gap.

In the measurement control information, it is indicated to the UE that event-triggered reporting with Event A3 is used. The test consists of two successive time periods, with time duration of T1, and T2 respectively. During time duration T1, the UE shall not have any timing information of NR cell 2.

Supported test configurations are shown in table A.7.6.2.4.1-1.

UE needs to be provided with new Timing Advance Command MAC control element at least once during each time alignment timer period to maintain uplink time alignment. Furthermore UE is allocated with PUSCH resource at every DRX cycle.

Table A.7.6.2.4.1-1: SA event triggered reporting tests with SSB index reading for FR2-FR2

Config	Description
1	120 kHz SSB SCS, 100 MHz bandwidth, TDD duplex mode
Note 1: Void.	

Table A.7.6.2.4.1-2: General test parameters for SA inter-frequency event triggered reporting for FR2 with SSB time index detection

Parameter	Unit	Test configuration	Value		Comment
			Test 1	Test 2	
NR RF Channel Number		Config 1	1, 2		Two FR2 NR carrier frequencies is used.
Active cell		Config 1	NR cell 1 (Pcell)		NR Cell 1 is on NR RF channel number 1.
Neighbour cell		Config 1	NR cell 2		NR cell 2 is on NR RF channel number 2.
Gap Pattern Id		Config 1	13		As specified in clause 9.1.2-1.
Measurement gap offset		Config 1	39		
SMTC-SSB parameters		Config 1	SSB.3 FR2		As specified in clause A.3.10.2
A3-Offset	dB	Config 1	-6		
Hysteresis	dB	Config 1	0		
CP length		Config 1	Normal		
TimeToTrigger	s	Config 1	0		
Filter coefficient		Config 1	0		L3 filtering is not used
DRX		Config 1	DRX.1	DRX.7	As specified in clause A.3.3
Time offset between serving and neighbour cells		Config 1	3μs		Synchronous cells.
T1	s	Config 1	5		
T2	s	Config 1	11 for PC1; 6.5 for other PC	108 for PC1; 67 for other PC	

Table A.7.6.2.4.1-3: Cell specific test parameters for CA inter-frequency event triggered reporting with SSB time index detection

Parameter		Unit	Test configuration	Cell 1		Cell 2	
				T1	T2	T1	T2
AoA setup			Config 1	Setup 1 as specified in clause A.3.15			
Beam Assumption ^{Note 7}			Config 1	Rough			
NR RF Channel Number			Config 1	1		2	
Duplex mode			Config 1	TDD		TDD	
TDD configuration			Config 1	TDDConf.3.1		TDDConf.3.1	
BW _{channel}		MHz	Config 1	100: N _{RB,c} = 66		100: N _{RB,c} = 66	
Data RBs allocated			Config 1	66		66	
BWP BW		MHz	Config 1	100: N _{RB,c} = 66		100: N _{RB,c} = 66	
BWP configuration	Initial DL BWP		Config 1	DLBWP.0.1		N/A	
	Initial UL BWP			ULBWP.0.1		N/A	
	Dedicated DL BWP			DLBWP.1.1		N/A	

	Dedicated UL BWP			ULBWP.1.1	N/A	
OCNG Patterns defined in A.3.2.1.1			Config 1	OP.1	OP.1	
PDSCH Reference measurement channel			Config 1	SR.3.1 TDD	-	
CORESET Reference Channel			Config 1	CR.3.1 TDD	-	
SMTTC configuration defined in A.3.11.1 and A.3.11.2			Config 1	SMTTC.1	SMTTC.1	
PDSCH/PDCCH subcarrier spacing		kHz	Config 1	120	120	
TRS configuration			Config 1	TRS.2.1 TDD	N/A	
PDSCH/PDCCH TCI state			Config 1	TCI.State.2	N/A	
EPRE ratio of PSS to SSS			Config 1	0	0	
EPRE ratio of PBCH DMRS to SSS						
EPRE ratio of PBCH to PBCH DMRS						
EPRE ratio of PDCCH DMRS to SSS						
EPRE ratio of PDCCH to PDCCH DMRS						
EPRE ratio of PDSCH DMRS to SSS						
EPRE ratio of PDSCH to PDSCH						
EPRE ratio of OCNG DMRS to SSS(Note 1)						
EPRE ratio of OCNG to OCNG DMRS (Note 1)						
N_{oc} Note2	dBm/15 kHz Note5			-104.7	-104.7	
N_{oc} Note2	dBm/S CS Note4	Config 1		-95.7	-95.7	
SSB_RP Note3	dBm/S CS Note5	Config 1	-89.7	-89.7	-Infinity	-86.7
\hat{E}_s / I_{ot}	dB	Config 1	6	6	-Infinity	9
\hat{E}_s / N_{oc}	dB	Config 1	6	6	-Infinity	9
I_o Note3	dBm/95 .04 MHz Note5	Config 1	-59.7	-59.7	-66.7	-57.2
Propagation Condition			Config 1	AWGN		AWGN

Note 1:	OCNG shall be used such that both cells are fully allocated and a constant total transmitted power spectral density is achieved for all OFDM symbols.
Note 2:	Interference from other cells and noise sources not specified in the test is assumed to be constant over subcarriers and time and shall be modelled as AWGN of appropriate power for N_{oc} to be fulfilled.
Note 3:	SSB_RP and I_0 levels have been derived from other parameters for information purposes. They are not settable parameters themselves.
Note 4:	Void
Note 5:	Equivalent power received by an antenna with 0 dBi gain at the centre of the quiet zone
Note 6:	As observed with 0 dBi gain antenna at the centre of the quiet zone
Note 7:	Information about types of UE beam is given in B.2.1.3, and does not limit UE implementation or test system implementation

A.7.6.2.4.2 Test Requirements

In test 1 the UE shall send one Event A3 triggered measurement report, with a measurement reporting delay less than $X1$ ms from the beginning of time period T2, where $X1$ is

10080 for UE supporting power class 1, or

6240 for UE supporting other power class.

In test 2 the UE shall send one Event A3 triggered measurement report, with a measurement reporting delay less than $X2$ ms from the beginning of time period T2, where $X2$ is

107520 for UE supporting power class 1, or

66560 for UE supporting other power class.

In test 1 and 2 UE is required to report SSB time index. The UE shall not send event triggered measurement reports, as long as the reporting criteria are not fulfilled. The rate of correct events observed during repeated tests shall be at least 90%.

NOTE: The actual overall delays measured in the test may be up to $2xTTI_{DCCCH}$ higher than the measurement reporting delays above because of TTI insertion uncertainty of the measurement report in DCCCH.

A.7.6.2.5 SA event triggered reporting tests for FR2 without SSB time index detection when DRX is not used (PCell in FR1)

A.7.6.2.5.1 Test Purpose and Environment

The purpose of this test is to verify that the UE makes correct reporting of an event. This test will partly verify the SA inter-frequency NR cell search requirements in clause 9.3.4.

In this test, there are two cells: NR cell 1 as PCell in FR1 on NR RF channel 2 and NR cell 2 as neighbour cell in FR2 on NR RF channel 2. The test parameters and configurations are given in Tables A.7.6.2.5.1-1, A.7.6.2.5.1-2, and A.7.6.2.5.1-3.

In test 1 per-UE measurement gap pattern configuration # 0 as defined in Table A.7.6.2.5.1-2 is provided for a UE that does not support per-FR gap and in test 2 no gap pattern is configured as defined in Table A.7.6.2.5.1-2. If the UE supports per-FR gap, it is only required to pass test 2. Otherwise it is only required to pass test 1.

In the measurement control information, it is indicated to the UE that event-triggered reporting with Event A4 is used. The test consists of two successive time periods, with time duration of T1, and T2 respectively. During time duration T1, the UE shall not have any timing information of NR cell 2.

Supported test configurations are shown in table A.7.6.2.5.1-1.

Table A.7.6.2.5.1-1 SA event triggered reporting tests without SSB index reading for FR1-FR2

Config	Description of serving cell	Description of target cell
1	NR 15 kHz SSB SCS, 10 MHz bandwidth, FDD duplex mode	120 kHz SSB SCS, 100 MHz bandwidth, TDD duplex mode
2	NR 15 kHz SSB SCS, 10 MHz bandwidth, TDD duplex mode	
3	NR 30kHz SSB SCS, 40 MHz bandwidth, TDD duplex mode	
Note: The UE is only required to be tested in one of the supported test configurations		

Table A.7.6.2.5.1-2: General test parameters for SA inter-frequency event triggered reporting for FR2 without SSB time index detection

Parameter	Unit	Test configuration	Value		Comment
			Test 1	Test 2	
NR RF Channel Number		Config 1,2,3	1, 2		One NR FR1 and one NR FR2 carrier frequency is used.
Active cell		Config 1,2,3	NR cell 1 (Pcell)		NR Cell 1 is on NR RF channel number 1.
Neighbour cell		Config 1,2,3	NR cell 2		NR cell 2 is on NR RF channel number 2.
Gap Pattern Id		Config 1,2,3	0	Gap not configured	As specified in clause 9.1.2-1.
Measurement gap offset		Config 1,2,3	39	N/A	
SMTC-SSB parameters on NR RF Channel 1		Config 1	SSB.1 FR1		As specified in clause A.3.10.1
		Config 2	SSB.1 FR1		As specified in clause A.3.10.1
		Config 3	SSB.2 FR1		As specified in clause A.3.10.1
CSI-RS for tracking parameters on NR RF Channel 1		Config 1	TRS.1.1 FDD		
		Config 2	TRS.1.1 TDD		
		Config 3	TRS.1.2 TDD		
SMTC-SSB parameters on NR RF Channel 2		Config 1,2,3	SSB.3 FR2		As specified in clause A.3.10.2
<i>offsetMO</i>	dB	Config 1,2,3	6		
Hysteresis	dB	Config 1,2,3	0		
<i>a4-Threshold</i>	dBm	Config 1,2,3	-105		
CP length		Config 1,2,3	Normal		
TimeToTrigger	s	Config 1,2,3	0		
Filter coefficient		Config 1,2,3	0		L3 filtering is not used
DRX		Config 1,2,3	OFF		DRX is not used
Time offset between serving and neighbour cells		Config 1	3ms		Asynchronous cells. The timing of Cell 2 is 3ms later than the timing of Cell 1.
		Config 2,3	3μs		Synchronous cells.
T1	s	Config 1,2,3	5		
T2	s	Config 1,2,3	5.2 for PC1; 3.5 for other PC	3 for PC1; 2 for other PC	

Table A.7.6.2.5.1-3: Cell specific test parameters for SA inter-frequency event triggered reporting for FR2 without SSB time index detection

Parameter	Unit	Test configuration	Cell 1		Cell 2	
			T1	T2	T1	T2
AoA setup		Config 1,2,3	N/A		Setup 1 as specified in clause A.3.15	
Beam Assumption ^{Note 7}		Config 1,2,3	N/A		Rough	

NR RF Channel Number			Config 1,2,3	1	2
Duplex mode			Config 1	FDD	TDD
			Config 2,3	TDD	TDD
TDD configuration			Config 1	Not Applicable	TDDConf.3.1
			Config 2	TDDConf.1.1	TDDConf.3.1
			Config 3	TDDConf.2.1	TDDConf.3.1
BW _{channel}		MHz	Config 1	10: N _{RB,c} = 52	100: N _{RB,c} = 66
			Config 2	10: N _{RB,c} = 52	100: N _{RB,c} = 66
			Config 3	40: N _{RB,c} = 106	100: N _{RB,c} = 66
Data RBs allocated			Config 1	52	66
			Config 2	52	66
			Config 3	106	66
BWP BW		MHz	Config 1	10: N _{RB,c} = 52	100: N _{RB,c} = 66
			Config 2	10: N _{RB,c} = 52	100: N _{RB,c} = 66
			Config 3	40: N _{RB,c} = 106	100: N _{RB,c} = 66
BWP configuration	Initial DL BWP		Config 1,2,3	DLBWP.0.1	N/A
	Initial UL BWP			ULBWP.0.1	N/A
	Dedicated DL BWP			DLBWP.1.1	N/A
	Dedicated UL BWP			ULBWP.1.1	N/A
OCNG Patterns defined in A.3.2.1.1 (OP.1)			Config 1,2,3	OP.1	OP.1
PDSCH Reference measurement channel			Config 1	SR.1.1 FDD	-
			Config 2	SR.1.1 TDD	
			Config 3	SR2.1 TDD	
RMSI CORESET Reference Channel			Config 1	CR.1.1 FDD	-
			Config 2	CR.1.1 TDD	
			Config 3	CR2.1 TDD	
Dedicated CORESET RMC configuration			Config 1	CCR.1.1 FDD	-
			Config 2	CCR.1.1 TDD	
			Config 3	CCR.2.1 TDD	
SMTC configuration defined in A.3.11.1 and A.3.11.2			Config 1	SMTC.2	SMTC.2
			Config 2,3	SMTC.1	SMTC.1
PDSCH/PDCCH subcarrier spacing		kHz	Config 1,2	15	120
			Config 3	30	120
EPRE ratio of PSS to SSS			Config 1,2,3	0	0
EPRE ratio of PBCH DMRS to SSS					
EPRE ratio of PBCH to PBCH DMRS					
EPRE ratio of PDCCH DMRS to SSS					
EPRE ratio of PDCCH to PDCCH DMRS					
EPRE ratio of PDSCH DMRS to SSS					
EPRE ratio of PDSCH to PDSCH					
EPRE ratio of OCNG DMRS to SSS(Note 1)					

EPRE ratio of OCNG to OCNG DMRS (Note 1)					
\hat{E}_s	dBm/S CS	Config 1,2,3	Link only, see clause A.3.7A	-Infinity	-87
SSB_RP ^{Note 3}	dBm/S CS Note5	Config 1,2		-Infinity	-87
\hat{E}_s / I_{ot_BB} ^{Note 8}	dB	Config 1,2,3		-Infinity	14.69
I_o ^{Note3}	dBm/95 .04 MHz Note5	Config 1,2,3		-Infinity	-58.01
Propagation Condition		Config 1,2,3		No external noise (Note 9)	
<p>Note 1: OCNG shall be used such that both cells are fully allocated and a constant total transmitted power spectral density is achieved for all OFDM symbols.</p> <p>Note 2: Void</p> <p>Note 3: SSB_RP, E_s/I_{ot} and I_o levels have been derived from other parameters for information purposes. They are not settable parameters themselves.</p> <p>Note 4: Void</p> <p>Note 5: Equivalent power received by an antenna with 0 dBi gain at the centre of the quiet zone</p> <p>Note 6: As observed with 0 dBi gain antenna at the centre of the quiet zone</p> <p>Note 7: Information about types of UE beam is given in B.2.1.3, and does not limit UE implementation or test system implementation</p> <p>Note 8: Calculation of E_s/I_{ot_BB} includes the effect of UE internal noise up to the value assumed for the associated Refsens requirement in clause 7.3.2 of TS 38.101-2 [19], and an allowance of 1dB for UE multi-band relaxation factor ΔMB_S from TS 38.101-2 [19] Table 6.2.1.3-4.</p> <p>Note 9: The downlink connection between the System Simulator and the UE is without Additive White Gaussian Noise, and has no fading or multipath effects as specified in TS 38.521-2 B.0 [29].</p>					

A.7.6.2.5.2 Test Requirements

In test 1, with per-UE , the UE shall send one Event A4 triggered measurement report, with a measurement reporting delay less than X ms from the beginning of time period T2, where X is

5120 for UE supporting power class 1, or

3200 for UE supporting other power class.

In test 2, without the gap, the UE shall send one Event A4 triggered measurement report, with a measurement reporting delay less than X ms from the beginning of time period T2, where X is

2560 for UE supporting power class 1, or

1600 for UE supporting other power class.

In test 1 and 2 UE is not required to report SSB time index. The UE shall not send event triggered measurement reports, as long as the reporting criteria are not fulfilled. The rate of correct events observed during repeated tests shall be at least 90%.

NOTE: The actual overall delays measured in the test may be up to $2xTTI_{DCC}$ higher than the measurement reporting delays above because of TTI insertion uncertainty of the measurement report in DCC.

A.7.6.2.6 SA event triggered reporting tests for FR2 without SSB time index detection when DRX is used (PCell in FR1)

A.7.6.2.6.1 Test Purpose and Environment

The purpose of this test is to verify that the UE makes correct reporting of an event. This test will partly verify the SA inter-frequency NR cell search requirements in clause 9.3.4.

In this test, there are two cells: NR cell 1 as PCell in FR1 on NR RF channel 2 and NR cell 2 as neighbour cell in FR2 on NR RF channel 2. The test parameters and configurations are given in Tables A.7.6.2.6.1-1, A.7.6.2.6.1-2, and A.7.6.2.6.1-3.

In test 1&2 per-UE measurement gap pattern configuration # 0 as defined in Table A.7.6.2.6.1-2 is provided for a UE that does not support per-FR gap and in test 3&4 no gap pattern is configured as defined in Table A.7.6.2.6.1-2. If a UE supports per-FR gap it is only required to pass test 3&4. Otherwise it is only required to pass test 1&2.

In the measurement control information, it is indicated to the UE that event-triggered reporting with Event A4 is used. The test consists of two successive time periods, with time duration of T1, and T2 respectively. During time duration T1, the UE shall not have any timing information of NR cell 2.

Supported test configurations are shown in table A.7.6.2.6.1-1.

UE needs to be provided with new Timing Advance Command MAC control element at least once during each time alignment timer period to maintain uplink time alignment. Furthermore UE is allocated with PUSCH resource at every DRX cycle.

Table A.7.6.2.6.1-1: SA event triggered reporting tests without SSB index reading for FR1-FR2

Config	Description of serving cell	Description of target cell
1	NR 15 kHz SSB SCS, 10 MHz bandwidth, FDD duplex mode	120 kHz SSB SCS, 100 MHz bandwidth, TDD duplex mode
2	NR 15 kHz SSB SCS, 10 MHz bandwidth, TDD duplex mode	
3	NR 30 kHz SSB SCS, 40 MHz bandwidth, TDD duplex mode	
Note: The UE is only required to be tested in one of the supported test configurations		

Table A.7.6.2.6.1-2: General test parameters for SA inter-frequency event triggered reporting for FR2 without SSB time index detection

Parameter	Unit	Test configuration	Value				Comment
			Test 1	Test 2	Test 3	Test 4	
NR RF Channel Number		Config 1,2,3	1, 2				One NR FR1 and one NR FR2 carrier frequency is used.
Active cell		Config 1,2,3	NR cell 1 (Pcell)				NR Cell 1 is on NR RF channel number 1.
Neighbour cell		Config 1,2,3	NR cell 2				NR cell 2 is on NR RF channel number 2.
Gap Pattern Id		Config 1,2,3	0		Gap not configured		As specified in clause 9.1.2-1.
Measurement gap offset		Config 1,2,3	39		N/A		
SMTC-SSB parameters on NR RF Channel 1		Config 1	SSB.1 FR1				As specified in clause A.3.10.1
		Config 2	SSB.1 FR1				As specified in clause A.3.10.1
		Config 3	SSB.2 FR1				As specified in clause A.3.10.1
CSI-RS for tracking parameters on NR RF Channel 1		Config 1	TRS.1.1 FDD				
		Config 2	TRS.1.1 TDD				
		Config 3	TRS.1.2 TDD				

SMTC-SSB parameters on NR RF Channel 2		Config 1,2,3	SSB.3 FR2				As specified in clause A.3.10.2
<i>offsetMO</i>	dB	Config 1,2,3	6				
Hysteresis	dB	Config 1,2,3	0				
<i>a4-Threshold</i>	dBm	Config 1,2,3	-105				
CP length		Config 1,2,3	Normal				
TimeToTrigger	s	Config 1,2,3	0				
Filter coefficient		Config 1,2,3	0				L3 filtering is not used
DRX		Config 1,2,3	DRX .1	DRX .7	DRX .1	DRX .7	As specified in clause A.3.3
Time offset between serving and neighbour cells		Config 1	3ms				Asynchronous cells. The timing of Cell 2 is 3ms later than the timing of Cell 1.
		Config 2,3	3μs				Synchronous cells.
T1	s	Config 1,2,3	5				
T2	s	Config 1,2,3	8 for PC1; 5 for other PC	82 for PC1; 52 for other PC	8 for PC1; 5 for other PC	82 for PC1; 52 for other PC	

Table A.7.6.2.6.1-3: Cell specific test parameters for SA inter-frequency event triggered reporting for FR2 without SSB time index detection

Parameter		Unit	Test configuration	Cell 1		Cell 2	
				T1	T2	T1	T2
AoA setup			Config 1,2,3	NA		Setup 1 as specified in clause A.3.15	
Beam Assumption ^{Note 7}			Config 1,2,3	N/A		Rough	
NR RF Channel Number			Config 1,2,3	1		2	
Duplex mode			Config 1	FDD		TDD	
			Config 2,3	TDD		TDD	
TDD configuration			Config 1	Not Applicable		TDDConf.3.1	
			Config 2	TDDConf.1.1		TDDConf.3.1	
			Config 3	TDDConf.2.1		TDDConf.3.1	
BW _{channel}		MHz	Config 1	10: N _{RB,c} = 52		100: N _{RB,c} = 66	
			Config 2	10: N _{RB,c} = 52		100: N _{RB,c} = 66	
			Config 3	40: N _{RB,c} = 106		100: N _{RB,c} = 66	
Data RBs allocated			Config 1	52		66	
			Config 2	52		66	
			Config 3	106		66	
BWP BW		MHz	Config 1	10: N _{RB,c} = 52		100: N _{RB,c} = 66	
			Config 2	10: N _{RB,c} = 52		100: N _{RB,c} = 66	
			Config 3	40: N _{RB,c} = 106		100: N _{RB,c} = 66	
BWP configuration	Initial DL BWP		Config 1,2,3	DLBWP.0.1		N/A	
	Initial UL BWP			ULBWP.0.1		N/A	
	Dedicated DL BWP			DLBWP.1.1		N/A	
	Dedicated UL BWP			ULBWP.1.1		N/A	
OCNG Patterns defined in A.3.2.1.1 (OP.1)			Config 1,2,3	OP.1		OP.1	

PDSCH Reference measurement channel		Config 1	SR.1.1 FDD	-	
		Config 2	SR.1.1 TDD		
		Config 3	SR2.1 TDD		
RMSI CORESET Reference Channel		Config 1	CR.1.1 FDD	-	
		Config 2	CR.1.1 TDD		
		Config 3	CR2.1 TDD		
Dedicated CORESET RMC configuration		Config 1	CCR.1.1 FDD	-	
		Config 2	CCR.1.1 TDD		
		Config 3	CCR.2.1 TDD		
SMTC configuration defined in A.3.11.1 and A.3.11.2		Config 1	SMTC.2	SMTC.2	
		Config 2,3	SMTC.1	SMTC.1	
PDSCH/PDCCH subcarrier spacing	kHz	Config 1,2	15	120	
		Config 3	30	120	
EPRE ratio of PSS to SSS		Config 1,2,3	0	0	
EPRE ratio of PBCH DMRS to SSS					
EPRE ratio of PBCH to PBCH DMRS					
EPRE ratio of PDCCH DMRS to SSS					
EPRE ratio of PDCCH to PDCCH DMRS					
EPRE ratio of PDSCH DMRS to SSS					
EPRE ratio of PDSCH to PDSCH					
EPRE ratio of OCNG DMRS to SSS(Note 1)					
EPRE ratio of OCNG to OCNG DMRS (Note 1)					
N_{oc} ^{Note2}	dBm/15 kHz Note5		NA Link only, see clause A.3.7A	-104.7	
N_{oc} ^{Note2}	dBm/S CS Note4	Config 1,2		-95.7	
		Config 3		-95.7	
SSB_RP ^{Note 3}	dBm/S CS Note5	Config 1,2		-Infinity	-86.7
		Config 3		-Infinity	-86.7
\hat{E}_s / I_{ot}	dB	Config 1,2,3		-Infinity	9
\hat{E}_s / N_{oc}	dB	Config 1,2,3		-Infinity	9
I_o ^{Note3}	dBm/9.36MHz	Config 1,2		-	-
	dBm/38.16MHz	Config 3		-	-
	dBm/95.04 MHz Note5	Config 1,2,3		-66.7	-57.2
Propagation Condition		Config 1,2,3	AWGN		

Note 1:	OCNG shall be used such that both cells are fully allocated and a constant total transmitted power spectral density is achieved for all OFDM symbols.
Note 2:	Interference from other cells and noise sources not specified in the test is assumed to be constant over subcarriers and time and shall be modelled as AWGN of appropriate power for N_{oc} to be fulfilled.
Note 3:	SSB_RP and I_0 levels have been derived from other parameters for information purposes. They are not settable parameters themselves.
Note 4:	SSB_RP minimum requirements are specified assuming independent interference and noise at each receiver antenna port.
Note 5:	Equivalent power received by an antenna with 0 dBi gain at the centre of the quiet zone
Note 6:	As observed with 0 dBi gain antenna at the centre of the quiet zone
Note 7:	Information about types of UE beam is given in B.2.1.3, and does not limit UE implementation or test system implementation

A.7.6.2.6.2 Test Requirements

In test 1 with per-UE gap and in test 3 without the gap, the UE shall send one Event A4 triggered measurement report, with a measurement reporting delay less than X_1 ms from the beginning of time period T2, where X_1 is

7680 for UE supporting power class 1, or

4800 for UE supporting other power class.

In test 2 with per-UE gap and in test 4 without the gap, the UE shall send one Event A4 triggered measurement report, with a measurement reporting delay less than X_2 ms from the beginning of time period T2, where X_2 is

81920 for UE supporting power class 1, or

51200 for UE supporting other power class.

In test 1, 2, 3 and 4 UE is not required to report SSB time index. The UE shall not send event triggered measurement reports, as long as the reporting criteria are not fulfilled. The rate of correct events observed during repeated tests shall be at least 90%.

NOTE: The actual overall delays measured in the test may be up to $2xTTI_{DCCH}$ higher than the measurement reporting delays above because of TTI insertion uncertainty of the measurement report in DCCH.

A.7.6.2.7 SA event triggered reporting tests for FR2 with SSB time index detection when DRX is not used (PCell in FR1)

A.7.6.2.7.1 Test Purpose and Environment

The purpose of this test is to verify that the UE makes correct reporting of an event. This test will partly verify the SA inter-frequency NR cell search requirements in clause 9.3.4.

In this test, there are two cells: NR cell 1 as PCell in FR1 on NR RF channel 2 and NR cell 2 as neighbour cell in FR2 on NR RF channel 2. The test parameters and configurations are given in Tables A.7.6.2.7.1-1, A.7.6.2.7.1-2, and A.7.6.2.7.1-3.

In test 1 per-UE measurement gap pattern configuration # 0 as defined in Table A.7.6.2.7.1-2 is provided for a UE that does not support per-FR gap and in test 2 measurement no gap pattern is configured as defined in Table A.7.6.2.7.1-2. If the UE supports per-FR gap, it is only required to pass test 2. Otherwise it is only required to pass test 1.

In the measurement control information, it is indicated to the UE that event-triggered reporting with Event A4 is used. The test consists of two successive time periods, with time duration of T1, and T2 respectively. During time duration T1, the UE shall not have any timing information of NR cell 2.

Supported test configurations are shown in table A.7.6.2.7.1-1.

Table A.7.6.2.7.1-1: SA event triggered reporting tests with SSB index reading for FR1-FR2

Config	Description of serving cell	Description of target cell
1	NR 15 kHz SSB SCS, 10 MHz bandwidth, FDD duplex mode	120 kHz SSB SCS, 100 MHz bandwidth, TDD duplex mode
2	NR 15 kHz SSB SCS, 10 MHz bandwidth, TDD duplex mode	
3	NR 30 kHz SSB SCS, 40 MHz bandwidth, TDD duplex mode	
Note: The UE is only required to be tested in one of the supported test configurations		

Table A.7.6.2.7.1-2: General test parameters for SA inter-frequency event triggered reporting for FR2 with SSB time index detection

Parameter	Unit	Test configuration	Value		Comment
			Test 1	Test 2	
NR RF Channel Number		Config 1,2,3	1, 2		One NR FR1 and one NR FR2 carrier frequency is used.
Active cell		Config 1,2,3	NR cell 1 (Pcell)		NR Cell 1 is on NR RF channel number 1.
Neighbour cell		Config 1,2,3	NR cell 2		NR cell 2 is on NR RF channel number 2.
Gap Pattern Id		Config 1,2,3	0	Gap not configured	As specified in clause 9.1.2-1.
Measurement gap offset		Config 1,2,3	39	N/A	
SMTC-SSB parameters on NR RF Channel 1		Config 1	SSB.1 FR1		As specified in clause A.3.10.1
		Config 2	SSB.1 FR1		As specified in clause A.3.10.1
		Config 3	SSB.2 FR1		As specified in clause A.3.10.1
CSI-RS for tracking parameters on NR RF Channel 1		Config 1	TRS.1.1 FDD		
		Config 2	TRS.1.1 TDD		
		Config 3	TRS.1.2 TDD		
SMTC-SSB parameters on NR RF Channel 2		Config 1,2,3	SSB.3 FR2		As specified in clause A.3.10.2
<i>offsetMO</i>	dB	Config 1,2,3	6		
Hysteresis	dB	Config 1,2,3	0		
<i>a4-Threshold</i>	dBm	Config 1,2,3,4,5,6	-105		
CP length		Config 1,2,3	Normal		
TimeToTrigger	s	Config 1,2,3	0		
Filter coefficient		Config 1,2,3	0		L3 filtering is not used
DRX		Config 1,2,3	OFF		DRX is not used
Time offset between serving and neighbour cells		Config 1	3ms		Asynchronous cells. The timing of Cell 2 is 3ms later than the timing of Cell 1.
		Config 2,3	3μs		Synchronous cells.
T1	s	Config 1,2,3	5		
T2	s	Config 1,2,3	7 for PC1; 4.5 for other PC	3.5 for PC1; 2.5 for other PC	

Table A.7.6.2.7.1-3: Cell specific test parameters for SA inter-frequency event triggered reporting for FR2 with SSB time index detection

Parameter	Unit	Test configuration	Cell 1		Cell 2	
			T1	T2	T1	T2

AoA setup			Config 1,2,3	NA	Setup 1 as specified in clause A.3.15
Beam Assumption ^{Note 7}			Config 1,2,3	N/A	Rough
NR RF Channel Number			Config 1,2,3	1	2
Duplex mode			Config 1	FDD	TDD
			Config 2,3	TDD	TDD
TDD configuration			Config 1	Not Applicable	TDDConf.3.1
			Config 2	TDDConf.1.1	TDDConf.3.1
			Config 3	TDDConf.2.1	TDDConf.3.1
BW _{channel}		MHz	Config 1	10: N _{RB,c} = 52	100: N _{RB,c} = 66
			Config 2	10: N _{RB,c} = 52	100: N _{RB,c} = 66
			Config 3	40: N _{RB,c} = 106	100: N _{RB,c} = 66
Data RBs allocated			Config 1	52	66
			Config 2	52	66
			Config 3	106	66
BWP BW		MHz	Config 1	10: N _{RB,c} = 52	100: N _{RB,c} = 66
			Config 2	10: N _{RB,c} = 52	100: N _{RB,c} = 66
			Config 3	40: N _{RB,c} = 106	100: N _{RB,c} = 66
BWP configuration	Initial DL BWP		Config 1,2,3	DLBWP.0.1	N/A
	Initial UL BWP			ULBWP.0.1	N/A
	Dedicated DL BWP			DLBWP.1.1	N/A
	Dedicated UL BWP			ULBWP.1.1	N/A
OCNG Patterns defined in A.3.2.1.1 (OP.1)			Config 1,2,3	OP.1	OP.1
PDSCH Reference measurement channel			Config 1	SR.1.1 FDD	-
			Config 2	SR.1.1 TDD	
			Config 3	SR2.1 TDD	
RMSI CORESET Reference Channel			Config 1	CR.1.1 FDD	-
			Config 2	CR.1.1 TDD	
			Config 3	CR2.1 TDD	
Dedicated CORESET RMC configuration			Config 1	CCR.1.1 FDD	-
			Config 2	CCR.1.1 TDD	
			Config 3	CCR.2.1 TDD	
SMTC configuration defined in A.3.11.1 and A.3.11.2			Config 1	SMTC.2	SMTC.2
			Config 2,3	SMTC.1	SMTC.1
PDSCH/PDCCH subcarrier spacing		kHz	Config 1,2	15	120
			Config 3	30	120
EPRE ratio of PSS to SSS			Config 1,2,3	0	0
EPRE ratio of PBCH DMRS to SSS					
EPRE ratio of PBCH to PBCH DMRS					
EPRE ratio of PDCCH DMRS to SSS					
EPRE ratio of PDCCH to PDCCH DMRS					
EPRE ratio of PDSCH DMRS to SSS					

EPRE ratio of PDSCH to PDSCH					
EPRE ratio of OCNG DMRS to SSS(Note 1)					
EPRE ratio of OCNG to OCNG DMRS (Note 1)					
\hat{E}_s	dBm/S CS	Config 1,2, 3	Link only, see clause A.3.7A	-Infinity	-87
SSB_RP ^{Note 3}	dBm/S CS Note5	Config 1,2		-Infinity	-87
		Config 3		-Infinity	-87
$\hat{E}_s / I_{ot\ BB}$ ^{Note 8}	dB	Config 1,2,3		-Infinity	14.69
I_o ^{Note3}	dBm/95 .04 MHz Note5	Config 1,2,3		Infinity	-58.01
Propagation Condition		Config 1,2,3		No external noise (Note 9)	
<p>Note 1: OCNG shall be used such that both cells are fully allocated and a constant total transmitted power spectral density is achieved for all OFDM symbols.</p> <p>Note 2: Void</p> <p>Note 3: SSB_RP, E_s/I_{ot} and I_o levels have been derived from other parameters for information purposes. They are not settable parameters themselves.</p> <p>Note 4: Void</p> <p>Note 5: Equivalent power received by an antenna with 0 dBi gain at the centre of the quiet zone</p> <p>Note 6: As observed with 0 dBi gain antenna at the centre of the quiet zone</p> <p>Note 7: Information about types of UE beam is given in B.2.1.3, and does not limit UE implementation or test system implementation</p> <p>Note 8: Calculation of $E_s/I_{ot\ BB}$ includes the effect of UE internal noise up to the value assumed for the associated Refsens requirement in clause 7.3.2 of TS 38.101-2 [19], and an allowance of 1dB for UE multi-band relaxation factor ΔMB_s from TS 38.101-2 [19] Table 6.2.1.3-4.</p> <p>Note 9: The downlink connection between the System Simulator and the UE is without Additive White Gaussian Noise, and has no fading or multipath effects as specified in TS 38.521-2 B.0 [29].</p>					

A.7.6.2.7.2 Test Requirements

In test 1 with per-UE gap, the UE shall send one Event A4 triggered measurement report, with a measurement reporting delay less than X ms from the beginning of time period T2, where X is

6720 for UE supporting power class 1, or

4160 for UE supporting other power class.

In test 2 without the gap, the UE shall send one Event A4 triggered measurement report, with a measurement reporting delay less than X ms from the beginning of time period T2, where X is

3360 for UE supporting power class 1, or

2080 for UE supporting other power class.

In test 1 and 2 UE is required to report SSB time index. The UE shall not send event triggered measurement reports, as long as the reporting criteria are not fulfilled. The rate of correct events observed during repeated tests shall be at least 90%.

NOTE: The actual overall delays measured in the test may be up to $2xTTI_{DCCCH}$ higher than the measurement reporting delays above because of TTI insertion uncertainty of the measurement report in DCCCH.

A.7.6.2.8 SA event triggered reporting tests for FR2 with SSB time index detection when DRX is used (PCell in FR1)

A.7.6.2.8.1 Test Purpose and Environment

The purpose of this test is to verify that the UE makes correct reporting of an event. This test will partly verify the SA inter-frequency NR cell search requirements in clause 9.3.4.

In this test, there are two cells: NR cell 1 as PCell in FR1 on NR RF channel 2 and NR cell 2 as neighbour cell in FR2 on NR RF channel 2. The test parameters and configurations are given in Tables A.7.6.2.8.1-1, A.7.6.2.8.1-2, and A.7.6.2.8.1-3.

In test 1&2 per-UE measurement gap pattern configuration # 0 as defined in Table A.7.6.2.8.1-2 is provided for a UE that does not support per-FR gap and in test 3&4 measurement no gap pattern is configured as defined in Table A.7.6.2.8.1-2. If a UE supports per-FR gap, it is only required to pass test 3&4. Otherwise it is only required to pass test 1&2.

In the measurement control information, it is indicated to the UE that event-triggered reporting with Event A4 is used. The test consists of two successive time periods, with time duration of T1, and T2 respectively. During time duration T1, the UE shall not have any timing information of NR cell 2.

Supported test configurations are shown in table A.7.6.2.8.1-1.

UE needs to be provided with new Timing Advance Command MAC control element at least once during each time alignment timer period to maintain uplink time alignment. Furthermore UE is allocated with PUSCH resource at every DRX cycle.

Table A.7.6.2.8.1-1: SA event triggered reporting tests with SSB index reading for FR1-FR2

Config	Description of serving cell	Description of target cell
1	NR 15 kHz SSB SCS, 10 MHz bandwidth, FDD duplex mode	120 kHz SSB SCS, 100 MHz bandwidth, TDD duplex mode
2	NR 15 kHz SSB SCS, 10 MHz bandwidth, TDD duplex mode	
3	NR 30 kHz SSB SCS, 40 MHz bandwidth, TDD duplex mode	
Note: The UE is only required to be tested in one of the supported test configurations		

Table A.7.6.2.8.1-2: General test parameters for SA inter-frequency event triggered reporting for FR2 with SSB time index detection

Parameter	Unit	Test configuration	Value				Comment
			Test 1	Test 2	Test 3	Test 4	
NR RF Channel Number		Config 1,2,3	1, 2				One NR FR1 and one NR FR2 carrier frequency is used.
Active cell		Config 1,2,3	NR cell 1 (Pcell)				NR Cell 1 is on NR RF channel number 1.
Neighbour cell		Config 1,2,3	NR cell 2				NR cell 2 is on NR RF channel number 2.
Gap Pattern Id		Config 1,2,3	0		Gap not configured		As specified in clause 9.1.2-1.
Measurement gap offset		Config 1,2,3	39		N/A		
SMTC-SSB parameters on NR RF Channel 1		Config 1	SSB.1 FR1				As specified in clause A.3.10.1
		Config 2	SSB.1 FR1				As specified in clause A.3.10.1
		Config 3	SSB.2 FR1				As specified in clause A.3.10.1
		Config 1	TRS.1.1 FDD				
		Config 2	TRS.1.1 TDD				

CSI-RS for tracking parameters on NR RF Channel 1		Config 3	TRS.1.2 TDD				
SMTC-SSB parameters on NR RF Channel 2		Config 1,2,3	SSB.3 FR2				As specified in clause A.3.10.2
<i>offsetMO</i>	dB	Config 1,2,3	6				
Hysteresis	dB	Config 1,2,3	0				
<i>a4-Threshold</i>	dBm	Config 1,2,3	-105				
CP length		Config 1,2,3	Normal				
TimeToTrigger	s	Config 1,2,3	0				
Filter coefficient		Config 1,2,3	0				L3 filtering is not used
DRX		Config 1,2,3	DRX .1	DRX .7	DRX .1	DRX .7	As specified in clause A.3.3
Time offset between serving and neighbour cells		Config 1	3ms				Asynchronous cells. The timing of Cell 2 is 3ms later than the timing of Cell 1.
		Config 2,3	3µs				Synchronous cells.
T1	s	Config 1,2,3	5				
T2	s	Config 1,2,3	11 for PC1; 6.5 for othe r PCT BD	108 for PC1; 67 for othe r PCT BD	11 for PC1; 6.5 for othe r PCT BD	108 for PC1; 67 for othe r PCT BD	

Table A.7.6.2.8.1-3: Cell specific test parameters for SA inter-frequency event triggered reporting for FR2 with SSB time index detection

Parameter		Unit	Test configuration	Cell 1		Cell 2	
				T1	T2	T1	T2
AoA setup			Config 1,2,3	NA		Setup 1 as specified in clause A.3.15	
Beam Assumption ^{Note 7}			Config 1,2,3	N/A		Rough	
NR RF Channel Number			Config 1,2,3	1		2	
Duplex mode			Config 1	FDD		TDD	
			Config 2,3	TDD		TDD	
TDD configuration			Config 1	Not Applicable		TDDConf.3.1	
			Config 2	TDDConf.1.1		TDDConf.3.1	
			Config 3	TDDConf.2.1		TDDConf.3.1	
BW _{channel}		MHz	Config 1	10: N _{RB,c} = 52		100: N _{RB,c} = 66	
			Config 2	10: N _{RB,c} = 52		100: N _{RB,c} = 66	
			Config 3	40: N _{RB,c} = 106		100: N _{RB,c} = 66	
Data RBs allocated			Config 1	52		66	
			Config 2	52		66	
			Config 3	106		66	
BWP BW		MHz	Config 1	10: N _{RB,c} = 52		100: N _{RB,c} = 66	
			Config 2	10: N _{RB,c} = 52		100: N _{RB,c} = 66	
			Config 3	40: N _{RB,c} = 106		100: N _{RB,c} = 66	
BWP configuration	Initial DL BWP		Config 1,2,3	DLBWP.0.1		N/A	
	Initial UL BWP			ULBWP.0.1		N/A	

	Dedicated DL BWP			DLBWP.1.1	N/A	
	Dedicated UL BWP			ULBWP.1.1	N/A	
OCNG Patterns defined in A.3.2.1.1 (OP.1)			Config 1,2,3	OP.1	OP.1	
PDSCH Reference measurement channel			Config 1	SR.1.1 FDD	-	
			Config 2	SR.1.1 TDD		
			Config 3	SR2.1 TDD		
RMSI CORESET Reference Channel			Config 1	CR.1.1 FDD	-	
			Config 2	CR.1.1 TDD		
			Config 3	CR2.1 TDD		
Dedicated CORESET RMC configuration			Config 1	CCR.1.1 FDD	-	
			Config 2	CCR.1.1 TDD		
			Config 3	CCR.2.1 TDD		
SMTC configuration defined in A.3.11.1 and A.3.11.2			Config 1	SMTC.2	SMTC.2	
			Config 2,3	SMTC.1	SMTC.1	
PDSCH/PDCCH subcarrier spacing	kHz		Config 1,2	15	120	
			Config 3	30	120	
EPRE ratio of PSS to SSS		Config 1,2,3	0	0	0	
EPRE ratio of PBCH DMRS to SSS						
EPRE ratio of PBCH to PBCH DMRS						
EPRE ratio of PDCCH DMRS to SSS						
EPRE ratio of PDCCH to PDCCH DMRS						
EPRE ratio of PDSCH DMRS to SSS						
EPRE ratio of PDSCH to PDSCH						
EPRE ratio of OCNG DMRS to SSS(Note 1)						
EPRE ratio of OCNG to OCNG DMRS (Note 1)						
N_{oc} ^{Note2}	dBm/15 kHz Note5		NA Link only, see clause A.3.7A	-104.7		
N_{oc} ^{Note2}	dBm/S CS Note4	Config 1,2		-95.7		
		Config 3		-95.7		
SSB_RP ^{Note 3}	dBm/S CS Note5	Config 1,2		-Infinity	-86.7	
		Config 3		-Infinity	-86.7	
\hat{E}_s/I_{ot}	dB	Config 1,2,3		-Infinity	9	
\hat{E}_s/N_{oc}	dB	Config 1,2,3		-Infinity	9	
I_o ^{Note3}	dBm/9.36MHz	Config 1,2		-	-	
	dBm/38.16MHz	Config 3		-	-	

	dBm/95 .04 MHz Note5	Config 1,2,3		-66.7	-57.2
Propagation Condition		Config 1,2,3		AWGN	
Note 1:	OCNG shall be used such that both cells are fully allocated and a constant total transmitted power spectral density is achieved for all OFDM symbols.				
Note 2:	Interference from other cells and noise sources not specified in the test is assumed to be constant over subcarriers and time and shall be modelled as AWGN of appropriate power for N_{oc} to be fulfilled.				
Note 3:	SSB_RP and lo levels have been derived from other parameters for information purposes. They are not settable parameters themselves.				
Note 4:	SSB_RP minimum requirements are specified assuming independent interference and noise at each receiver antenna port.				
Note 5:	Equivalent power received by an antenna with 0 dBi gain at the centre of the quiet zone				
Note 6:	As observed with 0 dBi gain antenna at the centre of the quiet zone				
Note 7:	Information about types of UE beam is given in B.2.1.3, and does not limit UE implementation or test system implementation.				

A.7.6.2.8.2 Test Requirements

In test 1 with per-UE gap and in test 3 without the gap, the UE shall send one Event A4 triggered measurement report, with a measurement reporting delay less than X1 ms from the beginning of time period T2, where X1 is

10080 for UE supporting power class 1, or

6240 for UE supporting other power class.

In test 2 with per-UE gap and in test 4 without the gap, the UE shall send one Event A4 triggered measurement report, with a measurement reporting delay less than X2 ms from the beginning of time period T2, where X2 is

107520 for UE supporting power class 1, or

66560 for UE supporting other power class.

In test 1, 2, 3 and 4 UE is required to report SSB time index. The UE shall not send event triggered measurement reports, as long as the reporting criteria are not fulfilled. The rate of correct events observed during repeated tests shall be at least 90%.

NOTE: The actual overall delays measured in the test may be up to $2xTTI_{DCC}$ higher than the measurement reporting delays above because of TTI insertion uncertainty of the measurement report in DCC.

A.7.6.3 L1-RSRP measurement for beam reporting

A.7.6.3.1 SSB based L1-RSRP measurement when DRX is not used

A.7.6.3.1.1 Test Purpose and Environment

The purpose of this test is to verify that the UE makes correct reporting of L1-RSRP measurement. This test will partly verify the L1-RSRP measurement requirements in clause 9.5.4.1, with the testing configurations for NR cells in Table A.7.6.3.1.1-1.

The AoA setup for this test is Setup 1 as defined in clause A.3.15

Table A.7.6.3.1.1-1: Applicable NR configurations for FR2 SSB based L1-RSRP test

Config	Description
1	NR 120 kHz SSB SCS, 100 MHz bandwidth, TDD duplex mode

2	NR 240 kHz SSB SCS, 100 MHz bandwidth, TDD duplex mode
Note:	The UE is only required to be tested in one of the supported test configurations

A.7.6.3.1.2 Test parameters

There is one cells in the test, the FR2 PCell (Cell 1). The test parameters for the Cell 1 are given in Table A.7.6.3.1.2-1 and Table A.7.6.3.1.2-2 below.

In CSI measurement configuration, UE is indicated to perform L1-RSRP measurement on the SSBs and report periodically. The test consists of two successive time periods, with time duration of T1 and T2 respectively. The test has higher layer parameter *timeRestrictionForChannelMeasurements* configured.

There is no measurement gap configured in the test. Before the test, UE is configured to perform RLM, BFD and L1-RSRP measurement based on the SSBs.

Table A.7.6.3.1.2-1: General test parameters

Parameter	Config	Unit	Value
SSB GSCN	1~2		freq1
Duplex mode	1~2		TDD
TDD Configuration	1~2		TDDConf.3.1
BW _{channel}	1~2	MHz	100: N _{RB,c} = 66
Data RBs allocated	1~2		66
PDSCH Reference measurement channel	1		SR.3.2 TDD
	2		SR.3.3 TDD
RMSI CORESET Reference Channel	1		CR.3.1 TDD
	2		CR.3.2 TDD
Dedicated CORESET Reference Channel	1		CCR.3.1 TDD
	2		CCR.3.7 TDD
SSB configuration	1		SSB.1 FR2
	2		SSB.2 FR2
OCNG Patterns	1~2		OP.1
Initial BWP Configuration	1~2		DLBWP.0.1 ULBWP.0.1
Dedicated BWP configuration	1~2		DLBWP.1.3 ULBWP.1.3
SMTC configuration	1~2		SMTC.1
TRS Configuration	1~2		TRS.2.1 TDD
PDCCH/PDSCH TCI Configuration	1~2		TCI.State.2
DRX configuration	1~2		Off
reportConfigType	1~2		periodic
reportQuantity	1~2		ssb-Index-RSRP
Number of reported RS	1~2		2
L1-RSRP reporting period	1~2	slot	320
T1	1~2	s	5
T2	1~2	s	2
EPRE ratio of PSS to SSS	1~2	dB	0
EPRE ratio of PBCH DMRS to SSS			
EPRE ratio of PBCH to PBCH DMRS			
EPRE ratio of PDCCH DMRS to SSS			
EPRE ratio of PDCCH to PDCCH DMRS			
EPRE ratio of PDSCH DMRS to SSS			

EPRE ratio of PDSCH to PDSCH DMRS			
EPRE ratio of OCNG DMRS to SSS ^{Note 1}			
EPRE ratio of OCNG to OCNG DMRS ^{Note 1}			
Propagation condition	1~2		AWGN
Note 1: OCNG shall be used such that the resources in Cell 1 are fully allocated and a constant total transmitted power spectral density is achieved for all OFDM symbols.			

Table A.7.6.3.1.2-2: SSB specific test parameters

Parameter	Config	Unit	SSB#0		SSB#1	
			T1	T2	T1	T2
Angle of arrival configuration			Setup 1 according to A.3.15.1			
Beam Assumption ^{Note 4}	1-2		Rough			
N_{oc} ^{Note 2}	1~2	dBm/15kHz	-105			
N_{oc} ^{Note 2}	1	dBm/SSB SCS	-96			
	2		-93			
\hat{E}_s/I_{ot}	1~2	dB	0	0	-Infinity	9
SSB_RP ^{Note 3}	1	dBm/SSB SCS	-96	-96	-Infinity	-87
	2		-93	-93	-Infinity	-84
I_o ^{Note 3}	1	dBm/95.04MHz	-63.97	-63.97	-66.98	-57.47
	2		-63.97	-63.97	-66.98	-57.47
\hat{E}_s/N_{oc}	1~2	dB	0	0	-Infinity	9
<p>Note 1: The resources for uplink transmission are assigned to the UE prior to the start of time period T2.</p> <p>Note 2: Interference from other cells and noise sources not specified in the test is assumed to be constant over subcarriers and time and shall be modelled as AWGN of appropriate power for N_{oc} to be fulfilled.</p> <p>Note 3: SSB_RP and I_o levels have been derived from other parameters for information purposes. They are not settable parameters themselves</p> <p>Note 4: Information about types of UE beam is given in B.2.1.3, and does not limit UE implementation or test system implementation</p>						

A.7.6.3.1.3 Test Requirements

The UE shall send L1-RSRP report every 320 slots. No later than X ms plus 320 slots from the beginning of time period T2, UE shall send L1-RSRP report including the results for both SSB#0 and SSB#1 while meeting the accuracy requirements defined in clause 10.1.20.1, where X is

- 1680 for UE supporting power class 1
- 1200 for UE supporting power class 2,3 or 4.

The reported L1-RSRP value shall include the Rx antenna gain in the range of -10 to +20 dB.

The rate of correct events observed during repeated tests shall be at least 90%.

A.7.6.3.2 SSB based L1-RSRP measurement when DRX is used

A.7.6.3.2.1 Test Purpose and Environment

The purpose of this test is to verify that the UE makes correct reporting of L1-RSRP measurement. This test will partly verify the L1-RSRP measurement requirements in clause 9.5.4.1, with the testing configurations for NR cells in Table A.7.6.3.2.1-1.

The AoA setup for this test is Setup 1 as defined in clause A.3.15

Table A.7.6.3.2.1-1: Applicable NR configurations for FR2 SSB based L1-RSRP test

Config	Description
1	NR 120 kHz SSB SCS, 100 MHz bandwidth, TDD duplex mode
2	NR 240 kHz SSB SCS, 100 MHz bandwidth, TDD duplex mode
Note:	The UE is only required to be tested in one of the supported test configurations

A.7.6.3.2.2 Test parameters

There is one cells in the test, the FR2 PCell (Cell 1). The test parameters for the Cell 1 are given in Table A.7.6.3.2.2-1 and Table A.7.6.3.2.2-2 below.

In CSI measurement configuration, UE is indicated to perform L1-RSRP measurement on the SSBs and report periodically. The test consists of two successive time periods, with time duration of T1 and T2 respectively. The test has higher layer parameter *timeRestrictionForChannelMeasurements* configured.

There is no measurement gap configured in the test. Before the test, UE is configured to perform RLM, BFD and L1-RSRP measurement based on the SSBs.

Table A.7.6.3.2.2-1: General test parameters

Parameter	Config	Unit	Value
SSB GSCN	1~2		freq1
Duplex mode	1~2		TDD
TDD Configuration	1~2		TDDConf.3.1
BW _{channel}	1~2	MHz	100: N _{RB,c} = 66
Data RBs allocated	1~2		66
PDSCH Reference measurement channel	1		SR.3.2 TDD
	2		SR.3.3 TDD
RMSI CORESET Reference Channel	1		CR.3.1 TDD
	2		CR.3.2 TDD
Dedicated CORESET Reference Channel	1		CCR.3.1 TDD
	2		CCR.3.7 TDD
SSB configuration	1		SSB.1 FR2
	2		SSB.2 FR2
OCNG Patterns	1~2		OP.1
Initial BWP Configuration	1~2		DLBWP.0.1
			ULBWP.0.1
Dedicated BWP configuration	1~2		DLBWP.1.3
			ULBWP.1.3
SMTc configuration	1~2		SMTc.1
TRS Configuration	1~2		TRS.2.1 TDD
PDCCH/PDSCH TCI Configuration	1~2		TCI.State.2
DRX configuration	1~2		DRX.3

reportConfigType	1~2		periodic
reportQuantity	1~2		ssb-Index-RSRP
Number of reported RS	1~2		2
L1-RSRP reporting period	1~2	slot	320
T1	1~2	s	5
T2	1~2	s	3
EPRE ratio of PSS to SSS	1~2	dB	0
EPRE ratio of PBCH DMRS to SSS			
EPRE ratio of PBCH to PBCH DMRS			
EPRE ratio of PDCCH DMRS to SSS			
EPRE ratio of PDCCH to PDCCH DMRS			
EPRE ratio of PDSCH DMRS to SSS			
EPRE ratio of PDSCH to PDSCH DMRS			
EPRE ratio of OCNG DMRS to SSS ^{Note 1}			
EPRE ratio of OCNG to OCNG DMRS ^{Note 1}			
Propagation condition	1~2		AWGN
<p>Note 1: OCNG shall be used such that the resources in Cell 1 are fully allocated and a constant total transmitted power spectral density is achieved for all OFDM symbols.</p>			

Table A.7.6.3.2.2-2: SSB specific test parameters

Parameter	Config	Unit	SSB#0		SSB#1	
			T1	T2	T1	T2
Angle of arrival configuration			Setup 1 according to A.3.15.1			
Beam Assumption ^{Note 4}	1-2		Rough			
N_{oc} ^{Note2}	1~2	dBm/15kHz	-105			
N_{oc} ^{Note2}	1	dBm/SSB SCS	-96			
	2		-93			
\hat{E}_s / I_{ot}	1~2	dB	0	0	-Infinity	9
SSB_RP ^{Note3}	1	dBm/SSB SCS	-96	-96	-Infinity	-87
	2		-93	-93	-Infinity	-84
I_o ^{Note3}	1	dBm/95.04MHz	-63.97	-63.97	-66.98	-57.47
	2		-63.97	-63.97	-66.98	-57.47
\hat{E}_s / N_{oc}	1~2	dB	0	0	-Infinity	9
<p>Note 1: The resources for uplink transmission are assigned to the UE prior to the start of time period T2.</p> <p>Note 2: Interference from other cells and noise sources not specified in the test is assumed to be constant over subcarriers and time and shall be modelled as AWGN of appropriate power for N_{oc} to be fulfilled.</p> <p>Note 3: SSB_RP and I_o levels have been derived from other parameters for information purposes. They are not settable parameters themselves.</p> <p>Note 4: Information about types of UE beam is given in B.2.1.3, and does not limit UE implementation or test system implementation</p>						

A.7.6.3.2.3 Test Requirements

The UE shall send L1-RSRP report every 320 slots. No later than X ms plus 320 slots from the beginning of time period T2, UE shall send L1-RSRP report including the results for both SSB#0 and SSB#1 while meeting the accuracy requirements defined in clause 10.1.20.1, where X is

- 2880 for UE supporting power class 1
- 1920 for UE supporting power class 2,3 or 4.

The reported L1-RSRP value shall include the Rx antenna gain in the range of -10 to +20 dB.

The rate of correct events observed during repeated tests shall be at least 90%.

A.7.6.3.3 CSI-RS based L1-RSRP measurement when DRX is not used

A.7.6.3.3.1 Test Purpose and Environment

The purpose of this test is to verify that the UE makes correct reporting of L1-RSRP measurement. This test will partly verify the L1-RSRP measurement requirements in clause 9.5.4.2, with the testing configurations for NR cells in Table A.7.6.3.3.1-1.

Table A.7.6.3.3.1-1: Applicable NR configurations for FR2 CSI-RS based L1-RSRP test

Config	Description
1	NR 120 kHz CSI-RS SCS, 100 MHz bandwidth, TDD duplex mode
Note: The UE is only required to be tested in one of the supported test configurations	

A.7.6.3.3.2 Test parameters

There is one cells in the test, the FR2 PCell (Cell 1). The test parameters for the Cell 1 are given in Table A.7.6.3.3.2-1 and Table A.7.6.3.3.2-2 below.

In CSI measurement configuration, UE is indicated to perform L1-RSRP measurement on the CSI-RS and report aperiodically. The test consists of a single time period T1, during which the UE is triggered via DCI to report L1-RSRP on aperiodic CSI-RS resources. UE is also configured to measure L1-RSRP based on SSB. After 480ms from the beginning of the test, the DCI trigger comes in slot 1 of a frame and UE provides the report back based on the reporting configuration as defined in Table A.7.6.3.3.2-1.

There is no measurement gap configured in the test. Before the test, UE is configured to perform RLM and BFD based on the SSBs.

Table A.7.6.3.3.2-1: General test parameters

Parameter	Config	Unit	Value
SSB GSCN	1		freq1
Duplex mode	1		TDD
TDD Configuration	1		TDDConf.3.1
BW _{channel}	1	MHz	100: N _{RB,c} = 66
PDSCH Reference measurement channel	1		SR.3.1 TDD
RMSI CORESET Reference Channel	1		CR.3.1 TDD
Dedicated CORESET Reference Channel	1		CCR.3.1 TDD
SSB configuration	1		SSB.1 FR2
CSI-RS configuration	1		CSI-RS.3.3 TDD

OCNG Patterns	1		OP.1
Initial BWP Configuration	1		DLBWP.0.1 ULBWP.0.1
Dedicated BWP configuration	1		DLBWP.1.1 ULBWP.1.1
SMTC configuration	1		SMTC.1
TRS Configuration	1		TRS.2.1 TDD
PDCCH/PDSCH TCI Configuration	1		TCI.State.2
DRX configuration	1		Off
reportConfigType	1		aperiodic
reportQuantity	1		cri-RSRP
Number of reported RS	1		2
qcl-Info	1		SSB#0 for resource#0 SSB#1 for resource#1
reportSlotOffsetList	1		8
Propagation condition	1		AWGN
T1	1	s	5
EPRE ratio of PSS to SSS	1	dB	0
EPRE ratio of PBCH DMRS to SSS			
EPRE ratio of PBCH to PBCH DMRS			
EPRE ratio of PDCCH DMRS to SSS			
EPRE ratio of PDCCH to PDCCH DMRS			
EPRE ratio of PDSCH DMRS to SSS			
EPRE ratio of PDSCH to PDSCH DMRS			
EPRE ratio of OCNG DMRS to SSS ^{Note 1}			
EPRE ratio of OCNG to OCNG DMRS ^{Note 1}			
Note 1: OCNG shall be used such that the resources in Cell 1 are fully allocated and a constant total transmitted power spectral density is achieved for all OFDM symbols.			

Table A.7.6.3.3.2-1: CSI-RS specific test parameters

Parameter	Config	Unit	CSI-RS#0	CSI-RS#1
Angle of arrival configuration	1		Setup 1 according to A.3.15.1	
Beam Assumption ^{Note 4}	1		Rough	
N_{oc} ^{Note1}	1	dBm/15kHz	-105	
N_{oc} ^{Note1}	1	dBm/SSB SCS	-95.97	
\hat{E}_s / I_{ot}	1	dB	0	9
CSI-RS RSRP ^{Note2}	1	dBm/SSB SCS	-95.97	-86.97
I_o ^{Note2}	1	dBm/95.04MHz	-63.97	-57.47
\hat{E}_s / N_{oc}	1	dB	0	9
Note 2: Interference from other cells and noise sources not specified in the test is assumed to be constant over subcarriers and time and shall be modelled as AWGN of appropriate power for N_{oc} to be fulfilled.				
Note 3: CSI-RS RSRP and I_o levels have been derived from other parameters for information purposes. They are not settable parameters themselves.				

Note 4: Information about types of UE beam is given in B.2.1.3, and does not limit UE implementation or test system implementation

A.7.6.3.3.3 Test Requirements

After 480ms from the beginning of the test, the UE shall send L1-RSRP report at slot 8 from the reception of DCI triggering the L1-RSRP measurement. The L1-RSRP report shall include the results for both CSI-RS#0 and CSI-RS#1 while meeting the accuracy requirements defined in clause 10.1.20.1.

For absolute accuracy of CSI-RS0 and absolute accuracy of CSI-RS1, the UE is deemed to meet the requirement if the reported L1-RSRP is in the range shown in Table A.7.6.3.3.3-1.

For relative accuracy of CSI-RS0 compared with CSI-RS1, the UE is deemed to meet the requirement if the difference in reported L1-RSRP meets the requirements in Table 10.1.20.2.2-1.

Table A.7.6.3.3.3-1: L1-RSRP absolute accuracy test requirement

	Test requirement ^{Notes1,2,3}
CSI-RS0	$\text{CSI-RS_RP0} - \delta + G_{\min} \leq \text{Reported RSRP(dBm)} \leq \text{CSI-RS_RP0} + \delta + G_{\max}$
CSI-RS1	$\text{CSI-RS_RP1} - \delta + G_{\min} \leq \text{Reported RSRP(dBm)} \leq \text{CSI-RS_RP1} + \delta + G_{\max}$
Note 1:	CSI-RS_RPn is the equivalent power received by an antenna with 0dBi gain at the centre of the quiet zone configured in the test for the CSI-RS n under consideration
Note 2:	δ is the RSRP absolute accuracy requirement from Table 10.1.20.2.1-1, selected according to the I_0 used in the test
Note 3:	G_{\min} and G_{\max} are the minimum and maximum UE gain values from Table B.2.1.5.1-1, selected according to the UE power class

The rate of correct events observed during repeated tests shall be at least 90%.

A.7.6.3.4 CSI-RS based L1-RSRP measurement when DRX is used

A.7.6.3.4.1 Test Purpose and Environment

The purpose of this test is to verify that the UE makes correct reporting of L1-RSRP measurement. This test will partly verify the L1-RSRP measurement requirements in clause 9.5.4.2, with the testing configurations for NR cells in Table A.7.6.3.4.1-1.

Table A.7.6.3.4.1-1: Applicable NR configurations for FR2 CSI-RS based L1-RSRP test

Config	Description
1	NR 120 kHz CSI-RS SCS, 100 MHz bandwidth, TDD duplex mode
Note:	The UE is only required to be tested in one of the supported test configurations

A.7.6.3.4.2 Test parameters

There is one cells in the test, the FR2 PCell (Cell 1). The test parameters for the Cell 1 are given in Table A.7.6.3.4.2-1 and Table A.7.6.3.4.2-2 below.

In CSI measurement configuration, UE is indicated to perform L1-RSRP measurement on the CSI-RS and report aperiodically. The test consists of a single time period T1, during which the UE is triggered via DCI to report L1-RSRP on aperiodic CSI-RS resources. UE is also configured to measure L1-RSRP based on SSB. After 1440ms from the beginning of the test, the DCI trigger comes in slot 1 of a frame and UE provides the report back based on the reporting configuration as defined in Table A.7.6.3.4.2-1.

There is no measurement gap configured in the test. Before the test, UE is configured to perform RLM and BFD based on the SSBs.

Table A.7.6.3.4.2-1: General test parameters

Parameter	Config	Unit	Value
SSB GSCN	1		freq1
Duplex mode	1		TDD
TDD Configuration	1		TDDConf.3.1
BW _{channel}	1	MHz	100: N _{RB,c} = 66
PDSCH Reference measurement channel	1		SR.3.1 TDD
RMSI CORESET Reference Channel	1		CR.3.1 TDD
Dedicated CORESET Reference Channel	1		CCR.3.1 TDD
SSB configuration	1		SSB.1 FR2
CSI-RS configuration	1		CSI-RS.3.3 TDD
OCNG Patterns	1		OP.1
Initial BWP Configuration	1		DLBWP.0.1 ULBWP.0.1
Dedicated BWP configuration	1		DLBWP.1.1 ULBWP.1.1
SMTc configuration	1		SMTc.1
TRS Configuration	1		TRS.2.1 TDD
PDCCH/PDSCH TCI Configuration	1		TCI.State.2
DRX configuration	1		DRX.3
reportConfigType	1		aperiodic
reportQuantity	1		cri-RSRP
Number of reported RS	1		2
qcl-Info	1		SSB#0 for resource#0
			SSB#1 for resource#1
reportSlotOffsetList	1		8
Propagation condition	1		AWGN
T1	1	s	5
EPRE ratio of PSS to SSS	1	dB	0
EPRE ratio of PBCH DMRS to SSS			
EPRE ratio of PBCH to PBCH DMRS			
EPRE ratio of PDCCH DMRS to SSS			
EPRE ratio of PDCCH to PDCCH DMRS			
EPRE ratio of PDSCH DMRS to SSS			
EPRE ratio of PDSCH to PDSCH DMRS			
EPRE ratio of OCNG DMRS to SSS ^{Note 1}			
EPRE ratio of OCNG to OCNG DMRS ^{Note 1}			
Note 1: OCNG shall be used such that the resources in Cell 1 are fully allocated and a constant total transmitted power spectral density is achieved for all OFDM symbols.			

Table A.7.6.3.4.2-1: CSI-RS specific test parameters

Parameter	Config	Unit	CSI-RS#0	CSI-RS#1
Angle of arrival configuration	1		Setup 1 according to A.3.15.1	

Beam Assumption ^{Note 4}	1		Rough	
N_{oc} ^{Note1}	1	dBm/15kHz	-105	
N_{oc} ^{Note1}	1	dBm/SSB SCS	-95.97	
\hat{E}_s/I_{ot}	1	dB	0	9
CSI-RS RSRP ^{Note2}	1	dBm/SSB SCS	-95.97	-86.97
I_o ^{Note2}	1	dBm/95.04MHz	-63.97	-57.47
\hat{E}_s/N_{oc}	1	dB	0	9
<p>Note 2: Interference from other cells and noise sources not specified in the test is assumed to be constant over subcarriers and time and shall be modelled as AWGN of appropriate power for N_{oc} to be fulfilled.</p> <p>Note 3: CSI-RS RSRP and I_o levels have been derived from other parameters for information purposes. They are not settable parameters themselves.</p> <p>Note 4: Information about types of UE beam is given in B.2.1.3, and does not limit UE implementation or test system implementation</p>				

A.7.6.3.4.3 Test Requirements

After 1440ms from the beginning of the test, the UE shall send L1-RSRP report at slot 8 from the reception of DCI triggering the L1-RSRP measurement. The L1-RSRP report shall include the results for both CSI-RS#0 and CSI-RS#1 while meeting the accuracy requirements defined in clause 10.1.20.1.

For absolute accuracy of CSI-RS0 and absolute accuracy of CSI-RS1, the UE is deemed to meet the requirement if the reported L1-RSRP is in the range shown in Table A.7.6.3.4.3-1.

For relative accuracy of CSI-RS0 compared with CSI-RS1, the UE is deemed to meet the requirement if the difference in reported L1-RSRP meets the requirements in Table 10.1.20.2.2-1.

Table A.7.6.3.4.3-1: L1-RSRP absolute accuracy test requirement

	Test requirement ^{Notes1,2,3}
CSI-RS0	$CSI-RS_RP0 - \delta + G_{min} \leq \text{Reported RSRP(dBm)} \leq CSI-RS_RP0 + \delta + G_{max}$
CSI-RS1	$CSI-RS_RP1 - \delta + G_{min} \leq \text{Reported RSRP(dBm)} \leq CSI-RS_RP1 + \delta + G_{max}$
Note 1:	CSI-RS_RPn is the equivalent power received by an antenna with 0dBi gain at the centre of the quiet zone configured in the test for the CSI-RS n under consideration
Note 2:	δ is the RSRP absolute accuracy requirement from Table 10.1.20.2.1-1, selected according to the I_o used in the test
Note 3:	G_{min} and G_{max} are the minimum and maximum UE gain values from Table B.2.1.5.1-1, selected according to the UE power class

The rate of correct events observed during repeated tests shall be at least 90%.

A.7.7 Measurement Performance requirements

Unless explicitly stated otherwise:

- Reported measurements shall be within defined range of accuracy limits defined in Clause 10 for at least 90 % of the reported cases. If multiple measurement performance requirements are verified in the same test, the reported measurements for each requirement shall be within defined range of accuracy limits of the corresponding requirement defined in Clause 10 for at least 90% of the reported cases.

- Measurements are performed in RRC_CONNECTED state.
- The reference channels assume transmission of PDSCH with a maximum number of 5 HARQ transmissions unless otherwise specified.

A.7.7.1 SS-RSRP

A.7.7.1.1 SA intra-frequency case measurement accuracy with FR2 serving cell and FR2 target cell

A.7.7.1.1.1 Test Purpose and Environment

The purpose of this test is to verify that the SS-RSRP measurement accuracy is within the specified limits. This test will verify the requirements in clauses 10.1.3.1.1 and 10.1.3.1.2 for intra-frequency measurements.

A.7.7.1.1.2 Test parameters

In this set of test cases all cells are on the same carrier frequency. Supported test configurations are shown in Table A.7.7.1.1.2-1. Both absolute and relative accuracy of SS-RSRP intra-frequency measurements are tested by using the parameters in Table A.7.7.1.1.2-2 and A.7.7.1.1.2-3. In all test cases, Cell 1 is the PCell and Cell 2 the target cell. The TCI status for Cell 1 is defined in Table A.3.16.2-1 and TRS configuration for Cell 1 is defined in Table A.3.17.2.1-1. The test consists of two time phases T1 and T2.

Table A.7.7.1.1.2-1: SS-RSRP Intra frequency SS-RSRP supported test configurations

Configuration	Description
1	120 kHz SSB SCS, 100 MHz bandwidth, TDD duplex mode

Table A.7.7.1.1.2-2: SS-RSRP Intra frequency general test parameters

Parameter	Unit	T1		T2	
		Cell 1	Cell 2	Cell 1	Cell 2
Cell ID		489	0	489	0
SSB ARFCN		freq1		freq1	
Duplex mode		TDD		TDD	
TDD configuration		TDDConf.3.1		TDDConf.3.1	
BW _{channel}	MHz	100: N _{RB,c} = 66		100: N _{RB,c} = 66	
Data RBs allocated		24		24	
Downlink initial BWP configuration		DLB WP.0. 1	-	DLB WP.0. 1	-
Downlink dedicated BWP configuration		DLB WP.1. 1	-	DLB WP.1. 1	-
Uplink initial BWP configuration		ULB WP.0. 1	-	ULB WP.0. 1	-
Uplink dedicated BWP configuration		ULB WP.1. 1	-	ULB WP.1. 1	-
DRX cycle configuration		Not applic able	-	Not applic able	-
TRS configuration		TRS.2 .1 TDD	-	TRS.2 .1 TDD	-
TCI state		TCI.St ate.0	-	TCI.St ate.0	-

PDSCH Reference measurement channel		SR.3.2 TDD	-	SR.3.2 TDD	-
RMSI CORESET Reference Channel		CR.3.1 TDD	-	CR.3.1 TDD	-
Dedicated CORESET Reference channel		CCR.3.1 TDD	-	CCR.3.1 TDD	-
OCNG Patterns		OP.3	OP.3	OP.3	OP.3
SSB configuration		SSB.3 FR2	SSB.3 FR2	SSB.3 FR2	SSB.3 FR2
SMTC configuration		SMTC .1	SMTC .1	SMTC .1	SMTC .1
Time offset with Cell 1	μs	-	3	-	3
PDSCH/PDCCH subcarrier spacing	kHz	120	120	120	120
EPRE ratio of PSS to SSS	dB	0	0	0	0
EPRE ratio of PBCH_DMRS to SSS					
EPRE ratio of PBCH to PBCH_DMRS					
EPRE ratio of PDCCH_DMRS to SSS					
EPRE ratio of PDCCH to PDCCH_DMRS					
EPRE ratio of PDSCH_DMRS to SSS					
EPRE ratio of PDSCH to PDSCH_DMRS					
EPRE ratio of OCNG DMRS to SSS ^{Note 1}					
EPRE ratio of OCNG to OCNG DMRS ^{Note 1}					
Propagation conditions					
Antenna configuration		1x2	1x2	1x2	1x2
<p>Note 1: OCNG shall be used such that both cells are fully allocated and a constant total transmitted power spectral density is achieved for all OFDM symbols.</p> <p>Note 2: Void</p> <p>Note 3: Void</p> <p>Note 4: Void</p> <p>Note 5: Void</p>					

Table A.7.7.1.1.2-3: SS-RSRP Intra frequency OTA related test parameters

Parameter	Unit	T1		T2	
		Cell 1	Cell 2	Cell 1	Cell 2
Angle of arrival configuration		Setup 1 according to clause A.3.15.1			
Assumption for UE beams ^{Note 7}		Rough		Rough	
N_{oc} ^{Note1}	dBm/15kHz _Z ^{Note4}	-91.6		N/A	
N_{oc} ^{Note1}	dBm/SCS ^{Note4}	-82.6		N/A	
\hat{E}_s/N_{oc}	dB	6.0	1.0	N/A	N/A

E_s	dBm/SCS Note4			(Table B.2.2-2 Rx Beam Peak +2.1dB)	(Table B.2.2-2 Rx Beam Peak +2.1dB)
SSB_RP ^{Note2}	dBm/SCS	-76.6	-81.6	(Table B.2.2-2 Rx Beam Peak +2.1dB)	(Table B.2.2-2 Rx Beam Peak +2.1dB)
$\hat{E}_s / I_{ot\ BB}$ ^{Note6}	dB	2.44	-5.98	-5.98	-5.98
I_0 ^{Note2}	dBm/95.04 MHz Note4	-50.05		(Table B.2.2-2 Rx Beam Peak +29.70dB)	
<p>Note 1: Where used, interference from other cells and noise sources not specified in the test is assumed to be constant over subcarriers and time and shall be modelled as AWGN of appropriate power for N_{oc} to be fulfilled.</p> <p>Note 2: SSB_RP, E_s/I_{ot} and I_0 levels have been derived from other parameters for information purposes. They are not settable parameters themselves.</p> <p>Note 3: Void</p> <p>Note 4: Equivalent power received by an antenna with 0 dBi gain at the centre of the quiet zone</p> <p>Note 5: Void</p> <p>Note 6: Calculation of $E_s/I_{ot\ BB}$ includes the effect of UE internal noise up to the value assumed for the associated Refsens requirement in clause 7.3.2 of TS 38.101-2 [19], and an allowance of 1dB for UE multi-band relaxation factor ΔMB_P from TS 38.101-2 [19] Table 6.2.1.3-4.</p> <p>Note 7: Information about types of UE beam is given in B.2.1.3, and does not limit UE implementation or test system implementation</p>					

A.7.7.1.1.3 Test Requirements

The SS-RSRP measurement accuracy shall fulfil the absolute accuracy requirements in clauses 10.1.3.1.1 and relative accuracy requirements in clause 10.1.3.1.2. The following requirements are to be verified:

During T1:

Absolute accuracy of Cell 1 and absolute accuracy of Cell 2. The UE is deemed to meet the requirement if the reported SS-RSRP is in the range shown in table A.7.7.1.1.3-1.

Relative accuracy of Cell 2 compared with Cell 1. The UE is deemed to meet the requirement if the difference in reported SS-RSRP meets the requirements in Table 10.1.3.1.2-1.

During T2:

Absolute accuracy of Cell 1 and absolute accuracy of Cell 2. The UE is deemed to meet the requirement if the reported SS-RSRP is in the range shown in table A.7.7.1.1.3-1.

Relative accuracy of Cell 2 compared with Cell 1. The UE is deemed to meet the requirement if the difference in reported SS-RSRP meets the requirements in Table 10.1.3.1.2-1.

During T1 and T2:

Relative accuracy of Cell 1 during T2 compared with Cell 1 during T1. The UE is deemed to meet the requirement if the difference in reported SS-RSRP meets the requirements in Table 10.1.3.1.2-1.

Relative accuracy of Cell 2 during T2 compared with Cell 2 during T1. The UE is deemed to meet the requirement if the difference in reported SS-RSRP meets the requirements in Table 10.1.3.1.2-1.

Table A.7.7.1.1.3-1: SS-RSRP absolute accuracy test requirement

	Test requirement ^{Notes1,2,3}
Cell 1	$SSB_RP1 - \delta + G_{min} \leq \text{Reported RSRP(dBm)} \leq SSB_RP1 + \delta + G_{max}$
Cell 2	$SSB_RP2 - \delta + G_{min} \leq \text{Reported RSRP(dBm)} \leq SSB_RP2 + \delta + G_{max}$
Note 1:	SSB_RPn is the equivalent power received by an antenna with 0dBi gain at the centre of the quiet zone configured in the test for the cell n under consideration
Note 2:	δ is the RSRP absolute accuracy requirement from Table 10.1.3.1.1-1, selected according to the lo used in the test
Note 3:	G_{min} and G_{max} are the minimum and maximum UE gain values from Table B.2.1.5.1-1, selected according to the UE power class

A.7.7.1.2 SA inter-frequency case measurement accuracy with FR2 serving cell and FR2 target cell

A.7.7.1.2.1 Test Purpose and Environment

The purpose of this test is to verify that the SS-RSRP measurement accuracy is within the specified limits. This test will verify the requirements in clauses 10.1.5.1.1 and 10.1.5.1.2 for intrer-frequency measurements with the testing configurations for NR cells in Table A.7.7.1.2.1-1.

Table A.7.7.1.2.1-1: Applicable NR configurations for FR2 inter-frequency SS-RSRP accuracy test

Configuration	Description
1	120 kHz SSB SCS, 100 MHz bandwidth, TDD duplex mode
2	240 kHz SSB SCS, 100 MHz bandwidth, TDD duplex mode

A.7.7.1.2.2 Test parameters

In this set of test cases there are two cells in the test, PCell (Cell 1) and a FR2 neighbour cell (Cell 2) on a different frequency than the PCell. The test parameters and applicability for Cell 1 are defined in A.3.7.2. The test parameters for the Cell 1 and Cell 2 are given in Table A.7.7.1.2.2-1 and Table A.7.7.1.2.2-2 below. Both absolute and relative accuracy of RSRP inter-frequency measurements are tested by using the parameters in Table A.7.7.1.2.2-1 and Table A.7.7.1.2.2-1. The inter-frequency measurements are supported by a measurement gap.

Table A.7.7.1.2.2-1: SS-RSRP inter-frequency test parameters

Parameter	Config	Unit	Test 1		Test 2	
			Cell 1	Cell 2	Cell 1	Cell 2
SSB ARFCN	1~2		freq1	freq2	freq1	freq2
BW _{channel}	1~2		100: N _{RB,c} = 66		100: N _{RB,c} = 66	
Data RBs allocated	1 2		24 48		24 48	
Gap pattern ID			0		0	
Duplex mode	1~2		TDD		TDD	
TDD configuration	1~2		TDDConf.3.1		TDDConf.3.1	
PDSCH Reference measurement channel	1		SR.3.2 TDD	-	SR.3.2 TDD	-
	2		SR.3.3 TDD		SR.3.3 TDD	
RMSI CORESET Reference Channel	1		CR.3.2 TDD	-	CR.3.2 TDD	-
	2		CR.3.2 TDD		CR.3.2 TDD	
Dedicated CORESET Reference Channel	1		CCR.3.1 TDD	-	CCR.3.1 TDD	-
	2		CCR.3.7 TDD		CCR.3.7 TDD	
SSB configuration	1		SSB.3 FR2		SSB.3 FR2	

	2		SSB.4 FR2		SSB.4 FR2	
PDSCH/PDCCH subcarrier spacing	1~2	kHz	120		120	
OCNG Patterns	1~2		OP.3		OP.3	
Initial BWP Configuration	1~2		DLBWP.0.1 ULBWP.0.1		DLBWP.0.1 ULBWP.0.1	
Dedicated BWP configuration	1~2		DLBWP.1.3 ULBWP.1.3		DLBWP.1.3 ULBWP.1.3	
TRS Configuration	1~2		TRS.2.1 TDD		TRS.2.1 TDD	
PDCCH/PDSCH TCI Configuration	1~2		TCI.State.2		TCI.State.2	
SMTTC configuration	1~2		SMTTC.1		SMTTC.1	
Time offset between Cell 2 and Cell 1	1~2	µs	3		3	
EPRE ratio of PSS to SSS	1~2	dB	0	0	0	0
EPRE ratio of PBCH DMRS to SSS						
EPRE ratio of PBCH to PBCH DMRS						
EPRE ratio of PDCCH DMRS to SSS						
EPRE ratio of PDCCH to PDCCH DMRS						
EPRE ratio of PDSCH DMRS to SSS						
EPRE ratio of PDSCH to PDSCH DMRS						
EPRE ratio of OCNG DMRS to SSS ^{Note 1}						
EPRE ratio of OCNG to OCNG DMRS ^{Note 1}						
Propagation condition	1~2	-	AWGN	AWGN	AWGN	AWGN
Antenna configuration	1~2	-	1x2	1x2	1x2	1x2
Note 1: OCNG shall be used such that a constant total transmitted power spectral density is achieved for all OFDM symbols.						
Note 2: Void						

Table A.7.7.1.2.2-2: SS-RSRP inter frequency OTA related test parameters

Parameter	Config	Unit	Test 1		Test 2	
			Cell 1	Cell 2	Cell 1	Cell 2
Angle of arrival configuration	1~2		Setup 4b according to clause A.3.15.4.2		Setup 4b according to clause A.3.15.4.2	
			AoA1 Spherical coverage	AoA2 Rx Beam Peak	AoA1 Spherical coverage	AoA2 Rx Beam Peak
Assumption for UE beams ^{Note 7}	1~2		Rough		Rough	
N_{oc} ^{Note 1}	1	dBm/15kHz ^{Note 4}	-90.6	-90.6	(Table B.2.3-2 Rx Beam Peak ^{Note 8} +1.97dB)	(Table B.2.3-2 Rx Beam Peak ^{Note 8} -3.03dB)
	2		-93.7	-93.7		
N_{oc} ^{Note 1}	1	dBm/SCS ^{Note 4}	-81.6	-81.6	(Table B.2.3-2 Rx Beam Peak ^{Note 8} +11.0dB)	(Table B.2.3-2 Rx Beam Peak ^{Note 8} +6.0dB)

	2		-81.7	-81.7	(Table B.2.3-2 Rx Beam Peak ^{Note 8} +14.0dB)	(Table B.2.3-2 Rx Beam Peak ^{Note 8} +9.0dB)
\hat{E}_s / N_{oc}	1~2	dB	6.0	6.0	17.0	-1.0
SSB_RP ^{Note2}	1	dBm/SCS	-75.6	-75.6	(Table B.2.3-2 Rx Beam Peak ^{Note 8} +28.0dB)	(Table B.2.3-2 Rx Beam Peak ^{Note 8} +5.0dB)
	2		-75.7	-75.7	(Table B.2.3-2 Rx Beam Peak ^{Note 8} +31.0dB)	(Table B.2.3-2 Rx Beam Peak ^{Note 8} +8.0dB)
(SSB_RP _{Cell 1} – SSB_RP _{Cell 2})	1~2	dB	0		23.00	
$\hat{E}_s / I_{ot\ BB}$ ^{Note6}	1	dB	5.26	5.96	9.53	-3.46
	2		4.61	5.91		
I _o ^{Note2}	1	dBm/95.04 MHz ^{Note4}	-50.00	-50.00	(Table B.2.3-2 Rx Beam Peak ^{Note 8} +52.68dB)	(Table B.2.3-2 Rx Beam Peak ^{Note 8} +33.13dB)
	2		-50.09	-50.09	(Table B.2.3-2 Rx Beam Peak ^{Note 8} +55.69dB)	(Table B.2.3-2 Rx Beam Peak ^{Note 8} +36.14dB)
(I _{ofreq 1} – I _{ofreq 2})	1~2	dB	0		19.55	
<p>Note 1: Where used, interference from other cells and noise sources not specified in the test is assumed to be constant over subcarriers and time and shall be modelled as AWGN of appropriate power for N_{oc} to be fulfilled.</p> <p>Note 2: SSB_RP, Es/I_{ot}, I_o, (SSB_RP_{Cell 2} – SSB_RP_{Cell 1}) and (I_{ofreq 2} – I_{ofreq 1}) levels have been derived from other parameters for information purposes. They are not settable parameters themselves.</p> <p>Note 3: Void</p> <p>Note 4: Equivalent power received by an antenna with 0 dBi gain at the centre of the quiet zone</p> <p>Note 5: Void</p> <p>Note 6: Calculation of Es/I_{ot} includes the effect of UE internal noise up to the value assumed for the associated Refsens requirement in clause 7.3.2 of TS 38.101-2 [19], and an allowance of 1dB for UE multi-band relaxation factor ΔMB_P or ΔMB_S from TS 38.101-2 [19] Table 6.2.1.3-4.</p> <p>Note 7: Information about types of UE beam is given in B.2.1.3, and does not limit UE implementation or test system implementation</p> <p>Note 8: The value in Table B.2.3-2 is the Minimum SSB_RP for SCS_{SSB} = 120 kHz, selected according to the operating band of cell 2 and UE power class, without $\Delta MB_{P,n}$ adjustment.</p>						

A.7.7.1.2.3 Test Requirements

The SS-RSRP measurement accuracy for Cell 1 and Cell 2 shall fulfil the absolute requirements in clause 10.1.5.1.1 and the relative requirements in clause 10.1.5.1.2.

Test 1:

Absolute accuracy of Cell 1 and absolute accuracy of Cell 2. The UE is deemed to meet the requirement if the reported SS-RSRP is in the range shown in Table A.7.7.1.2.3-1.

Relative accuracy of Cell 2 compared with Cell 1. The UE is deemed to meet the requirement if the difference in reported SS-RSRP meets the requirements in A.7.7.1.2.3-2.

Test 2:

Absolute accuracy of Cell 1 and absolute accuracy of Cell 2. The UE is deemed to meet the requirement if the reported SS-RSRP is in the range shown in Table A.7.7.1.2.3-1.

Relative accuracy of Cell 2 compared with Cell 1. The UE is deemed to meet the requirement if the difference in reported SS-RSRP meets the requirements in A.7.7.1.2.3-2.

Table A.7.7.1.2.3-1: SS-RSRP absolute accuracy test requirement

	Test requirement ^{Notes1,2,3,4}
Cell 1	$SSB_RP1 - \delta + G_{min} + X \leq \text{Reported RSRP(dBm)} \leq SSB_RP1 + \delta + G_{max}$
Cell 2	$SSB_RP2 - \delta + G_{min} \leq \text{Reported RSRP(dBm)} \leq SSB_RP2 + \delta + G_{max}$
Note 1:	SSB_RPn is the equivalent power received by an antenna with 0dBi gain at the centre of the quiet zone configured in the test for the cell n under consideration
Note 2:	δ is the RSRP absolute accuracy requirement from Table 10.1.5.1.1-1, selected according to the lo used in the test
Note 3:	G_{min} and G_{max} are the minimum and maximum UE gain values from Table B.2.1.5.1-1, selected according to the UE power class
Note 4:	X is the Spherical coverage gain difference in dB, derived as (UE Refsens – UE Spherical coverage) from TS 38.101-2 [19] clauses 7.3.2 and 7.3.4, selected according to the UE power class and operating band. X is always a negative value.

Table A.7.7.1.2.3-2: SS-RSRP relative accuracy test requirement

	Test requirement ^{Notes1,2,3,4, 5, 6, 7}
Cell 2 – Cell 1	$SSB_RP2 - SSB_RP1 - \delta - D - G_{inter} \leq \text{Reported RSRP(dB)} \leq SSB_RP2 - SSB_RP1 + \delta + G_{inter} - (X) + E$
Note 1:	SSB_RPn is the equivalent power received by an antenna with 0dBi gain at the centre of the quiet zone configured in the test for the cell n under consideration
Note 2:	δ is the RSRP relative accuracy requirement from Table 10.1.5.1.2-1
Note 3:	Void
Note 4:	X is the Spherical coverage gain difference in dB, derived as (UE Refsens – UE Spherical coverage) from TS 38.101-2 [19] clauses 7.3.2 and 7.3.4, selected according to the UE power class and operating band. X is always a negative value.
Note 5:	D is the margin due to mis-alignment between fine beam and rough beam. D is the Rough Beam gain reduction in Rx beam peak direction from Table B.2.1.5.3-1, selected according to the UE power class. D is always a positive value.
Note 6:	G_{inter} is the margin due to different antenna gain caused by frequency separation. G_{inter} is from Table B.2.1.5.2-1, selected according to the UE power class, and is always a positive value.
Note 7:	E = 3 (dB) is an additional margin to account for the actual gain difference between peak direction and spherical coverage using rough beams.

A.7.7.1.3 SA inter-frequency measurement accuracy with FR1 serving cell and FR2 target cell

A.7.7.1.3.1 Test Purpose and Environment

The purpose of this test is to verify that the SS-RSRP measurement accuracy is within the specified limits. This test will verify the requirements in clauses 10.1.5.1.1 for inter-frequency measurements with the testing configurations in Table A.7.7.1.3.1-1.

Table A.7.7.1.3.1-1: Applicable NR configurations for FR2 inter-frequency SS-RSRP accuracy test

Config	Description of serving cell	Description of target cell
1	NR 15 kHz SSB SCS, 10 MHz bandwidth, FDD duplex mode	120 kHz SSB SCS, 100 MHz bandwidth, TDD duplex mode
2	NR 15 kHz SSB SCS, 10 MHz bandwidth, TDD duplex mode	
3	NR 30 kHz SSB SCS, 40 MHz bandwidth, TDD duplex mode	

A.7.7.1.3.2 Test parameters

In this set of test cases there are two cells in the test, PCell (Cell 1) in FR1 and Cell 2 in FR2 . The test parameters for the Cell 1 and Cell 2 are given in Table A.7.7.1.3.2-1 and Table A.7.7.1.3.2-2 below. Absolute accuracy of RSRP inter-frequency measurements are tested by using the parameters in Table A.7.7.1.3.2-1 and Table A.7.7.1.3.2-2. The inter-frequency measurements are supported by a measurement gap.

Table A.7.7.1.3.2-1: SS-RSRP inter-frequency test parameters

Parameter	Config	Unit	Test 1		Test 2	
			Cell 1	Cell 2	Cell 1	Cell 2
SSB ARFCN	1~3		freq1	freq2	freq1	freq2
BW _{channel}	1	MHz	10: N _{RB,c} = 52	100: N _{RB,c} = 66	10: N _{RB,c} = 52	100: N _{RB,c} = 66
	2		10: N _{RB,c} = 52		10: N _{RB,c} = 52	
	3		40: N _{RB,c} = 106		40: N _{RB,c} = 106	
Data RBs allocated	1,2 3		52 106	24	52 106	66
Duplex mode	1 2 3		FDD TDD TDD	TDD	FDD TDD TDD	TDD
TDD configuration	1 2 3		N/A TDDConf. 1.1 TDDConf. 2.1	TDDConf. 3.1	N/A TDDConf. 1.1 TDDConf. 2.1	TDDConf. 3.1
PDSCH Reference measurement channel	1 2 3		SR.1.1 FDD SR.1.1 TDD SR.2.1 FDD	-	SR.1.1 FDD SR.1.1 TDD SR.2.1 FDD	-
RMSI CORESET Reference Channel	1 2 3		CR.1.1 FDD CR.1.1 TDD CR.2.1 FDD	-	CR.1.1 FDD CR.1.1 TDD CR.2.1 FDD	-
Dedicated CORESET Reference Channel	1 2 3		CCR.1.1 FDD CCR.1.1 TDD CCR.2.1 TDD	-	CCR.1.1 FDD CCR.1.1 TDD CCR.2.1 TDD	-
SSB configuration	1		SSB.1 FR1	SSB.3 FR2	SSB.1 FR1	SSB.3 FR2

	2		SSB.1 FR1		SSB.1 FR1	
	3		SSB.2 FR1		SSB.2 FR1	
OCNG Patterns	1~3		OP.1	OP.3	OP.1	OP.1
Initial BWP Configuration	1~3		DLBWP.0.1 ULBWP.0.1		DLBWP.0.1 ULBWP.0.1	
Dedicated BWP configuration	1~3		DLBWP.1.3 ULBWP.1.3		DLBWP.1.3 ULBWP.1.3	
TRS Configuration	1~3		TRS.2.1 TDD		TRS.2.1 TDD	
PDCCH/PDSCH TCI Configuration	1~3		TCI.State.2		TCI.State.2	
SMTC configuration	1~3		SMTC.1		SMTC.1	
Time offset between Cell 2 and Cell 1	1~3	μs	3		3	
EPRE ratio of PSS to SSS	1~3	dB	0	0	0	0
EPRE ratio of PBCH DMRS to SSS						
EPRE ratio of PBCH to PBCH DMRS						
EPRE ratio of PDCCH DMRS to SSS						
EPRE ratio of PDCCH to PDCCH DMRS						
EPRE ratio of PDSCH DMRS to SSS						
EPRE ratio of PDSCH to PDSCH DMRS						
EPRE ratio of OCNG DMRS to SSS ^{Note 1}						
EPRE ratio of OCNG to OCNG DMRS ^{Note 1}						
Propagation condition						
Antenna configuration	1~3	-	Link only, see clause A.3.7A	1x2	Link only, see clause A.3.7A	1x2
<p>Note 1: OCNG shall be used such that both cells are fully allocated and a constant total transmitted power spectral density is achieved for all OFDM symbols.</p> <p>Note 2: Void</p>						

Table A.7.7.1.3.2-2: SS-RSRP inter-frequency OTA related test parameters

Parameter	Config	Unit	Test 1		Test 2 ^{NOTE 3}	
			Cell 1	Cell 2	Cell 1	Cell 2
Angle of arrival configuration according to clause A.3.15			NA	Setup 2b	NA	Setup 2b
Assumption for UE beams ^{Note 4}			N/A	Rough	N/A	Rough
σ_{arr}	1~3	dBm/15 kHz	NA Link only, see clause A.3.7A	-90	NA Link only, see clause A.3.7A	NA
σ_{arr}	1~3	dBm/SSB SCS		-80.97		NA
\hat{E}_s / N_{oc}	1~3	dB		5		NA
E_s	1~3	dBm/SCS				(Table B.2.3-2 Spherical coverage +1dB)

SSB_RP ^{Note1}	1~3	dBm/SC S	-76.0	Table B.2.3-2 Spherical coverage +1dB)
\hat{E}_s/I_{otBB} ^{Note6}	1~3	dB	4.35	-3.81
Io ^{Note1}	1~3	dBm/ 95.04M Hz	-50.18	SSB_RP+ 28.98
<p>Note 1: Es/Iot, SSB_RP and Io levels have been derived from other parameters for information purposes. They are not settable parameters themselves.</p> <p>Note 2: Void</p> <p>Note 3: No additional noise is added by the test system in Test 2.</p> <p>Note 4: Information about types of UE beam is given in B.2.1.3, and does not limit UE implementation or test system implementation</p> <p>Note 5: Where used, interference from other cells and noise sources not specified in the test is assumed to be constant over subcarriers and time and shall be modelled as AWGN of appropriate power for N_{OC} to be fulfilled.</p> <p>Note 6: Calculation of Es/Iot_{BB} includes the effect of UE internal noise up to the value assumed for the associated Refsens requirement in clause 7.3.2 of TS 38.101-2 [19], and an allowance of 1dB for UE multi-band relaxation factor ΔMBs from TS 38.101-2 [19] Table 6.2.1.3-4.</p>				

A.7.7.1.3.3 Test Requirements

The SS-RSRP measurement accuracy for Cell 2 shall fulfil the Absolute requirement in clause 10.1.5.1.1.

Test 1:

Absolute accuracy of Cell 2. The UE is deemed to meet the requirement if the reported SS-RSRP is in the range shown in Table A.7.7.1.3.3.

Test 2:

Absolute accuracy of Cell 2. The UE is deemed to meet the requirement if the reported SS-RSRP is in the range shown in Table A.7.7.1.3.3.

Table A.7.7.1.3.3: SS-RSRP absolute accuracy test requirement

	Test requirement ^{Notes1,2,3,4}
Cell 2	$SSB_RP1 - \delta + G_{min} + X \leq \text{Reported RSRP(dBm)} \leq SSB_RP1 + \delta + G_{max}$
Note 1:	SSB_RPn is the equivalent power received by an antenna with 0dBi gain at the centre of the quiet zone configured in the test for the cell n under consideration
Note 2:	δ is the RSRP absolute accuracy requirement from Table 10.1.5.1.1-1, selected according to the Io used in the test
Note 3:	G _{min} and G _{max} are the minimum and maximum UE gain values from Table B.2.1.5.1-1, selected according to the UE power class
Note 4:	X is the Spherical coverage gain difference in dB, derived as (UE Refsens - UE Spherical coverage) from TS 38.101-2 [19] clauses 7.3.2 and 7.3.4, selected according to the UE power class and operating band. X is always a negative value.

A.7.7.2 SS-RSRQ

A.7.7.2.1 SA intra-frequency measurement accuracy with FR2 serving cell and FR2 target cell

A.7.7.2.1.1 Test Purpose and Environment

The purpose of this test is to verify that the SS-RSRQ measurement accuracy is within the specified limits. This test will verify the requirements in Clause 10.1.8.1.1.

A.7.7.2.1.2 Test Parameters

In this test case all cells are on the same carrier frequency. Supported test configurations are shown in Table A.7.7.2.1.2-1. The absolute accuracy of SS-RSRQ intra-frequency measurement is test by using the parameters in Table A.7.7.2.1.2-2 and Table A.7.7.2.1.2-3. In all test cases, Cell 1 is the PCell and Cell 2 the target cell.

Table A.7.7.2.1.2-1: SS-RSRQ Intra frequency SS-RSRQ supported test configurations

Configuration	Description
1	120 kHz SSB SCS, 100 MHz bandwidth, TDD duplex mode

Table A.7.7.2.1.2-2: SS-RSRQ Intra frequency test parameters

Parameter	Unit	Test 1		Test 2	
		Cell 1	Cell 2	Cell 1	Cell 2
Cell ID		489	0	489	0
SSB ARFCN		Freq1		Freq1	
Duplex mode		TDD		TDD	
TDD configuration		TDDConf.3.1		TDDConf.3.1	
BW _{channel}	MHz	100: N _{RB,c} = 66		100: N _{RB,c} = 66	
Data RBs allocated		66		66	
BWP configuration	Initial DL BWP	DLBWP.0.1			
	Dedicated DL BWP	DLBWP.1.1			
	Initial UL BWP	ULBWP.0.1			
	Dedicated UL BWP	ULBWP.1.1			
TRS configuration		TRS.2.1 TDD		TRS.2.1 TDD	
TCI state		TCI.Stat e.0		TCI.Stat e.0	
PDSCH Reference measurement channel		SR.3.1 TDD		SR.3.1 TDD	
RMSI CORESET Reference Channel		CR.3.1 TDD	-	CR.3.1 TDD	
Control channel RMC		CCR.3.1 TDD	-	CCR.3.1 TDD	-
OCNG Patterns		OP.1	OP.1	OP.1	OP.1
SMTc configuration		SMTc.1			
SSB configuration		SSB.1 FR2	SSB.1 FR2	SSB.1 FR2	SSB.1 FR2
PDSCH/PDCCH subcarrier spacing	kHz	120	120	120	120
SS-RSSI-Measurement		Not Applicable			
EPRE ratio of PSS to SSS	dB	0	0	0	0
EPRE ratio of PBCH_DMRS to SSS					
EPRE ratio of PBCH to PBCH_DMRS					
EPRE ratio of PDCCH_DMRS to SSS					
EPRE ratio of PDCCH to PDCCH_DMRS					
EPRE ratio of PDSCH_DMRS to SSS					
EPRE ratio of PDSCH to PDSCH_DMRS					

EPRE ratio of OCNG DMRS to SSS ^{Note 1}					
EPRE ratio of OCNG to OCNG DMRS ^{Note 1}					
Propagation condition		AWGN		AWGN	
Antenna configuration		1x2	1x2	1x2	1x2
Note 1: OCNG shall be used such that both cells are fully allocated and a constant total transmitted power spectral density is achieved for all OFDM symbols.					
Note 2: Void					
Note 3: Void					
Note 4: Void					
Note 5: Void					

Table A.7.7.2.1.2-3: SS-RSRQ Intra frequency OTA related test parameters

	Unit	Test 1		Test 2	
		Cell 1	Cell 2	Cell 1	Cell 2
Angle of arrival configuration		Setup 1 according to clause A.3.15.1		Setup 1 according to clause A.3.15.1	
Assumption for UE beams ^{Note 9}		Rough			
N_{oc} ^{Note1}	dBm/15kHz ^{Note4}	-95		-95	
N_{oc} ^{Note1}	dBm/SCS ^{Note3}	-86		-86	
\hat{E}_s / N_{oc}	dB	3	-3	-3	3
SSB_RP ^{Note2}	dBm/SCS ^{Note4}	-83	-83	-89	-89
SS-RSRQ ^{Note2}	dB	-14.77	-14.77	-16.81	-16.81
\hat{E}_s / I_{ot}	dB	-1.76	-1.76	-4.76	-4.76
I_o ^{Note2}	dBm/95.04 MHz ^{Note4}	-50		-54	
Note 1: Interference from other cells and noise sources not specified in the test is assumed to be constant over subcarriers and time and shall be modelled as AWGN of appropriate power for N_{oc} to be fulfilled.					
Note 2: SS-RSRQ, SSB_RP, and I_o levels have been derived from other parameters for information purposes. They are not settable parameters themselves.					
Note 3: SS-RSRQ and SS-RSRP minimum requirements are specified assuming independent interference and noise at each receiver antenna port.					
Note 4: Equivalent power received by an antenna with 0dBi gain at the centre of the quiet zone					
Note 5: As observed with 0dBi gain antenna at the centre of the quiet zone					
Note 6: Void					
Note 7: Void					
Note 8: Void					
Note 9: Information about types of UE beam is given in B.2.1.3, and does not limit UE implementation or test system implementation					

A.7.7.2.1.3 Test Requirements

The SS-RSRQ absolute measurement accuracy in test 1 shall be within the range Nominal SS-RSRQ+2.5dB to Nominal SS-RSRQ-2.5dB and the SS-RSRQ measurement accuracy in test 2 shall be within the range Nominal RSRQ+3.5dB to Nominal RSRQ-3.5dB according to the requirements in clause 10.1.8.1.1. Nominal RSRQ is the value shown in table A.7.7.2.1.2-3.

A.7.7.2.2 SA Inter-frequency measurement accuracy with FR2 serving cell and FR2 TDD target cell

A.7.7.2.2.1 Test Purpose and Environment

The purpose of this test is to verify that the SS-RSRQ measurement accuracy is within the specified limits. This test will verify the requirements in clause 10.1.9.1.1 and 10.1.9.1.2 for inter-frequency measurement.

A.7.7.2.2.2 Test Parameters

In this test case the two cells (i.e., Cell 1 and Cell 2) are on different carrier frequencies and measurement gaps are provided. Supported test configurations are shown in Table A.7.7.2.2.2-1. Both absolute accuracy and relative accuracy requirements of SS-RSRQ inter-frequency measurement are tested by using test parameters in Table A.7.7.2.2.2-2 and Table A.7.7.2.2-3.. In all test cases, Cell 1 is the PCell and Cell 2 is target cell.

Table A.7.7.2.2.2-1: SS-RSRQ Inter frequency SS-RSRQ supported test configurations

Configuration	Description
1	120 kHz SSB SCS, 100 MHz bandwidth, TDD duplex mode

Table A.7.7.2.2.2-2: SS-RSRQ Inter frequency general test parameters

Parameter	Unit	Test 1		Test 2	
		Cell 1	Cell 2	Cell 1	Cell 2
SSB ARFCN		Freq1	freq2	freq1	Freq2
SSB Configuration		SSB.1 FR2	SSB. 1 FR2	SSB.1 FR2	SSB.1 FR2
Duplex mode		TDD		TDD	
TDD configuration		TDDConf.3.1		TDDConf.3.1	
BW _{channel}	MHz	100: N _{RB,c} = 66		100: N _{RB,c} = 66	
Data RBs allocated		66		66	
BWP configuration	Initial DL BWP	DLBWP.0.1			
	Dedicated DL BWP	DLBWP.1.1			
	Initial UL BWP	ULBWP.0.1			
	Dedicated UL BWP	ULBWP.1.1			
TRS configuration		TRS.2. 1 TDD	-	TRS.2. 1 TDD	-
TCI state		TCI.Sta te.0	-	TCI.Sta te.0	-
PDSCH Reference measurement channel		SR.3.1 TDD	-	SR.3.1 TDD	-
RMSI CORESET Reference Channel		CR.3.1 TDD	-	CR.3.1 TDD	-
OCNG Patterns		OP.1	OP.1	OP.1	OP.1
SMTTC configuration		SMTTC. 1	SMT C.1	SMTTC. 1	SMTTC.1
PDSCH/PDCCH subcarrier spacing	kHz	120	120	120	120
EPRE ratio of PSS to SSS	dB	0	0	0	0
EPRE ratio of PBCH_DMRS to SSS					
EPRE ratio of PBCH to PBCH_DMRS					
EPRE ratio of PDCCH_DMRS to SSS					
EPRE ratio of PDCCH to PDCCH_DMRS					
EPRE ratio of PDSCH_DMRS to SSS					
EPRE ratio of PDSCH to PDSCH_DMRS					
EPRE ratio of OCNG DMRS to SSS ^{Note 1}					

EPRE ratio of OCNG to OCNG DMRS ^{Note 1}					
Propagation conditions		AWGN	AWGN	AWGN	AWGN
Antenna configuration		1x2	1x2	1x2	1x2
<p>Note 1: OCNG shall be used such that both cells are fully allocated and a constant total transmitted power spectral density is achieved for all OFDM symbols.</p> <p>Note 2: Void</p> <p>Note 3: Void</p> <p>Note 4: Void</p>					

Table A.7.7.2.2-3: SS-RSRQ Inter frequency OTA related test parameters

Parameter	Unit	Test 1		Test 2	
		Cell 1	Cell 2	Cell 1	Cell 2
AoA setup		Setup 1 in clause A.3.15.		Setup 1 in clause A.3.15.	
Assumption for UE beams ^{Note 8}		Rough		Rough	
N_{oc} ^{Note1}	dBm/15kHz ^{Note4}	-94.03	-94.03	-94.03	-94.03
N_{oc} ^{Note1}	dBm/SCS ^{Note3}	-85.0	-85.0	-85.0	-85.0
\hat{E}_s / N_{oc}	dB	-1.75	-1.75	-3	-1.75
SSB_RP ^{Note2}	dBm/SCS ^{Note4}	-86.75	-86.75	-88	-88
SS-RSRQ ^{Note2}	dB	-14.75	-14.75	-15.56	-15.56
\hat{E}_s / I_{ot}	dB	-1.75	-1.75	-3	-3
I_o ^{Note2}	dBm/95.04 MHz ^{Note4}	-53.8	-53.8	-54.25	-54.25
<p>Note 1: Interference from other cells and noise sources not specified in the test is assumed to be constant over subcarriers and time and shall be modelled as AWGN of appropriate power for N_{oc} to be fulfilled.</p> <p>Note 2: SS-RSRQ, SSB_RP, and I_o levels have been derived from other parameters for information purposes. They are not settable parameters themselves.</p> <p>Note 3: SS-RSRQ and SS-RSRP minimum requirements are specified assuming independent interference and noise at each receiver antenna port.</p> <p>Note 4: Equivalent power received by an antenna with 0dBi gain at the centre of the quiet zone</p> <p>Note 5: As observed with 0dBi gain antenna at the centre of the quiet zone</p> <p>Note 6: Void</p> <p>Note 7: Void</p> <p>Note 8: Information about types of UE beam is given in B.2.1.3, and does not limit UE implementation or test system implementation</p>					

A.7.7.2.2.3 Test Requirements

The SS-RSRQ absolute measurement accuracy in test 1 shall be within the range Nominal SS-RSRQ+2.5dB to Nominal SS-RSRQ -2.5dB and the SS-RSRQ measurement accuracy in test 2 shall be within the range Nominal SS-RSRQ +3.5dB to Nominal SS-RSRQ -3.5dB according to the requirements in clause 10.1.10.1.1.

The SS-RSRQ relative measurement accuracy shall fulfil the requirements in clause 10.1.10.1.2.

A.7.7.3 SS-SINR

A.7.7.3.1 SA intra-frequency case measurement accuracy with FR2 serving cell and FR2 target cell

A.7.7.3.1.1 Test Purpose and Environment

The purpose of this test is to verify that the SS-SINR measurement accuracy is within the specified limits. This test will verify the requirements in Clause 10.1.13.1.1.

A.7.7.3.1.2 Test Parameters

In this test case all cells are on the same carrier frequency. Supported test configurations are shown in Table A.7.7.3.1.2-1. The absolute accuracy of SS-SINR intra-frequency measurement is test by using the parameters in Table A.7.7.3.1.2-2 and Table A.7.7.3.1.2-3. In all test cases, Cell 1 is the PCell and Cell 2 the target cell. The TCI status for Cell 1 is defined in Table A.3.16.2-1 and TRS configuration for Cell 1 is defined in Table A.3.17.2.1-1.

Table A.7.7.3.1.2-1: SS-SINR Intra frequency SS-SINR supported test configurations

Configuration	Description
1	120 kHz SSB SCS, 100 MHz bandwidth, TDD duplex mode

Table A.7.7.3.1.2-2: SS-SINR Intra frequency test parameters

Parameter	Unit	Test 1		Test 2	
		Cell 1	Cell 2	Cell 1	Cell 2
Cell ID		489	0	489	0
SSB ARFCN		freq2		freq2	
Duplex mode		TDD		TDD	
TDD configuration		TDDConf.3.1		TDDConf.3.1	
BW _{channel}	MHz	100: N _{RB,c} = 66		100: N _{RB,c} = 66	
Data RBs allocated		66		66	
Downlink initial BWP configuration		DLBWP.0.1			
Downlink dedicated BWP configuration		DLBWP.1.1			
Uplink initial BWP configuration		ULBWP.0.1			
Uplink dedicated BWP configuration		ULBWP.1.1			
DRX cycle configuration	ms	Not applicable			
TRS configuration		TRS.2.1 TDD			
TCI state		TCI.State.0			
PDSCH Reference measurement channel		SR.3.1 TDD		SR.3.1 TDD	
RMSI CORESET Reference Channel		CR.3.1 TDD	-	CR.3.1 TDD	
Dedicated RMSI CORESET Reference Channel		CCR.3.1 TDD	-	CCR.3.1 TDD	-
OCNG Patterns		OP.1	OP.1	OP.1	OP.1
SMTTC configuration		SMTTC.1			
SSB configuration		SSB.1 FR2	SSB.1 FR2	SSB.1 FR2	SSB.1 FR2
PDSCH/PDCCH subcarrier spacing	kHz	120	120	120	120
SS-RSSI-Measurement		Not Applicable			
EPRE ratio of PSS to SSS	dB	0	0	0	0
EPRE ratio of PBCH_DMRS to SSS					
EPRE ratio of PBCH to PBCH_DMRS					
EPRE ratio of PDCCH_DMRS to SSS					
EPRE ratio of PDCCH to PDCCH_DMRS					
EPRE ratio of PDSCH_DMRS to SSS					
EPRE ratio of PDSCH to PDSCH_DMRS					
EPRE ratio of OCNG DMRS to SSS ^{Note 1}					

EPRE ratio of OCNG to OCNG DMRS ^{Note 1}				
Propagation conditions		AWGN		
Note 1:	OCNG shall be used such that both cells are fully allocated and a constant total transmitted power spectral density is achieved for all OFDM symbols.			
Note 2:	Void			
Note 3:	Void			
Note 4:	Void			

Table A.7.7.3.1.2-3: SS-SINR Intra frequency OTA related test parameters

Parameter	Unit	Test 1		Test 3	
		Cell 1	Cell 2	Cell 1	Cell 2
Angle of arrival configuration		Setup 1 according to clause A.3.15.1		Setup 1 according to clause A.3.15.1	
Assumption for UE beams ^{Note 9}		Rough		Rough	
N_{oc} ^{Note1}	dBm/15kHz ^{Note4}	-105		-105	
N_{oc} ^{Note1}	dBm/SCS ^{Note3}	-96		-96	
\hat{E}_s / N_{oc}	dB	4.54	2.66	-3	-3
SSB_RP ^{Note2}	dBm/SCS ^{Note4}	-91.46	-93.34	-99	-99
SS-SINR ^{Note2}	dB	0	-3.2	-4.76	-4.76
\hat{E}_s / I_{ot}	dB	0	-3.2	-4.76	-4.76
I_o ^{Note2}	dBm/95.04 MHz ^{Note4}	-59.2		-64	
Note 1:	Interference from other cells and noise sources not specified in the test is assumed to be constant over subcarriers and time and shall be modelled as AWGN of appropriate power for N_{oc} to be fulfilled.				
Note 2:	SS-SINR, SSB_RP, and I_o levels have been derived from other parameters for information purposes. They are not settable parameters themselves.				
Note 3:	SS-SINR and SS-RSRP minimum requirements are specified assuming independent interference and noise at each receiver antenna port.				
Note 4:	Equivalent power received by an antenna with 0 dBi gain at the centre of the quiet zone				
Note 5:	As observed with 0 dBi gain antenna at the centre of the quiet zone				
Note 6:	Void				
Note 7:	Void				
Note 8:	Void				
Note 9:	Information about types of UE beam is given in B.2.1.3, and does not limit UE implementation or test system implementation				

A.7.7.3.1.3 Test Requirements

The SS-SINR absolute measurement accuracy in test 1 shall be within the range Nominal SS-SINR+3B to Nominal SS-SINR -3dB and the SS-SINR measurement accuracy in test 2 shall be within the range Nominal SS-SINR +3.5dB to Nominal SS-SINR -3.5dB according to the requirements in clause 10.1.10.13.1.

A.7.7.3.2 SA Inter-frequency measurement accuracy with FR2 serving cell and FR2 TDD target cell

A.7.7.3.2.1 Test Purpose and Environment

The purpose of this test is to verify that the SS-SINR measurement accuracy is within the specified limits. This test will verify the requirements in Clause 10.1.15.1.1 and 10.1.15.1.2 for inter-frequency measurement.

A.7.7.3.2.2 Test Parameters

In this test case the two cells (i.e., Cell 1 and Cell 2) are on different carrier frequencies and measurement gaps are provided. Supported test configurations are shown in Table A.7.7.3.2.2-1. Both absolute accuracy and relative accuracy requirements of SS-SINR inter-frequency measurement are tested by using test parameters in Table A.7.7.3.2.2-2 and Table A.7.7.3.2.2-3. In all test cases, Cell 1 is the PCell and Cell 2 is target cell. The TCI status for Cell 1 is defined in Table A.3.16.2-1 and TRS configuration for Cell 1 is defined in Table A.3.17.2.1-1.

Table A.7.7.3.2.2-1: SS-SINR Inter frequency SS-SINR supported test configurations

Configuration	Description
1	120 kHz SSB SCS, 100 MHz bandwidth, TDD duplex mode

Table A.7.7.3.2.2-2: SS-SINR Inter frequency general test parameters

Parameter	Unit	Test 1		Test 2		Test 3	
		Cell 1	Cell 2	Cell 1	Cell 2	Cell 1	Cell 2
SSB ARFCN		freq1	freq2	freq1	freq2	freq1	freq2
Duplex mode		TDD		TDD		TDD	
TDD configuration		TDDConf.3.1		TDDConf.3.1		TDDConf.3.1	
BW _{channel}	MHz	100: N _{RB,c} = 66		100: N _{RB,c} = 66		100: N _{RB,c} = 66	
Data RBs allocated		66		66		66	
Downlink initial BWP configuration		DLBWP.0.1					
Downlink dedicated BWP configuration		DLBWP.1.1					
Uplink initial BWP configuration		ULBWP.0.1					
Uplink dedicated BWP configuration		ULBWP.1.1					
DRX cycle configuration	ms	Not applicable					
TRS configuration		TRS.2.1 TDD					
TCI state		TCI.State.0					
PDSCH Reference measurement channel		SR.3.1 TDD	-	SR.3.1 TDD	-	SR.3.1 TDD	-
RMSI CORESET Reference Channel		CR.3.1 TDD	-	CR.3.1 TDD	-	CR.3.1 TDD	-
OCNG Patterns		OP.1	OP.1	OP.1	OP.1	OP.1	OP.1
SMTC configuration		SMTC.1	SMTC.1	SMTC.1	SMTC.1	SMTC.1	SMTC.1
SSB configuration		SSB.3 FR2	SSB.3 FR2	SSB.3 FR2	SSB.3 FR2	SSB.3 FR2	SSB.3 FR2
PDSCH/PDCCH subcarrier spacing	kHz	120	120	120	120	120	120
EPRE ratio of PSS to SSS	dB	0	0	0	0	0	0
EPRE ratio of PBCH_DMRS to SSS							
EPRE ratio of PBCH to PBCH_DMRS							
EPRE ratio of PDCCH_DMRS to SSS							
EPRE ratio of PDCCH to PDCCH_DMRS							
EPRE ratio of PDSCH_DMRS to SSS							
EPRE ratio of PDSCH to PDSCH_DMRS							
EPRE ratio of OCNG DMRS to SSS ^{Note 1}							

EPRE ratio of OCNG to OCNG DMRS ^{Note 1}							
Propagation conditions		AWGN	AWGN	AWGN	AWGN	AWGN	AWGN
Antenna configuration		1x2	1x2	1x2	1x2	1x2	1x2
<p>Note 1: OCNG shall be used such that both cells are fully allocated and a constant total transmitted power spectral density is achieved for all OFDM symbols.</p> <p>Note 2: Void</p> <p>Note 3: Void</p> <p>Note 4: Void</p>							

Table A.7.7.3.2.2-3: SS-SINR Inter frequency OTA related test parameters

Parameter	Unit	Test 1		Test 2		Test 3	
		Cell 1	Cell 2	Cell 1	Cell 2	Cell 1	Cell 2
Angle of arrival configuration	degrees	Setup 1 according to A.3.15.1		Setup 1 according to A.3.15.1		Setup 1 according to A.3.15.1	
Assumption for UE beams ^{Note 10}		Rough		Rough		Rough	
N_{oc} ^{Note1}	dBm/15kHz ^{Note4}	-105	-105	-105	-105	-105	-105
N_{oc} ^{Note1}	dBm/SCS ^{Note3}	-96	-96	-96	-96	-96	-96
\hat{E}_s / N_{oc}	dB	-0.5	-0.5	11.0	11.0	-3.0	-3.0
SSB_RP ^{Note2}	dBm/SCS ^{Note4}	-96.5	-96.5	-85	-85	-99	-99
SS-SINR ^{Note2}	dB	-0.5	-0.5	11	11	-3.0	-3.0
\hat{E}_s / I_{ot}	dB	-0.5	-0.5	11	11	-3.0	-3.0
I_o ^{Note2}	dBm/95.04 MHz ^{Note4}	-69.3	-69.3	-55.4	-55.4	-65.24	-65.24
<p>Note 1: Interference from other cells and noise sources not specified in the test is assumed to be constant over subcarriers and time and shall be modelled as AWGN of appropriate power for N_{oc} to be fulfilled.</p> <p>Note 2: SS-SINR, SSB_RP, and I_o levels have been derived from other parameters for information purposes. They are not settable parameters themselves.</p> <p>Note 3: SS-SINR and SS-RSRP minimum requirements are specified assuming independent interference and noise at each receiver antenna port.</p> <p>Note 4: Equivalent power received by an antenna with 0dBi gain at the centre of the quiet zone</p> <p>Note 5: As observed with 0dBi gain antenna at the centre of the quiet zone</p> <p>Note 6: Void</p> <p>Note 7: Void</p> <p>Note 8: Void</p> <p>Note 9: Void</p> <p>Note 10: Information about types of UE beam is given in B.2.1.3, and does not limit UE implementation or test system implementation</p>							

A.7.7.3.2.3 Test Requirements

The SS-SINR absolute measurement accuracy in test 1 shall be within the range Nominal SS-SINR +3dB to Nominal SS-SINR -3dB and the SS-SINR measurement accuracy in test 2 shall be within the range Nominal SS-SINR +3.5dB to Nominal SS-SINR -3.5dB according to the requirements in clause 10.1.15.1.1.

The SS-SINR relative measurement accuracy shall fulfil the requirements in clause 10.1.15.1.2.

A.7.7.4 L1-RSRP measurement for beam reporting

A.7.7.4.1 SSB based L1-RSRP measurement

A.7.7.4.1.1 Test Purpose and Environment

The purpose of this test is to verify that the L1-RSRP measurement accuracy is within the specified limits. This test will verify the requirements in clauses 9.5.2 and clause 10.1.20.1 for L1-RSRP measurements based on SSB with the testing configurations for NR cells in Table A.7.7.4.1.1-1.

The AoA setup for this test is Setup 1 as defined in clause A.3.15.

Table A.7.7.4.1.1-1: Applicable NR configurations for FR2 SSB based L1-RSRP test

Config	Description
1	NR 120 kHz SSB SCS, 100 MHz bandwidth, TDD duplex mode
2	NR 240 kHz SSB SCS, 100 MHz bandwidth, TDD duplex mode
Note:	The UE is only required to be tested in one of the supported test configurations in each supported band

A.7.7.4.1.2 Test parameters

In this set of test cases there is one cell in the test, PCell (Cell 1). The test parameters for the Cell 1 are given in Table A.7.7.4.1.2-1 and Table A.7.7.4.1.2-2 below. The absolute and relative accuracy of L1-RSRP measurements are tested by using the parameters in Table A.7.7.4.1.2-1 and Table A.7.7.4.1.2-2.

Here is no measurement gap configured in the test. Before the test, UE is configured one SSB resource set with two SSB resources. UE is configured to perform RLM, BFD and L1-RSRP measurement based on the SSB resources 0 and 1.

Table A.7.7.4.1.2-1: FR2 SSB based L1-RSRP general test parameters

Parameter	Config	Unit	Test 1	Test 2
SSB GSCN	1~2		freq1	freq1
Duplex mode	1~2		TDD	TDD
TDD Configuration	1~2		TDDConf.3.1	TDDConf.3.1
BW _{channel}	1~2	MHz	100: N _{RB,c} = 66	100: N _{RB,c} = 66
Data RBs allocated	1~2		66	66
PDSCH Reference measurement channel	1		SR.3.2 TDD	SR.3.2 TDD
	2		SR.3.3 TDD	SR.3.3 TDD
RMSI CORESET Reference Channel	1		CR.3.1 TDD	CR.3.1 TDD
	2		CR.3.2 TDD	CR.3.2 TDD
Dedicated CORESET Reference Channel	1		CCR.3.1 TDD	CCR.3.1 TDD
	2		CCR.3.7 TDD	CCR.3.7 TDD
SSB configuration	1		SSB.1 FR2	SSB.1 FR2
	2		SSB.2 FR2	SSB.2 FR2
OCNG Patterns	1~2		OP.1	OP.1
Initial BWP Configuration	1~2		DLBWP.0.1	DLBWP.0.1
			ULBWP.0.1	ULBWP.0.1
Dedicated BWP configuration	1~2		DLBWP.1.3	DLBWP.1.3
			ULBWP.1.3	ULBWP.1.3
TRS Configuration	1~2		TRS.2.1 TDD	TRS.2.1 TDD
PDCCH/PDSCH TCI Configuration	1~2		TCI.State.2	TCI.State.2
SMTC configuration	1~2		SMTC.1	SMTC.1
reportConfigType	1~2		periodic	periodic
reportQuantity	1~2		ssb-Index-RSRP	ssb-Index-RSRP

Number of reported RS	1~2		2	2
L1-RSRP reporting period	1~2		slot320	slot320
Propagation condition	1~2		AWGN	AWGN
Antenna configuration	1~2		1x2	1x2
EPRE ratio of PSS to SSS	1~2	dB	0	0
EPRE ratio of PBCH DMRS to SSS				
EPRE ratio of PBCH to PBCH DMRS				
EPRE ratio of PDCCH DMRS to SSS				
EPRE ratio of PDCCH to PDCCH DMRS				
EPRE ratio of PDSCH DMRS to SSS				
EPRE ratio of PDSCH to PDSCH DMRS				
EPRE ratio of OCNG DMRS to SSS ^{Note 1}				
EPRE ratio of OCNG to OCNG DMRS ^{Note 1}				
<p>Note 1: OCNG shall be used such that both cells are fully allocated and a constant total transmitted power spectral density is achieved for all OFDM symbols.</p> <p>Note 2: Interference from other cells and noise sources not specified in the test is assumed to be constant over subcarriers and time and shall be modelled as AWGN of appropriate power for N_{oc} to be fulfilled.</p>				

Table A.7.7.4.1.2-2: FR2 SSB based L1-RSRP OTA related test parameters

Parameter	Config	Unit	Test 1		Test 2 ^{NOTE 3}	
			SSB0	SSB1	SSB0	SSB1
Angle of arrival configuration			Setup 1 according to A.3.15.1		Setup 1 according to A.3.15.1	
Assumption for UE beams ^{Note 4}			Rough		Rough	
N_{oc}	1, 2	dBm/15 kHz	-100		n.a.	
N_{oc}	1	dBm/SS	-91		n.a.	
	2	B SCS	-88		n.a.	
\hat{E}_s/I_{ot}	1~2	dB	10	-2	n.a.	
SSB_RP ^{Note1}	1	dBm/SC	-81	-93	As in Table B.2.4-2	
	2	S	-78	-90	As in Table B.2.4-2	
I_o ^{Note1}	1~2	dBm/95.04M Hz	-51.57		SS-RSRP+28.98	
\hat{E}_s/N_{oc}	1~2	dB	10	-2	n.a.	
<p>Note 1: SSB_RP and I_o levels have been derived from other parameters for information purposes. They are not settable parameters themselves.</p> <p>Note 2: Void</p> <p>Note 3: No additional noise is added by the test system in Test 2.</p> <p>Note 4: Information about types of UE beam is given in B.2.1.3, and does not limit UE implementation or test system implementation.</p>						

A.7.7.4.1.3 Test Requirements

After 320ms from the beginning of the test, the L1-RSRP measurement accuracy for SSB#0 and SSB#1 of Cell 1 shall fulfil the requirements in clauses 10.1.20.1. The following requirements are to be verified:

For Test 1:

Absolute accuracy of SSB0. The UE is deemed to meet the requirement if the reported L1-RSRP is in the range shown in Table A.7.7.4.1.3-1.

Relative accuracy of SSB0 compared with SSB1. The UE is deemed to meet the requirement if the difference in reported L1-RSRP meets the requirements in Table 10.1.20.1.2-1.

For Test 2:

Absolute accuracy of SSB resource reported by UE in L1-RSRP report (SSB0 or SSB1). The UE is deemed to meet the requirement if the reported L1-RSRP is in the range shown in Table A.7.7.4.1.3-1.

Relative accuracy of SSB0 compared with SSB1. The UE is deemed to meet the requirement if the difference in reported L1-RSRP meets the requirements in Table 10.1.20.1.2-1.

Table A.7.7.4.1.3-1: L1-RSRP absolute accuracy test requirement

	Test requirement ^{Notes1,2,3}
SSB0	$SSB_RP0 - \delta + G_{min} \leq \text{Reported RSRP(dBm)} \leq SSB_RP0 + \delta + G_{max}$
SSB1	$SSB_RP1 - \delta + G_{min} \leq \text{Reported RSRP(dBm)} \leq SSB_RP1 + \delta + G_{max}$
Note 1:	SSB_RPn is the equivalent power received by an antenna with 0dBi gain at the centre of the quiet zone configured in the test for the SSB n under consideration
Note 2:	δ is the RSRP absolute accuracy requirement from Table 10.1.20.1.1-1, selected according to the I_0 used in the test
Note 3:	G_{min} and G_{max} are the minimum and maximum UE gain values from Table B.2.1.5.1-1, selected according to the UE power class

A.7.7.4.2 CSI-RS based L1-RSRP measurement on resource set with repetition off

A.7.7.4.2.1 Test Purpose and Environment

The purpose of this test is to verify that the L1-RSRP measurement accuracy is within the specified limits. This test will verify the requirements in clauses 9.5.3 and clause 10.1.20.2 for L1-RSRP measurements based on CSI-RS with the testing configurations for NR cells in Table A.7.7.4.2.1-1.

The AoA setup for this test is Setup 1 as defined in clause A.3.15.

Table A.7.7.4.2.1-1: Applicable NR configurations for FR1 CSI-RS based L1-RSRP test

Config	Description
1	NR 120 kHz CSI-RS SCS, 100 MHz bandwidth, TDD duplex mode

A.7.7.4.2.2 Test parameters

In this set of test cases there are one cell in the test, PCell (Cell 1). The test parameters for the Cell 1 are given in Table A.7.7.4.2.2-1 and Table A.7.7.4.2.2-2 below. The absolute and relative accuracy of L1-RSRP measurements are tested by using the parameters in Table A.7.7.4.2.2-1 and Table A.7.7.4.2.2-2.

There is no measurement gap configured in the test. Before the test, UE is configured one CSI-RS resource set with two CSI-RS resources. UE is configured to perform RLM and BFD based on SSB 0 and 1. CSI-RS is not transmitted in the same OFDM symbols as SSB.

Table A.7.7.4.2.2-1: FR2 CSI-RS based L1-RSRP general test parameters

Parameter	Config	Unit	Test 1	Test 2
SSB GSCN	1		freq1	freq1
Duplex mode	1		TDD	TDD
TDD Configuration	1		TDDConf.3.1	TDDConf.3.1
BW _{channel}	1	MHz	100: N _{RB,c} = 66	100: N _{RB,c} = 66
PDSCH Reference measurement channel	1		SR.3.1 TDD	SR.3.1 TDD

RMSI CORESET Reference Channel	1		CR.3.1 TDD	CR.3.1 TDD
Dedicated CORESET Reference Channel	1		CCR.3.1 TDD	CCR.3.1 TDD
SSB configuration	1		SSB.1 FR2	SSB.1 FR2
OCNG Patterns	1		OP.1	OP.1
Initial BWP Configuration	1		DLBWP.0.1 ULBWP.0.1	DLBWP.0.1 ULBWP.0.1
Dedicated BWP configuration	1		DLBWP.1.1 ULBWP.1.1	DLBWP.1.1 ULBWP.1.1
TRS Configuration	1		TRS.2.1 TDD	TRS.2.1 TDD
PDCCH/PDSCH TCI Configuration	1		TCI.State.2	TCI.State.2
SMTC configuration	1		SMTC.1	SMTC.1
CSI-RS	1		CSI-RS.3.2 TDD	CSI-RS.3.2 TDD
reportConfigType	1		periodic	periodic
reportQuantity	1		cri-RSRP	cri-RSRP
Number of reported RS	1		2	2
L1-RSRP reporting period	1		slot80	slot80
Propagation condition	1		AWGN	AWGN
Antenna configuration	1		1x2	1x2
EPRE ratio of PSS to SSS	1	dB	0	0
EPRE ratio of PBCH DMRS to SSS				
EPRE ratio of PBCH to PBCH DMRS				
EPRE ratio of PDCCH DMRS to SSS				
EPRE ratio of PDCCH to PDCCH DMRS				
EPRE ratio of PDSCH DMRS to SSS				
EPRE ratio of PDSCH to PDSCH DMRS				
EPRE ratio of OCNG DMRS to SSS ^{Note 1}				
EPRE ratio of OCNG to OCNG DMRS ^{Note 1}				
<p>Note 1: OCNG shall be used such that both cells are fully allocated and a constant total transmitted power spectral density is achieved for all OFDM symbols.</p> <p>Note 2: Interference from other cells and noise sources not specified in the test is assumed to be constant over subcarriers and time and shall be modelled as AWGN of appropriate power for N_{oc} to be fulfilled.</p>				

Table A.7.7.4.2.2-2: FR2 CSI-RS based L1-RSRP OTA related test parameters

Parameter	Config	Unit	Test 1		Test 2 ^{NOTE 3}	
			CSI-RS0	CSI-RS1	CSI-RS0	CSI-RS1
Angle of arrival configuration			Setup 1 according to A.3.15.1		Setup 1 according to A.3.15.1	
Assumption for UE beams ^{Note 4}			Rough		Rough	
N_{oc}	1~2	dBm/15 kHz	-100		n.a.	
N_{oc}	1~2	dBm/SS B SCS	-91		n.a.	
\hat{E}_s / I_{ot}	1~2	dB	10	-2	n.a.	
CSI-RS-RSRP ^{Note1}	1~2	dBm/SC S	-81	-93	As in Table B.2.4-2	
I_o ^{Note1}	1~2	dBm/95.04M Hz	-59.86		SS-RSRP+28.98	
\hat{E}_s / N_{oc}	1~2	dB	-51.57	-2	n.a.	

Note 1:	RSRP and I_o levels have been derived from other parameters for information purposes. They are not settable parameters themselves.
Note 2:	RSRP minimum requirements are specified assuming independent interference and noise at each receiver antenna port.
Note 3:	No additional noise is added by the test system in Test 2.
Note 4:	Information about types of UE beam is given in B.2.1.3, and does not limit UE implementation or test system implementation

A.7.7.4.2.3 Test Requirements

After 640ms from the beginning of the test, the L1-RSRP measurement accuracy for CSI-RS#0 and CSI-RS#1 of Cell 1 shall fulfil the requirements in clause 10.1.20.2. The following requirements are to be verified:

For Test 1:

Absolute accuracy of CSI-RS0. The UE is deemed to meet the requirement if the reported L1-RSRP is in the range shown in Table A.7.7.4.2.3-1.

Relative accuracy of CSI-RS0 compared with CSI-RS1. The UE is deemed to meet the requirement if the difference in reported L1-RSRP meets the requirements in Table 10.1.20.2.2-1.

For Test 2:

Absolute accuracy of CSI-RS resource reported by UE in L1-RSRP report (CSI-RS0 or CSI-RS1). The UE is deemed to meet the requirement if the reported L1-RSRP is in the range shown in Table A.7.7.4.2.3-1.

Relative accuracy of CSI-RS0 compared with CSI-RS1. The UE is deemed to meet the requirement if the difference in reported L1-RSRP meets the requirements in Table 10.1.20.2.2-1.

Table A.7.7.4.2.3-1: L1-RSRP absolute accuracy test requirement

	Test requirement ^{Notes1,2,3}
CSI-RS0	$CSI-RS_RP0 - \delta + G_{min} \leq \text{Reported RSRP(dBm)} \leq CSI-RS_RP0 + \delta + G_{max}$
CSI-RS1	$CSI-RS_RP1 - \delta + G_{min} \leq \text{Reported RSRP(dBm)} \leq CSI-RS_RP1 + \delta + G_{max}$
Note 1:	CSI-RS_RPn is the equivalent power received by an antenna with 0dBi gain at the centre of the quiet zone configured in the test for the CSI-RS n under consideration
Note 2:	δ is the RSRP absolute accuracy requirement from Table 10.1.20.2.1-1, selected according to the I_o used in the test
Note 3:	G_{min} and G_{max} are the minimum and maximum UE gain values from Table B.2.1.5.1-1, selected according to the UE power class

A.8 E-UTRA standalone tests for NR RRM

Editor notes: All NR RRM tests under E-UTRA standalone operations are included in this Annex. All EN-DC related NR RRM tests are in A.4 and A.5.

A.8.1 Void

A.8.2 RRC_IDLE state mobility

A.8.2.1 Inter-RAT NR Cell re-selection

A.8.2.1.1 E-UTRA Cell reselection to higher priority NR target Cell in FR1

A.8.2.1.1.1 Test Purpose and Environment

This test is to verify the requirement for the E-UTRAN to NR inter-RAT cell reselection requirements specified in clause 4.2.2.5.6 in TS 36.133 [15].

The test scenario comprises of 1 E-UTRA cell and 1 NR cell as given in tables A.8.2.1.1.1-1, A.8.2.1.1.1-2, A.8.2.1.1.1-3 and A.8.2.1.1.1-4. The test consists of three successive time periods, with time duration of T1, T2, and T3 respectively. E-UTRA cell 1 is already identified by the UE prior to the start of the test. Cell 2 is of higher priority than cell 1.

Table A.8.2.1.1.1-1: Supported test configurations

Configuration	Description
1	LTE FDD, NR 15 kHz SSB SCS, 10 MHz bandwidth, FDD duplex mode
2	LTE FDD, NR 15 kHz SSB SCS, 10 MHz bandwidth, TDD duplex mode
3	LTE FDD, NR 30 kHz SSB SCS, 40 MHz bandwidth, TDD duplex mode
4	LTE TDD, NR 15 kHz SSB SCS, 10 MHz bandwidth, FDD duplex mode
5	LTE TDD, NR 15 kHz SSB SCS, 10 MHz bandwidth, TDD duplex mode
6	LTE TDD, NR 30 kHz SSB SCS, 40 MHz bandwidth, TDD duplex mode

Note: The UE is only required to be tested in one of the supported test configurations

Table A.8.2.1.1.1-2: General test parameters for E-UTRA cell re-selection FR1 NR cell test case

Parameter		Unit	Test configuration	Value	Comment
Initial condition	Active cell		1, 2, 3, 4, 5, 6	Cell2	The UE camps on cell 2 in the initial phase
	Neighbour cell		1, 2, 3, 4, 5, 6	Cell1	
T1 end condition	Active cell			Cell1	During T1 period the UE reselects to cell 1
	Neighbour cell			Cell2	
T3 end condition	Active cell		1, 2, 3, 4, 5, 6	Cell2	The UE shall perform reselection to cell 2 during T3
	Neighbour cell		1, 2, 3, 4, 5, 6	Cell1	
RF Channel Number			1, 2, 3, 4, 5, 6	1, 2	E-UTRAN radio channel (1) and NR radio channel (2) are used for this test
Time offset between cells			1, 4	3 ms	Asynchronous cells
			2, 5	3 μ s	Synchronous cells
			3, 6	3 μ s	Synchronous cells
Access Barring Information		-	1, 2, 3, 4, 5, 6	Not Sent	No additional delays in random access procedure.
DRX cycle length		s	1, 2, 3, 4, 5, 6	1.28	The value shall be used for all cells in the test.
NR PRACH configuration index			1, 2, 3, 4, 5, 6	102	The detailed configuration is specified in TS 38.211 clause 6.3.3.2
T1		s	1, 2, 3, 4, 5, 6	15	T1 needs to be defined so that cell re-selection reaction time is taken into account.

T2	s	1, 2, 3, 4, 5, 6	>7	During T2, cell 2 shall be powered off, and during the off time the physical cell identity shall be changed. The intention is to ensure that cell 2 has not been detected by the UE prior to the start of period T3.
T3	s	1, 2, 3, 4, 5, 6	75	T3 needs to be defined so that cell re-selection reaction time is taken into account.

Table A.8.2.1.1-3: Cell specific test parameters for NR cell 2

Parameter	Unit	Test configuration	Cell 2		
			T1	T2	T3
TDD configuration		1, 4	N/A		
		2, 5	TDDConf.1.1		
		3, 6	TDDConf.2.1		
PDSCH Reference measurement channel		1, 4	SR.1.1 FDD		
		2, 5	SR.1.1 TDD		
		3, 6	SR.2.1 TDD		
RMSI CORESET Reference Channel		1, 4	CR.1.1 FDD		
		2, 5	CR.1.1 TDD		
		3, 6	CR.2.1 TDD		
RMC CORESET Reference Channel		1, 4	CCR.1.1 FDD		
		2, 5	CCR.1.1 TDD		
		3, 6	CCR.2.1 TDD		
OCNG Patterns		1, 2, 3, 4, 5, 6	OP.1		
SMTc configuration		1, 2, 3, 4, 5, 6	SMTc.1		
SSB configuration		1, 4	SSB.1 FR1		
		2, 5	SSB.1 FR1		
		3, 6	SSB.2 FR1		
Initial DL BWP configuration		1, 2, 3, 4, 5, 6	DLBWP.0.1		
Initial UL BWP configuration		1, 2, 3, 4, 5, 6	ULBWP.0.1		
RLM-RS		1, 2, 3, 4, 5, 6	SSB		
Qrxlevmin	dBm/SCS	1, 2, 4, 5	-140		
		3, 6	-137		
Pcompensation	dB	1, 2, 3, 4, 5, 6	0		
Qhysts	dB	1, 2, 3, 4, 5, 6	0		
Qoffsets _{s,n}	dB	1, 2, 3, 4, 5, 6	0		
Cell_selection_and_reselection_quality_measurement		1, 2, 3, 4, 5, 6	SS-RSRP		
\hat{E}_s / I_{oc}	dB	1, 4	-4	-infinity	12
		2, 5			
		3, 6			
N_{oc} ^{Note2}	dBm/SCS	1, 4	-98		
		2, 5	-98		
		3, 6	-95		
N_{oc} ^{Note2}	dBm/15 kHz	1, 4	-98		
		2, 5			
		3, 6			
\hat{E}_s / N_{oc}	dB	1, 4	-4	-infinity	12
		2, 5			
		3, 6			
SS-RSRP ^{Note3}	dBm/SCS	1, 4	-102	-infinity	-86
		2, 5	-102	-infinity	-86
		3, 6	-99	-infinity	-83

I _o	dBm/9.36 MHz	1, 4	-68.60	-70.05	-57.78
	dBm/9.36 MHz	2, 5	-68.60	-70.05	-57.78
	dBm/38.16 MHz	3, 6	-62.50	-63.95	-51.69
T _{res} selection	s	1, 2, 3, 4, 5, 6	0	0	0
S _{nonintra} searchP	dB	1, 2, 3, 4, 5, 6	50		
Thresh _{x, highP}	dB	1, 2, 3, 4, 5, 6	48		
Thresh _{serv} lowP	dB	1, 2, 3, 4, 5, 6	44		
Thresh _{x, lowP}	dB	1, 2, 3, 4, 5, 6	50		
Propagation Condition		1, 2, 3, 4, 5, 6	AWGN		
<p>Note 1: OCNG shall be used such that both cells are fully allocated and a constant total transmitted power spectral density is achieved for all OFDM symbols.</p> <p>Note 2: Interference from other cells and noise sources not specified in the test is assumed to be constant over subcarriers and time and shall be modelled as AWGN of appropriate power for N_{oc} to be fulfilled.</p> <p>Note 3: SS-RSRP levels have been derived from other parameters for information purposes. They are not settable parameters themselves.</p>					

Table A.8.2.1.1-4: Cell specific test parameters for E-UTRA cell 1

Parameter	Unit	Cell 1		
		T1	T2	T3
E-UTRA RF Channel number		1		
BW_{channel}	MHz	10		
OCNG Patterns defined in TS 36.133 [15] clause A.3.2		OP.2 TDD for test configuration 1, 2, 3; OP.2 FDD for test configuration 4, 5, 6		
PBCH_RA	dB	0		
PBCH_RB	dB			
PSS_RA	dB			
SSS_RA	dB			
PCFICH_RB	dB			
PHICH_RA	dB			
PHICH_RB	dB			
PDCCH_RA	dB			
PDCCH_RB	dB			
PDSCH_RA	dB			
PDSCH_RB	dB			
OCNG_RA ^{Note 1}	dB			
OCNG_RB ^{Note 1}	dB			
Qrxlevmin	dBm	-140		
N_{oc} ^{Note 2}	dBm/15 kHz	-98		
RSRP ^{Note 3}	dBm/15 KHz	-84	-84	-84
\hat{E}_s / I_{ot}	dB	14	14	14
\hat{E}_s / N_{oc}	dB	14	14	14
Treselection ^{EUTRAN}	S	0		
SnonintrasearchP	dB	50		
Thresh _{x, highP}	dB	48		
Thresh _{-serving, lowP}	dB	44		
Thresh _{x, lowP}	dB	50		
Propagation Condition		AWGN		
<p>Note 1: OCNG shall be used such that both cells are fully allocated and a constant total transmitted power spectral density is achieved for all OFDM symbols.</p> <p>Note 2: Interference from other cells and noise sources not specified in the test is assumed to be constant over subcarriers and time and shall be modelled as AWGN of appropriate power for N_{oc} to be fulfilled.</p> <p>Note 3: RSRP levels have been derived from other parameters for information purposes. They are not settable parameters themselves.</p>				

A.8.2.1.1.2 Test Requirements

The cell reselection delay to a higher priority NR cell is defined as the time from the beginning of time period T3, to the moment when the UE camps on cell 2, and starts to send preambles on the PRACH for sending the *RRCSetupRequest* message to perform a Registration procedure for mobility and periodic registration update on cell 2.

The cell re-selection delay to a higher priority cell shall be less than 68 s.

The rate of correct cell reselections observed during repeated tests shall be at least 90%.

NOTE: The cell re-selection delay to a higher priority cell can be expressed as: $T_{\text{higher_priority_search}} + T_{\text{evaluate, NR}} + T_{\text{SI-NR}}$, and to a lower priority cell can be expressed as: $T_{\text{evaluate, EUTRAN}} + T_{\text{SI-EUTRA}}$.

Where:

$T_{\text{higher_priority_search}}$	See clause 4.2.2 in TS 36.133 [15]
$T_{\text{evaluate, NR}}$	See Table 4.2.2.5.6-1 in clause 4.2.2.5.6 in TS 36.133 [15]
$T_{\text{SI-NR}}$	Maximum repetition period of relevant system info blocks that needs to be received by the UE to camp on a cell; 1280 ms is assumed in this test case.
$T_{\text{evaluate, EUTRAN}}$	See Table 4.2.2.5-1 in clause 4.2.2.5
$T_{\text{SI-EUTRA}}$	Maximum repetition period of relevant system info blocks that needs to be received by the UE to camp on a cell; 1280 ms is assumed in this test case.

This gives a total of 67.68 s, allow 68 s for the cell re-selection delay to a higher priority NR cell and 7.68 s for the cell re-selection delay to a lower priority cell in the test case, which we allow 8 s.

A.8.3 RRC_CONNECTED state mobility

A.8.3.1 Handover

A.8.3.1.1 E-UTRAN - NR handover in FR1

A.8.3.1.1.1 Test Purpose and Environment

This test shall verify the E-UTRAN to NR FR1 handover requirements as specified in clause 6.1.2.1 specified in clause 5.3.4 in TS 36.133 [15].

The test comprises of one E-UTRA carrier and one NR carrier. There are two cells and one cell on each carrier. Cell 1 is the E-UTRAN and Cell 2 is an inter-RAT NR neighbour cell. The test consists of three successive time periods, with time durations of T1, T2 and T3 respectively. At the start of time duration T1, the UE does not have any timing information of Cell 2. Starting T2, Cell 2 becomes detectable and the UE is expected to detect and send a measurement report. Gap pattern configuration with id #0 as specified in Table 8.1.2.1-1 of TS 36.133 [15] is configured before T2 begins to enable inter-RAT frequency monitoring.

A RRC message implying handover shall be sent to the UE during period T2 after the UE has reported Event B2. The start of T3 is the instant when the last TTI containing the RRC message implying handover is sent to the UE. The handover message shall contain Cell 2 as the target cell.

Supported test configurations are shown in table A.8.3.1.1-1. General test parameters are provided in Table A.8.3.1.1-2. Cell specific test parameters for Cell 1 and Cell 2 are provided in Tables A.8.3.1.1-3 and A.8.3.1.1-4 respectively.

Table A.8.3.1.1-1: Supported test configurations for E-UTRAN inter-RAT NR handover

Configuration	Description
1	LTE FDD, NR 15 kHz SSB SCS, 10 MHz bandwidth, FDD duplex mode
2	LTE FDD, NR 15 kHz SSB SCS, 10 MHz bandwidth, TDD duplex mode
3	LTE FDD, NR 30 kHz SSB SCS, 40 MHz bandwidth, TDD duplex mode
4	LTE TDD, NR 15 kHz SSB SCS, 10 MHz bandwidth, FDD duplex mode
5	LTE TDD, NR 15 kHz SSB SCS, 10 MHz bandwidth, TDD duplex mode
6	LTE TDD, NR 30 kHz SSB SCS, 40 MHz bandwidth, TDD duplex mode
Note:	The UE is only required to be tested in one of the supported test configurations

Table A.8.3.1.1-2: General test parameters for E-UTRAN inter-RAT NR handover

Parameter	Unit	Value	Comment
NR RF Channel Number		1	1 NR carrier frequency is used in the test

LTE RF Channel Number		2	1 E-UTRAN carrier frequency is used in the test
Initial conditions	Active cell	Cell 1	E-UTRAN cell
	Neighbouring cell	Cell 2	NR cell
Final condition	Active cell	Cell 2	
NR measurement quantity		SS-RSRP	
E-UTRAN measurement quantity		RSRP	
b2-Threshold1	dBm	-83	Absolute E-UTRAN RSRP threshold for event B2
b2-Threshold2NR	dBm	As specified in Table A.8.3.1.1-4	Absolute NR SS-RSRP threshold for event B2
Hysteresis	dB	0	
TimeToTrigger	s	0	
Filter coefficient		0	L3 filtering is not used
DRX		OFF	Non-DRX test
Access Barring Information	-	Not sent	No additional delays in random access procedure
Time offset between cells		3 ms	Asynchronous cells
Gap pattern configuration Id		0	As specified in Table 8.1.2.1-1 started before T2 starts [15]
T1	s	5	
T2	s	≤5	
T3	s	1	

Table A.8.3.1.1-3: Cell specific test parameters for E-UTRAN inter-RAT NR handover (Cell 1)

Parameter	Unit	Configuration	Cell 1		
			T1	T2	T3
RF channel number		1, 2, 3, 4, 5, 6		2	
Duplex mode		1, 2, 3	FDD		
		4, 5, 6	TDD		
TDD special subframe configuration ^{Note1}		4, 5, 6	6		
TDD uplink-downlink configuration ^{Note1}		4, 5, 6	1		
BW _{channel}	MHz	1, 2, 3, 4, 5, 6	5 MHz: N _{RB,c} = 25 10 MHz: N _{RB,c} = 50 20 MHz: N _{RB,c} = 100		
PRACH Configuration ^{Note2}		1, 2, 3	4		
		4, 5, 6	53		
PDSCH parameters: DL Reference Measurement Channel ^{Note3}		1, 2, 3	5 MHz: R.7 FDD 10 MHz: R.3 FDD 20 MHz: R.6 FDD		
		4, 5, 6	5 MHz: R.4 TDD 10 MHz: R.0 TDD 20 MHz: R.3 TDD		
PCFICH/PDCCH/PHICH parameters: DL Reference Measurement Channel ^{Note3}		1, 2, 3	5 MHz: R.11 FDD 10 MHz: R.6 FDD 20 MHz: R.10 FDD		
		4, 5, 6	5 MHz: R.11 TDD 10 MHz: R.6 TDD 20 MHz: R.10 TDD		
OCNG Patterns ^{Note3}		1, 2, 3	5 MHz: OP.20 FDD 10 MHz: OP.10 FDD 20 MHz: OP.17 FDD		
		4, 5, 6	5 MHz: OP.9 TDD 10 MHz: OP.1 TDD 20 MHz: OP.7 TDD		
PBCH_RA	dB	1, 2, 3, 4, 5, 6	0		

PBCH_RB					
PSS_RA					
SSS_RA					
PCFICH_RB					
PHICH_RA					
PHICH_RB					
PDCCH_RA					
PDCCH_RB					
PDSCH_RA					
PDSCH_RB					
OCNG_RA ^{Note4}					
OCNG_RB ^{Note4}					
N_{oc} ^{Note5}	dBm/15kHz	1, 2, 3, 4, 5, 6	-98		
\hat{E}_s/N_{oc}	dB	1, 2, 3, 4, 5, 6	7	7	7
\hat{E}_s/I_{ot} ^{Note6}	dB	1, 2, 3, 4, 5, 6	7	7	7
RSRP ^{Note6}	dBm/15kHz	1, 2, 3, 4, 5, 6	-91	-91	-91
SCH_RP ^{Note6}	dBm/15kHz	1, 2, 3, 4, 5, 6	-91	-91	-91
I_o ^{Note6}	dBm/9MHz	1, 2, 3, 4, 5, 6	-62.43	-62.43	-62.43
Propagation Condition		1, 2, 3, 4, 5, 6	AWGN		
Antenna Configuration and Correlation Matrix ^{Note7}		1, 2, 3, 4, 5, 6	1x2 Low		
<p>Note 1: Special subframe and uplink-downlink configurations are specified in table 4.2-1 in TS 36.211 [23].</p> <p>Note 2: PRACH configurations are specified in table 5.7.1-2 and table 5.7.1-3 in TS 36.211 [23].</p> <p>Note 3: DL RMCs and OCNG patterns are specified in clauses A 3.1 and A 3.2 of TS 36.133 [15] respectively.</p> <p>Note 4: OCNG shall be used such that all cells are fully allocated and a constant total transmitted power spectral density is achieved for all OFDM symbols.</p> <p>Note 5: Interference from other cells and noise sources not specified in the test is assumed to be constant over subcarriers and time and shall be modelled as AWGN of appropriate power for N_{oc} to be fulfilled.</p> <p>Note 6: \hat{E}_s/I_{ot}, RSRP, SCH_RP and I_o levels have been derived from other parameters for information purposes. They are not settable parameters themselves.</p> <p>Note 7: Propagation condition and correlation matrix are defined in clause B.2 in TS 36.101 [25].</p>					

Table A.8.3.1.1-4: Cell specific test parameters E-UTRAN inter-RAT NR handover (Cell 2)

Parameter	Unit	Configuration	Cell 2		
			T1	T2	T3
RF channel number		1, 2, 3, 4, 5, 6	1		
Duplex mode		1, 4	FDD		
		2, 3, 5, 6	TDD		
TDD Configuration		2, 5	TDDConf.1.1		
		3, 6	TDDConf.2.1		
$BW_{channel}$	MHz	1, 4	10: $N_{RB,c} = 52$ (FDD)		
		2, 5	10: $N_{RB,c} = 52$ (TDD)		
		3, 6	40: $N_{RB,c} = 106$ (TDD)		
PDSCH reference measurement channel		1, 4	SR.1.1 FDD		
		2, 5	SR.1.1 TDD		
		3, 6	SR.2.1 TDD		
CORSET reference channel		1, 4	CR.1.1 FDD		
		2, 5	CR.1.1 TDD		
		3, 6	CR.2.1 TDD		
PRACH configuration			FR1 PRACH configuration 1		
OCNG pattern ^{Note1}		1, 2, 3, 4, 5, 6	OP.1		
BWP	Initial DL BWP	1, 2, 3, 4, 5, 6	DLBWP.0.1		
	Dedicated DL BWP		DLBWP.1.1		
	Initial UL BWP		ULBWP.0.1		
	Dedicated UL BWP		ULBWP.1.1		

SMTC configuration		1, 2, 3, 4, 5, 6	SMTC.1		
SSB configuration		1, 2, 4, 5	SSB.1 FR1		
		3, 6	SSB.2 FR1		
b2-Threshold2NR	dBm	1, 2, 4, 5	-106		
		3, 6	-103		
EPRE ratio of PSS to SSS	dB	1, 2, 3, 4, 5, 6	0		
EPRE ratio of PBCH_DMRS to SSS					
EPRE ratio of PBCH to PBCH_DMRS					
EPRE ratio of PDCCH_DMRS to SSS					
EPRE ratio of PDCCH to PDCCH_DMRS					
EPRE ratio of PDSCH_DMRS to SSS					
EPRE ratio of PDSCH to PDSCH_DMRS					
EPRE ratio of OCNG DMRS to SSS					
EPRE ratio of OCNG to OCNG DMRS					
N_{oc}^{Note2}					
N_{oc}^{Note2}	dBm/SCS	1, 2, 4, 5	-98		
		3, 6	-95		
\hat{E}_s/N_{oc}	dB	1, 2, 3, 4, 5, 6	-infinity	0	0
\hat{E}_s/I_{ot}^{Note3}	dB	1, 2, 3, 4, 5, 6	-infinity	0	0
SS-RSRP ^{Note3}	dBm/SCS	1, 2, 4, 5	-infinity	-98	-98
		3, 6	-infinity	-95	-95
I_o^{Note3}	dBm/9.36 MHz	1, 2, 4, 5	-70.05	-67.04	-67.04
	dBm/38.16 MHz	3, 6	-63.96	-60.94	-60.94
Propagation condition		1, 2, 3, 4, 5, 6	AWGN		
Antenna Configuration and Correlation Matrix		1, 2, 3, 4, 5, 6	1x2 Low		
<p>Note 1: OCNG shall be used such that both cells are fully allocated and a constant total transmitted power spectral density is achieved for all OFDM symbols.</p> <p>Note 2: Interference from other cells and noise sources not specified in the test is assumed to be constant over subcarriers and time and shall be modelled as AWGN of appropriate power for N_{oc} to be fulfilled.</p> <p>Note 3: \hat{E}_s/I_{ot}, SS-RSRP, and I_o levels have been derived from other parameters for information purposes. They are not settable parameters themselves.</p>					

A.8.3.1.1.2 Test Requirements

The UE shall start to transmit the PRACH to Cell 2 less than 112 ms from the beginning of time period T3.

The rate of correct handovers observed during repeated tests shall be at least 90%.

NOTE: The handover delay can be expressed as: RRC procedure delay + $T_{interrupt}$, where:

RRC procedure delay = 50 ms and is specified in TS36.133.

$T_{interrupt}$ = 62 ms in the test; $T_{interrupt}$ is defined in TS36.133 clause 5.3.4.3.

A.8.4 Measurement procedure

A.8.4.1 E-UTRA – NR Inter-RAT SFTD Measurement Delay

A.8.4.1.1 E-UTRA – NR Inter-RAT SFTD Measurement Delay in non-DRX

A.8.4.1.1.1 Test Purpose and Environment

The purpose of this test is to partly verify that measurement reporting delay for SFTD between E-UTRA PCell and inter-RAT NR neighbour cell in FR1 is within the requirements stated in clauses 8.1.2.4.25 and 8.1.2.4.26 of TS 36.133 [15] for E-UTRA FDD and TDD, respectively, when no measurement gaps are provided and no DRX is configured.

The tests consist of a single time period of duration T1. Two carriers are used in the tests: one E-UTRA carrier with the PCell (Cell 1), and one NR carrier with the NR neighbour cell (Cell 2).

Prior to the start of time duration T1, the UE is connected to Cell 1 and configured to carry out intra-frequency measurements only. The point in time at which the UE receives, at the UE antenna connector(s), a RRC message containing a measurement configuration for SFTD measurements on RF channel 1 defines the start of time duration T1. Following the start of T1 the UE shall detect Cell 2, determine the SFN and frame time difference of Cell 2 relative to Cell 1, and send a measurement report.

The supported test configurations are listed in Table A.8.4.1.1.1-1 below. Test parameters and cell-specific parameters for the NR cell are provided in Tables A.8.4.1.1.1-2 and A.8.4.1.1.1-3 below, respectively. Cell-specific parameters for the E-UTRA cell are provided in Table A.3.7.2.1-1 in clause A.3.7.2.1.

Table A.8.4.1.1.1-1: Applicable E-UTRA and NR configurations for inter-RAT SFTD measurement delay test

Config	Description
1	LTE FDD, NR 15 kHz SSB SCS, 10 MHz bandwidth, FDD duplex mode
2	LTE FDD, NR 15 kHz SSB SCS, 10 MHz bandwidth, TDD duplex mode
3	LTE FDD, NR 30 kHz SSB SCS, 40 MHz bandwidth, TDD duplex mode
4	LTE TDD, NR 15 kHz SSB SCS, 10 MHz bandwidth, FDD duplex mode
5	LTE TDD, NR 15 kHz SSB SCS, 10 MHz bandwidth, TDD duplex mode
6	LTE TDD, NR 30 kHz SSB SCS, 40 MHz bandwidth, TDD duplex mode

Note: The UE is only required to be tested in one of the supported test configurations

Table A.8.4.1.1.1-2: Applicable E-UTRA and NR configurations for inter-RAT SFTD measurement delay test

Parameter	Unit	Test configuration	Value		Comment
			Test 1	Test 2	
E-UTRA RF Channel Number		Config 1,2,3,4,5,6	1		One E-UTRAN carrier frequencies is used.
NR RF Channel Number		Config 1,2,3,4,5,6	1		One NR FR1 carrier frequencies is used.
Active cell		Config 1,2,3,4,5,6	Cell 1		Cell 1 is on E-UTRA RF channel number 1.
Neighbour cell		Config 1,2,3,4,5,6	Cell 2		Cell 2 is on NR RF channel number 1.
SSB configuration		Config 1,4	SSB.1 FR1		As specified in clause A.3.10.1
		Config 2,5	SSB.1 FR1		As specified in clause A.3.10.1
		Config 3,6	SSB.2 FR1		As specified in clause A.3.10.1
CP length		Config 1,2,3,4,5,6	Normal		Applicable to both cells.
DRX		Config 1,2,3,4,5,6	OFF		DRX is not used

Frame time offset between serving and neighbour cells	ms	Config 1,2,3,4	3	7	Asynchronous cells. The timing of Cell 2 relative to the timing of Cell 1.
	μ s	Config 5,6	3		Synchronous cells.
SFN offset between serving and neighbour cells		Config 1,2,3,4,5,6	0	1	SFN of Cell 2 relative to SFN of Cell 1.
T1	s	Config 1,2,3,4,5,6	1		

Table A.8.4.1.1-3: Cell specific test parameters for Cell 2 in inter-RAT SFTD measurement delay test

Parameter	Unit	Test configuration	Cell 2
NR RF Channel Number		Config 1,2,3,4,5,6	1
Duplex mode		Config 1,4	FDD
		Config 2,3,5,6	TDD
BW _{channel}	MHz	Config 1,4	10: N _{RB,c} = 52
		Config 2,5	10: N _{RB,c} = 52
		Config 3,6	40: N _{RB,c} = 106
TDD configuration		Config 2,5	TDDConf.1.1
		Config 3,6	TDDConf.2.1
OCNG Pattern defined in A.3.2.1.1		Config 1,2,3,4,5,6	OP.1
SMTC configuration		Config 1,2,3,4,5,6	SMTC.1
PDSCH/PDCCH subcarrier spacing	kHz	Config 1,2,4,5	15
		Config 3,6	30
EPRE ratio of PSS to SSS	dB	Config 1,2,3,4,5,6	0
EPRE ratio of PBCH DMRS to SSS	dB		
EPRE ratio of PBCH to PBCH DMRS	dB		
EPRE ratio of OCNG DMRS to SSS ^{Note 1}	dB		
EPRE ratio of OCNG to OCNG DMRS ^{Note 1}	dB		
N _{oc} ^{Note2}	dBm/15kHz		-98
N _{oc} ^{Note2}	dBm/SCS	Config 1,2,4,5	-98
		Config 3,6	-95
SS-RSRP ^{Note 3, 4}	dBm/SCS	Config 1,2,4,5	-94
		Config 3,6	-91
\hat{E}_s/I_{ot}	dB	Config 1,2,3,4,5,6	4
\hat{E}_s/N_{oc}	dB	Config 1,2,3,4,5,6	4
I _o ^{Note 3}	dBm/9.36MHz	Config 1,2,4,5	-64.59
	dBm/38.16MHz	Config 3,6	-58.50
Propagation Condition		Config 1,2,3,4,5,6	AWGN

Note 1:	OCNG shall be used such that the cell is fully allocated and a constant total transmitted power spectral density is achieved for all OFDM symbols.
Note 2:	Interference from other cells and noise sources not specified in the test is assumed to be constant over subcarriers and time and shall be modelled as AWGN of appropriate power for N_{oc} to be fulfilled.
Note 3:	SS-RSRP and I_0 levels have been derived from other parameters for information purposes. They are not settable parameters themselves.
Note 4:	SS-RSRP minimum requirements are specified assuming independent interference and noise at each receiver antenna port.

A.8.4.1.1.2 Test Requirements

Following the start of T1, the UE shall detect Cell 2 and determine the relative time difference between Cell 1 and Cell 2. At latest at $T_{RRC_procedure_delay} + T_{measure_SFTD1}$ after the beginning of time duration T1, the UE shall send a measurement report on SFTD between Cell 1 and Cell 2.

The observed rate of successful SFTD reports in repeated tests shall be at least 90%.

NOTE: The actual overall delays measured in the test may be up to $2 \times TTI_{DCCH}$ longer than the measurement reporting delays above due to TTI insertion uncertainty of the measurement report in DCCH.

A.8.4.1.2 E-UTRA – NR Inter-RAT SFTD Measurement Delay in DRX

A.8.4.1.2.1 Test Purpose and Environment

The purpose of this test is to partly verify that measurement reporting delay for SFTD between E-UTRA PCell and inter-RAT NR neighbour cell in FR1 is within the requirements stated in clauses 8.1.2.4.25 and 8.1.2.4.26 of TS 36.133 [15] for E-UTRA FDD and TDD, respectively, when no measurement gaps are provided and DRX is configured.

The tests consist of a single time period of duration T1. Two carriers are used in the tests: one E-UTRA carrier with the PCell (Cell 1), and one NR carrier with the NR neighbour cell (Cell 2).

Prior to the start of time duration T1, the UE is connected to Cell 1 and configured to carry out intra-frequency measurements only. The point in time at which the UE receives, at the UE antenna connector(s), a RRC message containing a measurement configuration for SFTD measurements on RF channel 1 defines the start of time duration T1. Following the start of T1 the UE shall detect Cell 2, determine the SFN and frame time difference of Cell 2 relative to Cell 1, and send a measurement report.

The supported test configurations are listed in Table A.8.4.1.2.1-1 below. Test parameters are provided in Tables A.8.4.1.2.1-2 below. Cell-specific parameters for the E-UTRA and NR cells are provided in Table A.3.7.2.1-1 in clause A.3.7.2.1, and Table A.8.4.1.1.1-3 in clause A.8.4.1.1.1, respectively.

Table A.8.4.1.2.1-1: Applicable E-UTRA and NR configurations for inter-RAT SFTD measurement delay test in DRX

Config	Description
1	LTE FDD, NR 15 kHz SSB SCS, 10 MHz bandwidth, FDD duplex mode
2	LTE FDD, NR 15 kHz SSB SCS, 10 MHz bandwidth, TDD duplex mode
3	LTE FDD, NR 30 kHz SSB SCS, 40 MHz bandwidth, TDD duplex mode
4	LTE TDD, NR 15 kHz SSB SCS, 10 MHz bandwidth, FDD duplex mode
5	LTE TDD, NR 15 kHz SSB SCS, 10 MHz bandwidth, TDD duplex mode
6	LTE TDD, NR 30 kHz SSB SCS, 40 MHz bandwidth, TDD duplex mode
Note:	The UE is only required to be tested in one of the supported test configurations

Table A.8.4.1.2.1-2: Applicable E-UTRA and NR configurations for inter-RAT SFTD measurement delay test in DRX

Parameter	Unit	Test configuration	Value		Comment
			Test 1	Test 2	
E-UTRA RF Channel Number		Config 1,2,3,4,5,6	1		One E-UTRAN carrier frequencies is used.
NR RF Channel Number		Config 1,2,3,4,5,6	1		One NR FR1 carrier frequencies is used.
Active cell		Config 1,2,3,4,5,6	Cell 1		Cell 1 is on E-UTRA RF channel number 1.
Neighbour cell		Config 1,2,3,4,5,6	Cell 2		Cell 2 is on NR RF channel number 1.
SSB configuration		Config 1,4	SSB.1 FR1		As specified in clause A.3.10.1
		Config 2,5	SSB.1 FR1		As specified in clause A.3.10.1
		Config 3,6	SSB.2 FR1		As specified in clause A.3.10.1
CP length		Config 1,2,3,4,5,6	Normal		Applicable to both cells.
DRX		Config 1,2,3,4,5,6	DRX.4		DRX configuration as specified in clause A.3.3.4
Frame time offset between serving and neighbour cells	ms	Config 1,2,4,5	3	7	Asynchronous cells. The timing of Cell 2 relative to the timing of Cell 1.
	µs	Config 3,6	3		Synchronous cells.
SFN offset between serving and neighbour cells		Config 1,2,3,4,5,6	0	1	SFN of Cell 2 relative to SFN of Cell 1.
T1	s	Config 1,2,3,4,5,6	1		

A.8.4.1.2.2 Test Requirements

Following the start of T1, the UE shall detect Cell 2 and determine the relative time difference between Cell 1 and Cell 2. At latest at the earliest DRX activity time following upon $T_{RRC_procedure_delay} + T_{measure_SFTD1}$ from the beginning of time duration T1, the UE shall send a measurement report on SFTD between Cell 1 and Cell 2.

The observed rate of successful SFTD reports in repeated tests shall be at least 90%.

NOTE: The actual overall delays measured in the test may be up to $2 \times TTI_{DCC}$ longer than the measurement reporting delays above due to TTI insertion uncertainty of the measurement report in DCC.

A.8.4.2 E-UTRA – NR Inter-RAT Measurements

A.8.4.2.1 NR Inter-RAT event triggered reporting tests for FR1 without SSB time index detection when DRX is not used

A.8.4.2.1.1 Test Purpose and Environment

The purpose of this test is to verify that the UE makes correct reporting of an event. This test will partly verify the NR inter-RAT cell search requirements in clause 8.1.2.4.21 of TS 36.133 [15] for E-UTRAN FDD-NR measurements and clause 8.1.2.4.22 of TS 36.133 [15] for E-UTRAN TDD-NR measurements.

In this test, there are two cells: E-UTRA cell 1 as PCell on E-UTRA RF channel 1 and NR cell 2 as neighbour cell in FR1 on NR RF channel 1. The test parameters are given in Tables A.8.4.2.1.1-1, A.8.4.2.1.1-2, A.8.4.2.1.1-3 and A.8.4.2.1.1-4.

Measurement gap pattern configuration is defined in Table A.8.4.2.1.1-2.

In the measurement control information, it is indicated to the UE that event-triggered reporting with Event B2 (PCell becomes worse than threshold1 and inter RAT neighbour becomes better than threshold2) [16] is used. The test consists of two successive time periods, with time duration of T1, and T2 respectively. During time duration T1, the UE shall not have any timing information of NR cell 2.

Table A.8.4.2.1.1-1: NR inter-RAT event triggered reporting tests without SSB index reading for FR1

Configuration	Description
1	LTE FDD, NR 15 kHz SSB SCS, 10 MHz bandwidth, FDD duplex mode
2	LTE FDD, NR 15 kHz SSB SCS, 10 MHz bandwidth, TDD duplex mode
3	LTE FDD, NR 30 kHz SSB SCS, 40 MHz bandwidth, TDD duplex mode
4	LTE TDD, NR 15 kHz SSB SCS, 10 MHz bandwidth, FDD duplex mode
5	LTE TDD, NR 15 kHz SSB SCS, 10 MHz bandwidth, TDD duplex mode
6	LTE TDD, NR 30 kHz SSB SCS, 40 MHz bandwidth, TDD duplex mode

Note 1: The UE is only required to be tested in one of the supported test configurations.

Table A.8.4.2.1.1-2: General test parameters for NR inter-RAT event triggered reporting for FR1 without SSB time index detection

Parameter	Unit	Test configuration	Value	Comment
E-UTRA RF Channel Number		1, 2, 3, 4, 5, 6	1	One E-UTRA carrier frequency is used.
NR RF Channel Number		1, 2, 3, 4, 5, 6	1	One FR1 NR carrier frequency is used.
Active cell		1, 2, 3, 4, 5, 6	E-UTRA cell 1 (PCell)	E-UTRA cell 1 is on E-UTRA RF channel number 1.
Neighbour cell		1, 2, 3, 4, 5, 6	NR cell 2	NR cell 2 is on NR RF channel number 1.
Gap Pattern Id		1, 2, 3, 4, 5, 6	0	As specified in clause Table 8.1.2.1-1 of TS 36.133 [15].
Measurement gap offset		1, 2, 3, 4, 5, 6	39	As specified in TS 36.331 [16].
b2-Threshold1	dBm	1, 2, 3, 4, 5, 6	Note 1	E-UTRA RSRP threshold for E-UTRA RSRP measurement on cell 1 for event B2 [16]
b2-Threshold2NR	dBm	1, 2, 3, 4, 5, 6	Note 2	SS-RSRP threshold for SS-RSRP measurement on cell 2 for event B2 [16]
Hysteresis	dB	1, 2, 3, 4, 5, 6	0	
CP length		1, 2, 3, 4, 5, 6	Normal	
TimeToTrigger	s	1, 2, 3, 4, 5, 6	0	
Filter coefficient		1, 2, 3, 4, 5, 6	0	L3 filtering is not used
DRX		1, 2, 3, 4, 5, 6	OFF	DRX is not used

Time offset between serving and neighbour cells		1, 4	3ms	Asynchronous cells. The timing of Cell 2 is 3ms later than the timing of Cell 1.
		2, 3, 5, 6	3 μ s	Synchronous cells.
T1	s	1, 2, 3, 4, 5, 6	5	
T2	s	1, 2, 3, 4, 5, 6	1	
Note 1: The value of b2-Threshold1 is defined in Table A.8.4.2.1.1-3				
Note 2: The value of b2-Threshold2NR is defined in Table A.8.4.2.1.1-4				

Table A.8.4.2.1.1-3: E-UTRAN PCell specific test parameters for NR inter-RAT event triggered reporting in non-DRX with NR neighbour cell in FR1 without SSB time index detection

Parameter	Unit	Configuration	Cell 1	
			T1	T2
RF channel number		1, 2, 3, 4, 5, 6	1	
Duplex mode		1, 2, 3	FDD	
		4, 5, 6	TDD	
TDD special subframe configuration ^{Note1}		4, 5, 6	6	
TDD uplink-downlink configuration ^{Note1}		4, 5, 6	1	
BW _{channel}	MHz	1, 2, 3, 4, 5, 6	5 MHz: N _{RB,c} = 25 10 MHz: N _{RB,c} = 50 20 MHz: N _{RB,c} = 100	
PDSCH parameters: DL Reference Measurement Channel ^{Note2}		1, 2, 3	5 MHz: R.7 FDD 10 MHz: R.3 FDD 20 MHz: R.6 FDD	
		4, 5, 6	5 MHz: R.4 TDD 10 MHz: R.0 TDD 20 MHz: R.3 TDD	
PCFICH/PDCCH/PHICH parameters: DL Reference Measurement Channel ^{Note2}		1, 2, 3	5 MHz: R.11 FDD 10 MHz: R.6 FDD 20 MHz: R.10 FDD	
		4, 5, 6	5 MHz: R.11 TDD 10 MHz: R.6 TDD 20 MHz: R.10 TDD	
OCNG Patterns ^{Note2}		1, 2, 3	5 MHz: OP.20 FDD 10 MHz: OP.10 FDD 20 MHz: OP.17 FDD	
		4, 5, 6	5 MHz: OP.9 TDD 10 MHz: OP.1 TDD 20 MHz: OP.7 TDD	
b2-Threshold1	dBm	1, 2, 3, 4, 5, 6	-79	
PBCH_RA	dB	1, 2, 3, 4, 5, 6	0	
PBCH_RB				
PSS_RA				
SSS_RA				
PCFICH_RB				
PHICH_RA				
PHICH_RB				
PDCCH_RA				
PDCCH_RB				
PDSCH_RA				
PDSCH_RB				
OCNG_RA ^{Note3}				
OCNG_RB ^{Note3}				
N _{oc} ^{Note4}				

\hat{E}_s/N_{oc}	dB	1, 2, 3, 4, 5, 6	17	17
\hat{E}_s/I_{ot} ^{Note5}	dB	1, 2, 3, 4, 5, 6	17	17
RSRP ^{Note5}	dBm/15kHz	1, 2, 3, 4, 5, 6	-87	-87
SCH_RP ^{Note5}	dBm/15kHz	1, 2, 3, 4, 5, 6	-87	-87
I_o ^{Note5}	dBm/9MHz	1, 2, 3, 4, 5, 6	$-59.13+10\log(N_{RB,c}/50)$	$-59.13+10\log(N_{RB,c}/50)$
Propagation Condition ^{Note6}		1, 2, 3, 4, 5, 6	AWGN	
Antenna Configuration and Correlation Matrix ^{Note6}		1, 2, 3, 4, 5, 6	1x2	
<p>Note 1: Special subframe and uplink-downlink configurations are specified in table 4.2-1 in TS 36.211 [23].</p> <p>Note 2: DL RMCs and OCNG patterns are specified in clauses A 3.1 and A 3.2 of TS 36.133 [15] respectively.</p> <p>Note 3: OCNG shall be used such that all cells are fully allocated and a constant total transmitted power spectral density is achieved for all OFDM symbols.</p> <p>Note 4: Interference from other cells and noise sources not specified in the test is assumed to be constant over subcarriers and time and shall be modelled as AWGN of appropriate power for N_{oc} to be fulfilled.</p> <p>Note 5: \hat{E}_s/I_{ot}, RSRP, SCH_RP and I_o levels have been derived from other parameters for information purposes. They are not settable parameters themselves.</p> <p>Note 6: Propagation condition and correlation matrix are defined in clause B.2 in TS 36.101 [25].</p>				

Table A.8.4.2.1.1-4: NR neighbour cell specific test parameters for NR inter-RAT event triggered reporting for FR1 without SSB time index detection

Parameter	Unit	Test configuration	Cell 2	
			T1	T2
NR RF Channel Number		1, 2, 3, 4, 5, 6	1	
Duplex mode		1, 4	FDD	
		2, 3, 5, 6	TDD	
TDD configuration		2, 5	TDDConf.1.1	
		3, 6	TDDConf.2.1	
$BW_{channel}$	MHz	1, 2, 4, 5	10: $N_{RB,c} = 52$	
		3, 6	40: $N_{RB,c} = 106$	
OCNG Patterns defined in A.3.2.1.1 (OP.1)		1, 2, 3, 4, 5, 6	OP.1	
SMTC configuration defined in A.3.11.1 and A.3.11.2		1, 4	SMTC.2	
		2, 3, 5, 6	SMTC.1	
PDSCH/PDCCH subcarrier spacing	kHz	1, 2, 4, 5	15	
		3, 6	30	
b2-Threshold2NR	dBm/SCS	1, 2, 4, 5	-101	
		3, 6	-98	
EPRE ratio of PSS to SSS		1, 2, 3, 4, 5, 6	0	
EPRE ratio of PBCH DMRS to SSS				
EPRE ratio of PBCH to PBCH DMRS				
EPRE ratio of PDCCH DMRS to SSS				
EPRE ratio of PDCCH to PDCCH DMRS				
EPRE ratio of PDSCH DMRS to SSS				
EPRE ratio of PDSCH to PDSCH				
EPRE ratio of OCNG DMRS to SSS (Note 1)				
EPRE ratio of OCNG to OCNG DMRS (Note 1)				
N_{oc} ^{Note2}	dBm/15kHz	1, 2, 3, 4, 5, 6	-98	
N_{oc} ^{Note2}	dBm/SCS	1, 2, 4, 5	-98	
		3, 6	-95	
SS-RSRP ^{Note3}	dBm/SCS	1, 2, 4, 5	-Infinity	-91
		3, 6	-Infinity	-88
\hat{E}_s/I_{ot}	dB	1, 2, 3, 4, 5, 6	-Infinity	7
\hat{E}_s/N_{oc}	dB	1, 2, 3, 4, 5, 6	-Infinity	7
I_o ^{Note3}	dBm/9.36MHz	1, 2, 4, 5	-70.05	-62.26

	dBm/38.16MHz z	3, 6	-63.95	-56.16
Propagation Condition		1, 2, 3, 4, 5, 6	AWGN	
Antenna Configuration and Correlation Matrix		1, 2, 3, 4, 5, 6	1x2	
Note 1:	OCNG shall be used such that the cell is fully allocated and a constant total transmitted power spectral density is achieved for all OFDM symbols.			
Note 2:	Interference from other cells and noise sources not specified in the test is assumed to be constant over subcarriers and time and shall be modelled as AWGN of appropriate power for N_{oc} to be fulfilled.			
Note 3:	SS-RSRP and I_o levels have been derived from other parameters for information purposes. They are not settable parameters themselves.			
Note 4:	SS-RSRP minimum requirements are specified assuming independent interference and noise at each receiver antenna port.			

A.8.4.2.1.2 Test Requirements

The UE shall send one Event B2 triggered measurement report, with a measurement reporting delay less than 920 ms from the beginning of time period T2. The UE shall not send event triggered measurement reports, as long as the reporting criteria are not fulfilled. The rate of correct events observed during repeated tests shall be at least 90%.

The UE is not required to report SSB time index.

NOTE: The actual overall delays measured in the test may be up to $2xTTI_{DCCH}$ higher than the measurement reporting delays above because of TTI insertion uncertainty of the measurement report in DCCH.

A.8.4.2.2 NR Inter-RAT event triggered reporting tests for FR1 without SSB time index detection when DRX is used

A.8.4.2.2.1 Test Purpose and Environment

The purpose of this test is to verify that the UE makes correct reporting of an event. This test will partly verify the NR inter-RAT cell search requirements in clause 8.1.2.4.21 of TS 36.133 [15] for E-UTRAN FDD-NR measurements and clause 8.1.2.4.22 of TS 36.133 [15] for E-UTRAN TDD-NR measurements.

In this test, there are two cells: E-UTRA cell 1 as PCell on E-UTRA RF channel 1 and NR cell 2 as neighbour cell in FR1 on NR RF channel 1. The test parameters are given in Tables A.8.4.2.2.1-1, A.8.4.2.2.1-2, A.8.4.2.2.1-3 and A.8.4.2.2.1-4.

In tests 1 and 2, measurement gap pattern configuration is defined in Table A.8.4.2.2.1-2.

In the measurement control information, it is indicated to the UE that event-triggered reporting with Event B2 (PCell becomes worse than threshold1 and inter RAT neighbour becomes better than threshold2) [16] is used. The test consists of two successive time periods, with time duration of T1, and T2 respectively. During time duration T1, the UE shall not have any timing information of NR cell 2.

Table A.8.4.2.2.1-1: NR inter-RAT event triggered reporting tests without SSB index reading for FR1

Configuration	Description
1	LTE FDD, NR 15 kHz SSB SCS, 10 MHz bandwidth, FDD duplex mode
2	LTE FDD, NR 15 kHz SSB SCS, 10 MHz bandwidth, TDD duplex mode
3	LTE FDD, NR 30 kHz SSB SCS, 40 MHz bandwidth, TDD duplex mode
4	LTE TDD, NR 15 kHz SSB SCS, 10 MHz bandwidth, FDD duplex mode
5	LTE TDD, NR 15 kHz SSB SCS, 10 MHz bandwidth, TDD duplex mode
6	LTE TDD, NR 30 kHz SSB SCS, 40 MHz bandwidth, TDD duplex mode
Note 1:	The UE is only required to be tested in one of the supported test configurations.

Table A.8.4.2.2.1-2: General test parameters for NR inter-RAT event triggered reporting for FR1 without SSB time index detection

Parameter	Unit	Test configuration	Value		Comment
			Test 1	Test 2	
E-UTRA RF Channel Number		1, 2, 3, 4, 5, 6	1		One E-UTRA carrier frequency is used.
NR RF Channel Number		1, 2, 3, 4, 5, 6	1		One FR1 NR carrier frequency is used.
Active cell		1, 2, 3, 4, 5, 6	E-UTRA cell 1 (PCell)		E-UTRA cell 1 is on E-UTRA RF channel number 1.
Neighbour cell		1, 2, 3, 4, 5, 6	NR cell 2		NR cell 2 is on NR RF channel number 1.
Gap Pattern Id		1, 2, 3, 4, 5, 6	0		As specified in clause Table 8.1.2.1-1 of TS 36.133 [15].
Measurement gap offset		1, 2, 3, 4, 5, 6	39		As specified in TS 36.331 [16].
b2-Threshold1	dBm	1, 2, 3, 4, 5, 6	Note 1		E-UTRA RSRP threshold for E-UTRA RSRP measurement on cell 1 for event B2 [16]
b2-Threshold2NR	dBm	1, 2, 3, 4, 5, 6	Note 2		SS-RSRP threshold for SS-RSRP measurement on cell 2 for event B2 [16]
Hysteresis	dB	1, 2, 3, 4, 5, 6	0		
CP length		1, 2, 3, 4, 5, 6	Normal		
TimeToTrigger	s	1, 2, 3, 4, 5, 6	0		
Filter coefficient		1, 2, 3, 4, 5, 6	0		L3 filtering is not used
DRX		1, 2, 3, 4, 5, 6	DRX.9	DRX.12	As specified in clause A.3.3
Time offset between serving and neighbour cells		1, 4	3ms		Asynchronous cells. The timing of Cell 2 is 3ms later than the timing of Cell 1.
		2, 3, 5, 6	3μs		Synchronous cells.
T1	s	1, 2, 3, 4, 5, 6	5		
T2	s	1, 2, 3, 4, 5, 6	2	11	
Note 1: The value of b2-Threshold1 is defined in Table A.8.4.2.2.1-3					
Note 2: The value of b2-Threshold2NR is defined in Table A.8.4.2.2.1-4					

Table A.8.4.2.2.1-3: E-UTRAN PCell specific test parameters for NR inter-RAT event triggered reporting in non-DRX with NR neighbour cell in FR1 without SSB time index detection

Parameter	Unit	Configuration	Cell 1	
			T1	T2
RF channel number		1, 2, 3, 4, 5, 6	1	
Duplex mode		1, 2, 3	FDD	
		4, 5, 6	TDD	
TDD special subframe configuration ^{Note1}		4, 5, 6	6	
TDD uplink-downlink configuration ^{Note1}		4, 5, 6	1	
BW _{channel}	MHz	1, 2, 3, 4, 5, 6	5 MHz: N _{RB,c} = 25 10 MHz: N _{RB,c} = 50	

PDSCH parameters: DL Reference Measurement Channel ^{Note2}		1, 2, 3	20 MHz: $N_{RB,c} = 100$ 5 MHz: R.7 FDD 10 MHz: R.3 FDD 20 MHz: R.6 FDD	
		4, 5, 6	5 MHz: R.4 TDD 10 MHz: R.0 TDD 20 MHz: R.3 TDD	
PCFICH/PDCCH/PHICH parameters: DL Reference Measurement Channel ^{Note2}		1, 2, 3	5 MHz: R.11 FDD 10 MHz: R.6 FDD 20 MHz: R.10 FDD	
		4, 5, 6	5 MHz: R.11 TDD 10 MHz: R.6 TDD 20 MHz: R.10 TDD	
OCNG Patterns ^{Note2}		1, 2, 3	5 MHz: OP.20 FDD 10 MHz: OP.10 FDD 20 MHz: OP.17 FDD	
		4, 5, 6	5 MHz: OP.9 TDD 10 MHz: OP.1 TDD 20 MHz: OP.7 TDD	
b2-Threshold1	dBm	1, 2, 3, 4, 5, 6	-77	
PBCH_RA	dB	1, 2, 3, 4, 5, 6	0	
PBCH_RB				
PSS_RA				
SSS_RA				
PCFICH_RB				
PHICH_RA				
PHICH_RB				
PDCCH_RA				
PDCCH_RB				
PDSCH_RA				
PDSCH_RB				
OCNG_RA ^{Note3}				
OCNG_RB ^{Note3}				
N_{oc} ^{Note4}				
\hat{E}_s/N_{oc}	dB	1, 2, 3, 4, 5, 6	17	17
\hat{E}_s/I_{ot} ^{Note5}	dB	1, 2, 3, 4, 5, 6	17	17
RSRP ^{Note5}	dBm/15kHz	1, 2, 3, 4, 5, 6	-87	-87
SCH_RP ^{Note5}	dBm/15kHz	1, 2, 3, 4, 5, 6	-87	-87
I_o ^{Note5}	dBm/9MHz	1, 2, 3, 4, 5, 6	$-59.13+10\log(N_{RB,c}/50)$	$-59.13+10\log(N_{RB,c}/50)$
Propagation Condition ^{Note6}		1, 2, 3, 4, 5, 6	AWGN	
Antenna Configuration and Correlation Matrix ^{Note6}		1, 2, 3, 4, 5, 6	1x2	
<p>Note 1: Special subframe and uplink-downlink configurations are specified in table 4.2-1 in TS 36.211 [23].</p> <p>Note 2: DL RMCs and OCNG patterns are specified in clauses A 3.1 and A 3.2 of TS 36.133 [15] respectively.</p> <p>Note 3: OCNG shall be used such that all cells are fully allocated and a constant total transmitted power spectral density is achieved for all OFDM symbols.</p> <p>Note 4: Interference from other cells and noise sources not specified in the test is assumed to be constant over subcarriers and time and shall be modelled as AWGN of appropriate power for N_{oc} to be fulfilled.</p> <p>Note 5: \hat{E}_s/I_{ot}, RSRP, SCH_RP and I_o levels have been derived from other parameters for information purposes. They are not settable parameters themselves.</p> <p>Note 6: Propagation condition and correlation matrix are defined in clause B.2 in TS 36.101 [25].</p>				

Table A.8.4.2.2.1-4: NR neighbour cell specific test parameters for NR inter-RAT event triggered reporting for FR1 without SSB time index detection

Parameter	Unit	Test configuration	Cell 2	
			T1	T2
NR RF Channel Number		1, 2, 3, 4, 5, 6	1	

Duplex mode		1, 4	FDD	
		2, 3, 5, 6	TDD	
TDD configuration		2, 5	TDDConf.1.1	
		3, 6	TDDConf.2.1	
BW_{channel}	MHz	1, 2, 4, 5	10: $N_{RB,c} = 52$	
		3, 6	40: $N_{RB,c} = 106$	
OCNG Patterns defined in A.3.2.1.1 (OP.1)		1, 2, 3, 4, 5, 6	OP.1	
SMTC configuration defined in A.3.11.1 and A.3.11.2		1, 4	SMTC.2	
		2, 3, 5, 6	SMTC.1	
PDSCH/PDCCH subcarrier spacing	kHz	1, 2, 4, 5	15	
		3, 6	30	
b2-Threshold2NR	dBm/SCS	1, 2, 4, 5	-101	
		3, 6	-98	
EPRE ratio of PSS to SSS		1, 2, 3, 4, 5, 6	0	
EPRE ratio of PBCH DMRS to SSS				
EPRE ratio of PBCH to PBCH DMRS				
EPRE ratio of PDCCH DMRS to SSS				
EPRE ratio of PDCCH to PDCCH DMRS				
EPRE ratio of PDSCH DMRS to SSS				
EPRE ratio of PDSCH to PDSCH				
EPRE ratio of OCNG DMRS to SSS (Note 1)				
EPRE ratio of OCNG to OCNG DMRS (Note 1)				
N_{oc} ^{Note2}	dBm/15kHz	1, 2, 3, 4, 5, 6	-98	
N_{oc} ^{Note2}	dBm/SCS	1, 2, 4, 5	-98	
		3, 6	-95	
SS-RSRP ^{Note 3}	dBm/SCS	1, 2, 4, 5	-Infinity	-91
		3, 6	-Infinity	-88
\hat{E}_s/I_{n0}	dB	1, 2, 3, 4, 5, 6	-Infinity	7
\hat{E}_s/N_{oc}	dB	1, 2, 3, 4, 5, 6	-Infinity	7
I_{0} ^{Note3}	dBm/9.36MHz	1, 2, 4, 5	-70.05	-62.26
	dBm/38.16MHz	3, 6	-63.95	-56.16
Propagation Condition		1, 2, 3, 4, 5, 6	AWGN	
Antenna Configuration and Correlation Matrix		1, 2, 3, 4, 5, 6	1x2	
<p>Note 1: OCNG shall be used such that the cell is fully allocated and a constant total transmitted power spectral density is achieved for all OFDM symbols.</p> <p>Note 2: Interference from other cells and noise sources not specified in the test is assumed to be constant over subcarriers and time and shall be modelled as AWGN of appropriate power for N_{oc} to be fulfilled.</p> <p>Note 3: SS-RSRP and I_0 levels have been derived from other parameters for information purposes. They are not settable parameters themselves.</p> <p>Note 4: SS-RSRP minimum requirements are specified assuming independent interference and noise at each receiver antenna port.</p>				

A.8.4.2.2.2 Test Requirements

In test 1 with per-UE gap, the UE shall send one Event B2 triggered measurement report, with a measurement reporting delay less than 1080 ms from the beginning of time period T2. The UE shall not send event triggered measurement reports, as long as the reporting criteria are not fulfilled. The rate of correct events observed during repeated tests shall be at least 90%.

In test 2 with per-UE gap, the UE shall send one Event B2 triggered measurement report, with a measurement reporting delay less than 10240 ms from the beginning of time period T2. The UE shall not send event triggered measurement reports, as long as the reporting criteria are not fulfilled. The rate of correct events observed during repeated tests shall be at least 90%.

In tests 1 and 2, the UE is not required to report SSB time index.

NOTE: The actual overall delays measured in the test may be up to $2 \times TTI_{DCCH}$ higher than the measurement reporting delays above because of TTI insertion uncertainty of the measurement report in DCCH.

A.8.4.2.3 NR Inter-RAT event triggered reporting tests for FR1 with SSB time index detection when DRX is not used

A.8.4.2.3.1 Test Purpose and Environment

The purpose of this test is to verify that the UE makes correct reporting of an event. This test will partly verify the NR inter-RAT cell search requirements in clause 8.1.2.4.21 of TS 36.133 [15] for E-UTRAN FDD-NR measurements and clause 8.1.2.4.22 of TS 36.133 [15] for E-UTRAN TDD-NR measurements.

In this test, there are two cells: E-UTRA cell 1 as PCell on E-UTRA RF channel 1 and NR cell 2 as neighbour cell in FR1 on NR RF channel 1. The test parameters are given in Tables A.8.4.2.3.1-1, A.8.4.2.3.1-2, A.8.4.2.3.1-3 and A.8.4.2.3.1-4.

Measurement gap pattern configuration is defined in Table A.8.4.2.3.1-2.

In the measurement control information, it is indicated to the UE that event-triggered reporting with Event B2 (PCell becomes worse than threshold1 and inter RAT neighbour becomes better than threshold2) [16] is used. In the measurement configuration the UE shall be indicated to report the SSB index of the identified NR cell. The test consists of two successive time periods, with time duration of T1, and T2 respectively. During time duration T1, the UE shall not have any timing information of NR cell 2.

Table A.8.4.2.3.1-1: NR inter-RAT event triggered reporting tests without SSB index reading for FR1

Configuration	Description
1	LTE FDD, NR 15 kHz SSB SCS, 10 MHz bandwidth, FDD duplex mode
2	LTE FDD, NR 15 kHz SSB SCS, 10 MHz bandwidth, TDD duplex mode
3	LTE FDD, NR 30 kHz SSB SCS, 40 MHz bandwidth, TDD duplex mode
4	LTE TDD, NR 15 kHz SSB SCS, 10 MHz bandwidth, FDD duplex mode
5	LTE TDD, NR 15 kHz SSB SCS, 10 MHz bandwidth, TDD duplex mode
6	LTE TDD, NR 30 kHz SSB SCS, 40 MHz bandwidth, TDD duplex mode

Note 1: The UE is only required to be tested in one of the supported test configurations.

Table A.8.4.2.3.1-2: General test parameters for NR inter-RAT event triggered reporting for FR1 without SSB time index detection

Parameter	Unit	Test configuration	Value	Comment
E-UTRA RF Channel Number		1, 2, 3, 4, 5, 6	1	One E-UTRA carrier frequency is used.
NR RF Channel Number		1, 2, 3, 4, 5, 6	1	One FR1 NR carrier frequency is used.
Active cell		1, 2, 3, 4, 5, 6	E-UTRA cell 1 (PCell)	E-UTRA cell 1 is on E-UTRA RF channel number 1.
Neighbour cell		1, 2, 3, 4, 5, 6	NR cell 2	NR cell 2 is on NR RF channel number 1.
Gap Pattern Id		1, 2, 3, 4, 5, 6	0	As specified in clause Table 8.1.2.1-1 of TS 36.133 [15].
Measurement gap offset		1, 2, 3, 4, 5, 6	39	As specified in TS 36.331 [16].

b2-Threshold1	dBm	1, 2, 3, 4, 5, 6	Note 1	E-UTRA RSRP threshold for E-UTRA RSRP measurement on cell 1 for event B2 [16]
b2-Threshold2NR	dBm	1, 2, 3, 4, 5, 6	Note 2	SS-RSRP threshold for SS-RSRP measurement on cell 2 for event B2 [16]
Hysteresis	dB	1, 2, 3, 4, 5, 6	0	
CP length		1, 2, 3, 4, 5, 6	Normal	
TimeToTrigger	s	1, 2, 3, 4, 5, 6	0	
Filter coefficient		1, 2, 3, 4, 5, 6	0	L3 filtering is not used
DRX		1, 2, 3, 4, 5, 6	OFF	DRX is not used
Time offset between serving and neighbour cells		1, 4	3ms	Asynchronous cells. The timing of Cell 2 is 3 ms later than the timing of Cell 1.
		2, 3, 5, 6	3µs	Synchronous cells.
T1	s	1, 2, 3, 4, 5, 6	5	
T2	s	1, 2, 3, 4, 5, 6	2	
Note 1: The value of b2-Threshold1 is defined in Table A.8.4.2.3.1-3				
Note 2: The value of b2-Threshold2NR is defined in Table A.8.4.2.3.1-4				

Table A.8.4.2.3.1-3: E-UTRAN PCell specific test parameters for NR inter-RAT event triggered reporting in non-DRX with NR neighbour cell in FR1 without SSB time index detection

Parameter	Unit	Configuration	Cell 1	
			T1	T2
RF channel number		1, 2, 3, 4, 5, 6	1	
Duplex mode		1, 2, 3	FDD	
		4, 5, 6	TDD	
TDD special subframe configuration ^{Note1}		4, 5, 6	6	
TDD uplink-downlink configuration ^{Note1}		4, 5, 6	1	
BW _{channel}	MHz	1, 2, 3, 4, 5, 6	5 MHz: N _{RB,c} = 25 10 MHz: N _{RB,c} = 50 20 MHz: N _{RB,c} = 100	
PDSCH parameters: DL Reference Measurement Channel ^{Note2}		1, 2, 3	5 MHz: R.7 FDD 10 MHz: R.3 FDD 20 MHz: R.6 FDD	
		4, 5, 6	5 MHz: R.4 TDD 10 MHz: R.0 TDD 20 MHz: R.3 TDD	
PCFICH/PDCCH/PHICH parameters: DL Reference Measurement Channel ^{Note2}		1, 2, 3	5 MHz: R.11 FDD 10 MHz: R.6 FDD 20 MHz: R.10 FDD	
		4, 5, 6	5 MHz: R.11 TDD 10 MHz: R.6 TDD 20 MHz: R.10 TDD	
OCNG Patterns ^{Note2}		1, 2, 3	5 MHz: OP.20 FDD 10 MHz: OP.10 FDD 20 MHz: OP.17 FDD	
		4, 5, 6	5 MHz: OP.9 TDD 10 MHz: OP.1 TDD 20 MHz: OP.7 TDD	

b2-Threshold1	dBm	1, 2, 3, 4, 5, 6	-77	
PBCH_RA	dB	1, 2, 3, 4, 5, 6	0	
PBCH_RB				
PSS_RA				
SSS_RA				
PCFICH_RB				
PHICH_RA				
PHICH_RB				
PDCCH_RA				
PDCCH_RB				
PDSCH_RA				
PDSCH_RB				
OCNG_RA ^{Note3}				
OCNG_RB ^{Note3}				
N _{oc} ^{Note4}				
\bar{E}_s/N_{oc}	dB	1, 2, 3, 4, 5, 6	17	17
\bar{E}_s/I_{ot} ^{Note5}	dB	1, 2, 3, 4, 5, 6	17	17
RSRP ^{Note5}	dBm/15kHz	1, 2, 3, 4, 5, 6	-87	-87
SCH_RP ^{Note5}	dBm/15kHz	1, 2, 3, 4, 5, 6	-87	-87
I _o ^{Note5}	dBm/9MHz	1, 2, 3, 4, 5, 6	-59.13+10log (N _{RB,c} /50)	-59.13+10log (N _{RB,c} /50)
Propagation Condition ^{Note6}		1, 2, 3, 4, 5, 6	AWGN	
Antenna Configuration and Correlation Matrix ^{Note6}		1, 2, 3, 4, 5, 6	1x2	
<p>Note 1: Special subframe and uplink-downlink configurations are specified in table 4.2-1 in TS 36.211 [23].</p> <p>Note 2: DL RMCs and OCNG patterns are specified in clauses A 3.1 and A 3.2 of TS 36.133 [15] respectively.</p> <p>Note 3: OCNG shall be used such that all cells are fully allocated and a constant total transmitted power spectral density is achieved for all OFDM symbols.</p> <p>Note 4: Interference from other cells and noise sources not specified in the test is assumed to be constant over subcarriers and time and shall be modelled as AWGN of appropriate power for N_{oc} to be fulfilled.</p> <p>Note 5: \bar{E}_s/I_{ot}, RSRP, SCH_RP and I_o levels have been derived from other parameters for information purposes. They are not settable parameters themselves.</p> <p>Note 6: Propagation condition and correlation matrix are defined in clause B.2 in TS 36.101 [25].</p>				

Table A.8.4.2.3.1-4: NR neighbour cell specific test parameters for NR inter-RAT event triggered reporting for FR1 without SSB time index detection

Parameter	Unit	Test configuration	Cell 2	
			T1	T2
NR RF Channel Number		1, 2, 3, 4, 5, 6	1	
Duplex mode		1, 4	FDD	
		2, 3, 5, 6	TDD	
TDD configuration		2, 5	TDDConf.1.1	
		3, 6	TDDConf.2.1	
BW _{channel}	MHz	1, 2, 4, 5	10: N _{RB,c} = 52	
		3, 6	40: N _{RB,c} = 106	
OCNG Patterns defined in A.3.2.1.1 (OP.1)		1, 2, 3, 4, 5, 6	OP.1	
SMTC configuration defined in A.3.11.1 and A.3.11.2		1, 4	SMTC.2	
		2, 3, 5, 6	SMTC.1	
PDSCH/PDCCH subcarrier spacing	kHz	1, 2, 4, 5	15	
		3, 6	30	
b2-Threshold2NR	dBm/SCS	1, 2, 4, 5	-101	
		3, 6	-98	
EPRE ratio of PSS to SSS		1, 2, 3, 4, 5, 6	0	
EPRE ratio of PBCH DMRS to SSS				
EPRE ratio of PBCH to PBCH DMRS				
EPRE ratio of PDCCH DMRS to SSS				
EPRE ratio of PDCCH to PDCCH DMRS				

EPRE ratio of PDSCH DMRS to SSS				
EPRE ratio of PDSCH to PDSCH				
EPRE ratio of OCNG DMRS to SSS (Note 1)				
EPRE ratio of OCNG to OCNG DMRS (Note 1)				
N_{oc} ^{Note2}	dBm/15kHz	1, 2, 3, 4, 5, 6		-98
N_{oc} ^{Note2}	dBm/SCS	1, 2, 4, 5		-98
		3, 6		-95
SS-RSRP ^{Note 3}	dBm/SCS	1, 2, 4, 5	-Infinity	-91
		3, 6	-Infinity	-88
\hat{E}_s/I_n	dB	1, 2, 3, 4, 5, 6	-Infinity	7
\hat{E}_s/N_{oc}	dB	1, 2, 3, 4, 5, 6	-Infinity	7
I_o ^{Note3}	dBm/9.36MHz	1, 2, 4, 5	-70.05	-62.26
	dBm/38.16MHz	3, 6	-63.95	-56.16
Propagation Condition		1, 2, 3, 4, 5, 6		AWGN
Antenna Configuration and Correlation Matrix		1, 2, 3, 4, 5, 6		1x2
<p>Note 1: OCNG shall be used such that the cell is fully allocated and a constant total transmitted power spectral density is achieved for all OFDM symbols.</p> <p>Note 2: Interference from other cells and noise sources not specified in the test is assumed to be constant over subcarriers and time and shall be modelled as AWGN of appropriate power for N_{oc} to be fulfilled.</p> <p>Note 3: SS-RSRP and I_o levels have been derived from other parameters for information purposes. They are not settable parameters themselves.</p> <p>Note 4: SS-RSRP minimum requirements are specified assuming independent interference and noise at each receiver antenna port.</p>				

A.8.4.2.3.2 Test Requirements

The UE shall send one Event B2 triggered measurement report, with a measurement reporting delay less than 1040 ms from the beginning of time period T2. The UE shall not send event triggered measurement reports, as long as the reporting criteria are not fulfilled. The rate of correct events observed during repeated tests shall be at least 90%.

The UE is required to report SSB time index.

NOTE: The actual overall delays measured in the test may be up to $2 \times TTI_{DCCH}$ higher than the measurement reporting delays above because of TTI insertion uncertainty of the measurement report in DCCH.

A.8.4.2.4 NR Inter-RAT event triggered reporting tests for FR1 with SSB time index detection when DRX is used

A.8.4.2.4.1 Test Purpose and Environment

The purpose of this test is to verify that the UE makes correct reporting of an event. This test will partly verify the NR inter-RAT cell search requirements in clause 8.1.2.4.21 of TS 36.133 [15] for E-UTRAN FDD-NR measurements and clause 8.1.2.4.22 of TS 36.133 [15] for E-UTRAN TDD-NR measurements.

In this test, there are two cells: E-UTRA cell 1 as PCell on E-UTRA RF channel 1 and NR cell 2 as neighbour cell in FR1 on NR RF channel 1. The test parameters are given in Tables A.8.4.2.4.1-1, A.8.4.2.4.1-2, A.8.4.2.4.1-3 and A.8.4.2.4.1-4.

In tests 1 and 2, measurement gap pattern configuration is defined in Table A.8.4.2.4.1-2.

In the measurement control information, it is indicated to the UE that event-triggered reporting with Event B2 (PCell becomes worse than threshold1 and inter RAT neighbour becomes better than threshold2) [16] is used. In the measurement configuration the UE shall be indicated to report the SSB index of the identified NR cell. The test

consists of two successive time periods, with time duration of T1, and T2 respectively. During time duration T1, the UE shall not have any timing information of NR cell 2.

Table A.8.4.2.4.1-1: NR inter-RAT event triggered reporting tests without SSB index reading for FR1

Configuration	Description
1	LTE FDD, NR 15 kHz SSB SCS, 10 MHz bandwidth, FDD duplex mode
2	LTE FDD, NR 15 kHz SSB SCS, 10 MHz bandwidth, TDD duplex mode
3	LTE FDD, NR 30 kHz SSB SCS, 40 MHz bandwidth, TDD duplex mode
4	LTE TDD, NR 15 kHz SSB SCS, 10 MHz bandwidth, FDD duplex mode
5	LTE TDD, NR 15 kHz SSB SCS, 10 MHz bandwidth, TDD duplex mode
6	LTE TDD, NR 30 kHz SSB SCS, 40 MHz bandwidth, TDD duplex mode

Note 1: The UE is only required to be tested in one of the supported test configurations.

Table A.8.4.2.4.1-2: General test parameters for NR inter-RAT event triggered reporting for FR1 without SSB time index detection

Parameter	Unit	Test configuration	Value		Comment
			Test 1 Test 2	Test 3 Test 4	
E-UTRA RF Channel Number		1, 2, 3, 4, 5, 6	1		One E-UTRA carrier frequency is used.
NR RF Channel Number		1, 2, 3, 4, 5, 6	1		One FR1 NR carrier frequency is used.
Active cell		1, 2, 3, 4, 5, 6	E-UTRA cell 1 (PCell)		E-UTRA cell 1 is on E-UTRA RF channel number 1.
Neighbour cell		1, 2, 3, 4, 5, 6	NR cell 2		NR cell 2 is on NR RF channel number 1.
Gap Pattern Id		1, 2, 3, 4, 5, 6	0		As specified in clause Table 8.1.2.1-1 of TS 36.133 [15].
Measurement gap offset		1, 2, 3, 4, 5, 6	39		As specified in TS 36.331 [16].
b2-Threshold1	dBm	1, 2, 3, 4, 5, 6	Note 1		E-UTRA RSRP threshold for E-UTRA RSRP measurement on cell 1 for event B2 [16]
b2-Threshold2NR	dBm	1, 2, 3, 4, 5, 6	Note 2		SS-RSRP threshold for SS-RSRP measurement on cell 2 for event B2 [16]
Hysteresis	dB	1, 2, 3, 4, 5, 6	0		
CP length		1, 2, 3, 4, 5, 6	Normal		
TimeToTrigger	s	1, 2, 3, 4, 5, 6	0		
Filter coefficient		1, 2, 3, 4, 5, 6	0		L3 filtering is not used
DRX		1, 2, 3, 4, 5, 6	DRX.9	DRX.12	As specified in clause A.3.3
Time offset between serving and neighbour cells		1, 4	3ms		Asynchronous cells. The timing of Cell 2 is 3ms later than the timing of Cell 1.
		2, 3, 5, 6	3μs		Synchronous cells.
T1	s	1, 2, 3, 4, 5, 6	5		
T2	s	1, 2, 3, 4, 5, 6	2	13	

Note 1: The value of b2-Threshold1 is defined in Table A.8.4.2.4.1-3
Note 2: The value of b2-Threshold2NR is defined in Table A.8.4.2.4.1-4

Table A.8.4.2.4.1-3: E-UTRAN PCell specific test parameters for NR inter-RAT event triggered reporting in non-DRX with NR neighbour cell in FR1 without SSB time index detection

Parameter	Unit	Configuration	Cell 1	
			T1	T2
RF channel number		1, 2, 3, 4, 5, 6	1	
Duplex mode		1, 2, 3	FDD	
		4, 5, 6	TDD	
TDD special subframe configuration ^{Note1}		4, 5, 6	6	
TDD uplink-downlink configuration ^{Note1}		4, 5, 6	1	
BW _{channel}	MHz	1, 2, 3, 4, 5, 6	5 MHz: N _{RB,c} = 25 10 MHz: N _{RB,c} = 50 20 MHz: N _{RB,c} = 100	
PDSCH parameters: DL Reference Measurement Channel ^{Note2}		1, 2, 3	5 MHz: R.7 FDD 10 MHz: R.3 FDD 20 MHz: R.6 FDD	
		4, 5, 6	5 MHz: R.4 TDD 10 MHz: R.0 TDD 20 MHz: R.3 TDD	
PCFICH/PDCCH/PHICH parameters: DL Reference Measurement Channel ^{Note2}		1, 2, 3	5 MHz: R.11 FDD 10 MHz: R.6 FDD 20 MHz: R.10 FDD	
		4, 5, 6	5 MHz: R.11 TDD 10 MHz: R.6 TDD 20 MHz: R.10 TDD	
OCNG Patterns ^{Note2}		1, 2, 3	5 MHz: OP.20 FDD 10 MHz: OP.10 FDD 20 MHz: OP.17 FDD	
		4, 5, 6	5 MHz: OP.9 TDD 10 MHz: OP.1 TDD 20 MHz: OP.7 TDD	
b2-Threshold1	dBm	1, 2, 3, 4, 5, 6	-77	
PBCH_RA	dB	1, 2, 3, 4, 5, 6	0	
PBCH_RB				
PSS_RA				
SSS_RA				
PCFICH_RB				
PHICH_RA				
PHICH_RB				
PDCCH_RA				
PDCCH_RB				
PDSCH_RA				
PDSCH_RB				
OCNG_RA ^{Note3}				
OCNG_RB ^{Note3}				
N _{oc} ^{Note4}				
\bar{E}_s/N_{oc}	dB	1, 2, 3, 4, 5, 6	17	17
\bar{E}_s/I_{ot} ^{Note5}	dB	1, 2, 3, 4, 5, 6	17	17
RSRP ^{Note5}	dBm/15kHz	1, 2, 3, 4, 5, 6	-87	-87
SCH_RP ^{Note5}	dBm/15kHz	1, 2, 3, 4, 5, 6	-87	-87
I _o ^{Note5}	dBm/9MHz	1, 2, 3, 4, 5, 6	-59.13+10log (N _{RB,c} /50)	-59.13+10log (N _{RB,c} /50)
Propagation Condition ^{Note6}		1, 2, 3, 4, 5, 6	AWGN	
Antenna Configuration and Correlation Matrix ^{Note6}		1, 2, 3, 4, 5, 6	1x2	

Note 1: Special subframe and uplink-downlink configurations are specified in table 4.2-1 in TS 36.211 [23].

Note 2:	DL RMCs and OCNG patterns are specified in clauses A 3.1 and A 3.2 of TS 36.133 [15] respectively.
Note 3:	OCNG shall be used such that all cells are fully allocated and a constant total transmitted power spectral density is achieved for all OFDM symbols.
Note 4:	Interference from other cells and noise sources not specified in the test is assumed to be constant over subcarriers and time and shall be modelled as AWGN of appropriate power for N_{oc} to be fulfilled.
Note 5:	\hat{E}_s/I_{ot} , RSRP, SCH_RP and I_o levels have been derived from other parameters for information purposes. They are not settable parameters themselves.
Note 6:	Propagation condition and correlation matrix are defined in clause B.2 in TS 36.101 [25].

Table A.8.4.2.4.1-4: NR neighbour cell specific test parameters for NR inter-RAT event triggered reporting for FR1 without SSB time index detection

Parameter	Unit	Test configuration	Cell 2	
			T1	T2
NR RF Channel Number		1, 2, 3, 4, 5, 6	1	
Duplex mode		1, 4	FDD	
TDD configuration		2, 3, 5, 6	TDD	
		2, 5	TDDConf.1.1	
$BW_{channel}$	MHz	3, 6	TDDConf.2.1	
		1, 2, 4, 5	10: $N_{RB,c} = 52$	
		3, 6	40: $N_{RB,c} = 106$	
OCNG Patterns defined in A.3.2.1.1 (OP.1)		1, 2, 3, 4, 5, 6	OP.1	
SMTC configuration defined in A.3.11.1 and A.3.11.2		1, 4	SMTC.2	
		2, 3, 5, 6	SMTC.1	
PDSCH/PDCCH subcarrier spacing	kHz	1, 2, 4, 5	15	
		3, 6	30	
b2-Threshold2NR	dBm/SCS	1, 2, 4, 5	-101	
		3, 6	-98	
EPRE ratio of PSS to SSS		1, 2, 3, 4, 5, 6	0	
EPRE ratio of PBCH DMRS to SSS				
EPRE ratio of PBCH to PBCH DMRS				
EPRE ratio of PDCCH DMRS to SSS				
EPRE ratio of PDCCH to PDCCH DMRS				
EPRE ratio of PDSCH DMRS to SSS				
EPRE ratio of PDSCH to PDSCH				
EPRE ratio of OCNG DMRS to SSS (Note 1)				
EPRE ratio of OCNG to OCNG DMRS (Note 1)				
N_{oc} ^{Note2}	dBm/15kHz	1, 2, 3, 4, 5, 6	-98	
N_{oc} ^{Note2}	dBm/SCS	1, 2, 4, 5	-98	
		3, 6	-95	
SS-RSRP ^{Note 3}	dBm/SCS	1, 2, 4, 5	-Infinity	-91
		3, 6	-Infinity	-88
\hat{E}_s/I_{tot}	dB	1, 2, 3, 4, 5, 6	-Infinity	7
\hat{E}_s/N_{oc}	dB	1, 2, 3, 4, 5, 6	-Infinity	7
I_o ^{Note3}	dBm/9.36MHz	1, 2, 4, 5	-70.05	-62.26
	dBm/38.16MHz	3, 6	-63.95	-56.16
Propagation Condition		1, 2, 3, 4, 5, 6	AWGN	
Antenna Configuration and Correlation Matrix		1, 2, 3, 4, 5, 6	1x2	

Note 1:	OCNG shall be used such that the cell is fully allocated and a constant total transmitted power spectral density is achieved for all OFDM symbols.
Note 2:	Interference from other cells and noise sources not specified in the test is assumed to be constant over subcarriers and time and shall be modelled as AWGN of appropriate power for N_{oc} to be fulfilled.
Note 3:	SS-RSRP and I_0 levels have been derived from other parameters for information purposes. They are not settable parameters themselves.
Note 4:	SS-RSRP minimum requirements are specified assuming independent interference and noise at each receiver antenna port.

A.8.4.2.4.2 Test Requirements

In test 1 with per-UE gap, the UE shall send one Event B2 triggered measurement report, with a measurement reporting delay less than 1280 ms from the beginning of time period T2. The UE shall not send event triggered measurement reports, as long as the reporting criteria are not fulfilled. The rate of correct events observed during repeated tests shall be at least 90%.

In test 2 with per-UE gap, the UE shall send one Event B2 triggered measurement report, with a measurement reporting delay less than 12160 ms from the beginning of time period T2. The UE shall not send event triggered measurement reports, as long as the reporting criteria are not fulfilled. The rate of correct events observed during repeated tests shall be at least 90%.

In tests 1 and 2, the UE is required to report SSB time index.

NOTE: The actual overall delays measured in the test may be up to $2 \times TTI_{DCCH}$ higher than the measurement reporting delays above because of TTI insertion uncertainty of the measurement report in DCCH.

A.8.4.2.5 NR Inter-RAT event triggered reporting tests for FR2 without SSB time index detection when DRX is not used

A.8.4.2.5.1 Test Purpose and Environment

The purpose of this test is to verify that the UE makes correct reporting of an event. This test will partly verify the NR inter-RAT cell search requirements in clause 8.1.2.4.21 of TS 36.133 [15] for E-UTRAN FDD-NR measurements and clause 8.1.2.4.22 of TS 36.133 [15] for E-UTRAN TDD-NR measurements.

In this test, there are two cells: E-UTRA cell 1 as PCell on E-UTRA RF channel 1 and NR cell 2 as neighbour cell in FR2 on NR RF channel 1. The test parameters are given in Tables A.8.4.2.5.1-1, A.8.4.2.5.1-2 and A.8.4.2.5.1-3.

The cell specific test parameters for E-UTRA cell 1 as PCell are defined in clause A.3.7.2.2.

Measurement gap pattern configuration defined in Table A.8.4.2.5.1-2 is provided for a UE that does not support per-FR gap, and no gap pattern (Gap Pattern Id and Measurement gap offset) is configured for a UE capable of per-FR gap.

In the measurement control information, it is indicated to the UE that event-triggered reporting with Event B1 (Inter RAT neighbour becomes better than threshold) [16] is used. The test consists of two successive time periods, with time duration of T1, and T2 respectively. During time duration T1, the UE shall not have timing information of NR cell 2.

Table A.8.4.2.5.1-1: NR inter-RAT event triggered reporting tests without SSB index reading for FR2 in non-DRX

Configuration	Description
1	LTE FDD, NR 120 kHz SSB SCS, 100 MHz bandwidth, TDD duplex mode
2	LTE TDD, NR 120 kHz SSB SCS, 100 MHz bandwidth, TDD duplex mode

Note 1: The UE is only required to be tested in one of the supported test configurations.

Table A.8.4.2.5.1-2: General test parameters for NR inter-RAT event triggered reporting for FR2 without SSB time index detection in non-DRX

Parameter	Unit	Test configuration	Value	Comment
E-UTRA RF Channel Number		1, 2	1	One E-UTRA carrier frequency is used.
NR RF Channel Number		1, 2	1	One FR2 NR carrier frequency is used.
Active cell		1, 2	E-UTRA cell 1 (PCell)	E-UTRA cell 1 is on E-UTRA RF channel number 1 as defined in clause A.3.7.2.2.
Neighbour cell		1, 2	NR cell 2	NR cell 2 is on NR RF channel number 1.
Gap Pattern Id		1, 2	0	As specified in clause Table 8.1.2.1-1 of TS 36.133 [15].
Measurement gap offset		1, 2	39	As specified in TS 36.331 [16].
b1-ThresholdNR	dBm	1, 2	Note 1	SS-RSRP threshold for SS-RSRP measurement on cell 2 for event B1 [16]
Hysteresis	dB	1, 2	0	
CP length		1, 2	Normal	
TimeToTrigger	s	1, 2	0	
Filter coefficient		1, 2	0	L3 filtering is not used
DRX		1, 2	OFF	DRX is not used
Time offset between serving and neighbour cells		1	3ms	Asynchronous cells. The timing of Cell 2 is 3ms later than the timing of Cell 1.
		2	3µs	Synchronous cells.
T1	s	1, 2	10	
T2	s	1, 2	6	

Note 1: The value of b1-ThresholdNR is defined in Table A.8.4.2.5.1-3

Table A.8.4.2.5.1-3: NR neighbour cell specific test parameters for NR inter-RAT event triggered reporting for FR2 without SSB time index detection in non-DRX

Parameter	Unit	Test configuration	Cell 2	
			T1	T2
AoA setup defined in A.3.15.2.1		1, 2	Setup 2a	
Assumption for UE beams ^{Note 5}		1, 2	Rough	
NR RF Channel Number		1, 2	1	
Duplex mode		1, 2	TDD	
TDD configuration		1, 2	TDDConf.3.1	
BW _{channel}	MHz	1, 2	100: N _{RB,c} = 24	
OCNG patterns defined in A.3.2.1.3		1, 2	OP.3	
SMTC configuration defined in A.3.11.1 and A.3.11.2		1	SMTC.2	
		2	SMTC.1	
PDSCH/PDCCH subcarrier spacing	kHz	1, 2	120	
b1-ThresholdNR	UE power class 3 dBm/SCS	1, 2	-112	
EPRE ratio of PSS to SSS		1, 2	0	
EPRE ratio of PBCH DMRS to SSS				
EPRE ratio of PBCH to PBCH DMRS				
EPRE ratio of PDCCH DMRS to SSS				
EPRE ratio of PDCCH to PDCCH DMRS				
EPRE ratio of PDSCH DMRS to SSS				
EPRE ratio of PDSCH to PDSCH				

EPRE ratio of OCNG DMRS to SSS (Note 1)				
EPRE ratio of OCNG to OCNG DMRS (Note 1)				
\hat{E}_s	dBm/SCS	1, 2	-Infinity	-80.6
SSB-RP ^{Note 3}	dBm/SCS	1, 2	-Infinity	-80.6
\hat{E}_s/I_{BB} ^{Note 6}	dB	1, 2	-Infinity	8.3
I_o ^{Note 3}	dBm/95.04MHz z	1, 2	-Infinity	-56.0
Propagation Condition		1, 2	AWGN	
<p>Note 1: OCNG shall be used such that a constant total transmitted power spectral density is achieved for all OFDM symbols.</p> <p>Note 2: Void</p> <p>Note 3: SSB-RP and I_o levels have been derived from other parameters for information purposes. They are not settable parameters themselves.</p> <p>Note 4: Void</p> <p>Note 5: Information about types of UE beam is given in B.2.1.3, and does not limit UE implementation or test system implementation</p> <p>Note 6: Calculation of E_s/I_{BB} includes the effect of UE internal noise up to the value assumed for the associated Refsens requirement in clause 7.3.2 of TS 36.101-2 [19], and an allowance of 1dB for UE multi-band relaxation factor ΔMB_P from TS 38.101-2 [19] Table 6.2.1.3-4.</p>				

A.8.4.2.5.2 Test Requirements

The UE shall send one Event B1 triggered measurement report, with a measurement reporting delay less than D1 ms and D2 ms from the beginning of time period T2 for a UE incapable of per-FR gap and for a UE capable of per-FR gap, respectively. The UE shall not send event triggered measurement reports, as long as the reporting criteria are not fulfilled. The rate of correct events observed during repeated tests shall be at least 90%.

The UE is not required to report SSB time index.

Table A.8.4.2.5.2-1: Test requirements for NR inter-RAT event triggered reporting for FR2 without SSB time index detection in non-DRX

Test case	Measurement reporting delay (ms)	
	D1 ms	D2 ms
UE power class 3	3200	1600

NOTE: The actual overall delays measured in the test may be up to $2xTTI_{\text{DCCH}}$ higher than the measurement reporting delays above because of TTI insertion uncertainty of the measurement report in DCCH.

A.8.4.2.6 NR Inter-RAT event triggered reporting tests for FR2 without SSB time index detection when DRX is used

A.8.4.2.6.1 Test Purpose and Environment

The purpose of this test is to verify that the UE makes correct reporting of an event. This test will partly verify the NR inter-RAT cell search requirements in clause 8.1.2.4.21 of TS 36.133 [15] for E-UTRAN FDD-NR measurements and clause 8.1.2.4.22 of TS 36.133 [15] for E-UTRAN TDD-NR measurements.

In this test, there are two cells: E-UTRA cell 1 as PCell on E-UTRA RF channel 1 and NR cell 2 as neighbour cell in FR2 on NR RF channel 1. The test parameters are given in Tables A.8.4.2.6.1-1, A.8.4.2.6.1-2 and A.8.4.2.6.1-3.

The cell specific test parameters for E-UTRA cell1 as PCell are defined in clause A.3.7.2.2.

Measurement gap pattern configuration defined in Table A.8.4.2.6.1-2 is provided for a UE that does not support per-FR gap, and no gap pattern (Gap Pattern Id and Measurement gap offset) is configured for a UE capable of per-FR gap.

In the measurement control information, it is indicated to the UE that event-triggered reporting with Event B1 (Inter RAT neighbour becomes better than threshold) [16] is used. The test consists of two successive time periods, with time duration of T1, and T2 respectively. During time duration T1, the UE shall not have timing information of NR cell 2.

Table A.8.4.2.6.1-1: NR inter-RAT event triggered reporting tests without SSB index reading for FR2 in DRX

Configuration	Description
1	LTE FDD, NR 120 kHz SSB SCS, 100 MHz bandwidth, TDD duplex mode
2	LTE TDD, NR 120 kHz SSB SCS, 100 MHz bandwidth, TDD duplex mode

Note 1: The UE is only required to be tested in one of the supported test configurations.

Table A.8.4.2.6.1-2: General test parameters for NR inter-RAT event triggered reporting for FR2 without SSB time index detection in DRX

Parameter	Unit	Test configuration	Value		Comment
			Test 1	Test 2	
E-UTRA RF Channel Number		1, 2	1		One E-UTRA carrier frequency is used.
NR RF Channel Number		1, 2	1		One FR2 NR carrier frequency is used.
Active cell		1, 2, 3, 4, 5, 6	E-UTRA cell 1 (PCell)		E-UTRA cell 1 is on E-UTRA RF channel number 1 as defined in clause A.3.7.2.2.
Neighbour cell		1, 2, 3, 4, 5, 6	NR cell 2		NR cell 2 is on NR RF channel number 1.
Gap Pattern Id		1, 2, 3, 4, 5, 6	0		As specified in clause Table 8.1.2.1-1 of TS 36.133 [15].
Measurement gap offset		1, 2, 3, 4, 5, 6	39		As specified in TS 36.331 [16].
b1-ThresholdNR	dBm	1, 2	Note 1		SS-RSRP threshold for SS-RSRP measurement on cell 2 for event B1 [16]
Hysteresis	dB	1, 2, 3, 4, 5, 6	0		
CP length		1, 2, 3, 4, 5, 6	Normal		
TimeToTrigger	s	1, 2, 3, 4, 5, 6	0		
Filter coefficient		1, 2, 3, 4, 5, 6	0		L3 filtering is not used
DRX		1, 2, 3, 4, 5, 6	DRX.9	DRX.12	As specified in clause A.3.3
Time offset between serving and neighbour cells		1	3ms		Asynchronous cells. The timing of Cell 2 is 3ms later than the timing of Cell 1.
		2	3μs		Synchronous cells.
T1	s	1, 2, 3, 4, 5, 6	5		
T2	s	1, 2, 3, 4, 5, 6	6	83	

Note 1: The value of b1-ThresholdNR is defined in Table A.8.4.2.6.1-3

Table A.8.4.2.6.1-3: NR neighbour cell specific test parameters for NR inter-RAT event triggered reporting for FR2 without SSB time index detection in DRX

Parameter	Unit	Test configuration	Cell 2	
			T1	T2
AoA setup defined in A.3.15.1		1, 2	Setup 1	
Assumption for UE beams ^{Note 5}		1, 2	Rough	
NR RF Channel Number		1, 2	1	
Duplex mode		1, 2	TDD	
TDD configuration		1, 2	TDDConf.3.1	
BW _{channel}	MHz	1, 2	100: N _{RB,c} = 66	
OCNG patterns defined in A.3.2.1.1 (OP.1)		1, 2	OP.1	
SMTTC configuration defined in A.3.11.1 and A.3.11.2		1	SMTTC.2	
		2	SMTTC.1	
PDSCH/PDCCH subcarrier spacing	kHz	1, 2	120	
b1-ThresholdNR	UE power class 3 dBm/SCS	1, 2	-106	
EPRE ratio of PSS to SSS		1, 2	0	
EPRE ratio of PBCH DMRS to SSS				
EPRE ratio of PBCH to PBCH DMRS				
EPRE ratio of PDCCH DMRS to SSS				
EPRE ratio of PDCCH to PDCCH DMRS				
EPRE ratio of PDSCH DMRS to SSS				
EPRE ratio of PDSCH to PDSCH				
EPRE ratio of OCNG DMRS to SSS (Note 1)				
EPRE ratio of OCNG to OCNG DMRS (Note 1)				
N_{oc} ^{Note2}	dBm/15kHz	1, 2	-104.7	
N_{oc} ^{Note2}	dBm/SCS	1, 2	-95.7	
SS-RSRP ^{Note 3}	dBm/SCS	1, 2	-Infinity	-87.7
\hat{E}_s/I_{ns}	dB	1, 2	-Infinity	8
\hat{E}_s/N_{oc}	dB	1, 2	-Infinity	8
I_o ^{Note3}	dBm/95.04MHz	1, 2	-66.7	-58.0
Propagation Condition		1, 2	AWGN	
<p>Note 1: OCNG shall be used such that the cell is fully allocated and a constant total transmitted power spectral density is achieved for all OFDM symbols.</p> <p>Note 2: Interference from other cells and noise sources not specified in the test is assumed to be constant over subcarriers and time and shall be modelled as AWGN of appropriate power for N_{oc} to be fulfilled.</p> <p>Note 3: SS-RSRP and I_o levels have been derived from other parameters for information purposes. They are not settable parameters themselves.</p> <p>Note 4: SS-RSRP minimum requirements are specified assuming independent interference and noise at each receiver antenna port.</p> <p>Note 5: Information about types of UE beam is given in B.2.1.3, and does not limit UE implementation or test system implementation</p>				

A.8.4.2.6.2 Test Requirements

In test 1, the UE shall send one Event B1 triggered measurement report, with a measurement reporting delay less than D1 ms and D3 ms from the beginning of time period T2 for a UE incapable of per-FR gap and for a UE capable of per-FR gap, respectively. The UE shall not send event triggered measurement reports, as long as the reporting criteria are not fulfilled. The rate of correct events observed during repeated tests shall be at least 90%.

In test 2, the UE shall send one Event B1 triggered measurement report, with a measurement reporting delay less than D2 ms and D4 ms from the beginning of time period T2 for a UE incapable of per-FR gap and for a UE capable of per-FR gap, respectively. The UE shall not send event triggered measurement reports, as long as the reporting criteria are not fulfilled. The rate of correct events observed during repeated tests shall be at least 90%.

In tests 1 and 2, the UE is not required to report SSB time index.

Table A.8.4.2.6-1: Test requirements for NR inter-RAT event triggered reporting for FR2 without SSB time index detection in DRX

Test case	Measurement reporting delay (ms)			
	D1 ms	D2 ms	D3 ms	D4 ms
UE power class 3	4800	51200	4800	51200

NOTE: The actual overall delays measured in the test may be up to $2 \times TTI_{DCC}$ higher than the measurement reporting delays above because of TTI insertion uncertainty of the measurement report in DCC.

A.8.4.2.7 NR Inter-RAT event triggered reporting tests for FR2 with SSB time index detection when DRX is not used

A.8.4.2.7.1 Test Purpose and Environment

The purpose of this test is to verify that the UE makes correct reporting of an event. This test will partly verify the NR inter-RAT cell search requirements in clause 8.1.2.4.21 of TS 36.133 [15] for E-UTRAN FDD-NR measurements and clause 8.1.2.4.22 of TS 36.133 [15] for E-UTRAN TDD-NR measurements.

In this test, there are two cells: E-UTRA cell 1 as PCell on E-UTRA RF channel 1 and NR cell 2 as neighbour cell in FR2 on NR RF channel 1. The test parameters are given in Tables A.8.4.2.7.1-1, A.8.4.2.7.1-2 and A.8.4.2.7.1-3.

The cell specific test parameters for E-UTRA cell1 as PCell are defined in clause A.3.7.2.2.

Measurement gap pattern configuration defined in Table A.8.4.2.7.1-2 is provided for a UE that does not support per-FR gap, and no gap pattern (Gap Pattern Id and Measurement gap offset) is configured for a UE capable of per-FR gap.

In the measurement control information, it is indicated to the UE that event-triggered reporting with Event B1 (Inter RAT neighbour becomes better than threshold) [16] is used. In the measurement configuration the UE shall be indicated to report the SSB index of the identified NR cell. The test consists of two successive time periods, with time duration of T1, and T2 respectively. During time duration T1, the UE shall not have any timing information of NR cell 2.

Table A.8.4.2.7.1-1: NR inter-RAT event triggered reporting tests with SSB index reading for FR2 in non-DRX

Configuration	Description
1	LTE FDD, NR 120 kHz SSB SCS, 100 MHz bandwidth, TDD duplex mode
2	LTE TDD, NR 120 kHz SSB SCS, 100 MHz bandwidth, TDD duplex mode
Note 1: The UE is only required to be tested in one of the supported test configurations.	

Table A.8.4.2.7.1-2: General test parameters for NR inter-RAT event triggered reporting for FR2 with SSB time index detection in non-DRX

Parameter	Unit	Test configuration	Value	Comment
E-UTRA RF Channel Numbers		1, 2	1	One E-UTRA carrier frequency is used.
NR RF Channel Numbers		1, 2	1	One FR2 NR carrier frequency is used.
Active cell		1, 2	E-UTRA cell 1 (PCell)	E-UTRA cell 1 is on E-UTRA RF channel number 1 as defined in clause A.3.7.2.2.
Neighbour cell		1, 2	NR cell 2	NR cell 2 is on NR RF channel number 1.
Gap Pattern Id		1, 2	0	As specified in clause Table 8.1.2.1-1 of TS 36.133 [15].
Measurement gap offset		1, 2	39	As specified in TS 36.331 [16].
b1-ThresholdNR	dBm	1, 2	Note 1	SS-RSRP threshold for SS-RSRP measurement on cell 2 for event B1 [16]
Hysteresis	dB	1, 2	0	
CP length		1, 2	Normal	
TimeToTrigger	s	1, 2	0	
Filter coefficient		1, 2	0	L3 filtering is not used
DRX		1, 2	OFF	DRX is not used
Time offset between serving and neighbour cells		1	3ms	Asynchronous cells. The timing of Cell 2 is 3ms later than the timing of Cell 1.
		2	3µs	Synchronous cells.
T1	s	1, 2	5	
T2	s	1, 2	5	

Note 1: The value of b1-ThresholdNR is defined in Table A.8.4.2.7.1-3

Table A.8.4.2.7.1-3: NR neighbour cell specific test parameters for NR inter-RAT event triggered reporting for FR2 with SSB time index detection in non-DRX

Parameter	Unit	Test configuration	Cell 2	
			T1	T2
AoA setup defined in A.3.15.1		1, 2	Setup 1	
Assumption for UE beams ^{Note 5}		1, 2	Rough	
NR RF Channel Number		1, 2	1	
Duplex mode		1, 2	TDD	
TDD configuration		1, 2	TDDConf.3.1	
BW _{channel}	MHz	1, 2	100: N _{RB,c} = 66	
OCNG patterns defined in A.3.2.1.1		1, 2	OP.1	
SMTC configuration defined in A.3.11.1 and A.3.11.2		1	SMTC.2	
		2	SMTC.1	
PDSCH/PDCCH subcarrier spacing	kHz	1, 2	120	
b1-ThresholdNR	UE power class 3 dBm/SCS	1, 2	-106	
EPRE ratio of PSS to SSS		1, 2	0	
EPRE ratio of PBCH DMRS to SSS				
EPRE ratio of PBCH to PBCH DMRS				
EPRE ratio of PDCCH DMRS to SSS				
EPRE ratio of PDCCH to PDCCH DMRS				
EPRE ratio of PDSCH DMRS to SSS				
EPRE ratio of PDSCH to PDSCH				
EPRE ratio of OCNG DMRS to SSS (Note 1)				

EPRE ratio of OCNB to OCNB DMRS (Note 1)				
N_{oc} Note2	dBm/15kHz	1, 2	-104.7	
N_{oc} Note2	dBm/SCS	1, 2	-95.7	
SS-RSRP Note 3	dBm/SCS	1, 2	-Infinity	-87.7
\hat{E}_s/\hat{I}_{oa}	dB	1, 2	-Infinity	8
\hat{E}_s/N_{oc}	dB	1, 2	-Infinity	8
I_o Note3	dBm/95.04MH z	1, 2	-66.7	-58.0
Propagation Condition		1, 2	AWGN	
<p>Note 1: OCNB shall be used such that the cell is fully allocated and a constant total transmitted power spectral density is achieved for all OFDM symbols.</p> <p>Note 2: Interference from other cells and noise sources not specified in the test is assumed to be constant over subcarriers and time and shall be modelled as AWGN of appropriate power for N_{oc} to be fulfilled.</p> <p>Note 3: SS-RSRP and I_o levels have been derived from other parameters for information purposes. They are not settable parameters themselves.</p> <p>Note 4: SS-RSRP minimum requirements are specified assuming independent interference and noise at each receiver antenna port.</p> <p>Note 5: Information about types of UE beam is given in B.2.1.3, and does not limit UE implementation or test system implementation</p>				

A.8.4.2.7.2 Test Requirements

the UE shall send one Event B1 triggered measurement report, with a measurement reporting delay less than D1 ms and D2 ms from the beginning of time period T2 for a UE incapable of per-FR gap and for a UE capable of per-FR gap, respectively. The UE shall not send event triggered measurement reports, as long as the reporting criteria are not fulfilled. The rate of correct events observed during repeated tests shall be at least 90%.

The UE is required to report SSB time index.

NOTE: The actual overall delays measured in the test may be up to $2 \times TTI_{DCCH}$ higher than the measurement reporting delays above because of TTI insertion uncertainty of the measurement report in DCCH.

Table A.8.4.2.7.2-1: Test requirements for NR inter-RAT event triggered reporting for FR2 with SSB time index detection in non-DRX

Test case	Measurement reporting delay (ms)	
	D1 ms	D2 ms
UE power class 3	4160	2080

A.8.4.2.8 NR Inter-RAT event triggered reporting tests for FR2 with SSB time index detection when DRX is used

A.8.4.2.8.1 Test Purpose and Environment

The purpose of this test is to verify that the UE makes correct reporting of an event. This test will partly verify the NR inter-RAT cell search requirements in clause 8.1.2.4.21 of TS 36.133 [15] for E-UTRAN FDD-NR measurements and clause 8.1.2.4.22 of TS 36.133 [15] for E-UTRAN TDD-NR measurements.

In this test, there are two cells: E-UTRA cell 1 as PCell on E-UTRA RF channel 1 and NR cell 2 as neighbour cell in FR2 on NR RF channel 1. The test parameters are given in Tables A.8.4.2.8.1-1, A.8.4.2.8.1-2 and A.8.4.2.8.1-3.

The cell specific test parameters for E-UTRA cell1 as PCell are defined in clause A.3.7.2.2.

Measurement gap pattern configuration defined in Table A.8.4.2.8.1-2 is provided for a UE that does not support per-FR gap, and no gap pattern (Gap Pattern Id and Measurement gap offset) is configured for a UE capable of per-FR gap.

In the measurement control information, it is indicated to the UE that event-triggered reporting with Event B1 (Inter RAT neighbour becomes better than threshold) [16] is used. In the measurement configuration the UE shall be indicated to report the SSB index of the identified NR cell. The test consists of two successive time periods, with time duration of T1, and T2 respectively. During time duration T1, the UE shall not have any timing information of NR cell 2.

Table A.8.4.2.8.1-1: NR inter-RAT event triggered reporting tests with SSB index reading for FR2 in DRX

Configuration	Description
1	LTE FDD, NR 120 kHz SSB SCS, 100 MHz bandwidth, TDD duplex mode
2	LTE TDD, NR 120 kHz SSB SCS, 100 MHz bandwidth, TDD duplex mode
Note 1: The UE is only required to be tested in one of the supported test configurations.	

Table A.8.4.2.8.1-2: General test parameters for NR inter-RAT event triggered reporting for FR2 with SSB time index detection in DRX

Parameter	Unit	Test configuration	Value		Comment
			Test 1	Test 2	
E-UTRA RF Channel Number		1, 2	1		One E-UTRA carrier frequency is used.
NR RF Channel Number		1, 2	1		One FR2 NR carrier frequency is used.
Active cell		1, 2	E-UTRA cell 1 (PCell)		E-UTRA cell 1 is on E-UTRA RF channel number 1 as defined in clause A.3.7.2.2.
Neighbour cell		1, 2	NR cell 2		NR cell 2 is on NR RF channel number 1.
Gap Pattern Id		1, 2	0		As specified in clause Table 8.1.2.1-1 of TS 36.133 [15].
Measurement gap offset		1, 2	39		As specified in TS 36.331 [16].
b1-ThresholdNR	dBm	1, 2	Note 1		SS-RSRP threshold for SS-RSRP measurement on cell 2 for event B1 [16]
Hysteresis	dB	1, 2	0		
CP length		1, 2	Normal		
TimeToTrigger	s	1, 2	0		
Filter coefficient		1, 2	0		L3 filtering is not used
DRX			DRX.9	DRX.12	As specified in clause A.3.3
Time offset between serving and neighbour cells		1	3ms		Asynchronous cells. The timing of Cell 2 is 3ms later than the timing of Cell 1.
		2	3μs		Synchronous cells.
T1	s	1, 2	5		
T2	s	1, 2	7	70	
Note 1: The value of b1-ThresholdNR is defined in Table A.8.4.2.8.1-3					

Table A.8.4.2.8.1-3: NR neighbour cell specific test parameters for NR inter-RAT event triggered reporting for FR2 with SSB time index detection

Parameter	Unit	Test configuration	Cell 2	
			T1	T2
AoA setup defined in A.3.15.1		1, 2	Setup 1	
Assumption for UE beams ^{Note 5}		1, 2	Rough	
NR RF Channel Number		1, 2	1	
Duplex mode		1, 2	TDD	
TDD configuration		1, 2	TDDConf.3.1	
BW _{channel}	MHz	1, 2	100: N _{RB,c} = 66	
OCNG patterns defined in A.3.2.1.1		1, 2	OP.1	
SMTC configuration defined in A.3.11.1 and A.3.11.2		1	SMTC.2	
		2	SMTC.1	
PDSCH/PDCCH subcarrier spacing	kHz	1, 2	120	
b1-Threshold _{NR} UE power class 3	dBm/SCS	1, 2	-106	
EPRE ratio of PSS to SSS		1, 2	0	
EPRE ratio of PBCH DMRS to SSS				
EPRE ratio of PBCH to PBCH DMRS				
EPRE ratio of PDCCH DMRS to SSS				
EPRE ratio of PDCCH to PDCCH DMRS				
EPRE ratio of PDSCH DMRS to SSS				
EPRE ratio of PDSCH to PDSCH				
EPRE ratio of OCNG DMRS to SSS (Note 1)				
EPRE ratio of OCNG to OCNG DMRS (Note 1)				
N _{oc} ^{Note2}	dBm/15kHz			
N _{oc} ^{Note2}	dBm/SCS	1, 2	-95.7	
SS-RSRP ^{Note 3}	dBm/SCS	1, 2	-Infinity	-87.7
\hat{E}_s / I_{no}	dB	1, 2	-Infinity	8
\hat{E}_s / N_{oc}	dB	1, 2	-Infinity	8
I _o ^{Note3}	dBm/95.04MHz	1, 2	-66.7	-58.0
Propagation Condition		1, 2	AWGN	
<p>Note 1: OCNG shall be used such that the cell is fully allocated and a constant total transmitted power spectral density is achieved for all OFDM symbols.</p> <p>Note 2: Interference from other cells and noise sources not specified in the test is assumed to be constant over subcarriers and time and shall be modelled as AWGN of appropriate power for N_{oc} to be fulfilled.</p> <p>Note 3: SS-RSRP and I_o levels have been derived from other parameters for information purposes. They are not settable parameters themselves.</p> <p>Note 4: SS-RSRP minimum requirements are specified assuming independent interference and noise at each receiver antenna port.</p> <p>Note 5: Information about types of UE beam is given in B.2.1.3, and does not limit UE implementation or test system implementation</p>				

A.8.4.2.8.2 Test Requirements

In test 1, the UE shall send one Event B1 triggered measurement report, with a measurement reporting delay less than D1 ms and D3 ms from the beginning of time period T2 for a UE incapable of per-FR gap and for a UE capable of per-FR gap, respectively. The UE shall not send event triggered measurement reports, as long as the reporting criteria are not fulfilled. The rate of correct events observed during repeated tests shall be at least 90%.

In test 2, the UE shall send one Event B1 triggered measurement report, with a measurement reporting delay less than D2 ms from the beginning of time period T2 for a UE incapable of per-FR gap and for a UE capable of per-FR

gap, respectively. The UE shall not send event triggered measurement reports, as long as the reporting criteria are not fulfilled. The rate of correct events observed during repeated tests shall be at least 90%.

In tests 1 and 2, the UE is required to report SSB time index.

Table A.8.4.2.8.2-1: Test requirements for NR inter-RAT event triggered reporting for FR2 with SSB time index detection in DRX

Test case	Measurement reporting delay (ms)			
	D1 ms	D2 ms	D3 ms	D4 ms
UE power class 3	6240	66560	6240	66560

NOTE: The actual overall delays measured in the test may be up to $2 \times TTI_{DCCH}$ higher than the measurement reporting delays above because of TTI insertion uncertainty of the measurement report in DCCH.

A.8.5 Measurement performance

A.8.5.1 SFTD accuracy

A.8.5.1.1 SFTD accuracy

A.8.5.1.1.1 Test Purpose

The purpose of this set of tests is to verify that the SFTD measurement accuracy is within the specified limits. This test will verify the requirements as specified in clause 9.1.27 in TS 36.133 [15] for inter-RAT FR1 SFTD measurements.

A.8.5.1.1.2 Test Environment

Supported test configurations are shown in Table A.8.5.1.1.2-1. In this set of test cases there are two cells on different carriers. Cell 1 is E-UTRAN PCell and Cell 2 is inter-RAT NR FR1 target cell. The test parameters of cell 1 are given in clause A.8.5.1.1.2-2. The test parameters of cell 2 are given in Table A.8.5.1.1.2-3. The SFTD between PCell and target cell shall be set by the test equipment to one of the time differences in Table A.8.5.1.1.2-4.

Table A.8.5.1.1.2-1: Supported test configurations for SFTD accuracy

Configuration	Description
1	NR 15 kHz SSB SCS, 10 MHz bandwidth, FDD duplex mode, LTE FDD
2	NR 15 kHz SSB SCS, 10 MHz bandwidth, TDD duplex mode, LTE FDD
3	NR 30 kHz SSB SCS, 40 MHz bandwidth, TDD duplex mode, LTE FDD
4	NR 15 kHz SSB SCS, 10 MHz bandwidth, FDD duplex mode, LTE TDD
5	NR 15 kHz SSB SCS, 10 MHz bandwidth, TDD duplex mode, LTE TDD
6	NR 30kHz SSB SCS, 40 MHz bandwidth, TDD duplex mode, LTE TDD

Note: The UE is only required to be tested in one of the supported test configurations

Table A.8.5.1.1.2-2: Test parameters for SFTD accuracy (Cell 1)

Parameter	Unit	Test 1
E-UTRA RF Channel Number		1
Duplex mode		FDD or TDD
TDD special subframe configuration ^{Note1}		6
TDD uplink-downlink configuration ^{Note1}		1
BW _{channel}		5 MHz: $N_{RB,c} = 25$ 10 MHz: $N_{RB,c} = 50$ 20 MHz: $N_{RB,c} = 100$

PDSCH parameters: DL Reference Measurement Channel ^{Note2}		5 MHz: R.7 FDD 10 MHz: R.3 FDD 20 MHz: R.6 FDD 5 MHz: R.4 TDD 10 MHz: R.0 TDD 20 MHz: R.3 TDD
PCFICH/PDCCH/PHICH parameters: DL Reference Measurement Channel ^{Note2}		5 MHz: R.11 FDD 10 MHz: R.6 FDD 20 MHz: R.10 FDD 5 MHz: R.11 TDD 10 MHz: R.6 TDD 20 MHz: R.10 TDD
OCNG Patterns ^{Note2}		5 MHz: OP.20 FDD 10 MHz: OP.10 FDD 20 MHz: OP.17 FDD 5 MHz: OP.9 TDD 10 MHz: OP.1 TDD 20 MHz: OP.7 TDD
PBCH_RA	dB	0
PBCH_RB	dB	
PSS_RA	dB	
SSS_RA	dB	
PCFICH_RB	dB	
PHICH_RA	dB	
PHICH_RB	dB	
PDCCH_RA	dB	
PDCCH_RB	dB	
PDSCH_RA	dB	
PDSCH_RB	dB	
OCNG_RA ^{Note3}	dB	
OCNG_RB ^{Note3}	dB	
N_{oc} ^{Note4}	dBm/15 kHz	
\bar{E}_s/N_{oc}	dB	-3
\bar{E}_s/I_{ot}	dB	-3
RSRP ^{Note5}	dBm/15 kHz	-107
SCH_RP ^{Note5}	dBm/15 kHz	-107
I_o ^{Note5}	dBm/Ch BW	-74.45 +10log ($N_{RB,c} / 50$)
Propagation Condition		AWGN
Antenna Configuration		1x2
<p>Note 1: Special subframe and uplink-downlink configurations are specified in table 4.2-1 in TS 36.211 [23].</p> <p>Note 2: DL RMCs and OCNG patterns are specified in clauses A 3.1 and A 3.2 of TS 36.133 [15] respectively.</p> <p>Note 3: OCNG shall be used such that all cells are fully allocated and a constant total transmitted power spectral density is achieved for all OFDM symbols.</p> <p>Note 4: Interference from other cells and noise sources not specified in the test is assumed to be constant over subcarriers and time and shall be modelled as AWGN of appropriate power for N_{oc} to be fulfilled.</p> <p>Note 5: E_s/I_{ot}, RSRP, SCH_RP and I_o levels have been derived from other parameters for information purposes. They are not settable parameters themselves.</p>		

Table A.8.5.1.1.2-3: Test parameters for SFTD accuracy (Cell 2)

Parameter	Config	Unit	Test 1
SSB GSCN	1~6		freq1
Duplex mode	1,4		FDD
	2,5		TDD
	3,6		TDD
TDD Configuration	1,4		N/A

		2,5		TDDConf.1.1
		3,6		TDDConf.2.1
BW _{channel}		1,4	MHz	10: N _{RB,c} = 52
		2,5		10: N _{RB,c} = 52
		3,6		40: N _{RB,c} = 106
PDSCH Reference measurement channel		1,4		SR.1.1 FDD
		2,5		SR.1.1 TDD
		3,6		SR.2.1 TDD
RMSI CORESET Reference Channel		1,4		CR.1.1 FDD
		2,5		CR.1.1 TDD
		3,6		CR.2.1 TDD
RMC CORESET Reference Channel		1,4		CCR.1.1 FDD
		2,5		CCR.1.1 TDD
		3,6		CCR.2.1 TDD
SSB configuration		1,4		SSB.1 FR1
		2,5		SSB.1 FR1
		3,6		SSB.2 FR1
SMTC configuration		1~6		SMTC.1
DL BWP configuration		1~6		DLBWP.1.1
UL BWP configuration		1~6		ULBWP.1.1
OCNG Patterns		1~6		OP.1
EPRE ratio of PSS to SSS		1~6	dB	0
EPRE ratio of PBCH DMRS to SSS				
EPRE ratio of PBCH to PBCH DMRS				
EPRE ratio of PDCCH DMRS to SSS				
EPRE ratio of PDCCH to PDCCH DMRS				
EPRE ratio of PDSCH DMRS to SSS				
EPRE ratio of PDSCH to PDSCH DMRS				
EPRE ratio of OCNG DMRS to SSS ^{Note 1}				
EPRE ratio of OCNG to OCNG DMRS ^{Note 1}				
N _{oc} ^{Note2}	NR_FDD_FR1_A, NR_TDD_FR1_A ^{NOTE 5}			
	NR_FDD_FR1_B			
	NR_TDD_FR1_C			
	NR_FDD_FR1_D, NR_TDD_FR1_D			
	NR_FDD_FR1_E, NR_TDD_FR1_E			
	NR_FDD_FR1_G			
	NR_FDD_FR1_H			
	NR_FDD_FR1_A, NR_TDD_FR1_A ^{NOTE 5}			
N _{oc} ^{Note2}	NR_FDD_FR1_B	1,2,4,5	dBm/SSB SCS	-104
	NR_TDD_FR1_C			
	NR_FDD_FR1_D, NR_TDD_FR1_D			
	NR_FDD_FR1_E, NR_TDD_FR1_E			
	NR_FDD_FR1_G			
	NR_FDD_FR1_H			
	NR_FDD_FR1_A, NR_TDD_FR1_A ^{NOTE 5}			
	NR_FDD_FR1_B			
	NR_TDD_FR1_C	3,6	-101	
	NR_FDD_FR1_D, NR_TDD_FR1_D			

	NR_FDD_FR1_E, NR_TDD_FR1_E							
	NR_FDD_FR1_G NR_FDD_FR1_H							
	\hat{E}_s / I_{tot}	1~6	dB	-3				
	\hat{E}_s / N_{oc}	1~6	dB	-3				
SS-RSRP Note3	NR_FDD_FR1_A, NR_TDD_FR1_A <small>NOTE 5</small>	1,2,4,5	dBm/SCS	-107				
	NR_FDD_FR1_B							
	NR_TDD_FR1_C							
	NR_FDD_FR1_D, NR_TDD_FR1_D							
	NR_FDD_FR1_E, NR_TDD_FR1_E							
	NR_FDD_FR1_G NR_FDD_FR1_H							
	NR_FDD_FR1_A, NR_TDD_FR1_A <small>NOTE 5</small>	3,6		-104				
	NR_FDD_FR1_B							
	NR_TDD_FR1_C							
	NR_FDD_FR1_D, NR_TDD_FR1_D							
	NR_FDD_FR1_E, NR_TDD_FR1_E							
	NR_FDD_FR1_G NR_FDD_FR1_H							
	NR_FDD_FR1_A, NR_TDD_FR1_A <small>NOTE 5</small>				1,2,4,5	dBm/9.36 MHz	-74.28	
	NR_FDD_FR1_B							
NR_TDD_FR1_C								
NR_FDD_FR1_D, NR_TDD_FR1_D								
NR_FDD_FR1_E, NR_TDD_FR1_E								
NR_FDD_FR1_G NR_FDD_FR1_H								
Io <small>Note3</small>	NR_FDD_FR1_A, NR_TDD_FR1_A <small>NOTE 5</small>	3,6	dBm/38.16 MHz	-68.18				
	NR_FDD_FR1_B							
	NR_TDD_FR1_C							
	NR_FDD_FR1_D, NR_TDD_FR1_D							
	NR_FDD_FR1_E, NR_TDD_FR1_E							
	NR_FDD_FR1_G NR_FDD_FR1_H							
	Propagation condition				1~6		AWGN	
	Antenna configuration				1~6		1x2	
<p>Note 1: OCNG shall be used such that both cells are fully allocated and a constant total transmitted power spectral density is achieved for all OFDM symbols.</p> <p>Note 2: Interference from other cells and noise sources not specified in the test is assumed to be constant over subcarriers and time and shall be modelled as AWGN of appropriate power for N_{oc} to be fulfilled.</p> <p>Note 3: SS-RSRP and Io levels have been derived from other parameters for information purposes. They are not settable parameters themselves.</p> <p>Note 4: SS-RSRP minimum requirements are specified assuming independent interference and noise at each receiver antenna port.</p> <p>Note 5: The test configuration excludes support for band n51 and it is not required to run this test on band n51 in this release of the specification.</p>								

Table A.8.5.1.1.2-4: Timing offsets for SFTD accuracy test

Condition	SFN offset between PCell and PSCell	Frame boundary offset between PCell and PSCell (Ts)
1	100	-122000
2	300	-60540
3	500	1000
4	700	62540
5	900	124000

A.8.5.1.1.3 Test Requirements

The SFTD reported by the UE consists of 2 elements, SFN offset and frame boundary offset between PCell and inter-RAT NR target cell. The reported SFTD accuracy shall fulfil the requirement in clause 9.1.27 in TS 36.133 [15].

A.8.5.2 E-UTRA – NR Inter-RAT Measurement Performance requirements

A.8.5.2.1 SS-RSRP

A.8.5.2.1.1 E-UTRAN – NR inter-RAT measurements with FR1 target cell

A.8.5.2.1.1.1 Test Purpose and Environment

The purpose of this test is to verify that the SS-RSRP measurement accuracy is within the specified limits. This test will verify the requirements in clause 9.11.1 in TS 36.133 [15] for inter-RAT FR1 SS-RSRP measurements.

A.8.5.2.1.1.2 Test Parameters

Supported test configurations are shown in Table A.8.5.2.1.1.2-1. In this test case there are two cells on different carriers. Cell 1 is the E-UTRA cell which specific test parameters for this test case are specified in Table A.3.7.2.1-1. Cell 2 is the inter-RAT NR FR1 target cell. The absolute accuracy requirements of SS-RSRP inter-RAT measurement is tested by using test parameters in Table A.8.5.2.1.1.2-2.

Table A.8.5.2.1.1.2-1: SS-RSRP Inter-RAT SS-RSRP supported test configurations

Config	Description
1	LTE FDD, NR 15 kHz SSB SCS, 10 MHz bandwidth, FDD duplex mode
2	LTE FDD, NR 15 kHz SSB SCS, 10 MHz bandwidth, TDD duplex mode
3	LTE FDD, NR 30 kHz SSB SCS, 40 MHz bandwidth, TDD duplex mode
4	LTE TDD, NR 15 kHz SSB SCS, 10 MHz bandwidth, FDD duplex mode
5	LTE TDD, NR 15 kHz SSB SCS, 10 MHz bandwidth, TDD duplex mode
6	LTE TDD, NR 30 kHz SSB SCS, 40 MHz bandwidth, TDD duplex mode
Note:	The UE is only required to be tested in one of the supported test configurations

Table A.8.5.2.1.1.2-2: SS-RSRP inter-RAT test parameters

Parameter		Unit	Test 1		Test 2	
			Cell 2	Cell 2	Cell 2	Cell 2
SSB ARFCN			freq1		freq1	
Duplex mode	Config 1,4		FDD			
	Config 2,3,5,6		TDD			
TDD configuration	Config 1,4		Not Applicable			
	Config 2,5		TDDConf.1.1			
	Config 3,6		TDDConf.2.1			
Downlink initial BWP configuration			DLBWP.0.1			
Uplink initial BWP configuration			ULBWP.0.1			
DRX Cycle configuration		ms	Not Applicable			
PDSCH Reference measurement channel	Config 1,4					
	Config 2,5		-		-	
	Config 3,6					
RMSI CORESET Reference Channel	Config 1,4					
	Config 2,5		-		-	
	Config 3,6					
Dedicated CORESET Reference Channel	Config 1,4					
	Config 2,5		-		-	
	Config 3,6					
OCNG Patterns			OP.1			
SS-RSSI-Measurement			Not Applicable			
SMTC configuration			SMTC.1			
SSB configuration	Config 1,2,4,5		SSB.1 FR1			
	Config 3,6		SSB.2 FR1			
PDSCH/PDCCH subcarrier spacing	Config 1,2,4,5	kHz	15			
	Config 3,6		30			
EPRE ratio of PSS to SSS		dB	0	0	0	0
EPRE ratio of PBCH DMRS to SSS						
EPRE ratio of PBCH to PBCH DMRS						
EPRE ratio of PDCCH DMRS to SSS						
EPRE ratio of PDCCH to PDCCH DMRS						
EPRE ratio of PDSCH DMRS to SSS						
EPRE ratio of PDSCH to PDSCH						
EPRE ratio of OCNG DMRS to SSS(Note 1)						
EPRE ratio of OCNG to OCNG DMRS (Note 1)						
<i>N_{oc}</i> <small>Note2</small>	Config 1,2,3,4,5,6	NR_FDD_FR1_A	-94.65		-117	
		NR_TDD_FR1_A				
		NR_FDD_FR1_B				
		NR_TDD_FR1_C				
					-116.5	
					-116	

		NR_FDD_FR1_D			-115.5
		NR_TDD_FR1_D			-115
		NR_FDD_FR1_E			-114
		NR_TDD_FR1_E			-113.5
		NR_FDD_FR1_G			-113.5
		NR_FDD_FR1_H			-113.5
N_{oc} Note2	Config 1,2,4,5		dBm/SC S	-94.65	Same as Noc for 15kHz
	Config 3,6	NR_FDD_FR1_A		-91.65	-114
		NR_TDD_FR1_A NOTE 6			-113.5
		NR_FDD_FR1_B			-113
		NR_TDD_FR1_C			-112.5
		NR_FDD_FR1_D			-112
		NR_TDD_FR1_D			-111
		NR_FDD_FR1_E			-110.5
NR_TDD_FR1_E	-110.5				
NR_FDD_FR1_G	-110.5				
NR_FDD_FR1_H	-110.5				
\hat{E}_s / I_{at}			dB	10	-4
\hat{E}_s / N_{oc}			dB	10	-4
SS-RSRP _{Not e3}	Config 1,2,4,5	NR_FDD_FR1_A	dBm/SC S	-84.65	-121
		NR_TDD_FR1_A NOTE 6			-120.5
		NR_FDD_FR1_B			-120
		NR_TDD_FR1_C			-119.5
		NR_FDD_FR1_D			-119
		NR_TDD_FR1_D			-118
		NR_FDD_FR1_E			-117.5
		NR_TDD_FR1_E			-117.5
	NR_FDD_FR1_G	-117			
	NR_FDD_FR1_H	-117			
	Config 3,6	NR_FDD_FR1_A	-81.65	-118	
		NR_TDD_FR1_A NOTE 6		-117.5	
		NR_FDD_FR1_B		-117	
		NR_TDD_FR1_C		-116.5	
		NR_FDD_FR1_D		-116	
		NR_TDD_FR1_D		-115	
NR_FDD_FR1_E		-114.5			
NR_TDD_FR1_E		-114.5			
NR_FDD_FR1_G	-114.5				
NR_FDD_FR1_H	-114.5				
I_o Note3	Config 1,2,4,5	NR_FDD_FR1_A	dBm/ 9.36MHz	-56.28	-87.76
		NR_TDD_FR1_A NOTE 6			-87.26
		NR_FDD_FR1_B			-86.76
		NR_TDD_FR1_C			-86.26
		NR_FDD_FR1_D			-85.76
		NR_TDD_FR1_D			-84.76
		NR_FDD_FR1_E			-84.26
		NR_TDD_FR1_E			-84.26
	NR_FDD_FR1_G	-84.26			
	NR_FDD_FR1_H	-84.26			
	Config 3,6	NR_FDD_FR1_A	dBm/ 38.16MH Z	-50.19	-84.76
		NR_TDD_FR1_A NOTE 6			-84.26
		NR_FDD_FR1_B			-83.76
		NR_TDD_FR1_C			-83.26
NR_FDD_FR1_D		-83.26			
NR_TDD_FR1_D		-83.26			

		NR_TDD_FR1_D			
		NR_FDD_FR1_E			-82.76
		NR_TDD_FR1_E			
		NR_FDD_FR1_G			-81.76
		NR_FDD_FR1_H			-81.26
Propagation condition			-	AWGN	
Antenna configuration			-	1x2	
Note 1: OCNG shall be used such that both cells are fully allocated and a constant total transmitted power spectral density is achieved for all OFDM symbols.					
Note 2: Interference from other cells and noise sources not specified in the test is assumed to be constant over subcarriers and time and shall be modelled as AWGN of appropriate power for N_{oc} to be fulfilled.					
Note 3: SS-RSRP, and Io levels have been derived from other parameters for information purposes. They are not settable parameters themselves.					
Note 4: SS-RSRP minimum requirements are specified assuming independent interference and noise at each receiver antenna port.					
Note 5: NR operating band groups are as defined in clause 3.5.2.					
Note 6: The test configuration excludes support for band n51 and it is not required to run this test on band n51 in this release of the specification.					

A.8.5.2.1.1.3 Test Requirements

The SS-RSRP measurement accuracy for Cell 2 shall fulfil the requirement in clause 9.11.1 in TS 36.133 [15].

A.8.5.2.1.2 E-UTRAN – NR inter-RAT measurements with FR2 target cell

A.8.5.2.1.2.1 Test Purpose and Environment

The purpose of this test is to verify that the SS-RSRP measurement accuracy is within the specified limits. This test will verify the requirements in clause 9.11.1 in TS 36.133 [15] for inter-RAT FR2 SS-RSRP measurements.

A.8.5.2.1.2.2 Test Parameters

Supported test configurations are shown in Table A.8.5.2.1.2.2-1. In this test case there are two cells on different carriers. Absolute accuracy requirements of SS-RSRP inter-RAT measurement are tested by using test setup in Table A.8.5.2.1.2.2-2 and Table A.8.5.2.1.2.2-3. In all test cases, Cell 2 is target cell. Cell 1 is the E-UTRA cell which specific test parameters for this test case are specified in Table A.3.7.2.1-1.

Table A.8.5.2.1.2.2-1: SS-RSRP Inter-RAT SS-RSRP supported test configurations

Configuration	Description
1	LTE FDD, NR 120 kHz SSB SCS, 100 MHz bandwidth, TDD duplex mode
2	LTE TDD, NR 120 kHz SSB SCS, 100 MHz bandwidth, TDD duplex mode

Table A.8.5.2.1.2.2-2: SS-RSRP Inter-RAT general test parameters

Parameter	Unit	Test 1	Test 2
		Cell 2	Cell 2
SSB ARFCN		Freq1	freq1
Duplex mode		TDD	TDD
TDD configuration		TDDConf.3.1	TDDConf.3.1
$BW_{channel}$	MHz	100: $N_{RB,c} = 66$	100: $N_{RB,c} = 66$
Downlink initial BWP configuration		DLBWP.0.1	
Uplink initial BWP configuration		ULBWP.0.1	
DRX cycle configuration	ms	Not applicable	
PDSCH Reference measurement channel		-	-
RMSI CORESET Reference Channel		-	-
OCNG Patterns		OP.1	OP.1

SMTC configuration		SMTC.1	SMTC.1
SSB configuraiton		SSB.3 FR2	SSB.3 FR2
PDSCH/PDCCH subcarrier spacing	kHz	120	120
EPRE ratio of PSS to SSS	dB	0	0
EPRE ratio of PBCH_DMRS to SSS			
EPRE ratio of PBCH to PBCH_DMRS			
EPRE ratio of PDCCH_DMRS to SSS			
EPRE ratio of PDCCH to PDCCH_DMRS			
EPRE ratio of PDSCH_DMRS to SSS			
EPRE ratio of PDSCH to PDSCH_DMRS			
EPRE ratio of OCNG DMRS to SSS ^{Note 1}			
<p>Note 1: OCNG shall be used such that both cells are fully allocated and a constant total transmitted power spectral density is achieved for all OFDM symbols.</p> <p>Note 2: Void.</p> <p>Note 3: Void.</p> <p>Note 4: Void.</p>			

Table A.8.5.2.1.2.2-3: SS-RSRP Inter-RAT OTA related test parameters

Parameter	Unit	Test 1	Test 2
		Cell 2	Cell 2
Angle of arrival configuration		Setup 1 according to A.3.15.1	Setup 1 according to A.3.15.1
Assumption for UE beams ^{Note 10}		Rough	Rough
N_{oc} ^{Note 1}	dBm/15kHz ^{Note 4}	-105	N/A
N_{oc} ^{Note 1}	dBm/SCS ^{Note 4}	-96	N/A
E_s	dBm/SCS ^{Note 4}		(Table B.2.3-2 Rx Beam Peak +1dB) (Note 7)
\hat{E}_s / N_{oc}	dB	11	N/A
SSB_RP ^{Note 2}	dBm/SCS ^{Note 4}	-85	(Table B.2.3-2 Rx Beam Peak +1dB) (Note 7)
\hat{E}_s / I_{ot_BB} ^{Note 2, Note 9}	dB	9.97	-3.81
I_o ^{Note 2}	dBm/95.04 MHz ^{Note 4}	-55.65	(Table B.2.3-2 Rx Beam Peak +30dB) (Note 8)
<p>Note 1: Where used, interference from other cells and noise sources not specified in the test is assumed to be constant over subcarriers and time and shall be modelled as AWGN of appropriate power for N_{oc} to be fulfilled.</p> <p>Note 2: SSB_RP, E_s/I_{ot} and I_o levels have been derived from other parameters for information purposes. They are not settable parameters themselves.</p> <p>Note 3: Void</p> <p>Note 4: Equivalent power received by an antenna with 0dBi gain at the centre of the quiet zone.</p> <p>Note 5: Void</p> <p>Note 6: Void</p>			

Note 7:	SSB_RP is applied at 1dB above the minimum level specified in Table B.2.3-2 for beam peak.
Note 8:	Io is applied at $10\log_{10}(792)\text{dB}+1\text{dB}$ above the minimum level specified in Table B.2.3-2 for beam peak.
Note 9:	Calculation of $E_s/I_{ot_{BB}}$ includes the effect of UE internal noise up to the value assumed for the associated Refsens requirement in clause 7.3.2 of TS 36.101-2 [19], and an allowance of 1dB for UE multi-band relaxation factor ΔMB_P from TS 38.101-2 [19] Table 6.2.1.3-4.
Note 10:	Information about types of UE beam is given in B.2.1.3, and does not limit UE implementation or test system implementation.

A.8.5.2.1.2.3 Test Requirements

The SS-RSRP measurement accuracy for Cell 2 shall fulfil the requirement in clause 9.11.1 in TS 36.133 [15].

A.8.5.2.2 SS-RSRQ

A.8.5.2.2.1 E-UTRAN – NR inter-RAT measurements with FR1 target cell

A.8.5.2.2.1.1 Test Purpose and Environment

The purpose of this test is to verify that the SS-RSRQ measurement accuracy is within the specified limits. This test will verify the requirements in clause 9.11.2 in TS 36.133 [15] for inter-RAT FR1 SS-RSRQ measurements.

A.8.5.2.2.1.2 Test Parameters

Supported test configurations are shown in Table A.8.5.2.2.1.2-1. In this test case there are two cells on different carriers. Cell 1 is the E-UTRA cell which specific test parameters for this test case are specified in Table A.3.7.2.1-1. Cell 2 is the inter-RAT NR FR1 target cell. The absolute accuracy requirements of SS-RSRP inter-RAT measurement is tested by using test parameters in Table A.8.5.2.2.1.2-2.

Table A.8.5.2.2.1.2-1: SS-RSRQ Inter-RAT SS-RSRQ supported test configurations

Config	Description
1	LTE FDD, NR 15 kHz SSB SCS, 10 MHz bandwidth, FDD duplex mode
2	LTE FDD, NR 15 kHz SSB SCS, 10 MHz bandwidth, TDD duplex mode
3	LTE FDD, NR 30kHz SSB SCS, 40 MHz bandwidth, TDD duplex mode
4	LTE TDD, NR 15 kHz SSB SCS, 10 MHz bandwidth, FDD duplex mode
5	LTE TDD, NR 15 kHz SSB SCS, 10 MHz bandwidth, TDD duplex mode
6	LTE TDD, NR 30kHz SSB SCS, 40 MHz bandwidth, TDD duplex mode
Note:	The UE is only required to be tested in one of the supported test configurations

Table A.8.5.2.2.1.2-2: SS-RSRQ inter-RAT test parameters

Parameter		Unit	Test 1		Test 2		Test 3	
			Cell 2		Cell 2		Cell 2	
SSB ARFCN			freq1		freq1		freq1	
Duplex mode	Config 1,4		FDD					
	Config 2,3,5,6		TDD					
TDD configuration	Config 1,4		Not Applicable					
	Config 2,5		TDDConf.1.1					
	Config 3,6		TDDConf.2.1					
Downlink initial BWP configuration			DLBWP.0.1					
Uplink initial BWP configuration			ULBWP.0.1					
DRX Cycle configuration		ms	Not Applicable					
PDSCH Reference measurement channel	Config 1,4							
	Config 2,5		-		-		-	
	Config 3,6							
RMSI CORESET Reference Channel	Config 1,4							
	Config 2,5		-		-		-	
	Config 3,6							
Dedicated CORESET Reference Channel	Config 1,4							
	Config 2,5		-		-		-	
	Config 3,6							
OCNG Patterns			OP.1					
SS-RSSI-Measurement			Not Applicable					
SMTc configuration			SMTc.1					
SSB configuration	Config 1,2,4,5		SSB.1 FR1					
	Config 3,6		SSB.2 FR1					
PDSCH/PDCCH subcarrier spacing	Config 1,2,4,5	kHz	15					
	Config 3,6		30					
EPRE ratio of PSS to SSS		dB	0	0	0	0	0	0
EPRE ratio of PBCH DMRS to SSS								
EPRE ratio of PBCH to PBCH DMRS								
EPRE ratio of PDCCH DMRS to SSS								
EPRE ratio of PDCCH to PDCCH DMRS								
EPRE ratio of PDSCH DMRS to SSS								
EPRE ratio of PDSCH to PDSCH								
EPRE ratio of OCNG DMRS to SSS(Note 1)								
EPRE ratio of OCNG to OCNG DMRS (Note 1)								
N_{oc} Note2	Config 1,2,4,5							
		NR_TDD_FR1_A NOTE 6						
		NR_FDD_FR1_B						
		NR_TDD_FR1_C						
								-116
								-115.5
								-115

		NR_FDD_FR1_D NR_TDD_FR1_D				-114.5
		NR_FDD_FR1_E NR_TDD_FR1_E				-114
		NR_FDD_FR1_G				-113
		NR_FDD_FR1_H				-112.5
	Config 3,6			-86.27	-113	Same as Noc for Config 1,2,4,5
N_{oc}	Config 1,2,4,5			-80.18	-106	Same as Noc for 15kHz
	Config 3,6	NR_FDD_FR1_A NR_TDD_FR1_A NOTE 6	dBm/SC S	-83.27	-110	-113
		NR_FDD_FR1_B				-112.5
		NR_TDD_FR1_C				-112
		NR_FDD_FR1_D NR_TDD_FR1_D				-111.5
		NR_FDD_FR1_E NR_TDD_FR1_E				-111
		NR_FDD_FR1_G				-110
		NR_FDD_FR1_H				-109.5
\hat{E}_s / I_{oc}						dB
\hat{E}_s / N_{oc}			dB	-1.75	-1.75	-1.75
SS-RSRP ^{Not e3}	Config 1,2,4,5	NR_FDD_FR1_A NR_TDD_FR1_A NOTE 6	dBm/SC S	-81.93	-107.75	-117.75
		NR_FDD_FR1_B				-117.25
		NR_TDD_FR1_C				-116.75
		NR_FDD_FR1_D NR_TDD_FR1_D				-116.25
		NR_FDD_FR1_E NR_TDD_FR1_E				-115.75
		NR_FDD_FR1_G				-114.75
		NR_FDD_FR1_H				-114.25
	Config 3,6	NR_FDD_FR1_A NR_TDD_FR1_A NOTE 6				-114.75
		NR_FDD_FR1_B				-114.25
		NR_TDD_FR1_C				-113.75
		NR_FDD_FR1_D NR_TDD_FR1_D				-113.25
		NR_FDD_FR1_E NR_TDD_FR1_E				-112.75
		NR_FDD_FR1_G				-111.75
		NR_FDD_FR1_H				-111.25
SS-RSRQ ^{Note3}		NR_FDD_FR1_A NR_TDD_FR1_A NOTE 6	dB	-14.77	-40.59	-14.76
		NR_FDD_FR1_B				
		NR_TDD_FR1_C				
		NR_FDD_FR1_D NR_TDD_FR1_D				
		NR_FDD_FR1_E NR_TDD_FR1_E				
		NR_FDD_FR1_G				
		NR_FDD_FR1_H				
I_o ^{Note3}	Config 1,2,4,5	NR_FDD_FR1_A NR_TDD_FR1_A NOTE 6	dBm/ 9.36MHz	-50	-75.83	-85.83
		NR_FDD_FR1_B				-85.33

Config 3,6	NR_TDD_FR1_C	dBm/ 38.16MHz z	-50	-76.73	-84.83
	NR_FDD_FR1_D				-84.33
	NR_TDD_FR1_D				-83.83
	NR_FDD_FR1_E				-82.83
	NR_TDD_FR1_E				-82.33
	NR_FDD_FR1_G				-79.73
	NR_TDD_FR1_A NOTE 6				-79.23
	NR_FDD_FR1_B				-78.73
	NR_TDD_FR1_C				-78.23
	NR_FDD_FR1_D				-77.73
	NR_TDD_FR1_D				-76.73
	NR_FDD_FR1_E				-76.53
	NR_TDD_FR1_E				
	NR_FDD_FR1_G				
NR_TDD_FR1_H					
Propagation condition		-	AWGN		
Antenna configuration		-	1x2		
<p>Note 1: OCNG shall be used such that both cells are fully allocated and a constant total transmitted power spectral density is achieved for all OFDM symbols.</p> <p>Note 2: Interference from other cells and noise sources not specified in the test is assumed to be constant over subcarriers and time and shall be modelled as AWGN of appropriate power for N_{∞} to be fulfilled.</p> <p>Note 3: SS-RSRQ, SS-RSRP, and I_o levels have been derived from other parameters for information purposes. They are not settable parameters themselves.</p> <p>Note 4: SS-RSRQ minimum requirements are specified assuming independent interference and noise at each receiver antenna port.</p> <p>Note 5: NR operating band groups are as defined in clause 3.5.2.</p> <p>Note 6: The test configuration excludes support for band n51 and it is not required to run this test on band n51 in this release of the specification.</p>					

A.8.5.2.2.1.3 Test Requirements

The SS-RSRQ measurement accuracy for Cell 2 shall fulfil the requirement in clause 9.11.2 in TS 36.133 [15].

A.8.5.2.2.2 E-UTRAN – NR inter-RAT measurements with FR2 target cell

A.8.5.2.2.2.1 Test Purpose and Environment

The purpose of this test is to verify that the SS-RSRQ measurement accuracy is within the specified limits. This test will verify the requirements in clause 9.11.2 in TS 36.133 [15] for inter-RAT FR2 SS-RSRQ measurements.

A.8.5.2.2.2.2 Test Parameters

Supported test configurations are shown in Table A.8.5.2.2.2.2-1. In this test case there are two cells on different carriers. Absolute accuracy requirements of SS-RSRQ inter-RAT measurement are tested by using test setup in Table A.8.5.2.2.2.2-2 and Table A.8.5.2.2.2.2-3. In all test cases, Cell 2 is target cell. Cell 1 is the E-UTRA cell which specific test parameters for this test case are specified in Table A.3.7.2.1-1.

Table A.8.5.2.2.2-1: SS-RSRQ Inter-RAT SS-RSRQ supported test configurations

Configuration	Description
1	LTE FDD, NR 120 kHz SSB SCS, 100 MHz bandwidth, TDD duplex mode
2	LTE TDD, NR 120 kHz SSB SCS, 100 MHz bandwidth, TDD duplex mode

Table A.8.5.2.2.2-2: SS-RSRQ Inter-RAT general test parameters

Parameter	Unit	Test 1	Test 2
		Cell 2	Cell 2
SSB ARFCN		Freq1	freq1
Duplex mode		TDD	TDD
TDD configuration		TDDConf.3.1	TDDConf.3.1
BW_{channel}	MHz	100: $N_{\text{RB,c}} = 66$	100: $N_{\text{RB,c}} = 66$
Downlink initial BWP configuration		DLBWP.0.1	
Uplink initial BWP configuration		ULBWP.0.1	
DRX cycle configuration	ms	Not applicable	
PDSCH Reference measurement channel		-	-
RMSI CORESET Reference Channel		-	-
OCNG Patterns		OP.1	OP.1
SMTC configuration		SMTC.1	SMTC.1
SSB configuration		SSB.3 FR2	SSB.3 FR2
PDSCH/PDCCH subcarrier spacing	kHz	120	120
EPRE ratio of PSS to SSS	dB	0	0
EPRE ratio of PBCH_DMRS to SSS			
EPRE ratio of PBCH to PBCH_DMRS			
EPRE ratio of PDCCH_DMRS to SSS			
EPRE ratio of PDCCH to PDCCH_DMRS			
EPRE ratio of PDSCH_DMRS to SSS			
EPRE ratio of PDSCH to PDSCH_DMRS			
EPRE ratio of OCNG DMRS to SSS ^{Note 1}			
Note 1: OCNG shall be used such that both cells are fully allocated and a constant total transmitted power spectral density is achieved for all OFDM symbols.			
Note 2: Void.			
Note 3: Void.			
Note 4: Void.			

Table A.8.5.2.2.2-3: SS-RSRQ Inter-RAT OTA related test parameters

Parameter	Unit	Test 1	Test 2
		Cell 2	Cell 2
Angle of arrival configuration		Setup 1 according to A.3.15.1	Setup 1 according to A.3.15.1
Assumption for UE beams ^{Note 10}		Rough	Rough
N_{oc} ^{Note1}	$\text{dBm}/15\text{kHz}$ ^{Note4}	-104.7	(Table B.2.3-2 Rx Beam Peak -5dB) (Note 7)
N_{oc} ^{Note1}	dBm/SCS ^{Note4}	-95.7	(Table B.2.3-2 Rx Beam Peak +4dB) (Note 7)
\hat{E}_s / N_{oc}	dB	-0.5	-1.75
SSB_RP ^{Note2}	dBm/SCS ^{Note4}	-96.2	(Table B.2.3-2 Rx Beam Peak +2.25dB) (Note 8)
SS-RSRQ ^{Note2}	dB	-3.27	-14.82
\hat{E}_s / I_{ot} ^{Note2}	dB	-0.5	-1.75

I_{o}^{Note2}	dBm/95.04 MHz ^{Note4}	-63.95	(Table B.2.3-2 Rx Beam Peak +35.22dB) (Note 9)
Note 1:	Interference from other cells and noise sources not specified in the test is assumed to be constant over subcarriers and time and shall be modelled as AWGN of appropriate power for N_{oc} to be fulfilled.		
Note 2:	SSB_RP, SS-RSRQ, Es/lot and I_o levels have been derived from other parameters for information purposes. They are not settable parameters themselves.		
Note 3:	Void		
Note 4:	Equivalent power received by an antenna with 0dBi gain at the centre of the quiet zone.		
Note 5:	Void		
Note 6:	Void		
Note 7:	N_{oc} for SCS 15kHz is applied at $-10\log_{10}(8)+4\text{dB}$ above the minimum level specified in Table B.2.3-2 for beam peak. N_{oc} for SCS 120kHz is applied at 4dB above the minimum level specified in Table B.2.3-2 for beam peak.		
Note 8:	SSB_RP is applied at 2.25dB above the minimum level specified in Table B.2.3-2 for beam peak.		
Note 9:	I_o is applied at $10\log_{10}(792)+6.22\text{dB}$ above the minimum level specified in Table B.2.3-2 for beam peak.		
Note 10:	Information about types of UE beam is given in B.2.1.3, and does not limit UE implementation or test system implementation.		

A.8.5.2.2.3 Test Requirements

The SS-RSRQ measurement accuracy for Cell 2 shall fulfil the requirement in clause 9.11.2 in TS 36.133 [15].

In this test case there are two cells on different carriers and measurement gaps are provided

A.8.5.2.3 SS-SINR

A.8.5.2.3.1 E-UTRAN – NR inter-RAT measurements with FR1 target cell

A.8.5.2.3.1.1 Test Purpose and Environment

The purpose of this test is to verify that the SS- SINR measurement accuracy is within the specified limits. This test will verify the requirements in clause 9.11.3 in TS 36.133 [15] for inter-RAT FR1 SS-SINR measurements.

A.8.5.2.3.1.2 Test Parameters

Supported test configurations are shown in Table A.8.5.2.3.1.2-1. In this test case there are two cells on different carriers. Cell 1 is the E-UTRA cell which specific test parameters for this test case are specified in Table A.3.7.2.1-1. Cell 2 is the inter-RAT NR FR1 target cell. The absolute accuracy requirements of SS-RSRP inter-RAT measurement is tested by using test parameters in Table A.8.5.2.3.1.2-2.

Table A.8.5.2.3.1.2-1: SS- SINR Inter-RAT SS- SINR supported test configurations

Config	Description
1	LTE FDD, NR 15 kHz SSB SCS, 10 MHz bandwidth, FDD duplex mode
2	LTE FDD, NR 15 kHz SSB SCS, 10 MHz bandwidth, TDD duplex mode
3	LTE FDD, NR 30kHz SSB SCS, 40 MHz bandwidth, TDD duplex mode
4	LTE TDD, NR 15 kHz SSB SCS, 10 MHz bandwidth, FDD duplex mode
5	LTE TDD, NR 15 kHz SSB SCS, 10 MHz bandwidth, TDD duplex mode
6	LTE TDD, NR 30kHz SSB SCS, 40 MHz bandwidth, TDD duplex mode
Note:	The UE is only required to be tested in one of the supported test configurations

Table A.8.5.2.3.1.2-2: SS-SINR inter-RAT test parameters

Parameter		Unit	Test 1	Test 2	Test 3			
			Cell 2	Cell 2	Cell 2			
SSB ARFCN			freq1	freq1	freq1			
Duplex mode	Config 1,4		FDD					
	Config 2,3,5,6		TDD					
TDD configuration	Config 1,4		Not Applicable					
	Config 2,5		TDDConf.1.1					
	Config 3,6		TDDConf.2.1					
Downlink initial BWP configuration			DLBWP.0.1					
Uplink initial BWP configuration			ULBWP.0.1					
DRX Cycle configuration		ms	Not Applicable					
PDSCH Reference measurement channel	Config 1,4		-	-	-			
	Config 2,5		-	-	-			
	Config 3,6		-	-	-			
RMSI CORESET Reference Channel	Config 1,4		-	-	-			
	Config 2,5		-	-	-			
	Config 3,6		-	-	-			
Dedicated CORESET Reference Channel	Config 1,4		-	-	-			
	Config 2,5		-	-	-			
	Config 3,6		-	-	-			
OCNG Patterns			OP.1					
SS-RSSI-Measurement			Not Applicable					
SMTC configuration			SMTC.1					
SSB configuration	Config 1,2,4,5		SSB.1 FR1					
	Config 3,6		SSB.2 FR1					
PDSCH/PDCCH subcarrier spacing	Config 1,2,4,5	kHz	15					
	Config 3,6		30					
EPRE ratio of PSS to SSS		dB	0	0	0	0	0	
EPRE ratio of PBCH DMRS to SSS								
EPRE ratio of PBCH to PBCH DMRS								
EPRE ratio of PDCCH DMRS to SSS								
EPRE ratio of PDCCH to PDCCH DMRS								
EPRE ratio of PDSCH DMRS to SSS								
EPRE ratio of PDSCH to PDSCH								
EPRE ratio of OCNG DMRS to SSS ^(Note 1)								
EPRE ratio of OCNG to OCNG DMRS ^(Note 1)								
N_{oc} ^{Note2}	Config 1,2,4,5							NR_FDD_FR1_A
		NR_TDD_FR1_A NOTE 6						
		NR_FDD_FR1_B	-119					

		NR_TDD_FR1_C				-118.5	
		NR_FDD_FR1_D NR_TDD_FR1_D				-118	
		NR_FDD_FR1_E NR_TDD_FR1_E				-117.5	
		NR_FDD_FR1_G				-116.5	
		NR_FDD_FR1_H				-116	
N_{oc}	Config 1,2,4,5		dBm/SC S	-88	-108.5	Same as Noc for 15kHz	
	Config 3,6	NR_FDD_FR1_A NR_TDD_FR1_A NOTE 6			-85	-105.5	-116.5
		NR_FDD_FR1_B					-116
		NR_TDD_FR1_C					-115.5
		NR_FDD_FR1_D NR_TDD_FR1_D					-115
		NR_FDD_FR1_E NR_TDD_FR1_E					-114.5
		NR_FDD_FR1_G					-114.5
NR_FDD_FR1_H		-113					
\hat{E}_s / I_{oc}			dB	-1.75	20	-4.0	
\hat{E}_s / N_{oc}			dB	-1.75	20	-4.0	
SS-RSRP ^{Not e3}	Config 1,2,4,5	NR_FDD_FR1_A NR_TDD_FR1_A NOTE 6	dBm/SC S	-89.75	-88.5	-123.5	
		NR_FDD_FR1_B				-123	
		NR_TDD_FR1_C				-122.5	
		NR_FDD_FR1_D NR_TDD_FR1_D				-122	
		NR_FDD_FR1_E NR_TDD_FR1_E				-121.5	
		NR_FDD_FR1_G				-120.5	
		NR_FDD_FR1_H				-120	
	Config 3,6	NR_FDD_FR1_A NR_TDD_FR1_A NOTE 6		-86.75	-85.5	-120.5	
		NR_FDD_FR1_B				-120	
		NR_TDD_FR1_C				-119.5	
		NR_FDD_FR1_D NR_TDD_FR1_D				-119	
		NR_FDD_FR1_E NR_TDD_FR1_E				-118.5	
		NR_FDD_FR1_G				-117.5	
		NR_FDD_FR1_H				-117	
SS-SINR ^{Note3}		NR_FDD_FR1_A NR_TDD_FR1_A NOTE 6	dB	-1.75	20	-4.0	
		NR_FDD_FR1_B					
		NR_TDD_FR1_C					
		NR_FDD_FR1_D NR_TDD_FR1_D					
		NR_FDD_FR1_E NR_TDD_FR1_E					
		NR_FDD_FR1_G					
I_o ^{Note3}	Config 1,2,4,5	NR_FDD_FR1_A NR_TDD_FR1_A NOTE 6	dBm/ 9.36MHz	-57.83	-60.5	-90.09	
		NR_FDD_FR1_B				-89.59	
		NR_TDD_FR1_C				-89.09	

Config 3,6	NR_FDD_FR1_D	dBm/ 38.16MHz z	-51.73	-54.41	-88.59
	NR_TDD_FR1_D				-88.09
	NR_FDD_FR1_E				-87.09
	NR_TDD_FR1_E				-86.59
	NR_FDD_FR1_G				-84
	NR_TDD_FR1_G				-83.5
	NR_FDD_FR1_H				-83
	NR_TDD_FR1_H				-82.5
	NR_FDD_FR1_A				-82
	NR_TDD_FR1_A				-81
	NOTE 6				-80.5
	NR_FDD_FR1_B				
	NR_TDD_FR1_B				
	NR_FDD_FR1_C				
NR_TDD_FR1_C					
Propagation condition		-	AWGN		
Antenna configuration		-	1x2		
<p>Note 1: OCNG shall be used such that both cells are fully allocated and a constant total transmitted power spectral density is achieved for all OFDM symbols.</p> <p>Note 2: Interference from other cells and noise sources not specified in the test is assumed to be constant over subcarriers and time and shall be modelled as AWGN of appropriate power for N_{oc} to be fulfilled.</p> <p>Note 3: SS-SINR, SS-RSRP, and I_o levels have been derived from other parameters for information purposes. They are not settable parameters themselves.</p> <p>Note 4: SS-SINR, SS-RSRP minimum requirements are specified assuming independent interference and noise at each receiver antenna port.</p> <p>Note 5: NR operating band groups are as defined in clause 3.5.2.</p> <p>Note 6: The test configuration excludes support for band n51 and it is not required to run this test on band n51 in this release of the specification</p>					

A.8.5.2.3.1.3 Test Requirements

The SS-SINR measurement accuracy for Cell 2 shall fulfil the requirement in clause 9.11.3 in TS 36.133 [15].

A.8.5.2.3.2 E-UTRAN – NR inter-RAT measurements with FR2 target cell

A.8.5.2.3.2.1 Test Purpose and Environment

The purpose of this test is to verify that the SS- SINR measurement accuracy is within the specified limits. This test will verify the requirements in clause 9.11.3 in TS 36.133 [15] for inter-RAT FR2 SS-SINR measurements.

A.8.5.2.3.2.2 Test Parameters

Supported test configurations are shown in Table A.8.5.2.3.2.2-1. In this test case there are two cells on different carriers. Absolute accuracy requirements of SS-SINR inter-RAT measurement are tested by using test setup in Table A.8.5.2.3.2.2-2 and A.8.5.2.3.2.2-3. In all test cases, Cell 2 is target cell. Cell 1 is the E-UTRA cell which specific test parameters for this test case are specified in Table A.3.7.2.1-1.

Table A.8.5.2.3.2.2-1: SS-SINR Inter-RAT SS-SINR supported test configurations

Configuration	Description
1	LTE FDD, NR 120 kHz SSB SCS, 100 MHz bandwidth, TDD duplex mode
2	LTE TDD, NR 120 kHz SSB SCS, 100 MHz bandwidth, TDD duplex mode

Table A.8.5.2.3.2.2-2: SS-SINR Inter-RAT general test parameters

Parameter	Unit	Test 1	Test 2	Test 3
-----------	------	--------	--------	--------

		Cell 2	Cell 2	Cell 2
SSB ARFCN		Freq1	freq1	freq1
Duplex mode		TDD	TDD	TDD
TDD configuration		TDDConf.3.1	TDDConf.3.1	TDDConf.3.1
$BW_{channel}$	MHz	100: $N_{RB,c} = 66$	100: $N_{RB,c} = 66$	100: $N_{RB,c} = 66$
Downlink initial BWP configuration		DLBWP.0.1		
Uplink initial BWP configuration		ULBWP.0.1		
DRX cycle configuration	ms	Not applicable		
PDSCH Reference measurement channel		-	-	-
RMSI CORESET Reference Channel		-	-	-
OCNG Patterns		OP.1	OP.1	OP.1
SMTC configuration		SMTC.1	SMTC.1	SMTC.1
SSB configuration		SSB.3 FR2	SSB.3 FR2	SSB.3 FR2
PDSCH/PDCCH subcarrier spacing	kHz	120	120	120
EPRE ratio of PSS to SSS	dB	0	0	0
EPRE ratio of PBCH_DMRS to SSS				
EPRE ratio of PBCH to PBCH_DMRS				
EPRE ratio of PDCCH_DMRS to SSS				
EPRE ratio of PDCCH to PDCCH_DMRS				
EPRE ratio of PDSCH_DMRS to SSS				
EPRE ratio of PDSCH to PDSCH_DMRS				
EPRE ratio of OCNG DMRS to SSS ^{Note 1}				
<p>Note 1: OCNG shall be used such that both cells are fully allocated and a constant total transmitted power spectral density is achieved for all OFDM symbols.</p> <p>Note 2: Void.</p> <p>Note 3: Void.</p> <p>Note 4: Void.</p>				

Table A.8.5.2.3.2.2-3: SS-SINR Inter-RAT OTA related test parameters

Parameter	Unit	Test 1	Test 2	Test 3
		Cell 2	Cell 2	Cell 2
Angle of arrival configuration		Setup 1 according to A.3.15.1	Setup 1 according to A.3.15.1	Setup 1 according to A.3.15.1
Assumption for UE beams ^{Note 10}		Rough	Rough	Rough
N_{oc} ^{Note1}	dBm/15kHz ^{Note4}	-104.7	-104.7	(Table B.2.3-2 Rx Beam Peak -5dB) (Note 7)
N_{oc} ^{Note1}	dBm/SCS ^{Note4}	-95.7	-95.7	(Table B.2.3-2 Rx Beam Peak +4dB) (Note 7)
\hat{E}_s / N_{oc}	dB	-0.5	11	-1.0
SSB_RP ^{Note2}	dBm/SCS ^{Note4}	-96.2	-84.7	(Table B.2.3-2 Rx Beam Peak +3dB) (Note 8)
SS-SINR ^{Note2}	dB	-0.5	11	-1.0
\hat{E}_s / I_{ot} ^{Note2}	dB	-0.5	11	-1.0
I_o ^{Note2}	dBm/95.04 MHz ^{Note4}	-63.95	-55.38	(Table B.2.3-2 Rx Beam Peak +35.54dB)

				(Note 9)
Note 1:	Interference from other cells and noise sources not specified in the test is assumed to be constant over subcarriers and time and shall be modelled as AWGN of appropriate power for N_{oc} to be fulfilled.			
Note 2:	SSB_RP, SS-SINR, Es/Iot and Io levels have been derived from other parameters for information purposes. They are not settable parameters themselves.			
Note 3:	Void			
Note 4:	Equivalent power received by an antenna with 0 dBi gain at the centre of the quiet zone.			
Note 5:	Void			
Note 6:	Void			
Note 7:	N_{oc} for SCS 15kHz is applied at $-10\log_{10}(8)+4\text{dB}$ above the minimum level specified in Table B.2.3-2 for beam peak. N_{oc} for SCS 120kHz is applied at 4dB above the minimum level specified in Table B.2.3-2 for beam peak.			
Note 8:	SSB_RP is applied at 3dB above the minimum level specified in Table B.2.3-2 for beam peak.			
Note 9:	Io is applied at level $10\log_{10}(792)+6.54\text{dB}$ above the minimum level specified in Table B.2.3-2 for beam peak.			
Note 10:	Information about types of UE beam is given in B.2.1.3, and does not limit UE implementation or test system implementation.			

A.8.5.2.3.2.3 Test Requirements

The SS-SINR measurement accuracy for Cell 2 shall fulfil the requirement in clause 9.11.3 in TS 36.133 [15].

Annex B (normative): Conditions for RRM requirements applicability for operating bands

B.1 Conditions for NR RRC_IDLE state mobility

B.1.1 Introduction

In Annex B.1, the following conditions are specified:

- UE conditions which shall apply for UE intra-frequency measurements procedures and requirements in clause 4,
- UE conditions which shall apply for UE inter-frequency measurements procedures and requirements in clause 4.

B.1.2 Conditions for measurements on NR intra-frequency cells for cell re-selection

This clause defines the following conditions for NR intra-frequency measurements performed based on SSBs for cell re-selection: SSB_{RP} and SSB \dot{E}_s/lot , applicable for a corresponding operating band.

The conditions are defined in Table B.1.2-1 for FR1 NR cells.

The conditions are defined in Table B.1.2-2 for FR2 NR cells.

Table B.1.2-1: Conditions for intra-frequency cell re-selection in FR1

Parameter	NR operating band groups ^{Note1}	Minimum SSB _{RP}		SSB \dot{E}_s/lot
		dBm / SCS _{SSB}		dB
		SCS _{SSB} = 15 kHz	SCS _{SSB} = 30 kHz	
Conditions	NR_FDD_FR1_A, NR_TDD_FR1_A	-124	-121	≥ -4
	NR_FDD_FR1_B	-123.5	-120.5	
	NR_TDD_FR1_C	-123	-120	
	NR_FDD_FR1_D, NR_TDD_FR1_D	-122.5	-119.5	
	NR_FDD_FR1_E, NR_TDD_FR1_E	-122	-119	
	NR_FDD_FR1_G	-121	-118	
	NR_FDD_FR1_H	-120.5	-117.5	

NOTE 1: NR operating band groups are defined in clause 3.5.2.

Table B.1.2-2: Conditions for intra-frequency cell re-selection in FR2

Parameter	Angle of arrival	NR operating bands	Minimum SSB _{RP} ^{Note 2, Note 3}				SSB \dot{E}_s/lot
			dBm / SCS _{SSB}				dB
			SCS _{SSB} = 120 kHz			SCS _{SSB} = 240 kHz	
			UE Power class			UE Power class	
Conditions	Rx Beam Peak	n257	-107.3	-110.8	-109.1	124.8+Y ₄	≥ -4
		n258	-107.3	-110.8	-109.1	124.8+Y ₄	
		n260	-104.3		-106.5	122.8+Y ₄	
		n261	-107.3	-110.8	-109.1	124.8+Y ₄	

(Value for SCS_{SSB} = 120 kHz) +3dB

	Spherical coverage Note 1	n257	-99.3	-99.8	-98.2	- 115.8+Z ₄	(Value for SCS _{SSB} = 120 kHz) +3dB	≥-4
		n258	-99.3	-99.8	-98.2	- 115.8+Z ₄		
		n260	-96.3		-93.9	- 110.8+Z ₄		
		n261	-99.3	-99.8	-98.2	- 115.8+Z ₄		
<p>NOTE 1: Values based on EIS spherical coverage as defined in clause 7.3.4 of TS 38.101-2 [19]. Side condition applies for directions in which EIS spherical coverage requirement is met.</p> <p>NOTE 2: Values specified at the Reference point to give minimum SSB \hat{E}_s/I_{ot}, with no applied noise.</p> <p>NOTE 3: For UEs that support multiple FR2 bands, Rx Beam Peak values are increased by $\Delta MB_{P,n}$ and Spherical coverage values are increased by $\Delta MB_{S,n}$, the UE multi-band relaxation factor in dB specified in clause 6.2.1 of TS 38.101-2 [19].</p>								

Editor's notes for Table B.1.2-2:

- The value of Y for Power class 4 is FFS, where Y₄ is the rough/fine beam gain difference in Rx beam peak direction for Power class 4
- The value of Z for Power class 4 is FFS, where Z₄ is the rough/fine beam gain difference in spherical coverage directions for Power class 4

B.1.3 Conditions for measurements on NR inter-frequency cells for cell re-selection

This clause defines the following conditions for NR inter-frequency measurements performed based on SSBs for cell re-selection: SSB_{RP} and SSB \hat{E}_s/I_{ot} , applicable for a corresponding operating band.

The conditions defined in Table B.1.2-1 for FR1 NR intra-frequency cell re-selection shall also apply for FR1 NR inter-frequency cells in this clause.

The conditions defined in Table B.1.2-2 for FR2 NR intra-frequency cell re-selection shall also apply for FR2 NR inter-frequency cells in this clause.

B.2 Conditions for UE measurements procedures and performance requirements in RRC_CONNECTED state

B.2.1 Introduction

B.2.1.1 General

In Annex B.2, the following conditions are specified:

- The conditions for RRC connection release with redirection to NR requirements in clause 6.2.3.2.1,
- The conditions for UE transmit timing adjustment in clause 7.1,
- UE conditions which shall apply for UE intra-frequency measurements procedures and requirements in clause 9, UE conditions which shall apply for UE inter-frequency measurements procedures and requirements in clause 9,
- UE conditions which shall apply for UE intra-frequency measurements performance requirements in clause 10,
- UE conditions which shall apply for UE inter-frequency measurements performance requirements in clause 10.

B.2.1.2 Derivation of Minimum SSB_{RP} values for FR1

[FFS]

B.2.1.3 Derivation of Minimum SSB_RP values for FR2

Editor's note:

- The Assumption for UE beams (fine or rough) in Annex A RRM test cases is defined based on power class 3, and unless otherwise stated also applies for other UE power classes

B.2.1.3.1 Minimum SSB_RP values for Rx Beam Peak angle of arrival

Minimum SSB_RP values in Tables B.2.2-2 and B.2.3-2 are based on reference sensitivity for the Operating band and for the UE power class, taking a baseline of UE power class 3 in Band n260 with 50 MHz channel bandwidth.

Minimum SSB_RP = Reference sensitivity_{PC3, n260, 50MHz} + Y - 10Log₁₀(PRB_{Refsens} × 12) - SNR_{Refsens} + SSB Ês/Iot + ΔMB_{P,n}

where:

Reference sensitivity_{PC3, n260, 50MHz} is the reference sensitivity value in dBm specified for power class 3 in Band n260 for 50 MHz Channel bandwidth in Table 7.3.2.3-1 of TS 38.101-2 [19];

Y is the gain difference between fine and rough beams, which is defined in Table B.2.1.3.1-1;

Table B.2.1.3.1-1: Gain difference Y between fine and rough beams, Rx beam peak direction

Value "Y" in dB, for each UE power class			
1	2	3	4
18	9.0	7.0	FFS

PRB_{Refsens} is N_{RB} associated with subcarrier spacing 120 kHz for 50MHz in TS 38.101-2 [19] Table 5.3.2-1, and is 32;

12 is the number of subcarriers in a PRB;

SNR_{Refsens} is the SNR used for simulation of Refsens and EIS spherical coverage, and is -1 dB;

SSB Ês/Iot is the minimum value required by the UE to perform measurements, and is -6 dB for intra-frequency measurements and -4 dB for inter-frequency measurements. The only contribution to Iot is the UE internal noise;

ΔMB_{P,n} is the UE multi-band relaxation factor value in dB specified in TS 38.101-2 [19] clause 6.2.1.

The calculated Minimum SSB_RP value for the baseline of UE power class 3 in Band n260 is (-109.5+ΔMB_{P,n}) dBm/120kHz for intra-frequency measurements and (-107.5+ΔMB_{P,n}) dBm/120kHz for inter-frequency measurements.

The following methodology to define the Minimum SSB_RP level for power class X (PC_X) and operating band Y (Band_Y) is used:

For Intra-frequency: Minimum SSB_RP (PC_X, Band_Y) = -109.5 dBm/120kHz + Refsens_{PC_X, Band_Y, 50MHz} - Refsens_{PC3, n260, 50MHz} + Y_{PC_X} - Y_{PC3} + ΔMB_{P,n},

For Inter-frequency: Minimum SSB_RP (PC_X, Band_Y) = -107.5 dBm/120kHz + Refsens_{PC_X, Band_Y, 50MHz} - Refsens_{PC3, n260, 50MHz} + Y_{PC_X} - Y_{PC3} + ΔMB_{P,n}.

B.2.1.3.2 Minimum SSB_RP values for angle of arrival within Spherical coverage

Minimum SSB_RP values in Tables B.2.2-2 and B.2.3-2 are based on EIS spherical coverage for the Operating band and for the UE power class, taking a baseline of UE power class 3 in Band n260 with 50 MHz channel bandwidth.

Minimum SSB_RP = EIS spherical coverage_{PC3, n260, 50MHz} + Z - 10Log₁₀(PRB_{Refsens} × 12) - SNR_{Refsens} + SSB Ês/Iot + ΔMB_{S,n},

where:

EIS spherical coverage_{PC3, n260, 50MHz} is the EIS spherical coverage value in dBm specified for power class 3 in Band n260 for 50MHz Channel bandwidth in TS 38.101-2 [19] Table 7.3.4.3-1;

Z is the gain difference between fine and rough beams, and is defined in Table B.2.1.3.2-1;

Table B.2.1.3.2-1: Gain difference Z between fine and rough beams, Spherical coverage directions

Value "Z" in dB, for each UE power class			
1	2	3	4
18	9.0	7.0	FFS

PRB_{Refsens} is N_{RB} associated with subcarrier spacing 120 kHz for 50MHz in TS 38.101-2 [19] Table 5.3.2-1, and is 32;

12 is the number of subcarriers in a PRB;

SNR_{Refsens} is the SNR used for simulation of Refsens and EIS spherical coverage, and is -1 dB;

$SSB \hat{E}_s/I_{ot}$ is the minimum value required by the UE to perform measurements, and is -6 dB for intra-frequency measurements and -4 dB for inter-frequency measurements. The only contribution to I_{ot} is the UE internal noise;

$\Delta MB_{S,n}$ is the UE multi-band relaxation factor value in dB specified in TS 38.101-2 [19] clause 6.2.1.

The calculated Minimum SSB_{RP} value for the baseline of UE power class 3 in Band n260 is $(-96.9 + \Delta MB_{S,n})$ dBm/120kHz for intra-frequency measurements and is $(-94.9 + \Delta MB_{S,n})$ dBm/120kHz for inter-frequency measurements.

The following methodology to define the Minimum SSB_{RP} level for power class X (PC_X) and operating band Y (Band_Y) is used:

For Intra-frequency: Minimum $SSB_{\text{RP}}(\text{PC}_X, \text{Band}_Y) = -96.9 \text{ dBm/120kHz} + \text{EIS spherical coverage}_{\text{PC}_X, \text{Band}_Y, 50\text{MHz}} - \text{EIS spherical coverage}_{\text{PC}_3, \text{n260}, 50\text{MHz}} + Z_{\text{PC}_X} - Z_{\text{PC}_3} + \Delta MB_{S,n}$

For Inter-frequency: Minimum $SSB_{\text{RP}}(\text{PC}_X, \text{Band}_Y) = -94.9 \text{ dBm/120kHz} + \text{EIS spherical coverage}_{\text{PC}_X, \text{Band}_Y, 50\text{MHz}} - \text{EIS spherical coverage}_{\text{PC}_3, \text{n260}, 50\text{MHz}} + Z_{\text{PC}_X} - Z_{\text{PC}_3} + \Delta MB_{S,n}$

B.2.1.4 Gain to SS-RSRP measurement point for FR1

In FR1 conducted requirements are specified at the UE antenna connector, which is also the SS-RSRP measurement point.

B.2.1.5 Gain to SS-RSRP measurement point for FR2

B.2.1.5.1 Gain to SS-RSRP measurement point for Rx Beam Peak angle of arrival

In clause 5.1.1 of TS 38.215 [4] SS-RSRP is defined to be measured based on the combined signal from antenna elements corresponding to a given receiver branch. The reference point for requirement parameters from the UE perspective is the input of the UE antenna array. The gain "G" relates the combined signal from antenna elements corresponding to a given receiver branch to the reference point for requirement parameters.

The gain "G" affects absolute signal level values reported by the UE.

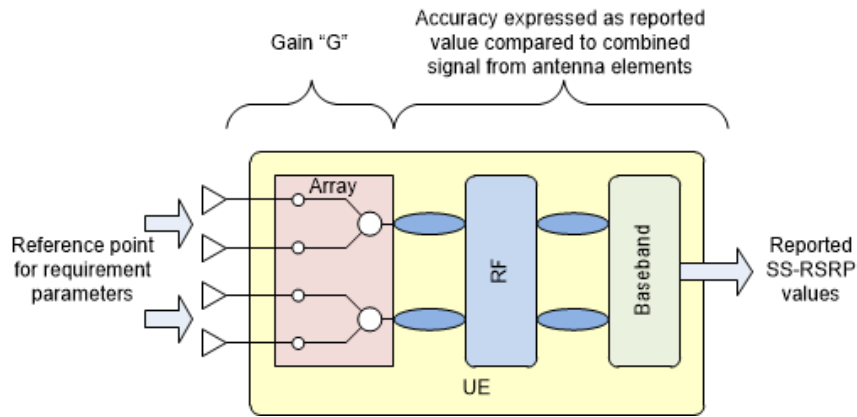

Figure B.2.1.5.1-1: Gain and Reference point for requirement parameters

The gain range for each power class is specified in Table B.2.1.5.1-1.

Table B.2.1.5.1-1: UE gain G, Rx beam peak direction

	UE Power class			
	1	2	3	4
Minimum, dBi	0	FFS	-10	FFS
Maximum, dBi	+50	FFS	+20	FFS

Gain range in spherical coverage directions may be lower than in Rx beam peak direction, according to the difference between the EIS spherical coverage value specified in TS 38.101-2 [19] clause 7.3.4 and the Reference sensitivity level specified in TS 38.101-2 [19] clause 7.3.2.

B.2.1.5.2 Gain to SS-RSRP measurement point for different frequency

In any specific direction, the UE gain G may be different depending on frequencies. The gain “G_{inter}” affects relative signal level values reported by the UE when measuring between different frequencies and is specified in Table B.2.1.5.2-1 for each power class.

Table B.2.1.5.2-1: UE gain difference between inter-frequencies G_{inter}

	UE Power class			
	1	2	3	4
Maximum difference, dB	3	FFS	3	FFS

B.2.1.5.3 Alignment of Rough beam to Rx beam Peak

The definition of Rx Beam Peak in TS 38.101-2 [19] clause 7.3.2 is based on Throughput at Reference sensitivity power level, and assumes use of Fine beams. In many RRM scenarios the UE can use Rough beams, but the largest Rough beam gain direction may not be aligned to the Fine beam Peak direction.

When the Rx Beam Peak is selected and defined based on Fine Beams, the rough beam gain in that direction may be lower than the largest rough beam gain in another direction within Spherical Coverage. The term “D” is the maximum allowed rough beam gain reduction, and is specified in Table B.2.1.5.3-1 for each power class.

Table B.2.1.5.3-1: Rough Beam gain reduction “D” in Rx Beam Peak direction

	UE Power class			
	1	2	3	4
Maximum gain reduction, dB	11.5	FFS	5.5	FFS

B.2.2 Conditions for NR intra-frequency measurements

This clause defines the following conditions for NR intra-frequency measurements and corresponding procedures performed based on SSBs: SSB_{RP} and SSB \hat{E} s/Iot, applicable for a corresponding operating band.

The conditions are defined in Table B.2.2-1 for FR1 NR cells.

The conditions are defined in Table B.2.2-2 for FR2 NR cells.

Table B.2.2-1: Conditions for intra-frequency measurements in FR1

Parameter	NR operating band groups ^{Note1}	Minimum SSB _{RP}		SSB \hat{E} s/Iot
		dBm / SCS _{SSB}		dB
		SCS _{SSB} = 15 kHz	SCS _{SSB} = 30 kHz	
Conditions	NR_FDD_FR1_A, NR_TDD_FR1_A, NR_SDL_FR1_A	-127	-124	≥ -6
	NR_FDD_FR1_B	-126.5	-123.5	
	NR_TDD_FR1_C	-126	-123	
	NR_FDD_FR1_D, NR_TDD_FR1_D	-125.5	-122.5	
	NR_FDD_FR1_E, NR_TDD_FR1_E	-125	-122	
	NR_FDD_FR1_G	-124	-121	
	NR_FDD_FR1_H	-123.5	-120.5	

NOTE 1: NR operating band groups are defined in clause 3.5.2.

Table B.2.2-2: Conditions for intra-frequency measurements in FR2

Parameter	Angle of arrival	NR operating bands	Minimum SSB _{RP} ^{Note 2, Note 3}				SSB \hat{E} s/Iot		
			dBm / SCS _{SSB}				dB		
			SCS _{SSB} = 120 kHz			SCS _{SSB} = 240 kHz			
			UE power class			UE power class			
			1	2	3	4	1, 2, 3, 4		
Conditions	Rx Beam Peak	n257	-110.3	-113.8	-112.1	-	127.8+Y ₄	(Value for SCS _{SSB} = 120 kHz) +3dB	≥ -6
		n258	-110.3	-113.8	-112.1	-	127.8+Y ₄		
		n260	-107.3		-109.5	-	125.8+Y ₄		
		n261	-110.3	-113.8	-112.1	-	127.8+Y ₄		
	Spherical coverage ^{Note 1}	n257	-102.3	-102.8	-101.2	-	118.8+Z ₄	(Value for SCS _{SSB} = 120 kHz) +3dB	≥ -6
		n258	-102.3	-102.8	-101.2	-	118.8+Z ₄		
		n260	-99.3		-96.9	-	113.8+Z ₄		
		n261	-102.3	-102.8	-101.2	-	118.8+Z ₄		

Note 1: Values based on EIS spherical coverage as defined in clause 7.3.4 of TS 38.101-2 [19]. Side condition applies for directions in which EIS spherical coverage requirement is met.

Note 2: Values specified at the Reference point to give minimum SSB \hat{E} s/Iot, with no applied noise.

Note 3: For UEs that support multiple FR2 bands, Rx Beam Peak values are increased by $\Delta MB_{P,n}$ and Spherical coverage values are increased by $\Delta MB_{S,n}$, the UE multi-band relaxation factor in dB specified in clause 6.2.1 of TS 38.101-2 [19].

Editor's notes for Table B.2.2-2:

- The value of Y for power class 4 is FFS, where Y₄ is the rough/fine beam gain difference in Rx beam peak direction for power class 4

- The value of Z for power class 4 is FFS , where Z_4 is the rough/fine beam gain difference in spherical coverage directions for power class 4

B.2.3 Conditions for NR inter-frequency measurements

This clause defines the following conditions for NR inter-frequency measurements and corresponding procedures performed based on SSBs: SSB_{RP} and $SSB_{\hat{E}s/lot}$, applicable for a corresponding operating band.

The conditions are defined in Table B.2.3-1 for FR1 NR cells.

The conditions are defined in Table B.2.3-2 for FR2 NR cells.

Table B.2.3-1: Conditions for inter-frequency measurements in FR1

Parameter	NR operating band groups ^{Note1}	Minimum SSB_{RP}		$SSB_{\hat{E}s/lot}$
		dBm / SCS_{SSB}		
		$SCS_{SSB} = 15$ kHz	$SCS_{SSB} = 30$ kHz	dB
Conditions	NR_FDD_FR1_A, NR_TDD_FR1_A, NR_SDL_FR1_A	-125	-122	≥ -4
	NR_FDD_FR1_B	-124.5	-121.5	
	NR_TDD_FR1_C	-124	-121	
	NR_FDD_FR1_D, NR_TDD_FR1_D	-124.5	-120.5	
	NR_FDD_FR1_E, NR_TDD_FR1_E	-123	-120	
	NR_FDD_FR1_G	-122	-119	
	NR_FDD_FR1_H	-121.5	-118.5	

NOTE 1: NR operating band groups are defined in clause 3.5.2.

Table B.2.3-2: Conditions for inter-frequency measurements in FR2

Parameter	Angle of arrival	NR operating bands	Minimum SSB_{RP} ^{Note 2, Note 3}				$SSB_{\hat{E}s/lot}$	
			dBm / SCS_{SSB}					
			$SCS_{SSB} = 120$ kHz		$SCS_{SSB} = 240$ kHz		dB	
			UE power class					
			1	2	3	4		1, 2, 3, 4
Conditions	Rx Beam Peak	n257	-108.3	-111.8	-110.1	-	(Value for $SCS_{SSB} = 120$ kHz) +3dB	≥ -4
		n258	-108.3	-111.8	-110.1	-		
		n260	-105.3		-107.5	-		
		n261	-108.3	-111.8	-110.1	-		
	Spherical coverage ^{Note 1}	n257	-100.3	-100.8	-99.2	-	(Value for $SCS_{SSB} = 120$ kHz) +3dB	≥ -4
		n258	-100.3	-100.8	-99.2	-		
		n260	-97.3		-94.9	-		
		n261	-100.3	-100.8	-99.2	-		

NOTE 1: Values based on EIS spherical coverage as defined in clause 7.3.4 of TS 38.101-2 [19]. Side condition applies for directions in which EIS spherical coverage requirement is met.

NOTE 2: Values specified at the Reference point to give minimum $SSB_{\hat{E}s/lot}$, with no applied noise.

NOTE 3: For UEs that support multiple FR2 bands, Rx Beam Peak values are increased by $\Delta MB_{P,n}$ and Spherical coverage values are increased by $\Delta MB_{S,n}$, the UE multi-band relaxation factor in dB specified in clause 6.2.1 of TS 38.101-2 [19].

Editor’s notes for Table B.2.3-2:

- The value of Y for power class 4 is FFS , where Y_4 is the rough/fine beam gain difference in Rx beam peak direction for power class 4

- The value of Z for power class 4 is FFS, where Z_4 is the rough/fine beam gain difference in spherical coverage directions for power class 4

B.2.4 Conditions for NR L1-RSRP reporting

B.2.4.1 Conditions for SSB based L1-RSRP reporting

This clause defines the following conditions for NR L1-RSRP measurement reporting and corresponding procedures performed based on SSBs: SSB_{RP} and SSB \hat{E}_s/lot , applicable for a corresponding operating band.

The conditions are defined in Table B.2.4.1-1 for FR1 NR cells.

The conditions are defined in Table B.2.4.1-2 for FR2 NR cells.

Table B.2.4.1-1: Conditions for SSB based L1-RSRP measurements in FR1

Parameter	NR operating band groups ^{Note1}	Minimum SSB _{RP}		SSB \hat{E}_s/lot
		dBm / SCS _{SSB}		
		SCS _{SSB} = 15 kHz	SCS _{SSB} = 30 kHz	dB
Conditions	NR_FDD_FR1_A, NR_TDD_FR1_A, NR_SDL_FR1_A	-124	-121	≥ -3
	NR_FDD_FR1_B	-123.5	-120.5	
	NR_TDD_FR1_C	-123	-120	
	NR_FDD_FR1_D, NR_TDD_FR1_D	-122.5	-119.5	
	NR_FDD_FR1_E, NR_TDD_FR1_E	-122	-119	
	NR_FDD_FR1_G	-121	-118	
	NR_FDD_FR1_H	-120.5	-117.5	

NOTE 1: NR operating band groups are defined in clause 3.5.2.

Table B.2.4.1-2: Conditions for SSB based L1-RSRP measurements in FR2

Parameter	Angle of arrival	NR operating bands	Minimum SSB _{RP} ^{Note 2, Note 3}				SSB \hat{E}_s/lot	
			dBm / SCS _{SSB}					
			SCS _{SSB} = 120 kHz			SCS _{SSB} = 240 kHz	dB	
			UE power class			UE power class		
1	2	3	4	1, 2, 3, 4				
Conditions	Rx Beam Peak	n257	-107.3	-110.8	-109.1	- 124.8+Y ₄	(Value for SCS _{SSB} = 120 kHz) +3dB	≥ -3
		n258	-107.3	-110.8	-109.1	- 124.8+Y ₄		
		n260	-104.3		-106.5	- 122.8+Y ₄		
		n261	-107.3	-110.8	-109.1	- 124.8+Y ₄		
	Spherical coverage ^{Note 1}	n257	-99.3	-99.8	-98.2	- 115.8+Z ₄	(Value for SCS _{SSB} = 120 kHz) +3dB	≥ -3
		n258	-99.3	-99.8	-98.2	- 115.8+Z ₄		
		n260	-96.3		-93.9	- 110.8+Z ₄		
		n261	-99.3	-99.8	-98.2	- 115.8+Z ₄		

NOTE 1: Values based on EIS spherical coverage as defined in clause 7.3.4 of TS 38.101-2 [19]. Side condition applies for directions in which EIS spherical coverage requirement is met.

NOTE 2: Values specified at the Reference point to give minimum SSB \hat{E}_s/lot , with no applied noise.

NOTE 3: For UEs that support multiple FR2 bands, Rx Beam Peak values are increased by $\Delta\text{MB}_{P,n}$ and Spherical coverage values are increased by $\Delta\text{MB}_{S,n}$, the UE multi-band relaxation factor in dB specified in clause 6.2.1 of TS 38.101-2 [19].

Editor's notes for Table B.2.4.1-2:

- The value of Y for power class 4 is FFS, where Y_4 is the rough/fine beam gain difference in Rx beam peak direction for power class 4

- The value of Z for power class 4 is FFS, where Z_4 is the rough/fine beam gain difference in spherical coverage directions for power class 4

B.2.4.2 Conditions for CSI-RS based L1-RSRP reporting

This clause defines the following conditions for NR L1-RSRP measurement reporting and corresponding procedures performed based on CSI-RS: CSI-RS_{RP} and CSI-RS \hat{E} s/lot, applicable for a corresponding operating band.

The conditions are defined in Table B.2.4.2-1 for FR1 NR cells.

The conditions are defined in Table B.2.4.2-2 for FR2 NR cells.

Table B.2.4.2-1: Conditions for CSI-RS based L1-RSRP measurements in FR1

Parameter	NR operating band groups ^{Note1}	Minimum CSI-RS _{RP}			CSI-RS \hat{E} s/lot
		dBm / SCS _{CSI-RS}			dB
		SCS _{CSI-RS} = 15 kHz	SCS _{CSI-RS} = 30 kHz	SCS _{CSI-RS} = 60 kHz	
Conditions	NR_FDD_FR1_A, NR_TDD_FR1_A, NR_SDL_FR1_A	-124	-121	-118	≥ -3
	NR_FDD_FR1_B	-123.5	-120.5	-117.5	
	NR_TDD_FR1_C	-123	-120	-117	
	NR_FDD_FR1_D, NR_TDD_FR1_D	-122.5	-119.5	-116.5	
	NR_FDD_FR1_E, NR_TDD_FR1_E	-122	-119	-116	
	NR_FDD_FR1_G	-121	-118	-115	
	NR_FDD_FR1_H	-120.5	-117.5	-114.5	

NOTE 1: NR operating band groups are defined in clause 3.5.2.

Table B.2.4.2-2: Conditions for CSI-RS based L1-RSRP measurements in FR2

Parameter	Angle of arrival	NR operating bands	Minimum CSI-RS _{RP} ^{Note 2, Note 3}				CSI-RS \hat{E} s/lot	
			dBm / SCS _{CSI-RS}				dB	
			SCS _{CSI-RS} = 60 kHz			SCS _{CSI-RS} = 120 kHz		
			UE power class			UE power class		
			1	2	3	4		1, 2, 3, 4
Conditions	Rx Beam Peak	n257	-110.3	-113.8	-112.1	- 127.8+ Y_4	(Value for SCS _{CSI-RS} = 60 kHz) +3dB	≥ -3
		n258	-110.3	-113.8	-112.1	- 127.8+ Y_4		
		n260	-107.3		-109.5	- 125.8+ Y_4		
		n261	-110.3	-113.8	-112.1	- 127.8+ Y_4		
	Spherical coverage ^{Note 1}	n257	-102.3	-102.8	-101.2	- 118.8+ Z_4	(Value for SCS _{CSI-RS} = 60 kHz) +3dB	≥ -3
		n258	-102.3	-102.8	-101.2	- 118.8+ Z_4		
		n260	-99.3		-96.9	- 113.8+ Z_4		
		n261	-102.3	-102.8	-101.2	- 118.8+ Z_4		

NOTE 1: Values based on EIS spherical coverage as defined in clause 7.3.4 of TS 38.101-2 [19]. Side condition applies for directions in which EIS spherical coverage requirement is met.
 NOTE 2: Values specified at the Reference point to give minimum CSI-RS \hat{E} s/lot, with no applied noise.
 NOTE 3: For UEs that support multiple FR2 bands, Rx Beam Peak values are increased by $\Delta MB_{P,n}$ and Spherical coverage values are increased by $\Delta MB_{S,n}$, the UE multi-band relaxation factor in dB specified in clause 6.2.1 of TS 38.101-2 [19].

Editor’s notes for Table B.2.4.2-2:

- The value of Y for power class 4 is FFS, where Y_4 is the rough/fine beam gain difference in Rx beam peak direction for power class 4
- The value of Z for power class 4 is FFS, where Z_4 is the rough/fine beam gain difference in spherical coverage directions for power class 4

B.2.5 Conditions for RRC connection release with redirection to NR

This clause defines the following conditions for RRC connection release with redirection to NR: SSB_{RP} and SSB_{Es/lot}, applicable for a corresponding operating band.

The conditions are defined in Table B.2.5-1 for FR1 NR cells.

The conditions are defined in Table B.2.5-2 for FR2 NR cells.

Table B.2.5-1: Conditions for RRC connection release with redirection to NR in FR1

Parameter	NR operating band groups ^{Note1}	Minimum SSB _{RP}		SSB _{Es/lot}
		dBm / SCS _{SSB}		
		SCS _{SSB} = 15 kHz	SCS _{SSB} = 30 kHz	dB
Conditions	NR_FDD_FR1_A, NR_TDD_FR1_A	-125	-122	≥ -4
	NR_FDD_FR1_B	-124.5	-121.5	
	NR_TDD_FR1_C	-124	-121	
	NR_FDD_FR1_D, NR_TDD_FR1_D	-124.5	-120.5	
	NR_FDD_FR1_E, NR_TDD_FR1_E	-123	-120	
	NR_FDD_FR1_G	-122	-119	
	NR_FDD_FR1_H	-121.5	-118.5	

NOTE 1: NR operating band groups are defined in clause 3.5.2.

Table B.2.5-2: Conditions for RRC connection release with redirection to NR in FR2

Parameter	Angle of arrival	NR operating bands	Minimum SSB _{RP} ^{Note 2, Note 3}				SSB _{Es/lot}	
			dBm / SCS _{SSB}					
			SCS _{SSB} = 120 kHz			SCS _{SSB} = 240 kHz	dB	
			UE power class			UE power class		
1	2	3	4	1, 2, 3, 4				
Conditions	Rx Beam Peak	n257	-108.3	-111.8	-110.1	-	(Value for SCS _{SSB} = 120 kHz) +3dB	≥ -4
		n258	-108.3	-111.8	-110.1	-		
		n260	-105.3	-	-107.5	-		
		n261	-108.3	-111.8	-110.1	-		
	Spherical coverage ^{Note 1}	n257	-100.3	-100.8	-99.2	116.8+Z ₄	(Value for SCS _{SSB} = 120 kHz) +3dB	
		n258	-100.3	-100.8	-99.2	116.8+Z ₄		
		n260	-97.3	-	-94.9	111.8+Z ₄		
		n261	-100.3	-100.8	-99.2	116.8+Z ₄		

NOTE 1: Values based on EIS spherical coverage as defined in clause 7.3.4 of TS 38.101-2 [19]. Side condition applies for directions in which EIS spherical coverage requirement is met.

NOTE 2: Values specified at the Reference point to give minimum SSB_{Es/lot}, with no applied noise.

NOTE 3: For UEs that support multiple FR2 bands, Rx Beam Peak values are increased by $\Delta MB_{P,n}$ and Spherical coverage values are increased by $\Delta MB_{S,n}$, the UE multi-band relaxation factor in dB specified in clause 6.2.1 of TS 38.101-2 [19].

Editor's notes for Table B.2.5.2-2:

- The value of Y for power class 4 is FFS, where Y_4 is the rough/fine beam gain difference in Rx beam peak direction for power class 4
- The value of Z for power class 4 is FFS, where Z_4 is the rough/fine beam gain difference in spherical coverage directions for power class 4

B.2.6 Void

B.2.6.1 Void

Table B.2.6.1-1: Void

Table B.2.6.1-2: Void

B.2.6.2 Void

B.3 RRM Requirements Exceptions

B.3.1 Introduction

Annex B.3 covers exceptions for side conditions based on receiver sensitivity for CA, DC, and SUL.

B.3.2 Receiver sensitivity relaxation for CA

B.3.2.1 Receiver sensitivity relaxation for UE supporting CA in FR1

For a UE supporting inter-band carrier aggregation configuration with uplink in NR band, if there is a relaxation of receiver sensitivity $\Delta R_{IB,c} > 0$ dB as defined in clause 7.3A.3 of TS 38.101-1 [18], the relevant side conditions specifying received power levels (SSB_RP and I_o) shall be increased by the amount $\Delta = \Delta R_{IB,c}$ defined for the corresponding downlink NR bands.

For a UE supporting CA configuration in FR1, the requirement in this clause applies for both SC and CA operation.

B.3.2.2 Receiver sensitivity relaxation for UE configured with CA in FR1

B.3.2.2.1 Inter-band carrier aggregation

For a UE configured with inter-band carrier aggregation with active uplink in NR band, if there is a relaxation of receiver sensitivity $\Delta R_{IB,c} > 0$ dB as defined in clause 7.3A.3 of TS 38.101-1 [18], the relevant side conditions specifying received power levels (SSB_RP and I_o) shall be increased by the amount $\Delta = \Delta R_{IB,c}$ defined for the corresponding downlink NR bands.

If the relaxation Δ specified in this clause applies, then the relaxation specified in clause B.3.2.1 should not be applied.

B.3.2.2.2 Reference sensitivity exceptions due to UL harmonic interference for CA

In this clause, requirements exceptions are described for the UE configured with a band in FR1 when it is impacted by UL harmonic interference from another band in FR1 of the same CA configuration.

A relevant side condition (SSB_RP and I_o) in a requirement shall be increased by the amount $\Delta = L2 - L1$, where $L1$ is the reference sensitivity level specified in clause 7.3.2 of TS 38.101-1 [18], and $L2$ is the reference sensitivity level based on the requirements in clause 7.3A.4 of TS 38.101-1 [18], when the following conditions are fulfilled,

- corresponding downlink component carriers on different NR bands are configured with CA and active,
- the uplink is configured in the NR low operating band and is active,

- the uplink configuration is as specified in clause 7.3A.4 of TS 38.101-1 [18], and
- the exception requirements specified in clause 7.3A.4 of TS 38.101-1 [18] apply.

If the relaxation Δ specified in this clause applies, then the relaxation specified in clause B.3.2.1 should not be applied.

B.3.2.2.3 Reference sensitivity exceptions due to intermodulation interference due to 2UL CA

In this clause, requirements exceptions are described for the UE with an inter-band carrier aggregation with uplink assigned to two NR bands.

A relevant side condition (SSB_{RP} and I_o) in a requirement shall be increased by the amount $\Delta=L2-L1$, where L1 is the reference sensitivity level specified in clause 7.3.2 of TS 38.101-1 [18], and L2 is the reference sensitivity level based on the requirements in clause 7.3A.5 of TS 38.101-1 [18], when the following conditions are fulfilled,

- corresponding downlink component carriers on different bands are configured with CA and active,
- uplinks are assigned to two NR bands,
- the exception requirements specified in clause 7.3A.5 of TS 38.101-1 [18] apply.

If the relaxation Δ specified in this clause applies, then the relaxation specified in clause B.3.2.1 should not be applied.

B.3.2.3 Receiver sensitivity relaxation for UE supporting CA in FR2

B.3.2.4 Receiver sensitivity relaxation for UE configured with CA in FR2

B.3.2.4.1 Intra-band contiguous carrier aggregation

For a UE configured with intra-band contiguous carrier aggregation in NR band in FR2, if there is a relaxation of receiver sensitivity $\Delta R_{IB} > 0$ dB as defined in clause 7.3A.2.1 of TS 38.101-2 [19] depending on the aggregated channel bandwidth, the relevant side conditions specifying received power levels (SSB_{RP} and I_o) shall be increased by the amount $\Delta = \Delta R_{IB}$ defined for the corresponding downlink NR bands.

B.3.2.4.2 Intra-band non-contiguous carrier aggregation

For a UE configured with intra-band non-contiguous carrier aggregation in NR band in FR2, if there is a relaxation of receiver sensitivity $\Delta R_{IB} > 0$ dB as defined in clause 7.3A.2.1 of TS 38.101-2 [19] depending on the aggregated channel bandwidth, the relevant side conditions specifying received power levels (SSB_{RP} and I_o) shall be increased by the amount $\Delta = \Delta R_{IB}$ defined for the corresponding downlink NR bands.

B.3.3 Receiver sensitivity relaxation for DC

B.3.3.1 Receiver sensitivity relaxation for EN-DC

Editor's note: TBD

B.3.3.2 Receiver sensitivity relaxation for NE-DC

Editor's note: TBD

B.3.4 Receiver sensitivity relaxation for SUL

B.3.4.1 Receiver sensitivity relaxation for UE supporting SUL in FR1

For a UE supporting a SUL configuration in FR1, if there is a relaxation of receiver sensitivity $\Delta R_{IB,c} > 0$ dB as defined in clause 7.3C.3 of TS 38.101-1 [18], the relevant side conditions specifying received power levels (SSB_{RP} and I_o) shall be increased by the amount $\Delta = \Delta R_{IB,c}$ defined for the corresponding downlink NR bands.

For a UE supporting a SUL configuration in FR1, the requirement in this clause applies for both SC and SUL operation.

B.3.4.2 Receiver sensitivity relaxation for UE configured with SUL in FR1

B.3.4.2.1 Reference sensitivity exceptions due to UL harmonic interference for SUL

In this clause, requirements exceptions are described for the UE with a band in FR1 when it is impacted by UL harmonic interference from another band in FR1 of the same SUL configuration.

A relevant side condition (SSB_{RP} and I_o) in a requirement shall be increased by the amount $\Delta=L2-L1$, where L1 is the reference sensitivity level specified in clause 7.3.2 of TS 38.101-1 [18], and L2 is the reference sensitivity level based on the requirements in clause 7.3C.2 of TS 38.101-1 [18], when the following conditions are fulfilled,

- a downlink component carrier is configured in NR band and is active,
- the uplink is configured in the NR low operating band and is active,
- the uplink configuration is as specified in clause 7.3C.2 of TS 38.101-1 [18], and
- the exception requirements specified in clause 7.3C.2 of TS 38.101-1 [18] apply.

If the relaxation Δ specified in this clause applies, then the relaxation specified in clause B.3.4.1 should not be applied.

Annex C (informative): Change history

Change history							
Date	Meeting	TDoc	CR	Rev	Cat	Subject/Comment	New version
2017-05	RAN4#83	R4-1706324				Specification skeleton	0.0.1
2017-09						Email approved	0.1.0
2017-09	RAN4-NR AH #3	R4-1709413				Capture TPs approved in the meeting	0.2.0
2017-10	RAN4#84 -Bis	R4-1711985				Capture TPs approved in the meeting	0.3.0
2017-12	RAN4#85	R4-1714546				Capture TPs approved in RAN4#85	0.4.0
2017-12	RAN#78	RP-172407				v1.0.0 submitted for plenary approval	1.0.0
2017-12	RAN#78					Approved by plenary – Rel-15 spec under change control	15.0.0
2018-03	RAN#79	RP-180264	0032		B	CR to TS38.133	15.1.0
2018-06	RAN#80	RP-181075	0037		B	CR to TS 38.133: Implementation of endorsed draft CRs from RAN4 #86bis and RAN4 #87	15.2.0
2018-09	RAN#81	RP-181896	0043		B	CR to TS 38.133: Implementation of endorsed draft CRs from RAN4-AH-1807 and RAN4 #88	15.3.0
2018-12	RAN#82	RP-182763	0057	3	B	CR to TS 38.133: Implementation of endorsed draft CRs from RAN4-88bis and RAN4-89	15.4.0
2019-03	RAN#83	RP-190569	0064	1	B	CR to TS 38.133: Implementation of endorsed draft CRs from RAN4#90	15.5.0
2019-06	RAN#84	RP-191240	0072	1	F	CR to TS 38.133: Implementation of endorsed draft CRs from RAN4#90bis and RAN4#91	15.6.0
2019-09	RAN#85	RP-192022	0084		F	CR to TS 38.133: Implementation of endorsed draft CRs from RAN4#92 (Rel-15)	15.7.0
2019-12	RAN#86	RP-193039	0089		F	Correction to the starting point of the DRX cycle length interval	15.8.0
2019-12	RAN#86	RP-193042	0090		F	CR to 38.133 R15 Add the missing units to DRX cycle values	15.8.0
2019-12	RAN#86	RP-192997	0092	1	F	Specification of UE antenna gain range	15.8.0
2019-12	RAN#86	RP-192992	0094		F	Add RRM Test case setup for 1 AoA in Rx beam peak and 1 in non Rx beam peak	15.8.0
2019-12	RAN#86	RP-192997	0096		F	Update of Parameters, Test case A.7.7.1.1 FR2 Intra-frequency SS-RSRP accuracy	15.8.0
2019-12	RAN#86	RP-192997	0098		F	Update of Parameters, Test case A.5.7.1.1 FR2 Intra-frequency SS-RSRP accuracy	15.8.0
2019-12	RAN#86	RP-192997	0100		F	Update of Parameters, Test case A.7.7.1.2 FR2 Inter-frequency SS-RSRP accuracy	15.8.0
2019-12	RAN#86	RP-192997	0102		F	Update of Parameters, Test case A.5.7.1.2 FR2 Inter-frequency SS-RSRP accuracy	15.8.0
2019-12	RAN#86	RP-192992	0104		F	Correction to Random access test case in FR1 for PSCell in EN-DC	15.8.0
2019-12	RAN#86	RP-193040	0106		F	CR on handover 38.133	15.8.0
2019-12	RAN#86	RP-192994	0108		F	CR on the BWP switch test cases EN-DC FR1 (clause A.4.5.6)	15.8.0
2019-12	RAN#86	RP-192994	0109		F	CR on the BWP switch test cases EN-DC FR2 (clause A.5.5.6)	15.8.0
2019-12	RAN#86	RP-192994	0110		F	CR on the BWP switch test cases SA FR1 (clause A.6.5.6)	15.8.0
2019-12	RAN#86	RP-192994	0111		F	CR on the BWP switch test cases SA FR2 (clause A.7.5.6)	15.8.0
2019-12	RAN#86	RP-193042	0116		F	CR to TS38.133 on correction for BWP switching with SCS changing (Clause 8.2.1.2.7, 8.2.2.2.5 and 8.6.2)	15.8.0
2019-12	RAN#86	RP-193040	0120		F	CR on handover RRM requirement (clause 6.1.1.5) (R15)	15.8.0
2019-12	RAN#86	RP-192994	0122		F	CR on test cases for EN-DC FR2 inter-frequency measurement (clause A.5.6.2) (R15)	15.8.0
2019-12	RAN#86	RP-192994	0126		F	CR on test cases for Redirection from NR in FR2 to NR in FR2 (clause A.7.3.2.3) (R15)	15.8.0
2019-12	RAN#86	RP-192994	0128		F	CR on test cases for FR2 handover (clause A.7.3.1) (R15)	15.8.0
2019-12	RAN#86	RP-193042	0130		F	CR to 38.133 on TCI state switching (Clause 8.10) (R15)	15.8.0
2019-12	RAN#86	RP-192994	0136		F	CR on TC with monitoring PDCCH not in first 3 OFDM symbols R15	15.8.0
2019-12	RAN#86	RP-193042	0144		F	Editorial correction for SCell activation and deactivation delay	15.8.0
2019-12	RAN#86	RP-193040	0147		F	CR on inter-RAT measurement in TS38.133 (clause 9.4.2, 9.4.3)	15.8.0
2019-12	RAN#86	RP-193041	0155		F	CR on NR MTTD and MRTD definition for R15	15.8.0
2019-12	RAN#86	RP-193039	0158		F	CR for SCell activation delay in FR2	15.8.0
2019-12	RAN#86	RP-193040	0160		F	CR for scheduling restriction due to L1-RSRP measurement	15.8.0
2019-12	RAN#86	RP-192993	0166	1	F	CR on SSB setting for new gap and SMTC setting (Clause A.3.10)	15.8.0
2019-12	RAN#86	RP-192995	0168		F	CR on TS38.133 for EN-DC SS-SINR tests with PSCell in FR1 (Clause A.4.7.3)	15.8.0
2019-12	RAN#86	RP-192995	0170		F	CR on TS38.133 for SA SS-SINR tests with PCell in FR1 (Clause A.6.7.3)	15.8.0

2019-12	RAN#86	RP-192993	0184		F	CR on cell-reselection test cases for NR SA FR2 R15	15.8.0
2019-12	RAN#86	RP-192995	0186		F	endorsed CR on intra-frequency measurement and reporting for EN-DC FR2 R15	15.8.0
2019-12	RAN#86	RP-192996	0188		F	endorsed CR on intra-frequency measurement and reporting for NR SA FR2 R15	15.8.0
2019-12	RAN#86	RP-192996	0190		F	endorsed CR on RLM scheduling restrictions for EN-DC FR2 R15	15.8.0
2019-12	RAN#86	RP-192996	0192		F	endorsed CR on RLM scheduling restrictions for NR SA FR2 R15	15.8.0
2019-12	RAN#86	RP-192992	0200	1	F	Correction to PRACH configuration index in test cases	15.8.0
2019-12	RAN#86	RP-193039	0208		F	Correction on the TCI state switching (clause 8.10)	15.8.0
2019-12	RAN#86	RP-193039	0214	1	F	CR for 38133 editorial for clause 8.1,8.8,8.9,8.10,8.11 in Rel-15	15.8.0
2019-12	RAN#86	RP-193039	0215	1	F	CR for 38133 editorial for clause 8.5 in Rel-15	15.8.0
2019-12	RAN#86	RP-193039	0216	1	F	CR for 38133 editorial for clause 9.3 in Rel-15	15.8.0
2019-12	RAN#86	RP-193040	0217	1	F	CR on 38133 for removal the duplicated reference in clause 2	15.8.0
2019-12	RAN#86	RP-193040	0218	1	F	CR on 38133 for clause 11 in Rel-15	15.8.0
2019-12	RAN#86	RP-192994	0224	2	F	CR on TC of UE transmit timing (A.4.4.1.1, A.5.4.1.1, A.6.4.1.1, A.7.4.1.1) Rel-15	15.8.0
2019-12	RAN#86	RP-193042	0229	1	F	Update on requirements related to inter-band EN-DC and NE-DC synchronous requirements	15.8.0
2019-12	RAN#86	RP-192995	0232	1	F	Editorial corrections to measurement accuracy tests	15.8.0
2019-12	RAN#86	RP-192992	0234		F	Corrections to SS-RSRQ and SS-SINR OTA tests with SA	15.8.0
2019-12	RAN#86	RP-192992	0236		F	Corrections to SS-RSRQ and SS-SINR OTA tests with EN-DC	15.8.0
2019-12	RAN#86	RP-193042	0238	1	F	Editorial corrections to clause 9.2	15.8.0
2019-12	RAN#86	RP-192992	0241		F	Corrections to band applicability of measurement accuracy tests	15.8.0
2019-12	RAN#86	RP-192996	0243	1	F	Introduction of bandwidth limited OCNG for OTA testing	15.8.0
2019-12	RAN#86	RP-192992	0247	1	F	Corrections to test cases for SA FR2 inter-frequency measurement (clause A.7.6.2)	15.8.0
2019-12	RAN#86	RP-193041	0249		F	CR to 38.133 NR reporting criteria	15.8.0
2019-12	RAN#86	RP-192993	0263	1	F	CR on correcting CSI-RS based BFD and link recovery tests for EN-DC in FR1	15.8.0
2019-12	RAN#86	RP-192993	0265	1	F	CR on correcting CSI-RS based BFD and link recovery tests for SA in FR1	15.8.0
2019-12	RAN#86	RP-192993	0267	1	F	CR on correcting CSI-RS based BFD and link recovery tests for EN-DC in FR2	15.8.0
2019-12	RAN#86	RP-192993	0269	1	F	CR on correcting CSI-RS based BFD and link recovery tests for SA in FR2	15.8.0
2019-12	RAN#86	RP-193040	0275	1	F	CR on delay uncertainty of RRC Release with redirection requirements in TS 38.133	15.8.0
2019-12	RAN#86	RP-193040	0277	1	F	CR on known condition of PSCell addition requirement in NE-DC	15.8.0
2019-12	RAN#86	RP-193041	0279	1	F	CR on known condition of PSCell addition requirement in NR DC	15.8.0
2019-12	RAN#86	RP-193041	0281	1	F	CR on RRC Re-establishment requirements in TS 38.133	15.8.0
2019-12	RAN#86	RP-193041	0283	2	F	CR on scope of interruption requirements of EN-DC in TS 38.133	15.8.0
2019-12	RAN#86	RP-193041	0285	1	F	CR on scope of MTTD requirements in TS 38.133	15.8.0
2019-12	RAN#86	RP-192994	0287	1	F	CR on SSB-based RLM test case for EN-DC FR1	15.8.0
2019-12	RAN#86	RP-192994	0289	1	F	CR on SSB-based RLM test case for NR SA FR1	15.8.0
2019-12	RAN#86	RP-193042	0291	1	F	Editorial CR on clause 8.2	15.8.0
2019-12	RAN#86	RP-193041	0295	1	F	CR on NR inter-frequency identification	15.8.0
2019-12	RAN#86	RP-193041	0297	1	F	CR on NR intra-frequency measurements	15.8.0
2019-12	RAN#86	RP-193039	0311	1	F	Correction on CSSF within measurement gap (clause 9.1.5.2)	15.8.0
2019-12	RAN#86	RP-193041	0313		F	CR on RLM scheduling restriction (clause 8.1.7)	15.8.0
2019-12	RAN#86	RP-193041	0315	1	F	CR on SCell activation requirements (clause 8.3.2)	15.8.0
2019-12	RAN#86	RP-193042	0317		F	CR to add QCL definition (clause 3.6)	15.8.0
2019-12	RAN#86	RP-192993	0319		F	CR on power offset in TRS RMC (A.3.17)	15.8.0
2019-12	RAN#86	RP-192995	0321		F	CR to introduce new PDCCH RMC (A.3.1.3.2)	15.8.0
2019-12	RAN#86	RP-192997	0323		F	Maintenance CR for measurement accuracy (clause 10.1)	15.8.0
2019-12	RAN#86	RP-192996	0325		F	FR1 CSI-RS RLM test OOS/IS non-DRX for EN-DC (clause A.4.5.1)	15.8.0
2019-12	RAN#86	RP-192996	0327	1	F	FR2 CSI-RS RLM test OOS/IS non-DRX for EN-DC (clause A.4.5.1)	15.8.0
2019-12	RAN#86	RP-192996	0329		F	FR1 CSI-RS RLM test OOS/IS non-DRX for SA (clause A.6.5.1)	15.8.0
2019-12	RAN#86	RP-192996	0331	1	F	FR2 CSI-RS RLM test OOS/IS non-DRX for SA (clause A.6.5.1)	15.8.0
2019-12	RAN#86	RP-192997	0333	1	F	L1-RSRP delay test FR1 EN-DC (clause A.4.6.3)	15.8.0
2019-12	RAN#86	RP-192997	0335		F	L1-RSRP delay test FR2 EN-DC (clause A.5.6.3)	15.8.0
2019-12	RAN#86	RP-192997	0337	1	F	L1-RSRP delay test FR1 SA (clause A.6.6.4)	15.8.0
2019-12	RAN#86	RP-192997	0339		F	L1-RSRP delay test FR2 SA (clause A.7.6.3)	15.8.0
2019-12	RAN#86	RP-192996	0343		F	L1-RSRP accuracy test FR2 EN-DC (clause A.5.7.4)	15.8.0
2019-12	RAN#86	RP-192996	0345		F	L1-RSRP accuracy test FR2 SA (clause A.7.7.4)	15.8.0
2019-12	RAN#86	RP-193039	0357		F	CR 38.133 (8.3.2) Amendment of requirements depending on T_SMTc_Max	15.8.0
2019-12	RAN#86	RP-193039	0359		F	CR 38.133 (8.3.3) Correction of SCell deactivation delay	15.8.0
2019-12	RAN#86	RP-192992	0361		F	CR 38.133 (A.7.5.7) TCs for PSCell addition and release delay	15.8.0
2019-12	RAN#86	RP-192995	0365		F	CR to TS 38.133: New common clause with OTA related definitions for FR2 testing (Rel-15)	15.8.0
2019-12	RAN#86	RP-192995	0367		F	CR to TS 38.133: Configuration of NR FR1 cell in NR FR1-FR2 tests (Rel-15)	15.8.0

2019-12	RAN#86	RP-192995	0369		F	CR to TS 38.133: Clarificatins to Antenna Configurations for FR2 (Rel-15)	15.8.0
2019-12	RAN#86	RP-192995	0371		F	CR to TS 38.133: Corrections to CORESET RMCs (Rel-15)	15.8.0
2019-12	RAN#86	RP-192995	0373		F	CR to TS 38.133: Corrections to FR2 test configurations (Rel-15)	15.8.0
2019-12	RAN#86	RP-193042	0375	1	F	Editorial updates (clause 9.4)	15.8.0
2019-12	RAN#86	RP-193039	0377	1	F	Correction in interruption requirements (clause 8.2)	15.8.0
2019-12	RAN#86	RP-193042	0379	1	F	Editorial updates (Annex B)	15.8.0
2019-12	RAN#86	RP-193040	0381		F	CR on 38133 for MRTD and MTTD in intra-band EN-DC	15.8.0
2019-12	RAN#86	RP-192992	0384	1	F	CR for MAC-CE based TCI State switch for ENDC (Clause A.5.5.8)	15.8.0
2019-12	RAN#86	RP-192993	0385	1	B	CR for MAC-CE based TCI State switch for NR SA (Clause A.7.5.7)	15.8.0
2019-12	RAN#86	RP-192993	0386	1	B	CR for RRC based TCI State switch for NR SA (Clause A.7.5.7)	15.8.0
2019-12	RAN#86	RP-192993	0387	1	F	CR for RRC based TCI State switch for EN-DC (Clause A.5.5.8)	15.8.0
2019-12	RAN#86	RP-192992	0388	1	F	CR for FR1 handover test cases (Clause A.6.3.1.1, A.6.3.1.2, A.6.3.1.3)	15.8.0
2019-12	RAN#86	RP-193041	0389	1	F	CR on MTTD for intra-band EN-DC	15.8.0
2019-12	RAN#86	RP-193040	0397		F	CR on corrections on NR intra frequency measurement reporting requirements (Clause 9.2.4)	15.8.0
2020-03	RAN#87	RP-200400	0404	1	F	[CR] handover requirements 38.133 R15	15.9.0
2020-03	RAN#87	RP-200400	0411	1	F	[CR] SCell activation delay 38.133 R15	15.9.0
2020-03	RAN#87	RP-200400	0416		F	Corrections to RRM Test case A.7.1.1.2	15.9.0
2020-03	RAN#87	RP-200400	0418		F	Correction to Active UL BWP for SA intra-frequency event triggered reporting with per-UE gaps	15.9.0
2020-03	RAN#87	RP-200400	0420		F	Correction to FR1-E-UTRA Inter-RAT cell re-selection test cases	15.9.0
2020-03	RAN#87	RP-200400	0422		F	Removal of Time offset between PCell and PSCell in SA RRM Test cases	15.9.0
2020-03	RAN#87	RP-200400	0424		F	Correction to SRS periodicity and Offset for UL transit timing with DRx config	15.9.0
2020-03	RAN#87	RP-200400	0426		F	Update of Test Requirements, FR2 Intra-frequency SS-RSRP accuracy Test cases	15.9.0
2020-03	RAN#87	RP-200400	0428		F	Update of Test requirements, FR2 Inter-frequency SS-RSRP accuracy Test cases	15.9.0
2020-03	RAN#87	RP-200484	0438	2	F	CR on test cases for SA FR2 inter-frequency measurement R15 (section A.7.6.2)	15.9.0
2020-03	RAN#87	RP-200400	0444	1	F	Editorial corrections for 38.133 Perf Part R15	15.9.0
2020-03	RAN#87	RP-200400	0446		F	Editorial corrections for 38.133 Core Part R15	15.9.0
2020-03	RAN#87	RP-200400	0453		F	Editorial correction for active TCI state switching delay	15.9.0
2020-03	RAN#87	RP-200400	0461	1	F	Corrections for BWP switch delay R15	15.9.0
2020-03	RAN#87	RP-200400	0463		F	CR for reference correction on L1-RSRP measurement period (section 9.5.3)	15.9.0
2020-03	RAN#87	RP-200400	0465		F	CR for measurement restriction in FR2 across CCs (section 8.1.2.3, 8.1.3.3, 8.5.2.3, 8.5.3.3, 8.5.5.3, 8.5.6.3, 9.5.5.1, 9.5.5.2)	15.9.0
2020-03	RAN#87	RP-200400	0467		F	CR for SSB based candidate beam detection (section 8.5.5.2)	15.9.0
2020-03	RAN#87	RP-200400	0487		F	CR to TS 38.133: Corrections to FR1-FR2 event triggered test cases Annex A.5 (Rel-15)	15.9.0
2020-03	RAN#87	RP-200400	0489		F	CR to TS 38.133: Corrections to FR1-FR2 event triggered test cases Annex A.7 (Rel-15)	15.9.0
2020-03	RAN#87	RP-200400	0491		F	CR to TS 38.133: Clarifications to AoA setup and AoA cell assignment Annex A.5 (Rel-15)	15.9.0
2020-03	RAN#87	RP-200400	0493		F	CR to TS 38.133: Clarifications to AoA setup Annex A.8 (Rel-15)	15.9.0
2020-03	RAN#87	RP-200400	0495		F	CR to TS 38.133: Addition of TC A.4.7.2.2 (Rel-15)	15.9.0
2020-03	RAN#87	RP-200400	0499		F	Editorial correction of EN-DC FR1 L1-RSRP measurement for beam reporting	15.9.0
2020-03	RAN#87	RP-200400	0501		F	Editorial correction of NR SA FR1 L1-RSRP measurement for beam reporting	15.9.0
2020-03	RAN#87	RP-200400	0508		F	CR on removing one-shot timing adjustment requirements	15.9.0
2020-03	RAN#87	RP-200400	0515	1	F	Correction to BWP switching delay	15.9.0
2020-03	RAN#87	RP-200400	0517	1	F	Correction to inter-RAT measurement on LTE serving carrier	15.9.0
2020-03	RAN#87	RP-200400	0519	1	F	Correction to configurations for TRS	15.9.0
2020-03	RAN#87	RP-200400	0521		F	Correction to FR1 SA inter-RAT measurement TCs	15.9.0
						NOTE The CR is not implemented because the changes in this CR were already implemented in the latest version of the specification.	
2020-03	RAN#87	RP-200400	0523		F	Correction to interruption TCs	15.9.0
						NOTE The CR is not implemented because some parts of changes in the CR were already implemented in the latest version of the specification.	
2020-03	RAN#87	RP-200400	0527		F	Correction to RF channels configuration	15.9.0
2020-03	RAN#87	RP-200400	0529		F	Correction to RRC release with redirection TCs	15.9.0

2020-03	RAN#87	RP-200400	0531		F	Correction to UL reconfiguration delay TCs	15.9.0
2020-03	RAN#87	RP-200400	0537		F	CR on SSB RLM test cases EN-DC R15	15.9.0
2020-03	RAN#87	RP-200400	0539		F	CR on SSB RLM test cases SA R15	15.9.0
2020-03	RAN#87	RP-200400	0541		F	CR on cell reselection test cases for FR2 SA R15	15.9.0
2020-03	RAN#87	RP-200400	0543		F	OCNG pattern for TDM-ed SSB R15	15.9.0
2020-03	RAN#87	RP-200400	0563		F	NR editorial correction	15.9.0
2020-03	RAN#87	RP-200400	0579	1	F	CR 38.133 (8.11) Corrections to PSCell change delay requirements	15.9.0
2020-03	RAN#87	RP-200400	0586		F	PRACH configurations in FR1 SSB based RLM tests	15.9.0
2020-03	RAN#87	RP-200400	0588		F	PRACH configurations in FR1 SSB based BFR tests	15.9.0
2020-06	RAN#88	RP-200987	0594	1	F	[CR] Editorial corrections for 38.133 R15 Core Part	15.10.0
2020-06	RAN#88	RP-200987	0597	1	F	[CR] Editorial corrections for 38.133 R15 Perf Part	15.10.0
2020-06	RAN#88	RP-200987	0601	1	F	CR to Intra-frequency handover from FR1 to FR1	15.10.0
2020-06	RAN#88	RP-200987	0605		F	CR to A.6.1.2.1 Cell reselection to higher priority E-UTRAN	15.10.0
2020-06	RAN#88	RP-200987	0607		F	Correction to General test parameters in A.6.6.1.2	15.10.0
2020-06	RAN#88	RP-200987	0619	1	F	CR on CSSF correction for R15 TS38.133	15.10.0
2020-06	RAN#88	RP-200987	0628	1	F	CR on Active TCI State Switching requirements - Rel15	15.10.0
2020-06	RAN#88	RP-200988	0633	2	F	Rapporteur CR for TS38.133	15.10.0
2020-06	RAN#88	RP-200987	0650		F	Add UE Beam assumption for RRM Test cases in A.7.3, A.7.4, A.7.7	15.10.0
2020-06	RAN#88	RP-200987	0652		F	Add UE Beam assumption for RRM Test cases in A.5.3, A.5.4, A.5.7	15.10.0
2020-06	RAN#88	RP-200987	0654		F	Update of FR2 RLM Test cases with 2 Angles of Arrival	15.10.0
2020-06	RAN#88	RP-200987	0656		F	Update of Tx Timing Test cases	15.10.0
2020-06	RAN#88	RP-200987	0658		F	Update of FR2 RLM and BFD-LR Test cases	15.10.0
2020-06	RAN#88	RP-200987	0660		F	Update of FR2 SS-RSRP Test cases	15.10.0
2020-06	RAN#88	RP-200987	0662	1	F	CR on TCI state switch	15.10.0
2020-06	RAN#88	RP-200987	0664		F	CR on PDSCH RMC	15.10.0
2020-06	RAN#88	RP-200987	0679		F	Correction of CFRA RSRP threshold	15.10.0
2020-06	RAN#88	RP-200987	0695	1	F	CR on SMTC period for beam management requirements	15.10.0
2020-06	RAN#88	RP-200987	0697		F	CR for CSI-RS based L1-RSRP measurement period	15.10.0
2020-06	RAN#88	RP-200987	0699		F	CR on RACH test cases with CSI-RS resource R15	15.10.0
2020-06	RAN#88	RP-200987	0703		F	CR on TS38.133 for modification of the layer 3 and layer 1 measurement sharing factor when both SSB and RSI symbol to be measured are considered	15.10.0
2020-06	RAN#88	RP-200987	0705		F	CR on TS38.133 for modification on number of cells and number of SSB to be measured for FR2 intra-frequency measurement	15.10.0
2020-06	RAN#88	RP-200987	0707	1	F	[CR] TCI state switch delay 38.133 R15	15.10.0
2020-06	RAN#88	RP-200987	0714		F	Correction of NR SA FR2 inter-freq measurement reporting	15.10.0
2020-06	RAN#88	RP-200987	0726		F	CR: Correction of L1-RSRP measurement period	15.10.0
2020-06	RAN#88	RP-200987	0728	1	F	CR to TS 38.133: Correction to CSI-RS configurations in A.3.14 (Rel-15)	15.10.0
2020-06	RAN#88	RP-200987	0730		F	CR to TS 38.133: Correction to SMTC configuration in measurement accuracy tests (Rel-15)	15.10.0
2020-06	RAN#88	RP-200987	0732		F	CR to TS 38.133: Clarifications to AoA setup Annex A.5 (Rel-15)	15.10.0
2020-06	RAN#88	RP-200987	0734		F	CR to TS 38.133: Clarifications to AoA setup Annex A.7 (Rel-15)	15.10.0
2020-06	RAN#88	RP-200987	0737	1	F	Applicability of QCL	15.10.0
2020-06	RAN#88	RP-200987	0747	1	F	CR on Psharingfactor	15.10.0
2020-06	RAN#88	RP-200987	0749	1	F	CR on E-UTRAN Serving Cell Parameters	15.10.0
2020-06	RAN#88	RP-200987	0751	1	F	CR on Modified parameters for BFD TCs with 4Rx antenna	15.10.0
2020-06	RAN#88	RP-200987	0753	1	F	CR on BFD TCs	15.10.0
2020-06	RAN#88	RP-200987	0755	1	F	CR on UL carrier RRC reconfiguration Delay TC	15.10.0
2020-06	RAN#88	RP-200987	0757	1	F	CR to FR1 SCell activation delay test cases	15.10.0
2020-06	RAN#88	RP-200987	0759	1	F	CR to inter-frequency measurement TCs	15.10.0
2020-06	RAN#88	RP-200987	0761	1	F	CR to interruption TCs	15.10.0
2020-06	RAN#88	RP-200987	0776		F	CR on interruption due to Active BWP switch	15.10.0
2020-06	RAN#88	RP-200987	0780		F	CR on UE transmit timing	15.10.0
2020-06	RAN#88	RP-200987	0782		F	Editorial CR on TS 38.133 Rel-15	15.10.0
2020-06	RAN#88	RP-200987	0784		F	CR on RRC Connection Release with Redirection test cases	15.10.0
2020-06	RAN#88	RP-200987	0786		F	CR on RRC Re-establishment test cases	15.10.0
2020-06	RAN#88	RP-200987	0788		F	CR on Timing advance test cases for EN-DC	15.10.0
2020-06	RAN#88	RP-200987	0790		F	CR on Timing test cases for NR SA	15.10.0
2020-06	RAN#88	RP-200987	0798		F	Correction on TCI state switching R15	15.10.0
2020-06	RAN#88	RP-200987	0800		F	Accuracy of carrier aggregation in NR R15	15.10.0
2020-06	RAN#88	RP-200987	0812		F	CR 38.133 (8.10.5) Corrections to RRC-based TCI state change	15.10.0
2020-06	RAN#88	RP-200987	0815	2	F	CR 38.133 (8.3.2) Corrections to SCell Activation delay requirements	15.10.0
2020-06	RAN#88	RP-200987	0820		F	CR on FR2 measurement requirements outside gaps R15	15.10.0
2020-06	RAN#88	RP-200987	0822		F	CR on inter-RAT RSTD requirements for NE-DC in 38.133 R15	15.10.0
2020-06	RAN#88	RP-200987	0824	1	F	CR on SCell activation requirements R15	15.10.0
2020-06	RAN#88	RP-200987	0826		F	CR on SSB based L1-RSRP measurement R15	15.10.0
2020-06	RAN#88	RP-200987	0828		F	CR on L1-RSRP delay tests for FR2 R15	15.10.0
2020-06	RAN#88	RP-200987	0830		F	CR to L1-RSRP accuracy TC for FR2 EN-DC R15	15.10.0
2020-06	RAN#88	RP-200987	0832		F	CR to L1-RSRP accuracy TC for FR2 SA R15	15.10.0

2020-06	RAN#88	RP-200987	0834		F	CR to TCI state switch TC R15	15.10.0
2020-06	RAN#88	RP-200987	0866		F	Clarification on RLM	15.10.0
2020-09	RAN#89	RP-201512	0888		F	CR to Redirection from NR in FR1 to E-UTRAN	15.11.0
2020-09	RAN#89	RP-201512	0890		F	CR to timing advance adjustment accuracy in FR1	15.11.0
2020-09	RAN#89	RP-201512	0894		F	CR to SS-RSRQ Intra-Frequency and Inter-frequency FR1 measurement accuracy	15.11.0
2020-09	RAN#89	RP-201512	0896		F	Update to FR2 240kHz SSB Configurations	15.11.0
2020-09	RAN#89	RP-201512	0898		F	Update of FR2 Random Access Test cases	15.11.0
2020-09	RAN#89	RP-201512	0900		F	Update to FR2 event-triggered reporting RRM Test cases in A.5.6 and A.7.6	15.11.0
2020-09	RAN#89	RP-201512	0902		F	Update to FR2 SS-RSRP RRM Test cases in A.5.7 and A.7.7	15.11.0
2020-09	RAN#89	RP-201512	0904		F	CR to EN-DC timing advance adjustment accuracy in FR2	15.11.0
2020-09	RAN#89	RP-201512	0906		F	CR to configuration of CSI-RS for tracking	15.11.0
2020-09	RAN#89	RP-201512	0908	1	F	Update of RRC-based Active BWP Switch test cases	15.11.0
2020-09	RAN#89	RP-201512	0910		F	Update to FR2 Annex B RRM side conditions	15.11.0
2020-09	RAN#89	RP-201512	0912		F	Add UE Beam assumption for RRM Test cases in A.5.5	15.11.0
2020-09	RAN#89	RP-201512	0921		F	Add UE Beam assumption for RRM Test cases in A.7.5 Rel-15	15.11.0
2020-09	RAN#89	RP-201512	0932		F	CR for TS38.133 Rel-15, Correction for RRM core requirements	15.11.0
2020-09	RAN#89	RP-201512	0934	1	F	CR for TS38.133 Rel-15, Correction for test cases of BWP switching	15.11.0
2020-09	RAN#89	RP-201512	0945	1	F	CR on TS38.133 for handover test cases	15.11.0
2020-09	RAN#89	RP-201512	0947		F	CR on TS38.133 for introducing the PDSCH RMC configuration in cell re-selection test cases	15.11.0
2020-09	RAN#89	RP-201512	0955	1	F	CR on FR2 measurement capability for R15	15.11.0
2020-09	RAN#89	RP-201512	0962		F	CR on Inter-RAT RSTD measurements (section 9.4.4)	15.11.0
2020-09	RAN#89	RP-201512	0964	1	F	CR on active BWP switch in R15	15.11.0
2020-09	RAN#89	RP-201512	0985		F	CR for SCell activation delay in FR2 in R15	15.11.0
2020-09	RAN#89	RP-201512	0987	1	F	CR on TCI state switch delay in R15	15.11.0
2020-09	RAN#89	RP-201512	1002	1	F	Fine/rough beam assumption for idle mode and measurement procedure test case	15.11.0
2020-09	RAN#89	RP-201512	1022		F	Clarification of SNR values in RLM Test cases	15.11.0
2020-09	RAN#89	RP-201512	1024		F	CR to TS 38.133: Corrections to CSI-RS configurations in A.3.14 (Rel-15)	15.11.0
2020-09	RAN#89	RP-201512	1026		F	CR to TS 38.133: Corrections to event triggered test cases (Rel-15)	15.11.0
2020-09	RAN#89	RP-201512	1028		F	CR to TS 38.133: Corrections to inter-RAT test cases (Rel-15)	15.11.0
2020-09	RAN#89	RP-201512	1030		F	CR to TS 38.133: Corrections to AoA setup information in some test cases (Rel-15)	15.11.0
2020-09	RAN#89	RP-201512	1032	1	F	CR on maintaining handover tests in Rel-15	15.11.0
2020-09	RAN#89	RP-201512	1047	1	F	CR on reporting criteria for EN-DC in 38.133 R15	15.11.0
2020-09	RAN#89	RP-201512	1049	1	F	CR on test cases for Active TCI state switch delay R15	15.11.0
2020-09	RAN#89	RP-201512	1051	1	F	Addition of new default configurations for RMC scheduling	15.11.0
2020-09	RAN#89	RP-201512	1053	1	F	Correction to beam failure detection and link recovery test cases	15.11.0
2020-09	RAN#89	RP-201512	1055	1	F	Correction to BWP switching delay test cases	15.11.0
2020-09	RAN#89	RP-201512	1057		F	Correction to FR1 intra-frequency measurement with gap test cases	15.11.0
2020-09	RAN#89	RP-201512	1059	1	F	Correction to inter-RAT HO test cases	15.11.0
2020-09	RAN#89	RP-201512	1069		F	CR on correction to CSSF within gap R15	15.11.0
2020-09	RAN#89	RP-201512	1071	1	F	CR on SCell activation requirements R15	15.11.0
2020-09	RAN#89	RP-201512	1073	1	F	CR on BWP switching delay requirements R15	15.11.0
2020-09	RAN#89	RP-201512	1074	1	F	CR on UL BWP configuration for RRM test cases R15	15.11.0
2020-09	RAN#89	RP-201512	1076	1	F	CR to add UE beam assumption for TC in A.5.6 R15	15.11.0
2020-09	RAN#89	RP-201512	1096	1	F	CR to 38.133: Correction to RRC based BWP switch delay requirements	15.11.0
2020-09	RAN#89	RP-201512	1098	1	F	CR to 38.133: Correction to interruption requirements for per-FR gap in FR2	15.11.0
2020-09	RAN#89	RP-201512	1110		F	[CR] Replacing x in references with correct numbers (Core R15 Cat F)	15.11.0
2020-09	RAN#89	RP-201512	1112		F	[CR] Replacing x in references with correct numbers (Perf R15 Cat F)	15.11.0
2020-12	RAN#90	RP-202487	1118	1	F	RB allocation and Noc level in RLM Test cases	15.12.0
2020-12	RAN#90	RP-202487	1120		F	Update FR2 event-triggered reporting Test cases in A.5.6, A.7.6	15.12.0
2020-12	RAN#90	RP-202487	1122		F	240kHz SSB SCS Configuration for FR2 SS-RSRP Test cases	15.12.0
2020-12	RAN#90	RP-202487	1124	1	F	Correct UE beam assumption for Test Cases in A.5.6	15.12.0
2020-12	RAN#90	RP-202487	1126	1	F	Aggregation level of CORESET for RMC scheduling	15.12.0
2020-12	RAN#90	RP-202487	1128		F	Clarify FR1 NSA SS-SINR measurement TCs	15.12.0
2020-12	RAN#90	RP-202487	1130		F	FR1 Inter-frequency Event triggered Reporting tests in DRX	15.12.0
2020-12	RAN#90	RP-202487	1132		F	E-UTRAN	15.12.0
2020-12	RAN#90	RP-202486	1145	1	F	CR on CSI-RS BW condition for BFD/CBD R15	15.12.0
2020-12	RAN#90	RP-202486	1147	1	F	CR on AP-CSI-RS based L1-RSRP measurement R15	15.12.0
2020-12	RAN#90	RP-202487	1159		F	CR on TS38.133 for cell activation and deactivation test case	15.12.0
2020-12	RAN#90	RP-202487	1161	4	F	CR on TS38.133 for cell reselection test case	15.12.0
2020-12	RAN#90	RP-202487	1163	1	F	Correction of active BWP switch test case	15.12.0
2020-12	RAN#90	RP-202487	1167		F	CR for TS38.133 Rel-15, Correction for RRM core and test cases	15.12.0

2020-12	RAN#90	RP-202486	1195		F	CR on carrier frequency range of PCell/PSCell for the maximum number of RLM-RS resources	15.12.0
2020-12	RAN#90	RP-202486	1201	1	F	CR on MO merge in R15	15.12.0
2020-12	RAN#90	RP-202487	1208	1	F	Correction on beamFailureInstanceMaxCount for test case of availability restriction during FR2 BFR in R15	15.12.0
2020-12	RAN#90	RP-202487	1215		F	Correction of RRM tests	15.12.0
2020-12	RAN#90	RP-202487	1224		F	Correction to types of requirements in annex A	15.12.0
2020-12	RAN#90	RP-202487	1226	1	F	Corrections to frequency range in interfrequency measurement procedures tests	15.12.0
2020-12	RAN#90	RP-202487	1229		F	Correction on TBD values in FR1+FR2 interfrequency RSRP accuracy tests	15.12.0
2020-12	RAN#90	RP-202486	1231		F	Addition of symbol definitions	15.12.0
2020-12	RAN#90	RP-202487	1235	1	F	Square bracket removal in 38.133 section A.1 to A.5	15.12.0
2020-12	RAN#90	RP-202487	1237	1	F	Square bracket removal in 38.133 section A.6 to A.8	15.12.0
2020-12	RAN#90	RP-202486	1251	1	F	CR to TS 38.133 on DCI based BWP switch requirements applicability	15.12.0
2020-12	RAN#90	RP-202487	1258	1	F	Correction to CSI-RS RMC configuration R15	15.12.0
2020-12	RAN#90	RP-202487	1260	1	F	Correction to cell reselection test cases R15	15.12.0
2020-12	RAN#90	RP-202487	1262	1	F	Correction to inter-RAT handover test cases R15	15.12.0
2020-12	RAN#90	RP-202487	1264	1	F	Correction to NR measurement under LTE SA test cases R15	15.12.0
2020-12	RAN#90	RP-202487	1266	1	F	Correction to inter-RAT SFTD measurement test cases R15	15.12.0
2020-12	RAN#90	RP-202487	1270		F	CR on maintaining BFD/CBD measurements test cases R15	15.12.0
2020-12	RAN#90	RP-202486	1295	1	F	CR on RRC-based BWP switch requirements	15.12.0
2020-12	RAN#90	RP-202487	1297	1	F	CR on RRC-based active TCI state switch test case Rel-15	15.12.0
2020-12	RAN#90	RP-202486	1310		F	[CR] Specify RRC processing delay in TCI state switching delay	15.12.0
2020-12	RAN#90	RP-202487	1312	1	F	[CR] NR Perf Maintenance R15 Cat F	15.12.0
2020-12	RAN#90	RP-202486	1316	1	F	CR on SCell activation requirements R15	15.12.0
2020-12	RAN#90	RP-202487	1318		F	CR on FR2 unknown SCell activation test cases R15	15.12.0
2020-12	RAN#90	RP-202487	1320		F	CR on BWP in L1-RSRP delay and accuracy test cases R15	15.12.0
2020-12	RAN#90	RP-202486	1335	1	F	Introducing reference to the source of the Lmax and NRLM.	15.12.0
2020-12	RAN#90	RP-202487	1341	1	F	CR to TS 38.133: Corrections to inter-RAT FR1 test cases (Rel-15)	15.12.0
2020-12	RAN#90	RP-202487	1343	1	F	CR to TS 38.133: Corrections to inter-RAT FR2 test cases (Rel-15)	15.12.0
2020-12	RAN#90	RP-202487	1349		F	CR 38.133 Corrections to test cases for TCI state switching	15.12.0
2020-12	RAN#90	RP-202487	1363	1	F	Removal of annex B.2.6 on one shot timing adjustment in 38.133	15.12.0
2020-12	RAN#90	RP-202487	1365	1	F	Correction to NR FR1 DL active BWP switch of Cell with non-DRX in SA (A.6.5.6.2.1)	15.12.0
2020-12	RAN#90	RP-202486	1371	2	F	CR to 38.133 on Active BWP switch and Active TCI State Switching requirements - Rel15	15.12.0
2021-03	RAN#91	RP-210116	1404	1	F	CR on correcting SSB and RACH configuration in CSI-RS based beam failure detection and link recovery tests	15.13.0
2021-03	RAN#91	RP-210116	1416	1	F	[CR] RRM test case maintenance R15 Cat F	15.13.0
2021-03	RAN#91	RP-210116	1422	1	F	Update FR2 Reference channels and OCNB for FR2 RRM Test cases	15.13.0
2021-03	RAN#91	RP-210116	1425		F	CR to FR1 SA SS-SINR measurement TCs	15.13.0
2021-03	RAN#91	RP-210116	1428		F	CR on E-UTRA carrier for EN-DC event triggered reporting tests	15.13.0
2021-03	RAN#91	RP-210116	1431		F	Add missing FR2 Test case setups and Beam assumptions	15.13.0
2021-03	RAN#91	RP-210116	1494		F	Correction to cell reselection test case	15.13.0
2021-03	RAN#91	RP-210116	1503		F	Update of DRX configuration in FR1 Event-triggered Test cases	15.13.0
2021-03	RAN#91	RP-210116	1512		F	Correction on PRACH configuration for FR2 Non-Contention based Random Access in R15	15.13.0
2021-03	RAN#91	RP-210116	1515	1	F	Correction on PRACH configuration for Beam Failure Detection and Link Recovery Test in R15	15.13.0
2021-03	RAN#91	RP-210116	1518		F	Correction on PRACH RMC for FR1 CSI-RS based Non-Contention based Random Access for BFR in R15	15.13.0
2021-03	RAN#91	RP-210117	1537	2	F	CR on SCell activation delay maintenance (R15)	15.13.0
2021-03	RAN#91	RP-210116	1545		F	CR for test requirements correction of SA event triggered reporting tests for FR1 inter-frequency measurements with SSB time index detection when DRX is used	15.13.0
2021-03	RAN#91	RP-210117	1548	1	F	CR on R15 remaining issues	15.13.0
2021-03	RAN#91	RP-210116	1563	1	F	Correction on the power of the first preamble for random access in EN-DC and SA in R15	15.13.0
2021-03	RAN#91	RP-210116	1566	2	F	Correction on the time for SCell activation and CSI-report in R15	15.13.0
2021-03	RAN#91	RP-210116	1569	1	F	Correction on the Noc level in TS38.133 in R15	15.13.0
2021-03	RAN#91	RP-210117	1605	1	F	CR on the filter for beam failure indications in 38.133	15.13.0
2021-03	RAN#91	RP-210116	1614		F	Correction to Aperiodic CSI-RS configurations R15	15.13.0
2021-03	RAN#91	RP-210116	1617		F	Correction to radio link monitoring test cases R15	15.13.0
2021-03	RAN#91	RP-210116	1620	2	F	Correction to beam failure recovery test cases R15	15.13.0
2021-03	RAN#91	RP-210116	1623	1	F	Correction to L1-RSRP reporting delay test cases R15	15.13.0
2021-03	RAN#91	RP-210122	1634	2	F	CR on maintaining Antenna configurations in TS38.133 R15	15.13.0
2021-03	RAN#91	RP-210122	1637	1	F	CR on test requirements for measurement performance tests R15	15.13.0
2021-03	RAN#91	RP-210116	1653	1	F	Correction on test cases of inter-frequency Measurements R15	15.13.0
2021-03	RAN#91	RP-210116	1712	1	F	CR to TS 38.133: Redundant and incorrect TCI state in tests with TRS (Rel-15)	15.13.0
2021-03	RAN#91	RP-210116	1715	1	F	CR to TS 38.133: Corrections to TC A.4.5.7.1 (Rel-15)	15.13.0

2021-03	RAN#91	RP-210116	1749		F	CR on test cases for inter-RAT measurement r15	15.13.0
2021-03	RAN#91	RP-210117	1752	2	F	CR on SCell activation delay, cell identification requirements on deactivated SCell and inter-RAT ECID requirements for NE-DC R15	15.13.0
2021-03	RAN#91	RP-210116	1755	1	F	CR on SCell activation TCs R15	15.13.0
2021-03	RAN#91	RP-210116	1779	2	F	Cat-F CR to addition of TRS Configurations in Rel-15 Test Cases	15.13.0
2021-06	RAN#92	RP-211080	1810	1	F	CR to Interruptions during measurements on deactivated NR SCC	15.14.0
2021-06	RAN#92	RP-211083	1813		F	CR to CSI-RS based L1-RSRP measurement on resource set with repetition off TCs	15.14.0
2021-06	RAN#92	RP-211084	1816		F	CR to the notation of SMTC in the general test parameters of Re-establishment TCs	15.14.0
2021-06	RAN#92	RP-211084	1819		F	CR to BWP configuration for interruption test case.	15.14.0
2021-06	RAN#92	RP-211080	1825	1	F	Update of DRX configuration in Event-triggered Test cases	15.14.0
2021-06	RAN#92	RP-211081	1831	1	F	Update RRM Test cases where 66RBs gives insufficient dB range	15.14.0
2021-06	RAN#92	RP-211081	1834	1	F	Update Reference channels and OCNG for FR2 240kHz SSB SCS RRM Test cases	15.14.0
2021-06	RAN#92	RP-211081	1837	1	F	Cat-F CR to Cell Reselection Tests with Async Cells in Rel-15	15.14.0
2021-06	RAN#92	RP-211081	1842	1	F	Cat-F CR to FR2 CORESET and Search Space RMC in Rel-15	15.14.0
2021-06	RAN#92	RP-211085	1845		F	Cat-F CR to PDSCH RMC in Rel-15	15.14.0
2021-06	RAN#92	RP-211085	1848		F	Cat-F CR to TRS Configuration in Rel-15 Test Case	15.14.0
2021-06	RAN#92	RP-211081	1855	1	F	Maintenance CR for test cases - R15	15.14.0
2021-06	RAN#92	RP-211085	1862		F	CR on BFD and link recovery test cases	15.14.0
2021-06	RAN#92	RP-211080	1885	1	F	Maintenance on CSSF for EN-DC and deactivated SCell measurement R15	15.14.0
2021-06	RAN#92	RP-211080	1896	1	F	Core requirement maintenance on signal characteristics (R15)	15.14.0
2021-06	RAN#92	RP-211081	1928	1	F	Correction on the SS-RSRP difference value for SS-RSRP measurement TC in R15	15.14.0
2021-06	RAN#92	RP-211081	1931	1	F	Correction on the CSI-reporting period for SCell activation delay in R15	15.14.0
2021-06	RAN#92	RP-211080	1938	1	F	CR on scheduling restriction of UE during intra-frequency measurements on FR2 in R15	15.14.0
2021-06	RAN#92	RP-211087	1981		F	CR to TS 38.133: Correction of TDD Configuration for several TCs (Rel-15)	15.14.0
2021-06	RAN#92	RP-211081	1984	1	F	CR to TS 38.133: Correction of OCNG pattern for several TCs (Rel-15)	15.14.0
2021-06	RAN#92	RP-211087	1987		F	CR to TS 38.133: Correction of IRAT TCs (Rel-15)	15.14.0
2021-06	RAN#92	RP-211087	1990		F	CR to TS 38.133: Corrections to SS-RSRP/RSRQ/SINR accuracy TCs (Rel 15)	15.14.0
2021-06	RAN#92	RP-211080	1993	1	F	CR to TS 38.133: Several corrections to TCs (Rel 15)	15.14.0
2021-06	RAN#92	RP-211087	2031		F	CR on measurement on deactivated SCell and interruption to NR serving cells for measurements on deactivated NR SCell	15.14.0
2021-06	RAN#92	RP-211088	2056		F	Correction to CSI-RS reference configuration_R15	15.14.0
2021-06	RAN#92	RP-211089	2063		F	Correction to TRS reference configuration_R15	15.14.0
2021-06	RAN#92	RP-211081	2066	1	F	Correction to FR1 test cases using DLBWP.0.2_R15	15.14.0
2021-06	RAN#92	RP-211089	2070		F	Correction to reference configurations related to DLBWP.0.2_R15	15.14.0
2021-06	RAN#92	RP-211089	2072		F	Correction to interruption during measurement on deactivated SCell test cases_R15	15.14.0
2021-06	RAN#92	RP-211089	2074		F	Correction of test parameters for SA inter-frequency event triggered reporting TCs	15.14.0
2021-06	RAN#92	RP-211080	2103	1	F	CR on Rel-15 SCell activation, SMTC determination and UL timing 38133	15.14.0
2021-06	RAN#92	RP-211090	2109		F	CR on NR-DC PSCell addition and release delay in Rel15	15.14.0
2021-06	RAN#92	RP-211081	2112	1	F	Maintenance CR for RRM test cases in Rel15	15.14.0
2021-06	RAN#92	RP-211081	2137	1	F	Correction to AoA setup in FR2	15.14.0
2021-09	RAN#93	RP-211922	2197		F	Big CR to TS 38.133: NR_newRAT-Core maintenance (Rel-15)	15.15.0
2021-09	RAN#93	RP-211925	2200		F	Big CR to TS 38.133: NR_newRAT-Perf maintenance Part 1 (Rel-15)	15.15.0
2021-09	RAN#93	RP-211925	2203		F	Big CR to TS 38.133: NR_newRAT-Perf maintenance Part 2 (Rel-15)	15.15.0
2021-09	RAN#93	RP-211925	2206		F	Big CR to TS 38.133: NR_newRAT-Perf maintenance Part 3 (Rel-15)	15.15.0
2021-12	RAN#94	RP-212854	2237		F	Big CR to TS 38.133: NR_newRAT-Core maintenance (Rel-15)	15.16.0
2021-12	RAN#94	RP-212855	2240		F	Big CR to TS 38.133: NR_newRAT-Perf maintenance (Rel-15)	15.16.0
2022-03	RAN#95	RP-220337	2270		F	Big CR to TS 38.133: NR_newRAT-Core maintenance (Rel-15)	15.17.0
2022-03	RAN#95	RP-220337	2273	1	F	Big CR to TS 38.133: NR_newRAT-Perf maintenance (Rel-15)	15.17.0
2022-06	RAN#96	RP-221660	2311	1	F	CR to maintain test case of PSCell addition and release delay (A4.5.7)_R15	15.18.0
2022-06	RAN#96	RP-221655	2404		F	Big CR for TS 38.133 Core Maintenance Part-1 (Rel-15)	15.18.0
2022-06	RAN#96	RP-221655	2407		F	Big CR for TS 38.133 Core Maintenance Part-2 (Rel-15)	15.18.0
2022-06	RAN#96	RP-221660	2410		F	Big CR for TS 38.133 Perf Maintenance Part-1 (Rel-15)	15.18.0
2022-06	RAN#96	RP-221660	2413		F	Big CR for TS 38.133 Perf Maintenance Part-2 (Rel-15)	15.18.0
2022-09	RAN#97	RP-222023	2568		F	Big CR for 38.133 maintenance part1 (Rel-15)	15.19.0
2022-12	RAN#98-e	RP-223290	2662		F	CR on NR RRM maintenance R15	15.20.0

2022-12	RAN#98-e	RP-223293	2674	1	F	CR to CSI-RS, RLM and BWP switching in annex	15.20.0
2022-12	RAN#98-e	RP-223293	2677	1	F	Update on Scell activation and deactivation and Control Channel RMC for RLM FR2 (Rel-15)	15.20.0
2022-12	RAN#98-e	RP-223292	2680		F	Update to L1-RSRP test scenarios (Rel-15)	15.20.0
2022-12	RAN#98-e	RP-223293	2693	1	F	R15 Cat-F CR testcase correction from R15 TS 38.133	15.20.0
2022-12	RAN#98-e	RP-223292	2700		F	CR on test case correction for timing advance	15.20.0
2022-12	RAN#98-e	RP-223293	2709	1	F	CR on TC for known PSCell addition in R15	15.20.0
2022-12	RAN#98-e	RP-223292	2712		F	CR on TC for inter-RAT NR Cell reselection in R15	15.20.0
2022-12	RAN#98-e	RP-223293	2747	2	F	Correction on Aperiodic CSI-RS RMCs and RLM in-sync test cases for R15	15.20.0
2023-03	RAN#99	RP-230505	2793	1	F	CR on TC for FR2 inter-frequency relative accuracy in R15	15.21.0
2023-03	RAN#99	RP-230504	2797		F	CR on TC for known PSCell addition in R15	15.21.0
2023-03	RAN#99	RP-230504	2801		F	CR to SNR on RLM-RS2 for FR2 CSI-RS based RLM OOS/IS tests	15.21.0
2023-03	RAN#99	RP-230505	2805	1	F	CR to SNR of q0 level for BFD and LR in FR2	15.21.0
2023-03	RAN#99	RP-230504	2809		F	CR to ConfigNo of SSB Configuration and CSI-RS for tracking in redirection test	15.21.0
2023-03	RAN#99	RP-230505	2828	2	F	R15 Cat-F CR SA NR-LTE HO testcase correction	15.21.0
2023-03	RAN#99	RP-230504	2943	1	F	CR on measurement requirements with per-FR gap R15	15.21.0
2023-06	RAN#100	RP-231357	3109		F	CR on relationship between SNR, RSRP level and thresholds for FR1 BFD and LR	15.22.0
2023-06	RAN#100	RP-231357	3113		F	CR on R15 NR Inter-RAT measurements testcase correction	15.22.0
2023-06	RAN#100	RP-231357	3121		F	CR to TS 38.133: Corrections to NR RRM test cases (Rel 15)	15.22.0
2023-06	RAN#100	RP-231357	3140		F	CR to FR2 RLM In-syn test cases (Cat-F Rel-15)	15.22.0
2023-06	RAN#100	RP-231355	3154		F	CR of known cell condition for HO on 38.133 R15	15.22.0
2023-06	RAN#100	RP-231358	3195	1	F	Correction to inter-RAT NR measurement TCs_R15	15.22.0
2023-06	RAN#100	RP-231357	3199		F	Correction to inter-frequency NR measurement TCs_R15	15.22.0
2023-06	RAN#100	RP-231358	3274		F	CR on maintaining antenna connections for 4Rx capable UEs R15	15.22.0
2023-06	RAN#100	RP-231356	3292	1	F	CR on R15 SCell activation	15.22.0
2023-06	RAN#100	RP-231355	3328		F	38.133 CR on interruptions at SCell activation and deactivation	15.22.0
2023-09	RAN#101	RP-232487	3375		F	CR on FR2 Active TCI state switch delay testcase correction	15.23.0
2023-09	RAN#101	RP-232503	3396	1	F	[NR_newRAT-Perf] CR to BWP Switch Delay TCs	15.23.0
2023-09	RAN#101	RP-232502	3409		F	[NR_newRAT-Perf] CR for Active TCI State switch test requirements - Rel15	15.23.0
2023-09	RAN#101	RP-232487	3534		F	CR on maintaining SS-RSRQ/SS-SINR measurement accuracy tests R15	15.23.0
2023-09	RAN#101	RP-232503	3628		F	2AoA Relative angular offset between active probes for PC1 devices (Rel-15)	15.23.0
2023-09	RAN#101	RP-232503	3639	1	F	[NR_newRAT-Perf] Inter-frequency measurement for UE capable of independentGapConfig (Cat-F Rel-15)	15.23.0
2023-12	RAN#102	RP-233330	3683		F	CR on RRM test cases with testability issues - R15	15.24.0
2023-12	RAN#102	RP-233334	3743	1	F	[NR_newRAT-Perf] Correction to CORESET RMC and SS-RSRQ accuracy test cases_R15	15.24.0
2023-12	RAN#102	RP-233334	3764		F	[NR_newRAT-Perf] CR of correction in TC A.6.5.5.4	15.24.0
2023-12	RAN#102	RP-233334	3823	1	F	NR_newRAT-Perf CR clarification on MAC-CE based TCI state switch delay	15.24.0
2023-12	RAN#102	RP-233342	3867	1	F	[NR_unlic-Core]: Modify the condition for gradual timing adjustment.	15.24.0
2024-03	RAN#103	RP-240561	4018	1	F	(NR_newRAT) CR on NR-E-UTRAN HO requirement maintenance R15	15.25.0
2024-03	RAN#103	RP-240567	4049		F	(NR_newRAT-Perf) 38.133 CR on corrections for SMTC configuration – R15	15.25.0
2024-03	RAN#103	RP-240567	4057		F	(NR_newRAT-Perf) CR to A.6.3.2.1.3 Intra-freq RRC re-establishment	15.25.0
2024-03	RAN#103	RP-240567	4059		F	(NR_newRAT-Perf) CR to FR1 SA intra-frequency SS-RSRQ measurement accuracy	15.25.0
2024-03	RAN#103	RP-240569	4061	1	F	(NR_newRAT-Perf) CR to CORESET and PDSCH RMCs of A.5.6.1.3, A.5.3.1.4 SSB SCS 240kHz config	15.25.0
2024-03	RAN#103	RP-240567	4114		F	(NR_newRAT-Perf) Corrections to TCI states switching test cases R15	15.25.0
2024-03	RAN#103	RP-240569	4118	1	F	(NR_newRAT-Perf) Correcting propagation condition of test cases not configuring Noc Rel-15	15.25.0
2024-03	RAN#103	RP-240565	4138	1	F	(NR_newRAT-Core) CR to correct and clarify Rel-15 TCI state switching delay requirements	15.25.0
2024-03	RAN#103	RP-240568	4190		F	(NR_newRAT-Perf)CR on test cases for SCell activation delay reduction in R15	15.25.0
2024-03	RAN#103	RP-240564	4217		F	(NR_newRAT-Core) CR on MG related requirements	15.25.0
2024-03	RAN#103	RP-240568	4258		F	(NR_newRAT-Perf) Inter-frequency measurement for UE capable of independentGapConfig (Cat-F Rel-15)	15.25.0
2024-06	RAN#104	RP-241385	4323	1	F	(NR_newRAT-Perf) CR on test for scheduling availability during BFD/CBD in FR2	15.26.0
2024-06	RAN#104	RP-241384	4327		F	(NR_newRAT-Perf) CR on test for SCell activation	15.26.0
2024-06	RAN#104	RP-241385	4356	1	F	(NR_newRAT-Perf) CR for test case of intra-frequency handover from FR2 to FR2 R15	15.26.0

2024-06	RAN#104	RP-241385	4369	1	F	(NR_newRAT-Perf) Inter-RAT measurement for UE capable of independentGapConfig (Cat-F Rel-15)	15.26.0
2024-06	RAN#104	RP-241385	4424	1	F	(NR_newRAT-Perf) R15 SUL test setup correction	15.26.0
2024-06	RAN#104	RP-241385	4427		F	[NR_newRAT-Perf] CR clarification on MAC-CE based TCI state switch delay	15.26.0
2024-06	RAN#104	RP-241385	4482	1	F	(NR_newRAT-Perf) Correction to intra-frequency re-establishment test case_R15	15.26.0
2024-06	RAN#104	RP-241388	4523	1	F	CR to 38.133 Rel-15 CatF on Missing PC1 Test Parameters for RAN5	15.26.0
2024-06	RAN#104	RP-241385	4583		F	[NR_newRAT-Perf] CR for R15 test case of L1-RSRP measurement	15.26.0
2024-09	RAN#105	RP-242175	4625		F	(NR_newRAT-Perf) CR to A.6.7.1.2.2 config 3 duplex mode	15.27.0
2024-09	RAN#105	RP-242175	4693		F	(NR_newRAT-Perf) CR to TS 38.133: Corrections to RRM FR2 test cases (Rel 15)	15.27.0
2024-09	RAN#105	RP-242175	4697		F	(NR_newRAT-Perf) CR to TS 38.133: Corrections to RRM FR2 conditions for PC1 (Rel 15)	15.27.0
2024-09	RAN#105	RP-242173	4721	1	F	(NR_newRAT) CR on NR-E-UTRAN HO requirement	15.27.0
2024-09	RAN#105	RP-242175	4752		F	(NR_newRAT-Perf) Correction to FR1 BFR test cases_R15	15.27.0
2024-09	RAN#105	RP-242176	4756	1	F	(NR_newRAT-Perf) Correction to PRACH RMCs_R15	15.27.0
2024-09	RAN#105	RP-242174	4798	1	F	(NR_newRAT-Core) Corrections on measurement restriction for RLM, BFD and CBD R15	15.27.0
2024-09	RAN#105	RP-242174	4898	1	F	(NR_newRAT-Core) CR on SCell activation in FR2_R15	15.27.0

History

Document history		
V15.2.0	July 2018	Publication
V15.3.0	October 2018	Publication
V15.4.0	April 2019	Publication
V15.5.0	July 2019	Publication
V15.6.0	July 2019	Publication
V15.7.0	October 2019	Publication
V15.8.0	February 2020	Publication
V15.9.0	April 2020	Publication
V15.10.0	September 2020	Publication
V15.11.0	December 2020	Publication
V15.12.0	February 2021	Publication
V15.13.0	June 2021	Publication
V15.14.0	September 2021	Publication
V15.15.0	December 2021	Publication
V15.16.0	April 2022	Publication
V15.17.0	May 2022	Publication
V15.18.0	July 2022	Publication
V15.19.0	January 2023	Publication
V15.20.0	January 2023	Publication
V15.21.0	June 2023	Publication
V15.22.0	July 2023	Publication
V15.23.0	October 2023	Publication
V15.24.0	February 2024	Publication
V15.25.0	June 2024	Publication
V15.26.0	August 2024	Publication
V15.27.0	November 2024	Publication