

# ETSI TS 138 133 V16.19.0 (2024-06)



**5G;  
NR;  
Requirements for support of radio resource management  
(3GPP TS 38.133 version 16.19.0 Release 16)**



---

**Reference**

RTS/TSGR-0438133vgj0

---

**Keywords**

5G

**ETSI**

---

650 Route des Lucioles  
F-06921 Sophia Antipolis Cedex - FRANCE

Tel.: +33 4 92 94 42 00 Fax: +33 4 93 65 47 16

Siret N° 348 623 562 00017 - APE 7112B  
Association à but non lucratif enregistrée à la  
Sous-Préfecture de Grasse (06) N° w061004871

---

**Important notice**

The present document can be downloaded from:  
<https://www.etsi.org/standards-search>

The present document may be made available in electronic versions and/or in print. The content of any electronic and/or print versions of the present document shall not be modified without the prior written authorization of ETSI. In case of any existing or perceived difference in contents between such versions and/or in print, the prevailing version of an ETSI deliverable is the one made publicly available in PDF format at [www.etsi.org/deliver](http://www.etsi.org/deliver).

Users of the present document should be aware that the document may be subject to revision or change of status. Information on the current status of this and other ETSI documents is available at <https://portal.etsi.org/TB/ETSIDeliverableStatus.aspx>

If you find errors in the present document, please send your comment to one of the following services:  
<https://portal.etsi.org/People/CommitteeSupportStaff.aspx>

If you find a security vulnerability in the present document, please report it through our Coordinated Vulnerability Disclosure Program:  
<https://www.etsi.org/standards/coordinated-vulnerability-disclosure>

---

**Notice of disclaimer & limitation of liability**

The information provided in the present deliverable is directed solely to professionals who have the appropriate degree of experience to understand and interpret its content in accordance with generally accepted engineering or other professional standard and applicable regulations.

No recommendation as to products and services or vendors is made or should be implied.

No representation or warranty is made that this deliverable is technically accurate or sufficient or conforms to any law and/or governmental rule and/or regulation and further, no representation or warranty is made of merchantability or fitness for any particular purpose or against infringement of intellectual property rights.

In no event shall ETSI be held liable for loss of profits or any other incidental or consequential damages.

Any software contained in this deliverable is provided "AS IS" with no warranties, express or implied, including but not limited to, the warranties of merchantability, fitness for a particular purpose and non-infringement of intellectual property rights and ETSI shall not be held liable in any event for any damages whatsoever (including, without limitation, damages for loss of profits, business interruption, loss of information, or any other pecuniary loss) arising out of or related to the use of or inability to use the software.

---

**Copyright Notification**

No part may be reproduced or utilized in any form or by any means, electronic or mechanical, including photocopying and microfilm except as authorized by written permission of ETSI.

The content of the PDF version shall not be modified without the written authorization of ETSI.  
The copyright and the foregoing restriction extend to reproduction in all media.

© ETSI 2024.  
All rights reserved.

---

# Intellectual Property Rights

## Essential patents

IPRs essential or potentially essential to normative deliverables may have been declared to ETSI. The declarations pertaining to these essential IPRs, if any, are publicly available for **ETSI members and non-members**, and can be found in ETSI SR 000 314: "*Intellectual Property Rights (IPRs); Essential, or potentially Essential, IPRs notified to ETSI in respect of ETSI standards*", which is available from the ETSI Secretariat. Latest updates are available on the ETSI Web server (<https://ipr.etsi.org/>).

Pursuant to the ETSI Directives including the ETSI IPR Policy, no investigation regarding the essentiality of IPRs, including IPR searches, has been carried out by ETSI. No guarantee can be given as to the existence of other IPRs not referenced in ETSI SR 000 314 (or the updates on the ETSI Web server) which are, or may be, or may become, essential to the present document.

## Trademarks

The present document may include trademarks and/or tradenames which are asserted and/or registered by their owners. ETSI claims no ownership of these except for any which are indicated as being the property of ETSI, and conveys no right to use or reproduce any trademark and/or tradename. Mention of those trademarks in the present document does not constitute an endorsement by ETSI of products, services or organizations associated with those trademarks.

**DECT™**, **PLUGTESTS™**, **UMTS™** and the ETSI logo are trademarks of ETSI registered for the benefit of its Members. **3GPP™** and **LTE™** are trademarks of ETSI registered for the benefit of its Members and of the 3GPP Organizational Partners. **oneM2M™** logo is a trademark of ETSI registered for the benefit of its Members and of the oneM2M Partners. **GSM®** and the GSM logo are trademarks registered and owned by the GSM Association.

---

# Legal Notice

This Technical Specification (TS) has been produced by the ETSI 3rd Generation Partnership Project (3GPP).

The present document may refer to technical specifications or reports using their 3GPP identities. These shall be interpreted as being references to the corresponding ETSI deliverables.

The cross reference between 3GPP and ETSI identities can be found under <https://webapp.etsi.org/key/queryform.asp>.

---

# Modal verbs terminology

In the present document "**shall**", "**shall not**", "**should**", "**should not**", "**may**", "**need not**", "**will**", "**will not**", "**can**" and "**cannot**" are to be interpreted as described in clause 3.2 of the [ETSI Drafting Rules](#) (Verbal forms for the expression of provisions).

"**must**" and "**must not**" are **NOT** allowed in ETSI deliverables except when used in direct citation.

# Contents

Intellectual Property Rights .....	2
Legal Notice .....	2
Modal verbs terminology.....	2
Foreword.....	69
1 Scope .....	71
2 References .....	71
3 Definitions, symbols and abbreviations .....	72
3.1 Definitions .....	72
3.2 Symbols.....	73
3.3 Abbreviations .....	74
3.4 Test tolerances .....	77
3.5 Frequency bands grouping .....	77
3.5.1 Introduction.....	77
3.5.2 NR operating bands in FR1 .....	77
3.5.3 NR operating bands in FR2 .....	78
3.6 Applicability of requirements in this specification version .....	78
3.6.1 RRC connected state requirements in DRX.....	79
3.6.2 Number of serving carriers .....	79
3.6.2.1 Number of serving carriers for SA .....	79
3.6.2.2 Number of serving carriers for EN-DC.....	79
3.6.2.3 Number of serving carriers for NE-DC.....	79
3.6.2.4 Number of serving carriers for NR-DC.....	80
3.6.3 Applicability for intra-band FR2 .....	80
3.6.4 Applicability for FR2 UE power classes.....	80
3.6.5 Applicability for SDL bands .....	80
3.6.6 Applicability of requirements for NGEN-DC operation.....	80
3.6.7 Applicability of QCL.....	80
3.6.9 Applicability of requirements for scheduling availability.....	81
3.6.10 Applicability of requirements for measurement restrictions.....	81
4 SA: RRC_IDLE state mobility.....	81
4.1 Cell Selection .....	81
4.2 Cell Re-selection .....	81
4.2.1 Introduction.....	81
4.2.2 Requirements .....	82
4.2.2.1 UE measurement capability .....	82
4.2.2.2 Measurement and evaluation of serving cell.....	82
4.2.2.3 Measurements of intra-frequency NR cells.....	83
4.2.2.4 Measurements of inter-frequency NR cells.....	84
4.2.2.5 Measurements of inter-RAT E-UTRAN cells.....	86
4.2.2.6 Maximum interruption in paging reception.....	88
4.2.2.7 General requirements .....	88
4.2.2.8 Minimum requirement at transitions .....	88
4.2.2.9 Measurements of intra-frequency NR cells for UE configured with relaxed measurement criterion .....	89
4.2.2.9.1 Introduction .....	89
4.2.2.9.2 Measurements for UE fulfilling low mobility criterion .....	89
4.2.2.9.3 Measurements for UE fulfilling not-at-cell edge criterion.....	90
4.2.2.9.4 Measurements for UE fulfilling low mobility and not-at-cell edge criteria.....	90
4.2.2.10 Measurements of inter-frequency NR cells for UE configured with relaxed measurement criterion .....	91
4.2.2.10.1 Introduction .....	91
4.2.2.10.2 Measurements for UE fulfilling low mobility criterion.....	91
4.2.2.10.3 Measurements for UE fulfilling not-at-cell edge criterion.....	92
4.2.2.10.4 Measurements for UE fulfilling low mobility and not-at-cell edge criterion .....	93

4.2.2.11	Measurements of inter-RAT E-UTRAN cells for UE configured with relaxed measurement criterion .....	93
4.2.2.11.1	Introduction .....	93
4.2.2.11.2	Measurements for UE fulfilling low mobility criterion .....	93
4.2.2.11.3	Measurements for UE fulfilling with not-at-cell edge criterion .....	95
4.2.2.11.4	Measurements for UE fulfilling low mobility and not-at-cell edge criterion .....	96
4.2A	Cell Re-selection when subject to CCA .....	96
4.2A.1	Introduction.....	96
4.2A.2	Requirements .....	97
4.2A.2.1	UE measurement capability .....	97
4.2A.2.2	Measurement and evaluation when subject to CCA on the serving cell .....	97
4.2A.2.3	Measurements of intra-frequency NR cells when subject to CCA on the serving cell and target cell.....	98
4.2A.2.4	Measurements of inter-frequency NR cells when subject to CCA on the target cell .....	99
4.2A.2.5	Measurements of inter-RAT E-UTRAN cells when subject to CCA on the serving cell.....	101
4.2A.2.6	Maximum interruption in paging reception when subject to CCA on the target cell .....	101
4.2A.2.7	General requirements .....	101
4.3	Minimization of Drive Tests (MDT).....	101
4.3.1	Introduction.....	101
4.3.2	Measurement Requirements.....	102
4.3.3	Requirements for Relative Time Stamp Accuracy.....	102
4.3.4	Requirements for Relative Time Stamp Accuracy for RRC Connection Establishment Failure Log Reporting .....	102
4.3.5	Requirements for Relative Time Stamp Accuracy for Radio Link Failure and Handover Failure Log Reporting .....	103
4.4	Idle Mode CA/DC Measurements .....	103
4.4.1	Introduction.....	103
4.4.2	Measurement Requirements.....	103
4.4.2.1	Detected cell requirement during state transition and Idle mode .....	103
4.4.2.2	Measurements of inter-frequency CA/DC candidate cells .....	104
4.4.2.3	Measurements on serving cell.....	105
4.4.2.4	Measurements of E-UTRAN inter-RAT DC candidate cells .....	105
5	SA: RRC_INACTIVE state mobility .....	106
5.1	Cell Re-selection .....	106
5.1.1	Introduction.....	106
5.1.2	Requirements .....	106
5.1.2.1	UE measurement capability .....	106
5.1.2.2	Measurement and evaluation of serving cell.....	106
5.1.2.3	Measurements of intra-frequency NR cells .....	106
5.1.2.4	Measurements of inter-frequency NR cells.....	106
5.1.2.5	Measurements of inter-RAT E-UTRAN cells.....	106
5.1.2.6	Maximum interruption in paging reception.....	106
5.1.2.7	General requirements .....	106
5.1A	Cell Re-selection with CCA .....	106
5.1A.1	Introduction.....	106
5.1A.2	Requirements .....	107
5.1A.2.1	UE measurement capability .....	107
5.1A.2.2	Measurement and evaluation when CCA is used on the serving cell.....	107
5.1A.2.3	Measurements of intra-frequency NR cells when CCA is used on the serving cell and target cell.....	107
5.1A.2.4	Measurements of inter-frequency NR cells when CCA is used on the target cell.....	107
5.1A.2.5	Measurements of inter-RAT E-UTRAN cells when CCA is used on the serving cell.....	107
5.1A.2.6	Maximum interruption in paging reception when CCA is used on the target cell .....	107
5.1A.2.7	General requirements .....	107
5.2	Void.....	107
5.3	Minimization of Drive Tests (MDT).....	107
5.3.1	Introduction.....	107
5.3.2	Measurement Requirements.....	108
5.3.3	Requirements for Relative Time Stamp Accuracy.....	108
5.3.4	Requirements for Relative Time Stamp Accuracy for RRC Connection Establishment Failure Log Reporting .....	108

5.3.5	Requirements for Relative Time Stamp Accuracy for Radio Link Failure and Handover Failure Log Reporting .....	108
5.3.6	Requirements for Relative Time Stamp Accuracy for RRC Resume Failure Log Reporting .....	108
5.4	Inactive Mode CA/DC Measurements .....	108
5.4.1	Introduction.....	108
5.4.2	Measurement Requirements.....	108
5.4.2.1	Detected cell requirement during state transition and inactive mode.....	109
5.4.2.2	Measurements of inter-frequency CA/DC candidate cells .....	109
5.4.2.3	Measurements on serving cell.....	109
5.4.2.4	Measurements on E-UTRAN inter-RAT DC candidate cells .....	109
6	RRC_CONNECTED state mobility .....	109
6.1	Handover .....	109
6.1.1	NR Handover .....	109
6.1.1.1	Introduction.....	109
6.1.1.2	NR FR1 - NR FR1 Handover .....	109
6.1.1.2.1	Handover delay.....	109
6.1.1.2.2	Interruption time.....	109
6.1.1.3	NR FR2- NR FR1 Handover .....	110
6.1.1.3.1	Handover delay.....	110
6.1.1.3.2	Interruption time.....	110
6.1.1.4	NR FR2- NR FR2 Handover .....	111
6.1.1.4.1	Handover delay.....	111
6.1.1.4.2	Interruption time.....	111
6.1.1.5	NR FR1- NR FR2 Handover .....	112
6.1.1.5.1	Handover delay.....	112
6.1.1.5.2	Interruption time.....	112
6.1.2	NR Handover to other RATs .....	113
6.1.2.1	NR – E-UTRAN Handover .....	113
6.1.2.1.1	Introduction .....	113
6.1.2.1.2	Handover delay.....	113
6.1.2.1.3	Interruption time.....	113
6.1.2.2	NR – UTRAN Handover.....	114
6.1.2.2.1	Introduction.....	114
6.1.2.2.2	Handover delay.....	114
6.1.2.2.3	Interruption time.....	114
6.1.3	NR DAPS Handover .....	115
6.1.3.1	Introduction.....	115
6.1.3.2	NR FR1 - NR FR1 DAPS Handover.....	115
6.1.3.2.1	DAPS handover delay .....	115
6.1.3.2.2	Interruption time.....	116
6.1.3.3	NR FR2- NR FR1 DAPS Handover.....	118
6.1.3.3.1	DAPS handover delay .....	118
6.1.3.3.2	Interruption time.....	118
6.1.3.4	NR FR1- NR FR2 DAPS Handover.....	119
6.1.3.4.1	DAPS handover delay .....	119
6.1.3.4.2	Interruption time.....	119
6.1.4	NR Conditional Handover .....	120
6.1.4.1	Introduction.....	120
6.1.4.2	NR FR1 – NR FR1 conditional handover .....	120
6.1.4.3	NR FR2 – NR FR1 conditional handover .....	121
6.1.4.4	NR FR2 – NR FR2 conditional handover .....	121
6.1.4.4.1	Handover delay.....	122
6.1.4.4.2	Measurement time .....	122
6.1.4.4.3	Preparation time.....	122
6.1.4.4.4	Interruption time.....	122
6.1.4.5	NR FR1 – NR FR2 conditional handover .....	123
6.1A	Void.....	123
6.1A.1	Void .....	123
6.1A.1.1	Void.....	123
6.1A.1.2	Void.....	123
6.1A.1.2.1	Void.....	123

6.1A.1.2.2	Void .....	123
6.1B	Handover to target cell using CCA .....	123
6.1B.1	NR Handover .....	123
6.1B.1.1	Introduction .....	123
6.1B.1.2	NR FR1 - NR FR1 Handover .....	124
6.1B.1.2.1	Handover delay .....	124
6.1B.1.2.2	Interruption time .....	124
6.2	RRC Connection Mobility Control .....	125
6.2.1	SA: RRC Re-establishment .....	125
6.2.1.1	Introduction .....	125
6.2.1.2	Requirements .....	125
6.2.1.2.1	UE Re-establishment delay requirement .....	125
6.2.1A	RRC Re-establishment with CCA .....	126
6.2.1A.1	Introduction .....	126
6.2.1A.2	Requirements .....	127
6.2.1A.2.1	UE Re-establishment with CCA delay requirement .....	127
6.2.2	Random access .....	128
6.2.2.1	Introduction .....	128
6.2.2.2	Requirements for 4-step RA type .....	129
6.2.2.2.1	Contention based random access .....	129
6.2.2.2.2	Non-Contention based random access .....	130
6.2.2.2.3	UE behaviour when configured with supplementary UL .....	131
6.2.2.3	Requirements for 2-step RA type .....	131
6.2.2.3.1	Contention based random access .....	131
6.2.2.3.2	Non-Contention based random access .....	132
6.2.2.3.3	UE behaviour when configured with supplementary UL .....	133
6.2.2A	Random access when CCA is used on target frequency .....	133
6.2.2A.1	Introduction .....	133
6.2.2A.2	Requirements for 4-step RA type .....	133
6.2.2A.2.1	Contention based random access .....	133
6.2.2A.2.2	Non-Contention based random access .....	134
6.2.2A.3	Requirements for 2-step RA type .....	135
6.2.2A.3.1	Contention based random access .....	136
6.2.2A.3.2	Non-Contention based random access .....	137
6.2.3	SA: RRC Connection Release with Redirection .....	137
6.2.3.1	Introduction .....	137
6.2.3.2	Requirements .....	138
6.2.3.2.1	RRC connection release with redirection to NR .....	138
6.2.3.2.2	RRC connection release with redirection to E-UTRAN .....	139
6.2.3.2.3	RRC connection release with redirection to NR carrier subject to CCA .....	139
7	Timing .....	140
7.1	UE transmit timing .....	140
7.1.1	Introduction .....	140
7.1.2	Requirements .....	140
7.1.2.1	Gradual timing adjustment .....	142
7.1.2.2	Void .....	142
7.2	UE timer accuracy .....	142
7.2.1	Introduction .....	142
7.2.2	Requirements .....	142
7.3	Timing advance .....	143
7.3.1	Introduction .....	143
7.3.2	Requirements .....	143
7.3.2.1	Timing Advance adjustment delay .....	143
7.3.2.2	Timing Advance adjustment accuracy .....	143
7.4	Cell phase synchronization accuracy .....	143
7.4.1	Definition .....	143
7.4.2	Minimum requirements .....	143
7.5	Maximum Transmission Timing Difference .....	143
7.5.1	Introduction .....	143
7.5.2	Minimum Requirements for inter-band EN-DC .....	144
7.5.2.1	Minimum Requirements for inter-band synchronous EN-DC .....	144

7.5.3	Minimum Requirements for intra-band EN-DC .....	145
7.5.4	Minimum Requirements for NR Carrier Aggregation .....	145
7.5.5	Minimum Requirements for inter-band NE-DC .....	145
7.5.5.1	Minimum Requirements for inter-band synchronous NE-DC .....	146
7.5.6	Minimum Requirements for inter-band NR DC .....	146
7.6	Maximum Receive Timing Difference.....	147
7.6.1	Introduction.....	147
7.6.2	Minimum Requirements for inter-band EN-DC .....	147
7.6.2.1	Minimum Requirements for inter-band synchronous EN-DC .....	147
7.6.3	Minimum Requirements for intra-band EN-DC .....	148
7.6.4	Minimum Requirements for NR Carrier Aggregation .....	148
7.6.5	Minimum Requirements for inter-band NE-DC .....	149
7.6.5.1	Minimum Requirements for inter-band synchronous NE-DC .....	149
7.6.6	Minimum Requirements for inter-band NR DC .....	150
7.7	<i>deriveSSB-IndexFromCell</i> tolerance .....	150
7.7.1	Minimum requirements.....	150
7.8	Void.....	151
8	Signalling characteristics.....	151
8.1	Radio Link Monitoring.....	151
8.1.1	Introduction.....	151
8.1.2	Requirements for SSB based radio link monitoring .....	152
8.1.2.1	Introduction.....	152
8.1.2.2	Minimum requirement .....	152
8.1.2.3	Measurement restrictions for SSB based RLM.....	154
8.1.3	Requirements for CSI-RS based radio link monitoring .....	155
8.1.3.1	Introduction.....	155
8.1.3.2	Minimum requirement .....	155
8.1.3.3	Measurement restrictions for CSI-RS based RLM.....	157
8.1.4	Minimum requirement at transitions.....	158
8.1.5	Minimum requirement for UE turning off the transmitter .....	158
8.1.6	Minimum requirement for L1 indication .....	159
8.1.7	Scheduling availability of UE during radio link monitoring.....	159
8.1.7.1	Scheduling availability of UE performing radio link monitoring with a same subcarrier spacing as PDSCH/PDCCH on FR1 .....	159
8.1.7.2	Scheduling availability of UE performing radio link monitoring with a different subcarrier spacing than PDSCH/PDCCH on FR1 .....	159
8.1.7.3	Scheduling availability of UE performing radio link monitoring on FR2.....	159
8.1.7.4	Scheduling availability of UE performing radio link monitoring on FR1 or FR2 in case of FR1-FR2 inter-band CA and NR-DC.....	160
8.1A	Radio Link Monitoring with CCA on Target Frequency .....	160
8.1A.1	Introduction.....	160
8.1A.2	Requirements for SSB Based Radio Link Monitoring.....	161
8.1A.2.1	Introduction.....	161
8.1A.2.2	Minimum Requirement .....	162
8.1A.3	Minimum requirement at transitions.....	163
8.1A.4	Minimum requirement for UE turning off the transmitter .....	163
8.1A.5	Minimum requirement for L1 indication .....	163
8.1A.6	Scheduling availability of UE during radio link monitoring.....	164
8.1A.6.1	Scheduling availability of UE performing radio link monitoring with the same subcarrier spacing as PDSCH/PDCCH .....	164
8.1A.6.2	Scheduling availability of UE performing radio link monitoring with a different subcarrier spacing than PDSCH/PDCCH .....	164
8.2	Interruption.....	164
8.2.1	EN-DC Interruption .....	164
8.2.1.1	Introduction.....	164
8.2.1.2	Requirements .....	165
8.2.1.2.1	Interruptions at transitions between active and non-active during DRX .....	165
8.2.1.2.2	Interruptions at transitions from non-DRX to DRX .....	165
8.2.1.2.3	Interruptions at SCell addition/release.....	165
8.2.1.2.4	Interruptions at SCell activation/deactivation.....	167
8.2.1.2.5	Interruptions during measurements on SCC.....	168



8.2.1.2.6	Interruptions at UL carrier RRC reconfiguration .....	169
8.2.1.2.7	Interruptions due to Active BWP switching Requirement .....	170
8.2.1.2.8	Interruptions at direct SCell activation and hibernation .....	171
8.2.1.2.9	Interruptions at SCell hibernation.....	171
8.2.1.2.10	Interruptions at SCell activation/deactivation with multiple downlink SCells .....	172
8.2.1.2.11	Interruptions due to UE-specific CBW change .....	172
8.2.1.2.12	Interruptions at NR SRS carrier based switching .....	172
8.2.1.2.13	Interruptions at E-UTRA SRS carrier based switching .....	174
8.2.1.2.14	DL Interruptions at switching between two uplink carriers.....	174
8.2.1.2.15	Interruptions due to SCell dormancy .....	175
8.2.1.2.16	Interruptions when identifying CGI of an NR cell with autonomous gaps.....	175
8.2.1.2.17	Interruptions when identifying CGI of an E-UTRA cell with autonomous gaps .....	176
8.2.2	SA: Interruptions with Standalone NR Carrier Aggregation .....	177
8.2.2.1	Introduction.....	177
8.2.2.2	Requirements .....	177
8.2.2.2.1	Interruptions at SCell addition/release.....	177
8.2.2.2.2	Interruptions at SCell activation/deactivation.....	178
8.2.2.2.3	Interruptions during measurements on deactivated SCC.....	179
8.2.2.2.4	Interruptions at UL carrier RRC reconfiguration .....	180
8.2.2.2.5	Interruptions due to Active BWP switching Requirement .....	180
8.2.2.2.6	Interruptions at inter-frequency SFTD measurement .....	181
8.2.2.2.7	Interruptions at SCell activation/deactivation with multiple downlink SCells .....	182
8.2.2.2.8	Interruptions due to UE-specific CBW change .....	182
8.2.2.2.9	Interruptions at NR SRS carrier based switching .....	182
8.2.2.2.10	DL Interruptions at UE switching between two uplink carriers .....	184
8.2.2.2.11	Interruptions at direct SCell activation.....	184
8.2.2.2.12	Interruptions due to SCell dormancy.....	185
8.2.2.2.13	Interruptions at transitions between active and non-active during DRX .....	185
8.2.2.2.14	Interruptions when identifying CGI of an NR cell with autonomous gaps.....	185
8.2.2.2.15	Interruptions when identifying CGI of an E-UTRA cell with autonomous gaps .....	186
8.2.3	NE-DC Interruptions.....	186
8.2.3.1	Introduction.....	186
8.2.3.2	Requirements .....	187
8.2.3.2.1	Interruptions at transitions between active and non-active during DRX .....	187
8.2.3.2.2	Interruptions at transitions from non-DRX to DRX .....	187
8.2.3.2.3	Interruptions at PSCell/SCell addition/release .....	187
8.2.3.2.4	Interruptions at SCell activation/deactivation.....	189
8.2.3.2.5	Interruptions during measurements on SCC.....	190
8.2.3.2.6	Interruptions at UL carrier RRC reconfiguration .....	191
8.2.3.2.7	Interruptions due to Active BWP switching Requirement .....	191
8.2.3.2.8	Interruptions at direct SCell activation and hibernation .....	191
8.2.3.2.9	Interruptions at SCell hibernation.....	192
8.2.3.2.10	Interruptions at SCell activation/deactivation with multiple downlink SCells .....	192
8.2.3.2.11	Interruptions at NR SRS carrier based switching .....	192
8.2.3.2.12	Interruptions at E-UTRA SRS carrier based switching .....	194
8.2.3.2.13	Interruptions due to SCell dormancy .....	195
8.2.3.2.14	Interruptions when identifying CGI of an NR cell with autonomous gaps.....	195
8.2.3.2.15	Interruptions when identifying CGI of an E-UTRA cell with autonomous gaps .....	196
8.2.3.2.16	Interruptions due to UE-specific CBW change .....	196
8.2.4	NR-DC: Interruptions .....	196
8.2.4.1	Introduction.....	196
8.2.4.2	Requirements .....	197
8.2.4.2.1	Interruptions at PSCell/SCell addition/release .....	197
8.2.4.2.3	Interruptions during measurements on SCC.....	199
8.2.4.2.4	Interruptions at UL carrier RRC reconfiguration .....	199
8.2.4.2.5	Interruptions due to Active BWP switching Requirement .....	199
8.2.4.2.6	Interruptions at transitions between active and non-active during DRX .....	199
8.2.4.2.7	Interruptions at transitions from non-DRX to DRX .....	200
8.2.4.2.8	Interruptions at SCell activation/deactivation with multiple downlink SCells .....	200
8.2.4.2.9	Interruptions at NR SRS carrier based switching .....	200
8.2.4.2.10	Interruptions at direct SCell activation.....	202
8.2.4.2.11	Interruptions when identifying CGI of an NR cell with autonomous gaps.....	202

8.2.4.2.12	Interruptions when identifying CGI of an E-UTRA cell with autonomous gaps .....	202
8.2.4.2.13	Interruptions due to SCell dormancy .....	203
8.2.4.2.14	Interruptions due to UE-specific CBW change .....	204
8.2.4.2A	Void.....	204
8.2.4.2A.1	Void .....	204
8.2.4.2A.2	Void .....	204
8.2.4.2A.3	Void .....	204
8.3	SCell Activation and Deactivation Delay .....	204
8.3.1	Introduction.....	204
8.3.2	SCell Activation Delay Requirement for Deactivated SCell .....	204
8.3.3	SCell Deactivation Delay Requirement for Activated SCell .....	208
8.3.4	Direct SCell Activation at SCell addition.....	209
8.3.5	Direct SCell Activation at Handover .....	210
8.3.7	SCell Activation Delay Requirement for Deactivated SCell with Multiple Downlink SCells .....	212
8.3.8	SCell Deactivation Delay Requirement for Activated SCell with Multiple Downlink SCells .....	216
8.3.9	Direct SCell Activation of Multiple Downlink SCells at SCell addition.....	216
8.3.10	Direct SCell Activation of Multiple Downlink SCells at Handover .....	217
8.3A	SCell Activation and Deactivation Delay in Carriers with CCA.....	219
8.3A.1	Introduction.....	219
8.3A.2	SCell Activation Delay Requirement for Deactivated SCell .....	219
8.3A.3	SCell Deactivation Delay Requirement for Activated SCell .....	222
8.4	UE UL carrier RRC reconfiguration delay.....	222
8.4.1	Introduction.....	222
8.4.2	UE UL carrier configuration delay requirement .....	222
8.4.3	UE UL carrier deconfiguration delay requirement .....	222
8.5	Link Recovery Procedures .....	223
8.5.1	Introduction.....	223
8.5.2	Requirements for SSB based beam failure detection.....	224
8.5.2.1	Introduction.....	224
8.5.2.2	Minimum requirement .....	224
8.5.2.3	Measurement restriction for SSB based beam failure detection.....	226
8.5.3	Requirements for CSI-RS based beam failure detection.....	226
8.5.3.1	Introduction.....	226
8.5.3.2	Minimum requirement .....	227
8.5.3.3	Measurement restrictions for CSI-RS beam failure detection.....	229
8.5.4	Minimum requirement for L1 indication .....	230
8.5.5	Requirements for SSB based candidate beam detection .....	230
8.5.5.1	Introduction.....	230
8.5.5.2	Minimum requirement .....	230
8.5.5.3	Measurement restriction for SSB based candidate beam detection.....	232
8.5.6	Requirements for CSI-RS based candidate beam detection.....	233
8.5.6.1	Introduction.....	233
8.5.6.2	Minimum requirement .....	233
8.5.6.3	Measurement restriction for CSI-RS based candidate beam detection .....	235
8.5.7	Scheduling availability of UE during beam failure detection .....	236
8.5.7.1	Scheduling availability of UE performing beam failure detection with a same subcarrier spacing as PDSCH/PDCCH on FR1 .....	236
8.5.7.2	Scheduling availability of UE performing beam failure detection with a different subcarrier spacing than PDSCH/PDCCH on FR1 .....	236
8.5.7.3	Scheduling availability of UE performing beam failure detection on FR2 .....	236
8.5.7.4	Scheduling availability of UE performing beam failure detection on FR1 or FR2 in case of FR1-FR2 inter-band CA and NR DC .....	237
8.5.8	Scheduling availability of UE during candidate beam detection .....	237
8.5.8.1	Scheduling availability of UE performing L1-RSRP measurement with a same subcarrier spacing as PDSCH/PDCCH on FR1 .....	237
8.5.8.2	Scheduling availability of UE performing L1-RSRP measurement with a different subcarrier spacing than PDSCH/PDCCH on FR1 .....	237
8.5.8.3	Scheduling availability of UE performing L1-RSRP measurement on FR2 .....	237
8.5.8.4	Scheduling availability of UE performing L1-RSRP measurement on FR1 or FR2 in case of FR1-FR2 inter-band CA and NR-DC.....	238
8.5.9	Requirements for Beam Failure Recovery in SCell.....	238
8.5.9.1	Introduction.....	238

8.5.9.2	Requirement .....	238
8.5.10	Minimum requirement at transitions for beam failure detection.....	238
8.5A	Link Recovery Procedures when CCA is used on target frequency .....	239
8.5A.1	Introduction.....	239
8.5A.2	Requirements for SSB based beam failure detection .....	239
8.5A.2.1	Introduction.....	239
8.5A.2.2	Minimum requirement .....	240
8.5A.2.3	Measurement restriction for SSB based beam failure detection.....	240
8.5A.4	Minimum requirement for L1 indication .....	241
8.5A.5	Requirements for SSB based candidate beam detection .....	241
8.5A.5.1	Introduction.....	241
8.5A.5.2	Minimum requirement .....	241
8.5A.5.3	Measurement restriction for SSB based candidate beam detection.....	242
8.5A.7	Scheduling availability of UE during beam failure detection .....	242
8.5A.7.1	Scheduling availability of UE performing beam failure detection with a same subcarrier spacing as PDSCH/PDCCH .....	242
8.5A.7.2	Scheduling availability of UE performing beam failure detection with a different subcarrier spacing than PDSCH/PDCCH .....	242
8.5A.8	Scheduling availability of UE during candidate beam detection .....	242
8.5A.8.1	Scheduling availability of UE performing L1-RSRP measurement with a same subcarrier spacing as PDSCH/PDCCH .....	242
8.5A.8.2	Scheduling availability of UE performing L1-RSRP measurement with a different subcarrier spacing than PDSCH/PDCCH .....	243
8.6	Active BWP switch delay.....	243
8.6.1	Introduction.....	243
8.6.2	DCI and timer based BWP switch delay on a single CC .....	243
8.6.2A	DCI based BWP switch delay on multiple CCs.....	244
8.6.2A.1	Simultaneous DCI based BWP switch delay on multiple CCs .....	244
8.6.2A.2	Non-simultaneous DCI based BWP switch delay on multiple CCs .....	246
8.6.2B	Timer based BWP switch delay on multiple CCs.....	246
8.6.2B.1	Simultaneous timer based BWP switch delay on multiple CCs .....	246
8.6.2B.2	Non-simultaneous timer based BWP switch delay on multiple CCs .....	246
8.6.3	RRC based BWP switch delay on a single CC .....	247
8.6.3A	RRC based BWP switch delay on multiple CCs.....	248
8.6.3A.1	Simultaneous RRC based BWP switch delay on multiple CCs .....	248
8.6.3A.2	Non-simultaneous RRC based BWP switch delay on multiple CCs .....	248
8.6.4	BWP switch delay on Consistent UL CCA recovery.....	249
8.7	Void.....	249
8.8	NE-DC: E-UTRAN PSCell Addition and Release Delay .....	249
8.8.1	Introduction.....	249
8.8.2	E-UTRAN PSCell Addition Delay Requirement.....	249
8.8.3	E-UTRAN PSCell Release Delay Requirement .....	250
8.9	NR-DC: PSCell Addition and Release Delay.....	250
8.9.1	Introduction.....	250
8.9.2	PSCell Addition Delay Requirement .....	250
8.9.3	PSCell Release Delay Requirement.....	251
8.10	Active TCI state switching delay .....	251
8.10.4	DCI based TCI state switch delay.....	252
8.10.5	RRC based TCI state switch delay.....	253
8.10.6	Active TCI state list update delay .....	253
8.10A	Active TCI state switching delay with CCA .....	253
8.10A.1	Introduction.....	253
8.10A.2	Known conditions for TCI state.....	254
8.10A.3	MAC-CE based TCI state switch delay .....	254
8.10A.4	DCI based TCI state switch delay.....	255
8.10A.5	RRC based TCI state switch delay.....	255
8.10A.6	Active TCI state list update delay .....	256
8.11	PSCell Change.....	256
8.11A	void.....	256
8.11B	Conditional PSCell Change .....	256
8.11B.1	Introduction.....	256
8.11B.2	Conditional PSCell Change delay.....	256

8.11B.2.1	Measurement time .....	257
8.12	Uplink spatial relation switch delay .....	258
8.12.1	Introduction.....	258
8.12.2	Known conditions for spatial relation when associated with DL-RS .....	258
8.12.3	MAC-CE based spatial relation switch delay .....	258
8.12.4	DCI based spatial relation switch delay .....	259
8.12.5	RRC based spatial relation switch delay .....	259
8.13	UE-specific CBW change.....	259
8.13.1	Introduction.....	259
8.13.2	UE-specific CBW change delay .....	260
8.14	Pathloss reference signal switching delay.....	260
8.14.1	Introduction.....	260
8.14.2	Known conditions for pathloss reference signal .....	260
8.14.3	MAC-CE based pathloss reference signal switch delay .....	261
9	Measurement Procedure .....	261
9.1	General measurement requirement.....	261
9.1.1	Introduction.....	261
9.1.2	Measurement gap.....	262
9.1.2.1	EN-DC: Measurement Gap Sharing.....	270
9.1.2.1a	SA: Measurement Gap Sharing.....	271
9.1.2.1b	NE-DC: Measurement Gap Sharing.....	271
9.1.2.1c	NR-DC: Measurement Gap Sharing .....	272
9.1.3	UE Measurement capability.....	273
9.1.3.1	EN-DC: Monitoring of multiple layers using gaps .....	273
9.1.3.1a	SA: Monitoring of multiple layers using gaps .....	274
9.1.3.1b	NE-DC: Monitoring of multiple layers using gaps .....	274
9.1.3.1c	NR-DC: Monitoring of multiple layers using gaps .....	275
9.1.3.2	EN-DC: Maximum allowed layers for multiple monitoring .....	275
9.1.3.2a	SA: Maximum allowed layers for multiple monitoring .....	276
9.1.3.2b	NE-DC: Maximum allowed layers for multiple monitoring .....	277
9.1.3.2c	NR-DC: Maximum allowed layers for multiple monitoring .....	277
9.1A.3.2	Void.....	278
9.1.3A	UE Measurement capability under operation mode with CCA.....	278
9.1.3A.1	EN-DC: Monitoring of multiple layers using gaps under CCA .....	278
9.1.3A.1A	SA: Monitoring of multiple layers using gaps under CCA .....	278
9.1.3A.2	EN-DC: Maximum allowed layers for multiple monitoring under CCA .....	278
9.1A.3.2a	Void.....	279
9.1.3A.2A	SA: Maximum allowed layers for multiple monitoring under CCA .....	279
9.1.4	Capabilities for Support of Event Triggering and Reporting Criteria.....	279
9.1.4.1	Introduction.....	279
9.1.4.2	Requirements .....	280
9.1.5	Carrier-specific scaling factor.....	282
9.1.5.1	Monitoring of multiple layers outside gaps.....	282
9.1.5.1.1	EN-DC mode: carrier-specific scaling factor for SSB-based, CSI-RS based L3 measurements and RSSI and channel occupancy measurements performed outside gaps.....	284
9.1.5.1.2	SA mode: carrier-specific scaling factor for SSB-based, CSI-RS based L3 measurements and RSSI and channel occupancy measurements performed outside gaps.....	285
9.1.5.1.3	NR-DC mode: carrier-specific scaling factor for SSB-based and CSI-RS based L3 measurements performed outside gaps.....	286
9.1.5.1.4	NE-DC mode: carrier-specific scaling factor for SSB-based and CSI-RS based measurements performed outside gaps.....	286
9.1.5.2	Monitoring of multiple layers within gaps .....	287
9.1.5.2.1	EN-DC mode: carrier-specific scaling factor for SSB, CSI-RS-based L3 measurements and RSSI and channel occupancy measurements performed within gaps .....	288
9.1.5.2.2	SA mode: carrier-specific scaling factor for SSB, CSI-RS-based L3 measurements and RSSI and channel occupancy measurements performed within gaps .....	290
9.1.5.2.3	NE-DC: carrier-specific scaling factor for SSB-based and CSI-RS based L3 measurements performed within gaps .....	292
9.1.5.2.4	NR-DC: carrier-specific scaling factor for SSB-based and CSI-RS-based L3 measurements performed within gaps .....	293
9.1.5.2.5	SA mode: carrier-specific scaling factor for PRS-based measurements performed within gaps.....	295

9.1.5.2.6	NE-DC: carrier-specific scaling factor for PRS-based measurements performed within gaps.....	296
9.1.5.2.7	NR-DC: carrier-specific scaling factor for PRS-based measurements performed within gaps .....	296
9.1.6	Minimum requirement at transitions.....	296
9.2	NR intra-frequency measurements .....	296
9.2.1	Introduction.....	296
9.2.2	Requirements applicability .....	297
9.2.3	Number of cells and number of SSB .....	297
9.2.3.1	Requirements for FR1 .....	297
9.2.3.2	Requirements for FR2 .....	297
9.2.4	Measurement Reporting Requirements.....	298
9.2.4.1	Periodic Reporting .....	298
9.2.4.2	Event-triggered Periodic Reporting.....	298
9.2.4.3	Event Triggered Reporting.....	298
9.2.5	Intrafrequency measurements without measurement gaps.....	299
9.2.5.1	Intrafrequency cell identification .....	299
9.2.5.2	Measurement period.....	301
9.2.5.3	Scheduling availability of UE during intra-frequency measurements.....	303
9.2.5.3.1	Scheduling availability of UE performing measurements in TDD bands on FR1 .....	303
9.2.5.3.2	Scheduling availability of UE performing measurements with a different subcarrier spacing than PDSCH/PDCCH on FR1 .....	303
9.2.5.3.3	Scheduling availability of UE performing measurements on FR2 .....	304
9.2.5.3.4	Scheduling availability of UE performing measurements on FR1 or FR2 in case of FR1-FR2 inter-band CA .....	305
9.2.5.4	SFTD Measurements between PCell and PSCell.....	305
9.2.5.4.1	Introduction .....	305
9.2.5.4.2	SFTD Measurement delay.....	305
9.2.5.4.3	SFTD Measurement Reporting Delay .....	306
9.2.6	Intra-frequency measurements with measurement gaps .....	306
9.2.6.1	Void.....	306
9.2.6.2	Intra-frequency cell identification .....	306
9.2.6.3	Intrafrequency Measurement Period .....	307
9.2A	NR intra-frequency measurements with CCA.....	308
9.2A.1	Introduction.....	308
9.2A.2	Requirements applicability .....	309
9.2A.3	Number of cells and number of SSB .....	309
9.2A.4	Measurement Reporting Requirements.....	310
9.2A.5	Intra-frequency measurements without measurement gaps .....	310
9.2A.5.2	Measurement period.....	312
9.2A.5.3	Scheduling availability of UE during intra-frequency measurements.....	313
9.2A.5.3.1	Scheduling availability of UE performing measurements in TDD bands.....	313
9.2A.5.3.2	Scheduling availability of UE performing measurements with a different subcarrier spacing than PDSCH/PDCCH.....	314
9.2A.6	Intra-frequency measurements with measurement gaps .....	314
9.2A.6.1	Intra-frequency cell identification .....	314
9.2A.6.2	Intra-frequency Measurement Period.....	315
9.2A.7	Intra-frequency RSSI and Channel occupancy measurements.....	316
9.2A.7.1	Intra-frequency RSSI measurements.....	316
9.2A.7.2	Intra-frequency Channel occupancy measurements.....	317
9.2A.7.3	Scheduling restriction during RSSI and Channel Occupancy measurements .....	318
9.3	NR inter-frequency measurements .....	318
9.3.1	Introduction.....	318
9.3.2	Requirements applicability .....	319
9.3.2.1	Void.....	319
9.3.2.2	Void.....	319
9.3.3	Number of cells and number of SSB .....	319
9.3.3.1	Requirements for FR1 .....	319
9.3.3.2	Requirements for FR2 .....	319
9.3.4	Inter-frequency measurement with measurement gaps .....	320
9.3.4.1	Void.....	321
9.3.4.2	Void.....	321
9.3.5	Inter-frequency measurements.....	321
9.3.5.1	Void.....	322

9.3.5.2	Void.....	322
9.3.5.3	Void.....	322
9.3.6	Inter-frequency measurements reporting requirements.....	322
9.3.6.1	Periodic Reporting .....	322
9.3.6.2	Event-triggered Periodic Reporting.....	322
9.3.6.3	Event-triggered Reporting.....	322
9.3.7	Void.....	323
9.3.8	Inter-frequency SFTD measurement requirements.....	323
9.3.8.1	Introduction.....	323
9.3.8.2	SFTD Measurement delay.....	323
9.3.8.3	SFTD Measurement reporting delay.....	324
9.3.9	Inter frequency measurements without measurement gaps.....	324
9.3.9.1	Inter frequency Cell identification .....	324
9.3.9.2	Measurement period.....	326
9.3.9.3	Scheduling availability of UE during inter-frequency measurements.....	326
9.3.9.3.1	Scheduling availability of UE performing measurements in TDD bands on FR1 .....	326
9.3.9.3.2	Scheduling availability of UE performing measurements with a different subcarrier spacing than PDSCH/PDCCH on FR1 .....	327
9.3.9.3.3	Scheduling availability of UE performing measurements on FR2 .....	327
9.3.9.3.4	Scheduling availability of UE performing measurements on FR1 or FR2 in case of FR1-FR2 inter-band CA .....	328
9.3A	NR inter-frequency measurements in carrier frequencies with CCA.....	328
9.3A.1	Introduction.....	328
9.3A.2	Requirements applicability .....	328
9.3A.3	Number of cells and number of SSB .....	329
9.3A.3.1	Requirements .....	329
9.3A.4	Inter-frequency cell identification.....	329
9.3A.5	Inter-frequency measurements.....	330
9.3A.6	NR Inter-frequency measurements reporting requirements .....	331
9.3A.6.1	Periodic Reporting .....	331
9.3A.6.2	Event-triggered Periodic Reporting.....	331
9.3A.6.3	Event-triggered Reporting.....	331
9.3A.8	Inter-frequency RSSI measurements .....	331
9.3A.9	Inter-frequency channel occupancy measurements .....	332
9.4	Inter-RAT measurements .....	332
9.4.1	Introduction.....	332
9.4.2	NR – E-UTRAN FDD measurements .....	334
9.4.2.1	Introduction.....	334
9.4.2.2	Requirements when no DRX is used.....	334
9.4.2.3	Requirements when DRX is used.....	335
9.4.2.4	Measurement reporting requirements.....	336
9.4.2.4.1	Periodic Reporting.....	336
9.4.2.4.2	Event-Triggered Periodic Reporting.....	336
9.4.2.4.3	Event-Triggered Reporting.....	336
9.4.3	NR – E-UTRAN TDD measurements .....	336
9.4.3.1	Introduction.....	336
9.4.3.2	Requirements when no DRX is used.....	336
9.4.3.3	Requirements when DRX is used.....	337
9.4.3.4	Measurement reporting requirements.....	339
9.4.3.4.1	Periodic Reporting.....	339
9.4.3.4.2	Event-Triggered Periodic Reporting.....	339
9.4.3.4.3	Event-Triggered Reporting.....	339
9.4.4	Inter-RAT RSTD measurements.....	339
9.4.4.1	NR – E-UTRAN FDD RSTD measurements.....	339
9.4.4.1.1	Introduction .....	339
9.4.4.1.2	Requirements .....	340
9.4.4.2	NR – E-UTRAN TDD RSTD measurements .....	343
9.4.4.2.1	Introduction .....	343
9.4.4.2.2	Requirements .....	343
9.4.5	Inter-RAT E-CID measurements .....	347
9.4.5.1	NR–E-UTRAN FDD E-CID RSRP and RSRQ measurements .....	347
9.4.5.1.1	Introduction .....	347

9.4.5.1.2	Requirements .....	347
9.4.5.1.3	Measurement Reporting Delay .....	347
9.4.5.2	NR–E-UTRAN TDD E-CID RSRP and RSRQ measurements .....	347
9.4.5.2.1	Introduction .....	347
9.4.5.2.2	Requirements .....	347
9.4.5.2.3	Measurement Reporting Delay .....	347
9.4.6	NR – UTRAN FDD measurements .....	348
9.4.6.1	Introduction .....	348
9.4.6.2	Requirements when no DRX is used .....	348
9.4.6.3	Requirements when DRX is used .....	349
9.4.7	NR – E-UTRAN measurements with autonomous gaps .....	351
9.4.7.1	CGI identification of an E-UTRA cell with autonomous gaps .....	351
9.4.7.2	CGI reporting delay .....	351
9.5	L1-RSRP measurements for Reporting .....	351
9.5.1	Introduction .....	351
9.5.2	Requirements applicability .....	351
9.5.3	Measurement Reporting Requirements .....	352
9.5.3.1	Periodic Reporting .....	352
9.5.3.2	Semi-Persistent Reporting .....	352
9.5.3.3	Aperiodic Reporting .....	353
9.5.4	L1-RSRP measurement requirements .....	353
9.5.4.1	SSB based L1-RSRP Reporting .....	353
9.5.4.2	CSI-RS based L1-RSRP Reporting .....	355
9.5.4A	Void .....	357
9.5.4A.1	Void .....	357
9.5.5	Measurement restriction for CSI-RS and SSB for L1-RSRP measurement .....	357
9.5.5.1	Measurement restriction for SSB based L1-RSRP .....	357
9.5.5.2	Measurement restriction for CSI-RS based L1-RSRP .....	358
9.5.6	Scheduling availability of UE during L1-RSRP measurement .....	359
9.5.6.1	Scheduling availability of UE performing L1-RSRP measurement with a same subcarrier spacing as PDSCH/PDCCH on FR1 .....	359
9.5.6.2	Scheduling availability of UE performing L1-RSRP measurement with a different subcarrier spacing than PDSCH/PDCCH on FR1 .....	359
9.5.6.3	Scheduling availability of UE performing L1-RSRP measurement on FR2 .....	359
9.5.6.4	Scheduling availability of UE performing L1-RSRP measurement on FR1 or FR2 in case of FR1-FR2 inter-band CA .....	360
9.5A	L1-RSRP measurements for Reporting under CCA .....	360
9.5A.1	Introduction .....	360
9.5A.2	Requirements applicability .....	360
9.5A.3	Measurement Reporting Requirements .....	361
9.5A.3.1	Periodic Reporting .....	361
9.5A.3.2	Semi-Persistent Reporting .....	361
9.5A.3.3	Aperiodic Reporting .....	361
9.5A.4	L1-RSRP measurement requirements .....	362
9.5A.4.1	SSB based L1-RSRP Reporting .....	362
9.5A.5	Measurement restriction for L1-RSRP measurement .....	362
9.5A.5.1	Measurement restriction for SSB based L1-RSRP .....	363
9.5A.6	Scheduling availability of UE during L1-RSRP measurement .....	363
9.5A.6.1	Scheduling availability of UE performing L1-RSRP measurement with a same subcarrier spacing as PDSCH/PDCCH .....	363
9.5A.6.2	Scheduling availability of UE performing L1-RSRP measurement with a different subcarrier spacing than PDSCH/PDCCH .....	363
9.5A.6.3	Scheduling availability of UE performing L1-RSRP measurement in case of FR1-FR2 inter-band CA .....	363
9.6	NE-DC: Measurements .....	363
9.6.1	Introduction .....	363
9.6.2	SFTD Measurements .....	364
9.6.2.1	Introduction .....	364
9.6.2.2	SFTD Measurement requirements .....	364
9.7	Cross Link Interference measurements .....	364
9.7.1	Introduction .....	364
9.7.2	SRS-RSRP measurements .....	365

9.7.2.1	Introduction.....	365
9.7.2.2	Requirements applicability.....	365
9.7.2.3	Measurement Reporting Requirements.....	365
9.7.2.3.1	Periodic Reporting.....	365
9.7.2.3.2	Event-triggered Periodic Reporting.....	365
9.7.2.3.3	Event Triggered Reporting.....	365
9.7.2.4	Measurement capability.....	366
9.7.2.5	SRS-RSRP measurement period.....	366
9.7.3	CLI-RSSI measurements.....	366
9.7.3.1	Introduction.....	366
9.7.3.2	Requirements applicability.....	366
9.7.3.3	Measurement Reporting Requirements.....	366
9.7.3.3.1	Periodic Reporting.....	367
9.7.3.3.2	Event-triggered Periodic Reporting.....	367
9.7.3.3.3	Event Triggered Reporting.....	367
9.7.3.4	Measurement capability.....	367
9.7.3.5	CLI-RSSI measurement period.....	367
9.7.4	Scheduling availability of UE during CLI measurements.....	367
9.7.4.1	Scheduling availability of UE performing measurement on FR1.....	367
9.7.4.2	Scheduling availability of UE performing measurement on FR2.....	368
9.8	L1-SINR measurements for Reporting.....	369
9.8.1	Introduction.....	369
9.8.2	Requirements applicability.....	369
9.8.3	Measurement Reporting Requirements.....	370
9.8.3.1	Periodic Reporting.....	370
9.8.3.2	Semi-Persistent Reporting.....	370
9.8.3.3	Aperiodic Reporting.....	370
9.8.4	L1-SINR measurement requirements.....	370
9.8.4.1	L1-SINR reporting with CSI-RS based CMR and no dedicated IMR configured.....	370
9.8.4.3	L1-SINR reporting with CSI-RS based CMR and dedicated IMR configured.....	374
9.8.5	Measurement restriction for L1-SINR measurement.....	376
9.8.5.1	Measurement restriction if SSB configured for L1-SINR Measurement.....	376
9.8.5.2	Measurement restriction if CSI-RS configured for L1-SINR measurement.....	376
9.8.5.3	Measurement restriction if CSI-IM configured for L1-SINR measurement.....	377
9.8.6	Scheduling availability of UE during L1-SINR measurement.....	377
9.8.6.1	Scheduling availability of UE performing L1-SINR measurement with a same subcarrier spacing as PDSCH/PDCCH on FR1.....	377
9.8.6.2	Scheduling availability of UE performing L1-SINR measurement with a different subcarrier spacing than PDSCH/PDCCH on FR1.....	378
9.8.6.4	Scheduling availability of UE performing L1-SINR measurement on FR1 or FR2 in case of FR1-FR2 inter-band CA.....	378
9.9	NR measurements for positioning.....	379
9.9.1	Introduction.....	379
9.9.2	RSTD measurements.....	379
9.9.2.1	Introduction.....	379
9.9.2.2	Requirements Applicability.....	379
9.9.2.3	Measurement Capability.....	379
9.9.2.4	Measurement Reporting Requirements.....	379
9.9.2.4.1	Void.....	380
9.9.2.4.2	Void.....	380
9.9.2.4.3	Void.....	380
9.9.2.5	Measurements Period Requirements.....	380
9.9.2.6	Void.....	382
9.9.3	PRS-RSRP measurements.....	382
9.9.3.1	Introduction.....	382
9.9.3.2	Requirements applicability.....	382
9.9.3.3	Measurement Capability.....	382
9.9.3.4	Measurement Reporting Requirements.....	382
9.9.3.5	Measurement Period Requirements.....	382
9.9.4	UE Rx-Tx time difference measurements.....	384
9.9.4.1	Introduction.....	384
9.9.4.2	Requirements Applicability.....	384



9.9.4.3	Measurement Capability.....	385
9.9.4.4	Measurement Reporting Requirements .....	385
9.9.4.5	Measurement Period Requirements .....	385
9.9.5	NR E-CID measurements .....	387
9.9.5.1	Introduction.....	387
9.9.5.2	Measurement Requirements.....	387
9.9.5.2.1	Intra-frequency Measurement Requirements.....	387
9.9.5.2.2	Inter-frequency Measurement Requirements.....	388
9.9.5.2.3	Measurement Reporting Delay.....	388
9.10	CSI-RS based L3 measurements .....	389
9.10.1	Introduction.....	389
9.10.2	CSI-RS based intra-frequency measurements.....	389
9.10.2.1	Introduction.....	389
9.10.2.2	Requirements applicability.....	389
9.10.2.3	Number of cells and number of CSI-RS .....	390
9.10.2.3.1	Requirements for FR1 .....	390
9.10.2.3.2	Requirements for FR2 .....	391
9.10.2.4	Measurement Reporting Requirements.....	391
9.10.2.4.1	Periodic Reporting.....	391
9.10.2.4.2	Event-triggered Periodic Reporting.....	391
9.10.2.4.3	Event Triggered Reporting .....	391
9.10.2.5	Intra-frequency measurements without measurement gaps.....	392
9.10.2.6	Scheduling availability of UE during CSI-RS based intra-frequency measurements .....	393
9.10.2.6.1	Scheduling availability of UE performing CSI-RS based measurements in TDD bands .....	393
9.10.2.6.2	Scheduling availability of UE performing CSI-RS based measurements in FR2.....	393
9.10.3	CSI-RS based Inter-frequency measurements .....	393
9.10.3.1	Introduction.....	393
9.10.3.2	Requirements applicability.....	394
9.10.3.3	Number of cells and number of CSI-RS resources .....	394
9.10.3.3.1	Requirements for FR1 .....	394
9.10.3.3.2	Requirements for FR2 .....	395
9.10.3.4	Measurements reporting requirements .....	395
9.10.3.4.1	Periodic Reporting.....	395
9.10.3.4.2	Event-triggered Periodic Reporting.....	395
9.10.3.4.3	Event-triggered Reporting .....	395
9.10.3.5	Inter frequency measurements with measurement gaps .....	395
9.11	NR measurements with autonomous gaps.....	396
9.11.1	Introduction.....	396
9.11.2	CGI identification of an NR cell with autonomous gaps .....	397
9.11.3	CGI reporting delay .....	398
10	Measurement Performance requirements.....	398
10.1	NR measurements.....	398
10.1.1	Introduction.....	398
10.1.2	Intra-frequency RSRP accuracy requirements for FR1.....	399
10.1.2.1	Intra-frequency SS-RSRP accuracy requirements.....	399
10.1.2.1.1	Absolute SS-RSRP Accuracy .....	399
10.1.2.1.2	Relative SS-RSRP Accuracy .....	399
10.1.2.2	Void.....	400
10.1.2.3	Intra-frequency CSI-RSRP accuracy requirements.....	400
10.1.2.3.1	Absolute CSI-RSRP Accuracy .....	400
10.1.2.3.2	Relative CSI-RSRP Accuracy .....	401
10.1.2B	Intra-frequency RSRP accuracy requirements for FR1 for CA/DC Idle Mode Measurements .....	402
10.1.2B.1	Intra-frequency SS-RSRP accuracy requirements.....	402
10.1.2B.1.1	Absolute SS-RSRP Accuracy .....	402
10.1.3	Intra-frequency RSRP accuracy requirements for FR2.....	403
10.1.3.1	Intra-frequency SS-RSRP accuracy requirements.....	403
10.1.3.1.1	Absolute SS-RSRP Accuracy .....	403
10.1.3.1.2	Relative SS-RSRP Accuracy .....	404
10.1.3.2	Void.....	404
10.1.3.3	Intra-frequency CSI-RSRP accuracy requirements.....	405
10.1.3.3.1	Absolute CSI-RSRP Accuracy .....	405

10.1.3.3.2	Relative CSI-RSRP Accuracy .....	405
10.1.3B	Intra-frequency RSRP accuracy requirements for FR2 for CA/DC Idle Mode Measurements .....	406
10.1.3B.1	Intra-frequency SS-RSRP accuracy requirements.....	406
10.1.3B.1.1	Absolute SS-RSRP Accuracy.....	406
10.1.4	Inter-frequency RSRP accuracy requirements for FR1.....	407
10.1.4.1	Inter-frequency SS-RSRP accuracy requirements.....	407
10.1.4.1.1	Absolute Accuracy of SS-RSRP in FR1.....	407
10.1.4.1.2	Relative Accuracy of SS-RSRP in FR1 .....	408
10.1.4.2	Void.....	409
10.1.4.3	Inter-frequency CSI-RSRP accuracy requirements .....	409
10.1.4.3.1	Absolute Accuracy of CSI-RSRP in FR1 .....	409
10.1.4.3.2	Relative Accuracy of CS-RSRP in FR1 .....	410
10.1.4B	Inter-frequency RSRP accuracy requirements for FR1 for CA/DC Idle Mode Measurements .....	411
10.1.4B.1	Inter-frequency SS-RSRP accuracy requirements.....	411
10.1.4B.1.1	Absolute Accuracy of SS-RSRP in FR1.....	411
10.1.5	Inter-frequency RSRP accuracy requirements for FR2.....	412
10.1.5.1	Inter-frequency SS-RSRP accuracy requirements.....	412
10.1.5.1.1	Absolute SS-RSRP Accuracy .....	412
10.1.5.1.2	Relative SS-RSRP Accuracy .....	412
10.1.5.2	Void.....	413
10.1.5.3	Inter-frequency CSI-RSRP accuracy requirements .....	413
10.1.5.3.1	Absolute CSI-RSRP Accuracy .....	413
10.1.5.3.2	Relative CSI-RSRP Accuracy .....	414
10.1.5B	Inter-frequency RSRP accuracy requirements for FR2 for CA/DC Idle Mode Measurements .....	415
10.1.6 RSRP	Measurement Report Mapping .....	416
10.1.7	Intra-frequency RSRQ accuracy requirements for FR1 .....	417
10.1.7.1	Intra-frequency SS-RSRQ accuracy requirements in FR1 .....	417
10.1.7.1.1	Absolute SS-RSRQ Accuracy in FR1 .....	417
10.1.7.2	Intra-frequency CSI-RSRQ accuracy requirements .....	418
10.1.7.2.1	Absolute CSI-RSRQ Accuracy .....	418
10.1.7B	Intra-frequency RSRQ accuracy requirements for FR1 for CA/DC Idle Mode Measurements.....	419
10.1.7B.1	Intra-frequency SS-RSRQ accuracy requirements in FR1 .....	419
10.1.7B.1.1	Absolute SS-RSRQ Accuracy in FR1 .....	419
10.1.8	Intra-frequency RSRQ accuracy requirements for FR2.....	420
10.1.8.1	Intra-frequency SS-RSRQ accuracy requirements in FR2 .....	420
10.1.8.1.1	Absolute SS-RSRQ Accuracy in FR2 .....	420
10.1.8.2	Intra-frequency CSI-RSRQ accuracy requirements .....	421
10.1.8.2.1	Absolute CSI-RSRQ Accuracy .....	421
10.1.8B	Intra-frequency RSRQ accuracy requirements for FR2 for CA/DC Idle Mode Measurements.....	421
10.1.8B.1	Intra-frequency SS-RSRQ accuracy requirements in FR2 .....	421
10.1.8B.1.1	Absolute SS-RSRQ Accuracy in FR2 .....	422
10.1.9	Inter-frequency RSRQ accuracy requirements for FR1 .....	422
10.1.9.1	Inter-frequency SS-RSRQ accuracy requirements in FR1 .....	422
10.1.9.1.1	Absolute Accuracy of SS-RSRQ in FR1 .....	422
10.1.9.1.2	Relative Accuracy of SS-RSRQ in FR1 .....	423
10.1.9.2	Inter-frequency CSI-RSRQ accuracy requirements .....	424
10.1.9.2.1	Absolute CSI-RSRQ Accuracy .....	424
10.1.9.2.2	Relative CSI-RSRQ Accuracy.....	425
10.1.9B	Inter-frequency RSRQ accuracy requirements for FR1 for CA/DC Idle Mode Measurements.....	426
10.1.9B.1	Inter-frequency SS-RSRQ accuracy requirements in FR1 .....	426
10.1.9B.1.1	Absolute Accuracy of SS-RSRQ in FR1 .....	426
10.1.10	Inter-frequency RSRQ accuracy requirements for FR2.....	427
10.1.10.2	Inter-frequency CSI-RSRQ accuracy requirements .....	428
10.1.10.2.1	Absolute CSI-RSRQ Accuracy .....	428
10.1.10.2.2	Relative CSI-RSRQ Accuracy.....	429
10.1.10B	Inter-frequency RSRQ accuracy requirements for FR2 for CA/DC Idle Mode Measurements.....	430
10.1.10B.1	Inter-frequency SS-RSRQ accuracy requirements in FR2 .....	430
10.1.10B.1.1	Absolute Accuracy of SS-RSRQ in FR2 .....	430
10.1.11	RSRQ report mapping .....	430
10.1.12	Intra-frequency SINR accuracy requirements for FR1 .....	431
10.1.12.2	Intra-frequency CSI-SINR accuracy requirements in FR1.....	432
10.1.12.2.1	Absolute CSI-SINR Accuracy in FR1 .....	432

10.1.13	Intra-frequency SINR accuracy requirements for FR2 .....	433
10.1.13.2	Intra-frequency CSI-SINR accuracy requirements in FR2 .....	433
10.1.13.2.1	Absolute CSI-SINR Accuracy in FR2 .....	433
10.1.14	Inter-frequency SINR accuracy requirements for FR1 .....	434
10.1.14.2	Inter-frequency CSI-SINR accuracy requirements in FR1 .....	435
10.1.14.2.1	Absolute Accuracy of CSI-SINR in FR1 .....	435
10.1.15	Inter-frequency SINR accuracy requirements for FR2 .....	437
10.1.15.2	Inter-frequency CSI-SINR accuracy requirements in FR2 .....	439
10.1.15.2.1	Absolute Accuracy of CSI-SINR in FR2 .....	439
10.1.15.2.2	Relative Accuracy of CSI-SINR in FR2 .....	439
10.1.16	SINR report mapping .....	440
10.1.17	Power Headroom .....	441
10.1.18	$P_{\text{CMAX},c,f}$ .....	442
10.1.19	L1-RSRP accuracy requirements for FR1 .....	442
10.1.20	L1-RSRP accuracy requirements for FR2 .....	445
10.1.21	SFTD accuracy requirements .....	448
10.1.22	CLI measurement accuracy requirements .....	452
10.1.24.3.1	Absolute PRS-RSRP Measurement Report Mapping .....	455
10.1.24.3.2	Differential Report Mapping for PRS-RSRP Measurement .....	456
10.1.23	RSTD Measurements .....	458
10.1.23.1	Introduction .....	458
10.1.23.2	Measurement Accuracy Requirements .....	458
10.1.23.3	Report mapping .....	462
10.1.23.3.1	Absolute DL RSTD Measurement Reporting .....	462
10.1.23.3.2	Differential Reporting for DL RSTD Measurement .....	464
10.1.23.3.3	Additional Path Report Mapping for DL RSTD .....	466
10.1.24	PRS-RSRP Measurements .....	468
10.1.24.1	Introduction .....	468
10.1.24.2	Measurement Accuracy Requirements .....	468
10.1.24.2.1	Absolute PRS RSRP accuracy .....	468
10.1.24.3	Report mapping .....	471
10.1.24.3.1	Absolute PRS-RSRP Measurement Report Mapping .....	471
10.1.24.3.2	Differential Report Mapping for PRS-RSRP Measurement .....	472
10.1.25	UE Rx-Tx Time Difference Measurements .....	474
10.1.25.1	Introduction .....	474
10.1.25.2	Measurement Accuracy Requirements .....	474
10.1.25.3	Report mapping .....	479
10.1.25.3.1	Absolute UE Rx-Tx Measurement Report Mapping .....	479
10.1.25.3.2	Differential UE Rx-Tx Measurement Report Mapping .....	481
10.1.25.3.3	Additional Path Report Mapping for UE Rx-Tx Time Difference .....	482
10.1.26	FR2 P-MPR report .....	484
10.1.26.1	Report mapping .....	484
10.1.27	L1-SINR accuracy requirements for FR1 .....	484
10.1.27.1	L1-SINR accuracy requirements with CSI-RS based CMR and no dedicated IMR configured .....	484
10.1.27.1.1	Absolute Accuracy .....	484
10.1.27.1.2	Relative Accuracy .....	485
10.1.27.2	L1-SINR accuracy requirements with SSB based CMR and dedicated IMR configured .....	486
10.1.27.2.1	Absolute Accuracy .....	486
10.1.27.2.2	Relative Accuracy .....	487
10.1.27.3	L1-SINR accuracy requirements with CSI-RS based CMR and dedicated IMR configured .....	489
10.1.27.3.1	Absolute Accuracy .....	489
10.1.27.3.2	Relative Accuracy .....	490
10.1.28	L1-SINR accuracy requirements for FR2 .....	492
10.1.28.1	L1-SINR accuracy requirements with CSI-RS based CMR and no dedicated IMR configured .....	492
10.1.28.1.1	Absolute Accuracy .....	492
10.1.28.1.2	Relative Accuracy .....	492
10.1.28.2	L1-SINR accuracy requirements with SSB based CMR and dedicated IMR configured .....	493
10.1.28.2.1	Absolute Accuracy .....	493
10.1.28.2.2	Relative Accuracy .....	494
10.1.28.3	L1-SINR accuracy requirements with CSI-RS based CMR and dedicated IMR configured .....	496
10.1.28.3.1	Absolute Accuracy .....	496
10.1.28.3.2	Relative Accuracy .....	497

10.1.29	Intra-frequency RSRQ accuracy requirements under CCA .....	498
10.1.29.1	Intra-frequency SS-RSRQ accuracy requirements in FR1 .....	498
10.1.29.1.1	Absolute SS-RSRQ Accuracy .....	498
10.1.30	Inter-frequency RSRQ accuracy requirements under CCA .....	499
10.1.30.1	Inter-frequency SS-RSRQ accuracy requirements in FR1 .....	499
10.1.30.1.1	Absolute Accuracy of SS-RSRQ .....	499
10.1.30.1.2	Relative Accuracy of SS-RSRQ .....	499
10.1.31	Intra-frequency SINR accuracy requirements under CCA .....	500
10.1.32	Inter-frequency SINR accuracy requirements under CCA .....	501
10.1.33	L1-RSRP accuracy requirements under CCA .....	502
10.1.34	RSSI measurements under CCA .....	503
10.1.34.1	Intra-frequency absolute RSSI measurement accuracy requirements in FR1 .....	503
10.1.34.2	Inter-frequency absolute RSSI measurement accuracy requirements in FR1 .....	503
10.1.34.3	RSSI measurement report mapping .....	504
10.1.35	Channel occupancy measurements under CCA .....	504
10.1.35.1	Intra-frequency channel occupancy measurement accuracy requirements in FR1 .....	504
10.1.35.2	Inter-frequency channel occupancy measurement accuracy requirements in FR1 .....	504
10.1.36	Intra-frequency RSRP accuracy requirements under CCA .....	505
10.1.36.1	Intra-frequency SS-RSRP accuracy requirements in FR1 .....	505
10.1.36.1.1	Absolute SS-RSRP Accuracy .....	505
10.1.36.1.2	Relative SS-RSRP Accuracy .....	505
10.1.37	Inter-frequency RSRP accuracy requirements under CCA .....	506
10.1.37.1	Inter-frequency SS-RSRP accuracy requirements in FR1 .....	506
10.1.37.1.1	Absolute Accuracy of SS-RSRP .....	506
10.1.37.1.2	Relative Accuracy of SS-RSRP .....	507
10.2	E-UTRAN measurements .....	507
10.2.1	Introduction .....	507
10.2.2	E-UTRAN RSRP measurements .....	508
10.2.3	E-UTRAN RSRQ measurements .....	508
10.2.4	E-UTRAN RSTD measurements .....	508
10.2.5	E-UTRAN RS-SINR measurements .....	508
10.2.6	E-UTRAN RSRP measurements for CA/DC Idle Mode Measurements .....	508
10.2.7	E-UTRAN RSRQ measurements for CA/DC Idle Mode Measurements .....	509
10.3	UTRAN FDD Measurements .....	509
10.3.1	UTRAN FDD CPICH RSCP .....	509
10.3.2	UTRAN FDD CPICH Ec/No .....	510
10.4	V2X measurements .....	510
10.4.1	Introduction .....	510
10.4.2	Intra-frequency PSBCH-RSRP accuracy requirements for FR1 .....	511
10.4.2.1	PSBCH-RSRP Absolute Accuracy .....	511
10.4.2.2	PSBCH-RSRP Relative Accuracy .....	511
10.4.3	Intra-Frequency SL-RSSI Measurement Accuracy Requirements for FR1 .....	512
10.4.3.1	Absolute SL-RSSI Accuracy .....	512
10.4.4	Intra-Frequency L1 SL-RSRP Measurement Accuracy Requirements for FR1 .....	512
10.4.4.1	Absolute L1 SL-RSRP Accuracy .....	512
11	Void .....	513
12	V2X Requirements .....	513
12.1	Introduction .....	513
12.2	UE Transmit Timing .....	513
12.2.1	Introduction .....	513
12.2.2	GNSS as synchronization reference source .....	514
12.2.3	NR Cell as synchronization reference source .....	514
12.2.4	E-URTAN Cell as synchronization reference source .....	514
12.2.5	SyncRef UE as synchronization reference source .....	515
12.3	Initiation/Cease of SLSS Transmissions .....	515
12.3.1	Introduction .....	515
12.3.1.1	Initiation/Cease of SLSS transmissions with NR cell as synchronization reference source .....	515
12.3.1.2	Initiation/Cease of SLSS transmissions with EUTRAN cell as synchronization reference source .....	516
12.3.1.3	Initiation/Cease of SLSS transmissions with GNSS as synchronization reference source .....	517
12.3.1.4	Initiation/Cease of SLSS transmissions with SyncRef UE as synchronization reference source .....	517

12.4	Selection / Reselection of V2X Synchronization Reference Source .....	517
12.5	L1 SL-RSRP measurements .....	518
12.5.1	Introduction.....	518
12.5.2	SL-RSRP measurements.....	518
12.6	Congestion Control measurements.....	519
12.7	Interruption.....	519
12.7.1	Interruptions to WAN due to V2X Sidelink Communication.....	519
12.7.2	V2X Sidelink Communication Dropping due to synchronization source change.....	519
12.7.3	Interruptions to WAN due to switching between E-UTRA V2X Sidelink and NR V2X Sidelink .....	521
12.8	Reliability of GNSS signal .....	521
12.9	Scheduling availability .....	522
12.9.1	Scheduling availability of UE switching between E-UTRA sidelink and NR sidelink .....	522
13	Measurement Performance Requirements for NR gNB .....	522
13.1	UL-RTOA .....	522
13.1.1	Report mapping .....	522
13.2	gNB Rx-Tx time difference.....	524
13.2.1	Report mapping .....	524
13.2.2	Measurement Accuracy Requirements .....	526
13.2.2.1	Introduction.....	526
13.2.2.2	Requirements .....	526
13.3	UL SRS RSRP measurement.....	527
13.3.1	Report mapping .....	527
13.3.2	Measurement accuracy requirements.....	528
13.3.2.1	Introduction.....	528
13.3.2.2	Requirements .....	528
13.4	AoA/ZoA.....	529
13.4.1	Report mapping .....	529
<b>Annex A (normative): Test Cases .....</b>		<b>531</b>
A.1	Purpose of annex .....	531
A.2	Requirement classification for statistical testing.....	531
A.2.1	Types of requirements in TS 38.133 .....	531
A.2.1.1	Time and delay requirements on UE higher layer actions .....	531
A.2.1.2	Measurements of power levels, relative powers and time .....	531
A.2.1.3	Implementation requirements .....	532
A.2.1.4	Physical layer timing requirements.....	532
A.2.1.5	Requirements under CCA .....	532
A.3	RRM test configurations .....	532
A.3.1	Reference measurement channels.....	532
A.3.1.1	PDSCH .....	532
A.3.1.1.1	FDD.....	532
A.3.1.1.2	TDD .....	533
A.3.1A	Reference measurement channels under CCA .....	536
A.3.1A.1	PDSCH .....	536
A.3.1A.1.1	TDD .....	536
A.3.1A.2	CORESET for RMSI scheduling .....	536
A.3.1A.2.1	TDD .....	536
A.3.1A.3	CORESET for RMC scheduling.....	537
A.3.1A.3.1	TDD .....	537
A.3.1A.4	TDD UL/DL configuration.....	538
A.3.1A.5	RMC burst transmission model .....	538
A.3.1.2	CORESET for RMSI scheduling.....	538
A.3.1.2.1	FDD.....	538
A.3.1.2.2	TDD .....	539
A.3.1.3	CORESET for RMC scheduling.....	541
A.3.1.3.1	FDD.....	541
A.3.1.3.2	TDD .....	542
A.3.1.4	TDD UL/DL configuration.....	544
A.3.2	OFDMA channel noise generator (OCNG).....	545

A.3.2.1	Generic OFDMA Channel Noise Generator (OCNG) .....	545
A.3.2.1.1	OCNG pattern 1: Generic OCNG pattern for all unused REs .....	545
A.3.2.1.2	OCNG pattern 2: Generic OCNG pattern for all unused REs for 2AoA setup .....	545
A.3.2.1.3	OCNG pattern 3: Generic OCNG pattern for unused REs in the same bandwidth as CORESET .....	546
A.3.2.1.4	OCNG pattern 4: Generic OCNG pattern for all unused REs outside SSB slot(s).....	546
A.3.2.2	Void .....	547
A.3.3	Reference DRX configurations .....	547
A.3.3.1	DRX Configuration 1: DRX cycle = 40 ms and TAT = 500 ms.....	547
A.3.3.2	DRX Configuration 2: DRX cycle = 640 ms and TAT = 500 ms.....	547
A.3.3.3	DRX Configuration 3: DRX cycle = 40 ms and TAT = Infinity .....	548
A.3.3.4	DRX Configuration 4: DRX cycle = 160 ms and TAT = Infinity .....	548
A.3.3.5	DRX Configuration 5: DRX cycle = 320 ms and TAT = Infinity .....	548
A.3.3.6	DRX Configuration 6: DRX cycle = 320 ms and TAT = 500 ms.....	548
A.3.3.7	DRX Configuration 7: DRX cycle = 640 ms and TAT = Infinity .....	549
A.3.3.8	DRX Configuration 8: DRX cycle = 320 ms and TAT = Infinity .....	549
A.3.3.9	DRX Configuration 9: DRX cycle = 40 ms and TAT = 500 ms.....	549
A.3.3.10	DRX Configuration 10: DRX cycle = 640 ms and TAT = 500 ms.....	549
A.3.3.11	DRX Configuration 11: DRX cycle = 20 ms and TAT = Infinity .....	550
A.3.3.12	DRX Configuration 12: DRX cycle = 640 ms and TAT = Infinity .....	550
A.3.4	Test Cases with Different Channel Bandwidths.....	550
A.3.4.1	Test Cases with Different E-UTRA Channel Bandwidths.....	550
A.3.4.1.1	Introduction.....	550
A.3.4.1.2	Principle of testing .....	550
A.3.5	Test Cases for Synchronous and Asynchronous DC Operations.....	551
A.3.5.1	EN-DC Test Cases for Synchronous and Asynchronous EN-DC Operations .....	551
A.3.5.1.1	Introduction.....	551
A.3.5.1.2	Principle of Testing.....	551
A.3.6	Antenna configurations .....	551
A.3.6.1	Antenna configurations for FR1 .....	551
A.3.6.1.1	Antenna connection for 4 Rx capable UEs .....	551
A.3.6.1.1.1	Introduction .....	551
A.3.6.1.1.2	Principle of testing.....	551
A.3.6.2	Antenna configurations for FR2 .....	553
A.3.6A	Antenna configurations with unlicensed bands .....	554
A.3.6A.1	Antenna configurations for FR1 .....	554
A.3.6A.1.1	Antenna connection for 4 Rx capable UEs .....	554
A.3.6A.1.1.1	Introduction .....	554
A.3.6A.1.1.2	Principle of testing.....	554
A.3.7	EN-DC test setup.....	555
A.3.7.1	Introduction.....	555
A.3.7.2	E-UTRAN Serving Cell Parameters .....	555
A.3.7.2.1	E-UTRAN Serving Cell Parameters for Tests with NR Cell(s) in FR1 .....	555
A.3.7.2.2	E-UTRAN Serving Cell Parameters for Tests with NR Cell(s) in FR2 .....	556
A.3.7A	NR FR1-FR2 test setup .....	557
A.3.7B	EN-DC test setup with unlicensed bands .....	558
A.3.7B.1	Introduction.....	558
A.3.7B.2	E-UTRAN Serving Cell Parameters .....	558
A.3.7B.2.1	E-UTRAN Serving Cell Parameters for Tests with NR Cell(s) under CCA in FR1 .....	558
A.3.7C	LTE-FR1/FR2 test setup .....	559
A.3.7D	NE-DC test setup.....	559
A.3.7D.1	Introduction.....	559
A.3.7D.2	E-UTRAN Serving Cell Parameters .....	559
A.3.7D.2.1	E-UTRAN Serving Cell Parameters for Tests with NR Cell(s) in FR1 .....	559
A.3.7D.2.2	E-UTRAN Serving Cell Parameters for Tests with NR Cell(s) in FR2 .....	559
A.3.8	PRACH configurations.....	559
A.3.8.1	Introduction.....	559
A.3.8.2	PRACH configurations in FR1 .....	559
A.3.8.2.1	FR1 PRACH configuration 1 .....	559
A.3.8.2.2	FR1 PRACH configuration 2 .....	560
A.3.8.2.3	FR1 PRACH configuration 3 .....	561
A.3.8.2.4	FR1 PRACH configuration 4 .....	561
A.3.8.3	PRACH configurations in FR2.....	562

A.3.8.3.1	FR2 PRACH configuration 1 .....	562
A.3.8.3.2	FR2 PRACH configuration 2 .....	562
A.3.8.3.3	FR2 PRACH configuration 3 .....	563
A.3.8.3.4	FR2 PRACH configuration 4 .....	564
A.3.8A	PRACH configurations under CCA .....	564
A.3.8A.1	Introduction.....	564
A.3.8A.2	PRACH configurations in FR1 .....	565
A.3.8A.2.1	FR1 PRACH configuration 1 under CCA .....	565
A.3.8A.2.2	FR1 PRACH configuration 2 under CCA .....	565
A.3.9	BWP configurations .....	566
A.3.9.1	Introduction.....	566
A.3.9.2	Downlink BWP configurations.....	566
A.3.9.2.1	Initial BWP .....	566
A.3.9.2.2	Dedicated BWP.....	566
A.3.9.3	Uplink BWP configurations.....	567
A.3.9.3.1	Initial BWP .....	567
A.3.9.3.2	Dedicated BWP.....	567
A.3.10	SSB Configurations.....	568
A.3.10.1	SSB Configurations for FR1 .....	568
A.3.10.1.1	SSB pattern 1 in FR1: SSB allocation for SSB SCS=15 kHz in 10 MHz.....	568
A.3.10.1.5	SSB pattern 5 in FR1: SSB allocation for SSB SCS=15 kHz starting from odd SFN in 10 MHz .....	569
A.3.10A	SSB Configurations under CCA.....	573
A.3.10A.1	SSB Configurations under CCA for FR1.....	573
A.3.10A.1.1	SSB pattern 1 under CCA for semi-static channel access: SSB allocation for SSB SCS=30kHz in 40MHz .....	573
A.3.10A.1.2	SSB pattern 2 under CCA for dynamic channel access: SSB allocation for SSB SCS=30kHz in 40MHz .....	573
A.3.10A.1.3	SSB pattern 3 under CCA for semi-static channel access: SSB allocation for SSB SCS=30 kHz in 40 MHz .....	573
A.3.10A.1.4	SSB pattern 4 under CCA for dynamic channel access: SSB allocation for SSB SCS=30 kHz in 40 MHz .....	574
A.3.11	SMTC Configurations .....	574
A.3.11.1	SMTC pattern 1: SMTC period = 20 ms with SMTC duration = 1 ms.....	574
A.3.11.2	SMTC pattern 2: SMTC period = 20 ms with SMTC duration = 5 ms.....	574
A.3.11.3	SMTC pattern 3: SMTC period = 160 ms with SMTC duration = 1 ms.....	575
A.3.11.4	SMTC pattern 4: SMTC period = 20 ms with SMTC duration = 1 ms.....	575
A.3.11.5	SMTC pattern 5: SMTC period = 20 ms with SMTC duration = 5 ms.....	575
A.3.11.6	SMTC pattern 6: SMTC period = 20 ms with SMTC duration = 5 ms.....	575
A.3.11.7	Void.....	575
A.3.11.8	Void.....	575
A.3.11.9	SMTC pattern 9: SMTC period = 20 ms with SMTC duration = 1 ms.....	575
A.3.12	Test Cases with Different CC Configurations .....	575
A.3.12.1	EN-DC Test Cases with Different EN-DC Configurations .....	575
A.3.12.1.1	Introduction.....	575
A.3.12.1.2	Principle of testing .....	576
A.3.12.2	Carrier Aggregation Test Cases with Different CA Configurations .....	576
A.3.12.2.1	Introduction.....	576
A.3.12.2.2	Principle of testing .....	576
A.3.13	Test Cases in SA and EN-DC Operations .....	576
A.3.13.1	Introduction.....	576
A.3.13.2	Principle of Testing.....	576
A.3.13A	Test Cases involving E-UTRA/FR1 and FR2 carriers.....	577
A.3.13A.1	Introduction.....	577
A.3.13A.2	Principle of Testing in EN-DC .....	577
A.3.13A.3	Principle of Testing in SA .....	577
A.3.13B	Test Cases for EN-DC and NE-DC Operations.....	578
A.3.13B.1	Active BWP switch Test Cases for EN-DC and NE-DC Operations.....	578
A.3.13B.1.1	Introduction.....	578
A.3.13B.1.2	Principle of Testing .....	578
A.3.13B.2	SFTD accuracy Test Cases for EN-DC and NE-DC Operations .....	578
A.3.13B.2.1	Introduction.....	578
A.3.13B.2.2	Principle of Testing.....	578

A.3.14	CSI-RS configurations .....	579
A.3.14.1	FDD .....	579
A.3.14.2	TDD .....	580
A.3.15	Angle of Arrival (AoA) for FR2 RRM test cases .....	585
A.3.15.1	Setup 1: Single AoA in Rx beam peak direction .....	586
A.3.15.2	Setup 2: Single AoA in non Rx beam peak direction .....	586
A.3.15.2.1	Setup 2a: Single AoA in non Rx beam peak direction without change in direction .....	586
A.3.15.2.2	Setup 2b: Single AoA in non Rx beam peak direction with change in direction .....	586
A.3.15.3	Setup 3: 2 AoAs .....	586
A.3.15.4	Setup 4: 2 AoAs, 1 AoA in Rx beam peak direction, 1 in non Rx beam peak .....	586
A.3.15.4.1	Setup 4a: 2 AoAs, 1 AoA in Rx beam peak direction, 1 in non Rx beam peak without change in direction .....	586
A.3.15.4.2	Setup 4b: 2 AoAs, 1 AoA in Rx beam peak direction, 1 in non Rx beam peak with change in direction .....	586
A.3.16	TCI State Configuration .....	587
A.3.16.1	Introduction .....	587
A.3.16.2	TCI states .....	587
A.3.17	Configurations of CSI-RS for tracking .....	587
A.3.17.1	Configuration of CSI-RS for tracking for FR1 .....	587
A.3.17.1.1	FDD .....	587
A.3.17.1.2	TDD .....	588
A.3.17.2	Configuration of CSI-RS for tracking for FR2 .....	589
A.3.17.2.1	TDD .....	589
A.3.18	Additional definitions related to OTA testing for FR2 RRM test cases .....	589
A.3.18.1	Introduction .....	589
A.3.18.2	PRACH Power Measurement .....	590
A.3.19	Test applicability for DAPS handover .....	590
A.3.19.1	Introduction .....	590
A.3.19.2	Principle of testing .....	590
A.3.20	MsgA configurations .....	590
A.3.20.1	Introduction .....	590
A.3.20.2	MsgA configurations in FR1 .....	590
A.3.20.2.1	FR1 MsgA configuration 1 .....	590
A.3.20.2.2	FR1 MsgA configuration 2 .....	591
A.3.20.3	MsgA configurations in FR2 .....	592
A.3.20.3.1	FR2 MsgA configuration 1 .....	592
A.3.20.3.2	FR2 MsgA configuration 2 .....	593
A.3.20A	MsgA configurations under CCA .....	594
A.3.20A.1	Introduction .....	594
A.3.20A.2	MsgA configurations in FR1 .....	594
A.3.20A.2.1	FR1 MsgA configuration 1 under CCA .....	594
A.3.20A.2.2	FR1 MsgA configuration 2 under CCA .....	595
A.3.21	V2X sidelink communication .....	596
A.3.21.1	Introduction .....	596
A.3.21.2	Reference resource pool configurations for V2X Sidelink Communication .....	596
A.3.21.3	Reference measurement channels for V2X Sidelink Communication .....	598
A.3.22	CSI-IM configurations .....	599
A.3.22.1	FDD .....	599
A.3.22.2	TDD .....	600
A.3.23	Spatial Relation Configuration .....	601
A.3.23.1	Introduction .....	601
A.3.23.2	Spatial Relation .....	601
A.3.24	SRS configuration .....	602
A.3.25	Channel bandwidth (CBW) configurations .....	604
A.3.25.1	DL UE specific CBW .....	604
A.3.26	CCA model .....	604
A.3.26.1	Introduction .....	604
A.3.26.2	CCA model for operation on a carrier frequency with CCA in FR1 .....	604
A.3.26.2.1	DL CCA model .....	604
A.3.26.2.2	UL CCA model .....	606
A.3.27	Test Cases with at Least One Cell on a Carrier Frequency with CCA .....	606
A.3.27.1	Introduction .....	606



A.3.27.2	NR Standalone Tests with NR SCell under CCA and All Other NR Cells in FR1 .....	606
A.3.27.3	EN-DC Tests with NR PSCell under CCA and Other NR Cells in FR1 .....	606
A.3.27.4	NR Standalone Tests with NR PCell under CCA and Other NR Cells in FR1 .....	607
A.3.27.5	E-UTRA Standalone Tests with at Least One NR Cell under CCA .....	607
A.3.28	Discovery Burst Transmission Window configuration under CCA .....	607
A.3.28.1	DBT Window pattern 1: DBT Window period = 20 ms with DBT Window duration = 1 ms .....	607
A.3.29	Testing principles for UE capable of only NR bands with shared spectrum access .....	607
A.3.29.1	Introduction.....	607
A.3.29.2	Principle of testing for UE capable of EN-DC with only NR bands with shared spectrum access.....	607
A.3.29.3	Principle of testing for UE capable of SA operation with only NR bands with shared spectrum access .....	608
A.3.30	CSI-RS configurations for RRM.....	608
A.3.30.1	FDD .....	608
A.3.30.2	TDD.....	608
A.3.31	PRS Configurations.....	610
A.3.31.1.	PRS Configurations for FR1 .....	610
A.3.31.1.1.	PRS pattern 1 in FR1: SCS=15 KHz.....	610
A.3.31.1.2.	PRS pattern 2 in FR1: SCS=30 KHz.....	610
A.3.31.2.	PRS Configurations for FR2.....	611
A.3.31.2.1.	PRS pattern 1 in FR2: SCS=120 KHz.....	611
A.4	EN-DC tests with all NR cells in FR1 .....	611
A.4.1	Void.....	611
A.4.2	Void.....	611
A.4.3	RRC_CONNECTED state mobility .....	611
A.4.3.1	Void .....	611
A.4.3.2	RRC Connection Mobility Control.....	611
A.4.3.2.1	Void.....	611
A.4.3.2.2	Random Access.....	611
A.4.3.2.2.1	4-step RA type contention based random access test in FR1 for PSCell in EN-DC.....	611
A.4.3.2.2.2	4-step RA type non-contention based random access test in FR1 for PSCell in EN-DC .....	614
A.4.3.2.2.3	2-step RA type contention based random access test in FR1 for PSCell in EN-DC.....	617
A.4.3.2.2.4	2-step RA type non-contention based random access test in FR1 for PSCell in EN-DC .....	619
A.4.3.2.3	Void.....	621
A.4.4	Timing .....	621
A.4.4.1	UE transmit timing .....	621
A.4.4.1.1	NR UE Transmit Timing Test for FR1 .....	621
A.4.4.1.1.1	Test Purpose and environment .....	621
A.4.4.1.1.2	Test requirements .....	624
A.4.4.2	UE timer accuracy .....	624
A.4.4.3	Timing advance .....	624
A.4.4.3.1	EN-DC FR1 timing advance adjustment accuracy.....	624
A.4.4.3.1.1	Test Purpose and Environment.....	624
A.4.4.3.1.2	Test Parameters .....	625
A.4.4.3.1.3	Test Requirements.....	627
A.4.5	Signaling characteristics.....	627
A.4.5.1	Radio link Monitoring .....	627
A.4.5.1.1	Radio Link Monitoring Out-of-sync Test for FR1 PSCell configured with SSB-based RLM RS in non-DRX mode .....	628
A.4.5.1.1.1	Test Purpose and Environment.....	628
A.4.5.1.1.2	Test Requirements.....	630
A.4.5.1.2	Radio Link Monitoring In-sync Test for FR1 PSCell configured with SSB-based RLM RS in non-DRX mode .....	631
A.4.5.1.2.1	Test Purpose and Environment.....	631
A.4.5.1.2.2	Test Requirements.....	634
A.4.5.1.3	Radio Link Monitoring Out-of-sync Test for FR1 PSCell configured with SSB-based RLM RS in DRX mode .....	634
A.4.5.1.3.1	Test Purpose and Environment.....	634
A.4.5.1.3.2	Test Requirements .....	637
A.4.5.1.4	Radio Link Monitoring In-sync Test for FR1 PSCell configured with SSB-based RLM RS in DRX mode .....	637
A.4.5.1.4.1	Test Purpose and Environment.....	637

A.4.5.1.4.2	Test Requirements .....	640
A.4.5.1.5	EN-DC Radio Link Monitoring Out-of-sync Test for FR1 PSCell configured with CSI-RS-based RLM in non-DRX mode .....	641
A.4.5.1.5.1	Test Purpose and Environment.....	641
A.4.5.1.5.2	Test Requirements .....	644
A.4.5.1.6	EN-DC Radio Link Monitoring In-sync Test for FR1 PSCell configured with CSI-RS-based RLM in non-DRX mode .....	644
A.4.5.1.6.1	Test Purpose and Environment.....	644
A.4.5.1.6.2	Test Requirements .....	647
A.4.5.1.7	EN-DC Radio Link Monitoring Out-of-sync Test for FR1 PSCell configured with CSI-RS-based RLM in DRX mode.....	647
A.4.5.1.7.1	Test Purpose and Environment.....	647
A.4.5.1.7.2	Test Requirements .....	650
A.4.5.1.8	EN-DC Radio Link Monitoring In-sync Test for FR1 PSCell configured with CSI-RS-based RLM in DRX mode.....	650
A.4.5.1.8.1	Test Purpose and Environment.....	650
A.4.5.1.8.2	Test Requirements .....	654
A.4.5.2	Interruption .....	654
A.4.5.2.1	E-UTRAN – NR FR1 interruptions at transitions between active and non-active during DRX in synchronous EN-DC .....	654
A.4.5.2.1.1	Test Purpose and Environment.....	654
A.4.5.2.1.2	Test Requirements .....	656
A.4.5.2.2	E-UTRAN – NR FR1 interruptions at transitions between active and non-active during DRX in asynchronous EN-DC.....	656
A.4.5.2.2.1	Test Purpose and Environment.....	656
A.4.5.2.2.2	Test Requirements .....	658
A.4.5.2.3	E-UTRAN – NR FR1 interruptions during measurements on deactivated NR SCC in synchronous EN-DC .....	658
A.4.5.2.3.1	Test Purpose and Environment.....	658
A.4.5.2.3.2	Test Requirements .....	662
A.4.5.2.4	E-UTRAN – NR FR1 interruptions during measurements on deactivated NR SCC in asynchronous EN-DC.....	663
A.4.5.2.4.1	Test Purpose and Environment.....	663
A.4.5.2.4.2	Test Requirements .....	667
A.4.5.2.5	E-UTRAN – NR FR1 interruptions during measurements on deactivated E-UTRAN SCC in synchronous EN-DC .....	668
A.4.5.2.5.1	Test Purpose and Environment.....	668
A.4.5.2.5.2	Test Requirements .....	669
A.4.5.2.6	E-UTRAN – NR FR1 interruptions during measurements on deactivated E-UTRAN SCC in asynchronous EN-DC.....	670
A.4.5.2.6.1	Test Purpose and Environment.....	670
A.4.5.2.6.2	Test Requirements .....	672
A.4.5.2.7	Void.....	672
A.4.5.2.8	E-UTRAN - NR FR1 interruptions at NR SRS carrier based switching in asynchronous EN-DC .....	672
A.4.5.2.8.1	Test Purpose and Environment.....	672
A.4.5.2.8.2	Test Requirements .....	675
A.4.5.2.9	E-UTRAN – NR interruptions at E-UTRA SRS carrier based switching .....	675
A.4.5.2.9.1	Test Purpose and Environment.....	675
A.4.5.2.9.2	Test Requirements .....	677
A.4.5.3	SCell Activation and Deactivation Delay .....	678
A.4.5.3.1	SCell Activation and deactivation of known SCell in FR1 for 160ms SCell measurement cycle .....	678
A.4.5.3.1.1	Test Purpose and Environment.....	678
A.4.5.3.1.2	Test Requirements .....	683
A.4.5.3.2	SCell Activation and deactivation of known SCell in FR1 for 640ms SCell measurement cycle .....	684
A.4.5.3.2.1	Test Purpose and Environment.....	684
A.4.5.3.2.2	Test Requirements .....	684
A.4.5.3.3	SCell Activation and deactivation of unknown SCell in FR1 .....	684
A.4.5.3.3.1	Test Purpose and Environment.....	684
A.4.5.3.3.2	Test Requirements .....	685
A.4.5.3.4	SCell Activation and deactivation of multiple unknown SCells in FR1 with single activation/deactivation command.....	685
A.4.5.3.4.1	Test Purpose and Environment.....	685

A.4.5.3.4.2	Test Requirements .....	687
A.4.5.3.5	Direct SCell activation at SCell addition of known SCell in FR1 .....	688
A.4.5.3.5.1	Test Purpose and Environment .....	688
A.4.5.3.5.2	Test Requirements .....	692
A.4.5.4	UE UL carrier RRC reconfiguration Delay .....	693
A.4.5.4.1	UE UL carrier RRC reconfiguration Delay .....	693
A.4.5.4.1.1	Test Purpose and Environment .....	693
A.4.5.4.1.2	Test Requirements .....	698
A.4.5.5	Beam Failure Detection and Link recovery procedures .....	699
A.4.5.5.1	EN-DC Beam Failure Detection and Link Recovery Test for FR1 PSCell configured with SSB-based BFD and LR in non-DRX mode .....	699
A.4.5.5.1.1	Test Purpose and Environment .....	699
A.4.5.5.1.2	Test Requirements .....	702
A.4.5.5.2	EN-DC Beam Failure Detection and Link Recovery Test for FR1 PSCell configured with SSB-based BFD and LR in DRX mode .....	703
A.4.5.5.2.1	Test Purpose and Environment .....	703
A.4.5.5.2.2	Test Requirements .....	706
A.4.5.5.3	EN-DC Beam Failure Detection and Link Recovery Test for FR1 PSCell configured with CSI-RS-based BFD and LR in non-DRX mode .....	707
A.4.5.5.3.1	Test Purpose and Environment .....	707
A.4.5.5.3.2	Test Requirements .....	710
A.4.5.5.4	EN-DC Beam Failure Detection and Link Recovery Test for FR1 PSCell configured with CSI-RS-based BFD and LR in DRX mode .....	711
A.4.5.5.4.1	Test Purpose and Environment .....	711
A.4.5.5.4.2	Test Requirements .....	715
A.4.5.5.5	EN-DC Beam Failure Detection and Link Recovery Test for FR1 SCell configured with CSI-RS-based BFD and SSB-based LR in non-DRX mode .....	715
A.4.5.5.5.1	Test Purpose and Environment .....	715
A.4.5.5.5.2	Test Requirements .....	719
A.4.5.5.6	EN-DC Beam Failure Detection and Link Recovery Test for FR1 SCell configured with CSI-RS-based BFD and SSB-based LR in DRX mode .....	719
A.4.5.5.6.1	Test Purpose and Environment .....	719
A.4.5.5.6.2	Test Requirements .....	723
A.4.5.6	Active BWP switch .....	724
A.4.5.6.1	DCI-based and Timer-based Active BWP Switch .....	724
A.4.5.6.1.1	E-UTRAN – NR PSCell FR1 DL active BWP switch in non-DRX in synchronous EN-DC .....	724
A.4.5.6.1.2	E-UTRAN – NR PSCell FR1 DL active BWP switch with FR1 SCell in non-DRX in synchronous EN-DC .....	727
A.4.5.6.2	RRC-based Active BWP Switch .....	733
A.4.5.6.3	Simultaneous DCI-based and Timer-based Active BWP Switch on multiple CCs .....	736
A.4.5.6.3.1	Simultaneous E-UTRAN – NR PSCell FR1 DL active BWP switch in non-DRX in EN-DC on multiple CCs .....	736
A.4.5.6.3.1.2	Test Requirements .....	740
A.4.5.6.4	SCell dormancy switch .....	741
A.4.5.6.4.1	E-UTRAN – NR FR1 PSCell SCell dormancy switch of single FR1 SCell outside active time .....	741
A.4.5.6.4.1.1	Test Purpose and Environment .....	741
A.4.5.6.4.1.2	Test Requirements .....	746
A.4.5.6.4.2	E-UTRAN – NR FR1 PSCell SCell dormancy switch of two FR1 SCells inside active time .....	746
A.4.5.6.4.2.1	Test Purpose and Environment .....	746
A.4.5.6.4.2.2	Test Requirements .....	752
A.4.5.6.5	Simultaneous RRC-based Active BWP Switch on multiple CCs .....	753
A.4.5.6.5.1	E-UTRAN – NR PSCell FR1 DL active BWP switch in non-DRX in synchronous EN-DC on multiple CCs .....	753
A.4.5.7	PSCell addition and release delay .....	757
A.4.5.7.1	Addition and Release Delay of known NR PSCell .....	757
A.4.5.7.1.1	Test purpose and environment .....	757
A.4.5.7.1.2	Test Requirements .....	760
A.4.5.8	DL Interruptions at switching between two uplink carriers .....	760
A.4.5.8.1	Test Purpose and Environment .....	760
A.4.5.8.2	Test Requirements .....	763
A.4.5.9	UE specific CBW change .....	763
A.4.5.9.1	UE specific CBW change on FR1 NR PSCell with non-DRX in synchronous EN- DC .....	763

A.4.5.9.1.1	Test Purpose and Environment.....	763
A.4.5.9.1.2	Test Requirements.....	765
A.4.6	Measurement procedure.....	766
A.4.6.1	Intra-frequency Measurements.....	766
A.4.6.1.1	EN-DC event triggered reporting tests without gap under non-DRX.....	766
A.4.6.1.1.1	Test purpose and Environment.....	766
A.4.6.1.1.2	Test parameters.....	766
A.4.6.1.1.3	Test Requirements.....	768
A.4.6.1.2	EN-DC event triggered reporting tests without gap under DRX.....	768
A.4.6.1.2.1	Test purpose and Environment.....	768
A.4.6.1.2.2	Test parameters.....	768
A.4.6.1.2.2	Test Requirements.....	770
A.4.6.1.3	EN-DC event triggered reporting tests with per-UE gaps under non-DRX.....	770
A.4.6.1.3.1	Test purpose and Environment.....	770
A.4.6.1.3.2	Test parameters.....	770
A.4.6.1.3.3	Test Requirements.....	772
A.4.6.1.4	EN-DC event triggered reporting tests with per-UE gaps under DRX.....	773
A.4.6.1.4.1	Test purpose and Environment.....	773
A.4.6.1.4.2	Test parameters.....	773
A.4.6.1.4.3	Test Requirements.....	775
A.4.6.1.5	EN-DC event triggered reporting tests without gap under non-DRX with SSB index reading.....	775
A.4.6.1.5.1	Test purpose and Environment.....	775
A.4.6.1.5.2	Test parameters.....	775
A.4.6.1.5.3	Test Requirements.....	777
A.4.6.1.6	EN-DC event triggered reporting tests with SSB index reading with per-UE gaps.....	777
A.4.6.1.6.1	Test purpose and Environment.....	777
A.4.6.1.6.2	Test parameters.....	777
A.4.6.1.6.3	Test Requirements.....	779
A.4.6.1.7	EN-DC event triggered reporting tests under DRX for UE configured with highSpeedMeasFlag-r16.....	779
A.4.6.1.7.1	Test purpose and Environment.....	779
A.4.6.1.7.2	Test parameters.....	779
A.4.6.1.7.3	Test Requirements.....	781
A.4.6.2	Inter-frequency Measurements.....	782
A.4.6.2.1	EN-DC event triggered reporting tests for FR1 cell without SSB time index detection when DRX is not used.....	782
A.4.6.2.1.1	Test Purpose and Environment.....	782
A.4.6.2.1.2	Test Requirements.....	784
A.4.6.2.2	EN-DC event triggered reporting tests for FR1 cell without SSB time index detection when DRX is used.....	784
A.4.6.2.2.1	Test Purpose and Environment.....	784
A.4.6.2.2.2	Test Requirements.....	787
A.4.6.2.3	Void.....	788
A.4.6.2.4	Void.....	788
A.4.6.2.5	EN-DC event triggered reporting tests for FR1 cell with SSB time index detection when DRX is not used.....	788
A.4.6.2.5.1	Test Purpose and Environment.....	788
A.4.6.2.5.2	Test Requirements.....	790
A.4.6.2.6	EN-DC event triggered reporting tests for FR1 cell with SSB time index detection when DRX is used.....	791
A.4.6.2.6.1	Test Purpose and Environment.....	791
A.4.6.2.6.2	Test Requirements.....	793
A.4.6.2.7	Void.....	794
A.4.6.2.8	Void.....	794
A.4.6.3	Void.....	794
A.4.6.4	L1-RSRP measurement for beam reporting.....	794
A.4.6.4.1	SSB based L1-RSRP measurement when DRX is not used.....	794
A.4.6.4.1.1	Test Purpose and Environment.....	794
A.4.6.4.1.2	Test parameters.....	794
A.4.6.4.1.3	Test Requirements.....	796
A.4.6.4.2	SSB based L1-RSRP measurement when DRX is used.....	796
A.4.6.4.2.1	Test Purpose and Environment.....	796

A.4.6.4.2.2	Test parameters.....	796
A.4.6.4.2.3	Test Requirements .....	798
A.4.6.4.3	CSI-RS based L1-RSRP measurement when DRX is not used.....	798
A.4.6.4.3.1	Test Purpose and Environment.....	798
A.4.6.4.3.2	Test parameters.....	798
A.4.6.4.3.3	Test Requirements .....	800
A.4.6.4.4	CSI-RS based L1-RSRP measurement when DRX is used.....	800
A.4.6.4.4.1	Test Purpose and Environment.....	800
A.4.6.4.4.2	Test parameters.....	800
A.4.6.4.4.3	Test Requirements .....	802
A.4.6.4.5	SSB based L1-RSRP measurement when DRX is used for UE configured with <i>highSpeedMeasFlag-r16</i> .....	802
A.4.6.4.5.1	Test Purpose and Environment.....	802
A.4.6.4.5.2	Test parameters.....	803
A.4.6.4.5.3	Test Requirements .....	804
A.4.6.5	CLI measurements .....	804
A.4.6.5.1	SRS-RSRP measurement with non-DRX.....	804
A.4.6.5.1.1	Test Purpose and Environment.....	804
A.4.6.5.1.2	Test Parameters .....	805
A.4.6.5.1.3	Test Requirements .....	807
A.4.6.5.2	CLI-RSSI measurement with non-DRX.....	807
A.4.6.5.2.1	Test Purpose and Environment.....	807
A.4.6.5.2.2	Test Parameters .....	807
A.4.6.5.2.3	Test Requirements .....	809
A.4.6.6	Measurements with autonomous gaps .....	809
A.4.6.6.1	EN-DC-intra-frequency CGI identification of NR FR1 cell with autonomous gaps in synchronous EN-DC .....	809
A.4.6.6.1.1	Test Purpose and Environment.....	809
A.4.6.6.1.2	Test Requirements .....	811
A.4.6.7	L1-SINR measurement for beam reporting .....	812
A.4.6.7.1	L1-SINR measurement with CSI-RS based CMR and no dedicated IMR when DRX is not used....	812
A.4.6.7.1.1	Test Purpose and Environment.....	812
A.4.6.7.1.2	Test parameters.....	812
A.4.6.7.1.3	Test Requirements .....	814
A.4.6.7.2	L1-SINR measurement with SSB based CMR and dedicated IMR when DRX is used .....	814
A.4.6.7.2.1	Test Purpose and Environment.....	814
A.4.6.7.2.2	Test parameters.....	814
A.4.6.7.2.3	Test Requirements .....	816
A.4.6.7.3	L1-SINR measurement with CSI-RS based CMR and dedicated IMR configured when DRX is used .....	816
A.4.6.7.3.1	Test Purpose and Environment.....	816
A.4.6.7.3.2	Test parameters.....	816
A.4.6.7.3.3	Test Requirements .....	818
A.4.6.8	CSI-RS based intra-frequency Measurement.....	818
A.4.6.8.1	EN-DC event triggered reporting tests without gap under DRX.....	818
A.4.6.8.1.1	Test purpose and Environment .....	818
A.4.6.8.1.2	Test Requirements .....	821
A.4.6.9	CSI-RS based inter-frequency Measurement.....	821
A.4.6.9.1	EN-DC event triggered reporting tests for FR1 cell when non-DRX is used.....	821
A.4.6.9.1.1	Test Purpose and Environment.....	821
A.4.6.9.1.2	Test Requirements .....	824
A.4.7	Measurement Performance requirements .....	825
A.4.7.1	SS-RSRP.....	825
A.4.7.1.1	EN-DC Intra-frequency measurement accuracy with FR1 serving cell and FR1 target cell.....	825
A.4.7.1.1.1	Test Purpose and Environment.....	825
A.4.7.1.1.2	Test parameters.....	825
A.4.7.1.1.3	Test Requirements .....	828
A.4.7.1.2	EN-DC inter-frequency measurement accuracy with FR1 serving cell and FR1 target cell .....	828
A.4.7.1.2.1	Test Purpose and Environment.....	828
A.4.7.1.2.2	Test parameters.....	828
A.4.7.1.2.3	Test Requirements .....	831
A.4.7.1.3	Void.....	831

A.4.7.2	SS-RSRQ .....	831
A.4.7.2.1	EN-DC Intra-frequency measurement accuracy with FR1 serving cell and FR1 target cell .....	831
A.4.7.2.1.1	Test Purpose and Environment .....	831
A.4.7.2.1.2	Test Parameters .....	831
A.4.7.2.1.3	Test Requirements .....	834
A.4.7.2.2	EN-DC Inter-frequency measurement accuracy with FR1 serving cell and FR1 target cell .....	834
A.4.7.2.2.1	Test Purpose and Environment .....	834
A.4.7.2.2.2	Test Parameters .....	834
A.4.7.2.2.3	Test Requirements .....	837
A.4.7.3	SS-SINR .....	838
A.4.7.3.1	EN-DC Intra-frequency measurement accuracy with FR1 serving cell and FR1 target cell .....	838
A.4.7.3.1.1	Test Purpose and Environment .....	838
A.4.7.3.1.2	Test Parameters .....	838
A.4.7.3.1.3	Test Requirements .....	841
A.4.7.3.2	EN-DC Inter-frequency measurement accuracy with FR1 serving cell and FR1 target cell .....	841
A.4.7.3.2.1	Test Purpose and Environment .....	841
A.4.7.3.2.2	Test Parameters .....	841
A.4.7.3.2.3	Test Requirements .....	844
A.4.7.4	L1-RSRP measurement for beam reporting .....	844
A.4.7.4.1	SSB based L1-RSRP measurement .....	844
A.4.7.4.1.1	Test Purpose and Environment .....	844
A.4.7.4.1.2	Test parameters .....	844
A.4.7.4.1.3	Test Requirements .....	847
A.4.7.4.2	CSI-RS based L1-RSRP measurement on resource set with repetition off .....	847
A.4.7.4.2.1	Test Purpose and Environment .....	847
A.4.7.4.2.2	Test parameters .....	847
A.4.7.4.2.3	Test Requirements .....	850
A.4.7.5	SFTD accuracy .....	850
A.4.7.5.1	SFTD accuracy .....	850
A.4.7.5.1.1	Test Purpose and Environment .....	850
A.4.7.5.1.2	Test Parameters .....	850
A.4.7.5.1.3	Test Requirements .....	852
A.4.7.5.2	Void .....	853
A.4.7.5.3	Void .....	853
A.4.7.6	CLI measurements .....	853
A.4.7.6.1	EN-DC SRS-RSRP measurement accuracy with FR1 serving cell .....	853
A.4.7.6.1.1	Test Purpose and Environment .....	853
A.4.7.6.1.2	Test parameters .....	853
A.4.7.6.1.3	Test Requirements .....	856
A.4.7.6.2	EN-DC CLI-RSSI measurement accuracy with FR1 serving cell .....	856
A.4.7.6.2.1	Test Purpose and Environment .....	856
A.4.7.6.2.2	Test parameters .....	856
A.4.7.6.2.3	Test Requirements .....	858
A.4.7.7	L1-SINR measurement for beam reporting .....	858
A.4.7.7.1	L1-SINR measurement with CSI-RS based CMR and no dedicated IMR configured and CSI-RS resource set with repetition off .....	858
A.4.7.7.1.1	Test Purpose and Environment .....	858
A.4.7.7.1.2	Test parameters .....	858
A.4.7.7.1.3	Test Requirements .....	861
A.4.7.7.2	L1-SINR measurement with SSB based CMR and dedicated IMR .....	861
A.4.7.7.2.1	Test Purpose and Environment .....	861
A.4.7.7.2.2	Test parameters .....	861
A.4.7.7.2.3	Test Requirements .....	864
A.4.7.7.3	L1-SINR measurement with CSI-RS based CMR and dedicated IMR .....	864
A.4.7.7.3.1	Test Purpose and Environment .....	864
A.4.7.7.3.2	Test parameters .....	864
A.4.7.7.3.3	Test Requirements .....	867
A.4.7.8	CSI-RSRP .....	867
A.4.7.8.1	EN-DC Intra-frequency measurement accuracy with FR1 serving cell and FR1 target cell .....	867
A.4.7.8.1.1	Test Purpose and Environment .....	867
A.4.7.8.1.2	Test parameters .....	867
A.4.7.8.1.3	Test Requirements .....	871

A.4.7.8.2	EN-DC inter-frequency measurement accuracy with FR1 serving cell and FR1 target cell .....	871
A.4.7.8.2.1	Test Purpose and Environment.....	871
A.4.7.8.2.2	Test parameters.....	872
A.4.7.8.2.3	Test Requirements .....	875
A.4.7.9	CSI-RSRQ .....	876
A.4.7.9.1	EN-DC Intra-frequency measurement accuracy with FR1 serving cell and FR1 target cell.....	876
A.4.7.9.1.1	Test Purpose and Environment.....	876
A.4.7.9.1.2	Test Parameters .....	876
A.4.7.9.1.3	Test Requirements .....	879
A.4.7.9.2	EN-DC Inter-frequency measurement accuracy with FR1 serving cell and FR1 target cell.....	879
A.4.7.9.2.1	Test Purpose and Environment.....	879
A.4.7.9.2.2	Test Parameters .....	879
A.4.7.9.2.3	Test Requirements .....	883
A.4.7.10	CSI-SINR.....	883
A.4.7.10.1	EN-DC Intra-frequency measurement accuracy with FR1 serving cell and FR1 target cell.....	883
A.4.7.10.1.1	Test Purpose and Environment.....	883
A.4.7.10.1.2	Test Parameters .....	883
A.4.7.10.1.3	Test Requirements .....	886
A.4.7.10.2	EN-DC Inter-frequency measurement accuracy with FR1 serving cell and FR1 target cell.....	887
A.4.7.10.2.1	Test Purpose and Environment.....	887
A.4.7.10.2.2	Test Parameters .....	887
A.4.7.10.2.3	Test Requirements .....	890
A.4.8	Void.....	890
A.4A	NE-DC test with all NR cells in FR1 .....	891
A.4A.1	Signaling characteristics.....	891
A.4A.1.1	E-UTRAN PSCell addition.....	891
A.4A.1.1.1	Test purpose and environment .....	891
A.4A.1.1.2	Test Requirements.....	894
A.4A.1.2	Active BWP switch.....	895
A.4A.1.2.1	E-UTRAN PSCell – NR PCell FR1 DCI-based and Timer-based DL active BWP switch in non-DRX in synchronous NE-DC.....	895
A.4A.1.2.1.1	Test Purpose and Environment.....	895
A.4A.1.2.1.2	Test Requirements.....	898
A.4A.2	Measurement performance .....	898
A.4A.2.1	SFTD accuracy .....	898
A.4A.2.1.1	SFTD accuracy.....	898
A.4A.2.1.1.1	Test Purpose .....	898
A.4A.2.1.1.2	Test Environment .....	898
A.4A.2.1.1.3	Test Requirements .....	901
A.5	EN-DC tests with one or more NR cells in FR2 .....	902
A.5.1	Void.....	902
A.5.2	Void.....	902
A.5.3	RRC_CONNECTED state mobility .....	902
A.5.3.1	Void.....	902
A.5.3.2	RRC Connection Mobility Control.....	902
A.5.3.2.1	Void.....	902
A.5.3.2.2	Random Access.....	902
A.5.3.2.2.1	4-step RA type contention based random access test in FR2 for PSCell/SCell in EN-DC.....	902
A.5.3.2.2.2	4-step RA type non-contention based random access test in FR2 for PSCell/SCell in EN-DC .....	905
A.5.3.2.2.3	2-step RA type contention based random access test in FR2 for PSCell/SCell in EN-DC.....	908
A.5.3.2.2.4	2-step RA type non-contention based random access test in FR2 for PSCell/SCell in EN-DC .....	911
A.5.3.2.3	Void.....	913
A.5.4	Timing .....	913
A.5.4.1	UE transmit timing .....	913
A.5.4.1.1	NR UE Transmit Timing Test for FR2 .....	913
A.5.4.1.1.1	Test Purpose and environment .....	913
A.5.4.1.1.2	Test requirements .....	915
A.5.4.2	UE timer accuracy .....	916
A.5.4.3	Timing advance .....	916
A.5.4.3.1	EN-DC FR2 timing advance adjustment accuracy .....	916

A.5.4.3.1.1	Test Purpose and Environment .....	916
A.5.4.3.1.2	Test Parameters .....	916
A.5.4.3.1.3	Test Requirements .....	919
A.5.5	Signaling characteristics .....	919
A.5.5.1	Radio link Monitoring .....	919
A.5.5.1.1	Radio Link Monitoring Out-of-sync Test for FR2 PSCell configured with SSB-based RLM RS in non-DRX mode .....	919
A.5.5.1.1.1	Test Purpose and Environment .....	919
A.5.5.1.1.2	Test Requirements .....	922
A.5.5.1.2	Radio Link Monitoring In-sync Test for FR2 PSCell configured with SSB-based RLM RS in non-DRX mode .....	922
A.5.5.1.2.1	Test Purpose and Environment .....	922
A.5.5.1.2.2	Test Requirements .....	925
A.5.5.1.3	Radio Link Monitoring Out-of-sync Test for FR2 PSCell configured with SSB-based RLM RS in DRX mode .....	926
A.5.5.1.3.1	Test Purpose and Environment .....	926
A.5.5.1.3.2	Test Requirements .....	928
A.5.5.1.4	Radio Link Monitoring In-sync Test for FR2 PSCell configured with SSB-based RLM RS in DRX mode .....	928
A.5.5.1.4.1	Test Purpose and Environment .....	928
A.5.5.1.4.2	Test Requirements .....	931
A.5.5.1.5	EN-DC Radio Link Monitoring Out-of-sync Test for FR2 PSCell configured with CSI-RS-based RLM in non-DRX mode .....	931
A.5.5.1.6	EN-DC Radio Link Monitoring In-sync Test for FR2 PSCell configured with CSI-RS-based RLM in non-DRX mode .....	934
A.5.5.1.7	EN-DC Radio Link Monitoring Out-of-sync Test for FR2 PSCell configured with CSI-RS-based RLM in DRX mode .....	938
A.5.5.1.8	EN-DC Radio Link Monitoring In-sync Test for FR2 PSCell configured with CSI-RS-based RLM in DRX mode .....	942
A.5.5.1.8.2	Test Requirements .....	945
A.5.5.1.9	EN-DC Radio Link Monitoring UE Scheduling Restrictions on FR2 .....	945
A.5.5.1.9.1	Test Purpose and Environment .....	945
A.5.5.1.9.2	Test Requirements .....	947
A.5.5.2	Interruption .....	947
A.5.5.2.1	E-UTRAN – NR FR2 interruptions at transitions between active and non-active during DRX in synchronous EN-DC .....	947
A.5.5.2.1.1	Test Purpose and Environment .....	947
A.5.5.2.1.2	Test Requirements .....	949
A.5.5.2.2	E-UTRAN – NR FR2 interruptions at transitions between active and non-active during DRX in asynchronous EN-DC .....	950
A.5.5.2.2.1	Test Purpose and Environment .....	950
A.5.5.2.2.2	Test Requirements .....	952
A.5.5.2.3	E-UTRAN – NR FR2 interruptions during measurements on deactivated NR SCC in synchronous EN-DC .....	952
A.5.5.2.3.1	Test Purpose and Environment .....	952
A.5.5.2.3.2	Test Requirements .....	954
A.5.5.2.4	E-UTRAN – NR FR2 interruptions during measurements on deactivated NR SCC in asynchronous EN-DC .....	955
A.5.5.2.4.1	Test Purpose and Environment .....	955
A.5.5.2.4.2	Test Requirements .....	957
A.5.5.2.5	E-UTRAN – NR FR2 interruptions during measurements on deactivated E-UTRAN SCC in synchronous EN-DC .....	957
A.5.5.2.5.1	Test Purpose and Environment .....	957
A.5.5.2.5.2	Test Requirements .....	959
A.5.5.2.6	E-UTRAN – NR FR2 interruptions during measurements on deactivated E-UTRAN SCC in asynchronous EN-DC .....	960
A.5.5.2.6.1	Test Purpose and Environment .....	960
A.5.5.2.6.2	Test Requirements .....	961
A.5.5.2.7	E-UTRAN – NR FR2 interruptions at E-UTRA SRS carrier based switching .....	962
A.5.5.2.7.1	Test Purpose and Environment .....	962
A.5.5.2.7.2	Test Requirements .....	964
A.5.5.2.8	E-UTRAN – NR FR2 interruptions at NR SRS carrier based switching .....	964



A.5.5.2.8.1	Test Purpose and Environment .....	964
A.5.5.2.8.3	Test Requirements .....	966
A.5.5.3	SCell Activation and Deactivation Delay .....	967
A.5.5.3.1	SCell Activation and deactivation of SCell in FR2 intra-band .....	967
A.5.5.3.1.1	Test Purpose and Environment .....	967
A.5.5.3.1.2	Test Requirements .....	968
A.5.5.3.2	SCell Activation and deactivation of known SCell in FR1 for 160ms SCell measurement cycle .....	968
A.5.5.3.2.1	Test Purpose and Environment .....	968
A.5.5.3.2.2	Test Requirements .....	970
A.5.5.3.3	Void .....	971
A.5.5.3.4	Void .....	971
A.5.5.3.5	SCell Activation and deactivation of SCell in FR2 .....	971
A.5.5.3.5.1	Test Purpose and Environment .....	971
A.5.5.3.5.2	Test Requirements .....	973
A.5.5.3.6	Multiple SCell Activation and deactivation of one unknown SCell and one known SCell in FR2 .....	974
A.5.5.3.6.1	Test Purpose and Environment .....	974
A.5.5.3.6.2	Test Requirements .....	977
A.5.5.3.7	Direct SCell activation at SCell addition of known SCell in FR2 .....	977
A.5.5.3.7.1	Test Purpose and Environment .....	977
A.5.5.3.7.2	Test Requirements .....	980
A.5.5.4	Void .....	980
A.5.5.5	Beam Failure Detection and Link recovery procedures .....	980
A.5.5.5.1	EN-DC Beam Failure Detection and Link Recovery Test for FR2 PSCell configured with SSB-based BFD and LR in non-DRX mode .....	980
A.5.5.5.1.1	Test Purpose and Environment .....	980
A.5.5.5.1.2	Test Requirements .....	984
A.5.5.5.2	EN-DC Beam Failure Detection and Link Recovery Test for FR2 PSCell configured with SSB-based BFD and LR in DRX mode .....	984
A.5.5.5.2.1	Test Purpose and Environment .....	984
A.5.5.5.2.2	Test Requirements .....	987
A.5.5.5.3	EN-DC Beam Failure Detection and Link Recovery Test for FR2 PSCell configured with CSI-RS-based BFD and LR in non-DRX mode .....	988
A.5.5.5.3.1	Test Purpose and Environment .....	988
A.5.5.5.3.2	Test Requirements .....	991
A.5.5.5.4	EN-DC Beam Failure Detection and Link Recovery Test for FR2 PSCell configured with CSI-RS-based BFD and LR in DRX mode .....	991
A.5.5.5.4.1	Test Purpose and Environment .....	991
A.5.5.5.4.2	Test Requirements .....	994
A.5.5.5.5	EN-DC scheduling availability restriction during Beam Failure Detection and Link Recovery for FR2 PSCell configured with SSB-based BFD and LR in non-DRX mode .....	995
A.5.5.5.5.1	Test Purpose and Environment .....	995
A.5.5.5.5.2	Test Requirements .....	998
A.5.5.5.6	EN-DC Beam Failure Detection and Link Recovery Test for FR2 SCell configured with CSI-RS-based BFD and LR in non-DRX mode .....	998
A.5.5.5.6.1	Test Purpose and Environment .....	998
A.5.5.5.6.2	Test Requirements .....	1001
A.5.5.5.7	EN-DC Beam Failure Detection and Link Recovery Test for FR2 SCell configured with CSI-RS-based BFD and LR in DRX mode .....	1002
A.5.5.5.7.1	Test Purpose and Environment .....	1002
A.5.5.5.7.2	Test Requirements .....	1005
A.5.5.6	Active BWP switch .....	1006
A.5.5.6.1	DCI-based and Timer-based Active BWP Switch .....	1006
A.5.5.6.1.1	E-UTRAN – NR PSCell FR2 DL active BWP switch with non-DRX in synchronous EN-DC .....	1006
A.5.5.6.1.1.1	Test Purpose and Environment .....	1006
A.5.5.6.1.1.2	Test Requirements .....	1008
A.5.5.6.1.2	E-UTRAN – NR PSCell FR2 with FR2 SCell DL active BWP switch in non-DRX in synchronous EN-DC .....	1009
A.5.5.6.2	RRC-based Active BWP Switch .....	1012
A.5.5.6.3	Simultaneous DCI-based and Timer-based Active BWP Switch on multiple CCs .....	1015
A.5.5.6.3.1	E-UTRAN – NR PSCell FR2 and NR SCell FR2 DL active BWP switch on multiple CCs in synchronous EN-DC .....	1015
A.5.5.6.3.1.1	Test Purpose and Environment .....	1015

A.5.5.6.4	SCell dormancy switch .....	1018
A.5.5.6.4.1	E-UTRAN – NR FR2 PSCell SCell dormancy switch of single FR2 SCell inside active time...	1018
A.5.5.6.4.1.1	Test Purpose and Environment .....	1018
A.5.5.6.4.1.2	Test Requirements .....	1021
A.5.5.6.4.2	E-UTRAN – NR FR1 PSCell SCell dormancy switch of two FR2 SCells outside active time...	1022
A.5.5.6.4.2.1	Test Purpose and Environment .....	1022
A.5.5.6.4.2.2	Test Requirements .....	1026
A.5.5.6.5	Simultaneous RRC-based Active BWP Switch on multiple CCs .....	1026
A.5.5.7	PSCell addition and release delay .....	1029
A.5.5.7.1	Addition and Release Delay of NR PSCell .....	1029
A.5.5.7.1.1	Test purpose and environment .....	1029
A.5.5.7.1.2	Test Requirements .....	1031
A.5.5.8	Active TCI state switch delay .....	1032
A.5.5.8.1	MAC-CE based active TCI state switch .....	1032
A.5.5.8.1.1	E-UTRAN – NR PSCell FR2 active TCI state switch for a known TCI state .....	1032
A.5.5.8.1.1.1	Test Purpose and Environment .....	1032
A.5.5.8.1.1.2	Test Requirements .....	1035
A.5.5.8.2	RRC based active TCI state switch .....	1035
A.5.5.8.2.1	E-UTRAN – NR PSCell FR2 active TCI state switch for a known TCI state .....	1035
A.5.5.8.2.1.1	Test Purpose and Environment .....	1035
A.5.5.8.2.1.2	Test Requirements .....	1039
A.5.5.9	Uplink spatial relation switch delay .....	1039
A.5.5.9.1	MAC-CE based uplink spatial relation switch .....	1039
A.5.5.9.1.1	E-UTRAN – NR PSCell FR2 uplink spatial relation switch for a known spatial relation .....	1039
A.5.5.9.1.1.1	Test Purpose and Environment .....	1039
A.5.5.9.1.1.2	Test Requirements .....	1041
A.5.5.9.2	RRC based spatial relation switch .....	1041
A.5.5.9.2.1	E-UTRAN – NR PSCell FR2 spatial relation switch associated with a known DL-RS .....	1041
A.5.5.9.2.1.1	Test Purpose and Environment .....	1041
A.5.5.9.2.1.2	Test Requirements .....	1043
A.5.5.10	UE specific CBW change .....	1043
A.5.5.10.1	UE specific CBW change on FR2 NR PSCell .....	1043
A.5.5.10.1.1	Test Purpose and Environment .....	1043
A.5.5.10.1.2	Test Requirements .....	1046
A.5.6	Measurement procedure .....	1046
A.5.6.1	Intra-frequency Measurements .....	1046
A.5.6.1.1	EN-DC event triggered reporting test without gap under non-DRX .....	1046
A.5.6.1.1.1	Test purpose and Environment .....	1046
A.5.6.1.1.2	Test Requirements .....	1049
A.5.6.1.2	EN-DC event triggered reporting test without gap under DRX .....	1049
A.5.6.1.2.1	Test purpose and Environment .....	1049
A.5.6.1.2.2	Test Requirements .....	1051
A.5.6.1.3	EN-DC event triggered reporting test with per-UE gaps under non-DRX .....	1052
A.5.6.1.3.1	Test purpose and Environment .....	1052
A.5.6.1.3.2	Test Requirements .....	1054
A.5.6.1.4	EN-DC event triggered reporting test with per-UE gaps under DRX .....	1055
A.5.6.1.4.1	Test purpose and Environment .....	1055
A.5.6.1.4.2	Test Requirements .....	1057
A.5.6.2	Inter-frequency Measurements .....	1057
A.5.6.2.1	EN-DC event triggered reporting tests for FR2 cell without SSB time index detection when DRX is not used .....	1057
A.5.6.2.1.1	Test Purpose and Environment .....	1057
A.5.6.2.1.2	Test Requirements .....	1060
A.5.6.2.2	EN-DC event triggered reporting tests for FR2 cell without SSB time index detection when DRX is used .....	1060
A.5.6.2.2.1	Test Purpose and Environment .....	1060
A.5.6.2.2.2	Test Requirements .....	1063
A.5.6.2.3	EN-DC event triggered reporting tests for FR2 cell with SSB time index detection when DRX is not used .....	1063
A.5.6.2.3.1	Test Purpose and Environment .....	1063
A.5.6.2.3.2	Test Requirements .....	1066

A.5.6.2.4	EN-DC event triggered reporting tests for FR2 cell with SSB time index detection when DRX is used .....	1066
A.5.6.2.4.1	Test Purpose and Environment.....	1066
A.5.6.2.4.2	Test Requirements.....	1069
A.5.6.2.5	EN-DC event triggered reporting tests for FR2 cell without SSB time index detection when DRX is not used .....	1069
A.5.6.2.5.1	Test Purpose and Environment.....	1069
A.5.6.2.5.2	Test Requirements.....	1072
A.5.6.2.6	EN-DC event triggered reporting tests for FR2 cell without SSB time index detection when DRX is used.....	1072
A.5.6.2.6.1	Test Purpose and Environment.....	1072
A.5.6.2.6.2	Test Requirements.....	1075
A.5.6.2.7	EN-DC event triggered reporting tests for FR2 cell with SSB time index detection when DRX is not used .....	1076
A.5.6.2.7.1	Test Purpose and Environment.....	1076
A.5.6.2.7.2	Test Requirements.....	1079
A.5.6.2.8	EN-DC event triggered reporting tests for FR2 cell with SSB time index detection when DRX is used .....	1079
A.5.6.2.8.1	Test Purpose and Environment.....	1079
A.5.6.2.8.2	Test Requirements.....	1083
A.5.6.3	L1-RSRP measurement for beam reporting.....	1083
A.5.6.3.1	SSB based L1-RSRP measurement when DRX is not used.....	1083
A.5.6.3.1.1	Test Purpose and Environment.....	1083
A.5.6.3.1.2	Test parameters.....	1083
A.5.6.3.1.3	Test Requirements.....	1085
A.5.6.3.2	SSB based L1-RSRP measurement when DRX is used.....	1085
A.5.6.3.2.1	Test Purpose and Environment.....	1085
A.5.6.3.2.2	Test parameters.....	1085
A.5.6.3.2.3	Test Requirements.....	1087
A.5.6.3.3	CSI-RS based L1-RSRP measurement when DRX is not used.....	1087
A.5.6.3.3.1	Test Purpose and Environment.....	1087
A.5.6.3.3.2	Test parameters.....	1088
A.5.6.3.3.3	Test Requirements.....	1089
A.5.6.3.4	CSI-RS based L1-RSRP measurement when DRX is used.....	1089
A.5.6.3.4.1	Test Purpose and Environment.....	1089
A.5.6.3.4.2	Test parameters.....	1090
A.5.6.3.4.3	Test Requirements.....	1091
A.5.6.4	CLI measurements .....	1092
A.5.6.4.1	SRS-RSRP measurement with DRX.....	1092
A.5.6.4.1.1	Test Purpose and Environment.....	1092
A.5.6.4.1.2	Test Parameters .....	1092
A.5.6.4.1.3	Test Requirements.....	1094
A.5.6.4.2	CLI-RSSI measurement with DRX.....	1094
A.5.6.4.2.1	Test Purpose and Environment.....	1094
A.5.6.4.2.2	Test Parameters .....	1094
A.5.6.4.2.3	Test Requirements.....	1096
A.5.6.5	Measurements with autonomous gaps .....	1096
A.5.6.5.1	EN-DC inter-frequency CGI identification of NR neighbor cell in FR2 .....	1096
A.5.6.5.1.1	Test Purpose and Environment.....	1096
A.5.6.5.1.2	Test Requirements.....	1099
A.5.6.6	L1-SINR measurement for beam reporting .....	1099
A.5.6.6.1	L1-SINR measurement with CSI-RS based CMR and no dedicated IMR configured when DRX is used.....	1099
A.5.6.6.1.1	Test Purpose and Environment.....	1099
A.5.6.6.1.2	Test parameters.....	1099
A.5.6.6.1.3	Test Requirements.....	1101
A.5.6.6.2	L1-SINR measurement with SSB based CMR and dedicated IMR when DRX is not used .....	1101
A.5.6.6.2.1	Test Purpose and Environment.....	1101
A.5.6.6.2.2	Test parameters.....	1101
A.5.6.6.2.3	Test Requirements.....	1103
A.5.6.6.3	L1-SINR measurement with CSI-RS based CMR and dedicated IMR configured when DRX is not used .....	1104

A.5.6.6.3.1	Test Purpose and Environment.....	1104
A.5.6.6.3.2	Test parameters.....	1104
A.5.6.6.3.3	Test Requirements .....	1105
A.5.6.7	CSI-RS based Intra-frequency Measurements .....	1106
A.5.6.7.1	EN-DC event triggered reporting test without gap under non-DRX .....	1106
A.5.6.7.1.1	Test purpose and Environment .....	1106
A.5.6.7.1.2	Test Requirements .....	1107
A.5.6.8	CSI-RS based Inter-frequency Measurements .....	1108
A.5.6.8.1	EN-DC event triggered reporting tests for NR FR2 cell when DRX is used .....	1108
A.5.6.8.1.1	Test Purpose and Environment.....	1108
A.5.6.8.1.2	Test Requirements .....	1110
A.5.7	Measurement Performance requirements .....	1110
A.5.7.1	SS-RSRP.....	1111
A.5.7.1.1	EN-DC intra-frequency case measurement accuracy with FR2 serving cell and FR2 target cell ....	1111
A.5.7.1.1.1	Test Purpose and Environment.....	1111
A.5.7.1.1.2	Test parameters.....	1111
A.5.7.1.1.3	Test Requirements .....	1113
A.5.7.1.2	EN-DC inter-frequency case measurement accuracy with FR2 serving cell and FR2 target cell ....	1113
A.5.7.1.2.1	Test Purpose and Environment.....	1113
A.5.7.1.2.2	Test parameters.....	1113
A.5.7.1.2.3	Test Requirements .....	1116
A.5.7.1.3	EN-DC inter-frequency measurement accuracy with FR1 serving cell and FR2 target cell .....	1117
A.5.7.1.3.1	Test Purpose and Environment.....	1117
A.5.7.1.3.2	Test parameters.....	1117
A.5.7.1.3.3	Test Requirements .....	1119
A.5.7.2	SS-RSRQ .....	1119
A.5.7.2.1	EN-DC Intra-frequency measurement accuracy with FR2 serving cell and FR2 TDD target cell .....	1119
A.5.7.2.1.1	Test Purpose and Environment .....	1119
A.5.7.2.1.2	Test Parameters .....	1119
A.5.7.2.1.3	Test Requirements .....	1121
A.5.7.2.2	EN-DC Inter-frequency measurement accuracy with FR2 serving cell and FR2 TDD target cell....	1121
A.5.7.2.2.1	Test Purpose and Environment.....	1121
A.5.7.2.2.2	Test Parameters .....	1122
A.5.7.2.2.3	Test Requirements .....	1123
A.5.7.3	SS-SINR .....	1123
A.5.7.3.1	EN-DC Intra-frequency measurement accuracy with FR2 serving cell and FR2 TDD target cell....	1123
A.5.7.3.1.1	Test Purpose and Environment.....	1123
A.5.7.3.1.2	Test Parameters .....	1123
A.5.7.3.1.3	Test Requirements .....	1125
A.5.7.3.2	EN-DC Inter-frequency measurement accuracy with FR2 serving cell and FR2 TDD target cell....	1125
A.5.7.3.2.1	Test Purpose and Environment.....	1125
A.5.7.3.2.2	Test Parameters .....	1125
A.5.7.3.2.3	Test Requirements .....	1127
A.5.7.4	L1-RSRP measurement for beam reporting.....	1127
A.5.7.4.1	SSB based L1-RSRP measurement.....	1127
A.5.7.4.1.1	Test Purpose and Environment.....	1127
A.5.7.4.1.2	Test parameters.....	1127
A.5.7.4.1.3	Test Requirements .....	1129
A.5.7.4.2	CSI-RS based L1-RSRP measurement on resource set with repetition off.....	1129
A.5.7.4.2.1	Test Purpose and Environment.....	1129
A.5.7.4.2.2	Test parameters.....	1130
A.5.7.4.2.3	Test Requirements .....	1131
A.5.7.5	CLI measurements .....	1132
A.5.7.5.1	EN-DC SRS-RSRP measurement accuracy with FR2 serving cell.....	1132
A.5.7.5.1.1	Test Purpose and Environment.....	1132
A.5.7.5.1.2	Test parameters.....	1132
A.5.7.5.1.3	Test Requirements .....	1134
A.5.7.5.2	EN-DC CLI-RSSI measurement accuracy with FR2 serving cell.....	1134
A.5.7.5.2.1	Test Purpose and Environment.....	1134
A.5.7.5.2.2	Test parameters.....	1134
A.5.7.5.2.3	Test Requirements .....	1136

A.5.7.6	L1-SINR measurement for beam reporting .....	1137
A.5.7.6.1	L1-SINR measurement with CSI-RS based CMR and no dedicated IMR configured and CSI-RS resource set with repetition off.....	1137
A.5.7.6.1.1	Test Purpose and Environment.....	1137
A.5.7.6.1.2	Test parameters.....	1137
A.5.7.6.1.3	Test Requirements .....	1138
A.5.7.6.2	L1-SINR measurement with SSB based CMR and dedicated IMR .....	1139
A.5.7.6.2.1	Test Purpose and Environment.....	1139
A.5.7.6.2.2	Test parameters.....	1139
A.5.7.6.2.3	Test Requirements .....	1141
A.5.7.6.3	L1-SINR measurement with CSI-RS based CMR and dedicated IMR.....	1142
A.5.7.6.3.1	Test Purpose and Environment.....	1142
A.5.7.6.3.2	Test parameters.....	1142
A.5.7.6.3.3	Test Requirements .....	1143
A.5.7.7	CSI-RSRP.....	1144
A.5.7.7.1	EN-DC intra-frequency case measurement accuracy with FR2 serving cell and FR2 target cell .....	1144
A.5.7.7.1.2	Test parameters.....	1144
A.5.7.7.1.3	Test Requirements .....	1146
A.5.7.7.2	EN-DC inter-frequency case measurement accuracy with FR2 serving cell and FR2 target cell ....	1147
A.5.7.7.2.1	Test Purpose and Environment.....	1147
A.5.7.7.2.2	Test parameters.....	1147
A.5.7.7.2.3	Test Requirements .....	1149
A.5.7.8	CSI-RSRQ .....	1150
A.5.7.8.1	EN-DC Intra-frequency measurement accuracy with FR2 serving cell and FR2 target cell.....	1150
A.5.7.8.1.1	Test Purpose and Environment.....	1150
A.5.7.8.1.2	Test Parameters .....	1150
A.5.7.8.1.3	Test Requirements .....	1151
A.5.7.8.2	EN-DC Inter-frequency measurement accuracy with FR2 serving cell and FR2 TDD target cell....	1152
A.5.7.8.2.1	Test Purpose and Environment.....	1152
A.5.7.8.2.2	Test Parameters .....	1152
A.5.7.9	CSI-SINR.....	1153
A.5.7.9.1	EN-DC Intra-frequency measurement accuracy with FR2 serving cell and FR2 TDD target cell....	1153
A.5.7.9.1.1	Test Purpose and Environment.....	1153
A.5.7.9.1.2	Test Parameters .....	1153
Table A.5.7.9.1.2-1:	CSI-SINR Intra frequency CSI-SINR supported test configurations .....	1154
A.5.7.9.1.3	Test Requirements .....	1155
A.5.7.9.2	EN-DC Inter-frequency measurement accuracy with FR2 serving cell and FR2 TDD target cell....	1155
A.5.7.9.2.1	Test Purpose and Environment.....	1155
A.5.7.9.2.2	Test Parameters .....	1155
A.5.7.9.2.3	Test Requirements .....	1157
A.5.8	Void.....	1157
A.6	NR standalone tests with all NR cells in FR1 .....	1158
A.6.1	SA: RRC_IDLE state mobility .....	1158
A.6.1.1	Cell re-selection to NR .....	1158
A.6.1.1.1	Cell reselection to FR1 intra-frequency NR case .....	1158
A.6.1.1.1.1	Test Purpose and Environment.....	1158
A.6.1.1.1.2	Test Parameters .....	1158
A.6.1.1.1.3	Test Requirements .....	1160
A.6.1.1.2	Cell reselection to FR1 inter-frequency NR case .....	1160
A.6.1.1.2.1	Test Purpose and Environment.....	1160
A.6.1.1.2.2	Test Parameters .....	1160
A.6.1.1.2.3	Test Requirements .....	1162
A.6.1.1.3	Cell reselection to FR1 intra-frequency NR case for UE fulfilling low mobility relaxed measurement criterion.....	1163
A.6.1.1.3.1	Test Purpose and Environment.....	1163
A.6.1.1.3.2	Test Parameters .....	1163
A.6.1.1.3.3	Test Requirements .....	1165
A.6.1.1.4	Cell reselection to FR1 intra-frequency NR case for UE fulfilling not-at-cell edge relaxed measurement criterion.....	1166
A.6.1.1.4.1	Test Purpose and Environment.....	1166

A.6.1.1.4.2	Test Parameters .....	1166
A.6.1.1.4.3	Test Requirements .....	1168
A.6.1.1.5	Cell reselection to FR1 inter-frequency NR case for UE fulfilling low mobility relaxed measurement criterion .....	1168
A.6.1.1.5.1	Test Purpose and Environment .....	1168
A.6.1.1.5.2	Test Parameters .....	1168
A.6.1.1.5.3	Test Requirements .....	1172
A.6.1.1.6	Cell reselection to FR1 inter-frequency NR case for UE fulfilling not-at-cell edge relaxed measurement criterion .....	1172
A.6.1.1.6.1	Test Purpose and Environment .....	1172
A.6.1.1.6.2	Test Parameters .....	1172
A.6.1.1.6.3	Test Requirements .....	1176
A.6.1.1.7	Cell reselection to FR1 intra-frequency NR case for UE configured with <i>highSpeedMeasFlag-r16</i> .....	1176
A.6.1.1.7.1	Test Purpose and Environment .....	1176
A.6.1.1.7.2	Test Parameters .....	1176
A.6.1.1.7.3	Test Requirements .....	1179
A.6.1.2	Inter-RAT E-UTRAN cell re-selection .....	1179
A.6.1.2.1	Cell reselection to higher priority E-UTRAN .....	1179
A.6.1.2.1.1	Test Purpose and Environment .....	1179
A.6.1.2.1.2	Test Parameters .....	1179
A.6.1.2.1.3	Test Requirements .....	1182
A.6.1.2.2	Cell reselection to lower priority E-UTRAN .....	1182
A.6.1.2.2.1	Test Purpose and Environment .....	1182
A.6.1.2.2.2	Test Parameters .....	1182
A.6.1.2.2.3	Test Requirements .....	1185
A.6.1.2.3	Cell reselection to lower priority E-UTRAN for UE fulfilling low mobility relaxed measurement criterion .....	1185
A.6.1.2.3.1	Test Purpose and Environment .....	1185
A.6.1.2.3.2	Test Parameters .....	1185
A.6.1.2.3.3	Test Requirements .....	1188
A.6.1.2.4	Cell reselection to lower priority E-UTRAN for UE fulfilling not-at-cell edge relaxed measurement criterion .....	1188
A.6.1.2.4.1	Test Purpose and Environment .....	1188
A.6.1.2.4.2	Test Parameters .....	1188
A.6.1.2.4.3	Test Requirements .....	1191
A.6.1.2.5.3	Test Requirements .....	1194
A.6.2	SA: RRC_INACTIVE state mobility .....	1194
A.6.3	RRC_CONNECTED state mobility .....	1194
A.6.3.1	Handover .....	1194
A.6.3.1.1	Intra-frequency handover from FR1 to FR1; known target cell .....	1194
A.6.3.1.1.1	Test Purpose and Environment .....	1194
A.6.3.1.1.2	Test Parameters .....	1194
A.6.3.1.1.3	Test Requirements .....	1196
A.6.3.1.2	Intra-frequency handover from FR1 to FR1; unknown target cell .....	1196
A.6.3.1.2.1	Test Purpose and Environment .....	1196
A.6.3.1.2.2	Test Parameters .....	1197
A.6.3.1.2.3	Test Requirements .....	1198
A.6.3.1.3	Inter-frequency handover from FR1 to FR1; unknown target cell .....	1198
A.6.3.1.3.1	Test Purpose and Environment .....	1198
A.6.3.1.3.2	Test Parameters .....	1199
A.6.3.1.3.3	Test Requirements .....	1200
A.6.3.1.4	SA NR - E-UTRAN handover .....	1200
A.6.3.1.4.1	Test Purpose and Environment .....	1200
A.6.3.1.4.2	Test Requirements .....	1204
A.6.3.1.5	SA NR - E-UTRAN handover with unknown target cell .....	1204
A.6.3.1.5.1	Test Purpose and Environment .....	1204
A.6.3.1.5.2	Test Requirements .....	1207
A.6.3.1.6	SA NR - UTRAN FDD handover .....	1207
A.6.3.1.6.1	Test Purpose and Environment .....	1207
A.6.3.1.6.2	Test Requirements .....	1209
A.6.3.1.7	Intra-frequency synchronous DAPS handover in FR1 .....	1209

A.6.3.1.7.1	Test Purpose and Environment.....	1209
A.6.3.1.7.2	Test Parameters .....	1210
A.6.3.1.7.3	Test Requirements .....	1212
A.6.3.1.8	Intra-frequency asynchronous DAPS handover in FR1 .....	1212
A.6.3.1.8.1	Test Purpose and Environment.....	1212
A.6.3.1.8.2	Test Parameters .....	1212
A.6.3.1.8.3	Test Requirements .....	1214
A.6.3.1.9	Intra-band inter-frequency synchronous DAPS handover test in SA for FR1 .....	1215
A.6.3.1.9.1	Test Purpose and Environment.....	1215
A.6.3.1.9.2	Test Parameters .....	1215
A.6.3.1.9.3	Test Requirements .....	1217
A.6.3.1.10	Intra-band inter-frequency asynchronous DAPS handover test in SA for FR1 .....	1217
A.6.3.1.10.1	Test Purpose and Environment.....	1217
A.6.3.1.10.2	Test Parameters .....	1218
A.6.3.1.10.3	Test Requirements .....	1219
A.6.3.1.11	Inter-band inter-frequency synchronous DAPS handover from FR1 to FR1 .....	1220
A.6.3.1.11.1	Test Purpose and Environment.....	1220
A.6.3.1.11.2	Test Parameters .....	1220
A.6.3.1.11.3	Test Requirements .....	1223
A.6.3.1.12	Inter-band inter-frequency asynchronous DAPS handover from FR1 to FR1 .....	1224
A.6.3.1.12.1	Test Purpose and Environment.....	1224
A.6.3.1.12.2	Test Parameters .....	1224
A.6.3.1.12.3	Test Requirements .....	1227
A.6.3.2	RRC Connection Mobility Control.....	1228
A.6.3.2.1	SA: RRC Re-establishment.....	1228
A.6.3.2.1.1	Intra-frequency RRC Re-establishment in FR1 .....	1228
A.6.3.2.1.2	Inter-frequency RRC Re-establishment in FR1 .....	1230
A.6.3.2.1.3	Intra-frequency RRC Re-establishment in FR1 without serving cell timing .....	1233
A.6.3.2.2	Random Access.....	1235
A.6.3.2.2.1	4-step RA type contention based random access test in FR1 for NR standalone .....	1235
A.6.3.2.2.2	4-step RA type non-contention based random access test in FR1 for NR standalone .....	1238
A.6.3.2.2.3	2-step RA type contention based random access test in FR1 for NR standalone .....	1241
A.6.3.2.2.4	2-step RA type non-contention based test in FR1 for NR standalone .....	1244
A.6.3.2.3	SA: RRC Connection Release with Redirection .....	1246
A.6.3.2.3.1	Redirection from NR in FR1 to NR in FR1 .....	1246
A.6.3.2.3.2	Redirection from NR in FR1 to E-UTRAN.....	1248
A.6.3.3	Conditional handover.....	1251
A.6.3.3.1	Intra-frequency conditional handover from FR1 to FR1.....	1251
A.6.3.3.1.1	Test Purpose and Environment.....	1251
A.6.3.3.1.2	Test Parameters .....	1251
A.6.3.3.1.3	Test Requirements .....	1253
A.6.3.3.2	Inter-frequency conditional handover from FR1 to FR1.....	1254
A.6.3.3.2.1	Test Purpose and Environment.....	1254
A.6.3.3.2.2	Test Parameters .....	1254
A.6.3.3.2.3	Test Requirements .....	1255
A.6.4	Timing .....	1256
A.6.4.1	UE transmit timing .....	1256
A.6.4.1.1	NR UE Transmit Timing Test for FR1 .....	1256
A.6.4.1.1.1	Test Purpose and environment .....	1256
A.6.4.1.1.2	Test requirements .....	1258
A.6.4.2	UE timer accuracy .....	1259
A.6.4.3	Timing advance .....	1259
A.6.4.3.1	SA FR1 timing advance adjustment accuracy.....	1259
A.6.4.3.1.1	Test Purpose and Environment.....	1259
A.6.4.3.1.2	Test Parameters .....	1259
A.6.4.3.1.3	Test Requirements .....	1261
A.6.5	Signalling characteristics.....	1261
A.6.5.1	Radio link Monitoring .....	1261
A.6.5.1.1	Radio Link Monitoring Out-of-sync Test for FR1 PCell configured with SSB-based RLM RS in non-DRX mode .....	1262
A.6.5.1.1.1	Test Purpose and Environment.....	1262
A.6.5.1.1.2	Test Requirements .....	1264

A.6.5.1.2	Radio Link Monitoring In-sync Test for FR1 PCell configured with SSB-based RLM RS in non-DRX mode .....	1265
A.6.5.1.2.1	Test Purpose and Environment.....	1265
A.6.5.1.2.2	Test Requirements .....	1268
A.6.5.1.3	Radio Link Monitoring Out-of-sync Test for FR1 PCell configured with SSB-based RLM RS in DRX mode .....	1268
A.6.5.1.3.1	Test Purpose and Environment.....	1268
A.6.5.1.3.2	Test Requirements .....	1271
A.6.5.1.4	Radio Link Monitoring In-sync Test for FR1 PCell configured with SSB-based RLM RS in DRX mode.....	1271
A.6.5.1.4.1	Test Purpose and Environment.....	1271
A.6.5.1.4.2	Test Requirements .....	1274
A.6.5.1.5	Radio Link Monitoring Out-of-sync Test for FR1 PCell configured with CSI-RS-based RLM in non-DRX mode .....	1274
A.6.5.1.5.1	Test Purpose and Environment.....	1274
A.6.5.1.5.2	Test Requirements .....	1277
A.6.5.1.6	Radio Link Monitoring In-sync Test for FR1 PCell configured with CSI-RS-based RLM in non-DRX mode .....	1278
A.6.5.1.6.1	Test Purpose and Environment.....	1278
A.6.5.1.6.2	Test Requirements .....	1280
A.6.5.1.7	Radio Link Monitoring Out-of-sync Test for FR1 PCell configured with CSI-RS-based RLM in DRX mode .....	1281
A.6.5.1.7.1	Test Purpose and Environment.....	1281
A.6.5.1.7.2	Test Requirements .....	1283
A.6.5.1.8	Radio Link Monitoring In-sync Test for FR1 PCell configured with CSI-RS-based RLM in DRX mode.....	1283
A.6.5.1.8.1	Test Purpose and Environment.....	1283
A.6.5.1.8.2	Test Requirements .....	1286
A.6.5.2	Interruption .....	1287
A.6.5.2.1	Interruptions during measurements on deactivated NR SCC in FR1 .....	1287
A.6.5.2.1.2	Test Requirements .....	1290
A.6.5.2.2	SA interruptions at NR SRS carrier based switching.....	1291
A.6.5.2.2.1	Test Purpose and Environment.....	1291
A.6.5.2.2.2	Test Parameters .....	1291
A.6.5.2.2.3	Test Requirements .....	1293
A.6.5.3	SCell Activation and Deactivation Delay .....	1293
A.6.5.3.1	SCell Activation and deactivation of known SCell in FR1 in non-DRX for 160ms SCell measurement cycle.....	1293
A.6.5.3.1.1	Test Purpose and Environment.....	1293
A.6.5.3.1.2	Test Requirements .....	1297
A.6.5.3.2	SCell Activation and deactivation of known SCell in FR1 in non-DRX for 640 ms SCell measurement cycle.....	1298
A.6.5.3.2.1	Test Purpose and Environment.....	1298
A.6.5.3.2.2	Test Requirements .....	1298
A.6.5.3.3	SCell Activation and deactivation of unknown SCell in FR1 in non-DRX .....	1298
A.6.5.3.3.1	Test Purpose and Environment.....	1298
A.6.5.3.3.2	Test Requirements .....	1299
A.6.5.3.4	Direct SCell activation at SCell addition of known SCell in FR1 .....	1299
A.6.5.3.4.1	Test Purpose and Environment.....	1299
A.6.5.3.4.2	Test Requirements .....	1303
A.6.5.3.5	Direct SCell activation at handover with known SCell in FR1 .....	1303
A.6.5.3.5.1	Test Purpose and Environment.....	1303
A.6.5.3.5.2	Test Requirements .....	1307
A.6.5.4	UE UL carrier RRC reconfiguration Delay .....	1308
A.6.5.4.1	UE UL carrier RRC reconfiguration Delay.....	1308
A.6.5.4.1.1	Test Purpose and Environment.....	1308
A.6.5.4.1.2	Test Requirements .....	1314
A.6.5.4.2	Void.....	1314
A.6.5.5	Beam Failure Detection and Link recovery procedures.....	1314
A.6.5.5.1	Beam Failure Detection and Link Recovery Test for FR1 PCell configured with SSB-based BFD and LR in non-DRX mode .....	1314
A.6.5.5.1.1	Test Purpose and Environment.....	1314



A.6.5.5.1.2	Test Requirements .....	1318
A.6.5.5.2	Beam Failure Detection and Link Recovery Test for FR1 PCell configured with SSB-based BFD and LR in DRX mode .....	1319
A.6.5.5.2.1	Test Purpose and Environment.....	1319
A.6.5.5.2.2	Test Requirements .....	1323
A.6.5.5.3	Beam Failure Detection and Link Recovery Test for FR1 PCell configured with CSI-RS-based BFD and LR in non-DRX mode .....	1323
A.6.5.5.3.1	Test Purpose and Environment.....	1323
A.6.5.5.3.2	Test Requirements .....	1327
A.6.5.5.4	Beam Failure Detection and Link Recovery Test for FR1 PCell configured with CSI-RS-based BFD and LR in DRX mode.....	1327
A.6.5.5.4.1	Test Purpose and Environment.....	1327
A.6.5.5.4.2	Test Requirements .....	1331
A.6.5.5.5	Beam Failure Detection and Link Recovery Test for FR1 SCell configured with CSI-RS-based BFD and SSB-based LR in non-DRX mode .....	1331
A.6.5.5.5.1	Test Purpose and Environment.....	1331
A.6.5.5.5.2	Test Requirements .....	1335
A.6.5.5.6	Beam Failure Detection and Link Recovery Test for FR1 SCell configured with CSI-RS-based BFD and SSB-based LR in DRX mode .....	1335
A.6.5.5.6.1	Test Purpose and Environment.....	1335
A.6.5.5.6.2	Test Requirements .....	1339
A.6.5.6	Active BWP switch.....	1339
A.6.5.6.1	DCI-based and Timer-based Active BWP Switch .....	1339
A.6.5.6.1.1	NR FR1- NR FR1 DL active BWP switch of SCell with non-DRX in SA .....	1339
A.6.5.6.1.2	NR FR1 DL active BWP switch with non-DRX in SA .....	1344
A.6.5.6.2	RRC-based Active BWP Switch .....	1347
A.6.5.6.2.1	NR FR1 DL active BWP switch of Cell with non-DRX in SA .....	1347
A.6.5.6.3	Simultaneous DCI-based and Timer-based Active BWP Switch on multiple CCs.....	1350
A.6.5.6.3.1	NR FR1- NR FR1 DL active BWP switch on multiple CCs with non-DRX in SA .....	1350
A.6.5.6.4	SCell dormancy switch .....	1356
A.6.5.6.4.1	NR FR1 PCell SCell dormancy switch of single FR1 SCell outside active time .....	1356
A.6.5.6.4.2	NR FR1 PCell SCell dormancy switch of two FR1 SCells inside active time .....	1361
A.6.5.6.5	Simultaneous RRC-based Active BWP Switch on multiple CCs .....	1367
A.6.5.6.5.1	NR FR1- NR FR1 DL active BWP switch on multiple CCs with non-DRX in SA .....	1367
A.6.5.7	DL interruptions at switching between two uplink carriers .....	1371
A.6.5.7.1	DL interruptions at switching between two uplink carriers in FDD-TDD CA .....	1371
A.6.5.7.1.1	Test Purpose and Environment.....	1371
A.6.5.7.1.2	Test Requirements .....	1373
A.6.5.7.2	DL interruptions at switching between two uplink carriers in TDD-TDD CA .....	1373
A.6.5.7.2.1	Test Purpose and Environment.....	1373
A.6.5.7.2.2	Test Requirements .....	1375
A.6.5.8	UE specific CBW change .....	1375
A.6.5.8.1	UE specific CBW change on PCell in FR1 in non-DRX .....	1375
A.6.5.8.1.1	Test Purpose and Environment.....	1375
A.6.5.8.1.2	Test Requirements .....	1377
A.6.5.9	Pathloss reference signal switching delay.....	1378
A.6.5.9.1	MAC-CE based pathloss reference signal switch delay .....	1378
A.6.5.9.1.1	Test Purpose and Environment.....	1378
A.6.5.9.1.2	Test Requirements .....	1380
A.6.6	Measurement procedure .....	1380
A.6.6.1	Intra-frequency Measurements .....	1380
A.6.6.1.1	SA event triggered reporting tests without gap under non-DRX .....	1380
A.6.6.1.1.1	Test purpose and Environment.....	1380
A.6.6.1.1.2	Test parameters.....	1381
A.6.6.1.1.3	Test Requirements .....	1382
A.6.6.1.2	SA event triggered reporting tests without gap under DRX.....	1383
A.6.6.1.2.1	Test purpose and Environment.....	1383
A.6.6.1.2.2	Test parameters.....	1383
A.6.6.1.2.3	Test Requirements .....	1385
A.6.6.1.3	SA event triggered reporting tests with per-UE gaps under non-DRX .....	1385
A.6.6.1.3.1	Test purpose and Environment .....	1385
A.6.6.1.3.2	Test parameters.....	1385

A.6.6.1.3.3	Test Requirements .....	1387
A.6.6.1.4	SA event triggered reporting tests with per-UE gaps under DRX.....	1387
A.6.6.1.4.1	Test purpose and Environment .....	1387
A.6.6.1.4.2	Test parameters.....	1387
A.6.6.1.4.3	Test Requirements .....	1389
A.6.6.1.5	SA event triggered reporting tests without gap under non-DRX with SSB index reading.....	1390
A.6.6.1.5.1	Test purpose and Environment .....	1390
A.6.6.1.5.2	Test parameters.....	1390
A.6.6.1.5.3	Test Requirements .....	1391
A.6.6.1.6	SA event triggered reporting tests with per-UE gaps under non-DRX with SSB index reading .....	1391
A.6.6.1.6.1	Test purpose and Environment .....	1391
A.6.6.1.6.2	Test parameters.....	1391
A.6.6.1.6.3	Test Requirements .....	1393
A.6.6.1.7	SA event triggered reporting tests under DRX for UE configured with highSpeedMeasFlag-r16 ...	1393
A.6.6.1.7.1	Test purpose and Environment .....	1393
A.6.6.1.7.2	Test parameters.....	1393
A.6.6.1.7.3	Test Requirements .....	1395
A.6.6.2	Inter-frequency Measurements .....	1395
A.6.6.2.1	SA event triggered reporting tests for FR1 without SSB time index detection when DRX is not used .....	1395
A.6.6.2.1.1	Test Purpose and Environment.....	1395
A.6.6.2.1.2	Test Requirements .....	1398
A.6.6.2.2	SA event triggered reporting tests for FR1 without SSB time index detection when DRX is used ..	1398
A.6.6.2.2.1	Test Purpose and Environment.....	1398
A.6.6.2.2.2	Test Requirements .....	1401
A.6.6.2.3	Void.....	1401
A.6.6.2.4	Void.....	1401
A.6.6.2.5	SA event triggered reporting tests for FR1 with SSB time index detection when DRX is not used .	1401
A.6.6.2.5.1	Test Purpose and Environment.....	1401
A.6.6.2.5.2	Test Requirements .....	1404
A.6.6.2.6	SA event triggered reporting tests for FR1 with SSB time index detection when DRX is used .....	1404
A.6.6.2.6.1	Test Purpose and Environment.....	1404
A.6.6.2.6.2	Test Requirements .....	1406
A.6.6.2.7	Void.....	1407
A.6.6.2.8	Void.....	1407
A.6.6.2.9	SA event triggered reporting tests with additional mandatory gap pattern .....	1407
A.6.6.2.9.1	Test Purpose and Environment.....	1407
A.6.6.2.9.2	Test Requirements .....	1409
A.6.6.2.10	SA event triggered reporting tests for FR1 when DRX is used.....	1409
A.6.6.2.10.1	Test Purpose and Environment.....	1409
A.6.6.2.10.2	Test Requirements .....	1412
A.6.6.2.11	SA event triggered reporting tests for FR1 without gap when DRX is not used.....	1412
A.6.6.2.11.1	Test Purpose and Environment.....	1412
A.6.6.2.11.2	Test Requirements .....	1414
A.6.6.3	Inter-RAT Measurements .....	1414
A.6.6.3.1	SA NR - E-UTRAN event-triggered reporting in non-DRX in FR1 .....	1414
A.6.6.3.1.1	Test Purpose and Environment.....	1414
A.6.6.3.1.2	Test Requirements .....	1417
A.6.6.3.2	SA NR - E-UTRAN event-triggered reporting in DRX in FR1 .....	1418
A.6.6.3.2.1	Test Purpose and Environment.....	1418
A.6.6.3.2.2	Test Requirements .....	1421
A.6.6.3.3	SA NR - E-UTRAN event-triggered reporting in DRX in FR1 for UE configured with highSpeedMeasFlag-r16 .....	1421
A.6.6.3.3.1	Test Purpose and Environment.....	1421
A.6.6.3.3.2	Test Requirements .....	1424
A.6.6.4	L1-RSRP measurement for beam reporting.....	1424
A.6.6.4.1	SSB based L1-RSRP measurement when DRX is not used .....	1424
A.6.6.4.1.1	Test Purpose and Environment.....	1424
A.6.6.4.1.2	Test parameters.....	1425
A.6.6.4.1.3	Test Requirements .....	1426
A.6.6.4.2	SSB based L1-RSRP measurement when DRX is used .....	1426
A.6.6.4.2.1	Test Purpose and Environment.....	1426

A.6.6.4.2.2	Test parameters.....	1427
A.6.6.4.2.3	Test Requirements .....	1428
A.6.6.4.3	CSI-RS based L1-RSRP measurement when DRX is not used.....	1428
A.6.6.4.3.1	Test Purpose and Environment.....	1428
A.6.6.4.3.2	Test parameters.....	1429
A.6.6.4.3.3	Test Requirements .....	1430
A.6.6.4.4	CSI-RS based L1-RSRP measurement when DRX is used.....	1430
A.6.6.4.4.1	Test Purpose and Environment.....	1430
A.6.6.4.4.2	Test parameters.....	1431
A.6.6.4.4.3	Test Requirements .....	1432
A.6.6.4.5	SSB based L1-RSRP measurement when DRX is used for UE configured with <i>highSpeedMeasFlag-r16</i> .....	1432
A.6.6.4.5.1	Test Purpose and Environment.....	1432
A.6.6.4.5.2	Test parameters.....	1433
A.6.6.4.5.3	Test Requirements .....	1434
A.6.6.5	1435	
A.6.6.5.1	SA NR - UTRAN FDD event-triggered reporting in non-DRX in FR1 .....	1435
A.6.6.5.1.1	Test Purpose and Environment.....	1435
A.6.6.5.1.2	Test Requirements .....	1437
A.6.6.6	CLI measurements .....	1437
A.6.6.6.1	SRS-RSRP measurement with DRX.....	1437
A.6.6.6.1.1	Test Purpose and Environment.....	1437
A.6.6.6.1.2	Test Parameters .....	1437
A.6.6.6.1.3	Test Requirements .....	1440
A.6.6.6.2	CLI-RSSI measurement with DRX.....	1440
A.6.6.6.2.1	Test Purpose and Environment.....	1440
A.6.6.6.2.2	Test Parameters .....	1440
A.6.6.6.2.3	Test Requirements .....	1441
A.6.6.7	NR measurements with autonomous gaps .....	1442
A.6.6.7.1	SA intra-frequency CGI identification of NR neighbor cell in FR1 .....	1442
A.6.6.7.1.1	Test Purpose and Environment.....	1442
A.6.6.7.1.2	Test Parameters .....	1442
A.6.6.7.1.3	Test Requirements .....	1444
A.6.6.7.2	Identification of a new CGI of inter-RAT E-UTRA cell using autonomous gaps in NR SA.....	1444
A.6.6.7.2.1	Test Purpose and Environment.....	1444
A.6.6.7.2.2	Test Requirements .....	1447
A.6.6.8	L1-SINR measurement for beam reporting .....	1447
A.6.6.8.1	L1-SINR measurement with CSI-RS based CMR and no dedicated IMR configured when DRX is used.....	1447
A.6.6.8.1.1	Test Purpose and Environment.....	1447
A.6.6.8.2	L1-SINR measurement with SSB based CMR and dedicated IMR when DRX is not used .....	1449
A.6.6.8.2.1	Test Purpose and Environment.....	1449
A.6.6.8.2.2	Test parameters.....	1450
A.6.6.8.2.3	Test Requirements .....	1452
A.6.6.8.3	L1-SINR measurement with CSI-RS based CMR and dedicated IMR configured when DRX is not used .....	1452
A.6.6.8.3.1	Test Purpose and Environment.....	1452
A.6.6.8.3.2	Test parameters.....	1452
A.6.6.8.3.3	Test Requirements .....	1454
A.6.6.9	Idle Mode CA/DC Measurements .....	1454
A.6.6.9.1	SA Idle mode CA/DC measurement for FR1 .....	1454
A.6.6.9.1.1	Test Purpose and Environment.....	1454
A.6.6.9.1.2	Test Requirements .....	1458
A.6.6.10	CSI-RS based intra-frequency Measurements .....	1458
A.6.6.10.1	SA event triggered reporting tests without gap under non-DRX .....	1458
A.6.6.10.1.1	Test purpose and Environment.....	1458
A.6.6.10.1.2	Test Requirements .....	1460
A.6.6.11	CSI-RS based inter-frequency Measurements .....	1460
A.6.6.11.1	SA event triggered reporting tests with gap under DRX.....	1460
A.6.6.11.1.1	Test Purpose and Environment.....	1460
A.6.6.11.1.2	Test Requirements .....	1463
A.6.6.12	RSTD measurements .....	1463

A. 6.6.12.1	NR RSTD measurement reporting delay test case for single positioning frequency layer in FR1	
	SA .....	1463
A. 6.6.12.1.1	Test Purpose and Environment.....	1463
A.6.6.12.1.2	Test Requirements .....	1467
A. 6.6.12.2	NR RSTD measurement reporting delay test case for dual positioning frequency layers in FR1	
	SA .....	1467
A. 6.6.12.2.1	Test Purpose and Environment.....	1467
A.6.6.12.2.2	Test Requirements .....	1471
A.6.6.13	PRS-RSRP measurements .....	1471
A.6.6.13.1	PRS-RSRP reporting delay test case for single positioning frequency layer .....	1471
A.6.6.13.1.1	Test purpose and Environment.....	1471
A.6.6.13.1.2	Test Requirements .....	1473
A.6.6.13.2	PRS-RSRP reporting delay test case for dual positioning frequency layer.....	1474
A.6.6.13.2.1	Test purpose and Environment.....	1474
A.6.6.13.2.2	Test Requirements .....	1476
A.6.6.14	UE Rx-Tx time difference measurements.....	1476
A.6.6.14.1	UE Rx-Tx time difference measurement for single positioning frequency layer in FR1 SA .....	1476
A.6.6.14.1.1	Test purpose and environment.....	1476
A.6.6.14.1.2	Test requirements .....	1479
A.6.6.14.2	UE Rx-Tx time difference measurement for dual positioning frequency layers in FR1 SA .....	1479
A.6.6.14.2.1	Test purpose and environment.....	1479
A.6.6.14.2.2	Test requirements .....	1481
A.6.6.15	Idle Mode measurements of inter-RAT DC candidate cells for early reporting .....	1481
A.6.6.15.1	Test Purpose and Environment .....	1481
A.6.6.15.2	Test Requirements.....	1486
A.6.7	Measurement Performance requirements .....	1486
A.6.7.1	SS-RSRP.....	1486
A.6.7.1.1	SA: intra-frequency case measurement accuracy with FR1 serving cell and FR1 target cell .....	1486
A.6.7.1.1.1	Test Purpose and Environment.....	1486
A.6.7.1.1.2	Test parameters.....	1486
A.6.7.1.1.3	Test Requirements .....	1490
A.6.7.1.2	SA inter-frequency case measurement accuracy with FR1 serving cell and FR1 target cell .....	1490
A.6.7.1.2.1	Test Purpose and Environment.....	1490
A.6.7.1.2.2	Test parameters.....	1490
A.6.7.1.2.3	Test Requirements .....	1492
A.6.7.1.3	Void.....	1493
A.6.7.2	SS-RSRQ.....	1493
A.6.7.2.1	SA: Intra-frequency measurement accuracy with FR1 serving cell and FR1 target cell.....	1493
A.6.7.2.1.1	Test Purpose and Environment.....	1493
A.6.7.2.1.2	Test Parameters .....	1493
A.6.7.2.1.3	Test Requirements .....	1496
A.6.7.2.2	SA Inter-frequency measurement accuracy with FR1 serving cell and FR1 target cell.....	1496
A.6.7.2.2.1	Test Purpose and Environment.....	1496
A.6.7.2.2.2	Test Parameters .....	1496
A.6.7.2.2.3	Test Requirements .....	1500
A.6.7.3	SS-SINR .....	1500
A.6.7.3.1	SA intra-frequency measurement accuracy with FR1 serving cell and FR1 target cell .....	1500
A.6.7.3.1.1	Test Purpose and Environment.....	1500
A.6.7.3.1.2	Test Parameters .....	1500
A.6.7.3.1.3	Test Requirements .....	1503
A.6.7.3.2	SA Inter-frequency measurement accuracy with FR1 serving cell and FR1 target cell.....	1503
A.6.7.3.2.1	Test Purpose and Environment.....	1503
A.6.7.3.2.2	Test Parameters .....	1503
A.6.7.3.2.3	Test Requirements .....	1506
A.6.7.4	L1-RSRP measurement for beam reporting.....	1506
A.6.7.4.1	SSB based L1-RSRP measurement.....	1506
A.6.7.4.1.1	Test Purpose and Environment.....	1506
A.6.7.4.1.2	Test parameters.....	1506
A.6.7.4.1.3	Test Requirements .....	1509
A.6.7.4.2	CSI-RS based L1-RSRP measurement on resource set with repetition off.....	1509
A.6.7.4.2.1	Test Purpose and Environment.....	1509
A.6.7.4.2.2	Test parameters.....	1509

A.6.7.4.2.3	Test Requirements .....	1512
A.6.7.5	E-UTRAN RSRP .....	1512
A.6.7.5.1	SA: inter-RAT measurement accuracy with FR1 serving cell .....	1512
A.6.7.5.1.1	Test Purpose and Environment.....	1512
A.6.7.5.1.2	Test parameters.....	1512
A.6.7.5.1.3	Test Requirements .....	1515
A.6.7.6	E-UTRAN RSRQ .....	1515
A.6.7.6.1	SA: inter-RAT measurement accuracy with FR1 serving cell .....	1515
A.6.7.6.1.1	Test Purpose and Environment.....	1515
A.6.7.6.1.2	Test parameters.....	1515
A.6.7.6.1.3	Test Requirements .....	1518
A.6.7.7	E-UTRAN RS-SINR.....	1518
A.6.7.7.1	SA: inter-RAT measurement accuracy with FR1 serving cell .....	1518
A.6.7.7.1.1	Test Purpose and Environment.....	1518
A.6.7.7.1.2	Test parameters.....	1518
A.6.7.7.1.3	Test Requirements .....	1521
A.6.7.8	CLI measurements .....	1522
A.6.7.8.1	SA SRS-RSRP measurement accuracy with FR1 serving cell.....	1522
A.6.7.8.1.1	Test Purpose and Environment.....	1522
A.6.7.8.1.2	Test parameters.....	1522
A.6.7.8.1.3	Test Requirements.....	1525
A.6.7.8.2	SA CLI-RSSI measurement accuracy with FR1 serving cell.....	1525
A.6.7.8.2.1	Test Purpose and Environment.....	1525
A.6.7.8.2.2	Test parameters.....	1525
A.6.7.8.2.3	Test Requirements .....	1527
A.6.7.9	L1-SINR measurement for beam reporting .....	1527
A.6.7.9.1	L1-SINR measurement with CSI-RS based CMR and no dedicated IMR configured and CSI-RS resource set with repetition off.....	1527
A.6.7.9.1.1	Test Purpose and Environment.....	1527
A.6.7.9.1.2	Test parameters.....	1527
A.6.7.9.1.3	Test Requirements .....	1530
A.6.7.9.2	L1-SINR measurement with SSB based CMR and dedicated IMR .....	1530
A.6.7.9.2.1	Test Purpose and Environment.....	1530
A.6.7.9.2.2	Test parameters.....	1530
A.6.7.9.2.3	Test Requirements .....	1533
A.6.7.9.3	L1-SINR measurement with CSI-RS based CMR and dedicated IMR.....	1533
A.6.7.9.3.1	Test Purpose and Environment.....	1533
A.6.7.9.3.2	Test parameters.....	1534
A.6.7.9.3.3	Test Requirements .....	1536
A.6.7.10	CSI-RSRP .....	1537
A.6.7.10.1	SA: intra-frequency case measurement accuracy with FR1 serving cell and FR1 target cell .....	1537
A.6.7.10.1.1	Test Purpose and Environment.....	1537
A.6.7.10.1.2	Test parameters.....	1537
A.6.7.10.1.3	Test Requirements .....	1540
A.6.7.10.2	SA inter-frequency case measurement accuracy with FR1 serving cell and FR1 target cell .....	1540
A.6.7.10.2.1	Test Purpose and Environment.....	1540
A.6.7.10.2.2	Test parameters.....	1540
A.6.7.10.2.3	Test Requirements .....	1544
A.6.7.11	CSI-RSRQ .....	1544
A.6.7.11.1	SA: Intra-frequency measurement accuracy with FR1 serving cell and FR1 target cell.....	1544
A.6.7.11.1.1	Test Purpose and Environment.....	1544
A.6.7.11.1.2	Test Parameters .....	1544
A.6.7.11.1.3	Test Requirements .....	1547
A.6.7.11.2	SA Inter-frequency measurement accuracy with FR1 serving cell and FR1 target cell.....	1547
A.6.7.11.2.1	Test Purpose and Environment.....	1547
A.6.7.11.2.2	Test Parameters .....	1548
A.6.7.11.2.3	Test Requirements .....	1551
A.6.7.12	CSI-SINR.....	1551
A.6.7.12.1	SA intra-frequency measurement accuracy with FR1 serving cell and FR1 target cell .....	1551
A.6.7.12.1.1	Test Purpose and Environment.....	1551
A.6.7.12.1.2	Test Parameters .....	1551
A.6.7.12.1.3	Test Requirements .....	1554

A.6.7.12.2	SA Inter-frequency measurement accuracy with FR1 serving cell and FR1 target cell .....	1554
A.6.7.12.2.1	Test Purpose and Environment .....	1554
A.6.7.12.2.2	Test Parameters .....	1555
A.6.7.12.2.3	Test Requirements .....	1559
A.6.7.13	RSTD measurements .....	1559
A.6.7.13.1	RSTD measurement accuracy test case for single positioning frequency layer .....	1559
A.6.7.13.1.1	Test purpose and Environment .....	1559
A.6.7.13.1.2	Test Requirements .....	1561
A.6.7.13.2	RSTD measurement accuracy test case for dual positioning frequency layer .....	1561
A.6.7.13.2.1	Test purpose and Environment .....	1561
A.6.7.13.2.2	Test Requirements .....	1563
A.6.7.14	PRS-RSRP measurements .....	1563
A.6.7.14.1	SA: measurement accuracy with PRS in FR1 .....	1563
A.6.7.14.1.1	Test Purpose and Environment .....	1563
A.6.7.14.1.2	Test parameters .....	1563
A.6.7.14.1.3	Test Requirements .....	1565
A.6.7.15	UE Rx-Tx time difference measurements .....	1566
A.6.7.15.1	UE Rx-Tx time difference measurement accuracy for single positioning frequency layer in FR1 SA .....	1566
A.6.7.15.1.1	Test purpose and environment .....	1566
A.6.7.15.1.2	Test parameters .....	1566
A.6.7.15.1.3	Test requirements .....	1568
A.7.1	SA: RRC_IDLE state mobility .....	1568
A.7.1.1	Cell re-selection to NR .....	1568
A.7.1.1.1	Cell reselection to FR2 intra-frequency NR case .....	1568
A.7.1.1.1.1	Test Purpose and Environment .....	1568
A.7.1.1.1.2	Test Parameters .....	1568
A.7.1.1.1.3	Test Requirements .....	1570
A.7.1.1.2	Cell reselection to FR2 inter-frequency NR case .....	1570
A.7.1.1.2.1	Test Purpose and Environment .....	1570
A.7.1.1.2.2	Test Parameters .....	1570
A.7.1.1.2.3	Test Requirements .....	1572
A.7.1.1.3	Cell reselection to FR2 intra-frequency NR case for UE fulfilling low mobility relaxed measurement criterion .....	1573
A.7.1.1.3.1	Test Purpose and Environment .....	1573
A.7.1.1.3.2	Test Parameters .....	1573
A.7.1.1.3.3	Test Requirements .....	1575
A.7.1.1.4	Cell reselection to FR2 intra-frequency NR case for UE fulfilling not-at-cell edge relaxed measurement criterion .....	1575
A.7.1.1.4.1	Test Purpose and Environment .....	1575
A.7.1.1.4.2	Test Parameters .....	1575
A.7.1.1.4.3	Test Requirements .....	1577
A.7.1.1.5	Cell reselection to FR2 inter-frequency NR case for UE fulfilling low mobility relaxed measurement criterion .....	1577
A.7.1.1.5.1	Test Purpose and Environment .....	1577
A.7.1.1.5.2	Test Parameters .....	1577
A.7.1.1.5.3	Test Requirements .....	1579
A.7.1.1.6	Cell reselection to FR2 inter-frequency NR case for UE fulfilling not-at-cell edge relaxed measurement criterion .....	1580
A.7.1.1.6.1	Test Purpose and Environment .....	1580
A.7.1.1.6.2	Test Parameters .....	1580
A.7.1.1.6.3	Test Requirements .....	1582
A.7.2	SA: RRC_INACTIVE state mobility .....	1583
A.7.3	RRC_CONNECTED state mobility .....	1583
A.7.3.1	Handover .....	1583
A.7.3.1.1	Inter-frequency handover from FR1 to FR2; unknown target cell .....	1583
A.7.3.1.1.1	Test Purpose and Environment .....	1583
A.7.3.1.1.2	Test Parameters .....	1583
A.7.3.1.1.3	Test Requirements .....	1585
A.7.3.1.2	Intra-frequency handover from FR2 to FR2; unknown target cell .....	1585
A.7.3.1.2.1	Test Purpose and Environment .....	1585
A.7.3.1.2.2	Test Parameters .....	1585
A.7.3.1.2.3	Test Requirements .....	1586

A.7.3.1.3	Inter-frequency handover from FR2 to FR2; unknown target cell .....	1587
A.7.3.1.3.1	Test Purpose and Environment .....	1587
A.7.3.1.3.2	Test Parameters .....	1587
A.7.3.1.3.3	Test Requirements .....	1588
A.7.3.1.4	Inter-band inter-frequency synchronous DAPS handover from FR1 to FR2 .....	1588
A.7.3.1.4.1	Test Purpose and Environment .....	1588
A.7.3.1.4.2	Test Parameters .....	1588
A.7.3.1.4.3	Test Requirements .....	1592
A.7.3.1.5	Inter-band inter-frequency asynchronous DAPS handover from FR1 to FR2 .....	1592
A.7.3.1.5.1	Test Purpose and Environment .....	1592
A.7.3.1.5.2	Test Parameters .....	1592
A.7.3.1.5.3	Test Requirements .....	1596
A.7.3.2	RRC Connection Mobility Control .....	1596
A.7.3.2.1	SA: RRC Re-establishment .....	1596
A.7.3.2.1.1	Intra-frequency RRC Re-establishment in FR2 .....	1596
A.7.3.2.1.2	Inter-frequency RRC Re-establishment in FR2 .....	1598
A.7.3.2.1.3	Intra-frequency RRC Re-establishment in FR2 without serving cell timing .....	1600
A.7.3.2.1.3.1	Test Purpose and Environment .....	1600
A.7.3.2.1.3.2	Test Requirements .....	1602
A.7.3.2.2	Random Access .....	1602
A.7.3.2.2.1	4-step RA type contention based random access test in FR2 for NR Standalone .....	1602
A.7.3.2.2.2	4-step RA type non-contention based random access test in FR2 for NR Standalone .....	1605
A.7.3.2.2.3	2-step RA type contention based random access test in FR2 for NR Standalone .....	1608
A.7.3.2.2.4	2-step RA type non-contention based random access test in FR2 for NR Standalone .....	1611
A.7.3.2.3	SA: RRC Connection Release with Redirection .....	1614
A.7.3.2.3.1	Redirection from NR in FR2 to NR in FR2 .....	1614
A.7.3.3	Conditional Handover .....	1615
A.7.3.3.1	Intra-frequency conditional handover from FR2 to FR2 .....	1615
A.7.3.3.1.1	Test Purpose and Environment .....	1615
A.7.3.3.1.2	Test Parameters .....	1616
A.7.3.3.1.2.3	Test Requirements .....	1617
A.7.3.3.2	Inter-frequency conditional handover from FR2 to FR2; unknown target cell .....	1617
A.7.3.3.2.1	Test Purpose and Environment .....	1617
A.7.3.3.2.2	Test Parameters .....	1617
A.7.3.3.2.3	Test Requirements .....	1619
A.7.4	Timing .....	1619
A.7.4.1	UE transmit timing .....	1619
A.7.4.1.1	NR UE Transmit Timing Test for FR2 .....	1619
A.7.4.1.1.1	Test Purpose and environment .....	1619
A.7.4.1.1.2	Test requirements .....	1621
A.7.4.2	UE timer accuracy .....	1622
A.7.4.3	Timing advance .....	1622
A.7.4.3.1	SA FR2 timing advance adjustment accuracy .....	1622
A.7.4.3.1.1	Test Purpose and Environment .....	1622
A.7.4.3.1.2	Test Parameters .....	1622
A.7.4.3.1.3	Test Requirements .....	1624
A.7.5	Signaling characteristics .....	1624
A.7.5.1	Radio link Monitoring .....	1624
A.7.5.1.1	Radio Link Monitoring Out-of-sync Test for FR2 PCell configured with SSB-based RLM RS in non-DRX mode .....	1625
A.7.5.1.1.1	Test Purpose and Environment .....	1625
A.7.5.1.1.2	Test Requirements .....	1627
A.7.5.1.2	Radio Link Monitoring In-sync Test for FR2 PCell configured with SSB-based RLM RS in non-DRX mode .....	1628
A.7.5.1.2.1	Test Purpose and Environment .....	1628
A.7.5.1.2.2	Test Requirements .....	1630
A.7.5.1.3	Radio Link Monitoring Out-of-sync Test for FR2 PCell configured with SSB-based RLM RS in DRX mode .....	1631
A.7.5.1.3.1	Test Purpose and Environment .....	1631
A.7.5.1.3.2	Test Requirements .....	1633
A.7.5.1.4	Radio Link Monitoring In-sync Test for FR2 PCell configured with SSB-based RLM RS in DRX mode .....	1633

A.7.5.1.4.1	Test Purpose and Environment.....	1633
A.7.5.1.4.2	Test Requirements .....	1636
A.7.5.1.5	Radio Link Monitoring Out-of-sync Test for FR2 PCell configured with CSI-RS-based RLM in non-DRX mode .....	1636
A.7.5.1.5.1	Test Purpose and Environment.....	1636
A.7.5.1.5.2	Test Requirements .....	1639
A.7.5.1.6	Radio Link Monitoring In-sync Test for FR2 PCell configured with CSI-RS-based RLM in non-DRX mode .....	1639
A.7.5.1.6.1	Test Purpose and Environment.....	1639
A.7.5.1.6.2	Test Requirements .....	1642
A.7.5.1.7	Radio Link Monitoring Out-of-sync Test for FR2 PCell configured with CSI-RS-based RLM in DRX mode .....	1642
A.7.5.1.7.1	Test Purpose and Environment.....	1642
A.7.5.1.7.2	Test Requirements .....	1644
A.7.5.1.8	Radio Link Monitoring In-sync Test for FR2 PCell configured with CSI-RS-based RLM in DRX mode.....	1644
A.7.5.1.8.1	Test Purpose and Environment.....	1644
A.7.5.1.8.2	Test Requirements .....	1647
A.7.5.1.9	UE Radio Link Monitoring Scheduling Restrictions on FR2.....	1647
A.7.5.1.9.1	Test Purpose and Environment.....	1647
A.7.5.1.9.2	Test Requirements .....	1649
A.7.5.2	Interruption .....	1649
A.7.5.2.1	Interruptions during measurements on deactivated NR SCC in FR2 .....	1649
A.7.5.2.2	SA interruptions at NR SRS carrier-based switching.....	1652
A.7.5.2.2.1	Test Purpose and Environment.....	1652
A.7.5.2.2.2	Test Parameters .....	1652
A.7.5.2.2.3	Test Requirements .....	1654
A.7.5.3	SCell Activation and Deactivation Delay .....	1654
A.7.5.3.1	SCell Activation and deactivation for SCell in FR2 intra-band in non-DRX .....	1654
A.7.5.3.1.1	Test Purpose and Environment.....	1654
A.7.5.3.1.2	Test Requirements .....	1655
A.7.5.3.2	SCell Activation and deactivation for FR1+FR2 inter-band with target SCell in FR2 .....	1656
A.7.5.3.2.1	Test Purpose and Environment.....	1656
A.7.5.3.2.2	Test Requirements .....	1658
A.7.5.3.3	SCell Activation and deactivation for SCell in FR2 inter-band in non-DRX .....	1659
A.7.5.3.3.1	Test Purpose and Environment.....	1659
A.7.5.3.3.2	Test Requirements .....	1661
A.7.5.3.4	Direct SCell activation at SCell addition of known SCell in FR2.....	1662
A.7.5.3.4.1	Test Purpose and Environment.....	1662
A.7.5.3.4.2	Test Requirements .....	1664
A.7.5.3.5	Direct SCell activation at handover with known SCell in FR2.....	1665
A.7.5.3.5.1	Test Purpose and Environment.....	1665
A.7.5.3.5.2	Test Requirements .....	1667
A.7.5.4	Void .....	1668
A.7.5.5	Beam Failure Detection and Link recovery procedures.....	1668
A.7.5.5.1	Beam Failure Detection and Link Recovery Test for FR2 PCell configured with SSB-based BFD and LR in non-DRX mode .....	1668
A.7.5.5.1.1	Test Purpose and Environment.....	1668
A.7.5.5.1.2	Test Requirements .....	1671
A.7.5.5.2	Beam Failure Detection and Link Recovery Test for FR2 PCell configured with SSB-based BFD and LR in DRX mode .....	1671
A.7.5.5.2.1	Test Purpose and Environment.....	1671
A.7.5.5.2.2	Test Requirements .....	1674
A.7.5.5.3	Beam Failure Detection and Link Recovery Test for FR2 PCell configured with CSI-RS-based BFD and LR in non-DRX mode .....	1675
A.7.5.5.3.1	Test Purpose and Environment.....	1675
A.7.5.5.3.2	Test Requirements .....	1678
A.7.5.5.4	Beam Failure Detection and Link Recovery Test for FR2 PCell configured with CSI-RS-based BFD and LR in DRX mode.....	1678
A.7.5.5.4.1	Test Purpose and Environment.....	1678
A.7.5.5.4.2	Test Requirements .....	1681



A.7.5.5.5	Scheduling availability restriction during Beam Failure Detection and Link Recovery for FR2 PCell configured with SSB-based BFD and LR in non-DRX mode .....	1681
A.7.5.5.5.1	Test Purpose and Environment.....	1681
A.7.5.5.5.2	Test Requirements .....	1684
A.7.5.5.6	Beam Failure Detection and Link Recovery Test for FR2 SCell configured with CSI-RS-based BFD and LR in non-DRX mode .....	1684
A.7.5.5.6.1	Test Purpose and Environment.....	1684
A.7.5.5.6.2	Test Requirements .....	1687
A.7.5.5.7	Beam Failure Detection and Link Recovery Test for FR2 SCell configured with CSI-RS-based BFD and LR in DRX mode.....	1688
A.7.5.5.7.1	Test Purpose and Environment.....	1688
A.7.5.5.7.2	Test Requirements .....	1691
A.7.5.6	Active BWP switch.....	1692
A.7.5.6.1	DCI-based and Timer-based Active BWP Switch .....	1692
A.7.5.6.1.1	NR FR2- NR FR2 DL active BWP switch of SCell with non-DRX in SA .....	1692
A.7.5.6.1.2	NR FR1- NR FR2 DL active BWP switch of SCell with non-DRX in SA A.7.5.6.1.2.1 Test Purpose and Environment.....	1695
A.7.5.6.1.3	NR FR2 DL active BWP switch with non-DRX in SA .....	1699
A.7.5.6.1.3.1	Test Purpose and Environment .....	1699
A.7.5.6.1.3.2	Test Requirements .....	1701
A.7.5.6.2	RRC-based Active BWP Switch .....	1701
A.7.5.6.3	Simultaneous DCI-based and Timer-based Active BWP Switch on multiple CCs.....	1704
A.7.5.6.3.1	Active BWP switch on multiple SCells with non-DRX in SA .....	1704
A.7.5.6.4	SCell dormancy switch .....	1707
A.7.5.6.4.1	NR FR2 PCell SCell dormancy switch of single FR2 SCell inside active time .....	1707
A.7.5.6.4.2	NR FR1 PCell SCell dormancy switch of two FR2 SCells outside active time .....	1711
A.7.5.6.4.2.2	Test Requirements .....	1714
A.7.5.6.5	Simultaneous RRC-based Active BWP Switch on multiple CCs .....	1714
A.7.5.6.5.1	Active BWP switch on multiple SCells with non-DRX in SA .....	1714
A.7.5.7	PSCell addition and release delay.....	1717
A.7.5.7.1	Addition and Release Delay of known NR PSCell .....	1717
A.7.5.7.1.1	Test Purpose and Environment.....	1717
A.7.5.7.2	Addition and Release Delay of unknown NR PSCell .....	1719
A.7.5.7.2.1	Test Purpose and Environment.....	1719
A.7.5.7.2.2	Test Requirements .....	1722
A.7.5.8	Active TCI state switch delay.....	1722
A.7.5.8.1	MAC-CE based active TCI state switch.....	1722
A.7.5.8.2	RRC based active TCI state switch.....	1725
A.7.5.9	Uplink spatial relation switch delay.....	1729
A.7.5.9.1	MAC-CE based Spatial Relation switch .....	1729
A.7.5.9.1.1	NR PCell FR2 spatial relation associated with known DL-RS.....	1729
A.7.5.9.1.1.2	Test Requirements .....	1731
A.7.5.9.2	RRC based spatial relation switch.....	1731
A.7.5.9.2.1	NR PCell FR2 spatial relation switch associated with a known DL-RS.....	1731
A.7.5.9.2.1.1	Test Purpose and Environment .....	1731
A.7.5.9.2.1.2	Test Requirements .....	1733
A.7.5.10	UE specific CBW change .....	1733
A.7.5.10.1	NR FR2 UE specific CBW change of PCell with non-DRX in SA .....	1733
A.7.5.10.1.1	Test Purpose and Environment.....	1733
A.7.5.10.1.2	Test Requirements .....	1736
A.7.6	Measurement procedure .....	1736
A.7.6.1	Intra-frequency Measurements .....	1736
A.7.6.1.1	SA event triggered reporting test without gap under non-DRX .....	1736
A.7.6.1.1.1	Test purpose and Environment .....	1736
A.7.6.1.1.2	Test Requirements .....	1738
A.7.6.1.2	SA event triggered reporting test without gap under DRX .....	1738
A.7.6.1.2.1	Test purpose and Environment .....	1738
A.7.6.1.2.2	Test Requirements .....	1741
A.7.6.1.3	SA event triggered reporting test with per-UE gaps under non-DRX.....	1741
A.7.6.1.3.1	Test purpose and Environment .....	1741
A.7.6.1.3.2	Test Requirements .....	1744
A.7.6.1.4	SA event triggered reporting test with per-UE gaps under DRX.....	1744

A.7.6.1.4.1	Test purpose and Environment .....	1744
A.7.6.1.4.2	Test Requirements .....	1746
A.7.6.2	Inter-frequency Measurements .....	1747
A.7.6.2.1	SA event triggered reporting tests For FR2 without SSB time index detection when DRX is not used (PCell in FR2) .....	1747
A.7.6.2.1.1	Test Purpose and Environment .....	1747
A.7.6.2.1.2	Test Requirements .....	1749
A.7.6.2.2	SA event triggered reporting tests For FR2 without SSB time index detection when DRX is used (PCell in FR2) .....	1749
A.7.6.2.2.1	Test Purpose and Environment .....	1749
A.7.6.2.2.2	Test Requirements .....	1751
A.7.6.2.3	SA event triggered reporting tests For FR2 with SSB time index detection when DRX is not used (PCell in FR2) .....	1752
A.7.6.2.3.1	Test Purpose and Environment .....	1752
A.7.6.2.3.2	Test Requirements .....	1754
A.7.6.2.4	SA event triggered reporting tests For FR2 with SSB time index detection when DRX is used (PCell in FR2) .....	1754
A.7.6.2.4.1	Test Purpose and Environment .....	1754
A.7.6.2.4.2	Test Requirements .....	1756
A.7.6.2.5	SA event triggered reporting tests for FR2 without SSB time index detection when DRX is not used (PCell in FR1) .....	1757
A.7.6.2.5.1	Test Purpose and Environment .....	1757
A.7.6.2.5.2	Test Requirements .....	1759
A.7.6.2.6	SA event triggered reporting tests for FR2 without SSB time index detection when DRX is used (PCell in FR1) .....	1760
A.7.6.2.6.1	Test Purpose and Environment .....	1760
A.7.6.2.6.2	Test Requirements .....	1763
A.7.6.2.7	SA event triggered reporting tests for FR2 with SSB time index detection when DRX is not used (PCell in FR1) .....	1763
A.7.6.2.7.1	Test Purpose and Environment .....	1763
A.7.6.2.7.2	Test Requirements .....	1766
A.7.6.2.8	SA event triggered reporting tests for FR2 with SSB time index detection when DRX is used (PCell in FR1) .....	1766
A.7.6.2.8.1	Test Purpose and Environment .....	1766
A.7.6.2.8.2	Test Requirements .....	1769
A.7.6.2.9	SA event triggered reporting tests For FR2 without SSB time index detection when DRX is not used (PCell in FR2) (rel16 additional mandatory gap pattern 17) .....	1770
A.7.6.2.9.1	Test Purpose and Environment .....	1770
A.7.6.2.9.2	Test Requirements .....	1772
A.7.6.2.10	SA event triggered reporting test without gap under non-DRX .....	1772
A.7.6.2.10.1	Test Purpose and Environment .....	1772
A.7.6.2.10.2	Test Requirements .....	1774
A.7.6.2.11	SA event triggered reporting test without gap under DRX .....	1774
A.7.6.2.11.1	Test Purpose and Environment .....	1774
A.7.6.2.11.2	Test Requirements .....	1776
A.7.6.3	L1-RSRP measurement for beam reporting .....	1776
A.7.6.3.1	SSB based L1-RSRP measurement when DRX is not used .....	1776
A.7.6.3.1	SSB based L1-RSRP measurement when DRX is not used .....	1776
A.7.6.3.1.1	Test Purpose and Environment .....	1776
A.7.6.3.1.2	Test parameters .....	1777
A.7.6.3.1.3	Test Requirements .....	1778
A.7.6.3.2	SSB based L1-RSRP measurement when DRX is used .....	1778
A.7.6.3.2.1	Test Purpose and Environment .....	1778
A.7.6.3.2.2	Test parameters .....	1779
A.7.6.3.2.3	Test Requirements .....	1780
A.7.6.3.3	CSI-RS based L1-RSRP measurement when DRX is not used .....	1781
A.7.6.3.3.1	Test Purpose and Environment .....	1781
A.7.6.3.3.2	Test parameters .....	1781
A.7.6.3.3.3	Test Requirements .....	1782
A.7.6.3.4	CSI-RS based L1-RSRP measurement when DRX is used .....	1783
A.7.6.3.4.1	Test Purpose and Environment .....	1783
A.7.6.3.4.2	Test parameters .....	1783

A.7.6.3.3.3	Test Requirements .....	1784
A.7.6.4	CLI measurements .....	1785
A.7.6.4.1	SRS-RSRP measurement with non-DRX .....	1785
A.7.6.4.1.1	Test Purpose and Environment .....	1785
A.7.6.4.1.2	Test Parameters .....	1785
A.7.6.4.1.3	Test Requirements .....	1787
A.7.6.4.2	CLI-RSSI measurement with non-DRX .....	1787
A.7.6.4.2.1	Test Purpose and Environment .....	1787
A.7.6.4.2.2	Test Parameters .....	1787
A.7.6.4.2.3	Test Requirements .....	1789
A.7.6.5	NR Measurements with autonomous gaps .....	1789
A.7.6.5.1	SA interfrequency CGI reporting in autonomous gaps test (PCell in FR2) .....	1789
A.7.6.5.1.1	Test Purpose and Environment .....	1789
A.7.6.5.1.2	Test Requirements .....	1792
A.7.6.6	L1-SINR measurement for beam reporting .....	1792
A.7.6.6.1	L1-SINR measurement with CSI-RS based CMR and no dedicated IMR configured when DRX is not used .....	1792
A.7.6.6.1.1	Test Purpose and Environment .....	1792
A.7.6.6.1.2	Test parameters .....	1792
A.7.6.6.1.3	Test Requirements .....	1793
A.7.6.6.2	L1-SINR measurement with SSB based CMR and dedicated IMR when DRX is used .....	1794
A.7.6.6.2.1	Test Purpose and Environment .....	1794
A.7.6.6.2.2	Test parameters .....	1794
A.7.6.6.2.3	Test Requirements .....	1795
A.7.6.6.3	L1-SINR measurement with CSI-RS based CMR and dedicated IMR configured when DRX is used .....	1796
A.7.6.6.3.1	Test Purpose and Environment .....	1796
A.7.6.6.3.2	Test parameters .....	1796
A.7.6.6.3.3	Test Requirements .....	1797
A.7.6.7	CSI-RS based intra-frequency Measurements .....	1798
A.7.6.7.1	SA event triggered reporting test without gap under DRX for CSI-RS based intra-frequency measurement .....	1798
A.7.6.7.1.1	Test purpose and Environment .....	1798
A.7.6.7.1.2	Test Requirements .....	1800
A.7.6.8	CSI-RS based inter-frequency Measurements .....	1801
A.7.6.8.1	SA event triggered reporting tests for FR2 CSI-RS based measurement when non-DRX is used (PCell in FR2) .....	1801
A.7.6.8.1.1	Test Purpose and Environment .....	1801
A.7.6.2.2.2	Test Requirements .....	1804
A.7.6.9	RSTD measurements .....	1804
A.7.6.9.1	NR RSTD measurement reporting delay test case for single positioning frequency layer in FR2 SA .....	1804
A.7.6.9.1.1	Test Purpose and Environment .....	1804
A.7.6.9.1.2	Test Requirements .....	1808
A.7.6.9.2	NR RSTD measurement reporting delay test case for dual positioning frequency layers in FR2 SA .....	1808
A.7.6.9.2.1	Test Purpose and Environment .....	1808
A.7.6.9.2.2	Test Requirements .....	1812
A.7.6.10	PRS-RSRP measurements .....	1812
A.7.6.10.1	PRS-RSRP reporting delay test case for single positioning frequency layer .....	1812
A.7.6.10.1.1	Test Purpose and Environment .....	1812
A.7.6.10.1.2	Test Requirements .....	1815
A.7.6.10.2	PRS-RSRP reporting delay test case for dual positioning frequency layer .....	1815
A.7.6.10.2.1	Test Purpose and Environment .....	1815
A.7.6.10.2.2	Test Requirements .....	1817
A.7.6.11	UE Rx-Tx time difference measurements .....	1817
A.7.6.11.1	UE Rx-Tx time difference measurements for single positioning frequency layer in FR2 SA .....	1817
A.7.6.11.1.1	Test purpose and environment .....	1817
A.7.6.11.1.2	Test requirements .....	1819
A.7.6.11.2	UE Rx-Tx time difference measurement period for dual positioning frequency layers in FR2 SA .....	1820
A.7.6.11.2.1	Test purpose and environment .....	1820
A.7.6.11.2.2	Test requirements .....	1822

A.7.7	Measurement Performance requirements .....	1822
A.7.7.1	SS-RSRP .....	1822
A.7.7.1.1	SA intra-frequency case measurement accuracy with FR2 serving cell and FR2 target cell .....	1822
A.7.7.1.1.1	Test Purpose and Environment .....	1822
A.7.7.1.1.2	Test parameters .....	1823
A.7.7.1.1.3	Test Requirements .....	1825
A.7.7.1.2	SA inter-frequency case measurement accuracy with FR2 serving cell and FR2 target cell .....	1825
A.7.7.1.2.1	Test Purpose and Environment .....	1825
A.7.7.1.2.2	Test parameters .....	1826
A.7.7.1.2.3	Test Requirements .....	1828
A.7.7.1.3	SA inter-frequency measurement accuracy with FR1 serving cell and FR2 target cell .....	1829
A.7.7.1.3.1	Test Purpose and Environment .....	1829
A.7.7.1.3.2	Test parameters .....	1829
A.7.7.1.3.3	Test Requirements .....	1831
A.7.7.2	SS-RSRQ .....	1831
A.7.7.2.1	SA intra-frequency measurement accuracy with FR2 serving cell and FR2 target cell .....	1831
A.7.7.2.1.1	Test Purpose and Environment .....	1831
A.7.7.2.1.2	Test Parameters .....	1831
A.7.7.2.1.3	Test Requirements .....	1833
A.7.7.2.2	SA Inter-frequency measurement accuracy with FR2 serving cell and FR2 TDD target cell .....	1833
A.7.7.2.2.1	Test Purpose and Environment .....	1833
A.7.7.2.2.2	Test Parameters .....	1833
A.7.7.2.2.3	Test Requirements .....	1835
A.7.7.3	SS-SINR .....	1835
A.7.7.3.1	SA intra-frequency case measurement accuracy with FR2 serving cell and FR2 target cell .....	1835
A.7.7.3.1.1	Test Purpose and Environment .....	1835
A.7.7.3.1.2	Test Parameters .....	1835
A.7.7.3.1.3	Test Requirements .....	1836
A.7.7.3.2	SA Inter-frequency measurement accuracy with FR2 serving cell and FR2 TDD target cell .....	1836
A.7.7.3.2.1	Test Purpose and Environment .....	1836
A.7.7.3.2.2	Test Parameters .....	1837
A.7.7.3.2.3	Test Requirements .....	1838
A.7.7.4	L1-RSRP measurement for beam reporting .....	1838
A.7.7.4.1	SSB based L1-RSRP measurement .....	1838
A.7.7.4.1.1	Test Purpose and Environment .....	1838
A.7.7.4.1.2	Test parameters .....	1838
A.7.7.4.1.3	Test Requirements .....	1840
A.7.7.4.2	CSI-RS based L1-RSRP measurement on resource set with repetition off .....	1841
A.7.7.4.2.1	Test Purpose and Environment .....	1841
A.7.7.4.2.2	Test parameters .....	1841
A.7.7.4.2.3	Test Requirements .....	1842
A.7.7.5	CLI measurements .....	1843
A.7.7.5.1	SA SRS-RSRP measurement accuracy with FR2 serving cell .....	1843
A.7.7.5.1.1	Test Purpose and Environment .....	1843
A.7.7.5.1.2	Test parameters .....	1843
A.7.7.5.1.3	Test Requirements .....	1845
A.7.7.5.2	SA CLI-RSSI measurement accuracy with FR2 serving cell .....	1845
A.7.7.5.2.1	Test Purpose and Environment .....	1845
A.7.7.5.2.2	Test parameters .....	1846
A.7.7.5.2.3	Test Requirements .....	1847
A.7.7.6	L1-SINR measurement for beam reporting .....	1848
A.7.7.6.1	L1-SINR measurement with CSI-RS based CMR and no dedicated IMR configured and CSI-RS resource set with repetition off .....	1848
A.7.7.6.1.1	Test Purpose and Environment .....	1848
A.7.7.6.1.2	Test parameters .....	1848
A.7.7.6.1.3	Test Requirements .....	1849
A.7.7.6.2	L1-SINR measurement with SSB based CMR and dedicated IMR .....	1850
A.7.7.6.2.1	Test Purpose and Environment .....	1850
A.7.7.6.2.2	Test parameters .....	1850
A.7.7.6.2.3	Test Requirements .....	1852
A.7.7.6.3	L1-SINR measurement with CSI-RS based CMR and dedicated IMR .....	1852
A.7.7.6.3.1	Test Purpose and Environment .....	1852

A.7.7.6.3.2	Test parameters.....	1852
A.7.7.6.3.3	Test Requirements .....	1854
A.7.7.7	CSI-RSRP .....	1854
A.7.7.7.1	SA intra-frequency case measurement accuracy with FR2 serving cell and FR2 target cell .....	1854
A.7.7.7.1.1	Test Purpose and Environment.....	1854
A.7.7.7.1.2	Test parameters.....	1855
A.7.7.7.1.3	Test Requirements .....	1857
A.7.7.7.2	SA inter-frequency case measurement accuracy with FR2 serving cell and FR2 target cell .....	1857
A.7.7.7.2.1	Test Purpose and Environment.....	1857
A.7.7.7.2.2	Test parameters.....	1857
A.7.7.7.2.3	Test Requirements .....	1859
A.7.7.8	CSI-RSRQ .....	1860
A.7.7.8.1	SA intra-frequency measurement accuracy with FR2 serving cell and FR2 target cell .....	1860
A.7.7.8.1.1	Test Purpose and Environment.....	1860
A.7.7.8.1.2	Test Parameters .....	1860
A.7.7.8.1.3	Test Requirements .....	1862
A.7.7.8.2	SA Inter-frequency measurement accuracy with FR2 serving cell and FR2 TDD target cell.....	1862
A.7.7.8.2.1	Test Purpose and Environment.....	1862
A.7.7.8.2.2	Test Parameters .....	1862
A.7.7.8.2.3	Test Requirements .....	1863
A.7.7.9	CSI-SINR.....	1864
A.7.7.9.1	SA intra-frequency case measurement accuracy with FR2 serving cell and FR2 target cell .....	1864
A.7.7.9.1.1	Test Purpose and Environment.....	1864
A.7.7.9.1.2	Test Parameters .....	1864
A.7.7.9.1.3	Test Requirements .....	1865
A.7.7.9.2	SA Inter-frequency measurement accuracy with FR2 serving cell and FR2 TDD target cell.....	1865
A.7.7.9.2.2	Test Parameters .....	1866
A.7.7.9.2.3	Test Requirements .....	1867
A.7.7.10	RSTD measurements .....	1867
A.7.7.10.1	RSTD measurement accuracy test case for single positioning frequency layer .....	1867
A.7.7.10.1.1	Test purpose and Environment.....	1867
A.7.7.10.1.2	Test Requirements .....	1869
A.7.7.10.2	RSTD measurement accuracy test case for dual positioning frequency layer.....	1869
A.7.7.10.2.1	Test purpose and Environment.....	1869
A.7.7.10.2.2	Test Requirements .....	1871
A.7.7.11	PRS-RSRP measurements .....	1871
A.7.7.11.1	SA measurement accuracy with PRS in FR2 .....	1871
A.7.7.11.1.1	Test Purpose and Environment.....	1871
A.7.7.11.1.2	Test parameters.....	1871
A.7.7.11.1.3	Test Requirements .....	1873
A.7.7.12	UE Rx-Tx time difference measurements.....	1873
A.7.7.12.1	UE Rx-Tx time difference measurement accuracy for single positioning frequency layer in FR2 SA .....	1873
A.7.7.12.1.1	Test purpose and environment.....	1873
A.7.7.12.1.2	Test parameters.....	1874
A.7.7.12.1.3	Test requirements .....	1875
A.8	E-UTRA standalone tests for NR RRM .....	1875
A.8.1	Void.....	1876
A.8.2	RRC_IDLE state mobility .....	1876
A.8.2.1	Inter-RAT NR Cell re-selection.....	1876
A.8.2.1.1	E-UTRA Cell reselection to higher priority NR target Cell in FR1 .....	1876
A.8.2.1.1.1	Test Purpose and Environment.....	1876
A.8.2.1.1.2	Test Requirements .....	1879
A.8.2.1.2	E-UTRA Cell reselection to lower priority NR target Cell in FR1 for UE configured with highSpeedInterRAT-NR-r16.....	1880
A.8.2.1.2.1	Test Purpose and Environment.....	1880
A.8.2.1.2.2	Test Requirements .....	1883
A.8.2.2	E-UTRA – NR Inter-RAT Early Measurement Reporting .....	1883
A.8.2.2.1	E-UTRA – NR Early Measurement Reporting for NR in FR1 .....	1883
A.8.2.2.1.1	Test Purpose and Environment.....	1883
A.8.2.2.1.2	Test Requirements .....	1886
A.8.2.2.2	E-UTRA – NR Early Measurement Reporting for NR in FR2 .....	1886

A.8.2.2.2.1	Test Purpose and Environment.....	1886
A.8.2.2.2.2	Test Requirements.....	1889
A.8.3	RRC_CONNECTED state mobility.....	1889
A.8.3.1	Handover.....	1889
A.8.3.1.1	E-UTRAN - NR handover in FR1.....	1889
A.8.3.1.1.1	Test Purpose and Environment.....	1889
A.8.3.1.1.2	Test Requirements.....	1892
A.8.4	Measurement procedure.....	1892
A.8.4.1	E-UTRA – NR Inter-RAT SFTD Measurement Delay.....	1892
A.8.4.1.1	E-UTRA – NR Inter-RAT SFTD Measurement Delay in non-DRX.....	1892
A.8.4.1.1.1	Test Purpose and Environment.....	1892
A.8.4.1.1.2	Test Requirements.....	1894
A.8.4.1.2	E-UTRA – NR Inter-RAT SFTD Measurement Delay in DRX.....	1894
A.8.4.1.2.1	Test Purpose and Environment.....	1894
A.8.4.1.2.2	Test Requirements.....	1895
A.8.4.2	E-UTRA – NR Inter-RAT Measurements.....	1896
A.8.4.2.1	NR Inter-RAT event triggered reporting tests for FR1 without SSB time index detection when DRX is not used.....	1896
A.8.4.2.1.1	Test Purpose and Environment.....	1896
A.8.4.2.1.2	Test Requirements.....	1899
A.8.4.2.2	NR Inter-RAT event triggered reporting tests for FR1 without SSB time index detection when DRX is used.....	1899
A.8.4.2.2.1	Test Purpose and Environment.....	1899
A.8.4.2.2.2	Test Requirements.....	1902
A.8.4.2.3	NR Inter-RAT event triggered reporting tests for FR1 with SSB time index detection when DRX is not used.....	1903
A.8.4.2.3.1	Test Purpose and Environment.....	1903
A.8.4.2.3.2	Test Requirements.....	1906
A.8.4.2.4	NR Inter-RAT event triggered reporting tests for FR1 with SSB time index detection when DRX is used.....	1906
A.8.4.2.4.1	Test Purpose and Environment.....	1906
A.8.4.2.4.2	Test Requirements.....	1909
A.8.4.2.5	NR Inter-RAT event triggered reporting tests for FR2 without SSB time index detection when DRX is not used.....	1910
A.8.4.2.5.1	Test Purpose and Environment.....	1910
A.8.4.2.5.2	Test Requirements.....	1911
A.8.4.2.6	NR Inter-RAT event triggered reporting tests for FR2 without SSB time index detection when DRX is used.....	1912
A.8.4.2.6.1	Test Purpose and Environment.....	1912
A.8.4.2.6.2	Test Requirements.....	1914
A.8.4.2.7	NR Inter-RAT event triggered reporting tests for FR2 with SSB time index detection when DRX is not used.....	1914
A.8.4.2.7.1	Test Purpose and Environment.....	1914
A.8.4.2.7.2	Test Requirements.....	1916
A.8.4.2.8	NR Inter-RAT event triggered reporting tests for FR2 with SSB time index detection when DRX is used.....	1917
A.8.4.2.8.1	Test Purpose and Environment.....	1917
A.8.4.2.8.2	Test Requirements.....	1919
A.8.4.2.9	NR Inter-RAT event triggered reporting tests for FR1 with SSB time index detection in DRX for UE configured with highSpeedInterRAT-NR-r16.....	1920
A.8.4.2.9.1	Test Purpose and Environment.....	1920
A.8.4.2.9.2	Test Requirements.....	1923
A.8.5	Measurement performance.....	1923
A.8.5.1	SFTD accuracy.....	1923
A.8.5.1.1	SFTD accuracy.....	1923
A.8.5.1.1.1	Test Purpose.....	1923
A.8.5.1.1.2	Test Environment.....	1923
A.8.5.1.1.3	Test Requirements.....	1927
A.8.5.2	E-UTRA – NR Inter-RAT Measurement Performance requirements.....	1927
A.8.5.2.1.1	E-UTRAN – NR inter-RAT measurements with FR1 target cell.....	1927
A.8.5.2.1.2	E-UTRAN – NR inter-RAT measurements with FR2 target cell.....	1930
A.8.5.2.1.2.1	Test Purpose and Environment.....	1930

A.8.5.2.1.2.2	Test Parameters .....	1930
A.8.5.2.1.2.3	Test Requirements .....	1931
A.8.5.2.2	SS-RSRQ .....	1931
A.8.5.2.2.1	E-UTRAN – NR inter-RAT measurements with FR1 target cell .....	1931
A.8.5.2.2.2	E-UTRAN – NR inter-RAT measurements with FR2 target cell .....	1935
A.8.5.2.2.2.1	Test Purpose and Environment .....	1935
A.8.5.2.2.2.2	Test Parameters .....	1935
A.8.5.2.2.2.3	Test Requirements .....	1936
A.8.5.2.3	SS-SINR.....	1937
A.8.5.2.3.1	E-UTRAN – NR inter-RAT measurements with FR1 target cell .....	1937
A.8.5.2.3.2	E-UTRAN – NR inter-RAT measurements with FR2 target cell .....	1939
A.8.5.2.3.2.1	Test Purpose and Environment .....	1939
A.8.5.2.3.2.2	Test Parameters.....	1939
A.8.5.2.3.2.3	Test Requirements .....	1941
A.9	V2X Tests.....	1941
A.9.1	V2X Tests in FR1 .....	1941
A.9.1.1	Test for V2X UE Transmit Timing.....	1941
A.9.1.1.1	Test for GNSS as Synchronization Reference Source.....	1941
A.9.1.1.1.1	Test Purpose and Environment.....	1941
A.9.1.1.1.2	Test requirements .....	1941
A.9.1.1.2	Test for SyncRef UE as Synchronization Reference Source.....	1942
A.9.1.1.2.1	Test Purpose and Environment.....	1942
A.9.1.1.2.2	Test requirements .....	1942
A.9.1.1.3	Test for FR1 NR Cell as Synchronization Reference Source.....	1942
A.9.1.1.3.1	Test Purpose and Environment.....	1942
A.9.1.1.3.2	Test requirements .....	1944
A.9.1.2	Test for Initiation/Cease of S-SSB Transmission with V2X Sidelink Communication.....	1944
A.9.1.2.1	Test for FR1 NR Cell as synchronization reference source without gap under non-DRX .....	1944
A.9.1.2.1.1	Test Purpose and Environment.....	1944
A.9.1.2.1.2	Test Requirements .....	1946
A.9.1.2.2	Test for SyncRef UE as synchronization reference source .....	1946
A.9.1.2.2.1	Test Purpose and Environment.....	1946
A.9.1.2.2.2	Test Requirements .....	1948
A.9.1.3	Test for V2X Synchronization Reference Selection/Reselection.....	1948
A.9.1.3.1	Test for GNSS configured as the highest priority .....	1948
A.9.1.3.1.1	Test Purpose and Environment.....	1948
A.9.1.3.1.2	Test Requirements .....	1950
A.9.1.3.2	Test for FR1 NR Cell configured as the highest priority .....	1951
A.9.1.3.2.1	Test Purpose and Environment.....	1951
A.9.1.3.2.2	Test Requirements .....	1952
A.9.1.4	Test for L1 SL-RSRP Measurement .....	1953
A.9.1.4.1	Test for V2X UE Autonomous Resource Selection/Reselection .....	1953
A.9.1.4.1.1	Test Purpose and Environment.....	1953
A.9.1.4.1.2	Test Requirements .....	1955
A.9.1.4.2	Test for V2X UE Resource Pre-emption.....	1955
A.9.1.4.2.1	Test Purpose and Environment.....	1955
A.9.1.4.2.2	Test Requirements .....	1957
A.9.1.4.3	Test for V2X UE Resource Re-evaluation.....	1957
A.9.1.4.3.1	Test Purpose and Environment.....	1957
A.9.1.4.3.2	Test Requirements .....	1960
A.9.1.5	Test for Congestion Control Measurement.....	1961
A.9.1.5.1	Test Purpose and Environment .....	1961
A.9.1.5.2	Test Requirements.....	1964
A.9.1.6	Test for Interruption.....	1964
A.9.1.6.1	Test for Interruption to WAN due to V2X Sidelink Communication .....	1964
A.9.1.6.1.1	Test Purpose and Environment.....	1964
A.9.1.6.1.2	Test Requirements .....	1966
A.10	EN-DC Tests with NR PSCell under CCA and Other NR Cells in FR1 .....	1966
A.10.1	RRC_CONNECTED state mobility .....	1967
A.10.1.1	RRC connection mobility control .....	1967

A.10.1.1.1	Random Access .....	1967
A.10.1.1.1.1	4-step RA type contention-based random access for NR PSCell with CCA .....	1967
A.10.1.1.1.1.1	Test Purpose and Environment .....	1967
A.10.1.1.1.1.2	Test Requirements .....	1968
A.10.1.1.1.1.2.1	Random Access Preamble Transmission.....	1968
A.10.1.1.1.1.2.2	Random Access Response Reception.....	1969
A.10.1.1.1.1.2.3	No Random Access Response Reception.....	1969
A.10.1.1.1.1.2.4	Receiving an UL grant for msg3 retransmission .....	1969
A.10.1.1.1.1.2.5	Contention Resolution Timer expiry .....	1969
A.10.1.1.1.2	4-step RA type non-contention based random access for NR PSCell with CCA .....	1970
A.10.1.1.1.2.1	Test Purpose and Environment .....	1970
A.10.1.1.1.2.2	Test Requirements .....	1971
A.10.1.1.1.2.2.1	SSB-based Random Access Preamble Transmission .....	1971
A.10.1.1.1.2.2.2	Random Access Response Reception.....	1972
A.10.1.1.1.2.2.3	No Random Access Response Reception.....	1972
A.10.1.1.1.3	2-step RA type contention-based random access for NR PSCell with CCA .....	1972
A.10.1.1.1.3.1	Test Purpose and Environment .....	1972
A.10.1.1.1.3.2	Test Requirements .....	1974
A.10.1.1.1.3.2.1	MsgA Transmission .....	1974
A.10.1.1.1.3.2.2	MsgB Reception.....	1975
A.10.1.1.1.3.2.3	No MsgB Reception .....	1975
A.10.1.1.1.4	2-step RA type non-contention based random access for NR PSCell with CCA .....	1975
A.10.1.1.1.4.1	Test Purpose and Environment .....	1975
A.10.1.1.1.4.2	Test Requirements .....	1977
A.10.1.1.1.4.2.1	MsgA Transmission .....	1977
A.10.1.1.1.4.2.2	MsgB Reception.....	1978
A.10.1.1.1.4.2.3	No MsgB Reception .....	1978
A.10.2	Timing .....	1978
A.10.2.1	UE transmit timing .....	1978
A.10.2.2	UE timing advance.....	1981
A.10.3	Signalling characteristics.....	1984
A.10.3.1	Radio link monitoring.....	1984
A.10.3.1.1	Introduction.....	1984
A.10.3.1.2	Radio link monitoring out-of-sync test for PSCell configured with SSB-based RLM RS in non-DRX mode .....	1984
A.10.3.1.2.1	Test purpose and environment.....	1984
A.10.3.1.2.2	Test requirements .....	1987
A.10.3.1.3	Radio link monitoring in-sync test for PSCell configured with SSB-based RLM RS in non-DRX mode.....	1987
A.10.3.1.3.1	Test purpose and environment.....	1987
A.10.3.1.3.2	Test requirements .....	1990
A.10.3.1.4	Void.....	1991
A.10.3.1.4.1	Void.....	1991
A.10.3.1.4.2	Void.....	1991
A.10.3.1.5	Void.....	1991
A.10.3.1.5.1	Void.....	1991
A.10.3.1.5.2	Void.....	1991
A.10.3.2	Interruption .....	1991
A.10.3.2.1	E-UTRAN – NR interruptions during SCell operations with CCA .....	1991
A.10.3.2.1.1	Test Purpose and Environment.....	1991
A.10.3.2.1.2	Test Requirements.....	1993
A.10.3.3	SCell activation and deactivation delay .....	1994
A.10.3.3.2	SCell Activation and Deactivation of known NR SCell with NR PSCell and NR SCell under CCA, 640 ms SCell measurement cycle.....	1997
A.10.3.3.2.1	Test Purpose and Environment.....	1997
A.10.3.3.2.2	Test Requirements .....	1997
A.10.3.3.3	SCell Activation and Deactivation of unknown NR SCell with NR PSCell and NR SCell under CCA .....	1998
A.10.3.3.3.1	Test Purpose and Environment.....	1998
A.10.3.3.3.2	Test Requirements .....	1998
A.10.3.4	Beam failure detection and link recovery procedures.....	1998
A.10.3.4.1	EN-DC Beam Failure Detection and Link Recovery Test for FR1 PSCell configured with SSB-based BFD and LR in non-DRX mode .....	1998



A.10.3.4.1.1	Test Purpose and Environment.....	1998
A.10.3.4.1.2	Test Requirements .....	2002
A.10.3.4.2	EN-DC Beam Failure Detection and Link Recovery Test for FR1 PSCell configured with SSB-based BFD and LR in DRX mode.....	2002
A.10.3.4.2.1	Test Purpose and Environment.....	2002
A.10.3.4.2.2	Test Requirements .....	2006
A.10.3.5	Active BWP switching.....	2006
A.10.3.5.1	UL active BWP switch delay with consistent UL LBT failure on PSCell subject to UL CCA in EN-DC .....	2006
A.10.3.5.1.1	Test Purpose and Environment.....	2006
A.10.3.5.1.2	Test Requirements .....	2009
A.10.3.5.2	DCI-based and Timer-based Active BWP Switch .....	2010
A.10.3.5.2.1	E-UTRAN – NR PSCell FR1 DL active BWP switch in non-DRX in synchronous EN-DC .....	2010
A.10.3.5.2.2	E-UTRAN – NR PSCell FR1 DL active BWP switch with FR1 SCell in non-DRX in synchronous EN-DC.....	2013
A.10.3.5.3	RRC-based Active BWP Switch .....	2016
A.10.3.6	PSCell addition and release delay.....	2018
A.10.3.6.1	Addition and Release Delay of known NR PSCell on the carrier under CCA.....	2018
A.10.3.6.1.1	Test purpose and environment.....	2018
A.10.3.6.1.2	Test Requirements .....	2021
A.10.3.7	Void .....	2022
A.10.4	Measurement procedure .....	2022
A.10.4.1	Intra-frequency measurements.....	2022
A.10.4.1.1	Event-triggered reporting tests on PSCC without gaps under non-DRX .....	2022
A.10.4.1.1.1	Test purpose and environment.....	2022
A.10.4.1.1.2	Test parameters.....	2022
A.10.4.1.1.3	Test Requirements .....	2024
A.10.4.1.2	Void.....	2024
A.10.4.1.3	Void.....	2025
A.10.4.1.4	Event-triggered reporting tests on PSCC with per-UE gaps under DRX .....	2025
A.10.4.1.4.1	Test purpose and environment.....	2025
A.10.4.1.4.2	Test parameters.....	2025
A.10.4.1.4.3	Test Requirements .....	2027
A.10.4.1.5	Void.....	2028
A.10.4.1.6	Void.....	2028
A.10.4.1.7	Void.....	2028
A.10.4.1.8	Void.....	2028
A.10.4.1.9	RSSI measurement reporting on PSCC.....	2028
A.10.4.1.9.1	Test purpose and environment.....	2028
A.10.4.1.9.2	Test parameters.....	2028
A.10.4.1.10	Channel occupancy measurement reporting on PSCC .....	2028
A.10.4.1.10.1	Test purpose and environment.....	2028
A.10.4.1.10.2	Test parameters.....	2028
A.10.4.1.11	RSSI measurement reporting on SCC .....	2029
A.10.4.1.11.1	Test purpose and environment.....	2029
A.10.4.1.11.2	Test parameters.....	2029
A.10.4.1.12	Channel occupancy measurement reporting on SCC .....	2029
A.10.4.1.12.1	Test purpose and environment.....	2029
A.10.4.1.12.2	Test parameters.....	2029
A.10.4.2	Inter-frequency measurements.....	2030
A.10.4.2.1	RSSI measurement reporting .....	2030
A.10.4.2.1.1	Test purpose and environment.....	2030
A.10.4.2.1.2	Test parameters.....	2030
A.10.4.2.2	Channel occupancy measurement reporting.....	2030
A.10.4.2.2.1	Test purpose and environment.....	2030
A.10.4.2.2.2	Test parameters.....	2030
A.10.4.2.3	EN-DC event triggered reporting tests for FR1 with CCA cell without SSB time index detection when DRX is not used.....	2031
A.10.4.2.3.1	Test Purpose and Environment.....	2031
A.10.4.2.3.2	Test Requirements .....	2033
A.10.4.2.4	EN-DC event triggered reporting tests for FR1 cell with CCA without SSB time index detection when DRX is used.....	2034

A.10.4.2.4.1	Test Purpose and Environment.....	2034
A.10.4.2.4.2	Test Requirements .....	2037
A.10.4.2.5	EN-DC event triggered reporting tests for FR1 cell with CCA with SSB time index detection when DRX is not used.....	2037
A.10.4.2.5.1	Test Purpose and Environment.....	2037
A.10.4.2.5.2	Test Requirements .....	2040
A.10.4.2.6	EN-DC event triggered reporting tests for FR1 cell with CCA with SSB time index detection when DRX is used.....	2040
A.10.4.2.6.1	Test Purpose and Environment.....	2040
A.10.4.2.6.2	Test Requirements .....	2043
A.10.4.2.7	EN-DC event triggered reporting tests for FR1 cell without SSB time index detection when DRX is not used .....	2044
A.10.4.2.7.1	Test Purpose and Environment.....	2044
A.10.4.2.7.2	Test Requirements .....	2047
A.10.4.2.8	EN-DC event triggered reporting tests for FR1 cell without SSB time index detection when DRX is used.....	2048
A.10.4.2.8.1	Test Purpose and Environment.....	2048
A.10.4.2.8.2	Test Requirements .....	2051
A.10.4.2.9	EN-DC event triggered reporting tests for FR1 cell with SSB time index detection when DRX is not used .....	2052
A.10.4.2.9.1	Test Purpose and Environment.....	2052
A.10.4.2.9.2	Test Requirements .....	2055
A.10.4.2.10	EN-DC event triggered reporting tests for FR1 cell with SSB time index detection when DRX is used .....	2056
A.10.4.2.10.1	Test Purpose and Environment.....	2056
A.10.4.2.10.2	Test Requirements .....	2060
A.10.4.3	L1-RSRP measurements for beam reporting .....	2060
A.10.4.3.1	SSB based L1-RSRP measurement on PSCC when DRX is not used .....	2060
A.10.4.3.1.1	Test Purpose and Environment.....	2060
A.10.4.3.1.2	Test parameters.....	2061
A.10.4.3.1.3	Test Requirements .....	2063
A.10.4.3.2	SSB based L1-RSRP measurement on PSCC when DRX is used .....	2063
A.10.4.3.2.1	Test Purpose and Environment.....	2063
A.10.4.3.2.2	Test parameters.....	2063
A.10.4.3.2.3	Test Requirements .....	2065
A.10.4.3.3	SSB based L1-RSRP measurement on SCC when DRX is not used .....	2065
A.10.4.3.3.1	Test Purpose and Environment.....	2065
A.10.4.3.3.2	Test parameters.....	2065
A.10.4.3.3.3	Test Requirements .....	2067
A.10.4.3.4	SSB based L1-RSRP measurement on SCC when DRX is used .....	2068
A.10.4.3.4.1	Test Purpose and Environment.....	2068
A.10.4.3.4.2	Test parameters.....	2068
A.10.4.3.4.3	Test Requirements .....	2070
A.10.4.4	E-UTRAN-NR inter-RAT measurements on NR carrier frequency under CCA .....	2070
A.10.4.4.1	E-UTRAN-NR inter-RAT event triggered reporting tests for FR1 without SSB time index detection when DRX is not used .....	2070
A.10.4.4.1.1	Test Purpose and Environment.....	2070
A.10.4.4.1.2	Test Requirements .....	2074
A.10.4.4.2	E-UTRAN-NR inter-RAT event triggered reporting tests for FR1 without SSB time index detection when DRX is used .....	2074
A.10.4.4.2.1	Test Purpose and Environment.....	2074
A.10.4.4.2.2	Test Requirements .....	2078
A.10.4.4.3	NR Inter-RAT event triggered reporting tests for FR1 with SSB time index detection when DRX is not used .....	2078
A.10.4.4.3.1	Test Purpose and Environment.....	2078
A.10.4.4.3.2	Test Requirements .....	2082
A.10.4.4.4	NR Inter-RAT event triggered reporting tests for FR1 with SSB time index detection when DRX is used.....	2082
A.10.4.4.4.1	Test Purpose and Environment.....	2082
A.10.4.4.4.2	Test Requirements .....	2086
A.10.5	Measurement performance .....	2086
A.10.5.1	SS-RSRP.....	2086

A.10.5.1.1	Intra-frequency measurement accuracy on a CCA serving cell .....	2086
A.10.5.1.1.1	Test Purpose and Environment.....	2086
A.10.5.1.1.2	Test parameters.....	2087
A.10.5.1.1.3	Test Requirements .....	2088
A.10.5.1.2	Inter-frequency measurement accuracy with FR1 CCA serving cell and FR1 CCA target cell.....	2089
A.10.5.1.2.1	Test Purpose and Environment.....	2089
A.10.5.1.2.2	Test parameters.....	2089
A.10.5.1.2.3	Test Requirements .....	2090
A.10.5.2	SS-RSRQ .....	2091
A.10.5.2.1	Intra-frequency measurement accuracy with FR1 CCA serving cell and FR1 CCA target cell.....	2091
A.10.5.2.1.1	Test Purpose and Environment.....	2091
A.10.5.2.1.2	Test Parameters .....	2091
A.10.5.2.1.3	Test Requirements .....	2092
A.10.5.2.2	Inter-frequency measurement accuracy with FR1 CCA serving cell and FR1 CCA target cell.....	2092
A.10.5.2.2.1	Test Purpose and Environment.....	2092
A.10.5.2.2.2	Test Parameters .....	2092
A.10.5.2.2.3	Test Requirements .....	2094
A.10.5.3	SS-SINR .....	2094
A.10.5.3.1	Intra-frequency measurement accuracy on PSCC.....	2094
A.10.5.3.1.1	Test Purpose and Environment.....	2094
A.10.5.3.1.2	Test Parameters .....	2094
A.10.5.3.1.3	Test Requirements .....	2096
A.10.5.3.2	Inter-frequency measurement accuracy on PSCC .....	2096
A.10.5.3.2.1	Test Purpose and Environment.....	2096
A.10.5.3.2.2	Test Parameters .....	2096
A.10.5.3.2.3	Test Requirements .....	2098
A.10.5.3.3	Intra-frequency measurement accuracy on SCC .....	2098
A.10.5.3.3.1	Test Purpose and Environment.....	2098
A.10.5.3.3.2	Test Parameters .....	2098
A.10.5.3.3.3	Test Requirements .....	2100
A.10.5.4	L1-RSRP measurement for beam reporting with CCA serving cell .....	2100
A.10.5.4.1	SSB based L1-RSRP measurement.....	2100
A.10.5.4.1.1	Test Purpose and Environment.....	2100
A.10.5.4.1.2	Test parameters.....	2100
A.10.5.4.1.3	Test Requirements .....	2101
A.10.5.5	RSSI.....	2102
A.10.5.5.1	RSSI measurement accuracy on PSCC with CCA.....	2102
A.10.5.5.1.1	Test Purpose and Environment .....	2102
A.10.5.5.1.2	Test parameters .....	2102
A.10.5.5.1.3	Test Requirements.....	2103
A.10.5.5.2	RSSI measurement accuracy on SCC with CCA.....	2103
A.10.5.5.2.1	Test Purpose and Environment .....	2103
A.10.5.5.2.2	Test parameters .....	2103
A.10.5.5.2.3	Test Requirements.....	2105
A.10.5.5.3	Inter-frequency RSSI measurement accuracy on a carrier with CCA.....	2105
A.10.5.5.3.1	Test Purpose and Environment .....	2105
A.10.5.5.3.2	Test parameters .....	2105
A.10.5.5.3.3	Test Requirements.....	2107
A.10.5.6	Channel occupancy .....	2107
A.10.5.6.1	Channel occupancy measurement accuracy on PSCC with CCA.....	2107
A.10.5.6.1.1	Test Purpose and Environment .....	2107
A.10.5.6.1.2	Test parameters .....	2107
A.10.5.6.1.3	Test Requirements.....	2109
A.10.5.6.2	Channel occupancy measurement accuracy on SCC with CCA .....	2109
A.10.5.6.2.1	Test Purpose and Environment .....	2109
A.10.5.6.2.2	Test parameters .....	2109
A.10.5.6.2.3	Test Requirements.....	2111
A.10.5.6.3	Inter-frequency channel occupancy measurement accuracy on a carrier with CCA.....	2111
A.10.5.6.3.1	Test Purpose and Environment .....	2111
A.10.5.6.3.2	Test parameters .....	2111
A.10.5.6.3.3	Test Requirements.....	2113

A.11 NR Standalone Tests with NR PCell under CCA and Other NR Cells in FR1 .....	2113
A.11.1 RRC_IDLE state mobility .....	2113
A.11.1.1 Cell re-selection with both source and target NR carrier frequencies under CCA.....	2113
A.11.1.1.1 Cell reselection to FR1 intra-frequency NR cells when subject to CCA on the serving and target cell.....	2113
A.11.1.1.1.1 Test Purpose and Environment.....	2113
A.11.1.1.1.2 Test Parameters .....	2113
A.11.1.1.1.3 Test Requirements .....	2115
A.11.1.1.2 Cell reselection to FR1 inter-frequency NR case when subject to CCA on the serving and target cell.....	2116
A.11.1.1.2.1 Test Purpose and Environment.....	2116
A.11.1.1.2.2 Test Parameters .....	2116
A.11.1.1.2.3 Test Requirements .....	2118
A.11.1.2 Cell re-selection to NR with source NR carrier frequency under CCA .....	2118
A.11.1.2.1 Cell reselection to FR1 inter-frequency NR case when serving cell is subject to CCA.....	2118
A.11.1.2.1.1 Test Purpose and Environment.....	2118
A.11.1.2.1.2 Test Parameters .....	2118
A.11.1.2.1.3 Test Requirements .....	2121
A.11.1.3 Cell re-selection from NR carrier with target NR carrier frequency under CCA.....	2122
A.11.1.3.1 Cell reselection to FR1 inter-frequency NR case when target cell is subject to CCA.....	2122
A.11.1.3.1.1 Test Purpose and Environment.....	2122
A.11.1.3.1.2 Test Parameters .....	2122
A.11.1.3.1.3 Test Requirements .....	2125
A.11.1.4 Inter-RAT cell re-selection to E-UTRAN with source NR carrier frequency under CCA .....	2126
A.11.1.4.1 Cell reselection to higher priority E-UTRAN when serving cell is subject to CCA .....	2126
A.11.1.4.1.1 Test Purpose and Environment.....	2126
A.11.1.4.1.2 Test Parameters .....	2126
A.11.1.4.1.3 Test Requirements .....	2128
A.11.1.4.2 Cell reselection to lower priority E-UTRAN when serving cell is subject to CCA .....	2129
A.11.1.4.2.1 Test Purpose and Environment.....	2129
A.11.1.4.2.2 Test Requirements .....	2131
A.11.2 RRC_CONNECTED state mobility .....	2132
A.11.2.1 Handover .....	2132
A.11.2.1.1 Intra-frequency handover from FR1 carrier under CCA to FR1 carrier under CCA; known target cell.....	2132
A.11.2.1.1.1 Test Purpose and Environment.....	2132
A.11.2.1.1.2 Test Parameters .....	2132
A.11.2.1.1.3 Test Requirements .....	2134
A.11.2.1.2 Intra-frequency handover from FR1 carrier under CCA to FR1 carrier under CCA; unknown target cell.....	2134
A.11.2.1.2.1 Test Purpose and Environment.....	2134
A.11.2.1.2.2 Test Parameters .....	2134
A.11.2.1.2.3 Test Requirements .....	2136
A.11.2.1.3 Inter-frequency handover from FR1 carrier under CCA to FR1 carrier under CCA; unknown target cell.....	2137
A.11.2.1.3.1 Test Purpose and Environment.....	2137
A.11.2.1.3.2 Test Parameters .....	2137
A.11.2.1.3.3 Test Requirements .....	2139
A.11.2.1.4 Inter-frequency handover from FR1 carrier under CCA to FR1; known target cell .....	2139
A.11.2.1.4.1 Test Purpose and Environment.....	2139
A.11.2.1.4.2 Test Parameters .....	2139
A.11.2.1.4.3 Test Requirements .....	2142
A.11.2.1.5 Inter-frequency handover from FR1 carrier under CCA to FR1; unknown target cell .....	2142
A.11.2.1.5.1 Test Purpose and Environment.....	2142
A.11.2.1.5.2 Test Parameters .....	2142
A.11.2.1.5.3 Test Requirements .....	2144
A.11.2.1.6 Inter-frequency handover from FR1 to FR1 carrier under CCA; unknown target cell .....	2145
A.11.2.1.6.1 Test Purpose and Environment.....	2145
A.11.2.1.6.2 Test Parameters .....	2145
A.11.2.1.6.3 Test Requirements .....	2147
A.11.2.1.7 SA NR FR1 carrier under CCA - E-UTRAN handover with known target cell .....	2147
A.11.2.1.7.1 Test Purpose and Environment.....	2147

A.11.2.1.7.2	Test Requirements .....	2151
A.11.2.1.8	SA NR FR1 carrier under CCA - E-UTRAN handover with unknown target cell.....	2151
A.11.2.1.8.1	Test Purpose and Environment.....	2151
A.11.2.1.8.2	Test Requirements .....	2154
A.11.2.2	RRC connection mobility control .....	2154
A.11.2.2.1	RRC re-establishment .....	2154
A.11.2.2.1.1	Intra-frequency RRC Re-establishment with CCA in FR1.....	2154
A.11.2.2.1.2	Inter-frequency RRC Re-establishment with CCA in FR1.....	2157
A.11.2.2.1.3	Intra-frequency RRC Re-establishment with CCA in FR1 without serving cell timing.....	2160
A.11.2.2.1.4	Inter-frequency RRC Re-establishment from NR FR1 carrier without CCA to NR FR1 carrier under CCA.....	2162
A.11.2.2.2	Random Access.....	2165
A.11.2.2.2.1	4-step RA type contention-based random access for NR PCell with CCA .....	2165
A.11.2.2.2.1.1	Test Purpose and Environment .....	2165
A.11.2.2.2.1.2	Test Requirements .....	2166
A.11.2.2.2.1.2.1	Random Access Preamble Transmission.....	2167
A.11.2.2.2.1.2.2	Random Access Response Reception.....	2167
A.11.2.2.2.1.2.3	No Random Access Response Reception.....	2167
A.11.2.2.2.1.2.4	Receiving an UL grant for msg3 retransmission .....	2168
A.11.2.2.2.1.2.5	Reception of an Incorrect Message over Temporary C-RNTI .....	2168
A.11.2.2.2.1.2.6	Reception of a Correct Message over Temporary C-RNTI.....	2168
A.11.2.2.2.1.2.7	Contention Resolution Timer expiry.....	2168
A.11.2.2.2.2	4-step RA type non-contention based random access for NR PCell with CCA .....	2168
A.11.2.2.2.2.1	Test Purpose and Environment .....	2168
A.11.2.2.2.2.2	Test Requirements .....	2170
A.11.2.2.2.2.2.1	SSB-based Random Access Preamble Transmission .....	2170
A.11.2.2.2.2.2.2	Random Access Response Reception.....	2170
A.11.2.2.2.2.2.3	No Random Access Response Reception.....	2171
A.11.2.2.2.3	2-step RA type contention-based random access for NR PCell with CCA .....	2171
A.11.2.2.2.3.1	Test Purpose and Environment .....	2171
A.11.2.2.2.3.2	Test Requirements .....	2172
A.11.2.2.2.3.2.1	MsgA Transmission .....	2173
A.11.2.2.2.3.2.2	MsgB Reception.....	2173
A.11.2.2.2.3.2.3	No MsgB Reception .....	2174
A.11.2.2.2.4	2-step RA type non-contention-based random access for NR PCell with CCA .....	2174
A.11.2.2.2.4.1	Test Purpose and Environment .....	2174
A.11.2.2.2.4.2	Test Requirements .....	2176
A.11.2.2.2.4.2.1	MsgA Transmission .....	2176
A.11.2.2.2.4.2.2	MsgB Reception.....	2176
A.11.2.2.2.4.2.3	No MsgB Reception .....	2177
A.11.2.2.3	RRC connection release with redirection .....	2177
A.11.2.2.3.1	Redirection from NR FR1 carrier under CCA to NR FR1 carrier under CCA.....	2177
A.11.3	Timing .....	2183
A.11.3.1	UE transmit timing .....	2183
A.11.3.2	UE timing advance.....	2185
A.11.3.2.1	UE Timing Advance Adjustment Accuracy with PCell under DL CCA .....	2185
A.11.3.2.1.1	Test Purpose and Environment.....	2185
A.11.3.2.1.2	Test Parameters .....	2185
A.11.3.2.1.3	Test Requirements .....	2187
A.11.4	Signalling characteristics.....	2188
A.11.4.1	Radio link monitoring.....	2188
A.11.4.1.1	Introduction.....	2188
A.11.4.1.2	Radio link monitoring out-of-sync test for PCell configured with SSB-based RLM RS in non-DRX mode .....	2188
A.11.4.1.2.1	Test purpose and environment.....	2188
A.11.4.1.2.2	Test requirements .....	2191
A.11.4.1.3	Radio link monitoring in-sync test for PCell configured with SSB-based RLM RS in non-DRX mode.....	2191
A.11.4.1.3.1	Test purpose and environment.....	2191
A.11.4.1.3.2	Test requirements .....	2194
A.11.4.1.4	Void.....	2194
A.11.4.1.4.1	Void.....	2194

A.11.4.1.4.2	Void .....	2194
A.11.4.1.5	Void.....	2195
A.11.4.1.5.1	Void .....	2195
A.11.4.1.5.2	Void .....	2195
A.11.4.2	Interruption .....	2195
A.11.4.2.1	NR interruptions during SCell operations with CCA on PCell and SCell .....	2195
A.11.4.2.1.1	Test Purpose and Environment .....	2195
A.11.4.2.1.2	Test Requirements .....	2197
A.11.4.3	SCell activation and deactivation delay .....	2197
A.11.4.3.2	SCell Activation and Deactivation of known SCell with PCell and SCell under CCA, 640 ms SCell measurement cycle .....	2200
A.11.4.3.2.1	Test Purpose and Environment.....	2200
A.11.4.3.2.2	Test Requirements .....	2201
A.11.4.4	Beam failure detection and link recovery procedures.....	2202
A.11.4.4.1	Beam Failure Detection and Link Recovery Test for FR1 PCell configured with SSB-based BFD and LR in non-DRX mode .....	2202
A.11.4.4.1.1	Test Purpose and Environment.....	2202
A.11.4.4.1.2	Test Requirements .....	2205
A.11.4.4.2	Beam Failure Detection and Link Recovery Test for FR1 PCell configured with SSB-based BFD and LR in DRX mode .....	2206
A.11.4.4.2.1	Test Purpose and Environment.....	2206
A.11.4.4.2.2	Test Requirements .....	2209
A.11.4.5	Active BWP switching.....	2209
A.11.4.5.1	UL active BWP switch delay with consistent UL LBT failure on PCell subject to UL CCA.....	2209
A.11.4.5.1.1	Test Purpose and Environment.....	2209
A.11.4.5.1.2	Test Requirements .....	2212
A.11.4.6	Void .....	2220
A.11.5	Measurement procedure .....	2220
A.11.5.1	Intra-frequency measurements.....	2220
A.11.5.1.1	Event-triggered reporting tests on PCC without gaps under non-DRX .....	2220
A.11.5.1.1.1	Test purpose and environment.....	2220
A.11.5.1.1.2	Test parameters.....	2220
A.11.5.1.1.3	Test Requirements .....	2222
A.11.5.1.2	Event-triggered reporting tests on PCC without gaps under DRX .....	2222
A.11.5.1.2.1	Test purpose and environment.....	2222
A.11.5.1.2.2	Test parameters.....	2222
A.11.5.1.2.3	Test Requirements .....	2224
A.11.5.1.3	Event-triggered reporting tests on PCC with per-UE gaps under non-DRX .....	2224
A.11.5.1.3.1	Test purpose and environment.....	2224
A.11.5.1.3.2	Test parameters.....	2225
A.11.5.1.3.3	Test Requirements .....	2225
A.11.5.1.4	Event-triggered reporting tests on PCC with per-UE gaps under DRX .....	2225
A.11.5.1.4.1	Test purpose and environment.....	2225
A.11.5.1.4.2	Test parameters.....	2225
A.11.5.1.4.3	Test Requirements .....	2225
A.11.5.1.5	Event-triggered reporting tests on SCC without gaps under non-DRX .....	2225
A.11.5.1.5.1	Test purpose and environment.....	2225
A.11.5.1.5.2	Test parameters.....	2225
A.11.5.1.6	Event-triggered reporting tests on SCC without gaps under DRX .....	2226
A.11.5.1.6.1	Test purpose and environment.....	2226
A.11.5.1.6.2	Test parameters.....	2226
A.11.5.1.6.3	Test Requirements .....	2226
A.11.5.1.7	Event-triggered reporting tests on SCC with per-UE gaps under non-DRX .....	2226
A.11.5.1.7.1	Test purpose and environment.....	2226
A.11.5.1.7.2	Test parameters.....	2226
A.11.5.1.7.3	Test Requirements .....	2226
A.11.5.1.8	Event-triggered reporting tests on SCC with per-UE gaps under DRX .....	2226
A.11.5.1.8.1	Test purpose and environment.....	2226
A.11.5.1.8.2	Test parameters.....	2227
A.11.5.1.8.3	Test Requirements .....	2227
A.11.5.1.9	RSSI measurement reporting on PCC .....	2227
A.11.5.1.9.1	Test purpose and environment.....	2227

A.11.5.1.9.2	Test parameters.....	2227
A.11.5.1.10	Channel occupancy measurement reporting on PCC .....	2227
A.11.5.1.10.1	Test purpose and environment.....	2227
A.11.5.1.10.2	Test parameters.....	2227
A.11.5.1.11	RSSI measurement reporting on SCC .....	2228
A.11.5.1.11.1	Test purpose and environment.....	2228
A.11.5.1.11.2	Test parameters.....	2228
A.11.5.1.12	Channel occupancy measurement reporting on SCC .....	2228
A.11.5.1.12.1	Test purpose and environment.....	2228
A.11.5.1.12.2	Test parameters.....	2228
A.11.5.2	Inter-frequency measurements.....	2229
A.11.5.2.1	RSSI measurement reporting .....	2229
A.11.5.2.1.1	Test purpose and environment.....	2229
A.11.5.2.1.2	Test parameters.....	2229
A.11.5.2.2	Channel occupancy measurement reporting.....	2229
A.11.5.2.2.1	Test purpose and environment.....	2229
A.11.5.2.2.2	Test parameters.....	2229
A.11.5.2.3	Event triggered reporting tests for FR1 with CCA without SSB time index detection when DRX is not used .....	2229
A.11.5.2.3.1	Test Purpose and Environment.....	2229
A.11.5.2.3.2	Test Requirements .....	2232
A.11.5.2.4	Event triggered reporting tests for FR1 with CCA without SSB time index detection when DRX is used.....	2232
A.11.5.2.4.1	Test Purpose and Environment.....	2232
A.11.5.2.4.2	Test Requirements .....	2235
A.11.5.2.5	Event triggered reporting tests for FR1 with CCA with SSB time index detection when DRX is not used .....	2236
A.11.5.2.5.1	Test Purpose and Environment.....	2236
A.11.5.2.5.2	Test Requirements .....	2238
A.11.5.2.6	Event triggered reporting tests for FR1 with CCA with SSB time index detection when DRX is used .....	2239
A.11.5.2.6.1	Test Purpose and Environment.....	2239
A.11.5.2.6.2	Test Requirements .....	2242
A.11.5.2.7	Event triggered reporting tests for FR1 without SSB time index detection when DRX is not used .....	2242
A.11.5.2.7.1	Test Purpose and Environment.....	2242
A.11.5.2.7.2	Test Requirements .....	2245
A.11.5.2.8	Event triggered reporting tests for FR1 without SSB time index detection when DRX is used .....	2246
A.11.5.2.8.1	Test Purpose and Environment.....	2246
A.11.5.2.8.2	Test Requirements .....	2249
A.11.5.2.9	Event triggered reporting tests for FR1 with SSB time index detection when DRX is not used .....	2249
A.11.5.2.9.1	Test Purpose and Environment.....	2249
A.11.5.2.9.2	Test Requirements .....	2252
A.11.5.2.10	Event triggered reporting tests for FR1 with SSB time index detection when DRX is used.....	2253
A.11.5.2.10.1	Test Purpose and Environment.....	2253
A.11.5.2.10.2	Test Requirements .....	2256
A.11.5.3	Inter-RAT E-UTRAN measurements .....	2256
A.11.5.3.1	SA NR - E-UTRAN event-triggered reporting in non-DRX in FR1 .....	2256
A.11.5.3.1.1	Test Purpose and Environment.....	2256
A.11.5.3.1.2	Test Requirements .....	2259
A.11.5.3.2	SA NR - E-UTRAN event-triggered reporting in DRX in FR1 .....	2259
A.11.5.3.2.1	Test Purpose and Environment.....	2259
A.11.5.3.2.2	Test Requirements .....	2262
A.11.5.4	L1-RSRP measurements for beam reporting .....	2263
A.11.5.4.1	SSB based L1-RSRP measurement when DRX is not used.....	2263
A.11.5.4.1.1	Test Purpose and Environment.....	2263
A.11.5.4.1.2	Test parameters.....	2263
A.11.5.4.1.3	Test Requirements .....	2265
A.11.5.4.2	SSB based L1-RSRP measurement when DRX is used .....	2265
A.11.5.4.2.1	Test Purpose and Environment.....	2265
A.11.5.4.2.2	Test parameters.....	2265
A.11.5.4.2.3	Test Requirements .....	2267
A.11.5.4.3	SSB based L1-RSRP measurement on SCC when DRX is not used .....	2267

A.11.5.4.3.1	Test Purpose and Environment.....	2267
A.11.5.4.3.2	Test parameters.....	2267
A.11.5.4.3.3	Test Requirements .....	2269
A.11.5.4.4	SSB based L1-RSRP measurement on SCC when DRX is used .....	2269
A.11.5.4.4.1	Test Purpose and Environment.....	2269
A.11.5.4.4.2	Test parameters.....	2270
A.11.5.4.4.3	Test Requirements .....	2271
A.11.6	Measurement performance .....	2272
A.11.6.1	SS-RSRP.....	2272
A.11.6.1.1	Intra-frequency measurement accuracy on a carrier frequency with CCA .....	2272
A.11.6.1.1.1	Test Purpose and Environment.....	2272
A.11.6.1.1.2	Test parameters.....	2272
A.11.6.1.1.3	Test Requirements .....	2273
A.11.6.1.2	Intra-frequency measurement accuracy on SCC on a carrier frequency with CCA .....	2274
A.11.6.1.2.1	Test Purpose and Environment.....	2274
A.11.6.1.2.2	Test parameters.....	2274
A.11.6.1.2.3	Test Requirements .....	2275
A.11.6.2	SS-RSRQ .....	2275
A.11.6.2.1	Intra-frequency measurement accuracy.....	2275
A.11.6.2.1.1	Test Purpose and Environment.....	2275
A.11.6.2.1.2	Test Parameters .....	2275
A.11.6.2.1.3	Test Requirements .....	2277
A.11.6.2.2	Inter-frequency measurement accuracy.....	2277
A.11.6.2.2.1	Test Purpose and Environment.....	2277
A.11.6.2.2.2	Test Parameters .....	2277
A.11.6.2.2.3	Test Requirements .....	2279
A.11.6.2.3	Intra-frequency measurement accuracy on SCC .....	2279
A.11.6.2.3.1	Test Purpose and Environment.....	2279
A.11.6.2.3.2	Test Parameters .....	2279
A.11.6.2.3.3	Test Requirements .....	2281
A.11.6.2.4	Inter-frequency measurement accuracy.....	2281
A.11.6.2.4.1	Test Purpose and Environment.....	2281
A.11.6.2.4.2	Test Parameters .....	2281
A.11.6.2.4.3	Test Requirements .....	2286
A.11.6.3	SS-SINR .....	2286
A.11.6.3.1	Intra-frequency measurement accuracy.....	2286
A.11.6.3.1.1	Test Purpose and Environment.....	2286
A.11.6.3.1.2	Test Parameters .....	2286
A.11.6.3.1.3	Test Requirements .....	2287
A.11.6.3.2	Inter-frequency measurement accuracy.....	2288
A.11.6.3.2.1	Test Purpose and Environment.....	2288
A.11.6.3.2.2	Test Parameters .....	2288
A.11.6.3.2.3	Test Requirements .....	2289
A.11.6.3.3	Intra-frequency measurement accuracy on SCC .....	2289
A.11.6.3.3.1	Test Purpose and Environment.....	2289
A.11.6.3.3.2	Test Parameters .....	2289
A.11.6.3.3.3	Test Requirements .....	2291
A.11.6.3.4	Inter-frequency measurement accuracy.....	2291
A.11.6.3.4.1	Test Purpose and Environment.....	2291
A.11.6.3.4.2	Test Parameters .....	2291
A.11.6.3.4.3	Test Requirements .....	2295
A.11.6.4	L1-RSRP measurement for beam reporting with CCA serving cell .....	2296
A.11.6.4.1	SSB based L1-RSRP measurement.....	2296
A.11.6.4.1.1	Test Purpose and Environment.....	2296
A.11.6.4.1.2	Test parameters.....	2296
A.11.6.4.1.3	Test Requirements .....	2297
A.11.6.5	RSSI.....	2297
A.11.6.5.1	Intra-frequency RSSI measurement accuracy on PCC with CCA .....	2297
A.11.6.5.1.1	Test Purpose and Environment .....	2297
A.11.6.5.1.2	Test parameters .....	2297
A.11.6.5.1.3	Test Requirements.....	2299
A.11.6.5.2	Intra-frequency RSSI measurement accuracy on SCC with CCA .....	2299



A.11.6.5.2.1	Test Purpose and Environment .....	2299
A.11.6.5.2.2	Test parameters .....	2299
A.11.6.5.2.3	Test Requirements.....	2301
A.11.6.5.3	Inter-frequency RSSI measurement accuracy on a carrier with CCA.....	2301
A.11.6.5.3.1	Test Purpose and Environment .....	2301
A.11.6.5.3.2	Test parameters .....	2301
A.11.6.5.3.3	Test Requirements.....	2302
A.11.6.6	Channel occupancy .....	2303
A.11.6.6.1	Intra-frequency channel occupancy measurement accuracy on PCC with CCA .....	2303
A.11.6.6.1.1	Test Purpose and Environment .....	2303
A.11.6.6.1.2	Test parameters .....	2303
A.11.6.6.1.3	Test Requirements.....	2304
A.11.6.6.2	Intra-frequency channel occupancy measurement accuracy on SCC with CCA .....	2304
A.11.6.6.2.1	Test Purpose and Environment .....	2304
A.11.6.6.2.2	Test parameters .....	2304
A.11.6.6.2.3	Test Requirements.....	2306
A.11.6.6.3	Inter-frequency channel occupancy measurement accuracy on a carrier with CCA.....	2306
A.11.6.6.3.1	Test Purpose and Environment .....	2306
A.11.6.6.3.2	Test parameters .....	2306
A.11.6.6.3.3	Test Requirements.....	2308
A.11.6.7	E-UTRAN RSRP .....	2308
A.11.6.8	E-UTRAN RSRQ .....	2308
A.11.6.9	E-UTRAN SINR.....	2308
A.12	E-UTRA Standalone Tests with at Least One NR Cell under CCA .....	2308
A.12.1	RRC_IDLE state mobility .....	2308
A.12.1.1	Inter-RAT cell re-selection to NR on a carrier frequency with CCA .....	2308
A.12.1.1.1	E-UTRA Cell reselection to higher priority NR target Cell in FR1 when target cell is subject to CCA .....	2308
A.12.1.1.1.1	Test Purpose and Environment.....	2308
A.12.1.1.1.2	Test Requirements.....	2311
A.12.2	RRC_CONNECTED state mobility .....	2312
A.12.2.1	Handover .....	2312
A.12.2.1.1	E-UTRAN - NR with CCA handover .....	2312
A.12.2.1.1.1	Test Purpose and Environment.....	2312
A.12.2.1.1.2	Test Requirements .....	2315
A.12.3	Signalling characteristics.....	2316
A.12.3.1	Interruptions.....	2316
A.12.4	Measurement procedure .....	2316
A.12.4.1	E-UTRAN–NR inter-RAT SFTD measurements .....	2316
A.12.4.1.1	E-UTRA – NR Inter-RAT SFTD Measurement Delay with NR under CCA in non-DRX .....	2316
A.12.4.1.1.1	Test Purpose and Environment.....	2316
A.12.4.1.1.2	Test Requirements.....	2318
A.12.4.2	E-UTRAN–NR inter-RAT measurements on NR carrier frequency under CCA .....	2318
A.12.4.2.1	E-UTRA-NR inter-RAT event triggered reporting tests for FR1 without SSB time index detection when DRX is not used .....	2318
A.12.4.2.1.1	Test Purpose and Environment.....	2318
A.12.4.2.1.2	Test Requirements .....	2321
A.12.4.2.2	E-UTRA-NR inter-RAT event triggered reporting tests for FR1 without SSB time index detection when DRX is used .....	2322
A.12.4.2.2.1	Test Purpose and Environment.....	2322
A.12.4.2.2.2	Test Requirements .....	2325
A.12.4.2.3	NR Inter-RAT event triggered reporting tests for FR1 with SSB time index detection when DRX is not used .....	2325
A.12.4.2.3.1	Test Purpose and Environment.....	2325
A.12.4.2.3.2	Test Requirements.....	2329
A.12.4.2.4	NR Inter-RAT event triggered reporting tests for FR1 with SSB time index detection when DRX is used.....	2329
A.12.4.2.4.1	Test Purpose and Environment.....	2329
A.12.4.2.4.2	Test Requirements .....	2332
A.12.4.2.5	RSSI measurement reporting .....	2333
A.12.4.2.5.1	Test purpose and environment.....	2333

A.12.4.2.5.2	Test parameters.....	2333
A.12.4.2.5.3	Test Requirements .....	2335
A.12.4.2.6	Channel occupancy measurement reporting.....	2335
A.12.4.2.6.1	Test purpose and environment.....	2335
A.12.4.2.6.2	Test parameters.....	2335
A.12.4.2.6.3	Test Requirements .....	2337
A.12.5	Measurement performance .....	2337
A.12.5.1	E-UTRAN-NR SFTD .....	2337
A.12.5.2	E-UTRAN-NR SS-RSRP.....	2340
A.12.5.3	E-UTRAN-NR SS-RSRQ.....	2340
A.12.5.4	E-UTRAN-NR SS-SINR .....	2340
A.12.5.5	E-UTRAN-NR RSSI.....	2340
A.12.5.6	E-UTRAN-NR channel occupancy.....	2340
A.13	NR Standalone Tests with NR SCell under CCA and All Other NR Cells in FR1 .....	2340
A.13.1	Timing .....	2340
A.13.1.1	UE transmit timing .....	2340
A.13.1.2	Timing advance .....	2340
A.13.2	Signalling characteristics.....	2340
A.13.2.1	Interruption .....	2340
A.13.2.1.1	NR interruptions during SCell operations with CCA on SCell .....	2340
A.13.2.1.1.1	Test Purpose and Environment.....	2340
A.13.2.1.1.2	Test Requirements .....	2342
A.13.2.2	SCell activation and deactivation delay .....	2343
A.13.2.2.2	SCell Activation and Deactivation of known SCell under CCA, 640 ms SCell measurement cycle .....	2346
A.13.2.2.2.1	Test Purpose and Environment.....	2346
A.13.2.2.2.2	Test Requirements .....	2346
A.13.2.2.3	SCell Activation and Deactivation of unknown SCell under CCA .....	2347
A.13.2.2.3.1	Test Purpose and Environment.....	2347
A.13.2.2.3.2	Test Requirements .....	2347
A.13.2.3	Void.....	2348
A.13.3	Measurement procedure .....	2348
A.13.3.1	Intra-frequency measurements.....	2348
A.13.3.1.1	Event-triggered reporting tests on SCC without gaps under non-DRX .....	2348
A.13.3.1.1.1	Test purpose and environment.....	2348
A.13.3.1.1.2	Test parameters.....	2348
A.13.3.1.1.3	Test Requirements .....	2350
A.13.3.1.2	Event-triggered reporting tests on SCC without gaps under DRX.....	2350
A.13.3.1.2.1	Test purpose and environment.....	2350
A.13.3.1.2.2	Test parameters.....	2350
A.13.3.1.2.3	Test Requirements .....	2353
A.13.3.1.3	Event-triggered reporting tests on SCC with per-UE gaps under non-DRX .....	2353
A.13.3.1.3.1	Test purpose and environment.....	2353
A.13.3.1.3.2	Test parameters.....	2353
A.13.3.1.3.3	Test Requirements .....	2356
A.13.3.1.4	Event-triggered reporting tests on SCC with per-UE gaps under DRX .....	2356
A.13.3.1.4.1	Test purpose and environment.....	2356
A.13.3.1.4.2	Test parameters.....	2356
A.13.3.1.4.3	Test Requirements .....	2359
A.13.3.1.5	RSSI measurement reporting on SCC .....	2359
A.13.3.1.5.1	Test purpose and environment.....	2359
A.13.3.1.5.2	Test parameters.....	2359
A.13.3.1.6	Channel occupancy measurement reporting on SCC .....	2360
A.13.3.1.6.1	Test purpose and environment.....	2360
A.13.3.1.6.2	Test parameters.....	2360
A.13.3.2	Inter-frequency measurements.....	2361
A.13.3.2.1	RSSI measurement reporting .....	2361
A.13.3.2.1.1	Test purpose and environment.....	2361
A.13.3.2.1.2	Test parameters.....	2361
A.13.3.2.2	Channel occupancy measurement reporting.....	2361
A.13.3.2.2.1	Test purpose and environment.....	2361
A.13.3.2.2.2	Test parameters.....	2361

A.13.3.2.3	Event triggered reporting tests for FR1 with CCA without SSB time index detection when DRX is not used .....	2362
A.13.3.2.3.1	Test Purpose and Environment.....	2362
A.13.3.2.3.2	Test Requirements.....	2365
A.13.3.2.4	Event triggered reporting tests for FR1 with CCA without SSB time index detection when DRX is used.....	2365
A.13.3.2.4.1	Test Purpose and Environment.....	2365
A.13.3.2.4.2	Test Requirements.....	2369
A.13.3.2.5	Event triggered reporting tests for FR1 with CCA with SSB time index detection when DRX is not used .....	2370
A.13.3.2.5.1	Test Purpose and Environment.....	2370
A.13.3.2.5.2	Test Requirements.....	2373
A.13.3.2.6	Event triggered reporting tests for FR1 with CCA with SSB time index detection when DRX is used .....	2373
A.13.3.2.6.1	Test Purpose and Environment.....	2373
A.13.3.2.6.2	Test Requirements.....	2377
A.13.3.3	L1-RSRP measurements for beam reporting .....	2377
A.13.3.3.1	SSB based L1-RSRP measurement when DRX is not used.....	2377
A.13.3.3.1.1	Test Purpose and Environment.....	2377
A.13.3.3.1.2	Test parameters.....	2378
A.13.3.3.1.3	Test Requirements.....	2380
A.13.3.3.2	SSB based L1-RSRP measurement when DRX is used.....	2380
A.13.3.3.2.1	Test Purpose and Environment.....	2380
A.13.3.3.2.2	Test parameters.....	2380
A.13.3.3.2.3	Test Requirements.....	2383
A.13.4	Measurement performance .....	2383
A.13.4.1	SS-RSRP.....	2383
A.13.4.1.1	Intra-frequency measurement accuracy on a carrier frequency with CCA .....	2383
A.13.4.1.1.1	Test Purpose and Environment.....	2383
A.13.4.1.1.2	Test parameters.....	2383
A.13.4.1.1.3	Test Requirements.....	2385
A.13.4.2	SS-RSRQ.....	2385
A.13.4.2.1	Intra-frequency measurement accuracy on SCC .....	2385
A.13.4.2.1.1	Test Purpose and Environment.....	2385
A.13.4.2.1.2	Test Parameters .....	2385
A.13.4.2.1.3	Test Requirements.....	2390
A.13.4.3	SS-SINR .....	2390
A.13.4.3.1	Intra-frequency measurement accuracy on SCC .....	2390
A.13.4.3.1.1	Test Purpose and Environment.....	2390
A.13.4.3.1.2	Test Parameters .....	2390
A.13.4.3.1.3	Test Requirements.....	2394
A.13.4.4	L1-RSRP measurement for beam reporting with CCA serving cell .....	2395
A.13.4.4.1	SSB based L1-RSRP measurement.....	2395
A.13.4.4.1.1	Test Purpose and Environment.....	2395
A.13.4.4.1.2	Test parameters.....	2395
A.13.4.4.1.3	Test Requirements.....	2397
A.13.4.5	RSSI.....	2398
A.13.4.5.1	Intra-frequency RSSI measurement accuracy on a carrier with CCA.....	2398
A.13.4.5.1.1	Test Purpose and Environment .....	2398
A.13.4.5.1.2	Test parameters .....	2398
A.13.4.5.1.3	Test Requirements.....	2399
A.13.4.5.2	Inter-frequency RSSI measurement accuracy on a carrier with CCA.....	2400
A.13.4.5.2.1	Test Purpose and Environment .....	2400
A.13.4.5.2.2	Test parameters .....	2400
A.13.4.5.2.3	Test Requirements.....	2401
A.13.4.6	Channel occupancy .....	2402
A.13.4.6.1	Intra-frequency channel occupancy measurement accuracy on SCC with CCA .....	2402
A.13.4.6.1.1	Test Purpose and Environment .....	2402
A.13.4.6.1.2	Test parameters .....	2402
A.13.4.6.1.3	Test Requirements.....	2403
A.13.4.6.2	Inter-frequency channel occupancy measurement accuracy on a carrier with CCA.....	2404
A.13.4.6.2.1	Test Purpose and Environment .....	2404

A.13.4.6.2.2	Test parameters .....	2404
A.13.4.6.2.3	Test Requirements.....	2405

## **Annex B (normative):           Conditions for RRM requirements applicability for operating bands .2406**

B.1	Conditions for NR RRC_IDLE state mobility .....	2406
B.1.1	Introduction .....	2406
B.1.2	Conditions for measurements on NR intra-frequency cells for cell re-selection .....	2406
B.1.3	Conditions for measurements on NR inter-frequency cells for cell re-selection .....	2407
B.2	Conditions for UE measurements procedures and performance requirements in RRC_CONNECTED state .....	2407
B.2.1	Introduction .....	2407
B.2.1.1	General.....	2407
B.2.1.2	Derivation of Minimum SSB_RP values for FR1.....	2408
B.2.1.3	Derivation of Minimum SSB_RP values for FR2.....	2408
B.2.1.3.1	Minimum SSB_RP values for Rx Beam Peak angle of arrival .....	2408
B.2.1.3.2	Minimum SSB_RP values for angle of arrival within Spherical coverage .....	2408
B.2.1.4	Gain to SS-RSRP and CSI-RSRP measurement point for FR1 .....	2409
B.2.1.5	Gain to SS-RSRP and CSI-RSRP measurement point for FR2 .....	2409
B.2.1.5.1	Gain to SS-RSRP and CSI-RSRP measurement point for Rx Beam Peak angle of arrival.....	2409
B.2.1.5.2	Gain to SS-RSRP measurement point for different frequency.....	2410
B.2.1.5.3	Alignment of Rough beam to Rx beam Peak .....	2410
B.2.1.6	Gain to PRS-RSRP measurement point for FR2.....	2411
B.2.1.6.1	Gain to PRS-RSRP measurement point for Rx Beam Peak angle of arrival .....	2411
B.2.2	Conditions for NR intra-frequency measurements .....	2411
B.2.3	Conditions for NR inter-frequency measurements .....	2412
B.2.4	Conditions for NR L1-RSRP reporting .....	2414
B.2.4.1	Conditions for SSB based L1-RSRP reporting .....	2414
B.2.4.2	Conditions for CSI-RS based L1-RSRP reporting.....	2415
B.2.5	Conditions for RRC connection release with redirection to NR.....	2416
B.2.6	Void.....	2417
B.2.6.1	Void.....	2417
B.2.6.2	Void.....	2417
B.2.7	Conditions for SRS-RSRP measurements .....	2417
B.2.8	Conditions for NR L1-SINR reporting.....	2418
B.2.8.1	Conditions for L1-SINR reporting with CSI-RS based CMR and no dedicated IMR configured .....	2418
B.2.8.2	Conditions for L1-SINR reporting with SSB based CMR and dedicated IMR configured .....	2419
B.2.8.2.1	L1-SINR reporting with SSB based CMR and dedicated ZP-IMR configured.....	2419
B.2.8.2.2	L1-SINR reporting with SSB based CMR and dedicated NZP-IMR configured.....	2420
B.2.8.3	Conditions for L1-SINR reporting with CSI-RS based CMR and dedicated IMR configured .....	2421
B.2.8.3.1	L1-SINR reporting with CSI-RS based CMR and dedicated ZP-IMR configured .....	2421
B.2.8.3.2	L1-SINR reporting with CSI-RS based CMR and dedicated NZP-IMR configured.....	2422
B.2.9	Conditions for NR intra-frequency measurements under CCA .....	2423
B.2.10	Conditions for NR inter-frequency measurements under CCA .....	2423
B.2.11	Conditions for NR L1-RSRP reporting under CCA .....	2423
B.2.11.1	Conditions for SSB based L1-RSRP reporting .....	2423
B.2.12	Conditions for NR CSI-RS based intra-frequency measurements.....	2424
B.2.13	Conditions for NR CSI-RS based inter-frequency measurements.....	2425
B.2.14	Conditions for NR PRS-based measurements .....	2426
B.3	RRM Requirements Exceptions .....	2427
B.3.1	Introduction .....	2427
B.3.2	Receiver sensitivity relaxation for CA .....	2428
B.3.2.1	Receiver sensitivity relaxation for UE supporting CA in FR1 .....	2428
B.3.2.2	Receiver sensitivity relaxation for UE configured with CA in FR1 .....	2428
B.3.2.2.1	Inter-band carrier aggregation.....	2428
B.3.2.2.2	Reference sensitivity exceptions due to UL harmonic interference for CA .....	2428
B.3.2.2.3	Reference sensitivity exceptions due to intermodulation interference due to 2UL CA .....	2428
B.3.2.3	Receiver sensitivity relaxation for UE supporting CA in FR2.....	2429
B.3.2.4	Receiver sensitivity relaxation for UE configured with CA in FR2 .....	2429
B.3.2.4.1	Intra-band contiguous carrier aggregation .....	2429
B.3.2.4.2	Intra-band non-contiguous carrier aggregation .....	2429

B.3.3	Receiver sensitivity relaxation for DC .....	2429
B.3.3.1	Receiver sensitivity relaxation for EN-DC .....	2429
B.3.3.2	Receiver sensitivity relaxation for NE-DC .....	2429
B.3.4	Receiver sensitivity relaxation for SUL .....	2429
B.3.4.1	Receiver sensitivity relaxation for UE supporting SUL in FR1.....	2429
B.3.4.2	Receiver sensitivity relaxation for UE configured with SUL in FR1 .....	2429
B.3.4.2.1	Reference sensitivity exceptions due to UL harmonic interference for SUL .....	2429
B.4	Conditions for V2X.....	2430
B.4.1	Test parameters for GNSS signals.....	2430
B.4.2	Conditions for PSBCH-RSRP Accuracy Requirements.....	2430
B.4.3	Conditions for Selection/Reselection to Intra-frequency SyncRef UE.....	2430
B.4.4	Conditions for L1 SL-RSRP Accuracy Requirements .....	2431
<b>Annex C (informative): Change history .....</b>		<b>2432</b>
History .....		2450

---

# Foreword

This Technical Specification has been produced by the 3rd Generation Partnership Project (3GPP).

The contents of the present document are subject to continuing work within the TSG and may change following formal TSG approval. Should the TSG modify the contents of the present document, it will be re-released by the TSG with an identifying change of release date and an increase in version number as follows:

Version x.y.z

where:

- x the first digit:
  - 1 presented to TSG for information;
  - 2 presented to TSG for approval;
  - 3 or greater indicates TSG approved document under change control.
- y the second digit is incremented for all changes of substance, i.e. technical enhancements, corrections, updates, etc.
- z the third digit is incremented when editorial only changes have been incorporated in the document.

In the present document, modal verbs have the following meanings:

- shall** indicates a mandatory requirement to do something
- shall not** indicates an interdiction (prohibition) to do something

The constructions "shall" and "shall not" are confined to the context of normative provisions, and do not appear in Technical Reports.

The constructions "must" and "must not" are not used as substitutes for "shall" and "shall not". Their use is avoided insofar as possible, and they are not used in a normative context except in a direct citation from an external, referenced, non-3GPP document, or so as to maintain continuity of style when extending or modifying the provisions of such a referenced document.

- should** indicates a recommendation to do something
- should not** indicates a recommendation not to do something
- may** indicates permission to do something
- need not** indicates permission not to do something

The construction "may not" is ambiguous and is not used in normative elements. The unambiguous constructions "might not" or "shall not" are used instead, depending upon the meaning intended.

- can** indicates that something is possible
- cannot** indicates that something is impossible

The constructions "can" and "cannot" are not substitutes for "may" and "need not".

- will** indicates that something is certain or expected to happen as a result of action taken by an agency the behaviour of which is outside the scope of the present document
- will not** indicates that something is certain or expected not to happen as a result of action taken by an agency the behaviour of which is outside the scope of the present document
- might** indicates a likelihood that something will happen as a result of action taken by some agency the behaviour of which is outside the scope of the present document

**might not** indicates a likelihood that something will not happen as a result of action taken by some agency the behaviour of which is outside the scope of the present document

In addition:

**is** (or any other verb in the indicative mood) indicates a statement of fact

**is not** (or any other negative verb in the indicative mood) indicates a statement of fact

The constructions "is" and "is not" do not indicate requirements.

---

# 1 Scope

The present document specifies requirements for support of Radio Resource Management for the FDD and TDD modes of New Radio (NR). These requirements include requirements on measurements in NR and the UE as well as requirements on node dynamical behaviour and interaction, in terms of delay and response characteristics.

---

# 2 References

The following documents contain provisions which, through reference in this text, constitute provisions of the present document.

- References are either specific (identified by date of publication, edition number, version number, etc.) or non-specific.
- For a specific reference, subsequent revisions do not apply.
- For a non-specific reference, the latest version applies. In the case of a reference to a 3GPP document (including a GSM document), a non-specific reference implicitly refers to the latest version of that document *in the same Release as the present document*.

- [1] 3GPP TS 38.304: "NR; User Equipment (UE) procedures in idle mode".
- [2] 3GPP TS 38.331: "NR; Radio Resource Control (RRC); Protocol specification".
- [3] 3GPP TS 38.213: "NR; Physical layer procedures for control".
- [4] 3GPP TS 38.215: "NR; Physical layer measurements".
- [5] 3GPP TS 38.533: "NR; User Equipment (UE) conformance specification; Radio Resource Management (RRM)".
- [6] 3GPP TS 38.211: "NR; Physical channels and modulation".
- [7] 3GPP TS 38.321: "NR; Medium Access Control (MAC) protocol specification".
- [8] 3GPP TS 38.212: "NR; Multiplexing and channel coding".
- [9] 3GPP TS 38.202: "NR; Physical layer services provided by the physical layer".
- [10] 3GPP TS 38.300: "NR; Overall description; Stage-2".
- [11] 3GPP TR 21.905: "Vocabulary for 3GPP Specifications".
- [12] 3GPP TS 38.423: "NG-RAN; Xn Application Protocol (XnAP)".
- [13] 3GPP TS 38.104: "NR; Base Station (BS) radio transmission and reception".
- [14] 3GPP TS 38.306: "NR; User Equipment (UE) radio access capabilities".
- [15] 3GPP TS 36.133: "Evolved Universal Terrestrial Radio Access (E-UTRA); Requirements for support of radio resource management".
- [16] 3GPP TS 36.331: "Evolved Universal Terrestrial Radio Access (E-UTRA); Radio Resource Control (RRC) protocol specification".
- [17] 3GPP TS 37.340: "Evolved Universal Terrestrial Radio Access (E-UTRA) and NR; Multi-connectivity", Stage 2.
- [18] 3GPP TS 38.101-1: "NR; User Equipment (UE) radio transmission and reception; Part 1: Range 1 Standalone".
- [19] 3GPP TS 38.101-2: "NR; User Equipment (UE) radio transmission and reception; Part 2: Range 2 Standalone".



- [20] 3GPP TS 38.101-3: "NR; User Equipment (UE) radio transmission and reception; Part 3: Range 1 and Range 2 Interworking operation with other radios".
- [21] 3GPP TS 38.101-4: "NR; User Equipment (UE) radio transmission and reception; Part 4: Performance requirements".
- [22] 3GPP TS 38.305: "NG Radio Access Network (NG-RAN); Stage 2 functional specification of User Equipment (UE) positioning in NG-RAN".
- [23] 3GPP TS 36.211: "Evolved Universal Terrestrial Radio Access (E-UTRA); Physical Channels and Modulation".
- [24] 3GPP TS 36.300: "Evolved Universal Terrestrial Radio Access (E-UTRA); Overall description".
- [25] 3GPP TS 36.101: "Technical Specification Group Radio Access Network; Evolved Universal Terrestrial Radio Access (E-UTRA); User Equipment (UE) radio transmission and reception".
- [26] 3GPP TS 38.214: "NR; Physical layer procedures for data".
- [27] 3GPP TS 36.355: "Evolved Universal Terrestrial Radio Access (E-UTRA); LTE Positioning Protocol (LPP)".
- [28] Void.
- [29] 3GPP TS 25.133: "Requirements for Support of Radio Resource Management (FDD)".
- [30] 3GPP TS 25.302: "Services provided by the Physical Layer".
- [31] 3GPP TS 37.320: "Universal Terrestrial Radio Access (UTRA), Evolved Universal Terrestrial Radio Access (E-UTRA) and Next Generation Radio Access; Radio measurement collection for Minimization of Drive Tests (MDT); Overall description; Stage 2".
- [32] 3GPP TS 25.214: "Physical layer procedures (FDD)".
- [33] 3GPP TS 37.213: "Physical layer procedures for shared spectrum channel access"
- [34] 3GPP TS 37.355: "LTE Positioning Protocol (LPP) ".
- [35] 3GPP TS 38.455 : "NG-RAN; NR Positioning Protocol A (NRPPa) ".
- [36] 3GPP TS 37.106: "User Equipment (UE) requirements for shared spectrum channel access".
- [37] 3GPP TS 38.521-2: " NR; User Equipment (UE) conformance specification; Radio transmission and reception; Part 2: Range 2 Standalone".

---

## 3 Definitions, symbols and abbreviations

### 3.1 Definitions

For the purposes of the present document, the terms and definitions given in TR 21.905 [11] and the following apply. A term defined in the present document takes precedence over the definition of the same term, if any, in TR 21.905 [11].

**Active DL BWP:** Active DL bandwidth part as defined in TS 38.213 [3].

**Blackbox Approach:** Testing methodology, in which the UE internal implementation of certain specific UE functionality involved in the test, is unknown.

**Control Resource Set:** As defined in TS 38.213 [3].

**DL BWP:** DL bandwidth part as defined in TS 38.213 [3].

**EN-DC:** E-UTRA-NR Dual Connectivity as defined in clause 4.1.2 of TS 37.340 [17].

**en-gNB:** As defined in TS 37.340 [17].

**FR1:** Frequency range 1 as defined in clause 5.1 of TS 38.104 [13].

**FR2:** Frequency range 2 as defined in clause 5.1 of TS 38.104 [13].

**gNB:** as defined in TS 38.300 [10].

**LMF:** as defined in TS 38.305 [22].

**Master Cell Group:** As defined in TS 38.331 [2].

**Multi-Radio Dual Connectivity:** Dual Connectivity between E-UTRA and NR nodes, or between two NR nodes, as defined in TS 37.340 [17].

**ng-eNB:** As defined in TS 38.300 [10].

**NE-DC:** NR-E-UTRA Dual Connectivity as defined in clause 4.1.3.2 of TS 37.340 [17].

**NGEN-DC:** NG-RAN E-UTRA-NR Dual Connectivity as defined in clause 4.1.3.1 of TS 37.340 [17].

**NR-DC:** NR-NR Dual Connectivity as defined in clause 4.1.3.3 of TS 37.340 [17].

**Primary Cell:** As defined in TS 38.331 [2].

**PRS resource instance:** An instance in time of a configured PRS resource as defined in TS 38.331 [2], which may or not overlap with a measurement gap occasion.

**Quasi Co-Location:** As defined in TS 38.214 [26].

**RLM-RS resource:** A resource out of the set of resources configured for RLM by higher layer parameter RLM-RS-List [2] as defined in TS 38.213 [3].

**SA operation mode:** Operation mode when the UE is configured with at least PCell and not any MR-DC.

**Secondary Cell:** As defined in TS 38.331 [2].

**Secondary Cell Group:** As defined in TS 38.331 [2].

**Serving Cell:** As defined in TS 38.331 [2].

**SMTC:** An SSB-based measurement timing configuration configured by *SSB-MeasurementTimingConfiguration* as specified in TS 38.331 [2].

**Special Cell:** As defined in TS 38.331 [2].

**SSB:** SS/PBCH block as defined in clause 7.8.3 of TS 38.211 [6].

**Timing Advance Group:** As defined in TS 38.331 [2].

## 3.2 Symbols

For the purposes of the present document, the following symbols apply:

[...]	Values included in square bracket must be considered for further studies, because it means that a decision about that value was not taken.
$BW_{\text{Channel}}$	Channel bandwidth, defined in TS 38.101-1, 38.101-2 and 38.101-3 subclause 3.2
$\hat{E}_s$	Received energy per RE (power normalized to the subcarrier spacing) during the useful part of the symbol, i.e. excluding the cyclic prefix, at the UE antenna connector or radiated interface boundary
$F_c$	<i>RF reference frequency</i> on the channel raster, given in table 5.4.2.2-1 in TS 38.101-1 and 38.101-2
$F_{c,\text{low}}$	The $F_c$ of the lowest carrier, expressed in MHz
$I_o$	The total received power density, including signal and interference, as measured at the UE antenna connector or radiated interface boundary.

I <sub>oc</sub>	The power spectral density (integrated in a noise bandwidth equal to the chip rate and normalized to the chip rate) of a band limited noise source (simulating interference from cells, which are not defined in a test procedure) as measured at the UE antenna connector or radiated interface boundary.
I <sub>ot</sub>	The received power spectral density of the total noise and interference for a certain RE (power integrated over the RE and normalized to the subcarrier spacing) as measured at the UE antenna connector or radiated interface boundary
N <sub>oc</sub>	The power spectral density of a white noise source (average power per RE normalised to the subcarrier spacing), simulating interference from cells that are not defined in a test procedure, as measured at the UE antenna connector or radiated interface boundary
n <sub>PRB</sub>	Physical Resource Block number as defined in clause 3.2 in TS 38.211.
N <sub>TA</sub>	Timing offset between uplink and downlink radio frames at the UE, as defined in clause 4.2 in TS 38.213.
N <sub>TA_offset</sub>	Fixed timing advance offset, as defined in clause 7.1.2 in TS 38.133.
P <sub>C<sub>MAX</sub></sub>	Configured UE transmitted power as defined in clause 6.2.4 in TS 38.101-1, 38-101-2 and 38.101-3.
P <sub>C<sub>MAX,c</sub></sub>	Configured UE transmitted power on a serving cell <i>c</i> as defined in clause 6.2.4 in TS 38.101-1, 38-101-2 and 38.101-3
S	Cell Selection Criterion defined in TS 38.304, subclause 5.2.3.2 for NR
SSB <sub>RP</sub>	Received (linear) average power of the resource elements that carry NR synchronisation burst, measured at the UE antenna connector or radiated interface boundary
S <sub>rxlev</sub>	Cell selection RX level, defined in TS 38.304, subclause 5.2.3.2
S <sub>qual</sub>	Cell selection quality, defined in TS 38.304, subclause 5.2.3.2
S <sub>intrasearch</sub>	Defined in TS 38.304 , subclause 5.2.4.7 for E-UTRAN amd 38.304 subclause 5.2.4.7 for NR
S <sub>nonintrasearch</sub>	Defined in TS 38.304 , subclause 5.2.4.7
Thresh <sub>x,high</sub>	Defined in TS 38.304 , subclause 5.2.4.7
Thresh <sub>x,low</sub>	Defined in TS 38.304 , subclause 5.2.4.7
Thresh <sub>serv,low</sub>	Defined in TS 38.304 , subclause 5.2.4.7
T <sub>RE-ESTABLISH-REQ</sub>	The RRC Re-establishment delay requirement, the time between the moment when erroneous CRCs are applied, to when the UE starts to send preambles on the PRACH.
T <sub>c</sub>	Basic time unit, defined in clause 4.1 of TS 38.211 [6].
T <sub>s</sub>	Reference time unit, defined in clause 4.1 of TS 38.211 [6].
T <sub>reselection</sub>	Defined in TS 25.304, subclause 5.2.6.1.5
T <sub>reselectionRAT</sub>	Defined in TS 36.304 , subclause 5.2.4.7
T <sub>reselectionEUTRA</sub>	Defined in TS 36.304 , subclause 5.2.4.7
T <sub>reselectionUTRA</sub>	Defined in TS 36.304 , subclause 5.2.4.7
T <sub>reselectionGERAN</sub>	Defined in TS 36.304 , subclause 5.2.4.
Thresh <sub>x,high</sub>	Defined in TS 38.304 , subclause 5.2.4.7
Thresh <sub>x,low</sub>	Defined in TS 38.304 , subclause 5.2.4.7
Thresh <sub>serv,low</sub>	Defined in TS 38.304 , subclause 5.2.4.7
T <sub>UE_re-establish_delay</sub>	Time between the moments when any of the conditions requiring RRC re-establishment as defined in clause 5.3.7 in TS 38.331 [2] is detected by the UE and when the UE sends PRACH to the target PCell.

### 3.3 Abbreviations

For the purposes of the present document, the abbreviations given in TR 21.905 [11] and the following apply. An abbreviation defined in the present document takes precedence over the definition of the same abbreviation, if any, in TR 21.905 [11].

AoA	Angle of Arrival
AoD	Angle of Departure
BFD	Beam Failure Detection
BFD-RS	BFD Reference Signal
BLER	Block Error Rate
BM-RS	Beam Management Reference Signal
BWP	Bandwidth Part
CA	Carrier Aggregation

CBD	Candidate Beam Detection
CBW	Channel Bandwidth
CC	Component Carrier
CCA	Clear Channel Assessment
CLI	Cross Link Interference
CMR	Channel Measurement Resource
CORESET	Control Resource Set
CP	Cyclic Prefix
CSI	Channel-State Information
CSI-RS	CSI Reference Signal
CSI-RSRP	CSI Reference Signal based Reference Signal Received Power
CSI-RSRQ	CSI Reference Signal based Reference Signal Received Quality
CSI-SINR	CSI Reference Signal based Signal to Noise and Interference Ratio
CSI_RP	Received (linear) average power of the resource elements that carry NR CSI-RS signals and channels, measured at the UE antenna connector
DBT	Discovery Burst Transmission
DC	Dual Connectivity
DCI	Downlink Control Information
DL	Downlink
DL-AoD	Downlink Angle-of-Departure
DL-TDOA	Downlink Time Difference Of Arrival
DMRS	Demodulation Reference Signal
DRX	Discontinuous Reception
E-CID	Enhanced Cell ID
E-UTRA	Evolved UTRA
E-UTRAN	Evolved UTRAN
EN-DC	E-UTRA-NR Dual Connectivity
FDD	Frequency Division Duplex
FR	Frequency Range
HARQ	Hybrid Automatic Repeat Request
HO	Handover
IMR	Interference Measurement Resource
L1-RSRP	Layer 1 RSRP
L1 SL-RSRP	Layer 1 Sidelink RSRP which corresponds to PSCCH-RSRP and/or PSSCH-RSRP
LMF	Location Management Function
LPP	LTE Positioning Protocol
MAC	Medium Access Control
MCG	Master Cell Group
MDT	Minimization of Drive Tests
MG	Measurement Gap
MGL	Measurement Gap Length
MGRP	Measurement Gap Repetition Period
MIB	Master Information Block
MN	Master Node
MR-DC	Multi-Radio Dual Connectivity
NE-DC	NR-E-UTRA Dual Connectivity
NGEN-DC	NG-RAN E-UTRA-NR Dual Connectivity
NR	New Radio
NR-DC	NR-NR Dual Connectivity
OFDM	Orthogonal Frequency Division Multiplexing
OFDMA	Orthogonal Frequency Division Multiple Access
OTDOA	Observed Time Difference Of Arrival
PBCH	Physical Broadcast Channel
PCC	Primary Component Carrier
PCell	Primary Cell
PDCCH	Physical Downlink Control Channel
PDSCH	Physical Downlink Shared Channel
PLMN	Public Land Mobile Network
PRACH	Physical RACH
PRP	PRS Received Power
PRS	Positioning Reference Signal
PRS-RSRP	Positioning Reference Signal based Reference Signal Received Power

PSBCH	Physical Sidelink Broadcast Channel
PSBCH-RSRP	Physical Sidelink Broadcast Channel DMRS based Reference Signal Received Power
PSCCH	Physical Sidelink Control Channel
PSCCH-RSRP	Physical Sidelink Control Channel DMRS based Reference Signal Received Power
PSCell	Primary SCell
PSS	Primary Synchronization Signal
PSSCH	Physical Sidelink Shared Channel
PSSCH-RSRP	Physical Sidelink Shared Channel DMRS based Reference Signal Received Power
pTAG	Primary Timing Advance Group
PUCCH	Physical Uplink Control Channel
PUSCH	Physical Uplink Shared Channel
QCL	Quasi Co-Location
RACH	Random Access Channel
RAT	Radio Access Technology
RLM	Radio Link Monitoring
RLM-RS	Reference Signal for RLM
RMSI	Remaining Minimum System Information
RRC	Radio Resource Control
RRM	Radio Resource Management
RSSI	Received Signal Strength Indicator
RSRP	Reference Signal Received Power
RSRQ	Reference Signal Received Quality
RSTD	Reference Signal Time Difference
RTT	Round Trip Time
S-SSB	Sidelink Synchronization Signal Block
S-SSB_RP	Received (linear) average power of the resource elements that carry NR S-SSB signals and channels, measured at the UE antenna connector
SA	Standalone operation mode
SCC	Secondary Component Carrier
SCell	Secondary Cell
SCG	Secondary Cell Group
SCS	Subcarrier Spacing
SCS <sub>SSB</sub>	SSB subcarrier spacing
SDL	Supplementary Downlink
SFN	System Frame Number
SFTD	SFN and Frame Timing DifferenceSI System Information
SIB	System Information Block
SL-RSSI	Sidelink Received Signal Strength Indicator
SLSS	Sidelink Synchronization Signal
SMTC	SSB-based Measurement Timing configuration
SpCell	Special Cell
SRS	Sounding Reference Signal
SRS-RSRP	Sounding Reference Signal based Reference Signal Received Power
SS-RSRP	Synchronization Signal based Reference Signal Received Power
SS-RSRQ	Synchronization Signal based Reference Signal Received Quality
SS-SINR	Synchronization Signal based Signal to Noise and Interference Ratio
SSB	Synchronization Signal Block
SSB_RP	Received (linear) average power of the resource elements that carry NR SSB signals and channels, measured at the UE antenna connector or radiated interface boundary.
SSS	Secondary Synchronization Signal
sTAG	Secondary Timing Advance Group
SUL	Supplementary Uplink
TA	Timing Advance
TAG	Timing Advance Group
TCI	Transmission Configuration Indicator
TDD	Time Division Duplex
TDOA	Time Difference Of Arrival
TRP	Transmission-Reception Point
TTI	Transmission Time Interval
UE	User Equipment
UL	Uplink

## 3.4 Test tolerances

The requirements given in the present document make no allowance for measurement uncertainty. The test specification 38.533 [5] defines the test tolerances.

## 3.5 Frequency bands grouping

### 3.5.1 Introduction

The intention with the frequency band grouping below is to increase the readability of the specification.

The frequency bands grouping is derived based on UE REFSENS requirements specified in [18, 19, 20] and assuming 0.5 dB step between the neighbour groups. The groups are defined in the order of increasing REFSENS, i.e., the group A has the smallest REFSENS among the groups. For the same SCS and a given bandwidth, the bands within the same group have the same  $I_0$  conditions in a corresponding requirement in this specification, provided the bands support this SCS. For different SCSs supported by a frequency band and the same bandwidth, different  $I_0$  conditions may apply for the frequency band in the requirements, while the band group is the same, based on the lowest REFSENS requirement normalized by the number of subcarriers among its supported SCSs for this bandwidth. For the same SCS but different supported bandwidths, the group for a band is determined based on the lowest REFSENS requirement normalized by the number of subcarriers among its supported bandwidths.

### 3.5.2 NR operating bands in FR1

NR frequency bands grouping for FR1 is specified in Table 3.5.2-1.

**Table 3.5.2-1: NR frequency band groups for FR1**

Group	NR FDD		NR TDD		NR SDL		NR CCA <sup>10</sup>	
	Band group notation	Operating bands	Band group notation	Operating bands	Band group notation	Operating bands	Band group notation	Operating bands
A	NR_FDD_FR1_A	n1, n18, n70, n74 <sup>4</sup> , n91, n92, n93, n94	NR_TDD_FR1_A	n34, n38 <sup>9</sup> , n39, n40, n50, n51, n53	NR_SDL_FR1_A	n75, n76	NR_CCA_FR1_A	-
B	NR_FDD_FR1_B	n65, n66, n74 <sup>3</sup>	NR_TDD_FR1_B	n38 <sup>7</sup>	NR_SDL_FR1_B	-	NR_CCA_FR1_B	-
C	NR_FDD_FR1_C	n30	NR_TDD_FR1_C	n48, n77 <sup>1</sup> , n78, n79	NR_SDL_FR1_C	-	NR_CCA_FR1_C	-
D	NR_FDD_FR1_D	n28	NR_TDD_FR1_D	n77 <sup>2</sup>	NR_SDL_FR1_D	-	NR_CCA_FR1_D	-
E	NR_FDD_FR1_E	n2, n5, n7	NR_TDD_FR1_E	n41, n90	NR_SDL_FR1_E	-	NR_CCA_FR1_E	-
F	NR_FDD_FR1_F	n26 <sup>6</sup>	NR_TDD_FR1_F	-	NR_SDL_FR1_F	-	NR_CCA_FR1_F	-
G	NR_FDD_FR1_G	n3, n8, n12, n14, n20, n71	NR_TDD_FR1_G	-	NR_SDL_FR1_G	n29	NR_CCA_FR1_G	-
H	NR_FDD_FR1_H	n25	NR_TDD_FR1_H	-	NR_SDL_FR1_H	-	NR_CCA_FR1_H	-
I	NR_FDD_FR1_I	-	NR_TDD_FR1_I	-	NR_SDL_FR1_I	-	NR_CCA_FR1_I	n46
J	NR_FDD_FR1_J	-	NR_TDD_FR1_J	n47 <sup>8</sup>	NR_SDL_FR1_J	-	NR_CCA_FR1_J	n96

NOTE 1: Except 3.8 GHz to 4.2 GHz.

NOTE 2: Only 3.8 GHz to 4.2 GHz.

NOTE 3: Except 1475.9 MHz to 1510.9 MHz.

NOTE 4: Only when the band is confined in 1475.9 MHz to 1510.9 MHz.

NOTE 5: These bands are used only in NR carrier aggregation with other NR bands according to NR CA band combinations specified in TS 38.101-1 [18] and TS 38.101-3 [20].

NOTE 6: The minimum  $I_0$  condition is reduced by 0.5 dB when the carrier frequency of the assigned NR channel bandwidth is within 865-894 MHz.

NOTE 7: When this band is only used for V2X SL service, the band is exclusively used for NR V2X in particular regions.

NOTE 8: This band is unlicensed band used for V2X service. There is no expected network deployment in this band.

NOTE 9: When this band is only used for WAN service.

NOTE 10: Operating bands where operation on carrier frequencies with CCA is supported.

### 3.5.3 NR operating bands in FR2

NR frequency bands grouping for FR2 is specified in Table 3.5.3-1.

**Table 3.5.3-1: NR frequency band groups for FR2**

Group	Band group notation	Operating bands
A	NR_TDD_FR2_A	n257 <sup>1</sup> , n258 <sup>1</sup> , n261 <sup>1</sup>
B	NR_TDD_FR2_B	n257 <sup>4</sup> , n258 <sup>4</sup> , n261 <sup>4</sup>
C	NR_TDD_FR2_C	
D	NR_TDD_FR2_D	
E	NR_TDD_FR2_E	
F	NR_TDD_FR2_F	n260 <sup>4</sup>
G	NR_TDD_FR2_G	n260 <sup>1</sup>
H	NR_TDD_FR2_H	
I	NR_TDD_FR2_I	
J	NR_TDD_FR2_J	
K	NR_TDD_FR2_K	
L	NR_TDD_FR2_L	n257 <sup>2</sup> , n258 <sup>2</sup> , n261 <sup>2</sup>
M	NR_TDD_FR2_M	
N	NR_TDD_FR2_N	
O	NR_TDD_FR2_O	
P	NR_TDD_FR2_P	
Q	NR_TDD_FR2_Q	
R	NR_TDD_FR2_R	
S	NR_TDD_FR2_S	
T	NR_TDD_FR2_T	n257 <sup>3</sup> , n258 <sup>3</sup> , n261 <sup>3</sup>
U	NR_TDD_FR2_U	
V	NR_TDD_FR2_V	
W	NR_TDD_FR2_W	
X	NR_TDD_FR2_X	
Y	NR_TDD_FR2_Y	n260 <sup>3</sup>
Z	NR_TDD_FR2_Z	
AA	NR_TDD_FR2_AA	n259 <sup>3</sup>
NOTE 1: UE power class 1. NOTE 2: UE power class 2. NOTE 3: UE power class 3. NOTE 4: UE power class 4.		

## 3.6 Applicability of requirements in this specification version

In this specification,

- ‘cell’, ‘PCell’, ‘PSCell’ and ‘SCell’ refer to NR cell, NR PCell, NR PSCell, and NR SCell,
- E-UTRA cells are referred to as ‘E-UTRA cell’, ‘E-UTRA PCell’, ‘E-UTRA PSCell’, and ‘E-UTRA SCell’,
- E-UTRA-NR dual connectivity where E-UTRA is the master is referred to as ‘E-UTRA-NR dual connectivity’ or ‘EN-DC’.
- NR-NR dual connectivity which involves two gNB acting as Master gNB and Secondary gNB is referred to as “NR-NR dual connectivity” or “NR-DC”. NR-DC in Rel-15 only includes the scenarios where all serving cells in MCG in FR1 and all serving cells in SCG in FR2.
- ‘active serving cell’ refers to PCell, PSCell and activated SCells

For UE configured with supplementary UL, the requirements in clause 7.1 and 7.3 shall also apply to uplink transmissions on supplementary UL.

Unless explicitly stated, requirements do not apply when CCA is used on serving or neighbour cells.

### 3.6.1 RRC connected state requirements in DRX

For the requirements in RRC connected state specified in this version of the specification, the UE shall assume that no DRX is used provided the following conditions are met:

- DRX parameters are not configured or
- DRX parameters are configured and
  - *drx-InactivityTimer* is running or
  - *drx-RetransmissionTimerDL* is running or
  - *drx-RetransmissionTimerUL* is running or
  - *ra-ContentionResolutionTimer* is running or
- a Scheduling Request sent on PUCCH is pending or
  - a PDCCH indicating a new transmission addressed to the C-RNTI of the MAC entity has not been received after successful reception of a Random Access Response for the preamble not selected by the MAC entity

Otherwise the UE shall assume that DRX is used.

### 3.6.2 Number of serving carriers

#### 3.6.2.1 Number of serving carriers for SA

Requirements for standalone NR with NR PCell are applicable for the UE configured with the following number of serving NR CCs:

- up to 10 NR DL CCs in total, with 1 UL (or 2 UL if SUL is configured) in PCell and up to 8 UL (or 9 UL if SUL is configured) in total for SCells.
- SUL may be configured together with one of the UL

#### 3.6.2.2 Number of serving carriers for EN-DC

Requirements for EN-DC operation of E-UTRA and NR with E-UTRA PCell and NR PSCell are applicable for the UE configured with the following number of serving NR CCs:

- up to 9 NR DL CCs in total, with 1 UL (or 2 UL if SUL is configured) in PSCell, up to 7 UL (or 8 UL if SUL is configured) in total for SCells in the FR of PSCell and up to 1 UL (or 2 UL if SUL is configured) in SCell in different FR with PSCell.
- SUL may be configured together with one of the UL

The applicable number of E-UTRA CC for EN-DC in the MCG for both UL and DL is specified in TS 36.133 [15].

#### 3.6.2.3 Number of serving carriers for NE-DC

Requirements for NE-DC operation of NR and E-UTRA with NR PCell and E-UTRA PSCell are applicable for the UE configured with the following number of serving NR CCs:

- up to 7 NR DL CCs in total, with 1 UL (or 2 UL if SUL is configured) in PCell and up to 1 UL (or 2 UL if SUL is configured) in SCell.
- SUL may be configured together with one of the UL

The applicable number of E-UTRA CC for NE-DC in the SCG for both UL and DL is specified in TS 36.133 [15].



### 3.6.2.4 Number of serving carriers for NR-DC

Requirements for NR-DC are applicable for the UE configured with the following number of serving NR CCs:

- up to 2 NR DL CCs in total in FR1, up to 8 NR DL CCs in total in FR2, with 1 UL in PCell, 1 UL in PSCell, and up to 1 UL in each SCell.

### 3.6.3 Applicability for intra-band FR2

For the requirements in RRC connected state specified in this version of the specification, UE shall assume that the transmitted signals from the serving cells should have the same downlink spatial domain transmission filter on one OFDM symbol in the same band in FR2. Otherwise, the UE is not supposed to satisfy any requirements for SCell.

### 3.6.4 Applicability for FR2 UE power classes

For the requirements of each FR2 power class specified in this version of the specification, certain UE types with specific device architectures are assumed. The UE types can be found in TS 38.101-2 [19].

### 3.6.5 Applicability for SDL bands

The measurements accuracy requirements for SDL bands in this version of specification in clause 10.1 shall apply for NR intra-frequency measurements on SCC (SS-RSRP, SS-RSRQ, SS-SINR, and L1-RSRP) and inter-frequency measurements (SS-RSRP, SS-RSRQ, and SS-SINR).

### 3.6.6 Applicability of requirements for NGEN-DC operation

All the requirements in this specification applicable for EN-DC are also applicable for NGEN-DC.

### 3.6.7 Applicability of QCL

For the requirements specified in this version of the specification, a reference signal is considered to be QCLed to another reference signal if it is in the same TCI chain as the other reference signal, provided that the number of Reference Signals in the chain is no more than 4. It is assumed there is single QCL type per TCI chain.

A TCI chain consists of an SSB, and one or more CSI-RS resources, and the TCI state of each Reference Signal includes another Reference Signal in the same TCI chain.

DMRS of PDCCH or PDSCH is QCLed with the reference signal in its active TCI state and any other reference signal that is QCLed, based on above criteria, with the reference signal in the active TCI state.

### 3.6.8 Applicability of 2-step RA and 4-step RA in RRM requirements

Unless explicitly stated otherwise the requirements under the following clauses, where the UE transmits random access (with requirements in clause 6.2.2) to NR serving cell or NR target cell, are applicable for both 2-step RA and 4-step RA procedures [3]:

- Handover requirements in clause 6.1, except for clauses 6.1.2 and 6.1B,
- RRC connection re-establishment requirements in clause 6.2.1,
- RRC connection release with redirection to NR requirements in clause 6.2.3.2.1,
- UE transmit timing requirements in clause 7.1,
- PSCell addition delay requirements in clause 8.9.2,
- PSCell change requirements in clause 8.11 and
- Conditional PSCell change requirements in clause 8.11B.

Unless explicitly stated otherwise the requirements under the following clauses, where the UE transmits random access (with requirements in clause 6.2.2A) to NR serving cell or NR target cell subject to uplink CCA, are applicable for both 2-step RA and 4-step RA procedures [3]:

- Handover requirements with CCA in clause 6.1B,
- RRC connection re-establishment requirements with CCA in clause 6.2.1A,
- RRC connection release with redirection to NR requirements with CCA in clause 6.2.3.2.3, and
- UE transmit timing requirements with CCA in clause 7.1.

### 3.6.9 Applicability of requirements for scheduling availability

The scheduling availability requirements in clause 8.1.7.3, 8.5.7.3, 8.5.8.3, 9.5.6.3 and 9.10.2.6.2 assumes that:

- The UE is not configured with simultaneous UL/DL between two FR2 bands if the UE does not have the capability of supporting *simultaneousRxTxInterBandCA*, and
- The UE is not configured with mixed numerology on two FR2 CCs if the UE does not have the capability of supporting simultaneous reception with two different numerologies between FR2 CCs in DL.

The scheduling availability requirements in clause 8.1.7.1, 8.1.7.2, 8.5.7.1, 8.5.7.2, 8.5.8.1, 8.5.8.2, 9.5.6.1, 9.5.6.2, 9.8.6.1, and 9.8.6.2 assumes that the UE is not configured with simultaneous UL/DL between two FR1 bands if the UE does not have the capability of supporting *simultaneousRxTxInterBandCA*.

The scheduling availability requirements in clause 8.1.7.4, 8.5.7.4, 8.5.8.4, 9.5.6.4 and 9.8.6.4 assumes that the UE is not configured with simultaneous UL/DL between FR1 and FR2 bands if the UE does not have the capability of supporting *simultaneousRxTxInterBandCA* on this band combination.

### 3.6.10 Applicability of requirements for measurement restrictions

The requirements for measurement restrictions in clause 8.1.2.3, 8.1.3.3, 8.5.2.3, 8.5.3.3, 8.5.5.3, 8.5.6.3, 9.5.5 and 9.8.5 are not applicable if the following condition is met:

- The network configures mixed numerology on two CCs if the UE does not have the capability of supporting simultaneous reception with different numerologies between the two CCs in DL.

---

## 4 SA: RRC\_IDLE state mobility

### 4.1 Cell Selection

After a UE has switched on and a PLMN has been selected, the Cell selection process takes place, as described in TS 38.304 [1]. This process allows the UE to select a suitable cell where to camp on in order to access available services. In this process, the UE can use stored information (*Stored information cell selection*) or not (*Initial cell selection*).

### 4.2 Cell Re-selection

#### 4.2.1 Introduction

The cell reselection procedure allows the UE to select a more suitable cell and camp on it.

When the UE is in either *Camped Normally* state or *Camped on Any Cell* state on a cell, the UE shall attempt to detect, synchronise, and monitor intra-frequency, inter-frequency and inter-RAT cells indicated by the serving cell. For intra-frequency and inter-frequency cells the serving cell may not provide explicit neighbour list but carrier frequency information and bandwidth information only. UE measurement activity is also controlled by measurement rules defined in TS 38.304 [1], allowing the UE to limit its measurement activity

In the requirements of clause 4.2, the exceptions for side conditions apply as follows:

- for the UE capable of CA, the applicable exceptions for side conditions are specified in Annex B, clause B.3.2.1, B.3.2.3, or B.3.2.5 for UE supporting CA in FR1, CA in FR2 and CA between FR1 and FR2, respectively;
- for the UE capable of SUL, the applicable exceptions for side conditions are specified in Annex B, clause B.3.4.1 for UE supporting SUL in FR1.

## 4.2.2 Requirements

### 4.2.2.1 UE measurement capability

For idle mode cell re-selection purposes, and for UE supporting *idleInactiveNR-MeasReport-r16* or *idleInactiveEUTRA-MeasReport-r16*, for NR CA and MR-DC measurement purpose, the UE shall be capable of monitoring at least:

- Intra-frequency carrier, and
- Depending on UE capability, 7 NR inter-frequency carriers, and
- Depending on UE capability, 7 FDD E-UTRA inter-RAT carriers, and
- Depending on UE capability, 7 TDD E-UTRA inter-RAT carriers.

In addition to the requirements defined above, a UE supporting E-UTRA measurements in RRC\_IDLE state shall be capable of monitoring a total of at least 14 carrier frequency layers, which includes serving layer, comprising of any above defined combination of E-UTRA FDD, E-UTRA TDD and NR layers.

### 4.2.2.2 Measurement and evaluation of serving cell

The UE shall measure the SS-RSRP and SS-RSRQ level of the serving cell and evaluate the cell selection criterion S defined in TS 38.304 [1] for the serving cell at least once every  $M1 \cdot N1$  DRX cycle; where:

$M1=2$  if SMTC periodicity ( $T_{SMTC}$ ) > 20 ms and DRX cycle  $\leq$  0.64 second,

otherwise  $M1=1$ .

The UE shall filter the SS-RSRP and SS-RSRQ measurements of the serving cell using at least 2 measurements. Within the set of measurements used for the filtering, at least two measurements shall be spaced by, at least DRX cycle/2.

If the UE has evaluated according to Table 4.2.2.2-1 in  $N_{serv}$  consecutive DRX cycles that the serving cell does not fulfil the cell selection criterion S, the UE shall initiate the measurements of all neighbour cells indicated by the serving cell, regardless of the measurement rules currently limiting UE measurement activities.

If the UE in RRC\_IDLE has not found any new suitable cell based on searches and measurements using the intra-frequency, inter-frequency and inter-RAT information indicated in the system information for 10 s, the UE shall initiate cell selection procedures for the selected PLMN as defined in TS 38.304 [1].

**Table 4.2.2.2-1:  $N_{serv}$**

DRX cycle length [s]	Scaling Factor ( $N1$ )		$N_{serv}$ [number of DRX cycles]
	FR1	FR2 <sup>Note1</sup>	
0.32	1	8	$M1 \cdot N1 \cdot 4$
0.64		5	$M1 \cdot N1 \cdot 4$
1.28		4	$N1 \cdot 2$
2.56		3	$N1 \cdot 2$
Note 1: Applies for UE supporting power class 2&3&4. For UE supporting power class 1, $N1 = 8$ for all DRX cycle length.			

### 4.2.2.3 Measurements of intra-frequency NR cells

The UE shall be able to identify new intra-frequency cells and perform SS-RSRP and SS-RSRQ measurements of the identified intra-frequency cells without an explicit intra-frequency neighbour list containing physical layer cell identities.

The UE shall be able to evaluate whether a newly detectable intra-frequency cell meets the reselection criteria defined in TS38.304 [1] within  $T_{\text{detect,NR\_Intra}}$  when that  $T_{\text{reselection}} = 0$ . An intra frequency cell is considered to be detectable according to the conditions defined in Annex B.1.2 for a corresponding Band.

The UE shall measure SS-RSRP and SS-RSRQ at least every  $T_{\text{measure,NR\_Intra}}$  (see table 4.2.2.3-1 or table 4.2.2.3-2) for intra-frequency cells that are identified and measured according to the measurement rules.

The UE shall filter SS-RSRP and SS-RSRQ measurements of each measured intra-frequency cell using at least 2 measurements. Within the set of measurements used for the filtering, at least two measurements shall be spaced by at least  $T_{\text{measure,NR\_Intra}}/2$ .

The UE shall not consider a NR neighbour cell in cell reselection, if it is indicated as not allowed in the measurement control system information of the serving cell.

For an intra-frequency cell that has been already detected, but that has not been reselected to, the filtering shall be such that the UE shall be capable of evaluating that the intra-frequency cell has met reselection criterion defined in TS38.304 [1] within  $T_{\text{evaluate,NR\_Intra}}$  when  $T_{\text{reselection}} = 0$  as specified in table 4.2.2.3-1 or table 4.2.2.3-2 provided that:

when *rangeToBestCell* is not configured:

- the cell is at least 3dB better ranked in FR1 or 4.5dB better ranked in FR2.

when *rangeToBestCell* is configured:

- the cell has the highest number of beams above the threshold *absThreshSS-BlocksConsolidation* among all detected cells whose cell-ranking criterion R value in TS38.304 [1] is within *rangeToBestCell* of the cell-ranking criterion R value of the highest ranked cell.
- if there are multiple such cells, the cell has the highest rank among them.
  - the cell is at least 3dB better ranked in FR1 or 4.5dB better ranked in FR2 if the current serving cell is among them.

When evaluating cells for reselection, the SSB side conditions apply to both serving and non-serving intra-frequency cells.

If  $T_{\text{reselection}}$  timer has a non zero value and the intra-frequency cell is satisfied with the reselection criteria which are defined in TS38.304 [1], the UE shall evaluate this intra-frequency cell for the  $T_{\text{reselection}}$  time. If this cell remains satisfied with the reselection criteria within this duration, then the UE shall reselect that cell.

For UE not configured with *highSpeedMeasFlag-r16*,  $T_{\text{detect,NR\_Intra}}$ ,  $T_{\text{measure,NR\_Intra}}$  and  $T_{\text{evaluate,NR\_Intra}}$  are specified in Table 4.2.2.3-1. For UE configured with *highSpeedMeasFlag-r16*,  $T_{\text{detect,NR\_Intra}}$ ,  $T_{\text{measure,NR\_Intra}}$  and  $T_{\text{evaluate,NR\_Intra}}$  are specified in Table 4.2.2.3-2.

For a UE configured with *highSpeedMeasFlag-r16*, and configured with relaxed measurement criterion (*lowMobilityEvaluation* or both *lowMobilityEvaluation* and *cellEdgeEvaluation*), it is up to UE implementation whether to apply the relaxed measurements requirements specified in clause 4.2.2.9.2 or high speed requirements specified in this clause provided that the relaxed measurement criteria in section 4.2.2.9.2 are fulfilled.

The requirements in Table 4.2.2.3-2 apply only when the UE supports *measurementEnhancement-r16* or *intraNR-MeasurementEnhancement-r16*. For UE not supporting either *measurementEnhancement-r16* or *intraNR-MeasurementEnhancement-r16*, the UE is not required to meet the requirements specified in Table 4.2.2.3-2.

**Table 4.2.2.3-1:  $T_{\text{detect,NR\_Intra}}$ ,  $T_{\text{measure,NR\_Intra}}$  and  $T_{\text{evaluate,NR\_Intra}}$**

DRX cycle length [s]	Scaling Factor (N1)		$T_{\text{detect,NR\_Intra}}$ [s] (number of DRX cycles)	$T_{\text{measure,NR\_Intra}}$ [s] (number of DRX cycles)	$T_{\text{evaluate,NR\_Intra}}$ [s] (number of DRX cycles)
	FR1	FR2 <sup>Note1</sup>			

0.32	1	8	$11.52 \times N1 \times M2$ (36 x N1 x M2)	$1.28 \times N1 \times M2$ (4 x N1 x M2)	$5.12 \times N1 \times M2$ (16 x N1 x M2)
0.64		5	$17.92 \times N1$ (28 x N1)	$1.28 \times N1$ (2 x N1)	$5.12 \times N1$ (8 x N1)
1.28		4	$32 \times N1$ (25 x N1)	$1.28 \times N1$ (1 x N1)	$6.4 \times N1$ (5 x N1)
2.56		3	$58.88 \times N1$ (23 x N1)	$2.56 \times N1$ (1 x N1)	$7.68 \times N1$ (3 x N1)
Note 1:	Applies for UE supporting power class 2&3&4. For UE supporting power class 1, N1 = 8 for all DRX cycle length.				
Note 2:	M2 = 1.5 if SMTC periodicity of measured intra-frequency cell > 20 ms; otherwise M2=1. If different SMTC periodicities are configured for different cells, the SMTC periodicity in this note is the one used by the cell being identified. During PSS/SSS detection, the periodicity of the SMTC configured for the intra-frequency carrier is assumed, and if the actual SSB transmission periodicity is greater than the SMTC configured for the intra-frequency carrier, longer $T_{\text{detect, NR\_intra}}$ is expected.				

**Table 4.2.2.3-2:  $T_{\text{detect, NR\_Intra}}$ ,  $T_{\text{measure, NR\_Intra}}$  and  $T_{\text{evaluate, NR\_Intra}}$  for UE configured with *highSpeedMeasFlag-r16* (Frequency range FR1)**

DRX cycle length [s]	$T_{\text{detect, NR\_Intra}}$ [s] (number of DRX cycles)	$T_{\text{measure, NR\_Intra}}$ [s] (number of DRX cycles)	$T_{\text{evaluate, NR\_Intra}}$ [s] (number of DRX cycles)
0.32	$2.56 \times M2$ (8 x M2)	$0.32 \times M3$ (1 x M3)	$0.96 \times M4$ (3 x M4)
0.64	5.12 (8)	0.64 (1)	1.92 (3)
1.28	8.96 (7)	1.28 (1)	3.84 (3)
2.56	58.88 (23)	2.56 (1)	7.68 (3)
Note 1:	when SMTC <= 40 ms, M2 = M3 = M4 = 1; and when SMTC > 40 ms, M2 = 1.5, M3 = M4 = 2		
Note 2:	When <i>highSpeedMeasFlag-r16</i> is configured, the requirements apply only to UE supporting either <i>measurementEnhancement-r16</i> or <i>intraNR-MeasurementEnhancement-r16</i> .		

#### 4.2.2.4 Measurements of inter-frequency NR cells

The UE shall be able to identify new inter-frequency cells and perform SS-RSRP or SS-RSRQ measurements of identified inter-frequency cells if carrier frequency information is provided by the serving cell, even if no explicit neighbour list with physical layer cell identities is provided.

If  $S_{\text{rxlev}} > S_{\text{nonIntraSearchP}}$  and  $S_{\text{qual}} > S_{\text{nonIntraSearchQ}}$  then the UE shall search for inter-frequency layers of higher priority at least every  $T_{\text{higher\_priority\_search}}$  where  $T_{\text{higher\_priority\_search}}$  is described in clause 4.2.2.7.

If  $S_{\text{rxlev}} \leq S_{\text{nonIntraSearchP}}$  or  $S_{\text{qual}} \leq S_{\text{nonIntraSearchQ}}$  then the UE shall search for and measure inter-frequency layers of higher, equal or lower priority in preparation for possible reselection. In this scenario, the minimum rate at which the UE is required to search for and measure higher priority layers shall be the same as that defined below in this clause.

The UE shall be able to evaluate whether a newly detectable inter-frequency cell meets the reselection criteria defined in TS38.304 [1] within  $K_{\text{carrier}} * T_{\text{detect, NR\_Inter}}$  if at least carrier frequency information is provided for inter-frequency neighbour cells by the serving cells when  $T_{\text{reselection}} = 0$  provided that the reselection criteria is met by a margin of at least 5 dB in FR1 or 6.5dB in FR2 for reselections based on ranking or 6dB in FR1 or 7.5dB in FR2 for SS-RSRP reselections based on absolute priorities or 4dB in FR1 and 4dB in FR2 for SS-RSRQ reselections based on absolute priorities.

The parameter  $K_{\text{carrier}}$  is the number of NR inter-frequency carriers indicated by the serving cell. The parameter  $K_{\text{carrier}}$  for a UE configured with idle mode CA measurements (while T331 is running), is the combined number of NR inter-frequency carriers indicated by the serving cell and the number of NR inter-frequency carriers configured for idle mode CA measurements.

Note: combined total number means that if a carrier is an inter-frequency carrier indicated by the serving cell for mobility and additionally a carrier configured for idle mode CA measurements, it only counts as one carrier.

An inter-frequency cell is considered to be detectable according to the conditions defined in Annex B.1.3 for a corresponding Band.

When higher priority cells are found by the higher priority search, they shall be measured at least every  $T_{\text{measure, NR\_Inter}}$ . If, after detecting a cell in a higher priority search, it is determined that reselection has not occurred then the UE is not

required to continuously measure the detected cell to evaluate the ongoing possibility of reselection. However, the minimum measurement filtering requirements specified later in this clause shall still be met by the UE before it makes any determination that it may stop measuring the cell. If the UE detects on a NR carrier a cell whose physical identity is indicated as not allowed for that carrier in the measurement control system information of the serving cell, the UE is not required to perform measurements on that cell.

The UE shall measure SS-RSRP or SS-RSRQ at least every  $K_{\text{carrier}} * T_{\text{measure,NR\_Inter}}$  (see table 4.2.2.4-1) for identified lower or equal priority inter-frequency cells. If the UE detects on a NR carrier a cell whose physical identity is indicated as not allowed for that carrier in the measurement control system information of the serving cell, the UE is not required to perform measurements on that cell.

The UE shall filter SS-RSRP or SS-RSRQ measurements of each measured higher, lower and equal priority inter-frequency cell using at least 2 measurements. Within the set of measurements used for the filtering, at least two measurements shall be spaced by at least  $T_{\text{measure,NR\_Inter}}/2$ .

The UE shall not consider a NR neighbour cell in cell reselection, if it is indicated as not allowed in the measurement control system information of the serving cell.

For an inter-frequency cell that has been already detected, but that has not been reselected to, the filtering shall be such that the UE shall be capable of evaluating that the inter-frequency cell has met reselection criterion defined TS 38.304 [1] within  $K_{\text{carrier}} * T_{\text{evaluate,NR\_Inter}}$  when  $T_{\text{reselection}} = 0$  as specified in table 4.2.2.4-1 provided that the reselection criteria is met by

- the condition when performing equal priority reselection and when *rangeToBestCell* is not configured:
  - the cell is at least 5dB better ranked in FR1 or 6.5dB better ranked in FR2 or.
- when *rangeToBestCell* is configured:
  - the cell has the highest number of beams above the threshold *absThreshSS-BlocksConsolidation* among all detected cells whose cell-ranking criterion R value in TS38.304 [1] is within *rangeToBestCell* of the cell-ranking criterion R value of the highest ranked cell.
    - if there are multiple such cells, the cell has the highest rank among them
    - the cell is at least 5dB better ranked in FR1 or 6.5dB better ranked in FR2 if the current serving cell is among them. or
  - 6dB in FR1 or 7.5dB in FR2 for SS-RSRP reselections based on absolute priorities or
  - 4dB in FR1 or 4dB in FR2 for SS-RSRQ reselections based on absolute priorities.

When evaluating cells for reselection, the SSB side conditions apply to both serving and inter-frequency cells.

If  $T_{\text{reselection}}$  timer has a non zero value and the inter-frequency cell is satisfied with the reselection criteria, the UE shall evaluate this inter-frequency cell for the  $T_{\text{reselection}}$  time. If this cell remains satisfied with the reselection criteria within this duration, then the UE shall reselect that cell.

The UE is not expected to meet the measurement requirements for an inter-frequency carrier under DRX cycle=320 ms defined in Table 4.2.2.4-1 under the following conditions:

- $T_{\text{SMTC\_intra}} = T_{\text{SMTC\_inter}} = 160$  ms; where
  - $T_{\text{SMTC\_intra}}$  is the periodicity of the SMTC configured for the intra-frequency carrier if no identified intra-frequency cell is in the PCI list of *smtc2-LP* on this intra-frequency carrier;  $T_{\text{SMTC\_intra}}$  is the periodicity of the *smtc2-LP* configured for the intra-frequency carrier if at least one identified intra-frequency cell is in the PCI list of *smtc2-LP* on this intra-frequency carrier. During PSS/SSS detection, the periodicity of the SMTC configured for the intra-frequency carrier is assumed for  $T_{\text{SMTC\_intra}}$ . If the actual SSB transmission periodicity is greater than the SMTC configured for the intra-frequency carrier, longer  $T_{\text{detect, NR\_intra}}$  is expected.
  - $T_{\text{SMTC\_inter}}$  is the actual SMTC periodicity used by the inter-frequency cell being identified. During PSS/SSS detection, the periodicity of the SMTC configured for the inter-frequency carrier is assumed for  $T_{\text{SMTC\_inter}}$ . If the actual SSB transmission periodicity is greater than the SMTC configured for the inter-frequency carrier, longer  $T_{\text{detect, NR\_inter}}$  is expected.

- SMTC occasions configured for the inter-frequency carrier occur up to 1 ms before the start or up to 1 ms after the end of the SMTC occasions configured for the intra-frequency carrier, and
- SMTC occasions configured for the intra-frequency carrier and for the inter-frequency carrier occur up to 1 ms before the start or up to 1 ms after the end of the paging occasion in TS38.304 [1].

**Table 4.2.2.4-1:  $T_{\text{detect,NR\_Inter}}$ ,  $T_{\text{measure,NR\_Inter}}$  and  $T_{\text{evaluate,NR\_Inter}}$** 

DRX cycle length [s]	Scaling Factor (N1)		$T_{\text{detect,NR\_Inter}}$ [s] (number of DRX cycles)	$T_{\text{measure,NR\_Inter}}$ [s] (number of DRX cycles)	$T_{\text{evaluate,NR\_Inter}}$ [s] (number of DRX cycles)
	FR1	FR2 <sup>Note1</sup>			
0.32	1	8	$11.52 \times N1 \times 1.5$ (36 x N1 x 1.5)	$1.28 \times N1 \times 1.5$ (4 x N1 x 1.5)	$5.12 \times N1 \times 1.5$ (16 x N1 x 1.5)
0.64		5	$17.92 \times N1$ (28 x N1)	$1.28 \times N1$ (2 x N1)	$5.12 \times N1$ (8 x N1)
1.28		4	$32 \times N1$ (25 x N1)	$1.28 \times N1$ (1 x N1)	$6.4 \times N1$ (5 x N1)
2.56		3	$58.88 \times N1$ (23 x N1)	$2.56 \times N1$ (1 x N1)	$7.68 \times N1$ (3 x N1)
Note 1: Applies for UE supporting power class 2&3&4. For UE supporting power class 1, N1 = 8 for all DRX cycle length.					

#### 4.2.2.5 Measurements of inter-RAT E-UTRAN cells

If  $S_{\text{rxlev}} > S_{\text{nonIntraSearchP}}$  and  $S_{\text{qual}} > S_{\text{nonIntraSearchQ}}$  then the UE shall search for inter-RAT E-UTRAN layers of higher priority at least every  $T_{\text{higher\_priority\_search}}$  where  $T_{\text{higher\_priority\_search}}$  is described in clause 4.2.2.

If  $S_{\text{rxlev}} \leq S_{\text{nonIntraSearchP}}$  or  $S_{\text{qual}} \leq S_{\text{nonIntraSearchQ}}$  then the UE shall search for and measure inter-RAT E-UTRAN layers of higher, lower priority in preparation for possible reselection. In this scenario, the minimum rate at which the UE is required to search for and measure higher priority inter-RAT E-UTRAN layers shall be the same as that defined below for lower priority RATs.

The requirements in this clause apply for inter-RAT E-UTRAN FDD measurements and E-UTRA TDD measurements. When the measurement rules indicate that inter-RAT E-UTRAN cells are to be measured, the UE shall measure RSRP and RSRQ of detected E-UTRA cells in the neighbour frequency list at the minimum measurement rate specified in this clause.

The parameter  $N_{\text{EUTRA\_carrier}}$  is the total number of configured E-UTRA carriers indicated to meet non high speed requirements in the neighbour frequency list. The parameter  $N_{\text{EUTRA\_carrier\_HST}}$  is the total number of configured E-UTRA carriers indicated to meet high speed requirements in the neighbour frequency list. If  $S_{\text{rxlev}} \leq S_{\text{nonIntraSearchP}}$  or  $S_{\text{qual}} \leq S_{\text{nonIntraSearchQ}}$ , an inter-RAT E-UTRAN layer is indicated to meet high speed requirements if  $\text{highSpeedMeasFlag-r16}$  is configured and the carrier to be measured is configured with  $\text{highSpeedEUTRACarrier-r16}$  and UE supports the enhanced inter-RAT E-UTRAN measurement requirements. If  $S_{\text{rxlev}} > S_{\text{nonIntraSearchP}}$  and  $S_{\text{qual}} > S_{\text{nonIntraSearchQ}}$ , UE is required to meet non high speed requirements no matter whether  $\text{highSpeedMeasFlag-r16}$  or  $\text{highSpeedEUTRACarrier-r16}$  is configured or not.

For a UE configured with  $\text{highSpeedMeasFlag-r16}$ , and configured with relaxed measurement criterion ( $\text{lowMobilityEvaluation}$  or both  $\text{lowMobilityEvaluation}$  and  $\text{cellEdgeEvaluation}$ ), it is up to UE implementation whether to apply the relaxed measurements requirements specified in clause 4.2.2.11.2 or high speed requirements specified in this clause provided that the relaxed measurement criteria in section 4.2.2.11.2 are fulfilled.

The parameter  $N_{\text{EUTRA\_carrier}}$  for a UE configured with idle mode DC measurements (while T331 is running), is the combined number of configured E-UTRA carriers in the neighbour frequency list and E-UTRA carriers configured for idle mode DC measurements, excluding the configured E-UTRA carriers indicated to meet high speed requirements in the neighbour frequency list.

Note: combined total number means that if a carrier is an E-UTRA carrier indicated by the serving cell for mobility and additionally a carrier configured for idle mode CA measurements, it only counts as one carrier.

The UE shall filter RSRP and RSRQ measurements of each measured E-UTRA cell using at least 2 measurements. Within the set of measurements used for the filtering, at least two measurements shall be spaced by at least half the minimum specified measurement period.

An inter-RAT E-UTRA cell is considered to be detectable provided the following conditions are fulfilled:

- the same conditions as for inter-frequency RSRP measurements specified in TS 36.133 [15, Annex B.1.2] are fulfilled for a corresponding Band, and
- the same conditions as for inter-frequency RSRQ measurements specified in TS 36.133 [15, Annex B.1.2] are fulfilled for a corresponding Band.
- SCH conditions specified in TS 36.133 [15, Annex B.1.2] are fulfilled for a corresponding Band

The UE shall be able to evaluate whether a newly detectable inter-RAT E-UTRAN cell meets the reselection criteria defined in TS38.304 [1] within  $N_{\text{EUTRA\_carrier\_HST}} * T_{\text{detect,EUTRAN\_HST}} + N_{\text{EUTRA\_carrier}} * T_{\text{detect,EUTRAN}}$  when  $S_{\text{rxlev}} \leq S_{\text{nonIntraSearchP}}$  or  $S_{\text{qual}} \leq S_{\text{nonIntraSearchQ}}$  when  $T_{\text{reselction}} = 0$  provided that the reselection criteria is met by a margin of at least 6dB for RSRP reselections based on absolute priorities or 4dB for RSRQ reselections based on absolute priorities.

Cells which have been detected shall be measured at least every  $N_{\text{EUTRA\_carrier\_HST}} * T_{\text{measure,EUTRAN\_HST}} + N_{\text{EUTRA\_carrier}} * T_{\text{measure,EUTRAN}}$  when  $S_{\text{rxlev}} \leq S_{\text{nonIntraSearchP}}$  or  $S_{\text{qual}} \leq S_{\text{nonIntraSearchQ}}$ .

When higher priority cells are found by the higher priority search, they shall be measured at least every  $T_{\text{measure,EUTRAN}}$ . If, after detecting a cell in a higher priority search, it is determined that reselection has not occurred then the UE is not required to continuously measure the detected cell to evaluate the ongoing possibility of reselection. However, the minimum measurement filtering requirements specified later in this clause shall still be met by the UE before it makes any determination that it may stop measuring the cell.

If the UE detects on an inter-RAT E-UTRAN carrier a cell whose physical identity is indicated as not allowed for that carrier in the measurement control system information of the serving cell, the UE is not required to perform measurements on that cell.

The UE shall not consider an inter-RAT E-UTRA cell in cell reselection, if it is indicated as not allowed in the measurement control system information of the serving cell.

For a cell that has been already detected, but that has not been reselected to, the filtering shall be such that the UE shall be capable of evaluating that an already identified inter-RAT E-UTRA cell has met reselection criterion defined in TS 38.304 [1] within  $N_{\text{EUTRA\_carrier\_HST}} * T_{\text{evaluate,EUTRAN\_HST}} + N_{\text{EUTRA\_carrier}} * T_{\text{evaluate,EUTRAN}}$  when  $T_{\text{reselction}} = 0$  as specified in table 4.2.2.5-1 and 4.2.2.5-2 provided that the reselection criteria is met by a margin of at least 6dB for RSRP reselections based on absolute priorities or 4dB for RSRQ reselections based on absolute priorities.

If  $T_{\text{reselction}}$  timer has a non zero value and the inter-RAT E-UTRA cell is satisfied with the reselection criteria which are defined in TS 38.304 [1], the UE shall evaluate this E-UTRA cell for the  $T_{\text{reselction}}$  time. If this cell remains satisfied with the reselection criteria within this duration, then the UE shall reselect that cell.

**Table 4.2.2.5-1:  $T_{\text{detect,EUTRAN}}$ ,  $T_{\text{measure,EUTRAN}}$ , and  $T_{\text{evaluate,EUTRAN}}$**

DRX cycle length [s]	$T_{\text{detect,EUTRAN}}$ [s] (number of DRX cycles)	$T_{\text{measure,EUTRAN}}$ [s] (number of DRX cycles)	$T_{\text{evaluate,EUTRAN}}$ [s] (number of DRX cycles)
0.32	11.52 (36)	1.28 (4)	5.12 (16)
0.64	17.92 (28)	1.28 (2)	5.12 (8)
1.28	32(25)	1.28 (1)	6.4 (5)
2.56	58.88 (23)	2.56 (1)	7.68 (3)

**Table 4.2.2.5-2:  $T_{\text{detect,EUTRAN\_HST}}$ ,  $T_{\text{measure,EUTRAN\_HST}}$ , and  $T_{\text{evaluate,EUTRAN\_HST}}$  for UE configured with highSpeedMeasFlag-r16**

DRX cycle length [s]	$T_{\text{detect,EUTRAN\_HST}}$ [s] (number of DRX cycles)	$T_{\text{measure,EUTRAN\_HST}}$ [s] (number of DRX cycles)	$T_{\text{evaluate,EUTRAN\_HST}}$ [s] (number of DRX cycles)
0.32	4.16 (13)	0.64 (2)	0.96 (3)
0.64	7.68 (12)	1.28 (2)	1.92 (3)
1.28	8.96 (7)	1.28 (1)	3.84 (3)
2.56	58.88 (23)	2.56 (1)	7.68 (3)
Note 1: When highSpeedMeasFlag-r16 is configured, the requirements apply only to UE supporting either <i>measurementEnhancement-r16</i> or [ <i>interRAT-MeasurementEnhancement-r16</i> ].			



The requirements in Table 4.2.2.5-2 apply only when the UE supports *measurementEnhancement-r16* or *interRAT-MeasurementEnhancement-r16*. For UE not supporting either *measurementEnhancement-r16* or *interRAT-MeasurementEnhancement-r16*, the UE is not required to meet the requirements specified in Table 4.2.2.5-2.

#### 4.2.2.6 Maximum interruption in paging reception

UE shall perform the cell re-selection with minimum interruption in monitoring downlink channels for paging reception.

At intra-frequency and inter-frequency cell re-selection, the UE shall monitor the downlink of serving cell for paging reception until the UE is capable to start monitoring downlink channels of the target intra-frequency and inter-frequency cell for paging reception. The interruption time shall not exceed  $T_{SI-NR} + 2 * T_{target\_cell\_SMTC\_period}$  ms.  $T_{target\_cell\_SMTC\_period}$  is the periodicity of the SMTC occasions configured for the target NR cell. If the target cell is in the PCI list of *smtc2-LP*, the SMTC periodicity follows *smtc2-LP*; otherwise, the SMTC periodicity follows *smtc*.

At inter-RAT cell re-selection, the UE shall monitor the downlink of serving cell for paging reception until the UE is capable to start monitoring downlink channels for paging reception of the target inter-RAT cell. For NR to E-UTRAN cell re-selection the interruption time must not exceed  $T_{SI-EUTRA} + 55$  ms.

$T_{SI-NR}$  is the time required for receiving all the relevant system information data according to the reception procedure and the RRC procedure delay of system information blocks defined in TS 38.331 [2] for an NR cell.

$T_{SI-EUTRA}$  is the time required for receiving all the relevant system information data according to the reception procedure and the RRC procedure delay of system information blocks defined in TS 36.331 [16] for an E-UTRAN cell.

These requirements assume sufficient radio conditions, so that decoding of system information can be made without errors and does not take into account cell re-selection failure.

#### 4.2.2.7 General requirements

The UE shall search every layer of higher priority at least every  $T_{higher\_priority\_search} = (60 * N_{layers})$  seconds, where  $N_{layers}$  is the total number of higher priority NR and E-UTRA carrier frequencies broadcasted in system information.

For a UE configured with early measurement reporting, while T331 is running,  $N_{layers}$  is the combined total number of higher priority NR and E-UTRA carrier frequencies broadcasted in system information and carriers configured for idle mode CA measurements.

Note: combined total number means that if a carrier is a high priority carrier and additionally a carrier configured for idle mode CA measurements, it only counts as one carrier.

#### 4.2.2.8 Minimum requirement at transitions

When switching from low mobility scenario or not-at-cell-edge scenario to low mobility and not-at-cell-edge scenario during cell-reselection period, the UE shall fulfill the requirements corresponding to low mobility scenario or not-at-cell-edge scenario over measurement period ( $T_{relaxed}$ ) and thereafter switch to requirements corresponding to low mobility and not-at-cell-edge scenario. The measurement period,  $T_{relaxed}$ , is any of:

- $T_{measure,NR\_Intra}$  and  $T_{evaluate,NR\_Intra}$ , defined in section 4.2.2.9 for intra-frequency measurements on NR cells,
- $T_{measure,NR\_Inter}$  and  $T_{evaluate,NR\_Inter}$  defined in section 4.2.2.10 for inter-frequency measurements on NR cells and
- $T_{measure,EUTRAN}$  and  $T_{evaluate,EUTRAN}$  defined in sections 4.2.2.11 for inter-RAT E-UTRAN measurements.

When switching from low mobility and not-at-cell-edge scenario to low mobility scenario or not-at-cell-edge scenario during cell-reselection period, the UE shall fulfill the requirements corresponding to low mobility scenario or not-at-cell-edge scenario upon fulfilling the switching criteria.

When switching from normal mode to low mobility scenario or not-at-cell-edge scenario or low mobility and not-at-cell-edge scenario during cell-reselection period, the UE shall fulfill the requirements corresponding to normal mode over measurement period ( $T_{normal}$ ) and thereafter switch to requirements corresponding to low mobility scenario or not-at-cell-edge scenario or low mobility and not-at-cell-edge scenario. The measurement period,  $T_{normal}$ , is any of:

- $T_{\text{measure,NR\_Intra}}$  and  $T_{\text{evaluate,NR\_Intra}}$ , defined in section 4.2.2.3 for intra-frequency measurements on NR cells,
- $T_{\text{measure,NR\_Inter}}$  and  $T_{\text{evaluate,NR\_Inter}}$  defined in section 4.2.2.4 for inter-frequency measurements on NR cells and
- $T_{\text{measure,EUTRAN}}$  and  $T_{\text{evaluate,EUTRAN}}$  defined in sections 4.2.2.5 for inter-RAT E-UTRAN measurements.

When switching from low mobility scenario or not-at-cell-edge scenario or low mobility and not-at-cell-edge scenario to normal mode during cell-reselection period, the UE shall fulfill the requirements corresponding to normal mode upon fulfilling the switching criteria.

No requirement is defined for multiple transitions of scenarios within one measurement period.

## 4.2.2.9 Measurements of intra-frequency NR cells for UE configured with relaxed measurement criterion

### 4.2.2.9.1 Introduction

This clause contains the requirements for measurements on intra-frequency NR cells when  $S_{\text{rxlev}} \leq S_{\text{IntraSearchP}}$  or  $S_{\text{qual}} \leq S_{\text{IntraSearchQ}}$  and when the UE is configured any of the following relaxed measurement criteria:

- Relaxed measurement criterion for UE with low mobility defined in clause 5.2.4.9.1 in [1],
- Relaxed measurement criterion for UE not-at-cell edge defined in clause 5.2.4.9.2 in [1],
- Both low mobility criterion and not-at-cell edge criterion as defined in clauses 5.2.4.9.1 and 5.2.4.9.2 in [1] respectively.

### 4.2.2.9.2 Measurements for UE fulfilling low mobility criterion

This clause contains requirements for measurements on intra-frequency NR cells provided that:

- UE is configured with *lowMobilityEvaluation* [2] criterion and UE has fulfilled, or
- UE is configured with both *lowMobilityEvaluation* [2] criterion and *cellEdgeEvaluation* [2] criterion and *combineRelaxedMeasCondition* [2] not configured, and UE has fulfilled only the *lowMobilityEvaluation* [2] criterion.

The requirements defined in clause 4.2.2.3 apply for this clause except that:

- $T_{\text{detect,NR\_Intra}}$  as specified in Table 4.2.2.9.2-1.
- $T_{\text{measure,NR\_Intra}}$  as specified in Table 4.2.2.9.2-1.
- $T_{\text{evaluate,NR\_Intra}}$  as specified in Table 4.2.2.9.2-1.

**Table 4.2.2.9.2-1:  $T_{\text{detect,NR\_Intra}}$ ,  $T_{\text{measure,NR\_Intra}}$  and  $T_{\text{evaluate,NR\_Intra}}$**

DRX cycle length [s]	Scaling Factor (N1)		$T_{\text{detect,NR\_Intra}}$ [s] (number of DRX cycles)	$T_{\text{measure,NR\_Intra}}$ [s] (number of DRX cycles)	$T_{\text{evaluate,NR\_Intra}}$ [s] (number of DRX cycles)
	FR1	FR2 <sup>Note1</sup>			
0.32	1	8	$11.52 \times N1 \times M2 \times K1$ ( $36 \times N1 \times M2 \times K1$ )	$1.28 \times N1 \times M2 \times K1$ (4 x $N1 \times M2 \times K1$ )	$5.12 \times N1 \times M2 \times K1$ (16 x $N1 \times M2 \times K1$ )
0.64		5	$17.92 \times N1 \times K1$ (28 x $N1 \times K1$ )	$1.28 \times N1 \times K1$ (2 x $N1 \times K1$ )	$5.12 \times N1 \times K1$ (8 x $N1 \times K1$ )
1.28		4	$32 \times N1 \times K1$ (25 x $N1 \times K1$ )	$1.28 \times N1 \times K1$ (1 x $N1 \times K1$ )	$6.4 \times N1 \times K1$ (5 x $N1 \times K1$ )
2.56		3	$58.88 \times N1 \times K1$ (23 x $N1 \times K1$ )	$2.56 \times N1 \times K1$ (1 x $N1 \times K1$ )	$7.68 \times N1 \times K1$ (3 x $N1 \times K1$ )

Note 1:	Applies for UE supporting power class 2&3&4. For UE supporting power class 1, $N1 = 8$ for all DRX cycle length.
Note 2:	$M2 = 1.5$ if SMTC periodicity of measured intra-frequency cell $> 20$ ms; otherwise $M2=1$ . If high layer signalling <i>smtc2-LP-r16</i> is configured, for cells indicated in the <i>pci-List</i> parameter in <i>smtc2-LP-r16</i> , the SMTC periodicity corresponds to the value of higher layer parameter <i>smtc2-LP-r16</i> ; for the other cells, the SMTC periodicity corresponds to the value of higher layer parameter <i>smtc</i> .
Note 3:	$K1 = 3$ is the measurement relaxation factor applicable for UE fulfilling the <i>lowMobilityEvaluation</i> [2] criterion.

#### 4.2.2.9.3 Measurements for UE fulfilling not-at-cell edge criterion

This clause contains requirements for measurements on intra-frequency NR cells provided that:

- UE is configured with *cellEdgeEvaluation* [2] criterion and UE has fulfilled, or
- UE is configured with both *lowMobilityEvaluation* [2] criterion and *cellEdgeEvaluation* [2] criteria and *combineRelaxedMeasCondition* [2] not configured, and UE has fulfilled only the *cellEdgeEvaluation* [2] criterion.

The requirements defined in clause 4.2.2.3 apply for this clause except that:

- $T_{\text{detect,NR\_Intra}}$  as specified in Table 4.2.2.9.3-1.
- $T_{\text{measure,NR\_Intra}}$  as specified in Table 4.2.2.9.3-1.
- $T_{\text{evaluate,NR\_Intra}}$  as specified in Table 4.2.2.9.3-1.

**Table 4.2.2.9.3-1:  $T_{\text{detect,NR\_Intra}}$ ,  $T_{\text{measure,NR\_Intra}}$  and  $T_{\text{evaluate,NR\_Intra}}$**

DRX cycle length [s]	Scaling Factor (N1)		$T_{\text{detect,NR\_Intra}}$ [s] (number of DRX cycles)	$T_{\text{measure,NR\_Intra}}$ [s] (number of DRX cycles)	$T_{\text{evaluate,NR\_Intra}}$ [s] (number of DRX cycles)
	FR1	FR2 <sup>Note1</sup>			
0.32	1	8	$11.52 \times N1 \times M2 \times K1$ ( $36 \times N1 \times M2 \times K1$ )	$1.28 \times N1 \times M2 \times K1$ (4 x $N1 \times M2 \times K1$ )	$5.12 \times N1 \times M2 \times K1$ (16 x $N1 \times M2 \times K1$ )
0.64		5	$17.92 \times N1 \times K1$ (28 x $N1 \times K1$ )	$1.28 \times N1 \times K1$ (2 x $N1 \times$ $K1$ )	$5.12 \times N1 \times K1$ (8 x $N1 \times$ $K1$ )
1.28		4	$32 \times N1 \times K1$ (25 x $N1$ x $K1$ )	$1.28 \times N1 \times K1$ (1 x $N1 \times$ $K1$ )	$6.4 \times N1 \times K1$ (5 x $N1 \times$ $K1$ )
2.56		3	$58.88 \times N1 \times K1$ (23 x $N1 \times K1$ )	$2.56 \times N1 \times K1$ (1 x $N1 \times$ $K1$ )	$7.68 \times N1 \times K1$ (3 x $N1 \times$ $K1$ )
Note 1:	Applies for UE supporting power class 2&3&4. For UE supporting power class 1, $N1 = 8$ for all DRX cycle length.				
Note 2:	$M2 = 1.5$ if SMTC periodicity of measured intra-frequency cell $> 20$ ms; otherwise $M2=1$ . If high layer signalling <i>smtc2-LP-r16</i> is configured, for cells indicated in the <i>pci-List</i> parameter in <i>smtc2-LP-r16</i> , the SMTC periodicity corresponds to the value of higher layer parameter <i>smtc2-LP-r16</i> ; for the other cells, the SMTC periodicity corresponds to the value of higher layer parameter <i>smtc</i> .				
Note 3:	$K1 = 3$ is the measurement relaxation factor applicable for UE fulfilling the <i>cellEdgeEvaluation</i> [2] criterion.				

#### 4.2.2.9.4 Measurements for UE fulfilling low mobility and not-at-cell edge criteria

This clause contains requirements for measurements on intra-frequency NR cells provided that:

- UE is configured with both *lowMobilityEvaluation* [2] criterion and *cellEdgeEvaluation* [2] criterion, and
- has also fulfilled both criteria, and
- less than 1 hour have passed since measurements for cell reselection were last performed

In this case the UE is not required to meet  $T_{\text{detect,NR\_Intra}}$ ,  $T_{\text{measure,NR\_Intra}}$  and  $T_{\text{evaluate,NR\_Intra}}$  as defined in Table 4.2.2.3-1.

#### 4.2.2.10 Measurements of inter-frequency NR cells for UE configured with relaxed measurement criterion

##### 4.2.2.10.1 Introduction

This clause contains the requirements for measurements on inter-frequency NR cells when the UE is configured with any of following relaxed measurement criteria:

- Relaxed measurement criterion for UE with low mobility defined in clause 5.2.4.9.1 in [1],
- Relaxed measurement criterion for UE not-at-cell edge defined in clause 5.2.4.9.2 in [1],
- Both low mobility criterion and not-at-cell edge criterion as defined in clauses 5.2.4.9.1 and 5.2.4.9.2 in [1] respectively.

##### 4.2.2.10.2 Measurements for UE fulfilling low mobility criterion

This clause contains requirements for measurements on inter-frequency NR cells provided that:

- UE is configured with *lowMobilityEvaluation* [2] criterion and UE has fulfilled, or
- UE is configured with both *lowMobilityEvaluation* [2] and *cellEdgeEvaluation* [2] criterion and *combineRelaxedMeasCondition* [2] not configured, and
- UE has fulfilled only the *lowMobilityEvaluation* [2] criterion.

The UE shall not relax measurements on NR inter-frequency carriers configured for idle mode CA/DC measurements (defined in clause 4.4) while T331 is running.

When  $S_{rxlev} \leq S_{nonIntraSearchP}$  or  $S_{qual} \leq S_{nonIntraSearchQ}$  then the requirements are defined as follows :

- $T_{detect,NR\_Inter\_Relax}$  as specified in Table 4.2.2.10.2-1.
- $T_{measure,NR\_Inter\_Relax}$  as specified in Table 4.2.2.10.2-1.
- $T_{evaluate,NR\_Inter\_Relax}$  as specified in Table 4.2.2.10.2-1.
- The UE shall be able to evaluate whether a newly detectable inter-frequency NR cell meets the reselection criteria defined in TS38.304 [1] within  $N_{carrier\_Relax} * T_{detect,NR\_Inter\_Relax} + N_{carrier\_Non\_relax} * T_{detect,NR\_Inter}$ . Cells which have been detected shall be measured at least every  $N_{carrier\_Relax} * T_{measure,NR\_Inter\_Relax} + N_{carrier\_Non\_relax} * T_{measure,NR\_Inter}$ . The UE shall be able to evaluate that an already identified inter-frequency NR cell has met reselection criterion defined in TS 38.304 [1] within  $N_{carrier\_Relax} * T_{evaluate,NR\_Inter\_Relax} + N_{carrier\_Non\_relax} * T_{evaluate,NR\_Inter}$ .
- When T331 is running,
  - The parameter  $N_{carrier\_Relax}$  is the total number of NR inter-frequency carriers not configured for idle mode CA/DC measurements.
  - The parameter  $N_{carrier\_Non\_relax}$  is the total number of NR inter-frequency carriers configured for idle mode CA/DC measurements.
- When T331 is not running,
  - The parameter  $N_{carrier\_Relax}$  is the total number of inter-frequency carriers configured for mobility measurements only and the number of inter-frequency carriers configured for both mobility measurement and idle mode CA/DC measurements.
- The parameter  $N_{carrier\_Non\_relax} = 0$ .

When  $S_{rxlev} > S_{nonIntraSearchP}$  and  $S_{qual} > S_{nonIntraSearchQ}$  and the UE is configured with *highPriorityMeasRelax* [2] then the UE shall search for inter-frequency layers of higher priority at least every  $K2 * T_{higher\_priority\_search}$  seconds where  $T_{higher\_priority\_search}$  is described in clause 4.2.2.7 and,  $K2 = 60$ . Otherwise if the UE is not configured with

*highPriorityMeasRelax* [2] then the UE shall search for inter-frequency layers of higher priority at least every  $T_{\text{higher\_priority\_search}}$  where  $T_{\text{higher\_priority\_search}}$  is described in clause 4.2.2.7.

**Table 4.2.2.10.2-1:  $T_{\text{detect,NR\_Inter\_Relax}}$ ,  $T_{\text{measure,NR\_Inter\_Relax}}$  and  $T_{\text{evaluate,NR\_Inter\_Relax}}$**

DRX cycle length [s]	Scaling Factor (N1)		$T_{\text{detect,NR\_Inter\_Relax}}$ [s] (number of DRX cycles)	$T_{\text{measure,NR\_Inter\_Relax}}$ [s] (number of DRX cycles)	$T_{\text{evaluate,NR\_Inter\_Relax}}$ [s] (number of DRX cycles)
	FR1	FR2 <sup>Note1</sup>			
0.32	1	8	$11.52 \times N1 \times 1.5 \times K1$ ( $36 \times N1 \times 1.5 \times K1$ )	$1.28 \times N1 \times 1.5 \times K1$ (4 x $N1 \times 1.5 \times K1$ )	$5.12 \times N1 \times 1.5 \times K1$ (16 x $N1 \times 1.5 \times K1$ )
0.64		5	$17.92 \times N1 \times K1$ (28 x $N1 \times K1$ )	$1.28 \times N1 \times K1$ (2 x $N1 \times$ $K1$ )	$5.12 \times N1 \times K1$ (8 x $N1 \times$ $K1$ )
1.28		4	$32 \times N1 \times K1$ (25 x $N1 \times$ $K1$ )	$1.28 \times N1 \times K1$ (1 x $N1 \times$ $K1$ )	$6.4 \times N1 \times K1$ (5 x $N1 \times$ $K1$ )
2.56		3	$58.88 \times N1 \times K1$ (23 x $N1 \times K1$ )	$2.56 \times N1 \times K1$ (1 x $N1 \times$ $K1$ )	$7.68 \times N1 \times K1$ (3 x $N1 \times$ $K1$ )
Note 1: Applies for UE supporting power class 2&3&4. For UE supporting power class 1, $N1 = 8$ for all DRX cycle length.					
Note 2: $K1 = 3$ is the measurement relaxation factor applicable for UE fulfilling the low mobility.					

#### 4.2.2.10.3 Measurements for UE fulfilling not-at-cell edge criterion

This clause contains requirements for measurements on inter-frequency NR cells provided that:

- UE is configured with *cellEdgeEvaluation* [2] criterion, and UE has fulfilled or
- UE is configured with both *lowMobilityEvaluation* [2] criterion and *cellEdgeEvaluation* [2] criterion and *combineRelaxedMeasCondition* [2] not configured, and
- UE has fulfilled only the *cellEdgeEvaluation* [2] criterion.

The UE shall not relax measurements on NR inter-frequency carriers configured for idle mode CA/DC measurements (defined in clause 4.4) while T331 is running.

When  $S_{\text{rxlev}} \leq S_{\text{nonIntraSearchP}}$  or  $S_{\text{qual}} \leq S_{\text{nonIntraSearchQ}}$  then the requirements defined in clause 4.2.2.4 apply for this clause except that:

- $T_{\text{detect,NR\_Inter\_Relax}}$  as specified in Table 4.2.2.10.3-1.
- $T_{\text{measure,NR\_Inter\_Relax}}$  as specified in Table 4.2.2.10.3-1.
- $T_{\text{evaluate,NR\_Inter\_Relax}}$  as specified in Table 4.2.2.10.3-1.- The UE shall be able to evaluate whether a newly detectable inter-frequency NR cell meets the reselection criteria defined in TS38.304 [1] within  $N_{\text{carrier\_Relax}} * T_{\text{detect,NR\_Inter\_Relax}} + N_{\text{carrier\_Non\_relax}} * T_{\text{detect,NR\_Inter}}$ . Cells which have been detected shall be measured at least every  $N_{\text{carrier\_Relax}} * T_{\text{measure,NR\_Inter\_Relax}} + N_{\text{carrier\_Non\_relax}} * T_{\text{measure,NR\_Inter}}$ . The UE shall be able to evaluate that an already identified inter-frequency NR cell has met reselection criterion defined in TS 38.304 [1] within  $N_{\text{carrier\_Relax}} * T_{\text{evaluate,NR\_Inter\_Relax}} + N_{\text{carrier\_Non\_relax}} * T_{\text{evaluate,NR\_Inter}}$ .
- When T331 is running,
  - The parameter  $N_{\text{carrier\_Relax}}$  is the total number of NR inter-frequency carriers not configured for idle mode CA/DC measurements.
  - The parameter  $N_{\text{carrier\_Non\_relax}}$  is the total number of NR inter-frequency carriers configured for idle mode CA/DC measurements.
- When T331 is not running,
  - The parameter  $N_{\text{carrier\_Relax}}$  is the total number of inter-frequency carriers configured for mobility measurements only and the number of inter-frequency carriers configured for both mobility measurement and idle mode CA/DC measurements.

- The parameter  $N_{\text{carrier\_Non\_relax}} = 0$ .

When  $S_{\text{rxlev}} > S_{\text{nonIntraSearchP}}$  and  $S_{\text{qual}} > S_{\text{nonIntraSearchQ}}$  and regardless of whether the UE is configured with *highPriorityMeasRelax* [2] or not, the UE shall search for inter-frequency layers of higher priority at least every  $T_{\text{higher\_priority\_search}}$  where  $T_{\text{higher\_priority\_search}}$  is described in clause 4.2.2.7

**Table 4.2.2.10.3-1:  $T_{\text{detect,NR\_Inter\_Relax}}$ ,  $T_{\text{measure,NR\_Inter\_Relax}}$  and  $T_{\text{evaluate,NR\_Inter\_Relax}}$**

DRX cycle length [s]	Scaling Factor (N1)		$T_{\text{detect,NR\_Inter\_Relax}}$ [s] (number of DRX cycles)	$T_{\text{measure,NR\_Inter\_Relax}}$ [s] (number of DRX cycles)	$T_{\text{evaluate,NR\_Inter\_Relax}}$ [s] (number of DRX cycles)
	FR1	FR2 <sup>Note1</sup>			
0.32	1	8	$11.52 \times N1 \times 1.5 \times K1$ (36 x N1 x 1.5 x K1)	$1.28 \times N1 \times 1.5 \times K1$ (4 x N1 x 1.5 x K1)	$5.12 \times N1 \times 1.5 \times K1$ (16 x N1 x 1.5 x K1)
0.64		5	$17.92 \times N1 \times K1$ (28 x N1 x K1)	$1.28 \times N1 \times K1$ (2 x N1 x K1)	$5.12 \times N1 \times K1$ (8 x N1 x K1)
1.28		4	$32 \times N1 \times K1$ (25 x N1 x K1)	$1.28 \times N1 \times K1$ (1 x N1 x K1)	$6.4 \times N1 \times K1$ (5 x N1 x K1)
2.56		3	$58.88 \times N1 \times K1$ (23 x N1 x K1)	$2.56 \times N1 \times K1$ (1 x N1 x K1)	$7.68 \times N1 \times K1$ (3 x N1 x K1)
Note 1:	Applies for UE supporting power class 2&3&4. For UE supporting power class 1, N1 = 8 for all DRX cycle length.				
Note 2:	K1 = 3 is the measurement relaxation factor applicable for UE fulfilling the <i>cellEdgeEvaluation</i> [2] criterion.				

#### 4.2.2.10.4 Measurements for UE fulfilling low mobility and not-at-cell edge criterion

This clause contains requirements for measurements on inter-frequency NR cells provided that:

- T331 timer is not running for EMR measurements on inter-frequency NR carrier, and
- UE is configured with both *lowMobilityEvaluation* [2] criterion and *cellEdgeEvaluation* [2] criterion, and
- Has also fulfilled both criteria

In this case the UE is not required to meet  $T_{\text{detect,NR\_Inter}}$ ,  $T_{\text{measure,NR\_Inter}}$  and  $T_{\text{evaluate,NR\_Inter}}$  as defined in Table 4.2.2.4-1.

When  $S_{\text{rxlev}} \leq S_{\text{nonIntraSearchP}}$  or  $S_{\text{qual}} \leq S_{\text{nonIntraSearchQ}}$ , the UE shall search for, measure and evaluate inter-frequency layers of higher, equal or lower priority at least every 1 hour.

When  $S_{\text{rxlev}} > S_{\text{nonIntraSearchP}}$  and  $S_{\text{qual}} > S_{\text{nonIntraSearchQ}}$ , the UE shall search for inter-frequency layers of higher priority at least every  $K2 \cdot T_{\text{higher\_priority\_search}}$  where  $T_{\text{higher\_priority\_search}}$  is described in clause 4.2.2.7 and  $K2=60$ .

#### 4.2.2.11 Measurements of inter-RAT E-UTRAN cells for UE configured with relaxed measurement criterion

##### 4.2.2.11.1 Introduction

This clause contains the requirements for measurements on inter-RAT E-UTRAN cells when the UE is configured with any of following relaxed measurement criteria:

- Relaxed measurement criterion for UE with low mobility defined in clause 5.2.4.9.1 in [1],
- Relaxed measurement criterion for UE not-at-cell edge defined in clause 5.2.4.9.2 in [1],
- Both low mobility criterion and not-at-cell edge criterion as defined in clauses 5.2.4.9.1 and 5.2.4.9.2 in [1] respectively.

##### 4.2.2.11.2 Measurements for UE fulfilling low mobility criterion

This clause contains requirements for measurements on inter-RAT E-UTRAN cells provided that:

- T331 timer is not running for EMR measurements on inter-RAT E-UTRAN, and
- UE is configured with *lowMobilityEvaluation* [2] criterion and UE has fulfilled, or
- UE is configured with both *lowMobilityEvaluation* [2] criterion and *cellEdgeEvaluation* [2] criterion and *combineRelaxedMeasCondition* [2] not configured, and
- UE has fulfilled only the *lowMobilityEvaluation* [2] criterion.

The UE shall not relax measurements on inter-RAT E-UTRAN carriers configured for idle mode CA/DC measurements (defined in clause 4.4) while T331 is running.

When  $S_{rxlev} \leq S_{nonIntraSearchP}$  and  $S_{qual} \leq S_{nonIntraSearchQ}$  then the requirements defined in clause 4.2.2.5 apply for this clause except that:

- $T_{detect,EUTRAN\_Relax}$  as specified in Table 4.2.2.11.2-1.
- $T_{measure,EUTRAN\_Relax}$  as specified in Table 4.2.2.11.2-1.
- $T_{evaluate,EUTRAN\_Relax}$  as specified in Table 4.2.2.11.2-1.
- The UE shall be able to evaluate whether a newly detectable inter-RAT E-UTRAN cell meets the reselection criteria defined in TS38.304 [1] within  $N_{EUTRAN\ carrier\_Relax} * T_{detect,EUTRAN\_Relax} + N_{EUTRAN\ carrier\_Non\_relax} * T_{detect,EUTRAN}$ . Cells which have been detected shall be measured at least every  $N_{EUTRAN\ carrier\_Relax} * T_{measure,EUTRAN\_Relax} + N_{EUTRAN\ carrier\_Non\_relax} * T_{measure,EUTRAN}$ . The UE shall be able to evaluate that an already identified inter-RAT E-UTRAN cell has met reselection criterion defined in TS 38.304 [1] within  $N_{EUTRAN\ carrier\_Relax} * T_{evaluate,EUTRAN\_Relax} + N_{EUTRAN\ carrier\_Non\_relax} * T_{evaluate,EUTRAN}$ .
- When T331 is running,
  - The parameter  $N_{EUTRAN\ carrier\_Relax}$  is the total number of inter-RAT E-UTRAN carriers not configured for idle mode CA/DC measurements.
  - The parameter  $N_{EUTRAN\ carrier\_Non\_relax}$  is the total number of inter-RAT E-UTRAN carriers configured for idle mode CA/DC measurements.
- When T331 is not running,
  - The parameter  $N_{EUTRAN\ carrier\_Relax}$  is the total number of inter-RAT E-UTRAN carriers configured for mobility measurements only and the number of inter-RAT E-UTRAN carriers configured for both mobility measurement and idle mode CA/DC measurements.
  - The parameter  $N_{EUTRAN\ carrier\_Non\_relax} = 0$ .

When  $S_{rxlev} > S_{nonIntraSearchP}$  and  $S_{qual} > S_{nonIntraSearchQ}$  and the UE is configured with *highPriorityMeasRelax* [2] then the UE shall search for E-UTRA inter-RAT frequency layers of higher priority at least every  $K2 * T_{higher\_priority\_search}$  seconds where  $T_{higher\_priority\_search}$  is described in clause 4.2.2.7 and,  $K2 = 60$ . Otherwise if the UE is not configured with *highPriorityMeasRelax* [2] then the UE shall search for E-UTRA inter-RAT frequency layers of higher priority at least every  $T_{higher\_priority\_search}$  where  $T_{higher\_priority\_search}$  is described in clause 4.2.2.7.

**Table 4.2.2.11.2-1:  $T_{detect,EUTRAN\_Relax}$ ,  $T_{measure,EUTRAN\_Relax}$ , and  $T_{evaluate,EUTRAN\_Relax}$**

DRX cycle length [s]	$T_{detect,EUTRAN\_Relax}$ [s] (number of DRX cycles)	$T_{measure,EUTRAN\_Relax}$ [s] (number of DRX cycles)	$T_{evaluate,EUTRAN\_Relax}$ [s] (number of DRX cycles)
0.32	$11.52 \times K1$ ( $36 \times K1$ )	$1.28 \times K1$ ( $4 \times K1$ )	$5.12 \times K1$ ( $16 \times K1$ )
0.64	$17.92 \times K1$ ( $28 \times K1$ )	$1.28 \times K1$ ( $2 \times K1$ )	$5.12 \times K1$ ( $8 \times K1$ )
1.28	$32 \times K1$ ( $25 \times K1$ )	$1.28 \times K1$ ( $1 \times K1$ )	$6.4 \times K1$ ( $5 \times K1$ )
2.56	$58.88 \times K1$ ( $23 \times K1$ )	$2.56 \times K1$ ( $1 \times K1$ )	$7.68 \times K1$ ( $3 \times K1$ )
Note 1: $K1 = 3$ is the measurement relaxation factor applicable for UE fulfilling the <i>lowMobilityEvaluation</i> [2] criterion.			

#### 4.2.2.11.3 Measurements for UE fulfilling with not-at-cell edge criterion

This clause contains requirements for measurements on inter-RAT E-UTRAN cells provided that:

- T331 timer is not running for EMR measurements on inter-RAT E-UTRAN, and
- UE is configured with *cellEdgeEvaluation* [2] criterion and UE has fulfilled, or
- UE is configured with both *lowMobilityEvaluation* [2] criterion and *cellEdgeEvaluation* [2] criterion and *combineRelaxedMeasCondition* [2] not configured, and
- UE has fulfilled only the *cellEdgeEvaluation* [2] criterion.

The UE shall not relax measurements on inter-RAT E-UTRAN carriers configured for idle mode CA/DC measurements (defined in clause 4.4) while T331 is running.

When  $S_{rxlev} \leq S_{nonIntraSearchP}$  and  $S_{qual} \leq S_{nonIntraSearchQ}$  then the requirements defined in clause 4.2.2.5 apply for this clause except that:

- $T_{detect,EUTRAN\_Relax}$  as specified in Table 4.2.2.11.3-1.
- $T_{measure,EUTRAN\_Relax}$  as specified in Table 4.2.2.11.3-1.
- $T_{evaluate,EUTRAN\_Relax}$  as specified in Table 4.2.2.11.3-1.
- The UE shall be able to evaluate whether a newly detectable inter-RAT E-UTRAN cell meets the reselection criteria defined in TS38.304 [1] within  $N_{EUTRAN\ carrier\_Relax} * T_{detect,EUTRAN\_Relax} + N_{EUTRAN\ carrier\_Non\_relax} * T_{detect,EUTRAN}$ . Cells which have been detected shall be measured at least every  $N_{EUTRAN\ carrier\_Relax} * T_{measure,EUTRAN\_Relax} + N_{EUTRAN\ carrier\_Non\_relax} * T_{measure,EUTRAN}$ . The UE shall be able to evaluate that an already identified inter-RAT E-UTRAN cell has met reselection criterion defined in TS 38.304 [1] within  $N_{EUTRAN\ carrier\_Relax} * T_{evaluate,EUTRAN\_Relax} + N_{EUTRAN\ carrier\_Non\_relax} * T_{evaluate,EUTRAN}$ .
- When T331 is running,
  - The parameter  $N_{EUTRAN\ carrier\_Relax}$  is the total number of inter-RAT E-UTRAN carriers not configured for idle mode CA/DC measurements.
  - The parameter  $N_{EUTRAN\ carrier\_Non\_relax}$  is the total number of inter-RAT E-UTRAN carriers configured for idle mode CA/DC measurements.
- When T331 is not running,
  - The parameter  $N_{EUTRAN\ carrier\_Relax}$  is the total number of inter-RAT E-UTRAN carriers configured for mobility measurements only and the number of inter-RAT E-UTRAN carriers configured for both mobility measurement and idle mode CA/DC measurements.
  - The parameter  $N_{EUTRAN\ carrier\_Non\_relax} = 0$ .

When  $S_{rxlev} > S_{nonIntraSearchP}$  and  $S_{qual} > S_{nonIntraSearchQ}$  and regardless of whether the UE is configured with *highPriorityMeasRelax* [2] or not, the UE shall search for inter-RAT E-UTRAN frequency layers of higher priority at least every  $T_{higher\_priority\_search}$  where  $T_{higher\_priority\_search}$  is described in clause 4.2.2.7.

**Table 4.2.2.11.3-1:  $T_{detect,EUTRAN\_Relax}$ ,  $T_{measure,EUTRAN\_Relax}$ , and  $T_{evaluate,EUTRAN\_Relax}$**

DRX cycle length [s]	$T_{detect,EUTRAN}$ [s] (number of DRX cycles)	$T_{measure,EUTRAN}$ [s] (number of DRX cycles)	$T_{evaluate,EUTRAN}$ [s] (number of DRX cycles)
0.32	$11.52 \times K1$ (36 x K1)	$1.28 \times K1$ (4 x K1)	$5.12 \times K1$ (16 x K1)
0.64	$17.92 \times K1$ (28 x K1)	$1.28 \times K1$ (2 x K1)	$5.12 \times K1$ (8 x K1)



1.28	32 x K1 (25 x K1)	1.28 x K1 (1 x K1)	6.4 x K1 (5 x K1)
2.56	58.88 x K1 (23 x K1)	2.56 x K1 (1 x K1)	7.68 x K1 (3 x K1)
Note 1:	K1 = 3 is the measurement relaxation factor applicable for UE fulfilling the <i>cellEdgeEvaluation</i> [2] criterion.		

#### 4.2.2.11.4 Measurements for UE fulfilling low mobility and not-at-cell edge criterion

This clause contains requirements for measurements on inter-RAT E-UTRAN cells provided that:

- T331 timer is not running for EMR measurements on inter-RAT E-UTRAN, and
- UE is configured with both *lowMobilityEvaluation* [2] criterion and *cellEdgeEvaluation* [2] criterion, and
- has also fulfilled both criteria

In this case the UE is not required to meet  $T_{\text{detect,EUTRAN}}$ ,  $T_{\text{measure,EUTRAN}}$  and  $T_{\text{evaluate,EUTRAN}}$  as defined in Table 4.2.2.5-1.

When  $S_{\text{rxlev}} \leq S_{\text{nonIntraSearchP}}$  or  $S_{\text{qual}} \leq S_{\text{nonIntraSearchQ}}$ , the UE shall search for, measure and evaluate inter-RAT E-UTRAN layers of higher or lower priority at least every 1 hour.

When  $S_{\text{rxlev}} > S_{\text{nonIntraSearchP}}$  and  $S_{\text{qual}} > S_{\text{nonIntraSearchQ}}$ , the UE shall search for inter-RAT E-UTRAN of higher priority at least every  $K2 \cdot T_{\text{higher\_priority\_search}}$  where  $T_{\text{higher\_priority\_search}}$  is described in clause 4.2.2.7 and  $K2=60$ .

## 4.2A Cell Re-selection when subject to CCA

### 4.2A.1 Introduction

The cell reselection procedure allows the UE to select a more suitable cell and camp on it. The requirements in clauses 4.2A.2.3, 4.2A.2.4, and 4.2A.2.6, apply when at least the target cell is on a carrier frequency subject to CCA, and the requirements in clauses 4.2A.2.2, and 4.2A.2.5 apply when at least the camping cell is on a carrier frequency subject to CCA.

When the UE is in either *Camped Normally* state or *Camped on Any Cell* state on a cell, the UE shall attempt to detect, synchronise, and monitor intra-frequency, inter-frequency and inter-RAT cells indicated by the serving cell. For intra-frequency and inter-frequency cells the serving cell may not provide explicit neighbour list but carrier frequency information and bandwidth information only. UE measurement activity is also controlled by measurement rules defined in TS 38.304, allowing the UE to limit its measurement activity.

In the requirements of clause 4.2A, the exceptions for side conditions apply as follows:

- for the UE capable of CA, the applicable exceptions for side conditions are specified in Annex B, clause B.x.y for UE supporting CA in FR1.

In the requirements of clause 4.2A.2, the term SMTC occasion not available at the UE refers to when the SMTC contains SSBs configured by gNB in a cell on a carrier frequency subject to CCA, but  $N$  candidate SSB positions for the same SS/PBCH block index within the discovery burst transmission window are not available at the UE due to DL CCA failures at gNB during the corresponding detection, measurement, or evaluation period, where:

- For the cell detection procedure:  $N$  is at least one candidate SSB position (NOTE: the one candidate SSB position for the cell detection shall not be impacted by the set of candidate SSB positions which are already being measured by the UE within the current measurement period of the on-going measurements), and
- For other procedures in clause 4.2A.2:  $N$  are the first two successive candidate SSB positions when two or more candidate SSB positions are configured for this SSB index in one discovery burst transmission window, otherwise  $N$  is one candidate SSB position;

otherwise the SMTC occasion is considered as available at the UE.

## 4.2A.2 Requirements

### 4.2A.2.1 UE measurement capability

For idle mode cell re-selection purposes, the UE shall be capable of monitoring at least:

- Intra-frequency carrier, and
- Depending on UE capability, 7 NR inter-frequency carriers, and
- Depending on UE capability, 7 FDD E-UTRA inter-RAT carriers, and
- Depending on UE capability, 7 TDD E-UTRA inter-RAT carriers.

In addition to the requirements defined above, a UE supporting E-UTRA measurements in RRC\_IDLE state shall be capable of monitoring a total of at least 14 carrier frequency layers, which includes serving layer, comprising of any above defined combination of E-UTRA FDD, E-UTRA TDD and NR layers. The inter-frequency carriers include carriers on unlicensed band and/or licensed band.

### 4.2A.2.2 Measurement and evaluation when subject to CCA on the serving cell

The UE shall measure the SS-RSRP and SS-RSRQ level of the serving cell and evaluate the cell selection criterion  $S$  defined in TS 38.304 [1] for the serving cell at least once every  $(1+M_n)*M_1$  DRX cycles in  $N_{serv\_CCA}$  consecutive DRX cycles; where:

$M_1=2$  if SMTC periodicity ( $T_{SMTC}$ ) > 20 ms and DRX cycle  $\leq$  0.64 second,

otherwise  $M_1=1$ .

$M_n$  is the maximum separation in DRX cycles between two measurements that are used for filtering.

The UE shall filter the SS-RSRP and SS-RSRQ measurements of the serving cell using at least 2 measurements. Within the set of measurements used for the filtering, at least two measurements shall be spaced by, at least DRX cycle/2 but not separated in time by more than  $M_n$ , where  $M_n=2$ .

If the UE has evaluated according to Table 4.2A.2.2-1 in  $N_{serv\_CCA}$  consecutive DRX cycles that the serving cell does not fulfil the cell selection criterion  $S$ , the UE shall initiate the measurements of all neighbour cells indicated by the serving cell, regardless of the measurement rules currently limiting UE measurement activities.

UE shall initiate measurements on neighbour cells indicated by the serving cell if it is unable to measure on the serving cell for at least  $M_p$  consecutive number of DRX cycles each with at least one SMTC occasion not available at the UE, where  $M_p=4$  when DRX cycle length <1.28 s,  $M_p=2$  when DRX cycle length  $\geq$ 1.28 s.

UE shall initiate the measurements on neighbour cells of any intra-frequency or inter-frequency if it is unable to measure on serving cell during at least consecutive  $M_q$  number of DRX cycles each with at least one SMTC occasion not available at the UE, regardless of any condition of  $S_{nonIntraSearchP}$  and  $S_{nonIntraSearchQ}$ , where  $M_q=8$  when DRX cycle length <1.28 s,  $M_q=4$  when DRX cycle length  $\geq$ 1.28 s.

If the UE in RRC\_IDLE has not found any new suitable cell based on searches and measurements using the intra-frequency, inter-frequency and inter-RAT information indicated in the system information for 10 s, the UE shall initiate cell selection procedures for the selected PLMN as defined in TS 38.304 [1].

**Table 4.2A.2.2-1:  $N_{serv\_CCA}$**

DRX cycle length [s]	$N_{serv\_CCA}$ [number of DRX cycles]
0.32	$M_1*4+M_1*M_s$
0.64	$M_1*4+M_1*M_s$
1.28	$2+M_s$
2.56	$2+M_s$

Note 1:	$M_s$ is the number of DRX cycles each with at least one SMTC occasion not available at the UE during $N_{serv\_CCA}$ , and $M_s < M_{s,max}$
Note2:	$M_{s,max}=8$ for DRX cycle length $< 1.28$ s, $M_{s,max} = 4$ for DRX cycle length $\geq 1.28$ s.

The UE shall restart the measurements used for serving cell evaluation if  $M_s$  exceeds  $M_{s,max}$ .

#### 4.2A.2.3 Measurements of intra-frequency NR cells when subject to CCA on the serving cell and target cell

The UE shall be able to identify new intra-frequency cells with CCA and perform SS-RSRP and SS-RSRQ measurements of the identified intra-frequency cells without an explicit intra-frequency neighbour list containing physical layer cell identities.

The UE shall be able to evaluate whether a newly detectable intra-frequency cell meets the reselection criteria defined in TS38.304 within  $T_{detect,NR\_Intra\_CCA}$  when that  $T_{reselection}=0$ . An intra frequency cell is considered to be detectable according to the conditions defined in Annex B.2.8 for a corresponding Band.

The UE shall measure SS-RSRP and SS-RSRQ at least every  $T_{measure,NR\_Intra\_CCA}$  (see table 4.2A.2.3-1) for intra-frequency cells that are identified and measured according to the measurement rules. For a cell that is already identified, after 2 unsuccessful measurement attempts due to exceeding the maximum number of SMTC occasions not available at the UE, the UE shall detect cells on any of the configured serving- and/or non-serving carriers.

The UE shall filter SS-RSRP and SS-RSRQ measurements of each measured intra-frequency cell using at least 2 measurements. Within the set of measurements used for the filtering, at least two measurements shall be spaced by at least  $T_{measure,NR\_Intra\_CCA}/2$ .

The UE shall not consider a NR neighbour cell in cell reselection, if it is indicated as not allowed in the measurement control system information of the serving cell.

For an intra-frequency cell that has been already detected, but that has not been reselected to, the filtering shall be such that the UE shall be capable of evaluating that the intra-frequency cell has met reselection criterion defined [1] within  $T_{evaluate,NR\_Intra\_CCA}$  when  $T_{reselection} = 0$  as specified in table 4.2A.2.3-1 provided that:

when *rangeToBestCell* is not configured:

- the cell is at least 3dB better ranked in FR1.

when *rangeToBestCell* is configured:

- the cell has the highest number of beams above the threshold *absThreshSS-BlocksConsolidation* among all detected cells whose cell-ranking criterion R value [1] is within *rangeToBestCell* of the cell-ranking criterion R value of the highest ranked cell.
- if there are multiple such cells, the cell has the highest rank among them.
- the cell is at least 3dB better ranked in FR1 if the current serving cell is among them.

When evaluating cells for reselection, the SSB side conditions apply to both serving and non-serving intra-frequency cells.

If  $T_{reselection}$  timer has a non-zero value and the intra-frequency cell is satisfied with the reselection criteria, which are defined in TS38.304 [1], the UE shall evaluate this intra-frequency cell for the  $T_{reselection}$  time. If this cell remains satisfied with the reselection criteria within this duration, then the UE shall reselect that cell.

**Table 4.2A.2.3-1:  $T_{detect,NR\_Intra\_CCA}$ ,  $T_{measure,NR\_Intra\_CCA}$  and  $T_{evaluate,NR\_Intra\_CCA}$**

DRX cycle length [s]	$T_{detect,NR\_Intra\_CCA}$ [s] (number of DRX cycles)	$T_{measure,NR\_Intra\_CCA}$ [s] (number of DRX cycles)	$T_{evaluate,NR\_Intra\_CCA}$ [s] (number of DRX cycles)
0.32	$0.32 \times (36 + M_d) \times M2$ $\{([36] + M_d) \times M2\}$	$0.32 \times (4 + M_m) \times M2$ $\{([4] + M_m) \times M2\}$	$0.32 \times (16 + M_e) \times M2$ $\{(16 + M_e) \times M2\}$

0.64	$0.64x(28+M_d)$ {28+M <sub>d</sub> }	$0.64x(2+M_m)$ {2+M <sub>m</sub> }	$0.64x(8+M_e)$ {8+M <sub>e</sub> }
1.28	$1.28x(25+M_d)$ {25+M <sub>d</sub> }	$1.28x(1+M_m)$ {1+M <sub>m</sub> }	$1.28x(5+M_e)$ {5+M <sub>e</sub> }
2.56	$2.56x(23+M_d)$ {23+M <sub>d</sub> }	$2.56x(1+M_m)$ {1+M <sub>m</sub> }	$2.56x(3+M_e)$ {3+M <sub>e</sub> }
Note 1:	M <sub>2</sub> = 1.5 if SMTC periodicity of measured intra-frequency cell > 20 ms; otherwise M <sub>2</sub> =1.		
Note 2:	M <sub>d</sub> , M <sub>m</sub> , M <sub>e</sub> are the number of DRX cycles each with at least one SMTC occasion not available during the T <sub>detect,NR_Intra_CCA</sub> , T <sub>measure,NR_Intra_CCA</sub> and T <sub>evaluate,NR_Intra_CCA</sub> , and M <sub>m</sub> ≤ M <sub>m,max</sub> , M <sub>d</sub> ≤ M <sub>d,max</sub> and M <sub>e</sub> ≤ M <sub>e,max</sub>		
Note 3:	M <sub>m,max</sub> = 16 for DRX cycle length = 0.32s; M <sub>m,max</sub> = 8 for DRX cycle length = 0.64s; M <sub>m,max</sub> = 4 for DRX cycle length = 1.28s; M <sub>m,max</sub> = 4 for DRX cycle length = 2.56 s.		
Note 4:	M <sub>d,max</sub> =4*M <sub>m,max</sub> , M <sub>e,max</sub> =2*M <sub>m,max</sub> .		

The UE shall restart the measurements upon exceeding M<sub>m,max</sub>, M<sub>d,max</sub>, or M<sub>e,max</sub>.

#### 4.2A.2.4 Measurements of inter-frequency NR cells when subject to CCA on the target cell

The UE shall be able to identify new inter-frequency cells and perform SS-RSRP or SS-RSRQ measurements of identified inter-frequency cells if carrier frequency information is provided by the serving cell, even if no explicit neighbour list with physical layer cell identities is provided.

If  $S_{rxlev} > S_{nonIntraSearchP}$  and  $S_{qual} > S_{nonIntraSearchQ}$  then the UE shall search for inter-frequency layers of higher priority at least every T<sub>higher\_priority\_search</sub> where T<sub>higher\_priority\_search</sub> is described in clause 4.2A.2.7.

If  $S_{rxlev} \leq S_{nonIntraSearchP}$  or  $S_{qual} \leq S_{nonIntraSearchQ}$  then the UE shall search for and measure inter-frequency layers of higher, equal or lower priority in preparation for possible reselection. In this scenario, the minimum rate at which the UE is required to search for and measure higher priority layers shall be the same as that defined below in this clause.

The UE shall be able to evaluate whether a newly detectable inter-frequency cell meets the reselection criteria defined in TS38.304 within  $K_{carrier} * T_{detect,NR\_Inter} + K_{carrier\_CCA} * T_{detect,NR\_Inter\_CCA}$  if at least carrier frequency information is provided for inter-frequency neighbour cells by the serving cells when T<sub>reselection</sub> = 0 provided that the reselection criteria is met by a margin of at least 5 dB in FR1 for reselections based on ranking or 6dB in FR1 for SS-RSRP reselections based on absolute priorities or 4dB in FR1 for SS-RSRQ reselections based on absolute priorities. The parameter K<sub>carrier</sub> is the number of NR inter-frequency carriers on licensed band and K<sub>carrier\_CCA</sub> is the number of NR inter-frequency carriers on unlicensed band indicated by the serving cell. An inter-frequency cell is considered to be detectable according to the conditions defined in Annex B.2.9 for a corresponding Band.

When higher priority cells are found by the higher priority search, they shall be measured at least every T<sub>measure,NR\_Inter\_CCA</sub>. If after detecting a cell in a higher priority search, it is determined that reselection has not occurred then the UE is not required to continuously measure the detected cell to evaluate the ongoing possibility of reselection. However, the minimum measurement filtering requirements specified later in this clause shall still be met by the UE before it makes any determination that it may stop measuring the cell. If the UE detects on a NR carrier a cell whose physical identity is indicated as not allowed for that carrier in the measurement control system information of the serving cell, the UE is not required to perform measurements on that cell.

The UE shall measure SS-RSRP or SS-RSRQ at least every  $K_{carrier} * T_{measure,NR\_Inter} + K_{carrier\_CCA} * T_{measure,NR\_Inter\_CCA}$  for identified lower or equal priority inter-frequency cells. If the UE detects on a NR carrier a cell whose physical identity is indicated as not allowed for that carrier in the measurement control system information of the serving cell, the UE is not required to perform measurements on that cell.

For a cell that is already identified, after 2 unsuccessful measurement attempts due to exceeding the maximum number of SMTC occasions not available at the UE, the UE shall detect cells on any of the configured serving- and/or non-serving carriers.

The UE shall filter SS-RSRP or SS-RSRQ measurements of each measured higher, lower and equal priority inter-frequency cell using at least 2 measurements. Within the set of measurements used for the filtering, at least two measurements shall be spaced by at least T<sub>measure,NR\_Inter\_CCA</sub>/2.

The UE shall not consider a NR neighbour cell in cell reselection, if it is indicated as not allowed in the measurement control system information of the serving cell.

For an inter-frequency cell that has been already detected, but that has not been reselected to, the filtering shall be such that the UE shall be capable of evaluating that the inter-frequency cell has met reselection criterion defined TS 38.304 within  $K_{\text{carrier}} * T_{\text{evaluate,NR\_Inter}} + K_{\text{carrier\_CCA}} * T_{\text{evaluate,NR\_Inter\_CCA}}$  when  $T_{\text{reselection}} = 0$  as specified in table 4.2A.2.4-1 provided that the reselection criteria is met by

- the condition when performing equal priority reselection and

when *rangeToBestCell* is not configured:

- the cell is at least 5dB better ranked in FR1 or.

when *rangeToBestCell* is configured:

- the cell has the highest number of beams above the threshold *absThreshSS-BlocksConsolidation* among all detected cells whose cell-ranking criterion R value [1] is within *rangeToBestCell* of the cell-ranking criterion R value of the highest ranked cell.
  - if there are multiple such cells, the cell has the highest rank among them
  - the cell is at least 5dB better ranked in FR1 if the current serving cell is among them. or
- 6dB in FR1 for SS-RSRP reselections based on absolute priorities or
- 4dB in FR1 for SS-RSRQ reselections based on absolute priorities.

When evaluating cells for reselection, the SSB side conditions apply to both serving and inter-frequency cells.

If  $T_{\text{reselection}}$  timer has a non zero value and the inter-frequency cell is satisfied with the reselection criteria, the UE shall evaluate this inter-frequency cell for the  $T_{\text{reselection}}$  time. If this cell remains satisfied with the reselection criteria within this duration, then the UE shall reselect that cell.

The UE is not expected to meet the measurement requirements for an inter-frequency carrier under DRX cycle=320 ms defined in Table 4.2A.2.4-1 under the following conditions:

- $T_{\text{SMTC\_intra}} = T_{\text{SMTC\_inter}} = 160$  ms; where  $T_{\text{SMTC\_intra}}$  and  $T_{\text{SMTC\_inter}}$  are periodicities of the SMTC occasions configured for the intra-frequency carrier and the inter-frequency carrier respectively, and
- SMTC occasions configured for the inter-frequency carrier occur up to 1 ms before the start or up to 1 ms after the end of the SMTC occasions configured for the intra-frequency carrier, and
- SMTC occasions configured for the intra-frequency carrier and for the inter-frequency carrier occur up to 1 ms before the start or up to 1 ms after the end of the paging occasion [1].

**Table 4.2A.2.4-1:  $T_{\text{detect,NR\_Inter\_CCA}}$ ,  $T_{\text{measure,NR\_Inter\_CCA}}$  and  $T_{\text{evaluate,NR\_Inter\_CCA}}$**

DRX cycle length [s]	$T_{\text{detect,NR\_Inter\_CCA}}$ [s] (number of DRX cycles)	$T_{\text{measure,NR\_Inter\_CCA}}$ [s] (number of DRX cycles)	$T_{\text{evaluate,NR\_Inter\_CCA}}$ [s] (number of DRX cycles)
0.32	$0.32 \times (36 + M_d) \times M_2$ {(36+ $M_d$ ) $\times M_2$ }	$0.32 \times (4 + M_m) \times M_2$ {(4+ $M_m$ ) $\times M_2$ }	$0.32 \times (16 + M_e) \times M_2$ {(16+ $M_e$ ) $\times M_2$ }
0.64	$0.64 \times (28 + M_d)$ {28+ $M_d$ }	$0.64 \times (2 + M_m)$ {2+ $M_m$ }	$0.64 \times (8 + M_e)$ {8+ $M_e$ }
1.28	$1.28 \times (25 + M_d)$ {25+ $M_d$ }	$1.28 \times (1 + M_m)$ {1+ $M_m$ }	$1.28 \times (5 + M_e)$ {5+ $M_e$ }
2.56	$2.56 \times (23 + M_d)$ {23+ $M_d$ }	$2.56 \times (1 + M_m)$ {1+ $M_m$ }	$2.56 \times (3 + M_e)$ {3+ $M_e$ }

Note 1:	$M2 = 1.5$ if SMTC periodicity of measured intra-frequency cell $> 20$ ms; otherwise $M2=1$ .
Note 2:	$M_d$ , $M_m$ , $M_e$ are the number of DRX cycles with at least one SMTC where there are no SSBs available at the UE during $T_{\text{detect,NR\_Inter\_CCA}}$ , $T_{\text{measure,NR\_Inter\_CCA}}$ and $T_{\text{evaluate,NR\_Inter\_CCA}}$ , and $M_m \leq M_{m,\text{max}}$ , $M_d \leq M_{d,\text{max}}$ and $M_e \leq M_{e,\text{max}}$
Note 3:	$M_{m,\text{max}} = 16$ for DRX cycle length = 0.32s; $M_{m,\text{max}} = 8$ for DRX cycle length = 0.64s; $M_{m,\text{max}} = 4$ for DRX cycle length = 1.28s; $M_{m,\text{max}} = 4$ for DRX cycle length = 2.56s.
Note 4:	$M_{d,\text{max}} = 4 * M_{m,\text{max}}$ , $M_{e,\text{max}} = 2 * M_{m,\text{max}}$ .

The UE shall restart the measurements upon exceeding  $M_{m,\text{max}}$ ,  $M_{d,\text{max}}$ , or  $M_{e,\text{max}}$ .

#### 4.2A.2.5 Measurements of inter-RAT E-UTRAN cells when subject to CCA on the serving cell

The requirements in clause 4.2.2.5 shall apply.

#### 4.2A.2.6 Maximum interruption in paging reception when subject to CCA on the target cell

UE shall perform the cell re-selection with minimum interruption in monitoring downlink channels for paging reception.

At intra-frequency and inter-frequency cell re-selection, the UE shall monitor the downlink of serving cell for paging reception until the UE is capable to start monitoring downlink channels of the target intra-frequency and inter-frequency cell for paging reception. The interruption time shall not exceed  $T_{\text{SI\_CCA}} + 2 * T_{\text{target\_cell\_SMTC\_period}}$ .

At inter-RAT cell re-selection, the UE shall monitor the downlink of serving cell for paging reception until the UE is capable to start monitoring downlink channels for paging reception of the target inter-RAT cell. For NR to E-UTRAN cell re-selection the interruption time shall not exceed  $T_{\text{SI\_EUTRA}} + 55$  ms.

$T_{\text{SI\_CCA}}$  is the time required for receiving all the relevant system information data according to the reception procedure and the RRC procedure delay of system information blocks defined in TS 38.331 [2] for an NR cell.

$T_{\text{SI\_EUTRA}}$  is the time required for receiving all the relevant system information data according to the reception procedure and the RRC procedure delay of system information blocks defined in TS 36.331 [16] for an E-UTRAN cell.

These requirements assume sufficient radio conditions, so that decoding of system information can be made without errors and does not take into account cell re-selection failure.

#### 4.2A.2.7 General requirements

The requirements in clause 4.2.2.7 shall apply.

### 4.3 Minimization of Drive Tests (MDT)

#### 4.3.1 Introduction

UE supporting minimisation of drive tests in RRC\_IDLE shall be capable of:

- logging measurements in RRC\_IDLE, reporting the logged measurements and meeting requirements in clause 4.3;
- logging of RRC connection establishment failure, reporting the logged failure and meeting requirements in clause 4.3;
- logging of radio link failure and handover failure, reporting the logged failure and meeting requirements in clause 4.3.

The logged MDT requirements consist of measurement requirements as specified in clause 4.3.2 and relative time stamp accuracy requirements as specified in clause 4.3.3. Both sets of requirements are applicable for intra-frequency, inter-frequency and inter-RAT cases in RRC\_IDLE state. The MDT procedures are described in TS 37.320 [31].

For RRC connection establishment failure logging and reporting, the MDT requirements consist of requirements for measurements performed and logged in RRC\_IDLE state specified in clause 4.3.2 and relative time stamp accuracy requirement for RRC connection establishment failure log reporting as specified in clause 4.3.4.

## 4.3.2 Measurement Requirements

The requirements specified in this clause apply for the following measurements performed and logged by the UE for MDT in RRC\_IDLE:

- inter-RAT E-UTRA FDD and TDD RSRP,
- inter-RAT E-UTRA FDD and TDD RSRQ,
- SS-RSRP per cell,
- SS-RSRQ per cell,
- SS-RSRP per SSB index of the serving cell,
- SS-RSRQ per SSB index of the serving cell,
- best SSB index of the serving cell,
- the number of SSBs with different SSB index which are above the threshold *absThreshSS-BlocksConsolidation* for all detected cells whose cell-ranking criterion R value is within *rangeToBestCell* of the cell-ranking criterion R value of the highest ranked cell.

The requirements apply for the measurements included in logged MDT reports and RRC connection establishment failure reports.

The measurement values that are used to meet

- serving cell and reselection requirements as specified in clauses 4.2.2.2–4.2.2.7

shall also apply to values logged for MDT measurements in RRC\_IDLE state.

## 4.3.3 Requirements for Relative Time Stamp Accuracy

The relative time stamp for a logged measurement is defined as the time from the moment the MDT configuration was received at the UE until the measurement was logged, see TS 38.331 [2].

The accuracy of the relative time stamping is such that the drift of the time stamping shall be not more than  $\pm 2$  seconds per hour.

## 4.3.4 Requirements for Relative Time Stamp Accuracy for RRC Connection Establishment Failure Log Reporting

Relative time stamp for RRC connection establishment failure log reporting is defined as the time elapsed from the last RRC connection establishment failure to the time when the log is included in the report TS 38.331 [2]. The UE shall report the RRC connection establishment failure log, while meeting the accuracy requirement specified in this clause.

The accuracy of the relative time stamping for RRC connection establishment failure log reporting is such that the drift of the time stamping shall not be larger than  $\pm 0.72$  seconds per hour and  $\pm 10$  seconds over 48 hours. The relative time stamp accuracy requirements shall apply provided that:

- no power off or detach occurs after the RRC connection establishment failure had been detected and until the log is time-stamped.

### 4.3.5 Requirements for Relative Time Stamp Accuracy for Radio Link Failure and Handover Failure Log Reporting

The UE shall report the radio link and handover failure log, while meeting the accuracy requirements specified in this clause.

Relative time stamp accuracy requirements for *timeSinceFailure* reported for MDT in a radio link failure or handover failure log are specified in this clause. *timeSinceFailure* determines the time elapsed from the last radio link failure or handover failure in NR to the time when the log is included in the report TS 38.331 [2].

The accuracy of the relative time stamping for *timeSinceFailure* is such that the drift of the time stamping shall not be larger than  $\pm 0.72$  seconds per hour and  $\pm 10$  seconds over 48 hours. These relative time stamp accuracy requirements shall apply provided that:

- no power off or detach occurs after the RLF or handover failure had been detected and until the log is time-stamped.

## 4.4 Idle Mode CA/DC Measurements

### 4.4.1 Introduction

A UE supporting *idleInactiveNR-MeasReport-r16* or *idleInactiveEUTRA-MeasReport-r16* shall perform the idle mode measurement on the inter-frequency CA and DC candidate frequencies/cells and E-UTRAN inter-RAT DC candidate frequencies/cells indicated by higher layers and meet the requirement specified in this clause. The UE shall perform idle mode measurements provided that the serving cell support early measurement and is within the validity area. The idle mode measurement requirements apply to a configured carrier frequency and the serving cell are among the supported band combination of the UE.

### 4.4.2 Measurement Requirements

For a UE which supports *idleInactiveNR-MeasReport-r16* or *idleInactiveEUTRA-MeasReport-r16* the UE shall support the idle mode CA measurements on the serving cell, and carriers configured for idle mode CA/DC measurement reporting provided T331 has not expired, the serving cell is supporting idle mode CA/DC measurement reporting and the serving cell is in the validity area.

#### 4.4.2.1 Detected cell requirement during state transition and Idle mode

This subclause defines the requirements for the detected cell status for the idle mode CA/DC measurement when UE transitions from RRC Connected mode to Idle mode and after UE has entered Idle mode. The requirements are applicable to an NE-DC and NR carrier aggregation capable UE which has been configured with one or more of following, one or more SCells, one E-UTRAN PSCell or one or more downlink E-UTRAN SCells during the Connected mode and which supports *idleInactiveNR-MeasReport-r16* or *idleInactiveEUTRA-MeasReport-r16*. The requirements are applicable for SCell(s) and E-UTRAN FDD and TDD PSCell and SCells.

Upon releasing the connection and if the UE has been configured with idle mode CA measurement reporting, following requirements apply concerning the detected cells in Connected mode upon state transitioning to Idle mode and during Idle mode:

- A cell which is detected cell in Connected mode prior to connection release, shall remain detected after UE has entered Idle mode and during Idle mode, provided that the following conditions are met:
  - The UE has been provided with a list of cells and/or carrier frequencies for early measurement reporting by dedicated RRC signaling and
  - The detected cell is among the list of cells or on a carrier frequency provided for early measurement reporting, and
  - The UE is provided with a valid timer T331 by dedicated RRC signaling, and
  - The detected cell and SSBs remains detectable until UE reconnect to the network and transmits the early measurement report, and



- The carrier frequency of the detected cell and the carrier frequency of the serving cell are among the supported band combination of the UE.

An inter-RAT E-UTRAN cell is considered detectable according to RSRP, RSRP  $\hat{E}_s/I_{ot}$ , SCH<sub>RP</sub> and SCH  $\hat{E}_s/I_{ot}$  defined in Annex B.1.1 and Annex B.1.2 in [15] for a corresponding Band. An inter-frequency cell is considered detectable according to the conditions in Annex B.1.2 and B.1.3 for a corresponding band. An SSB of an inter-frequency cell is considered detectable according to SSB<sub>RP</sub> and SSB  $\hat{E}_s/I_{ot}$  defined in Annex B.1.2 and B.1.3 for a corresponding Band.

#### 4.4.2.2 Measurements of inter-frequency CA/DC candidate cells

While T331 is running, the UE shall perform measurement on the configured inter-frequency carriers for idle mode CA/DC measurement reporting according to the UE measurement capability.

A UE which supports *idleInactiveNR-MeasReport-r16* shall support idle mode CA/DC measurements of:

- at least 7 inter-frequency carriers which are also configured for inter-frequency mobility measurements, and
- at least 7 inter-frequency carriers which are not configured for inter-frequency mobility measurements.

The UE shall be capable of monitoring a total of at least 7 inter-frequency carriers for idle mode CA/DC measurements comprising of carriers configured for inter-frequency mobility measurements and carriers not configured for inter-frequency mobility measurements.

For inter-frequency carriers configured for idle mode CA/DC measurements, if  $S_{rxlev} \leq S_{nonIntraSearchP}$  or  $S_{qual} \leq S_{nonIntraSearchQ}$  the inter-frequency measurement requirements in clause 4.2.2.4 shall apply, where UE shall search for and measure inter-frequency layers configured for idle mode CA/DC measurements in preparation for possible reporting. If  $S_{rxlev} > S_{nonIntraSearchP}$  and  $S_{qual} > S_{nonIntraSearchQ}$  the UE shall search for inter-frequency layers configured for idle mode CA/DC measurements at least every  $T_{higher\_priority\_search}$  where  $T_{higher\_priority\_search}$  is described in clause 4.2.2.7, where UE shall search for and measure inter-frequency layers configured for idle mode CA/DC measurements in preparation for possible reporting.

For UE supporting *idleInactiveNR-MeasBeamReport-r16*, if the UE is configured with *beamMeasConfigIdle-r16* on one or more carrier for idle mode CA/DC measurement, the UE, on each carrier, shall be able to:

- detect a newly detectable inter-frequency NR cell and perform RSRP/RSRQ measurement in preparation for reporting, and
- acquire the SSB index for a newly detectable inter-frequency NR cell if *beamMeasConfigIdle-r16* is configured on this carrier and perform RSRP/RSRQ measurement in preparation for reporting,

within the requirements defined in clause 4.2.2.4 plus  $k \cdot T_{SSB\_index, NR}$ , where  $k$  is the number of carriers configured for idle mode CA measurement with *beamMeasConfigIdle-r16*, and  $T_{SSB\_index, NR}$  is the additional time period used to acquire the index of the SSB being measured as defined in table 4.4.2.2-1.

**Table 4.4.2.2-1:  $T_{SSB\_index, NR\_Inter}$**

DRX cycle length [s]	Scaling Factor (N1)		$T_{SSB\_index, NR\_Inter}$ [s] (number of DRX cycles)
	FR1	FR2 <sup>Note1</sup>	
0.32	1	8	$N2 \times 1.28 \times N1 \times 1.5$ ( $N2 \times 4 \times N1 \times 1.5$ )
0.64		5	$N2 \times 1.28 \times N1$ ( $N2 \times 2 \times N1$ )
1.28		4	$N2 \times 1.28 \times N1$ ( $N2 \times 1 \times N1$ )
2.56		3	$N2 \times 2.56 \times N1$ ( $N2 \times 1 \times N1$ )

Note 1:	Applies for UE supporting power class 2&3&4. For UE supporting power class 1, $N1 = 8$ for all DRX cycle length.
NOTE 2:	$N2 = 3$ if the NR inter-frequency carrier for idle mode CA/DC measurement reporting is in FR1, and $N2 = 5$ if the NR inter-frequency carrier for idle mode CA/DC measurement reporting is in FR2.

In the absence or expiration of T331, it is up to UE implementation to perform the idle mode CA/DC measurement.

For inter-frequency carriers configured for idle mode CA/DC measurements, the UE shall be capable of performing SS-RSRP and SS-RSRQ measurements of the carriers, and the UE physical layer shall be capable of reporting SS-RSRP and SS-RSRQ measurements of the carriers configured for idle mode CA/DC measurements to higher layers, with measurement accuracy as specified in clauses 10.1.4B and 10.1.5B and 10.1.9B and 10.1.10B, respectively.

The UE shall be able to report idle mode CA/DC measurements when idle mode CA/DC measurement reporting is requested by the network.

#### 4.4.2.3 Measurements on serving cell

The UE shall measure the RSRP and RSRQ level of the serving cell and evaluate the cell selection criterion  $S$  defined in clause 4.2.2.2 and the UE physical layer shall be capable of reporting RSRP and RSRQ measurements of the serving cell to higher layers, with measurement accuracy as specified in 10.1.2B, 10.1.3B, 10.1.7B and 10.1.8B.

#### 4.4.2.4 Measurements of E-UTRAN inter-RAT DC candidate cells

While T331 is running, the UE shall perform measurement on the configured inter-RAT carriers for idle mode CA/DC measurement reporting according to the UE measurement capability.

A UE which supports *idleInactiveEUTRA-MeasReport-r16* shall support idle mode DC measurements of:

- at least 7 E-UTRAN inter-RAT carriers which are also configured for E-UTRAN inter-RAT mobility measurements, and
- at least 1 E-UTRAN inter-RAT carrier which is not configured for E-UTRAN inter-RAT mobility measurements.

The UE shall be capable of monitoring a total of at least 7 inter-RAT carriers for idle mode CA/DC measurements comprising of carriers configured for inter-RAT mobility measurements and carriers not configured for inter-RAT mobility measurements.

For inter-RAT carriers configured for idle mode CA/DC measurements, if  $S_{rxlev} \leq S_{nonIntraSearchP}$  or  $S_{qual} \leq S_{nonIntraSearchQ}$  the inter-RAT measurement requirements in clause 4.2.2.5 shall apply, where UE shall search for and measure inter-RAT layers configured for idle mode CA/DC measurements in preparation for possible reporting. If  $S_{rxlev} > S_{nonIntraSearchP}$  and  $S_{qual} > S_{nonIntraSearchQ}$  the UE shall search for inter-RAT layers configured for idle mode CA/DC measurements at least every  $T_{higher\_priority\_search}$  where  $T_{higher\_priority\_search}$  is described in clause 4.2.2, where UE shall search for and measure inter-RAT layers configured for idle mode CA/DC measurements in preparation for possible reporting.

For overlapping inter-RAT carriers configured for idle mode CA/DC measurements, the UE shall be capable of performing RSRP and RSRQ measurements of the carriers, and the UE physical layer shall be capable of reporting RSRP and RSRQ measurements of the carriers configured for idle mode CA/DC measurements to higher layers, with measurement accuracy as specified in clauses in 9.1.3B.3 and 9.1.6B.2 [15], respectively.

The UE shall be able to report idle mode CA measurements when idle mode CA measurement reporting is requested by the network.

---

## 5 SA: RRC\_INACTIVE state mobility

### 5.1 Cell Re-selection

#### 5.1.1 Introduction

The cell reselection procedure allows the UE to select a more suitable cell and camp on it.

When the UE is in *Camped Normally* state on a cell, the UE shall attempt to detect, synchronise, and monitor intra-frequency, inter-frequency and inter-RAT cells indicated by the serving cell. For intra-frequency and inter-frequency cells the serving cell may not provide explicit neighbour list but carrier frequency information and bandwidth information only. UE measurement activity is also controlled by measurement rules defined in TS38.304 [1], allowing the UE to limit its measurement activity.

#### 5.1.2 Requirements

##### 5.1.2.1 UE measurement capability

The requirements in clause 4.2.2.1 shall apply.

##### 5.1.2.2 Measurement and evaluation of serving cell

The requirements in clause 4.2.2.2 shall apply.

##### 5.1.2.3 Measurements of intra-frequency NR cells

The requirements in clause 4.2.2.3 shall apply. The requirements in clause 4.2.2.9 apply for UE configured with relaxed measurement criterion.

##### 5.1.2.4 Measurements of inter-frequency NR cells

The requirements in clause 4.2.2.4 shall apply regardless of whether the serving cell is subject to CCA or not. The requirements in clause 4.2.2.10 shall apply regardless of whether the serving cell is subject to CCA or not for UE configured with relaxed measurement criterion.

##### 5.1.2.5 Measurements of inter-RAT E-UTRAN cells

The requirements in clause 4.2.2.5 shall apply. The requirements in clause 4.2.2.11 shall apply for UE configured with relaxed measurement criterion.

##### 5.1.2.6 Maximum interruption in paging reception

The requirements in clause 4.2.2.6 shall apply.

##### 5.1.2.7 General requirements

The requirements in clause 4.2.2.7 shall apply.

### 5.1A Cell Re-selection with CCA

#### 5.1A.1 Introduction

The cell reselection procedure allows the UE to select a more suitable cell and camp on it. The requirements in subclauses 5.1A.2.3, 5.1A.2.4, and 5.1A.2.6 apply when at least the target cell is on a carrier frequency with CCA, and

the requirements in subclauses 5.1A.2.2 and 5.1A.2.5 apply when at least the camping cell is on a carrier frequency with CCA.

When the UE is in *Camped Normally* state on a cell, the UE shall attempt to detect, synchronise, and monitor intra-frequency, inter-frequency and inter-RAT cells indicated by the serving cell. For intra-frequency and inter-frequency cells the serving cell may not provide explicit neighbour list but carrier frequency information and bandwidth information only. UE measurement activity is also controlled by measurement rules defined in TS38.304, allowing the UE to limit its measurement activity.

## 5.1A.2 Requirements

### 5.1A.2.1 UE measurement capability

The requirements in clause 4.2A.2.1 shall apply.

### 5.1A.2.2 Measurement and evaluation when CCA is used on the serving cell

The requirements in clause 4.2A.2.2 shall apply.

### 5.1A.2.3 Measurements of intra-frequency NR cells when CCA is used on the serving cell and target cell

The requirements in clause 4.2A.2.3 shall apply.

### 5.1A.2.4 Measurements of inter-frequency NR cells when CCA is used on the target cell

The requirements in clause 4.2A.2.4 shall apply.

### 5.1A.2.5 Measurements of inter-RAT E-UTRAN cells when CCA is used on the serving cell

The requirements in clause 4.2.2.5 shall apply.

### 5.1A.2.6 Maximum interruption in paging reception when CCA is used on the target cell

The requirements in clause 4.2A.2.6 shall apply.

### 5.1A.2.7 General requirements

The requirements in clause 4.2.2.7 shall apply.

## 5.2 Void

## 5.3 Minimization of Drive Tests (MDT)

### 5.3.1 Introduction

UE supporting minimisation of drive tests in RRC\_INACTIVE shall be capable of:

- logging measurements in RRC\_INACTIVE, reporting the logged measurements and meeting requirements in clause 5.3.1;
- logging of RRC connection establishment failure, reporting the logged failure and meeting requirements in clause 5.3.1;

- logging of radio link failure and handover failure, reporting the logged failure and meeting requirements in clause 5.3.1.

The logged MDT requirements consist of measurement requirements as specified in clause 5.3.2 and relative time stamp accuracy requirements as specified in clause 5.3.3. Both sets of requirements are applicable for intra-frequency, inter-frequency and inter-RAT cases in RRC\_INACTIVE state. The MDT procedures are described in TS 37.320 [31].

For RRC connection establishment failure logging and reporting, the MDT requirements consist of requirements for measurements performed and logged in RRC\_INACTIVE state specified in clause 5.3.2 and relative time stamp accuracy requirement for RRC connection establishment failure log reporting as specified in clause 5.3.4.

## 5.3.2 Measurement Requirements

The measurements and measurement requirements applicable for MDT in RRC\_INACTIVE are the same as specified for MDT in RRC\_IDLE in clause 4.3.2.

## 5.3.3 Requirements for Relative Time Stamp Accuracy

The requirements for relative time stamp accuracy applicable for MDT in RRC\_INACTIVE are the same as specified for MDT in RRC\_IDLE in clause 4.3.3.

## 5.3.4 Requirements for Relative Time Stamp Accuracy for RRC Connection Establishment Failure Log Reporting

The requirements for relative time stamp accuracy for RRC connection establishment failure applicable for MDT in RRC\_INACTIVE are the same as specified for MDT in RRC\_IDLE in clause 4.3.4.

## 5.3.5 Requirements for Relative Time Stamp Accuracy for Radio Link Failure and Handover Failure Log Reporting

The requirements for relative time stamp accuracy for RRC link failure and handover failure applicable for MDT in RRC\_INACTIVE are the same as specified for MDT in RRC\_IDLE in clause 4.3.5.

## 5.3.6 Requirements for Relative Time Stamp Accuracy for RRC Resume Failure Log Reporting

The requirements for relative time stamp accuracy for RRC resume failure applicable for MDT in RRC\_INACTIVE are the same as specified for MDT in RRC\_IDLE in clause 4.3.4.

# 5.4 Inactive Mode CA/DC Measurements

## 5.4.1 Introduction

A UE supporting *idleInactiveNR-MeasReport-r16* or *idleInactiveEUTRA-MeasReport-r16* shall perform the inactive mode measurement on the inter-frequency CA and DC candidate frequencies/cells and E-UTRAN inter-RAT DC candidate frequencies/cells indicated by higher layers and meet the requirement specified in this clause. The UE shall perform inactive mode measurements provided that the serving cell support early measurement and is within the validity area. The inactive mode measurement requirements apply to a configured carrier frequency and the serving cell are among the supported band combination of the UE.

## 5.4.2 Measurement Requirements

The requirements in clause 4.4.2 shall apply.

#### 5.4.2.1 Detected cell requirement during state transition and inactive mode

The requirements in clause 4.4.2.1 shall apply.

#### 5.4.2.2 Measurements of inter-frequency CA/DC candidate cells

The requirements in clause 4.4.2.2 shall apply.

#### 5.4.2.3 Measurements on serving cell

The requirements in clause 4.4.2.3 shall apply.

#### 5.4.2.4 Measurements on E-UTRAN inter-RAT DC candidate cells

The requirements in clause 4.4.2.4 shall apply.

## 6 RRC\_CONNECTED state mobility

### 6.1 Handover

#### 6.1.1 NR Handover

##### 6.1.1.1 Introduction

The purpose of NR handover is to change the NR PCell to another NR cell. The requirements in this clause are applicable to SA NR, NE-DC and NR-DC.

##### 6.1.1.2 NR FR1 - NR FR1 Handover

The requirements in this clause are applicable to both intra-frequency and inter-frequency handovers from NR FR1 cell to NR FR1 cell, and to inter-frequency handover from NR FR1 cell in a carrier frequency with CCA to NR FR1 cell.

##### 6.1.1.2.1 Handover delay

When the UE receives a RRC message implying handover the UE shall be ready to start the transmission of the new uplink PRACH channel within  $D_{\text{handover}}$  msec from the end of the last TTI containing the RRC command.

Where:

$D_{\text{handover}}$  equals the applicable RRC procedure delay defined in clause 12 in TS 38.331 [2] plus the interruption time stated in clause 6.1.1.2.2.

##### 6.1.1.2.2 Interruption time

The interruption time is the time between end of the last TTI containing the RRC command on the old PDSCH and the time the UE starts transmission of the new PRACH, excluding the RRC procedure delay.

When intra-frequency or inter-frequency handover is commanded, the interruption time shall be less than  $T_{\text{interrupt}}$

$$T_{\text{interrupt}} = T_{\text{search}} + T_{\text{IU}} + T_{\text{processing}} + T_{\Delta} + T_{\text{margin}} \text{ ms}$$

Where:

$T_{\text{search}}$  is the time required to search the target cell when the target cell is not already known when the handover command is received by the UE. If the target cell is known, then  $T_{\text{search}} = 0$  ms. If the target cell is an unknown intra-frequency cell and the target cell  $E_s/I_{\text{ot}} \geq -2$  dB, then  $T_{\text{search}} = T_{\text{rs}}$  ms. If the target cell is an unknown inter-

frequency cell and the target cell  $E_s/I_{ot} \geq -2$  dB, then  $T_{\text{search}} = 3 * T_{\text{rs}}$  ms. Regardless of whether DRX is in use by the UE,  $T_{\text{search}}$  shall still be based on non-DRX target cell search times.

$T_{\Delta}$  is time for fine time tracking and acquiring full timing information of the target cell.  $T_{\Delta} = T_{\text{rs}}$  for both known and unknown target cell.

$T_{\text{processing}}$  is time for UE processing.  $T_{\text{processing}}$  can be up to 20ms.

$T_{\text{margin}}$  is time for SSB post-processing.  $T_{\text{margin}}$  can be up to 2ms.

$T_{\text{IU}}$  is the interruption uncertainty in acquiring the first available PRACH occasion in the new cell.  $T_{\text{IU}}$  can be up to the summation of SSB to PRACH occasion association period and 10 ms. SSB to PRACH occasion associated period is defined in the table 8.1-1 of TS 38.213 [3].

$T_{\text{rs}}$  is the SMTC periodicity of the target NR cell if the UE has been provided with an SMTC configuration for the target cell in the handover command, otherwise  $T_{\text{rs}}$  is the SMTC configured in the `measObjectNR` having the same SSB frequency and subcarrier spacing. If the `measObjectNRs` having the same SSB frequency and subcarrier spacing configured by MN and SN have different SMTC,  $T_{\text{rs}}$  is the periodicity of one of the SMTC which is up to UE implementation. If the UE is not provided SMTC configuration or measurement object on this frequency, the requirement in this clause is applied with  $T_{\text{rs}}=5$ ms assuming the SSB transmission periodicity is 5ms. There is no requirement if the SSB transmission periodicity is not 5ms. If the UE has been provided with higher layer in TS 38.331 [2] signaling of `smtc2` prior to the handover command,  $T_{\text{rs}}$  follows `smtc1` or `smtc2` according to the physical cell ID of the target cell.

In the interruption requirement a cell is known if it has been meeting the relevant cell identification requirement during the last 5 seconds otherwise it is unknown. Relevant cell identification requirements are described in Clause 9.2.5 for intra-frequency handover and Clause 9.3.4 for inter-frequency handover.

### 6.1.1.3 NR FR2- NR FR1 Handover

The requirements in this clause are applicable to inter-frequency handovers from NR FR2 cell to NR FR1 cell.

#### 6.1.1.3.1 Handover delay

When the UE receives a RRC message implying handover the UE shall be ready to start the transmission of the new uplink PRACH channel within  $D_{\text{handover}}$  ms from the end of the last TTI containing the RRC command.

Where:

$D_{\text{handover}}$  equals the applicable RRC procedure delay defined in clause 12 in TS 38.331 [2] plus the interruption time stated in clause 6.1.1.3.2.

#### 6.1.1.3.2 Interruption time

The interruption time is the time between the end of the last TTI containing the RRC command on the old PDSCH and the time the UE starts transmission of the new PRACH, excluding the RRC procedure delay.

When inter-frequency handover is commanded, the interruption time shall be less than  $T_{\text{interrupt}}$

$$T_{\text{interrupt}} = T_{\text{search}} + T_{\text{IU}} + T_{\text{processing}} + T_{\Delta} + T_{\text{margin}} \text{ ms}$$

Where:

$T_{\text{search}}$  is the time required to search the target cell when the target cell is not already known when the handover command is received by the UE. If the target cell is known, then  $T_{\text{search}} = 0$  ms. If the target cell is an unknown inter-frequency cell and the target cell  $E_s/I_{ot} \geq -2$  dB, then  $T_{\text{search}} = 3 * T_{\text{rs}}$  ms. Regardless of whether DRX is in use by the UE,  $T_{\text{search}}$  shall still be based on non-DRX target cell search times.

$T_{\Delta}$  is time for fine time tracking and acquiring full timing information of the target cell.  $T_{\Delta} = T_{\text{rs}}$  for both known and unknown target cell.

$T_{\text{processing}}$  is time for UE processing.  $T_{\text{processing}}$  can be up to 40ms.

$T_{\text{margin}}$  is time for SSB post-processing.  $T_{\text{margin}}$  can be up to 2ms.

$T_{IU}$  is the interruption uncertainty in acquiring the first available PRACH occasion in the new cell.  $T_{IU}$  can be up to the summation of SSB to PRACH occasion association period and 10 ms. SSB to PRACH occasion associated period is defined in the table 8.1-1 of TS 38.213 [3].

$T_{rs}$  is the SMTC periodicity of the target NR cell if the UE has been provided with an SMTC configuration for the target cell in the handover command, otherwise  $T_{rs}$  is the SMTC configured in the measObjectNR having the same SSB frequency and subcarrier spacing. If such measObjectNRs configured by MN and SN have different SMTC,  $T_{rs}$  is the periodicity of one of the SMTC which is up to UE implementation. If the UE is not provided SMTC configuration or measurement object on this frequency, the requirement in this clause is applied with  $T_{rs}=5\text{ms}$  assuming the SSB transmission periodicity is 5ms. There is no requirement if the SSB transmission periodicity is not 5ms.

In the interruption requirement a cell is known if it has been meeting the relevant cell identification requirement during the last 5 seconds otherwise it is unknown. Relevant cell identification requirements are described in Clause 9.2.5 for intra-frequency handover and Clause 9.3.4 for inter-frequency handover.

#### 6.1.1.4 NR FR2- NR FR2 Handover

The requirements in this clause are applicable to both intra-frequency and inter-frequency handovers from NR FR2 cell to NR FR2 cell.

##### 6.1.1.4.1 Handover delay

When the UE receives a RRC message implying handover the UE shall be ready to start the transmission of the new uplink PRACH channel within  $D_{\text{handover}}$  ms from the end of the last TTI containing the RRC command.

Where:

$D_{\text{handover}}$  equals the applicable RRC procedure delay defined in clause 12 in TS 38.331 [2] plus the interruption time stated in clause 6.1.1.4.2.

##### 6.1.1.4.2 Interruption time

The interruption time is the time between end of the last TTI containing the RRC command on the old PDSCH and the time the UE starts transmission of the new PRACH, excluding the RRC procedure delay.

When intra-frequency or inter-frequency handover is commanded, the interruption time shall be less than  $T_{\text{interrupt}}$

$$T_{\text{interrupt}} = T_{\text{search}} + T_{IU} + T_{\text{processing}} + T_{\Delta} + T_{\text{margin}} \text{ ms}$$

Where:

$T_{\text{search}}$  is the time required to search the target cell when the handover command is received by the UE. If the target cell is a known cell, then  $T_{\text{search}} = 0$  ms. If the target cell is an unknown intra-frequency cell and the target cell  $E_s/I_{ot} \geq -2$  dB, then  $T_{\text{search}} = 8 * T_{rs}$  ms. If the target cell is an unknown inter-frequency cell and the target cell  $E_s/I_{ot} \geq -2$  dB, then  $T_{\text{search}} = 8 * 3 * T_{rs}$  ms. Regardless of whether DRX is in use by the UE,  $T_{\text{search}}$  shall still be based on non-DRX target cell search times.

$T_{\text{processing}}$  is time for UE processing.  $T_{\text{processing}}$  can be up to 20ms.

$T_{\text{margin}}$  is time for SSB post-processing.  $T_{\text{margin}}$  can be up to 2ms.

$T_{\Delta}$  is time for fine time tracking and acquiring full timing information of the target cell.  $T_{\Delta} = T_{rs}$  for both known and unknown target cell.

$T_{IU}$  is the interruption uncertainty in acquiring the first available PRACH occasion in the new cell.  $T_{IU}$  can be up to the summation of SSB to PRACH occasion association period and 10 ms. SSB to PRACH occasion associated period is defined in the table 8.1-1 of TS 38.213 [3].

$T_{rs}$  is the SMTC periodicity of the target NR cell if the UE has been provided with an SMTC configuration for the target cell in the handover command, otherwise  $T_{rs}$  is the SMTC configured in the measObjectNR having the same SSB frequency and subcarrier spacing. If such measObjectNRs configured by MN and SN have different SMTC,  $T_{rs}$  is the periodicity of one of the SMTC which is up to UE implementation. If the UE is not provided SMTC configuration or measurement object on this frequency, the requirement in this clause is applied with  $T_{rs}=5\text{ms}$  assuming the SSB



transmission periodicity is 5ms. There is no requirement if the SSB transmission periodicity is not 5ms. If the UE has been provided with higher layer in TS 38.331 [2] signaling of *smtc2* prior to the handover command,  $T_{rs}$  follows *smtc1* or *smtc2* according to the physical cell ID of the target cell.

In FR2, the target cell is known if it has been meeting the following conditions:

- During the last 5 seconds before the reception of the handover command:
  - the UE has sent a valid measurement report for the target cell and
  - One of the SSBs measured from the NR target cell being configured remains detectable according to the cell identification conditions specified in clause 9.2 for intra-frequency cell and in clause 9.3 for inter-frequency cell,
- One of the SSBs measured from the target cell also remains detectable during the handover delay according to the cell identification conditions specified in clause 9.2 for intra-frequency cell and in clause 9.3 for inter-frequency cell.

otherwise it is unknown.

### 6.1.1.5 NR FR1- NR FR2 Handover

The requirements in this clause are applicable to inter-frequency handovers from NR FR1 cell to NR FR2 cell.

#### 6.1.1.5.1 Handover delay

When the UE receives a RRC message implying handover the UE shall be ready to start the transmission of the new uplink PRACH channel within  $D_{handover}$  ms from the end of the last TTI containing the RRC command.

Where:

$D_{handover}$  equals the applicable RRC procedure delay defined in clause 12 in TS 38.331 [2] plus the interruption time stated in clause 6.1.1.5.2.

#### 6.1.1.5.2 Interruption time

The interruption time is the time between end of the last TTI containing the RRC command on the old PDSCH and the time the UE starts transmission of the new PRACH, excluding the RRC procedure delay.

When in inter-frequency handover is commanded, the interruption time shall be less than  $T_{interrupt}$

$$T_{interrupt} = T_{search} + T_{IU} + T_{processing} + T_{\Delta} + T_{margin} \text{ ms}$$

Where:

$T_{search}$  is the time required to search the target cell when the handover command is received by the UE. If the target cell is a known cell, then  $T_{search} = 0$  ms. If the target cell is an unknown inter-frequency cell and the target cell  $E_s/I_{ot} \geq -2$  dB, then  $T_{search} = 8 \cdot 3 \cdot T_{rs}$  ms. Regardless of whether DRX is in use by the UE,  $T_{search}$  shall still be based on non-DRX target cell search times.

$T_{processing}$  is time for UE processing.  $T_{processing}$  can be up to 40ms.

$T_{margin}$  is time for SSB post-processing.  $T_{margin}$  can be up to 2ms.

$T_{\Delta}$  is time for fine time tracking and acquiring full timing information of the target cell.  $T_{\Delta} = T_{rs}$  for both known and unknown target cell.

$T_{IU}$  is the interruption uncertainty in acquiring the first available PRACH occasion in the new cell.  $T_{IU}$  can be up to the summation of SSB to PRACH occasion association period and 10 ms. SSB to PRACH occasion associated period is defined in the table 8.1-1 of TS 38.213 [3].

$T_{rs}$  is the SMTC periodicity of the target NR cell if the UE has been provided with an SMTC configuration for the target cell in the handover command, otherwise  $T_{rs}$  is the SMTC configured in the *measObjectNR* having the same SSB frequency and subcarrier spacing. If such *measObjectNRs* configured by MN and SN have different SMTC,  $T_{rs}$  is the periodicity of one of the SMTC which is up to UE implementation. If the UE is not provided SMTC configuration or

measurement object on this frequency, the requirement in this clause is applied with  $T_{rs}=5\text{ms}$  assuming the SSB transmission periodicity is 5ms. There is no requirement if the SSB transmission periodicity is not 5ms.

In FR2, the target cell is known if it has been meeting the following conditions:

During the last 5 seconds before the reception of the handover command:

- the UE has sent a valid measurement report for the target cell and
- One of the SSBs measured from the NR target cell being configured remains detectable according to the cell identification conditions specified in clause 9.3,
- One of the SSBs measured from the target cell also remains detectable during the handover delay according to the cell identification conditions specified in clause 9.3.

otherwise it is unknown.

## 6.1.2 NR Handover to other RATs

### 6.1.2.1 NR – E-UTRAN Handover

#### 6.1.2.1.1 Introduction

The purpose of inter-RAT handover from NR to E-UTRAN is to change the radio access mode of PCell from NR to E-UTRAN. The handover procedure is initiated from NR with a RRC message that implies a handover as described in TS 38.331 [2]. The requirements in this clause are applicable to SA NR, NE-DC and NR-DC, and to handover from SA NR cell in a carrier frequency with CCA to E-UTRAN.

#### 6.1.2.1.2 Handover delay

When the UE receives a RRC message implying handover to E-UTRAN the UE shall be ready to start the transmission of the uplink PRACH channel in E-UTRA within  $D_{\text{handover}}$  ms from the end of the last TTI containing the RRC command.  $D_{\text{handover}}$  is defined as

$$D_{\text{handover}} = T_{\text{RRC\_procedure\_delay}} + T_{\text{interrupt}}$$

Where:

$T_{\text{RRC\_procedure\_delay}}$ : it is the RRC procedure delay, which is 50ms

$T_{\text{interrupt}}$ : it is the time between end of the last TTI containing the RRC command on the NR PDSCH and the time the UE starts transmission of the PRACH in E-UTRAN, excluding  $T_{\text{RRC\_procedure\_delay}}$ .  $T_{\text{interrupt}}$  is defined in clause 6.1.2.1.3.

#### 6.1.2.1.3 Interruption time

When the inter-RAT handover to E-UTRAN is commanded, the interruption time shall be less than  $T_{\text{interrupt}}$

$$T_{\text{interrupt}} = T_{\text{search}} + T_{\text{IU}} + 20 \text{ ms}$$

Where:

$T_{\text{search}}$  is the time required to search the target cell when the target cell is not already known when the handover command is received by the UE. If the target cell is known, then  $T_{\text{search}} = 0$  ms. If the target cell is unknown and signal quality is sufficient for successful cell detection on the first attempt, then  $T_{\text{search}} = 80$  ms. Regardless of whether DRX is in use by the UE,  $T_{\text{search}}$  shall still be based on non-DRX target cell search times.

$T_{\text{IU}}$  is the interruption uncertainty in acquiring the first available PRACH occasion in the new cell.  $T_{\text{IU}}$  can be up to 30 ms.

NOTE: The actual value of  $T_{\text{IU}}$  shall depend upon the PRACH configuration used in the target cell.

In the interruption requirement a cell is known if it has been meeting the relevant cell identification requirement during the last 5 seconds otherwise it is unknown. Relevant E-UTRAN cell identification requirements are described in clause 9.4.1.

## 6.1.2.2 NR – UTRAN Handover

### 6.1.2.2.1 Introduction

The purpose of inter-RAT handover from NR to UTRAN is to change the radio access mode from NR to UTRAN. The handover procedure is initiated from NR with a RRC message that implies a hard handover as described in TS 38.331 [2].

#### 6.1.2.2.2 Handover delay

When the UE receives a RRC message implying handover to UTRAN the UE shall be ready to start the transmission of the new UTRA uplink DPCH within  $D_{\text{handover}}$  ms from the end of the last NR TTI containing the RRC *MobilityfromNRCommand* command.

where:

- $D_{\text{handover}}$  equals the RRC procedure delay, which is 50 ms plus the interruption time stated in clause 6.1.2.2.3.

#### 6.1.2.2.3 Interruption time

The interruption time is the time between the end of the last TTI containing the RRC command on the NR PDSCH and the time the UE starts transmission on the uplink DPCH in UTRAN, excluding the RRC procedure delay. The interruption time depends on whether the target cell is known to the UE or not.

The target cell is known if it has been measured by the UE during the last 5 seconds otherwise it is unknown. The UE shall always perform a UTRA synchronisation procedure as part of the handover procedure.

If the target cell is known the interruption time shall be less than  $T_{\text{interrupt1}}$

$$T_{\text{interrupt1}} = T_{\text{IU}} + T_{\text{sync}} + 50 + 10 * F_{\text{max}} + T_{\text{MC}} \text{ ms}$$

If the target cell is unknown the interruption time shall be less than  $T_{\text{interrupt2}}$

$$T_{\text{interrupt2}} = T_{\text{IU}} + T_{\text{sync}} + 150 + 10 * F_{\text{max}} + T_{\text{MC}} \text{ ms}$$

This requirement shall be met, provided that there is one target cell in the *MobilityfromNRCommand* command. Performance requirements for E-UTRA to UTRA soft handover are not specified. When UE is connected to an NR cell, UTRA SFN timing measurements are not reported. This implies that the timing of the DPCH of the UTRA target cells in the active set cannot be configured by UTRAN to guarantee that all target cells fall within the UE reception window of  $T_0 \pm 148$  chips.

Where:

- $T_{\text{IU}}$  is the interruption uncertainty when changing the timing from the NR to the new UTRAN cell.  $T_{\text{IU}}$  can be up to one UTRA frame (10 ms).
- $F_{\text{max}}$  denotes the maximum number of radio frames within the transmission time intervals of all transport channels that are multiplexed into the same CCTrCH on the UTRA target cell. If HS-PDSCH is configured in the UTRA target cell,  $F_{\text{max}}$  is 4 radio frames.
- $T_{\text{sync}}$  is the time required for measuring the downlink DPCH channel as stated in TS 25.214 [32], clause 4.3.1.2. In case higher layers indicate the usage of a post-verification period  $T_{\text{sync}}=0$  ms. Otherwise  $T_{\text{sync}}=40$  ms.
- $T_{\text{MC}}$  is 0ms if a single UTRA cell is configured as the handover target, otherwise 20ms if handover to UTRA with 1, 2 or 3 UTRA carriers with secondary HS-PDSCH is configured.

The phase reference is the primary CPICH.

The requirements in this clause assume that N312 has the smallest possible value i.e. only one insync is required.

## 6.1.3 NR DAPS Handover

### 6.1.3.1 Introduction

The requirements in this clause are applicable to DAPS handover to change the NR PCell to another NR cell.

Note: requirements only apply if

- the UE indicates ‘no-gap’ via *intraFreq-needForGap* for intra-frequency measurement of source cell and intra-frequency measurement of target cell, or
- the SSB of source cell is completely contained in the active DL BWP of the source cell, and the SSB of target cell is completely contained in the active DL BWP of the target cell, or
- the initial DL and UL BWP of source cell is confined within the active DL and UL BWP of the source cell respectively, and the initial DL and UL BWP of target cell is confined within the active DL and UL BWP of the target cell respectively.

### 6.1.3.2 NR FR1 - NR FR1 DAPS Handover

The requirements in this clause are applicable to both intra-frequency and inter-frequency handovers from NR FR1 cell to NR FR1 cell. A DAPS handover is intra-frequency if the centre frequency of the SSB of the source cell and the centre frequency of the SSB of the target cell are the same, and the subcarrier spacing of the two SSBs are also the same.

Note: For intra-frequency DAPS handover, no requirement applies if active DL and UL BWP of target cell is not confined within the active DL and UL BWP of the source cell respectively.

Note: For inter-frequency DAPS handover, no requirement applies if the BWP of target cell is overlapped with the BWP of source cell in frequency domain.

An FR1 DAPS handover is synchronous if it meets the conditions in table 6.1.3.2-1, otherwise it is asynchronous

**Table 6.1.3.2-1: Sync conditions for FR1 DAPS handover**

Type of handover	Maximum receive timing difference between source and target cell ( $\mu\text{s}$ ) for sync DAPS handover	Maximum transmit timing difference between source and target cell ( $\mu\text{s}$ ) for sync DAPS handover
Intra-frequency <sup>Note 1,2,3</sup>	6 $\mu\text{s}$	7.6 $\mu\text{s}$
Intra-band inter-frequency <sup>Note 1,2,3</sup>	6 $\mu\text{s}$	7.6 $\mu\text{s}$
Inter-band inter-frequency	33 $\mu\text{s}$	34.6 $\mu\text{s}$
<p>Note 1: For synchronous DAPS handover, if the receive time difference exceeds the cyclic prefix length of that SCS, demodulation performance degradation is expected for the first symbol of the slot. For asynchronous DAPS handover, if the receive time difference exceeds the cyclic prefix length of that SCS, interruptions may occur depending on UE implementation. The duration and frequency of occurrence of such interruptions is not specified.</p> <p>Note 2: For DAPS handover on a TDD band, after starting RACH procedure, a UE is not required to transmit in the uplink to any of source and target cells earlier than <math>N_{\text{RX-TX}}</math> after the end of the last received downlink symbol from any of source and target cells in the same TDD band where <math>N_{\text{RX-TX}}=25600T_c</math>.</p> <p>Note 3: For DAPS handover on a TDD band, after starting RACH procedure, a UE is not required to receive in the downlink from any of source and target cells earlier than <math>N_{\text{TX-RX}}</math> after the end of the last transmitted uplink symbol to any of source and target cells in the same TDD band where <math>N_{\text{TX-RX}}=25600T_c</math>.</p>		

#### 6.1.3.2.1 DAPS handover delay

Procedure delays for the procedure that can command a DAPS handover are specified in TS 38.331 [2].

When the UE receives a RRC message implying handover, the UE shall be ready to start the transmission of the new uplink PRACH channel within  $D_{\text{handover1}}$  seconds from the end of the last TTI containing the RRC command when UE is configured with dual active protocol stack handover.

$$D_{\text{handover1}} = T_{\text{RRC\_procedure}} + T_{\text{search}} + T_{\text{IU}} + T_{\text{processing}} + T_{\Delta} + T_{\text{margin}} \text{ ms}$$

Where:

$T_{\text{RRC\_procedure}}$  is the maximum RRC procedure delay as specified in clause 12 in TS 38.331 [2].

$T_{\text{search}}$ ,  $T_{\text{IU}}$ ,  $T_{\text{processing}}$ ,  $T_{\Delta}$  and  $T_{\text{margin}}$  are defined in clause 6.1.1.2.2.

After successful RACH procedure of the target cell, when the UE receives an RRC message implying source cell release command, the UE shall accomplish the release actions specified in TS 38.331 [2] within  $D_{\text{handover2}}$ .

$$D_{\text{handover2}} = T_{\text{RRC\_procedure}} + T_{\text{interrupt2}}$$

Where:

$T_{\text{RRC\_procedure}}$  is the RRC procedure delay as specified in clause 12 in TS 38.331 [2].

$T_{\text{interrupt2}}$  is defined in clause 6.1.3.2.2.

### 6.1.3.2.2 Interruption time

During  $D_{\text{handover1}}$ , the UE is allowed an interruption of up to  $T_{\text{interrupt1}}$  on source cell.

For FR1-to-FR1 intra-frequency handover,  $T_{\text{interrupt1}}$  is specified in Table 6.1.3.2.2-1.

**Table 6.1.3.2.2-1:  $T_{\text{interrupt1}}$  for FR1-to-FR1 intra-frequency DAPS HO**

$\mu$	NR Slot length (ms)	Interruption length $T_{\text{interrupt1}}$ (slots <sup>Note 1</sup> ), synchronous DAPS HO	Interruption length $T_{\text{interrupt1}}$ (slots <sup>Note 1</sup> ), asynchronous DAPS HO
0	1	1	2
1	0.5	2	3
2	0.25	4	5
Note 1: The same SCS of source cell and target cell is assumed. Note 2: It is assumed that the BWP of target cell is not larger than the BWP of source cell. It is assumed that the CBW of target cell is not larger than the CBW of source cell Note 3: Void			

For FR1-to-FR1 intra-band inter-frequency handover,  $T_{\text{interrupt1}}$  is specified in Table 6.1.3.2.2-2.

**Table 6.1.3.2.2-2:  $T_{\text{interrupt1}}$  for FR1-to-FR1 intra-band inter-frequency DAPS HO**

$\mu$	NR Slot length (ms)	$T_{\text{interrupt1}}$ (slots <sup>Note 1</sup> ), synchronous DAPS HO	$T_{\text{interrupt1}}$ (slots <sup>Note 1</sup> ), asynchronous DAPS HO
0	1	$1 + T_{\text{SMTC\_duration}} * N_{\text{slot}}^{\text{subframe}, \mu}$	$2 + T_{\text{SMTC\_duration}} * N_{\text{slot}}^{\text{subframe}, \mu}$
1	0.5	$2 + T_{\text{SMTC\_duration}} * N_{\text{slot}}^{\text{subframe}, \mu}$	$3 + T_{\text{SMTC\_duration}} * N_{\text{slot}}^{\text{subframe}, \mu}$
2	0.25	$4 + T_{\text{SMTC\_duration}} * N_{\text{slot}}^{\text{subframe}, \mu}$	$5 + T_{\text{SMTC\_duration}} * N_{\text{slot}}^{\text{subframe}, \mu}$
Note 1: The same SCS of source cell and target cell is assumed. Note 2: $T_{\text{SMTC\_duration}}$ measured in subframes is the longest SMTC duration between source cell and target cell. Note 3: Void Note 4: $N_{\text{slot}}^{\text{subframe}, \mu}$ is as defined in TS 38.211 [6].			

For FR1-to-FR1 inter-band handover,  $T_{\text{interrupt1}}$  is specified in Table 6.1.3.2.2-3.

**Table 6.1.3.2.2-3:  $T_{\text{interrupt1}}$  for FR1-to-FR1 inter-band DAPS HO**

$\mu$	NR Slot length (ms) of source cell	$T_{\text{interrupt1}}$ (slots)	
		Sync	Async
0	1	1	2
1	0.5	2	3
2	0.25	5	5

During  $D_{\text{handover2}}$ , the UE is allowed an interruption of up to  $T_{\text{interrupt2}}$  on target cell.

For FR1-to-FR1 intra-frequency handover,  $T_{\text{interrupt2}}$  is specified in Table 6.1.3.2.2-4 when the BWP of target cell is smaller than the BWP of source cell, and  $T_{\text{interrupt2}}$  is specified in Table 6.1.3.2.2-5 when the same BWP is used for target cell and source cell.

**Table 6.1.3.2.2-4:  $T_{\text{interrupt2}}$  for FR1-to-FR1 intra-frequency DAPS HO**

$\mu$	NR Slot length (ms)	Interruption length X (slots <sup>Note 1</sup> )	$T_{\text{interrupt2}}$ (slots <sup>Note 1</sup> ) for asynchronous DAPS HO
0	1	2	3
1	0.5	4	5
2	0.25	8	9

Note 1: The same SCS of source cell and target cell is assumed.  
Note 2: It is assumed that the BWP of target cell is smaller than the BWP of source cell.

**Table 6.1.3.2.2-5:  $T_{\text{interrupt2}}$  for FR1-to-FR1 intra-frequency DAPS HO**

$\mu$	NR Slot length (ms)	Interruption length X (slots <sup>Note 1</sup> )	$T_{\text{interrupt2}}$ (slots <sup>Note 1</sup> ) for asynchronous DAPS HO
0	1	1	2
1	0.5	2	3
2	0.25	4	5

Note 1: The same SCS of source cell and target cell is assumed.  
Note 2: It is assumed that the BWP of target cell is the same as the BWP of source cell.  
Note 3: Void

For FR1-to-FR1 intra-band inter-frequency handover,  $T_{\text{interrupt2}}$  is specified in Table 6.1.3.2.2-6.

**Table 6.1.3.2.2-6:  $T_{\text{interrupt2}}$  for FR1-to-FR1 intra-band inter-frequency DAPS HO**

$\mu$	NR Slot length (ms)	$T_{\text{interrupt2}}$ (slots <sup>Note 1</sup> ) for synchronous DAPS HO	$T_{\text{interrupt2}}$ (slots <sup>Note 1</sup> ) for asynchronous DAPS HO
0	1	$1 + T_{\text{SMTC\_duration}} * N_{\text{slot}}^{\text{subframe}, \mu}$	$2 + T_{\text{SMTC\_duration}} * N_{\text{slot}}^{\text{subframe}, \mu}$
1	0.5	$2 + T_{\text{SMTC\_duration}} * N_{\text{slot}}^{\text{subframe}, \mu}$	$3 + T_{\text{SMTC\_duration}} * N_{\text{slot}}^{\text{subframe}, \mu}$
2	0.25	$4 + T_{\text{SMTC\_duration}} * N_{\text{slot}}^{\text{subframe}, \mu}$	$5 + T_{\text{SMTC\_duration}} * N_{\text{slot}}^{\text{subframe}, \mu}$

Note 1: The same SCS of source cell and target cell is assumed.  
Note 2:  $T_{\text{SMTC\_duration}}$  measured in subframes is the longest SMTC duration between source cell and target cell.  
Note 3: Void.  
Note 4:  $N_{\text{slot}}^{\text{subframe}, \mu}$  is as defined in TS 38.211 [6].

For FR1-to-FR1 inter-band handover,  $T_{\text{interrupt2}}$  is specified in Table 6.1.3.2.2-7.

**Table 6.1.3.2.2-7:  $T_{\text{interrupt2}}$  for FR1-to-FR1 inter-band DAPS HO**

$\mu$	NR slot length (ms) of target cell	$T_{\text{interrupt2}}$ (slots)	
		Sync	Async
0	1	1	2

1	0.5	2	3
2	0.25	5	5

### 6.1.3.3 NR FR2- NR FR1 DAPS Handover

The requirements in this clause are applicable to inter-frequency handovers from NR FR2 cell to NR FR1 cell.

An FR2-FR1 DAPS handover is synchronous if it meets the conditions in table 6.1.3.3-1, otherwise it is asynchronous

**Table 6.1.3.3-1: Sync condition for FR2-FR1 DAPS handover**

Frequency Range of the pair of carriers	Maximum receive timing difference between source and target cell ( $\mu$ s) for sync DAPS handover	Maximum transmit timing difference between source and target cell ( $\mu$ s) for sync DAPS handover
Between FR1 and FR2	25	26.1

#### 6.1.3.3.1 DAPS handover delay

Procedure delays for the procedure that can command a DAPS handover are specified in TS 38.331 [2].

When the UE receives a RRC message implying handover, the UE shall be ready to start the transmission of the new uplink PRACH channel within  $D_{\text{handover1}}$  ms from the end of the last TTI containing the RRC command when UE is configured with dual active protocol stack handover.

$$D_{\text{handover1}} = T_{\text{RRC\_procedure}} + T_{\text{search}} + T_{\text{IU}} + T_{\text{processing}} + T_{\Delta} + T_{\text{margin}} \text{ ms}$$

Where:

$T_{\text{RRC\_procedure}}$  is the maximum RRC procedure delay as specified in clause 12 in TS 38.331 [2].

$T_{\text{search}}$ ,  $T_{\text{IU}}$ ,  $T_{\text{processing}}$ ,  $T_{\Delta}$  and  $T_{\text{margin}}$  are defined in clause 6.1.1.3.2.

After successful RACH procedure of the target cell, when the UE receives an RRC message implying source cell release command, the UE shall accomplish the release actions specified in TS 38.331 [2] within  $D_{\text{handover2}}$ .

$$D_{\text{handover2}} = T_{\text{RRC\_procedure}} + T_{\text{interrupt2}}$$

Where:

$T_{\text{RRC\_procedure}}$  is the RRC procedure delay as specified in clause 12 in TS 38.331 [2].

$T_{\text{interrupt2}}$  is defined in clause 6.1.3.3.2.

#### 6.1.3.3.2 Interruption time

During  $D_{\text{handover1}}$ , the UE is allowed an interruption of up to  $T_{\text{interrupt1}}$  on source cell.

For FR2-to-FR1 inter-band handover,  $T_{\text{interrupt1}}$  is specified in Table 6.1.3.3.2-1.

**Table 6.1.3.3.2-1:  $T_{\text{interrupt1}}$  for FR2-to-FR1 inter-band DAPS HO**

$\mu$	NR slot length (ms) of source cell	$T_{\text{interrupt1}}$ (slots)	
		Sync	Async
2	0.25	5	5
3	0.125	9	9

During  $D_{\text{handover2}}$ , the UE is allowed an interruption of up to  $T_{\text{interrupt2}}$  on target cell.

For FR2-to-FR1 inter-band handover,  $T_{\text{interrupt2}}$  is specified in Table 6.1.3.3.2-2.

**Table 6.1.3.3.2-2:  $T_{\text{interrupt}2}$  for FR2-to-FR1 inter-band DAPS HO**

$\mu$	NR slot length (ms) of target cell	$T_{\text{interrupt}2}$ (slots)	
		Sync	Async
0	1	1	2
1	0.5	2	3
2	0.25	5	5

#### 6.1.3.4 NR FR1- NR FR2 DAPS Handover

The requirements in this clause are applicable to inter-frequency handovers from NR FR1 cell to NR FR2 cell.

An FR1-FR2 DAPS handover is synchronous if it meets the conditions in table 6.1.3.4-1, otherwise it is asynchronous

**Table 6.1.3.4-1, : Sync condition for FR1-FR2 DAPS handover**

Frequency Range of the pair of carriers	Maximum receive timing difference between source and target cell ( $\mu\text{s}$ ) for sync DAPS handover	Maximum transmit timing difference between source and target cell ( $\mu\text{s}$ ) Note 1 sync DAPS handover
Between FR1 and FR2	25	26.1

##### 6.1.3.4.1 DAPS handover delay

Procedure delays for the procedure that can command a DAPS handover are specified in TS 38.331 [2].

When the UE receives a RRC message implying handover, the UE shall be ready to start the transmission of the new uplink PRACH channel within  $D_{\text{handover}1}$  ms from the end of the last TTI containing the RRC command when UE is configured with dual active protocol stack handover.

$$D_{\text{handover}1} = T_{\text{RRC\_procedure}} + T_{\text{search}} + T_{\text{IU}} + T_{\text{processing}} + T_{\Delta} + T_{\text{margin}} \text{ ms}$$

Where:

$T_{\text{RRC\_procedure}}$  is the maximum RRC procedure delay as specified in clause 12 in TS 38.331 [2].

$T_{\text{search}}$ ,  $T_{\text{IU}}$ ,  $T_{\text{processing}}$ ,  $T_{\Delta}$  and  $T_{\text{margin}}$  are defined in clause 6.1.1.5.2.

After successful RACH procedure of the target cell, when the UE receives an RRC message implying source cell release command, the UE shall accomplish the release actions specified in TS 38.331 [2] within  $D_{\text{handover}2}$ .

$$D_{\text{handover}2} = T_{\text{RRC\_procedure}} + T_{\text{interrupt}2}$$

Where:

$T_{\text{RRC\_procedure}}$  is the RRC procedure delay as specified in clause 12 in TS 38.331 [2].

$T_{\text{interrupt}2}$  is defined in clause 6.1.3.4.2.

##### 6.1.3.4.2 Interruption time

During  $D_{\text{handover}1}$ , the UE is allowed an interruption of up to  $T_{\text{interrupt}1}$  on source cell.

For FR1-to-FR2 inter-band handover,  $T_{\text{interrupt}1}$  is specified in Table 6.1.3.4.2-1.

**Table 6.1.3.4.2-1:  $T_{\text{interrupt}1}$  for FR1-to-FR2 inter-band DAPS HO**

$\mu$	NR slot length (ms) of source cell	$T_{\text{interrupt}1}$ (slots)	
		Sync	Async
0	1	1	2
1	0.5	2	3



2	0.25	5	5
---	------	---	---

During  $D_{\text{handover}2}$ , the UE is allowed an interruption of up to  $T_{\text{interrupt}2}$  on target cell.

For FR1-to-FR2 inter-band handover,  $T_{\text{interrupt}2}$  is specified in Table 6.1.3.4.2-2.

**Table 6.1.3.4.2-2:  $T_{\text{interrupt}2}$  for FR1-to-FR2 inter-band DAPS HO**

$\mu$	NR slot length (ms) of target cell	$T_{\text{interrupt}2}$ (slots)	
		Sync	Async
2	0.25	5	5
3	0.125	9	9

## 6.1.4 NR Conditional Handover

### 6.1.4.1 Introduction

The requirements in this clause are applicable to conditional handover to change the NR PCell to another NR cell.

### 6.1.4.2 NR FR1 – NR FR1 conditional handover

The requirements in this clause are applicable to both intra-frequency and inter-frequency conditional handover from NR FR1 cell to NR FR1 cell.

#### 6.1.4.2.1 Handover delay

Procedure delays for all procedures that can command a conditional handover are specified in TS 38.331 [2].

When the UE receives a RRC message implying conditional handover the UE shall be ready to start the transmission of the new uplink PRACH channel within  $D_{\text{CHO}}$  seconds from the end of the last TTI containing the RRC command.

$$D_{\text{CHO}} = T_{\text{RRC}} + T_{\text{Event\_DU}} + T_{\text{measure}} + T_{\text{interrupt}} + T_{\text{CHO\_execution}}$$

Where:

$T_{\text{RRC}}$  is the RRC procedure delay defined in clause 12 in TS 38.331 [2].

$T_{\text{Event\_DU}}$  is the delay uncertainty which is the time from when the UE successfully decodes a conditional handover command until a condition exists at the measurement reference point which will trigger the conditional handover.

$T_{\text{measure}}$  is the measurements time stated in clause 6.1.4.2.2.

$T_{\text{CHO\_execution}}$  is the conditional execution preparation time in clause 6.1.4.2.3.

$T_{\text{interrupt}}$  is the interruption time stated in clause 6.1.4.2.4.

#### 6.1.4.2.2 Measurement time

The measurement time delay is defined from the end of  $T_{\text{Event\_DU}}$  until UE executes a handover to a target cell and interruption time starts.

For intra-frequency handover, the measurement time delay measured without Time To Trigger (TTT) and L3 filtering shall be less than  $T_{\text{identify\_intra\_with\_index}}$  or  $T_{\text{identify\_intra\_without\_index}}$  defined in clause 9.2.5.1 or clause 9.2.6.2.

For inter-frequency handover, the measurement time delay measured without Time To Trigger (TTT) and L3 filtering shall be less than  $T_{\text{identify\_inter\_with\_index}}$  or  $T_{\text{identify\_inter\_without\_index}}$  defined in clause 9.3.4 or clause 9.3.9.

When TTT or L3 filtering is used an additional delay can be expected.

A cell is detectable only if at least one SSB measured from the cell being configured remains detectable during the time period  $T_{\text{identify\_intra\_without\_index}}$  Or  $T_{\text{identify\_intra\_with\_index}}$  for intra-frequency handover or  $T_{\text{identify\_inter\_without\_index}}$  for inter-frequency handover. If a cell which has been detectable at least for the time period  $T_{\text{identify\_intra\_without\_index}}$  Or  $T_{\text{identify\_intra\_with\_index}}$  for intra-frequency handover or  $T_{\text{identify\_inter\_without\_index}}$  for inter-frequency handover becomes undetectable for a period and then the cell becomes detectable again and triggers a handover, the measurement time delay shall be less than  $T_{\text{SSB\_measurement\_period\_intra}}$  Or  $T_{\text{SSB\_measurement\_period\_inter}}$  provided the timing to that cell has not changed more than  $\pm 3200/2^{\mu}$  Tc while the measurement gap has not been available and the L3 filter has not been used, where  $\mu$  is the SCS configuration as defined in clause 4.2 of TS 38.211 [3]. When L3 filtering is used, an additional delay can be expected.

#### 6.1.4.2.3 Preparation time

$T_{\text{CHO\_execution}}$  is the UE execution preparation time for conditional handover, and starts after UE realizes the condition of CHO is met and identity of the target cell is determined.  $T_{\text{CHO\_execution}}$  can be up to 10ms.

#### 6.1.4.2.4 Interruption time

The interruption time is the time between when the UE starts to execute the conditional handover to the target cell and the time the UE starts transmission of the new PRACH.

For intra-frequency or inter-frequency conditional conditional handover, the interruption time shall be less than

$$T_{\text{interrupt}} = T_{\text{processing}} + T_{\text{IU}} + T_{\Delta} + T_{\text{margin}} \text{ ms}$$

Where:

$T_{\text{processing}}$  is time for UE processing.  $T_{\text{processing}}$  can be up to 20ms.

$T_{\text{IU}}$  is the interruption uncertainty in acquiring the first available PRACH occasion in the new cell.  $T_{\text{IU}}$  can be up to the summation of SSB to PRACH occasion association period and 10 ms. SSB to PRACH occasion associated period is defined in the table 8.1-1 of TS 38.213 [3]

$T_{\Delta}$  is time for fine time tracking and acquiring full timing information of the target cell.  $T_{\Delta} = T_{\text{rs}}$ .

$T_{\text{margin}}$  is time for SSB post-processing.  $T_{\text{margin}}$  can be up to 2ms.

$T_{\text{rs}}$  is the SMTC periodicity of the target NR cell if the UE has been provided with an SMTC configuration for the target cell in the handover command, otherwise  $T_{\text{rs}}$  is the SMTC configured in the measObjectNR having the same SSB frequency and subcarrier spacing. If the UE is not provided SMTC configuration or measurement object on this frequency, the requirement in this clause is applied with  $T_{\text{rs}}=5\text{ms}$  assuming the SSB transmission periodicity is 5ms. There is no requirement if the SSB transmission periodicity is not 5ms. If the UE has been provided with higher layer in TS 38.331 [2] signaling of *smtc2* prior to the handover command,  $T_{\text{rs}}$  follows *smtc1* or *smtc2* according to the physical cell ID of the target cell.

NOTE 1: The actual value of  $T_{\text{IU}}$  shall depend upon the PRACH configuration used in the target cell.

#### 6.1.4.3 NR FR2 – NR FR1 conditional handover

The requirements in this clause are applicable to inter-frequency conditional handover from NR FR2 cell to NR FR1 cell.

The requirements defined in clause 6.1.4.2 applies assuming inter-frequency handover and:

$T_{\text{processing}}$  is time for UE processing.  $T_{\text{processing}}$  can be up to 40ms.

#### 6.1.4.4 NR FR2 – NR FR2 conditional handover

The requirements in this clause are applicable to both intra-frequency and inter-frequency conditional handover from NR FR2 cell to NR FR2 cell.

#### 6.1.4.4.1 Handover delay

Procedure delays for all procedures that can command a conditional handover are specified in TS 38.331 [2].

When the UE receives a RRC message implying conditional handover the UE shall be ready to start the transmission of the new uplink PRACH channel within  $D_{CHO}$  seconds from the end of the last TTI containing the RRC command.

$$D_{CHO} = T_{RRC} + T_{Event\_DU} + T_{measure} + T_{interrupt} + T_{CHO\_execution}$$

Where:

$T_{RRC}$  is the RRC procedure delay defined in clause 12 in TS 38.331 [2].

$T_{Event\_DU}$  is the delay uncertainty which is the time from when the UE successfully decodes a conditional handover command until a condition exists at the measurement reference point which will trigger the conditional handover.

$T_{measure}$  is the measurements time stated in clause 6.1.4.4.2.

$T_{CHO\_execution}$  is the conditional execution preparation time in clause 6.1.4.4.3.  $T_{interrupt}$  is the interruption time stated in clause 6.1.4.4.4.

#### 6.1.4.4.2 Measurement time

The measurement time delay is defined from the end of  $T_{Event\_DU}$  until UE executes a handover to a target cell and interruption time starts.

For intra-frequency handover, the measurement time delay measured without Time To Trigger (TTT) and L3 filtering shall be less than  $T_{identify\_intra\_with\_index}$  Or  $T_{identify\_intra\_without\_index}$  defined in clause 9.2.5.1 or clause 9.2.6.2.

For inter-frequency handover, the measurement time delay measured without Time To Trigger (TTT) and L3 filtering shall be less than  $T_{identify\_inter\_with\_index}$  Or  $T_{identify\_inter\_without\_index}$  defined in clause 9.3.4 or clause 9.3.9.

When TTT or L3 filtering is used an additional delay can be expected.

A cell is detectable only if at least one SSB measured from the cell being configured remains detectable during the time period  $T_{identify\_intra\_without\_index}$  Or  $T_{identify\_intra\_with\_index}$  for intra-frequency handover or  $T_{identify\_inter\_without\_index}$  for inter-frequency handover. If a cell which has been detectable at least for the time period  $T_{identify\_intra\_without\_index}$  Or  $T_{identify\_intra\_with\_index}$  for intra-frequency handover or  $T_{identify\_inter\_without\_index}$  for inter-frequency handover becomes undetectable for a period and then the cell becomes detectable again and triggers a handover, the measurement time delay shall be less than  $T_{SSB\_measurement\_period\_intra}$  Or  $T_{SSB\_measurement\_period\_inter}$  provided the timing to that cell has not changed more than  $\pm 3200/2^\mu T_c$  while the measurement gap has not been available and the L3 filter has not been used, where  $\mu$  is the SCS configuration as defined in clause 4.2 of TS 38.211 [3]. When L3 filtering is used, an additional delay can be expected.

#### 6.1.4.4.3 Preparation time

$T_{CHO\_execution}$  is the UE execution preparation time for conditional handover, and starts after UE realizes the condition of CHO is met and identity of the target cell is determined.  $T_{CHO\_execution}$  can be up to 10ms.

#### 6.1.4.4.4 Interruption time

The interruption time is the time between when the UE starts to execute the conditional handover to the target cell and the time the UE starts transmission of the new PRACH.

For intra-frequency or inter-frequency conditional handover, the interruption time shall be less than

$$T_{interrupt} = T_{processing} + T_{IU} + T_{\Delta} + T_{margin} \text{ ms}$$

Where:

$T_{processing}$  is time for UE processing.  $T_{processing}$  can be up to 20ms.

$T_{IU}$  is the interruption uncertainty in acquiring the first available PRACH occasion in the new cell.  $T_{IU}$  can be up to the summation of SSB to PRACH occasion association period and 10 ms. SSB to PRACH occasion associated period is defined in the table 8.1-1 of TS 38.213 [3]

$T_{\Delta}$  is time for fine time tracking and acquiring full timing information of the target cell.  $T_{\Delta} = T_{rs}$ .

$T_{margin}$  is time for SSB post-processing.  $T_{margin}$  can be up to 2ms.

$T_{rs}$  is the SMTC periodicity of the target NR cell if the UE has been provided with an SMTC configuration for the target cell in the handover command, otherwise  $T_{rs}$  is the SMTC configured in the measObjectNR having the same SSB frequency and subcarrier spacing. If the UE is not provided SMTC configuration or measurement object on this frequency, the requirement in this clause is applied with  $T_{rs}=5$ ms assuming the SSB transmission periodicity is 5ms. There is no requirement if the SSB transmission periodicity is not 5ms. If the UE has been provided with higher layer in TS 38.331 [2] signaling of *smtc2* prior to the handover command,  $T_{rs}$  follows *smtc1* or *smtc2* according to the physical cell ID of the target cell.

NOTE 1: The actual value of  $T_{IU}$  shall depend upon the PRACH configuration used in the target cell.

#### 6.1.4.5 NR FR1 – NR FR2 conditional handover

The requirements in this clause are applicable to inter-frequency conditional handover from NR FR1 cell to NR FR2 cell.

The requirements defined in clause 6.1.4.4 applies assuming inter-frequency handover and:

$T_{processing}$  is time for UE processing.  $T_{processing}$  can be up to 40ms.

### 6.1A Void

#### 6.1A.1 Void

##### 6.1A.1.1 Void

##### 6.1A.1.2 Void

##### 6.1A.1.2.1 Void

##### 6.1A.1.2.2 Void

### 6.1B Handover to target cell using CCA

#### 6.1B.1 NR Handover

##### 6.1B.1.1 Introduction

The purpose of NR handover to target cell using CCA is to change the NR PCell to a target NR cell in a carrier frequency with CCA. The requirements in this clause are applicable to NR SA.

In the requirements of clause 6.1B.1, the term SMTC occasion not available at the UE refers to when the SMTC contains SSBs configured by gNB in a cell on a carrier frequency subject to CCA, but the first two successive candidate SSB positions for the same SSB index within the discovery burst transmission window are not available at the UE due to DL CCA failures at gNB during the corresponding detection or time tracking period; otherwise the SMTC occasion is considered as available at the UE.

In the requirements of clause 6.1B.1, the term PRACH occasion unavailable for transmission refers to when the PRACH occasion is configured by gNB but not transmitted by the UE during the corresponding period due to UL CCA failure at the UE.

### 6.1B.1.2 NR FR1 - NR FR1 Handover

The requirements in this clause are applicable to inter-frequency handovers from NR FR1 cell to NR FR1 cell in carrier frequencies with CCA, and to both intra-frequency and inter-frequency handovers from NR FR1 cell in carrier frequencies with CCA to NR FR1 cell in carrier frequencies with CCA.

#### 6.1B.1.2.1 Handover delay

When the UE receives an RRC message implying handover the UE shall be ready to start the transmission of the new uplink PRACH channel within  $D_{\text{handover}}$  ms from the end of the last TTI containing the RRC command.

Where:

$D_{\text{handover}}$  equals the applicable RRC procedure delay to be defined in clause 12 in TS 38.331 [2] plus the interruption time stated in clause 6.1B.1.2.2.

#### 6.1B.1.2.2 Interruption time

The interruption time is the time between end of the last TTI containing the RRC command on the old PDSCH and the time the UE starts transmission of the new PRACH, excluding the RRC procedure delay.

When intra-frequency or inter-frequency handover is commanded, the interruption time shall be less than  $T_{\text{interrupt}}$

$$T_{\text{interrupt}} = T_{\text{search}} + T_{\text{IU}} + T_{\text{processing}} + T_{\Delta} + T_{\text{margin}} \text{ ms}$$

Where:

$T_{\text{search}}$  is the time required to search the target cell when the target cell is not already known when the handover command is received by the UE. If the target cell is known, then  $T_{\text{search}} = 0$  ms. If the target cell is an unknown intra-frequency cell and the target cell  $E_s/I_{ot} \geq -2$  dB, then  $T_{\text{search}} = (1+L_1) * T_{rs}$ . If the target cell is an unknown inter-frequency cell and the target cell  $E_s/I_{ot} \geq -2$  dB, then  $T_{\text{search}} = (3+L_1') * T_{rs}$  where  $L_1$  and  $L_1'$  are the number of SMTC occasions not available at the UE during the intra-frequency and inter-frequency detection period, respectively. Regardless of whether DRX is in use by the UE,  $T_{\text{search}}$  shall still be based on non-DRX target cell search times.

$T_{\Delta}$  is time for fine time tracking and acquiring full timing information of the target cell.  $T_{\Delta} = (1+L_2) * T_{rs}$  ms, where  $L_2$  is the number of SMTC occasions not available at the UE during the time tracking period.

$T_{\text{processing}}$  is time for UE processing.  $T_{\text{processing}}$  can be up to 20ms.

$T_{\text{margin}}$  is time for SSB post-processing.  $T_{\text{margin}}$  can be up to 2ms.

$T_{\text{IU}}$  is the interruption uncertainty due to the random access procedure when sending PRACH to the new cell.  $T_{\text{IU}}$  can be up to:  $(1+L_3) * T_{\text{SSB,RO}} + 10$  ms where  $T_{\text{SSB,RO}}$  is the SSB to PRACH occasion association period as defined in Table 8.1-1 of TS 38.213 [3] and  $L_3$  is the number of consecutive SSB to PRACH occasion association periods during which no PRACH occasion is available for PRACH transmission due to UL CCA failure.  $L_3 = 0$  for Type 2C UL channel access procedure as defined in TS 37.213 [33]. When the UE is configured with both the UL BWP with PRACH occasion on the target cell and UL CCA failure detection/recovery, the interruption can be longer.

$T_{rs}$  is the SMTC periodicity of the target NR cell in a carrier frequency with CCA if the UE has been provided with an SMTC configuration for the target cell in the handover command, otherwise  $T_{rs}$  is the SMTC configured in the measObjectNR having the same SSB frequency and subcarrier spacing. If the UE is not provided SMTC configuration or measurement object on this frequency, the requirement in this clause is applied with  $T_{rs}=5$ ms assuming the SSB transmission periodicity is 5ms. There is no requirement if the SSB transmission periodicity is not 5ms.

NOTE 1: The interruption time considering the potential extensions caused by  $L_1, L_1', L_2, L_3$  and by the UL CCA failure detection/recovery mechanism is limited by the T304 timer. The UE behaviour at the T304 timer expiry is detailed in TS 38.331 [2].

In the interruption requirement a cell is known if it has been meeting the relevant cell identification requirement during the last 5 seconds otherwise it is unknown. Relevant cell identification requirements are described in Clause 9.2A.5 for intra-frequency handover and Clause 9.3A.4 for inter-frequency handover to a carrier frequency with CCA.

## 6.2 RRC Connection Mobility Control

### 6.2.1 SA: RRC Re-establishment

#### 6.2.1.1 Introduction

This clause contains requirements on the UE regarding RRC connection re-establishment procedure. RRC connection re-establishment is initiated when a UE in RRC\_CONNECTED state on the carrier without CCA or on the carrier with CCA loses RRC connection due to any of failure cases, including radio link failure, handover failure, and RRC connection reconfiguration failure. The RRC connection re-establishment procedure is specified in clause 5.3.7 of TS 38.331 [2].

The requirements in this clause are applicable for RRC connection re-establishment to NR cell.

#### 6.2.1.2 Requirements

In RRC\_CONNECTED state the UE shall be capable of sending *RRCReestablishmentRequest* message within  $T_{re-establish\_delay}$  seconds from the moment it detects a loss in RRC connection. The total RRC connection delay ( $T_{re-establish\_delay}$ ) shall be less than:

$$T_{re-establish\_delay} = T_{UE\_re-establish\_delay} + T_{UL\_grant}$$

$T_{UL\_grant}$ : It is the time required to acquire and process uplink grant from the target PCell. The uplink grant is required to transmit *RRCReestablishmentRequest* message.

The UE re-establishment delay ( $T_{UE\_re-establish\_delay}$ ) is specified in clause 6.2.1.2.1.

##### 6.2.1.2.1 UE Re-establishment delay requirement

The UE re-establishment delay ( $T_{UE\_re-establish\_delay}$ ) is the time between the moments when any of the conditions requiring RRC re-establishment as defined in clause 5.3.7 in TS 38.331 [2] is detected by the UE and when the UE sends PRACH to the target PCell. The UE re-establishment delay ( $T_{UE\_re-establish\_delay}$ ) requirement shall be less than:

$$T_{UE\_re-establish\_delay} = 50 \text{ ms} + T_{identify\_intra\_NR} + \sum_{i=1}^{N_{freq}-1} T_{identify\_inter\_NR,i} + T_{SI-NR} + T_{PRACH}$$

The intra-frequency target NR cell shall be considered detectable if each relevant SSB can satisfy that:

- SS-RSRP related side conditions given in clause 10.1.2 and 10.1.3 are fulfilled for a corresponding NR Band for FR1 and FR2, respectively, and
- the conditions of SSB<sub>RP</sub> and SSB  $\hat{E}_s/I_{ot}$  according to Annex B.2.2 for a corresponding NR Band are fulfilled.

The inter-frequency target NR cell shall be considered detectable when for each relevant SSB:

- SS-RSRP related side conditions given in clause 10.1.4 and 10.1.5 are fulfilled for a corresponding NR Band for FR1 and FR2, respectively, and
- the conditions of SSB<sub>RP</sub> and SSB  $\hat{E}_s/I_{ot}$  according to Annex B.2.3 for a corresponding NR Band are fulfilled.

$T_{identify\_intra\_NR}$ : It is the time to identify the target intra-frequency NR cell and it depends on whether the target NR cell is known cell or unknown cell and on the FR of the target NR cell. If the UE is not configured with intra-frequency NR carrier for RRC re-establishment then  $T_{identify\_intra\_NR}=0$ ; otherwise  $T_{identify\_intra\_NR}$  shall not exceed the values defined in Table 6.2.1.2.1-1.

$T_{identify\_inter\_NR,i}$ : It is the time to identify the target inter-frequency NR cell on inter-frequency carrier  $i$  configured for RRC re-establishment and it depends on whether the target NR cell is known cell or unknown cell and on the FR of the target NR cell.  $T_{identify\_inter\_NR,i}$  shall not exceed the values defined in Table 6.2.1.2.1-2.

$T_{\text{SMTC}}$ : It is the periodicity of the SMTC occasion configured for the intra-frequency carrier. If the UE has been provided with higher layer in TS 38.331 [2] signaling of  $\text{smtc2}$ ,  $T_{\text{smtc}}$  follows  $\text{smtc1}$  or  $\text{smtc2}$  according to the physical cell ID of the target cell.

$T_{\text{SMTC},i}$ : It is the periodicity of the SMTC occasion configured for the inter-frequency carrier  $i$ . If it is not configured, the UE may assume that the target SSB periodicity is no larger than 20 ms.

$T_{\text{SI-NR}}$ : It is the time required for receiving all the relevant system information according to the reception procedure and the RRC procedure delay of system information blocks defined in TS 38.331 [2] for the target NR cell.

$T_{\text{PRACH}}$ : It is the delay uncertainty in acquiring the first available PRACH occasion in the target NR cell.  $T_{\text{PRACH}}$  can be up to the summation of SSB to PRACH occasion association period and 10 ms. SSB to PRACH occasion associated period is defined in the table 8.1-1 of TS 38.213 [3].

$N_{\text{freq}}$ : It is the total number of NR frequencies to be monitored for RRC re-establishment;  $N_{\text{freq}} = 1$  if the target intra-frequency NR cell is known, else  $N_{\text{freq}} = 2$  and  $T_{\text{identify\_intra\_NR}} = 0$  if the target inter-frequency NR cell is known.

There is no requirement if the target cell does not contain the UE context.

In the requirement defined in the below tables, the target FR1 cell is known if it has been meeting the relevant cell identification requirement during the last 5 seconds otherwise it is unknown.

**Table 6.2.1.2.1-1: Time to identify target NR cell for RRC connection re-establishment to NR intra-frequency cell**

Serving cell SSB $\hat{E}_s/\text{lot}$ (dB)	FR of target NR cell	$T_{\text{identify\_intra\_NR}}$ [ms]	
		Known NR cell	Unknown NR cell
$\geq -8$	FR1	MAX (200 ms, $5 \times T_{\text{SMTC}}$ )	MAX (800 ms, $10 \times T_{\text{SMTC}}$ )
$\geq -8$	FR2	N/A	MAX (1000 ms, $80 \times T_{\text{SMTC}}$ )
$< -8$	FR1	N/A	800 <sup>Note1</sup>
$< -8$	FR2	N/A	3520 <sup>Note1</sup>

Note 1: The UE is not required to successfully identify a cell on any NR frequency layer when  $T_{\text{SMTC}} > 20$  ms and serving cell SSB  $\hat{E}_s/\text{lot} < -8$  dB.

**Table 6.2.1.2.1-2: Time to identify target NR cell for RRC connection re-establishment to NR inter-frequency cell**

Serving cell SSB $\hat{E}_s/\text{lot}$ (dB)	FR of target NR cell	$T_{\text{identify\_inter\_NR},i}$ [ms]	
		Known NR cell	Unknown NR cell
$\geq -8$	FR1	MAX (200 ms, $6 \times T_{\text{SMTC},i}$ )	MAX (800 ms, $13 \times T_{\text{SMTC},i}$ )
$\geq -8$	FR2	N/A	MAX (1000 ms, $104 \times T_{\text{SMTC},i}$ )
$< -8$	FR1	N/A	800 <sup>Note1</sup>
$< -8$	FR2	N/A	4000 <sup>Note1</sup>

Note 1: The UE is not required to successfully identify a cell on any NR frequency layer when  $T_{\text{SMTC},i} > 20$  ms and serving cell SSB  $\hat{E}_s/\text{lot} < -8$  dB.

## 6.2.1A RRC Re-establishment with CCA

### 6.2.1A.1 Introduction

This clause contains requirements on the UE regarding RRC connection re-establishment procedure on the carrier with CCA. RRC connection re-establishment on the carrier with CCA is initiated when a UE in RRC\_CONNECTED state on the carrier w/o or with CCA loses RRC connection due to any of failure cases, including radio link failure, handover failure, and RRC connection reconfiguration failure. The RRC connection re-establishment procedure is specified in clause 5.3.7 of TS 38.331 [2].

In the requirements of clause 6.2.1A, the term SMTC occasion not available at the UE refers to when the SMTC contains SSBs configured by gNB in a cell on a carrier frequency subject to CCA, but the first two successive candidate SSB positions for the same SSB index within the discovery burst transmission window are not available at the UE due

to DL CCA failures at gNB during the corresponding RRC re-establishment period; otherwise the SMTC occasion is considered as available at the UE.

In the requirements of clause 6.2.1A, the term PRACH occasion unavailable for transmission refers to when the PRACH occasion is configured by gNB but not transmitted by the UE during the corresponding period due to UL CCA failure at the UE; otherwise the PRACH occasion is considered as available for transmission.

The requirements in this clause are applicable for RRC connection re-establishment to NR cell on the carrier with CCA.

## 6.2.1A.2 Requirements

In RRC\_CONNECTED state on the carrier w/o or with CCA the UE shall be capable of sending *RRCReestablishmentRequest* message within  $T_{re-establish\_delay\_CCA}$  seconds from the moment it detects a loss in RRC connection. The total RRC connection delay ( $T_{re-establish\_delay\_CCA}$ ) shall be less than:

$$T_{re-establish\_delay\_CCA} = T_{UE\_re-establish\_delay\_CCA} + T_{UL\_grant}$$

$T_{UL\_grant}$ : It is the time required to acquire and process uplink grant from the target PCell with CCA. The uplink grant is required to transmit *RRCReestablishmentRequest* message.

The UE re-establishment delay ( $T_{UE\_re-establish\_delay\_CCA}$ ) is specified in clause 6.2.1A.2.1.

### 6.2.1A.2.1 UE Re-establishment with CCA delay requirement

The UE re-establishment on the carrier with CCA delay ( $T_{UE\_re-establish\_delay\_CCA}$ ) is the time between the moments when any of the conditions requiring RRC re-establishment on the carrier with CCA as defined in clause 5.3.7 in TS 38.331 [2] is detected by the UE and when the UE sends PRACH to the target PCell on the carrier with CCA. The UE re-establishment delay requirement ( $T_{UE\_re-establish\_delay\_CCA}$ ) on the carrier with CCA shall be less than:

$$T_{UE\_re-establish\_delay\_CCA} = 50 \text{ ms} + T_{identify\_intra\_NR\_CCA} + \sum_{i=1}^{N_{freq}-1} T_{identify\_inter\_NR\_CCA,i} + T_{SI-NR\_CCA} + T_{PRACH\_CCA}$$

The intra-frequency target NR cell with CCA shall be considered detectable if each relevant SSB can satisfy that:

- SS-RSRP related side conditions given in clause 10.1.2 are fulfilled for a corresponding NR Band for FR1, and
- the conditions of SSB<sub>RP</sub> and SSB  $\hat{E}_s/I_{ot}$  according to Annex B.2.3 for a corresponding NR Band are fulfilled.

The inter-frequency target NR cell on the carrier with CCA shall be considered detectable when for each relevant SSB:

- SS-RSRP related side conditions given in clause 10.1.4 are fulfilled for a corresponding NR Band for FR1, and
- the conditions of SSB<sub>RP</sub> and SSB  $\hat{E}_s/I_{ot}$  according to Annex B.2.2 for a corresponding NR Band are fulfilled.

$T_{identify\_intra\_NR\_CCA}$ : If the target intra-frequency carrier is the carrier without CCA, it is the time to identify the target intra-frequency NR cell which is defined in clause 6.2.1; otherwise it is the time to identify the target intra-frequency NR cell on the carrier with CCA and it depends on whether the target NR cell on the carrier with CCA is known cell or unknown cell and on the frequency range (FR) of the target NR cell on the carrier with CCA. If the UE is not configured with intra-frequency NR carrier with CCA for RRC re-establishment then  $T_{identify\_intra\_NR\_CCA}=0$ ; otherwise  $T_{identify\_intra\_NR\_CCA}$  shall not exceed the values defined in Table 6.2.1A.2.1-1.

$T_{identify\_inter\_NR\_CCA,i}$ : If the target inter-frequency carrier is the carrier without CCA, it is the time to identify the target inter-frequency NR cell which is defined in clause 6.2.1; otherwise it is the time to identify the target inter-frequency NR cell on inter-frequency carrier  $i$  with CCA configured for RRC re-establishment and it depends on whether the target NR cell on the inter-frequency carrier with CCA is known or unknown.  $T_{identify\_inter\_NR\_CCA,i}$  shall not exceed the values defined in Table 6.2.1A.2.1-2.

$T_{SMTC}$ : It is the periodicity of the SMTC occasion configured for the intra-frequency carrier. If the UE has been provided with higher layer in TS 38.331 [2] signaling of *smtc2*,  $T_{smtc}$  follows *smtc1* or *smtc2* according to the physical cell ID of the target cell.

$T_{SMTC,i}$ : It is the periodicity of the SMTC occasion configured for the inter-frequency carrier  $i$ . If it is not configured, the UE may assume that the target SSB periodicity is not larger than 20 ms.



$T_{SI-NR\_CCA}$ : It is the time required for receiving all the relevant system information according to the reception procedure and the RRC procedure delay of system information blocks defined in TS 38.331 [2] for the target NR cell on the carrier with CCA.

*Editor's note: The actual value for  $T_{SI-NR\_CCA}$  is to be discussed in the performance part, considering LBT failures and receiver assumptions, etc.*

$T_{PRACH\_CCA}$  is the delay uncertainty in acquiring the first available PRACH occasion in the target NR Cell on the carrier with CCA:

$T_{PRACH\_CCA} = (1 + K_3) * T_{SSB,RO} + 10$  ms, where:

- $T_{SSB,RO}$  is the SSB to PRACH occasion association period as defined in Table 8.1-1 of TS 38.213 [39].
- $K_3$  is the number of consecutive SSB to PRACH occasion association periods during which no PRACH occasion is available for PRACH transmission due to UL CCA failure.  $K_3 = 0$  for Type 2C UL channel access procedure as defined in TS 37.213 [57].

$N_{freq}$ : It is the total number of NR frequencies to be monitored for RRC re-establishment;  $N_{freq} = 1$  if the target NR cell on the intra-frequency carrier with CCA is known, else  $N_{freq} = 2$  and  $T_{identify\_intra\_NR\_CCA} = 0$  if the target NR cell on the inter-frequency carrier with CCA is known.

There is no requirement if the target cell on the carrier with CCA does not contain the UE context.

In the requirement defined in the below tables, the target cell on the carrier with CCA is known if it has been meeting the relevant cell identification requirement during the last 8 seconds otherwise it is unknown.

**Table 6.2.1A.2.1-1: Time to identify target NR cell for RRC connection re-establishment to NR intra-frequency cell with CCA**

Serving cell SSB $\hat{E}_s/lot$ (dB)	Frequency range (FR) of target NR cell	$T_{identify\_intra\_NR\_CCA}$ [ms]	
		Known NR cell	Unknown NR cell
$\geq -8$	FR1	MAX (200 ms, $(5+K_1) \times T_{SMTC}$ )	MAX (800 ms, $(10+ K_1) \times T_{SMTC}$ )
$< -8$	FR1	N/A	$(800+20 \times K_1)$ <sup>Note1</sup>
Note 1: The UE is not required to successfully identify a cell on any NR frequency layer with CCA when $T_{SMTC} > 20$ ms and serving cell SSB $\hat{E}_s/lot < -8$ dB.			
Note 2: $K_1$ is the number of SMTC occasions not available at the UE due during RRC re-establishment period on the carrier with CCA.			

**Table 6.2.1A.2.1-2: Time to identify target NR cell for RRC connection re-establishment to NR inter-frequency cell on the carrier with CCA**

Serving cell SSB $\hat{E}_s/lot$ (dB)	Frequency range (FR) of target NR cell	$T_{identify\_inter\_NR\_CCA, i}$ [ms]	
		Known NR cell	Unknown NR cell
$\geq -8$	FR1	MAX (200 ms, $([6]+K_{2,i}) \times T_{SMTC, i}$ )	MAX (800 ms, $([13]+K_{2,i}) \times T_{SMTC, i}$ )
$< -8$	FR1	N/A	$(800+20 \times K_{2,i})$ <sup>Note1</sup>
Note 1: The UE is not required to successfully identify a cell on any NR frequency layer with CCA when $T_{SMTC, i} > 20$ ms and serving cell SSB $\hat{E}_s/lot < -8$ dB.			
Note 2: $K_{2,i}$ is the number of SMTC occasions not available at the UE during RRC re-establishment period on the "i" th carrier with CCA,			

## 6.2.2 Random access

### 6.2.2.1 Introduction

This clause contains requirements on the UE regarding random access procedure. The random access procedure is initiated to establish uplink time synchronization for a UE which either has not acquired or has lost its uplink synchronization, or to convey UE's request Other SI, or for beam failure recovery. The random access is specified in clause 8 of TS 38.213 [3] and the control of the RACH transmission is specified in clause 5.1 of TS 38.321 [7]. Two

types of procedure are defined for the random access, the 4-step RA type, and the 2-step RA type [7]. The decision on which type of procedure to adopt is as described in clause 5.1.1 of TS 38.321 [7]. The requirements for the 4-step RA type procedure are described in clause 6.2.2.2, whereas the requirements for the 2-step RA type procedure are described in the clause 6.2.2.3 of this specification.

### 6.2.2.2 Requirements for 4-step RA type

The UE shall select the type of random access at initiation of the random access procedure based on network configuration, as specified in clause 5.1.1 in TS 38.321 [7].

The UE shall have capability to calculate PRACH transmission power according to the PRACH power formula defined in clause 7.4 of TS 38.213 [3] and apply this power level at the first preamble or additional preambles. The absolute power applied to the first preamble shall have an accuracy as specified in Table 6.3.4.2-1 of TS 38.101-1 [18] for FR1 and in Table 6.3.4.2-1 of TS 38.101-2 [19] for FR2. The relative power applied to additional preambles shall have an accuracy as specified in Table 6.3.4.3-1 of TS 38.101-1 [18] for FR1 and clause 6.3.4.3 of TS 38.101-2 [19] for FR2.

The UE shall indicate a random access problem to upper layers if the maximum number of preamble transmission counter has been reached for the random access procedure on PCell or PSCell as specified in clause 5.1.4 in TS 38.321 [7].

The requirements in this clause apply for UE in SA operation mode or any MR-DC operation mode.

#### 6.2.2.2.1 Contention based random access

##### 6.2.2.2.1.1 Correct behaviour when transmitting Random Access Preamble

With the UE selected SSB with SS-RSRP above *rsrp-ThresholdSSB*, UE shall have the capability to select a Random Access Preamble randomly with equal probability from the Random Access Preambles associated with the selected SSB if the association between Random Access Preambles and SSB is configured, as specified in clause 5.1.2 in TS 38.321 [7].

With the UE selected SSB with SS-RSRP above *rsrp-ThresholdSSB*, UE shall have the capability to transmit Random Access Preamble on the next available PRACH occasion from the PRACH occasions corresponding to the selected SSB permitted by the restrictions given by the *ra-ssb-OccasionMaskIndex* if configured, if the association between PRACH occasions and SSBs is configured, and PRACH occasion shall be randomly selected with equal probability amongst the selected SSB associated PRACH occasions occurring simultaneously but on different subcarriers, as specified in clause 5.1.2 in TS 38.321 [7].

##### 6.2.2.2.1.2 Correct behaviour when receiving Random Access Response

The UE may stop monitoring for Random Access Response(s) and shall transmit the msg3 if the Random Access Response contains a Random Access Preamble identifier corresponding to the transmitted Random Access Preamble.

The UE shall again perform the Random Access Resource selection procedure defined in clause 5.1.2 in TS 38.321 [7], and transmit with the calculated PRACH transmission power when the backoff time expires if all received Random Access Responses contain Random Access Preamble identifiers that do not match the transmitted Random Access Preamble.

##### 6.2.2.2.1.3 Correct behaviour when not receiving Random Access Response

The UE shall again perform the Random Access Resource selection procedure defined in clause 5.1.2 in TS 38.321 [7], and transmit with the calculated PRACH transmission power when the backoff time expires if no Random Access Response is received within the RA Response window defined in clause 5.1.4 in TS 38.321 [7].

##### 6.2.2.2.1.4 Correct behaviour when receiving an UL grant for msg3 retransmission

The UE shall re-transmit the msg3 upon the reception of an UL grant for msg3 retransmission.

##### 6.2.2.2.1.5 SA: Correct behaviour when receiving a message over Temporary C-RNTI

The UE shall send ACK if the Contention Resolution is successful.

The UE shall again perform the Random Access Resource selection procedure defined in clause 5.1.2 in TS 38.321 [7], and transmit with the calculated PRACH transmission power when the backoff time expires unless the received message includes a UE Contention Resolution Identity MAC control element and the UE Contention Resolution Identity included in the MAC control element matches the CCCH SDU transmitted in the uplink message.

#### 6.2.2.2.1.6 Correct behaviour when contention Resolution timer expires

The UE shall re-select a preamble and transmit with the calculated PRACH transmission power when the backoff time expires if the Contention Resolution Timer expires.

#### 6.2.2.2.2 Non-Contention based random access

##### 6.2.2.2.2.1 Correct behaviour when transmitting Random Access Preamble

If the contention-free Random Access Resources and the contention-free PRACH occasions associated with SSBs is configured, with the UE selected SSB with SS-RSRP above *rsrp-ThresholdSSB* amongst the associated SSBs, UE shall have the capability to select the Random Access Preamble corresponding to the selected SSB, and to transmit Random Access Preamble on the next available PRACH occasion from the PRACH occasions corresponding to the selected SSB permitted by the restrictions given by the *ra-ssb-OccasionMaskIndex* if configured, and PRACH occasion shall be randomly selected with equal probability amongst the selected SSB associated PRACH occasions occurring simultaneously but on different subcarriers, as specified in clause 5.1.2 in TS 38.321 [7].

If the contention-free Random Access Resources and the contention-free PRACH occasions associated with CSI-RSs is configured, with the UE selected CSI-RS with CSI-RSRP above *rsrp-ThresholdCSI-RS* amongst the associated CSI-RSs, UE shall have the capability to select the Random Access Preamble corresponding to the selected CSI-RS, and to transmit Random Access Preamble on the next available PRACH occasion from the PRACH occasions in *ra-OccasionList* corresponding to the selected CSI-RS, and PRACH occasion shall be randomly selected with equal probability amongst the selected CSI-RS associated PRACH occasions occurring simultaneously but on different subcarriers, as specified in clause 5.1.2 in TS 38.321 [7].

If the random access procedure is initialized for beam failure recovery and if the contention-free Random Access Resources and the contention-free PRACH occasions for beam failure recovery request associated with any of the SSBs and/or CSI-RSs is configured, UE shall have the capability to select the Random Access Preamble corresponding to the selected SSB with SS-RSRP above *rsrp-ThresholdSSB* amongst the associated SSBs or the selected CSI-RS with CSI-RSRP above *rsrp-ThresholdCSI-RS* amongst the associated CSI-RSs, and to transmit Random Access Preamble on the next available PRACH occasion from the PRACH occasions corresponding to the selected SSB permitted by the restrictions given by the *ra-ssb-OccasionMaskIndex* if configured, or from the PRACH occasions in *ra-OccasionList* corresponding to the selected CSI-RS, and PRACH occasion shall be randomly selected with equal probability amongst the selected SSB associated PRACH occasions or the selected CSI-RS associated PRACH occasions occurring simultaneously but on different subcarriers, as specified in clause 5.1.2 in TS 38.321 [7].

##### 6.2.2.2.2.2 Correct behaviour when receiving Random Access Response

The UE may stop monitoring for Random Access Response(s), if the Random Access Response contains a Random Access Preamble identifier corresponding to the transmitted Random Access Preamble, unless the random access procedure is initialized for Other SI request from UE.

The UE may stop monitoring for Random Access Response(s) and shall monitor the Other SI transmission if the Random Access Response only contains a Random Access Preamble identifier which is corresponding to the transmitted Random Access Preamble and the random access procedure is initialized for SI request from UE, as specified in clause 5.1.4 in TS 38.321 [7].

The UE may stop monitoring for Random Access Response(s), if the contention-free Random Access Preamble for beam failure recovery request was transmitted and if the PDCCH addressed to UE's C-RNTI is received, as specified in clause 5.1.4 in TS 38.321 [7].

The UE shall again perform the Random Access Resource selection procedure defined in clause 5.1.2 in TS 38.321 [7] for the next available PRACH occasion, and transmit the preamble with the calculated PRACH transmission power if all received Random Access Responses contain Random Access Preamble identifiers that do not match the transmitted Random Access Preamble.

#### 6.2.2.2.3 Correct behaviour when not receiving Random Access Response

The UE shall again perform the Random Access Resource selection procedure defined in clause 5.1.2 in TS 38.321 [7] for the next available PRACH occasion, and transmit the preamble with the calculated PRACH transmission power, if no Random Access Response is received within the RA Response window configured in *RACH-ConfigCommon* or if no PDCCH addressed to UE's C-RNTI is received within the RA Response window configured in *BeamFailureRecoveryConfig*, as defined in clause 5.1.4 in TS 38.321 [7].

#### 6.2.2.2.3 UE behaviour when configured with supplementary UL

In addition to the requirements defined in clause 6.2.2.2.1 and 6.2.2.2.2, a UE configured with supplementary UL carrier shall use RACH configuration for the supplementary UL carrier contained in RMSI and RRC dedicated signalling. If the cell for the random access procedure is configured with supplementary UL, the UE shall transmit or re-transmit PRACH preamble on the supplementary UL carrier if the SS-RSRP measured by the UE on the DL carrier is lower than the *rsrp-ThresholdSSB-SUL* as defined in TS 38.331 [2].

### 6.2.2.3 Requirements for 2-step RA type

The UE shall select the type of random access at initiation of the random access procedure based on network configuration, as specified in clause 5.1.1 in TS 38.321 [7].

The UE shall have capability to calculate MsgA PRACH transmission power according to the PRACH power formula defined in clause 7.4 of TS 38.213 [3] and the MsgA PUSCH power formula of clause 7.1.1 of TS 38.213 [3] and apply this power level at the first MsgA or additional MsgA repetitions. The absolute power applied to the first preamble shall have an accuracy as specified in Table 6.3.4.2-1 of TS 38.101-1 [18] for frequency range 1 and in Table 6.3.4.2-1 of TS 38.101-2 [19] for frequency range 2. The relative power applied to additional preambles shall have an accuracy as specified in Table 6.3.4.3-1 of TS 38.101-1 [18] for frequency range 1 and clause 6.3.4.3 of TS 38.101-2 [19] for frequency range 2.

The UE shall switch to 4-step RA type procedure if the MsgA transmission counter has exceeded *msgA-TransMax*, if configured, as specified in clause 5.1.4a of TS 38.321 [7]. The UE shall indicate a Random Access problem to upper layers if the maximum number of preamble transmission counter has been reached for the random access procedure on PCell or PSCell as specified in clause 5.1.4a in TS 38.321 [7].

The requirements in this clause apply for UE in SA operation mode or any MR-DC operation mode.

#### 6.2.2.3.1 Contention based random access

##### 6.2.2.3.1.1 Correct behaviour when transmitting MsgA

With the UE selected SSB with SS-RSRP above *msgA-RSRP-ThresholdSSB*, the UE shall have the capability to select a Random Access Preamble randomly with equal probability from the Random Access Preambles associated with the selected SSB if the association between Random Access Preambles and SS blocks is configured, as specified in clause 5.1.2a in TS 38.321 [7].

With the UE selected SSB with SS-RSRP above *msgA-RSRP-ThresholdSSB*, UE shall have the capability to transmit MsgA PRACH on the next available PRACH occasion from the PRACH occasions corresponding to the selected SSB permitted by the restrictions given first by the *msgA-SSB-SharedRO-MaskIndex* if configured, or next by the *ra-ssb-OccasionMaskIndex* if configured, if the association between PRACH occasions and SSBs is configured.

The PRACH preamble and PRACH occasion shall be randomly selected with equal probability amongst the selected SSB associated PRACH occasions occurring simultaneously but on different subcarriers, as specified in clause 5.1.2a in TS 38.321 [7].

In association with the MsgA PRACH, the UE should have the capability to transmit MsgA PUSCH on the corresponding PUSCH occasion associated with a DMRS resource, which is mapped from the MsgA PRACH occasion, and preamble index as defined in clause 8.1A in TS 38.213 [3].

#### 6.2.2.3.1.2 Correct behaviour when receiving MsgB

The UE shall stop monitoring for MsgB, when the UE has successfully received the PDCCH addressed to UE as specified in clause 8.2A in TS 38.213 [3] containing a successRAR MAC subPDU or a fallbackRAR MAC subPDU as described in clause 5.1.4a in TS 38.321 [7].

The UE shall send ACK if Success RAR is received in MsgB and the Contention Resolution is successful, as defined in clause 5.1.4a in TS 38.321 [7].

If MsgB contains a fallbackRAR MAC subPDU the UE shall fallback to the 4-step RA type by transmitting the msg3 containing the payload of MsgA PUSCH and monitor contention resolution as described in clause 8.2A in TS 38.213 [3].

The UE shall again perform the Random Access Resource selection procedure defined in clause 5.1.2a in TS 38.321 [7], and transmit with the calculated MsgA PRACH and MsgA PUSCH transmission power when the backoff time expires unless the Random Access Response reception is considered as successful, as defined in clause 5.1.4a in TS 38.321 [7].

#### 6.2.2.3.1.3 Correct behaviour when not receiving MsgB

The UE shall again perform the Random Access Resource selection procedure defined in clause 5.1.2a in TS 38.321 [7], and transmit with the calculated MsgA PRACH and MsgA PUSCH transmission power when the backoff time expires unless the Random Access Response reception is considered as successful, as defined in clause 5.1.4a in TS 38.321 [7].

### 6.2.2.3.2 Non-Contention based random access

#### 6.2.2.3.2.1 Correct behaviour when transmitting MsgA

If the contention-free Random Access Resources and the contention-free PRACH occasions associated with SSBs is configured, with the UE selected SSB with  $SS\text{-RSRP}$  above  $msgA\text{-RSRP}\text{-ThresholdSSB}$  amongst the associated SSBs, UE shall have the capability to select the Random Access Preamble corresponding to the selected SSB, and to transmit Random Access Preamble on the next available PRACH occasion from the PRACH occasions corresponding to the selected SSB permitted by the restrictions given first by the  $msgA\text{-SSB}\text{-SharedRO}\text{-MaskIndex}$  if configured, or next by the  $ra\text{-ssb}\text{-OccasionMaskIndex}$  if configured, and PRACH occasion shall be randomly selected with equal probability amongst the selected SSB associated PRACH occasions occurring simultaneously but on different subcarriers, as specified in clause 5.1.2a in TS 38.321 [7].

In association with the MsgA PRACH, the UE should have the capability to transmit MsgA PUSCH on the corresponding PUSCH occasion associated with a DMRS resource, which is mapped from the MsgA PRACH occasion, and preamble index as defined in clause 8.1A in TS 38.213 [3].

#### 6.2.2.3.2.2 Correct behaviour when receiving MsgB

The UE may stop monitoring for MsgB, when the UE has successfully received the PDCCH addressed to UE as specified in clause 8.2A in TS 38.213 [3] containing a successRAR MAC subPDU or a fallbackRAR MAC subPDU as described in clause 5.1.4a in TS 38.321 [7].

If MsgB contains a fallbackRAR MAC subPDU the UE shall fallback to the 4-step RA type by transmitting the msg3 containing the payload of MsgA PUSCH as described in clause 8.2A in TS 38.213 [3].

The UE shall again perform the Random Access Resource selection procedure defined in clause 5.1.2a in TS 38.321 [7] for the next available PRACH occasion, and transmit the preamble with the calculated MsgA PRACH and MsgA PUSCH transmission power if all received MsgBs contain Random Access Preamble identifiers that do not match the transmitted Random Access Preamble.

#### 6.2.2.3.2.3 Correct behaviour when not receiving MsgB

The UE shall again perform the Random Access Resource selection procedure defined in clause 5.1.2a in TS 38.321 [7] for the next available PRACH occasion, and transmit MsgA with the calculated MsgA PRACH and MsgA PUSCH transmission power, if no MsgB is received within the MsgB Response window configured in *RACH*-

*ConfigGenericTwoStepRA* and the Random Access Response Reception has not been considered as successful as defined in clause 5.1.4a in TS 38.321 [7].

### 6.2.2.3.3 UE behaviour when configured with supplementary UL

In addition to the requirements defined in clause 6.2.2.3.1 and 6.2.2.3.2, a UE configured with supplementary UL carrier shall use RACH configuration for the supplementary UL carrier contained in RMSI and RRC dedicated signalling. If the cell for the random access procedure is configured with supplementary UL, the UE shall transmit or re-transmit PRACH preamble on the supplementary UL carrier if the SS-RSRP measured by the UE on the DL carrier is lower than the *rsrp-ThresholdSSB-SUL* as defined in TS 38.321 [7].

## 6.2.2A Random access when CCA is used on target frequency

### 6.2.2A.1 Introduction

This clause contains requirements on the UE regarding random access procedure when CCA is used on the target frequency. The random access procedure is initiated to establish uplink time synchronization for a UE which either has not acquired or has lost its uplink synchronization, or to convey UE's request Other SI, or for beam failure recovery. The random access is specified in clause 8 of TS 38.213 [3] and the control of the RACH transmission is specified in clause 5.1 of TS 38.321 [7]. Two types of procedure are defined for the random access, the 4-step RA type, and the 2-step RA type [7]. The decision on which type of procedure to adopt is as described in clause 5.1.1 of TS 38.321 [7]. The requirements for the 4-step RA type procedure are described in clause 6.2.2A.2, whereas the requirements for the 2-step RA type procedure are described in the clause 6.2.2A.3 of this specification.

### 6.2.2A.2 Requirements for 4-step RA type

The UE shall select the type of random access at initiation of the random access procedure based on network configuration, as specified in clause 5.1.1 in TS 38.321 [7].

The UE shall have capability to calculate PRACH transmission power according to the PRACH power formula defined in clause 7.4 of TS 38.213 [3] and apply this power level at the first preamble or additional preambles. The absolute power applied to the first preamble shall have an accuracy as specified in Table 6.3.4.2-1 of TS 38.101-1 [18]. The relative power applied to additional preambles shall have an accuracy as specified in Table 6.3.4.3-1 of TS 38.101-1 [18].

The UE shall indicate a random access problem to upper layers if the maximum number of preamble transmission counter has been reached for the random access procedure on PCell or PSCell as specified in clause 5.1.4 in TS 38.321 [7].

The requirements in this clause apply for UE operating in a carrier frequency with CCA in SA operation mode or any MR-DC operation mode, in a carrier frequency with CCA.

#### 6.2.2A.2.1 Contention based random access

##### 6.2.2A.2.1.1 Correct behaviour when transmitting Random Access Preamble

With the UE selected SSB with SS-RSRP above *rsrp-ThresholdSSB*, UE shall have the capability to select a Random Access Preamble randomly with equal probability from the Random Access Preambles associated with the selected SSB if the association between Random Access Preambles and SSB is configured, as specified in clause 5.1.2 in TS 38.321 [7].

If the UL CCA is successful on the next available PRACH occasion, with the UE selected SSB with SS-RSRP above *rsrp-ThresholdSSB*, UE shall transmit Random Access Preamble on the next available PRACH occasion from the PRACH occasions corresponding to the selected SSB permitted by the restrictions given by the *ra-sb-OccasionMaskIndex* if configured, if the association between PRACH occasions and SSBs is configured, and PRACH occasion shall be randomly selected with equal probability amongst the selected SSB associated PRACH occasions occurring simultaneously but on different subcarriers, as specified in clause 5.1.2 in TS 38.321 [7].

If UE is configured *lbt-FailureRecoveryConfig* and is capable of *ul-LBT-FailureDetectionRecovery* [2] then upon detecting uplink CCA failure during the random access procedure for random access preamble transmission, as outlined

in Clause 5.21.2 of TS 38.321 [7], the UE shall perform the Random Access Resource selection procedure again, as specified in clause 5.1.3 in TS 38.321 [7].

If UE is not configured *lbt-FailureRecoveryConfig* or is not capable of *ul-LBT-FailureDetectionRecovery* [2] then upon detecting uplink CCA failure during the random access procedure for random access preamble transmission, as outlined in Clause 5.21.2 of TS 38.321 [7], the UE shall increment PREAMBLE\_TRANSMISSION\_COUNTER by 1. The UE shall again perform the Random Access Resource selection procedure if PREAMBLE\_TRANSMISSION\_COUNTER < *preambleTransMax* + 1, as specified in clause 5.1.3 in TS 38.321 [7].

#### 6.2.2A.2.1.2 Correct behaviour when receiving Random Access Response

The UE may stop monitoring for Random Access Response(s) and shall transmit the msg3 if the Random Access Response contains a Random Access Preamble identifier corresponding to the transmitted Random Access Preamble.

The UE shall again perform the Random Access Resource selection procedure defined in clause 5.1.2 in TS 38.321 [7], and transmit with the calculated PRACH transmission power when the backoff time expires if all received Random Access Responses contain Random Access Preamble identifiers that do not match the transmitted Random Access Preamble.

#### 6.2.2A.2.1.3 Correct behaviour when not receiving Random Access Response

The UE shall again perform the Random Access Resource selection procedure defined in clause 5.1.2 in TS 38.321 [7], if the UL CCA is successful, and transmit with the calculated PRACH transmission power when the backoff time expires if no Random Access Response is received within the RA Response window defined in clause 5.1.4 in TS 38.321 [7].

#### 6.2.2A.2.1.4 Correct behaviour when receiving an UL grant for msg3 retransmission

The UE shall re-transmit the msg3 upon the reception of an UL grant for msg3 retransmission, if the UL CCA is successful,

#### 6.2.2A.2.1.5 Correct behaviour when receiving a message over Temporary C-RNTI

If the UL CCA is successful, The UE shall send ACK if the Contention Resolution is successful.

The UE shall again perform the Random Access Resource selection procedure defined in clause 5.1.2 in TS 38.321 [7], and transmit with the calculated PRACH transmission power when the backoff time expires and the UL CCA is successful, unless the received message includes a UE Contention Resolution Identity MAC control element and the UE Contention Resolution Identity included in the MAC control element matches the CCCH SDU transmitted in the uplink message.

#### 6.2.2A.2.1.6 Correct behaviour when contention Resolution timer expires

The UE shall re-select a preamble and transmit with the calculated PRACH transmission power when the backoff time expires if the Contention Resolution Timer expires.

### 6.2.2A.2.2 Non-Contention based random access

#### 6.2.2A.2.2.1 Correct behaviour when transmitting Random Access Preamble

If the UL CCA is successful on the next available PRACH occasion and if the contention-free Random Access Resources and the contention-free PRACH occasions associated with SSBs is configured, with the UE selected SSB with SS-RSRP above *rsrp-ThresholdSSB* amongst the associated SSBs, UE shall have the capability to select the Random Access Preamble corresponding to the selected SSB, and to transmit Random Access Preamble on the next available PRACH occasion from the PRACH occasions corresponding to the selected SSB permitted by the restrictions given by the *ra-ssb-OccasionMaskIndex* if configured, and PRACH occasion shall be randomly selected with equal probability amongst the selected SSB associated PRACH occasions occurring simultaneously but on different subcarriers, as specified in clause 5.1.2 in TS 38.321 [7].

If the UL CCA is successful, and if the random access procedure is initialized for beam failure recovery and if the contention-free Random Access Resources and the contention-free PRACH occasions for beam failure recovery request associated with SSBs configured, UE shall have the capability to select the Random Access Preamble corresponding to

the selected SSB with SS-RSRP above *rsrp-ThresholdSSB* amongst the associated SSBs, and to transmit Random Access Preamble on the next available PRACH occasion from the PRACH occasions corresponding to the selected SSB permitted by the restrictions given by the *ra-ssb-OccasionMaskIndex* if configured, and PRACH occasion shall be randomly selected with equal probability amongst the selected SSB associated PRACH occasions occurring simultaneously but on different subcarriers, as specified in clause 5.1.2 in TS 38.321 [7].

If UE is configured *lbt-FailureRecoveryConfig* and is capable of *ul-LBT-FailureDetectionRecovery* [2] then upon detecting uplink CCA failure during the random access procedure for random access preamble transmission, as outlined in Clause 5.21.2 of TS 38.321 [7], the UE shall perform the Random Access Resource selection procedure again, as specified in clause 5.1.3 in TS 38.321 [7].

If UE is not configured *lbt-FailureRecoveryConfig* or is not capable of *ul-LBT-FailureDetectionRecovery* [2] then upon detecting uplink CCA failure during the random access procedure for random access preamble transmission, as outlined in Clause 5.21.2 of TS 38.321 [7], the UE shall increment `PREAMBLE_TRANSMISSION_COUNTER` by 1. The UE shall again perform the Random Access Resource selection procedure if `PREAMBLE_TRANSMISSION_COUNTER` < *preambleTransMax* + 1, as specified in clause 5.1.3 in TS 38.321 [7].

#### 6.2.2A.2.2.2 Correct behaviour when receiving Random Access Response

The UE may stop monitoring for Random Access Response(s), if the Random Access Response contains a Random Access Preamble identifier corresponding to the transmitted Random Access Preamble, unless the random access procedure is initialized for Other SI request from UE.

The UE may stop monitoring for Random Access Response(s) and shall monitor the Other SI transmission if the Random Access Response only contains a Random Access Preamble identifier which is corresponding to the transmitted Random Access Preamble and the random access procedure is initialized for SI request from UE, as specified in clause 5.1.4 in TS 38.321 [7].

The UE may stop monitoring for Random Access Response(s), if the contention-free Random Access Preamble for beam failure recovery request was transmitted and if the PDCCH addressed to UE's C-RNTI is received, as specified in clause 5.1.4 in TS 38.321 [7].

The UE shall again perform the Random Access Resource selection procedure defined in clause 5.1.2 in TS 38.321 [7] for the next available PRACH occasion if the UL CCA is successful, and transmit the preamble with the calculated PRACH transmission power if all received Random Access Responses contain Random Access Preamble identifiers that do not match the transmitted Random Access Preamble.

#### 6.2.2A.2.2.3 Correct behaviour when not receiving Random Access Response

The UE shall again perform the Random Access Resource selection procedure defined in clause 5.1.2 in TS 38.321 [7] for the next available PRACH occasion if the UL CCA is successful, and transmit the preamble with the calculated PRACH transmission power, if no Random Access Response is received within the RA Response window configured in *RACH-ConfigCommon* or if no PDCCH addressed to UE's C-RNTI is received within the RA Response window configured in *BeamFailureRecoveryConfig*, as defined in clause 5.1.4 in TS 38.321 [7].

### 6.2.2A.3 Requirements for 2-step RA type

The UE shall select the type of random access at initiation of the random access procedure based on network configuration, as specified in clause 5.1.1 in TS 38.321 [7].

The UE shall have capability to calculate MsgA PRACH transmission power according to the PRACH power formula defined in clause 7.4 of TS 38.213 [3] and the MsgA PUSCH power formula of clause 7.1.1 of TS 38.213 [3] and apply this power level at the first MsgA or additional MsgA repetitions. The absolute power applied to the first preamble shall have an accuracy as specified in Table 6.3.4.2-1 of TS 38.101-1 [18]. The relative power applied to additional preambles shall have an accuracy as specified in Table 6.3.4.3-1 of TS 38.101-1 [18].

The UE shall switch to 4-step RA type procedure if the MsgA transmission counter has exceeded *msgA-TransMax*, if configured, as specified in clause 5.1.4a of TS 38.321 [7]. The UE shall indicate a Random Access problem to upper layers if the maximum number of preamble transmission counter has been reached for the random access procedure on PCell or PSCell as specified in clause 5.1.4a in TS 38.321 [7].

The requirements in this clause apply for UE operating in a carrier frequency with CCA in SA operation mode or any MR-DC operation mode, in a carrier frequency with CCA.



### 6.2.2A.3.1 Contention based random access

#### 6.2.2A.3.1.1 Correct behaviour when transmitting MsgA

With the UE selected SSB with SS-RSRP above *msgA-RSRP-ThresholdSSB*, the UE shall have the capability to select a Random Access Preamble randomly with equal probability from the Random Access Preambles associated with the selected SSB if the association between Random Access Preambles and SS blocks is configured, as specified in clause 5.1.2a in TS 38.321 [7].

If the UL CCA is successful on the next available PRACH occasion, with the UE selected SSB with SS-RSRP above *msgA-RSRP-ThresholdSSB*, UE shall have the capability to transmit MsgA PRACH on the next available PRACH occasion from the PRACH occasions corresponding to the selected SSB permitted by the restrictions given first by the *msgA-SSB-SharedRO-MaskIndex* if configured, or next by the *ra-ssb-OccasionMaskIndex* if configured, if the association between PRACH occasions and SSBs is configured.

The PRACH preamble and PRACH occasion shall be randomly selected with equal probability amongst the selected SSB associated PRACH occasions occurring simultaneously but on different subcarriers, as specified in clause 5.1.2a in TS 38.321 [7].

In association with the MsgA PRACH, if the UL CCA is successful, the UE should have the capability to transmit MsgA PUSCH on the corresponding PUSCH occasion associated with a DMRS resource, which is mapped from the MsgA PRACH occasion, and preamble index as defined in clause 8.1A in TS 38.213 [3].

If UE is configured *lbt-FailureRecoveryConfig* and is capable of *ul-LBT-FailureDetectionRecovery* [2] then upon detecting uplink CCA failure during the random access procedure for MsgA transmission, as outlined in Clause 5.21.2 of TS 38.321 [7], the UE shall cancel the transmission of the MsgA payload on the associated PUSCH resource and perform the Random Access Resource selection procedure, as specified in clause 5.1.3a in TS 38.321 [7].

If UE is not configured *lbt-FailureRecoveryConfig* or is not capable of *ul-LBT-FailureDetectionRecovery* [2] then upon detecting uplink CCA failure during the random access procedure for MsgA transmission, as outlined in Clause 5.21.2 of TS 38.321 [7], the UE shall cancel the transmission of the MsgA payload on the associated PUSCH resource and increment `PREAMBLE_TRANSMISSION_COUNTER` by 1. The UE shall again perform the Random Access Resource selection procedure if `PREAMBLE_TRANSMISSION_COUNTER < preambleTransMax + 1`, as specified in clause 5.1.3a in TS 38.321 [7]. If the Random Access Procedure is not complete and the UE is configured with *msgA-TransMax* then, as specified in clause 5.1.3a in TS 38.321 [7], the UE shall perform the Random Access Resource selection procedure with 4-step RA type provided that `PREAMBLE_TRANSMISSION_COUNTER = msgA-TransMax + 1`.

#### 6.2.2A.3.1.2 Correct behaviour when receiving MsgB

The UE shall stop monitoring for MsgB, when the UE has successfully received the PDCCH addressed to UE as specified in clause 8.2A in TS 38.213 [3] containing a successRAR MAC subPDU or a fallbackRAR MAC subPDU as described in clause 5.1.4a in TS 38.321 [7].

If the UL CCA is successful, the UE shall send ACK if Success RAR is received in MsgB and the Contention Resolution is successful, as defined in clause 5.1.4a in TS 38.321 [7].

If MsgB contains a fallbackRAR MAC subPDU the UE shall fallback to the 4-step RA type by transmitting the msg3 containing the payload of MsgA PUSCH if the UL CCA is successful, and monitor contention resolution as described in clause 8.2A in TS 38.213 [3].

The UE shall again perform the Random Access Resource selection procedure defined in clause 5.1.2a in TS 38.321 [7], and transmit with the calculated MsgA PRACH and MsgA PUSCH transmission power, if the UL CCA is successful on the next available PRACH occasion, when the backoff time expires unless the Random Access Response reception is considered as successful, as defined in clause 5.1.4a in TS 38.321 [7].

#### 6.2.2A.3.1.3 Correct behaviour when not receiving MsgB

The UE shall again perform the Random Access Resource selection procedure defined in clause 5.1.2a in TS 38.321 [7], and if the UL CCA is successful, transmit with the calculated MsgA PRACH and MsgA PUSCH transmission power if the UL CCA is successful on the next available PRACH occasion when the backoff time expires unless the Random Access Response reception is considered as successful, as defined in clause 5.1.4a in TS 38.321 [7].

### 6.2.2A.3.2 Non-Contention based random access

#### 6.2.2A.3.2.1 Correct behaviour when transmitting MsgA

If the UL CCA is successful, if the contention-free Random Access Resources and the contention-free PRACH occasions associated with SSBs is configured, with the UE selected SSB with *SS-RSRP* above *msgA-RSRP-ThresholdSSB* amongst the associated SSBs, UE shall have the capability to select the Random Access Preamble corresponding to the selected SSB, and to transmit Random Access Preamble on the next available PRACH occasion from the PRACH occasions corresponding to the selected SSB permitted by the restrictions given first by the *msgA-SSB-SharedRO-MaskIndex* if configured, or next by the *ra-ssb-OccasionMaskIndex* if configured, and PRACH occasion shall be randomly selected with equal probability amongst the selected SSB associated PRACH occasions occurring simultaneously but on different subcarriers, as specified in clause 5.1.2a in TS 38.321 [7].

In association with the MsgA PRACH, the UE should have the capability to transmit MsgA PUSCH, if the UL CCA is successful, on the corresponding PUSCH occasion associated with a DMRS resource, which is mapped from the MsgA PRACH occasion, and preamble index as defined in clause 8.1A in TS 38.213 [3].

If UE is configured *lbt-FailureRecoveryConfig* and is capable of *ul-LBT-FailureDetectionRecovery* [2] then upon detecting uplink CCA failure during the random access procedure for MsgA transmission, as outlined in Clause 5.21.2 of TS 38.321 [7], the UE shall have cancel the transmission of the MsgA payload on the associated PUSCH resource and perform the Random Access Resource selection procedure, as specified in clause 5.1.3a in TS 38.321 [7].

If UE is not configured *lbt-FailureRecoveryConfig* or is not capable of *ul-LBT-FailureDetectionRecovery* [2] then upon detecting uplink CCA failure during the random access procedure for MsgA transmission, as outlined in Clause 5.21.2 of TS 38.321 [7], the UE shall cancel the transmission of the MsgA payload on the associated PUSCH resource and increment *PREAMBLE\_TRANSMISSION\_COUNTER* by 1. The UE shall again perform the Random Access Resource selection procedure if *PREAMBLE\_TRANSMISSION\_COUNTER* < *preambleTransMax* + 1, as specified in clause 5.1.3a in TS 38.321 [7]. If the Random Access Procedure is not complete and the UE is configured with *msgA-TransMax* then, as specified in clause 5.1.3a in TS 38.321 [7], the UE shall perform the Random Access Resource selection procedure with 4-step RA type provided that *PREAMBLE\_TRANSMISSION\_COUNTER* = *msgA-TransMax* + 1.

#### 6.2.2A.3.2.2 Correct behaviour when receiving MsgB

The UE may stop monitoring for MsgB, when the UE has successfully received the PDCCH addressed to UE as specified in clause 8.2A in TS 38.213 [3] containing a successRAR MAC subPDU or a fallbackRAR MAC subPDU as described in clause 5.1.4a in TS 38.321 [7].

If MsgB contains a fallbackRAR MAC subPDU the UE shall fallback to the 4-step RA type by transmitting the msg3 containing the payload of MsgA PUSCH if the UL CCA is successful, as described in clause 8.2A in TS 38.213 [3].

The UE shall again perform the Random Access Resource selection procedure defined in clause 5.1.2a in TS 38.321 [7] for the next available PRACH occasion, and transmit the preamble with the calculated MsgA PRACH and MsgA PUSCH transmission power if the UL CCA is successful, if all received MsgBs contain Random Access Preamble identifiers that do not match the transmitted Random Access Preamble.

#### 6.2.2A.3.2.3 Correct behaviour when not receiving MsgB

The UE shall again perform the Random Access Resource selection procedure defined in clause 5.1.2a in TS 38.321 [7] for the next available PRACH occasion, and transmit MsgA with the calculated MsgA PRACH and MsgA PUSCH transmission power if the UL CCA is successful on the next available PRACH occasion, if no MsgB is received within the MsgB Response window configured in *RACH-ConfigGenericTwoStepRA* and the Random Access Response Reception has not been considered as successful as defined in clause 5.1.4a in TS 38.321 [7].

## 6.2.3 SA: RRC Connection Release with Redirection

### 6.2.3.1 Introduction

This clause contains requirements on the UE regarding RRC connection release with redirection procedure. RRC connection release with redirection is initiated by the *RRCRelease* message with redirection to E-UTRAN or NR from

NR specified in TS 38.331 [2]. The RRC connection release with redirection procedure is specified in clause 5.3.8 of TS 38.331 [2].

In the requirements of clause 6.2.3.2, the term SMTC occasion not available at the UE refers to when the SMTC contains SSBs configured by gNB in a cell on a carrier frequency subject to CCA, but the first two successive candidate SSB positions for the same SSB index within the discovery burst transmission window are not available at the UE due to DL CCA failures at gNB during the corresponding identification period; otherwise the SMTC occasion is considered as available at the UE.

In the requirements of clause 6.2.3.2, the term PRACH occasion unavailable for transmission refers to when the PRACH occasion is configured by gNB but not transmitted by the UE during the corresponding period due to UL CCA failure at the UE.

## 6.2.3.2 Requirements

### 6.2.3.2.1 RRC connection release with redirection to NR

The UE shall be capable of performing the RRC connection release with redirection to the target NR cell within  $T_{\text{connection\_release\_redirect\_NR}}$ .

The time delay ( $T_{\text{connection\_release\_redirect\_NR}}$ ) is the time between the end of the last slot containing the RRC command, “*RRCRelease*” (TS 38.331 [2]) on the NR PDSCH and the time the UE starts to send random access to the target NR cell. The time delay ( $T_{\text{connection\_release\_redirect\_NR}}$ ) shall be less than:

$$T_{\text{connection\_release\_redirect\_NR}} = T_{\text{RRC\_procedure\_delay}} + T_{\text{identify-NR}} + T_{\text{SI-NR}} + T_{\text{RACH}}$$

The target NR cell shall be considered detectable when for each relevant SSB, the side conditions should be met that,

- the conditions of SSB<sub>RP</sub> and SSB  $\hat{E}_s/I_{ot}$  according to Annex B.2.5 for a corresponding NR Band are fulfilled.

$T_{\text{RRC\_procedure\_delay}}$ : It is the RRC procedure delay for processing the received message “*RRCRelease*” as defined in clause 6.2.2 of TS 38.331 [2].

$T_{\text{identify-NR}}$ : It is the time to identify the target NR cell and depends on the FR of the target NR cell. It is defined in Table 6.2.3.2.1-1. Note that  $T_{\text{identify-NR}} = T_{\text{PSS/SSS-sync}} + T_{\text{meas}}$ , in which  $T_{\text{PSS/SSS-sync}}$  is the cell search time and  $T_{\text{meas}}$  is the measurement time due to cell selection criteria evaluation.

$T_{\text{SI-NR}}$ : It is the time required for acquiring all the relevant system information of the target NR cell. This time depends upon whether the UE is provided with the relevant system information of the target NR cell or not by the old NR cell before the RRC connection is released.  $T_{\text{RACH}}$ : It is the delay uncertainty in acquiring the first available PRACH occasion in the target NR cell.  $T_{\text{RACH}}$  can be up to the summation of SSB to PRACH occasion association period and 10 ms. SSB to PRACH occasion associated period is defined in the table 8.1-1 of TS 38.213 [3].

$T_{\text{rs}}$  is the SMTC periodicity of the target NR cell if the UE has been provided with an SMTC configuration for the target cell in the redirection command, otherwise  $T_{\text{rs}}$  is the SMTC periodicity configured in the *measObjectNR* having the same SSB frequency and subcarrier spacing configured for the RRC connection release with redirection. If the *measObjectNR*s having the same SSB frequency and subcarrier spacing configured by MN and SN have different SMTC,  $T_{\text{rs}}$  is the periodicity of one of the SMTC which is up to UE implementation. If the UE is not provided with SMTC configuration or measurement object for the frequency which is also configured for the RRC connection release with redirection then:

- the requirement in this clause is applied with  $T_{\text{rs}} = 20$  ms if the SSB transmission periodicity is not larger than 20 ms; otherwise,
- there is no requirement if the SSB transmission periodicity is larger than 20ms.

**Table 6.2.3.2.1-1: Time to identify target NR cell for RRC connection release with redirection to NR**

FR of target NR cell	$T_{\text{identify-NR}}$
FR1	MAX (680 ms, 11 x $T_{\text{rs}}$ )
FR2	MAX (880 ms, 8x11 x $T_{\text{rs}}$ )
Note:	If the UE has been provided with higher layer signaling of <i>smtc2</i> specified in TS 38.331 [2] prior to the redirection command, $T_{\text{rs}}$ follows <i>smtc1</i> or <i>smtc2</i> according to the physical cell ID of the target cell.

### 6.2.3.2.2 RRC connection release with redirection to E-UTRAN

The UE shall be capable of performing the RRC connection release with redirection to the target E-UTRAN cell within  $T_{\text{connection\_release\_redirect\_E-UTRA}}$ .

The time delay ( $T_{\text{connection\_release\_redirect\_E-UTRA}}$ ) is the time between the end of the last slot containing the RRC command, “*RRCRelease*” (TS 38.331 [2]) on the PDSCH and the time the UE starts to send random access to the target E-UTRAN cell. The time delay ( $T_{\text{connection\_release\_redirect\_E-UTRA}}$ ) shall be less than:

$$T_{\text{connection\_release\_redirect\_E-UTRA}} = T_{\text{RRC\_procedure\_delay}} + T_{\text{identify-E-UTRA}} + T_{\text{SI-E-UTRA}} + T_{\text{RACH}}$$

The target E-UTRAN FDD or TDD cell shall be considered detectable provided the following conditions are fulfilled:

- the same conditions as for inter-frequency RSRP measurements specified in annex B.1.2 of TS 36.133 [15] are fulfilled for a corresponding Band, and
- the same conditions as for inter-frequency RSRQ measurements specified in annex B.1.2 of TS 36.133 [15] are fulfilled for a corresponding Band, and
- SCH conditions specified in annex B.1.2 of TS 36.133 [15] are fulfilled for a corresponding Band.

$T_{\text{RRC\_procedure\_delay}}$ : It is the RRC procedure delay for processing the received message “*RRCRelease*” as defined in clause 6.2.2 of TS 38.331 [2].

$T_{\text{identify-E-UTRA}}$ : It is the time to identify the target E-UTRAN cell. It shall be less than 320 ms.

$T_{\text{SI-E-UTRA}}$ : It is the time required for acquiring all the relevant system information of the target E-UTRAN cell. This time depends upon whether the UE is provided with the relevant system information (SI) of the target E-UTRAN cell or not by the old NR cell before the RRC connection is released.

$T_{\text{RACH}}$ : It is the delay caused due to the random access procedure when sending random access to the target E-UTRAN cell.

### 6.2.3.2.3 RRC connection release with redirection to NR carrier subject to CCA

The UE shall be capable of performing the RRC connection release with redirection to the target NR cell subject to CCA within  $T_{\text{connection\_release\_redirect\_NR\_CCA}}$ .

The time delay ( $T_{\text{connection\_release\_redirect\_NR\_CCA}}$ ) is the time between the end of the last slot containing the RRC command, “*RRCRelease*” (TS 38.331 [2]) on the NR PDSCH and the time the UE starts to send random access to the target NR cell. The time delay ( $T_{\text{connection\_release\_redirect\_NR\_CCA}}$ ) shall be less than:

$$T_{\text{connection\_release\_redirect\_NR\_CCA}} = T_{\text{RRC\_procedure\_delay}} + T_{\text{identify-NR\_CCA}} + T_{\text{SI-NR\_CCA}} + T_{\text{RACH\_CCA}}$$

The target NR cell shall be considered detectable when for each relevant SSB, the side conditions should be met that,

- the conditions of SSB<sub>RP</sub> and SSB  $\hat{E}_s/I_{ot}$  according to Annex B.2.5 for a corresponding NR Band are fulfilled.

$T_{\text{RRC\_procedure\_delay}}$ : It is the RRC procedure delay for processing the received message “*RRCRelease*” as defined in clause 6.2.2 of TS 38.331 [2].

$T_{\text{identify-NR\_CCA}}$ : It is the time to identify the target NR cell and is defined as:

- $T_{\text{identify-NR\_CCA}} = T_{\text{PSS/SSS-sync}} + T_{\text{meas}}$ ;  $T_{\text{PSS/SSS-sync}}$  is the cell search time and  $T_{\text{meas}}$  is the measurement time due to cell selection criteria evaluation.
- $T_{\text{identify-NR\_CCA}} = \text{MAX}(680 \text{ ms}, (L_1+11) \times T_{\text{rs}})$ ; where  $L_1$  is the number of SMTC occasions not available at the UE due to DL CCA failures. If  $L_1 > L_{1,\text{max}}$  then the UE shall initiate cell selection procedures for the selected PLMN as defined in TS 38.304 [1]; where  $L_{1,\text{max}}$  is defined in Table 6.2.3.2.3-1.

$T_{\text{SI-NR\_CCA}}$ : It is the time required for acquiring all the relevant system information of the target NR cell. This time depends upon whether the UE is provided with the relevant system information of the target NR cell or not by the old NR cell before the RRC connection is released.

$T_{\text{RACH\_CCA}}$ : It is the delay uncertainty in acquiring the first available PRACH occasion in the target NR cell:

- $T_{RACH\_CCA} = (1+L_2) \times T_{SSB,RO} + 10 \text{ ms } T_{PRACH}$ ; where:
  - $L_2$  is the consecutive number of SSB to PRACH occasion association periods during which no PRACH occasion is available for PRACH transmission due to UL CCA failures.  $L_2 = 0$  for Type 2C UL channel access procedure as defined in TS 37.213 [33].
  - $T_{SSB,RO}$  is the SSB to PRACH occasion association period as defined in the table 8.1-1 of TS 38.213 [3].
  - The value of  $L_2$  is limited by *PREAMBLE\_TRANSMISSION\_COUNTER*, which is increased when PRACH occasion is unavailable for PRACH transmission due to UL CCA failure as specified in TS 38.321 [7]. The UE behaviour when *PREAMBLE\_TRANSMISSION\_COUNTER* reaches the *preambleTransMax* is specified in TS 38.321 [7].

$T_{rs}$  is the SMTC periodicity of the target NR cell if the UE has been provided with an SMTC configuration for the target cell in the redirection command, otherwise  $T_{rs}$  is the SMTC periodicity configured in the *measObjectNR* having the same SSB frequency and subcarrier spacing configured for the RRC connection release with redirection. If the UE is not provided with SMTC configuration or measurement object for the frequency which is also configured for the RRC connection release with redirection then:

- the requirement in this clause is applied with  $T_{rs} = 20 \text{ ms}$  if the SSB transmission periodicity is not larger than 20 ms;
- otherwise, there is no requirement if the SSB transmission periodicity is larger than 20ms.

**Table 6.2.3.2.3-1: Maximum allowed number of missed SMTC occasions during cell identification**

SMTC periodicity ( $T_{rs}$ ) [ms]	Maximum allowed number of missed SMTC occasions ( $L_{1,max}$ )
$T_{rs} \leq 40$	8
$T_{rs} > 40$	4

## 7 Timing

### 7.1 UE transmit timing

#### 7.1.1 Introduction

The UE shall have capability to follow the frame timing change of the reference cell in connected state. The uplink frame transmission takes place  $(N_{TA} + N_{TA \text{ offset}}) \times T_c$  before the reception of the first detected path (in time) of the corresponding downlink frame from the reference cell. For serving cell(s) in pTAG, UE shall use the SpCell as the reference cell for deriving the UE transmit timing for cells in the pTAG. For serving cell(s) in sTAG, UE shall use any of the activated SCells as the reference cell for deriving the UE transmit timing for the cells in the sTAG. UE initial transmit timing accuracy and gradual timing adjustment requirements are defined in the following requirements.

In the requirements of clause 7.1.2, the term reference cell on a carrier frequency subject to CCA is not available at the UE refers to when at least one SSB is configured by gNB, but the first two successive candidate SSB positions for the same SSB index within the discovery burst transmission window are not available during at least one discovery burst transmission window, at the UE due to DL CCA failures at gNB during the last 1280 ms; otherwise the reference cell on the carrier frequency subject to CCA is considered as available at the UE.

#### 7.1.2 Requirements

The UE initial transmission timing error shall be less than or equal to  $\pm T_e$  where the timing error limit value  $T_e$  is specified in Table 7.1.2-1. This requirement applies:

- when it is the first transmission in a DRX cycle for PUCCH, PUSCH and SRS, or it is the PRACH transmission, or it is the msgA transmission..

The UE shall meet the  $T_e$  requirement for an initial transmission provided that at least one SSB is available at the UE during the last 160 ms. The reference point for the UE initial transmit timing control requirement shall be the downlink timing of the reference cell minus  $(N_{TA} + N_{TA\text{ offset}}) \times T_c$ . The downlink timing is defined as the time when the first detected path (in time) of the corresponding downlink frame is received from the reference cell.  $N_{TA}$  for PRACH is defined as 0.

$(N_{TA} + N_{TA\text{ offset}}) \times T_c$  (in  $T_c$  units) for other channels is the difference between UE transmission timing and the downlink timing immediately after when the last timing advance in clause 7.3 was applied.  $N_{TA}$  for other channels is not changed until next timing advance is received. The value of  $N_{TA\text{ offset}}$  depends on the duplex mode of the cell in which the uplink transmission takes place and the frequency range (FR).  $N_{TA\text{ offset}}$  is defined in Table 7.1.2-2.

**Table 7.1.2-1:  $T_e$  Timing Error Limit**

Frequency Range	SCS of SSB signals (kHz)	SCS of uplink signals (kHz)	$T_e$
1	15	15	$12 \cdot 64 \cdot T_c$
		30	$10 \cdot 64 \cdot T_c$
		60	$10 \cdot 64 \cdot T_c$
	30	15	$8 \cdot 64 \cdot T_c$
		30	$8 \cdot 64 \cdot T_c$
		60	$7 \cdot 64 \cdot T_c$
2	120	60	$3.5 \cdot 64 \cdot T_c$
		120	$3.5 \cdot 64 \cdot T_c$
	240	60	$3 \cdot 64 \cdot T_c$
		120	$3 \cdot 64 \cdot T_c$

Note 1:  $T_c$  is the basic timing unit defined in TS 38.211 [6]

**Table 7.1.2-2: The Value of  $N_{TA\text{ offset}}$**

Frequency range and band of cell used for uplink transmission	$N_{TA\text{ offset}}$ (Unit: $T_c$ )
FR1 FDD or TDD band with neither E-UTRA-NR nor NB-IoT-NR coexistence case	25600 (Note 1)
FR1 FDD band with E-UTRA-NR and/or NB-IoT-NR coexistence case	0 (Note 1)
FR1 TDD band with E-UTRA-NR and/or NB-IoT-NR coexistence case	39936 (Note 1)
FR2	13792
<p>Note 1: The UE identifies <math>N_{TA\text{ offset}}</math> based on the information n-TimingAdvanceOffset as specified in TS 38.331 [2]. If UE is not provided with the information n-TimingAdvanceOffset, the default value of <math>N_{TA\text{ offset}}</math> is set as 25600 for FR1 band. In case of multiple UL carriers in the same TAG, UE expects that the same value of n-TimingAdvanceOffset is provided for all the UL carriers according to clause 4.2 in TS 38.213 [3] and the value 39936 of <math>N_{TA\text{ offset}}</math> can also be provided for a FDD serving cell.</p>	
<p>Note 2: Void</p>	

When it is not the first transmission in a DRX cycle or there is no DRX cycle, and when it is the transmission for PUCCH, PUSCH and SRS transmission, the UE shall be capable of changing the transmission timing according to the received downlink frame of the reference cell except when the timing advance in clause 7.3 is applied.

**Table 7.1.2-3: void**

If the UE uses a reference cell on a carrier frequency subject to CCA for deriving the UE transmit timing, then the UE shall meet all the transmit timing requirements defined in clause 7.1.2 provided that the reference cell is available at the UE. If the reference cell is not available at the UE on a carrier frequency subject to CCA, then the UE is allowed to transmit in the uplink provided that the UE meets all the transmit timing requirements defined in clause 7.1.2; otherwise the UE shall not transmit any uplink signal.

If a reference cell on a carrier frequency belonging to the PTAG, which is subject to CCA, is not available at the UE then the UE is allowed to use any of available activated SCell(s) at the UE in PTAG as a new reference cell. If the SCell used as reference cell is deactivated, or becomes not available, the UE is allowed to use another active serving cell in PTAG as new reference cell.

If a reference cell on a carrier frequency belonging to the STAG, which is subject to CCA is not available at the UE then the UE is allowed to use any of available activated SCell(s) at the UE in STAG as a new reference cell.

### 7.1.2.1 Gradual timing adjustment

Requirements in this section shall apply regardless of whether the reference cell is on a carrier frequency subject to CCA or not.

When the transmission timing error between the UE and the reference timing exceeds  $\pm T_e$  then the UE shall adjust the timing such that timing error is to within  $\pm T_e$ . The reference timing shall be  $(N_{TA} + N_{TA\text{offset}}) \times T_c$  before the downlink timing of the reference cell. All adjustments made to the UE uplink timing shall follow these rules:

- 1) The maximum amount of the magnitude of the timing change in one adjustment shall be  $T_q$ .
- 2) The minimum aggregate adjustment rate shall be  $T_p$  per second.
- 3) The maximum aggregate adjustment rate shall be  $T_q$  per 200 ms.

where the maximum autonomous time adjustment step  $T_q$  and the aggregate adjustment rate  $T_p$  are specified in Table 7.1.2.1-1.

**Table 7.1.2.1-1:  $T_q$  Maximum Autonomous Time Adjustment Step and  $T_p$  Minimum Aggregate Adjustment rate**

Frequency Range	SCS of uplink signals (kHz)	$T_q$	$T_p$
1	15	$5.5 \cdot 64 \cdot T_c$	$5.5 \cdot 64 \cdot T_c$
	30	$5.5 \cdot 64 \cdot T_c$	$5.5 \cdot 64 \cdot T_c$
	60	$5.5 \cdot 64 \cdot T_c$	$5.5 \cdot 64 \cdot T_c$
2	60	$2.5 \cdot 64 \cdot T_c$	$2.5 \cdot 64 \cdot T_c$
	120	$2.5 \cdot 64 \cdot T_c$	$2.5 \cdot 64 \cdot T_c$
NOTE: $T_c$ is the basic timing unit defined in TS 38.211 [6]			

### 7.1.2.2 Void

**Table 7.1.2.2-1: Void**

## 7.2 UE timer accuracy

### 7.2.1 Introduction

UE timers are used in different protocol entities to control the UE behaviour.

### 7.2.2 Requirements

For UE timers specified in TS 38.331 [2], the UE shall comply with the timer accuracies according to Table 7.2.2-1.

The requirements are only related to the actual timing measurements internally in the UE. They do not include the following:

- Inaccuracy in the start and stop conditions of a timer (e.g. UE reaction time to detect that start and stop conditions of a timer is fulfilled), or

- Inaccuracies due to restrictions in observability of start and stop conditions of a UE timer (e.g. slot alignment when UE sends messages at timer expiry).

**Table 7.2.2-1**

Timer value [s]	Accuracy
timer value < 4	$\pm 0.1\text{s}$
timer value $\geq 4$	$\pm 2.5\%$

## 7.3 Timing advance

### 7.3.1 Introduction

The timing advance is initiated from gNB to UE in EN-DC, NR-DC, NE-DC and NR SA operation modes, with MAC message that implies the adjustment of the timing advance, as defined in clause 5.2 of TS 38.321 [7].

### 7.3.2 Requirements

#### 7.3.2.1 Timing Advance adjustment delay

UE shall adjust the timing of its uplink transmission timing at time slot  $n+k+1$  for a timing advance command received in time slot  $n$ , and the value of  $k$  is defined in clause 4.2 in TS 38.213 [3]. The same requirement applies also when the UE is not able to transmit a configured uplink transmission due to the channel assessment procedure.

#### 7.3.2.2 Timing Advance adjustment accuracy

The UE shall adjust the timing of its transmissions with a relative accuracy better than or equal to the UE Timing Advance adjustment accuracy requirement in Table 7.3.2.2-1, to the signalled timing advance value compared to the timing of preceding uplink transmission. The timing advance command step is defined in TS 38.213 [3].

**Table 7.3.2.2-1: UE Timing Advance adjustment accuracy**

UL Sub Carrier Spacing(kHz)	15	30	60	120
UE Timing Advance adjustment accuracy	$\pm 256 T_c$	$\pm 256 T_c$	$\pm 128 T_c$	$\pm 32 T_c$

## 7.4 Cell phase synchronization accuracy

### 7.4.1 Definition

Cell phase synchronization accuracy for TDD is defined as the maximum absolute deviation in frame start timing between any pair of cells on the same frequency that have overlapping coverage areas.

### 7.4.2 Minimum requirements

The cell phase synchronization accuracy measured at BS antenna connectors or radiated interface boundaries shall be better than  $3 \mu\text{s}$ .

## 7.5 Maximum Transmission Timing Difference

### 7.5.1 Introduction

A UE shall be capable of handling a relative transmission timing difference between subframe timing boundary of E-UTRA PCell and the closest slot timing boundary of PSCell to be aggregated for EN-DC operation.



A UE shall be capable of handling a relative transmission timing difference among the closest slot timing boundaries of different carriers to be aggregated in NR carrier aggregation.

A UE shall be capable of handling a relative transmission timing difference between slot timing boundary of PCell and subframe timing boundary of E-UTRA PSCell to be aggregated for NE-DC operation.

A UE shall be capable of handling a relative transmission timing difference between slot timing boundaries of PCell and the closest slot timing boundary of PSCell to be aggregated in NR DC operation.

## 7.5.2 Minimum Requirements for inter-band EN-DC

The UE shall be capable of handling a maximum uplink transmission timing difference between E-UTRA PCell and PSCell as shown in Table 7.5.2-1.

**Table 7.5.2-1 Maximum uplink transmission timing difference requirement for asynchronous EN-DC**

Sub-carrier spacing in E-UTRA PCell (kHz)	UL Sub-carrier spacing for data in PSCell (kHz)	Maximum uplink transmission timing difference ( $\mu$ s)
15	15	500
15	30	250
15	60	125
15	120 <sup>Note1</sup>	62.5
NOTE 1: For E-UTRA FDD-NR FDD intra-band EN-DC, for which the requirement is defined in clause 7.5.3 and this Table 7.5.2-1 is also applicable, the scenario with 120kHz PSCell does not exist.		

**Table 7.5.2-2 Void**

### 7.5.2.1 Minimum Requirements for inter-band synchronous EN-DC

The requirements in this clause apply as a reference for inter-band synchronous EN-DC.

The UE shall be capable of handling a maximum uplink transmission timing difference (MTTD) between E-UTRA PCell and PSCell for inter-band synchronous EN-DC as shown in Table 7.5.2.1-1 1. The requirements for synchronous EN-DC are applicable for E-UTRA TDD-NR TDD, E-UTRA FDD-NR FDD, E-UTRA TDD-NR FDD and E-UTRA FDD-NR TDD inter-band EN-DC.

For E-UTRA TDD-NR TDD inter-band EN-DC with overlapping or partially overlapping DL bands, only synchronized operation is assumed. The UE shall be capable of handling a maximum uplink transmission timing difference (MTTD) between E-UTRA PCell and PSCell as shown in Table 7.5.2.1-1 provided that UE indicates that it is capable of *interBandMRDC-WithOverlapDL-Bands-r16*, and in Table 7.5.3-1 provided that UE does not indicate it is capable of *interBandMRDC-WithOverlapDL-Bands-r16*.

For E-UTRA FDD-NR FDD inter-band EN-DC with overlapping DL bands, only synchronized operation is assumed if UE does not indicate that it is capable of asynchronous FDD-FDD EN-DC operation. The UE shall be capable of handling a maximum uplink transmission timing difference (MTTD) between E-UTRA Pcell and PSCell as shown in Table 7.5.2.1-1 provided that UE indicates that it is capable of *interBandMRDC-WithOverlapDL-Bands-r16*, and in Table 7.5.3-1 provided that UE does not indicate it is capable of *interBandMRDC-WithOverlapDL-Bands-r16*.

**Table 7.5.2.1-1 Maximum uplink transmission timing difference requirement for inter-band synchronous EN-DC**

Sub-carrier spacing in E-UTRA PCell (kHz)	UL Sub-carrier spacing for data in PSCell (kHz)	Maximum uplink transmission timing difference ( $\mu$ s)
15	15	35.21
15	30	35.21
15	60	35.21
15	120	35.21

### 7.5.3 Minimum Requirements for intra-band EN-DC

For intra-band EN-DC, only co-located deployment is applied.

The UE shall be capable of handling a maximum uplink transmission timing difference (MTTD) between E-UTRA PCell and PSCell as shown in Table 7.5.2-1 for E-UTRA FDD-NR FDD intra-band EN-DC provided the UE indicates that it is capable of asynchronous EN-DC operation [2].

The UE shall be capable of handling a maximum uplink transmission timing difference (MTTD) between E-UTRA PCell and PSCell as shown in Table 7.5.3-1 for E-UTRA TDD-NR TDD and E-UTRA FDD-NR FDD intra-band EN-DC provided the UE does not indicate that it is capable of asynchronous FDD-FDD EN-DC operation [16].

**Table 7.5.3-1: Maximum uplink transmission timing difference requirement for intra-band synchronous EN-DC**

Sub-carrier spacing in E-UTRA PCell (kHz)	UL Sub-carrier spacing for data in PSCell (kHz)	Maximum uplink transmission timing difference ( $\mu$ s)
15	15	5.21 <sup>Note 1, Note 2</sup>
15	30	5.21 <sup>Note 2</sup>
15	60	5.21 <sup>Note 2</sup>
NOTE 1: This is not applicable for a UE which indicates the capability of only supporting single UL timing ( <i>ul-TimingAlignmentEUTRA-NR</i> is signalled). Single UL timing for E-UTRA and NR cell is assumed for this UE.		
NOTE 2: If the transmission timing difference exceeds the cyclic prefix length of the UL Sub-carrier spacing for data in PSCell, NR UE Tx EVM degradation is expected for the symbol that is overlapping the LTE subframe boundary.		
NOTE 3: The requirement in this table is also applicable for intra-band synchronous NE-DC.		

### 7.5.4 Minimum Requirements for NR Carrier Aggregation

The UE shall be capable of handling at least a relative transmission timing difference between slot timing of all pairs of TAGs as shown in Table 7.5.4-1, provided that the UE is:

- configured with the pTAG and the sTAG for inter-band NR carrier aggregation in SA or NR-DC mode, or
- configured with more than one sTAG for inter-band NR carrier aggregation in EN-DC or NE-DC mode.

**Table 7.5.4-1: Maximum uplink transmission timing difference requirement for inter-band NR carrier aggregation**

Frequency Range of the pair of TAGs	Maximum uplink transmission timing difference ( $\mu$ s)
FR1	34.6
FR2	8.5 <sup>Note 1</sup>
Between FR1 and FR2	26.1
Note 1: This requirement applies to the UE capable of independent beam management for FR2 inter-band CA.	

### 7.5.5 Minimum Requirements for inter-band NE-DC

The UE shall be capable of handling a maximum uplink transmission timing difference between PCell and E-UTRA PSCell as shown in Table 7.5.5-1 for inter-band asynchronous NE-DC.

**Table 7.5.5-1: Maximum uplink transmission timing difference requirement for inter-band asynchronous NE-DC**

Sub-carrier spacing in PCell (kHz)	UL Sub-carrier spacing for data in E-UTRA PSCell (kHz)	Maximum uplink transmission timing difference ( $\mu$ s)
15	15	500
30	15	250
60	15	125
120	15	62.5
NOTE 1: Void		

**Table 7.5.5-2 Void**

### 7.5.5.1 Minimum Requirements for inter-band synchronous NE-DC

The requirements in this clause apply as a reference for inter-band synchronous NE-DC.

The UE shall be capable of handling a maximum uplink transmission timing difference (MTTD) between PCell and E-UTRA PSCell for inter-band synchronous NE-DC as shown in Table 7.5.5.1-1. The requirements for synchronous NE-DC are applicable for NR TDD- E-UTRA TDD, NR FDD- E-UTRA FDD, NR TDD- E-UTRA FDD and NR FDD- E-UTRA TDD inter-band NE-DC.

For NR FDD-E-UTRA FDD inter-band NE-DC with overlapping DL bands, only synchronized operation is assumed if UE does not indicate that it is capable of asynchronous FDD-FDD NE-DC operation. The UE shall be capable of handling a maximum uplink transmission timing difference (MTTD) between NR PCell and PSCell as shown in Table 7.5.5.1-1 provided that the UE indicates that it is capable of *interBandMRDC-WithOverlapDL-Bands-r16*, and in Table 7.5.3-1 provided that UE does not indicate it is capable of *interBandMRDC-WithOverlapDL-Bands-r16*.

**Table 7.5.5.1-1: Maximum uplink transmission timing difference requirement for inter-band synchronous NE-DC**

Sub-carrier spacing in PCell (kHz)	UL Sub-carrier spacing for data in E-UTRA PSCell (kHz)	Maximum uplink transmission timing difference ( $\mu$ s)
15	15	35.21
30	15	35.21
60	15	35.21
120	15	35.21

### 7.5.6 Minimum Requirements for inter-band NR DC

The UE shall be capable of handling a maximum uplink transmission timing difference (MTTD) between PCell and PSCell as shown in Table 7.5.6-1 provided that the UE indicates that it is capable of synchronous NR DC only [14].

**Table 7.5.6-1: Maximum uplink transmission timing difference requirement for inter-band synchronous NR DC**

Frequency Range		Maximum uplink transmission timing difference ( $\mu$ s)
Cell in MCG	Cell in SCG	
FR1	FR1	34.6
FR2	FR2	8.5
FR1	FR2	34.1

The UE shall be capable of handling a maximum uplink transmission timing difference (MTTD) between PCell and PSCell as shown in Table 7.5.6-2 provided that the UE indicates that it is capable of asynchronous NR DC [14].

**Table 7.5.6-2 Maximum uplink transmission timing difference requirement for inter-band asynchronous NR DC**

Max {Sub-carrier spacing in PCell (kHz), Sub-carrier spacing in PSCell (kHz)}	Maximum uplink transmission timing difference ( $\mu$ s)
15	500
30	250
60	125
120	62.5

## 7.6 Maximum Receive Timing Difference

### 7.6.1 Introduction

A UE shall be capable of handling a relative receive timing difference between subframe timing boundary of an E-UTRA cell belonging to the MCG and the closest slot timing boundary of a cell belonging to SCG to be aggregated for EN-DC operation.

A UE shall be capable of handling a relative receive timing difference between subframe timing boundary of an E-UTRA cell belonging to the SCG to be aggregated for NE-DC operation and the closest slot timing boundary of a cell belonging to MCG.

A UE shall be capable of handling a relative receive timing difference between slot timing boundary of a cell belonging to MCG and the closest slot timing boundary of a cell belonging to the SCG to be aggregated for NR DC operation.

A UE shall be capable of handling a relative receive timing difference among the closest slot timing boundaries of different carriers to be aggregated in NR carrier aggregation.

The requirements defined in clause 7.6 are also applicable when UE is configured to receive multiple PDSCH transmission occasions from one or more QCL sources on any one of the aggregated NR carriers.

### 7.6.2 Minimum Requirements for inter-band EN-DC

The UE shall be capable of handling at least a relative receive timing difference between subframe timing of signal from a E-UTRA cell belonging to the MCG and slot timing of signal from a cell belonging to SCG at the UE receiver as shown in Table 7.6.2-1.

**Table 7.6.2-1: Maximum receive timing difference requirement for asynchronous EN-DC**

Sub-carrier spacing of E-UTRA cell in MCG (kHz)	DL Sub-carrier spacing of cell in SCG (kHz) (Note 1)	Maximum receive timing difference ( $\mu$ s)
15	15	500
15	30	250
15	60	125
15	120 <sup>Note2</sup>	62.5
NOTE 1: DL Sub-carrier spacing is $\min\{SCS_{SS}, SCS_{DATA}\}$ .		
NOTE 2: For E-UTRA FDD-NR FDD intra-band EN-DC, for which the requirement is defined in clause 7.6.3 and this Table 7.6.2-1 is also applicable, the scenario with 120 kHz does not exit.		

**Table 7.6.2-2 Void**

**Table 7.6.2-3 Void**

#### 7.6.2.1 Minimum Requirements for inter-band synchronous EN-DC

The requirements in this clause apply as a reference for inter-band synchronous EN-DC.

For E-UTRA TDD-NR TDD inter-band EN-DC with overlapping or partially overlapping DL bands, only synchronized operation is assumed. The UE shall be capable of handling at least a relative receive timing difference between subframe timing of signal from a E-UTRA cell belonging to the MCG and slot timing of signal from a cell belonging to the SCG at the UE receiver as shown in Table 7.6.2.1-1 provided that UE indicates that it is capable of *interBandMRDC-WithOverlapDL-Bands-r16*, and in Table 7.6.3-1 provided that UE does not indicate it is capable of *interBandMRDC-WithOverlapDL-Bands-r16*.

For E-UTRA FDD-NR FDD inter-band EN-DC with overlapping DL bands, only synchronized operation is assumed if UE does not indicate that it is capable of asynchronous FDD-FDD EN-DC operation. The UE shall be capable of handling at least a relative receive timing difference between subframe timing of signal from a E-UTRA cell belonging to the MCG and slot timing of signal from a cell belonging to the SCG at the UE receiver as shown in Table 7.6.2.1-1 provided that UE indicates that it is capable of *interBandMRDC-WithOverlapDL-Bands-r16*, and in Table 7.6.3-1 provided that UE does not indicate it is capable of *interBandMRDC-WithOverlapDL-Bands-r16*.

**Table 7.6.2.1-1: Maximum receive timing difference requirement for inter-band synchronous EN-DC**

Sub-carrier spacing of E-UTRA cell in MCG (kHz)	DL Sub-carrier spacing of cell in SCG (kHz) (Note1)	Maximum receive timing difference ( $\mu$ s)
15	15	33
15	30	
15	60	
15	120	
Note 1: DL Sub-carrier spacing is $\min\{SCS_{SS}, SCS_{DATA}\}$ .		

### 7.6.3 Minimum Requirements for intra-band EN-DC

For intra-band EN-DC, only co-located deployment is applied.

The UE shall be capable of handling at least a relative receive timing difference between subframe timing of signal from a E-UTRA cell belonging to the MCG and slot timing of signal from a cell belonging to the SCG as shown in Table 7.6.2-1 for E-UTRA FDD-NR FDD intra-band EN-DC provided the UE indicates that it is capable of asynchronous EN-DC operation [2].

The UE shall be capable of handling at least a relative receive timing difference between subframe timing of signal from a E-UTRA cell belonging to the MCG and slot timing of signal from a cell belonging to the SCG as shown in Table 7.6.3-1 for E-UTRA FDD-NR FDD and E-UTRA TDD-NR TDD intra-band EN-DC provided the UE does not indicate that it is capable of asynchronous FDD-FDD EN-DC operation [16].

**Table 7.6.3-1 Maximum receive timing difference requirement for intra-band synchronous EN-DC**

Sub-carrier spacing of E-UTRA cell in MCG (kHz)	DL Sub-carrier spacing of cell in SCG (kHz) <sup>Note1</sup>	Maximum receive timing difference ( $\mu$ s)
15	15	3
15	30	3
15	60	3
NOTE 1: DL Sub-carrier spacing is $\min\{SCS_{SS}, SCS_{DATA}\}$ .		
NOTE 2: The requirement in this table is also applicable for intra-band synchronous NE-DC.		

**Table 7.6.3-2 Void**

### 7.6.4 Minimum Requirements for NR Carrier Aggregation

For intra-band CA, only co-located deployment is applied. For intra-band non-contiguous NR carrier aggregation, the UE shall be capable of handling at least a relative receive timing difference between slot timing of different carriers to be aggregated at the UE receiver as shown in Table 7.6.4-1 below.

**Table 7.6.4-1: Maximum receive timing difference requirement for intra-band non-contiguous NR carrier aggregation**

Frequency Range	Maximum receive timing difference ( $\mu\text{s}$ )
FR1	3 <sup>1</sup>
FR2	0.26
Note 1: In the case of different SCS on different CCs, if the receive time difference exceeds the cyclic prefix length of that SCS, demodulation performance degradation is expected for the first symbol of the slot.	

For inter-band NR carrier aggregation, the UE shall be capable of handling at least a relative receive timing difference between slot timing of all pairs of carriers to be aggregated at the UE receiver as shown in Table 7.6.4-2 below.

**Table 7.6.4-2: Maximum receive timing difference requirement for inter-band NR carrier aggregation**

Frequency Range of the pair of carriers	Maximum receive timing difference ( $\mu\text{s}$ )
FR1	33
FR2	8 <sup>note1</sup>
Between FR1 and FR2	25
Note1: This requirement applies to the UE capable of independent beam management for FR2 inter-band CA.	

## 7.6.5 Minimum Requirements for inter-band NE-DC

The UE shall be capable of handling at least a relative receive timing difference between slot timing of signal from a cell belonging to the MCG and subframe timing of signal from an E-UTRA cell belonging to the SCG at the UE receiver for asynchronous NE-DC as shown in Table 7.6.5-1.

**Table 7.6.5-1: Maximum receive timing difference requirement for asynchronous NE-DC**

Sub-carrier spacing of cell in MCG (kHz)	DL Sub-carrier spacing of EUTRA cell in SCG (kHz) (Note 1)	Maximum receive timing difference ( $\mu\text{s}$ )
15	15	500
30	15	250
60	15	125
120	15	62.5
NOTE 1: DL Sub-carrier spacing is $\min\{\text{SCS}_{\text{SS}}, \text{SCS}_{\text{DATA}}\}$ .		
NOTE 2: Void		

**Table 7.6.5-2: Void**

### 7.6.5.1 Minimum Requirements for inter-band synchronous NE-DC

The requirements in this clause apply as a reference for inter-band synchronous NE-DC.

The UE shall be capable of handling at least a relative receive timing difference between slot timing of signal from a cell belonging to the MCG and subframe timing of signal from an E-UTRA cell belonging to the SCG at the UE receiver for inter-band synchronous NE-DC as shown in Table 7.6.5.1-1. The requirements for synchronous NE-DC are applicable for NR TDD- E-UTRA TDD, NR FDD- E-UTRA FDD, NR TDD- E-UTRA FDD and NR FDD- E-UTRA TDD inter-band NE-DC.

For NR FDD-E-UTRA FDD inter-band NE-DC with overlapping DL bands, only synchronized operation is assumed if UE does not indicate that it is capable of asynchronous FDD-FDD NE-DC operation. The UE shall be capable of handling at least a relative receive timing difference between subframe timing of signal from a cell belonging to the

MCG and slot timing of signal from a cell belonging to the SCG at the UE receiver as shown in Table 7.6.2.1-1 provided that UE indicates that it is capable of *interBandMRDC-WithOverlapDL-Bands-r16*, and in Table 7.6.3-1 provided that UE does not indicate it is capable of *interBandMRDC-WithOverlapDL-Bands-r16*.

**Table 7.6.5.1-1: Maximum receive timing difference requirement for inter-band synchronous NE-DC**

Sub-carrier spacing of cell in MCG (kHz)	DL Sub-carrier spacing of EUTRA cell in SCG (kHz) (Note1)	Maximum receive timing difference ( $\mu$ s)
15	15	33
30	15	
60	15	
120	15	

## 7.6.6 Minimum Requirements for inter-band NR DC

The UE shall be capable of handling at least a relative receive timing difference between slot timing of signal from a cell belonging to the MCG and slot timing of signal from a cell belonging to the SCG at the UE receiver as shown in Table 7.6.6-1 provided that the UE indicates that it is capable of synchronous NR DC only [16].

**Table 7.6.6-1: Maximum receive timing difference requirement for inter-band synchronous NR DC**

Frequency Range		Maximum receive timing difference ( $\mu$ s)
Cell in MCG	Cell in SCG	
FR1	FR1	33
FR2	FR2	8
FR1	FR2	33

The UE shall be capable of handling at least a relative receive timing difference between slot timing of signal from a cell belonging to the MCG and slot timing of signal from a cell belonging to the SCG at the UE receiver as shown in Table 7.6.6-2 provided that the UE indicates that it is capable of asynchronous NR DC [16].

**Table 7.6.6-2 Maximum receive timing difference requirement for inter-band asynchronous NR DC**

Max {Sub-carrier spacing in PCell (kHz), Sub-carrier spacing in PSCell (kHz)}	Maximum receive timing difference ( $\mu$ s)
15	500
30	250
60	125
120	62.5

## 7.7 *deriveSSB-IndexFromCell* tolerance

### 7.7.1 Minimum requirements

When *deriveSSB-IndexFromCell* is enabled, the UE assumes frame boundary alignment (including half frame, subframe and slot boundary alignment) across cells on the same frequency carrier is within a tolerance not worse than min(2 SSB symbols, 1 PDSCH symbol) and the SFNs of all cells on the same frequency carrier are the same.

## 7.8 Void

# 8 Signalling characteristics

## 8.1 Radio Link Monitoring

### 8.1.1 Introduction

The requirements in clause 8.1 apply for radio link monitoring on:

- PCell in SA NR, NR-DC and NE-DC operation mode,
- PSCell in NR-DC and EN-DC operation mode.

The UE shall monitor the downlink radio link quality based on the reference signal configured as RLM-RS resource(s) in order to detect the downlink radio link quality of the PCell and PSCell as specified in TS 38.213 [3]. The configured RLM-RS resources can be all SSBs, or all CSI-RSs, or a mix of SSBs and CSI-RSs. UE is not required to perform RLM outside the active DL BWP.

On each RLM-RS resource, the UE shall estimate the downlink radio link quality and compare it to the thresholds  $Q_{out}$  and  $Q_{in}$  for the purpose of monitoring downlink radio link quality of the cell.

The threshold  $Q_{out}$  is defined as the level at which the downlink radio link cannot be reliably received and shall correspond to the out-of-sync block error rate ( $BLER_{out}$ ) as defined in Table 8.1.1-1. For SSB based radio link monitoring,  $Q_{out\_SSB}$  is derived based on the hypothetical PDCCH transmission parameters listed in Table 8.1.2.1-1. For CSI-RS based radio link monitoring,  $Q_{out\_CSI-RS}$  is derived based on the hypothetical PDCCH transmission parameters listed in Table 8.1.3.1-1.

The threshold  $Q_{in}$  is defined as the level at which the downlink radio link quality can be received with significantly higher reliability than at  $Q_{out}$  and shall correspond to the in-sync block error rate ( $BLER_{in}$ ) as defined in Table 8.1.1-1. For SSB based radio link monitoring,  $Q_{in\_SSB}$  is derived based on the hypothetical PDCCH transmission parameters listed in Table 8.1.2.1-2. For CSI-RS based radio link monitoring,  $Q_{in\_CSI-RS}$  is derived based on the hypothetical PDCCH transmission parameters listed in Table 8.1.3.1-2.

The out-of-sync block error rate ( $BLER_{out}$ ) and in-sync block error rate ( $BLER_{in}$ ) are determined from the network configuration via parameter *rlmInSyncOutOfSyncThreshold* signalled by higher layers. When UE is not configured with *rlmInSyncOutOfSyncThreshold* from the network, UE determines out-of-sync and in-sync block error rates from Configuration #0 in Table 8.1.1-1 by default. All requirements in clause 8.1 are applicable for BLER Configuration #0 in Table 8.1.1-1.

**Table 8.1.1-1: Out-of-sync and in-sync block error rates**

Configuration	$BLER_{out}$	$BLER_{in}$
0	10%	2%

UE shall be able to monitor up to  $N_{RLM}$  RLM-RS resources of the same or different types in each corresponding carrier frequency range, depending on a maximum number  $L_{max}$  of SSBs per half frame according to TS 38.213 [3], where  $N_{RLM}$  is specified in Table 8.1.1-2 according TS 38.213 [3], and meet the requirements as specified in clause 8.1. UE is not required to meet the requirements in clause 8.1 if RLM-RS is not configured and no TCI state for PDCCH is activated.

**Table 8.1.1-2: Maximum number of RLM-RS resources  $N_{RLM}$**

Carrier frequency range of PCell/PSCell	$L_{max}$	Maximum number of RLM-RS resources, $N_{RLM}$
FR1, $\leq 3$ GHz <sup>Note</sup>	4	2
FR1, $> 3$ GHz <sup>Note</sup>	8	4
FR2	64	8



NOTE: For unpaired spectrum operation with Case C - 30 kHz SCS, 3GHz is replaced by 1.88GHz, as specified in clause 4.1 in TS 38.213 [3].

## 8.1.2 Requirements for SSB based radio link monitoring

### 8.1.2.1 Introduction

The requirements in this clause apply for each SSB based RLM-RS resource configured for PCell or PSCell, provided that the SSB configured for RLM is actually transmitted within UE active DL BWP during the entire evaluation period specified in clause 8.1.2.2.

**Table 8.1.2.1-1: PDCCH transmission parameters for out-of-sync evaluation**

Attribute	Value for BLER Configuration #0
DCI format	1-0
Number of control OFDM symbols	2
Aggregation level (CCE)	8
Ratio of hypothetical PDCCH RE energy to average SSS RE energy	4dB
Ratio of hypothetical PDCCH DMRS energy to average SSS RE energy	4dB
Bandwidth (PRBs)	24
Sub-carrier spacing (kHz)	SCS of the active DL BWP
DMRS precoder granularity	REG bundle size
REG bundle size	6
CP length	Normal
Mapping from REG to CCE	Distributed

**Table 8.1.2.1-2: PDCCH transmission parameters for in-sync evaluation**

Attribute	Value for BLER Configuration #0
DCI payload size	1-0
Number of control OFDM symbols	2
Aggregation level (CCE)	4
Ratio of hypothetical PDCCH RE energy to average SSS RE energy	0dB
Ratio of hypothetical PDCCH DMRS energy to average SSS RE energy	0dB
Bandwidth (PRBs)	24
Sub-carrier spacing (kHz)	SCS of the active DL BWP
DMRS precoder granularity	REG bundle size
REG bundle size	6
CP length	Normal
Mapping from REG to CCE	Distributed

### 8.1.2.2 Minimum requirement

UE shall be able to evaluate whether the downlink radio link quality on the configured RLM-RS resource estimated over the last  $T_{\text{Evaluate\_out\_SSB}}$  [ms] period becomes worse than the threshold  $Q_{\text{out\_SSB}}$  within  $T_{\text{Evaluate\_out\_SSB}}$  [ms] evaluation period.

UE shall be able to evaluate whether the downlink radio link quality on the configured RLM-RS resource estimated over the last  $T_{\text{Evaluate\_in\_SSB}}$  [ms] period becomes better than the threshold  $Q_{\text{in\_SSB}}$  within  $T_{\text{Evaluate\_in\_SSB}}$  [ms] evaluation period.

$T_{\text{Evaluate\_out\_SSB}}$  and  $T_{\text{Evaluate\_in\_SSB}}$  are defined in Table 8.1.2.2-1 for FR1.

$T_{\text{Evaluate\_out\_SSB}}$  and  $T_{\text{Evaluate\_in\_SSB}}$  are defined in Table 8.1.2.2-2 for FR2 with scaling factor  $N=8$ .

For FR1,

- $P = \frac{1}{1 - \frac{T_{\text{SSB}}}{\text{MGRP}}}$ , when in the monitored cell there are measurement gaps configured for intra-frequency, inter-frequency or inter-RAT measurements, and these measurement gaps are overlapping with some but not all occasions of the SSB; and
- $P = 1$  when in the monitored cell there are no measurement gaps overlapping with any occasion of the SSB.

For FR2,

- $P = \frac{1}{1 - \frac{T_{\text{SSB}}}{T_{\text{SMTCperiod}}}}$ , when RLM-RS resource is not overlapped with measurement gap and the RLM-RS resource is partially overlapped with SMTC occasion ( $T_{\text{SSB}} < T_{\text{SMTCperiod}}$ ).
- $P$  is  $P_{\text{sharing factor}}$ , when the RLM-RS resource is not overlapped with measurement gap and RLM-RS resource is fully overlapped with SMTC period ( $T_{\text{SSB}} = T_{\text{SMTCperiod}}$ ).
- $P = \frac{1}{1 - \frac{T_{\text{SSB}}}{\text{MGRP}} - \frac{T_{\text{SSB}}}{T_{\text{SMTCperiod}}}}$ , when the RLM-RS resource is partially overlapped with measurement gap and the RLM-RS resource is partially overlapped with SMTC occasion ( $T_{\text{SSB}} < T_{\text{SMTCperiod}}$ ) and SMTC occasion is not overlapped with measurement gap and
  - $T_{\text{SMTCperiod}} \neq \text{MGRP}$  or
  - $T_{\text{SMTCperiod}} = \text{MGRP}$  and  $T_{\text{SSB}} < 0.5 * T_{\text{SMTCperiod}}$
- $P = \frac{P_{\text{sharing factor}}}{1 - \frac{T_{\text{SSB}}}{\text{MGRP}}}$ , when the RLM-RS is partially overlapped with measurement gap and the RLM-RS is partially overlapped with SMTC occasion ( $T_{\text{SSB}} < T_{\text{SMTCperiod}}$ ) and SMTC occasion is not overlapped with measurement gap and  $T_{\text{SMTCperiod}} = \text{MGRP}$  and  $T_{\text{SSB}} = 0.5 \times T_{\text{SMTCperiod}}$
- $P = \frac{1}{1 - \frac{T_{\text{SSB}}}{\text{Min}(\text{MGRP}, T_{\text{SMTCperiod}})}}$ , when the RLM-RS resource is partially overlapped with measurement gap and the RLM-RS resource is partially overlapped with SMTC occasion ( $T_{\text{SSB}} < T_{\text{SMTCperiod}}$ ) and SMTC occasion is partially or fully overlapped with measurement gap
- $P = \frac{P_{\text{sharing factor}}}{1 - \frac{T_{\text{SSB}}}{\text{MGRP}}}$ , when the RLM-RS resource is partially overlapped with measurement gap and the RLM-RS resource is fully overlapped with SMTC occasion ( $T_{\text{SSB}} = T_{\text{SMTCperiod}}$ ) and SMTC occasion is partially overlapped with measurement gap ( $T_{\text{SMTCperiod}} < \text{MGRP}$ )
- $P_{\text{sharing factor}} = 1$ , if the RLM-RS resource outside measurement gap is
  - not overlapped with the SSB symbols indicated by *SSB-ToMeasure* and 1 data symbol before each consecutive SSB symbols indicated by *SSB-ToMeasure* and 1 data symbol after each consecutive SSB symbols indicated by *SSB-ToMeasure*, given that *SSB-ToMeasure* is configured, where the *SSB-ToMeasure* is the union set of *SSB-ToMeasure* from all the configured measurement objects merged on the same serving carrier, and,
  - not overlapped by the RSSI symbols indicated by *ss-RSSI-Measurement* and 1 data symbol before each RSSI symbol indicated by *ss-RSSI-Measurement* and 1 data symbol after each RSSI symbol indicated by *ss-RSSI-Measurement*, given that *ss-RSSI-Measurement* is configured.
- $P_{\text{sharing factor}} = 3$ , otherwise.

where,

If the high layer in TS 38.331 [2] signaling of *smtc2* is present,  $T_{\text{SMTCperiod}}$  follows *smtc2*; Otherwise  $T_{\text{SMTCperiod}}$  follows *smtc1*.  $T_{\text{SMTCperiod}}$  is the shortest SMTC period among all CCs in the same FR2 band, provided the SMTC offset of all CCs in FR2 have the same offset.

If the high layer in TS 38.331 [2] signaling of *smtc2* is present,  $T_{\text{SMTCPeiod}}$  follows *smtc2*; Otherwise  $T_{\text{SMTCPeiod}}$  follows *smtc1*.

Longer evaluation period would be expected if the combination of RLM-RS resource, SMTC occasion and measurement gap configurations does not meet previous conditions.

For either an FR1 or FR2 serving cell, longer evaluation period would be expected during the period  $T_{\text{identify\_CGI}}$  when the UE is requested to decode an NR CGI.

For either an FR1 or FR2 serving cell, longer evaluation period would be expected during the period  $T_{\text{identify\_CGI,E-UTRAN}}$  when the UE is requested to decode an LTE CGI.

**Table 8.1.2.2-1: Evaluation period  $T_{\text{Evaluate\_out\_SSB}}$  and  $T_{\text{Evaluate\_in\_SSB}}$  for FR1**

Configuration	$T_{\text{Evaluate\_out\_SSB}}$ (ms)	$T_{\text{Evaluate\_in\_SSB}}$ (ms)
no DRX	$\text{Max}(200, \text{Ceil}(10 \times P) \times T_{\text{SSB}})$	$\text{Max}(100, \text{Ceil}(5 \times P) \times T_{\text{SSB}})$
DRX cycle $\leq 320\text{ms}$	$\text{Max}(200, \text{Ceil}(15 \times P) \times \text{Max}(T_{\text{DRX}}, T_{\text{SSB}}))$	$\text{Max}(100, \text{Ceil}(7.5 \times P) \times \text{Max}(T_{\text{DRX}}, T_{\text{SSB}}))$
DRX cycle $> 320\text{ms}$	$\text{Ceil}(10 \times P) \times T_{\text{DRX}}$	$\text{Ceil}(5 \times P) \times T_{\text{DRX}}$
NOTE: $T_{\text{SSB}}$ is the periodicity of the SSB configured for RLM. $T_{\text{DRX}}$ is the DRX cycle length.		

**Table 8.1.2.2-2: Evaluation period  $T_{\text{Evaluate\_out\_SSB}}$  and  $T_{\text{Evaluate\_in\_SSB}}$  for FR2**

Configuration	$T_{\text{Evaluate\_out\_SSB}}$ (ms)	$T_{\text{Evaluate\_in\_SSB}}$ (ms)
no DRX	$\text{Max}(200, \text{Ceil}(10 \times P \times N) \times T_{\text{SSB}})$	$\text{Max}(100, \text{Ceil}(5 \times P \times N) \times T_{\text{SSB}})$
DRX cycle $\leq 320\text{ms}$	$\text{Max}(200, \text{Ceil}(15 \times P \times N) \times \text{Max}(T_{\text{DRX}}, T_{\text{SSB}}))$	$\text{Max}(100, \text{Ceil}(7.5 \times P \times N) \times \text{Max}(T_{\text{DRX}}, T_{\text{SSB}}))$
DRX cycle $> 320\text{ms}$	$\text{Ceil}(10 \times P \times N) \times T_{\text{DRX}}$	$\text{Ceil}(5 \times P \times N) \times T_{\text{DRX}}$
NOTE: $T_{\text{SSB}}$ is the periodicity of the SSB configured for RLM. $T_{\text{DRX}}$ is the DRX cycle length.		

### 8.1.2.3 Measurement restrictions for SSB based RLM

The UE is required to be capable of measuring SSB for RLM without measurement gaps. The UE is required to perform the SSB measurements with measurement restrictions as described in the following scenarios.

For FR1, when the SSB for RLM is in the same OFDM symbol as CSI-RS for RLM, BFD, CBD or L1-RSRP measurement,

- If SSB and CSI-RS have same SCS, UE shall be able to measure the SSB for RLM without any restriction;
- If SSB and CSI-RS have different SCS,
  - If UE supports *simultaneousRxDataSSB-DiffNumerology*, UE shall be able to measure the SSB for RLM without any restriction;
  - If UE does not support *simultaneousRxDataSSB-DiffNumerology*, UE is required to measure one of but not both SSB for RLM and CSI-RS. Longer measurement period for SSB based RLM is expected, and no requirements are defined.

For FR2, when the SSB for RLM measurement on one CC is in the same OFDM symbol as CSI-RS for RLM, BFD, CBD or L1-RSRP measurement on the same CC or different CCs in the same band, UE is required to measure one of but not both SSB for RLM and CSI-RS. Longer measurement period for SSB based RLM is expected, and no requirements are defined.

For FR2, there is no measurement restriction allowed when the network configures mixed numerology between SSB for RLM measurement on one FR2 band and CSI-RS for RLM, BFD, CBD, L1-RSRP or L1-SINR measurement on the other FR2 band, provided that UE is capable of independent beam management on this FR2 band pair.

## 8.1.3 Requirements for CSI-RS based radio link monitoring

### 8.1.3.1 Introduction

The requirements in this clause apply for each CSI-RS based RLM-RS resource configured for PCell or PSCell, provided that the CSI-RS configured for RLM is actually transmitted within UE active DL BWP during the entire evaluation period specified in clause 8.1.3.2. UE is not expected to perform radio link monitoring measurements on the CSI-RS configured as RLM-RS if the CSI-RS is not in the active TCI state of any CORESET configured in the UE active BWP.

**Table 8.1.3.1-1: PDCCH transmission parameters for out-of-sync evaluation**

Attribute	Value for BLER Configuration #0
DCI format	1-0
Number of control OFDM symbols	2
Aggregation level (CCE)	8
Ratio of hypothetical PDCCH RE energy to average CSI-RS RE energy	4dB
Ratio of hypothetical PDCCH DMRS energy to average CSI-RS RE energy	4dB
Bandwidth (PRBs)	48
Sub-carrier spacing (kHz)	SCS of the active DL BWP
DMRS precoder granularity	REG bundle size
REG bundle size	6
CP length	Normal
Mapping from REG to CCE	Distributed

**Table 8.1.3.1-2: PDCCH transmission parameters for in-sync evaluation**

Attribute	Value for BLER Configuration #0
DCI payload size	1-0
Number of control OFDM symbols	2
Aggregation level (CCE)	4
Ratio of hypothetical PDCCH RE energy to average CSI-RS RE energy	0dB
Ratio of hypothetical PDCCH DMRS energy to average CSI-RS RE energy	0dB
Bandwidth (PRBs)	48
Sub-carrier spacing (kHz)	SCS of the active DL BWP
DMRS precoder granularity	REG bundle size
REG bundle size	6
CP length	Normal
Mapping from REG to CCE	Distributed

### 8.1.3.2 Minimum requirement

UE shall be able to evaluate whether the downlink radio link quality on the configured RLM-RS resource estimated over the last  $T_{\text{Evaluate\_out\_CSI-RS}}$  ms period becomes worse than the threshold  $Q_{\text{out\_CSI-RS}}$  within  $T_{\text{Evaluate\_out\_CSI-RS}}$  ms evaluation period.

UE shall be able to evaluate whether the downlink radio link quality on the configured RLM-RS resource estimated over the last  $T_{\text{Evaluate\_in\_CSI-RS}}$  ms period becomes better than the threshold  $Q_{\text{in\_CSI-RS}}$  within  $T_{\text{Evaluate\_in\_CSI-RS}}$  ms evaluation period.

- $T_{\text{Evaluate\_out\_CSI-RS}}$  and  $T_{\text{Evaluate\_in\_CSI-RS}}$  are defined in Table 8.1.3.2-1 for FR1.

- $T_{\text{Evaluate\_out\_CSI-RS}}$  and  $T_{\text{Evaluate\_in\_CSI-RS}}$  are defined in Table 8.1.3.2-2 for FR2 with scaling factor  $N=1$ .

The requirements of  $T_{\text{Evaluate\_out\_CSI-RS}}$  and  $T_{\text{Evaluate\_in\_CSI-RS}}$  apply provided that the CSI-RS for RLM is not in a resource set configured with repetition ON. The requirements do not apply when the CSI-RS resource in the active TCI state of CORESET is the same CSI-RS resource for RLM and the TCI state information of the CSI-RS resource is not given, wherein the TCI state information means QCL Type-D to SSB for L1-RSRP or CSI-RS with repetition ON.

For FR1,

- $P = \frac{1}{1 - \frac{T_{\text{CSI-RS}}}{\text{MGRP}}}$ , when in the monitored cell there are measurement gaps configured for intra-frequency, inter-frequency or inter-RAT measurements, and these measurement gaps are overlapping with some but not all occasions of the CSI-RS; and
- $P=1$  when in the monitored cell there are no measurement gaps overlapping with any occasion of the CSI-RS.

For FR2,

- $P=1$ , when the RLM-RS resource is not overlapped with measurement gap and also not overlapped with SMTC occasion.
- $P = \frac{1}{1 - \frac{T_{\text{CSI-RS}}}{\text{MGRP}}}$ , when the RLM-RS resource is partially overlapped with measurement gap and the RLM-RS resource is not overlapped with SMTC occasion ( $T_{\text{CSI-RS}} < \text{MGRP}$ )
- $P = \frac{1}{1 - \frac{T_{\text{CSI-RS}}}{T_{\text{SMTCperiod}}}}$ , when the RLM-RS resource is not overlapped with measurement gap and the RLM-RS resource is partially overlapped with SMTC occasion ( $T_{\text{CSI-RS}} < T_{\text{SMTCperiod}}$ ).
- $P = P_{\text{sharing factor}}$ , when the RLM-RS resource is not overlapped with measurement gap and RLM-RS resource is fully overlapped with SMTC occasion ( $T_{\text{CSI-RS}} = T_{\text{SMTCperiod}}$ ).
- $P = \frac{1}{1 - \frac{T_{\text{CSI-RS}}}{\text{MGRP}} - \frac{T_{\text{CSI-RS}}}{T_{\text{SMTCperiod}}}}$ , when the RLM-RS resource is partially overlapped with measurement gap and the RLM-RS resource is partially overlapped with SMTC occasion ( $T_{\text{CSI-RS}} < T_{\text{SMTCperiod}}$ ) and SMTC occasion is not overlapped with measurement gap and
  - $T_{\text{SMTCperiod}} \neq \text{MGRP}$  or
  - $T_{\text{SMTCperiod}} = \text{MGRP}$  and  $T_{\text{CSI-RS}} < 0.5 \times T_{\text{SMTCperiod}}$
- $P = \frac{P_{\text{sharing factor}}}{1 - \frac{T_{\text{CSI-RS}}}{\text{MGRP}}}$ , when the RLM-RS resource is partially overlapped with measurement gap and the RLM-RS resource is partially overlapped with SMTC occasion ( $T_{\text{CSI-RS}} < T_{\text{SMTCperiod}}$ ) and SMTC occasion is not overlapped with measurement gap and  $T_{\text{SMTCperiod}} = \text{MGRP}$  and  $T_{\text{CSI-RS}} = 0.5 \times T_{\text{SMTCperiod}}$
- $P = \frac{1}{1 - \frac{T_{\text{CSI-RS}}}{\text{Min}(\text{MGRP}, T_{\text{SMTCperiod}})}}$ , when the RLM-RS resource is partially overlapped with measurement gap and the RLM-RS resource is partially overlapped with SMTC occasion ( $T_{\text{CSI-RS}} < T_{\text{SMTCperiod}}$ ) and SMTC occasion is partially or fully overlapped with measurement gap
- $P = \frac{P_{\text{sharing factor}}}{1 - \frac{T_{\text{CSI-RS}}}{\text{MGRP}}}$ , when the RLM-RS resource is partially overlapped with measurement gap and the RLM-RS resource is fully overlapped with SMTC occasion ( $T_{\text{CSI-RS}} = T_{\text{SMTCperiod}}$ ) and SMTC occasion is partially overlapped with measurement gap ( $T_{\text{SMTCperiod}} < \text{MGRP}$ )
- $P_{\text{sharing factor}} = 1$ , if the RLM-RS resource outside measurement gap is
  - not overlapped with the SSB symbols indicated by *SSB-ToMeasure* and 1 data symbol before each consecutive SSB symbols indicated by *SSB-ToMeasure* and 1 data symbol after each consecutive SSB symbols indicated by *SSB-ToMeasure*, given that *SSB-ToMeasure* is configured, where the *SSB-ToMeasure* is the union set of *SSB-ToMeasure* from all the configured measurement objects merged on the same serving carrier, and,

- not overlapped by the RSSI symbols indicated by *ss-RSSI-Measurement* and 1 data symbol before each RSSI symbol indicated by *ss-RSSI-Measurement* and 1 data symbol after each RSSI symbol indicated by *ss-RSSI-Measurement*, given that *ss-RSSI-Measurement* is configured.
- $P_{\text{sharing factor}} = 3$ , otherwise.

where,

If the high layer in TS 38.331 [2] signaling of *smtc2* is present,  $T_{\text{SMTCperiod}}$  follows *smtc2*; Otherwise  $T_{\text{SMTCperiod}}$  follows *smtc1*.  $T_{\text{SMTCperiod}}$  is the shortest SMTC period among all CCs in the same FR2 band, provided the SMTC offset of all CCs in FR2 have the same offset.

If the high layer in TS 38.331 [2] signaling of *smtc2* is present,  $T_{\text{SMTCperiod}}$  follows *smtc2*; Otherwise  $T_{\text{SMTCperiod}}$  follows *smtc1*.

Note: The overlap between CSI-RS for RLM and SMTC means that CSI-RS based RLM is within the SMTC window duration.

Longer evaluation period would be expected if the combination of RLM-RS resource, SMTC occasion and measurement gap configurations does not meet previous conditions.

For either an FR1 or FR2 serving cell, longer evaluation period would be expected during the period  $T_{\text{identify\_CGI}}$  when the UE is requested to decode an NR CGI.

For either an FR1 or FR2 serving cell, longer evaluation period would be expected during the period  $T_{\text{identify\_CGI,E-UTRAN}}$  when the UE is requested to decode an LTE CGI.

The values of  $M_{\text{out}}$  and  $M_{\text{in}}$  used in Table 8.1.3.2-1 and Table 8.1.3.2-2 are defined as:

- $M_{\text{out}} = 20$  and  $M_{\text{in}} = 10$ , if the CSI-RS resource configured for RLM is transmitted with higher layer CSI-RS parameter *density* [6, clause 7.4.1] set to 3 and over the bandwidth  $\geq 24$  PRBs.

**Table 8.1.3.2-1: Evaluation period  $T_{\text{Evaluate\_out\_CSI-RS}}$  and  $T_{\text{Evaluate\_in\_CSI-RS}}$  for FR1**

Configuration	$T_{\text{Evaluate\_out\_CSI-RS}}$ (ms)	$T_{\text{Evaluate\_in\_CSI-RS}}$ (ms)
no DRX	$\text{Max}(200, \text{Ceil}(M_{\text{out}} \times P) \times T_{\text{CSI-RS}})$	$\text{Max}(100, \text{Ceil}(M_{\text{in}} \times P) \times T_{\text{CSI-RS}})$
$\text{DRX} \leq 320\text{ms}$	$\text{Max}(200, \text{Ceil}(1.5 \times M_{\text{out}} \times P) \times \text{Max}(T_{\text{DRX}}, T_{\text{CSI-RS}}))$	$\text{Max}(100, \text{Ceil}(1.5 \times M_{\text{in}} \times P) \times \text{Max}(T_{\text{DRX}}, T_{\text{CSI-RS}}))$
$\text{DRX} > 320\text{ms}$	$\text{Ceil}(M_{\text{out}} \times P) \times T_{\text{DRX}}$	$\text{Ceil}(M_{\text{in}} \times P) \times T_{\text{DRX}}$
NOTE:	$T_{\text{CSI-RS}}$ is the periodicity of the CSI-RS resource configured for RLM. The requirements in this table apply for $T_{\text{CSI-RS}}$ equal to 5 ms, 10ms, 20 ms or 40 ms. $T_{\text{DRX}}$ is the DRX cycle length.	

**Table 8.1.3.2-2: Evaluation period  $T_{\text{Evaluate\_out\_CSI-RS}}$  and  $T_{\text{Evaluate\_in\_CSI-RS}}$  for FR2**

Configuration	$T_{\text{Evaluate\_out\_CSI-RS}}$ (ms)	$T_{\text{Evaluate\_in\_CSI-RS}}$ (ms)
no DRX	$\text{Max}(200, \text{Ceil}(M_{\text{out}} \times P \times N) \times T_{\text{CSI-RS}})$	$\text{Max}(100, \text{Ceil}(M_{\text{in}} \times P \times N) \times T_{\text{CSI-RS}})$
$\text{DRX} \leq 320\text{ms}$	$\text{Max}(200, \text{Ceil}(1.5 \times M_{\text{out}} \times P \times N) \times \text{Max}(T_{\text{DRX}}, T_{\text{CSI-RS}}))$	$\text{Max}(100, \text{Ceil}(1.5 \times M_{\text{in}} \times P \times N) \times \text{Max}(T_{\text{DRX}}, T_{\text{CSI-RS}}))$
$\text{DRX} > 320\text{ms}$	$\text{Ceil}(M_{\text{out}} \times P \times N) \times T_{\text{DRX}}$	$\text{Ceil}(M_{\text{in}} \times P \times N) \times T_{\text{DRX}}$
NOTE:	$T_{\text{CSI-RS}}$ is the periodicity of the CSI-RS resource configured for RLM. The requirements in this table apply for $T_{\text{CSI-RS}}$ equal to 5 ms, 10 ms, 20 ms or 40 ms. $T_{\text{DRX}}$ is the DRX cycle length.	

### 8.1.3.3 Measurement restrictions for CSI-RS based RLM

The UE is required to be capable of measuring CSI-RS for RLM without measurement gaps. The UE is required to perform the CSI-RS measurements with measurement restrictions as described in the following clauses.

For both FR1 and FR2, when the CSI-RS for RLM is in the same OFDM symbol as SSB for RLM, BFD, CBD or L1-RSRP measurement, UE is not required to receive CSI-RS for RLM in the PRBs that overlap with an SSB.

For FR1, when the SSB for RLM, BFD, CBD, or L1-RSRP measurement is within the active BWP and has same SCS than CSI-RS for RLM, the UE shall be able to perform CSI-RS measurement without restrictions.

For FR1, when the SSB for RLM, BFD, CBD or L1-RSRP measurement is within the active BWP and has different SCS than CSI-RS for RLM, the UE shall be able to perform CSI-RS measurement with restrictions according to its capabilities:

- If the UE supports *simultaneousRxDataSSB-DiffNumerology* the UE shall be able to perform CSI-RS for RLM measurement without restrictions.
- If the UE does not support *simultaneousRxDataSSB-DiffNumerology*, UE is required to measure one of but not both CSI-RS for RLM and SSB. Longer measurement period for CSI-RS based RLM is expected, and no requirements are defined.

For FR1, when the CSI-RS for RLM is in the same OFDM symbol as another CSI-RS for RLM, BFD, CBD or L1-RSRP measurement, UE shall be able to measure the CSI-RS for RLM without any restriction.

For FR2, when the CSI-RS for RLM measurement on one CC is in the same OFDM symbol as SSB for RLM, BFD, or L1-RSRP measurement on the same CC or different CCs in the same band, or in the same symbol as SSB for CBD measurement on the same CC or different CCs in the same band when beam failure is detected, UE is required to measure one of but not both CSI-RS for RLM and SSB. Longer measurement period for CSI-RS based RLM is expected, and no requirements are defined.

For FR2, when the CSI-RS for RLM measurement on one CC is in the same OFDM symbol as another CSI-RS for RLM, BFD, CBD or L1-RSRP measurement on the same CC or different CCs in the same band,

- In the following cases, UE is required to measure one of but not both CSI-RS for RLM and the other CSI-RS. Longer measurement period for CSI-RS based RLM is expected, and no requirements are defined.
  - The CSI-RS for RLM or the other CSI-RS in a resource set configured with repetition ON, or
  - The other CSI-RS is configured in q1 and beam failure is detected, or
  - The two CSI-RS-es are not QCL-ed w.r.t. QCL-TypeD, or the QCL information is not known to UE,
- Otherwise, UE shall be able to measure the CSI-RS for RLM without any restriction.

#### 8.1.4 Minimum requirement at transitions

When the UE transitions between DRX and no DRX or when DRX cycle periodicity changes, for each RLM-RS resource, for a duration of time equal to the evaluation period corresponding to the second mode after the transition occurs, the UE shall use an evaluation period that is no less than the minimum of evaluation period corresponding to the first mode and the second mode. Subsequent to this duration, the UE shall use an evaluation period corresponding to the second mode for each RLM-RS resource. This requirement shall be applied to both out-of-sync evaluation and in-sync evaluation of the monitored cell.

When the UE transitions from a first configuration of RLM resources to a second configuration of RLM resources that is different from the first configuration, for each RLM resource present in the second configuration, for a duration of time equal to the evaluation period corresponding to the second configuration after the transition occurs, the UE shall use an evaluation period that is no less than the minimum of evaluation periods corresponding to the first configuration and the second configuration. Subsequent to this duration, the UE shall use an evaluation period corresponding to the second configuration for each RLM resource present in the second configuration. This requirement shall be applied to both out-of-sync evaluation and in-sync evaluation of the monitored cell.

When the UE transitions from a first configuration of active TCI state of the CORESET to a second configuration of active TCI state of the CORESET, for each CSI-RS for RLM present in the second configuration, the UE shall use an evaluation period corresponding to the second configuration from the time of transition. This requirement shall be applied to both out-of-sync evaluation and in-sync evaluation of the monitored cell.

#### 8.1.5 Minimum requirement for UE turning off the transmitter

The transmitter power of the UE in the monitored cell shall be turned off within 40ms after expiry of T310 timer as specified in TS 38.331 [2].

## 8.1.6 Minimum requirement for L1 indication

When the downlink radio link quality on all the configured RLM-RS resources is worse than  $Q_{out}$ , layer 1 of the UE shall send an out-of-sync indication for the cell to the higher layers. A layer 3 filter shall be applied to the out-of-sync indications as specified in TS 38.331 [2].

When the downlink radio link quality on at least one of the configured RLM-RS resources is better than  $Q_{in}$ , layer 1 of the UE shall send an in-sync indication for the cell to the higher layers. A layer 3 filter shall be applied to the in-sync indications as specified in TS 38.331 [2].

The out-of-sync and in-sync evaluations for the configured RLM-RS resources shall be performed as specified in clause 5 in TS 38.213 [3]. Two successive indications from layer 1 shall be separated by at least  $T_{Indication\_interval}$ .

When DRX is not used  $T_{Indication\_interval}$  is  $\max(10\text{ms}, T_{RLM-RS,M})$ , where  $T_{RLM,M}$  is the shortest periodicity of all configured RLM-RS resources for the monitored cell, which corresponds to  $T_{SSB}$  specified in clause 8.1.2 if the RLM-RS resource is SSB, or  $T_{CSI-RS}$  specified in clause 8.1.3 if the RLM-RS resource is CSI-RS.

In case DRX is used,  $T_{Indication\_interval}$  is  $\text{Max}(10\text{ms}, 1.5 \times \text{DRX\_cycle\_length}, 1.5 \times T_{RLM-RS,M})$  if DRX cycle\_length is less than or equal to 320ms, and  $T_{Indication\_interval}$  is DRX\_cycle\_length if DRX cycle\_length is greater than 320ms. Upon start of T310 timer as specified in TS 38.331 [2], the UE shall monitor the configured RLM-RS resources for recovery using the evaluation period and layer 1 indication interval corresponding to the no DRX mode until the expiry or stop of T310 timer.

## 8.1.7 Scheduling availability of UE during radio link monitoring

When the reference signal to be measured for RLM has different subcarrier spacing than PDSCH/PDCCH or is on frequency range 2, there are restrictions on the scheduling availability as described in the following clauses.

### 8.1.7.1 Scheduling availability of UE performing radio link monitoring with a same subcarrier spacing as PDSCH/PDCCH on FR1

There are no scheduling restrictions due to radio link monitoring performed with a same subcarrier spacing as PDSCH/PDCCH on FR1.

### 8.1.7.2 Scheduling availability of UE performing radio link monitoring with a different subcarrier spacing than PDSCH/PDCCH on FR1

For UEs which support *simultaneousRxDataSSB-DiffNumerology* [14] there are no restrictions on scheduling availability due to radio link monitoring based on SSB as RLM-RS. For UEs which do not support *simultaneousRxDataSSB-DiffNumerology* [14] the following restrictions apply due to radio link monitoring based on SSB as RLM-RS.

- The UE is not expected to transmit PUCCH, PUSCH or SRS or receive PDCCH, PDSCH or CSI-RS for tracking or CSI-RS for CQI on SSB symbols to be measured for radio link monitoring.

When intra-band carrier aggregation in FR1 is performed, the scheduling restrictions on FR1 serving PCell or PSCell applies to all serving cells in the same band on the symbols that fully or partially overlap with the restricted symbols. When inter-band carrier aggregation within FR1 is performed, there are no scheduling restrictions on FR1 serving cell(s) in the bands due to radio link monitoring performed on FR1 serving PCell or PSCell in different bands.

### 8.1.7.3 Scheduling availability of UE performing radio link monitoring on FR2

The following scheduling restriction applies due to radio link monitoring on an FR2 serving PCell and/or PSCell.

- If the RLM-RS is CSI-RS which is type-D QCLed with active TCI state for PDCCH or PDSCH, and the CSI-RS is not in a CSI-RS resource set with repetition ON,
  - There are no scheduling restrictions due to radio link monitoring based on the CSI-RS.
- Otherwise



- The UE is not expected to transmit PUCCH, PUSCH or SRS or receive PDCCH, PDSCH or CSI-RS for tracking or CSI-RS for CQI on RLM-RS symbols to be measured for radio link monitoring.

When intra-band carrier aggregation in FR2 is performed, the scheduling restrictions on FR2 serving PCell or PSCell applies to all serving cells in the same band on the symbols that fully or partially overlap with restricted symbols.

When inter-band carrier aggregation in FR2 is performed, there are no scheduling restrictions on FR2 serving cell(s) in the bands for the following cases, provided that UE is capable of independent beam management on this FR2 band pair:

when performing radio link monitoring performed on FR2 serving PCell or PSCell in different bands,

- the UE is configured with same or different numerology between SSB on one FR2 band and data on the other FR2 band.

For FR2, if following conditions are met,

- UE has been notified about system information update through paging,
- The gap between UE's reception of PDCCH that UE monitors in the Type2-PDCCH CSS set and that notifies system information update, and the PDCCH that UE monitors in the Type0-PDCCH CSS set, is greater than 2 slots,

For the SSB for RLM and CORESET for RMSI scheduling multiplexing patterns 3, UE is expected to receive the PDCCH that UE monitors in the Type0-PDCCH CSS set, and the corresponding PDSCH, on SSB symbols to be measured for RLM; and

For the SSB for RLM and CORESET for RMSI scheduling multiplexing patterns 2, UE is expected to receive PDSCH that corresponds to the PDCCH that UE monitors in the Type0-PDCCH CSS set, on SSB symbols to be measured for RLM.

#### 8.1.7.4 Scheduling availability of UE performing radio link monitoring on FR1 or FR2 in case of FR1-FR2 inter-band CA and NR-DC

There are no scheduling restrictions on FR1 serving cell(s) due to radio link monitoring performed on FR2 serving PCell and/or PSCell.

There are no scheduling restrictions on FR2 serving cell(s) due to radio link monitoring performed on FR1 serving PCell and/or PSCell.

## 8.1A Radio Link Monitoring with CCA on Target Frequency

### 8.1A.1 Introduction

The requirements in clause 8.1A apply for radio link monitoring on a carrier frequency with CCA for cells:

- PCell in SA NR operation mode,
- PSCell in EN-DC operation mode.

The UE shall monitor the downlink radio link quality based on the reference signal configured as RLM-RS resource(s) in order to detect the downlink radio link quality of the PCell and PSCell as specified in TS 38.213 [3]. The configured RLM-RS resources can be all SSBs, or all CSI-RSs, or a mix of SSBs and CSI-RSs. UE is not required to perform RLM outside the active DL BWP.

On each RLM-RS resource, the UE shall estimate the downlink radio link quality and compare it to the thresholds  $Q_{out,CCA}$  and  $Q_{in,CCA}$  for the purpose of monitoring downlink radio link quality of the cell.

The threshold  $Q_{out,CCA}$  is defined as the level at which the downlink radio link cannot be reliably received and shall correspond to the out-of-sync block error rate ( $BLER_{out,CCA}$ ) as defined in Table 8.1A.1-1. For SSB based radio link monitoring,  $Q_{out,SSB,CCA}$  is derived based on the hypothetical PDCCH transmission parameters listed in Table 8.1A.2.1-1.

The threshold  $Q_{in,CCA}$  is defined as the level at which the downlink radio link quality can be received with significantly higher reliability than at  $Q_{out,CCA}$  and shall correspond to the in-sync block error rate ( $BLER_{in}$ ) as defined in Table 8.1A.1-1. For SSB based radio link monitoring,  $Q_{in,SSB,CCA}$  is derived based on the hypothetical PDCCH transmission parameters listed in Table 8.1A.2.1-2.

The out-of-sync block error rate ( $BLER_{out,CCA}$ ) and in-sync block error rate ( $BLER_{in,CCA}$ ) are determined from the network configuration via parameter *rlmInSyncOutOfSyncThreshold* signalled by higher layers. When UE is not configured with *rlmInSyncOutOfSyncThreshold* from the network, UE determines out-of-sync and in-sync block error rates from Configuration #0 in Table 8.1A.1-1 as default. All requirements in clause 8.1A are applicable for BLER Configuration #0 in Table 8.1A.1-1.

**Table 8.1A.1-1: Out-of-sync and in-sync block error rates**

Configuration	$BLER_{out,CCA}$	$BLER_{in,CCA}$
0	10%	2%

UE shall be able to monitor up to  $N_{RLM}$  RLM-RS resources of the same or different types in each corresponding carrier frequency range, depending on a maximum number  $L_{max}$  of SSBs per half frame according to TS 38.213 [3], where  $N_{RLM}$  is specified in Table 8.1A.1-2, and meet the requirements as specified in clause 8.1A. UE is not required to meet the requirements in clause 8.1A if RLM-RS is not configured and no TCI state for PDCCH is activated.

**Table 8.1A.1-2: Maximum number of RLM-RS resources  $N_{RLM}$**

$L_{max}$	Maximum number of RLM-RS resources, $N_{RLM}$
8	4

The requirements in clause 8.1A apply for any *channelAccessMode* configuration [TS 38.331, 2].

In the requirements of clause 8.1A, the term RLM-RS SSB occasion not available at the UE refers to when the RLM-RS SSB is configured by gNB in a cell on a carrier frequency subject to CCA, but the first two successive candidate SSB positions for the same SSB index within the set of configured RLM-RS resources are not available at the UE due to DL CCA failures at gNB during the corresponding evaluation period; otherwise the RLM-RS SSB is considered as available at the UE.

## 8.1A.2 Requirements for SSB Based Radio Link Monitoring

### 8.1A.2.1 Introduction

The requirements in this clause apply for each SSB based RLM-RS resource configured for PCell or PSCell, provided that the SSB configured for RLM are actually configured to be transmitted within UE active DL BWP during the entire evaluation period specified in clause 8.1A.2.2 but occasionally may not be transmitted due to CCA operation.

**Table 8.1A.2.1-1: PDCCH transmission parameters for out-of-sync evaluation**

Attribute	Value for BLER Configuration #0
DCI format	1-0
Number of control OFDM symbols	2
Aggregation level (CCE)	8
Ratio of hypothetical PDCCH RE energy to average SSS RE energy	4 dB
Ratio of hypothetical PDCCH DMRS energy to average SSS RE energy	4 dB
Bandwidth (PRBs)	24
Sub-carrier spacing (kHz)	SCS of the active DL BWP
DMRS precoder granularity	REG bundle size
REG bundle size	6
CP length	Normal

Mapping from REG to CCE	Distributed
-------------------------	-------------

Table 8.1A.2.1-2: PDCCH transmission parameters for in-sync evaluation

Attribute	Value for BLER Configuration #0
DCI payload size	1-0
Number of control OFDM symbols	2
Aggregation level (CCE)	4
Ratio of hypothetical PDCCH RE energy to average SSS RE energy	0dB
Ratio of hypothetical PDCCH DMRS energy to average SSS RE energy	0dB
Bandwidth (PRBs)	24
Sub-carrier spacing (kHz)	SCS of the active DL BWP
DMRS precoder granularity	REG bundle size
REG bundle size	6
CP length	Normal
Mapping from REG to CCE	Distributed

### 8.1A.2.2 Minimum Requirement

UE shall be able to evaluate whether the downlink radio link quality on the configured RLM-RS resource estimated over the last  $T_{\text{Evaluate\_out\_SSB,CCA}}$  [ms] period becomes worse than the threshold  $Q_{\text{out\_SSB,CCA}}$  within  $T_{\text{Evaluate\_out\_SSB,CCA}}$  [ms] evaluation period.

UE shall be able to evaluate whether the downlink radio link quality on the configured RLM-RS resource estimated over the last  $T_{\text{Evaluate\_in\_SSB,CCA}}$  [ms] period becomes better than the threshold  $Q_{\text{in\_SSB,CCA}}$  within  $T_{\text{Evaluate\_in\_SSB,CCA}}$  [ms] evaluation period. During the in-sync evaluation procedure, layer 1 of the UE shall not send any in-sync indication for the cell to the higher layers when  $L_{\text{in}}$  exceeds  $L_{\text{in,max}}$ , where  $L_{\text{in}}$  and  $L_{\text{in,max}}$  are defined in Table 8.1A.2.2-1.

$T_{\text{Evaluate\_out\_SSB,CCA}}$  and  $T_{\text{Evaluate\_in\_SSB,CCA}}$  are defined in Table 8.1A.2.2-1, where

- $P = \frac{1}{1 - \frac{T_{\text{SSB}}}{MRGP}}$ , when in the monitored cell there are measurement gaps configured for intra-frequency, inter-frequency or inter-RAT measurements, and these measurement gaps are overlapping with some but not all occasions of the SSB RLM-RS resources; and
- $P=1$  when in the monitored cell there are no measurement gaps overlapping with any occasion of the SSB RLM-RS resources.

Longer evaluation period would be expected if the combination of RLM-RS, and measurement gap configurations does not meet previous conditions.

Table 8.1A.2.2-1: Evaluation period  $T_{\text{Evaluate\_out\_SSB,CCA}}$  and  $T_{\text{Evaluate\_in\_SSB,CCA}}$ 

Configuration	$T_{\text{Evaluate\_out\_SSB,CCA}}$ (ms)		$T_{\text{Evaluate\_in\_SSB,CCA}}$ (ms)
	RLM-RS SSB Es/lot <sup>Note4</sup> $\geq -7$ dB	RLM-RS SSB Es/lot <sup>Note4</sup> $< -7$ dB	
no DRX	$\text{Max}(200, \text{Ceil}(17 \cdot P) \cdot T_{\text{SSB}})$	$\text{Max}(200, \text{Ceil}(24 \cdot P) \cdot T_{\text{SSB}})$	$\text{Max}(100, \text{Ceil}((5 + L_{\text{in}}) \cdot P) \cdot T_{\text{SSB}})$
DRX cycle $\leq 320$	$\text{Max}(200, \text{Ceil}(1.5 \cdot 15 \cdot P) \cdot \text{Max}(T_{\text{DRX}}, T_{\text{SSB}}))$	$\text{Max}(200, \text{Ceil}(1.5 \cdot 20 \cdot P) \cdot \text{Max}(T_{\text{DRX}}, T_{\text{SSB}}))$	$\text{Max}(100, \text{Ceil}(1.5 \cdot (5 + L_{\text{in}}) \cdot P) \cdot \text{Max}(T_{\text{DRX}}, T_{\text{SSB}}))$
DRX cycle $> 320$	$\text{Ceil}(13 \cdot P) \cdot T_{\text{DRX}}$	$\text{Ceil}(16 \cdot P) \cdot T_{\text{DRX}}$	$\text{Ceil}((5 + L_{\text{in}}) \cdot P) \cdot T_{\text{DRX}}$

NOTE 1:  $T_{\text{SSB}}$  is the periodicity of the SSB configured for RLM.  $T_{\text{DRX}}$  is the DRX cycle length.

NOTE 2: When DRX is not configured,  $L_{\text{in}}$  is the number of RLM-RS SSB occasions which are not available at the UE during  $T_{\text{Evaluate\_in\_SSB,CCA}}$ , where  $L_{\text{in}} \leq L_{\text{in,max}}$ . When DRX is configured,  $L_{\text{in}}$  is the number of DRX cycles in which at least one RLM-RS SSB occasion is not available at the UE during  $T_{\text{Evaluate\_in\_SSB,CCA}}$ , where  $L_{\text{in}} \leq L_{\text{in,max}}$ . The UE is not required to determine the availability of SSB occasions more frequent than Once per  $\text{Max}(10\text{ms}, P \cdot T_{\text{SSB}})$  if no DRX is used,

<p>Once per <math>\text{Max}(10\text{ms}, \text{Ceil}(1.5 * P) * \text{Max}(T_{\text{DRX}}, T_{\text{SSB}}))</math> if DRX cycle <math>\leq 320\text{ms}</math>,  Once per <math>P * T_{\text{DRX}}</math> if DRX cycle <math>&gt; 320\text{ms}</math>.</p> <p>NOTE 3: <math>L_{\text{in,max}}=7</math> for <math>\text{Max}(T_{\text{DRX}}, T_{\text{SSB}}) \leq 40</math> assuming <math>T_{\text{DRX}}=0</math> for non-DRX case,  <math>L_{\text{in,max}}=5</math> for <math>40 &lt; \text{Max}(T_{\text{DRX}}, T_{\text{SSB}}) \leq 320</math>,  <math>L_{\text{in,max}}=3</math> for <math>T_{\text{DRX}} &gt; 320</math>.</p> <p>NOTE 4: RLM-RS SSB Es/lot is the averaged Es/lot over the most recent previous out-of-sync evaluation period.</p>
---

### 8.1A.2.3 Measurement Restrictions for SSB based RLM

The UE is required to be capable of measuring SSB for RLM without measurement gaps. The UE is required to perform the SSB measurements with measurement restrictions as described in the following clauses.

When the SSB for RLM is in the same OFDM symbol as CSI-RS for RLM, BFD, CBD or L1-RSRP measurement,

- If SSB and CSI-RS have same SCS, UE shall be able to measure the SSB for RLM without any restriction;
- If SSB and CSI-RS have different SCS,
  - If UE supports *simultaneousRxDataSSB-DiffNumerology*, UE shall be able to measure the SSB for RLM without any restriction;
  - If UE does not support *simultaneousRxDataSSB-DiffNumerology*, UE is required to measure SSB for RLM.

### 8.1A.3 Minimum requirement at transitions

When the UE transitions between DRX and no DRX or when DRX cycle periodicity changes, for each RLM-RS resource, for a duration of time equal to the evaluation period corresponding to the second mode after the transition occurs, the UE shall use an evaluation period that is no less than the minimum of evaluation period corresponding to the first mode and the second mode. Subsequent to this duration, the UE shall use an evaluation period corresponding to the second mode for each RLM-RS resource. This requirement shall be applied to both out-of-sync evaluation and in-sync evaluation of the monitored cell.

When the UE transitions from a first configuration of RLM resources to a second configuration of RLM resources that is different from the first configuration, for each RLM resource present in the second configuration, for a duration of time equal to the evaluation period corresponding to the second configuration after the transition occurs, the UE shall use an evaluation period that is no less than the minimum of evaluation periods corresponding to the first configuration and the second configuration. Subsequent to this duration, the UE shall use an evaluation period corresponding to the second configuration for each RLM resource present in the second configuration. This requirement shall be applied to both out-of-sync evaluation and in-sync evaluation of the monitored cell.

### 8.1A.4 Minimum requirement for UE turning off the transmitter

The transmitter power of the UE in the monitored cell shall be turned off within 40ms after expiry of T310 timer as specified in TS 38.331 [2]. The UE shall not perform CCA procedure on any of the serving carrier frequencies with CCA after the expiry of T310.

### 8.1A.5 Minimum requirement for L1 indication

When the downlink radio link quality on all the configured RLM-RS resources is worse than  $Q_{\text{out,CCA}}$ , layer 1 of the UE shall send an out-of-sync indication for the cell to the higher layers. A layer 3 filter shall be applied to the out-of-sync indications as specified in TS 38.331 [2].

When the downlink radio link quality on at least one of the configured RLM-RS resources is better than  $Q_{\text{in,CCA}}$ , layer 1 of the UE shall send an in-sync indication for the cell to the higher layers. A layer 3 filter shall be applied to the in-sync indications as specified in TS 38.331 [2].

The out-of-sync and in-sync evaluations for the configured RLM-RS resources shall be performed as specified in clause 5 in TS 38.213 [3]. Two successive indications from layer 1 shall be separated by at least  $T_{\text{Indication\_interval,CCA}}$ .

When DRX is not used  $T_{\text{Indication\_interval,CCA}}$  is  $\max(10\text{ms}, T_{\text{RLM-RS,M}})$ , where  $T_{\text{RLM,M}}$  is the shortest periodicity of all configured RLM-RS resources for the monitored cell, which corresponds to  $T_{\text{SSB}}$  specified in clause 8.1A.2 if the RLM-RS resource is SSB.

In case DRX is used,  $T_{\text{Indication\_interval,CCA}}$  is  $\text{Max}(10\text{ms}, 1.5 \times \text{DRX\_cycle\_length}, 1.5 \times T_{\text{RLM-RS,M}})$  if DRX cycle\_length is less than or equal to 320ms, and  $T_{\text{Indication\_interval,CCA}}$  is DRX\_cycle\_length if DRX cycle\_length is greater than 320ms. Upon start of T310 timer as specified in TS 38.331 [2], the UE shall monitor the configured RLM-RS resources for recovery using the evaluation period and layer 1 indication interval corresponding to the no DRX mode until the expiry or stop of T310 timer.

## 8.1A.6 Scheduling availability of UE during radio link monitoring

When the reference signal to be measured for RLM on a carrier frequency with CCA has different subcarrier spacing than PDSCH/PDCCH, there are restrictions on the scheduling availability as described in the following clauses.

### 8.1A.6.1 Scheduling availability of UE performing radio link monitoring with the same subcarrier spacing as PDSCH/PDCCH

There are no scheduling restrictions due to radio link monitoring performed with a same subcarrier spacing as PDSCH/PDCCH.

### 8.1A.6.2 Scheduling availability of UE performing radio link monitoring with a different subcarrier spacing than PDSCH/PDCCH

For UEs which support *simultaneousRxDataSSB-DiffNumerology* [14] there are no restrictions on scheduling availability due to radio link monitoring based on SSB as RLM-RS. For UEs which do not support *simultaneousRxDataSSB-DiffNumerology* [14] the following restrictions apply due to radio link monitoring based on SSB as RLM -RS.

- The UE is not expected to transmit PUCCH, PUSCH or SRS or receive PDCCH, PDSCH or CSI-RS for tracking or CSI-RS for CQI on SSB symbols to be measured for radio link monitoring.

When intra-band carrier aggregation is performed, the scheduling restrictions on PCell or PSCell applies to all serving cells in the same band on the symbols that fully or partially overlap with the restricted symbols.

## 8.2 Interruption

### 8.2.1 EN-DC Interruption

#### 8.2.1.1 Introduction

This clause contains the requirements related to the interruptions on PSCell, and SCell, when

- E-UTRA PCell transitions between active and non-active during DRX, or
- E-UTRA PCell transitions from non-DRX to DRX, or
- E-UTRA SCell in MCG or SCell in SCG is added or released, or
- E-UTRA SCell in MCG or SCell(s) in SCG is activated or deactivated, or
- measurements on SCC with deactivated SCell in either E-UTRA MCG or NR SCG, or
- a supplementary UL carrier or an UL carrier is configured or de-configured, or
- UL/DL active BWP is switched on PSCell or SCell in SCG, or
- E-UTRA SCell in MCG or SCell(s) in SCG is directly activated and hibernated, or
- E-UTRA SCell in MCG is hibernated, or

Multiple SCells in SCG are activated or deactivated, or  
 SCell dormancy switches, or  
 CQI/RRM measurement happens during SCell dormancy, or  
 UE-specific CBW is changed on PSCell or SCell in SCG, or  
 CGI reading of an NR neighbour cell with autonomous gaps, or  
 CGI reading of an E-UTRA neighbour cell with autonomous gaps.  
 NR SRS carrier based switching, or  
 E-UTRA SRS carrier based switching, or  
 UE dynamic Tx switches between two uplink carriers.

The requirements shall apply for E-UTRA-NR DC with an E-UTRA PCell.

This clause contains interruptions where victim cell is PSCell or SCell belonging to SCG. Requirements for interruptions requirements when the victim cell is E-UTRA PCell or E-UTRA SCell belonging to MCG are specified in TS 36.133 [15].

For a UE which does not support per-FR measurement gaps, interruptions to the PSCell or activated SCG SCells may be caused by EUTRA PCell, EUTRA SCells or SCells on any frequency range. For UE which support per-FR gaps, interruptions to the PSCell or activated SCG SCells may be caused by EUTRA PCell, EUTRA SCells or SCells on the same frequency range as the victim cell.

## 8.2.1.2 Requirements

### 8.2.1.2.1 Interruptions at transitions between active and non-active during DRX

Interruption on PSCell and the activated SCell if configured due to E-UTRA PCell transitions between active and non-active during DRX when PSCell or SCell is in non-DRX are allowed with up to 1% probability of missed ACK/NACK when the configured E-UTRA PCell DRX cycle is less than 640 ms, and 0.625% probability of missed ACK/NACK is allowed when the configured E-UTRA PCell DRX cycle is 640 ms or longer. Each interruption shall not exceed X slot as defined in table 8.2.1.2.1-1.

**Table 8.2.1.2.1-1: Interruption length X at transition between active and non-active during DRX**

$\mu$	NR Slot length (ms)	Interruption length X (slots)	
		Sync	Async
0	1	1	2
1	0.5	1	2
2	0.25	3	
3	0.125	5	

When both E-UTRA PCell and PSCell are in DRX, no interruption is allowed.

### 8.2.1.2.2 Interruptions at transitions from non-DRX to DRX

Interruption on PSCell and the activated SCell if configured due to E-UTRA PCell transitions from non-DRX to DRX when PSCell or SCell is in non-DRX shall not exceed X slot as defined in table 8.2.1.2.1-1.

When PSCell and the activated SCell are in DRX, no interruption due to E-UTRA PCell transitions from non-DRX to DRX is allowed.

### 8.2.1.2.3 Interruptions at SCell addition/release

The requirements in this clause shall apply for the UE configured with PSCell.

When one E-UTRA SCell in MCG is added or released:

- the UE is allowed an interruption on any active serving cell in SCG:
  - of up to X1 slot, if the active serving cell is not in the same band as the E-UTRA SCell being added or released, or
  - of up to X1 slot, if the active serving cell is in the band overlapping or partially overlapping with the E-UTRA SCell being added or released and UE indicates it is capable of *interBandMRDC-WithOverlapDL-Bands-r16* on this band pair, or
  - of up to  $\max\{Y1 \text{ slot} + T_{\text{SMTC\_duration}}, 5\text{ms}\}$ , if the active serving cells are in the same band or in the band overlapping or partially overlapping with the E-UTRA SCell being added or released, and UE does not indicate it is capable of *interBandMRDC-WithOverlapDL-Bands-r16* on this band pair, provided the cell specific reference signals from the active serving cells and the E-UTRA SCell being added or released are available in the same slot, where  $T_{\text{SMTC\_duration}}$  is the longest SMTC duration among all above active serving cells in SCG;

Where X1 and Y1 are specified in Table 8.2.1.2.3-1.

When one SCell in SCG is added or released:

- the UE is allowed an interruption on any active serving cell in SCG:
  - of up to X1 slot, if the active serving cell and the SCell being added or released are in a FR1 band pair or in a FR1+FR2 band pair.
  - of up to X1 slot, if the active serving cell and the SCell being added or released are in a FR2 band pair and UE is capable of independent beam management on this FR2 band pair

or

- of up to  $Y1 \text{ slot} + T_{\text{SMTC\_duration}}$  if the active serving cells are in the same band as the SCell being added or released, provided the cell specific reference signals from the active serving cells and the SCell being added or released are available in the same slot, where,  $T_{\text{SMTC\_duration}}$  is
  - the longest SMTC duration among all above active serving cells in SCG and the SCell being added when one SCell is added. If SSB configuration (*absoluteFrequencySSB*) but no SMTC configuration is provided for the SCell being added, the SSB transmission periodicity is assumed to be 5ms and  $T_{\text{SMTC\_duration}}$  for the SCell being added is x ms, where x = the number of consecutive subframes containing all SSBs in one SSB burst transmitted by the SCell being added. If no SSB configuration (*absoluteFrequencySSB*) nor SMTC configuration is provided for the SCell being added,  $T_{\text{SMTC\_duration}}$  for the SCell being added is 0 ms;
  - the longest SMTC duration among all above active serving cells in SCG when one SCell is released.

Where X1 and Y1 are specified in Table 8.2.1.2.3-2.

**Table 8.2.1.2.3-1: Interruption length X1 and Y1 at E-UTRA SCell addition/Release**

$\mu$	NR Slot length (ms)	Interruption length X1 (slots)		Interruption length Y1 (slots)	
		Sync	Async	Sync	Async
0	1	1	2	1	2
1	0.5	2	3	2	3
2	0.25	5		4	5
3	0.125	9		N/A	- N/A

**Table 8.2.1.2.3-2: Interruption length X1 and Y1 at SCell addition/Release**

$\mu$	NR Slot length (ms) of victim cell	Interruption length X1 (slots)	Interruption length Y1 (slots)
0	1	1	1
1	0.5	2	2

2	0.25	Both aggressor cell and victim cell are on FR2	4	4
		Either aggressor cell or victim cell is on FR1	5	
3	0.125	Aggressor cell is on FR2	8	8
		Aggressor cell is on FR1	9	

#### 8.2.1.2.4 Interruptions at SCell activation/deactivation

The requirements in this clause shall apply for the UE configured with PSCell and one SCell.

When one E-UTRA SCell in MCG is activated from deactivated or dormant state, or deactivated from activated or dormant state:

- the UE is allowed an interruption on any active serving cell in SCG:
  - of up to X2 slot, if the active serving cell is not in the same band as the E-UTRA SCell being activated or deactivated, or
  - of up to X2 slot, if the active serving cell is in the band overlapping or partially overlapping with the E-UTRA SCell being activated or deactivated and UE indicates it is capable of *interBandMRDC-WithOverlapDL-Bands-r16* on this band pair, or
  - of up to  $\max\{Y2 \text{ slot} + T_{\text{SMTC\_duration}}, 5\text{ms}\}$ , if the active serving cells are in the same band or in the band overlapping or partially overlapping with the E-UTRA SCell being activated or deactivated, and UE does not indicate it is capable of *interBandMRDC-WithOverlapDL-Bands-r16* on this band pair, provided the cell specific reference signals from the active serving cells and the E-UTRA SCell being activated or deactivated are available in the same slot, where  $T_{\text{SMTC\_duration}}$  is the longest SMTC duration among all above active serving cells in SCG.

Where X2 and Y2 are specified in Table 8.2.1.2.4-1.

When one SCell in SCG is activated or deactivated:

- an interruption on any active serving cell in SCG:
  - of up to X2 slot, if the active serving cell and the SCell being activated or deactivated are in a FR1 band pair or in a FR1+FR2 band pair.
  - of up to X2 slot, if the active serving cells and the SCell being activated or deactivated are in a FR2 band pair and UE is capable of independent beam management on this FR2 band pair.

or

- of up to  $Y2 \text{ slot} + T_{\text{SMTC\_duration}}$  if the active serving cells are in the same band as the SCell being activated or deactivated, provided the cell specific reference signals from the active serving cells and the SCell being activated or deactivated are available in the same slot, where,  $T_{\text{SMTC\_duration}}$  is
  - the longest SMTC duration among all above active serving cells in SCG and the SCell being activated when one SCell is activated. If SSB configuration (*absoluteFrequencySSB*) but no SMTC configuration is provided for the SCell being activated, the SSB transmission periodicity is assumed to be 5ms and  $T_{\text{SMTC\_duration}}$  for the SCell being activated is  $x \text{ ms}$ , where  $x$  = the number of consecutive subframes containing all SSBs in one SSB burst transmitted by the SCell being activated. If no SSB configuration (*absoluteFrequencySSB*) nor SMTC configuration is provided for the SCell being activated,  $T_{\text{SMTC\_duration}}$  for the SCell being activated is 0ms;
  - the longest SMTC duration among all above active serving cells in SCG when one SCell is deactivated.

Where X2 and Y2 are specified in Table 8.2.1.2.4-2.

**Table 8.2.1.2.4-1: Interruption length X2 and Y2 at E-UTRA SCell activation/deactivation**

$\mu$	NR Slot length	Interruption length X2 (slots)	Interruption length Y2 (slots)
-------	----------------	--------------------------------	--------------------------------



	(ms)	Sync	Async	Sync	Async
0	1	1	2	1	2
1	0.5	1	2	1	2
2	0.25	3		2	3
3	0.125	5		N/A	N/A

**Table 8.2.1.2.4-2: Interruption length X2 and Y2 at SCell activation/deactivation**

$\mu$	NR Slot length (ms) of victim cell	Interruption length X2 (slots)		Interruption length Y2 (slots)
0	1	1		1
1	0.5	1		1
2	0.25	Both aggressor cell and victim cell are on FR2	2	2
		Either aggressor cell or victim cell is on FR1	3	
3	0.125	Aggressor cell is on FR2	4	4
		Aggressor cell is on FR1	5	

### 8.2.1.2.5 Interruptions during measurements on SCC

#### 8.2.1.2.5.1 Interruptions during measurements on deactivated NR SCC

Interruption on PSCell and other activated NR SCell(s) during measurement on the deactivated NR SCC shall meet requirements in clause 8.2.2.2.3, where the term PCell in clause 8.2.2.2.3 shall be deemed to be replaced with PSCell.

#### 8.2.1.2.5.2 Interruptions during measurements on deactivated E-UTRAN SCC

When one E-UTRA SCell in MCG is deactivated, the UE is allowed due to measurements on the E-UTRA SCC with the deactivated E-UTRA SCell:

- an interruption on PSCell or any activated SCell with up to 0.5% probability of missed ACK/NACK when any of the configured *measCycleSCell* [15] for the deactivated E-UTRA SCells is 640 ms or longer.
- an interruption on PSCell or any activated SCell with up to 0.5% probability of missed ACK/NACK regardless of the configured *measCycleSCell* [15] for the deactivated E-UTRA SCells if indicated by the network using *IE allowInterruptions* [15].

Each interruption shall not exceed

- X3 slot, if the PSCell or activated SCell is not in the same band as the E-UTRA deactivated SCC being measured, or
- X3 slot, if the PSCell or activated SCell is in the band overlapping or partially overlapping with the E-UTRA deactivated SCC being measured, and UE indicates it is capable of *interBandMRDC-WithOverlapDL-Bands-r16* on this band pair, or
- Y3 slot + SMTC duration, if the PSCell or activated SCell is in the same band or in the band overlapping or partially overlapping with the E-UTRA deactivated SCC being measured, and UE does not indicate it is capable of *interBandMRDC-WithOverlapDL-Bands-r16* on this band pair, provided the cell specific reference signals from the PSCell or activated SCell and the E-UTRA deactivated SCC being measured are available in the same slot.

**Table 8.2.1.2.5.2-1: Interruption length X3 and Y3 at measurements on deactivated E-UTRA SCC**

$\mu$	NR Slot length (ms)	Interruption length X3 (slots)		Interruption length Y3 (slots)	
		Sync	Async	Sync	Async
0	1	1	2	1	2

1	0.5	1	2	1	2
2	0.25	3		2	3
3	0.125	5		N/A	N/A

#### 8.2.1.2.5.3 Interruptions during CQI measurements on dormant E-UTRAN SCell

When one E-UTRA SCell in MCG is dormant, the UE is allowed due to CQI measurements on the dormant E-UTRA SCell:

- an interruption on PSCell or any activated SCell with up to 0.5% probability of missed ACK/NACK.

Each interruption shall not exceed

- X3 slot, if the PSCell or activated SCell is not in the same band as the E-UTRA dormant SCell being measured, or
- X3 slot, if the PSCell or activated SCell is in the band overlapping or partially overlapping with the E-UTRA dormant SCC being measured, and UE indicates it is capable of *interBandMRDC-WithOverlapDL-Bands-r16* on this band pair, or
- Y3 slot + SMTC duration, if the PSCell or activated SCell is in the same band or in the band overlapping or partially overlapping with the E-UTRA dormant SCell being measured, and UE does not report *interBandMRDC-WithOverlapDL-Bands-r16* on this band pair, provided the cell specific reference signals from the PSCell or activated SCell and the E-UTRA dormant SCell being measured are available in the same slot.

Where X3 and Y3 are defined in Table 8.2.1.2.5.2-1.

#### 8.2.1.2.5.4 Interruptions during RRM measurements on dormant E-UTRAN SCC

When one E-UTRA SCell in MCG is dormant, the UE is allowed due to RRM measurements on the E-UTRA SCC with the dormant E-UTRA SCell:

- an interruption on PSCell or any activated SCell with up to 0.5% probability of missed ACK/NACK.

Each interruption shall not exceed

- X3 slot, if the PSCell or activated SCell is not in the same band as the E-UTRA dormant SCC being measured, or
- X3 slot, if the PSCell or activated SCell is in the band overlapping or partially overlapping with the E-UTRA dormant SCC being measured and UE reports *interBandMRDC-WithOverlapDL-Bands-r16* on this band pair, or
- Y3 slot + SMTC duration, if the PSCell or activated SCell is in the same band or in the band overlapping or partially overlapping with the E-UTRA dormant SCC being measured, and UE does not report *interBandMRDC-WithOverlapDL-Bands-r16* on this band pair, provided the cell specific reference signals from the PSCell or activated SCell and the E-UTRA dormant SCC being measured are available in the same slot.

Where X3 and Y3 are defined in Table 8.2.1.2.5.2-1.

#### 8.2.1.2.6 Interruptions at UL carrier RRC reconfiguration

The requirements in this clause shall apply when a supplementary UL carrier or an UL carrier is configured or de-configured in NR non-standalone operation as defined in TS 38.331 [2].

When an UL carrier or supplementary UL carrier is configured or de-configured, an interruption of up to X4 slot, is allowed during the RRC reconfiguration procedure [2] on E-UTRA PCell, all activated E-UTRA SCells, PSCell and all

activated SCells within the same FR as the reconfigured uplink carrier. The interruption is for both uplink and downlink of E-UTRA PCell, all activated E-UTRA SCells, PSCell and all activated SCells within the same FR as the configured or de-configured UL.

**Table 8.2.1.2.6-1: Interruption length X4 at UL carrier RRC reconfiguration**

$\mu$	NR Slot length (ms)	Interruption length X4 (slots)	
		Sync	Async
0	1	1	2
1	0.5	2	3
2	0.25	5	
3	0.125	9	

### 8.2.1.2.7 Interruptions due to Active BWP switching Requirement

The requirements for DCI-based BWP switch, timer-based BWP switch or UL BWP switch triggered by consistent uplink CCA failures in this clause apply to the case that the BWP switch is performed on a single CC or multiple CCs.

When either of the DCI-based, timer-based or RRC-based downlink BWP switch and/or uplink BWP switch occur on multiple CCs simultaneously or over partially overlapping period, the interruption requirements described in this clause apply for each BWP switch.

When UE receives a DCI indicating UE to switch its active BWP involving changes in any of the parameters listed in Table 8.2.1.2.7-2, the UE is allowed to cause interruption of up to X slot to other active serving cells if the UE is not capable of per-FR gap, or if the BWP switching involves SCS changing. When the BWP switch imposes changes in any of the parameters listed in Table 8.2.1.2.7-2 and the UE is capable of per-FR gap, the UE is allowed to cause interruption of up to X slot to other active serving cells in the same frequency range wherein the UE is performing BWP switching. X is defined in Table 8.2.1.2.7-1. The starting time of interruption is only allowed within the BWP switching delay  $T_{\text{BWPswitchDelay}}$  as defined in clause 8.6.2 when BWP switch occurs on a single CC. The starting time of interruption caused by each BWP switch is only allowed within the BWP switch delay  $T_{\text{MultipleBWPswitchDelay}} + Y$  as defined in clause 8.6.2A.1 when BWP switch occurs on multiple CCs. Interruptions are not allowed during BWP switch involving any other parameter change.

When a BWP timer *bwp-InactivityTimer* defined in TS 38.331 [2] expires, UE is allowed to cause interruption of up to X slot to other active serving cells due to switching its active BWP involving changes in any of the parameters listed in Table 8.2.1.2.7-2 if the UE is not capable of per-FR gap, or if the BWP switching involves SCS changing. When the BWP switch imposes changes in any of the parameters listed in Table 8.2.1.2.7-2 and the UE is capable of per-FR gap, the UE is allowed to cause interruption of up to X slot to other active serving cells in the same frequency range wherein the UE is performing BWP switching. X is defined in Table 8.2.1.2.7-1. The starting time of interruption is only allowed within the BWP switching delay  $T_{\text{BWPswitchDelay}}$  as defined in clause 8.6.2 when BWP switch occurs on a single CC. The starting time of interruption caused by each BWP switch is only allowed within the BWP switch delay  $T_{\text{MultipleBWPswitchDelay}}$  as defined in clause 8.6.2B.1 when BWP switch occurs on multiple CCs simultaneously or  $T_{\text{MultipleBWPswitchDelayTotal}}$  as defined in clause 8.6.2B.2 when BWP switch occurs on multiple CCs over partially overlapping time period. Interruptions are not allowed during BWP switch involving any other parameter change.

When UE receives an RRC reconfiguration that only requests UE to switch its active BWP on one single CC, the UE is allowed to cause interruption of up to X slot to other active serving cells due to switching its active BWP involving changes in any of the parameters listed in Table 8.2.1.2.7-2 if the UE is not capable of per-FR gap, or if the BWP switching involves SCS changing. When the BWP switch imposes changes in any of the parameters listed in Table 8.2.1.2.7-2 and the UE is capable of per-FR gap, the UE is allowed to cause interruption of up to X slot to other active serving cells in the same frequency range wherein the UE is performing BWP switching. X is defined in Table 8.2.1.2.7-1. The interruption is only allowed within the delay  $T_{\text{RRCprocessingDelay}} + T_{\text{BWPswitchDelayRRC}}$  defined in clause 8.6.3 when BWP switch occurs on a single CC. The interruption is only allowed within the delay  $T_{\text{RRCprocessingDelay}} + T_{\text{BWPswitchDelayRRC}} + D_{\text{RRC}} * (N-1)$  as defined in clause 8.6.3A when BWP switch occurs on multiple CCs.

When UL BWP switch is triggered by consistent uplink CCA failures [7], the UE is allowed to cause interruption of up to X slot to other active serving cells due to switching its active UL BWP involving changes in any of the parameters listed in Table 8.2.1.2.7-2 if the UE is not capable of per-FR gap, or if the UL BWP switching involves SCS changing. When the UL BWP switch imposes changes in any of the parameters listed in Table 8.2.1.2.7-2 and the UE is capable of per-FR gap, the UE is allowed to cause interruption of up to X slot to other active serving cells in the same frequency range wherein the UE is performing UL BWP switching. X is defined in Table 8.2.1.2.7-1. The starting time of

interruption is only allowed within the UL BWP switching delay  $T_{\text{BWPswitchDelay}}$  as defined in clause 8.6.2. Interruptions are not allowed during UL BWP switch involving other parameter change.

**Table 8.2.1.2.7-1: interruption length X**

$\mu$	NR Slot length (ms)	Interruption length X (slots)
0	1	1
1	0.5	1
2	0.25	3
3	0.125	5
Note1: void		

**Table 8.2.1.2.7-2: Parameters which cause interruption other than SCS**

Parameters	Comment
<i>locationAndBandwidth</i>	From TS 38.331 [2]
<i>nrofSRS-Ports</i>	
<i>maxMIMO-Layers-r16</i>	

### 8.2.1.2.8 Interruptions at direct SCell activation and hibernation

#### 8.2.1.2.8.1 Interruptions during direct SCell activation and hibernation of E-UTRA SCell

When one E-UTRA SCell in MCG is directly activated and hibernated:

- the UE is allowed an interruption on any active serving cell in SCG:
  - of up to X1 slots, if the active serving cell is not in the same band as any of the E-UTRA SCells being directly activated or hibernated, or
  - of up to X1 slots, if the active serving cell is in the band overlapping or partially overlapping with any of the E-UTRA SCells being directly activated or hibernated and UE reports *interBandMRDC-WithOverlapDL-Bands-r16* on this band pair, or
  - of up to  $\max\{Y1 \text{ slots} + T_{\text{SMTC\_duration}}, 5\text{ms}\}$ , if the active serving cells are in the same band or in the band overlapping or partially overlapping with any of the E-UTRA SCells being directly activated or hibernated, and UE does not report *interBandMRDC-WithOverlapDL-Bands-r16* on this band pair, provided the cell specific reference signals from the active serving cells and the E-UTRA SCells being directly activated or hibernated are available in the same slot, where  $T_{\text{SMTC\_duration}}$  is the longest SMTC duration among all above active serving cells in MCG Where X1 and Y1 are specified in Table 8.2.1.2.3-1.

#### 8.2.1.2.8.2 Interruptions during direct SCell activation

When one or multiple SCell(s) in SCG are directly activated at SCell addition:

- the UE is allowed an interruption on any active serving cell in SCG:
  - of up to X1 slot, if the active serving cell is not in the same band as the SCell being directly activated, or
  - of up to  $\max\{Y1 \text{ slot} + T_{\text{SMTC\_duration}}, 5\text{ms}\}$  if the active serving cells are in the same band as the SCell being directly activated, provided the cell specific reference signals from the active serving cells and the SCell being directly activated are available in the same slot, where  $T_{\text{SMTC\_duration}}$  is the longest SMTC duration among all above active serving cells in SCG.

Where X1 and Y1 are specified in Table 8.2.1.2.3-2.

#### 8.2.1.2.9 Interruptions at SCell hibernation

When one E-UTRA SCell in MCG is hibernated:

- the UE is allowed an interruption on any active serving cell in SCG:
  - of up to X2 slots, if the active serving cell is not in the same band as any of the E-UTRA SCells being hibernated, or
  - of up to X2 slots, if the active serving cell is in the band overlapping or partially overlapping with any of the E-UTRA SCells being hibernated and UE reports *interBandMRDC-WithOverlapDL-Bands-r16* on this band pair, or
  - of up to  $\max\{Y2 \text{ slots} + T_{\text{SMTC\_duration}}, 5\text{ms}\}$ , if the active serving cells are in the same band or in the band overlapping or partially overlapping with any of the E-UTRA SCells being hibernated, and UE does not report *interBandMRDC-WithOverlapDL-Bands-r16* on this band pair, provided the cell specific reference signals from the active serving cells and the E-UTRA SCells being hibernated are available in the same slot, where  $T_{\text{SMTC\_duration}}$  is the longest SMTC duration among all above active serving cells in MCG.

Where X2 and Y2 are specified in Table 8.2.1.2.4-1.

#### 8.2.1.2.10 Interruptions at SCell activation/deactivation with multiple downlink SCells

The requirements in this clause shall apply for the UE configured with PSCell and up to 6 downlink SCell(s).

When multiple SCells in SCG are activated or deactivated by one single MAC CE command:

- an interruption on any serving cell in SCG is specified as in clause 8.2.1.2.4.

#### 8.2.1.2.11 Interruptions due to UE-specific CBW change

When UE receives an RRC reconfiguration that changes *offsetToCarrier* or *carrierBandwidth*, the UE is allowed to cause interruption of up to X slot to other active serving cells due to switching its CBW. X is defined in Table 8.2.1.2.11-1. The interruption is only allowed within the delay  $T_{\text{RRCPprocessingDelay}} + T_{\text{CBWchangeDelayRRC}}$  defined in clause 8.7.

**Table 8.2.1.2.11-1: interruption length X**

$\mu$	NR Slot length (ms)	Interruption length X (slots)
0	1	1
1	0.5	1
2	0.25	3
3	0.125	5

#### 8.2.1.2.12 Interruptions at NR SRS carrier based switching

SRS transmission can be configured on a carrier not configured for PUCCH/PUSCH transmission. When a UE needs to transmit periodic, semi-persistent or aperiodic SRS on a carrier of a serving cell not configured for PUCCH/PUSCH transmission, the UE can perform carrier based switching to one or more carriers not configured for PUCCH/PUSCH transmission from a carrier with PUCCH/PUSCH transmission or from a carrier not configured for PUCCH/PUSCH transmission prior to transmitting SRS, provided that:

- switching is from a configured carrier to an active UL BWP of another activated carrier;
- the carrier of SCells not configured for PUCCH/PUSCH transmission to which SRS carrier based switching is performed is indicated by DCI SRS request field for aperiodic SRS transmission, or indicated by MAC-CE for semi-persistent SRS transmission, or configured via RRC for periodic SRS transmission;
- the serving cell, from which SRS carrier based switching is performed and whose UL transmission may therefore be interrupted, is indicated by *srs-SwitchFromServCellIndex* and *srs-SwitchFromCarrier* in TS38.331 [2];
- the SRS switching is not colliding with any other transmission with higher priority defined in TS 38.214 [26].
- the SRS switching is not colliding with any SSB/CSI-RS based L3 measurements and the measurements for RLM/BFD in SCG.

- for UE, which does not support simultaneous reception and transmission for inter-band TDD CA specified in TS 38.331 [2], and is compliant to the requirements for inter-band CA with uplink in one NR band and without simultaneous Rx/Tx specified in TS 38.101 [5], the SRS transmission are not simultaneously scheduled with DL SSB/CSI-RS for L3 or L1 measurements transmission on other carriers.

The UE shall not perform SRS carrier based switching if the above conditions cannot be met.

When SRS carrier based switching is performed between carriers, the UE is allowed interruptions on any active serving cell in SCG if UE is not capable of Per-FR gap, or on active serving cell(s) in SCG in FR1 if UE is capable of Per-FR gap, during the switching to the carrier of a serving cell in FR1 not configured for PUCCH/PUSCH transmission,

- with up to X1 slot as specified in Table 8.2.1.2.12-1.

When SRS carrier based switching is performed between carriers, the UE is allowed interruptions on any active serving cell in SCG if UE is not capable of Per-FR gap, or on active serving cell(s) in SCG in FR2 if UE is capable of Per-FR gap, during the switching to the carrier of a serving cell in FR2 not configured for PUCCH/PUSCH transmission,

- with up to X2 slot as specified in Table 8.2.1.2.12-2.

When SRS carrier based switching is performed between carriers, the UE is allowed interruptions on any active serving cell in SCG if UE is not capable of Per-FR gap, or on active serving cell(s) in SCG in FR1 if UE is capable of Per-FR gap, during the switching from the carrier of a serving cell in FR1 not configured for PUCCH/PUSCH transmission,

- with up to X1 slot as specified in Table 8.2.1.2.12-1.

When SRS carrier based switching is performed between carriers, the UE is allowed interruptions on any active serving cell in SCG if UE is not capable of Per-FR gap, or on active serving cell(s) in SCG in FR2 if UE is capable of Per-FR gap, during the switching from the carrier of a serving cell in FR2 not configured for PUCCH/PUSCH transmission,

- with up to X2 slot as specified in Table 8.2.1.2.12-2.

**Table 8.2.1.2.12-1: Interruption length X1 (slot)**

$\mu$	NR Slot length (ms) of victim cell	SRS carrier switching time (us) <sup>Note 1</sup>	Interruption length X1 (slots)	
			Sub carrier spacing for aggressor cell (kHz)	
			15	30
0	1	$\leq 200$	2	2
		300, 500	2	2
		900	3	3
1	0.5	$\leq 200$	3	2
		300, 500	3	3
		900	4	4
2	0.25	$\leq 200$	4	3
		300, 500	5	4
		900	7	6
3	0.125	$\leq 200$	7	5
		300, 500	9	7
		900	12	10
Note1: NR SRS carrier switching time is UE capability indicated by higher layer parameter <i>SRS-SwitchingTimeNR</i> .				

**Table 8.2.1.2.12-2: Interruption length X2 (slot)**

$\mu$	NR Slot length (ms) of victim cell	SRS carrier switching time (us) <sup>Note1</sup>	Interruption length X2 (slots)	
			Sub carrier spacing for aggressor cell (kHz)	
			60	120
0	1	$\leq 200$	2	2
1	0.5	$\leq 200$	2	2
2	0.25	$\leq 200$	3	3
3	0.125	$\leq 200$	4	4
Note1: NR SRS carrier switching time is UE capability indicated by higher layer parameter <i>SRS-SwitchingTimeNR</i> .				

For intra-band SRS carrier switching in FR1 or FR2, interruptions in Table 8.2.1.2.12-1 and in Table 8.2.1.2.12-2 based on SRS carrier switching time  $\leq 200\mu\text{s}$  shall apply. For inter-band SRS carrier switching in FR1, interruptions in Table 8.2.1.2.12-1 and in Table 8.2.1.2.12-2 shall apply.

### 8.2.1.2.13 Interruptions at E-UTRA SRS carrier based switching

A PUSCH-less carrier of E-UTRA SCell is a TDD carrier without PUCCH/PUSCH configured. When a UE needs to transmit periodic or aperiodic SRS [23] and/or non-contention based PRACH on a PUSCH-less carrier of E-UTRA SCell, the UE can perform carrier based switching to one or more PUSCH-less carrier of E-UTRA SCells from a E-UTRA carrier with PUSCH or from another PUSCH-less E-UTRA carrier of SCell prior to transmitting SRS and/or PRACH, provided that:

- switching is from a configured E-UTRA carrier to another activated TDD E-UTRA carrier;
- the PUSCH-less carrier of E-UTRA SCells to which SRS carrier based switching is performed is indicated by DCI SRS request field for aperiodic SRS transmission or configured via RRC [15] for periodic SRS transmission;
- the E-UTRA serving cell, from which SRS carrier based switching is performed and whose UL transmission may therefore be interrupted, is indicated by *srs-SwitchFromServCellIndex* [15];
- the SRS switching is not colliding with any other transmission with higher priority defined in TS36.213 [26];
- the SRS switching is not colliding with PDCCH in subframe 0 and 5 as specified in TS36.213 [26];
- for UE, which does not support simultaneous reception and transmission for inter-band TDD CA specified in TS 36.331 [2], and is compliant to the requirements for inter-band CA with uplink in one E-UTRA band and without simultaneous Rx/Tx specified in TS 36.101 [25], the SRS or RACH transmission are not simultaneously scheduled with DL subframe #0 or DL subframe #5 on other E-UTRA carriers.

The UE shall not perform SRS carrier based switching if the above conditions cannot be met.

When SRS carrier based switching is performed between E-UTRA carriers, the UE is allowed interruptions on any active serving cell in SCG if UE is not capable of Per-FR gap, or on active serving cell(s) in SCG in FR1 if UE is capable of Per-FR gap, during the switching to the PUSCH-less carrier of a serving cell,

- with up to X3 slot as specified in Table 8.2.1.2.13-1.

When SRS carrier based switching is performed between E-UTRA carriers, the UE is allowed interruptions on any active serving cell in SCG if UE is not capable of Per-FR gap, or on active serving cell(s) in SCG in FR1 if UE is capable of Per-FR gap, during the switching from the PUSCH-less carrier of a serving cell,

- with up to X3 slot as specified in Table 8.2.1.2.13-1

**Table 8.2.1.2.13-1: Interruption length X3 (slot)**

$\mu$	NR Slot length (ms)	Interruption length X3 (slots)
0	1	2
1	0.5	3
2	0.25	5
3	0.125	9

### 8.2.1.2.14 DL Interruptions at switching between two uplink carriers

The DL interruption requirements at dynamic switching between two uplink carriers specified in this clause are applicable for an uplink band pair of an inter-band EN-DC configuration when the capability *uplinkTxSwitchingPeriod* is present, and is only applicable for uplink switching mechanism specified in clause 6.1.6 of TS 38.214 [26], where E-UTRA UL carrier is capable of one transmit antenna connector and NR UL carrier is capable of two transmit antenna connectors, and the two uplink carriers are in different bands with different carrier frequencies.

When dynamic switching between two uplink carriers is conducted, UE is allowed to cause DL interruption of X OFDM symbols in NR downlink carrier(s) as indicated by *uplinkTxSwitching-DL-Interruption* [2]. The DL interruption starts from the first OFDM symbol which fully or partially overlaps with the UL switching period located in NR carrier. The DL interruption lengths of X for NR carrier(s) are defined in Table 8.2.1.2.14-1.

No DL interruption is allowed in the NR downlink carrier(s) which is not indicated by *uplinkTxSwitching-DL-Interruption*. No DL interruption is allowed for some inter-band EN-DC configurations as specified in clause 5.5B.4 of TS 38.101-3 [20].

**Table 8.2.1.2.14-1: DL interruption length on NR carrier(s) in the unit of OFDM symbols (X) for switching between two uplink carriers**

$\mu$	NR Slot length (ms)	Uplink Tx switching period Note1	
		35us	140us
0	1	2	3
1	0.5	3	6
2	0.25	4	10
Note 1: Uplink Tx switching period depends on UE capability <i>uplinkTxSwitchingPeriod</i> .			

### 8.2.1.2.15 Interruptions due to SCell dormancy

#### 8.2.1.2.15.1 Interruptions due to SCell dormancy switch

When one SCell in SCG is switched from dormancy to non-dormancy or from non-dormancy to dormancy [7] when UE is in DRX active time,

- the UE is allowed an interruption on active serving cell in SCG as defined in clause 8.2.1.2.7, except that the interruption is allowed regardless of which parameters change between the dormant BWP and the non-dormant BWP
- The starting time of interruption shall be within the dormancy switching delay as defined in clause 8.6.2.

When multiple SCells in SCG are switched from dormancy to non-dormancy or vice versa when the UE is in DRX active time, the interruption requirement described above applies for each BWP switch.

#### 8.2.1.2.15.2 Interruptions due to CQI measurements during SCell dormancy

When one or more SCells are in dormancy, the UE is for the purpose of CQI measurements on the dormant SCell(s) allowed to cause interruptions to non-dormant serving cell(s).

The rate of ACK/NACK feedback loss on any non-dormant serving cell resulting from CQI measurements on dormant SCells shall not exceed 0.5%.

#### 8.2.1.2.15.3 Interruptions due to RRM measurements during SCell dormancy

When one or more SCells are in dormancy, the UE is for the purpose of RRM measurements on the dormant SCell(s) allowed to cause interruptions to non-dormant serving cell(s).

The rate of ACK/NACK feedback loss on any non-dormant serving cell resulting from RRM measurements on dormant SCells shall not exceed 1.0%.

### 8.2.1.2.16 Interruptions when identifying CGI of an NR cell with autonomous gaps

When a UE is identifying CGI of an NR cell with autonomous gaps, the UE is allowed interruptions on PSCell or any activated SCell:

- with up to K1 interruptions with interrupted slots up to interruption length X1 specified in Table 8.2.1.2.16-1 for each interruption during MIB decoding time period  $T_{MIB}$  (ms) specified in clause 9.11.



- with up to L1 interruptions with interrupted slots up to interruption length Y1 specified in Table 8.2.1.2.16-1 for each interruption during SIB1 decoding time period  $T_{SIB1}$  (ms) specified in clause 9.11 for SSB and CORESET for RMSI scheduling multiplexing patterns 1.
- with up to L2 interruptions with interrupted slots up to interruption length Y2 specified in Table 8.2.1.2.16-1 for each interruption during SIB1 decoding time period  $T_{SIB1}$  (ms) specified in clause 9.11 for SSB and CORESET for RMSI scheduling multiplexing patterns 2 and 3.

Where:

- $K1 = 6$  for the target cell carrier frequency on FR1 and  $K1 = 25$  for the target cell carrier frequency on FR2, and
- $L1 = T_{SIB1}/20$ , and
- $L2 = T_{SIB1}/T_{SMTC}$ , where  $T_{SMTC}$  is the periodicity of the SMTC occasion configured for the target cell carrier.

**Table 8.2.1.2.16-1: Interruption length X1, Y1 and Y2 during measurements with autonomous gaps**

$\mu$	NR Slot length (ms) of victim cell	Interruption length X1 (slots)	Interruption length Y1 (slots)	Interruption length Y2 (slots)
0	1	6	7	6
1	0.5	12	13	10
2	0.25	24	25	19
3	0.125	48	49	37

### 8.2.1.2.17 Interruptions when identifying CGI of an E-UTRA cell with autonomous gaps

When a UE is identifying CGI of an E-UTRA FDD cell or E-UTRA TDD cell with autonomous gaps, within time period

- $T_{\text{identify\_CGI, intra}}$  specified in clause 8.1.2.2.3, or clause 8.1.2.2.4 in TS 36.133 [15], or
- $T_{\text{identify\_CGI, inter}}$  specified in clause 8.1.2.3.5, or clause 8.1.2.3.6, or clause 8.1.2.3.7, or clause 8.1.2.3.6 in TS 36.133 [15], or
- $T_{\text{identify\_CGI, E-UTRA}}$  specified in clause 9.4.7.1

the UE shall be able to transmit at least the number of ACK/NACKs specified in Table 8.2.1.2.17-1 on PSCell or any activated SCell in the frequency range where autonomous gaps are used, provided that:

- there is continuous DL data allocation,
- no DRX cycle is used,
- no measurement gaps are configured,
- only one code word is transmitted in each slot,
- 2 slot ACK/NACK feedback is configured,
- 20 ms SMTC period is configured.

**Table 8.2.1.2.17-1: Minimum number of ACK/NACKs transmitted by the UE**

Minimum number of transmitted ACK/NACKs	Configuration of the serving cell in which the transmitted ACK/NACKs are counted	
	Duplex mode configuration	SCS
84	FDD	15 kHz
193	FDD	30 kHz
402	FDD	60 kHz
28	TDD <sup>Note 1</sup>	15 kHz
81	TDD <sup>Note 1</sup>	30 kHz
159	TDD <sup>Note 1</sup>	60 kHz

233	TDD <sup>Note 2</sup>	60 kHz
491	TDD <sup>Note 2</sup>	120 kHz
NOTE 1: TDD UL-DL configuration is as specified in Table A.3.3.1-1 of TS 38.101-1 [18].		
NOTE 2: TDD UL-DL configuration is as specified in Table A.3.3.1-1 of TS 38.101-2 [19].		

## 8.2.2 SA: Interruptions with Standalone NR Carrier Aggregation

### 8.2.2.1 Introduction

This clause contains the requirements related to the interruptions on PCell and activated SCell if configured, when up to 7 SCells are configured, de-configured, activated or deactivated, or a supplementary UL carrier or an UL carrier is configured or de-configured, or measurements on SCC with deactivated SCell in NR SCG, or UL/DL BWP is switched on PCell or SCell, or CGI reading of an NR neighbour cell with autonomous gaps, or CGI reading of an E-UTRA neighbour cell with autonomous gaps. UE-specific CBW is changed on PCell or SCell, or NR SRS carrier based switching, or UE dynamic Tx switches between two uplink carriers.

Note: interruptions at SCell addition/release, activation/deactivation and during measurements on SCC may not be required by all UEs.

The interruptions shall not interrupt RRC signalling or ACK/NACKs related to RRC reconfiguration procedure according to TS38.331 [2] for SCell addition/release or MAC control signalling according to TS37.340 [17] for SCell activation/deactivation command.

This clause additionally contains requirements related to interruptions at inter-frequency SFTD between PCell in FR1 and neighbour cell in FR2.

For a UE which does not support per-FR measurement gap, interruptions to the PCell and activated SCell may be caused by SCells on any frequency range. For a UE which supports per-FR gaps, interruptions to PCell and activated SCell may be caused by SCells on the same frequency range as the victim cell.

In addition to standalone NR carrier aggregation when no CCA is configured, the requirements in clause 8.2.2. and all subclauses of 8.2.2 apply when the UE is configured with

- A PCell not using CCA in downlink and one or more SCells using CCA in downlink or
- A PCell and one or more SCells using CCA in downlink

### 8.2.2.2 Requirements

#### 8.2.2.2.1 Interruptions at SCell addition/release

When any number of SCells between one and 7 is added or released using the same *RRCConnectionReconfiguration* message as defined in TS 38.331 [2], the UE is allowed an interruption on any active serving cell during the RRC reconfiguration procedure as follows:

- an interruption on any active serving cell:
  - of up to X1 slot, if the active serving cell and the SCell being added or released are in a FR1 band pair or in a FR1+FR2 band pair.

- of up to X1 slot, if the active serving cell and the SCell being added or released are in a FR2 band pair and UE is capable of independent beam management on this FR2 band pair.

Where X1 is specified in Table 8.2.2.2.1-1.

or

- of up to the duration shown in table 8.2.2.2.1-2, if the active serving cells are in the same band as the SCell being added or released, provided the cell specific reference signals from the active serving cells and the SCell being added or released are available in the same slot.

**Table 8.2.2.2.1-1: Interruption length X1 for SCell addition/release for inter-band CA**

$\mu$	NR Slot length (ms) of victim cell	Interruption length X1 (slots)	
0	1	1	
1	0.5	2	
2	0.25	Both aggressor cell and victim cell are on FR2	4
		Either aggressor cell or victim cell is on FR1	5
3	0.125	Aggressor cell is on FR2	8
		Aggressor cell is on FR1	9

**Table 8.2.2.2.1-2: Interruption duration for SCell addition/release for intra-band CA**

$\mu$	NR Slot length (ms)	Interruption length (slot)
0	1	$1 + T_{\text{SMTC\_duration}} * N_{\text{slot}}^{\text{subframe},\mu}$
1	0.5	$2 + T_{\text{SMTC\_duration}} * N_{\text{slot}}^{\text{subframe},\mu}$
2	0.25	$4 + T_{\text{SMTC\_duration}} * N_{\text{slot}}^{\text{subframe},\mu}$
3	0.125	$8 + T_{\text{SMTC\_duration}} * N_{\text{slot}}^{\text{subframe},\mu}$

NOTE 1:  $T_{\text{SMTC\_duration}}$  measured in subframes is

- the longest SMTC duration among all above active serving cells and the SCell being added when one SCell is added. If SSB configuration (*absoluteFrequencySSB*) but no SMTC configuration is provided for the SCell being added, the SSB transmission periodicity is assumed to be 5ms and  $T_{\text{SMTC\_duration}}$  for the SCell being added is x ms, where x = the number of consecutive subframes containing all SSBs in one SSB burst transmitted by the SCell being added. If no SSB configuration (*absoluteFrequencySSB*) nor SMTC configuration is provided for the SCell being added,  $T_{\text{SMTC\_duration}}$  for the SCell being added is 0ms;
- the longest SMTC duration among all active serving cells in the same band when one SCell is released.

NOTE 2:  $N_{\text{slot}}^{\text{subframe},\mu}$  is as defined in TS 38.211 [6].

### 8.2.2.2.2 Interruptions at SCell activation/deactivation

When an SCell is activated or deactivated as defined in TS 37.340 [17], the UE is allowed

- an interruption on any active serving cell:
  - of up to X2 slot, if the active serving cell and the SCell being activated or deactivated are in a FR1 band pair or in a FR1+FR2 band pair.
  - of up to X2 slot, if the active serving cell and the SCell being activated or deactivated are in a FR2 band pair and UE is capable of independent beam management on this FR2 band pair.

Where X2 is specified in Table 8.2.2.2.2-1.

or

- of up to the duration shown in table 8.2.2.2-2, if the active serving cells are in the same band as the SCell being activated or deactivated provided the cell specific reference signals from the active serving cells and the SCell being activated or deactivated are available in the same slot.

**Table 8.2.2.2-1: Interruption length X2 for SCell activation/deactivation for inter-band CA**

$\mu$	NR Slot length (ms) of victim cell	Interruption length X2 (slots)	
0	1		1
1	0.5		1
2	0.25	Both aggressor cell and victim cell are on FR2	2
		Either aggressor cell or victim cell is on FR1	3
3	0.125	Aggressor cell is on FR2	4
		Aggressor cell is on FR1	5

**Table 8.2.2.2-2: Interruption duration for SCell activation/deactivation for intra-band CA**

$\mu$	NR Slot length (ms)	Interruption length (slots)
0	1	$1 + T_{\text{SMTC\_duration}} * N_{\text{slot}}^{\text{subframe},\mu}$
1	0.5	$1 + T_{\text{SMTC\_duration}} * N_{\text{slot}}^{\text{subframe},\mu}$
2	0.25	$2 + T_{\text{SMTC\_duration}} * N_{\text{slot}}^{\text{subframe},\mu}$
3	0.125	$4 + T_{\text{SMTC\_duration}} * N_{\text{slot}}^{\text{subframe},\mu}$

NOTE 1:  $T_{\text{SMTC\_duration}}$  measured in subframes is  
 - the longest SMTC duration among all above active serving cells and the SCell being activated when one SCell is activated. If SSB configuration (*absoluteFrequencySSB*) but no SMTC configuration is provided for the SCell being activated, the SSB transmission periodicity is assumed to be 5ms and  $T_{\text{SMTC\_duration}}$  for the SCell being activated is x ms, where x = the number of consecutive subframes containing all SSBs in one SSB burst transmitted by the SCell being activated. If no SSB configuration (*absoluteFrequencySSB*) nor SMTC configuration is provided for the SCell being activated,  $T_{\text{SMTC\_duration}}$  for the SCell being activated is 0ms;  
 - the longest SMTC duration among all active servingNOTE 2:  $N_{\text{slot}}^{\text{subframe},\mu}$  is as defined in TS 38.211 [6].

8.2.2.2.3 Interruptions during measurements on deactivated SCC

Interruptions on PCell or activated SCell(s) due to measurements when an SCell is deactivated are allowed with up to 0.5% probability of missed ACK/NACK when the configured *measCycleSCell* [2] is 640 ms or longer.

- If the PCell or activated SCell(s) is not in the same band as the deactivated SCell, the UE is only allowed to cause interruptions on PCell or activated SCell(s) immediately before and immediately after an SMTC. Each interruption shall not exceed requirement in Table 8.2.2.2-1.
- If the PCell or activated SCell(s) is in the same band as the deactivated SCell, the UE is only allowed to cause an interruption on PCell or activated SCell(s) no earlier than X slots before  $T_{\text{SMTC\_duration}}$  and no later than X slots after  $T_{\text{SMTC\_duration}}$ , provided the cell specific reference signals from the active serving cells and the deactivated SCell are available in the same slot, where X and  $T_{\text{SMTC\_duration}}$  are given by Table 8.2.2.2.3-1. The interruption shall not exceed requirements in Table 8.2.2.2.3-1.

**Table 8.2.2.2.3-1: Interruption duration for measurement on deactivated SCell for intra-band CA**

$\mu$	NR Slot length (ms)	X (slots)	Interruption length (slots)
0	1	1	$2 + T_{\text{SMTC\_duration}} * N_{\text{slot}}^{\text{subframe},\mu}$
1	0.5	1	$2 + T_{\text{SMTC\_duration}} * N_{\text{slot}}^{\text{subframe},\mu}$
2	0.25	2	$4 + T_{\text{SMTC\_duration}} * N_{\text{slot}}^{\text{subframe},\mu}$

3	0.125	4	$8 + T_{\text{SMTC\_duration}} * N_{\text{slot}}^{\text{subframe},\mu}$
NOTE 1: $T_{\text{SMTC\_duration}}$ measured in subframes is the longest SMTC duration among all above active serving cells and the deactivated SCell to be measured;			
NOTE 2: $N_{\text{slot}}^{\text{subframe},\mu}$ is as defined in TS 38.211 [6].			

#### 8.2.2.2.4 Interruptions at UL carrier RRC reconfiguration

The requirements in this clause shall apply when a supplementary UL carrier or an UL carrier is configured or de-configured in NR standalone carrier aggregation as defined in TS 38.331 [2].

When an UL carrier or supplementary UL carrier is configured or de-configured, an interruption of up to the duration shown in table 8.2.2.2.4-1, is allowed during the RRC reconfiguration procedure [2] on PCell and all activated SCells within the same FR as the reconfigured uplink carrier. The interruption is for both uplink and downlink of PCell and all the activated SCells within the same FR as the configured or de-configured UL.

**Table 8.2.2.2.4-1: Interruption duration for UL carrier RRC reconfiguration**

$\mu$	NR Slot length (ms)	Interruption length (slots)
0	1	1
1	0.5	2
2	0.25	4
3	0.125	8

#### 8.2.2.2.5 Interruptions due to Active BWP switching Requirement

The requirements for DCI-based BWP switch, timer-based BWP switch or UL BWP switch triggered by consistent uplink CCA failures in this clause apply to the case that the BWP switch is performed on a single CC or multiple CCs.

When either of the DCI-based, timer-based or RRC-based downlink BWP switch and/or uplink BWP switch occur on multiple CCs simultaneously or over partially overlapping period, the interruption requirements described in this clause apply for each BWP switch.

When UE receives a DCI indicating UE to switch its active BWP involving changes in any of the parameters listed in Table 8.2.2.2.5-2, the UE is allowed to cause interruption of up to X slot to other active serving cells if the UE is not capable of per-FR gap, or if the BWP switching involves SCS changing. When the BWP switch imposes changes in any of the parameters listed in Table 8.2.2.2.5-2 and the UE is capable of per-FR gap the UE is allowed to cause interruption of up to X slot to other active serving cells in the same frequency range wherein the UE is performing BWP switching. X is defined in Table 8.2.2.2.5-1. The starting time of interruption is only allowed within the BWP switching delay  $T_{\text{BWPswitchDelay}}$  as defined in clause 8.6.2 when BWP switch occurs on a single CC. The starting time of interruption caused by each BWP switch is only allowed within the BWP switch delay  $T_{\text{MultipleBWPswitchDelay}} + Y$  as defined in clause 8.6.2A.1 when BWP switch occurs on multiple CCs. Interruptions are not allowed during BWP switch involving any other parameter change.

When a BWP timer *bwp-InactivityTimer* defined in TS 38.331 [2] expires, UE is allowed to cause interruption of up to X slot to other active serving cells due to switching its active BWP involving changes in any of the parameters listed in Table 8.2.2.2.5-2 if the UE is not capable of per-FR gap, or if the BWP switching involves SCS changing. When the BWP switch imposes changes in any of the parameters listed in Table 8.2.2.2.5-2 and the UE is capable of per-FR gap, the UE is allowed to cause interruption of up to X slot to other active serving cells in the same frequency range wherein the UE is performing BWP switching. X is defined in Table 8.2.2.2.5-1. The starting time of interruption is only allowed within the BWP switching delay  $T_{\text{BWPswitchDelay}}$  as defined in clause 8.6.2 when BWP switch occurs on a single CC. The starting time of interruption caused by each BWP switch is only allowed within the BWP switch delay  $T_{\text{MultipleBWPswitchDelay}}$  as defined in clause 8.6.2B.1 when BWP switch occurs on multiple CCs simultaneously or  $T_{\text{MultipleBWPswitchDelayTotal}}$  as defined in clause 8.6.2B.2 when BWP switch occurs on multiple CCs over partially overlapping time period. Interruptions are not allowed during BWP switch involving any other parameter change.

When UE receives an RRC reconfiguration that only requests UE to switch its active BWP on one single CC, the UE is allowed to cause interruption of up to X slot to other active serving cells due to switching its active BWP involving changes in any of the parameters listed in Table 8.2.2.2.5-2 if the UE is not capable of per-FR gap, or if the BWP

switching involves SCS changing. When the BWP switch imposes changes in any of the parameters listed in Table 8.2.2.2.5-2 and the UE is capable of per-FR gap, the UE is allowed to cause interruption of up to X slot to other active serving cells in the same frequency range wherein the UE is performing BWP switching. X is defined in Table 8.2.2.2.5-1. The interruption is only allowed within the delay  $T_{\text{RRCprocessingDelay}} + T_{\text{BWPswitchDelayRRC}}$  defined in clause 8.6.3 when BWP switch occurs on a single CC. The interruption is only allowed within the delay  $T_{\text{RRCprocessingDelay}} + T_{\text{BWPswitchDelayRRC}} + D_{\text{RRC}} \cdot (N-1)$  as defined in clause 8.6.3A when BWP switch occurs on multiple CCs.

When UL BWP switch is triggered by consistent uplink CCA failures [7], UE is allowed to cause interruption of up to X slot to other active serving cells due to switching its active UL BWP involving changes in any of the parameters listed in Table 8.2.2.2.5-2 if the UE is not capable of per-FR gap, or if the BWP switching involves SCS changing. When the UL BWP switch imposes changes in any of the parameters listed in Table 8.2.2.2.5-2 and the UE is capable of per-FR gap, the UE is allowed to cause interruption of up to X slot to other active serving cells in the same frequency range wherein the UE is performing UL BWP switching. X is defined in Table 8.2.2.2.5-1. The starting time of interruption is only allowed within the UL BWP switching delay  $T_{\text{BWPswitchDelay}}$  as defined in clause 8.6.2. Interruptions are not allowed during BWP switch involving other parameter change.

**Table 8.2.2.2.5-1: Interruption length X**

$\mu$	NR Slot length (ms)	Interruption length X (slots)
0	1	1
1	0.5	1
2	0.25	3
3	0.125	5
Note1:	void	

**Table 8.2.2.2.5-2: Parameters which cause interruption other than SCS**

Parameters	Comment
<i>locationAndBandwidth</i>	From TS 38.331 [2]
<i>nrofSRS-Ports</i>	
<i>maxMIMO-Layers-r16</i>	

#### 8.2.2.2.6 Interruptions at inter-frequency SFTD measurement

The requirements in this clause concern interruptions on PCell, as well as on activated SCells in MCG, when the UE is performing SFTD measurements on inter-frequency neighbour cell(s). The following requirements apply when no PSCell is configured.

For a UE with per-FR gap capability:

- for neighbour cell in FR1:
  - the percentage of interrupted slots on uplink and downlink on FR1 serving cells during the SFTD measurement period  $T_{\text{measure\_SFTD1}}$  specified in Clause 9.3.8 shall not exceed the percentages specified in Table 8.2.2.2.6-1. No interruption is allowed on FR2 serving cells.
  - the length of each interruption on FR1 serving cells shall not exceed the number of slots specified in Table 8.2.2.2.6-2.
- for neighbour cell in FR2:
  - the percentage of interrupted slots on uplink and downlink on FR2 serving cells during the SFTD measurement period  $T_{\text{measure\_SFTD1}}$  specified in Clause 9.3.8 shall not exceed the percentages specified in Table 8.2.2.2.6-1. No interruption is allowed on FR1 serving cells.
  - the length of each interruption on FR2 serving cells shall not exceed the number of slots specified in Table 8.2.2.2.6-2.

For a UE with per-UE gap capability:

- for neighbour cell in FR1 or FR2:
  - the percentage of interrupted slots on uplink and downlink on FR1 and FR2 serving cells during the SFTD measurement period  $T_{\text{measure\_SFTD1}}$  specified in Clause 9.3.8 shall not exceed the percentages specified in Table 8.2.2.2.6-1.
  - the length of each interruption on FR1 and FR2 serving cells shall not exceed the number of slots specified in Table 8.2.2.2.6-2.

**Table 8.2.2.2.6-1: Requirements on maximum percentage of interrupted slots in serving cell in inter-frequency SFTD**

SFTD configuration	Serving cell $\mu$	Neighbour cell SMTc periodicity					
		5ms	10ms	20ms	40ms	80ms	160ms
With RSRP report	0	8.4%	6.3%	8.4%	6.3%	5.3%	4.7%
	1						
	2						
	3						
Without RSRP report	0	11.4%	8.6%	7.9%	6.8%	6.3%	6.0%
	1						
	2						
	3						

**Table 8.2.2.2.6-2: Interruption duration for FR1 serving cell in inter-frequency SFTD with neighbour cell in FR1**

$\mu$	NR Slot length (ms)	Interruption length (slots)
0	1	1
1	0.5	2
2	0.25	4
3	0.125	8

**Table 8.2.2.2.6-3: Void**

**Table 8.2.2.2.6-4: Void**

**8.2.2.2.7 Interruptions at SCell activation/deactivation with multiple downlink SCells**

The requirements in this clause shall apply for the UE configured with PCell and up to 7 downlink SCell(s).

When multiple SCell is activated or deactivated by one single MAC CE command:

- an interruption on any active serving cell is specified as in clause 8.2.2.2.2:

**8.2.2.2.8 Interruptions due to UE-specific CBW change**

The requirements in clause 8.2.1.2.11 apply for this clause.

**8.2.2.2.9 Interruptions at NR SRS carrier based switching**

SRS transmission can be configured on a carrier not configured for PUCCH/PUSCH transmission. When a UE needs to transmit periodic, semi-persistent or aperiodic SRS on a carrier of a serving cell not configured for PUCCH/PUSCH transmission, the UE can perform carrier based switching to one or more carriers not configured for PUCCH/PUSCH transmission from a carrier with PUCCH/PUSCH transmission or from a carrier not configured for PUCCH/PUSCH transmission prior to transmitting SRS, provided that:

- switching is from a configured carrier to another activated carrier;

- the carrier of SCells not configured for PUCCH/PUSCH transmission to which SRS carrier based switching is performed is indicated by DCI SRS request field for aperiodic SRS transmission, or indicated by MAC-CE for semi-persistent SRS transmission, or configured via RRC for periodic SRS transmission;
- the serving cell, from which SRS carrier based switching is performed and whose UL transmission may therefore be interrupted, is indicated by srs-SwitchFromServCellIndex and srs-SwitchFromCarrier in TS38.331 [2];
- the SRS switching is not colliding with any other transmission with higher priority defined in TS 38.214 [26].
- the SRS switching is not colliding with any SSB/CSI-RS based L3 measurements and the measurements for RLM/BFD.
- for UE, which does not support simultaneous reception and transmission for inter-band TDD CA specified in TS 38.331 [2], and is compliant to the requirements for inter-band CA with uplink in one NR band and without simultaneous Rx/Tx specified in TS 38.101 [5], the SRS transmission are not simultaneously scheduled with DL SSB/CSI-RS for L3 or L1 measurements transmission on other carriers.

The UE shall not perform SRS carrier based switching if the above conditions cannot be met.

When SRS carrier based switching is performed between carriers, the UE is allowed interruptions on any active serving cell if UE is not capable of Per-FR gap, or on active serving cell(s) in FR1 if UE is capable of Per-FR gap, during the switching to the carrier of a serving cell in FR1 not configured for PUCCH/PUSCH transmission,

- with up to X1 slot as specified in Table 8.2.2.2.9-1.

When SRS carrier based switching is performed between carriers, the UE is allowed interruptions on any active serving cell if UE is not capable of Per-FR gap, or on active serving cell(s) in FR2 if UE is capable of Per-FR gap, during the switching to the carrier of a serving cell in FR2 not configured for PUCCH/PUSCH transmission,

- with up to X2 slot as specified in Table 8.2.2.2.9-2.

When SRS carrier based switching is performed between carriers, the UE is allowed interruptions on any active serving cell if UE is not capable of Per-FR gap, or on active serving cell(s) in FR1 if UE is capable of Per-FR gap, during the switching from the carrier of a serving cell in FR1 not configured for PUCCH/PUSCH transmission,

- with up to X1 slot as specified in Table 8.2.2.2.9-1.

When SRS carrier based switching is performed between carriers, the UE is allowed interruptions on any active serving cell if UE is not capable of Per-FR gap, or on active serving cell(s) in FR2 if UE is capable of Per-FR gap, during the switching from the carrier of a serving cell in FR2 not configured for PUCCH/PUSCH transmission,

- with up to X2 slot as specified in Table 8.2.2.2.9-2.

**Table 8.2.2.2.9-1: Interruption length X1 (slot)**

$\mu$	NR Slot length (ms) of victim cell	SRS carrier switching time (us) <sup>Note 1</sup>	Interruption length X1 (slots)	
			Sub carrier spacing for aggressor cell (kHz)	
			15	30
0	1	≤ 200	2	2
		300, 500	2	2
		900	2	2
1	0.5	≤ 200	3	2
		300, 500	3	3
		900	4	4
2	0.25	≤ 200	4	3
		300, 500	5	4
		900	7	6
3	0.125	≤ 200	7	5
		300, 500	9	7
		900	12	10

Note1: NR SRS carrier switching time is UE capability indicated by higher layer parameter *SRS-SwitchingTimeNR*.



**Table 8.2.2.2.9-2: Interruption length X2 (slot)**

$\mu$	NR Slot length (ms) of victim cell	SRS carrier switching time (us) <sup>Note 1</sup>	Interruption length X2 (slots)	
			Sub carrier spacing for aggressor cell (kHz)	
			60	120
0	1	$\leq 200$	2	2
1	0.5	$\leq 200$	2	2
2	0.25	$\leq 200$	3	3
3	0.125	$\leq 200$	4	4
Note1: NR SRS carrier switching time is UE capability indicated by higher layer parameter <i>SRS-SwitchingTimeNR</i> .				

For intra-band SRS carrier switching in FR1 or FR2, interruptions in Table 8.2.2.2.9-1 and in Table 8.2.2.2.9-2 based on SRS carrier switching time  $\leq 200\mu\text{s}$  shall apply. For inter-band SRS carrier switching in FR1, interruptions in Table 8.2.2.2.9-1 and in Table 8.2.2.2.9-2 shall apply.

#### 8.2.2.2.10 DL Interruptions at UE switching between two uplink carriers

The DL interruption requirements at dynamic switching between two uplink carriers specified in this clause are applicable for an uplink band pair of an inter-band UL CA configuration when the capability *uplinkTxSwitchingPeriod* is present, and is only applicable for uplink switching mechanism specified in clause 6.1.6 of TS 38.214 [26], where NR uplink carrier 1 is capable of one transmit antenna connector and NR uplink carrier 2 is capable of two transmit antenna connectors, and the two uplink carriers are in different bands with different carrier frequencies.

When dynamic switching between two uplink carriers is conducted, UE is allowed to cause DL interruption of X OFDM symbols in NR downlink carrier(s) as indicated by *uplinkTxSwitching-DL-Interruption* [2]. The DL interruption starts from the first OFDM symbol which fully or partially overlaps with the UL switching period located in either NR carrier 1 or carrier 2 as indicated in RRC signalling [2]. The DL interruption lengths of X are defined in Table 8.2.2.2.10-1.

No DL interruption is allowed in the NR downlink carrier(s) which is not indicated by *uplinkTxSwitching-DL-Interruption*. No DL interruption is allowed for some inter-band UL CA configurations as specified in clause 5.2A.2 of TS 38.101-1 [18].

**Table 8.2.2.2.10-1: DL interruption length on NR carrier(s) in the unit of OFDM symbols (X) for switching between two uplink carriers**

$\mu$	NR Slot length (ms)	Uplink Tx switching period <sup>Note1</sup>		
		35us	140us	210us
0	1	2	3	4
1	0.5	3	6	7
2	0.25	4	10	14
Note 1: Uplink Tx switching period depends on UE capability <i>uplinkTxSwitchingPeriod</i>				

#### 8.2.2.2.11 Interruptions at direct SCell activation

When one or multiple SCell(s) are directly activated at SCell addition,

- the UE is allowed an interruption on any active serving cell:
  - of up to the duration shown in Table 8.2.2.2.1-1, if the active serving cell is not in the same band as the SCell being directly activated, or
  - of up to the duration shown in Table 8.2.2.2.1-2, if the active serving cells are in the same band as the SCell being activated provided the cell specific reference signals from the active serving cells and the SCell being activated are available in the same slot.

### 8.2.2.2.12 Interruptions due to SCell dormancy

#### 8.2.2.2.12.1 Interruptions due to SCell dormancy switch

When one SCell in MCG is switched from dormancy to non-dormancy or from non-dormancy to dormancy [7] when UE is in DRX active time,

- the UE is allowed an interruption on active serving cell in MCG as defined in clause 8.2.2.2.5, except that the interruption is allowed regardless of which parameters change between the dormant BWP and the non-dormant BWP
- The starting time of interruption shall be within the dormancy switching delay as defined in clause 8.6.2.

When multiple SCells in MCG are switched from dormancy to non-dormancy or vice versa when the UE is in DRX active time, the interruption requirement described above applies for each BWP switch.

#### 8.2.2.2.12.2 Interruptions due to CQI measurements during SCell dormancy

When one or more SCells are in dormancy, the UE is for the purpose of CQI measurements on the dormant SCell(s) allowed to cause interruptions to non-dormant serving cell(s).

The rate of ACK/NACK feedback loss on any non-dormant serving cell resulting from CQI measurements on dormant SCells shall not exceed 0.5%.

#### 8.2.2.2.12.3 Interruptions due to RRM measurements during SCell dormancy

When one or more SCells are in dormancy, the UE is for the purpose of RRM measurements on the dormant SCell(s) allowed to cause interruptions to non-dormant serving cell(s).

The rate of ACK/NACK feedback loss on any non-dormant serving cell resulting from RRM measurements on dormant SCells shall not exceed 1.0%.

### 8.2.2.2.13 Interruptions at transitions between active and non-active during DRX

For the UEs that are capable of *secondaryDRX-Group*[14] in FR1+FR2 CA, when two DRX groups are configured each group of serving cells, no interruption is allowed for UEs supporting either per UE or per FR gaps.

### 8.2.2.2.14 Interruptions when identifying CGI of an NR cell with autonomous gaps

When a UE is identifying CGI of an NR cell with autonomous gaps, the UE is allowed interruptions on PCell or any activated SCell:

- with up to  $K1$  interruptions with interrupted slots up to interruption length  $X1$  specified in Table 8.2.2.2.14-1 for each interruption during MIB decoding time period  $T_{MIB}$  (ms) specified in clause 9.11.
- with up to  $L1$  interruptions with interrupted slots up to interruption length  $Y1$  specified in Table 8.2.2.2.14-1 for each interruption during SIB1 decoding time period  $T_{SIB1}$  (ms) specified in clause 9.11 for SSB and CORESET for RMSI scheduling multiplexing patterns 1.
- with up to  $L2$  interruptions with interrupted slots up to interruption length  $Y2$  specified in Table 8.2.2.2.14-1 for each interruption during SIB1 decoding time period  $T_{SIB1}$  (ms) specified in clause 9.11 for SSB and CORESET for RMSI scheduling multiplexing patterns 2 and 3.

Where:

- $K1 = 6$  for the target cell carrier frequency on FR1 and  $K1 = 25$  for the target cell carrier frequency on FR2, and
- $L1 = T_{SIB1}/20$ , and
- $L2 = T_{SIB1}/T_{SMTTC}$ , where  $T_{SMTTC}$  is the periodicity of the SMTTC occasion configured for the target cell carrier .

**Table 8.2.2.2.14-1: Interruption length X1, Y1 and Y2 during measurements with autonomous gaps**

$\mu$	NR Slot length (ms) of victim cell	Interruption length X1 (slots)	Interruption length Y1 (slots)	Interruption length Y2 (slots)
0	1	6	7	6
1	0.5	12	13	10
2	0.25	24	25	19
3	0.125	48	49	37

### 8.2.2.2.15 Interruptions when identifying CGI of an E-UTRA cell with autonomous gaps

When a UE is identifying CGI of an E-UTRA FDD cell or E-UTRA TDD cell with autonomous gaps, within time period  $T_{\text{identify\_CGI, E-UTRA}}$  specified in clause 9.4.7.1, the UE shall be able to transmit at least the number of ACK/NACKs specified in Table 8.2.2.2.15-1 on PCell or any activated SCell in the frequency range where autonomous gaps are used, provided that:

- there is continuous DL data allocation,
- no DRX cycle is used,
- no measurement gaps are configured,
- only one code word is transmitted in each slot,
- 2 slot ACK/NACK feedback is configured,
- 20 ms SMTC period is configured.

**Table 8.2.2.2.15-1: Minimum number of ACK/NACKs transmitted by the UE during  $T_{\text{identify\_CGI, E-UTRA}}$** 

Minimum number of transmitted ACK/NACKs	SCS	
	Duplex mode configuration	SCS
	Duplex mode configuration	SCS
84	FDD	15 kHz
193	FDD	30 kHz
402	FDD	60 kHz
28	TDD <sup>Note 1</sup>	15 kHz
81	TDD <sup>Note 1</sup>	30 kHz
159	TDD <sup>Note 1</sup>	60 kHz
233	TDD <sup>Note 2</sup>	60 kHz
491	TDD <sup>Note 2</sup>	120 kHz

NOTE 1: TDD UL-DL configuration is as specified in Table A.3.3.1-1 of TS 38.101-1 [18].  
NOTE 2: TDD UL-DL configuration is as specified in Table A.3.3.1-1 of TS 38.101-2 [19].

## 8.2.3 NE-DC Interruptions

### 8.2.3.1 Introduction

This clause contains the requirements related to the interruptions on PCell and SCell, when

- E-UTRA PSCell transitions between active and non-active during DRX, or
- E-UTRA PSCell transitions from non-DRX to DRX, or
- E-UTRA PSCell/SCell in SCG or SCell in MCG is added or released, or
- E-UTRA PSCell/SCell in SCG or SCell(s) in MCG is activated or deactivated, or
- measurements on SCC with deactivated SCell in either E-UTRA SCG or NR MCG or

PUSCH/PUCCH carrier configuration and deconfiguration in NR MCG, or  
 UL/DL BWP is switched on PCell or SCell in MCG, or  
 UE-specific CBW is changed on PCell or SCell in MCG, or  
 CGI reading of an NR neighbour cell with autonomous gaps, or  
 CGI reading of an E-UTRA neighbour cell with autonomous gaps.  
 NR SRS carrier based switching, or  
 E-UTRA SRS carrier based switching.

The requirements shall apply for NE-DC with an NR PCell.

This clause contains interruptions where victim cell is PCell or SCell belonging to MCG. Requirements for interruptions requirements when the victim cell is E-UTRA PSCell or E-UTRA SCell belonging to SCG are specified in TS 36.133 [15].

For a UE which does not support per-FR measurement gap, interruptions to the PCell, E-UTRA PSCell or activated MCG SCells may be caused by EUTRA PSCell, EUTRA SCells or SCells on any frequency range. For UE which support per-FR gap, interruptions to the PCell, E-UTRA PSCell or activated MCG SCells may be caused by EUTRA PSCell, EUTRA SCells or SCells on the same frequency range as the victim cell.

## 8.2.3.2 Requirements

### 8.2.3.2.1 Interruptions at transitions between active and non-active during DRX

Interruption on PCell and the activated SCell if configured due to E-UTRA PSCell transitions between active and non-active during DRX when PCell or SCell is in non-DRX are allowed with up to 1% probability of missed ACK/NACK when the configured E-UTRA PSCell DRX cycle is less than 640 ms, and 0.625% probability of missed ACK/NACK is allowed when the configured E-UTRA PCell DRX cycle is 640 ms or longer. Each interruption shall not exceed X slot as defined in table 8.2.3.2.1-1.

**Table 8.2.3.2.1-1: Interruption length X at transition between active and non-active during DRX**

$\mu$	NR slot length (ms)	Interruption length X (slots)	
		Sync	Async
0	1	1	2
1	0.5	1	2
2	0.25	3	
3	0.125	5	

When both PCell and E-UTRA PSCell are in DRX, no interruption is allowed.

### 8.2.3.2.2 Interruptions at transitions from non-DRX to DRX

Interruption on PCell and the activated SCell if configured due to E-UTRA PSCell transitions from non-DRX to DRX when PCell or SCell is in non-DRX shall not exceed X slots as defined in table 8.2.3.2.1-1.

### 8.2.3.2.3 Interruptions at PSCell/SCell addition/release

The requirements in this clause shall apply for the UE configured with E-UTRA PSCell.

When one E-UTRA PSCell/SCell in SCG is added or released:

- the UE is allowed an interruption on any active serving cell in MCG:
  - of up to X1 slots, if the active serving cell is not in the same band as the E-UTRA PSCell/SCell being added or released, or

- of up to  $\max\{Y1 \text{ slots} + T_{\text{SMTC\_duration}}, 5\text{ms}\}$  if the active serving cells are in the same band as the E-UTRA PSCell/SCell being added or released, provided the cell specific reference signals from the active serving cells and the E-UTRA PSCell/SCell being added or released are available in the same slot, where  $T_{\text{SMTC\_duration}}$  is the longest SMTC duration among all above activated serving cells in MCG;

Where X1 and Y1 are specified in Table 8.2.3.2.3-1.

When one SCell in MCG is added or released:

- the UE is allowed an interruption on any activated serving cell in MCG:
- of up to X1 slots, if the active serving cell and the SCell being added or released are in a FR1 band pair or in a FR1+FR2 band pair.
- of up to X1 slot, if the active serving cell and the SCell being added or released are in a FR2 band pair and UE is capable of independent beam management on this FR2 band pair.

or

- of up to  $Y1 \text{ slots} + T_{\text{SMTC\_duration}}$  if the active serving cells are in the same band as any of the SCells being added or released, provided the cell specific reference signals from the active serving cells and the SCells being added or released are available in the same slot, where,  $T_{\text{SMTC\_duration}}$  is
  - the longest SMTC duration among all above active serving cells in MCG and the SCell being added when one SCell is added. If SSB configuration (*absoluteFrequencySSB*) but no SMTC configuration is provided for the SCell being added, the SSB transmission periodicity is assumed to be 5ms and  $T_{\text{SMTC\_duration}}$  for the SCell being added is  $x \text{ ms}$ , where  $x =$  the number of consecutive subframes containing all SSBs in one SSB burst transmitted by the SCell being added. If no SSB configuration (*absoluteFrequencySSB*) nor SMTC configuration is provided for the SCell being added,  $T_{\text{SMTC\_duration}}$  for the SCell being added is 0ms;
  - the longest SMTC duration among all above active serving cells in MCG when one SCell is released.

Where X1 and Y1 are specified in Table 8.2.3.2.3-2.

**Table 8.2.3.2.3-1: Interruption length X1 and Y1 at E-UTRA PSCell/SCell addition/release**

$\mu$	NR Slot length (ms)	Interruption length X1 (slots)		Interruption length Y1 (slots)	
		Sync	Async	Sync	Async
0	1	1	2	1	2
1	0.5	2	3	2	3
2	0.25	5		4	5
3	0.125	9		N/A	N/A

**Table 8.2.3.2.3-2: Interruption length X1 and Y1 at SCell addition/Release**

$\mu$	NR Slot length (ms) of victim cell	Interruption length X1 (slots)		Interruption length Y1 (slots)
0	1	1		1
1	0.5	2		2
2	0.25	Both aggressor cell and victim cell are on FR2	4	4
		Either aggressor cell or victim cell is on FR1	5	
3	0.125	Aggressor cell is on FR2	8	8
		Aggressor cell is on FR1	9	

8.2.3.2.4 Interruptions at SCell activation/deactivation

The requirements in this clause shall apply for the UE configured with E-UTRA PSCell and one SCell.

When one E-UTRA SCell in SCG is activated from deactivated or dormant state, or deactivated from activated or dormant state:

- the UE is allowed an interruption on any active serving cell in MCG:
  - of up to X2 slots, if the active serving cell is not in the same band as the E-UTRA SCell being activated or deactivated, or
  - of up to  $\max\{Y2 \text{ slots} + T_{\text{SMTC\_duration}}, 5\text{ms}\}$  if the active serving cells are in the same band as the E-UTRA SCell being activated or deactivated, provided the cell specific reference signals from the active serving cells and the E-UTRA SCell being activated or deactivated are available in the same slot, where  $T_{\text{SMTC\_duration}}$  is the longest SMTC duration among all above active serving cells in MCG.

Where X2 and Y2 are specified in Table 8.2.3.2.4-1.

Where X2 and Y2 are specified in Table 8.2.3.2.4-1.

When one SCell in MCG is activated or deactivated:

- the UE is allowed an interruption on any serving cell in MCG:
  - of up to X2 slots, if the active serving cell is not in the same band as the SCell being activated or deactivated, or
  - of up to  $Y2 \text{ slots} + T_{\text{SMTC\_duration}}$  if the active serving cells are in the same band as the SCell being activated or deactivated, provided the cell specific reference signals from the active serving cells and the SCell being activated or deactivated are available in the same slot, where,  $T_{\text{SMTC\_duration}}$  is
    - the longest SMTC duration among all above active serving cells in MCG and the SCell being activated when one SCell is activated, If SSB configuration (*absoluteFrequencySSB*) but no SMTC configuration is provided for the SCell being activated, the SSB transmission periodicity is assumed to be 5ms and  $T_{\text{SMTC\_duration}}$  for the SCell being activated is  $x \text{ ms}$ , where  $x = \text{the number of consecutive subframes containing all SSBs in one SSB burst transmitted by the SCell being activated}$ . If no SSB configuration (*absoluteFrequencySSB*) nor SMTC configuration is provided for the SCell being activated,  $T_{\text{SMTC\_duration}}$  for the SCell being activated is 0ms;
    - the longest SMTC duration among all above active serving cells in MCG when one SCell is deactivated.

Where X2 and Y2 are specified in Table 8.2.3.2.4-2.

**Table 8.2.3.2.4-1: Interruption length X2 and Y2 at E-UTRA SCell activation/deactivation**

$\mu$	NR Slot length (ms)	Interruption length X2 (slots)		Interruption length Y2 (slots)	
		Sync	Async	Sync	Async
0	1	1	2	1	2
1	0.5	1	2	1	2
2	0.25	3		2	3
3	0.125	5		N/A	N/A

**Table 8.2.3.2.4-2: Interruption length X2 and Y2 at SCell activation/deactivation**

$\mu$	NR Slot length (ms) of victim cell	Interruption length X2 (slots)	Interruption length Y2 (slots)
0	1	1	1
1	0.5	1	1

2	0.25	Both aggressor cell and victim cell are on FR2	2	2
		Either aggressor cell or victim cell is on FR1	3	
3	0.125	Aggressor cell is on FR2	4	4
		Aggressor cell is on FR1	5	

### 8.2.3.2.5 Interruptions during measurements on SCC

#### 8.2.3.2.5.1 Interruptions during measurements on deactivated NR SCC

Interruption on PCell and other activated SCell(s) during measurement on the deactivated NR SCC shall meet requirements in clause 8.2.2.2.3.

#### 8.2.3.2.5.2 Interruptions during measurements on deactivated E-UTRAN SCC

When one E-UTRA SCell in SCG is deactivated, the UE is allowed due to measurements on the E-UTRA SCC with the deactivated E-UTRA SCell:

- an interruption on PCell or any activated SCell with up to 0.5% probability of missed ACK/NACK when any of the configured *measCycleSCell* [15] for the deactivated E-UTRA SCCells is 640 ms or longer.
- an interruption on PCell or any activated SCell with up to 0.5% probability of missed ACK/NACK regardless of the configured *measCycleSCell* [15] for the deactivated E-UTRA SCCells if indicated by the network using IE *allowInterruptions* [15].

Each interruption shall not exceed

- X3 slots, if the PCell or activated SCell is not in the same band as the E-UTRA deactivated SCC being measured, or
- Y3 slots + SMTC duration, if the PCell or activated SCell is in the same band as the E-UTRA deactivated SCC being measured, provided the cell specific reference signals from the PCell or activated SCell and the E-UTRA deactivated SCC being measured are available in the same slot.

Where X3 and Y3 are specified in Table 8.2.3.2.5-1

**Table 8.2.3.2.5-1: Interruption length X3 and Y3 at measurements on deactivated E-UTRA SCC**

$\mu$	NR Slot length (ms)	Interruption length X3 (slots)		Interruption length Y3 (slot)	
		Sync	Async	Sync	Async
0	1	1	2	1	2
1	0.5	1	2	1	2
2	0.25	3		2	3
3	0.125	5		N/A	N/A

#### 8.2.3.2.5.3 Interruptions during CQI measurements on dormant E-UTRAN SCC

When one E-UTRA SCell in SCG is dormant, the UE is allowed due to CQI measurements on the dormant E-UTRA SCell:

- an interruption on PCell or any activated SCell with up to 0.5% probability of missed ACK/NACK.

Each interruption shall not exceed

- X3 slots, if the PCell or activated SCell is not in the same band as the E-UTRA dormant SCell being measured, or
- Y3 slots + SMTC duration, if the PCell or activated SCell is in the same band as the E-UTRA dormant SCell being measured, provided the cell specific reference signals from the PCell or activated SCell and the E-UTRA dormant SCell being measured are available in the same slot.

Where X3 and Y3 are defined in Table 8.2.3.2.5.2-1.

#### 8.2.3.2.5.4 Interruptions during RRM measurements on dormant E-UTRAN SCC

When one E-UTRA SCell in SCG is dormant, the UE is allowed due to RRM measurements on the E-UTRA SCC with the dormant E-UTRA SCell:

- an interruption on PCell or any activated SCell with up to 0.5% probability of missed ACK/NACK.

Each interruption shall not exceed

- X3 slots, if the PCell or activated SCell is not in the same band as the E-UTRA dormant SCC being measured, or
- Y3 slots + SMTC duration, if the PCell or activated SCell is in the same band as the E-UTRA dormant SCC being measured, provided the cell specific reference signals from the PSCell or activated SCell and the E-UTRA dormant SCC being measured are available in the same slot.

Where X3 and Y3 are defined in Table 8.2.3.2.5.2-1.

#### 8.2.3.2.6 Interruptions at UL carrier RRC reconfiguration

The requirements in this clause shall apply when a supplementary UL carrier or an UL carrier is configured or de-configured in NE-DC.

When an UL carrier or supplementary UL carrier is configured or deconfigured, an interruption of up to X4 slot as specified in Table 8.2.3.2.6-1, is allowed during the RRC reconfiguration procedure in TS 38.331 [2] on PCell, all activated SCells within the same FR as the reconfigured uplink carrier. The interruption is for both uplink and downlink of PCell, all activated E-UTRA SCells, E-UTRA PSCell and all activated SCells within the same FR as the configured or de-configured UL.

**Table 8.2.3.2.6-1: Interruption length X4 at UL carrier RRC reconfiguration**

$\mu$	NR Slot length (ms)	Interruption length X4 (slots)	
		Sync	Async
0	1	1	2
1	0.5	2	3
2	0.25	5	
3	0.125	9	

#### 8.2.3.2.7 Interruptions due to Active BWP switching Requirement

The requirements for DCI-based BWP switch, timer-based BWP switch or UL BWP switch triggered by consistent uplink CCA failures in this clause apply to the case that the BWP switch is performed on a single CC or multiple CCs.

When either of the DCI-based, timer-based or RRC-based downlink BWP switch and/or uplink BWP switch occur on multiple CCs simultaneously or over partially overlapping period, the interruption requirements described in this clause apply for each BWP switch.

When UE receives a DCI indicating the UE to switch its active BWP, or when a BWP timer *bwp-InactivityTimer* defined in TS 38.331 [2] expires, or when the UE receives an RRC command indicating the UE to switch its active BWP or when UL BWP switch is triggered by consistent uplink CCA failures, the UE is allowed an interruption on PCell and any activated SCells as defined in clause 8.2.2.2.5.

#### 8.2.3.2.8 Interruptions at direct SCell activation and hibernation

##### 8.2.3.2.8.1 Interruptions during direct SCell activation and hibernation of E-UTRA SCell

When one E-UTRA SCell in SCG is directly activated and hibernated:

- the UE is allowed an interruption on any active serving cell in MCG:



- of up to X1 slot, if the active serving cell is not in the same band as any of the E-UTRA SCells being directly activated or hibernated, or
- of up to  $\max\{Y1 \text{ slot} + T_{\text{SMTC\_duration}}, 5\text{ms}\}$  if the active serving cells are in the same band as any of the E-UTRA SCells being directly activated or hibernated, provided the cell specific reference signals from the active serving cells and the E-UTRA SCells being directly activated or hibernated are available in the same slot, where  $T_{\text{SMTC\_duration}}$  is the longest SMTC duration among all above active serving cells in MCG.

Where X1 and Y1 are specified in Table 8.2.3.2.3-1.

#### 8.2.3.2.8.2 Interruptions during direct SCell activation

When one or multiple SCell(s) in MCG are directly activated at SCell addition:

- the UE is allowed an interruption on any active serving cell in MCG:
  - of up to X1 slot, if the active serving cell is not in the same band as the SCell being directly activated, or
  - of up to  $\max\{Y1 \text{ slot} + T_{\text{SMTC\_duration}}, 5\text{ms}\}$  if the active serving cells are in the same band as the SCell being directly activated, provided the cell specific reference signals from the active serving cells and the SCell being directly activated are available in the same slot, where  $T_{\text{SMTC\_duration}}$  is the longest SMTC duration among all above active serving cells in MCG.

Where X1 and Y1 are specified in Table 8.2.3.2.3-2.

#### 8.2.3.2.9 Interruptions at SCell hibernation

When one E-UTRA SCell in SCG is hibernated:

- the UE is allowed an interruption on any active serving cell in MCG:
  - of up to X2 slot, if the active serving cell is not in the same band as any of the E-UTRA SCells being hibernated, or
  - of up to  $\max\{Y2 \text{ slot} + T_{\text{SMTC\_duration}}, 5\text{ms}\}$  if the active serving cells are in the same band as any of the E-UTRA SCells being hibernated, provided the cell specific reference signals from the active serving cells and the E-UTRA SCells being hibernated are available in the same slot, where  $T_{\text{SMTC\_duration}}$  is the longest SMTC duration among all above active serving cells in MCG.

Where X2 and Y2 are specified in Table 8.2.3.2.4-1.

#### 8.2.3.2.10 Interruptions at SCell activation/deactivation with multiple downlink SCells

The requirements in this clause shall apply for the UE configured with E-UTRA PCell and up to 6 downlink SCell(s).

When multiple SCells in MCG are activated or deactivated by one single MAC CE command:

- an interruption on any serving cell in MCG is specified as in clause 8.2.3.2.4.

#### 8.2.3.2.11 Interruptions at NR SRS carrier based switching

SRS transmission can be configured on a carrier not configured for PUCCH/PUSCH transmission. When a UE needs to transmit periodic, semi-persistent or aperiodic SRS on a carrier of a serving cell not configured for PUCCH/PUSCH transmission, the UE can perform carrier based switching to one or more carriers not configured for PUCCH/PUSCH transmission from a carrier with PUCCH/PUSCH transmission or from a carrier not configured for PUCCH/PUSCH transmission prior to transmitting SRS, provided that:

- switching is from a configured carrier to another activated carrier;
- the carrier of SCells not configured for PUCCH/PUSCH transmission to which SRS carrier based switching is performed is indicated by DCI SRS request field for aperiodic SRS transmission, or indicated by MAC-CE for semi-persistent SRS transmission, or configured via RRC for periodic SRS transmission;

- the serving cell, from which SRS carrier based switching is performed and whose UL transmission may therefore be interrupted, is indicated by srs-SwitchFromServCellIndex and srs-SwitchFromCarrier in TS38.331 [2];
- the SRS switching is not colliding with any other transmission with higher priority defined in TS 38.214 [26].
- the SRS switching is not colliding with any SSB/CSI-RS based L3 measurements and the measurements for RLM/BFD in MCG.- for UE, which does not support simultaneous reception and transmission for inter-band TDD CA specified in TS 38.331 [2], and is compliant to the requirements for inter-band CA with uplink in one NR band and without simultaneous Rx/Tx specified in TS 38.101 [5], the SRS transmission are not simultaneously scheduled with DL SSB/CSI-RS for L3 or L1 measurements transmission on other carriers.

The UE shall not perform SRS carrier based switching if the above conditions cannot be met.

When SRS carrier based switching is performed between carriers, the UE is allowed interruptions on any active serving cell in MCG if UE is not capable of Per-FR gap, or on active serving cell(s) in MCG in FR1 if UE is capable of Per-FR gap, during the switching to the carrier of a serving cell in FR1 not configured for PUCCH/PUSCH transmission,

- with up to X1 slot as specified in Table 8.2.3.2.11-1.

When SRS carrier based switching is performed between carriers, the UE is allowed interruptions on any active serving cell in MCG if UE is not capable of Per-FR gap, or on active serving cell(s) in MCG in FR2 if UE is capable of Per-FR gap, during the switching to the carrier of a serving cell in FR2 not configured for PUCCH/PUSCH transmission,

- with up to X2 slot as specified in Table 8.2.3.2.11-2.

When SRS carrier based switching is performed between carriers, the UE is allowed interruptions on any active serving cell in MCG if UE is not capable of Per-FR gap, or on active serving cell(s) in MCG in FR1 if UE is capable of Per-FR gap, during the switching from the carrier of a serving cell in FR1 not configured for PUCCH/PUSCH transmission,

- with up to X1 slot as specified in Table 8.2.3.2.11-1.

When SRS carrier based switching is performed between carriers, the UE is allowed interruptions on any active serving cell in MCG if UE is not capable of Per-FR gap, or on active serving cell(s) in MCG in FR2 if UE is capable of Per-FR gap, during the switching from the carrier of a serving cell in FR2 not configured for PUCCH/PUSCH transmission,

- with up to X2 slot as specified in Table 8.2.3.2.11-2.

**Table 8.2.3.2.11-1: Interruption length X1 (slot)**

$\mu$	NR Slot length (ms) of victim cell	SRS carrier switching time (us) <sup>Note 1</sup>	Interruption length X1 (slots)	
			Sub carrier spacing for agressor cell (kHz)	
			15	30
0	1	≤ 200	2	2
		300, 500	2	2
		900	3	3
1	0.5	≤ 200	3	2
		300, 500	3	3
		900	4	4
2	0.25	≤ 200	4	3
		300, 500	5	4
		900	7	6
3	0.125	≤ 200	7	5
		300, 500	9	7
		900	12	10
Note1: NR SRS carrier switching time is UE capability indicated by higher layer parameter <i>SRS-SwitchingTimeNR</i> .				

**Table 8.2.3.2.11-2: Interruption length X2 (slot)**

$\mu$	NR Slot length (ms) of victim cell	SRS carrier switching time (us) <sup>Note 1</sup>	Interruption length X2 (slots)	
			Sub carrier spacing for agressor cell (kHz)	
			60	120
0	1	≤ 200	2	2

1	0.5	$\leq 200$	2	2
2	0.25	$\leq 200$	3	3
3	0.125	$\leq 200$	4	4
Note1: NR SRS carrier switching time is UE capability indicated by higher layer parameter <i>SRS-SwitchingTimeNR</i> .				

For intra-band SRS carrier switching in FR1 or FR2, interruptions in Table 8.2.3.2.11-1 and in Table 8.2.3.2.11-2 based on SRS carrier switching time  $\leq 200\mu\text{s}$  shall apply. For inter-band SRS carrier switching in FR1, interruptions in Table 8.2.3.2.11-1 and in Table 8.2.3.2.11-2 shall apply.

### 8.2.3.2.12 Interruptions at E-UTRA SRS carrier based switching

A PUSCH-less carrier of E-UTRA SCell is a TDD carrier without PUCCH/PUSCH configured. When a UE needs to transmit periodic or aperiodic SRS [23] and/or non-contention based PRACH on a PUSCH-less E-UTRA carrier of SCell, the UE can perform carrier based switching to one or more PUSCH-less carrier of E-UTRA SCells from a E-UTRA carrier with PUSCH or from another PUSCH-less E-UTRA carrier of SCell prior to transmitting SRS and/or PRACH, provided that:

- switching is from a configured E-UTRA carrier to another activated TDD carrier;
- the PUSCH-less carrier of E-UTRA SCells to which SRS carrier based switching is performed is indicated by DCI SRS request field for aperiodic SRS transmission or configured via RRC [15] for periodic SRS transmission;
- the E-UTRA serving cell, from which SRS carrier based switching is performed and whose UL transmission may therefore be interrupted, is indicated by *srs-SwitchFromServCellIndex* [15];
- the SRS switching is not colliding with any other transmission with higher priority defined in TS36.213 [TBD];
- the SRS switching is not colliding with PDCCH in subframe 0 and 5 as specified in TS36.213 [TBD];
- for UE, which does not support simultaneous reception and transmission for inter-band TDD CA specified in TS 36.331 [2], and is compliant to the requirements for inter-band CA with uplink in one E-UTRA band and without simultaneous Rx/Tx specified in TS 36.101 [25], the SRS or RACH transmission are not simultaneously scheduled with DL subframe #0 or DL subframe #5 on other E-UTRA carriers.

The UE shall not perform SRS carrier based switching if the above conditions cannot be met.

When SRS carrier based switching is performed between E-UTRA carriers, the UE is allowed interruptions on any active serving cell in MCG if UE is not capable of Per-FR gap, or on active serving cell(s) in MCG in FR1 if UE is capable of Per-FR gap, during the switching to the PUSCH-less carrier of a serving cell,

- with up to X2 slot as specified in Table 8.2.3.2.12-1.

When SRS carrier based switching is performed between E-UTRA carriers, the UE is allowed interruptions on any active serving cell in MCG if UE is not capable of Per-FR gap, or on active serving cell(s) in MCG in FR1 if UE is capable of Per-FR gap, during the switching from the PUSCH-less carrier of a serving cell,

- with up to X2 slot as specified in Table 8.2.3.2.12-1

**Table 8.2.3.2.12-1: Interruption length X2 (slot)**

$\mu$	NR Slot length (ms)	Interruption length X2 (slots)
0	1	2
1	0.5	3
2	0.25	5
3	0.125	9

### 8.2.3.2.13 Interruptions due to SCell dormancy

#### 8.2.3.2.13.1 Interruptions due to SCell dormancy switch

When one SCell in MCG is switched from dormancy to non-dormancy or from non-dormancy to dormancy [7] when UE is in DRX active time,

- the UE is allowed an interruption on active serving cell in MCG as defined in clause 8.2.3.2.7, except that the interruption is allowed regardless of which parameters change between the dormant BWP and the non-dormant BWP
- The starting time of interruption shall be within the dormancy switching delay as defined in clause 8.6.2.

When multiple SCells in MCG are switched from dormancy to non-dormancy or vice versa when the UE is in DRX active time, the interruption requirement described above applies for each BWP switch.

#### 8.2.3.2.13.2 Interruptions due to CQI measurements during SCell dormancy

When one or more SCells are in dormancy, the UE is for the purpose of CQI measurements on the dormant SCell(s) allowed to cause interruptions to non-dormant serving cell(s).

The rate of ACK/NACK feedback loss on any non-dormant serving cell resulting from CQI measurements on dormant SCells shall not exceed 0.5%.

#### 8.2.3.2.13.3 Interruptions due to RRM measurements during SCell dormancy

When one or more SCells are in dormancy, the UE is for the purpose of RRM measurements on the dormant SCell(s) allowed to cause interruptions to non-dormant serving cell(s).

The rate of ACK/NACK feedback loss on any non-dormant serving cell resulting from RRM measurements on dormant SCells shall not exceed 1.0%.

### 8.2.3.2.14 Interruptions when identifying CGI of an NR cell with autonomous gaps

When a UE is identifying CGI of an NR cell with autonomous gaps, the UE is allowed interruptions on PCell or any activated SCell:

- with up to  $K1$  interruptions with interrupted slots up to interruption length  $X1$  specified in Table 8.2.3.2.14-1 for each interruption during MIB decoding time period  $T_{MIB}$  (ms) specified in clause 9.11.
- with up to  $L1$  interruptions with interrupted slots up to interruption length  $Y1$  specified in Table 8.2.3.2.14-1 for each interruption during SIB1 decoding time period  $T_{SIB1}$  (ms) specified in clause 9.11 for SSB and CORESET for RMSI scheduling multiplexing patterns 1.
- with up to  $L2$  interruptions with interrupted slots up to interruption length  $Y2$  specified in Table 8.2.3.2.14-1 for each interruption during SIB1 decoding time period  $T_{SIB1}$  (ms) specified in clause 9.11 for SSB and CORESET for RMSI scheduling multiplexing patterns 2 and 3.

Where:

- $K1 = 6$  for the target cell carrier frequency on FR1 and  $K1 = 25$  for the target cell carrier frequency on FR2, and
- $L1 = T_{SIB1}/20$ , and
- $L2 = T_{SIB1}/T_{SMTTC}$ , where  $T_{SMTTC}$  is the periodicity of the SMTTC occasion configured for the target cell carrier .

**Table 8.2.3.2.14-1: Interruption length  $X1$ ,  $Y1$  and  $Y2$  during measurements with autonomous gaps**

$\mu$	NR Slot length (ms) of victim cell	Interruption length $X1$ (slots)	Interruption length $Y1$ (slots)	Interruption length $Y2$ (slots)
0	1	6	7	6
1	0.5	12	13	10
2	0.25	24	25	19

3	0.125	48	49	37
---	-------	----	----	----

### 8.2.3.2.15 Interruptions when identifying CGI of an E-UTRA cell with autonomous gaps

When a UE is identifying CGI of an E-UTRA FDD cell or E-UTRA TDD cell with autonomous gaps, within time period

- $T_{\text{identify\_CGI, intra}}$  specified in clause 8.1.2.2.3, or clause 8.1.2.2.4 in TS 36.133 [15], or
- $T_{\text{identify\_CGI, inter}}$  specified in clause 8.1.2.3.5, or clause 8.1.2.3.6, or clause 8.1.2.3.7, or clause 8.1.2.3.6 in TS 36.133 [15], or
- $T_{\text{identify\_CGI, E-UTRA}}$  specified in clause 9.4.7.1

the UE shall be able to transmit at least the number of ACK/NACKs specified in Table 8.2.3.2.15-1 on PCell or any activated SCell in the frequency range where autonomous gaps are used, provided that:

- there is continuous DL data allocation,
- no DRX cycle is used,
- no measurement gaps are configured,
- only one code word is transmitted in each slot,
- 2 slot ACK/NACK feedback is configured,
- 20 ms SMTC period is configured.

**Table 8.2.3.2.15-1: Minimum number of ACK/NACKs transmitted by the UE**

Minimum number of transmitted ACK/NACKs	Configuration of the serving cell in which the transmitted ACK/NACKs are counted	
	Duplex mode configuration	SCS
84	FDD	15 kHz
193	FDD	30 kHz
402	FDD	60 kHz
28	TDD <sup>Note 1</sup>	15 kHz
81	TDD <sup>Note 1</sup>	30 kHz
159	TDD <sup>Note 1</sup>	60 kHz
233	TDD <sup>Note 2</sup>	60 kHz
491	TDD <sup>Note 2</sup>	120 kHz

NOTE 1: TDD UL-DL configuration is as specified in Table A.3.3.1-1 of TS 38.101-1 [18].  
NOTE 2: TDD UL-DL configuration is as specified in Table A.3.3.1-1 of TS 38.101-2 [19].

### 8.2.3.2.16 Interruptions due to UE-specific CBW change

The requirements in clause 8.2.1.2.11 apply for this clause.

## 8.2.4 NR-DC: Interruptions

### 8.2.4.1 Introduction

This clause contains the requirements related to the interruptions on PCell, PSCell and activated SCell if configured, when

- up to 1 SCell in FR1 and up to 7 SCell(s) in FR2 are configured, deconfigured, activated or deactivated or,
- a supplementary UL carrier or an UL carrier is configured or de-configured, or

measurements on SCC with deactivated SCell in NR SCG, or  
 UL/DL BWP is switched on PCell, PSCell or SCell,  
 UE-specific CBW is changed on PCell, PSCell or SCell, or  
 transitions between active and non-active during DRX, or  
 transitions from non-DRX to DRX, or  
 CGI reading of an NR neighbour cell with autonomous gaps, or  
 CGI reading of an E-UTRA neighbour cell with autonomous gaps.  
 NR SRS carrier based switching.

Note: interruptions at SCell addition/release, activation/deactivation and during measurements on SCC may not be required by all UEs.

The interruptions shall not interrupt RRC signalling or ACK/NACKs related to RRC reconfiguration procedure [2] for SCell addition/release or MAC control signalling [17] for SCell activation/deactivation command.

The requirements shall apply for NR-DC with an NR PCell, PSCell or SCell.

For a UE which does not support per-FR measurement gap, interruptions to the PCell and activated SCell may be caused by SCells on any frequency range. For a UE which supports per-FR gaps, interruptions to PCell, PSCell and activated SCell may be caused by SCells on the same frequency range as the victim cell.

## 8.2.4.2 Requirements

### 8.2.4.2.1 Interruptions at PSCell/SCell addition/release

When PSCell or one or more SCells is added or released using the same *RRCConnectionReconfiguration* message as defined in TS 38.331 [2], the UE is allowed an interruption on any activated serving cell during the RRC reconfiguration procedure as follows:

- an interruption on any active serving cell:
  - of up to the duration shown in table 8.2.4.2.1-1, if the active serving cell is not in the same band as the PSCell or SCell being added or released, where the requirements for Sync apply for synchronous NR-DC, and for asynchronous NR-DC if the active serving cell is in the same CG as the PSCell or SCell being added or released, and the requirements for Async apply for asynchronous NR-DC if the active serving cell is not in the same CG as the PSCell or SCell being added or released, or
  - of up to the duration shown in table 8.2.4.2.1-2, if the active serving cells are in the same band as the SCell being added or released, provided the cell specific reference signals from the active serving cells and the SCell being added or released are available in the same slot.

**Table 8.2.4.2.1-1: Interruption duration for PSCell/SCell addition/release for inter-band DC/CA**

$\mu$	NR Slot length (ms) of victim cell	Interruption length (slots)		
		Sync		Async
0	1	1		2
1	0.5	2		3
2	0.25	Both aggressor cell and victim cell are on FR2	4	5
		Either aggressor cell or victim cell is on FR1	5	
3	0.125	Aggressor cell is on FR2	8	9

	Aggressor cell is on FR1	9	
--	--------------------------	---	--

**T Table 8.2.4.2.1-2: Interruption duration for SCell addition/release for intra-band DC/CA**

$\mu$	NR Slot length (ms)	Interruption length (slots)
0	1	$1 + T_{\text{SMTC\_duration}} * N_{\text{slot}}^{\text{subframe},\mu}$
1	0.5	$2 + T_{\text{SMTC\_duration}} * N_{\text{slot}}^{\text{subframe},\mu}$
2	0.25	$4 + T_{\text{SMTC\_duration}} * N_{\text{slot}}^{\text{subframe},\mu}$
3	0.125	$8 + T_{\text{SMTC\_duration}} * N_{\text{slot}}^{\text{subframe},\mu}$

NOTE 1:  $T_{\text{SMTC\_duration}}$  measured in subframes is  
 - the longest SMTC duration among all above activeserving cells and the SCell being added when one SCell is added. If SSB configuration (*absoluteFrequencySSB*) but no SMTC configuration is provided for the SCell being added, the SSB transmission periodicity is assumed to be 5ms and  $T_{\text{SMTC\_duration}}$  for the SCell being added is x ms, where x = the number of consecutive subframes containing all SSBs in one SSB burst transmitted by the SCell being added. If no SSB configuration (*absoluteFrequencySSB*) nor SMTC configuration is provided for the SCell being added,  $T_{\text{SMTC\_duration}}$  for the SCell being added is 0ms;  
 - the longest SMTC duration among all active serving cells in the same band when one SCell is released.

NOTE 2:  $N_{\text{slot}}^{\text{subframe},\mu}$  is as defined in TS 38.211 [6].

**8.2.4.2.2 Interruptions at SCell activation/deactivation**

When a SCell is activated or deactivated as defined in TS 37.340 [17], the UE is allowed

- an interruption on any active serving cell:
- of up to the duration shown in table 8.2.4.2.2-1, if the active serving cell is not in the same band as the SCell being activated or deactivated, where the requirements for Sync apply for synchronous NR-DC, and for asynchronous NR-DC if the active serving cell is in the same CG as the SCell being activated, and the requirements for Async apply for asynchronous NR-DC if the active serving cell is not in the same CG as the SCell being activated, or
- of up to the duration shown in table 8.2.4.2.2-2, if the active serving cells are in the same band as the SCell being activated or deactivated provided the cell specific reference signals from the active serving cells and the SCell being activated or deactivated are available in the same slot.

**Table 8.2.4.2.2-1: Interruption duration for SCell activation/deactivation for inter-band DC/CA**

$\mu$	NR Slot length (ms) of victim cell	Interruption length (slots)	
		Sync	Async
0	1	1	2
1	0.5	1	2
2	0.25	Both aggressor cell and victim cell are on FR2	2
		Either aggressor cell or victim cell is on FR1	3
3	0.125	Aggressor cell is on FR2	4
		Aggressor cell is on FR1	5

**Table 8.2.4.2.2-2: Interruption duration for SCell activation/deactivation for intra-band DC/CA**

$\mu$	NR Slot length (ms)	Interruption length (slots)
0	1	$1 + T_{\text{SMTC\_duration}} * N_{\text{slot}}^{\text{subframe},\mu}$
1	0.5	$1 + T_{\text{SMTC\_duration}} * N_{\text{slot}}^{\text{subframe},\mu}$
2	0.25	$2 + T_{\text{SMTC\_duration}} * N_{\text{slot}}^{\text{subframe},\mu}$
3	0.125	$4 + T_{\text{SMTC\_duration}} * N_{\text{slot}}^{\text{subframe},\mu}$

NOTE 1:  $T_{\text{SMTC\_duration}}$  measured in subframes is

- the longest SMTC duration among all above active serving cells and the SCell being activated when one SCell is activated. If SSB configuration (*absoluteFrequencySSB*) but no SMTC configuration is provided for the SCell being activated, the SSB transmission periodicity is assumed to be 5ms and  $T_{\text{SMTC\_duration}}$  for the SCell being activated is  $x$  ms, where  $x$  = the number of consecutive subframes containing all SSBs in one SSB burst transmitted by the SCell being activated. If no SSB configuration (*absoluteFrequencySSB*) nor SMTC configuration is provided for the SCell being activated,  $T_{\text{SMTC\_duration}}$  for the SCell being activated is 0ms;
- the longest SMTC duration among all active serving cells in the same band when one SCell is deactivated.

NOTE 2:  $N_{\text{slot}}^{\text{subframe},\mu}$  is as defined in TS 38.211 [6].

#### 8.2.4.2.3 Interruptions during measurements on SCC

Interruption on PCell, PSCell and other activated SCell(s) during measurement on the deactivated NR SCC shall meet requirements in clause 8.2.2.2.3, where the term PCell in clause 8.2.2.2.3 shall be deemed to be replaced with SpCell.

#### 8.2.4.2.4 Interruptions at UL carrier RRC reconfiguration

The requirements in this clause shall apply when a supplementary UL carrier or an UL carrier is configured or de-configured in NR-DC as defined in TS 38.331 [2].

When an UL carrier or supplementary UL carrier is configured or de-configured, an interruption of up to the duration shown in table 8.2.4.2.4-1, is allowed during the RRC reconfiguration procedure in TS38.331 [2] on all the other activated serving cells within the same FR as the reconfigured uplink carrier. The interruption is for both uplink and downlink of all the other serving cells within the same FR as the configured or de-configured UL.

**Table 8.2.4.2.4-1: Interruption duration for UL carrier RRC reconfiguration**

$\mu$	NR Slot length (ms)	Interruption length (slots)
0	1	1
1	0.5	2
2	0.25	4
3	0.125	8

#### 8.2.4.2.5 Interruptions due to Active BWP switching Requirement

The requirements for DCI-based BWP switch, timer-based BWP switch or UL BWP switch triggered by consistent uplink CCA failures in this clause apply to the case that the BWP switch is performed on a single CC or multiple CCs.

When either of the DCI-based, timer-based or RRC-based downlink BWP switch and/or uplink BWP switch occur on multiple CCs simultaneously or over partially overlapping period, the interruption requirements described in this clause apply for each BWP switch.

When UE receives a DCI indicating the UE to switch its active BWP, or when a BWP timer *bwp-InactivityTimer* defined in TS 38.331 [2] expires, or when the UE receives an RRC command indicating the UE to switch its active BWP or when UL BWP switch is triggered by consistent uplink CCA failures, the UE is allowed to cause an interruption on any other serving cells as defined in clause 8.2.2.2.5. In addition to what is defined in 8.2.2.5, when RRC-based BWP switch occurs on multiple CCs over partially overlapping period, the interruption is only allowed within the delay  $T_{\text{RRCprocessingDelay}} + T_{\text{Waiting}} + T_{\text{BWPswitchDelayRRC}} + D_{\text{RRC}} \cdot (M-1)$  as defined in clause 8.6.3A.3.

Besides, in asynchronous scenario the UE is allowed an additional interrupt of 1 slot length.

#### 8.2.4.2.6 Interruptions at transitions between active and non-active during DRX

When PCell is in non-DRX and PSCell is in DRX, interruptions on PCell and the activated SCell in MCG if configured due to transitions from active to non-active and from non-active to active during PSCell DRX are allowed with up to 1% probability of missed ACK/NACK when the configured PSCell DRX cycle is less than 640 ms, and 0.625% probability of missed ACK/NACK is allowed when the configured PSCell DRX cycle is 640 ms or longer. Each interruption shall not exceed X slot as defined in table 8.2.4.2.6-1.



When PSCell is in non-DRX and PCell is in DRX, interruptions on PSCell on the activated SCell in SCG if configured due to transitions from active to non-active and from non-active to active during PCell DRX are allowed with up to 1 % probability of missed ACK/NACK when the configured PCell DRX cycle is less than 640 ms, and 0.625% probability of missed ACK/NACK is allowed when the configured PCell DRX cycle is 640 ms or longer. Each interruption shall not exceed X slot as defined in table 8.2.4.2.6-1.

**Table 8.2.4.2.6-1: Interruption length X at transition between active and non-active during DRX**

$\mu$	NR Slot length (ms)	Interruption length X (slots)	
		Sync	Async
0	1	1	2
1	0.5	1	2
2	0.25	3	
3	0.125	5	

When both PCell and PSCell are in DRX, no interruption is allowed.

#### 8.2.4.2.7 Interruptions at transitions from non-DRX to DRX

Interruption on PCell and the activated SCell in MCG if configured due to PSCell transitions from non-DRX to DRX when PCell is in non-DRX shall not exceed X slots as defined in table 8.2.4.2.6-1.

Interruption on PSCell and the activated SCell in SCG if configured due to PCell transitions from non-DRX to DRX when PSCell is in non-DRX shall not exceed X slots as defined in table 8.2.4.2.6-1.

#### 8.2.4.2.8 Interruptions at SCell activation/deactivation with multiple downlink SCells

The requirements in this clause shall apply for the UE configured with NR-DC and up to 1 downlink SCell in FR1 and up to 7 downlink SCell(s) in FR2.

When multiple SCell are activated or deactivated by one single MAC CE command in MCG or SCG:

- an interruption on any serving cell in MCG or SCG is specified as in clause 8.2.4.2.2.

When multiple SCell are activated or deactivated in both MCG and SCG by two MAC CE commands respectively:

- an interruption on any serving cell in MCG is specified as in clause 8.2.4.2.2, and
- an interruption on any serving cell in SCG is specified as in clause 8.2.4.2.2.

#### 8.2.4.2.9 Interruptions at NR SRS carrier based switching

SRS transmission can be configured on a carrier not configured for PUCCH/PUSCH transmission. When a UE needs to transmit periodic, semi-persistent or aperiodic SRS on a carrier of a serving cell not configured for PUCCH/PUSCH transmission, the UE can perform carrier based switching to one or more carriers not configured for PUCCH/PUSCH transmission from a carrier with PUCCH/PUSCH transmission or from a carrier not configured for PUCCH/PUSCH transmission prior to transmitting SRS, provided that:

- switching is from a configured carrier to another activated carrier;
- the carrier of SCells not configured for PUCCH/PUSCH transmission to which SRS carrier based switching is performed is indicated by DCI SRS request field for aperiodic SRS transmission, or indicated by MAC-CE for semi-persistent SRS transmission, or configured via RRC for periodic SRS transmission;
- the serving cell, from which SRS carrier based switching is performed and whose UL transmission may therefore be interrupted, is indicated by srs-SwitchFromServCellIndex and srs-SwitchFromCarrier in TS38.331 [2];
- the SRS switching is not colliding with any other transmission with higher priority defined in TS 38.214 [26].
- the SRS switching is not colliding with any SSB/CSI-RS based L3 measurements and the measurements for RLM/BFD in the same CG.- for UE, which does not support simultaneous reception and transmission for inter-band TDD CA specified in TS 38.331 [2], and is compliant to the requirements for inter-band CA with

uplink in one NR band and without simultaneous Rx/Tx specified in TS 38.101 [5], the SRS transmission are not simultaneously scheduled with DL SSB/CSI-RS for L3 or L1 measurements transmission on other carriers.

The UE shall not perform SRS carrier based switching if the above conditions cannot be met.

When SRS carrier based switching is performed between carriers, the UE is allowed interruptions on any active serving cell if UE is not capable of Per-FR gap, or on active serving cell(s) in FR1 if UE is capable of Per-FR gap, during the switching to the carrier of a serving cell in FR1 not configured for PUCCH/PUSCH transmission,

- with up to X1 slot as specified in Table 8.2.4.2.9-1.

When SRS carrier based switching is performed between carriers, the UE is allowed interruptions on any active serving cell if UE is not capable of Per-FR gap, or on active serving cell(s) in FR2 if UE is capable of Per-FR gap, during the switching to the carrier of a serving cell in FR2 not configured for PUCCH/PUSCH transmission,

- with up to X2 slot as specified in Table 8.2.4.2.9-2.

When SRS carrier based switching is performed between carriers, the UE is allowed interruptions on any active serving cell if UE is not capable of Per-FR gap, or on active serving cell(s) in FR1 if UE is capable of Per-FR gap, during the switching from the carrier of a serving cell in FR1 not configured for PUCCH/PUSCH transmission,

- with up to X1 slot as specified in Table 8.2.4.2.9-1.

When SRS carrier based switching is performed between carriers, the UE is allowed interruptions on any active serving cell if UE is not capable of Per-FR gap, or on active serving cell(s) in FR2 if UE is capable of Per-FR gap, during the switching from the carrier of a serving cell in FR2 not configured for PUCCH/PUSCH transmission,

- with up to X2 slot as specified in Table 8.2.4.2.9-2.

**Table 8.2.4.2.9-1: Interruption length X1 (slot)**

$\mu$	NR Slot length (ms) of victim cell	SRS carrier switching time (us) <sup>Note 1</sup>	Interruption length X1 (slots)	
			Sub carrier spacing for aggressor cell (kHz)	
			15	30
0	1	$\leq 200$	2	2
		300, 500	2	2
		900	3	3
1	0.5	$\leq 200$	3	2
		300, 500	3	3
		900	4	4
2	0.25	$\leq 200$	4	3
		300, 500	5	4
		900	7	6
3	0.125	$\leq 200$	7	5
		300, 500	9	7
		900	12	10
Note1: NR SRS carrier switching time is UE capability indicated by higher layer parameter <i>SRS-SwitchingTimeNR</i> .				

**Table 8.2.4.2.9-2: Interruption length X2 (slot)**

$\mu$	NR Slot length (ms) of victim cell	SRS carrier switching time (us) <sup>Note 1</sup>	Interruption length X2 (slots)	
			Sub carrier spacing for aggressor cell (kHz)	
			60	120
0	1	$\leq 200$	2	2
1	0.5	$\leq 200$	2	2
2	0.25	$\leq 200$	3	3
3	0.125	$\leq 200$	4	4
Note1: NR SRS carrier switching time is UE capability indicated by higher layer parameter <i>SRS-SwitchingTimeNR</i> .				

For intra-band SRS carrier switching in FR1 or FR2, interruptions in Table 8.2.2.2.9-1 and in Table 8.2.2.2.9-2 based on SRS carrier switching time  $\leq 200\mu\text{s}$  shall apply. For inter-band SRS carrier switching in FR1, interruptions in Table 8.2.2.2.9-1 and in Table 8.2.2.2.9-2 shall apply.

#### 8.2.4.2.10 Interruptions at direct SCell activation

When one or multiple SCell(s) are directly activated at SCell addition:

- the UE is allowed an interruption on any active serving cell:
  - of up to the duration shown in Table 8.2.4.2.1-1, if the active serving cell is not in the same band as the SCell being directly activated, where the requirements for Sync apply for synchronous NR-DC, and for asynchronous NR-DC if the active serving cell is in the same CG as the SCell being directly activated, and the requirements for Async apply for asynchronous NR-DC if the active serving cell is not in the same CG as the SCell being directly activated, or
  - of up to the duration shown in Table 8.2.4.2.1-2, if the active serving cells are in the same band as the SCell being directly activated provided the cell specific reference signals from the active serving cells and the SCell being directly activated are available in the same slot.

#### 8.2.4.2.11 Interruptions when identifying CGI of an NR cell with autonomous gaps

When a UE is identifying CGI of an NR cell with autonomous gaps, the UE is allowed interruptions on PCell, PSCell or any activated SCell:

- with up to  $K1$  interruptions with interrupted slots up to interruption length  $X1$  specified in Table 8.2.4.2.11-1 for each interruption during MIB decoding time period  $T_{\text{MIB}}$  (ms) specified in clause 9.11.
- with up to  $L1$  interruptions with interrupted slots up to interruption length  $Y1$  specified in Table 8.2.4.2.11-1 for each interruption during SIB1 decoding time period  $T_{\text{SIB1}}$  (ms) specified in clause 9.11 for SSB and CORESET for RMSI scheduling multiplexing patterns 1.
- with up to  $L2$  interruptions with interrupted slots up to interruption length  $Y2$  specified in Table 8.2.4.2.11-1 for each interruption during SIB1 decoding time period  $T_{\text{SIB1}}$  (ms) specified in clause 9.11 for SSB and CORESET for RMSI scheduling multiplexing patterns 2 and 3.

Where:

- $K1 = 6$  for the target cell carrier frequency on FR1 and  $K1 = 25$  for the target cell carrier frequency on FR2, and
- $L1 = T_{\text{SIB1}}/20$ , and
- $L2 = T_{\text{SIB1}}/T_{\text{SMTC}}$ , where  $T_{\text{SMTC}}$  is the periodicity of the SMTC occasion configured for the target cell carrier .

**Table 8.2.4.2.11-1: Interruption length  $X1$ ,  $Y1$  and  $Y2$  during measurements with autonomous gaps**

$\mu$	NR Slot length (ms) of victim cell	Interruption length $X1$ (slots)	Interruption length $Y1$ (slots)	Interruption length $Y2$ (slots)
0	1	6	7	6
1	0.5	12	13	10
2	0.25	24	25	19
3	0.125	48	49	37

#### 8.2.4.2.12 Interruptions when identifying CGI of an E-UTRA cell with autonomous gaps

When a UE is identifying CGI of an E-UTRA FDD cell or E-UTRA TDD cell with autonomous gaps, within time period  $T_{\text{identify\_CGI\_E-UTRA}}$  specified in clause 9.4.7.1, the UE shall be able to transmit at least the number of ACK/NACKS specified in Table 8.2.4.2.12-1 on PCell, PSCell or any activated SCell in the frequency range where autonomous gaps are used, provided that:

- there is continuous DL data allocation,

- no DRX cycle is used,
- no measurement gaps are configured,
- only one code word is transmitted in each slot,
- 2 slot ACK/NACK feedback is configured,
- 20 ms SMTC period is configured.

**Table 8.2.4.2.12-1: Minimum number of ACK/NACKs transmitted by the UE during  $T_{\text{identify\_CGI, E-UTRA}}$**

Minimum number of transmitted ACK/NACKs	Configuration of the serving cell in which the transmitted ACK/NACKs are counted	
	Duplex mode configuration	SCS
84	FDD	15 kHz
193	FDD	30 kHz
402	FDD	60 kHz
28	TDD <sup>Note 1</sup>	15 kHz
81	TDD <sup>Note 1</sup>	30 kHz
159	TDD <sup>Note 1</sup>	60 kHz
233	TDD <sup>Note 2</sup>	60 kHz
491	TDD <sup>Note 2</sup>	120 kHz

NOTE 1: TDD UL-DL configuration is as specified in Table A.3.3.1-1 of TS 38.101-1 [18].  
NOTE 2: TDD UL-DL configuration is as specified in Table A.3.3.1-1 of TS 38.101-2 [19].

### 8.2.4.2.13 Interruptions due to SCell dormancy

#### 8.2.4.2.13.1 Interruptions due to SCell dormancy switch

When one SCell in MCG or SCG is switched from dormancy to non-dormancy or from non-dormancy to dormancy [7] when UE is in DRX active time,

- the UE is allowed an interruption on active serving cell in MCG and SCG as defined in clause 8.2.4.2.5, except that the interruption is allowed regardless of which parameters change between the dormant BWP and the non-dormant BWP
- The starting time of interruption shall be within the dormancy switching delay as defined in clause 8.6.2.

When multiple SCells in MCG or SCG are switched from dormancy to non-dormancy or vice versa when the UE is in DRX active time, the interruption requirement described above applies for each BWP switch.

#### 8.2.4.2.13.2 Interruptions due to CQI measurements during SCell dormancy

When one or more SCells are in dormancy, the UE is for the purpose of CQI measurements on the dormant SCell(s) allowed to cause interruptions to non-dormant serving cell(s).

The rate of ACK/NACK feedback loss on any non-dormant serving cell resulting from CQI measurements on dormant SCells shall not exceed 0.5%.

#### 8.2.4.2.13.3 Interruptions due to RRM measurements during SCell dormancy

When one or more SCells are in dormancy, the UE is for the purpose of RRM measurements on the dormant SCell(s) allowed to cause interruptions to non-dormant serving cell(s).

The rate of ACK/NACK feedback loss on any non-dormant serving cell resulting from RRM measurements on dormant SCells shall not exceed 1.0%.

#### 8.2.4.2.14 Interruptions due to UE-specific CBW change

The requirements in clause 8.2.1.2.11 apply for this clause.

8.2.4.2A Void

8.2.4.2A.1 Void

8.2.4.2A.2 Void

8.2.4.2A.3 Void

## 8.3 SCell Activation and Deactivation Delay

### 8.3.1 Introduction

This clause defines requirements for the delay within which the UE shall be able to activate at least one deactivated SCell and deactivate at least one activated SCell in EN-DC, or in standalone NR carrier aggregation, or in NE-DC, or in NR-DC.

The requirements shall apply for EN-DC, standalone NR carrier aggregation, NE-DC, and NR-DC.

### 8.3.2 SCell Activation Delay Requirement for Deactivated SCell

The requirements in this clause shall apply for the UE configured with at least one downlink SCell in EN-DC, or in standalone NR carrier aggregation or in NE-DC or in NR-DC and when one SCell is being activated.

The delay within which the UE shall be able to activate the deactivated SCell depends upon the specified conditions.

Upon receiving SCell activation command in slot  $n$ , the UE shall be capable to transmit valid CSI report and apply actions related to the activation command for the SCell being activated no later than in slot  $n +$

$\frac{T_{\text{HARQ}} + T_{\text{activation\_time}} + T_{\text{CSI\_Reporting}}}{\text{NR slot length}}$ , where:

$T_{\text{HARQ}}$  (in ms) is the timing between DL data transmission and acknowledgement as specified in TS 38.213 [3]

$T_{\text{activation\_time}}$  is the SCell activation delay in millisecond.

If the SCell is known and belongs to FR1,  $T_{\text{activation\_time}}$  is:

- $T_{\text{FirstSSB}} + 5\text{ms}$ , if the measurement period of the SCell being activated is equal to or smaller than 2400ms.
- $T_{\text{FirstSSB\_MAX}} + T_{\text{rs}} + 5\text{ms}$ , if the measurement period of the SCell being activated is larger than 2400ms.

If the SCell is unknown and belongs to FR1, and if one of the following conditions is met

- 'ssb-PositionInBurst' indicates only one SSB is being actually transmitted, or
- 'ssb-PositionInBurst' indicates multiple SSBs and TCI indication is provided in same MAC PDU with SCell activation,

provided that the side condition  $\hat{E}_s/I_{ot} \geq -2\text{dB}$  is fulfilled,  $T_{\text{activation\_time}}$  is:

- $T_{\text{FirstSSB\_MAX}} + T_{\text{SMTC\_MAX}} + T_{\text{rs}} + 5\text{ms}$ , if the following conditions are met,
  - the SCell is contiguous to an active serving cell in the same band, and
  - its *ssb-PositionInBurst* is same as the one of contiguous FR1 active serving cell, and
  - its SMTC offset is same as the one of contiguous FR1 active serving cell, and

- its RTD with contiguous FR1 active serving cell is smaller than or equal to 260ns, and its reception power difference with contiguous FR1 active serving cell is smaller than or equal to 6dB;
- $T_{\text{FirstSSB\_MAX}} + T_{\text{SMTC\_MAX}} + 2 \cdot T_{\text{rs}} + 5\text{ms}$ , otherwise.

otherwise, provided that the side condition  $\hat{E}_s/\text{Iot} \geq -2\text{dB}$  is fulfilled,  $T_{\text{activation\_time}}$  is:

- $6\text{ms} + T_{\text{FirstSSB\_MAX}} + T_{\text{SMTC\_MAX}} + T_{\text{rs}} + T_{\text{L1-RSRP,measure}} + T_{\text{L1-RSRP,report}} + T_{\text{HARQ}} + \max(T_{\text{uncertainty\_MAC}} + T_{\text{FineTiming}} + 2\text{ms}, T_{\text{uncertainty\_SP}})$ , if semi-persistent CSI-RS is used for CSI reporting,
- $3\text{ms} + T_{\text{FirstSSB\_MAX}} + T_{\text{SMTC\_MAX}} + T_{\text{rs}} + T_{\text{L1-RSRP,measure}} + T_{\text{L1-RSRP,report}} + \max(T_{\text{HARQ}} + T_{\text{uncertainty\_MAC}} + 5\text{ms} + T_{\text{FineTiming}}, T_{\text{uncertainty\_RRC}} + T_{\text{RRC\_delay}})$ , if periodic CSI-RS is used for CSI reporting.
- However, when the following conditions are fulfilled, no activation requirement will be applied for this unknown SCell:
  - the SCell is contiguous to an active serving cell in the same band, and
  - A single SSB is used in the unknown SCell; or multiple SSBs are used in the SCell and TCI state indication for PDCCH is provided by the same MAC PDU used for SCell activation; and
  - its *ssb-PositionInBurst* is same as the one of contiguous FR1 active serving cell, and
  - its SMTC offset is same as the one of contiguous FR1 active serving cell
  - its RTD with contiguous FR1 active serving cell is larger than, or its reception power difference with contiguous FR1 active serving cell is larger than 6dB;
- If the SCell being activated belongs to FR1 and if there is at least one active serving cell contiguous to the SCell on that FR1 band, if the UE is not provided with SSB configuration (*absoluteFrequencySSB*) nor SMTC configuration for the target SCell,  $T_{\text{activation\_time}}$  is 3 ms for UE supporting *scellWithoutSSB*, provided
  - The RTD between the target SCell and the contiguous active serving cell is within within  $\pm 260\text{ns}$ , and
  - The difference of the reception power with the contiguous active serving cell is  $\leq 6\text{dB}$ , and
  - The RS(s) of SCell being activated is (are) QCL-TypeA with TRS(s) of the SCell being activated, and the TRS(s) of the SCell being activated is (are) further QCL-TypeC with SSB(s) of any active serving cell that is contiguous to the SCell being activated on that FR1 band.

If the SCell being activated belongs to FR2 and if there is at least one active serving cell on that FR2 band, then  $T_{\text{activation\_time}}$  is  $T_{\text{FirstSSB}} + 5\text{ms}$  provided:

- The UE is provided with SMTC for the target SCell, and
- The SSBs in the serving cell(s) and the SSBs in the SCell fulfil the condition defined in clause 3.6.3, and
- The parameter *ssb-PositionsInBurst* is same for the serving cell(s) and the SCell, and
- SSB is in the same half-frame on the SCell and the contiguous FR2 active serving cell.

If the SCell being activated belongs to FR2 and if there is at least one active serving cell on that FR2 band, if the UE supporting *scellWithoutSSB* is not provided with any SMTC for the target SCell,  $T_{\text{activation\_time}}$  is 3 ms, provided

- the RS (s) of SCell being activated is (are) QCL-TypeD with RS (s) of one active serving cell on that FR2 band.

If the SCell being activated belongs to FR2 and if there is no active serving cell on that FR2 band provided that PCell or PSCell is in FR1 or in FR2:

If the target SCell is known to UE and semi-persistent CSI-RS is used for CSI reporting, then  $T_{\text{activation\_time}}$  is:

- $3\text{ms} + \max(T_{\text{uncertainty\_MAC}} + T_{\text{FineTiming}} + 2\text{ms}, T_{\text{uncertainty\_SP}})$ , where  $T_{\text{uncertainty\_MAC}}=0$  and  $T_{\text{uncertainty\_SP}}=0$  if UE receives the SCell activation command, semi-persistent CSI-RS activation command and TCI state activation command at the same time.

If the target SCell is known to UE and periodic CSI-RS is used for CSI reporting, then  $T_{\text{activation\_time}}$  is:

- $\max(T_{\text{uncertainty\_MAC}} + 5\text{ms} + T_{\text{FineTiming}}, T_{\text{uncertainty\_RRC}} + T_{\text{RRC\_delay}} - T_{\text{HARQ}})$ , where  $T_{\text{uncertainty\_MAC}}=0$  if UE receives the SCell activation command and TCI state activation commands at the same time.

If the PCell/PSCell and the target SCell are configured as FR1-FR2 CA or if the PCell/PSCell and the target SCell are in a FR2 band pair with independent beam management, and the target SCell is unknown to UE and semi-persistent CSI-RS is used for CSI reporting, provided that the side condition  $\hat{E}_s/\text{Tot} \geq -2\text{dB}$  is fulfilled, then  $T_{\text{activation\_time}}$  is:

- $6\text{ms} + T_{\text{FirstSSB\_MAX}} + 15 * T_{\text{SMTC\_MAX}} + 8 * T_{\text{TS}} + T_{\text{L1-RSRP, measure}} + T_{\text{L1-RSRP, report}} + T_{\text{HARQ}} + \max(T_{\text{uncertainty\_MAC}} + T_{\text{FineTiming}} + 2\text{ms}, T_{\text{uncertainty\_SP}})$ .

If the PCell/PSCell and the target SCell are configured as FR1-FR2 CA or if the PCell/PSCell and the target SCell are in a FR2 band pair with independent beam management, and the target SCell is unknown to UE and periodic CSI-RS is used for CSI reporting, provided that the side condition  $\hat{E}_s/\text{Tot} \geq -2\text{dB}$  is fulfilled, then  $T_{\text{activation\_time}}$  is:

- $3\text{ms} + T_{\text{FirstSSB\_MAX}} + 15 * T_{\text{SMTC\_MAX}} + 8 * T_{\text{TS}} + T_{\text{L1-RSRP, measure}} + T_{\text{L1-RSRP, report}} + \max\{(T_{\text{HARQ}} + T_{\text{uncertainty\_MAC}} + 5\text{ms} + T_{\text{FineTiming}}), (T_{\text{uncertainty\_RRC}} + T_{\text{RRC\_delay}})\}$ .

where,

$T_{\text{SMTC\_MAX}}$ :

- In FR1, in case of intra-band SCell activation,  $T_{\text{SMTC\_MAX}}$  is the longer SMTC periodicity between active serving cells and SCell being activated provided the cell specific reference signals from the active serving cells and the SCells being activated or released are available in the same slot; in case of inter-band SCell activation,  $T_{\text{SMTC\_MAX}}$  is the SMTC periodicity of SCell being activated.
- In FR2, in case of intra-band SCell activation,  $T_{\text{SMTC\_MAX}}$  is the longer SMTC periodicity between active serving cells and SCell being activated provided that in Rel-15 only support FR2 intra-band CA; in case of FR2 inter-band SCell activation,  $T_{\text{SMTC\_MAX}}$  is the SMTC periodicity of SCell being activated.
- $T_{\text{SMTC\_MAX}}$  is bounded to a minimum value of 10ms.

$T_{\text{TS}}$  is the SMTC periodicity of the SCell being activated if the UE has been provided with an SMTC configuration for the SCell in SCell addition message, otherwise  $T_{\text{TS}}$  is the SMTC configured in the measObjectNR having the same SSB frequency and subcarrier spacing. If the measObjectNRs having the same SSB frequency and subcarrier spacing configured by MN and SN have different SMTC,  $T_{\text{TS}}$  is the periodicity of one of the SMTC which is up to UE implementation. If the UE is not provided SMTC configuration or measurement object on this frequency, the requirement which involves  $T_{\text{TS}}$  is applied with  $T_{\text{TS}} = 5\text{ms}$  assuming the SSB transmission periodicity is 5ms. There are no requirements if the SSB transmission periodicity is not 5ms.

$T_{\text{FirstSSB}}$ : is the time to the end of the first complete SSB burst indicated by the SMTC, or within 5ms if SMTC is not configured, after slot  $n + \frac{T_{\text{HARQ}} + 3\text{ms}}{\text{NR slot length}}$ .

$T_{\text{FirstSSB\_MAX}}$ : Is the time to the end of the first complete SSB burst indicated by the SMTC, or within 5ms if SMTC is not configured, after slot  $n + \frac{T_{\text{HARQ}} + 3\text{ms}}{\text{NR slot length}}$ , further fulfilling:

- In FR1, in case of intra-band SCell activation, the occasion when all active serving cells and SCells being activated or released are transmitting SSB bursts in the same slot; in case of inter-band SCell activation, the first occasion when the SCell being activated is transmitting SSB burst.
- In FR2, the occasion when all active serving cells and SCells being activated or released are transmitting SSB bursts in the same slot.

$T_{\text{FineTiming}}$  is the time period between UE finish processing the last activation command for PDCCH TCI, PDSCH TCI (when applicable) and the timing of first complete available SSB corresponding to the TCI state.

$T_{\text{L1-RSRP, measure}}$  is L1-RSRP measurement delay  $T_{\text{L1-RSRP\_Measurement\_Period\_SSB}}$  ms or  $T_{\text{L1-RSRP\_Measurement\_Period\_CSI-RS}}$  based on applicability as defined in clause 9.5 assuming  $M=1$  and  $T_{\text{Report}}=0$ .

$T_{L1\text{-RSRP, report}}$  is delay of acquiring CSI reporting resources.

$T_{\text{uncertainty\_MAC}}$  is the time period between reception of the last activation command for PDCCH TCI, PDSCH TCI (when applicable) relative to

- SCell activation command for known case;
- First valid L1-RSRP reporting for unknown case.

$T_{\text{uncertainty\_RRC}}$  is the time period between reception of the RRC configuration message for TCI of periodic CSI-RS for CQI reporting (when applicable) relative to

- SCell activation command for known case;
- First valid L1-RSRP reporting for unknown case.

$T_{\text{uncertainty\_SP}}$  is the time period between reception of the activation command for semi-persistent CSI-RS resource set for CQI reporting relative to

- SCell activation command for known case;
- First valid L1-RSRP reporting for unknown case.

$T_{\text{RRC\_delay}}$  is the RRC procedure delay as specified in TS38.331 [2].

Longer delays for RRM measurement requirements, and in case of FR2 also SSB based RLM/BFD/CBD/L1-RSRP measurement requirements, can be expected during the cell detection time for unknown SCell activation.

When *absoluteFrequencySSB* is not configured in *DownlinkConfigCommon* for target SCell but *SMTTC* for target SCell is configured, no requirement would be applied.

$T_{\text{CSI\_reporting}}$  is the delay (in ms) including uncertainty in acquiring the first available downlink CSI reference resource, UE processing time for CSI reporting and uncertainty in acquiring the first available CSI reporting resources as specified in TS 38.331 [2].

SCell in FR1 is known if it has been meeting the following conditions:

- During the period equal to  $\max(5 \cdot \text{measCycleSCell}, 5 \cdot \text{DRX cycles})$  for FR1 before the reception of the SCell activation command:
  - the UE has sent a valid measurement report for the SCell being activated and
  - the SSB measured remains detectable according to the cell identification conditions specified in clause 9.2 and 9.3.
- the SSB measured during the period equal to  $\max(5 \cdot \text{measCycleSCell}, 5 \cdot \text{DRX cycles})$  also remains detectable during the SCell activation delay according to the cell identification conditions specified in clause 9.2 and 9.3.

Otherwise SCell in FR1 is unknown.

For the first SCell activation in FR2 bands, the SCell is known if it has been meeting the following conditions:

- During the period equal to 4s for UE supporting power class1 and 3s for UE supporting power class 2/3/4 before UE receives the last activation command for PDCCH TCI, PDSCH TCI (when applicable) and semi-persistent CSI-RS for CQI reporting (when applicable):
  - the UE has sent a valid L3-RSRP measurement report with SSB index, and
  - SCell activation command is received after L3-RSRP reporting and no later than the time when UE receives MAC-CE command for TCI activation
- During the period from L3-RSRP reporting to the valid CQI reporting, the reported SSBs with indexes remain detectable according to the cell identification conditions specified in clauses 9.2 and 9.3, and the TCI state is selected based on one of the latest reported SSB indexes.



Otherwise, the first SCell in FR2 band is unknown. The requirement for unknown SCell applies provided that the activation commands for PDCCH TCI, PDSCH TCI (when applicable), semi-persistent CSI-RS for CQI reporting (when applicable), and configuration message for TCI of periodic CSI-RS for CQI reporting (when applicable) are based on the latest valid L1-RSRP reporting.

If the UE has been provided with higher layer in TS 38.331 [2] signaling of *smtc2* prior to the activation command,  $T_{\text{SMTc\_Scell}}$  follows *smtc1* or *smtc2* according to the physical cell ID of the target cell being activated.  $T_{\text{SMTc\_MAX}}$  follows *smtc1* or *smtc2* according to the physical cell IDs of the target cells being activated and the active serving cells.

In addition to CSI reporting defined above, UE shall also apply other actions related to the activation command specified in TS 38.331 [2] for a SCell at the first opportunities for the corresponding actions once the SCell is activated.

The starting point of an interruption window on spCell or any activated SCell, as specified in clause 8.2, shall not occur before slot  $n+1+\frac{T_{\text{HARQ}}}{\text{NR slot length}}$  and not occur after slot  $n+1+\frac{T_{\text{HARQ}}+3\text{ms}+T_{\text{X}}}{\text{NR slot length}}$ , where NR slot length is with respect to the numerology used in the SCell being activated, and  $T_{\text{X}}$  is:

- 0, if  $T_{\text{activation\_time}}$  is 3ms
- $T_{\text{FirstSSB}}$ , for any scenario where  $T_{\text{activation\_time}}$  includes  $T_{\text{FirstSSB}}$ ;
- $T_{\text{FirstSSB\_MAX}}$ , for any scenario where  $T_{\text{activation\_time}}$  includes  $T_{\text{FirstSSB\_MAX}}$ ;
- $T_{\text{uncertainty\_MAC}} + T_{\text{FineTiming}}$ , for any scenario where  $T_{\text{activation\_time}}$  includes only  $T_{\text{FineTiming}}$  and no  $T_{\text{FirstSSB\_MAX}}$ .

The length of the interruption window may be different for different victim cells, and depends on the applicable scenario and on the frequency band relation between the aggressor cell and the victim cell.

The requirements in this clause and requirements on interruption due to SCell activation in clause 8.2 apply provided that the SSB of the to-be-activated SCell is within the first active DL BWP of the SCell.

Starting from slot  $n + T_{\text{HARQ}} + 3$  ms where slot  $n$  is the slot where SCell activation command is received (as specified in clause 4.3 of TS 38.213 [3]) and until the SCell activation completion at UE, after at least one CSI-RS transmission occasion for the channel measurement and reporting (specified in clause 5.2.2.5 of TS 38.214 [26]), the UE shall report out of range if the UE has available uplink resources to report CQI for the SCell.

Starting from the slot specified in clause 4.3 of TS 38.213 [3] (timing for secondary Cell activation/deactivation) and until the UE has completed a first L1-RSRP measurement, the UE shall report lowest valid L1 SS-RSRP range if the UE has available uplink resources to report L1-RSRP for the SCell.

### 8.3.3 SCell Deactivation Delay Requirement for Activated SCell

The requirements in this clause shall apply for the UE configured with at least one downlink SCell in EN-DC, or in standalone NR carrier aggregation or in NE-DC or in NR-DC and when one SCell is being deactivated.

Upon receiving SCell deactivation command in slot  $n$ , the UE shall accomplish the deactivation actions for the SCell being deactivated no later than in slot  $n + \frac{T_{\text{HARQ}}+3\text{ms}}{\text{NR slot length}}$ . The starting point of an interruption window on spCell or any activated SCell, as specified in clause 8.2, shall not occur before slot  $n+1+\frac{T_{\text{HARQ}}}{\text{NR slot length}}$  and not occur after slot  $n+1+\frac{T_{\text{HARQ}}+3\text{ms}}{\text{NR slot length}}$ , where NR slot length is with respect to the numerology used in the SCell being deactivated.

Upon expiry of the *sCellDeactivationTimer* in slot  $n$ , the UE shall accomplish the deactivation actions for the SCell being deactivated no later than in slot  $n + \frac{3\text{ms}}{\text{NR slot length}}$ . The starting point of an interruption window on spCell or any activated SCell, as specified in clause 8.2, shall not occur before slot  $n+1$  and not occur after slot  $n+1+\frac{3\text{ms}}{\text{NR slot length}}$ , where NR slot length is with respect to the numerology used in the SCell being deactivated.

The length of the interruption window may be different for different victim cells, and depends on the applicable scenario and on the frequency band relation between the aggressor cell and the victim cell.

### 8.3.4 Direct SCell Activation at SCell addition

The requirements in this clause apply for UE being configured in the RRC reconfiguration message, TS 38.331 [2], with one SCell for which the parameter *sCellState* is set to *activated*. If the RRC reconfiguration message for direct SCell activation also configures PSCell addition or PSCell change, the direct SCell activation delay may be longer than the requirements defined in this clause.

The UE shall configure the SCell in activated state upon successful completion of the RRC reconfiguration procedure within the specified delay. The UE shall be capable to transmit valid CSI report and apply actions for the directly activated SCell no later than in slot  $n + \frac{N_{direct}}{NR\ slot\ length}$ ,

where:

- Slot  $n$  is the last slot overlapping with the PDSCH containing the RRC reconfiguration message,
- $N_{direct} = T_{RRC\_Process} + T_1 + T_{activation\_time} + T_{CSI\_Reporting} - 3ms$  for the cases specified in clause 8.3.2 that TCI state is not indicated within  $T_{activation\_time}$ ; otherwise,  $N_{direct} = T_{RRC\_Process} + T_1 + T_{HARQ} + T_{activation\_time} + T_{CSI\_Reporting}$
- $T_{RRC\_Process}$ : RRC procedure delay as specified in clause 11.2 of TS 36.331 [16] if the corresponding RRC message is embedded in E-UTRA RRC message, otherwise it is the RRC procedure delay defined in clause 12 of TS 38.331 [2],
- $T_1$ : Delay from slot  $n + \frac{T_{RRC\_Process}}{NR\ slot\ length}$  until the transmission of *RRCReconfigurationComplete* message,

Note:  $T_1$  is UE implementation dependent.

- $T_{HARQ}$  (in ms) is the timing between DL data transmission and acknowledgement as specified in TS 38.213 [3],
- If the SCell is known and belongs to FR1,  $T_{CSI\_Reporting}$  is specified in clause 8.3.2 and  $T_{activation\_time}$  is defined as:
  - $T_{FirstSSB} + 5ms$ , if the measurement period of the SCell being activated is equal to or smaller than 2400ms.
  - $T_{FirstSSB\_MAX} + T_{rs} + 5ms$ , if measurement period of the SCell being activated is larger than 2400ms.

where,

the measurement period in Table 9.2.5.2-1 applies if the target SCell was in an intra-frequency layer corresponding to an activated SCell;

the measurement period in Table 9.2.5.2-3 applies if the target SCell was in an intra-frequency layer corresponding to a deactivated SCell;

the measurement period in Table 9.3.5-1 applies if the target SCell was in an inter-frequency layer.

- Otherwise,  $T_{activation\_time}$  and  $T_{CSI\_Reporting}$  are specified in clause 8.3.2, where the following definitions of  $T_{FirstSSB}$  and  $T_{FirstSSB\_MAX}$  shall override the existing ones:
  - $T_{FirstSSB}$ : the time to the end of the first complete SSB burst indicated by the SMTC after slot  $n + \frac{T_{RRC\_Process} + T_1}{NR\ slot\ length}$
  - $T_{FirstSSB\_MAX}$ : the time to the end of the first complete SSB burst indicated by the SMTC after slot  $n + \frac{T_{RRC\_Process} + T_1}{NR\ slot\ length}$ 
    - In FR1, in case of intra-band SCell activation, the occasion when all active serving cells and SCells being activated or released are transmitting SSB bursts in the same slot; in case of inter-band SCell activation, the first occasion when the SCell being activated is transmitting SSB burst.
    - In FR2, the occasion when all active serving cells and SCells being activated or released are transmitting SSB bursts in the same slot.

In addition to CSI reporting defined above, UE shall also apply other actions related to the activation command specified in TS38.321 [7] for an SCell at the first opportunities for the corresponding actions once the SCell is activated.

The SCell in FR1 is known provided the following conditions are met for the SCell:

- During the last 5 seconds before the reception of the direct SCell configuration command:
  - the UE has sent a valid measurement report for the SCell being directly activated, and
  - the SSB measured remains detectable according to the cell identification conditions specified in sections 9.2 and 9.3,
- the SSB measured during the period equal to [5] seconds also remains detectable during the SCell activation delay according to the cell identification conditions specified in clause 9.2 and 9.3.

Otherwise, the SCell is unknown.

The SCell in FR2 is known provided it meets the corresponding conditions as defined in clause 8.3.2. Otherwise, the SCell is unknown.

The UE may be allowed to cause interruptions to serving cells on other component carriers during an interruption window, as specified in clause 8.2. The starting point of an interruption window on spCell or any activated SCell shall not occur before slot  $n+1$ , and shall not occur after slot  $n+1 + \frac{T_{RRC\_Process} + T_1 + T_X}{NR\ slot\ length}$ , where NR slot length is with respect to the numerology of the SCell being activated, and  $T_X$  is:

- $T_{FirstSSB}$ , for any scenario where  $T_{activation\_time}$  includes  $T_{FirstSSB}$ ;
- $T_{FirstSSB\_MAX}$ , for any scenario where  $T_{activation\_time}$  includes  $T_{FirstSSB\_MAX}$ ;
- $T_{uncertainty\_MAC} + T_{FineTiming}$ , for any scenario where  $T_{activation\_time}$  includes  $T_{FineTiming}$ .

The length of the interruption window may be different for different victim cells, and depends on the applicable scenario and on the frequency band relation between the aggressor cell and the victim cell.

Starting from the slot  $n + \frac{T_{RRC\_Process} + T_1}{NR\ slot\ length}$  until the UE has completed the direct SCell activation, the UE shall report CQI index = 0 (out of range) if the UE has available uplink resources to report CQI for the SCell.

### 8.3.5 Direct SCell Activation at Handover

The requirements in this clause apply for UE being configured in the RRC reconfiguration message, TS 38.331 [2], for handover with one SCell for which the parameter *sCellState* is set to *activated*.

The UE shall configure the SCell in activated state upon successful completion of the RRC reconfiguration procedure within the specified delay. The UE shall be capable to transmit valid CSI report and apply actions for the directly activated SCell no later than in slot  $n + \frac{N_{direct}}{NR\ slot\ length}$ ,

Where:

- Slot  $n$  is the last slot overlapping with the PDSCH containing RRC reconfiguration message.
- $N_{direct} = T_{RRC\_process} + T_{interrupt} + T_2 + T_3 + T_{activation\_time} + T_{CSI\_Reporting} - 3ms$  for the cases specified in clause 8.3.2 that TCI state is not indicated within  $T_{activation\_time}$ ; otherwise,  $N_{direct} = T_{RRC\_process} + T_{interrupt} + T_2 + T_3 + T_{HARQ} + T_{activation\_time} + T_{CSI\_Reporting}$
- $T_{RRC\_Process}$ : RRC procedure delay as specified in clause 11.2 of TS 36.331 [16] if the corresponding RRC message is embedded in E-UTRA RRC message, otherwise it is the RRC procedure delay defined in clause 12 of TS 38.331 [2],
- $T_{interrupt}$ : Interruption time during handover as specified in clause 6.1.1,
- $T_2$ : Delay from slot  $n + \frac{T_{RRC\_Process} + T_{interrupt}}{NR\ slot\ length}$  until UE has obtained a valid TA command for the target PCell,
- $T_3$ : Delay for applying the received TA for uplink transmission in the target PCell, and greater than or equal to  $k+1$  slot, where  $k$  is defined in clause 4.2 in TS 38.213,
- $T_{HARQ}$  (in ms) is the timing between DL data transmission and acknowledgement as specified in TS 38.213 [3],

- If the SCell is configured as deactivated SCell before handover,  $T_{CSI\_Reporting}$  is specified in clause 8.3.2 and  $T_{activation\_time}$  is defined as:
  - $T_{FirstSSB} + 5\text{ms}$ , if the measurement period of the SCell being activated is equal to or smaller than [2400ms].
  - $T_{FirstSSB\_MAX} + T_{rs} + 5\text{ms}$ , if the measurement period of the SCell being activated is larger than [2400ms].
- If the SCell is not configured as deactivated SCell but known and belongs to FR1,  $T_{CSI\_Reporting}$  is specified in clause 8.3.2 and  $T_{activation\_time}$  is defined as:
  - $T_{FirstSSB} + 5\text{ms}$ , if the measurement period of the SCell being activated is equal to or smaller than [2400ms].
  - $T_{FirstSSB\_MAX} + T_{rs} + 5\text{ms}$ , if measurement period of the SCell being activated is larger than [2400ms].

where,

the measurement period in Table 9.2.5.2-1 applies if the target SCell was in an intra-frequency layer corresponding to an activated SCell;

the measurement period in Table 9.2.5.2-3 applies if the target SCell was in an intra-frequency layer corresponding to a deactivated SCell;

the measurement period in Table 9.3.5-1 applies if the target SCell was in an inter-frequency layer.

- Otherwise,  $T_{activation\_time}$  and  $T_{CSI\_Reporting}$  are specified in clause 8.3.2, where the following definitions of  $T_{FirstSSB}$  and

$T_{FirstSSB\_MAX}$  shall override the existing ones:

- $T_{FirstSSB}$ : the time to the end of the first complete SSB burst indicated by the SMTC after slot  $n + \frac{T_{RRC\_Process} + T_{interrupt} + T_2 + T_3}{NR\ slot\ length}$
- $T_{FirstSSB\_MAX}$ : the time to the end of the first complete SSB burst indicated by the SMTC after slot  $n + \frac{T_{RRC\_Process} + T_{interrupt} + T_2 + T_3}{NR\ slot\ length}$ 
  - In FR1, in case of intra-band SCell activation, the occasion when all active serving cells and SCells being activated or released are transmitting SSB bursts in the same slot; in case of inter-band SCell activation, the first occasion when the SCell being activated is transmitting SSB burst.
  - In FR2, the occasion when all active serving cells and SCells being activated or released are transmitting SSB bursts in the same slot.

In addition to CSI reporting defined above, UE shall also apply other actions related to the activation command specified in TS 38.321 [7] for an SCell at the first opportunities for the corresponding actions once the SCell is activated.

The SCell in FR1 is known provided the following conditions are met for the SCell:

- During the last 5 seconds before the reception of the direct SCell configuration command:
  - the UE has sent a valid measurement report for the SCell being directly activated, and
  - the SSB measured remains detectable according to the cell identification conditions specified in sections 9.2 and 9.3,
- the SSB measured during the period equal to [5] seconds also remains detectable during the SCell activation delay according to the cell identification conditions specified in clause 9.2 and 9.3.

Otherwise, the SCell is unknown.

The SCell in FR2 is known provided it meets the corresponding conditions as defined in clause 8.3.2. Otherwise, the SCell is unknown.

The UE may be allowed to cause interruptions to PCell during an interruption window, as specified in clause 8.2. The starting point of an interruption window on PCell shall not occur before slot  $n+1 + \frac{T_{RRC\ Processing} + T_{interrupt} + T_2 + T_3}{NR\ slot\ length}$ , and not occur after slot  $n+1 + \frac{T_{RRC\ Processing} + T_{interrupt} + T_2 + T_3 + T_X}{NR\ slot\ length}$ , where NR slot length is with respect to the numerology of the SCell being activated, and  $T_X$  is:

- $T_{FirstSSB}$ , for any scenario where  $T_{activation\_time}$  includes  $T_{FirstSSB}$ ;
- $T_{FirstSSB\_MAX}$ , for any scenario where  $T_{activation\_time}$  includes  $T_{FirstSSB\_MAX}$ ;
- $T_{uncertainty\_MAC} + T_{FineTiming}$ , for any scenario where  $T_{activation\_time}$  includes  $T_{FineTiming}$ .

The length of the interruption window depends on the frequency band relation between the aggressor SCell and the victim PCell.

Starting from the slot  $n + \frac{T_{RRC\_Process} + T_{interrupt} + T_2 + T_3}{NR\ slot\ length}$  and until the UE has completed the direct SCell activation, the UE shall report CQI index = 0 (out of range) if the UE has available uplink resources to report CQI for the SCell.

### 8.3.6 Direct SCell Activation at RRCResume

The requirements in this clause apply for UE being configured in the RRC reconfiguration message in TS38.331 [2] for RRC Resume with one SCell for which the parameter  $sCellState$  is set to *activated*.

The requirements in clause 8.3.4 shall apply, except that the definition of  $T_I$  shall be deemed to be replaced with

$T_I$ : Delay from slot  $n + \frac{T_{RRC\_Process}}{NR\ slot\ length}$  until the transmission of RRCResumeComplete message,

### 8.3.7 SCell Activation Delay Requirement for Deactivated SCell with Multiple Downlink SCells

The requirements in this clause shall apply for the UE configured with more than one downlink SCells.

In EN-DC, NE-DC, standalone NR carrier aggregation, or in one CG of NR-DC, the requirements in this clause shall apply when the following conditions are met:

- UE only receives one single MAC command for multiple SCell activation within the activation period defined in this clause
- in each single CG, there are no other SCell activation, deactivation, addition or release before activation is completed for all the SCells activated by the single MAC CE in this clause, and
- in EN-DC and NE-DC, there are no E-UTRAN SCell activation, deactivation, addition or release before multiple SCell activation is completed in this clause, and
- any to-be-activated unknown SCell has active serving cell(s) or known to-be-activated SCell(s) on the same band

In two CGs of NR-DC, the requirements in this clause shall apply when the following conditions are met:

- UE receives one MAC command per CG for multiple SCell activation within the activation period defined in this clause, and
- UE supports per-FR measurement gap capability, and
- any to-be-activated unknown SCell has active serving cell(s) or known to-be-activated SCell(s) on the same band

The delay within which the UE shall be able to activate the deactivated SCell with other downlink to-be-activated SCell(s) depends upon the specified conditions.

Upon receiving SCell activation command in slot  $n$  for more than one SCell, for each of the to-be-activated SCell, the UE shall be capable to transmit valid CSI report and apply actions related to the activation command for the SCell being activated no later than in slot  $n + \frac{T_{HARQ} + T_{activation\_time\_multiple\_scells} + T_{CSI\_Reporting}}{NR\ slot\ length}$ , where:

$T_{\text{HARQ}}$  (in ms) is the timing between DL data transmission and acknowledgement as specified in TS 38.213 [3]

$T_{\text{activation\_time\_multiple\_scells}}$  is the target SCell activation delay in millisecond in multiple SCell activation scenario.

If the SCell is known and belongs to FR1 and the measurement period of the SCell being activated is equal to or smaller than [2400ms],  $T_{\text{activation\_time\_multiple\_scells}}$  is:

- $T_{\text{FirstSSB\_MAX\_multiple\_scells}} + T_{\text{rs}} + 5\text{ms}$ , if on the same band UE also has at least one parallel to-be-activated SCell which is FR1 known Scell with the measurement period larger than [2400ms] but does not have any parallel to-be-activated SCell which is FR1 unknown SCell.
- $T_{\text{FirstSSB\_MAX\_multiple\_scells}} + T_{\text{SMTC\_MAX\_multiple\_scells}} + T_{\text{rs}} + 5\text{ms}$ , if on the same band UE also has at least one parallel to-be-activated SCell which is FR1 unknown Scell
- otherwise,  $T_{\text{FirstSSB\_MAX\_multiple\_scells}} + 5\text{ms}$ .

If the SCell is known and belongs to FR1 and the measurement period of the SCell being activated is larger than [2400ms],  $T_{\text{activation\_time\_multiple\_scells}}$  is:

- $T_{\text{FirstSSB\_MAX\_multiple\_scells}} + T_{\text{SMTC\_MAX\_multiple\_scells}} + T_{\text{rs}} + 5\text{ms}$ , if on the same band UE also has at least one parallel to-be-activated SCell which is FR1 unknown Scell
- otherwise,  $T_{\text{FirstSSB\_MAX\_multiple\_scells}} + T_{\text{rs}} + 5\text{ms}$

If the SCell is unknown and belongs to FR1, provided that the side condition  $\hat{E}_s/I_{ot} \geq -2\text{dB}$  is fulfilled,  $T_{\text{activation\_time\_multiple\_scells}}$  is:

- $T_{\text{FirstSSB\_MAX\_multiple\_scells}} + T_{\text{SMTC\_MAX\_multiple\_scells}} + T_{\text{rs}} + 5\text{ms}$ , if the SCell is not counted in  $N_1$
- The activation delay may be longer if SSB is not in the same half-frame on the SCell and the contiguous FR1 known cell or contiguous FR1 active serving cell

otherwise

- if the following conditions are met
  - 'ssb-PositionInBurst' indicates only one SSB is being actually transmitted, or
  - 'ssb-PositionInBurst' indicates multiple SSBs and TCI indication is provided in same MAC PDU with SCell activation,

$T_{\text{activation\_time\_multiple\_scells}}$  is:

- $T_{\text{FirstSSB\_MAX\_multiple\_scells}} + T_{\text{SMTC\_MAX\_multiple\_scells}} + T_{\text{rs}} * N_1 + T_{\text{rs}} + 5\text{ms}$ ,

Otherwise:

$T_{\text{activation\_time\_multiple\_scells}}$  is:

- $6\text{ms} + T_{\text{FirstSSB\_MAX\_multiple\_scells}} + T_{\text{SMTC\_MAX\_multiple\_scells}} + T_{\text{rs}} * N_1 + T_{\text{L1-RSRP,measure}} + T_{\text{L1-RSRP,report}} + T_{\text{HARQ}} + \max(T_{\text{uncertainty\_MAC\_multiple\_scells}} + T_{\text{FineTiming}} + 2\text{ms}, T_{\text{uncertainty\_SP\_multiple\_scells}})$ , if semi-persistent CSI-RS is used for CSI reporting,
- $3\text{ms} + T_{\text{FirstSSB\_MAX\_multiple\_scells}} + T_{\text{SMTC\_MAX\_multiple\_scells}} + T_{\text{rs}} * N_1 + T_{\text{L1-RSRP,measure}} + T_{\text{L1-RSRP,report}} + \max(T_{\text{HARQ}} + T_{\text{uncertainty\_MAC\_multiple\_scells}} + 5\text{ms} + T_{\text{FineTiming}}, T_{\text{uncertainty\_RRC\_multiple\_scells}} + T_{\text{RRC\_delay}})$ , if periodic CSI-RS is used for CSI reporting.

If the SCell being activated belongs to FR1 and if there is at least one active serving cell contiguous to the SCell on that FR1 band, if the UE is not provided with SSB configuration (*absoluteFrequencySSB*) nor SMTC configuration for the target SCell,  $T_{\text{activation\_time\_multiple\_scells}}$  is same as single SCell activation delay requirement as defined in clause 8.3.2.

If the SCell being activated belongs to FR2 and if there is at least one active serving cell on that FR2 band, then  $T_{\text{activation\_time\_multiple\_scells}}$  is same as single SCell activation delay requirement as defined in clause 8.3.2.

If the SCell being activated belongs to FR2 and if there is no active serving cell on that FR2 band provided that PCell or PSCell is FR1:

If the target SCell is known to UE and semi-persistent CSI-RS is used for CSI reporting, then  $T_{\text{activation\_time\_multiple\_scells}}$  is same as single SCell activation delay requirement as defined in clause 8.3.2.

If the target SCell is known to UE and periodic CSI-RS is used for CSI reporting, then  $T_{\text{activation\_time\_multiple\_scells}}$  is same as single SCell activation delay requirement as defined in clause 8.3.2.

If the target SCell is unknown to UE and semi-persistent CSI-RS is used for CSI reporting, provided that the side condition  $\hat{E}_s/I_{ot} \geq -2\text{dB}$  is fulfilled, then  $T_{\text{activation\_time\_multiple\_scells}}$  is:

- $3 \text{ ms} + \max(T_{\text{uncertainty\_MAC\_multiple\_scells}} + T_{\text{FineTiming}} + 2\text{ms}, T_{\text{uncertainty\_SP\_multiple\_scells}})$ , if on the same band UE also has at least one parallel to-be-activated SCell which is FR2 known SCell.  $T_{\text{uncertainty\_MAC\_multiple\_scells}} = 0$  and  $T_{\text{uncertainty\_SP\_multiple\_scells}} = 0$  if UE receives the SCell activation command, semi-persistent CSI-RS activation command and TCI state activation commands at the same time.

If the target SCell is unknown to UE and periodic CSI-RS is used for CSI reporting, provided that the side condition  $\hat{E}_s/I_{ot} \geq -2\text{dB}$  is fulfilled, then  $T_{\text{activation\_time\_multiple\_scells}}$  is:

- $\max(T_{\text{uncertainty\_MAC\_multiple\_scells}} + 5\text{ms} + T_{\text{FineTiming}}, T_{\text{uncertainty\_RRC\_multiple\_scells}} + T_{\text{RRC\_delay}} - T_{\text{HARQ}})$ , if on the same band UE also has at least one parallel to-be-activated SCell which is FR2 known SCell .  $T_{\text{uncertainty\_MAC\_multiple\_scells}} = 0$  if UE receives the SCell activation command and TCI state activation commands at the same time.

The requirements for FR2 unknown SCells apply provided that the parameter *ssb-PositionsInBurst* is same for the SCell and the known serving cell on the same FR2 band. The activation delay FR2 unknown SCell may be longer if SSB is not in the same half-frame on the SCell and the contiguous FR2 known cell.

Where,

$N_1$  is the number counting for parallel FR1 unknown to-be-activated SCell(s) only except the ones which fulfilled the following conditions:

- contiguous to an active serving cell in the same band, or to a known SCell in the same band being activated by the same MAC PDU, and
- A single SSB is used in the unknown SCell; or multiple SSBs are used in the unknown SCell and TCI state indication for PDCCH is provided by the same MAC PDU used for SCell activation; and
- its *ssb-PositionInBurst* is same as the one of contiguous FR1 known cell or contiguous FR1 active serving cell, and
- its RTD with contiguous FR1 known cell or contiguous FR1 active serving cell is smaller than or equal to 260ns and its reception power difference with contiguous FR1 known cell or contiguous FR1 active serving cell is smaller than or equal to 6dB, and
- its SMTC offset is same as the one of contiguous FR1 known cell or contiguous FR1 active serving cell

However, when the following conditions are fulfilled, no activation requirement will be applied for this unknown SCell and other SCells being activated and counted in  $N_1$ :

- contiguous to an active serving cell in the same band, or to a known SCell in the same band being activated by the same MAC PDU, and
- A single SSB is used in the unknown SCell; or multiple SSBs are used in the unknown SCell and TCI state indication for PDCCH is provided by the same MAC PDU used for SCell activation; and
- its *ssb-PositionInBurst* is same as the one of FR1 known cell or FR1 active serving cell, and
- its RTD with contiguous FR1 known cell or contiguous FR1 active serving cell is larger than 260ns or its reception power difference with contiguous FR1 known cell or contiguous FR1 active serving cell is larger than 6dB, and
- its SMTC offset is same as the one of FR1 known cell or FR1 active serving cell

$T_{\text{SMTC\_MAX\_multiple\_scells}}$ :

- In FR1, in case of intra-band SCell activation,  $T_{\text{SMTC\_MAX\_multiple\_scells}}$  is the longest SMTC periodicity between active serving cells and SCells being activated on the same band provided the cell specific reference signals from the active serving cells and the SCells being activated or released are available in the same slot; in case of inter-band SCell activation,  $T_{\text{SMTC\_MAX\_multiple\_scells}}$  is the longest SMTC periodicity of SCells being activated on the same band.
- In FR2,  $T_{\text{SMTC\_MAX\_multiple\_scells}}$  is the longest SMTC periodicity between active serving cells and SCell(s) being activated in FR2 intra-band CA.
- $T_{\text{SMTC\_MAX\_multiple\_scells}}$  is bounded to a minimum value of 10ms.

$T_{\text{FirstSSB\_MAX\_multiple\_scells}}$ : is the time to the end of the first complete SSB burst indicated by the SMTC after slot  $n + \frac{T_{\text{HARQ}} + 3\text{ms}}{\text{NR slot length}}$ , further fulfilling:

- In FR1, in case of intra-band SCell activation, the occasion when all active serving cells and SCells being activated or released are transmitting SSB bursts in the same slot; in case of inter-band SCell activation, the first occasion when the SCells being activated are transmitting SSB burst.
- In FR2, the occasion when all active serving cells and SCells being activated or released are transmitting SSB bursts in the same slot.

$T_{\text{uncertainty\_MAC\_multiple\_scells}}$  is the time period between reception of the activation command for PDCCH TCI, PDSCH TCI (when applicable) and SCell activation command of this unknown SCell.

$T_{\text{uncertainty\_SP\_multiple\_scells}}$  is the time period between reception of the activation command for semi-persistent CSI-RS resource set for CQI reporting and SCell activation command of this unknown SCell.

$T_{\text{uncertainty\_RRC\_multiple\_scells}}$  is the time period between reception of the RRC configuration message for TCI of periodic CSI-RS for CQI reporting (when applicable) and SCell activation command of this unknown SCell.

$T_{\text{rs}}$ ,  $T_{\text{FineTiming}}$ , and  $T_{\text{RRC\_delay}}$  is defined in clause 8.3.2.

Longer delays for RRM measurement requirements, and in case of FR2 also SSB based RLM/BFD/CBD/L1-RSRP measurement requirements, can be expected during the cell detection time for unknown SCell activation.

The condition of known SCell in FR1 or FR2 is defined in clause 8.3.2.

If the UE has been provided with higher layer in TS 38.331 [2] signaling of *smtc2* prior to the activation command,  $T_{\text{SMTC\_Scell}}$  follows *smtc1* or *smtc2* according to the physical cell ID of the target cell being activated.

$T_{\text{SMTC\_MAX\_multiple\_scell}}$  follows *smtc1* or *smtc2* according to the physical cell IDs of the target cells being activated and the active serving cells.

The starting point and the end-point of an interruption window on PCell or any activated SCell in MCG for NR standalone mode, or on PSCell or any activated SCell in SCG for EN-DC mode is same as single SCell activation requirement in clause 8.3.2.

Upon receiving SCell activation command in slot  $n$ , if the start of the first complete SSB used in the  $T_X$  in the different bands which have SCells being activated after  $n + \frac{T_{\text{HARQ}} + 3\text{ms}}{\text{NR slot length}}$  are not aligned on time domain among

- SCells in different bands being activated by the same MAC CE if UE does not support per FR gap, or
- SCells in different FR1 bands being activated by the same MAC CE if UE supports per FR gap,

additional interruptions may be expected for the activated serving cells, where

- The number of additional interruptions is no more than the number of FR1 bands which have both SCell being activated for which the activation requirements involve  $T_{\text{FirstSSB\_MAX\_multiple\_scells}}$  with  $T_{\text{rs}}$  and the active serving cell, and

- In each interruption occasion, the interruption length is defined in clause 8.2.2.2.2, and

- Longer activation delay may be expected for multiple SCell activation under one MAC CE with multiple interruptions, and

- $T_X$  is:



- $T_{FirstSSB}$ , for any scenario where  $T_{activation\_time\_multiple\_scells}$  includes  $T_{FirstSSB}$ ;
- $T_{FirstSSB\_MAX\_multiple\_scells}$ , for any scenario where  $T_{activation\_time\_multiple\_scells}$  includes  $T_{FirstSSB\_MAX\_multiple\_scells}$ ;
- $T_{uncertainty\_MAC} + T_{FineTiming}$  or  $T_{uncertainty\_MAC\_multiple\_scells} + T_{FineTiming}$ , for any scenario where  $T_{activation\_time\_multiple\_scells}$  includes  $T_{FineTiming}$ .

Otherwise, no additional interruption is expected due to activation of multiple SCells.

Starting from slot  $n + T_{HARQ} + 3$  ms where slot  $n$  is the slot where SCell activation command is received (as specified in clause 4.3 of TS 38.213 [3]) and until the SCell activation completion at UE, after at least one CSI-RS transmission occasion for the channel measurement and reporting (specified in clause 5.2.2.5 of TS 38.214 [26]), the UE shall report out of range if the UE has available uplink resources to report CQI for the SCell.

Starting from the slot specified in clause 4.3 of TS 38.213 [3] (timing for secondary Cell activation/deactivation) and until the UE has completed a first L1-RSRP measurement, the UE shall report lowest valid L1 SS-RSRP range if the UE has available uplink resources to report L1-RSRP for the SCell.

### 8.3.8 SCell Deactivation Delay Requirement for Activated SCell with Multiple Downlink SCells

The requirements in this clause shall apply for the UE configured with multiple downlink SCells in EN-DC, or in standalone NR carrier aggregation, or in NE-DC, or in NR-DC, provided that,

- in each single CG, there are no other SCell activation, deactivation, addition or release before deactivation is completed for all the SCells deactivated by the single MAC CE in this clause, and
- in EN-DC and NE-DC, there are no E-UTRAN SCell activation, deactivation, addition or release before multiple SCell deactivation is completed in this clause, and
- in EN-DC, NE-DC, NR-DC and standalone NR, UE only receives one single MAC command for multiple SCell deactivation within the deactivation period defined in this clause, or, in NR-DC, per-FR measurement gap capable UE receives one MAC command per CG for multiple SCell deactivation within the deactivation period defined in this clause

Upon receiving SCell deactivation command in slot  $n$ , the UE shall accomplish the deactivation actions for the SCell being deactivated within the same delay as specified in clause 8.3.3.

The starting point and the end-point of an interruption window on PCell or any activated SCell in MCG for NR standalone mode, or on PSCell or any activated SCell in SCG for EN-DC mode is same as single SCell activation requirement in clause 8.3.3.

### 8.3.9 Direct SCell Activation of Multiple Downlink SCells at SCell addition

The requirements in this clause apply for UE being configured in the RRC reconfiguration message, TS 38.331 [2], with 2 SCells for which the parameter *sCellState* is set to *activated*.

In EN-DC, NE-DC, stand-alone NR, or in one CG of NR-DC, the requirements in this clause shall apply when the following conditions are met:

- UE only receives one RRC reconfiguration message for direct activation of SCells within the activation period defined in this clause,
- in each single CG, there are no other SCell activation, deactivation, addition or release before direct activation is completed for all the SCells activated by the single RRC reconfiguration message in this clause, and
- in EN-DC and NE-DC, there are no E-UTRAN SCell activation, deactivation, addition or release before the direct SCell activation of multiple SCells in this clause is completed.

In two CGs of NR-DC, the requirements in this clause shall apply when the following conditions are met:

- UE receives one RRC message per CG for direct activation of SCells within the activation period defined in this clause,

- UE supports per-FR measurement gap capability, and
- any to-be-activated unknown SCell has active serving cell(s) or known to-be-activated SCell(s) on the same band.

The UE shall configure the SCells in activated state upon successful completion of the RRC reconfiguration procedure within the specified delay. The UE shall be capable to transmit valid CSI report and apply actions for the directly activated SCell no later than in slot  $n + \frac{N_{\text{direct\_multiple\_scells}}}{NR \text{ slot length}}$ ,

where:

- Slot  $n$  is the last slot overlapping with the PDSCH containing the RRC reconfiguration message.
- $N_{\text{direct\_multiple\_scells}} = T_{\text{RRC\_Process}} + T_1 + T_{\text{activation\_time\_multiple\_scells}} + T_{\text{CSI\_Reporting}} - 3\text{ms}$  for the cases specified in clause 8.3.7 that TCI state is not indicated within  $T_{\text{activation\_time}}$ ; otherwise,  $N_{\text{direct\_multiple\_scells}} = T_{\text{RRC\_Process}} + T_1 + T_{\text{HARQ}} + T_{\text{activation\_time\_multiple\_scells}} + T_{\text{CSI\_Reporting}}$
- $T_1$  and  $T_{\text{RRC\_Process}}$  are specified in clause 8.3.4,
- $T_{\text{HARQ}}$  (in ms) is the timing between DL data transmission and acknowledgement as specified in TS 38.213 [3],
- $T_{\text{activation\_time\_multiple\_scells}}$  and  $T_{\text{CSI\_Reporting}}$  are specified in clause 8.3.7, where the following definition of  $T_{\text{FirstSSB}}$ ,  $T_{\text{FirstSSB\_MAX}}$ , and  $T_{\text{FirstSSB\_MAX\_multiple\_scells}}$  shall override the existing ones:
  - $T_{\text{FirstSSB}}$  and  $T_{\text{FirstSSB\_MAX}}$ : as specified in clause 8.3.4,
  - $T_{\text{FirstSSB\_MAX\_multiple\_scells}}$ : the time to the end of the first complete SSB burst indicated by the SMTC after slot  $n + \frac{T_{\text{RRC\_Process}} + T_1}{NR \text{ slot length}}$ , further fulfilling:
    - In FR1, in case of intra-band SCell activation, the occasion when all active serving cells and SCells being activated or released are transmitting SSB bursts in the same slot; in case of inter-band SCell activation, the first occasion when the SCells being activated are transmitting SSB burst.
    - In FR2, the occasion when all active serving cells and SCells being activated or released are transmitting SSB bursts in the same slot.

In addition to CSI reporting defined above, UE shall also apply other actions related to the activation command specified in TS38.321 [7] for an SCell at the first opportunities for the corresponding actions once the SCell is activated.

The UE may be allowed to cause interruptions to serving cells on other component carriers during an interruption window, as specified in clause 8.2. The starting point of an interruption window on spCell or any activated SCell shall not occur before slot  $n+1 + \frac{T_{\text{HARQ}}}{NR \text{ slot length}}$ , and shall not occur after slot  $n+1 + \frac{T_{\text{RRC\_Process}} + T_1 + T_X}{NR \text{ slot length}}$ , where NR slot length is with respect to the numerology of the SCell being activated, and  $T_X$  is:

- $T_{\text{FirstSSB}}$ , for any scenario where  $T_{\text{activation\_time\_multiple\_scells}}$  includes  $T_{\text{FirstSSB}}$ ;
- $T_{\text{FirstSSB\_MAX}}$ , for any scenario where  $T_{\text{activation\_time\_multiple\_scells}}$  includes  $T_{\text{FirstSSB\_MAX}}$ ;
- $T_{\text{FirstSSB\_MAX\_multiple\_scells}}$ , for any scenario where  $T_{\text{activation\_time\_multiple\_scells}}$  includes  $T_{\text{FirstSSB\_MAX\_multiple\_scells}}$ ;
- $T_{\text{uncertainty\_MAC}} + T_{\text{FineTiming}}$ , for any scenario where  $T_{\text{activation\_time\_multiple\_scells}}$  includes  $T_{\text{FineTiming}}$ .

The length of the interruption window may be different for different victim cells, and depends on the applicable scenario and on the frequency band relation between the aggressor cell and the victim cell.

Starting from the slot  $n + \frac{T_{\text{RRC\_Process}} + T_1}{NR \text{ slot length}}$  until the UE has completed the direct SCell activation, the UE shall report CQI index = 0 (out of range) if the UE has available uplink resources to report CQI for the SCells.

### 8.3.10 Direct SCell Activation of Multiple Downlink SCells at Handover

The requirements in this clause apply for UE being configured in the RRC reconfiguration message, TS 38.331 [2], for handover with 2 SCells for which the parameter *sCellState* is set to *activated*.

In MCG of NE-DC, MCG of NR-DC, or in stand-alone NR, the requirements in this clause shall apply when the following conditions are met:

- UE does not receive any RRC reconfiguration message for direct activation of SCells within the activation period defined in this clause,
- there is no other SCell activation, deactivation, addition or release before direct activation is completed for all the SCells activated by the single RRC reconfiguration message in this clause, and
- in NE-DC, there is no E-UTRAN SCell activation, deactivation, addition or release before the direct activation of SCells in this clause is completed.

The UE shall configure the SCells in activated state upon successful completion of the RRC reconfiguration procedure within the specified delay. The UE shall be capable to transmit valid CSI report and apply actions for the directly activated SCells no later than in slot  $n + \frac{N_{\text{direct\_multiple\_scells}}}{NR \text{ slot length}}$  where:

- Slot  $n$  is the last slot overlapping with the PDSCH containing the RRC reconfiguration message,
- $N_{\text{direct\_multiple\_scells}} = T_{\text{RRC\_process}} + T_{\text{interrupt}} + T_2 + T_3 + T_{\text{activation\_time\_multiple\_scells}} + T_{\text{CSI\_Reporting}} - 3\text{ms}$  for the cases specified in clause 8.3.7 that TCI state is not indicated within  $T_{\text{activation\_time}}$ ; otherwise,  $N_{\text{direct\_multiple\_scells}} = T_{\text{RRC\_process}} + T_{\text{interrupt}} + T_2 + T_3 + T_{\text{HARQ}} + T_{\text{activation\_time\_multiple\_scells}} + T_{\text{CSI\_Reporting}}$
- $T_{\text{RRC\_Process}}$ ,  $T_{\text{interrupt}}$ ,  $T_2$ , and  $T_3$  are specified in clause 8.3.5,
- $T_{\text{HARQ}}$  (in ms) is the timing between DL data transmission and acknowledgement as specified in TS 38.213 [3],
- $T_{\text{activation\_time\_multiple\_scells}}$  and  $T_{\text{CSI\_Reporting}}$  are specified in clause 8.3.7, where the following definitions of  $T_{\text{FirstSSB}}$ ,  $T_{\text{FirstSSB\_MAX}}$ , and  $T_{\text{FirstSSB\_MAX\_multiple\_scells}}$  shall override the existing ones:
  - $T_{\text{FirstSSB}}$ ,  $T_{\text{FirstSSB\_MAX}}$ : as specified in clause 8.3.5,
  - $T_{\text{FirstSSB\_MAX\_multiple\_scell}}$ : the time to the end of the first complete SSB burst indicated by the SMTC after slot  $n + \frac{T_{\text{RRC\_Process}} + T_{\text{interrupt}} + T_2 + T_3}{NR \text{ slot length}}$ , further fulfilling:
    - In FR1, in case of intra-band SCell activation, the occasion when all active serving cells and SCells being activated or released are transmitting SSB bursts in the same slot; in case of inter-band SCell activation, the first occasion when the SCells being activated are transmitting SSB burst.
    - In FR2, the occasion when all active serving cells and SCells being activated or released are transmitting SSB bursts in the same slot.

In addition to CSI reporting defined above, UE shall also apply other actions related to the activation command specified in TS 38.321 [7] for an SCell at the first opportunities for the corresponding actions once the SCell is activated.

The UE may be allowed to cause interruptions to PCell during an interruption window, as specified in clause 8.2. The starting point of an interruption window on PCell shall not occur before slot  $n+1 + \frac{T_{\text{RRC Processing}} + T_{\text{interrupt}} + T_2 + T_3}{NR \text{ slot length}}$ , and not occur after slot  $n+1 + \frac{T_{\text{RRC Processing}} + T_{\text{interrupt}} + T_2 + T_3 + T_X}{NR \text{ slot length}}$ , where NR slot length is with respect to the numerology of the SCell being activated, and  $T_X$  is:

- $T_{\text{FirstSSB}}$ , for any scenario where  $T_{\text{activation\_time\_multiple\_scells}}$  includes  $T_{\text{FirstSSB}}$ ;
- $T_{\text{FirstSSB\_MAX}}$ , for any scenario where  $T_{\text{activation\_time\_multiple\_scells}}$  includes  $T_{\text{FirstSSB\_MAX}}$ ;
- $T_{\text{FirstSSB\_MAX\_multiple\_scell}}$ , for any scenario where  $T_{\text{activation\_time\_multiple\_scells}}$  includes  $T_{\text{FirstSSB\_MAX\_multiple\_scells}}$ ;
- $T_{\text{uncertainty\_MAC}} + T_{\text{FineTiming}}$ , for any scenario where  $T_{\text{activation\_time\_multiple\_scells}}$  includes  $T_{\text{FineTiming}}$ .

The length of the interruption window depends on the frequency band relation between the aggressor SCell and the victim PCell.

Starting from the slot  $n + \frac{T_{RRC\_Process} + T_{interrupt} + T_2 + T_3}{NR\_slot\_length}$  and until the UE has completed the direct SCell activation, the UE shall report CQI index = 0 (out of range) if the UE has available uplink resources to report CQI for the SCells.

### 8.3.11 Direct SCell Activation of Multiple Downlink SCells at RRC Resume

The requirements in this clause apply for UE being configured in the RRC reconfiguration message in TS38.331 [2] for RRC Resume with 2 SCells for which the parameter *sCellState* is set to *activated*.

The requirements in clause 8.3.9 shall apply, except that the definition of  $T_1$  shall be replaced by the corresponding definition in clause 8.3.6.

## 8.3A SCell Activation and Deactivation Delay in Carriers with CCA

### 8.3A.1 Introduction

This clause defines requirements for the delay within which the UE shall be able to activate a deactivated SCell operating with CCA and deactivate an activated SCell operating with CCA in EN-DC or in standalone NR carrier aggregation.

In the requirements of clause 8.3A, the term SMTC occasion not available at the UE refers to when the SMTC contains SSBs configured by gNB in a cell on a carrier frequency subject to CCA, but the first two successive candidate SSB positions for the same SSB index within the discovery burst transmission window are not available at the UE due to DL CCA failures at gNB during the corresponding period; otherwise the SMTC occasion is considered as available at the UE.

In the requirements of clause 8.3A, the term CSI-RS occasion not available at the UE due to DL CCA failures refers to when the CSI-RS is configured by gNB for the UE but not available at the UE due to DL CCA failures at gNB during the corresponding period.

The requirements shall apply for EN-DC and standalone NR carrier aggregation.

### 8.3A.2 SCell Activation Delay Requirement for Deactivated SCell

The requirements in this clause shall apply for the UE configured with at least one downlink SCell operating with CCA in EN-DC or in standalone NR carrier aggregation and when one SCell operating with CCA is being activated but none of the RRC parameters *CO-DurationPerCell-r16*, *SlotFormatIndicator*, and *CSI-RS-ValidationWith-DCI-r16* is configured and all of the CSI reporting resources for being-activated SCell are available.

The delay within which the UE shall be able to activate the deactivated SCell depends upon the specified conditions.

Upon receiving SCell activation command in slot  $n$ , the UE shall be capable to transmit valid CSI report and apply actions related to the activation command for the SCell being activated no later than in slot  $n + (T_{HARQ} + T_{activation\_time\_withCCA} + T_{CSI\_reporting\_withCCA})/NR\_slot\_length$ , where:

- $T_{HARQ}$  (in ms) is the timing between DL data transmission and acknowledgement as specified in TS 38.213 [3]. In the event of UE not being able to transmit the acknowledgment due to UL CCA failures:  $T_{HARQ}$  is extended to also include the time to all next HARQ feedback transmission and retransmission opportunities, until the time of its successful transmission, as specified in TS 38.213 [3]; no extension of  $T_{HARQ}$  due to UL CCA failures is allowed for Type 2C UL channel access procedure as defined in TS 37.213 [57].
- $T_{activation\_time\_withCCA}$  is the SCell activation delay in millisecond.
  - If the SCell is known,  $T_{activation\_time\_withCCA}$  is:
    - $T_{FirstSSB} + L_1 * T_{TS} + 5ms$ , if the measurement period of the SCell being activated is equal to or smaller than 2400ms.
    - $T_{FirstSSB\_MAX} + L_{2,1} * T_{SMTC\_MAX} + (1 + L_{2,2}) * T_{TS} + 5ms$ , if the measurement period of the SCell being activated is larger than 2400ms.

- If the SCell is unknown, provided that the side condition  $\hat{E}_s/I_{ot} \geq -2$  dB is fulfilled and the SCell can be successfully detected in one attempt,  $T_{\text{activation\_time\_withCCA}}$  is:

$$T_{\text{FirstSSB\_MAX}} + (1 + L_{3,1}) * T_{\text{SMTC\_MAX}} + (2 + L_{3,2}) * T_{\text{rs}} + 5\text{ms}.$$

Where,

$T_{\text{SMTC\_MAX}}$ :

- In case of intra-band SCell activation,  $T_{\text{SMTC\_MAX}}$  is the longest SMTC periodicity between active serving cells and SCell being activated provided the cell specific reference signals from the active serving cells and the SCells being activated or released are available in the same slot;
- In case of inter-band SCell activation,  $T_{\text{SMTC\_MAX}}$  is the SMTC periodicity of SCell being activated;
- $T_{\text{SMTC\_MAX}}$  is bounded to a minimum value of 10ms.

$T_{\text{rs}}$  is the SMTC periodicity of the SCell being activated if the UE has been provided with an SMTC configuration for the SCell in SCell addition message, otherwise  $T_{\text{rs}}$  is the SMTC configured in the measObjectNR having the same SSB frequency and subcarrier spacing. If the UE is not provided SMTC configuration or measurement object on this frequency, the requirement which involves  $T_{\text{rs}}$  is applied with  $T_{\text{rs}} = 5\text{ms}$  assuming the SSB transmission periodicity is 5ms. There are no requirements if the SSB transmission periodicity is not 5ms

$T_{\text{FirstSSB}}$ : is the time to the end of the first complete configured SSB burst indicated by the SMTC after slot  $n + (T_{\text{HARQ}} + 3\text{ms}) / NR\_slot\_length$

$T_{\text{FirstSSB\_MAX}}$ : is the time to the end of first complete configured SSB burst indicated by the SMTC after slot  $n + (T_{\text{HARQ}} + 3\text{ms}) / NR\_slot\_length$  when all active serving cells and SCells being activated or released have configured SSB bursts in the same slot for intra-band scenario. In case of inter-band SCell activation,  $T_{\text{FirstSSB\_MAX}}$  is the time to the end of the first complete configured SSB burst of the SCell being activated.

$L_1$  ( $L_1 \leq L_{1,\text{max}}$ ) is the number of configured SMTC occasions not available at the UE.  $L_{1,\text{max}} = 2$  if  $T_{\text{rs}} \leq 40$  ms; otherwise  $L_{1,\text{max}} = 1$ .

$L_{2,1}$  ( $L_{2,1} \leq L_{2,1,\text{max}}$ ) and  $L_{3,1}$  ( $L_{3,1} \leq L_{3,1,\text{max}}$ ) are the numbers of configured SMTC occasions not available at the UE, for a known and unknown SCell activation respectively,

in the SCell being activated, for inter-band scenario, or

in any of the SCells already activated or being activated provided their cell specific reference signals are configured in the same slot, for intra-band scenario

and  $L_{2,1,\text{max}} = 2$  if  $T_{\text{SMTC\_MAX}} \leq 40$  ms; otherwise  $L_{2,1,\text{max}} = 1$ .  $L_{3,1,\text{max}} = 2$  if  $T_{\text{SMTC\_MAX}} \leq 40$  ms; otherwise  $L_{3,1,\text{max}} = 1$ .

$L_{2,2}$  ( $L_{2,2} \leq L_{2,2,\text{max}}$ ) and  $L_{3,2}$  ( $L_{3,2} \leq L_{3,2,\text{max}}$ ) are the number of configured SMTC occasions not available at the UE in the SCell being activated.  $L_{2,2,\text{max}} = 2$  if  $T_{\text{rs}} \leq 40$  ms; otherwise  $L_{2,2,\text{max}} = 1$ .  $L_{3,2,\text{max}} = 2$  if  $T_{\text{rs}} \leq 40$  ms; otherwise  $L_{3,2,\text{max}} = 1$ .

$T_{\text{CSI\_reporting\_withCCA}} = T_{\text{CSI\_reporting}} + T_{\text{CSI\_ReportingDelay}}$ , where

$T_{\text{CSI\_reporting}}$  is the delay (in ms) including uncertainty in acquiring the first available downlink CSI reference resource, UE processing time for CSI reporting and uncertainty in acquiring the first available CSI reporting resources as specified in TS 38.331 [2].

$T_{\text{CSI\_ReportingDelay}}$  is the additional delay in transmission of CSI reporting due to UL CCA failures at the UE. If there are no uplink resources for reporting the valid CSI, then the UE shall use the next available opportunities for reporting the corresponding valid CSI as specified in TS 38.213 [3].

Upon exceeding any of the maximum numbers  $L_{1,\text{max}}$ ,  $L_{2,1,\text{max}}$ ,  $L_{2,2,\text{max}}$ ,  $L_{3,1,\text{max}}$ , and  $L_{3,2,\text{max}}$  of SMTC occasions or CSI-RS occasions, respectively, not available at the UE, the UE shall abandon the SCell activation procedure.

SCell operating with CCA is known if it has been meeting the following conditions:

- During the period equal to  $\max(5 \text{ measCycleSCell}, 5 \text{ DRX cycles})$  before the reception of the SCell activation command:
  - the UE has sent a valid measurement report for the SCell being activated and
  - the SSB measured remains detectable in the SMTC occasions available at the UE, according to the cell identification conditions specified in clause 9.2A and 9.3A.
- the SSB measured during the period equal to  $\max(5 \text{ measCycleSCell}, 5 \text{ DRX cycles})$  also remains detectable - the SSB measured during the period equal to  $\max(5 \text{ measCycleSCell}, 5 \text{ DRX cycles})$  also remains detectable in the SMTC occasions available at the UE during the SCell activation delay according to the cell identification conditions specified in clause 9.2A and 9.3A.

Otherwise SCell operating with CCA is unknown.

If the UE has been provided with higher layer in TS 38.331 [2] signaling of *smtc2* prior to the activation command,  $T_{\text{SMTC\_Scell}}$  follows *smtc1* or *smtc2* according to the physical cell ID of the target cell being activated.  $T_{\text{SMTC\_MAX}}$  follows *smtc1* or *smtc2* according to the physical cell IDs of the target cells being activated and the active serving cells.

In addition to CSI reporting defined above, UE shall also apply other actions related to the activation command specified in TS 38.331 [2] for a SCell at the first opportunities for the corresponding actions once the SCell is activated.

For intra-band CA, the starting point of an interruption window on SpCell or any activated SCell as specified in clause 8.2, shall not occur before slot  $n+1+\frac{T_{\text{HARQ}}}{\text{NR slot length}}$  and not occur after slot  $n+1+\frac{T_{\text{HARQ}}+3+T_X}{\text{NR slot length}}$ , where  $T_X$  is:

- $T_{\text{FirstSSB}}$ , for known SCell activation when SCell measurement cycle is equal to or smaller than 160ms;
- $T_{\text{FirstSSB\_MAX}} + L_{2,1} * T_{\text{SMTC\_MAX}}$  for known SCell activation when SCell measurement cycle is greater than 160ms;
- $T_{\text{FirstSSB\_MAX}} + L_{3,1} * T_{\text{SMTC\_MAX}}$  for unknown SCell activation

For inter-band CA, the starting point of an interruption window on SpCell or any activated SCell as specified in clause 8.2, shall not occur before slot  $n+1+\frac{T_{\text{HARQ}}}{\text{NR slot length}}$  and not occur after slot  $n+1+\frac{T_{\text{HARQ}}+3+T_X}{\text{NR slot length}}$ , where  $T_X$  is:

- $T_{\text{FirstSSB}}$ , for known SCell activation when SCell measurement cycle is equal to, or smaller than, 160ms.

For intra-band CA,

- While the SCell being activated is known with measurement cycle equal to or smaller than 160ms, no more than one interruption is allowed during SCell activation.
- While the SCell being activated is known with measurement cycle greater than 160ms, up to  $1+L_{2,1}$  interruptions are allowed during SCell activation,
- While the SCell being activated is unknown, up to  $1+L_{3,1}$  interruptions are allowed during SCell activation. When  $L_{3,1}>0$ , performance degradation may be expected on any activated intra-band victim cells during the SCell activation
- For a single interruption ( $L=0$ ), interruption window length at SCell activation does not depend on DL CCA failures.

For inter-band CA,

- For any active cell in the same band with the SCell being activated, the interruption requirements (i.e. number of interruptions and starting point of an interruption) for intra-band CA apply.
- For any active cell outside the band with the SCell being activated, a single interruption applies

The number of interruptions and length of each interruption window may be different for different victim cells and depends on the applicable scenario and on the frequency band relation between the aggressor cell and the victim cell. For a single interruption ( $L=0$ ), the interruption window length at SCell activation does not depend on DL CCA failures.

Starting from slot  $n + T_{\text{HARQ}} + 3$  ms where slot  $n$  is the slot where SCell activation command is received (as specified in clause 4.3 of TS 38.213 [3]) and until the SCell activation completion at UE, after at least one CSI-RS transmission occasion for the channel measurement and reporting (specified in clause 5.2.2.5 of TS 38.214 [26]), the UE shall report out of range if the UE has available uplink resources to report CQI for the SCell.

Starting from the slot specified in clause 4.3 of TS 38.213 [3] (timing for secondary Cell activation/deactivation) and until the UE has completed a first L1-RSRP measurement, the UE shall report lowest valid L1 SS-RSRP range if the UE has available uplink resources to report L1-RSRP for the SCell.

The requirements in this section do not apply when *sCellDeactivationTimer* [2] is not configured and when  $T_{\text{activation\_time\_withCCA}}$  exceeds 1280 ms.

### 8.3A.3 SCell Deactivation Delay Requirement for Activated SCell

The requirements in this clause shall apply for the UE configured with at least one downlink SCell operating with CCA in EN-DC or in standalone NR carrier aggregation and one SCell is deactivated.

Upon receiving SCell deactivation command in slot  $n$ , the UE shall accomplish the deactivation actions for the SCell being deactivated no later than in slot  $n + (T_{\text{HARQ}} + 3\text{ms}) / \text{NR\_slot\_length}$ . The starting point of an interruption window on spCell or any activated SCell, as specified in clause 8.2, shall not occur before slot  $n + 1 + \frac{T_{\text{HARQ}}}{\text{NR\_slot\_length}}$  and not occur after slot  $n + 1 + \frac{T_{\text{HARQ}} + 3\text{ms}}{\text{NR\_slot\_length}}$ , where NR slot length is with respect to the numerology used in the SCell being deactivated.

Upon expiry of the *sCellDeactivationTimer* in slot  $n$ , the UE shall accomplish the deactivation actions for the SCell being deactivated no later than in slot  $n + \frac{3\text{ms}}{\text{NR\_slot\_length}}$ . The starting point of an interruption window on spCell or any activated SCell, as specified in clause 8.2, shall not occur before slot  $n + 1$  and not occur after slot  $n + 1 + \frac{3\text{ms}}{\text{NR\_slot\_length}}$ , where NR slot length is with respect to the numerology used in the SCell being deactivated.

The length of the interruption window may be different for different victim cells, and depends on the applicable scenario and on the frequency band relation between the aggressor cell and the victim cell.

The requirements in this section do not apply when *sCellDeactivationTimer* [2] is not configured and when SCell deactivation delay exceeds 1280 ms.

## 8.4 UE UL carrier RRC reconfiguration delay

### 8.4.1 Introduction

The requirements in this clause apply for a UE being configured or deconfigured with a supplementary UL carrier or NR UL carrier.

### 8.4.2 UE UL carrier configuration delay requirement

When the UE receives a RRC message implying NR UL or supplementary UL carrier configuration, the UE shall be ready to start transmission on the newly configured carrier within  $T_{\text{UL\_carrier\_config}}$  from the end of the slot  $n$ .

Where

- Slot  $n$  is the last slot overlapping with the PDSCH containing the RRC command.
- $T_{\text{UL\_carrier\_config}}$  equals the maximum RRC procedure delay defined in clause 11.2 in TS 36.331 [16] if the corresponding RRC message is embedded in E-UTRA RRC message, otherwise it equals the maximum RRC procedure delay defined in clause 12 in TS 38.331 [2].

### 8.4.3 UE UL carrier deconfiguration delay requirement

When the UE receives a RRC message implying NR UL or supplementary UL carrier deconfiguration RRC signalling, the UE shall stop UL signalling on the deconfigured UL carrier within  $T_{\text{UL\_carrier\_deconfig}}$  from the end of the slot  $n$ .

Where

- Slot  $n$  is the last slot overlapping with the PDSCH containing the RRC command.
- $T_{UL\_carrier\_deconfig}$  equals the maximum RRC procedure delay defined in clause 11.2 in TS 36.331 [16] if the corresponding RRC message is embedded in E-UTRA RRC message, otherwise it equals the maximum RRC procedure delay defined in clause 12 in TS 38.331 [2].

## 8.5 Link Recovery Procedures

### 8.5.1 Introduction

The UE shall assess the downlink radio link quality of a serving cell based on the reference signal in the set  $\bar{Q}_0$  as specified in TS 38.213 [3] in order to detect beam failure on:

- PCell in SA, NR-DC, or NE-DC operation mode,
- PSCell in NR-DC and EN-DC operation mode,
- SCell in SA, NR-DC, NE-DC or EN-DC operation mode.

The RS resource configurations in the set  $\bar{Q}_0$  on PCell or PSCell can be periodic CSI-RS resources and/or SSBs. RS resource configuration in the set  $\bar{Q}_0$  on SCell shall be periodic CSI-RS. UE is not required to perform beam failure detection outside the active DL BWP. UE is not required to meet the requirements in clause 8.5.2 and 8.5.3 if UE does not have set  $\bar{Q}_0$ . UE is not required to perform beam failure detection on a deactivated SCell, and also not required to perform beam failure detection on resources which is implicitly configured for a deactivated SCell. When more than 2 periodic CSI-RS resources on a CC are configured in the set  $\bar{Q}_0$  for current SCell or implicitly configured in the set  $\bar{Q}_0$  for other SCell, it is up to UE implementation to select two of CSI-RS resources in active BWP in current CC to perform beam failure detection. UE is not required to perform beam failure detection on a SCell on which  $\bar{Q}_0$  is not configured.

On each RS resource configuration in the set  $\bar{Q}_0$ , the UE shall estimate the radio link quality and compare it to the threshold  $Q_{out\_LR}$  for the purpose of accessing downlink radio link quality of the serving cell beams.

The threshold  $Q_{out\_LR}$  is defined as the level at which the downlink radio level link of a given resource configuration on set  $\bar{Q}_0$  cannot be reliably received and shall correspond to the  $BLER_{out} = 10\%$  block error rate of a hypothetical PDCCH transmission. For SSB based beam failure detection,  $Q_{out\_LR\_SSB}$  is derived based on the hypothetical PDCCH transmission parameters listed in Table 8.5.2.1-1. For CSI-RS based beam failure detection,  $Q_{out\_LR\_CSI-RS}$  is derived based on the hypothetical PDCCH transmission parameters listed in Table 8.5.3.1-1.

Upon request the UE shall deliver configuration indexes from the set  $\bar{Q}_0$  as specified in TS 38.213 [3], to higher layers, and the corresponding L1-RSRP measurement provided that the measured L1-RSRP is equal to or better than the threshold  $Q_{in\_LR}$ , which is indicated by higher layer parameter *rsrp-ThresholdSSB*. The UE applies the  $Q_{in\_LR}$  threshold to the L1-RSRP measurement obtained from an SSB. The UE applies the  $Q_{in\_LR}$  threshold to the L1-RSRP measurement obtained for a CSI-RS resource after scaling a respective CSI-RS reception power with a value provided by higher layer parameter *powerControlOffsetSS*. The RS resource configurations in the set  $\bar{Q}_0$  can be periodic CSI-RS resources or SSBs or both SSB and CSI-RS resources. UE is not required to perform candidate beam detection outside the active DL BWP. UE is not required to perform candidate beam detection on a SCell on which  $\bar{Q}_0$  is not configured.



## 8.5.2 Requirements for SSB based beam failure detection

### 8.5.2.1 Introduction

The requirements in this clause apply for each SSB resource in the set  $\bar{Q}$  configured for a serving cell, provided that the SSB configured for beam failure detection is actually transmitted within the UE active DL BWP during the entire evaluation period specified in clause 8.5.2.2. The requirements in this clause could not be applicable if UE is required to perform beam failure detection on more than 1 serving cell per band.

**Table 8.5.2.1-1: PDCCH transmission parameters for beam failure instance**

Attribute	Value for BLER
DCI format	1-0
Number of control OFDM symbols	2
Aggregation level (CCE)	8
Ratio of hypothetical PDCCH RE energy to average SSS RE energy	0dB
Ratio of hypothetical PDCCH DMRS energy to average SSS RE energy	0dB
Bandwidth (PRBs)	24
Sub-carrier spacing (kHz)	Same as the SCS of RMSI CORESET
DMRS precoder granularity	REG bundle size
REG bundle size	6
CP length	Normal
Mapping from REG to CCE	Distributed

### 8.5.2.2 Minimum requirement

UE shall be able to evaluate whether the downlink radio link quality on the configured SSB resource in set  $\bar{Q}$  estimated over the last  $T_{\text{Evaluate\_BFD\_SSB}}$  ms period becomes worse than the threshold  $Q_{\text{out\_LR\_SSB}}$  within  $T_{\text{Evaluate\_BFD\_SSB}}$  ms period.

The value of  $T_{\text{Evaluate\_BFD\_SSB}}$  is defined in Table 8.5.2.2-1 for FR1.

The value of  $T_{\text{Evaluate\_BFD\_SSB}}$  is defined in Table 8.5.2.2-2 for FR2 with scaling factor  $N=8$

For FR1,

- $P = \frac{1}{1 - \frac{T_{SSB}}{MGRP}}$ , when in the monitored cell there are measurement gaps configured for intra-frequency, inter-frequency or inter-RAT measurements, which are overlapping with some but not all occasions of the SSB.
- $P=1$  when in the monitored cell there are no measurement gaps overlapping with any occasion of the SSB.

For FR2,

- $P = \frac{1}{1 - \frac{T_{SSB}}{T_{SMTCperiod}}}$ , when BFD-RS resource is not overlapped with measurement gap and the BFD-RS resource is partially overlapped with SMTC occasion ( $T_{SSB} < T_{SMTCperiod}$ ).
- $P = P_{\text{sharing factor}}$ , when the BFD-RS resource is not overlapped with measurement gap and the BFD-RS resource is fully overlapped with SMTC period ( $T_{SSB} = T_{SMTCperiod}$ ).

- $P = \frac{1}{1 - \frac{T_{SSB}}{MGRP} - \frac{T_{SSB}}{T_{SMTCperiod}}}$ , when the BFD-RS resource is partially overlapped with measurement gap and the

BFD-RS resource is partially overlapped with SMTC occasion ( $T_{SSB} < T_{SMTCperiod}$ ) and SMTC occasion is not overlapped with measurement gap and

- $T_{SMTCperiod} \neq MGRP$  or

- $T_{\text{SMTCperiod}} = \text{MGRP}$  and  $T_{\text{SSB}} < 0.5 \cdot T_{\text{SMTCperiod}}$
- $P = \frac{P_{\text{sharing factor}}}{1 - \frac{T_{\text{SSB}}}{\text{MGRP}}}$ , when the BFD-RS resource is partially overlapped with measurement gap and the BFD-RS resource is partially overlapped with SMTC occasion ( $T_{\text{SSB}} < T_{\text{SMTCperiod}}$ ) and SMTC occasion is not overlapped with measurement gap and  $T_{\text{SMTCperiod}} = \text{MGRP}$  and  $T_{\text{SSB}} = 0.5 \cdot T_{\text{SMTCperiod}}$
- $P = \frac{1}{1 - \frac{T_{\text{SSB}}}{\text{Min}(\text{MGRP}, T_{\text{SMTCperiod}})}}$ , when the BFD-RS resource is partially overlapped with measurement gap ( $T_{\text{SSB}} < \text{MGRP}$ ) and the BFD-RS resource is partially overlapped with SMTC occasion ( $T_{\text{SSB}} < T_{\text{SMTCperiod}}$ ) and SMTC occasion is partially or fully overlapped with measurement gap.
- $P = \frac{P_{\text{sharing factor}}}{1 - \frac{T_{\text{SSB}}}{\text{MGRP}}}$ , when the BFD-RS resource is partially overlapped with measurement gap and the BFD-RS resource is fully overlapped with SMTC occasion ( $T_{\text{SSB}} = T_{\text{SMTCperiod}}$ ) and SMTC occasion is partially overlapped with measurement gap ( $T_{\text{SMTCperiod}} < \text{MGRP}$ )
- $P_{\text{sharing factor}} = 1$ , if the BFD-RS resource outside measurement gap is
  - not overlapped with the SSB symbols indicated by SSB-ToMeasure and 1 data symbol before each consecutive SSB symbols indicated by SSB-ToMeasure and 1 data symbol after each consecutive SSB symbols indicated by SSB-ToMeasure, given that SSB-ToMeasure is configured, where the *SSB-ToMeasure* is the union set of *SSB-ToMeasure* from all the configured measurement objects merged on the same serving carrier, and;
  - not overlapped with the RSSI symbols indicated by *ss-RSSI-Measurement* and 1 data symbol before each RSSI symbol indicated by *ss-RSSI-Measurement* and 1 data symbol after each RSSI symbol indicated by *ss-RSSI-Measurement*, given that *ss-RSSI-Measurement* is configured.
- $P_{\text{sharing factor}} = 3$ , otherwise.

where,

If the high layer in TS 38.331 [2] signaling of *smtc2* is configured,  $T_{\text{SMTCperiod}}$  corresponds to the value of higher layer parameter *smtc2*; Otherwise  $T_{\text{SMTCperiod}}$  corresponds to the value of higher layer parameter *smtc1*.  $T_{\text{SMTCperiod}}$  is the shortest SMTC period among all CCs in the same FR2 band, given the SMTC offset of all CCs in FR2 provided the same offset.

Longer evaluation period would be expected if the combination of BFD-RS resource, SMTC occasion and measurement gap configurations does not meet pervious conditions.

For either an FR1 or FR2 serving cell, longer evaluation period would be expected during the period  $T_{\text{identify\_CGI}}$  when the UE is requested to decode an NR CGI.

For either an FR1 or FR2 serving cell, longer BFD evaluation period would be expected during the period  $T_{\text{identify\_CGI, E-UTRAN}}$  when the UE is requested to decode an LTE CGI.

**Table 8.5.2.2-1: Evaluation period  $T_{\text{Evaluate\_BFD\_SSB}}$  for FR1**

Configuration	$T_{\text{Evaluate\_BFD\_SSB}}$ (ms)
no DRX	$\text{Max}(50, \text{Ceil}(5 \times P) \times T_{\text{SSB}})$
DRX cycle $\leq 320\text{ms}$	$\text{Max}(50, \text{Ceil}(7.5 \times P) \times \text{Max}(T_{\text{DRX}}, T_{\text{SSB}}))$
DRX cycle $> 320\text{ms}$	$\text{Ceil}(5 \times P) \times T_{\text{DRX}}$
Note: $T_{\text{SSB}}$ is the periodicity of SSB in the set $\bar{q}_0$ . $T_{\text{DRX}}$ is the DRX cycle length.	

**Table 8.5.2.2-2: Evaluation period  $T_{\text{Evaluate\_BFD\_SSB}}$  for FR2**

Configuration	$T_{\text{Evaluate\_BFD\_SSB}}$ (ms)
no DRX	$\text{Max}(50, \text{Ceil}(5 \times P \times N) \times T_{\text{SSB}})$
DRX cycle $\leq 320\text{ms}$	$\text{Max}(50, \text{Ceil}(7.5 \times P \times N) \times \text{Max}(T_{\text{DRX}}, T_{\text{SSB}}))$
DRX cycle $> 320\text{ms}$	$\text{Ceil}(5 \times P \times N) \times T_{\text{DRX}}$
Note: $T_{\text{SSB}}$ is the periodicity of SSB in the set $\bar{q}_0$ . $T_{\text{DRX}}$ is the DRX cycle length.	

### 8.5.2.3 Measurement restriction for SSB based beam failure detection

The UE is required to be capable of measuring SSB for BFD without measurement gaps. The UE is required to perform the SSB measurements with measurement restrictions as described in the following scenarios.

For FR1, when the SSB for BFD measurement is in the same OFDM symbol as CSI-RS for RLM, BFD, CBD or L1-RSRP measurement,

- If SSB and CSI-RS have same SCS, UE shall be able to measure the SSB for BFD measurement without any restriction;
- If SSB and CSI-RS have different SCS,
  - If UE supports *simultaneousRxDataSSB-DiffNumerology*, UE shall be able to measure the SSB for BFD measurement without any restriction;
  - If UE does not support *simultaneousRxDataSSB-DiffNumerology*, UE is required to measure one of but not both SSB for BFD measurement and CSI-RS. Longer measurement period for SSB based BFD measurement is expected, and no requirements are defined.

For FR2, when the SSB for BFD measurement on one CC is in the same OFDM symbol as CSI-RS for RLM, BFD, CBD or L1-RSRP measurement on the same CC or different CCs in the same band, UE is required to measure one of but not both SSB for BFD measurement and CSI-RS. Longer measurement period for SSB based BFD measurement is expected, and no requirements are defined.

For FR2, if the network configures same or mixed numerology between SSB for BFD measurement on one FR2 band and CSI-RS for RLM, BFD, CBD, L1-RSRP or L1-SINR measurement on the other FR2 band, UE shall be able to perform the related SSB based measurements in one band without any measurement restrictions on the other band, provided that UE is capable of independent beam management on this FR2 band pair.

## 8.5.3 Requirements for CSI-RS based beam failure detection

### 8.5.3.1 Introduction

The requirements in this clause apply for each CSI-RS resource in the set  $\bar{q}_0$  of resource configurations for a serving cell, provided that the CSI-RS resource(s) in set  $\bar{q}_0$  for beam failure detection are actually transmitted within the UE active DL BWP during the entire evaluation period specified in clause 8.5.3.2. UE is not expected to perform beam failure detection measurements on the CSI-RS configured for BFD if the CSI-RS is not QCL-ed, with QCL-TypeD when applicable, with the RS in the active TCI state of any CORESET configured in the UE active BWP. The requirements in this clause apply when UE is required to perform beam failure detection on no more than 1 serving cell per band.

**Table 8.5.3.1-1: PDCCH transmission parameters for beam failure instance**

Attribute	Value for BLER
DCI format	1-0
Number of control OFDM symbols	2
Aggregation level (CCE)	8
Ratio of hypothetical PDCCH RE energy to average CSI-RS RE energy	0dB
Ratio of hypothetical PDCCH DMRS energy to average CSI-RS RE energy	0dB
Bandwidth (PRBs)	48
Sub-carrier spacing (kHz)	SCS of the active DL BWP
DMRS precoder granularity	REG bundle size
REG bundle size	6
CP length	Normal
Mapping from REG to CCE	Distributed

### 8.5.3.2 Minimum requirement

UE shall be able to evaluate whether the downlink radio link quality on the CSI-RS resource in set  $\bar{Q}$  estimated over the last  $T_{\text{Evaluate\_BFD\_CSI-RS}}$  ms period becomes worse than the threshold  $Q_{\text{out\_LR\_CSI-RS}}$  within  $T_{\text{Evaluate\_BFD\_CSI-RS}}$  ms period.

The value of  $T_{\text{Evaluate\_BFD\_CSI-RS}}$  is defined in Table 8.5.3.2-1 for FR1.

The value of  $T_{\text{Evaluate\_BFD\_CSI-RS}}$  is defined in Table 8.5.3.2-2 for FR2 with  $N=1$ . The requirements of  $T_{\text{Evaluate\_BFD\_CSI-RS}}$  apply provided that the CSI-RS for BFD is not in a resource set configured with repetition ON. The requirements shall not apply when the CSI-RS resource in the active TCI state of CORESET is the same CSI-RS resource for BFD and the TCI state information of the CSI-RS resource is not given, wherein the TCI state information means QCL Type-D to SSB for L1-RSRP or CSI-RS with repetition ON.

For FR1,

- $P = \frac{1}{1 - \frac{T_{\text{CSI-RS}}}{\text{MGRP}}}$ , when in the monitored cell there are measurement gaps configured for intra-frequency, inter-frequency or inter-RAT measurements, which are overlapping with some but not all occasions of the CSI-RS.
- $P = 1$  when in the monitored cell there are no measurement gaps overlapping with any occasion of the CSI-RS.

For FR2,

- $P = 1$ , when the BFD-RS resource is not overlapped with measurement gap and also not overlapped with SMTC occasion.
- $P = \frac{1}{1 - \frac{T_{\text{CSI-RS}}}{\text{MGRP}}}$ , when the BFD-RS resource is partially overlapped with measurement gap and the BFD-RS resource is not overlapped with SMTC occasion ( $T_{\text{CSI-RS}} < \text{MGRP}$ )
- $P = \frac{1}{1 - \frac{T_{\text{CSI-RS}}}{T_{\text{SMTCperiod}}}}$ , when the BFD-RS resource is not overlapped with measurement gap and the BFD-RS resource is partially overlapped with SMTC occasion ( $T_{\text{CSI-RS}} < T_{\text{SMTCperiod}}$ ).
- $P = P_{\text{sharing factor}}$ , when the BFD-RS resource is not overlapped with measurement gap and the BFD-RS resource is fully overlapped with SMTC occasion ( $T_{\text{CSI-RS}} = T_{\text{SMTCperiod}}$ ).
- $P = \frac{1}{1 - \frac{T_{\text{CSI-RS}}}{\text{MGRP}} - \frac{T_{\text{CSI-RS}}}{T_{\text{SMTCperiod}}}}$ , when the BFD-RS resource is partially overlapped with measurement gap and the BFD-RS resource is partially overlapped with SMTC occasion ( $T_{\text{CSI-RS}} < T_{\text{SMTCperiod}}$ ) and SMTC occasion is not overlapped with measurement gap and
  - $T_{\text{SMTCperiod}} \neq \text{MGRP}$  or
  - $T_{\text{SMTCperiod}} = \text{MGRP}$  and  $T_{\text{CSI-RS}} < 0.5 \times T_{\text{SMTCperiod}}$
- $P = \frac{P_{\text{sharing factor}}}{1 - \frac{T_{\text{CSI-RS}}}{\text{MGRP}}}$ , when the BFD-RS resource is partially overlapped with measurement gap and the BFD-RS resource is partially overlapped with SMTC occasion ( $T_{\text{CSI-RS}} < T_{\text{SMTCperiod}}$ ) and SMTC occasion is not overlapped with measurement gap and  $T_{\text{SMTCperiod}} = \text{MGRP}$  and  $T_{\text{CSI-RS}} = 0.5 \times T_{\text{SMTCperiod}}$
- $P = \frac{1}{1 - \frac{T_{\text{CSI-RS}}}{\text{Min}(\text{MGRP}, T_{\text{SMTCperiod}})}}$ , when the BFD-RS resource is partially overlapped with measurement gap ( $T_{\text{CSI-RS}} < \text{MGRP}$ ) and the BFD-RS resource is partially overlapped with SMTC occasion ( $T_{\text{CSI-RS}} < T_{\text{SMTCperiod}}$ ) and SMTC occasion is partially or fully overlapped with measurement gap.
- $P = \frac{P_{\text{sharing factor}}}{1 - \frac{T_{\text{CSI-RS}}}{\text{MGRP}}}$ , when the BFD-RS resource is partially overlapped with measurement gap and the BFD-RS resource is fully overlapped with SMTC occasion ( $T_{\text{CSI-RS}} = T_{\text{SMTCperiod}}$ ) and SMTC occasion is partially overlapped with measurement gap ( $T_{\text{SMTCperiod}} < \text{MGRP}$ )
- $P_{\text{sharing factor}} = 1$ , if the BFD-RS resource outside measurement gap is

- not overlapped with the SSB symbols indicated by *SSB-ToMeasure* and 1 data symbol before each consecutive SSB symbols indicated by *SSB-ToMeasure* and 1 data symbol after each consecutive SSB symbols indicated by *SSB-ToMeasure*, given that *SSB-ToMeasure* is configured, where the *SSB-ToMeasure* is the union set of *SSB-ToMeasure* from all the configured measurement objects merged on the same serving carrier, and;
- not overlapped with the RSSI symbols indicated by *ss-RSSI-Measurement* and 1 data symbol before each RSSI symbol indicated by *ss-RSSI-Measurement* and 1 data symbol after each RSSI symbol indicated by *ss-RSSI-Measurement*, given that *ss-RSSI-Measurement* is configured,
- $P_{\text{sharing factor}} = 3$ , otherwise.

where,

If the high layer in TS 38.331 [2] signaling of *smtc2* is configured,  $T_{\text{SMTCperiod}}$  corresponds to the value of higher layer parameter *smtc2*; Otherwise  $T_{\text{SMTCperiod}}$  corresponds to the value of higher layer parameter *smtc1*.  $T_{\text{SMTCperiod}}$  is the shortest SMTC period among all CCs in the same FR2 band, provided the SMTC offset of all CCs in FR2 have the same offset.

Note: The overlap between CSI-RS for BFD and SMTC means that CSI-RS for BFD is within the SMTC window duration.

Longer evaluation period would be expected if the combination of the BFD-RS resource, SMTC occasion and measurement gap configurations does not meet previous conditions.

For either an FR1 or FR2 serving cell, longer evaluation period would be expected during the period  $T_{\text{identify\_CGI}}$  when the UE is requested to decode an NR CGI.

For either an FR1 or FR2 serving cell, longer BFD evaluation period would be expected during the period  $T_{\text{identify\_CGI, E-UTRAN}}$  when the UE is requested to decode an LTE CGI.

The values of  $M_{\text{BFD}}$  used in Table 8.5.3.2-1 and Table 8.5.3.2-2 are defined as

- $M_{\text{BFD}} = 10$ , if the CSI-RS resource(s) in set  $\bar{q}_0$  used for BFD is transmitted with Density = 3 and over the bandwidth  $\geq 24$  PRBs.

The values of  $P_{\text{BFD}}$  used in Table 8.5.3.2-1 and Table 8.5.3.2-2 are defined as

For each CSI-RS resource in the set  $\bar{q}_0$  configured for PCell or PSCell in EN-DC or NE-DC or SA; or PCell in NR-DC

- $P_{\text{BFD}} = 1$ .

For each CSI-RS resource in the set  $\bar{q}_0$  configured for PSCell in NR-DC

$P_{\text{BFD}} = 2$  if UE is configured for beam failure detection on SCell, 1 otherwise.

For each CSI-RS resource in the set  $\bar{q}_0$  configured for a SCell

- $P_{\text{BFD}} = Z$  in EN-DC or NE-DC or SA.
- $P_{\text{BFD}} = 2 * Z$  in NR-DC.

Where Z is the number of band(s) on which UE is performing beam failure detection only for SCell

**Table 8.5.3.2-1: Evaluation period  $T_{\text{Evaluate\_BFD\_CSI-RS}}$  for FR1**

Configuration	$T_{\text{Evaluate\_BFD\_CSI-RS}}$ (ms)
no DRX	$\text{Max}(50, \text{Ceil}(M_{\text{BFD}} \times P \times P_{\text{BFD}}) \times T_{\text{CSI-RS}})$
DRX cycle $\leq 320$ ms	$\text{Max}(50, \text{Ceil}(1.5 \times M_{\text{BFD}} \times P \times P_{\text{BFD}}) \times \text{Max}(T_{\text{DRX}}, T_{\text{CSI-RS}}))$
DRX cycle $> 320$ ms	$\text{Ceil}(M_{\text{BFD}} \times P \times P_{\text{BFD}}) \times T_{\text{DRX}}$

Note:	$T_{\text{CSI-RS}}$ is the periodicity of CSI-RS resource in the set $\bar{q}_0$ . $T_{\text{DRX}}$ is the DRX cycle length.
-------	--

**Table 8.5.3.2-2: Evaluation period  $T_{\text{Evaluate\_BFD\_CSI-RS}}$  for FR2**

Configuration	$T_{\text{Evaluate\_BFD\_CSI-RS}}$ (ms)
no DRX	$\text{Max}(50, \text{Ceil}(M_{\text{BFD}} \times P \times N \times P_{\text{BFD}}) \times T_{\text{CSI-RS}})$
DRX cycle $\leq 320\text{ms}$	$\text{Max}(50, \text{Ceil}(1.5 \times M_{\text{BFD}} \times P \times N \times P_{\text{BFD}}) \times \text{Max}(T_{\text{DRX}}, T_{\text{CSI-RS}}))$
DRX cycle $> 320\text{ms}$	$\text{Ceil}(M_{\text{BFD}} \times P \times N \times P_{\text{BFD}}) \times T_{\text{DRX}}$
Note:	$T_{\text{CSI-RS}}$ is the periodicity of CSI-RS resource in the set $\bar{q}_0$ . $T_{\text{DRX}}$ is the DRX cycle length.

### 8.5.3.3 Measurement restrictions for CSI-RS beam failure detection

The UE is required to be capable of measuring CSI-RS for BFD without measurement gaps. The UE is required to perform the CSI-RS measurements with measurement restrictions as described in the following scenarios.

For both FR1 and FR2, when the CSI-RS for BFD measurement is in the same OFDM symbol as SSB for RLM, BFD, CBD or L1-RSRP measurement, UE is not required to receive CSI-RS for BFD measurement in the PRBs that overlap with an SSB.

For FR1, when the SSB for RLM, BFD, CBD or L1-RSRP measurement is within the active BWP and has same SCS than CSI-RS for BFD measurement, the UE shall be able to perform CSI-RS measurement without restrictions.

For FR1, when the SSB for RLM, BFD, CBD or L1-RSRP measurement is within the active BWP and has different SCS than CSI-RS for BFD measurement, the UE shall be able to perform CSI-RS measurement with restrictions according to its capabilities:

- If the UE supports *simultaneousRxDataSSB-DiffNumerology* the UE shall be able to perform CSI-RS measurement without restrictions.
- If the UE does not support *simultaneousRxDataSSB-DiffNumerology*, UE is required to measure one of but not both CSI-RS for BFD measurement and SSB. Longer measurement period for CSI-RS based BFD measurement is expected, and no requirements are defined.

For FR1, when the CSI-RS for BFD measurement is in the same OFDM symbol as another CSI-RS for RLM, BFD, CBD or L1-RSRP measurement, UE shall be able to measure the CSI-RS for BFD measurement without any restriction.

For FR2, when the CSI-RS for BFD measurement on one CC is in the same OFDM symbol as SSB for RLM, BFD or L1-RSRP measurement on the same CC or different CCs in the same band, or in the same symbol as SSB for CBD measurement on the same CC or different CCs in the same band when beam failure is detected, UE is required to measure one of but not both CSI-RS for BFD measurement and SSB. Longer measurement period for CSI-RS based BFD measurement is expected, and no requirements are defined.

For FR2, when the CSI-RS for BFD measurement on one CC is in the same OFDM symbol as another CSI-RS for RLM, BFD, CBD or L1-RSRP measurement on the same CC or different CCs in the same band,

- In the following cases, UE is required to measure one of but not both CSI-RS for BFD measurement and the other CSI-RS. Longer measurement period for CSI-RS based BFD measurement is expected, and no requirements are defined.
  - The CSI-RS for BFD measurement or the other CSI-RS in a resource set configured with repetition ON, or
  - The other CSI-RS is configured in set  $\bar{q}_1$  and beam failure is detected, or
  - The two CSI-RS-es are not QCL-ed w.r.t. QCL-TypeD, or the QCL information is not known to UE,
- Otherwise, UE shall be able to measure the CSI-RS for BFD measurement without any restriction.

## 8.5.4 Minimum requirement for L1 indication

When the radio link quality on all the RS resources in set  $\bar{Q}$  is worse than  $Q_{\text{out\_LR}}$ , layer 1 of the UE shall send a beam failure instance indication to the higher layers.

The beam failure instance evaluation for the RS resources in set  $\bar{Q}$  shall be performed as specified in clause 6 in TS 38.213 [3]. Two successive indications from layer 1 shall be separated by at least  $T_{\text{Indication\_interval\_BFD}}$ .

When DRX is not used,  $T_{\text{Indication\_interval\_BFD}}$  is  $\max(2\text{ms}, T_{\text{SSB-RS,M}})$  or  $\max(2\text{ms}, T_{\text{CSI-RS,M}})$ , where  $T_{\text{SSB-RS,M}}$  and  $T_{\text{CSI-RS,M}}$  is the shortest periodicity of all RS resources in set  $\bar{Q}$  for the accessed cell, corresponding to either the shortest periodicity of the SSB in the set  $\bar{Q}$  or CSI-RS resource in the set  $\bar{Q}$ .

When DRX is used, for SSB based link quality measurement,

- $T_{\text{Indication\_interval\_BFD}} = \text{Max}(1.5 \times \text{DRX\_cycle\_length}, 1.5 \times T_{\text{SSB-RS,M}})$ , if  $\text{DRX\_cycle\_length} \leq 320\text{ms}$ ,
- $T_{\text{Indication\_interval\_BFD}} = \text{DRX\_cycle\_length}$ , if  $\text{DRX\_cycle\_length} > 320\text{ms}$ .

When DRX is used, for CSI-RS based link quality measurement,

- $T_{\text{Indication\_interval\_BFD}} = \text{Max}(1.5 \times \text{DRX\_cycle\_length}, 1.5 \times T_{\text{CSI-RS,M}})$ , if  $\text{DRX\_cycle\_length} \leq 320\text{ms}$ ,
- $T_{\text{Indication\_interval\_BFD}} = \text{DRX\_cycle\_length}$ , if  $\text{DRX\_cycle\_length} > 320\text{ms}$ .

## 8.5.5 Requirements for SSB based candidate beam detection

### 8.5.5.1 Introduction

The requirements in this clause apply for each SSB resource in the set  $\bar{q}_1$  configured for a serving cell, provided that the SSBs configured for candidate beam detection are actually transmitted within UE active DL BWP during the entire evaluation period specified in clause 8.5.5.2. The requirements in this clause apply when UE is required to perform beam failure detection on no more than 1 serving cell per band.

### 8.5.5.2 Minimum requirement

Upon request the UE shall be able to evaluate whether the L1-RSRP measured on the configured SSB resource in set  $\bar{q}_1$  estimated over the last  $T_{\text{Evaluate\_CBD\_SSB}}$  ms period becomes better than the threshold  $Q_{\text{in\_LR}}$  provided SSB\_RP and SSB  $\hat{E}_s/I_{\text{ot}}$  are according to Annex Table B.2.4.1 for a corresponding band.

The UE shall monitor the configured SSB resources using the evaluation period in table 8.5.5.2-1 and 8.5.5.2-2 corresponding to the non-DRX mode, if the configured DRX cycle  $\leq 320\text{ms}$ .

The value of  $T_{\text{Evaluate\_CBD\_SSB}}$  is defined in Table 8.5.5.2-1 for FR1.

The value of  $T_{\text{Evaluate\_CBD\_SSB}}$  is defined in Table 8.5.5.2-2 for FR2 with scaling factor  $N=8$ .

where,

For FR1,

- $P = \frac{1}{1 - \frac{T_{\text{SSB}}}{MGRP}}$ , when in the monitored cell there are measurement gaps configured for intra-frequency, inter-frequency or inter-RAT measurements, which are overlapping with some but not all occasions of the SSB,
- $P = 1$  when in the monitored cell there are no measurement gaps overlapping with any occasion of the SSB.

For FR2,

- $P = \frac{1}{1 - \frac{T_{SSB}}{T_{SMTCperiod}}}$ , when candidate beam detection RS is not overlapped with measurement gap and candidate beam detection RS is partially overlapped with SMTC occasion ( $T_{SSB} < T_{SMTCperiod}$ ).
- $P$  is  $P_{sharing}$  factor, when candidate beam detection RS is not overlapped with measurement gap and candidate beam detection RS is fully overlapped with SMTC period ( $T_{SSB} = T_{SMTCperiod}$ ).
- $P = \frac{1}{1 - \frac{T_{SSB}}{MGRP} - \frac{T_{SSB}}{T_{SMTCperiod}}}$ , when candidate beam detection RS is partially overlapped with measurement gap and candidate beam detection RS is partially overlapped with SMTC occasion ( $T_{SSB} < T_{SMTCperiod}$ ) and SMTC occasion is not overlapped with measurement gap and
  - $T_{SMTCperiod} \neq MGRP$  or
  - $T_{SMTCperiod} = MGRP$  and  $T_{SSB} < 0.5 \times T_{SMTCperiod}$
- $P = \frac{P_{sharing factor}}{1 - \frac{T_{SSB}}{MGRP}}$ , when candidate beam detection RS is partially overlapped with measurement gap and candidate beam detection RS is partially overlapped with SMTC occasion ( $T_{SSB} < T_{SMTCperiod}$ ) and SMTC occasion is not overlapped with measurement gap and  $T_{SMTCperiod} = MGRP$  and  $T_{SSB} = 0.5 \times T_{SMTCperiod}$
- $P = \frac{1}{1 - \frac{T_{SSB}}{\min(MGRP, T_{SMTCperiod})}}$ , when candidate beam detection RS is partially overlapped with measurement gap and candidate beam detection RS is partially overlapped with SMTC occasion ( $T_{SSB} < T_{SMTCperiod}$ ) and SMTC occasion is partially or fully overlapped with measurement gap
- $P = \frac{P_{sharing factor}}{1 - \frac{T_{SSB}}{MGRP}}$ , when candidate beam detection RS is partially overlapped with measurement gap and candidate beam detection RS is fully overlapped with SMTC occasion ( $T_{SSB} = T_{SMTCperiod}$ ) and SMTC occasion is partially overlapped with measurement gap ( $T_{SMTCperiod} < MGRP$ )
- $P_{sharing factor} = 1$ , if the candidate beam detection RS outside measurement gap is
  - not overlapped with the SSB symbols indicated by *SSB-ToMeasure* and 1 data symbol before each consecutive SSB symbols indicated by *SSB-ToMeasure* and 1 data symbol after each consecutive SSB symbols indicated by *SSB-ToMeasure*, given that *SSB-ToMeasure* is configured, where the *SSB-ToMeasure* is the union set of *SSB-ToMeasure* from all the configured measurement objects merged on the same serving carrier, and;
  - not overlapped with the RSSI symbols indicated by *ss-RSSI-Measurement* and 1 data symbol before each RSSI symbol indicated by *ss-RSSI-Measurement* and 1 data symbol after each RSSI symbol indicated by *ss-RSSI-Measurement*, given that *ss-RSSI-Measurement* is configured
- $P_{sharing factor} = 3$ , otherwise.

where,

If the high layer in TS 38.331 [2] signaling of *smtc2* is present,  $T_{SMTCperiod}$  follows *smtc2*; Otherwise  $T_{SMTCperiod}$  follows *smtc1*.  $T_{SMTCperiod}$  is the shortest SMTC period among all CCs in the same FR2 band, provided the SMTC offset of all CCs in FR2 have the same offset.

Longer evaluation period would be expected if the combination of the CBD-RS resource, SMTC occasion and measurement gap configurations does not meet previous conditions.

For either an FR1 or FR2 serving cell, longer evaluation period would be expected during the period  $T_{identify\_CGI}$  when the UE is requested to decode an NR CGI.

For either an FR1 or FR2 serving cell, longer CBD evaluation period would be expected during the period  $T_{identify\_CGI,E-UTRAN}$  when the UE is requested to decode an LTE CGI.

The values of  $P_{CBD}$  used in Table 8.5.5.2-1 and Table 8.5.5.2-2 are defined as

For each SSB resource in the set  $\bar{q}_1$  configured for PCell or PSCell in EN-DC or NE-DC or SA; or PCell in NR-DC



- $P_{\text{CBD}} = 1$ .

For each SSB resource in the set  $\bar{q}_1$  configured for PSCell in NR-DC

- $P_{\text{CBD}} = 2$  if UE is configured for candidate beam detection on SCell, 1 otherwise.

For each SSB resource in the set  $\bar{q}_1$  configured for a SCell

- $P_{\text{CBD}} = Z$  in EN-DC or NE-DC or SA.
- $P_{\text{CBD}} = 2 * Z$  in NR-DC.

Where Z is the number of band(s) on which UE is performing beam failure detection only for SCell

**Table 8.5.5.2-1: Evaluation period  $T_{\text{Evaluate\_CBD\_SSB}}$  for FR1**

Configuration	$T_{\text{Evaluate\_CBD\_SSB}}$ (ms)
non-DRX, DRX cycle $\leq 320\text{ms}$	$\text{Max}(25, \text{Ceil}(3 \times P \times P_{\text{CBD}}) \times T_{\text{SSB}})$
DRX cycle $> 320\text{ms}$	$\text{Ceil}(3 \times P \times P_{\text{CBD}}) \times T_{\text{DRX}}$
Note:	$T_{\text{SSB}}$ is the periodicity of SSB in the set $\bar{q}_1$ . $T_{\text{DRX}}$ is the DRX cycle length.

**Table 8.5.5.2-2: Evaluation period  $T_{\text{Evaluate\_CBD\_SSB}}$  for FR2**

Configuration	$T_{\text{Evaluate\_CBD\_SSB}}$ (ms)
non-DRX, DRX cycle $\leq 320\text{ms}$	$\text{Max}(25, \text{Ceil}(3 \times P \times N \times P_{\text{CBD}}) \times T_{\text{SSB}})$
DRX cycle $> 320\text{ms}$	$\text{Ceil}(3 \times P \times N \times P_{\text{CBD}}) \times T_{\text{DRX}}$
Note:	$T_{\text{SSB}}$ is the periodicity of SSB in the set $\bar{q}_1$ . $T_{\text{DRX}}$ is the DRX cycle length.

### 8.5.5.3 Measurement restriction for SSB based candidate beam detection

For FR1, when the SSB for CBD measurement is in the same OFDM symbol as CSI-RS for RLM, BFD, CBD or L1-RSRP measurement,

- If SSB and CSI-RS have same SCS, UE shall be able to measure the SSB for CBD measurement without any restrictions;
- If SSB and CSI-RS have different SCS-es,
  - If UE supports *simultaneousRxDataSSB-DiffNumerology*, UE shall be able to measure the SSB for CBD measurement without any restriction;
  - If UE does not support *simultaneousRxDataSSB-DiffNumerology*, UE is required to measure one of but not both SSB for CBD measurement and CSI-RS. Longer measurement period for SSB based CBD measurement is expected, and no requirements are defined.

For FR2, when the SSB for CBD measurement on one CC is in the same OFDM symbol as CSI-RS for RLM, BFD, CBD or L1-RSRP measurement on the same CC or different CCs in the same band, UE is required to measure one of but not both SSB for CBD measurement and CSI-RS. Longer measurement period for SSB based CBD measurement is expected, and no requirements are defined.

For FR2, if the network configures same or mixed numerology between SSB for CBD measurement on one FR2 band and CSI-RS for RLM, BFD, CBD, L1-RSRP or L1-SINR measurement on the other FR2 band, UE shall be able to perform the related SSB based measurements in one band without any measurement restrictions in the other band, provided that UE is capable of independent beam management on this FR2 band pair.

## 8.5.6 Requirements for CSI-RS based candidate beam detection

### 8.5.6.1 Introduction

The requirements in this clause apply for each CSI-RS resource in the set  $\bar{q}_1$  configured for a serving cell, provided that the CSI-RS resources configured for candidate beam detection are actually transmitted within UE active DL BWP during the entire evaluation period specified in clause 8.5.6.2. The requirements in this clause apply when UE is required to perform beam failure detection on no more than 1 serving cell per band.

### 8.5.6.2 Minimum requirement

Upon request the UE shall be able to evaluate whether the L1-RSRP measured on the configured CSI-RS resource in set  $\bar{q}_1$  estimated over the last  $T_{\text{Evaluate\_CBD\_CSI-RS}}$  [ms] period becomes better than the threshold  $Q_{\text{in\_LR}}$  within  $T_{\text{Evaluate\_CBD\_CSI-RS}}$  [ms] period provided CSI-RS  $\hat{E}_s/I_{\text{ot}}$  is according to Annex Table B.2.4.2 for a corresponding band.

The UE shall monitor the configured CSI-RS resources using the evaluation period in table 8.5.6.2-1 and 8.5.6.2-2 corresponding to the non-DRX mode, if the configured DRX cycle  $\leq 320$ ms.

The value of  $T_{\text{Evaluate\_CBD\_CSI-RS}}$  is defined in Table 8.5.6.2-1 for FR1.

The value of  $T_{\text{Evaluate\_CBD\_CSI-RS}}$  is defined in Table 8.5.6.2-2 for FR2 with scaling factor  $N=8$ .

For FR1,

- $P = \frac{1}{1 - \frac{T_{\text{CSI-RS}}}{\text{MGRP}}}$ , when in the monitored cell there are measurement gaps configured for intra-frequency, inter-frequency or inter-RAT measurements, which are overlapping with some but not all occasions of the CSI-RS; and
- $P = 1$  when in the monitored cell there are no measurement gaps overlapping with any occasion of the CSI-RS.

For FR2,

- $P = 1$ , when candidate beam detection RS is not overlapped with measurement gap and also not overlapped with SMTC occasion.
- $P = \frac{1}{1 - \frac{T_{\text{CSI-RS}}}{\text{MGRP}}}$  when candidate beam detection RS is partially overlapped with measurement gap and candidate beam detection RS is not overlapped with SMTC occasion ( $T_{\text{CSI-RS}} < \text{MGRP}$ )
- $P = \frac{1}{1 - \frac{T_{\text{CSI-RS}}}{T_{\text{SMTCperiod}}}}$ , when candidate beam detection RS is not overlapped with measurement gap and candidate beam detection RS is partially overlapped with SMTC occasion ( $T_{\text{CSI-RS}} < T_{\text{SMTCperiod}}$ ).
- $P = P_{\text{sharing factor}}$ , when candidate beam detection RS is not overlapped with measurement gap and candidate beam detection RS is fully overlapped with SMTC occasion ( $T_{\text{CSI-RS}} = T_{\text{SMTCperiod}}$ ).
- $P = \frac{1}{1 - \frac{T_{\text{CSI-RS}}}{\text{MGRP}} - \frac{T_{\text{CSI-RS}}}{T_{\text{SMTCperiod}}}}$ , when candidate beam detection RS is partially overlapped with measurement gap and candidate beam detection RS is partially overlapped with SMTC occasion ( $T_{\text{CSI-RS}} < T_{\text{SMTCperiod}}$ ) and SMTC occasion is not overlapped with measurement gap and
  - $T_{\text{SMTCperiod}} \neq \text{MGRP}$  or
  - $T_{\text{SMTCperiod}} = \text{MGRP}$  and  $T_{\text{CSI-RS}} < 0.5 \times T_{\text{SMTCperiod}}$
- $P = \frac{P_{\text{sharing factor}}}{1 - \frac{T_{\text{CSI-RS}}}{\text{MGRP}}}$ , when candidate beam detection RS is partially overlapped with measurement gap and candidate beam detection RS is partially overlapped with SMTC occasion ( $T_{\text{CSI-RS}} < T_{\text{SMTCperiod}}$ ) and SMTC occasion is not overlapped with measurement gap and  $T_{\text{SMTCperiod}} = \text{MGRP}$  and  $T_{\text{CSI-RS}} = 0.5 \times T_{\text{SMTCperiod}}$

- $P = \frac{1}{1 - \frac{T_{\text{CSI-RS}}}{\min(MGRP, T_{\text{SMTCperiod}})}}$ , when candidate beam detection RS is partially overlapped with measurement gap and candidate beam detection RS is partially overlapped with SMTC occasion ( $T_{\text{CSI-RS}} < T_{\text{SMTCperiod}}$ ) and SMTC occasion is partially or fully overlapped with measurement gap
- $P = \frac{3}{1 - \frac{T_{\text{CSI-RS}}}{MGRP}}$ , when candidate beam detection RS is partially overlapped with measurement gap and candidate beam detection RS is fully overlapped with SMTC occasion ( $T_{\text{CSI-RS}} = T_{\text{SMTCperiod}}$ ) and SMTC occasion is partially overlapped with measurement gap ( $T_{\text{SMTCperiod}} < MGRP$ )
- $P_{\text{sharing factor}} = 1$ , if the candidate beam detection RS outside measurement gap is
  - not overlapped with the SSB symbols indicated by *SSB-ToMeasure* and 1 data symbol before each consecutive SSB symbols indicated by *SSB-ToMeasure* and 1 data symbol after each consecutive SSB symbols indicated by *SSB-ToMeasure*, given that *SSB-ToMeasure* is configured, where the *SSB-ToMeasure* is the union set of *SSB-ToMeasure* from all the configured measurement objects merged on the same serving carrier, and;
  - not overlapped with the RSSI symbols indicated by *ss-RSSI-Measurement* and 1 data symbol before each RSSI symbol indicated by *ss-RSSI-Measurement* and 1 data symbol after each RSSI symbol indicated by *ss-RSSI-Measurement*, given that *ss-RSSI-Measurement* is configured.
- $P_{\text{sharing factor}} = 3$ , otherwise.

where,

If the high layer in TS 38.331 [2] signaling of *smtc2* is present,  $T_{\text{SMTCperiod}}$  follows *smtc2*; Otherwise  $T_{\text{SMTCperiod}}$  follows *smtc1*.  $T_{\text{SMTCperiod}}$  is the shortest SMTC period among all CCs in the same FR2 band, provided the SMTC offset of all CCs in FR2 have the same offset.

Note: The overlap between CSI-RS for CBD and SMTC means that CSI-RS for CBD is within the SMTC window duration.

Longer evaluation period would be expected if the combination of the CBD-RS resource, SMTC occasion and measurement gap configurations does not meet previous conditions.

Longer evaluation period would be expected if the CSI-RS is on the same OFDM symbols with RLM, BFD, BM-RS, or other CBD-RS, according to the measurement restrictions defined in clause 8.5.6.3.

For either an FR1 or FR2 serving cell, longer evaluation period would be expected during the period  $T_{\text{identify\_CGI}}$  when the UE is requested to decode an NR CGI.

For either an FR1 or FR2 serving cell, longer CBD evaluation period would be expected during the period  $T_{\text{identify\_CGI,E-UTRAN}}$  when the UE is requested to decode an LTE CGI.

The values of  $M_{\text{CBD}}$  used in Table 8.5.6.2-1 and Table 8.5.6.2-2 are defined as

- $M_{\text{CBD}} = 3$ , if the CSI-RS resource configured in the set  $\bar{q}_1$  is transmitted with Density = 3 and over the bandwidth  $\geq 24$  PRBs.

The values of  $P_{\text{CBD}}$  used in Table 8.5.6.2-1 and Table 8.5.6.2-2 are defined as

For each CSI-RS resource in the set  $\bar{q}_1$  configured for PCell or PSCell in EN-DC or NE-DC or SA; or PCell in NR-DC

- $P_{\text{CBD}} = 1$ .

For each CSI-RS resource in the set  $\bar{q}_1$  configured for PSCell in NR-DC

- $P_{\text{CBD}} = 2$  if UE configured for candidate beam detection on SCell, 1 otherwise.

For each CSI-RS resource in the set  $\bar{q}_1$  configured for a SCell

- $P_{\text{CBD}} = Z$  in EN-DC or NE-DC or SA.

- $P_{\text{CBD}} = 2 * Z$  in NR-DC.

Where  $Z$  is the number of band(s) on which UE is performing beam failure detection only for SCell

**Table 8.5.6.2-1: Evaluation period  $T_{\text{Evaluate\_CBD\_CSI-RS}}$  for FR1**

Configuration	$T_{\text{Evaluate\_CBD\_CSI-RS}}$ (ms)
non-DRX, DRX cycle $\leq 320\text{ms}$	$\text{Max}(25, \text{Ceil}(M_{\text{CBD}} \times P \times P_{\text{CBD}}) \times T_{\text{CSI-RS}})$
DRX cycle $> 320\text{ms}$	$\text{Ceil}(M_{\text{CBD}} \times P \times P_{\text{CBD}}) \times T_{\text{DRX}}$
Note:	$T_{\text{CSI-RS}}$ is the periodicity of CSI-RS resource in the set $\bar{q}_1$ . $T_{\text{DRX}}$ is the DRX cycle length.

**Table 8.5.6.2-2: Evaluation period  $T_{\text{Evaluate\_CBD\_CSI-RS}}$  for FR2**

Configuration	$T_{\text{Evaluate\_CBD\_CSI-RS}}$ (ms)
non-DRX, DRX cycle $\leq 320\text{ms}$	$\text{Max}(25, \text{Ceil}(M_{\text{CBD}} \times P \times N \times P_{\text{CBD}}) \times T_{\text{CSI-RS}})$
DRX cycle $> 320\text{ms}$	$\text{Ceil}(M_{\text{CBD}} \times P \times N \times P_{\text{CBD}}) \times T_{\text{DRX}}$
Note:	$T_{\text{CSI-RS}}$ is the periodicity of CSI-RS resource in the set $\bar{q}_1$ . $T_{\text{DRX}}$ is the DRX cycle length.

### 8.5.6.3 Measurement restriction for CSI-RS based candidate beam detection

For both FR1 and FR2, when the CSI-RS for CBD measurement is in the same OFDM symbol as SSB for RLM, BFD, CBD or L1-RSRP measurement, UE is not required to receive CSI-RS for CBD measurement in the PRBs that overlap with an SSB.

For FR1, when the SSB for RLM, BFD, CBD or L1-RSRP measurement is within the active BWP and has same SCS than CSI-RS for CBD measurement, the UE shall be able to perform CSI-RS based CBD measurement without restrictions.

For FR1, when the SSB for RLM, BFD, CBD or L1-RSRP measurement is within the active BWP and has different SCS than CSI-RS for CBD measurement, the UE shall be able to perform CSI-RS based CBD measurement with restrictions according to its capabilities:

- If the UE supports *simultaneousRxDataSSB-DiffNumerology* the UE shall be able to perform CSI-RS based CBD measurement for without restrictions.
- If the UE does not support *simultaneousRxDataSSB-DiffNumerology*, UE is required to measure one of but not both CSI-RS for CBD measurement and SSB. Longer measurement period for CSI-RS based CBD measurement is expected, and no requirements are defined.

For FR1, when the CSI-RS for CBD measurement is in the same OFDM symbol as another CSI-RS for RLM, BFD, CBD or L1-RSRP measurement, UE shall be able to measure the CSI-RS for CBD measurement without any restriction.

For FR2, when the CSI-RS for CBD measurement on one CC is in the same OFDM symbol as SSB for RLM, BFD, CBD or L1-RSRP measurement on the same CC or different CCs in the same band, UE is required to measure one of but not both CSI-RS for CBD measurement and SSB. Longer evaluation period for CSI-RS based CBD measurement is expected, and no requirements are defined.

For FR2, when the CSI-RS for CBD measurement on one CC is in the same OFDM symbol as another CSI-RS for RLM, BFD, CBD or L1-RSRP measurement on the same CC or different CCs in the same band, UE is required to measure one of but not both CSI-RS for CBD measurement and the other CSI-RS. Longer evaluation period for CSI-RS based CBD measurement is expected, and no requirements are defined.

## 8.5.7 Scheduling availability of UE during beam failure detection

Scheduling availability restrictions when the UE is performing beam failure detection are described in the following clauses.

### 8.5.7.1 Scheduling availability of UE performing beam failure detection with a same subcarrier spacing as PDSCH/PDCCH on FR1

There are no scheduling restrictions due to beam failure detection performed on SSB and CSI-RS configured for BFD with the same SCS as PDSCH or PDCCH in FR1.

### 8.5.7.2 Scheduling availability of UE performing beam failure detection with a different subcarrier spacing than PDSCH/PDCCH on FR1

For UEs which support *simultaneousRxDataSSB-DiffNumerology* [14] there are no restrictions on scheduling availability due to beam failure detection when SSB is configured as BFD. For UEs which do not support *simultaneousRxDataSSB-DiffNumerology* [14] the following restrictions apply due to beam failure detection when SSB is configured as BFD.

- The UE is not expected to transmit PUCCH, PUSCH or SRS or receive PDCCH, PDSCH or CSI-RS for tracking or CSI-RS for CQI on SSB symbols to be measured for beam failure detection.

When intra-band carrier aggregation in FR1 is configured, the scheduling restrictions on FR1 serving PCell or PSCell apply to all serving cells in the same band on the symbols that fully or partially overlap with restricted symbols. When inter-band carrier aggregation within FR1 is configured, there are no scheduling restrictions on FR1 serving cell(s) configured in other bands than the bands in which PCell or PSCell is configured.

### 8.5.7.3 Scheduling availability of UE performing beam failure detection on FR2

The following scheduling restriction applies due to beam failure detection.

- For the case where no RSs are provided for BFD, or when CSI-RS is configured for BFD is explicitly configured and is type-D QCLed with active TCI state for PDCCH or PDSCH, and the CSI-RS is not in a CSI-RS resource set with repetition ON
  - There are no scheduling restrictions due to beam failure detection performed based on the CSI-RS.
- Otherwise
  - The UE is not expected to transmit PUCCH, PUSCH or SRS or receive PDCCH, PDSCH or CSI-RS for tracking or CSI-RS for CQI on BFD-RS resource symbols to be measured for beam failure detection.

When intra-band carrier aggregation in FR2 is performed, the scheduling restrictions on FR2 serving PCell or PSCell apply to all serving cells in the same band on the symbols that fully or partially overlap with restricted symbols.

When inter-band carrier aggregation in FR2 is performed, there are no scheduling restrictions on FR2 serving cells in the bands due to beam failure detection performed on FR2 serving cell(s) in different band(s), provided that UE is capable of independent beam management on this FR2 band pair. Additionally, there is no scheduling restriction if the UE is configured with different numerology between SSB on one FR2 band and data on the other FR2 band provided the UE is configured for IBM operation for the band pair.

For FR2, if following conditions are met,

- UE has been notified about system information update through paging,
- The gap between UE's reception of PDCCH that UE monitors in the Type2-PDCCH CSS set and that notifies system information update, and the PDCCH that UE monitors in the Type0-PDCCH CSS set, is greater than 2 slots,

For the SSB and CORESET for RMSI scheduling multiplexing patterns 3, UE is expected to receive the PDCCH that UE monitors in the Type0-PDCCH CSS set, and the corresponding PDSCH, on SSB symbols to be measured for BFD measurement; and

For the SSB and CORESET for RMSI scheduling multiplexing patterns 2, UE is expected to receive PDSCH that corresponds to the PDCCH that UE monitors in the Type0-PDCCH CSS set, on SSB symbols to be measured for BFD measurement.

#### 8.5.7.4 Scheduling availability of UE performing beam failure detection on FR1 or FR2 in case of FR1-FR2 inter-band CA and NR DC

There are no scheduling restrictions on FR1 serving cell(s) due to beam failure detection performed on FR2 serving PCell and/or PSCell.

There are no scheduling restrictions on FR2 serving cell(s) due to beam failure detection performed on FR1 serving PCell and/or PSCell.

### 8.5.8 Scheduling availability of UE during candidate beam detection

Scheduling availability restrictions when the UE is performing L1-RSRP measurement for candidate beam detection are described in the following clauses.

#### 8.5.8.1 Scheduling availability of UE performing L1-RSRP measurement with a same subcarrier spacing as PDSCH/PDCCH on FR1

There are no scheduling restrictions due to L1-RSRP measurement performed on SSB and CSI-RS configured as link recovery detection resource with the same SCS as PDSCH or PDCCH in FR1.

#### 8.5.8.2 Scheduling availability of UE performing L1-RSRP measurement with a different subcarrier spacing than PDSCH/PDCCH on FR1

For UEs which support *simultaneousRxDataSSB-DiffNumerology* [14] there are no restrictions on scheduling availability due to L1-RSRP measurement based on SSB as link recovery detection resource. For UEs which do not support *simultaneousRxDataSSB-DiffNumerology* [14] the following restrictions apply due to L1-RSRP measurement based on SSB configured as link recovery detection resource.

- The UE is not expected to transmit PUCCH, PUSCH or SRS or receive PDCCH, PDSCH, TRS, CSI-RS for tracking or CSI-RS for CQI on SSB symbols to be measured for L1-RSRP.

When intra-band carrier aggregation in FR1 is configured, the scheduling restrictions on one serving cell apply to all other serving cells in the same band on the symbols that fully or partially overlap with the restricted symbols. When inter-band carrier aggregation within FR1 is configured, there are no scheduling restrictions on FR1 serving cell(s) configured in other bands.

#### 8.5.8.3 Scheduling availability of UE performing L1-RSRP measurement on FR2

The following scheduling restriction applies due to candidate beam detection

- The UE is not expected to transmit PUCCH, PUSCH or SRS or receive PDCCH, PDSCH, CSI-RS for tracking or CSI-RS for CQI on reference symbols to be measured for candidate beam detection.

When intra-band carrier aggregation in FR2 is configured, the scheduling restrictions on to one serving cell apply to all serving cells in the same band on the symbols that fully or partially overlap with restricted symbols.

When inter-band carrier aggregation in FR2 is performed, there are no scheduling restrictions on FR2 serving cells in the bands due to candidate beam detection performed on FR2 serving cell(s) in different band(s), provided that the FR2 serving cell(s) and the FR2 serving cell(s) for candidate beam detection are in a FR2 band pair and UE is capable of independent beam management on this FR2 band pair. Additionally, there is no scheduling restriction if the UE is configured with different numerology between SSB on one FR2 band and data on the other FR2 band provided the UE is configured for IBM operation for the band pair.

For FR2, if following conditions are met,

- UE has been notified about system information update through paging,

- The gap between UE's reception of PDCCH that UE monitors in the Type2-PDCCH CSS set and that notifies system information update, and the PDCCH that UE monitors in the Type0-PDCCH CSS set, is greater than 2 slots,

For the SSB and CORESET for RMSI scheduling multiplexing patterns 3, UE is expected to receive the PDCCH that UE monitors in the Type0-PDCCH CSS set, and the corresponding PDSCH, on SSB symbols to be measured for CBD measurement; and

For the SSB and CORESET for RMSI scheduling multiplexing patterns 2, UE is expected to receive PDSCH that corresponds to the PDCCH that UE monitors in the Type0-PDCCH CSS set, on SSB symbols to be measured for CBD measurement.

#### 8.5.8.4 Scheduling availability of UE performing L1-RSRP measurement on FR1 or FR2 in case of FR1-FR2 inter-band CA and NR-DC

There are no scheduling restrictions on FR1 serving cell(s) due to L1-RSRP measurement performed on FR2 serving cell(s).

There are no scheduling restrictions on FR2 serving cell(s) due to L1-RSRP measurement performed on FR1 serving cell(s).

### 8.5.9 Requirements for Beam Failure Recovery in SCell

#### 8.5.9.1 Introduction

For the UE provided with a configuration of PUCCH transmission with a link recovery request (LRR) as described in clause 9.2.4 in TS 38.213 [3], if beam recovery procedure is triggered for any of SCells, the UE shall transmit SR for UL resource, followed by MAC CE providing one index for at least one corresponding SCell with radio link quality is worse than  $Q_{out,LR}$ , and the index  $q_{new}$  for a periodic CSI-RS configuration or for a SSB provided by higher layer, as described in clause 5.17 of TS38.321 [7], if any, for a corresponding SCell.

For the UE not provided with a configuration of PUCCH transmission with a link recovery request (LRR) as described in clause 9.2.4 in TS 38.213 [3], if beam recovery procedure is triggered for any of SCells, the UE shall transmit preamble for UL-SCH resource application, followed by MAC CE providing one index for at least one corresponding SCell with radio link quality is worse than  $Q_{out,LR}$ , and the index  $q_{new}$  for a periodic CSI-RS configuration or for a SSB provided by higher layer, as described in clause 5.17 of TS38.321 [7], if any, for a corresponding SCell.

#### 8.5.9.2 Requirement

Provided that UE is configured by *schedulingRequestIDForBFR* a configuration for LRR in a PUCCH transmission, after BFR is triggered on any of SCells as described in clause 5.17 of TS38.321 [7], UE shall be capable of transmit PUCCH with a LRR within a period of T, where

- $T = T_1 \times \text{Ceil}((T_2+D) / T_1)$  in which  $T_1$ ,  $T_2$  and D are defined as
  - $T_1$  is equal to the periodicity of PUCCH configured with *schedulingRequestIDForBFR*.
  - $T_2 = T_{\text{Evaluate\_CBD}}$  is the evaluation period specified in clause 8.5.5 or 8.5.6 for SSB or CSI-RS based candidate beam detection, that is  $T_{\text{Evaluate\_CBD\_SSB}}$  or  $T_{\text{Evaluate\_CBD\_CSI-RS}}$ , depending on the applicable reference signal configured for candidate beam detection.
  - $D = 2\text{ms}$  is the UE Processing time.

#### 8.5.10 Minimum requirement at transitions for beam failure detection

When the UE transitions between DRX and no DRX or when DRX cycle periodicity changes, for each BFD-RS resource, for a duration of time equal to the evaluation period corresponding to the second mode after the transition occurs, the UE shall use an evaluation period that is no less than the minimum of evaluation period corresponding to the first mode and the second mode. Subsequent to this duration, the UE shall use an evaluation period corresponding to the second mode for each BFD-RS resource.

When the UE transitions from a first configuration of BFD resources to a second configuration of BFD resources that is different from the first configuration, for each BFD resource present in the second configuration, for a duration of time equal to the evaluation period corresponding to the second configuration after the transition occurs, the UE shall use an evaluation period that is no less than the minimum of evaluation periods corresponding to the first configuration and the second configuration. Subsequent to this duration, the UE shall use an evaluation period corresponding to the second configuration for each BFD resource present in the second configuration.

When the UE transitions from a first configuration of active TCI state of the CORESET to a second configuration of active TCI state of the CORESET, for each CSI-RS for BFD present in the second configuration, the UE shall use an evaluation period corresponding to the second configuration from the time of transition.

## 8.5A Link Recovery Procedures when CCA is used on target frequency

### 8.5A.1 Introduction

The requirements for link recovery procedure in the clause apply when CCA is used on a serving frequency on the downlink.

The UE shall assess the downlink radio link quality of a serving cell based on the reference signal in the set  $\bar{q}_0$  as specified in TS 38.213 [3] in order to detect beam failure on:

- PCell in SA operation mode,
- PSCell in EN-DC operation mode.

The RS resource configurations in the set  $\bar{q}_0$  can be periodic SSBs. UE is not required to perform beam failure detection outside the active DL BWP. UE is not required to meet the requirements in clause 8.5A.2 and 8.5A.3 if UE does not have set  $\bar{q}_0$ .

On each RS resource configuration in the set  $\bar{q}_0$ , the UE shall estimate the radio link quality and compare it to the threshold  $Q_{\text{out\_LR,CCA}}$  for the purpose of accessing downlink radio link quality of the serving cell beams.

The threshold  $Q_{\text{out\_LR,CCA}}$  is defined as the level at which the downlink radio level link of a given resource configuration on set  $\bar{q}_0$  cannot be reliably received and shall correspond to the  $\text{BLER}_{\text{out,CCA}} = 10\%$  block error rate of a hypothetical PDCCH transmission. For SSB based beam failure detection,  $Q_{\text{out\_LR,SSB,CCA}}$  is derived based on the hypothetical PDCCH transmission parameters listed in Table 8.5A.2.1-1.

Upon request the UE shall deliver configuration indexes from the set  $\bar{q}_1$  as specified in TS 38.213 [3], to higher layers, and the corresponding L1-RSRP measurement provided that the measured L1-RSRP is equal to or better than the threshold  $Q_{\text{in\_LR,CCA}}$ , which is indicated by higher layer parameter *rsrp-ThresholdSSB*. The UE applies the  $Q_{\text{in\_LR,CCA}}$  threshold to the L1-RSRP measurement obtained from an SSB. The RS resource configurations in the set  $\bar{q}_1$  can be periodic SSBs. UE is not required to perform candidate beam detection outside the active DL BWP.

In the requirements of clause 8.5A, the term CBD-RS SSB occasions not available at the UE refers to when the CBD-RS SSB is configured by gNB in a cell on a carrier frequency subject to CCA, but the first two successive candidate SSB positions for the same SSB index within the set of configured CBD-RS resources are not available at the UE due to DL CCA failures at gNB during the corresponding evaluation period; otherwise the CBD-RS SSB is considered as available at the UE.

The requirements in clause 8.5A apply for any *channelAccessMode* configuration [TS 38.331, 2].

### 8.5A.2 Requirements for SSB based beam failure detection

#### 8.5A.2.1 Introduction

The requirements in this clause apply for each SSB resource in the set  $\bar{q}_0$  configured for a serving cell, provided that the SSB configured for beam failure detection is actually transmitted within the UE active DL BWP during the entire evaluation period specified in clause 8.5A.2.2, but occasionally may not be transmitted due to CCA operation.



**Table 8.5A.2.1-1: PDCCH transmission parameters for beam failure instance**

Attribute	Value for BLER
DCI format	1-0
Number of control OFDM symbols	2
Aggregation level (CCE)	8
Ratio of hypothetical PDCCH RE energy to average SSS RE energy	0dB
Ratio of hypothetical PDCCH DMRS energy to average SSS RE energy	0dB
Bandwidth (PRBs)	24
Sub-carrier spacing (kHz)	Same as the SCS of RMSI CORESET
DMRS precoder granularity	REG bundle size
REG bundle size	6
CP length	Normal
Mapping from REG to CCE	Distributed

### 8.5A.2.2 Minimum requirement

UE shall be able to evaluate whether the downlink radio link quality on the configured BFD-RS SSB resource in set  $\bar{q}_0$  estimated over the last  $T_{\text{Evaluate\_BFD\_SSB\_CCA}}$  ms period becomes worse than the threshold  $Q_{\text{out\_LR\_SSB\_CCA}}$  within  $T_{\text{Evaluate\_BFD\_SSB\_CCA}}$  ms period.

The value of  $T_{\text{Evaluate\_BFD\_SSB\_CCA}}$  is defined in Table 8.5A.2.2-1, where

- $P = \frac{1}{1 - \frac{T_{\text{SSB}}}{MRGP}}$ , when in the monitored cell there are measurement gaps configured for intra-frequency, inter-frequency or inter-RAT measurements, which are overlapping with some but not all occasions of the BFD-RS SSB.
- $P=1$  when in the monitored cell there are no measurement gaps overlapping with any occasion of the BFD-RS SSB.

If the high layer in TS 38.331 [2] signaling of *smtc2* is configured,  $T_{\text{SMTCPERIOD}}$  corresponds to the value of higher layer parameter *smtc2*; Otherwise  $T_{\text{SMTCPERIOD}}$  corresponds to the value of higher layer parameter *smtc1*.

Longer evaluation period would be expected if the combination of BFD-RS SSB resource, SMTC occasion and measurement gap configurations does not meet previous conditions.

**Table 8.5A.2.2-1: Evaluation period  $T_{\text{Evaluate\_BFD\_SSB\_CCA}}$** 

Configuration	$T_{\text{Evaluate\_BFD\_SSB\_CCA}}$ (ms)	
	BFD-RS SSB Es/lot <sup>Note2</sup> $\geq -7$ dB	BFD-RS SSB Es/lot <sup>Note2</sup> $< -7$ dB
no DRX	$\text{Max}(50, \text{Ceil}((10 \times P) \times T_{\text{SSB}}))$	$\text{Max}(50, \text{Ceil}((12 \times P) \times T_{\text{SSB}}))$
DRX cycle $\leq 320$ ms	$\text{Max}(50, \text{Ceil}(1.5 \times 8 \times P) \times \text{Max}(T_{\text{DRX}}, T_{\text{SSB}}))$	$\text{Max}(50, \text{Ceil}(1.5 \times 10 \times P) \times \text{Max}(T_{\text{DRX}}, T_{\text{SSB}}))$
DRX cycle $> 320$ ms	$\text{Ceil}(7 \times P) \times T_{\text{DRX}}$	$\text{Ceil}(8 \times P) \times T_{\text{DRX}}$
Note 1: $T_{\text{SSB}}$ is the periodicity of SSB in the set $\bar{q}_0$ . $T_{\text{DRX}}$ is the DRX cycle length.		
Note 2: BFD-RS SSB Es/lot is the averaged BFD-RS SSB Es/lot over the most recent previous evaluation period.		

### 8.5A.2.3 Measurement restriction for SSB based beam failure detection

The UE is required to be capable of measuring SSB for BFD without measurement gaps. The UE is required to perform the SSB measurements with measurement restrictions as described in the following clauses.

When the SSB for BFD measurement is in the same OFDM symbol as CSI-RS for BFD, CBD or L1-RSRP measurement,

- If SSB and CSI-RS have same SCS, UE shall be able to measure the SSB for BFD measurement without any restriction;

- If SSB and CSI-RS have different SCS,
- If UE supports *simultaneousRxDataSSB-DiffNumerology*, UE shall be able to measure the SSB for BFD measurement without any restriction;
- If UE does not support *simultaneousRxDataSSB-DiffNumerology*, UE is required to measure SSB for BFD measurement.

### 8.5A.4 Minimum requirement for L1 indication

When the radio link quality on all the RS resources in set  $\bar{q}_0$  is worse than  $Q_{\text{out\_LR\_CCA}}$ , layer 1 of the UE shall send a beam failure instance indication to the higher layers.

The beam failure instance evaluation for the RS resources in set  $\bar{q}_0$  shall be performed as specified in clause 6 in TS 38.213 [3]. Two successive indications from layer 1 shall be separated by at least  $T_{\text{Indication\_interval\_BFD\_CCA}}$ .

When DRX is not used,  $T_{\text{Indication\_interval\_BFD\_CCA}}$  is  $\max(2\text{ms}, T_{\text{SSB-RS,M}})$ , where  $T_{\text{SSB-RS,M}}$  is the shortest periodicity of all RS resources in set  $\bar{q}_0$  for the accessed cell, corresponding to either the shortest periodicity of the SSB in the set  $\bar{q}_0$ .

When DRX is used, for SSB based link quality measurement,

- $T_{\text{Indication\_interval\_BFD\_CCA}} = \text{Max}(1.5 \times \text{DRX\_cycle\_length}, 1.5 \times T_{\text{SSB-RS,M}})$ , if  $\text{DRX\_cycle\_length} \leq 320\text{ms}$ ,
- $T_{\text{Indication\_interval\_BFD\_CCA}} = \text{DRX\_cycle\_length}$ , if  $\text{DRX\_cycle\_length} > 320\text{ms}$ .

### 8.5A.5 Requirements for SSB based candidate beam detection

#### 8.5A.5.1 Introduction

The requirements in this clause apply for each CBD-RS SSB resource in the set  $\bar{q}_1$  configured for a serving cell, provided that the SSBs configured for candidate beam detection are actually transmitted within UE active DL BWP during the entire evaluation period specified in clause 8.5A.5.2, but occasionally may not be transmitted due to CCA operation.

#### 8.5A.5.2 Minimum requirement

Upon request the UE shall be able to evaluate whether the L1-RSRP measured on the configured CBD-RS SSB resource in set  $\bar{q}_1$  estimated over the last  $T_{\text{Evaluate\_CBD\_SSB\_CCA}}$  ms period becomes better than the threshold  $Q_{\text{in\_LR\_CCA}}$  provided  $\text{SSB\_RP}$  and  $\text{SSB } \hat{E}_s/\text{Iot}$  are according to Annex Table B.2.4.1 for a corresponding band.

The UE shall monitor the configured SSB resources using the evaluation period in table 8.5A.5.2-1 corresponding to the non-DRX mode, if the configured DRX cycle  $\leq 320\text{ms}$ .

The value of  $T_{\text{Evaluate\_CBD\_SSB\_CCA}}$  is defined in Table 8.5A.5.2-1, where

- $P = \frac{1}{1 - \frac{T_{\text{SSB}}}{\text{MRGP}}}$ , when in the monitored cell there are measurement gaps configured for intra-frequency, inter-frequency or inter-RAT measurements, which are overlapping with some but not all occasions of the CBD-RS SSB,
- $P = 1$  when in the monitored cell there are no measurement gaps overlapping with any occasion of the CBD-RS SSB.

**Table 8.5A.5.2-1: Evaluation period  $T_{\text{Evaluate\_CBD\_SSB\_CCA}}$**

Configuration	$T_{\text{Evaluate\_CBD\_SSB\_CCA}}$ (ms)
non-DRX, DRX cycle $\leq 320\text{ms}$	$\text{Max}(25, \text{Ceil}((3 + L_{\text{CBD}}) \times P) \times T_{\text{SSB}})$
DRX cycle $> 320\text{ms}$	$\text{Ceil}((3 + L_{\text{CBD}}) \times P) \times T_{\text{DRX}}$
Note 1: $T_{\text{SSB}}$ is the periodicity of SSB in the set $\bar{q}_1$ . $T_{\text{DRX}}$ is the DRX cycle length.	

Note 2:	When DRX is not configured, $L_{CBD}$ is the number of CBD-RS SSB occasions not available at the UE during $T_{Evaluate\_CBD\_SSB\_CCA}$ where $L_{CBD} \leq L_{CBD,max}$ . When DRX is configured, $L_{CBD}$ is the number of DRX cycles in which at least one of the CBD-RS SSB occasions not available at the UE during $T_{Evaluate\_CBD\_SSB\_CCA}$ where $L_{CBD} \leq L_{CBD,max}$ . The UE, which is configured with DRX, is not required to determine the availability of SSB occasions more frequent than Once per $\text{Max}(25\text{ms}, P * T_{SSB})$ if DRX cycle $\leq 320\text{ms}$ , Once per $P * T_{DRX}$ if DRX cycle $> 320\text{ms}$ .
Note 3:	$L_{CBD,max}=7$ for $\text{Max}(T_{DRX}, T_{SSB}) \leq 40$ assuming $T_{DRX}=0$ for non-DRX, $L_{CBD,max}=5$ for $40 < \text{Max}(T_{DRX}, T_{SSB}) \leq 320$ , $L_{CBD,max}=3$ for $T_{DRX} > 320$ .
Note 4:	If $L_{CBD} > L_{CBD,max}$ , the UE shall assume no new candidate beams are found for this evaluation period.

### 8.5A.5.3 Measurement restriction for SSB based candidate beam detection

When the SSB for CBD measurement is in the same OFDM symbol as CSI-RS for BFD, CBD or L1-RSRP measurement,

- If SSB and CSI-RS have same SCS, UE shall be able to measure the SSB for CBD measurement without any restrictions;
- If SSB and CSI-RS have different SCS-es,
  - If UE supports *simultaneousRxDataSSB-DiffNumerology*, UE shall be able to measure the SSB for CBD measurement without any restriction;
  - If UE does not support *simultaneousRxDataSSB-DiffNumerology*, UE is required to measure SSB for CBD measurement.

### 8.5A.7 Scheduling availability of UE during beam failure detection

Scheduling availability restrictions when the UE is performing beam failure detection are described in the following clauses.

#### 8.5A.7.1 Scheduling availability of UE performing beam failure detection with a same subcarrier spacing as PDSCH/PDCCH

In this clause, the same requirements apply as in Clause 8.5.7.1.

#### 8.5A.7.2 Scheduling availability of UE performing beam failure detection with a different subcarrier spacing than PDSCH/PDCCH

In this clause, the same requirements apply as in Clause 8.5.7.2.

### 8.5A.8 Scheduling availability of UE during candidate beam detection

Scheduling availability restrictions when the UE is performing L1-RSRP measurement for candidate beam detection are described in the following clauses.

#### 8.5A.8.1 Scheduling availability of UE performing L1-RSRP measurement with a same subcarrier spacing as PDSCH/PDCCH

In this clause, the same requirements apply as in Clause 8.5.8.1.

## 8.5A.8.2 Scheduling availability of UE performing L1-RSRP measurement with a different subcarrier spacing than PDSCH/PDCCH

In this clause, the same requirements apply as in Clause 8.5.8.2.

## 8.6 Active BWP switch delay

### 8.6.1 Introduction

The requirements in this clause apply for a UE configured PCell or any activated SCell in standalone NR or NE-DC, PCell, PSCell or any activated SCell in MCG or SCG in NR-DC, or PSCell or any activated SCell in SCG in EN-DC. The requirements in this clause also apply for a UE configured with more than one BWP on PCell or any activated SCell with CCA in standalone NR, or PSCell or any activated SCell with CCA in SCG in EN-DC. The requirements in 8.6.4 apply for a UE which is capable of *ul-LBT-FailureDetectionRecovery-r16* configured with more than one UL BWP on PCell with CCA in standalone NR or PSCell with CCA in EN-DC.

UE shall complete the switch of active DL and/or UL BWP within the delay defined in this clause.

### 8.6.2 DCI and timer based BWP switch delay on a single CC

The requirements in this clause only apply to the case that the BWP switch is performed on a single CC with more than one BWP configurations configured.

For DCI-based BWP switch, after the UE receives BWP switching request at DL slot  $n$  on a serving cell, UE shall be able to receive PDSCH (for DL active BWP switch) or transmit PUSCH (for UL active BWP switch) on the new BWP on the serving cell on which BWP switch on the first DL or UL slot occurs right after a time duration of  $T_{\text{BWPswitchDelay}} + Y$  which starts from the beginning of DL slot  $n$ . Where,

- $Y=0$ , if the serving cell where UE receives DCI for BWP switch request is same as the serving cell on which BWP switch occurs.
- $Y$  equals to the length of 1 slot, if the serving cell where UE receives DCI for BWP switch is different from the serving cell on which BWP switch occurs for any involved serving cell. In this scenario,  $T_{\text{BWPswitchDelay}} + Y$  shall follow the smaller SCS of scheduling cell, scheduled cells before and scheduled cells after active BWP change.

The UE is not required to transmit UL signals or receive DL signals until the first DL or UL slot occurs right after a time duration of  $T_{\text{BWPswitchDelay}}$  which starts from the beginning of DL slot  $n$  except DCI triggering BWP switch on the cell where DCI-based BWP switch occurs. The UE is not required to follow the requirements defined in this clause when performing a DCI-based BWP switch between the BWPs in disjoint channel bandwidths or in partially overlapping channel bandwidths.

For timer-based BWP switch, the UE shall start BWP switch at DL slot  $n$ , where slot  $n$  is the first slot of a DL subframe (FR1) or DL half-subframe (FR2) immediately after a BWP-inactivity timer *bwp-InactivityTimer* [2] expires on a serving cell, and the UE shall be able to receive PDSCH (for DL active BWP switch) or transmit PUSCH (for UL active BWP switch) on the new BWP on the serving cell on which BWP switch on the first DL or UL slot occurs right after a time duration of  $T_{\text{BWPswitchDelay}}$  which starts from the beginning of DL slot  $n$ .

The UE is not required to transmit UL signals or receive DL signals during time duration  $T_{\text{BWPswitchDelay}}$  after *bwp-InactivityTimer* [2] expires on the cell where timer-based BWP switch occurs.

Depending on UE capability *bwp-SwitchingDelay* [2], UE shall finish BWP switch within the time duration  $T_{\text{BWPswitchDelay}}$  defined in Table 8.6.2-1.

**Table 8.6.2-1: BWP switch delay**

$\mu$	NR Slot length (ms)	BWP switch delay $T_{\text{BWPswitchDelay}}$ (slots)	
		Type 1 <sup>Note 1</sup>	Type 2 <sup>Note 1</sup>
0	1	1	3
1	0.5	2	5
2	0.25	3	9

3	0.125	6	18
Note 1:	Depends on UE capability.		
Note 2:	If the BWP switch involves changing of SCS, the BWP switch delay is determined by the smaller SCS between the SCS before BWP switch and the SCS after BWP switch.		

Provided the UE does not have the required TCI-state information to receive PDCCH and PDSCH in the new BWP, the UE shall use old TCI-states before the BWP switch until a new MAC CE updating the required TCI-state information for PDCCH and PDSCH is received after the BWP switch.

If UE has the information on the required TCI-state information to receive PDCCH and PDSCH in the new BWP,

- UE shall be able to receive PDCCH and PDSCH with old TCI-states before the delay as specified in Clause 8.10 in the new BWP.
- UE shall be able to receive PDCCH and PDSCH with new TCI-states after the delay as specified in Clause 8.10 in the new BWP.

If the BWP switch is triggered within or outside DRX active time, and one of the two BWPs in a BWP switching is a dormant BWP [TS 38.321, 7], UE shall be able to complete active BWP switching within the time duration of

- $T_{\text{dormantBWPswitchDelay}} = T_{\text{BWPswitchDelay}} + X$ , provided that the dormancy indication is received in any of the first 3 OFDM symbols of a slot in the serving cell where DCI for dormancy indication is received, or
- $T_{\text{dormantBWPswitchDelay}} = T_{\text{BWPswitchDelay}} + X + Z$ , provided that the dormancy indication is received after the first 3 OFDM symbols of a slot in the serving cell where DCI for dormancy indication is received, where
- $T_{\text{BWPswitchDelay}}$  is defined in Table 8.6.2-1 corresponding to the smallest value among the SCS of the serving cell where UE receives dormancy indication and the SCSs of the dormant BWP and the active BWP immediately before or after switching the BWP of the serving cell where BWP switching occurs;
- X equals to the length of 1 slot corresponding to the smallest value among the SCS of the serving cell where UE receives dormancy indication and the SCSs of the dormant BWP and the active BWP immediately before or after switching the BWP of the serving cell where BWP switching occurs.
- Z equals to the length of 1 slot corresponding to the SCS of the serving cell where UE receives dormancy indication.

For DCI-based BWP switch, if the new BWP is a dormant BWP, after the UE receives BWP switching request at DL slot n on a serving cell, UE shall be able to receive CSI-RS (for DL active BWP switch) on the new BWP on the serving cell on which BWP switch on the first DL slot occurs right after a time duration of  $T_{\text{dormantBWPswitchDelay}}$  which starts from the beginning of DL slot n.

## 8.6.2A DCI based BWP switch delay on multiple CCs

The requirements in this clause only apply to the case when the same type of BWP switch (DCI based BWP switch) is performed on multiple CCs simultaneously or over partially overlapping time period.

### 8.6.2A.1 Simultaneous DCI based BWP switch delay on multiple CCs

The delay requirements for simultaneous DCI based BWP switch on multiple CCs in this clause apply only if the timing difference among the first symbol of slot carrying DCI for all CCs is received within the MRTD for inter-band CA as defined in clause 7.6.4.

For DCI-based BWP switch on multiple CCs, after the UE receives BWP switching request, UE shall be able to receive PDSCH (for DL active BWP switch) or transmit PUSCH (for UL active BWP switch) on the new BWPs on the serving cells on which BWP switch on the first DL or UL slot occurs right after a time duration of  $T_{\text{MultipleBWPswitchDelay}}$  which starts from the beginning of DL slot n, where slot n is slot which UE receives the earliest BWP switching request among CCs on which UE is performing simultaneous DCI-based BWP switching.

The UE is not required to transmit UL signals or receive DL signals until the first DL or UL slot occurs right after a time duration of  $T_{\text{MultipleBWPswitchDelay}}$  which starts from the beginning of DL slot n except DCI triggering BWP switch on

the cell where DCI-based BWP switch occurs. The UE is not required to follow the requirements defined in this clause when performing a DCI-based BWP switch between the BWPs in disjoint channel bandwidths or in partially overlapping channel bandwidths on any serving cell.

UE shall finish BWP switch within the time duration  $T_{\text{MultipleBWPswitchDelay}} + Y$ , which is defined as:

$$T_{\text{MultipleBWPswitchDelay}} = T_{\text{BWPswitchDelay}} + D \cdot (N-1)$$

Where:

- $T_{\text{BWPswitchDelay}}$  is the BWP switching delay on single CC defined in Table 8.6.2-1 depending on UE capability *bwp-SwitchingDelay* [2].  $T_{\text{BWPswitchDelay}}$  shall be based on the smallest SCS among SCS of all involved CCs before and after BWP switch. If the BWP switch on multiple CCs results in the change of the SCS on any CC among involved CCs,  $T_{\text{BWPswitchDelay}}$  should be based on the smallest SCS among all SCS values of all involved CCs.
- $D$  is the incremental delay for each additional CC involved in simultaneous BWP switch and depends on UE capability *bwp-SwitchingMultiCCs-r16* [TS 38.306, 14] for switching between non-dormant BWPs, and *bwp-SwitchingMultiDormancyCCs-r16* for switching between non-dormant and dormant BWPs.
- For UE which is capable of per-FR gap, and no BWP switch involves SCS change,  $N$  is the number of CCs in same FR; For UE which is not capable of per-FR gap, or the BWP switches on any CC involves SCS changing,  $N$  is the number of CCs undergoing simultaneous BWP switch.
- $Y=0$ , if the serving cell where UE receives DCI for BWP switch is same as the serving cell on which BWP switch occurs for each involved serving cell.

$Y$  equals to the length of one slot at smaller SCS of scheduling cell, scheduled cells before and scheduled cells after active BWP change,

- if the serving cell where UE receives DCI for BWP switch is different from the serving cell on which BWP switch occurs for any involved serving cell.

Provided the UE does not have the required TCI-state information to receive PDCCH and PDSCH in the new BWP, the UE shall use old TCI-states before the BWP switch until a new MAC CE updating the required TCI-state information for PDCCH and PDSCH is received after the BWP switch.

If UE has the information on the required TCI-state information to receive PDCCH and PDSCH in the new BWP,

- UE shall be able to receive PDCCH and PDSCH with old TCI-states before the delay as specified in Clause 8.10 in the new BWP.
- UE shall be able to receive PDCCH and PDSCH with new TCI-states after the delay as specified in Clause 8.10 in the new BWP.

If the BWP switch is triggered on multiple CCs simultaneously within or outside DRX active time, and one of the two BWPs on each CC in a BWP switching is a dormant BWP [TS 38.321, 7], UE shall be able to complete active BWP switching within the time duration of

- $T_{\text{DormantMultipleBWPswitchDelay}} = T_{\text{MultipleBWPswitchDelay}} + X$ , provided that the dormancy indication is received in any of the first 3 OFDM symbols of a slot in the serving cell where DCI for dormancy indication is received, or
- $T_{\text{DormantMultipleBWPswitchDelay}} = T_{\text{MultipleBWPswitchDelay}} + X + Z$ , provided that the dormancy indication is received after the first 3 OFDM symbols of a slot in the serving cell where DCI for dormancy indication is received, where
- $T_{\text{MultipleBWPswitchDelay}}$  is defined above corresponding to the smallest value among the SCS of the serving cell where UE receives dormancy indication and the SCSs of the dormant BWP and the active BWP immediately before or after switching the BWP of the serving cell where BWP switching occurs;
- $X$  equals to the length of 1 slot corresponding to the smallest value among the SCS of the serving cell where UE receives dormancy indication and the SCSs of the dormant BWP and the active BWP immediately before or after switching the BWP of the serving cell where BWP switching occurs.
- $Z$  equals to the length of 1 slot corresponding to the SCS of the serving cell where DCI for dormancy indication is received.

The number of CCs,  $N$ , on which the UE can simultaneously switch BWPs while still meeting the requirements, if any, related to allocations on downlink, uplink, or transmission of HARQ-ACK, depends on the UE reported capabilities related to BWP switching, the network configuration and the BWP switch method.

### 8.6.2A.2 Non-simultaneous DCI based BWP switch delay on multiple CCs

In non-simultaneous case, the DCI-based BWP switch on multiple CCs is triggered over partially overlapping time period between CCs or multiple CCs in different Cell groups. The delay requirements for non-simultaneous DCI based BWP switch on multiple CCs in this clause apply only if:

- the timing difference among the first symbol of slot carrying DCI for all CCs involved in non-simultaneous BWP switch is received exceeds the MRTD for inter-band CA as defined in clause 7.6.4, and
- UE is operating in NR-DC (FR1+FR2), and
- UE is capable of per-FR gap, and
- BWP switch does not involve SCS change

For non-simultaneous DCI based BWP switch on multiple CCs, BWP switching delay requirements defined in clause 8.6.2 apply when BWP switching occurs on single CC in the cell group. BWP switching delay requirements defined in clause 8.6.2A.1 apply when simultaneous BWP switching occurs on multiple CCs in the cell group.

### 8.6.2B Timer based BWP switch delay on multiple CCs

The requirements in this clause only apply to the case when the same type of BWP switch (timer based BWP switch) is performed on multiple CCs simultaneously or over partially overlapping time period.

#### 8.6.2B.1 Simultaneous timer based BWP switch delay on multiple CCs

The delay requirements for simultaneous timer based BWP switch on multiple CCs in this clause apply only if the timing difference among the beginning of the slot where timer based BWP switching starts for all CCs is within the MRTD for inter-band CA as defined in clause 7.6.4.

For timer-based BWP switch on multiple CCs, UE shall start BWP switch at DL slot  $n$ , where slot  $n$  is the first slot of a DL subframe (in FR1) or DL half-subframe ((in FR2) immediately after the earliest BWP-inactivity timer *bwp-InactivityTimer* [2] expiration occurs on multiple serving cells, and the UE shall be able to receive PDSCH (for DL active BWP switch) or transmit PUSCH (for UL active BWP switch) on the new BWPs on the serving cells on which BWP switch on the first DL or UL slot occurs right after a time duration of  $T_{\text{MultipleBWPswitchDelay}}$  which starts from the beginning of DL slot  $n$ , where  $T_{\text{MultipleBWPswitchDelay}}$  is defined in 8.6.2A.1.

The UE is not required to transmit UL signals or receive DL signals during time duration  $T_{\text{MultipleBWPswitchDelay}}$  after *bwp-InactivityTimer* [2] expires on the cell where timer-based BWP switch occurs.

Provided the UE does not have the required TCI-state information to receive PDCCH and PDSCH in the new BWP, the UE shall use old TCI-states before the BWP switch until a new MAC CE updating the required TCI-state information for PDCCH and PDSCH is received after the BWP switch.

If UE has the information on the required TCI-state information to receive PDCCH and PDSCH in the new BWP,

- UE shall be able to receive PDCCH and PDSCH with old TCI-states before the delay as specified in Clause 8.10 in the new BWP.
- UE shall be able to receive PDCCH and PDSCH with new TCI-states after the delay as specified in Clause 8.10 in the new BWP.

#### 8.6.2B.2 Non-simultaneous timer based BWP switch delay on multiple CCs

In non-simultaneous case, the timer-based BWP switch on multiple CCs is triggered over partially overlapping time period.

The delay requirements for non-simultaneous timer based BWP switch on multiple CCs in this clause apply if the timing difference among the beginning of the slot where timer based BWP switching starts for all CCs is exceeds the MRTD for inter-band CA as defined in clause 7.6.4, and the BWP switch does not involve SCS change. The UE performs the non-simultaneous timer-based BWP switch on the CCs sequentially.

For non-simultaneous timer-based BWP switch, the UE shall be able to receive PDSCH (for DL active BWP switch) or transmit PUSCH (for UL active BWP switch) on the new BWP on the serving cell on which BWP switch on the first DL or UL slot occurs right after a time duration of  $T_{\text{MultipleBWPswitchDelayTotal}}$  which starts from the beginning of DL slot n, where slot n is the first slot of a DL subframe (in FR1) or DL half-subframe (in FR2) immediately after the earliest BWP-inactivity timer *bwp-InactivityTimer* [2] expires.

$$T_{\text{MultipleBWPswitchDelayTotal}} = T_{\text{Delay}} + T_{\text{MultipleBWPswitchDelay}}$$

Where:

$T_{\text{Delay}}$  is the time required to complete the ongoing timer-based BWP switching on other CCs.

$T_{\text{MultipleBWPswitchDelay}}$  is the timer-based BWP switch delay on current single CC defined in clause 8.6.2 or simultaneously triggered on multiple CCs defined in clause 8.6.2B.1.

The UE is not required to transmit UL signals or receive DL signals during time duration  $T_{\text{MultipleBWPswitchDelayTotal}}$  after *bwp-InactivityTimer* [2] expires on the cell where timer-based BWP switch occurs.

Provided the UE does not have the required TCI-state information to receive PDCCH and PDSCH in the new BWP, the UE shall use old TCI-states before the BWP switch until a new MAC CE updating the required TCI-state information for PDCCH and PDSCH is received after the BWP switch.

If UE has the information on the required TCI-state information to receive PDCCH and PDSCH in the new BWP,

- UE shall be able to receive PDCCH and PDSCH with old TCI-states before the delay as specified in Clause 8.10 in the new BWP.
- UE shall be able to receive PDCCH and PDSCH with new TCI-states after the delay as specified in Clause 8.10 in the new BWP.

### 8.6.3 RRC based BWP switch delay on a single CC

The requirements in this clause only apply to the case that the BWP switch is performed on a single CC with one or more than one BWP configuration(s) configured, with

- Active BWP switch or parameter change of its active BWPs for SpCell
- Parameter change of its active BWPs except parameter *firstActiveDownlinkBWP-Id* and *firstActiveUplinkBWP-Id* for SCell

For RRC-based BWP switch, after the UE receives RRC reconfiguration involving active BWP switching or parameter change of its active BWP, UE shall be able to receive PDSCH/PDCCH (for DL active BWP switch) or transmit PUSCH (for UL active BWP switch) on the new BWP on the serving cell on which BWP switch occurs on the first DL or UL slot right after a time duration of  $\frac{T_{\text{RRCprocessingDelay}} + T_{\text{BWPswitchDelayRRC}}}{NR \text{ Slot length}}$  slots which begins from the beginning of DL slot n, where

DL slot n is the last slot overlapping with the PDSCH containing the RRC command, and

*NR Slot length* is determined by the smaller SCS between the SCS before BWP switch and the SCS after BWP switch if the BWP switch involves changing of SCS.

$T_{\text{RRCprocessingDelay}}$  is the length of the RRC procedure delay in ms as defined in clause 11.2 in TS 36.331 [16] if the corresponding RRC message is embedded in E-UTRA RRC message, otherwise it is the length of the RRC procedure delay in ms as defined in clause 12 in TS 38.331 [2], and

$T_{\text{BWPswitchDelayRRC}} = 6ms$  is the time used by the UE to perform BWP switch.

The UE is not required to transmit UL signals or receive DL signals during the time defined by  $T_{\text{RRCprocessingDelay}} + T_{\text{BWPswitchDelayRRC}}$  on the cell where RRC-based BWP switch occurs. When  $T_{\text{HARQ}} > T_{\text{RRCprocessingDelay}}$  a longer



switching delay is allowed. Where  $T_{HARQ}$  is the time between DL data transmission and acknowledgement as specified in TS 38.213 [3].

### 8.6.3A RRC based BWP switch delay on multiple CCs

The requirements in this clause only apply to the case when the same type of BWP switch (RRC based BWP switch) is performed on multiple CCs simultaneously or over partially overlapping time period.

The requirements in this clause shall apply:

- Active BWP switching or parameter change of its active BWPs for SpCell
- Parameter change of its active BWPs except parameter *firstActiveDownlinkBWP-Id* and *firstActiveUplinkBWP-Id* for SCells

#### 8.6.3A.1 Simultaneous RRC based BWP switch delay on multiple CCs

Requirements in this clause apply only if RRC based BWP switching on multiple CCs for NR-CA is triggered by a single RRC command.

For RRC-based BWP switch, after the UE receives RRC reconfiguration involving active BWP switching or parameter change of its active BWPs, UE shall be able to receive PDSCH/PDCCH (for DL active BWP switch) or transmit PUSCH (for UL active BWP switch) on the new BWPs on the serving cells on which BWP switch occurs on the first DL or UL slot right after a time duration of  $\frac{T_{RRCprocessingDelay} + T_{BWPswitchDelayRRC} + D_{RRC} * (N - 1)}{NR\ slot\ length}$  slots which begins from the beginning of DL slot n, where

DL slot n is the last slot overlapping with the PDSCH containing the RRC command, and

$T_{RRCprocessingDelay}$  and  $T_{BWPswitchDelayRRC}$  are defined in clause 8.6.3, and

$D_{RRC} = 0$  for UE which is capable of type 1 BWP switching delay depending on UE capability *bwp-SwitchingDelay* [2].  $D_{RRC} = D$  for UE which is capable of type 2 BWP switching delay depending on UE capability *bwp-SwitchingDelay* [2], where D is the incremental delay for each additional CC involved in simultaneous BWP switch and depends on UE capability [TS 38.306, 14].

N is the number of CCs within the NR-CA configured for performing simultaneous BWP switch.

The UE is not required to transmit UL signals or receive DL signals during the time defined by  $T_{RRCprocessingDelay} + T_{BWPswitchDelayRRC} + D_{RRC} * (N - 1)$  on the cells where RRC-based BWP switch occurs.

#### 8.6.3A.2 Non-simultaneous RRC based BWP switch delay on multiple CCs

In non-simultaneous case, the RRC-based BWP switch on multiple CCs is triggered over partially overlapping time period in different Cell groups. The delay requirements in this clause apply only if:

BWP switching on multiple CCs in different cell groups are triggered by separate RRC commands, and

UE is operating in NR-DC (FR1+FR2), and

UE is capable of per-FR gap, and

BWP switch does not involve SCS change.

For non-simultaneous RRC-based BWP switch, after the UE receives RRC reconfiguration involving active BWP switching or parameter change of its active BWPs, UE shall be able to receive PDSCH/PDCCH (for DL active BWP switch) or transmit PUSCH (for UL active BWP switch) on the new BWPs on the serving cells on which BWP switch occurs on the first DL or UL slot right after a time duration of

$\frac{T_{Waiting} + T_{RRCprocessingDelay} + T_{BWPswitchDelayRRC} + D_{RRC} * (M - 1)}{NR\ slot\ length}$  slots which begins from the beginning of DL slot n, where

DL slot n is the last slot containing the RRC command,

$T_{Waiting}$  is the waiting time for RRC based BWP switch which is upper bounded by the ongoing BWP switch time in the first CG defined in clause 8.6.3A.1,

$M$  is the number of CCs within the NR-CA configured for performing simultaneous BWP switch in the second CG;  $M=1$  if the BWP switch is performed on single CC,

$T_{RRCprocessingDelay}$  and  $T_{BWPswitchDelayRRC}$  are defined in clause 8.6.3, and

$D_{RRC}$  is defined in clause 8.6.3A.1.

The UE is not required to transmit UL signals or receive DL signals during the time defined by  $T_{RRCprocessingDelay} + T_{BWPswitchDelayRRC} + D_{RRC} * (M - 1)$  on the cells in the second CG where RRC-based BWP switch occurs.

## 8.6.4 BWP switch delay on Consistent UL CCA recovery

Upon detection of consistent UL CCA failure is slot# $n$  in SpCell when UE detects *lbt-FailureInstanceMaxCount* number of CCA failure within *lbt-FailureDetectionTimer*, the UE shall switch the active UL BWP to an UL BWP configured with PRACH occasion and for which consistent CCA failure has not been triggered as defined in TS 38.321 clause 5.21 [7]. The UE shall be ready to transmit PRACH on the new UL BWP of the SpCell on the first UL slot occurs right after slot  $n + T_{BWPswitchDelay} + 1$ , where  $T_{BWPswitchDelay}$  is defined in Table 8.6.2-1. The UE shall finish the UL BWP switch within the time duration  $T_{BWPswitchDelay}$  depending on UE capability *bwp-SwitchingDelay* [2].

Note: Additional delay in acquiring the first available RACH occasion will be derived in a way similar to that in handover in clause 6.1B.1.

The UE is not required to transmit UL signals or receive DL signals during time duration  $T_{BWPswitchDelay}$  on the SpCell in the UL BWP switch. The UE is not required to follow the requirements defined in this clause when performing a UL BWP switch between the UL BWPs in disjoint channel bandwidths or in partially overlapping channel bandwidths.

## 8.7 Void

## 8.8 NE-DC: E-UTRAN PSCell Addition and Release Delay

### 8.8.1 Introduction

This clause defines requirements for the delay within which the UE shall be able to configure an E-UTRAN PSCell in NR - E-UTRA dual connectivity. The requirements are applicable to an NR - E-UTRA dual connectivity capable UE.

### 8.8.2 E-UTRAN PSCell Addition Delay Requirement

The requirements in this clause shall apply for the UE, which is configured with PCell, and may also be configured with one or more SCells.

Upon receiving E-UTRAN PSCell addition in subframe  $n$ , the UE shall be capable to transmit PRACH preamble towards E-UTRAN PSCell no later than in subframe  $n + T_{config\_EUTRAN-PSCell}$ :

Where:

$$T_{config\_EUTRAN-PSCell} = T_{RRC\_delay} + T_{activation\_time} + 50ms + T_{E-UTRAN-PSCell\_DU}$$

$T_{RRC\_delay}$  is the RRC procedure delay as specified in TS 38.331 [2].

$T_{activation\_time}$  is the E-UTRAN PSCell activation delay. If the E-UTRAN PSCell is known, then  $T_{activation\_time}$  is 20ms. If the E-UTRAN PSCell is unknown, then  $T_{activation\_time}$  is 30ms provided the E-UTRAN PSCell can be successfully detected on the first attempt.

$T_{E-UTRAN-PSCell\_DU}$  is the delay uncertainty in acquiring the first available PRACH occasion in the E-UTRAN PSCell.  $T_{E-UTRAN-PSCell\_DU}$  is up to 30ms.

E-UTRAN PSCell is known if it has been meeting the following conditions:

- During the last 5 seconds before the reception of the E-UTRAN PSCell configuration command:
  - the UE has sent a valid measurement report for the E-UTRAN PSCell being configured and
  - the E-UTRAN PSCell being configured remains detectable according to the cell identification conditions specified in clause 8.8 of TS 36.133 [15],
- E-UTRAN PSCell being configured also remains detectable during the E-UTRAN PSCell configuration delay  $T_{\text{config\_EUTRAN-PSCell}}$  according to the cell identification conditions specified in clause 8.8 of TS 36.133 [15].

otherwise it is unknown.

The PCell interruption specified in clause 8.2 is allowed only during the RRC reconfiguration procedure [2].

### 8.8.3 E-UTRAN PSCell Release Delay Requirement

The requirements in this clause shall apply for a UE which is configured with PCell and E-UTRAN PSCell and may also be configured with one or more SCells and/or E-UTRAN SCells.

Upon receiving E-UTRAN PSCell release in subframe  $n$ , the UE shall accomplish the release actions specified in TS 38.331 [2] no later than in subframe  $n + T_{\text{RRC\_delay}}$ .

Where

$T_{\text{RRC\_delay}}$  is the RRC procedure delay as specified in TS 38.331 [2].

The PCell interruption specified in clause 8.2 is allowed only during the RRC reconfiguration procedure [2].

## 8.9 NR-DC: PSCell Addition and Release Delay

### 8.9.1 Introduction

This clause defines requirements for the delay within which the UE shall be able to configure an PSCell in NR dual connectivity. The requirements are applicable to an NR dual connectivity capable UE.

### 8.9.2 PSCell Addition Delay Requirement

The requirements in this clause shall apply for the UE configured with only PCell in FR1.

Upon receiving PSCell addition in subframe  $n$ , the UE shall be capable to transmit PRACH preamble towards PSCell in FR2 no later than in slot  $n + \frac{T_{\text{config\_PSCell}}}{\text{NR slot length}}$ .

where:

$$T_{\text{config\_PSCell}} = T_{\text{RRC\_delay}} + T_{\text{processing}} + T_{\text{search}} + T_{\Delta} + T_{\text{PSCell\_DU}} + 2 \text{ ms}$$

$T_{\text{RRC\_delay}}$  is the RRC procedure delay as specified in TS 38.331 [2].

$T_{\text{processing}}$  is the SW processing time needed by UE, including RF warm up period.  $T_{\text{processing}} = 40 \text{ ms}$ .

$T_{\text{search}}$  is the time for AGC settling and PSS/SSS detection. If the target cell is known,  $T_{\text{search}} = 0 \text{ ms}$ . If the target cell is unknown and the target cell  $\hat{E}_s/I_{ot} \geq -2\text{dB}$ ,  $T_{\text{search}} = 24 * Tr_s \text{ ms}$ .

$T_{\Delta}$  is time for fine time tracking and acquiring full timing information of the target cell.  $T_{\Delta} = 1 * Tr_s \text{ ms}$  for a known or unknown PSCell.

$T_{\text{PSCell\_DU}}$  is the delay uncertainty in acquiring the first available PRACH occasion in the PSCell.  $T_{\text{PSCell\_DU}}$  is up to the summation of SSB to PRACH occasion association period and 10 ms. SSB to PRACH occasion associated period is defined in Table 8.1-1 of TS 38.213 [3].

$Tr_s$  is the SMTC periodicity of the target cell if the UE has been provided with an SMTC configuration for the target cell in PSCell addition message, otherwise  $Tr_s$  is the SMTC configured in the measObjectNR having the

same SSB frequency and subcarrier spacing. If the UE is not provided SMTC configuration or measurement object on this frequency, the requirement in this clause is applied with  $T_{rs} = 5$  ms assuming the SSB transmission periodicity is 5 ms. There is no requirement if the SSB transmission periodicity is not 5 ms.

In FR1 and FR2, the PSCell is known if it has been meeting the following conditions:

- During the last 5 seconds before the reception of the PSCell configuration command:
  - the UE has sent a valid measurement report for the PSCell being configured and
  - One of the SSBs measured from the PSCell being configured remains detectable according to the cell identification conditions specified in clause 9.3.
- One of the SSBs measured from PSCell being configured also remains detectable during the PSCell configuration delay  $T_{\text{config\_PSCell}}$  according to the cell identification conditions specified in clause 9.3.

otherwise it is unknown.

The PCell interruption specified in clause 8.2 is allowed only during the RRC reconfiguration procedure [2].

### 8.9.3 PSCell Release Delay Requirement

The requirements in this clause shall apply for a UE which is configured with PCell and one PSCell.

Upon receiving PSCell release in subframe  $n$ , the UE shall accomplish the release actions specified in TS 38.331 [2] no later than in slot  $n + \frac{T_{\text{RRC\_delay}}}{\text{NR slot length}}$ :

where

$T_{\text{RRC\_delay}}$  is the RRC procedure delay as specified in TS 38.331 [2].

The PCell interruption specified in clause 8.2 is allowed only during the RRC reconfiguration procedure [2].

## 8.10 Active TCI state switching delay

### 8.10.1 Introduction

The requirements in this clause apply for a UE configured with one or more TCI state configurations on serving cell in MR-DC or standalone NR. UE shall complete the switch of active TCI state within the delay defined in this clause.

### 8.10.2 Known conditions for TCI state

The TCI state is known if the following conditions are met:

- During the period from the last transmission of the RS resource used for the L1-RSRP measurement reporting for the target TCI state to the completion of active TCI state switch, where the RS resource for L1-RSRP measurement is the RS in target TCI state or QCLed to the target TCI state
  - TCI state switch command is received within 1280 ms upon the last transmission of the RS resource for beam reporting or measurement
  - The UE has sent at least 1 L1-RSRP report for the target TCI state before the TCI state switch command
  - The TCI state remains detectable during the TCI state switching period
  - The SSB associated with the TCI state remain detectable during the TCI switching period
    - SNR of the TCI state  $\geq -3\text{dB}$

Otherwise, the TCI state is unknown.

### 8.10.3 MAC-CE based TCI state switch delay

If the target TCI state is known, upon receiving PDSCH carrying MAC-CE for indication of UE-specific PDCCH TCI state as defined in clause 6.1.3.15 of TS 38.321 [7] in slot  $n$ , UE shall be able to receive PDCCH with target TCI state of the serving cell on which TCI state switch occurs at the first slot that is after slot  $n + T_{\text{HARQ}} + 3N_{\text{slot}}^{\text{subframe},\mu} + T_{\text{OK}} \cdot (T_{\text{first-SSB}} + T_{\text{SSB-proc}}) / NR \text{ slot length}$ . The UE shall be able to receive PDCCH with the old TCI state until slot  $n + T_{\text{HARQ}} + 3N_{\text{slot}}^{\text{subframe},\mu}$ . Where  $T_{\text{HARQ}}$  is the timing between DL data transmission and acknowledgement as specified in TS 38.213 [3];

- $T_{\text{first-SSB}}$  is time to first SSB transmission after MAC CE command is decoded by the UE; The SSB shall be the QCL-TypeA or QCL-TypeC to target TCI state
- $T_{\text{SSB-proc}} = 2 \text{ ms}$ ;
- $T_{\text{OK}} = 1$  if target TCI state is not in the active TCI state list for PDSCH, 0 otherwise.

If the target TCI state is unknown, upon receiving PDSCH carrying MAC-CE for indication of UE-specific PDCCH TCI state as defined in clause 6.1.3.15 of TS 38.321 [7] in slot  $n$ , UE shall be able to receive PDCCH with target TCI state of the serving cell on which TCI state switch occurs at the first slot that is after slot  $n + T_{\text{HARQ}} + 3N_{\text{slot}}^{\text{subframe},\mu} + T_{\text{L1-RSRP}} + T_{\text{OK}} \cdot (T_{\text{first-SSB}} + T_{\text{SSB-proc}}) / NR \text{ slot length}$ . The UE shall be able to receive PDCCH with the old TCI state until slot  $n + T_{\text{HARQ}} + 3N_{\text{slot}}^{\text{subframe},\mu}$ .

Where

- $T_{\text{L1-RSRP}} = 0$  in FR1 or when the TCI state switching not involving QCL-TypeD in FR2. Otherwise,
- $T_{\text{L1-RSRP}}$  is the time for Rx beam refinement in FR2, defined as
- $T_{\text{L1-RSRP\_Measurement\_Period\_SSB}}$  for SSB as specified in clause 9.5.4.1,
  - with the assumption of  $M=1$
  - with  $T_{\text{Report}} = 0$
- $T_{\text{L1-RSRP\_Measurement\_Period\_CSI-RS}}$  for CSI-RS as specified in clause 9.5.4.2
  - configured with higher layer parameter *repetition* set to ON
  - with the assumption of  $M=1$  for periodic CSI-RS
  - for aperiodic CSI-RS if number of resources in resource set at least equal to *MaxNumberRxBeam*
  - with  $T_{\text{Report}} = 0$
- $T_{\text{OK}} = 1$  for CSI-RS based L1-RSRP measurement, and 0 for SSB based L1-RSRP measurement when TCI state switching involves QCL-TypeD
- $T_{\text{OK}} = 1$  when TCI state switching involves other QCL types only
- $T_{\text{first-SSB}}$  is time to first SSB transmission after L1-RSRP measurement when TCI state switching involves QCL-TypeD;
- $T_{\text{first-SSB}}$  is time to first SSB transmission after MAC CE command is decoded by the UE for other QCL types;
- The SSB shall be the QCL-TypeA or QCL-TypeC to target TCI state

### 8.10.4 DCI based TCI state switch delay

If the target TCI state is known, when a UE is configured with the higher layer parameter *tci-PresentInDCI* which is set as 'enabled' for the CORESET scheduling PDSCH at slot  $n$ , UE shall be able to receive PDSCH with target TCI state of the serving cell on which TCI state switch occurs at the first slot that is after slot  $n + \text{timeDurationForQCL}$ , where, *timeDurationForQCL* is the time required by the UE to perform PDCCH reception and applying spatial QCL information received in DCI for PDSCH processing as described in TS 38.214 [26], the value of *timeDurationForQCL* is defined in TS 38.331 [2].

The known condition for TCI state defined in clause 8.10.2 is applied.

### 8.10.5 RRC based TCI state switch delay

If the target TCI state is known, UE shall be able to receive PDCCH with target TCI state of the serving cell on which TCI state switch occurs at the first slot that is after slot  $n + (T_{\text{RRC\_processing}} + \text{TO}_k * (T_{\text{first-SSB}} + T_{\text{SSB-proc}})) / NR \text{ slot length}$ , The UE is not required to receive PDCCH/PDSCH/CSI-RS or transmit PUCCH/PUSCH until the end of switching period.

Where

- Slot  $n$  is the last slot overlapping with the PDSCH carrying RRC activation command.
- $T_{\text{RRC\_processing}}$  is the RRC processing delay defined in Clause 11.2 of TS 36.331 [16] if the corresponding RRC message is embedded in E-UTRA RRC message, otherwise it is the RRC processing delay defined in Clause 12 of TS 38.331 [2].
- $T_{\text{first-SSB}}$  is time to first SSB transmission after RRC processing by the UE; The SSB shall be the QCL-TypeA or QCL-TypeC to target TCI state.
- $T_{\text{SSB-proc}}$  and  $\text{TO}_k$  are defined in clause 8.10.3.

If the target TCI state is unknown, UE shall be able to receive PDCCH with target TCI state of the serving cell on which TCI state switch occurs at the first slot that is after slot  $n + (T_{\text{RRC\_processing}} + T_{\text{L1-RSRP}} + \text{TO}_{\text{uk}} * (T_{\text{first-SSB}} + T_{\text{SSB-proc}})) / NR \text{ slot length}$ , The UE is not required to receive PDCCH/PDSCH/CSI-RS or transmit PUCCH/PUSCH until the end of switching period.

Where

- Slot  $n$  is the last slot overlapping with the PDSCH carrying RRC activation command.
- $T_{\text{RRC\_processing}}$  is the RRC processing delay defined in Clause 11.2 of TS 36.331 [16] if the corresponding RRC message is embedded in E-UTRA RRC message, otherwise it is the RRC processing delay defined in Clause 12 of TS 38.331 [2].
- $T_{\text{first-SSB}}$  is time to first SSB transmission after L1-RSRP measurement when TCI state switching involves QCL-TypeD;
- $T_{\text{first-SSB}}$  is time to first SSB transmission after RRC processing time at the UE for other QCL types;
  - The SSB shall be the QCL-TypeA or QCL-TypeC to target TCI state
- $T_{\text{L1-RSRP}}$ ,  $\text{TO}_{\text{uk}}$  and  $T_{\text{SSB-proc}}$  are defined in clause 8.10.3.

The requirements for RRC based TCI state switch delay apply when only 1 TCI state is configured in RRC TCI state list. When  $T_{\text{HARQ}} > T_{\text{RRC\_processing}}$  a longer switching delay is allowed. Where  $T_{\text{HARQ}}$  is the time between DL data transmission and acknowledgement as specified in TS 38.213 [3].

### 8.10.6 Active TCI state list update delay

If the target TCI state is known, upon receiving PDSCH carrying MAC-CE for activation/deactivation of UE-specific PDSCH TCI state as defined in clause 6.1.3.14 of TS 38.321 [7] at slot  $n$ , UE shall be able to receive PDCCH to schedule PDSCH with the new target TCI state at the first slot that is after  $n + T_{\text{HARQ}} + 3N_{\text{slot}}^{\text{subframe},\mu} + \text{TO}_k * (T_{\text{first-SSB}} + T_{\text{SSB-proc}}) / NR \text{ slot length}$ . Where  $T_{\text{HARQ}}$ ,  $T_{\text{first-SSB}}$ ,  $T_{\text{SSB-proc}}$  and  $\text{TO}_k$  are defined in clause 8.10.3.

## 8.10A Active TCI state switching delay with CCA

### 8.10A.1 Introduction

The requirements in this clause apply for a UE configured with one or more TCI state configurations on serving cell in EN-DC with PCell on a carrier frequency with CCA or SA NR with PCell on a carrier frequency with CCA. UE shall complete the switch of active TCI state within the delay defined in this clause.

In the requirements of clause 8.10A, the term SSB occasion not available at the UE refers to when the SSB is configured by gNB in a cell on a carrier frequency subject to CCA, but the first two successive candidate SSB positions for the same SSB index within the discovery burst transmission window are not available at the UE due to DL CCA failures at gNB during the corresponding period; otherwise the SSB occasion is considered as available at the UE.

### 8.10A.2 Known conditions for TCI state

The TCI state is known if the following conditions are met:

- During the period from the last transmission of the RS resource used for the L1-RSRP measurement reporting for the target TCI state to the completion of active TCI state switch, where the RS resource for L1-RSRP measurement is the RS in target TCI state or QCLed to the target TCI state
- TCI state switch command is received within 1280 ms of the last transmission of the RS resource for beam reporting or measurement
- The UE has sent at least 1 L1-RSRP report for the target TCI state before the TCI state switch command
- The TCI state remain detectable during the TCI state switching period in the SSB occasions available at the UE
- The SSB associated with the TCI state remain detectable during the TCI switching period in the SSB occasions available at the UE
  - SNR of the TCI state is  $\geq -3\text{dB}$

Otherwise, the TCI state is unknown.

### 8.10A.3 MAC-CE based TCI state switch delay

If the target TCI state is known, upon receiving PDSCH carrying MAC-CE activation command at slot  $n$ , UE shall be able to receive PDCCH with target TCI state of the serving cell on which TCI state switch occurs at the first slot that is after slot  $n + 3N_{\text{slot}}^{\text{subframe},\mu} + (T_{\text{HARQ}} + \text{TO}_k * (T_{\text{first-SSB}} + T_{\text{SSB-proc}} + T_{\text{SSB}} * L_{\text{MAC,known}})) / NR \text{ slot length}$ . The UE shall be able to receive on the old TCI state until slot  $n + 3N_{\text{slot}}^{\text{subframe},\mu} + (T_{\text{HARQ}} + \text{TO}_k * (T_{\text{first-SSB}} + T_{\text{SSB}} * L_{\text{MAC,known}})) / NR \text{ slot length}$ , where

$T_{\text{HARQ}}$  (in ms) is the timing between DL data transmission and acknowledgement as specified in TS 38.213 [3]. In the event of UE not being able to transmit the acknowledgment due to UL CCA failures:  $T_{\text{HARQ}}$  is extended to also include the time to all next HARQ feedback transmissions and retransmission opportunities, until the time of its successful transmission, as specified in TS 38.213 [3]; no extension of  $T_{\text{HARQ}}$  due to UL CCA failures is allowed for Type 2C UL channel access in TS 37.213;

$T_{\text{first-SSB}}$  is time to first SSB transmission occasion after MAC CE command is decoded by the UE, during which some SSB occasions may not be available at the UE due to DL CCA failures;

The SSB shall be the QCL-TypeA or QCL-TypeC to target TCI state;

$T_{\text{SSB-proc}} = 2 \text{ ms}$ ;

$\text{TO}_k = 1$  if target TCI state is not in the active TCI state list for PDSCH, 0 otherwise;

$T_{\text{SSB}} = \text{ssb-periodicityServingCell}$ ;

$L_{\text{MAC,known}} \leq L_{\text{MAC,known,max}}$  is the corresponding number of SSB occasions not available at the UE;

$L_{\text{MAC,known,max}} = 2$  for  $T_{\text{SSB}} \leq 40 \text{ ms}$ ,  $L_{\text{MAC,known,max}} = 1$  for  $T_{\text{SSB}} > 40 \text{ ms}$ .

If the target TCI state is unknown, upon receiving PDSCH carrying MAC-CE activation command at slot  $n$ , UE shall be able to receive PDCCH with target TCI state of the serving cell on which TCI state switch occurs at the first slot that is after slot  $n + 3N_{\text{slot}}^{\text{subframe},\mu} + (T_{\text{HARQ}} + \text{TO}_{\text{uk}} * (T_{\text{first-SSB}} + T_{\text{SSB-proc}} + T_{\text{SSB}} * L_{\text{MAC,unknown}})) / NR \text{ slot length}$ . The UE shall be able to receive on the old TCI state until slot  $n + 3N_{\text{slot}}^{\text{subframe},\mu} + (T_{\text{HARQ}} + \text{TO}_{\text{uk}} * (T_{\text{first-SSB}} + T_{\text{SSB}} * L_{\text{MAC,unknown}})) / NR \text{ slot length}$ , where:

$L_{MAC,unknown} \leq L_{MAC,unknown,max}$  is the corresponding number of SSB occasions not available at the UE;

$L_{MAC,unknown,max} = 2$  for  $T_{SSB} \leq 40$  ms,  $L_{MAC,unknown,max} = 1$  for  $T_{SSB} > 40$  ms;

$TO_{uk} = 1$ .

## 8.10A.4 DCI based TCI state switch delay

If the target TCI state is known, when a UE is configured with the higher layer parameter *tcj-PresentInDCI* which is set as 'enabled' for the CORESET scheduling the PDSCH at slot *n*, UE shall be able to receive PDSCH with target TCI state of the serving cell on which TCI state switch occurs at the first slot that is after slot  $n + timeDurationForQCL$ , where, *timeDurationForQCL* is the time required by the UE to perform PDCCH reception and applying spatial QCL information received in DCI for PDSCH processing as described in TS 38.214 [26], the value of *timeDurationForQCL* is defined in TS 38.306 [14].

The known condition for TCI state defined in clause 8.10A.2 is applied.

## 8.10A.5 RRC based TCI state switch delay

If the target TCI state is known, UE shall be able to receive PDCCH with target TCI state of the serving cell on which TCI state switch occurs at the first slot that is after slot  $n + (T_{RRC\_processing} + TO_k * (T_{first-SSB} + T_{SSB-proc} + T_{SSB} * L_{RRC,known})) / NR\ slot\ length$ . The UE is not required to receive PDCCH/PDSCH/CSI-RS or transmit PUCCH/PUSCH until the end of switching period.

Where

- Slot *n* is last slot overlapping with the PDSCH carrying RRC activation command.
- $T_{RRC\_processing}$  is the RRC processing delay defined in Clause 11.2 of 36.331 [16] is the corresponding RRC message is embedded in E-UTRA RRC message, otherwise it is the RRC processing delay defined in Clause 12 of TS38.331 [2]
- $T_{first-SSB}$  is time to first SSB transmission occasion after RRC processing by the UE, during which some of the SSB occasions may not be available due to DL CCA failures;
  - The SSB shall be the QCL-TypeA or QCL-TypeC to target TCI state;
- $L_{RRC,known} \leq L_{RRC,known,max}$  is the corresponding number of SSB occasions not available at the UE;
  - $L_{RRC,known,max} = 2$  for  $T_{SSB} \leq 40$  ms,  $L_{RRC,known,max} = 1$  for  $T_{SSB} > 40$  ms.
- $T_{SSB-proc}$ ,  $TO_k$ , and  $T_{SSB}$  are as defined in clause 8.10A.3.

If the target TCI state is unknown, UE shall be able to receive PDCCH with target TCI state of the serving cell on which TCI state switch occurs at the first slot that is after slot  $n + (T_{RRC\_processing} + TO_{uk} * (T_{first-SSB} + T_{SSB-proc} + T_{SSB} * L_{RRC,unknown})) / NR\ slot\ length$ . The UE is not required to receive PDCCH/PDSCH/CSI-RS or transmit PUCCH/PUSCH until the end of switching period.

Where,

- Slot *n* is the last slot overlapping with the PDSCH carrying RRC activation command.
- $T_{RRC\_processing}$  is the RRC processing delay defined in Clause 11.2 of 36.331 [16] is the corresponding RRC message is embedded in E-UTRA RRC message, otherwise it is the RRC processing delay defined in Clause 12 of TS38.331 [2].
- $T_{first-SSB}$  is time to first SSB transmission occasion after RRC processing time at the, during which some SSB occasions may not be available at the UE due to DL CCA failures;
  - The SSB shall be the QCL-TypeA or QCL-TypeC to target TCI state;
- $L_{RRC,unknown} \leq L_{RRC,unknown,max}$  is the corresponding number of SSB occasions not available at the UE;



- $L_{\text{RRC,unknown,max}} = 2$  for  $T_{\text{SSB}} \leq 40$  ms,  $L_{\text{RRC,unknown,max}} = 1$  for  $T_{\text{SSB}} > 40$  ms.
- $TO_k$ ,  $T_{\text{SSB-proc}}$ , and  $T_{\text{SSB}}$  are as defined in clause 8.10A.3

The requirements for RRC based TCI state switch delay apply when only 1 TCI state is configured in RRC TCI state list. When  $T_{\text{HARQ}} > T_{\text{RRC\_processing}}$  a longer switching delay is allowed. Where  $T_{\text{HARQ}}$  is the time between DL data transmission and acknowledgement as specified in TS 38.213 [3].

## 8.10A.6 Active TCI state list update delay

If the target TCI state is known, upon receiving PDSCH carrying MAC-CE active TCI state list update at slot  $n$ , UE shall be able to receive PDCCH to schedule PDSCH with the new target TCI state at the first slot that is after  $n + 3N_{\text{slot}}^{\text{subframe},\mu} + (T_{\text{HARQ}} + TO_k * (T_{\text{first-SSB}} + T_{\text{SSB-proc}} + T_{\text{SSB}} * L_{\text{MAC,known}})) / NR \text{ slot length}$ . Where  $T_{\text{HARQ}}$ ,  $T_{\text{first-SSB}}$ ,  $T_{\text{SSB-proc}}$ ,  $T_{\text{SSB}}$ ,  $L_{\text{MAC,known}}$  and  $TO_k$  are as defined in clause 8.10A.3.

## 8.11 PSCell Change

This clause defines requirements for the delay within which the UE shall be able to change PSCell to other cell in EN-DC or NR-DC. The requirements in this clause are applicable to EN-DC and NR-DC.

The UE shall be capable of transmitting PRACH preamble towards the target PSCell no later than specified in clause 8.9.2 for the case of NR-DC and in TS 36.133 clause 7.31.2 for the case of EN-DC, where the following values for slot  $n$ ,  $T_{\text{processing}}$  and  $T_{\text{RRC\_delay}}$  shall override the existing ones:

- Slot  $n$  is the last slot overlapping with the PDSCH containing PSCell change,
- $T_{\text{processing}} = 20$  ms when source and target cells are in the same FR,
- $T_{\text{processing}} = 40$  ms when source and target cells are in different FRs.
- $T_{\text{RRC\_delay}}$  is the RRC procedure delay as specified in TS 36.331 [16] if the corresponding RRC message is embedded in E-UTRA RRC message, otherwise it is the RRC procedure delay as specified in TS 38.331 [2].

If the SMTC periodicity of the target cell is not provided within the PSCell change message, and measObjectNRs having the same SSB frequency and subcarrier spacing configured by MN and SN have different SMTC,  $T_{\text{rs}}$  is the periodicity of one of the SMTC which is up to UE implementation.

The target PSCell is known if it has been meeting the conditions in clause 8.9.2 for the case of NR-DC and in TS36.133 clause 7.31.2 for the case of EN-DC.

The interruption on PCell and other serving cells specified in TS36.133 clause 7.32.2.1 for EN-DC and in TS38.133 clause 8.2.4.2.1 for NR-DC is allowed only during the RRC reconfiguration procedure [2].

### 8.11A void

### 8.11B Conditional PSCell Change

#### 8.11B.1 Introduction

This clause defines requirements for the delay within which the UE shall be able to perform conditional PSCell change in EN-DC or NR-DC. The requirements in this clause are applicable to EN-DC and NR-DC.

#### 8.11B.2 Conditional PSCell Change delay

The requirements in this clause shall apply for the UE configured with only PCell in FR1.

The UE shall be capable to transmit PRACH preamble towards the new target PSCell no later than in slot  $n + T_{\text{config\_PSCell\_Conditional}}$ .

Where:

- Slot  $n$  is the last slot overlapping with the PDSCH containing conditional PSCell change.
- $T_{\text{config\_PSCell\_Conditional}} = T_{\text{RRC\_delay}} + T_{\text{Event\_DU}} + T_{\text{measure}} + T_{\text{UE\_preparation}} + T_{\text{processing}} + T_{\Delta} + T_{\text{PSCell\_DU}} + 2 \text{ ms}$ 
  - $T_{\text{RRC\_delay}}$  is the RRC processing delay defined in Clause 11.2 in 36.331 [16] is the corresponding RRC message is embedded in E-UTRA RRC message, otherwise it is the RRC procedure delay defined in clause 12 in TS 38.331 [2] for processing the conditional PSCell change command.
  - $T_{\text{Event\_DU}}$  is the delay uncertainty which is the time from when the UE successfully decodes a conditional PSCell change command until a condition exists at the measurement reference point which will trigger the conditional PSCell change.
  - $T_{\text{measure}}$  is the measurements time stated in clause 8.11B.2.1.
  - $T_{\text{UE\_preparation}}$  is the UE preparation time for conditional PSCell change, and starts after UE realizes the condition of PSCell change is met and identity of new PSCell is determined.  $T_{\text{UE\_preparation}}$  is up to 10ms.
  - $T_{\text{processing}}$  is the SW processing time needed by UE, including RF warm up period.  $T_{\text{processing}} = 20 \text{ ms}$  when source and target cells are in the same FR, and  $T_{\text{processing}} = 40 \text{ ms}$  when source and target cells are in different FRs.
  - $T_{\Delta}$  is time for fine time tracking and acquiring full timing information of the target cell.  $T_{\Delta} = 1 * T_{\text{rs}} \text{ ms}$ .
    - $T_{\text{rs}}$  is the SMTC periodicity of the target cell if the UE has been provided with an SMTC configuration for the target cell in PSCell addition message, otherwise  $T_{\text{rs}}$  is the SMTC configured in the measObjectNR having the same SSB frequency and subcarrier spacing. If the UE is not provided SMTC configuration or measurement object on this frequency, the requirement in this clause is applied with  $T_{\text{rs}} = 5 \text{ ms}$  assuming the SSB transmission periodicity is 5 ms. There is no requirement if the SSB transmission periodicity is not 5 ms.
  - $T_{\text{PSCell\_DU}}$  is the delay uncertainty in acquiring the first available PRACH occasion in the PSCell.  $T_{\text{PSCell\_DU}}$  is up to the summation of SSB to PRACH occasion association period and 10 ms. SSB to PRACH occasion associated period is defined in Table 8.1-1 of TS 38.213 [3].

The PCell interruption specified in clause 8.2 is allowed only after the UE starts to execute a conditional PSCell change.

### 8.11B.2.1 Measurement time

The measurement time delay is defined from the end of  $T_{\text{Event\_DU}}$  until UE executes a PSCell change to a target cell and interruption time starts.

For intra-frequency PSCell change, the measurement time delay measured without Time To Trigger (TTT) and L3 filtering shall be less than  $T_{\text{identify\_intra\_with\_index}}$  or  $T_{\text{identify\_intra\_without\_index}}$  defined in clause 9.2.5.1 or clause 9.2.6.2.

For inter-frequency PSCell change, the measurement time delay measured without Time To Trigger (TTT) and L3 filtering shall be less than  $T_{\text{identify\_inter\_without\_index}}$  or  $T_{\text{identify\_inter\_with\_index}}$  defined in clause 9.3.4. When TTT or L3 filtering is used an additional delay can be expected.

A cell is detectable only if at least one SSB measured from the cell being configured remains detectable during the time period  $T_{\text{identify\_intra\_without\_index}}$  or  $T_{\text{identify\_intra\_with\_index}}$  for intra-frequency PSCell change or the time period  $T_{\text{identify\_inter\_without\_index}}$  or  $T_{\text{identify\_inter\_with\_index}}$  for inter-frequency PSCell change. If a cell, which has been detectable at least for the time period  $T_{\text{identify\_intra\_without\_index}}$  or  $T_{\text{identify\_intra\_with\_index}}$  for intra-frequency PSCell change or the time period  $T_{\text{identify\_inter\_without\_index}}$  or  $T_{\text{identify\_inter\_with\_index}}$  for inter-frequency PSCell change, becomes undetectable for a period and then the cell becomes detectable again and triggers a PSCell change, the measurement time delay shall be less than  $T_{\text{SSB\_measurement\_period\_intra}}$  or  $T_{\text{SSB\_measurement\_period\_inter}}$  provided the timing to that cell has not changed more than  $\pm 3200/2^{\mu}$  Tc while the measurement gap has not been available and the L3 filter has not been used, where  $\mu$  is the SCS configuration as defined in clause 4.2 of TS 38.211 [3]. When L3 filtering is used, an additional delay can be expected.

## 8.12 Uplink spatial relation switch delay

### 8.12.1 Introduction

The requirements in this clause apply for a UE configured with one or more spatial relation configurations on serving cell in MR-DC or standalone NR. There is no requirement when the UE is requested to switch to a spatial relation with the higher layer parameter *spatialRelationInfo* associated to SRS. UE shall complete the switch of active spatial relation within the delay defined in this clause when the UE is requested to switch to a spatial relation with the higher layer parameter *spatialRelationInfo* associated to a DL RS.

### 8.12.2 Known conditions for spatial relation when associated with DL-RS

The spatial relation associated to DL RS is known if the following conditions are met:

- During the period from the last transmission of the DL RS resource used for the L1-RSRP measurement reporting for the target spatial relation to the completion of active spatial relation switch, where the DL RS resource for L1-RSRP measurement is the DL RS in target spatial relation or QCLed to the target spatial relation with QCL type-D.
  - Spatial relation switch command is received within 1280 ms upon the last transmission of the DL RS resource for beam reporting or measurement
  - The UE has sent at least 1 L1-RSRP report for the target spatial relation before the spatial relation switch command
  - The DL RS configured in spatial relation remains detectable during the spatial relation switching period
    - SNR of the DL RS configured in spatial relation  $\geq -3\text{dB}$
  - The SSB associated with the spatial relation remain detectable during the spatial relation switching period
    - SNR of the SSB associated with the spatial relation  $\geq -3\text{dB}$

Otherwise, the spatial relation is unknown.

### 8.12.3 MAC-CE based spatial relation switch delay

If the target spatial relation associated to DL RS is known, upon receiving PDSCH carrying MAC-CE activation command in slot  $n$ , for UL spatial relation switch for PUCCH or semi-persistent SRS transmission of serving cell with a target UL spatial relation, the UE shall be able to transmit PUCCH or semi-persistent SRS with the target UL spatial relation in the slot  $n + T_{\text{HARQ}} + 3N_{\text{slot}}^{\text{subframe},\mu} + 1$  when *beamCorrespondenceWithoutUL-BeamSweeping* is set to 1 where  $T_{\text{HARQ}}$  is the timing between DL data transmission and acknowledgement as specified in TS 38.213 [3].

If the target spatial relation associated to DL RS is unknown, upon receiving PDSCH carrying MAC-CE activation command in slot  $n$ , for UL spatial relation switch for PUCCH or semi-persistent SRS transmission of serving cell with a target UL spatial relation, the UE shall be able to transmit PUCCH or semi-persistent SRS with the target UL spatial relation in the slot  $n + T_{\text{HARQ}} + 3N_{\text{slot}}^{\text{subframe},\mu} + T_{\text{L1-RSRP}} + 1$  when *beamCorrespondenceWithoutUL-BeamSweeping* is set to 1.

Where

- $T_{\text{HARQ}}$  is the timing between DL data transmission and acknowledgement as specified in TS 38.213 [3],
- $T_{\text{L1-RSRP}}$  is the time for Rx beam refinement in FR2, defined as
  - $T_{\text{L1-RSRP\_Measurement\_Period\_SSB}}$  for SSB as specified in clause 9.5.4.1,
    - with the assumption of  $M=1$
    - with  $T_{\text{Report}} = 0$
  - $T_{\text{L1-RSRP\_Measurement\_Period\_CSI-RS}}$  for CSI-RS as specified in clause 9.5.4.2

- configured with higher layer parameter *repetition* set to ON
- with the assumption of  $M=1$  for periodic CSI-RS
- for aperiodic CSI-RS if number of resources in resource set at least equal to *MaxNumberRxBeam*
- with  $T_{\text{Report}} = 0$

The UE shall be able to transmit with the old UL spatial relation until slot  $n + T_{\text{HARQ}} + 3N_{\text{slot}}^{\text{subframe},\mu}$ .

When the UL spatial relation info switch for PUCCH changes both the associated DL RS and *pucch-PathlossReferenceRS* with the same MAC-CE activation, and if both the DL RS and *pucch-PathlossReferenceRS* are known as specified in clause 8.12.2 and 8.14.2 respectively, the UE shall be able to transmit PUCCH with the target UL spatial relation after the delay specified in clause 8.14.3. If either the associated DL RS or *pucch-PathlossReferenceRS* are unknown, a longer switching delay is allowed. The UE is not required to transmit PUCCH with the target UL spatial relation until the DL RS and pathloss reference RS switch are completed.

## 8.12.4 DCI based spatial relation switch delay

If the target spatial relation associated to DL RS is known, when a UE receives the DCI triggering aperiodic SRS at slot  $n$  with the higher layer parameter *spatialRelationInfo*, UE shall be able to transmit aperiodic SRS with target spatial

relation of the serving cell on which spatial relation switch occurs in the slot  $\left\lfloor n \cdot \frac{2^{\mu_{\text{SRS}}}}{2^{\mu_{\text{PDCCH}}}} \right\rfloor + k + 1$ , where,  $k$  is configured

via higher layer parameter *slotOffset*[2] for each triggered SRS resources set and is based on the subcarrier spacing of the triggered SRS transmission,  $\mu_{\text{SRS}}$  and  $\mu_{\text{PDCCH}}$  are the subcarrier spacing configurations for triggered SRS and PDCCH carrying the triggering command respectively in TS 38.214 [26].

The known condition for spatial relation associated to DL RS defined in clause 8.12.2 is applied.

## 8.12.5 RRC based spatial relation switch delay

If the target spatial relation associated to DL RS is known, UE shall be able to transmit target periodic SRS with spatial relation of the serving cell on which periodic SRS with spatial relation reconfigured in the slot  $n + T_{\text{RRC\_processing}} / NR \text{ slot length} + 1$  when *beamCorrespondenceWithoutUL-BeamSweeping* is set to 1

Where

- Slot  $n$  is the last slot overlapping with the PDSCH carrying RRC activation command,
- $T_{\text{RRC\_processing}}$  is the RRC processing delay defined in 36.331 [16] if the corresponding RRC message is embedded in E-UTRA RRC message, otherwise it is the RRC processing delay defined in TS38.331 [2].

If the target spatial relation associated to DL RS is unknown, UE shall be able to transmit target periodic SRS with spatial relation of the serving cell on which periodic SRS with spatial relation reconfigured in the slot  $n + T_{\text{RRC\_processing}} / NR \text{ slot length} + T_{\text{LI-RSRP}} + 1$  when *beamCorrespondenceWithoutUL-BeamSweeping* is set to 1.

Where

- Slot  $n$  is the last slot overlapping with the PDSCH carrying RRC activation command,
- $T_{\text{RRC\_processing}}$  is the RRC processing delay defined in 36.331 [16] if the corresponding RRC message is embedded in E-UTRA RRC message, otherwise it is the RRC processing delay defined in TS38.331 [2].
- $T_{\text{LI-RSRP}}$  is defined in clause 8.12.3

## 8.13 UE-specific CBW change

### 8.13.1 Introduction

The requirements in this clause apply for a UE receives reconfiguration of *offsetToCarrier* or *carrierBandwidth* to change channel bandwidth.

## 8.13.2 UE-specific CBW change delay

After the UE receives RRC reconfiguration involving *offsetToCarrier* or *carrierBandwidth* change on the old CBW, UE shall be able to receive PDSCH/PDCCH on the DL BWP with BWP ID *firstActiveDownlinkBWP-Id* or transmit PUSCH on the UL BWP with BWP ID *firstActiveUplinkBWP-Id* of the new CBW right after a time duration of  $\frac{T_{RRCprocessingDelay} + T_{CBWchangeDelayRRC}}{NR\ Slot\ length}$  slots which begins from the beginning of DL slot *n*, where

DL slot *n* is the last slot overlapping with the PDSCH containing the RRC command, and

$T_{RRCprocessingDelay}$  is the length of the RRC procedure delay in millisecond as defined in clause 11.2 in TS 36.331 [6] if the corresponding RRC message is embedded in E-UTRA RRC message, otherwise it is the length of the RRC procedure delay in millisecond as defined in clause 12 in TS 38.331 [2], and

$T_{CBWchangeDelayRRC} = 6ms$  is the time used by the UE to perform CBW change.

The UE is not required to transmit UL signals or receive DL signals during the above defined time duration  $\frac{T_{RRCprocessingDelay} + T_{CBWchangeDelayRRC}}{NR\ Slot\ length}$  on the cell where UE-specific CBW change occurs. When  $T_{HARQ} >$

$T_{RRCprocessingDelay}$  a longer switching delay is allowed. Where  $T_{HARQ}$  is the time between DL data transmission and acknowledgement as specified in TS 38.213 [3].

## 8.14 Pathloss reference signal switching delay

### 8.14.1 Introduction

The requirements in this clause apply for pathloss reference signal activated or updated on serving cell in MR-DC or standalone NR in clause 7.1.1 in TS 38.213 [3].

UE shall complete the switch of pathloss reference signal within the delay defined in this clause.

### 8.14.2 Known conditions for pathloss reference signal

In FR2, the pathloss reference signal is known if the following conditions are met during the period between the last transmission of the RS resource used for L1-RSRP measurement reporting and the completion of pathloss reference signal switch, where the RS resource is the target pathloss reference signal or QCLed (with Type D) to the target pathloss reference signal.

- Pathloss reference signal switch command is received within 1280 ms upon the last transmission of the RS resource for beam reporting or measurement
- The UE has sent at least 1 L1-RSRP report for the target pathloss reference signal before the pathloss reference signal switch command
- The target pathloss reference signal remains detectable during the pathloss reference signal switching period
  - SNR of the target pathloss reference signal  $\geq -3dB$
- The associated SSBs with the target pathloss reference signal remain detectable during the pathloss reference signal switching period
  - SNR of the associated SSB  $\geq -3dB$

In FR1, the pathloss reference signal is known if the following conditions are met

- The target pathloss reference signal remains detectable during the pathloss reference signal switching period
  - SNR of the target pathloss reference signal  $\geq -3dB$

Otherwise, the pathloss reference signal is unknown.

### 8.14.3 MAC-CE based pathloss reference signal switch delay

The requirements in this clause apply for a UE to update a pathloss reference signal by MAC-CE for PUCCH, PUSCH, semi-persistent SRS and aperiodic SRS.

If the target pathloss reference signal is known, upon receiving PDSCH carrying MAC-CE activation in slot  $n$ , UE shall be able to apply the target pathloss reference signal of the serving cell on which pathloss reference signal switch occurs no later than the slot  $n + T_{HARQ} + 3N_{slot}^{subframe,\mu} + NM * \left\lceil \frac{5 * T_{target\_PL-RS} + 2ms}{NR\ slot\ length} \right\rceil$ . The UE shall be able to apply old pathloss reference signals until the slot  $n + T_{HARQ} + 3N_{slot}^{subframe,\mu}$ . Where

- $T_{HARQ}$  is the timing between pathloss reference MAC-CE activation command and acknowledgement as specified in TS 38.321 [7].
- $NM = 1$ , if the target PL-RS is not maintained by the UE, 0 otherwise.

In FR2, if the target pathloss reference signal is SSB, the requirements in this clause shall apply when the target pathloss reference signal is maintained by the UE.

- $T_{target\_PL-RS}$  is the periodicity of the target pathloss reference signal which would be SSB or NZP CSI-RS.
- PL-RS is maintained provided:
  - There are no more than 4 different RS activated as PL-RS per serving cell among all active spatial relations for PUSCH/PUCCH/SRS transmissions.
  - The target pathloss reference signal remains detectable during TCI state switching period
    - SNR of the target pathloss reference signal  $\geq -3dB$
  - The associated SSBs with the target pathloss reference signal remain detectable during the TCI state switching period.
    - SNR of the associated SSB  $\geq -3dB$

Note: longer application time is expected if measurement sample is not available due to measurement gap, DRX or other UE activities.

Note: longer application time is expected if the pathloss reference signal is unknown.

## 9 Measurement Procedure

### 9.1 General measurement requirement

#### 9.1.1 Introduction

This clause contains general requirements on the UE regarding measurement reporting in RRC\_CONNECTED state. The requirements are split in intra-frequency, inter-frequency, inter-RAT E-UTRAN FDD, inter-RAT E-UTRAN TDD, and L1-RSRP measurements requirements. These measurements may be used by the NG-RAN. The measurement quantities are defined in TS38.215 [4], the measurement model is defined in TS38.300 [10], TS37.340 [17] and measurement accuracies are specified in clause 10. Control of measurement reporting is specified in TS 38.331 [2].

In the requirements of clause 9, the exceptions for side conditions apply as follows:

- for the UE capable of CA but not configured with any SCell, the applicable exceptions for side conditions are specified in Annex B, clause B.3.2.1 for UE supporting CA in FR1, and clause B.3.2.3 for UE supporting CA in FR2, respectively;
- for the UE capable of CA and configured with at least one SCell, the applicable exceptions for side conditions are specified in Annex B, clause B.3.2.2 for UE configured with CA in FR1, and clause B.3.2.4 for UE supporting CA in FR2, respectively;

- for the UE capable of SUL but not configured with SUL, the applicable exceptions for side conditions are specified in Annex B, clause B.3.4.1 for UE supporting SUL in FR1;
- for the UE capable of SUL and configured with at least one SUL, the applicable exceptions for side conditions are specified in Annex B, clause B.3.4.2 for UE configured with SUL in FR1.

## 9.1.2 Measurement gap

If the UE requires measurement gaps to identify and measure intra-frequency cells and/or inter-frequency cells and/or inter-RAT E-UTRAN cells, and the UE does not support independent measurement gap patterns for different frequency ranges as specified in Table 5.1-1 in [18, 19, 20], in order for the requirements in the following clauses to apply the network must provide a single per-UE measurement gap pattern for concurrent monitoring of all frequency layers.

If the UE requires measurement gaps to identify and measure intra-frequency cells and/or inter-frequency cells and/or inter-RAT E-UTRAN cells, and the UE supports independent measurement gap patterns for different frequency ranges as specified in Table 5.1-1 in [18, 19, 20], in order for the requirements in the following clauses to apply the network must provide either per-FR measurement gap patterns for frequency range where UE requires per-FR measurement gap for concurrent monitoring of all frequency layers of each frequency range independently, or a single per-UE measurement gap pattern for concurrent monitoring of all frequency layers of all frequency ranges.

If the UE is configured via LPP [34] to measure PRS for any RSTD, PRS-RSRP, and UE Rx-Tx time difference measurement defined in TS 38.215 [4], in order for the requirements in clauses 9.9.2, 9.9.3, and 9.9.4 to apply, the network must provide

- a single per-UE measurement gap pattern for concurrent monitoring of all positioning frequency layers and intra-frequency, inter-frequency and/or inter-RAT frequency layers of all frequency ranges, or

During the per-UE measurement gaps the UE:

- is not required to conduct reception/transmission from/to the corresponding E-UTRAN PCell, E-UTRAN SCell(s) and NR serving cells for E-UTRA-NR dual connectivity except the reception of signals used for RRM measurement(s) and the signals used for random access procedure according to TS38.321 [7].
- is not required to conduct reception/transmission from/to the corresponding NR serving cells for SA (with single carrier or CA configured) except the reception of signals used for RRM measurement(s), PRS measurement(s) and the signals used for random access procedure according to [7].
- is not required to conduct reception/transmission from/to the corresponding PCell, SCell(s) and E-UTRAN serving cells for NR-E-UTRA dual connectivity except the reception of signals used for RRM measurement(s), PRS measurement(s) and the signals used for random access procedure according to [7].
- is not required to conduct reception/transmission from/to the corresponding NR serving cells for NR-DC except the reception of signals used for RRM measurement(s), PRS measurement(s) and the signals used for random access procedure according to [7].

During the per-FR measurement gaps the UE:

- is not required to conduct reception/transmission from/to the corresponding E-UTRAN PCell, E-UTRAN SCell(s) and NR serving cells in the corresponding frequency range for E-UTRA-NR dual connectivity except the reception of signals used for RRM measurement(s) and the signals used for random access procedure according to TS38.321 [7].
- is not required to conduct reception/transmission from/to the corresponding NR serving cells in the corresponding frequency range for SA (with single carrier or CA configured) except the reception of signals used for RRM measurement(s) and the signals used for random access procedure according to TS38.321 [7].
- is not required to conduct reception/transmission from/to the corresponding PCell, SCell(s) and E-UTRAN serving cells in the corresponding frequency range for NR-E-UTRA dual connectivity except the reception of signals used for RRM measurement(s) and the signals used for random access procedure according to TS38.321 [7].
- is not required to conduct reception/transmission from/to the corresponding NR serving cells in the corresponding frequency range for NR-DC except the reception of signals used for RRM measurement(s) and the signals used for random access procedure according to TS38.321 [7].

UEs shall support the measurement gap patterns listed in Table 9.1.2-1 based on the applicability specified in table 9.1.2-2 and 9.1.2-3. UE determines measurement gap timing based on gap offset configuration and measurement gap timing advance configuration provided by higher layer signalling as specified in TS 38.331 [2] and TS 36.331 [16].

**Table 9.1.2-1: Gap Pattern Configurations**

Gap Pattern Id	Measurement Gap Length (MGL, ms)	Measurement Gap Repetition Period (MGRP, ms)
0	6	40
1	6	80
2	3	40
3	3	80
4	6	20
5	6	160
6	4	20
7	4	40
8	4	80
9	4	160
10	3	20
11	3	160
12	5.5	20
13	5.5	40
14	5.5	80
15	5.5	160
16	3.5	20
17	3.5	40
18	3.5	80
19	3.5	160
20	1.5	20
21	1.5	40
22	1.5	80
23	1.5	160
24	10	80
25	20	160

**Table 9.1.2-2: Applicability for Gap Pattern Configurations supported by the E-UTRA-NR dual connectivity UE or NR-E-UTRA dual connectivity UE**

Measurement gap pattern configuration	Serving cell	Measurement Purpose <sup>Note 5</sup>	Applicable Gap Pattern Id
Per-UE Measurement gap	E-UTRA + FR1, or E-UTRA + FR2, or E-UTRA + FR1 + FR2	non-NR RAT <sup>Note 1,2</sup>	0,1,2,3
		FR1 and/or FR2 <sup>Note 7</sup>	0-11, 24, 25
		non-NR RAT <sup>Note 1,2</sup> and FR1 and/or FR2 <sup>Note 7</sup>	0, 1, 2, 3, 4, 6, 7, 8,10, 24
Per-FR measurement gap	E-UTRA and, FR1 if configured	non-NR RAT <sup>Note 1,2</sup>	0,1,2,3
	FR2 if configured		No gap
	E-UTRA and, FR1 if configured	FR1 only	0-11
	FR2 if configured		No gap
	E-UTRA and, FR1 if configured	FR2 only	No gap
	FR2 if configured		12-23
	E-UTRA and, FR1 if configured	non-NR RAT <sup>Note 1,2</sup> and FR1	0, 1, 2, 3, 4, 6, 7, 8,10
	FR2 if configured		No gap
	E-UTRA and, FR1 if configured	FR1 and FR2	0-11
FR2 if configured	12-23		



	E-UTRA and, FR1 if configured	non-NR RAT <sup>Note1,2</sup> and FR2	0, 1, 2, 3, 4, 6, 7, 8,10
	FR2 if configured		12-23
	E-UTRA and, FR1 if configured	non-NR RAT <sup>Note1,2</sup> and FR1 and FR2	0, 1, 2, 3, 4, 6, 7, 8,10
	FR2 if configured		12-23
Note:	In E-UTRA-NR dual connectivity mode, if GSM or UTRA TDD or UTRA FDD inter-RAT frequency layer is configured to be monitored, only measurement gap pattern #0 and #1 can be used for per-FR gap in E-UTRA and FR1 if configured, or for per-UE gap. In NR-E-UTRA dual connectivity mode, if UTRA FDD inter-RAT frequency layer is configured to be monitored for SRVCC, only measurement gap pattern #0 and #1 can be used for per-FR gap in E-UTRA and FR1 if configured, or for per-UE gap.		
NOTE 1:	In E-UTRA-NR dual connectivity mode, non-NR RAT includes E-UTRA, UTRA and/or GSM. In NR-E-UTRA dual connectivity mode, non-NR RAT means E-UTRA, and UTRA for SRVCC.		
NOTE 2:	Void		
NOTE 3:	When E-UTRA inter-frequency RSTD measurements are configured and the UE requires measurement gaps for performing such measurements, only Gap Pattern #0 can be used.		
NOTE 4:	For UE supporting <i>supportedGapPattern-NRonly-NEDC</i> or <i>measGapPatterns-NRonly-ENDC-r16</i> but not supporting <i>supportedGapPattern</i> for the corresponding gap patterns among GP2-11, the corresponding gap patterns are not applicable to measurement of non-NR RATs as defined in NOTE 1.		
NOTE 5:	Inclusion of positioning measurements: Measurement purpose which includes E-UTRA measurements includes also E-UTRA RSRP and E-UTRA RSRQ measurements for E-CID.		
NOTE 6:	Measurement gap patterns #24 and #25 can be requested [2] only when the UE is configured at least with any of RSTD, UE Rx-Tx, or PRS-RSRP measurements requiring such gaps and can only be used during the corresponding positioning measurement period		
NOTE 7:	Inclusion of positioning measurements for per-UE measurement gaps: Measurement purpose which includes any of FR1 and FR2 measurements includes also RSTD, UE Rx-Tx, and PRS-RSRP measurements.		

In E-UTRA-NR dual connectivity mode,

- if per-UE measurement gap is configured with MG timing advance of  $T_{MG}$  ms, the measurement gap starts at time  $T_{MG}$  ms advanced to the end of the latest E-UTRA subframe occurring immediately before the configured measurement gap among MCG serving cells subframes.
- if per-FR measurement gap for FR1 is configured with MG timing advance of  $T_{MG}$  ms, the measurement gap for FR1 starts at time  $T_{MG}$  ms advanced to the end of the latest E-UTRA subframe occurring immediately before the configured measurement gap among MCG serving cells subframes.
- if per-FR measurement gap for FR2 is configured with MG timing advance of  $T_{MG}$  ms, the measurement gap for FR2 starts at time  $T_{MG}$  ms advanced to the end of the latest NR subframe occurring immediately before the configured measurement gap among SCG serving cells subframes in FR2.

In NR-E-UTRA dual connectivity mode,

- if per-UE measurement gap is configured with MG timing advance of  $T_{MG}$  ms, the measurement gap starts at time  $T_{MG}$  ms advanced to the end of the latest NR subframe occurring immediately before the configured measurement gap among MCG serving cells subframes.
- if per-FR measurement gap for FR1 is configured with MG timing advance of  $T_{MG}$  ms and UE has NR serving cell in FR1, the measurement gap for FR1 starts at time  $T_{MG}$  ms advanced to the end of the latest NR subframe occurring immediately before the configured measurement gap among MCG serving cells subframes in FR1.
- if per-FR measurement gap for FR1 is configured with MG timing advance of  $T_{MG}$  ms and UE doesn't have NR serving cell in FR1, the measurement gap for FR1 starts at time  $T_{MG}$  ms advanced to the end of the latest E-UTRA subframe occurring immediately before the configured measurement gap among SCG serving cells subframes.
- if per-FR measurement gap for FR2 is configured with MG timing advance of  $T_{MG}$  ms, the measurement gap for FR2 starts at time  $T_{MG}$  ms advanced to the end of the latest NR subframe occurring immediately before the configured measurement gap among MCG serving cells subframes in FR2.

In NR-NR dual connectivity mode,

- If per-UE measurement gap is configured with MG timing advance of  $T_{MG}$  ms, the measurement gap starts at time  $T_{MG}$  ms advanced to the end of the latest MCG subframe occurring immediately before the configured measurement gap among MCG serving cells subframes.
- If per-FR measurement gap for FR1 is configured with MG timing advance of  $T_{MG}$  ms, the measurement gap for FR1 starts at time  $T_{MG}$  ms advanced to the end of the latest MCG subframe occurring immediately before the configured measurement gap among MCG serving cells subframes.
- If per-FR measurement gap for FR2 is configured with MG timing advance of  $T_{MG}$  ms, the measurement gap for FR2 starts at time  $T_{MG}$  ms advanced to the end of the latest SCG subframe occurring immediately before the configured measurement gap among SCG serving cells subframes in FR2.

$T_{MG}$  is the MG timing advance value provided in *mgta* according to TS38.331 [2].

In determining the measurement gap starting point, UE shall use the DL timing of the latest E-UTRA or NR subframe occurring immediately before the configured measurement gap among E-UTRA or NR serving cells.

For per-FR measurement gap capable UE configured with E-UTRA-NR dual connectivity or NR-E-UTRA dual connectivity, when serving cells are in E-UTRA and FR1, measurement objects are in both E-UTRA/FR1 and FR2,

- If MN indicates UE that the measurement gap from MN applies to E-UTRA/FR1/FR2 serving cells, UE fulfils the per-UE measurement requirements for both E-UTRA/FR1 and FR2 measurement objects based on the measurement gap pattern configured by MN;
- If MN indicates UE that the measurement gap from MN applies to only LTE/FR1 serving cell(s),
  - UE fulfils the measurement requirements for FR1/LTE measurement objects based on the configured measurement gap pattern;
  - UE fulfils the requirements for FR2 measurement objects based on effective  $MGRP=20ms$ ;

For per-FR measurement gap capable configured with E-UTRA-NR dual connectivity, NR-E-UTRA dual connectivity or NR-NR dual connectivity, when serving cells are in E-UTRA, FR1 and FR2, or in E-UTRA and FR2, or in FR1 and FR2, measurement objects are in both E-UTRA /FR1 and FR2,

- If MN indicates UE that the measurement gap from MN applies to E-UTRA/FR1/FR2 serving cells, UE fulfils the per-UE measurement requirements for both E-UTRA/FR1 and FR2 measurement objects based on the measurement gap pattern configured by MN.

**Table 9.1.2-3: Applicability for Gap Pattern Configurations supported by the UE with NR standalone operation (with single carrier, NR CA and NR-DC configuration)**

Measurement gap pattern configuration	Serving cell	Measurement Purpose <sup>NOTE 2</sup>	Applicable Gap Pattern Id
Per-UE measurement gap	FR1 <sup>NOTE5</sup> , or FR1 + FR2	non-NR RAT <sup>NOTE3,6</sup>	0,1,2,3
		FR1 and/or FR2 <sup>NOTE 9</sup>	0-11, 24, 25
		non-NR RAT and FR1 and/or FR2 <sup>NOTE3,6,9</sup>	0, 1, 2, 3, 4, 6, 7, 8,10, 24
	FR2 <sup>NOTE5</sup>	non-NR RAT only <sup>NOTE3,6</sup>	0,1,2,3
		FR1 only <sup>NOTE 9</sup>	0-11, 24, 25
		FR1 and FR2 <sup>NOTE 9</sup>	0-11, 24, 25
		non-NR RAT and FR1 and/or FR2 <sup>NOTE3,6,9</sup>	0, 1, 2, 3, 4, 6, 7, 8,10, 24
		FR2 only <sup>NOTE 9</sup>	12-23
	FR1 if configured	non-NR RAT only <sup>NOTE3,6</sup>	0,1,2,3
	FR2 if configured		No gap
	FR1 if configured	FR1 only	0-11
	FR2 if configured		No gap
	FR1 if configured	FR2 only	No gap

Per-FR measurement gap	FR2 if configured		12-23
	FR1 if configured	non-NR RAT and	0, 1, 2, 3, 4, 6, 7, 8,10
	FR2 if configured	FR1 <sup>NOTE3,6</sup>	No gap
	FR1 if configured	FR1 and FR2	0-11
	FR2 if configured		12-23
	FR1 if configured	non-NR RAT and	0, 1, 2, 3, 4, 6, 7, 8,10
	FR2 if configured	FR2 <sup>NOTE3,6</sup>	12-23
	FR1 if configured	non-NR RAT and	0, 1, 2, 3, 4, 6, 7, 8,10
	FR2 if configured	FR1 and FR2 <sup>NOTE3,6</sup>	12-23
<p>NOTE 1: When E-UTRA inter-RAT RSTD measurements are configured and the UE requires measurement gaps for performing such measurements, only Gap Pattern #0 can be used.</p> <p>NOTE 2: Measurement purpose which includes E-UTRA measurements includes also inter-RAT E-UTRA RSRP and RSRQ measurements for E-CID; measurement purpose which includes E-UTRA measurements includes also E-UTRA RSRP and E-UTRA RSRQ measurements for E-CID.</p> <p>NOTE 3: Void</p> <p>NOTE4: If per-UE measurement gap is configured with MG timing advance of <math>T_{MG}</math> ms, the measurement gap starts at time <math>T_{MG}</math> ms advanced to the end of the latest subframe occurring immediately before the configured measurement gap among all serving cells subframes. If per-FR measurement gap for FR1 is configured with MG timing advance of <math>T_{MG}</math> ms, the measurement gap for FR1 starts at time <math>T_{MG}</math> ms advanced to the end of the latest subframe occurring immediately before the configured measurement gap among serving cells subframes in FR1. If per-FR measurement gap for FR2 is configured with MG timing advance of <math>T_{MG}</math> ms, the measurement gap for FR2 starts at time <math>T_{MG}</math> ms advanced to the end of the latest subframe occurring immediately before the configured measurement gap among serving cells subframes in FR2. <math>T_{MG}</math> is the MG timing advance value provided in <i>mgta</i> according to [2]. In determining the measurement gap starting point, UE shall use the DL timing of the latest subframe occurring immediately before the configured measurement gap among serving cells.</p> <p>NOTE 5: NR-DC in Rel-15 only includes the scenarios where all serving cells in MCG in FR1 and all serving cells in SCG in FR2.</p> <p>NOTE 6: In NR single carrier, NR CA, and NR-DC mode, non-NR RAT means E-UTRA, and UTRA for SRVCC. In NR single carrier, NR CA, and NR-DC mode, if UTRA FDD inter-RAT frequency layer is configured to be monitored for SRVCC, only measurement gap pattern #0 and #1 can be used for per-FR gap in E-UTRA and FR1 if configured, or for per-UE gap.</p> <p>NOTE 7: For UE only supporting <i>supportedGapPattern-NRonly</i> for any gap patterns among GP2-11, the corresponding gap patterns are not applicable to measurement of non-NR RATs as defined in NOTE 6.</p> <p>NOTE 8: Measurement gap patterns #24 and #25 can be requested [2] only when the UE is configured with any of RSTD, UE Rx-Tx, or PRS-RSRP measurements requiring such gaps and can only be used during the corresponding positioning measurement period.</p> <p>NOTE 9: Inclusion of positioning measurements for per-UE measurement gaps: Measurement purpose which includes any of FR1 and FR2 measurements includes also RSTD, UE Rx-Tx, and PRS-RSRP measurements.</p>			

For per-FR measurement gap capable UE in NR standalone operation (with single carrier, NR CA and NR-DC configuration), for per-FR gap based measurement, when there is no serving cell in a particular FR, where measurement objects are configured, regardless if explicit per-FR measurement gap is configured in this FR, the effective MGRP in this FR is used to determine requirements;

- 20 ms for FR2 NR measurements
- 40 ms for FR1 NR measurements
- 40 ms for LTE measurements
- 40 ms for FR1+LTE measurements

For per-FR measurement gap capable UE in NR standalone operation (with single carrier, NR CA and NR-DC configuration), when serving cells are in FR1 or FR2, measurement objects are in both E-UTRA /FR1 and FR2,

- If MN indicates UE that the measurement gap from MN applies to E-UTRA/FR1/FR2 serving cells, UE fulfils the per-UE measurement requirements for both E-UTRA/FR1 and FR2 measurement objects based on the measurement gap pattern configured by MN;

If measurement gap is configured in one FR but measurement object is not configured in the FR, the scheduling opportunity in the FR depends on the configured measurement gap pattern.

For single carrier or CA with aligned frame boundaries,

For E-UTRA-NR dual connectivity (with NR single carrier, NR CA configuration), if UE is not capable of per-FR-gap, total interruption time on SCG during MGL is defined only when  $MGL(N) = 20\text{ms}, 10\text{ms}, 6\text{ms}, 4\text{ms}$  and  $3\text{ms}$ . And if UE is capable of per-FR-gap, total interruption time on FR1 serving cells in SCG during MGL is defined only when  $MGL(N) = 20\text{ms}, 10\text{ms}, 6\text{ms}, 4\text{ms}$  and  $3\text{ms}$ , and total interruption time on FR2 serving cells in SCG during MGL is defined only when  $MGL(N) = 20\text{ms}, 10\text{ms}, 5.5\text{ms}, 3.5\text{ms}$  and  $1.5\text{ms}$ .

For NR standalone operation (with single carrier, NR CA and NR-DC configuration), if UE is not capable of per-FR-gap, total interruption time on a serving cell during MGL is defined when  $MGL(N) = 20\text{ms}, 10\text{ms}, 6\text{ms}, 5.5\text{ms}, 4\text{ms}, 3.5\text{ms}, 3\text{ms}$ , and  $1.5\text{ms}$ . And if UE is capable of per-FR-gap, total interruption time on FR1 serving cells during MGL is defined only when  $MGL(N) = 20\text{ms}, 10\text{ms}, 6\text{ms}, 4\text{ms}$ , and  $3\text{ms}$ , and total interruption time on FR2 serving cells during MGL is defined only when  $MGL(N) = 20\text{ms}, 10\text{ms}, 5.5\text{ms}, 3.5\text{ms}$ , and  $1.5\text{ms}$ .

For NR-E-UTRA dual connectivity (with NR single carrier, NR CA configuration), if UE is not capable of per-FR-gap, total interruption time on MCG during MGL is defined only when  $MGL(N) = 20\text{ms}, 10\text{ms}, 6\text{ms}, 4\text{ms}$ , and  $3\text{ms}$ . And if UE is capable of per-FR-gap, total interruption time on FR1 serving cells in MCG during MGL is defined only when  $MGL(N) = 20\text{ms}, 10\text{ms}, 6\text{ms}, 4\text{ms}$ , and  $3\text{ms}$ , and total interruption time on FR2 serving cells in MCG during MGL is defined only when  $MGL(N) = 20\text{ms}, 10\text{ms}, 5.5\text{ms}, 3.5\text{ms}$ , and  $1.5\text{ms}$ .

For CA with non-aligned frame boundaries,

- The total interruption time on an SCC is the same as the case CA with aligned frame boundaries, if no SCC slots are partially overlapped with the measurement gap.
- The total interruption time on an SCC will be additionally extended by one SCC slot, if there exist SCC slots partially overlapped with the measurement gap.

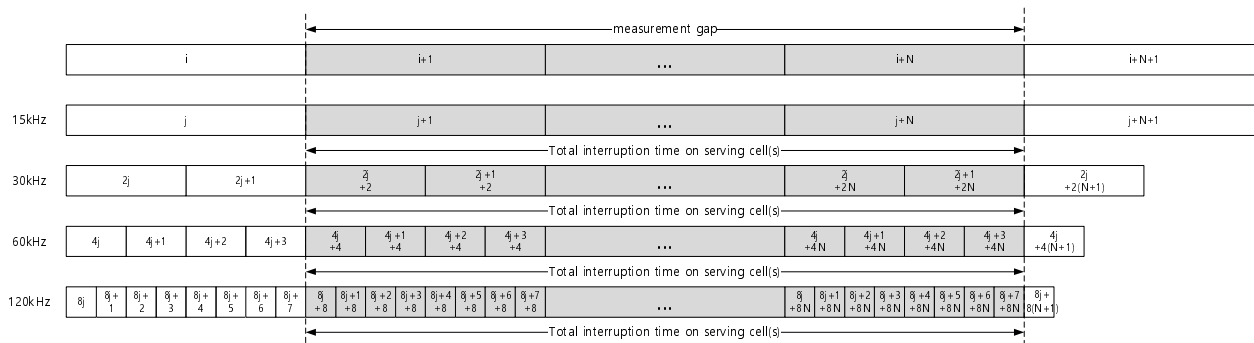

- (a) Measurement gap with  $MGL = N(\text{ms})$  with MG timing advance of  $0\text{ms}$  for all serving cells in synchronous EN-DC, NR standalone operation (with single carrier, NR CA and synchronous NR-DC configuration) and synchronous NE-DC, and for serving cells in MCG in NR standalone operation (with asynchronous NR-DC configuration)

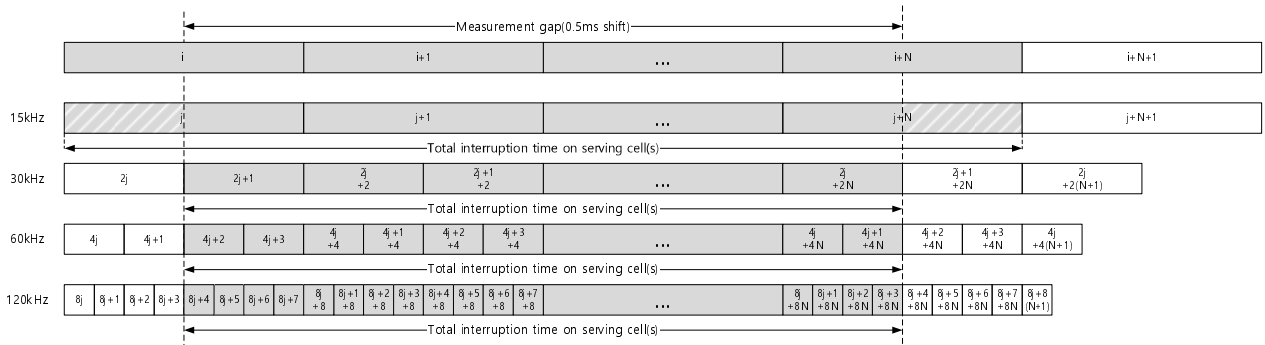

(b) Measurement gap with MGL = N(ms) with MG timing advance of 0.5ms for all serving cells in synchronous EN-DC, NR standalone operation (with single carrier, NR CA and synchronous NR-DC configuration) and synchronous NE-DC, and for serving cells in MCG in NR standalone operation (with asynchronous NR-DC configuration)

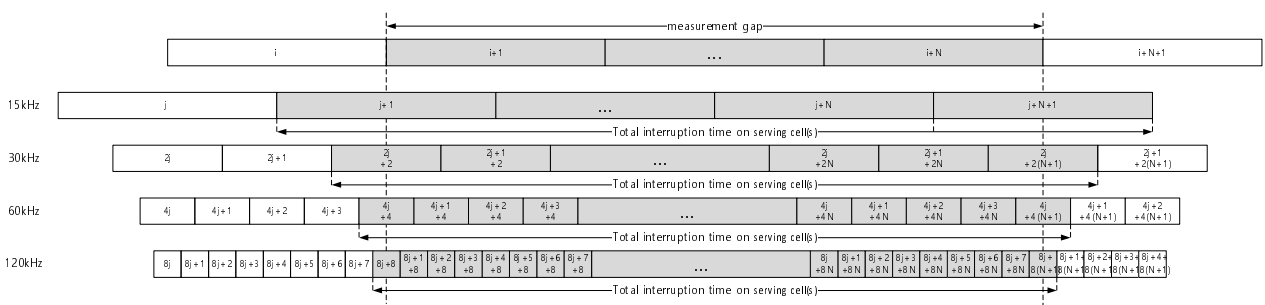

(c) Measurement gap with MGL = N(ms) with MG timing advance of 0ms for all serving cells in asynchronous EN-DC and asynchronous NE-DC, and for serving cells in SCG in NR standalone operation (with asynchronous NR-DC configuration)

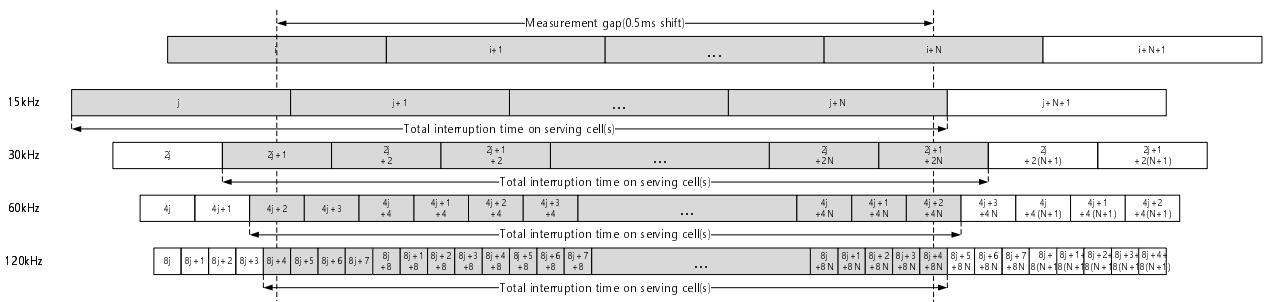

(d) Measurement gap with MGL = N(ms) with MG timing advance of 0.5ms for all serving cells in asynchronous EN-DC and asynchronous NE-DC, and for serving cells in SCG in NR standalone operation (with asynchronous NR-DC configuration)

**Figure 9.1.2-1: Measurement GAP and total interruption time on serving cells for EN-DC, NR standalone operation (with single carrier, NR CA and NR-DC configuration) and NE-DC**

The corresponding total number of interrupted slots on serving cells is listed in Table 9.1.2-4 for all serving cells in synchronous EN-DC, NR standalone (with single carrier, NR CA and synchronous NR-DC configuration) and NE-DC, and for serving cells in MCG in NR standalone operation (with asynchronous NR-DC configuration). The corresponding total number of interrupted slots on serving cells is listed in Table 9.1.2-4a for asynchronous EN-DC, and for serving cells in SCG in NR standalone operation (with asynchronous NR-DC configuration).

**Table 9.1.2-4: Total number of interrupted slots on all serving cells during MGL for Synchronous EN-DC, NR standalone operation (with single carrier, NR CA and synchronous NR-DC configuration) and NE-DC, and on all serving cells in MCG for NR standalone operation (with asynchronous NR-DC configuration) with per-UE measurement gap or per-FR measurement gap for FR1**

NR	Total number of interrupted slots on serving cells
----	--

SCS (kHz)	When MG timing advance of 0ms is applied					When MG timing advance of 0.5ms is applied				
	MGL=20ms	MGL=10ms	MGL=6ms	MGL=4ms	MGL=3ms	MGL=20ms	MGL=10ms	MGL=6ms	MGL=4ms	MGL=3ms
15	20	10	6	4	3	21 <sup>Note3</sup>	11 <sup>Note3</sup>	7 <sup>Note3</sup>	5 <sup>Note3</sup>	4 <sup>Note3</sup>
30	40	20	12	8	6	40	20	12	8	6
60	80	40	24	16	12	80	40	24	16	12
120	160	80	48	32	24	160	80	48	32	24

NOTE 1: Void.  
 NOTE 2: NR SCS of 120 kHz is only applicable to the case with per-UE measurement gap.  
 NOTE 3: Non-overlapped half-slots occur before and after the measurement gap. Whether a Rel-15 UE can receive and/or transmit in those half-slots is up to UE implementation.

**Table 9.1.2-4a: Total number of interrupted slots on serving cells during MGL for Asynchronous EN-DC, and on all serving cells in SCG for NR standalone operation (with asynchronous NR-DC configuration) with per-UE measurement gap or per-FR measurement gap for FR1**

NR SCS (kHz)	Total number of interrupted slots on serving cells									
	When MG timing advance of 0ms is applied					When MG timing advance of 0.5ms is applied				
	MGL=20ms	MGL=10ms	MGL=6ms	MGL=4ms	MGL=3ms	MGL=20ms	MGL=10ms	MGL=6ms	MGL=4ms	MGL=3ms
15	21	11	7	5	4	21	11	7	5	4
30	41	21	13	9	7	41	21	13	9	7
60	81	41	25	17	13	81	41	25	17	13
120	161	81	49	33	25	161	81	49	33	25

NOTE 1: Void.  
 NOTE 2: NR SCS of 120 kHz is only applicable to the case with per-UE measurement gap.

In case that UE capable of per-FR measurement gap is configured with per-FR measurement gap for FR2 serving cells, total number of interrupted slots on FR2 serving cells during MGL is listed in Table9.1.2-4b.

**Table 9.1.2-4b: Total number of interrupted slots on FR2 serving cells during MGL for EN-DC, NR standalone operation (with single carrier, NR CA and NR-DC configuration) and NE-DC with per-UE measurement gap or per-FR measurement gap for FR2**

NR SCS (kHz)	Total number of interrupted slots on FR2 serving cells									
	When MG timing advance of 0ms is applied					When MG timing advance of 0.25ms is applied				
	MGL=20ms	MGL=10ms	MGL=5.5ms	MGL=3.5ms	MGL=1.5ms	MGL=20ms	MGL=10ms	MGL=5.5ms	MGL=3.5ms	MGL=1.5ms
60	80	40	22	14	6	80	40	22	14	6
120	160	80	44	28	12	160	80	44	28	12

NOTE 1: The total number of interrupted slots is based on that SFN and subframe reference for per-FR gap in FR2 indicated by high layer parameter *refServCellIndicator* is an FR2 serving cell.  
 NOTE 2: Slot occurs before or after the measurement gap may be interrupted additionally if SFN and subframe reference for per-FR gap in FR2 indicated by high layer parameter *refServCellIndicator* is an FR1 serving cell.

It is up to UE implementation whether or not the UE is able to conduct transmission in the following slot(s),

- when MGTA is not applied, in the L consecutive UL slots with respect to the SCS of the UL carrier with the same slot indices as the DL slots occurring immediately after measurement gap
- when MGTA is applied and the SCS of the UL carrier is other than 15kHz, in the L consecutive UL slots with respect to the SCS of the UL carrier with the same slot indices as the DL slots occurring immediately after measurement gap
- when MGTA is applied and the SCS of the UL carrier is 15kHz, in the L consecutive UL slots with respect to the SCS of the UL carrier with the same slot indices as the DL slots occurring immediately after the slot partially overlapped with measurement gap

where UL slot denotes that all the symbols in the slot are uplink symbols, and  $L=1$  if  $(N_{TA} + N_{TA\text{offset}}) \times T_c$  for the UL transmission is less than the length of one slot;  $L=2$  otherwise.

Note: Network is supposed to take into account the possible difference between the estimated TA at network and actual TA at UE when scheduling UE in the above slot(s).

**Table 9.1.2-5: (Void)**

### 9.1.2.1 EN-DC: Measurement Gap Sharing

For E-UTRA-NR dual connectivity UE configured with per-UE measurement gap, measurement gap sharing shall be applied when UE requires measurement gaps to identify and measure cells on intra-frequency carriers or when SMTC configured for intra-frequency measurement are fully overlapping with per-UE measurement gaps, and when UE requires measurement gaps to identify and measure cells on inter-frequency carriers for both SSB and CSI-RS based L3 measurement or when all of SMTC configured for inter-frequency SSB based measurement without measurement gaps are fully overlapping with per-UE measurement gaps, E-UTRA gap-needed inter-frequency carriers and inter-RAT UTRAN carriers and/or inter-RAT GSM carriers.

For E-UTRA-NR dual connectivity UE configured with per-FR1 measurement gap, measurement gap sharing shall be applied when UE requires measurement gaps to identify and measure cells on FR1 intra-frequency carriers or when SMTC configured for FR1 intra-frequency measurement are fully overlapping with per-FR1 measurement gaps, and when UE requires measurement gaps to identify and measure cells on FR1 inter-frequency carriers for both SSB and CSI-RS based L3 measurement or when all of SMTC configured for inter-frequency SSB based measurement without measurement gaps are fully overlapping with per-FR1 measurement gaps, E-UTRA gap-needed inter-frequency carriers, inter-RAT UTRAN carriers and/or inter-RAT GSM carriers.

For E-UTRA-NR dual connectivity UE configured with per-FR2 measurement gap, measurement gap sharing shall be applied when UE requires measurement gaps to identify and measure cells on FR2 intra-frequency carriers or when SMTC configured for FR2 intra-frequency measurement are fully overlapping with per-FR2 measurement gaps, and when UE requires measurement gaps to identify and measure cells on FR2 inter-frequency carriers for both SSB and CSI-RS based L3 measurement, or when all of SMTC configured for inter-frequency SSB based measurement without measurement gaps are fully overlapping with per-FR2 measurement gaps.

When network signals “01”, “10” or “11” with RRC parameter *MeasGapSharingScheme* [2][16] and the value of X is defined as in Table 9.1.2.1-1, and

- $K_{\text{intra}} = 1 / X * 100$ ,
- $K_{\text{inter}} = 1 / (100 - X) * 100$ ,

When network signals “00” indicating equal splitting gap sharing, X is not applied.

The RRC parameter *MeasGapSharingScheme* shall be applied to the calculation of carrier specific scaling factor as specified in clause 9.1.5.2.1.

**Table 9.1.2.1-1: Value of parameter X for EN-DC measurement gap sharing**

<i>measGapSharingScheme</i>	Value of X (%)
‘00’	Equal splitting
‘01’	25
‘10’	50
‘11’	75
Note:	It is left to UE implementation to determine which measurement gap sharing scheme in the table <i>to be applied</i> , when <i>MeasGapSharingScheme</i> is absent and there is no stored value in the field.

### 9.1.2.1a SA: Measurement Gap Sharing

For NR standalone UE without NR-DC operation and configured with per-UE measurement gap, measurement gap sharing shall be applied when UE requires measurement gaps to identify and measure cells on intra-frequency carriers or when SMTC configured for intra-frequency measurement are fully overlapping with per-UE measurement gaps, and when UE requires measurement gaps to identify and measure cells on inter-frequency carriers for both SSB and CSI-RS based L3 measurement, or when all of SMTC configured for inter-frequency SSB based measurement without measurement gaps are fully overlapping with per-UE measurement gaps, and/or inter-RAT E-UTRAN carriers, and/or inter-RAT UTRAN carriers for SRVCC, and when UE is configured to measure positioning frequency layers.

For NR standalone UE without NR-DC operation and configured with per-FR1 measurement gap, measurement gap sharing shall be applied when UE requires measurement gaps to identify and measure cells on FR1 intra-frequency carriers or when SMTC configured for FR1 intra-frequency measurement are fully overlapping with per-FR1 measurement gaps, and when UE requires measurement gaps to identify and measure cells on FR1 inter-frequency carriers for both SSB and CSI-RS based L3 measurement and/or inter-RAT E-UTRAN carriers, or when all of SMTC configured for inter-frequency SSB based measurement without measurement gaps are fully overlapping with per-FR1 measurement gaps, and/or inter-RAT UTRAN carriers for SRVCC, and when UE is configured to measure positioning frequency layers in FR1.

For NR standalone UE without NR-DC operation and configured with per-FR2 measurement gap, measurement gap sharing shall be applied when UE requires measurement gaps to identify and measure cells on FR2 intra-frequency carriers or when SMTC configured for FR2 intra-frequency measurement are fully overlapping with per-FR2 measurement gaps, and when UE requires measurement gaps to identify and measure cells on FR2 inter-frequency carriers for both SSB and CSI-RS based L3 measurement, or when all of SMTC configured for inter-frequency SSB based measurement without measurement gaps are fully overlapping with per-FR2 measurement gaps, and when UE is configured to measure positioning frequency layers in FR2.

When network signals “01”, “10” or “11” with RRC parameter *MeasGapSharingScheme* [2] and the value of X is defined as in Table 9.1.2.1a-1, and

- $K_{\text{intra}} = 1 / X * 100$ ,
- $K_{\text{inter}} = 1 / (100 - X) * 100$ ,

When network signals “00” indicating equal splitting gap sharing, X is not applied.

The RRC parameter *MeasGapSharingScheme* shall be applied to the calculation of carrier specific scaling factor as specified in clause 9.1.5.2.2.

**Table 9.1.2.1a-1: Value of parameter X for NR standalone measurement gap sharing**

<i>measGapSharingScheme</i>	Value of X (%)
‘00’	Equal splitting
‘01’	25
‘10’	50
‘11’	75
Note:	It is left to UE implementation to determine which measurement gap sharing scheme in the table <i>to be applied</i> , when <i>MeasGapSharingScheme</i> is absent and there is no stored value in the field.

### 9.1.2.1b NE-DC: Measurement Gap Sharing

For NR-E-UTRA dual connectivity UE configured with per-UE measurement gap, measurement gap sharing shall be applied when UE requires measurement gaps to identify and measure cells on intra-frequency carriers or when SMTC configured for intra-frequency measurement are fully overlapping with per-UE measurement gaps, and when UE requires measurement gaps to identify and measure cells on inter-frequency carriers for both SSB and CSI-RS based L3 measurement, E-UTRA gap-needed inter-frequency carriers, or when all of SMTC configured for inter-frequency SSB based measurement without measurement gaps are fully overlapping with per-UE measurement gaps, and/or inter-RAT E-UTRA carriers, and/or inter-RAT UTRAN carriers for SRVCC, and when UE is configured to measure positioning frequency layers.



For NR-E-UTRA dual connectivity UE configured with per-FR1 measurement gap, measurement gap sharing shall be applied when UE requires measurement gaps to identify and measure cells on FR1 intra-frequency carriers or when SMTC configured for FR1 intra-frequency measurement are fully overlapping with per-FR1 measurement gaps, and when UE requires measurement gaps to identify and measure cells on inter-frequency carriers for both SSB and CSI-RS based L3 measurement, or when all of SMTC configured for inter-frequency SSB based measurement without measurement gaps are fully overlapping with per-FR1 measurement gaps, E-UTRA gap-needed inter-frequency carriers, and/or inter-RAT E-UTRA carriers, and/or inter-RAT UTRAN carriers for SRVCC, and when UE is configured to measure positioning frequency layers in FR1.

For NR-E-UTRA dual connectivity UE configured with per-FR2 measurement gap, measurement gap sharing shall be applied when UE requires measurement gaps to identify and measure cells on FR2 intra-frequency carriers or when SMTC configured for FR2 intra-frequency measurement are fully overlapping with per-FR2 measurement gaps, and when UE requires measurement gaps to identify and measure cells on FR2 inter-frequency carriers for both SSB and CSI-RS based L3 measurement, or when all of SMTC configured for inter-frequency SSB based measurement without measurement gaps are fully overlapping with per-FR2 measurement gaps, and when UE is configured to measure positioning frequency layers in FR2.

When network signals “01”, “10” or “11” with RRC parameter *measGapSharingConfig* [2][16] and the value of X is defined as in Table 9.1.2.1b-1, and

- $K_{\text{intra}} = 1 / X * 100$ ,
- $K_{\text{inter}} = 1 / (100 - X) * 100$ ,

When network signals “00” indicating equal splitting gap sharing, X is not applied.

The RRC parameter *MeasGapSharingScheme* shall be applied to the calculation of carrier specific scaling factor as specified in clause 9.1.5.2.3.

**Table 9.1.2.1b-1: Value of parameter X for NE-DC measurement gap sharing**

<i>measGapSharingScheme</i>	Value of X (%)
'00'	Equal splitting
'01'	25
'10'	50
'11'	75
Note:	It is left to UE implementation to determine which measurement gap sharing scheme in the table <i>to be applied</i> , when <i>MeasGapSharingScheme</i> is absent and there is no stored value in the field.

### 9.1.2.1c NR-DC: Measurement Gap Sharing

For UE with NR-DC operation and configured with per-UE measurement gap, measurement gap sharing shall be applied when UE requires measurement gaps to identify and measure cells on intra-frequency carriers or when SMTC configured for intra-frequency measurement are fully overlapping with per-UE measurement gaps, and when UE requires measurement gaps to identify and measure cells on inter-frequency carriers for both SSB and CSI-RS based L3 measurement, and/or inter-RAT E-UTRAN carriers, or when all of SMTC configured for inter-frequency SSB based measurement without measurement gaps are fully overlapping with per-UE measurement gaps, and/or inter-RAT UTRAN carriers for SRVCC, and when UE is configured to measure positioning frequency layers.

For UE with NR-DC operation and configured with per-FR1 measurement gap, measurement gap sharing shall be applied when UE requires measurement gaps to identify and measure cells on FR1 intra-frequency carriers or when SMTC configured for FR1 intra-frequency measurement are fully overlapping with per-FR1 measurement gaps, and when UE requires measurement gaps to identify and measure cells on FR1 inter-frequency carriers for both SSB and CSI-RS based L3 measurement and/or inter-RAT E-UTRAN carriers, or when all of SMTC configured for inter-frequency SSB based measurement without measurement gaps are fully overlapping with per-FR1 measurement gaps, and/or inter-RAT UTRAN carriers for SRVCC, and when UE is configured to measure positioning frequency layers in FR1.

For UE with NR-DC operation and configured with per-FR2 measurement gap, measurement gap sharing shall be applied when UE requires measurement gaps to identify and measure cells on FR2 intra-frequency carriers or when

SMTC configured for FR2 intra-frequency measurement are fully overlapping with per-FR2 measurement gaps, and when UE requires measurement gaps to identify and measure cells on FR2 inter-frequency carriers for both SSB and CSI-RS based L3 measurement, or when all of SMTC configured for inter-frequency SSB based measurement without measurement gaps are fully overlapping with per-FR2 measurement gaps, and when UE is configured to measure positioning frequency layers in FR2.

When network signals “01”, “10” or “11” with RRC parameter *measGapSharingConfig* [2] and the value of X is defined as in Table 9.1.2.1c-1, and

- $K_{\text{intra}} = 1 / X * 100$ ,
- $K_{\text{inter}} = 1 / (100 - X) * 100$ ,

When network signals “00” indicating equal splitting gap sharing, X is not applied.

The RRC parameter *MeasGapSharingScheme* shall be applied to the calculation of carrier specific scaling factor as specified in clause 9.1.5.2..4.

**Table 9.1.2.1c-1: Value of parameter X for NR-DC measurement gap sharing**

<i>measGapSharingConfig</i>	Value of X (%)
'00'	Equal splitting
'01'	25
'10'	50
'11'	75
Note:	It is left to UE implementation to determine which measurement gap sharing scheme in the table <i>to be applied</i> , when <i>MeasGapSharingScheme</i> is absent and there is no stored value in the field.

## 9.1.3 UE Measurement capability

### 9.1.3.1 EN-DC: Monitoring of multiple layers using gaps

The requirements in this clause are applicable for UE capable of and configured with the EN-DC operation mode.

When monitoring of multiple inter-frequency E-UTRAN, inter-RAT NR, GSM, UTRA FDD and UTRA TDD carriers as configured by E-UTRA PCell, and inter-frequency NR carriers (with or without CCA) as configured by PSCell using gaps (or without using gaps provided the UE supports such capability or the effective MGRP is applied for per-FR measurement gap capable UE) is configured, the UE shall be capable of performing one measurement of the configured measurement type (SS-RSRP, SS-RSRQ, SS-SINR, CSI-RSRP, CSI-RSRQ, CSI-SINR, SFTD, E-UTRAN RSRP, E-UTRAN RSRQ, E-UTRAN RS-SINR measurements, UTRAN TDD P-CCPCH RSCP, UTRAN FDD CPICH measurements, GSM carrier RSSI, etc.) of detected cells on all the layers.

For UE configured with the EN-DC operation, the effective total number of frequencies excluding the frequencies of the PSCell, SCells, E-UTRA PCell, and E-UTRA SCells being monitored is  $N_{\text{freq, EN-DC}}$ , which is defined as:

$$N_{\text{freq, EN-DC}} = N_{\text{freq, EN-DC, NR}} + N_{\text{freq, EN-DC, E-UTRA}} + N_{\text{freq, EN-DC, UTRA}} + M_{\text{EN-DC, GSM}},$$

where

$N_{\text{freq, EN-DC, E-UTRA}}$  is the number of E-UTRA inter-frequency carriers being monitored (FDD and TDD) as configured by E-UTRA PCell or via LPP [22],

$$N_{\text{freq, EN-DC, NR}} \leq N_{\text{freq, EN-DC, NR, inter-RAT}} + N_{\text{freq, EN-DC, NR, inter-freq}}$$

where

$N_{\text{freq, EN-DC, NR, inter-RAT}}$  is the number of NR inter-RAT carriers excluding NR serving carrier(s) being monitored as configured by E-UTRA PCell [15],

$N_{\text{freq, EN-DC, NR, inter-freq}}$  is the number of NR inter-frequency carriers being monitored as configured by PSCell,

$N_{\text{freq, EN-DC, UTRA}}$  is the number of UTRA inter-RAT carriers being monitored as configured by E-UTRA PCell (FDD and TDD).

$M_{\text{EN-DC, GSM}}$  is an integer which is a function of the number of GSM inter-RAT carriers as configured by E-UTRA PCell on which measurements are being performed.  $M_{\text{EN-DC, GSM}}$  is equal to 0 if no GSM carrier is being monitored. For a MGRP of 40 ms,  $M_{\text{EN-DC, GSM}}$  is equal to 1 if cells on up to 32 GSM carriers are being measured. For a MGRP of 80 ms,  $M_{\text{EN-DC, GSM}}$  is equal to  $\text{ceil}(N_{\text{carriers, GSM}}/20)$  where  $N_{\text{carriers, GSM}}$  is the number of GSM carriers on which cells are being measured.

### 9.1.3.1a SA: Monitoring of multiple layers using gaps

The requirements in this clause are applicable for UE configured with SA NR operation mode.

When monitoring of multiple inter-RAT E-UTRAN carriers, inter-frequency NR carriers (with or without CCA) and inter-RAT UTRA FDD carriers using gaps (or without using gaps provided the UE supports such capability or the effective MGRP is applied for per-FR measurement gap capable UE) is configured by PCell, the UE shall be capable of performing one measurement of the configured measurement type (SS-RSRP, SS-RSRQ, SS-SINR, CSI-RSRP, CSI-RSRQ, CSI-SINR, E-UTRAN RSRP, E-UTRAN RSRQ, E-UTRAN RS-SINR measurements, UTRAN FDD CPICH measurement, etc.) of detected cells on all the layers.

For UE configured with the NR SA operation, the effective total number of frequencies, excluding the frequencies of the PCell, PSCell and SCells being monitored, is  $N_{\text{freq, SA}}$ , which is defined as:

$$N_{\text{freq, SA}} = N_{\text{freq, SA, NR}} + N_{\text{freq, SA, E-UTRA}} + N_{\text{freq, SA, UTRA}},$$

where

$N_{\text{freq, SA, E-UTRA}}$  is the number of E-UTRA inter-RAT carriers being monitored (FDD and TDD) as configured by PCell or via LPP [22],

- $N_{\text{freq, SA, UTRA}}$  is the number of UTRA FDD inter-RAT carriers being monitored as configured by PCell,

$N_{\text{freq, SA, NR}}$  is the number of NR inter-frequency carriers being monitored as configured by PCell.

### 9.1.3.1b NE-DC: Monitoring of multiple layers using gaps

The requirements in this clause are applicable for UE capable of and configured with the NE-DC operation mode.

UTRAN carriers as configured by PCell, inter-RAT UTRA FDD carriers as configured by PCell, and inter-frequency NR carriers as configured by PCell using gaps (or without using gaps provided the UE supports such capability or the effective MGRP is applied for per-FR measurement gap capable UE) is configured, the UE shall be capable of performing one measurement of the configured measurement type (SS-RSRP, SS-RSRQ, SS-SINR, CSI-RSRP, CSI-RSRQ, CSI-SINR, SFTD, E-UTRAN RSRP, E-UTRAN RSRQ, and E-UTRAN RS-SINR measurements, UTRAN FDD CPICH measurements, etc.) of detected cells on all the layers.

For UE configured with the NE-DC operation, the effective total number of frequencies excluding the frequencies of the PCell, SCells, E-UTRA PSCell, and E-UTRA SCells being monitored is  $N_{\text{freq, NE-DC}}$ , which is defined as:

$$N_{\text{freq, NE-DC}} = N_{\text{freq, NE-DC, NR}} + N_{\text{freq, NE-DC, E-UTRA}} + N_{\text{freq, NE-DC, UTRA}},$$

where

$N_{\text{freq, NE-DC, NR}}$  is the number of NR inter-frequency carriers being monitored as configured by PCell,

$N_{\text{freq, NE-DC, UTRA}}$  is the number of UTRA FDD inter-RAT carriers being monitored as configured by PCell,

$N_{\text{freq, NE-DC, E-UTRA}} \leq N_{\text{freq, NE-DC, E-UTRA, inter-RAT}} + N_{\text{freq, NE-DC, E-UTRA, inter-freq}}$

where

$N_{\text{freq, NE-DC, E-UTRA, inter-RAT}}$  is the number of E-UTRA inter-RAT carriers (FDD and TDD) excluding E-UTRA serving carrier(s) being monitored as configured by PCell or via LPP [22],

$N_{\text{freq, NE-DC, E-UTRA, inter-freq}}$  is the number of E-UTRA inter-frequency carriers (FDD and TDD) being monitored as configured by E-UTRA PCell [15] or via LPP [22].

### 9.1.3.1c NR-DC: Monitoring of multiple layers using gaps

The requirements in this clause are applicable for UE configured with NR-DC operation mode.

When monitoring of multiple inter-RAT E-UTRAN carriers and inter-frequency NR carriers using gaps (or without using gaps provided the UE supports such capability or the effective MGRP is applied for per-FR measurement gap capable UE) as configured by PCell, inter-RAT UTRA FDD carriers as configured by PCell, and inter-frequency NR carriers as configured by PCell is configured, the UE shall be capable of performing one measurement of the configured measurement type (SS-RSRP, SS-RSRQ, SS-SINR, CSI-RSRP, CSI-RSRQ, CSI-SINR, E-UTRAN RSRP, E-UTRAN RSRQ, E-UTRAN RS-SINR measurements, UTRAN FDD CPICH measurements, etc.) of detected cells on all the layers.

For UE configured with the NR-DC operation, the effective total number of frequencies, excluding the frequencies of the PCell, PSCell and SCells being monitored, is  $N_{\text{freq, NR-DC}}$ , which is defined as:

$$N_{\text{freq, NR-DC}} = N_{\text{freq, NR-DC, NR}} + N_{\text{freq, NR-DC, E-UTRA}} + N_{\text{freq, NR-DC, UTRA}},$$

where

- $N_{\text{freq, NR-DC, E-UTRA}}$  is the number of E-UTRA inter-RAT carriers being monitored (FDD and TDD) as configured by PCell or via LPP [22].
- $N_{\text{freq, NE-DC, UTRA}}$  is the number of UTRA FDD inter-RAT carriers being monitored as configured by PCell,
- $N_{\text{freq, NR-DC, NR}}$  is the number of NR inter-frequency carriers being monitored as configured by PCell and PSCell.

### 9.1.3.2 EN-DC: Maximum allowed layers for multiple monitoring

If a UE is configured with EN-DC operation, the UE shall be capable of monitoring at least:

- Depending on UE capability, 7 NR SSB inter-frequency carriers configured by PSCell, and
- Depending on UE capability, 8 NR inter-frequency carriers including SSB and CSI-RS in total configured by PSCell, and
- Depending on UE capability, 7 NR SSB inter-RAT carriers excluding NR serving carrier(s) configured by E-UTRA PCell [15], and
- Depending on UE capability, 6 E-UTRA TDD inter-frequency carriers configured by E-UTRA PCell [15], and
- Depending on UE capability, 6 E-UTRA FDD inter-frequency carriers configured by E-UTRA PCell [15], and
- Depending on UE capability, 3 FDD UTRA carriers, and
- Depending on UE capability, 3 TDD UTRA carriers, and
- Depending on UE capability, 32 GSM carriers (one GSM layer corresponds to 32 carriers), and
- Depending on UE capability, 1 E-UTRA FDD inter-frequency carrier for RSTD measurements configured via LPP [22], and
- Depending on UE capability, 1 E-UTRA TDD inter-frequency carrier for RSTD measurements configured via LPP [22].

In addition to the requirements defined above, the UE shall be capable of monitoring a total of at least 13 effective carrier frequency layers comprising of any above defined combination of NR, E-UTRA FDD, E-UTRA TDD, UTRA FDD, UTRA TDD and GSM (one GSM layer corresponds to 32 carriers) layers. The UE shall be capable of monitoring a total of at least  $7 + N_{\text{CSI}}$  effective NR carrier frequency layers excluding NR serving carrier(s), comprising of any above defined combination of NR inter-RAT carriers excluding NR serving carrier(s) configured by E-UTRA PCell and NR inter-frequency carriers configured by PSCell,  $N_{\text{CSI}}$  equals 1 if UE supports CSI-RS based L3 measurement, and  $N_{\text{CSI}} = 0$  otherwise.

The number of SSB frequency layers configured by PSCell equals to the total number of MOs with

- *ssb-ConfigMobility* configured, or
- *ssb-ConfigMobility* not configured but *csi-rs-ResourceConfigMobility* configured with *associatedSSB*.

If *ssbfrequency*, *smtc1*, *smtc2* and *ssbSubcarrierSpacing* are same in multiple MOs, the multiple MOs are counted as one SSB frequency layer.

The number of CSI-RS frequency layers equals to the number of MOs with *csi-rs-ResourceConfigMobility* configured assuming single MO is configured per frequency layer.

When the E-UTRA PCell and PSCell configures the same NR carrier frequency layer to be monitored by the UE in synchronous intra-band EN-DC, this layer shall be counted only once to the total number of effective carrier frequency layers provided that the SFN-s and slot boundaries are aligned, unless the configured NR carrier frequency layers to be monitored have

- different RSSI measurement resources or
- different *deriveSSB-IndexFromCell* indications or
- different SMTC configurations or
- different *ssb-PositionQCL-Common-r16* indications or cell list of *ssb-PositionQCL* on NR carrier frequency layer with CCA or
- different *rmtc-Config-r16* indication on NR carrier frequency layer with CCA.

Note 1: The E-UTRA-NR dual connectivity capable UE configured with PSCell shall fulfil the requirements defined in only one of clause 9.1.3.2 and clause 8.1.2.1.1b.1 of TS 36.133 [15].

### 9.1.3.2a SA: Maximum allowed layers for multiple monitoring

If a UE is configured with SA NR operation mode, the UE shall be capable of monitoring at least:

- Depending on UE capability, 7 NR SSB inter-frequency carriers configured by PCell, and
- Depending on UE capability, 8 NR inter-frequency carriers including SSB and CSI-RS in total configured by PCell, and
- Depending on UE capability, 7 E-UTRA TDD inter-RAT carriers configured by PCell, and
- Depending on UE capability, 7 E-UTRA FDD inter-RAT carriers configured by PCell, and
- Depending on UE capability, 3 UTRA FDD inter-RAT carriers configured by PCell, and
- Depending on UE capability, 1 E-UTRA FDD inter-RAT carrier for RSTD measurements configured via LPP [22], and
- Depending on UE capability, 1 E-UTRA TDD inter-RAT carrier for RSTD measurements configured via LPP [22].

In addition to the requirements defined above, the UE shall be capable of monitoring a total of at least [13] effective carrier frequency layers comprising of any above defined combination of NR, E-UTRA FDD, E-UTRA TDD and UTRA FDD layers.

The number of SSB frequency layers equals to the total number of MOs with

- *ssb-ConfigMobility* configured, or
- *ssb-ConfigMobility* not configured but *csi-rs-ResourceConfigMobility* configured with *associatedSSB*.

If *ssbfrequency*, *smtc1*, *smtc2* and *ssbSubcarrierSpacing* are same in multiple MOs, the multiple MOs are counted as one SSB frequency layer.

The number of CSI-RS frequency layers equals to the number of MOs with *csi-rs-ResourceConfigMobility* configured assuming single MO is configured per frequency layer.

### 9.1.3.2b NE-DC: Maximum allowed layers for multiple monitoring

If a UE is configured with NE-DC operation mode, the UE shall be capable of monitoring at least:

- Depending on UE capability, 7 NR SSB inter-frequency carriers configured by PCell, and
- Depending on UE capability, 8 NR inter-frequency carriers including SSB and CSI-RS in total configured by PCell, and
- Depending on UE capability, 6 E-UTRA TDD inter-RAT carriers excluding E-UTRA serving carriers configured by PCell, and
- Depending on UE capability, 6 E-UTRA FDD inter-RAT carriers excluding E-UTRA serving carriers configured by PCell, and
- Depending on UE capability, 6 E-UTRA TDD inter-frequency carriers configured by E-UTRA PSCell [15], and
- Depending on UE capability, 6 E-UTRA FDD inter-frequency carriers configured by E-UTRA PSCell [15], and
- Depending on UE capability, 3 UTRA FDD inter-RAT carriers configured by PCell, and
- Depending on UE capability, 1 E-UTRA FDD inter-frequency carrier for RSTD measurements configured via LPP [22], and
- Depending on UE capability, 1 E-UTRA TDD inter-frequency carrier for RSTD measurements configured via LPP [22].

In addition to the requirements defined above, the UE shall be capable of monitoring a total of at least 13 effective carrier frequency layers comprising of any above defined combination of NR, E-UTRA FDD, E-UTRA TDD and UTRA FDD layers. The UE shall be capable of monitoring a total of at least 6 effective E-UTRA carrier frequency layers, excluding E-UTRA serving carrier(s), comprising of any above defined combination of E-UTRA inter-RAT carriers excluding E-UTRA serving carrier(s) configured by PCell and E-UTRA inter-frequency carriers configured by E-UTRA PSCell.

The number of SSB frequency layers configured by PCell equals to the total number of MOs with

- *ssb-ConfigMobility* configured, or
- *ssb-ConfigMobility* not configured but *csi-rs-ResourceConfigMobility* configured with *associatedSSB*.

If *ssbfrequency*, *smtc1*, *smtc2* and *ssbSubcarrierSpacing* are same in multiple MOs, the multiple MOs are counted as one SSB frequency layer.

The number of CSI-RS frequency layers equals to the number of MOs with *csi-rs-ResourceConfigMobility* configured assuming single MO is configured per frequency layer.

### 9.1.3.2c NR-DC: Maximum allowed layers for multiple monitoring

If a UE is configured with NR-DC operation, the UE shall be capable of monitoring at least:

- Depending on UE capability, 7 NR SSB inter-frequency carriers configured by PCell, and
- Depending on UE capability, 8 NR inter-frequency carriers including SSB and CSI-RS in total configured by PCell, and
- Depending on UE capability, 7 NR SSB inter-frequency carriers configured by PSCell, and
- Depending on UE capability, 8 NR inter-frequency carriers including SSB and CSI-RS in total configured by PSCell, and
- Depending on UE capability, 7 E-UTRA TDD inter-RAT carriers configured by PCell, and
- Depending on UE capability, 7 E-UTRA FDD inter-RAT carriers configured by PCell, and
- Depending on UE capability, 3 UTRA FDD inter-RAT carriers configured by PCell, and

- Depending on UE capability, 1 E-UTRA FDD inter-RAT carrier for RSTD measurements configured via LPP [22], and
- Depending on UE capability, 1 E-UTRA TDD inter-RAT carrier for RSTD measurements configured via LPP [22].

In addition to the requirements defined above, the UE shall be capable of monitoring a total of at least 13 effective carrier frequency layers comprising of any above defined combination of NR, E-UTRA FDD, E-UTRA TDD and UTRA FDD layers. The UE shall be capable of monitoring a total of at least  $7 + N_{\text{CSI}}$  effective NR carrier frequency layers excluding NR serving carrier(s), which are configured by PCell and PSCell,  $N_{\text{CSI}}$  equals 1 if UE supports CSI-RS based L3 measurement, and  $N_{\text{CSI}} = 0$  otherwise.

The number of SSB frequency layers equals to the total number of MOs with

- *ssb-ConfigMobility* configured, or
- *ssb-ConfigMobility* not configured but *csi-rs-ResourceConfigMobility* configured with *associatedSSB*.

If *ssbfrequency*, *smtc1*, *smtc2* and *ssbSubcarrierSpacing* are same in multiple MOs, the multiple MOs are counted as one SSB frequency layer.

The number of CSI-RS frequency layers equals to the number of MOs with *csi-rs-ResourceConfigMobility* configured assuming single MO is configured per frequency layer.

When PCell and PSCell configures the same NR carrier frequency layer to be monitored by the UE in NR-DC, this layer shall be counted only once to the total number of effective carrier frequency layers provided that the SFN-s and slot boundaries are aligned, unless the configured NR carrier frequency layers to be monitored have

- different RSSI measurement resources or
- different *deriveSSB-IndexFromCell* indications or
- different SMTC configurations or
- different *ssb-PositionQCL-Common-r16* indications or cell list of *ssb-PositionQCL* on NR carrier frequency layer with CCA or
- different *rmtc-Config-r16* indication on NR carrier frequency layer with CCA.

### 9.1A.3.2 Void

## 9.1.3A UE Measurement capability under operation mode with CCA

### 9.1.3A.1 EN-DC: Monitoring of multiple layers using gaps under CCA

The requirements in clause 9.1.3.1 are also applicable for the UE capable of and configured with the EN-DC operation mode with CCA on PSCC.

#### 9.1.3A.1A SA: Monitoring of multiple layers using gaps under CCA

The requirements in clause 9.1.3.1a are also applicable for UE configured with SA NR operation mode with CCA on PCC.

### 9.1.3A.2 EN-DC: Maximum allowed layers for multiple monitoring under CCA

If a UE is configured with EN-DC operation when CCA is used on PSCell, the UE shall be capable of monitoring at least:

- Depending on UE capability, 7 NR inter-frequency carriers configured by PSCell, and
- Depending on UE capability, 7 NR inter-RAT carriers excluding NR serving carrier(s) configured by E-UTRA PCell [15], and

- Depending on UE capability, 6 E-UTRA TDD inter-frequency carriers configured by E-UTRA PCell [15], and
- Depending on UE capability, 6 E-UTRA FDD inter-frequency carriers configured by E-UTRA PCell [15], and
- Depending on UE capability, 3 FDD UTRA carriers, and
- Depending on UE capability, 3 TDD UTRA carriers, and
- Depending on UE capability, 32 GSM carriers (one GSM layer corresponds to 32 carriers), and

In addition to the requirements defined above, the UE shall be capable of monitoring a total of at least 13 effective carrier frequency layers comprising of any above defined combination of NR, E-UTRA FDD, E-UTRA TDD, UTRA FDD, UTRA TDD and GSM (one GSM layer corresponds to 32 carriers) layers. The UE shall be capable of monitoring a total of at least 7 effective NR carrier frequency layers excluding NR serving carrier(s), comprising of any above defined combination of NR inter-RAT carriers excluding NR serving carrier(s) configured by E-UTRA PCell and NR inter-frequency carriers configured by PSCell.

When the E-UTRA PCell and PSCell configures the same NR carrier frequency layer to be monitored by the UE in synchronous intra-band EN-DC, this layer shall be counted only once to the total number of effective carrier frequency layers provided that the SFN-s and slot boundaries are aligned, unless the configured NR carrier frequency layers to be monitored have

- different RSSI measurement resources or
- different *deriveSSB-IndexFromCell* indications or
- different SMTC configurations or
- different *ssb-PositionQCL-Common-r16* indications or cell list of *ssb-PositionQCL* on NR carrier frequency layer with CCA or
- different *rmtc-Config-r16* indication on NR carrier frequency layer with CCA.

#### 9.1A.3.2a Void

#### 9.1.3A.2A SA: Maximum allowed layers for multiple monitoring under CCA

If a UE is configured with SA NR operation mode when CCA is used on PCell or SCell only, the UE shall be capable of monitoring at least:

- Depending on UE capability, 7 NR inter-frequency carriers configured by PCell, and
- Depending on UE capability, 7 E-UTRA TDD inter-RAT carriers configured by PCell, and
- Depending on UE capability, 7 E-UTRA FDD inter-RAT carriers configured by PCell, and

In addition to the requirements defined above, the UE shall be capable of monitoring a total of at least [13] effective carrier frequency layers comprising of any above defined combination of NR, E-UTRA FDD and E-UTRA TDD layers.

### 9.1.4 Capabilities for Support of Event Triggering and Reporting Criteria

#### 9.1.4.1 Introduction

This clause contains requirements on UE capabilities for support of event triggering and reporting criteria. As long as the measurement configuration does not exceed the requirements stated in clause 9.1.4.2, the UE shall meet all other performance requirements defined in clause 9 and clause 10. The requirements in this clause also apply for a UE in EN-DC with PSCell on a carrier frequency with CCA or SA NR with PCell on a carrier frequency with CCA.

The UE can be requested to make measurements under different measurement identities defined in TS 38.331 [2]. Each measurement identity corresponds to either event-based reporting, periodic reporting, or no reporting. In case of event-based reporting, each measurement identity is associated with an event triggering criterion. In case of periodic reporting, a measurement identity is associated with one periodic reporting criterion. In case of no reporting, a measurement identity is associated with one no reporting criterion.



The purpose of this clause is to set some limits on the number of different event triggering, periodic, and no reporting criteria the UE may be requested to track in parallel.

### 9.1.4.2 Requirements

In this clause a reporting criterion corresponds to either one event (in the case of event-based reporting), or one periodic reporting criterion (in case of periodic reporting), or one no reporting criterion (in case of no reporting). For event-based reporting, each instance of event, with the same or different event identities, is counted as separate reporting criterion in Table 9.1.4.2-1.

The UE shall be able to support in parallel per category up to  $E_{cat}$  reporting criteria according to Table 9.1.4.2-1. For the measurement categories belonging to intra-frequency, inter-frequency, and inter-RAT measurements (i.e. without counting other categories that the UE shall always support in parallel), the UE need not support more than the total number of reporting criteria as follows:

- For UE configured with EN-DC:  $E_{cat,EN-DC,NR} + E_{cat,EN-DC,E-UTRA}$ , where

$E_{cat,EN-DC,NR} = 10 + 9 \times n$  is the total number of NR reporting criteria configured by PSCell (NR intra- and inter-frequency reporting criteria) and by E-UTRA PCell on NR serving frequencies (NR intra-frequency reporting criteria) applicable for UE configured with EN-DC according to Table 9.1.4.2-1, and  $n$  is the number of configured NR serving frequencies, including PSCell and SCells carrier frequencies,

$E_{cat,EN-DC,E-UTRA}$  is the total number of reporting criteria configured by E-UTRA PCell except PSCell and SCells carrier frequencies, as specified in TS 36.133 [15] for UE configured with EN-DC.

- For UE configured with NE-DC:  $E_{cat,NE-DC,NR} + E_{cat,NE-DC,E-UTRA}$ , where

$E_{cat,NE-DC,NR} = 10 + 9 \times n$  is the total number of NR reporting criteria according to Table 9.1.4.2-1, and  $n$  is the number of configured NR serving frequencies, including PCell and SCells carrier frequencies,

$E_{cat,NE-DC,E-UTRA} = E_{cat,NE-DC,E-UTRA,inter-RAT} + E_{cat,NE-DC,E-UTRA,intra-RAT}$ , where

$E_{cat,NE-DC,E-UTRA,inter-RAT}$  is the total number of inter-RAT E-UTRA reporting criteria configured by PCell except E-UTRA PSCell and E-UTRA SCells carrier frequencies, according to Table 9.1.4.2-1,

$E_{cat,NE-DC,E-UTRA,intra-RAT}$  is the total number of E-UTRA reporting criteria including E-UTRA PSCell and E-UTRA SCells carrier frequencies as specified in TS 36.133 [15] for UE configured with NE-DC.

- For UE configured with SA operation mode:  $E_{cat,SA,NR} + E_{cat,SA,E-UTRA}$ , where

$E_{cat,SA,NR} = 10 + 9 \times n$  is the total number of NR reporting criteria according to Table 9.1.4.2-1, and  $n$  is the number of configured NR serving frequencies, including PCell, and SCells carrier frequencies,

$E_{cat,SA,E-UTRA}$  is the total number of inter-RAT E-UTRA reporting criteria according to Table 9.1.4.2-1.

- For UE configured with NR-DC:  $E_{cat,NR-DC,NR} + E_{cat,NR-DC,E-UTRA}$ , where

$E_{cat,NR-DC,NR} = 10 + 9 \times n$  is the total number of NR reporting criteria according to Table 9.1.4.2-1, and  $n$  is the number of configured NR serving frequencies, including PCell, PSCell and SCells carrier frequencies,

$E_{cat,NR-DC,E-UTRA}$  is the total number of inter-RAT E-UTRA reporting criteria according to Table 9.1.4.2-1.

**Table 9.1.4.2-1: Requirements for reporting criteria per measurement category**

Measurement category	$E_{cat}$	Note
Intra-frequency <sup>Note 1,2,3,4,5</sup>	9	Events for any one or a combination of intra-frequency SS-RSRP, SS-RSRQ, SS-SINR, CSI-RSRP, CSI-RSRQ, and CSI-SINR for NG-RAN intra-frequency cells

Inter-frequency <sup>Note 2,3,4,5</sup>	10	Events for any one or a combination of inter-frequency SS-RSRP, SS-RSRQ, SS-SINR, CSI-RSRP, CSI-RSRQ, and CSI-SINR for NG-RAN inter-frequency cells
Inter-RAT (E-UTRA FDD, E-UTRA TDD) <sup>Note 2,4,5</sup>	10	Only applicable for UE with this (inter-RAT) capability. These reporting criteria apply for any E-UTRA carrier frequencies other than the carrier frequency of the E-UTRA PSCell or E-UTRA SCell.
Inter-RAT (E-UTRA FDD, E-UTRA TDD) RSTD <sup>Note 2,4,5</sup>	1	Inter-RAT RSTD measurement reporting for UE supporting OTDOA; 1 report capable of minimum 16 inter-RAT cell measurements. Only applicable for UE with this (inter-RAT RSTD via LPP [22]) capability. These reporting criteria apply for any E-UTRA carrier frequencies other than the carrier frequency of the E-UTRA PSCell or E-UTRA SCell.
Inter-RAT (E-UTRA FDD, E-UTRA TDD) RSRP and RSRQ measurements for E-CID <sup>Note 2,4,5</sup>	1	Inter-RAT RSRP and RSRQ measurements for E-CID reported to E-SMLC via LPP [22]. One report capable of at least in total 10 inter-RAT RSRP and RSRQ measurements. Applicable to UE capable of reporting inter-RAT RSRP and RSRQ to E-SMLC via LPP. These reporting criteria apply for any E-UTRA carrier frequencies other than the carrier frequency of the E-UTRA PSCell or E-UTRA SCell.
Intra-frequency RSSI and channel occupancy measurements with CCA <sup>Note 1,2,3</sup>	1	One report capable of one RSSI and one channel occupancy measurements over a channel [TS 37.213] with CCA. Applicable for UE capable of performing and reporting RSSI and channel occupancy on carrier frequencies under CCA.
Inter-frequency RSSI and channel occupancy measurements with CCA <sup>Note 2,3</sup>	1	One report capable of one RSSI and one channel occupancy measurements over a channel [TS 37.213] with CCA. Applicable for UE capable of performing and reporting RSSI and channel occupancy on carrier frequencies under CCA.
Intra-frequency SSB-based measurements for NR E-CID <sup>Note 1,2,3,4,5</sup>	1	Intra-frequency SS-RSRP and SS-RSRQ measurements for NR E-CID reported to LMF via LPP [34]. One report capable of at least in total 9 intra-frequency SS-RSRP and SS-RSRQ measurements. Applicable to UE capable of reporting at least one of SS-RSRP and SS-RSRQ to LMF via LPP.
Intra-frequency CSI-RS based measurements for NR E-CID <sup>Note 1,2,3,4,5</sup>	1	Intra-frequency CSI-RSRP and CSI-RSRQ measurements for NR E-CID reported to LMF via LPP [22]. One report capable of at least in total 9 intra-frequency CSI-RSRP and/or CSI-RSRQ measurements. Applicable to UE capable of reporting any of CSI-RSRP and CSI-RSRQ to LMF via LPP, as indicated in <i>nr-ECID-MeasSupported-r16</i> .
Inter-frequency SSB-based measurements for NR E-CID <sup>Note 2,3,4,5</sup>	1	Inter-frequency SS-RSRP and SS-RSRQ measurements for NR E-CID reported to LMF via LPP [34]. One report capable of at least in total 10 inter-frequency SS-RSRP and SS-RSRQ measurements. Applicable to UE capable of reporting at least one of SS-RSRP and SS-RSRQ to LMF via LPP.

Inter-frequency CSI-RS based measurements for NR E-CID <sup>Note 2,3,4,5</sup>	1	Inter-frequency CSI-RSRP and CSI-RSRQ measurements for NR E-CID reported to LMF via LPP [22]. One report capable of at least in total 10 inter-frequency CSI-RSRP and CSI-RSRQ measurements. Applicable to UE capable of reporting any of CSI-RSRP and CSI-RSRQ to LMF via LPP, as indicated in <i>nr-ECID-MeasSupported-r16</i> .
DL RSTD <sup>Note 2,4,5</sup>	1	DL RSTD measurement reporting; 1 report capable of multiple (within the UE PRS measurement capability, <i>nr-DL-TDOA-MeasCapability</i> , indicated via LPP [34]) DL RSTD measurements and if supported also multiple corresponding DL PRS-RSRP measurements configured for DL-TDOA. Only applicable for UE capable of reporting measurements for DL-TDOA to LMF via LPP [34].
UE Rx-Tx <sup>Note 2,4,5</sup>	1	UE Rx-Tx measurement reporting; 1 report capable of multiple (within the UE PRS measurement capability, <i>nr-DL-PRS-MeasCapability</i> , indicated via LPP [34] for multi-RTT) UE Rx-Tx measurements and if supported also multiple corresponding DL PRS-RSRP measurements configured for multi-RTT. Only applicable for UE capable of reporting measurements for multi-RTT to LMF via LPP [34].
DL PRS-RSRP <sup>Note 2,4,5</sup>	1	DL PRS-RSRP measurement reporting; 1 report capable of multiple (within the UE PRS measurement capability, <i>nr-DL-PRS-MeasCapability</i> , indicated via LPP [34] for AoD) DL PRS-RSRP measurements configured for DL-AoD. Only applicable for UE capable of reporting measurements for DL-AoD to LMF via LPP [34].
SRS-RSRP <sup>Note 2,3,4,5</sup>	1	SRS-RSRP measurement reporting for CLI; 1 report capable of up to 32 SRS resources measurements. Only applicable for UE supporting <i>cli-SRS-RSRP-Meas-r16</i> .
CLI-RSSI <sup>Note 2,3,4,5</sup>	1	CLI-RSSI measurement reporting for CLI; 1 report capable of up to 64 CLI-RSSI resources measurements. Only applicable for UE supporting <i>cli-RSSI-Meas-r16</i> .
<p>NOTE 1: When the UE is configured with PCell and SCell carrier frequencies, <math>E_{cat}</math> for Intra-frequency is applied per corresponding NR serving frequency.</p> <p>NOTE 2: Applicable for UE configured with SA NR operation mode.</p> <p>NOTE 3: Applicable for UE configured with EN-DC operation mode.</p> <p>NOTE 4: Applicable for UE configured with NE-DC operation mode.</p> <p>NOTE 5: Applicable for UE configured with NR-DC operation mode.</p>		

## 9.1.5 Carrier-specific scaling factor

This clause specifies the derivation of carrier-specific scaling factor (CSSF) values, which scales the measurement delay requirements given in clause 9.2, 9.2A, 9.3, 9.3A 9.4, and NR PRS-based positioning measurements in clause 9.9 and CSI-RS based L3 measurement in clause 9.10 when UE is configured to monitor multiple measurement objects. The CSSF values are categorized into  $CSSF_{outside\_gap,i}$  and  $CSSF_{within\_gap,i}$ , for the measurements conducted outside measurement gaps and within measurement gaps, respectively.

### 9.1.5.1 Monitoring of multiple layers outside gaps

The carrier-specific scaling factor  $CSSF_{outside\_gap,i}$  for measurement object  $i$  derived in this chapter is applied to following measurement types:

- SSB-based intra-frequency measurement with no measurement gap in clause 9.2.5 and 9.2A.5, when none of the SMTC occasions of this intra-frequency measurement object are overlapped by the measurement gap.
- SSB-based intra-frequency measurement with no measurement gap in clause 9.2.5 and 9.2A.5, when part of the SMTC occasions of this intra-frequency measurement object are overlapped by the measurement gap.
- For a UE in E-UTRA-NR dual connectivity operation, NR SSB-based inter-RAT measurement object configured by the E-UTRAN PCell on an NR serving carrier
  - the SSB is completely contained in the active BWP of the UE, and
  - none or part of the SMTC occasions of this inter-RAT measurement object are overlapped by the measurement gap;
- CSI-RS based intra-frequency measurement in clause 9.10.2, when none of CSI-RS resources for L3 measurement of this intra-frequency measurement object are overlapped by the measurement gap.
- CSI-RS based intra-frequency measurement in clause 9.10.2, when all CSI-RS resources for L3 measurement of this intra-frequency measurement object are partially overlapped by the measurement gap.
- SSB-based inter-frequency measurement with no measurement gap in clause 9.3.9, when none of the SMTC occasions of this inter-frequency measurement object are overlapped by the measurement gap, if UE supports *interFrequencyMeas-NoGap-r16* and the flag *interFrequencyConfig-NoGap-r16* is configured by the Network.
- SSB-based inter-frequency measurement with no measurement gap in clause 9.3.9, when part of the SMTC occasions of this inter-frequency measurement object are overlapped by the measurement gap, if UE supports *interFrequencyMeas-NoGap-r16* and the flag *interFrequencyConfig-NoGap-r16* is configured by the Network.
- Intra-frequency RSSI and channel occupancy measurement with no measurement gap on a carrier subject to CCA when SMTC and RMTC are overlapping and RMTCs are not fully overlapped with measurement gap.

For a UE in E-UTRA-NR dual connectivity operation, if a measurement object configured by PCell and an NR inter-RAT measurement object configured by E-UTRAN PCell are on the same serving carrier, they shall be counted as one intra-frequency measurement object, provided that they meet the measurement object merging conditions in clause 9.1.3.2.

The number of frequency layers for SSB measurements shall include the total number of MOs with

- *ssb-ConfigMobility* configured, or
- *ssb-ConfigMobility* not configured but *csi-rs-ResourceConfigMobility* configured with *associatedSSB*.

If *ssbfrequency*, *smtc1*, *smtc2* and *ssbSubcarrierSpacing* are same in multiple MOs, the multiple MOs are counted as one SSB frequency layer.

If the higher layer signaling in TS 38.331 [2] of *smtc2* is present and *smtc1* is fully overlapping with measurement gaps and *smtc2* is partially overlapping with measurement gaps,  $CSSF_{\text{outside\_gap},i}$  and requirements derived from  $CSSF_{\text{outside\_gap},i}$  are not specified.

The UE cell identification and measurement periods derived based on  $CSSF_{\text{outside\_gap},i}$  in clauses 9.2.5.1, 9.2.5.2 and 9.10.2 may be extended for measurement objects of which the cell identification and measurement periods are overlapped with  $T_{\text{measure\_SFTD1}}$  specified in clause 9.3.8 when no measurement gaps are provided.

The requirements in this clause apply provided that

- The SMTC on all CCs and inter-frequency layers without measurement gap in FR2 have the same offset, and one of following conditions is met
  - If *smtc2* is configured on any FR2 CC,
    - All CCs have the same configuration for *smtc1*, and
    - All CCs configured with *smtc2* have the same configuration for *smtc2*
  - If *smtc2* is not configured on any FR2 CC,

- The total number of different SMTC periodicities on all serving CCs and inter-frequency layers without measurement gap does not exceed 4
- The starting point of the first 5ms window for CSI-RS measurement as defined in clause 9.10.1 on all CCs in FR2 is same and one of following conditions is met
  - If any CSI-RS resource is configured in the second 5ms window for CSI-RS measurement as defined in clause 9.10.1 on any FR2 CC,
    - All CCs with CSI-RS resources only in the first 5ms window have the same CSI-RS resource periodicity, and
    - All CCs with CSI-RS resources both in the first and the second 5ms window have the same CSI-RS resource periodicity
  - If no CSI-RS resource is configured in the second 5ms window for CSI-RS measurement as defined in clause 9.10.1 on any FR2 CC,
    - The total number of different CSI-RS resources periodicities on all serving CCs does not exceed 3

Note: Longer delays for cell identification and measurement periods derived based on  $CSSF_{outside\_gap,i}$  in clauses 9.2.5.1, 9.2.5.2, can be expected, if the UE is configured with more than 4 different SMTC periodicities on FR2 serving carriers. The longer delay applies for the FR2 intra-frequency measurement objects with the longest SMTC periodicity/periodicities.

**9.1.5.1.1 EN-DC mode: carrier-specific scaling factor for SSB-based, CSI-RS based L3 measurements and RSSI and channel occupancy measurements performed outside gaps**

For UE configured with the E-UTRA-NR dual connectivity operation, the carrier-specific scaling factor  $CSSF_{outside\_gap,i}$  for intra-frequency SSB-based measurements, inter-frequency SSB-based measurements performed outside measurements gaps, intra-frequency CSI-RS L3 measurement and RSSI/channel occupancy measurement with no measurement gap on a carrier subject to CCA when SMTC and RMTC are overlapping will be as specified in Table 9.1.5.1.1-1.

**Table 9.1.5.1.1-1:  $CSSF_{outside\_gap,i}$  scaling factor for EN-DC mode**

Scenario	$CSSF_{outside\_gap,i}$ for FR1 PSCC	$CSSF_{outside\_gap,i}$ for FR1 SCC	$CSSF_{outside\_gap,i}$ for FR2 PSCC	$CSSF_{outside\_gap,i}$ for FR2 SCC where neighbour cell measurement is required <sup>Note 2</sup>	$CSSF_{outside\_gap,i}$ for FR2 SCC where neighbour cell measurement is not required	$CSSF_{outside\_gap,i}$ for inter-frequency MO with no measurement gp
EN-DC with FR1 only CA	$1+N_{PSCC\_CSIRS}+N_{PSCC\_CCA\_RS}$ SI/CO	$N_{SCC\_SSB}+Y+2X$ $N_{SCC\_CSIRS}+$ $N_{SCC\_CCA\_RSSI/CO}$ O	N/A	N/A	N/A	$N_{SCC\_SSB}+Y+2X$ $N_{SCC\_CSIRS}+$ $N_{SCC\_CCA\_RSSI/CO}$
EN-DC with FR2 only intra band CA	N/A	N/A	$1+N_{PSCC\_CSIRS}$	N/A	$N_{SCC\_SSB}+Y+2X$ $N_{SCC\_CSIRS}$	$N_{SCC\_SSB}+Y+2X$ $N_{SCC\_CSIRS}$
EN-DC with FR2 only inter band CA	N/A	N/A	$1+N_{PSCC\_CSIRS}$	$2x(1+N_{SCC\_CSIRS\_FR2\_NC})$ <sup>Note 3,5</sup>	$2x(N_{SCC\_SSB}+Y+2X N_{SCC\_CSIRS}-1-N_{SCC\_CSIRS\_FR2\_NCM})$	$2x(N_{SCC\_SSB}+Y+2X N_{SCC\_CSIRS}-1-N_{SCC\_CSIRS\_FR2\_NCM})$
EN-DC with FR1 +FR2 CA (FR1 PSCell) <sup>Note 1</sup>	$1+N_{PSCC\_CSIRS}$	$2x(N_{SCC\_SSB}+Y+2X N_{SCC\_CSIRS}-1-N_{SCC\_CSIRS\_FR2\_NCM})$	N/A	$2x(1+N_{SCC\_CSIRS\_FR2\_NCM})$ <sup>Note 3</sup>	$2x(N_{SCC\_SSB}+Y+2X N_{SCC\_CSIRS}-1-N_{SCC\_CSIRS\_FR2\_NCM})$	$2x(N_{SCC\_SSB}+Y+2X N_{SCC\_CSIRS}-1-N_{SCC\_CSIRS\_FR2\_NCM})$
EN-DC with FR1 +FR2 CA (FR2 PSCell) <sup>Note 1</sup>	N/A	$N_{SCC\_SSB}+Y+2X$ $N_{SCC\_CSIRS}$	$1+N_{PSCC\_CSIRS}$	N/A	$N_{SCC\_SSB}+Y+2X$ $N_{SCC\_CSIRS}$	$N_{SCC\_SSB}+Y+2X$ $N_{SCC\_CSIRS}$

Note 1: Only one NR FR1 operating band and one NR FR2 operating band are included for FR1+FR2 inter-band EN-DC.

Note 2: Selection of FR2 SCC where neighbour cell measurement is required follows clause 9.2.3.2.

Note 3:	$CSSF_{outside\_gap,i} = 1$ if only one SCell is configured and no inter-frequency MO without gap and only SSB based L3 measurement is configured on SCC; $CSSF_{outside\_gap,i} = 2$ if only one SCell is configured and no inter-frequency MO without gap and either both SSB and CSI-RS based L3 configured or only CSI-RS based L3 measurement is configured on SCC.
Note 4:	Y is the number of configured inter-frequency MOs without MG that are being measured outside of MG; otherwise, it is 0.
Note 5:	Only two NR FR2 operating band are included for EN-DC with FR2 only inter-band CA
Note 6:	$N_{PSCC\_CSIRS} = 1$ if PSCC is with either both SSB and CSI-RS based L3 configured or only CSI-RS based L3 measurement configured; otherwise, $N_{PSCC\_CSIRS} = 0$ .
Note 7:	$N_{SCC\_CSIRS} =$ Number of configured SCell(s) with either both SSB and CSI-RS based L3 measurement configured or only CSI-RS based L3 measurement configured
Note 8:	$N_{SCC\_CSIRS\_FR2\_NCM} = 1$ if FR2 SCC, where neighbour cell measurement is required, is with either both SSB and CSI-RS configured or only CSI-RS measurement configured; otherwise, $N_{SCC\_CSIRS\_FR2\_NCM} = 0$ .
Note 9:	$N_{SCC\_SSB} =$ Number of configured SCell(s) with only SSB based L3 measurement configured
Note 10:	$N_{PSCC\_CCA\_RSSI/CO} = 1$ if PSCC is configured with RSSI/CO measurements without MG when RMTC and SMTC are overlapping; $N_{SCC\_CCA\_RSSI/CO} =$ Number of MOs for SCell(s) configured with RSSI/CO measurements without MG when RMTC and SMTC are overlapping.

9.1.5.1.2 SA mode: carrier-specific scaling factor for SSB-based, CSI-RS based L3 measurements and RSSI and channel occupancy measurements performed outside gaps

For UE in SA operation mode, the carrier-specific scaling factor  $CSSF_{outside\_gap,i}$  for intra-frequency SSB-based measurements, inter-frequency SSB-based measurements performed outside measurements gaps, intra-frequency CSI-RS L3 measurement and RSSI/channel occupancy measurement with no measurement gap on a carrier subject to CCA when SMTC and RMTC are overlapping will be as specified in Table 9.1.5.1.2-1, which shall also be applied for a UE configured with NE-DC operation.

Table 9.1.5.1.2-1:  $CSSF_{outside\_gap,i}$  scaling factor for SA mode

Scenario	$CSSF_{outside\_gap,i}$ for FR1 PCC	$CSSF_{outside\_gap,i}$ for FR1 SCC	$CSSF_{outside\_gap,i}$ for FR2 PCC	$CSSF_{outside\_gap,i}$ for FR2 SCC where neighbour cell measurement is required	$CSSF_{outside\_gap,i}$ for FR2 SCC where neighbour cell measurement is not required	$CSSF_{outside\_gap,i}$ for inter-frequency MO with no measurement gap
FR1 only CA	$1 + N_{PCC\_CSIRS} + N_{PCC\_CCA\_RSSI/CO}$	$N_{SCC\_SSB} + Y + 2X$ $N_{SCC\_CSIRS} + N_{SCC\_CCA\_RSSI/CO}$	N/A	N/A	N/A	$N_{SCC\_SSB} + Y + 2X$ $N_{SCC\_CSIRS} + N_{SCC\_CCA\_RSSI/CO}$
FR2 only intra band CA	N/A	N/A	$1 + N_{PCC\_CSIRS}$	N/A	$N_{SCC\_SSB} + Y + 2X$ $N_{SCC\_CSIRS}$	$N_{SCC\_SSB} + Y + 2X$ $N_{SCC\_CSIRS}$
FR2 only inter band CA	N/A	N/A	$1 + N_{PCC\_CSIRS}$	$2 * (1 + N_{SCC\_CSIRS\_FR2\_NCM})$ Note 3,5	$2 * (N_{SCC\_SSB} + Y + 2X - N_{SCC\_CSIRS\_FR2\_NCM})$	$2 * (N_{SCC\_SSB} + Y + 2X - N_{SCC\_CSIRS\_FR2\_NCM})$
FR1 +FR2 CA (FR1 PCell) Note 1	$1 + N_{PCC\_CSIRS}$	$2 * (N_{SCC\_SSB} + Y + 2X - N_{SCC\_CSIRS\_FR2\_NCM})$	N/A	$2 * (1 + N_{SCC\_CSIRS\_FR2\_NCM})$ Note 3,5	$2 * (N_{SCC\_SSB} + Y + 2X - N_{SCC\_CSIRS\_FR2\_NCM})$	$2 * (N_{SCC\_SSB} + Y + 2X - N_{SCC\_CSIRS\_FR2\_NCM})$
FR1 +FR2 CA (FR2 PCell) Note 1	N/A	$N_{SCC\_SSB} + Y + 2X$ $N_{SCC\_CSIRS}$	$1 + N_{PCC\_CSIRS}$	N/A	$N_{SCC\_SSB} + Y + 2X$ $N_{SCC\_CSIRS}$	$N_{SCC\_SSB} + Y + 2X$ $N_{SCC\_CSIRS}$
Note 1: Only one FR1 operating band and one FR2 operating band are included for FR1+FR2 inter-band CA. Note 2: Selection of FR2 SCC where neighbour cell measurement is required follows clause 9.2.3.2. Note 3: $CSSF_{outside\_gap,i} = 1$ if only one SCell is configured and no inter-frequency MO without gap and only SSB based L3 measurement is configured on SCC; $CSSF_{outside\_gap,i} = 2$ if only one SCell is configured and no inter-frequency MO without gap and either both SSB and CSI-RS based L3 configured or only CSI-RS based L3 measurement is configured on SCC.						

Note 4:	Y is the number of configured inter-frequency MOs without MG that are being measured outside of MG; otherwise, it is 0.
Note 5:	Only two NR FR2 operating bands are included for FR2 inter-band CA.
Note 6:	$N_{PCC\_CSIRS}=1$ if PCC is with either both SSB and CSI-RS based L3 configured or only CSI-RS based L3 measurement configured; otherwise, $N_{PCC\_CSIRS}=0$ .
Note 7:	$N_{SCC\_CSIRS}$ =Number of configured SCell(s) with either both SSB and CSI-RS based L3 measurement configured or only CSI-RS based L3 measurement configured
Note 8:	$N_{SCC\_CSIRS\_FR2\_NCM}=1$ if FR2 SCC, where neighbour cell measurement is required, is with either both SSB and CSI-RS configured or only CSI-RS measurement configured; otherwise, $N_{SCC\_CSIRS\_FR2\_NCM}=0$ .
Note 9:	$N_{SCC\_SSB}$ =Number of configured SCell(s) with only SSB based L3 measurement configured
Note 10:	$N_{PCC\_CCA\_RSSI/CO}=1$ if PSCC is configured with RSSI/CO measurements without MG when RMTc and SMTC are overlapping; $N_{SCC\_CCA\_RSSI/CO}$ = Number of MOs for SCell(s) configured with RSSI/CO measurements without MG when RMTc and SMTC are overlapping..

9.1.5.1.3 NR-DC mode: carrier-specific scaling factor for SSB-based and CSI-RS based L3 measurements performed outside gaps

For UE configured with NR-DC operation, the carrier-specific scaling factor  $CSSF_{outside\_gap,i}$  for intra-frequency SSB-based measurement, inter-frequency SSB-based measurements performed outside measurements gaps and intra-frequency CSI-RS based L3 measurement will be as specified in Table 9.1.5.1.3-1.

Table 9.1.5.1.3-1:  $CSSF_{outside\_gap,i}$  scaling factor for NR-DC mode

Scenario	$CSSF_{outside\_gap,i}$ for FR1 PCC	$CSSF_{outside\_gap,i}$ for FR1 SCC	$CSSF_{outside\_gap,i}$ for FR2 PSCC	$CSSF_{outside\_gap,i}$ for FR2 SCC where neighbour cell measurement is not required	$CSSF_{outside\_gap,i}$ for inter-frequency MO with no measurement gap
FR1 + FR2 NR-DC (FR1 PCell and FR2 PCell) Note 1	$1+N_{PCC\_CSIRS}$	$2x(N_{SCC\_SSB} + Y + 2xN_{SCC\_CSIRS})$	$2x(1 + \frac{N_{PSCC\_CSIRS}}{2})$ Note	$2x(N_{SCC\_SSB} + Y + 2x N_{SCC\_CSIRS})$	$2x(N_{SCC\_SSB} + Y + 2x N_{SCC\_CSIRS})$
Note 1:	NR-DC in Rel-15 only includes the scenarios where all serving cells in MCG in FR1 and all serving cells in SCG in FR2.				
Note 2:	$CSSF_{outside\_gap,i}=1$ if no SCell is configured and no inter-frequency MO without gap and only SSB based L3 measurement is configured on PSCC; $CSSF_{outside\_gap,i}=2$ if no SCell is configured and no inter-frequency MO without gap and either both SSB and CSI-RS based L3 configured or only CSI-RS based L3 measurement is configured on PSCC.				
Note 3:	Y is the number of configured inter-frequency SSB based frequency layers without MG that are being measured outside of MG; otherwise, it is 0.				
Note 4:	$N_{PCC\_CSIRS}=1$ if PCC is with either both SSB and CSI-RS based L3 configured or only CSI-RS based L3 measurement configured; otherwise, $N_{PCC\_CSIRS}=0$ .				
Note 5:	$N_{PSCC\_CSIRS}=1$ if PSCC is with either both SSB and CSI-RS based L3 configured or only CSI-RS based L3 measurement configured; otherwise, $N_{PSCC\_CSIRS}=0$ .				
Note 6:	$N_{SCC\_CSIRS}$ =Number of configured SCell(s) with either both SSB and CSI-RS based L3 measurement configured or only CSI-RS based L3 measurement configured				
Note 7:	Void				
Note 8:	$N_{SCC\_SSB}$ =Number of configured SCell(s) with only SSB based L3 measurement configured				

9.1.5.1.4 NE-DC mode: carrier-specific scaling factor for SSB-based and CSI-RS based measurements performed outside gaps

For UE configured with NE-DC operation, the carrier-specific scaling factor  $CSSF_{outside\_gap,i}$  for intra-frequency SSB-based measurement and inter-frequency SSB-based measurements performed outside measurements gaps and intra-frequency CSI-RS based L3 measurement will be as specified in Table 9.1.5.1.4-1.

Table 9.1.5.1.4-1:  $CSSF_{outside\_gap,i}$  scaling factor for NE-DC mode

Scenario	$CSSF_{outside\_gap,i}$ for FR1 PCC	$CSSF_{outside\_gap,i}$ for FR1 SCC	$CSSF_{outside\_gap,i}$ for FR2 PCC	$CSSF_{outside\_gap,i}$ for FR2 SCC where neighbour	$CSSF_{outside\_gap,i}$ for FR2 SCC where neighbour cell	$CSSF_{outside\_gap,i}$ for inter-frequency MO with no

				cell measurement is required	measurement is not required	measurement gap
NE-DC with FR1 only CA	$1+N_{PCC\_CSIRS}$	$N_{SCC\_SSB} + Y + 2X$ $N_{SCC\_CSIRS}$	N/A	N/A	N/A	$N_{SCC\_SSB} + Y + 2X$ $N_{SCC\_CSIRS}$
NE-DC with FR2 only intra band CA	N/A	N/A	$1+N_{PCC\_CSIRS}$	N/A	$N_{SCC\_SSB} + Y + 2X$ $N_{SCC\_CSIRS}$	$N_{SCC\_SSB} + Y + 2X$ $N_{SCC\_CSIRS}$
NE-DC with FR2 only inter band CA	N/A	N/A	$1+N_{PCC\_CSIRS}$	$2*(1+N_{SCC\_CSIRS\_FR2\_NCM})$ Note 3,5	$2*(N_{SCC\_SSB} + Y + 2X - N_{SCC\_CSIRS\_FR2\_NCM})$	$2*(N_{SCC\_SSB} + Y + 2X - N_{SCC\_CSIRS\_FR2\_NCM})$
NE-DC with FR1 +FR2 CA (FR1 PCell) Note 1	$1+N_{PCC\_CSIRS}$	$2*(N_{SCC\_SSB} + Y + 2X - N_{SCC\_CSIRS\_FR2\_NCM})$	N/A	$2*(1+N_{SCC\_CSIRS\_FR2\_NCM})$ Note 3,5	$2*(N_{SCC\_SSB} + Y + 2X - N_{SCC\_CSIRS\_FR2\_NCM})$	$2*(N_{SCC\_SSB} + Y + 2X - N_{SCC\_CSIRS\_FR2\_NCM})$
Note 1:	Only one FR1 operating band and one FR2 operating band are included for FR1+FR2 inter-band CA.					
Note 2:	Selection of FR2 SCC where neighbour cell measurement is required follows clause 9.2.3.2.					
Note 3:	CSSF <sub>outside_gap,i</sub> = 1 if only one SCell is configured and no inter-frequency MO without gap and only SSB based L3 measurement is configured on SCC; CSSF <sub>outside_gap,i</sub> = 2 if only one SCell is configured and no inter-frequency MO without gap and either both SSB and CSI-RS based L3 configured or only CSI-RS based L3 measurement is configured on SCC.					
Note 4:	Y is the number of configured inter-frequency MOs without MG that are being measured outside of MG.					
Note 5:	Only two NR FR2 operating band are included for NE-DC with FR2 only inter-band CA.					
Note 6:	$N_{PCC\_CSIRS}$ = 1 if PCC is with either both SSB and CSI-RS based L3 configured or only CSI-RS based L3 measurement configured; otherwise, $N_{PCC\_CSIRS}$ = 0.					
Note 7:	$N_{SCC\_CSIRS}$ = Number of configured SCell(s) with either both SSB and CSI-RS based L3 measurement configured or only CSI-RS based L3 measurement configured					
Note 8:	$N_{SCC\_CSIRS\_FR2\_NCM}$ = 1 if FR2 SCC, where neighbour cell measurement is required, is with either both SSB and CSI-RS configured or only CSI-RS measurement configured; otherwise, $N_{SCC\_CSIRS\_FR2\_NCM}$ = 0.					
Note 9:	$N_{SCC\_SSB}$ = Number of configured SCell(s) with only SSB based L3 measurement configured					

### 9.1.5.2 Monitoring of multiple layers within gaps

The carrier-specific scaling factor  $CSSF_{within\_gap,i}$  for a measurement object  $i$  derived in this chapter is applied to following measurement types:

- SSB-based intra-frequency measurement object with no measurement gap in clause 9.2.5 and 9.2A.5, when all of the SMTC occasions of this intra-frequency measurement object are overlapped by the measurement gap.
- SSB-based intra-frequency measurement object with measurement gap in clause 9.2.6 and 9.2A.6.
- CSI-RS based inter-frequency measurement in clause 9.10.3, when CSI-RS resources for L3 measurement of this inter-frequency measurement object are overlapped by the measurement gap.
- CSI-RS based inter-frequency measurement in clause 9.10.3, when CSI-RS resources for L3 measurement of this inter-frequency measurement object are partially overlapped by the measurement gap.
- SSB-based inter-frequency measurement object with measurement gap in clause 9.3.4.
- SSB-based inter-frequency measurement object without measurement gap for UE capable of *interFrequencyMeas-NoGap* in clause 9.3.9, when
  - all of the SMTC occasions of this inter-frequency measurement object are overlapped by the measurement gap, or
  - part of the SMTC occasions of this inter-frequency measurement object are overlapped by the measurement gap, but the flag *interFrequencyConfig-NoGap-r16* is not configured by the Network.
- Intra-frequency RSSI/CO measurement with measurement gap in clause 9.2A.7.



- Intra-frequency RSSI/CO measurement with no measurement gap in clause 9.2A.7 when all of the RMTC occasions of this intra-frequency RSSI/CO measurement are overlapped by the measurement gap
- Inter-frequency RSSI/CO measurement in clause 9.3A.8 and 9.3A.9.
- E-UTRA Inter-RAT measurement object in clauses 9.4.2 and 9.4.3.
- For a UE in E-UTRA-NR dual connectivity operation, NR SSB-based Inter-RAT measurement object configured by the E-UTRAN PCell (TS 36.133 [15] clause 8.17.4) on an NR serving carrier
  - the SSB is not completely contained in the active BWP of the UE, or
  - all of the SMTC occasions of this inter-RAT measurement object are overlapped by the measurement gap;
- NR SSB-based Inter-RAT measurement object configured by the E-UTRAN PCell (TS 36.133 [15] clause 8.17.4) on an NR non-serving carrier.
- E-UTRAN Inter-frequency measurement object configured by the E-UTRAN PCell (TS 36.133 [15] clause 8.17.3) and by the E-UTRAN PSCell (TS 36.133 [15] clause 8.19.3).
- E-UTRAN Inter-frequency RSTD measurement configured by the E-UTRAN PCell (TS 36.133 [15] clause 8.17.15).
- UTRA Inter-RAT measurement object configured by the E-UTRAN PCell (TS 36.133 [15] clauses 8.17.5 to 8.17.12).
- GSM Inter-RAT measurements configured by the E-UTRAN PCell (TS 36.133 [15] clauses 8.17.13 and 8.17.14).

UE is expected to conduct the measurement of this measurement object  $i$  only within the measurement gaps.

If the higher layer signaling in TS 38.331 [2] of *smtc2* is present and *smtc1* is fully overlapping with measurement gaps and *smtc2* is partially overlapping with measurement gaps,  $CSSF_{\text{within\_gap},i}$  and requirements derived from  $CSSF_{\text{outside\_gap},i}$  are not specified.

Number of SSB layers should include SSB for mobility and that as associated SSB for CSI-RS mobility. The *ssbfrequency* is counted only once if the *ssbfrequency* for mobility and associated SSB are the same, or *ssbfrequency* and *smtc* in multiple MOs are the same.

SSB-based measurement and CSI-RS based measurement for mobility configured in the same measurement object are considered as different layers.

#### 9.1.5.2.1 EN-DC mode: carrier-specific scaling factor for SSB, CSI-RS-based L3 measurements and RSSI and channel occupancy measurements performed within gaps

The scaling value  $CSSF_{\text{within\_gap},i}$  below has been derived without considering GSM inter-RAT carriers.

When one or more measurement objects are monitored within measurement gaps, the carrier specific scaling factor for a target measurement object with index  $i$  is designated as  $CSSF_{\text{within\_gap},i}$  and is derived as described in this clause.

For UE supporting per-FR gap, for each measurement object  $i$  that are measured based on effective MGRP as defined in clause 9.1.2,  $CSSF_{\text{within\_gap},i}$  used for deriving the measurement requirements is defined as  $2 * N_{\text{with\_CSI-RS}} + N_{\text{SSB\_only}}$ , where

- $N_{\text{with\_CSI-RS}}$  is the number of measurement objects with either both SSB and CSI-RS based L3 configured or only CSI-RS based L3 measurement configured in the same FR as measurement object  $i$ , and
- $N_{\text{SSB\_only}}$  is the number of measurement objects with only SSB based L3 measurement configured in the same FR as measurement object  $i$ .

For a UE in E-UTRA-NR dual connectivity operation, if a SSB-based measurement object configured by PSCell and an NR SSB-based inter-RAT measurement object configured by E-UTRAN PCell are on the same carrier, they shall be counted as one measurement object in  $M_{\text{tot},i,j}$ , provided that they meet the measurement object merging conditions [in clause 9.1.3.2].

If measurement object  $i$  refers to an RSTD measurement with periodicity  $T_{prs} > 160\text{ms}$  or with periodicity  $T_{prs} = 160\text{ms}$  but  $prs\text{-MutingInfo-r9}$  is configured,  $CSSF_{\text{within\_gap},i} = 1$ . Otherwise, the  $CSSF_{\text{within\_gap},i}$  for other measurement objects (including RSTD measurement with periodicity  $T_{prs} = 160\text{ms}$ ) participate in the gap competition are derived as below.

For each measurement gap  $j$  not used for an RSTD measurement with periodicity  $T_{prs} > 160\text{ms}$  or with periodicity  $T_{prs} = 160\text{ms}$  but  $prs\text{-MutingInfo-r9}$  is configured within an arbitrary 160ms period, count the total number of intra-frequency measurement objects and inter-frequency/inter-RAT measurement objects which are candidates to be measured within the gap  $j$ .

- An NR measurement object with SSB measurement configured is a candidate to be measured in a gap if its SMTC duration is fully covered by the MGL excluding RF switching time. For intra-frequency NR carriers, if the higher layer in TS 38.331 [2] signaling of  $smtc2$  is configured, the assumed periodicity of SMTC occasions corresponds to the value of higher layer parameter  $smtc2$ ; otherwise the assumed periodicity of SMTC occasions corresponds to the value of higher layer parameter  $smtc1$ .
- An NR measurement object with CSI-RS measurement configured is a candidate to be measured in a gap if the window confining all CSI-RS resources are fully covered by the MGL excluding RF switching time. -
- An NR measurement object with RSSI and channel occupancy measurement is a candidate to be measurement in a gap if the RMTC duration is fully covered by MGL excluding RF switching time.
- An inter-RAT UTRA measurement object configured by E-UTRA PCell [15] is a candidate to be measured in all measurement gaps.
- An inter-frequency E-UTRA measurement object configured by E-UTRA PCell [15] is a candidate to be measured in all measurement gaps.
- For UEs which support and are configured with per FR gaps, the counting is done on a per FR basis, and for UEs which are configured with per UE gaps the counting is done on a per UE basis.
- $M_{\text{intra},i,j}$ : Number of intra-frequency measurement objects, including both SSB, CSI-RS based and RSSI/CO measurement, which are candidates to be measured in gap  $j$  where the measurement object  $i$  is also a candidate. Otherwise  $M_{\text{intra},i,j}$  equals 0.
- $M_{\text{inter},i,j}$ : Number of NR inter-frequency layers including both SSB and CSI-RS based, NR inter-RAT frequency layer and RSSI/CO measurement, configured by E-UTRA PCell, EUTRA inter-frequency measurement objects configured by E-UTRA PCell, or UTRA inter-RAT measurement objects configured by E-UTRA PCell which are candidates to be measured in gap  $j$  where the measurement object  $i$  is also a candidate. Otherwise  $M_{\text{inter},i,j}$  equals 0.
- A measurement object  $i$  in  $M_{\text{intra},i,j}$  and in  $M_{\text{inter},i,j}$  is counted twice if the measurement object is configured with both RMTC and SMTC which are candidates to be measured in gap  $j$  where the measurement object  $i$  is also a candidate
- $M_{\text{tot},i,j} = M_{\text{intra},i,j} + M_{\text{inter},i,j}$ : Total number of intra-frequency, inter-frequency and inter-RAT frequency layers which are candidates to be measured in gap  $j$  where the measurement object  $i$  is also a candidate. Otherwise  $M_{\text{tot},i,j}$  equals 0.

For each measurement gap  $j$  used for an RSTD measurement with periodicity  $T_{prs} > 160\text{ms}$  or with periodicity  $T_{prs} = 160\text{ms}$  but  $prs\text{-MutingInfo-r9}$  is configured within an arbitrary 160ms period,  $M_{\text{intra},i,j} = M_{\text{inter},i,j} = M_{\text{tot},i,j} = 0$ .

The carrier specific scaling factor  $CSSF_{\text{within\_gap},i}$  is given by:

If  $measGapSharingScheme$  is equal sharing,  $CSSF_{\text{within\_gap},i} = \max(\text{ceil}(R_i \times M_{\text{tot},i,j}))$ , where  $j = 0 \dots (160/\text{MGRP}) - 1$

If  $measGapSharingScheme$  is not equal sharing and

- measurement object  $i$  is an intra-frequency measurement object,  $CSSF_{\text{within\_gap},i}$  is the maximum among
  - $\text{ceil}(R_i \times K_{\text{intra}} \times M_{\text{intra},i,j})$  in gaps where  $M_{\text{inter},i,j} \neq 0$ , where  $j = 0 \dots (160/\text{MGRP}) - 1$
  - $\text{ceil}(R_i \times M_{\text{intra},i,j})$  in gaps where  $M_{\text{inter},i,j} = 0$ , where  $j = 0 \dots (160/\text{MGRP}) - 1$
- measurement object  $i$  is an inter-frequency or inter-RAT measurement object,  $CSSF_{\text{within\_gap},i}$  is the maximum among

- $\text{ceil}(R_i \times K_{\text{inter}} \times M_{\text{inter},i,j})$  in gaps where  $M_{\text{intra},i,j} \neq 0$ , where  $j=0 \dots (160/\text{MGRP})-1$
- $\text{ceil}(R_i \times M_{\text{inter},i,j})$  in gaps where  $M_{\text{intra},i,j}=0$ , where  $j=0 \dots (160/\text{MGRP})-1$

Where  $R_i$  is the maximal ratio of the number of measurement gap where measurement object  $i$  is a candidate to be measured over the number of measurement gap where measurement object  $i$  is a candidate and not used for RSTD measurement with periodicity  $T_{\text{prs}} > 160\text{ms}$  or with periodicity  $T_{\text{prs}} = 160\text{ms}$  but *prs-MutingInfo-r9* is configured within an arbitrary 1280ms period.

#### 9.1.5.2.2 SA mode: carrier-specific scaling factor for SSB, CSI-RS-based L3 measurements and RSSI and channel occupancy measurements performed within gaps

When one or more measurement objects are monitored within measurement gaps, the carrier specific scaling factor for a target measurement object with index  $i$  is designated as  $\text{CSSF}_{\text{within\_gap},i}$  and is derived as described in this clause.

For UE supporting per-FR gap, for each measurement object  $i$  that are measured based on effective MGRP as defined in clause 9.1.2,  $\text{CSSF}_{\text{within\_gap},i}$  used for deriving the measurement requirements is defined as  $2 * N_{\text{with\_CSI-RS}} + N_{\text{SSB\_only}}$ , where

- $N_{\text{with\_CSI-RS}}$  is the number of measurement objects with either both SSB and CSI-RS based L3 configured or only CSI-RS based L3 measurement configured in the same FR as measurement object  $i$ , and
- $N_{\text{SSB\_only}}$  is the number of measurement objects with only SSB based L3 measurement configured in the same FR as measurement object  $i$ .

If measurement object  $i$  refers to a long-periodicity measurement which is any of:

- an E-UTRA RSTD measurement with periodicity  $T_{\text{prs}} > 160\text{ms}$  or with periodicity  $T_{\text{prs}} = 160\text{ms}$  but *prs-MutingInfo-r9* is configured, or
- an NR measurement for positioning frequency layer  $i$  with  $T_{\text{available\_PRS},i} > 160\text{ms}$ , where  $T_{\text{available\_PRS},i}$  is defined in clauses 9.9.2.5, 9.9.3.5 and 9.9.4.5 for RSTD, PRS-RSRP and UE Rx-Tx time difference measurements, respectively.

then  $\text{CSSF}_{\text{within\_gap},i} = 1$ . Otherwise, the  $\text{CSSF}_{\text{within\_gap},i}$  for other measurement objects (including E-UTRA RSTD measurement with periodicity  $T_{\text{prs}} = 160\text{ms}$ ) participate in the gap competition and the  $\text{CSSF}_{\text{within\_gap},i}$  are derived as below.

**Table 9.1.5.2.2-1: void**

When multiple positioning frequency layers are configured,

- for each positioning frequency layer  $i$ ,  $\text{CSSF}_{\text{within\_gap},i}$  is derived with the following steps assuming no other positioning frequency layer is configured.
- for each RRM frequency layer  $i$ ,  $\text{CSSF}_{\text{within\_gap},i}$  is derived as follows:
  - o an intermediate  $\text{CSSF}_{\text{within\_gap},i,k}$  is derived with the following steps assuming only positioning frequency layer  $k$  is configured, and
  - o  $\text{CSSF}_{\text{within\_gap},i} = \max(\text{CSSF}_{\text{within\_gap},i,k})$ , where  $k=0 \dots K-1$ , and  $K$  is the number of configured positioning frequency layers.

For each measurement gap  $j$  not used for a long-periodicity measurement defined above, count the total number of intra-frequency measurement objects and inter-frequency/inter-RAT measurement objects and NR PRS measurements on all positioning frequency layers which are candidates to be measured within the gap  $j$ .

- An NR measurement object with SSB measurement configured is a candidate to be measured in a gap if its SMTC duration is fully covered by the MGL excluding RF switching time. For intra-frequency NR measurement objects, if the higher layer in TS 38.331 [2] signaling of *smtc2* is configured, the assumed periodicity of SMTC occasions corresponds to the value of higher layer parameter *smtc2*; otherwise the assumed periodicity of SMTC occasions corresponds to the value of higher layer parameter *smtc1*.

- An NR measurement object with CSI-RS measurement configured is a candidate to be measured in a gap if the window confining all CSI-RS resources are fully covered by the MGL excluding RF switching time.
- An NR measurement object with RSSI and channel occupancy measurement is a candidate to be measurement in a gap if the RMTC duration is fully covered by MGL excluding RF switching time.
- An inter-frequency SFTD measurement object, if to be measured with measurement gaps, is a candidate to be measured in all measurement gaps.
- A positioning frequency layer is counted as candidate for a MG occasion if at least one PRS resource on that positioning frequency layer is fully covered by the MGL excluding RF switching time.
- For UEs which support and are configured with per FR gaps, the counting is done on a per FR basis, and for UEs which are configured with per UE gaps the counting is done on a per UE basis. For UEs which support and are configured with per FR gaps, the CSSF requirements do not apply when NR PRS measurement in one FR gap collides with SSB/CSI-RS/PRS measurements in the other FR gap in time domain.
- $M_{intra,i,j}$ : Number of intra-frequency measurement objects, including both SSB, CSI-RS based and RSSI/CO measurements, which are candidates to be measured in gap  $j$  where the measurement object  $i$  is also a candidate. Otherwise  $M_{intra,i,j}$  equals 0.
- $M_{inter,i,j}$ : Number of NR inter-frequency layers including both SSB and CSI-RS based, EUTRA inter-RAT and UTRA inter-RAT frequency layers, up to one positioning frequency layer, RSSI/CO measurements, which are candidates to be measured in gap  $j$  where the measurement object  $i$  is also a candidate. Otherwise  $M_{inter,i,j}$  equals 0.
- A measurement object  $i$  in  $M_{intra,i,j}$  and in  $M_{inter,i,j}$  is counted twice if the measurement object is configured with both RMTC and SMTC which are candidates to be measured in gap  $j$  where the measurement object  $i$  is also a candidate
- $M_{tot,i,j} = M_{intra,i,j} + M_{inter,i,j}$ : Total number of intra-frequency, inter-frequency and inter-RAT frequency layers and up to one NR PRS measurement on any one positioning frequency layer, which are candidates to be measured in gap  $j$  where the measurement object  $i$  is also a candidate. Otherwise  $M_{tot,i,j}$  equals 0.

For each measurement gap  $j$  used for a long-periodicity measurement defined above,  $M_{intra,i,j} = M_{inter,i,j} = M_{tot,i,j} = 0$ . The carrier specific scaling factor  $CSSF_{within\_gap,i}$  is given by:

If *measGapSharingScheme* is equal sharing,  $CSSF_{within\_gap,i} = \max(\text{ceil}(R_i \times M_{tot,i,j}))$ , where  $j=0 \dots (160/MGRP)-1$

If *measGapSharingScheme* is not equal sharing and

- measurement object  $i$  is an intra-frequency measurement object,  $CSSF_{within\_gap,i}$  is the maximum among
  - $\text{ceil}(R_i \times K_{intra} \times M_{intra,i,j})$  in gaps where  $M_{inter,i,j} \neq 0$ , where  $j=0 \dots (160/MGRP)-1$
  - $\text{ceil}(R_i \times M_{intra,i,j})$  in gaps where  $M_{inter,i,j} = 0$ , where  $j=0 \dots (160/MGRP)-1$
- measurement object  $i$  is an inter-frequency or inter-RAT measurement object or NR PRS measurement on any one positioning frequency layer,  $CSSF_{within\_gap,i}$  is the maximum among
  - $\text{ceil}(R_i \times K_{inter} \times M_{inter,i,j})$  in gaps where  $M_{intra,i,j} \neq 0$ , where  $j=0 \dots (160/MGRP)-1$
  - $\text{ceil}(R_i \times M_{inter,i,j})$  in gaps where  $M_{intra,i,j} = 0$ , where  $j=0 \dots (160/MGRP)-1$

Where  $R_i$  is the maximal ratio of the number of measurement gap where measurement object  $i$  is a candidate to be measured over the number of measurement gap where measurement object  $i$  is a candidate and not used for a long-periodicity measurement defined above.

$CSSF_{within\_gap,k} = 1$  during  $T_{\text{Detect, E-UTRAN FDD}}$  specified in clause 9.4.4.1.2.2 and  $T_{\text{Detect, E-UTRAN TDD}}$  specified in clause 9.4.4.2.2.2, where  $k$  is the carrier frequency where the UE is performing cell detection of the inter-RAT E-UTRA OTDOA assistance data reference cell when acquiring the subframe and slot timing of the cell according to clause 9.4.4. In this case, the UE cell identification and measurement periods derived based on  $CSSF_{within\_gap,i}$  in clauses 9.2.5.1, 9.2.5.2, 9.2.6.2, 9.2.6.3, 9.3.4, 9.3.5, 9.4.2.2, 9.4.2.3 and 9.10.2 may be extended for measurement objects of which the cell identification and measurement periods are overlapped with  $T_{\text{Detect, E-UTRAN FDD}}$  and  $T_{\text{Detect, E-UTRAN TDD}}$ .

### 9.1.5.2.3 NE-DC: carrier-specific scaling factor for SSB-based and CSI-RS based L3 measurements performed within gaps

When one or more measurement objects are monitored within measurement gaps, the carrier specific scaling factor for a target measurement object with index  $i$  is designated as  $CSSF_{\text{within\_gap},i}$  and is derived as described in this clause.

For UE supporting per-FR gap, for each measurement object  $i$  that are measured based on effective MGRP as defined in clause 9.1.2,  $CSSF_{\text{within\_gap},i}$  used for deriving the measurement requirements is defined as  $2 * N_{\text{with\_CSI-RS}} + N_{\text{SSB\_only}}$ , where

- $N_{\text{with\_CSI-RS}}$  is the number of measurement objects with either both SSB and CSI-RS based L3 configured or only CSI-RS based L3 measurement configured in the same FR as measurement object  $i$ , and
- $N_{\text{SSB\_only}}$  is the number of measurement objects with only SSB based L3 measurement configured in the same FR as measurement object  $i$ .

If measurement object  $i$  refers to a long-periodicity measurement which is any of:

- an E-UTRA RSTD measurement with periodicity  $T_{\text{prs}} > 160\text{ms}$  or with periodicity  $T_{\text{prs}} = 160\text{ms}$  but *prs-MutingInfo-r9* is configured, or
- an NR measurement for positioning frequency layer  $i$  with  $T_{\text{available\_PRS},i} > 160\text{ms}$ , where  $T_{\text{available\_PRS},i}$  is defined in clauses 9.9.2.5, 9.9.3.5 and 9.9.4.5 for RSTD, PRS-RSRP and UE Rx-Tx time difference measurements, respectively.

then  $CSSF_{\text{within\_gap},i} = 1$ . Otherwise, the  $CSSF_{\text{within\_gap},i}$  for other measurement objects (including E-UTRA RSTD measurement with periodicity  $T_{\text{prs}} = 160\text{ms}$ ) participate in the gap competition are derived as below.

When multiple positioning frequency layers are configured,

- for each positioning frequency layer  $i$ ,  $CSSF_{\text{within\_gap},i}$  is derived with the following steps assuming no other positioning frequency layer is configured.
- for each RRM frequency layer  $i$ ,  $CSSF_{\text{within\_gap},i}$  is derived as follows:
  - o an intermediate  $CSSF_{\text{within\_gap},i,k}$  is derived with the following steps assuming only positioning frequency layer  $k$  is configured, and
  - o  $CSSF_{\text{within\_gap},i} = \max(CSSF_{\text{within\_gap},i,k})$ , where  $k = 0 \dots K-1$ , and  $K$  is the number of configured positioning frequency layers.

For each measurement gap  $j$  not used for a long-periodicity measurement defined above, count the total number of intra-frequency measurement objects and inter-frequency/inter-RAT measurement objects and NR PRS measurements on all positioning frequency layers which are candidates to be measured within the gap  $j$ .

- An NR measurement object with SSB measurement configured is a candidate to be measured in a gap if its SMTC duration is fully covered by the MGL excluding RF switching time. For intra-frequency NR measurement objects, if the higher layer in TS 38.331 [2] signaling of *smtc2* is configured, the assumed periodicity of SMTC occasions corresponds to the value of higher layer parameter *smtc2*; otherwise the assumed periodicity of SMTC occasions corresponds to the value of higher layer parameter *smtc1*.
- An NR measurement object with CSI-RS measurement configured is a candidate to be measured in a gap if the window confining all CSI-RS resources are fully covered by the MGL excluding RF switching time.
- An inter-RAT measurement object is a candidate to be measured in all measurement gaps.
- An inter-frequency E-UTRA measurement object is a candidate to be measured in all measurement gaps.
- A positioning frequency layer is counted as candidate for a MG occasion if at least one PRS resource on that positioning frequency layer is fully covered by the MGL excluding RF switching time.

For UEs which support and are configured with per FR gaps, the counting is done on a per FR basis, and for UEs which are configured with per UE gaps the counting is done on a per UE basis. For UEs which support and are configured with per FR gaps, the CSSF requirements do not apply when NR PRS measurement in one FR gap collides with SSB/CSI-RS/PRS measurements in the other FR gap in time domain.

If the number of configured interfrequency and interRAT measurement objects and NR PRS measurements on all positioning frequency layers is non-zero and the UE is configured with per UE gaps, or if the UE is configured with per FR gaps:

FR1 and FR2 intrafrequency measurement objects belong to group A

Interfrequency and interRAT measurement objects belong to group B

$M_{\text{groupA},i,j}$ : Sum of the number of FR1 intra-frequency measurement objects  $M_{\text{intra-FR1},i,j}$  and the number of FR2 intra-frequency measurement objects  $M_{\text{intra-FR2},i,j}$ , including both SSB and CSI-RS based, which are candidates to be measured in gap  $j$  where the measurement object  $i$  is also a candidate. Otherwise  $M_{\text{groupA},i,j}$  equals 0.

$M_{\text{groupB},i,j}$ : Number of NR inter-frequency layers including both SSB and CSI-RS based, EUTRA inter-RAT and UTRA inter-RAT measurement objects, up to one positioning frequency layer, which are candidates to be measured in gap  $j$  where the measurement object  $i$  is also a candidate. Otherwise  $M_{\text{groupB},i,j}$  equals 0.

If the number of configured inter-frequency and inter-RAT measurement objects and NR PRS measurements on all positioning frequency layers is zero and the UE is configured with per UE gaps:

FR1 intrafrequency measurement objects belong to group A

FR2 intrafrequency measurement objects belong to group B

$M_{\text{groupA},i,j}$ : The number of FR1 intrafrequency measurement objects  $M_{\text{intra-FR1},i,j}$ , including both SSB and CSI-RS based, which are candidates to be measured in gap  $j$  where the measurement object  $i$  is also a candidate. Otherwise  $M_{\text{groupA},i,j}$  equals 0.

$M_{\text{groupB},i,j}$ : The number of FR2 intrafrequency measurement objects  $M_{\text{intra-FR2},i,j}$ , including both SSB and CSI-RS based, which are candidates to be measured in gap  $j$  where the measurement object  $i$  is also a candidate. Otherwise  $M_{\text{groupB},i,j}$  equals 0.

$M_{\text{tot},i,j} = M_{\text{groupA},i,j} + M_{\text{groupB},i,j}$ : Total number of group A and group B measurement objects which are candidates to be measured in gap  $j$  where the measurement object  $i$  is also a candidate. Otherwise  $M_{\text{tot},i,j}$  equals 0.

For each measurement gap  $j$  used for a long-periodicity measurement defined above,  $M_{\text{intra},i,j} = M_{\text{inter},i,j} = M_{\text{tot},i,j} = 0$ . The carrier specific scaling factor  $\text{CSSF}_{\text{within\_gap},i}$  is given by:

If *measGapSharingScheme* is equal sharing,  $\text{CSSF}_{\text{within\_gap},i} = \max(\text{ceil}(R_i \times M_{\text{tot},i,j}))$ , where  $j=0 \dots (160/\text{MGRP})-1$

If *measGapSharingScheme* is not equal sharing and

- measurement object  $i$  is a group A measurement object,  $\text{CSSF}_{\text{within\_gap},i}$  is the maximum among
  - $\text{ceil}(R_i \times K_{\text{intra}} \times M_{\text{groupA},i,j})$  in gaps where  $M_{\text{groupB},i,j} \neq 0$ , where  $j=0 \dots (160/\text{MGRP})-1$
  - $\text{ceil}(R_i \times M_{\text{groupA},i,j})$  in gaps where  $M_{\text{groupB},i,j} = 0$ , where  $j=0 \dots (160/\text{MGRP})-1$
- measurement object  $i$  is an group B measurement object,  $\text{CSSF}_{\text{within\_gap},i}$  is the maximum among
  - $\text{ceil}(R_i \times K_{\text{inter}} \times M_{\text{groupB},i,j})$  in gaps where  $M_{\text{groupA},i,j} \neq 0$ , where  $j=0 \dots (160/\text{MGRP})-1$
  - $\text{ceil}(R_i \times M_{\text{groupB},i,j})$  in gaps where  $M_{\text{groupA},i,j} = 0$ , where  $j=0 \dots (160/\text{MGRP})-1$

Where  $R_i$  is the maximal ratio of the number of measurement gap where measurement object  $i$  is a candidate to be measured over the number of measurement gap where measurement object  $i$  is a candidate and not used for a long-periodicity measurement defined above.

#### 9.1.5.2.4 NR-DC: carrier-specific scaling factor for SSB-based and CSI-RS-based L3 measurements performed within gaps

When one or more measurement objects are monitored within measurement gaps, the carrier specific scaling factor for a target measurement object with index  $i$  is designated as  $\text{CSSF}_{\text{within\_gap},i}$  and is derived as described in this clause.

For UE supporting per-FR gap, for each measurement object  $i$  that are measured based on effective MGRP as defined in clause 9.1.2,  $CSSF_{within\_gap,i}$  used for deriving the measurement requirements is defined as  $2 * N_{with\_CSI-RS} + N_{SSB\_only}$ , where

- $N_{with\_CSI-RS}$  is the number of measurement objects with either both SSB and CSI-RS based L3 configured or only CSI-RS based L3 measurement configured in the same FR as measurement object  $i$ , and
- $N_{SSB\_only}$  is the number of measurement objects with only SSB based L3 measurement configured in the same FR as measurement object  $i$ .

If measurement object  $i$  refers to a long-periodicity measurement which is any of:

- an E-UTRA RSTD measurement with periodicity  $T_{prs} > 160ms$  or with periodicity  $T_{prs} = 160ms$  but *prs-MutingInfo-r9* is configured, or
- an NR measurement for positioning frequency layer  $i$  with  $T_{available\_PRS,i} > 160ms$ , where  $T_{available\_PRS,i}$  is defined in clauses 9.9.2.5, 9.9.3.5 and 9.9.4.5 for RSTD, PRS-RSRP and UE Rx-Tx time difference measurements, respectively.

then  $CSSF_{within\_gap,i} = 1$ . Otherwise, the  $CSSF_{within\_gap,i}$  for other measurement objects (including E-UTRA RSTD measurement with periodicity  $T_{prs} = 160ms$ ) participate in the gap competition and the  $CSSF_{within\_gap,i}$  are derived as below.

When multiple positioning frequency layers are configured,

- for each positioning frequency layer  $i$ ,  $CSSF_{within\_gap,i}$  is derived with the following steps assuming no other positioning frequency layer is configured.
- for each RRM frequency layer  $i$ ,  $CSSF_{within\_gap,i}$  is derived as follows:
  - an intermediate  $CSSF_{within\_gap,i,k}$  is derived with the following steps assuming only positioning frequency layer  $k$  is configured, and
  - $CSSF_{within\_gap,i} = \max(CSSF_{within\_gap,i,k})$ , where  $k = 0 \dots K-1$ , and  $K$  is the number of configured positioning frequency layers.

For each measurement gap  $j$  not used for an RSTD measurement with periodicity  $T_{prs} > 160ms$  or with periodicity  $T_{prs} = 160ms$  but *prs-MutingInfo-r9* is configured within an arbitrary 160ms period, count the total number of intra-frequency measurement objects and inter-frequency/inter-RAT measurement objects and NR PRS measurements on all positioning frequency layers which are candidates to be measured within the gap  $j$ .

- An NR measurement object with SSB measurement configured is a candidate to be measured in a gap if its SMTC duration is fully covered by the MGL excluding RF switching time. For intra-frequency NR measurement objects, if the higher layer in TS 38.331 [2] signaling of *smtc2* is configured, the assumed periodicity of SMTC occasions corresponds to the value of higher layer parameter *smtc2*; otherwise the assumed periodicity of SMTC occasions corresponds to the value of higher layer parameter *smtc1*.
- An NR measurement object with CSI-RS measurement configured is a candidate to be measured in a gap if the window confining all CSI-RS resources are fully covered by the MGL excluding RF switching time.
- A positioning frequency layer is counted as candidate for a MG occasion if at least one PRS resource on that positioning frequency layer is fully covered by the MGL excluding RF switching time.

For UEs which support and are configured with per FR gaps, the counting is done on a per FR basis, and for UEs which are configured with per UE gaps the counting is done on a per UE basis. For UEs which support and are configured with per FR gaps, the CSSF requirements do not apply when NR PRS measurement in one FR gap collides with SSB/CSI-RS/PRS measurements in the other FR gap in time domain.

If the number of configured interfrequency and interRAT measurement objects and NR PRS measurements on all positioning frequency layers is non-zero and the UE is configured with per UE gaps, or if the UE is configured with per FR gaps:

FR1 and FR2 intrafrequency measurement objects belong to group A

Interfrequency and interRAT measurement objects and up to one NR PRS measurement on any one positioning frequency layer belong to group B

$M_{\text{groupA},i,j}$ : Sum of the number of FR1 intra-frequency measurement objects  $M_{\text{intra-FR1},i,j}$  and the number of FR2 intra-frequency measurement objects  $M_{\text{intra-FR2},i,j}$ , including both SSB and CSI-RS based, which are candidates to be measured in gap  $j$  where the measurement object  $i$  is also a candidate. Otherwise  $M_{\text{groupA},i,j}$  equals 0.

$M_{\text{groupB},i,j}$ : Number of NR inter-frequency layers including both SSB and CSI-RS based, EUTRA inter-RAT and UTRA inter-RAT measurement objects and up to one positioning frequency layer, which are candidates to be measured in gap  $j$  where the measurement object  $i$  is also a candidate. Otherwise  $M_{\text{groupB},i,j}$  equals 0.

If the number of configured interfrequency and interRAT measurement objects and NR PRS measurements on all positioning frequency layers is zero and the UE is configured with per UE gaps:

FR1 intrafrequency measurement objects belong to group A

FR2 intrafrequency measurement objects belong to group B

$M_{\text{groupA},i,j}$ : The number of FR1 intrafrequency measurement objects  $M_{\text{intra-FR1},i,j}$ , including both SSB and CSI-RS based, which are candidates to be measured in gap  $j$  where the measurement object  $i$  is also a candidate. Otherwise  $M_{\text{groupA},i,j}$  equals 0.

$M_{\text{groupB},i,j}$ : The number of FR2 intrafrequency measurement objects  $M_{\text{intra-FR2},i,j}$ , including both SSB and CSI-RS based, which are candidates to be measured in gap  $j$  where the measurement object  $i$  is also a candidate. Otherwise  $M_{\text{groupB},i,j}$  equals 0.

$M_{\text{tot},i,j} = M_{\text{groupA},i,j} + M_{\text{groupB},i,j}$ : Total number of group A and group B measurement objects which are candidates to be measured in gap  $j$  where the measurement object  $i$  is also a candidate. Otherwise  $M_{\text{tot},i,j}$  equals 0.

For each measurement gap  $j$  used for a long-periodicity measurement defined above,  $M_{\text{intra},i,j} = M_{\text{inter},i,j} = M_{\text{tot},i,j} = 0$ . The carrier specific scaling factor  $\text{CSSF}_{\text{within\_gap},i}$  is given by:

If *measGapSharingScheme* is equal sharing,  $\text{CSSF}_{\text{within\_gap},i} = \max(\text{ceil}(R_i \times M_{\text{tot},i,j}))$ , where  $j=0 \dots (160/\text{MGRP})-1$

If *measGapSharingScheme* is not equal sharing and

- measurement object  $i$  is a group A measurement object,  $\text{CSSF}_{\text{within\_gap},i}$  is the maximum among
  - $\text{ceil}(R_i \times K_{\text{intra}} \times M_{\text{groupA},i,j})$  in gaps where  $M_{\text{groupB},i,j} \neq 0$ , where  $j=0 \dots (160/\text{MGRP})-1$
  - $\text{ceil}(R_i \times M_{\text{groupA},i,j})$  in gaps where  $M_{\text{groupB},i,j} = 0$ , where  $j=0 \dots (160/\text{MGRP})-1$
- measurement object  $i$  is a group B measurement object,  $\text{CSSF}_{\text{within\_gap},i}$  is the maximum among
  - $\text{ceil}(R_i \times K_{\text{inter}} \times M_{\text{groupB},i,j})$  in gaps where  $M_{\text{groupA},i,j} \neq 0$ , where  $j=0 \dots (160/\text{MGRP})-1$
  - $\text{ceil}(R_i \times M_{\text{groupB},i,j})$  in gaps where  $M_{\text{groupA},i,j} = 0$ , where  $j=0 \dots (160/\text{MGRP})-1$

$R_i$  is the maximal ratio of the number of measurement gap where measurement object  $i$  is a candidate to be measured over the number of measurement gap where measurement object  $i$  is a candidate and not used for a long-periodicity measurement defined above.

#### 9.1.5.2.5 SA mode: carrier-specific scaling factor for PRS-based measurements performed within gaps

The requirements in this clause apply for NR PRS-based measurements for positioning in clause 9.9.

When NR PRS-based measurements for positioning are configured on one or more positioning frequency layers within measurement gaps, the carrier specific scaling factor for a target PRS-based positioning measurement on a positioning frequency layer with index  $i$  is designated as  $\text{CSSF}_{\text{within\_gap},i}$  and is derived as described in clause 9.1.5.2.2.

NR Positioning measurement requirements for long periodicity measurements apply in case all PRS resources in the PFL are configured with periodicity > 160 ms.



#### 9.1.5.2.6 NE-DC: carrier-specific scaling factor for PRS-based measurements performed within gaps

The requirements in this clause apply for NR PRS-based measurements for positioning in clause 9.9.

When NR PRS-based measurements for positioning are configured on one or more positioning frequency layers within measurement gaps, the carrier specific scaling factor for a target measurement on a positioning frequency layer with index  $i$  is designated as  $CSSF_{\text{within\_gap},i}$  and is derived as described in clause 9.1.5.2.3.

NR Positioning measurement requirements for long periodicity measurements apply in case all PRS resources in the PFL are configured with periodicity  $> 160$  ms.

#### 9.1.5.2.7 NR-DC: carrier-specific scaling factor for PRS-based measurements performed within gaps

The requirements in this clause apply for NR PRS-based measurements for positioning in clause 9.9.

When NR PRS-based measurements for positioning are configured on one or more positioning frequency layers within measurement gaps, the carrier specific scaling factor for a target measurement on a positioning frequency layer with index  $i$  is designated as  $CSSF_{\text{within\_gap},i}$  and is derived as described in clause 9.1.5.2.4.

NR Positioning measurement requirements for long periodicity measurements apply in case all PRS resources in the PFL are configured with periodicity  $> 160$  ms.

### 9.1.6 Minimum requirement at transitions

When the measurement on one intra-frequency measurement object transitions from measurements performed outside gaps to measurements performed within gaps or vice versa during one measurement period, the cell identification and measurement period requirements with the longer delay apply.

The carrier-specific scaling factor specified in clause 9.1.5 that applies to the other impacted measurement objects will also apply based on the longer measurement or cell identification delay before or after the transition.

When the UE transitions between DRX and non-DRX or when DRX cycle periodicity changes, the cell identification and measurement period requirements apply based on the longer delay before or after the transition.

Subsequent to this measurement period, the cell identification and measurement period requirements on each measurement object are corresponding to the second mode after transition.

## 9.2 NR intra-frequency measurements

### 9.2.1 Introduction

A measurement is defined as a SSB based intra-frequency measurement provided the centre frequency of the SSB of the serving cell indicated for measurement and the centre frequency of the SSB of the neighbour cell are the same, and the subcarrier spacing of the two SSBs are also the same.

The UE shall be able to identify new intra-frequency cells and perform SS-RSRP, SS-RSRQ, and SS-SINR measurements of identified intra-frequency cells if carrier frequency information is provided by PCell or the PSCell, even if no explicit neighbour list with physical layer cell identities is provided.

The UE can perform intra-frequency SSB based measurements without measurement gaps if

- the UE indicates 'no-gap' via *intraFreq-needForGap* for intra-frequency measurement, or
- the SSB is completely contained in the active BWP of the UE, or
- the active downlink BWP is initial BWP[3].

For intra-frequency SSB based measurements without measurement gaps, UE may cause scheduling restriction as specified in clause 9.2.5.3.

SSB based measurements are configured along with one or two measurement timing configuration(s) (SMTC(s)) which provides periodicity, duration and offset information on a window of up to 5ms where the measurements are to be performed. For intra-frequency connected mode measurements, up to two measurement window periodicities may be configured. A single measurement window offset and measurement duration are configured per intra-frequency measurement object.

When measurement gaps are needed, the UE is not expected to detect SSB and measure RSSI of RSRQ which start earlier than the gap starting time + switching time, nor detect SSB and measure RSSI of RSRQ which end later than the gap end – switching time. Switching time is 0.5ms for frequency range FR1 and 0.25ms for frequency range FR2.

The requirements in this clause shall also apply, when the UE is configured to perform SRS carrier based switching and using measurement gaps.

The measurement requirements defined for an activated SCell with a non-dormant active BWP defined in this clause shall also apply to an activated SCell with dormant BWP as active BWP.

## 9.2.2 Requirements applicability

The requirements in clause 9.2 apply, provided:

- The cell being identified or measured is detectable.

An intra-frequency cell shall be considered detectable when for each relevant SSB:

- SS-RSRP related side conditions given in clauses 10.1.2 and 10.1.3 for FR1 and FR2, respectively, for a corresponding Band,
- SS-RSRQ related side conditions given in clauses 10.1.7 and 10.1.8 for FR1 and FR2, respectively, for a corresponding Band,
- SS-SINR related side conditions given in clauses 10.1.12 and 10.1.13 for FR1 and FR2, respectively, for a corresponding Band,
- SSB<sub>RP</sub> and SSB  $\hat{E}_s/I_{ot}$  according to Annex B.2.2 for a corresponding Band.

## 9.2.3 Number of cells and number of SSB

### 9.2.3.1 Requirements for FR1

For each intra-frequency layer, during each layer 1 measurement period, the UE shall be capable of performing SS-RSRP, SS-RSRQ, and SS-SINR measurements for at least:

- 8 identified cells, and
- 14 SSBs with different SSB index and/or PCI on the intra-frequency layer, where the number of SSBs in the serving cell (except for the SCell) is not smaller than the number of configured RLM-RS SSB resources.

### 9.2.3.2 Requirements for FR2

For one single intra-frequency layer in a band, during each layer 1 measurement period, the UE shall be capable of performing SS-RSRP, SS-RSRQ, and SS-SINR measurements for at least:

- 6 identified cells, and
- 24 SSBs with different SSB index and/or PCI,

where this single intra-frequency layer shall be:

- PCC when UE is configured with SA NR operation mode with PCC in the band; or
- PSCC when UE is configured with EN-DC with PSCC in the band; or
- PSCC when UE is configured with NR-DC with PSCC in the band; or

- One of the SCCs on which UE is configured to report SSB based measurements when neither PCC nor PSCC is in the same band, so that the selected SCC shall be an SCC where the UE is configured with SS-RSRP measurement reporting if such SCC exists, otherwise the selected SCC is determined by UE implementation.

The UE shall also be capable of performing SS-RSRP, SS-RSRQ, and SS-SINR measurements for at least 2 SSBs on serving cell for each of the other intra-frequency layer(s) in the same band.

## 9.2.4 Measurement Reporting Requirements

### 9.2.4.1 Periodic Reporting

Reported RSRP, RSRQ, and RS-SINR measurements contained in periodic measurement reports shall meet the requirements in clauses 10.1.2.1 (RSRP for FR1), 10.1.3.1 (RSRP for FR2), 10.1.7.1 (RSRQ for FR1), 10.1.8.1 (RSRQ for FR2), 10.1.12.1 (RS-SINR for FR1) and 10.1.13.1 (RS-SINR for FR2).

### 9.2.4.2 Event-triggered Periodic Reporting

Reported RSRP, RSRQ, and RS-SINR measurements contained in event-triggered periodic measurement reports shall meet the requirements in clauses 10.1.2.1 (RSRP for FR1), 10.1.3.1 (RSRP for FR2), 10.1.7.1 (RSRQ for FR1), 10.1.8.1 (RSRQ for FR2), 10.1.12.1 (RS-SINR for FR1) and 10.1.13.1 (RS-SINR for FR2).

The first report in event triggered periodic measurement reporting shall meet the requirements specified in clause 9.2.4.3.

### 9.2.4.3 Event Triggered Reporting

Reported RSRP, RSRQ, and RS-SINR measurements contained in event triggered measurement reports shall meet the requirements in clauses 10.1.2.1 (RSRP for FR1), 10.1.3.1 (RSRP for FR2), 10.1.7.1 (RSRQ for FR1), 10.1.8.1 (RSRQ for FR2), 10.1.12.1 (RS-SINR for FR1) and 10.1.13.1 (RS-SINR for FR2).

The UE shall not send any event triggered measurement reports as long as no reporting criteria is fulfilled.

The measurement reporting delay is defined as the time between an event that will trigger a measurement report and the point when the UE starts to transmit the measurement report over the air interface. This requirement assumes that the measurement report is not delayed by other RRC signalling on the DCCH. This measurement reporting delay excludes a delay uncertainty resulted when inserting the measurement report to the TTI of the uplink DCCH. The delay uncertainty is:  $2 \times TTI_{DCCH}$ . This measurement reporting delay excludes a delay which caused by no UL resources being available for UE to send the measurement report on.

The event triggered measurement reporting delay, measured without L3 filtering shall be less than  $T_{\text{identify intra with index}}$  or  $T_{\text{identify intra without index}}$  defined in clause 9.2.5.1 or clause 9.2.6.2. When L3 filtering is used an additional delay can be expected. In EN-DC and NE-DC operation, when the UE is configured to perform E-UTRA SRS carrier-based switching an additional delay can be expected in FR1 if the UE is capable of per-FR gap, or an additional delay can be expected in both FR1 and FR2 if the UE is not capable of per-FR gap.

A cell is detectable only if at least one SSBs measured from the Cell being configured remains detectable during the time period  $T_{\text{identify intra without index}}$  or  $T_{\text{identify intra with index}}$  as defined in clause 9.2.5.1 or clause 9.2.6.2. If a cell which has been detectable at least for the time period  $T_{\text{identify intra without index}}$  or  $T_{\text{identify intra with index}}$  defined in clause 9.2.5.1 or clause 9.2.6.2 becomes undetectable for a period  $\leq 5$  seconds and then the cell becomes detectable again with the same spatial reception parameter and triggers an event, the event triggered measurement reporting delay shall be less than  $T_{\text{SSB\_measurement\_period\_intra}}$  provided the timing to that cell has not changed more than  $\pm 3200/2^\mu T_c$  while the measurement gap has not been available and L3 filtering has not been used, where  $\mu$  is the SCS configuration as defined in clause 4.2 of TS 38.211 [3]. When L3 filtering is used, an additional delay can be expected. In EN-DC and NE-DC operation, when the UE is configured to perform E-UTRA SRS carrier-based switching an additional delay can be expected in FR1 if the UE is capable of per-FR gap, or an additional delay can be expected in both FR1 and FR2 if the UE is not capable of per-FR gap.

## 9.2.5 Intrafrequency measurements without measurement gaps

### 9.2.5.1 Intrafrequency cell identification

The UE shall be able to identify a new detectable intra-frequency cell within  $T_{\text{identify\_intra\_without\_index}}$  if the UE is not indicated to report SSB based RRM measurement result with the associated SSB index (*reportQuantityRsIndexes* or *maxNrofRSIndexesToReport* is not configured), or the UE is indicated that the neighbour cell is synchronous with the serving cell (*deriveSSB-IndexFromCell* is enabled). Otherwise UE shall be able to identify a new detectable intra frequency cell within  $T_{\text{identify\_intra\_with\_index}}$ . The UE shall be able to identify a new detectable intra frequency SS block of an already detected cell within  $T_{\text{identify\_intra\_without\_index}}$ . It is assumed that *deriveSSB-IndexFromCell* is always enabled for FR1 TDD and FR2.

$$T_{\text{identify\_intra\_without\_index}} = (T_{\text{PSS/SSS\_sync\_intra}} + T_{\text{SSB\_measurement\_period\_intra}}) \text{ ms}$$

$$T_{\text{identify\_intra\_with\_index}} = (T_{\text{PSS/SSS\_sync\_intra}} + T_{\text{SSB\_measurement\_period\_intra}} + T_{\text{SSB\_time\_index\_intra}}) \text{ ms}$$

Where:

$T_{\text{PSS/SSS\_sync\_intra}}$ : it is the time period used in PSS/SSS detection given in table 9.2.5.1-1, 9.2.5.1-2, 9.2.5.1-4 (deactivated SCell) or 9.2.5.1-5 (deactivated SCell)

$T_{\text{SSB\_time\_index\_intra}}$ : it is the time period used to acquire the index of the SSB being measured given in table 9.2.5.1-3 or 9.2.5.1-6 (deactivated SCell)

$T_{\text{SSB\_measurement\_period\_intra}}$ : equal to a measurement period of SSB based measurement given in table 9.2.5.2-1, table 9.2.5.2-2 table 9.2.5.2-3 (deactivated SCell) or 9.2.5.2-4 (deactivated SCell)

$\text{CSSF}_{\text{intra}}$ : it is a carrier specific scaling factor and is determined

according to  $\text{CSSF}_{\text{outside\_gap},i}$  in clause 9.1.5.1 for measurement conducted outside measurement gaps, i.e. when intra-frequency SMTC is fully non overlapping or partially overlapping with measurement gaps, or according to  $\text{CSSF}_{\text{within\_gap},i}$  in clause 9.1.5.2 for measurement conducted within measurement gaps, i.e. when intra-frequency SMTC is fully overlapping with measurement gaps.

if the high layer in TS 38.331 [2] signalling of *smtc2* is configured, the assumed periodicity of intra-frequency SMTC occasions corresponds to the value of higher layer parameter *smtc2*; Otherwise the assumed periodicity of intra-frequency SMTC occasions corresponds to the value of higher layer parameter *smtc1*.

$M_{\text{pss/sss\_sync\_w/o\_gaps}}$  : For a UE supporting FR2 power class 1,  $M_{\text{pss/sss\_sync\_w/o\_gaps}} = 40$ . For a UE supporting power class 2,  $M_{\text{pss/sss\_sync\_w/o\_gaps}} = 24$ . For a UE supporting FR2 power class 3,  $M_{\text{pss/sss\_sync\_w/o\_gaps}} = 24$ . For a UE supporting FR2 power class 4,  $M_{\text{pss/sss\_sync\_w/o\_gaps}} = 24$

$M_{\text{meas\_period\_w/o\_gaps}}$  : For a UE supporting power class 1,  $M_{\text{meas\_period\_w/o\_gaps}} = 40$ . For a UE supporting FR2 power class 2,  $M_{\text{meas\_period\_w/o\_gaps}} = 24$ . For a UE supporting power class 3,  $M_{\text{meas\_period\_w/o\_gaps}} = 24$ . For a UE supporting power class 4,  $M_{\text{meas\_period\_w/o\_gaps}} = 24$ .

When intra-frequency SMTC is fully non overlapping with measurement gaps or intra-frequency SMTC is fully overlapping with MGs,  $K_p = 1$

When intra-frequency SMTC is partially overlapping with measurement gaps,  $K_p = 1 / (1 - (\text{SMTC period} / \text{MGRP}))$ , where SMTC period < MGRP. For calculation of  $K_p$ , if the high layer signalling (TS 38.331 [2]) of *smtc2* is configured, for cells indicated in the *pci-List* parameter in *smtc2*, the SMTC periodicity corresponds to the value of higher layer parameter *smtc2*; for the other cells, the SMTC periodicity corresponds to the value of higher layer parameter *smtc1*.

If the higher layer signaling in TS38.331 [2] signalling of *smtc2* is present and *smtc1* is fully overlapping with measurement gaps and *smtc2* is partially overlapping with measurement gaps, requirements are not specified for  $T_{\text{identify\_intra\_without\_index}}$  or  $T_{\text{identify\_intra\_with\_index}}$

For FR2,

$$K_{\text{layer1\_measurement}} = 1,$$

- if all of the reference signals configured for RLM, BFD, CBD or L1-RSRP for beam reporting on any FR2 serving frequency in the same band outside measurement gap are not fully overlapped by intra-frequency SMTC occasions, or
- if all of the reference signal configured for RLM, BFD, CBD or L1-RSRP for beam reporting on any FR2 serving frequency in the same band outside measurement gap and fully-overlapped by intra-frequency SMTC occasions are not overlapped with any of the SSB symbols and the RSSI symbols, and 1 symbol before each consecutive SSB symbols and the RSSI symbols, and 1 symbol after each consecutive SSB symbols and the RSSI symbols, given that *SSB-ToMeasure* and *SS-RSSI-Measurement* are configured, where SSB symbols are indicated by the union set of *SSB-ToMeasure* from all the configured measurement objects on the same serving carrier which can be merged. and RSSI symbols are indicated by *SS-RSSI-Measurement*;

$K_{layer1\_measurement}=1.5$ , otherwise.

If the above-mentioned reference signal configured for L1-RSRP measurement is aperiodic CSI-RS resource, longer cell identification delay would be expected.

If MCG DRX is in use, cell identification requirements for intra-frequency measurement in MCG specified in Table 9.2.5.1-1, Table 9.2.5.1-2, Table 9.2.5.1-3, Table 9.2.5.1-4, Table 9.2.5.1-5 and Table 9.2.5.1-6 shall depend on the MCG DRX cycle. If SCG DRX is in use, cell identification requirements for intra-frequency measurement in SCG specified in Table 9.2.5.1-1, Table 9.2.5.1-2, Table 9.2.5.1-3, Table 9.2.5.1-4, Table 9.2.5.1-5 and Table 9.2.5.1-6 shall depend on the SCG DRX cycle. Otherwise, the requirements for when DRX is not in use shall apply.

**Table 9.2.5.1-1: Time period for PSS/SSS detection, (Frequency range FR1)**

DRX cycle	$T_{PSS/SSS\_sync\_intra}$
No DRX	$\max(600\text{ms}, \text{ceil}(5 \times K_p) \times \text{SMTC period})^{\text{Note 1}} \times \text{CSSF}_{intra}$
DRX cycle $\leq 320\text{ms}$	$\max(600\text{ms}, \text{ceil}(M2^{\text{Note 2}} \times 5 \times K_p) \times \max(\text{SMTC period}, \text{DRX cycle})) \times \text{CSSF}_{intra}$
DRX cycle $> 320\text{ms}$	$\text{ceil}(5 \times K_p) \times \text{DRX cycle} \times \text{CSSF}_{intra}$
NOTE 1: If different SMTC periodicities are configured for different cells, the SMTC period in the requirement is the one used by the cell being identified	
NOTE 2: When <i>highSpeedMeasFlag-r16</i> is not configured, $M2 = 1.5$ ; When <i>highSpeedMeasFlag-r16</i> is configured, $M2 = 1.5$ if SMTC periodicity $> 40$ ms; otherwise $M2=1$ .	
NOTE 3: When <i>highSpeedMeasFlag-r16</i> is configured, the requirements apply only to UE supporting either <i>measurementEnhancement-r16</i> or <i>intraNR-MeasurementEnhancement-r16</i> on measurements of the primary component carrier and do not apply to measurements of a secondary component carrier with active SCell.	

**Table 9.2.5.1-2: Time period for PSS/SSS detection, (Frequency range FR2)**

DRX cycle	$T_{PSS/SSS\_sync\_intra}$
No DRX	$\max(600\text{ms}, \text{ceil}(M_{pss/sss\_sync\_w/o\_gaps} \times K_p \times K_{layer1\_measurement}) \times \text{SMTC period})^{\text{Note 1}} \times \text{CSSF}_{intra}$
DRX cycle $\leq 320\text{ms}$	$\max(600\text{ms}, \text{ceil}(1.5 \times M_{pss/sss\_sync\_w/o\_gaps} \times K_p \times K_{layer1\_measurement}) \times \max(\text{SMTC period}, \text{DRX cycle})) \times \text{CSSF}_{intra}$
DRX cycle $> 320\text{ms}$	$\text{ceil}(M_{pss/sss\_sync\_w/o\_gaps} \times K_p \times K_{layer1\_measurement}) \times \text{DRX cycle} \times \text{CSSF}_{intra}$
NOTE 1: If different SMTC periodicities are configured for different cells, the SMTC period in the requirement is the one used by the cell being identified	

**Table 9.2.5.1-3: Time period for time index detection (FR1)**

DRX cycle	$T_{SSB\_time\_index\_intra}$
No DRX	$\max(120\text{ms}, \text{ceil}(3 \times K_p) \times \text{SMTC period})^{\text{Note 1}} \times \text{CSSF}_{intra}$
DRX cycle $\leq 320\text{ms}$	$\max(120\text{ms}, \text{ceil}(M2^{\text{Note 2}} \times 3 \times K_p) \times \max(\text{SMTC period}, \text{DRX cycle})) \times \text{CSSF}_{intra}$
DRX cycle $> 320\text{ms}$	$\text{Ceil}(3 \times K_p) \times \text{DRX cycle} \times \text{CSSF}_{intra}$

NOTE 1: If different SMTC periodicities are configured for different cells, the SMTC period in the requirement is the one used by the cell being identified
NOTE 2: When <i>highSpeedMeasFlag-r16</i> is not configured, $M2 = 1.5$ ; When <i>highSpeedMeasFlag-r16</i> is configured, $M2 = 1.5$ if SMTC periodicity $> 40$ ms; otherwise $M2=1$
NOTE 3: When <i>highSpeedMeasFlag-r16</i> is configured, the requirements apply only to UE supporting either <i>measurementEnhancement-r16</i> or <i>intraNR-MeasurementEnhancement-r16</i> on measurements of the primary component carrier and do not apply to measurements of a secondary component carrier with active SCell

**Table 9.2.5.1-4: Time period for PSS/SSS detection, deactivated SCell (FR1)**

DRX cycle	$T_{PSS/SSS\_sync\_intra}$
No DRX	$\text{Ceil}(5 \times K_p) \times \text{measCycleSCell} \times \text{CSSF}_{intra}$
DRX cycle $\leq 320$ ms	$\text{Ceil}(5 \times K_p) \times \max(\text{measCycleSCell}, 1.5 \times \text{DRX cycle}) \times \text{CSSF}_{intra}$
DRX cycle $> 320$ ms	$\text{Ceil}(5 \times K_p) \times \max(\text{measCycleSCell}, \text{DRX cycle}) \times \text{CSSF}_{intra}$

**Table 9.2.5.1-5: Time period for PSS/SSS detection, deactivated SCell (FR2)**

DRX cycle	$T_{PSS/SSS\_sync\_intra}$
No DRX	$\text{Ceil}(M_{pss/sss\_sync\_w/o\_gaps} \times K_p) \times \text{measCycleSCell} \times \text{CSSF}_{intra}$
DRX cycle $\leq 320$ ms	$\text{Ceil}(M_{pss/sss\_sync\_w/o\_gaps} \times K_p) \times \max(\text{measCycleSCell}, 1.5 \times \text{DRX cycle}) \times \text{CSSF}_{intra}$
DRX cycle $> 320$ ms	$\text{Ceil}(M_{pss/sss\_sync\_w/o\_gaps} \times K_p) \times \max(\text{measCycleSCell}, \text{DRX cycle}) \times \text{CSSF}_{intra}$

**Table 9.2.5.1-6: Time period for time index detection, deactivated SCell (FR1)**

DRX cycle	$T_{SSB\_time\_index\_intra}$
No DRX	$\text{Ceil}(3 \times K_p) \times \text{measCycleSCell} \times \text{CSSF}_{intra}$
DRX cycle $\leq 320$ ms	$\text{Ceil}(3 \times K_p) \times \max(\text{measCycleSCell}, 1.5 \times \text{DRX cycle}) \times \text{CSSF}_{intra}$
DRX cycle $> 320$ ms	$\text{Ceil}(3 \times K_p) \times \max(\text{measCycleSCell}, \text{DRX cycle}) \times \text{CSSF}_{intra}$

**Table 9.2.5.1-7: Void****Table 9.2.5.1-8: Void**

## 9.2.5.2 Measurement period

The measurement period for intra-frequency measurements without gaps is as shown in table 9.2.5.2-1, 9.2.5.2-2, 9.2.5.2-3 (deactivated SCell) or 9.2.5.2-4 (deactivated SCell). When *highSpeedMeasFlag-r16* is configured,  $T_{SSB\_measurement\_period\_intra}$  is specified in Table 9.2.5.2-5.

If the higher layer signaling in TS38.331 [2] signalling of *smtc2* is present and *smtc1* is fully overlapping with measurement gaps and *smtc2* is partially overlapping with measurement gaps, requirements are not specified for  $T_{SSB\_measurement\_period\_intra}$

If MCG DRX is in use, measurement period requirements for intra-frequency measurement in MCG specified in Table 9.2.5.2-1, Table 9.2.5.2-2, Table 9.2.5.2-3 and Table 9.2.5.2-4 shall depend on the MCG DRX cycle. If SCG DRX is in use, measurement period requirements for intra-frequency measurement in SCG specified in Table 9.2.5.2-1, Table 9.2.5.2-2, Table 9.2.5.2-3 and Table 9.2.5.2-4 shall depend on the SCG DRX cycle. Otherwise, the requirements for when DRX is not in use shall apply.

For FR2, a longer measurement period is allowed, if aperiodic CSI-RS resource is measured for L1-RSRP measurement on any FR2 serving frequency in the same band, and the CSI-RS resource is outside measurement gap and overlapped with any of the SSB symbols and the RSSI symbols, and 1 symbol before each consecutive SSB symbols and the RSSI

symbols, and 1 symbol after each consecutive SSB symbols and the RSSI symbols. If *SSB-ToMeasure* or *SS-RSSI-Measurement* is configured, the SSB symbols are indicated by the union set of *SSB-ToMeasure* from all the configured measurement objects on the same band which can be merged and the RSSI symbols are indicated by *SS-RSSI-Measurement*.

**Table 9.2.5.2-1: Measurement period for intra-frequency measurements without gaps (FR1)**

DRX cycle	$T_{SSB\_measurement\_period\_intra}$
No DRX	$\max(200\text{ms}, \text{ceil}(5 \times K_p) \times \text{SMTC period})^{\text{Note 1}} \times \text{CSSF}_{intra}$
DRX cycle $\leq 320\text{ms}$	$\max(200\text{ms}, \text{ceil}(1.5 \times 5 \times K_p) \times \max(\text{SMTC period}, \text{DRX cycle})) \times \text{CSSF}_{intra}$
DRX cycle $> 320\text{ms}$	$\text{ceil}(5 \times K_p) \times \text{DRX cycle} \times \text{CSSF}_{intra}$

NOTE 1: If different SMTC periodicities are configured for different cells, the SMTC period in the requirement is the one used by the cell being identified

**Table 9.2.5.2-2: Measurement period for intra-frequency measurements without gaps(FR2)**

DRX cycle	$T_{SSB\_measurement\_period\_intra}$
No DRX	$\max(400\text{ms}, \text{ceil}(M_{meas\_period\_w/o\_gaps} \times K_p \times K_{layer1\_measurement}) \times \text{SMTC period})^{\text{Note 1}} \times \text{CSSF}_{intra}$
DRX cycle $\leq 320\text{ms}$	$\max(400\text{ms}, \text{ceil}(1.5 \times M_{meas\_period\_w/o\_gaps} \times K_p \times K_{layer1\_measurement}) \times \max(\text{SMTC period}, \text{DRX cycle})) \times \text{CSSF}_{intra}$
DRX cycle $> 320\text{ms}$	$\text{ceil}(M_{meas\_period\_w/o\_gaps} \times K_p \times K_{layer1\_measurement}) \times \text{DRX cycle} \times \text{CSSF}_{intra}$

NOTE 1: If different SMTC periodicities are configured for different cells, the SMTC period in the requirement is the one used by the cell being identified

**Table 9.2.5.2-3: Measurement period for intra-frequency measurements without gaps (deactivated SCell) (FR1)**

DRX cycle	$T_{SSB\_measurement\_period\_intra}$
No DRX	$\text{Ceil}(5 \times K_p) \times \text{measCycleSCell} \times \text{CSSF}_{intra}$
DRX cycle $\leq 320\text{ms}$	$\text{Ceil}(5 \times K_p) \times \max(\text{measCycleSCell}, 1.5 \times \text{DRX cycle}) \times \text{CSSF}_{intra}$
DRX cycle $> 320\text{ms}$	$\text{Ceil}(5 \times K_p) \times \max(\text{measCycleSCell}, \text{DRX cycle}) \times \text{CSSF}_{intra}$

**Table 9.2.5.2-4: Measurement period for intra-frequency measurements without gaps (deactivated SCell) (FR2)**

DRX cycle	$T_{SSB\_measurement\_period\_intra}$
No DRX	$\text{Ceil}(M_{meas\_period\_w/o\_gaps} \times K_p) \times \text{measCycleSCell} \times \text{CSSF}_{intra}$
DRX cycle $\leq 320\text{ms}$	$\text{Ceil}(M_{meas\_period\_w/o\_gaps} \times K_p) \times \max(\text{measCycleSCell}, 1.5 \times \text{DRX cycle}) \times \text{CSSF}_{intra}$
DRX cycle $> 320\text{ms}$	$\text{Ceil}(M_{meas\_period\_w/o\_gaps} \times K_p) \times \max(\text{measCycleSCell}, \text{DRX cycle}) \times \text{CSSF}_{intra}$

**Table 9.2.5.2-5:  $T_{SSB\_measurement\_period\_intra}$  When *highSpeedMeasFlag-r16* is configured (Frequency range FR1)**

DRX cycle	$T_{SSB\_measurement\_period\_intra}$
No DRX <sup>Note 2</sup>	$\max(200\text{ms}, \text{ceil}(5 \times K_p) \times \text{SMTC period})^{\text{Note 1}} \times \text{CSSF}_{intra}$
DRX cycle $\leq 160\text{ms}$	$\max(200\text{ms}, \text{ceil}(5 \times M2^{\text{Note 2}} \times K_p) \times \max(\text{SMTC period}, \text{DRX cycle})) \times \text{CSSF}_{intra}$
$160\text{ms} < \text{DRX cycle} \leq 320\text{ms}$	$\text{ceil}(4 \times M2^{\text{Note 2}} \times K_p) \times \text{DRX cycle} \times \text{CSSF}_{intra}$

DRX cycle > 320ms	$\text{ceil}(Y^{\text{Note 3}} \times K_p) \times \text{DRX cycle} \times \text{CSSF}_{\text{intra}}$
NOTE 1: If different SMTC periodicities are configured for different cells, the SMTC period in the requirement is the one used by the cell being identified	
NOTE 2: $M2 = 1.5$ if SMTC period > 40 ms, otherwise $M2=1$	
NOTE 3: $Y=3$ when SMTC period $\leq 40$ ms, $Y=5$ when SMTC period > 40ms	
NOTE 4: When <i>highSpeedMeasFlag-r16</i> is configured, the requirements apply only to UE supporting either <i>measurementEnhancement-r16</i> or <i>intraNR-MeasurementEnhancement-r16</i> on measurements of the primary component carrier and do not apply to measurements of a secondary component carrier with active SCell.	

### 9.2.5.3 Scheduling availability of UE during intra-frequency measurements

UE shall be capable of measuring without measurement gaps when the SSB is completely contained in the active bandwidth part of the UE. When any of the conditions in the following clauses is met, there are restrictions on the scheduling availability; otherwise, there is no scheduling restriction. Note that the SSB symbols indicated by the union set of *SSB-ToMeasure* from all the configured measurement objects on the same serving carrier which can be merged [2], if it is configured; otherwise, all  $L$  SSB symbols within the SMTC window duration defined in clause 4.1 of TS 38.213 [3] are included.

#### 9.2.5.3.1 Scheduling availability of UE performing measurements in TDD bands on FR1

When the UE performs intra-frequency measurements in a TDD band, the following restrictions apply due to SS-RSRP or SS-SINR measurement

- The UE is not expected to transmit PUCCH/PUSCH/SRS on SSB symbols to be measured, and on 1 data symbol before each consecutive SSB symbols to be measured and 1 data symbol after each consecutive SSB symbols to be measured within SMTC window duration. If the high layer in TS 38.331 [2] signalling of *smtc2* is configured, the SMTC periodicity follows *smtc2*; Otherwise SMTC periodicity follows *smtc1*.

When the UE performs intra-frequency measurements in a TDD band, the following restrictions apply due to SS-RSRQ measurement

- The UE is not expected to transmit PUCCH/PUSCH/SRS on SSB symbols to be measured, RSSI measurement symbols, and on 1 data symbol before each consecutive SSB to be measured/RSSI symbols and 1 data symbol after each consecutive SSB to be measured/RSSI symbols within SMTC window duration. If the high layer signalling of *smtc2* is configured in TS 38.331 [2], the SMTC periodicity follows *smtc2*; Otherwise the SMTC periodicity follows *smtc1*.

When TDD intra-band carrier aggregation is performed, the scheduling restrictions due to a given serving cell should also apply to all other serving cells in the same band on the symbols that fully or partially overlap with the aforementioned restricted symbols.

When TDD inter-band carrier aggregation is performed, the scheduling restrictions due to a given serving cell should also apply to another serving cell in a different band on the symbols that fully or partially overlap with the aforementioned restricted symbols, if UE does not have the capability of supporting *simultaneousRxTxInterBandCA* for this band pair.

#### 9.2.5.3.2 Scheduling availability of UE performing measurements with a different subcarrier spacing than PDSCH/PDCCH on FR1

For UE which do not support *simultaneousRxDataSSB-DiffNumerology* [14] the following restrictions apply due to SS-RSRP/RSRQ/SINR measurement

- If *deriveSSB\_IndexFromCell* is enabled the UE is not expected to transmit PUCCH/PUSCH/SRS or receive PDCCH/PDSCH/TRS/CSI-RS for CQI on SSB symbols to be measured, and on 1 data symbol before each consecutive SSB symbols to be measured and 1 data symbol after each consecutive SSB symbols to be measured within SMTC window duration. If the high layer signalling of *smtc2* is configured (in TS 38.331 [2]), the SMTC periodicity follows *smtc2*; Otherwise the SMTC periodicity follows *smtc1*.
- If *deriveSSB\_IndexFromCell* is not enabled the UE is not expected to transmit PUCCH/PUSCH/SRS or receive PDCCH/PDSCH/TRS/CSI-RS for CQI on all symbols within SMTC window duration. If the high layer



signalling of *smtc2* is configured in TS 38.331 [2], the SMTC periodicity follows *smtc2*; Otherwise the SMTC periodicity follows *smtc1*.

If the following conditions are met:

- The UE has been notified about system information update through paging,
- The gap between the UE's reception of PDCCH that UE monitors in the Type 2-PDCCH CSS set that notifies system information update, and the PDCCH that UE monitors in the Type0-PDCCH CSS set, is greater than 2 slots

The UE is expected to receive the PDCCH that the UE monitors in the Type0-PDCCH CSS set, and/or the corresponding PDSCH, on SSB symbols to be measured.

When intra-band carrier aggregation is performed, the scheduling restrictions due to a given serving cell should also apply to all other serving cells in the same band on the symbols that fully or partially overlap with the aforementioned restricted symbols.

### 9.2.5.3.3 Scheduling availability of UE performing measurements on FR2

The following scheduling restriction applies due to SS-RSRP or SS-SINR measurement on an FR2 intra-frequency cell

The UE is not expected to transmit PUCCH/PUSCH/SRS or receive PDCCH/PDSCH/TRS/CSI-RS for CQI on SSB symbols to be measured, and on 1 data symbol before each consecutive SSB symbols to be measured and 1 data symbol after each consecutive SSB symbols to be measured within SMTC window duration (The signaling *deriveSSB\_IndexFromCell* is always enabled for FR2). If the high layer signalling of *smtc2* is configured in TS 38.331 [2], the SMTC periodicity follows *smtc2*; Otherwise the SMTC periodicity follows *smtc1*.

The following scheduling restriction applies to SS-RSRQ measurement on an FR2 intra-frequency cell

- The UE is not expected to transmit PUCCH/PUSCH/SRS or receive PDCCH/PDSCH/TRS/CSI-RS for CQI on SSB symbols to be measured, RSSI measurement symbols, and on 1 data symbol before each consecutive SSB to be measured/RSSI symbols and 1 data symbol after each consecutive SSB to be measured/RSSI symbols within SMTC window duration (The signaling *deriveSSB\_IndexFromCell* is always enabled for FR2). If the high layer signalling of *smtc2* is configured in TS 38.331 [2], the SMTC periodicity follows *smtc2*; Otherwise the SMTC periodicity follows *smtc1*.

When intra-band carrier aggregation in FR2 is performed, the scheduling restrictions due to a given serving cell should also apply to all other serving cells in the same band on the symbols that fully or partially overlap with aforementioned restricted symbols.

When inter-band carrier aggregation in FR2 is performed, there are no scheduling restrictions on FR2 serving cells in the bands due to SS-RSRP, SS-RSRQ or SS-SINR measurement on an FR2 intra-frequency cell in different bands, provided that UE is capable of independent beam management on this FR2 band pair. Additionally, there is no scheduling restriction if the UE is configured with different numerology between SSB on one FR2 band and data on the other FR2 band provided the UE is configured for IBM operation for the band pair.

Note: When inter-band carrier aggregation in FR2 is performed, the scheduling restrictions as defined in clause 9.2.5.3.1 due to a given serving cell should also apply to another serving cell in a different FR2 band on the symbols that fully or partially overlap with the aforementioned restricted symbols, if UE does not have the capability of supporting *simultaneousRxTxInterBandCA* for this FR2 band pair.

If following conditions are met:

- The UE has been notified about system information update through paging,
- The gap between the UE's reception of PDCCH that UE monitors in the Type 2-PDCCH CSS set that notifies system information update, and the PDCCH that UE monitors in the Type0-PDCCH CSS set, is greater than 2 slots

For the SSB and CORESET for RMSI scheduling multiplexing patterns 3, the UE is expected to receive the PDCCH that the UE monitors in the Type0-PDCCH CSS set, and the corresponding PDSCH, on SSB symbols to be measured; and

For the SSB and CORESET for RMSI scheduling multiplexing patterns 2, the UE is expected to receive PDSCH that corresponds to the PDCCH that the UE monitors in the Type0-PDCCH CSS set, on SSB symbols to be measured.

#### 9.2.5.3.4 Scheduling availability of UE performing measurements on FR1 or FR2 in case of FR1-FR2 inter-band CA

There are no scheduling restrictions on FR1 serving cell(s) due to measurements performed on FR2 serving cell frequency layer. However, the scheduling restrictions as defined in clause 9.2.5.3.1 due to a given serving cell in FR2 should also apply to another serving cell in an FR1 band on the symbols that fully or partially overlap with the aforementioned restricted symbols, if UE does not have the capability of supporting *simultaneousRxTxInterBandCA* for this FR1-FR2 band pair.

There are no scheduling restrictions on FR2 serving cell(s) due to measurements performed on FR1 serving cell frequency layer. However, the scheduling restrictions as defined in clause 9.2.5.3.1 due to a given serving cell in FR1 should also apply to another serving cell in an FR2 band on the symbols that fully or partially overlap with the aforementioned restricted symbols, if UE does not have the capability of supporting *simultaneousRxTxInterBandCA* for this FR1-FR2 band pair.

### 9.2.5.4 SFTD Measurements between PCell and PSCell

#### 9.2.5.4.1 Introduction

This clause contains SFTD measurement requirements for UE which supports NR-DC and is configured with a PSCell in RRC\_CONNECTED state. The UE shall perform SFTD measurement between PCell and PSCell, and report the SFTD result with/without SS-RSRP after the network requests with *reportType* for the associated *reportConfig* set to *reportSFTD*. The overall delay includes RRC procedure delay defined in clause 12 in TS 38.331 [2], and SFTD measurement reporting delay in clause 9.2.5.4.3..

#### 9.2.5.4.2 SFTD Measurement delay

When no DRX is used in either of PCell and PSCell, the physical layer measurement period of the SFTD measurement shall be  $T_{\text{measure\_SFTD1}} = \max(200, 5 \times \text{SMTC period})$  ms, where the SMTC period refers to the maximum between the configured SMTC period in PCell and PSCell.

When DRX is used in either of the PCell or the PSCell, or in both PCell and PSCell, the physical layer measurement period ( $T_{\text{measure\_SFTD1}}$ ) of the SFTD measurement shall be as specified in Table 9.2.5.4.2-1.

**Table 9.2.5.4.2-1: SFTD measurement requirement when DRX is used**

DRX cycle length (s) <sup>Note 3</sup>	$T_{\text{measure\_SFTD1}}$ (s)
$\leq 0.04$	$\max(0.2, 5 \times \text{SMTC period})$ (Note2)
$0.04 < \text{DRX cycle} \leq 0.32$	$8 \times \max(\text{DRX cycle}, \text{SMTC period})$
$0.32 < \text{DRX cycle} \leq 10.24$	$5 \times \text{DRX cycle}$
Note 1: SMTC period in this table refers to the maximum between the configured SMTC period in PCell and PSCell. Note 2: Number of DRX cycles depends upon the DRX cycle in use Note 3: DRX cycle length in this table refers to the DRX cycle length configured for PCell or PSCell. When DRX is used in both PCell and PSCell, DRX cycle length in this table refers to the longer of the DRX cycle lengths for PCell and PSCell.	

If PSCell is changed without changing carrier frequency of PSCell, while the UE is performing SFTD measurements, the UE shall still meet SFTD measurement and accuracy requirements for the new PSCell. In this case the UE shall restart the SFTD measurement, and the total physical layer measurement period shall not exceed  $T_{\text{measure\_SFTD2}}$  as defined by the following expression:

$$T_{\text{measure\_SFTD2}} = (M+1) \cdot (T_{\text{measure\_SFTD1}}) + M \cdot T_{\text{PSCell\_change\_NRDC}}$$

where:

$M$  is the number of times the NR PSCell is changed over the measurement period ( $T_{\text{measure\_SFTD2}}$ ), and

$T_{\text{PSCell\_change\_NRDC}}$  is the time necessary to change the PSCell; it can be up to 25ms.

If PCell is changed, or if PSCell is changed with different carrier frequency from PSCell, the UE shall terminate SFTD measurements.

The measurement accuracy for the SFTD measurement when DRX is used as well as when no DRX is used shall be as specified in the clause 10.1.21.

#### 9.2.5.4.3 SFTD Measurement Reporting Delay

The SFTD measurement reporting delay is defined as the time between a command that will trigger an SFTD measurement report and the point when the UE starts to transmit the measurement report over the air interface. This requirement assumes that the measurement report is not delayed by other RRC signalling on the DCCH. This measurement reporting delay excludes a delay uncertainty resulted when inserting the measurement report to the TTI of the uplink DCCH. The delay uncertainty is:  $2 \times T_{\text{TI}_{\text{DCCH}}}$ . This measurement reporting delay excludes any delay caused by no UL resources available for UE to send the measurement report.

The SFTD measurement reporting delay shall be less than measurement period defined in clause 9.2.5.4.2 plus the RRC procedure delay defined in TS 38.331 [2].

## 9.2.6 Intra-frequency measurements with measurement gaps

### 9.2.6.1 Void

### 9.2.6.2 Intra-frequency cell identification

The UE shall be able to identify a new detectable intra frequency cell within  $T_{\text{identify\_intra\_without\_index}}$  if UE is not indicated to report SSB based RRM measurement result with the associated SSB index (*reportQuantityRsIndexes* or *maxNrofRSIndexesToReport* is not configured), or the UE has been indicated that the neighbour cell is synchronous with the serving cell (*deriveSSB-IndexFromCell* is enabled). Otherwise UE shall be able to identify a new detectable intra frequency cell within  $T_{\text{identify\_intra\_with\_index}}$ . The UE shall be able to identify a new detectable intra frequency SS block of an already detected cell within  $T_{\text{identify\_intra\_without\_index}}$ . It is assumed that *deriveSSB-IndexFromCell* is always enabled for FR1 TDD and FR2.

$$T_{\text{identify\_intra\_without\_index}} = T_{\text{PSS/SSS\_sync\_intra}} + T_{\text{SSB\_measurement\_period\_intra}} \text{ ms}$$

$$T_{\text{identify\_intra\_with\_index}} = T_{\text{PSS/SSS\_sync\_intra}} + T_{\text{SSB\_measurement\_period\_intra}} + T_{\text{SSB\_time\_index\_intra}} \text{ ms}$$

Where:

$T_{\text{PSS/SSS\_sync\_intra}}$ : it is the time period used in PSS/SSS detection given in table 9.2.6.2-1 or 9.2.6.2-2.

$T_{\text{SSB\_time\_index\_intra}}$ : it is the time period used to acquire the index of the SSB being measured given in table 9.2.6.2-3.

$T_{\text{SSB\_measurement\_period\_intra}}$ : equal to a measurement period of SSB based measurement given in table 9.2.6.3-1 or 9.2.6.3-2.

$\text{CSSF}_{\text{intra}}$ : it is a carrier specific scaling factor and is determined according to  $\text{CSSF}_{\text{within\_gap},i}$  in clause 9.1.5.2 for measurement conducted within measurement gaps.

$M_{\text{pss/sss\_sync\_with\_gaps}}$ : For a UE supporting FR2 power class 1,  $M_{\text{pss/sss\_sync\_with\_gaps}}=40$ . For a UE supporting FR2 power class 2,  $M_{\text{pss/sss\_sync\_with\_gaps}}=24$ . For a UE supporting FR2 power class 3,  $M_{\text{pss/sss\_sync\_with\_gaps}}=24$ . For a UE supporting power class 4,  $M_{\text{pss/sss\_sync\_with\_gaps}}=24$ .

$M_{\text{meas\_period\_with\_gaps}}$ : For a UE supporting power class 1,  $M_{\text{meas\_period\_with\_gaps}}=40$ . For a UE supporting power class 2,  $M_{\text{meas\_period\_with\_gaps}}=24$ . For a UE supporting power class 3,  $M_{\text{meas\_period\_with\_gaps}}=24$ . For a UE supporting power class 4,  $M_{\text{meas\_period\_with\_gaps}}=24$ .

If the higher layer signaling in TS 38.331 [2] of *smtc2* is present and *smtc1* is fully overlapping with measurement gaps and *smtc2* is partially overlapping with measurement gaps, requirements are not specified for  $T_{\text{identify\_intra\_without\_index}}$  OR  $T_{\text{identify\_intra\_with\_index}}$ .

If MCG DRX is in use, cell identification requirements for intra-frequency measurement in MCG specified in Table 9.2.6.2-1, Table 9.2.6.2-2, and Table 9.2.6.2-3 shall depend on the MCG DRX cycle. If SCG DRX is in use, cell identification requirements for intra-frequency measurement in SCG specified in Table 9.2.6.2-1, Table 9.2.6.2-2, and Table 9.2.6.2-3 shall depend on the SCG DRX cycle. Otherwise, the requirements for when DRX is not in use shall apply.

**Table 9.2.6.2-1: Time period for PSS/SSS detection (FR1)**

DRX cycle	$T_{\text{PSS/SSS\_sync\_intra}}$
No DRX	$\max(600\text{ms}, 5 \times \max(\text{MGRP}, \text{SMTC period})) \times \text{CSSF}_{\text{intra}}$
DRX cycle $\leq 320\text{ms}$	$\max(600\text{ms}, \text{ceil}(M2^{\text{Note 1}} \times 5) \times \max(\text{MGRP}, \text{SMTC period}, \text{DRX cycle})) \times \text{CSSF}_{\text{intra}}$
DRX cycle $> 320\text{ms}$	$5 \times \max(\text{MGRP}, \text{DRX cycle}) \times \text{CSSF}_{\text{intra}}$
NOTE 1: When <i>highSpeedMeasFlag-r16</i> is not configured, $M2 = 1.5$ ; When <i>highSpeedMeasFlag-r16</i> is configured, $M2 = 1.5$ if SMTC periodicity $> 40$ ms, otherwise $M2=1$ .	
NOTE 2: When <i>highSpeedMeasFlag-r16</i> is configured, the requirements apply only to UE supporting either <i>measurementEnhancement-r16</i> or <i>intraNR-MeasurementEnhancement-r16</i> on measurements of the primary component carrier and do not apply to measurements of a secondary component carrier with active SCell.	

**Table 9.2.6.2-2: Time period for PSS/SSS detection (FR2)**

DRX cycle	$T_{\text{PSS/SSS\_sync\_intra}}$
No DRX	$\max(600\text{ms}, M_{\text{pss/sss\_sync\_with\_gaps}} \times \max(\text{MGRP}, \text{SMTC period})) \times \text{CSSF}_{\text{intra}}$
DRX cycle $\leq 320\text{ms}$	$\max(600\text{ms}, \text{ceil}(1.5 \times M_{\text{pss/sss\_sync\_with\_gaps}}) \times \max(\text{MGRP}, \text{SMTC period}, \text{DRX cycle})) \times \text{CSSF}_{\text{intra}}$
DRX cycle $> 320\text{ms}$	$M_{\text{pss/sss\_sync\_with\_gaps}} \times \max(\text{MGRP}, \text{DRX cycle}) \times \text{CSSF}_{\text{intra}}$

**Table 9.2.6.2-3: Time period for time index detection (Frequency range FR1)**

DRX cycle	$T_{\text{SSB\_time\_index\_intra}}$
No DRX	$\max(120\text{ms}, 3 \times \max(\text{MGRP}, \text{SMTC period})) \times \text{CSSF}_{\text{intra}}$
DRX cycle $\leq 320\text{ms}$	$\max(120\text{ms}, \text{ceil}(M2^{\text{Note 1}} \times 3) \times \max(\text{MGRP}, \text{SMTC period}, \text{DRX cycle})) \times \text{CSSF}_{\text{intra}}$
DRX cycle $> 320\text{ms}$	$3 \times \max(\text{MGRP}, \text{DRX cycle}) \times \text{CSSF}_{\text{intra}}$
NOTE 1: When <i>highSpeedMeasFlag-r16</i> is not configured, $M2 = 1.5$ ; When <i>highSpeedMeasFlag-r16</i> is configured, $M2 = 1.5$ if SMTC periodicity $> 40$ ms, otherwise $M2=1$ .	
NOTE 2: When <i>highSpeedMeasFlag-r16</i> is configured, the requirements apply only to UE supporting either <i>measurementEnhancement-r16</i> or <i>intraNR-MeasurementEnhancement-r16</i> on measurements of the primary component carrier and do not apply to measurements of a secondary component carrier with active SCell.	

**Table 9.2.6.2-7: Void**

**Table 9.2.6.2-8: Void**

### 9.2.6.3 Intrafrequency Measurement Period

The measurement period for FR1 intrafrequency measurements with gaps is as shown in table 9.2.6.3-1.

The measurement period for FR2 intrafrequency measurements with gaps is as shown in table 9.2.6.3-2.

When *highSpeedMeasFlag-r16* is configured,  $T_{\text{SSB\_measurement\_period\_intra}}$  is specified in Table 9.2.6.3-3.

If MCG DRX is in use, measurement period requirements for intra-frequency measurement in MCG specified in Table 9.2.6.3-1 and Table 9.2.6.3-2, shall depend on the MCG DRX cycle. If SCG DRX is in use, measurement period requirements for intra-frequency measurement in SCG specified in Table 9.2.6.3-1 and Table 9.2.6.3-2, shall depend on the SCG DRX cycle. Otherwise, the requirements for when DRX is not in use shall apply.

For either an FR1 or FR2 serving cell, longer measurement period would be expected during the period  $T_{\text{identify\_CGI}}$  when the UE is requested to decode an NR CGI.

**Table 9.2.6.3-1: Measurement period for intra-frequency measurements with gaps(FR1)**

DRX cycle	$T_{\text{SSB\_measurement\_period\_intra}}$
No DRX	$\max(200\text{ms}, 5 \times \max(\text{MGRP}, \text{SMTC period})) \times \text{CSSF}_{\text{intra}}$
DRX cycle $\leq 320\text{ms}$	$\max(200\text{ms}, \text{ceil}(1.5 \times 5) \times \max(\text{MGRP}, \text{SMTC period}, \text{DRX cycle})) \times \text{CSSF}_{\text{intra}}$
DRX cycle $> 320\text{ms}$	$5 \times \max(\text{MGRP}, \text{DRX cycle}) \times \text{CSSF}_{\text{intra}}$

**Table 9.2.6.3-2: Measurement period for intra-frequency measurements with gaps(FR2)**

DRX cycle	$T_{\text{SSB\_measurement\_period\_intra}}$
No DRX	$\max(400\text{ms}, M_{\text{meas\_period with\_gaps}} \times \max(\text{MGRP}, \text{SMTC period})) \times \text{CSSF}_{\text{intra}}$
DRX cycle $\leq 320\text{ms}$	$\max(400\text{ms}, \text{ceil}(1.5 \times M_{\text{meas\_period with\_gaps}}) \times \max(\text{MGRP}, \text{SMTC period}, \text{DRX cycle})) \times \text{CSSF}_{\text{intra}}$ <sup>Note 1</sup>
DRX cycle $> 320\text{ms}$	$M_{\text{meas\_period with\_gaps}} \times \max(\text{MGRP}, \text{DRX cycle}) \times \text{CSSF}_{\text{intra}}$

**Table 9.2.6.3-3: Measurement period When *highSpeedMeasFlag-r16* is configured (Frequency Range FR1)**

DRX cycle	$T_{\text{SSB\_measurement\_period\_intra}}$
No DRX	$\max(200\text{ms}, 5 \times \max(\text{MGRP}, \text{SMTC period})) \times \text{CSSF}_{\text{intra}}$ <sup>Note 1</sup>
DRX cycle $\leq 160\text{ms}$	$\max(200\text{ms}, \text{ceil}(M2^{\text{Note 2}} \times 5) \times \max(\text{MGRP}, \text{SMTC period}, \text{DRX cycle})) \times \text{CSSF}_{\text{intra}}$
$160\text{ms} < \text{DRX cycle} \leq 320\text{ms}$	$\max(200\text{ms}, \text{ceil}(M2^{\text{Note 2}} \times 4) \times \max(\text{MGRP}, \text{DRX cycle})) \times \text{CSSF}_{\text{intra}}$
DRX cycle $> 320\text{ms}$	$Y^{\text{Note 3}} \times \max(\text{MGRP}, \text{DRX cycle}) \times \text{CSSF}_{\text{intra}}$
NOTE 1: If different SMTC periodicities are configured for different cells, the SMTC period in the requirement is the one used by the cell being identified NOTE 2: $M2 = 1.5$ if SMTC periodicity $> 40$ ms, otherwise $M2=1$ NOTE 3: $Y=3$ when SMTC $\leq 40\text{ms}$ , $Y=5$ when SMTC $> 40\text{ms}$ NOTE 4: When <i>highSpeedMeasFlag-r16</i> is configured, the requirements apply only to UE supporting either <i>measurementEnhancement-r16</i> or <i>intraNR-MeasurementEnhancement-r16</i> on measurements of the primary component carrier and do not apply to measurements of a secondary component carrier with active SCell.	

## 9.2A NR intra-frequency measurements with CCA

### 9.2A.1 Introduction

The requirements in clause 9.2.A apply for intra-frequency measurements on carrier frequency with CCA.

A measurement is defined as a SSB based intra-frequency measurement provided the centre frequency of the SSB of the serving cell indicated for measurement and the centre frequency of the SSB of the neighbour cell are the same, and the subcarrier spacing of the two SSBs are also the same.

The UE shall be able to identify new intra-frequency cells and perform SS-RSRP, SS-RSRQ, and SS-SINR measurements of identified intra-frequency cells if carrier frequency information is provided by PCell or the PSCell, even if no explicit neighbour list with physical layer cell identities is provided.

The UE can perform intra-frequency SSB based measurements without measurement gaps if

- the SSB is completely contained in the active BWP of the UE, or
- the active downlink BWP is initial BWP[3].

For intra-frequency SSB based measurements without measurement gaps, UE may cause scheduling restriction as specified in clause 9.2A.5.3.

SSB based measurements are configured along with one or two measurement timing configuration(s) (SMTC(s)) which provides periodicity, duration and offset information on a window of up to 5ms where the measurements are to be performed. For intra-frequency connected mode measurements, up to two measurement window periodicities may be configured. A single measurement window offset and measurement duration are configured per intra-frequency measurement object.

When measurement gaps are needed, the UE is not expected to detect SSB which start earlier than the gap starting time + switching time, nor detect SSB which end later than the gap end – switching time. Switching time is 0.5ms.

In the requirements of clause 9.2A, the term SMTC occasion not available at the UE refers to when the SMTC contains SSBs configured by gNB in a cell on a carrier frequency subject to CCA, but  $N$  candidate SSB positions for the same SSB index within the discovery burst transmission window are not available at the UE due to DL CCA failures at gNB during the corresponding period, where:

- For the cell detection procedure:  $N$  is at least one candidate SSB position (NOTE: the one candidate SSB position for the cell detection shall not be impacted by the set of candidate SSB positions which are already being measured by the UE within the current measurement period of the on-going measurements), and
- For other procedures in clause 9.2A:  $N$  are the first two successive candidate SSB positions when two or more candidate SSB positions are configured for this SSB index in one discovery burst transmission window, otherwise  $N$  is one candidate SSB position;

otherwise the SMTC occasion is considered as available at the UE.

## 9.2A.2 Requirements applicability

The requirements in clause 9.2A apply, provided:

- The cell being identified or measured is detectable.

An intra-frequency cell shall be considered detectable when for each relevant SSB:

- SS-RSRP related side conditions given in clause 10.1.27, for a corresponding Band,
- SS-RSRQ related side conditions given in clause 10.1.29, for a corresponding Band,
- SS-SINR related side conditions given in clause 10.1.31, for a corresponding Band,
- SSB<sub>RP</sub> and SSB  $\hat{E}_s/I_{ot}$  according to Annex B.2.8 for a corresponding Band.

## 9.2A.3 Number of cells and number of SSB

For each intra-frequency layer, during each layer 1 measurement period, the UE shall be capable of performing SS-RSRP, SS-RSRQ, and SS-SINR measurements for at least:

- 8 identified cells, and
- 14 SSBs with different SSB index and/or PCI on the intra-frequency layer, where the number of SSBs in the serving cell (except for the SCell) is not smaller than the number of configured RLM-RS SSB resources.

## 9.2A.4 Measurement Reporting Requirements

### 9.2A.4.1 Periodic Reporting

Reported RSRP, RSRQ, and RS-SINR measurements contained in periodically triggered measurement reports shall meet the requirements in clauses 10.1.27, 20.1.29, and 10.1.31, respectively.

### 9.2A.4.2 Event-triggered Periodic Reporting

Reported RSRP, RSRQ, and RS-SINR measurements contained in periodically triggered measurement reports shall meet the requirements in clauses 10.1.27, 20.1.29, and 10.1.31, respectively.

The first report in event triggered periodic measurement reporting shall meet the requirements specified in clause 9.2A.4.3.

### 9.2A.4.3 Event Triggered Reporting

Reported RSRP, RSRQ, and RS-SINR measurements contained in periodically triggered measurement reports shall meet the requirements in clauses 10.1.27, 20.1.29, and 10.1.31, respectively.

The UE shall not send any event triggered measurement reports as long as no reporting criteria is fulfilled.

The measurement reporting delay is defined as the time between an event that will trigger a measurement report and the point when the UE starts to transmit the measurement report over the air interface. This requirement assumes that the measurement report is not delayed by other RRC signalling on the DCCH. This measurement reporting delay excludes a delay uncertainty resulted when inserting the measurement report to the TTI of the uplink DCCH. The delay uncertainty is:  $2 \times TTI_{DCCH}$ . This measurement reporting delay excludes a delay which caused by no UL resources being available for UE to send the measurement report on, and all delays due to UL CCA failures until the successful transmission of the report.

The event triggered measurement reporting delay, measured without L3 filtering shall be less than  $T_{\text{identify\_intra\_with\_index\_CCA}}$  or  $T_{\text{identify\_intra\_without\_index\_CCA}}$  defined in clause 9.2A.5.1 or clause 9.2A.6.2. When L3 filtering is used an additional delay can be expected.

A cell is detectable only if at least one SSBs measured from the Cell being configured remains detectable during the time period  $T_{\text{identify\_intra\_without\_index\_CCA}}$  or  $T_{\text{identify\_intra\_with\_index\_CCA}}$  as defined in clause 9.2A.5.1 or clause 9.2A.6.2. If a cell which has been detectable at least for the time period  $T_{\text{identify\_intra\_without\_index\_CCA}}$  or  $T_{\text{identify\_intra\_with\_index\_CCA}}$  defined in clause 9.2A.5.1 or clause 9.2A.6.2 becomes undetectable for a period  $\leq 8$  seconds and then the cell becomes detectable again with the same spatial reception parameter and triggers an event, the event triggered measurement reporting delay shall be less than  $T_{\text{SSB\_measurement\_period\_intra\_CCA}}$  provided the timing to that cell has not changed more than  $\pm 3200/2^\mu T_c$  while the measurement gap has not been available and the L3 filter has not been used, where  $\mu$  is the SCS configuration as defined in clause 4.2 of TS 38.211 [3]. When L3 filtering is used, an additional delay can be expected.

## 9.2A.5 Intra-frequency measurements without measurement gaps

### 9.2A.5.1 Intra-frequency cell identification

The UE shall be able to identify a new detectable intra frequency cell within  $T_{\text{identify\_intra\_without\_index\_CCA}}$  if UE is not indicated to report SSB based RRM measurement result with the associated SSB index (*reportQuantityRsIndexes* or *maxNrofRSIndexesToReport* is not configured), or the UE is indicated that the neighbour cell is synchronous with the serving cell (*deriveSSB-IndexFromCell* is enabled). Otherwise UE shall be able to identify a new detectable intra frequency cell within  $T_{\text{identify\_intra\_with\_index\_CCA}}$ . The UE shall be able to identify a new detectable intra frequency SS block of an already detected cell within  $T_{\text{identify\_intra\_without\_index\_CCA}}$ .

$$T_{\text{identify\_intra\_without\_index\_CCA}} = (T_{\text{PSS/SSS\_sync\_intra\_CCA}} + T_{\text{SSB\_measurement\_period\_intra\_CCA}}) \text{ ms}$$

$$T_{\text{identify\_intra\_with\_index\_CCA}} = (T_{\text{PSS/SSS\_sync\_intra\_CCA}} + T_{\text{SSB\_measurement\_period\_intra\_CCA}} + T_{\text{SSB\_time\_index\_intra\_CCA}}) \text{ ms}$$

Where:

$T_{PSS/SSS\_sync\_intra\_CCA}$ : it is the time period used in PSS/SSS detection given in table 9.2A.5.1-1, 9.2A.5.1-3 (deactivated SCell).

$T_{SSB\_time\_index\_intra\_CCA}$ : it is the time period used to acquire the index of the SSB being measured given in table 9.2A.5.1-2 or 9.2A.5.1-4 (deactivated SCell).

$T_{SSB\_measurement\_period\_intra\_CCA}$ : equal to a measurement period of SSB based measurement given in table 9.2A.5.2-1, 9.2A.5.2-2 (deactivated SCell).  $CSSF_{intra}$ : it is a carrier specific scaling factor and is determined

- according to  $CSSF_{outside\_gap,i}$  in clause 9.1.5.1 for measurement conducted outside measurement gaps, i.e. when intra-frequency SMTC is fully non overlapping or partially overlapping with measurement gaps, or according to  $CSSF_{within\_gap,i}$  in clause 9.1.5.2 for measurement conducted within measurement gaps, i.e. when intra-frequency SMTC is fully overlapping with measurement gaps.

When intra-frequency SMTC is fully non overlapping with measurement gaps or intra-frequency SMTC is fully overlapping with MGs,  $K_p=1$

When intra-frequency SMTC is partially overlapping with measurement gaps,  $K_p = 1/(1 - (\text{SMTC period} / \text{MGRP}))$ , where SMTC period < MGRP.

If SCG DRX is in use, intra-frequency cell identification requirements specified in Table 9.2A.5.1-1, Table 9.2A.5.1-2, Table 9.2A.5.1-3, and Table 9.2A.5.1-4 shall depend on the SCG DRX cycle. Otherwise, the requirements for when DRX is not in use shall apply.

The requirements apply provided any two closest SMTC occasions available at the UE for the measurement shall be separated by no more than the maximum time requirement for the cell to remain known defined in clause 9.2A.4.3.

**Table 9.2A.5.1-1: Time period for PSS/SSS detection**

Condition	$T_{PSS/SSS\_sync\_intra\_CCA}$
No DRX	$\max(600\text{ms}, \text{ceil}((5+L_{PSS/SSS}) \times K_p) \times \text{SMTC period})^{\text{Note 1}} \times CSSF_{intra}$
DRX cycle $\leq 320\text{ms}$	$\max(600\text{ms}, \text{ceil}(1.5 \times (5+L_{PSS/SSS}) \times K_p) \times \max(\text{SMTC period}, \text{DRX cycle})) \times CSSF_{intra}$
DRX cycle $> 320\text{ms}$	$\text{ceil}((5+L_{PSS/SSS}) \times K_p) \times \text{DRX cycle} \times CSSF_{intra}$
NOTE 1: If different SMTC periodicities are configured for different cells, the SMTC period in the requirement is the one used by the cell being identified	
NOTE 2: When DRX is not configured, $L_{PSS/SSS}$ is the number of SMTC occasions not available at the UE during $T_{PSS/SSS\_sync\_intra\_CCA}$ for PSS/SSS detection, where $L_{PSS/SSS} < L_{PSS/SSS,max}$ . When DRX is configured, $L_{PSS/SSS}$ is the number of DRX cycles in which at least one SMTC occasion is not available at the UE during $T_{PSS/SSS\_sync\_intra\_CCA}$ for PSS/SSS detection, where $L_{PSS/SSS} < L_{PSS/SSS,max}$ . When configured with DRX, the UE is not required to determine the availability of SMTC occasions more frequent than once per DRX cycle. FFS: The UE is not required to determine the availability of SMTC occasions more frequent than what is required by $CSSF_{intra}$ .	
NOTE 3: $L_{PSS/SSS,max} = 7$ for $\max(\text{DRX cycle}, \text{SMTC period}) \leq 40\text{ms}$ where DRX cycle is 0 for non-DRX, $L_{PSS/SSS,max} = 5$ for $40\text{ms} < \max(\text{DRX cycle}, \text{SMTC period}) \leq 320\text{ms}$ , $L_{PSS/SSS,max} = 3$ for DRX cycle $> 320\text{ms}$ .	
NOTE 4: Upon exceeding $L_{PSS/SSS,max}$ , the UE is not required to meet the requirements for PSS/SSS detection.	

**Table 9.2A.5.1-2: Time period for time index detection**

Condition	$T_{SSB\_time\_index\_intra\_CCA}$
No DRX	$\max(120\text{ms}, \text{ceil}((3+L_{ind}) \times K_p) \times \text{SMTC period})^{\text{Note 1}} \times CSSF_{intra}$
DRX cycle $\leq 320\text{ms}$	$\max(120\text{ms}, \text{ceil}(1.5 \times (3+L_{ind}) \times K_p) \times \max(\text{SMTC period}, \text{DRX cycle})) \times CSSF_{intra}$
DRX cycle $> 320\text{ms}$	$\text{Ceil}((3+L_{ind}) \times K_p) \times \text{DRX cycle} \times CSSF_{intra}$
NOTE 1: If different SMTC periodicities are configured for different cells, the SMTC period in the requirement is the one used by the cell being identified	
NOTE 2: When DRX is not configured, $L_{ind}$ is the number of SMTC occasions not available at the UE during $T_{SSB\_time\_index\_intra\_CCA}$ for index detection, where $L_{ind} \leq L_{ind,max}$ . When DRX is configured, $L_{ind}$ is the number of DRX cycles in which at least one SMTC occasion is not available at the UE during $T_{SSB\_time\_index\_intra\_CCA}$ for index detection, where $L_{ind} \leq L_{ind,max}$ . When configured with DRX, the UE is not required to determine the availability of SMTC occasions more frequent than once per DRX cycle.	



FFS: The UE is not required to determine the availability of SMTC occasions more frequent than what is required by $CSSF_{intra}$ .
NOTE 3: $L_{ind,max} = 5$ for $\text{Max}(\text{DRX cycle}, \text{SMTC period}) \leq 40\text{ms}$ where DRX cycle is 0 for non-DRX, $L_{ind,max} = 3$ for $40\text{ms} < \text{Max}(\text{DRX cycle}, \text{SMTC period}) \leq 320\text{ms}$ , $L_{ind,max} = 2$ for $\text{DRX cycle} > 320\text{ms}$ .
NOTE 4: Upon exceeding $L_{ind,max}$ over the period of time $T_{SSB\_time\_index\_intra\_CCA}$ , the UE has to restart the time index detection procedure.

**Table 9.2A.5.1-3: Time period for PSS/SSS detection, deactivated SCell**

Condition	$T_{PSS/SSS\_sync\_intra\_CCA}$
No DRX	$(5 + L_{PSS/SSS,deact}) \times \text{measCycleSCell} \times CSSF_{intra}$
DRX cycle $\leq 320\text{ms}$	$(5 + L_{PSS/SSS,deact}) \times \max(\text{measCycleSCell}, 1.5 \times \text{DRX cycle}) \times CSSF_{intra}$
DRX cycle $> 320\text{ms}$	$(5 + L_{PSS/SSS,deact}) \times \max(\text{measCycleSCell}, \text{DRX cycle}) \times CSSF_{intra}$

NOTE 1: When DRX is not configured,  $L_{PSS/SSS,deact}$  is the number of SMTC occasions not available at the UE during  $T_{PSS/SSS\_sync\_intra\_CCA}$  for PSS/SSS detection, where  $L_{PSS/SSS,deact} < L_{PSS/SSS,deact,max}$ . When DRX is configured,  $L_{PSS/SSS,deact}$  is the number of DRX cycles in which at least one SMTC occasion is not available at the UE during  $T_{PSS/SSS\_sync\_intra\_CCA}$  for PSS/SSS detection, where  $L_{PSS/SSS,deact} < L_{PSS/SSS,deact,max}$ . When configured with DRX, the UE is not required to determine the availability of SMTC occasions more frequent than once per DRX cycle. When configured with measurement cycles, the UE is not required to determine the availability of SMTC occasions more frequent than once per measurement cycle. FFS: The UE is not required to determine the availability of SMTC occasions more frequent than what is required by  $CSSF_{intra}$ .

NOTE 2:  $L_{PSS/SSS,deact,max} = 7$  for non-DRX,  $L_{PSS/SSS,deact,max} = 5$  for  $40\text{ms} < \text{Max}(\text{DRX cycle}, \text{measCycleSCell}) \leq 320\text{ms}$ ,  $L_{PSS/SSS,deact,max} = 3$  for  $\text{Max}(\text{DRX cycle}, \text{measCycleSCell}) > 320\text{ms}$ .

NOTE 3: Upon exceeding  $L_{PSS/SSS,deact,max}$ , the UE is not required to meet the requirements for PSS/SSS detection.

**Table 9.2A.5.1-4: Time period for time index detection, deactivated SCell**

Condition	$T_{SSB\_time\_index\_intra\_CCA}$
No DRX	$(3 + L_{ind,deact}) \times \text{measCycleSCell} \times CSSF_{intra}$
DRX cycle $\leq 320\text{ms}$	$(3 + L_{ind,deact}) \times \max(\text{measCycleSCell}, 1.5 \times \text{DRX cycle}) \times CSSF_{intra}$
DRX cycle $> 320\text{ms}$	$(3 + L_{ind,deact}) \times \max(\text{measCycleSCell}, \text{DRX cycle}) \times CSSF_{intra}$

NOTE 1: When DRX is not configured,  $L_{ind,deact}$  is the number of SMTC occasions not available at the UE during  $T_{SSB\_time\_index\_intra\_CCA}$  for index detection, where  $L_{ind,deact} < L_{ind,deact,max}$ . When DRX is configured,  $L_{ind,deact}$  is the number of DRX cycles in which at least one SMTC occasion is not available at the UE during  $T_{SSB\_time\_index\_intra\_CCA}$  for index detection, where  $L_{ind,deact} < L_{ind,deact,max}$ . When configured with DRX, the UE is not required to determine the availability of SMTC occasions more frequent than once per DRX cycle. When configured with measurement cycles, the UE is not required to determine the availability of SMTC occasions more frequent than once per measurement cycle. FFS: The UE is not required to determine the availability of SMTC occasions more frequent than what is required by  $CSSF_{intra}$ .

NOTE 2:  $L_{ind,deact,max} = 5$  for non-DRX,  $L_{ind,deact,max} = 3$  for  $40\text{ms} < \text{Max}(\text{DRX cycle}, \text{measCycleSCell}) \leq 320\text{ms}$ ,  $L_{ind,deact,max} = 2$  for  $\text{Max}(\text{DRX cycle}, \text{measCycleSCell}) > 320\text{ms}$ .

NOTE 3: Upon exceeding  $L_{ind,deact,max}$  over the period of time  $T_{SSB\_time\_index\_intra\_CCA}$ , the UE has to restart the time index detection procedure.

### 9.2A.5.2 Measurement period

The measurement period for intra-frequency measurements without gaps is as shown in table 9.2A.5.2-1, 9.2A.5.2-2 (deactivated SCell).

If SCG DRX is in use, intra-frequency measurement period requirements specified in Table 9.2A.5.2-1, Table 9.2A.5.2-2 shall depend on the SCG DRX cycle. Otherwise, the requirements for when DRX is not in use shall apply.

The requirements apply provided any two closest SMTC occasions available at the UE for the measurement shall be separated by no more than the maximum time requirement for the cell to remain known defined in clause 9.2A.4.3.

When the time period of unsuccessful measurement attempts due to exceeding the maximum number of unavailable at the UE SMTC occasions of an already identified cell exceeds the maximum time requirement for the cell to remain

known defined in clause 9.2A.4.3, UE shall stop the measurement attempts on this SSB and perform the detection procedure again like for any other SSB.

**Table 9.2A.5.2-1: Measurement period for intra-frequency measurements without gaps**

Condition	$T_{SSB\_measurement\_period\_intra\_CCA}$
No DRX	$\max(200\text{ms}, \text{ceil}((5+L_{meas}) \times K_p) \times \text{SMTC period})^{\text{Note 1}} \times \text{CSSF}_{intra}$
DRX cycle $\leq$ 320ms	$\max(200\text{ms}, \text{ceil}(1.5 \times (5+L_{meas}) \times K_p) \times \max(\text{SMTC period}, \text{DRX cycle})) \times \text{CSSF}_{intra}$
DRX cycle $>$ 320ms	$\text{ceil}((5+L_{meas}) \times K_p) \times \text{DRX cycle} \times \text{CSSF}_{intra}$
NOTE 1: If different SMTC periodicities are configured for different cells, the SMTC period in the requirement is the one used by the cell being identified	
NOTE 2: When DRX is not configured, $L_{meas}$ is the number of SMTC occasions not available at the UE during $T_{SSB\_measurement\_period\_intra\_CCA}$ for measurement, where $L_{meas} < L_{meas,max}$ . When DRX is configured, $L_{meas}$ is the number of DRX cycles in which at least one SMTC occasion is not available at the UE during $T_{SSB\_measurement\_period\_intra\_CCA}$ for measurement, where $L_{meas} < L_{meas,max}$ . When configured with DRX, the UE is not required to determine the availability of SMTC occasions more frequent than once per DRX cycle. FFS: The UE is not required to determine the availability of SMTC occasions more frequent than what is required by $\text{CSSF}_{intra}$ .	
NOTE 3: $L_{meas,max} = 7$ for $\text{Max}(\text{DRX cycle}, \text{SMTC period}) \leq 40\text{ms}$ where DRX cycle is 0 for non-DRX, $L_{meas,max} = 5$ for $40\text{ms} < \text{Max}(\text{DRX cycle}, \text{SMTC period}) \leq 320\text{ms}$ , $L_{meas,max} = 3$ for $\text{DRX cycle} > 320\text{ms}$ .	
NOTE 4: Upon exceeding $L_{meas,max}$ over the period of time $T_{SSB\_measurement\_period\_intra\_CCA}$ , the UE has to restart the measurement procedure.	

**Table 9.2A.5.2-2: Measurement period for intra-frequency measurements without gaps (deactivated SCell)**

Condition	$T_{SSB\_measurement\_period\_intra\_CCA}$
No DRX	$(5+L_{meas,deact}) \times \text{measCycleSCell} \times \text{CSSF}_{intra}$
DRX cycle $\leq$ 320ms	$(5+L_{meas,deact}) \times \max(\text{measCycleSCell}, 1.5 \times \text{DRX cycle}) \times \text{CSSF}_{intra}$
DRX cycle $>$ 320ms	$(5+L_{meas,deact}) \times \max(\text{measCycleSCell}, \text{DRX cycle}) \times \text{CSSF}_{intra}$
NOTE 1: When DRX is not configured, $L_{meas,deact}$ is the number of SMTC occasions not available at the UE during $T_{SSB\_measurement\_period\_intra\_CCA}$ for measurement, where $L_{meas,deact} < L_{meas,deact,max}$ . When DRX is configured, $L_{meas,deact}$ is the number of DRX cycles in which at least one SMTC occasion is not available at the UE during $T_{SSB\_measurement\_period\_intra\_CCA}$ for measurement, where $L_{meas,deact} < L_{meas,deact,max}$ . When configured with DRX, the UE is not required to determine the availability of SMTC occasions more frequent than once per DRX cycle. When configured with measurement cycles, the UE is not required to determine the availability of SMTC occasions more frequent than once per measurement cycle. FFS: The UE is not required to determine the availability of SMTC occasions more frequent than what is required by $\text{CSSF}_{intra}$ .	
NOTE 2: $L_{meas,deact,max} = 7$ for non-DRX, $L_{meas,deact,max} = 5$ for $40\text{ms} < \text{Max}(\text{DRX cycle}, \text{measCycleSCell}) \leq 320\text{ms}$ , $L_{meas,deact,max} = 3$ for $\text{Max}(\text{DRX cycle}, \text{measCycleSCell}) > 320\text{ms}$ .	
NOTE 3: Upon exceeding $L_{meas,deact,max}$ over the period of time $T_{SSB\_measurement\_period\_intra\_CCA}$ , the UE has to restart the measurement procedure.	

### 9.2A.5.3 Scheduling availability of UE during intra-frequency measurements

UE shall be capable of measuring without measurement gaps when the SSB is completely contained in the active bandwidth part of the UE. When any of the conditions in the following clauses is met, there are restrictions on the scheduling availability; otherwise, there is no scheduling restriction. Note that the SSB symbols indicated by the union set of *SSB-ToMeasure* from all the configured measurement objects on the same serving carrier which can be merged [2], if it is configured; otherwise, all  $L$  SSB symbols within SMTC window duration defined in clause 4.1 of TS 38.213 [3] are included.

#### 9.2A.5.3.1 Scheduling availability of UE performing measurements in TDD bands

When UE performs intra-frequency measurements in a TDD band, the following restrictions apply due to SS-RSRP or SS-SINR measurement

- The UE is not expected to transmit PUCCH/PUSCH/SRS on SSB symbols configured to be measured, and on 1 data symbol before each consecutive SSB symbols configured to be measured and 1 data symbol after each consecutive SSB symbols configured to be measured within SMTC window duration if *deriveSSB\_IndexFromCell* is enabled. If the high layer in TS 38.331 [2] signaling of *smtc2* is configured, the SMTC periodicity follows *smtc2*; Otherwise SMTC periodicity follows *smtc1*.
- The UE is not expected to transmit PUCCH/PUSCH/SRS on all symbols within SMTC window duration if *deriveSSB\_IndexFromCell* is not enabled. If the high layer in TS 38.331 [2] signaling of *smtc2* is configured, the SMTC periodicity follows *smtc2*; Otherwise SMTC periodicity follows *smtc1*.

When the UE performs intra-frequency measurements in a TDD band, the following restrictions apply due to SS-RSRQ measurement

- The UE is not expected to transmit PUCCH/PUSCH/SRS on SSB symbols configured to be measured, RSSI measurement symbols, and on 1 data symbol before each consecutive SSB configured to be measured/RSSI symbols and 1 data symbol after each consecutive SSB configured to be measured/RSSI symbols within SMTC window duration if *deriveSSB\_IndexFromCell* is enabled. If the high layer signaling of *smtc2* is configured (in TS 38.331), the SMTC periodicity follows *smtc2*; Otherwise the SMTC periodicity follows *smtc1*.
- The UE is not expected to transmit PUCCH/PUSCH/SRS on all symbols within SMTC window duration if *deriveSSB\_IndexFromCell* is not enabled. If the high layer in TS 38.331 signaling of *smtc2* is configured, the SMTC periodicity follows *smtc2*; Otherwise SMTC periodicity follows *smtc1*.

When intra-band carrier aggregation in unlicensed spectrum is performed, the scheduling restrictions due to a given serving cell should also apply to all other serving cells in the same band on the symbols that fully or partially overlap with the aforementioned restricted symbols.

#### 9.2A.5.3.2 Scheduling availability of UE performing measurements with a different subcarrier spacing than PDSCH/PDCCH

For UE which do not support *simultaneousRxDataSSB-DiffNumerology* [14] the following restrictions apply due to SS-RSRP/RSRQ/SINR measurement

- If *deriveSSB\_IndexFromCell* is enabled the UE is not expected to transmit PUCCH/PUSCH/SRS or receive PDCCH/PDSCH/TRS/CSI-RS for CQI on SSB symbols to be measured, and on 1 data symbol before each consecutive SSB symbols to be measured and 1 data symbol after each consecutive SSB symbols to be measured within SMTC window duration.
- If *deriveSSB\_IndexFromCell* is not enabled the UE is not expected to transmit PUCCH/PUSCH/SRS or receive PDCCH/PDSCH/TRS/CSI-RS for CQI on all symbols within SMTC window duration.

When intra-band carrier aggregation is performed, the scheduling restrictions due to a given serving cell should also apply to all other serving cells in the same band on the symbols that fully or partially overlap with aforementioned restricted symbols.

### 9.2A.6 Intra-frequency measurements with measurement gaps

#### 9.2A.6.1 Intra-frequency cell identification

The UE shall be able to identify a new detectable intra frequency cell within  $T_{\text{identify\_intra\_without\_index\_CCA}}$  if UE is not indicated to report SSB based RRM measurement result with the associated SSB index (*reportQuantityRsIndexes* or *maxNrofRSIndexesToReport* is not configured), or the UE has been indicated that the neighbour cell is synchronous with the serving cell (*deriveSSB-IndexFromCell* is enabled). Otherwise UE shall be able to identify a new detectable intra frequency cell within  $T_{\text{identify\_intra\_with\_index\_CCA}}$ . The UE shall be able to identify a new detectable intra frequency SS block of an already detected cell within  $T_{\text{identify\_intra\_without\_index\_CCA}}$ .

$$T_{\text{identify\_intra\_without\_index\_CCA}} = T_{\text{PSS/SSS\_sync\_intra\_CCA}} + T_{\text{SSB\_measurement\_period\_intra\_CCA}} \text{ ms}$$

$$T_{\text{identify\_intra\_with\_index\_CCA}} = T_{\text{PSS/SSS\_sync\_intra\_CCA}} + T_{\text{SSB\_measurement\_period\_intra\_CCA}} + T_{\text{SSB\_time\_index\_intra\_CCA}}$$

Where:

$T_{\text{PSS/SSS\_sync\_intra\_CCA}}$ : it is the time period used in PSS/SSS detection given in table 9.2A.6.1-1.

$T_{SSB\_time\_index\_intra\_CCA}$ : it is the time period used to acquire the index of the SSB being measured given in table 9.2A.6.1-2.

$T_{SSB\_measurement\_period\_intra\_CCA}$ : equal to a measurement period of SSB based measurement given in table 9.2A.6.2-1 or 9.2A.6.1-3.  $CSSF_{intra}$ : it is a carrier specific scaling factor and is determined according to  $CSSF_{within\_gap,i}$  in clause 9.1.5.2 for measurement conducted within measurement gaps.

If SCG DRX is in use, intra-frequency cell identification requirements specified in Table 9.2A.6.1-1 and Table 9.2A.6.1-2 shall depend on the SCG DRX cycle. Otherwise, the requirements for when DRX is not in use shall apply.

The requirements apply provided any two closest SMTC occasions available at the UE for the measurement shall be separated by no more than the maximum time requirement for the cell to remain known defined in clause 9.2A.4.3.

**Table 9.2A.6.1-1: Time period for PSS/SSS detection**

Condition	$T_{PSS/SSS\_sync\_intra\_CCA}$
No DRX	$\max(600\text{ms}, (5+L_{PSS/SSS,gaps}) \times \max(\text{MGRP, SMTC period})) \times CSSF_{intra}$
DRX cycle $\leq 320\text{ms}$	$\max(600\text{ms}, \text{ceil}(1.5 \times (5+L_{PSS/SSS,gaps})) \times \max(\text{DRX cycle, MGRP, SMTC period})) \times CSSF_{intra}$
DRX cycle $> 320\text{ms}$	$(5+L_{PSS/SSS,gaps}) \times (\text{MGRP, DRX cycle}) \times CSSF_{intra}$
<p>NOTE 1: When DRX is not configured, <math>L_{PSS/SSS,gaps}</math> is the number of SMTC occasions not available at the UE during <math>T_{PSS/SSS\_sync\_intra\_CCA}</math> for PSS/SSS detection, where <math>L_{PSS/SSS,gaps} &lt; L_{PSS/SSS,gaps,max}</math>. When DRX is configured, <math>L_{PSS/SSS,gaps}</math> is the number of DRX cycles in which at least one SMTC occasion is not available at the UE during <math>T_{PSS/SSS\_sync\_intra\_CCA}</math> for PSS/SSS detection, where <math>L_{PSS/SSS,gaps} &lt; L_{PSS/SSS,gaps,max}</math>. When configured with DRX, the UE is not required to determine the availability of SMTC occasions more frequent than once per DRX cycle. When configured with measurement gaps, the UE is not required to determine the availability of SMTC occasions more frequent than once during MGRP. FFS: The UE is not required to determine the availability of SMTC occasions more frequent than what is required by <math>CSSF_{intra}</math>.</p> <p>NOTE 2: <math>L_{PSS/SSS,gaps,max} = 7</math> for <math>\text{Max}(\text{DRX cycle, SMTC period, MGRP}) \leq 40\text{ms}</math> where DRX cycle is 0 for non-DRX, <math>L_{PSS/SSS,gaps,max} = 5</math> for <math>40\text{ms} &lt; \text{Max}(\text{DRX cycle, SMTC period, MGRP}) \leq 320\text{ms}</math>, <math>L_{PSS/SSS,gaps,max} = 3</math> for DRX cycle <math>&gt; 320\text{ms}</math>.</p> <p>NOTE 3: Upon exceeding <math>L_{PSS/SSS,gaps,max}</math>, the UE is not required to meet the requirements for PSS/SSS detection.</p>	

**Table 9.2A.6.1-2: Time period for time index detection**

Condition	$T_{SSB\_time\_index\_intra\_CCA}$
No DRX	$\max(120\text{ms}, (3+L_{ind,gaps}) \times \max(\text{MGRP, SMTC period})) \times CSSF_{intra}$
DRX cycle $\leq 320\text{ms}$	$\max(120\text{ms}, \text{ceil}(1.5 \times (3+L_{ind,gaps})) \times \max(\text{MGRP, SMTC period, DRX cycle})) \times CSSF_{intra}$
DRX cycle $> 320\text{ms}$	$(3+L_{ind,gaps}) \times (\text{MGRP, DRX cycle}) \times CSSF_{intra}$
<p>NOTE 1: When DRX is not configured, <math>L_{ind,gaps}</math> is the number of SMTC occasions not available at the UE during <math>T_{SSB\_time\_index\_intra\_CCA}</math> for index detection where <math>L_{ind,gaps} &lt; L_{ind,gaps,max}</math>. When DRX is configured, <math>L_{ind,gaps}</math> is the number of DRX cycles in which at least one SMTC occasion is not available at the UE during <math>T_{SSB\_time\_index\_intra\_CCA}</math> for index detection where <math>L_{ind,gaps} &lt; L_{ind,gaps,max}</math>. When configured with DRX, the UE is not required to determine the availability of SMTC occasions more frequent than once per DRX cycle. When configured with measurement gaps, the UE is not required to determine the availability of SMTC occasions more frequent than once during MGRP. FFS: The UE is not required to determine the availability of SMTC occasions more frequent than what is required by <math>CSSF_{intra}</math>.</p> <p>NOTE 2: <math>L_{ind,gaps,max} = 5</math> for <math>\text{Max}(\text{DRX cycle, SMTC period, MGRP}) \leq 40\text{ms}</math> where DRX cycle is 0 for non-DRX, <math>L_{ind,gaps,max} = 3</math> for <math>40\text{ms} &lt; \text{Max}(\text{DRX cycle, SMTC period, MGRP}) \leq 320\text{ms}</math>, <math>L_{ind,gaps,max} = 2</math> for DRX cycle <math>&gt; 320\text{ms}</math>.</p> <p>NOTE 3: Upon exceeding <math>L_{ind,gaps,max}</math> over the <math>T_{SSB\_time\_index\_intra\_CCA}</math> period of time, the UE has to restart the time index detection procedure.</p>	

## 9.2A.6.2 Intra-frequency Measurement Period

The measurement period for intra-frequency measurements with gaps is as shown in table 9.2A.6.2-1.

If SCG DRX is in use, intra-frequency measurement period requirements specified in Table 9.2A.6.2-1 shall depend on the SCG DRX cycle. Otherwise, the requirements for when DRX is not in use shall apply.

The requirements apply provided any two closest SMTC occasions available at the UE for the measurement shall be separated by no more than the maximum time requirement for the cell to remain known defined in clause 9.2A.4.3.

When the time period of unsuccessful measurement attempts due to exceeding the maximum number of unavailable at the UE SMTC occasions of an already identified cell exceeds the maximum time requirement for the cell to remain known defined in clause 9.2A.4.3, UE shall stop the measurement attempts on this SSB and perform the detection procedure again like for any other SSB.

**Table 9.2A.6.2-1: Measurement period for intra-frequency measurements with gaps**

Condition	$T_{SSB\_measurement\_period\_intra\_CCA}$
No DRX	$\max(200\text{ms}, (5+L_{meas,gaps}) \times \max(\text{MGRP}, \text{SMTC period})) \times \text{CSSF}_{intra}$
DRX cycle $\leq$ 320ms	$\max(200\text{ms}, \text{ceil}(1.5 \times (5+L_{meas,gaps})) \times \max(\text{MGRP}, \text{SMTC period}, \text{DRX cycle})) \times \text{CSSF}_{intra}$
DRX cycle $>$ 320ms	$(5+L_{meas,gaps}) \times (\text{MGRP}, \text{DRX cycle}) \times \text{CSSF}_{intra}$
NOTE 1: When DRX is not configured, $L_{meas,gaps}$ is the number of SMTC occasions not available at the UE during $T_{SSB\_time\_index\_intra\_CCA}$ for measurement where $L_{meas,gaps} < L_{meas,gaps,max}$ . When DRX is configured, $L_{meas,gaps}$ is the number of DRX cycles in which at least one SMTC occasion is not available at the UE during $T_{SSB\_time\_index\_intra\_CCA}$ for measurement where $L_{meas,gaps} < L_{meas,gaps,max}$ . When configured with DRX, the UE is not required to determine the availability of SMTC occasions more frequent than once per DRX cycle. When configured with measurement gaps, the UE is not required to determine the availability of SMTC occasions more frequent than once during MGRP. FFS: The UE is not required to determine the availability of SMTC occasions more frequent than what is required by $\text{CSSF}_{intra}$ .	
NOTE 2: $L_{meas,gaps,max} = 7$ for $\max(\text{DRX cycle}, \text{SMTC period}, \text{MGRP}) \leq 40\text{ms}$ where DRX cycle is 0 for non-DRX, $L_{meas,gaps,max} = 5$ for $40\text{ms} < \max(\text{DRX cycle}, \text{SMTC period}, \text{MGRP}) \leq 320\text{ms}$ , $L_{meas,gaps,max} = 3$ for DRX cycle $>$ 320ms.	
NOTE 3: Upon exceeding $L_{meas,gaps,max}$ over the $T_{SSB\_measurement\_period\_intra\_CCA}$ period of time, the UE has to restart the measurement procedure.	

## 9.2A.7 Intra-frequency RSSI and Channel occupancy measurements

### 9.2A.7.1 Intra-frequency RSSI measurements

An RSSI measurement is defined as an intra-frequency measurement provided that the RSSI measurement bandwidth is fully contained within the current carrier bandwidth of the UE.

The UE physical layer shall be capable of performing the RSSI measurements, defined in TS 38.215 [4] on one or more serving carriers operating with CCA, TS 37.213 [33], if the carrier(s) are indicated by higher layers [2], and report the RSSI measurements to higher layers. The UE physical layer shall provide to higher layers a single RSSI sample for each OFDM symbol within each configured RSSI measurement duration [2] occurring with a configured RSSI measurement timing configuration periodicity [2], *rmtc-Periodicity*.

The UE can perform RSSI measurements without measurement gaps if RSSI measurement bandwidth is fully within the active DL BWP of the UE.

The measurement period for intra-frequency RSSI measurements without measurement gaps is as shown in Table 9.2A.7.1-1 and Table 9.2A.7.1-2. The measurement period for intra-frequency RSSI measurements with measurement gaps is as shown in Table 9.2A.7.1-3.

**Table 9.2A.7.1-1: Measurement period for intra-frequency RSSI measurements without measurement gaps when SMTC and RMTc are overlapping**

Condition <sup>NOTE1,2</sup>	$T_{RSSI\_measurement\_period\_intra\_cca}$
No DRX	$\max(\text{reportInterval}, \text{rmtc-Periodicity}) \times \text{CSSF}_{outside\_gap,i}$
DRX	$\max(\text{reportInterval}, \max(\text{rmtc-Periodicity}, \text{DRX cycle})) \times \text{CSSF}_{outside\_gap,i}$
NOTE 1: DRX or non DRX requirements apply according to the conditions described in clause 3.6.1	
NOTE 2: $\text{CSSF}_{outside\_gap,i}$ is a carrier specific scaling factor and is determined according to $\text{CSSF}_{outside\_gap,i}$ in clause 9.1.5.1 for measurement conducted outside measurement gap.	

**Table 9.2A.7.1-2: Measurement period for intra-frequency RSSI measurements without measurement gaps when SMTC and RMTC are not overlapping**

Condition <sup>NOTE1,2</sup>	T <sub>RSSI_measurement_period_intra_cca</sub>
No DRX	$\max(\text{reportInterval}, N_{\text{intra-MO}} \cdot \text{rmtc-Periodicity})$
DRX	$\max(\text{reportInterval}, N_{\text{intra-MO}} \cdot \max(\text{rmtc-Periodicity}, \text{DRXcycle length}))$
NOTE 1: DRX or non DRX requirements apply according to the conditions described in clause 3.6.1	
NOTE 2: $N_{\text{intra-MO}}$ is defined as the number of measurement objects that can be measured without gaps	

**Table 9.2A.7.1-3: Measurement period for intra-frequency RSSI measurements with measurement gaps**

Condition <sup>NOTE1,2</sup>	T <sub>RSSI_measurement_period_intra_cca</sub>
No DRX	$\max(\text{reportInterval}, \max(\text{rmtc-Periodicity}, \text{MGRP}) \times \text{CSSF}_{\text{intra}})$
DRX	$\max(\text{reportInterval}, \max(\text{rmtc-Periodicity}, \text{MGRP}, \text{DRX cycle length}) \times \text{CSSF}_{\text{intra}})$
NOTE 1: DRX or non DRX requirements apply according to the conditions described in clause 3.6.1	
NOTE 2: $\text{CSSF}_{\text{intra}}$ is a carrier specific scaling factor and is determined according to $\text{CSSF}_{\text{within\_gap},i}$ in clause 9.1.5.2 for measurement conducted within measurement gaps.	

If the UE requires measurement gaps to perform intra-frequency measurements, a single measurement gap pattern is used for all concurrent intra-frequency measurements, including intra-frequency RSSI measurements. The RSSI measurement duration and the measurement gap should be aligned, and the following additional condition should be fulfilled:

- Entire RSSI measurement duration should be contained in the measurement gap.

The RSSI measurement performed and reported according to this clause shall meet the RSSI measurement accuracy requirement in Clause 10.1.34.1. The reported RSSI measurement values contained in measurement reports shall be based on the measurement report mapping requirements specified in Clause 10.1.34.3.

## 9.2A.7.2 Intra-frequency Channel occupancy measurements

The UE shall be capable of estimating the channel occupancy on one or more serving carrier frequencies indicated by higher layers [2], based on RSSI samples provided by the physical layer.

The UE can perform channel occupancy measurements without measurement gaps if RSSI measurement bandwidth is fully within the active DL BWP of the UE.

The measurement period for intra-frequency channel occupancy measurements without measurement gap is as shown in Table 9.2A.7.2-1 and Table 9.2A.7.1-2. The measurement period for intra-frequency RSSI measurements with measurement gaps is as shown in Table 9.2A.7.2-3.

**Table 9.2A.7.2-1: Measurement period for intra-frequency Channel Occupancy measurements without measurement gaps when SMTC and RMTC are overlapping**

Condition <sup>NOTE1,2</sup>	T <sub>RSSI_measurement_period_intra_cca</sub>
No DRX	$\max(\text{reportInterval}, \text{rmtc-Periodicity} \cdot \text{CSSF}_{\text{outside\_gap},i})$
DRX	$\max(\text{reportInterval}, \max(\text{rmtc-Periodicity}, \text{DRX cycle}) \cdot \text{CSSF}_{\text{outside\_gap},i})$
NOTE 1: DRX or non DRX requirements apply according to the conditions described in clause 3.6.1	
NOTE 2: $\text{CSSF}_{\text{outside\_gap},i}$ is a carrier specific scaling factor and is determined according to $\text{CSSF}_{\text{within\_gap},i}$ in clause 9.1.5.1 for measurement conducted outside measurement gap.	

**Table 9.2A.7.2-2: Measurement period for intra-frequency Channel Occupancy measurements without measurement gaps when SMTC and RMTC are not overlapping**

Condition <sup>NOTE1,2</sup>	T <sub>RSSI_measurement_period_intra_cca</sub>
No DRX	$\max(\text{reportInterval}, N_{\text{intra-MO}} \cdot \text{rmtc-Periodicity})$
DRX	$\max(\text{reportInterval}, N_{\text{intra-MO}} \cdot \max(\text{rmtc-Periodicity}, \text{DRXcycle length}))$
NOTE 1: DRX or non DRX requirements apply according to the conditions described in clause 3.6.1	
NOTE 2: $N_{\text{intra-MO}}$ is defined as the number of measurement objects that can be measured without gaps	

**Table 9.2A.7.2-3: Measurement period for intra-frequency Channel Occupancy measurements with measurement gaps**

Condition <sup>NOTE1,2</sup>	$T_{\text{RSSI\_measurement\_period\_intra\_cca}}$
No DRX	$\max(\text{reportInterval}, \max(\text{rmtc-Periodicity}, \text{MGRP}) \times \text{CSSF}_{\text{intra}})$
DRX	$\max(\text{reportInterval}, \max(\text{rmtc-Periodicity}, \text{MGRP}, \text{DRX cycle length}) \times \text{CSSF}_{\text{intra}})$
NOTE 1: DRX or non DRX requirements apply according to the conditions described in clause 3.6.1	
NOTE 2: $\text{CSSF}_{\text{intra}}$ is a carrier specific scaling factor and is determined according to $\text{CSSF}_{\text{within\_gap},i}$ in clause 9.1.5.2 for measurement conducted within measurement gaps.	

If the UE requires measurement gaps to perform intra-frequency measurements, a single measurement gap pattern is used for all concurrent intra-frequency measurements, including intra-frequency RSSI measurements. The RSSI measurement duration and the measurement gap should be aligned, and the following additional condition should be fulfilled:

- Entire RSSI measurement duration should be contained in the measurement gap.

The channel occupancy measurement performed and reported according to this clause shall meet the channel occupancy measurement accuracy requirements in Clause 10.1.35.1. The reported channel occupancy measurement values contained in measurement reports shall be based on the measurement reporting range specified in TS 38.331 [2].

### 9.2A.7.3 Scheduling restriction during RSSI and Channel Occupancy measurements

When the UE performs intra-frequency RSSI/CO measurements in unlicensed spectrum, the following restrictions apply due to RSSI/CO measurements:

- The UE is not expected to transmit PUCCH/PUSCH/SRS on UL symbols which are overlapping in time with the RSSI measurement symbols configured by RMTTC.

When intra-band carrier aggregation in unlicensed spectrum is performed, the scheduling restrictions due to a given serving cell should also apply to all other serving cells in the same band on the symbols that fully or partially overlap with the aforementioned restricted symbols.

## 9.3 NR inter-frequency measurements

### 9.3.1 Introduction

A measurement is defined as an SSB based inter-frequency measurement provided it is not defined as an intra-frequency measurement according to clause 9.2.

The UE shall be able to identify new inter-frequency cells and perform SS-RSRP, SS-RSRQ, and SS-SINR measurements of identified inter-frequency cells if carrier frequency information is provided by PCell or PSCell, even if no explicit neighbour list with physical layer cell identities is provided.

A measurement is defined as an inter-frequency SSB based measurements without measurement gaps for UE capable of *interFrequencyMeas-NoGap* provided

- the UE supports *interFrequencyMeas-Nogap-r16* [15], and
- the SSB is completely contained in the active BWP of the UE.

For inter-frequency SSB based measurements without measurement gaps, UE may cause scheduling restriction as specified in clause 9.3.5.3.

Note: Non-CA capable UE is not expected to indicate support of *interFrequencyMeas-Nogap-r16* [15].

SSB based measurements are configured along with a measurement timing configuration (SMTC) per carrier, which provides periodicity, duration and offset information on a window of up to 5ms where the measurements on the configured inter-frequency carrier are to be performed. For inter-frequency connected mode measurements, one measurement window periodicity may be configured per inter-frequency measurement object.

When measurement gaps are needed, the UE is not expected to detect SSB and measure RSSI of RSRQ on an inter-frequency measurement object which start earlier than the gap starting time + switching time, nor detect SSB and measure RSSI of RSRQ which ends later than the gap end – switching time. When the inter-frequency cells are in FR2 and the per-FR gap is configured to the UE in EN-DC, SA NR, NE-DC and NR-DC, or the serving cells are in FR2, the inter-frequency cells are in FR2 and the per-UE gap is configured to the UE in SA NR and NR-DC, the switching time is 0.25ms. Otherwise the switching time is 0.5ms.

The requirements in this clause shall also apply, when the UE is configured to perform SRS carrier based switching and using measurement gaps.

Longer measurement period would be expected during the period  $T_{\text{identify\_CGI}}$  when the UE is requested to decode an NR CGI.

## 9.3.2 Requirements applicability

The requirements in clause 9.3 apply, provided:

- The cell being identified or measured is detectable.

An inter-frequency cell shall be considered detectable when for each relevant SSB:

- SS-RSRP related side conditions given in clauses 10.1.4 and 10.1.5 for FR1 and FR2, respectively, for a corresponding Band,
- SS-RSRQ related side conditions given in clauses 10.1.9 and 10.1.10 for FR1 and FR2, respectively, for a corresponding Band,
- SS-SINR related side conditions given in clauses 10.1.14 and 10.1.15 for FR1 and FR2, respectively, for a corresponding Band,
- SSB<sub>RP</sub> and SSB  $\hat{E}_s/I_{ot}$  according to Annex B.2.3 for a corresponding Band.

### 9.3.2.1 Void

### 9.3.2.2 Void

## 9.3.3 Number of cells and number of SSB

### 9.3.3.1 Requirements for FR1

For each inter-frequency layer, during each layer 1 measurement period, the UE shall be capable of performing SS-RSRP, SS-RSRQ, and SS-SINR measurements for at least:

- 4 identified cells, and
- 7 SSBs with different SSB index and/or PCI on the inter-frequency layer.

### 9.3.3.2 Requirements for FR2

For each inter-frequency layer, during each layer 1 measurement period, the UE shall be capable of performing SS-RSRP, SS-RSRQ, and SS-SINR measurements for at least:

- 4 identified cells, and
- 10 SSBs with different SSB index and/or PCI on the inter-frequency layer, and
- 1 SSB per identified cell.



### 9.3.4 Inter-frequency measurement with measurement gaps

When measurement gaps are provided, or the UE supports capability of conducting such measurements without gaps, the UE shall be able to identify a new detectable inter frequency cell within  $T_{\text{identify\_inter\_without\_index}}$  if UE is not indicated to report SSB based RRM measurement result with the associated SSB index (*reportQuantityRsIndexes* or *maxNrofRSIndexesToReport* is not configured). Otherwise UE shall be able to identify a new detectable inter frequency cell within  $T_{\text{identify\_inter\_with\_index}}$ . The UE shall be able to identify a new detectable inter frequency SS block of an already detected cell within  $T_{\text{identify\_inter\_without\_index}}$ .

$$T_{\text{identify\_inter\_without\_index}} = (T_{\text{PSS/SSS\_sync\_inter}} + T_{\text{SSB\_measurement\_period\_inter}}) \text{ ms}$$

$$T_{\text{identify\_inter\_with\_index}} = (T_{\text{PSS/SSS\_sync\_inter}} + T_{\text{SSB\_measurement\_period\_inter}} + T_{\text{SSB\_time\_index\_inter}}) \text{ ms}$$

Where:

$T_{\text{PSS/SSS\_sync\_inter}}$ : it is the time period used in PSS/SSS detection given in table 9.3.4-1 and table 9.3.4-2.

$T_{\text{SSB\_time\_index\_inter}}$ : it is the time period used to acquire the index of the SSB being measured given in table 9.3.4-3 and table 9.3.4-4.

$T_{\text{SSB\_measurement\_period\_inter}}$ : equal to a measurement period of SSB based measurement given in table 9.3.5-1 and table 9.3.5-2.

$M_{\text{pss/sss\_sync\_inter}}$ : For a UE supporting FR2 power class 1,  $M_{\text{pss/sss\_sync\_inter}} = 64$  samples. For a UE supporting FR2 power class 2,  $M_{\text{pss/sss\_sync\_inter}} = 40$  samples. For a UE supporting FR2 power class 3,  $M_{\text{pss/sss\_sync\_inter}} = 40$  samples. For a UE supporting FR2 power class 4,  $M_{\text{pss/sss\_sync\_inter}} = 40$  samples.

$M_{\text{SSB\_index\_inter}}$ : For a UE supporting FR2 power class 1,  $M_{\text{SSB\_index\_inter}} = 40$  samples. For a UE supporting FR2 power class 2,  $M_{\text{SSB\_index\_inter}} = 24$  samples. For a UE supporting FR2 power class 3,  $M_{\text{SSB\_index\_inter}} = 24$  samples. For a UE supporting FR2 power class 4,  $M_{\text{SSB\_index\_inter}} = 24$  samples.

$M_{\text{meas\_period\_inter}}$ : For a UE supporting FR2 power class 1,  $M_{\text{meas\_period\_inter}} = 64$  samples. For a UE supporting FR2 power class 2,  $M_{\text{meas\_period\_inter}} = 40$  samples. For a UE supporting FR2 power class 3,  $M_{\text{meas\_period\_inter}} = 40$  samples. For a UE supporting FR2 power class 4,  $M_{\text{meas\_period\_inter}} = 40$  samples.

$\text{CSSF}_{\text{inter}}$ : it is a carrier specific scaling factor and is determined according to  $\text{CSSF}_{\text{within\_gap},i}$  in clause 9.1.5.2 for measurement conducted within measurement gaps.

**Table 9.3.4-1: Time period for PSS/SSS detection (Frequency range FR1)**

Condition <sup>NOTE1,2</sup>	$T_{\text{PSS/SSS\_sync\_inter}}$
No DRX	$\text{Max}(600\text{ms}, 8 \times \text{Max}(\text{MGRP}, \text{SMTC period})) \times \text{CSSF}_{\text{inter}}$
DRX cycle $\leq 320\text{ms}$	$\text{Max}(600\text{ms}, \text{Ceil}(8 \times 1.5) \times \text{Max}(\text{MGRP}, \text{SMTC period}, \text{DRX cycle})) \times \text{CSSF}_{\text{inter}}$
DRX cycle $> 320\text{ms}$	$8 \times \text{DRX cycle} \times \text{CSSF}_{\text{inter}}$
NOTE 1: DRX or non DRX requirements apply according to the conditions described in clause 3.6.1	
NOTE 2: In EN-DC operation, the parameters, timers and scheduling requests referred to in clause 3.6.1 are for the secondary cell group. The DRX cycle is the DRX cycle of the secondary cell group.	

**Table 9.3.4-2: Time period for PSS/SSS detection, (Frequency range FR2)**

Condition <sup>NOTE1,2</sup>	$T_{\text{PSS/SSS\_sync\_inter}}$
No DRX	$\text{Max}(600\text{ms}, M_{\text{pss/sss\_sync\_inter}} \times \text{Max}(\text{MGRP}, \text{SMTC period})) \times \text{CSSF}_{\text{inter}}$
DRX cycle $\leq 320\text{ms}$	$\text{Max}(600\text{ms}, (1.5 \times M_{\text{pss/sss\_sync\_inter}}) \times \text{Max}(\text{MGRP}, \text{SMTC period}, \text{DRX cycle})) \times \text{CSSF}_{\text{inter}}$
DRX cycle $> 320\text{ms}$	$M_{\text{pss/sss\_sync\_inter}} \times \text{DRX cycle} \times \text{CSSF}_{\text{inter}}$
NOTE 1: DRX or non DRX requirements apply according to the conditions described in clause 3.6.1	
NOTE 2: In EN-DC operation, the parameters, timers and scheduling requests referred to in clause 3.6.1 are for the secondary cell group. The DRX cycle is the DRX cycle of the secondary cell group.	

**Table 9.3.4-3: Time period for time index detection (Frequency range FR1)**

Condition <sup>NOTE1,2</sup>	$T_{\text{SSB\_time\_index\_inter}}$
No DRX	$\text{Max}(120\text{ms}, 3 \times \text{Max}(\text{MGRP}, \text{SMTC period})) \times \text{CSSF}_{\text{inter}}$

DRX cycle $\leq$ 320ms	$\text{Max}(120\text{ms}, \text{Ceil}(3 \times 1.5) \times \text{Max}(\text{MGRP}, \text{SMTC period}, \text{DRX cycle})) \times \text{CSSF}_{\text{inter}}$
DRX cycle $>$ 320ms	$3 \times \text{DRX cycle} \times \text{CSSF}_{\text{inter}}$
NOTE 1: DRX or non DRX requirements apply according to the conditions described in clause 3.6.1	
NOTE 2: In EN-DC operation, the parameters, timers and scheduling requests referred to in clause 3.6.1 are for the secondary cell group. The DRX cycle is the DRX cycle of the secondary cell group.	

**Table 9.3.4-4: Time period for time index detection (Frequency range FR2)**

Condition <sup>NOTE1,2</sup>	$T_{\text{SSB\_time\_index\_inter}}$
No DRX	$\text{Max}(200\text{ms}, M_{\text{SSB\_index\_inter}} \times \text{Max}(\text{MGRP}, \text{SMTC period})) \times \text{CSSF}_{\text{inter}}$
DRX cycle $\leq$ 320ms	$\text{Max}(200\text{ms}, (1.5 \times M_{\text{SSB\_index\_inter}}) \times \text{Max}(\text{MGRP}, \text{SMTC period}, \text{DRX cycle})) \times \text{CSSF}_{\text{inter}}$
DRX cycle $>$ 320ms	$M_{\text{SSB\_index\_inter}} \times \text{DRX cycle} \times \text{CSSF}_{\text{inter}}$
NOTE 1: DRX or non DRX requirements apply according to the conditions described in clause 3.6.1	
NOTE 2: In EN-DC operation, the parameters, timers and scheduling requests referred to in clause 3.6.1 are for the secondary cell group. The DRX cycle is the DRX cycle of the secondary cell group.	

9.3.4.1 Void

9.3.4.2 Void

### 9.3.5 Inter-frequency measurements

When measurement gaps are provided for inter frequency measurements, or the UE supports capability of conducting such measurements without gaps, the UE physical layer shall be capable of reporting SS-RSRP, SS-RSRQ and SS-SINR measurements to higher layers with measurement accuracy as specified in clauses 10.1.4, 10.1.5, 10.1.9, 10.1.10, 10.1.14 and 10.1.15, respectively, as shown in table 9.3.5-1 and 9.3.5-2:

**Table 9.3.5-1: Measurement period for inter-frequency measurements with gaps (Frequency FR1)**

Condition <sup>NOTE1,2</sup>	$T_{\text{SSB\_measurement\_period\_inter}}$
No DRX	$\text{Max}(200\text{ms}, 8 \times \text{Max}(\text{MGRP}, \text{SMTC period})) \times \text{CSSF}_{\text{inter}}$
DRX cycle $\leq$ 320ms	$\text{Max}(200\text{ms}, \text{Ceil}(8 \times 1.5) \times \text{Max}(\text{MGRP}, \text{SMTC period}, \text{DRX cycle})) \times \text{CSSF}_{\text{inter}}$
DRX cycle $>$ 320ms	$8 \times \text{DRX cycle} \times \text{CSSF}_{\text{inter}}$
NOTE 1: DRX or non DRX requirements apply according to the conditions described in clause 3.6.1	
NOTE 2: In EN-DC operation, the parameters, timers and scheduling requests referred to in clause 3.6.1 are for the secondary cell group. The DRX cycle is the DRX cycle of the secondary cell group.	

**Table 9.3.5-2: Measurement period for inter-frequency measurements with gaps (Frequency FR2)**

Condition <sup>NOTE1,2</sup>	$T_{\text{SSB\_measurement\_period\_inter}}$
No DRX	$\text{Max}(400\text{ms}, M_{\text{meas\_period\_inter}} \times \text{Max}(\text{MGRP}, \text{SMTC period})) \times \text{CSSF}_{\text{inter}}$
DRX cycle $\leq$ 320ms	$\text{Max}(400\text{ms}, (1.5 \times M_{\text{meas\_period\_inter}}) \times \text{Max}(\text{MGRP}, \text{SMTC period}, \text{DRX cycle})) \times \text{CSSF}_{\text{inter}}$
DRX cycle $>$ 320ms	$M_{\text{meas\_period\_inter}} \times \text{DRX cycle} \times \text{CSSF}_{\text{inter}}$
NOTE 1: DRX or non DRX requirements apply according to the conditions described in clause 3.6.1	
NOTE 2: In EN-DC operation, the parameters, timers and scheduling requests referred to in clause 3.6.1 are for the secondary cell group. The DRX cycle is the DRX cycle of the secondary cell group.	

9.3.5.1 Void

9.3.5.2 Void

9.3.5.3 Void

## 9.3.6 Inter-frequency measurements reporting requirements

### 9.3.6.1 Periodic Reporting

Reported SS-RSRP, SS-RSRQ, and SS-SINR measurements contained in periodically triggered measurement reports shall meet the requirements in clauses 10.1.4.1, 10.1.5.1, 10.1.9.1, 10.1.10.1, 10.1.14.1 and 10.1.15.1, respectively.

### 9.3.6.2 Event-triggered Periodic Reporting

Reported SS-RSRP, SS-RSRQ, and SS-SINR measurements contained in event triggered periodic measurement reports shall meet the requirements in clauses 10.1.4.1, 10.1.5.1, 10.1.9.1, 10.1.10.1, 10.1.14.1 and 10.1.15.1, respectively.

The first report in event triggered periodic measurement reporting shall meet the requirements specified in clause 9.3.6.3.

### 9.3.6.3 Event-triggered Reporting

Reported SS-RSRP, SS-RSRQ, and SS-SINR measurements contained in event triggered measurement reports shall meet the requirements in clauses 10.1.4.1, 10.1.5.1, 10.1.9.1, 10.1.10.1, 10.1.14.1 and 10.1.15.1, respectively.

The UE shall not send any event triggered measurement reports, as long as no reporting criteria are fulfilled.

The measurement reporting delay is defined as the time between an event that will trigger a measurement report and the point when the UE starts to transmit the measurement report over the air interface. This requirement assumes that the measurement report is not delayed by other RRC signalling on the DCCH. This measurement reporting delay excludes a delay uncertainty resulted when inserting the measurement report to the TTI of the uplink DCCH. The delay uncertainty is:  $2 \times TTI_{DCCH}$ . This measurement reporting delay excludes a delay which caused by no UL resources for UE to send the measurement report.

The event triggered measurement reporting delay, measured without L3 filtering shall be within  $T_{\text{identify\_inter\_without\_index}}$  if UE is not indicated to report SSB based RRM measurement result with the associated SSB index. Otherwise UE shall be able to identify a new detectable inter frequency cell within  $T_{\text{identify\_inter\_with\_index}}$ . Both  $T_{\text{identify\_inter\_without\_index}}$  and  $T_{\text{identify\_inter\_with\_index}}$  are defined in clause 9.3.4. When L3 filtering is used an additional delay can be expected. In EN-DC and NE-DC operation, when the UE is configured to perform E-UTRA SRS carrier-based switching an additional delay can be expected in FR1 if the UE is capable of per-FR gap, or in both FR1 and FR2 if the UE is not capable of per-FR gap.

A cell is detectable only if at least one SSB measured from the cell being configured remains detectable during the time period  $T_{\text{identify\_inter\_without\_index}}$  or  $T_{\text{identify\_inter\_with\_index}}$  defined in clause 9.3.4. If a cell which has been detectable at least for the time period  $T_{\text{identify\_inter\_without\_index}}$  or  $T_{\text{identify\_inter\_with\_index}}$  defined in clause 9.3.4 becomes undetectable for a period  $\leq 5$  seconds and then the cell becomes detectable again with the same spatial reception parameter and then triggers the measurement report as per TS 38.331 [2], the event triggered measurement reporting delay shall be less than  $T_{\text{SSB\_measurement\_period\_inter}}$  defined in clause 9.3.5 provided the timing to that cell has not changed more than  $\pm 3200/2^{\mu}$  Tc while measurement gap has not been available and the L3 filtering has not been used, where  $\mu$  is the SCS configuration as defined in clause 4.2 of TS 38.211 [3]. When L3 filtering is used an additional delay can be expected. In EN-DC and NE-DC operation, when the UE is configured to perform E-UTRA SRS carrier-based switching an additional delay can be expected in FR1 if the UE is capable of per-FR gap, or in both FR1 and FR2 if the UE is not capable of per-FR gap.

## 9.3.7 Void

## 9.3.8 Inter-frequency SFTD measurement requirements

### 9.3.8.1 Introduction

This clause contains requirements for a UE supporting NR inter-frequency SFTD measurement and is applicable in RRC\_CONNECTED state. The UE shall, depending on network request, perform inter-frequency SFTD measurement and report SFTD result with or without SS-RSRP. The overall delay includes RRC procedure delay defined in clause 12 in TS 38.331 [2] and SFTD measurement reporting delay in clause 9.3.8.3.

UE which fulfils the requirements in clause 9.3.8 is not supposed to fulfil the requirements defined in clause 9.2.5.4.

### 9.3.8.2 SFTD Measurement delay

The requirements on SFTD measurement delay defined in this clause are applicable under the side condition  $\hat{E}_s/I_{ot} \geq -3$  dB for the inter-frequency neighbour cell. Depending on configuration, the SFTD measurement may be carried out with or without the support of configured measurement gaps. In the current release, indication on whether to carry out the SFTD measurement with or without measurement gaps is implicit and depending on whether measurement gaps are configured.

The UE shall be able to detect, identify and measure SFTD of up to 3 of the strongest applicable inter-frequency neighbour cells on the carrier frequency provided in the SFTD measurement configuration. Further depending on the SFTD measurement configuration, the UE shall additionally report SS-RSRP for the one or more strongest cells. The UE may or may not be configured with *cellsForWhichToReportSFTD*. The UE does not expect *cellsForWhichToReportSFTD* to change during an ongoing SFTD measurement.

When no measurement gaps are provided, the UE shall be capable of finding the inter-frequency neighbour cell regardless of its SSB position in the SMTC period, provided that the carrier frequency where SFTD measurement is configured and the serving carrier(s) form a supported CA or NR-DC band combination of the UE. The SFTD measurement shall be conducted with sustained connection to the PCell and activated SCell(s) in MCG. Depending on capability, the UE may be allowed to cause a certain amount of interruptions for reconfiguration of the radio receiver, as specified in clause 8.2.2.2.6.

When measurement gaps are provided, the UE shall be capable of finding the inter-frequency neighbour cell under the additional condition that the SSB at least occasionally falls within the measurement gap.

When no DRX is used, the UE shall be capable of determining SFTD within a physical layer measurement period of  $T_{\text{measure\_SFTD1}}$  as follows:

- For SFTD measurements without measurement gaps, and without additional SS-RSRP reporting:
  - For carrier frequency in FR1:  $T_{\text{measure\_SFTD1}} = 14$  SMTC periods
  - For carrier frequency in FR2:  $T_{\text{measure\_SFTD1}} = 112$  SMTC periods
- For SFTD measurements in measurement gaps, and without additional SS-RSRP reporting:
  - For carrier frequency in FR1:  $T_{\text{measure\_SFTD1}} = \text{CSSF}_{\text{inter}} \times 8 \times \text{Max}(\text{MGRP}, \text{SMTC period})$
  - For carrier frequency in FR2:  $T_{\text{measure\_SFTD1}} = \text{CSSF}_{\text{inter}} \times 64 \times \text{Max}(\text{MGRP}, \text{SMTC period})$
- For SFTD measurements without measurement gaps, and with additional SS-RSRP reporting:
  - For carrier frequency in FR1:  $T_{\text{measure\_SFTD1}} = 19$  SMTC periods
  - For carrier frequency in FR2:  $T_{\text{measure\_SFTD1}} = 152$  SMTC periods
- For SFTD measurements in measurement gaps, and with additional SS-RSRP reporting:
  - For carrier frequency in FR1:  $T_{\text{measure\_SFTD1}} = \text{CSSF}_{\text{inter}} \times 13 \times \text{Max}(\text{MGRP}, \text{SMTC period})$
  - For carrier frequency in FR2:  $T_{\text{measure\_SFTD1}} = \text{CSSF}_{\text{inter}} \times 104 \times \text{Max}(\text{MGRP}, \text{SMTC period})$

where  $CSSF_{inter}$  is a carrier specific scaling factor and is determined according to  $CSSF_{within\_gap,i}$  in clause 9.1.5.2 for measurement conducted within measurement gaps.

When DRX is used, the same  $T_{measure\_SFTD1}$  as for non-DRX applies, but the reporting delay depends on the DRX cycle length in use.

In case PCell is changed due to handover, the UE shall terminate the inter-frequency SFTD measurement.

The measurement accuracy for the SFTD measurement shall fulfil the requirement in clause 10.1.21.3. The measurement accuracy for additionally reported SS-RSRP shall fulfil the requirement in clauses 10.1.4.1 and 10.1.5.1 for neighbour cell in FR1 and FR2, respectively.

### 9.3.8.3 SFTD Measurement reporting delay

The SFTD measurement reporting delay is defined as the time between a command that will trigger an SFTD measurement report and the point when the UE starts to transmit the measurement report over the air interface. This requirement assumes that the measurement report is not delayed by other RRC signalling on the DCCH. This measurement reporting delay excludes a delay uncertainty of  $2 \times TTI_{DCCH}$  resulting when inserting the measurement report to the TTI of the uplink DCCH. This measurement reporting delay excludes any delay caused by lack of UL resources for UE to send the measurement report.

The SFTD measurement reporting delay shall be less than  $T_{measure\_SFTD1}$  defined in clause 9.3.8.2 plus the RRC procedure delay defined in TS 38.331 [2].

## 9.3.9 Inter frequency measurements without measurement gaps

### 9.3.9.1 Inter frequency Cell identification

If UE supports *interFrequencyMeas-NoGap-r16* and the flag *interFrequencyConfig-NoGap-r16* is configured by the Network, UE shall be able to identify a new detectable inter frequency cell within  $T_{identify\_inter\_without\_index}$  if UE is not indicated to report SSB based RRM measurement result with the associated SSB index (*reportQuantityRsIndexes* or *maxNrofRSIndexesToReport* is not configured). Otherwise UE shall be able to identify a new detectable inter frequency cell within  $T_{identify\_inter\_with\_index}$ . The UE shall be able to identify a new detectable inter frequency SS block of an already detected cell within  $T_{identify\_inter\_without\_index}$ . It is assumed that when UE performs inter-frequency measurements without measurement gaps in a TDD bands on FR1 and FR2, the following condition is met:

- SFN and frame boundary across serving cell and inter-frequency neighbor cells is aligned

$T_{identify\_inter\_without\_index} = (T_{PSS/SSS\_sync\_inter} + T_{SSB\_measurement\_period\_inter})$  ms

$T_{identify\_inter\_with\_index} = (T_{PSS/SSS\_sync\_inter} + T_{SSB\_measurement\_period\_inter} + T_{SSB\_time\_index\_inter})$  ms

Where:

$T_{PSS/SSS\_sync\_inter}$ : it is the time period used in PSS/SSS detection given in table 9.3.9.1-1 and table 9.3.9.1-2.

$T_{SSB\_time\_index\_inter}$ : it is the time period used to acquire the index of the SSB being measured given in table 9.3.9.1-3.

$T_{SSB\_measurement\_period\_inter}$ : equal to a measurement period of SSB based measurement given in table 9.3.9.2-1 and table 9.3.9.2-2.

$CSSF_{inter}$ : it is a carrier specific scaling factor and is determined according to  $CSSF_{outside\_gap,i}$  in clause 9.1.5.1 for measurement conducted outside measurement gaps, i.e. when interfrequency SMTC is fully non overlapping or partially overlapping with measurement gaps or according to  $CSSF_{within\_gap,i}$  in clause 9.1.5.2 for measurement conducted within measurement gaps, i.e. when interfrequency SMTC is fully overlapping with measurement gaps.

$M_{pss/sss\_sync\_inter}$ : For a UE supporting FR2 power class 1,  $M_{pss/sss\_sync\_inter} = 40$  samples. For a UE supporting FR2 power class 2,  $M_{pss/sss\_sync\_inter} = 24$  samples. For a UE supporting FR2 power class 3,  $M_{pss/sss\_sync\_inter} = 24$  samples. For a UE supporting FR2 power class 4,  $M_{pss/sss\_sync} = 24$  samples.

$M_{\text{meas\_period\_inter}}$ : For a UE supporting FR2 power class 1,  $M_{\text{meas\_period\_inter}} = 40$  samples. For a vehicle mounted UE supporting FR2 power class 2,  $M_{\text{meas\_period\_inter}} = 24$  samples. For a UE supporting FR2 power class 3,  $M_{\text{meas\_period\_inter}} = 24$  samples. For a UE supporting FR2 power class 4,  $M_{\text{meas\_period\_inter}} = 24$  samples.

When interfrequency SMTC is fully non overlapping with measurement gaps or interfrequency SMTC is fully overlapping with MGs,  $K_p = 1$ .

When interfrequency SMTC is partially overlapping with measurement gaps,  $K_p = 1 / (1 - (\text{SMTC period} / \text{MGRP}))$ , where  $\text{SMTC period} < \text{MGRP}$ .

For FR2,

$K_{\text{layer1\_measurement}} = 1$ ,

- if all of the reference signals configured for RLM, BFD, CBD or L1-RSRP for beam reporting on any FR2 serving frequency in the same band outside measurement gap are not fully overlapped by inter-frequency SMTC occasions, or
- if all of the reference signal configured for RLM, BFD, CBD or L1-RSRP for beam reporting on any FR2 serving frequency in the same band outside measurement gap and fully-overlapped by inter-frequency SMTC occasions are not overlapped with any of the SSB symbols and the RSSI symbols, and 1 symbol before each consecutive SSB symbols and the RSSI symbols, and 1 symbol after each consecutive SSB symbols and the RSSI symbols, given that *SSB-ToMeasure* and *SS-RSSI-Measurement* are configured, where SSB symbols are indicated by *SSB-ToMeasure* and RSSI symbols are indicated by *SS-RSSI-Measurement*;

$K_{\text{layer1\_measurement}} = 1.5$ , otherwise.

If the above-mentioned reference signal configured for L1-RSRP measurement is aperiodic CSI-RS resource, longer cell identification delay would be expected.

**Table 9.3.9.1-1: Time period for PSS/SSS detection, (FR1)**

DRX cycle	$T_{\text{PSS/SSS\_sync\_inter}}$
No DRX	$\max(600\text{ms}, \text{ceil}(5 \times K_p) \times \text{SMTC period})^{\text{Note 1}} \times \text{CSSF}_{\text{inter}}$
$\text{DRX cycle} \leq 320\text{ms}$	$\max(600\text{ms}, \text{ceil}(1.5 \times 5 \times K_p) \times \max(\text{SMTC period}, \text{DRX cycle})) \times \text{CSSF}_{\text{inter}}$
$\text{DRX cycle} > 320\text{ms}$	$\text{ceil}(5 \times K_p) \times \text{DRX cycle} \times \text{CSSF}_{\text{inter}}$
NOTE 1: If different SMTC periodicities are configured for different cells, the SMTC period in the requirement is the one used by the cell being identified	

**Table 9.3.9.1-2: Time period for PSS/SSS detection, (FR2)**

DRX cycle	$T_{\text{PSS/SSS\_sync\_inter}}$
No DRX	$\max(600\text{ms}, \text{ceil}(M_{\text{pss/sss\_sync\_inter}} \times K_p \times K_{\text{layer1\_measurement}}) \times \text{SMTC period})^{\text{Note 1}} \times \text{CSSF}_{\text{inter}}$
$\text{DRX cycle} \leq 320\text{ms}$	$\max(600\text{ms}, \text{ceil}(1.5 \times M_{\text{pss/sss\_sync\_inter}} \times K_p \times K_{\text{layer1\_measurement}}) \times \max(\text{SMTC period}, \text{DRX cycle})) \times \text{CSSF}_{\text{inter}}$
$\text{DRX cycle} > 320\text{ms}$	$\text{ceil}(M_{\text{pss/sss\_sync\_inter}} \times K_p \times K_{\text{layer1\_measurement}}) \times \text{DRX cycle} \times \text{CSSF}_{\text{inter}}$
NOTE 1: If different SMTC periodicities are configured for different cells, the SMTC period in the requirement is the one used by the cell being identified	

**Table 9.3.9.1-3: Time period for time index detection (FR1)**

DRX cycle	$T_{\text{SSB\_time\_index\_inter}}$
No DRX	$\max(120\text{ms}, \text{ceil}(3 \times K_p) \times \text{SMTC period})^{\text{Note 1}} \times \text{CSSF}_{\text{inter}}$
$\text{DRX cycle} \leq 320\text{ms}$	$\max(120\text{ms}, \text{ceil}(1.5 \times 3 \times K_p) \times \max(\text{SMTC period}, \text{DRX cycle})) \times \text{CSSF}_{\text{inter}}$
$\text{DRX cycle} > 320\text{ms}$	$\text{Ceil}(3 \times K_p) \times \text{DRX cycle} \times \text{CSSF}_{\text{inter}}$

NOTE 1: If different SMTC periodicities are configured for different cells, the SMTC period in the requirement is the one used by the cell being identified

### 9.3.9.2 Measurement period

The UE physical layer shall be capable of reporting SS-RSRP, SS-RSRQ and SS-SINR measurements to higher layers with measurement accuracy as specified in clauses 10.1.4, 10.1.5, 10.1.9, 10.1.10, 10.1.14 and 10.1.15, respectively, as shown in table 9.3.9.2-1 and 9.3.9.2-2, if UE supports inter-frequency measurement without measurement gaps:

**Table 9.3.9.2-1: Measurement period for inter-frequency measurements without gaps ((FR1))**

DRX cycle	$T_{SSB\_measurement\_period\_inter}$
No DRX	$\max(200\text{ms}, \text{ceil}(5 \times K_p) \times \text{SMTC period})^{\text{Note 1}} \times \text{CSSF}_{inter}$
DRX cycle $\leq 320\text{ms}$	$\max(200\text{ms}, \text{ceil}(1.5 \times 5 \times K_p) \times \max(\text{SMTC period}, \text{DRX cycle})) \times \text{CSSF}_{inter}$
DRX cycle $> 320\text{ms}$	$\text{ceil}(5 \times K_p) \times \text{DRX cycle} \times \text{CSSF}_{inter}$
NOTE 1: If different SMTC periodicities are configured for different cells, the SMTC period in the requirement is the one used by the cell being identified	

**Table 9.3.9.2-2: Measurement period for inter-frequency measurements without gaps (FR2)**

DRX cycle	$T_{SSB\_measurement\_period\_inter}$
No DRX	$\max(400\text{ms}, \text{ceil}(M_{meas\_period\_inter} \times K_p \times K_{layer1\_measurement}) \times \text{SMTC period})^{\text{Note 1}} \times \text{CSSF}_{inter}$
DRX cycle $\leq 320\text{ms}$	$\max(400\text{ms}, \text{ceil}(1.5 \times M_{meas\_period\_inter} \times K_p \times K_{layer1\_measurement}) \times \max(\text{SMTC period}, \text{DRX cycle})) \times \text{CSSF}_{inter}$
DRX cycle $> 320\text{ms}$	$\text{ceil}(M_{meas\_period\_inter} \times K_p \times K_{layer1\_measurement}) \times \text{DRX cycle} \times \text{CSSF}_{inter}$
NOTE 1: If different SMTC periodicities are configured for different cells, the SMTC period in the requirement is the one used by the cell being identified	

### 9.3.9.3 Scheduling availability of UE during inter-frequency measurements

If UE supports *interFrequencyMeas-NoGap-r16* and the flag *interFrequencyConfig-NoGap-r16* is configured by the Network, UE is required to be capable of measuring without measurement gaps when the SSB is completely contained in the active bandwidth part of the UE. When any of the conditions in the following clauses is met, there are restrictions on the scheduling availability; otherwise, there is no scheduling restriction. Note that the SSB symbols to be measured in the following clauses are the SSB symbols indicated by SSB-ToMeasure [2], if it is configured; otherwise, all L SSB symbols within the SMTC window duration defined in clause 4.1 of TS 38.213 [3] are included.

The scheduling availability requirements when UE performs inter-frequency measurements without measurement gaps in a TDD bands on FR1 and FR2 in clause 9.3.9.3.1~9.3.9.3.3 are valid under the following conditions:

- SFN and frame boundary across serving cell and inter-frequency neighbor cells is aligned, and

#### 9.3.9.3.1 Scheduling availability of UE performing measurements in TDD bands on FR1

When UE performs inter-frequency measurements without measurement gaps in a TDD band, the following restrictions apply due to SS-RSRP or SS-SINR measurement

- UE is not expected to transmit PUCCH/PUSCH/SRS on SSB symbols to be measured, and on 1 data symbol before each consecutive SSB symbols to be measured and 1 data symbol after each consecutive SSB symbols to be measured within SMTC window duration.

When UE performs inter-frequency measurements without measurement gaps in a TDD band, the following restrictions apply due to SS-RSRQ measurement

- UE is not expected to transmit PUCCH/PUSCH/SRS on SSB symbols to be measured, RSSI measurement symbols, and on 1 data symbol before each consecutive SSB to be measured/RSSI symbols and 1 data symbol after each consecutive SSB to be measured/RSSI symbols within SMTC window duration.

When TDD intra-band carrier aggregation is performed, the scheduling restrictions due to one serving cell should also apply to all other serving cells in the same band on the symbols that fully or partially overlap with aforementioned restricted symbols.

### 9.3.9.3.2 Scheduling availability of UE performing measurements with a different subcarrier spacing than PDSCH/PDCCH on FR1

For UE which do not support *simultaneousRxDataSSB-DiffNumerology-Inter-r16* [14] the following restrictions apply due to SS-RSRP/RSRQ/SINR measurement

- If UE performs inter-frequency measurements without measurement gaps in a TDD band, UE is not expected to transmit PUCCH/PUSCH/SRS or receive PDCCH/PDSCH/TRS/CSI-RS for CQI on SSB symbols to be measured, and on 1 data symbol before each consecutive SSB symbols to be measured and 1 data symbol after each consecutive SSB symbols to be measured within SMTC window duration.
- If UE performs inter-frequency measurements without measurement gaps in a FDD band, UE is not expected to transmit PUCCH/PUSCH/SRS or receive PDCCH/PDSCH/TRS/CSI-RS for CQI on all symbols within SMTC window duration.

When intra-band carrier aggregation is performed, the scheduling restrictions due to a given serving cell should also apply to all other serving cells in the same band on the symbols that fully or partially overlap with aforementioned restricted symbols.

### 9.3.9.3.3 Scheduling availability of UE performing measurements on FR2

The following scheduling restriction applies due to SS-RSRP or SS-SINR measurement on an FR2 inter-frequency cell

The UE is not expected to transmit PUCCH/PUSCH/SRS or receive PDCCH/PDSCH/TRS/CSI-RS for CQI on SSB symbols to be measured, and on 1 data symbol before each consecutive SSB symbols to be measured and 1 data symbol after each consecutive SSB symbols to be measured within SMTC window duration.

The following scheduling restriction applies to SS-RSRQ measurement on an FR2 inter-frequency cell

- The UE is not expected to transmit PUCCH/PUSCH/SRS or receive PDCCH/PDSCH/TRS/CSI-RS for CQI on SSB symbols to be measured, RSSI measurement symbols, and on 1 data symbol before each consecutive SSB to be measured/RSSI symbols and 1 data symbol after each consecutive SSB to be measured/RSSI symbols within SMTC window duration.

When intra-band carrier aggregation is performed, the scheduling restrictions due to a given serving cell should also apply to all other serving cells in the same band on the symbols that fully or partially overlap with aforementioned restricted symbols.

If following conditions are met:

- The UE has been notified about system information update through paging,
- The gap between the UE's reception of PDCCH that UE monitors in the Type 2-PDCCH CSS set that notifies system information update, and the PDCCH that UE monitors in the Type0-PDCCH CSS set, is greater than 2 slots

For the SSB and CORESET for RMSI scheduling multiplexing patterns 3, the UE is expected to receive the PDCCH that the UE monitors in the Type0-PDCCH CSS set, and the corresponding PDSCH, on SSB symbols to be measured; and

For the SSB and CORESET for RMSI scheduling multiplexing patterns 2, the UE is expected to receive PDSCH that corresponds to the PDCCH that the UE monitors in the Type0-PDCCH CSS set, on SSB symbols to be measured.



#### 9.3.9.3.4 Scheduling availability of UE performing measurements on FR1 or FR2 in case of FR1-FR2 inter-band CA

There are no scheduling restrictions on FR1 serving cell(s) due to measurements performed on FR2 serving cell frequency layer.

There are no scheduling restrictions on FR2 serving cell(s) due to measurements performed on FR1 serving cell frequency layer.

## 9.3A NR inter-frequency measurements in carrier frequencies with CCA

### 9.3A.1 Introduction

The requirements in clause 9.3A apply for inter-frequency measurements on a carrier frequency with CCA. A measurement is defined as an SSB based inter-frequency measurement provided it is not defined as an intra-frequency measurement according to clause 9.2A. The UE shall be able to identify new inter-frequency cells in carrier frequencies with CCA and perform SS-RSRP, SS-RSRQ, and SS-SINR measurements of identified inter-frequency cells if carrier frequency information is provided by PCell or PSCell, even if no explicit neighbour list with physical layer cell identities is provided.

SSB based measurements are configured along with a measurement timing configuration (SMTC) per carrier, which provides periodicity, duration and offset information on a window of up to 5ms where the measurements on the configured inter-frequency carrier are to be performed. For inter-frequency connected mode measurements, one measurement window periodicity may be configured per inter-frequency measurement object.

When measurement gaps are needed, the UE is not expected to detect SSB on an inter-frequency measurement object which start earlier than the gap starting time + switching time, nor detect SSB which end later than the gap end – switching time.

In the requirements of clause 9.3A, the term SMTC occasion not available at the UE refers to when the SMTC contains SSBs configured by gNB in a cell on a carrier frequency subject to CCA, but  $N$  candidate SSB positions for the same SS/PBCH block index within the discovery burst transmission window are not available at the UE due to DL CCA failures at gNB during the corresponding evaluation or measurement period, where:

- For the cell detection procedure:  $N$  is at least one candidate SSB position (NOTE: the one candidate SSB position for the cell detection shall not be impacted by the set of candidate SSB positions which are already being measured by the UE within the current measurement period of the on-going measurements), and
- For other procedures in clause 9.3A:  $N$  are the first two successive candidate SSB positions when two or more candidate SSB positions are configured for this SSB index in one discovery burst transmission window, otherwise  $N$  is one candidate SSB position;

otherwise the SMTC occasion is considered as available at the UE.

### 9.3A.2 Requirements applicability

The requirements in clause 9.3A apply, provided:

- The cell being identified or measured is detectable.

An inter-frequency CCA cell shall be considered detectable when for each relevant SSB:

- SS-RSRP related side conditions given in clause 10.1.28,
- SS-RSRQ related side conditions given in clause 10.1.30,
- SS-SINR related side conditions given in clause 10.1.32,
- SSB<sub>RP</sub> and SSB  $\hat{E}_s/I_{ot}$  according to Annex B.2.9.

### 9.3A.3 Number of cells and number of SSB

#### 9.3A.3.1 Requirements

For each inter-frequency layer, during each layer 1 measurement period, the UE shall be capable of performing SS-RSRP, SS-RSRQ, and SS-SINR measurements for at least:

- 4 identified cells, and
- 7 SSBs with different SSB indexes and/or PCI on the inter-frequency layer.

#### 9.3A.4 Inter-frequency cell identification

When measurement gaps are provided, or the UE supports capability of conducting such measurements without gaps, the UE shall be able to identify a new detectable inter-frequency cell within  $T_{\text{identify\_inter\_cca\_without\_index}}$  if UE is not indicated to report SSB based RRM measurement result with the associated SSB index (*reportQuantityRsinIndexes* or *maxNrofRSIndexesToReport* is not configured). Otherwise UE shall be able to identify a new detectable inter-frequency cell, in carrier frequencies with CCA, within  $T_{\text{identify\_inter\_cca\_with\_index}}$ . The UE shall be able to identify a new detectable inter-frequency SS block, in carrier frequencies with CCA, of an already detected cell within  $T_{\text{identify\_inter\_cca\_without\_index}}$ .

$$T_{\text{identify\_inter\_cca\_without\_index}} = (T_{\text{PSS/SSS\_sync\_inter\_cca}} + T_{\text{SSB\_measurement\_period\_inter\_cca}}) \text{ ms}$$

$$T_{\text{identify\_inter\_cca\_with\_index}} = (T_{\text{PSS/SSS\_sync\_inter\_cca}} + T_{\text{SSB\_measurement\_period\_inter\_cca}} + T_{\text{SSB\_time\_index\_inter\_cca}}) \text{ ms}$$

Where:

$T_{\text{PSS/SSS\_sync\_inter\_cca}}$ : it is the time period used in PSS/SSS detection given in table 9.3A.4-1.

$T_{\text{SSB\_time\_index\_inter\_cca}}$ : it is the time period used to acquire the index of the SSB being measured given in table 9.3A.4-2.

$T_{\text{SSB\_measurement\_period\_inter\_cca}}$ : equal to a measurement period of SSB based measurement given in table 9.3A.5-1.

$\text{CSSF}_{\text{inter}}$ : it is a carrier specific scaling factor and is determined according to  $\text{CSSF}_{\text{within\_gap},i}$  in clause 9.1.5.2 for measurement conducted within measurement gaps.

**Table 9.3A.4-1: Time period for PSS/SSS detection**

Condition <sup>NOTE1,2,3,4</sup>	$T_{\text{PSS/SSS\_sync\_inter\_cca}}$
No DRX	$\max(600\text{ms}, (8+L_{\text{PSS/SSS,gaps}}) \times \max(\text{MGRP}, \text{SMTC period})) \times \text{CSSF}_{\text{inter}}$
DRX cycle $\leq$ 320ms	$\max(600\text{ms}, \text{ceil}((8+L_{\text{PSS/SSS,gaps}}) \times 1.5) \times \max(\text{MGRP}, \text{SMTC period}, \text{DRX cycle})) \times \text{CSSF}_{\text{inter}}$
DRX cycle > 320ms	$(8+L_{\text{PSS/SSS,gaps}}) \times \text{DRX cycle} \times \text{CSSF}_{\text{inter}}$
NOTE 1: DRX or non DRX requirements apply according to the conditions described in clause 3.6.1	
NOTE 2: In EN-DC operation, the parameters, timers and scheduling requests referred to in clause 3.6.1 are for the secondary cell group. The DRX cycle is the DRX cycle of the secondary cell group.	
NOTE 3: When DRX is not configured, $L_{\text{PSS/SSS,gaps}}$ is the number of SMTC occasions not available at the UE during $T_{\text{PSS/SSS\_sync\_inter\_cca}}$ , for PSS/SSS detection, where $L_{\text{PSS/SSS,gaps}} \leq L_{\text{PSS/SSS,gaps,max}}$ . When DRX is configured, $L_{\text{PSS/SSS,gaps}}$ is the number of DRX cycles in which at least one SMTC occasion is not available at the UE during $T_{\text{PSS/SSS\_sync\_inter\_cca}}$ , for PSS/SSS detection, where $L_{\text{PSS/SSS,gaps}} \leq L_{\text{PSS/SSS,gaps,max}}$ . When configured with DRX, the UE is not required to determine the availability of SMTC occasions more frequent than once per DRX cycle. When configured with measurement gaps, the UE is not required to determine the availability of SMTC occasions more frequent than once during MGRP. FFS: The UE is not required to determine the availability of SMTC occasions more frequent than what is required by $\text{CSSF}_{\text{inter}}$ .	
NOTE 4: $L_{\text{PSS/SSS,gaps,max}} = 12$ for $\max(\text{DRX cycle}, \text{SMTC period}, \text{MGRP}) \leq 40$ ms $L_{\text{PSS/SSS,gaps,max}} = 8$ for $40$ ms < $\max(\text{DRX cycle}, \text{SMTC period}, \text{MGRP}) \leq 320$ ms, and $L_{\text{PSS/SSS,gaps,max}} = 5$ for DRX cycle > 320 ms.	

Upon exceeding  $L_{\text{PSS/SSS,gaps,max}}$ , the UE is not required to meet the corresponding PSS/SSS detection requirement. The requirements apply provided that any two closest SMTC occasions available at the UE for the measurement shall be separated by no more than the maximum time requirement for the cell to remain known.

Table 9.3A.4-2: Time period for time index detection

Condition <sup>NOTE1,2,3,4</sup>	$T_{SSB\_time\_index\_inter\_cca}$
No DRX	$\max(120\text{ms}, (3+ L_{ind,gaps}) \times \max(\text{MGRP}, \text{SMTC period})) \times \text{CSSF}_{inter}$
DRX cycle $\leq 320\text{ms}$	$\max(120\text{ms}, \text{ceil}((3+ L_{ind,gaps}) \times 1.5) \times \max(\text{MGRP}, \text{SMTC period}, \text{DRX cycle})) \times \text{CSSF}_{inter}$
DRX cycle $> 320\text{ms}$	$(3 + L_{ind,gaps}) \times \text{DRX cycle} \times \text{CSSF}_{inter}$
NOTE 1: DRX or non DRX requirements apply according to the conditions described in clause 3.6.1	
NOTE 2: In EN-DC operation, the parameters, timers and scheduling requests referred to in clause 3.6.1 are for the secondary cell group. The DRX cycle is the DRX cycle of the secondary cell group.	
NOTE 3: When DRX is not configured, $L_{ind,gaps}$ is the number of SMTC occasions not available at the UE during $T_{SSB\_time\_index\_inter\_cca}$ for time index identification, where $L_{ind,gaps} \leq L_{ind,gaps,max}$ . When DRX is configured, $L_{ind,gaps}$ is the number of DRX cycles in which at least one SMTC occasion is not available at the UE during $T_{SSB\_time\_index\_inter\_cca}$ for time index identification, where $L_{ind,gaps} \leq L_{ind,gaps,max}$ . When configured with DRX, the UE is not required to determine the availability of SMTC occasions more frequent than once per DRX cycle. When configured with measurement gaps, the UE is not required to determine the availability of SMTC occasions more frequent than once during MGRP. FFS: The UE is not required to determine the availability of SMTC occasions more frequent than what is required by $\text{CSSF}_{inter}$ .	
NOTE 4: $L_{ind,gaps,max} = 5$ for $\max(\text{DRX cycle}, \text{SMTC period}, \text{MGRP}) \leq 40$ ms, $L_{ind,gaps,max} = 3$ for $40$ ms $<$ $\max(\text{DRX cycle}, \text{SMTC period}, \text{MGRP}) \leq 320$ ms, and $L_{ind,gaps,max} = 2$ for DRX cycle $> 320$ ms.	

The UE shall restart the time index detection upon exceeding  $L_{ind,gaps,max}$ . The requirements apply provided that any two closest SMTC occasions available at the UE for the measurement shall be separated by no more than the maximum time requirement for the cell to remain known.

### 9.3A.5 Inter-frequency measurements

When measurement gaps are provided for inter-frequency measurements in carrier frequencies with CCA, or the UE supports capability of conducting such measurements without gaps, the UE physical layer shall be capable of reporting SS-RSRP, SS-RSRQ and SS-SINR measurements to higher layers with measurement accuracy as specified in clauses 10.1.28, 10.1.30, 10.1.32, respectively, as shown in table 9.3A.5-1:

Table 9.3A.5-1: Measurement period for inter-frequency measurements with gaps

Condition <sup>NOTE1,2,3,4</sup>	$T_{SSB\_measurement\_period\_inter\_cca}$
No DRX	$\max(200\text{ms}, (8+ L_{meas}) \times \max(\text{MGRP}, \text{SMTC period})) \times \text{CSSF}_{inter}$
DRX cycle $\leq 320\text{ms}$	$\max(200\text{ms}, \text{ceil}((8+ L_{meas}) \times 1.5) \times \max(\text{MGRP}, \text{SMTC period}, \text{DRX cycle})) \times \text{CSSF}_{inter}$
DRX cycle $> 320\text{ms}$	$(8+ L_{meas}) \times \text{DRX cycle} \times \text{CSSF}_{inter}$
NOTE 1: DRX or non DRX requirements apply according to the conditions described in clause 3.6.1	
NOTE 2: In EN-DC operation, the parameters, timers and scheduling requests referred to in clause 3.6.1 are for the secondary cell group. The DRX cycle is the DRX cycle of the secondary cell group.	
NOTE 3: When DRX is not configured, $L_{meas}$ is the number of SMTC occasions not available at the UE during $T_{SSB\_measurement\_period\_NR\_cca}$ , for inter-frequency measurements with gaps, where $L_{meas} \leq L_{meas,max}$ . When DRX is configured, $L_{meas}$ is the number of DRX cycles in which at least one SMTC occasion is not available at the UE during $T_{SSB\_measurement\_period\_NR\_cca}$ , for inter-frequency measurements with gaps, where $L_{meas} \leq L_{meas,max}$ . When configured with DRX, the UE is not required to determine the availability of SMTC occasions more frequent than once per DRX cycle. When configured with measurement gaps, the UE is not required to determine the availability of SMTC occasions more frequent than once during MGRP. FFS: The UE is not required to determine the availability of SMTC occasions more frequent than what is required by $\text{CSSF}_{inter}$ .	
NOTE 4: $L_{meas,max} = 12$ for $\max(\text{DRX cycle}, \text{SMTC period}, \text{MGRP}) \leq 40$ ms, $L_{meas,max} = 8$ for $40$ ms $<$ $\max(\text{DRX cycle}, \text{SMTC period}, \text{MGRP}) \leq 320$ ms, and $L_{meas,max} = 5$ for DRX cycle $> 320$ ms.	

The UE shall restart the measurement upon exceeding  $L_{meas,max}$ . The requirements apply provided that any two closest SMTC occasions available at the UE for the measurement shall be separated by no more than the maximum time requirement for the cell to remain known.

The UE shall stop the measurement attempts on the SSB of a cell and perform the detection procedure again, like for any other SSB, when the following conditions are met:

- $L_{meas} > L_{meas,max}$ , and

- The time period of unsuccessful measurement attempts exceeds the maximum time required for the cell to remain known as defined in clause 9.3A.6.3.

## 9.3A.6 NR Inter-frequency measurements reporting requirements

### 9.3A.6.1 Periodic Reporting

Reported SS-RSRP, SS-RSRQ, and SS-SINR measurements contained in periodically triggered measurement reports shall meet the requirements in clauses 10.1.28, 10.1.30, and 10.1.32, respectively.

### 9.3A.6.2 Event-triggered Periodic Reporting

Reported SS-RSRP, SS-RSRQ, and SS-SINR measurements contained in event triggered periodic measurement reports shall meet the requirements in clauses 10.1.28, 10.1.30, and 10.1.32, respectively.

The first report in event triggered periodic measurement reporting shall meet the requirements specified in clause 9.3A.6.3.

### 9.3A.6.3 Event-triggered Reporting

Reported SS-RSRP, SS-RSRQ, and SS-SINR measurements contained in event triggered measurement reports shall meet the requirements in clauses 10.1.28, 10.1.30, and 10.1.32, respectively.

The UE shall not send any event triggered measurement reports, as long as no reporting criteria are fulfilled.

The measurement reporting delay is defined as the time between an event that will trigger a measurement report and the point when the UE starts to transmit the measurement report over the air interface. This requirement assumes that the measurement report is not delayed by other RRC signalling on the DCCH. This measurement reporting delay excludes a delay uncertainty resulted when inserting the measurement report to the TTI of the uplink DCCH. The delay uncertainty is:  $2 \times TTI_{DCCH}$ . This measurement reporting delay excludes a delay which caused by no UL resources for UE to send the measurement report, and all delays due to UL CCA failures until the successful transmission of the report.

The event triggered measurement reporting delay, measured without L3 filtering shall be within  $T_{\text{identify\_inter\_cca\_without\_index}}$  if UE is not indicated to report SSB based RRM measurement result with the associated SSB index. Otherwise UE shall be able to identify a new detectable inter-frequency cell within  $T_{\text{identify\_inter\_cca\_with\_index}}$ . Both  $T_{\text{identify\_inter\_cca\_without\_index}}$  and  $T_{\text{identify\_inter\_cca\_with\_index}}$  are defined in clause 9.3A.4. When L3 filtering is used an additional delay can be expected.

A cell is detectable only if at least one SSB measured from the cell being configured remains detectable during the time period  $T_{\text{identify\_inter\_cca\_without\_index}}$  OR  $T_{\text{identify\_inter\_cca\_with\_index}}$  defined in clause 9.3A.4. If a cell which has been detectable at least for the time period  $T_{\text{identify\_inter\_cca\_without\_index}}$  OR  $T_{\text{identify\_inter\_cca\_with\_index}}$  defined in clause 9.3A.4 becomes undetectable for a period  $\leq 8$  seconds and then the cell becomes detectable again with the same spatial reception parameter and then triggers the measurement report as per TS 38.331 [2], the event triggered measurement reporting delay shall be less than  $T_{\text{SSB\_measurement\_period\_inter\_cca}}$  defined in clause 9.3A.5 provided the timing to that cell has not changed more than  $\pm 3200/2^\mu T_c$  while measurement gap has not been available and the L3 filtering has not been used, where  $\mu$  is the SCS configuration as defined in clause 4.2 of TS 38.211 [3]. When L3 filtering is used an additional delay can be expected.

## 9.3A.8 Inter-frequency RSSI measurements

An RSSI measurement is defined as an inter-frequency measurement provided that the RSSI measurement bandwidth is not contained within the current carrier bandwidth of the UE.

The UE physical layer shall be capable of performing the RSSI measurements, defined in TS 38.215 [4] on one or more inter-frequency carriers operating with CCA, TS 37.213 [33], if the carrier(s) are indicated by higher layers [2], and report the RSSI measurements to higher layers. The UE physical layer shall provide to higher layers a single RSSI sample for each OFDM symbol within each configured RSSI measurement duration [2] occurring with a configured RSSI measurement timing configuration periodicity [2], *rmtc-Periodicity*. The requirements apply if *rmtc-SubframeOffset* [2] is configured.

**Table 9.3A.8-1: Measurement period for inter-frequency RSSI measurements with gaps**

Condition <sup>NOTE1,2,3,4</sup>	$T_{\text{RSSI\_measurement\_period\_inter\_cca}}$
No DRX	$\max(\text{reportInterval}, \max(\text{rmtc-Periodicity}, \text{MGRP}) \times \text{CSSF}_{\text{inter}})$
DRX	$\max(\text{reportInterval}, \max(\text{rmtc-Periodicity}, \text{MGRP}, \text{DRX cycle}) \times \text{CSSF}_{\text{inter}})$
NOTE 1: DRX or non DRX requirements apply according to the conditions described in clause 3.6.1	
NOTE 2: $\text{CSSF}_{\text{inter}}$ is a carrier specific scaling factor and is determined according to $\text{CSSF}_{\text{within\_gap},i}$ in clause 9.1.5.2 for measurement conducted within measurement gaps.	

If the UE requires measurement gaps to perform inter-frequency measurements, a single measurement gap pattern is used for all concurrent inter-frequency measurements, including inter-frequency RSSI measurements. The RSSI measurement duration and the measurement gap should be aligned, and the following additional condition should be fulfilled:

- Entire RSSI measurement duration should be contained in the measurement gap.

The RSSI measurement performed and reported according to this clause shall meet the RSSI measurement accuracy requirement in Clause 10.1.34.2. The reported RSSI measurement values contained in measurement reports shall be based on the measurement report mapping requirements specified in Clause 10.1.34.3.

## 9.3A.9 Inter-frequency channel occupancy measurements

The UE shall be capable of estimating the channel occupancy on one or more carrier frequencies indicated by higher layers [2], based on RSSI samples provided by the physical layer. The requirements apply if *rmtc-SubframeOffset* [2] is configured.

**Table 9.3A.9-1: Measurement period for inter-frequency Channel Occupancy measurements with gaps**

Condition <sup>NOTE1,2,3,4</sup>	$T_{\text{CO\_measurement\_period\_inter\_cca}}$
No DRX	$\max(\text{reportInterval}, \max(\text{rmtc-Periodicity}, \text{MGRP}) \times \text{CSSF}_{\text{inter}})$
DRX	$\max(\text{reportInterval}, \max(\text{rmtc-Periodicity}, \text{MGRP}, \text{DRX cycle}) \times \text{CSSF}_{\text{inter}})$
NOTE 1: DRX or non DRX requirements apply according to the conditions described in clause 3.6.1	
NOTE 2: $\text{CSSF}_{\text{inter}}$ is a carrier specific scaling factor and is determined according to $\text{CSSF}_{\text{within\_gap},i}$ in clause 9.1.5.2 for measurement conducted within measurement gaps.	

If the UE requires measurement gaps to perform inter-frequency measurements, a single measurement gap pattern is used for all concurrent inter-frequency measurements, including inter-frequency channel occupancy measurements. The RSSI measurement duration used for channel occupancy measurement and the measurement gap should be aligned, and the following additional condition should be fulfilled:

- Entire RSSI measurement duration should be contained in the measurement gap.

The channel occupancy measurement performed and reported according to this clause shall meet the channel occupancy measurement accuracy requirements in Clause 10.1.35.2. The reported channel occupancy measurement values contained in measurement reports shall be based on the measurement reporting range specified in TS 38.331 [2].

## 9.4 Inter-RAT measurements

### 9.4.1 Introduction

The requirements in this clause are specified for NR–E-UTRAN FDD and NR–E-UTRAN TDD measurements and are applicable without an explicit E-UTRAN neighbour cell list containing physical layer cell identities, for a UE:

- in RRC\_CONNECTED state, and
- configured
- with SA or NR-DC operation mode or configured in NE-DC operation mode by PCell with NR–E-UTRAN FDD or TDD measurement (RSRP, RSRQ, RS-SINR, RSTD, or E-CID RSRP and RSRQ) on E-UTRA non-serving frequency carrier, or

- with SA operation mode on NR carrier frequencies with CCA by PCell with NR-E-UTRAN FDD or TDD measurement (RSRP, RSRQ, RS-SINR) on E-UTRA non-serving frequency carrier, and
- configured with an appropriate measurement gap pattern according to Table 9.1.2-3.

When the UE is in NE-DC operation mode and an NR-E-UTRAN FDD or TDD measurement (RSRP, RSRQ, RS-SINR, or E-CID RSRP and RSRQ) configured by NR PCell is on a E-UTRA serving frequency carrier, then the corresponding E-UTRA intra-frequency measurements requirements specified in clause 8.19 of TS 36.133 [15] shall apply.

When *highSpeedMeasFlag-r16* is configured but UE does not support either *measurementEnhancement-r16* or *interRAT-MeasurementEnhancement-r16*, the UE is not required to meet the requirements specified in Table 9.4.2.3-2 and Table 9.4.3.3-2.

*Editor's note: the exact signalling names in the above brackets and in Table 9.4.2.3-2 and Table 9.4.3.3-2 are subject to RAN2 definitions and the brackets shall be replaced by the correct signalling names according to RAN2 specification.*

Parameter  $T_{\text{inter1}}$  used in inter-RAT requirements in clause 9.4 is specified in Table 9.4.1-1.

**Table 9.4.1-1: Minimum available time for inter-RAT measurements**

Gap Pattern Id	MeasurementGap Length (MGL, ms)	Measurement Gap Repetition Period (MGRP, ms)	Minimum available time for inter-frequency and inter-RAT measurements during 480 ms period ( $T_{\text{inter1}}$ , ms)
0	6	40	60
1	6	80	30
2	3	40	24 <sup>Note 1</sup>
3	3	80	12 <sup>Note 1</sup>
4	6	20	120 <sup>Note 1</sup>
6	4	20	72 <sup>Note 1,3,6</sup>
7	4	40	36 <sup>Note 1,4,6</sup>
8	4	80	18 <sup>Note 1,5,6</sup>
10	3	20	48 <sup>Note 1</sup>

NOTE 1: When determining UE requirements using  $T_{\text{inter1}}$  for gap pattern IDs 2, 3, 4, 6, 7, 8, 10,  $T_{\text{inter1}} = 60$  for gap pattern IDs 2, 4, 6, 7, 10, and  $T_{\text{inter1}} = 30$  for gap pattern IDs 3 and 8 shall be used.

NOTE 2: Measurement gaps pattern configurations applicability is as specified in Table 9.1.2-1.

NOTE 3: When this gap pattern is used, the  $T_{\text{inter}}$  for E-UTRA inter-frequency measurements is 48 ms corresponding to the first 3 ms of the 4 ms gap.

NOTE 4: When this gap pattern is used, the  $T_{\text{inter}}$  for E-UTRA inter-frequency measurements is 24 ms corresponding to the first 3 ms of the 4 ms gap.

NOTE 5: When this gap pattern is used, the  $T_{\text{inter}}$  for E-UTRA inter-frequency measurements is 12 ms corresponding to the first 3 ms of the 4 ms gap.

NOTE 6: This gap pattern is applicable for E-UTRA inter-frequency measurements only if gap based NR measurements are also configured.

A UE configured with gap pattern ID 2, 3 or 10 shall be able to detect a target cell, provided that

- the E-UTRA subframe #0 or #5 of the target E-UTRAN cell begins not earlier than 500  $\mu\text{s}$  from the start of the measurement gap, and
- the E-UTRA subframe #0 or #5 of the target E-UTRAN cell ends not later than 500  $\mu\text{s}$  before the end of the measurement gap in case of FDD and not later than 750  $\mu\text{s}$  before the end of measurement gap in case of TDD.

A UE configured with gap pattern ID 6, 7 or 8 shall be able to detect a target cell, provided that

- the E-UTRA subframe #0 or #5 of the target E-UTRAN cell begins not earlier than 500  $\mu\text{s}$  from the start of the measurement gap, and

- the E-UTRA subframe #0 or #5 of the target E-UTRAN cell ends no later than 1500  $\mu$ s before the end of the measurement gap in case of FDD and no later than 1750  $\mu$ s before the end of measurement gap in case of TDD.

## 9.4.2 NR – E-UTRAN FDD measurements

### 9.4.2.1 Introduction

The requirements are applicable for NR–E-UTRAN FDD RSRP, RSRQ, and RS-SINR measurements.

In the requirements, an E-UTRAN FDD cell is considered to be detectable when:

- RSRP related conditions in the accuracy requirements in clause 10.2.2 are fulfilled for a corresponding Band, together with the corresponding side conditions in Annex B.2.3 and Annex B.3.3 of TS 36.133 [15],
- RSRQ related conditions in the accuracy requirements in clause 10.2.3 are fulfilled for a corresponding Band, together with the corresponding side conditions in Annex B.2.3 and Annex B.3.3 of TS 36.133 [15],
- RS-SINR related conditions in the accuracy requirements in clause 10.2.5 are fulfilled for a corresponding Band, together with the corresponding side conditions in Annex B.2.3 and Annex B.3.19 of TS 36.133 [15].

### 9.4.2.2 Requirements when no DRX is used

When the UE requires measurement gaps to identify and measure inter-RAT cells and an appropriate measurement gap pattern is scheduled, or the UE supports capability of conducting such measurements without gaps, the UE shall be able to identify a new detectable FDD cell within  $T_{\text{Identify, E-UTRAN FDD}}$  according to the following expression:

$$T_{\text{Identify, E-UTRAN FDD}} = T_{\text{BasicIdentify}} \cdot \frac{480}{T_{\text{Inter1}}} \cdot \text{CSSF}_{\text{interRAT}} \quad \text{ms},$$

where:

$$T_{\text{BasicIdentify}} = 480 \text{ ms},$$

$T_{\text{Inter1}}$  is defined in clause 9.4.1,

$\text{CSSF}_{\text{interRAT}} = \text{CSSF}_{\text{within\_gap}, i}$  is the scaling factor for the measured inter-RAT E-UTRA carrier  $i$  which is calculated as specified in clause 9.1.5.2.

Identification of a cell shall include detection of the cell and additionally performing a single measurement with measurement period of  $T_{\text{Measure, E-UTRAN FDD}}$  defined in Table 9.4.2.2-1.

**Table 9.4.2.2-1: Measurement period and measurement bandwidth**

Configuration	Physical Layer Measurement period: $T_{\text{Measure, E-UTRAN FDD}}$ [ms]	Measurement bandwidth [RB]
0	$480 \times \text{CSSF}_{\text{interRAT}}$	6
1 (Note 1)	$240 \times \text{CSSF}_{\text{interRAT}}$	50
NOTE 1: This configuration is optional.		

When measurement gaps are scheduled for E-UTRAN FDD inter-RAT measurements, or the UE supports capability of conducting such measurements without gaps, the UE physical layer shall be capable of reporting RSRP, RSRQ, and RS-SINR measurements to higher layers with measurement period  $T_{\text{Measure, E-UTRAN FDD}}$  given by table 9.4.2.2-1.

The UE shall be capable of identifying and performing NR – E-UTRAN FDD RSRP, RSRQ, and RS-SINR measurements of at least 4 identified E-UTRAN FDD cells per E-UTRA FDD carrier frequency layer during each layer 1 measurement period, for up to 7 E-UTRA FDD carrier frequency layers.

If higher layer filtering is used, an additional cell identification delay can be expected.

The NR – E-UTRAN FDD RSRP measurement accuracy for all measured cells shall be as specified in clause 10.2.2.

The NR – E-UTRAN FDD RSRQ measurement accuracy for all measured cells shall be as specified in clause 10.2.3.

The NR – E-UTRAN FDD RS-SINR measurement accuracy for all measured cells shall be as specified in clause 10.2.5.

### 9.4.2.3 Requirements when DRX is used

When DRX is in use and measurement gaps are configured, the UE shall be able to identify a new detectable E-UTRAN FDD cell within  $T_{\text{Identify, E-UTRAN FDD}}$  specified in Table 9.4.2.3-1. When *highSpeedMeasFlag-r16* is configured and UE supports the enhanced inter-RAT E-UTRAN measurement requirements, the UE shall be able to identify a new detectable E-UTRAN FDD cell within  $T_{\text{Identify, E-UTRAN FDD}}$  specified in Table 9.4.2.3-2.

**Table 9.4.2.3-1: Requirement to identify a newly detectable E-UTRAN FDD cell**

DRX cycle length (s)	$T_{\text{Identify, E-UTRAN FDD}}$ (s) (DRX cycles)	
	Gap period = 40 ms, 20 ms	Gap period = 80 ms
$\leq 0.16$	Non-DRX requirements in clause 9.4.2.2 apply	Non-DRX requirements in clause 9.4.2.2 apply
0.256	$5.12^* \text{CSSF}_{\text{interRAT}}$ ( $20^* \text{CSSF}_{\text{interRAT}}$ )	$7.68^* \text{CSSF}_{\text{interRAT}}$ ( $30^* \text{CSSF}_{\text{interRAT}}$ )
0.32	$6.4^* \text{CSSF}_{\text{interRAT}}$ ( $20^* \text{CSSF}_{\text{interRAT}}$ )	$7.68^* \text{CSSF}_{\text{interRAT}}$ ( $24^* \text{CSSF}_{\text{interRAT}}$ )
$0.32 < \text{DRX-cycle} \leq 10.24$	Note1 ( $20^* \text{CSSF}_{\text{interRAT}}$ )	Note1 ( $20^* \text{CSSF}_{\text{interRAT}}$ )
NOTE 1: The time depends on the DRX cycle length. NOTE 2: $\text{CSSF}_{\text{interRAT}}$ is as defined in clause 9.4.2.2.		

**Table 9.4.2.3-2: Requirement to identify a newly detectable E-UTRAN FDD cell when *highSpeedMeasFlag-r16* is configured**

DRX cycle length (s)	$T_{\text{Identify, E-UTRAN FDD}}$ (s) (DRX cycles)	
	Gap period = 40 ms, 20 ms	Gap period = 80 ms
$\leq 0.16$	Non-DRX requirements in clause 9.4.2.2 apply	Non-DRX requirements in clause 9.4.2.2 apply
$0.16 < \text{DRx cycle} \leq 0.32$	Note 1 ( $15^* \text{CSSF}_{\text{interRAT}}$ )	
$0.32 < \text{DRx cycle} \leq 0.64$	Note 1 ( $10^* \text{CSSF}_{\text{interRAT}}$ )	
DRx cycle = 1.024	Note 1 ( $10^* \text{CSSF}_{\text{interRAT}}$ )	Note 1 ( $10^* \text{CSSF}_{\text{interRAT}}$ )
DRx cycle = 1.28	Note 1 ( $8^* \text{CSSF}_{\text{interRAT}}$ )	Note 1 ( $8^* \text{CSSF}_{\text{interRAT}}$ )
$1.28 < \text{DRX-cycle} \leq 10.24$	Note1 ( $20^* \text{CSSF}_{\text{interRAT}}$ )	Note1 ( $20^* \text{CSSF}_{\text{interRAT}}$ )
NOTE 1: The time depends on the DRX cycle length. NOTE 2: $\text{CSSF}_{\text{interRAT}}$ is as defined in clause 9.4.2.2. NOTE 3: When <i>highSpeedMeasFlag-r16</i> is configured, the requirements apply only to UE supporting either <i>measurementEnhancement-r16</i> or <i>interRAT-MeasurementEnhancement-r16</i> .		

When DRX is in use, the UE shall be capable of performing NR – E-UTRAN FDD RSRP, RSRQ, and RS-SINR measurements of at least 4 identified E-UTRAN FDD cells per E-UTRA FDD frequency layer during each layer 1 measurement period, for up to 7 E-UTRA FDD carrier frequency layers, and the UE physical layer shall be capable of reporting NR – E-UTRAN FDD RSRP, RSRQ, and RS-SINR measurements to higher layers with the measurement period  $T_{\text{measure, E-UTRAN FDD}}$  specified in Table 9.4.2.3-2.

**Table 9.4.2.3-2: Requirement to measure E-UTRAN FDD cells**

DRX cycle length (s)	$T_{\text{measure, E-UTRAN FDD}}$ (s) (DRX cycles)
$\leq 0.08$	Non-DRX requirements in clause 9.4.2.2 apply
$0.08 < \text{DRX-cycle} \leq 10.24$	Note1 ( $5^* \text{CSSF}_{\text{interRAT}}$ )
NOTE 1: The time depends on the DRX cycle length. NOTE 2: $\text{CSSF}_{\text{interRAT}}$ is as defined in clause 9.4.2.2.	

If higher layer filtering is used, an additional cell identification delay can be expected.

The NR – E-UTRAN FDD RSRP measurement accuracy for all measured cells shall be as specified in clause 10.2.2.

The NR – E-UTRAN FDD RSRQ measurement accuracy for all measured cells shall be as specified in clause 10.2.3.

The NR – E-UTRAN FDD RS-SINR measurement accuracy for all measured cells shall be as specified in clause 10.2.5.



## 9.4.2.4 Measurement reporting requirements

### 9.4.2.4.1 Periodic Reporting

The reported NR – E-UTRAN FDD RSRP, RSRQ, and RS-SINR measurements contained in periodically triggered measurement reports shall meet the requirements in clauses 10.2.2, 10.2.3, and 10.2.5, respectively.

### 9.4.2.4.2 Event-Triggered Periodic Reporting

The reported NR – E-UTRAN FDD RSRP, RSRQ, and RS-SINR measurements contained in event-triggered periodic measurement reports shall meet the requirements in clauses 10.2.2, 10.2.3, and 10.2.5, respectively.

The first report in event-triggered periodic measurement reporting shall meet the requirements specified in clause 9.4.2.4.3.

### 9.4.2.4.3 Event-Triggered Reporting

The reported NR – E-UTRAN FDD RSRP, RSRQ, and RS-SINR measurements contained in event-triggered measurement reports shall meet the requirements in clauses 10.2.2, 10.2.3, and 10.2.5, respectively.

The UE shall not send any event-triggered measurement reports as long as no reporting criteria are fulfilled.

The measurement reporting delay is defined as the time between an event that will trigger a measurement report and the point when the UE starts to transmit the measurement report over the air interface. This requirement assumes that the measurement report is not delayed by other RRC signalling on the DCCH. This measurement reporting delay excludes a delay uncertainty resulted when inserting the measurement report to the TTI of the uplink DCCH. The delay uncertainty is:  $2 \times TTI_{DCCH}$  where  $TTI_{DCCH}$  is the duration of subframe or slot or subslot when the measurement report is transmitted on the PUSCH with subframe or slot or subslot duration. This measurement reporting delay excludes a delay which caused by no UL resources for UE to send the measurement report.

The event triggered measurement reporting delay, measured without L3 filtering shall be less than  $T_{Identify, E-UTRAN FDD}$  defined in clauses 9.4.2.2 and 9.4.2.3 without DRX and with DRX, respectively. When L3 filtering is used, an additional delay can be expected.

If a cell which has been detectable at least for the time period  $T_{Identify, E-UTRAN FDD}$  becomes undetectable for a period  $\leq 5$  seconds and then the cell becomes detectable again and triggers an event as per TS 38.331 [2], the event triggered measurement reporting delay shall be less than  $T_{Measure, E-UTRAN FDD}$  provided the timing to that cell has not changed more than  $\pm 50 T_s$  while measurement gap has not been available and the L3 filter has not been used.

## 9.4.3 NR – E-UTRAN TDD measurements

### 9.4.3.1 Introduction

The requirements are applicable for NR–E-UTRAN TDD RSRP, RSRQ, and RS-SINR measurements.

In the requirements, an E-UTRAN TDD cell is considered to be detectable when:

- RSRP related conditions in the accuracy requirements in clause 10.2.2 are fulfilled for a corresponding Band, together with the corresponding side conditions in Annex B.2.3 and Annex B.3.3 of TS 36.133 [15],
- RSRQ related conditions in the accuracy requirements in clause 10.2.3 are fulfilled for a corresponding Band, together with the corresponding side conditions in Annex B.2.3 and Annex B.3.3 of TS 36.133 [15],

RS-SINR related conditions in the accuracy requirements in clause 10.2.5 are fulfilled for a corresponding Band, together with the corresponding side conditions in Annex B.2.3 and Annex B.3.19 of TS 36.133 [15].

### 9.4.3.2 Requirements when no DRX is used

When the UE requires measurement gaps to identify and measure inter-RAT cells and an appropriate measurement gap pattern is scheduled, or the UE supports capability of conducting such measurements without gaps, the UE shall be able to identify a new detectable TDD cell within  $T_{Identify, E-UTRAN TDD}$  according to the following expression:

- When configuration 0 or configuration 1 in Table 9.4.3.2-1 is applied,

$$T_{\text{Identify,E-UTRAN TDD}} = T_{\text{BasicIdentify}} \cdot \frac{480}{T_{\text{Inter1}}} \cdot \text{CSSF}_{\text{interRAT}} \quad \text{ms},$$

- When configuration 2 or configuration 3 in Table 9.4.3.2-1 is applied,

$$T_{\text{Identify,E-UTRAN TDD}} = T_{\text{BasicIdentify}} \cdot \frac{480}{T_{\text{Inter1}}} \cdot \text{CSSF}_{\text{interRAT}} + 240 \cdot \text{CSSF}_{\text{interRAT}} \quad \text{ms},$$

where:

$$T_{\text{BasicIdentify}} = 480 \text{ ms},$$

$T_{\text{Inter1}}$  is defined in clause 9.4.1,

$\text{CSSF}_{\text{interRAT}} = \text{CSSF}_{\text{within\_gap},i}$  is the scaling factor for the measured inter-RAT E-UTRA carrier  $i$  which is calculated as specified in clause 9.1.5.2.

Identification of a cell shall include detection of the cell and additionally performing a single measurement with measurement period of  $T_{\text{Measure, E-UTRAN TDD}}$  defined in Table 9.4.3.2-1.

**Table 9.4.3.2-1:  $T_{\text{Measure, E-UTRAN TDD}}$  for different configurations**

Configuration	Measurement bandwidth (RB)	Number of UL/DL sub-frames per half frame (5 ms)		DwPTS		$T_{\text{Measure, E-UTRAN TDD}}$ (ms)
		DL	UL	Normal CP	Extended CP	
0	6	2	2	$19760 \cdot T_s$	$20480 \cdot T_s$	$480 \times \text{CSSF}_{\text{interRAT}}$
1 (Note 1)	50	2	2	$19760 \cdot T_s$	$20480 \cdot T_s$	$240 \times \text{CSSF}_{\text{interRAT}}$
2	6	1	3	$19760 \cdot T_s$	$20480 \cdot T_s$	$720 \times \text{CSSF}_{\text{interRAT}}$
3 (Note 1)	50	1	3	$19760 \cdot T_s$	$20480 \cdot T_s$	$480 \times \text{CSSF}_{\text{interRAT}}$

NOTE 1: This configuration is optional.  
NOTE 2: Void

When measurement gaps are scheduled for E-UTRAN TDD inter-RAT measurements, or the UE supports capability of conducting such measurements without gaps, the UE physical layer shall be capable of reporting RSRP, RSRQ, and RS-SINR measurements to higher layers with measurement period  $T_{\text{measure, E-UTRAN TDD}}$  given by table 9.4.3.2-1.

The UE shall be capable of identifying and performing NR – E-UTRAN TDD RSRP, RSRQ, and RS-SINR measurements of at least 4 identified E-UTRAN TDD cells per E-UTRA TDD carrier frequency layer during each layer 1 measurement period, for up to 7 E-UTRA TDD carrier frequency layers.

If higher layer filtering is used, an additional cell identification delay can be expected.

The NR – E-UTRAN TDD RSRP measurement accuracy for all measured cells shall be as specified in clause 10.2.2.  
The NR – E-UTRAN TDD RSRQ measurement accuracy for all measured cells shall be as specified in clause 10.2.3.  
The NR – E-UTRAN TDD RS-SINR measurement accuracy for all measured cells shall be as specified in clause 10.2.5.

### 9.4.3.3 Requirements when DRX is used

When DRX is in use and measurement gaps are configured, the UE shall be able to identify a new detectable E-UTRAN TDD cell within  $T_{\text{Identify, E-UTRAN TDD}}$  specified in Table 9.4.3.3-1. When *highSpeedMeasFlag-r16* is configured and UE supports the enhanced inter-RAT E-UTRAN measurement requirements, the UE shall be able to identify a new detectable E-UTRAN TDD cell within  $T_{\text{Identify, E-UTRAN TDD}}$  specified in Table 9.4.3.3-2.

**Table 9.4.3.3-1: Requirement to identify a newly detectable E-UTRAN TDD cell**

DRX cycle length (s)	$T_{\text{Identify, E-UTRAN TDD}}$ (s) (DRX cycles)
----------------------	---

	Gap period = 40 ms, 20 ms	Gap period = 80 ms
$\leq 0.16$	Non-DRX requirements in clause 9.4.3.2 apply	Non-DRX requirements in clause 9.4.3.2 apply
0.256	$5.12 * \text{CSSF}_{\text{interRAT}}$ ( $20 * \text{CSSF}_{\text{interRAT}}$ )	$7.68 * \text{CSSF}_{\text{interRAT}}$ ( $30 * \text{CSSF}_{\text{interRAT}}$ )
0.32	$6.4 * \text{CSSF}_{\text{interRAT}}$ ( $20 * \text{CSSF}_{\text{interRAT}}$ )	$7.68 * \text{CSSF}_{\text{interRAT}}$ ( $24 * \text{CSSF}_{\text{interRAT}}$ )
$0.32 < \text{DRX-cycle} \leq 10.24$	Note1 ( $20 * \text{CSSF}_{\text{interRAT}}$ )	Note1 ( $20 * \text{CSSF}_{\text{interRAT}}$ )
NOTE 1: The time depends on the DRX cycle length.		
NOTE 2: $\text{CSSF}_{\text{interRAT}}$ is as defined in clause 9.4.3.2.		

**Table 9.4.3.3-2: Requirement to identify a newly detectable E-UTRAN TDD cell when *highSpeedMeasFlag-r16* is configured**

DRX cycle length (s)	$T_{\text{Identify, E-UTRAN TDD}}$ (s) (DRX cycles)	
	Gap period = 40 ms, 20 ms	Gap period = 80 ms
$\leq 0.16$	Non-DRX requirements in clause 9.4.3.2 apply	Non-DRX requirements in clause 9.4.3.2 apply
$0.16 < \text{DRx cycle} \leq 0.32$	Note 1 ( $15 * \text{CSSF}_{\text{interRAT}}$ )	
$0.32 < \text{DRx cycle} \leq 0.64$	Note 1 ( $10 * \text{CSSF}_{\text{interRAT}}$ )	
DRx cycle = 1.024	Note 1 ( $10 * \text{CSSF}_{\text{interRAT}}$ )	Note 1 ( $10 * \text{CSSF}_{\text{interRAT}}$ )
DRx cycle = 1.28	Note 1 ( $8 * \text{CSSF}_{\text{interRAT}}$ )	Note 1 ( $8 * \text{CSSF}_{\text{interRAT}}$ )
$1.28 < \text{DRX-cycle} \leq 10.24$	Note1 ( $20 * \text{CSSF}_{\text{interRAT}}$ )	Note1 ( $20 * \text{CSSF}_{\text{interRAT}}$ )
NOTE 1: The time depends on the DRX cycle length.		
NOTE 2: $\text{CSSF}_{\text{interRAT}}$ is as defined in clause 9.4.3.2.		
NOTE 3: When <i>highSpeedMeasFlag-r16</i> is configured, the requirements apply only to UE supporting either <i>measurementEnhancement-r16</i> or <i>interRAT-MeasurementEnhancement-r16</i> .		

When DRX is in use, the UE shall be capable of performing NR – E-UTRAN TDD RSRP, RSRQ, and RS-SINR measurements of at least 4 identified E-UTRAN TDD cells per E-UTRA TDD frequency layer during each layer 1 measurement period, for up to 7 E-UTRA TDD carrier frequency layers, and the UE physical layer shall be capable of reporting NR – E-UTRAN TDD RSRP, RSRQ, and RS-SINR measurements to higher layers with the measurement period  $T_{\text{measure, E-UTRAN TDD}}$  specified in Table 9.4.3.3-2.

**Table 9.4.3.3-2: Requirement to measure E-UTRAN TDD cells**

DRX cycle length (s)	$T_{\text{measure, E-UTRAN TDD}}$ (s) (DRX cycles)
$\leq 0.08$	Non-DRX Requirements in clause 9.4.3.2 apply
0.128	For configuration 2 <sup>Note3</sup> , non-DRX requirements in clause 9.4.3.2 apply, Otherwise: Note1 ( $5 * \text{CSSF}_{\text{interRAT}}$ )
$0.128 < \text{DRX-cycle} \leq 10.24$	Note1 ( $5 * \text{CSSF}_{\text{interRAT}}$ )
NOTE 1: The time depends on the DRX cycle length.	
NOTE 2: $\text{CSSF}_{\text{interRAT}}$ is as defined in clause 9.4.3.2.	
NOTE 3: See Table 9.4.3.2-1.	

If higher layer filtering is used, an additional cell identification delay can be expected.

The NR – E-UTRAN TDD RSRP measurement accuracy for all measured cells shall be as specified in clause 10.2.2.  
The NR – E-UTRAN TDD RSRQ measurement accuracy for all measured cells shall be as specified in clause 10.2.3.  
The NR – E-UTRAN TDD RS-SINR measurement accuracy for all measured cells shall be as specified in clause 10.2.5.

## 9.4.3.4 Measurement reporting requirements

### 9.4.3.4.1 Periodic Reporting

The reported NR – E-UTRAN TDD RSRP, RSRQ, and RS-SINR measurements contained in periodically triggered measurement reports shall meet the requirements in clauses 10.2.2, 10.2.3, and 10.2.5, respectively.

### 9.4.3.4.2 Event-Triggered Periodic Reporting

The reported NR – E-UTRAN TDD RSRP, RSRQ, and RS-SINR measurements contained in event-triggered periodic measurement reports shall meet the requirements in clauses 10.2.2, 10.2.3, and 10.2.5, respectively.

The first report in event-triggered periodic measurement reporting shall meet the requirements specified in clause 9.4.3.4.3.

### 9.4.3.4.3 Event-Triggered Reporting

The reported NR – E-UTRAN TDD RSRP, RSRQ, and RS-SINR measurements contained in event-triggered measurement reports shall meet the requirements in clauses 10.2.2, 10.2.3, and 10.2.5, respectively.

The UE shall not send any event-triggered measurement reports as long as no reporting criteria are fulfilled.

The measurement reporting delay is defined as the time between an event that will trigger a measurement report and the point when the UE starts to transmit the measurement report over the air interface. This requirement assumes that the measurement report is not delayed by other RRC signalling on the DCCH. This measurement reporting delay excludes a delay uncertainty resulted when inserting the measurement report to the TTI of the uplink DCCH. The delay uncertainty is:  $2 \times TTI_{DCCH}$  where  $TTI_{DCCH}$  is the duration of subframe or slot or subslot when the measurement report is transmitted on the PUSCH with subframe or slot or subslot duration. This measurement reporting delay excludes a delay which caused by no UL resources for UE to send the measurement report.

The event triggered measurement reporting delay, measured without L3 filtering shall be less than  $T_{Identify, E-UTRAN TDD}$  defined in clauses 9.4.3.2 and 9.4.3.3 without DRX and with DRX, respectively. When L3 filtering is used, an additional delay can be expected.

If a cell which has been detectable at least for the time period  $T_{Identify, E-UTRAN TDD}$  becomes undetectable for a period  $\leq 5$  seconds and then the cell becomes detectable again and triggers an event as per TS 38.331 [2], the event triggered measurement reporting delay shall be less than  $T_{Measure, E-UTRAN TDD}$  provided the timing to that cell has not changed more than  $\pm 50 T_s$  while measurement gap has not been available and the L3 filter has not been used.

## 9.4.4 Inter-RAT RSTD measurements

### 9.4.4.1 NR – E-UTRAN FDD RSTD measurements

#### 9.4.4.1.1 Introduction

The requirements are applicable for NR–E-UTRAN FDD RSTD measurements requested via LPP [22, 27].

When the UE is in NE-DC operation mode and an NR–E-UTRAN FDD RSTD measurement configured by NR PCell is on a E-UTRA serving frequency carrier, then the corresponding E-UTRA intra-frequency measurements requirements as follows shall apply.

- Measurements configured on E-UTRA PSCC shall meet E-UTRAN OTDOA intra-frequency measurements requirements in clause 8.1.2.5. The applicable measurement accuracy requirements are in clause 9.1.10.
- Measurements configured on E-UTRA SCC shall meet all applicable requirements in clause 8.4, except that the terms PCell and primary component carrier shall be deemed to be swapped with PSCell and PSCC. The applicable measurement accuracy requirements are in clause 9.1.12, except that the terms PCell and primary component carrier shall be deemed to be swapped with PSCell and PSCC.

The requirements in clause 9.4.4.1 apply when:

- the UE is provided with the LTE timing information via LPP [27], including both *nr-LTE-SFN-Offset* and *nr-LTE-fineTiming-Offset*, or
- the UE is not provided with *nr-LTE-SFN-Offset* or *nr-LTE-fineTiming-Offset*, or
- the UE is provided with *nr-LTE-SFN-Offset* but not with *nr-LTE-fineTiming-Offset*.

When the UE is not aware of the SFN of at least one LTE cell in the OTDOA assistance data, the UE may be using autonomous gaps to acquire SFN of the OTDOA assistance data reference cell prior to requesting measurement gaps for performing the requested E-UTRA RSTD measurements before the  $T_{\text{RSTD InterRAT, E-UTRAN FDD}}$  time period starts while meeting all the requirements in clause 9.4.4.1.2, provided that the OTDOA assistance data is provided to allow sufficient time for the UE to acquire the SFN before the  $T_{\text{RSTD InterRAT, E-UTRAN FDD}}$  starts.

When the UE is not aware of and cannot derive the subframe timing difference between the NR serving cell and the OTDOA assistance data reference cell, the UE may need to request measurement gaps to perform cell detection for the OTDOA assistance data reference cell prior to requesting measurement gaps for performing the requested E-UTRA RSTD measurements before the  $T_{\text{RSTD InterRAT, E-UTRAN FDD}}$  time period starts while meeting all the requirements in clause 9.4.4.1.2, provided that the OTDOA assistance data is provided to allow sufficient time for the UE to detect the cell before the  $T_{\text{RSTD InterRAT, E-UTRAN FDD}}$  starts.

#### 9.4.4.1.2 Requirements

When the physical layer cell identities of neighbour cells together with the OTDOA assistance data are provided, the UE shall be able to detect and measure inter-RAT E-UTRAN FDD RSTD, specified in TS 38.215 [4], for at least  $n=16$  cells, including the reference cell, within  $T_{\text{RSTD InterRAT, E-UTRAN FDD}}$  ms as given below:

$$T_{\text{RSTD InterRAT, E-UTRAN FDD}} = T_{\text{PRS}} \cdot (M - 1) + \Delta \quad \text{ms},$$

where

$T_{\text{RSTD InterRAT, E-UTRAN FDD}}$  is the total time for detecting and measuring at least  $n$  cells,

$T_{\text{PRS}}$  is the largest value of the cell-specific positioning subframe configuration period, defined in TS 36.211 [23], among the measured  $n$  cells including the reference cell,

$M$  is the number of PRS positioning occasions as defined in Table 9.4.4.1.2-1, where each PRS positioning occasion comprises of  $N_{\text{PRS}}$  ( $1 \leq N_{\text{PRS}} \leq 6$ ) consecutive downlink positioning subframes defined in TS 36.211 [23],

$\text{CSSF}_{\text{interRAT}} = \text{CSSF}_{\text{within\_gap},i}$  is the scaling factor determined by the gap sharing scheme for the RSTD measurements on the carrier frequency  $i$  as defined in clause 9.1.5.2,

$\Delta = 160 \cdot \left\lceil \frac{n}{M} \right\rceil$  ms is the measurement time for a single PRS positioning occasion which includes the sampling time and the processing time, and

the  $n$  cells are distributed on up to two E-UTRAN FDD carrier frequencies.

**Table 9.4.4.1.2-1: Number of PRS positioning occasions within  $T_{\text{RSTD InterRAT, E-UTRAN FDD}}$**

Positioning subframe configuration period, $T_{\text{PRS}}$	Number of PRS positioning occasions, $M$	
	f2 <sup>Note1</sup>	f1 and f2 <sup>Note2</sup>
160 ms	$16 \times \text{CSSF}_{\text{interRAT}}$	$32 \times \text{CSSF}_{\text{interRAT}}$
>160 ms	$8 \times \text{CSSF}_{\text{interRAT}}$	$16 \times \text{CSSF}_{\text{interRAT}}$
NOTE 1: When inter-RAT E-UTRAN FDD RSTD measurements are performed over the reference cell and neighbour cells, which belong to the E-UTRAN FDD carrier frequency f2.		
NOTE 2: When inter-RAT E-UTRAN FDD RSTD measurements are performed over the reference cell and the neighbour cells, which belong to the E-UTRAN FDD carrier frequency f1 and the E-UTRAN FDD carrier frequency f2 respectively.		

The UE physical layer shall be capable of reporting RSTD for the reference cell and all the neighbor cells  $i$  out of at least  $(n-1)$  neighbor cells within  $T_{\text{RSTD InterRAT, E-UTRAN FDD}}$  provided:

$(\text{PRS } \hat{E}_s / \text{Iot})_{\text{ref}} \geq -6$  dB for all Frequency Bands for the reference cell,  
 $(\text{PRS } \hat{E}_s / \text{Iot})_i \geq -13$  dB for all Frequency Bands for neighbour cell  $i$ ,  
 $(\text{PRS } \hat{E}_s / \text{Iot})_{\text{ref}}$  and  $(\text{PRS } \hat{E}_s / \text{Iot})_i$  conditions apply for all subframes of at least  $L = \frac{M}{2}$  PRS positioning occasions,  
 PRP 1,2<sub>dBm</sub> according to TS 36.133 [15, Annex B.2.6] for a corresponding Band,

$\text{PRS } \hat{E}_s / \text{Iot}$  is defined as the ratio of the average received energy per PRS resource element during the useful part of the symbol to the average received power spectral density of the total noise and interference for this resource element, where the ratio is measured over all resource elements which carry PRS.

The time  $T_{\text{RSTD InterRAT, E-UTRAN FDD}}$  starts from the first subframe of the PRS positioning occasion closest in time after both the *OTDOA-RequestLocationInformation* message and the OTDOA assistance data in the *OTDOA-ProvideAssistanceData* message via LPP as specified in TS 38.305 [22], are delivered to the physical layer of the UE.

The RSTD measurement accuracy for all measured neighbor cells  $i$  shall be fulfilled according to the accuracy as specified in clause 10.2.4.

#### 9.4.4.1.2.1 RSTD Measurement Reporting Delay

This requirement assumes that the measurement report is not delayed by other LPP signalling on the DCCH. This measurement reporting delay excludes a delay uncertainty resulted when inserting the measurement report to the TTI of the uplink DCCH. The delay uncertainty is:  $2 \times \text{TTI}_{\text{DCCH}}$  where  $\text{TTI}_{\text{DCCH}}$  is the duration of subframe or slot or subslot when the measurement report is transmitted on the PUSCH with subframe or slot or subslot duration. This measurement reporting delay excludes any delay caused by no UL resources for UE to send the measurement report.

#### 9.4.4.1.2.2 Requirements for acquiring the timing of the E-UTRA OTDOA reference cell

When the UE is not aware of the SFN of at least one LTE cell in the OTDOA assistance data, the UE supporting per-FR gaps may make autonomous gaps in downlink reception and uplink transmission of the PCell, PSCell, and each of the SCells in FR1 for acquiring SFN of the reference cell in the E-UTRA OTDOA assistance data, while no autonomous gaps in downlink reception or uplink transmission are allowed in any of the UE serving cells in FR2. The UE, which are only supporting per-UE gaps, may make autonomous gaps in downlink reception and uplink transmission of the PCell, PSCell, and each of the SCells for acquiring the SFN of the reference cell in the E-UTRA OTDOA assistance data.

When the UE is not aware of and cannot derive the subframe timing difference between the NR serving cell and the OTDOA assistance data reference cell, the UE may need to request measurement gaps while indicating *utra-FineTimingDetection* according to TS 38.331 [2] for detecting the reference cell in the E-UTRA OTDOA assistance data.

When the UE is performing one or both of SFN acquisition or cell detection as specified above, the UE shall be able to determine the timing of the E-UTRA OTDOA assistance data reference cell during the time period

$$T_{\text{RefCell,E-UTRAN}} = T_{\text{Detect, E-UTRAN FDD}} + T_{\text{MIB}} + T_{\text{ECGI}},$$

where

$T_{\text{Detect, E-UTRAN FDD}} = T_{\text{Identify, E-UTRAN FDD}} - T_{\text{measure, E-UTRAN FDD}}$  is according to clause 9.4.2 assuming  $\text{CSSF}_{\text{interRAT}}=1$  and it is the time needed to detect the E-UTRA OTDOA assistance data reference cell when the UE needs to acquire the subframe and slot timing of the cell, provided the UE is configured with measurement gaps ( $T_{\text{Detect, E-UTRAN FDD}}=0$  when both *nr-LTE-SFN-Offset* and *nr-LTE-fineTiming-Offset* are provided in the E-UTRA OTDOA assistance data or the E-UTRA OTDOA assistance data reference cell is known to the UE), and

$T_{\text{MIB}} = 50$  ms is the time required to acquire SFN and/or PHICH configuration of the E-UTRA OTDOA assistance data reference cell provided the OTDOA assistance data reference cell is decodable and at least all E-UTRA subframes #0

during  $T_{MIB}$  are available at the UE receiver ( $T_{MIB}=0$  when *nr-LTE-SFN-Offset* is provided in the E-UTRA OTDOA assistance data and ECGI acquisition is not needed), and

$T_{ECGI} = 100$  ms is the time required to acquire ECGI of the E-UTRA OTDOA assistance data reference cell when *cellGlobalId* is included in *OTDOA-ReferenceCellInfo* and the UE is not aware of the ECGI of this cell ( $T_{ECGI} = 0$  when *cellGlobalId* is not included in *OTDOA-ReferenceCellInfo* or the UE is aware of the ECGI of the E-UTRA OTDOA assistance data reference cell).

When detecting the E-UTRAN OTDOA reference cell, the requirements in this clause shall be met, provided the conditions for the detectable cell are fulfilled according to clause 9.4.2.1. In addition, the MIB of the E-UTRA OTDOA reference cell whose SFN is acquired shall be considered decodable by the UE provided the PBCH demodulation requirements are met according to TS 36.101 [25].

The requirement for acquiring the timing of the E-UTRA OTDOA reference cell within  $T_{RefCell,E-UTRAN}$  is applicable when no DRX is used as well as when any of the DRX cycles specified in TS 38.331 [2] is used.

When  $T_{MIB}>0$  and UE is using autonomous gaps during  $T_{MIB}$ , the UE shall transmit at least  $N_{ACK/NACK, MIB, FDD}$  ACK/NACKs on PCell, PSCell, and each of activated SCell(s) in the frequency range where the autonomous gaps are created, specified in Table 9.4.4.1.2.2-1. When both  $T_{MIB}>0$  and  $T_{ECGI}>0$  and UE is using autonomous gaps during  $T_{MIB}+T_{ECGI}$ , the UE shall transmit on PCell, PSCell, and each of activated SCell(s) in the frequency range where autonomous gaps are created at least  $N_{ACK/NACK, MIB+ECGI, FDD}$  ACK/NACKs specified in Table 9.4.4.1.2.2-3, provided the OTDOA reference cell bandwidth is configured in the OTDOA assistance data [22, 27]. The requirements in Tables 9.4.4.1.2.2-1, 9.4.4.1.2.2-2, and 9.4.4.1.2.2-3 apply, provided that:

- there is continuous DL data allocation,
- no DRX cycle is used,
- no measurement gaps are configured,
- only one code word is transmitted in each slot,
- 2 slot ACK/NACK feedback is configured,
- 20 ms SMTC period is configured,
- SSBs are transmitted in one slot within SMTC window.

**Table 9.4.4.1.2.2-2: Void**

**Table 9.4.4.1.2.2-2: Number of ACK/NACKs transmitted by the UE during  $T_{ECGI}$**

$N_{ACK/NACK, ECGI, FDD}$	Configuration of the serving cell in which the transmitted ACK/NACKs are counted	
	Duplex mode configuration	SCS
66	FDD	15 kHz
145	FDD	30 kHz
298	FDD	60 kHz
28	TDD <sup>Note 1</sup>	15 kHz
67	TDD <sup>Note 1</sup>	30 kHz
144	TDD <sup>Note 1</sup>	60 kHz
175	TDD <sup>Note 2</sup>	60 kHz
363	TDD <sup>Note 2</sup>	120 kHz

NOTE 1: TDD UL-DL configuration is as specified in Table A.3.3.1-1 of TS 38.101-1 [18].  
 NOTE 2: TDD UL-DL configuration is as specified in Table A.3.3.1-1 of TS 38.101-2 [19].

**Table 9.4.4.1.2.2-3: Number of ACK/NACKs transmitted by the UE during  $T_{MIB}+T_{ECGI}$**

$N_{ACK/NACK, MIB+ECGI, FDD}$	Configuration of the serving cell in which the transmitted ACK/NACKs are counted	
	Duplex mode configuration	SCS
84	FDD	15 kHz
193	FDD	30 kHz

402	FDD	60 kHz
28	TDD <sup>Note 1</sup>	15 kHz
81	TDD <sup>Note 1</sup>	30 kHz
159	TDD <sup>Note 1</sup>	60 kHz
233	TDD <sup>Note 2</sup>	60 kHz
491	TDD <sup>Note 2</sup>	120 kHz
NOTE 1: TDD UL-DL configuration is as specified in Table A.3.3.1-1 of TS 38.101-1 [18].		
NOTE 2: TDD UL-DL configuration is as specified in Table A.3.3.1-1 of TS 38.101-2 [19].		

## 9.4.4.2 NR – E-UTRAN TDD RSTD measurements

### 9.4.4.2.1 Introduction

The requirements are applicable for NR–E-UTRAN TDD RSTD measurements requested via LPP [22, 27].

When the UE is in NE-DC operation mode and an NR–E-UTRAN TDD RSTD measurement configured by NR PCell is on a E-UTRA serving frequency carrier, then the corresponding E-UTRA intra-frequency measurements requirements as follows shall apply.

- Measurements configured on E-UTRA PSCC shall meet E-UTRAN OTDOA intra-frequency measurements requirements in clause 8.1.2.5. The applicable measurement accuracy requirements are in clause 9.1.10.
- Measurements configured on E-UTRA SCC shall meet all applicable requirements in clause 8.4, except that the terms PCell and primary component carrier shall be deemed to be swapped with PSCell and PSCC. The applicable measurement accuracy requirements are in clause 9.1.12, except that the terms PCell and primary component carrier shall be deemed to be swapped with PSCell and PSCC.

The requirements in clause 9.4.4.1 apply when:

- the UE is provided with the LTE timing information via LPP [27], including both *nr-LTE-SFN-Offset* and *nr-LTE-fineTiming-Offset*, or
- the UE is not provided with *nr-LTE-SFN-Offset* or *nr-LTE-fineTiming-Offset*, or
- the UE is provided with *nr-LTE-SFN-Offset* but not with *nr-LTE-fineTiming-Offset*.

When the UE is not aware of the SFN of at least one LTE cell in the OTDOA assistance data, the UE may be using autonomous gaps to acquire SFN of the OTDOA assistance data reference cell prior to requesting measurement gaps for performing the requested E-UTRA RSTD measurements before the  $T_{\text{RSTD InterRAT,E-UTRAN TDD}}$  time period starts while meeting all the requirements in clause 9.4.4.2.2, provided that the OTDOA assistance data is provided to allow sufficient time for the UE to acquire the SFN before the  $T_{\text{RSTD InterRAT,E-UTRAN TDD}}$  starts. When the UE is not aware of and cannot derive the subframe timing difference between the NR serving cell and the OTDOA assistance data reference cell, the UE may need to request measurement gaps to perform cell detection for the OTDOA assistance data reference cell prior to requesting measurement gaps for performing the requested E-UTRA RSTD measurements before the  $T_{\text{RSTD InterRAT,E-UTRAN TDD}}$  time period starts while meeting all the requirements in clause 9.4.4.2.2, provided that the OTDOA assistance data is provided to allow sufficient time for the UE to detect the cell before the  $T_{\text{RSTD InterRAT,E-UTRAN TDD}}$  starts.

### 9.4.4.2.2 Requirements

When the physical layer cell identities of neighbour cells together with the OTDOA assistance data are provided, the UE shall be able to detect and measure inter-RAT -UTRAN TDD RSTD, specified in TS 38.215 [4], for at least  $n=16$  cells, including the reference cell, within  $T_{\text{RSTD InterRAT,E-UTRAN TDD}}$  ms as given below:

$$T_{\text{RSTD InterRAT,E-UTRAN TDD}} = T_{\text{PRS}} \cdot (M - 1) + \Delta \quad \text{ms} \quad ,$$

where



$T_{\text{RSTD InterRAT, E-UTRAN TDD}}$  is the total time for detecting and measuring at least  $n$  cells,

$T_{\text{PRS}}$  is the largest value of the cell-specific positioning subframe configuration period, defined in TS 36.211 [23], among the measured  $n$  cells including the reference cell,

$M$  is the number of PRS positioning occasions as defined in Table 9.4.4.2.2-1, where a PRS positioning occasion is as defined in clause 9.4.4.1.2,

$\text{CSSF}_{\text{interRAT}} = \text{CSSF}_{\text{within\_gap}, i}$  is the scaling factor determined by the gap sharing scheme for the RSTD measurements on the carrier frequency  $i$  as defined in clause 9.1.5.2,

$\Delta = 160 \cdot \left\lceil \frac{n}{M} \right\rceil$  ms is the measurement time for a single PRS positioning occasion which includes the sampling time and the processing time, and

the  $n$  cells are distributed on up to two E-UTRAN TDD carrier frequencies.

**Table 9.4.4.2.2-1: Number of PRS positioning occasions within  $T_{\text{RSTD InterRAT, E-UTRAN TDD}}$**

Positioning subframe $T_{\text{PRS}}$ configuration period,	Number of PRS positioning occasions, $M$	
	f2 <sup>Note1</sup>	f1 and f2 <sup>Note2</sup>
160 ms	$16 \times \text{CSSF}_{\text{interRAT}}$	$32 \times \text{CSSF}_{\text{interRAT}}$
>160 ms	$8 \times \text{CSSF}_{\text{interRAT}}$	$16 \times \text{CSSF}_{\text{interRAT}}$
NOTE 1: When inter-RAT E-UTRAN TDD RSTD measurements are performed over the reference cell and neighbour cells, which belong to the E-UTRAN TDD carrier frequency f2.		
NOTE 2: When inter-RAT E-UTRAN TDD RSTD measurements are performed over the reference cell and the neighbour cells, which belong to the E-UTRAN TDD carrier frequency f1 and the E-UTRAN TDD carrier frequency f2 respectively.		

The requirements in this clause shall apply for all TDD special subframe configurations specified in TS 36.211 [23] and for the TDD uplink-downlink configurations as specified in Table 9.4.4.2.2-2 for UE requiring measurement gaps for these measurements. For UEs capable of performing inter-RAT RSTD measurements without measurement gaps, TDD uplink-downlink subframe configurations as specified in Table 9.4.4.2.2-3 shall apply.

**Table 9.4.4.2.2-2: TDD uplink-downlink subframe configurations applicable for inter-RAT RSTD requirements**

PRS Transmission Bandwidth (RB)	Applicable TDD uplink-downlink configurations
6, 15	3, 4 and 5
25	1, 2, 3, 4, 5 and 6
50, 75, 100	0, 1, 2, 3, 4, 5 and 6
NOTE 1: Uplink-downlink configurations are specified in Table 4.2-2 in TS 36.211 [23].	

**Table 9.4.4.2.2-3: TDD uplink-downlink subframe configurations applicable for inter-RAT RSTD requirements without gaps**

PRS Transmission Bandwidth (RB)	Applicable TDD uplink-downlink configurations
6, 15	1, 2, 3, 4 and 5
25, 50, 75, 100	0, 1, 2, 3, 4, 5 and 6
NOTE 1: Uplink-downlink configurations are specified in Table 4.2-2 in TS 36.211 [23].	

The UE physical layer shall be capable of reporting RSTD for the reference cell and all the neighbor cells  $i$  out of at least  $(n-1)$  neighbor cells within  $T_{\text{RSTD InterRAT, E-UTRAN TDD}}$  provided:

$$\left( \text{PRS } \hat{E}_s / I_{\text{ot}} \right)_{\text{ref}} \geq -6 \text{ dB for all Frequency Bands for the reference cell,}$$

$(\text{PRS } \hat{E}_s / \text{Iot})_i \geq -13$  dB for all Frequency Bands for neighbour cell  $i$ ,

$(\text{PRS } \hat{E}_s / \text{Iot})_{ref}$  and  $(\text{PRS } \hat{E}_s / \text{Iot})_i$  conditions apply for all subframes of at least  $L = \frac{M}{2}$  PRS positioning

occasions,

PRP 1,2<sub>dBm</sub> according to TS 36.133 [15, Annex B.2.6] for a corresponding Band,

$\text{PRS } \hat{E}_s / \text{Iot}$  is as defined in clause 9.4.4.1.2.

The time  $T_{\text{RSTD InterRAT, E-UTRAN TDD}}$  starts from the first subframe of the PRS positioning occasion closest in time after both the OTDOA-RequestLocationInformation message and the OTDOA assistance data in the OTDOA-ProvideAssistanceData message via LPP as specified in TS 38.305 [22], are delivered to the physical layer of the UE.

The RSTD measurement accuracy for all measured neighbor cells  $i$  shall be fulfilled according to the accuracy as specified in clause 10.2.4.

#### 9.4.4.2.2.1 RSTD Measurement Reporting Delay

This requirement assumes that the measurement report is not delayed by other LPP signalling on the DCCH. This measurement reporting delay excludes a delay uncertainty resulted when inserting the measurement report to the TTI of the uplink DCCH. The delay uncertainty is:  $2 \times \text{TTI}_{\text{DCCH}}$  where  $\text{TTI}_{\text{DCCH}}$  is the duration of subframe or slot or subslot when the measurement report is transmitted on the PUSCH with subframe or slot or subslot duration. This measurement reporting delay excludes any delay caused by no UL resources for UE to send the measurement report.

#### 9.4.4.2.2.2 Requirements for acquiring the timing of the E-UTRA OTDOA reference cell

When the UE is not aware of the SFN of at least one LTE cell in the OTDOA assistance data, the UE supporting per-FR gaps may make autonomous gaps in downlink reception and uplink transmission of the PCell, PSCell, and each of the SCells in FR1 for acquiring SFN of the reference cell in the E-UTRA OTDOA assistance data, while no autonomous gaps in downlink reception or uplink transmission are allowed in any of the UE serving cells in FR2. The UE, which are only supporting per-UE gaps, may make autonomous gaps in downlink reception and uplink transmission of the PCell, PSCell, and each of the SCells for acquiring the SFN of the reference cell in the E-UTRA OTDOA assistance data.

When the UE is not aware of and cannot derive the subframe timing difference between the NR serving cell and the OTDOA assistance data reference cell, the UE may need to request measurement gaps while indicating *utra-FineTimingDetection* according to TS 38.331 [2] for detecting the reference cell in the E-UTRA OTDOA assistance data.

When the UE is performing one or both of SFN acquisition or cell detection as specified above, the UE shall be able to determine the timing of the E-UTRA OTDOA assistance data reference cell during the time period

$$T_{\text{RefCell, E-UTRAN}} = T_{\text{Detect, E-UTRAN TDD}} + T_{\text{MIB}} + T_{\text{ECGI}},$$

where

$T_{\text{Detect, E-UTRAN TDD}} = T_{\text{Identify, E-UTRAN TDD}} - T_{\text{measure, E-UTRAN TDD}}$  is according to clause 9.4.3 assuming  $\text{CSSF}_{\text{interRAT}}=1$  and it is the time needed to detect the E-UTRA OTDOA assistance data reference cell when the UE needs to acquire the subframe and slot timing of the cell, provided the UE is configured with measurement gaps ( $T_{\text{Detect, E-UTRAN TDD}}=0$  when both *nr-LTE-SFN-Offset* and *nr-LTE-fineTiming-Offset* are provided in the E-UTRA OTDOA assistance data or the E-UTRA OTDOA assistance data reference cell is known to the UE), and

$T_{\text{MIB}} = 50$  ms is the time required to acquire SFN and/or PHICH configuration of the E-UTRA OTDOA assistance data reference cell provided the OTDOA assistance data reference cell is decodable and at least all E-UTRA subframes #0 during  $T_{\text{MIB}}$  are available at the UE receiver ( $T_{\text{MIB}}=0$  when *nr-LTE-SFN-Offset* is provided in the E-UTRA OTDOA assistance data and ECGI acquisition is not needed), and

$T_{\text{ECGI}} = 100$  ms is the time required to acquire ECGI of the E-UTRA OTDOA assistance data reference cell when *cellGlobalId* is included in *OTDOA-ReferenceCellInfo* and the UE is not aware of the ECGI of this cell ( $T_{\text{ECGI}} = 0$  when *cellGlobalId* is not included in *OTDOA-ReferenceCellInfo* or the UE is aware of the ECGI of the E-UTRA OTDOA assistance data reference cell).

When detecting the E-UTRAN OTDOA reference cell, the requirements in this clause shall be met, provided the conditions for the detectable cell are fulfilled according to clause 9.4.3.1. In addition, the MIB of the E-UTRA OTDOA reference cell whose SFN is acquired shall be considered decodable by the UE provided the PBCH demodulation requirements are met according to TS 36.101 [25].

The requirement for acquiring the timing of the E-UTRA OTDOA reference cell within  $T_{\text{RefCell,E-UTRAN}}$  is applicable when no DRX is used as well as when any of the DRX cycles specified in TS 38.331 [2] is used.

When  $T_{\text{MIB}} > 0$  and UE is using autonomous gaps during  $T_{\text{MIB}}$ , the UE shall transmit at least  $N_{\text{ACK/NACK, MIB, TDD}}$  ACK/NACKs on PCell, PSCell, and each of activated SCell(s) in the frequency range where the autonomous gaps are created, specified in Table 9.4.4.2.2.2-1. When both  $T_{\text{MIB}} > 0$  and  $T_{\text{ECGI}} > 0$  and UE is using autonomous gaps during  $T_{\text{MIB}} + T_{\text{ECGI}}$ , the UE shall transmit on PCell, PSCell, and each of activated SCell(s) in the frequency range where autonomous gaps are created at least  $N_{\text{ACK/NACK, MIB+ECGI, TDD}}$  ACK/NACKs specified in Table 9.4.4.2.2.2-3, provided the OTDOA reference cell bandwidth is configured in the OTDOA assistance data [22, 27]. The requirements in Tables 9.4.4.2.2.2-1, 9.4.4.2.2.2-2 and 9.4.4.2.2.2-3 apply, provided that:

- there is continuous DL data allocation,
- no DRX cycle is used,
- no measurement gaps are configured,
- only one code word is transmitted in each slot,
- 2 slot ACK/NACK feedback is configured,
- 20 ms SMTC period is configured,
- SSBs are transmitted in one slot within SMTC window.

**Table 9.4.4.2.2-1: Minimum number of ACK/NACKs transmitted by the UE during  $T_{\text{MIB}}$**

$N_{\text{ACK/NACK, MIB, TDD}}$	Configuration of the serving cell in which the transmitted ACK/NACKs are counted	
	Duplex mode configuration	SCS
15	FDD	15 kHz
39	FDD	30 kHz
85	FDD	60 kHz
0	TDD <sup>Note 1</sup>	15 kHz
4	TDD <sup>Note 1</sup>	30 kHz
12	TDD <sup>Note 1</sup>	60 kHz
46	TDD <sup>Note 2</sup>	60 kHz
104	TDD <sup>Note 2</sup>	120 kHz

NOTE 1: TDD UL-DL configuration is as specified in Table A.3.3.1-1 of TS 38.101-1 [18].  
NOTE 2: TDD UL-DL configuration is as specified in Table A.3.3.1-1 of TS 38.101-2 [19].

**Table 9.4.4.2.2-2: Void**

**Table 9.4.4.2.2-3: Minimum number of ACK/NACKs transmitted by the UE during  $T_{\text{MIB}} + T_{\text{ECGI}}$**

$N_{\text{ACK/NACK, MIB+ECGI, TDD}}$	Configuration of the serving cell in which the transmitted ACK/NACKs are counted	
	Duplex mode configuration	SCS
84	FDD	15 kHz
193	FDD	30 kHz
402	FDD	60 kHz
28	TDD <sup>Note 1</sup>	15 kHz
81	TDD <sup>Note 1</sup>	30 kHz
159	TDD <sup>Note 1</sup>	60 kHz
233	TDD <sup>Note 2</sup>	60 kHz
491	TDD <sup>Note 2</sup>	120 kHz

NOTE 1: TDD UL-DL configuration is as specified in Table A.3.3.1-1 of TS 38.101-1 [18].  
NOTE 2: TDD UL-DL configuration is as specified in Table A.3.3.1-1 of TS 38.101-2 [19].

## 9.4.5 Inter-RAT E-CID measurements

### 9.4.5.1 NR–E-UTRAN FDD E-CID RSRP and RSRQ measurements

#### 9.4.5.1.1 Introduction

The requirements in clause 9.4.5.1. shall apply provided the UE has received *ECID-RequestLocationInformation* message from LMF via LPP requesting the UE to report inter-RAT E-UTRAN FDD E-CID RSRP and RSRQ measurements [22, 27].

#### 9.4.5.1.2 Requirements

The requirements in clause 9.4.2 also apply for this clause except the measurement reporting requirements. The measurement reporting requirements for E-CID RSRP and RSRQ are defined in clause 9.4.5.1.3.

#### 9.4.5.1.3 Measurement Reporting Delay

This requirement assumes that the measurement report is not delayed by other LPP signalling on the DCCH. This measurement reporting delay excludes a delay uncertainty resulted when inserting the measurement report to the TTI of the uplink DCCH. The delay uncertainty is:  $2 \times TTI_{DCCH}$  where  $TTI_{DCCH}$  is the duration of subframe or slot or subslot when the measurement report is transmitted on the PUSCH with subframe or slot or subslot duration. This measurement reporting delay excludes any delay caused by no UL resources for UE to send the measurement report.

Reported RSRP and RSRQ measurements contained in periodically triggered measurement reports shall meet the requirements in clauses 10.2.2 and 10.2.3, respectively.

### 9.4.5.2 NR–E-UTRAN TDD E-CID RSRP and RSRQ measurements

#### 9.4.5.2.1 Introduction

The requirements in clause 9.4.5.2. shall apply provided the UE has received *ECID-RequestLocationInformation* message from LMF via LPP requesting the UE to report inter-RAT E-UTRAN TDD E-CID RSRP and RSRQ measurements [22, 27].

#### 9.4.5.2.2 Requirements

The requirements in clause 9.4.3 also apply for this clause except the measurement reporting requirements. The measurement reporting requirements for E-CID RSRP and RSRQ are defined in clause 9.4.5.2.3.

#### 9.4.5.2.3 Measurement Reporting Delay

This requirement assumes that the measurement report is not delayed by other LPP signalling on the DCCH. This measurement reporting delay excludes a delay uncertainty resulted when inserting the measurement report to the TTI of the uplink DCCH. The delay uncertainty is:  $2 \times TTI_{DCCH}$  where  $TTI_{DCCH}$  is the duration of subframe or slot or subslot when the measurement report is transmitted on the PUSCH with subframe or slot or subslot duration. This measurement reporting delay excludes any delay caused by no UL resources for UE to send the measurement report.

Reported RSRP and RSRQ measurements contained in periodically triggered measurement reports shall meet the requirements in clauses 10.2.2 and 10.2.3, respectively.

## 9.4.6 NR – UTRAN FDD measurements

### 9.4.6.1 Introduction

The requirements are applicable for NR– UTRAN FDD CPICH RSCP and CPICH Ec/No measurements for SRVCC.

### 9.4.6.2 Requirements when no DRX is used

#### 9.4.6.2.1 Identification of a new UTRA FDD cell

When explicit neighbour list is provided and no DRX is used, either measurement gaps are scheduled or the UE supports capability of conducting such measurements without gaps, the UE shall be able to identify a new detectable cell belonging to the monitored set within

$$T_{\text{identify\_UTRA\_FDD}} = T_{\text{basic\_identify\_UTRA\_FDD}} \cdot \frac{480}{T_{\text{inter1}}} \cdot \text{CSSF}_{\text{interRAT}} \text{ ms}$$

A cell shall be considered detectable when

- CPICH Ec/Io  $\geq$  -20 dB,
- SCH\_Ec/Io  $\geq$  -17 dB for at least one channel tap and SCH\_Ec/Io is equally divided between primary synchronisation code and secondary synchronisation code. When L3 filtering is used an additional delay can be expected.

#### 9.4.6.2.2 UE UTRA FDD CPICH measurement capability

When measurement gaps are scheduled for UTRA FDD inter RAT measurements, or the UE supports capability of conducting such measurements without gaps, the UE physical layer shall be capable of reporting measurements to higher layers with measurement accuracy as specified in Clause 10 with measurement period given by

$$T_{\text{measurement\_UTRA\_FDD}} = \text{Max} \left\{ T_{\text{Measurement\_Period\_UTRA\_FDD}} \cdot \text{CSSF}_{\text{interRAT}}, T_{\text{basic\_measurement\_UTRA\_FDD}} \cdot \frac{480}{T_{\text{inter1}}} \cdot \text{CSSF}_{\text{interRAT}} \right\} \text{ms}$$

The UE shall be capable of performing UTRA FDD CPICH measurements for  $X_{\text{basic\_measurementUTRA\_FDD}}$  inter-frequency cells per FDD frequency and the UE physical layer shall be capable of reporting measurements to higher layers with the measurement period of  $T_{\text{Measurement\_UTRA\_FDD}}$ .

$$X_{\text{basic\_measurement\_UTRA\_FDD}} = 6$$

$T_{\text{Measurement\_Period\_UTRA\_FDD}} = 480$  ms. The period used for calculating the measurement period  $T_{\text{measurement\_UTRA\_FDD}}$  for UTRA FDD CPICH measurements.

$T_{\text{basic\_identify\_UTRA\_FDD}} = 300$  ms. This is the time period used in the inter RAT equation in clause 9.4.6.2.1 where the maximum allowed time for the UE to identify a new UTRA FDD cell is defined.

$T_{\text{basic\_measurement\_UTRA\_FDD}} = 50$  ms. This is the time period used in the equation for defining the measurement period for inter RAT CPICH measurements.

$\text{CSSF}_{\text{interRAT}} = \text{CSSF}_{\text{within\_gap},i}$  is the scaling factor for the measured inter-RAT UTRA carrier  $i$  which is calculated as specified in clause 9.1.5.2.

$T_{\text{inter1}}$  is defined in clause 9.4.1.

#### 9.4.6.2.3 Periodic Reporting

Reported measurements in periodically triggered measurement reports shall meet the requirements in clause 10.

#### 9.4.6.2.4 Event Triggered Reporting

Reported measurements in event triggered measurement reports shall meet the requirements in clause 10.

The UE shall not send any event triggered measurement reports, as long as the reporting criteria is not fulfilled.

The measurement reporting delay is defined as the time between any event that will trigger a measurement report until the UE starts to transmit the measurement report over the Uu interface. This requirement assumes that the measurement report is not delayed by other RRC signalling on the DCCH. This measurement reporting delay excludes a delay uncertainty resulted when inserting the measurement report to the TTI of the uplink DCCH. The delay uncertainty is twice the TTI of the uplink DCCH. This measurement reporting delay excludes a delay which caused by no UL resources for UE to send the measurement report.

The event triggered measurement reporting delay, measured without L3 filtering shall be less than  $T_{\text{identify, UTRA\_FDD}}$  defined in Clause 9.4.6.2.1 for the minimum requirements. When L3 filtering is used an additional delay can be expected.

If a cell which has been detectable at least for the time period  $T_{\text{identify, UTRA\_FDD}}$  defined in clause 9.4.6.2.1 for the minimum requirements and then triggers the measurement report as per TS 38.331 [2], the event triggered measurement reporting delay shall be less than  $T_{\text{measurement\_UTRA\_FDD}}$  defined in clause 9.4.6.2.2 provided the timing to that cell has not changed more than  $\pm 32$  chips while measurement gap has not been available and the L3 filter has not been used. When L3 filtering is used, an additional delay can be expected.

#### 9.4.6.2.5 Event-triggered Periodic Reporting

Reported measurements contained in event triggered periodic measurement reports shall meet the requirements in clause 10.

The first report in event triggered periodic measurement reporting shall meet the requirements specified in clause 9.4.6.2.4 Event Triggered Reporting.

#### 9.4.6.3 Requirements when DRX is used

When explicit neighbour list is provided and DRX is used, either measurement gaps are scheduled or the UE supports capability of conducting such measurements without gaps, the UE shall be able to identify a new detectable cell belonging to the neighbour cell list within  $T_{\text{identify, UTRA\_FDD}}$  as shown in table 9.4.6.3-1

**Table 9.4.6.3-1: Requirement to identify a newly detectable UTRA FDD cell**

DRX cycle length (s)	$T_{\text{identify\_UTRA\_FDD}}$ (s) (DRX cycles)	
	Gap period = 40 ms	Gap period = 80 ms
$\leq 0.04$	Non DRX Requirements in clause 9.4.6.2 are applicable	Non DRX Requirements in clause 9.4.6.2 are applicable
0.064	$2.56 * \text{CSSF}_{\text{interRAT}}$ ( $40 * \text{CSSF}_{\text{interRAT}}$ )	$4.8 * \text{CSSF}_{\text{interRAT}}$ (75 $* \text{CSSF}_{\text{interRAT}}$ )
0.08	$3.2 * \text{CSSF}_{\text{interRAT}}$ (40 $* \text{CSSF}_{\text{interRAT}}$ )	$4.8 * \text{CSSF}_{\text{interRAT}}$ (60* $\text{CSSF}_{\text{interRAT}}$ )
0.128	$3.2 * \text{CSSF}_{\text{interRAT}}$ (25* $\text{CSSF}_{\text{interRAT}}$ )	$4.8 * \text{CSSF}_{\text{interRAT}}$ (37.5* $\text{CSSF}_{\text{interRAT}}$ )
0.16	$3.2 * \text{CSSF}_{\text{interRAT}}$ (20 $* \text{CSSF}_{\text{interRAT}}$ )	$4.8 * \text{CSSF}_{\text{interRAT}}$ (30 $* \text{CSSF}_{\text{interRAT}}$ )
$0.16 < \text{DRX-cycle} \leq 2.56$	Note1 (20 $* \text{CSSF}_{\text{interRAT}}$ )	Note1 (20 $* \text{CSSF}_{\text{interRAT}}$ )
Note 1: Time depends upon the DRX cycle in use.		
Note 2: $\text{CSSF}_{\text{interRAT}}$ is as defined in clause 9.4.2.2.		

A cell shall be considered detectable provided following conditions are fulfilled: A cell shall be considered detectable when

- CPICH  $E_c/I_0 \geq -20$  dB,
- SCH  $E_c/I_0 \geq -17$  dB for at least one channel tap and SCH  $E_c/I_0$  is equally divided between primary synchronisation code and secondary synchronisation code. When L3 filtering is used an additional delay can be expected.

The UE shall be capable of performing RSCP and Ec/Io measurements of at least 6 UTRA cells per UTRA FDD carrier for up to 3 UTRA FDD carriers and the UE physical layer shall be capable of reporting RSCP and Ec/Io measurements to higher layers with the measurement period defined in table 9.4.6.3-2 when DRX is used, either measurement gaps are scheduled or the UE supports capability of conducting such measurements without gaps.

**Table 9.4.6.3-2: Requirement to measure UTRA FDD cells**

DRX cycle length (s)	$T_{\text{measure\_UTRA\_FDD}}$ (s) (DRX cycles)	
	Gap period = 40 ms	Gap period = 80 ms
$\leq 0.04$	Non DRX Requirements in clause 9.4.6.2 are applicable	Non DRX Requirements in clause 9.4.6.2 are applicable
0.064	$0.48 * \text{CSSF}_{\text{interRAT}}$ ( $7.5 * N_{\text{freq}} * \text{CSSF}_{\text{interRAT}}$ )	$0.8 * \text{CSSF}_{\text{interRAT}}$ ( $12.5 * \text{CSSF}_{\text{interRAT}}$ )
0.08	$0.48 * \text{CSSF}_{\text{interRAT}}$ ( $6 * \text{CSSF}_{\text{interRAT}}$ )	$0.8 * \text{CSSF}_{\text{interRAT}}$ (10 $* \text{CSSF}_{\text{interRAT}}$ )
0.128	$0.64 * \text{CSSF}_{\text{interRAT}}$ ( $5 * \text{CSSF}_{\text{interRAT}}$ )	$0.8 * \text{CSSF}_{\text{interRAT}}$ (6.25 $* \text{CSSF}_{\text{interRAT}}$ )
$0.128 < \text{DRX-cycle} \leq 2.56$	Note1 (5 $* \text{CSSF}_{\text{interRAT}}$ )	Note1 (5 $* \text{CSSF}_{\text{interRAT}}$ )
Note 1: Time depends upon the DRX cycle in use.		
Note 2: $\text{CSSF}_{\text{interRAT}}$ is as defined in clause 9.4.2.2.		

The measurement accuracy for all measured cells shall be as specified in the clause 10.3.

#### 9.4.6.3.1 Periodic Reporting

Reported measurements in periodically triggered measurement reports shall meet the requirements in clause 10.

#### 9.4.6.3.2 Event Triggered Reporting

Reported measurements in event triggered measurement reports shall meet the requirements in clause 10.

The UE shall not send any event triggered measurement reports, as long as the reporting criteria is not fulfilled.

The measurement reporting delay is defined as the time between any event that will trigger a measurement report until the UE starts to transmit the measurement report over the Uu interface. This requirement assumes that the measurement report is not delayed by other RRC signalling on the DCCH. This measurement reporting delay excludes a delay uncertainty resulted when inserting the measurement report to the TTI of the uplink DCCH. The delay uncertainty is twice the TTI of the uplink DCCH. This measurement reporting delay excludes a delay which caused by no UL resources for UE to send the measurement report.

The event triggered measurement reporting delay, measured without L3 filtering shall be less than  $T_{\text{identify,UTRA\_FDD}}$  defined in Clause 9.4.6.3. When L3 filtering is used an additional delay can be expected.

If a cell which has been detectable at least for the time period  $T_{\text{identify,UTRA\_FDD}}$  defined in clause 9.4.6.3 and then triggers the measurement report as per TS 38.331 [2], the event triggered measurement reporting delay shall be less than  $T_{\text{measurement\_UTRA\_FDD}}$  defined in clause 9.4.6.3 provided the timing to that cell has not changed more than  $\pm 32$  chips while measurement gap has not been available and the L3 filter has not been used. When L3 filtering is used, an additional delay can be expected.

#### 9.4.6.3.3 Event-triggered Periodic Reporting

Reported measurements contained in event triggered periodic measurement reports shall meet the requirements in clause 10.

The first report in event triggered periodic measurement reporting shall meet the requirements specified in clause 9.4.6.3.2 Event Triggered Reporting.

## 9.4.7 NR – E-UTRAN measurements with autonomous gaps

### 9.4.7.1 CGI identification of an E-UTRA cell with autonomous gaps

The requirements in this clause apply when the UE is configured with standalone NR, NE-DC or NR-DC. The UE shall identify and report the CGI when requested by an NR PCell for the purpose 'reportCGI'. The UE may make autonomous gaps in downlink reception and uplink transmission for receiving MIB and SIB1 message according to clause 5.5.3.1 in TS 38.331 [2]. If autonomous gaps are used for measurement with the purpose of 'reportCGI', regardless of whether DRX is used or not, or regardless of whether SCell(s) are configured or not, the UE shall be able to identify a new CGI of E-UTRA cell within  $T_{\text{identify\_CGI, E-UTAN}} = 150$  ms. This is the maximum allowed time for the UE to identify a new CGI of an E-UTRA cell, provided that the E-UTRA cell has been already identified by the UE.

A cell shall be considered identifiable following conditions are fulfilled:

- RSRP related side conditions given in Clause 9.1 in [15] are fulfilled for a corresponding Band,
- SCH<sub>RP</sub> and SCH<sub>Es/lot</sub> according to Annex B.2.2 in [15] for a corresponding Band

The MIB of an E-UTRA cell whose CGI is identified shall be considered decodable by the UE provided the PBCH demodulation requirements are met according to [25].

The requirement for identifying a new CGI of an E-UTRA cell within  $T_{\text{identify\_CGI, E-UTRAN}}$  is applicable when no DRX is used as well as when any of the DRX cycles specified in TS 38.331 [2] is used.

### 9.4.7.2 CGI reporting delay

The E-UTRA CGI reporting delay is defined as the time between a command that will trigger an E-UTRA CGI report and the point when the UE starts to transmit the measurement report over the air interface. This requirement assumes that the measurement report is not delayed by other RRC signalling on the DCCH. This measurement reporting delay excludes a delay uncertainty of  $2 \times TTI_{\text{DCCH}}$  resulting when inserting the measurement report to the TTI of the uplink DCCH. This measurement reporting delay excludes any delay caused by lack of UL resources for UE to send the measurement report.

The CGI reporting delay shall be less than  $T_{\text{identify\_CGI, E-UTAN}}$  plus RRC procedure delay defined in clause 12 in TS 38.331 [2], and an additional 30ms margin.

## 9.5 L1-RSRP measurements for Reporting

### 9.5.1 Introduction

When configured by the network, the UE shall be able to perform L1-RSRP measurements of configured CSI-RS, SSB or CSI-RS and SSB resources for L1-RSRP. The measurements shall be performed for a serving cell, including PCell, PSCell, or SCell, on the resources configured for L1-RSRP measurements within the active BWP.

The UE shall be able to measure all CSI-RS resources and/or SSB resources of the *nzp-CSI-RS-ResourceSet* and/or *csi-SSB-ResourceSet* within the *CSI-ResourceConfig* settings configured for L1-RSRP for the active BWP, provided that the number of resources does not exceed the UE capability indicated by *beamManagementSSB-CSI-RS*.

The UE shall report the measurement quantity (*reportQuantity*) and send periodic, semi-persistent or aperiodic reports, according to the *reportConfigType* according to the CSI reporting configuration(s) (*CSI-ReportConfig*) for the active BWP.

In EN-DC and NE-DC operation, when the UE is configured to perform E-UTRA SRS carrier-based switching an additional delay can be expected in FR1 if the UE is capable of per-FR gap, or an additional delay can be expected in both FR1 and FR2 if the UE is not capable of per-FR gap.

### 9.5.2 Requirements applicability

The requirements in clause 9.5 apply, provided:



- The CSI-RS or SSB or CSI-RS and SSB resources configured for L1-RSRP measurements are measurable.

An SSB resource configured for L1-RSRP shall be considered measurable when for each relevant SSB the following conditions are met:

- L1-RSRP related side conditions given in clauses 10.1.19.1 and 10.1.20.1 for FR1 and FR2, respectively, for a corresponding band,
- SSB<sub>RP</sub> and SSB  $\hat{E}_s/I_{ot}$  according to Annex B.2.4.1 for a corresponding band.

A CSI-RS resource configured for L1-RSRP shall be considered measurable when for each relevant CSI-RS the following conditions are met:

- L1-RSRP related side conditions given in clauses 10.1.19.2 and 10.1.20.2 for FR1 and FR2, respectively, for a corresponding band,
- CSI-RS<sub>RP</sub> and CSI-RS  $\hat{E}_s/I_{ot}$  according to Annex B.2.4.2 for a corresponding band.

A CSI-RS and SSB resource configured for L1-RSRP shall be considered measurable when the measurable resource conditions are met for both CSI-RS resource and SSB resource.

Requirements are defined for periodic, semi-persistent and aperiodic resources.

### 9.5.3 Measurement Reporting Requirements

The UE shall send L1-RSRP reports only for report configurations configured for the active BWP.

The UE shall report the L1-RSRP value as a 7-bit value in the range [-140, -44] dBm with 1dB step size according to clause 10.1.19 for FR1 and 10.1.20 for FR2 if *nrofReportedRS* is configured to one. If *nrofReportedRS* is configured to be larger than one, or if *groupBasedBeamReporting* is enabled, the UE shall use differential L1-RSRP based reporting as defined in clause 10.1.19 for FR1 and 10.1.20 for FR2. The differential L1-RSRP is quantized to a 4-bit value with 2dB step size. The mapping between the reported L1-RSRP value and the measured quantity is described in 10.1.6.

In EN-DC and NE-DC operation, when the UE is configured to perform E-UTRA SRS carrier-based switching an additional delay can be expected in FR1 if the UE is capable of per-FR gap, or an additional delay can be expected in both FR1 and FR2 if the UE is not capable of per-FR gap.

#### 9.5.3.1 Periodic Reporting

Reported L1-RSRP measurements contained in periodic L1-RSRP measurement reports shall meet the requirements in clauses 10.1.19 for FR1 and 10.1.20 for FR2, respectively.

The UE shall only send periodic L1-RSRP measurement reports for an active BWP.

The UE shall transmit the periodic L1-RSRP reporting on PUCCH over the air interface according to the periodicity defined in clause 5.2.1.4 in TS 38.214 [26].

#### 9.5.3.2 Semi-Persistent Reporting

Reported L1-RSRP measurements contained in a Semi-Persistent L1-RSRP measurement report shall meet the requirements in clauses 10.1.19 for FR1 and 10.1.20 for FR2, respectively. This requirement applies for semi-persistent L1-RSRP reports sent on PUSCH or PUCCH.

The UE shall only send semi-persistent L1-RSRP measurement reports on PUSCH, if a DCI request has been received.

The UE shall only send semi-persistent L1-RSRP measurement reports on PUCCH, if an activation command [7] has been received.

The UE shall transmit the semi-persistent L1-RSRP reporting on PUSCH or PUCCH over the air interface according to the periodicity defined in clause 5.2.1.4 in TS 38.214 [26].

### 9.5.3.3 Aperiodic Reporting

Reported L1-RSRP measurements contained in aperiodic triggered, aperiodic triggered periodic and aperiodic triggered semi-persistent L1-RSRP reports shall meet the requirements in clauses 10.1.19 for FR1 and 10.1.20 for FR2, respectively.

The UE shall only send aperiodic L1-RSRP measurement reports, if a DCI trigger has been received.

After the UE receives CSI request in DCI, the UE shall transmit the aperiodic L1-RSRP reporting on PUSCH over the air interface at the time specified according to clause 6.1.2.1 in TS 38.214 [26].

## 9.5.4 L1-RSRP measurement requirements

### 9.5.4.1 SSB based L1-RSRP Reporting

The UE shall be capable of performing L1-RSRP measurements based on the configured SSB resource for L1-RSRP computation, and the UE physical layer shall be capable of reporting L1-RSRP measured over the measurement period of  $T_{L1-RSRP\_Measurement\_Period\_SSB}$ .

The value of  $T_{L1-RSRP\_Measurement\_Period\_SSB}$  is defined in Table 9.5.4.1-1 for FR1 and Table 9.5.4.1-2 for FR2, where

- $M=1$  if higher layer parameter *timeRestrictionForChannelMeasurement* is configured, and  $M=3$  otherwise
- $N=8$ .

For FR1,

- $P = \frac{1}{1 - \frac{T_{SSB}}{MGRP}}$ , when in the monitored cell there are measurement gaps configured for intra-frequency, inter-frequency or inter-RAT measurements, which are overlapping with some but not all occasions of the SSB; and
- $P=1$  when in the monitored cell there are no measurement gaps overlapping with any occasion of the SSB.

For FR2,

- $P = \frac{1}{1 - \frac{T_{SSB}}{T_{SMTCperiod}}}$ , when SSB is not overlapped with measurement gap and SSB is partially overlapped with SMTC occasion ( $T_{SSB} < T_{SMTCperiod}$ ).
- $P$  is  $P_{sharing}$  factor, when SSB is not overlapped with measurement gap and SSB is fully overlapped with SMTC period ( $T_{SSB} = T_{SMTCperiod}$ ).
- $P = \frac{1}{1 - \frac{T_{SSB}}{MGRP} \frac{T_{SSB}}{T_{SMTCperiod}}}$ , when SSB is partially overlapped with measurement gap and SSB is partially overlapped with SMTC occasion ( $T_{SSB} < T_{SMTCperiod}$ ) and SMTC occasion is not overlapped with measurement gap and
  - $T_{SMTCperiod} \neq MGRP$  or
  - $T_{SMTCperiod} = MGRP$  and  $T_{SSB} < 0.5 * T_{SMTCperiod}$
- $P$  is  $\frac{P_{sharing\ factor}}{1 - \frac{T_{SSB}}{MGRP}}$ , when SSB is partially overlapped with measurement gap and SSB is partially overlapped with SMTC occasion ( $T_{SSB} < T_{SMTCperiod}$ ) and SMTC occasion is not overlapped with measurement gap and  $T_{SMTCperiod} = MGRP$  and  $T_{SSB} = 0.5 * T_{SMTCperiod}$
- $P = \frac{1}{1 - \frac{T_{SSB}}{\min(T_{SMTCperiod}, MGRP)}}$ , when SSB is partially overlapped with measurement gap ( $T_{SSB} < MGRP$ ) and SSB is partially overlapped with SMTC occasion ( $T_{SSB} < T_{SMTCperiod}$ ) and SMTC occasion is partially or fully overlapped with measurement gap.
- $P$  is  $\frac{P_{sharing\ factor}}{1 - \frac{T_{SSB}}{MGRP}}$ , when SSB is partially overlapped with measurement gap and SSB is fully overlapped with SMTC occasion ( $T_{SSB} = T_{SMTCperiod}$ ) and SMTC occasion is partially overlapped with measurement gap ( $T_{SMTCperiod} < MGRP$ )

- $P_{\text{sharing factor}} = 1$ , if the SSB configured for L1-RSRP measurement outside measurement gap is
  - not overlapped with the SSB symbols indicated by *SSB-ToMeasure* and 1 data symbol before each consecutive SSB symbols indicated by *SSB-ToMeasure* and 1 data symbol after each consecutive SSB symbols indicated by *SSB-ToMeasure*, given that *SSB-ToMeasure* is configured, where the *SSB-ToMeasure* is the union set of *SSB-ToMeasure* from all the configured measurement objects merged on the same serving carrier, and,
  - not overlapped with the RSSI symbols indicated by *ss-RSSI-Measurement* and 1 data symbol before each RSSI symbol indicated by *ss-RSSI-Measurement* and 1 data symbol after each RSSI symbol indicated by *ss-RSSI-Measurement*, given that *ss-RSSI-Measurement* is configured,
- $P_{\text{sharing factor}} = 3$ , otherwise.

Where:

- $T_{\text{SSB}} = \text{ssb-periodicityServingCell}$
- $T_{\text{SMTCperiod}} = \text{the configured SMTC period}$

If the high layer in TS 38.331 [2] signaling of *smtc2* is configured,  $T_{\text{SMTCperiod}}$  corresponds to the value of higher layer parameter *smtc2*; Otherwise  $T_{\text{SMTCperiod}}$  corresponds to the value of higher layer parameter *smtc1*.  $T_{\text{SMTCperiod}}$  is the shortest SMTC period among all CCs in the same FR2 band, provided the SMTC offset of all CCs in FR2 have the same offset.

Longer evaluation period would be expected if the combination of SSB, SMTC occasion and measurement gap configurations does not meet pervious conditions.

For either an FR1 or FR2 serving cell, longer evaluation period would be expected during the period  $T_{\text{identify\_CGI}}$  when the UE is requested to decode an NR CGI.

For either an FR1 or FR2 serving cell, longer L1 RSRP measurement period would be expected during the period  $T_{\text{identify\_CGI,E-UTRAN}}$  when the UE is requested to decode an LTE CGI.

**Table 9.5.4.1-1: Measurement period  $T_{\text{L1-RSRP\_Measurement\_Period\_SSB}}$  for FR1**

Configuration	$T_{\text{L1-RSRP\_Measurement\_Period\_SSB}}$ (ms)
non-DRX	$\max(T_{\text{Report}}, \text{ceil}(M \cdot P) \cdot T_{\text{SSB}})$
DRX cycle $\leq 320\text{ms}$	$\max(T_{\text{Report}}, \text{ceil}(K \cdot M \cdot P) \cdot \max(T_{\text{DRX}}, T_{\text{SSB}}))$
DRX cycle $> 320\text{ms}$	$\text{ceil}(M \cdot P) \cdot T_{\text{DRX}}$
Note 1:	$T_{\text{SSB}} = \text{ssb-periodicityServingCell}$ is the periodicity of the SSB-Index configured for L1-RSRP measurement. $T_{\text{DRX}}$ is the DRX cycle length. $T_{\text{Report}}$ is configured periodicity for reporting.
Note 2:	$K = 1$ when $T_{\text{SSB}} \leq 40\text{ms}$ and <i>highSpeedMeasFlag-r16</i> are configured; otherwise $K = 1.5$ .
Note 3:	When <i>highSpeedMeasFlag-r16</i> is configured, the requirements apply only to UE supporting either <i>measurementEnhancement-r16</i> or <i>intraNR-MeasurementEnhancement-r16</i> .

**Table 9.5.4.1-2: Measurement period  $T_{\text{L1-RSRP\_Measurement\_Period\_SSB}}$  for FR2**

Configuration	$T_{\text{L1-RSRP\_Measurement\_Period\_SSB}}$ (ms)
non-DRX	$\max(T_{\text{Report}}, \text{ceil}(M \cdot P \cdot N) \cdot T_{\text{SSB}})$
DRX cycle $\leq 320\text{ms}$	$\max(T_{\text{Report}}, \text{ceil}(1.5 \cdot M \cdot P \cdot N) \cdot \max(T_{\text{DRX}}, T_{\text{SSB}}))$
DRX cycle $> 320\text{ms}$	$\text{ceil}(1.5 \cdot M \cdot P \cdot N) \cdot T_{\text{DRX}}$
Note:	$T_{\text{SSB}} = \text{ssb-periodicityServingCell}$ is the periodicity of the SSB-Index configured for L1-RSRP measurement. $T_{\text{DRX}}$ is the DRX cycle length. $T_{\text{Report}}$ is configured periodicity for reporting.

### 9.5.4.2 CSI-RS based L1-RSRP Reporting

The UE shall be capable of performing L1-RSRP measurements based on the configured CSI-RS resource for L1-RSRP computation, and the UE physical layer shall be capable of reporting L1-RSRP measured over the measurement period of  $T_{L1-RSRP\_Measurement\_Period\_CSI-RS}$ .

The value of  $T_{L1-RSRP\_Measurement\_Period\_CSI-RS}$  is defined in Table 9.5.4.2-1 for FR1 and in Table 9.5.4.2-2 for FR2, where

- For periodic and semi-persistent CSI-RS resources,  $M=1$  if higher layer parameter *timeRestrictionForChannelMeasurement* is configured, and  $M=3$  otherwise
- For aperiodic CSI-RS resources  $M=1$
- For periodic CSI-RS resources in a resource set configured with higher layer parameter *repetition* set to OFF,  $N=1$ . The requirements apply if *qcl-InfoPeriodicCSI-RS* is configured for all the resources in the resource set and for each resource one RS has QCL-TypeD with
  - SSB for L1-RSRP measurement, or
  - another CSI-RS in resource set configured with repetition ON.
- For periodic CSI-RS resources in a resource set configured with higher layer parameter *repetition* set to ON,  $N=\text{ceil}(\text{maxNumberRxBeam} / N_{\text{res\_per\_set}})$ , where  $N_{\text{res\_per\_set}}$  is number of resources in the resource set. The requirements apply provided *qcl-InfoPeriodicCSI-RS* is configured with QCL-TypeD for all resources in the resource set.
- For semi-persistent CSI-RS resources in a resource set configured with higher layer parameter *repetition* set to OFF,  $N=1$ . The requirements apply provided TCI state is provided for all resources in the resource set in the MAC CE activating the resource set and for each resource one RS has QCL-TypeD with
  - SSB for L1-RSRP measurement, or
  - another CSI-RS in resource set configured with repetition ON.
- For semi-persistent CSI-RS resources in a resource set configured with higher layer parameter *repetition* set to ON,  $N=\text{ceil}(\text{maxNumberRxBeam} / N_{\text{res\_per\_set}})$ , where  $N_{\text{res\_per\_set}}$  is number of resources in the resource set. The requirements apply provided TCI state is provided with QCL-TypeD for all resources in the resource set in the MAC CE activating the resource set.
- For aperiodic CSI-RS resources in a resource set configured with higher layer parameter *repetition* set to OFF,  $N=1$ . The requirements apply provided *qcl-info* is configured for all resources in the resource set and for each resource one RS has QCL-TypeD with
  - SSB for L1-RSRP measurement, or
  - another CSI-RS in resource set configured with repetition ON.
- For aperiodic CSI-RS resources in a resource set configured with higher layer parameter *repetition* set to ON,  $N=1$ . UE is not required to meet the accuracy requirements in clause 10.1.19.2 and 10.1.20.2 if number of resources in the resource set is smaller than *maxNumberRxBeam*. The requirements apply provided *qcl-info* is configured with QCL-TypeD for all resources in the resource set.

For FR1,

- $P = \frac{1}{1 - \frac{T_{\text{CSI-RS}}}{M_{\text{GRP}}}}$ , when in the monitored cell there are measurement gaps configured for intra-frequency, inter-frequency or inter-RAT measurements, which are overlapping with some but not all occasions of the CSI-RS; and
- $P=1$  when in the monitored cell there are no measurement gaps overlapping with any occasion of the CSI-RS.

For FR2,

- $P=1$ , when CSI-RS is not overlapped with measurement gap and also not overlapped with SMTC occasion.

- $P = \frac{1}{1 - \frac{T_{\text{CSI-RS}}}{\text{MGRP}}}$ , when CSI-RS is partially overlapped with measurement gap and CSI-RS is not overlapped with SMTC occasion ( $T_{\text{CSI-RS}} < \text{MGRP}$ )
- $P = \frac{1}{1 - \frac{T_{\text{CSI-RS}}}{T_{\text{SMTCperiod}}}}$ , when CSI-RS is not overlapped with measurement gap and CSI-RS is partially overlapped with SMTC occasion ( $T_{\text{CSI-RS}} < T_{\text{SMTCperiod}}$ ).
- $P = P_{\text{sharing factor}}$ , when CSI-RS is not overlapped with measurement gap and CSI-RS is fully overlapped with SMTC occasion ( $T_{\text{CSI-RS}} = T_{\text{SMTCperiod}}$ ).
- $P = 1$ , when aperiodic CSI-RS resource is not overlapped with measurement gap
- $P = \frac{1}{1 - \frac{T_{\text{CSI-RS}}}{\text{MGRP}} - \frac{T_{\text{CSI-RS}}}{T_{\text{SMTCperiod}}}}$ , when CSI-RS is partially overlapped with measurement gap and CSI-RS is partially overlapped with SMTC occasion ( $T_{\text{CSI-RS}} < T_{\text{SMTCperiod}}$ ) and SMTC occasion is not overlapped with measurement gap and
  - $T_{\text{SMTCperiod}} \neq \text{MGRP}$  or
  - $T_{\text{SMTCperiod}} = \text{MGRP}$  and  $T_{\text{CSI-RS}} < 0.5 * T_{\text{SMTCperiod}}$
- $P = \frac{3}{1 - \frac{T_{\text{CSI-RS}}}{\text{MGRP}}}$ , when CSI-RS is partially overlapped with measurement gap and CSI-RS is partially overlapped with SMTC occasion ( $T_{\text{CSI-RS}} < T_{\text{SMTCperiod}}$ ) and SMTC occasion is not overlapped with measurement gap and  $T_{\text{SMTCperiod}} = \text{MGRP}$  and  $T_{\text{CSI-RS}} = 0.5 * T_{\text{SMTCperiod}}$
- $P = \frac{1}{1 - \frac{T_{\text{CSI-RS}}}{\min(T_{\text{SMTCperiod}}, \text{MGRP})}}$ , when CSI-RS is partially overlapped with measurement gap ( $T_{\text{CSI-RS}} < \text{MGRP}$ ) and CSI-RS is partially overlapped with SMTC occasion ( $T_{\text{CSI-RS}} < T_{\text{SMTCperiod}}$ ) and SMTC occasion is partially or fully overlapped with measurement gap.
- $P = \frac{P_{\text{sharing factor}}}{1 - \frac{T_{\text{CSI-RS}}}{\text{MGRP}}}$ , when CSI-RS is partially overlapped with measurement gap and CSI-RS is fully overlapped with SMTC occasion ( $T_{\text{CSI-RS}} = T_{\text{SMTCperiod}}$ ) and SMTC occasion is partially overlapped with measurement gap ( $T_{\text{SMTCperiod}} < \text{MGRP}$ )
- $P_{\text{sharing factor}} = 1$ , if the CSI-RS configured for L1-RSRP measurement outside measurement gap is
  - not overlapped with the SSB symbols indicated by *SSB-ToMeasure* and 1 data symbol before each consecutive SSB symbols indicated by *SSB-ToMeasure* and 1 data symbol after each consecutive SSB symbols indicated by *SSB-ToMeasure*, given that *SSB-ToMeasure* is configured, where the *SSB-ToMeasure* is the union set of *SSB-ToMeasure* from all the configured measurement objects merged on the same serving carrier, and,
  - not overlapped with the RSSI symbols indicated by *ss-RSSI-Measurement* and 1 data symbol before each RSSI symbol indicated by *ss-RSSI-Measurement* and 1 data symbol after each RSSI symbol indicated by *ss-RSSI-Measurement*, given that *ss-RSSI-Measurement* is configured
- $P_{\text{sharing factor}} = 3$ , otherwise.

Where:

$T_{\text{SMTCperiod}}$  = the configured SMTC period.

$T_{\text{CSI-RS}}$  = the periodicity of CSI-RS configured for L1-RSRP measurement

If the high layer in TS 38.331 [2] signaling of *smtc2* is configured,  $T_{\text{SMTCperiod}}$  corresponds to the value of higher layer parameter *smtc2*; Otherwise  $T_{\text{SMTCperiod}}$  corresponds to the value of higher layer parameter *smtc1*.  $T_{\text{SMTCperiod}}$  is the shortest SMTC period among all CCs in the same FR2 band, provided the SMTC offset of all CCs in FR2 have the same offset.

Note: The overlap between CSI-RS for L1-RSRP measurement and SMTC means that CSI-RS for L1-RSRP measurement is within the SMTC window duration.

Longer evaluation period would be expected if the combination of CSI-RS, SMTC occasion and measurement gap configurations does not meet previous conditions.

For either an FR1 or FR2 serving cell, longer evaluation period would be expected during the period  $T_{\text{identify\_CGI}}$  when the UE is requested to decode an NR CGI.

For either an FR1 or FR2 serving cell, longer L1 RSRP measurement period would be expected during the period  $T_{\text{identify\_CGI,E-UTRAN}}$  when the UE is requested to decode an LTE CGI.

**Table 9.5.4.2-1: Measurement period  $T_{\text{L1-RSRP\_Measurement\_Period\_CSI-RS}}$  for FR1**

Configuration	$T_{\text{L1-RSRP\_Measurement\_Period\_CSI-RS}}$ (ms)
non-DRX	$\max(T_{\text{Report}}, \text{ceil}(M \cdot P) \cdot T_{\text{CSI-RS}})$
DRX cycle $\leq 320\text{ms}$	$\max(T_{\text{Report}}, \text{ceil}(K \cdot M \cdot P) \cdot \max(T_{\text{DRX}}, T_{\text{CSI-RS}}))$
DRX cycle $> 320\text{ms}$	$\text{ceil}(M \cdot P) \cdot T_{\text{DRX}}$
Note 1:	$T_{\text{CSI-RS}}$ is the periodicity of CSI-RS configured for L1-RSRP measurement. $T_{\text{DRX}}$ is the DRX cycle length. $T_{\text{Report}}$ is configured periodicity for reporting.
Note 2:	the requirements are applicable provided that the CSI-RS resource configured for L1-RSRP measurement is transmitted with Density = 3.
Note 3:	$K = 1$ when $T_{\text{CSI-RS}} \leq 40\text{ms}$ and <i>highSpeedMeasFlag-r16</i> are configured; otherwise $K = 1.5$ .
Note 4:	When <i>highSpeedMeasFlag-r16</i> is configured, the requirements apply only to UE supporting either <i>measurementEnhancement-r16</i> or <i>intraNR-MeasurementEnhancement-r16</i> .

**Table 9.5.4.2-2: Measurement period  $T_{\text{L1-RSRP\_Measurement\_Period\_CSI-RS}}$  for FR2**

Configuration	$T_{\text{L1-RSRP\_Measurement\_Period\_CSI-RS}}$ (ms)
non-DRX	$\max(T_{\text{Report}}, \text{ceil}(M \cdot P \cdot N) \cdot T_{\text{CSI-RS}})$
DRX cycle $\leq 320\text{ms}$	$\max(T_{\text{Report}}, \text{ceil}(1.5 \cdot M \cdot P \cdot N) \cdot \max(T_{\text{DRX}}, T_{\text{CSI-RS}}))$
DRX cycle $> 320\text{ms}$	$\text{ceil}(M \cdot P \cdot N) \cdot T_{\text{DRX}}$
Note 1:	$T_{\text{CSI-RS}}$ is the periodicity of CSI-RS configured for L1-RSRP measurement. $T_{\text{DRX}}$ is the DRX cycle length. $T_{\text{Report}}$ is configured periodicity for reporting.
Note 2:	the requirements are applicable provided that the CSI-RS resource configured for L1-RSRP measurement is transmitted with Density = 3.

## 9.5.4A Void

### 9.5.4A.1 Void

## 9.5.5 Measurement restriction for CSI-RS and SSB for L1-RSRP measurement

The UE is required to be capable of measuring SSB and CSI-RS for L1-RSRP without measurement gaps. The UE is required to perform the SSB and CSI-RS measurements with measurement restrictions as described in the following clauses.

### 9.5.5.1 Measurement restriction for SSB based L1-RSRP

For FR1, when the SSB for L1-RSRP measurement is in the same OFDM symbol as CSI-RS for RLM, BFD, CBD or L1-RSRP measurement,

- If SSB and CSI-RS have same SCS, UE shall be able to measure the SSB for L1-RSRP measurement without any restriction;
- If SSB and CSI-RS have different SCS,

- If UE supports *simultaneousRxDataSSB-DiffNumerology*, UE shall be able to measure the SSB for L1-RSRP measurement without any restriction;
- If UE does not support *simultaneousRxDataSSB-DiffNumerology*, UE is required to measure one of but not both SSB for L1-RSRP measurement and CSI-RS. Longer measurement period for SSB based L1-RSRP measurement is expected, and no requirements are defined.

For FR2, when the SSB for L1-RSRP measurement on one CC is in the same OFDM symbol as CSI-RS for RLM, BFD, CBD or L1-RSRP measurement on the same CC or different CCs in the same band, UE is required to measure one of but not both SSB for L1-RSRP measurement and CSI-RS. Longer measurement period for SSB based L1-RSRP measurement is expected, and no requirements are defined.

For FR2, if the network configures same or mixed numerology between SSB for L1-RSRP measurement on one FR2 band and CSI-RS for RLM, BFD, CBD, L1-RSRP or L1-SINR measurement on the other FR2 band, UE shall be able to perform the related SSB based measurements in one band without any measurement restrictions in the other band, provided that UE is capable of independent beam management on this FR2 band pair.

### 9.5.5.2 Measurement restriction for CSI-RS based L1-RSRP

For both FR1 and FR2, when the CSI-RS for L1-RSRP measurement is in the same OFDM symbol as SSB for RLM, BFD, CBD or L1-RSRP measurement, UE is not required to receive CSI-RS for L1-RSRP measurement in the PRBs that overlap with an SSB.

For FR1, when the SSB for RLM, BFD, CBD or L1-RSRP measurement is within the active BWP and has same SCS than CSI-RS for L1-RSRP measurement, the UE shall be able to perform CSI-RS measurement without restrictions.

For FR1, when the SSB for RLM, BFD, CBD or L1-RSRP measurement is within the active BWP and has different SCS than CSI-RS for L1-RSRP measurement, the UE shall be able to perform CSI-RS measurement with restrictions according to its capabilities:

- If the UE supports *simultaneousRxDataSSB-DiffNumerology* the UE shall be able to perform CSI-RS measurement without restrictions.
- If the UE does not support *simultaneousRxDataSSB-DiffNumerology*, UE is required to measure one of but not both CSI-RS for L1-RSRP measurement and SSB. Longer measurement period for CSI-RS based L1-RSRP measurement is expected, and no requirements are defined.

For FR1, when the CSI-RS for L1-RSRP measurement is in the same OFDM symbol as another CSI-RS for RLM, BFD, CBD or L1-RSRP measurement, UE shall be able to measure the CSI-RS for L1-RSRP measurement without any restriction.

For FR2, when the CSI-RS for L1-RSRP measurement on one CC is in the same OFDM symbol as SSB for RLM, BFD or L1-RSRP measurement on the same CC or different CCs in the same band, or in the same symbol as SSB for CBD measurement on the same CC or different CCs in the same band when beam failure is detected, UE is required to measure one of but not both CSI-RS for L1-RSRP measurement and SSB. Longer measurement period for CSI-RS based L1-RSRP measurement is expected, and no requirements are defined.

For FR2, when the CSI-RS for L1-RSRP measurement on one CC is in the same OFDM symbol as another CSI-RS for RLM, BFD, CBD or L1-RSRP measurement on the same CC or different CCs in the same band,

- In the following cases, UE is required to measure one of but not both CSI-RS for L1-RSRP measurement and the other CSI-RS. Longer measurement period for CSI-RS based L1-RSRP measurement is expected, and no requirements are defined.
  - The CSI-RS for L1-RSRP measurement or the other CSI-RS in a resource set configured with repetition ON, or
  - The other CSI-RS is configured in q1 and beam failure is detected, or
  - The two CSI-RS-es are not QCL-ed w.r.t. QCL-TypeD, or the QCL information is not known to UE,
- Otherwise, UE shall be able to measure the CSI-RS for L1-RSRP measurement without any restriction.

## 9.5.6 Scheduling availability of UE during L1-RSRP measurement

Scheduling availability restrictions when the UE is performing L1-RSRP measurement are described in the following clauses.

### 9.5.6.1 Scheduling availability of UE performing L1-RSRP measurement with a same subcarrier spacing as PDSCH/PDCCH on FR1

There are no scheduling restrictions due to L1-RSRP measurement performed on SSB and CSI-RS configured as RS for L1-RSRP measurement with the same SCS as PDSCH/PDCCH in FR1.

### 9.5.6.2 Scheduling availability of UE performing L1-RSRP measurement with a different subcarrier spacing than PDSCH/PDCCH on FR1

For UEs which support *simultaneousRxDataSSB-DiffNumerology* [14] there are no restrictions on scheduling availability due to L1-RSRP measurement based on SSB as RS for L1-RSRP measurement. For UEs which do not support *simultaneousRxDataSSB-DiffNumerology* [14] the following restrictions apply due to L1-RSRP measurement based on SSB configured for L1-RSRP measurement.

- The UE is not expected to transmit PUCCH/PUSCH/SRS or receive PDCCH/PDSCH/CSI-RS for tracking/CSI-RS for CQI on symbols corresponding to the SSB indexes configured for L1-RSRP measurement.

When intra-band carrier aggregation in FR1 is configured, the scheduling restrictions on serving cell where L1-RSRP measurement is performed apply to all serving cells in the same band on the symbols that fully or partially overlap with restricted symbols. When inter-band carrier aggregation within FR1 is configured, there are no scheduling restrictions on FR1 serving cell(s) configured in other bands than the bands in which the serving cell where L1-RSRP measurement is performed is configured.

### 9.5.6.3 Scheduling availability of UE performing L1-RSRP measurement on FR2

The following scheduling restriction applies due to L1-RSRP measurement.

- For the case where RS for L1-RSRP measurement is CSI-RS which is QCLed with active TCI state for PDCCH/PDSCH and not in a CSI-RS resource set with repetition ON, and N=1 applies as specified in clause 9.5.4.2
  - There are no scheduling restrictions due to L1-RSRP measurement performed based on the CSI-RS.
- Otherwise
  - The UE is not expected to transmit PUCCH/PUSCH/SRS or receive PDCCH/PDSCH/CSI-RS for tracking/CSI-RS for CQI on
    - symbols corresponding to the SSB indexes configured for L1-RSRP measurement, and/or
    - symbols corresponding to the periodic CSI-RS resource configured for L1-RSRP measurement, and/or
    - symbols corresponding to the semi-persistent CSI-RS resource configured for L1-RSRP measurement when the resource is activated, and/or
    - symbols corresponding to the aperiodic CSI-RS resource configured for L1-RSRP measurement when the reporting is triggered.

When intra-band carrier aggregation in FR2 is performed, the scheduling restrictions on serving cell where L1-RSRP measurement is performed apply to all serving cells in the band on the symbols that fully or partially overlap with restricted symbols.

When inter-band carrier aggregation in FR2 is performed, there are no scheduling restrictions on FR2 serving cells in the bands due to L1-RSRP measurement performed on FR2 serving cell(s) in different band(s), provided that UE is capable of independent beam management on this FR2 band pair. Additionally, there is no scheduling restriction if the UE is configured with different numerology between SSB on one FR2 band and data on the other FR2 band provided the UE is configured for IBM operation for the band pair.



If following conditions are met,

- UE has been notified about system information update through paging,
- The gap between UE's reception of PDCCH that UE monitors in the Type 2-PDCCH CSS set and that notifies system information update, and the PDCCH that UE monitors in the Type0-PDCCH CSS set, is greater than 2 slots,

For the SSB and CORESET for RMSI scheduling multiplexing patterns 3, UE is expected to receive the PDCCH that UE monitors in the Type0-PDCCH CSS set, and the corresponding PDSCH, on SSB symbols to be measured for L1-RSRP measurement; and

For the SSB and CORESET for RMSI scheduling multiplexing patterns 2, UE is expected to receive PDSCH that corresponds to the PDCCH that UE monitors in the Type0-PDCCH CSS set, on SSB symbols to be measured for L1-RSRP measurement.

#### 9.5.6.4 Scheduling availability of UE performing L1-RSRP measurement on FR1 or FR2 in case of FR1-FR2 inter-band CA

There are no scheduling restrictions on FR1 serving cell(s) due to L1-RSRP measurement performed on FR2 serving cell(s).

There are no scheduling restrictions on FR2 serving cell(s) due to L1-RSRP measurement performed on FR1 serving cell(s).

## 9.5A L1-RSRP measurements for Reporting under CCA

### 9.5A.1 Introduction

When configured by the network, the UE shall be able to perform L1-RSRP measurements of configured SSB resources for L1-RSRP. The measurements shall be performed for a serving cell under CCA operating mode, including PCell, PSCell, or SCell, on the resources configured for L1-RSRP measurements within the active BWP.

The UE shall be able to measure all SSB resources of the *csi-SSB-ResourceSet* within the *CSI-ResourceConfig* settings configured for L1-RSRP for the active BWP, provided that the number of resources does not exceed the UE capability indicated by *beamManagementSSB-CSI-RS*.

The UE shall report the measurement quantity (*reportQuantity*) and send periodic, semi-persistent or aperiodic reports, according to the *reportConfigType* according to the CSI reporting configuration(s) (*CSI-ReportConfig*) for the active BWP.

In EN-DC operation, when the UE is configured to perform E-UTRA SRS carrier-based switching an additional delay can be expected.

The requirements in clause 9.5A apply for any *channelAccessMode* configuration [TS 38.331, 2].

In the requirements of clause 9.5A, the term SSB occasion not available at the UE refers to when the SSB is configured by gNB in a cell on a carrier frequency subject to CCA, but the first two successive candidate SSB positions for the same SS/PBCH block index within the set of configured SSB are not available at the UE due to DL CCA failures at gNB during the corresponding evaluation or measurement period; otherwise the SSB occasion is considered as available at the UE.

### 9.5A.2 Requirements applicability

The requirements in clause 9.5A apply, provided:

- The SSB resources configured for L1-RSRP measurements are measurable.

An SSB resource configured for L1-RSRP shall be considered measurable when for each relevant SSB the following conditions are met:

- L1-RSRP related side conditions given in clause 10.1.19.1 for FR1 for a corresponding band,

- SSB\_RP and SSB  $\hat{E}_s/I_{ot}$  according to Annex B.2.4.1 for a corresponding band.

An SSB resource configured for L1-RSRP shall be considered measurable when the measurable resource conditions are met for SSB resource.

Requirements are defined for periodic, semi-persistent and aperiodic resources.

### 9.5A.3 Measurement Reporting Requirements

The UE shall send L1-RSRP reports only for report configurations configured for the active BWP.

The UE shall report the L1-RSRP value as a 7-bit value in the range [-140, -44] dBm with 1dB step size according to clause 10.1.19 if *nrofReportedRS* is configured to one. If *nrofReportedRS* is configured to be larger than one, or if *groupBasedBeamReporting* is enabled, the UE shall use differential L1-RSRP based reporting as defined in clause 10.1.19. The differential L1-RSRP is quantized to a 4-bit value with 2dB step size. The mapping between the reported L1-RSRP value and the measured quantity is described in 10.1.6.

In EN-DC operation, when the UE is configured to perform E-UTRA SRS carrier-based switching an additional delay can be expected if the UE is capable of per-FR gap, or an additional delay can be expected.

#### 9.5A.3.1 Periodic Reporting

Reported L1-RSRP measurements contained in periodic L1-RSRP measurement reports shall meet the requirements in clauses 10.1.19.

The UE shall only send periodic L1-RSRP measurement reports for an active BWP.

The UE shall transmit the periodic L1-RSRP reporting on PUCCH over the air interface according to the periodicity defined in clause 5.2.1.4 in TS 38.214 [26].

#### 9.5A.3.2 Semi-Persistent Reporting

Reported L1-RSRP measurements contained in a Semi-Persistent L1-RSRP measurement report shall meet the requirements in clauses 10.1.19. This requirement applies for semi-persistent L1-RSRP reports send on PUSCH or PUCCH.

The UE shall only send semi-persistent L1-RSRP measurement reports on PUSCH, if a DCI request has been received.

The UE shall only send semi-persistent L1-RSRP measurement reports on PUCCH, if an activation command [7] has been received.

The UE shall transmit the semi-persistent L1-RSRP reporting on PUSCH or PUCCH over the air interface according to the periodicity defined in clause 5.2.1.4 in TS 38.214 [26].

When CCA is used on target frequency, if UE cannot transmit HARQ-ACK for the MAC CE activation command due to UL CCA failure, the UE shall not perform MAC CE activation at the MAC action time based on the originally scheduled HARQ-ACK transmission time specified in clause 5.2.1.5.2 in TS 38.214 [26].

When CCA is used on target frequency, if UE cannot transmit HARQ-ACK for the MAC CE deactivation command due to UL CCA failure, the UE shall perform MAC CE deactivation at the MAC action time based on the originally scheduled HARQ-ACK transmission time specified in clause 5.2.1.5.2 in TS 38.214 [26].

#### 9.5A.3.3 Aperiodic Reporting

Reported L1-RSRP measurements contained in aperiodic triggered, aperiodic triggered periodic and aperiodic triggered semi-persistent L1-RSRP reports shall meet the requirements in clauses 10.1.19.

The UE shall only send aperiodic L1-RSRP measurement reports, if a DCI trigger has been received.

After the UE receives CSI request in DCI, the UE shall transmit the aperiodic L1-RSRP reporting on PUSCH over the air interface at the time specified according to clause 6.1.2.1 in TS 38.214 [26].

## 9.5A.4 L1-RSRP measurement requirements

### 9.5A.4.1 SSB based L1-RSRP Reporting

The UE shall be capable of performing L1-RSRP measurements based on the configured SSB resource for L1-RSRP computation, and the UE physical layer shall be capable of reporting L1-RSRP measured over the measurement period of  $T_{L1-RSRP\_Measurement\_Period\_SSB\_CCA}$ .

The value of  $T_{L1-RSRP\_Measurement\_Period\_SSB\_CCA}$  is defined in Table 9.5A.4.1-1 for FR1, where

- $M=1$  if higher layer parameter *timeRestrictionForChannelMeasurement* is configured, and  $M=3$  otherwise

For FR1,

- $P = \frac{1}{1 - \frac{T_{SSB}}{MRGP}}$ , when in the monitored cell there are measurement gaps configured for intra-frequency, inter-frequency or inter-RAT measurements, which are overlapping with some but not all occasions of the SSB; and
- $P=1$  when in the monitored cell there are no measurement gaps overlapping with any occasion of the SSB.

Where:

$T_{SSB} = \text{ssb-periodicityServingCell}$

$T_{SMTCperiod} =$  the configured SMTC1 period or SMTC2 period if configured

If the high layer in TS 38.331 [2] signaling of *smtc2* is configured,  $T_{SMTCperiod}$  corresponds to the value of higher layer parameter *smtc2*; Otherwise  $T_{SMTCperiod}$  corresponds to the value of higher layer parameter *smtc1*.

Longer evaluation period would be expected if the combination of SSB, SMTC occasion and measurement gap configurations does not meet previous conditions.

UE shall report RSRP\_0 (Not valid) if  $L_1 > L_{1max}$ , where  $L_1$  and  $L_{1max}$  are defined in Table 9.5A.4.1-1.

**Table 9.5A.4.1-1: Measurement period  $T_{L1-RSRP\_Measurement\_Period\_SSB\_CCA}$  for FR1**

Configuration	$T_{L1-RSRP\_Measurement\_Period\_SSB\_CCA}$ (ms)
non-DRX	$\max(T_{Report}, \text{ceil}((M+L1)*P)*T_{SSB})$
DRX cycle $\leq 320$ ms	$\max(T_{Report}, \text{ceil}(1.5*(M+L1)*P)*\max(T_{DRX}, T_{SSB}))$
DRX cycle $> 320$ ms	$\text{ceil}((M+L1)*P)*T_{DRX}$
Note 1:	$T_{SSB} = \text{ssb-periodicityServingCell}$ is the periodicity of the SSB-Index configured for L1-RSRP measurement. $T_{DRX}$ is the DRX cycle length. $T_{Report}$ is configured periodicity for reporting.
Note 2:	$L1=0$ if higher layer parameter <i>timeRestrictionForChannelMeasurement</i> is configured. Otherwise, when DRX is not configured $L1$ is the number of SSBs not available at the UE during $T_{L1-RSRP\_Measurement\_Period\_SSB\_CCA}$ , and when DRX is configured $L1$ is the number of DRX cycles in which at least one SSB is not available at the UE during $T_{L1-RSRP\_Measurement\_Period\_SSB\_CCA}$ , where $L1 \leq L_{1max}$ . The UE is not required to determine the availability of SSB occasions more frequent than Once per $\max(T_{Report}, P * T_{SSB})$ if no DRX is used, Once per $\max(T_{Report}, \text{Ceil}(1.5 * P) * \max(T_{DRX}, T_{SSB}))$ if DRX cycle $\leq 320$ ms, Once per $P * T_{DRX}$ if DRX cycle $> 320$ ms.
Note 3:	$L_{1max} = 7$ for $\max(T_{DRX}, T_{SSB}) \leq 40$ ms assuming $T_{DRX}=0$ for non-DRX, $L_{1max} = 5$ for $40\text{ms} < \max(T_{DRX}, T_{SSB}) \leq 320$ ms, $L_{1max} = 3$ for $T_{DRX} > 320$ ms.

### 9.5A.5 Measurement restriction for L1-RSRP measurement

The UE is required to be capable of measuring SSB for L1-RSRP without measurement gaps. The UE is required to perform the SSB measurements with measurement restrictions as described in the following clauses.

### 9.5A.5.1 Measurement restriction for SSB based L1-RSRP

When the SSB for L1-RSRP measurement is in the same OFDM symbol as CSI-RS for RLM, BFD, CBD or L1-RSRP measurement,

- If SSB and CSI-RS have same SCS, UE shall be able to measure the SSB for L1-RSRP measurement without any restriction;
- If SSB and CSI-RS have different SCS,
  - If UE supports *simultaneousRxDataSSB-DiffNumerology*, UE shall be able to measure the SSB for L1-RSRP measurement without any restriction;
  - If UE does not support *simultaneousRxDataSSB-DiffNumerology*, UE is required to measure SSB for L1-RSRP measurement.

### 9.5A.6 Scheduling availability of UE during L1-RSRP measurement

Scheduling availability restrictions when the UE is performing L1-RSRP measurement are described in the following clauses.

#### 9.5A.6.1 Scheduling availability of UE performing L1-RSRP measurement with a same subcarrier spacing as PDSCH/PDCCH

There are no scheduling restrictions due to L1-RSRP measurement performed on SSB configured as RS for L1-RSRP measurement with the same SCS as PDSCH/PDCCH.

#### 9.5A.6.2 Scheduling availability of UE performing L1-RSRP measurement with a different subcarrier spacing than PDSCH/PDCCH

For UEs which support *simultaneousRxDataSSB-DiffNumerology* [14] there are no restrictions on scheduling availability due to L1-RSRP measurement based on SSB as RS for L1-RSRP measurement. For UEs which do not support *simultaneousRxDataSSB-DiffNumerology* [14] the following restrictions apply due to L1-RSRP measurement based on SSB configured for L1-RSRP measurement.

- The UE is not expected to transmit PUCCH/PUSCH/SRS or receive PDCCH/PDSCH/CSI-RS for tracking/CSI-RS for CQI on symbols corresponding to the SSB indexes configured for L1-RSRP measurement.

When intra-band carrier aggregation is configured, the scheduling restrictions on serving cell where L1-RSRP measurement is performed apply to all serving cells in the same band on the symbols that fully or partially overlap with restricted symbols. When inter-band carrier aggregation is configured, there are no scheduling restrictions serving cell(s) configured in other bands than the bands in which the serving cell where L1-RSRP measurement is performed is configured.

#### 9.5A.6.3 Scheduling availability of UE performing L1-RSRP measurement in case of FR1-FR2 inter-band CA

There are no scheduling restrictions on FR2 serving cell(s) due to L1-RSRP measurement performed on serving cell(s) under CCA.

## 9.6 NE-DC: Measurements

### 9.6.1 Introduction

This clause contains requirements for UE supporting dual connectivity with NR PCell and E-UTRA FDD or TDD PSCell. The requirements apply to UEs that have been configured with NE-DC.

## 9.6.2 SFTD Measurements

### 9.6.2.1 Introduction

This clause contains requirements on UE capabilities for reporting of SFN and frame time difference between NR PCell and E-UTRA PSCell in RRC\_CONNECTED state. The requirements comprise measurement reporting delay and measurement accuracy. The overall measurement reporting delay includes a RRC procedure delay specified in TS 38.331 [2], and the SFTD measurement reporting delay specified below.

### 9.6.2.2 SFTD Measurement requirements

When no DRX is used in either of the NR PCell and E-UTRA PSCell, the physical layer measurement period of the SFTD measurement shall be  $T_{\text{measure\_SFTD1}} = \max(0.2, 5 * \text{SMTC period})$  s.

When DRX is used in either of the NR PCell or the E-UTRA PSCell, or in both PCell and PSCell, the physical layer measurement period ( $T_{\text{measure\_SFTD1}}$ ) of the SFTD measurement shall be as specified in Table 9.6.2.2-1.

**Table 9.6.2.2-1: SFTD measurement requirement when DRX is used**

DRX cycle length (s) <sup>Note2</sup>	$T_{\text{measure\_SFTD1}}$ (s)
DRX cycle $\leq 0.04$	$\max(0.2, 5 \times \text{SMTC period})$ (Note1)
$0.04 < \text{DRX cycle} \leq 0.32$	$8 \times \max(\text{DRX cycle}, \text{SMTC period})$
$0.32 < \text{DRX cycle} \leq 10.24$	$5 \times \text{DRX cycle}$
Note1:	Number of DRX cycles depends upon the DRX cycle in use
Note2:	DRX cycle length in this table refers to the DRX cycle length configured for PCell or PSCell. When DRX is used in both PCell and PSCell, DRX cycle length in this table refers to the longer of the DRX cycle lengths for PCell and PSCell.

If PSCell is changed without changing carrier frequency of PSCell while the UE is performing SFTD measurements, the UE shall still meet SFTD measurement and accuracy requirements for the new PSCell. In this case the UE shall restart the SFTD measurement, and the total physical layer measurement period shall not exceed  $T_{\text{measure\_SFTD2}}$  as defined by the following expression:

$$T_{\text{measure\_SFTD2}} = (M+1) * (T_{\text{measure\_SFTD1}}) + M * T_{\text{PSCell\_change\_NEDC}}$$

where:

M is the number of times the E-UTRA PSCell is changed over the measurement period ( $T_{\text{measure\_SFTD2}}$ ), and

$T_{\text{PSCell\_change\_NEDC}}$  is the time necessary to change the PSCell; it can be up to 25 ms.

If PCell is changed, or if PSCell is changed to a different carrier frequency, the UE shall terminate the SFTD measurement.

The measurement accuracy for the SFTD measurement when DRX is used as well as when no DRX is used shall be as specified in clause 10.1.21.1.

## 9.7 Cross Link Interference measurements

### 9.7.1 Introduction

The UE capable of performing CLI measurements shall be able to measure SRS-RSRP and CLI-RSSI which are defined in TS38.215 [4] within active DL BWP. The measurements requirements in this clause apply for TDD mode only.

CLI measurements are only applicable for RRC\_CONNECTED intra-frequency:

- when SRS-RSRP measurement resource is fully confined within BW of DL active BWP
- when CLI-RSSI measurement resource is configured within active BWP

When the UE measures SRS-RSRP and CLI-RSSI, a constant offset relative to the downlink reference timing in the serving cell shall be applied. The constant offset value is derived by UE implementation and shall be at least  $T_c \cdot N_{TA\_offset}$ .

For performing CLI measurement in FR2, UE can assume the configured CLI measurement resources are QCL-ed with TypeD to one of the latest received PDSCH and the latest monitored CORESET.

CLI measurement requirements defined in clause 9.7 are applicable if

- CLI measurement is not performed on an NR carrier in the same band as E-UTRA serving carrier; and
- UE supports simultaneous Rx/Tx for inter-band CA, inter-band EN-DC, inter-band NE-DC, and NR-DC.

## 9.7.2 SRS-RSRP measurements

### 9.7.2.1 Introduction

When configured by the network, the UE shall be able to perform SRS-RSRP measurements of configured *srs-ResourceConfigCLI*. The requirements apply when the subcarrier spacing for SRS-RSRP measurement resource configuration is the same as the subcarrier spacing of the active DL BWP of serving cell. The UE is not required to measure SRS using different SCS compared to the downlink active BWP SCS of the same carrier.

### 9.7.2.2 Requirements applicability

The requirements in clause 9.7.2 apply, provided:

- SRS resources configured for SRS-RSRP measurements are measurable.

An SRS resource configured for SRS-RSRP shall be considered measurable when for each relevant SRS the following conditions are met:

- SRS-RSRP related side conditions given in clauses 10.1.22.1 for FR1 and FR2 for a corresponding band,
- SRS<sub>RP</sub> and SRS  $\hat{E}_s/I_{ot}$  according to Annex B.2.7 for a corresponding band.

### 9.7.2.3 Measurement Reporting Requirements

The UE shall send SRS-RSRP reports only for report configurations according to *reportType* which is *cliPeriodical* or *cliEventTriggered* when SRS-RSRP report is configured.

The UE shall report the SRS-RSRP value as a 7-bit value in the range [-140, -44] dBm with 1dB step size according to clause 10.1.22.1 for FR1 and FR2.

#### 9.7.2.3.1 Periodic Reporting

Reported SRS-RSRP measurements contained in periodically triggered measurement reports shall meet the requirements in clause 10.1.22.1.

#### 9.7.2.3.2 Event-triggered Periodic Reporting

Reported SRS-RSRP measurements contained in periodically triggered measurement reports shall meet the requirements in clauses 10.1.22.1.

The first report in event triggered periodic measurement reporting shall meet the requirements specified in clause 9.7.2.3.3.

#### 9.7.2.3.3 Event Triggered Reporting

Reported SRS-RSRP measurements contained in periodically triggered measurement reports shall meet the requirements in clause 10.1.22.1.

The UE shall not send any event triggered measurement reports as long as no reporting criteria is fulfilled.

The measurement reporting delay is defined as the time between an event that will trigger a measurement report and the point when the UE starts to transmit the measurement report over the air interface. This requirement assumes that the measurement report is not delayed by other RRC signalling on the DCCH. This measurement reporting delay excludes a delay uncertainty resulted when inserting the measurement report to the TTI of the uplink DCCH. The delay uncertainty is:  $2 \times TTI_{DCCH}$ . This measurement reporting delay excludes a delay which caused by no UL resources for UE to send the measurement report on.

#### 9.7.2.4 Measurement capability

The UE shall be capable of performing SRS-RSRP measurements on the SRS resources configured for measurement, provided that the number of SRS to be monitored by UE does not exceed 8 within a slot, and the total number of SRSs to be monitored by the UE does not exceed 32.

#### 9.7.2.5 SRS-RSRP measurement period

The UE shall be capable of performing SRS-RSRP measurement based on the configured SRS resource, and the UE shall be capable of reporting SRS-RSRP measured over measurement period of  $T_{SRS\_RSRP\_measurement\_period}$  for FR1 and FR2.

**Table 9.7.2.5-1 Measurement period  $T_{SRS\_RSRP\_measurement\_period}$**

Configuration	$T_{SRS\_measurement\_period}$ (ms)
No DRX	$\text{Max}(60, 3 \times T_{SRS})$
DRX cycle $\leq 320\text{ms}$	$\text{Max}(60, \text{Ceil}(1.5 \times 3) \times \text{max}(T_{SRS}, T_{DRX}))$
DRX cycle $> 320\text{ms}$	$3 \times T_{DRX}$
Note:	$T_{SRS}$ is SRS measurement periodicity configured <i>SRS-PeriodicityAndOffset</i> , and $T_{DRX}$ is the DRX cycle length.

If the SRS resources configured for measurement are partially or fully overlapping with SMTC window, SSB or CSI-RS configured for RLM, BFD, CBD or L1-RSRP measurement or measurement gaps, requirements are not specified for  $T_{SRS\_RSRP\_measurement\_period}$ .

### 9.7.3 CLI-RSSI measurements

#### 9.7.3.1 Introduction

When configured by the network, the UE shall be able to perform CLI-RSSI measurement of configured *rssi-ResourceConfigCLI*. The subcarrier spacing for CLI-RSSI measurement resource configuration can be same or different from the subcarrier spacing of active BWP. UE shall perform CLI-RSSI measurement with the SCS of the active BWP.

#### 9.7.3.2 Requirements applicability

The requirements in clause 9.7.3 apply, provided:

- The measurement resources configured for CLI-RSSI measurements are measurable.

A measurement resource configured for CLI-RSSI shall be considered measurable when for each relevant CLI-RSSI resource the following conditions are met:

- CLI-RSSI related side conditions given in clauses 10.1.22.2 for FR1 and FR2 for a corresponding band.

#### 9.7.3.3 Measurement Reporting Requirements

The UE shall send CLI-RSSI reports only for report configurations according to *reportType* which is *cliPeriodical* or *cliEventTriggered* when CLI-RSSI report is configured.

The UE shall report the CLI-RSSI value as a 7-bit value in the range [-100, -25] dBm with 1dB step size according to clause 10.1.22.2 for FR1 and FR2.

#### 9.7.3.3.1 Periodic Reporting

Reported CLI-RSSI measurements contained in periodically triggered measurement reports shall meet the requirements in clause 10.1.22.2.

#### 9.7.3.3.2 Event-triggered Periodic Reporting

Reported CLI-RSSI measurements contained in periodically triggered measurement reports shall meet the requirements in clauses 10.1.22.2.

The first report in event triggered periodic measurement reporting shall meet the requirements specified in clause 9.7.3.3.3.

#### 9.7.3.3.3 Event Triggered Reporting

Reported CLI-RSSI measurements contained in periodically triggered measurement reports shall meet the requirements in clause 10.1.22.2.

The UE shall not send any event triggered measurement reports as long as no reporting criteria is fulfilled.

The measurement reporting delay is defined as the time between an event that will trigger a measurement report and the point when the UE starts to transmit the measurement report over the air interface. This requirement assumes that the measurement report is not delayed by other RRC signalling on the DCCH. This measurement reporting delay excludes a delay uncertainty resulted when inserting the measurement report to the TTI of the uplink DCCH. The delay uncertainty is:  $2 \times TTI_{DCCH}$ . This measurement reporting delay excludes a delay which caused by no UL resources for UE to send the measurement report on.

#### 9.7.3.4 Measurement capability

The UE should be capable of performing CLI-RSSI measurement based on the configured resource, provided that the maximum number of CLI-RSSI measurement resources for the UE does not exceed 64.

#### 9.7.3.5 CLI-RSSI measurement period

The UE shall be capable of performing CLI-RSSI measurement based on the configured measurement resource within  $T_{CLI\_RSSI\_measurement\_period}$ . The UE shall be able to provide a single RSSI sample for each measurement resource configured for CLI-RSSI measurement occurring with a configured periodicity. The CLI-RSSI measurement period  $T_{CLI\_RSSI\_measurement\_period}$  corresponds to the CLI-RSSI measurement resource periodicity, which is configured for by higher layers via *RSSI-PeriodicityAndOffset*.

If the CLI-RSSI measurement resources configured for measurement are partially or fully overlapping with SMTC window, SSB or CSI-RS configured for RLM, BFD, CBD or L1-RSRP measurement or measurement gaps, requirements are not specified for  $T_{CLI\_RSSI\_measurement\_period}$ .

### 9.7.4 Scheduling availability of UE during CLI measurements

Scheduling availability restrictions when the UE is performing CLI measurements which are SRS-RSRP and CLI-RSSI are described in the following clause.

#### 9.7.4.1 Scheduling availability of UE performing measurement on FR1

The following scheduling restriction applies due to CLI measurements.

- The UE is not expected to transmit PUCCH/PUSCH/SRS on OFDM symbols on which the UE performs CLI measurements, and on 1 data symbol before an OFDM symbol used for CLI measurements for 15 kHz and 30 kHz subcarrier spacing.
- For the UE which does not support *cli-SRS-RSRP-FDM\_DL*, the UE is not expected to receive PDCCH/PDSCH/CSI-RS for tracking/CSI-RS for CQI on OFDM symbols on which the UE performs SRS-RSRP measurements, and on 1 data symbol before an OFDM symbol used for SRS-RSRP measurements for 15 kHz and 30 kHz subcarrier spacing.



- For the UE which does not support *cli-RSSI-FDM-DL*, the UE is not expected to receive PDCCH/PDSCH/CSI-RS for tracking/CSI-RS for CQI on OFDM symbols on which the UE performs CLI-RSSI measurements, and on 1 data symbol before an OFDM symbol used for CLI-RSSI measurements for 15 kHz and 30 kHz subcarrier spacing.
- The UE is not expected to transmit PUCCH/PUSCH/SRS on OFDM symbols on which the UE performs CLI measurement, and on 2 data symbols before an OFDM symbol used for CLI measurements for 60 kHz subcarrier spacing.
- For the UE which does not support *cli-SRS-RSRP-FDM\_DL*, the UE is not expected to receive PDCCH/PDSCH/CSI-RS for tracking/CSI-RS for CQI on OFDM symbols on which the UE performs SRS-RSRP measurement, and on 2 data symbols before an OFDM symbol used for SRS-RSRP measurements for 60 kHz subcarrier spacing.
- For the UE which does not support *cli-RSSI-FDM-DL*, the UE is not expected to receive PDCCH/PDSCH/CSI-RS for tracking/CSI-RS for CQI on OFDM symbols on which the UE performs CLI-RSSI measurement, and on 2 data symbols before an OFDM symbol used for CLI-RSSI measurements for 60 kHz subcarrier spacing.

When TDD intra-band carrier aggregation is configured, the scheduling restrictions on serving cell where CLI measurements are performed apply on all serving cells in the same band on the symbols that fully or partially overlap with restricted symbols.

#### 9.7.4.2 Scheduling availability of UE performing measurement on FR2

The following scheduling restriction applies due to CLI measurements.

- The UE is not expected to transmit PUCCH/PUSCH/SRS on OFDM symbols on which the UE performs CLI measurements, and on 1 data symbol before an OFDM symbol used for CLI measurements for 60 kHz subcarrier spacing.
- For the UE which does not support *cli-SRS-RSRP-FDM\_DL*, the UE is not expected to receive PDCCH/PDSCH/CSI-RS for tracking/CSI-RS for CQI on OFDM symbols on which the UE performs SRS-RSRP measurements, and on 1 data symbol before an OFDM symbol used for SRS-RSRP measurements for 60 kHz subcarrier spacing.
- For the UE which does not support *cli-RSSI-FDM-DL*, the UE is not expected to receive PDCCH/PDSCH/CSI-RS for tracking/CSI-RS for CQI on OFDM symbols on which the UE performs CLI-RSSI measurements, and on 1 data symbol before an OFDM symbol used for CLI-RSSI measurements for 60 kHz subcarrier spacing.
- The UE is not expected to transmit PUCCH/PUSCH/SRS on OFDM symbols on which the UE performs CLI measurements, and on 2 data symbols before an OFDM symbol used for CLI measurements for 120 kHz subcarrier spacing.
- For the UE which does not support *cli-SRS-RSRP-FDM\_DL*, the UE is not expected to receive PDCCH/PDSCH/CSI-RS for tracking/CSI-RS for CQI on OFDM symbols on which the UE performs SRS-RSRP measurements, and on 2 data symbols before an OFDM symbol used for SRS-RSRP measurements for 120 kHz subcarrier spacing.
- For the UE which does not support *cli-RSSI-FDM-DL*, the UE is not expected to receive PDCCH/PDSCH/CSI-RS for tracking/CSI-RS for CQI on OFDM symbols on which the UE performs CLI-RSSI measurements, and on 2 data symbols before an OFDM symbol used for CLI-RSSI measurements for 120 kHz subcarrier spacing.

When TDD intra-band carrier aggregation is configured, the scheduling restrictions on serving cell where CLI measurements are performed apply on all serving cells in the same band on the symbols that fully or partially overlap with restricted symbols.

## 9.8 L1-SINR measurements for Reporting

### 9.8.1 Introduction

When configured by the network, the UE shall be able to perform L1-SINR measurements with the measurement resources configured as the selection of:

- CSI-RS based CMR and no dedicated IMR configured;
- SSB based CMR and dedicated IMR configured;
- CSI-RS based CMR and dedicated IMR configured.

The measurements shall be performed for a serving cell, including PCell, PSCell, or SCell, on the resources configured for L1-SINR measurements within the active BWP.

The UE shall be able to measure all CSI-RS resources and/or SSB resources and/or CSI-IM resources of the *nzp-CSI-RS-ResourceSet* and/or *csi-SSB-ResourceSet* and/or *CSI-IM-ResourceSet* within the *CSI-ResourceConfig* settings for L1-SINR for the active BWP and measure interference on corresponding NZP CSI-RS or CSI-IM resources if configured, provided that the number of resources does not exceed the UE capability indicated by *beamManagementSSB-CSI-RS*.

The UE shall report the measurement quantity (*reportQuantity*) and send periodic, semi-persistent or aperiodic reports, according to the *reportConfigType* according to the CSI reporting configuration(s) (*CSI-ReportConfig*) for the active BWP.

### 9.8.2 Requirements applicability

The requirements in clause 9.8 apply, provided:

- CMR resources configured for L1-SINR measurements are measurable, and
- NZP-IMR resources configured for L1-SINR measurements if applicable are measurable.

Requirements are defined for periodic, semi-persistent and aperiodic resources.

For CSI-RS based CMR and no dedicated IMR configured, a CSI-RS resource configured for L1-SINR shall be considered measurable when for each relevant CSI-RS the following conditions are met:

- L1-SINR related side conditions given in clauses 10.1.27 and 10.1.28 for FR1 and FR2, respectively, for a corresponding band,
- CSI-RS<sub>RP</sub> and CSI-RS  $\hat{E}_s/I_{ot}$  according to Annex B.2.8.1 for a corresponding band.

For SSB based CMR and dedicated IMR configured, a SSB and a dedicated IMR configured for L1-SINR shall be considered measurable when for each relevant SSB and IMR the following conditions are met:

- L1-SINR related side conditions given in clauses 10.1.27 and 10.1.28 for FR1 and FR2, respectively, for a corresponding band,
- SSB<sub>RP</sub> and SSB  $\hat{E}_s/I_{ot}$  according to Annex B.2.8.2 for a corresponding band.
- NZP-IMR  $\hat{E}_s/I_{ot}$  according to Annex B.2.8.2 for a corresponding band, if NZP-IMR is configured as dedicated IMR.

For CSI-RS based CMR and dedicated IMR configured, a CSI-RS and a dedicated IMR configured for L1-SINR shall be considered measurable when for each relevant CSI-RS and IMR the following conditions are met:

- L1-SINR related side conditions given in clauses 10.1.27 and 10.1.28 for FR1 and FR2, respectively, for a corresponding band,
- CSI-RS<sub>RP</sub> and CSI-RS  $\hat{E}_s/I_{ot}$  according to Annex B.2.8.3 for a corresponding band

- NZP-IMR  $\hat{E}_s/I_{ot}$  according to Annex B.2.8.3 for a corresponding band, if NZP-IMR is configured as dedicated IMR.

### 9.8.3 Measurement Reporting Requirements

The UE shall send L1-SINR reports only for report configurations configured for the active BWP.

The UE shall report the L1-SINR value as a 7-bit value in the range [-23, 40] dB with 0.5dB step size if *nrofReportedRS* is configured to one. If *nrofReportedRS* is configured to be larger than one, or if *groupBasedBeamReporting* is enabled, the UE shall use differential L1-SINR based reporting. The differential L1-SINR is quantized to a 4-bit value with 1dB step size. The mapping between the reported L1-SINR value and the measured quantity is described in 10.1.16.

#### 9.8.3.1 Periodic Reporting

Reported L1-SINR measurements contained in periodic L1-SINR measurement reports shall meet the requirements in clauses 10.1.27 for FR1 and 10.1.28 for FR2, respectively.

#### 9.8.3.2 Semi-Persistent Reporting

Reported L1-SINR measurements contained in a Semi-Persistent L1-SINR measurement report shall meet the requirements in clauses 10.1.27 for FR1 and 10.1.28 for FR2, respectively. This requirement applies for semi-persistent L1-SINR reports sent on PUSCH or PUCCH.

The UE shall only send semi-persistent L1-SINR measurement reports on PUSCH, if a DCI for triggering report has been received.

The UE shall only send semi-persistent L1-SINR measurement reports on PUCCH, if an activation command as described in clause 6.1.3.16 in TS38.321 [7] has been received.

The UE shall transmit the semi-persistent L1-SINR reporting on PUSCH or PUCCH over the air interface according to the periodicity defined in clause 5.2.1.4 in TS 38.214 [26].

#### 9.8.3.3 Aperiodic Reporting

Reported L1-SINR measurements contained in aperiodic triggered, aperiodic triggered periodic and aperiodic triggered semi-persistent L1-SINR reports shall meet the requirements in clauses 10.1.27 for FR1 and 10.1.28 for FR2, respectively.

The UE shall only send aperiodic L1-SINR measurement reports, if a DCI for triggering report has been received.

After the UE receives CSI request in DCI, the UE shall transmit the aperiodic L1-SINR reporting on PUSCH over the air interface at the time specified according to clause 5.2.1.4 in TS 38.214 [26].

### 9.8.4 L1-SINR measurement requirements

#### 9.8.4.1 L1-SINR reporting with CSI-RS based CMR and no dedicated IMR configured

The UE shall be capable of performing L1-SINR measurements with the CSI-RS resource configured as CMR and no dedicated resource configured as IMR for L1-SINR computation, and the UE physical layer shall be capable of reporting L1-SINR measured over the measurement period of  $T_{L1-SINR\_Measurement\_Period\_CSI-RS\_CMR\_Only}$ .

The value of  $T_{L1-SINR\_Measurement\_Period\_CSI-RS\_CMR\_Only}$  is defined in Table 9.8.4.1-1 for FR1 and in Table 9.8.4.1-2 for FR2, where

For the value of M,

- For periodic and semi-persistent CSI-RS resources as CMR, M=1 if higher layer parameter *timeRestrictionForChannelMeasurement* is configured, and M=3 otherwise;
- For aperiodic CSI-RS resources as CMR, M=1.

For the value of N in FR2

- For periodic CSI-RS resources as CMR in a resource set configured with higher layer parameter *repetition* set to OFF, N=1. The requirements apply if *qcl-InfoPeriodicCSI-RS* is configured for all the resources in the resource set and for each resource one RS has QCL-TypeD with
  - SSB for L1-RSRP or L1-SINR measurement, or
  - another CSI-RS in resource set configured with repetition ON.
- For periodic CSI-RS resources as CMR in a resource set configured with higher layer parameter *repetition* set to ON,  $N = \text{ceil}(\text{maxNumberRxBeam} / N_{\text{res\_per\_set}})$ , where  $N_{\text{res\_per\_set}}$  is number of resources in the resource set. The requirements apply provided *qcl-InfoPeriodicCSI-RS* is configured for all resources in the resource set.
- For semi-persistent CSI-RS resources as CMR in a resource set configured with higher layer parameter *repetition* set to OFF, N=1. The requirements apply provided TCI state is provided for all resources in the resource set in the MAC CE activating the resource set and for each resource has QCL-TypeD with
  - SSB for L1-RSRP or L1-SINR measurement, or
  - another CSI-RS in resource set configured with repetition ON.
- For semi-persistent CSI-RS resources as CMR in a resource set configured with higher layer parameter *repetition* set to ON,  $N = \text{ceil}(\text{maxNumberRxBeam} / N_{\text{res\_per\_set}})$ , where  $N_{\text{res\_per\_set}}$  is number of resources in the resource set. The requirements apply provided TCI state is provided for all resources in the resource set in the MAC CE activating the resource set.
- For aperiodic CSI-RS resources as CMR in a resource set configured with higher layer parameter *repetition* set to OFF, N=1. The requirements apply provided *qcl-info* is configured for all resources in the resource set and for each resource has QCL-TypeD with
  - SSB for L1-RSRP or L1-SINR measurement, or
  - another CSI-RS in resource set configured with repetition ON.
- For aperiodic CSI-RS resources as CMR in a resource set configured with higher layer parameter *repetition* set to ON, N=1. UE is not required to meet the accuracy requirements in clause 10.1.28.1 and 10.1.28.3 if number of resources in the resource set is smaller than *maxNumberRxBeam*. The requirements apply provided *qcl-info* is configured for all resources in the resource set.

For the value of P in FR1,

- $P = \frac{1}{1 - \frac{T_{\text{CSI-RS}}}{\text{MRGP}}}$ , when in the monitored cell there are measurement gaps configured for intra-frequency, inter-frequency or inter-RAT measurements, which are overlapping with some but not all occasions of the CSI-RS; and
- P=1 when in the monitored cell there are no measurement gaps overlapping with any occasion of the CSI-RS.

For the value of P in FR2,

- P=1, when CSI-RS is not overlapped with measurement gap and also not overlapped with SMTC occasion.
- $P = \frac{1}{1 - \frac{T_{\text{CSI-RS}}}{\text{MRGP}}}$ , when CSI-RS is partially overlapped with measurement gap and CSI-RS is not overlapped with SMTC occasion ( $T_{\text{CSI-RS}} < \text{MRGP}$ )
- $P = \frac{1}{1 - \frac{T_{\text{CSI-RS}}}{T_{\text{SMTCperiod}}}}$ , when CSI-RS is not overlapped with measurement gap and CSI-RS is partially overlapped with SMTC occasion ( $T_{\text{CSI-RS}} < T_{\text{SMTCperiod}}$ ).
- P=3, when CSI-RS is not overlapped with measurement gap and CSI-RS is fully overlapped with SMTC occasion ( $T_{\text{CSI-RS}} = T_{\text{SMTCperiod}}$ ).

- $P = \frac{1}{1 - \frac{T_{CSI-RS}}{MGRP} - \frac{T_{CSI-RS}}{T_{SMTCperiod}}}$ , when CSI-RS is partially overlapped with measurement gap and CSI-RS is partially overlapped with SMTC occasion ( $T_{CSI-RS} < T_{SMTCperiod}$ ) and SMTC occasion is not overlapped with measurement gap and
  - $T_{SMTCperiod} \neq MGRP$  or
  - $T_{SMTCperiod} = MGRP$  and  $T_{CSI-RS} < 0.5 * T_{SMTCperiod}$
- $P = \frac{3}{1 - \frac{T_{CSI-RS}}{MGRP}}$ , when CSI-RS is partially overlapped with measurement gap and CSI-RS is partially overlapped with SMTC occasion ( $T_{CSI-RS} < T_{SMTCperiod}$ ) and SMTC occasion is not overlapped with measurement gap and  $T_{SMTCperiod} = MGRP$  and  $T_{CSI-RS} = 0.5 * T_{SMTCperiod}$
- $P = \frac{1}{1 - \frac{T_{CSI-RS}}{\min(T_{SMTCperiod}, MGRP)}}$ , when CSI-RS is partially overlapped with measurement gap ( $T_{CSI-RS} < MGRP$ ) and CSI-RS is partially overlapped with SMTC occasion ( $T_{CSI-RS} < T_{SMTCperiod}$ ) and SMTC occasion is partially or fully overlapped with measurement gap.
- $P = \frac{3}{1 - \frac{T_{CSI-RS}}{MGRP}}$ , when CSI-RS is partially overlapped with measurement gap and CSI-RS is fully overlapped with SMTC occasion ( $T_{CSI-RS} = T_{SMTCperiod}$ ) and SMTC occasion is partially overlapped with measurement gap ( $T_{SMTCperiod} < MGRP$ )

Where:

$T_{SMTCperiod}$  = the configured SMTC1 period or SMTC2 period if configured.

$T_{CSI-RS}$  = the periodicity of CSI-RS configured for L1-SINR measurement

If the high layer in TS 38.331 [2] signaling of *smtc2* is configured,  $T_{SMTCperiod}$  corresponds to the value of higher layer parameter *smtc2*; Otherwise  $T_{SMTCperiod}$  corresponds to the value of higher layer parameter *smtc1*.

Note: The overlap between CSI-RS for L1-SINR measurement and SMTC means that CSI-RS for L1-SINR measurement is within the SMTC window duration.

Longer evaluation period would be expected if the combination of CSI-RS, SMTC occasion and measurement gap configurations does not meet previous conditions.

**Table 9.8.4.1-1: Measurement period  $T_{L1-SINR\_Measurement\_Period\_CSI-RS\_CMR\_Only}$  for FR1**

Configuration	$T_{L1-SINR\_Measurement\_Period\_CSI-RS\_CMR\_Only}$ (ms)
non-DRX	$\max(T_{Report}, \text{ceil}(M * P) * T_{CSI-RS})$
DRX cycle $\leq$ 320ms	$\max(T_{Report}, \text{ceil}(1.5 * M * P) * \max(T_{DRX}, T_{CSI-RS}))$
DRX cycle > 320ms	$\text{ceil}(M * P) * T_{DRX}$
Note 1:	$T_{CSI-RS}$ is the periodicity of CSI-RS configured for L1-SINR measurement. $T_{DRX}$ is the DRX cycle length. $T_{Report}$ is configured periodicity for reporting.
Note 2:	the requirements are applicable provided that the CSI-RS resource configured for L1-SINR measurement is transmitted with Density = 3.

**Table 9.8.4.1-2: Measurement period  $T_{L1-SINR\_Measurement\_Period\_CSI-RS\_CMR\_Only}$  for FR2**

Configuration	$T_{L1-SINR\_Measurement\_Period\_CSI-RS\_CMR\_Only}$ (ms)
non-DRX	$\max(T_{Report}, \text{ceil}(M * P * N) * T_{CSI-RS})$
DRX cycle $\leq$ 320ms	$\max(T_{Report}, \text{ceil}(1.5 * M * P * N) * \max(T_{DRX}, T_{CSI-RS}))$
DRX cycle > 320ms	$\text{ceil}(M * P * N) * T_{DRX}$
Note 1:	$T_{CSI-RS}$ is the periodicity of CSI-RS configured for L1-SINR measurement. $T_{DRX}$ is the DRX cycle length. $T_{Report}$ is configured periodicity for reporting.
Note 2:	the requirements are applicable provided that the CSI-RS resource configured for L1-SINR measurement is transmitted with Density = 3.

### 9.8.4.2 L1-SINR reporting with SSB based CMR and dedicated IMR configured

The UE shall be capable of performing L1-SINR measurements with the SSB configured as CMR and dedicated resource configured as IMR for L1-SINR computation, in which the NZP-CSI-RS or CSI-IM resource configured as dedicated IMR shall be 1-to-1 mapped to SSB configured as CMR, with the same periodicity. The UE physical layer shall be capable of reporting L1-SINR measured over the measurement period of  $T_{L1-SINR\_Measurement\_Period\_SSB\_CMR\_IMR}$ .

The requirements in this clause are not applicable if NZP-CSI-RS or CSI-IM resource configured as dedicated IMR is scheduled with different periodicity as SSB configured as CMR.

The value of  $T_{L1-SINR\_Measurement\_Period\_SSB\_CMR\_IMR}$  is defined in Table 9.8.4.2-1 for FR1 and in Table 9.8.4.2-2 for FR2, where

For the value of M

- For periodic or semi-persistent NZP CSI-RS or CSI-IM resource as dedicated IMR, M=1 if the higher layer parameters *timeRestrictionForChannelMeasurements* and/or *timeRestrictionForInterferenceMeasurements* are configured, and M=3 otherwise;

For the value of N in FR2

- N = 8.

P is defined as the maximum value between  $P_{CMR}$  and  $P_{IMR}$ , i.e.,  $P = \max(P_{CMR}, P_{IMR})$ , where

- the value of  $P_{CMR}$  shall be derived in the same way as the value of P used for SSB based L1-RSRP measurement in clause 9.5.4.1, in which the occasions and period of the SSB for CMR shall be used instead.
- the value of  $P_{IMR}$  shall be derived in the same way as the value of P used for CSI-RS based L1-RSRP measurement in clause 9.5.4.2, in which the occasions and period of the NZP CSI-RS for NZP-IMR or CSI-IM for ZP-IMR shall be used instead.

Longer evaluation period would be expected if the combination of SSB, SMTC occasion and measurement gap configurations does not meet previous conditions.

For L1-SINR measurement with SSB as CMR and CSI-RS or CSI-IM as IMR, the requirement shall apply if the CSI-RS is configured as IMR with repetition field as “repetition = OFF” or CSI-IM is configured as IMR.

For L1-SINR measurement with SSB as CMR and CSI-RS/CSI-IM as IMR, no requirement shall apply if SSB occasions for CMR or CSI-RS/CSI-IM occasions for IMR are fully overlapped with the configured measurement gap.

**Table 9.8.4.2-1: Measurement period  $T_{L1-SINR\_Measurement\_Period\_SSB\_CMR\_IMR}$  for FR1**

Configuration	$T_{L1-SINR\_Measurement\_Period\_SSB\_CMR\_IMR}$ (ms)
non-DRX	$\max(T_{Report}, \text{ceil}(M \cdot P) \cdot T_{SSB})$
DRX cycle $\leq$ 320ms	$\max(T_{Report}, \text{ceil}(1.5 \cdot M \cdot P) \cdot \max(T_{DRX}, T_{SSB}))$
DRX cycle $>$ 320ms	$\text{ceil}(M \cdot P) \cdot T_{DRX}$
Note 1:	$T_{SSB} = \text{ssb-periodicityServingCell}$ is the periodicity of the SSB-Index configured for L1-SINR channel measurement. $T_{DRX}$ is the DRX cycle length. $T_{Report}$ is configured periodicity for reporting.
Note 2:	The requirements are applicable provided that the CSI-RS resource configured for interference measurement shall be 1-to-1 mapped to SSB configured for channel measurement, with the same periodicity.

**Table 9.8.4.2-2: Measurement period  $T_{L1-SINR\_Measurement\_Period\_SSB\_CMR\_IMR}$  for FR2**

Configuration	$T_{L1-SINR\_Measurement\_Period\_SSB\_CMR\_IMR}$ (ms)
non-DRX	$\max(T_{Report}, \text{Ceil}(M \cdot P \cdot N) \cdot T_{SSB})$
DRX cycle $\leq$ 320ms	$\max(T_{Report}, \text{ceil}(1.5 \cdot M \cdot P \cdot N) \cdot \max(T_{DRX}, T_{SSB}))$
DRX cycle $>$ 320ms	$\text{ceil}(1.5 \cdot M \cdot P \cdot N) \cdot T_{DRX}$
Note 1:	$T_{SSB} = \text{ssb-periodicityServingCell}$ is the periodicity of the SSB-Index configured for L1-SINR measurement. $T_{DRX}$ is the DRX cycle length. $T_{Report}$ is configured periodicity for reporting.

Note 2: The requirements are applicable provided that the CSI-RS resource configured for interference measurement shall be 1-to-1 mapped to SSB configured for channel measurement, with the same periodicity.

### 9.8.4.3 L1-SINR reporting with CSI-RS based CMR and dedicated IMR configured

The UE shall be capable of performing L1-SINR measurements with the CSI-RS resource configured as CMR and dedicated resource configured as IMR for L1-SINR computation, in which the NZP-CSI-RS or CSI-IM resource configured as dedicated IMR shall be 1-to-1 mapped to CSI-RS resource configured as CMR, with the same periodicity. The UE physical layer shall be capable of reporting L1-SINR measured over the measurement period of  $T_{L1}$ .

$SINR\_Measurement\_Period\_CSI-RS\_CMR\_IMR$ .

The requirements in this clause are not applicable if NZP-CSI-RS or CSI-IM resource configured as dedicated IMR is scheduled with different periodicity as CSI-RS resource configured as CMR.

The value of  $T_{L1-SINR\_Measurement\_Period\_CSI-RS\_CMR\_IMR}$  is defined in Table 9.8.4.3-1 for FR1 and in Table 9.8.4.3-2 for FR2, where

For the value of M,

- M=1 shall be applied if
  - aperiodic NZP-CSI-RS as CMR or dedicated IMR, or
  - aperiodic CSI-IMR as dedicated IMR, or
  - periodic and semi-persistent NZP-CSI-RS as CMR or dedicated IMR and the higher layer parameters *timeRestrictionForChannelMeasurement* and/or *timeRestrictionForInterferenceMeasurements* are configured, or
  - periodic and semi-persistent CSI-IM as dedicated IMR and the higher layer parameters *timeRestrictionForChannelMeasurement* and/or *timeRestrictionForInterferenceMeasurements* are configured;
- M=3 otherwise.

For the value of N in FR2

- For periodic CSI-RS resources as CMR in a resource set configured with higher layer parameter *repetition* set to OFF, N=1. The requirements apply if *qcl-InfoPeriodicCSI-RS* is configured for all the resources in the resource set and for each resource one RS has QCL-TypeD with
  - SSB for L1-RSRP or L1-SINR measurement, or
  - another CSI-RS in resource set configured with repetition ON.
- For periodic CSI-RS resources as CMR in a resource set configured with higher layer parameter *repetition* set to ON,  $N = \text{ceil}(\text{maxNumberRxBeam} / N_{\text{res\_per\_set}})$ , where  $N_{\text{res\_per\_set}}$  is number of resources in the resource set. The requirements apply provided *qcl-InfoPeriodicCSI-RS* is configured for all resources in the resource set.
- For semi-persistent CSI-RS resources as CMR in a resource set configured with higher layer parameter *repetition* set to OFF, N=1. The requirements apply provided TCI state is provided for all resources in the resource set in the MAC CE activating the resource set and for each resource has QCL-TypeD with
  - SSB for L1-RSRP or L1-SINR measurement, or
  - another CSI-RS in resource set configured with repetition ON.
- For semi-persistent CSI-RS resources as CMR in a resource set configured with higher layer parameter *repetition* set to ON,  $N = \text{ceil}(\text{maxNumberRxBeam} / N_{\text{res\_per\_set}})$ , where  $N_{\text{res\_per\_set}}$  is number of resources in the resource set. The requirements apply provided TCI state is provided for all resources in the resource set in the MAC CE activating the resource set.

- For aperiodic CSI-RS resources as CMR in a resource set configured with higher layer parameter *repetition* set to OFF,  $N=1$ . The requirements apply provided *qcl-info* is configured for all resources in the resource set and for each resource has QCL-TypeD with
  - SSB for L1-RSRP or L1-SINR measurement, or
  - another CSI-RS in resource set configured with repetition ON.
- For aperiodic CSI-RS resources as CMR in a resource set configured with higher layer parameter *repetition* set to ON,  $N=1$ . UE is not required to meet the accuracy requirements in clause 10.1.28.1 and 10.1.28.3 if number of resources in the resource set is smaller than *maxNumberRxBeam*. The requirements apply provided *qcl-info* is configured for all resources in the resource set.

$P$  is defined as the maximum value between  $P_{\text{CMR}}$  and  $P_{\text{IMR}}$ , i.e.,  $P = \max(P_{\text{CMR}}, P_{\text{IMR}})$ , where

- The value of  $P_{\text{CMR}}$  and  $P_{\text{IMR}}$  shall be derived in the same way as the value of  $P$  used for CSI-RS based L1-RSRP measurement in clause 9.5.4.2, in which the occasions and period of the CSI-RS for CMR and NZP CSI-RS for NZP-IMR or CSI-IM for ZP-IMR shall be used instead respectively.

Longer evaluation period would be expected if the combination of CSI-RS, SMTC occasion and measurement gap configurations does not meet previous conditions.

For L1-SINR measurement with CSI-RS as CMR and CSI-RS as IMR, the requirement shall apply only if CSI-RS resources as CMR and IMR are configured with the same repetition field and the number of CSI-RS resources in the resource sets for CMR and IMR are same.

For L1-SINR measurement with CSI-RS as CMR and CSI-IM as IMR, the requirement shall apply only if the number of CSI-RS resources in the resource set for CMR and the number of CSI-IM resources in the resource set for IMR are same.

For L1-SINR measurement with CSI-RS as CMR and CSI-RS/CSI-IM as IMR, no requirement shall apply if CSI-RS occasions for CMR or CSI-RS/CSI-IM occasions for IMR are fully overlapped with the configured measurement gap.

**Table 9.8.4.3-1: Measurement period  $T_{\text{L1-SINR\_Measurement\_Period\_CSI-RS\_CMR\_IMR}}$  for FR1**

Configuration	$T_{\text{L1-SINR\_Measurement\_Period\_CSI-RS\_CMR\_IMR}}$ (ms)
non-DRX	$\max(T_{\text{Report}}, \text{ceil}(M \cdot P) \cdot T_{\text{CSI-RS}})$
DRX cycle $\leq 320\text{ms}$	$\max(T_{\text{Report}}, \text{ceil}(1.5 \cdot M \cdot P) \cdot \max(T_{\text{DRX}}, T_{\text{CSI-RS}}))$
DRX cycle $> 320\text{ms}$	$\text{ceil}(M \cdot P) \cdot T_{\text{DRX}}$
Note 1:	$T_{\text{CSI-RS}}$ is the periodicity of CSI-RS configured for L1-SINR measurement. $T_{\text{DRX}}$ is the DRX cycle length. $T_{\text{Report}}$ is configured periodicity for reporting.
Note 2:	the requirements are applicable provided that the CSI-RS resource configured for L1-SINR measurement is transmitted with Density = 3.
Note 3:	The requirements are applicable provided that the CSI-RS resource configured for interference measurement shall be 1-to-1 mapped to CSI-RS configured for channel measurement, with the same periodicity.

**Table 9.8.4.3-2: Measurement period  $T_{\text{L1-SINR\_Measurement\_Period\_CSI-RS\_CMR\_IMR}}$  for FR2**

Configuration	$T_{\text{L1-SINR\_Measurement\_Period\_CSI-RS\_CMR\_IMR}}$ (ms)
non-DRX	$\max(T_{\text{Report}}, \text{ceil}(M \cdot P \cdot N) \cdot T_{\text{CSI-RS}})$
DRX cycle $\leq 320\text{ms}$	$\max(T_{\text{Report}}, \text{ceil}(1.5 \cdot M \cdot P \cdot N) \cdot \max(T_{\text{DRX}}, T_{\text{CSI-RS}}))$
DRX cycle $> 320\text{ms}$	$\text{ceil}(M \cdot P \cdot N) \cdot T_{\text{DRX}}$
Note 1:	$T_{\text{CSI-RS}}$ is the periodicity of CSI-RS configured for L1-SINR measurement. $T_{\text{DRX}}$ is the DRX cycle length. $T_{\text{Report}}$ is configured periodicity for reporting.
Note 2:	the requirements are applicable provided that the CSI-RS resource configured for L1-SINR measurement is transmitted with Density = 3.
Note 3:	The requirements are applicable provided that the CSI-RS resource configured for interference measurement shall be 1-to-1 mapped to CSI-RS configured for channel measurement, with the same periodicity.



## 9.8.5 Measurement restriction for L1-SINR measurement

The UE is required to be capable of measuring L1-SINR without measurement gaps. The UE is required to perform the SSB and CSI-RS/CSI-IM measurements with measurement restrictions as described in the following clauses.

### 9.8.5.1 Measurement restriction if SSB configured for L1-SINR Measurement

For FR1, when the SSB configured as CMR for L1-SINR measurement is in the same OFDM symbol as CSI-RS for RLM, BFD, CBD, L1-RSRP or L1-SINR measurement,

- If SSB and CSI-RS have same SCS, UE shall be able to measure the SSB for L1-SINR measurement without any restriction;
- If SSB and CSI-RS have different SCS,
  - If UE supports *simultaneousRxDataSSB-DiffNumerology*, UE shall be able to measure the SSB for L1-SINR measurement without any restriction;
  - If UE does not support *simultaneousRxDataSSB-DiffNumerology*, UE is required to measure one of but not both SSB for L1-SINR measurement and CSI-RS. Longer measurement period for SSB based L1-SINR measurement is expected, and no requirements are defined.

For FR2, when the SSB configured as CMR for L1-SINR measurement on one CC is in the same OFDM symbol as CSI-RS for RLM, BFD, CBD, L1-RSRP or L1-SINR measurement on the same CC or different CCs in the same band, UE is required to measure one of but not both SSB for L1-SINR measurement and CSI-RS. Longer measurement period for SSB based L1-RSRP measurement is expected, and no requirements are defined.

For FR2, there is no measurement restriction allowed when the network configures mixed numerology between SSB configured as CMR for L1-SINR measurement on one FR2 band and CSI-RS for RLM, BFD, CBD, L1-RSRP or L1-SINR measurement on the other FR2 band, provided that UE is capable of independent beam management on this FR2 band pair.

### 9.8.5.2 Measurement restriction if CSI-RS configured for L1-SINR measurement

For both FR1 and FR2, when the CSI-RS configured for L1-SINR measurement is in the same OFDM symbol as SSB for RLM, BFD, CBD, L1-RSRP or L1-SINR measurement, UE is not required to receive CSI-RS for L1-SINR measurement in the PRBs that overlap with an SSB.

For FR1, when the SSB for RLM, BFD, CBD, L1-RSRP or L1-SINR measurement is within the active BWP and has same SCS than CSI-RS configured for L1-SINR measurement, the UE shall be able to perform CSI-RS measurement without restrictions.

For FR1, when the SSB for RLM, BFD, CBD, L1-RSRP or L1-SINR measurement is within the active BWP and has different SCS than CSI-RS configured for L1-SINR measurement, the UE shall be able to perform CSI-RS measurement with restrictions according to its capabilities:

- If the UE supports *simultaneousRxDataSSB-DiffNumerology*, UE shall be able to perform CSI-RS measurement without restrictions.
- If the UE does not support *simultaneousRxDataSSB-DiffNumerology*, UE is required to measure one of but not both CSI-RS for L1-SINR measurement and SSB. Longer measurement period for CSI-RS based L1-SINR measurement is expected, and no requirements are defined.

For FR1, when the CSI-RS configured for L1-SINR measurement is in the same OFDM symbol as another CSI-RS for RLM, BFD, CBD, L1-RSRP or L1-SINR measurement, UE shall be able to measure the CSI-RS for L1-SINR measurement without any restriction.

For FR2, when the CSI-RS configured for L1-SINR measurement on one CC is in the same OFDM symbol as SSB for RLM, BFD, L1-RSRP or L1-SINR measurement on the same CC or different CCs in the same band, or in the same symbol as SSB for CBD measurement on the same CC or different CCs in the same band when beam failure is detected, UE is required to measure one of but not both CSI-RS for L1-SINR measurement and SSB. Longer measurement period for CSI-RS based L1-SINR measurement is expected, and no requirements are defined.

For FR2, when the CSI-RS configured for L1-SINR measurement on one CC is in the same OFDM symbol as another CSI-RS for RLM, BFD, CBD, L1-RSRP or L1-SINR measurement on the same CC or different CCs in the same band,

- In the following cases, UE is required to measure one of but not both CSI-RS for L1-SINR measurement and the other CSI-RS. Longer measurement period for CSI-RS based L1-SINR measurement is expected, and no requirements are defined.
  - The CSI-RS for L1-SINR measurement or the other CSI-RS in a resource set configured with repetition ON, or
  - The CSI-RS or the other CSI-RS is configured as dedicated IMR for L1-SINR computation with SSB as CMR, or
  - The other CSI-RS is configured in q1 and beam failure is detected, or
  - The two CSI-RS-es are not QCL-ed w.r.t. QCL-TypeD, or the QCL information is not known to UE,
- Otherwise, UE shall be able to measure the CSI-RS configured for L1-SINR measurement without any restriction.

### 9.8.5.3 Measurement restriction if CSI-IM configured for L1-SINR measurement

For both FR1 and FR2, when the CSI-IM configured for L1-SINR measurement is in the same OFDM symbol as SSB for RLM, BFD, CBD, L1-RSRP or L1-SINR measurement, UE is not required to measure CSI-IM for L1-SINR measurement in the PRBs that overlap with an SSB.

For FR1, UE shall be able to measure the CSI-IM configured for L1-SINR measurement without any restriction.

For FR2, when the CSI-IM configured for L1-SINR measurement on one CC is in the same OFDM symbol as SSB for RLM, BFD, L1-RSRP or L1-SINR measurement on the same CC or different CCs in the same band, or in the same symbol as SSB for CBD measurement on the same CC or different CCs in the same band when beam failure is detected, UE is required to measure one of but not both CSI-IM for L1-SINR measurement and SSB. Longer measurement period for L1-SINR measurement is expected, and no requirements are defined.

For FR2, when the CSI-IM configured for L1-SINR measurement on one CC is in the same OFDM symbol as the CSI-RS for RLM, BFD, CBD, L1-RSRP or L1-SINR measurement on the same CC or different CCs in the same band,

- In the following cases, UE is required to measure one of but not both CSI-IM for L1-SINR measurement and CSI-RS. Longer measurement period for L1-SINR measurement is expected, and no requirements are defined.
  - The CSI-RS in a resource set configured with repetition ON, or
  - The CSI-IM or the CSI-RS is configured as dedicated IMR for L1-SINR computation with SSB as CMR, or
  - The CSI-RS is configured in q1 and beam failure is detected, or
  - The CMR for L1-SINR measurement and the CSI-RS are not QCL-ed w.r.t. QCL-TypeD, or the QCL information is not known to UE,
- Otherwise, UE shall be able to measure the CSI-IM configured for L1-SINR measurement without any restriction.

## 9.8.6 Scheduling availability of UE during L1-SINR measurement

Scheduling availability restrictions when the UE is performing L1-SINR measurement are described in the following clauses.

### 9.8.6.1 Scheduling availability of UE performing L1-SINR measurement with a same subcarrier spacing as PDSCH/PDCCH on FR1

There are no scheduling restrictions due to L1-SINR measurement performed on SSB and CSI-RS configured for L1-SINR measurement with the same SCS as PDSCH/PDCCH in FR1.

### 9.8.6.2 Scheduling availability of UE performing L1-SINR measurement with a different subcarrier spacing than PDSCH/PDCCH on FR1

For UEs which support *simultaneousRxDataSSB-DiffNumerology* [14] there are no restrictions on scheduling availability due to L1-SINR measurement based on SSB configured for L1-SINR measurement. For UEs which do not support *simultaneousRxDataSSB-DiffNumerology* [14] the following restrictions apply due to L1-SINR measurement based on SSB configured for L1-SINR measurement.

- The UE is not expected to transmit PUCCH/PUSCH/SRS or receive PDCCH/PDSCH/CSI-RS for tracking /CSI-RS for CQI on SSB symbols to be measured for L1-SINR measurement.

When intra-band carrier aggregation in FR1 is configured, the scheduling restrictions on serving cell where L1-SINR measurement is performed apply to all serving cells in the same band on the symbols that fully or partially overlap with restricted symbols. When inter-band carrier aggregation within FR1 is configured, there are no scheduling restrictions on FR1 serving cell(s) configured in other bands than the bands in which the serving cell where L1-SINR measurement is performed is configured.

### 9.8.6.3 Scheduling availability of UE performing L1-SINR measurement on FR2

The following scheduling restriction applies due to L1-SINR measurement.

- For the cases of CSI-RS used for L1-SINR measurement of CSI-RS based CMR only case and CSI-RS based CMR plus CSI-RS based ZP-IMR/NZP-IMR case and CSI-RS based CMR plus ZP-IMR case, where CSI-RS is QCLed with active TCI state for PDCCH/PDSCH and not in a CSI-RS resource set with repetition ON, and N=1 applies as specified in clause 9.8.4
- There are no scheduling restrictions due to L1-SINR measurement performed based on the CSI-RS.
- Otherwise
- The UE is not expected to transmit PUCCH/PUSCH/SRS or receive PDCCH/PDSCH/CSI-RS for tracking/CSI-RS for CQI on the symbols to be measured for L1-SINR.

When intra-band carrier aggregation is performed, the scheduling restrictions on serving cell where L1-SINR measurement is performed apply to all serving cells in the band on the symbols that fully or partially overlap with restricted symbols.

If following conditions are met,

- UE has been notified about system information update through paging,
- The gap between UE's reception of PDCCH that UE monitors in the Type 2-PDCCH CSS set and that notifies system information update, and the PDCCH that UE monitors in the Type0-PDCCH CSS set, is greater than 2 slots,

for the SSB and CORESET for RMSI scheduling multiplexing patterns 3, UE is expected to receive the PDCCH that UE monitors in the Type0-PDCCH CSS set, and the corresponding PDSCH, on SSB symbols to be measured for L1-SINR measurement; and

for the SSB and CORESET for RMSI scheduling multiplexing patterns 2, UE is expected to receive PDSCH that corresponds to the PDCCH that UE monitors in the Type0-PDCCH CSS set, on SSB symbols to be measured for L1-SINR measurement.

### 9.8.6.4 Scheduling availability of UE performing L1-SINR measurement on FR1 or FR2 in case of FR1-FR2 inter-band CA

There are no scheduling restrictions on FR1 serving cell(s) due to L1-SINR measurement performed on FR2 serving cell(s).

There are no scheduling restrictions on FR2 serving cell(s) due to L1-SINR measurement performed on FR1 serving cell(s).

## 9.9 NR measurements for positioning

### 9.9.1 Introduction

This clause contains requirements for UE capable of performing NR positioning measurements defined in TS 38.215 [4], including RSTD, PRS-RSRP, UE Rx-Tx time difference, and NR E-CID measurements.

For RSTD, PRS-RSRP and UE Rx-Tx time difference measurements, the requirements in clauses 9.9.2, 9.9.3 and 9.9.4 apply provided:

- UE is configured with per-UE measurement gaps
- No active BWP switching occurs during the measurement gaps for PRS measurement, and

All measurement requirements specified in clause 9.9.2, 9.9.3 and 9.9.4 shall apply without DRX as well as for any DRX configuration specified in TS 38.331 [2].

UE is not required to perform additional SSB measurement for the SSB configured as QCL source of PRS resources.

UE is only required to measure PRS resources that are fully or partially overlapped with measurement gaps, and the requirements in clause 9.9.2, 9.9.3 and 9.9.4 are applicable to PRS resources that are fully or partially overlapped with measurement gaps.

A PRS resource is considered to be fully (partially) overlapped with measurement gaps if all (some) of its instances are overlapped with a measurement gap occasion. A PRS resource instance is considered to be overlapped with measurement gap occasion if the minimum number of unmuted repetitions of the instance taking into account *nr-DL-PRS-ExpectedRSTD-Uncertainty* and *nr-DL-PRS-ExpectedRSTD* is fully covered by the MGL excluding RF switching time, where the minimum number is given in the accuracy requirements in clause 10.1.23, 10.1.24 and 10.1.25 for RSTD, PRS-RSRP and UE Rx-Tx time difference, respectively.

When UE is configured with measurement for more than one positioning requests, the measurement period for each request may be longer than measurement period when UE is configured with measurement for single positioning request.

### 9.9.2 RSTD measurements

#### 9.9.2.1 Introduction

The requirements in clause 9.9.2 shall apply provided the UE has received *NR-DL-TDOA-RequestLocationInformation* message from LMF via LPP [34] requesting the UE to measure and report DL RSTD measurements defined in TS 38.215 [4].

#### 9.9.2.2 Requirements Applicability

The requirements in clause 9.9.2 apply for periodic and triggered RSTD measurements, provided:

- PRS-RSTD related side conditions given in clause 10.1.23 for FR1 and FR2 are fulfilled, for a corresponding Band.

#### 9.9.2.3 Measurement Capability

UE PRS RSTD measurement capability is as indicated by the UE in *NR-DL-TDOA-ProvideCapabilities*, according to TS 37.355[34].

#### 9.9.2.4 Measurement Reporting Requirements

The measurement reporting delay is defined as the time between the moment when the periodic measurement report is triggered and the moment when the UE starts to transmit the measurement report over the air interface. This requirement assumes that the measurement report is not delayed by other LPP signalling on the DCCH. This

measurement reporting delay excludes a delay uncertainty resulted when inserting the measurement report to the TTI of the uplink DCCH. The delay uncertainty is:  $2 \times TTI_{DCCH}$  where  $TTI_{DCCH}$  is the duration of subframe or slot or subslot when the measurement report is transmitted on the PUSCH with subframe or slot or subslot duration. This measurement reporting delay excludes any delay caused by no UL resources for UE to send the measurement report.

The reported RSTD measurement values contained in measurement reports shall be based on the measurement report mapping requirements specified in clauses 10.1.23.3.

The RSTD measurements performed and reported according to this section shall meet the RSTD measurement accuracy requirements in clause 10.1.23, for each measured DL PRS resource.

9.9.2.4.1 Void

9.9.2.4.2 Void

9.9.2.4.3 Void

### 9.9.2.5 Measurements Period Requirements

When physical layer receives last of *NR-TDOA-ProvideAssistanceData* message and *NR-TDOA-RequestLocationInformation* message from LMF via LPP [34], the UE shall be able to measure multiple (up to the UE capability specified in Clause 9.9.2.3) DL RSTD measurements, defined in TS 38.215 [4], during the measurement period  $T_{RSTD,Total}$  defined as:

$$T_{RSTD,Total} = \sum_{i=1}^L T_{RSTD,i} + (L - 1) * \max(T_{effect,i})$$

Where ,

$i$  is the index of positioning frequency layer,

$L$  is total number of positioning frequency layers, and

$T_{effect,i}$  is the periodicity of the PRS RSTD measurement in positioning frequency layer  $i$

$T_{RSTD,i}$  is the measurement period for PRS RSTD measurement in positioning frequency layer  $i$  as specified below:

$$T_{RSTD,i} = \left( CSSF_{PRS,i} * N_{RxBeam,i} * \left\lceil \frac{N_{PRS,i}^{slot}}{N} \right\rceil \left\lfloor \frac{L_{available\_PRS,i}}{N} \right\rfloor * N_{sample} - 1 \right) * T_{effect,i} + T_{last,i} ,$$

where:

$N_{RxBeam,i}$  is the UE Rx beam sweeping factor. In FR1,  $N_{RxBeam,i} = 1$ ; and in FR2,  $N_{RxBeam,i} = 8$ .

$CSSF_{PRS,i}$  is the carrier-specific scaling factor for NR PRS-based positioning measurements in positioning frequency layer  $i$  as defined in clause 9.1.5.2.

$N_{PRS,i}^{slot}$  is the maximum number of DL PRS resources in positioning frequency layer  $i$  configured in a slot.

$L_{available\_PRS,i}$  is the time duration of available PRS in the positioning frequency layer  $i$  to be measured during  $T_{available\_PRS,i}$ , and is calculated in the same way as PRS duration  $K$  defined in clause 5.1.6.5 of TS 38.214 [26]. For calculation of  $L_{available\_PRS,i}$ , only the PRS resources unmuted and fully or partially overlapped with MG are considered.

$N_{sample}$  is the number of PRS RSTD samples and  $N_{sample} = 4$ .

$T_{last,i}$  is the measurement duration for the last PRS RSTD sample in positioning frequency layer  $i$ , including the sampling time and processing time,  $T_{last,i} = T_i + T_{available\_PRS,i}$  ,

$T_{effect,i}$  is the periodicity of the PRS RSTD measurement in positioning frequency layer  $i$  defined as:

$$T_{effect,i} = \left\lceil \frac{T_i}{T_{available\_PRS,i}} \right\rceil * T_{available\_PRS,i}$$

Where,

$T_i$  corresponds to *durationOfPRS-ProcessingSymbolsInEveryTms* in TS 37.355 [34],

$T_{available\_PRS,i} = LCM(T_{PRS,i}, MGRP_i)$ , the least common multiple between  $T_{PRS,i}$  and  $MGRP_i$ .

$MGRP_i$  is the repetition periodicity of the measurement gap applicable for measurement in the PRS frequency layer  $i$ .

$T_{PRS,i}$  is the periodicity of DL PRS resource with muting on positioning frequency layer  $i$ .

If more than one PRS periodicities are configured in positioning frequency layer  $i$ , the least common multiple of PRS periodicities  $T_{per}^{PRS\ with\ muting}$  among all DL PRS resource sets in the positioning frequency layer is used to derive  $T_{PRS,i}$ , where,

$T_{per}^{PRS\ with\ muting} = N_{muting} * T_{per}^{PRS}$ , is the PRS periodicity with muting per PRS resource,

$T_{per}^{PRS}$  is the periodicity of PRS resource sets given by the higher-layer parameter *DL-PRS-Periodicity*.

$N_{muting}$  is the scaling factor considering PRS resource muting.  $N_{muting} = T_{muting}^{PRS} * L_{muting}$ , where

$T_{muting}^{PRS}$  is the muting repetition factor given by the higher-layer parameter *DL-PRS-MutingBitRepetitionFactor*, and  $L_{muting}$  is the size of the bitmap  $\{b^1\}$ .

Note: For the purpose of calculating  $T_{PRS,i}$ , only the PRS resources fully or partially covered by the MG are considered.

$\{N, T\}$  is UE capability combination per band where  $N$  is a duration of DL PRS symbols in ms corresponding to *durationOfPRS-ProcessingSymbols* in TS 37.355 [34] processed every  $T$  ms corresponding to *durationOfPRS-ProcessingSymbolsInEveryTms* in TS 37.355 [34] for a given maximum bandwidth supported by UE corresponding to *supportedBandwidthPRS* in TS 37.355 [34].

$N'$  is UE capability for number of DL PRS resources that it can process in a slot as indicated by *maxNumOfDL-PRS-ResProcessedPerSlot* specified in TS 37.355 [34].

Except for deferred MT-LR as defined in clause 4.1a.5 [TS 23.273], the time  $T_{RSTD,Total}$  starts from the first MG instance aligned with a DL PRS resource(s) in the assistance data after both the *NR-TDOA-ProvideAssistanceData* message and *NR-TDOA-RequestLocationInformation* message are delivered from LMF to the physical layer of UE via LPP [34].

For deferred MT-LR with other event than “Periodic Location” as defined in clause 4.1a.5.1 [TS 23.273], the time  $T_{RSTD,Total}$  starts from the first MG instance aligned with a DL PRS resource(s) in the assistance data after the associated event(s) occurs.

For deferred MT-LR with event “Periodic Location” as defined in clause 4.1a.5.1 [TS 23.273], the UE shall perform the RSTD measurement in each reporting period and activate the location report at the time when the periodic timer expires.

Note: No per-positioning frequency layer requirement is applied in scenarios when multiple positioning frequency layers are configured.

If during the measurement period of one or more positioning frequency layers, the MG pattern is reconfigured, the measurement period can be longer. When PRS-RSRP is configured for DL-TDOA, RSTD and RSRP are performed over the same measurement period.

The measurement requirements in this clause apply, provided no PRS symbols are dropped during the measurement period  $T_{RSTD,Total}$  within measurement gaps due to collisions with other signals; otherwise, the measurement period can be longer.

If CSSF changes during the measurement period, the measurement period could be longer.

The measurement requirements do not apply for a PRS resource, if the PRS resource is across two sampling duration of  $N$  within duration  $L_{available\_PRS,i}$ .

The measurement requirements do not apply for a PRS resource, if time span of the PRS resource instance (including at least the minimum number of repetitions specified in the accuracy requirements) is greater than UE reported capability  $N$ .

The requirements in clause 9.9.2 do not apply if the PRS configuration given by higher layer parameters *NR-DL-PRS-AssistanceData* exceeds any of the UE measurement capabilities given by *NR-DL-PRS-ResourcesCapability* in *NR-DL-TDOA-ProvideCapabilities*, and it is up to UE implementation which PRS resources are measured, subject to UE measurement capabilities.

If handover occurs while RSTD measurements are being performed, then the UE shall continue and complete the ongoing RSTD measurements. The RSTD measurement period can be longer. The UE shall meet the RSTD measurement accuracy requirements in clause 10.1.23.

### 9.9.2.6 Void

## 9.9.3 PRS-RSRP measurements

### 9.9.3.1 Introduction

The requirements in clause 9.9.3.5 shall apply provided the UE has received a message from LMF via LPP [34] requesting the UE to measure and report PRS-RSRP measurements defined in TS 38.215 [4].

### 9.9.3.2 Requirements applicability

The requirements in clause 9.9.3 apply for periodic and triggered PRS-RSRP measurements, provided:

- PRS-RSRP related side conditions given in clause 10.1.24 are met for a corresponding Band.

### 9.9.3.3 Measurement Capability

UE PRS-RSRP measurement capability is as indicated by the UE in *NR-DL-AoD-ProvideCapabilities* according to TS 37.355 [34].

### 9.9.3.4 Measurement Reporting Requirements

This requirement assumes that the measurement report is not delayed by other LPP signalling on the DCCH. This measurement reporting delay excludes a delay uncertainty resulted when inserting the measurement report to the TTI of the uplink DCCH. The delay uncertainty is:  $2 \times TTI_{DCCH}$  where  $TTI_{DCCH}$  is the duration of subframe or slot or subslot when the measurement report is transmitted on the PUSCH with subframe or slot or subslot duration. This measurement reporting delay excludes any delay caused by no UL resources for UE to send the measurement report.

The reported PRS-RSRP measurement values contained in measurement reports shall be based on the measurement report mapping requirements specified in clauses 10.1.24.3.

The PRS-RSRP measurement accuracy for all measured PRS resources shall be fulfilled according to the accuracy requirements specified in the clauses 10.1.24.

### 9.9.3.5 Measurement Period Requirements

When the physical layer receives *NR-DL-AoD-ProvideAssistanceData* message and *NR-DL-AoD-RequestLocationInformation* message from LMF via LPP [34], the UE shall be able to measure multiple (up to the UE capability specified in Clause 9.9.3.3) PRS-RSRP measurements, defined in TS 38.215 [4], from configured PRS resources for configured TRPs on configured positioning frequency layers, within  $T_{PRS-RSRP, total}$  ms.

$$T_{PRS-RSRP, total} = \sum_{i=1}^L T_{PRS-RSRP, i} + (L - 1) * \max(T_{effect, i})$$

where

$i$  is the index of positioning frequency layer,

L is total number of positioning frequency layers,

$T_{\text{effect},i}$  is the periodicity of the PRS-RSRP measurement in positioning frequency layer  $i$ .

$$T_{\text{PRS-RSRP},i} = \left( \text{CSSF}_i * N_{\text{RxBeam},i} * \left\lceil \frac{N_{\text{PRS},i}^{\text{slot}}}{N} \right\rceil \left\lfloor \frac{L_{\text{available\_PRS},i}}{N} \right\rfloor * N_{\text{sample}} - 1 \right) * T_{\text{effect},i} + T_{\text{last}}$$

where

$\text{CSSF}_i$  is the carrier specific scaling factor for PRS-RSRP measurements specified in clause 9.1.5.2,

$N_{\text{RxBeam},i}$  is the scaling factor for Rx beam sweeping, and  $N_{\text{RxBeam},i}=1$  if positioning frequency layer  $i$  is in FR1 and  $N_{\text{RxBeam},i}=8$  if positioning frequency layer  $i$  is in FR2,

$L_{\text{available\_PRS},i}$  is the time duration of available PRS to be measured in the positioning frequency layer  $i$  to be measured during  $T_{\text{available\_PRS},i}$ , and is calculated in the same way as PRS duration K defined in clause 5.1.6.5 of TS 38.214 [26]. For calculation of  $L_{\text{available\_PRS},i}$ , only the PRS resources unmuted and fully or partially overlapped with MG are considered.

$N_{\text{PRS},i}^{\text{slot}}$  is the maximum number of DL PRS resources of positioning frequency layer  $i$  configured in a slot,

$\{N, T\}$  is UE capability combination per band where  $N$  is a duration of DL PRS symbols in ms corresponding to *durationOfPRS-ProcessingSymbols* in TS 37.355 [34] processed every  $T$  ms corresponding to *durationOfPRS-ProcessingSymbolsInEveryTms* in TS 37.355 [34] for a given maximum bandwidth supported by UE corresponding to *supportedBandwidthPRS* in TS 37.355 [34],

$N'$  is UE capability for number of DL PRS resources that it can process in a slot as indicated by *maxNumOfDL-PRS-ResProcessedPerSlot* in clause 6.4.3 of TS 37.355 [34],

$N_{\text{sample}}$  is the number of PRS-RSRP measurement samples and  $N_{\text{sample}}=4$ ,

$T_{\text{last}} = T_i + T_{\text{available\_PRS},i}$  is the measurement duration for the last PRS-RSRP sample, including the sampling time and processing time,

$T_{\text{effect},i} = \left\lceil \frac{T_i}{T_{\text{available\_PRS},i}} \right\rceil * T_{\text{available\_PRS},i}$  is the periodicity of PRS-RSRP measurement in positioning frequency layer  $i$ ,

$T_i$  corresponds to *durationOfPRS-ProcessingSymbolsInEveryTms* in TS 37.355 [34],

$T_{\text{available\_PRS},i} = \text{LCM}(T_{\text{PRS},i}, \text{MGRP}_i)$  is the least common multiple between  $T_{\text{PRS},i}$  and  $\text{MGRP}_i$ ,

$T_{\text{PRS},i}$  is the maximum PRS resource periodicity among all PRS resources in positioning frequency layer  $i$ ,

$\text{MGRP}_i$  is the measurement gap repetition period in positioning frequency layer  $i$ .

If positioning frequency layer  $i$  has more than one DL PRS resource set with different PRS periodicities with muting,  $T_{\text{per}}^{\text{PRS with muting}} = N_{\text{muting}} * T_{\text{per}}^{\text{PRS}}$ , the least common multiple of  $T_{\text{per}}^{\text{PRS with muting}}$  among the DL PRS resource sets is used to derive  $T_{\text{PRS},i}$ , where:

$T_{\text{per}}^{\text{PRS}}$  is the periodicity of PRS resource sets given by the higher-layer parameter *DL-PRS-Periodicity*.

$N_{\text{muting}}$  is the scaling factor considering PRS resource muting.  $N_{\text{muting}} = T_{\text{muting}}^{\text{PRS}} * L_{\text{muting}}$ , where  $T_{\text{muting}}^{\text{PRS}}$  is the muting repetition factor given by the higher-layer parameter *DL-PRS-MutingBitRepetitionFactor*, and  $L_{\text{muting}}$  is the size of the bitmap  $\{b^1\}$ .

Note: For the purpose of calculating  $T_{\text{PRS},i}$ , only the PRS resources fully or partially covered by the MG are considered.

When PRS-RSRP measurements are configured for DL-AoD, except for deferred MT-LR as defined in clause 4.1a.5 [TS 23.273], the time  $T_{\text{PRS-RSRP},\text{total}}$  starts from the first MG instance aligned with DL PRS resources in the assistance



data after both the *NR-DL-AoD-RequestLocationInformation* message and *NR-DL-AoD-ProvideAssistanceData* message from LMF via LPP [34] are delivered to the physical layer of UE.

For deferred MT-LR with other event than “Periodic Location” as defined in clause 4.1a.5.1 [TS 23.273], the time  $T_{PRS-RSRP,total}$  starts from the first MG instance aligned with a DL PRS resource(s) in the assistance data after the associated event(s) occurs.

For deferred MT-LR with event “Periodic Location” as defined in clause 4.1a.5.1 [TS 23.273], the UE shall perform the PRS-RSRP measurement in each reporting period and activate the location report at the time when the periodic timer expires.

Note: No per-positioning frequency layer requirement is applied in scenarios when multiple positioning frequency layers are configured.

When the PRS-RSRP measurement is configured together with RSTD measurement then the PRS-RSRP measurement shall meet the RSTD measurement requirements defined in clause 9.9.2.

When the PRS-RSRP measurement is configured together with UE Rx-Tx time difference measurement then the PRS-RSRP measurement shall meet the UE Rx-Tx time difference measurement requirements defined in clause 9.9.4.

If CSSF changes during the measurement period, the measurement period could be longer.

The measurement requirements do not apply for a PRS resource:

- if the PRS resource is across two sampling duration of N within duration  $L_{available\_PRS,i}$  OR
- if time span of the PRS resource instance (including at least the minimum number of repetitions specified in the accuracy requirements) is greater than UE reported capability N.

If during the measurement period of one or more positioning frequency layers, the MG pattern is reconfigured either per UE request or not per UE request, the measurement period can be longer.

The requirements in this section apply, provided no PRS symbols are dropped during the measurement period  $T_{PRS-RSRP,total}$  within measurement gaps due to collisions with other signals; otherwise, a longer measurement period may be used.

The requirements in clause 9.9.3 do not apply if the PRS configuration given by higher layer parameters *NR-DL-PRS-AssistanceData* exceeds any of the UE measurement capabilities given by *NR-DL-PRS-ResourcesCapability* in *NR-DL-AoD-ProvideCapabilities*, and it is up to UE implementation which PRS resources are measured, subject to UE measurement capabilities.

If handover occurs while PRS-RSRP measurements are being performed then the UE shall complete the ongoing PRS-RSRP measurements session. The PRS-RSRP measurement period can be longer. The UE shall meet the PRS-RSRP measurement accuracy requirements in clause 10.1.24.

## 9.9.4 UE Rx-Tx time difference measurements

### 9.9.4.1 Introduction

The requirements in this clause shall apply, provided the UE has received *nr-Multi-RTT-RequestLocationInformation* message from LMF via LPP [34] requesting the UE to measure and report one or more UE Rx-Tx time difference measurements defined in TS 38.215 [4].

### 9.9.4.2 Requirements Applicability

The requirements in clause 9.9.4 apply for periodic and triggered UE Rx-Tx time difference measurements, provided:

- UE Rx-Tx time difference measurement related side conditions given in clause 10.1.25 are met for a corresponding band.
- SRS is configured on at least one of the PCell, PSCell and SCell.

- The UE transmits SRS within [-160, 160] msec of at least one DL PRS resource of each of the TRPs in the assistance data.

### 9.9.4.3 Measurement Capability

UE Rx-Tx time difference measurement capability is as indicated by the UE in *NR-Multi-RTT-ProvideCapabilities*, according to TS 37.355 [34].

### 9.9.4.4 Measurement Reporting Requirements

This requirement assumes that the measurement report is not delayed by other LPP signalling on the DCCH. This measurement reporting delay excludes a delay uncertainty resulted when inserting the measurement report to the TTI of the uplink DCCH. The delay uncertainty is:  $2 \times \text{TTIDCCH}$  where TTIDCCH is the duration of subframe or slot or subslot when the measurement report is transmitted on the PUSCH with subframe or slot or subslot duration. This measurement reporting delay excludes any delay caused by no UL resources for UE to send the measurement report.

The UE Rx-Tx time difference measurement values contained in measurement reports shall be based on the measurement report mapping requirements specified in clause 10.1.25.

The UE Rx-Tx time difference measurement accuracy for all measured DL PRS resources shall be fulfilled according to the accuracy requirements specified in clause 10.1.25.

### 9.9.4.5 Measurement Period Requirements

When physical layer receives last of *NR-Multi-RTT-ProvideAssistanceData* message and *NR-Multi-RTT-RequestLocationInformation* message from LMF via LPP [34], UE shall be able to measure multiple (up to the UE capability specified in clause 9.9.4.3) UE Rx-Tx time difference measurements as defined in TS 38.215 [4] in configured positioning frequency layers within the measurement period  $T_{\text{UERxTx,Total}}$  ms.

$$T_{\text{UERxTx, Total}} = \sum_{i=1}^L T_{\text{UERxTx},i} + (L - 1) * \max(T_{\text{effect},i}).$$

where  $i$  is the index of positioning frequency layer,

$T_{\text{UERxTx},i}$  is the measurement period for UE Rx-Tx time difference measurements in positioning frequency layer  $i$  as further defined in this clause,

$L$  is total number of positioning frequency layers, and

$T_{\text{effect},i}$  is the periodicity of the UE Rx-Tx time difference measurement in positioning frequency layer  $i$  as defined further in this clause.

$$T_{\text{UERxTx},i} = \left( \text{CSSF}_i * N_{\text{RxBeam},i} * \left\lceil \frac{N_{\text{PRS},i}^{\text{slot}}}{N} \right\rceil \left\lfloor \frac{L_{\text{available\_PRS},i}}{N} \right\rfloor * N_{\text{sample}} - 1 \right) * T_{\text{effect},i} + T_{\text{last},i}$$

Where

$\text{CSSF}_i$  is the carrier-specific scaling factor for NR PRS-based measurement in the positioning frequency layer  $i$  as defined in clause 9.1.5.2,

$N_{\text{RxBeam},i}$  is the scaling factor for Rx beam sweeping, and  $N_{\text{RxBeam},i}=1$  if positioning frequency layer  $i$  is in FR1 and  $N_{\text{RxBeam},i}=8$  if positioning frequency layer  $i$  is in FR2,

$L_{\text{available\_PRS},i}$  is the time duration of available PRS resources in the positioning frequency layer  $i$ , to be measured during  $T_{\text{available\_PRS},i}$ , and is calculated in the same way as PRS duration  $K$  defined in clause 5.1.6.5 of TS 38.214 [26]. For calculation of  $L_{\text{available\_PRS},i}$ , only the PRS resources unmuted and fully or partially overlapped with MG are considered.

$N_{\text{PRS},i}^{\text{slot}}$  is the maximum number of DL PRS resources of positioning frequency layer  $i$  configured in a slot,

$\{N, T\}$  is UE capability combination per band where  $N$  is a duration of DL PRS symbols in ms corresponding to *durationOfPRS-ProcessingSymbols* in TS 37.355 [34] processed every  $T$  ms corresponding to *durationOfPRS-ProcessingSymbolsInEveryTms* in TS 37.355 [34] for a given maximum bandwidth supported by UE corresponding to *supportedBandwidthPRS* in clause 4.2.7.2 of TS 37.355 [34],

$N'$  is UE capability for number of DL PRS resources that it can process in a slot corresponding to *maxNumOfDL-PRS-ResProcessedPerSlot* as specified in clause 6.4.3 of TS 37.355 [34],

$N_{sample}$  is the number of UE Rx-Tx time difference measurement samples and  $N_{sample} = 4$ ,

$T_{last,i}$  is the measurement duration for the last UE Rx-Tx time difference measurement sample in the positioning layer  $i$ , including the sampling time and processing time,  $T_{last,i} = T_i + T_{available\_PRS,i}$ ,

$T_{effect,i}$  is periodicity of UE Rx-Tx time difference measurement in positioning frequency layer  $i$ :

$$T_{effect,i} = \left\lceil \frac{T_i}{T_{available\_PRS,i}} \right\rceil * T_{available\_PRS,i}$$

where

$T_i$  corresponds to *durationOfPRS-ProcessingSymbolsInEveryTms* in TS 37.355 [34],

$T_{available\_PRS,i} = LCM(T_{PRS,i}, MGRP_i)$ , the least common multiple between  $T_{PRS,i}$  and  $MGRP_i$

$MGRP_i$  is the measurement gap repetition periodicity in positioning frequency layer  $i$ .

$T_{PRS,i}$  is the PRS resource periodicity in positioning frequency layer  $i$ . If the positioning frequency layer  $i$  has more than one DL PRS resource sets with different PRS periodicities with muting,  $T_{per}^{PRS\ with\ muting} = N_{muting} * T_{per}^{PRS}$ , the least common multiple of  $T_{per}^{PRS\ with\ muting}$  among DL PRS resource sets is used to derive  $T_{PRS,i}$ , where

$T_{per}^{PRS}$  is the periodicity of PRS resource sets given by the higher-layer parameter *DL-PRS-Periodicity*.

$N_{muting}$  is the scaling factor considering PRS resource muting.  $N_{muting} = T_{muting}^{PRS} * L_{muting}$ , where  $T_{muting}^{PRS}$  is the muting repetition factor given by the higher-layer parameter *DL-PRS-MutingBitRepetitionFactor*, and  $L_{muting}$  is the size of the bitmap  $\{b^1\}$ .

Note: For the purpose of calculating  $T_{PRS,i}$ , only the PRS resources fully or partially covered by the MG are considered.

Except for deferred MT-LR as defined in clause 4.1a.5 [TS 23.273], the time  $T_{UERxTx,Total}$  starts from the first MG instance aligned with DL PRS resources in the assistance data after both the *NR-Multi-RTT-RequestLocationInformation* message and *NR-Multi-RTT-ProvideAssistanceData* message from LMF via LPP [34] are delivered to the physical layer of UE.

For deferred MT-LR with other event than “Periodic Location” as defined in clause 4.1a.5.1 [TS 23.273], the time  $T_{UERxTx,Total}$  starts from the first MG instance aligned with a DL PRS resource(s) in the assistance data after the associated event(s) occurs.

For deferred MT-LR with event “Periodic Location” as defined in clause 4.1a.5.1 [TS 23.273], the UE shall perform the PRS-RSRP measurement in each reporting period and activate the location report at the time when the periodic timer expires.

Note: No per-positioning frequency layer requirement is applied in scenarios when multiple positioning frequency layers are configured.

The UE Rx-Tx time difference measurement period is restarted if HO occurs during the measurement period and after SRS reconfiguration on the target cell is complete.

The measurement requirements do not apply for a PRS resource:

- if the PRS resource is across two sampling duration of  $N$  within duration  $L_{available\_PRS,i}$  OR
- if time span of the PRS resource instance (including at least the minimum number of repetitions specified in the accuracy requirements) is greater than UE reported capability  $N$ .

If during the measurement period of one or more positioning frequency layers, the MG pattern is reconfigured either per UE request or not per UE request, the measurement period can be longer.

The requirements in this section apply, provided no PRS symbols are dropped during the measurement period  $T_{\text{UE Rx-Tx, Total}}$  within measurement gaps due to collisions with other signals; otherwise, a longer measurement period may be used.

When PRS-RSRP is configured for multi-RTT, the UE Rx-Tx time difference measurements and PRS-RSRP measurements are performed over the same measurement period.

The requirements in clause 9.9.4 do not apply if the PRS configuration given by higher layer parameters *NR-DL-PRS-AssistanceData* exceeds any of the UE measurement capabilities given by *NR-DL-PRS-ResourcesCapability* in *NR-Multi-RTT-ProvideCapabilities*, and it is up to UE implementation which PRS resources are measured, subject to UE measurement capabilities.

When PSCell or SCell addition or release does not cause SRS reconfiguration during the measurement period, UE continues the UE Rx-Tx time difference measurement, and the measurement period requirements apply.

When PSCell or SCell addition or release causes SRS reconfiguration during the measurement period, UE shall restart the UE Rx-Tx time difference measurement after the SRS reconfiguration on the target cell is complete.

When SRS is reconfigured without serving cell change during the measurement period, UE shall restart the UE Rx-Tx time difference measurement after the SRS reconfiguration is complete. If UE uplink transmission timing changes due to the network-configured Timing Advance command during the UE Rx-Tx measurement period, then the UE Rx-Tx time difference measurement period is restarted after uplink transmission timing changes, and the UE Rx-Tx time difference measurement period requirements in this clause shall not apply.

When a serving cell change occurs during the measurement period, the UE shall continue and complete the UE Rx-Tx time difference measurement provided that the serving cell change does not impact SRS configuration for the UE Rx-Tx time difference measurement.

If UE uplink transmission timing changes due to the change in the  $N_{\text{TA\_offset}}$  defined in Table 7.1.2-2 during the UE Rx-Tx measurement period, then the UE Rx-Tx time difference measurement period is restarted after uplink transmission timing changes, and the UE Rx-Tx time difference measurement period requirements in this clause shall not apply.

If UE uplink transmission timing changes due to the UE autonomous timing adjustment defined in clause 7.1.2 during the UE Rx-Tx measurement period, then:

- UE Rx-Tx measurement period requirements in this clause shall apply for a cell, which is also the downlink reference cell (defined in section 7.1.1) for SRS transmission.
- UE Rx-Tx measurement period requirements in this clause shall not apply for a cell, which is not the downlink reference cell (defined in section 7.1.1) for SRS transmission. The UE Rx-Tx time difference measurement period may be restarted in such case.

## 9.9.5 NR E-CID measurements

### 9.9.5.1 Introduction

The requirements in clause 9.9.5 shall apply provided the UE has received *nr-ECID-RequestLocationInformation* message from LMF via LPP [34] requesting the UE to report one or more of the following measurements for NR E-CID positioning [22]: SS-RSRP, SS-RSRQ, CSI-RSRP, and CSI-RSRQ.

### 9.9.5.2 Measurement Requirements

#### 9.9.5.2.1 Intra-frequency Measurement Requirements

The intra-frequency NR E-CID measurements shall meet the requirements in clause 9.2 and clause 9.10.2, except the measurement reporting requirements. The NR E-CID measurement reporting requirements are defined in clause 9.9.5.2.3.

The reported intra-frequency NR E-CID measurements shall also meet:

- for FR1 SS-RSRP, the accuracy requirements in clauses 10.1.2.1,
- for FR1 SS-RSRQ, the accuracy requirements in clauses 10.1.7.1,
- for FR1 CSI-RSRP, the accuracy requirements in clause 10.1.2.3,
- for FR1 CSI-RSRQ, the accuracy requirements in clause 10.1.7.2,
- for FR2 SS-RSRP, the accuracy requirements in clauses 10.1.3.1,
- for FR2 SS-RSRQ, the accuracy requirements in clauses 10.1.8.1,
- for FR2 CSI-RSRP, the accuracy requirements in clause 10.1.3.3,
- for FR2 CSI-RSRQ, the accuracy requirements in clause 10.1.8.2.

#### 9.9.5.2.2 Inter-frequency Measurement Requirements

The inter-frequency NR E-CID measurements shall meet the requirements in clause 9.3 and 9.10.4, except the measurement reporting requirements. The NR E-CID measurement reporting requirements are defined in clause 9.9.5.2.3.

The reported inter-frequency NR E-CID measurements shall also meet:

- for FR1 SS-RSRP, the accuracy requirements in clauses 10.1.4.1,
- for FR1 SS-RSRQ, the accuracy requirements in clauses 10.1.9.1,
- for FR1 CSI-RSRP, the accuracy requirements 10.1.4.3,
- for FR1 CSI-RSRQ, the accuracy requirements 10.1.9.2,
- for FR2 SS-RSRP, the accuracy requirements in clauses 10.1.5.1,
- for FR2 SS-RSRQ, the accuracy requirements in clauses 10.1.10.1,
- for FR2 CSI-RSRP, the accuracy requirements 10.1.5.3,
- for FR2 CSI-RSRQ, the accuracy requirements 10.1.10.2.

#### 9.9.5.2.3 Measurement Reporting Delay

The measurement reporting delay is defined as the time between the moment when the periodic measurement report is triggered and the moment when the UE starts to transmit the measurement report over the air interface. This requirement assumes that the measurement report is not delayed by other LPP signalling on the DCCH. This measurement reporting delay excludes a delay uncertainty resulted when inserting the measurement report to the TTI of the uplink DCCH. The delay uncertainty is:  $2 \times TTI_{DCCH}$  where  $TTI_{DCCH}$  is the duration of subframe or slot or subslot when the measurement report is transmitted on the PUSCH with subframe or slot or subslot duration. This measurement reporting delay excludes any delay caused by no UL resources for UE to send the measurement report.

The reported NR E-CID measurement values contained in periodically triggered measurement reports shall be based on the measurement report mapping requirements specified in clause 10.1.6 for SS-RSRP and CSI-RSRP, and clause 10.1.11 for SS-RSRQ and CSI-RSRQ.

The UE shall not send any measurement reports as long as no corresponding reporting criteria specified in clause 9.1.4 are fulfilled.

## 9.10 CSI-RS based L3 measurements

### 9.10.1 Introduction

This clause contains general requirements on the UE regarding CSI-RS based measurement reporting in RRC\_CONNECTED state. The requirements are split in intra-frequency and inter-frequency measurements requirements.

The requirements in this clause apply, provided:

- Only one MO is configured per CSI-RS frequency layer, and
- all CSI-RS resources in the same MO are configured with the same *csi-rs-MeasurementBW*, and
- all CSI-RS resources in the same MO are configured with the same periodicity, and
- *associatedSSB* is configured in *CSI-RS-Resource-Mobility* and detectable, and
- the associated SSB is QCLed with the corresponding CSI-RS resources in FR2, and
- the number of CSI-RS resources in any duration that equals to the length of a slot is no larger than UE capability *maxNumberCSI-RS-RRM-RS-SINR*.
- When there are mixed numerologies, the length of a slot is defined based on the smallest SCS

### 9.10.2 CSI-RS based intra-frequency measurements

#### 9.10.2.1 Introduction

A measurement is defined as a CSI-RS based intra-frequency measurement provided that:

- the SCS of the CSI-RS resource of the neighbour cell configured for measurement is the same as the SCS of the CSI-RS resource on the serving cell indicated for measurement, and
- the CP type of the CSI-RS resource of neighbour cell configured for measurement is the same as the CP type of the CSI-RS resource of the serving cell indicated for measurement, and
  - It is applied for SCS = 60KHz
- the centre frequency of the CSI-RS resource of the neighbour cell configured for measurement is the same as the centre frequency of the CSI-RS resource of the serving cell indicated for measurement

The UE shall be able to identify new intra-frequency cells and perform CSI-RSRP, CSI-RSRQ and CSI-SINR measurements of identified intra-frequency cells if carrier frequency information is provided by PCell or the PSCell.

No measurement gap is needed for intra-frequency CSI-RS resources measurements.

For intra-frequency CSI-RS based measurements, UE may cause scheduling restriction as specified in clause 9.10.2.6.

Note: Extended CP for CSI-RS based measurement is not supported in this release.

#### 9.10.2.2 Requirements applicability

The measurement of the associated SSB follows the same requirements as SSB based measurements defined in 9.2.

The requirements in clause 9.10.2 apply, provided:

- Only one intra-frequency CSI-RS layer per serving cell is configured, and
- The BW of the CSI-RS on the intra-frequency neighbor cell is within the active BWP of the UE, and
- The associated SSB of the CSI-RS resources being identified or measured are detectable, and the CSI-RS resources configured for CSI-RS based L3 measurements are measurable, and

- The bandwidth of CSI-RS resources of intra-MO is the same as that of the CSI-RS resources configured for the serving cell, and
- All CSI-RS resources on one intra-frequency layer are configured within up to two separate windows where each window is up to 5ms, and
  - for the case of single window further provided
    - The periodicity of the configured CSI-RS resources is 10ms, 20ms or 40ms
  - for the case of two separate windows further provided
    - The two windows are either both fully non-overlapped with MG or both partially overlapped with MG
    - The periodicity of the configured CSI-RS resources is 20ms or 40ms
- The starting point of the first window is the slot boundary of the serving cell, where the corresponding slot contains the configured L3 CSI-RS resource of the serving cell in the servingCellMO with the smallest offset, and
- The starting point of the second window if configured is determined by an offset of half of the CSI-RS periodicity in slots with regards to the starting point of the first window, and
- Numerology for intra-frequency CSI-RS and data of serving cell are the same.

An intra-frequency cell shall be considered detectable when for each relevant associated SSB:

SS-RSRP related side conditions given in clauses 10.1.2.1 and 10.1.3.1 for FR1 and FR2, respectively, for a corresponding Band,

- SS-RSRQ related side conditions given in clauses 10.1.7.1 and 10.1.8.1 for FR1 and FR2, respectively, for a corresponding Band,
- SS-SINR related side conditions given in clauses 10.1.12.1 and 10.1.13.1 for FR1 and FR2, respectively, for a corresponding Band,
- SSB<sub>RP</sub> and SSB  $\hat{E}_s/I_{ot}$  according to Annex B.2.2 for a corresponding Band.

A CSI-RS resource shall be considered measurable when for each relevant CSI-RS resource:

- CSI-RSRP related side conditions given in clauses 10.1.2.3 and 10.1.3.3 for FR1 and FR2, respectively, for a corresponding Band,
- CSI-RSRQ related side conditions given in clauses 10.1.7.2 and 10.1.8.2 for FR1 and FR2, respectively, for a corresponding Band,
- CSI-SINR related side conditions given in clauses 10.1.12.2 and 10.1.13.2 for FR1 and FR2, respectively, for a corresponding Band,
- CSI<sub>RP</sub> and CSI-RS  $\hat{E}_s/I_{ot}$  according to Annex B.2.12 for a corresponding Band.

### 9.10.2.3 Number of cells and number of CSI-RS

#### 9.10.2.3.1 Requirements for FR1

For each intra-frequency CSI-RS layer, during each layer 1 measurement period, the UE shall be capable of performing CSI-RSRP, CSI-RSRQ, and CSI-SINR measurements for at least:

- 32 CSI-RSs with different CSI-RS index and/or PCI on the intra-frequency layer, and
- the cells to be monitored based on CSI-RS are the same set or a subset of the cells monitored based on the layer of the associated SSB

### 9.10.2.3.2 Requirements for FR2

For one single intra-frequency CSI-RS layer in a band, during each layer 1 measurement period, the UE shall be capable of performing CSI-RSRP, CSI-RSRQ, and CSI-SINR measurements for at least:

- 32 CSI-RSs with different CSI-RS index and/or PCI, and
- the cells to be monitored based on CSI-RS are the same set or a subset of the cells monitored based on the layer of the associated SSB.

where this single intra-frequency layer shall be:

- PCC on which UE is configured to report CSI-RS measurement when UE is configured with SA NR operation mode with PCC in the band; or
- PSCC on which UE is configured to report CSI-RS measurement when UE is configured with EN-DC with PSCC in the band; or
- One of the SCCs on which UE is configured to report CSI-RS based measurements when neither PCC nor PSCC is in the same band, so that the selected SCC shall be an SCC where the UE is configured with CSI-RSRP measurement reporting if such SCC exists, otherwise the selected SCC is determined by UE implementation.

The UE shall also be capable of performing CSI-RSRP, CSI-RSRQ, and CSI-SINR measurements for at least 2 CSI-RSs on serving cell for each of the other intra-frequency layer(s) in the same band.

For each FR2 band, UE is only required to measure neighbour cell CSI-RS on the CSI-RS layer, whose associated SSB should be on the same SSB layer as the one where UE is required to measure neighbour cell SSB.

### 9.10.2.4 Measurement Reporting Requirements

Note: The UE is not required to report CSI-RS based L3 measurements when the timing offset between the reference measurement timing and the target CSI-RS in one layer is larger than one CP. If the UE reports CSI-RS based L3 measurements when the timing offset exceeds one CP, the UE may not meet the CSI-RS based L3 measurement accuracy requirements for CSI-RSRP, CSI-RSRQ and CSI-SINR in TS 38.133 section 10.1, which apply only when the timing offset is no larger than one CP.

#### 9.10.2.4.1 Periodic Reporting

Reported CSI-RSRP, CSI-RSRQ, and CSI-SINR measurements contained in periodic measurement reports shall meet the requirements in clauses 10.1.2.3, 10.1.3.3, 10.1.7.2, 10.1.8.2, 10.1.12.2 and 10.1.13.2.

#### 9.10.2.4.2 Event-triggered Periodic Reporting

Reported CSI-RSRP, CSI-RSRQ, and CSI-SINR measurements contained in event-triggered periodic measurement reports shall meet the requirements in clauses 10.1.2.3, 10.1.3.3, 10.1.7.2, 10.1.8.2, 10.1.12.2 and 10.1.13.2.

The first report in event triggered periodic measurement reporting shall meet the requirements specified in clause 9.10.2.4.3.

#### 9.10.2.4.3 Event Triggered Reporting

Reported CSI-RSRP, CSI-RSRQ, and CSI-SINR measurements contained in event triggered measurement reports shall meet the requirements in clauses 10.1.2.3, 10.1.3.3, 10.1.7.2, 10.1.8.2, 10.1.12.2 and 10.1.13.2.

The UE shall not send any event triggered measurement reports as long as no reporting criterion is fulfilled.

The measurement reporting delay is defined as the time between an event that will trigger a measurement report and the point when the UE starts to transmit the measurement report over the air interface. This requirement assumes that the measurement report is not delayed by other RRC signalling on the DCCH. This measurement reporting delay excludes a delay uncertainty resulted when inserting the measurement report to the TTI of the uplink DCCH. The delay uncertainty is:  $2 \times TTI_{DCCH}$ . This measurement reporting delay excludes a delay which caused by no UL resources being available for UE to send the measurement report on.



The event triggered measurement reporting delay, measured without L3 filtering shall be less than the CSI-RS based measurement defined in clause 9.10.2.5. When L3 filtering is used an additional delay can be expected.

### 9.10.2.5 Intra-frequency measurements without measurement gaps

If a UE is configured with the higher layer parameters *CSI-RS-Resource-Mobility* and *associatedSSB*, the CSI-RS based measurement shall include PSS/SSS detection time of associatedSSB, the time period used to acquire the SFN information and CSI-RS based measurement period without gap.

- PSS/SSS detection time of associatedSSB is the intra-frequency  $T_{\text{PSS/SSS\_sync\_intra}}$  in Clause 9.2.5.1.
- The time period used to acquire the SFN information is equal to 0 if the UE is indicated that the neighbour cell is synchronous with the serving cell (*deriveSSB-IndexFromCell* is enabled). Otherwise, the time period used to acquire the SFN information is  $T_{\text{CSI-RS\_SFN\_intra}}$  as shown in Table 9.10.2.5-3 for FR1. It is assumed that *deriveSSB-IndexFromCell* is always enabled for FR1 TDD and FR2.
- If the associatedSSB, which has been detectable at least for the time period  $T_{\text{identify\_intra\_with\_index}}$  defined in clause 9.2.5.1, becomes undetectable for a period  $\leq 5$  seconds and then the associatedSSB becomes detectable again with the same spatial reception parameter provided the timing to that cell has not changed more than  $\pm 3200/2^\mu T_c$ , where  $\mu$  is the SCS configuration as defined in clause 4.2 of TS 38.211 [3], PSS/SSS detection time and time period used to acquire the SFN information are equal to 0.

The measurement period for CSI-RS based intra-frequency measurements without gaps is as shown in table 9.10.2.5-1 and Table 9.10.2.5-2.

Additionally, for a given CSI-RS resource, if the associated SS/PBCH block is configured but not detected by the UE, or if CSI-RS is configured with associated SSB but not QCL-ed to the associated SSB, the UE is not required to monitor the corresponding CSI-RS resource.

**Table 9.10.2.5-1: Measurement period for intra-frequency CSI-RS based measurements without gaps (FR1)**

DRX cycle	$T_{\text{CSI-RS\_measurement\_period\_intra}}$
No DRX	$\max(200\text{ms}, \text{ceil}(5 \times K_p_{\text{CSI-RS}}) \times \text{CSI-RS period}) \times \text{CSSF}_{\text{intra}}$
DRX cycle $\leq 320\text{ms}$	$\max(200\text{ms}, \text{ceil}(1.5 \times 5 \times K_p_{\text{CSI-RS}}) \times \max(\text{CSI-RS period}, \text{DRX cycle})) \times \text{CSSF}_{\text{intra}}$
DRX cycle $> 320\text{ms}$	$\text{ceil}(5 \times K_p_{\text{CSI-RS}}) \times \text{DRX cycle} \times \text{CSSF}_{\text{intra}}$
NOTE 1: The requirements apply assuming CSI-RS configuration with $\{D=3$ with PRBs $\geq 48\}$ . D is frequency domain density for the 1-port CSI-RS for L3 mobility defined in clause 7.4.1 of TS38.211 [6].	

**Table 9.10.2.5-2: Measurement period for intra-frequency CSI-RS based measurements without gaps (FR2)**

DRX cycle	$T_{\text{CSI-RS\_measurement\_period\_intra}}$
No DRX	$\max(400\text{ms}, \text{ceil}(M_{\text{meas\_period\_w/o\_gaps}} \times K_p_{\text{CSI-RS}}) \times \text{CSI-RS period}) \times \text{CSSF}_{\text{intra}}$
DRX cycle $\leq 320\text{ms}$	$\max(400\text{ms}, \text{ceil}(1.5 \times M_{\text{meas\_period\_w/o\_gaps}} \times K_p_{\text{CSI-RS}}) \times \max(\text{CSI-RS period}, \text{DRX cycle})) \times \text{CSSF}_{\text{intra}}$
DRX cycle $> 320\text{ms}$	$M_{\text{meas\_period\_w/o\_gaps}} \times \text{DRX cycle} \times \text{CSSF}_{\text{intra}}$
NOTE 1: The requirements apply assuming CSI-RS configuration with $\{D=3$ with PRBs $\geq 48\}$ . D is frequency domain density for the 1-port CSI-RS for L3 mobility defined in clause 7.4.1 of TS38.211 [6].	

**Table 9.10.2.5-3: Time period for SFN acquisition for intra-frequency CSI-RS based measurements without gaps (FR1)**

DRX cycle	$T_{\text{CSI-RS\_SFN\_intra}}$
No DRX	$\max(200\text{ms}, \text{ceil}(5 \times K_p) \times \text{SMTC period})^{\text{Note 1}} \times \text{CSSF}_{\text{intra}}$
DRX cycle $\leq 320\text{ms}$	$\max(2000\text{ms}, \text{ceil}(1.5 \times 5 \times K_p) \times \max(\text{SMTC period}, \text{DRX cycle})) \times \text{CSSF}_{\text{intra}}$
DRX cycle $> 320\text{ms}$	$\text{Ceil}(5 \times K_p) \times \text{DRX cycle} \times \text{CSSF}_{\text{intra}}$

NOTE 1: If different SMTC periodicities are configured for different cells, the SMTC period in the requirement is the one used by the cell being identified

$M_{\text{meas\_period\_w/o\_gaps}}$  : For a UE supporting power class 1,  $M_{\text{meas\_period\_w/o\_gaps}} = 40$ . For a UE supporting FR2 power class 2,  $M_{\text{meas\_period\_w/o\_gaps}} = 24$ . For a UE supporting power class 3,  $M_{\text{meas\_period\_w/o\_gaps}} = 24$ . For a UE supporting power class 4,  $M_{\text{meas\_period\_w/o\_gaps}} = 24$ .

$\text{CSSF}_{\text{intra}}$ : it is a carrier specific scaling factor and is determined according to  $\text{CSSF}_{\text{outside\_gap},i}$  in clause 9.1.5.

- if intra-frequency CSI-RS resource is fully non overlapping with measurement gaps,  $K_{p\_CSI-RS}=1$ ;
- if intra-frequency CSI-RS resource is partially overlapping with measurement gaps,  $K_{p\_CSI-RS} = 1/(1 - (\text{CSI-RS resource period} / \text{MGRP}))$ , where CSI-RS resource period < MGRP.

### 9.10.2.6 Scheduling availability of UE during CSI-RS based intra-frequency measurements

UE is required to be capable of measuring without measurement gaps when CSI-RS resources are completely contained in the active BWP of the UE. Note the configured CSI-RS symbol is indicated in *firstOFDMSymbolInTimeDomain* included in *CSI-RS-ResourceConfigMobility* for RRM. When UE is required to perform CSI-RS based RRM measurements, and any of the conditions in the following clauses is met, there are restrictions on the scheduling availability; otherwise, there is no scheduling restriction. Note same numerology for intra-frequency CSI-RS and data of serving cell is considered in this release.

#### 9.10.2.6.1 Scheduling availability of UE performing CSI-RS based measurements in TDD bands

When UE performs CSI-RS intra-frequency measurements in a TDD band,

- UE is not expected to transmit PUCCH/PUSCH/SRS on configured CSI-RS resource symbols, and on 1 OFDM symbol before and after each consecutively configured CSI-RS symbols.

When TDD intra-band carrier aggregation is performed, the scheduling restrictions due to a given serving cell should also apply to all other serving cells in the same band on the symbols that fully or partially overlap with the aforementioned restricted symbols.

#### 9.10.2.6.2 Scheduling availability of UE performing CSI-RS based measurements in FR2

When the UE performs CSI-RS based intra-frequency measurements for L3 mobility management in FR2, the following restrictions apply.

- The UE is not expected to transmit PUCCH/PUSCH/SRS or receive PDCCH/PDSCH/TRS/CSI-RS for CQI on the configured CSI-RS symbol within the configured slot as indicated in *slotConfig* of the corresponding CSI-RS resource to be measured for mobility.

When intra-band carrier aggregation in FR2 is performed, the scheduling restrictions due to a given serving cell should also apply to all other serving cells in the same band on the symbols that fully or partially overlap with aforementioned restricted symbols.

When inter-band carrier aggregation in FR2 is performed, there are no scheduling restrictions on FR2 serving cells in the bands due to CSI-RSRP, CSI-RSRQ or CSI-SINR measurement on an FR2 intra-frequency cell in different bands, provided that UE is capable of independent beam management on this FR2 band pair.

## 9.10.3 CSI-RS based Inter-frequency measurements

### 9.10.3.1 Introduction

A measurement is defined as a CSI-RS based inter-frequency measurement provided it is not defined as an intra-frequency measurement according to clause 9.10.2.

If a UE is configured with the higher layer parameter *CSI-RS-Resource-Mobility* and the higher layer parameter *associatedSSB* is configured, the UE shall be able to identify inter-frequency cells indicated for measurement and perform CSI-RSRP, CSI-RSRQ, and CSI-SINR measurements of identified inter-frequency cells.

When measurement gaps are needed, the UE is not expected to detect the associated SSB nor perform measurement of the CSI-RS resource configured in *CSI-RS-Resource-Mobility* on an inter-frequency measurement object which start earlier than the gap starting time + switching time, and ends later than the gap end – switching time. When the inter-frequency cells are in FR2 and the per-FR gap is configured to the UE in EN-DC, SA NR, NE-DC and NR-DC, or the serving cells are in FR2, the inter-frequency cells are in FR2 and the per-UE gap is configured to the UE in SA NR and NR-DC, the switching time is 0.25ms. Otherwise the switching time is 0.5ms.

### 9.10.3.2 Requirements applicability

The associated SSB layer of the CSI-RS follows the same requirements as SSB based measurements defined in 9.3.

The requirements in clause 9.10.3 apply, provided:

- The associated SSB of the cell being identified or measured is detectable, and
- All CSI-RS resources on one inter-frequency layer are configured within a window of up to 5ms, and
- The periodicity of the configured CSI-RS resources is 10ms, 20ms or 40ms, and
- CSI-RS resources for measurements and the associated SSB for cell identification are configured within measurement gap.

An inter-frequency cell shall be considered detectable when for each relevant associated SSB:

- SS-RSRP related side conditions given in clauses 10.1.4.1 and 10.1.5.1 for FR1 and FR2, respectively, for a corresponding Band,
- SS-RSRQ related side conditions given in clauses 10.1.9.1 and 10.1.10.1 for FR1 and FR2, respectively, for a corresponding Band,
- SS-SINR related side conditions given in clauses 10.1.14.1 and 10.1.15.1 for FR1 and FR2, respectively, for a corresponding Band,
- SSB<sub>RP</sub> and SSB  $\hat{E}_s/I_{ot}$  according to Annex B.2.3 for a corresponding Band.

A CSI-RS resource shall be considered measurable when for each relevant CSI-RS resource:

- CSI-RSRP related side conditions given in clauses 10.1.4.3 and 10.1.5.3 for FR1 and FR2, respectively, for a corresponding Band,
- CSI-RSRQ related side conditions given in clauses 10.1.9.2 and 10.1.10.2 for FR1 and FR2, respectively, for a corresponding Band,
- CSI-SINR related side conditions given in clauses 10.1.14.2 and 10.1.15.2 for FR1 and FR2, respectively, for a corresponding Band,
- CSI<sub>RP</sub> and CSI-RS  $\hat{E}_s/I_{ot}$  according to Annex B.2.13 for a corresponding Band.

### 9.10.3.3 Number of cells and number of CSI-RS resources

#### 9.10.3.3.1 Requirements for FR1

For each inter-frequency CSI-RS layer, during each layer 1 measurement period, the UE shall be capable of performing CSI-RSRP, CSI-RSRQ, and CSI-SINR measurements for at least:

- 14 CSI-RSs with different CSI-RS index and/or PCI, and
- The cells to be monitored based on CSI-RS are the same set or a subset of the cells monitored based on the layer of the associated SSB.

### 9.10.3.3.2 Requirements for FR2

For each inter-frequency CSI-RS layer, during each layer 1 measurement period, the UE shall be capable of performing CSI-RSRP, CSI-RSRQ, and CSI-SINR measurements for at least:

- 24 CSI-RSs with different CSI-RS index and/or PCI, and
- The cells to be monitored based on CSI-RS are the same set or a subset of the cells monitored based on the layer the associated SSB.

### 9.10.3.4 Measurements reporting requirements

Note: The UE is not required to report CSI-RS based L3 measurements when the timing offset between the reference measurement timing and the target CSI-RS in one layer is larger than one CP. If the UE reports CSI-RS based L3 measurements when the timing offset exceeds one CP, the UE may not meet the CSI-RS based L3 measurement accuracy requirements for CSI-RSRP, CSI-RSRQ and CSI-SINR in TS 38.133 section 10.1, which apply only when the timing offset is no larger than one CP.

#### 9.10.3.4.1 Periodic Reporting

Reported CSI-RSRP, CSI-RSRQ, and CSI-SINR measurements contained in periodically triggered measurement reports shall meet the requirements in clauses 10.1.4.2, 10.1.5.2, 10.1.9.2, 10.1.10.2, 10.1.14.2 and 10.1.15.2.

#### 9.10.3.4.2 Event-triggered Periodic Reporting

Reported CSI-RSRP, CSI-RSRQ, and CSI-SINR measurements contained in periodically triggered measurement reports shall meet the requirements in clauses 10.1.4.2, 10.1.5.2, 10.1.9.2, 10.1.10.2, 10.1.14.2 and 10.1.15.2.

The first report in event triggered periodic measurement reporting shall meet the requirements specified in clause 9.10.3.4.3.

#### 9.10.3.4.3 Event-triggered Reporting

Reported CSI-RSRP, CSI-RSRQ, and CSI-SINR measurements contained in periodically triggered measurement reports shall meet the requirements in clauses 10.1.4.2, 10.1.5.2, 10.1.9.2, 10.1.10.2, 10.1.14.2 and 10.1.15.2.

The UE shall not send any event triggered measurement reports, as long as no reporting criteria are fulfilled.

The measurement reporting delay is defined as the time between an event that will trigger a measurement report and the point when the UE starts to transmit the measurement report over the air interface. This requirement assumes that the measurement report is not delayed by other RRC signalling on the DCCH. This measurement reporting delay excludes a delay uncertainty resulted when inserting the measurement report to the TTI of the uplink DCCH. The delay uncertainty is:  $2 \times T_{\text{TTI}_{\text{DCCH}}}$ . This measurement reporting delay excludes a delay which caused by no UL resources for UE to send the measurement report.

The event triggered measurement reporting delay, measured without L3 filtering shall be within CSI-RS based measurement defined in clause 9.10.3.5. When L3 filtering is used an additional delay can be expected.

### 9.10.3.5 Inter frequency measurements with measurement gaps

When measurement gaps are provided, if configured with the higher layer parameters *CSI-RS-Resource-Mobility* and *associatedSSB*, the UE shall be able to identify a new detectable CSI-RS based inter frequency cell within  $T_{\text{CSI-RS\_identify\_inter}}$ ,

$$T_{\text{CSI-RS\_identify\_inter}} = (T_{\text{PSS/SSS\_sync}} + T_{\text{CSI-RS\_measurement\_period\_inter}} + T_{\text{CSI-RS\_SFN\_inter}}) \text{ ms}$$

Where:

$T_{\text{PSS/SSS\_sync}}$  is the time period used in PSS/SSS detection which is determined according to  $T_{\text{PSS/SSS\_sync\_inter}}$  in clause 9.3.4,

$T_{\text{CSI-RS\_SFN\_inter}}$  is the time period used to acquire the SFN information of the cell being measured, which is shown in Table 9.10.3.5-3 for FR1 and equals inter-frequency  $T_{\text{SSB\_time\_index\_inter}}$  in Clause 9.3.4 for FR2,

$T_{\text{CSI-RS\_measurement\_period\_inter}}$ : equal to a measurement period of CSI-RS based measurement given in table 9.10.3.5-1 and table 9.10.3.5-2.

$M_{\text{meas\_period\_inter}}$ : For a UE supporting FR2 power class 1,  $M_{\text{meas\_period\_inter}}=8 \times N$  samples. For a UE supporting FR2 power class 2,  $M_{\text{meas\_period\_inter}}=5 \times N$  samples. For a UE supporting FR2 power class 3,  $M_{\text{meas\_period\_inter}}=5 \times N$  samples. For a UE supporting FR2 power class 4,  $M_{\text{meas\_period\_inter}}=5 \times N$  samples. Note that scaling factor  $N = \lceil 8 \cdot \text{CSSF}_{\text{inter}} \rceil$ ; it is a carrier specific scaling factor and is determined according to  $\text{CSSF}_{\text{within\_gap},i}$  in clause 9.1.5 for measurement conducted within measurement gaps.

Additionally, for a given CSI-RS resource, if the associated SSB is configured but not detected by the UE, or if CSI-RS configured with associated SSB but not QCL-ed to the associated SSB, the UE is not required to monitor the corresponding CSI-RS resource.

**Table 9.10.3.5-1: Measurement period for CSI-RS based inter-frequency measurements with gaps (FR1)**

Condition <sup>NOTE1,2</sup>	$T_{\text{CSI-RS\_measurement\_period\_inter}}$
No DRX	$\text{Max}(200\text{ms}, 8 \times \text{Max}(\text{MGRP}, \text{CSI-RS period})) \times \text{CSSF}_{\text{inter}}$
DRX cycle $\leq 320\text{ms}$	$\text{Max}(200\text{ms}, \text{Ceil}(8 \times 1.5) \times \text{Max}(\text{MGRP}, \text{CSI-RS period}, \text{DRX cycle})) \times \text{CSSF}_{\text{inter}}$
DRX cycle $> 320\text{ms}$	$8 \times \text{DRX cycle} \times \text{CSSF}_{\text{inter}}$
NOTE 1: DRX or non DRX requirements apply according to the conditions described in clause 3.6.1	
NOTE 2: In EN-DC operation, the parameters, timers and scheduling requests referred to in clause 3.6.1 are for the secondary cell group. The DRX cycle is the DRX cycle of the secondary cell group.	

**Table 9.10.3.5-2: Measurement period for CSI-RS based inter-frequency measurements with gaps (FR2)**

Condition <sup>NOTE1,2</sup>	$T_{\text{CSI-RS\_measurement\_period\_inter}}$
No DRX	$\text{Max}(400 \text{ ms}, M_{\text{meas\_period\_inter}} \times \text{Max}(\text{MGRP}, \text{CSI-RS period})) \times \text{CSSF}_{\text{inter}}$
DRX cycle $\leq 320\text{ms}$	$\text{Max}(400 \text{ ms}, (1.5 \times M_{\text{meas\_period\_inter}}) \times \text{Max}(\text{MGRP}, \text{CSI-RS period}, \text{DRX cycle})) \times \text{CSSF}_{\text{inter}}$
DRX cycle $> 320\text{ms}$	$M_{\text{meas\_period\_inter}} \times \text{DRX cycle} \times \text{CSSF}_{\text{inter}}$
NOTE 1: DRX or non DRX requirements apply according to the conditions described in clause 3.6.1	
NOTE 2: In EN-DC operation, the parameters, timers and scheduling requests referred to in clause 3.6.1 are for the secondary cell group. The DRX cycle is the DRX cycle of the secondary cell group.	

**Table 9.10.3.5-3: Time period for SFN acquisition for interfrequency CSI-RS based measurements with gaps (FR1)**

Condition <sup>NOTE1,2</sup>	$T_{\text{CSI-RS\_SFN\_inter}}$
No DRX	$\text{Max}(200\text{ms}, 5 \times \text{Max}(\text{MGRP}, \text{SMTTC period})) \times \text{CSSF}_{\text{inter}}$
DRX cycle $\leq 320\text{ms}$	$\text{Max}(200\text{ms}, \text{Ceil}(5 \times 1.5) \times \text{Max}(\text{MGRP}, \text{SMTTC period}, \text{DRX cycle})) \times \text{CSSF}_{\text{inter}}$
DRX cycle $> 320\text{ms}$	$5 \times \text{DRX cycle} \times \text{CSSF}_{\text{inter}}$
NOTE 1: DRX or non DRX requirements apply according to the conditions described in clause 3.6.1	
NOTE 2: In EN-DC operation, the parameters, timers and scheduling requests referred to in clause 3.6.1 are for the secondary cell group. The DRX cycle is the DRX cycle of the secondary cell group.	

## 9.11 NR measurements with autonomous gaps

### 9.11.1 Introduction

The requirements in this clause are applicable for CGI identification of an intra frequency and inter frequency NR target cell.

The requirements in this clause are specified for CGI identification of an NR target cell and are applicable for a UE:

- in RRC\_CONNECTED state, and
- configured with SA or NR-DC or NE-DC operation mode, or with EN-DC operation mode for CGI identification requested by NR PSCell.

The overall CGI reporting delay is defined in clause 9.11.3.

## 9.11.2 CGI identification of an NR cell with autonomous gaps

The UE shall identify and report the CGI of a known NR target cell when requested by the network for the purpose of reportCGI. Only one cell is provided to the UE with *cellForWhichToReportCGI* for identifying the CGI. The UE may make autonomous gaps in both downlink reception and uplink transmission for receiving MIB and SIB1 message according to clause 5.5.3 of TS 38.331 [2]. Note that a UE is not required to use autonomous gap if *useAutonomousGaps* is set to false. If autonomous gaps are used for measurement with the purpose of reportCGI, regardless of whether DRX is used or not, or whether SCell(s) are configured or not, the UE shall be able to identify a new CGI of NR cell within:

$$T_{\text{identify\_CGI}} = (T_{\text{MIB}} + T_{\text{SIB1}}) \text{ ms}$$

Where:

$T_{\text{MIB}}$  is the time period used to acquire MIB message.  $T_{\text{MIB}} = 6 * T_{\text{SMTC}}$  ms for target cell carrier frequency on FR1 and  $T_{\text{MIB}} = 25 * T_{\text{SMTC}}$  ms for target cell carrier frequency on FR2.

$T_{\text{SIB1}}$  is the time period used to acquire SIB1 message.  $T_{\text{SIB1}} = 6 * T_{\text{RMSI-scheduling}}$  ms.

Where  $T_{\text{SMTC}}$  is the SMTC periodicity configured for the target cell measurement, and  $T_{\text{RMSI-scheduling}}$  is

- the maximum between the periodicity with which the SIB1 is actually transmitted by the NR target cell and 20ms when SSB and RMSI CORESET multiplexing pattern is 1
- the maximum between the periodicity with which the SIB1 is actually transmitted by the NR target cell and  $T_{\text{SMTC}}$  when SSB and RMSI CORESET multiplexing pattern is 2 or 3.

The requirement for identifying the CGI of an NR cell within  $T_{\text{identify\_CGI}}$  is applicable when no DRX is used as well as when any of the DRX cycles specified in TS 38.331 [2] is used.

Within the time  $T_{\text{identify\_CGI}}$ , over which the UE identifies the CGI of an NR cell, the UE shall fulfil interruption requirements specified in,

- Clause 8.2.1.2.16 for NR serving cells and Clause 7.32.2.15 in TS36.133 [15] for E-UTRA serving cells if the UE is configured with EN-DC operation mode,
- Clause 8.2.2.2.14 if the UE is configured with SA operation mode,
- Clause 8.2.3.2.14 for NR serving cells and Clause 7.36.2.14 in TS36.133 [15] for E-UTRA serving cells if the UE is configured with NE-DC operation mode,
- Clause 8.2.4.2.11 if the UE is configured with NR-DC operation mode.

In the requirement a cell is known if,

- During the last 5 seconds for FR1 or 3 seconds for FR2 before the reception of the report CGI command:
  - The UE has sent a valid L3-RSRP measurement report with SSB index for the target cell and
- During MIB decoding at least reported SSBs remains detectable according to the cell identification conditions specified in clauses 9.2 or 9.3 of TS 38.133, and
- During SIB1 decoding the SSB used for MIB decoding remains detectable according to the cell identification conditions specified in clauses 9.2 or 9.3 of TS 38.133, and
- During MIB decoding, the SSB for MIB decoding remains detectable with  $\text{SNR} \geq -3\text{dB}$

- During SIB1 decoding, the PDSCH for SIB1 decoding remains detectable with  $\text{SNR} \geq -3\text{dB}$

### 9.11.3 CGI reporting delay

The CGI reporting delay is defined as the time between a command that will trigger a CGI report and the point when the UE starts to transmit the measurement report over the air interface. This requirement assumes that the measurement report is not delayed by other RRC signalling on the DCCH. This measurement reporting delay excludes a delay uncertainty of  $2 \times T_{\text{TI}_{\text{DCCH}}}$  resulting when inserting the measurement report to the TTI of the uplink DCCH. This measurement reporting delay excludes any delay caused by lack of UL resources for UE to send the measurement report.

The CGI reporting delay shall be less than  $T_{\text{identify\_CGI}}$  defined in clause 9.11.2 plus RRC procedure delay defined in clause 12 in TS 38.331 [2], and additional 20ms margin if target cell is on FR2.

---

## 10 Measurement Performance requirements

### 10.1 NR measurements

#### 10.1.1 Introduction

The requirements in clause 10.1 apply as follows:

- intra-frequency requirements apply for PCell measurements in SA, NR-DC, or NE-DC operation mode,
- intra-frequency requirements apply for PSCell measurements in NR-DC or EN-DC operation mode,
- intra-frequency requirements apply for SCell measurements in SA operation mode with NR CA or any MR-DC operation mode with NR CA,
- inter-frequency requirements apply for non-serving cell measurements on NR carrier frequencies.
- inter-frequency requirements apply for measurements from one cell on a frequency compared to the measurement from another cell on a different frequency.

In the requirements of clause 10.1, the exceptions for side conditions apply as follows:

- for the UE capable of CA but not configured with any SCell, the applicable exceptions for side conditions are specified in Annex B, clause B.3.2.1 for UE supporting CA in FR1, and clause B.3.2.3 for UE supporting CA in FR2, respectively;
- for the UE capable of CA and configured with at least one SCell, the applicable exceptions for side conditions are specified in Annex B, clause B.3.2.2 for UE configured with CA in FR1, and clause B.3.2.4 for UE supporting CA in FR2 respectively;
- for the UE capable of SUL but not configured with SUL, the applicable exceptions for side conditions are specified in Annex B, clause B.3.4.1 for UE supporting SUL in FR1;
- for the UE capable of SUL and configured with at least one SUL, the applicable exceptions for side conditions are specified in Annex B, clause B.3.4.2 for UE configured with SUL in FR1.

## 10.1.2 Intra-frequency RSRP accuracy requirements for FR1

### 10.1.2.1 Intra-frequency SS-RSRP accuracy requirements

#### 10.1.2.1.1 Absolute SS-RSRP Accuracy

Unless otherwise specified, the requirements for absolute accuracy of SS-RSRP in this clause apply to a cell on the same frequency as that of the serving cell in FR1. The accuracy requirements in this clause are also applicable when *highSpeedMeasFlag-r16* is configured.

The accuracy requirements in Table 10.1.2.1.1-1 are valid under the following conditions:

- Conditions defined in clause 7.3 of TS 38.101-1 [18] for reference sensitivity are fulfilled.
- Conditions for intra-frequency measurements are fulfilled according to Annex B.2.2 for a corresponding Band for each relevant SSB.

**Table 10.1.2.1.1-1: SS-RSRP Intra frequency absolute accuracy in FR1**

Accuracy		Conditions					
Normal condition	Extreme condition	SSB $\hat{E}_s/\text{lot}$	$I_o$ <sup>Note 1</sup> range				
			NR operating band groups <small>Note 2</small>	Minimum $I_o$		Maximum $I_o$	
dB	dB	dB		dBm / $SCS_{SSB}$		dBm/ $BW_{\text{Channel}}$	dBm/ $BW_{\text{Channel}}$
				$SCS_{SSB} = 15 \text{ kHz}$	$SCS_{SSB} = 30 \text{ kHz}$		
$\pm 4.5$	$\pm 9$	$\geq -6$	NR_FDD_FR1_A, NR_TDD_FR1_A, NR_SDL_FR1_A	-121	-118	N/A	-70
			NR_FDD_FR1_B	-120.5	-117.5	N/A	-70
			NR_TDD_FR1_C	-120	-117	N/A	-70
			NR_FDD_FR1_D, NR_TDD_FR1_D	-119.5	-116.5	N/A	-70
			NR_FDD_FR1_E, NR_TDD_FR1_E	-119	-116	N/A	-70
			NR_FDD_FR1_F	-118.5	-115.5	N/A	-70
			NR_FDD_FR1_G	-118	-115	N/A	-70
$\pm 8$	$\pm 11$	$\geq -6$	NR_FDD_FR1_H	-117.5	-114.5	N/A	-70
	N/A	N/A	-70	-50			

NOTE 1:  $I_o$  is assumed to have constant EPRE across the bandwidth.

NOTE 2: NR operating band groups in FR1 are as defined in clause 3.5.2.

#### 10.1.2.1.2 Relative SS-RSRP Accuracy

The relative accuracy of SS-RSRP is defined as the SS-RSRP measured from one cell compared to the SS-RSRP measured from another cell on the same frequency, or between any two SS-RSRP levels measured on the same cell in FR1. The accuracy requirements in this clause are also applicable when *highSpeedMeasFlag-r16* is configured.

The accuracy requirements in Table 10.1.2.1.2-1 are valid under the following conditions:

- Conditions defined in clause 7.3 of TS 38.101-1 [18] for reference sensitivity are fulfilled.



- Conditions for intra-frequency measurements are fulfilled according to Annex B.2.2 for a corresponding Band for each relevant SSB.

**Table 10.1.2.1.2-1: SS-RSRP Intra frequency relative accuracy in FR1**

Accuracy		Conditions					
Normal condition	Extreme condition	SSB $\hat{E}_s/\text{lot}$ Note 2	$I_0$ <sup>Note 1</sup> range				
			NR operating band groups <sup>Note 4</sup>	Minimum $I_0$		Maximum $I_0$	
dB	dB	dB		dBm / $SCS_{SSB}$		dBm/ $BW_{\text{Channel}}$	dBm/ $BW_{\text{Channel}}$
			$SCS_{SSB} = 15 \text{ kHz}$	$SCS_{SSB} = 30 \text{ kHz}$			
$\pm 2$	$\pm 3$	$\geq -3$	NR_FDD_FR1_A, NR_TDD_FR1_A, NR_SDL_FR1_A	-121	-118	N/A	-50
			NR_FDD_FR1_B	-120.5	-117.5	N/A	-50
			NR_TDD_FR1_C	-120	-117	N/A	-50
			NR_FDD_FR1_D, NR_TDD_FR1_D	-119.5	-116.5	N/A	-50
			NR_FDD_FR1_E, NR_TDD_FR1_E	-119	-116	N/A	-50
			NR_FDD_FR1_F	-118.5	-115.5	N/A	-50
			NR_FDD_FR1_G	-118	-115	N/A	-50
			NR_FDD_FR1_H	-117.5	-114.5	N/A	-50
$\pm 3$	$\pm 3$	$\geq -6$	Note 3	Note 3	Note 3	N/A	Note 3

NOTE 1:  $I_0$  is assumed to have constant EPRE across the bandwidth.  
NOTE 2: The parameter SSB  $\hat{E}_s/\text{lot}$  is the minimum SSB  $\hat{E}_s/\text{lot}$  of the pair of cells to which the requirement applies.  
NOTE 3: The same bands and the same  $I_0$  conditions for each band apply for this requirement as for the corresponding highest accuracy requirement.  
NOTE 4: NR operating band groups in FR1 are as defined in clause 3.5.2.

### 10.1.2.2 Void

### 10.1.2.3 Intra-frequency CSI-RSRP accuracy requirements

#### 10.1.2.3.1 Absolute CSI-RSRP Accuracy

Unless otherwise specified, the requirements for absolute accuracy of CSI-RSRP in this clause apply to a cell where the CSI-RS resources to be measured have the same center frequency as the CSI-RS resources indicated for measurement in the serving cell in FR1.

The accuracy requirements in Table 10.1.2.3.1-1 are valid under the following conditions:

- Conditions defined in clause 7.3 of TS 38.101-1 [18] for reference sensitivity are fulfilled.
- Conditions for intra-frequency measurements are fulfilled according to Annex B.2.2 for a corresponding Band for each associated SSB.
- Conditions for intra-frequency measurements are fulfilled according to Annex B.2.12 for a corresponding Band for each relevant CSI-RS to be measured.
- The bandwidth of CSI-RS is 48 PRBs and the density is 3. The performance with larger bandwidth of CSI-RS is equal to or better than the accuracy requirements in Table 10.1.2.3.1-1.- The timing offset between the reference measurement timing and the target CSI-RS in one layer is no larger than CP.

Note: The reference measurement timing for one layer for intra-frequency measurement is serving cell timing.

**Table 10.1.2.3.1-1: CSI-RSRP Intra frequency absolute accuracy in FR1**

Accuracy		Conditions						
Normal condition	Extreme condition	CSI-RS $\hat{\epsilon}$ /lot	NR operating band groups <sup>Note 2</sup>	Io <sup>Note 1</sup> range			Maximum Io	
				Minimum Io				
dB	dB	dB		dBm / SCS <sub>CSI-RS</sub>			dBm/BW <sub>Channel</sub>	dBm/BW <sub>Channel</sub>
				SCS <sub>CSI-RS</sub> = 15 kHz	SCS <sub>CSI-RS</sub> = 30 kHz	SCS <sub>CSI-RS</sub> = 60 kHz		
±4.5	±9	≥6	NR_FDD_FR1_A, NR_TDD_FR1_A, NR_SDL_FR1_A	-121	-118	-115	N/A	-70
			NR_FDD_FR1_B	-120.5	-117.5	-114.5	N/A	-70
			NR_TDD_FR1_C	-120	-117	-114	N/A	-70
			NR_FDD_FR1_D, NR_TDD_FR1_D	-119.5	-116.5	-113.5	N/A	-70
			NR_FDD_FR1_E, NR_TDD_FR1_E	-119	-116	-113	N/A	-70
			NR_FDD_FR1_F	-118.5	-115.5	-112.5	N/A	-70
			NR_FDD_FR1_G	-118	-115	-112	N/A	-70
			NR_FDD_FR1_H	-117.5	-114.5	-111.5	N/A	-70
±8	±11	≥6	NR_FDD_FR1_A, NR_TDD_FR1_A, NR_SDL_FR1_A, NR_FDD_FR1_B, NR_TDD_FR1_C, NR_FDD_FR1_D, NR_TDD_FR1_D, NR_FDD_FR1_E, NR_TDD_FR1_E, NR_FDD_FR1_F, NR_FDD_FR1_G, NR_FDD_FR1_H	N/A	N/A	N/A	-70	-50

NOTE 1: Io is assumed to have constant EPRE across the bandwidth.  
 NOTE 2: NR operating band groups in FR1 are as defined in clause 3.5.2.

**10.1.2.3.2 Relative CSI-RSRP Accuracy**

The relative accuracy of CSI-RSRP is defined as the CSI-RSRP measured from one cell compared to the CSI-RSRP measured from another cell on the same center frequency, or between any two CSI-RSRP levels measured on the same cell in FR1.

The accuracy requirements in Table 10.1.2.3.2-1 are valid under the following conditions:

- Conditions defined in clause 7.3 of TS 38.101-1 [18] for reference sensitivity are fulfilled.
- Conditions for intra-frequency measurements are fulfilled according to Annex B.2.2 for a corresponding Band for each associated SSB.
- Conditions for intra-frequency measurements are fulfilled according to Annex B.2.12 for a corresponding Band for each relevant CSI-RS to be measured.
- The bandwidth of CSI-RS is 48 PRBs and the density is 3. The performance with larger bandwidth of CSI-RS is equal to or better than the accuracy requirements in Table 10.1.2.3.2-1. - The timing offset between the reference measurement timing and the target CSI-RS in one layer is no larger than CP.

Note: The reference measurement timing for one layer for intra-frequency measurement is serving cell timing.

**Table 10.1.2.3.2-1: CSI-RSRP Intra frequency relative accuracy in FR1**

Accuracy		Conditions						
Normal condition	Extreme condition	CSI-RS $\hat{E}_s/\text{lot}$ Note 2	NR operating band groups Note 4	$I_o$ Note 1 range			Maximum $I_o$	
				Minimum $I_o$				
dB	dB	dB		dBm / $SCS_{\text{CSI-RS}}$			dBm/BW <sub>Channel</sub>	dBm/BW <sub>Channel</sub>
				$SCS_{\text{CSI-RS}} = 15 \text{ kHz}$	$SCS_{\text{CSI-RS}} = 30 \text{ kHz}$	$SCS_{\text{CSI-RS}} = 60 \text{ kHz}$		
$\pm 2$	$\pm 3$	$\geq -3$	NR_FDD_FR1_A, NR_TDD_FR1_A, NR_SDL_FR1_A	-121	-118	-115	N/A	-50
			NR_FDD_FR1_B	-120.5	-117.5	-114.5	N/A	-50
			NR_TDD_FR1_C	-120	-117	-114	N/A	-50
			NR_FDD_FR1_D, NR_TDD_FR1_D	-119.5	-116.5	-113.5	N/A	-50
			NR_FDD_FR1_E, NR_TDD_FR1_E	-119	-116	-113	N/A	-50
			NR_FDD_FR1_F	-118.5	-115.5	-112.5	N/A	-50
			NR_FDD_FR1_G	-118	-115	-112	N/A	-50
			NR_FDD_FR1_H	-117.5	-114.5	-111.5	N/A	-50
$\pm 3$	$\pm 3$	$\geq -6$	Note 3	Note 3	Note 3	Note 3	N/A	Note 3

NOTE 1:  $I_o$  is assumed to have constant EPRE across the bandwidth.  
 NOTE 2: The parameter CSI-RS  $\hat{E}_s/\text{lot}$  is the minimum CSI-RS  $\hat{E}_s/\text{lot}$  of the pair of cells to which the requirement applies.  
 NOTE 3: The same bands and the same  $I_o$  conditions for each band apply for this requirement as for the corresponding highest accuracy requirement.  
 NOTE 4: NR operating band groups in FR1 are as defined in clause 3.5.2.

### 10.1.2B Intra-frequency RSRP accuracy requirements for FR1 for CA/DC Idle Mode Measurements

#### 10.1.2B.1 Intra-frequency SS-RSRP accuracy requirements

The requirements in this clause are applicable for a UE:

- in state RRC\_IDLE or RRC\_INACTIVE
- that is synchronised to the cell that is measured.

The requirements are for absolute accuracy of SS-RSRP.

##### 10.1.2B.1.1 Absolute SS-RSRP Accuracy

Unless otherwise specified, the requirements for absolute accuracy of SS-RSRP in this clause apply to the serving cell in FR1.

The accuracy requirements in Table 10.1.2B.1.1-1 are valid under the following conditions:

- Conditions defined in clause 7.3 of TS 38.101-1 [18] for reference sensitivity are fulfilled.
- Conditions for intra-frequency measurements are fulfilled according to Annex B.1.2 for a corresponding Band for each relevant SSB.

**Table 10.1.2B.1.1-1: SS-RSRP Intra frequency absolute accuracy in FR1**

Accuracy		Conditions		
Normal condition	Extreme condition	SSB $\hat{E}_s/\text{lot}$	$I_o$ Note 1 range	
			NR operating band groups Note 2	Maximum $I_o$
			Minimum $I_o$	

dB	dB	dB		dBm / SCS <sub>SSB</sub>		dBm/BW <sub>Channel</sub>	dBm/BW <sub>Channel</sub>
				SCS <sub>SSB</sub> = 15 kHz	SCS <sub>SSB</sub> = 30 kHz		
±6	±10.5	≥-4	NR_FDD_FR1_A, NR_TDD_FR1_A, NR_SDL_FR1_A	-121	-118	N/A	-70
			NR_FDD_FR1_B	-120.5	-117.5	N/A	-70
			NR_TDD_FR1_C	-120	-117	N/A	-70
			NR_FDD_FR1_D, NR_TDD_FR1_D	-119.5	-116.5	N/A	-70
			NR_FDD_FR1_E, NR_TDD_FR1_E	-119	-116	N/A	-70
			NR_FDD_FR1_F	-118.5	-115.5	N/A	-70
			NR_FDD_FR1_G	-118	-115	N/A	-70
			NR_FDD_FR1_H	-117.5	-114.5	N/A	-70
±9.5	±12.5	≥-4	NR_FDD_FR1_A, NR_TDD_FR1_A, NR_SDL_FR1_A, NR_FDD_FR1_B, NR_TDD_FR1_C, NR_FDD_FR1_D, NR_TDD_FR1_D, NR_FDD_FR1_E, NR_TDD_FR1_E, NR_FDD_FR1_F, NR_FDD_FR1_G, NR_FDD_FR1_H	N/A	N/A	-70	-50

NOTE 1:  $I_0$  is assumed to have constant EPRE across the bandwidth.  
 NOTE 2: NR operating band groups in FR1 are as defined in clause 3.5.2.

### 10.1.3 Intra-frequency RSRP accuracy requirements for FR2

#### 10.1.3.1 Intra-frequency SS-RSRP accuracy requirements

##### 10.1.3.1.1 Absolute SS-RSRP Accuracy

Unless otherwise specified, the requirements for absolute accuracy of SS-RSRP in this clause apply to a cell on the same frequency as that of the serving cell in FR2.

The accuracy requirements in Table 10.1.3.1.1-1 are valid under the following conditions:

- Conditions defined in clause 7.3 of TS 38.101-2 [19] for reference sensitivity are fulfilled.
- Conditions for intra-frequency measurements are fulfilled according to Annex B.2.2 for a corresponding Band for each relevant SSB.
- The measured signals are in the directions covered by the percentile EIS spherical coverage of the UE, defined in clause 7.3.4 of TS 38.101-2 [19].

**Table 10.1.3.1.1-1: SS-RSRP Intra frequency absolute accuracy in FR2**

Accuracy		Conditions			
Normal condition	Extreme condition	SSB $\hat{E}_s$ /lot	$I_0$ <sup>Note 2</sup> range		
			Minimum $I_0$		Maximum $I_0$
dB	dB	dB	dBm / SCS <sub>SSB</sub> <sup>Note 1</sup>		dBm/BW <sub>Channel</sub>
			SCS <sub>SSB</sub> = 120kHz	SCS <sub>SSB</sub> = 240kHz	
±6	±9	≥-6	Same value as SSB_RP in Table B.2.2-2,		N/A
					-70

			according to UE Power class, operating band and angle of arrival		
±8	±11		N/A	-70	-50
Note 1: Values based on Refsens and EIS spherical coverage as defined in clauses 7.3.2 and 7.3.4 of TS 38.101-2 [19]. Applicable side condition selected depending on angle of arrival. Note 2: $I_0$ specified at the Reference point, and assumed to have constant EPRE across the bandwidth. Note 3: In the test cases, the SSB $\hat{E}_s/lot$ and related parameters may need to be adjusted to ensure $\hat{E}_s/lot$ at UE baseband is above the value defined in this table.					

10.1.3.1.2 Relative SS-RSRP Accuracy

The relative accuracy of SS-RSRP is defined as the SS-RSRP measured from one cell compared to the SS-RSRP measured from another cell on the same frequency, or between any two SS-RSRP levels measured on the same cell in FR2.

- Conditions defined in clause 7.3 of TS 38.101-2 [19] for reference sensitivity are fulfilled.
- Conditions for intra-frequency measurements are fulfilled according to Annex B.2.2 for a corresponding Band for each relevant SSB.
- The measured signals are in the directions covered by the percentile EIS spherical coverage of the UE, defined in clause 7.3.4 of TS 38.101-2 [19].

**Table 10.1.3.1.2-1: SS-RSRP Intra frequency relative accuracy in FR2**

Accuracy		Conditions		
Normal condition	Extreme condition	SSB $\hat{E}_s/lot$	$I_0$ <sup>Note 2</sup> range	
			Minimum $I_0$	Maximum $I_0$
dB	dB	dB	dBm / $SCS_{SSB}$ <sup>Note 1</sup>	
			$SCS_{SSB} = 120kHz$	$SCS_{SSB} = 240kHz$
±6	±9	≥-6	Same value as SSB <sub>RP</sub> in Table B.2.2-2, according to UE Power class, operating band and angle of arrival	
Note 1: Values based on Refsens and EIS spherical coverage as defined in clauses 7.3.2 and 7.3.4 of TS 38.101-2 [19]. Applicable side condition selected depending on angle of arrival. Note 2: $I_0$ specified at the Reference point, and assumed to have constant EPRE across the bandwidth. Note 3: In the test cases, the SSB $\hat{E}_s/lot$ and related parameters may need to be adjusted to ensure $\hat{E}_s/lot$ at UE baseband is above the value defined in this table. Note 4: The parameter SSB $\hat{E}_s/lot$ is the minimum SSB $\hat{E}_s/lot$ of the pair of cells to which the requirement applies.				

10.1.3.2 Void

### 10.1.3.3 Intra-frequency CSI-RSRP accuracy requirements

#### 10.1.3.3.1 Absolute CSI-RSRP Accuracy

Unless otherwise specified, the requirements for absolute accuracy of CSI-RSRP in this clause apply to a cell where the CSI-RS resources to be measured have the same center frequency as the CSI-RS resources indicated for measurement in the serving cell in FR2.

The accuracy requirements in Table 10.1.3.3.1-1 are valid under the following conditions:

- Conditions defined in clause 7.3 of TS 38.101-2 [19] for reference sensitivity are fulfilled.
- Conditions for intra-frequency measurements are fulfilled according to Annex B.2.2 for a corresponding Band for each associated SSB(s).
- Conditions for intra-frequency measurements are fulfilled according to Annex B.2.12 for a corresponding Band for each relevant CSI-RS to be measured.
- The bandwidth of CSI-RS is 48 PRBs and the density is 3. The performance with larger bandwidth of CSI-RS is equal to or better than the accuracy requirements in Table 10.1.3.3.1-1.
- The timing offset between the reference measurement timing and the target CSI-RS in one layer is no larger than CP.

Note: The reference measurement timing for one layer for intra-frequency measurement is serving cell timing.

- The measured signals are in the directions covered by the percentile EIS spherical coverage of the UE, defined in clause 7.3.4 of TS 38.101-2 [19].

**Table 10.1.3.3.1-1: CSI-RSRP Intra frequency absolute accuracy in FR2**

Accuracy		Conditions			
Normal condition	Extreme condition	CSI-RS $\hat{E}_s/\text{lot}$	$l_0$ <sup>Note 2</sup> range		
			Minimum $l_0$		Maximum $l_0$
dB	dB	dB	dBm / $SCS_{\text{CSI-RS}}$ <sup>Note 1</sup>		dBm/ $BW_{\text{Channel}}$
			$SCS_{\text{CSI-RS}} = 60\text{kHz}$	$SCS_{\text{CSI-RS}} = 120\text{kHz}$	
$\pm 6$	$\pm 9$	$\geq -6$	Same value as CSI-RS_RP in Table B.2.12-2, according to UE Power class, operating band and angle of arrival		N/A
$\pm 8$	$\pm 11$		N/A		-70
					-50

Note 1: Values based on Refsens and EIS spherical coverage as defined in clauses 7.3.2 and 7.3.4 of TS 38.101-2 [19]. Applicable side condition selected depending on angle of arrival.  
 Note 2:  $l_0$  specified at the Reference point, and assumed to have constant EPRE across the bandwidth.  
 Note 3: In the test cases, the CSI-RS  $\hat{E}_s/\text{lot}$  and related parameters may need to be adjusted to ensure  $\hat{E}_s/\text{lot}$  at UE baseband is above the value defined in this table.

#### 10.1.3.3.2 Relative CSI-RSRP Accuracy

The relative accuracy of CSI-RSRP is defined as the CSI-RSRP measured from one cell compared to the CSI-RSRP measured from another cell on the same center frequency, or between any two CSI-RSRP levels measured on the same cell in FR2.

- Conditions defined in clause 7.3 of TS 38.101-2 [19] for reference sensitivity are fulfilled.
- Conditions for intra-frequency measurements are fulfilled according to Annex B.2.2 for a corresponding Band for each associated SSB(s).
- Conditions for intra-frequency measurements are fulfilled according to Annex B.2.12 for a corresponding Band for each CSI-RS to be measured.

- The bandwidth of CSI-RS is 48 PRBs and the density is 3. The performance with larger bandwidth of CSI-RS is equal to or better than the accuracy requirements in Table 10.1.3.3.2-1.
- The timing offset between the reference measurement timing and the target CSI-RS in one layer is no larger than CP.

Note: The reference measurement timing for one layer for intra-frequency measurement is serving cell timing.

- The measured signals are in the directions covered by the percentile EIS spherical coverage of the UE, defined in clause 7.3.4 of TS 38.101-2 [19].

**Table 10.1.3.3.2-1: CSI-RSRP Intra frequency relative accuracy in FR2**

Accuracy		Conditions			
Normal condition	Extreme condition	CSI-RS $\hat{E}s/lot$	$I_o$ <sup>Note 2</sup> range		dBm/BW <sub>Channel</sub>
			Minimum $I_o$		
dB	dB	dB	dBm / SCS <sub>CSI-RS</sub> <sup>Note 1</sup>		
			SCS <sub>CSI-RS</sub> = 60kHz	SCS <sub>CSI-RS</sub> = 120kHz	
$\pm 6$	$\pm 9$	$\geq -6$	Same value as CSI-RS <sub>RP</sub> in Table B.2.12-2, according to UE Power class, operating band and angle of arrival		-50
<p>Note 1: Values based on Refsens and EIS spherical coverage as defined in clauses 7.3.2 and 7.3.4 of TS 38.101-2 [19]. Applicable side condition selected depending on angle of arrival.</p> <p>Note 2: <math>I_o</math> specified at the Reference point, and assumed to have constant EPRE across the bandwidth.</p> <p>Note 3: In the test cases, the CSI-RS <math>\hat{E}s/lot</math> and related parameters may need to be adjusted to ensure <math>\hat{E}s/lot</math> at UE baseband is above the value defined in this table.</p> <p>Note 4: The parameter CSI-RS <math>\hat{E}s/lot</math> is the minimum CSI-RS <math>\hat{E}s/lot</math> of the pair of cells to which the requirement applies.</p>					

### 10.1.3B Intra-frequency RSRP accuracy requirements for FR2 for CA/DC Idle Mode Measurements

#### 10.1.3B.1 Intra-frequency SS-RSRP accuracy requirements

The requirements in this clause are applicable for a UE:

- in state RRC\_IDLE or RRC\_INACTIVE
- that is synchronised to the cell that is measured.

The requirements are for absolute accuracy of SS-RSRP.

##### 10.1.3B.1.1 Absolute SS-RSRP Accuracy

Unless otherwise specified, the requirements for absolute accuracy of SS-RSRP in this clause apply to the serving cell in FR2.

The accuracy requirements in Table 10.1.3B.1.1-1 are valid under the following conditions:

- Conditions defined in clause 7.3 of TS 38.101-2 [19] for reference sensitivity are fulfilled.

- Conditions for intra-frequency measurements are fulfilled according to Annex B.1.2 for a corresponding Band for each relevant SSB.
- The measured signals are in the directions covered by the percentile EIS spherical coverage of the UE, defined in clause 7.3.4 of TS 38.101-2 [19].

**Table 10.1.3B.1.1-1: SS-RSRP Intra frequency absolute accuracy in FR2**

Accuracy		Conditions			
Normal condition	Extreme condition	SSB $\hat{E}_s/\text{lot}$	$I_o$ <sup>Note 2</sup> range		
			Minimum $I_o$		Maximum $I_o$
dB	dB	dB	dBm / $SCS_{SSB}$ <sup>Note 1</sup>		dBm/ $BW_{Channel}$
			$SCS_{SSB} = 120\text{kHz}$	$SCS_{SSB} = 240\text{kHz}$	
$\pm 7.5$	$\pm 10.5$	$\geq -4$	Same value as SSB_RP in Table B.2.2-2, according to UE Power class, operating band and angle of arrival		N/A
$\pm 9.5$	$\pm 12.5$		N/A		-70
					-50

Note 1: Values based on Refsens and EIS spherical coverage as defined in clauses 7.3.2 and 7.3.4 of TS 38.101-2 [19]. Applicable side condition selected depending on angle of arrival.

Note 2:  $I_o$  specified at the Reference point and assumed to have constant EPRE across the bandwidth.

Note 3: In the test cases, the SSB  $\hat{E}_s/\text{lot}$  and related parameters may need to be adjusted to ensure  $\hat{E}_s/\text{lot}$  at UE baseband is above the value defined in this table.

## 10.1.4 Inter-frequency RSRP accuracy requirements for FR1

### 10.1.4.1 Inter-frequency SS-RSRP accuracy requirements

#### 10.1.4.1.1 Absolute Accuracy of SS-RSRP in FR1

The requirements for absolute accuracy of SS-RSRP in this clause apply to a cell on a frequency in FR1 that has different carrier frequency from the serving cell.

The accuracy requirements in Table 10.1.4.1.1-1 are valid under the following conditions:

- Conditions defined in clause 7.3 of TS 38.101-1 [18] for reference sensitivity are fulfilled.
- Conditions for inter-frequency measurements are fulfilled according to Annex B.2.3 for a corresponding Band for each relevant SSB.

**Table 10.1.4.1.1-1: SS-RSRP Inter frequency Absolute accuracy in FR1**

Accuracy		Conditions				
Normal condition	Extreme condition	SSB $\hat{E}_s/\text{lot}$ <sup>Note 2</sup>	$I_o$ <sup>Note 1</sup> range			
			NR operating band groups <sup>Note 3</sup>	Minimum $I_o$		Maximum $I_o$
dB	dB	dB		dBm / $SCS_{SSB}$		dBm/ $BW_{Channel}$
			$SCS_{SSB} = 15\text{ kHz}$	$SCS_{SSB} = 30\text{ kHz}$		
$\pm 4.5$	$\pm 9$	$\geq -6$	NR_FDD_FR1_A, NR_TDD_FR1_A, NR_SDL_FR1_A	-121	-118	N/A
			NR_FDD_FR1_B	-120.5	-117.5	N/A
			NR_TDD_FR1_C	-120	-117	N/A
			NR_FDD_FR1_D, NR_TDD_FR1_D	-119.5	-116.5	N/A



			NR_FDD_FR1_E, NR_TDD_FR1_E	-119	-116	N/A	-70
			NR_FDD_FR1_F	-118.5	-115.5	N/A	-70
			NR_FDD_FR1_G	-118	-115	N/A	-70
			NR_FDD_FR1_H	-117.5	-114.5	N/A	-70
±8	±11	≥6	NR_FDD_FR1_A, NR_TDD_FR1_A, NR_SDL_FR1_A, NR_FDD_FR1_B, NR_TDD_FR1_C, NR_FDD_FR1_D, NR_TDD_FR1_D, NR_FDD_FR1_E, NR_TDD_FR1_E, NR_FDD_FR1_F, NR_FDD_FR1_G, NR_FDD_FR1_H	N/A	N/A	-70	-50

NOTE 1:  $I_0$  is assumed to have constant EPRE across the bandwidth.  
 NOTE 2: Void  
 NOTE 3: NR operating band groups in FR1 are as defined in clause 3.5.2.

### 10.1.4.1.2 Relative Accuracy of SS-RSRP in FR1

The relative accuracy of SS-RSRP in inter frequency case is defined as the RSRP measured from one cell on a frequency in FR1 compared to the RSRP measured from another cell on a different frequency in FR1.

The accuracy requirements in Table 10.1.4.1.2-1 are valid under the following conditions:

- Conditions defined in clause 7.3 of TS 38.101-1 [18] Clause 7.3 for reference sensitivity are fulfilled.
- Conditions for inter-frequency measurements are fulfilled according to Annex B.2.3 for a corresponding Band for each relevant SSB.
- $|SSB\_RP1_{dBm} - SSB\_RP2_{dBm}| \leq 27$  dB
- $|Channel\ 1\_I_0 - Channel\ 2\_I_0| \leq 20$  dB

**Table 10.1.4.1.2-1: SS-RSRP Inter frequency relative accuracy in FR1**

Accuracy		Conditions					
Normal condition	Extreme condition	SSB $\dot{E}_s/lot$ Note 2	$I_0$ Note 1 range				
			NR operating band groups Note 3	Minimum $I_0$		Maximum $I_0$	
dB	dB	dB		dBm / $SCS_{SSB}$		dBm/ $BW_{Channel}$	dBm/ $BW_{Channel}$
				$SCS_{SSB} = 15$ kHz	$SCS_{SSB} = 30$ kHz		
±4.5	±6	≥6	NR_FDD_FR1_A, NR_TDD_FR1_A, NR_SDL_FR1_A	-121	-118	N/A	-50
			NR_FDD_FR1_B	-120.5	-117.5	N/A	-50
			NR_TDD_FR1_C	-120	-117	N/A	-50
			NR_FDD_FR1_D, NR_TDD_FR1_D	-119.5	-116.5	N/A	-50
			NR_FDD_FR1_E, NR_TDD_FR1_E	-119	-116	N/A	-50
			NR_FDD_FR1_F	-118.5	-115.5	N/A	-50
			NR_FDD_FR1_G	-118	-115	N/A	-50
			NR_FDD_FR1_H	-117.5	-114.5	N/A	-50

NOTE 1:  $I_0$  is assumed to have constant EPRE across the bandwidth.  
 NOTE 2: The parameter SSB  $\dot{E}_s/lot$  is the minimum SSB  $\dot{E}_s/lot$  of the pair of cells to which the requirement applies.  
 NOTE 3: NR operating band groups in FR1 are as defined in clause 3.5.2.

## 10.1.4.2 Void

## 10.1.4.3 Inter-frequency CSI-RSRP accuracy requirements

## 10.1.4.3.1 Absolute Accuracy of CSI-RSRP in FR1

The requirements for absolute accuracy of CSI-RSRP in this clause apply to a cell where the CSI-RS resources to be measured have the different center frequency as the CSI-RS resources indicated for measurement in the serving cell in FR1.

The accuracy requirements in Table 10.1.4.3.1-1 are valid under the following conditions:

- Conditions defined in clause 7.3 of TS 38.101-1 [18] for reference sensitivity are fulfilled.
- Conditions for inter-frequency measurements are fulfilled according to Annex B.2.3 for a corresponding Band for each relevant SSB.
- Conditions for inter-frequency measurements are fulfilled according to Annex B.2.13 for a corresponding Band for each relevant CSI-RS to be measured.
- The bandwidth of CSI-RS is 48 PRBs and the density is 3. The performance with larger bandwidth of CSI-RS is equal to or better than the accuracy requirements in Table 10.1.4.3.1-1.
- The timing offset between the reference measurement timing and the target CSI-RS in one layer is no larger than CP.

Note: The reference measurement timing for one layer for inter-frequency measurement is up to UE implementation and shall be based on the timing of one of the target cells.

**Table 10.1.4.3.1-1: CSI-RSRP Inter frequency Absolute accuracy in FR1**

Accuracy		Conditions						
Normal condition	Extreme condition	CSI-RS $\hat{\epsilon}_s/\text{lot}$	$I_o$ <sup>Note 1</sup> range					
			NR operating band groups <sup>Note 2</sup>	Minimum $I_o$			Maximum $I_o$	
dB	dB	dB		dBm / $SCS_{\text{CSI-RS}}$			dBm/BW <sub>Channel</sub>	dBm/BW <sub>Channel</sub>
			$SCS_{\text{CSI-RS}} = 15$ kHz	$SCS_{\text{CSI-RS}} = 30$ kHz	$SCS_{\text{CSI-RS}} = 60$ kHz			
$\pm 4.5$	$\pm 9$	$\geq 6$	NR_FDD_FR1_A, NR_TDD_FR1_A, NR_SDL_FR1_A	-121	-118	-115	N/A	-70
			NR_FDD_FR1_B	-120.5	-117.5	-114.5	N/A	-70
			NR_TDD_FR1_C	-120	-117	-114	N/A	-70
			NR_FDD_FR1_D, NR_TDD_FR1_D	-119.5	-116.5	-113.5	N/A	-70
			NR_FDD_FR1_E, NR_TDD_FR1_E	-119	-116	-113	N/A	-70
			NR_FDD_FR1_F	-118.5	-115.5	-112.5	N/A	-70
			NR_FDD_FR1_G	-118	-115	-112	N/A	-70
$\pm 8$	$\pm 11$	$\geq 6$	NR_FDD_FR1_A, NR_TDD_FR1_A, NR_SDL_FR1_A, NR_FDD_FR1_B, NR_TDD_FR1_C,	N/A	N/A	N/A	-70	-50

			NR_FDD_FR1_D, NR_TDD_FR1_D, NR_FDD_FR1_E, NR_TDD_FR1_E, NR_FDD_FR1_F, NR_FDD_FR1_G, NR_FDD_FR1_H					
NOTE 1: $I_o$ is assumed to have constant EPRE across the bandwidth. NOTE 2: NR operating band groups in FR1 are as defined in clause 3.5.2.								

### 10.1.4.3.2 Relative Accuracy of CS-RSRP in FR1

The relative accuracy of CSI-RSRP in inter frequency case is defined as the CSI-RSRP measured from one cell on a frequency in FR1 compared to the CSI-RSRP measured from another cell on a different frequency in FR1.

The accuracy requirements in Table 10.1.4.3.2-1 are valid under the following conditions:

- Conditions defined in clause 7.3 of TS 38.101-1 [18] Clause 7.3 for reference sensitivity are fulfilled.
- Conditions for inter-frequency measurements are fulfilled according to Annex B.2.3 for a corresponding Band for each relevant SSB.
- Conditions for inter-frequency measurements are fulfilled according to Annex B.2.13 for a corresponding Band for each relevant CSI-RS to be measured.
- The bandwidth of CSI-RS is 48 PRBs and the density is 3. The performance with larger bandwidth of CSI-RS is equal to or better than the accuracy requirements in Table 10.1.4.3.2-1.
- The timing offset between the reference measurement timing and the target CSI-RS in one layer is no larger than CP.

Note: The reference measurement timing for one layer for inter-frequency measurement is up to UE implementation and shall be based on the timing of one of the target cells.

- $|CSI\_RP1_{dBm} - CSI\_RP2_{dBm}| \leq 27$  dB
- $|Channel\ 1_{I_o} - Channel\ 2_{I_o}| \leq 20$  dB

**Table 10.1.4.3.2-1: CSI-RSRP Inter frequency relative accuracy in FR1**

Accuracy		Conditions						
Normal condition	Extreme condition	CSI-RS $\hat{E}_s/I_{ot}$ Note 2	$I_o$ Note 1 range					
			NR operating band groups Note 4	Minimum $I_o$			Maximum $I_o$	
dB	dB	dB		dBm / $SCS_{CSI-RS}$			dBm/ $BW_{Channel}$	dBm/ $BW_{Channel}$
			$SCS_{CSI-RS} = 15$ kHz	$SCS_{CSI-RS} = 30$ kHz	$SCS_{CSI-RS} = 60$ kHz			
$\pm 4.5$	$\pm 6$	$\geq -6$	NR_FDD_FR1_A, NR_TDD_FR1_A, NR_SDL_FR1_A	-121	-118	-115	N/A	-50
			NR_FDD_FR1_B	-120.5	-117.5	-114.5	N/A	-50
			NR_TDD_FR1_C	-120	-117	-114	N/A	-50
			NR_FDD_FR1_D, NR_TDD_FR1_D	-119.5	-116.5	-113.5	N/A	-50
			NR_FDD_FR1_E, NR_TDD_FR1_E	-119	-116	-113	N/A	-50
			NR_FDD_FR1_F	-118.5	-115.5	-112.5	N/A	-50
			NR_FDD_FR1_G	-118	-115	-112	N/A	-50

			NR_FDD_FR1_H	-117.5	-114.5	-111.5	N/A	-50
NOTE 1: $I_0$ is assumed to have constant EPRE across the bandwidth.								
NOTE 2: The parameter CSI-RS $\hat{E}_s/I_{ot}$ is the minimum CSI-RS $\hat{E}_s/I_{ot}$ of the pair of CSI-RS resources to which the requirement applies.								
NOTE 3: Void								
NOTE 4: NR operating band groups in FR1 are as defined in clause 3.5.2.								

### 10.1.4B Inter-frequency RSRP accuracy requirements for FR1 for CA/DC Idle Mode Measurements

#### 10.1.4B.1 Inter-frequency SS-RSRP accuracy requirements

The requirements in this clause are applicable for a UE:

- in state RRC\_IDLE or RRC\_INACTIVE
- that is synchronised to the cell that is measured.

The requirements are for absolute accuracy of SS-RSRP.

##### 10.1.4B.1.1 Absolute Accuracy of SS-RSRP in FR1

The requirements for absolute accuracy of SS-RSRP in this clause apply to a cell on a frequency in FR1 that has different carrier frequency from the serving cell.

The accuracy requirements in Table 10.1.4B.1.1-1 are valid under the following conditions:

- Conditions defined in clause 7.3 of TS 38.101-1 [18] for reference sensitivity are fulfilled.
- Conditions for inter-frequency measurements are fulfilled according to Annex B.1.3 for a corresponding Band for each relevant SSB.

**Table 10.1.4B.1.1-1: SS-RSRP Inter frequency Absolute accuracy in FR1**

Accuracy		Conditions					
Normal condition	Extreme condition	SSB $\hat{E}_s/I_{ot}$ Note 2	$I_0$ Note 1 range				
			NR operating band groups Note 3	Minimum $I_0$		Maximum $I_0$	
dB	dB	dB		dBm / $SCS_{SSB}$		dBm/ $BW_{Channel}$	dBm/ $BW_{Channel}$
				$SCS_{SSB} = 15$ kHz	$SCS_{SSB} = 30$ kHz		
±6	±10.5	≥4	NR_FDD_FR1_A, NR_TDD_FR1_A, NR_SDL_FR1_A	-121	-118	N/A	-70
			NR_FDD_FR1_B	-120.5	-117.5	N/A	-70
			NR_TDD_FR1_C	-120	-117	N/A	-70
			NR_FDD_FR1_D, NR_TDD_FR1_D	-119.5	-116.5	N/A	-70
			NR_FDD_FR1_E, NR_TDD_FR1_E	-119	-116	N/A	-70
			NR_FDD_FR1_F	-118.5	-115.5	N/A	-70
			NR_FDD_FR1_G	-118	-115	N/A	-70
			NR_FDD_FR1_H	-117.5	-114.5	N/A	-70
±9.5	±12.5	≥4	NR_FDD_FR1_A, NR_TDD_FR1_A, NR_SDL_FR1_A, NR_FDD_FR1_B, NR_TDD_FR1_C, NR_FDD_FR1_D, NR_TDD_FR1_D,	N/A	N/A	-70	-50

			NR_FDD_FR1_E, NR_TDD_FR1_E, NR_FDD_FR1_F, NR_FDD_FR1_G, NR_FDD_FR1_H				
NOTE 1: $I_0$ is assumed to have constant EPRE across the bandwidth. NOTE 2: Void NOTE 3: NR operating band groups in FR1 are as defined in clause 3.5.2.							

## 10.1.5 Inter-frequency RSRP accuracy requirements for FR2

### 10.1.5.1 Inter-frequency SS-RSRP accuracy requirements

#### 10.1.5.1.1 Absolute SS-RSRP Accuracy

Unless otherwise specified, the requirements for absolute accuracy of SS-RSRP in this clause apply to a cell on a frequency in FR2 that is on a different frequency than the serving cell.

The accuracy requirements in Table 10.1.5.1.1-1 are valid under the following conditions:

- Conditions defined in clause 7.3 of TS 38.101-2 [19] for reference sensitivity are fulfilled.
- Conditions for inter-frequency measurements are fulfilled according to Annex B.2.3 for a corresponding Band for each relevant SSB.
- The measured signals are in the directions covered by the percentile EIS spherical coverage of the UE, defined in clause 7.3.4 of TS 38.101-2 [19].

**Table 10.1.5.1.1-1: SS-RSRP Inter frequency absolute accuracy in FR2**

Accuracy		Conditions			
Normal condition	Extreme condition	SSB $\hat{E}_s/\text{lot}$	$I_0$ <sup>Note 2</sup> range		
			Minimum $I_0$		Maximum $I_0$
dB	dB	dB	dBm / $SCS_{SSB}$ <sup>Note 1</sup>		dBm/BW <sub>Channel</sub>
			$SCS_{SSB} = 120\text{kHz}$	$SCS_{SSB} = 240\text{kHz}$	
$\pm 6$	$\pm 9$	$\geq -4$	Same value as SSB_RP in Table B.2.3-2, according to UE Power class, operating band and angle of arrival		N/A
$\pm 8$	$\pm 11$		N/A		-70
Note 1: Values based on Refsens and EIS spherical coverage as defined in clauses 7.3.2 and 7.3.4 of TS 38.101-2 [19]. Applicable side condition selected depending on angle of arrival. Note 2: $I_0$ specified at the Reference point, and assumed to have constant EPRE across the bandwidth. Note 3: In the test cases, the SSB $\hat{E}_s/\text{lot}$ and related parameters may need to be adjusted to ensure $\hat{E}_s/\text{lot}$ at UE baseband is above the value defined in this table.					

#### 10.1.5.1.2 Relative SS-RSRP Accuracy

The relative accuracy of SS-RSRP is defined as the SS-RSRP measured from one cell on a frequency in FR2 compared to the SS-RSRP measured from another cell on another frequency in FR2.

The accuracy requirements in Table 10.1.5.1.2-1 are valid under the following conditions:

- Conditions defined in 38.101-2 [19] Clause 7.3 for reference sensitivity are fulfilled.
- Conditions for inter-frequency measurements are fulfilled according to Annex B.2.3 for a corresponding Band for each relevant SSB.

- $|\text{SSB\_RP1}_{\text{dBm}} - \text{SSB\_RP2}_{\text{dBm}}| \leq 27\text{dB}$
- $|\text{Channel 1\_Io} - \text{Channel 2\_Io}| \leq 20\text{ dB}$
- The measured signals are in the directions covered by the percentile EIS spherical coverage of the UE, defined in clause 7.3.4 of TS 38.101-2 [19].

**Table 10.1.5.1.2-1: SS-RSRP Inter frequency relative accuracy in FR2**

Accuracy		Conditions			
Normal condition	Extreme condition	SSB $\hat{E}_s/\text{lot}$	$I_o$ <sup>Note 2</sup> range		Maximum $I_o$
			Minimum $I_o$		
dB	dB	dB	dBm / $SCS_{\text{SSB}}$ <sup>Note 1</sup>		dBm/ $BW_{\text{Channel}}$
			$SCS_{\text{SSB}} = 120\text{kHz}$	$SCS_{\text{SSB}} = 240\text{kHz}$	
$\pm 6$	$\pm 9$	$\geq -4$	Same value as SSB_RP in Table B.2.3-2, according to UE Power class, operating band and angle of arrival		-50
<p>Note 1: Values based on Refsens and EIS spherical coverage as defined in clauses 7.3.2 and 7.3.4 of TS 38.101-2 [19]. Applicable side condition selected depending on angle of arrival.</p> <p>Note 2: <math>I_o</math> specified at the Reference point, and assumed to have constant EPRE across the bandwidth.</p> <p>Note 3: In the test cases, the SSB <math>\hat{E}_s/\text{lot}</math> and related parameters may need to be adjusted to ensure <math>\hat{E}_s/\text{lot}</math> at UE baseband is above the value defined in this table.</p> <p>Note 4: The parameter SSB <math>\hat{E}_s/\text{lot}</math> is the minimum SSB <math>\hat{E}_s/\text{lot}</math> of the pair of cells to which the requirement applies.</p>					

### 10.1.5.2 Void

### 10.1.5.3 Inter-frequency CSI-RSRP accuracy requirements

#### 10.1.5.3.1 Absolute CSI-RSRP Accuracy

Unless otherwise specified, the requirements for absolute accuracy of CSI-RSRP in this clause apply to a cell on a frequency in FR2 where the CSI-RS resources to be measured have the different center frequency as the CSI-RS resources indicated for measurement in the serving cell.

The accuracy requirements in Table 10.1.5.3.1-1 are valid under the following conditions:

- Conditions defined in clause 7.3 of TS 38.101-2 [19] for reference sensitivity are fulfilled.
- Conditions for inter-frequency measurements are fulfilled according to Annex B.2.3 for a corresponding Band for each relevant associated SSB.
- Conditions for inter-frequency measurements are fulfilled according to Annex B.2.13 for a corresponding Band for each relevant CSI-RS to be measured.
- The bandwidth of CSI-RS is 48 PRBs and the density is 3. The performance with larger bandwidth of CSI-RS is equal to or better than the accuracy requirements in Table 10.1.5.3.1-1.
- The timing offset between the reference measurement timing and the target CSI-RS in one layer is no larger than CP.

Note: The reference measurement timing for one layer for inter-frequency measurement is up to UE implementation and shall be based on the timing of one of the target cells.

- The measured signals are in the directions covered by the percentile EIS spherical coverage of the UE, defined in clause 7.3.4 of TS 38.101-2 [19].

**Table 10.1.5.3.1-1: CSI-RSRP Inter frequency absolute accuracy in FR2**

Accuracy		Conditions			
Normal condition	Extreme condition	CSI-RS $\hat{E}_s/\text{lot}$	$I_o$ <sup>Note 2</sup> range		
			Minimum $I_o$		Maximum $I_o$
dB	dB	dB	dBm / $SCS_{\text{CSI-RS}}$ <sup>Note 1</sup>		dBm/BW <sub>Channel</sub>
			$SCS_{\text{CSI-RS}} = 60\text{kHz}$	$SCS_{\text{CSI-RS}} = 120\text{kHz}$	
$\pm 6$	$\pm 9$	$\geq -4$	Same value as CSI_RP in Table B.2.13-2, according to UE Power class, operating band and angle of arrival		N/A
$\pm 8$	$\pm 11$		N/A		-70
Note 1: Values based on Refsens and EIS spherical coverage as defined in clauses 7.3.2 and 7.3.4 of TS 38.101-2 [19]. Applicable side condition selected depending on angle of arrival. Note 2: $I_o$ specified at the Reference point, and assumed to have constant EPRE across the bandwidth. Note 3: In the test cases, the CSI-RS $\hat{E}_s/\text{lot}$ and related parameters may need to be adjusted to ensure $\hat{E}_s/\text{lot}$ at UE baseband is above the value defined in this table.					

**10.1.5.3.2 Relative CSI-RSRP Accuracy**

The relative accuracy of CSI-RSRP in inter frequency case is defined as the CSI-RSRP measured from one cell on a frequency in FR2 compared to the CSI-RSRP measured from another cell on another frequency in FR2.

The accuracy requirements in Table 10.1.5.3.2-1 are valid under the following conditions:

- Conditions defined in 38.101-2 [19] Clause 7.3 for reference sensitivity are fulfilled.
- Conditions for inter-frequency measurements are fulfilled according to Annex B.2.3 for a corresponding Band for each relevant associated SSB.
- Conditions for inter-frequency measurements are fulfilled according to Annex B.2.13 for a corresponding Band for each relevant CSI-RS to be measured.
- The bandwidth of CSI-RS is 48 PRBs and the density is 3. The performance with larger bandwidth of CSI-RS is equal to or better than the accuracy requirements in Table 10.1.5.3.2-1.
- The timing offset between the reference measurement timing and the target CSI-RS in one layer is no larger than CP.

Note: The reference measurement timing for one layer for inter-frequency measurement is up to UE implementation and shall be based on the timing of one of the target cells.

- $|CSI\_RP1_{\text{dBm}} - CSI\_RP2_{\text{dBm}}| \leq 27\text{dB}$
- $|Channel\ 1_{I_o} - Channel\ 2_{I_o}| \leq 20\ \text{dB}$
- The measured signals are in the directions covered by the percentile EIS spherical coverage of the UE, defined in clause 7.3.4 of TS 38.101-2 [19].

**Table 10.1.5.3.2-1: CSI-RSRP Inter frequency relative accuracy in FR2**

Accuracy		Conditions		
Normal condition	Extreme condition	CSI-RS $\hat{E}_s/\text{lot}$	$I_o$ <sup>Note 2</sup> range	
			Minimum $I_o$	Maximum $I_o$
dB	dB	dB	dBm / $SCS_{\text{CSI-RS}}$ <sup>Note 1</sup>	
				dBm/BW <sub>Channel</sub>

			SCS <sub>CSI-RS</sub> = 60kHz	SCS <sub>CSI-RS</sub> = 120kHz	
±6	±9	≥-4	Same value as CSI_RP in Table B.2.13-2, according to UE Power class, operating band and angle of arrival		-50
Note 1: Values based on Refsens and EIS spherical coverage as defined in clauses 7.3.2 and 7.3.4 of TS 38.101-2 [19]. Applicable side condition selected depending on angle of arrival. Note 2: I <sub>o</sub> specified at the Reference point, and assumed to have constant EPRE across the bandwidth. Note 3: In the test cases, the CSI-RS Ês/lot and related parameters may need to be adjusted to ensure Ês/lot at UE baseband is above the value defined in this table. Note 4: The parameter CSI-RS Ês/lot is the minimum CSI-RS Ês/lot of the pair of cells to which the requirement applies.					

### 10.1.5B Inter-frequency RSRP accuracy requirements for FR2 for CA/DC Idle Mode Measurements

#### 10.1.5B.1 Inter-frequency SS-RSRP accuracy requirements

The requirements in this clause are applicable for a UE:

- in state RRC\_IDLE or RRC\_INACTIVE
- that is synchronised to the cell that is measured.

The requirements are for absolute accuracy of SS-RSRP.

##### 10.1.5B.1.1 Absolute SS-RSRP Accuracy

Unless otherwise specified, the requirements for absolute accuracy of SS-RSRP in this clause apply to a cell on a frequency in FR2 that is on a different frequency than the serving cell.

The accuracy requirements in Table 10.1.5B.1.1-1 are valid under the following conditions:

- Conditions defined in clause 7.3 of TS 38.101-2 [19] for reference sensitivity are fulfilled.
- Conditions for inter-frequency measurements are fulfilled according to Annex B.1.3 for a corresponding Band for each relevant SSB.
- The measured signals are in the directions covered by the percentile EIS spherical coverage of the UE, defined in clause 7.3.4 of TS 38.101-2 [19].

**Table 10.1.5B.1.1-1: SS-RSRP Inter frequency absolute accuracy in FR2**

Accuracy		Conditions			
Normal condition	Extreme condition	SSB Ês/lot	I <sub>o</sub> <sup>Note 2</sup> range		
			Minimum I <sub>o</sub>		Maximum I <sub>o</sub>
dB	dB	dB	dBm / SCS <sub>SSB</sub> <sup>Note 1</sup>		dBm/BW <sub>Channel</sub>
			SCS <sub>SSB</sub> = 120kHz	SCS <sub>SSB</sub> = 240kHz	
±7.5	±10.5	≥-4	Same value as SSB_RP in Table B.2.3-2, according to UE Power class, operating band and angle of arrival		N/A
±9.5	±12.5		N/A		-70
					-50



Note 1:	Values based on Refsens and EIS spherical coverage as defined in clauses 7.3.2 and 7.3.4 of TS 38.101-2 [19]. Applicable side condition selected depending on angle of arrival.
Note 2:	lo specified at the Reference point, and assumed to have constant EPRE across the bandwidth.
Note 3:	In the test cases, the SSB $\hat{E}_s$ /lot and related parameters may need to be adjusted to ensure $\hat{E}_s$ /lot at UE baseband is above the value defined in this table.

## 10.1.6 RSRP Measurement Report Mapping

The reporting range of SS-RSRP and CSI-RSRP for L3 reporting is defined from -156 dBm to -31 dBm with 1 dB resolution. The reporting range of SS-RSRP and CSI-RSRP for L1 reporting is defined from -140 to -44 dBm with 1 dB resolution.

The mapping of measured quantity is defined in Table 10.1.6.1-1. The range in the signalling may be larger than the guaranteed accuracy range.

The reporting range of differential SS-RSRP and CSI-RSRP for L1 reporting and L3 reporting is defined from 0 dB to -30 dB with 2 dB resolution.

The mapping of measured quantity is defined in Table 10.1.6.1-2. The range in the signalling may be larger than the guaranteed accuracy range.

**Table 10.1.6.1-1: SS-RSRP and CSI-RSRP measurement report mapping**

Reported value	Measured quantity value (L3 SS-RSRP and CSI-RSRP)	Measured quantity value (L1 SS-RSRP and CSI-RSRP)	Unit
RSRP_0	RSRP<-156	Not valid	dBm
RSRP_1	-156≤RSRP<-155	Not valid	dBm
RSRP_2	-155≤RSRP<-154	Not valid	dBm
RSRP_3	-154≤RSRP<-153	Not valid	dBm
RSRP_4	-153≤RSRP<-152	Not valid	dBm
RSRP_5	-152≤RSRP<-151	Not valid	dBm
RSRP_6	-151≤RSRP<-150	Not valid	dBm
RSRP_7	-150≤RSRP<-149	Not valid	dBm
RSRP_8	-149≤RSRP<-148	Not valid	dBm
RSRP_9	-148≤RSRP<-147	Not valid	dBm
RSRP_10	-147≤RSRP<-146	Not valid	dBm
RSRP_11	-146≤RSRP<-145	Not valid	dBm
RSRP_12	-145≤RSRP<-144	Not valid	dBm
RSRP_13	-144≤RSRP<-143	Not valid	dBm
RSRP_14	-143≤RSRP<-142	Not valid	dBm
RSRP_15	-142≤RSRP<-141	Not valid	dBm
RSRP_16	-141≤RSRP<-140	RSRP<-140	dBm
RSRP_17	-140≤RSRP<-139	-140≤RSRP<-139	dBm
RSRP_18	-139≤RSRP<-138	-139≤RSRP<-138	dBm
...	...		...
RSRP_111	-46≤RSRP<-45	-46≤RSRP<-45	dBm
RSRP_112	-45≤RSRP<-44	-45≤RSRP<-44	dBm
RSRP_113	-44≤RSRP<-43	-44≤RSRP	dBm
RSRP_114	-43≤RSRP<-42	Not valid	dBm
RSRP_115	-42≤RSRP<-41	Not valid	dBm
RSRP_116	-41≤RSRP<-40	Not valid	dBm

RSRP_117	$-40 \leq \text{RSRP} < -39$	Not valid	dBm
RSRP_118	$-39 \leq \text{RSRP} < -38$	Not valid	dBm
RSRP_119	$-38 \leq \text{RSRP} < -37$	Not valid	dBm
RSRP_120	$-37 \leq \text{RSRP} < -36$	Not valid	dBm
RSRP_121	$-36 \leq \text{RSRP} < -35$	Not valid	dBm
RSRP_122	$-35 \leq \text{RSRP} < -34$	Not valid	dBm
RSRP_123	$-34 \leq \text{RSRP} < -33$	Not valid	dBm
RSRP_124	$-33 \leq \text{RSRP} < -32$	Not valid	dBm
RSRP_125	$-32 \leq \text{RSRP} < -31$	Not valid	dBm
RSRP_126	$-31 \leq \text{RSRP}$	Not valid	dBm
RSRP_127 (Note)	Infinity	Infinity	dBm
Note:	The value of RSRP_127 is applicable for RSRP threshold configured by the network as defined in TS 38.331 [2], but not for the purpose of measurement reporting.		

**Table 10.1.6.1-2: Differential SS-RSRP and CSI-RSRP measurement (for L1 reporting and L3 reporting) report mapping**

Reported value	Measured quantity value (difference in measured RSRP from strongest RSRP)	Unit
DIFFRSRP_0	$0 \geq \Delta \text{RSRP} > -2$	dB
DIFFRSRP_1	$-2 \geq \Delta \text{RSRP} > -4$	dB
DIFFRSRP_2	$-4 \geq \Delta \text{RSRP} > -6$	dB
DIFFRSRP_3	$-6 \geq \Delta \text{RSRP} > -8$	dB
DIFFRSRP_4	$-8 \geq \Delta \text{RSRP} > -10$	dB
DIFFRSRP_5	$-10 \geq \Delta \text{RSRP} > -12$	dB
DIFFRSRP_6	$-12 \geq \Delta \text{RSRP} > -14$	dB
DIFFRSRP_7	$-14 \geq \Delta \text{RSRP} > -16$	dB
DIFFRSRP_8	$-16 \geq \Delta \text{RSRP} > -18$	dB
DIFFRSRP_9	$-18 \geq \Delta \text{RSRP} > -20$	dB
DIFFRSRP_10	$-20 \geq \Delta \text{RSRP} > -22$	dB
DIFFRSRP_11	$-22 \geq \Delta \text{RSRP} > -24$	dB
DIFFRSRP_12	$-24 \geq \Delta \text{RSRP} > -26$	dB
DIFFRSRP_13	$-26 \geq \Delta \text{RSRP} > -28$	dB
DIFFRSRP_14	$-28 \geq \Delta \text{RSRP} > -30$	dB
DIFFRSRP_15	$-30 \geq \Delta \text{RSRP}$	dB

## 10.1.7 Intra-frequency RSRQ accuracy requirements for FR1

### 10.1.7.1 Intra-frequency SS-RSRQ accuracy requirements in FR1

#### 10.1.7.1.1 Absolute SS-RSRQ Accuracy in FR1

Unless otherwise specified, the requirements for absolute accuracy of SS-RSRQ in this clause apply to a cell on the same frequency as that of the serving cell in FR1. The accuracy requirements in this clause are also applicable when *highSpeedMeasFlag-r16* is configured.

The accuracy requirements in Table 10.1.7.1.1-1 are valid under the following conditions:

- Conditions defined in clause 7.3 of TS 38.101-1 [18] for reference sensitivity are fulfilled.
- Conditions for intra-frequency measurements are fulfilled according to Annex B.2.2 for a corresponding Band for each relevant SSB.

**Table 10.1.7.1.1-1: SS-RSRQ Intra frequency absolute accuracy in FR1**

Accuracy		Conditions					
Normal condition	Extreme condition	SSB Es/lot	Io <sup>Note 1</sup> range				
			NR operating band groups <sup>Note 3</sup>	Minimum Io		Maximum Io	
dB	dB	dB		dBm / SCS <sub>SSB</sub>		dBm/BW <sub>Channel</sub>	dBm/BW <sub>Channel</sub>
			SCS <sub>SSB</sub> = 15 kHz	SCS <sub>SSB</sub> = 30 kHz			
±2.5	±4	≥3	NR_FDD_FR1_A, NR_TDD_FR1_A, NR_SDL_FR1_A	-121	-118	N/A	-50
			NR_FDD_FR1_B	-120.5	-117.5	N/A	-50
			NR_TDD_FR1_C	-120	-117	N/A	-50
			NR_FDD_FR1_D, NR_TDD_FR1_D	-119.5	-116.5	N/A	-50
			NR_FDD_FR1_E, NR_TDD_FR1_E	-119	-116	N/A	-50
			NR_FDD_FR1_F	-118.5	-115.5	N/A	-50
			NR_FDD_FR1_G	-118	-115	N/A	-50
			NR_FDD_FR1_H	-117.5	-114.5	N/A	-50
±3.5	±4	≥6	Note 2	Note 2	Note 2	Note 2	Note 2

NOTE 1: Io is assumed to have constant EPRE across the bandwidth.  
NOTE 2: The same bands and the same Io conditions for each band apply for this requirement as for the corresponding highest accuracy requirement.  
NOTE 3: NR operating band groups in FR1 are as defined in clause 3.5.2.

## 10.1.7.2 Intra-frequency CSI-RSRQ accuracy requirements

### 10.1.7.2.1 Absolute CSI-RSRQ Accuracy

Unless otherwise specified, the requirements for absolute accuracy of CSI-RSRQ in this clause apply to the intra-frequency measurement defined in 9.10.2.1 in FR1.

The accuracy requirements in Table 10.1.7.2.1-1 are valid under the following conditions:

- Conditions defined in clause 7.3 of TS 38.101-1 [18] for reference sensitivity are fulfilled.
- Conditions for intra-frequency measurements are fulfilled according to Annex B.2.2 for a corresponding Band for associated SSB.
- Conditions for intra-frequency measurements are fulfilled according to Annex B.2.12 for a corresponding Band for each relevant CSI-RS.
- The bandwidth of CSI-RS is 48 PRBs and the density is 3.

The performance with larger bandwidth of CSI-RS is equal to or better than the accuracy requirements in Table 10.1.7.2.1-1.

- The timing offset between the reference measurement timing and the target CSI-RS in one layer is no larger than CP.

Note: The reference measurement timing for one layer for intra-frequency measurement is serving cell timing.

**Table 10.1.7.2.1-1: CSI-RSRQ Intra frequency absolute accuracy in FR1**

Accuracy		Conditions						
Normal condition	Extreme condition	CSI-RS $\hat{\epsilon}_s/\text{lot}$	$I_o$ <sup>Note 1</sup> range					
			NR operating band groups <sup>Note 3</sup>	Minimum $I_o$			Maximum $I_o$	
dB	dB	dB		dBm / SCS <sub>CSI-RS</sub>			dBm/BW <sub>Channel</sub>	dBm/BW <sub>Channel</sub>
			SCS <sub>CSI-RS</sub> = 15 kHz	SCS <sub>CSI-RS</sub> = 30 kHz	SCS <sub>CSI-RS</sub> = 60 kHz			
±2.5	±4	≥-3	NR_FDD_FR1_A, NR_TDD_FR1_A, NR_SDL_FR1_A	-121	-118	-115	N/A	-50
			NR_FDD_FR1_B	-120.5	-117.5	-114.5	N/A	-50
			NR_TDD_FR1_C	-120	-117	-114	N/A	-50
			NR_FDD_FR1_D, NR_TDD_FR1_D	-119.5	-116.5	-113.5	N/A	-50
			NR_FDD_FR1_E, NR_TDD_FR1_E	-119	-116	-113	N/A	-50
			NR_FDD_FR1_F	-118.5	-115.5	-112.5	N/A	-50
			NR_FDD_FR1_G	-118	-115	-112	N/A	-50
			NR_FDD_FR1_H	-117.5	-114.5	-111.5	N/A	-50
±3.5	±4	≥-6	Note 2	Note 2	Note 2	Note 2	Note 2	Note 2

NOTE 1:  $I_o$  is assumed to have constant EPRE across the bandwidth.  
 NOTE 2: The same bands and the same  $I_o$  conditions for each band apply for this requirement as for the corresponding highest accuracy requirement.  
 NOTE 3: NR operating band groups in FR1 are as defined in clause 3.5.2.

### 10.1.7B Intra-frequency RSRQ accuracy requirements for FR1 for CA/DC Idle Mode Measurements

#### 10.1.7B.1 Intra-frequency SS-RSRQ accuracy requirements in FR1

The requirements in this clause are applicable for a UE:

- in state RRC\_IDLE or RRC\_INACTIVE
- that is synchronised to the cell that is measured.

The requirements are for absolute accuracy of SS-RSRQ.

##### 10.1.7B.1.1 Absolute SS-RSRQ Accuracy in FR1

Unless otherwise specified, the requirements for absolute accuracy of SS-RSRQ in this clause apply to the serving cell in FR1.

The accuracy requirements in Table 10.1.7B.1.1-1 are valid under the following conditions:

- Conditions defined in clause 7.3 of TS 38.101-1 [18] for reference sensitivity are fulfilled.
- Conditions for intra-frequency measurements are fulfilled according to Annex B.1.2 for a corresponding Band for each relevant SSB.

**Table 10.1.7B.1.1-1: SS-RSRQ Intra frequency absolute accuracy in FR1**

Accuracy		Conditions			
Normal condition	Extreme condition	SSB $\hat{\epsilon}_s/\text{lot}$	$I_o$ <sup>Note 1</sup> range		
			NR operating band groups <sup>Note 3</sup>	Minimum $I_o$	

dB	dB	dB		dBm / SCS <sub>SSB</sub>		dBm/BW <sub>Channel</sub>	dBm/BW <sub>Channel</sub>
				SCS <sub>SSB</sub> = 15 kHz	SCS <sub>SSB</sub> = 30 kHz		
±4	±5.5	≥3	NR_FDD_FR1_A, NR_TDD_FR1_A, NR_SDL_FR1_A	-121	-118	N/A	-50
			NR_FDD_FR1_B	-120.5	-117.5	N/A	-50
			NR_TDD_FR1_C	-120	-117	N/A	-50
			NR_FDD_FR1_D, NR_TDD_FR1_D	-119.5	-116.5	N/A	-50
			NR_FDD_FR1_E, NR_TDD_FR1_E	-119	-116	N/A	-50
			NR_FDD_FR1_F	-118.5	-115.5	N/A	-50
			NR_FDD_FR1_G	-118	-115	N/A	-50
			NR_FDD_FR1_H	-117.5	-114.5	N/A	-50
±5	±5.5	≥4	Note 2	Note 2	Note 2	Note 2	Note 2

NOTE 1:  $I_0$  is assumed to have constant EPRE across the bandwidth.  
 NOTE 2: The same bands and the same  $I_0$  conditions for each band apply for this requirement as for the corresponding highest accuracy requirement.  
 NOTE 3: NR operating band groups in FR1 are as defined in clause 3.5.2.

### 10.1.8 Intra-frequency RSRQ accuracy requirements for FR2

#### 10.1.8.1 Intra-frequency SS-RSRQ accuracy requirements in FR2

##### 10.1.8.1.1 Absolute SS-RSRQ Accuracy in FR2

Unless otherwise specified, the requirements for absolute accuracy of SS-RSRQ in this clause apply to a cell on the same frequency as that of the serving cell in FR2.

The accuracy requirements in Table 10.1.8.1.1-1 are valid under the following conditions:

- Conditions defined in clause 7.3 of TS 38.101-2 [19] for reference sensitivity are fulfilled.
- Conditions for intra-frequency measurements are fulfilled according to Annex B.2.2 for a corresponding Band for each relevant SSB.
- The measured signals are in the directions covered by the percentile EIS spherical coverage of the UE, defined in clause 7.3.4 of TS 38.101-2 [19].

**Table 10.1.8.1.1-1: SS-RSRQ Intra frequency absolute accuracy in FR2**

Accuracy		Conditions			
Normal condition	Extreme condition	SSB $\hat{E}_s/\text{lot}$	$I_0$ <sup>Note 2</sup> range		Maximum $I_0$ dBm/BW <sub>Channel</sub>
			Minimum $I_0$ dBm / SCS <sub>SSB</sub> <sup>Note 1</sup>		
dB	dB	dB	SCS <sub>SSB</sub> = 120kHz	SCS <sub>SSB</sub> = 240kHz	dBm/BW <sub>Channel</sub>
			±2.5	±4	
±3.5	±4	≥-6			

Note 1: Values based on Refsens and EIS spherical coverage as defined in clauses 7.3.2 and 7.3.4 of TS 38.101-2 [19]. Applicable side condition selected depending on angle of arrival.  
 Note 2:  $I_0$  specified at the Reference point, and assumed to have constant EPRE across the bandwidth.  
 Note 3: In the test cases, the SSB  $\hat{E}_s/\text{lot}$  and related parameters may need to be adjusted to ensure  $\hat{E}_s/\text{lot}$  at UE baseband is above the value defined in this table.

## 10.1.8.2 Intra-frequency CSI-RSRQ accuracy requirements

### 10.1.8.2.1 Absolute CSI-RSRQ Accuracy

Unless otherwise specified, the requirements for absolute accuracy of CSI-RSRQ in this clause apply to the intra-frequency measurement defined in 9.10.2.1 in FR2.

The accuracy requirements in Table 10.1.8.2.1-1 are valid under the following conditions:

- Conditions defined in clause 7.3 of TS 38.101-2 [19] for reference sensitivity are fulfilled.
- Conditions for intra-frequency measurements are fulfilled according to Annex B.2.2 for a corresponding Band for each relevant SSB.
- Conditions for intra-frequency measurements are fulfilled according to Annex B.2.12 for a corresponding Band for each relevant CSI-RS.
- The bandwidth of CSI-RS is 48 PRBs and the density is 3.

The performance with larger bandwidth of CSI-RS is equal to or better than the accuracy requirements in Table 10.1.8.2.1-1.

- The timing offset between the reference measurement timing and the target CSI-RS in one layer is no larger than CP.

Note: The reference measurement timing for one layer for intra-frequency measurement is serving cell timing.

- The measured signals are in the directions covered by the percentile EIS spherical coverage of the UE, defined in clause 7.3.4 of TS 38.101-2 [19].

**Table 10.1.8.2.1-1: CSI-RSRQ Intra frequency absolute accuracy in FR2**

Accuracy		Conditions		
Normal condition	Extreme condition	CSI-RS $\hat{E}_s/\text{lot}$	$I_0$ <sup>Note 2</sup> range	
			Minimum $I_0$	Maximum $I_0$
dB	dB	dB	$\text{dBm} / \text{SCS}_{\text{CSI-RS}}$ <sup>Note 1</sup>	
			$\text{SCS}_{\text{CSI-RS}} = 60\text{kHz}$	$\text{SCS}_{\text{CSI-RS}} = 120\text{kHz}$
$\pm 2.5$	$\pm 4$	$\geq -3$	Same value as CSI_RP in Table B.2.12-2, according to UE Power class, operating band and angle of arrival	
$\pm 3.5$	$\pm 4$	$\geq -6$		
-50				
Note 1: Values based on Refsens and EIS spherical coverage as defined in clauses 7.3.2 and 7.3.4 of TS 38.101-2 [19]. Applicable side condition selected depending on angle of arrival. Note 2: $I_0$ specified at the Reference point, and assumed to have constant EPRE across the bandwidth. Note 3: In the test cases, the CSI-RS $\hat{E}_s/\text{lot}$ and related parameters may need to be adjusted to ensure $\hat{E}_s/\text{lot}$ at UE baseband is above the value defined in this table.				

## 10.1.8B Intra-frequency RSRQ accuracy requirements for FR2 for CA/DC Idle Mode Measurements

### 10.1.8B.1 Intra-frequency SS-RSRQ accuracy requirements in FR2

The requirements in this clause are applicable for a UE:

- in state RRC\_IDLE or RRC\_INACTIVE
- that is synchronised to the cell that is measured.

The requirements are for absolute accuracy of SS-RSRQ.

### 10.1.8B.1.1 Absolute SS-RSRQ Accuracy in FR2

Unless otherwise specified, the requirements for absolute accuracy of SS-RSRQ in this clause apply to the serving cell in FR2.

The accuracy requirements in Table 10.1.8B.1.1-1 are valid under the following conditions:

- Conditions defined in clause 7.3 of TS 38.101-2 [19] for reference sensitivity are fulfilled.
- Conditions for intra-frequency measurements are fulfilled according to Annex B.1.2 for a corresponding Band for each relevant SSB.
- The measured signals are in the directions covered by the percentile EIS spherical coverage of the UE, defined in clause 7.3.4 of TS 38.101-2 [19].

**Table 10.1.8B.1.1-1: SS-RSRQ Intra frequency absolute accuracy in FR2**

Accuracy		Conditions			
Normal condition	Extreme condition	SSB $\hat{E}_s/\text{lot}$	$I_o$ <sup>Note 2</sup> range		Maximum $I_o$ dBm/BW <sub>Channel</sub>
			Minimum $I_o$		
dB	dB	dB	dBm / SCS <sub>SSB</sub> <sup>Note 1</sup>		dBm/BW <sub>Channel</sub>
			SCS <sub>SSB</sub> = 120kHz	SCS <sub>SSB</sub> = 240kHz	
±4	±5.5	≥-3	Same value as SSB_RP in Table B.2.2-2, according to UE Power class, operating band and angle of arrival		-50
±5	±5.5	≥-4			
Note 1: Values based on Refsens and EIS spherical coverage as defined in clauses 7.3.2 and 7.3.4 of TS 38.101-2 [19]. Applicable side condition selected depending on angle of arrival. Note 2: $I_o$ specified at the Reference point, and assumed to have constant EPRE across the bandwidth. Note 3: In the test cases, the SSB $\hat{E}_s/\text{lot}$ and related parameters may need to be adjusted to ensure $\hat{E}_s/\text{lot}$ at UE baseband is above the value defined in this table.					

## 10.1.9 Inter-frequency RSRQ accuracy requirements for FR1

### 10.1.9.1 Inter-frequency SS-RSRQ accuracy requirements in FR1

#### 10.1.9.1.1 Absolute Accuracy of SS-RSRQ in FR1

The requirements for absolute accuracy of SS-RSRQ in this clause apply to a cell on a frequency in FR1 that has different carrier frequency from the serving cell.

The accuracy requirements in Table 10.1.9.1.1-1 are valid under the following conditions:

- Conditions defined in clause 7.3 of TS 38.101-1 [18] for reference sensitivity are fulfilled.
- Conditions for inter-frequency measurements are fulfilled according to Annex B.2.3 for a corresponding Band for each relevant SSB.

**Table 10.1.9.1.1-1: SS-RSRQ Inter frequency absolute accuracy in FR1**

Accuracy		Conditions					
Normal condition	Extreme condition	SSB $\hat{E}_s/\text{lot}$	$I_o$ <sup>Note 1</sup> range				
			NR operating band groups <sup>Note 3</sup>	Minimum $I_o$		Maximum $I_o$	
dB	dB	dB		dBm / SCS <sub>SSB</sub>		dBm/BW <sub>Channel</sub>	dBm/BW <sub>Channel</sub>
			SCS <sub>SSB</sub> = 15 kHz	SCS <sub>SSB</sub> = 30 kHz			
			NR_FDD_FR1_A, NR_TDD_FR1_A,	-121	-118	N/A	-50

±2.5	±4	≥3	NR_SDL_FR1_A				
			NR_FDD_FR1_B	-120.5	-117.5	N/A	-50
			NR_TDD_FR1_C	-120	-117	N/A	-50
			NR_FDD_FR1_D, NR_TDD_FR1_D	-119.5	-116.5	N/A	-50
			NR_FDD_FR1_E, NR_TDD_FR1_E	-119	-116	N/A	-50
			NR_FDD_FR1_F	-118.5	-115.5	N/A	-50
			NR_FDD_FR1_G	-118	-115	N/A	-50
			NR_FDD_FR1_H	-117.5	-114.5	N/A	-50
±3.5	±4	≥6	Note 2	Note 2	Note 2	Note 2	Note 2

NOTE 1:  $I_o$  is assumed to have constant EPRE across the bandwidth.  
 NOTE 2: The same bands and the same  $I_o$  conditions for each band apply for this requirement as for the corresponding highest accuracy requirement.  
 NOTE 3: NR operating band groups in FR1 are as defined in clause 3.5.2.

10.1.9.1.2 Relative Accuracy of SS-RSRQ in FR1

The relative accuracy of SS-RSRQ in inter frequency case is defined as the RSRQ measured from one cell on a frequency in FR1 compared to the RSRP measured from another cell on a different frequency in FR1.

The accuracy requirements in Table 10.1.9.1.2-1 are valid under the following conditions:

- Conditions defined in clause 7.3 of TS 38.101-1 [18] for reference sensitivity are fulfilled.
- Conditions for inter-frequency measurements are fulfilled according to Annex B.2.3 for a corresponding Band for each relevant SSB.
- $|SSB\_RP1_{dBm} - SSB\_RP2_{dBm}| \leq 27$  dB
- $|Channel\ 1\_I_o - Channel\ 2\_I_o| \leq 20$  dB

Table 10.1.9.1.2-1: SS-RSRQ Inter frequency relative accuracy in FR1

Accuracy		Conditions					
Normal condition	Extreme condition	SSB $\hat{E}s/lot$ Note 2	$I_o$ Note 1 range				
			NR operating band groups Note 4	Minimum $I_o$		Maximum $I_o$	
dB	dB	dB		dBm / $SCS_{SSB}$			dBm/ $BW_{Channel}$
			$SCS_{SSB} = 15$ kHz	$SCS_{SSB} = 30$ kHz			
±3	±4	≥3	NR_FDD_FR1_A, NR_TDD_FR1_A, NR_SDL_FR1_A	-121	-118	N/A	-50
			NR_FDD_FR1_B	-120.5	-117.5	N/A	-50
			NR_TDD_FR1_C	-120	-117	N/A	-50
			NR_FDD_FR1_D, NR_TDD_FR1_D	-119.5	-116.5	N/A	-50
			NR_FDD_FR1_E, NR_TDD_FR1_E	-119	-116	N/A	-50
			NR_FDD_FR1_F	-118.5	-115.5	N/A	-50
			NR_FDD_FR1_G	-118	-115	N/A	-50
			NR_FDD_FR1_H	-117.5	-114.5	N/A	-50
±4	±4	≥6	Note 3	Note 3	Note 3	Note 3	Note 3

NOTE 1:  $I_o$  is assumed to have constant EPRE across the bandwidth.  
 NOTE 2: The parameter SSB  $\hat{E}s/lot$  is the minimum SSB  $\hat{E}s/lot$  of the pair of cells to which the requirement applies.  
 NOTE 3: The same bands and the same  $I_o$  conditions for each band apply for this requirement as for the corresponding highest accuracy requirement.  
 NOTE 4: NR operating band groups in FR1 are as defined in clause 3.5.2.



### 10.1.9.2 Inter-frequency CSI-RSRQ accuracy requirements

#### 10.1.9.2.1 Absolute CSI-RSRQ Accuracy

Unless otherwise specified, the requirements for absolute accuracy of CSI-RSRQ in this clause apply to the inter-frequency measurement defined in 9.10.3.1 in FR1.

The accuracy requirements in Table 10.1.9.2.1-1 are valid under the following conditions:

- Conditions defined in clause 7.3 of TS 38.101-1 [18] for reference sensitivity are fulfilled.
- Conditions for inter-frequency measurements are fulfilled according to Annex B.2.3 for a corresponding Band for associated SSB.
- Conditions for inter-frequency measurements are fulfilled according to Annex B.2.13 for a corresponding Band for each relevant CSI-RS.
- The bandwidth of CSI-RS is 48 PRBs and the density is 3.

The performance with larger bandwidth of CSI-RS is equal to or better than the accuracy requirements in Table 10.1.9.2.1-1.

- The timing offset between the reference measurement timing and the target CSI-RS in one layer is no larger than CP.
- Note: The reference measurement timing for one layer for inter-frequency measurement is up to UE implementation and shall be based on the timing of one of the target cells.

**Table 10.1.9.2.1-1: CSI-RSRQ Inter frequency absolute accuracy in FR1**

Accuracy		Conditions						
Normal condition	Extreme condition	CSI-RS $\hat{E}_s/\text{lot}$	$I_o$ <sup>Note 1</sup> range					Maximum $I_o$
			NR operating band groups <sup>Note 3</sup>	Minimum $I_o$			$\text{dBm}/\text{BW}_{\text{Channel}}$	
dB	dB	dB		$\text{dBm} / \text{SCS}_{\text{CSI-RS}}$				$\text{dBm}/\text{BW}_{\text{Channel}}$
				$\text{SCS}_{\text{CSI-RS}} = 15 \text{ kHz}$	$\text{SCS}_{\text{CSI-RS}} = 30 \text{ kHz}$	$\text{SCS}_{\text{CSI-RS}} = 60 \text{ kHz}$		
$\pm 2.5$	$\pm 4$	$\geq -3$	NR_FDD_FR1_A, NR_TDD_FR1_A, NR_SDL_FR1_A	-121	-118	-115	N/A	-50
			NR_FDD_FR1_B	-120.5	-117.5	-114.5	N/A	-50
			NR_TDD_FR1_C	-120	-117	-114	N/A	-50
			NR_FDD_FR1_D, NR_TDD_FR1_D	-119.5	-116.5	-113.5	N/A	-50
			NR_FDD_FR1_E, NR_TDD_FR1_E	-119	-116	-113	N/A	-50
			NR_FDD_FR1_F	-118.5	-115.5	-112.5	N/A	-50
			NR_FDD_FR1_G	-118	-115	-112	N/A	-50
			NR_FDD_FR1_H	-117.5	-114.5	-111.5	N/A	-50
$\pm 3.5$	$\pm 4$	$\geq -6$	Note 2	Note 2	Note 2	Note 2	Note 2	Note 2

NOTE 1:  $I_o$  is assumed to have constant EPRE across the bandwidth.  
 NOTE 2: The same bands and the same  $I_o$  conditions for each band apply for this requirement as for the corresponding highest accuracy requirement.  
 NOTE 3: NR operating band groups in FR1 are as defined in clause 3.5.2.

10.1.9.2.2 Relative CSI-RSRQ Accuracy

The relative accuracy of CSI-RSRQ is defined as the CSI-RSRQ measured from one cell compared to the CSI-RSRQ measured from another cell with the same center frequency, or between any two CSI-RSRQ levels measured on the same cell in FR1.

The accuracy requirements in Table 10.1.9.2.2-1 are valid under the following conditions:

- Conditions defined in clause 7.3 of TS 38.101-1 [18] for reference sensitivity are fulfilled.
- Conditions for inter-frequency measurements are fulfilled according to Annex B.2.3 for a corresponding Band for the associated SSB.
- Conditions for inter-frequency measurements are fulfilled according to Annex B.2.13 for a corresponding Band for each relevant CSI-RS.
- The bandwidth of CSI-RS is 48 PRBs and the density is 3.

The performance with larger bandwidth of CSI-RS is equal to or better than the accuracy requirements in Table 10.1.9.2.2-1.

- The timing offset between the reference measurement timing and the target CSI-RS in one layer is no larger than CP.

Note: The reference measurement timing for one layer for inter-frequency measurement is up to UE implementation and shall be based on the timing of one of the target cells.

Table 10.1.9.2.2-1: CSI-RSRQ Inter frequency relative accuracy in FR1

Accuracy		Conditions						
Normal condition	Extreme condition	CSI-RS $\hat{E}_s/\text{lot}$ Note 2	$l_0$ Note 1 range					Maximum $l_0$
			NR operating band groups Note 4	Minimum $l_0$			dBm/BW <sub>Channel</sub>	
				dBm / SCS <sub>CSI-RS</sub>				
dB	dB	dB		SCS <sub>CSI-RS</sub> = 15 kHz	SCS <sub>CSI-RS</sub> = 30 kHz	SCS <sub>CSI-RS</sub> = 60 kHz	dBm/BW <sub>Channel</sub>	
±3	±4	≥-3	NR_FDD_FR1_A, NR_TDD_FR1_A, NR_SDL_FR1_A	-121	-118	-115	N/A	-50
			NR_FDD_FR1_B	-120.5	-117.5	-114.5	N/A	-50
			NR_TDD_FR1_C	-120	-117	-114	N/A	-50
			NR_FDD_FR1_D, NR_TDD_FR1_D	-119.5	-116.5	-113.5	N/A	-50
			NR_FDD_FR1_E, NR_TDD_FR1_E	-119	-116	-113	N/A	-50
			NR_FDD_FR1_F	-118.5	-115.5	-112.5	N/A	-50
			NR_FDD_FR1_G	-118	-115	-112	N/A	-50
			NR_FDD_FR1_H	-117.5	-114.5	-111.5	N/A	-50
±4	±4	≥-6	Note 3	Note 3	Note 3	Note 3	Note 3	Note 3

NOTE 1:  $l_0$  is assumed to have constant EPRE across the bandwidth.  
 NOTE 2: The parameter CSI-RS  $\hat{E}_s/\text{lot}$  is the minimum CSI-RS  $\hat{E}_s/\text{lot}$  of the pair of cells to which the requirement applies.  
 NOTE 3: The same bands and the same  $l_0$  conditions for each band apply for this requirement as for the corresponding highest accuracy requirement.  
 NOTE 4: NR operating band groups in FR1 are as defined in clause 3.5.2.

### 10.1.9B Inter-frequency RSRQ accuracy requirements for FR1 for CA/DC Idle Mode Measurements

#### 10.1.9B.1 Inter-frequency SS-RSRQ accuracy requirements in FR1

The requirements in this clause are applicable for a UE:

- in state RRC\_IDLE or RRC\_INACTIVE
- that is synchronised to the cell that is measured.

The requirements are for absolute accuracy of SS-RSRQ.

##### 10.1.9B.1.1 Absolute Accuracy of SS-RSRQ in FR1

The requirements for absolute accuracy of SS-RSRQ in this clause apply to a cell on a frequency in FR1 that has different carrier frequency from the serving cell.

The accuracy requirements in Table 10.1.9B.1.1-1 are valid under the following conditions:

- Conditions defined in clause 7.3 of TS 38.101-1 [18] for reference sensitivity are fulfilled.
- Conditions for inter-frequency measurements are fulfilled according to Annex B.1.3 for a corresponding Band for each relevant SSB.

**Table 10.1.9B.1.1-1: SS-RSRQ Inter frequency absolute accuracy in FR1**

Accuracy		Conditions					
Normal condition	Extreme condition	SSB $\hat{E}_s/\text{lot}$	$I_o$ <sup>Note 1</sup> range				
			NR operating band groups <sup>Note 3</sup>	Minimum $I_o$		Maximum $I_o$	
dB	dB	dB		dBm / $SCS_{SSB}$		dBm/BW <sub>Channel</sub>	dBm/BW <sub>Channel</sub>
				$SCS_{SSB} = 15 \text{ kHz}$	$SCS_{SSB} = 30 \text{ kHz}$		
$\pm 4$	$\pm 5.5$	$\geq 3$	NR_FDD_FR1_A, NR_TDD_FR1_A, NR_SDL_FR1_A	-121	-118	N/A	-50
			NR_FDD_FR1_B	-120.5	-117.5	N/A	-50
			NR_TDD_FR1_C	-120	-117	N/A	-50
			NR_FDD_FR1_D, NR_TDD_FR1_D	-119.5	-116.5	N/A	-50
			NR_FDD_FR1_E, NR_TDD_FR1_E	-119	-116	N/A	-50
			NR_FDD_FR1_F	-118.5	-115.5	N/A	-50
			NR_FDD_FR1_G	-118	-115	N/A	-50
			NR_FDD_FR1_H	-117.5	-114.5	N/A	-50
$\pm 5$	$\pm 5.5$	$\geq 4$	Note 2	Note 2	Note 2	Note 2	Note 2

NOTE 1:  $I_o$  is assumed to have constant EPRE across the bandwidth.  
 NOTE 2: The same bands and the same  $I_o$  conditions for each band apply for this requirement as for the corresponding highest accuracy requirement.  
 NOTE 3: NR operating band groups in FR1 are as defined in clause 3.5.2.

## 10.1.10 Inter-frequency RSRQ accuracy requirements for FR2

### 10.1.10.1 Inter-frequency SS-RSRQ accuracy requirements in FR2

#### 10.1.10.1.1 Absolute Accuracy of SS-RSRQ in FR2

The requirements for absolute accuracy of SS-RSRQ in this clause apply to a cell on a frequency in FR2 that has different carrier frequency from the serving cell.

The accuracy requirements in Table 10.1.10.1.1-1 are valid under the following conditions:

- Conditions defined in clause 7.3 of TS 38.101-2 [19] for reference sensitivity are fulfilled.
- Conditions for inter-frequency measurements are fulfilled according to Annex B.2.3 for a corresponding Band for each relevant SSB.
- The measured signals are in the directions covered by the percentile EIS spherical coverage of the UE, defined in clause 7.3.4 of TS 38.101-2 [19].

**Table 10.1.10.1.1-1: SS-RSRQ Inter frequency absolute accuracy in FR2**

Accuracy		Conditions		
Normal condition	Extreme condition	SSB $\hat{E}_s/\text{lot}$	$I_o$ <sup>Note 2</sup> range	
			Minimum $I_o$	
dB	dB	dB	dBm / $SCS_{SSB}$ <sup>Note 1</sup>	
			$SCS_{SSB} = 120\text{kHz}$	$SCS_{SSB} = 240\text{kHz}$
$\pm 2.5$	$\pm 4$	$\geq -3$	Same value as SSB_RP in Table B.2.2-2, according to UE Power class, operating band and angle of arrival	
$\pm 3.5$	$\pm 4$	$\geq -4$		
			dBm/ $BW_{\text{Channel}}$	
			-50	

Note 1: Values based on Refsens and EIS spherical coverage as defined in clauses 7.3.2 and 7.3.4 of TS 38.101-2 [19]. Applicable side condition selected depending on angle of arrival.  
 Note 2:  $I_o$  specified at the Reference point, and assumed to have constant EPRE across the bandwidth.  
 Note 3: In the test cases, the SSB  $\hat{E}_s/\text{lot}$  and related parameters may need to be adjusted to ensure  $\hat{E}_s/\text{lot}$  at UE baseband is above the value defined in this table.

#### 10.1.10.1.2 Relative Accuracy of SS-RSRQ in FR2

The relative accuracy of SS-RSRQ in inter frequency case is defined as the RSRQ measured from one cell on a frequency in FR2 compared to the RSRP measured from another cell on a different frequency in FR2.

The accuracy requirements in Table 10.1.10.1.2-1 are valid under the following conditions:

- Conditions defined in clause 7.3 of TS 38.101-2 [19] for reference sensitivity are fulfilled.
- Conditions for inter-frequency measurements are fulfilled according to Annex B.2.3 for a corresponding Band for each relevant SSB.
- $|SSB\_RP1_{\text{dBm}} - SSB\_RP2_{\text{dBm}}| \leq 27 \text{ dB}$
- $| \text{Channel 1 } I_o - \text{Channel 2 } I_o | \leq 20 \text{ dB}$
- The measured signals are in the directions covered by the percentile EIS spherical coverage of the UE, defined in clause 7.3.4 of TS 38.101-2 [19].

**Table 10.1.10.1.2-1: SS-RSRQ Inter frequency relative accuracy in FR2**

Accuracy	Conditions
----------	------------

Normal condition	Extreme condition	SSB $\hat{E}_s/\text{lot}$	$I_o$ <sup>Note 2</sup> range		
			Minimum $I_o$		Maximum $I_o$
			dBm / $SCS_{SSB}$ <sup>Note 1</sup>		
dB	dB	dB	$SCS_{SSB} = 120\text{kHz}$	$SCS_{SSB} = 240\text{kHz}$	
$\pm 3$	$\pm 4$	$\geq -3$	Same value as SSB_RP in Table B.2.2-2, according to UE Power class, operating band and angle of arrival		-50
$\pm 4$	$\pm 4$	$\geq -4$			
Note 1: Values based on Refsens and EIS spherical coverage as defined in clauses 7.3.2 and 7.3.4 of TS 38.101-2 [19]. Applicable side condition selected depending on angle of arrival. Note 2: $I_o$ specified at the Reference point, and assumed to have constant EPRE across the bandwidth. Note 3: The parameter SSB $\hat{E}_s/\text{lot}$ is the minimum SSB $\hat{E}_s/\text{lot}$ of the pair of cells to which the requirement applies. Note 4: In the test cases, the SSB $\hat{E}_s/\text{lot}$ and related parameters may need to be adjusted to ensure $\hat{E}_s/\text{lot}$ at UE baseband is above the value defined in this table.					

### 10.1.10.2 Inter-frequency CSI-RSRQ accuracy requirements

#### 10.1.10.2.1 Absolute CSI-RSRQ Accuracy

Unless otherwise specified, the requirements for absolute accuracy of CSI-RSRQ in this clause apply the inter-frequency measurement defined in 9.10.3.1 in FR2.

The accuracy requirements in Table 10.1.10.2.1-1 are valid under the following conditions:

- Conditions defined in clause 7.3 of TS 38.101-2 [19] for reference sensitivity are fulfilled.
- Conditions for inter-frequency measurements are fulfilled according to Annex B.2.3 for a corresponding Band for associated SSB.
- Conditions for inter-frequency measurements are fulfilled according to Annex B.2.13 for a corresponding Band for each relevant CSI-RS.
- The bandwidth of CSI-RS is 48 PRBs and the density is 3.

The performance with larger bandwidth of CSI-RS is equal to or better than the accuracy requirements in Table 10.1.10.2.1-1.

- The timing offset between the reference measurement timing and the target CSI-RS in one layer is no larger than CP.

Note: The reference measurement timing for one layer for inter-frequency measurement is up to UE implementation and shall be based on the timing of one of the target cells.

**Table 10.1.10.2.1-1: CSI-RSRQ Inter frequency absolute accuracy in FR2**

Accuracy		CSI-RS $\hat{E}_s/\text{lot}$	Conditions		
Normal condition	Extreme condition		$I_o$ <sup>Note 2</sup> range		
			Minimum $I_o$		Maximum $I_o$
dB	dB	dB	dBm / $SCS_{CSI-RS}$ <sup>Note 1</sup>		
			$SCS_{CSI-RS} = 60\text{kHz}$	$SCS_{CSI-RS} = 120\text{kHz}$	
$\pm 2.5$	$\pm 4$	$\geq -3$	Same value as CSI_RP in Table B.2.13-2, according to UE Power class, operating band and angle of arrival		-50

$\pm 3.5$	$\pm 4$	$\geq -4$	
<p>Note 1: Values based on Refsens and EIS spherical coverage as defined in clauses 7.3.2 and 7.3.4 of TS 38.101-2 [19]. Applicable side condition selected depending on angle of arrival.</p> <p>Note 2: <math>I_0</math> specified at the Reference point, and assumed to have constant EPRE across the bandwidth.</p> <p>Note 3: In the test cases, the CSI-RS <math>\hat{E}_s/I_0</math> and related parameters may need to be adjusted to ensure <math>\hat{E}_s/I_0</math> at UE baseband is above the value defined in this table.</p>			

### 10.1.10.2.2 Relative CSI-RSRQ Accuracy

The relative accuracy of CSI-RSRQ is defined as the CSI-RSRQ measured from one cell compared to the CSI-RSRQ measured from another cell with the same center frequency, or between any two CSI-RSRQ levels measured on the same cell in FR2.

The accuracy requirements in Table 10.1.10.2.2-1 are valid under the following conditions:

- Conditions defined in clause 7.3 of TS 38.101-2 [19] for reference sensitivity are fulfilled.
- Conditions for inter-frequency measurements are fulfilled according to Annex B.2.3 for a corresponding Band for the associated SSB.
- Conditions for inter-frequency measurements are fulfilled according to Annex B.2.13 for a corresponding Band for each relevant CSI-RS.
- The bandwidth of CSI-RS is 48 PRBs and the density is 3.

The performance with larger bandwidth of CSI-RS is equal to or better than the accuracy requirements in Table 10.1.10.2.2-1.

- The timing offset between the reference measurement timing and the target CSI-RS in one layer is no larger than CP.

Note: The reference measurement timing for one layer for inter-frequency measurement is up to UE implementation and shall be based on the timing of one of the target cells.

**Table 10.1.10.2.2-1: CSI-RSRQ Inter frequency relative accuracy in FR2**

Accuracy		Conditions		
Normal condition	Extreme condition	CSI-RS $\hat{E}_s/I_0$	$I_0$ <sup>Note 2</sup> range	
			Minimum $I_0$	Maximum $I_0$
dB	dB	dB	<sup>Note 1</sup>	
			dBm / $SCS_{CSI-RS}$	dBm/BW <sub>Channel</sub>
			$SCS_{CSI-RS} = 60\text{kHz}$	$SCS_{CSI-RS} = 120\text{kHz}$
$\pm 3$	$\pm 4$	$\geq -3$	Same value as CSI_RP in Table B.2.13-2, according to UE Power class, operating band and angle of arrival	
$\pm 4$	$\pm 4$	$\geq -4$		
<p>Note 1: Values based on Refsens and EIS spherical coverage as defined in clauses 7.3.2 and 7.3.4 of TS 38.101-2 [19]. Applicable side condition selected depending on angle of arrival.</p> <p>Note 2: <math>I_0</math> specified at the Reference point, and assumed to have constant EPRE across the bandwidth.</p> <p>Note 3: The parameter CSI-RS <math>\hat{E}_s/I_0</math> is the minimum CSI-RS <math>\hat{E}_s/I_0</math> of the pair of cells to which the requirement applies.</p> <p>Note 4: In the test cases, the CSI-RS <math>\hat{E}_s/I_0</math> and related parameters may need to be adjusted to ensure <math>\hat{E}_s/I_0</math> at UE baseband is above the value defined in this table.</p>				

## 10.1.10 Inter-frequency RSRQ accuracy requirements for FR2 for CA/DC Idle Mode Measurements

### 10.1.10B.1 Inter-frequency SS-RSRQ accuracy requirements in FR2

The requirements in this clause are applicable for a UE:

- in state RRC\_IDLE or RRC\_INACTIVE
- that is synchronised to the cell that is measured.

The requirements are for absolute accuracy of SS-RSRQ.

#### 10.1.10B.1.1 Absolute Accuracy of SS-RSRQ in FR2

The requirements for absolute accuracy of SS-RSRQ in this clause apply to a cell on a frequency in FR2 that has different carrier frequency from the serving cell.

The accuracy requirements in Table 10.1.10B.1.1-1 are valid under the following conditions:

- Conditions defined in clause 7.3 of TS 38.101-2 [19] for reference sensitivity are fulfilled.
- Conditions for inter-frequency measurements are fulfilled according to Annex B.1.3 for a corresponding Band for each relevant SSB.
- The measured signals are in the directions covered by the percentile EIS spherical coverage of the UE, defined in clause 7.3.4 of TS 38.101-2 [19].

**Table 10.1.10B.1.1-1: SS-RSRQ Inter frequency absolute accuracy in FR2**

Accuracy		Conditions		
Normal condition	Extreme condition	SSB $\hat{E}_s/\text{lot}$	$I_o$ <sup>Note 2</sup> range	
dB	dB		dBm / $SCS_{SSB}$ <sup>Note 1</sup>	
			Minimum $I_o$	Maximum $I_o$
			$SCS_{SSB} = 120\text{kHz}$	$SCS_{SSB} = 240\text{kHz}$
$\pm 4$	$\pm 5.5$	$\geq -3$	Same value as SSB_RP in Table B.2.2-2, according to UE Power class, operating band and angle of arrival	
$\pm 5$	$\pm 5.5$	$\geq -4$		
Note 1: Values based on Refsens and EIS spherical coverage as defined in clauses 7.3.2 and 7.3.4 of TS 38.101-2 [19]. Applicable side condition selected depending on angle of arrival. Note 2: $I_o$ specified at the Reference point, and assumed to have constant EPRE across the bandwidth. Note 3: In the test cases, the SSB $\hat{E}_s/\text{lot}$ and related parameters may need to be adjusted to ensure $\hat{E}_s/\text{lot}$ at UE baseband is above the value defined in this table.				

## 10.1.11 RSRQ report mapping

### 10.1.11.1 SS-RSRQ and CSI-RSRQ measurement report mapping

The reporting range of SS-RSRQ and CSI-RSRQ measurement is defined from -43 dB to 20 dB with 0.5 dB resolution. The mapping of measured quantity is defined in Table 10.1.11.1-1. The range in the signalling may be larger than the guaranteed accuracy range.

Table 10.1.11.1-1: SS-RSRQ and CSI-RSRQ measurement report mapping

Reported value	Measured quantity value	Unit
SS-RSRQ_0	SS-RSRQ<-43	dB
SS-RSRQ_1	-43 ≤ SS-RSRQ<-42.5	dB
SS-RSRQ_2	-42.5 ≤ SS-RSRQ<-42	dB
SS-RSRQ_3	-42 ≤ SS-RSRQ<-41.5	dB
SS-RSRQ_4	-41.5 ≤ SS-RSRQ<-41	dB
..	..	...
SS-RSRQ_122	17.5 ≤ SS-RSRQ<18	dB
SS-RSRQ_123	18 ≤ SS-RSRQ<18.5	dB
SS-RSRQ_124	18.5 ≤ SS-RSRQ<19	dB
SS-RSRQ_125	19 ≤ SS-RSRQ<19.5	dB
SS-RSRQ_126	19.5 ≤ SS-RSRQ<20	dB
SS-RSRQ_127	20 ≤ SS-RSRQ	dB

## 10.1.12 Intra-frequency SINR accuracy requirements for FR1

### 10.1.12.1 Intra-frequency SS-SINR accuracy requirements in FR1

#### 10.1.12.1.1 Absolute SS-SINR Accuracy in FR1

Unless otherwise specified, the requirements for absolute accuracy of SS-SINR in this clause apply to a cell on the same frequency as that of the serving cell in FR1.

The accuracy requirements in Table 10.1.12.1.1-1 are valid under the following conditions:

- Conditions defined in clause 7.3 of TS 38.101-1 [18] for reference sensitivity are fulfilled.
- Conditions for intra-frequency measurements are fulfilled according to Annex B.2.2 for a corresponding Band.

Table 10.1.12.1.1-1: SS-SINR Intra frequency absolute accuracy in FR1

Accuracy		Conditions					
Normal condition	Extreme condition	SSB $\hat{E}_s/\text{lot}$ Note 3	$I_0$ <sup>Note 1</sup> range				
			NR operating band groups Note 4	Minimum $I_0$		Maximum $I_0$	
dB	dB	dB		dBm / $SCS_{SSB}$		dBm/ $BW_{\text{Channel}}$	dBm/ $BW_{\text{Channel}}$
			$SCS_{SSB} = 15 \text{ kHz}$	$SCS_{SSB} = 30 \text{ kHz}$			
±3.0	±4	≥3	NR_FDD_FR1_A, NR_TDD_FR1_A, NR_SDL_FR1_A	-121	-118	N/A	-50
			NR_FDD_FR1_B	-120.5	-117.5	N/A	-50
			NR_TDD_FR1_C	-120	-117	N/A	-50
			NR_FDD_FR1_D, NR_TDD_FR1_D	-119.5	-116.5	N/A	-50
			NR_FDD_FR1_E, NR_TDD_FR1_E	-119	-116	N/A	-50
			NR_FDD_FR1_F	-118.5	-115.5	N/A	-50
			NR_FDD_FR1_G	-118	-115	N/A	-50
			NR_FDD_FR1_H	-117.5	-114.5	N/A	-50
±3.5	±4	≥-6	Note 2	Note 2	Note 2	Note 2	Note 2

NOTE 1:  $I_0$  is assumed to have constant EPRE across the bandwidth.



NOTE 2: The same bands and the same  $I_o$  conditions for each band apply for this requirement as for the corresponding highest accuracy requirement.  
 NOTE 3: The requirements apply for SSB  $\hat{E}_s/lot \leq 25$  dB under non-HST scenarios.  
 NOTE 4: NR operating band groups in FR1 are as defined in clause 3.5.2.  
 NOTE 5: The requirements apply for SSB  $\hat{E}_s/lot \leq 5$  dB with SCS 15kHz or 30kHz under NR high speed scenarios.

### 10.1.12.2 Intra-frequency CSI-SINR accuracy requirements in FR1

#### 10.1.12.2.1 Absolute CSI-SINR Accuracy in FR1

Unless otherwise specified, the requirements for absolute accuracy of CSI-SINR in this clause apply to a cell on the same frequency as that of the serving cell in FR1.

The accuracy requirements in Table 10.1.12.2.1-1 are valid under the following conditions:

- Conditions defined in clause 7.3 of TS 38.101-1 [18] for reference sensitivity are fulfilled.
- Conditions for intra-frequency measurements are fulfilled according to Annex B.2.12 for a corresponding Band.
- The timing offset between the reference measurement timing and the target CSI-RS in one layer is no larger than CP.
  - Note: The reference measurement timing for intra-frequency measurement is serving cell timing.
- The bandwidth of CSI-RS is 48 PRBs and the density is 3.
- The performance with larger bandwidth of CSI-RS is equal to or better than the accuracy requirements in Table 10.1.12.2.1-1.

**Table 10.1.12.2.1-1: CSI-SINR Intra frequency absolute accuracy in FR1**

Accuracy			Conditions					
Normal condition	Extreme condition	CSI-RS $\hat{E}_s/lot$	$I_o$ <sup>Note 1</sup> range				Maximum $I_o$	
			NR operating band groups	Minimum $I_o$				dBm/BW Channel
dB	dB	dB		dBm / SCS			dBm/BW Channel	
			SCS (kHz)			dBm/BW Channel		
			15	30	60			
±3	±4	≥-3	NR_FDD_FR1_A, NR_TDD_FR1_A, NR_SDL_FR1_A	-121	-118	-115	N/A	-70
			NR_FDD_FR1_B	-120.5	-117.5	-114.5	N/A	-70
			NR_TDD_FR1_C	-120	-117	-114	N/A	-70
			NR_FDD_FR1_D, NR_TDD_FR1_D	-119.5	-116.5	-113.5	N/A	-70
			NR_FDD_FR1_E, NR_TDD_FR1_E	-119	-116	-113	N/A	-70
			NR_FDD_FR1_F	-118.5	-115.5	-112.5	N/A	-70
			NR_FDD_FR1_G	-118	-115	-112	N/A	-70
			NR_FDD_FR1_H	-117.5	-114.5	-111.5	N/A	-70
±3.5	±4	≥-6	Note 2	Note 2	Note 2	Note 2	N/A	Note 2

NOTE 1:  $I_o$  is assumed to have constant EPRE across the bandwidth.  
 NOTE 2: The same bands and the same  $I_o$  conditions for each band apply for this requirement as for the corresponding highest accuracy requirement.  
 NOTE 3: NR operating band groups in FR1 are as defined in clause 3.5.2.  
 NOTE 4: The requirements apply for CSI-RS  $\hat{E}_s/lot \leq X$  dB.  $X=15$  if timing offset between the reference measurement timing and the target CSI-RS is no larger than  $0.5 \cdot CP$ , and  $X=4$  if timing offset between the reference measurement timing and the target CSI-RS is larger than  $0.5 \cdot CP$  but no larger than  $CP$ .

## 10.1.13 Intra-frequency SINR accuracy requirements for FR2

### 10.1.13.1 Intra-frequency SS-SINR accuracy requirements in FR2

#### 10.1.13.1.1 Absolute SS-SINR Accuracy in FR2

Unless otherwise specified, the requirements for absolute accuracy of SS-SINR in this clause apply to a cell on the same frequency as that of the serving cell in FR2.

The accuracy requirements in Table 10.1.13.1.1-1 are valid under the following conditions:

- Conditions defined in clause 7.3 of TS 38.101-2 [19] for reference sensitivity are fulfilled.
- Conditions for intra-frequency measurements are fulfilled according to Annex B.2.2 for a corresponding Band.
- The measured signals are in the directions covered by the percentile EIS spherical coverage of the UE, defined in clause 7.3.4 of TS 38.101-2 [19].

**Table 10.1.13.1.1-1: SS-SINR Intra frequency absolute accuracy in FR2**

Accuracy		Conditions			
Normal condition	Extreme condition	SSB $\hat{E}_s/\text{lot}$	$I_o$ <sup>Note 2</sup> range		
			$I_o$ <sup>Note 2</sup> range		
dB	dB	dB	Minimum $I_o$		Maximum $I_o$ dBm/BW <sub>Channel</sub>
			dBm / SCS <sub>SSB</sub> <sup>Note 1</sup>		
			SCS <sub>SSB</sub> = 120kHz	SCS <sub>SSB</sub> = 240kHz	
$\pm 3$	$\pm 4$	$\geq -3$	Same value as SSB_RP in Table B.2.2-2, according to UE Power class, operating band and angle of arrival		-50
$\pm 3.5$	$\pm 4$	$\geq -6$			
Note 1: Values based on Refsens and EIS spherical coverage as defined in clauses 7.3.2 and 7.3.4 of TS 38.101-2 [19]. Applicable side condition selected depending on angle of arrival. Note 2: $I_o$ specified at the Reference point, and assumed to have constant EPRE across the bandwidth. Note 3: In the test cases, the SSB $\hat{E}_s/\text{lot}$ and related parameters may need to be adjusted to ensure $\hat{E}_s/\text{lot}$ at UE baseband is above the value defined in this table. Note 4: The requirements apply for SSB $\hat{E}_s/\text{lot} \leq 25$ dB.					

### 10.1.13.2 Intra-frequency CSI-SINR accuracy requirements in FR2

#### 10.1.13.2.1 Absolute CSI-SINR Accuracy in FR2

Unless otherwise specified, the requirements for absolute accuracy of CSI-SINR in this clause apply to a cell on the same frequency as that of the serving cell in FR2.

The accuracy requirements in Table 10.1.13.2.1-1 are valid under the following conditions:

- Conditions defined in clause 7.3 of TS 38.101-2 [19] for reference sensitivity are fulfilled.
- Conditions for inter-frequency measurements are fulfilled according to Annex B.2.12 for a corresponding Band.
- The measured signals are in the directions covered by the percentile EIS spherical coverage of the UE, defined in clause 7.3.4 of TS 38.101-2 [19].
- The timing offset between the reference measurement timing and the target CSI-RS in one layer is no larger than CP.

Note: The reference measurement timing for intra-frequency measurement is serving cell timing.

- The bandwidth of CSI-RS is 48 PRBs and the density is 3.

The performance with larger bandwidth of CSI-RS is equal to or better than the accuracy requirements in Table 10.1.13.2.1-1.

**Table 10.1.13.2.1-1: CSI-SINR Intra frequency absolute accuracy in FR2**

Accuracy		Conditions				
Normal condition	Extreme condition	CSI-RS $\hat{E}_s/\text{lot}$	$I_o$ <sup>Note 2</sup> range			
			Minimum $I_o$		Maximum $I_o$	
			dBm / $SCS_{\text{CSI-RS}}$ <sup>Note 1</sup>		dBm/ $BW_{\text{Channel}}$	
dB	dB	dB	$SCS_{\text{CSI-RS}} = 60\text{kHz}$	$SCS_{\text{CSI-RS}} = 120\text{kHz}$	dBm/ $BW_{\text{Channel}}$	
$\pm 3$	$\pm 4$	$\geq -3$	Same value as CSI_RP in Table B.2.12-2, according to UE Power class, operating band and angle of arrival		-50	
$\pm 3.5$	$\pm 4$	$\geq -6$				
Note 1: Values based on Refsens and EIS spherical coverage as defined in clauses 7.3.2 and 7.3.4 of TS 38.101-2 [19]. Applicable side condition selected depending on angle of arrival. Note 2: $I_o$ specified at the Reference point, and assumed to have constant EPRE across the bandwidth. Note 3: In the test cases, the CSI-RS $\hat{E}_s/\text{lot}$ and related parameters may need to be adjusted to ensure $\hat{E}_s/\text{lot}$ at UE baseband is above the value defined in this table. Note 4: The requirements apply for CSI-RS $\hat{E}_s/\text{lot} \leq X\text{dB}$ . $X=15$ if timing offset between the reference measurement timing and the target CSI-RS is no larger than $0.5 \cdot CP$ , and $X=4$ if timing offset between the reference measurement timing and the target CSI-RS is larger than $0.5 \cdot CP$ but no larger than $CP$ .						

### 10.1.14 Inter-frequency SINR accuracy requirements for FR1

#### 10.1.14.1 Inter-frequency SS-SINR accuracy requirements in FR1

##### 10.1.14.1.1 Absolute Accuracy of SS-SINR in FR1

The requirements for absolute accuracy of SS-SINR in this clause apply to a cell on a frequency in FR1 that has different carrier frequency from the serving cell.

The accuracy requirements in Table 10.1.14.1.1-1 are valid under the following conditions:

- Conditions defined in clause 7.3 of TS 38.101-1 [18] for reference sensitivity are fulfilled.
- Conditions for inter-frequency measurements are fulfilled according to Annex B.2.3 for a corresponding Band.

**Table 10.1.14.1.1-1: SS-SINR Inter frequency absolute accuracy in FR1**

Accuracy		Conditions					
Normal condition	Extreme condition	SSB $\hat{E}_s/\text{lot}$ <sup>Note 3</sup>	$I_o$ <sup>Note 1</sup> range				
			NR operating band groups <sup>Note 4</sup>	Minimum $I_o$		Maximum $I_o$	
				dBm / $SCS_{\text{SSB}}$			dBm/ $BW_{\text{Channel}}$
dB	dB	dB	$SCS_{\text{SSB}} = 15\text{kHz}$	$SCS_{\text{SSB}} = 30\text{kHz}$	dBm/ $BW_{\text{Channel}}$		
$\pm 3.0$	$\pm 4$	$\geq -3$	NR_FDD_FR1_A, NR_TDD_FR1_A, NR_SDL_FR1_A	-121	-118	N/A	-50
			NR_FDD_FR1_B	-120.5	-117.5	N/A	-50
			NR_TDD_FR1_C	-120	-117	N/A	-50
			NR_FDD_FR1_D, NR_TDD_FR1_D	-119.5	-116.5	N/A	-50
			NR_FDD_FR1_E, NR_TDD_FR1_E	-119	-116	N/A	-50
			NR_FDD_FR1_F	-118.5	-115.5	N/A	-50

			NR_FDD_FR1_G	-118	-115	N/A	-50
			NR_FDD_FR1_H	-117.5	-114.5	N/A	-50
±3.5	±4	≥-6	Note 2	Note 2	Note 2	Note 2	Note 2

NOTE 1:  $I_o$  is assumed to have constant EPRE across the bandwidth.  
 NOTE 2: The same bands and the same  $I_o$  conditions for each band apply for this requirement as for the corresponding highest accuracy requirement.  
 NOTE 3: The requirements apply for SSB  $\hat{E}_s/lot \leq 25$  dB.  
 NOTE 4: NR operating band groups in FR1 are as defined in clause 3.5.2.

10.1.14.1.2 Relative Accuracy of SS-SINR in FR1

The relative accuracy of SS-SINR in inter frequency case is defined as the SS-SINR measured from one cell on a frequency in FR1 compared to the SS-SINR measured from another cell on a different frequency in FR1.

The accuracy requirements in Table 10.1.14.1.2-1 are valid under the following conditions:

- Conditions defined in clause 7.3 of TS 38.101-1 [18] for reference sensitivity are fulfilled.
- Conditions for inter-frequency measurements are fulfilled according to Annex B.2.3 for a corresponding Band.
- $|SSB_{RP1_{dBm}} - SSB_{RP2_{dBm}}| \leq 27$  dB
- $|Channel\ 1_{I_o} - Channel\ 2_{I_o}| \leq 20$  dB

Table 10.1.14.1.2-1: SS-SINR Inter frequency relative accuracy in FR1

Accuracy		Conditions					
Normal condition	Extreme condition	SSB $\hat{E}_s/lot$ Note 2,4	$I_o$ Note 1 range				
			NR operating band groups Note 5	Minimum $I_o$		Maximum $I_o$	
dB	dB	dB		dBm / SCS <sub>SSB</sub>		dBm/BW <sub>Channel</sub>	dBm/BW <sub>Channel</sub>
				SCS <sub>SSB</sub> = 120 kHz	SCS <sub>SSB</sub> = 240 kHz		
±3.5	±4	≥-3	NR_FDD_FR1_A, NR_TDD_FR1_A, NR_SDL_FR1_A	-121	-118	N/A	-50
			NR_FDD_FR1_B	-120.5	-117.5	N/A	-50
			NR_TDD_FR1_C	-120	-117	N/A	-50
			NR_FDD_FR1_D, NR_TDD_FR1_D	-119.5	-116.5	N/A	-50
			NR_FDD_FR1_E, NR_TDD_FR1_E	-119	-116	N/A	-50
			NR_FDD_FR1_F	-118.5	-115.5	N/A	-50
			NR_FDD_FR1_G, NR_FDD_FR1_H	-118 -117.5	-115 -114.5	N/A N/A	-50 -50
±4	±4	≥-6	Note 3	Note 3	Note 3	Note 3	Note 3

NOTE 1:  $I_o$  is assumed to have constant EPRE across the bandwidth.  
 NOTE 2: The parameter SSB  $\hat{E}_s/lot$  is the minimum SSB  $\hat{E}_s/lot$  of the pair of cells to which the requirement applies.  
 NOTE 3: The same bands and the same  $I_o$  conditions for each band apply for this requirement as for the corresponding highest accuracy requirement.  
 NOTE 4: The requirements apply for SSB  $\hat{E}_s/lot \leq [25]$  dB.  
 NOTE 5: NR operating band groups in FR1 are as defined in clause 3.5.2.

10.1.14.2 Inter-frequency CSI-SINR accuracy requirements in FR1

10.1.14.2.1 Absolute Accuracy of CSI-SINR in FR1

The requirements for absolute accuracy of CSI-SINR in this clause apply to a cell on a frequency in FR1 that has different carrier frequency from the serving cell.

The accuracy requirements in Table 10.1.14.2.1-1 are valid under the following conditions:

- Conditions defined in clause 7.3 of TS 38.101-1 [18] for reference sensitivity are fulfilled.
- Conditions for inter-frequency measurements are fulfilled according to Annex B.2.13 for a corresponding Band.
- The timing offset between the reference measurement timing and the target CSI-RS in one layer is no larger than CP.

Note: The reference measurement timing for inter-frequency measurement is up to UE implementation and shall be based on the timing of one of the target cells.

- The bandwidth of CSI-RS is 48 PRBs and the density is 3.

The performance with larger bandwidth of CSI-RS is equal to or better than the accuracy requirements in Table 10.1.14.2.1-1.

**Table 10.1.14.2.1-1: CSI-SINR Inter frequency absolute accuracy in FR1**

Accuracy			Conditions					
Normal condition	Extreme condition	CSI-RS $\hat{E}_s/\text{lot}$	$I_o$ <sup>Note 1</sup> range					Maximum $I_o$
			NR operating band groups	Minimum $I_o$			dBm/BW Channel	
dBm / SCS								
SCS (kHz)								
dB	dB	dB	15	30	60			
±3	±4	≥3	NR_FDD_FR1_A, NR_TDD_FR1_A, NR_SDL_FR1_A	-121	-118	-115	N/A	-70
			NR_FDD_FR1_B	-120.5	-117.5	-114.5	N/A	-70
			NR_TDD_FR1_C	-120	-117	-114	N/A	-70
			NR_FDD_FR1_D, NR_TDD_FR1_D	-119.5	-116.5	-113.5	N/A	-70
			NR_FDD_FR1_E, NR_TDD_FR1_E	-119	-116	-113	N/A	-70
			NR_FDD_FR1_F	-118.5	-115.5	-112.5	N/A	-70
			NR_FDD_FR1_G	-118	-115	-112	N/A	-70
			NR_FDD_FR1_H	-117.5	-114.5	-111.5	N/A	-70
±3.5	±4	≥6	Note 2	Note 2	Note 2	Note 2	N/A	Note 2

NOTE 1:  $I_o$  is assumed to have constant EPRE across the bandwidth.  
 NOTE 2: The same bands and the same  $I_o$  conditions for each band apply for this requirement as for the corresponding highest accuracy requirement.  
 NOTE 3: NR operating band groups in FR1 are as defined in clause 3.5.2.  
 NOTE 4: The requirements apply for CSI-RS  $\hat{E}_s/\text{lot} \leq X\text{dB}$ .  $X=15$  if timing offset between the reference measurement timing and the target CSI-RS is no larger than  $0.5 \cdot \text{CP}$ , and  $X=4$  if timing offset between the reference measurement timing and the target CSI-RS is larger than  $0.5 \cdot \text{CP}$  but no larger than CP.

**10.1.14.2.2 Relative Accuracy of CSI-SINR in FR1**

The relative accuracy of CSI-SINR in inter frequency case is defined as the CSI-SINR measured from one cell on a frequency in FR1 compared to the CSI-SINR measured from another cell on a different frequency in FR1.

The accuracy requirements in Table 10.1.14.2.2-1 are valid under the following conditions:

- Conditions defined in clause 7.3 of TS 38.101-1 [18] for reference sensitivity are fulfilled.
- Conditions for inter-frequency measurements are fulfilled according to Annex B.2.13 for a corresponding Band.
- $|\text{CSI\_RP1}_{\text{dBm}} - \text{CSI\_RP2}_{\text{dBm}}| \leq 27 \text{ dB}$
- $|\text{Channel 1}_{I_o} - \text{Channel 2}_{I_o}| \leq 20 \text{ dB}$
- The timing offset between the reference measurement timing and the target CSI-RS in one layer is no larger than CP.

Note: The reference measurement timing for inter-frequency measurement is up to UE implementation and shall be based on the timing of one of the target cells.

- The bandwidth of CSI-RS is 48 PRBs and the density is 3.

The performance with larger bandwidth of CSI-RS is equal to or better than the accuracy requirements in Table 10.1.14.2.2-1.

**Table 10.1.14.2.2-1: CSI-SINR Inter frequency relative accuracy in FR1**

Accuracy		Conditions						
Normal condition	Extreme condition	CSI-RS $\hat{E}s/lot$ Note 3	$Io$ <sup>Note 1</sup> range				Maximum $Io$	
			NR operating band groups	Minimum $Io$				dBm/BW Channel
dB	dB	dB		dBm / SCS			dBm/BW Channel	
			SCS (kHz)			dBm/BW Channel		
			15	30	60			
$\pm 3.5$	$\pm 4$	$\geq -3$	NR_FDD_FR1_A, NR_TDD_FR1_A, NR_SDL_FR1_A	-121	-118	-115	N/A	-70
			NR_FDD_FR1_B	-120.5	-117.5	-114.5	N/A	-70
			NR_TDD_FR1_C	-120	-117	-114	N/A	-70
			NR_FDD_FR1_D, NR_TDD_FR1_D	-119.5	-116.5	-113.5	N/A	-70
			NR_FDD_FR1_E, NR_TDD_FR1_E	-119	-116	-113	N/A	-70
			NR_FDD_FR1_F	-118.5	-115.5	-112.5	N/A	-70
			NR_FDD_FR1_G	-118	-115	-112	N/A	-70
			NR_FDD_FR1_H	-117.5	-114.5	-111.5	N/A	-70
$\pm 4$	$\pm 4$	$\geq -6$	Note 2	Note 2	Note 2	N/A	Note 2	

NOTE 1:  $Io$  is assumed to have constant EPRE across the bandwidth.  
 NOTE 2: The same bands and the same  $Io$  conditions for each band apply for this requirement as for the corresponding highest accuracy requirement.  
 NOTE 3: The parameter CSI-RS  $\hat{E}s/lot$  is the minimum CSI-RS  $\hat{E}s/lot$  of the pair of cells to which the requirement applies.  
 NOTE 4: NR operating band groups in FR1 are as defined in clause 3.5.2.  
 NOTE 5: The requirements apply for CSI-RS  $\hat{E}s/lot \leq X$ dB.  $X=15$  if timing offset between the reference measurement timing and the target CSI-RS is no larger than  $0.5 \cdot CP$ , and  $X=4$  if timing offset between the reference measurement timing and the target CSI-RS is larger than  $0.5 \cdot CP$  but no larger than  $CP$ .

### 10.1.15 Inter-frequency SINR accuracy requirements for FR2

#### 10.1.15.1 Inter-frequency SS-SINR accuracy requirements in FR2

##### 10.1.15.1.1 Absolute Accuracy of SS-SINR in FR2

The requirements for absolute accuracy of SS-SINR in this clause apply to a cell on a frequency in FR2 that has different carrier frequency from the serving cell.

The accuracy requirements in Table 10.1.15.1.1-1 are valid under the following conditions:

- Conditions defined in clause 7.3 of TS 38.101-2 [19] for reference sensitivity are fulfilled.
- Conditions for inter-frequency measurements are fulfilled according to Annex B.2.3 for a corresponding Band.
- The measured signals are in the directions covered by the percentile EIS spherical coverage of the UE, defined in clause 7.3.4 of TS 38.101-2 [19].

**Table 10.1.15.1.1-1: SS-SINR Inter frequency absolute accuracy in FR2**

Accuracy		Conditions	
Normal condition	Extreme condition	SSB $\hat{E}s/lot$	$Io$ <sup>Note 2</sup> range
			Minimum $Io$

dB	dB	dB	dBm / SCS <sub>SSB</sub> <sup>Note 1</sup>		dBm/BW <sub>Channel</sub>
			SCS <sub>SSB</sub> = 120kHz	SCS <sub>SSB</sub> = 240kHz	
±3	±4	≥-3	Same value as SSB_RP in Table B.2.2-2, according to UE Power class, operating band and angle of arrival		-50
±3.5	±4	≥-4			
<p>Note 1: Values based on Refsens and EIS spherical coverage as defined in clauses 7.3.2 and 7.3.4 of TS 38.101-2 [19]. Applicable side condition selected depending on angle of arrival.</p> <p>Note 2: I<sub>o</sub> specified at the Reference point, and assumed to have constant EPRE across the bandwidth.</p> <p>Note 3: In the test cases, the SSB Ês/lot and related parameters may need to be adjusted to ensure Ês/lot at UE baseband is above the value defined in this table.</p> <p>Note 4: The requirements apply for SSB Ês/lot ≤ 25 dB.</p>					

### 10.1.15.1.2 Relative Accuracy of SS-SINR in FR2

The relative accuracy of SS-SINR in inter frequency case is defined as the SS-SINR measured from one cell on a frequency in FR2 compared to the SS-SINR measured from another cell on a different frequency in FR2.

The accuracy requirements in Table 10.1.15.1.2-1 are valid under the following conditions:

- Conditions defined in clause 7.3 of TS 38.101-2 [19] for reference sensitivity are fulfilled.
- Conditions for inter-frequency measurements are fulfilled according to Annex B.2.3 for a corresponding Band.
- $|\text{SSB\_RP1}_{\text{dBm}} - \text{SSB\_RP2}_{\text{dBm}}| \leq 27$  dB
- $|\text{Channel 1\_I}_o - \text{Channel 2\_I}_o| \leq 20$  dB
- The measured signals are in the directions covered by the percentile EIS spherical coverage of the UE, defined in clause 7.3.4 of TS 38.101-2 [19].

**Table 10.1.15.1.2-1: SS-SINR Inter frequency relative accuracy in FR2**

Accuracy			Conditions		
Normal condition	Extreme condition	SSB Ês/lot	I <sub>o</sub> <sup>Note 2</sup> range		dBm/BW <sub>Channel</sub>
			Minimum I <sub>o</sub>		
dB	dB	dB	dBm / SCS <sub>SSB</sub> <sup>Note 1</sup>		
			SCS <sub>SSB</sub> = 120kHz	SCS <sub>SSB</sub> = 240kHz	
±3.5	±4	≥-3	Same value as SSB_RP in Table B.2.2-2, according to UE Power class, operating band and angle of arrival		-50
±4	±4	≥-6			
<p>Note 1: Values based on Refsens and EIS spherical coverage as defined in clauses 7.3.2 and 7.3.4 of TS 38.101-2 [19]. Applicable side condition selected depending on angle of arrival.</p> <p>Note 2: I<sub>o</sub> specified at the Reference point, and assumed to have constant EPRE across the bandwidth.</p> <p>Note 3: The parameter SSB Ês/lot is the minimum SSB Ês/lot of the pair of cells to which the requirement applies.</p> <p>Note 4: In the test cases, the SSB Ês/lot and related parameters may need to be adjusted to ensure Ês/lot at UE baseband is above the value defined in this table.</p> <p>Note 5: The requirements apply for SSB Ês/lot ≤ 25 dB.</p>					

### 10.1.15.2 Inter-frequency CSI-SINR accuracy requirements in FR2

#### 10.1.15.2.1 Absolute Accuracy of CSI-SINR in FR2

The requirements for absolute accuracy of CSI-SINR in this clause apply to a cell on a frequency in FR2 that has different carrier frequency from the serving cell.

The accuracy requirements in Table 10.1.15.2.1-1 are valid under the following conditions:

- Conditions defined in clause 7.3 of TS 38.101-2 [19] for reference sensitivity are fulfilled.
- Conditions for inter-frequency measurements are fulfilled according to Annex B.2.13 for a corresponding Band.
- The measured signals are in the directions covered by the percentile EIS spherical coverage of the UE, defined in clause 7.3.4 of TS 38.101-2 [19].
- The timing offset between the reference measurement timing and the target CSI-RS in one layer is no larger than CP.

Note: The reference measurement timing for inter-frequency measurement is up to UE implementation and shall be based on the timing of one of the target cells.

- The bandwidth of CSI-RS is 48 PRBs and the density is 3.
- The performance with larger bandwidth of CSI-RS is equal to or better than the accuracy requirements in Table 10.1.15.2.1-1.

**Table 10.1.15.2.1-1: CSI-SINR Inter frequency absolute accuracy in FR2**

Accuracy		Conditions		
Normal condition	Extreme condition	CSI-RS $\hat{E}s/lot$	$I_o$ <sup>Note 2</sup> range	
dB	dB		dBm / $SCS_{CSI-RS}$ <sup>Note 1</sup>	
			Minimum $I_o$	Maximum $I_o$
			$SCS_{CSI-RS} = 60kHz$	$SCS_{CSI-RS} = 120kHz$
$\pm 3$	$\pm 4$	$\geq -3$	Same value as CSI_RP in Table B.2.13-2, according to UE Power class, operating band and angle of arrival	
3.5	$\pm 4$	$\geq -4$		
Note 1: Values based on Refsens and EIS spherical coverage as defined in clauses 7.3.2 and 7.3.4 of TS 38.101-2 [19]. Applicable side condition selected depending on angle of arrival. Note 2: $I_o$ specified at the Reference point, and assumed to have constant EPRE across the bandwidth. Note 3: In the test cases, the CSI-RS $\hat{E}s/lot$ and related parameters may need to be adjusted to ensure $\hat{E}s/lot$ at UE baseband is above the value defined in this table. Note 4: The requirements apply for CSI-RS $\hat{E}s/lot \leq X$ dB. $X=15$ if timing offset between the reference measurement timing and the target CSI-RS is no larger than $0.5 \cdot CP$ , and $X=4$ if timing offset between the reference measurement timing and the target CSI-RS is larger than $0.5 \cdot CP$ but no larger than CP.				

#### 10.1.15.2.2 Relative Accuracy of CSI-SINR in FR2

The relative accuracy of CSI-SINR in inter frequency case is defined as the CSI-SINR measured from one cell on a frequency in FR2 compared to the CSI-SINR measured from another cell on a different frequency in FR2.

The accuracy requirements in Table 10.1.15.2.2-1 are valid under the following conditions:

- Conditions defined in clause 7.3 of TS 38.101-2 [19] for reference sensitivity are fulfilled.
- Conditions for inter-frequency measurements are fulfilled according to Annex B.2.y for a corresponding Band.
- $|CSI\_RP1_{dBm} - CSI\_RP2_{dBm}| \leq 27$  dB
- $|Channel\ 1_{I_o} - Channel\ 2_{I_o}| \leq 20$  dB



- The measured signals are in the directions covered by the percentile EIS spherical coverage of the UE, defined in clause 7.3.4 of TS 38.101-2 [19].
- The timing offset between the reference measurement timing and the target CSI-RS in one layer is no larger than CP.

Note: The reference measurement timing for inter-frequency measurement is up to UE implementation and shall be based on the timing of one of the target cells.

- The bandwidth of CSI-RS is 48 PRBs and the density is 3.
  - The performance with larger bandwidth of CSI-RS is equal to or better than the accuracy requirements in Table 10.1.15.2.2-1.

**Table 10.1.15.2.2-1: CSI-SINR Inter frequency relative accuracy in FR2**

Accuracy		Conditions			
Normal condition	Extreme condition	CSI-RS $\hat{E}_s/\text{lot}$	$I_0$ <sup>Note 2</sup> range		Maximum $I_0$ dBm/BW <sub>Channel</sub>
			Minimum $I_0$ dBm / $SCS_{\text{CSI-RS}}$ <sup>Note 1</sup>		
dB	dB	dB	$SCS_{\text{CSI-RS}} = 60\text{kHz}$	$SCS_{\text{CSI-RS}} = 120\text{kHz}$	
$\pm 3.5$	$\pm 4$	$\geq -3$	Same value as CSI_RP in Table B.2.13-2, according to UE Power class, operating band and angle of arrival		-50
$\pm 4$	$\pm 4$	$\geq -6$			
Note 1: Values based on Refsens and EIS spherical coverage as defined in clauses 7.3.2 and 7.3.4 of TS 38.101-2 [19]. Applicable side condition selected depending on angle of arrival. Note 2: $I_0$ specified at the Reference point, and assumed to have constant EPRE across the bandwidth. Note 3: In the test cases, the CSI-RS $\hat{E}_s/\text{lot}$ and related parameters may need to be adjusted to ensure $\hat{E}_s/\text{lot}$ at UE baseband is above the value defined in this table. Note 4: The requirements apply for CSI-RS $\hat{E}_s/\text{lot} \leq X\text{dB}$ . $X=15$ if timing offset between the reference measurement timing and the target CSI-RS is no larger than $0.5 \cdot \text{CP}$ , and $X=4$ if timing offset between the reference measurement timing and the target CSI-RS is larger than $0.5 \cdot \text{CP}$ but no larger than CP.					

### 10.1.16 SINR report mapping

#### 10.1.16.1 SS-SINR and CSI-SINR measurement report mapping

The reporting range of SS-SINR and CSI-SINR for L3 reporting and L1 reporting is defined from -23 dB to 40 dB with 0.5 dB resolution. The mapping of measured quantity is defined in Table 10.1.16.1-1. The range in the signalling may be larger than the guaranteed accuracy range.

The reporting range of differential SS-SINR and CSI-SINR for L1 reporting and L3 reporting is defined from -15 dB to 0 dB with 1 dB resolution.

The mapping of measured quantity is defined in Table 10.1.16.1-2. The range in the signalling may be larger than the guaranteed accuracy range.

**Table 10.1.16.1-1: SS-SINR and CSI-SINR measurement report mapping**

Reported value	Measured quantity value (L3 SS-SINR and L3 CSI-SINR)	Measured quantity value (L1 SS-SINR and L1 CSI-SINR)	Unit
SINR_0	$\text{SINR} < -23$	$\text{SINR} < -23$	dB
SINR_1	$-23 \leq \text{SINR} < -22.5$	$-23 \leq \text{SINR} < -22.5$	dB
SINR_2	$-22.5 \leq \text{SINR} < -22$	$-22.5 \leq \text{SINR} < -22$	dB
SINR_3	$-22 \leq \text{SINR} < -21.5$	$-22 \leq \text{SINR} < -21.5$	dB
SINR_4	$-21.5 \leq \text{SINR} < -21$	$-21.5 \leq \text{SINR} < -21$	dB

..	..	..	...
SINR_123	$38 \leq \text{SINR} < 38.5$	$38 \leq \text{SINR} < 38.5$	dB
SINR_124	$38.5 \leq \text{SINR} < 39$	$38.5 \leq \text{SINR} < 39$	dB
SINR_125	$39 \leq \text{SINR} < 39.5$	$39 \leq \text{SINR} < 39.5$	dB
SINR_126	$39.5 \leq \text{SINR} < 40$	$39.5 \leq \text{SINR} < 40$	dB
SINR_127	$40 \leq \text{SINR}$	$40 \leq \text{SINR}$	dB

**Table 10.1.16.1-2: Differential SS-SINR and CSI-SINR measurement (for L1 reporting and L3 reporting) report mapping**

Reported value	Measured quantity value (difference in measured SINR from largest SINR)	Unit
DIFFSINR_0	$0 \geq \Delta \text{SINR} > -1$	dB
DIFFSINR_1	$-1 \geq \Delta \text{SINR} > -2$	dB
DIFFSINR_2	$-2 \geq \Delta \text{SINR} > -3$	dB
DIFFSINR_3	$-3 \geq \Delta \text{SINR} > -4$	dB
DIFFSINR_4	$-4 \geq \Delta \text{SINR} > -5$	dB
DIFFSINR_5	$-5 \geq \Delta \text{SINR} > -6$	dB
DIFFSINR_6	$-6 \geq \Delta \text{SINR} > -7$	dB
DIFFSINR_7	$-7 \geq \Delta \text{SINR} > -8$	dB
DIFFSINR_8	$-8 \geq \Delta \text{SINR} > -9$	dB
DIFFSINR_9	$-9 \geq \Delta \text{SINR} > -10$	dB
DIFFSINR_10	$-10 \geq \Delta \text{SINR} > -11$	dB
DIFFSINR_11	$-11 \geq \Delta \text{SINR} > -12$	dB
DIFFSINR_12	$-12 \geq \Delta \text{SINR} > -13$	dB
DIFFSINR_13	$-13 \geq \Delta \text{SINR} > -14$	dB
DIFFSINR_14	$-14 \geq \Delta \text{SINR} > -15$	dB
DIFFSINR_15	$-15 \geq \Delta \text{SINR}$	dB

### 10.1.17 Power Headroom

#### 10.1.17.1 Power Headroom Report

##### 10.1.17.1.1 Power Headroom Report Mapping

The power headroom reporting range is from -32 ...+38 dB. Table 10.1.17.1-1 defines the report mapping.

**Table 10.1.17.1-1: Power headroom report mapping**

Reported value	Measured quantity value (dB)
POWER_HEADROOM_0	$\text{PH} < -32$
POWER_HEADROOM_1	$-32 \leq \text{PH} < -31$
POWER_HEADROOM_2	$-31 \leq \text{PH} < -30$
POWER_HEADROOM_3	$-30 \leq \text{PH} < -29$
...	...
POWER_HEADROOM_53	$20 \leq \text{PH} < 21$
POWER_HEADROOM_54	$21 \leq \text{PH} < 22$
POWER_HEADROOM_55	$22 \leq \text{PH} < 24$
POWER_HEADROOM_56	$24 \leq \text{PH} < 26$
POWER_HEADROOM_57	$26 \leq \text{PH} < 28$
POWER_HEADROOM_58	$28 \leq \text{PH} < 30$

POWER_HEADROOM_59	$30 \leq PH < 32$
POWER_HEADROOM_60	$32 \leq PH < 34$
POWER_HEADROOM_61	$34 \leq PH < 36$
POWER_HEADROOM_62	$36 \leq PH < 38$
POWER_HEADROOM_63	$PH \geq 38$

### 10.1.18 $P_{\text{CMAX},c,f}$

The UE is required to report the UE configured maximum output power ( $P_{\text{CMAX},c,f}$ ) together with the power headroom. This clause defines the requirements for the  $P_{\text{CMAX},c,f}$  reporting.

#### 10.1.18.1 Report Mapping

The  $P_{\text{CMAX},c,f}$  reporting range is defined from -29 dBm to 33 dBm with 1 dB resolution. Table 10.1.18.1-1 defines the reporting mapping.

**Table 10.1.18.1-1 Mapping of  $P_{\text{CMAX},c,f}$**

Reported value	Measured quantity value	Unit
PCMAX_C_00	$P_{\text{CMAX},c,f} < -29$	dBm
PCMAX_C_01	$-29 \leq P_{\text{CMAX},c,f} < -28$	dBm
PCMAX_C_02	$-28 \leq P_{\text{CMAX},c,f} < -27$	dBm
...	...	...
PCMAX_C_61	$31 \leq P_{\text{CMAX},c,f} < 32$	dBm
PCMAX_C_62	$32 \leq P_{\text{CMAX},c,f} < 33$	dBm
PCMAX_C_63	$33 \leq P_{\text{CMAX},c,f}$	dBm

### 10.1.19 L1-RSRP accuracy requirements for FR1

#### 10.1.19.1 SSB based L1-RSRP accuracy requirements

##### 10.1.19.1.1 Absolute Accuracy

Unless otherwise specified, the requirements for absolute accuracy of SSB based L1-RSRP in this clause apply to all SSBs of the serving cell configured for L1-RSRP measurement.

The accuracy requirements in Table 10.1.19.1.1-1 are valid under the following conditions:

- Conditions defined in clause 7.3 of TS 38.101-1 [18] for reference sensitivity are fulfilled.
- Conditions for L1-RSRP measurements are fulfilled according to Annex B.2.4.1 for a corresponding Band for each relevant SSB.

**Table 10.1.19.1.1-1: SSB based L1-RSRP absolute accuracy in FR1**

Accuracy		Conditions				
Normal condition	Extreme condition	SSB $\hat{E}_s/\text{lot}$	$I_0$ <sup>Note 1</sup> range			
			NR operating band groups <sup>Note 2</sup>	Minimum $I_0$		Maximum $I_0$
dB	dB	dB		dBm / $\text{SCS}_{\text{SSB}}$		dBm/ $\text{BW}_{\text{Channel}}$
				$\text{SCS}_{\text{SSB}} = 15 \text{ kHz}$	$\text{SCS}_{\text{SSB}} = 30 \text{ kHz}$	
			NR_FDD_FR1_A, NR_TDD_FR1_A, NR_SDL_FR1_A	-121	-118	N/A
			NR_FDD_FR1_B	-120.5	-117.5	N/A
			NR_TDD_FR1_C	-120	-117	N/A

±5.0	±9.5	≥-3	NR_FDD_FR1_D, NR_TDD_FR1_D	-119.5	-116.5	N/A	-70
			NR_FDD_FR1_E, NR_TDD_FR1_E	-119	-116	N/A	-70
			NR_FDD_FR1_F	-118.5	-115.5	N/A	-70
			NR_FDD_FR1_G	-118	-115	N/A	-70
			NR_FDD_FR1_H	-117.5	-114.5	N/A	-70
±8.5	±11.5	≥-3	NR_FDD_FR1_A, NR_TDD_FR1_A, NR_SDL_FR1_A, NR_FDD_FR1_B, NR_TDD_FR1_C, NR_FDD_FR1_D, NR_TDD_FR1_D, NR_FDD_FR1_E, NR_TDD_FR1_E, NR_FDD_FR1_F, NR_FDD_FR1_G, NR_FDD_FR1_H,	N/A	N/A	-70	-50

NOTE 1:  $I_o$  is assumed to have constant EPRE across the bandwidth.  
 NOTE 2: NR operating band groups in FR1 are as defined in clause 3.5.2.

### 10.1.19.1.2 Relative Accuracy

The relative accuracy of SSB based L1-RSRP is defined as the L1-RSRP measured from one SSB compared to the largest measured value of L1-RSRP among all SSBs of the serving cell.

The accuracy requirements in Table 10.1.19.1.2-1 are valid under the following conditions:

- Conditions defined in clause 7.3 of TS 38.101-1 [18] for reference sensitivity are fulfilled.
- Conditions for L1-RSRP measurements are fulfilled according to Annex B.2.4.1 for a corresponding Band for each relevant SSB.

**Table 10.1.19.1.2-1: SSB based L1-RSRP relative accuracy in FR1**

Accuracy		Conditions					
Normal condition	Extreme condition	SSB $\hat{E}_s/\text{lot}$ Note 2	$I_o$ Note 1 range				
			NR operating band groups Note 4	Minimum $I_o$		Maximum $I_o$	
dB	dB	dB		dBm / $SCS_{SSB}$		dBm/ $BW_{\text{Channel}}$	dBm/ $BW_{\text{Channel}}$
				$SCS_{SSB} = 15 \text{ kHz}$	$SCS_{SSB} = 30 \text{ kHz}$		
±3	±4	≥-3	NR_FDD_FR1_A, NR_TDD_FR1_A, NR_SDL_FR1_A	-121	-118	N/A	-50
			NR_FDD_FR1_B	-120.5	-117.5	N/A	-50
			NR_TDD_FR1_C	-120	-117	N/A	-50
			NR_FDD_FR1_D, NR_TDD_FR1_D	-119.5	-116.5	N/A	-50
			NR_FDD_FR1_E, NR_TDD_FR1_E	-119	-116	N/A	-50
			NR_FDD_FR1_F	-118.5	-115.5	N/A	-50
			NR_FDD_FR1_G	-118	-115	N/A	-50
			NR_FDD_FR1_H	-117.5	-114.5	N/A	-50

NOTE 1:  $I_o$  is assumed to have constant EPRE across the bandwidth.  
 NOTE 2: The parameter SSB  $\hat{E}_s/\text{lot}$  is the minimum SSB  $\hat{E}_s/\text{lot}$  of the pair of SSBs to which the requirement applies.  
 NOTE 3: Void  
 NOTE 4: NR operating band groups in FR1 are as defined in clause 3.5.2.

### 10.1.19.2 CSI-RS based L1-RSRP accuracy requirements

#### 10.1.19.2.1 Absolute Accuracy

Unless otherwise specified, the requirements for absolute accuracy of CSI-RS based L1-RSRP in this clause apply to all CSI-RS resources of the serving cell configured for L1-RSRP measurement.

The accuracy requirements in Table 10.1.19.2.1-1 are valid under the following conditions:

- Conditions defined in clause 7.3 of TS 38.101-1 [18] for reference sensitivity are fulfilled.
- Conditions for L1-RSRP measurements are fulfilled according to Annex B.2.4.2 for a corresponding Band for each relevant CSI-RS.
- The bandwidth of CSI-RS is 48 PRBs and the density is 3.

The performance with larger bandwidth of CSI-RS is equal to or better than the accuracy requirements in Table 10.1.19.2.1-1.

**Table 10.1.19.2.1-1: CSI-RS based L1-RSRP absolute accuracy in FR1**

Accuracy		Conditions						
Normal condition	Extreme condition	CSI-RS $\hat{E}_s/\text{lot}$	$I_0$ <sup>Note 1</sup> range					
			NR operating band groups <sup>Note 2</sup>	Minimum $I_0$			Maximum $I_0$	
dB	dB	dB		dBm / $SCS_{\text{CSI-RS}}$			dBm/BW <sub>Channel</sub>	dBm/BW <sub>Channel</sub>
				$SCS_{\text{CSI-RS}} = 15$ kHz	$SCS_{\text{CSI-RS}} = 30$ kHz	$SCS_{\text{CSI-RS}} = 60$ kHz		
±5.0	±9.5	≥-3	NR_FDD_FR1_A, NR_TDD_FR1_A, NR_SDL_FR1_A	-121	-118	-115	N/A	-70
			NR_FDD_FR1_B	-120.5	-117.5	-114.5	N/A	-70
			NR_TDD_FR1_C	-120	-117	-114	N/A	-70
			NR_FDD_FR1_D, NR_TDD_FR1_D	-119.5	-116.5	-113.5	N/A	-70
			NR_FDD_FR1_E, NR_TDD_FR1_E	-119	-116	-113	N/A	-70
			NR_FDD_FR1_F	-118.5	-115.5	-112.5	N/A	-70
			NR_FDD_FR1_G	-118	-115	-112	N/A	-70
			NR_FDD_FR1_H	-117.5	-114.5	-111.5	N/A	-70
±8.5	±11.5	≥-3	NR_FDD_FR1_A, NR_TDD_FR1_A, NR_SDL_FR1_A, NR_FDD_FR1_B, NR_TDD_FR1_C, NR_FDD_FR1_D, NR_TDD_FR1_D, NR_FDD_FR1_E, NR_TDD_FR1_E, NR_FDD_FR1_F, NR_FDD_FR1_G, NR_FDD_FR1_H	N/A	N/A	N/A	-70	-50

NOTE 1:  $I_0$  is assumed to have constant EPRE across the bandwidth.  
 NOTE 2: NR operating band groups in FR1 are as defined in clause 3.5.2.

#### 10.1.19.2.2 Relative Accuracy

The relative accuracy of CSI-RS based L1-RSRP is defined as the L1-RSRP measured from one CSI-RS compared to the largest measured value of L1-RSRP among all CSI-RS resources of the serving cell.

The accuracy requirements in Table 10.1.19.2.2-1 are valid under the following conditions:

- Conditions defined in clause 7.3 of TS 38.101-1 [18] for reference sensitivity are fulfilled.
- Conditions for L1-RSRP measurements are fulfilled according to Annex B.2.4.2 for a corresponding Band for each relevant CSI-RS.
- The bandwidth of CSI-RS is 48 PRBs and the density is 3.

The performance with larger bandwidth of CSI-RS is equal to or better than the accuracy requirements in Table 10.1.19.2.2-1.

**Table 10.1.19.2.2-1: CSI-RS based L1-RSRP relative accuracy in FR1**

Accuracy		Conditions						
Normal condition	Extreme condition	CSI-RS $\hat{E}_s/\text{lot}$ Note 2	$I_o$ Note 1 range					
			NR operating band groups Note 4	Minimum $I_o$			Maximum $I_o$	
dB	dB	dB		dBm / $SCS_{\text{CSI-RS}}$			dBm/ $BW_{\text{Channel}}$	dBm/ $BW_{\text{Channel}}$
				$SCS_{\text{CSI-RS}} = 15$ kHz	$SCS_{\text{CSI-RS}} = 30$ kHz	$SCS_{\text{CSI-RS}} = 60$ kHz		
$\pm 3$	$\pm 4$	$\geq -3$	NR_FDD_FR1_A, NR_TDD_FR1_A, NR_SDL_FR1_A	-121	-118	-115	N/A	-50
			NR_FDD_FR1_B	-120.5	-117.5	-114.5	N/A	-50
			NR_TDD_FR1_C	-120	-117	-114	N/A	-50
			NR_FDD_FR1_D, NR_TDD_FR1_D	-119.5	-116.5	-113.5	N/A	-50
			NR_FDD_FR1_E, NR_TDD_FR1_E	-119	-116	-113	N/A	-50
			NR_FDD_FR1_F	-118.5	-115.5	-112.5	N/A	-50
			NR_FDD_FR1_G	-118	-115	-112	N/A	-50
			NR_FDD_FR1_H	-117.5	-114.5	-111.5	N/A	-50

NOTE 1:  $I_o$  is assumed to have constant EPRE across the bandwidth.  
 NOTE 2: The parameter CSI-RS  $\hat{E}_s/\text{lot}$  is the minimum CSI-RS  $\hat{E}_s/\text{lot}$  of the pair of CSI-RS resources to which the requirement applies.  
 NOTE 3: Void  
 NOTE 4: NR operating band groups in FR1 are as defined in clause 3.5.2.

## 10.1.20 L1-RSRP accuracy requirements for FR2

### 10.1.20.1 SSB based L1-RSRP accuracy requirements

#### 10.1.20.1.1 Absolute Accuracy

Unless otherwise specified, the requirements for absolute accuracy of SSB based L1-RSRP in this clause apply to all SSBs of the serving cell configured for L1-RSRP measurement.

The accuracy requirements in Table 10.1.20.1.1-1 are valid under the following conditions:

- Conditions defined in clause 7.3 of TS 38.101-2 [19] for reference sensitivity are fulfilled.
- Conditions for L1-RSRP measurements are fulfilled according to Annex B.2.4.1 for a corresponding Band for each relevant SSB.
- The measured signals are in the directions covered by the percentile EIS spherical coverage of the UE, defined in clause 7.3.4 of TS 38.101-2 [19].

**Table 10.1.20.1.1-1: SSB based L1-RSRP absolute accuracy in FR2**

Accuracy		Conditions			
Normal condition	Extreme condition	SSB $\hat{E}_s/\text{lot}$	$I_o$ <sup>Note 1</sup> range		
			Minimum $I_o$		Maximum $I_o$
dB	dB	dB	dBm / $SCS_{SSB}$ <sup>Note 2</sup>		dBm/ $BW_{Channel}$
			$SCS_{SSB} = 120\text{kHz}$	$SCS_{SSB} = 240\text{kHz}$	
$\pm 6.5$	$\pm 9.5$	$\geq -3$	Same value as SSB_RP in Table B.2.4.1-2, according to UE Power class, operating band and angle of arrival		N/A
$\pm 8.5$	$\pm 11.5$	$\geq -3$	N/A		-70
NOTE 1: $I_o$ specified at the Reference point, and assumed to have constant EPRE across the bandwidth.					
NOTE 2: Values based on Refsens and EIS spherical coverage as defined in clauses 7.3.2 and 7.3.4 of TS 38.101-2 [19]. Applicable side condition selected depending on angle of arrival.					
NOTE 3: In the test cases, the SSB $\hat{E}_s/\text{lot}$ and related parameters may need to be adjusted to ensure $\hat{E}_s/\text{lot}$ at UE baseband is above the value defined in this table.					

### 10.1.20.1.2 Relative Accuracy

The relative accuracy of SSB based L1-RSRP is defined as the L1-RSRP measured from one SSB compared to the largest measured value of L1-RSRP among all SSBs of the serving cell.

The accuracy requirements in Table 10.1.20.1.2-1 are valid under the following conditions:

- Conditions defined in clause 7.3 of TS 38.101-2 [19] for reference sensitivity are fulfilled.
- Conditions for L1-RSRP measurements are fulfilled according to Annex B.2.4.1 for a corresponding Band for each relevant SSB.
- The measured signals are in the directions covered by the percentile EIS spherical coverage of the UE, defined in clause 7.3.4 of TS 38.101-2 [19].

**Table 10.1.20.1.2-1: SSB based L1-RSRP relative accuracy in FR2**

Accuracy		Conditions			
Normal condition	Extreme condition	SSB $\hat{E}_s/\text{lot}$	$I_o$ <sup>Note 1</sup> range		
			Minimum $I_o$		Maximum $I_o$
dB	dB	dB	dBm / $SCS_{SSB}$ <sup>Note 3</sup>		dBm/ $BW_{Channel}$
			$SCS_{SSB} = 120\text{kHz}$	$SCS_{SSB} = 240\text{kHz}$	
$\pm 6.5$	$\pm 9.5$	$\geq -3$	Same value as SSB_RP in Table B.2.4.1-2, according to UE Power class, operating band and angle of arrival		-50
NOTE 1: $I_o$ specified at the Reference point, and assumed to have constant EPRE across the bandwidth.					
NOTE 2: The parameter SSB $\hat{E}_s/\text{lot}$ is the minimum SSB $\hat{E}_s/\text{lot}$ of the pair of SSBs to which the requirement applies.					
NOTE 3: Values based on Refsens and EIS spherical coverage as defined in clauses 7.3.2 and 7.3.4 of TS 38.101-2 [19]. Applicable side condition selected depending on angle of arrival.					
NOTE 4: In the test cases, the SSB $\hat{E}_s/\text{lot}$ and related parameters may need to be adjusted to ensure $\hat{E}_s/\text{lot}$ at UE baseband is above the value defined in this table.					

## 10.1.20.2 CSI-RS based L1-RSRP accuracy requirements

### 10.1.20.2.1 Absolute Accuracy

Unless otherwise specified, the requirements for absolute accuracy of CSI-RS based L1-RSRP in this clause apply to all CSI-RS resources of the serving cell configured for L1-RSRP measurement.

The accuracy requirements in Table 10.1.20.2.1-1 are valid under the following conditions:

- Conditions defined in clause 7.3 of TS 38.101-2 [19] for reference sensitivity are fulfilled.
- Conditions for L1-RSRP measurements are fulfilled according to Annex B.2.4.2 for a corresponding Band for each relevant CSI-RS.
- The bandwidth of CSI-RS is 48 PRBs and the density is 3.
- The measured signals are in the directions covered by the percentile EIS spherical coverage of the UE, defined in clause 7.3.4 of TS 38.101-2 [19].

The performance with larger bandwidth of CSI-RS is equal to or better than the accuracy requirements in Table 10.1.20.2.1-1.

**Table 10.1.20.2.1-1: CSI-RS based L1-RSRP absolute accuracy in FR2**

Accuracy		Conditions			
Normal condition	Extreme condition	CSI-RS $\hat{E}_s/\text{lot}$	$I_0$ <sup>Note 1</sup> range		
			Minimum $I_0$		Maximum $I_0$
dB	dB	dB	dBm / $SCS_{\text{CSI-RS}}$ <sup>Note 2</sup>		dBm/ $BW_{\text{Channel}}$
			$SCS_{\text{CSI-RS}} = 60\text{kHz}$	$SCS_{\text{CSI-RS}} = 120\text{kHz}$	
$\pm 6.5$	$\pm 9.5$	$\geq -3$	Same value as CSI-RS_RP in Table B.2.4.2-2, according to UE Power class, operating band and angle of arrival		-70
$\pm 8.5$	$\pm 11.5$	$\geq -3$	N/A		-50

NOTE 1:  $I_0$  specified at the Reference point, and assumed to have constant EPRE across the bandwidth.  
 NOTE 2: Values based on Refsens and EIS spherical coverage as defined in clauses 7.3.2 and 7.3.4 of TS 38.101-2 [19]. Applicable side condition selected depending on angle of arrival.  
 NOTE 3: In the test cases, the CSI-RS  $\hat{E}_s/\text{lot}$  and related parameters may need to be adjusted to ensure  $\hat{E}_s/\text{lot}$  at UE baseband is above the value defined in this table.

### 10.1.20.2.2 Relative Accuracy

The relative accuracy of CSI-RS based L1-RSRP is defined as the L1-RSRP measured from one CSI-RS compared to the largest measured value of L1-RSRP among all CSI-RS resources of the serving cell.

The accuracy requirements in Table 10.1.20.2.2-1 are valid under the following conditions:

- Conditions defined in clause 7.3 of TS 38.101-2 [19] for reference sensitivity are fulfilled.
- Conditions for L1-RSRP measurements are fulfilled according to Annex B.2.4.2 for a corresponding Band for each relevant CSI-RS.
- The bandwidth of CSI-RS is 48 PRBs and the density is 3.
- The measured signals are in the directions covered by the percentile EIS spherical coverage of the UE, defined in clause 7.3.4 of TS 38.101-2 [19].

The performance with larger bandwidth of CSI-RS is equal to or better than the accuracy requirements in Table 10.1.20.2.2-1.



**Table 10.1.20.2.2-1: CSI-RS based L1-RSRP relative accuracy in FR2**

Accuracy		Conditions		
Normal condition	Extreme condition	CSI-RS $\hat{E}s/lot$	$I_o$ <sup>Note 1</sup> range	
			Minimum $I_o$	Maximum $I_o$
dB	dB	dB	dBm / $SCS_{CSI-RS}$	
			$SCS_{CSI-RS} = 60kHz$	$SCS_{CSI-RS} = 120kHz$
$\pm 6.5$	$\pm 9.5$	$\geq -3$	Same value as CSI-RS RP in Table B.2.4.2-2, according to UE Power class, operating band and angle of arrival	
NOTE 1: $I_o$ specified at the Reference point, and assumed to have constant EPRE across the bandwidth. NOTE 2: The parameter CSI-RS $\hat{E}s/lot$ is the minimum CSI-RS $\hat{E}s/lot$ of the pair of CSI-RS resources to which the requirement applies. NOTE 3: Values based on Refsens and EIS spherical coverage as defined in clauses 7.3.2 and 7.3.4 of TS 38.101-2 [19]. Applicable side condition selected depending on angle of arrival. NOTE 4: In the test cases, the CSI-RS $\hat{E}s/lot$ and related parameters may need to be adjusted to ensure $\hat{E}s/lot$ at UE baseband is above the value defined in this table.				

### 10.1.21 SFTD accuracy requirements

#### 10.1.21.1 SFTD accuracy requirements for NE-DC

The SFN and frame timing difference (SFTD) is measured between PCell and E-UTRAN PSCell under NE-DC.

The accuracy requirements in Table 10.1.21.1-4 are applicable under the following conditions:

For FR1 PCell SFN and frame timing measurement:

- Conditions defined in clause 7.3 of TS 38.101-1 [18] for reference sensitivity are fulfilled.
- $I_o$  range defined in Table 10.1.21.1-1.

**Table 10.1.21.1-1: PCell  $I_o$  range conditions in FR1**

Parameter	$I_o$ <sup>Note 1</sup> range			
	NR operating band groups <sup>Note 4, 5</sup>	Minimum $I_o$ <sup>Note 2, 3</sup>		Maximum $I_o$ dBm/ $BW_{Channel}$
		dBm/ $SCS_{SSB}$		
		$SCS_{SSB} = 15$ kHz	$SCS_{SSB} = 30$ kHz	
<b>Conditions</b>	NR_FDD_FR1_A, NR_TDD_FR1_A	-121	-118	-50
	NR_FDD_FR1_B	-120.5	-117.5	-50
	NR_TDD_FR1_C	-120	-117	-50
	NR_FDD_FR1_D, NR_TDD_FR1_D	-119.5	-116.5	-50
	NR_FDD_FR1_E, NR_TDD_FR1_E	-119	-116	-50
	NR_FDD_FR1_F	-118.5	-115.5	-50
	NR_FDD_FR1_G	-118	-115	-50
	NR_FDD_FR1_H	-117.5	-114.5	-50
NOTE 1: $I_o$ is assumed to have constant EPRE across the bandwidth. NOTE 2: The condition level is increased by $\Delta R_{IB,c}$ as defined in clause 7.3B in TS 38.101-3 [20], depending on E-UTRA – NR band combination. NOTE 3: The condition level is increased by MSD as defined in clause 7.3B in TS 38.101-3 [20], if applicable depending on E-UTRA – NR band combination. NOTE 4: NR operating band groups are as defined in clause 3.5. NOTE 5: Only NR bands within EN-DC band combinations as specified in clause 5.5B in TS 38.101-3 [20] are applicable.				

For FR2 PCell SFN and frame timing measurement:

- Conditions defined in clause 7.3 of TS 38.101-2 [19] for reference sensitivity are fulfilled.
- Io range defined in Table 10.1.21.1-2.

**Table 10.1.21.1-2: PCell Io range conditions in FR2**

Parameter	Io <sup>Note 1</sup> range		
	Minimum Io <sup>Note 2, 3</sup>		Maximum Io
	dBm/ SCS <sub>SSB</sub>		
	SCS <sub>SSB</sub> = 15 kHz	SCS <sub>SSB</sub> = 30 kHz	dBm/BW <sub>Channel</sub>
Conditions	Same value as SSB_RP in Table B.2.4.1-2, according to UE Power class, operating band and angle of arrival	Same value as SSB_RP in Table B.2.4.1-2, according to UE Power class, operating band and angle of arrival	-50
NOTE 1: Io is assumed to have constant EPRE across the bandwidth and specified at the Reference point.			
NOTE 2: Values based on Refsens and EIS spherical coverage as defined in clauses 7.3.2 and 7.3.4 of TS 38.101-2 [19]. Applicable side condition selected depending on angle of arrival.			
NOTE 3: In the test cases, the SSB Ês/Iot and related parameters may need to be adjusted to ensure Ês/Iot at UE baseband is above the value defined in this table.			

For E-UTRA PSCell SFN and frame timing measurement:

- Cell specific reference signals are transmitted either from one, two or four antenna ports.
- Conditions defined in TS 36.101 [25] Clause 7.3 for reference sensitivity are fulfilled.
- No changes to the uplink transmission timing are applied during the measurement period.
- RSRP<sub>dBm</sub> according to Annex B.3.5 in TS 36.101 [25] for a corresponding Band.
- Io range defined in Table 10.1.21.1-3.

**Table 10.1.21.1-3: E-UTRA PSCell Io range conditions**

Parameter	Io <sup>Note 1</sup> range		
	E-UTRA operating band groups <sup>Note 3</sup>	Minimum Io	Maximum Io
Conditions		dBm/15kHz <sup>Note 2</sup>	dBm/BW <sub>Channel</sub>
	FDD_A, TDD_A	-121	-50
	FDD_C, TDD_C	-120	-50
	FDD_D	-119.5	-50
	FDD_E, TDD_E	-119	-50
	FDD_F	-118.5	-50
	FDD_G	-118	-50
	FDD_H	-117.5	-50
	FDD_N	-114.5	-50
NOTE 1: When in dBm/15kHz, the minimum Io condition is expressed as the average Io per RE over all REs in that symbol. Io may be different in different symbols within a subframe.			
NOTE 2: The condition level is increased by Δ>0, when applicable, as described in clauses B.4.2 and B.4.3 in TS36.133 [15].			
NOTE 3: E-UTRA operating band groups are as defined in clause 3.5 in TS 36.133 [15].			

**Table 10.1.21.1-4: SFTD measurement accuracy**

Accuracy	Conditions	
	Ês/Iot <sup>Note 2</sup>	Frequency range
T <sub>s</sub> <sup>Note 1</sup>	dB	
40*64*Tc	≥-3	FR1
40*64*Tc		FR2
NOTE 1: Tc is the basic timing unit defined in TS 38.211 [6].		

NOTE 2: The parameter  $\hat{E}_s/\text{lot}$  is the minimum  $\hat{E}_s/\text{lot}$  of the pair of cells to which the requirement applies.

### 10.1.21.2 SFTD accuracy requirements for NR-DC

The SFN and frame timing difference (SFTD) is measured between PCell in FR1 and PSCell in FR2 under NR dual connectivity.

The accuracy requirements in Table 10.1.21.2-3 are applicable under the following conditions:

For FR1 PCell SFN and frame timing measurement:

- Conditions defined in clause 7.3 of TS 38.101-1 [18] for reference sensitivity are fulfilled.
- $I_o$  range defined in Table 10.1.21.2-1.

**Table 10.1.21.2-1: PCell  $I_o$  range conditions in FR1**

Parameter	$I_o$ <sup>Note 1</sup> range			
	NR operating band groups <sup>Note 2</sup>	Minimum $I_o$		Maximum $I_o$ dBm/BW <sub>Channel</sub>
		dBm/ SCS <sub>SSB</sub>		
		SCS <sub>SSB</sub> = 15 kHz	SCS <sub>SSB</sub> = 30 kHz	
Conditions	NR_FDD_FR1_A, NR_TDD_FR1_A	-121	-118	-50
	NR_FDD_FR1_B	-120.5	-117.5	-50
	NR_TDD_FR1_C	-120	-117	-50
	NR_FDD_FR1_D, NR_TDD_FR1_D	-119.5	-116.5	-50
	NR_FDD_FR1_E, NR_TDD_FR1_E	-119	-116	-50
	NR_FDD_FR1_F	-118.5	-115.5	-50
	NR_FDD_FR1_G	-118	-115	-50
	NR_FDD_FR1_H	-117.5	-114.5	-50

NOTE 1:  $I_o$  is assumed to have constant EPRE across the bandwidth.  
 NOTE 2: NR operating band groups are as defined in clause 3.5.2.

For FR2 PSCell SFN and frame timing measurement:

- Conditions defined in clause 7.3 of TS 38.101-2 [19] for reference sensitivity are fulfilled.
- $I_o$  range defined in Table 10.1.21.2-2.
- The measured signals are in the directions covered by the percentile EIS spherical coverage of the UE, defined in clause 7.3.4 of TS 38.101-2 [19].

**Table 10.1.21.2-2: PSCell  $I_o$  range conditions in FR2**

Parameter	$I_o$ <sup>Note 1</sup> range		
	Minimum $I_o$ <sup>Note 2, 3</sup>		Maximum $I_o$ dBm/BW <sub>Channel</sub>
	dBm/ SCS <sub>SSB</sub>		
	SCS <sub>SSB</sub> = 15 kHz	SCS <sub>SSB</sub> = 30 kHz	
Conditions	Same value as SSB_RP in Table B.2.4.1-2, according to UE Power class, operating band and angle of arrival	Same value as SSB_RP in Table B.2.4.1-2, according to UE Power class, operating band and angle of arrival	-50

NOTE 1:  $I_o$  is assumed to have constant EPRE across the bandwidth and specified at the Reference point.  
 NOTE 2: Values based on Refsens and EIS spherical coverage as defined in clauses 7.3.2 and 7.3.4 of TS 38.101-2 [19]. Applicable side condition selected depending on angle of arrival.  
 NOTE 3: In the test cases, the SSB  $\hat{E}_s/\text{lot}$  and related parameters may need to be adjusted to ensure  $\hat{E}_s/\text{lot}$  at UE baseband is above the value defined in this table.

**Table 10.1.21.2-3: SFTD measurement accuracy**

Accuracy	Conditions	
	$\hat{E}s/lot$ <sup>Note 2</sup>	Frequency range
$T_S$ <sup>Note 1</sup>	dB	
$40 \cdot 64 \cdot T_C$	$\geq -3$	Between FR1 and FR2
NOTE 1: $T_C$ is the basic timing unit defined in TS 38.211 [6].		
NOTE 2: The parameter $\hat{E}s/lot$ is the minimum $\hat{E}s/lot$ of the pair of cells to which the requirement applies.		

**10.1.21.3 Inter frequency SFTD accuracy requirements**

The SFN and frame timing difference (SFTD) is measured between PCell and inter-frequency neighbour cell.

The accuracy requirements in Table 10.1.21.3-3 are applicable under the following conditions:

For FR1 PCell, inter frequency neighbour cell SFN and frame timing measurement:

- Conditions defined in clause 7.3 of TS 38.101-1 [18] for reference sensitivity are fulfilled.
- $I_o$  range defined in Table 10.1.21.3-1.

**Table 10.1.21.3-1: PCell, inter frequency neighbour cell  $I_o$  range conditions in FR1**

Parameter	$I_o$ <sup>Note 1</sup> range			
	NR operating band groups <sup>Note 2</sup>	Minimum $I_o$		Maximum $I_o$
		dBm/ $SCS_{SSB}$		
		$SCS_{SSB} = 15$ kHz	$SCS_{SSB} = 30$ kHz	dBm/ $BW_{Channel}$
Conditions	NR_FDD_FR1_A, NR_TDD_FR1_A	-121	-118	-50
	NR_FDD_FR1_B	-120.5	-117.5	-50
	NR_TDD_FR1_C	-120	-117	-50
	NR_FDD_FR1_D, NR_TDD_FR1_D	-119.5	-116.5	-50
	NR_FDD_FR1_E, NR_TDD_FR1_E	-119	-116	-50
	NR_FDD_FR1_F	-118.5	-115.5	-50
	NR_FDD_FR1_G	-118	-115	-50
	NR_FDD_FR1_H	-117.5	-114.5	-50
NOTE 1: $I_o$ is assumed to have constant EPRE across the bandwidth.				
NOTE 2: NR operating band groups are as defined in clause 3.5.2.				

For FR2 PCell, inter frequency neighbour cell SFN and frame timing measurement:

- Conditions defined in clause 7.3 of TS 38.101-2 [19] for reference sensitivity are fulfilled.
- $I_o$  range defined in Table 10.1.21.3-2.
- The measured signals are in the directions covered by the percentile EIS spherical coverage of the UE, defined in clause 7.3.4 of TS 38.101-2 [19].

**Table 10.1.21.3-2: PCell, inter frequency neighbour cell  $I_o$  range conditions in FR2**

Parameter	$I_o$ <sup>Note 1</sup> range		
	Minimum $I_o$ <sup>Note 2, 3</sup>		Maximum $I_o$
	dBm/ $SCS_{SSB}$		
	$SCS_{SSB} = 15$ kHz	$SCS_{SSB} = 30$ kHz	dBm/ $BW_{Channel}$
Conditions	Same value as $SSB\_RP$ in Table B.2.4.1-2, according to UE Power class, operating band and angle of arrival	Same value as $SSB\_RP$ in Table B.2.4.1-2, according to UE Power class, operating band and angle of arrival	-50
NOTE 1: $I_o$ is assumed to have constant EPRE across the bandwidth and specified at the Reference point.			
NOTE 2: Values based on Refsens and EIS spherical coverage as defined in clauses 7.3.2 and 7.3.4 of TS 38.101-2 [19]. Applicable side condition selected depending on angle of arrival.			

NOTE 3: In the test cases, the SSB  $\hat{\epsilon}_s/\text{lot}$  and related parameters may need to be adjusted to ensure  $\hat{\epsilon}_s/\text{lot}$  at UE baseband is above the value defined in this table.

**Table 10.1.21.3-3: Inter frequency SFTD measurement accuracy**

Accuracy	Conditions	
	$\hat{\epsilon}_s/\text{lot}$ <sup>Note 2</sup>	Frequency range
$T_s$ <sup>Note 1</sup>	dB	
$40 \cdot 64 \cdot T_c$	$\geq -3$	FR1, FR2
NOTE 1: $T_c$ is the basic timing unit defined in TS 38.211 [6].		
NOTE 2: The parameter $\hat{\epsilon}_s/\text{lot}$ is the minimum $\hat{\epsilon}_s/\text{lot}$ of the pair of cells to which the requirement applies.		

## 10.1.22 CLI measurement accuracy requirements

### 10.1.22.1 SRS-RSRP

#### 10.1.22.1.1 SRS-RSRP Accuracy

The SRS-RSRP measurement reported by the UE shall fulfil the accuracy requirements defined in Table 10.1.22.1.1-1 for FR1 and Table 10.1.22.1.1-2 for FR2, provided that the following conditions are met. The accuracy requirements in this clause are derived based on AWGN radio propagation conditions.

- Conditions defined in clause 7.3 of TS 38.101-1 [18] for reference sensitivity are fulfilled.
- Conditions for SRS-RSRP measurements are fulfilled according to Annex B.2.z for a corresponding Band for each relevant SRS resource configured for measurement.
- The time difference between UE’s DL reference timing in the serving cell and SRS arrival time is no larger than  $T_{\text{error\_SRS\_RSRP}}$ , where
  - $T_{\text{error\_SRS\_RSRP}} = T_C \times N_{TA\_offset} + 4.67\mu\text{s}$  for FR1
  - $T_{\text{error\_SRS\_RSRP}} = T_C \times N_{TA\_offset} + 3.67\mu\text{s}$  for FR2
  - $N_{TA\_offset}$  is defined in Table 7.1.2-2
  - $T_C$  is 0.509ns
- The number of SRS ports in the SRS resource configured for measurement is 1,
- The number of symbols in the SRS resource configured for measurement is 1,
- The number of repetitions in the SRS resource configured for measurement is 1,
- Frequency hopping, sequence group hopping or sequence hopping is disabled in the SRS resource configured for measurement,
- The bandwidth of the SRS resource is 48 PRBs.
- One of the following conditions is met
  - There is no other SRS resource with the same root sequence and on the same symbol and with same comb as the relevant SRS resource.
  - If multiple SRS resources are on the same symbol and with same comb, the distance between cyclic shifts of any two resources is no less than 6 if  $\text{transmissionComb} = n_4$ , and no less than 4 if  $\text{transmissionComb} = n_2$ .

**Table 10.1.22.1.1-1: SRS-RSRP absolute accuracy in FR1**

Accuracy	Conditions
----------	------------

Normal condition			Extreme condition			SRS $\hat{E}_s/\text{lot}$	$I_o$ <sup>Note 1</sup> range					
dB			dB				NR operating band groups <sup>Note 2</sup>	Minimum $I_o$			Maximum $I_o$	
SCS <sub>SRS</sub> (kHz)			SCS <sub>SRS</sub> (kHz)			dB		dBm / SCS <sub>SRS</sub>			dBm/BW <sub>Channel</sub>	dBm/BW <sub>Channel</sub>
15	30	60	15	30	60		SCS <sub>S</sub> RS = 15 kHz	SCS <sub>S</sub> RS = 30 kHz	SCS <sub>S</sub> RS = 60 kHz			
±3	±3.5	±5	±7.5	±8	±9.5	≥1	NR_TDD_FR1_A,	-120	-117	-114	N/A	-70
							NR_TDD_FR1_C	-119	-116	-113	N/A	-70
							NR_TDD_FR1_D	-118.5	-115.5	-112.5	N/A	-70
							NR_TDD_FR1_E	-118	-115	-112	N/A	-70
±6.5	±7	±8.5	±9.5	±10	±11.5	≥1	NR_TDD_FR1_A, NR_TDD_FR1_C, NR_TDD_FR1_D, NR_TDD_FR1_E	N/A	N/A	N/A	-70	-50

NOTE 1:  $I_o$  is assumed to have constant EPRE across the bandwidth.  
 NOTE 2: NR operating band groups in FR1 are as defined in clause 3.5.2.

Table 10.1.22.1.1-2: SRS-RSRP absolute accuracy in FR2

Accuracy				Conditions			
Normal condition		Extreme condition		SRS $\hat{E}_s/\text{lot}$	$I_o$ <sup>Note 1</sup> range		
dB		dB			Minimum $I_o$		Maximum $I_o$
SCS <sub>SRS</sub> (kHz)		SCS <sub>SRS</sub> (kHz)		dB	dBm / SCS <sub>SRS</sub> <sup>Note 2</sup>		dBm/BW <sub>Channel</sub>
60	120	60	120		SCS <sub>SRS</sub> = 60kHz	SCS <sub>SRS</sub> = 120kHz	
±6	±8.5	±9	±11.5	≥1	Same value as SRS_RP in Table B.2.7-2, according to UE Power class, operating band and angle of arrival		-70
±9	±11.5	±11	±13.5	≥1	N/A		-50

NOTE 1:  $I_o$  specified at the Reference point, and assumed to have constant EPRE across the bandwidth.  
 NOTE 2: Values based on Refsens and EIS spherical coverage as defined in clauses 7.3.2 and 7.3.4 of TS 38.101-2 [19]. Applicable side condition selected depending on angle of arrival.  
 NOTE 3: In the test cases, the SSB  $\hat{E}_s/\text{lot}$  and related parameters may need to be adjusted to ensure  $\hat{E}_s/\text{lot}$  at UE baseband is above the value defined in this table.

10.1.22.1.2 SRS-RSRP report mapping

The reporting range of SRS-RSRP is defined from -140 dBm to -44 dBm with 1 dB resolution. The mapping of measured quantity is defined in Table 10.1.22.1.2-1. The range in the signalling may be larger than the guaranteed accuracy range.

**Table 10.1.22.1.2-1: SRS-RSRP measurement report mapping**

Reported value	Measured quantity value	Unit
SRS-RSRP_0	SRS-RSRP<-140	dBm
SRS-RSRP_1	-140≤ SRS-RSRP<-139	dBm
SRS-RSRP_2	-139≤ SRS-RSRP<-138	dBm
SRS-RSRP_3	-138≤ SRS-RSRP<-137	dBm
SRS-RSRP_4	-137≤ SRS-RSRP<-136	dBm
..	..	...
SRS-RSRP_95	-46≤ SRS-RSRP<-45	dBm
SRS-RSRP_96	-45≤ SRS-RSRP<-44	dBm
SRS-RSRP_97	-44≤ SRS-RSRP	dBm
SRS-RSRP_98	Infinity	
Note: 'Infinity' means that UE cannot detect SRS due to too strong signal to measure.		

10.1.22.2 CLI-RSSI

10.1.22.2.1 CLI-RSSI Accuracy

The CLI-RSSI measurement reported by the UE shall fulfil the accuracy requirements defined in Table 10.1.22.2.1-1 for FR1 and Table 10.1.22.2.1-2 for FR2, provided that the following conditions are met.

- Conditions defined in clause 7.3 of TS 38.101-1 [18] for reference sensitivity are fulfilled.

**Table 10.1.22.2.1-1: CLI-RSSI absolute accuracy in FR1**

Accuracy		Conditions					
Normal condition	Extreme condition	Io <sup>Note 1</sup> range					
		NR operating band groups <sup>Note 2</sup>	Minimum Io			Maximum Io	
dB	dB			dBm / SCS <sub>SRS</sub>			dBm/BW <sub>Channel</sub>
		SCS <sub>SRS</sub> = 15 kHz		SCS <sub>SRS</sub> = 30 kHz	SCS <sub>SRS</sub> = 60 kHz		
±3.5	±6.5	NR_TDD_FR1_A,	-120	-117	-114	N/A	-70
		NR_TDD_FR1_C	-119	-116	-113	N/A	-70
		NR_TDD_FR1_D	-118.5	-115.5	-112.5	N/A	-70
		NR_TDD_FR1_E	-118	-115	-112	N/A	-70
±5.5	±8.5	Note 3	Note 3	Note 3	Note 3	-70	-50

NOTE 1: Io is assumed to have constant EPRE across the bandwidth.  
 NOTE 2: NR operating band groups in FR1 are as defined in clause 3.5.2.  
 NOTE 3: The same bands and the same Io conditions for each band apply for this requirement as for the corresponding highest accuracy requirement.

**Table 10.1.22.2.1-2: CLI-RSSI absolute accuracy in FR2**

Accuracy		Conditions			
Normal condition	Extreme condition	Io <sup>Note 1</sup> range			
		Minimum Io		Maximum Io	
dB	dB	dBm / SCS <sub>SRS</sub> <sup>Note 2</sup>		dBm/BW <sub>Channel</sub>	dBm/BW <sub>Channel</sub>
		SCS <sub>SRS</sub> = 60kHz	SCS <sub>SRS</sub> = 120kHz		
±5	±8	Same value as SRS_RP in Table B.2.7-2, according to UE Power class, operating band and angle of arrival		N/A	-70

$\pm 7$	$\pm 10$	Note 4	-70	-50
NOTE 1: $I_0$ specified at the Reference point, and assumed to have constant EPRE across the bandwidth.				
NOTE 2: Values based on Refsens and EIS spherical coverage as defined in clauses 7.3.2 and 7.3.4 of TS 38.101-2 [19]. Applicable side condition selected depending on angle of arrival.				
NOTE 3: In the test cases, the SSB $\hat{E}_s$ /lot and related parameters may need to be adjusted to ensure $\hat{E}_s$ /lot at UE baseband is above the value defined in this table.				
NOTE 4: The same bands and the same $I_0$ conditions for each band apply for this requirement as for the corresponding highest accuracy requirement.				

### 10.1.22.2.2 CLI-RSSI report mapping

The reporting range of CLI-RSSI is defined from -100 dBm to -25 dBm with 1 dB resolution. The mapping of measured quantity is defined in Table 10.1.22.2.2-1. The range in the signalling may be larger than the guaranteed accuracy range. UE shall scale the measured CLI-RSSI to report a nominal RSSI equivalent to 6RB measurement with 15kHz SCS.

**Table 10.1.22.2.2-1: CLI-RSSI measurement report mapping**

Reported value	Measured quantity value	Unit
CLI-RSSI_00	CLI-RSSI < -100	dBm
CLI-RSSI_01	$-100 \leq \text{CLI-RSSI} < -99$	dBm
CLI-RSSI_02	$-99 \leq \text{CLI-RSSI} < -98$	dBm
...	...	...
CLI-RSSI_74	$-27 \leq \text{CLI-RSSI} < -26$	dBm
CLI-RSSI_75	$-26 \leq \text{CLI-RSSI} < -25$	dBm
CLI-RSSI_76	$-25 \leq \text{CLI-RSSI}$	dBm

### 10.1.24.3.1 Absolute PRS-RSRP Measurement Report Mapping

The reporting range of absolute PRS-RSRP measurement is defined from -156 dBm to -31 dBm with 1 dB resolution.

The mapping of measured quantity is defined in Table 10.1.24.3.1-1. The range in the signalling may be larger than the guaranteed accuracy range.

**Table 10.1.24.3.1-1: Measurement report mapping for PRS-RSRP**

Reported value	Measured quantity value	Unit
PRS_RSRP_0	PRS-RSRP < -156	dBm
PRS_RSRP_1	$-156 \leq \text{PRS-RSRP} < -155$	dBm
PRS_RSRP_2	$-155 \leq \text{PRS-RSRP} < -154$	dBm
PRS_RSRP_3	$-154 \leq \text{PRS-RSRP} < -153$	dBm
PRS_RSRP_4	$-153 \leq \text{PRS-RSRP} < -152$	dBm
PRS_RSRP_5	$-152 \leq \text{PRS-RSRP} < -151$	dBm
PRS_RSRP_6	$-151 \leq \text{PRS-RSRP} < -150$	dBm
PRS_RSRP_7	$-150 \leq \text{PRS-RSRP} < -149$	dBm
PRS_RSRP_8	$-149 \leq \text{PRS-RSRP} < -148$	dBm
PRS_RSRP_9	$-148 \leq \text{PRS-RSRP} < -147$	dBm
PRS_RSRP_10	$-147 \leq \text{PRS-RSRP} < -146$	dBm
PRS_RSRP_11	$-146 \leq \text{PRS-RSRP} < -145$	dBm
PRS_RSRP_12	$-145 \leq \text{PRS-RSRP} < -144$	dBm
PRS_RSRP_13	$-144 \leq \text{PRS-RSRP} < -143$	dBm
PRS_RSRP_14	$-143 \leq \text{PRS-RSRP} < -142$	dBm
PRS_RSRP_15	$-142 \leq \text{PRS-RSRP} < -141$	dBm
PRS_RSRP_16	$-141 \leq \text{PRS-RSRP} < -140$	dBm
PRS_RSRP_17	$-140 \leq \text{PRS-RSRP} < -139$	dBm
PRS_RSRP_18	$-139 \leq \text{PRS-RSRP} < -138$	dBm
...	...	...
PRS_RSRP_111	$-46 \leq \text{PRS-RSRP} < -45$	dBm
PRS_RSRP_112	$-45 \leq \text{PRS-RSRP} < -44$	dBm



PRS_RSRP_113	$-44 \leq \text{PRS-RSRP} < -43$	dBm
PRS_RSRP_114	$-43 \leq \text{PRS-RSRP} < -42$	dBm
PRS_RSRP_115	$-42 \leq \text{PRS-RSRP} < -41$	dBm
PRS_RSRP_116	$-41 \leq \text{PRS-RSRP} < -40$	dBm
PRS_RSRP_117	$-40 \leq \text{PRS-RSRP} < -39$	dBm
PRS_RSRP_118	$-39 \leq \text{PRS-RSRP} < -38$	dBm
PRS_RSRP_119	$-38 \leq \text{PRS-RSRP} < -37$	dBm
PRS_RSRP_120	$-37 \leq \text{PRS-RSRP} < -36$	dBm
PRS_RSRP_121	$-36 \leq \text{PRS-RSRP} < -35$	dBm
PRS_RSRP_122	$-35 \leq \text{PRS-RSRP} < -34$	dBm
PRS_RSRP_123	$-34 \leq \text{PRS-RSRP} < -33$	dBm
PRS_RSRP_124	$-33 \leq \text{PRS-RSRP} < -32$	dBm
PRS_RSRP_125	$-32 \leq \text{PRS-RSRP} < -31$	dBm
PRS_RSRP_126	$-31 \leq \text{PRS-RSRP}$	dBm

### 10.1.24.3.2 Differential Report Mapping for PRS-RSRP Measurement

The reporting range of differential PRS-RSRP is defined from -30 dB to 0 dB with 1 dB resolution when *nr-DL-AoD-RequestLocationInformation* message is received.

The mapping of measured quantity is defined in Table 10.1.24.3.2-1. The range in the signalling may be larger than the guaranteed accuracy range.

The reporting range of differential PRS-RSRP is defined from -30 dB to 30 dB with 1 dB resolution when *nr-DL-TDOA-RequestLocationInformation* or *nr-Multi-RTT-RequestLocationInformation* is received.

The mapping of measured quantity is defined in Table 10.1.24.3.2-2. The range in the signalling may be larger than the guaranteed accuracy range or the range supported by the UE receiver for differential RSRP measured on different PRS resources in frequency domain at the same time.

**Table 10.1.24.3.2-1: Measurement report mapping for differential PRS-RSRP**

Reported value	Measured quantity value	Unit
DIFFRSRP_0	$-30 \geq \Delta \text{RSRP}$	dB
DIFFRSRP_1	$-29 \geq \Delta \text{RSRP} > -30$	dB
DIFFRSRP_2	$-28 \geq \Delta \text{RSRP} > -29$	dB
DIFFRSRP_3	$-27 \geq \Delta \text{RSRP} > -28$	dB
DIFFRSRP_4	$-26 \geq \Delta \text{RSRP} > -27$	dB
DIFFRSRP_5	$-25 \geq \Delta \text{RSRP} > -26$	dB
DIFFRSRP_6	$-24 \geq \Delta \text{RSRP} > -25$	dB
DIFFRSRP_7	$-23 \geq \Delta \text{RSRP} > -24$	dB
DIFFRSRP_8	$-22 \geq \Delta \text{RSRP} > -23$	dB
DIFFRSRP_9	$-21 \geq \Delta \text{RSRP} > -22$	dB
DIFFRSRP_10	$-20 \geq \Delta \text{RSRP} > -21$	dB
DIFFRSRP_11	$-19 \geq \Delta \text{RSRP} > -20$	dB
DIFFRSRP_12	$-18 \geq \Delta \text{RSRP} > -19$	dB
DIFFRSRP_13	$-17 \geq \Delta \text{RSRP} > -18$	dB
DIFFRSRP_14	$-16 \geq \Delta \text{RSRP} > -17$	dB
DIFFRSRP_15	$-15 \geq \Delta \text{RSRP} > -16$	dB
DIFFRSRP_16	$-14 \geq \Delta \text{RSRP} > -15$	dB
DIFFRSRP_17	$-13 \geq \Delta \text{RSRP} > -14$	dB
DIFFRSRP_18	$-12 \geq \Delta \text{RSRP} > -13$	dB
DIFFRSRP_19	$-11 \geq \Delta \text{RSRP} > -12$	dB
DIFFRSRP_20	$-10 \geq \Delta \text{RSRP} > -11$	dB
DIFFRSRP_21	$-9 \geq \Delta \text{RSRP} > -10$	dB
DIFFRSRP_22	$-8 \geq \Delta \text{RSRP} > -9$	dB
DIFFRSRP_23	$-7 \geq \Delta \text{RSRP} > -8$	dB
DIFFRSRP_24	$-6 \geq \Delta \text{RSRP} > -7$	dB

DIFFRSRP_25	$-5 \geq \Delta \text{RSRP} > -6$	dB
DIFFRSRP_26	$-4 \geq \Delta \text{RSRP} > -5$	dB
DIFFRSRP_27	$-3 \geq \Delta \text{RSRP} > -4$	dB
DIFFRSRP_28	$-2 \geq \Delta \text{RSRP} > -3$	dB
DIFFRSRP_29	$-1 \geq \Delta \text{RSRP} > -2$	dB
DIFFRSRP_30	$0 \geq \Delta \text{RSRP} > -1$	dB

Table 10.1.24.3.2-2: Measurement report mapping for differential PRS-RSRP

Reported value	Measured quantity value	Unit
DIFFRSRP_0	$-30 \geq \Delta \text{RSRP}$	dB
DIFFRSRP_1	$-29 \geq \Delta \text{RSRP} > -30$	dB
DIFFRSRP_2	$-28 \geq \Delta \text{RSRP} > -29$	dB
DIFFRSRP_3	$-27 \geq \Delta \text{RSRP} > -28$	dB
DIFFRSRP_4	$-26 \geq \Delta \text{RSRP} > -27$	dB
DIFFRSRP_5	$-25 \geq \Delta \text{RSRP} > -26$	dB
DIFFRSRP_6	$-24 \geq \Delta \text{RSRP} > -25$	dB
DIFFRSRP_7	$-23 \geq \Delta \text{RSRP} > -24$	dB
DIFFRSRP_8	$-22 \geq \Delta \text{RSRP} > -23$	dB
DIFFRSRP_9	$-21 \geq \Delta \text{RSRP} > -22$	dB
DIFFRSRP_10	$-20 \geq \Delta \text{RSRP} > -21$	dB
DIFFRSRP_11	$-19 \geq \Delta \text{RSRP} > -20$	dB
DIFFRSRP_12	$-18 \geq \Delta \text{RSRP} > -19$	dB
DIFFRSRP_13	$-17 \geq \Delta \text{RSRP} > -18$	dB
DIFFRSRP_14	$-16 \geq \Delta \text{RSRP} > -17$	dB
...	...	...
DIFFRSRP_25	$-5 \geq \Delta \text{RSRP} > -6$	dB
DIFFRSRP_26	$-4 \geq \Delta \text{RSRP} > -5$	dB
DIFFRSRP_27	$-3 \geq \Delta \text{RSRP} > -4$	dB
DIFFRSRP_28	$-2 \geq \Delta \text{RSRP} > -3$	dB
DIFFRSRP_29	$-1 \geq \Delta \text{RSRP} > -2$	dB
DIFFRSRP_30	$0 \geq \Delta \text{RSRP} > -1$	dB
DIFFRSRP_31	$1 \geq \Delta \text{RSRP} > 0$	dB
DIFFRSRP_32	$2 \geq \Delta \text{RSRP} > 1$	dB
DIFFRSRP_33	$3 \geq \Delta \text{RSRP} > 2$	dB
DIFFRSRP_34	$4 \geq \Delta \text{RSRP} > 3$	dB
DIFFRSRP_35	$5 \geq \Delta \text{RSRP} > 4$	dB
DIFFRSRP_36	$6 \geq \Delta \text{RSRP} > 5$	dB
...	...	...
DIFFRSRP_47	$17 \geq \Delta \text{RSRP} > 16$	dB
DIFFRSRP_48	$18 \geq \Delta \text{RSRP} > 17$	dB
DIFFRSRP_49	$19 \geq \Delta \text{RSRP} > 18$	dB
DIFFRSRP_50	$20 \geq \Delta \text{RSRP} > 19$	dB
DIFFRSRP_51	$21 \geq \Delta \text{RSRP} > 20$	dB
DIFFRSRP_52	$22 \geq \Delta \text{RSRP} > 21$	dB
DIFFRSRP_53	$23 \geq \Delta \text{RSRP} > 22$	dB
DIFFRSRP_54	$24 \geq \Delta \text{RSRP} > 23$	dB
DIFFRSRP_55	$25 \geq \Delta \text{RSRP} > 24$	dB
DIFFRSRP_56	$26 \geq \Delta \text{RSRP} > 25$	dB
DIFFRSRP_57	$27 \geq \Delta \text{RSRP} > 26$	dB
DIFFRSRP_58	$28 \geq \Delta \text{RSRP} > 27$	dB
DIFFRSRP_59	$29 \geq \Delta \text{RSRP} > 28$	dB
DIFFRSRP_60	$30 \geq \Delta \text{RSRP} > 29$	dB
DIFFRSRP_61	$\Delta \text{RSRP} > 30$	dB

## 10.1.23 RSTD Measurements

### 10.1.23.1 Introduction

The requirements in Clause 10.1.23 shall apply, provided the UE has received *nr-DL-TDOA-RequestLocationInformation* message from LMF via LPP [34] requesting the UE to report one or more DL RSTD measurements defined in TS 38.215 [4].

### 10.1.23.2 Measurement Accuracy Requirements

The accuracy requirements for RSTD measurement shall be within  $\pm(X+Y+Z+\Delta) T_c$ .

X is defined in Table 10.1.23.2-1 for AWGN channel and Table 10.1.23.2-3 for fading channel for FR1, provided that the following conditions are met.

- Conditions defined in clause 7.3 of TS 38.101-1 [18] for reference sensitivity are fulfilled.
- Conditions for RSTD measurements are fulfilled according to Annex B.2.14 for a corresponding Band for each relevant PRS resource configured for measurement.

X is defined in Table 10.1.23.2-2 for AWGN channel and Table 10.1.23.2-4 for fading channel for FR2, provided that the following conditions are met.

- Conditions defined in clause 7.3 of TS 38.101-2 [19] for reference sensitivity are fulfilled.
- Conditions for RSTD measurements are fulfilled according to Annex B.2.14 for a corresponding Band for each relevant PRS resource configured for measurement.

Note: The requirements for fading channel in this clause are derived based on TDL-A (30 ns delay spread, 5Hz) and TDL-C (60 ns delay spread, 300 Hz) channel models for FR1 and FR2 respectively.

When UE measures RSTD on PRS resources belonging to different PFLs, then the RSTD accuracy is defined as the accuracy corresponding to the largest accuracy value among different PFLs.

When UE measures RSTD on PRS resources belonging to same PFL,  $Y=32 T_c$ , provided that the time offset between the two PRS resource instances from the reference cell and the neighbor cell, which are used for a single RSTD estimate, is no greater than 160 ms.

When UE measures RSTD on PRS resources belonging different PFLs,  $Y=256 T_c$ , provided that the time offset between the two PRS resource instances from the reference cell and the neighbor cell, which are used for a single RSTD estimate, is no greater than 1280 ms.

Z is defined in Table 10.1.23.2-5 for FR1 and Table 10.1.23.2-6 for FR2, respectively.

$\Delta$  is zero for single PFL, and is defined in Table 10.1.23.2-5a for FR1 and Table 10.1.23.2-6a for FR2, respectively, for dual PFL.

**Table 10.1.23.2-1: RSTD absolute accuracy in FR1 for AWGN channel**

Accuracy	Conditions						
	PRS $\hat{E}_s/\text{lot}$	PRS SCS	PRS bandwidth Note 1	PRS resource repetition ( $T_{\text{rep}}^{\text{PRS}} * L_{\text{PRS}} / K_{\text{comb}}^{\text{PRS}}$ ) Note 2	Io <sup>Note 3</sup> range		
					NR operating band groups Note 4	Minimum Io	Maximum Io
$T_c$ Note 5	dB	kHz	RB			dBm/SCS	dBm/BW <sub>Channel</sub>
132	(PRS $\hat{E}_s/\text{lot}$ ) <sub>ref</sub> $\geq$ -6dB	15	$\geq$ 24	$\geq$ 4	NR_FDD_FR1_A, NR_TDD_FR1_A, NR_SDL_FR1_A NR_FDD_FR1_B	-127 -126.5	-50 -50

98	(PRS $\hat{E}_s/\text{lot}$ ) <sub>i</sub> ≥ -13dB	30	≥24	≥ 4	NR_TDD_FR1_C	-126	-50	
					NR_FDD_FR1_D, NR_TDD_FR1_D	-125.5	-50	
					NR_FDD_FR1_E, NR_TDD_FR1_E	-125	-50	
					NR_FDD_FR1_F	-124.5	-50	
					NR_FDD_FR1_G, NR_TDD_FR1_G	-124	-50	
					NR_FDD_FR1_H	-123.5	-50	
		≥52	≥1	Note 6	Note 6	Note 6		
		42	≥104	≥1	Note 6	Note 6	Note 6	
		75	30	≥24	≥ 4	NR_FDD_FR1_A, NR_TDD_FR1_A, NR_SDL_FR1_A	-124	-50
						NR_FDD_FR1_B	-123.5	-50
						NR_TDD_FR1_C	-123	-50
						NR_FDD_FR1_D, NR_TDD_FR1_D	-122.5	-50
NR_FDD_FR1_E, NR_TDD_FR1_E	-122					-50		
NR_FDD_FR1_F	-121.5					-50		
NR_FDD_FR1_G, NR_TDD_FR1_G	-121					-50		
NR_FDD_FR1_H	-120.5					-50		
48	≥ 48	≥ 1	Note 6	Note 6	Note 6			
24	≥ 132	≥ 1	Note 6	Note 6	Note 6			
50	60	≥ 24	≥ 4	NR_FDD_FR1_A, NR_TDD_FR1_A, NR_SDL_FR1_A	-121	-50		
				NR_FDD_FR1_B	-120.5	-50		
				NR_TDD_FR1_C	-120	-50		
				NR_FDD_FR1_D, NR_TDD_FR1_D	-119.5	-50		
				NR_FDD_FR1_E, NR_TDD_FR1_E	-119	-50		
				NR_FDD_FR1_F	-118.5	-50		
				NR_FDD_FR1_G, NR_TDD_FR1_G	-118	-50		
				NR_FDD_FR1_H	-117.5	-50		
24	≥ 64	≥ 1	Note 6	Note 6	Note 6			
10	≥ 132	≥ 1	Note 6	Note 6	Note 6			

NOTE 1: Minimum PRS bandwidth, which is minimum of the PRS bandwidths of the reference resource and the measured neighbour resource i.

NOTE 2: Minimum number of PRS resource repetitions among the reference resource and the measured neighbour resource i.  $T_{\text{rep}}^{\text{PRS}}, L_{\text{PRS}}, K_{\text{comb}}^{\text{PRS}}$  are configured by higher layer parameter *dl-PRS-ResourceRepetitionFactor*, *dl-PRS-NumSymbols* and *dl-PRS-CombSizeN* defined in TS 37.355 [34], respectively.

NOTE 3:  $I_0$  is assumed to have constant EPRE across the bandwidth.

NOTE 4: NR operating band groups in FR1 are as defined in clause 3.5.2.

NOTE 5:  $T_c$  is the basic timing unit defined in TS 38.211 [6].

NOTE 6: The same bands and the same  $I_0$  conditions for each band apply for this requirement as for the corresponding requirement with the PRS bandwidth of the smallest RB number for the corresponding SCS.

NOTE 7: Void

Table 10.1.23.2-2: RSTD absolute accuracy in FR2 for AWGN channel

Accuracy	Conditions					
	PRS $\hat{E}_s/\text{lot}$	PRS SCS	PRS bandwidth Note 1	PRS resource repetition ( $T_{\text{rep}}^{\text{PRS}} * L_{\text{PRS}} / K_{\text{comb}}^{\text{PRS}}$ ) Note 2	$I_0$ Note 3 range	
					Minimum $I_0$	Maximum $I_0$
$T_c$ Note 4	dB	kHz	RB		dBm/SCS	dBm/BW <sub>Channel</sub>
35		60	≥ 24	≥ 4	Same value as PRS_RP in Table B.2.14-2, according to	-50

					UE Power class, operating band and angle of arrival	
24	(PRS $\hat{E}_s/\text{lot}$ ) <sub>ref</sub> $\geq$ -6dB		$\geq 64$	$\geq 1$	Note 5	Note 5
11			$\geq 132$	$\geq 1$	Note 5	Note 5
24	(PRS $\hat{E}_s/\text{lot}$ ) <sub>i</sub> $\geq$ -13dB	120	$\geq 32$	$\geq 4$	Same value as PRS_RP in Table B.2.14-2, according to UE Power class, operating band and angle of arrival	-50
13			$\geq 64$	$\geq 1$	Note 5	Note 5
6			$\geq 128$	$\geq 1$	Note 5	Note 5

NOTE 1: Minimum PRS bandwidth, which is minimum of the PRS bandwidths of the reference resource and the measured neighbour resource i.  
 NOTE 2: Minimum number of PRS resource repetitions among the reference resource and the measured neighbour resource i.  $T_{\text{rep}}^{\text{PRS}}$ ,  $L_{\text{PRS}}$ ,  $K_{\text{comb}}^{\text{PRS}}$  are configured by higher layer parameter *dl-PRS-ResourceRepetitionFactor*, *dl-PRS-NumSymbols* and *dl-PRS-CombSizeN* defined in TS 37.355 [34], respectively.  
 NOTE 3:  $l_0$  is assumed to have constant EPRE across the bandwidth.  
 NOTE 4:  $T_c$  is the basic timing unit defined in TS 38.211 [6].  
 NOTE 5: The same bands and the same  $l_0$  conditions for each band apply for this requirement as for the corresponding requirement with the PRS bandwidth of the smallest RB number for the corresponding SCS.  
 NOTE 6: Void

Table 10.1.23.2-3: RSTD absolute accuracy in FR1 for fading channel

Accuracy	Conditions						
	PRS $\hat{E}_s/\text{lot}$	PRS SCS	PRS bandwidth Note 1	PRS resource repetition ( $T_{\text{rep}}^{\text{PRS}} * L_{\text{PRS}} / K_{\text{comb}}^{\text{PRS}}$ ) Note 2	$l_0$ Note 3 range		
					NR operating band groups Note 4	Minimum $l_0$	Maximum $l_0$
$T_c$ Note 5	dB	kHz	RB		dBm/SCS	dBm/BW <sub>Channel</sub>	
247	(PRS $\hat{E}_s/\text{lot}$ ) <sub>ref</sub> $\geq$ -6dB	15	$\geq 24$	$\geq 4$	NR_FDD_FR1_A, NR_TDD_FR1_A, NR_SDL_FR1_A	-127	-50
					NR_FDD_FR1_B	-126.5	-50
					NR_TDD_FR1_C	-126	-50
					NR_FDD_FR1_D, NR_TDD_FR1_D	-125.5	-50
					NR_FDD_FR1_E, NR_TDD_FR1_E	-125	-50
					NR_FDD_FR1_F	-124.5	-50
					NR_FDD_FR1_G, NR_TDD_FR1_G	-124	-50
					NR_FDD_FR1_H	-123.5	-50
140	(PRS $\hat{E}_s/\text{lot}$ ) <sub>ref</sub> $\geq$ -6dB		$\geq 52$	$\geq 1$	Note 6	Note 6	
86			$\geq 104$	$\geq 1$	Note 6	Note 6	
118	(PRS $\hat{E}_s/\text{lot}$ ) <sub>i</sub> $\geq$ -13dB	30	$\geq 24$	$\geq 4$	NR_FDD_FR1_A, NR_TDD_FR1_A, NR_SDL_FR1_A	-124	-50
					NR_FDD_FR1_B	-123.5	-50
					NR_TDD_FR1_C	-123	-50
					NR_FDD_FR1_D, NR_TDD_FR1_D	-122.5	-50
					NR_FDD_FR1_E, NR_TDD_FR1_E	-122	-50
					NR_FDD_FR1_F	-121.5	-50
					NR_FDD_FR1_G, NR_TDD_FR1_G	-121	-50
					NR_FDD_FR1_H	-120.5	-50
109	(PRS $\hat{E}_s/\text{lot}$ ) <sub>i</sub> $\geq$ -13dB		$\geq 48$	$\geq 1$	Note 6	Note 6	
28			$\geq 132$	$\geq 1$	Note 6	Note 6	
147		60	$\geq 24$	$\geq 4$	NR_FDD_FR1_A, NR_TDD_FR1_A, NR_SDL_FR1_A	-121	-50

					NR_FDD_FR1_B	-120.5	-50
					NR_TDD_FR1_C	-120	-50
					NR_FDD_FR1_D, NR_TDD_FR1_D	-119.5	-50
					NR_FDD_FR1_E, NR_TDD_FR1_E	-119	-50
					NR_FDD_FR1_F	-118.5	-50
					NR_FDD_FR1_G, NR_TDD_FR1_G	-118	-50
					NR_FDD_FR1_H	-117.5	-50
27			≥ 64	≥ 1	Note 6	Note 6	Note 6
21			≥ 132	≥ 1	Note 6	Note 6	Note 6

NOTE 1: Minimum PRS bandwidth, which is minimum of the PRS bandwidths of the reference resource and the measured neighbour resource *i*.

NOTE 2: Minimum number of PRS resource repetitions among the reference resource and the measured neighbour resource *i*.  $T_{rep}^{PRS}$ ,  $L_{PRS}$ ,  $K_{comb}^{PRS}$  are configured by higher layer parameter *dl-PRS-ResourceRepetitionFactor*, *dl-PRS-NumSymbols* and *dl-PRS-CombSizeN* defined in TS 37.355 [34], respectively.

NOTE 3:  $I_0$  is assumed to have constant EPRE across the bandwidth.

NOTE 4: NR operating band groups in FR1 are as defined in clause 3.5.2.

NOTE 5:  $T_c$  is the basic timing unit defined in TS 38.211 [6].

NOTE 6: The same bands and the same  $I_0$  conditions for each band apply for this requirement as for the corresponding requirement with the PRS bandwidth of the smallest RB number for the corresponding SCS.

NOTE 7: Void

Table 10.1.23.2-4: RSTD absolute accuracy in FR2 for fading channel

Accuracy	Conditions					
	PRS $\hat{E}_s/lot$	PRS SCS	PRS bandwidth Note 1	PRS resource repetition ( $T_{rep}^{PRS} * L_{PRS} / K_{comb}^{PRS}$ ) Note 2	$I_0$ Note 3 range	
					Minimum $I_0$	Maximum $I_0$
$T_c$ Note 4	dB	kHz	RB		dBm/SCS	dBm/BW <sub>Channel</sub>
83	(PRS $\hat{E}_s/lot$ ) <sub>ref</sub> ≥ -6dB	60	≥ 24	≥ 4	Same value as PRS_RP in Table B.2.14-2, according to UE Power class, operating band and angle of arrival	-50
64			≥ 64	≥ 1	Note 5	Note 5
46			≥ 132	≥ 1	Note 5	Note 5
48	(PRS $\hat{E}_s/lot$ ) <sub>i</sub> ≥ -13dB	120	≥ 32	≥ 4	Same value as PRS_RP in Table B.2.14-2, according to UE Power class, operating band and angle of arrival	-50
54			≥ 64	≥ 1	Note 5	Note 5
36			≥ 128	≥ 1	Note 5	Note 5

NOTE 1: Minimum PRS bandwidth, which is minimum of the PRS bandwidths of the reference resource and the measured neighbour resource *i*.

NOTE 2: Minimum number of PRS resource repetitions among the reference resource and the measured neighbour resource *i*.  $T_{rep}^{PRS}$ ,  $L_{PRS}$ ,  $K_{comb}^{PRS}$  are configured by higher layer parameter *dl-PRS-ResourceRepetitionFactor*, *dl-PRS-NumSymbols* and *dl-PRS-CombSizeN* defined in TS 37.355 [34], respectively.

NOTE 3:  $I_0$  is assumed to have constant EPRE across the bandwidth.

NOTE 4:  $T_c$  is the basic timing unit defined in TS 38.211 [6].

NOTE 5: The same bands and the same  $I_0$  conditions for each band apply for this requirement as for the corresponding requirement with the PRS bandwidth of the smallest RB number for the corresponding SCS.

NOTE 6: Void

Table 10.1.23.2-5: Margin for RSTD measurement accuracy in FR1

PRS BW (RB number)			Margin ( $T_c$ )
SCS=15kHz	SCS=30kHz	SCS=60kHz	
≥ 24	N/A	N/A	120
≥ 52	≥ 24	N/A	72
≥ 104	≥ 48	≥ 24	36

N/A	$\geq 132$	$\geq 64$	16
N/A	N/A	$\geq 132$	12

Table 10.1.23.2-5a: Margin  $\Delta$  for RSTD measurement accuracy in FR1

PRS BW (RB number)			Margin (Tc)
SCS=15kHz	SCS=30kHz	SCS=60kHz	
$\geq 24$	N/A	N/A	128
$\geq 52$	$\geq 24$	N/A	64
$\geq 104$	$\geq 48$	$\geq 24$	32
N/A	$\geq 132$	$\geq 64$	16
N/A	N/A	$\geq 132$	8

Table 10.1.23.2-6: Margin for RSTD measurement accuracy in FR2

PRS BW (RB number)		Margin (Tc)
SCS=60kHz	SCS=120kHz	
$\geq 24$	N/A	72
$\geq 64$	$\geq 32$	32
$\geq 132$	$\geq 64$	16
N/A	$\geq 128$	12

Table 10.1.23.2-6a: Margin  $\Delta$  for RSTD measurement accuracy in FR2

PRS BW (RB number)		Margin (Tc)
SCS=60kHz	SCS=120kHz	
$\geq 24$	N/A	32
$\geq 64$	$\geq 32$	16
$\geq 132$	$\geq 64$	8
N/A	$\geq 128$	4

### 10.1.23.3 Report mapping

#### 10.1.23.3.1 Absolute DL RSTD Measurement Reporting

The reporting range for the DL RSTD measurement is defined from  $-985024 \times T_c$  to  $985024 \times T_c$  with the resolution step of  $2^k \times T_c$ , where

$T_c$  is defined in TS 38.211 [6],

$$k_{min} \leq k \leq k_{max},$$

$k_{min}=2$  and  $k_{max}=5$ , when configured PRS resource of at least one of the reference cell and neighbor cell measured for the RSTD measurement is in FR1,

$k_{min}=0$  and  $k_{max}=5$ , when configured PRS resource of both the reference cell and neighbor cell measured for the RSTD measurement are in FR2,

$k \geq \text{timingReportingGranularityFactor}$  [34] configured by LMF via LPP for the RSTD measurement.

The measurement report mapping for different  $k$  values are specified in Tables 10.1.23.3.1-1 – 10.1.23.3.1-6.

Table 10.1.23.3.1-1: Report mapping for  $k=0$ 

Reported Quantity Value, RSTD_i	Measured Quantity Value, RSTD	Unit
RSTD_0000000	RSTD < -985024	$T_c$
RSTD_0000001	$-985024 \leq \text{RSTD} < -985023$	$T_c$
RSTD_0000002	$-985023 \leq \text{RSTD} < -985022$	$T_c$

...	...	...
RSTD_0985024	$-1 \leq \text{RSTD} < 0$	$T_c$
RSTD_0985025	$0 \leq \text{RSTD} < 1$	$T_c$
...	...	...
RSTD_1970047	$985022 \leq \text{RSTD} < 985023$	$T_c$
RSTD_1970048	$985023 \leq \text{RSTD} < 985024$	$T_c$
RSTD_1970049	$985024 \leq \text{RSTD}$	$T_c$

**Table 10.1.23.3.1-2: Report mapping for  $k=1$**

Reported Quantity Value, RSTD <sub>i</sub>	Measured Quantity Value, RSTD	Unit
RSTD_000000	$\text{RSTD} < -985024$	$T_c$
RSTD_000001	$-985024 \leq \text{RSTD} < -985022$	$T_c$
RSTD_000002	$-985022 \leq \text{RSTD} < -985020$	$T_c$
...	...	...
RSTD_492512	$-2 \leq \text{RSTD} < 0$	$T_c$
RSTD_492513	$0 \leq \text{RSTD} < 2$	$T_c$
...	...	...
RSTD_985023	$985020 \leq \text{RSTD} < 985022$	$T_c$
RSTD_985024	$985022 \leq \text{RSTD} < 985024$	$T_c$
RSTD_985025	$985024 \leq \text{RSTD}$	$T_c$

**Table 10.1.23.3.1-3: Report mapping for  $k=2$**

Reported Quantity Value, RSTD <sub>i</sub>	Measured Quantity Value, RSTD	Unit
RSTD_000000	$\text{RSTD} < -985024$	$T_c$
RSTD_000001	$-985024 \leq \text{RSTD} < -985020$	$T_c$
RSTD_000002	$-985020 \leq \text{RSTD} < -985016$	$T_c$
...	...	...
RSTD_246256	$-4 \leq \text{RSTD} < 0$	$T_c$
RSTD_246257	$0 \leq \text{RSTD} < 4$	$T_c$
...	...	...
RSTD_492511	$985016 \leq \text{RSTD} < 985020$	$T_c$
RSTD_492512	$985020 \leq \text{RSTD} < 985024$	$T_c$
RSTD_492513	$985024 \leq \text{RSTD}$	$T_c$

**Table 10.1.23.3.1-4: Report mapping for  $k=3$**

Reported Quantity Value RSTD <sub>i</sub>	Measured Quantity Value, RSTD	Unit
RSTD_000000	$\text{RSTD} < -985024$	$T_c$
RSTD_000001	$-985024 \leq \text{RSTD} < -985016$	$T_c$
RSTD_000002	$-985016 \leq \text{RSTD} < -985008$	$T_c$
...	...	...
RSTD_123128	$-8 \leq \text{RSTD} < 0$	$T_c$
RSTD_123129	$0 \leq \text{RSTD} < 8$	$T_c$
...	...	...
RSTD_246255	$985008 \leq \text{RSTD} < 985016$	$T_c$
RSTD_246256	$985016 \leq \text{RSTD} < 985024$	$T_c$
RSTD_246257	$985024 \leq \text{RSTD}$	$T_c$

**Table 10.1.23.3.1-5: Report mapping for  $k=4$**

Reported Quantity Value, RSTD <sub>i</sub>	Measured Quantity Value, RSTD	Unit
---	----------------------------------	------



RSTD_000000	RSTD < -985024	T <sub>c</sub>
RSTD_000001	-985024 ≤ RSTD < -985008	T <sub>c</sub>
RSTD_000002	-985008 ≤ RSTD < -984992	T <sub>c</sub>
...	...	...
RSTD_061564	-16 ≤ RSTD < 0	T <sub>c</sub>
RSTD_061565	0 ≤ RSTD < 16	T <sub>c</sub>
...	...	...
RSTD_123127	984992 ≤ RSTD < 985008	T <sub>c</sub>
RSTD_123128	985008 ≤ RSTD < 985024	T <sub>c</sub>
RSTD_123129	985024 ≤ RSTD	T <sub>c</sub>

Table 10.1.23.3.1-6: Report mapping for  $k=5$ 

Reported Quantity Value, RSTD_i	Measured Quantity Value, RSTD	Unit
RSTD_00000	RSTD < -985024	T <sub>c</sub>
RSTD_00001	-985024 ≤ RSTD < -984992	T <sub>c</sub>
RSTD_00002	-984992 ≤ RSTD < -984960	T <sub>c</sub>
...	...	...
RSTD_30782	-32 ≤ RSTD < 0	T <sub>c</sub>
RSTD_30783	0 ≤ RSTD < 32	T <sub>c</sub>
...	...	...
RSTD_61563	984960 ≤ RSTD < 984992	T <sub>c</sub>
RSTD_61564	984992 ≤ RSTD < 985024	T <sub>c</sub>
RSTD_61565	985024 ≤ RSTD	T <sub>c</sub>

### 10.1.23.3.2 Differential Reporting for DL RSTD Measurement

A first DL RSTD measurement is reported by means of differential reporting, i.e. as  $\Delta$ RSTD, relative to a second DL RSTD measurement (RSTD2), provided that:

- the absolute measured quantity value of the second DL RSTD measurement (RSTD2) is not larger than the absolute measured quantity value of the first DL RSTD measurement (RSTD1), i.e.,  $\Delta$ RSTD=RSTD1-RSTD2 $\geq$ 0, and
- the absolute value of the second DL RSTD measurement (RSTD2) is reported together with  $\Delta$ RSTD for the first DL RSTD measurement.

The reporting range for differential reporting  $\Delta$ RSTD of the first DL RSTD measurement is defined from 0 up to  $8191 \times T_c$  with the resolution step of  $2^k \times T_c$ , where

$T_c$  is defined in TS 38.211 [6],

$$k_{min} \leq k \leq k_{max},$$

$k_{min}=2$  and  $k_{max}=5$ , when configured PRS resource of at least one of the reference cell and neighbor cell measured for the first RSTD measurement or second RSTD measurement is in FR1,

$k_{min}=0$  and  $k_{max}=5$ , when configured PRS resource of both the reference cell and neighbor cell measured for both of the first RSTD measurement and the second RSTD measurement are in FR2,

$k \geq \text{timingReportingGranularityFactor}$  [34] configured by LMF via LPP for the RSTD measurement.

The measurement report mapping for different  $k$  values are specified in Tables 10.1.23.3.2-1 – 10.1.23.3.2-6.

Table 10.1.23.3.2-1: Report mapping for  $k=0$ 

Reported Quantity Value, DIFFRSTD_i	$\Delta$ RSTD = RSTD1 – RSTD2	Unit
DIFFRSTD_0000	$0 \leq \Delta$ RSTD < 1	T <sub>c</sub>
DIFFRSTD_0001	$1 \leq \Delta$ RSTD < 2	T <sub>c</sub>
DIFFRSTD_0002	$2 \leq \Delta$ RSTD < 3	T <sub>c</sub>

...	...	...
DIFFRSTD_8189	$8189 \leq \Delta RSTD < 8190$	$T_c$
DIFFRSTD_8190	$8190 \leq \Delta RSTD < 8191$	$T_c$
DIFFRSTD_8191	$8191 \leq \Delta RSTD$	$T_c$

**Table 10.1.23.3.2-2: Report mapping for  $k=1$** 

Reported Quantity Value, DIFFRSTD_i	$\Delta RSTD = RSTD1 - RSTD2$	Unit
DIFFRSTD_0000	$0 \leq \Delta RSTD < 2$	$T_c$
DIFFRSTD_0001	$2 \leq \Delta RSTD < 4$	$T_c$
DIFFRSTD_0002	$4 \leq \Delta RSTD < 6$	$T_c$
...	...	...
DIFFRSTD_4093	$8186 \leq \Delta RSTD < 8188$	$T_c$
DIFFRSTD_4094	$8188 \leq \Delta RSTD < 8190$	$T_c$
DIFFRSTD_4095	$8190 \leq \Delta RSTD$	$T_c$

**Table 10.1.23.3.2-3: Report mapping for  $k=2$** 

Reported Quantity Value, DIFFRSTD_i	$\Delta RSTD = RSTD1 - RSTD2$	Unit
DIFFRSTD_0000	$0 \leq \Delta RSTD < 4$	$T_c$
DIFFRSTD_0001	$4 \leq \Delta RSTD < 8$	$T_c$
DIFFRSTD_0002	$8 \leq \Delta RSTD < 12$	$T_c$
...	...	...
DIFFRSTD_2045	$8180 \leq \Delta RSTD < 8184$	$T_c$
DIFFRSTD_2046	$8184 \leq \Delta RSTD < 8188$	$T_c$
DIFFRSTD_2047	$8188 \leq \Delta RSTD$	$T_c$

**Table 10.1.23.3.2-4: Report mapping for  $k=3$** 

Reported Quantity Value, DIFFRSTD_i	$\Delta RSTD = RSTD1 - RSTD2$	Unit
DIFFRSTD_0000	$0 \leq \Delta RSTD < 8$	$T_c$
DIFFRSTD_0001	$8 \leq \Delta RSTD < 16$	$T_c$
DIFFRSTD_0002	$16 \leq \Delta RSTD < 24$	$T_c$
...	...	...
DIFFRSTD_1021	$8168 \leq \Delta RSTD < 8176$	$T_c$
DIFFRSTD_1022	$8176 \leq \Delta RSTD < 8184$	$T_c$
DIFFRSTD_1023	$8184 \leq \Delta RSTD$	$T_c$

**Table 10.1.23.3.2-5: Report mapping for  $k=4$** 

Reported Quantity Value, DIFFRSTD_i	$\Delta RSTD = RSTD1 - RSTD2$	Unit
DIFFRSTD_000	$0 \leq \Delta RSTD < 16$	$T_c$
DIFFRSTD_001	$16 \leq \Delta RSTD < 32$	$T_c$
DIFFRSTD_002	$32 \leq \Delta RSTD < 48$	$T_c$
...	...	...
DIFFRSTD_509	$8144 \leq \Delta RSTD < 8160$	$T_c$
DIFFRSTD_510	$8160 \leq \Delta RSTD < 8176$	$T_c$
DIFFRSTD_511	$8176 \leq \Delta RSTD$	$T_c$

**Table 10.1.23.3.2-6: Report mapping for  $k=5$** 

Reported Quantity Value, DIFFRSTD_i	$\Delta RSTD = RSTD1 - RSTD2$	Unit
DIFFRSTD_000	$0 \leq \Delta RSTD < 32$	$T_c$

DIFFRSTD_001	$32 \leq \Delta RSTD < 64$	$T_c$
DIFFRSTD_002	$64 \leq \Delta RSTD < 96$	$T_c$
...	...	...
DIFFRSTD_253	$8096 \leq \Delta RSTD < 8128$	$T_c$
DIFFRSTD_254	$8128 \leq \Delta RSTD < 8160$	$T_c$
DIFFRSTD_255	$8160 \leq \Delta RSTD$	$T_c$

### 10.1.23.3.3 Additional Path Report Mapping for DL RSTD

The reporting range for the additional path reporting for an RSTD measurement is defined up to the range from  $-8175 \times T_c$  to  $8175 \times T_c$  with the resolution step of  $2^k \times T_c$ , where

$T_c$  is defined in TS 38.211 [6],

$$k_{min} \leq k \leq k_{max},$$

$k_{min}=2$  and  $k_{max}=5$ , when configured PRS resource of at least one of the reference cell and neighbor cell measured for the RSTD measurement is in FR1,

$k_{min}=0$  and  $k_{max}=5$ , when configured PRS resource of both the reference cell and neighbor cell measured for the RSTD measurement are in FR2,

$k \geq \text{timingReportingGranularityFactor}$  [34] configured by LMF via LPP for the RSTD measurement.

The UE can report the timing of up to two additional paths with respect to the path timing determining the RSTD measurement.

The report mappings for different  $k$  values are specified in Tables 10.1.23.3.3-1 – 10.1.23.3.3-6.

**Table 10.1.23.3.3-1: Report mapping for  $k=0$**

Reported Quantity Value, path_i	Measured Quantity Value, $\Delta\text{path}$	Unit
path_00000	$\Delta\text{path} < -8175$	$T_c$
path_00001	$-8175 \leq \Delta\text{path} < -8174$	$T_c$
path_00002	$-8174 \leq \Delta\text{path} < -8173$	$T_c$
...	...	...
path_08175	$-1 \leq \Delta\text{path} < 0$	$T_c$
path_08176	$0 \leq \Delta\text{path} < 1$	$T_c$
...	...	...
path_16349	$8173 \leq \Delta\text{path} < 8174$	$T_c$
path_16350	$8174 \leq \Delta\text{path} < 8175$	$T_c$
path_16351	$8175 \leq \Delta\text{path}$	$T_c$

**Table 10.1.23.3.3-2: Report mapping for  $k=1$**

Reported Quantity Value, path_i	Measured Quantity Value, $\Delta\text{path}$	Unit
path_0000	$\Delta\text{path} < -8175$	$T_c$
path_0001	$-8175 \leq \Delta\text{path} < -8173$	$T_c$
path_0002	$-8173 \leq \Delta\text{path} < -8171$	$T_c$
...	...	...
path_4088	$-1 \leq \Delta\text{path} < 1$	$T_c$
...	...	...
path_8174	$8171 \leq \Delta\text{path} < 8173$	$T_c$
path_8175	$8173 \leq \Delta\text{path} < 8175$	$T_c$
path_8176	$8175 \leq \Delta\text{path}$	$T_c$

**Table 10.1.23.3.3-3: Report mapping for  $k=2$** 

Reported Quantity Value, path_i	Measured Quantity Value, $\Delta\text{path}$	Unit
path_0000	$\Delta\text{path} < -8174$	$T_c$
path_0001	$-8174 \leq \Delta\text{path} < -8170$	$T_c$
path_0002	$-8170 \leq \Delta\text{path} < -8166$	$T_c$
...	...	...
path_2044	$-2 \leq \Delta\text{path} < 2$	$T_c$
...	...	...
path_4086	$8166 \leq \Delta\text{path} < 8170$	$T_c$
path_4087	$8170 \leq \Delta\text{path} < 8174$	$T_c$
path_4088	$8174 \leq \Delta\text{path}$	$T_c$

**Table 10.1.23.3.3-4: Report mapping for  $k=3$** 

Reported Quantity Value, path_i	Measured Quantity Value, $\Delta\text{path}$	Unit
path_0000	$\Delta\text{path} < -8172$	$T_c$
path_0001	$-8172 \leq \Delta\text{path} < -8164$	$T_c$
path_0002	$-8164 \leq \Delta\text{path} < -8156$	$T_c$
...	...	...
path_1022	$-4 \leq \Delta\text{path} < 4$	$T_c$
...	...	...
path_2042	$8156 \leq \Delta\text{path} < 8164$	$T_c$
path_2043	$8164 \leq \Delta\text{path} < 8172$	$T_c$
path_2044	$8172 \leq \Delta\text{path}$	$T_c$

**Table 10.1.23.3.3-5: Report mapping for  $k=4$** 

Reported Quantity Value, path_i	Measured Quantity Value, $\Delta\text{path}$	Unit
path_0000	$\Delta\text{path} < -8168$	$T_c$
path_0001	$-8168 \leq \Delta\text{path} < -8152$	$T_c$
path_0002	$-8152 \leq \Delta\text{path} < -8136$	$T_c$
...	...	...
path_511	$-8 \leq \Delta\text{path} < 8$	$T_c$
...	...	...
path_1020	$8136 \leq \Delta\text{path} < 8152$	$T_c$
path_1021	$8152 \leq \Delta\text{path} < 8168$	$T_c$
path_1022	$8168 \leq \Delta\text{path}$	$T_c$

**Table 10.1.23.3.3-6: Report mapping for  $k=5$** 

Reported Quantity Value, path_i	Measured Quantity Value, $\Delta\text{path}$	Unit
path_000	$\Delta\text{path} < -8160$	$T_c$
path_001	$-8160 \leq \Delta\text{path} < -8128$	$T_c$
path_002	$-8128 \leq \Delta\text{path} < -8096$	$T_c$
...	...	...
path_256	$0 \leq \Delta\text{path} < 32$	$T_c$
...	...	...
path_509	$8096 \leq \Delta\text{path} < 8128$	$T_c$
path_510	$8128 \leq \Delta\text{path} < 8160$	$T_c$
path_511	$8160 \leq \Delta\text{path}$	$T_c$

## 10.1.24 PRS-RSRP Measurements

### 10.1.24.1 Introduction

The requirements in Clause 10.1.24 shall apply, provided the UE has received *nr-DL-TDOA-RequestLocationInformation* or *nr-Multi-RTT-RequestLocationInformation* or *nr-DL-AoD-RequestLocationInformation* message from LMF via LPP [34] requesting the UE to report one or more DL PRS-RSRP measurements defined in TS 38.215 [4].

### 10.1.24.2 Measurement Accuracy Requirements

#### 10.1.24.2.1 Absolute PRS RSRP accuracy

The absolute accuracy requirements for PRS-RSRP measurement for FR1 defined in Table 10.1.24.2.1-1 are valid under the following conditions:

Conditions defined in 38.101-1 Clause 7.3 for reference sensitivity are fulfilled.

PRP 1,2<sub>dBm</sub> according to Annex B.2.14 for a corresponding Band

The absolute accuracy requirements for PRS-RSRP measurement for FR2 defined in Table 10.1.24.2.1-2 are valid under the following conditions:

Conditions defined in 38.101-2 Clause 7.3 for reference sensitivity are fulfilled.

PRP 1,2<sub>dBm</sub> according to Annex B.2.14 for a corresponding Band

**Table 10.1.24.2.1-1: PRS-RSRP absolute accuracy for FR1**

Accuracy		Conditions							
Normal condition	Extreme condition	PRS $\hat{E}_s/\text{lot}$	PRS BW	Repetition factor ( $T_{\text{rep}}^{\text{PRS}} * L_{\text{PRS}}/K_{\text{comb}}^{\text{PRS}}$ )	NR operating band groups Note 8	$I_o$ Note 7 range			Maximum $I_o$
						Minimum $I_o$ Note 1 dBm / $SCS_{\text{PRS}}$			
dB	dB	dB	PRB	-		dBm / $SCS_{\text{PRS}}$			dBm/BW <sub>Channel</sub>
						dBm/15kHz Note 6	dBm/30kHz Note 6	dBm/60kHz Note 6	
$\pm 3.5$	$\pm 8$	$\geq -3\text{dB}$	$\geq 24$	All	NR_FDD_FR1_A, NR_TDD_FR1_A, NR_SDL_FR1_A	-127	-124	-121	-50
					NR_FDD_FR1_B	-126.5	-123.5	-120.5	-50
					NR_TDD_FR1_C	-126	-123	-120	-50
					NR_FDD_FR1_D, NR_TDD_FR1_D	-125.5	-122.5	-119.5	-50
					NR_FDD_FR1_E, NR_TDD_FR1_E	-125	-122	-119	-50
					NR_FDD_FR1_F	-124.5	-121.5	-118.5	-50
					NR_FDD_FR1_G,	-124	-121	-118	-50

					NR_TDD_FR1_G				
					NR_FDD_FR1_H	-123.5	-120.5	-117.5	-50
					Note 4				
					Note 4				
±8.5	±13	≥-13dB	24 ≤ BW ≤ 52	All	Note 4				
±6	±10.5		52 < BW ≤ 104	All	Note 4				
±4.5	±9		BW >104	All	Note 4				

NOTE 1: This minimum  $l_0$  condition is expressed as the average  $l_0$  per RE over all REs in an OFDM symbol.  
 NOTE 2: Void.  
 NOTE 3: PRS bandwidth is as indicated in *prs-Bandwidth* in the OTDOA or DL-AoD assistance data defined in [34].  
 NOTE 4: The same bands and the same  $l_0$  conditions for each band apply for this requirement as for the corresponding requirement with the PRS bandwidth ≥ 24 RB.  
 NOTE 5: The serving cell, the reference cell, and the measured neighbour cell  $i$  are on the same carrier frequency.  
 NOTE 6: The condition level is increased by  $\Delta > 0$ , when applicable, as described in Sections B.3.2 and B.3.3.  
 NOTE 7: The  $l_0$  is defined in PRS positioning subframes. The same  $l_0$  range applies to PRS and non-PRS symbols.  $l_0$  levels are different in PRS and non-PRS symbols within the same subframe.  
 NOTE 8: NR operating band groups are as defined in Section 3.5.2.

**Table 10.1.24.2.1-2: PRS-RSRP absolute accuracy for FR2**

Accuracy		Conditions					
Normal condition	Extreme condition	PRS $\hat{E}_s/\text{lot}$	PRS BW	Repetition factor ( $T_{\text{rep}}^{\text{PRS}} * L_{\text{PRS}} / K_{\text{comb}}^{\text{PRS}}$ )	$l_0$ <sup>Note 7</sup> range		Maximum $l_0$
					Minimum $l_0$ <sup>Note 1</sup> dBm / SCS <sub>PRS</sub>		
dB	dB	dB	PRB	-	dBm / SCS <sub>PRS</sub>		dBm/BW <sub>Channel</sub>
					dBm/120kHz <small>Note 6</small>	dBm/60kHz <small>Note 6</small>	
±5	±8	≥-3dB	≥24	All	Same value as PRP in Table B.2.14 -2, according to UE Power class, operating band and angle of arrival		-50
					Note 4		
					Note 4		
±8.5	±11.5	≥-13dB	24 ≤ BW ≤ 64	All	Note 4		
±6	±9		BW >64	All	Note 4		

NOTE 1: This minimum  $l_0$  condition is expressed as the average  $l_0$  per RE over all REs in an OFDM symbol.  
 NOTE 2: Void.  
 NOTE 3: PRS bandwidth is as indicated in *prs-Bandwidth* in the OTDOA or DL-AoD assistance data defined in [34].  
 NOTE 4: The same bands and the same  $l_0$  conditions for each band apply for this requirement as for the corresponding requirement with the PRS bandwidth ≥ 24 RB.  
 NOTE 5: The serving cell, the reference cell, and the measured neighbour cell  $i$  are on the same carrier frequency.  
 NOTE 6: The condition level is increased by  $\Delta > 0$ , when applicable, as described in Sections B.3.2 and B.3.3.  
 NOTE 7: The  $l_0$  is defined in PRS positioning subframes. The same  $l_0$  range applies to PRS and non-PRS symbols.  $l_0$  levels are different in PRS and non-PRS symbols within the same subframe.  
 NOTE 8: NR operating band groups are as defined in Section 3.5.2.

10.1.24.2.2 Relative PRS RSRP accuracy

The relative accuracy of PRS-RSRP is defined as accuracy of the difference between two PRS-RSRP measurements.

The relative PRS-RSRP accuracy requirements apply for the cases when PRS-RSRP is measured from PRS resources in the same PRS resource set in FR1 or FR2, and measured with same Rx beam in case of FR2.

The accuracy requirements for PRS-RSRP measurement for FR1 defined in Table 10.1.24.2.2-1 are valid under the following conditions:

Conditions defined in 38.101-1 Clause 7.3 for reference sensitivity are fulfilled.

PRP 1,2<sub>dBm</sub> according to Annex B.2.14 for a corresponding Band

The accuracy requirements for PRS-RSRP measurement for FR2 defined in Table 10.1.24.2.2-2 are valid under the following conditions:

Conditions defined in 38.101-2 Clause 7.3 for reference sensitivity are fulfilled.

PRP 1,2<sub>dBm</sub> according to Annex B.2.14 for a corresponding Band

**Table 10.1.24.2.2-1: PRS-RSRP relative accuracy for FR1**

Accuracy		Conditions										
Normal condition	Extreme condition	PRS $\hat{E}_s$ /lot	PRS BW	Repetition factor ( $T_{rep}^{PRS} * L_{PRS} / K_{comb}^{PRS}$ )	NR operating band groups Note 8	$I_o$ Note 7 range			Maximum $I_o$			
						Minimum $I_o$ Note 1 dBm / SCS <sub>PRS</sub>						
dB	dB	dB	PRB	-		dBm / SCS <sub>PRS</sub>			dBm/BW <sub>Channel</sub>			
						dBm/15kHz z Note 6	dBm/30kHz z Note 6	dBm/60kHz Note 6				
±3.5	±5.0	≥-3dB	≥24	All	NR_FDD_FR1_A, NR_TDD_FR1_A, NR_SDL_FR1_A	-127	-124	-121	-50			
					NR_FDD_FR1_B, NR_TDD_FR1_C	-126.5	-123.5	-120.5	-50			
					NR_FDD_FR1_D, NR_TDD_FR1_D	-126	-123	-120	-50			
					NR_FDD_FR1_E, NR_TDD_FR1_E	-125.5	-122.5	-119.5	-50			
					NR_FDD_FR1_F, NR_TDD_FR1_G	-125	-122	-119	-50			
					NR_FDD_FR1_G, NR_TDD_FR1_H	-124.5	-121.5	-118.5	-50			
					NR_FDD_FR1_H, NR_TDD_FR1_H	-124	-121	-118	-50			
					NR_FDD_FR1_H, NR_TDD_FR1_H	-123.5	-120.5	-117.5	-50			
								Note 4				
								Note 4				
±9.5	±11.0	≥-13dB	24 ≤ BW ≤ 52	All	Note 4							
±6.5	±8.0		52 < BW ≤ 104	All	Note 4							
±5.0	±6.5		BW > 104	All	Note 4							

NOTE 1: This minimum  $I_o$  condition is expressed as the average  $I_o$  per RE over all REs in an OFDM symbol.  
 NOTE 2: Void.  
 NOTE 3: PRS bandwidth is as indicated in *prs-Bandwidth* in the OTDOA or DL-AoD assistance data defined in [34].  
 NOTE 4: The same bands and the same  $I_o$  conditions for each band apply for this requirement as for the corresponding requirement with the PRS bandwidth ≥ 24 RB.

NOTE 5: The serving cell, the reference cell, and the measured neighbour cell *i* are on the same carrier frequency.  
 NOTE 6: The condition level is increased by  $\Delta > 0$ , when applicable, as described in Sections B.3.2 and B.3.3.  
 NOTE 7: The  $I_o$  is defined in PRS positioning subframes. The same  $I_o$  range applies to PRS and non-PRS symbols.  $I_o$  levels are different in PRS and non-PRS symbols within the same subframe.  
 NOTE 8: NR operating band groups are as defined in Section 3.5.2.

**Table 10.1.24.2.2-2: PRS-RSRP relative accuracy for FR2**

Accuracy		Conditions				
Normal condition	Extreme condition	PRS $\hat{E}_s/\text{lot}$	PRS BW	Repetition factor ( $T_{\text{rep}}^{\text{PRS}} * L_{\text{PRS}} / K_{\text{comb}}^{\text{PRS}}$ )	$I_o$ <sup>Note 7</sup> range	
					Minimum $I_o$ <sup>Note 1</sup> dBm / SCS <sub>PRS</sub>	Maximum $I_o$
dB	dB	dB	PRB	-	dBm / SCS <sub>PRS</sub>	
					dBm/120kHz <small>Note 6</small>	dBm/60kHz <small>Note 6</small>
$\pm 5.0$	$\pm 8.0$	$\geq -3\text{dB}$	$\geq 24$	All	Same value as PRP in Table B.2.14-2, according to UE Power class, operating band and angle of arrival	
					-50	
Note 4						
Note 4						
$\pm 10$ $\pm 7.5$	$\pm 13$	$\geq -13\text{dB}$	$24 \leq \text{BW} \leq 64$	All	Note 4	
	$\pm 10.5$		$\text{BW} > 64$	All	Note 4	

NOTE 1: This minimum  $I_o$  condition is expressed as the average  $I_o$  per RE over all REs in an OFDM symbol.  
 NOTE 2: Void.  
 NOTE 3: PRS bandwidth is as indicated in *prs-Bandwidth* in the OTDOA or DL-AoD assistance data defined in [34].  
 NOTE 4: The same bands and the same  $I_o$  conditions for each band apply for this requirement as for the corresponding requirement with the PRS bandwidth  $\geq 24$  RB.  
 NOTE 5: The serving cell, the reference cell, and the measured neighbour cell *i* are on the same carrier frequency.  
 NOTE 6: The condition level is increased by  $\Delta > 0$ , when applicable, as described in Sections B.3.2 and B.3.3.  
 NOTE 7: The  $I_o$  is defined in PRS positioning subframes. The same  $I_o$  range applies to PRS and non-PRS symbols.  $I_o$  levels are different in PRS and non-PRS symbols within the same subframe.  
 NOTE 8: NR operating band groups are as defined in Section 3.5.2.

### 10.1.24.3 Report mapping

#### 10.1.24.3.1 Absolute PRS-RSRP Measurement Report Mapping

The reporting range of absolute PRS-RSRP measurement is defined from -156 dBm to -31 dBm with 1 dB resolution.

The mapping of measured quantity is defined in Table 10.1.24.3.1-1. The range in the signalling may be larger than the guaranteed accuracy range.

**Table 10.1.24.3.1-1: Measurement report mapping for PRS-RSRP**

Reported value	Measured quantity value	Unit
PRS_RSRP_0	PRS-RSRP < -156	dBm
PRS_RSRP_1	$-156 \leq \text{PRS-RSRP} < -155$	dBm
PRS_RSRP_2	$-155 \leq \text{PRS-RSRP} < -154$	dBm
PRS_RSRP_3	$-154 \leq \text{PRS-RSRP} < -153$	dBm
PRS_RSRP_4	$-153 \leq \text{PRS-RSRP} < -152$	dBm
PRS_RSRP_5	$-152 \leq \text{PRS-RSRP} < -151$	dBm
PRS_RSRP_6	$-151 \leq \text{PRS-RSRP} < -150$	dBm



PRS_RSRP_7	$-150 \leq \text{PRS-RSRP} < -149$	dBm
PRS_RSRP_8	$-149 \leq \text{PRS-RSRP} < -148$	dBm
PRS_RSRP_9	$-148 \leq \text{PRS-RSRP} < -147$	dBm
PRS_RSRP_10	$-147 \leq \text{PRS-RSRP} < -146$	dBm
PRS_RSRP_11	$-146 \leq \text{PRS-RSRP} < -145$	dBm
PRS_RSRP_12	$-145 \leq \text{PRS-RSRP} < -144$	dBm
PRS_RSRP_13	$-144 \leq \text{PRS-RSRP} < -143$	dBm
PRS_RSRP_14	$-143 \leq \text{PRS-RSRP} < -142$	dBm
PRS_RSRP_15	$-142 \leq \text{PRS-RSRP} < -141$	dBm
PRS_RSRP_16	$-141 \leq \text{PRS-RSRP} < -140$	dBm
PRS_RSRP_17	$-140 \leq \text{PRS-RSRP} < -139$	dBm
PRS_RSRP_18	$-139 \leq \text{PRS-RSRP} < -138$	dBm
...	...	...
PRS_RSRP_111	$-46 \leq \text{PRS-RSRP} < -45$	dBm
PRS_RSRP_112	$-45 \leq \text{PRS-RSRP} < -44$	dBm
PRS_RSRP_113	$-44 \leq \text{PRS-RSRP} < -43$	dBm
PRS_RSRP_114	$-43 \leq \text{PRS-RSRP} < -42$	dBm
PRS_RSRP_115	$-42 \leq \text{PRS-RSRP} < -41$	dBm
PRS_RSRP_116	$-41 \leq \text{PRS-RSRP} < -40$	dBm
PRS_RSRP_117	$-40 \leq \text{PRS-RSRP} < -39$	dBm
PRS_RSRP_118	$-39 \leq \text{PRS-RSRP} < -38$	dBm
PRS_RSRP_119	$-38 \leq \text{PRS-RSRP} < -37$	dBm
PRS_RSRP_120	$-37 \leq \text{PRS-RSRP} < -36$	dBm
PRS_RSRP_121	$-36 \leq \text{PRS-RSRP} < -35$	dBm
PRS_RSRP_122	$-35 \leq \text{PRS-RSRP} < -34$	dBm
PRS_RSRP_123	$-34 \leq \text{PRS-RSRP} < -33$	dBm
PRS_RSRP_124	$-33 \leq \text{PRS-RSRP} < -32$	dBm
PRS_RSRP_125	$-32 \leq \text{PRS-RSRP} < -31$	dBm
PRS_RSRP_126	$-31 \leq \text{PRS-RSRP}$	dBm

### 10.1.24.3.2 Differential Report Mapping for PRS-RSRP Measurement

The reporting range of differential PRS-RSRP is defined from -30 dB to 0 dB with 1 dB resolution when *nr-DL-AoD-RequestLocationInformation* message is received.

The mapping of measured quantity is defined in Table 10.1.24.3.2-1. The range in the signalling may be larger than the guaranteed accuracy range.

The reporting range of differential PRS-RSRP is defined from -30 dB to 30 dB with 1 dB resolution when *nr-DL-TDOA-RequestLocationInformation* or *nr-Multi-RTT-RequestLocationInformation* is received.

The mapping of measured quantity is defined in Table 10.1.24.3.2-2. The range in the signalling may be larger than the guaranteed accuracy range or the range supported by the UE receiver for differential RSRP measured on different PRS resources in frequency domain at the same time.

**Table 10.1.24.3.2-1: Measurement report mapping for differential PRS-RSRP**

Reported value	Measured quantity value	Unit
DIFFRSRP_0	$-30 \geq \Delta \text{RSRP}$	dB
DIFFRSRP_1	$-29 \geq \Delta \text{RSRP} > -30$	dB
DIFFRSRP_2	$-28 \geq \Delta \text{RSRP} > -29$	dB
DIFFRSRP_3	$-27 \geq \Delta \text{RSRP} > -28$	dB
DIFFRSRP_4	$-26 \geq \Delta \text{RSRP} > -27$	dB
DIFFRSRP_5	$-25 \geq \Delta \text{RSRP} > -26$	dB
DIFFRSRP_6	$-24 \geq \Delta \text{RSRP} > -25$	dB
DIFFRSRP_7	$-23 \geq \Delta \text{RSRP} > -24$	dB
DIFFRSRP_8	$-22 \geq \Delta \text{RSRP} > -23$	dB
DIFFRSRP_9	$-21 \geq \Delta \text{RSRP} > -22$	dB
DIFFRSRP_10	$-20 \geq \Delta \text{RSRP} > -21$	dB

DIFFRSRP_11	$-19 \geq \Delta \text{RSRP} > -20$	dB
DIFFRSRP_12	$-18 \geq \Delta \text{RSRP} > -19$	dB
DIFFRSRP_13	$-17 \geq \Delta \text{RSRP} > -18$	dB
DIFFRSRP_14	$-16 \geq \Delta \text{RSRP} > -17$	dB
DIFFRSRP_15	$-15 \geq \Delta \text{RSRP} > -16$	dB
DIFFRSRP_16	$-14 \geq \Delta \text{RSRP} > -15$	dB
DIFFRSRP_17	$-13 \geq \Delta \text{RSRP} > -14$	dB
DIFFRSRP_18	$-12 \geq \Delta \text{RSRP} > -13$	dB
DIFFRSRP_19	$-11 \geq \Delta \text{RSRP} > -12$	dB
DIFFRSRP_20	$-10 \geq \Delta \text{RSRP} > -11$	dB
DIFFRSRP_21	$-9 \geq \Delta \text{RSRP} > -10$	dB
DIFFRSRP_22	$-8 \geq \Delta \text{RSRP} > -9$	dB
DIFFRSRP_23	$-7 \geq \Delta \text{RSRP} > -8$	dB
DIFFRSRP_24	$-6 \geq \Delta \text{RSRP} > -7$	dB
DIFFRSRP_25	$-5 \geq \Delta \text{RSRP} > -6$	dB
DIFFRSRP_26	$-4 \geq \Delta \text{RSRP} > -5$	dB
DIFFRSRP_27	$-3 \geq \Delta \text{RSRP} > -4$	dB
DIFFRSRP_28	$-2 \geq \Delta \text{RSRP} > -3$	dB
DIFFRSRP_29	$-1 \geq \Delta \text{RSRP} > -2$	dB
DIFFRSRP_30	$0 \geq \Delta \text{RSRP} > -1$	dB

Table 10.1.24.3.2-2: Measurement report mapping for differential PRS-RSRP

Reported value	Measured quantity value	Unit
DIFFRSRP_0	$-30 \geq \Delta \text{RSRP}$	dB
DIFFRSRP_1	$-29 \geq \Delta \text{RSRP} > -30$	dB
DIFFRSRP_2	$-28 \geq \Delta \text{RSRP} > -29$	dB
DIFFRSRP_3	$-27 \geq \Delta \text{RSRP} > -28$	dB
DIFFRSRP_4	$-26 \geq \Delta \text{RSRP} > -27$	dB
DIFFRSRP_5	$-25 \geq \Delta \text{RSRP} > -26$	dB
DIFFRSRP_6	$-24 \geq \Delta \text{RSRP} > -25$	dB
DIFFRSRP_7	$-23 \geq \Delta \text{RSRP} > -24$	dB
DIFFRSRP_8	$-22 \geq \Delta \text{RSRP} > -23$	dB
DIFFRSRP_9	$-21 \geq \Delta \text{RSRP} > -22$	dB
DIFFRSRP_10	$-20 \geq \Delta \text{RSRP} > -21$	dB
DIFFRSRP_11	$-19 \geq \Delta \text{RSRP} > -20$	dB
DIFFRSRP_12	$-18 \geq \Delta \text{RSRP} > -19$	dB
DIFFRSRP_13	$-17 \geq \Delta \text{RSRP} > -18$	dB
DIFFRSRP_14	$-16 \geq \Delta \text{RSRP} > -17$	dB
...	...	...
DIFFRSRP_25	$-5 \geq \Delta \text{RSRP} > -6$	dB
DIFFRSRP_26	$-4 \geq \Delta \text{RSRP} > -5$	dB
DIFFRSRP_27	$-3 \geq \Delta \text{RSRP} > -4$	dB
DIFFRSRP_28	$-2 \geq \Delta \text{RSRP} > -3$	dB
DIFFRSRP_29	$-1 \geq \Delta \text{RSRP} > -2$	dB
DIFFRSRP_30	$0 \geq \Delta \text{RSRP} > -1$	dB
DIFFRSRP_31	$1 \geq \Delta \text{RSRP} > 0$	dB
DIFFRSRP_32	$2 \geq \Delta \text{RSRP} > 1$	dB
DIFFRSRP_33	$3 \geq \Delta \text{RSRP} > 2$	dB
DIFFRSRP_34	$4 \geq \Delta \text{RSRP} > 3$	dB
DIFFRSRP_35	$5 \geq \Delta \text{RSRP} > 4$	dB
DIFFRSRP_36	$6 \geq \Delta \text{RSRP} > 5$	dB
...	...	...
DIFFRSRP_47	$17 \geq \Delta \text{RSRP} > 16$	dB
DIFFRSRP_48	$18 \geq \Delta \text{RSRP} > 17$	dB
DIFFRSRP_49	$19 \geq \Delta \text{RSRP} > 18$	dB
DIFFRSRP_50	$20 \geq \Delta \text{RSRP} > 19$	dB
DIFFRSRP_51	$21 \geq \Delta \text{RSRP} > 20$	dB

DIFFRSRP_52	$22 \geq \Delta \text{RSRP} > 21$	dB
DIFFRSRP_53	$23 \geq \Delta \text{RSRP} > 22$	dB
DIFFRSRP_54	$24 \geq \Delta \text{RSRP} > 23$	dB
DIFFRSRP_55	$25 \geq \Delta \text{RSRP} > 24$	dB
DIFFRSRP_56	$26 \geq \Delta \text{RSRP} > 25$	dB
DIFFRSRP_57	$27 \geq \Delta \text{RSRP} > 26$	dB
DIFFRSRP_58	$28 \geq \Delta \text{RSRP} > 27$	dB
DIFFRSRP_59	$29 \geq \Delta \text{RSRP} > 28$	dB
DIFFRSRP_60	$30 \geq \Delta \text{RSRP} > 29$	dB
DIFFRSRP_61	$\Delta \text{RSRP} > 30$	dB

## 10.1.25 UE Rx-Tx Time Difference Measurements

### 10.1.25.1 Introduction

The requirements in Clause 10.1.25 shall apply, provided the UE has received *nr-Multi-RTT-RequestLocationInformation* message from LMF via LPP [34] requesting the UE to report one or more UE Rx-Tx time difference measurements defined in TS 38.215 [4].

### 10.1.25.2 Measurement Accuracy Requirements

The UE Rx-Tx time difference measurement accuracy requirements in this clause shall not apply, if:

$N_{TA\_offset}$  defined in Table 7.1.2-2 changes during the UE Rx-Tx measurement period or

if the uplink transmission timing changes during the UE Rx-Tx measurement period due to the network-configured Timing Advance.

The UE Rx-Tx time difference measurement accuracy requirements in this clause shall apply provided that:

- The UE transmits SRS within [-160, 160] msec of at least one DL PRS resource of each of the TRPs in the assistance data.

If the uplink transmission timing changes during the UE Rx-Tx measurement period due to the autonomous timing adjustment defined in clause 7.1.2 then:

- UE Rx-Tx measurement accuracy requirements shall apply for a cell, which is also the downlink reference cell (defined in section 7.1.1) for SRS transmission even if the uplink transmission timing changes during the UE Rx-Tx measurement period due to autonomous adjustment.
- UE Rx-Tx measurement accuracy requirements shall not apply for a cell, which is not the downlink reference cell (defined in section 7.1.1) for SRS transmission, if the uplink transmission timing changes during the UE Rx-Tx measurement period due to autonomous adjustment.

When a serving cell change occurs during the UE Rx-Tx measurement period, the UE Rx-Tx time difference measurement accuracy requirements in this clause shall apply provided that the serving cell change does not impact SRS configuration for the UE Rx-Tx measurement.

Note: The requirements for fading channel in this clause are derived based on TDL-A (30 ns delay spread, 5Hz) and TDL-C (60 ns delay spread, 300 Hz) channel models for FR1 and FR2 respectively.

The accuracy requirements in Table 10.1.25.2-1 for FR1 are valid under the following conditions:

Conditions defined in clause 7.3 of TS 38.101-1 [18] for reference sensitivity are fulfilled.

$PRP_{dBm}$  according to Annex B.2.14 for a corresponding Band.

AWGN propagation condition.

Table 10.1.25.2-1: UE Rx-Tx time difference measurement accuracy in FR1 in AWGN

Accuracy	Conditions						
	PRS Es/lot	Minimum PRS bandwidth	PRS SCS	PRS resource repetition ( $T_{rep}^{PRS} *$ $L_{PRS}/K_{comb}^{PRS}$ Note 3)	NR operating band groups <sup>Note 2</sup>	Io <sup>Note 4</sup> range	
						Minimum Io <sup>Note 1</sup>	Maximum Io
Tc <sup>Note 5</sup>	dB	RB	kHz			dBm / SCS <sub>PRS</sub>	dBm/BW
± 78+δ	-3	≥24	15	≥4	NR_FDD_FR1_A, NR_TDD_FR1_A, NR_SDL_FR1_A	-127	-50
					NR_FDD_FR1_B	-126.5	
					NR_TDD_FR1_C	-126	
					NR_FDD_FR1_D, NR_TDD_FR1_D	-125.5	
					NR_FDD_FR1_E, NR_TDD_FR1_E	-125	
					NR_FDD_FR1_F	-124.5	
					NR_FDD_FR1_G, NR_TDD_FR1_G	-124	
NR_FDD_FR1_H	-123.5						
± 59+δ		≥52		≥1	Note 6	Note 6	Note 6
± 30+δ		>104		≥1	Note 6	Note 6	Note 6
± 57+δ		≥24	30	≥4	NR_FDD_FR1_A, NR_TDD_FR1_A, NR_SDL_FR1_A	-124	-50
					NR_FDD_FR1_B	-123.5	
					NR_TDD_FR1_C	-123	
					NR_FDD_FR1_D, NR_TDD_FR1_D	-122.5	
					NR_FDD_FR1_E, NR_TDD_FR1_E	-122	
					NR_FDD_FR1_F	-121.5	
					NR_FDD_FR1_G, NR_TDD_FR1_G	-121	
NR_FDD_FR1_H	-120.5						
± 30+δ		≥48		≥1	NOTE 6	NOTE 6	NOTE 6
± 15+δ		≥132		≥1	NOTE 6	NOTE 6	NOTE 6
± 29+δ		≥24	60	≥4	NR_FDD_FR1_A, NR_TDD_FR1_A, NR_SDL_FR1_A	-121	-50
					NR_FDD_FR1_B	-120.5	
					NR_TDD_FR1_C	-120	
					NR_FDD_FR1_D, NR_TDD_FR1_D	-119.5	
					NR_FDD_FR1_E, NR_TDD_FR1_E	-119	
					NR_FDD_FR1_F	-118.5	
					NR_FDD_FR1_G, NR_TDD_FR1_G	-118	
NR_FDD_FR1_H	-117.5						
± 15+δ		≥ 64		≥1	NOTE 6	NOTE 6	NOTE 6
± 7+δ		≥ 132		≥1	NOTE 6	NOTE 6	NOTE 6
± 101+δ	-13	≥24	15	≥4	NOTE 6	NOTE 6	NOTE 6
± 75+δ		≥52		≥1	NOTE 6	NOTE 6	NOTE 6
± 37+δ		>104		≥1	NOTE 6	NOTE 6	NOTE 6
± 58+δ		≥24	30	≥4	NOTE 6	NOTE 6	NOTE 6
± 39+δ		≥48		≥1	NOTE 6	NOTE 6	NOTE 6
± 16+δ		≥132		≥1	NOTE 6	NOTE 6	NOTE 6
± 36+δ		≥24	60	≥4	NOTE 6	NOTE 6	NOTE 6
± 16+δ		≥ 64		≥1	NOTE 6	NOTE 6	NOTE 6
± 8+δ		≥ 132		≥1	NOTE 6	NOTE 6	NOTE 6

NOTE 1: This minimum Io condition is expressed as the average Io per RE over all REs in an OFDM symbol.

NOTE 2: NR operating band groups are as defined in Section 3.5.

NOTE 3:  $T_{rep}^{PRS}$ ,  $L_{PRS}$ ,  $K_{comb}^{PRS}$  are configured by higher layer parameter *dl-PRS-ResourceRepetitionFactor*, *dl-PRS-NumSymbols* and *dl-PRS-CombSizeN* defined in TS 37.355 [34].

NOTE 4: The  $l_o$  is defined in PRS slots. The same  $l_o$  range applies to PRS and non-PRS symbols.  $l_o$  levels are different in PRS and non-PRS symbols within the same slot.

NOTE 5:  $T_c$  is the basic timing unit defined in TS 38.211 [6].

NOTE 6: The same bands and the same  $l_o$  conditions for each band apply for this requirement as for the corresponding requirement with the PRS bandwidth of the smallest RB number for the corresponding SCS.

NOTE 7:  $\delta$  is the margin determined from Table 10.1.25.2-5.

The accuracy requirements in Table 10.1.25.2-2 for FR1 are valid under the following conditions:

Conditions defined in clause 7.3 of TS 38.101-1 [18] for reference sensitivity are fulfilled.

$PRP_{dBm}$  according to Annex B.2.14 for a corresponding Band.

Fading propagation condition.

**Table 10.1.25.2-2: UE Rx-Tx time difference measurement accuracy in FR1 in fading**

Accuracy	Conditions						
	PRS $\hat{E}_s/l_o$	Minimum PRS bandwidth	PRS SCS	PRS resource repetition ( $T_{rep}^{PRS} * L_{PRS}/K_{comb}^{PRS}$ Note 3)	NR operating band groups Note 2	$l_o$ Note 4 range	
						Minimum $l_o$ Note 1	Maximum $l_o$
$T_c$ Note 5	dB	RB	kHz			dBm / SCS <sub>PRS</sub>	dBm/BW
$\pm 137+\delta$	-3	$\geq 24$	15	$\geq 4$	NR_FDD_FR1_A, NR_TDD_FR1_A, NR_SDL_FR1_A	-127	-50
					NR_FDD_FR1_B	-126.5	
					NR_TDD_FR1_C	-126	
					NR_FDD_FR1_D, NR_TDD_FR1_D	-125.5	
					NR_FDD_FR1_E, NR_TDD_FR1_E	-125	
					NR_FDD_FR1_F	-124.5	
					NR_FDD_FR1_G, NR_TDD_FR1_G	-124	
					NR_FDD_FR1_H	-123.5	
$\pm 96+\delta$		$\geq 52$		$\geq 1$	NOTE 6	NOTE 6	NOTE 6
$\pm 62+\delta$		$>104$		$\geq 1$	NOTE 6	NOTE 6	NOTE 6
$\pm 87+\delta$		$\geq 24$	30	$\geq 4$	NR_FDD_FR1_A, NR_TDD_FR1_A, NR_SDL_FR1_A	-124	-50
					NR_FDD_FR1_B	-123.5	
					NR_TDD_FR1_C	-123	
					NR_FDD_FR1_D, NR_TDD_FR1_D	-122.5	
					NR_FDD_FR1_E, NR_TDD_FR1_E	-122	
					NR_FDD_FR1_F	-121.5	
					NR_FDD_FR1_G, NR_TDD_FR1_G	-121	
					NR_FDD_FR1_H	-120.5	
$\pm 68+\delta$		$\geq 48$		$\geq 1$	NOTE 6	NOTE 6	NOTE 6
$\pm 44+\delta$		$\geq 132$		$\geq 1$	NOTE 6	NOTE 6	NOTE 6
$\pm 59+\delta$		$\geq 24$	60	$\geq 4$	NR_FDD_FR1_A, NR_TDD_FR1_A, NR_SDL_FR1_A	-121	-50
					NR_FDD_FR1_B	-120.5	
					NR_TDD_FR1_C	-120	
					NR_FDD_FR1_D, NR_TDD_FR1_D	-119.5	

				NR_FDD_FR1_E, NR_TDD_FR1_E	-119	
				NR_FDD_FR1_F	-118.5	
				NR_FDD_FR1_G, NR_TDD_FR1_G	-118	
				NR_FDD_FR1_H	-117.5	
$\pm 42+\delta$	$\geq 64$		$\geq 1$	NOTE 6	NOTE 6	NOTE 6
$\pm 36+\delta$	$\geq 132$		$\geq 1$	NOTE 6	NOTE 6	NOTE 6
$\pm 180+\delta$	$\geq 24$	15	$\geq 4$	NOTE 6	NOTE 6	NOTE 6
$\pm 98+\delta$	$\geq 52$		$\geq 1$	NOTE 6	NOTE 6	NOTE 6
$\pm 68+\delta$	$>104$		$\geq 1$	NOTE 6	NOTE 6	NOTE 6
$\pm 87+\delta$	$\geq 24$	30	$\geq 4$	NOTE 6	NOTE 6	NOTE 6
$\pm 85+\delta$	$\geq 48$		$\geq 1$	NOTE 6	NOTE 6	NOTE 6
$\pm 44+\delta$	$\geq 132$		$\geq 1$	NOTE 6	NOTE 6	NOTE 6
$\pm 139+\delta$	$\geq 24$	60	$\geq 4$	NOTE 6	NOTE 6	NOTE 6
$\pm 46+\delta$	$\geq 64$		$\geq 1$	NOTE 6	NOTE 6	NOTE 6
$\pm 30+\delta$	$\geq 132$		$\geq 1$	NOTE 6	NOTE 6	NOTE 6

NOTE 1: This minimum  $l_o$  condition is expressed as the average  $l_o$  per RE over all REs in an OFDM symbol.  
 NOTE 2: NR operating band groups are as defined in Section 3.5.  
 NOTE 3:  $T_{rep}^{PRS}, L_{PRS}, K_{comb}^{PRS}$  are configured by higher layer parameter *dl-PRS-ResourceRepetitionFactor*, *dl-PRS-NumSymbols* and *dl-PRS-CombSizeN* defined in TS 37.355 [34].  
 NOTE 4: The  $l_o$  is defined in PRS slots. The same  $l_o$  range applies to PRS and non-PRS symbols.  $l_o$  levels are different in PRS and non-PRS symbols within the same slot.  
 NOTE 5:  $T_c$  is the basic timing unit defined in TS 38.211 [6].  
 NOTE 6: The same bands and the same  $l_o$  conditions for each band apply for this requirement as for the corresponding requirement with the PRS bandwidth of the smallest RB number for the corresponding SCS.  
 NOTE 7:  $\delta$  is the margin determined from Table 10.1.25.2-5.

The accuracy requirements in Table 10.1.25.2-3 for FR2 are valid under the following conditions:

Conditions defined in clause 7.3 of TS 38.101-2 [19] for reference sensitivity are fulfilled.

$PRP|_{dBm}$  according to Annex B.2.14 for a corresponding Band.

AWGN propagation condition.

**Table 10.1.25.2-3: UE Rx-Tx time difference measurement accuracy in FR2 in AWGN**

Accuracy	Conditions					
	PRS Ês/lot	Minimum PRS bandwidth	PRS SCS	PRS resource repetition ( $T_{rep}^{PRS} * L_{PRS} / K_{comb}^{PRS}$ ) Note 3	$l_o^{Note 4}$ range	
					Minimum $l_o^{Note 1}$	Maximum $l_o$
$T_c^{Note 5}$	dB	RB	kHz		dBm / SCS <sub>PRS</sub>	dBm/BW <sub>Channel</sub>
$\pm 22+\delta$	-3	$\geq 24$	60	$\geq 4$	Same value as PRP in Table B.2.14-2, according to UE Power class, operating band and angle of arrival	-50
$\pm 15+\delta$		$\geq 64$		$\geq 1$	NOTE 6	NOTE 6
$\pm 7+\delta$		$\geq 132$		$\geq 1$	NOTE 6	NOTE 6
$\pm 12+\delta$	-13	$\geq 32$	120	$\geq 4$	Same value as PRP in Table B.2.14-2, according to UE Power class, operating band and angle of arrival	-50
$\pm 7+\delta$		$\geq 64$		$\geq 1$	NOTE 6	NOTE 6
$\pm 4+\delta$		$\geq 128$		$\geq 1$	NOTE 6	NOTE 6
$\pm 35+\delta$		$\geq 24$	60	$\geq 4$	NOTE 6	NOTE 6
$\pm 15+\delta$		$\geq 64$		$\geq 1$	NOTE 6	NOTE 6
$\pm 7+\delta$		$\geq 132$		$\geq 1$	NOTE 6	NOTE 6
$\pm 14+\delta$		$\geq 32$	120	$\geq 4$	NOTE 6	NOTE 6
$\pm 9+\delta$		$\geq 64$		$\geq 1$	NOTE 6	NOTE 6
$\pm 4+\delta$		$\geq 128$		$\geq 1$	NOTE 6	NOTE 6

- NOTE 1: This minimum  $I_0$  condition is expressed as the average  $I_0$  per RE over all REs in an OFDM symbol.  
 NOTE 2: NR operating band groups are as defined in Section 3.5.  
 NOTE 3:  $T_{rep}^{PRS}$ ,  $L_{PRS}$ ,  $K_{comb}^{PRS}$  are configured by higher layer parameter *dl-PRS-ResourceRepetitionFactor*, *dl-PRS-NumSymbols* and *dl-PRS-CombSizeN* defined in TS 37.355 [34].  
 NOTE 4: The  $I_0$  is defined in PRS slots. The same  $I_0$  range applies to PRS and non-PRS symbols.  $I_0$  levels are different in PRS and non-PRS symbols within the same slot.  
 NOTE 5:  $T_c$  is the basic timing unit defined in TS 38.211 [6].  
 NOTE 6: The same bands and the same  $I_0$  conditions for each band apply for this requirement as for the corresponding requirement with the PRS bandwidth of the smallest RB number for the corresponding SCS.  
 NOTE 7:  $\delta$  is the margin determined from Table 10.1.25.2-6.

The accuracy requirements in Table 10.1.25.2-4 for FR2 are valid under the following conditions:

Conditions defined in clause 7.3 of TS 38.101-2 [19] for reference sensitivity are fulfilled.

PRP<sub>dBm</sub> according to Annex B.2.14 for a corresponding Band.

Fading propagation condition.

**Table 10.1.25.2-4: UE Rx-Tx time difference measurement accuracy in FR2 in fading**

Accuracy	Conditions					
	PRS Es/lot	Minimum PRS bandwidth	PRS SCS	PRS resource repetition ( $T_{rep}^{PRS} * L_{PRS} / K_{comb}^{PRS}$ Note 3)	$I_0$ Note 4 range	
					Minimum $I_0$ Note 1	Maximum $I_0$
$T_c$ Note 5	dB	RB	kHz		dBm / SCS <sub>PRS</sub>	dBm/BW <sub>Channel</sub>
$\pm 75+\delta$	-3	$\geq 24$	60	$\geq 4$	Same value as PRP in Table B.2.14-2, according to UE Power class, operating band and angle of arrival	-50
$\pm 72+\delta$		$\geq 64$		$\geq 1$	NOTE 6	NOTE 6
$\pm 57+\delta$		$\geq 132$		$\geq 1$	NOTE 6	NOTE 6
$\pm 61+\delta$	-13	$\geq 32$	120	$\geq 4$	Same value as PRP in Table B.2.14-2, according to UE Power class, operating band and angle of arrival	-50
$\pm 64+\delta$		$\geq 64$		$\geq 1$	NOTE 6	NOTE 6
$\pm 55+\delta$		$\geq 128$	$\geq 1$	NOTE 6	NOTE 6	
$\pm 92+\delta$		$\geq 24$	60	$\geq 4$	NOTE 6	NOTE 6
$\pm 70+\delta$		$\geq 64$		$\geq 1$	NOTE 6	NOTE 6
$\pm 57+\delta$		$\geq 132$		$\geq 1$	NOTE 6	NOTE 6
$\pm 60+\delta$	$\geq 32$	120		$\geq 4$	NOTE 6	NOTE 6
$\pm 66+\delta$	$\geq 64$		$\geq 1$	NOTE 6	NOTE 6	
$\pm 62+\delta$	$\geq 128$		$\geq 1$	NOTE 6	NOTE 6	

NOTE 1: This minimum  $I_0$  condition is expressed as the average  $I_0$  per RE over all REs in an OFDM symbol.  
 NOTE 2: NR operating band groups are as defined in Section 3.5.  
 NOTE 3:  $T_{rep}^{PRS}$ ,  $L_{PRS}$ ,  $K_{comb}^{PRS}$  are configured by higher layer parameter *dl-PRS-ResourceRepetitionFactor*, *dl-PRS-NumSymbols* and *dl-PRS-CombSizeN* defined in TS 37.355 [34].  
 NOTE 4: The  $I_0$  is defined in PRS slots. The same  $I_0$  range applies to PRS and non-PRS symbols.  $I_0$  levels are different in PRS and non-PRS symbols within the same slot.  
 NOTE 5:  $T_c$  is the basic timing unit defined in TS 38.211 [6].  
 NOTE 6: The same bands and the same  $I_0$  conditions for each band apply for this requirement as for the corresponding requirement with the PRS bandwidth of the smallest RB number for the corresponding SCS.  
 NOTE 7:  $\delta$  is the margin determined from Table 10.1.25.2-6.

**Table 10.1.25.2-5: Margin for UE Rx-Tx time difference measurement accuracy in FR1**

Min(PRS BW, SRS BW) (RB)			Margin ( $T_c$ Note 1)
SCS = 15 kHz	SCS = 30 kHz	SCS = 60 kHz	
$\geq 24$	N/A	N/A	160
$\geq 52$	$\geq 24$	N/A	80

≥ 104	≥ 48	≥ 24	56
N/A	≥ 132	≥ 64	24
N/A	N/A	≥ 132	24

NOTE 1:  $T_c$  is the basic timing unit defined in TS 38.211 [6].  
 NOTE 2: If SRS and PRS have different SCS, the margin corresponding to the smallest RS BW in MHz applies.

**Table 10.1.25.2-6: Margin for UE Rx-Tx time difference measurement accuracy in FR2**

Min(PRS BW, SRS BW) (MHz)		Margin ( $T_c$ <sup>Note 1</sup> )
SCS = 60 kHz	SCS = 120 kHz	
≥ 24	N/A	76
≥ 64	≥ 32	32
≥ 132	≥ 64	24
N/A	≥ 128	20

NOTE 1:  $T_c$  is the basic timing unit defined in TS 38.211 [6].  
 NOTE 2: If SRS and PRS have different SCS, the margin corresponding to the smallest RS BW in MHz applies.

10.1.25.3 Report mapping

10.1.25.3.1 Absolute UE Rx-Tx Measurement Report Mapping

The reporting range for the absolute UE Rx-Tx time difference measurement ( $T_{UE\ Rx-Tx}$ ) is defined from  $-985024 \times T_c$  to  $985024 \times T_c$  with the resolution step of  $2^k \times T_c$ , where:

$T_c$  is defined in TS 38.211 [6],

$$k_{min} \leq k \leq k_{max},$$

$k_{min}=2$  and  $k_{max}=5$ , when at least one of the PRS and the SRS resources configured for  $T_{UE\ Rx-Tx}$  is in FR1,

$k_{min}=0$  and  $k_{max}=5$ , when both PRS and SRS resources configured for  $T_{UE\ Rx-Tx}$  are in FR2,

$k \geq \text{timingReportingGranularityFactor}$  [34] configured by LMF via LPP for the UE Rx-Tx time difference measurement.

The  $T_{UE\ Rx-Tx}$  report mapping for  $k = 0, 1, 2, 3, 4$ , and  $5$  are specified in Tables 10.1.25.3.1-1, 10.1.25.3.1-2, 10.1.25.3.1-3, 10.1.25.3.1-4, 10.1.25.3.1-5, and 10.1.25.3.1-6, respectively.

**Table 10.1.25.3.1-1: Absolute UE Rx-Tx time difference measurement report mapping for  $k=0$**

Reported Quantity Value	Measured Quantity Value	Unit
RX-TX_TIME_DIFFERENCE_0000	$T_{UE\ Rx-Tx} < -985024$	$T_c$
RX-TX_TIME_DIFFERENCE_0001	$-985024 \leq T_{UE\ Rx-Tx} < -985023$	$T_c$
RX-TX_TIME_DIFFERENCE_0002	$-985023 \leq T_{UE\ Rx-Tx} < -985022$	$T_c$
...	...	...
RX-TX_TIME_DIFFERENCE_985024	$-1 \leq T_{UE\ Rx-Tx} < 0$	$T_c$
RX-TX_TIME_DIFFERENCE_985025	$0 \leq T_{UE\ Rx-Tx} < 1$	$T_c$
...	...	...
RX-TX_TIME_DIFFERENCE_1970047	$985022 \leq T_{UE\ Rx-Tx} < 985023$	$T_c$
RX-TX_TIME_DIFFERENCE_1970048	$985023 \leq T_{UE\ Rx-Tx} < 985024$	$T_c$
RX-TX_TIME_DIFFERENCE_1970049	$985024 \leq T_{UE\ Rx-Tx}$	$T_c$

**Table 10.1.25.3.1-2: Absolute UE Rx-Tx time difference measurement report mapping for  $k=1$**

Reported Quantity Value	Measured Quantity Value	Unit
RX-TX_TIME_DIFFERENCE_0000	$T_{UE\ Rx-Tx} < -985024$	$T_c$
RX-TX_TIME_DIFFERENCE_0001	$-985024 \leq T_{UE\ Rx-Tx} < -985022$	$T_c$
RX-TX_TIME_DIFFERENCE_0002	$-985022 \leq T_{UE\ Rx-Tx} < -985020$	$T_c$
...	...	...



RX-TX_TIME_DIFFERENCE_492512	$-2 \leq T_{UE\ Rx-Tx} < 0$	$T_c$
RX-TX_TIME_DIFFERENCE_492513	$0 \leq T_{UE\ Rx-Tx} < 2$	$T_c$
...	...	...
RX-TX_TIME_DIFFERENCE_985023	$985020 \leq T_{UE\ Rx-Tx} < 985022$	$T_c$
RX-TX_TIME_DIFFERENCE_985024	$985022 \leq T_{UE\ Rx-Tx} < 985024$	$T_c$
RX-TX_TIME_DIFFERENCE_985025	$985024 \leq T_{UE\ Rx-Tx}$	$T_c$

**Table 10.1.25.3.1-3: Absolute UE Rx-Tx time difference measurement report mapping for k=2**

Reported Quantity Value	Measured Quantity Value	Unit
RX-TX_TIME_DIFFERENCE_0000	$T_{UE\ Rx-Tx} < -985024$	$T_c$
RX-TX_TIME_DIFFERENCE_0001	$-985024 \leq T_{UE\ Rx-Tx} < -985020$	$T_c$
RX-TX_TIME_DIFFERENCE_0002	$-985020 \leq T_{UE\ Rx-Tx} < -985016$	$T_c$
...	...	...
RX-TX_TIME_DIFFERENCE_246256	$-4 \leq T_{UE\ Rx-Tx} < 0$	$T_c$
RX-TX_TIME_DIFFERENCE_246257	$0 \leq T_{UE\ Rx-Tx} < 4$	$T_c$
...	...	...
RX-TX_TIME_DIFFERENCE_492511	$985016 \leq T_{UE\ Rx-Tx} < 985020$	$T_c$
RX-TX_TIME_DIFFERENCE_492512	$985020 \leq T_{UE\ Rx-Tx} < 985024$	$T_c$
RX-TX_TIME_DIFFERENCE_492513	$985024 \leq T_{UE\ Rx-Tx}$	$T_c$

**Table 10.1.25.3.1-4: Absolute UE Rx-Tx time difference measurement report mapping for k=3**

Reported Quantity Value	Measured Quantity Value	Unit
RX-TX_TIME_DIFFERENCE_0000	$T_{UE\ Rx-Tx} < -985024$	$T_c$
RX-TX_TIME_DIFFERENCE_0001	$-985024 \leq T_{UE\ Rx-Tx} < -985016$	$T_c$
RX-TX_TIME_DIFFERENCE_0002	$-985016 \leq T_{UE\ Rx-Tx} < -985008$	$T_c$
...	...	...
RX-TX_TIME_DIFFERENCE_123128	$-8 \leq T_{UE\ Rx-Tx} < 0$	$T_c$
RX-TX_TIME_DIFFERENCE_123129	$0 \leq T_{UE\ Rx-Tx} < 8$	$T_c$
...	...	...
RX-TX_TIME_DIFFERENCE_246255	$985008 \leq T_{UE\ Rx-Tx} < 985016$	$T_c$
RX-TX_TIME_DIFFERENCE_246256	$985016 \leq T_{UE\ Rx-Tx} < 985024$	$T_c$
RX-TX_TIME_DIFFERENCE_246257	$985024 \leq T_{UE\ Rx-Tx}$	$T_c$

**Table 10.1.25.3.1-5: Absolute UE Rx-Tx time difference measurement report mapping for k=4**

Reported Quantity Value	Measured Quantity Value	Unit
RX-TX_TIME_DIFFERENCE_0000	$T_{UE\ Rx-Tx} < -985024$	$T_c$
RX-TX_TIME_DIFFERENCE_0001	$-985024 \leq T_{UE\ Rx-Tx} < -985008$	$T_c$
RX-TX_TIME_DIFFERENCE_0002	$-985008 \leq T_{UE\ Rx-Tx} < -984992$	$T_c$
...	...	...
RX-TX_TIME_DIFFERENCE_61564	$-16 \leq T_{UE\ Rx-Tx} < 0$	$T_c$
RX-TX_TIME_DIFFERENCE_61565	$0 \leq T_{UE\ Rx-Tx} < 16$	$T_c$
...	...	...
RX-TX_TIME_DIFFERENCE_123127	$984992 \leq T_{UE\ Rx-Tx} < 985008$	$T_c$
RX-TX_TIME_DIFFERENCE_123128	$985008 \leq T_{UE\ Rx-Tx} < 985024$	$T_c$
RX-TX_TIME_DIFFERENCE_123129	$985024 \leq T_{UE\ Rx-Tx}$	$T_c$

**Table 10.1.25.3.1-6: Absolute UE Rx-Tx time difference measurement report mapping for k=5**

Reported Quantity Value	Measured Quantity Value	Unit
RX-TX_TIME_DIFFERENCE_0000	$T_{UE\ Rx-Tx} < -985024$	$T_c$
RX-TX_TIME_DIFFERENCE_0001	$-985024 \leq T_{UE\ Rx-Tx} < -984992$	$T_c$
RX-TX_TIME_DIFFERENCE_0002	$-984992 \leq T_{UE\ Rx-Tx} < -984960$	$T_c$
...	...	...
RX-TX_TIME_DIFFERENCE_30782	$-32 \leq T_{UE\ Rx-Tx} < 0$	$T_c$
RX-TX_TIME_DIFFERENCE_30783	$0 \leq T_{UE\ Rx-Tx} < 32$	$T_c$

...	...	...
RX-TX_TIME_DIFFERENCE_61563	$984960 \leq T_{UE\ Rx-Tx} < 984992$	$T_c$
RX-TX_TIME_DIFFERENCE_61564	$984992 \leq T_{UE\ Rx-Tx} < 985024$	$T_c$
RX-TX_TIME_DIFFERENCE_61565	$985024 \leq T_{UE\ Rx-Tx}$	$T_c$

### 10.1.25.3.2 Differential UE Rx-Tx Measurement Report Mapping

The reporting range for differential UE Rx-Tx time difference measurement ( $\Delta T_{UE\ Rx-Tx}$ ) is defined from 0 up to  $8191 \times T_c$  where:

$\Delta T_{UE\ Rx-Tx} = T_{UE\ Rx-Tx1} - T_{UE\ Rx-Tx2}$ ; where:

$T_{UE\ Rx-Tx1} > T_{UE\ Rx-Tx2}$ ,

$T_{UE\ Rx-Tx1}$  is the first absolute UE Rx-Tx time difference measurement,

$T_{UE\ Rx-Tx2}$  is the second absolute UE Rx-Tx time difference measurement,

$T_c$  is defined in TS 38.211 [6],

$k_{min} \leq k \leq k_{max}$ ,

$k_{min}=2$  and  $k_{max}=5$ , when at least one of the PRS and the SRS resources configured for  $\Delta T_{UE\ Rx-Tx}$  is in FR1,

$k_{min}=0$  and  $k_{max}=5$ , when all the PRS and SRS resources configured for  $\Delta T_{UE\ Rx-Tx}$  are in FR2,

$k \geq \text{timingReportingGranularityFactor}$  [34] configured by LMF via LPP for the UE Rx-Tx time difference measurement.

The  $\Delta T_{UE\ Rx-Tx}$  report mapping for  $k = 0, 1, 2, 3, 4$ , and  $5$  are specified in Tables 10.1.25.3.2-1, 10.1.25.3.2-2, 10.1.25.3.2-3, 10.1.25.3.2-4, 10.1.25.3.2-5, and 10.1.25.3.2-6, respectively.

**Table 10.1.25.3.2-1: Differential UE Rx-Tx time difference measurement report mapping for  $k=0$**

Reported Quantity Value	Measured Quantity Value	Unit
DIFF_RX-TX_TIME_DIFFERENCE_0000	$0 \leq \Delta T_{UE\ Rx-Tx} < 1$	$T_c$
DIFF_RX-TX_TIME_DIFFERENCE_0001	$1 \leq \Delta T_{UE\ Rx-Tx} < 2$	$T_c$
DIFF_RX-TX_TIME_DIFFERENCE_0002	$2 \leq \Delta T_{UE\ Rx-Tx} < 3$	$T_c$
...	...	...
DIFF_RX-TX_TIME_DIFFERENCE_8189	$8189 \leq \Delta T_{UE\ Rx-Tx} < 8190$	$T_c$
DIFF_RX-TX_TIME_DIFFERENCE_8190	$8190 \leq \Delta T_{UE\ Rx-Tx} < 8191$	$T_c$
DIFF_RX-TX_TIME_DIFFERENCE_8191	$8191 \leq \Delta T_{UE\ Rx-Tx}$	$T_c$

**Table 10.1.25.3.2-2: Differential UE Rx-Tx time difference measurement report mapping for  $k=1$**

Reported Quantity Value	Measured Quantity Value	Unit
DIFF_RX-TX_TIME_DIFFERENCE_0000	$0 \leq \Delta T_{UE\ Rx-Tx} < 2$	$T_c$
DIFF_RX-TX_TIME_DIFFERENCE_0001	$2 \leq \Delta T_{UE\ Rx-Tx} < 4$	$T_c$
DIFF_RX-TX_TIME_DIFFERENCE_0002	$4 \leq \Delta T_{UE\ Rx-Tx} < 6$	$T_c$
...	...	...
DIFF_RX-TX_TIME_DIFFERENCE_4093	$8186 \leq \Delta T_{UE\ Rx-Tx} < 8188$	$T_c$
DIFF_RX-TX_TIME_DIFFERENCE_4094	$8188 \leq \Delta T_{UE\ Rx-Tx} < 8190$	$T_c$
DIFF_RX-TX_TIME_DIFFERENCE_4095	$8190 \leq \Delta T_{UE\ Rx-Tx}$	$T_c$

**Table 10.1.25.3.2-3: Differential UE Rx-Tx time difference measurement report mapping for  $k=2$**

Reported Quantity Value	Measured Quantity Value	Unit
DIFF_RX-TX_TIME_DIFFERENCE_0000	$0 \leq \Delta T_{UE\ Rx-Tx} < 4$	$T_c$
DIFF_RX-TX_TIME_DIFFERENCE_0001	$4 \leq \Delta T_{UE\ Rx-Tx} < 8$	$T_c$
DIFF_RX-TX_TIME_DIFFERENCE_0002	$8 \leq \Delta T_{UE\ Rx-Tx} < 12$	$T_c$

...	...	...
DIFF_RX-TX_TIME_DIFFERENCE_2045	$8180 \leq \Delta T_{UE \text{ Rx-Tx}} < 8184$	$T_c$
DIFF_RX-TX_TIME_DIFFERENCE_2046	$8184 \leq \Delta T_{UE \text{ Rx-Tx}} < 8188$	$T_c$
DIFF_RX-TX_TIME_DIFFERENCE_2047	$8188 \leq \Delta T_{UE \text{ Rx-Tx}}$	$T_c$

**Table 10.1.25.3.2-4: Differential UE Rx-Tx time difference measurement report mapping for  $k=3$** 

Reported Quantity Value	Measured Quantity Value	Unit
DIFF_RX-TX_TIME_DIFFERENCE_0000	$0 \leq \Delta T_{UE \text{ Rx-Tx}} < 8$	$T_c$
DIFF_RX-TX_TIME_DIFFERENCE_0001	$8 \leq \Delta T_{UE \text{ Rx-Tx}} < 16$	$T_c$
DIFF_RX-TX_TIME_DIFFERENCE_0002	$16 \leq \Delta T_{UE \text{ Rx-Tx}} < 24$	$T_c$
...	...	...
DIFF_RX-TX_TIME_DIFFERENCE_1021	$8168 \leq \Delta T_{UE \text{ Rx-Tx}} < 8176$	$T_c$
DIFF_RX-TX_TIME_DIFFERENCE_1022	$8176 \leq \Delta T_{UE \text{ Rx-Tx}} < 8184$	$T_c$
DIFF_RX-TX_TIME_DIFFERENCE_1023	$8184 \leq \Delta T_{UE \text{ Rx-Tx}}$	$T_c$

**Table 10.1.25.3.2-5: Differential UE Rx-Tx time difference measurement report mapping for  $k=4$** 

Reported Quantity Value	Measured Quantity Value	Unit
DIFF_RX-TX_TIME_DIFFERENCE_0000	$0 \leq \Delta T_{UE \text{ Rx-Tx}} < 16$	$T_c$
DIFF_RX-TX_TIME_DIFFERENCE_0001	$16 \leq \Delta T_{UE \text{ Rx-Tx}} < 32$	$T_c$
DIFF_RX-TX_TIME_DIFFERENCE_0002	$32 \leq \Delta T_{UE \text{ Rx-Tx}} < 48$	$T_c$
...	...	...
DIFF_RX-TX_TIME_DIFFERENCE_509	$8144 \leq \Delta T_{UE \text{ Rx-Tx}} < 8160$	$T_c$
DIFF_RX-TX_TIME_DIFFERENCE_510	$8160 \leq \Delta T_{UE \text{ Rx-Tx}} < 8176$	$T_c$
DIFF_RX-TX_TIME_DIFFERENCE_511	$8176 \leq \Delta T_{UE \text{ Rx-Tx}}$	$T_c$

**Table 10.1.25.3.2-6: Differential UE Rx-Tx time difference measurement report mapping for  $k=5$** 

Reported Quantity Value	Measured Quantity Value	Unit
DIFF_RX-TX_TIME_DIFFERENCE_0000	$0 \leq \Delta T_{UE \text{ Rx-Tx}} < 32$	$T_c$
DIFF_RX-TX_TIME_DIFFERENCE_0001	$32 \leq \Delta T_{UE \text{ Rx-Tx}} < 64$	$T_c$
DIFF_RX-TX_TIME_DIFFERENCE_0002	$64 \leq \Delta T_{UE \text{ Rx-Tx}} < 96$	$T_c$
...	...	...
DIFF_RX-TX_TIME_DIFFERENCE_253	$8096 \leq \Delta T_{UE \text{ Rx-Tx}} < 8128$	$T_c$
DIFF_RX-TX_TIME_DIFFERENCE_254	$8128 \leq \Delta T_{UE \text{ Rx-Tx}} < 8160$	$T_c$
DIFF_RX-TX_TIME_DIFFERENCE_255	$8160 \leq \Delta T_{UE \text{ Rx-Tx}}$	$T_c$

### 10.1.25.3.3 Additional Path Report Mapping for UE Rx-Tx Time Difference

The reporting range for the additional path reporting for an UE Rx-Tx time difference measurement is defined up to the range from  $-8175 \times T_c$  to  $8175 \times T_c$  with the resolution step of  $2^k \times T_c$ , where

$T_c$  is defined in TS 38.211 [6],

$$k_{min} \leq k \leq k_{max},$$

$k_{min}=2$  and  $k_{max}=5$ , when at least one of the PRS resource and SRS resource configured for the UE Rx-Tx time difference measurement is in FR1,

$k_{min}=0$  and  $k_{max}=5$ , when both of the PRS resource and SRS resource configured for the UE Rx-Tx time difference measurement is in FR2,

$k \geq \text{timingReportingGranularityFactor}$  [34] configured by LMF via LPP for the UE Rx-Tx time difference measurement.

The UE can report the timing of up to two additional paths with respect to the path timing determining the UE Rx-Tx time difference measurement.

The report mappings for different  $k$  values are specified in Tables 10.1.25.3.3-1 – 10.1.25.3.3-6.

**Table 10.1.25.3.3-1: Report mapping for  $k=0$**

Reported Quantity Value, path_i	Measured Quantity Value, $\Delta\text{path}$	Unit
path_00000	$\Delta\text{path} < -8175$	$T_c$
path_00001	$-8175 \leq \Delta\text{path} < -8174$	$T_c$
path_00002	$-8174 \leq \Delta\text{path} < -8173$	$T_c$
...	...	...
path_08175	$-1 \leq \Delta\text{path} < 0$	$T_c$
path_08176	$0 \leq \Delta\text{path} < 1$	$T_c$
...	...	...
path_16349	$8173 \leq \Delta\text{path} < 8174$	$T_c$
path_16350	$8174 \leq \Delta\text{path} < 8175$	$T_c$
path_16351	$8175 \leq \Delta\text{path}$	$T_c$

**Table 10.1.25.3.3-2: Report mapping for  $k=1$**

Reported Quantity Value, path_i	Measured Quantity Value, $\Delta\text{path}$	Unit
path_0000	$\Delta\text{path} < -8175$	$T_c$
path_0001	$-8175 \leq \Delta\text{path} < -8173$	$T_c$
path_0002	$-8173 \leq \Delta\text{path} < -8171$	$T_c$
...	...	...
path_4088	$-1 \leq \Delta\text{path} < 1$	$T_c$
...	...	...
path_8174	$8171 \leq \Delta\text{path} < 8173$	$T_c$
path_8175	$8173 \leq \Delta\text{path} < 8175$	$T_c$
path_8176	$8175 \leq \Delta\text{path}$	$T_c$

**Table 10.1.25.3.3-3: Report mapping for  $k=2$**

Reported Quantity Value, path_i	Measured Quantity Value, $\Delta\text{path}$	Unit
path_0000	$\Delta\text{path} < -8174$	$T_c$
path_0001	$-8174 \leq \Delta\text{path} < -8170$	$T_c$
path_0002	$-8170 \leq \Delta\text{path} < -8166$	$T_c$
...	...	...
path_2044	$-2 \leq \Delta\text{path} < 2$	$T_c$
...	...	...
path_4086	$8166 \leq \Delta\text{path} < 8170$	$T_c$
path_4087	$8170 \leq \Delta\text{path} < 8174$	$T_c$
path_4088	$8174 \leq \Delta\text{path}$	$T_c$

**Table 10.1.25.3.3-4: Report mapping for  $k=3$**

Reported Quantity Value, path_i	Measured Quantity Value, $\Delta\text{path}$	Unit
path_0000	$\Delta\text{path} < -8172$	$T_c$
path_0001	$-8172 \leq \Delta\text{path} < -8164$	$T_c$
path_0002	$-8164 \leq \Delta\text{path} < -8156$	$T_c$
...	...	...
path_1022	$-4 \leq \Delta\text{path} < 4$	$T_c$
...	...	...
path_2042	$8156 \leq \Delta\text{path} < 8164$	$T_c$
path_2043	$8164 \leq \Delta\text{path} < 8172$	$T_c$
path_2044	$8172 \leq \Delta\text{path}$	$T_c$

**Table 10.1.25.3.3-5: Report mapping for  $k=4$** 

Reported Quantity Value, path_i	Measured Quantity Value, $\Delta\text{path}$	Unit
path_0000	$\Delta\text{path} < -8168$	$T_c$
path_0001	$-8168 \leq \Delta\text{path} < -8152$	$T_c$
path_0002	$-8152 \leq \Delta\text{path} < -8136$	$T_c$
...	...	...
path_511	$-8 \leq \Delta\text{path} < 8$	$T_c$
...	...	...
path_1020	$8136 \leq \Delta\text{path} < 8152$	$T_c$
path_1021	$8152 \leq \Delta\text{path} < 8168$	$T_c$
path_1022	$8168 \leq \Delta\text{path}$	$T_c$

**Table 10.1.25.3.3-6: Report mapping for  $k=5$** 

Reported Quantity Value, path_i	Measured Quantity Value, $\Delta\text{path}$	Unit
path_000	$\Delta\text{path} < -8160$	$T_c$
path_001	$-8160 \leq \Delta\text{path} < -8128$	$T_c$
path_002	$-8128 \leq \Delta\text{path} < -8096$	$T_c$
...	...	...
path_256	$0 \leq \Delta\text{path} < 32$	$T_c$
...	...	...
path_509	$8096 \leq \Delta\text{path} < 8128$	$T_c$
path_510	$8128 \leq \Delta\text{path} < 8160$	$T_c$
path_511	$8160 \leq \Delta\text{path}$	$T_c$

## 10.1.26 FR2 P-MPR report

The FR2 P-MPR report mapping is defined by this clause.

### 10.1.26.1 Report mapping

Table 10.1.26.1-1 defines the FR2 P-MPR report mapping.

**Table 10.1.26.1-1 Mapping of FR2 P-MPR**

Reported value	Measured quantity value	Unit
P-MPR_00	$3 \leq \text{PMP-R} < 6$	dB
P-MPR_01	$6 \leq \text{PMP-R} < 9$	dB
P-MPR_02	$9 \leq \text{PMP-R} < 12$	dB
P-MPR_03	$\text{PMP-R} \geq 12$	dB

## 10.1.27 L1-SINR accuracy requirements for FR1

### 10.1.27.1 L1-SINR accuracy requirements with CSI-RS based CMR and no dedicated IMR configured

#### 10.1.27.1.1 Absolute Accuracy

Unless otherwise specified, the requirements for absolute accuracy of CSI-RS based L1-SINR in this clause apply to all CSI-RS resources configured as CMR and no dedicated resource configured as IMR of the serving cell configured for L1-SINR measurement.

The accuracy requirements in Table 10.1.27.1.1-1 are valid under the following conditions:

- Conditions defined in clause 7.3 of TS 38.101-1 [18] for reference sensitivity are fulfilled.
- Conditions for L1-SINR measurements are fulfilled according to Annex B.2.8.1 for a corresponding Band for each relevant CSI-RS based CMR.
- The bandwidth of CSI-RS as CMR is 48 PRBs and the density is 3.
- AWGN radio propagation conditions.

The performance with larger bandwidth of CSI-RS as CMR is equal to or better than the accuracy requirements in Table 10.1.27.1.1-1.

**Table 10.1.27.1.1-1: L1-SINR absolute accuracy for CSI-RS based CMR only in FR1**

Accuracy		Conditions						
Normal condition	Extreme condition	CSI-RS CMR $\hat{E}_s/\text{lot}$	$I_0$ <sup>Note 1</sup> range					Maximum $I_0$
			NR operating band groups <sup>Note 2</sup>	Minimum $I_0$			dBm/BW Channel	
dB	dB	dB		dBm / $SCS_{\text{CSI-RS}}$				dBm/BW Channel
				$SCS_{\text{CSI-RS}} = 15 \text{ kHz}$	$SCS_{\text{CSI-RS}} = 30 \text{ kHz}$	$SCS_{\text{CSI-RS}} = 60 \text{ kHz}$		
$\pm 5.5$	$\pm 6.5$	$\geq 3$	NR_FDD_FR1_A, NR_TDD_FR1_A, NR_SDL_FR1_A	-121	-118	-115	N/A	-50
			NR_FDD_FR1_B	-120.5	-117.5	-114.5	N/A	-50
			NR_TDD_FR1_C	-120	-117	-114	N/A	-50
			NR_FDD_FR1_D, NR_TDD_FR1_D	-119.5	-116.5	-113.5	N/A	-50
			NR_FDD_FR1_E, NR_TDD_FR1_E	-119	-116	-113	N/A	-50
			NR_FDD_FR1_F	-118.5	-115.5	-112.5	N/A	-50
			NR_FDD_FR1_G	-118	-115	-112	N/A	-50
			NR_FDD_FR1_H	-117.5	-114.5	-111.5	N/A	-50

NOTE 1:  $I_0$  is assumed to have constant EPRE across the bandwidth.

NOTE 2: NR operating band groups in FR1 are as defined in clause 3.5.2.

10.1.27.1.2 Relative Accuracy

The relative accuracy of CSI-RS based L1-SINR is defined as the L1-SINR measured from one CSI-RS compared to the largest measured value of L1-SINR among all CSI-RS resources of the serving cell.

The accuracy requirements in Table 10.1.27.1.2-1 are valid under the following conditions:

- Conditions defined in clause 7.3 of TS 38.101-1 [18] for reference sensitivity are fulfilled.
- Conditions for L1-SINR measurements are fulfilled according to Annex B.2 for a corresponding Band for each relevant CSI-RS based CMR.
- The bandwidth of CSI-RS is 48 PRBs and the density is 3.
- AWGN radio propagation conditions.

The performance with larger bandwidth of CSI-RS as CMR is equal to or better than the accuracy requirements in Table 10.1.27.1.2-1.

**Table 10.1.27.1.2-1: L1-SINR relative accuracy for CSI-RS based CMR only in FR1**

Accuracy		Conditions	
Normal condition	Extreme condition	CSI-RS CMR	$I_0$ <sup>Note 1</sup> range

dB	dB	Ês/lot Note 2	NR operating band groups Note 2	Minimum lo			dBm/BW <sub>Channel</sub>	dBm/BW <sub>Channel</sub>
				dBm / SCS <sub>CSI-RS</sub>				
				SCS <sub>CSI-RS</sub> = 15 kHz	SCS <sub>CSI-RS</sub> = 30 kHz	SCS <sub>CSI-RS</sub> = 60 kHz		
±[4.5]	±[5.5]	≥3	NR_FDD_FR1_A, NR_TDD_FR1_A, NR_SDL_FR1_A	-121	-118	-115	N/A	-50
			NR_FDD_FR1_B	-120.5	-117.5	-114.5	N/A	-50
			NR_TDD_FR1_C	-120	-117	-114	N/A	-50
			NR_FDD_FR1_D, NR_TDD_FR1_D	-119.5	-116.5	-113.5	N/A	-50
			NR_FDD_FR1_E, NR_TDD_FR1_E	-119	-116	-113	N/A	-50
			NR_FDD_FR1_F	-118.5	-115.5	-112.5	N/A	-50
			NR_FDD_FR1_G	-118	-115	-112	N/A	-50
			NR_FDD_FR1_H	-117.5	-114.5	-111.5	N/A	-50

NOTE 1: lo is assumed to have constant EPRE across the bandwidth.  
 NOTE 2: The parameter CSI-RS CMR Ês/lot is the minimum CMR Ês/lot of the pair of CSI-RS resources to which the requirement applies.  
 NOTE 3: NR operating band groups in FR1 are as defined in clause 3.5.2.

### 10.1.27.2 L1-SINR accuracy requirements with SSB based CMR and dedicated IMR configured

#### 10.1.27.2.1 Absolute Accuracy

Unless otherwise specified, the requirements for absolute accuracy of SSB based L1-SINR in this clause apply to all SSBs configured as CMR and dedicated resources configured as IMR of the serving cell configured for L1-SINR measurement.

The accuracy requirements are defined in Table 10.1.27.2.1-1 for SSB based CMR and NZP-IMR and in Table 10.1.27.2.1-2 for SSB based CMR and ZP-IMR.

The accuracy requirements in Tables 10.1.27.2.1-1 and 10.1.27.2.1-2 are valid under the following conditions:

- Conditions defined in clause 7.3 of TS 38.101-1 [18] for reference sensitivity are fulfilled.
- Conditions for L1-SINR measurements are fulfilled according to Annex B.2.8.2 for a corresponding Band for each relevant SSB based CMR and IMR.
- The bandwidth of NZP-IMR and ZP-IMR is 48 PRBs and the density is 3.
- AWGN radio propagation conditions.

The performance with larger bandwidth of NZP-IMR and ZP-IMR is equal to or better than the accuracy requirements in Tables 10.1.27.2.1-1 and 10.1.27.2.1-2.

**Table 10.1.27.2.1-1: L1-SINR absolute accuracy for SSB based CMR and NZP-IMR in FR1**

Accuracy		Conditions				
Normal condition	Extreme condition	SSB-CMR Ês/lot	NZP-IMR Ês/lot	lo <sup>Note 1</sup> range		
				NR operating band groups <sup>Note 2</sup>	Minimum lo	Maximum lo
dB	dB	dB	dB	dBm / SCS <sub>SSB</sub>	dBm/BW <sub>Channel</sub>	dBm/BW <sub>Channel</sub>

					SCS <sub>SSB</sub> = 15 kHz	SCS <sub>SSB</sub> = 30 kHz		
±4.0	±5.0	≥0	≥0	NR_FDD_FR1_A, NR_TDD_FR1_A, NR_SDL_FR1_A	-121	-118	N/A	-50
				NR_FDD_FR1_B	-120.5	-117.5	N/A	-50
				NR_TDD_FR1_C	-120	-117	N/A	-50
				NR_FDD_FR1_D, NR_TDD_FR1_D	-119.5	-116.5	N/A	-50
				NR_FDD_FR1_E, NR_TDD_FR1_E	-119	-116	N/A	-50
				NR_FDD_FR1_F	-118.5	-115.5	N/A	-50
				NR_FDD_FR1_G	-118	-115	N/A	-50
				NR_FDD_FR1_H	-117.5	-114.5	N/A	-50

NOTE 1: I<sub>o</sub> is assumed to have constant EPRE across the bandwidth.

NOTE 2: NR operating band groups in FR1 are as defined in clause 3.5.2.

**Table 10.1.27.2.1-2: L1-SINR absolute accuracy for SSB based CMR and ZP-IMR in FR1**

Accuracy		Conditions					
Normal condition	Extreme condition	SSB-CMR Ês/lot	I <sub>o</sub> <sup>Note 1</sup> range				
			NR operating band groups <sup>Note 2</sup>	Minimum I <sub>o</sub>		Maximum I <sub>o</sub>	
dB	dB	dB		dBm / SCS <sub>SSB</sub>		dBm/BW <sub>Channel</sub>	dBm/BW <sub>Channel</sub>
				SCS <sub>SSB</sub> = 15 kHz	SCS <sub>SSB</sub> = 30 kHz		
±4.5	±5.5	≥-3	NR_FDD_FR1_A, NR_TDD_FR1_A, NR_SDL_FR1_A	-121	-118	N/A	-50
			NR_FDD_FR1_B	-120.5	-117.5	N/A	-50
			NR_TDD_FR1_C	-120	-117	N/A	-50
			NR_FDD_FR1_D, NR_TDD_FR1_D	-119.5	-116.5	N/A	-50
			NR_FDD_FR1_E, NR_TDD_FR1_E	-119	-116	N/A	-50
			NR_FDD_FR1_F	-118.5	-115.5	N/A	-50
			NR_FDD_FR1_G	-118	-115	N/A	-50
			NR_FDD_FR1_H	-117.5	-114.5	N/A	-50

NOTE 1: I<sub>o</sub> is assumed to have constant EPRE across the bandwidth.

NOTE 2: NR operating band groups in FR1 are as defined in clause 3.5.2.

### 10.1.27.2.2 Relative Accuracy

The relative accuracy of SSB based L1-SINR is defined as the L1-SINR measured from one SSB configured as CMR and one IMR configured as IMR compared to the largest measured value of L1-SINR among all SSBs and IMRs of the serving cell.

The accuracy requirements are defined in Table 10.1.27.2.2-1 for SSB based CMR and NZP-IMR and in Table 10.1.27.2.2-2 for SSB based CMR and ZP-IMR.

The accuracy requirements in Tables 10.1.27.2.2-1 and 10.1.27.2.2-2 are valid under the following conditions:

- Conditions defined in clause 7.3 of TS 38.101-1 [18] for reference sensitivity are fulfilled.
- Conditions for L1-SINR measurements are fulfilled according to Annex B.2.8.2 for a corresponding Band for each relevant SSB based CMR and IMR.
- The bandwidth of NZP-IMR and ZP-IMR is 48 PRBs and the density is 3.



- AWGN radio propagation conditions.

The performance with larger bandwidth of NZP-IMR and ZP-IMR is equal to or better than the accuracy requirements in Tables 10.1.27.2.2-1 and 10.1.27.2.2-2.

**Table 10.1.27.2.2-1: L1-SINR relative accuracy for SSB based CMR and NZP-IMR in FR1**

Accuracy		Conditions						
Normal condition	Extreme condition	SSB-CMR $\hat{E}_s/\text{lot}$ <small>Note 2</small>	NZP-IMR $\hat{E}_s/\text{lot}$	$I_o$ <small>Note 1</small> range				
				NR operating band groups <small>Note 3</small>	Minimum $I_o$		Maximum $I_o$	
dB	dB	dB	dB		dBm / $SCS_{SSB}$		dBm/ $BW_{\text{Channel}}$	dBm/ $BW_{\text{Channel}}$
					$SCS_{SSB} = 15$ kHz	$SCS_{SSB} = 30$ kHz		
$\pm[3.0]$	$\pm[4.0]$	$\geq 0$	$\geq 0$	NR_FDD_FR1_A, NR_TDD_FR1_A, NR_SDL_FR1_A	-121	-118	N/A	-50
				NR_FDD_FR1_B	-120.5	-117.5	N/A	-50
				NR_TDD_FR1_C	-120	-117	N/A	-50
				NR_FDD_FR1_D, NR_TDD_FR1_D	-119.5	-116.5	N/A	-50
				NR_FDD_FR1_E, NR_TDD_FR1_E	-119	-116	N/A	-50
				NR_FDD_FR1_F	-118.5	-115.5	N/A	-50
				NR_FDD_FR1_G	-118	-115	N/A	-50
				NR_FDD_FR1_H	-117.5	-114.5	N/A	-50

NOTE 1:  $I_o$  is assumed to have constant EPRE across the bandwidth.  
 NOTE 2: The parameter SSB CMR  $\hat{E}_s/\text{lot}$  is the minimum SSB CMR  $\hat{E}_s/\text{lot}$  of the pair of SSBs to which the requirement applies.  
 NOTE 3: NR operating band groups in FR1 are as defined in clause 3.5.2.

**Table 10.1.27.2.2-2: L1-SINR relative accuracy for SSB based CMR and ZP-IMR in FR1**

Accuracy		Conditions						
Normal condition	Extreme condition	SSB-CMR $\hat{E}_s/\text{lot}$ <small>Note 2</small>	$I_o$ <small>Note 1</small> range					
			NR operating band groups <small>Note 3</small>	Minimum $I_o$		Maximum $I_o$		
dB	dB	dB		dBm / $SCS_{SSB}$		dBm/ $BW_{\text{Channel}}$	dBm/ $BW_{\text{Channel}}$	
				$SCS_{SSB} = 15$ kHz	$SCS_{SSB} = 30$ kHz			
$\pm[3.5]$	$\pm[4.5]$	$\geq -3$	NR_FDD_FR1_A, NR_TDD_FR1_A, NR_SDL_FR1_A	-121	-118	N/A	-50	
			NR_FDD_FR1_B	-120.5	-117.5	N/A	-50	
			NR_TDD_FR1_C	-120	-117	N/A	-50	
			NR_FDD_FR1_D, NR_TDD_FR1_D	-119.5	-116.5	N/A	-50	
			NR_FDD_FR1_E, NR_TDD_FR1_E	-119	-116	N/A	-50	
			NR_FDD_FR1_F	-118.5	-115.5	N/A	-50	
			NR_FDD_FR1_G	-118	-115	N/A	-50	
			NR_FDD_FR1_H	-117.5	-114.5	N/A	-50	

NOTE 1:  $I_o$  is assumed to have constant EPRE across the bandwidth.  
 NOTE 2: The parameter SSB CMR  $\hat{E}_s/\text{lot}$  is the minimum SSB CMR  $\hat{E}_s/\text{lot}$  of the pair of SSBs to which the requirement applies.  
 NOTE 3: NR operating band groups in FR1 are as defined in clause 3.5.2.

### 10.1.27.3 L1-SINR accuracy requirements with CSI-RS based CMR and dedicated IMR configured

#### 10.1.27.3.1 Absolute Accuracy

Unless otherwise specified, the requirements for absolute accuracy of CSI-RS based L1-SINR in this clause apply to all CSI-RS resources configured as CMR and dedicated resources configured as IMR of the serving cell configured for L1-SINR measurement.

The accuracy requirements are defined in Table 10.1.27.3.1-1 for CSI-RS based CMR and NZP-IMR and in Table 10.1.27.3.1-2 for CSI-RS based CMR and ZP-IMR.

The accuracy requirements in Tables 10.1.27.3.1-1 and 10.1.27.3.1-2 are valid under the following conditions:

- Conditions defined in clause 7.3 of TS 38.101-1 [18] for reference sensitivity are fulfilled.
- Conditions for L1-SINR measurements are fulfilled according to Annex B.2.8.3 for a corresponding Band for each relevant CSI-RS based CMR and IMR.
- The bandwidth of CSI-RS as CMR, NZP-IMR and ZP-IMR is 48 PRBs and the density is 3.
- AWGN radio propagation conditions.

The performance with larger bandwidth of CSI-RS as CMR, NZP-IMR and ZP-IMR is equal to or better than the accuracy requirements in Tables 10.1.27.3.1-1 and 10.1.27.3.1-2.

**Table 10.1.27.3.1-1: L1-SINR absolute accuracy for CSI-RS based CMR and NZP-IMR in FR1**

Accuracy		Conditions							
Normal condition	Extreme condition	CSI-RS CMR $\hat{E}_s/\text{lot}$ <small>Note 2</small>	NZP-IMR $\hat{E}_s/\text{lot}$	$I_o$ <small>Note 1</small> range					
				NR operating band groups <small>Note 3</small>	Minimum $I_o$			Maximum $I_o$	
dB	dB	dB	dB		dBm / $SCS_{\text{CSI-RS}}$			dBm/BW <sub>Channel</sub>	dBm/BW <sub>Channel</sub>
					$SCS_{\text{SI-RS}} = 15$ kHz	$SCS_{\text{CSI-RS}} = 30$ kHz	$SCS_{\text{SI-RS}} = 60$ kHz		
±4.0	±5.0	≥0	≥0	NR_FDD_FR1_A, NR_TDD_FR1_A, NR_SDL_FR1_A	-121	-118	-115	N/A	-50
				NR_FDD_FR1_B	-120.5	-117.5	-114.5	N/A	-50
				NR_TDD_FR1_C	-120	-117	-114	N/A	-50
				NR_FDD_FR1_D, NR_TDD_FR1_D	-119.5	-116.5	-113.5	N/A	-50
				NR_FDD_FR1_E, NR_TDD_FR1_E	-119	-116	-113	N/A	-50
				NR_FDD_FR1_F	-118.5	-115.5	-112.5	N/A	-50
				NR_FDD_FR1_G	-118	-115	-112	N/A	-50
				NR_FDD_FR1_H	-117.5	-114.5	-111.5	N/A	-50

NOTE 1:  $I_o$  is assumed to have constant EPRE across the bandwidth.  
 NOTE 2: NR operating band groups in FR1 are as defined in clause 3.5.2.

**Table 10.1.27.3.1-2: L1-SINR absolute accuracy for CSI-RS based CMR and ZP-IMR in FR1**

Accuracy		Conditions						
Normal condition	Extreme condition	CSI-RS CMR $\hat{E}_s/\text{lot}$ <small>Note 2</small>	$I_o$ <small>Note 1</small> range					
			NR operating band groups <small>Note 3</small>	Minimum $I_o$			Maximum $I_o$	
dB	dB	dB		dBm / $SCS_{\text{CSI-RS}}$			dBm/ $BW_{\text{Channel}}$	dBm/ $BW_{\text{Channel}}$
			$SCS_{\text{CSI-RS}} = 15$ kHz	$SCS_{\text{CSI-RS}} = 30$ kHz	$SCS_{\text{CSI-RS}} = 60$ kHz			
$\pm 4.5$	$\pm 5.5$	$\geq -3$	NR_FDD_FR1_A, NR_TDD_FR1_A, NR_SDL_FR1_A	-121	-118	-115	N/A	-50
			NR_FDD_FR1_B	-120.5	-117.5	-114.5	N/A	-50
			NR_TDD_FR1_C	-120	-117	-114	N/A	-50
			NR_FDD_FR1_D, NR_TDD_FR1_D	-119.5	-116.5	-113.5	N/A	-50
			NR_FDD_FR1_E, NR_TDD_FR1_E	-119	-116	-113	N/A	-50
			NR_FDD_FR1_F	-118.5	-115.5	-112.5	N/A	-50
			NR_FDD_FR1_G	-118	-115	-112	N/A	-50
			NR_FDD_FR1_H	-117.5	-114.5	-111.5	N/A	-50

NOTE 1:  $I_o$  is assumed to have constant EPRE across the bandwidth.  
 NOTE 2: NR operating band groups in FR1 are as defined in clause 3.5.2.

**10.1.27.3.2 Relative Accuracy**

The relative accuracy of CSI-RS based L1-SINR is defined as the L1-SINR measured from one CSI-RS configured as CMR and one IMR configured as IMR compared to the largest measured value of L1-SINR among all CSI-RS and IMR resources of the serving cell.

The accuracy requirements are defined in Table 10.1.27.3.2-1 for CSI-RS based CMR and NZP-IMR and in Table 10.1.27.3.2-2 for CSI-RS based CMR and ZP-IMR.

The accuracy requirements in Tables 10.1.27.3.2-1 and 10.1.27.3.2-2 are valid under the following conditions:

- Conditions defined in clause 7.3 of TS 38.101-1 [18] for reference sensitivity are fulfilled.
- Conditions for L1-SINR measurements are fulfilled according to Annex B.2 for a corresponding Band for each relevant CSI-RS based CMR and IMR.
- The bandwidth of CSI-RS as CMR, NZP-IMR and ZP-IMR is 48 PRBs and the density is 3.
- An AWGN channel.

The performance with larger bandwidth of CSI-RS as CMR, NZP-IMR and ZP-IMR is equal to or better than the accuracy requirements in Tables 10.1.27.3.2-1 and 10.1.27.3.2-2.

**Table 10.1.27.3.2-1: L1-SINR relative accuracy for CSI-RS based CMR and NZP-IMR in FR1**

Accuracy		Conditions					
Normal condition	Extreme condition	CSI-RS CMR $\hat{E}_s/\text{lot}$	NZP-IMR $\hat{E}_s/\text{lot}$	$I_o$ <small>Note 1</small> range			
				NR operating band groups <small>Note 2</small>	Minimum $I_o$		Maximum $I_o$
dB	dB	dB	dB		dBm / $SCS_{\text{CSI-RS}}$		dBm/ $BW_{\text{Channel}}$

					SCS <sub>C</sub> SI-RS = 15 kHz	SCS <sub>CSI-RS</sub> RS = 30 kHz	SCS <sub>C</sub> SI-RS = 60 kHz		
±[3.0]	±[4.0]	≥0	≥0	NR_FDD_FR1_A, NR_TDD_FR1_A, NR_SDL_FR1_A	-121	-118	-115	N/A	-50
				NR_FDD_FR1_B	- 120.5	-117.5	-114.5	N/A	-50
				NR_TDD_FR1_C	-120	-117	-114	N/A	-50
				NR_FDD_FR1_D, NR_TDD_FR1_D	- 119.5	-116.5	-113.5	N/A	-50
				NR_FDD_FR1_E, NR_TDD_FR1_E	-119	-116	-113	N/A	-50
				NR_FDD_FR1_F	- 118.5	-115.5	-112.5	N/A	-50
				NR_FDD_FR1_G	-118	-115	-112	N/A	-50
				NR_FDD_FR1_H	- 117.5	-114.5	-111.5	N/A	-50

NOTE 1: I<sub>o</sub> is assumed to have constant EPRE across the bandwidth.  
 NOTE 2: The parameter CSI-RS CMR Ês/lot is the minimum CMR CMR Ês/lot of the pair of CSI-RS resources to which the requirement applies.  
 NOTE 3: NR operating band groups in FR1 are as defined in clause 3.5.2.

**Table 10.1.27.3.2-2: L1-SINR relative accuracy for CSI-RS based CMR and ZP-IMR in FR1**

Accuracy		Conditions						
Normal condition	Extreme condition	CSI-RS CMR Ês/lot	I <sub>o</sub> <sup>Note 1</sup> range					
			NR operating band groups <sup>Note 2</sup>	Minimum I <sub>o</sub>			Maximum I <sub>o</sub>	
dB	dB	dB		dBm / SCS <sub>CSI-RS</sub>			dBm/BW <sub>Channel</sub>	dBm/BW <sub>Channel</sub>
				SCS <sub>CSI-RS</sub> = 15 kHz	SCS <sub>CSI-RS</sub> = 30 kHz	SCS <sub>CSI-RS</sub> = 60 kHz		
±[3.5]	±[4.5]	≥-3	NR_FDD_FR1_A, NR_TDD_FR1_A, NR_SDL_FR1_A	-121	-118	-115	N/A	-50
			NR_FDD_FR1_B	-120.5	-117.5	-114.5	N/A	-50
			NR_TDD_FR1_C	-120	-117	-114	N/A	-50
			NR_FDD_FR1_D, NR_TDD_FR1_D	-119.5	-116.5	-113.5	N/A	-50
			NR_FDD_FR1_E, NR_TDD_FR1_E	-119	-116	-113	N/A	-50
			NR_FDD_FR1_F	-118.5	-115.5	-112.5	N/A	-50
			NR_FDD_FR1_G	-118	-115	-112	N/A	-50
			NR_FDD_FR1_H	-117.5	-114.5	-111.5	N/A	-50

NOTE 1: I<sub>o</sub> is assumed to have constant EPRE across the bandwidth.  
 NOTE 2: The parameter CSI-RS CMR Ês/lot is the minimum CMR CMR Ês/lot of the pair of CSI-RS resources to which the requirement applies.  
 NOTE 2: NR operating band groups in FR1 are as defined in clause 3.5.2.

## 10.1.28 L1-SINR accuracy requirements for FR2

### 10.1.28.1 L1-SINR accuracy requirements with CSI-RS based CMR and no dedicated IMR configured

#### 10.1.28.1.1 Absolute Accuracy

Unless otherwise specified, the requirements for absolute accuracy of CSI-RS based L1-SINR in this clause apply to all CSI-RS resources configured as CMR and no dedicated resource configured as IMR of the serving cell configured for L1-SINR measurement.

The accuracy requirements in Table 10.1.28.1.1-1 are valid under the following conditions:

- Conditions defined in clause 7.3 of TS 38.101-2 [19] for reference sensitivity are fulfilled.
- Conditions for L1-SINR measurements are fulfilled according to Annex B.2.8.1 for a corresponding Band for each relevant CSI-RS based CMR.
- The bandwidth of CSI-RS as CMR is 48 PRBs and the density is 3.
- The measured signals are in the directions covered by the percentile EIS spherical coverage of the UE, defined in clause 7.3.4 of TS 38.101-2 [19].
- AWGN radio propagation conditions.

The performance with larger bandwidth of CSI-RS as CMR is equal to or better than the accuracy requirements in Table 10.1.28.1.1-1.

**Table 10.1.28.1.1-1: L1-SINR absolute accuracy for CSI-RS based CMR only in FR2**

Accuracy		Conditions			
Normal condition	Extreme condition	CSI-RS CMR $\hat{E}s/lot$ <sup>Note 3</sup>	$I_o$ <sup>Note 1</sup> range		
			Minimum $I_o$		Maximum $I_o$
dB	dB	dB	dBm / $SCS_{CSI-RS}$ <sup>Note 2</sup>		dBm/ $BW_{Channel}$
			$SCS_{CSI-RS} = 60kHz$	$SCS_{CSI-RS} = 120kHz$	
$\pm 5.5$	$\pm 6.5$	$\geq -3$	Same value as CSI-RS_RP in Table in B.2.8.1, according to UE Power class, operating band and angle of arrival		N/A
NOTE 1: $I_o$ specified at the Reference point, and assumed to have constant EPRE across the bandwidth. NOTE 2: Values based on Refsens and EIS spherical coverage as defined in clauses 7.3.2 and 7.3.4 of TS 38.101-2 [19]. Applicable side condition selected depending on angle of arrival. NOTE 3: In the test cases, the CSI-RS CMR $\hat{E}s/lot$ and related parameters may need to be adjusted to ensure $\hat{E}s/lot$ at UE baseband is above the value defined in this table.					

#### 10.1.28.1.2 Relative Accuracy

The relative accuracy of CSI-RS based L1-SINR is defined as the L1-SINR measured from one CSI-RS compared to the largest measured value of L1-SINR among all CSI-RS resources of the serving cell.

The accuracy requirements in Table 10.1.28.1.2-1 are valid under the following conditions:

- Conditions defined in clause 7.3 of TS 38.101-2 [19] for reference sensitivity are fulfilled.
- Conditions for L1-SINR measurements are fulfilled according to Annex B.2.8.1 for a corresponding Band for each relevant CSI-RS based CMR.
- The bandwidth of CSI-RS as CMR is 48 PRBs and the density is 3.

- The measured signals are in the directions covered by the percentile EIS spherical coverage of the UE, defined in clause 7.3.4 of TS 38.101-2 [19].
- AWGN radio propagation conditions.

The performance with larger bandwidth of CSI-RS as CMR is equal to or better than the accuracy requirements in Table 10.1.28.1.2-1.

**Table 10.1.28.1.2-1: L1-SINR relative accuracy for CSI-RS based CMR only in FR2**

Accuracy		Conditions			
Normal condition	Extreme condition	CSI-RS CMR $\hat{E}_s/\text{lot}$ <sup>Note 2, Note 4</sup>	$I_o$ <sup>Note 1</sup> range		
			Minimum $I_o$		Maximum $I_o$
dB	dB	dB	dBm / $SCS_{\text{CSI-RS}}$ <sup>Note 3</sup>		dBm/BW <sub>Channel</sub>
			$SCS_{\text{CSI-RS}} = 60\text{kHz}$	$SCS_{\text{CSI-RS}} = 120\text{kHz}$	
$\pm 4.5$	$\pm 5.5$	$\geq -3$	Same value as CSI-RS_RP in Table in B.2.8.1, according to UE Power class, operating band and angle of arrival		N/A
NOTE 1: $I_o$ specified at the Reference point, and assumed to have constant EPRE across the bandwidth. NOTE 2: The parameter CSI-RS CMR $\hat{E}_s/\text{lot}$ is the minimum CSI-RS CMR $\hat{E}_s/\text{lot}$ of the pair of CSI-RS resources to which the requirement applies. NOTE 3: Values based on Refsens and EIS spherical coverage as defined in clauses 7.3.2 and 7.3.4 of TS 38.101-2 [19]. Applicable side condition selected depending on angle of arrival. NOTE 4: In the test cases, the CSI-RS CMR $\hat{E}_s/\text{lot}$ and related parameters may need to be adjusted to ensure $\hat{E}_s/\text{lot}$ at UE baseband is above the value defined in this table.					

## 10.1.28.2 L1-SINR accuracy requirements with SSB based CMR and dedicated IMR configured

### 10.1.28.2.1 Absolute Accuracy

Unless otherwise specified, the requirements for absolute accuracy of SSB based L1-SINR in this clause apply to all SSBs configured as CMR and dedicated resources configured as IMR of the serving cell configured for L1-SINR measurement.

The accuracy requirements are defined in Table 10.1.28.2.1-1 for SSB based CMR and NZP-IMR and in Table 10.1.28.2.1-2 for SSB based CMR and ZP-IMR.

The accuracy requirements in Tables 10.1.28.2.1-1 and 10.1.28.2.1-2 are valid under the following conditions:

- Conditions defined in clause 7.3 of TS 38.101-2 [19] for reference sensitivity are fulfilled.
- Conditions for L1-SINR measurements are fulfilled according to Annex B.2.8.2 for a corresponding Band for each relevant SSB based CMR and IMR.
- The bandwidth of NZP-IMR and ZP-IMR is 48 PRBs and the density is 3.
- The measured signals are in the directions covered by the percentile EIS spherical coverage of the UE, defined in clause 7.3.4 of TS 38.101-2 [19].
- AWGN radio propagation conditions.
- SSB based CMR and IMR in the test come from the same direction.

The performance with larger bandwidth of NZP-IMR and ZP-IMR is equal to or better than the accuracy requirements in Tables 10.1.28.2.1-1 and 10.1.28.2.1-2.

**Table 10.1.28.2.1-1: L1-SINR absolute accuracy for SSB based CMR and NZP-IMR in FR2**

Accuracy		Conditions					
Normal condition	Extreme condition	SSB CMR $\hat{E}s/lot$ Note 3	NZP-IMR $\hat{E}s/lot$ Note 3	$I_o$ Note 1 range			
				Minimum $I_o$		Maximum $I_o$	
dB	dB	dB	dB	dBm / $SCS_{SSB}$ Note 2		dBm/ $BW_{Channel}$	dBm/ $BW_{Channel}$
				$SCS_{SSB} = 120kHz$	$SCS_{SSB} = 240kHz$		
$\pm 4.0$	$\pm 5.0$	$\geq 0$	$\geq 0$	Same value as SSB_RP in Table in B.2.8.2, according to UE Power class, operating band and angle of arrival		N/A	-50

NOTE 1:  $I_o$  specified at the Reference point, and assumed to have constant EPRE across the bandwidth.  
NOTE 2: Values based on Refsens and EIS spherical coverage as defined in clauses 7.3.2 and 7.3.4 of TS 38.101-2 [19]. Applicable side condition selected depending on angle of arrival.  
NOTE 3: In the test cases, the SSB  $\hat{E}s/lot$ , NZP-IMR  $\hat{E}s/lot$  and related parameters may need to be adjusted to ensure  $\hat{E}s/lot$  at UE baseband is above the value defined in this table.

**Table 10.1.28.2.1-2: L1-SINR absolute accuracy for SSB based CMR and ZP-IMR in FR2**

Accuracy		Conditions					
Normal condition	Extreme condition	SSB CMR $\hat{E}s/lot$ Note 3	$I_o$ Note 1 range				
			Minimum $I_o$		Maximum $I_o$		
dB	dB	dB	dBm / $SCS_{SSB}$ Note 2		dBm/ $BW_{Channel}$	dBm/ $BW_{Channel}$	
			$SCS_{SSB} = 120kHz$	$SCS_{SSB} = 240kHz$			
$\pm 4.5$	$\pm 5.5$	$\geq -3$	Same value as SSB_RP in Table in B.2.8.2, according to UE Power class, operating band and angle of arrival		N/A	-50	

NOTE 1:  $I_o$  specified at the Reference point, and assumed to have constant EPRE across the bandwidth.  
NOTE 2: Values based on Refsens and EIS spherical coverage as defined in clauses 7.3.2 and 7.3.4 of TS 38.101-2 [19]. Applicable side condition selected depending on angle of arrival.  
NOTE 3: In the test cases, the SSB CMR  $\hat{E}s/lot$  and related parameters may need to be adjusted to ensure  $\hat{E}s/lot$  at UE baseband is above the value defined in this table.

### 10.1.28.2.2 Relative Accuracy

The relative accuracy of SSB based L1-SINR is defined as the L1-SINR measured from one SSB configured as CMR and one IMR configured as IMR compared to the largest measured value of L1-SINR among all SSB based CMRs and IMRs of the serving cell.

The accuracy requirements are defined in Table 10.1.28.2.2-1 for SSB based CMR and NZP-IMR and in Table 10.1.28.2.2-2 for SSB based CMR and ZP-IMR.

The accuracy requirements in Tables 10.1.28.2.2-1 and 10.1.28.2.2-2 are valid under the following conditions:

- Conditions defined in clause 7.3 of TS 38.101-2 [19] for reference sensitivity are fulfilled.
- Conditions for L1-SINR measurements are fulfilled according to Annex B.2.8.2 for a corresponding Band for each relevant SSB based CMR and IMR.
- The bandwidth of NZP-IMR and ZP-IMR is 48 PRBs and the density is 3.

- The measured signals are in the directions covered by the percentile EIS spherical coverage of the UE, defined in clause 7.3.4 of TS 38.101-2 [19].
- AWGN radio propagation conditions.
- SSB based CMR and IMR in the test come from the same direction.

The performance with larger bandwidth of NZP-IMR and ZP-IMR is equal to or better than the accuracy requirements in Tables 10.1.28.2.2-1 and 10.1.28.2.2-2.

**Table 10.1.28.2.2-1: L1-SINR relative accuracy for SSB based CMR and NZP-IMR in FR2**

Accuracy		Conditions				
Normal condition	Extreme condition	SSB CMR $\hat{E}s/lot$ Note 2, Note 4	NZP-IMR $\hat{E}s/lot$ Note 4	$I_o$ Note 1 range		
				Minimum $I_o$		Maximum $I_o$
dB	dB	dB	dB	dBm / $SCS_{SSB}$ Note 3		dBm/ $BW_{Channel}$
				$SCS_{SSB} = 120kHz$	$SCS_{SSB} = 240kHz$	
$\pm 3.0$	$\pm 4.0$	$\geq 0$	$\geq 0$	Same value as $SSB\_RP$ in Table in B.2.8.2, according to UE Power class, operating band and angle of arrival		-50

NOTE 1:  $I_o$  specified at the Reference point, and assumed to have constant EPRE across the bandwidth.  
 NOTE 2: The parameter SSB CMR  $\hat{E}s/lot$  is the minimum SSB CMR  $\hat{E}s/lot$  of the pair of SSBs to which the requirement applies.  
 NOTE 3: Values based on Refsens and EIS spherical coverage as defined in clauses 7.3.2 and 7.3.4 of TS 38.101-2 [19]. Applicable side condition selected depending on angle of arrival.  
 NOTE 4: In the test cases, the SSB CMR  $\hat{E}s/lot$ , NZP-IMR  $\hat{E}s/lot$  and related parameters may need to be adjusted to ensure  $\hat{E}s/lot$  at UE baseband is above the value defined in this table.

**Table 10.1.28.2.2-2: L1-SINR relative accuracy for SSB based CMR and ZP-IMR in FR2**

Accuracy		Conditions				
Normal condition	Extreme condition	SSB CMR $\hat{E}s/lot$ Note 2, Note 4	$I_o$ Note 1 range			
			Minimum $I_o$		Maximum $I_o$	
dB	dB	dB	dBm / $SCS_{SSB}$ Note 3		dBm/ $BW_{Channel}$	
			$SCS_{SSB} = 120kHz$	$SCS_{SSB} = 240kHz$		
$\pm 3.5$	$\pm 4.5$	$\geq -3$	Same value as $SSB\_RP$ in Table in B.2.8.2, according to UE Power class, operating band and angle of arrival		-50	

NOTE 1:  $I_o$  specified at the Reference point, and assumed to have constant EPRE across the bandwidth.  
 NOTE 2: The parameter SSB CMR  $\hat{E}s/lot$  is the minimum SSB CMR  $\hat{E}s/lot$  of the pair of SSBs to which the requirement applies.  
 NOTE 3: Values based on Refsens and EIS spherical coverage as defined in clauses 7.3.2 and 7.3.4 of TS 38.101-2 [19]. Applicable side condition selected depending on angle of arrival.  
 NOTE 4: In the test cases, the SSB CMR  $\hat{E}s/lot$  and related parameters may need to be adjusted to ensure  $\hat{E}s/lot$  at UE baseband is above the value defined in this table.



### 10.1.28.3 L1-SINR accuracy requirements with CSI-RS based CMR and dedicated IMR configured

#### 10.1.28.3.1 Absolute Accuracy

Unless otherwise specified, the requirements for absolute accuracy of CSI-RS based L1-SINR in this clause apply to all CSI-RS resources as CMR and dedicated resources configured as IMR of the serving cell configured for L1-SINR measurement.

The accuracy requirements are defined in Table 10.1.28.3.1-1 for CSI-RS based CMR and NZP-IMR and in Table 10.1.28.3.1-2 for CSI-RS based CMR and ZP-IMR.

The accuracy requirements in Tables 10.1.28.3.1-1 and 10.1.28.3.1-2 are valid under the following conditions:

- Conditions defined in clause 7.3 of TS 38.101-2 [19] for reference sensitivity are fulfilled.
- Conditions for L1-SINR measurements are fulfilled according to Annex B.2.8.3 for a corresponding Band for each relevant CSI-RS based CMR and IMR.
- The bandwidth of CSI-RS as CMR, NZP-IMR and ZP-IMR is 48 PRBs and the density is 3.
- The measured signals are in the directions covered by the percentile EIS spherical coverage of the UE, defined in clause 7.3.4 of TS 38.101-2 [19].
- AWGN radio propagation conditions.
- CSI-RS based CMR and IMR in the test come from the same direction.

The performance with larger bandwidth of CSI-RS as CMR, NZP-IMR and ZP-IMR is equal to or better than the accuracy requirements in Tables 10.1.28.3.1-1 and 10.1.28.3.1-2.

**Table 10.1.28.3.1-1: L1-SINR absolute accuracy for CSI-RS based CMR and NZP-IMR in FR2**

Accuracy		Conditions				
Normal condition	Extreme condition	CSI-RS CMR $\hat{E}_s/\text{lot}$ Note 3	NZP-IMR $\hat{E}_s/\text{lot}$ Note 3	$I_o$ Note 1 range		
				Minimum $I_o$		Maximum $I_o$
dB	dB	dB	dB	dBm / $SCS_{\text{CSI-RS}}$ Note 2		dBm/ $BW_{\text{Channel}}$
				$SCS_{\text{CSI-RS}} = 60\text{kHz}$	$SCS_{\text{CSI-RS}} = 120\text{kHz}$	
$\pm 4.0$	$\pm 5.0$	$\geq 0$	$\geq 0$	Same value as CSI-RS_RP in Table in B.2.8.3, according to UE Power class, operating band and angle of arrival		-50
NOTE 1: $I_o$ specified at the Reference point, and assumed to have constant EPRE across the bandwidth. NOTE 2: Values based on Refsens and EIS spherical coverage as defined in clauses 7.3.2 and 7.3.4 of TS 38.101-2 [19]. Applicable side condition selected depending on angle of arrival. NOTE 3: In the test cases, the CSI-RS $\hat{E}_s/\text{lot}$ , NZP-IMR $\hat{E}_s/\text{lot}$ and related parameters may need to be adjusted to ensure $\hat{E}_s/\text{lot}$ at UE baseband is above the value defined in this table.						

**Table 10.1.28.3.1-2: L1-SINR absolute accuracy for CSI-RS based CMR and ZP-IMR in FR2**

Accuracy		Conditions		
Normal condition	Extreme condition	CSI-RS CMR $\hat{E}_s/\text{lot}$ Note 3	$I_o$ Note 1 range	
			Minimum $I_o$	Maximum $I_o$

dB	dB	dB	dBm / SCS <sub>CSI-RS</sub> <sup>Note 2</sup>		dBm/BW <sub>Channel</sub>	dBm/BW <sub>Channel</sub>
			SCS <sub>CSI-RS</sub> = 60kHz	SCS <sub>CSI-RS</sub> = 120kHz		
±4.5	±5.5	≥-3	Same value as CSI-RS_RP in Table in B.2.8.3, according to UE Power class, operating band and angle of arrival		N/A	-50
NOTE 1: I <sub>o</sub> specified at the Reference point, and assumed to have constant EPRE across the bandwidth.						
NOTE 2: Values based on Refsens and EIS spherical coverage as defined in clauses 7.3.2 and 7.3.4 of TS 38.101-2 [19]. Applicable side condition selected depending on angle of arrival.						
NOTE 3: In the test cases, the CSI-RS Ês/lot and related parameters may need to be adjusted to ensure Ês/lot at UE baseband is above the value defined in this table.						

### 10.1.28.3.2 Relative Accuracy

The relative accuracy of CSI-RS based L1-SINR is defined as the L1-SINR measured from one CSI-RS configured as CMR and one IMR configured as IMR compared to the largest measured value of L1-SINR among all CSI-RS based CMRs and IMRs of the serving cell.

The accuracy requirements are defined in Table 10.1.28.3.2-1 for CSI-RS based CMR and NZP-IMR and in Table 10.1.28.3.2-2 for CSI-RS based CMR and ZP-IMR.

The accuracy requirements in Tables 10.1.28.3.2-1 and 10.1.28.3.2-2 are valid under the following conditions:

- Conditions defined in clause 7.3 of TS 38.101-2 [19] for reference sensitivity are fulfilled.
- Conditions for L1-SINR measurements are fulfilled according to Annex B.2.8.3 for a corresponding Band for each relevant CSI-RS based CMR and IMR.
- The bandwidth of CSI-RS as CMR, NZP-IMR and ZP-IMR is 48 PRBs and the density is 3.
- The measured signals are in the directions covered by the percentile EIS spherical coverage of the UE, defined in clause 7.3.4 of TS 38.101-2 [19].
- AWGN radio propagation conditions.
- CSI-RS based CMR and IMR in the test come from the same direction.

The performance with larger bandwidth of CSI-RS as CMR, NZP-IMR and ZP-IMR is equal to or better than the accuracy requirements in Tables 10.1.28.3.2-1 and 10.1.28.3.2-2.

**Table 10.1.28.3.2-1: L1-SINR relative accuracy for CSI-RS based CMR and NZP-IMR in FR2**

Accuracy		Conditions					
Normal condition	Extreme condition	CSI-RS CMR Ês/lot <sup>Note 2, Note 4</sup>	NZP-IMR Ês/lot <sup>Note 4</sup>	I <sub>o</sub> <sup>Note 1</sup> range			
				Minimum I <sub>o</sub>		Maximum I <sub>o</sub>	
dB	dB	dB	dB	dBm / SCS <sub>CSI-RS</sub> <sup>Note 3</sup>		dBm/BW <sub>Channel</sub>	dBm/BW <sub>Channel</sub>
				SCS <sub>CSI-RS</sub> = 60kHz	SCS <sub>CSI-RS</sub> = 120kHz		
±3.0	±4.0	≥0	≥0	Same value as CSI-RS_RP in Table in B.2.8.3, according to UE Power class, operating band and angle of arrival		N/A	-50

NOTE 1: I<sub>o</sub> specified at the Reference point, and assumed to have constant EPRE across the bandwidth.

NOTE 2: The parameter CSI-RS CMR  $\hat{E}_s/\text{lot}$  is the minimum CSI-RS CMR  $\hat{E}_s/\text{lot}$  of the pair of CSI-RS resources to which the requirement applies.  
 NOTE 3: Values based on Refsens and EIS spherical coverage as defined in clauses 7.3.2 and 7.3.4 of TS 38.101-2 [19]. Applicable side condition selected depending on angle of arrival.  
 NOTE 4: In the test cases, the CSI-RS CMR  $\hat{E}_s/\text{lot}$ , NZP-IMR  $\hat{E}_s/\text{lot}$  and related parameters may need to be adjusted to ensure  $\hat{E}_s/\text{lot}$  at UE baseband is above the value defined in this table.

**Table 10.1.28.3.2-2: L1-SINR relative accuracy for CSI-RS based CMR and ZP-IMR in FR2**

Accuracy		Conditions				
Normal condition	Extreme condition	CSI-RS CMR $\hat{E}_s/\text{lot}$ Note 2, Note 4	$I_o$ Note 1 range			
			Minimum $I_o$		Maximum $I_o$	
dB	dB	dB	dBm / $SCS_{\text{CSI-RS}}$ Note 3		dBm/BW <sub>Channel</sub>	dBm/BW <sub>Channel</sub>
			$SCS_{\text{CSI-RS}} = 60\text{kHz}$	$SCS_{\text{CSI-RS}} = 120\text{kHz}$		
$\pm 3.5$	$\pm 4.5$	$\geq -3$	Same value as CSI-RS_RP in Table in B.2.8.3, according to UE Power class, operating band and angle of arrival		N/A	-50

NOTE 1:  $I_o$  specified at the Reference point, and assumed to have constant EPRE across the bandwidth.  
 NOTE 2: The parameter CSI-RS CMR  $\hat{E}_s/\text{lot}$  is the minimum CSI-RS CMR  $\hat{E}_s/\text{lot}$  of the pair of CSI-RS resources to which the requirement applies.  
 NOTE 3: Values based on Refsens and EIS spherical coverage as defined in clauses 7.3.2 and 7.3.4 of TS 38.101-2 [19]. Applicable side condition selected depending on angle of arrival.  
 NOTE 4: In the test cases, the CSI-RS CMR  $\hat{E}_s/\text{lot}$  and related parameters may need to be adjusted to ensure  $\hat{E}_s/\text{lot}$  at UE baseband is above the value defined in this table.

### 10.1.29 Intra-frequency RSRQ accuracy requirements under CCA

#### 10.1.29.1 Intra-frequency SS-RSRQ accuracy requirements in FR1

##### 10.1.29.1.1 Absolute SS-RSRQ Accuracy

Unless otherwise specified, the requirements for absolute accuracy of SS-RSRQ in this clause apply to a cell on the same frequency as that of the serving cell under CCA.

The accuracy requirements in Table 10.1.29.1.1-1 are valid under the following conditions:

- Conditions defined in clause 7.3F of TS 38.101-1 [18] for reference sensitivity are fulfilled.
- Conditions for intra-frequency measurements are fulfilled according to Annex B.2.9 for a corresponding Band for each relevant SSB.

**Table 10.1.29.1.1-1: SS-RSRQ intra-frequency absolute accuracy under CCA**

Accuracy		Conditions					
Normal condition	Extreme condition	SSB $\hat{E}_s/\text{lot}$	$I_o$ Note 1 range				
			NR operating band groups Note 3	Minimum $I_o$		Maximum $I_o$	
dB	dB	dB		dBm / $SCS_{\text{SSB}}$		dBm/BW <sub>Channel</sub>	dBm/BW <sub>Channel</sub>
			$SCS_{\text{SSB}} = 15\text{ kHz}$	$SCS_{\text{SSB}} = 30\text{ kHz}$			
$\pm 2.5$	$\pm 4$	$\geq -3$	NR_CCA_FR1_I	-117	-114	N/A	-50
			NR_CCA_FR1_J	-116.5	-113.5		
$\pm 3.5$	$\pm 4$	$\geq -6$	Note 2	Note 2	Note 2	Note 2	Note 2

NOTE 1:  $I_o$  is assumed to have constant EPRE across the bandwidth.  
 NOTE 2: The same bands and the same  $I_o$  conditions for each band apply for this requirement as for the corresponding highest accuracy requirement.  
 NOTE 3: NR operating band groups are as defined in clause 3.5.2.

### 10.1.30 Inter-frequency RSRQ accuracy requirements under CCA

#### 10.1.30.1 Inter-frequency SS-RSRQ accuracy requirements in FR1

##### 10.1.30.1.1 Absolute Accuracy of SS-RSRQ

The requirements for absolute accuracy of SS-RSRQ in this clause apply to a cell on a frequency under CCA that has different carrier frequency from the serving cell.

The accuracy requirements in Table 10.1.30.1.1-1 are valid under the following conditions:

- Conditions defined in clause 7.3F of TS 38.101-1 [18] for reference sensitivity are fulfilled.
- Conditions for inter-frequency measurements are fulfilled according to Annex B.2.10 for a corresponding Band for each relevant SSB.

**Table 10.1.30.1.1-1: SS-RSRQ inter-frequency absolute accuracy under CCA**

Accuracy		Conditions					
Normal condition	Extreme condition	SSB $\hat{E}_s/I_{ot}$	$I_o$ <sup>Note 1</sup> range				
			NR operating band groups <sup>Note 3</sup>	Minimum $I_o$		Maximum $I_o$	
dB	dB	dB		dBm / $SCS_{SSB}$		dBm/ $BW_{Channel}$	dBm/ $BW_{Channel}$
				$SCS_{SSB} = 15$ kHz	$SCS_{SSB} = 30$ kHz		
$\pm 2.5$	$\pm 4$	$\geq -3$	NR_CCA_FR1_I	-117	-114	N/A	-50
			NR_CCA_FR1_J	-116.5	-113.5		
$\pm 3.5$	$\pm 4$	$\geq -6$	Note 2	Note 2	Note 2	Note 2	Note 2

NOTE 1:  $I_o$  is assumed to have constant EPRE across the bandwidth.  
 NOTE 2: The same bands and the same  $I_o$  conditions for each band apply for this requirement as for the corresponding highest accuracy requirement.  
 NOTE 3: NR operating band groups are as defined in clause 3.5.2.

##### 10.1.30.1.2 Relative Accuracy of SS-RSRQ

The relative accuracy of SS-RSRQ in inter-frequency case is defined as the RSRQ measured from one cell on a frequency compared to the RSRP measured from another cell on a different frequency, with at least one of the two frequencies being under CCA.

The accuracy requirements in Table 10.1.30.1.2-1 are valid under the following conditions:

- Conditions defined in clause 7.3F of TS 38.101-1 [18] for reference sensitivity are fulfilled.
- Conditions for inter-frequency measurements are fulfilled according to Annex B.2.10 for a corresponding Band for each relevant SSB.
- $|SSB\_RP1_{dBm} - SSB\_RP2_{dBm}| \leq 27$  dB
- $|Channel\ 1\_I_o - Channel\ 2\_I_o| \leq 20$  dB

Table 10.1.30.1.2-1: SS-RSRQ inter-frequency relative accuracy under CCA

Accuracy		Conditions					
Normal condition	Extreme condition	SSB $\hat{E}_s/\text{lot}$ Note 2	$I_o$ Note 1 range				
			NR operating band groups Note 4	Minimum $I_o$		Maximum $I_o$	
dB	dB	dB		dBm / $SCS_{SSB}$			dBm/ $BW_{Channel}$
			$SCS_{SSB} = 15 \text{ kHz}$	$SCS_{SSB} = 30 \text{ kHz}$			
$\pm 3$	$\pm 4$	$\geq -3$	NR_CCA_FR1_I	-117	-114	N/A	-50
			NR_CCA_FR1_J	-116.5	-113.5		
$\pm 4$	$\pm 4$	$\geq -6$	Note 3	Note 3	Note 3	Note 3	Note 3

NOTE 1:  $I_o$  is assumed to have constant EPRE across the bandwidth.  
NOTE 2: The parameter SSB  $\hat{E}_s/\text{lot}$  is the minimum SSB  $\hat{E}_s/\text{lot}$  of the pair of cells to which the requirement applies.  
NOTE 3: The same bands and the same  $I_o$  conditions for each band apply for this requirement as for the corresponding highest accuracy requirement.  
NOTE 4: NR operating band groups are as defined in clause 3.5.2.

## 10.1.31 Intra-frequency SINR accuracy requirements under CCA

### 10.1.31.1 Intra-frequency SS-SINR accuracy requirements in FR1

#### 10.1.31.1.1 Absolute SS-SINR Accuracy

Unless otherwise specified, the requirements for absolute accuracy of SS-SINR in this clause apply to a cell on the same frequency as that of the serving cell under CCA.

The accuracy requirements in Table 10.1.31.1.1-1 are valid under the following conditions:

- Conditions defined in clause 7.3F of TS 38.101-1 [18] for reference sensitivity are fulfilled.
- Conditions for intra-frequency measurements are fulfilled according to Annex B.2.9 for a corresponding Band.

Table 10.1.31.1.1-1: SS-SINR intra-frequency absolute accuracy under CCA

Accuracy		Conditions					
Normal condition	Extreme condition	SSB $\hat{E}_s/\text{lot}$ Note 3	$I_o$ Note 1 range				
			NR operating band groups Note 4	Minimum $I_o$		Maximum $I_o$	
dB	dB	dB		dBm / $SCS_{SSB}$			dBm/ $BW_{Channel}$
			$SCS_{SSB} = 15 \text{ kHz}$	$SCS_{SSB} = 30 \text{ kHz}$			
$\pm 3.0$	$\pm 4$	$\geq -3$	NR_CCA_FR1_I	-117	-114	N/A	-50
			NR_CCA_FR1_J	-116.5	-113.5		
$\pm 3.5$	$\pm 4$	$\geq -6$	Note 2	Note 2	Note 2	Note 2	Note 2

NOTE 1:  $I_o$  is assumed to have constant EPRE across the bandwidth.  
NOTE 2: The same bands and the same  $I_o$  conditions for each band apply for this requirement as for the corresponding highest accuracy requirement.  
NOTE 3: The requirements apply for SSB  $\hat{E}_s/\text{lot} \leq 25 \text{ dB}$ .  
NOTE 4: NR operating band groups are as defined in clause 3.5.2.

## 10.1.32 Inter-frequency SINR accuracy requirements under CCA

### 10.1.32.1 Inter-frequency SS-SINR accuracy requirements in FR1

#### 10.1.32.1.1 Absolute Accuracy of SS-SINR

The requirements for absolute accuracy of SS-SINR in this clause apply to a cell on a frequency under CCA that has different carrier frequency from the serving cell.

The accuracy requirements in Table 10.1.32.1.1-1 are valid under the following conditions:

- Conditions defined in clause 7.3F of TS 38.101-1 [18] for reference sensitivity are fulfilled.
- Conditions for inter-frequency measurements are fulfilled according to Annex B.2.10 for a corresponding Band.

**Table 10.1.32.1.1-1: SS-SINR inter-frequency absolute accuracy under CCA**

Accuracy		Conditions					
Normal condition	Extreme condition	SSB $\hat{E}_s/\text{lot}$ Note 3	$I_o$ <sup>Note 1</sup> range				
			NR operating band groups Note 4	Minimum $I_o$		Maximum $I_o$	
dB	dB	dB		dBm / $SCS_{SSB}$		dBm/ $BW_{Channel}$	dBm/ $BW_{Channel}$
				$SCS_{SSB} = 15$ kHz	$SCS_{SSB} = 30$ kHz		
$\pm 3.0$	$\pm 4$	$\geq 3$	NR_CCA_FR1_I	-117	-114	N/A	-50
			NR_CCA_FR1_J	116.5	-113.5		
$\pm 3.5$	$\pm 4$	$\geq 6$	Note 2	Note 2	Note 2	Note 2	Note 2

NOTE 1:  $I_o$  is assumed to have constant EPRE across the bandwidth.  
NOTE 2: The same bands and the same  $I_o$  conditions for each band apply for this requirement as for the corresponding highest accuracy requirement.  
NOTE 3: The requirements apply for SSB  $\hat{E}_s/\text{lot} \leq 25$  dB.  
NOTE 4: NR operating band groups are as defined in clause 3.5.2.

#### 10.1.32.1.2 Relative Accuracy of SS-SINR

The relative accuracy of SS-SINR in inter frequency case is defined as the SS-SINR measured from one cell on a frequency compared to the SS-SINR measured from another cell on a different frequency, with at least one of the two frequencies being under CCA.

The accuracy requirements in Table 10.1.32.1.2-1 are valid under the following conditions:

- Conditions defined in clause 7.3F of TS 38.101-1 [18] for reference sensitivity are fulfilled.
- Conditions for inter-frequency measurements are fulfilled according to Annex B.2.10 for a corresponding Band.
- $|\text{SSB\_RP1}_{\text{dBm}} - \text{SSB\_RP2}_{\text{dBm}}| \leq 27$  dB
- $|\text{Channel 1\_}I_o - \text{Channel 2\_}I_o| \leq 20$  dB

**Table 10.1.32.1.2-1: SS-SINR inter-frequency relative accuracy under CCA**

Accuracy		Conditions					
Normal condition	Extreme condition	SSB $\hat{E}_s/\text{lot}$ Note 2,4	$I_o$ <sup>Note 1</sup> range				
			NR operating band groups Note 5	Minimum $I_o$		Maximum $I_o$	
dB	dB	dB		dBm / $SCS_{SSB}$		dBm/ $BW_{Channel}$	dBm/ $BW_{Channel}$

				SCS <sub>SSB</sub> = 120 kHz	SCS <sub>SSB</sub> = 240 kHz		
±3.5	±4	≥-3	NR_CCA_FR1_I	-117	-114	N/A	-50
			NR_CCA_FR1_J	-116.5	-113.5		
±4	±4	≥-6	Note 3	Note 3	Note 3	Note 3	Note 3

NOTE 1:  $I_0$  is assumed to have constant EPRE across the bandwidth.  
 NOTE 2: The parameter SSB  $\hat{E}_s/I_0$  is the minimum SSB  $\hat{E}_s/I_0$  of the pair of cells to which the requirement applies.  
 NOTE 3: The same bands and the same  $I_0$  conditions for each band apply for this requirement as for the corresponding highest accuracy requirement.  
 NOTE 4: The requirements apply for SSB  $\hat{E}_s/I_0 \leq 25$  dB.  
 NOTE 5: NR operating band groups are as defined in clause 3.5.2.

### 10.1.33 L1-RSRP accuracy requirements under CCA

#### 10.1.33.1 SSB based L1-RSRP accuracy requirements in FR1

##### 10.1.33.1.1 Absolute Accuracy

Unless otherwise specified, the requirements for absolute accuracy of SSB based L1-RSRP in this clause apply to all SSBs of the serving cell configured for L1-RSRP measurement under CCA.

The accuracy requirements in Table 10.1.33.1.1-1 are valid under the following conditions:

- Conditions defined in clause 7.3F of TS 38.101-1 [18] for reference sensitivity are fulfilled.
- Conditions for L1-RSRP measurements are fulfilled according to Annex B.2.10.1 for a corresponding Band for each relevant SSB.

**Table 10.1.33.1.1-1: SSB based L1-RSRP absolute accuracy under CCA**

Accuracy		Conditions					
Normal condition	Extreme condition	SSB $\hat{E}_s/I_0$	$I_0$ <sup>Note 1</sup> range				
			NR operating band groups <sup>Note 2</sup>	Minimum $I_0$		Maximum $I_0$	
dB	dB	dB		dBm / SCS <sub>SSB</sub>		dBm/BW <sub>Channel</sub>	dBm/BW <sub>Channel</sub>
				SCS <sub>SSB</sub> = 15 kHz	SCS <sub>SSB</sub> = 30 kHz		
±5.0	±9.5	≥-3	NR_CCA_FR1_I	-117	-114	N/A	-70
			NR_CCA_FR1_J	-116.5	-113.5		
±8.5	±11.5	≥-3	NR_CCA_FR1_I	N/A	N/A	-70	-50
			NR_CCA_FR1_J				

NOTE 1:  $I_0$  is assumed to have constant EPRE across the bandwidth.  
 NOTE 2: NR operating band groups are as defined in clause 3.5.2.

##### 10.1.33.1.2 Relative Accuracy

The relative accuracy of SSB based L1-RSRP is defined as the L1-RSRP measured from one SSB compared to the largest measured value of L1-RSRP among all SSBs of the serving cell under CCA.

The accuracy requirements in Table 10.1.33.1.2-1 are valid under the following conditions:

- Conditions defined in clause 7.3F of TS 38.101-1 [18] for reference sensitivity are fulfilled.
- Conditions for L1-RSRP measurements are fulfilled according to Annex B.2.10.1 for a corresponding Band for each relevant SSB.

Table 10.1.33.1.2-1: SSB based L1-RSRP relative accuracy under CCA

Accuracy		Conditions					
Normal condition	Extreme condition	SSB $\hat{E}_s/\text{lot}$ Note 2	$I_o$ Note 1 range				
			NR operating band groups Note 3	Minimum $I_o$		Maximum $I_o$	
dB	dB	dB		dBm / $SCS_{SSB}$		dBm/ $BW_{\text{Channel}}$	dBm/ $BW_{\text{Channel}}$
			$SCS_{SSB} = 15 \text{ kHz}$	$SCS_{SSB} = 30 \text{ kHz}$			
$\pm 3$	$\pm 4$	$\geq -3$	NR_CCA_FR1_I	-117	-114	N/A	-50
			NR_CCA_FR1_J	-116.5	-113.5		

NOTE 1:  $I_o$  is assumed to have constant EPRE across the bandwidth.  
NOTE 2: The parameter SSB  $\hat{E}_s/\text{lot}$  is the minimum SSB  $\hat{E}_s/\text{lot}$  of the pair of SSBs to which the requirement applies.  
NOTE 3: NR operating band groups are as defined in clause 3.5.2.

## 10.1.34 RSSI measurements under CCA

### 10.1.34.1 Intra-frequency absolute RSSI measurement accuracy requirements in FR1

The accuracy requirements for intra-frequency RSSI measurements on a carrier frequency under CCA are specified in Table 10.1.34.1-1. The requirements apply for any configured RSSI *measDuration* [2], provided that:

- All symbols during each RSSI measurement duration are available for RSSI sampling within the same reporting interval.

The intra-frequency RSSI measurement bandwidth is the channel bandwidth defined in Clause 4 of TS 37.213 [33], where the channel has the center frequency configured by *ARFCN-valueNR*.

Table 10.1.34.1-1: Intra-frequency RSSI accuracy under CCA

Accuracy		Conditions				
Normal condition	Extreme condition	NR operating band groups Note 2	$I_o$ Note 1 range			
			Minimum $I_o$		Maximum $I_o$	
dB	dB		dBm / $SCS_{SSB}$		dBm/ $BW_{\text{Channel}}$	dBm/ $BW_{\text{Channel}}$
			$SCS_{SSB} = 15 \text{ kHz}$	$SCS_{SSB} = 30 \text{ kHz}$		
[ $\pm 3.5$ ]	[ $\pm 6.5$ ]	NR_CCA_FR1_I	-117	-114	N/A	-70
		NR_CCA_FR1_J	-116.5	-113.5		
[ $\pm 5.5$ ]	[ $\pm 8.5$ ]	NR_CCA_FR1_I	N/A	N/A	-70	-50
		NR_CCA_FR1_J				

NOTE 1:  $I_o$  is assumed to have constant EPRE across the bandwidth.  
NOTE 2: NR operating band groups are as defined in clause 3.5.2.

### 10.1.34.2 Inter-frequency absolute RSSI measurement accuracy requirements in FR1

The accuracy requirements for inter-frequency RSSI measurements on a carrier frequency under CCA are the same as specified in clause 10.1.34.1.

The inter-frequency RSSI measurement bandwidth is the channel bandwidth defined in Clause 4 of TS 37.213 [33], where the channel has the center frequency configured by *ARFCN-valueNR*.



### 10.1.34.3 RSSI measurement report mapping

The reporting range of RSSI measurement is defined from -100 dBm to -25 dBm with 1 dBm resolution.

The mapping of the measured quantity is defined in Table 10.1.34.3-1. The range in the signalling may be larger than the guaranteed accuracy range, provided that the following condition is met:

the RSSI measurement bandwidth is the channel bandwidth defined in Clause 4 of TS 37.213 [33], where the channel has the center frequency configured by *ARFCN-valueNR*.

**Table 10.1.34.3-1: RSSI measurement report mapping**

Reported value	Measured quantity value	Unit
RSSI_00	RSSI < -100	dBm
RSSI_01	-100 ≤ RSSI < -99	dBm
RSSI_02	-99 ≤ RSSI < -98	dBm
...	...	...
RSSI_74	-27 ≤ RSSI < -26	dBm
RSSI_75	-26 ≤ RSSI < -25	dBm
RSSI_76	-25 ≤ RSSI	dBm

### 10.1.35 Channel occupancy measurements under CCA

#### 10.1.35.1 Intra-frequency channel occupancy measurement accuracy requirements in FR1

The UE shall be able to correctly evaluate the intra-frequency channel occupancy configured according to TS 38.331 [2], provided that the following conditions are met:

- All symbols during each RSSI measurement duration are available for RSSI sampling within the same reporting interval,
- RSSI at the UE receiver meets the following condition with respect to the configured *channelOccupancyThreshold* [2]:

RSSI at the UE receiver is below  $channelOccupancyThreshold - \Delta_{RSSI}$ , or

RSSI at the UE receiver is above  $channelOccupancyThreshold + \Delta_{RSSI}$ ,

where  $\Delta_{RSSI}$  is the applicable RSSI measurement accuracy value from the RSSI measurement accuracy requirements specified in clause 10.1.34.1.

The channel occupancy measurement bandwidth is the same as the RSSI measurement bandwidth in Clause 10.1.34.1.

#### 10.1.35.2 Inter-frequency channel occupancy measurement accuracy requirements in FR1

The UE shall be able to correctly evaluate the inter-frequency channel occupancy configured according to TS 38.331 [2], provided that the following conditions are met:

- All symbols during each RSSI measurement duration are available for RSSI sampling within the same reporting interval,
- RSSI at the UE receiver meets the following condition with respect to the configured *channelOccupancyThreshold* [2]:

RSSI at the UE receiver is below  $channelOccupancyThreshold - \Delta_{RSSI}$ , or

RSSI at the UE receiver is above  $channelOccupancyThreshold + \Delta_{RSSI}$ .

where  $\Delta_{RSSI}$  is the applicable RSSI measurement accuracy value from the RSSI measurement accuracy requirements specified in clause 10.1.34.2.

The channel occupancy measurement bandwidth is the same as the RSSI measurement bandwidth in Clause 10.1.34.2.

### 10.1.36 Intra-frequency RSRP accuracy requirements under CCA

#### 10.1.36.1 Intra-frequency SS-RSRP accuracy requirements in FR1

##### 10.1.36.1.1 Absolute SS-RSRP Accuracy

Unless otherwise specified, the requirements for absolute accuracy of SS-RSRP in this clause apply to a cell on the same frequency as that of the serving cell under CCA.

The accuracy requirements in Table 10.1.36.1.1-1 are valid under the following conditions:

- Conditions defined in clause 7.3F of TS 38.101-1 [18] for reference sensitivity are fulfilled.
- Conditions for intra-frequency measurements are fulfilled according to Annex B.2.8 for a corresponding Band for each relevant SSB.

**Table 10.1.36.1.1-1: SS-RSRP intra-frequency absolute accuracy**

Accuracy		Conditions					
Normal condition	Extreme condition	SSB $\hat{E}_s/\text{lot}$	$l_o$ <sup>Note 1</sup> range				
			NR operating band groups <sup>Note 2</sup>	Minimum $l_o$		Maximum $l_o$	
dB	dB	dB		dBm / $SCS_{SSB}$		dBm/ $BW_{Channel}$	dBm/ $BW_{Channel}$
				$SCS_{SSB} = 15$ kHz	$SCS_{SSB} = 30$ kHz		
±4.5	±9	≥-6	NR_CCA_FR1_I	-117	-114	N/A	-70
			NR_CCA_FR1_J	-116.5	-113.5		
±8	±11	≥-6	NR_CCA_FR1_I	N/A	N/A	-70	-50
			NR_CCA_FR1_J				

NOTE 1:  $l_o$  is assumed to have constant EPRE across the bandwidth.  
 NOTE 2: NR operating band groups are as defined in clause 3.5.2.

##### 10.1.36.1.2 Relative SS-RSRP Accuracy

The relative accuracy of SS-RSRP is defined as the SS-RSRP measured from one cell compared to the SS-RSRP measured from another cell on the same frequency, or between any two SS-RSRP levels measured on the same cell under CCA.

The accuracy requirements in Table 10.1.36.1.2-1 are valid under the following conditions:

- Conditions defined in clause 7.3F of TS 38.101-1 [18] for reference sensitivity are fulfilled.
- Conditions for intra-frequency measurements are fulfilled according to Annex B.2.8 for a corresponding Band for each relevant SSB.

Table 10.1.36.1.2-1: SS-RSRP intra-frequency relative accuracy under CCA

Accuracy		Conditions					
Normal condition	Extreme condition	SSB $\hat{E}_s/\text{lot}$ Note 2	$I_o$ Note 1 range				
			NR operating band groups Note 4	Minimum $I_o$		Maximum $I_o$	
dB	dB	dB		dBm / $SCS_{SSB}$		dBm/ $BW_{Channel}$	dBm/ $BW_{Channel}$
			$SCS_{SSB} = 15$ kHz	$SCS_{SSB} = 30$ kHz			
$\pm 2$	$\pm 3$	$\geq -3$	NR_CCA_FR1_I	-117	-114	N/A	-50
			NR_CCA_FR1_J	-116.5	-113.5		
$\pm 3$	$\pm 3$	$\geq -6$	Note 3	Note 3	Note 3	N/A	Note 3

NOTE 1:  $I_o$  is assumed to have constant EPRE across the bandwidth.  
NOTE 2: The parameter SSB  $\hat{E}_s/\text{lot}$  is the minimum SSB  $\hat{E}_s/\text{lot}$  of the pair of cells to which the requirement applies.  
NOTE 3: The same bands and the same  $I_o$  conditions for each band apply for this requirement as for the corresponding highest accuracy requirement.  
NOTE 4: NR operating band groups are as defined in clause 3.5.2.

## 10.1.37 Inter-frequency RSRP accuracy requirements under CCA

### 10.1.37.1 Inter-frequency SS-RSRP accuracy requirements in FR1

#### 10.1.37.1.1 Absolute Accuracy of SS-RSRP

The requirements for absolute accuracy of SS-RSRP in this clause apply to a cell on a frequency under CCA that has different carrier frequency from the serving cell.

The accuracy requirements in Table 10.1.37.1.1-1 are valid under the following conditions:

- Conditions defined in clause 7.3F of TS 38.101-1 [18] for reference sensitivity are fulfilled.
- Conditions for inter-frequency measurements are fulfilled according to Annex B.2.9 for a corresponding Band for each relevant SSB.

Table 10.1.37.1.1-1: SS-RSRP inter-frequency absolute accuracy under CCA

Accuracy		Conditions					
Normal condition	Extreme condition	SSB $\hat{E}_s/\text{lot}$	$I_o$ Note 1 range				
			NR operating band groups Note 2	Minimum $I_o$		Maximum $I_o$	
dB	dB	dB		dBm / $SCS_{SSB}$		dBm/ $BW_{Channel}$	dBm/ $BW_{Channel}$
			$SCS_{SSB} = 15$ kHz	$SCS_{SSB} = 30$ kHz			
$\pm 4.5$	$\pm 9$	$\geq -6$	NR_CCA_FR1_I	-117	-114	N/A	-70
			NR_CCA_FR1_J	-116.5	-113.5		
$\pm 8$	$\pm 11$	$\geq -6$	NR_CCA_FR1_I	N/A	N/A	-70	-50
			NR_CCA_FR1_J				

NOTE 1:  $I_o$  is assumed to have constant EPRE across the bandwidth.  
NOTE 2: NR operating band groups are as defined in clause 3.5.2.

### 10.1.37.1.2 Relative Accuracy of SS-RSRP

The relative accuracy of SS-RSRP in inter frequency case is defined as the RSRP measured from one cell on a frequency compared to the RSRP measured from another cell on a different frequency, with at least one of the two frequencies being under CCA.

The accuracy requirements in Table 10.1.37.1.2-1 are valid under the following conditions:

- Conditions defined in clause 7.3F of TS 38.101-1 [18] for reference sensitivity are fulfilled.
- Conditions for inter-frequency measurements are fulfilled according to Annex B.2.9 for a corresponding Band for each relevant SSB.
- $|\text{SSB\_RP1}_{\text{dBm}} - \text{SSB\_RP2}_{\text{dBm}}| \leq 27 \text{ dB}$
- $|\text{Channel 1\_Io} - \text{Channel 2\_Io}| \leq 20 \text{ dB}$

**Table 10.1.37.1.2-1: SS-RSRP inter-frequency relative accuracy under CCA**

Accuracy		Conditions					
Normal condition	Extreme condition	SSB $\hat{E}_s/\text{lot}$ Note 2	$I_o$ Note 1 range				
			NR operating band groups Note 3	Minimum $I_o$		Maximum $I_o$	
dB	dB	dB		dBm / $SCS_{\text{SSB}}$		dBm/ $BW_{\text{Channel}}$	dBm/ $BW_{\text{Channel}}$
				$SCS_{\text{SSB}} = 15 \text{ kHz}$	$SCS_{\text{SSB}} = 30 \text{ kHz}$		
$\pm 4.5$	$\pm 6$	$\geq -6$	NR_CCA_FR1_I	-117	-114	N/A	-50
			NR_CCA_FR1_J	-116.5	-113.5		

NOTE 1:  $I_o$  is assumed to have constant EPRE across the bandwidth.  
 NOTE 2: The parameter SSB  $\hat{E}_s/\text{lot}$  is the minimum SSB  $\hat{E}_s/\text{lot}$  of the pair of cells to which the requirement applies.  
 NOTE 3: NR operating band groups are as defined in clause 3.5.2.

## 10.2 E-UTRAN measurements

### 10.2.1 Introduction

Accuracy requirements for measurements on E-UTRAN carrier frequencies are specified in clause 10.2 and apply for UE in SA or NR-DC or NE-DC operation mode, unless otherwise specified.

Unless otherwise specified, the requirements in clause 10.2 are applicable for a UE:

- in RRC\_CONNECTED state
- performing measurements with appropriate measurement gaps according to clause 9.1.2.
- that is synchronised to the cell that is measured.

The reported measurement result after layer 1 filtering shall be an estimate of the average value of the measured quantity over the measurement period. The reference point for the measurement result after layer 1 filtering is referred to as point B in the measurement model described in TS 36.300 [24].

The accuracy requirements of E-UTRA measurements in this clause are valid for the reported measurement result after layer 1 filtering. The accuracy requirements are verified from the measurement report at point D in the measurement model having the layer 3 filtering disabled.

If the UE needs measurement gaps to perform the inter-RAT NR — E-UTRAN FDD and NR — E-UTRAN TDD measurements, the relevant measurement procedure and measurement gap patterns stated in clause 9.1.2 shall apply.

## 10.2.2 E-UTRAN RSRP measurements

NOTE: This measurement is for handover between NR and E-UTRAN.

The measurement period of E-UTRA RSRP in RRC\_CONNECTED state is specified in clause 9.4.2 and 9.4.3.

The accuracy requirements of E-UTRA RSRP measurements in RRC\_CONNECTED state and the corresponding side conditions shall be the same as the inter-frequency RSRP Accuracy Requirements in clause 9.1.3 of TS 36.133 [15].

The reporting range and mapping specified for RSRP measurements in clause 9.1.4 of TS 36.133 [15] shall apply.

## 10.2.3 E-UTRAN RSRQ measurements

NOTE: This measurement is for handover between NR and E-UTRAN.

The measurement period of E-UTRA RSRQ in RRC\_CONNECTED state is specified in clause 9.4.2 and 9.4.3.

The accuracy requirements of E-UTRA RSRQ measurements in RRC\_CONNECTED state and the corresponding side conditions shall be the same as the inter-frequency RSRQ Accuracy Requirements in clause 9.1.6 of TS 36.133 [15].

The requirements for accuracy of E-UTRA RSRQ measurements in RRC\_CONNECTED state and the corresponding side conditions shall be the same as the inter-frequency RSRQ Accuracy Requirements in clause 9.1.6 of TS 36.133 [15].

The reporting range and mapping specified for RSRQ measurements in clause 9.1.7 of TS 36.133 [15] shall apply.

## 10.2.4 E-UTRAN RSTD measurements

The requirements in this clause are valid for UE supporting this capability.

The measurement period is specified in clauses 9.4.4.1 and 9.4.4.2 for inter-RAT NR — E-UTRAN FDD and inter-RAT NR — E-UTRAN TDD RSTD measurements, respectively.

The accuracy requirements and the corresponding side conditions shall be the same as the inter-frequency measurement accuracy requirements for RSTD measurements in RRC\_CONNECTED in clause 9.1.10.2 of TS 36.133 [15].

If the UE needs measurement gaps to perform the inter-RAT NR — E-UTRAN FDD and NR — E-UTRAN TDD RSTD measurements, the relevant measurement procedure and measurement gap patterns stated in clause 9.1.2 shall apply.

The reporting range and mapping for the inter-RAT NR — E-UTRAN FDD and NR — E-UTRAN TDD RSTD measurements is the same as specified for RSTD measurements in TS 36.133 [15, clauses 9.1.10.3 and 9.1.10.4].

## 10.2.5 E-UTRAN RS-SINR measurements

NOTE: This measurement is for handover between NR and E-UTRAN.

The measurement period of E-UTRA RS-SINR in RRC\_CONNECTED state is specified in clause 9.4.2 and 9.4.3.

The accuracy requirements of E-UTRA RS-SINR measurements in RRC\_CONNECTED state and the corresponding side conditions shall be the same as the inter-frequency RS-SINR Accuracy Requirements in clause 9.1.17.3 of TS 36.133 [15].

The reporting range and mapping for E-UTRA RS-SINR measurements shall be the same as specified for RS-SINR measurements in clause 9.1.17.1 of TS 36.133 [15].

## 10.2.6 E-UTRAN RSRP measurements for CA/DC Idle Mode Measurements

NOTE: This measurement is for CA/DC Idle Mode measurements between NR and E-UTRAN.

The requirements in this clause are applicable for a UE:

- in state RRC\_IDLE or RRC\_INACTIVE
- that is synchronised to the cell that is measured.

The requirements are for absolute accuracy of E-UTRA RSRP.

The measurement period of E-UTRA RSRP in RRC\_IDLE and RRC\_INACTIVE states are specified in clause 4.4.2.

The accuracy requirements of E-UTRA RSRP measurements in RRC\_IDLE and RRC\_INACTIVE states and the corresponding side conditions shall be as the inter-frequency RSRP Accuracy Requirements in clause 9.1.3B.2 of TS 36.133 [15].

The reporting range and mapping specified for RSRP measurements in clause 9.1.4 of TS 36.133 [15] shall apply.

## 10.2.7 E-UTRAN RSRQ measurements for CA/DC Idle Mode Measurements

NOTE: This measurement is for CA/DC Idle Mode measurements between NR and E-UTRAN.

The requirements in this clause are applicable for a UE:

- in state RRC\_IDLE or RRC\_INACTIVE
- that is synchronised to the cell that is measured.

The requirements are for absolute accuracy of E-UTRA RSRQ.

The measurement period of E-UTRA RSRQ in RRC\_IDLE and RRC\_INACTIVE states are specified in clause 4.4.2.

The accuracy requirements of E-UTRA RSRQ measurements in RRC\_IDLE and RRC\_INACTIVE states and the corresponding side conditions shall be as the inter-frequency RSRQ Accuracy Requirements in clause 9.1.6B.2 of TS 36.133 [15].

The reporting range and mapping specified for RSRQ measurements in clause 9.1.7 of TS 36.133 [15] shall apply.

## 10.3 UTRAN FDD Measurements

The requirements in this clause are applicable for a UE:

- in state RRC\_CONNECTED
- performing measurements according to clause 9.4.6 with appropriate measurement gaps
- that is synchronised to the cell that is measured.

The reported measurement result after layer 1 filtering shall be an estimate of the average value of the measured quantity over the measurement period. The reference point for the measurement result after layer 1 filtering is referred to as point B in the measurement model described in TS 25.302 [30].

The accuracy requirements in this clause are valid for the reported measurement result after layer 1 filtering. The accuracy requirements are verified from the measurement report at point D in the measurement model having the layer 3 filtering disabled.

### 10.3.1 UTRAN FDD CPICH RSCP

NOTE: This measurement is for handover between E-UTRAN and UTRAN FDD.

The requirements in this clause are valid for terminals supporting this capability.

The measurement period for RRC\_CONNECTED state is specified in clause 9.4.6.

In RRC\_CONNECTED state the accuracy requirements shall meet the absolute accuracy requirements in table 10.3.1-1, under the following conditions:

- CPICH Ec/Io condition for a detectable cell is as specified in clause 9.4.6;
- SCH\_Ec/Io condition for a detectable cell is as specified in clause 9.4.6.

**Table 10.3.1-1: UTRAN FDD CPICH\_RSCP absolute accuracy**

Accuracy		Conditions		
Normal condition	Extreme condition	Io range		
		UTRA operating bands	Minimum Io	Maximum Io
dB	dB		dBm/3.84 MHz	dBm/3.84 MHz
±6	±9	Band I, IV, VI, X XI, XIX and XXI	-94	-70
		Band IX	-93	-70
		Band II, V and VII	-92	-70
		Band III, VIII, XII, XIII, XIV , XX and XXII	-91	-70
		Band XXV, XXVI <sup>Note 1</sup>	-90.5	-70
±8	±11	Note 2	-70	-50
NOTE 1: For Band XXVI, the condition has the minimum Io of -92 dBm/3.84 MHz when the carrier frequency of the assigned UTRA channel is within 869-894 MHz for the UE which supports both Band V and Band XXVI operating frequencies.				
NOTE 2: The same bands apply for this requirement as for the corresponding highest accuracy requirement.				

If the UE, in RRC\_CONNECTED state, needs measurement gaps to perform UTRAN FDD measurements, the relevant UTRAN FDD measurement procedure and measurement gap pattern stated in clause 9.4.6 shall apply.

The reporting range and mapping specified for FDD CPICH RSCP in TS 25.133 [29] shall apply.

## 10.3.2 UTRAN FDD CPICH Ec/No

NOTE: This measurement is for handover between E-UTRAN and UTRAN FDD.

The requirements in this clause are valid for terminals supporting this capability.

The measurement period for RRC\_CONNECTED state is specified in clause 9.4.6.

In RRC\_CONNECTED state the accuracy requirements shall be the same as the inter-frequency measurement accuracy requirements for FDD CPICH Ec/No in TS 25.133 [29].

If the UE, in RRC\_CONNECTED state, needs measurement gaps to perform UTRAN FDD measurements, the UTRAN FDD measurement procedure and measurement gap pattern stated in clause 9.4.6 shall apply.

The reporting range and mapping specified for FDD CPICH Ec/No in TS 25.133 [29] shall apply.

## 10.4 V2X measurements

### 10.4.1 Introduction

The requirements in this section are applicable for a UE capable of V2X sidelink communication.

The accuracy requirements in this clause are:

- applicable for AWGN radio propagation conditions,
- assume independent interference (noise) at each receiver antenna port.

## 10.4.2 Intra-frequency PSBCH-RSRP accuracy requirements for FR1

### 10.4.2.1 PSBCH-RSRP Absolute Accuracy

The requirements for absolute accuracy of PSBCH-RSRP in this clause apply to a V2X synchronization source on the same frequency as that of the own V2X UE performing the measurement in FR1.

The accuracy requirements in Table 10.4.2.1-1 are valid under the following conditions:

- Demodulation reference signals are transmitted from one port.
- Conditions defined in Clause 7.3E of TS38.101-1 [18] for reference sensitivity are fulfilled.
- Conditions for PSBCH-RSRP measurements are fulfilled according to Annex B.4.2 for a corresponding Band for each relevant PSBCH-DMRS.

**Table 10.4.2.1-1: Intra-frequency PSBCH-RSRP absolute accuracy in FR1**

Accuracy		Conditions						
Normal condition	Extreme condition	$\hat{E}_s/\text{lot}$ Note 3	$I_o$ Note 1 range					
			NR V2X operating band groups Note 2	Minimum $I_o$			Maximum $I_o$	
dB	dB	dB		dBm / SCS <sub>SL</sub>			dBm/BW <sub>Channel</sub>	dBm/BW <sub>Channel</sub>
			SCS <sub>SL</sub> = 15 kHz	SCS <sub>SL</sub> = 30 kHz	SCS <sub>SL</sub> = 60 kHz			
±4.5	±9	≥-6	NR_TDD_FR1_B	-120.5	-117.5	-114.5	N/A	-70
			NR_TDD_FR1_J	-116.5	-113.5	-110.5	N/A	-70
±8	±11	≥-6	NR_TDD_FR1_B, NR_TDD_FR1_J	N/A	N/A	N/A	-70	-50

NOTE 1:  $I_o$  is assumed to have constant EPRE across the bandwidth.  
NOTE 2: NR V2X operating band groups in FR1 are as defined in clause 3.5.2.  
NOTE 3:  $\hat{E}_s/\text{lot}$  for a SyncRef UE is the  $\hat{E}_s/\text{lot}$  of PSBCH-DMRS.

### 10.4.2.2 PSBCH-RSRP Relative Accuracy

The relative accuracy of PSBCH-RSRP is defined as the PSBCH-RSRP measured from one V2X synchronization source compared to the PSBCH-RSRP measured from another V2X synchronization source on the same frequency in FR1.

The accuracy requirements in Table 10.4.2.2-1 are valid under the following conditions:

- Demodulation reference signals are transmitted from one port.
- Conditions defined in Clause 7.3E of TS38.101-1 [18] for reference sensitivity are fulfilled.
- Conditions for PSBCH-RSRP accuracy measurements are fulfilled according to Annex B.4.2 for a corresponding Band for each relevant PSBCH-DMRS.

**Table 10.4.2.2-1: Intra-frequency PSBCH-RSRP relative accuracy in FR1**

Accuracy		Conditions						
Normal condition	Extreme condition	$\hat{E}_s/\text{lot}$ Note 3	$I_o$ Note 1 range					
			NR V2X operating band groups Note 2	Minimum $I_o$			Maximum $I_o$	
dB	dB	dB		dBm / SCS <sub>SL</sub>			dBm/BW <sub>Channel</sub>	dBm/BW <sub>Channel</sub>
			SCS <sub>SL</sub> = 15 kHz	SCS <sub>SL</sub> = 30 kHz	SCS <sub>SL</sub> = 60 kHz			
±2	±3	≥-3	NR_TDD_FR1_B	-120.5	-117.5	-114.5	N/A	-50
			NR_TDD_FR1_J	-116.5	-113.5	-110.5	N/A	-50
±3	±3	≥-6	Note 4	Note 4	Note 4	Note 4	N/A	Note 4



NOTE 1:  $I_0$  is assumed to have constant EPRE across the bandwidth.  
 NOTE 2: NR V2X operating band groups in FR1 are as defined in clause 3.5.2.  
 NOTE 3:  $\hat{E}_s/\text{lot}$  for a SyncRef UE is the  $\hat{E}_s/\text{lot}$  of PSBCH-DMRS.  
 NOTE 4: The same bands and the same  $I_0$  conditions for each band apply for this requirement as for the corresponding highest accuracy requirement.

### 10.4.3 Intra-Frequency SL-RSSI Measurement Accuracy Requirements for FR1

#### 10.4.3.1 Absolute SL-RSSI Accuracy

The intra-frequency SL-RSSI requirements are specified in Table 10.4.3.1-1. The requirements apply for measurement period of 1 slot and for any configured measurement bandwidth larger than 10 RBs, provided that:

- All symbols during each RSSI measurement duration are available for RSSI sampling within the same measurement interval.

**Table 10.4.3.1-1: Intra-frequency SL-RSSI absolute accuracy**

Accuracy		Conditions				
Normal condition	Extreme condition	NR V2X operating band groups <small>Note 2</small>	$I_0$ <small>Note 1</small> range			Maximum $I_0$
			Minimum $I_0$			
dB	dB		dBm/SCS <sub>SL</sub>			dBm/BW <sub>Channel</sub>
			SCS <sub>SL</sub> = 15kHz	SCS <sub>SL</sub> = 30kHz	SCS <sub>SL</sub> = 60kHz	
±2.5	±5.5	NR_TDD_FR1_B	-120.5	-117.5	-114.5	-50
		NR_TDD_FR1_J	-116.5	-113.5	-110.5	-50
±4.5	±7.5	Note 3	Note 3	Note 3	Note 3	Note 3

NOTE 1:  $I_0$  is assumed to have constant EPRE across the bandwidth.  
 NOTE 2: NR V2X operating band groups are as defined in Section 3.5 for the corresponding NR operating bands.  
 NOTE 3: The same bands and the same  $I_0$  conditions for each band apply for this requirement as for the corresponding highest accuracy requirement.

### 10.4.4 Intra-Frequency L1 SL-RSRP Measurement Accuracy Requirements for FR1

#### 10.4.4.1 Absolute L1 SL-RSRP Accuracy

The requirements for absolute accuracy of L1 SL-RSRP in this clause apply to a UE performing PSCCH-RSRP and/or PSSCH-RSRP measurements on the same frequency as used by operating V2X sidelink communication.

The accuracy requirements in Table 10.4.4.1-1 are valid under the following conditions:

- Demodulation reference signals for PSCCH and/or PSSCH are transmitted from one port.
- Conditions defined in clause 7.3E of TS38.101-1 [18] for reference sensitivity are fulfilled.
- PSCCH-RSRP[dBm] and/or PSSCH-RSRP[dBm] according to Annex B.4.4 for a corresponding Band are fulfilled.

**Table 10.4.4.1-1: Intra-frequency L1 SL-RSRP absolute accuracy for UE capable of V2X sidelink communication**

Accuracy		Conditions				
			$I_0$ <small>Note 1</small> range			

Normal condition	Extreme condition	$\hat{E}s/lot$ Note 3	NR V2X operating band groups Note 2	Minimum $I_o$			Maximum $I_o$	
				dBm/SCS				dBm/BW <sub>Channel</sub>
dB	dB	dB		SCS = 15kHz	SCS = 30kHz	SCS = 60kHz		
$\pm 4.5$	$\pm 9$	$\geq 0$ dB	NR_TDD_FR1_B	-120.5	-117.5	-114.5	N/A	-70
			NR_TDD_FR1_J	-116.5	-113.5	-110.5	N/A	-70
$\pm 8$	$\pm 11$	$\geq 0$ dB	NR_TDD_FR1_B NR_TDD_FR1_J	N/A	N/A	N/A	-70	-50

NOTE 1:  $I_o$  is assumed to have constant EPRE across the bandwidth.  
NOTE 2: NR V2X operating band groups are as defined in Section 3.5 for the corresponding NR operating bands.  
NOTE 3: The parameter  $\hat{E}s/lot$  is the  $\hat{E}s/lot$  of PSCCH-DMRS and/or PSSCH-DMRS.

---

## 11 Void

---

## 12 V2X Requirements

### 12.1 Introduction

This clause contains the requirements for the UE capable of V2X sidelink communication when the UE is out of coverage on the carrier used for V2X sidelink operation, as defined in TS 38.304 [1]. The requirements apply when the UE is:

- in any cell selection state, or,
- configured for V2X SL operation on a V2X carrier which is dedicated to only V2X SL operation and configured with only a PCell on WAN carrier.

Note: Any cell selection state refers to a UE that is out of network coverage and is not associated with a serving cell on any carrier as defined in TS 38.304 [1].

Note: When a UE in RRC\_CONNECTED state is performing transmissions and/or reception for V2X sidelink communication, the UE shall meet all the requirements specified in Clause 9 assuming that UE has a dedicated RX/TX chain for V2X sidelink communication. Otherwise, the UE may interrupt the V2X sidelink communication in order to meet the measurement requirements specified in Clause 9.

### 12.2 UE Transmit Timing

#### 12.2.1 Introduction

This clause contains requirements of transmission timing for V2X sidelink communication when:

- GNSS is used as the synchronization reference source;
- NR Cell is used as the synchronization reference source;
- E-UTRAN Cell is used as the synchronization reference source;
- SyncRef UE is used as the synchronization reference source.

## 12.2.2 GNSS as synchronization reference source

The requirements in this subclause are applicable when the reference timing used by the UE for V2X sidelink communication is derived from GNSS.

The sidelink transmissions takes place  $(N_{TA,SL} + N_{TA\ offset}) \times T_c$  before the subframe starting boundary as defined in TS 38.331 [2], where  $N_{TA\ offset} = 0$  and  $N_{TA,SL} = 0$ .

The transmission timing error for sidelink transmissions shall be less than or equal to  $\pm T_e$  where the timing error limit value  $T_e$  is defined in Table 12.2.2-1.

**Table 12.2.2-1:  $T_e$  Timing Error Limit**

Frequency Range of sidelink	$T_e$
FR1	$12 \cdot 64 \cdot T_c$
Note 1: $T_c$ is the basic timing unit defined in TS 38.211 [6].	

## 12.2.3 NR Cell as synchronization reference source

The requirements in this subclause are applicable when the reference timing used for sidelink transmissions is a NR serving cell on a non-V2X sidelink carrier.

The sidelink transmissions takes place  $(N_{TA,SL} + N_{TA\ offset}) \times T_c$  before the reception of the first detected path (in time) of the corresponding downlink frame from the reference cell, where  $N_{TA\ offset} = 0$  and  $N_{TA,SL} = 0$ .

The transmission timing error for sidelink transmissions shall be less than or equal to  $\pm T_e$  where the timing error limit value  $T_e$  is defined in Table 12.2.3-1.

**Table 12.2.3-1:  $T_e$  Timing Error Limit**

Frequency Range of sidelink	SCS of SSB signals (kHz)	SCS of sidelink signals (kHz)	$T_e$
FR1	15	15	$14 \cdot 64 \cdot T_c$
		30	$12 \cdot 64 \cdot T_c$
		60	$12 \cdot 64 \cdot T_c$
	30	15	$10 \cdot 64 \cdot T_c$
		30	$10 \cdot 64 \cdot T_c$
		60	$9 \cdot 64 \cdot T_c$
Note 1: $T_c$ is the basic timing unit defined in TS 38.211 [6].			

## 12.2.4 E-UTRAN Cell as synchronization reference source

The requirements in this subclause are applicable when the reference timing used for sidelink transmissions is an E-UTRAN serving cell on a non-V2X sidelink carrier.

The sidelink transmissions takes place  $(N_{TA,SL} + N_{TA\ offset}) \times T_c$  before the reception of the first detected path (in time) of the corresponding E-UTRAN downlink frame from the reference cell, where  $N_{TA\ offset} = 0$  and  $N_{TA,SL} = 0$ .

The transmission timing error for sidelink transmissions shall be less than or equal to  $\pm T_e$  where the timing error limit value  $T_e$  is defined in Table 12.2.4-1.

**Table 12.2.4-1:  $T_e$  Timing Error Limit**

Frequency Range of sidelink	E-UTRAN downlink bandwidth (MHz)	$T_e$
FR1	$\geq 3$	$14 \cdot 64 \cdot T_c$

Note 1: $T_c$ is the basic timing unit defined in TS 38.211 [6].
--

## 12.2.5 SyncRef UE as synchronization reference source

The requirements in this subclause are applicable when the reference timing used for deriving sidelink transmission is from SyncRef UE transmitting sidelink synchronization signals.

The sidelink transmissions takes place  $(N_{TA,SL} + N_{TA\ offset}) \times T_c$  before the reception of the first detected path (in time) of the corresponding timing reference frame from the SyncRef UE, where  $N_{TA\ offset} = 0$  and  $N_{TA,SL} = 0$ .

The transmission timing error for sidelink transmissions shall be less than or equal to  $\pm T_e$  where the timing error limit value  $T_e$  is defined in Table 12.2.5-1.

**Table 12.2.5-1:  $T_e$  Timing Error Limit**

Frequency Range of sidelink	SCS of sidelink signals (kHz)	$T_e$
FR1	15	$12 \cdot 64 \cdot T_c$
	30	$8 \cdot 64 \cdot T_c$
	60	$5 \cdot 64 \cdot T_c$
Note 1: $T_c$ is the basic timing unit defined in TS 38.211 [6].		

## 12.3 Initiation/Cease of SLSS Transmissions

### 12.3.1 Introduction

The requirements in this subclause are applicable to the UE capable of V2X sidelink communication when:

- GNSS is used as the synchronization reference source;
- NR Cell is used as the synchronization reference source;
- EUTRAN Cell is used as the synchronization reference source;
- SyncRef UE is used as the synchronization reference source.

#### 12.3.1.1 Initiation/Cease of SLSS transmissions with NR cell as synchronization reference source

The requirements apply when the NR Cell is used as synchronization reference source and when the UE is

- out of coverage on the V2X NR sidelink carrier and in-coverage with a serving cell on a NR non-V2X sidelink carrier,

and when the conditions for SLSS transmissions specified in TS 38.331[2] are met; *networkControlledSyncTx* is not configured; and *syncTxThreshIC* is included in *SystemInformationBlockType12*. The UE shall be capable of measuring the RSRP of the cell used as synchronization reference source to evaluate to initiate/cease SLSS transmissions within  $T_{\text{evaluate,SLSS}}$

where,

- $T_{\text{evaluate,SLSS}}$  is as specified in Table 12.3.1.1-1 when UE performs SSB based measurements without measurement gaps.
- $T_{\text{evaluate,SLSS}}$  is as specified in Table 12.3.1.1-2 when UE performs SSB based measurements with measurement gaps.

**Table 12.3.1.1-1:  $T_{\text{evaluate,SLSS}}$  for measurements without measurement gaps when NR cell is used as synchronization reference source (FR1)**

DRX cycle in NR cell	$T_{\text{evaluate,SLSS}}$
No DRX	$\max(400\text{ms}, \text{ceil}(2 \times 5 \times K_p) \times \text{SMTC period})^{\text{Note 1}}$
DRX cycle $\leq 320\text{ms}$	$\max(400\text{ms}, \text{ceil}(1.5 \times 2 \times 5 \times K_p) \times \max(\text{SMTC period}, \text{DRX cycle}))$
DRX cycle $> 320\text{ms}$	$\text{ceil}(7 \times K_p) \times \text{DRX cycle}$

NOTE 1: If different SMTC periodicities are configured for different cells, the SMTC period in the requirement is the one used by the cell being identified

**Table 12.3.1.1-2:  $T_{\text{evaluate,SLSS}}$  for measurements with measurement gaps when NR cell is used as synchronization reference source (FR1)**

DRX cycle in NR cell	$T_{\text{evaluate,SLSS}}$
No DRX	$\max(400\text{ms}, 2 \times 5 \times \max(\text{MGRP}, \text{SMTC period})) \times \text{CSSF}_{\text{intra}}$
DRX cycle $\leq 320\text{ms}$	$\max(400\text{ms}, \text{ceil}(2 \times 1.5 \times 5) \times \max(\text{MGRP}, \text{SMTC period}, \text{DRX cycle})) \times \text{CSSF}_{\text{intra}}$
DRX cycle $> 320\text{ms}$	$7 \times \max(\text{MGRP}, \text{DRX cycle}) \times \text{CSSF}_{\text{intra}}$

If higher layer filtering is configured, an additional delay in evaluation to initiate/cease SLSS transmissions can be expected.

For the NR cell as synchronization reference source:

- SS-RSRP related side conditions given in clauses 10.1.2 for FR1, respectively, for a corresponding Band,
- SS-RSRQ related side conditions given in clauses 10.1.7 for FR1, respectively, for a corresponding Band,
- SS-SINR related side conditions given in clauses 10.1.12 for FR1, respectively, for a corresponding Band,
- SSB<sub>RP</sub> and SSB  $\hat{E}_s/\text{Iot}$  according to Annex B.2.2 for a corresponding Band.

### 12.3.1.2 Initiation/Cease of SLSS transmissions with EUTRAN cell as synchronization reference source

The requirements apply when the EUTRAN Cell is used as synchronization reference source and when the UE is

- out of coverage on the V2X NR sidelink carrier and in-coverage with a serving cell on a LTE non-V2X sidelink carrier,

and when the conditions for SLSS transmissions specified in TS 36.331[16] are met; *networkControlledSyncTx* is not configured; and *syncTxThreshIC* is included in *SystemInformationBlockType28*. The UE shall be capable of measuring the RSRP of the cell used as synchronization reference source to evaluate to initiate/cease SLSS transmissions within  $T_{\text{evaluate,SLSS}}$

where,

- $T_{\text{evaluate,SLSS}} = 0.4$  seconds when UE is not configured with DRX.
- $T_{\text{evaluate,SLSS}} =$  as specified in Table 12.3.1.2-1 when UE is configured with DRX.

**Table 12.3.1.2-1:  $T_{\text{evaluate,SLSS}}$  when EUTRAN cell is used as synchronization reference source**

DRX cycle length in EUTRAN cell[s]	$T_{\text{evaluate,SLSS}}$ [s] (number of DRX cycles)
$\leq 0.04$	0.4 (Note 1)
$0.04 < \text{DRX-cycle} \leq 2.56$	Note 2 (6)
Note1:	Number of DRX cycles depends upon the DRX cycle in use
Note2:	Time depends upon the DRX cycles in use

If higher layer filtering is configured, an additional delay in evaluation to initiate/cease SLSS transmissions can be expected.

For the cell as synchronization reference source:

- RSRP related side conditions given in TS 36.133[15] Clauses 9.1.2.1 and 9.1.2.2 and RSRQ related side conditions given in TS 36.133[15] Clause 9.1.5.1 for a corresponding Band are fulfilled,
- SCH<sub>RP</sub> and SCH<sub>Es/Iot</sub> according to TS 36.133[15] Annex B.2.1 for a corresponding Band are fulfilled.

### 12.3.1.3 Initiation/Cease of SLSS transmissions with GNSS as synchronization reference source

The requirements apply when GNSS is used as synchronization reference source and when the UE is

- out of coverage on the V2X sidelink carrier and in-coverage with a serving cell on a non-V2X sidelink carrier,

and when the conditions for SLSS transmissions specified in TS 38.331[2] are met; *networkControlledSyncTx* is not configured; and *syncTxThreshIC* is included in *SystemInformationBlockType12* in a NR cell.

When the conditions for SLSS transmissions specified in TS 36.331[16] are met; *networkControlledSyncTx* is not configured; and *syncTxThreshIC* is included in *SystemInformationBlockType28* in a EUTRAN cell.

The requirements in Clause 12.3.1.1 shall apply if the serving cell is a NR cell.

The requirements in Clause 12.3.1.2 shall apply if the serving cell is a EUTRAN cell.

### 12.3.1.4 Initiation/Cease of SLSS transmissions with SyncRef UE as synchronization reference source

The requirements apply when SyncRef UE is used as synchronization reference source and when the UE is

- in any cell selection state, or
- out of coverage on the V2X sidelink carrier and is associated with a serving cell on a non-V2X sidelink carrier,

and when the conditions for SLSS transmissions specified in TS 38.331[2] are met and when SyncRef UE is used as synchronization reference source and if *syncTxThreshOoC* is included in the preconfigured V2X parameters.

The UE shall be capable of measuring the PSBCH-RSRP of the selected SyncRef UE used as synchronization reference source and evaluate it to initiate/cease SLSS transmissions within  $T_{\text{evaluate,SLSS}} = 4$  S-SSB periods.

If higher layer filtering for PSBCH-RSRP measurements is pre-configured, an additional delay in evaluation to initiate/cease SLSS transmissions can be expected.

For the selected SyncRef UE as defined in TS 38.331 [2] used to derive transmission timing for V2X sidelink communication:

- PSBCH-RSRP related side conditions given in Clause 12.4 for a corresponding Band are fulfilled,
- S-SSB<sub>RP</sub> and S-SSB<sub>Es/Iot</sub> according to Annex B.4.3 for a corresponding Band are fulfilled.

## 12.4 Selection / Reselection of V2X Synchronization Reference Source

The requirements defined in this clause do not apply to the UEs that do not support transmission and reception of SLSS.

A SyncRef UE is considered to be detectable when

- PSBCH-RSRP related side conditions given in Clause 10 are fulfilled for a corresponding Band,
- S-SSB<sub>RP</sub> and S-SSB<sub>Es/Iot</sub> according to Annex B.4.3 for a corresponding Band are fulfilled.

When GNSS synchronization reference source is configured as the highest priority and

- UE is synchronized to GNSS directly,
  - UE shall not drop any V2X SLSS and data transmission for the purpose of selection/reselection to the SyncRef UE.
- UE is synchronized to a SyncRef UE that is synchronized to GNSS directly or in-directly,
  - UE shall not drop any V2X data transmission for the purpose of selection/reselection to the SyncRef UE. The UE shall be able to identify newly detectable intra-frequency SyncRef UE within  $T_{\text{detect,SyncRef UE\_V2X}}$  seconds if the SyncRef UE meets the selection / reselection criterion defined in TS 38.331[2].  $T_{\text{detect,SyncRef UE\_V2X}}$  is defined as 1.6 seconds at  $S\text{-SSB } \hat{E}_s/I_{ot} \geq 0$  dB, provided that the UE is allowed to drop a maximum of 30% of its SLSS transmissions during  $T_{\text{detect,SyncRef UE\_V2X}}$  for the purpose of selection / reselection to the SyncRef UE.
- in other case
  - The UE shall be able to identify newly detectable intra-frequency SyncRef UE within  $T_{\text{detect,SyncRef UE\_V2X}}$  seconds if the SyncRef UE meets the selection / reselection criterion defined in TS 38.331[2].  $T_{\text{detect,SyncRef UE\_V2X}}$  is defined as 8 seconds at  $S\text{-SSB } \hat{E}_s/I_{ot} \geq 0$  dB, provided that the UE is allowed to drop a maximum of 6 % of its V2X data and SLSS transmissions during  $T_{\text{detect,SyncRef UE\_V2X}}$  for the purpose of selection / reselection to the SyncRef UE.
  - UE is allowed to drop up to 2 slots of its V2X data reception per PSBCH monitoring occasion and overall drop rate shall not exceed 0.3% of its V2X data reception during  $T_{\text{detect,SyncRef UE\_V2X}}$  for the purpose of selection / reselection to the SyncRef UE.

When serving cell/PCell synchronization reference source is configured as the highest priority,

- UE shall be able to identify newly detectable intra-frequency SyncRef UE within  $T_{\text{detect,SyncRef UE\_V2X}}$  seconds if the SyncRef UE meets the selection / reselection criterion defined in TS 38.331[2].  $T_{\text{detect,SyncRef UE\_V2X}}$  is defined as 8 seconds at  $S\text{-SSB } \hat{E}_s/I_{ot} \geq 0$  dB, provided that the V2X UE is allowed to drop a maximum of 6 % of its V2X data and SLSS transmissions for the purpose of selection / reselection to the SyncRef UE.
- UE is allowed to drop up to 2 slots of its V2X data reception per PSBCH monitoring occasion and overall drop rate shall not exceed 0.3% of its V2X data reception during  $T_{\text{detect,SyncRef UE\_V2X}}$  for the purpose of selection / reselection to the SyncRef UE.

UE shall be capable of performing PSBCH-RSRP measurements for 3 identified intra-frequency SyncRef UEs with the measurement period of 320 ms. It is assumed that the SyncRef UE do not drop or delay any SLSS transmission within the measurement period. Otherwise, the measurement period may be extended.

When UE is synchronized to GNSS directly, before selection / reselection of the new synchronization reference source UE shall evaluate the GNSS synchronization source reliability for at least 20 seconds before changing the synchronization reference from GNSS to another synchronization reference source. UE shall be always synchronized to GNSS directly during the evaluation of GNSS synchronization source reliability.

## 12.5 L1 SL-RSRP measurements

### 12.5.1 Introduction

This clause contains the measurement requirements related to resource reselection and resource pre-emption of the UE capable of V2X sidelink communication.

### 12.5.2 SL-RSRP measurements

The UE physical layer shall be capable of performing the L1 SL-RSRP measurements on the carrier operating V2X sidelink communication for determining the subset of resources to be excluded in PSSCH resource selection in sidelink transmission mode 2. The L1 SL-RSRP measurement period corresponds to one slot and the measurement shall meet the L1 SL-RSRP measurement accuracy requirement in Clause 10. After resource (re-)selection procedure, re-

evaluation is performed on the reserved resources by L1 SL-RSRP measurements before transmission of SCI with reservation when the conditions specified in TS 38.214[26] are satisfied.

When the pre-emption mechanism is enabled for the resource pool that UE is monitoring and selecting resource from, after UE selects from the resource not excluded based on L1 SL-RSRP measurement procedure, the UE shall be capable of triggering reselection of already signalled resource(s) as a resource reservation when the conditions specified in TS38.214[26] are satisfied.

## 12.6 Congestion Control measurements

The UE shall be capable of estimating the channel busy ratio for one or more transmission pools indicated by higher layers in TS 38.331[2], based on SL-RSSI measurements provided by the physical layer.

When no sidelink transmissions occur, the UE physical layer shall perform a single-shot SL-RSSI measurement for each sub-channel included in all the slots configured as transmission pools.

The SL-RSSI measurement performed according to this clause shall meet the SL-RSSI measurement accuracy requirements defined in Clause 10.

The UE shall perform channel busy ratio (CBR) measurement based on SL-RSSI measurements as described in TS 38.215 [4].

## 12.7 Interruption

### 12.7.1 Interruptions to WAN due to V2X Sidelink Communication

This clause contains the requirements related to the interruptions on the PCell/serving cell due to V2X sidelink communication.

A UE capable of V2X sidelink communication may indicate its interest (initiation or termination) in V2X sidelink communication to the connected gNodeB using IE *SidelinkUEInformationNR* in TS38.331[2].

The UE is allowed an interruption of up to the duration shown in table 12.7.1-1 on the PCell/serving cell during the RRC reconfiguration procedure that includes the V2X sidelink communication configuration message *SL-ConfigDedicatedNR* in TS 38.331[2] (setup and release). This interruption is for both uplink and downlink of the PCell/serving cell.

**Table 12.7.1-1: Interruption length at V2X RRC reconfiguration**

$\mu$	NR Slot length (ms)	Interruption length (number of slots)
0	1	2
1	0.5	3
2	0.25	5
3	0.125	9

### 12.7.2 V2X Sidelink Communication Dropping due to synchronization source change

This clause contains the requirements related to the interruptions on the V2X sidelink communication due to synchronization source change.

For NR V2X UE not supporting gNB/eNB as synchronization reference source, UE is allowed to drop LTE and NR V2X SL transmission or reception for up to 1ms when synchronization source is changed, where the drop of LTE V2X SL transmission or reception applies only to in-device coexistence scenario in TS38.213 [3]:

- From GNSS



- to syncRef UE that is synchronized to GNSS directly/in-directly
- to syncRef UE that has the lowest priority
- From syncRef UE that is synchronized to GNSS directly/in-directly
  - to GNSS
  - to syncRef UE that has the lowest priority
- From syncRef UE that has the lowest priority
  - to GNSS
  - to syncRef UE that is synchronized to GNSS directly/in-directly
  - to syncRef UE that has the lowest priority

For NR V2X UE supporting gNB/eNB as synchronization reference source, UE is allowed to drop LTE and NR V2X SL transmission or reception for up to 1ms when synchronization source is changed, where the drop of LTE V2X SL transmission or reception applies only to in-device coexistence scenario in TS38.213 [3]:

- From GNSS
  - to syncRef UE that is synchronized to GNSS directly/in-directly
  - to gNB/eNB
  - to syncRef UE that is synchronized to gNB/eNB directly
  - to syncRef UE that is synchronized to gNB/eNB in-directly
  - to syncRef UE that has the lowest priority
- From syncRef UE that is synchronized to GNSS directly/in-directly
  - to GNSS
  - to gNB/eNB
  - to syncRef UE that is synchronized to gNB/eNB directly
  - to syncRef UE that is synchronized to gNB/eNB in-directly
  - to syncRef UE that has the lowest priority
- From gNB or eNB
  - to GNSS
  - to syncRef UE that is synchronized to GNSS directly/in-directly
  - to eNB or gNB
  - to syncRef UE that is synchronized to gNB or eNB directly
  - to syncRef UE that is synchronized to gNB or eNB in-directly
  - to syncRef UE that has the lowest priority
- From syncRef UE that is synchronized to gNB/eNB directly
  - to GNSS
  - to syncRef UE that is synchronized to GNSS directly/in-directly
  - to gNB/eNB
  - to syncRef UE that is synchronized to gNB/eNB directly

- to syncRef UE that is synchronized to gNB/eNB in-directly
- to syncRef UE that has the lowest priority
- From syncRef UE that is synchronized to gNB/eNB in-directly
  - to GNSS
  - to syncRef UE that is synchronized to GNSS directly/in-directly
  - to gNB/eNB
  - to syncRef UE that is synchronized to gNB/eNB directly
  - to syncRef UE that is synchronized to gNB/eNB in-directly
  - to syncRef UE that has the lowest priority
- From syncRef UE that has the lowest priority
  - to GNSS
  - to syncRef UE that is synchronized to GNSS directly
  - to syncRef UE that is synchronized to GNSS in-directly
  - to gNB/eNB
  - to syncRef UE that is synchronized to gNB/eNB directly
  - to syncRef UE that is synchronized to gNB/eNB in-directly
  - to syncRef UE that has the lowest priority

UE is allowed to interruption any V2X sidelink signals including PSSCH, PSCCH, PSBCH, PSFCH and SLSS signals.

### 12.7.3 Interruptions to WAN due to switching between E-UTRA V2X Sidelink and NR V2X Sidelink

This sub-clause contains the requirements related to the interruptions on the PCell/serving cell due to switching between E-UTRA V2X sidelink and NR V2X sidelink transmissions on a dedicated carrier. It is applicable for UE capable of both NR V2X sidelink and E-UTRA V2X sidelink transmissions in TDM-ed manner.

When a UE capable of switching between E-UTRA V2X sidelink and NR V2X sidelink, the UE is allowed an interruption of up to the duration shown in table 12.7.3-1 on the PCell/serving cell during the E-UTRA V2X sidelink and NR V2X sidelink switch.

This interruption is for both uplink and downlink of the PCell/serving cell.

**Table 12.7.3-1: Interruption length due to switching between E-UTRA V2X and NR V2X**

$\mu$	Slot length (ms)	Interruption length (number of slots)
0	1	2
1	0.5	2
2	0.25	2
3	0.125	3

## 12.8 Reliability of GNSS signal

This clause contains requirements regarding reliability of GNSS signal for the UE capable of V2X sidelink communication under the following additional condition:

- The UE is configured or pre-configured with parameters for enabling the UE to acquire the GNSS synchronization.

If UE considers GNSS is a reliable synchronization reference, the UE shall meet timing accuracy requirement as specified in 12.2 and frequency accuracy requirement as specified in 6.4E of TS38.101-1[18]. Otherwise, the UE shall be capable to select another synchronization reference source.

## 12.9 Scheduling availability

### 12.9.1 Scheduling availability of UE switching between E-UTRA sidelink and NR sidelink

This clause contains the restrictions on the scheduling availability for V2X sidelink due to switching between E-UTRA V2X sidelink and NR V2X sidelink transmission on a dedicated carrier. For the NR V2X sidelink, the assumed number of configured symbols in a slot is 14.

When switch from E-UTRA V2X sidelink to NR V2X sidelink occurs in NR slot 'n',

- UE is not expected to transmit or receive on NR V2X sidelink on the slot 'n'.

When switch from NR V2X sidelink to E-UTRA V2X sidelink occurs in NR slot 'n-1',

- UE is not expected to transmit or receive on NR V2X sidelink on the slot 'n-1'.

When switch from NR V2X sidelink to E-UTRA V2X sidelink occurs in E-UTRA subframe 'n',

- UE is not expected to transmit or receive on E-UTRA V2X sidelink on the subframe 'n'.

When switch from E-UTRA V2X sidelink to NR V2X sidelink occurs in E-UTRA subframe 'n-1',

- UE is not expected to transmit or receive E-UTRA on V2X sidelink on the subframe 'n-1'.

---

# 13 Measurement Performance Requirements for NR gNB

## 13.1 UL-RTOA

### 13.1.1 Report mapping

The reporting range of UL Relative Time of Arrival (UL-RTOA), as defined in Clause 5.2.2 of TS 38.215 [4], is defined from  $-985024T_c$  to  $+985024 \times T_c$ . The reporting resolution is uniform across the reporting range and is defined as  $T = T_c \times 2^k$  where k is selected by gNB from the set {0, 1, 2, 3, 4, 5}.

$T_c$  is defined in TS 38.211 [6].

LMF provides a recommended resolution parameter, *timingReportingGranularityFactor* [35]. gNB selects parameter k based on *timingReportingGranularityFactor* [35] and informs the LMF.

The mapping of measured quantity for each reporting resolution (k) is defined in Table 13.1.1-1 to Table 13.1.1-6.

**Table 13.1.1-1: UL-RTOA measurement report mapping for reporting resolution of  $T_c$  (k=0)**

Reported Value	Measured Quantity Value	Unit
UL_RTOA_0000	$-985024 > \text{UL\_RTOA}$	$T_c$
UL_RTOA_0001	$-985024 \leq \text{UL\_RTOA} < -985023$	$T_c$
UL_RTOA_0002	$-985023 \leq \text{UL\_RTOA} < -985022$	$T_c$
...	...	...
UL_RTOA_985023	$-2 \leq \text{UL\_RTOA} < -1$	$T_c$

UL_RTOA_985024	$-1 \leq \text{UL\_RTOA} \leq 0$	$T_c$
UL_RTOA_985025	$0 < \text{UL\_RTOA} \leq 1$	$T_c$
UL_RTOA_985026	$1 < \text{UL\_RTOA} \leq 2$	$T_c$
UL_RTOA_985027	$2 < \text{UL\_RTOA} \leq 3$	$T_c$
...	...	...
UL_RTOA_1970048	$985023 < \text{UL\_RTOA} \leq 985024$	$T_c$
UL_RTOA_1970049	$985024 < \text{UL\_RTOA}$	$T_c$

**Table 13.1.1-2: UL-RTOA measurement report mapping for reporting resolution of  $2T_c$  ( $k=1$ )**

Reported Value	Measured Quantity Value	Unit
UL_RTOA_0000	$-985024 > \text{UL\_RTOA}$	$T_c$
UL_RTOA_0001	$-985024 \leq \text{UL\_RTOA} < -985022$	$T_c$
UL_RTOA_0002	$-985022 \leq \text{UL\_RTOA} < -985020$	$T_c$
...	...	...
UL_RTOA_492511	$-4 \leq \text{UL\_RTOA} < -2$	$T_c$
UL_RTOA_492512	$-2 \leq \text{UL\_RTOA} \leq 0$	$T_c$
UL_RTOA_492513	$0 < \text{UL\_RTOA} \leq 2$	$T_c$
UL_RTOA_492514	$2 < \text{UL\_RTOA} \leq 4$	$T_c$
UL_RTOA_492515	$4 < \text{UL\_RTOA} \leq 6$	$T_c$
...	...	...
UL_RTOA_985024	$985022 < \text{UL\_RTOA} \leq 985024$	$T_c$
UL_RTOA_985025	$985024 < \text{UL\_RTOA}$	$T_c$

**Table 13.1.1-3: UL-RTOA measurement report mapping for reporting resolution of  $4T_c$  ( $k=2$ )**

Reported Value	Measured Quantity Value	Unit
UL_RTOA_0000	$-985024 > \text{UL\_RTOA}$	$T_c$
UL_RTOA_0001	$-985024 \leq \text{UL\_RTOA} < -985020$	$T_c$
UL_RTOA_0002	$-985020 \leq \text{UL\_RTOA} < -985018$	$T_c$
...	...	...
UL_RTOA_246255	$-8 \leq \text{UL\_RTOA} < -4$	$T_c$
UL_RTOA_246256	$-4 \leq \text{UL\_RTOA} \leq 0$	$T_c$
UL_RTOA_246257	$0 < \text{UL\_RTOA} \leq 4$	$T_c$
UL_RTOA_246258	$4 < \text{UL\_RTOA} \leq 8$	$T_c$
UL_RTOA_246259	$8 < \text{UL\_RTOA} \leq 12$	$T_c$
...	...	...
UL_RTOA_492512	$985020 < \text{UL\_RTOA} \leq 985024$	$T_c$
UL_RTOA_492513	$985024 < \text{UL\_RTOA}$	$T_c$

**Table 13.1.1-4: UL-RTOA measurement report mapping for reporting resolution of  $8T_c$  ( $k=3$ )**

Reported Value	Measured Quantity Value	Unit
UL_RTOA_0000	$-985024 > \text{UL\_RTOA}$	$T_c$
UL_RTOA_0001	$-985024 \leq \text{UL\_RTOA} < -985016$	$T_c$
UL_RTOA_0002	$-985016 \leq \text{UL\_RTOA} < -985008$	$T_c$
...	...	...
UL_RTOA_123127	$-16 \leq \text{UL\_RTOA} < -8$	$T_c$
UL_RTOA_123128	$-8 \leq \text{UL\_RTOA} \leq 0$	$T_c$
UL_RTOA_123129	$0 < \text{UL\_RTOA} \leq 8$	$T_c$
UL_RTOA_123130	$8 < \text{UL\_RTOA} \leq 16$	$T_c$
UL_RTOA_123131	$16 < \text{UL\_RTOA} \leq 24$	$T_c$
...	...	...
UL_RTOA_246256	$985016 < \text{UL\_RTOA} \leq 985024$	$T_c$
UL_RTOA_246257	$985024 < \text{UL\_RTOA}$	$T_c$

**Table 13.1.1-5: UL-RTOA measurement report mapping for reporting resolution of  $16T_c$  ( $k=4$ )**

Reported Value	Measured Quantity Value	Unit
----------------	-------------------------	------

UL_RTOA_0000	-985024 > UL_RTOA	$T_c$
UL_RTOA_0001	$-985024 \leq \text{UL\_RTOA} < -985008$	$T_c$
UL_RTOA_0002	$-985008 \leq \text{UL\_RTOA} < -984992$	$T_c$
...	...	...
UL_RTOA_61563	$-32 \leq \text{UL\_RTOA} < -16$	$T_c$
UL_RTOA_61564	$-16 \leq \text{UL\_RTOA} \leq 0$	$T_c$
UL_RTOA_61565	$0 < \text{UL\_RTOA} \leq 16$	$T_c$
UL_RTOA_61566	$16 < \text{UL\_RTOA} \leq 32$	$T_c$
UL_RTOA_61567	$32 < \text{UL\_RTOA} \leq 48$	$T_c$
...	...	...
UL_RTOA_123128	$985008 < \text{UL\_RTOA} \leq 985024$	$T_c$
UL_RTOA_123129	$985024 < \text{UL\_RTOA}$	$T_c$

**Table 13.1.1-5: UL-RTOA measurement report mapping for reporting resolution of  $32T_c$  ( $k=5$ )**

Reported Value	Measured Quantity Value	Unit
UL_RTOA_0000	-985024 > UL_RTOA	$T_c$
UL_RTOA_0001	$-985024 \leq \text{UL\_RTOA} < -984992$	$T_c$
UL_RTOA_0002	$-984992 \leq \text{UL\_RTOA} < -984960$	$T_c$
...	...	...
UL_RTOA_30781	$-64 \leq \text{UL\_RTOA} < -32$	$T_c$
UL_RTOA_30782	$-32 \leq \text{UL\_RTOA} \leq 0$	$T_c$
UL_RTOA_30783	$0 < \text{UL\_RTOA} \leq 32$	$T_c$
UL_RTOA_30784	$32 < \text{UL\_RTOA} \leq 64$	$T_c$
UL_RTOA_30785	$64 < \text{UL\_RTOA} \leq 96$	$T_c$
...	...	...
UL_RTOA_61564	$984992 < \text{UL\_RTOA} \leq 985024$	$T_c$
UL_RTOA_61565	$985024 < \text{UL\_RTOA}$	$T_c$

## 13.2 gNB Rx-Tx time difference

### 13.2.1 Report mapping

The reporting range of gNB Rx-Tx time difference, as defined in Clause 5.2.3 of TS 38.215 [4], is defined from  $-985024T_c$  to  $+985024T_c$ . The reporting resolution is uniform across the reporting range and is defined as  $T = T_c \cdot 2^k$  where  $k$  is selected by gNB from the set  $\{0, 1, 2, 3, 4, 5\}$ .

$T_c$  is defined in TS 38.211 [6].

LMF provides a recommended resolution parameter, *timingReportingGranularityFactor* [35]. gNB selects parameter  $k$  based on *timingReportingGranularityFactor* [35] and informs the LMF.

The mapping of measured quantity for each reporting resolution ( $k$ ) is defined in Table 13.2.1-1 to Table 13.2.1-6.

**Table 13.2.1-1: gNB Rx-Tx time difference measurement report mapping for reporting resolution of  $T_c$  ( $k=0$ )**

Reported Value	Measured Quantity Value	Unit
RX-TX_0000	-985024 > RX-TX	$T_c$
RX-TX_0001	$-985024 \leq \text{RX-TX} < -985023$	$T_c$
RX-TX_0002	$-985023 \leq \text{RX-TX} < -985022$	$T_c$
...	...	...
RX-TX_985023	$-2 \leq \text{RX-TX} < -1$	$T_c$
RX-TX_985024	$-1 \leq \text{RX-TX} \leq 0$	$T_c$
RX-TX_985025	$0 < \text{RX-TX} \leq 1$	$T_c$
RX-TX_985026	$1 < \text{RX-TX} \leq 2$	$T_c$
RX-TX_985027	$2 < \text{RX-TX} \leq 3$	$T_c$
...	...	...
RX-TX_1970048	$985023 < \text{RX-TX} \leq 985024$	$T_c$

RX-TX_1970049	985024 < RX-TX	T <sub>c</sub>
---------------	----------------	----------------

**Table 13.2.1-2: gNB Rx-Tx time difference measurement report mapping for reporting resolution of 2T<sub>c</sub> (k=1)**

Reported Value	Measured Quantity Value	Unit
RX-TX_0000	-985024 > RX-TX	T <sub>c</sub>
RX-TX_0001	-985024 ≤ RX-TX < -985022	T <sub>c</sub>
RX-TX_0002	-985022 ≤ RX-TX < -985020	T <sub>c</sub>
...	...	...
RX-TX_492511	-4 ≤ RX-TX < -2	T <sub>c</sub>
RX-TX_492512	-2 ≤ RX-TX ≤ 0	T <sub>c</sub>
RX-TX_492513	0 < RX-TX ≤ 2	T <sub>c</sub>
RX-TX_492514	2 < RX-TX ≤ 4	T <sub>c</sub>
RX-TX_492515	4 < RX-TX ≤ 6	T <sub>c</sub>
...	...	...
RX-TX_985024	985022 < RX-TX ≤ 985024	T <sub>c</sub>
RX-TX_985025	985024 < RX-TX	T <sub>c</sub>

**Table 13.2.1-3: gNB Rx-Tx time difference measurement report mapping for reporting resolution of 4T<sub>c</sub> (k=2)**

Reported Value	Measured Quantity Value	Unit
RX-TX_0000	-985024 > RX-TX	T <sub>c</sub>
RX-TX_0001	-985024 ≤ RX-TX < -985020	T <sub>c</sub>
RX-TX_0002	-985020 ≤ RX-TX < -985018	T <sub>c</sub>
...	...	...
RX-TX_246255	-8 ≤ RX-TX < -4	T <sub>c</sub>
RX-TX_246256	-4 ≤ RX-TX ≤ 0	T <sub>c</sub>
RX-TX_246257	0 < RX-TX ≤ 4	T <sub>c</sub>
RX-TX_246258	4 < RX-TX ≤ 8	T <sub>c</sub>
RX-TX_246259	8 < RX-TX ≤ 12	T <sub>c</sub>
...	...	...
RX-TX_492512	985020 < RX-TX ≤ 985024	T <sub>c</sub>
RX-TX_492513	985024 < RX-TX	T <sub>c</sub>

**Table 13.2.1-4: gNB Rx-Tx time difference measurement report mapping for reporting resolution of 8T<sub>c</sub> (k=3)**

Reported Value	Measured Quantity Value	Unit
RX-TX_0000	-985024 > RX-TX	T <sub>c</sub>
RX-TX_0001	-985024 ≤ RX-TX < -985016	T <sub>c</sub>
RX-TX_0002	-985016 ≤ RX-TX < -985008	T <sub>c</sub>
...	...	...
RX-TX_123127	-16 ≤ RX-TX < -8	T <sub>c</sub>
RX-TX_123128	-8 ≤ RX-TX ≤ 0	T <sub>c</sub>
RX-TX_123129	0 < RX-TX ≤ 8	T <sub>c</sub>
RX-TX_123130	8 < RX-TX ≤ 16	T <sub>c</sub>
RX-TX_123131	16 < RX-TX ≤ 24	T <sub>c</sub>
...	...	...
RX-TX_246256	985016 < RX-TX ≤ 985024	T <sub>c</sub>
RX-TX_246257	985024 < RX-TX	T <sub>c</sub>

**Table 13.2.1-5: gNB Rx-Tx time difference measurement report mapping for reporting resolution of 16T<sub>c</sub> (k=4)**

Reported Value	Measured Quantity Value	Unit
RX-TX_0000	-985024 > RX-TX	T <sub>c</sub>
RX-TX_0001	-985024 ≤ RX-TX < -985008	T <sub>c</sub>

RX-TX_0002	$-985008 \leq \text{RX-TX} < -984992$	$T_c$
...	...	...
RX-TX_61563	$-32 \leq \text{RX-TX} < -16$	$T_c$
RX-TX_61564	$-16 \leq \text{RX-TX} \leq 0$	$T_c$
RX-TX_61565	$0 < \text{RX-TX} \leq 16$	$T_c$
RX-TX_61566	$16 < \text{RX-TX} \leq 32$	$T_c$
RX-TX_61567	$32 < \text{RX-TX} \leq 48$	$T_c$
...	...	...
RX-TX_123128	$985008 < \text{RX-TX} \leq 985024$	$T_c$
RX-TX_123129	$985024 < \text{RX-TX}$	$T_c$

**Table 13.2.1-5: gNB Rx-Tx time difference measurement report mapping for reporting resolution of  $32T_c$  ( $k=5$ )**

Reported Value	Measured Quantity Value	Unit
RX-TX_0000	$-985024 > \text{RX-TX}$	$T_c$
RX-TX_0001	$-985024 \leq \text{RX-TX} < -984992$	$T_c$
RX-TX_0002	$-984992 \leq \text{RX-TX} < -984960$	$T_c$
...	...	...
RX-TX_30781	$-64 \leq \text{RX-TX} < -32$	$T_c$
RX-TX_30782	$-32 \leq \text{RX-TX} \leq 0$	$T_c$
RX-TX_30783	$0 < \text{RX-TX} \leq 32$	$T_c$
RX-TX_30784	$32 < \text{RX-TX} \leq 64$	$T_c$
RX-TX_30785	$64 < \text{RX-TX} \leq 96$	$T_c$
...	...	...
RX-TX_61564	$984992 < \text{RX-TX} \leq 985024$	$T_c$
RX-TX_61565	$985024 < \text{RX-TX}$	$T_c$

## 13.2.2 Measurement Accuracy Requirements

### 13.2.2.1 Introduction

This clause defines accuracy requirements for gNB Rx-Tx time difference measurement in FR1 and FR2. The requirements are applicable for gNB supporting gNB Rx-Tx time difference measurement. The gNB, which declares the support for gNB Rx-Tx time difference measurement also declares that it meets gNB Rx-Tx time difference accuracy requirements at least for one side condition  $\hat{E}_s/I_{ot} \geq +3$  dB or  $\hat{E}_s/I_{ot} \geq -13$  dB.

### 13.2.2.2 Requirements

The accuracy requirements for gNB Rx-Tx time difference measurement shall be within  $\pm(X+Y) T_c$  under the following conditions:

- AWGN propagation conditions.
- The measured signals are in the directions covered by RoAoA of OTA reference sensitivity requirements for gNB type 1-O and 2-O BS

where

- X is defined in Table 13.2.2.2-1 for gNB types 1-C, 1-H and 1-O and in Table 13.2.2.2-2 for gNB type 2-O.
- Y is declared by manufacturer and can be different for different gNB types 1-C, 1-H, 1-O and 2-O.

Note: The measurement accuracy requirements in Table 13.2.2.2-1 and Table 13.2.2.2-2 are defined under an assumption that gNB is not mandated to perform receive beam sweeping.

Table 13.2.2.2-1: gNB Rx-Tx time difference absolute accuracy in FR1 for gNB type 1-C, 1-H and 1-O

Accuracy Unit: Tc	SRS $\bar{E}_s$ /lot Unit: dB	SCS Unit: kHz	SRS bandwidth range Unit: RB
123	$\geq -13$	15	$44 \leq BW \leq 84$
48			$88 \leq BW \leq 168$
17			$176 \leq BW$
122	$\geq +3$		$24 \leq BW \leq 40$
62			$44 \leq BW \leq 84$
32			$88 \leq BW \leq 168$
16	$\geq -13$	30	$176 \leq BW$
42			$48 \leq BW \leq 84$
24			$88 \leq BW \leq 168$
8	$\geq +3$		$176 \leq BW$
32			$48 \leq BW \leq 84$
17			$88 \leq BW \leq 168$
9	$\geq -13$	60	$176 \leq BW$
21			$48 \leq BW \leq 84$
12			$88 \leq BW$
16	$\geq +3$		$48 \leq BW \leq 84$
9			$88 \leq BW$

Table 13.2.2.2-2: gNB Rx-Tx time difference absolute accuracy in FR2 for gNB type 2-O

Accuracy Unit: Tc	SRS $\bar{E}_s$ /lot Unit: dB	SCS Unit: kHz	SRS bandwidth range Unit: RB
9	$\geq -13$	60	$132 \leq BW \leq 168$
8			$176 \leq BW$
9	$\geq +3$		$132 \leq BW \leq 168$
8			$176 \leq BW$
22	$\geq -13$	120	$32 \leq BW \leq 40$
15			$44 \leq BW \leq 84$
8			$88 \leq BW$
16	$\geq +3$		$32 \leq BW \leq 40$
9			$44 \leq BW \leq 84$
8			$88 \leq BW$

## 13.3 UL SRS RSRP measurement

### 13.3.1 Report mapping

The reporting range of UL SRS RSRP, as defined in clause 5.2.5 of 38.215 [4], is defined from -156dBm to -31dBm with resolution 1dB.

The mapping of measured quantity is defined in Table 13.3.1-1. The range in the signalling may be larger than the guaranteed accuracy range.

Table 13.3.1-1: UL SRS RSRP report mapping

Reported value	Measured quantity value	Unit
SRS_RSRP_0	$SRS\text{-}RSRP < -156$	dBm
SRS_RSRP_1	$-156 \leq SRS\text{-}RSRP < -155$	dBm
SRS_RSRP_2	$-155 \leq SRS\text{-}RSRP < -154$	dBm
SRS_RSRP_3	$-154 \leq SRS\text{-}RSRP < -153$	dBm
SRS_RSRP_4	$-153 \leq SRS\text{-}RSRP < -152$	dBm
SRS_RSRP_5	$-152 \leq SRS\text{-}RSRP < -151$	dBm
SRS_RSRP_6	$-151 \leq SRS\text{-}RSRP < -150$	dBm
SRS_RSRP_7	$-150 \leq SRS\text{-}RSRP < -149$	dBm
SRS_RSRP_8	$-149 \leq SRS\text{-}RSRP < -148$	dBm
SRS_RSRP_9	$-148 \leq SRS\text{-}RSRP < -147$	dBm



SRS_RSRP_10	$-147 \leq \text{SRS-RSRP} < -146$	dBm
SRS_RSRP_11	$-146 \leq \text{SRS-RSRP} < -145$	dBm
SRS_RSRP_12	$-145 \leq \text{SRS-RSRP} < -144$	dBm
SRS_RSRP_13	$-144 \leq \text{SRS-RSRP} < -143$	dBm
SRS_RSRP_14	$-143 \leq \text{SRS-RSRP} < -142$	dBm
SRS_RSRP_15	$-142 \leq \text{SRS-RSRP} < -141$	dBm
SRS_RSRP_16	$-141 \leq \text{SRS-RSRP} < -140$	dBm
SRS_RSRP_17	$-140 \leq \text{SRS-RSRP} < -139$	dBm
SRS_RSRP_18	$-139 \leq \text{SRS-RSRP} < -138$	dBm
...	...	...
SRS_RSRP_111	$-46 \leq \text{SRS-RSRP} < -45$	dBm
SRS_RSRP_112	$-45 \leq \text{SRS-RSRP} < -44$	dBm
SRS_RSRP_113	$-44 \leq \text{SRS-RSRP} < -43$	dBm
SRS_RSRP_114	$-43 \leq \text{SRS-RSRP} < -42$	dBm
SRS_RSRP_115	$-42 \leq \text{SRS-RSRP} < -41$	dBm
SRS_RSRP_116	$-41 \leq \text{SRS-RSRP} < -40$	dBm
SRS_RSRP_117	$-40 \leq \text{SRS-RSRP} < -39$	dBm
SRS_RSRP_118	$-39 \leq \text{SRS-RSRP} < -38$	dBm
SRS_RSRP_119	$-38 \leq \text{SRS-RSRP} < -37$	dBm
SRS_RSRP_120	$-37 \leq \text{SRS-RSRP} < -36$	dBm
SRS_RSRP_121	$-36 \leq \text{SRS-RSRP} < -35$	dBm
SRS_RSRP_122	$-35 \leq \text{SRS-RSRP} < -34$	dBm
SRS_RSRP_123	$-34 \leq \text{SRS-RSRP} < -33$	dBm
SRS_RSRP_124	$-33 \leq \text{SRS-RSRP} < -32$	dBm
SRS_RSRP_125	$-32 \leq \text{SRS-RSRP} < -31$	dBm
SRS_RSRP_126	$-31 \leq \text{SRS-RSRP}$	dBm

## 13.3.2 Measurement accuracy requirements

### 13.3.2.1 Introduction

This clause defines accuracy requirements for SRS-RSRP measurement in FR1 and FR2. The requirements are applicable for gNB supporting SRS-RSRP measurement. The gNB, which declares the support for SRS-RSRP measurement also declares that it meets SRS-RSRP accuracy requirements at least for one side condition  $\hat{\text{E}}_s/\text{lot} \geq +3$  dB or  $\hat{\text{E}}_s/\text{lot} \geq -13$  dB.

### 13.3.2.2 Requirements

The accuracy requirements in Table 13.3.2.2-1, Table 13.3.2.2-2 and Table 13.3.2.2-3 are valid under the following conditions:

AWGN propagation conditions.

The measured signals are in the directions covered by RoAoA of OTA reference sensitivity requirements for gNB type 1-O and 2-O BS

Note: The measurement accuracy requirements in Table 13.3.2.2-1, Table 13.3.2.2-2 and Table 13.3.2.2-3 are defined under an assumption that gNB is not mandated to perform receive beam sweeping.

**Table 13.3.2.2-1 gNB SRS-RSRP absolute accuracy requirements in FR1 for gNB type 1-C**

Accuracy	Conditions	
	SRS $\hat{\text{E}}_s/\text{lot}$	SRS bandwidth range
dB	dB	RB
$\pm 4$	$\hat{\text{E}}_s/\text{lot} \geq +3$	$24 \leq \text{BW} < 48$
$\pm 4$		$48 \leq \text{BW} < 132$

$\pm 4$		$132 \leq \text{BW}$
$\pm 6.5$	$\hat{\epsilon}_s/\text{lot} \geq -13$	$48 \leq \text{BW} < 132$
$\pm 5.5$		$132 \leq \text{BW}$

Table 13.3.2.2-2 gNB SRS-RSRP absolute accuracy requirements in FR1 for gNB type 1-H and 1-O

Accuracy	Conditions	
	SRS $\hat{\epsilon}_s/\text{lot}$	SRS bandwidth range
dB	dB	RB
$\pm 5.5$	$\hat{\epsilon}_s/\text{lot} \geq +3$	$24 \leq \text{BW} < 48$
$\pm 5.5$		$48 \leq \text{BW} < 132$
$\pm 5.5$		$132 \leq \text{BW}$
$\pm 8$	$\hat{\epsilon}_s/\text{lot} \geq -13$	$48 \leq \text{BW} < 132$
$\pm 7$		$132 \leq \text{BW}$

Table 13.3.2.2-3 gNB SRS-RSRP absolute accuracy requirements in FR2 for gNB type 2-O

Accuracy	Conditions	
	SRS $\hat{\epsilon}_s/\text{lot}$	SRS bandwidth range
dB	dB	RB
$\pm 5.5$	$\hat{\epsilon}_s/\text{lot} \geq +3$	$32 \leq \text{BW} < 64$
$\pm 5.5$		$64 \leq \text{BW} < 132$
$\pm 5.5$		$132 \leq \text{BW}$
$\pm 8$	$\hat{\epsilon}_s/\text{lot} \geq -13$	$64 \leq \text{BW} < 132$
$\pm 7$		$132 \leq \text{BW}$

## 13.4 AoA/ZoA

### 13.4.1 Report mapping

The reporting range of UL Angle of Arrival (UL-AoA), as defined in Clause 5.2.4 of TS 38.215 [4], is defined from -180 degree to +180 degree for azimuth angle of arrival (A-AoA). The reporting resolution is 0.1 degree.

The reporting range of UL Angle of Arrival, as defined in Clause 5.2.4 of TS 38.215 [4], is defined from 0 degree to +180 degree for zenith angle of arrival (Z-AoA). The reporting resolution is 0.1 degree.

The mapping of A-AoA measured quantity is defined in Table 13.4.1-1. The mapping of Z-AoA measured quantity is defined in Table 13.4.1-2.

Table 13.4.1-1: Azimuth Angle of Arrival (A-AoA) measurement report mapping

Reported value	Measured quantity value (A-AoA)	Unit
A-AoA_0	$-180 \leq \text{A-AoA} < -179.9$	degree
A-AoA_1	$-179.9 \leq \text{A-AoA} < -179.8$	degree
A-AoA_2	$-179.8 \leq \text{A-AoA} < -179.7$	degree
...	...	...
A-AoA_1798	$-0.2 \leq \text{A-AoA} < -0.1$	degree
A-AoA_1799	$-0.1 \leq \text{A-AoA} < 0$	degree
A-AoA_1800	$0 \leq \text{A-AoA} < 0.1$	degree
A-AoA_1801	$0.1 \leq \text{A-AoA} < 0.2$	degree
A-AoA_1802	$0.2 \leq \text{A-AoA} < 0.3$	degree

...	...	...
A-AoA_3598	$179.8 \leq A\text{-AoA} < 179.9$	degree
A-AoA_3599	$179.9 \leq A\text{-AoA} < 180$	degree

**Table 13.4.1-2: Zenith Angle of Arrival (Z-AoA) measurement report mapping**

Reported value	Measured quantity value (Z-AoA)	Unit
Z-AoA_0	$0 \leq Z\text{-AoA} < 0.1$	degree
Z-AoA_1	$0.1 \leq Z\text{-AoA} < 0.2$	degree
Z-AoA_2	$0.2 \leq Z\text{-AoA} < 0.3$	degree
...	...	...
Z-AoA_1798	$179.8 \leq Z\text{-AoA} < 179.9$	degree
Z-AoA_1799	$179.9 \leq Z\text{-AoA} \leq 180$	degree

---

# Annex A (normative): Test Cases

---

## A.1 Purpose of annex

## A.2 Requirement classification for statistical testing

Requirements in this specification are either expressed as absolute requirements with a single value stating the requirement, or expressed as a success rate. There are no provisions for the statistical variations that will occur when the parameter is tested.

Annex A outlines the tests in more detail and lists the test parameters needed. The test will result in an outcome of a test variable value for the device under test (DUT) inside or outside the test limit. Overall, the probability of a "good" DUT being inside the test limit(s) and the probability of a "bad" DUT being outside the test limit(s) should be as high as possible. For this reason, when selecting the test variable and the test limit(s), the statistical nature of the test is accounted for.

The statistical nature depends on the type of requirement. Some have large statistical variations, while others are not statistical in nature at all. When testing a parameter with a statistical nature, a confidence level is set. This establishes the probability that a DUT passing the test actually meets the requirements and determines how many times a test has to be repeated and what the pass and fail criteria are. Those aspects are not covered by TS 38.133. The details of the tests on how many times to run it and how to establish confidence in the tests are described in TS 38.533 [5]. This Annex establishes the variable to be used in the test and whether it can be viewed as statistical in nature or not.

### A.2.1 Types of requirements in TS 38.133

#### A.2.1.1 Time and delay requirements on UE higher layer actions

A very large part of the RRM requirements are delay requirements:

- In RRC\_IDLE state mobility (clause A.6.1 and A.7.1) there is cell re-selection delay.
- In RRC\_CONNECTED state mobility (clauses A.4.3, A.4.6, A.5.3, A.5.6, A.6.3, A.6.6, A.7.3 and A.7.6) there is handover delay, cell search delay and measurement reporting delay.
- In RRC Connection Control (clauses A.4.3.2, A.5.3.2, A.6.3.2 and A.7.3.2) there is RRC re-establishment delay.

All have in common that the UE is required to perform an action observable in higher layers (e.g. camp on the correct cell) within a certain time after a specific event (e.g. when a new strong pilot or reference signal appears). The delay time is statistical in nature for several reasons, among others that several of the measurements are performed by the UE in a fading radio environment.

The variations make a strict limit unsuitable for a test. Instead there is a condition set for a correct action by the UE, e.g. that the UE shall camp on the correct cell within X seconds. Then the rate of correct events is observed during repeated tests and a limit is set on the rate of correct events, usually 90% correct events are required. How the limit is applied in the test depends on the confidence required, further detailed are in TS 38.533 [5].

#### A.2.1.2 Measurements of power levels, relative powers and time

A very large number of requirements are on measurements that the UE performs:

- In RRC\_CONNECTED state mobility (clauses A.4.3, A.5.3, A.6.3 and A.7.3) there are measurement reports.
- In Measurement Performance Requirements (clauses A.4.7, A.5.7, A.6.7 and A.7.7) there are requirements for all type of measurements.

The accuracy requirements on measurements are expressed in this specification as a fixed limit (e.g. +/-X dB), but the measurement error will have a distribution that is not easily confined in fixed limits. Assuming a Gaussian distribution of the error, the limits will have to be set at  $\pm 3.29\sigma$  if the probability of failing a "good DUT" in a single test is to be kept at 0.1%. It is more reasonable to set the limit tighter and test the DUT by counting the rate of measurements that are within the limits, in a way similar to the requirements on delay.

### A.2.1.3 Implementation requirements

A few requirements are strict actions the UE should take or capabilities the UE should have, without any allowance for deviations. These requirements are absolute and should be tested as such. Examples are:

- "Event triggered report rate" in RRC\_CONNECTED state mobility (clauses A.4.3, A.4.6, A.5.3, A.5.6, A.6.3, A.6.6, A.7.3 and A.7.6)
- "Correct behaviour at time-out" in RRC connection control (clauses A.4.3.2, A.5.3.2, A.6.3.2 and A.7.3.2)

### A.2.1.4 Physical layer timing requirements

There are requirements on Timing (clauses A.4.4, A.5.4, A.6.4 and A.7.4). There are both absolute and relative limits on timing accuracy depending upon the type of requirement. Examples are:

- Initial Transmit Timing (clauses A.4.4.1, A.5.4.1, A.6.4.1 and A.7.4.1) has an absolute limit on timing accuracy.
- Timing Advance (clauses A.4.4.2, A.5.4.2, A.6.4.2 and A.7.4.2) has a relative limit on timing accuracy.

### A.2.1.5 Requirements under CCA

A few requirements include CCA failures in DL and or UL. Considering that the CCA model is of statistical nature, requirements that include CCA failures are always considered of statistical nature.

## A.3 RRM test configurations

### A.3.1 Reference measurement channels

#### A.3.1.1 PDSCH

##### A.3.1.1.1 FDD

**Table A.3.1.1.1-1: PDSCH Reference Measurement Channels for SCS=15kHz**

Parameter	Unit	Value						
Reference channel		SR.1.1 FDD						
Channel bandwidth	MHz	Defined in test case						
Number of transmitter antennas		1						
Allocated resource blocks for PDSCH <small>Note 1</small>		24						
Allocated slots per Radio Frame		10						
Radio frame containing SSB	slots	Note 5						
Radio frame not containing SSB	slots	10						
MCS index		4						
Modulation		QPSK						
Target Coding Rate		1/3						
Number of control symbols		2						

PDSCH mapping type		Type A					
Information Bit Payload							
For slots with RMSI <sup>Note 2</sup>	bits	1608					
For slots without RMSI	bits	1864					
Number of Code Blocks per slot		1					
Binary Channel Bits Per slot							
For slots with RMSI <sup>Note 2, Note 4</sup>	bits	5184					
For slots without RMSI <sup>Note 6</sup>	bits	6048					
<p>Note 1: Allocated outside the SMTC duration in time and in resource blocks which do not overlap with the resource blocks allocated for SS/PBCH block.</p> <p>Note 2: PDSCH is scheduled on the slots with RMSI.</p> <p>Note 3: If necessary the information bit payload size can be adjusted to facilitate the test implementation. The payload sizes are defined in TS 38.213 [3].</p> <p>Note 4: Derived based on the PDSCH DMRS assumption: dmrs-TypeA-Position=2, dmrs-Type=1, dmrs-AdditionalPositions=2, maxLength=1, Antenna port index: 1000, and Number of PDSCH DMRS CDM group(s) without data: 2.</p> <p>Note 5: PDSCH is not scheduled in slots containing SSB according to the SSB configuration used in the test. SSB configurations are defined in clause A.3.10.</p> <p>Note 6: Derived based on the PDSCH DMRS assumption: dmrs-TypeA-Position=2, dmrs-Type=1, dmrs-AdditionalPositions=2, maxLength=1, Antenna port index: 1000, and Number of PDSCH DMRS CDM group(s) without data: 1.</p> <p>Note 7: When DRX is configured, PDCCH can be scheduled both for downlink assignment and/or UL grant only during (<math>[10]ms - drx-InactivityTimer</math>) from timing when drx-onDurationTimer starts, unless otherwise specified in the test case</p>							

### A.3.1.1.2 TDD

**Table A.3.1.1.2-1: PDSCH Reference Measurement Channels for SCS=15kHz**

Parameter	Unit	Value					
		SR.1.1 TDD	SR.1.2 TDD				
Reference channel		SR.1.1 TDD	SR.1.2 TDD				
Channel bandwidth	MHz	Defined in test case	Defined in test case				
Number of transmitter antennas		1	1				
Allocated resource blocks for PDSCH <sup>Note 1</sup>		24	24				
Allocated slots per Radio Frame							
Radio frame containing SSB	slots	Note 5	Note 5				
Radio frame not containing SSB	slots	4	6				
MCS table		64QAM	64QAM				
MCS index		4	4				
Modulation		QPSK	QPSK				
Target Coding Rate		1/3	1/3				
Number of control symbols		2	2				
PDSCH mapping type		Type A	Type A				
Information Bit Payload							
For slots with RMSI <sup>Note 2</sup>	bits	1608	1608				
For slots without RMSI	bits	1864	1864				
For special slots	bits	N/A	1128				
Number of Code Blocks per slot		1	1				
Binary Channel Bits Per slot							
For slots with RMSI <sup>Note 2, Note 4</sup>	bits	5184	5184				

For slots without RMSI Note 6	bits	6048	6048				
For special slots Note 6	bits	-	3744				
<p>Note 1: Allocated outside the SMTC duration in time and in resource blocks which do not overlap with the resource blocks allocated for SS/PBCH block.</p> <p>Note 2: PDSCH is scheduled on the slots with RMSI.</p> <p>Note 3: If necessary the information bit payload size can be adjusted to facilitate the test implementation. The payload sizes are defined in TS 38.213 [3].</p> <p>Note 4: Derived based on the PDSCH DMRS assumption: dmrs-TypeA-Position=2, dmrs-Type=1, dmrs-AdditionalPositions=2, maxLength=1, Antenna port index: 1000, and Number of PDSCH DMRS CDM group(s) without data: 2.</p> <p>Note 5: PDSCH is not scheduled in slots containing SSB according to the SSB configuration used in the test. SSB configurations are defined in clause A.3.10.</p> <p>Note 6: Derived based on the PDSCH DMRS assumption: dmrs-TypeA-Position=2, dmrs-Type=1, dmrs-AdditionalPositions=2, maxLength=1, Antenna port index: 1000, and Number of PDSCH DMRS CDM group(s) without data: 1.</p> <p>Note 7: When DRX is configured, PDCCH can be scheduled both for downlink assignment and/or UL grant only during ([10]ms - drx-InactivityTimer) from timing when drx-onDurationTimer starts, unless otherwise specified in the test case</p>							

**Table A.3.1.1.2-2: PDSCH Reference Measurement Channels for SCS=30kHz**

Parameter	Unit	Value					
Reference channel		SR.2.1 TDD					
Channel bandwidth	MHz	Defined in test case					
Number of transmitter antennas		1					
Allocated resource blocks for PDSCH Note 1		24					
Allocated slots per Radio Frame							
Radio frame containing SSB	slots	Note 5					
Radio frame not containing SSB	slots	10					
MCS table		64QAM					
MCS index		4					
Modulation		QPSK					
Target Coding Rate		1/3					
Number of control symbols		2					
PDSCH mapping type		Type A					
Information Bit Payload							
For slots with RMSI Note 2	bits	1608					
For slots without RMSI	bits	1864					
Number of Code Blocks per slot		1					
Binary Channel Bits Per slot							
For slots with RMSI Note 2, Note 4	bits	5184					
For slots without RMSI Note 6	bits	6048					
<p>Note 1: Allocated outside the SMTC duration in time and in resource blocks which do not overlap with the resource blocks allocated for SS/PBCH block.</p> <p>Note 2: PDSCH is scheduled on the slots with RMSI.</p> <p>Note 3: If necessary the information bit payload size can be adjusted to facilitate the test implementation. The payload sizes are defined in TS 38.213 [3].</p> <p>Note 4: Derived based on the PDSCH DMRS assumption: dmrs-TypeA-Position=2, dmrs-Type=1, dmrs-AdditionalPositions=2, maxLength=1, Antenna port index: 1000, and Number of PDSCH DMRS CDM group(s) without data: 2.</p> <p>Note 5: PDSCH is not scheduled in slots containing SSB according to the SSB configuration used in the test. SSB configurations are defined in clause A.3.10.</p>							

Note 6: Derived based on the PDSCH DMRS assumption: *dmrs-TypeA-Position=2*, *dmrs-Type=1*, *dmrs-AdditionalPositions=2*, *maxLength=1*, Antenna port index: 1000, and Number of PDSCH DMRS CDM group(s) without data: 1..

Note 7: When DRX is configured, PDCCH can be scheduled both for downlink assignment and/or UL grant only during ( $[10]ms - drx-InactivityTimer$ ) from timing when *drx-onDurationTimer* starts, unless otherwise specified in the test case

**Table A.3.1.1.2-3: PDSCH Reference Measurement Channels for SCS=120kHz**

Parameter	Unit	Value						
		SR.3.1 TDD	SR.3.2 TDD	SR.3.3 TDD				
Reference channel								
Channel bandwidth	MHz	100	100	100				
Number of transmitter antennas		1	1	1				
Allocated resource blocks for PDSCH		24 <sup>Note 1</sup>	24 <sup>Note 7</sup>	48 <sup>Note 7</sup>				
Allocated slots per Radio Frame								
Radio frame containing SSB	slots	Note 5	Note 5	Note 5				
Radio frame not containing SSB	slots	48	48	48				
MCS table		64QAM	64QAM	64QAM				
MCS index		4	4	4				
Modulation		QPSK	QPSK	QPSK				
Target Coding Rate		1/3	1/3	1/3				
Number of control symbols		2	2	2				
PDSCH mapping type		Type A	Type A	Type A				
Information Bit Payload								
For slots with RMSI	bits	1608	1608	3104				
For slots without RMSI	bits	1864	1864	3624				
Number of Code Blocks per slot		1	1	1				
Binary Channel Bits Per slot								
For slots with RMSI <sup>Note 4</sup>	bits	5184	5184	10368				
For slots without RMSI <sup>Note 6</sup>	bits	6048	6048	12096				
<p>Note 1: Allocated in resource blocks which do not overlap with the resource blocks allocated for SS/PBCH block</p> <p>Note 2: Void</p> <p>Note 3: If necessary the information bit payload size can be adjusted to facilitate the test implementation. The payload sizes are defined in TS 38.213 [3].</p> <p>Note 4: Derived based on the PDSCH DMRS assumption: <i>dmrs-TypeA-Position=2</i>, <i>dmrs-Type=1</i>, <i>dmrs-AdditionalPositions=2</i>, <i>maxLength=1</i>, Antenna port index: 1000, and Number of PDSCH DMRS CDM group(s) without data: 2.</p> <p>Note 5: PDSCH is not scheduled in slots containing SSB according to the SSB configuration used in the test. SSB configurations are defined in clause A.3.10.</p> <p>Note 6: Derived based on the PDSCH DMRS assumption: <i>dmrs-TypeA-Position=2</i>, <i>dmrs-Type=1</i>, <i>dmrs-AdditionalPositions=2</i>, <i>maxLength=1</i>, Antenna port index: 1000, and Number of PDSCH DMRS CDM group(s) without data: 1.</p> <p>Note 7: Allocated in the same resource blocks as the CORESET.</p> <p>Note 8: When DRX is configured, PDSCH is scheduled only while <i>drx-onDurationTimer</i> is running, unless otherwise specified in the test case.</p>								



## A.3.1A Reference measurement channels under CCA

### A.3.1A.1 PDSCH

#### A.3.1A.1.1 TDD

**Table A.3.1A.1.1-1: PDSCH Reference Measurement Channels for SCS=30kHz**

Parameter	Unit	Value					
Reference channel		SR.1.1 CCA					
Channel bandwidth	MHz	40					
Number of transmitter antennas		1					
Allocated resource blocks for PDSCH <sup>Note 1</sup>		24					
Allocated slots per Radio Frame							
Radio frame containing SSB	slots	Note 5					
Radio frame not containing SSB	slots	Note 7					
MCS table		64QAM					
MCS index		4					
Modulation		QPSK					
Target Coding Rate		1/3					
Number of control symbols		2					
PDSCH mapping type		Type A					
Information Bit Payload							
For slots with RMSI <sup>Note 2</sup>	bits	1608					
For slots without RMSI	bits	1864					
Number of Code Blocks per slot		1					
Binary Channel Bits Per slot							
For slots with RMSI <sup>Note 2, Note 4</sup>	bits	5184					
For slots without RMSI <sup>Note 6</sup>	bits	6048					
<p>Note 1: Allocated outside the discovery burst transmission window in time and in resource blocks which do not overlap with the resource blocks allocated for SS/PBCH block.</p> <p>Note 2: PDSCH is scheduled on the slots with RMSI.</p> <p>Note 3: If necessary the information bit payload size can be adjusted to facilitate the test implementation. The payload sizes are defined in TS 38.213 [3].</p> <p>Note 4: Derived based on the PDSCH DMRS assumption: dmrs-TypeA-Position=2, dmrs-Type=1, dmrs-AdditionalPositions=2, maxLength=1, Antenna port index: 1000, and Number of PDSCH DMRS CDM group(s) without data: 2.</p> <p>Note 5: PDSCH is not scheduled in slots containing SSB according to the SSB configuration used in the test. SSB configurations are defined in clause A.3.10A.</p> <p>Note 6: Derived based on the PDSCH DMRS assumption: dmrs-TypeA-Position=2, dmrs-Type=1, dmrs-AdditionalPositions=2, maxLength=1, Antenna port index: 1000, and Number of PDSCH DMRS CDM group(s) without data: 1.</p> <p>Note 7: PDSCH is transmitted during the RMC burst as specified in A.3.1A.5.</p>							

### A.3.1A.2 CORESET for RMSI scheduling

#### A.3.1A.2.1 TDD

**Table A.3.1A.2.1-1: RMSI CORESET Reference Channel for SCS=30KHz**

Parameter	Unit	Value
-----------	------	-------

Reference channel		CR.1.1 CCA						
Channel bandwidth	MHz	40						
Subcarrier spacing	kHz	30						
Allocated resource blocks for RMSI CORESET <sup>Note 7</sup>		48						
SSB and RMSI CORESET multiplexing configuration <sup>Note 7</sup>		Pattern 1						
Offset between SSB and RMSI CORESET <sup>Note 3, 7</sup>	RB	0 (Note 8)						
Configuration of PDCCH monitoring occasions for RMSI CORESET <sup>Note 4</sup>		Index 0						
Number of transmitter antennas		1						
Duration of RMSI CORESET <sup>Note 7</sup>	symbols	2						
DCI Format <sup>Note 1</sup>		Note 2						
Aggregation level	CCE	8						
DMRS precoder granularity		6						
REG bundle size		6						
Mapping from REG to CCE		Distributed						
Cell ID		Note 5						
Payload (without CRC)	bits	Note 6						
<p>Note 1: DCI formats are defined in TS 38.212.</p> <p>Note 2: DCI format shall depend upon the test configuration.</p> <p>Note 3: The offset is defined with respect to the subcarrier spacing of the CORESET from the smallest RB index of RMSI CORESET to the smallest RB index of the common RB overlapping with the first RB of the SS/PBCH block.</p> <p>Note 4: The configuration of PDCCH monitoring occasions for RMSI CORESET is defined in Table 13-11 in TS 38.213 [3].</p> <p>Note 5: Cell ID shall depend upon the test configuration.</p> <p>Note 6: Payload size shall depend upon the test configuration.</p> <p>Note 7: The configuration of set of resource blocks and slot symbols of control resource set for Type0-PDCCH search space corresponds to index 4 in Table 13-4A in TS 38.213 [3].</p> <p>Note 8: Other values can be used to align with GSCN [13] as long as SSB does not overlap the RMC.</p>								

### A.3.1A.3 CORESET for RMC scheduling

#### A.3.1A.3.1 TDD

**Table A.3.1A.3.1-1: Control Channel RMC with SCS=30KHz**

Parameter	Unit	Value						
Reference channel		CCR.1.1 CCA	CCR.1.2 CCA	CCR.1.3 CCA				
Channel bandwidth	MHz	40	40	40				
Subcarrier spacing	kHz	30	30	30				
Allocated resource blocks for CORESET <sup>Note 3</sup>		24	24	18				
Number of transmitter antennas		1	1	1				
Duration of CORESET	symbols	2	2	2				
REG bundle size		6	6	6				
DMRS precoder granularity		Same as REG bundle size	Same as REG bundle size	Same as REG bundle size				
CCE to REG mapping		Interleaved	Interleaved	Interleaved				

Interleave n_shift		0	0	0				
Interleave size		2	2	2				
Beamforming Pre-Coder		N/A	N/A	N/A				
Aggregation level	CCE	4	8	4				
DCI formats		Note 1	Note 1	Note 1				
Payload size (without CRC)	bits	Note 2	Note 2	Note 2				
Note 1: DCI format shall depend upon the test configuration. Note 2: Payload size shall depend upon the test configuration. Note 3: Allocated in the same resource blocks where the associated RMC is scheduled.								

### A.3.1A.4 TDD UL/DL configuration

**Table A.3.1A.4-1: TDD UL/DL configuration for SCS=30kHz**

Parameter	Unit	Value	
Reference channel		TDDConf.1.1 CCA	
referenceSubcarrierSpacing	kHz	N/A	
TDD UL/DL pattern 1 <sup>Note 2, Note 3</sup>		‘3D1S4U’ S=‘6DL:4GP:4UL’	
dl-UL-TransmissionPeriodicity	ms	N/A	
nrofDownlinkSlots		N/A	
nrofDownlinkSymbols		N/A	
nrofUplinkSlot		N/A	
nrofUplinkSymbols		N/A	
TDD UL/DL pattern 2 <sup>Note 2, Note 3</sup>		‘DD’	
dl-UL-TransmissionPeriodicity	ms	N/A	
nrofDownlinkSlots		N/A	
nrofDownlinkSymbols		N/A	
nrofUplinkSlot		N/A	
nrofUplinkSymbols		N/A	
Note 1: As specified in TS 38.213 [3] and TS 38.331 [2]. Note 2: Do not configure <i>tdd-UL-DL-ConfigurationCommon</i> using RRC configuration Note 3: The UE will be scheduled via DCI according to the TDD pattern defined in the table.			

### A.3.1A.5 RMC burst transmission model

RMC not conveying RMSI is scheduled during the RMC burst. The length of the transmission burst in slots is defined as N. The burst transmission format is determined according to the steps below:

1. Select N randomly from a given set of the number of slots  $S_1 = \{1,3,5\}$  with equal probability as the total length of RMC burst transmission format.
2. A uniform random variable from 0 to 1 is generated. If the random variable is less than  $P_{CCA\_DL}$ , a burst of N fully occupied slots is transmitted. Otherwise, the RMC burst transmission is muted and the muting duration is the same as the number N of slots for determined burst format.

RMC burst transmission is scheduled outside discovery burst transmission window. If transmission occurred in the previous slot, transmission is muted for a duration of one slot. Additionally, if the start time of the candidate RMC burst transmission is within 5 slots of the start of the discovery burst transmission window, RMC transmission is not performed.

### A.3.1.2 CORESET for RMSI scheduling

#### A.3.1.2.1 FDD

**Table A.3.1.2.1-1: RMSI CORESET Reference Channel for FDD with SCS=15KHz**

Parameter	Unit	Value
-----------	------	-------

Reference channel		CR.1.1 FDD						
Channel bandwidth	MHz	Defined in test case						
Subcarrier spacing for RMSI CORESET	kHz	15						
Allocated resource blocks for RMSI CORESET <small>Note 7</small>		24						
Subcarrier spacing for SSB	kHz	15						
SSB and RMSI CORESET multiplexing configuration <small>Note 7</small>		Pattern 1						
Offset between SSB and RMSI CORESET <small>Note 3, 7</small>	RB	0 (Note8)						
Configuration of PDCCH monitoring occasions for RMSI CORESET <small>Note 4</small>		Index 4						
Number of transmitter antennas		1						
Duration of RMSI CORESET <small>Note 7</small>	symbols	2						
DCI Format <small>Note 1</small>		Note 2						
Aggregation level	CCE	8						
DMRS precoder granularity		6						
REG bundle size		6						
Mapping from REG to CCE		Distributed						
Cell ID		Note 5						
Payload (without CRC)	bits	Note 6						
<p>Note 1: DCI formats are defined in TS 38.212.</p> <p>Note 2: DCI format shall depend upon the test configuration.</p> <p>Note 3: The offset is defined with respect to the subcarrier spacing of the CORESET from the smallest RB index of RMSI CORESET to the smallest RB index of the common RB overlapping with the first RB of the SS/PBCH block.</p> <p>Note 4: The configuration of PDCCH monitoring occasions for RMSI CORESET is defined in Table 13-11 in TS 38.213 [3].</p> <p>Note 5: Cell ID shall depend upon the test configuration.</p> <p>Note 6: Payload size shall depend upon the test configuration.</p> <p>Note 7: The configuration of set of resource blocks and slot symbols of control resource set for Type0-PDCCH search space corresponds to index 0 in Table 13-1 in TS 38.213 [3]</p> <p>Note 8: Other values can be used to align with GSCN [13] as long as SSB does not overlap the RMC.</p>								

A.3.1.2.2 TDD

Table A.3.1.2.2-1: RMSI CORESET Reference Channel for TDD with SCS=15KHz

Parameter	Unit	Value						
Reference channel		CR.1.1 TDD						
Channel bandwidth	MHz	Defined in test case						
Subcarrier spacing	kHz	15						
Allocated resource blocks for RMSI CORESET <small>Note 7</small>		24						
SSB and RMSI CORESET multiplexing configuration <small>Note 7</small>		Pattern 1						
Offset between SSB and RMSI CORESET <small>Note 3, 7</small>	RB	0 (Note 8)						
Configuration of PDCCH monitoring occasions for RMSI CORESET <small>Note 4</small>		Index 4						

Number of transmitter antennas		1						
Duration of RMSI CORESET <sup>Note 7</sup>	symbols	2						
DCI Format <sup>Note 1</sup>		Note 2						
Aggregation level	CCE	8						
DMRS precoder granularity		6						
REG bundle size		6						
Mapping from REG to CCE		Distributed						
Cell ID		Note 5						
Payload (without CRC)	bits	Note 6						
<p>Note 1: DCI formats are defined in TS 38.212.</p> <p>Note 2: DCI format shall depend upon the test configuration.</p> <p>Note 3: The offset is defined with respect to the subcarrier spacing of the CORESET from the smallest RB index of RMSI CORESET to the smallest RB index of the common RB overlapping with the first RB of the SS/PBCH block.</p> <p>Note 4: The configuration of PDCCH monitoring occasions for RMSI CORESET is defined in Table 13-11 in TS 38.213 [3].</p> <p>Note 5: Cell ID shall depend upon the test configuration.</p> <p>Note 6: Payload size shall depend upon the test configuration.</p> <p>Note 7: The configuration of set of resource blocks and slot symbols of control resource set for Type0-PDCCH search space corresponds to index 0 in Table 13-1 in TS 38.213 [3].</p> <p>Note 8: Other values can be used to align with GSCN [13] as long as SSB does not overlap the RMC.</p>								

**Table A.3.1.2.2-2: RMSI CORESET Reference Channel for TDD with SCS=30KHz**

Parameter	Unit	Value						
Reference channel		CR.2.1 TDD						
Channel bandwidth	MHz	Defined in test case						
Subcarrier spacing	kHz	30						
Allocated resource blocks for RMSI CORESET <sup>Note 7</sup>		24						
SSB and RMSI CORESET multiplexing configuration <sup>Note 7</sup>		Pattern 1						
Offset between SSB and RMSI CORESET <sup>Note 3, 7</sup>	RB	0 (Note 8)						
Configuration of PDCCH monitoring occasions for RMSI CORESET <sup>Note 4</sup>		Index 4						
Number of transmitter antennas		1						
Duration of RMSI CORESET <sup>Note 7</sup>	symbols	2						
DCI Format <sup>Note 1</sup>		Note 2						
Aggregation level	CCE	8						
DMRS precoder granularity		6						
REG bundle size		6						
Mapping from REG to CCE		Distributed						
Cell ID		Note 5						
Payload (without CRC)	bits	Note 6						
<p>Note 1: DCI formats are defined in TS 38.212.</p> <p>Note 2: DCI format shall depend upon the test configuration.</p> <p>Note 3: The offset is defined with respect to the subcarrier spacing of the CORESET from the smallest RB index of RMSI CORESET to the smallest RB index of the common RB overlapping with the first RB of the SS/PBCH block.</p> <p>Note 4: The configuration of PDCCH monitoring occasions for RMSI CORESET is defined in Table 13-11 in TS 38.213 [3].</p> <p>Note 5: Cell ID shall depend upon the test configuration.</p>								

Note 6: Payload size shall depend upon the test configuration.  
 Note 7: The configuration of set of resource blocks and slot symbols of control resource set for Type0-PDCCH search space corresponds to index 0 in Table 13-6 in TS 38.213 [3].  
 Note 8: Other values can be used to align with GSCN [13] as long as SSB does not overlap the RMC.

**Table A.3.1.2.2-3: RMSI CORESET Reference Channel for TDD with SCS=120KHz**

Parameter	Unit	Value						
		CR.3.1 TDD	CR.3.2 TDD					
Reference channel								
Channel bandwidth	MHz	100	100					
Subcarrier spacing	kHz	120	120					
Allocated resource blocks for RMSI CORESET		24 <sup>Note 7</sup>	48 <sup>Note 9</sup>					
SSB and RMSI CORESET multiplexing configuration		Pattern 1 <sup>Note 7</sup>	Pattern 1 <sup>Note 9</sup>					
Offset between SSB and RMSI CORESET <sup>Note 3</sup>	RB	0 (Note 8) <sup>Note 7</sup>	0 (Note 8) <sup>Note 9</sup>					
Configuration of PDCCH monitoring occasions for RMSI CORESET <sup>Note 4</sup>		Index 4	Index 4					
Number of transmitter antennas		1	1					
Duration of RMSI CORESET	symbols	2 <sup>Note 7</sup>	2 <sup>Note 9</sup>					
DCI Format <sup>Note 1</sup>		Note 2	Note 2					
Aggregation level	CCE	8	8					
DMRS precoder granularity		6	6					
REG bundle size		6	6					
Mapping from REG to CCE		Distributed	Distributed					
Cell ID		Note 5	Note 5					
Payload (without CRC)	bits	Note 6	Note 6					
Note 1: DCI formats are defined in TS 38.212. Note 2: DCI format shall depend upon the test configuration. Note 3: The offset is defined with respect to the subcarrier spacing of the CORESET from the smallest RB index of RMSI CORESET to the smallest RB index of the common RB overlapping with the first RB of the SS/PBCH block. Note 4: The configuration of PDCCH monitoring occasions for RMSI CORESET is defined in Table 13-12 in TS 38.213 [3]. Note 5: Cell ID shall depend upon the test configuration. Note 6: Payload size shall depend upon the test configuration. Note 7: The configuration of set of resource blocks and slot symbols of control resource set for Type0-PDCCH search space corresponds to index 0 in Table 13-8 in TS 38.213 [3]. Note 8: Other values can be used to align with GSCN [13] as long as SSB does not overlap the RMC. Note 9: The configuration of set of resource blocks and slot symbols of control resource set for Type0-PDCCH search space corresponds to index 2 in Table 13-10 in TS 38.213 [3].								

### A.3.1.3 CORESET for RMC scheduling

#### A.3.1.3.1 FDD

**Table A.3.1.3.1-1: Control Channel RMC for FDD with SCS=15KHz**

Parameter	Unit	Value						
		CCR.1.1 FDD	CCR.1.2 FDD	CCR.1.3 FDD	CCR.1.4 FDD	CCR.1.5 FDD		
Reference channel								
Channel bandwidth	MHz	Defined in test case	Defined in test case	Defined in test case	Defined in test case	Defined in test case		
Subcarrier spacing	kHz	15	15	15	15	15		
Allocated resource blocks for CORESET <sup>Note 3</sup>		24	18	24	18	24		

Number of transmitter antennas		1	1	1	1	1		
Duration of CORESET	symbols	2	2	2	2	2		
REG bundle size		6	6	6	6	6		
monitoringSymbolsWithinSlot		1000000 0000000	1000000 0000000	1000000 0000000	1000000 0000000	0010000 0000000		
DMRS precoder granularity		Same as REG bundle size	Same as REG bundle size	Same as REG bundle size	Same as REG bundle size	Same as REG bundle size		
CCE to REG mapping		Interleaved	Interleaved	Interleaved	Interleaved	Interleaved		
Interleave n_shift		0	0	0	0	0		
Interleave size		2	2	2	2	2		
Beamforming Pre-Coder		N/A	N/A	N/A	N/A	N/A		
Aggregation level	CCE	4	2	8	4	4		
DCI formats		Note 1	Note 1	Note 1	Note 1	Note 1		
Payload size (without CRC)	bits	Note 2	Note 2	Note 2	Note 2	Note 2		
Note 1: DCI format shall depend upon the test configuration. Note 2: Payload size shall depend upon the test configuration Note 3: Allocated in the resource blocks where the associated RMC is scheduled.								

A.3.1.3.2 TDD

Table A.3.1.3.2-1: Control Channel RMC for TDD with SCS=15KHz

Parameter	Unit	Value						
		CCR.1.1 TDD	CCR.1.2 TDD	CCR.1.3 TDD	CCR.1.4 TDD	CCR.1.5 TDD		
Reference channel		CCR.1.1 TDD	CCR.1.2 TDD	CCR.1.3 TDD	CCR.1.4 TDD	CCR.1.5 TDD		
Channel bandwidth	MHz	Defined in test case	Defined in test case	Defined in test case	Defined in test case	Defined in test case		
Subcarrier spacing	kHz	15	15	15	15	15		
Allocated resource blocks for CORESET <sup>Note 3</sup>		24	18	24	18	18		
Number of transmitter antennas		1	1	1	1	1		
Duration of CORESET	symbols	2	2	2	2	2		
monitoringSymbolsWithinSlot		1000000 0000000	1000000 0000000	1000000 0000000	1000000 0000000	0010000 0000000		
REG bundle size		6	6	6	6	6		
DMRS precoder granularity		Same as REG bundle size	Same as REG bundle size	Same as REG bundle size	Same as REG bundle size	Same as REG bundle size		
CCE to REG mapping		Interleaved	Interleaved	Interleaved	Interleaved	Interleaved		
Interleave n_shift		0	0	0	0	0		
Interleave size		2	2	2	2	2		
Beamforming Pre-Coder		N/A	N/A	N/A	N/A	N/A		
Aggregation level	CCE	4	2	8	4	4		
DCI formats		Note 1	Note 1	Note 1	Note 1	Note 1		
Payload size (without CRC)	bits	Note 2	Note 2	Note 2	Note 2	Note 2		
Note 1: DCI format shall depend upon the test configuration. Note 2: Payload size shall depend upon the test configuration Note 3: Allocated in the resource blocks where the associated RMC is scheduled.								

Table A.3.1.3.2-2: Control Channel RMC for TDD with SCS=30KHz

Parameter	Unit	Value					
		CCR.2.1 TDD	CCR.2.2 TDD	CCR.2.3 TDD	CCR.2.4 TDD		
Reference channel		CCR.2.1 TDD	CCR.2.2 TDD	CCR.2.3 TDD	CCR.2.4 TDD		
Channel bandwidth	MHz	Defined in test case	Defined in test case	Defined in test case	Defined in test case		
Subcarrier spacing	kHz	30	30	30	30		
Allocated resource blocks for CORESET <sup>Note 3</sup>		24	24	18	18		

Number of transmitter antennas		1	1	1	1			
Duration of CORESET	symbols	2	2	2	2			
REG bundle size		6	6	6	6			
DMRS precoder granularity		Same as REG bundle size	Same as REG bundle size	Same as REG bundle size	Same as REG bundle size			
CCE to REG mapping		Interleaved	Interleaved	Interleaved	Interleaved			
Interleave n_shift		0	0	0	0			
Interleave size		2	2	2	2			
Beamforming Pre-Coder		N/A	N/A	N/A	N/A			
Aggregation level	CCE	4	8	4	2			
DCI formats		Note 1	Note 1	Note 1	Note 1			
Payload size (without CRC)	bits	Note 2	Note 2	Note 2	Note 2			
Note 1: DCI format shall depend upon the test configuration. Note 2: Payload size shall depend upon the test configuration. Note 3: Allocated in the same resource blocks where the associated RMC is scheduled.								

**Table A.3.1.3.2-3: Control Channel RMC for TDD with SCS=120KHz**

Parameter	Unit	Value						
		CCR.3.1 TDD	CCR.3.2 TDD	CCR.3.3 TDD	CCR.3.4 TDD	CCR.3.5 TDD	CCR.3.6 TDD	CCR.3.7 TDD
Reference channel								
Channel bandwidth	MHz	100	100	100	100	100	100	100
Subcarrier spacing	kHz	120	120	120	120	120	120	120
Allocated resource blocks for CORESET <sup>Note 3</sup>		24	24	24	24	24	24	48
Number of transmitter antennas		1	1	1	1	1	1	1
monitoringSlotPeriodicityAndOffset		sl160 0	sl160 0	sl160 80	sl160 0	sl160 0	sl160 80	sl160 0
monitoringSlotPeriodicityAndOffset <sup>Note 4</sup>		1100000 0000000	0011000 0000000	1100000 0000000	1000000 0000000	0010000 0000000	1000000 0000000	1100000 0000000
Duration of CORESET	slot	1	1	1	2	2	2	1
REG bundle size		6	6	6	6	6	6	6
DMRS precoder granularity		Same as REG bundle size	Same as REG bundle size	Same as REG bundle size	Same as REG bundle size	Same as REG bundle size	Same as REG bundle size	Same as REG bundle size
CCE to REG mapping		Interleaved	Interleaved	Interleaved	Interleaved	Interleaved	Interleaved	Interleaved
Interleave n_shift		0	0	0	0	0	0	0
Interleave size		2	2	2	2	2	2	2
Beamforming Pre-Coder		N/A	N/A	N/A	N/A	N/A	N/A	N/A
Aggregation level	CCE	4	4	4	8	8	8	4
DCI formats		Note 1	Note 1	Note 1	Note 1	Note 1	Note 1	Note 1
Payload size (without CRC)	bits	Note 2	Note 2	Note 2	Note 2	Note 2	Note 2	Note 2
Note 1: DCI format shall depend upon the test configuration. Note 2: Payload size shall depend upon the test configuration. Note 3: Allocated in the same resource blocks where the associated PDSCH RMC is scheduled. Note 4: <i>monitoringSlotPeriodicityAndOffset</i> is set to "sl1 0" if it is specifically stated that cell(s) configured with one of the control channel RMCs above shall transmit PDCCHs continuously.								



## A.3.1.4 TDD UL/DL configuration

Table A.3.1.4-1: TDD UL/DL configuration for SCS=15kHz

Parameter	Unit	Value		
		TDDConf.1.1	TDDConf.1.2	
Reference channel				
<i>referenceSubcarrierSpacing</i>	kHz	15	15	
TDD UL/DL pattern 1 <sup>Note 2</sup>		'DSUU' S='10DL:2GP:2UL'	'DSUU' S='6DL:2GP:6UL'	
<i>dl-UL-TransmissionPeriodicity</i>	ms	4	4	
<i>nrofDownlinkSlots</i>		1	1	
<i>nrofDownlinkSymbols</i>		10	6	
<i>nrofUplinkSlot</i>		2	2	
<i>nrofUplinkSymbols</i>		2	6	
TDD UL/DL pattern 2 <sup>Note 2</sup>		'D'	'D'	
<i>dl-UL-TransmissionPeriodicity</i>	ms	1	1	
<i>nrofDownlinkSlots</i>		1	1	
<i>nrofDownlinkSymbols</i>		0	0	
<i>nrofUplinkSlot</i>		0	0	
<i>nrofUplinkSymbols</i>		0	0	
Note 1: As specified in TS 38.213 [3] and TS 38.331 [2].				
Note 2: For information				

Table A.3.1.4-2: TDD UL/DL configuration for SCS=30kHz

Parameter	Unit	Value		
		TDDConf.2.1	TDDConf.2.2	TDDConf.2.3
Reference channel				
<i>referenceSubcarrierSpacing</i>	kHz	30	30	30
TDD UL/DL pattern 1 <sup>Note 2</sup>		'3D1S4U' S='6DL:4GP:4UL'	'1D1S2U' S='11DL:1GP:2UL'	'3D1S4U' S='4DL:4GP:6UL'
<i>dl-UL-TransmissionPeriodicity</i>	ms	4	2	4
<i>nrofDownlinkSlots</i>		3	1	3
<i>nrofDownlinkSymbols</i>		6	11	4
<i>nrofUplinkSlot</i>		4	2	4
<i>nrofUplinkSymbols</i>		4	2	6
TDD UL/DL pattern 2 <sup>Note 2</sup>		'DD'	Not configured	'DD'
<i>dl-UL-TransmissionPeriodicity</i>	ms	1	Not configured	1
<i>nrofDownlinkSlots</i>		2	Not configured	2
<i>nrofDownlinkSymbols</i>		0	Not configured	0
<i>nrofUplinkSlot</i>		0	Not configured	0
<i>nrofUplinkSymbols</i>		0	Not configured	0
Note 1: As specified in TS 38.213 [3] and TS 38.331 [2].				
Note 2: For information				

Table A.3.1.4-3: TDD UL/DL configuration for SCS=120kHz

Parameter	Unit	Value		
		TDDConf.3.1	TDDConf.3.2	
Reference channel				
<i>referenceSubcarrierSpacing</i>	kHz	120	120	
TDD UL/DL pattern 1 <sup>Note 2</sup>		'DDDSU' S='10DL:2GP:2UL'	'DDDSU' S='6DL:2GP:6UL'	
<i>dl-UL-TransmissionPeriodicity</i>	ms	0.625	0.625	
<i>nrofDownlinkSlots</i>		3	3	
<i>nrofDownlinkSymbols</i>		10	6	
<i>nrofUplinkSlot</i>		1	1	
<i>nrofUplinkSymbols</i>		2	6	

TDD UL/DL pattern 2 <sup>Note 2</sup>		Not configured	Not configured	
<i>dl-UL-TransmissionPeriodicity</i>	ms	Not configured	Not configured	
<i>nrofDownlinkSlots</i>		Not configured	Not configured	
<i>nrofDownlinkSymbols</i>		Not configured	Not configured	
<i>nrofUplinkSlot</i>		Not configured	Not configured	
<i>nrofUplinkSymbols</i>		Not configured	Not configured	
Note 1: As specified in TS 38.213 [3] and TS 38.331 [2].				
Note 2: For information				

## A.3.2 OFDMA channel noise generator (OCNG)

### A.3.2.1 Generic OFDMA Channel Noise Generator (OCNG)

The OCNG pattern is used in a test for modelling allocations of unused resources in the channel bandwidth to virtual UEs (which are not under test). The OCNG pattern comprises PDCCH and PDSCH transmissions to the virtual UEs.

#### A.3.2.1.1 OCNG pattern 1: Generic OCNG pattern for all unused REs

**Table A.3.2.1.1-1: OP.1: Generic OCNG pattern for all unused REs**

OCNG Parameters	Control Region	Data Region
Resource allocation	Unused REs (Note 1)	Unused REs (Note 2)
Channel	PDCCH	PDSCH
Contents	Virtual UE IDs	Uncorrelated pseudo random QPSK modulated data
Antenna transmission scheme	Same as used in PDCCH RMC	Same as used in PDSCH RMC
Subcarrier spacing	Same as used in PDCCH RMC	Same as used in PDSCH RMC
Aggregation level	Same as used in PDCCH RMC	N/A
Code rate	Same as used in PDCCH RMC	Same as used in PDSCH RMC
Transmit Power	Same as used in PDCCH RMC	Same as used in PDSCH RMC
CP length	Same as used in PDCCH RMC	Same as used in PDSCH RMC
Note 1: REs not used in the active CORESETs where PDCCH is scheduled for the UE under test.		
Note 2: REs not allocated to any physical channels, CORESET, SSB or any other reference signal within the channel bandwidth of the cell, confined to $BW_{occupied}$ where specified in the test case.		

#### A.3.2.1.2 OCNG pattern 2: Generic OCNG pattern for all unused REs for 2AoA setup

**Table A.3.2.1.2-2: OP.2: Generic OCNG pattern for all unused REs for 2AoA setup**

OCNG Parameters	Control Region	Data Region
Probe	Transmitting the serving beam	
Resource allocation	Unused REs (Note 1) in the symbols where SSB/CSI-RS are not transmitted from both the serving beam probe and non-serving beam probe.	Unused REs (Note 2) in the symbols where SSB/CSI-RS are not transmitted from both the serving beam probe and non-serving beam probe.
Channel	PDCCH	PDSCH
Contents	Virtual UE IDs	Uncorrelated pseudo random QPSK modulated data
Antenna transmission scheme	Same as used in PDCCH RMC	Same as used in PDSCH RMC
Subcarrier spacing	Same as used in PDCCH RMC	Same as used in PDSCH RMC
Aggregation level	Same as used in PDCCH RMC	N/A
Code rate	Same as used in PDCCH RMC	Same as used in PDSCH RMC
Transmit Power	Same as used in PDCCH RMC	Same as used in PDSCH RMC
CP length	Same as used in PDCCH RMC	Same as used in PDSCH RMC
Note 1: REs not used in the active CORESETs where PDCCH is scheduled for the UE under test.		

- Note 2: REs not allocated to any physical channels, CORESET, SSB or any other reference signal within the channel bandwidth of the cell, confined to  $BW_{occupied}$  where specified in the test case.
- Note 3: No OCNG is transmitted from the probe transmitting non-serving beam.

### A.3.2.1.3 OCNG pattern 3: Generic OCNG pattern for unused REs in the same bandwidth as CORESET

**Table A.3.2.1.3-1: OP.3: Generic OCNG pattern for unused REs in the same BW as CORESET**

OCNG Parameters	Control Region	Data Region
Resource allocation	Unused REs (Note 1)	Unused REs (Note 2)
Channel	PDCCH	PDSCH
Contents	Virtual UE IDs	Uncorrelated pseudo random QPSK modulated data
Antenna transmission scheme	Same as used in PDCCH RMC	Same as used in PDSCH RMC
Subcarrier spacing	Same as used in PDCCH RMC	Same as used in PDSCH RMC
Aggregation level	Same as used in PDCCH RMC	N/A
Code rate	Same as used in PDCCH RMC	Same as used in PDSCH RMC
Transmit Power	Same as used in PDCCH RMC	Same as used in PDSCH RMC
CP length	Same as used in PDCCH RMC	Same as used in PDSCH RMC
Note 1:	REs not used in the active CORESETs where PDCCH is scheduled for the UE under test. REs for OCNG shall not be allocated outside the allocated bandwidth of the CORESET of the serving cell.	
Note 2:	REs not allocated to any physical channels, CORESET, SSB or any other reference signal within the allocated bandwidth of the CORESET of the serving cell. REs for OCNG shall not be allocated outside the allocated bandwidth of the CORESET of the serving cell.	

### A.3.2.1.4 OCNG pattern 4: Generic OCNG pattern for all unused REs outside SSB slot(s)

**Table A.3.2.1.4-1: OP.4: Generic OCNG pattern for all unused REs outside SSB slot(s)**

OCNG Parameters	Control Region	Data Region
Resource allocation	Unused REs (Note 1)	Unused REs (Note 2)
Channel	PDCCH	PDSCH
Contents	Virtual UE IDs	Uncorrelated pseudo random QPSK modulated data
Antenna transmission scheme	Same as used in PDCCH RMC	Same as used in PDSCH RMC
Subcarrier spacing	Same as used in PDCCH RMC	Same as used in PDSCH RMC
Aggregation level	Same as used in PDCCH RMC	N/A
Code rate	Same as used in PDCCH RMC	Same as used in PDSCH RMC
Transmit Power	Same as used in PDCCH RMC	Same as used in PDSCH RMC
CP length	Same as used in PDCCH RMC	Same as used in PDSCH RMC
Note 1:	REs not used in the active CORESETs where PDCCH is scheduled for the UE under test. REs for OCNG shall not be allocated in the slot(s) containing SSB of the respective cell.	
Note 2:	REs not allocated to any physical channels, CORESET, SSB or any other reference signal within the channel bandwidth of the cell. REs for OCNG shall not be allocated in the slot(s) containing SSB of the respective cell.	

### A.3.2.1.5 OCNG pattern 5: Generic OCNG pattern for unused REs in the same bandwidth as CORESET for 2AoA setup

**Table A.3.2.1.5-1: OP.5: Generic OCNG pattern for unused REs in the same BW as CORESET for 2AoA setup**

OCNG Parameters	Control Region	Data Region
Probe	Transmitting the serving beam	
Resource allocation	Unused REs (Note 1) in the symbols where SSB/CSI-RS are not transmitted from both the serving	Unused REs (Note 2) in the symbols where SSB/CSI-RS are not transmitted from both the

	beam probe and non-serving beam probe.	serving beam probe and non-serving beam probe.
Channel	PDCCH	PDSCH
Contents	Virtual UE IDs	Uncorrelated pseudo random QPSK modulated data
Antenna transmission scheme	Same as used in PDCCH RMC	Same as used in PDSCH RMC
Subcarrier spacing	Same as used in PDCCH RMC	Same as used in PDSCH RMC
Aggregation level	Same as used in PDCCH RMC	N/A
Code rate	Same as used in PDCCH RMC	Same as used in PDSCH RMC
Transmit Power	Same as used in PDCCH RMC	Same as used in PDSCH RMC
CP length	Same as used in PDCCH RMC	Same as used in PDSCH RMC
Note 1:	REs not used in the active CORESETs where PDCCH is scheduled for the UE under test. REs for OCNG shall not be allocated outside the allocated bandwidth of the CORESET of the serving cell.	
Note 2:	REs not allocated to any physical channels, CORESET, SSB or any other reference signal within the allocated bandwidth of the CORESET of the serving cell. REs for OCNG shall not be allocated outside the allocated bandwidth of the CORESET of the serving cell.	
Note 3:	No OCNG is transmitted from the probe transmitting non-serving beam.	

### A.3.2.2 Void

## A.3.3 Reference DRX configurations

### A.3.3.1 DRX Configuration 1: DRX cycle = 40 ms and TAT = 500 ms

**Table A.3.3.1-1: DRX.1: DRX cycle = 40 ms and time alignment timer (TAT) = 500 ms**

Field	Value
drx-onDurationTimer	1 ms
drx-InactivityTimer	1 ms
drx-RetransmissionTimerDL	1 slot
drx-RetransmissionTimerUL	1 slot
drx-LongCycleStartOffset	40 ms
shortDRX	disable
TimeAlignmentTimer	500 ms
Note:	This DRX configuration is applicable for NR serving cell. The DRX cycle and time alignment timer parameters are specified in clause 6.3.2 in TS 38.331 [2]

### A.3.3.2 DRX Configuration 2: DRX cycle = 640 ms and TAT = 500 ms

**Table A.3.3.2-1: DRX.2: DRX cycle = 640 ms and time alignment timer (TAT) = 500 ms**

Field	Value
drx-onDurationTimer	1 ms
drx-InactivityTimer	1 ms
drx-RetransmissionTimerDL	1 slot
drx-RetransmissionTimerUL	1 slot
drx-LongCycleStartOffset	640 ms
shortDRX	disable
TimeAlignmentTimer	500 ms
Note:	This DRX configuration is applicable for NR serving cell. The DRX cycle and time alignment timer parameters are specified in clause 6.3.2 in TS 38.331 [2]

### A.3.3.3 DRX Configuration 3: DRX cycle = 40 ms and TAT = Infinity

**Table A.3.3.3-1: DRX.3: DRX cycle = 40 ms and time alignment timer (TAT) = Infinity**

Field	Value
drx-onDurationTimer	6 ms
drx-InactivityTimer	1 ms
drx-RetransmissionTimerDL	1 slot
drx-RetransmissionTimerUL	1 slot
drx-LongCycleStartOffset	40 ms
shortDRX	disable
TimeAlignmentTimer	Infinity
Note:	This DRX configuration is applicable for NR serving cell. The DRX cycle and time alignment timer parameters are specified in clause 6.3.2 in TS 38.331 [2]

### A.3.3.4 DRX Configuration 4: DRX cycle = 160 ms and TAT = Infinity

**Table A.3.3.4-1: DRX.4: DRX cycle = 160 ms and time alignment timer (TAT) = Infinity**

Field	Value
drx-onDurationTimer	psf2
drx-InactivityTimer	psf2
drx-RetransmissionTimer	Psf16
longDRX-CycleStartOffset	sf160, 0
shortDRX	disable
TimeAlignmentTimer	Infinity
Note:	This DRX configuration is applicable for E-UTRA serving cell. For further information see clause 6.3.2 in TS 36.331 [16].

### A.3.3.5 DRX Configuration 5: DRX cycle = 320 ms and TAT = Infinity

**Table A.3.3.5-1: DRX.5: DRX cycle = 320 ms and time alignment timer (TAT) = Infinity**

Field	Value
drx-onDurationTimer	psf6
drx-InactivityTimer	psf1920
drx-RetransmissionTimer	psf16
longDRX-CycleStartOffset	sf320, 0
shortDRX	disable
TimeAlignmentTimer	Infinity
Note:	This DRX configuration is applicable for E-UTRA serving cell. For further information see clause 6.3.2 in TS 36.331 [16].

### A.3.3.6 DRX Configuration 6: DRX cycle = 320 ms and TAT = 500 ms

**Table A.3.3.6-1: DRX.6: DRX cycle = 320 ms and time alignment timer (TAT) = 500 ms**

Field	Value
drx-onDurationTimer	1 ms
drx-InactivityTimer	1 ms
drx-RetransmissionTimerDL	1 slot
drx-RetransmissionTimerUL	1 slot
drx-LongCycleStartOffset	320 ms
shortDRX	disable
TimeAlignmentTimer	500 ms
Note:	This DRX configuration is applicable for NR serving cell. The DRX cycle and time alignment timer parameters are specified in clause 6.3.2 in TS 38.331 [2]

### A.3.3.7 DRX Configuration 7: DRX cycle = 640 ms and TAT = Infinity

**Table A.3.3.7-1: DRX.7: DRX cycle = 640 ms and time alignment timer (TAT) = Infinity**

Field	Value
drx-onDurationTimer	6 ms
drx-InactivityTimer	1 ms
drx-RetransmissionTimerDL	1 slot
drx-RetransmissionTimerUL	1 slot
drx-LongCycleStartOffset	640 ms
shortDRX	disable
TimeAlignmentTimer	Infinity
Note:	This DRX configuration is applicable for NR serving cell. The DRX cycle and time alignment timer parameters are specified in clause 6.3.2 in TS 38.331 [2]

### A.3.3.8 DRX Configuration 8: DRX cycle = 320 ms and TAT = Infinity

**Table A.3.3.8-1: DRX.8: DRX cycle = 320 ms and time alignment timer (TAT) = Infinity**

Field	Value
drx-onDurationTimer	6 ms
drx-InactivityTimer	1 ms
drx-RetransmissionTimerDL	1 slot
drx-RetransmissionTimerUL	1 slot
drx-LongCycleStartOffset	320 ms
shortDRX	disable
TimeAlignmentTimer	Infinity
Note:	This DRX configuration is applicable for NR serving cell. The DRX cycle and time alignment timer parameters are specified in clause 6.3.2 in TS 38.331 [2]

### A.3.3.9 DRX Configuration 9: DRX cycle = 40 ms and TAT = 500 ms

**Table A.3.3.9-1: DRX.9: DRX cycle = 40 ms and time alignment timer (TAT) = 500 ms**

Field	Value
drx-onDurationTimer	psf2
drx-InactivityTimer	psf2
drx-RetransmissionTimer	psf16
longDRX-CycleStartOffset	sf40, 0
shortDRX	disable
TimeAlignmentTimer	500 ms
Note:	This DRX configuration is applicable for E-UTRA serving cell. For further information see clause 6.3.2 in TS 36.331 [16].

### A.3.3.10 DRX Configuration 10: DRX cycle = 640 ms and TAT = 500 ms

**Table A.3.3.10-1: DRX.10: DRX cycle = 640 ms and time alignment timer (TAT) = 500 ms**

Field	Value
drx-onDurationTimer	psf6
drx-InactivityTimer	psf2
drx-RetransmissionTimer	psf16
longDRX-CycleStartOffset	sf640, 0
shortDRX	disable

TimeAlignmentTimer	500 ms
Note:	This DRX configuration is applicable for E-UTRA serving cell. For further information see clause 6.3.2 in TS 36.331 [16].

### A.3.3.11 DRX Configuration 11: DRX cycle = 20 ms and TAT = Infinity

**Table A.3.3.11-1: DRX.11: DRX cycle = 20 ms and time alignment timer (TAT) = Infinity**

Field	Value
drx-onDurationTimer	6 ms
drx-InactivityTimer	1 ms
drx-RetransmissionTimerDL	1 slot
drx-RetransmissionTimerUL	1 slot
drx-LongCycleStartOffset	20 ms
shortDRX	disable
TimeAlignmentTimer	Infinity
Note:	This DRX configuration is applicable for NR serving cell. The DRX cycle and time alignment timer parameters are specified in clause 6.3.2 in TS 38.331 [2]

### A.3.3.12 DRX Configuration 12: DRX cycle = 640 ms and TAT = Infinity

**Table A.3.3.12-1: DRX.12: DRX cycle = 640 ms and time alignment timer (TAT) = Infinity**

Field	Value
drx-onDurationTimer	psf6
drx-InactivityTimer	psf2
drx-RetransmissionTimer	psf16
longDRX-CycleStartOffset	sf640, 0
shortDRX	disable
TimeAlignmentTimer	Infinity
Note:	This DRX configuration is applicable for E-UTRA serving cell. For further information see clause 6.3.2 in TS 36.331 [16].

## A.3.4 Test Cases with Different Channel Bandwidths

### A.3.4.1 Test Cases with Different E-UTRA Channel Bandwidths

#### A.3.4.1.1 Introduction

In Annex A test cases involving E-UTRA cell(s) may be defined with different E-UTRA channel bandwidths to verify the same type of RRM requirement.

#### A.3.4.1.2 Principle of testing

If multiple test cases involving E-UTRA cell(s) are defined with different E-UTRA channel bandwidths to verify the same type of RRM requirement that is E-UTRA channel bandwidth independent, then the UE needs to be tested with only one channel bandwidth in each E-UTRA cell and with the same bandwidth in all the E-UTRA cells used in the test case.

## A.3.5 Test Cases for Synchronous and Asynchronous DC Operations

### A.3.5.1 EN-DC Test Cases for Synchronous and Asynchronous EN-DC Operations

#### A.3.5.1.1 Introduction

This clause defines a principle which is applicable to test cases verifying RRM requirements for EN-DC operation in synchronous and asynchronous scenarios.

In Annex A test cases may be defined in both synchronous EN-DC and asynchronous EN-DC scenarios to verify the same type of RRM requirement.

#### A.3.5.1.2 Principle of Testing

If EN-DC test cases are defined in both synchronous and asynchronous EN-DC scenarios to verify the same type of RRM requirement then the UE capable of both synchronous and asynchronous EN-DC operations needs to be tested with one of the tests in either synchronous or asynchronous EN-DC scenarios.

## A.3.6 Antenna configurations

### A.3.6.1 Antenna configurations for FR1

Unless otherwise specified, NR FDD or NR TDD cells in all RRM Test cases in AWGN propagation condition are configured with Antenna Configuration 1x2.

#### A.3.6.1.1 Antenna connection for 4 Rx capable UEs

##### A.3.6.1.1.1 Introduction

All tests in clause A.4 and A.6 are specified for UEs supporting 2RX. In this clause, the antenna connection method for applying 2RX tests to UEs supporting 4RX antenna ports is specified. No tests are currently specified in clause A.4 or A.6 which are applicable only to 4RX antenna ports, so 4RX capable UEs are always tested by reusing tests which were originally specified for 2RX UEs.

##### A.3.6.1.1.2 Principle of testing

###### A.3.6.1.1.2.1 Single carrier tests

For 4RX capable UEs supporting at least one band where 2RX is supported and 4RX is not supported, the, all single carrier tests specified in clause A.4 and A.6 except those in A.4.7 and A.6.7 shall be tested on any band where 2RX is supported and 4RX is not supported with the antenna connection specified in A.3.6.1.1.2.4. For single carrier tests specified in clause A.4.7 or A.6.7, all tests shall be tested with the antenna connection specified in A.3.6.1.1.2.4 for bands where 2RX is supported and 4RX is not supported, and the antenna connection specified in A.3.6.1.1.2.5 for bands where 4RX is supported.

For 4RX capable UEs which do not support any band where 2RX is supported and 4RX is not supported, all tests specified in clauses A.4 and A.6 shall be tested using the antenna connection specified in clause A.3.6.1.1.2.5. For radio link monitoring tests, the SNR levels are modified according to table A.3.6.1.1.2.1-1 and table A.3.6.1.1.2.1-2. For beam failure detection and link recovery tests, the SNR levels are modified according to table A.3.6.1.1.2.1-3.

**Table A.3.6.1.1.2.1-1: Modified parameters for RLM out of sync testing with 4 RX antenna connection**

Test case	SNR during T3 (dB)			
	Test 1	Test 2	Test 3	Test 4
A.4.5.1.1	-18	N/A	N/A	N/A
A.4.5.1.3	-18	N/A	N/A	N/A
A.4.5.1.5	-18	N/A	N/A	N/A
A.4.5.1.7	-18	N/A	N/A	N/A
A.5.5.1.1	-18	N/A	N/A	N/A
A.5.5.1.3	-18	N/A	N/A	N/A



A.5.5.1.5	-18	N/A	N/A	N/A
A.5.5.1.7	-18	N/A	N/A	N/A
A.6.5.1.1	-18	N/A	N/A	N/A
A.6.5.1.3	-18	N/A	N/A	N/A
A.6.5.1.5	-18	N/A	N/A	N/A
A.6.5.1.7	-18	N/A	N/A	N/A
A.7.5.1.1	-18	N/A	N/A	N/A
A.7.5.1.3	-18	N/A	N/A	N/A
A.7.5.1.5	-18	N/A	N/A	N/A
A.7.5.1.7	-18	N/A	N/A	N/A

**Table A.3.6.1.1.2.1-2: Modified parameters for RLM in sync single carrier testing with 4 RX antenna connection**

Test case	SNR during T3 (dB)		SNR during T4 (dB)	
	Test 1	Test 2	Test 1	Test 2
A.4.5.1.2	-18	N/A	-8	N/A
A.4.5.1.4	-18	N/A	-8	N/A
A.4.5.1.6	-18	N/A	-8	N/A
A.4.5.1.8	-18	N/A	-8	N/A
A.5.5.1.2	-18	N/A	-8	N/A
A.5.5.1.4	-18	N/A	-8	N/A
A.5.5.1.6	-18	N/A	-8	N/A
A.5.5.1.8	-18	N/A	-8	N/A
A.6.5.1.2	-18	N/A	-8	N/A
A.6.5.1.4	-18	N/A	-8	N/A
A.6.5.1.6	-18	N/A	-8	N/A
A.6.5.1.8	-18	N/A	-8	N/A
A.7.5.1.2	-18	N/A	-8	N/A
A.7.5.1.4	-18	N/A	-8	N/A
A.7.5.1.6	-18	N/A	-8	N/A
A.7.5.1.8	-18	N/A	-8	N/A

**Table A.3.6.1.1.2.1-3: Modified parameters for Beam Failure Detection and Link Recovery testing with 4 RX antenna connection**

Test case	SNR for RS in set $q_0$ during T3, T4 and T5 (dB)
	Test 1
A.4.5.5.1	-15
A.4.5.5.2	-15
A.4.5.5.3	-15
A.4.5.5.4	-15
A.4.5.5.5	-15
A.4.5.5.6	-15
A.5.5.5.1	-15
A.5.5.5.2	-15
A.5.5.5.3	-15
A.5.5.5.4	-15
A.5.5.5.5	-15
A.5.5.5.6	-15
A.5.5.5.7	-15
A.6.5.5.1	-15
A.6.5.5.2	-15
A.6.5.5.3	-15
A.6.5.5.4	-15
A.6.5.5.5	-15
A.6.5.5.6	-15
A.7.5.5.1	-15
A.7.5.5.2	-15
A.7.5.5.3	-15
A.7.5.5.4	-15
A.7.5.5.5	-15
A.7.5.5.6	-15

#### A.3.6.1.1.2.2 Carrier aggregation tests

All carrier aggregation tests are performed using the antenna connection in clause A.3.6.1.1.2.4 for the PCell antenna connection if the PCell is on a band where 2RX is supported and 4RX is not supported, or using the antenna connection in A.3.6.1.1.2.5 for the PCell antenna connection if the PCell is on a band where 4RX is supported.

All carrier aggregation tests are performed using the antenna connection in clause A.3.6.1.1.2.4 for the SCell antenna connection if an SCell is on band where 2RX is supported and 4RX is not supported, or using the antenna connection in A.3.6.1.1.2.5 for the SCell antenna connection if an SCell is on a band where 4RX is supported.

#### A.3.6.1.1.2.3 EN-DC tests

All EN-DC tests are performed using the antenna connection in clause A.3.6.1.1.2.6 for the PCell antenna connection if the PCell is on a band where 2RX is supported and 4RX is not supported, or using the antenna connection in A.3.6.1.1.2.7 for the PCell antenna connection if the PCell is on a band where 4RX is supported.

All EN-DC tests are performed using the antenna connection in clause A.3.6.1.1.2.4 for the PSCell or SCell antenna connection if an SCell is on band where 2RX is supported and 4RX is not supported, or using the antenna connection in A.3.6.1.1.2.5 for the SCell antenna connection if an SCell or PSCell is on a band where 4RX is supported.

#### A.3.6.1.1.2.4 Antenna connection for bands where 2RX is supported

For bands where 2RX is supported and 4RX is not supported, it is left to the UE declaration and antenna port configuration to decide which 2 of the 4 Rx ports are connected with data source from system simulator. The remaining 2 RX ports shall be connected with zero input. No test parameters or requirements are modified.

#### A.3.6.1.1.2.5 Antenna connection for bands where 4RX is supported

For bands where 4RX is supported, all 4 RX antennas are connected with data source from system simulator. The system simulator shall provide independent noise and fading (low correlation) for each antenna port. Except for the modifications to radio link monitoring thresholds and beam failure detection thresholds described in clauses A.3.6.1.1.2.1, no test parameters or requirements are modified.

#### A.3.6.1.1.2.6 EN-DC LTE Antenna connection for bands where 2RX is supported

For E-UTRAN bands where 2RX is supported and 4RX is not supported, it is left to the UE declaration and antenna port configuration to decide which 2 of the 4 Rx ports are connected with data source from system simulator. The remaining 2 RX ports shall be connected with zero input. No test parameters or requirements are modified.

#### A.3.6.1.1.2.7 EN-DC LTE Antenna connection for bands where 4RX is supported

For E-UTRAN bands where 4RX is supported, all 4 RX antennas are connected with data source from system simulator. The system simulator shall provide independent noise and fading (low correlation) for each antenna port. Except for the modifications to radio link monitoring thresholds described in clauses A.3.8.1.2.1 and A.3.8.1.2.2 of TS 36.133 [15], no test parameters or requirements are modified.

### A.3.6.2 Antenna configurations for FR2

Unless otherwise specified, the default Downlink Antenna Configuration for NR FR2 cells is 1x2.

In case of Downlink Antenna Configuration 2x2 for NR FR2 cells, unless otherwise specified, the downlink signal is transmitted over the two polarizations (V and H) of the dual polarized antenna of the test equipment.

In both cases, the downlink signal is received assuming 2 UE baseband receivers. As the UE is tested following the Blackbox Approach with regard to the UE Rx antennas, the exact UE Rx antenna configuration is not relevant for the test configuration and has no impact on the test implementation.

## A.3.6A Antenna configurations with unlicensed bands

### A.3.6A.1 Antenna configurations for FR1

Unless otherwise specified, NR unlicensed cells in all RRM Test cases in AWGN propagation condition are configured with Antenna Configuration 1x2.

#### A.3.6A.1.1 Antenna connection for 4 Rx capable UEs

##### A.3.6A.1.1.1 Introduction

All tests in clause A.13, A.10, A.11, and A.12 are specified for UEs supporting 2RX. In this clause, the antenna connection method for applying 2RX tests to UEs supporting 4RX antenna ports is specified. No tests are currently specified in clause A.13, A.10, A.11 or A.12 which are applicable only to 4RX antenna ports, so 4RX capable UEs are always tested by reusing tests which were originally specified for 2RX UEs.

##### A.3.6A.1.1.2 Principle of testing

###### A.3.6A.1.1.2.1 Single carrier tests

For 4RX capable UEs supporting at least one 2RX band, the, all single carrier tests specified in clause A.13, A.10, A.11 and A.12 except those in A.13.4, A.10.5, A.11.6 and A.12.5 shall be tested on any band where 2RX is supported with the antenna connection specified in A.3.6A.1.1.2.4. For single carrier tests specified in clause A.13.4, A.10.5, A.11.6 or A.12.5, all tests shall be tested with the antenna connection specified in A.3.6A.1.1.2.4 for bands where 2RX is supported, and the antenna connection specified in A.3.6A.1.1.2.5 for bands where 4RX is supported.

For 4RX capable UEs which do not support any 2RX band, all tests specified in clauses A.13, A.10, A.11 and A.12 shall be tested using the antenna connection specified in clause A.3.6A.1.1.2.5. For radio link monitoring tests, the SNR levels are modified according to table A.3.6A.1.1.2.1-1 and table A.3.6A.1.1.2.1-2

**Table A.3.6A.1.1.2.1-1: Modified parameters for RLM out of sync testing with 4 RX antenna connection**

Test case	SNR during T3 (dB)			
	Test 1	Test 2	Test 3	Test 4
A.10.3.1.2	-18	N/A	N/A	N/A
A.10.3.1.4	TBD	N/A	N/A	N/A
A.11.4.1.2	-18	N/A	N/A	N/A
A.11.4.1.4	TBD	N/A	N/A	N/A

**Table A.3.6A.1.1.2.1-2: Modified parameters for RLM in sync single carrier testing with 4 RX antenna connection**

Test case	SNR during T3 (dB)		SNR during T4 (dB)	
	Test 1	Test 2	Test 1	Test 2
A.10.3.1.3	-18	N/A	-8	N/A
A.10.3.1.5	TBD	N/A	TBD	N/A
A.11.4.1.3	-18	N/A	-8	N/A
A.11.4.1.5	TBD	N/A	TBD	N/A

**Table A.3.6A.1.1.2.1-3: Modified parameters for Beam Failure Detection and Link Recovery testing with 4 RX antenna connection**

Test case	SNR for RS in set $q_0$ during T3, T4 and T5 (dB)	
	Test 1	Test 2
A.10.3.4.1	-15	N/A
A.10.3.4.2	-15	N/A
A.11.4.4.1	-15	N/A
A.11.4.4.2	-15	N/A

#### A.3.6A.1.1.2.2 Carrier aggregation tests

All carrier aggregation tests are performed using the antenna connection in clause A.3.6A.1.1.2.4 for the PCell antenna connection if the PCell is on a band where 2RX is supported or the antenna connection in A.3.6A.1.1.2.5 for the PCell antenna connection if the PCell is on a band where 4RX is supported.

All carrier aggregation tests are performed using the antenna connection in clause A.3.6A.1.1.2.4 for the SCell antenna connection if an SCell is on band where 2RX is supported or the testing procedure in A.3.6A.1.1.2.5 for the SCell antenna connection if an SCell is on a band where 4RX is supported.

#### A.3.6A.1.1.2.3 EN-DC tests

All carrier aggregation tests are performed using the antenna connection in clause A.3.6A.1.1.2.6 for the PCell antenna connection if the PCell is on a band where 2RX is supported or the antenna connection in A.3.6A.1.1.2.7 for the PCell antenna connection if the PCell is on a band where 4RX is supported.

All carrier aggregation tests are performed using the antenna connection in clause A.3.6A.1.1.2.4 for the PSCell or SCell antenna connection if an SCell is on band where 2RX is supported or the testing procedure in A.3.6A.1.1.2.5 for the SCell antenna connection if an SCell or PSCell is on a band where 4RX is supported.

#### A.3.6A.1.1.2.4 Antenna connection for bands where 2RX is supported

For bands where 2RX is supported, it is left to the UE declaration and AP configuration to decide which 2 of the 4 Rx ports are connected with data source from system simulator. The remaining 2 Rx ports shall be connected with zero input. No test parameters or requirements are modified.

#### A.3.6A.1.1.2.5 Antenna connection for bands where 4RX is supported

For bands where 4RX is supported, all 4 RX antennas are connected with data source from system simulator. The system simulator shall provide independent noise and fading (low correlation) for each antenna port. Except for the modifications to radio link monitoring thresholds described in clauses A.3.6A.1.1.2.1 and A.3.6A.1.1.2.2, no test parameters or requirements are modified.

#### A.3.6A.1.1.2.6 EN-DC LTE Antenna connection for bands where 2RX is supported

For bands where LTE 2RX is supported, it is left to the UE declaration and AP configuration to decide which 2 of the 4 Rx ports are connected with data source from system simulator. The remaining 2 Rx ports shall be connected with zero input. No test parameters or requirements are modified.

#### A.3.6A.1.1.2.7 EN-DC LTE Antenna connection for bands where 4RX is supported

For bands where LTE 4RX is supported, all 4 RX antennas are connected with data source from system simulator. The system simulator shall provide independent noise and fading (low correlation) for each antenna port. Except for the modifications to radio link monitoring thresholds described in clauses A.3.8.1.2.1 and A.3.8.1.2.2 of TS 36.133 [15], no test parameters or requirements are modified.

## A.3.7 EN-DC test setup

### A.3.7.1 Introduction

### A.3.7.2 E-UTRAN Serving Cell Parameters

#### A.3.7.2.1 E-UTRAN Serving Cell Parameters for Tests with NR Cell(s) in FR1

Table A.3.7.2.1-1 defines cell specific test parameters for E-UTRAN cell which can be used in EN-DC test cases or in any test case comprising at least one E-UTRA serving cell with all NR cells in FR1. Unless otherwise stated within the test, all measurements in Annex A.4 and A.5 are performed only on the NR carrier. The E-UTRA serving cell shall be configured to not interfere with NR operation and the E-UTRA serving cell signal power shall not be critical to the test purpose.

**Table A.3.7.2.1-1: E-UTRAN cell specific test parameters for tests with all NR cells in FR1**

Parameter	Unit	E-UTRAN Cell
Duplex mode		FDD or TDD
TDD special subframe configuration <sup>Note1</sup>		6
TDD uplink-downlink configuration <sup>Note1</sup>		1
BW <sub>channel</sub>		5 MHz: N <sub>RB,c</sub> = 25 10 MHz: N <sub>RB,c</sub> = 50 20 MHz: N <sub>RB,c</sub> = 100
PDSCH parameters: DL Reference Measurement Channel <sup>Note2</sup>		5 MHz: R.7 FDD 10 MHz: R.3 FDD 20 MHz: R.6 FDD 5 MHz: R.4 TDD 10 MHz: R.0 TDD 20 MHz: R.3 TDD
PCFICH/PDCCH/PHICH parameters: DL Reference Measurement Channel <sup>Note2</sup>		5 MHz: R.11 FDD 10 MHz: R.6 FDD 20 MHz: R.10 FDD 5 MHz: R.11 TDD 10 MHz: R.6 TDD 20 MHz: R.10 TDD
OCNG Patterns <sup>Note2</sup>		5 MHz: OP.20 FDD 10 MHz: OP.10 FDD 20 MHz: OP.17 FDD 5 MHz: OP.9 TDD 10 MHz: OP.1 TDD 20 MHz: OP.7 TDD
PBCH_RA	dB	0
PBCH_RB	dB	
PSS_RA	dB	
SSS_RA	dB	
PCFICH_RB	dB	
PHICH_RA	dB	
PHICH_RB	dB	
PDCCH_RA	dB	
PDCCH_RB	dB	
PDSCH_RA	dB	
PDSCH_RB	dB	
OCNG_RA <sup>Note3</sup>	dB	
OCNG_RB <sup>Note3</sup>	dB	
N <sub>oc</sub> <sup>Note4</sup>	dBm/15 kHz	
$\bar{E}_s/N_{oc}$	dB	17
$\bar{E}_s/I_{ot}$	dB	17
RSRP <sup>Note5</sup>	dBm/15 kHz	-87
SCH_RP <sup>Note5</sup>	dBm/15 kHz	-87
I <sub>o</sub> <sup>Note5</sup>	dBm/Ch BW	-59.13+10log(N <sub>RB,c</sub> /50)
Propagation Condition		AWGN
Antenna Configuration		1x2
<p>Note 1: Special subframe and uplink-downlink configurations are specified in table 4.2-1 in TS 36.211.</p> <p>Note 2: DL RMCs and OCNG patterns are specified in clauses A 3.1 and A 3.2 of TS 36.133 respectively.</p> <p>Note 3: OCNG shall be used such that all cells are fully allocated and a constant total transmitted power spectral density is achieved for all OFDM symbols.</p> <p>Note 4: Interference from other cells and noise sources not specified in the test is assumed to be constant over subcarriers and time and shall be modelled as AWGN of appropriate power for N<sub>oc</sub> to be fulfilled.</p> <p>Note 5: E<sub>s</sub>/I<sub>ot</sub>, RSRP, SCH_RP and I<sub>o</sub> levels have been derived from other parameters for information purposes. They are not settable parameters themselves.</p>		

**A.3.7.2.2 E-UTRAN Serving Cell Parameters for Tests with NR Cell(s) in FR2**

Table A.3.7.2.2-1 defines cell specific test parameters for E-UTRAN cell which can be used in EN-DC test cases or in any test case comprising at least one E-UTRA serving cell with one or more NR cells in FR2.

**Table A.3.7.2.2-1: E-UTRAN cell specific test parameters for tests with one or more NR cells in FR2**

Parameter	Unit	E-UTRAN Cell
Duplex mode		FDD or TDD
TDD special subframe configuration <sup>Note1</sup>		6
TDD uplink-downlink configuration <sup>Note1</sup>		1
BW <sub>channel</sub>	MHz	5 MHz: N <sub>RB,c</sub> = 25 10 MHz: N <sub>RB,c</sub> = 50 20 MHz: N <sub>RB,c</sub> = 100
PDSCH parameters: DL Reference Measurement Channel <sup>Note2</sup>		5 MHz: R.7 FDD 10 MHz: R.3 FDD 20 MHz: R.6 FDD 5 MHz: R.4 TDD 10 MHz: R.0 TDD 20 MHz: R.3 TDD
PCFICH/PDCCH/PHICH parameters: DL Reference Measurement Channel <sup>Note2</sup>		5 MHz: R.11 FDD 10 MHz: R.6 FDD 20 MHz: R.10 FDD 5 MHz: R.11 TDD 10 MHz: R.6 TDD 20 MHz: R.10 TDD
OCNG Patterns <sup>Note2</sup>		5 MHz: OP.20 FDD 10 MHz: OP.10 FDD 20 MHz: OP.17 FDD 5 MHz: OP.9 TDD 10 MHz: OP.1 TDD 20 MHz: OP.7 TDD
PBCH_RA	dB	0
PBCH_RB	dB	
PSS_RA	dB	
SSS_RA	dB	
PCFICH_RB	dB	
PHICH_RA	dB	
PHICH_RB	dB	
PDCCH_RA	dB	
PDCCH_RB	dB	
PDSCH_RA	dB	
PDSCH_RB	dB	
OCNG_RA <sup>Note3</sup>	dB	
OCNG_RB <sup>Note3</sup>	dB	
<p>Note 1: Special subframe and uplink-downlink configurations are specified in table 4.2-1 in TS 36.211.</p> <p>Note 2: DL RMCs and OCNG patterns are specified in clauses A 3.1 and A 3.2 of TS 36.133 respectively.</p> <p>Note 3: OCNG shall be used such that all cells are fully allocated and a constant total transmitted power spectral density is achieved for all OFDM symbols.</p> <p>Note 4: The E-UTRA signal is required only to ensure the E-UTRA link to the DUT in the EN-DC operation. The Test System shall provide a stable and noise-free E-UTRA signal without need of precise propagation modelling, path loss and polarization control. Further details of the E-UTRA signal configuration are not defined as part of the cell specific test parameters, since the E-UTRA link is not under performance verification and shall not affect the test result unless otherwise specifically stated in the test case.</p>		

## A.3.7A NR FR1-FR2 test setup

Some Test cases in clause A.7 have NR cells in both FR1 and FR2. Unless otherwise stated within the test, the NR FR1 Cell signal is required only to provide a link to the UE under test. The Test System shall provide a stable and noise-free NR FR1 signal without need of precise propagation modelling, path loss and polarization control. Further details of the NR FR1 signal configuration are not defined as part of the cell specific test parameters, since the NR FR1 link is not under performance verification and shall not affect the test result unless otherwise specifically stated in the test case.

## A.3.7B EN-DC test setup with unlicensed bands

### A.3.7B.1 Introduction

### A.3.7B.2 E-UTRAN Serving Cell Parameters

#### A.3.7B.2.1 E-UTRAN Serving Cell Parameters for Tests with NR Cell(s) under CCA in FR1

Table A.3.7B.2.1-1 defines cell specific test parameters for E-UTRAN cell which can be used in EN-DC test cases or in any test case comprising at least one E-UTRA serving cell with all NR cells under CCA in FR1. Unless otherwise stated within the test, all measurements in Annex A.4 and A.5 are performed only on the unlicensed NR carrier. The E-UTRA serving cell shall be configured to not interfere with NR operation and the E-UTRA serving cell signal power shall not be critical to the test purpose.

**Table A.3.7B.2.1-1: E-UTRAN cell specific test parameters for tests with all NR cells user CCA in FR1**

Parameter	Unit	E-UTRAN Cell
Duplex mode		FDD or TDD
TDD special subframe configuration <sup>Note1</sup>		6
TDD uplink-downlink configuration <sup>Note1</sup>		1
BW <sub>channel</sub>		5 MHz: N <sub>RB,c</sub> = 25 10 MHz: N <sub>RB,c</sub> = 50 20 MHz: N <sub>RB,c</sub> = 100
PDSCH parameters: DL Reference Measurement Channel <sup>Note2</sup>		5 MHz: R.7 FDD 10 MHz: R.3 FDD 20 MHz: R.6 FDD 5 MHz: R.4 TDD 10 MHz: R.0 TDD 20 MHz: R.3 TDD
PCFICH/PDCCH/PHICH parameters: DL Reference Measurement Channel <sup>Note2</sup>		5 MHz: R.11 FDD 10 MHz: R.6 FDD 20 MHz: R.10 FDD 5 MHz: R.11 TDD 10 MHz: R.6 TDD 20 MHz: R.10 TDD
OCNG Patterns <sup>Note2</sup>		5 MHz: OP.20 FDD 10 MHz: OP.10 FDD 20 MHz: OP.17 FDD 5 MHz: OP.9 TDD 10 MHz: OP.1 TDD 20 MHz: OP.7 TDD
PBCH_RA	dB	0
PBCH_RB	dB	
PSS_RA	dB	
SSS_RA	dB	
PCFICH_RB	dB	
PHICH_RA	dB	
PHICH_RB	dB	
PDCCH_RA	dB	
PDCCH_RB	dB	
PDSCH_RA	dB	
PDSCH_RB	dB	

OCNG_RA <sup>Note3</sup>	dB	
OCNG_RB <sup>Note3</sup>	dB	
$N_{oc}$ <sup>Note4</sup>	dBm/15 kHz	-104
$\hat{E}_s/N_{oc}$	dB	17
$\hat{E}_s/I_{ot}$	dB	17
RSRP <sup>Note5</sup>	dBm/15 kHz	-87
SCH_RP <sup>Note5</sup>	dBm/15 kHz	-87
$I_o$ <sup>Note5</sup>	dBm/Ch BW	$-59.13+10\log(N_{RB,c}/50)$
Propagation Condition		AWGN
Antenna Configuration		1x2
<p>Note 1: Special subframe and uplink-downlink configurations are specified in table 4.2-1 in TS 36.211.</p> <p>Note 2: DL RMCs and OCNG patterns are specified in clauses A 3.1 and A 3.2 of TS 36.133 respectively.</p> <p>Note 3: OCNG shall be used such that all cells are fully allocated and a constant total transmitted power spectral density is achieved for all OFDM symbols.</p> <p>Note 4: Interference from other cells and noise sources not specified in the test is assumed to be constant over subcarriers and time and shall be modelled as AWGN of appropriate power for <math>N_{oc}</math> to be fulfilled.</p> <p>Note 5: <math>\hat{E}_s/I_{ot}</math>, RSRP, SCH_RP and <math>I_o</math> levels have been derived from other parameters for information purposes. They are not settable parameters themselves.</p>		

### A.3.7C LTE-FR1/FR2 test setup

Some Test cases in clause A.5 have LTE and FR2 NR cells. Unless otherwise stated within the test, the LTE Cell signal is required only to provide a link to the UE under test. The Test System shall provide a stable and noise-free LTE signal without need of precise propagation modelling, path loss and polarization control. Further details of the LTE signal configuration are not defined as part of the cell specific test parameters, since the LTE link is not under performance verification and shall not affect the test result unless otherwise specifically stated in the test case.

### A.3.7D NE-DC test setup

#### A.3.7D.1 Introduction

#### A.3.7D.2 E-UTRAN Serving Cell Parameters

##### A.3.7D.2.1 E-UTRAN Serving Cell Parameters for Tests with NR Cell(s) in FR1

The parameters are same as as specified in clause A.3.7.2.1.

##### A.3.7D.2.2 E-UTRAN Serving Cell Parameters for Tests with NR Cell(s) in FR2

The parameters are same as as specified in clause A.3.7.2.2.

### A.3.8 PRACH configurations

#### A.3.8.1 Introduction

This clause provides the typical PRACH configurations used for RRM test cases defined in Annex A. To note that for other parameters not listed in this clause, either it can be derived from the set up of each test or it is subjected to RAN5 specifications.

#### A.3.8.2 PRACH configurations in FR1

##### A.3.8.2.1 FR1 PRACH configuration 1

FR1 PRACH configuration 1 in this clause provides the typical PRACH configuration for SSB-based contention based random access in FR1.



**Table A.3.8.2.1-1: Parameters for FR1 PRACH configuration 1**

Field	Value	Comment
prach-ConfigurationIndex	102	10ms PRACH periodicity, and other detailed configuration defined in table 6.3.3.2-2 and table 6.3.3.2-3 in TS 38.211 [6].
msg1-SubcarrierSpacing	Same as UL carrier SCS	
totalNumberOfRA-Preambles	48	Total number of preambles used for contention based and contention free random access
numberOfRA-PreamblesGroupA	48	No group B.
prach-RootSequenceIndex	0	Logic sequence index = 0, resulting in root sequence = 1.
ssb-perRACH-OccasionAndCB-PreamblesPerSSB	oneFourth, n48	OneFourth: 1 SSB associated with 4 RACH occasions n48: 48 contention based preambles per SSB
msg1-FDM	One	One PRACH transmission occasions FDMed in one time instance.
rsrp-ThresholdSSB	RSRP_51	The actual value of the threshold is -105dBm, as defined in TS 38.331 [2].
ra-ContentionResolutionTimer	sf48	48 sub-frames
powerRampingStep	dB2	
preambleReceivedTargetPower	dBm-120	
preambleTransMax	n6	Max number of RA preamble transmission performed before declaring a failure is 6
ra-ResponseWindow	sl10	10 slots
zeroCorrelationZoneConfig	11	N-CS configuration, N <sub>CS</sub> = 23
Backoff Parameter Index	2	20ms, as defined in table 7.2-1 in TS 38.321 [7].
Note:	For further information see clause 6.3.2 in TS 38.331 [2].	

**A.3.8.2.2 FR1 PRACH configuration 2**

FR1 PRACH configuration 2 in this clause provides the typical PRACH configuration for SSB based non-contention based random access in FR1.

**Table A.3.8.2.2-1: Parameters for FR1 PRACH configuration 2**

Field	Value	Comment
prach-ConfigurationIndex	102	10ms PRACH periodicity, and other detailed configuration defined in table 6.3.3.2-2 and table 6.3.3.2-3 in TS 38.211 [6].
msg1-SubcarrierSpacing	Same as UL carrier SCS	
totalNumberOfRA-Preambles	48	Total number of preambles used for contention based and contention free random access
numberOfRA-PreamblesGroupA	48	No group B.
prach-RootSequenceIndex	0	Logic sequence index = 0, resulting in root sequence = 1.
ssb-perRACH-Occasion	oneFourth	OneFourth: 1 SSB associated with 4 RACH occasions
msg1-FDM	One	One PRACH transmission occasions FDMed in one time instance.
powerRampingStep	dB2	
preambleReceivedTargetPower	dBm-120	
preambleTransMax	n6	Max number of RA preamble transmission performed before declaring a failure is 6
ra-ResponseWindow	sl10	10 slots
zeroCorrelationZoneConfig	11	N-CS configuration, N <sub>CS</sub> = 23
Backoff Parameter Index	2	20ms, as defined in table 7.2-1 in TS 38.321 [7].
ssb-ResourceList	ra-PreambleIndex = 50	Associated with SSB index 0. UE doesn't use ssb-ResourceList and BFR-SSB-Resource IEs at the same time. UE doesn't use this field if is transmitting CFRA to convey BFR.

<i>BFR-SSB-Resource</i>	ra-PreambleIndex = 50	Associated with SSB index 0. UE doesn't use ssb-ResourceList and BFR-SSB-Resource IEs at the same time. UE uses this field only if is transmitting CFRA to convey BFR
ra-ssb-OccasionMaskIndex	1	PRACH occasion index 1 is allowed
rsrp-ThresholdSSB	RSRP_51	The actual value of the threshold is -105dBm, as defined in TS 38.331 [2].
Note: For further information see clause 6.3.2 in TS 38.331 [2].		

### A.3.8.2.3 FR1 PRACH configuration 3

FR1 PRACH configuration 3 in this clause provides the typical PRACH configuration for CSI-RS based non-contention based random access in FR1.

**Table A.3.8.2.3-1: Parameters for FR1 PRACH configuration 3**

Field	Value	Comment
<i>prach-ConfigurationIndex</i>	102	10ms PRACH periodicity, and other detailed configuration defined in table 6.3.3.2-2 and table 6.3.3.2-3 in TS 38.211 [6].
msg1-SubcarrierSpacing	Same as UL carrier SCS	
totalNumberOfRA-Preambles	48	Total number of preambles used for contention based and contention free random access
numberOfRA-PreamblesGroupA	48	No group B.
prach-RootSequenceIndex	0	Logic sequence index = 0, resulting in root sequence = 1.
ssb-perRACH-Occasion	oneFourth	OneFourth: 1 SSB associated with 4 RACH occasions
msg1-FDM	One	One PRACH transmission occasions FDMed in one time instance.
powerRampingStep	dB2	
preambleReceivedTargetPower	dBm-120	
preambleTransMax	n6	Max number of RA preamble transmission performed before declaring a failure is 6
ra-ResponseWindow	sl10	10 slots
zeroCorrelationZoneConfig	11	N-CS configuration, Ncs = 23
Backoff Parameter Index	2	20ms, as defined in table 7.2-1 in TS 38.321 [7].
csirs-ResourceList	ra-PreambleIndex = 50	Associated with CSI-RS configured
ra-OccasionList	1	RA occasions allowed corresponding to CSI-RS
rsrp-ThresholdCSI-RS	RSRP_51	The actual value of the threshold is -105dBm, as defined in TS 38.331 [2].
Note: For further information see clause 6.3.2 in TS 38.331 [2].		

### A.3.8.2.4 FR1 PRACH configuration 4

FR1 PRACH configuration 4 in this clause provides the PRACH configuration for CSI-RS based non-contention based random access in FR1 to convey BFR.

**Table A.3.8.2.4-1: Parameters for FR1 PRACH configuration 4**

Field	Value	Comment
<i>prach-ConfigurationIndex</i>	102	10ms PRACH periodicity, and other detailed configuration defined in table 6.3.3.2-2 and table 6.3.3.2-3 in TS 38.211 [6].
totalNumberOfRA-Preambles	48	Total number of preambles used for contention based and contention free random access
numberOfRA-PreamblesGroupA	48	No group B.

prach-RootSequenceIndex	0	Logic sequence index = 0, resulting in root sequence = 1.
ssb-perRACH-Occasion	oneFourth	OneFourth: 1 SSB associated with 4 RACH occasions
msg1-FDM	One	One PRACH transmission occasions FDMed in one time instance.
powerRampingStep	dB2	
preambleReceivedTargetPower	dBm-120	
preambleTransMax	n200	Max number of RA preamble transmission performed before declaring a failure is 200
ra-ResponseWindow	sl1	1 slot
zeroCorrelationZoneConfig	11	N-CS configuration, N <sub>cs</sub> = 93
Backoff Parameter Index	2	20ms, as defined in table 7.2-1 in TS 38.321 [7].
BFR-CSIRS-Resource	ra-PreambleIndex = 50	Associated with CSI-RS configured
ra-OccasionList	1	RA occasions allowed corresponding to CSI-RS
rsrp-ThresholdSSB	RSRP_51	The actual value of the threshold is -105dBm, as defined in TS 38.331 [2].
Note: For further information see clause 6.3.2 in TS 38.331 [2].		

### A.3.8.3 PRACH configurations in FR2

#### A.3.8.3.1 FR2 PRACH configuration 1

FR2 PRACH configuration 1 in this clause provides the typical PRACH configuration for SSB-based contention based random access in FR2.

**Table A.3.8.3.1-1: Parameters for FR2 PRACH configuration 1**

Field	Value	Comment
prach-ConfigurationIndex	190	Preamble Format C2, with 10ms PRACH periodicity, and other detailed configuration defined in table 6.3.3.2-4 in TS 38.211 [6].
msg1-SubcarrierSpacing	Same as UL carrier SCS	
totalNumberOfRA-Preambles	48	Total number of preambles used for contention based and contention free random access
numberOfRA-PreamblesGroupA	48	No group B.
prach-RootSequenceIndex	0	Logic sequence index = 0, resulting in root sequence = 1.
ssb-perRACH-OccasionAndCB-PreamblesPerSSB	oneFourth, n48	OneFourth: 1 SSB associated with 4 RACH occasions n48: 48 contention based preambles per SSB
msg1-FDM	One	One PRACH transmission occasions FDMed in one time instance.
rsrp-ThresholdSSB	RSRP_51	The actual value of the threshold is -105dBm, as defined in TS 38.331 [2].
ra-ContentionResolutionTimer	sf48	48 sub-frames
powerRampingStep	dB2	
preambleReceivedTargetPower	dBm-120	
preambleTransMax	n6	Max number of RA preamble transmission performed before declaring a failure is 6
ra-ResponseWindow	sl10	10 slots
zeroCorrelationZoneConfig	11	N-CS configuration, N <sub>cs</sub> = 23
Backoff Parameter Index	2	20 ms, as defined in table 7.2-1 in TS 38.321 [7].
Note: For further information see clause 6.3.2 in TS 38.331 [2].		

#### A.3.8.3.2 FR2 PRACH configuration 2

FR2 PRACH configuration 2 in this clause provides the typical PRACH configuration for SSB based non-contention based random access in FR2.

**Table A.3.8.3.2-1: Parameters for FR2 PRACH configuration 2**

Field	Value	Comment
prach-ConfigurationIndex	190	Preamble Format C2, with 10ms PRACH periodicity, and other detailed configuration defined in table 6.3.3.2-4 in TS 38.211 [6].
msg1-SubcarrierSpacing	Same as UL carrier SCS	
totalNumberOfRA-Preambles	48	Total number of preambles used for contention based and contention free random access
numberOfRA-PreamblesGroupA	48	No group B.
prach-RootSequenceIndex	0	Logic sequence index = 0, resulting in root sequence = 1.
ssb-perRACH-Occasion	oneFourth	OneFourth: 1 SSB associated with 4 RACH occasions
msg1-FDM	One	One PRACH transmission occasions FDMed in one time instance.
powerRampingStep	dB2	
preambleReceivedTargetPower	dBm-120	
preambleTransMax	n6	Max number of RA preamble transmission performed before declaring a failure is 6
ra-ResponseWindow	sl10	10 slots
zeroCorrelationZoneConfig	11	N-CS configuration, N <sub>cs</sub> = 23
Backoff Parameter Index	2	20 ms, as defined in table 7.2-1 in TS 38.321 [7].
<i>ssb-ResourceList</i>	ra-PreambleIndex = 50	Associated with SSB index 0. UE doesn't use <i>ssb-ResourceList</i> and BFR-SSB-Resource IEs at the same time. UE doesn't use this field if is transmitting CFRA to convey BFR.
<i>BFR-SSB-Resource</i>	ra-PreambleIndex = 50	Associated with SSB index 0. UE doesn't use <i>ssb-ResourceList</i> and BFR-SSB-Resource IEs at the same time. UE uses this field only if is transmitting CFRA to convey BFR
ra-ssb-OccasionMaskIndex	1	PRACH occasion index 1 is allowed
rsrp-ThresholdSSB	RSRP_51	The actual value of the threshold is -105dBm, as defined in TS 38.331 [2].
Note: For further information see clause 6.3.2 in TS 38.331 [2].		

### A.3.8.3.3 FR2 PRACH configuration 3

FR2 PRACH configuration 3 in this clause provides the typical PRACH configuration for CSI-RS based non-contention based random access in FR2.

**Table A.3.8.3.3-1: Parameters for FR2 PRACH configuration 3**

Field	Value	Comment
prach-ConfigurationIndex	190	Preamble Format C2, with 10ms PRACH periodicity, and other detailed configuration defined in table 6.3.3.2-4 in TS 38.211 [6].
msg1-SubcarrierSpacing	Same as UL carrier SCS	
totalNumberOfRA-Preambles	48	Total number of preambles used for contention based and contention free random access
numberOfRA-PreamblesGroupA	48	No group B.
prach-RootSequenceIndex	0	Logic sequence index = 0, resulting in root sequence = 1.
ssb-perRACH-Occasion	oneFourth	OneFourth: 1 SSB associated with 4 RACH occasions
msg1-FDM	One	One PRACH transmission occasions FDMed in one time instance.
powerRampingStep	dB2	
preambleReceivedTargetPower	dBm-120	

preambleTransMax	n6	Max number of RA preamble transmission performed before declaring a failure is 6
ra-ResponseWindow	sl10	10 slots
zeroCorrelationZoneConfig	11	N-CS configuration, $N_{CS} = 23$
Backoff Parameter Index	2	20 ms, as defined in table 7.2-1 in TS 38.321 [7].
csirs-ResourceList	ra-PreambleIndex = 50	Associated with CSI-RS configured
ra-OccasionList	1	RA occasions allowed corresponding to CSI-RS
rsrp-ThresholdCSI-RS	RSRP_51	The actual value of the threshold is -105dBm, as defined in TS 38.331 [2].
Note: For further information see clause 6.3.2 in TS 38.331 [2].		

#### A.3.8.3.4 FR2 PRACH configuration 4

FR2 PRACH configuration 4 in this clause provides the PRACH configuration for CSI-RS based non-contention based random access in FR2 to convey BFR.

**Table A.3.8.3.4-1: Parameters for FR2 PRACH configuration 4**

Field	Value	Comment
prach-ConfigurationIndex	190	Preamble Format C2, with 10ms PRACH periodicity, and other detailed configuration defined in table 6.3.3.2-4 in TS 38.211 [6].
msg1-SubcarrierSpacing	Same as UL carrier SCS	
totalNumberOfRA-Preambles	48	Total number of preambles used for contention based and contention free random access
numberOfRA-PreamblesGroupA	48	No group B.
prach-RootSequenceIndex	0	Logic sequence index = 0, resulting in root sequence = 1.
ssb-perRACH-Occasion	oneFourth	OneFourth: 1 SSB associated with 4 RACH occasions
msg1-FDM	One	One PRACH transmission occasions FDMed in one time instance.
powerRampingStep	dB2	
preambleReceivedTargetPower	dBm-120	
preambleTransMax	n200	Max number of RA preamble transmission performed before declaring a failure is 200.
ra-ResponseWindow	sl40	40 slots
zeroCorrelationZoneConfig	11	N-CS configuration, $N_{CS} = 23$
Backoff Parameter Index	2	20 ms, as defined in table 7.2-1 in TS 38.321 [7].
BFR-CSIRS-Resource	ra-PreambleIndex = 50	Associated with CSI-RS configured
ra-OccasionList	1	RA occasions allowed corresponding to CSI-RS
rsrp-ThresholdSSB	RSRP_51	The actual value of the threshold is -105dBm, as defined in TS 38.331 [2].
Note: For further information see clause 6.3.2 in TS 38.331 [2].		

### A.3.8A PRACH configurations under CCA

#### A.3.8A.1 Introduction

This clause provides the typical PRACH configurations used for RRM test cases defined in Annex A. To note that for other parameters not listed in this clause, either it can be derived from the set up of each test or it is subjected to RAN5 specifications.

## A.3.8A.2 PRACH configurations in FR1

### A.3.8A.2.1 FR1 PRACH configuration 1 under CCA

FR1 PRACH configuration 1 under CCA in this clause provides the typical PRACH configuration for SSB-based contention based random access in FR1.

**Table A.3.8A.2.1-1: Parameters for FR1 PRACH configuration 1 under CCA**

Field	Value	Comment
prach-ConfigurationIndex	102	10ms PRACH periodicity, and other detailed configuration defined in table 6.3.3.2-2 and table 6.3.3.2-3 in TS 38.211 [6].
msg1-SubcarrierSpacing	Same as UL carrier SCS	
totalNumberOfRA-Preambles	48	Total number of preambles used for contention based and contention free random access
numberOfRA-PreamblesGroupA	48	No group B.
prach-RootSequenceIndex	0	Logic sequence index = 0, resulting in root sequence = 1.
ssb-perRACH-OccasionAndCB-PreamblesPerSSB	oneFourth, n48	OneFourth: 1 SSB associated with 4 RACH occasions n48: 48 contention based preambles per SSB
msg1-FDM	One	One PRACH transmission occasions FDMed in one time instance.
rsrp-ThresholdSSB	RSRP_51	The actual value of the threshold is -105dBm, as defined in TS 38.331 [2].
ra-ContentionResolutionTimer	sf48	48 sub-frames
powerRampingStep	dB2	
preambleReceivedTargetPower	dBm-114	Increased by 6 dB compared with FR1 PRACH configuration 1 for random access test with UL CCA failures.
preambleTransMax	n20	Max number of RA preamble transmission performed before declaring a failure is 20 to account for CCA failures
ra-ResponseWindow	Sl20	20 slots
zeroCorrelationZoneConfig	11	N-CS configuration, N <sub>cs</sub> = 23
Backoff Parameter Index	2	20ms, as defined in table 7.2-1 in TS 38.321 [7].
Note: For further information see clause 6.3.2 in TS 38.331 [2].		

### A.3.8A.2.2 FR1 PRACH configuration 2 under CCA

FR1 PRACH configuration 2 under CCA in this clause provides the typical PRACH configuration for SSB based non-contention based random access in FR1.

**Table A.3.8A.2.2-1: Parameters for FR1 PRACH configuration 2 under CCA**

Field	Value	Comment
prach-ConfigurationIndex	102	10ms PRACH periodicity, and other detailed configuration defined in table 6.3.3.2-2 and table 6.3.3.2-3 in TS 38.211 [6].
msg1-SubcarrierSpacing	Same as UL carrier SCS	
totalNumberOfRA-Preambles	48	Total number of preambles used for contention based and contention free random access
numberOfRA-PreamblesGroupA	48	No group B.
prach-RootSequenceIndex	0	Logic sequence index = 0, resulting in root sequence = 1.
ssb-perRACH-Occasion	oneFourth	OneFourth: 1 SSB associated with 4 RACH occasions
msg1-FDM	One	One PRACH transmission occasions FDMed in one time instance.
powerRampingStep	dB2	

preambleReceivedTargetPower	dBm-114	Increased by 6 dB compared with FR1 PRACH configuration 2 for random access test with UL CCA failures.
preambleTransMax	n20	Max number of RA preamble transmission performed before declaring a failure is 20 to account for CCA failures
ra-ResponseWindow	sl20	20 slots
zeroCorrelationZoneConfig	11	N-CS configuration, Ncs = 23
Backoff Parameter Index	2	20ms, as defined in table 7.2-1 in TS 38.321 [7].
ssb-ResourceList	ra-PreambleIndex = 50	Associated with SSB index 0. UE doesn't use ssb-ResourceList and BFR-SSB-Resource IEs at the same time. UE doesn't use this field if is transmitting CFRA to convey BFR.
BFR-SSB-Resource	ra-PreambleIndex = 50	Associated with SSB index 0. UE doesn't use ssb-ResourceList and BFR-SSB-Resource IEs at the same time. UE uses this field only if is transmitting CFRA to convey BFR
ra-ssb-OccasionMaskIndex	1	PRACH occasion index 1 is allowed
rsrp-ThresholdSSB	RSRP_51	The actual value of the threshold is -105dBm, as defined in TS 38.331 [2].
Note: For further information see clause 6.3.2 in TS 38.331 [2].		

### A.3.9 BWP configurations

#### A.3.9.1 Introduction

This clause provides the typical BWP configurations used for RRM test cases defined in Annex A. For downlink BWP, both initial BWP and dedicated BWP configurations are specified in clause A.3.9.2 and for uplink BWP, both initial BWP and dedicated BWP configurations are specified in clause A.3.9.3. To note that for other parameters not listed in this clause, either it can be derived from the set up of each test or it is subjected to RAN5 specifications.

#### A.3.9.2 Downlink BWP configurations

##### A.3.9.2.1 Initial BWP

**Table A.3.9.2.1-1: Downlink BWP patterns for initial BWP configuration**

BWP Parameters	Unit	Values	
		DLBWP.0.1	DLBWP.0.2
Reference BWP		DLBWP.0.1	DLBWP.0.2
Starting PRB index		0	RB <sub>a</sub> <sup>Note 1</sup>
Bandwidth	RB	Same as RF channel defined in each test	same as RMSI CORESET (CORESET #0) defined in each test
Note 1: RB <sub>c</sub> is the lowest PRB index to guarantee the BWP including CORESET #0 which is defined in Clause A.3.1.2.			

##### A.3.9.2.2 Dedicated BWP

**Table A.3.9.2.2-1: Downlink BWP patterns for dedicated BWP configuration**

BWP Parameters	Unit	Values
----------------	------	--------

Reference BWP		DLBWP.1.1	DLBWP.1.2	DLBWP.1.3	DLBWP.1.4	DLBWP.1.7
Starting PRB index		0	RB <sub>b</sub> <sup>Note 1</sup>	RB <sub>a</sub> <sup>Note 2</sup>	0	RB <sub>c</sub> <sup>Note 3</sup>
Bandwidth	RB	Same as RF channel defined in each test	25 for SSB SCS = 15KHz, 51 for SSB SCS = 30KHz, 32 for SSB SCS = 120KHz 48 for SSB SCS = 240KHz	25 for SSB SCS = 15KHz, 51 for SSB SCS = 30KHz, 32 for SSB SCS = 120KHz 48 for SSB SCS = 240KHz	24 for SSB SCS = 120KHz 24 for SSB SCS = 240KHz	25 for SSB SCS = 15KHz, 51 for SSB SCS = 30KHz, 32 for SSB SCS = 120KHz 48 for SSB SCS = 240KHz
<p>Note 1: RB<sub>b</sub> is the lowest PRB index to guarantee the BWP not fully overlapped with SSB PRB index (RB<sub>J</sub>, RB<sub>J+1</sub>,..., RB<sub>J+19</sub>) which is defined in Clause A.3.10.</p> <p>Note 2: RB<sub>a</sub> is the lowest PRB index to guarantee the BWP including SSB PRB index (RB<sub>J</sub>, RB<sub>J+1</sub>,..., RB<sub>J+19</sub>) which is defined in Clause A.3.10.</p> <p>Note 3: RB<sub>c</sub> is the PRB index having an offset of 6 PRBs with respect to the start of SSB PRB index (RB<sub>J</sub>, RB<sub>J+1</sub>,..., RB<sub>J+19</sub>) which is defined in Clause A.3.10.</p>						

### A.3.9.3 Uplink BWP configurations

#### A.3.9.3.1 Initial BWP

**Table A.3.9.3.1-1: Uplink BWP patterns for initial BWP configuration**

BWP Parameters	Unit	Values		
Reference BWP		ULBWP.0.1	ULBWP.0.2	
Starting PRB index		0	RB <sub>c</sub> <sup>Note 1</sup>	
Bandwidth	RB	Same as RF channel defined in each test	same as RMSI CORESET (CORESET #0) defined in each test	
Note 1: RB <sub>c</sub> is same as RB <sub>c</sub> for DLBWP.0.2 as defined in Table A.3.9.2.1-1..				

#### A.3.9.3.2 Dedicated BWP

**Table A.3.9.3.2-1: Uplink BWP patterns for dedicated BWP configuration**

BWP Parameters	Unit	Values				
Reference BWP		ULBWP.1.1	ULBWP.1.2	ULBWP.1.3	ULBWP.1.4	ULBWP.1.7
Starting PRB index		0	RB <sub>b</sub> <sup>Note 1</sup>	RB <sub>a</sub> <sup>Note 2</sup>	0	RB <sub>c</sub> <sup>Note 3</sup>
Bandwidth	RB	Same as RF channel defined in each test	25 for SSB SCS = 15KHz, 51 for SSB SCS = 30KHz, 32 for SSB SCS = 120KHz 48 for SSB SCS = 240KHz	25 for SSB SCS = 15KHz, 51 for SSB SCS = 30KHz, 32 for SSB SCS = 120KHz 48 for SSB SCS = 240KHz	24 for SSB SCS = 120KHz 24 for SSB SCS = 240KHz	25 for SSB SCS = 15KHz, 51 for SSB SCS = 30KHz, 32 for SSB SCS = 120KHz 48 for SSB SCS = 240KHz
<p>Note 1: RB<sub>b</sub> is same as RB<sub>b</sub> for DLBWP.1.2 as defined in Table A.3.9.2.2-1.</p> <p>Note 2: RB<sub>a</sub> is same as RB<sub>a</sub> for DLBWP.1.3 as defined in Table A.3.9.2.2-1.</p> <p>Note 3: RB<sub>c</sub> is same as RB<sub>c</sub> for DLBWP.1.7 as defined in Table A.3.9.2.2-1.</p>						



## A.3.10 SSB Configurations

### A.3.10.1 SSB Configurations for FR1

#### A.3.10.1.1 SSB pattern 1 in FR1: SSB allocation for SSB SCS=15 kHz in 10 MHz

**Table A.3.10.1.1-1: SSB.1 FR1: SSB Pattern 1 for SSB SCS=15 kHz in 10 MHz channel**

SSB Parameters	Values
Channel bandwidth	10 MHz
SSB SCS	15 kHz
SSB periodicity ( $T_{SSB}$ )	20 ms
Number of SSBs per SS-burst	1
SS/PBCH block index	0
Symbol numbers containing SSB <sup>Note 2</sup>	2-5
Slot numbers containing SSB <sup>Note 2</sup>	0
SFN containing SSB	SFN mod $(\max(T_{SSB}, 10\text{ms})/10\text{ms}) = 0$
RB numbers containing SSB within channel BW	$(RB_J, RB_{J+1}, \dots, RB_{J+19})^{\text{Note 1}}$
Note 1: RBs containing SSB can be configured in any frequency location within the cell bandwidth according to the allowed synchronization raster defined in TS 38.104 [13].	
Note 2: These values have been derived from other parameters for information purposes (as per TS 38.213 [3]). They are not settable parameters themselves.	

#### A.3.10.1.2 SSB pattern 2 in FR1: SSB allocation for SSB SCS=30 kHz in 40 MHz

**Table A.3.10.1.2-1: SSB.2 FR1: SSB Pattern 2 for SSB SCS=30 kHz in 40 MHz channel**

SSB Parameters	Values
Channel bandwidth	40 MHz
SSB SCS	30 kHz
SSB periodicity ( $T_{SSB}$ )	20 ms
Number of SSBs per SS-burst	1
SS/PBCH block index	0
Symbol numbers containing SSB <sup>Note 3</sup>	4-7 or 2-5 <sup>Note 2</sup>
Slot numbers containing SSB <sup>Note 3</sup>	0
SFN containing SSB	SFN mod $(\max(T_{SSB}, 10\text{ms})/10\text{ms}) = 0$
RB numbers containing SSB within channel BW	$(RB_J, RB_{J+1}, \dots, RB_{J+19})^{\text{Note 1}}$
Note 1: RBs containing SSB can be configured in any frequency location within the cell bandwidth according to the allowed synchronization raster defined in TS 38.104 [13].	
Note 2: Symbols 4-7 is chosen, if the SSB pattern Case B should be used for the current band as indicated by Table 5.4.3.3-1 of TS 38.104 [13]; Otherwise, symbol 2-5 is chosen.	
Note 3: These values have been derived from other parameters for information purposes (as per TS 38.213 [3]). They are not settable parameters themselves	

#### A.3.10.1.3 SSB pattern 3 in FR1: SSB allocation for SSB SCS=15 kHz in 10 MHz

**Table A.3.10.1.3-1: SSB.3 FR1: SSB Pattern 3 for SSB SCS=15 kHz in 10 MHz channel**

SSB Parameters	Values	
Channel bandwidth	10 MHz	
SSB SCS	15 kHz	
SSB periodicity ( $T_{SSB}$ )	20 ms	
Number of SSBs per SS-burst	2	
SS/PBCH block index	0	1
Symbol numbers containing SSB <sup>Note 2</sup>	2-5	8-11
Slot numbers containing SSB <sup>Note 2</sup>	0	0
SFN containing SSB	SFN mod $(\max(T_{SSB}, 10\text{ms})/10\text{ms}) = 0$	

RB numbers containing SSB within channel BW	$(RB_J, RB_{J+1}, \dots, RB_{J+19})^{\text{Note 1}}$
Note 1:	RBs containing SSB can be configured in any frequency location within the cell bandwidth according to the allowed synchronization raster defined in TS 38.104 [13].
Note 2:	These values have been derived from other parameters for information purposes (as per TS 38.213 [3]). They are not settable parameters themselves.

#### A.3.10.1.4 SSB pattern 4 in FR1: SSB allocation for SSB SCS=30 kHz in 40 MHz

**Table A.3.10.1.4-1: SSB.4 FR1: SSB Pattern 4 for SSB SCS=30 kHz in 40 MHz channel**

SSB Parameters	Values	
Channel bandwidth	40 MHz	
SSB SCS	30 kHz	
SSB periodicity ( $T_{SSB}$ )	20 ms	
Number of SSBs per SS-burst	2	
SS/PBCH block index	0	1
Symbol numbers containing SSB <sup>Note 3</sup>	4-7 or 2-5 <sup>Note 2</sup>	8-11
Slot numbers containing SSB <sup>Note 3</sup>	0	0
SFN containing SSB	SFN mod $(\max(T_{SSB}, 10\text{ms})/10\text{ms}) = 0$	
RB numbers containing SSB within channel BW	$(RB_J, RB_{J+1}, \dots, RB_{J+19})^{\text{Note 1}}$	
Note 1:	RBs containing SSB can be configured in any frequency location within the cell bandwidth according to the allowed synchronization raster defined in TS 38.104 [13].	
Note 2:	Symbols 4-7 is chosen, if the SSB pattern Case B should be used for the current band as indicated by Table 5.4.3.3-1 of TS 38.104 [13]; Otherwise, symbol 2-5 is chosen.	
Note 3:	These values have been derived from other parameters for information purposes (as per TS 38.213 [3]). They are not settable parameters themselves.	

#### A.3.10.1.5 SSB pattern 5 in FR1: SSB allocation for SSB SCS=15 kHz starting from odd SFN in 10 MHz

**Table A.3.10.1.5-1: SSB.5 FR1: SSB Pattern 5 for SSB SCS=15 kHz in 10 MHz channel**

SSB Parameters	Values	
Channel bandwidth	10 MHz	
SSB SCS	15 kHz	
SSB periodicity ( $T_{SSB}$ )	20 ms	
Number of SSBs per SS-burst	1	
SS/PBCH block index	0	
Symbol numbers containing SSB <sup>Note 2</sup>	2-5	
Slot numbers containing SSB <sup>Note 2</sup>	0	
SFN containing SSB	SFN mod $(\max(T_{SSB}, 10\text{ms})/10\text{ms}) = 1$	
RB numbers containing SSB within channel BW	$(RB_J, RB_{J+1}, \dots, RB_{J+19})^{\text{Note 1}}$	
Note 1:	RBs containing SSB can be configured in any frequency location within the cell bandwidth according to the allowed synchronization raster defined in TS 38.104 [13].	
Note 2:	These values have been derived from other parameters for information purposes (as per TS 38.213 [3]). They are not settable parameters themselves.	

#### A.3.10.1.6 SSB pattern 6 in FR1: SSB allocation for SSB SCS=30 kHz starting from odd SFN in 40 MHz

**Table A.3.10.1.6-1: SSB.6 FR1: SSB Pattern 6 for SSB SCS=30 kHz in 40 MHz channel**

SSB Parameters	Values	
Channel bandwidth	40 MHz	
SSB SCS	30 kHz	
SSB periodicity ( $T_{SSB}$ )	20 ms	
Number of SSBs per SS-burst	1	
SS/PBCH block index	0	

Symbol numbers containing SSB <sup>Note 3</sup>	4-7 or 2-5 <sup>Note 2</sup>
Slot numbers containing SSB <sup>Note 3</sup>	0
SFN containing SSB	SFN mod $(\max(T_{SSB}, 10\text{ms})/10\text{ms}) = 1$
RB numbers containing SSB within channel BW	$(RB_J, RB_{J+1}, \dots, RB_{J+19})$ <sup>Note 1</sup>
<p>Note 1: RBs containing SSB can be configured in any frequency location within the cell bandwidth according to the allowed synchronization raster defined in TS 38.104 [13].</p> <p>Note 2: Symbols 4-7 is chosen, if the SSB pattern Case B should be used for the current band as indicated by Table 5.4.3.3-1 of TS 38.104 [13]; Otherwise, symbol 2-5 is chosen.</p> <p>Note 3: These values have been derived from other parameters for information purposes (as per TS 38.213 [3]). They are not settable parameters themselves.</p>	

### A.3.10.2 SSB Configurations for FR2

#### A.3.10.2.1 SSB pattern 1 in FR2: SSB allocation for SSB SCS=120 kHz in 100 MHz

**Table A.3.10.2.1-1: SSB.1 FR2: SSB Pattern 1 for SSB SCS = 120 kHz in 100 MHz channel with 2 SSBs per SS-burst**

SSB Parameters	Values	
Channel bandwidth	100 MHz	
SSB SCS	120 kHz	
SSB periodicity ( $T_{SSB}$ )	20 ms	
Number of SSBs per SS-burst	2	
SS/PBCH block index	0	1
Symbol numbers containing SSBs <sup>Note 2</sup>	4-7	8-11
Slot numbers containing SSB <sup>Note 2</sup>	0	0
SFN containing SSB	SFN mod $(\max(T_{SSB}, 10\text{ms})/10\text{ms}) = 0$	
RB numbers containing SSBs within channel BW	$(RB_J, RB_{J+1}, \dots, RB_{J+19})$ <sup>Note 1</sup>	
<p>Note 1: RBs containing SSB can be configured in any frequency location within the cell bandwidth according to the allowed synchronization raster defined in TS 38.104 [13].</p> <p>Note 2: These values have been derived from other parameters for information purposes (as per TS 38.213 [3]). They are not settable parameters themselves.</p>		

#### A.3.10.2.2 SSB pattern 2 in FR2: SSB allocation for SSB SCS=240 kHz in 100 MHz

**Table A.3.10.2.2-1: SSB.2 FR2: SSB Pattern 2 for SSB SCS = 240 kHz in 100 MHz channel with 2 SSBs per SS-burst**

SSB Parameters	Values	
Channel bandwidth	100 MHz	
SSB SCS	240 kHz	
SSB periodicity ( $T_{SSB}$ )	20 ms	
Number of SSBs per SS-burst	2	
SS/PBCH block index	0	1
Symbol numbers containing SSBs <sup>Note 2</sup>	8-11	12-13, 0-1
Slot numbers containing SSB <sup>Note 2</sup>	0	0, 1
SFN containing SSB	SFN mod $(\max(T_{SSB}, 10\text{ms})/10\text{ms}) = 0$	
RB numbers containing SSBs within channel BW	$(RB_J, RB_{J+1}, \dots, RB_{J+39})$ <sup>Note 1</sup>	
<p>Note 1: RBs containing SSB can be configured in any frequency location within the cell bandwidth according to the allowed synchronization raster defined in TS 38.104 [13].</p> <p>Note 2: These values have been derived from other parameters for information purposes (as per TS 38.213 [3]). They are not settable parameters themselves.</p>		

#### A.3.10.2.3 SSB pattern 3 in FR2: SSB allocation for SSB SCS=120 kHz in 100 MHz

**Table A.3.10.2.3-1: SSB.3 FR2: SSB Pattern 3 for SSB SCS = 120 kHz in 100 MHz channel with 1 SSB per SS-burst**

SSB Parameters	Values
----------------	--------

Channel bandwidth	100 MHz
SSB SCS	120 kHz
SSB periodicity ( $T_{SSB}$ )	20 ms
Number of SSBs per SS-burst	1
SS/PBCH block index	0
Symbol numbers containing SSBs <sup>Note 2</sup>	4-7
Slot numbers containing SSB <sup>Note 2</sup>	0
SFN containing SSB	SFN mod ( $\max(T_{SSB}, 10\text{ms})/10\text{ms}$ ) = 0
RB numbers containing SSBs within channel BW	( $RB_J, RB_{J+1}, \dots, RB_{J+19}$ ) <sup>Note 1</sup>
Note 1: RBs containing SSB can be configured in any frequency location within the cell bandwidth according to the allowed synchronization raster defined in TS 38.104 [13].	
Note 2: These values have been derived from other parameters for information purposes (as per TS 38.213 [3]). They are not settable parameters themselves.	

#### A.3.10.2.4 SSB pattern 4 in FR2: SSB allocation for SSB SCS=240 kHz in 100 MHz

**Table A.3.10.2.4-1: SSB.4 FR2: SSB Pattern 4 for SSB SCS = 240 kHz in 100 MHz channel with 1 SSB per SS-burst**

SSB Parameters	Values
Channel bandwidth	100 MHz
SSB SCS	240 kHz
SSB periodicity ( $T_{SSB}$ )	20 ms
Number of SSBs per SS-burst	1
SS/PBCH block index	0
Symbol numbers containing SSBs <sup>Note 2</sup>	8-11
Slot numbers containing SSB <sup>Note 2</sup>	0
SFN containing SSB	SFN mod ( $\max(T_{SSB}, 10\text{ms})/10\text{ms}$ ) = 0
RB numbers containing SSBs within channel BW	( $RB_J, RB_{J+1}, \dots, RB_{J+39}$ ) <sup>Note 1</sup>
Note 1: RBs containing SSB can be configured in any frequency location within the cell bandwidth according to the allowed synchronization raster defined in TS 38.104 [13].	
Note 2: These values have been derived from other parameters for information purposes (as per TS 38.213 [3]). They are not settable parameters themselves.	

#### A.3.10.2.5 SSB pattern 5 in FR2: SSB allocation for SSB SCS=120 kHz in 100 MHz

**Table A.3.10.2.5-1: SSB.5 FR2: SSB Pattern 5 for SSB SCS = 120 kHz in 100 MHz channel with 2 SSBs per SS-burst**

SSB Parameters	Values
Channel bandwidth	100 MHz
SSB SCS	120 kHz
SSB periodicity ( $T_{SSB}$ )	20 ms
Number of SSBs per SS-burst	2
SS/PBCH block index	2      3
Symbol numbers containing SSBs <sup>Note 2</sup>	2-5      6-9
Slot numbers containing SSB <sup>Note 2</sup>	1      1
SFN containing SSB	SFN mod ( $\max(T_{SSB}, 10\text{ms})/10\text{ms}$ ) = 0
RB numbers containing SSBs within channel BW	( $RB_J, RB_{J+1}, \dots, RB_{J+19}$ ) <sup>Note 1</sup>
Note 1: RBs containing SSB can be configured in any frequency location within the cell bandwidth according to the allowed synchronization raster defined in TS 38.104 [13].	
Note 2: These values have been derived from other parameters for information purposes (as per TS 38.213 [3]). They are not settable parameters themselves.	

#### A.3.10.2.6 SSB pattern 6 in FR2: SSB allocation for SSB SCS=240 kHz in 100 MHz

**Table A.3.10.2.6-1: SSB.6 FR2: SSB Pattern 6 for SSB SCS = 240 kHz in 100 MHz channel with 2 SSBs per SS-burst**

SSB Parameters	Values
----------------	--------

Channel bandwidth	100 MHz	
SSB SCS	240 kHz	
SSB periodicity ( $T_{SSB}$ )	20 ms	
Number of SSBs per SS-burst	2	
SS/PBCH block index	2	3
Symbol numbers containing SSBs <sup>Note 2</sup>	2-5	6-9
Slot numbers containing SSB <sup>Note 2</sup>	1	1
SFN containing SSB	SFN mod ( $\max(T_{SSB}, 10\text{ms})/10\text{ms}$ ) = 0	
RB numbers containing SSBs within channel BW	$(RB_J, RB_{J+1}, \dots, RB_{J+39})$ <sup>Note 1</sup>	
Note 1: RBs containing SSB can be configured in any frequency location within the cell bandwidth according to the allowed synchronization raster defined in TS 38.104 [13].		
Note 2: These values have been derived from other parameters for information purposes (as per TS 38.213 [3]). They are not settable parameters themselves.		

### A.3.10.2.7 SSB pattern 7 in FR2: SSB allocation for SSB SCS=120 kHz in 100 MHz

**Table A.3.10.2.7-1: SSB.7 FR2: SSB Pattern 7 for SSB SCS = 120 kHz in 100 MHz channel with 1 SSB per SS-burst**

SSB Parameters	Values	
Channel bandwidth	100 MHz	
SSB SCS	120 kHz	
SSB periodicity ( $T_{SSB}$ )	20 ms	
Number of SSBs per SS-burst	1	
SS/PBCH block index	1	
Symbol numbers containing SSBs <sup>Note 2</sup>	8-11	
Slot numbers containing SSB <sup>Note 2</sup>	0	
SFN containing SSB	SFN mod ( $\max(T_{SSB}, 10\text{ms})/10\text{ms}$ ) = 0	
RB numbers containing SSBs within channel BW	$(RB_J, RB_{J+1}, \dots, RB_{J+19})$ <sup>Note 1</sup>	
Note 1: RBs containing SSB can be configured in any frequency location within the cell bandwidth according to the allowed synchronization raster defined in TS 38.104 [13].		
Note 2: These values have been derived from other parameters for information purposes (as per TS 38.213 [3]). They are not settable parameters themselves.		

### A.3.10.2.8 SSB pattern 8 in FR2: SSB allocation for SSB SCS=240 kHz in 100 MHz

**Table A.3.10.2.8-1: SSB.8 FR2: SSB Pattern 8 for SSB SCS = 240 kHz in 100 MHz channel with 1 SSB per SS-burst**

SSB Parameters	Values	
Channel bandwidth	100 MHz	
SSB SCS	240 kHz	
SSB periodicity ( $T_{SSB}$ )	20 ms	
Number of SSBs per SS-burst	1	
SS/PBCH block index	1	
Symbol numbers containing SSBs <sup>Note 2</sup>	12-13	0-1
Slot numbers containing SSB <sup>Note 2</sup>	0	1
SFN containing SSB	SFN mod ( $\max(T_{SSB}, 10\text{ms})/10\text{ms}$ ) = 0	
RB numbers containing SSBs within channel BW	$(RB_J, RB_{J+1}, \dots, RB_{J+39})$ <sup>Note 1</sup>	
Note 1: RBs containing SSB can be configured in any frequency location within the cell bandwidth according to the allowed synchronization raster defined in TS 38.104 [13].		
Note 2: These values have been derived from other parameters for information purposes (as per TS 38.213 [3]). They are not settable parameters themselves.		

## A.3.10A SSB Configurations under CCA

### A.3.10A.1 SSB Configurations under CCA for FR1

#### A.3.10A.1.1 SSB pattern 1 under CCA for semi-static channel access: SSB allocation for SSB SCS=30kHz in 40MHz

**Table A.3.10A.1.1-1: SSB.1 CCA: SSB Pattern 1 for SSB SCS=30 kHz in 40 MHz channel**

SSB Parameters	Values
Channel bandwidth	40 MHz
SSB SCS	30 kHz
SSB periodicity ( $T_{SSB}$ )	20 ms
Number of SSB indexes per SS-burst ( $N_{SSB}^{QCL}$ )	1
Number of SS/PBCH block candidates per SSB index	1
SS/PBCH block candidate position	0
SS/PBCH block index	0
Symbol numbers containing SSB <sup>Note 2</sup>	2-5
Slot numbers containing SSB <sup>Note 2</sup>	0
SFN containing SSB	SFN mod ( $\max(T_{SSB}, 10\text{ms})/10\text{ms}$ ) = 0
RB numbers containing SSB within channel BW	( $RB_J, RB_{J+1}, \dots, RB_{J+19}$ ) <sup>Note 1</sup>
Note 1: RBs containing SSB can be configured in any frequency location within the cell bandwidth according to the allowed synchronization raster defined in TS 38.104 [13].	
Note 2: These values have been derived from other parameters for information purposes (as per TS 38.213 [3]). They are not settable parameters themselves	

#### A.3.10A.1.2 SSB pattern 2 under CCA for dynamic channel access: SSB allocation for SSB SCS=30kHz in 40MHz

**Table A.3.10A.1.2-1: SSB.2 CCA: SSB Pattern 2 for SSB SCS=30 kHz in 40 MHz channel**

SSB Parameters	Values	
Channel bandwidth	40 MHz	
SSB SCS	30 kHz	
SSB periodicity ( $T_{SSB}$ )	20 ms	
Number of SSB indexes per SS-burst ( $N_{SSB}^{QCL}$ )	1	
Number of SS/PBCH block candidates per SSB index	2	
SS/PBCH block candidate position	0	2
SS/PBCH block index	0	0
Symbol numbers containing SSB <sup>Note 2</sup>	2-5	2-5
Slot numbers containing SSB <sup>Note 2</sup>	0	1
SFN containing SSB	SFN mod ( $\max(T_{SSB}, 10\text{ms})/10\text{ms}$ ) = 0	
RB numbers containing SSB within channel BW	( $RB_J, RB_{J+1}, \dots, RB_{J+19}$ ) <sup>Note 1</sup>	
Note 1: RBs containing SSB can be configured in any frequency location within the cell bandwidth according to the allowed synchronization raster defined in TS 38.104 [13].		
Note 2: These values have been derived from other parameters for information purposes (as per TS 38.213 [3]). They are not settable parameters themselves		

#### A.3.10A.1.3 SSB pattern 3 under CCA for semi-static channel access: SSB allocation for SSB SCS=30 kHz in 40 MHz

**Table A.3.10.1.3-1: SSB.3 CCA: SSB Pattern 3 for SSB SCS=30 kHz in 40 MHz channel**

SSB Parameters	Values
Channel bandwidth	40 MHz
SSB SCS	30 kHz
SSB periodicity ( $T_{SSB}$ )	20 ms
Number of SSB indexes per SS-burst ( $N_{SSB}^{QCL}$ )	2

Number of SS/PBCH block candidates per SSB index	1		
SS/PBCH block candidate position	0	1	
SS/PBCH block index	0	1	
Symbol numbers containing SSB <sup>Note 2</sup>	2-5	8-11	
Slot numbers containing SSB <sup>Note 2</sup>	0	0	
SFN containing SSB	SFN mod (max(T <sub>SSB</sub> ,10ms)/10ms) = 0		
RB numbers containing SSB within channel BW	(RB <sub>J</sub> , RB <sub>J+1</sub> ,..., RB <sub>J+19</sub> ) <sup>Note 1</sup>		
Note 1: RBs containing SSB can be configured in any frequency location within the cell bandwidth according to the allowed synchronization raster defined in TS 38.104 [13].			
Note 2: These values have been derived from other parameters for information purposes (as per TS 38.213 [3]). They are not settable parameters themselves.			

#### A.3.10A.1.4 SSB pattern 4 under CCA for dynamic channel access: SSB allocation for SSB SCS=30 kHz in 40 MHz

**Table A.3.10.1.4-1: SSB.4 CCA: SSB Pattern 4 for SSB SCS=30 kHz in 40 MHz channel**

SSB Parameters	Values			
Channel bandwidth	40 MHz			
SSB SCS	30 kHz			
SSB periodicity (T <sub>SSB</sub> )	20 ms			
Number of SSB indexes per SS-burst ( $N_{SSB}^{QCL}$ )	2			
Number of SS/PBCH block candidates per SSB index	2			
SS/PBCH block candidate position	0	2	1	3
SS/PBCH block index	0	0	1	1
Symbol numbers containing SSB <sup>Note 2</sup>	2-5	2-5	8-11	8-11
Slot numbers containing SSB <sup>Note 2</sup>	0	1	0	1
SFN containing SSB	SFN mod (max(T <sub>SSB</sub> ,10ms)/10ms) = 0			
RB numbers containing SSB within channel BW	(RB <sub>J</sub> , RB <sub>J+1</sub> ,..., RB <sub>J+19</sub> ) <sup>Note 1</sup>			
Note 1: RBs containing SSB can be configured in any frequency location within the cell bandwidth according to the allowed synchronization raster defined in TS 38.104 [13].				
Note 2: These values have been derived from other parameters for information purposes (as per TS 38.213 [3]). They are not settable parameters themselves.				

### A.3.11 SMTC Configurations

#### A.3.11.1 SMTC pattern 1: SMTC period = 20 ms with SMTC duration = 1 ms

**Table A.3.11.1-1: SMTC.1: SMTC Pattern 1 for SMTC period = 20 ms and duration = 1 ms**

SMTC Parameters	Values
SMTC periodicity	20 ms
SMTC offset	0 ms
SMTC duration	1 ms

#### A.3.11.2 SMTC pattern 2: SMTC period = 20 ms with SMTC duration = 5 ms

**Table A.3.11.2-1: SMTC.2: SMTC Pattern 2 for SMTC period = 20 ms and duration = 5 ms**

SMTC Parameters	Values
SMTC periodicity	20 ms
SMTC offset	0 ms
SMTC duration	5 ms

### A.3.11.3 SMTC pattern 3: SMTC period = 160 ms with SMTC duration = 1 ms

**Table A.3.11.3-1: SMTC.3: SMTC Pattern 3 for SMTC period = 20 ms and duration = 5 ms**

SMTC Parameters	Values
SMTC periodicity	160 ms
SMTC offset	0 ms
SMTC duration	1 ms

### A.3.11.4 SMTC pattern 4: SMTC period = 20 ms with SMTC duration = 1 ms

**Table A.3.11.4-1: SMTC.4: SMTC Pattern 4 for SMTC period = 20 ms and duration = 1 ms**

SMTC Parameters	Values
SMTC periodicity	20 ms
SMTC offset	10 ms
SMTC duration	1 ms

### A.3.11.5 SMTC pattern 5: SMTC period = 20 ms with SMTC duration = 5 ms

**Table A.3.11.5-1: SMTC.5: SMTC Pattern 5 for SMTC period = 20 ms and duration = 5 ms**

SMTC Parameters	Values
SMTC periodicity	20 ms
SMTC offset	10 ms
SMTC duration	5 ms

### A.3.11.6 SMTC pattern 6: SMTC period = 20 ms with SMTC duration = 5 ms

**Table A.3.11.6-1: SMTC.6: SMTC Pattern 6 for SMTC period = 20 ms and duration = 5 ms**

SMTC Parameters	Values
SMTC periodicity	20 ms
SMTC offset	17 ms
SMTC duration	5 ms

### A.3.11.7 Void

### A.3.11.8 Void

### A.3.11.9 SMTC pattern 9: SMTC period = 20 ms with SMTC duration = 1 ms

**Table A.3.11.9-1: SMTC.9: SMTC Pattern 6 for SMTC period = 20 ms and duration = 1 ms**

SMTC Parameters	Values
SMTC periodicity	20 ms
SMTC offset	13 ms
SMTC duration	1 ms

## A.3.12 Test Cases with Different CC Configurations

### A.3.12.1 EN-DC Test Cases with Different EN-DC Configurations

#### A.3.12.1.1 Introduction

In Annex A EN-DC test cases may be defined for two component carriers (CCs) as well as for more than two CCs to verify the same RRM requirement.



### A.3.12.1.2 Principle of testing

If multiple EN-DC test cases are defined for two CCs as well as for more than two CCs to verify the same type of RRM requirement, which depends on the number of CCs, then from the UE performance point of view the test coverage can be considered fulfilled by executing only the EN-DC test cases with the maximum number of CCs in EN-DC supported by the UE. Otherwise if the same type of RRM requirement is independent of the number of CCs then from the UE performance point of view the test coverage can be considered fulfilled by executing only the EN-DC test cases with two CCs in EN-DC supported by the UE.

*Editor's: The maximum number of CCs that can be used in FR2 tests in EN-DC would depend on the test equipment capability.*

## A.3.12.2 Carrier Aggregation Test Cases with Different CA Configurations

### A.3.12.2.1 Introduction

In Annex A carrier aggregation test cases may be defined for two CCs as well as for more than two CCs to verify the same RRM requirement.

### A.3.12.2.2 Principle of testing

If multiple carrier aggregation test cases are defined for two CCs as well as for more than two CCs to verify the same RRM requirement, which depends on the number of CCs, then from the UE performance point of view the test coverage can be considered fulfilled by executing only the CA test cases with the maximum number of CCs in CA supported by the UE. Otherwise if the same type of RRM requirement is independent of the number of CCs then from the UE performance point of view the test coverage can be considered fulfilled by executing only the CA test cases with at least two CCs in CA supported by the UE.

*Editor's: The maximum number of CCs that can be used in FR2 tests in CA would depend on the test equipment capability.*

## A.3.13 Test Cases in SA and EN-DC Operations

### A.3.13.1 Introduction

This clause defines a principle which is applicable to test cases verifying RRM requirements in standalone (SA) or EN-DC operations.

In Annex A test cases may be defined in SA and EN-DC operations to verify the same RRM requirement.

*Editor's note: this clause may need to define further for NE-DC and NR-DC test cases, which subjects to the test cases defined in the future.*

### A.3.13.2 Principle of Testing

If test cases are defined in both SA and EN-DC operations to verify the same RRM requirement then the UE capable of both SA and EN-DC operations needs to verify that RRM requirement by performing test case(s) in either SA operation or in EN-DC operation.

If test cases are defined in both SA and EN-DC operations to verify at least one common RRM requirement then the UE capable of both SA and EN-DC operations needs to verify RRM requirements by performing test case(s) in either SA operation or in EN-DC operation provided that the performed test case(s):

- verifies the largest number of RRM requirements and
- verifies at least all RRM requirements covered in the test case(s), which is not performed.

## A.3.13A Test Cases involving E-UTRA/FR1 and FR2 carriers

### A.3.13A.1 Introduction

The following applies to UE compliant to this version of the specification when undergoing tests with a mix of E-UTRA/NR FR1 and NR FR2 carriers in clauses A.5, A.7 and A.8.

### A.3.13A.2 Principle of Testing in EN-DC

For test cases in clause A.5 listed in Table A.3.13A.2-1, the following applies:

- UE does not have to pass the test case

**Table A.3.13A.2-1: Test cases UE does not have to pass in current version of specification (EN-DC)**

Clause	Test case slogan
A.5.5.2.7	E-UTRAN – NR FR2 interruptions at E-UTRA SRS carrier based switching
A.5.5.3.2	SCell Activation and deactivation of known SCell in FR1 for 160ms SCell measurement cycle
A.5.5.3.5	SCell Activation and deactivation of SCell in FR2
A.5.5.3.6	Multiple SCell Activation and deactivation of one unknown SCell and one known SCell in FR2
A.5.5.6.1.2	E-UTRAN – NR PSCell FR2 with FR2 SCell DL active BWP switch in non-DRX in synchronous EN-DC
A.5.5.6.4.2	E-UTRAN – NR FR1 PSCell SCell dormancy switch of two FR2 SCells outside active time
A.5.6.2.5	EN-DC event triggered reporting tests for FR2 cell without SSB time index detection when DRX is not used
A.5.6.2.6	EN-DC event triggered reporting tests for FR2 cell without SSB time index detection when DRX is used
A.5.6.2.7	EN-DC event triggered reporting tests for FR2 cell with SSB time index detection when DRX is not used
A.5.6.2.8	EN-DC event triggered reporting tests for FR2 cell with SSB time index detection when DRX is used
A.5.7.1.3	EN-DC inter-frequency measurement accuracy with FR1 serving cell and FR2 target cell

### A.3.13A.3 Principle of Testing in SA

For test cases in clause A.7 listed in Table A.3.13A.3-1, the following applies:

- UE does not have to pass the test case

**Table A.3.13A.3-1: Test cases UE does not have to pass in current version of specification (SA)**

Clause	Test case slogan
A.7.3.1.1	Inter-frequency handover from FR1 to FR2; unknown target cell
A.7.3.1.4	Inter-band inter-frequency synchronous DAPS handover from FR1 to FR2
A.7.3.1.5	Inter-band inter-frequency asynchronous DAPS handover from FR1 to FR2
A.7.5.3.2	SCell Activation and deactivation for FR1+FR2 inter-band with target SCell in FR2
A.7.5.6.1.2	NR FR1- NR FR2 DL active BWP switch of PCell with non-DRX in SA
A.7.5.6.4.2	NR FR1 PCell SCell dormancy switch of two FR2 SCells outside active time
A.7.5.7.1	Addition and Release Delay of known NR PSCell
A.7.5.7.2	Addition and Release Delay of unknown NR PSCell
A.7.6.2.5	SA event triggered reporting tests for FR2 without SSB time index detection when DRX is not used (PCell in FR1)
A.7.6.2.6	SA event triggered reporting tests for FR2 without SSB time index detection when DRX is used (PCell in FR1)
A.7.6.2.7	SA event triggered reporting tests for FR2 with SSB time index detection when DRX is not used (PCell in FR1)

A.7.6.2.8	SA event triggered reporting tests for FR2 with SSB time index detection when DRX is used (PCell in FR1)
A.7.7.1.3	SA inter-frequency measurement accuracy with FR1 serving cell and FR2 target cell

### A.3.13A.4 Principle of Testing in E-UTRA

For test cases in clause A.8 listed in Table A.3.13A.4-1, the following applies:

- UE does not have to pass the test case.

**Table A.3.13A.4-1: Test cases UE does not have to pass in current version of specification (E-UTRA)**

Clause	Test case slogan
A.8.2.2.2	E-UTRA – NR Early Measurement Reporting for NR in FR2
A.8.4.2.5	NR Inter-RAT event triggered reporting tests for FR2 without SSB time index detection when DRX is not used
A.8.4.2.6	NR Inter-RAT event triggered reporting tests for FR2 without SSB time index detection when DRX is used
A.8.4.2.7	NR Inter-RAT event triggered reporting tests for FR2 with SSB time index detection when DRX is not used
A.8.4.2.8	NR Inter-RAT event triggered reporting tests for FR2 with SSB time index detection when DRX is used

## A.3.13B Test Cases for EN-DC and NE-DC Operations

### A.3.13B.1 Active BWP switch Test Cases for EN-DC and NE-DC Operations

#### A.3.13B.1.1 Introduction

This clause defines a principle which is applicable to test cases verifying active BWP switch requirements for EN-DC operation and NE-DC operations.

In Annex A test cases are defined for both EN-DC and NE-DC operations to verify the same type of RRM requirement.

#### A.3.13B.1.2 Principle of Testing

UE capable of both EN-DC and NE-DC operations needs to be tested with one of the tests in either EN-DC or NE-DC operations.

### A.3.13B.2 SFTD accuracy Test Cases for EN-DC and NE-DC Operations

#### A.3.13B.2.1 Introduction

This clause defines a principle which is applicable to test cases verifying SFTD accuracy requirements for EN-DC operation and NE-DC operations.

In Annex A test cases are defined for both EN-DC and NE-DC operations to verify the same type of RRM requirement.

#### A.3.13B.2.2 Principle of Testing

UE capable of both EN-DC and NE-DC operations needs to be tested with one of the tests in either EN-DC or NE-DC operations.

## A.3.14 CSI-RS configurations

### A.3.14.1 FDD

**Table A.3.14.1-1: CSI-RS Reference Measurement Channels for SCS=15kHz**

	CSI-RS.1.1 FDD	CSI-RS.1.2 FDD	CSI-RS.1.3 FDD	CSI-RS.1.4 FDD	CSI-RS.1.5 FDD	CSI-RS.1.6 FDD
Resource Type	periodic	periodic	aperiodic	aperiodic	aperiodic	periodic
Resource Set Config						
nzp-CSI-ResourceSetId	0	0	0	0	0	0
repetition	n.a.	off	off	on	off	n.a.
aperiodicTriggeringOffset	n.a.	n.a.	0	0	0	n.a.
trs-Info	n.a.	n.a.	n.a.	n.a.	n.a.	n.a.
Resource Config						
nzp-CSI-RS-ResourceId	0 for resource #0	0 for resource #0	0 for resource #0	0 for resource #0	0 for resource #0	0 for resource #0
		1 for resource #1	1 for resource #1	1 for resource #1	1 for resource #1	
		2 for resource #2				
		3 for resource #3				
		4 for resource #4				
		5 for resource #5				
		6 for resource #6				
		7 for resource #7				
powerControlOffset	0	0	0	0	0	0
powerControlOffsetSS	db0	db0	db0	db0	db0	db0
scramblingID	0	0	0	0	0	0
Period (slots)	slot5	slot10	n.a.	n.a.	n.a.	slot40
Offset	1	1	n.a.	n.a.	n.a.	1
qcl-InfoPeriodicCSI-RS	TCI.State.0	TCI.State.0 TCI.State.1	n.a.	n.a.	n.a.	TCI.State.0
frequencyDomainAllocation	000001	0001	0001	0001	000001	000001
nrofPorts	2	1	1	1	1	2
firstOFDMSymbolInTimeDomain	4 for resource #0	6 for resource #0	6 for resource #0	0 for resource #0	Specified in the test case for resource #0	5 for resource #0
		1 for resource #1				
		2 for resource #2				
		3 for resource #3				
		10 for resource #1	10 for resource #1	4 for resource #4	n.a.	
		5 for resource #5				
		6 for resource #6				
		7 for resource #7				
cdm-Type	FD-CDM2	noCDM	noCDM	noCDM	noCDM	FD-CDM2
density	1	3	3	3	3	1
startingRB	0	0	0	0	0	0
nrofRBs	276 (Note 1)	276 (Note 1)	276 (Note 1)	276 (Note 1)	276 (Note 1)	276 (Note 1)
Note 1:	If the configured value of PRBs is larger than the width of the corresponding BWP relevant for the test case, the Test Equipment shall implement CSI-RS only in the width of that BWP.					

**Table A.3.14.1-1A: CSI-RS Reference Measurement Channels for SCS=15kHz**

	CSI-RS.1.1A FDD	CSI-RS.1.2A FDD	CSI-RS.1.3A FDD
Resource Type	periodic	aperiodic	periodic
<b>Resource Set Config</b>			
nzp-CSI-ResourceSetId	1	1	1
repetition	off	off	off
aperiodicTriggeringOffset	n.a.	0	n.a.
trs-Info	n.a.	n.a.	n.a.
<b>Resource Config</b>			
nzp-CSI-RS-ResourceId	12 for resource #0	22 for resource #0	14 for resource #0
	13 for resource #1	23 for resource #1	15 for resource #1
powerControlOffset	0	0	0
powerControlOffsetSS	db0	db0	db0
scramblingID	0	0	0
Period (slots)	slot20	n.a.	slot10
Offset	1	n.a.	2
qcl-InfoPeriodicCSI-RS	n.a.	n.a.	n.a.
frequencyDomainAllocation	0001	0001	0001
nrofPorts	1	1	1
firstOFDMSymbolInTimeDomain	6 for resource #0	7 for resource #0	6 for resource #0
	10 for resource #1	11 for resource #1	10 for resource #1
cdm-Type	noCDM	noCDM	noCDM
density	3	3	3
startingRB	0	0	0
nrofRBs	276 (Note 1)	276 (Note 1)	276 (Note 1)
Note 1: If the configured value of PRBs is larger than the width of the corresponding BWP relevant for the test case, the Test Equipment shall implement CSI-RS only in the width of that BWP.			

### A.3.14.2 TDD

**Table A.3.14.2-1: CSI-RS Reference Measurement Channels for SCS=15kHz**

	CSI-RS.1.1 TDD	CSI-RS.1.2 TDD	CSI-RS.1.3 TDD	CSI-RS.1.4 TDD	CSI-RS.1.5 TDD
Resource Type	periodic	periodic	aperiodic	aperiodic	periodic
<b>Resource Set Config</b>					
nzp-CSI-ResourceSetId	0	0	0	0	0
repetition	n.a.	off	off	on	n.a.
aperiodicTriggeringOffset	n.a.	n.a.	0	0	n.a.
trs-Info	n.a.	n.a.	n.a.	n.a.	n.a.
<b>Resource Config</b>					
		0 for resource #0	0 for resource #0	0 for resource #0	
				1 for resource #1	
				2 for resource #2	

nzp-CSI-RS-ResourceId	0 for resource #0	1 for resource #1	1 for resource #1	3 for resource #3	0 for resource #0
				4 for resource #4	
				5 for resource #5	
				6 for resource #6	
				7 for resource #7	
powerControlOffset	0	0	0	0	0
powerControlOffsetSS	db0	db0	db0	db0	db0
scramblingID	0	0	0	0	0
Period (slots)	slot5	slot10	n.a.	n.a.	slot40
Offset	1	1	n.a.	n.a.	1
qcl-InfoPeriodicCSI-RS	TCI.State.0	TCI.State.0	n.a.	n.a.	TCI.State.0
		TCI.State.1			
frequencyDomainAllocation	000001	0001	0001	0001	000001
nrofPorts	2	1	1	1	2
firstOFDMSymbolInTimeDomain	4 for resource #0	6 for resource #0	6 for resource #0	0 for resource #0	5 for resource #0
				1 for resource #1	
				2 for resource #2	
				3 for resource #3	
		10 for resource #1	10 for resource #1	4 for resource #4	
				5 for resource #5	
				6 for resource #6	
		7 for resource #7			
cdm-Type	FD-CDM2	noCDM	noCDM	noCDM	FD-CDM2
density	1	3	3	3	1
startingRB	0	0	0	0	0
nrofRBs	276 (Note 1)	276 (Note 1)	276 (Note 1)	276 (Note 1)	276 (Note 1)
Note 1: If the configured value of PRBs is larger than the width of the corresponding BWP relevant for the test case, the Test Equipment shall implement CSI-RS only in the width of that BWP.					

**Table A.3.14.2-1A: CSI-RS Reference Measurement Channels for SCS=15kHz**

	CSI-RS.1.1A TDD	CSI-RS.1.2A TDD	CSI-RS.1.3A TDD
Resource Type	periodic	aperiodic	periodic
<b>Resource Set Config</b>			
nzp-CSI-ResourceSetId	1	1	1
repetition	off	off	off
aperiodicTriggeringOffset	n.a.	0	n.a.
trs-Info	n.a.	n.a.	n.a.
<b>Resource Config</b>			
nzp-CSI-RS-ResourceId	12 for resource #0	22 for resource #0	14 for resource #0
	13 for resource #1	23 for resource #1	15 for resource #1
powerControlOffset	0	0	0
powerControlOffsetSS	db0	db0	db0

scramblingID	0	0	0
Period (slots)	slot20	n.a.	slot10
Offset	1	n.a.	2
qcl-InfoPeriodicCSI-RS	n.a.	n.a.	n.a.
frequencyDomainAllocation	0001	0001	0001
nrofPorts	1	1	1
firstOFDMSymbolInTimeDomain	6 for resource #0	7 for resource #0	6 for resource #0
	10 for resource #1	11 for resource #1	10 for resource #1
cdm-Type	noCDM	noCDM	noCDM
density	3	3	3
startingRB	0	0	0
nrofRBs	276 (Note 1)	276 (Note 1)	276 (Note 1)
Note 1: If the configured value of PRBs is larger than the width of the corresponding BWP relevant for the test case, the Test Equipment shall implement CSI-RS only in the width of that BWP.			

**Table A.3.14.2-2: CSI-RS Reference Measurement Channels for SCS=30kHz**

	CSI-RS.2.1 TDD	CSI-RS.2.2 TDD	CSI-RS.2.3 TDD	CSI-RS.2.4 TDD	CSI-RS.2.5 TDD	CSI-RS.2.6 TDD
Resource Type	periodic	periodic	aperiodic	aperiodic	aperiodic	periodic
<b>Resource Set Config</b>						
nzp-CSI-ResourceSetId	0	0	0	0	0	0
repetition	n.a.	off	off	on	off	n.a.
aperiodicTriggeringOffset	n.a.	n.a.	0	0	0	n.a.
trs-Info	n.a.	n.a.	n.a.	n.a.	n.a.	n.a.
<b>Resource Config</b>						
nzp-CSI-RS-ResourceId	0 for resource #0	0 for resource #0	0 for resource #0	0 for resource #0	0 for resource #0	0 for resource #0
				1 for resource #1		
				2 for resource #2		
				3 for resource #3		
		1 for resource #1	1 for resource #1	4 for resource #4	1 for resource #1	
				5 for resource #5		
				6 for resource #6		
		7 for resource #7				
powerControlOffset	0	0	0	0	0	0
powerControlOffsetSS	db0	db0	db0	db0	db0	db0
scramblingID	0	0	0	0	0	0
Period (slots)	slot10	slot20	n.a.	n.a.	n.a.	slot80
Offset	2	2	n.a.	n.a.	n.a.	2
qcl-InfoPeriodicCSI-RS	TCI.State.0	TCI.State.0 TCI.State.1	n.a.	n.a.	n.a.	TCI.State.0
frequencyDomainAllocation	000001	0001	0001	0001	000001	000001

nrofPorts	2	1	1	1	1	2
firstOFDMSymbolInTimeDomain	5 for resource #0	6 for resource #0	6 for resource #0	0 for resource #0	Specified in the test case for resource #0	5 for resource #0
				1 for resource #1		
				2 for resource #2		
				3 for resource #3		
		10 for resource #1	10 for resource #1	4 for resource #4	n.a.	
				5 for resource #5		
				6 for resource #6		
				7 for resource #7		
cdm-Type	FD-CDM2	noCDM	noCDM	noCDM	noCDM	FD-CDM2
density	1	3	3	3	3	1
startingRB	0	0	0	0	0	0
nrofRBs	276 (Note 1)	276 (Note 1)	276 (Note 1)	276 (Note 1)	276 (Note 1)	276 (Note 1)
Note 1: If the configured value of PRBs is larger than the width of the corresponding BWP relevant for the test case, the Test Equipment shall implement CSI-RS only in the width of that BWP.						

**Table A.3.14.2-2A: CSI-RS Reference Measurement Channels for SCS=30kHz**

	CSI-RS.2.1A TDD	CSI-RS.2.2A TDD	CSI-RS.2.3A TDD
Resource Type	periodic	aperiodic	periodic
Resource Set Config			
nzp-CSI-ResourceSetId	1	1	1
repetition	off	off	off
aperiodicTriggeringOffset	n.a.	0	n.a.
trs-Info	n.a.	n.a.	n.a.
Resource Config			
nzp-CSI-RS-ResourceId	12 for resource #0	22 for resource #0	14 for resource #0
	13 for resource #1	23 for resource #1	15 for resource #1
powerControlOffset	0	0	0
powerControlOffsetSS	db0	db0	db0
scramblingID	0	0	0
Period (slots)	slot40	n.a.	slot20
Offset	2	n.a.	4
qcl-InfoPeriodicCSI-RS	n.a.	n.a.	n.a.
frequencyDomainAllocation	0001	0001	0001
nrofPorts	1	1	1
firstOFDMSymbolInTimeDomain	6 for resource #0	7 for resource #0	6 for resource #0
	10 for resource #1	11 for resource #1	10 for resource #1



cdm-Type	noCDM	noCDM	noCDM
density	3	3	3
startingRB	0	0	0
nrofRBs	276 (Note 1)	276 (Note 1)	276 (Note 1)
Note 1: If the configured value of PRBs is larger than the width of the corresponding BWP relevant for the test case, the Test Equipment shall implement CSI-RS only in the width of that BWP.			

**Table A.3.14.2-3: CSI-RS Reference Measurement Channels for SCS=120kHz**

	CSI-RS.3.1 TDD	CSI-RS.3.2 TDD	CSI-RS.3.3 TDD	CSI-RS.3.4 TDD	CSI-RS.3.5 TDD
Resource Type	periodic	periodic	aperiodic	aperiodic	periodic
<b>Resource Set Config</b>					
nzp-CSI-ResourceSetId	0	0	0	0	0
repetition	n.a.	off	off	on	n.a.
aperiodicTriggeringOffset	n.a.	n.a.	4	4	n.a.
trs-Info	n.a.	n.a.	n.a.	n.a.	n.a.
<b>Resource Config</b>					
nzp-CSI-RS-ResourceId	0 for resource #0	0 for resource #0	0 for resource #0	0 for resource #0	0 for resource #0
		1 for resource #1	1 for resource #1	1 for resource #1	
		2 for resource #2		2 for resource #2	
		3 for resource #3		3 for resource #3	
		4 for resource #4		4 for resource #4	
		5 for resource #5		5 for resource #5	
		6 for resource #6		6 for resource #6	
		7 for resource #7		7 for resource #7	
powerControlOffset	0	0	0	0	0
powerControlOffsetSS	db0	db0	db0	db0	db0
scramblingID	0	0	0	0	0
Period (slots)	slot40	slot80	n.a.	n.a.	slot320
Offset	8	16	n.a.	n.a.	8
qcl-InfoPeriodicCSI-RS	TCI.State.0	TCI.State.0 TCI.State.1	n.a.	n.a.	TCI.State.0
frequencyDomainAllocation	000001	0001	0001	0001	000001
nrofPorts	2	1	1	1	1
firstOFDMsymbolInTimeDomain	5 for resource #0	6 for resource #0	6 for resource #0	0 for resource #0	5 for resource #0
		10 for resource #1	10 for resource #1	1 for resource #1	
				2 for resource #2	
				3 for resource #3	
				4 for resource #4	
				5 for resource #5	
				6 for resource #6	
				7 for resource #7	

cdm-Type	FD-CDM2	noCDM	noCDM	noCDM	FD-CDM2
density	1	3	3	3	1
startingRB	0	0	0	0	0
nrofRBs	276 (Note 1)	276 (Note 1)	276 (Note 1)	276 (Note 1)	276 (Note 1)
Note 1: If the configured value of PRBs is larger than the width of the corresponding BWP relevant for the test case, the Test Equipment shall implement CSI-RS only in the width of that BWP.					

**Table A.3.14.2-3A: CSI-RS Reference Measurement Channels for SCS=120kHz**

	CSI-RS.3.1A TDD	CSI-RS.3.2A TDD	CSI-RS.3.3A TDD
Resource Type	periodic	aperiodic	periodic
<b>Resource Set Config</b>			
nzp-CSI-ResourceSetId	1	1	1
repetition	off	off	off
aperiodicTriggeringOffset	n.a.	6	n.a.
trs-Info	n.a.	n.a.	n.a.
<b>Resource Config</b>			
nzp-CSI-RS-ResourceId	12 for resource #0	22 for resource #0	14 for resource #0
	13 for resource #1	23 for resource #1	15 for resource #1
powerControlOffset	0	0	0
powerControlOffsetSS	db0	db0	db0
scramblingID	0	0	0
Period (slots)	slot160	n.a.	slot80
Offset	8	n.a.	16
qcl-InfoPeriodicCSI-RS	n.a.	n.a.	n.a.
frequencyDomainAllocation	0001	0001	0001
nrofPorts	1	1	1
firstOFDMsymbolInTimeDomain	6 for resource #0	7 for resource #0	6 for resource #0
	10 for resource #1	11 for resource #1	10 for resource #1
cdm-Type	noCDM	noCDM	noCDM
density	3	3	3
startingRB	0	0	0
nrofRBs	276 (Note 1)	276 (Note 1)	276 (Note 1)
Note 1: If the configured value of PRBs is larger than the width of the corresponding BWP relevant for the test case, the Test Equipment shall implement CSI-RS only in the width of that BWP.			

### A.3.15 Angle of Arrival (AoA) for FR2 RRM test cases

This clause specifies the AoA setups for FR2 RRM test cases in clause A.5 and A.7. The applicable AoA setup is defined in each test case in clause A.5 and A.7.

### A.3.15.1 Setup 1: Single AoA in Rx beam peak direction

There is only one active probe in the test. The DL signals, and noise if applicable, transmitted from the probe, are aligned to the UE Rx beam peak direction (as defined in TS 38.101-2 [19]).

### A.3.15.2 Setup 2: Single AoA in non Rx beam peak direction

#### A.3.15.2.1 Setup 2a: Single AoA in non Rx beam peak direction without change in direction

There is only one active probe in the test. The DL signals, and noise if applicable, transmitted from the probe, align to a direction (AoA) which is from the set of directions corresponding to the EIS spherical coverage percentile of the DUT as defined in clause 7.3.4 of TS 38.101-2 [19] for each UE power class. The direction (AoA) of the signals shall not be changed between test iterations.

#### A.3.15.2.2 Setup 2b: Single AoA in non Rx beam peak direction with change in direction

There is only one active probe in the test. The DL signals, and noise if applicable, transmitted from the probe, align to a direction (AoA) which is from the set of directions corresponding to the EIS spherical coverage percentile of the DUT as defined in clause 7.3.4 of TS 38.101-2 [19] for each UE power class. For UE power class 3, the direction (AoA) of the signals shall be changed for each test iteration (for UE power classes other than 3, this is FFS).

### A.3.15.3 Setup 3: 2 AoAs

There are 2 active probes in the test. The DL signals, and noise if applicable, transmitted from the two active probes, align to directions (AoAs) which are from the set of directions corresponding to the EIS spherical coverage percentile of the DUT as defined in clause 7.3.4 of TS 38.101-2 [19] for each UE power class. The relative angular offset between the directions (AoAs) of the 2 active probes, shall be changed for each test iteration. The applicable set of relative angular offsets between the 2 active probes is given in Table 3.15.3-1 for each UE power class.

Editor Note: If RAN5 finds the changing of angular offset between the directions (AoAs) of the 2 active probes per test iteration to be infeasible from the perspectives of EIS spherical coverage and other impacts, e.g.: testing time, then the test setup will be revised.

**Table A.3.15.3-1: Set of relative angular offsets between active probes for each power class**

UE Power class	Relative angular offset between active probes
1	30°, 60°, 90° and 120°
2	FFS
3	30°, 60°, 90°, 120° and 150°
4	FFS

### A.3.15.4 Setup 4: 2 AoAs, 1 AoA in Rx beam peak direction, 1 in non Rx beam peak

#### A.3.15.4.1 Setup 4a: 2 AoAs, 1 AoA in Rx beam peak direction, 1 in non Rx beam peak without change in direction

There are 2 active probes in the test. The DL signals, and noise if applicable, are transmitted from the two active probes. One probe is aligned to the UE Rx beam peak direction as defined in TS 38.101-2 [19]. The second is aligned to a direction (AoA) which is from the set of directions corresponding to the EIS spherical coverage percentile of the DUT as defined in clause 7.3.4 of TS 38.101-2 [19] for each UE power class. The direction (AoA) of the non Rx beam peak signal shall not be changed between test iterations.

#### A.3.15.4.2 Setup 4b: 2 AoAs, 1 AoA in Rx beam peak direction, 1 in non Rx beam peak with change in direction

There are 2 active probes in the test. The DL signals, and noise if applicable, are transmitted from the two active probes. One probe is aligned to the UE Rx beam peak direction as defined in TS 38.101-2 [19]. The second is aligned to a

direction (AoA) which is from the set of directions corresponding to the EIS spherical coverage percentile of the DUT as defined in clause 7.3.4 of TS 38.101-2 [19] for each UE power class.

For UE power class 3, the relative angular offset between the directions (AoAs) of the 2 active probes shall be changed for each test iteration, within the probe alignment described above. The applicable set of relative angular offsets between the 2 active probes is given in Table 3.15.3-1 for each UE power class.

## A.3.16 TCI State Configuration

### A.3.16.1 Introduction

This clause provides the configurations for TCI states towards either SSB or CSI-RS. The TCI states defined in this clause are configured in each test when applicable to indicate that certain DL signals are QCL'ed with the referenceSignal configured in the TCI states.

### A.3.16.2 TCI states

**Table A.3.16.2-1: TCI States**

Parameter	TCI.State.0	TCI.State.1	TCI.State.2	TCI.State.3
tci-StateId	Id0	Id1	Id2	Id3
qcl-Type1	typeC	typeC	typeA	typeA
qcl-Type2 <sup>Note1</sup>	typeD	typeD	typeD	typeD
referenceSignal	SSB0	SSB1	Resource #4 in TRS resource set 1 <sup>Note3</sup>	Resource #4 in TRS resource set 2 <sup>Note3</sup>
Note 1: qcl-Type2 of typeD only where applicable. For RRM test cases, this will be only in FR2 Note 2: referenceSignal configurations towards which the TCI states are configured are defined in a test-specific manner. Note 3: Reference TRS resource sets are defined in A.3.17, and the applicable TRS resource set(s) are specified in each test case. When a single TRS resource set is configured in a test case, it is considered as resource set 1.				

**Table A.3.16.2-2: Void**

## A.3.17 Configurations of CSI-RS for tracking

### A.3.17.1 Configuration of CSI-RS for tracking for FR1

#### A.3.17.1.1 FDD

**Table A.3.17.1.1-1: CSI-RS for tracking for SCS=15kHz**

Parameter	Unit	Value
Reference channel		TRS.1.1 FDD
Bandwidth		BW of Active BWP <sup>Note 1</sup>
SCS	kHz	15
First subcarrier index in the PRB used for CSI-RS		$k_0=0$ for CSI-RS resource 1,2,3,4
First OFDM symbol in the slot used for CSI-RS		$l_0 = 5$ for CSI-RS resource 1 and 3 $l_0 = 9$ for CSI-RS resource 2 and 4
Number of CSI-RS ports (X)		1 for CSI-RS resource 1,2,3,4
CDM Type		'No CDM' for CSI-RS resource 1,2,3,4
Density ( $\rho$ )		3 for CSI-RS resource 1,2,3,4
CSI-RS periodicity	slots	20 for CSI-RS resource 1,2,3,4
CSI-RS offset	slots	10 for CSI-RS resource 1 and 2 11 for CSI-RS resource 3 and 4
EPRE ratio to SSS	dB	0 <sup>Note 2</sup>
TCI state		TCI.State.0
Note 1: BW of TRS is configured same as the BW size of UE active BWP in the RRM test cases		

Note 2: Unless otherwise specified in the test case
---

**Table A.3.17.1.1-2: CSI-RS for tracking for SCS=30kHz**

Parameter	Unit	Value
Reference channel		TRS.1.2 FDD
Bandwidth		BW of Active BWP <sup>Note 1</sup>
SCS	kHz	30
First subcarrier index in the PRB used for CSI-RS		$k_0=0$ for CSI-RS resource 1,2,3,4
First OFDM symbol in the slot used for CSI-RS		$l_0 = 5$ for CSI-RS resource 1 and 3 $l_0 = 9$ for CSI-RS resource 2 and 4
Number of CSI-RS ports (X)		1 for CSI-RS resource 1,2,3,4
CDM Type		'No CDM' for CSI-RS resource 1,2,3,4
Density ( $\rho$ )		3 for CSI-RS resource 1,2,3,4
CSI-RS periodicity	slots	40 for CSI-RS resource 1,2,3,4
CSI-RS offset	slots	20 for CSI-RS resource 1 and 2 21 for CSI-RS resource 3 and 4
EPRE ratio to SSS	dB	0 <sup>Note 2</sup>
TCI state		TCI.State.0
Note 1: BW of TRS is configured same as the BW size of UE active BWP in the RRM test cases		
Note 2: Unless otherwise specified in the test case		

## A.3.17.1.2 TDD

**Table A.3.17.1.2-1: CSI-RS for tracking for SCS=15kHz**

Parameter	Unit	Value
Reference channel		TRS.1.1 TDD
Bandwidth		BW of Active BWP <sup>Note 1</sup>
SCS	kHz	15
First subcarrier index in the PRB used for CSI-RS		$k_0=0$ for CSI-RS resource 1,2,3,4
First OFDM symbol in the slot used for CSI-RS		$l_0 = 5$ for CSI-RS resource 1 and 3 $l_0 = 9$ for CSI-RS resource 2 and 4
Number of CSI-RS ports (X)		1 for CSI-RS resource 1,2,3,4
CDM Type		'No CDM' for CSI-RS resource 1,2,3,4
Density ( $\rho$ )		3 for CSI-RS resource 1,2,3,4
CSI-RS periodicity	slots	20 for CSI-RS resource 1,2,3,4
CSI-RS offset	slots	10 for CSI-RS resource 1 and 2 11 for CSI-RS resource 3 and 4
EPRE ratio to SSS	dB	0 <sup>Note 2</sup>
TCI state		TCI.State.0
Note: BW of TRS is configured same as the BW size of UE active BWP in the RRM test cases		

**Table A.3.17.1.2-2: CSI-RS for tracking for SCS=30kHz**

Parameter	Unit	Value
Reference channel		TRS.1.2 TDD
Bandwidth		BW of Active BWP <sup>Note 1</sup>
SCS	kHz	30
First subcarrier index in the PRB used for CSI-RS		$k_0=0$ for CSI-RS resource 1,2,3,4
First OFDM symbol in the slot used for CSI-RS		$l_0 = 5$ for CSI-RS resource 1 and 3 $l_0 = 9$ for CSI-RS resource 2 and 4
Number of CSI-RS ports (X)		1 for CSI-RS resource 1,2,3,4
CDM Type		'No CDM' for CSI-RS resource 1,2,3,4
Density ( $\rho$ )		3 for CSI-RS resource 1,2,3,4
CSI-RS periodicity	slots	40 for CSI-RS resource 1,2,3,4
CSI-RS offset	slots	20 for CSI-RS resource 1 and 2 21 for CSI-RS resource 3 and 4
EPRE ratio to SSS	dB	0 <sup>Note 2</sup>
TCI state		TCI.State.0

Note 1:	BW of TRS is configured same as the BW size of UE active BWP in the RRM test cases
Note 2:	Unless otherwise specified in the test case

## A.3.17.2 Configuration of CSI-RS for tracking for FR2

### A.3.17.2.1 TDD

**Table A.3.17.2.1-1: CSI-RS for tracking for SCS=120kHz Set 1**

Parameter	Unit	Value
Reference channel		TRS.2.1 TDD
Bandwidth		BW of Active BWP <sup>Note 1,3</sup>
SCS	kHz	120
First subcarrier index in the PRB used for CSI-RS		$k_0=0$ for CSI-RS resource 1,2,3,4
First OFDM symbol in the slot used for CSI-RS		$l_0 = 1$ for CSI-RS resource 1 and 3 $l_0 = 5$ for CSI-RS resource 2 and 4
Number of CSI-RS ports (X)		1 for CSI-RS resource 1,2,3,4
CDM Type		'No CDM' for CSI-RS resource 1,2,3,4
Density ( $\rho$ )		3 for CSI-RS resource 1,2,3,4
CSI-RS periodicity	slots	80 for CSI-RS resource 1,2,3,4
CSI-RS offset	slots	40 for CSI-RS resource 1 and 2 41 for CSI-RS resource 3 and 4
EPRE ratio to SSS	dB	0 <sup>Note 2</sup>
TCI state		TCI.State.0
Note 1: BW of TRS is configured same as the BW size of UE active BWP in the RRM test cases		
Note 2: Unless otherwise specified in the test case		
Note 3: If active BWP is larger than 52RBs, BW of TRS is configured as 52RBs. Otherwise, same as active BWP size.		

**Table A.3.17.2.1-2: CSI-RS for tracking for SCS=120kHz Set 2**

Parameter	Unit	Value
Reference channel		TRS.2.2 TDD
Bandwidth		BW of Active BWP <sup>Note 1,3</sup>
SCS	kHz	120
First subcarrier index in the PRB used for CSI-RS		$k_0=0$ for CSI-RS resource 1,2,3,4
First OFDM symbol in the slot used for CSI-RS		$l_0 = 2$ for CSI-RS resource 1 and 3 $l_0 = 6$ for CSI-RS resource 2 and 4
Number of CSI-RS ports (X)		1 for CSI-RS resource 1,2,3,4
CDM Type		'No CDM' for CSI-RS resource 1,2,3,4
Density ( $\rho$ )		3 for CSI-RS resource 1,2,3,4
CSI-RS periodicity	slots	80 for CSI-RS resource 1,2,3,4
CSI-RS offset	slots	40 for CSI-RS resource 1 and 2 41 for CSI-RS resource 3 and 4
EPRE ratio to SSS	dB	0 <sup>Note 2</sup>
TCI state		TCI.State.1
Note 1: BW of TRS is configured same as the BW size of UE active BWP in the RRM test cases		
Note 2: Unless otherwise specified in the test case		
Note 3: If active BWP is larger than 52RBs, BW of TRS is configured as 52RBs. Otherwise, same as active BWP size.		

## A.3.18 Additional definitions related to OTA testing for FR2 RRM test cases

### A.3.18.1 Introduction

FR2 RRM test cases are performed over the air (OTA). This clause provides additional definitions and clarifications on the OTA measurements and metrics defined or referred in the test cases.

## A.3.18.2 PRACH Power Measurement

PRACH power is measured as EIRP(Link=Link angle, Meas=Link angle) as defined in clause 3.1 of TS 38.101-2 [19].

## A.3.19 Test applicability for DAPS handover

### A.3.19.1 Introduction

In Annex A test cases for DAPS handover may be defined with cells in on same or different carrier frequency to verify intra-frequency, intra-band inter-frequency and inter-band inter-frequency DAPS handover RRM requirements, respectively.

### A.3.19.2 Principle of testing

To verify intra-frequency DAPS handover requirements

- The UE capable of intra-frequency asynchronous DAPS handover on any band needs to be tested only in asynchronous scenario.
- The UE not capable of intra-frequency asynchronous DAPS handover on any band but capable of synchronous DAPS handover on some band needs to be tested only in synchronous scenario.

To verify intra-band inter-frequency DAPS handover requirements

- The UE capable of intra-band inter-frequency asynchronous DAPS handover on any band needs to be tested only in asynchronous scenario.
- The UE not capable of intra-band inter-frequency asynchronous DAPS handover on any band but capable of intra-band inter-frequency synchronous DAPS handover on some band needs to be tested only in synchronous scenario.

To verify inter-band inter-frequency DAPS handover requirements

- The UE capable of inter-band inter-frequency asynchronous DAPS handover on any band combination needs to be tested only in asynchronous scenario.
- The UE not capable of inter-band inter-frequency asynchronous DAPS handover on any band combination but capable of inter-band inter-frequency synchronous DAPS handover on some band combination needs to be tested only in synchronous scenario.

## A.3.20 MsgA configurations

### A.3.20.1 Introduction

This clause provides the typical PRACH and PUSCH configurations for MsgA used for RRM test cases defined in Annex A. To note that for other parameters not listed in this clause, either it can be derived from the set up of each test or it is subjected to RAN5 specifications.

### A.3.20.2 MsgA configurations in FR1

#### A.3.20.2.1 FR1 MsgA configuration 1

FR1 MsgA configuration 1 in this clause provides the typical MsgA configuration for SSB-based contention based random access for 2-step RA type in FR1.

**Table A.3.20.2.1-1: Parameters for FR1 MsgA configuration 1**

Field	Value	Comment
msgA-prach-ConfigurationIndex	102	10ms PRACH periodicity, and other detailed configuration defined in table 6.3.3.2-2 and table 6.3.3.2-3 in TS 38.211 [6].
msgA-SubcarrierSpacing	Same as UL carrier SCS	

msgA-totalNumberOfRA-Preambles	48	Total number of preambles used for contention based and contention free random access
numberOfRA-PreamblesGroupA	48	No group B.
msgA-PRACH-RootSequenceIndex	0	Logic sequence index = 0, resulting in root sequence = 1.
msgA-SSB-perRACH-OccasionAndCB-PreamblesPerSSB	oneFourth, n48	OneFourth: 1 SSB associated with 4 RACH occasions n48: 48 contention based preambles per SSB
msgA-RO-FDM	One	One PRACH transmission occasions FDMed in one time instance.
ra-ContentionResolutionTimer	sf48	48 sub-frames
msgA-PreamblePowerRampingStep	dB2	
msgA-PreambleReceivedTargetPower	dBm-120	
preambleTransMax	n6	Max number of RA preamble transmission performed before declaring a failure is 6
msgB-ResponseWindow	sl10	10 slots
msgA-ZeroCorrelationZoneConfig	11	N-CS configuration, Ncs = 23
Backoff Parameter Index	2	20ms, as defined in table 7.2-1 in TS 38.321 [7].
msgA-MCS	1	MCS index for MsgA PUSCH
nrofSlotsMsgA-PUSCH	1	Number of slots containing one or multiple PUSCH occasions
nrofMsgA-PO-PerSlot	1	Number of time domain PUSCH occasions in each slot
msgA-PUSCH-TimeDomainOffset	1	A single time offset with respect to the start of each PRACH slot, counted as the number of slots
PUSCH start symbol	0	
PUSCH allocation length	14	
mappingTypeMsgA-PUSCH	typeA	
nrofPRBs-PerMsgA-PO	2	Number of RBs per PUSCH occasion
nrofMsgA-PO-FDM	One	The number of MsgA PUSCH occasions FDMed in one time instance
msgA-DMRS-AdditionalPosition	pos1	Position for additional DM-RS
msgA-PUSCH-NrofPorts	1	Configure 1 port per CDM group
msgA-DeltaPreamble	3	Power offset of msgA PUSCH relative to the preamble received target power
msgA-Alpha	alpha1	Alpha value for MsgA PUSCH. Set 1
deltaMCS	Disabled	Whether to apply delta MCS
Note: For further information see clause 6.3.2 in TS 38.331 [2].		

### A.3.20.2.2 FR1 MsgA configuration 2

FR1 PRACH configuration 2 in this clause provides the typical MsgA configuration for SSB based non-contention based random access for 2-step RA type in FR1.

**Table A.3.20.2.2-1: Parameters for FR1 MsgA configuration 2**

Field	Value	Comment
msgA-prach-ConfigurationIndex	102	10ms PRACH periodicity, and other detailed configuration defined in table 6.3.3.2-2 and table 6.3.3.2-3 in TS 38.211 [6].
msgA-SubcarrierSpacing	Same as UL carrier SCS	
msgA-totalNumberOfRA-Preambles	48	Total number of preambles used for contention based and contention free random access
numberOfRA-PreamblesGroupA	48	No group B.
msgA-PRACH-RootSequenceIndex	0	Logic sequence index = 0, resulting in root sequence = 1.
ssb-perRACH-Occasion	oneFourth	OneFourth: 1 SSB associated with 4 RACH occasions
msgA-RO-FDM	One	One PRACH transmission occasions FDMed in one time instance.
msgA-PreamblePowerRampingStep	dB2	



msgA-PreambleReceivedTargetPower	dBm-120	
preambleTransMax	n6	Max number of RA preamble transmission performed before declaring a failure is 6
msgB-ResponseWindow	sl10	10 slots
msgA-ZeroCorrelationZoneConfig	11	N-CS configuration, Ncs = 23
Backoff Parameter Index	2	20ms, as defined in table 7.2-1 in TS 38.321 [7].
ssb-ResourceList	ra-PreambleIndex = 50	Associated with SSB index 0. UE doesn't use ssb-ResourceList and BFR-SSB-Resource IEs at the same time. UE doesn't use this field if is transmitting CFRA to convey BFR.
BFR-SSB-Resource	ra-PreambleIndex = 50	Associated with SSB index 0. UE doesn't use ssb-ResourceList and BFR-SSB-Resource IEs at the same time. UE uses this field only if is transmitting CFRA to convey BFR
ra-ssb-OccasionMaskIndex	1	PRACH occasion index 1 is allowed
msgA-MCS	1	MCS index for MsgA PUSCH
nrofSlotsMsgA-PUSCH	1	Number of slots containing one or multiple PUSCH occasions
nrofMsgA-PO-PerSlot	1	Number of time domain PUSCH occasions in each slot
msgA-PUSCH-TimeDomainOffset	1	A single time offset with respect to the start of each PRACH slot, counted as the number of slots
PUSCH start symbol	0	
PUSCH allocation length	14	
mappingTypeMsgA-PUSCH	typeA	
nrofPRBs-PerMsgA-PO	2	Number of RBs per PUSCH occasion
nrofMsgA-PO-FDM	One	The number of MsgA PUSCH occasions FDMed in one time instance
msgA-DMRS-AdditionalPosition	pos1	Position for additional DM-RS
msgA-PUSCH-NrofPorts	1	Configure 1 port per CDM group
msgA-DeltaPreamble	3	Power offset of msgA PUSCH relative to the preamble received target power
msgA-Alpha	alpha1	Alpha value for MsgA PUSCH. Set 1
deltaMCS	Disabled	Whether to apply delta MCS
Note: For further information see clause 6.3.2 in TS 38.331 [2].		

### A.3.20.3 MsgA configurations in FR2

#### A.3.20.3.1 FR2 MsgA configuration 1

FR2 MsgA configuration 1 in this clause provides the typical MsgA configuration for SSB-based contention based random access for 2-step RA type in FR2.

**Table A.3.20.3.1-1: Parameters for FR2 MsgA configuration 1**

Field	Value	Comment
msgA-prach-ConfigurationIndex	190	Preamble Format C2, with 10ms PRACH periodicity, and other detailed configurations defined in table 6.3.3.2-4 in TS 38.211 [6].
msgA-SubcarrierSpacing	Same as UL carrier SCS	
msgA-totalNumberOfRA-Preambles	48	Total number of preambles used for contention based and contention free random access
numberOfRA-PreamblesGroupA	48	No group B.
msgA-PRACH-RootSequenceIndex	0	Logic sequence index = 0, resulting in root sequence = 1.

msgA-SSB-perRACH-OccasionAndCB-PreamblesPerSSB	oneFourth, n48	OneFourth: 1 SSB associated with 4 RACH occasions n48: 48 contention-based preambles per SSB
msgA-RO-FDM	One	One PRACH transmission occasions FDMed in one time instance.
ra-ContentionResolutionTimer	sf48	48 sub-frames
msgA-PreamblePowerRampingStep	dB2	
msgA-PreambleReceivedTargetPower	dBm-120	
preambleTransMax	n6	Max number of RA preamble transmission performed before declaring a failure is 6
msgB-ResponseWindow	sl10	10 slots
msgA-ZeroCorrelationZoneConfig	11	N-CS configuration, Ncs = 23
Backoff Parameter Index	2	20 ms, as defined in table 7.2-1 in TS 38.321 [7].
msgA-MCS	1	MCS index for MsgA PUSCH
nrofSlotsMsgA-PUSCH	1	Number of slots containing one or multiple PUSCH occasions
nrofMsgA-PO-PerSlot	1	Number of time domain PUSCH occasions in each slot
msgA-PUSCH-TimeDomainOffset	1	A single time offset with respect to the start of each PRACH slot, counted as the number of slots
PUSCH start symbol	0	
PUSCH allocation length	10	
mappingTypeMsgA-PUSCH	typeA	
nrofPRBs-PerMsgA-PO	2	Number of RBs per PUSCH occasion
nrofMsgA-PO-FDM	One	The number of MsgA PUSCH occasions FDMed in one time instance
msgA-DMRS-AdditionalPosition	pos1	Position for additional DM-RS
msgA-PUSCH-NrofPorts	1	Configure 1 port per CDM group
msgA-DeltaPreamble	3	Power offset of msgA PUSCH relative to the preamble received target power
msgA-Alpha	alpha1	Alpha value for MsgA PUSCH. Set 1
deltaMCS	Disabled	Whether to apply delta MCS
Note: For further information see clause 6.3.2 in TS 38.331 [2].		

### A.3.20.3.2 FR2 MsgA configuration 2

FR2 MsgA configuration 2 in this clause provides the typical MsgA configuration for SSB based non-contention based random access for 2-step RA type in FR2.

**Table A.3.20.3.2-1: Parameters for FR2 MsgA configuration 2**

Field	Value	Comment
msgA-prach-ConfigurationIndex	190	Preamble Format C2, with 10ms PRACH periodicity, and other detailed configurations defined in table 6.3.3.2-4 in TS 38.211 [6].
msgA-SubcarrierSpacing	Same as UL carrier SCS	
totalNumberOfRA-Preambles	48	Total number of preambles used for contention based and contention free random access
numberOfRA-PreamblesGroupA	48	No group B.
msgA-PRACH-RootSequenceIndex	0	Logic sequence index = 0, resulting in root sequence = 1.
ssb-perRACH-Occasion	oneFourth	OneFourth: 1 SSB associated with 4 RACH occasions
msgA-RO-FDM	One	One PRACH transmission occasions FDMed in one time instance.
msgA-PreamblePowerRampingStep	dB2	
msgA-PreambleReceivedTargetPower	dBm-120	
preambleTransMax	n6	Max number of RA preamble transmission performed before declaring a failure is 6
msgB-ResponseWindow	sl10	10 slots

msgA-ZeroCorrelationZoneConfig	11	N-CS configuration, Ncs = 23
Backoff Parameter Index	2	20 ms, as defined in table 7.2-1 in TS 38.321 [7].
ssb-ResourceList	ra-PreambleIndex = 50	Associated with SSB index 0. UE doesn't use ssb-ResourceList and BFR-SSB-Resource IEs at the same time. UE doesn't use this field if is transmitting CFRA to convey BFR.
BFR-SSB-Resource	ra-PreambleIndex = 50	Associated with SSB index 0. UE doesn't use ssb-ResourceList and BFR-SSB-Resource IEs at the same time. UE uses this field only if is transmitting CFRA to convey BFR
ra-ssb-OccasionMaskIndex	1	PRACH occasion index 1 is allowed
msgA-MCS	1	MCS index for MsgA PUSCH
nrofSlotsMsgA-PUSCH	1	Number of slots containing one or multiple PUSCH occasions
nrofMsgA-PO-PerSlot	1	Number of time domain PUSCH occasions in each slot
msgA-PUSCH-TimeDomainOffset	1	A single time offset with respect to the start of each PRACH slot, counted as the number of slots
PUSCH start symbol	0	
PUSCH allocation length	10	
mappingTypeMsgA-PUSCH	typeA	
nrofPRBs-PerMsgA-PO	2	Number of RBs per PUSCH occasion
nrofMsgA-PO-FDM	One	The number of MsgA PUSCH occasions FDMed in one time instance
msgA-DMRS-AdditionalPosition	pos1	Position for additional DM-RS
msgA-PUSCH-NrofPorts	1	Configure 1 port per CDM group
msgA-DeltaPreamble	3	Power offset of msgA PUSCH relative to the preamble received target power
msgA-Alpha	alpha1	Alpha value for MsgA PUSCH. Set 1
deltaMCS	Disabled	Whether to apply delta MCS
Note: For further information see clause 6.3.2 in TS 38.331 [2].		

## A.3.20A MsgA configurations under CCA

### A.3.20A.1 Introduction

This clause provides the typical PRACH and PUSCH configurations for MsgA used for RRM test cases defined in Annex A. To note that for other parameters not listed in this clause, either it can be derived from the set up of each test or it is subjected to RAN5 specifications.

### A.3.20A.2 MsgA configurations in FR1

#### A.3.20A.2.1 FR1 MsgA configuration 1 under CCA

FR1 MsgA configuration 1 under CCA in this clause provides the typical MsgA configuration for SSB-based contention based random access for 2-step RA type in FR1.

**Table A.3.20A.2.1-1: Parameters for FR1 MsgA configuration 1 under CCA**

Field	Value	Comment
msgA-prach-ConfigurationIndex	102	10ms PRACH periodicity, and other detailed configuration defined in table 6.3.3.2-2 and table 6.3.3.2-3 in TS 38.211 [6].
msgA-SubcarrierSpacing	Same as UL carrier SCS	
msgA-totalNumberOfRA-Preambles	48	Total number of preambles used for contention based and contention free random access

numberOfRA-PreamblesGroupA	48	No group B.
msgA-PRACH-RootSequenceIndex	0	Logic sequence index = 0, resulting in root sequence = 1.
msgA-SSB-perRACH-OccasionAndCB-PreamblesPerSSB	oneFourth, n48	OneFourth: 1 SSB associated with 4 RACH occasions n48: 48 contention based preambles per SSB
msgA-RO-FDM	One	One PRACH transmission occasions FDMed in one time instance.
ra-ContentionResolutionTimer	sf48	48 sub-frames
msgA-PreamblePowerRampingStep	dB2	
msgA-PreambleReceivedTargetPower	dBm-114	Increased by 6 dB compared with FR1 MsgA configuration 1 for random access test with UL CCA failures.
preambleTransMax	n20	Max number of RA preamble transmission performed before declaring a failure is 20 to account for CCA failures
msgB-ResponseWindow	sl20	20 slots
msgA-ZeroCorrelationZoneConfig	11	N-CS configuration, Ncs = 23
Backoff Parameter Index	2	20ms, as defined in table 7.2-1 in TS 38.321 [7].
msgA-MCS	1	MCS index for MsgA PUSCH
nrofSlotsMsgA-PUSCH	1	Number of slots containing one or multiple PUSCH occasions
nrofMsgA-PO-PerSlot	1	Number of time domain PUSCH occasions in each slot
msgA-PUSCH-TimeDomainOffset	1	A single time offset with respect to the start of each PRACH slot, counted as the number of slots
PUSCH start symbol	0	
PUSCH allocation length	14	
mappingTypeMsgA-PUSCH	typeA	
nrofPRBs-PerMsgA-PO	2	Number of RBs per PUSCH occasion
nrofMsgA-PO-FDM	One	The number of MsgA PUSCH occasions FDMed in one time instance
msgA-DMRS-AdditionalPosition	pos1	Position for additional DM-RS
msgA-PUSCH-NrofPorts	1	Configure 1 port per CDM group
msgA-DeltaPreamble	3	Power offset of msgA PUSCH relative to the preamble received target power
msgA-Alpha	alpha1	Alpha value for MsgA PUSCH. Set 1
deltaMCS	Disabled	Whether to apply delta MCS
Note: For further information see clause 6.3.2 in TS 38.331 [2].		

### A.3.20A.2.2 FR1 MsgA configuration 2 under CCA

FR1 PRACH configuration 2 under CCA in this clause provides the typical MsgA configuration for SSB based non-contention based random access for 2-step RA type in FR1.

**Table A.3.20A.2.2-1: Parameters for FR1 MsgA configuration 2 under CCA**

Field	Value	Comment
msgA-prach-ConfigurationIndex	102	10ms PRACH periodicity, and other detailed configuration defined in table 6.3.3.2-2 and table 6.3.3.2-3 in TS 38.211 [6].
msgA-SubcarrierSpacing	Same as UL carrier SCS	
msgA-totalNumberOfRA-Preambles	48	Total number of preambles used for contention based and contention free random access
numberOfRA-PreamblesGroupA	48	No group B.
msgA-PRACH-RootSequenceIndex	0	Logic sequence index = 0, resulting in root sequence = 1.
ssb-perRACH-Occasion	oneFourth	OneFourth: 1 SSB associated with 4 RACH occasions
msgA-RO-FDM	One	One PRACH transmission occasions FDMed in one time instance.

msgA-PreamblePowerRampingStep	dB2	
msgA-PreambleReceivedTargetPower	dBm-114	Increased by 6 dB compared with FR1 MsgA configuration 2 for random access test with UL CCA failures.
preambleTransMax	n20	Max number of RA preamble transmission performed before declaring a failure is 20 to account for CCA failures
msgB-ResponseWindow	sl20	20 slots
msgA-ZeroCorrelationZoneConfig	11	N-CS configuration, Ncs = 23
Backoff Parameter Index	2	20ms, as defined in table 7.2-1 in TS 38.321 [7].
ssb-ResourceList	ra-PreambleIndex = 50	Associated with SSB index 0. UE doesn't use ssb-ResourceList and BFR-SSB-Resource IEs at the same time. UE doesn't use this field if is transmitting CFRA to convey BFR.
BFR-SSB-Resource	ra-PreambleIndex = 50	Associated with SSB index 0. UE doesn't use ssb-ResourceList and BFR-SSB-Resource IEs at the same time. UE uses this field only if is transmitting CFRA to convey BFR
ra-ssb-OccasionMaskIndex	1	PRACH occasion index 1 is allowed
msgA-MCS	1	MCS index for MsgA PUSCH
nrofSlotsMsgA-PUSCH	1	Number of slots containing one or multiple PUSCH occasions
nrofMsgA-PO-PerSlot	1	Number of time domain PUSCH occasions in each slot
msgA-PUSCH-TimeDomainOffset	1	A single time offset with respect to the start of each PRACH slot, counted as the number of slots
PUSCH start symbol	0	
PUSCH allocation length	14	
mappingTypeMsgA-PUSCH	typeA	
nrofPRBs-PerMsgA-PO	2	Number of RBs per PUSCH occasion
nrofMsgA-PO-FDM	One	The number of MsgA PUSCH occasions FDMed in one time instance
msgA-DMRS-AdditionalPosition	pos1	Position for additional DM-RS
msgA-PUSCH-NrofPorts	1	Configure 1 port per CDM group
msgA-DeltaPreamble	3	Power offset of msgA PUSCH relative to the preamble received target power
msgA-Alpha	alpha1	Alpha value for MsgA PUSCH. Set 1
deltaMCS	Disabled	Whether to apply delta MCS
Note: For further information see clause 6.3.2 in TS 38.331 [2].		

## A.3.21 V2X sidelink communication

### A.3.21.1 Introduction

This clause also defines the principle and the reference configurations that are applicable to test cases verifying RRM core requirements for V2X sidelink communication.

### A.3.21.2 Reference resource pool configurations for V2X Sidelink Communication

**Table A.3.21.2-1: V2X sidelink SL-BWP configuration for NR**

Field	Value	Comment
SL-BWP-ConfigCommon-r16		
sl-BWP-Generic-r16		

sl-LengthSymbols-r16	sym14	All 14 symbols in a slot without S-SSB are used for sidelink
sl-StartSymbol-r16	sym0	Symbol #0 is the starting symbol used for sidelink in a slot without S-SSB
sl-BWP-PoolConfigCommon-r16		
sl-RxPool-r16		Indicates the resource pool for reception on the configured BWP. 1 entry
SL-ResourcePool-r16[1]	Set according to Table A.3.21.2-2	Entry 1
sl-TxPoolSelectedNormal-r16		Indicates the resources pool for mode 2 sidelink communication on the configured BWP. 1 entry
SL-ResourcePoolConfig-r16[1]		Entry 1
sl-ResourcePool-r16	Set according to Table A.3.21.2-2	
sl-TxPoolExceptional-r16	Not present	

Table A.3.21.2-2: V2X sidelink resource pool configuration for NR

Field	Value	Comment
SL-ResourcePool-r16		
sl-PSCCH-Config-r16	Set according to Table A.3.21.3-1	
sl-PSSCH-Config-r16	Set according to Table A.3.21.3-2	
sl-PSFCH-Config-r16	Not present	
sl-SyncAllowed-r16		Indicates the allowed synchronization reference(s) which is (are) allowed to use the configured resource pool.
gnss-Sync-r16	true	
gnbEnb-Sync-r16	true	
ue-Sync-r16	true	
sl-SubchannelSize-r16	n10	Subchannel bandwidth is 10 RB
sl-StartRB-Subchannel-r16	0	The offset of lowest RB index of the subchannel with the lowest index in the resource pool with respect to the lowest RB index of a SL BWP
sl-NumSubchannel-r16	1	Number of subchannels in resource pool
sl-UE-SelectedConfigRP-r16		
sl-Thres-RSRP-List-r16	Set according to the specific test configuration	Indicates a list of 64 thresholds, and the threshold should be selected based on the priority in the decoded SCI and the priority in the SCI to be transmitted. A resource is excluded if it is indicated or reserved by a decoded SCI and PSSCH RSRP in the associated data resource is above a threshold.
sl-MultiReserveResource-r16	Not present	
sl-MaxNumPerReserve-r16	n2	At most 2 PSCCH/PSSCH resources can be reserved by a single SCI.
sl-SensingWindow-r16	ms100	Length of resource sensing window specified in TS 38.214 [26] subclause 8.1.4. which is 100ms.
sl-SelectionWindowList-r16		Parameter that determines the end of the selection window for each priority level 8 entries
SL-SelectionWindowConfig-r16[k,k=1..8]		entry k
sl-Priority-r16	k	for priority level = k
sl-SelectionWindow-r16	n20	Length of resource selection window specified in TS 38.214 [26] subclause 8.1.4. which is $20 \cdot 2^\mu$ slots, where $\mu=0,1,2,3$ refers to SCS 15,30,60,120 kHz respectively
sl-ResourceReservePeriodList-r16	Not present	

sl-RS-ForSensing-r16	pssch	PSSCH-RSRP measurement is used in the sensing operation.
sl-RxParametersNcell	Not present	
sl-ZoneConfigMCR-List-r16	Not present	
sl-PreemptionEnable-r16	enabled	
sl-MinMaxMCS-List-r16		1 entry
SL-MinMaxMCS-Config-r16[1]		Entry 1
sl-MCS-Table-r16	qam64	TS 38.214 [26] Table 5.1.3.1-1 is the MCS table used in the resource pool.
sl-TimeResource-r16	1111111111 1111111111	Every slot in a period of 20 slots during a SFN or DFN cycle can be used for sidelink
SL-TxPercentageList-r16		
SL-TxPercentageConfig-r16		
sl-TxPercentage-r16	p20	Indicates the portion of candidate single-slot PSSCH resources over the total resources. Value p20 corresponds to 20%, and so on.

**Table A.3.21.2-3: V2X sidelink UE autonomous resource selection configuration for NR**

Field	Value	Comment
SL-UE-SelectedConfig-r16		
sl-PSSCH-TxConfigList-r16		1 entry
SL-PSSCH-TxConfig-r16[1]		Entry 1
sl-TypeTxSync-r16	Not present	When this field is absent, the configuration is applicable for all synchronization reference types.
sl-ThresUE-Speed-r16	kmph200	UE shall apply the parameters in sl-ParametersAboveThres-r16 if UE absolute speed is higher than 200 km/h, otherwise UE shall apply the parameters in sl-ParametersBelowThres-r16
sl-ParametersAboveThres-r16		
sl-MinMCS-PSSCH-r16	0	The minimum MCS index value can be used for PSSCH transmission.
sl-MaxMCS-PSSCH-r16	15	The maximum MCS index value can be used for PSSCH transmission.
sl-MinSubChannelNumPSSCH-r16	1	The minimum number of subchannels can be used for PSSCH transmission.
sl-MaxSubchannelNumPSSCH-r16	1	The maximum number of subchannels can be used for PSSCH transmission.
sl-MaxTxTransNumPSSCH-r16	1	The maximum transmission number for PSSCH (including new transmission and retransmission).
sl-MaxTxPower-r16	Not present	Not applicable
sl-ParametersBelowThres-r16		
sl-MinMCS-PSSCH-r16	4	Same as above
sl-MaxMCS-PSSCH-r16	25	Same as above
sl-MinSubChannelNumPSSCH-r16	1	Same as above
sl-MaxSubchannelNumPSSCH-r16	1	Same as above
sl-MaxTxTransNumPSSCH-r16	1	Same as above
sl-MaxTxPower-r16	Not present	Same as above
sl-ProbResourceKeep-r16	v0dot8	The probability of UE keeping current resource is 80% when the resource reselection counter reaches 0 (see TS 38.321 [7]).
sl-ReselectAfter-r16	n1	Resource reselection is triggered after 1 sidelink transmission is skipped (see TS 38.321 [7]).

### A.3.21.3 Reference measurement channels for V2X Sidelink Communication

**Table A.3.21.3-1: PSCCH Reference Measurement Channels**

Parameter	Unit	Value
Reference channel		CC.1A HD

Channel bandwidth	MHz	Note2
Number of PSCCH symbols per slot		2
Number of PSCCH RB		10
Modulation		QPSK
Information Bit Payload (without CRC)	Bits	26
Information Bit	Number of DMRS ports	0 (1 port)
	Priority	As set by higher layers
	Resource reservation period	N/A
	Modulation and coding scheme	Set as the PSSCH MCS specified in the test
	DMRS pattern	0 (2 DMRS)
	2 <sup>nd</sup> stage SCI format	00 (SCI format 2-A)
	Beta offset indicator	Set as specified in the test
	Frequency resource assignment	Set as per PSSCH RB allocation specific in the test
	Time resource assignment	Set as per PSSCH slot allocation specific in the test
Reserved bits		Set all these bits to 0
Transport block CRC	Bits	24
Binary Channel Bits (see Note 1)	Bits	360
Note 1: Binary channel bits calculated under assumption of 2 CP-OFDM symbols per subframe.		
Note 2: Channel bandwidth depends on test configuration.		

Table A.3.21.3-2: PSSCH Reference Measurement Channels

Parameter	Unit	Value
Reference channel		CD.1A HD
Sidelink transmission mode		2
Channel bandwidth	MHz	Note1
Allocated PSSCH resource blocks		10
Number of PSSCH symbols per slot		10
Modulation		QPSK
Target Code Rate		1/3
Information Bit Payload (Transport block size)	Bits	672
Transport block CRC	Bits	24
Number of PSSCH HARQ retransmissions		0
Binary Channel Bits	Bits	2160
Note 1: Channel bandwidth depends on test configuration.		
Note 2: 2nd state SCI and PSFCH are not allocated per slot.		

## A.3.22 CSI-IM configurations

### A.3.22.1 FDD

Table A.3.22.1-1: CSI-IM Reference Measurement Channels for SCS=15kHz

	CSI-IM.1.1 FDD	CSI-IM.1.2 FDD	CSI-IM.1.3 FDD
Resource Type	periodic	aperiodic	periodic
Resource Set Config			
csi-IM-ResourceSetId	0	0	0
Resource Config			
csi-IM-ResourceId	0 for resource #0	10 for resource #0	2 for resource #0
	1 for resource #1	11 for resource #1	3 for resource #1
csi-IM-ResourceElementPattern	pattern1	pattern1	pattern1



subcarrierLocation-p1	s0	s0	s0
symbolLocation-p1	6 for resource #0	7 for resource #0	6 for resource #0
	10 for resource #1	11 for resource #1	10 for resource #1
Period (slots)	slot20	n.a.	slot10
Offset	1	n.a.	2
startingRB	0	0	0
nrofRBs	276 (Note 1)	276 (Note 1)	276 (Note 1)
Note 1: If the configured value of PRBs is larger than the width of the corresponding BWP relevant for the test case, the test Equipment shall implement CSI-RS only in the width of that BWP.			

### A.3.22.2 TDD

**Table A.3.22.2-1: CSI-IM Reference Measurement Channels for SCS=15kHz**

Resource Type	CSI-IM.1.1 TDD periodic	CSI-IM.1.2 TDD aperiodic	CSI-IM.1.3 TDD periodic
<b>Resource Set Config</b>			
csi-IM-ResourceSetId	0	0	0
<b>Resource Config</b>			
csi-IM-ResourceId	0 for resource #0	10 for resource #0	2 for resource #0
	1 for resource #1	11 for resource #1	3 for resource #1
csi-IM-ResourceElementPattern	pattern1	pattern1	pattern1
subcarrierLocation-p1	s0	s0	s0
symbolLocation-p1	6 for resource #0	7 for resource #0	6 for resource #0
	10 for resource #1	11 for resource #1	10 for resource #1
Period (slots)	slot20	n.a.	slot10
Offset	1	n.a.	2
startingRB	0	0	0
nrofRBs	276 (Note 1)	276 (Note 1)	276 (Note 1)
Note 1: If the configured value of PRBs is larger than the width of the corresponding BWP relevant for the test case, the test Equipment shall implement CSI-RS only in the width of that BWP.			

**Table A.3.22.2-2: CSI-IM Reference Measurement Channels for SCS=30kHz**

Resource Type	CSI-IM.2.1 TDD periodic	CSI-IM.2.2 TDD aperiodic	CSI-IM.2.3 TDD periodic
<b>Resource Set Config</b>			
csi-IM-ResourceSetId	0	0	0
<b>Resource Config</b>			
csi-IM-ResourceId	0 for resource #0	10 for resource #0	2 for resource #0
	1 for resource #1	11 for resource #1	3 for resource #1
csi-IM-ResourceElementPattern	pattern1	pattern1	pattern1
subcarrierLocation-p1	s0	s0	s0
symbolLocation-p1	6 for resource #0	7 for resource #0	6 for resource #0
	10 for resource #1	11 for resource #1	10 for resource #1
Period (slots)	slot40	n.a.	slot40
Offset	2	n.a.	4

startingRB	0	0	0
nrofRBs	276 (Note 1)	276 (Note 1)	276 (Note 1)
Note 1: If the configured value of PRBs is larger than the width of the corresponding BWP relevant for the test case, the test Equipment shall implement CSI-RS only in the width of that BWP.			

**Table A.3.22.2-3: CSI-RS Reference Measurement Channels for SCS=120kHz**

	CSI-IM.3.1 TDD	CSI-IM.3.2 TDD	CSI-IM.3.3 TDD
Resource Type	periodic	aperiodic	periodic
Resource Set Config			
csi-IM-ResourceSetId	0	0	0
Resource Config			
csi-IM-ResourceId	0 for resource #0	10 for resource #0	2 for resource #0
	1 for resource #1	11 for resource #1	3 for resource #1
csi-IM-ResourceElementPattern	pattern1	pattern1	pattern1
subcarrierLocation-p1	s0	s0	s0
symbolLocation-p1	6 for resource #0	7 for resource #0	6 for resource #0
	10 for resource #1	11 for resource #1	10 for resource #1
Period (slots)	slot160	n.a.	slot80
Offset	8	n.a.	16
startingRB	0	0	0
nrofRBs	276 (Note 1)	276 (Note 1)	276 (Note 1)
Note 1: If the configured value of PRBs is larger than the width of the corresponding BWP relevant for the test case, the test Equipment shall implement CSI-RS only in the width of that BWP.			

## A.3.23 Spatial Relation Configuration

### A.3.23.1 Introduction

This clause provides the configurations for spatial relation towards either SSB or CSI-RS. The spatial relation defined in this clause are configured in each test when applicable to indicate spatial setting for certain UL signals with the referenceSignal configured in the spatial relation.

### A.3.23.2 Spatial Relation

**Table A.3.23.2-1: PUCCH Spatial Relation**

Parameter	PUCCH.SRI.0	PUCCH.SRI.1
pucch-SpatialRelationInfoId	Id0	Id1
referenceSignal	SSB0	SSB1
PUCCH-PathlossReferenceRS	SSB0	SSB1
Note 1: referenceSignal configurations towards which the spatial relation are configured in a test-specific manner.		

**Table A.3.23.2-2: SRS Spatial Relation**

Parameter	SRS.SRI0	SRS.SRI1
srs-SpatialRelationInfoId	Id0	Id1
referenceSignal	SSB0	SSB1
Note 1: referenceSignal configurations towards which the spatial relation are configured in a test-specific manner.		

## A.3.24 SRS configuration

**Table A.3.24-1: Sounding Reference Symbol Configuration for SCS=15kHz**

	<b>SRS.1 TDD</b>	<b>SRS.4 TDD</b>	<b>POS-SRS.1</b>	
<b>Field</b>	<b>Value</b>	<b>Value</b>		<b>Comment</b>
c-SRS	12	12	Same as NRB,c in the test case	
b-SRS	0	0	n.a.	
b-hop	0	0	n.a.	Frequency hopping is disabled
groupOrSequenceHopping	neither	neither	neither	No group or sequence hopping
freqDomainPosition	0	0	0	Frequency domain position of SRS
freqDomainShift	0	0	0	
pathlossReferenceRS ssb-Index	0	0	0	SSB #0 is used for SRS path loss estimation
usage	antennaSwitching	antennaSwitching	n.a.	
startPosition	1	1	5	resourceMapping setting
nrofSymbols	1	1	4	SRS symbols belong to the same SRS resource.
repetitionFactor	n1	n1	n.a.	without repetition.
transmissionComb	n2	n2	n4	
combOffset	0	0	0	transmissionComb setting
cyclicShift	0	0	0	
nrofSRS-Ports	port1	port1	port1	Number of antenna ports used for SRS resource transmission
resourceType	Periodic	Aperiodic	Periodic	
periodicityAndOffset-p	sl40, 1	N/A	sl160, 20	SRS transmission periodicity

**Table A.3.24-2: Sounding Reference Symbol Configuration for SCS=30kHz**

	<b>SRS.2 TDD</b>	<b>SRS.5 TDD</b>	<b>POS-SRS.2</b>	
<b>Field</b>	<b>Value</b>	<b>Value</b>		<b>Comment</b>
c-SRS	24	24	Same as NRB,c in the test case	
b-SRS	0	0	n.a.	
b-hop	0	0	n.a.	Frequency hopping is disabled
groupOrSequenceHopping	neither	neither	neither	No group or sequence hopping
freqDomainPosition	0	0	0	Frequency domain position of SRS
freqDomainShift	0	0	0	

pathlossReferenceRS ssb-Index	0	0	0	SSB #0 is used for SRS path loss estimation
usage	antennaSwitching	antennaSwitching	n.a.	
startPosition	3	3	5	resourceMapping setting
nrofSymbols	1	1	4	SRS symbols belong to the same SRS resource.
repetitionFactor	n1	n1	n.a.	without repetition.
transmissionComb	n2	n2	n4	
combOffset-n2	0	0	0	transmissionComb setting
cyclicShift-n2	0	0	0	
nrofSRS-Ports	port1	port1	port1	Number of antenna ports used for SRS resource transmission
resourceType	Periodic	Aperiodic	Periodic	
periodicityAndOffset-p	sl80, 3	N/A	Sl320, 40	SRS transmission periodicity

**Table A.3.24-3: Sounding Reference Symbol Configuration for SCS=120kHz**

	SRS.3 TDD	SRS.6 TDD	POS-SRS.3	
Field	Value	Value		Comment
c-SRS	17	17	Same as NRB,c in the test case	
b-SRS	0	0	n.a.	
b-hop	0	0	n.a.	Frequency hopping is disabled
groupOrSequenceHopping	neither	neither	neither	No group or sequence hopping
freqDomainPosition	0	0	0	Frequency domain position of SRS
freqDomainShift	0	0	0	
pathlossReferenceRS ssb-Index	0	0	0	SSB #0 is used for SRS path loss estimation
usage	antennaSwitching	antennaSwitching	n.a.	
startPosition	1	1	5	resourceMapping setting
nrofSymbols	1	1	4	SRS symbols belong to the same SRS resource.
repetitionFactor	n1	n1	n.a.	without repetition.
transmissionComb	n2	n2	n4	
combOffset-n2	0	0	0	transmissionComb setting
cyclicShift-n2	0	0	0	
nrofSRS-Ports	port1	port1	port1	Number of antenna ports used for SRS resource transmission
resourceType	Periodic	Aperiodic	Periodic	
periodicityAndOffset-p	sl320, 3	N/A	Sl1280, 160	SRS transmission periodicity

## A.3.25 Channel bandwidth (CBW) configurations

### A.3.25.1 DL UE specific CBW

**Table A.3.25.1-1: DL CBW patterns for UE specific CBW configuration**

BWP Parameters	Unit	Values	
Reference CBW		DLCBW.1.1	DLCBW.1.2
OffsetToCarrier	RB	$RB_y$ <sup>Note 2</sup>	$RB_x$ <sup>Note 1</sup>
carrierBandwidth	RB	Same as RF channel defined in each test	Same as RF channel defined in each test
Note 1:	$RB_x$ is offset in frequency domain between Point A (lowest subcarrier of common RB 0) and the lowest usable subcarrier on this carrier. Note that $RB_x$ has to be within the CBW of BS.		
Note 2:	$RB_y$ is offset in frequency domain between Point A (lowest subcarrier of common RB 0) and the lowest usable subcarrier on this carrier. Note that $RB_y$ has to be within the CBW of BS and different with $RB_x$ , and CBW should include SSB and CORESET#0.		

**A.3.25.2 U Table A.3.25.2-1: UL CBW patterns for UE specific CBW configuration**

BWP Parameters	Unit	Values	
Reference CBW		ULCBW.1.1	ULCBW.1.2
OffsetToCarrier	RB	$RB_y$ <sup>Note 2</sup>	$RB_x$ <sup>Note 1</sup>
carrierBandwidth	RB	Same as RF channel defined in each test	Same as RF channel defined in each test
Note 1:	$RB_x$ is offset in frequency domain between Point A (lowest subcarrier of common RB 0) and the lowest usable subcarrier on this carrier. Note that $RB_x$ has to be within the CBW of BS.		
Note 2:	$RB_y$ is offset in frequency domain between Point A (lowest subcarrier of common RB 0) and the lowest usable subcarrier on this carrier. Note that $RB_y$ has to be within the CBW of BS and different with $RB_x$ .		

## A.3.26 CCA model

### A.3.26.1 Introduction

The CCA model is used in some RRM test cases with at least one cell on a carrier frequency with CCA. The intention with the CCA model is to emulate in the test equipment the behaviour of a gNB or UE which performs channel measurement to check that the channel is clear prior to performing one or more downlink or uplink transmissions.

### A.3.26.2 CCA model for operation on a carrier frequency with CCA in FR1

#### A.3.26.2.1 DL CCA model

The same DL CCA model is applicable regardless of whether DRX cycle is used or not with the following differences: - The counter,  $l_{CCA}$ , is used to monitor the number of unavailable DBT samples withing an evaluation window,  $W_{CCA\_DL}$ . DBT samples outside of the evaluation window  $W_{CCA\_DL}$  are discarded.

- If DRX cycle is not used then prior to each DBT window, the test equipment shall determine whether the DL CCA attempt is successful (i.e., the corresponding signals have to be transmitted), based on probability  $P_{CCA\_DL}$  of successful DL CCA configured in the corresponding test case. If DRX cycle is not used, then the DL CCA model shall increment the counter  $l_{CCA}$  for every unavailable DBT sample due to DL CCA failure.
- If DRX cycle is used, then the DL CCA model shall increment the counter,  $l_{CCA}$ , once per DRX cycle for a DRX cycle if the first DBT sample in that DRX cycle is unavailable due to DL CCA failure. DL CCA failures in a DRX cycle are determined as follows:

- The test system *in the first DBT window of each DRX cycle* determines whether the DL CCA attempt is successful or not using the principle as follows:
  - If the DL CCA is successful then the test system shall transmit in all DBT windows within that DRX cycle.
  - If the DL CCA is not successful then the test system shall not transmit in any of the DBT windows within that DRX cycle. In this case  $l_{CCA}$  is increased by 1.
- The parameters,  $L_{CCA\_DL}$ ,  $L_{CCA\_UL}$ ,  $W_{CCA\_DL}$  and  $W_{CCA\_UL}$  can be used as in non-DRX tests.

If the CCA attempt is successful for a transmission, then the test equipment shall transmit also other remaining transmissions, according to the configuration, within the same DBT window.

If the CCA attempt is not successful for a transmission within the DBT window, the test equipment shall determine whether the CCA attempt is successful for the next configured transmission, based on probability  $P_{CCA\_DL}$ .

The probability can be different in different time intervals  $T_i$  during a test case. One probability value (per cell) applies at any time point during a test; one or more probability values can be configured in the entire test, one value  $P_{CCA\_DL}$  per time interval  $T_i$  where  $i \geq 1$ , and the multiple time intervals (when  $i > 1$ ) do not overlap (e.g.,  $P_{CCA\_DL}=1.0$  in  $T_1$  and  $P_{CCA\_DL}=0.75$  in  $T_2$ ).

For semi-static channel access configuration, a single value  $P_{CCA\_DL}$  is used to configure the probability of CCA success in different time intervals  $T_i$  during a test realization. An additional limit  $L_{CCA\_DL}$  is used to determine the maximum number of unavailable DBT samples within an evaluation window  $W_{CCA\_DL}$ . If the number of unavailable DBT samples on the last  $W_{CCA\_DL}$  DBT samples is larger or equal to  $L_{CCA\_DL}$ , the CCA attempt is considered successful for transmission.

For dynamic channel access configuration, the parameters  $P_{CCA\_DL,1}$  and  $P_{CCA\_DL,2}$  are used to configure the probability of CCA success on the first and second SSB candidate positions, respectively, in different time intervals  $T_i$  during a test realization. An additional limit  $L_{CCA\_DL}$  is used to determine the maximum number of unavailable DBT samples within an evaluation window  $W_{CCA\_DL}$ . If the number of unavailable DBT samples on the last  $W_{CCA\_DL}$  DBT samples is larger or equal to  $L_{CCA\_DL}$ , the CCA attempt is considered successful for transmission.

For semi-static channel access configuration or for dynamic channel access configuration where one candidate SSB position is modeled, prior to each discovery burst transmission window within a time interval  $T_i$  of the test, the test equipment shall:

- 1 - Generate a uniform random variable  $p1$  from the range [0, 1] for the first candidate position.
- 2 - Transmit the discovery burst based on  $p1$  in the first candidate position. If  $p1 \leq P_{CCA\_DL}$ , the discovery burst is transmitted at the first candidate SSB location; else if  $l_{CCA}$  is larger than or equal to  $L_{CCA\_DL}$ , the discovery burst is transmitted at the first candidate SSB location, otherwise the discovery burst is muted. If DRX cycle is used, then the decision whether the discover burst is muted or not is repeated for the rest of the DRX cycle.

For dynamic channel access configuration where two candidate SSB positions are modelled, prior to each discovery burst transmission window within a time interval  $T_i$  of the test, the test equipment shall:

- 1 - Generate a uniform random variable  $p1$  from the range [0, 1] for the first candidate position.
- 2 - Transmit the discovery burst based on  $p1$  in the first candidate position: if  $p1 \leq P_{CCA\_DL1}$ , the discovery burst is transmitted at first candidate SSB location, else the test equipment shall:
  - a - Generate a uniform random variable  $p2$  from the range [0, 1] for the second candidate SSB position.
  - b - Transmit the discovery burst based on  $p2$  in the second candidate position. If  $p2 \leq P_{CCA\_DL2}$ , the discovery burst is transmitted at the second candidate SSB location; else if  $l_{CCA}$  is larger than or equal to  $L_{CCA\_DL}$ , the discovery burst is transmitted at the second candidate SSB location, otherwise the discovery burst is muted. If DRX cycle is used, then the decision whether the discover burst is muted or not is repeated for the rest of the DRX cycle.

The above steps are repeated for each discovery burst transmission window in each time interval  $T_i$  of the test. The limit  $L_{CCA\_DL}$  and window  $W_{CCA\_DL}$  is a configuration parameter for each test case.

In many test cases, the requirement under a test depends on the number of configured SSB transmissions which are not available during the test due to CCA failure, so the test equipment shall track how many such signal occasions are not transmitted in DL during the test period.

### A.3.26.2.2 UL CCA model

For UL CCA, the modelling approach is based on probability  $P_{\text{CCA\_UL}}$  of successful CCA. Probability  $P_{\text{CCA\_UL}}$  is configured in the corresponding test case, based on a set  $S_{\text{CCA\_UL}}$  of possible values including 75 % and 87% as typical values for dynamic and semi-static channel access configurations, 0% to model consistent UL CCA failures, and 100% to model no UL CCA failures.

Consistent UL CCA failures are modelled by configuring a low value for  $P_{\text{CCA\_UL}}$ , e.g.,  $P_{\text{CCA\_UL}} = 0\%$ .

In the same time interval  $T_i$  during the same test case,  $P_{\text{CCA\_UL}}$  can be different from  $P_{\text{CCA\_DL}}$ .

The probability can be different in different time intervals  $T_i$  during a test case. One probability value applies at any time point during a test; one or more probability values can be configured in the entire test, one value  $P_{\text{CCA\_UL}}$  per time interval  $T_i$  where  $I \geq 1$ , and the multiple time intervals (when  $I > 1$ ) do not overlap (e.g.,  $P_{\text{CCA\_UL}} = 1.0$  in  $T_1$  and  $P_{\text{CCA\_UL}} = 0.75$  in  $T_2$ ).

$T_{\text{CCA}}$   $\mu\text{s}$  prior to each UL transmission burst in the test, the test equipment (TE) shall generate a uniform random variable  $p$  from the range  $[0, 1]$ . If  $p > P_{\text{CCA\_UL}}$ , the TE transmits an OCNG noise pattern with an energy level  $X$  within the UE BW scheduled/configured for the UL transmission for at-least  $T_{\text{CCA}}$   $\mu\text{s}$ . Where  $T_{\text{CCA}}$   $\mu\text{s}$  is energy detection time for accessing the uplink channel as defined in section 5.1.1 of TS 37.106 [36]. Where:

- $X$  is 3 dB above the energy detection threshold defined in section 5.1.1 of TS 37.106 [36].
- $T_{\text{CCA}}$  is the channel sensing period depending on CCA category for the next UL transmission.

The TE shall count the number of UL CCA failures, and no further UL CCA failures are modeled if the number of failures exceeds the limit  $L_{\text{CCA\_UL}}$  within a window  $W_{\text{CCA\_UL}}$ . For each UL CCA failure generated by the model, the TE shall monitor the corresponding UL resource for the desired UL signal, and based on when and/or whether the TE received the desired UL signal, it deems the test case to pass or fail.

In many cases, the requirement under a test depends on the number of configured signal occasions which are not available during the test, so the test equipment shall track how many such signal occasions are not transmitted in UL during the test period.

## A.3.27 Test Cases with at Least One Cell on a Carrier Frequency with CCA

*Editor's note: This clause will include applicability rules for the corresponding test cases.*

### A.3.27.1 Introduction

### A.3.27.2 NR Standalone Tests with NR SCell under CCA and All Other NR Cells in FR1

*Editor's note: This clause will include applicability rules for the corresponding test cases.*

### A.3.27.3 EN-DC Tests with NR PSCell under CCA and Other NR Cells in FR1

*Editor's note: This clause will include applicability rules for the corresponding test cases.*

### A.3.27.4 NR Standalone Tests with NR PCell under CCA and Other NR Cells in FR1

*Editor's note: This clause will include applicability rules for the corresponding test cases.*

### A.3.27.5 E-UTRA Standalone Tests with at Least One NR Cell under CCA

*Editor's note: This clause will include applicability rules for the corresponding test cases.*

## A.3.28 Discovery Burst Transmission Window configuration under CCA

### A.3.28.1 DBT Window pattern 1: DBT Window period = 20 ms with DBT Window duration = 1 ms

**Table A.3.28.1-1: DBT.1: DBT Window Pattern 1 for DBT Window period = 20 ms and duration = 1 ms**

SMTC Parameters	Values
Discovery burst transmission window periodicity	20 ms
Discovery burst transmission window offset	0 ms
Discovery burst transmission window duration	1 ms

## A.3.29 Testing principles for UE capable of only NR bands with shared spectrum access

### A.3.29.1 Introduction

In annex A test cases are defined involving one or more NR cells operating on NR band(s) with shared spectrum channel access. The NR bands with shared spectrum channel access are defined in clause 5.2 of TS 38-101-1 [18].

### A.3.29.2 Principle of testing for UE capable of EN-DC with only NR bands with shared spectrum access

In Annex A, test cases in table A.3.29.2-1 are defined for UE capable of EN-DC with only NR band(s) with shared spectrum access and are not required for UE supporting also other NR band(s) (i.e. band with no shared spectrum access). The EN-DC configurations are defined in clause of 5.5B of TS 38.101-3 [20].

**Table A.3.29.2-1: Test cases applicable to UE supporting EN-DC with only NR bands with shared spectrum access**

Test category	Section	Test case
Active BWP switching	A.10.3.5.2.1	E-UTRAN – NR PSCell FR1 DL active BWP switch in non-DRX in synchronous EN-DC
	A.10.3.5.2.2	E-UTRAN – NR PSCell FR1 DL active BWP switch with FR1 SCell in non-DRX in synchronous EN-DC
	A.10.3.5.3.1	E-UTRAN – NR PSCell FR1 DL active BWP switch in non-DRX in synchronous EN-DC



### A.3.29.3 Principle of testing for UE capable of SA operation with only NR bands with shared spectrum access

In Annex A, test cases in table A.3.29.3-1 are defined for UE capable of NR SA operation with only NR band(s) with shared spectrum access and are not required for UE supporting also other NR band(s) (i.e. band with no shared spectrum access).

**Table A.3.29.3-1: Test cases applicable to UE supporting SA operation with only NR bands with shared spectrum access**

Test category	Section	Test case
Active BWP switching	A.11.4.5.2.1	NR FR1- NR FR1 DL active BWP switch of PCell with non-DRX in SA
	A.11.4.5.2.2	NR FR1 DL active BWP switch with non-DRX in SA
	A.11.4.5.3.1	NR FR1 DL active BWP switch of Cell with non-DRX in SA

## A.3.30 CSI-RS configurations for RRM

### A.3.30.1 FDD

**Table A.3.30.1-1: CSI-RS RRM Reference Measurement Channels for SCS=15kHz**

	CSI-RS.RRM.FR1.1 FDD
<b>CSI-RS-ResourceConfigMobility</b>	
subcarrierSpacing, kHz	15
<b>CSI-RS-CellMobility</b>	
cellId <sup>note1</sup>	0
nrofPRBs	48
startPRB	0
density	3
<b>CSI-RS-Resource-Mobility</b>	
csi-RS-Index	0
slotConfig: ms20 <sup>note2</sup>	slot1
associatedSSB	True
ssb-Index <sup>note3</sup>	0
isQuasiColocated	True
firstOFDMSymbolInTimeDomain <sup>note4</sup>	10
sequenceGenerationConfig	0
<b>Others</b>	
nrofPorts	1
CDM Type	NoCDM
EPRE ratio to SSS, dB	0
Note1: unless specified otherwise Note2: unless specified otherwise Note3: assume the same SS/PBCH block index of the corresponding cell in the test case Note4: unless specified otherwise	

### A.3.30.2 TDD

**Table A.3.30.2-1: CSI-RS RRM Reference Measurement Channels for SCS=15kHz**

	CSI-RS.RRM.FR1.1 TDD
<b>CSI-RS-ResourceConfigMobility</b>	
subcarrierSpacing, kHz	15
<b>CSI-RS-CellMobility</b>	
cellId <sup>note1</sup>	0

nrofPRBs	48
startPRB	0
density	3
<b>CSI-RS-Resource-Mobility</b>	
csi-RS-Index	0
slotConfig: ms20 <sup>note2</sup>	slot1
associatedSSB	True
ssb-Index <sup>note3</sup>	0
isQuasiColocated	True
firstOFDMSymbolInTimeDomain <sup>note4</sup>	10
sequenceGenerationConfig	0
<b>Others</b>	
nrofPorts	1
CDM Type	NoCDM
EPRE ratio to SSS, dB	0
Note1: unless specified otherwise Note2: unless specified otherwise Note3: assume the same SS/PBCH block index of the corresponding cell in the test case Note4: unless specified otherwise	

Table A.3.30.2-2: CSI-RS RRM Reference Measurement Channels for SCS=30kHz

	CSI-RS.RRM.FR1.2 TDD
<b>CSI-RS-ResourceConfigMobility</b>	
subcarrierSpacing, kHz	30
<b>CSI-RS-CellMobility</b>	
cellId <sup>note1</sup>	0
nrofPRBs	48
startPRB	0
density	3
<b>CSI-RS-Resource-Mobility</b>	
csi-RS-Index	0
slotConfig: ms20 <sup>note2</sup>	slot1
associatedSSB	True
ssb-Index <sup>note3</sup>	0
isQuasiColocated	True
firstOFDMSymbolInTimeDomain <sup>note4</sup>	10
sequenceGenerationConfig	0
<b>Others</b>	
nrofPorts	1
CDM Type	NoCDM
EPRE ratio to SSS, dB	0
Note1: unless specified otherwise Note2: unless specified otherwise Note3: assume the same SS/PBCH block index of the corresponding cell in the test case Note4: unless specified otherwise	

Table A.3.30.2-3: CSI-RS RRM Reference Measurement Channels for SCS=120kHz

	CSI-RS.RRM.FR2.1 TDD
<b>CSI-RS-ResourceConfigMobility</b>	
subcarrierSpacing, kHz	120
<b>CSI-RS-CellMobility</b>	
cellId <sup>note1</sup>	0
nrofPRBs	48
startPRB	0
density	3
<b>CSI-RS-Resource-Mobility</b>	

csi-RS-Index	0
slotConfig: ms20 <sup>note2</sup>	slot1
associatedSSB	True
ssb-Index <sup>note3</sup>	0
isQuasiColocated	True
firstOFDMsymbolInTimeDomain <sup>note4</sup>	10
sequenceGenerationConfig	0
<b>Others</b>	
nrofPorts	1
CDM Type	NoCDM
EPRE ratio to SSS, dB	0
Note1: unless specified otherwise	
Note2: unless specified otherwise	
Note3: assume the same SS/PBCH block index of the corresponding cell in the test case	
Note4: unless specified otherwise	

## A.3.31 PRS Configurations

### A.3.31.1. PRS Configurations for FR1

#### A.3.31.1.1. PRS pattern 1 in FR1: SCS=15 KHz

**Table A.3.31.1.1 -1: PRS.1 FR1: PRS Pattern 1 for SSB SCS=15 KHz**

PRS Parameters	Values					
	PRS.1.1 FR1	PRS.1.2 FR1	PRS.1.3 FR1	PRS.1.4 FR1		
Reference channel						
Resource index in resource set	0	0	0	1	0	1
PRS periodicity	160ms					
PRS Resource set slot offset <sup>Note 1</sup>	10 ms					
PRS Resource slot offset (slot) <sup>Note 1</sup>	0	4	0	4		
PRS RE offset <sup>Note 1</sup>	0		0	1	0	1
SCS	15kHz					
PRS comb size	2	4	2	4		
Number of PRS symbol	4	4	4	4		
Repetition factor	2	1	2	1		
PRS resource time gap (slot)	1	1	1	1		
RB numbers containing PRS within channel BW	0-23	0-103	0-23	0-103		
PRS Start PRB	0					
Note 1: Unless otherwise specified in the test case						

#### A.3.31.1.2. PRS pattern 2 in FR1: SCS=30 KHz

**Table A.3.31.1.2 -1: PRS.2 FR1: PRS Pattern 2 for SCS=30 KHz**

PRS Parameters	Values					
	PRS.2.1 FR1	PRS.2.2 FR1	PRS.2.3 FR1	PRS.2.4 FR1		
Reference channel						
Resource index in resource set	0	0	0	1	0	1
PRS periodicity	160ms					
PRS Resource set slot offset <sup>Note 1</sup>	10 ms					
PRS Resource slot offset (slot) <sup>Note 1</sup>	0	4	0	4		
PRS RE offset <sup>Note 1</sup>	0		0	1	0	1
SCS	30kHz					
PRS comb size	2	4	2	4		
Number of PRS symbol	4	4	4	4		
Repetition factor	2	1	2	1		
PRS resource time gap (slot)	1	1	1	1		
RB numbers containing PRS within channel BW	0-23	0-131	0-23	0-131		
PRS Start PRB	0					
Note 1: Unless otherwise specified in the test case						

## A.3.31.2. PRS Configurations for FR2

### A.3.31.2.1. PRS pattern 1 in FR2: SCS=120 KHz

**Table A.3.31.2.1-1: PRS.1 FR2: PRS Pattern 1 for SCS=120 KHz**

PRS Parameters	Values					
	PRS.1.1 FR2	PRS.1.2 FR2	PRS.1.3 FR2		PRS.1.4 FR2	
Reference channel						
Resource index in resource set	0	0	0	1	0	1
PRS periodicity	160ms					
PRS Resource set slot offset <sup>Note 1</sup>	10 ms					
PRS Resource slot offset (slot) <sup>Note 1</sup>	0	4	0		4	
PRS RE offset <sup>Note 1</sup>	0		0	1	0	1
SCS	120kHz					
PRS comb size	2	4	2		4	
Number of PRS symbol	4	4	4		4	
Repetition factor	2	1	2		1	
PRS resource time gap (slot)	1	1	1		1	
RB numbers containing PRS within channel BW	0-31	0-127	0-31		0-127	
PRS Start PRB	0					
Note 1: Unless otherwise specified in the test case						

## A.4 EN-DC tests with all NR cells in FR1

### A.4.1 Void

### A.4.2 Void

### A.4.3 RRC\_CONNECTED state mobility

#### A.4.3.1 Void

#### A.4.3.2 RRC Connection Mobility Control

##### A.4.3.2.1 Void

##### A.4.3.2.2 Random Access

###### A.4.3.2.2.1 4-step RA type contention based random access test in FR1 for PSCell in EN-DC

###### A.4.3.2.2.1.1 Test Purpose and Environment

The purpose of this test is to verify that the behavior of the random access procedure is according to the requirements and that the PRACH power settings and timing are within specified limits. This test will verify the requirements in clause 6.2.2.2 and clause 7.1.2 in an AWGN model.

For this test two cells are used, with the configuration of Cell 1 (E-UTRA PCell) specified in clause A.3.7.2.1 and Cell 2 configured as PSCell in FR1. Supported test parameters are shown in Table A.4.3.2.2.1.1-1. UE capable of EN-DC with PSCell in FR1 needs to be tested by using the parameters in Table A.4.3.2.2.1.1-2.

**Table A.4.3.2.2.1.1-1: Supported test configurations for contention based random access test in FR1 for PSCell in EN-DC**

Config	Description
1	LTE FDD, NR 15 kHz SSB SCS, 10 MHz bandwidth, FDD duplex mode
2	LTE TDD, NR 15 kHz SSB SCS, 10 MHz bandwidth, FDD duplex mode
3	LTE FDD, NR 30 kHz SSB SCS, 40 MHz bandwidth, TDD duplex mode
4	LTE TDD, NR 30 kHz SSB SCS, 40 MHz bandwidth, TDD duplex mode
Note: The UE is only required to be tested in one of the supported test configurations depending on UE capability	

**Table A.4.3.2.2.1.1-2: General test parameters for contention based random access test in FR1 for PSCell in EN-DC**

Parameter		Unit	Test-1	Comments	
SSB Configuration	Config 1,2		SSB pattern 3 in FR1	As defined in A.3.10	
	Config 3,4		SSB pattern 4 in FR1		
Duplex Mode for Cell 2	Config 1,2		FDD		
	Config 3,4		TDD		
TDD Configuration	Config 3,4		TDDConf.2.1		
OCNG Pattern <sup>Note 1</sup>			OCNG pattern 1	As defined in A.3.2.1.	
PDSCH parameters <small>Note 4</small>	Config 1,2		SR.1.1 FDD	As defined in A.3.1.1.	
	Config 3,4		SR.2.1 TDD		
RMSI CORESET Reference Channel	Config 1,2		CR.1.1 FDD		
	Config 3,4		CR.2.1 TDD		
Dedicated CORESET Reference Channel	Config 1,2		CCR.1.1 FDD		
	Config 3,4		CCR.2.1 TDD		
NR RF Channel Number			1		
EPRE ratio of PSS to SSS		dB	0		
EPRE ratio of PBCH_DMRS to SSS		dB			
EPRE ratio of PBCH to PBCH_DMRS		dB			
EPRE ratio of PDCCH_DMRS to SSS		dB			
EPRE ratio of PDCCH to PDCCH_DMRS		dB			
EPRE ratio of PDSCH_DMRS to SSS		dB			
EPRE ratio of PDSCH to PDSCH_DMRS		dB			
SSB with index 0	$\hat{E}_s/I_{ot}$		dB	3	Power of SSB with index 0 is set to be above configured <i>rsrp-ThresholdSSB</i>
	$N_{oc}$	Config 1,2	dBm/15kHz	-98	
		Config 3,4		-101	
	$\hat{E}_s/N_{oc}$		dB	3	
SS-RSRP <sup>Note 3</sup>		dBm/ SCS	-95		
SSB with index 1	$\hat{E}_s/I_{ot}$		dB	-17	Power of SSB with index 1 is set to be below configured <i>rsrp-ThresholdSSB</i>
	$N_{oc}$	Config 1,2	dBm/15kHz	-98	
		Config 3,4		-101	
	$\hat{E}_s/N_{oc}$		dB	-17	
SS-RSRP <sup>Note 3</sup>		dBm/ SCS	-115		
$I_o$ <sup>Note 2</sup>	Config 1,2	dBm	-65.3/9.36MHz	For symbols without SSB index 1	
	Config 3,4		-62.2/38.16MHz		
ss-PBCH-BlockPower		dBm/ SCS	-5	As defined in clause 6.3.2 in TS 38.331 [2].	
Configured UE transmitted power ( $P_{CMAX,f,c}$ )		dBm	23	As defined in clause 6.2.4 in TS 38.101-1.	
PRACH Configuration			FR1 PRACH configuration 1	As defined in A.3.8.2.	
Propagation Condition		-	AWGN		
<p>Note 1: OCNG shall be used such that the cell is fully allocated and a constant total transmitted power spectral density is achieved for all OFDM symbols. The OCNG pattern is chosen during the test according to the presence of a DL reference measurement channel.</p> <p>Note 2: SS-RSRP, <math>E_s/I_{ot}</math> and <math>I_o</math> levels have been derived from other parameters for information purpose. They are not settable parameters.</p> <p>Note 3: Void</p>					

Note 4: The DL PDSCH reference measurement channel is used in the test only when a downlink transmission dedicated to the UE under test is required.
--

#### A.4.3.2.2.1.2 Test Requirements

Contention based random access is triggered by *not* explicitly assigning a random access preamble via dedicated signalling in the downlink.

##### A.4.3.2.2.1.2.1 Random Access Preamble Transmission

To test the UE behavior specified in Clause 6.2.2.2.1.1 the System Simulator shall receive the Random Access Preamble which belongs to one of the Random Access Preambles associated with the SSB with index 0, which has SS-RSRP above the configured *rsrp-ThresholdSSB*.

In addition, the power applied to all preambles shall be in accordance with what is specified in Clause 6.2.2.2. The power of the first preamble shall be -22 dBm with an accuracy specified in clause 6.3.4.2 of TS 38.101-1 [18]. The relative power applied to additional preambles shall have an accuracy specified in clause 6.3.4.3 of TS 38.101-1 [18].

The transmit timing of all PRACH transmissions shall be within the accuracy specified in Clause 7.1.2.

##### A.4.3.2.2.1.2.2 Random Access Response Reception

To test the UE behavior specified in Clause 6.2.2.2.1.2 the System Simulator shall transmit a Random Access Response containing a Random Access Preamble identifier corresponding to the transmitted Random Access Preamble after 5 preambles have been received by the System Simulator. In response to the first 4 preambles, the System Simulator shall transmit a Random Access Response *not* corresponding to the transmitted Random Access Preamble.

The UE may stop monitoring for Random Access Response(s) and shall transmit the msg3 if the Random Access Response contains a Random Access Preamble identifier corresponding to the transmitted Random Access Preamble.

The UE shall again perform the Random Access Resource selection procedure specified in clause 5.1.2 in TS38.321 [7], and transmit with the calculated PRACH transmission power when the backoff time expires if all received Random Access Responses contain Random Access Preamble identifiers that do not match the transmitted Random Access Preamble.

In addition, the power applied to all preambles shall be in accordance with what is specified in Clause 6.2.2.2. The power of the first preamble shall be -22 dBm with an accuracy specified in clause 6.3.4.2 of TS 38.101-1 [18]. The relative power applied to additional preambles shall have an accuracy specified in clause 6.3.4.3 of TS 38.101-1 [18].

The transmit timing of all PRACH transmissions shall be within the accuracy specified in Clause 7.1.2.

##### A.4.3.2.2.1.2.3 No Random Access Response Reception

To test the UE behavior specified in clause 6.2.2.2.1.3 the System Simulator shall transmit a Random Access Response containing a Random Access Preamble identifier corresponding to the transmitted Random Access Preamble after 5 preambles have been received by the System Simulator. The System Simulator shall *not* respond to the first 4 preambles.

The UE shall again perform the Random Access Resource selection procedure specified in clause 5.1.2 in TS38.321 [7], and transmit with the calculated PRACH transmission power when the backoff time expires if no Random Access Response is received within the RA Response window.

In addition, the power applied to all preambles shall be in accordance with what is specified in Clause 6.2.2.2. The power of the first preamble shall be -22 dBm with an accuracy specified in clause 6.3.4.2 of TS 38.101-1 [18]. The relative power applied to additional preambles shall have an accuracy specified in clause 6.3.4.3 of TS 38.101-1 [18].

The transmit timing of all PRACH transmissions shall be within the accuracy specified in Clause 7.1.2.

##### A.4.3.2.2.1.2.4 Receiving an UL grant for msg3 retransmission

To test the UE behavior specified in clause 6.2.2.2.1.4, the System Simulator shall provide an UL grant for msg3 retransmission following a successful Random Access Response.

The UE shall re-transmit the msg3 upon the reception of an UL grant for msg3 retransmission..

A.4.3.2.2.1.2.5 Void

Clause A.4.3.2.2.1.2.6 Void

Clause A.4.3.2.2.1.2.7 Contention Resolution Timer expiry

To test the UE behavior specified in Clause 6.2.2.2.1.6 the System Simulator shall *not* send a response to a msg3.

The UE shall again perform the Random Access Resource selection procedure specified in clause 5.1.2 in TS38.321 [7], and transmit with the calculated PRACH transmission power when the backoff time expires if the Contention Resolution Timer expires.

A.4.3.2.2.2 4-step RA type non-contention based random access test in FR1 for PSCell in EN-DC

A.4.3.2.2.2.1 Test Purpose and Environment

The purpose of this test is to verify that the behavior of the random access procedure is according to the requirements and that the PRACH power settings and timing are within specified limits. This test will verify the requirements in clause 6.2.2.2 and clause 7.1.2 in an AWGN model.

For this test two cells are used, with the configuration of Cell 1 (E-UTRA PCell) specified in clause A.3.7.2.1 and Cell 2 configured as PSCell in FR1. Supported test parameters are shown in Table A.4.3.2.2.2.1-1. UE capable of EN-DC with PSCell in FR1 needs to be tested by using the parameters in Table A.4.3.2.2.2.1-2 for SSB-based non-contention based random access test (Test 1) and CSI-RS-based non-contention based random access test (Test 2). Test 2 is only applicable to UE which supports csi-RSRP-AndRSRQ-MeasWithSSB or csi-RSRP-AndRSRQ-MeasWithoutSSB.

**Table A.4.3.2.2.2.1-1: Supported test configurations for non-contention based random access test in FR1 for PSCell in EN-DC**

Config	Description
1	LTE FDD, NR 15 kHz SSB SCS, 10 MHz bandwidth, FDD duplex mode
2	LTE TDD, NR 15 kHz SSB SCS, 10 MHz bandwidth, FDD duplex mode
3	LTE FDD, NR 30 kHz SSB SCS, 40 MHz bandwidth, TDD duplex mode
4	LTE TDD, NR 30 kHz SSB SCS, 40 MHz bandwidth, TDD duplex mode

Note: The UE is only required to be tested in one of the supported test configurations depending on UE capability

**Table A.4.3.2.2.2.1-2: General test parameters for non-contention based random access test in FR1 for PSCell in EN-DC**

Parameter	Unit	Test-1	Test-2	Comments
SSB Configuration	Config 1,2	SSB pattern 3 in FR1	SSB pattern 3 in FR1	As defined in A.3.10
	Config 3,4			
CSI-RS Configuration	Config 1,2	N/A	CSI-RS.1.1 FDD	As defined in A.3.1.4
	Config 3,4		CSI-RS.2.1 TDD	
Duplex Mode for Cell 2	Config 1,2	FDD	FDD	
	Config 3,4	TDD	TDD	
TDD Configuration	Config 3,4	TDDConf.2.1	TDDConf.2.1	
OCNG Pattern <sup>Note 1</sup>		OCNG pattern 1	OCNG pattern 1	As defined in A.3.2.1.
PDSCH parameters <sup>Note 4</sup>	Config 1,2	SR.1.1 FDD	SR.1.1 FDD	As defined in A.3.1.1.
	Config 3,4	SR.2.1 TDD	SR.2.1 TDD	
RMSI CORESET Reference Channel	Config 1,2	CR.1.1 TDD	CR.1.1 TDD	
	Config 3,4	CR.2.1 TDD	CR.2.1 TDD	
Dedicated CORESET Reference Channel	Config 1,2	CCR.1.1 TDD	CCR.1.1 TDD	
	Config 3,4	CCR.2.1 TDD	CCR.2.1 TDD	
NR RF Channel Number		1	1	

EPRE ratio of PSS to SSS		dB				
EPRE ratio of PBCH_DMRS to SSS		dB				
EPRE ratio of PBCH to PBCH_DMRS		dB				
EPRE ratio of PDCCH_DMRS to SSS		dB	0	0		
EPRE ratio of PDCCH to PDCCH_DMRS		dB				
EPRE ratio of PDSCH_DMRS to SSS		dB				
EPRE ratio of PDSCH to PDSCH_DMRS		dB				
SSB with index 0	$\hat{E}_s/I_{ot}$		dB	3	3	Power of SSB with index 0 is set to be above configured <i>rsrp-ThresholdSSB</i>
	$N_{oc}$	Config 1,2	dBm/15kHz	-98	-98	
		Config 3,4		-101	-101	
	$\hat{E}_s/N_{oc}$		dB	3	3	
SS-RSRP <sup>Note 3</sup>		dBm/ SCS	-95	-95		
SSB with index 1	$\hat{E}_s/I_{ot}$		dB	-17	-17	Power of SSB with index 1 is set to be below configured <i>rsrp-ThresholdSSB</i>
	$N_{oc}$	Config 1,2	dBm/15kHz	-98	-98	
		Config 3,4		-101	-101	
	$\hat{E}_s/N_{oc}$		dB	-17	-17	
SS-RSRP <sup>Note 3</sup>		dBm/ SCS	-115	-115		
$I_0$ <sup>Note 2</sup>	Config 1,2	dBm	-65.3/9.36MHz	-65.3/9.36MHz	For symbols without SSB index 1	
	Config 3,4		-62.2/38.16MHz	-62.2/38.16MHz		
ss-PBCH-BlockPower		dBm/ SCS	-5	-5	As defined in clause 6.3.2 in TS 38.331 [2].	
Configured UE transmitted power ( $P_{CMAX,f,c}$ )		dBm	23	23	As defined in clause 6.2.4 in TS 38.101-1.	
PRACH Configuration			FR1 PRACH configuration 2	FR1 PRACH configuration 3	As defined in A.3.8.2.	
Propagation Condition		-	AWGN	AWGN		
<p>Note 1: OCNG shall be used such that the cell is fully allocated and a constant total transmitted power spectral density is achieved for all OFDM symbols. The OCNG pattern is chosen during the test according to the presence of a DL reference measurement channel.</p> <p>Note 2: SS-RSRP, <math>E_s/I_{ot}</math> and <math>I_0</math> levels have been derived from other parameters for information purpose. They are not settable parameters.</p> <p>Note 3: Void</p> <p>Note 4: The DL PDSCH reference measurement channel is used in the test only when a downlink transmission dedicated to the UE under test is required.</p>						

A.4.3.2.2.2.2 Test Requirements

Non-Contention based random access is triggered by explicitly assigning a random access preamble via dedicated signalling in the downlink. In the test, the non-contention based random access procedure is not initialized for Other SI requested from UE or beam failure recovery.

A.4.3.2.2.2.2.1 SSB-based Random Access Preamble Transmission

In Test-1, to test the UE behavior specified in Clause 6.2.2.2.1 for SSB-based Random Access Preamble transmission, with the contention-free Random Access Resources and the contention-free PRACH occasions associated with SSBs configured, the System Simulator shall receive the Random Access Preamble which has the Preamble Index associated with the SSB with index 0.

In addition, the System Simulator shall receive the Random Access Preamble on the PRACH occasion which belongs to the PRACH occasions corresponding to the SSB with index 0, and the selected PRACH occasion shall belongs to the PRACH occasions permitted by the restrictions given by the *ra-ssb-OccasionMaskIndex*.



In addition, the power applied to all preambles shall be in accordance with what is specified in Clause 6.2.2.2.. The power of the first preamble shall be -22 dBm with an accuracy specified in clause 6.3.4.2 of TS 38.101-1 [18]. The relative power applied to additional preambles shall have an accuracy specified in clause 6.3.4.3 of TS 38.101-1 [18].

The transmit timing of all PRACH transmissions shall be within the accuracy specified in Clause 7.1.2.

#### A.4.3.2.2.2.2 CSI-RS-based Random Access Preamble Transmission

In Test-2, to test the UE behavior specified in Clause 6.2.2.2.1 for CSI-RS-based Random Access Preamble transmission, with the contention-free Random Access Resources and the contention-free PRACH occasions associated with CSI-RSs configured, the System Simulator shall receive the Random Access Preamble which has the Preamble Index associated with the CSI-RS configured.

In addition, the System Simulator shall receive the Random Access Preamble on the PRACH occasion which belongs to the PRACH occasions corresponding to the CSI-RS configured, and the selected PRACH occasion shall belong to the PRACH occasions permitted by the restrictions given by the *ra-OccasionList*.

In addition, the power applied to all preambles shall be in accordance with what is specified in Clause 6.2.2.2. The power of the first preamble shall be -22 dBm with an accuracy specified in clause 6.3.4.2 of TS 38.101-1 [18]. The relative power applied to additional preambles shall have an accuracy specified in clause 6.3.4.3 of TS 38.101-1 [18].

The transmit timing of all PRACH transmissions shall be within the accuracy specified in Clause 7.1.2.

#### A.4.3.2.2.2.3 Random Access Response Reception

To test the UE behavior specified in Clause 6.2.2.2.2 the System Simulator shall transmit a Random Access Response containing a Random Access Preamble identifier corresponding to the transmitted Random Access Preamble after 5 preambles have been received by the System Simulator. In response to the first 4 preambles, the System Simulator shall transmit a Random Access Response *not* corresponding to the transmitted Random Access Preamble.

The UE may stop monitoring for Random Access Response(s) if the Random Access Response contains a Random Access Preamble identifier corresponding to the transmitted Random Access Preamble.

The UE shall again perform the Random Access Resource selection procedure specified in clause 5.1.2 in TS38.321 [7], and transmit with the calculated PRACH transmission power if all received Random Access Responses contain Random Access Preamble identifiers that do not match the transmitted Random Access Preamble.

In addition, the power applied to all preambles shall be in accordance with what is specified in Clause 6.2.2.2. The power of the first preamble shall be -22 dBm with an accuracy specified in clause 6.3.4.2 of TS 38.101-1 [18]. The relative power applied to additional preambles shall have an accuracy specified in clause 6.3.4.3 of TS 38.101-1 [18].

The transmit timing of all PRACH transmissions shall be within the accuracy specified in Clause 7.1.2.

#### A.4.3.2.2.2.4 No Random Access Response Reception

To test the UE behavior specified in clause 6.2.2.2.3 the System Simulator shall transmit a Random Access Response containing a Random Access Preamble identifier corresponding to the transmitted Random Access Preamble after 5 preambles have been received by the System Simulator. The System Simulator shall *not* respond to the first 4 preambles.

The UE shall again perform the Random Access Resource selection procedure specified in clause 5.1.2 in TS38.321 [7], and transmit with the calculated PRACH transmission power when the backoff time expires if no Random Access Response is received within the RA Response window configured in *RACH-ConfigCommon*.

In addition, the power applied to all preambles shall be in accordance with what is specified in Clause 6.2.2.2. The power of the first preamble shall be -22 dBm with an accuracy specified in clause 6.3.4.2 of TS 38.101-1 [18]. The relative power applied to additional preambles shall have an accuracy specified in clause 6.3.4.3 of TS 38.101-1 [18].

The transmit timing of all PRACH transmissions shall be within the accuracy specified in Clause 7.1.2.

A.4.3.2.2.3 2-step RA type contention based random access test in FR1 for PSCell in EN-DC

A.4.3.2.2.3.1 Test Purpose and Environment

The purpose of this test is to verify that the behaviour of the random access procedure is according to the requirements and that the MsgA PRACH, MsgA PUSCH power settings and timing are within specified limits. This test will verify the requirements in clause 6.2.2.3 and clause 7.1.2 in an AWGN model.

For this test two cells are used, with the configuration of Cell 1 (E-UTRA PCell) specified in clause A.3.7.2.1 and Cell 2 configured as PSCell in FR1. Supported test parameters are shown in Table A.4.3.2.2.3.1-1. UE capable of EN-DC with PSCell in FR1 needs to be tested by using the parameters in Table A.4.3.2.2.3.1-2.

**Table A.4.3.2.2.3.1-1: Supported test configurations for 2-step RA type contention based random access test in FR1 for PSCell in EN-DC**

Config	Description
1	LTE FDD, NR 15 kHz SSB SCS, 10 MHz bandwidth, FDD duplex mode
2	LTE TDD, NR 15 kHz SSB SCS, 10 MHz bandwidth, FDD duplex mode
3	LTE FDD, NR 30 kHz SSB SCS, 40 MHz bandwidth, TDD duplex mode
4	LTE TDD, NR 30 kHz SSB SCS, 40 MHz bandwidth, TDD duplex mode

Note: The UE is only required to be tested in one of the supported test configurations depending on UE capability

**Table A.4.3.2.2.3.1-2: General test parameters for 2-step RA type contention based random access test in FR1 for PSCell in EN-DC**

Parameter		Unit	Test-1	Comments
SSB Configuration	Config 1,2		SSB pattern 3 in FR1	As defined in A.3.10
	Config 3,4		SSB pattern 4 in FR1	
Duplex Mode for Cell 2	Config 1,2		FDD	
	Config 3,4		TDD	
TDD Configuration	Config 3,4		TDDConf.2.1	
OCNG Pattern <sup>Note 1</sup>			OCNG pattern 1	As defined in A.3.2.1.
PDSCH parameters <sup>Note 3</sup>	Config 1,2		SR.1.1 FDD	As defined in A.3.1.1.
	Config 3,4		SR.2.1 TDD	
RMSI CORESET Reference Channel	Config 1,2		CR.1.1 FDD	
	Config 3,4		CR.2.1 TDD	
Dedicated CORESET Reference Channel	Config 1,2		CCR.1.1 FDD	
	Config 3,4		CCR.2.1 TDD	
NR RF Channel Number			1	
EPRE ratio of PSS to SSS		dB	0	
EPRE ratio of PBCH_DMRS to SSS		dB		
EPRE ratio of PBCH to PBCH_DMRS		dB		
EPRE ratio of PDCCH_DMRS to SSS		dB		
EPRE ratio of PDCCH to PDCCH_DMRS		dB		
EPRE ratio of PDSCH_DMRS to SSS		dB		
EPRE ratio of PDSCH to PDSCH_DMRS		dB		
SSB with index 0	$\hat{E}_s / I_{ot}$	dB	3	Power of SSB with index 0 is set to be above configured <i>msgA-RSRP-ThresholdSSB</i>
	$N_{oc}$	Config 1,2	-98	
		Config 3,4	-101	
	$\hat{E}_s / N_{oc}$	dB	3	
SS-RSRP <sup>Note 2</sup>		dBm/ SCS	-95	
SSB with index 1	$\hat{E}_s / I_{ot}$	dB	-17	Power of SSB with index 1 is set to be below configured <i>msgA-RSRP-ThresholdSSB</i>
	$N_{oc}$	Config 1,2	-98	
		Config 3,4	-101	

	$\hat{E}_s/N_{oc}$	dB	-17	
	SS-RSRP <sup>Note 2</sup>	dBm/ SCS	-115	
Io	Config 1,2	dBm	-65.3/9.36MHz	For symbols without SSB index 1
	Config 3,4		-62.2/38.16MHz	
ss-PBCH-BlockPower		dBm/ SCS	-5	As defined in clause 6.3.2 in TS 38.331 [2].
Configured UE transmitted power ( $P_{CMAX,f,c}$ )		dBm	23	As defined in clause 6.2.4 in TS 38.101-1.
MsgA Configuration			FR1 MsgA configuration 1	As defined in A.3.20.2.1.
<i>msgA-RSRP-ThresholdSSB</i>		dBm	RSRP_51	The actual value of the threshold is -105dBm, as defined in TS 38.331 [2].
Propagation Condition		-	AWGN	
<p>Note 1: OCNG shall be used such that the cell is fully allocated and a constant total transmitted power spectral density is achieved for all OFDM symbols. The OCNG pattern is chosen during the test according to the presence of a DL reference measurement channel.</p> <p>Note 2: SS-RSRP, <math>E_s/I_{ot}</math> and <math>I_o</math> levels have been derived from other parameters for information purpose. They are not settable parameters.</p> <p>Note 3: The DL PDSCH reference measurement channel is used in the test only when a downlink transmission dedicated to the UE under test is required.</p>				

#### A.4.3.2.2.3.2 Test Requirements

Contention based random access is triggered by *not* explicitly assigning a random access preamble via dedicated signalling in the downlink.

##### A.4.3.2.2.3.2.1 MsgA Transmission

To test the UE behaviour specified in Clause 6.2.2.3.1.1 the System Simulator shall receive the MsgA with a preamble which belongs to one of the Random Access Preambles associated with the SSB with index 0, which has SS-RSRP above the configured *msgA-RSRP-ThresholdSSB*.

In addition, the power applied to all MsgA transmission shall be in accordance with what is specified in Clause 6.2.2.2. The power of the first MsgA preamble shall be -22 dBm with an accuracy specified in clause 6.3.4.2 of TS 38.101-1 [18]. The power of the first MsgA PUSCH transmission shall be  $0.6 + 3(\mu + 2)$  dBm with an accuracy specified in clause 6.3.4.2 of TS 38.101-1 [18], where  $\mu$  indicates the MsgA PUSCH numerology. The relative power applied to additional MsgA transmissions shall have an accuracy specified in clause 6.3.4.3 of TS 38.101-1 [18].

The transmit timing of all MsgA transmissions shall be within the accuracy specified in Clause 7.1.2.

##### A.4.3.2.2.3.2.2 MsgB Reception

To test the UE behaviour specified in Clause 6.2.2.3.1.2 the System Simulator shall transmit a MsgB with fallbackRAR containing a Random Access Preamble identifier corresponding to the transmitted Random Access Preamble after 5 preambles have been received by the System Simulator. In response to the first 4 preambles, the System Simulator shall transmit a MsgB *not* corresponding to the transmitted Random Access Preamble.

The UE may stop monitoring for MsgB(s) and shall transmit the msg3 if the MsgB with a fallbackRAR contains a Random Access Preamble identifier corresponding to the transmitted Random Access Preamble.

The UE shall again perform the Random Access Resource selection procedure specified in clause 5.1.2a in TS 38.321 [7], and transmit with the calculated MsgA PRACH and MsgA PUSCH transmission power when the backoff time expires if all received MsgB's contain Random Access Preamble identifiers that do not match the transmitted Random Access Preamble.

In addition, the power applied to all MsgA transmission shall be in accordance with what is specified in Clause 6.2.2.2. The power of the first MsgA preamble shall be -22 dBm with an accuracy specified in clause 6.3.4.2 of TS 38.101-1 [18]. The power of the first MsgA PUSCH transmission shall  $0.6 + 3(\mu + 2)$  dBm with an accuracy specified in clause 6.3.4.2 of TS 38.101-1 [18], where  $\mu$  indicates the MsgA PUSCH numerology. The relative power applied to additional MsgA transmissions shall have an accuracy specified in clause 6.3.4.3 of TS 38.101-1 [18].

The transmit timing of all MsgA transmissions shall be within the accuracy specified in Clause 7.1.2.

#### A.4.3.2.3.2.3 No MsgB Reception

To test the UE behavior specified in clause 6.2.2.3.1.3 the System Simulator shall transmit a MsgB with fallbackRAR containing a successRAR message and a Random Access Preamble identifier corresponding to the transmitted Random Access Preamble after 5 preambles have been received by the System Simulator. The System Simulator shall *not* respond to the first 4 preambles.

The UE shall again perform the Random Access Resource selection procedure specified in clause 5.1.2a in TS 38.321 [7], and transmit with the calculated MsgA PRACH and MsgA PUSCH transmission power when the backoff time expires if no MsgB is received within the MsgB Response window.

In addition, the power applied to all MsgA transmission shall be in accordance with what is specified in Clause 6.2.2.2. The power of the first MsgA preamble shall be -30 dBm with an accuracy specified in clause 6.3.4.2 of TS 38.101-1 [18]. The power of the first MsgA PUSCH transmission shall be  $0.6 + 3(\mu + 2)$  dBm with an accuracy specified in clause 6.3.4.2 of TS 38.101-1 [18], where  $\mu$  indicates the MsgA PUSCH numerology. The relative power applied to additional MsgA transmissions shall have an accuracy specified in clause 6.3.4.3 of TS 38.101-1 [18].

The transmit timing of all MsgA transmissions shall be within the accuracy specified in Clause 7.1.2.

#### A.4.3.2.2.4 2-step RA type non-contention based random access test in FR1 for PSCell in EN-DC

##### A.4.3.2.2.4.1 Test Purpose and Environment

The purpose of this test is to verify that the behavior of the random access procedure is according to the requirements and that the MsgA PRACH, MsgA PUSCH power settings and timing are within specified limits. This test will verify the requirements in clause 6.2.2.3 and clause 7.1.2 in an AWGN model.

For this test two cells are used, with the configuration of Cell 1 (E-UTRA PCell) specified in clause A.3.7.2.1 and Cell 2 configured as PSCell in FR1. Supported test parameters are shown in Table A.4.3.2.2.4.1-1. UE capable of EN-DC with PSCell in FR1 needs to be tested by using the parameters in Table A.4.3.2.2.4.1-2.

**Table A.4.3.2.2.4.1-1: Supported test configurations for non-contention based random access test for 2-step RA type in FR1 for PSCell in EN-DC**

Config	Description
1	LTE FDD, NR 15 kHz SSB SCS, 10 MHz bandwidth, FDD duplex mode
2	LTE TDD, NR 15 kHz SSB SCS, 10 MHz bandwidth, FDD duplex mode
3	LTE FDD, NR 30 kHz SSB SCS, 40 MHz bandwidth, TDD duplex mode
4	LTE TDD, NR 30 kHz SSB SCS, 40 MHz bandwidth, TDD duplex mode

Note: The UE is only required to be tested in one of the supported test configurations depending on UE capability

**Table A.4.3.2.2.4.1-2: General test parameters for non-contention based random access test for 2-step RA type in FR1 for PSCell in EN-DC**

Parameter	Unit	Test-1	Comments
SSB Configuration	Config 1,2	SSB pattern 3 in FR1	As defined in A.3.10
	Config 3,4	SSB pattern 4 in FR1	
Duplex Mode for Cell 2	Config 1,2	FDD	
	Config 3,4	TDD	
TDD Configuration	Config 3,4	TDDConf.2.1	
OCNG Pattern <sup>Note 1</sup>		OCNG pattern 1	As defined in A.3.2.1.
PDSCH parameters <sup>Note 3</sup>	Config 1,2	SR.1.1 FDD	As defined in A.3.1.1.
	Config 3,4	SR.2.1 TDD	
RMSI CORESET Reference Channel	Config 1,2	CR.1.1 TDD	
	Config 3,4	CR.2.1 TDD	
Dedicated CORESET Reference Channel	Config 1,2	CCR.1.1 TDD	
	Config 3,4	CCR.2.1 TDD	

NR RF Channel Number			1		
EPRE ratio of PSS to SSS		dB	0		
EPRE ratio of PBCH_DMRS to SSS		dB			
EPRE ratio of PBCH to PBCH_DMRS		dB			
EPRE ratio of PDCCH_DMRS to SSS		dB			
EPRE ratio of PDCCH to PDCCH_DMRS		dB			
EPRE ratio of PDSCH_DMRS to SSS		dB			
EPRE ratio of PDSCH to PDSCH_DMRS		dB			
SSB with index 0	$\hat{E}_s / I_{ot}$		dB	3	Power of SSB with index 0 is set to be above configured <i>msgA-RSRP-ThresholdSSB</i>
	$N_{oc}$	Config 1,2	dBm/15kHz	-98	
		Config 3,4		-101	
	$\hat{E}_s / N_{oc}$		dB	3	
	SS-RSRP		dBm/ SCS	-95	
SSB with index 1	$\hat{E}_s / I_{ot}$		dB	-17	Power of SSB with index 1 is set to be below configured <i>msgA-RSRP-ThresholdSSB</i>
	$N_{oc}$	Config 1,2	dBm/15kHz	-98	
		Config 3,4		-101	
	$\hat{E}_s / N_{oc}$		dB	-17	
	SS-RSRP		dBm/ SCS	-115	
I <sub>o</sub> <sup>Note 2</sup>	Config 1,2	dBm	-65.3/9.36MHz	For symbols without SSB index 1	
	Config 3,4		-62.2/38.16MHz		
ss-PBCH-BlockPower		dBm/ SCS	-5	As defined in clause 6.3.2 in TS 38.331 [2].	
Configured UE transmitted power (P <sub>C<sub>MAX,f,c</sub></sub> )		dBm	23	As defined in clause 6.2.4 in TS 38.101-1.	
MsgA Configuration			FR1 MsgA configuration 2	As defined in A.3.20.2.	
<i>msgA-RSRP-ThresholdSSB</i>		dBm	RSRP_51	The actual value of the threshold is -105dBm, as defined in TS 38.331 [2].	
Propagation Condition		-	AWGN		
<p>Note 1: OCNG shall be used such that the cell is fully allocated and a constant total transmitted power spectral density is achieved for all OFDM symbols. The OCNG pattern is chosen during the test according to the presence of a DL reference measurement channel.</p> <p>Note 2: SS-RSRP, Es/I<sub>ot</sub> and I<sub>o</sub> levels have been derived from other parameters for information purpose. They are not settable parameters.</p> <p>Note 3: The DL PDSCH reference measurement channel is used in the test only when a downlink transmission dedicated to the UE under test is required.</p>					

#### A.4.3.2.2.4.2 Test Requirements

Non-Contention based random access is triggered by explicitly assigning a random access preamble via dedicated signalling in the downlink. In the test, the non-contention based random access procedure is not initialized for Other SI requested from UE or beam failure recovery.

##### A.4.3.2.2.4.2.1 MsgA Transmission

In Test-1, to test the UE behavior specified in Clause 6.2.2.3.2.1 for MsgA transmission, with the contention-free Random Access Resources and the contention-free PRACH occasions associated with SSBs configured, the System Simulator shall receive the MsgA which has the Preamble Index associated with the SSB with index 0.

In addition, the System Simulator shall receive the MsgA on the PRACH occasion which belongs to the PRACH occasions corresponding to the SSB with index 0, and the selected PRACH occasion shall belong to the PRACH

occasions permitted by the restrictions given first by the *msgA-SSB-SharedRO-MaskIndex* if configured, or next by the *ra-ssb-OccasionMaskIndex* if configured.

In addition, the power applied to all MsgA transmission shall be in accordance with what is specified in Clause 6.2.2.2. The power of the first preamble shall be -22 dBm with an accuracy specified in clause 6.3.4.2 of TS 38.101-1 [18]. The power of the first MsgA PUSCH transmission shall be  $0.6 + 3(\mu + 2)$  dBm with an accuracy specified in clause 6.3.4.2 of TS 38.101-1 [18], where  $\mu$  indicates the MsgA PUSCH numerology. The relative power applied to additional MsgA transmissions shall have an accuracy specified in clause 6.3.4.3 of TS 38.101-1 [18].

The transmit timing of all MsgA transmissions shall be within the accuracy specified in Clause 7.1.2.

#### A.4.3.2.2.4.2.2 MsgB Reception

To test the UE behavior specified in Clause 6.2.2.3.2.2 the System Simulator shall transmit a MsgB containing a successRAR MAC subPDU corresponding to the transmitted Random Access Preamble after 5 MsgA transmissions have been received by the System Simulator. In response to the first 4 preambles, the System Simulator shall transmit a MsgB *not* corresponding to the transmitted Random Access Preamble.

The UE may stop monitoring for MsgB if the MsgB contains a successRAR MAC subPDU corresponding to the transmitted Random Access Preamble.

The UE shall again perform the Random Access Resource selection procedure specified in clause 5.1.2a in TS38.321 [7], and transmit with the calculated MsgA transmission power if Random Access Responses Reception has not been considered as successful.

In addition, the power applied to all MsgA transmissions shall be in accordance with what is specified in Clause 6.2.2.3. The power of the first preamble shall be -22 dBm with an accuracy specified in clause 6.3.4.2 of TS 38.101-1 [18]. The power of the first MsgA PUSCH transmission shall be  $0.6 + 3(\mu + 2)$  dBm with an accuracy specified in clause 6.3.4.2 of TS 38.101-1 [18], where  $\mu$  indicates the MsgA PUSCH numerology. The relative power applied to additional MsgA transmissions shall have an accuracy specified in clause 6.3.4.3 of TS 38.101-1 [18].

The transmit timing of all MsgA transmissions shall be within the accuracy specified in Clause 7.1.2.

#### A.4.3.2.2.4.2.3 No MsgB Reception

To test the UE behavior specified in clause 6.2.2.3.2.3 the System Simulator shall transmit a MsgB corresponding to the transmitted Random Access Preamble after 5 preambles have been received by the System Simulator. The System Simulator shall *not* respond to the first 4 preambles.

The UE shall again perform the Random Access Resource selection procedure specified in clause 5.1.2a in TS38.321 [7], and transmit with the calculated MsgA transmission power when the backoff time expires if no MsgB is received within the MsgB Response window configured in *RACH-ConfigGenericTwoStepRA*.

In addition, the power applied to all MsgA transmissions shall be in accordance with what is specified in Clause 6.2.2.3. The power of the first preamble shall be -22 dBm with an accuracy specified in clause 6.3.4.2 of TS 38.101-1 [18]. The power of the first MsgA PUSCH transmission shall be  $0.6 + 3(\mu + 2)$  dBm with an accuracy specified in clause 6.3.4.2 of TS 38.101-1 [18], where  $\mu$  indicates the MsgA PUSCH numerology. The relative power applied to additional MsgA transmissions shall have an accuracy specified in clause 6.3.4.3 of TS 38.101-1 [18].

The transmit timing of all MsgA transmissions shall be within the accuracy specified in Clause 7.1.2.

#### A.4.3.2.3 Void

### A.4.4 Timing

#### A.4.4.1 UE transmit timing

##### A.4.4.1.1 NR UE Transmit Timing Test for FR1

###### A.4.4.1.1.1 Test Purpose and environment

The purpose of this test is to verify that the UE can follow frame timing change of the connected gNodeB and that the UE initial transmit timing accuracy, maximum amount of timing change in one adjustment, minimum and maximum

adjustment rate are within the specified limits. This test will verify the requirements in clause 7.1.2. Supported test configurations are shown in Table 4.4.1.1.1-1.

**Table A.4.4.1.1.1-1: Supported test configurations for FR1 PSCell**

Configuration	Description
1	LTE FDD, NR FDD, SSB SCS 15 kHz, data SCS 15 kHz, BW 10 MHz
2	LTE FDD, NR TDD, SSB SCS 15 kHz, data SCS 15 kHz, BW 10 MHz
3	LTE FDD, NR TDD, SSB SCS 30 kHz, data SCS 30 kHz, BW 40 MHz
4	LTE TDD, NR FDD, SSB SCS 15 kHz, data SCS 15 kHz, BW 10 MHz
5	LTE TDD, NR TDD, SSB SCS 15 kHz, data SCS 15 kHz, BW 10 MHz
6	LTE TDD, NR TDD, SSB SCS 30 kHz, data SCS 30 kHz, BW 40 MHz
Note:	The UE is only required to be tested in one of the supported test configurations

The test consists of E-UTRA PCell and NR PSCell. The configuration for E-UTRA is given in A.3.7.2.1. Table A.4.4.1.1.1-2 defines the parameters to be configured and strength of the transmitted signals. The transmit timing is verified by the UE transmitting SRS using the configuration defined in Table A.4.4.1.1.1-3.

**Table A.4.4.1.1.1-2: Cell Specific Test Parameters for UL Transmit Timing test**

Parameter	Unit	Config	Test1	Test2	Band Group
SSB ARFCN		1,2,3,4,5,6	Freq1	Freq1	
Duplex Mode		1,4	FDD		
		2,3,5,6	TDD		
TDD configuration		1,4	Not Applicable		
		2,5	TDDConf.1.1		
		3,6	TDDConf.2.1		
BW <sub>channel</sub>	MHz	1,4	10: N <sub>RB,c</sub> = 52		
		2,5	10: N <sub>RB,c</sub> = 52		
		3,6	40: N <sub>RB,c</sub> = 106		
Initial BWP Configuration		1,2,3,4,5,6	DLBWP.0.1 ULBWP.0.1		
Dedicated BWP Configuration		1,2,3,4,5,6	DLBWP.1.1 ULBWP.1.1		
DRx Cycle	ms	1,2,3,4,5,6	N/A	DRX.8 <sup>Note5</sup>	
PDSCH Reference measurement channel		1,4	SR.1.1 FDD		
		2,5	SR.1.1 TDD		
		3,6	SR.2.1 TDD		
RMSI CORESET Reference Channel		1,4	CR.1.1 FDD		
		2,5	CR.1.1 TDD		
		3,6	CR.2.1 TDD		
Dedicated CORESET Reference Channel		1,4	CCR.1.1 FDD		
		2,5	CCR.1.1 TDD		
		3,6	CCR.2.1 TDD		
OCNG Patterns		1,2,3,4,5,6	OP.1		
SSB configuration		1,4	SSB.1 FR1		
		2,5	SSB.1 FR1		
		3,6	SSB.2 FR1		
SMTc configuration		1,2,3,4,5,6	SMTc.2		
TRS configuration		1,4	TRS.1.1 FDD		
		2,5	TRS.1.1 TDD		
		3,6	TRS.1.2 TDD		
PDSCH/PDCCH subcarrier spacing	kHz	1,2,4,5	15		
		3,6	30		
EPRE ratio of PSS to SSS					
EPRE ratio of PBCH DMRS to SSS					

EPRE ratio of PBCH to PBCH DMRS					
EPRE ratio of PDCCH DMRS to SSS					
EPRE ratio of PDCCH to PDCCH DMRS	dB	1,2,3,4,5,6	0	0	
EPRE ratio of PDSCH DMRS to SSS					
EPRE ratio of PDSCH to PDSCH					
EPRE ratio of OCNB DMRS to SSS(Note 1)					
EPRE ratio of OCNB to OCNB DMRS (Note 1)					
$N_{oc}^{Note2}$	dBm/15 kHz	1,2,3,4,5,6	-98	-98	
$N_{oc}^{Note2}$	dBm/SCS	1,2,4,5	-98	-98	
		3,6	-95	-95	
$\hat{E}_s / I_{ot}$		1,2,3,4,5,6	3	3	
$\hat{E}_s / N_{oc}$		1,2,3,4,5,6	3	3	
SS-RSRP <sup>Note3</sup>	dBm/SCS	1,2,4,5	-95	-95	
		3,6	-92	-92	
$I_o^{Note3}$	dBm/9.36MHz	1,2,4,5	-65.2	-65.2	
	dBm/38.1MHz	3,6	-59.2	-59.2	
Propagation condition		1,2,3,4,5,6	AWGN		
SRS Config		1,2,4,5	SRSCConf.1 <sup>Note6</sup>	SRSCConf.3 <sup>Note6</sup>	
		3, 6	SRSCConf.1 <sup>Note6</sup>	SRSCConf.2 <sup>Note6</sup>	
<p>Note 1: OCNB shall be used such that both cells are fully allocated and a constant total transmitted power spectral density is achieved for all OFDM symbols.</p> <p>Note 2: Interference from other cells and noise sources not specified in the test is assumed to be constant over subcarriers and time and shall be modelled as AWGN of appropriate power for <math>N_{oc}</math> to be fulfilled.</p> <p>Note 3: SS-RSRP and <math>I_o</math> levels have been derived from other parameters for information purposes. They are not settable parameters themselves.</p> <p>Note 4: SS-RSRP minimum requirements are specified assuming independent interference and noise at each receiver antenna port.</p> <p>Note 5: DRx related parameters are given in Table A.3.3.8-1</p> <p>Note 6: SRS configs are given in Table A.4.4.1.1.1-3</p>					

**Table A.4.4.1.1.1-3: SRS Configuration for Timing Accuracy Test**

	Field	SRSCConf.1	SRSCConf.2	SRSCConf.3	Comments
SRS-ResourceSet	srs-ResourceSetId	0	0	0	
	srs-ResourceIdList	0	0	0	
	resourceType	Periodic	Periodic	Periodic	
	Usage	Codebook	Codebook	Codebook	
SRS-Resource	SRS-ResourceId	0	0	0	
	nrofSRS-Ports	Port1	Port1	Port1	
	transmissionComb	n2	n2	n2	
	combOffset-n2	0	0	0	
	cyclicShift-n2	0	0	0	
	resourceMapping startPosition	0	0	0	
	resourceMapping nrofSymbols	n1	n1	n1	
	resourceMapping repetitionFactor	n1	n1	n1	
	freqDomainPosition	0	0	0	
	freqDomainShift	0	0	0	



freqHopping c-SRS	14 for test configuration 1,2,4,5 25 for test configuration 3,6	25	14	Matches $N_{RB,c}$
freqHopping b-SRS	0	0	0	
freqHopping b-hop	0	0	0	
groupOrSequenceHopping	Neither	Neither	Neither	
resourceType	Periodic	Periodic	Periodic	
periodicityAndOffset-p	sl1, 0	sl640, 5	sl320, 3	Offset to align with DRx periodicity
sequenceId	0	0	0	Any 10 bit number

#### A.4.4.1.1.2 Test requirements

The test sequence shall be carried out in RRC\_CONNECTED for every test case.

Following will be the test sequence for this test

- 1) Set up E-UTRA PCell according to parameters given in Table A.3.7.2.1-1 and setup NR PCell according to parameters given in Table A.4.4.1.1.1-1.
- 2) After connection set up with the cell, the test equipment will verify that the timing of the NR cell is within  $(N_{TA} + N_{TA\_offset}) \times T_c \pm T_e$  of the first detected path of DL SSB.
  - a. The  $N_{TA}$  offset value (in  $T_c$  units) is 25600
  - b. The  $T_e$  values depend on the DL and UL SCS for which the test is being run and are given in Table 7.1.2-1
- 3) The test system shall adjust the timing of the DL path by values given in Table A.4.4.1.1.2-1

**Table A.4.4.1.1.2-1: Adjustment Value for DL Timing**

SCS of SSB signals (kHz)	Adjustment Value	
	Test1	Test2
15	$+64 \cdot 64 T_c$	$+32 \cdot 64 T_c$
30	$+32 \cdot 64 T_c$	$+16 \cdot 64 T_c$

- 4) The test system shall verify that the adjustment step size and the adjustment rate shall be according to requirements specified in Clause 7.1.2 Table 7.1.2.1-1 until the UE transmit timing offset is within  $(N_{TA} + N_{TA\_offset}) \times T_c \pm T_e$  respective to the first detected path (in time) of DL SSB. Skip this step for test 2 with DRX configured.
- 5) The test system shall verify that the UE transmit timing offset stays within  $(N_{TA} + N_{TA\_offset}) \times T_c \pm T_e$  of the first detected path of DL SSB. For Test 2 the UE transmit timing offset shall be verified for the first transmission in the DRX cycle immediately after DL timing adjustment.

#### A.4.4.2 UE timer accuracy

#### A.4.4.3 Timing advance

##### A.4.4.3.1 EN-DC FR1 timing advance adjustment accuracy

###### A.4.4.3.1.1 Test Purpose and Environment

The purpose of the test is to verify UE Timing Advance adjustment delay and accuracy requirement defined in clause 7.3.

#### A.4.4.3.1.2 Test Parameters

Supported test configurations are shown in table A.4.4.3.1.2-1. Both timing advance adjustment delay and accuracy are tested by using the parameters in table A.4.4.3.1.2-2, A.4.4.3.1.2-3 and A.4.4.3.1.2-4. The configuration of Cell 1 (LTE PCell) is specified in clause A.3.7.2.1.

In all test cases, two cells are used. Cell 1 is the PCell in the primary Timing Advance Group (pTAG) and cell 2 is the PSCell in the secondary Timing Advance Group (sTAG). Each test consists of two successive time periods, with time duration of T1 and T2 respectively. In each time period, timing advance commands for sTAG are sent to the UE and Sounding Reference Signals (SRS), as specified in table A.4.4.3.1.2-3, are sent from the UE and received by the test equipment. By measuring the reception of the SRS, the transmit timing, and hence the timing advance adjustment accuracy, can be measured for PSCell in sTAG.

During time period T1, the test equipment shall send one message with a Timing Advance Command MAC Control Element for sTAG, as specified in clause 6.1.3.4 in TS 38.321 [7]. The Timing Advance Command value shall be set to 31, which according to clause 4.2 in TS 38.213 [3] results in zero adjustment of the Timing Advance. In this way, a reference value for the timing advance for sTAG used by the UE is established.

During time period T2, the test equipment shall send a sequence of messages with Timing Advance Command MAC Control Elements for sTAG, with Timing Advance Command value specified in table A.4.4.3.1.2-2. This value shall result in changes of the timing advance for sTAG used by the UE, and the accuracy of the change shall then be measured, using the SRS sent from the UE.

As specified in clause 7.3.2.1, the UE adjusts its uplink timing at slot  $n+k$  for a timing advance command received in slot  $n$ . This delay must be taken into account when measuring the timing advance adjustment accuracy, via the SRS sent from the UE.

The UE Time Alignment Timer, described in clause 5.2 in TS 38.321, shall be configured so that it does not expire in the duration of the test.

**Table A.4.4.3.1.2-1: Timing advance supported test configurations**

Config	Description
1	LTE FDD, NR 15 kHz SSB SCS, 10 MHz bandwidth, FDD duplex mode
2	LTE FDD, NR 15 kHz SSB SCS, 10 MHz bandwidth, TDD duplex mode
3	LTE FDD, NR 30 kHz SSB SCS, 40 MHz bandwidth, TDD duplex mode
4	LTE TDD, NR 15 kHz SSB SCS, 10 MHz bandwidth, FDD duplex mode
5	LTE TDD, NR 15 kHz SSB SCS, 10 MHz bandwidth, TDD duplex mode
6	LTE TDD, NR 30 kHz SSB SCS, 40 MHz bandwidth, TDD duplex mode

Note: The UE is only required to be tested in one of the supported test configurations

**Table A.4.4.3.1.2-2: General test parameters for timing advance**

Parameter	Unit	Value	Comment
RF channel number		Cell 1: 1 Cell 2: 2	1 for E-UTRAN PCell 2 for NR PSCell
Initial DL BWP		DLBWP.0.1	As specified in Table A.3.9.2.1-1
Dedicated DL BWP		DLBWP.1.1	As specified in Table A.3.9.2.2-1
Initial UL BWP		ULBWP.0.1	As specified in Table A.3.9.3.1-1
Dedicated UL BWP		ULBWP.1.1	As specified in Table A.3.9.3.2-1
Timing Advance Command ( $T_A$ ) value during T1		31	$N_{TA\_new} = N_{TA\_old}$ for the purpose of establishing a reference value from which the timing advance adjustment accuracy can be measured during T2
Timing Advance Command ( $T_A$ ) value during T2		39	For 15 kHz SCS $N_{TA\_new} = N_{TA\_old} + 8192 * T_c$ For 30 kHz SCS $N_{TA\_new} = N_{TA\_old} + 4096 * T_c$ (based on equation in clause 4.2 of TS 38.213 [3])
T1	s	5	
T2	s	5	

Table A.4.4.3.1.2-3: Cell specific test parameters for timing advance

Parameter		Unit	Test1	
			T1	T2
Duplex mode	Config 1,4		FDD	
	Config 2,3,5,6		TDD	
TDD configuration	Config 1,4		Not Applicable	
	Config 2,5		TDDConf.1.1	
	Config 3,6		TDDConf.2.1	
BW <sub>channel</sub>	Config 1,4	MHz	10: N <sub>RB,c</sub> = 52	
	Config 2,5		10: N <sub>RB,c</sub> = 52	
	Config 3,6		40: N <sub>RB,c</sub> = 106	
BWP BW	Config 1,4	MHz	10: N <sub>RB,c</sub> = 52	
	Config 2,5		10: N <sub>RB,c</sub> = 52	
	Config 3,6		40: N <sub>RB,c</sub> = 106	
DRx Cycle		ms	Not Applicable	
PDSCH Reference measurement channel	Config 1,4		SR.1.1 FDD	
	Config 2,5		SR.1.1 TDD	
	Config 3,6		SR2.1 TDD	
RMSI CORESET Reference Channel	Config 1,4		CR.1.1 FDD	
	Config 2,5		CR.1.1 TDD	
	Config 3,6		CR2.1 TDD	
Dedicated CORESET Reference Channel	Config 1,4		CCR.1.1 FDD	
	Config 2,5		CCR.1.1 TDD	
	Config 3,6		CCR.2.1 TDD	
TRS configuration	Config 1,4		TRS.1.1 FDD	
	Config 2,5		TRS.1.1 TDD	
	Config 3,6		TRS.1.2 TDD	
OCNG Patterns			OCNG pattern 1	
SSB Configuration	Config 1,2,4,5		SSB.1 FR1	
	Config 3,6		SSB.2 FR1	
SMTc configuration	Config 1,2,4,5		SMTc.1 FR1	
	Config 3,6		SMTc.2 FR1	
PDSCH/PDCCH subcarrier spacing	Config 1,2,4,5	kHz	15 kHz	
	Config 3,6		30 kHz	
PUCCH/PUSCH subcarrier spacing	Config 1,2,4,5	kHz	15 kHz	
	Config 3,6		30 kHz	
EPRE ratio of PSS to SSS		dB	0	
EPRE ratio of PBCH DMRS to SSS				
EPRE ratio of PBCH to PBCH DMRS				
EPRE ratio of PDCCH DMRS to SSS				
EPRE ratio of PDCCH to PDCCH DMRS				
EPRE ratio of PDSCH DMRS to SSS				
EPRE ratio of PDSCH to PDSCH				
EPRE ratio of OCNG DMRS to SSS(Note 1)				
EPRE ratio of OCNG to OCNG DMRS (Note 1)				
$N_{oc}$ <sup>Note2</sup>		dBm/15kHz	-98	
$N_{oc}$ <sup>Note2</sup>	Config 1,2,4,5	dBm/SCS	-98	
	Config 3,6		-95	
$\hat{E}_s / I_{ot}$		dB	3	
$\hat{E}_s / N_{oc}$		dB	3	
I <sub>o</sub> <sup>Note3</sup>	Config 1,2,4,5	dBm/9.36MHz	-67.57	
	Config 3,6	dBm/38.16MHz	-62.58	
Propagation condition		-	AWGN	
Note 1: OCNG shall be used such that both cells are fully allocated and a constant total transmitted power spectral density is achieved for all OFDM symbols.				
Note 2: Interference from other cells and noise sources not specified in the test is assumed to be constant over subcarriers and time and shall be modelled as AWGN of appropriate power for $N_{oc}$ to be fulfilled.				
Note 3: I <sub>o</sub> levels have been derived from other parameters for information purposes. They are not settable parameters themselves.				

**Table A.4.4.3.1.2-4: Sounding Reference Symbol Configuration for timing advance**

Field		Value	Comment
c-SRS	Config 1,2,4,5	12	Frequency hopping is disabled
	Config 3,6	24	
b-SRS		0	
b-hop		0	
freqDomainPosition		0	
freqDomainShift		0	Frequency domain position of SRS
groupOrSequenceHopping		neither	No group or sequence hopping
SRS-PeriodicityAndOffset		sl5=2 for SCS 15kHz sl5=4 for SCS 30kHz	Once every 5 slots
pathlossReferenceRS		ssb-Index=0	SSB #0 is used for SRS path loss estimation
usage		Codebook	Codebook based UL transmission
startPosition		0	resourceMapping setting. SRS on last symbol of slot, and 1symbols for SRS without repetition.
nrofSymbols		n1	
repetitionFactor		n1	
combOffset-n2		0	transmissionComb setting
cyclicShift-n2		0	
nrofSRS-Ports		port1	Number of antenna ports used for SRS transmission
Note: For further information see clause 6.3.2 in TS 38.331 [2].			

#### A.4.4.3.1.3 Test Requirements

The UE shall apply the signalled Timing Advance value for PSCell in sTAG to the transmission timing at the designated activation time i.e.  $k+1$  slots after the reception of the timing advance command, where  $k=5$ .

The Timing Advance adjustment accuracy for PSCell in sTAG shall be within the limits specified in clause 7.3.2.2.

The rate of correct Timing Advance adjustments observed during repeated tests shall be at least 90%.

### A.4.5 Signaling characteristics

#### A.4.5.1 Radio link Monitoring

In the following clause, any uplink signal transmitted by the UE is used for detecting the In-/Out-of-Sync state of the UE. In terms of measurement, the uplink signal is verified on the basis of the UE output power:

For intra-band contiguous carrier aggregation, transmit OFF power is measured as the mean power per component carrier.

For UE with multiple transmit antennas, transmit OFF power is measured as the mean power at each transmit connector.

- UE output power higher than Transmit OFF power -50 dBm (as defined in TS 38.101-3 [20]) means uplink signal
- UE output power equal to or less than Transmit OFF power -50 dBm (as defined in TS 38.101-3 [20]) means no uplink signal.

### A.4.5.1.1 Radio Link Monitoring Out-of-sync Test for FR1 PSCell configured with SSB-based RLM RS in non-DRX mode

#### A.4.5.1.1.1 Test Purpose and Environment

The purpose of this test is to verify that the UE properly detects the out of sync and in sync for the purpose of monitoring downlink radio link quality of the PSCell. This test will partly verify the FR1 PSCell radio link monitoring requirements in clause 8.1.

In the test, UE is configured to perform RLM on SSB, with *detectionResource* included in *RadioLinkMonitoringRS* set to SSB#0, and *purpose* set to 'rlf'. Supported test configurations are shown in table A.4.5.1.1.1-1. The test parameters are given in Tables A.4.5.1.1.1-2, A.4.5.1.1.1-3, and A.4.5.1.1.1-4 below. There are two cells, Cell 1 is the E-UTRAN PCell, and Cell 2 is the PSCell, in the test. The E-UTRAN PCell setting refers to Table A.3.7.2.1-1. The test consists of three successive time periods, with time duration of T1, T2 and T3 respectively. Figure A.4.5.1.1.1-1 shows the variation of the downlink SNR in the active Cell 2 to emulate out-of-sync and in-sync states. Prior to the start of the time duration T1, the UE shall be fully synchronized to Cell 1 and Cell 2. The UE shall be configured for periodic CSI reporting with a reporting periodicity of 5 ms. The UE is configured to perform inter-frequency measurements using Gap Pattern ID #0 (40ms) in test 1.

**Table A.4.5.1.1.1-1: Supported test configurations for FR1 PSCell**

Configuration	Description
1	LTE FDD, NR 15 kHz SSB SCS, 10 MHz bandwidth, FDD duplex mode
2	LTE FDD, NR 15 kHz SSB SCS, 10 MHz bandwidth, TDD duplex mode
3	LTE FDD, NR 30 kHz SSB SCS, 40 MHz bandwidth, TDD duplex mode
4	LTE TDD, NR 15 kHz SSB SCS, 10 MHz bandwidth, FDD duplex mode
5	LTE TDD, NR 15 kHz SSB SCS, 10 MHz bandwidth, TDD duplex mode
6	LTE TDD, NR 30 kHz SSB SCS, 40 MHz bandwidth, TDD duplex mode

Note: The UE is only required to pass in one of the supported test configurations in FR1

**Table A.4.5.1.1.1-2: General test parameters for FR1 out-of-sync testing in non-DRX mode**

Parameter	Unit	Value
		Test 1
Active E-UTRA PCell		Cell 1
E-UTRA RF Channel Number		1
Active PSCell		Cell 2
RF Channel Number		2
Duplex mode	Config 1, 4	FDD
	Config 2, 3, 5, 6	TDD
BW <sub>channel</sub>	Config 1, 4	10: N <sub>RB,c</sub> = 52
	Config 2, 5	10: N <sub>RB,c</sub> = 52
	Config 3, 6	40: N <sub>RB,c</sub> = 106
DL initial BWP configuration	Config 1, 2, 3, 4, 5, 6	DLBWP.0.1
DL dedicated BWP configuration	Config 1, 2, 3, 4, 5, 6	DLBWP.1.1
UL initial BWP configuration	Config 1, 2, 3, 4, 5, 6	ULBWP.0.1
UL dedicated BWP configuration	Config 1, 2, 3, 4, 5, 6	ULBWP.1.1
TDD Configuration	Config 1, 4	Not Applicable
	Config 2, 5	TDDConf.1.1
	Config 3, 6	TDDConf.2.1
RMSI CORESET Reference Channel	Config 1, 4	CR.1.1 FDD
	Config 2, 5	CR.1.1 TDD
	Config 3, 6	CR.2.1 TDD
Dedicated CORESET Reference Channel	Config 1, 4	CCR.1.3 FDD
	Config 2, 5	CCR.1.3 TDD
	Config 3, 6	CCR.2.2 TDD
SSB Configuration	Config 1, 4	SSB.1 FR1
	Config 2, 5	SSB.1 FR1

	Config 3, 6		SSB.2 FR1
SMTC Configuration	Config 1, 2, 4, 5		SMTC.1
PDSCH/PDCCH subcarrier spacing	Config 3, 6		15 kHz
PRACH Configuration	Config 1, 2, 4, 5		30 kHz
	Config 3, 6		Table A.3.8.2.1-1
SSB index assigned as RLM RS			0
OCNG parameters			OP.1
CP length			Normal
Correlation Matrix and Antenna Configuration			2x2 Low
Out of sync transmission parameters	DCI format		1-0
	Number of Control OFDM symbols		2
	Aggregation level	CCE	8
	Ratio of hypothetical PDCCH RE energy to average SSS RE energy	dB	4
	Ratio of hypothetical PDCCH DMRS energy to average SSS RE energy	dB	4
	DMRS precoder granularity		REG bundle size
REG bundle size			6
DRX			OFF
Gap pattern ID			gp0
Layer 3 filtering			Enabled
T310 timer		ms	0
T311 timer		ms	1000
N310			1
N311			1
CSI-RS for CSI reporting	Config 1, 4		CSI-RS.1.1 FDD
	Config 2, 5		CSI-RS.1.1 TDD
	Config 3, 6		CSI-RS.2.1 TDD
CSI-RS for tracking	Config 1, 4		TRS.1.1 FDD
	Config 2, 5		TRS.1.1 TDD
	Config 3, 6		TRS.1.2 TDD
T1		s	0.2
T2		s	0.48
T3		s	0.48
D1		s	0.44
Note 1: All configurations are assigned to the UE prior to the start of time period T1.			
Note 2: UE-specific PDCCH is not transmitted after T1 starts.			
Note 3: E-UTRAN is in non-DRX mode under test.			

**Table A.4.5.1.1-3: Cell specific test parameters for FR1 (Cell 2) for out-of-sync radio link monitoring tests in non-DRX mode**

Parameter		Unit	Test 1		
			T1	T2	T3
EPRE ratio of PDCCH DMRS to SSS		dB	4		
EPRE ratio of PDCCH to PDCCH DMRS		dB	0		
EPRE ratio of PBCH DMRS to SSS		dB	0		
EPRE ratio of PBCH to PBCH DMRS		dB			
EPRE ratio of PSS to SSS		dB			
EPRE ratio of PDSCH DMRS to SSS		dB			
EPRE ratio of PDSCH to PDSCH DMRS		dB			
EPRE ratio of OCNG DMRS to SSS		dB			
EPRE ratio of OCNG to OCNG DMRS		dB			
SNR on RLM-RS	Config 1, 4	dB	1	-7	-15
	Config 2, 5		1	-7	-15
	Config 3, 6		1	-7	-15

$N_{oc}$	Config 1, 4	dBm/1 5 kHz	-98
	Config 2, 5		-98
	Config 3, 6		-98
$N_{oc}$	Config 1, 4	dBm/S CS	-98
	Config 2, 5		-98
	Config 3, 6		-95
Propagation condition			TDL-C 300ns 100Hz
<p>Note 1: OCNG shall be used such that the resources in Cell 2 are fully allocated and a constant total transmitted power spectral density is achieved for all OFDM symbols.</p> <p>Note 2: The signal contains PDCCH for UEs other than the device under test as part of OCNG.</p> <p>Note 3: SNR levels correspond to the signal to noise ratio over the SSS REs.</p>			

Table A.4.5.1.1.1-4: Measurement gap configuration for out-of-sync tests in non-DRX mode

Field	Test 1
	Value
gapOffset	0
Note 1: E-UTRAN PCell and PSCell are SFN-synchronous and frame boundary aligned. (Ensure that RLM RS is partially overlapped with measurement gap).	

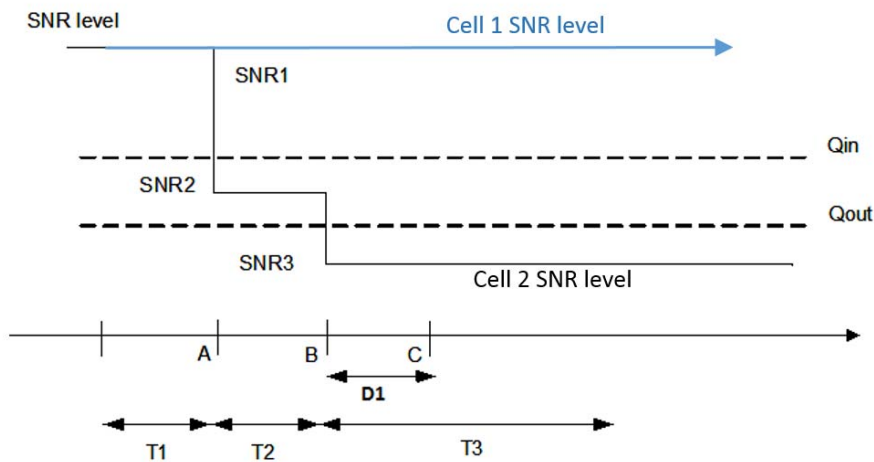

Figure A.4.5.1.1.1-1: SNR variation for out-of-sync testing

### A.4.5.1.1.2 Test Requirements

The UE behaviour in each test during time durations T1, T2 and T3 shall be as follows:

During the period from time point A to time point B the UE shall transmit uplink signal at least in all uplink slots configured for CSI transmission according to the configured periodic CSI reporting.

The UE shall stop transmitting uplink signal in Cell 2 no later than time point C (D1 second after the start of the time duration T3).

The rate of correct events observed during repeated tests shall be at least 90%.

## A.4.5.1.2 Radio Link Monitoring In-sync Test for FR1 PSCell configured with SSB-based RLM RS in non-DRX mode

### A.4.5.1.2.1 Test Purpose and Environment

The purpose of this test is to verify that the UE properly detects the out of sync and in sync for the purpose of monitoring downlink radio link quality of the PSCell. This test will partly verify the FR1 PSCell radio link monitoring requirements in clause 8.1.

In the test, UE is configured to perform RLM on SSB, with *detectionResource* included in *RadioLinkMonitoringRS* set to SSB#0, and *purpose* set to 'rlf'. Supported test configurations are shown in table A.4.5.1.2.1-1. The test parameters are given in Tables A.4.5.1.2.1-2, and A.4.5.1.2.1-3 below. There are two cells, Cell 1 is the E-UTRAN PCell, and Cell 2 is the PSCell, in the test. The E-UTRAN PCell setting refers to Table A.3.7.2.1-1. The test consists of five successive time periods, with time duration of T1, T2, T3, T4 and T5 respectively. Figure A.4.5.1.2.1-1 shows the variation of the downlink SNR in the active Cell 2 to emulate out-of-sync and in-sync states. Prior to the start of the time duration T1, the UE shall be fully synchronized to Cell 1 and Cell 2. The UE shall be configured for periodic CSI reporting with a reporting periodicity of 5 ms.

**Table A.4.5.1.2.1-1: Supported test configurations for FR1 PSCell**

Configuration	Description
1	LTE FDD, NR 15 kHz SSB SCS, 10 MHz bandwidth, FDD duplex mode
2	LTE FDD, NR 15 kHz SSB SCS, 10 MHz bandwidth, TDD duplex mode
3	LTE FDD, NR 30 kHz SSB SCS, 40 MHz bandwidth, TDD duplex mode
4	LTE TDD, NR 15 kHz SSB SCS, 10 MHz bandwidth, FDD duplex mode
5	LTE TDD, NR 15 kHz SSB SCS, 10 MHz bandwidth, TDD duplex mode
6	LTE TDD, NR 30 kHz SSB SCS, 40 MHz bandwidth, TDD duplex mode

Note: The UE is only required to pass in one of the supported test configurations in FR1

**Table A.4.5.1.2.1-2: General test parameters for FR1 in-sync testing in non-DRX mode**

Parameter	Unit	Value
		Test 1
Active E-UTRA PCell		Cell 1
E-UTRA RF Channel Number		1
Active PSCell		Cell 2
RF Channel Number		2
Duplex mode	Config 1, 4	FDD
	Config 2, 3, 5, 6	TDD
BW <sub>channel</sub>	Config 1, 4	10: N <sub>RB,c</sub> = 52
	Config 2, 5	10: N <sub>RB,c</sub> = 52
	Config 3, 6	40: N <sub>RB,c</sub> = 106
DL initial BWP configuration	Config 1, 2, 3, 4, 5, 6	DLBWP.0.1
DL dedicated BWP configuration	Config 1, 2, 3, 4, 5, 6	DLBWP.1.1
UL initial BWP configuration	Config 1, 2, 3, 4, 5, 6	ULBWP.0.1
UL dedicated BWP configuration	Config 1, 2, 3, 4, 5, 6	ULBWP.1.1
TDD Configuration	Config 1, 4	Not Applicable
	Config 2, 5	TDDConf.1.1
	Config 3, 6	TDDConf.2.1
RMSI CORESET Reference Channel	Config 1, 4	CR.1.1 FDD
	Config 2, 5	CR.1.1 TDD
	Config 3, 6	CR.2.1 TDD
Dedicated CORESET Reference Channel	Config 1, 4	CCR.1.1 FDD
	Config 2, 5	CCR.1.1 TDD
	Config 3, 6	CCR.2.1 TDD
SSB	Config 1, 4	SSB.1 FR1



Configuration	Config 2, 5		SSB.1 FR1
	Config 3, 6		SSB.2 FR1
SMTC Configuration	Config 1, 2, 4, 5		SMTC.1
	Config 3, 6		SMTC.1
PDSCH/PDCCH subcarrier spacing	Config 1, 2, 4, 5		15 kHz
	Config 3, 6		30 kHz
PRACH Configuration	Config 1, 2, 4, 5		Table A.3.8.2.1-1
	Config 3, 6		Table A.3.8.2.1-1
SSB index assigned as RLM RS			0
OCNG parameters			OP.1
CP length			Normal
Correlation Matrix and Antenna Configuration			2x2 Low
In sync transmission parameters	DCI format		1-0
	Number of Control OFDM symbols		2
	Aggregation level	CCE	4
	Ratio of hypothetical PDCCH RE energy to average SSS RE energy	dB	0
	Ratio of hypothetical PDCCH DMRS energy to average SSS RE energy	dB	0
	DMRS precoder granularity		REG bundle size
	REG bundle size		6
	Out of sync transmission parameters	DCI format	
Number of Control OFDM symbols			2
Aggregation level		CCE	8
Ratio of hypothetical PDCCH RE energy to average SSS RE energy		dB	4
Ratio of hypothetical PDCCH DMRS energy to average SSS RE energy		dB	4
DMRS precoder granularity			REG bundle size
REG bundle size			6
DRX			<i>OFF</i>
Gap pattern ID			N.A.
Layer 3 filtering			<i>Enabled</i>
T310 timer		ms	1000
T311 timer		ms	1000
N310			1
N311			1
CSI-RS for CSI reporting	Config 1, 4		CSI-RS.1.1 FDD
	Config 2, 5		CSI-RS.1.1 TDD
	Config 3, 6		CSI-RS.2.1 TDD
CSI-RS for	Config 1, 4		TRS.1.1 FDD

tracking	Config 2, 5		TRS.1.1 TDD
	Config 3, 6		TRS.1.2 TDD
T1		s	0.2
T2		s	0.2
T3		s	0.24
T4		s	0.2
T5		s	0.88
D1		s	0.84
Note 1: All configurations are assigned to the UE prior to the start of time period T1.			
Note 2: UE-specific PDCCH is not transmitted after T1 starts.			
Note 3: E-UTRAN is in non-DRX mode under test.			

**Table A.4.5.1.2.1-3: Cell specific test parameters for FR1 (Cell 2) for in-sync radio link monitoring tests in non-DRX mode**

Parameter	Unit	Test 1					
		T1	T2	T3	T4	T5	
EPRE ratio of PDCCH DMRS to SSS	dB	0					
EPRE ratio of PDCCH to PDCCH DMRS	dB	0					
EPRE ratio of PBCH DMRS to SSS	dB	0					
EPRE ratio of PBCH to PBCH DMRS	dB						
EPRE ratio of PSS to SSS	dB						
EPRE ratio of PDSCH DMRS to SSS	dB						
EPRE ratio of PDSCH to PDSCH DMRS	dB						
EPRE ratio of OCNG DMRS to SSS	dB						
EPRE ratio of OCNG to OCNG DMRS	dB						
SNR on RLM-RS	Config 1, 4						dB
	Config 2, 5		1	-7	-15	-4.5	1
	Config 3, 6		1	-7	-15	-4.5	1
$N_{oc}$	Config 1, 4	dBm/15 kHz	-98				
	Config 2, 5		-98				
	Config 3, 6		-98				
$N_{oc}$	Config 1, 4	dBm/SCS	-98				
	Config 2, 5		-98				
	Config 3, 6		-95				
Propagation condition			TDL-C 300ns 100Hz				
Note 1: OCNG shall be used such that the resources in Cell 2 are fully allocated and a constant total transmitted power spectral density is achieved for all OFDM symbols.							
Note 2: The signal contains PDCCH for UEs other than the device under test as part of OCNG.							
Note 3: SNR levels correspond to the signal to noise ratio over the SSS REs.							
Note 4: The SNR in time periods T1, T2, T3, T4 and T5 is denoted as SNR1, SNR2, SNR3, SNR4 and SNR5 respectively in Figure A.4.5.1.2.1-1.							
Note 5: The SNR values are specified for testing a UE which supports 2RX on at least one band. For testing of a UE which supports 4RX on all bands, the SNR during T3 and T4 is modified as specified in clause A.3.6.							

Table A.4.5.1.2.1-4: Void

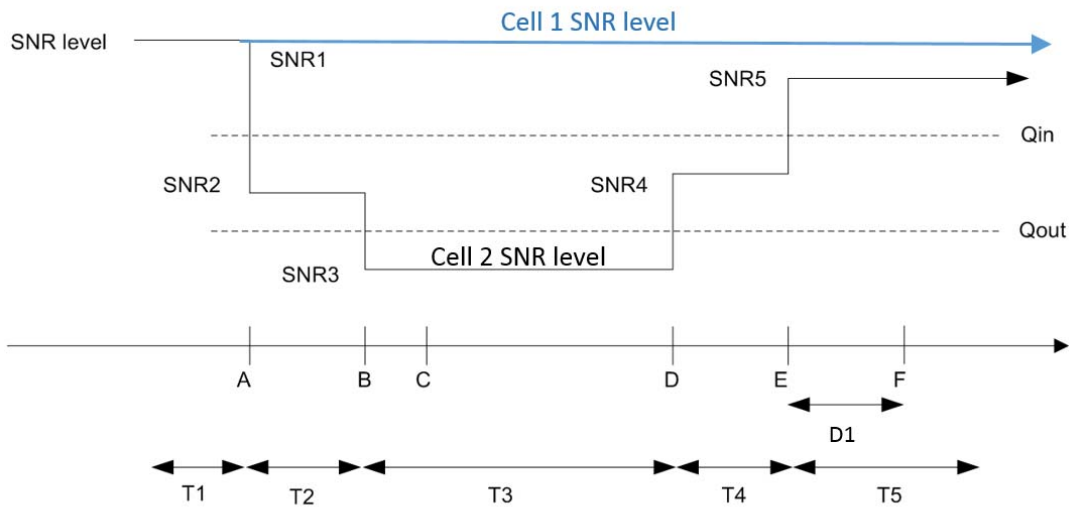

Figure A.4.5.1.2.1-1: SNR variation for in-sync testing

A.4.5.1.2.2 Test Requirements

The UE behaviour in each test during time durations T1, T2, T3, T4 and T5 shall be as follows:

During the period from time point A to time point F (D1 second after the start of time duration T5) the UE shall transmit uplink signal at least in all uplink slots configured for CSI transmission according to the configured periodic CSI reporting.

The rate of correct events observed during repeated tests shall be at least 90%.

A.4.5.1.3 Radio Link Monitoring Out-of-sync Test for FR1 PSCell configured with SSB-based RLM RS in DRX mode

A.4.5.1.3.1 Test Purpose and Environment

The purpose of this test is to verify that the UE properly detects the out of sync and in sync for the purpose of monitoring downlink radio link quality of the PSCell when DRX is used. This test will partly verify the FR1 radio link monitoring requirements in clause 8.1.

In the test, UE is configured to perform RLM on SSB, with *detectionResource* included in *RadioLinkMonitoringRS* set to SSB#0, and *purpose* set to 'rlf'. Supported test configurations are shown in table A.4.5.1.3.1-1. The test parameters are given in Tables A.4.5.1.3.1-2 and A.4.5.1.3.1-3. There are two cells, Cell 1 is the E-UTRAN PCell, and Cell 2 is the PSCell, in the test. The E-UTRAN PCell setting refers to Table A.3.7.2.1-1. The test consists of three successive time periods, with time duration of T1, T2 and T3 respectively. Figure A.4.5.1.3.1-1 shows the variation of the downlink SNR in the active Cell 2 to emulate out-of-sync and in-sync states. Prior to the start of the time duration T1, the UE shall be fully synchronized to Cell 1 and Cell 2. The UE shall be configured for periodic CSI reporting with a reporting periodicity of 5 ms. In the test, DRX configuration is enabled and DRX inactivity timer has already been expired, i.e. UE tries to decode PDCCH and to send periodic CSI during the period when On-duration timer is running. Time alignment timers shall be set to "infinity" so that UL timing alignment is maintained during the test.

Table A.4.5.1.3.1-1: Supported test configurations for FR1 PSCell

Configuration	Description
1	LTE FDD, NR 15 kHz SSB SCS, 10 MHz bandwidth, FDD duplex mode
2	LTE FDD, NR 15 kHz SSB SCS, 10 MHz bandwidth, TDD duplex mode
3	LTE FDD, NR 30 kHz SSB SCS, 40 MHz bandwidth, TDD duplex mode

4	LTE TDD, NR 15 kHz SSB SCS, 10 MHz bandwidth, FDD duplex mode
5	LTE TDD, NR 15 kHz SSB SCS, 10 MHz bandwidth, TDD duplex mode
6	LTE TDD, NR 30 kHz SSB SCS, 40 MHz bandwidth, TDD duplex mode
Note:	The UE is only required to pass in one of the supported test configurations in FR1

**Table A.4.5.1.3.1-2: General test parameters for FR1 out-of-sync testing in DRX mode**

Parameter		Unit	Value
			Test 1
Active E-UTRA PCell			Cell 1
E-UTRA RF Channel Number			1
Active PSCell			Cell 2
RF Channel Number			2
Duplex mode	Config 1, 4		FDD
	Config 2, 3, 5, 6		TDD
BW <sub>channel</sub>	Config 1, 4	MHz	10: N <sub>RB,c</sub> = 52
	Config 2, 5		10: N <sub>RB,c</sub> = 52
	Config 3, 6		40: N <sub>RB,c</sub> = 106
DL initial BWP configuration	Config 1, 2, 3, 4, 5, 6		DLBWP.0.1
DL dedicated BWP configuration	Config 1, 2, 3, 4, 5, 6		DLBWP.1.1
UL initial BWP configuration	Config 1, 2, 3, 4, 5, 6		ULBWP.0.1
UL dedicated BWP configuration	Config 1, 2, 3, 4, 5, 6		ULBWP.1.1
TDD Configuration	Config 1, 4		Not Applicable
	Config 2, 5		TDDConf.1.1
	Config 3, 6		TDDConf.2.1
RMSI CORESET Reference Channel	Config 1, 4		CR.1.1 FDD
	Config 2, 5		CR.1.1 TDD
	Config 3, 6		CR.2.1 TDD
Dedicated CORESET Reference Channel	Config 1, 4		CCR.1.3 FDD
	Config 2, 5		CCR.1.3 TDD
	Config 3, 6		CCR.2.2 TDD
SSB Configuration	Config 1, 4		SSB.1 FR1
	Config 2, 5		SSB.1 FR1
	Config 3, 6		SSB.2 FR1
SMTC Configuration	Config 1, 2, 4, 5		SMTC.1
	Config 3, 6		SMTC.1
PDSCH/PDCCH subcarrier spacing	Config 1, 2, 4, 5		15 kHz
	Config 3, 6		30 kHz
PRACH Configuration	Config 1, 2, 4, 5		Table A.3.8.2.1-1
	Config 3, 6		Table A.3.8.2.1-1
SSB index assigned as RLM RS			0
OCNG parameters			OP.1
CP length			Normal
Correlation Matrix and Antenna Configuration			2x2 Low
Out of sync transmission parameters	DCI format		1-0
	Number of Control OFDM symbols		2
	Aggregation level	CCE	8
	Ratio of hypothetical PDCCH RE energy to average SSS RE energy	dB	4
	Ratio of hypothetical	dB	4

	PDCCH DMRS energy to average SSS RE energy		
	DMRS precoder granularity		REG bundle size
	REG bundle size		6
DRX Configuration			DRX.3
Gap pattern ID			N.A.
Layer 3 filtering			<i>Enabled</i>
T310 timer		ms	0
T311 timer		ms	1000
N310			1
N311			1
CSI-RS for CSI reporting	Config 1, 4		CSI-RS.1.1 FDD
	Config 2, 5		CSI-RS.1.1 TDD
	Config 3, 6		CSI-RS.2.1 TDD
CSI-RS for tracking	Config 1, 4		TRS.1.1 FDD
	Config 2, 5		TRS.1.1 TDD
	Config 3, 6		TRS.1.2 TDD
T1		s	0.2
T2		s	0.68
T3		s	0.68
D1		s	0.64
Note 1: All configurations are assigned to the UE prior to the start of time period T1.			
Note 2: UE-specific PDCCH is not transmitted after T1 starts.			
Note 3: E-UTRAN is in non-DRX mode under test.			

**Table A.4.5.1.3.1-3: Cell specific test parameters for FR1 (Cell 2) for out-of-sync radio link monitoring tests in DRX mode**

Parameter		Unit	Test 1		
			T1	T2	T3
EPRE ratio of PDCCH DMRS to SSS		dB	4		
EPRE ratio of PDCCH to PDCCH DMRS			0		
EPRE ratio of PBCH DMRS to SSS			0		
EPRE ratio of PBCH to PBCH DMRS					
EPRE ratio of PSS to SSS					
EPRE ratio of PDSCH DMRS to SSS					
EPRE ratio of PDSCH to PDSCH DMRS					
EPRE ratio of OCNG DMRS to SSS					
EPRE ratio of OCNG to OCNG DMRS					
SNR on RLM-RS	Config 1, 4		dB	1	-7
	Config 2, 5	1		-7	-15
	Config 3, 6	1		-7	-15
$N_{oc}$	Config 1, 4	dBm/15k Hz	-98		
	Config 2, 5		-98		
	Config 3, 6		-98		
$N_{oc}$	Config 1, 4	dBm/SCS	-98		
	Config 2, 5		-98		
	Config 3, 6		-95		
Propagation condition			TDL-C 300ns 100Hz		
Note 1: OCNG shall be used such that the resources in Cell 2 are fully allocated and a constant total transmitted power spectral density is achieved for all OFDM symbols.					
Note 2: The signal contains PDCCH for UEs other than the device under test as part of OCNG.					
Note 3: SNR levels correspond to the signal to noise ratio over the SSS REs.					
Note 4: The SNR in time periods T1, T2 and T3 is denoted as SNR1, SNR2 and SNR3 respectively in Figure A.4.5.1.3.1-1.					
Note 5: The SNR values are specified for testing a UE which supports 2RX on at least one band. For testing of a UE which supports 4RX on all bands, the SNR during T3 is A.3.6.					

Table A.4.5.1.3.1-4: Void

Table A.4.5.1.3.1-5: Void

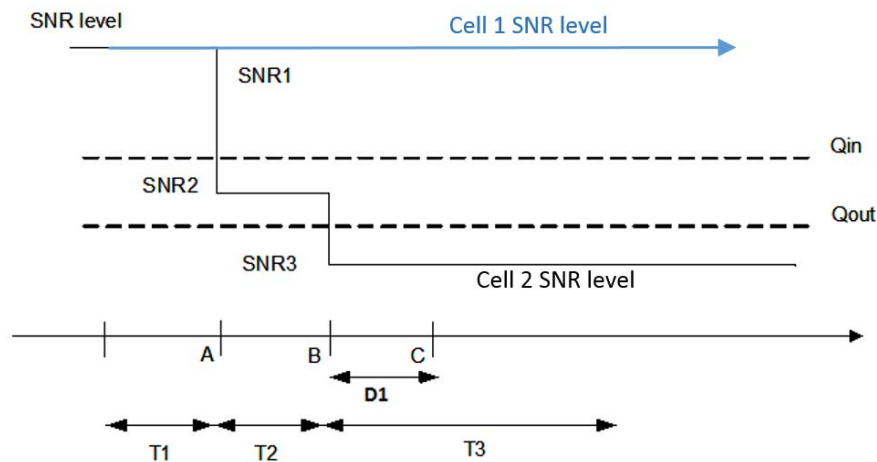

Figure A.4.5.1.3.1-1: SNR variation for out-of-sync testing

A.4.5.1.3.2 Test Requirements

The UE behaviour in each test during time durations T1, T2 and T3 shall be as follows:

During the period from time point A to time point B the UE shall transmit uplink signal at least in all uplink slots configured for CSI transmission according to the configured periodic CSI reporting.

The UE shall stop transmitting uplink signal in Cell 2 no later than time point C (D1 second after the start of the time duration T3).

The rate of correct events observed during repeated tests shall be at least 90%.

A.4.5.1.4 Radio Link Monitoring In-sync Test for FR1 PSCell configured with SSB-based RLM RS in DRX mode

A.4.5.1.4.1 Test Purpose and Environment

The purpose of this test is to verify that the UE properly detects the out of sync and in sync for the purpose of monitoring downlink radio link quality of the PSCell when DRX is used. This test will partly verify the FR1 radio link monitoring requirements in clause 8.1.

In the test, UE is configured to perform RLM on SSB, with *detectionResource* included in *RadioLinkMonitoringRS* set to SSB#0, and *purpose* set to ‘*rlf*’. Supported test configurations are shown in table A.4.5.1.4.1-1. The test parameters are given in Tables A.4.5.1.4.1-2, and A.4.5.1.4.1-3. There are two cells, Cell 1 is the E-UTRAN PCell, and Cell 2 is the PSCell, in the test. The E-UTRAN PCell setting refers to Table A.3.7.2.1-1. The test consists of five successive time periods, with time duration of T1, T2, T3, T4 and T5 respectively. Figure A.4.5.1.4.1-1 shows the variation of the downlink SNR in the active Cell 2 to emulate out-of-sync and in-sync states. Prior to the start of the time duration T1, the UE shall be fully synchronized to Cell 1 and Cell 2. The UE shall be configured for periodic CSI reporting with a reporting periodicity of 5 ms. In the test, DRX configuration is enabled and DRX inactivity timer has already been expired, i.e. UE tries to decode PDCCH and to send periodic CSI during the period when On-duration timer is running. Time alignment timers shall be set to “infinity” so that UL timing alignment is maintained during the test.

Table A.4.5.1.4.1-1: Supported test configurations for FR1 PSCell

Configuration	Description
1	LTE FDD, NR 15 kHz SSB SCS, 10 MHz bandwidth, FDD duplex mode
2	LTE FDD, NR 15 kHz SSB SCS, 10 MHz bandwidth, TDD duplex mode

3	LTE FDD, NR 30 kHz SSB SCS, 40 MHz bandwidth, TDD duplex mode
4	LTE TDD, NR 15 kHz SSB SCS, 10 MHz bandwidth, FDD duplex mode
5	LTE TDD, NR 15 kHz SSB SCS, 10 MHz bandwidth, TDD duplex mode
6	LTE TDD, NR 30 kHz SSB SCS, 40 MHz bandwidth, TDD duplex mode
Note:	The UE is only required to pass in one of the supported test configurations in FR1

Table A.4.5.1.4.1-2: General test parameters for FR1 in-sync testing in DRX mode

Parameter		Unit	Value
			Test 1
Active E-UTRA PCell			Cell 1
E-UTRA RF Channel Number			1
Active PSCell			Cell 2
RF Channel Number			2
Duplex mode	Config 1, 4		FDD
	Config 2, 3, 5, 6		TDD
BW <sub>channel</sub>	Config 1, 4	MHz	10: N <sub>RB,c</sub> = 52
	Config 2, 5		10: N <sub>RB,c</sub> = 52
	Config 3, 6		40: N <sub>RB,c</sub> = 106
DL initial BWP configuration	Config 1, 2, 3, 4, 5, 6		DLBWP.0.1
DL dedicated BWP configuration	Config 1, 2, 3, 4, 5, 6		DLBWP.1.1
UL initial BWP configuration	Config 1, 2, 3, 4, 5, 6		ULBWP.0.1
UL dedicated BWP configuration	Config 1, 2, 3, 4, 5, 6		ULBWP.1.1
TDD Configuration	Config 1, 4		Not Applicable
	Config 2, 5		TDDConf.1.1
	Config 3, 6		TDDConf.2.1
RMSI CORESET Reference Channel	Config 1, 4		CR.1.1 FDD
	Config 2, 5		CR.1.1 TDD
	Config 3, 6		CR.2.1 TDD
Dedicated CORESET Reference Channel	Config 1, 4		CCR.1.1 FDD
	Config 2, 5		CCR.1.1 TDD
	Config 3, 6		CCR.2.1 TDD
SSB Configuration	Config 1, 4		SSB.1 FR1
	Config 2, 5		SSB.1 FR1
	Config 3, 6		SSB.2 FR1
SMT C Configuration	Config 1, 2, 4, 5		SMT C.1
	Config 3, 6		SMT C.1
PDSCH/PDCCH subcarrier spacing	Config 1, 2, 4, 5		15 kHz
	Config 3, 6		30 kHz
PRACH Configuration	Config 1, 2, 4, 5		Table A A.3.8.2.1-1
	Config 3, 6		Table A.3.8.2.1-1
SSB index assigned as RLM RS			0
OCNG parameters			OP.1
CP length			Normal
Correlation Matrix and Antenna Configuration			2x2 Low
In sync transmission parameters	DCI format		1-0
	Number of Control OFDM symbols		2
	Aggregation level	CCE	4
	Ratio of hypothetical PDCCH RE energy to average SSS RE energy	dB	0

	Ratio of hypothetical PDCCH DMRS energy to average SSS RE energy	dB	0
	DMRS precoder granularity		REG bundle size
	REG bundle size		6
Out of sync transmission parameters	DCI format		1-0
	Number of Control OFDM symbols		2
	Aggregation level	CCE	8
	Ratio of hypothetical PDCCH RE energy to average SSS RE energy	dB	4
	Ratio of hypothetical PDCCH DMRS energy to average SSS RE energy	dB	4
	DMRS precoder granularity		REG bundle size
	REG bundle size		6
DRX Configuration			DRX.3
Gap pattern ID			N.A.
Layer 3 filtering			<i>Enabled</i>
T310 timer		ms	1000
T311 timer		ms	1000
N310			1
N311			1
CSI-RS for CSI reporting	Config 1, 4		CSI-RS.1.1 FDD
	Config 2, 5		CSI-RS.1.1 TDD
	Config 3, 6		CSI-RS.2.1 TDD
CSI-RS for tracking	Config 1, 4		TRS.1.1 FDD
	Config 2, 5		TRS.1.1 TDD
	Config 3, 6		TRS.1.2 TDD
T1		s	0.2
T2		s	0.2
T3		s	0.64
T4		s	0.2
T5		s	0.88
D1		s	0.84
Note 1: All configurations are assigned to the UE prior to the start of time period T1.			
Note 2: UE-specific PDCCH is not transmitted after T1 starts.			
Note 3: E-UTRAN is in non-DRX mode under test.			

**Table A.4.5.1.4.1-3: Cell specific test parameters for FR1 (Cell 2) for in-sync radio link monitoring tests in DRX mode**

Parameter	Unit	Test 1					
		T1	T2	T3	T4	T5	
EPRE ratio of PDCCH DMRS to SSS	dB	0					
EPRE ratio of PDCCH to PDCCH DMRS	dB	0					
EPRE ratio of PBCH DMRS to SSS	dB	0					
EPRE ratio of PBCH to PBCH DMRS	dB						
EPRE ratio of PSS to SSS	dB						
EPRE ratio of PDSCH DMRS to SSS	dB						
EPRE ratio of PDSCH to PDSCH DMRS	dB						
EPRE ratio of OCNG DMRS to SSS	dB						
EPRE ratio of OCNG to OCNG DMRS	dB						
SNR on RLM-RS	Config 1, 4	dB	1	-7	-15	-4.5	1
	Config 2, 5		1	-7	-15	-4.5	1
	Config 3, 6		1	-7	-15	-4.5	1



$N_{oc}$	Config 1, 4	dBm/15 kHz	-98
	Config 2, 5		-98
	Config 3, 6		-98
$N_{oc}$	Config 1, 4	dBm/SCS	-98
	Config 2, 5		-98
	Config 3, 6		-95
Propagation condition			TDL-C 300ns 100Hz
<p>Note 1: OCNG shall be used such that the resources in Cell 2 are fully allocated and a constant total transmitted power spectral density is achieved for all OFDM symbols.</p> <p>Note 2: The signal contains PDCCH for UEs other than the device under test as part of OCNG.</p> <p>Note 3: SNR levels correspond to the signal to noise ratio over the SSS REs.</p> <p>Note 4: The SNR in time periods T1, T2, T3, T4 and T5 is denoted as SNR1, SNR2, SNR3, SNR4 and SNR5 respectively in Figure A.4.5.1.4.1-1.</p> <p>Note 5: The SNR values are specified for testing a UE which supports 2RX on at least one band. For testing of a UE which supports 4RX on all bands, the SNR during T3 and T4 is modified as specified in clause A.3.6.</p>			

**Table A.4.5.1.4.1-4: Void**

**Table A.4.5.1.4.1-5: Void**

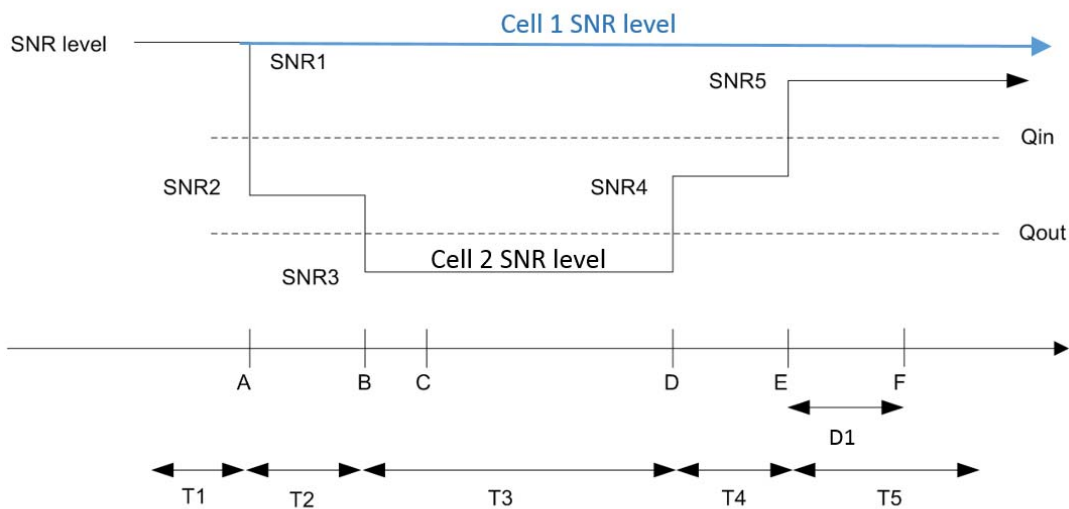

**Figure A.4.5.1.4.1-1: SNR variation for in-sync testing**

**A.4.5.1.4.2 Test Requirements**

The UE behaviour in each test during time durations T1, T2, T3, T4 and T5 shall be as follows:

During the period from time point A to time point F (D1 second after the start of time duration T5) the UE shall transmit uplink signal at least in all uplink slots configured for CSI transmission according to the configured periodic CSI reporting.

The rate of correct events observed during repeated tests shall be at least 90%.

### A.4.5.1.5 EN-DC Radio Link Monitoring Out-of-sync Test for FR1 PSCell configured with CSI-RS-based RLM in non-DRX mode

#### A.4.5.1.5.1 Test Purpose and Environment

The purpose of this test is to verify that the UE properly detects the out of sync for the purpose of monitoring downlink CSI-RS based radio link quality of the PSCell when no DRX is used. This test will partly verify the FR1 PSCell CSI-RS Out-of-sync radio link monitoring requirements in clause 8.1.

The test parameters are given in Tables A.4.5.1.5.1-1, A.4.5.1.5.1-2, A.4.5.1.5.1-3, and A.4.5.1.5.1-3A below. There are two cells, cell 1 is the E-UTRAN PCell, and cell 2 is the PSCell, in the test. The test consists of three successive time periods, with time duration of T1, T2 and T3 respectively. Figure A.4.5.1.5.1-1 shows the variation of the downlink SNR in the E-UTRAN PCell and the PSCell to emulate out-of-sync and in-sync states. Prior to the start of the time duration T1, the UE shall be fully synchronized to cell 1 and cell 2. The UE shall be configured for periodic CSI reporting with a reporting periodicity of 5ms. In the test, DRX configuration is not enabled. The UE is configured to perform inter-frequency measurements using GP ID #0 (40ms). In the test, SSB0 is configured as the BFD-RS.

**Table A.4.5.1.5.1-1: Supported test configurations for FR1 PSCell**

Configuration	Description
1	LTE FDD, NR 15 kHz SSB SCS, 10 MHz bandwidth, FDD duplex mode
2	LTE FDD, NR 15 kHz SSB SCS, 10 MHz bandwidth, TDD duplex mode
3	LTE FDD, NR 30 kHz SSB SCS, 40 MHz bandwidth, TDD duplex mode
4	LTE TDD, NR 15 kHz SSB SCS, 10 MHz bandwidth, FDD duplex mode
5	LTE TDD, NR 15 kHz SSB SCS, 10 MHz bandwidth, TDD duplex mode
6	LTE TDD, NR 30 kHz SSB SCS, 40 MHz bandwidth, TDD duplex mode
Note:	The UE is only required to pass in one of the supported test configurations in FR1

**Table A.4.5.1.5.1-2: General test parameters for FR1 PSCell for CSI-RS out-of-sync testing in non-DRX mode**

Parameter	Unit	Value
		Test 1
Active E-UTRA PCell		Cell 1
E-UTRA RF Channel Number		1
Active PSCell		Cell 2
RF Channel Number		2
Duplex mode	Config 1, 4	FDD
	Config 2, 3, 5, 6	TDD
TDD Configuration	Config 1, 4	Not Applicable
	Config 2, 5	TDDConf.1.1
	Config 3, 6	TDDConf.2.1
DL initial BWP configuration	Config 1, 2, 3, 4, 5, 6	DLBWP.0.1
DL dedicated BWP configuration	Config 1, 2, 3, 4, 5, 6	DLBWP.1.1
UL initial BWP configuration	Config 1, 2, 3, 4, 5, 6	ULBWP.0.1
UL dedicated BWP configuration	Config 1, 2, 3, 4, 5, 6	ULBWP.1.1
RMSI CORESET Reference Channel	Config 1, 4	CR.1.1 FDD
	Config 2, 5	CR.1.1 TDD
	Config 3, 6	CR.2.1 TDD
Dedicated CORESET Reference Channel	Config 1, 4	CCR.1.3 FDD
	Config 2, 5	CCR.1.3 TDD
	Config 3, 6	CCR.2.2 TDD
SSB Configuration	Config 1, 4	SSB.1 FR1
	Config 2, 5	SSB.1 FR1
	Config 3, 6	SSB.2 FR1
SMTC Configuration	Config 1, 2, 4, 5	SMTC.1
	Config 3, 6	SMTC.1
PDSCH/PDCCH subcarrier spacing	Config 1, 2, 4, 5	15 KHz
	Config 3, 6	30 KHz
TRS configuration	Config 1, 4	TRS.1.1 FDD

	Config 2, 5		TRS.1.1 TDD
	Config 3, 6		TRS.1.2 TDD
CSI-RS for RLM	Config 1, 4		Resource #4 in TRS.1.1 FDD
	Config 2, 5		Resource #4 in TRS.1.1 TDD
	Config 3, 6		Resource #4 in TRS.1.2 TDD
TCI configuration for PDCCH/PDSCH			TCI.State.2
OCNG parameters			OP.1
CP length			Normal
Correlation Matrix and Antenna Configuration			2x2 Low
Out of sync transmission parameters	DCI format		1-0
	Number of Control OFDM symbols		2
	Aggregation level	CCE	8
	Ratio of hypothetical PDCCH RE energy to average CSI-RS RE energy	dB	4
	Ratio of hypothetical PDCCH DMRS energy to average CSI-RS RE energy	dB	4
	DMRS precoder granularity		REG bundle size
	REG bundle size		6
DRX			OFF
Gap pattern ID			gp0
Layer 3 filtering			Enabled
T310 timer		ms	0
T311 timer		ms	1000
N310			1
N311			1
CSI-RS for reporting	Config 1, 4		CSI-RS1.1 FDD
	Config 2, 5		CSI-RS.1.1 TDD
	Config 3, 6		CSI-RS.2.1 TDD
T1		s	0.2
T2		s	0.48
T3		s	0.48
D1		s	0.44
Note 1: UE-specific PDCCH is not transmitted after T1 starts.			
Note 2: E-UTRAN is in non-DRX mode under test.			

**Table A.4.5.1.5.1-3: Cell specific test parameters for FR1 for CSI-RS out-of-sync radio link monitoring in non-DRX mode**

Parameter	Unit	Test 1		
		T1	T2	T3
EPRE ratio of PDCCH DMRS to SSS	dB		4	
EPRE ratio of PDCCH to PDCCH DMRS	dB			
EPRE ratio of PBCH to PBCH DMRS	dB			
EPRE ratio of PSS to SSS	dB			
EPRE ratio of PBCH DMRS to SSS	dB		0	
EPRE ratio of PDSCH to PDSCH DMRS	dB			
EPRE ratio of PDSCH DMRS to SSS	dB			
EPRE ratio of OCNG DMRS to SSS	dB			

EPRE ratio of OCNG to OCNG DMRS		dB			
SNR on RLM-RS	Config 1, 4	dB	1	-7	-15
	Config 2, 5		1	-7	-15
	Config 3, 6		1	-7	-15
$N_{oc}$	Config 1, 4	dBm/15KHz	-98		
	Config 2, 5		-98		
	Config 3, 6		-98		
Propagation condition		TDL-C 300ns 100Hz			
<p>Note 1: OCNG shall be used such that the resources in Cell 2 are fully allocated and a constant total transmitted power spectral density is achieved for all OFDM symbols.</p> <p>Note 2: The uplink resources for CSI reporting are assigned to the UE prior to the start of time period T1.</p> <p>Note 3: NZP CSI-RS resource set configuration for CSI reporting are assigned to the UE prior to the start of time period T1.</p> <p>Note 4: Measurement gap configuration is assigned to the UE prior to the start of time period T1.</p> <p>Note 5: The timers and layer 3 filtering related parameters are configured prior to the start of time period T1.</p> <p>Note 6: The signal contains PDCCH for UEs other than the device under test as part of OCNG.</p> <p>Note 7: SNR levels correspond to the signal to noise ratio over the SSS REs.</p> <p>Note 8: The SNR in time periods T1, T2 and T3 is denoted as SNR1, SNR2 and SNR3 respectively in figure A.4.5.1.5.1-1.</p> <p>Note 9: The SNR values are specified for testing a UE which supports 2RX on at least one band. For testing of a UE which supports 4RX on all bands, the SNR during T3 is specified in clause A.3.6.1.1..</p>					

**Table A.4.5.1.5.1-3A: Measurement gap configuration for FR1 CSI-RS out-of-sync radio link monitoring in non-DRX mode**

Field	Test 1 Value
	gapOffset
Note 1: E-UTRAN PCell and PSCell are SFN-synchronous and frame boundary aligned.	

**Table A.4.5.1.5.1-4: Void**

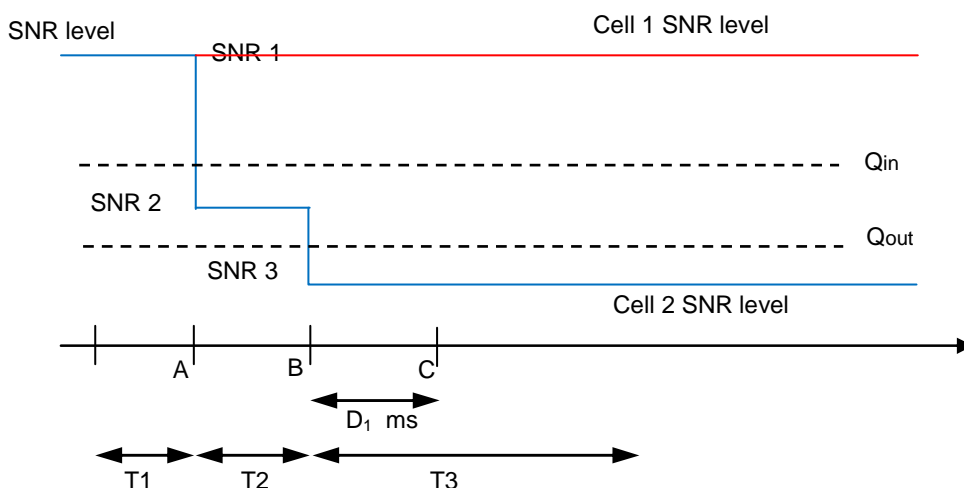

**Figure A.4.5.1.5.1-1: SNR variation for CSI-RS out-of-sync testing**

### A.4.5.1.5.2 Test Requirements

The UE behaviour during time durations T1, T2, and T3 shall be as follows:

During the period from time point A to time point B the UE shall transmit uplink signal in Cell 2 (PSCell) at least in all uplink slots configured for CSI transmission according to the configured periodic CSI reporting for Cell 2.

The UE shall stop transmitting uplink signal in Cell 2 (PSCell) no later than time point C ( $D_1$  after the start of the time duration T3) on the PSCell.

The rate of correct events observed during repeated tests shall be at least 90%.

### A.4.5.1.6 EN-DC Radio Link Monitoring In-sync Test for FR1 PSCell configured with CSI-RS-based RLM in non-DRX mode

#### A.4.5.1.6.1 Test Purpose and Environment

The purpose of this test is to verify that the UE properly detects the in sync for the purpose of monitoring downlink CSI-RS based radio link quality of the PSCell when no DRX is used. This test will partly verify the FR1 PSCell CSI-RS In-sync radio link monitoring requirements in clause 8.1.

The test parameters are given in Tables A.4.5.1.6.1-1, A.4.5.1.6.1-2, and A.4.5.1.6.1-3 below. There are two cells, cell 1 which is the E-UTRAN PCell, and cell 2 is the PSCell, in the test. The test consists of five successive time periods, with time duration of T1, T2, T3, T4 and T5 respectively. Figure A.4.5.1.6.1-1 shows the variation of the downlink SNR in the PSCell to emulate out-of-sync and in-sync states. Prior to the start of the time duration T1, the UE shall be fully synchronized to cell 1 and cell 2. The UE shall be configured for periodic CSI reporting with a reporting periodicity of 5ms. In the test, DRX configuration is not enabled. In the test, SSB0 is configured as the BFD-RS.

**Table A.4.5.1.6.1-1: Supported test configurations for FR1 PSCell**

Configuration	Description
1	LTE FDD, NR 15 kHz SSB SCS, 10 MHz bandwidth, FDD duplex mode
2	LTE FDD, NR 15 kHz SSB SCS, 10 MHz bandwidth, TDD duplex mode
3	LTE FDD, NR 30 kHz SSB SCS, 40 MHz bandwidth, TDD duplex mode
4	LTE TDD, NR 15 kHz SSB SCS, 10 MHz bandwidth, FDD duplex mode
5	LTE TDD, NR 15 kHz SSB SCS, 10 MHz bandwidth, TDD duplex mode
6	LTE TDD, NR 30 kHz SSB SCS, 40 MHz bandwidth, TDD duplex mode
Note:	The UE is only required to pass in one of the supported test configurations in FR1

**Table A.4.5.1.6.1-2: General test parameters for FR1 PSCell for CSI-RS in-sync testing in non-DRX mode**

Parameter	Unit	Value
		Test 1
Active E-UTRA PCell		Cell 1
E-UTRA RF Channel Number		1
Active PSCell		Cell 2
RF Channel Number		2
Duplex mode	Config 1, 4	FDD
	Config 2, 3, 5, 6	TDD
TDD Configuration	Config 1, 4	Not Applicable
	Config 2, 5	TDDConf.1.1
	Config 3, 6	TDDConf.2.1
DL initial BWP configuration	Config 1, 2, 3, 4, 5, 6	DLBWP.0.1
DL dedicated BWP configuration	Config 1, 2, 3, 4, 5, 6	DLBWP.1.1
UL initial BWP configuration	Config 1, 2, 3, 4, 5, 6	ULBWP.0.1
UL dedicated BWP configuration	Config 1, 2, 3, 4, 5, 6	ULBWP.1.1
RMSI CORESET Reference Channel	Config 1, 4	CR.1.1 FDD
	Config 2, 5	CR.1.1 TDD
	Config 3, 6	CR.2.1 TDD
Dedicated CORESET Reference Channel	Config 1, 4	CCR.1.1 FDD
	Config 2, 5	CCR.1.1 TDD

	Config 3, 6		CCR.2.1 TDD
SSB Configuration	Config 1, 4		SSB.1 FR1
	Config 2, 5		SSB.1 FR1
	Config 3, 6		SSB.2 FR1
SMTTC Configuration	Config 1, 2, 4, 5		SMTTC.1
	Config 3, 6		SMTTC.1
PDSCH/PDCCH subcarrier spacing	Config 1, 2, 4, 5		15 KHz
	Config 3, 6		30 KHz
TRS configuration	Config 1, 4		TRS.1.1 FDD
	Config 2, 5		TRS.1.1 TDD
	Config 3, 6		TRS.1.2 TDD
CSI-RS for RLM	Config 1, 4		Resource #4 in TRS.1.1 FDD
	Config 2, 5		Resource #4 in TRS.1.1 TDD
	Config 3, 6		Resource #4 in TRS.1.2 TDD
TCI configuration for PDCCH/PDSCH			TCI.State.2
OCNG parameters			OP.1
CP length			Normal
Correlation Matrix and Antenna Configuration			2x2 Low
Out of sync transmission parameters	DCI format		1-0
	Number of Control OFDM symbols		2
	Aggregation level	CCE	8
	Ratio of hypothetical PDCCH RE energy to average CSI-RS RE energy	dB	4
	Ratio of hypothetical PDCCH DMRS energy to average CSI-RS RE energy	dB	4
	DMRS precoder granularity		REG bundle size
	REG bundle size		6
In sync transmission parameters	DCI format		1-0
	Number of Control OFDM symbols		2
	Aggregation level	CCE	4
	Ratio of hypothetical PDCCH RE energy to average CSI-RS RE energy	dB	0
	Ratio of hypothetical PDCCH DMRS energy to average CSI-RS RE energy	dB	0
	DMRS precoder granularity		REG bundle size
	REG bundle size		6
DRX			OFF
Gap pattern ID			N.A.
Layer 3 filtering			Enabled
T310 timer	ms		1000
T311 timer	ms		1000
N310			1
N311			1
CSI-RS for reporting	Config 1, 4		CSI-RS.1.1 FDD
	Config 2, 5		CSI-RS.1.1 TDD
	Config 3, 6		CSI-RS.2.1 TDD
T1	s		0.2
T2	s		0.2
T3	s		0.44
T4	s		0.2
T5	s		0.88
T6	s		0.84
Note 1: UE-specific PDCCH is not transmitted after T1 starts.			
Note 2: E-UTRAN is in non-DRX mode under test.			

**Table A.4.5.1.6.1-3: Cell specific test parameters for FR1 for CSI-RS in-sync radio link monitoring in non-DRX mode**

Parameter		Unit	Test 1				
			T1	T2	T3	T4	T5
EPRE ratio of PDCCH DMRS to SSS		dB	0				
EPRE ratio of PDCCH to PDCCH DMRS		dB	0				
EPRE ratio of PBCH DMRS to SSS		dB					
EPRE ratio of PSS to SSS		dB					
EPRE ratio of PBCH to PBCH DMRS		dB					
EPRE ratio of PDSCH to PDSCH DMRS		dB					
EPRE ratio of PDSCH DMRS to SSS		dB					
EPRE ratio of OCNG DMRS to SSS		dB					
EPRE ratio of OCNG to OCNG DMRS		dB					
SNR on RLM-RS	Config 1, 4	dB					
	Config 2, 5		1	-7	-15	-4.5	1
	Config 3, 6		1	-7	-15	-4.5	1
$N_{oc}$	Config 1, 4	dBm/15KHz	-98				
	Config 2, 5		-98				
	Config 3, 6		-98				
Propagation condition			TDL-C 300ns 100Hz				
<p>Note 1: OCNG shall be used such that the resources in Cell 2 are fully allocated and a constant total transmitted power spectral density is achieved for all OFDM symbols.</p> <p>Note 2: The uplink resources for CSI reporting are assigned to the UE prior to the start of time period T1.</p> <p>Note 3: NZP CSI-RS resource set configuration for CSI reporting are assigned to the UE prior to the start of time period T1.</p> <p>Note 4: Measurement gap configuration is assigned to the UE prior to the start of time period T1.</p> <p>Note 5: The timers and layer 3 filtering related parameters are configured prior to the start of time period T1.</p> <p>Note 6: The signal contains PDCCH for UEs other than the device under test as part of OCNG.</p> <p>Note 7: SNR levels correspond to the signal to noise ratio over the SSS REs.</p> <p>Note 8: The SNR in time periods T1, T2, T3, T4 and T5 is denoted as SNR1, SNR2, SNR3, SNR4 and SNR5 respectively in figure A.4.5.1.6.1-1.</p> <p>Note 9: The SNR values are specified for testing a UE which supports 2RX on at least one band. For testing of a UE which supports 4RX on all bands, the SNR during T3 is specified in clause A.3.6.1.1..</p>							

**Table A.4.5.1.6.1-3A: Void**

**Table A.4.5.1.6.1-4: Void**

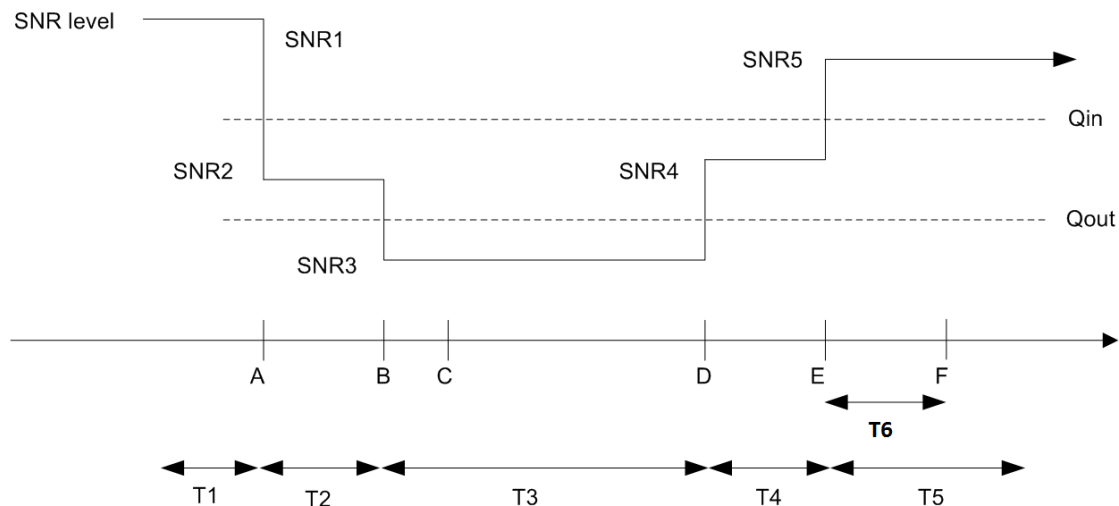

**Figure A.4.5.1.6.1-1: SNR variation for CSI-RS in-sync testing**

**A.4.5.1.6.2 Test Requirements**

The UE behaviour in each test during time durations T1, T2, T3, T4 and T5 shall be as follows:

During the period from time point A to time point F (T6 second after the start of time duration T5) the UE shall transmit uplink signal at least in all uplink slots configured for CSI transmission according to the configured periodic CSI reporting on the PSCell.

The rate of correct events observed during repeated tests shall be at least 90%.

**A.4.5.1.7 EN-DC Radio Link Monitoring Out-of-sync Test for FR1 PSCell configured with CSI-RS-based RLM in DRX mode**

**A.4.5.1.7.1 Test Purpose and Environment**

The purpose of this test is to verify that the UE properly detects the out of sync for the purpose of monitoring downlink CSI-RS based radio link quality of the PSCell when no DRX is used. This test will partly verify the FR1 PSCell CSI-RS Out-of-sync radio link monitoring requirements in clause 8.1.

The test parameters are given in Tables A.4.5.1.7.1-1, A.4.5.1.7.1-2, and A.4.5.1.7.1-3 below. There are two cells, cell 1 is the E-UTRAN PCell, and cell 2 is the PSCell, in the test. The test consists of three successive time periods, with time duration of T1, T2 and T3 respectively. Figure A.4.5.1.7.1-1 shows the variation of the downlink SNR in the E-UTRAN PCell and the PSCell to emulate out-of-sync and in-sync states. Prior to the start of the time duration T1, the UE shall be fully synchronized to cell 1 and cell 2. The UE shall be configured for periodic CSI reporting with a reporting periodicity of 5ms. In the test, DRX configuration is enabled in PSCell and DRX inactivity timer has already been expired, i.e. UE tries to decode PDCCH and to send periodic CQI during the period when On-duration timer is running. Time alignment timers shall be set to “infinity” so that UL timing alignment is maintained during the test. In the test, SSB0 is configured as the BFD-RS.

**Table A.4.5.1.7.1-1: Supported test configurations for FR1 PSCell**

Configuration	Description
1	LTE FDD, NR 15 kHz SSB SCS, 10 MHz bandwidth, FDD duplex mode
2	LTE FDD, NR 15 kHz SSB SCS, 10 MHz bandwidth, TDD duplex mode
3	LTE FDD, NR 30 kHz SSB SCS, 40 MHz bandwidth, TDD duplex mode
4	LTE TDD, NR 15 kHz SSB SCS, 10 MHz bandwidth, FDD duplex mode
5	LTE TDD, NR 15 kHz SSB SCS, 10 MHz bandwidth, TDD duplex mode
6	LTE TDD, NR 30 kHz SSB SCS, 40 MHz bandwidth, TDD duplex mode
Note:	The UE is only required to pass in one of the supported test configurations in FR1



**Table A.4.5.1.7.1-2: General test parameters for FR1 PSCell for CSI-RS out-of-sync testing in DRX mode**

Parameter		Unit	Value
			Test 1
Active E-UTRA PCell			Cell 1
E-UTRA RF Channel Number			1
Active PSCell			Cell 2
RF Channel Number			2
Duplex mode	Config 1, 4		FDD
	Config 2, 3, 5, 6		TDD
TDD Configuration	Config 1, 4		Not Applicable
	Config 2, 5		TDDConf.1.1
	Config 3, 6		TDDConf.2.1
DL initial BWP configuration	Config 1, 2, 3, 4, 5, 6		DLBWP.0.1
DL dedicated BWP configuration	Config 1, 2, 3, 4, 5, 6		DLBWP.1.1
UL initial BWP configuration	Config 1, 2, 3, 4, 5, 6		ULBWP.0.1
UL dedicated BWP configuration	Config 1, 2, 3, 4, 5, 6		ULBWP.1.1
RMSI CORESET Reference Channel	Config 1, 4		CR.1.1 FDD
	Config 2, 5		CR.1.1 TDD
	Config 3, 6		CR.2.1 TDD
Dedicated CORESET Reference Channel	Config 1, 4		CCR.1.3 FDD
	Config 2, 5		CCR.1.3 TDD
	Config 3, 6		CCR.2.2 TDD
SSB Configuration	Config 1, 4		SSB.1 FR1
	Config 2, 5		SSB.1 FR1
	Config 3, 6		SSB.2 FR1
SMTTC Configuration	Config 1, 2, 4, 5		SMTTC.1
	Config 3, 6		SMTTC.1
PDSCH/PDCCH subcarrier spacing	Config 1, 2, 4, 5		15 KHz
	Config 3, 6		30 KHz
TRS configuration	Config 1, 4		TRS.1.1 FDD
	Config 2, 5		TRS.1.1 TDD
	Config 3, 6		TRS.1.2 TDD
CSI-RS for RLM	Config 1, 4		Resource #4 in TRS.1.1 FDD
	Config 2, 5		Resource #4 in TRS.1.1 TDD
	Config 3, 6		Resource #4 in TRS.1.2 TDD
TCI configuration for PDCCH/PDSCH			TCI.State.2
OCNG parameters			OP.1
CP length			Normal
Correlation Matrix and Antenna Configuration			2x2 Low
Out of sync transmission parameters	DCI format		1-0
	Number of Control OFDM symbols		2
	Aggregation level	CCE	8
	Ratio of hypothetical PDCCH RE energy to average CSI-RS RE energy	dB	4
	Ratio of hypothetical PDCCH DMRS energy to average CSI-RS RE energy	dB	4
	DMRS precoder granularity		REG bundle size
	REG bundle size		6
DRX			DRX.3
Gap pattern ID			N.A.
Layer 3 filtering			Enabled
T310 timer		ms	0

T311 timer	ms	1000
N310		1
N311		1
CSI-RS for reporting	Config 1, 4	CSI-RS.1.1 FDD
	Config 2, 5	CSI-RS.1.1 TDD
	Config 3, 6	CSI-RS.2.1 TDD
T1	s	0.2
T2	s	1.28
T3	s	1.28
D1	s	1.24
Note 1: UE-specific PDCCH is not transmitted after T1 starts.		
Note 2: E-UTRAN is in non-DRX mode under test.		

**Table A.4.5.1.7.1-3: Cell specific test parameters for FR1 for CSI-RS out-of-sync radio link monitoring in DRX mode**

Parameter	Unit	Test 1					
		T1	T2	T3			
EPRE ratio of PDCCH DMRS to SSS	dB	4					
EPRE ratio of PDCCH to PDCCH DMRS		0					
EPRE ratio of PBCH DMRS to SSS							
EPRE ratio of PBCH to PBCH DMRS							
EPRE ratio of PBCH to PBCH DMRS							
EPRE ratio of PDSCH DMRS to SSS							
EPRE ratio of PDSCH to PDSCH DMRS							
EPRE ratio of OCNG DMRS to SSS							
EPRE ratio of OCNG to OCNG DMRS							
SNR on RLM-RS					Config 1, 4	1	-7
	Config 2, 5				1	-7	-15
	Config 3, 6	1	-7	-15			
$N_{oc}$	Config 1, 4	-98					
	Config 2, 5	-98					
	Config 3, 6	-98					
Propagation condition		TDL-C 300ns 100Hz					
<p>Note 1: OCNG shall be used such that the resources in Cell 2 are fully allocated and a constant total transmitted power spectral density is achieved for all OFDM symbols.</p> <p>Note 2: The uplink resources for CSI reporting are assigned to the UE prior to the start of time period T1.</p> <p>Note 3: NZP CSI-RS resource set configuration for CSI reporting are assigned to the UE prior to the start of time period T1.</p> <p>Note 4: Measurement gap configuration is assigned to the UE prior to the start of time period T1.</p> <p>Note 5: The timers and layer 3 filtering related parameters are configured prior to the start of time period T1.</p> <p>Note 6: The signal contains PDCCH for UEs other than the device under test as part of OCNG.</p> <p>Note 7: SNR levels correspond to the signal to noise ratio over the SSS REs.</p> <p>Note 8: The SNR in time periods T1, T2 and T3 is denoted as SNR1, SNR2 and SNR3 respectively in figure A.4.5.1.7.1-1.</p> <p>Note 9: The SNR values are specified for testing a UE which supports 2RX on at least one band. For testing of a UE which supports 4RX on all bands, the SNR during T3 is specified in clause A.3.6.1.1..</p>							

**Table A.4.5.1.7.1-3A: Void**

**Table A.4.5.1.7.1-4: Void**

**Table A.4.5.1.7.1-5: Void**

**Table A.4.5.1.7.1-6: Void**

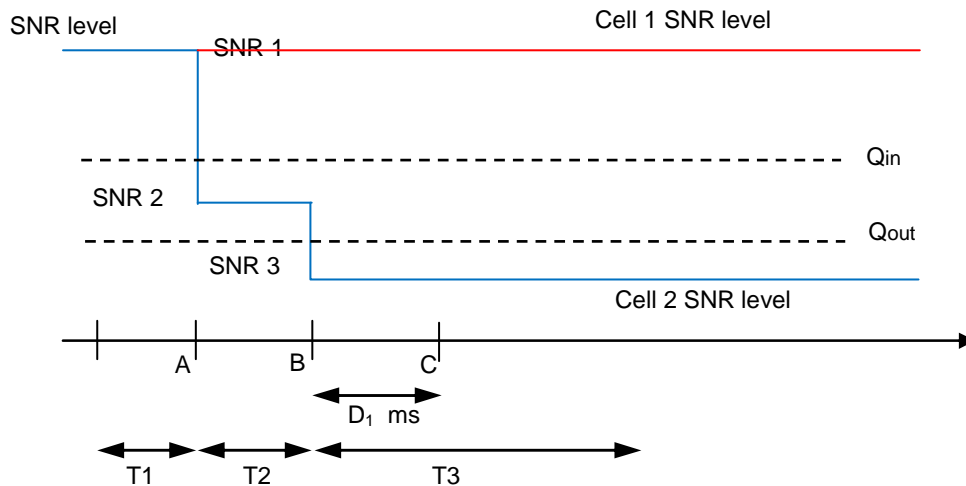

**Figure A.4.5.1.7.1-1: SNR variation for CSI-RS out-of-sync testing**

#### A.4.5.1.7.2 Test Requirements

The UE behaviour during time durations T1, T2, and T3 shall be as follows:

During the period from time point A to time point B the UE shall transmit uplink signal in Cell 2 (PSCell) at least in all uplink slots configured for CSI transmission according to the configured periodic CSI reporting for Cell 2.

The UE shall stop transmitting uplink signal in Cell 2 (PSCell) no later than time point C ( $D_1$  after the start of the time duration T3) on the PSCell.

The rate of correct events observed during repeated tests shall be at least 90%.

#### A.4.5.1.8 EN-DC Radio Link Monitoring In-sync Test for FR1 PSCell configured with CSI-RS-based RLM in DRX mode

##### A.4.5.1.8.1 Test Purpose and Environment

The purpose of this test is to verify that the UE properly detects the in sync for the purpose of monitoring downlink CSI-RS based radio link quality of the PSCell when no DRX is used. This test will partly verify the FR1 PSCell CSI-RS In-sync radio link monitoring requirements in clause 8.1.

The test parameters are given in Tables A.4.5.1.8.1-1, A.4.5.1.8.1-2, A.4.5.1.8.1-3 and A.4.5.1.8.1-3A below. There are two cells, cell 1 which is the E-UTRAN PCell, and cell 2 is the NR PSCell, in the test. The test consists of five successive time periods, with time duration of T1, T2, T3, T4 and T5 respectively. Figure A.4.5.1.8.1-1 shows the variation of the downlink SNR in the PSCell to emulate out-of-sync and in-sync states. Prior to the start of the time duration T1, the UE shall be fully synchronized to cell 1 and cell 2. The UE shall be configured for periodic CSI reporting with a reporting periodicity defined in CSI-RS configuration. In the test, DRX configuration is not enabled. The UE is configured to perform inter-frequency measurements using GP ID #0 (40ms). In the test, SSB0 is configured as the BFD-RS.

**Table A.4.5.1.8.1-1: Supported test configurations for FR1 PSCell**

Configuration	Description
1	LTE FDD, NR 15 kHz SSB SCS, 10 MHz bandwidth, FDD duplex mode
2	LTE FDD, NR 15 kHz SSB SCS, 10 MHz bandwidth, TDD duplex mode
3	LTE FDD, NR 30 kHz SSB SCS, 40 MHz bandwidth, TDD duplex mode
4	LTE TDD, NR 15 kHz SSB SCS, 10 MHz bandwidth, FDD duplex mode
5	LTE TDD, NR 15 kHz SSB SCS, 10 MHz bandwidth, TDD duplex mode
6	LTE TDD, NR 30 kHz SSB SCS, 40 MHz bandwidth, TDD duplex mode
Note: The UE is only required to pass in one of the supported test configurations in FR1	

**Table A.4.5.1.8.1-2: General test parameters for FR1 PSCell for CSI-RS in-sync testing in DRX mode**

Parameter		Unit	Value
			Test 1
Active E-UTRA PCell			Cell 1
E-UTRA RF Channel Number			1
Active PSCell			Cell 2
RF Channel Number			2
Duplex mode	Config 1, 4		FDD
	Config 2, 3, 5, 6		TDD
TDD Configuration	Config 1, 4		Not Applicable
	Config 2, 5		TDDConf.1.1
	Config 3, 6		TDDConf.2.1
DL initial BWP configuration	Config 1, 2, 3, 4, 5, 6		DLBWP.0.1
DL dedicated BWP configuration	Config 1, 2, 3, 4, 5, 6		DLBWP.1.1
UL initial BWP configuration	Config 1, 2, 3, 4, 5, 6		ULBWP.0.1
UL dedicated BWP configuration	Config 1, 2, 3, 4, 5, 6		ULBWP.1.1
RMSI CORESET Reference Channel	Config 1, 4		CR.1.1 FDD
	Config 2, 5		CR.1.1 TDD
	Config 3, 6		CR.2.1 TDD
Dedicated CORESET Reference Channel	Config 1, 4		CCR.1.1 FDD
	Config 2, 5		CCR.1.1 TDD
	Config 3, 6		CCR.2.1 TDD
SSB Configuration	Config 1, 4		SSB.1 FR1
	Config 2, 5		SSB.1 FR1
	Config 3, 6		SSB.2 FR1
SMTC Configuration	Config 1, 2, 4, 5		SMTC.1
	Config 3, 6		SMTC.1
PDSCH/PDCCH subcarrier spacing	Config 1, 2, 4, 5		15 KHz
	Config 3, 6		30 KHz
TRS configuration	Config 1, 4		TRS.1.1 FDD
	Config 2, 5		TRS.1.1 TDD
	Config 3, 6		TRS.1.2 TDD
CSI-RS for RLM	Config 1, 4		Resource #4 in TRS.1.1 FDD
	Config 2, 5		Resource #4 in TRS.1.1 TDD
	Config 3, 6		Resource #4 in TRS.1.2 TDD
TCI configuration for PDCCH/PDSCH			TCI.State.2
OCNG parameters			OP.1
CP length			Normal
Correlation Matrix and Antenna Configuration			2x2 Low
Out of sync transmission parameters	DCI format		1-0
	Number of Control OFDM symbols		2
	Aggregation level	CCE	8

	Ratio of hypothetical PDCCH RE energy to average CSI-RS RE energy	dB	4
	Ratio of hypothetical PDCCH DMRS energy to average CSI-RS RE energy	dB	4
	DMRS precoder granularity		REG bundle size
	REG bundle size		6
In sync transmission parameters	DCI format		1-0
	Number of Control OFDM symbols		2
	Aggregation level	CCE	4
	Ratio of hypothetical PDCCH RE energy to average CSI-RS RE energy	dB	0
	Ratio of hypothetical PDCCH DMRS energy to average CSI-RS RE energy	dB	0
	DMRS precoder granularity		REG bundle size
	REG bundle size		6
DRX			DRX.3
Gap pattern ID			gp0
Layer 3 filtering			Enabled
T310 timer	ms		2000
T311 timer	ms		1000
N310			1
N311			1
CSI-RS for reporting	Config 1, 4		CSI-RS.1.1 FDD
	Config 2, 5		CSI-RS.1.1 TDD
	Config 3, 6		CSI-RS.2.1 TDD
T1	s		0.2
T2	s		0.2
T3	s		1.24
T4	s		0.2
T5	s		1.88
T6	s		1.84
Note 1: UE-specific PDCCH is not transmitted after T1 starts.			
Note 2: E-UTRAN is in non-DRX mode under test.			

**Table A.4.5.1.8.1-3: Cell specific test parameters for FR1 for CSI-RS in-sync radio link monitoring in DRX mode**

Parameter	Unit	Test 1				
		T1	T2	T3	T4	T5
EPRE ratio of PDCCH DMRS to SSS	dB	0				
EPRE ratio of PDCCH to PDCCH DMRS	dB	0				
EPRE ratio of PBCH DMRS to SSS	dB					
EPRE ratio of PBCH to PBCH DMRS	dB					
EPRE ratio of PSS to SSS	dB					
EPRE ratio of PDSCH DMRS to SSS	dB					
EPRE ratio of PDSCH to PDSCH DMRS	dB					
EPRE ratio of OCNG DMRS to SSS	dB					

EPRE ratio of OCNG to OCNG DMRS		dB					
SNR on RLM-RS	Config 1, 4	dB	1	-7	-15	-4.5	1
	Config 2, 5		1	-7	-15	-4.5	1
	Config 3, 6		1	-7	-15	-4.5	1
$N_{oc}$	Config 1, 4	dBm/15KHz	-98				
	Config 2, 5		-98				
	Config 3, 6		-98				
Propagation condition			TDL-C 300ns 100Hz				
<p>Note 1: OCNG shall be used such that the resources in Cell 2 are fully allocated and a constant total transmitted power spectral density is achieved for all OFDM symbols.</p> <p>Note 2: The uplink resources for CSI reporting are assigned to the UE prior to the start of time period T1.</p> <p>Note 3: NZP CSI-RS resource set configuration for CSI reporting are assigned to the UE prior to the start of time period T1.</p> <p>Note 4: Measurement gap configuration is assigned to the UE prior to the start of time period T1.</p> <p>Note 5: The timers and layer 3 filtering related parameters are configured prior to the start of time period T1.</p> <p>Note 6: The signal contains PDCCH for UEs other than the device under test as part of OCNG.</p> <p>Note 7: SNR levels correspond to the signal to noise ratio over the SSS REs.</p> <p>Note 8: The SNR in time periods T1, T2, T3, T4 and T5 is denoted as SNR1, SNR2, SNR3, SNR4 and SNR5 respectively in figure A.4.5.1.8.1-1.</p> <p>Note 9: The SNR values are specified for testing a UE which supports 2RX on at least one band. For testing of a UE which supports 4RX on all bands, the SNR during T3 is specified in clause A.3.6.1.1.</p>							

**Table A.4.5.1.8.1-3A: Measurement gap configuration for FR1 CSI-RS in-sync radio link monitoring in DRX mode**

Field	Test 1
	Value
gapOffset	0
Note 1: E-UTRAN PCell and PSCell are SFN-synchronous and frame boundary aligned.	

**Table A.4.5.1.8.1-4: Void**

**Table A.4.5.1.8.1-5: Void**

**Table A.4.5.1.8.1-6: Void**

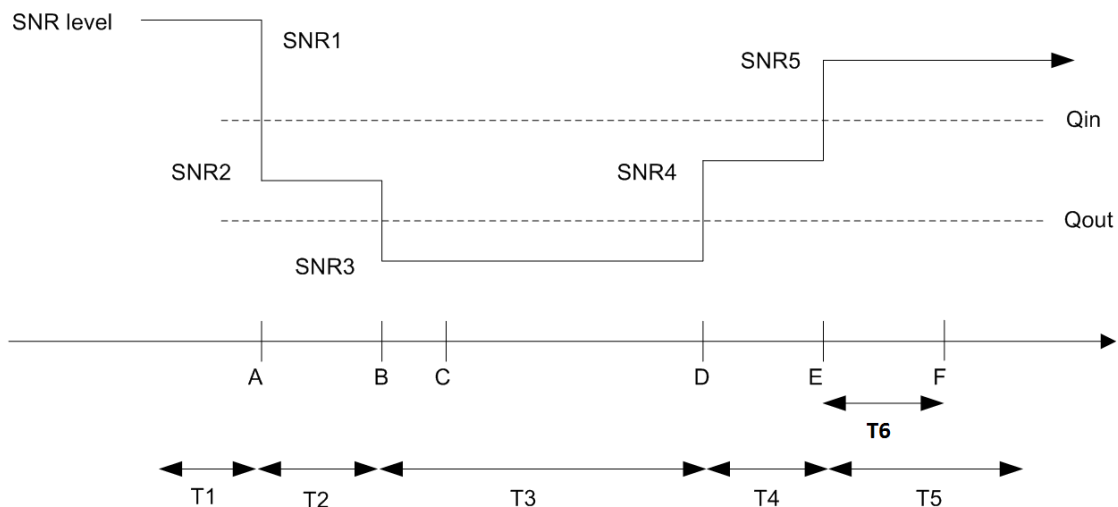

**Figure A.4.5.1.8.1-1: SNR variation for CSI-RS in-sync testing**

### A.4.5.1.8.2 Test Requirements

The UE behaviour in each test during time durations T1, T2, T3, T4 and T5 shall be as follows:

During the period from time point A to time point F (T6 second after the start of time duration T5) the UE shall transmit uplink signal at least in all uplink slots configured for CSI transmission according to the configured periodic CSI reporting on the PSCell.

The rate of correct events observed during repeated tests shall be at least 90%.

## A.4.5.2 Interruption

### A.4.5.2.1 E-UTRAN – NR FR1 interruptions at transitions between active and non-active during DRX in synchronous EN-DC

#### A.4.5.2.1.1 Test Purpose and Environment

The purpose of this test is to verify that when LTE PCell is in DRX and NR PSCell is in non-DRX, NR PSCell interruptions due to transitions from active to non-active and from non-active to active during LTE PCell DRX the UE missed ACK/NACK does not exceed the limits. This test will verify the missed ACK/NACK rate for NR PSCell in EN-DC specified in TS38.133 clause 8. 2.1.2. Supported test configurations are shown in table A.4.5.2.1.1-1.

The general test parameters and NR cell specific test parameters are given in Table A.4.5.2.1.1-2 and A.4.5.2.1.1-3. The E-UTRAN PCell DRX configuration parameters are given in Table A.4.5.2.1.1-4 below. And the E-UTRAN cell specific test parameters can refer to Table A.3.7.2.1-1. In the test there are two cells: Cell1 and Cell2. Cell1 is LTE PCell and Cell2 is NR FR1 PSCell. The test consists of one time period, with duration of T1. During T1, NR PSCell is continuously scheduled in DL while LTE PCell is not scheduled and has DRX configured. Prior to the start of the time duration T1, the UE shall be fully synchronized to Cell1 and Cell2. Cell1 shall be configured as LTE PCell and Cell2 shall be configured as NR PSCell. Prior to start of T1 the DRX inactivity timer for the LTE PCell has already expired. During T1 the UE shall be continuously scheduled on NR PSCell while not scheduled on LTE PCell. CORESET indicating a new transmission on PSCell shall be sent continuously during the entire time duration to ensure UE would not enter DRX state on PSCell.

**Table A.4.5.2.1.1-1: Interruption at transitions between active and non-active during DRX supported test configurations**

Config	Description
1	LTE FDD, NR 15 kHz SSB SCS, 10 MHz bandwidth, FDD duplex mode
2	LTE FDD, NR 15 kHz SSB SCS, 10 MHz bandwidth, TDD duplex mode
3	LTE FDD, NR 30 kHz SSB SCS, 40 MHz bandwidth, TDD duplex mode
4	LTE TDD, NR 15 kHz SSB SCS, 10 MHz bandwidth, FDD duplex mode
5	LTE TDD, NR 15 kHz SSB SCS, 10 MHz bandwidth, TDD duplex mode
6	LTE TDD, NR 30 kHz SSB SCS, 40 MHz bandwidth, TDD duplex mode

Note: The UE is only required to be tested in one of the supported test configurations

**Table A.4.5.2.1.1-2: General test parameters for E-UTRAN – NR FR1 interruptions at transitions between active and non-active during DRX in synchronous EN-DC**

Parameter	Unit	Value	Comment
RF Channel Number		1, 2	One is E-UTRAN RF channel and the other is NR RF channel
Active PCell		Cell1	PCell on E-UTRAN RF channel number 1.
Configured PSCell		Cell2	PSCell on NR RF channel number 2.
CP length		Normal	Applicable to Cell1 and Cell2
DRX		DRX.4	DRX related parameters are defined in Table A.3.3.4-1
Measurement gap pattern Id		OFF	
T1	s	10	

**Table A.4.5.2.1.1-3: NR cell specific test parameters for E-UTRAN – NR FR1 interruptions at transitions between active and non-active during DRX in synchronous EN-DC**

Parameter		Unit	Cell2
Frequency Range			FR1
Duplex mode	Config 1,4		FDD
	Config 2,3,5,6		TDD
TDD configuration	Config 1,4		Not Applicable
	Config 2,5		TDDConf.1.1
	Config 3,6		TDDConf.2.1
BW <sub>channel</sub>	Config 1,4		10: N <sub>RB,c</sub> = 52
	Config 2,5		10: N <sub>RB,c</sub> = 52
	Config 3,6		40: N <sub>RB,c</sub> = 106
Initial DL BWP Configuration	Config 1,4		DLBWP.0.1
	Config 2,5		DLBWP.0.1
	Config 3,6		DLBWP.0.1
Dedicated DL BWP Configuration	Config 1,4		DLBWP.1.1
	Config 2,5		DLBWP.1.1
	Config 3,6		DLBWP.1.1
Initial UL BWP Configuration	Config 1,4		ULBWP.0.1
	Config 2,5		ULBWP.0.1
	Config 3,6		ULBWP.0.1
Dedicated UL BWP Configuration	Config 1,4		ULBWP.1.1
	Config 2,5		ULBWP.1.1
	Config 3,6		ULBWP.1.1
PDSCH Reference measurement channel	Config 1,4		SR.1.1 FDD
	Config 2,5		SR.1.1 TDD
	Config 3,6		SR.2.1 TDD
RMSI CORESET parameters	Config 1,4		CR.1.1 FDD
	Config 2,5		CR.1.1 TDD
	Config 3,6		CR.2.1 TDD
PDCCH CORESET parameters	Config 1,4		CCR.1.1 FDD
	Config 2,5		CCR.1.1 TDD
	Config 3,6		CCR.2.1 TDD
OCNG Patterns			OP.1
SMTTC Configuration			SMTTC.1
TRS configuration	Config 1,4		TRS.1.1 FDD
	Config 2,5		TRS.1.1 TDD
	Config 3,6		TRS.1.2 TDD
SSB Configuration	Config 1,2,4,5		SSB.1 FR1
	Config 3,6		SSB.2 FR1
Correlation Matrix and Antenna Configuration			1x2 Low
EPRE ratio of PSS to SSS		dB	0
EPRE ratio of PBCH DMRS to SSS			
EPRE ratio of PBCH to PBCH DMRS			
EPRE ratio of PDCCH DMRS to SSS			
EPRE ratio of PDCCH to PDCCH DMRS			
EPRE ratio of PDSCH DMRS to SSS			
EPRE ratio of PDSCH to PDSCH			
EPRE ratio of OCNG DMRS to SSS (Note 1)			
EPRE ratio of OCNG to OCNG DMRS (Note 1)			
N <sub>oc</sub> <sup>Note 2</sup>			
SS-RSRP <sup>Note 3</sup>		dBm/15 kHz	-87
$\hat{E}_s/I_{ot}$		dB	17
$\hat{E}_s/N_{oc}$		dB	17
I <sub>o</sub> <sup>Note 3</sup>	Config 1,2,4,5	dBm/9.36MHz	-58.96
	Config 3,6	dBm/38.16MHz	-52.86
Time offset to Cell1 <sup>Note 4</sup>		μs	3 for intra-band EN-DC, 33 for inter-band EN-DC
Propagation Condition			AWGN



Note 1:	OCNG shall be used such that both cells are fully allocated and a constant total transmitted power spectral density is achieved for all OFDM symbols.
Note 2:	Interference from other cells and noise sources not specified in the test is assumed to be constant over subcarriers and time and shall be modeled as AWGN of appropriate power for $N_{oc}$ to be fulfilled.
Note 3:	SS-RSRP and $I_0$ levels have been derived from other parameters for information purposes. They are not settable parameters themselves.
Note 4:	Receive time difference of signals received between subframe timing boundary of E-UTRA PCell and slot timing boundary of PSCell at the UE antenna connector including time alignment error between the two cells

**Table A.4.5.2.1.1-4: Void**

#### A.4.5.2.1.2 Test Requirements

The UE shall be continuously scheduled in NR PSCell during the entire length of T1. UE shall not be scheduled in LTE PCell during T1. During the time duration T1 the UE shall transmit at least 99% of ACK/NACK on NR PSCell.

Interruption on NR PSCell shall not exceed X as defined in Table A.4.5.2.1.2-1.

**Table A.4.5.2.1.2-1: Interruption length X at transition between active and non-active during DRX**

$\mu$	NR Slot length (ms)	Interruption length X
		Sync
0	1	1
1	0.5	1

The rate of correct events observed during repeated tests shall be at least 90%.

#### A.4.5.2.2 E-UTRAN – NR FR1 interruptions at transitions between active and non-active during DRX in asynchronous EN-DC

##### A.4.5.2.2.1 Test Purpose and Environment

The purpose of this test is to verify that when LTE PCell is in DRX and NR PSCell is in non-DRX, NR PSCell interruptions due to transitions from active to non-active and from non-active to active during LTE PCell DRX the UE missed ACK/NACK does not exceed the limits. This test will verify the missed ACK/NACK rate for NR PSCell in EN-DC specified in TS 38.133 clause 8.2.1.2. Supported test configurations are shown in table A.4.5.2.2.1-1.

The general test parameters and NR cell specific test parameters are given in Table A.4.5.2.2.1-2 and A.4.5.2.2.1-3. The E-UTRAN PCell DRX configuration parameters are given in Table A.4.5.2.2.1-4 below. And the E-UTRAN cell specific test parameters can refer to Table A.3.7.2.1-1. In the test there are two cells: Cell1 and Cell2. Cell1 is LTE PCell and Cell2 is NR FR1 PSCell. The test consists of one time period, with duration of T1. During T1, NR PSCell is continuously scheduled in DL while LTE PCell is not scheduled and has DRX configured. Prior to the start of the time duration T1, Cell1 shall be configured as LTE PCell and Cell2 shall be configured as NR PSCell. Prior to start of T1 the DRX inactivity timer for the LTE PCell has already expired. During T1 the UE shall be continuously scheduled on NR PSCell while not scheduled on LTE PCell. PDCCH indicating a new transmission on PSCell shall be sent continuously during the entire time duration to ensure UE would not enter DRX state on PSCell.

**Table A.4.5.2.2.1-1: Interruption at transitions between active and non-active during DRX supported test configurations**

Config	Description
1	LTE FDD, NR 15 kHz SSB SCS, 10 MHz bandwidth, FDD duplex mode
2	LTE FDD, NR 15 kHz SSB SCS, 10 MHz bandwidth, TDD duplex mode
3	LTE FDD, NR 30 kHz SSB SCS, 40 MHz bandwidth, TDD duplex mode
4	LTE TDD, NR 15 kHz SSB SCS, 10 MHz bandwidth, FDD duplex mode
5	LTE TDD, NR 15 kHz SSB SCS, 10 MHz bandwidth, TDD duplex mode
6	LTE TDD, NR 30 kHz SSB SCS, 40 MHz bandwidth, TDD duplex mode

Note: The UE is only required to be tested in one of the supported test configurations

**Table A.4.5.2.2.1-2: General test parameters for E-UTRAN – NR FR1 interruptions at transitions between active and non-active during DRX in asynchronous EN-DC**

Parameter	Unit	Value	Comment
RF Channel Number		1, 2	One is E-UTRAN RF channel and the other is NR RF channel
Active PCell		Cell1	PCell on E-UTRAN RF channel number 1.
Configured PSCell		Cell2	PSCell on NR RF channel number 2.
CP length		Normal	Applicable to Cell1 and Cell2
DRX		DRX.4	DRX related parameters are defined in Table A.3.3.4-1
Measurement gap pattern Id		OFF	
T1	s	10	

**Table A.4.5.2.2.1-3: NR cell specific test parameters for E-UTRAN – NR FR1 interruptions at transitions between active and non-active during DRX in asynchronous EN-DC**

Parameter	Unit	Cell2
Frequency Range		FR1
Duplex mode	Config 1,4	FDD
	Config 2,3,5,6	TDD
TDD configuration	Config 1,4	Not Applicable
	Config 2,5	TDDConf.1.1
	Config 3,6	TDDConf.2.1
BW <sub>channel</sub>	Config 1,4	10: N <sub>RB,c</sub> = 52
	Config 2,5	10: N <sub>RB,c</sub> = 52
	Config 3,6	40: N <sub>RB,c</sub> = 106
Initial DL BWP Configuration	Config 1,4	DLBWP.0.1
	Config 2,5	DLBWP.0.1
	Config 3,6	DLBWP.0.1
Dedicated DL BWP Configuration	Config 1,4	DLBWP.1.1
	Config 2,5	DLBWP.1.1
	Config 3,6	DLBWP.1.1
Initial UL BWP Configuration	Config 1,4	ULBWP.0.1
	Config 2,5	ULBWP.0.1
	Config 3,6	ULBWP.0.1
Dedicated UL BWP Configuration	Config 1,4	ULBWP.1.1
	Config 2,5	ULBWP.1.1
	Config 3,6	ULBWP.1.1
PDSCH Reference measurement channel	Config 1,4	SR.1.1 FDD
	Config 2,5	SR.1.1 TDD
	Config 3,6	SR.2.1 TDD
RMSI CORESET parameters	Config 1,4	CR.1.1 FDD
	Config 2,5	CR.1.1 TDD
	Config 3,6	CR.2.1 TDD
PDCCH CORESET parameters	Config 1,4	CCR.1.1 FDD
	Config 2,5	CCR.1.1 TDD
	Config 3,6	CCR.2.1 TDD
OCNG Patterns		OP.1
SMTTC Configuration		SMTTC.1
TRS configuration	Config 1,4	TRS.1.1 FDD
	Config 2,5	TRS.1.1 TDD
	Config 3,6	TRS.1.2 TDD
SSB Configuration	Config 1,2,4,5	SSB.1 FR1
	Config 3,6	SSB.2 FR1
Correlation Matrix and Antenna Configuration		1x2 Low
EPRE ratio of PSS to SSS	dB	0
EPRE ratio of PBCH DMRS to SSS		
EPRE ratio of PBCH to PBCH DMRS		
EPRE ratio of PDCCH DMRS to SSS		
EPRE ratio of PDCCH to PDCCH DMRS		

EPRE ratio of PDSCH DMRS to SSS			
EPRE ratio of PDSCH to PDSCH			
EPRE ratio of OCNG DMRS to SSS(Note 1)			
EPRE ratio of OCNG to OCNG DMRS (Note 1)			
$N_{oc}$ <sup>Note 2</sup>		dBm/15 kHz	-104
SS-RSRP <sup>Note 3</sup>		dBm/15 kHz	-87
$\bar{E}_s/I_{ot}$		dB	17
$\bar{E}_s/N_{oc}$		dB	17
$I_o$ <sup>Note3</sup>	Config 1,2,4,5	dBm/9.36MHz	-58.96
	Config 3,6	dBm/38.16MH z	-52.86
Time offset to Cell1 <sup>Note 4</sup>	Config 1,2,4,5	$\mu$ s	500
	Config 3,6		250
Propagation Condition			AWGN
<p>Note 1: OCNG shall be used such that both cells are fully allocated and a constant total transmitted power spectral density is achieved for all OFDM symbols.</p> <p>Note 2: Interference from other cells and noise sources not specified in the test is assumed to be constant over subcarriers and time and shall be modeled as AWGN of appropriate power for <math>N_{oc}</math> to be fulfilled.</p> <p>Note 3: SS-RSRP and <math>I_o</math> levels have been derived from other parameters for information purposes. They are not settable parameters themselves.</p> <p>Note 4: Receive time difference of signals received between subframe timing boundary of E-UTRA PCell and slot timing boundary of PSCell at the UE antenna connector including time alignment error between the two cells</p>			

Table A.4.5.2.2.1-4: Void

#### A.4.5.2.2.2 Test Requirements

The UE shall be continuously scheduled in NR PSCell during the entire length of T1. UE shall not be scheduled in LTE PCell during T1. During the time duration T1 the UE shall transmit at least 99% of ACK/NACK on NR PSCell.

Interruption on NR PSCell shall not exceed X as defined in Table A.4.5.2.2.2-1.

**Table A.4.5.2.2.2-1: Interruption length X at transition between active and non-active during DRX**

$\mu$	NR Slot length (ms)	Interruption length X
		Async
0	1	2
1	0.5	2

The rate of correct events observed during repeated tests shall be at least 90%.

#### A.4.5.2.3 E-UTRAN – NR FR1 interruptions during measurements on deactivated NR SCC in synchronous EN-DC

##### A.4.5.2.3.1 Test Purpose and Environment

The purpose of this test is to verify E-UTRAN PCell and NR PSCell interruptions during the measurement on the deactivated NR SCC, the UE missed ACK/NACK does not exceed the limits. This test will verify the missed ACK/NACK rate for E-UTRAN PCell and NR PSCell in EN-DC specified in TS 38.133 clause 8.2.1.2. Supported test configurations for LTE PCell and NR PSCell are shown in table A.4.5.2.3.1-1. Supported test configurations for NR SCell are shown in table A.4.5.2.3.1-1A. Test configuration for LTE PCell and NR PSCell and test configuration for NR SCell are chosen independently.

The general test parameters and NR cell specific test parameters are given in Table A.4.5.2.3.1-2 and A.4.5.2.3.1-3 below. And the E-UTRAN cell specific test parameters can refer to Table A.3.7.2.1-1. In the test there are three cells: Cell1, Cell2 and Cell3. Cell1 is LTE PCell, Cell2 and Cell3 is NR PSCell and NR deactivated SCell. Cell1 shall be configured as LTE PCell and Cell2 shall be configured as NR PSCell. The test consists of one time period, with duration of T1. Prior to the start of the time duration T1, the UE is connected to Cell1 and Cell2 and the RRC message including *measCycleSCell* or *allowInterruptions* for the deactivated NR SCells is received at the UE antenna connector. During T1, LTE PCell and NR PSCell are continuously scheduled in DL.

**Table A.4.5.2.3.1-1: Interruptions during measurements on deactivated NR SCC supported test configurations for LTE PCell and NR PSCell**

Config	Description
1	LTE FDD, NR 15 kHz SSB SCS, $\geq 10$ MHz bandwidth, FDD duplex mode
2	LTE FDD, NR 15 kHz SSB SCS, $\geq 10$ MHz bandwidth, TDD duplex mode
3	LTE FDD, NR 30 kHz SSB SCS, $\geq 40$ MHz bandwidth, TDD duplex mode
4	LTE TDD, NR 15 kHz SSB SCS, $\geq 10$ MHz bandwidth, FDD duplex mode
5	LTE TDD, NR 15 kHz SSB SCS, $\geq 10$ MHz bandwidth, TDD duplex mode
6	LTE TDD, NR 30 kHz SSB SCS, $\geq 40$ MHz bandwidth, TDD duplex mode
Note 1:	The UE is only required to be tested in one of the supported test configurations
Note 2:	The UE is only required to be tested in one with smallest aggregated channel bandwidth from supported band combinations which is composed of CCs $\geq$ the bandwidth ( $BW_{channel}$ ) defined in each test configuration,

**Table A.4.5.2.3.1-1A: Interruptions during measurements on deactivated NR SCC supported test configurations for NR SCell**

Config <sub>SCell</sub>	Description
1	NR 15 kHz SSB SCS, $\geq 10$ MHz bandwidth, FDD duplex mode
2	NR 15 kHz SSB SCS, $\geq 10$ MHz bandwidth, TDD duplex mode
3	NR 30 kHz SSB SCS, $\geq 40$ MHz bandwidth, TDD duplex mode
Note 1:	The UE is only required to be tested in one of the supported test configurations
Note 2:	The UE is only required to be tested in one with smallest aggregated channel bandwidth from supported band combinations which is composed of CCs $\geq$ the bandwidth ( $BW_{channel}$ ) defined in each test configuration

**Table A.4.5.2.3.1-2: General test parameters for E-UTRAN – NR interruptions during measurements on deactivated NR SCC in synchronous EN-DC**

Parameter	Unit	Value	Comment
RF Channel Number		1, 2, 3	One is E-UTRAN RF channel and the other two are NR RF channels
Active PCell		Cell1	PCell on E-UTRAN RF channel number 1.
Active PSCell		Cell2	PSCell on NR RF channel number 2.
Configured deactivated SCell		Cell3	Deactivated SCell on NR RF channel number 3.
CP length		Normal	Applicable to Cell1, Cell2 and Cell3
DRX		OFF	
Measurement gap pattern Id		OFF	
SCell measurement cycle (measCycleSCell)	ms	640	
T1	s	10	

**Table A.4.5.2.3.1-3: NR cell specific test parameters for NR PSCell for E-UTRAN – NR interruptions during measurements on deactivated NR SCC in synchronous EN-DC**

Parameter	Unit	Cell2
Frequency Range		FR1
Duplex mode	Config 1,4	FDD
	Config 2,3,5,6	TDD
TDD configuration	Config 1,4	Not Applicable
	Config 2,5	TDDConf.1.1
	Config 3,6	TDDConf.2.1
$BW_{channel}$	Config 1,4	Note 8
	Config 2,5	Note 8
	Config 3,6	Note 8
$BW_{occupied}$	Config 1,4	52 <sup>Note 6</sup>
	Config 2,5	52 <sup>Note 6</sup>
	Config 3,6	106 <sup>Note 7</sup>

Initial DL BWP Configuration	Config 1,4		DLBWP.0.1
	Config 2,5		DLBWP.0.1
	Config 3,6		DLBWP.0.1
Dedicated DL BWP Configuration	Config 1,4		DLBWP.1.1
	Config 2,5		DLBWP.1.1
	Config 3,6		DLBWP.1.1
Initial UL BWP Configuration	Config 1,4		ULBWP.0.1
	Config 2,5		ULBWP.0.1
	Config 3,6		ULBWP.0.1
Dedicated UL BWP Configuration	Config 1,4		ULBWP.1.1
	Config 2,5		ULBWP.1.1
	Config 3,6		ULBWP.1.1
PDSCH Reference measurement channel	Config 1,4		SR.1.1 FDD
	Config 2,5		SR.1.1 TDD
	Config 3,6		SR.2.1 TDD
RMSI CORESET parameters	Config 1,4		CR.1.1 FDD
	Config 2,5		CR.1.1 TDD
	Config 3,6		CR.2.1 TDD
PDCCH CORESET parameters	Config 1,4		CCR.1.1 FDD
	Config 2,5		CCR.1.1 TDD
	Config 3,6		CCR.2.1 TDD
TRS configuration	Config 1,4		TRS.1.1 FDD
	Config 2,5		TRS.1.1 TDD
	Config 3,6		TRS.1.2 TDD
OCNG Patterns	Config 1,2,4,5		OP.1 <sup>Note 6</sup>
	Config 3,6		OP.1 <sup>Note 7</sup>
SMTC Configuration			SMTC.1
TCI state			TCI.State.0
SSB Configuration	Config 1,2,4,5		SSB.1 FR1
	Config 3,6		SSB.2 FR1
Correlation Matrix and Antenna Configuration			1x2 Low
EPRE ratio of PSS to SSS		dB	0
EPRE ratio of PBCH DMRS to SSS			
EPRE ratio of PBCH to PBCH DMRS			
EPRE ratio of PDCCH DMRS to SSS			
EPRE ratio of PDCCH to PDCCH DMRS			
EPRE ratio of PDSCH DMRS to SSS			
EPRE ratio of PDSCH to PDSCH			
EPRE ratio of OCNG DMRS to SSS <sup>Note 1</sup>			
EPRE ratio of OCNG to OCNG DMRS <sup>Note 1</sup>			
$N_{oc}$ <sup>Note 2</sup>		dBm/15 kHz	-104
SS-RSRP <sup>Note 3</sup>		dBm/15 kHz	-87
$\hat{E}_s/I_{ot}$		dB	17
$\hat{E}_s/N_{oc}$		dB	17
$I_o$ <sup>Note 3</sup>	Config 1,2,4,5	dBm/9.36MHz	-58.96
	Config 3,6	dBm/38.16MHz	-52.86
Time offset to Cell1 <sup>Note 4</sup>		$\mu$ s	3 for intra-band EN-DC, 33 for inter-band EN-DC
Time offset to Cell2 <sup>Note 5</sup>		$\mu$ s	-
Propagation Condition			AWGN

Note 1:	OCNG shall be used such that both cells are fully allocated and a constant total transmitted power spectral density is achieved for all OFDM symbols.
Note 2:	Interference from other cells and noise sources not specified in the test is assumed to be constant over subcarriers and time and shall be modeled as AWGN of appropriate power for $N_{oc}$ to be fulfilled within $BW_{occupied}$ .
Note 3:	SS-RSRP and $I_o$ levels have been derived from other parameters for information purposes. They are not settable parameters themselves.
Note 4:	Receive time difference of signals received between subframe timing boundary of E-UTRA PCell and slot timing boundary of PSCell at the UE antenna connector including time alignment error between the two cells
Note 5:	Receive time difference between slot boundaries of signals received from the two cells at the UE antenna connector including time alignment error between the two cells.
Note 6:	All UL/DL transmission shall be confined within $BW_{occupied}$ (i.e. 10 MHz, 52 RBs) from $F_{C,low}$ , and $I_o$ is independent of the $BW_{channel}$ configured.
Note 7:	All UL/DL transmission shall be confined within $BW_{occupied}$ (i.e. 40 MHz, 106 RBs) from $F_{C,low}$ , and $I_o$ is independent of the $BW_{channel}$ configured.
Note 8:	$N_{RB,c}$ is derived from Table 5.3.2-1 in TS38.101-1[2] with configured $BW_{channel}$ .

**Table A.4.5.2.3.1-4: NR cell specific test parameters for NR SCell for E-UTRAN – NR interruptions during measurements on deactivated NR SCC in synchronous EN-DC**

Parameter		Unit	Cell3
Frequency Range			FR1
Duplex mode	Config <sub>SCell</sub> 1		FDD
	Config <sub>SCell</sub> 2,3		TDD
TDD configuration	Config <sub>SCell</sub> 1		Not Applicable
	Config <sub>SCell</sub> 2		TDDConf.1.1
	Config <sub>SCell</sub> 3		TDDConf.2.1
$BW_{channel}$	Config <sub>SCell</sub> 1		Note 8
	Config <sub>SCell</sub> 2		Note 8
	Config <sub>SCell</sub> 3		Note 8
$BW_{occupied}$	Config <sub>SCell</sub> 1	RB	52 <sup>Note 6</sup>
	Config <sub>SCell</sub> 2		52 <sup>Note 6</sup>
	Config <sub>SCell</sub> 3		106 <sup>Note 7</sup>
Initial DL BWP Configuration	Config <sub>SCell</sub> 1		DLBWP.0.1
	Config <sub>SCell</sub> 2		DLBWP.0.1
	Config <sub>SCell</sub> 3		DLBWP.0.1
Dedicated DL BWP Configuration	Config <sub>SCell</sub> 1		DLBWP.1.1
	Config <sub>SCell</sub> 2		DLBWP.1.1
	Config <sub>SCell</sub> 3		DLBWP.1.1
Initial UL BWP Configuration	Config <sub>SCell</sub> 1		ULBWP.0.1
	Config <sub>SCell</sub> 2		ULBWP.0.1
	Config <sub>SCell</sub> 3		ULBWP.0.1
Dedicated UL BWP Configuration	Config <sub>SCell</sub> 1		ULBWP.1.1
	Config <sub>SCell</sub> 2		ULBWP.1.1
	Config <sub>SCell</sub> 3		ULBWP.1.1
PDSCH Reference measurement channel	Config <sub>SCell</sub> 1		-
	Config <sub>SCell</sub> 2		-
	Config <sub>SCell</sub> 3		-
RMSI CORESET parameters	Config <sub>SCell</sub> 1		CR.1.1 FDD
	Config <sub>SCell</sub> 2		CR.1.1 TDD
	Config <sub>SCell</sub> 3		CR.2.1 TDD
PDCCH CORESET parameters	Config <sub>SCell</sub> 1		CCR.1.1 FDD
	Config <sub>SCell</sub> 2		CCR.1.1 TDD
	Config <sub>SCell</sub> 3		CCR.2.1 TDD
TRS configuration	Config <sub>SCell</sub> 1		TRS.1.1 FDD

	Config <sub>SCell</sub> 2		TRS.1.1 TDD
	Config <sub>SCell</sub> 3		TRS.1.2 TDD
OCNG Patterns	Config <sub>SCell</sub> 1,2		OP.1 <sup>Note 6</sup>
	Config <sub>SCell</sub> 3		OP.1 <sup>Note 7</sup>
SMTC Configuration			SMTC.1
TCI state			TCI.State.0
SSB Configuration	Config <sub>SCell</sub> 1,2		SSB.1 FR1
	Config <sub>SCell</sub> 3		SSB.2 FR1
Correlation Matrix and Antenna Configuration			1x2 Low
EPRE ratio of PSS to SSS		dB	0
EPRE ratio of PBCH DMRS to SSS			
EPRE ratio of PBCH to PBCH DMRS			
EPRE ratio of PDCCH DMRS to SSS			
EPRE ratio of PDCCH to PDCCH DMRS			
EPRE ratio of PDSCH DMRS to SSS			
EPRE ratio of PDSCH to PDSCH			
EPRE ratio of OCNG DMRS to SSS <sup>Note 1</sup>			
EPRE ratio of OCNG to OCNG DMRS <sup>Note 1</sup>			
N <sub>oc</sub> <sup>Note 2</sup>		dBm/15 kHz	-104
SS-RSRP <sup>Note 3</sup>		dBm/15 kHz	-87
$\bar{E}_s/I_{ot}$		dB	17
$\bar{E}_s/N_{oc}$		dB	17
I <sub>o</sub> <sup>Note 3</sup>	Config <sub>SCell</sub> 1,2	dBm/9.36MHz	-58.96
	Config <sub>SCell</sub> 3	dBm/38.16MHz	-52.86
Time offset to Cell1 <sup>Note 4</sup>		μs	3 + Time offset to Cell2 for intra-band EN-DC, 33 + Time offset to Cell2 for inter-band EN-DC
Time offset to Cell2 <sup>Note 5</sup>		μs	3
Propagation Condition			AWGN
<p>Note 1: OCNG shall be used such that both cells are fully allocated and a constant total transmitted power spectral density is achieved for all OFDM symbols.</p> <p>Note 2: Interference from other cells and noise sources not specified in the test is assumed to be constant over subcarriers and time and shall be modeled as AWGN of appropriate power for N<sub>oc</sub> to be fulfilled within BW<sub>occupied</sub>.</p> <p>Note 3: SS-RSRP and I<sub>o</sub> levels have been derived from other parameters for information purposes. They are not settable parameters themselves.</p> <p>Note 4: Receive time difference of signals received between subframe timing boundary of E-UTRA PCell and slot timing boundary of PSCell at the UE antenna connector including time alignment error between the two cells</p> <p>Note 5: Receive time difference between slot boundaries of signals received from the two cells at the UE antenna connector including time alignment error between the two cells.</p> <p>Note 6: All UL/DL transmission shall be confined within BW<sub>occupied</sub> (i.e. 10 MHz, 52 RBs) from F<sub>C,low</sub>, and I<sub>o</sub> is independent of the BW<sub>channel</sub> configured.</p> <p>Note 7: All UL/DL transmission shall be confined within BW<sub>occupied</sub> (i.e. 40 MHz, 106 RBs) from F<sub>C,low</sub>, and I<sub>o</sub> is independent of the BW<sub>channel</sub> configured.</p> <p>Note 8: N<sub>RB,c</sub> is derived from Table 5.3.2-1 in TS38.101-1[2] with configured BW<sub>channel</sub>.</p>			

#### A.4.5.2.3.2 Test Requirements

The UE shall be continuously scheduled in LTE PCell and NR PSCell during the entire length of T1. During the time duration T1 the UE shall transmit at least 99.5% of ACK/NACK on NR PSCell.

If the NR PSCell is not in the same band as the deactivated SCell, the UE is only allowed to cause interruptions on NR PSCell immediately before and immediately after an SMTC. Each interruption on NR PSCell shall not exceed the value defined in Table A.4.5.2.3.2-1.

If the NR PSCell is in the same band as the deactivated SCell, the UE is only allowed to cause an interruption on PSCell no earlier than 1 slot before an SMTC and no later than 1 slot after the SMTC. the interruption on NR PSCell shall not exceed the value defined in Table A.4.5.2.3.2-2.

**Table A.4.5.2.3.2-1: Interruption duration if the NR PSCell is not in the same band as the deactivated SCell**

$\mu$	NR Slot length (ms)	Interruption length
0	1	1
1	0.5	1

**Table A.4.5.2.3.2-2: Interruption duration if the NR PSCell is in the same band as the deactivated SCell**

$\mu$	NR Slot length (ms)	Interruption length
0	1	2 + SMTC duration
1	0.5	2 + SMTC duration

For synchronous inter-band EN-DC, the UE is only allowed to cause interruptions on E-UTRA PCell immediately before and immediately after an SMTC. Each interruption on E-UTRA PCell shall not exceed 1 subframe.

For synchronous intra-band EN-DC, the UE is only allowed to cause an interruption on E-UTRA PCell no earlier than 1 subframe before an SMTC and no later than 1 subframe after the SMTC. The interruption on E-UTRA PCell shall not exceed SMTC duration + 2 subframes.

The rate of correct events observed during repeated tests shall be at least 90%.

#### A.4.5.2.4 E-UTRAN – NR FR1 interruptions during measurements on deactivated NR SCC in asynchronous EN-DC

##### A.4.5.2.4.1 Test Purpose and Environment

The purpose of this test is to verify E-UTRAN PCell and NR PSCell interruptions during the measurement on the deactivated NR SCC, the UE missed ACK/NACK does not exceed the limits. This test will verify the missed ACK/NACK rate for E-UTRAN PCell and NR PSCell in EN-DC specified in TS 38.133 clause 8.2.1. Supported test configurations for LTE PCell and NR PSCell are shown in table A.4.5.2.4.1-1. Supported test configurations for NR SCell are shown in table A.4.5.2.4.1-1. Test configuration for LTE PCell and NR PSCell and test configuration for NR SCell are chosen independently.

The general test parameters and NR cell specific test parameters are given in Table A.4.5.2.4.1-2 and A.4.5.2.4.1-3 below. And the E-UTRAN cell specific test parameters can refer to Table A.3.7.2.1-1. In the test there are three cells: Cell1, Cell2 and Cell3. Cell1 is LTE PCell, Cell2 and Cell3 is NR PSCell and NR deactivated SCell. Cell1 shall be configured as LTE PCell and Cell2 shall be configured as NR PSCell. The test consists of one time period, with duration of T1. Prior to the start of the time duration T1, the UE is connected to Cell1 and Cell2 and the RRC message including *measCycleSCell* or *allowInterruptions* for the deactivated NR SCells is received at the UE antenna connector. During T1, LTE PCell and NR PSCell are continuously scheduled in DL.

**Table A.4.5.2.4.1-1: Interruptions during measurements on deactivated NR SCC supported test configurations for LTE PCell and NR PSCell**

Config	Description
1	LTE FDD, NR 15 kHz SSB SCS, $\geq 10$ MHz bandwidth, FDD duplex mode
2	LTE FDD, NR 15 kHz SSB SCS, $\geq 10$ MHz bandwidth, TDD duplex mode
3	LTE FDD, NR 30 kHz SSB SCS, $\geq 40$ MHz bandwidth, TDD duplex mode
4	LTE TDD, NR 15 kHz SSB SCS, $\geq 10$ MHz bandwidth, FDD duplex mode



5	LTE TDD, NR 15 kHz SSB SCS, $\geq 10$ MHz bandwidth, TDD duplex mode
6	LTE TDD, NR 30 kHz SSB SCS, $\geq 40$ MHz bandwidth, TDD duplex mode
Note 1:	The UE is only required to be tested in one of the supported test configurations
Note 2:	The UE is only required to be tested in one with smallest aggregated channel bandwidth from supported band combinations which is composed of CCs $\geq$ the bandwidth ( $BW_{\text{channel}}$ ) defined in each test configuration,

**Table A.4.5.2.4.1-1A: Interruptions during measurements on deactivated NR SCC supported test configurations for NR SCell**

Config <sub>SCell</sub>	Description
1	NR 15 kHz SSB SCS, $\geq 10$ MHz bandwidth, FDD duplex mode
2	NR 15 kHz SSB SCS, $\geq 10$ MHz bandwidth, TDD duplex mode
3	NR 30 kHz SSB SCS, $\geq 40$ MHz bandwidth, TDD duplex mode
Note 1:	The UE is only required to be tested in one of the supported test configurations
Note 2:	The UE is only required to be tested in one with smallest aggregated channel bandwidth from supported band combinations which is composed of CCs $\geq$ the bandwidth ( $BW_{\text{channel}}$ ) defined in each test configuration

**Table A.4.5.2.4.1-2: General test parameters for E-UTRAN – NR interruptions during measurements on deactivated NR SCC in asynchronous EN-DC**

Parameter	Unit	Value	Comment
RF Channel Number		1, 2, 3	One is E-UTRAN RF channel and the other two are NR RF channels
Active PCell		Cell1	PCell on E-UTRAN RF channel number 1.
Configured PSCell		Cell2	PSCell on NR RF channel number 2.
Configured deactivated SCell		Cell3	Deactivated SCell on NR RF channel number 3.
CP length		Normal	Applicable to Cell1, Cell2 and Cell3
DRX		OFF	
Measurement gap pattern Id		OFF	
SCell measurement cycle (measCycleSCell)	ms	640	
T1	s	10	

**Table A.4.5.2.4.1-3: NR cell specific test parameters for NR PSCell for E-UTRAN – NR interruptions during measurements on deactivated NR SCC in asynchronous EN-DC**

Parameter	Unit	Cell2
Frequency Range		FR1
Duplex mode	Config 1,4	FDD
	Config 2,3,5,6	TDD
TDD configuration	Config 1,4	Not Applicable
	Config 2,5	TDDConf.1.1
	Config 3,6	TDDConf.2.1
$BW_{\text{channel}}$	Config 1,4	Note 8
	Config 2,5	Note 8
	Config 3,6	Note 8
$BW_{\text{occupied}}$	Config 1,4	52 <sup>Note 6</sup>
	Config 2,5	52 <sup>Note 6</sup>
	Config 3,6	106 <sup>Note 7</sup>
Initial BWP Configuration	Config 1,4	DLBWP.0.1
	Config 2,5	DLBWP.0.1
	Config 3,6	DLBWP.0.1
Dedicated DL BWP Configuration	Config 1,4	DLBWP.1.1
	Config 2,5	DLBWP.1.1
	Config 3,6	DLBWP.1.1
Initial UL BWP Configuration	Config 1,4	ULBWP.0.1
	Config 2,5	ULBWP.0.1
	Config 3,6	ULBWP.0.1
	Config 1,4	ULBWP.1.1

Dedicated UL BWP Configuration	Config 2,5		ULBWP.1.1
	Config 3,6		ULBWP.1.1
PDSCH Reference measurement channel	Config 1,4		SR.1.1 FDD
	Config 2,5		SR.1.1 TDD
	Config 3,6		SR.2.1 TDD
RMSI CORESET parameters	Config 1,4		CR.1.1 FDD
	Config 2,5		CR.1.1 TDD
	Config 3,6		CR.2.1 TDD
PDCCH CORESET parameters	Config 1,4		CCR.1.1 FDD
	Config 2,5		CCR.1.1 TDD
	Config 3,6		CCR.2.1 TDD
TRS configuration	Config 1,4		TRS.1.1 FDD
	Config 2,5		TRS.1.1 TDD
	Config 3,6		TRS.1.2 TDD
OCNG Patterns	Config 1,2,4,5		OP.1 <sup>Note 6</sup>
	Config 3,6		OP.1 <sup>Note 7</sup>
SSB Configuration	Config 1,2,4,5		SSB.1 FR1
	Config 3,6		SSB.2 FR1
SMTTC Configuration			SMTTC.1
TCI state			TCI.State.0
Correlation Matrix and Antenna Configuration			1x2 Low
EPRE ratio of PSS to SSS		dB	0
EPRE ratio of PBCH DMRS to SSS			
EPRE ratio of PBCH to PBCH DMRS			
EPRE ratio of PDCCH DMRS to SSS			
EPRE ratio of PDCCH to PDCCH DMRS			
EPRE ratio of PDSCH DMRS to SSS			
EPRE ratio of PDSCH to PDSCH			
EPRE ratio of OCNG DMRS to SSS <sup>Note 1</sup>			
EPRE ratio of OCNG to OCNG DMRS <sup>Note 1</sup>			
$N_{oc}$ <sup>Note 2</sup>			
SS-RSRP <sup>Note 3</sup>		dBm/15 kHz	-87
$\bar{E}_s/I_{ot}$		dB	17
$\bar{E}_s/N_{oc}$		dB	17
$I_o$ <sup>Note 3</sup>	Config 1,2,4,5	dBm/9.36MHz	-58.96
	Config 3,6	dBm/38.16MHz	-52.86
Time offset to Cell1 <sup>Note 4</sup>	Config 1,2,4,5	$\mu$ s	500
	Config 3,6		250
Time offset to Cell2 <sup>Note 5</sup>		$\mu$ s	-
Propagation Condition			AWGN
<p>Note 1: OCNG shall be used such that both cells are fully allocated and a constant total transmitted power spectral density is achieved for all OFDM symbols.</p> <p>Note 2: Interference from other cells and noise sources not specified in the test is assumed to be constant over subcarriers and time and shall be modeled as AWGN of appropriate power for <math>N_{oc}</math> to be fulfilled within <math>BW_{occupied}</math>.</p> <p>Note 3: SS-RSRP and <math>I_o</math> levels have been derived from other parameters for information purposes. They are not settable parameters themselves.</p> <p>Note 4: Receive time difference of signals received between subframe timing boundary of E-UTRA PCell and slot timing boundary of PSCell at the UE antenna connector including time alignment error between the two cells</p> <p>Note 5: Receive time difference between slot boundaries of signals received from the two cells at the UE antenna connector including time alignment error between the two cells.</p> <p>Note 6: All UL/DL transmission shall be confined within <math>BW_{occupied}</math> (i.e. 10 MHz, 52 RBs) from <math>F_{C,low}</math>, and <math>I_o</math> is independent of the <math>BW_{channel}</math> configured.</p> <p>Note 7: All UL/DL transmission shall be confined within <math>BW_{occupied}</math> (i.e. 40 MHz, 106 RBs) from <math>F_{C,low}</math>, and <math>I_o</math> is independent of the <math>BW_{channel}</math> configured.</p> <p>Note 8: <math>N_{RB,c}</math> is derived from Table 5.3.2-1 in TS38.101-1[2] with configured <math>BW_{channel}</math>.</p>			

**Table A.4.5.2.4.1-4: NR cell specific test parameters for NR SCell for E-UTRAN – NR interruptions during measurements on deactivated NR SCC in asynchronous EN-DC**

Parameter	Unit	Cell3
-----------	------	-------

Frequency Range			FR1
Duplex mode	Config <sub>SCell</sub> 1		FDD
	Config <sub>SCell</sub> 2,3		TDD
TDD configuration	Config <sub>SCell</sub> 1		Not Applicable
	Config <sub>SCell</sub> 2		TDDConf.1.1
	Config <sub>SCell</sub> 3		TDDConf.2.1
BW <sub>channel</sub>	Config <sub>SCell</sub> 1		Note 8
	Config <sub>SCell</sub> 2		Note 8
	Config <sub>SCell</sub> 3		Note 8
BW <sub>occupied</sub>	Config <sub>SCell</sub> 1	RB	52 <sup>Note 6</sup>
	Config <sub>SCell</sub> 2		52 <sup>Note 6</sup>
	Config <sub>SCell</sub> 3		106 <sup>Note 7</sup>
Initial BWP Configuration	Config <sub>SCell</sub> 1		DLBWP.0.1
	Config <sub>SCell</sub> 2		DLBWP.0.1
	Config <sub>SCell</sub> 3		DLBWP.0.1
Dedicated DL BWP Configuration	Config <sub>SCell</sub> 1		DLBWP.1.1
	Config <sub>SCell</sub> 2		DLBWP.1.1
	Config <sub>SCell</sub> 3		DLBWP.1.1
Initial UL BWP Configuration	Config <sub>SCell</sub> 1		ULBWP.0.1
	Config <sub>SCell</sub> 2		ULBWP.0.1
	Config <sub>SCell</sub> 3		ULBWP.0.1
Dedicated UL BWP Configuration	Config <sub>SCell</sub> 1		ULBWP.1.1
	Config <sub>SCell</sub> 2		ULBWP.1.1
	Config <sub>SCell</sub> 3		ULBWP.1.1
PDSCH Reference measurement channel	Config <sub>SCell</sub> 1		-
	Config <sub>SCell</sub> 2		-
	Config <sub>SCell</sub> 3		-
RMSI CORESET parameters	Config <sub>SCell</sub> 1		CR.1.1 FDD
	Config <sub>SCell</sub> 2		CR.1.1 TDD
	Config <sub>SCell</sub> 3		CR.2.1 TDD
PDCCH CORESET parameters	Config <sub>SCell</sub> 1		CCR.1.1 FDD
	Config <sub>SCell</sub> 2		CCR.1.1 TDD
	Config <sub>SCell</sub> 3		CCR.2.1 TDD
TRS configuration	Config <sub>SCell</sub> 1		TRS.1.1 FDD
	Config <sub>SCell</sub> 2		TRS.1.1 TDD
	Config <sub>SCell</sub> 3		TRS.1.2 TDD
OCNG Patterns	Config <sub>SCell</sub> 1,2		OP.1 <sup>Note 6</sup>
	Config <sub>SCell</sub> 3		OP.1 <sup>Note 7</sup>
SSB Configuration	Config <sub>SCell</sub> 1,2		SSB.1 FR1
	Config <sub>SCell</sub> 3		SSB.2 FR1
SMTc Configuration			SMTc.1
TCI state			TCI.State.0
Correlation Matrix and Antenna Configuration			1x2 Low
EPRE ratio of PSS to SSS		dB	0
EPRE ratio of PBCH DMRS to SSS			
EPRE ratio of PBCH to PBCH DMRS			
EPRE ratio of PDCCH DMRS to SSS			
EPRE ratio of PDCCH to PDCCH DMRS			
EPRE ratio of PDSCH DMRS to SSS			
EPRE ratio of PDSCH to PDSCH			
EPRE ratio of OCNG DMRS to SSS <sup>Note 1</sup>			
EPRE ratio of OCNG to OCNG DMRS <sup>Note 1</sup>			
N <sub>oc</sub> <sup>Note 2</sup>		dBm/15 kHz	-104
SS-RSRP <sup>Note 3</sup>		dBm/15 kHz	-87
$\bar{E}_s/I_{ot}$		dB	17
$\bar{E}_s/N_{oc}$		dB	17
I <sub>o</sub> <sup>Note 3</sup>	Config <sub>SCell</sub> 1,2	dBm/ 9.36MHz	-58.96
	Config <sub>SCell</sub> 3	dBm/ 38.16MHz	-52.86
Time offset to Cell1 <sup>Note 4</sup>	Config <sub>SCell</sub> 1,2	μs	500 + Time offset to Cell2
	Config <sub>SCell</sub> 3		250 + Time offset to Cell2
Time offset to Cell2 <sup>Note 5</sup>		μs	3
Propagation Condition			AWGN

Note 1:	OCNG shall be used such that both cells are fully allocated and a constant total transmitted power spectral density is achieved for all OFDM symbols.
Note 2:	Interference from other cells and noise sources not specified in the test is assumed to be constant over subcarriers and time and shall be modeled as AWGN of appropriate power for $N_{oc}$ to be fulfilled within $BW_{occupied}$ .
Note 3:	SS-RSRP and $l_0$ levels have been derived from other parameters for information purposes. They are not settable parameters themselves.
Note 4:	Receive time difference of signals received between subframe timing boundary of E-UTRA PCell and slot timing boundary of PSCell at the UE antenna connector including time alignment error between the two cells
Note 5:	Receive time difference between slot boundaries of signals received from the two cells at the UE antenna connector including time alignment error between the two cells.
Note 6:	All UL/DL transmission shall be confined within $BW_{occupied}$ (i.e. 10 MHz, 52 RBs) from $F_{C,low}$ , and $l_0$ is independent of the $BW_{channel}$ configured.
Note 7:	All UL/DL transmission shall be confined within $BW_{occupied}$ (i.e. 40 MHz, 106 RBs) from $F_{C,low}$ , and $l_0$ is independent of the $BW_{channel}$ configured.
Note 8:	$N_{RB,c}$ is derived from Table 5.3.2-1 in TS38.101-1[2] with configured $BW_{channel}$ .

#### A.4.5.2.4.2 Test Requirements

The UE shall be continuously scheduled in LTE PCell and NR PSCell during the entire length of T1. During the time duration T1 the UE shall transmit at least 99.5% of ACK/NACK on NR PSCell.

If the NR PSCell is not in the same band as the deactivated SCell, the UE is only allowed to cause interruptions on NR PSCell immediately before and immediately after an SMTC. Each interruption on NR PSCell shall not exceed the value defined in Table A.4.5.2.4.2-1.

If the NR PSCell is in the same band as the deactivated SCell, the UE is only allowed to cause an interruption on PSCell no earlier than 1 slot before an SMTC and no later than 1 slot after the SMTC. the interruption on NR PSCell shall not exceed the value defined in Table A.4.5.2.4.2-2.

**Table A.4.5.2.4.2-1: Interruption duration if the NR PSCell is not in the same band as the deactivated SCell**

$\mu$	NR Slot length (ms)	Interruption length
0	1	1
1	0.5	1

**Table A.4.5.2.4.2-2: Interruption duration if the NR PSCell is in the same band as the deactivated SCell**

$\mu$	NR Slot length (ms)	Interruption length
0	1	2 + SMTC duration
1	0.5	2 + SMTC duration

For asynchronous inter-band EN-DC, the UE is only allowed to cause interruptions on E-UTRA PCell immediately before and immediately after an SMTC. Each interruption on E-UTRA PCell shall not exceed 2 subframe.

The rate of correct events observed during repeated tests shall be at least 90%.

### A.4.5.2.5 E-UTRAN – NR FR1 interruptions during measurements on deactivated E-UTRAN SCC in synchronous EN-DC

#### A.4.5.2.5.1 Test Purpose and Environment

The purpose of this test is to verify E-UTRAN PCell and NR PSCell interruptions during the measurement on the deactivated E-UTRAN SCC, the UE missed ACK/NACK does not exceed the limits. This test will verify the missed ACK/NACK rate for E-UTRAN PCell and NR PSCell in EN-DC specified in TS38.133 clause 8. 2.1.2. Supported test configurations are shown in table A.4.5.2.5.1-1.

The general test parameters and NR cell specific test parameters are given in Table A.4.5.2.5.1-2 and A.4.5.2.5.1-3 below. And the E-UTRAN cell specific test parameters can refer to Table A.3.7.2.1-1. In the test there are three cells: Cell1, Cell2 and Cell3. Cell1 and Cell3 is E-UTRAN PCell and E-UTRAN deactivated SCell, Cell2 is NR FR1 PSCell. Cell1 shall be configured as LTE PCell and Cell2 shall be configured as NR PSCell. The test consists of one time period, with duration of T1. Prior to the start of the time duration T1, the UE is connected to Cell1 and Cell2 and the RRC message including *measCycleSCell* or *allowInterruptions* for the deactivated E-UTRAN SCells is received at the UE antenna connector. During T1, LTE PCell and NR PSCell are continuously scheduled in DL.

**Table A.4.5.2.5.1-1: Interruptions during measurements on deactivated E-UTRAN SCC supported test configurations**

Config	Description
	LTE PCell + NR PSCell <sup>Note 2</sup>
1	LTE FDD, NR 15 kHz SSB SCS, 10 MHz bandwidth, FDD duplex mode
2	LTE FDD, NR 15 kHz SSB SCS, 10 MHz bandwidth, TDD duplex mode
3	LTE FDD, NR 30 kHz SSB SCS, 40 MHz bandwidth, TDD duplex mode
4	LTE TDD, NR 15 kHz SSB SCS, 10 MHz bandwidth, FDD duplex mode
5	LTE TDD, NR 15 kHz SSB SCS, 10 MHz bandwidth, TDD duplex mode
6	LTE TDD, NR 30 kHz SSB SCS, 40 MHz bandwidth, TDD duplex mode

Note 1: The UE is only required to be tested in one of the supported test configurations  
Note 2: The duplex mode of the LTE SCell is determined based on the band combination to be tested.

**Table A.4.5.2.5.1-2: General test parameters for E-UTRAN – NR interruptions during measurements on deactivated E-UTRAN SCC in synchronous EN-DC**

Parameter	Unit	Value	Comment
RF Channel Number		1, 2, 3	One is NR RF channel and the other two are E-UTRAN RF channels
Active PCell		Cell1	PCell on E-UTRAN RF channel number 1.
Active PSCell		Cell2	PSCell on NR RF channel number 2.
Configured deactivated SCell		Cell3	Deactivated SCell on E-UTRAN RF channel number 3.
CP length		Normal	Applicable to Cell1, Cell2 and Cell3
DRX		OFF	
Measurement gap pattern Id		OFF	
SCell measurement cycle ( <i>measCycleSCell</i> )	ms	640	
T1	s	10	

**Table A.4.5.2.5.1-3: NR cell specific test parameters for E-UTRAN – NR interruptions during measurements on deactivated E-UTRAN SCC in synchronous EN-DC**

Parameter	Unit	Cell2
<b>Frequency Range</b>		FR1
Duplex mode	Config 1,4	FDD
	Config 2,3,5,6	TDD
TDD configuration	Config 1,4	Not Applicable
	Config 2,5	TDDConf.1.1
	Config 3,6	TDDConf.2.1
BW <sub>channel</sub>	Config 1,4	10: N <sub>RB,c</sub> = 52
	Config 2,5	10: N <sub>RB,c</sub> = 52
	Config 3,6	40: N <sub>RB,c</sub> = 106
Initial DL BWP	Config 1,4	DLBWP.0.1

Configuration	Config 2,5		DLBWP.0.1
	Config 3,6		DLBWP.0.1
Dedicated DL BWP Configuration	Config 1,4		DLBWP.1.1
	Config 2,5		DLBWP.1.1
	Config 3,6		DLBWP.1.1
Initial UL BWP Configuration	Config 1,4		ULBWP.0.1
	Config 2,5		ULBWP.0.1
	Config 3,6		ULBWP.0.1
Dedicated UL BWP Configuration	Config 1,4		ULBWP.1.1
	Config 2,5		ULBWP.1.1
	Config 3,6		ULBWP.1.1
PDSCH Reference measurement channel	Config 1,4		SR.1.1 FDD
	Config 2,5		SR.1.1 TDD
	Config 3,6		SR.2.1 TDD
RMSI CORESET parameters	Config 1,4		CR.1.1 FDD
	Config 2,5		CR.1.1 TDD
	Config 3,6		CR.2.1 TDD
PDCCH CORESET parameters	Config 1,4		CCR.1.1 FDD
	Config 2,5		CCR.1.1 TDD
	Config 3,6		CCR.2.1 TDD
TRS configuration	Config 1,4		TRS.1.1 FDD
	Config 2,5		TRS.1.1 TDD
	Config 3,6		TRS.1.2 TDD
OCNG Patterns			OP.1
SMTc Configuration			SMTc.1
TCI state			TCI.State.0
SSB Configuration	Config 1,2,4,5		SSB.1 FR1
	Config 3,6		SSB.2 FR1
Correlation Matrix and Antenna Configuration			1x2 Low
EPRE ratio of PSS to SSS		dB	0
EPRE ratio of PBCH DMRS to SSS			
EPRE ratio of PBCH to PBCH DMRS			
EPRE ratio of PDCCH DMRS to SSS			
EPRE ratio of PDCCH to PDCCH DMRS			
EPRE ratio of PDSCH DMRS to SSS			
EPRE ratio of PDSCH to PDSCH			
EPRE ratio of OCNG DMRS to SSS(Note 1)			
EPRE ratio of OCNG to OCNG DMRS (Note 1)			
$N_{oc}$ <sup>Note 2</sup>			
SS-RSRP <sup>Note 3</sup>		dBm/15 kHz	-87
$\bar{E}_s/I_{ot}$		dB	17
$\bar{E}_s/N_{oc}$		dB	17
$I_o$ <sup>Note3</sup>	Config 1,2,4,5	dBm/9.36MHz	-58.96
	Config 3,6	dBm/38.16MHz	-52.86
Time offset to Cell1 <sup>Note 4</sup>		$\mu s$	3 for intra-band EN-DC, 33 for inter-band EN-DC
Propagation Condition			AWGN
<p>Note 1: OCNG shall be used such that both cells are fully allocated and a constant total transmitted power spectral density is achieved for all OFDM symbols.</p> <p>Note 2: Interference from other cells and noise sources not specified in the test is assumed to be constant over subcarriers and time and shall be modeled as AWGN of appropriate power for <math>N_{oc}</math> to be fulfilled.</p> <p>Note 3: SS-RSRP and <math>I_o</math> levels have been derived from other parameters for information purposes. They are not settable parameters themselves.</p> <p>Note 4: Receive time difference of signals received between subframe timing boundary of E-UTRA PCell and slot timing boundary of PSCell at the UE antenna connector including time alignment error between the two cells</p>			

A.4.5.2.5.2 Test Requirements

The UE shall be continuously scheduled in LTE PCell and NR PSCell during the entire length of T1. During the time duration T1 the UE shall transmit at least 99.5% of ACK/NACK on NR PSCell. The UE is only allowed to cause one interruption on PCell and one interruption on PSCell. Each interruption on NR PSCell shall not exceed X defined in

Table A.4.5.2.5.2-1 if the NR PSCell is not in the same band as the E-UTRAN deactivated SCell or Y in Table A.4.5.2.3.2-1 if the NR PSCell is in the same band as the E-UTRAN deactivated SCell.

**Table A.4.5.2.5.2-1: Interruption length X and Y at measurements on deactivated E-UTRA SCC**

$\mu$	NR Slot length (ms)	Interruption length X slot	Interruption length Y slot
		Sync	
0	1	1	1+SMTC duration
1	0.5	1	1+SMTC duration

Each interruption on E-UTRAN PCell shall not exceed 1 subframe if the PCell is not in the same band as the deactivated SCell, or 5 subframes if the PCell is in the same band as the deactivated SCell.

The rate of correct events observed during repeated tests shall be at least 90%.

#### A.4.5.2.6 E-UTRAN – NR FR1 interruptions during measurements on deactivated E-UTRAN SCC in asynchronous EN-DC

##### A.4.5.2.6.1 Test Purpose and Environment

The purpose of this test is to verify E-UTRAN PCell and NR PSCell interruptions during the measurement on the deactivated NR SCC, the UE missed ACK/NACK does not exceed the limits. This test will verify the missed ACK/NACK rate for E-UTRAN PCell and NR PSCell in EN-DC specified in TS 38.133 clause 8.2.1. Supported test configurations are shown in table A.4.5.2.6.1-1.

The general test parameters and NR cell specific test parameters are given in Table A.4.5.2.6.1-1 and A.4.5.2.6.1-2 below. And the E-UTRAN cell specific test parameters can refer to Table A.3.7.2.1-1. In the test there are three cells: Cell1, Cell2 and Cell3. Cell1 and Cell3 is E-UTRAN PCell and E-UTRAN deactivated SCell, Cell2 is NR FR1 PSCell. Cell1 shall be configured as LTE PCell and Cell2 shall be configured as NR PSCell. The test consists of one time period, with duration of T1. Prior to the start of the time duration T1, the UE is connected to Cell1 and Cell2 and the RRC message including *measCycleSCell* or *allowInterruptions* for the deactivated NR SCells is received at the UE antenna connector. During T1, LTE PCell and NR PSCell are continuously scheduled in DL.

**Table A.4.5.2.6.1-1: Interruptions during measurements on deactivated E-UTRAN SCC supported test configurations**

Config	Description
	LTE PCell + NR PSCell <sup>Note 2</sup>
1	LTE FDD, NR 15 kHz SSB SCS, 10 MHz bandwidth, FDD duplex mode
2	LTE FDD, NR 15 kHz SSB SCS, 10 MHz bandwidth, TDD duplex mode
3	LTE FDD, NR 30 kHz SSB SCS, 40 MHz bandwidth, TDD duplex mode
4	LTE TDD, NR 15 kHz SSB SCS, 10 MHz bandwidth, FDD duplex mode
5	LTE TDD, NR 15 kHz SSB SCS, 10 MHz bandwidth, TDD duplex mode
6	LTE TDD, NR 30 kHz SSB SCS, 40 MHz bandwidth, TDD duplex mode

Note 1: The UE is only required to be tested in one of the supported test configurations  
Note 2: The duplex mode of the LTE SCell is determined based on the band combination to be tested.

**Table A.4.5.2.6.1-2: General test parameters for E-UTRAN – NR interruptions during measurements on deactivated E-UTRAN SCC in asynchronous EN-DC**

Parameter	Unit	Value	Comment
RF Channel Number		1, 2, 3	One is NR RF channel and the other two are E-UTRAN RF channels
Active PCell		Cell1	PCell on E-UTRAN RF channel number 1.
Configured PSCell		Cell2	PSCell on NR RF channel number 2.
Configured deactivated SCell		Cell3	Deactivated SCell on E-UTRAN RF channel number 3.
CP length		Normal	Applicable to Cell1, Cell2 and Cell3
DRX		OFF	
Measurement gap pattern Id		OFF	
SCell measurement cycle ( <i>measCycleSCell</i> )	ms	640	
T1	s	10	

**Table A.4.5.2.6.1-3: NR cell specific test parameters for E-UTRAN – NR interruptions during measurements on deactivated E-UTRAN SCC in asynchronous EN-DC**

Parameter		Unit	Cell2
Frequency Range			FR1
Duplex mode	Config 1,4		FDD
	Config 2,3,5,6		TDD
TDD configuration	Config 1,4		Not Applicable
	Config 2,5		TDDConf.1.1
	Config 3,6		TDDConf.2.1
BW <sub>channel</sub>	Config 1,4		10: N <sub>RB,c</sub> = 52
	Config 2,5		10: N <sub>RB,c</sub> = 52
	Config 3,6		40: N <sub>RB,c</sub> = 106
Initial DL BWP Configuration	Config 1,4		DLBWP.0.1
	Config 2,5		DLBWP.0.1
	Config 3,6		DLBWP.0.1
Dedicated DL BWP Configuration	Config 1,4		DLBWP.1.1
	Config 2,5		DLBWP.1.1
	Config 3,6		DLBWP.1.1
Initial UL BWP Configuration	Config 1,4		ULBWP.0.1
	Config 2,5		ULBWP.0.1
	Config 3,6		ULBWP.0.1
Dedicated UL BWP Configuration	Config 1,4		ULBWP.1.1
	Config 2,5		ULBWP.1.1
	Config 3,6		ULBWP.1.1
PDSCH Reference measurement channel	Config 1,4		SR.1.1 FDD
	Config 2,5		SR.1.1 TDD
	Config 3,6		SR.2.1 TDD
RMSI CORESET parameters	Config 1,4		CR.1.1 FDD
	Config 2,5		CR.1.1 TDD
	Config 3,6		CR.2.1 TDD
PDCCH CORESET parameters	Config 1,4		CCR.1.1 FDD
	Config 2,5		CCR.1.1 TDD
	Config 3,6		CCR.2.1 TDD
TRS configuration	Config 1,4		TRS.1.1 FDD
	Config 2,5		TRS.1.1 TDD
	Config 3,6		TRS.1.2 TDD
OCNG Patterns			OP.1
SMTC Configuration			SMTC.1
TCI state			TCI.State.0
SSB Configuration	Config 1,2,4,5		SSB.1 FR1
	Config 3,6		SSB.2 FR1
Correlation Matrix and Antenna Configuration			1x2 Low
EPRE ratio of PSS to SSS		dB	0
EPRE ratio of PBCH DMRS to SSS			
EPRE ratio of PBCH to PBCH DMRS			
EPRE ratio of PDCCH DMRS to SSS			
EPRE ratio of PDCCH to PDCCH DMRS			
EPRE ratio of PDSCH DMRS to SSS			
EPRE ratio of PDSCH to PDSCH			
EPRE ratio of OCNG DMRS to SSS(Note 1)			
EPRE ratio of OCNG to OCNG DMRS (Note 1)			
N <sub>oc</sub> <sup>Note 2</sup>		dBm/15 kHz	-104
SS-RSRP <sup>Note 3</sup>		dBm/15 kHz	-87
$\hat{E}_s/I_{ot}$		dB	17
$\hat{E}_s/N_{oc}$		dB	17
I <sub>o</sub> <sup>Note3</sup>	Config 1,2,4,5	dBm/9.36MHz	-58.96
	Config 3,6	dBm/38.16MHz	-52.86
Time offset to Cell1 <sup>Note 4</sup>	Config 1,2,4,5	$\mu$ s	500
	Config 3,6		250
Propagation Condition			AWGN



Note 1:	OCNG shall be used such that both cells are fully allocated and a constant total transmitted power spectral density is achieved for all OFDM symbols.
Note 2:	Interference from other cells and noise sources not specified in the test is assumed to be constant over subcarriers and time and shall be modeled as AWGN of appropriate power for $N_{oc}$ to be fulfilled.
Note 3:	SS-RSRP and $I_0$ levels have been derived from other parameters for information purposes. They are not settable parameters themselves.
Note 4:	Receive time difference of signals received between subframe timing boundary of E-UTRA PCell and slot timing boundary of PSCell at the UE antenna connector including time alignment error between the two cells

#### A.4.5.2.6.2 Test Requirements

The UE shall be continuously scheduled in LTE PCell and NR PSCell during the entire length of T1. During the time duration T1 the UE shall transmit at least 99.5% of ACK/NACK on E-UTRAN PCell and NR PSCell. The UE is only allowed to cause one interruption on PCell and one interruption on PSCell. Each interruption on NR PSCell shall not exceed the value defined in Table A.4.5.2.4.2-1 and Table A.4.5.2.4.2-2.

**Table A.4.5.2.6.2-1: Interruption duration if the NR PSCell is not in the same band as the E-UTRAN deactivated SCell**

$\mu$	NR Slot length (ms)	Interruption length
0	1	2
1	0.5	2

**Table A.4.5.2.6.2-2: Interruption duration if the NR PSCell is in the same band as the E-UTRAN deactivated SCell**

$\mu$	NR Slot length (ms)	Interruption length
0	1	2 + SMTC duration
1	0.5	2 + SMTC duration

Each interruption on E-UTRAN PCell shall not exceed 1 subframe if the PCell is not in the same band as the deactivated SCell, or 5 subframes if the PCell is in the same band as the deactivated SCell.

The rate of correct events observed during repeated tests shall be at least 90%.

#### A.4.5.2.7 Void

#### A.4.5.2.8 E-UTRAN - NR FR1 interruptions at NR SRS carrier based switching in asynchronous EN-DC

##### A.4.5.2.8.1 Test Purpose and Environment

The purpose of this test is to verify that when a UE needs to transmit aperiodic SRS, the UE can perform carrier based switching to one carrier not configured for PUCCH/PUSCH transmission from a CC with PUCCH/PUSCH transmission. The test will verify the interruption requirements on E-UTRAN PCell and NR PSCell in clause 8.2.1.2.12. Supported test configurations are shown in table A.4.5.2.8.1-1.

The general test parameters and NR cell specific test parameters are given in Table A.4.5.2.8.1-2 and A.4.5.2.8.1-3 below. And the E-UTRAN cell specific test parameters can refer to Table A.3.7.2.1-1. In the test there are three cells: Cell1, Cell2 and Cell3. Cell1 is E-UTRAN PCell, Cell2 is NR PSCell in FR1 with PUCCH/PUSCH transmission, Cell3 is an activated NR SCell in FR1 which operates in downlink without PUCCH/PUSCH transmission. The UE is configured with the SRS carrier based switching between PSCell and SCell.

The test consists of two successive time periods, with duration of T1 and T2, respectively. Throughout the test the UE shall be continuously scheduled on PCell and PSCell. Immediately at the beginning of T2, a PDCCH with TPC-SRS-RNTI is sent to the UE to initiate NR SRS switching.

**Table A.4.5.2.8.1-1: Interruptions at SRS carrier switching supported test configurations in FR1**

Config	Description
1	LTE FDD, NR 15 kHz SSB SCS, 10 MHz bandwidth, PSCell FDD duplex mode, SCell TDD duplex mode
2	LTE FDD, NR 15 kHz SSB SCS, 10 MHz bandwidth, PSCell TDD duplex mode, SCell TDD duplex mode
3	LTE FDD, NR 30 kHz SSB SCS, 40 MHz bandwidth, TDD duplex mode
4	LTE TDD, NR 15 kHz SSB SCS, 10 MHz bandwidth, PSCell FDD duplex mode, SCell TDD duplex mode
5	LTE TDD, NR 15 kHz SSB SCS, 10 MHz bandwidth, PSCell TDD duplex mode, SCell TDD duplex mode
6	LTE TDD, NR 30 kHz SSB SCS, 40 MHz bandwidth, TDD duplex mode
Note:	The UE is only required to be tested in one of the supported test configurations

**Table A.4.5.2.8.1-2: General test parameters for E-UTRAN – NR FR1 interruptions at SRS carrier based switching in asynchronous EN-DC**

Parameter	Unit	Value	Comment
RF Channel Number		1, 2, 3	One is E-UTRAN RF channel and the other two are NR RF channels
Active PCell		Cell1	PCell on E-UTRAN RF channel number 1.
Configured PSCell		Cell2	Configured PSCell on NR RF channel number 2.
Configured SCell		Cell3	Configured activated secondary cell on NR RF channel number 3.
CP length		Normal	Applicable to Cell1, Cell2 and Cell3.
DRX		OFF	Continuous monitoring of primary cell
Filter coefficient		0	L3 filtering is not used
T1	s	5	
T2	ms	40	UE shall perform SRS switching during T2

**Table A.4.5.2.8.1-3: NR Cell specific test parameters for E-UTRAN – NR FR1 interruptions at SRS carrier based switching in asynchronous EN-DC**

Parameter	Unit	Cell2	Cell3
Frequency Range		FR1	FR1
Duplex mode	Config 1,4	FDD	TDD
	Config 2,3,5,6	TDD	TDD
TDD configuration	Config 1,4	Not Applicable	TDDConfig.1.1
	Config 2,5	TDDConf.1.1	TDDConfig.1.1
	Config 3,6	TDDConf.2.1	TDDConfig.2.1
BW <sub>channel</sub>	Config 1,2,4,5	10: N <sub>RB,c</sub> = 52	10: N <sub>RB,c</sub> = 52
	Config 3,6	40: N <sub>RB,c</sub> = 106	40: N <sub>RB,c</sub> = 106
DL Initial BWP configuration	Config 1-6	DLBWP.0.1	DLBWP.0.1
DL dedicated BWP configuration	Config 1-6	DLBWP.1.1	DLBWP.1.1
UL Initial BWP configuration	Config 1-6	ULBWP.0.1	-
UL dedicated BWP configuration	Config 1-6	ULBWP.1.1	-
PDSCH Reference measurement channel	Config 1,4	SR.1.1 FDD	SR.1.1 TDD
	Config 2,5	SR.1.1 TDD	SR.1.1 TDD
	Config 3,6	SR.2.1 TDD	SR.2.1 TDD
RMSI CORESET Reference Channel	Config 1,4	CR.1.1 FDD	CR.1.1 TDD
	Config 2,5	CR.1.1 TDD	CR.1.1 TDD
	Config 3,6	CR.2.1 TDD	CR.2.1 TDD
RMC CORESET Reference Channel	Config 1,4	CCR.1.1 FDD	CCR.1.1 TDD
	Config 2,5	CCR.1.1 TDD	CCR.1.1 TDD

	Config 3,6		CCR.2.1 TDD	CCR.2.1 TDD
OCNG Patterns			OP.1	OP.1
TRS configuration	Config 1,4		TRS.1.1 FDD	TRS.1.1 TDD
	Config 2,5		TRS.1.1 TDD	TRS.1.1 TDD
	Config 3,6		TRS.1.2 TDD	TRS.1.2 TDD
SMTC configuration			SMTC.1	SMTC.1
SSB configuration	Config 1,2,4,5		SSB.1 FR1	SSB.1 FR1
	Config 3,6		SSB.2 FR1	SSB.2 FR1
PDSCH/PDCCH subcarrier spacing	Config 1,2,4,5	kHz	15 kHz	15 kHz
	Config 3,6		30 kHz	30 kHz
SRS Configuration	Config 1,2,4,5	kHz	-	SRS.4 TDD
	Config 3,6		-	SRS.5 TDD
PUCCH/PUSCH subcarrier spacing	Config 1,2,4,5	kHz	15 kHz	-
	Config 3,6		30 kHz	-
EPRE ratio of PSS to SSS		dB	0	0
EPRE ratio of PBCH DMRS to SSS				
EPRE ratio of PBCH to PBCH DMRS				
EPRE ratio of PDCCH DMRS to SSS				
EPRE ratio of PDCCH to PDCCH DMRS				
EPRE ratio of PDSCH DMRS to SSS				
EPRE ratio of PDSCH to PDSCH				
EPRE ratio of OCNG DMRS to SSS (Note 1)				
EPRE ratio of OCNG to OCNG DMRS (Note 1)				
$N_{oc}$ <sup>Note2</sup>		dBm/15kHz	-104	-104
$N_{oc}$ <sup>Note2</sup>	Config 1,2,4,5	dBm/SCS	-104	-104
	Config 3,6		-101	-101
SS-RSRP <sup>Note3</sup>	Config 1,2,4,5	dBm/SCS	-87	-87
	Config 3,6		-84	-84
$\hat{E}_s / I_{ot}$		dB	17	17
$\hat{E}_s / N_{oc}$		dB	17	17
$I_o$ <sup>Note3</sup>	Config 1,2,4,5	dBm/9.36MHz	-58.96	-58.96
	Config 3,6	dBm/38.16MHz	-52.86	-52.86
Time offset to Cell1 <sup>Note 5</sup>		$\mu$ s	-	3
Propagation condition		-	AWGN	AWGN
<p>Note 1: OCNG shall be used such that both cells are fully allocated and a constant total transmitted power spectral density is achieved for all OFDM symbols.</p> <p>Note 2: Interference from other cells and noise sources not specified in the test is assumed to be constant over subcarriers and time and shall be modelled as AWGN of appropriate power for <math>N_{oc}</math> to be fulfilled.</p> <p>Note 3: <math>I_o</math> levels have been derived from other parameters for information purposes. They are not settable parameters themselves.</p> <p>Note 5: Receive time difference between slot boundaries of signals received from the two cells at the UE antenna connector including time alignment error between the two cells.</p>				

Table A.4.5.2.8.1-4: Void

A.4.5.2.8.2 Test Requirements

During the time duration T2, the interruption on NR PSCell during the switching from NR PSCell to NR SCell shall not exceed the value as defined in Table A.4.5.2.8.2-1 dependent on the applied SRS carrier switching time.

**Table A4.5.2.8.2-1: Interruption length on NR active serving cells at NR SRS carrier switching (slot)**

$\mu$	NR Slot length (ms) of victim cell	SRS carrier switching time (us) <sup>Note 1</sup>	Interruption length X1 (slots)	
			Sub carrier spacing for aggressor cell (kHz)	
			15	30
0	1	≤ 200	2	2
		300, 500	2	2
		900	3	3
1	0.5	≤ 200	3	2
		300, 500	3	3
		900	4	4

Note1: NR SRS carrier switching time is UE capability indicated by higher layer parameter *SRS-SwitchingTimeNR*.

During the time duration T2, the interruption on E-UTRAN PCell during the switching from NR PSCell to NR SCell shall not exceed the value as defined in Table A.4.5.2.8.2-2 dependent on the applied SRS carrier switching time.

**Table 4.5.2.8.2-2: Interruption length on E-UTRAN active serving cells at NR SRS carrier switching**

NR SRS carrier switching time (us) <sup>note1</sup>	Interruption length X1 (subframes)
≤500	2
900	3

Note1: NR SRS carrier switching time is UE capability indicated by higher layer parameter *SRS-SwitchingTimeNR*.

The rate of correct events observed during repeated tests shall be at least 90%.

A.4.5.2.9 E-UTRAN – NR interruptions at E-UTRA SRS carrier based switching

A.4.5.2.9.1 Test Purpose and Environment

The purpose of this test is to verify that when a UE needs to transmit aperiodic SRS on a PUSCH-less carrier of SCell, the UE can perform carrier based switching to one PUSCH-less SCCs from a CC with PUSCH. The test will verify the interruption requirements on active serving cell in SCG in clause 8.2.1.2.13. Supported test configurations are shown in table A.4.5.2.9.1-1.

In the test there are three cells: cell1, cell2 and cell3. Cell1 is E-UTRAN PCell on the primary component carrier. Cell3 is E-UTRAN SCell on the TDD secondary component carrier which operates in downlink without PUCCH/PUSCH. Cell2 is NR FR1 PSCell. The UE is configured with the SRS switching between E-UTRAN PCell and E-UTRAN SCell. The general test parameters, NR cell specific test parameters and E-UTRA SRS configurations are given in Table A.4.5.2.9.1-2, A.4.5.2.9.1-3 and Table A.4.5.2.9.1-4 below. And the E-UTRAN cell specific test parameters (for cell1 and cell3) can refer to Table A.3.7.2.1-1. The test consists of two successive time periods, with duration of T1 and T2, respectively. During T1 LTE PCell and NR PSCell are continuously scheduled in DL. Immediately at the beginning of T2, the UE is triggered for SRS switching by DCI 2\_3 scheduling. After T2, the UE is expected to transmit aperiodic SRS on a special slot in the configured TDD UL/DL configuration, as scheduled by DCI 2\_3.

**Table A.4.5.2.9.1-1: E-UTRAN – NR interruptions at E-UTRA SRS carrier based switching supported test configurations**

Config	Description
--------	-------------

1	LTE FDD(cell1), LTE TDD (cell3), NR 15 kHz SSB SCS, 10 MHz bandwidth, FDD duplex mode
2	LTE FDD(cell1), LTE TDD (cell3), NR 15 kHz SSB SCS, 10 MHz bandwidth, TDD duplex mode
3	LTE FDD(cell1), LTE TDD (cell3), NR 30 kHz SSB SCS, 40 MHz bandwidth, TDD duplex mode
4	LTE TDD(cell1), LTE TDD (cell3), NR 15 kHz SSB SCS, 10 MHz bandwidth, FDD duplex mode
5	LTE TDD(cell1), LTE TDD (cell3), NR 15 kHz SSB SCS, 10 MHz bandwidth, TDD duplex mode
6	LTE TDD(cell1), LTE TDD (cell3), NR 30 kHz SSB SCS, 40 MHz bandwidth, TDD duplex mode
Note: The UE is only required to be tested in one of the supported test configurations	

**Table A.4.5.2.9.1-2: General test parameters for E-UTRAN – NR interruptions at E-UTRA SRS carrier based switching**

Parameter	Unit	Value	Comment
RF Channel Number		1, 2, 3	One is NR RF channel and the other two are E-UTRAN RF channels
Active PCell		Cell1	PCell on E-UTRAN RF channel number 1.
Active PSCell		Cell2	PSCell on NR RF channel number 2.
Activated SCell		Cell3	SCell on E-UTRAN RF channel number 3.
CP length		Normal	Applicable to Cell1, Cell2 and Cell3
DRX		OFF	
Measurement gap pattern Id		OFF	
T1	s	0.2	
T2	s	0.2	UE shall perform SRS switching during T2

**Table A.4.5.2.9.1-3: NR cell specific test parameters for E-UTRAN – NR interruptions at E-UTRA SRS carrier based switching**

Parameter	Unit	Cell2
<b>Frequency Range</b>		FR1
Duplex mode	Config 1,4	FDD
	Config 2,3,5,6	TDD
TDD configuration	Config 1,4	Not Applicable
	Config 2,5	TDDConf.1.1
	Config 3,6	TDDConf.2.1
BW <sub>channel</sub>	Config 1,4	10: N <sub>RB,c</sub> = 52
	Config 2,5	10: N <sub>RB,c</sub> = 52
	Config 3,6	40: N <sub>RB,c</sub> = 106
Initial DL BWP Configuration	Config 1,4	DLBWP.0.1
	Config 2,5	DLBWP.0.1
	Config 3,6	DLBWP.0.1
Dedicated DL BWP Configuration	Config 1,4	DLBWP.1.1
	Config 2,5	DLBWP.1.1
	Config 3,6	DLBWP.1.1
Initial UL BWP Configuration	Config 1,4	ULBWP.0.1
	Config 2,5	ULBWP.0.1
	Config 3,6	ULBWP.0.1
Dedicated UL BWP Configuration	Config 1,4	ULBWP.1.1
	Config 2,5	ULBWP.1.1
	Config 3,6	ULBWP.1.1
PDSCH Reference measurement channel	Config 1,4	SR.1.1 FDD
	Config 2,5	SR.1.1 TDD
	Config 3,6	SR.2.1 TDD
RMSI CORESET parameters	Config 1,4	CR.1.1 FDD
	Config 2,5	CR.1.1 TDD
	Config 3,6	CR.2.1 TDD
PDCCH CORESET parameters	Config 1,4	CCR.1.1 FDD
	Config 2,5	CCR.1.1 TDD
	Config 3,6	CCR.2.1 TDD
TRS configuration	Config 1,4	TRS.1.1 FDD

	Config 2,5		TRS.1.1 TDD
	Config 3,6		TRS.1.2 TDD
OCNG Patterns			OP.1
SMTC Configuration			SMTC.1
TCI state			TCI.State.0
SSB Configuration	Config 1,2,4,5		SSB.1 FR1
	Config 3,6		SSB.2 FR1
Correlation Matrix and Antenna Configuration			1x2 Low
EPRE ratio of PSS to SSS		dB	0
EPRE ratio of PBCH DMRS to SSS			
EPRE ratio of PBCH to PBCH DMRS			
EPRE ratio of PDCCH DMRS to SSS			
EPRE ratio of PDCCH to PDCCH DMRS			
EPRE ratio of PDSCH DMRS to SSS			
EPRE ratio of PDSCH to PDSCH			
EPRE ratio of OCNG DMRS to SSS(Note 1)			
EPRE ratio of OCNG to OCNG DMRS (Note 1)			
$N_{oc}$ <sup>Note 2</sup>		dBm/15 kHz	-104
SS-RSRP <sup>Note 3</sup>		dBm/15 kHz	-87
$\bar{E}_s/I_{ot}$		dB	17
$\bar{E}_s/N_{oc}$		dB	17
$I_o$ <sup>Note3</sup>	Config 1,2,4,5	dBm/9.36MHz	-58.96
	Config 3,6	dBm/38.16MHz	-52.86
Time offset to Cell1 <sup>Note 4</sup>		$\mu$ s	33
Propagation Condition			AWGN
<p>Note 1: OCNG shall be used such that both cells are fully allocated and a constant total transmitted power spectral density is achieved for all OFDM symbols.</p> <p>Note 2: Interference from other cells and noise sources not specified in the test is assumed to be constant over subcarriers and time and shall be modeled as AWGN of appropriate power for <math>N_{oc}</math> to be fulfilled.</p> <p>Note 3: SS-RSRP and <math>I_o</math> levels have been derived from other parameters for information purposes. They are not settable parameters themselves.</p> <p>Note 4: Receive time difference of signals received between subframe timing boundary of E-UTRA PCell and slot timing boundary of PSCell at the UE antenna connector including time alignment error between the two cells</p>			

**Table A.4.5.2.9.1-4: Sounding Reference Symbol Configuration for E-UTRAN – NR interruptions at E-UTRA SRS carrier based switching**

Field	Value	Comment
srsBandwidthConfiguration	bw5	
srsSubframeConfiguration	Sc8	Once every 5 subframes
ackNackSrsSimultaneousTransmission	FALSE	
srsMaxUpPTS	N/A	Not applicable
srsBandwidth	0	No hopping
srsHoppingBandwidth	hbw0	
frequencyDomainPosition	0	
Duration	TRUE	Indefinite duration
Srs-ConfigIndexAp	17	SRS periodicity of 10ms. See Table 8.2-5 in TS 36.213 for aperiodic SRS transmission.
transmissionComb	0	
cyclicShift	cs0	No cyclic shift
SRS-AntennaPort	an1	Number of antenna ports used for SRS transmission
Note: For further information see clause 6.3.2 in TS 36.331.		

**A.4.5.2.9.2 Test Requirements**

The UE shall be continuously scheduled in NR PSCell throughout the test and during the time duration T2, Each interruption on NR PSCell shall not exceed X defined in Table A.4.5.2.9.2-1.

**Table A.4.5.2.9.2-1: Interruption length X (slot) E-UTRAN – NR at E-UTRA SRS carrier based switching**

$\mu$	NR Slot length (ms)	Interruption length X3 (slots)
0	1	2
1	0.5	3

The rate of correct events observed during repeated tests shall be at least 90%.

### A.4.5.3 SCell Activation and Deactivation Delay

#### A.4.5.3.1 SCell Activation and deactivation of known SCell in FR1 for 160ms SCell measurement cycle

##### A.4.5.3.1.1 Test Purpose and Environment

The purpose of this test is to verify that the SCell activation and deactivation times are within the requirements stated in clause 8.3, when the SCell in FR1 is known by the UE at the time of activation.

The supported test configurations for LTE PCell and NR PSCell are shown in table A.4.5.3.1.1-1 below. Supported test configurations for NR SCell are shown in table A.4.5.3.1.1-1A below. Test configuration for LTE PCell and NR PSCell and test configuration for NR SCell are chosen independently. The test parameters are given in Tables A.4.5.3.1.1-2 and cell-specific parameters in A.4.5.3.1.1-3 and A.4.5.3.1.1-4 below. The test consists of three successive time periods, with duration of T1, T2 and T3, respectively. There are three carriers, E-UTRA has one cell, NR has two cells. All cells have constant signal levels throughout the test. Before the test starts the UE is connected to Cell 1 (PCell) on E-UTRA and Cell 2 (PSCell) on NR, but is not aware of Cell 3 (SCell) on NR. The UE is monitoring the PCell and PSCell. The UE shall be continuously scheduled in the PCell and PSCell throughout the whole test.

At the beginning of T1 the UE receives an RRC message by which the SCell (Cell 3) becomes configured on NR. The UE now starts monitoring the SCell. The test equipment sends a MAC message for activation of the SCell.

the start of time period T2. The UE shall be able to report valid CSI in PSCell for the activated SCell at latest in slot  $m + \frac{T_{\text{HARQ}} + T_{\text{activation\_time}} + T_{\text{CSI\_Reporting}}}{\text{NR slot length}}$ , as defined in clause 8.3. The UE shall start reporting CSI in PSCell after at least one CSI-RS transmission occasion for channel measurement and reporting after slot  $(m+k)$  and shall report CQI index 0 (out-of-range) until the SCell activation has been completed. Any PSCell interruption due to activation of SCell shall occur in the slot  $m + 1 + \frac{T_{\text{HARQ}}}{\text{NR slot length}}$  to slot  $m + 1 + \frac{T_{\text{HARQ}} + 3\text{ms} + T_X}{\text{NR slot length}} + N_{\text{interruption}}$ , as defined in clause 8.3, where  $N_{\text{interruption}}$  is the interruption length given in clause 8.2. Any E-UTRA PCell interruption due to activation of SCell shall occur in the subframe  $m_1 + 1 + \frac{T_{\text{HARQ}}}{\text{EUTRA slot length}}$  to subframe  $m_2 + 1 + \frac{T_{\text{HARQ}} + 3\text{ms} + T_X}{\text{EUTRA slot length}} + N_{\text{interruption}}$ , where  $m_1$  and  $m_2$  are the index of the first and last subframe of E-UTRA PCell which overlaps with slot  $m$ , and  $N_{\text{interruption}}$  is the interruption length given in TS 36.133 [14] clause 7.32.

Time period T3 starts when a MAC message for deactivation of SCell, sent from the test equipment to the UE in a slot # denoted  $n$ , is received at the UE antenna connector. The UE shall carry out deactivation of the SCell in a slot  $n + \frac{T_{\text{HARQ}} + 3\text{ms}}{\text{NR slot length}}$ , as defined in clause 8.3. The starting point of any PSCell interruption due to the deactivation shall occur in the slot  $n + 1 + \frac{T_{\text{HARQ}}}{\text{NR slot length}}$  to  $n + 1 + \frac{T_{\text{HARQ}} + 3\text{ms}}{\text{NR slot length}}$ , as defined in clause 8.3. The starting point of any E-UTRA PCell interruption due to the deactivation shall occur in the subframe  $n_1 + 1 + \frac{T_{\text{HARQ}}}{\text{EUTRA subframe length}}$  to subframe  $n_2 + 1 + \frac{T_{\text{HARQ}} + 3\text{ms}}{\text{EUTRA subframe length}}$ , where  $n_1$  and  $n_2$  are the index of the first and last subframe of E-UTRA PCell which overlaps with slot  $n$ .

The test equipment verifies that potential interruption is carried out in the correct time span by monitoring ACK/NACK sent in PSCell during activation and deactivation of SCell, respectively.

The test equipment verifies the activation time by counting the slots from the time when the SCell activation command is sent until a CSI report with other than CQI index 0 is received.

The test equipment verifies the deactivation time by counting the slots from the time when the SCell deactivation command is sent until CSI reporting for SCell is discontinued.

**Table A.4.5.3.1.1-1: known FR1 SCell activation in non-DRX for 160ms SCell measurement cycle supported test configurations for LTE PCell and NR PSCell**

Config	Description
1	LTE FDD, NR 15 kHz SSB SCS, $\geq 10$ MHz bandwidth, FDD duplex mode
2	LTE FDD, NR 15 kHz SSB SCS, $\geq 10$ MHz bandwidth, TDD duplex mode
3	LTE FDD, NR 30 kHz SSB SCS, $\geq 40$ MHz bandwidth, TDD duplex mode
4	LTE TDD, NR 15 kHz SSB SCS, $\geq 10$ MHz bandwidth, FDD duplex mode
5	LTE TDD, NR 15 kHz SSB SCS, $\geq 10$ MHz bandwidth, TDD duplex mode
6	LTE TDD, NR 30 kHz SSB SCS, $\geq 40$ MHz bandwidth, TDD duplex mode
Note 1:	The UE is only required to be tested in one of the supported test configurations
Note 2:	The UE is only required to be tested in one with smallest aggregated channel bandwidth from supported band combinations which is composed of CCs $\geq$ the bandwidth ( $BW_{channel}$ ) defined in each test configuration,

**Table A.4.5.3.1.1-1A: known FR1 SCell activation in non-DRX for 160ms SCell measurement cycle supported test configurations for NR SCell**

Config <sub>SCell</sub>	Description
1	NR 15 kHz SSB SCS, $\geq 10$ MHz bandwidth, FDD duplex mode
2	NR 15 kHz SSB SCS, $\geq 10$ MHz bandwidth, TDD duplex mode
3	NR 30 kHz SSB SCS, $\geq 40$ MHz bandwidth, TDD duplex mode
Note 1:	The UE is only required to be tested in one of the supported test configurations
Note 2:	The UE is only required to be tested in one with smallest aggregated channel bandwidth from supported band combinations which is composed of CCs $\geq$ the bandwidth ( $BW_{channel}$ ) defined in each test configuration,

**Table A.4.5.3.1.1-2: General test parameters for known FR1 SCell activation case, 160ms SCell measurement cycle**

Parameter	Unit	Value	Comment
RF Channel Number		1,2,3	One E-UTRAN radio channel (1) and two NR radio channel (2,3) are used for this test
Active PCell		Cell 1	Primary cell on E-UTRAN RF channel number 1. As specified in clause A.3.7.2.1
Active PSCell		Cell 2	Primary secondary cell on NR RF channel number 2.
Configured deactivated SCell		Cell 3	Configured deactivated secondary cell on NR RF channel number 3
CP length		Normal	
DRX		OFF	Continuous monitoring of primary cell
Cell-individual offset for cells on E-UTRA RF channel number	dB	0	Individual offset for cells on primary component carrier.
Cell-individual offset for cells on NR channel number	dB	0	Individual offset for cells on secondary component carrier.
SCell measurement cycle (measCycleSCell)	ms	160	
Cell3 timing offset to cell2	$\mu$ s	0	
Time alignment error between cell3 and cell2	$\mu$ s	$\leq$ Time alignment error as specified in TS 38.104 [13] clause 6.5.3.1.	The value of time alignment error depends upon the type of carrier aggregation.
T1	s	7	During this time the PSCell shall be known and the SCell configured and detected.
T2	s	1	During this time the UE shall activate the SCell.
T3	s	1	During this time the UE shall deactivate the SCell.
A3-offset	dB	-15	



$T_{HARQ}$	ms	$k_1$ NR slot length	$k_1$ is a number of slots indicated by the PDSCH-to-HARQ feedback timing indicator field in a corresponding DCI format or provided by <i>dl-DataToUL-ACK</i> if the PDSCH-to-HARQ feedback timing field is not present in the DCI format, the value is defined in 38.213 [3]
$T_{CSI\_Reporting}$	ms	15	The delay (in ms) including uncertainty in acquiring the first available downlink CSI reference resource, UE processing time for CSI reporting (clause 5.2.2.5 in TS 38.214) and uncertainty in acquiring the first available CSI reporting resources as specified in TS 38.331 [2]
$k$	slot	$k_1 + 3 \cdot N_{slot}^{subframe, \mu} + 1$	As specified in clause 4.3 of TS 38.213 [3]

**Table A.4.5.3.1.1-3: Cell specific test parameters for NR PSCell for known FR1 SCell activation case, 160ms SCell measurement cycle**

Parameter		Unit	Cell 2		
			T1	T2	T3
SSB ARFCN			freq1		
Duplex mode	Config 1,4		FDD		
	Config 2,3,5,6		TDD		
TDD configuration	Config 1,4		Not Applicable		
	Config 2,5		TDDConf.1.1		
	Config 3,6		TDDConf.2.1		
$BW_{channel}$	Config 1,4	MHz	Note 7		
	Config 2,5		Note 7		
	Config 3,6		Note 7		
$BW_{occupied}$	Config 1,4	RB	52 <sup>Note 5</sup>		
	Config 2,5		52 <sup>Note 5</sup>		
	Config 3,6		106 <sup>Note 6</sup>		
DL initial BWP configuration	Config 1, 2, 3, 4, 5, 6		DLBWP.0.1		
DL dedicated BWP configuration	Config 1, 2, 3, 4, 5, 6		DLBWP.1.1		
UL initial BWP configuration	Config 1, 2, 3, 4, 5, 6		ULBWP.0.1		
UL dedicated BWP configuration	Config 1, 2, 3, 4, 5, 6		ULBWP.1.1		
DRX Cycle		ms	Not Applicable		
PDSCH Reference measurement channel	Config 1,4		SR.1.1 FDD		
	Config 2,5		SR.1.1 TDD		
	Config 3,6		SR.2.1 TDD		
RMSI CORESET Reference Channel	Config 1,4		CR.1.1 FDD		
	Config 2,5		CR.1.1 TDD		
	Config 3,6		CR.2.1 TDD		
RMC CORESET Reference Channel	Config 1,4		CCR.1.1 FDD		
	Config 2,5		CCR.1.1 TDD		
	Config 3,6		CCR.2.1 TDD		
TRS configuration	Config 1,4		TRS.1.1 FDD		
	Config 2,5		TRS.1.1 TDD		
	Config 3,6		TRS.1.2 TDD		
OCNG Patterns	Config 1,2,4,5		OP.1 <sup>Note 5</sup>		
	Config 3,6		OP.1 <sup>Note 6</sup>		
SMTC configuration			SMTC.1		
SSB configuration	Config 1,2,4,5		SSB.1 FR1		
	Config 3,6		SSB.2 FR1		

CSI-RS configuration for CSI reporting	Config 1,4		CSI-RS.1.1 FDD
	Config 2,5		CSI-RS.1.1 TDD
	Config 3,6		CSI-RS.2.1 TDD
PDSCH/PDCCH subcarrier spacing	Config 1,2,4,5	kHz	15
	Config 3,6		30
reportConfigType	Config 1-6		periodic
reportQuantity	Config 1-6		cri-RI-PMI-CQI
CSI reporting periodicity	Config 1,2,4,5	slot	5
	Config 3,6		10
CSI reporting offset	Config 1,2,4,5	slot	2
	Config 3,6		4
EPRE ratio of PSS to SSS		dB	0
EPRE ratio of PBCH DMRS to SSS			
EPRE ratio of PBCH to PBCH DMRS			
EPRE ratio of PDCCH DMRS to SSS			
EPRE ratio of PDCCH to PDCCH DMRS			
EPRE ratio of PDSCH DMRS to SSS			
EPRE ratio of PDSCH to PDSCH			
EPRE ratio of OCNG DMRS to SSS <sup>Note 1</sup>			
EPRE ratio of OCNG to OCNG DMRS <sup>Note 1</sup>			
$N_{oc}^{Note2}$		dBm/15kHz	-104
$N_{oc}^{Note2}$	Config 1,2,4,5	dBm/SCS	-104
	Config 3,6		-101
$\hat{E}_s/I_{ot}$		dB	17
$\hat{E}_s/N_{oc}$		dB	17
SS-RSRP <sup>Note3</sup>	Config 1,2,4,5	dBm/SCS	-87
	Config 3,6		-84
SCH_RP <sup>Note 3</sup>		dBm/15 kHz	-87
$I_o^{Note3}$	Config 1,2,4,5	dBm/9.36MHz	-58.96
	Config 3,6	dBm/38.16MHz	-52.87
Propagation condition		-	AWGN
Correlation Matrix and Antenna Configuration		-	2x2 Low
<p>Note 1: OCNG shall be used such that both cells are fully allocated and a constant total transmitted power spectral density is achieved for all OFDM symbols.</p> <p>Note 2: Interference from other cells and noise sources not specified in the test is assumed to be constant over subcarriers and time and shall be modelled as AWGN of appropriate power for <math>N_{oc}</math> to be fulfilled within <math>BW_{occupied}</math>.</p> <p>Note 3: SS-RSRP, <math>I_o</math> and SCH_RP levels have been derived from other parameters for information purposes. They are not settable parameters themselves.</p> <p>Note 4: The uplink resources for CSI reporting are assigned to the UE prior to the start of time period T2.]</p> <p>Note 5: All UL/DL transmission shall be confined within <math>BW_{channel\_actual-occupied}</math> (i.e. 10 MHz, 52 RBs) from <math>F_{C,low}</math>, and <math>I_o</math> is independent of the <math>BW_{channel}</math> configured.</p> <p>Note 6: All UL/DL transmission shall be confined within <math>BW_{channel\_actual-occupied}</math> (i.e. 40 MHz, 106 RBs) from <math>F_{C,low}</math>, and <math>I_o</math> is independent of the <math>BW_{channel}</math> configured.</p> <p>Note 7: <math>N_{RB,c}</math> is derived from Table 5.3.2-1 in TS38.101-1[2] with configured <math>BW_{channel}</math>.</p>			

**Table A.4.5.3.1.1-4: Cell specific test parameters for NR SCell for known FR1 SCell activation case, 160ms SCell measurement cycle**

Parameter	Unit	Cell 3		
		T1	T2	T3
SSB ARFCN			freq2	
Duplex mode	Config <sub>SCell</sub> 1		FDD	
	Config <sub>SCell</sub> 2,3		TDD	

TDD configuration	Config <sub>sCell</sub> 1		Not Applicable
	Config <sub>sCell</sub> 2		TDDConf.1.1
	Config <sub>sCell</sub> 3		TDDConf.2.1
BW <sub>channel</sub>	Config <sub>sCell</sub> 1	MHz	Note 7
	Config <sub>sCell</sub> 2		Note 7
	Config <sub>sCell</sub> 3		Note 7
BW <sub>occupied</sub>	Config <sub>sCell</sub> 1	RB	52 <sup>Note 5</sup>
	Config <sub>sCell</sub> 2		52 <sup>Note 5</sup>
	Config <sub>sCell</sub> 3		106 <sup>Note 6</sup>
DL initial BWP configuration	Config <sub>sCell</sub> 1-3		DLBWP.0.1
DL dedicated BWP configuration	Config <sub>sCell</sub> 1-3		DLBWP.1.1
UL initial BWP configuration	Config <sub>sCell</sub> 1-3		ULBWP.0.1
UL dedicated BWP configuration	Config <sub>sCell</sub> 1-3		ULBWP.1.1
DRX Cycle		ms	Not Applicable
PDSCH Reference measurement channel	Config <sub>sCell</sub> 1		SR.1.1 FDD
	Config <sub>sCell</sub> 2		SR.1.1 TDD
	Config <sub>sCell</sub> 3		SR.2.1 TDD
RMSI CORESET Reference Channel	Config <sub>sCell</sub> 1		CR.1.1 FDD
	Config <sub>sCell</sub> 2		CR.1.1 TDD
	Config <sub>sCell</sub> 3		CR.2.1 TDD
RMC CORESET Reference Channel	Config <sub>sCell</sub> 1		CCR.1.1 FDD
	Config <sub>sCell</sub> 2		CCR.1.1 TDD
	Config <sub>sCell</sub> 3		CCR.2.1 TDD
TRS configuration	Config <sub>sCell</sub> 1		TRS.1.1 FDD
	Config <sub>sCell</sub> 2		TRS.1.1 TDD
	Config <sub>sCell</sub> 3		TRS.1.2 TDD
OCNG Patterns	Config <sub>sCell</sub> 1,2		OP.1 <sup>Note 5</sup>
	Config <sub>sCell</sub> 3		OP.1 <sup>Note 6</sup>
SMTTC configuration			SMTTC.1
SSB configuration	Config <sub>sCell</sub> 1,2		SSB.1 FR1
	Config <sub>sCell</sub> 3		SSB.2 FR1
CSI-RS configuration for CSI reporting	Config <sub>sCell</sub> 1		CSI-RS.1.1 FDD
	Config <sub>sCell</sub> 2		CSI-RS.1.1 TDD
	Config <sub>sCell</sub> 3		CSI-RS.2.1 TDD
PDSCH/PDCCH subcarrier spacing	Config <sub>sCell</sub> 1,2	kHz	15
	Config <sub>sCell</sub> 3		30
reportConfigType	Config <sub>sCell</sub> 1-3		periodic
reportQuantity	Config <sub>sCell</sub> 1-3		cri-RI-PMI-CQI
CSI reporting periodicity	Config <sub>sCell</sub> 1,2	slot	5
	Config <sub>sCell</sub> 3		10
CSI reporting offset	Config <sub>sCell</sub> 1,2	slot	2
	Config <sub>sCell</sub> 3		4
EPRE ratio of PSS to SSS		dB	0
EPRE ratio of PBCH DMRS to SSS			
EPRE ratio of PBCH to PBCH DMRS			
EPRE ratio of PDCCH DMRS to SSS			
EPRE ratio of PDCCH to PDCCH DMRS			
EPRE ratio of PDSCH DMRS to SSS			
EPRE ratio of PDSCH to PDSCH			
EPRE ratio of OCNG DMRS to SSS <sup>Note1</sup>			
EPRE ratio of OCNG to OCNG DMRS <sup>Note 1</sup>			
$N_{oc}$ <sup>Note2</sup>		dBm/15kHz	-104
$N_{oc}$ <sup>Note2</sup>	Config <sub>sCell</sub> 1,2	dBm/SCS	-104
	Config <sub>sCell</sub> 3		-101

$\hat{E}_s/I_{ot}$		dB	17
$\hat{E}_s/N_{oc}$		dB	17
SS-RSRP <sup>Note3</sup>	Config <sub>SCell</sub> 1,2	dBm/SCS	-87
	Config <sub>SCell</sub> 3		-84
SCH_RP <sup>Note 3</sup>		dBm/15 kHz	-87
I <sub>o</sub> <sup>Note3</sup>	Config <sub>SCell</sub> 1,2	dBm/9.36MHz	-58.96
	Config <sub>SCell</sub> 3	dBm/38.16MHz	-52.87
Propagation condition		-	AWGN
Correlation Matrix and Antenna Configuration		-	2x2 Low
<p>Note 1: OCNG shall be used such that both cells are fully allocated and a constant total transmitted power spectral density is achieved for all OFDM symbols.</p> <p>Note 2: Interference from other cells and noise sources not specified in the test is assumed to be constant over subcarriers and time and shall be modelled as AWGN of appropriate power for <math>N_{oc}</math> to be fulfilled within <math>BW_{occupied}</math>.</p> <p>Note 3: SS-RSRP, I<sub>o</sub> and SCH_RP levels have been derived from other parameters for information purposes. They are not settable parameters themselves.</p> <p>Note 4: The uplink resources for CSI reporting are assigned to the UE prior to the start of time period T2.]</p> <p>Note 5: All UL/DL transmission shall be confined within <math>BW_{channel\_actual-occupied}</math> (i.e. 10 MHz, 52 RBs) from <math>F_{C,low}</math>, and I<sub>o</sub> is independent of the <math>BW_{channel}</math> configured.</p> <p>Note 6: All UL/DL transmission shall be confined within <math>BW_{channel\_actual-occupied}</math> (i.e. 40 MHz, 106 RBs) from <math>F_{C,low}</math>, and I<sub>o</sub> is independent of the <math>BW_{channel}</math> configured.</p> <p>Note 7: <math>N_{RB,c}</math> is derived from Table 5.3.2-1 in TS38.101-1[2] with configured <math>BW_{channel}</math>.</p>			

#### A.4.5.3.1.2 Test Requirements

During T2 the UE shall send the first CSI report for SCell in the first available uplink resource after slot  $(m+k)$ . UE is allowed to postpone CSI report to next available uplink resource if an available uplink resource is subject to interruption. Whether CSI report in slot  $(m+k)$  was interrupted is checked by monitoring ACK/NACK sent in PCell in slot  $(m+k)$ .

During T2 the UE shall start sending CSI reports for SCell with non-zero CQI index at latest in a slot  $m + \frac{T_{HARQ} + T_{activation\_time} + T_{CSI\_Reporting}}{NR\ slot\ length}$ ,  $T_{activation\_time} = T_{FirstSSB} + 5ms$ , as defined in clause 8.3.

During T3 the UE shall stop sending CSI reports for SCell at latest in a slot  $n + \frac{T_{HARQ} + 3ms}{NR\ slot\ length}$ , as defined in clause 8.3.

During T2 interruption of PSCell during SCell activation shall not happen outside the slot  $m + 1 + \frac{T_{HARQ}}{NR\ slot\ length}$  to  $m + 1 + \frac{T_{HARQ} + 3ms + T_X}{NR\ slot\ length} + N_{interruption}$ , and interruption of E-UTRA PCell during SCell activation shall not happen outside the subframe  $m_1 + 1 + \frac{T_{HARQ}}{EUTRA\ slot\ length}$  to subframe  $m_2 + 1 + \frac{T_{HARQ} + 3ms + T_X}{EUTRA\ slot\ length} + N_{interruption}$ , as defined in clause 8.3.

During T3 the starting point of interruption of PSCell during SCell deactivation shall not happen outside the slot  $n + 1 + \frac{T_{HARQ}}{NR\ slot\ length}$  to  $n + 1 + \frac{T_{HARQ} + 3ms}{NR\ slot\ length}$ , as defined in clause 8.3 and the starting point of interruption of E-UTRA PCell during SCell deactivation shall not happen outside the subframe  $n_1 + 1 + \frac{T_{HARQ}}{EUTRA\ subframe\ length}$  to subframe  $n_2 + 1 + \frac{T_{HARQ} + 3ms}{EUTRA\ subframe\ length}$ .

The interruption of PSCell shall not be more than the values specified for EN-DC in Clause 8.2.1.2.4.

All of the above test requirements shall be fulfilled in order for the observed SCell activation delay and SCell deactivation delay to be counted as correct. The rate of correct observed SCell activation delay and SCell deactivation delay during repeated tests shall be at least 90%.

NOTE: During T2 if there are no uplink resources for reporting the valid CSI in a slot  $m + \frac{T_{HARQ} + T_{activation\_time} + T_{CSI\_Reporting}}{NR\ slot\ length}$  as defined in clause 8.3 then the UE shall use the next available uplink resource for reporting the corresponding valid CSI.

### A.4.5.3.2 SCell Activation and deactivation of known SCell in FR1 for 640ms SCell measurement cycle

#### A.4.5.3.2.1 Test Purpose and Environment

The purpose of this test case is the same as for the test defined in clause A.4.5.3.1.1. The supported test configurations are the same as defined in clause A.4.5.3.1.1. The test parameters are the same except those described in the following clause. The listed parameter values in Tables A.4.5.3.2.1-1 will replace the values of corresponding parameters in Tables A.4.5.3.1.1-2.

**Table A.4.5.3.2.1-1: General test parameters for known FR1 SCell activation case, 640ms SCell measurement cycle**

Parameter	Unit	Value	Comment
SCell measurement cycle (measCycleSCell)	ms	640	

#### A.4.5.3.2.2 Test Requirements

The test requirements defined in clause A.4.5.3.1.2 shall apply to this test case, except  $T_{\text{activation\_time}}$  will be replaced with the value  $T_{\text{FirstSSB\_MAX}} + T_{\text{rs}} + 5\text{ms}$ .

### A.4.5.3.3 SCell Activation and deactivation of unknown SCell in FR1

#### A.4.5.3.3.1 Test Purpose and Environment

The purpose of this test is to verify that the SCell activation and deactivation times are within the requirements stated in clause 8.3, when the SCell in FR1 is unknown by the UE at the time of activation.

The supported test configurations are defined in clause A.4.5.3.1.1. The test parameters are the same except those described in the following clause. The listed parameter values in Tables A.4.5.3.3.1-1 will replace the values of corresponding parameters in Tables A.4.5.3.1.1-2. The test consists of three successive time periods, with duration of T1, T2 and T3, respectively. There are three carriers, E-UTRA has one cell, NR has two cells. Cell 1 and Cell 2 have constant signal levels throughout the test. Before the test starts the UE is connected to Cell 1 (PCell) on E-UTRAN and Cell 2 (PSCell) on NR, but is not aware of Cell 3 (SCell) on NR. The UE is monitoring the PCell and PSCell. The UE shall be continuously scheduled in the PCell and PSCell throughout the whole test.

At the beginning of T1 the UE receives an RRC message by which the SCell (Cell 3) becomes configured on NR. During T1 the SCell is powered off and UE is not aware of SCell.

A MAC message for activation of SCell is sent by the test equipment 100ms after the RRC message, in a slot # denoted  $m$ . The point in time at which the MAC message for activation of SCell is received at the UE antenna connector defines the start of time period T2. The UE shall be able to report valid CSI for the activated SCell at latest in slot  $m + \frac{T_{\text{HARQ}} + T_{\text{activation\_time}} + T_{\text{CSI\_Reporting}}}{\text{NR slot length}}$  as defined in clause 8.3 provided the SCell can be successfully detected on the first attempt. The UE shall start reporting CSI after at least one CSI-RS transmission occasion for channel measurement and reporting after slot  $(m+k)$  and shall report CQI index 0 (out-of-range) until the SCell activation has been completed.

Any PSCell interruption due to activation of SCell shall occur in the slot  $m + 1 + \frac{T_{\text{HARQ}}}{\text{NR slot length}}$  to slot  $m + 1 + \frac{T_{\text{HARQ}} + 3\text{ms} + T_{\text{X}}}{\text{NR slot length}} + N_{\text{interruption}}$ , as defined in clause 8.3, where  $N_{\text{interruption}}$  is the interruption length given in clause 8.2.

Any E-UTRA PCell interruption due to activation of SCell shall occur in the subframe  $m_1 + 1 + \frac{T_{\text{HARQ}}}{\text{EUTRA slot length}}$  to subframe  $m_2 + 1 + \frac{T_{\text{HARQ}} + 3\text{ms} + T_{\text{X}}}{\text{EUTRA slot length}} + N_{\text{interruption}}$ , where  $m_1$  and  $m_2$  are the index of the first and last subframe of E-UTRA PCell which overlaps with slot  $m$ , and  $N_{\text{interruption}}$  is the interruption length given in TS 36.133 [14] clause 7.32.

Time period T3 starts when a MAC message for deactivation of the SCell, sent from the test equipment to the UE in a slot # denoted  $n$ , is received at the UE antenna connector. The UE shall carry out deactivation of the SCell at latest in slot  $n + \frac{T_{\text{HARQ}} + 3\text{ms}}{\text{NR slot length}}$  as defined in clause 8.3. The starting point of any PSCell interruption due to the deactivation shall occur in the slot  $n + 1 + \frac{T_{\text{HARQ}}}{\text{NR slot length}}$  to  $n + 1 + \frac{T_{\text{HARQ}} + 3\text{ms}}{\text{NR slot length}}$ , as defined in clause 8.3. The starting point of any E-

UTRA PCell interruption due to the deactivation shall occur in the subframe  $n_1 + 1 + \frac{T_{\text{HARQ}}}{\text{EUTRA subframe length}}$  to subframe  $n_2 + 1 + \frac{T_{\text{HARQ}}+3\text{ms}}{\text{EUTRA subframe length}}$ , where  $n_1$  and  $n_2$  are the index of the first and last subframe of E-UTRA PCell which overlaps with slot  $n$ .

The test equipment verifies the activation time by counting the slots from the time when the SCell activation command is sent until a CSI report with other than CQI index 0 is received.

The test equipment verifies the deactivation time by counting the slots from the time when the SCell deactivation command is sent until CSI reporting for SCell is discontinued.

**Table A.4.5.3.3.1-1: General test parameters for unknown FR1 SCell activation case, 160ms SCell measurement cycle**

Parameter	Unit	Value	Comment
T1	ms	100	During this time the PSCell shall be known and the SCell configured, but not detected.

#### A.4.5.3.3.2 Test Requirements

The test requirements defined in clause A.4.5.3.1.2 shall apply to this test case, except  $T_{\text{activation\_time}}$  will be replaced with the value  $T_{\text{FirstSSB\_MAX}} + T_{\text{SMTc\_MAX}} + 2 * T_{\text{rs}} + 5\text{ms}$  as defined in clause 8.3.

#### A.4.5.3.4 SCell Activation and deactivation of multiple unknown SCells in FR1 with single activation/deactivation command

##### A.4.5.3.4.1 Test Purpose and Environment

The purpose of this test is to verify that the multiple SCell activation and deactivation times are within the requirements stated in clause 8.3.7 and 8.3.8, when the two configured deactivated SCells in FR1 are unknown by the UE at the time of activation.

The supported test configurations are the same as defined in clause A.4.5.3.1.1. The test parameters are the same except those described in the following clause. The listed parameter values in Table A.4.5.3.4.1-1 will replace the values of corresponding parameters in Table A.4.5.3.1.1-2. The cell specific test parameter values in Table A.4.5.3.4.1-2 will replace the values of corresponding parameters in Table A.4.5.3.1.1-3.

The test consists of three successive time periods, with duration of T1, T2 and T3, respectively. There are four carriers, E-UTRA has one cell, NR has three cells. Cell 1 and Cell 2 have constant signal levels throughout the test. Before the test starts the UE is connected to Cell 1 (PCell) on E-UTRAN and Cell 2 (PSCell) on NR, but is not aware of Cell 3 (SCell) and Cell 4 (SCell) on NR. The UE is monitoring the PCell and PSCell. The UE shall be continuously scheduled in the PCell and PSCell throughout the whole test.

At the beginning of T1 the UE receives an RRC message by which the SCells (Cell 3 and Cell 4) become configured on NR. During T1 the SCells (Cell 3 and Cell 4) are powered off and UE is not aware of SCells.

A MAC message for activation of SCells (Cell 3 and Cell 4) is sent by the test equipment 100ms after the RRC message, in a slot # denoted  $m$ . The point in time at which the MAC message for activation of SCells is received at the UE antenna connector defines the start of time period T2. Immediately at beginning of T2 the transmission power of cell 3 and cell 4 are increased to same level as for cell 2. The UE shall be able to report valid CSI for the activated SCells (Cell 3 and Cell 4) at latest in slot  $m + \frac{T_{\text{HARQ}} + T_{\text{activation\_time\_multiple\_scells}} + T_{\text{CSI\_Reporting}}}{\text{NR slot length}}$  respectively as defined in clause

8.3.7 provided the SCells can be successfully detected on the first attempt. The UE shall start reporting CSI for cell 3 and cell 4 after at least one CSI-RS transmission occasion for channel measurement and reporting after slot  $(m+k)$  and shall report CQI index 0 (out-of-range) until the SCell activation for cell 3 and cell 4 has been completed, respectively.

Any PSCell interruption due to activation of SCells shall occur in the slot  $m + 1 + \frac{T_{\text{HARQ}}}{\text{NR slot length}}$  to slot  $m + 1 +$

$\frac{T_{\text{HARQ}}+3\text{ms}+T_{\text{X}}}{\text{NR slot length}} + N_{\text{interruption}}$ , as defined in clause 8.3, where  $N_{\text{interruption}}$  is the interruption length given in section

8.2. Any E-UTRA PCell interruption due to activation of SCells shall occur in the subframe  $m_1 + 1 + \frac{T_{\text{HARQ}}}{\text{EUTRA slot length}}$  to subframe  $m_2 + 1 + \frac{T_{\text{HARQ}}+3\text{ms}+T_{\text{X}}}{\text{EUTRA slot length}} + N_{\text{interruption}}$ , where  $m_1$  and  $m_2$  are the index of the first and last subframe of

E-UTRA PCell which overlaps with slot  $m$ , and  $N_{\text{interruption}}$  is the interruption length given in TS 36.133 [14] clause 7.32.

Time period T3 starts when a MAC message for deactivation of the SCells (Cell 3 and Cell 4), sent from the test equipment to the UE in a slot # denoted  $n$ , is received at the UE antenna connector. The UE shall carry out deactivation of the SCells at latest in slot  $n + \frac{T_{\text{HARQ}}+3\text{ms}}{\text{NR slot length}}$  as defined in clause 8.3. The starting point of any PSCell interruption due to the deactivation shall occur in the slot  $n + 1 + \frac{T_{\text{HARQ}}}{\text{NR slot length}}$  to  $n + 1 + \frac{T_{\text{HARQ}}+3\text{ms}}{\text{NR slot length}}$ , as defined in clause 8.3. The starting point of any E-UTRA PCell interruption due to the deactivation shall occur in the subframe  $n_1 + 1 + \frac{T_{\text{HARQ}}}{\text{EUTRA subframe length}}$  to subframe  $n_2 + 1 + \frac{T_{\text{HARQ}}+3\text{ms}}{\text{EUTRA subframe length}}$ , where  $n_1$  and  $n_2$  are the index of the first and last subframe of E-UTRA PCell which overlaps with slot  $n$ .

The test equipment verifies the activation time for Cell 3 by counting the slots from the time when the SCell activation command is sent until CSI report of activated Cell 3 with other than CQI index 0 is received.

The test equipment verifies the activation time for Cell 4 by counting the slots from the time when the SCell activation command is sent until CSI report of activated Cell 4 with other than CQI index 0 is received.

The test equipment verifies the deactivation time for Cell 3 by counting the slots from the time when the SCell deactivation command is sent until CSI reporting for Cell 3 is discontinued.

The test equipment verifies the deactivation time for Cell 4 by counting the slots from the time when the SCell deactivation command is sent until CSI reporting for Cell 4 is discontinued.

**Table A.4.5.3.4.1-1: General test parameters for unknown FR1 SCell activation case with 2 deactivated SCells, 160ms SCell measurement cycle**

Parameter	Unit	Value	Comment
Configured deactivated SCell 1		Cell 3	Configured deactivated secondary cell on NR RF channel number 3 which is an intra-band contiguous CC to PSCC of Cell 2; <i>ssb-PositionInBurst</i> of Cell 3 is same as the one for Cell 2
Configured deactivated SCell 2		Cell 4	Configured deactivated secondary cell on NR RF channel number 4 which is an inter-band CC to PSCC of Cell 2
Cell3 timing offset to cell2	μs	0	
Cell4 timing offset to cell2	μs	0	
Time alignment error between cell3 and cell2	μs	≤ Time alignment error as specified in TS 38.104 [13] clause 6.5.3.1.	The value of time alignment error depends upon the type of carrier aggregation.
Time alignment error between cell4 and cell2	μs	≤ Time alignment error as specified in TS 38.104 [13] clause 6.5.3.1.	The value of time alignment error depends upon the type of carrier aggregation.
T1	ms	100	During this time the PSCell shall be known and the SCell configured, but not detected.

**Table A.4.5.3.4.1-2: Cell specific test parameters for known FR1 SCell activation case, 160ms SCell measurement cycle**

Parameter	Unit	Cell 3		Cell 4	
		T2	T3	T2	T3
SSB ARFCN		Freq2		Freq3	
Duplex mode	Config 1,4	FDD			
	Config 2,3,5,6	TDD			
TDD configuration	Config 1,4	Not Applicable			
	Config 2,5	TDDConf.1.1			

	Config 3,6		TDDConf.2.1	
BW <sub>channel</sub>	Config 1,4	MHz	10: N <sub>RB,c</sub> = 52	
	Config 2,5		10: N <sub>RB,c</sub> = 52	
	Config 3,6		40: N <sub>RB,c</sub> = 106	
DL initial BWP configuration	Config 1, 2, 3, 4, 5, 6		DLBWP.0.1	
DL dedicated BWP configuration	Config 1, 2, 3, 4, 5, 6		DLBWP.1.1	
UL initial BWP configuration	Config 1, 2, 3, 4, 5, 6		ULBWP.0.1	
UL dedicated BWP configuration	Config 1, 2, 3, 4, 5, 6		ULBWP.1.1	
DRX Cycle		ms	Not Applicable	
PDSCH Reference measurement channel	Config 1,4		SR.1.1 FDD	SR.1.1 FDD
	Config 2,5		SR.1.1 TDD	SR.1.1 TDD
	Config 3,6		SR.2.1 TDD	SR.2.1 TDD
RMSI CORESET Reference Channel	Config 1,4		CR.1.1 FDD	CR.1.1 FDD
	Config 2,5		CR.1.1 TDD	CR.1.1 TDD
	Config 3,6		CR.2.1 TDD	CR.2.1 TDD
RMC CORESET Reference Channel	Config 1,4		CCR.1.1 FDD	CCR.1.1 FDD
	Config 2,5		CCR.1.1 TDD	CCR.1.1 TDD
	Config 3,6		CCR.2.1 TDD	CCR.2.1 TDD
TRS configuration	Config 1,4		TRS.1.1 FDD	TRS.1.1 FDD
	Config 2,5		TRS.1.1 TDD	TRS.1.1 TDD
	Config 3,6		TRS.1.2 TDD	TRS.1.2 TDD
OCNG Patterns			OP.1	
SMTC configuration			SMTC.1	
SSB configuration	Config 1,2,4,5		SSB.1 FR1	
	Config 3,6		SSB.2 FR1	
PDSCH/PDCCH subcarrier spacing	Config 1,2,4,5	kHz	15 kHz	
	Config 3,6		30kHz	
EPRE ratio of PSS to SSS		dB	0	
EPRE ratio of PBCH DMRS to SSS				
EPRE ratio of PBCH to PBCH DMRS				
EPRE ratio of PDCCH DMRS to SSS				
EPRE ratio of PDCCH to PDCCH DMRS				
EPRE ratio of PDSCH DMRS to SSS				
EPRE ratio of PDSCH to PDSCH				
EPRE ratio of OCNG DMRS to SSS(Note 1)				
EPRE ratio of OCNG to OCNG DMRS (Note 1)				
$N_{oc}^{Note2}$		dBm/15kHz	-104	
$N_{oc}^{Note2}$	Config 1,2,4,5	dBm/SCS	-104	
	Config 3,6		-101	
$\hat{E}_s/I_{ot}$		dB	17	
$\hat{E}_s/N_{oc}$		dB	17	
SS-RSRP <sup>Note3</sup>	Config 1,2,4,5	dBm/SCS	-87	
	Config 3,6		-84	
SCH_RP <sup>Note 3</sup>		dBm/15 kHz	-87	
Propagation condition		-	AWGN	

#### A.4.5.3.4.2 Test Requirements

The test requirements defined in clause A.4.5.3.1.2 shall apply to this test case for both Cell 3 and Cell 4, except the followings:

- For Cell 3 activation delay,  $T_{activation\_time}$  will be replaced with the value  $T_{activation\_time\_multiple\_scells} = T_{FirstSSB\_MAX\_multiple\_scells} + T_{SMTC\_MAX\_multiple\_scells} + T_{rs} + 5ms$  as defined in clause 8.3.7.



- For Cell 4 activation delay,  $T_{\text{activation\_time}}$  will be replaced with the value  $T_{\text{activation\_time\_multiple\_scells}} = T_{\text{FirstSSB\_MAX\_multiple\_scells}} + T_{\text{SMTC\_MAX\_multiple\_scells}} + 2 * T_{\text{rs}} + 5\text{ms}$  as defined in clause 8.3.7.

### A.4.5.3.5 Direct SCell activation at SCell addition of known SCell in FR1

#### A.4.5.3.5.1 Test Purpose and Environment

The purpose of this test is to verify that the direct SCell activation time is within the requirements stated in clause 8.3.4, when the SCell in FR1 is known by the UE at the time of activation.

The supported test configurations for LTE PCell and NR PSCell are shown in table A.4.5.3.5.1-1 below. The supported test configurations for NR SCell are shown in table A.4.5.3.5.1-1A below. Test configuration for LTE PCell and NR PSCell and test configuration for NR SCell are chosen independently. The test parameters are given in Tables A.4.5.3.5.1-2 and cell-specific parameters in A.4.5.3.5.1-3 and A.4.5.3.5.1-4 below. The test consists of two successive time periods, with duration of T1 and T2, respectively. There are three carriers, E-UTRA has one cell, NR has two cells. All cells have constant signal levels throughout the test. Before the test starts the UE is connected to Cell 1 (PCell) on E-UTRA and Cell 2 (PSCell) on NR, but is not aware of Cell 3 (SCell) on NR. The UE is monitoring the PCell and PSCell. The UE shall be continuously scheduled in the PCell and PSCell throughout the whole test.

At the beginning of T1 the UE receives an RRC message by which the measurement on Cell 3 is configured. The UE now starts measuring the Cell 3. During T1, Cell 3 should be detected and measured by the UE such that it meets the condition for known cell defined in clause 8.3.4 for direct SCell activation. At the end of T1, the test equipment sends an RRC message for direct SCell activation of the Cell 3.

The point in time at which the RRC message for direct SCell activation is received at the UE antenna connector, in a slot # denoted  $m$ , defines the start of time period T2. The UE shall be able to report valid CSI in PSCell for the activated SCell at latest in slot  $m + \frac{N_{\text{direct}}}{\text{NR slot length}}$ , as defined in clause 8.3.4. The UE shall start reporting CSI in PSCell in slot  $(m+k+T_{\text{RRC\_process}})$  and shall report CQI index 0 (out-of-range) until the SCell activation has been completed. Any PSCell interruption due to activation of SCell shall occur in the slot  $m + 1$  to slot  $m + 1 + \frac{T_{\text{RRC\_Process}} + T_1 + T_X}{\text{NR slot length}} + N_{\text{interruption}}$ , as defined in clause 8.3.4, where  $N_{\text{interruption}}$  is the interruption length given in clause 8.2. Any E-UTRA PCell interruption due to activation of SCell shall occur in the subframe  $m_1 + 1$  to subframe  $m_2 + 1 + \frac{T_{\text{RRC\_Process}} + T_1 + T_X}{\text{NR slot length}} + N_{\text{interruption}}$ , where  $m_1$  and  $m_2$  are the index of the first and last subframe of E-UTRA PCell which overlaps with slot  $m$ , and  $N_{\text{interruption}}$  is the interruption length given in TS 36.133 [14] clause 7.32.

The test equipment verifies that potential interruption is carried out in the correct time span by monitoring ACK/NACK sent in PSCell during activation of SCell.

The test equipment verifies the activation time by counting the slots from the time when the direct SCell activation command is sent until a CSI report with other than CQI index 0 is received.

**Table A.4.5.3.5.1-1: known FR1 direct SCell activation supported test configurations for LTE PCell and NR PSCell**

Config	Description
1	LTE FDD, NR 15 kHz SSB SCS, $\geq 10$ MHz bandwidth, FDD duplex mode
2	LTE FDD, NR 15 kHz SSB SCS, $\geq 10$ MHz bandwidth, TDD duplex mode
3	LTE FDD, NR 30 kHz SSB SCS, $\geq 40$ MHz bandwidth, TDD duplex mode
4	LTE TDD, NR 15 kHz SSB SCS, $\geq 10$ MHz bandwidth, FDD duplex mode
5	LTE TDD, NR 15 kHz SSB SCS, $\geq 10$ MHz bandwidth, TDD duplex mode
6	LTE TDD, NR 30 kHz SSB SCS, $\geq 40$ MHz bandwidth, TDD duplex mode

Note 1: The UE is only required to be tested in one of the supported test configurations  
Note 2: The UE is only required to be tested in one with smallest aggregated channel bandwidth from supported band combinations which is composed of CCs  $\geq$  the bandwidth ( $BW_{\text{channel}}$ ) defined in each test configuration.

**Table A.4.5.3.5.1-1A: known FR1 direct SCell activation supported test configurations for NR SCell**

Config <sub>SCell</sub>	Description
1	NR 15 kHz SSB SCS, $\geq 10$ MHz bandwidth, FDD duplex mode
2	NR 15 kHz SSB SCS, $\geq 10$ MHz bandwidth, TDD duplex mode

3	NR 30 kHz SSB SCS, $\geq 40$ MHz bandwidth, TDD duplex mode
Note 1:	The UE is only required to be tested in one of the supported test configurations
Note 2:	The UE is only required to be tested in one with smallest aggregated channel bandwidth from supported band combinations which is composed of CCs $\geq$ the bandwidth ( $BW_{\text{channel}}$ ) defined in each test configuration

Table A.4.5.3.5.1-2: General test parameters for known FR1 direct SCell activation

Parameter	Unit	Value	Comment
RF Channel Number		1,2,3	One E-UTRAN radio channel (1) and two NR radio channel (2,3) are used for this test
Active PCell		Cell 1	Primary cell on E-UTRAN RF channel number 1. As specified in clause A.3.7.2.1
Active PSCell		Cell 2	Primary secondary cell on NR RF channel number 2.
SCell		Cell 3	Secondary cell on NR RF channel number 3
CP length		Normal	
DRX		OFF	Continuous monitoring of primary cell
CQI/PMI periodicity and offset configuration index		0	CQI reporting for SCell every four slots.
Cell-individual offset for cells on E-UTRA RF channel number	dB	0	Individual offset for cells on primary component carrier.
Cell-individual offset for cells on NR channel number	dB	0	Individual offset for cells on secondary component carrier.
SCell measurement cycle (measCycleSCell)	ms	160	
Cell3 timing offset to cell2	$\mu\text{s}$	0	
Time alignment error between cell3 and cell2	$\mu\text{s}$	$\leq$ Time alignment error as specified in TS 38.104 [13] clause 6.5.3.1.	The value of time alignment error depends upon the type of carrier aggregation.
T1	s	7	During this time the Cell 3 shall be known.
T2	s	1	During this time the UE shall activate the SCell.
A3-offset	dB	-15	
$T_{\text{HARQ}}$	ms	$k_1 \times \text{NR slot length}$	$k_1$ is a number of slots indicated by the PDSCH-to-HARQ_feedback timing indicator field in a corresponding DCI format or provided by <i>dl-DataToUL-ACK</i> if the PDSCH-to-HARQ feedback timing field is not present in the DCI format, the value is defined in 38.213 [3]
$T_{\text{CSI\_Reporting}}$	ms	2	the delay uncertainty in acquiring the first available CSI reporting resources as specified in TS 38.331 [2]
k	ms	$k_1 + 3 \cdot N_{\text{slot}}^{\text{subframe}, \mu} + 1$	As specified in clause 4.3 of TS 38.213 [3]

Table A. 4.5.3.5.1-3: Cell specific test parameters for NR PSCell for known FR1 direct SCell activation

Parameter	Unit	Cell 2	
		T1	T2
<b>SSB ARFCN</b>		<b>freq1</b>	
Duplex mode	Config 1,4	FDD	
	Config 2,3,5,6	TDD	
TDD configuration	Config 1,4	Not Applicable	
	Config 2,5	TDDConf.1.1	
	Config 3,6	TDDConf.2.1	

BW <sub>channel</sub>	Config 1,4	MHz	10: N <sub>RB,c</sub> = 52
	Config 2,5		10: N <sub>RB,c</sub> = 52
	Config 3,6		40: N <sub>RB,c</sub> = 106
DL initial BWP configuration	Config 1,2,3,4,5,6		DLBWP.0.1
DL dedicated BWP configuration	Config 1,2,3,4,5,6		DLBWP.1.1
UL initial BWP configuration	Config 1,2,3,4,5,6		ULBWP.0.1
UL dedicated BWP configuration	Config 1,2,3,4,5,6		ULBWP.1.1
DRx Cycle		ms	Not Applicable
PDSCH Reference measurement channel	Config 1,4		SR.1.1 FDD
	Config 2,5		SR.1.1 TDD
	Config 3,6		SR.2.1 TDD
RMSI CORESET Reference Channel	Config 1,4		CR.1.1 FDD
	Config 2,5		CR.1.1 TDD
	Config 3,6		CR.2.1 TDD
RMC CORESET Reference Channel	Config 1,4		CCR.1.1 FDD
	Config 2,5		CCR.1.1 TDD
	Config 3,6		CCR.2.1 TDD
TRS configuration	Config 1,4		TRS.1.1 FDD
	Config 2,5		TRS.1.1 TDD
	Config 3,6		TRS.1.2 TDD
OCNG Patterns			OP.1
SMTC configuration			SMTC.1
SSB configuration	Config 1,2,4,5		SSB.1 FR1
	Config 3,6		SSB.2 FR1
PDSCH/PDCCH subcarrier spacing	Config 1,2,4,5	kHz	15 kHz
	Config 3,6		30kHz
CSI-RS configuration for CSI reporting	Config 1,4		CSI-RS.1.1 FDD
	Config 2,5		CSI-RS.1.1 TDD
	Config 3,6		CSI-RS.2.1 TDD
PDSCH/PDCCH subcarrier spacing	Config 1,2,4,5	kHz	15
	Config 3,6		30
reportConfigType	Config 1-6		periodic
reportQuantity	Config 1-6		cri-RI-PMI-CQI
CSI reporting periodicity	Config 1,2,4,5	slot	5
	Config 3,6		10
CSI reporting offset	Config 1,2,4,5	slot	2
	Config 3,6		4
EPRE ratio of PSS to SSS		dB	0
EPRE ratio of PBCH DMRS to SSS			
EPRE ratio of PBCH to PBCH DMRS			
EPRE ratio of PDCCH DMRS to SSS			
EPRE ratio of PDCCH to PDCCH DMRS			
EPRE ratio of PDSCH DMRS to SSS			
EPRE ratio of PDSCH to PDSCH			
EPRE ratio of OCNG DMRS to SSS <sup>Note 1</sup>			
EPRE ratio of OCNG to OCNG DMRS <sup>Note 1</sup>			
N <sub>oc</sub> <sup>Note2</sup>		dBm/15k Hz	-104
N <sub>oc</sub> <sup>Note2</sup>	Config 1,2,4,5	dBm/SC S	-104
	Config 3,6		-101
$\hat{E}_s / I_{ot}$		dB	17
$\hat{E}_s / N_{oc}$		dB	17
SS-RSRP <sup>Note3</sup>	Config 1,2,4,5	dBm/SC S	-87

	Config 3,6		-84
SCH_RP <sup>Note 3</sup>		dBm/15 kHz	-87
Propagation condition		-	AWGN
Note 1:	OCNG shall be used such that both cells are fully allocated and a constant total transmitted power spectral density is achieved for all OFDM symbols.		
Note 2:	Interference from other cells and noise sources not specified in the test is assumed to be constant over subcarriers and time and shall be modelled as AWGN of appropriate power for $N_{oc}$ to be fulfilled.		
Note 3:	SS-RSRP and SCH_RP levels have been derived from other parameters for information purposes. They are not settable parameters themselves.		
Note 4:	The uplink resources for CSI reporting are assigned to the UE prior to the start of time period T2.		

**Table A.4.5.3.5.1-4: Cell specific test parameters for NR SCell for known FR1 direct SCell activation**

Parameter		Unit	Cell 3	
			T1	T2
SSB ARFCN			freq2	
Duplex mode	Config <sub>SCell</sub> 1		FDD	
	Config <sub>SCell</sub> 2,3		TDD	
TDD configuration	Config <sub>SCell</sub> 1		Not Applicable	
	Config <sub>SCell</sub> 2		TDDConf.1.1	
	Config <sub>SCell</sub> 3		TDDConf.2.1	
BW <sub>channel</sub>	Config <sub>SCell</sub> 1	MHz	10: N <sub>RB,c</sub> = 52	
	Config <sub>SCell</sub> 2		10: N <sub>RB,c</sub> = 52	
	Config <sub>SCell</sub> 3		40: N <sub>RB,c</sub> = 106	
DL initial BWP configuration	Config <sub>SCell</sub> 1,2,3		DLBWP.0.1	
DL dedicated BWP configuration	Config <sub>SCell</sub> 1,2,3		DLBWP.1.1	
UL initial BWP configuration	Config <sub>SCell</sub> 1,2,3		ULBWP.0.1	
UL dedicated BWP configuration	Config <sub>SCell</sub> 1,2,3		ULBWP.1.1	
DRX Cycle		ms	Not Applicable	
PDSCH Reference measurement channel	Config <sub>SCell</sub> 1		SR.1.1 FDD	
	Config <sub>SCell</sub> 2		SR.1.1 TDD	
	Config <sub>SCell</sub> 3		SR.2.1 TDD	
RMSI CORESET Reference Channel	Config <sub>SCell</sub> 1		CR.1.1 FDD	
	Config <sub>SCell</sub> 2		CR.1.1 TDD	
	Config <sub>SCell</sub> 3		CR.2.1 TDD	
RMC CORESET Reference Channel	Config <sub>SCell</sub> 1		CCR.1.1 FDD	
	Config <sub>SCell</sub> 2		CCR.1.1 TDD	
	Config <sub>SCell</sub> 3		CCR.2.1 TDD	
TRS configuration	Config <sub>SCell</sub> 1		TRS.1.1 FDD	
	Config <sub>SCell</sub> 2		TRS.1.1 TDD	
	Config <sub>SCell</sub> 3		TRS.1.2 TDD	
OCNG Patterns			OP.1	
SMTc configuration			SMTc.1	
SSB configuration	Config <sub>SCell</sub> 1,2		SSB.1 FR1	
	Config <sub>SCell</sub> 3		SSB.2 FR1	
PDSCH/PDCCH subcarrier spacing	Config <sub>SCell</sub> 1,2	kHz	15	
	Config <sub>SCell</sub> 3		30	
CSI-RS configuration for CSI reporting	Config <sub>SCell</sub> 1		CSI-RS.1.1 FDD	
	Config <sub>SCell</sub> 2		CSI-RS.1.1 TDD	
	Config <sub>SCell</sub> 3		CSI-RS.2.1 TDD	
PDSCH/PDCCH subcarrier spacing	Config <sub>SCell</sub> 1,2	kHz	15	
	Config <sub>SCell</sub> 3		30	

reportConfigType	Config <sub>SCell</sub> 1-3		periodic
reportQuantity	Config <sub>SCell</sub> 1-3		cri-RI-PMI-CQI
CSI reporting periodicity	Config <sub>SCell</sub> 1,2	slot	5
	Config <sub>SCell</sub> 3		10
CSI reporting offset	Config <sub>SCell</sub> 1,2	slot	2
	Config <sub>SCell</sub> 3		4
EPRE ratio of PSS to SSS		dB	0
EPRE ratio of PBCH DMRS to SSS			
EPRE ratio of PBCH to PBCH DMRS			
EPRE ratio of PDCCH DMRS to SSS			
EPRE ratio of PDCCH to PDCCH DMRS			
EPRE ratio of PDSCH DMRS to SSS			
EPRE ratio of PDSCH to PDSCH			
EPRE ratio of OCNG DMRS to SSS <sup>Note 1</sup>			
EPRE ratio of OCNG to OCNG DMRS <sup>Note 1</sup>			
$N_{oc}$ <sup>Note 2</sup>		dBm/15kHz	-104
$N_{oc}$ <sup>Note 2</sup>	Config <sub>SCell</sub> 1,2	dBm/SCS	-104
	Config <sub>SCell</sub> 3		-101
$\hat{E}_s / I_{ot}$		dB	17
$\hat{E}_s / N_{oc}$		dB	17
SS-RSRP <sup>Note 3</sup>	Config <sub>SCell</sub> 1,2	dBm/SCS	-87
	Config <sub>SCell</sub> 3		-84
SCH_RP <sup>Note 3</sup>		dBm/15 kHz	-87
Propagation condition		-	AWGN
<p>Note 1: OCNG shall be used such that both cells are fully allocated and a constant total transmitted power spectral density is achieved for all OFDM symbols.</p> <p>Note 2: Interference from other cells and noise sources not specified in the test is assumed to be constant over subcarriers and time and shall be modelled as AWGN of appropriate power for <math>N_{oc}</math> to be fulfilled.</p> <p>Note 3: SS-RSRP and SCH_RP levels have been derived from other parameters for information purposes. They are not settable parameters themselves.</p> <p>Note 4: The uplink resources for CSI reporting are assigned to the UE prior to the start of time period T2.</p>			

#### A.4.5.3.5.2 Test Requirements

During T2 the UE shall send the first CSI report for SCell in the first available uplink resource after slot  $(m+k+T_{RRC\_process})$ . UE is allowed to postpone CSI report to next available uplink resource if an available uplink resource is subject to interruption. Whether CSI report in slot  $(m+k+T_{RRC\_process})$  was interrupted is checked by monitoring ACK/NACK sent in PCell in slot  $(m+k+T_{RRC\_process})$ .

During T2 the UE shall start sending CSI reports for SCell with non-zero CQI index at latest in a slot  $m + \frac{N_{direct}}{NR\ slot\ length}$ .  $N_{direct} = T_{RRC\_Process} + T_1 + T_{activation\_time} + T_{CSI\_Reporting} - 3ms$ , where  $T_{RRC\_Process} = 20$  ms and other components are defined in clause 8.3.4.

During T2 interruption of PSCell during direct SCell activation shall not happen outside the slot  $m + 1$  to  $m + 1 + \frac{T_{RRC\_Process} + T_1 + T_X}{NR\ slot\ length} + N_{interruption}$ , and interruption of E-UTRA PCell during SCell activation shall not happen outside the subframe  $m_1 + 1$  to subframe  $m_2 + 1 + \frac{T_{RRC\_Process} + T_1 + T_X}{NR\ slot\ length} + N_{interruption}$ , as defined in clause 8.3.4.

The interruption of PSCell shall not be more than the values specified for EN-DC in Clause 8.2.1.2.8.

All of the above test requirements shall be fulfilled in order for the observed direct SCell activation delay to be counted as correct. The rate of correct observed direct SCell activation delay during repeated tests shall be at least 90%.

NOTE: During T2 if there are no uplink resources for reporting the valid CSI in a slot  $m + \frac{T_{RRC\_Process} + T_1 + T_X}{NR\ slot\ length}$  as defined in clause 8.3.4 then the UE shall use the next available uplink resource for reporting the corresponding valid CSI.

## A.4.5.4 UE UL carrier RRC reconfiguration Delay

### A.4.5.4.1 UE UL carrier RRC reconfiguration Delay

**Table A.4.5.4.1-1 - Table A.4.5.4.1-4 : Void**

#### A.4.5.4.1.1 Test Purpose and Environment

The purpose of this test is to verify that when the UE receives a RRC message implying NR UL or Supplementary UL carrier configuration, the UE shall be ready to start transmission on the newly configured carrier within the time limits specified in clause 8.4.2 and 8.4.3 for configuring and deconfiguring, respectively.

There are three cells: E-UTRAN PCell (Cell 1), FR1 PSCell (Cell 2) and FR1 SCell (Cell 3). For SCell, both NR uplink and supplementary uplink are broadcast by *ServingCellConfigCommonSIB*. The test parameters for PSCell and SCell are given in Table A. 4.5.4.1.1-1, Table A. 4.5.4.1.1-2, Table A. 4.5.4.1.1-3 and Table A. 4.5.4.1.1-4 below. The test parameters and applicability for E-UTRAN PCell are defined in A.3.7.2. The test consists two tests. In test 1, the test consists of three time periods, with duration of T1, T2 and T3 respectively. During time duration T1, NR uplink of cell 3 is configured to UE. At the start of T2, a supplementary uplink of cell3 is configured to UE through *RRCReconfiguration*, then UE shall start transmission both on the NR uplink and supplementary uplink. At the start of T3, the supplementary uplink is released through *RRCReconfiguration*.

In test 2, the test consists of three time periods, with duration of T1, T2 and T3 respectively. During time duration T1, supplementary uplink on cell 3 is configured to UE. At the start of T2, a NR uplink is configured to UE through *RRCReconfiguration*, then UE shall start transmission both on the NR uplink and supplementary uplink. At the start of T3, the NR uplink is released through *RRCReconfiguration*.

**Table A.4.5.4.1.1-1: Supported test configurations**

Configuration	PSCell (Cell2)	SCell (Cell3)
1	15 kHz SSB SCS, $\geq 10$ MHz bandwidth, FDD duplex mode	DL and UL: 15kHz SSB SCS, $\geq 10$ MHz bandwidth, FDD duplex mode; SUL: 15kHz SCS, $\geq 10$ MHz bandwidth, SUL duplex mode
2	15 kHz SSB SCS, $\geq 10$ MHz bandwidth, FDD duplex mode	DL and UL: 15kHz SSB SCS, $\geq 10$ MHz bandwidth, TDD duplex mode; SUL: 15kHz SCS, $\geq 10$ MHz bandwidth, SUL duplex mode
3	15 kHz SSB SCS, $\geq 10$ MHz bandwidth, FDD duplex mode	DL and UL: 30kHz SSB SCS, $\geq 40$ MHz bandwidth, TDD duplex mode; SUL: 30kHz SCS, $\geq 40$ MHz bandwidth, SUL duplex mode
4	15 kHz SSB SCS, $\geq 10$ MHz bandwidth, TDD duplex mode	DL and UL: 15kHz SSB SCS, $\geq 10$ MHz bandwidth, FDD duplex mode; SUL: 15kHz SCS, 10 MHz bandwidth, SUL duplex mode
5	15 kHz SSB SCS, $\geq 10$ MHz bandwidth, TDD duplex mode	DL and UL: 15kHz SSB SCS, $\geq 10$ MHz bandwidth, TDD duplex mode; SUL: 15kHz SCS, 10 MHz bandwidth, SUL duplex mode
6	15 kHz SSB SCS, $\geq 10$ MHz bandwidth, TDD duplex mode	DL and UL: 30kHz SSB SCS, $\geq 40$ MHz bandwidth, TDD duplex mode; SUL: 30kHz SCS, $\geq 40$ MHz bandwidth, SUL duplex mode
7	30 kHz SSB SCS, $\geq 40$ MHz bandwidth, TDD duplex mode	DL and UL: 15kHz SSB SCS, $\geq 10$ MHz bandwidth, FDD duplex mode; SUL: 15kHz SCS, $\geq 10$ MHz bandwidth, SUL duplex mode
8	30 kHz SSB SCS, $\geq 40$ MHz bandwidth, TDD duplex mode	DL and UL: 15kHz SSB SCS, $\geq 10$ MHz bandwidth, TDD duplex mode;

		SUL: 15kHz SCS, ≥10 MHz bandwidth, SUL duplex mode
9	30 kHz SSB SCS, ≥40 MHz bandwidth, TDD duplex mode	DL and UL: 30kHz SSB SCS, ≥40 MHz bandwidth, TDD duplex mode; SUL: 30kHz SCS, ≥40 MHz bandwidth, SUL duplex mode
<p>Note 1: The UE is only required to be tested in one of the supported test configurations</p> <p>Note 2: The UE is only required to be tested in one with smallest aggregated channel bandwidth from supported band combinations which is composed of CCs ≥ the bandwidth (<math>BW_{channel}</math>) defined in each test configuration,</p>		

**Table A.4.5.4.1.1-2: General test parameters for EN-DC UE UL carrier RRC reconfiguration Delay**

Parameter	Unit	Test configuration	Value	Comment
RF Channel Number		Config 1,2,3, 4, 5, 6, 7, 8, 9	1, 2, 3	Three radio channels are used for these two tests.
Active cell		Config 1,2,3, 4, 5, 6, 7, 8, 9	Cell 1: E-UTRAN PCell Cell 2: FR1 PSCell Cell 3: FR1 SCell	E-UTRAN PCell on RF channel number 1 FR1 PSCell on RF channel number 2 FR1 SCell on RF channel number 3
CP length		Config 1,2,3, 4, 5, 6, 7, 8, 9	Normal	
DRX		Config 1,2,3, 4, 5, 6, 7, 8, 9	OFF	
Measurement gap pattern Id		Config 1,2,3, 4, 5, 6, 7, 8, 9	OFF	
Filter coefficient		Config 1,2,3, 4, 5, 6, 7, 8, 9	0	L3 filtering is not used
T1	s	Config 1,2,3, 4, 5, 6, 7, 8, 9	5	
T2	s	Config 1,2,3, 4, 5, 6, 7, 8, 9	5	
T3	s	Config 1,2,3, 4, 5, 6, 7, 8, 9	5	

**Table A.4.5.4.1.1-3: NR Cell specific test parameters for EN-DC UE UL carrier RRC reconfiguration Delay on PSCell (Cell 2)**

Parameter	Unit	Test Configuration	Test 1			Test 2		
			T1	T2	T3	T1	T2	T3
Channel number		Conf 1, 2, 3, 4, 5, 6, 7, 8, 9	2			2		
TDD configuration		Conf 1, 2, 3	N/A			N/A		
		Conf 4, 5, 6	TDD Conf.1.1			TDD Conf.1.1		
		Conf 7, 8, 9	TDD Conf.2.1			TDD Conf.2.1		
$BW_{channel}$	MHz	Conf 1, 2, 3	Note 6			Note 6		
		Conf 4, 5, 6	Note 6			Note 6		
		Conf 7, 8, 9	Note 6			Note 6		
$BW_{occupied}$	RB	Conf 1, 2, 3	52 <sup>Note 4</sup>			52 <sup>Note 4</sup>		
		Conf 4, 5, 6	52 <sup>Note 4</sup>			52 <sup>Note 4</sup>		
		Conf 7, 8, 9	106 <sup>Note 5</sup>			106 <sup>Note 5</sup>		
PDSCH reference measurement channel as defined in A.3.1.1		Conf 1, 2, 3	SR.1.1 FDD			SR.1.1 FDD		
		Conf 4, 5, 6	SR.1.1 TDD			SR.1.1 TDD		
		Conf 7, 8, 9	SR 2.1 TDD			SR 2.1 TDD		
RMSI CORESET reference measurement channel as defined in A.3.1.2		Conf 1, 2, 3	CR.1.1 FDD			CR.1.1 FDD		
		Conf 4, 5, 6	CR.1.1 TDD			CR.1.1 TDD		
		Conf 7, 8, 9	CR.2.1 TDD			CR.2.1 TDD		
RMC CORESET reference		Conf 1, 2, 3	CCR.1.1 FDD			CCR.1.1 FDD		
		Conf 4, 5, 6	CCR.1.1 TDD			CCR.1.1 TDD		

measurement channel as defined in A.3.1.3		Conf 7, 8, 9	CCR.2.1 TDD			CCR.2.1 TDD		
OCNG Pattern <sup>Note 1</sup>		Conf 1, 2, 3, 4, 5, 6	OP.1 <sup>Note 4</sup>			OP.1 <sup>Note 4</sup>		
		Config 7, 8, 9	OP.1 <sup>Note 5</sup>			OP.1 <sup>Note 5</sup>		
SSB configuration		Conf 1, 2, 3, 4, 5, 6	SSB.1 FR1			SSB.1 FR1		
		Conf 7, 8, 9	SSB.2 FR1			SSB.2 FR1		
SMTC configuration		Conf 1, 2, 3, 4, 5, 6, 7, 8, 9	SMTC.1			SMTC.1		
CSI-RS for tracking		Conf 1	TRS.1.1 FDD			TRS.1.1 FDD		
		Conf 2	TRS.1.1 FDD			TRS.1.1 FDD		
		Conf 3	TRS.1.1 FDD			TRS.1.1 FDD		
		Conf 4	TRS.1.1 TDD			TRS.1.1 TDD		
		Conf 5	TRS.1.1 TDD			TRS.1.1 TDD		
		Conf 6	TRS.1.1 TDD			TRS.1.1 TDD		
		Conf 7	TRS.1.2 TDD			TRS.1.2 TDD		
		Conf 8	TRS.1.2 TDD			TRS.1.2 TDD		
	Conf 9	TRS.1.2 TDD			TRS.1.2 TDD			
DL initial BWP configuration		Conf 1, 2, 3, 4, 5, 6, 7, 8, 9	DLBWP.0.1			DLBWP.0.1		
DL dedicated BWP configuration		Conf 1, 2, 3, 4, 5, 6, 7, 8, 9	DLBWP.1.1			DLBWP.1.1		
UL dedicated BWP configuration		Conf 1, 2, 3, 4, 5, 6, 7, 8, 9	ULBWP.1.1			ULBWP.1.1		
EPRE ratio of PSS to SSS	dB	Conf 1, 2, 3, 4, 5, 6, 7, 8, 9	0			0		
EPRE ratio of PBCH_DMRS to SSS								
EPRE ratio of PBCH to PBCH_DMRS								
EPRE ratio of PDCCH_DMRS to SSS								
EPRE ratio of PDCCH to PDCCH_DMRS								
EPRE ratio of PDSCH_DMRS to SSS								
EPRE ratio of PDSCH to PDSCH_DMRS								
EPRE ratio of OCNG DMRS to SSS								
EPRE ratio of OCNG to OCNG DMRS								
$N_{oc}$ <sup>Note 2</sup>								
	dBm/SCS	Conf 1,2,3,4,5,6	-102			-102		
		Conf 7,8,9	-99			-99		
$\hat{E}_s / N_{oc}$	dB	Conf 1, 2, 3, 4, 5, 6, 7, 8, 9	16	16	16	16	16	16
$\hat{E}_s / I_{ot}$ <sup>Note 3</sup>	dB	Conf 1, 2, 3, 4, 5, 6, 7, 8, 9	16	16	16	16	16	16
SS-RSRP <sup>Note 3</sup>	dBm/SCS	Conf 1,2,3,4,5,6	-86	-86	-86	-86	-86	-86
		Conf 7,8,9	-83	-83	-83	-83	-83	-83
$I_o$ <sup>Note 3</sup>	dBm/9.36 MHz	Conf 1,2,3,4,5,6	-57.9	-57.9	-57.9	-57.9	-57.9	-57.9



	dBm/ 38.16 MHz	Conf 7,8,9	-51.8	-51.8	-51.8	-51.8	-51.8	-51.8
Propagation Condition		Conf 1, 2, 3, 4, 5, 6, 7, 8, 9	AWGN			AWGN		
Antenna configuration		Conf 1, 2, 3, 4, 5, 6, 7, 8, 9	1 x 2			1 x 2		
<p>NOTE 1: OCNG shall be used such that both cells are fully allocated, and a constant total transmitted power spectral density is achieved for all OFDM symbols.</p> <p>NOTE 2: Interference from other cells and noise sources not specified in the test is assumed to be constant over subcarriers and time and shall be modelled as AWGN of appropriate power for <math>N_{oc}</math> to be fulfilled within <math>BW_{occupied}</math>.</p> <p>NOTE 3: <math>\hat{E}_s/I_{ot}</math>, <math>I_o</math>, and SS-RSRP levels have been derived from other parameters for information purposes. They are not settable parameters themselves.</p> <p>NOTE 4: All UL/DL transmission shall be confined within <math>BW_{occupied}</math> (i.e. 10 MHz, 52 RBs) from <math>F_{C,low}</math>, and <math>I_o</math> is independent of the <math>BW_{channel}</math> configured.</p> <p>NOTE 5: All UL/DL transmission shall be confined within <math>BW_{occupied}</math> (i.e. 40 MHz, 106 RBs) from <math>F_{C,low}</math>, and <math>I_o</math> is independent of the <math>BW_{channel}</math> configured.</p> <p>NOTE 6: <math>N_{RB,C}</math> is derived from Table 5.3.2-1 in TS38.101-1[2] with configured <math>BW_{channel}</math>.</p>								

**Table A.4.5.4.1.1-4: NR Cell specific test parameters for EN-DC UE UL carrier RRC reconfiguration Delay on SCell (Cell 3)**

Parameter	Unit	Test Configuration	Test 1			Test 2		
			T1	T2	T3	T1	T2	T3
Channel number		Conf 1, 2, 3, 4, 5, 6, 7, 8, 9	3			3		
TDD configuration		Conf 1, 4, 7	N/A			N/A		
		Conf 2, 5, 8	TDDConf.1.1			TDDConf.1.1		
		Conf 3, 6, 9	TDDConf.2.1			TDDConf.2.1		
$BW_{channel}$	MHz	Conf 1, 4, 7	Note 6			Note 6		
		Conf 2, 5, 8	Note 6			Note 6		
		Conf 3, 6, 9	Note 6			Note 6		
$BW_{occupied}$	RB	Conf 1, 4, 7	52 Note 4			52 Note 4		
		Conf 2, 5, 8	52 Note 4			52 Note 4		
		Conf 3, 6, 9	106 Note 5			106 Note 5		
PUSCH parameters for NR UL carrier		Conf 1, 4, 7	G-FR1-A3-10 in [13]	G-FR1-A3-10 in [13]	G-FR1-A3-10 in [13]	N/A	G-FR1-A3-10 in [13]	N/A
		Conf 2, 5, 8	G-FR1-A3-10 in [13]	G-FR1-A3-10 in [13]	G-FR1-A3-10 in [13]	N/A	G-FR1-A3-10 in [13]	N/A
		Conf 3, 6, 9	G-FR1-A3-14 in [13]	G-FR1-A3-14 in [13]	G-FR1-A3-14 in [13]	N/A	G-FR1-A3-14 in [13]	N/A
PUCCH parameters For NR UL carrier		Conf 1, 4, 7	Table 8.3.3.1.2-1 in [13]	Table 8.3.3.1.2-1 in [13]	Table 8.3.3.1.2-1 in [13]	N/A	N/A	N/A
		Conf 2, 5, 8	Table 8.3.3.1.2-1 in [13]	Table 8.3.3.1.2-1 in [13]	Table 8.3.3.1.2-1 in [13]	N/A	N/A	N/A
		Conf 3, 6, 9	Table 8.3.3.1.2-2 in [13]	Table 8.3.3.1.2-2 in [13]	Table 8.3.3.1.2-2 in [13]	N/A	N/A	N/A
PUSCH parameters for supplementary UL		Conf 1, 4, 7	N/A	G-FR1-A3-10 in [13]	N/A	G-FR1-A3-10 in [13]	G-FR1-A3-10 in [13]	G-FR1-A3-10 in [13]

		Conf 2, 5, 8	N/A	G-FR1-A3-10 in [13]	N/A	G-FR1-A3-10 in [13]	G-FR1-A3-10 in [13]	G-FR1-A3-10 in [13]
		Conf 3, 6, 9	N/A	G-FR1-A3-14 in [13]	N/A	G-FR1-A3-14 in [13]	G-FR1-A3-14 in [13]	G-FR1-A3-14 in [13]
PUCCH parameters for supplementary UL		Conf 1, 4, 7	N/A	N/A	N/A	Table 8.3.3.1.2-1 in [13]	Table 8.3.3.1.2-1 in [13]	Table 8.3.3.1.2-1 in [13]
		Conf 2, 5, 8	N/A	N/A	N/A	Table 8.3.3.1.2-1 in [13]	Table 8.3.3.1.2-1 in [13]	Table 8.3.3.1.2-1 in [13]
		Conf 3, 6, 9	N/A	N/A	N/A	Table 8.3.3.1.2-2 in [13]	Table 8.3.3.1.2-2 in [13]	Table 8.3.3.1.2-2 in [13]
PDSCH reference measurement channel as defined in A.3.1.1		Conf 1, 4, 7	SR.1.1 FDD			SR.1.1 FDD		
		Conf 2, 5, 8	SR.1.1 TDD			SR.1.1 TDD		
		Conf 3, 6, 9	SR.2.1 TDD			SR.2.1 TDD		
RMSI CORESET reference measurement channel as defined in A.3.1.2		Conf 1, 4, 7	CR.1.1 FDD			CR.1.1 FDD		
		Conf 2, 5, 8	CR.1.1 TDD			CR.1.1 TDD		
		Conf 3, 6, 9	CR.2.1 TDD			CR.2.1 TDD		
RMC CORESET reference measurement channel as defined in A.3.1.3		Conf 1, 4, 7	CCR.1.1 FDD			CCR.1.1 FDD		
		Conf 2, 5, 8	CCR.1.1 TDD			CCR.1.1 TDD		
		Conf 3, 6, 9	CCR.2.1 TDD			CCR.2.1 TDD		
OCNG Pattern <sup>Note 1</sup>		Conf 1, 2, 4, 5, 7, 8	OP.1 <sup>Note 4</sup>			OP.1 <sup>Note 4</sup>		
		Conf 3, 6, 9	OP.1 <sup>Note 5</sup>			OP.1 <sup>Note 5</sup>		
SSB configuration		Conf 1, 2, 4, 5, 7, 8	SSB.1 FR1			SSB.1 FR1		
		Conf 3, 6, 9	SSB.2 FR1			SSB.2 FR1		
SMTC configuration		Conf 1, 2, 3, 4, 5, 6, 7, 8, 9	SMTC.1			SMTC.1		
CSI-RS for tracking		Conf 1	TRS.1.1 FDD			TRS.1.1 FDD		
		Conf 2	TRS.1.1 TDD			TRS.1.1 TDD		
		Conf 3	TRS.1.2 TDD			TRS.1.2 TDD		
		Conf 4	TRS.1.1 FDD			TRS.1.1 FDD		
		Conf 5	TRS.1.1 TDD			TRS.1.1 TDD		
		Conf 6	TRS.1.2 TDD			TRS.1.2 TDD		
		Conf 7	TRS.1.1 FDD			TRS.1.1 FDD		
		Conf 8	TRS.1.1 TDD			TRS.1.1 TDD		
	Conf 9	TRS.1.2 TDD			TRS.1.2 TDD			
DL initial BWP configuration		Conf 1, 2, 3, 4, 5, 6, 7, 8, 9	DLBWP.0.1			DLBWP.0.1		
DL dedicated BWP configuration		Conf 1, 2, 3, 4, 5, 6, 7, 8, 9	DLBWP.1.1			DLBWP.1.1		
UL dedicated BWP configuration		Conf 1, 2, 3, 4, 5, 6, 7, 8, 9	ULBWP.1.1			ULBWP.1.1		
EPRE ratio of PSS to SSS	dB							
EPRE ratio of PBCH_DMRS to SSS								
EPRE ratio of PBCH to PBCH_DMRS								
EPRE ratio of PDCCH_DMRS to SSS								
EPRE ratio of PDCCH to PDCCH_DMRS		Conf 1, 2, 3, 4, 5, 6, 7, 8, 9	0			0		

EPRE ratio of PDSCH_DMRS to SSS								
EPRE ratio of PDSCH to PDSCH_DMRS								
EPRE ratio of OCNG DMRS to SSS								
EPRE ratio of OCNG to OCNG DMRS								
$N_{oc}$ Note 2	dBm / 15kHz	Conf 1, 2, 3, 4, 5, 6, 7, 8, 9	-102			-102		
	dBm/ SCS	Conf 1, 2, 4, 5, 7, 8	-102			-102		
		Conf 3, 6, 9	-99			-99		
$\hat{E}_s / N_{oc}$	dB	Conf 1, 2, 3, 4, 5, 6, 7, 8, 9	16	16	16	16	16	16
$\hat{E}_s / I_{ot}$ Note 3	dB	Conf 1, 2, 3, 4, 5, 6, 7, 8, 9	16	16	16	16	16	16
SS-RSRP Note 3	dBm/ SCS	Conf 1, 2, 4, 5, 7, 8	-86	-86	-86	-86	-86	-86
		Conf 3, 6, 9	-83	-83	-83	-83	-83	-83
$I_o$ Note 3	dBm/ 9.36 MHz	Conf 1, 2, 4, 5, 7, 8	-57.9	-57.9	-57.9	-57.9	-57.9	-57.9
	dBm/ 38.16 MHz	Conf 3, 6, 9	-51.8	-51.8	-51.8	-51.8	-51.8	-51.8
Propagation Condition		Conf 1, 2, 3, 4, 5, 6, 7, 8, 9	AWGN			AWGN		
Antenna configuration		Conf 1, 2, 3, 4, 5, 6, 7, 8, 9	1 x 2			1 x 2		
<p>NOTE 1: OCNG shall be used such that both cells are fully allocated, and a constant total transmitted power spectral density is achieved for all OFDM symbols.</p> <p>NOTE 2: Interference from other cells and noise sources not specified in the test is assumed to be constant over subcarriers and time and shall be modelled as AWGN of appropriate power for <math>N_{oc}</math> to be fulfilled within <math>BW_{occupied}</math>.</p> <p>NOTE 3: <math>\hat{E}_s / I_{ot}</math>, <math>I_o</math>, and SS-RSRP levels have been derived from other parameters for information purposes. They are not settable parameters themselves.</p> <p>NOTE 4: All UL/DL transmission shall be confined within <math>BW_{occupied}</math> (i.e. 10 MHz, 52 RBs) from <math>F_{C,low}</math>, and <math>I_o</math> is independent of the <math>BW_{channel}</math> configured.</p> <p>NOTE 5: All UL/DL transmission shall be confined within <math>BW_{occupied}</math> (i.e. 40 MHz, 106 RBs) from <math>F_{C,low}</math>, and <math>I_o</math> is independent of the <math>BW_{channel}</math> configured.</p> <p>NOTE 6: <math>N_{RB,c}</math> is derived from Table 5.3.2-1 in TS38.101-1[2] with configured <math>BW_{channel}</math>.</p>								

#### A.4.5.4.1.2 Test Requirements

In test 1 the UE shall be ready to start transmission on the supplementary uplink carrier on SCell within 20ms from the start of T2.

In test 1 the UE shall stop the transmission on the supplementary uplink carrier on SCell within 20ms from the start of T3.

In test 2 the UE shall be ready to start transmission on the NR uplink carrier on SCell within 20ms from the start of T2.

In test 2 the UE shall stop the transmission on the NR uplink carrier on SCell within 20ms from the start of T3.

All of the above test requirements shall be fulfilled in order for the observed UE UL carrier configuration delay and UE UL carrier release delay to be counted as correct. The rate of correct observed UE UL carrier configuration delay and UE UL carrier release delay during repeated tests shall be at least 90%.

## A.4.5.5 Beam Failure Detection and Link recovery procedures

### A.4.5.5.1 EN-DC Beam Failure Detection and Link Recovery Test for FR1 PSCell configured with SSB-based BFD and LR in non-DRX mode

#### A.4.5.5.1.1 Test Purpose and Environment

The purpose of this test is to verify that the UE properly detects SSB-based beam failure in the set  $q_0$  configured for a serving PSCell and that the UE performs correct SSB-based link recovery based on beam candidate set  $q_1$ . The purpose is to test the downlink monitoring for beam failure detection within the UEs active DL BWP of the PSCell, during the evaluation period, and link recovery, when no DRX is used. This test will partly verify the SSB based beam failure detection and link recovery for an FR1 serving cell requirements in clause 8.5.

The test parameters are given in Tables A.4.5.5.1.1-1, A.4.5.5.1.1-2, A.4.5.5.1.1-3 and A.4.5.5.1.1-4 below. There are two cells, cell 1 is the E-UTRAN PCell, and cell 2 is the PSCell, in the test. The test consists of five successive time periods, with time duration of T1, T2, T3, T4 and T5 respectively. Figure A.4.5.5.1.1-1 shows the variation of the downlink SNR of the PCell and the SNR of the SSB in set  $q_0$  in the active PSCell to emulate SSB based beam failure. Figure A.4.5.5.1.1-2 shows the variation of the downlink L1-RSRP of the SSB in set  $q_1$  of the candidate beam used for link recovery. Prior to the start of the time duration T1, the UE shall be fully synchronized to cell 1 and cell 2. The UE shall be configured for periodic CSI reporting with a reporting periodicity of 5 ms. In the test, DRX configuration is not enabled. The UE is configured to perform inter-frequency measurements using GP ID #0 (40ms) in test 1.

**Table A.4.5.5.1.1-1: Supported test configurations for FR1 PCell**

Configuration	Description
1	LTE FDD, NR 15 kHz SSB SCS, 10 MHz bandwidth, FDD duplex mode
2	LTE FDD, NR 15 kHz SSB SCS, 10 MHz bandwidth, TDD duplex mode
3	LTE FDD, NR 30 kHz SSB SCS, 40 MHz bandwidth, TDD duplex mode
4	LTE TDD, NR 15 kHz SSB SCS, 10 MHz bandwidth, FDD duplex mode
5	LTE TDD, NR 15 kHz SSB SCS, 10 MHz bandwidth, TDD duplex mode
6	LTE TDD, NR 30 kHz SSB SCS, 40 MHz bandwidth, TDD duplex mode
Note:	The UE is only required to pass in one of the supported test configurations in FR1

**Table A.4.5.5.1.1-2: General test parameters for FR1 PSCell for SSB-based beam failure detection and link recovery testing in non-DRX mode**

Parameter	Unit	Value	Comment
		Test 1	
Active E-UTRA PCell		Cell 1	
E-UTRA RF Channel Number		1	
Active PSCell		Cell 2	
RF Channel Number		2	
Duplex mode	Config 1, 4	FDD	
	Config 2, 3, 5, 6	TDD	
BWchannel	Config 1, 4	10: NRB,c = 52	
	Config 2, 5	10: NRB,c = 52	
	Config 3, 6	40: NRB,c = 106	
DL initial BWP configuration	Config 1, 2, 3, 4, 5, 6	DLBWP.0.1	
DL dedicated BWP configuration	Config 1, 2, 3, 4, 5, 6	DLBWP.1.1	
UL initial BWP configuration	Config 1, 2, 3, 4, 5, 6	ULBWP.0.1	
UL dedicated BWP configuration	Config 1, 2, 3, 4, 5, 6	ULBWP.1.1	
TDD Configuration	Config 1, 4	Not Applicable	
	Config 2, 5	TDDConf.1.1	
	Config 3, 6	TDDConf.2.1	
RMSI CORESET	Config 1, 4	CR.1.1 FDD	

Reference Channel	Config 2, 5		CR.1.1 TDD	
	Config 3, 6		CR.2.1 TDD	
Dedicated CORESET Reference Channel	Config 1, 4		CCR.1.1 FDD	
	Config 2, 5		CCR.1.1 TDD	
	Config 3, 6		CCR.2.1 TDD	
SSB Configuration	Config 1, 4		SSB.3 FR1	
	Config 2, 5		SSB.3 FR1	
	Config 3, 6		SSB.4 FR1	
SMTC Configuration	Config 1, 2, 4, 5		SMTC.1	
	Config 3, 6		SMTC.1	
PDSCH/PDCCH subcarrier spacing	Config 1, 2, 4, 5		15 KHz	
	Config 3, 6		30 KHz	
PRACH Configuration	Config 1, 2, 4, 5		Table A.3.8.2.2-1	
	Config 3, 6		Table A.3.8.2.2-1	
SSB Index assigned as BFD RS ( $q_0$ )			0	
SSB Index assigned as CBD RS ( $q_1$ )			1	
OCNG parameters			OP.1	
CP length			Normal	
Correlation Matrix and Antenna Configuration			2x2 Low	
Beam failure detection transmission parameters	DCI format		1-0	
	Number of Control OFDM symbols		2	
	Aggregation level	CCE	8	
	Ratio of hypothetical PDCCH RE energy to average SSS RE energy	dB	0	
	Ratio of hypothetical PDCCH DMRS energy to average SSS RE energy	dB	0	
	DMRS precoder granularity		REG bundle size	
	REG bundle size		6	
DRX			OFF	
Gap pattern ID			gp0	
gapOffset			0	
rimInSyncOutOfSyncThreshold			absent	When the field is absent, the UE applies the value 0. (Table 8.1.1-1).
rsrp-ThresholdSSB	Config 1, 2, 4, 5	dBm/SCS kHz	-98	Threshold used for $Q_{in\_LR\_SSB}$
	Config 3, 6		-95	
powerControlOffsetSS			db0	Used for deriving rsrp-ThresholdCSI-RS
beamFailureInstanceMaxCount			n1	see TS 38.321 [7], clause 5.17
beamFailureDetectionTimer			pbfd4	see TS 38.321 [7], clause 5.17

CSI-RS configuration for CSI reporting	Config 1, 4		CSI-RS.1.1 FDD	
	Config 2, 5		CSI-RS.1.1 TDD	
	Config 3, 6		CSI-RS.2.1 TDD	
CSI-RS for tracking	Config 1, 4		TRS.1.1 FDD	
	Config 2, 5		TRS.1.1 TDD	
	Config 3, 6		TRS.1.2 TDD	
SSB Index assigned as RLM RS			0,1	
T310 timer		ms	1000	
N310			2	
T1		s	0.2	During this time the the UE shall be fully synchronized to cell 1
T2		s	0.37	
T3		s	0.24	
T4		s	0	
T5		s	0.17	
D1		s	0.13	
Note 1: All configurations are assigned to the UE prior to the start of time period T1.				
Note 2: UE-specific PDCCH is not transmitted after T1 starts.				
Note 3: E-UTRAN is in non-DRX mode under test.				

**Table A.4.5.5.1.1-3: Cell specific test parameters for FR1 PSCell for SSB-based beam failure detection and link recovery testing in non-DRX mode**

Parameter	Unit	Test 1				
		T1	T2	T3	T4	T5
EPRE ratio of PDCCH DMRS to SSS	dB	0				
EPRE ratio of PDCCH to PDCCH DMRS						
EPRE ratio of PBCH DMRS to SSS						
EPRE ratio of PBCH to PBCH DMRS						
EPRE ratio of PSS to SSS						
EPRE ratio of PDSCH DMRS to SSS						
EPRE ratio of PDSCH to PDSCH DMRS						
EPRE ratio of OCNB DMRS to SSS						
EPRE ratio of OCNB to OCNB DMRS						
SNR_SSB of set $q_0$	Config 1, 4	5	-3	-12	-12	-12
	Config 2, 5	5	-3	-12	-12	-12
	Config 3, 6	5	-3	-12	-12	-12
SNR_SSB of set $q_1$	Config 1, 4	-10	-10	10	10	10
	Config 2, 5	-10	-10	10	10	10
	Config 3, 6	-10	-10	10	10	10
SSB_RP of set $q_1$	Config 1, 4	-108	-108	-88	-88	-88
	Config 2, 5	-108	-108	-88	-88	-88
	Config 3, 6	-105	-105	-85	-85	-85
$N_{oc}$	Config 1, 4	-98				
	Config 2, 5	-98				
	Config 3, 6	-98				
Propagation condition		TDL-C 300ns 100Hz				
Note 1: OCNB shall be used such that the resources in Cell 1 are fully allocated and a constant total transmitted power spectral density is achieved for all OFDM symbols.						
Note 2: The uplink resources for CSI reporting are assigned to the UE prior to the start of time period T1.						
Note 3: NZP CSI-RS resource set configuration for CSI reporting are assigned to the UE prior to the start of time period T1.						
Note 4: Measurement gap configuration is assigned to the UE prior to the start of time period T1.						
Note 5: The timers and layer 3 filtering related parameters are configured prior to the start of time period T1.						
Note 6: The signal contains PDCCH for UEs other than the device under test as part of OCNB.						
Note 7: SNR levels correspond to the signal to noise ratio over the SSS REs.						
Note 8: The SNR in time periods T1, T2, T3, T4 and T5 is denoted as SNR1, SNR2 and SNR3 respectively in figure A.4.5.5.1.1-1.						
Note 9: The SNR values are specified for testing a UE which supports 2RX on at least one band. For testing of a UE which supports 4RX on all bands, the SNR during T3 is modified as specified in clause A.3.6.						

Table A.4.5.5.1.1-4: Void

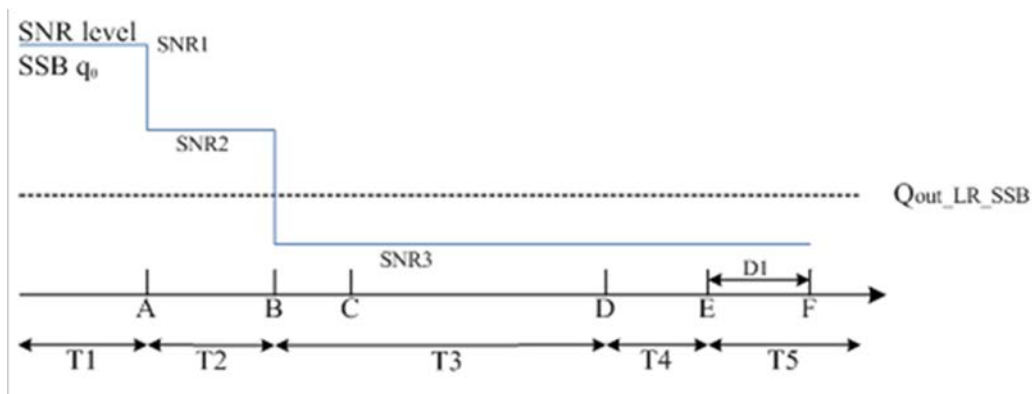

Figure A.4.5.5.1.1-1: SNR variation for SSB-based beam failure detection and link recovery testing in non-DRX mode

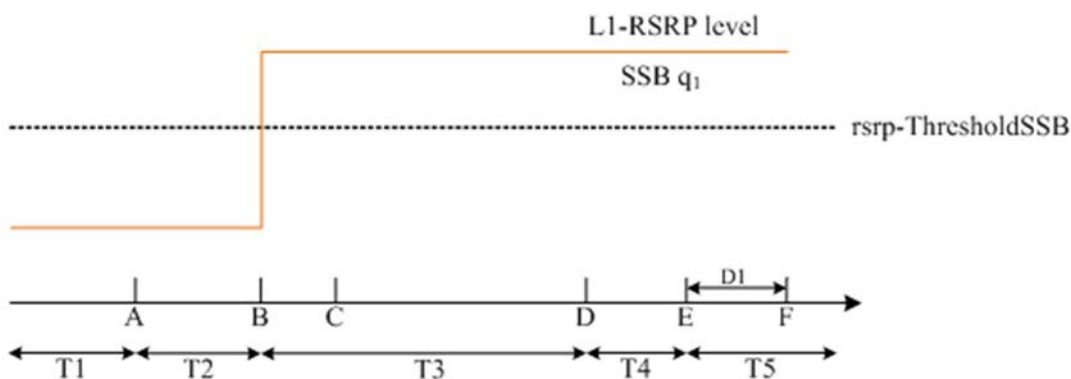

Figure A.4.5.5.1.1-2: L1-RSRP level variation for SSB-based beam failure detection and link recovery testing in non-DRX mode

A.4.5.5.1.2 Test Requirements

The UE behaviour during time durations T1, T2, T3, T4 and T5 shall be as follows:

During the time duration T1 and T2, the UE shall transmit uplink signal at least in all subframes configured for CSI transmission on Cell 1.

During the period from time point A to time point B the UE shall transmit uplink signal in Cell 1 in all uplink slots configured for CSI transmission according to the configured periodic CSI reporting for Cell 1.

During T3 the UE shall detect beam failure and initiate link recovery. During T4 and T5 the UE measures and evaluate beam candidate from beam candidate set  $q_1$ .

No later than time point F occurring no later than  $D1 = 120+10$  ms after the start of T5, the UE shall transmit preamble on a beam associated with the candidate beam set  $q_1$ . The UE shall not transmit preamble on a beam associated with the candidate beam set  $q_1$  earlier than time point B.

Test is concluded once the test equipment has received the initial preamble transmission from the UE. The rate of correct events observed during repeated tests shall be at least 90%.

## A.4.5.5.2 EN-DC Beam Failure Detection and Link Recovery Test for FR1 PSCell configured with SSB-based BFD and LR in DRX mode

### A.4.5.5.2.1 Test Purpose and Environment

The purpose of this test is to verify that the UE properly detects SSB-based beam failure in the set  $q_0$  configured for a serving PSCell and that the UE performs correct SSB-based link recovery based on beam candidate set  $q_1$ . The purpose is to test the downlink monitoring for beam failure detection within the UEs active DL BWP of the PSCell, during the evaluation period, and link recovery, when DRX is used. This test will partly verify the SSB based beam failure detection and link recovery for an FR1 serving cell requirements in clause 8.5.

The test parameters are given in Tables A.4.5.5.2.1-1, A.4.5.5.2.1-2, A.4.5.5.2.1-3, A.4.5.5.2.1-4 and A.4.5.5.2.1-5 below. There are two cells, cell 1 is the E-UTRAN PCell, and cell 2 is the PSCell, in the test. The test consists of five successive time periods, with time duration of T1, T2, T3, T4 and T5 respectively. Figure A.4.5.5.2.1-1 shows the variation of the downlink SNR of the PCell and the SNR of the SSB in set  $q_0$  in the active PSCell to emulate SSB based beam failure. Figure A.4.5.5.2.1-2 shows the variation of the downlink L1-RSRP of the SSB in set  $q_1$  of the candidate beam used for link recovery. Prior to the start of the time duration T1, the UE shall be fully synchronized to cell 1 and cell 2. The UE shall be configured for periodic CSI reporting with a reporting periodicity of 5 ms. In the test, DRX configuration is enabled in PSCell and DRX inactivity timer has already been expired, i.e. UE tries to decode PDCCH and to send periodic CQI during the period when On-duration timer is running. Time alignment timers shall be set to "infinity" so that UL timing alignment is maintained during the test.

**Table A.4.5.5.2.1-1: Supported test configurations for FR1 PCell**

Configuration	Description
1	LTE FDD, NR 15 kHz SSB SCS, 10 MHz bandwidth, FDD duplex mode
2	LTE FDD, NR 15 kHz SSB SCS, 10 MHz bandwidth, TDD duplex mode
3	LTE FDD, NR 30 kHz SSB SCS, 40 MHz bandwidth, TDD duplex mode
4	LTE TDD, NR 15 kHz SSB SCS, 10 MHz bandwidth, FDD duplex mode
5	LTE TDD, NR 15 kHz SSB SCS, 10 MHz bandwidth, TDD duplex mode
6	LTE TDD, NR 30 kHz SSB SCS, 40 MHz bandwidth, TDD duplex mode
Note:	The UE is only required to pass in one of the supported test configurations in FR1

**Table A.4.5.5.2.1-2: General test parameters for FR1 PCell for SSB-based beam failure detection and link recovery testing in DRX mode**

Parameter	Unit	Value	Comment
		Test 1	
Active E-UTRA PCell		Cell 1	
E-UTRA RF Channel Number		1	
Active PSCell		Cell 2	
RF Channel Number		2	
Duplex mode	Config 1, 4	FDD	
	Config 2, 3, 5, 6	TDD	
BWchannel	Config 1, 4	10: NRB,c = 52	
	Config 2, 5	10: NRB,c = 52	
	Config 3, 6	40: NRB,c = 106	
DL initial BWP configuration	Config 1, 2, 3, 4, 5, 6	DLBWP.0.1	
DL dedicated BWP configuration	Config 1, 2, 3, 4, 5, 6	DLBWP.1.1	
UL initial BWP configuration	Config 1, 2, 3, 4, 5, 6	ULBWP.0.1	
UL dedicated BWP configuration	Config 1, 2, 3, 4, 5, 6	ULBWP.1.1	
TDD Configuration	Config 1, 4	Not Applicable	
	Config 2, 5	TDDConf.1.1	
	Config 3, 6	TDDConf.2.1	
RMSI CORESET Reference Channel	Config 1, 4	CR.1.1 FDD	
	Config 2, 5	CR.1.1 TDD	



	Config 3, 6		CR.2.1 TDD	
Dedicated CORESET Reference Channel	Config 1, 4		CCR.1.1 FDD	
	Config 2, 5		CCR.1.1 TDD	
	Config 3, 6		CCR.2.1 TDD	
SSB Configuration	Config 1, 4		SSB.3 FR1	
	Config 2, 5		SSB.3 FR1	
	Config 3, 6		SSB.4 FR1	
SMTC Configuration	Config 1, 2, 4, 5		SMTC.1	
	Config 3, 6		SMTC.1	
PDSCH/PDCCH subcarrier spacing	Config 1, 2, 4, 5		15 KHz	
	Config 3, 6		30 KHz	
PRACH Configuration	Config 1, 2, 4, 5		Table A.3.8.2.2-1	
	Config 3, 6		Table A.3.8.2.2-1	
SSB Index assigned as BFD RS ( $q_0$ )			0	
SSB Index assigned as CBD RS ( $q_1$ )			1	
OCNG parameters			OP.1	
CP length			Normal	
Correlation Matrix and Antenna Configuration			2x2 Low	
Beam failure detection transmission parameters	DCI format		1-0	
	Number of Control OFDM symbols		2	
	Aggregation level	CCE	8	
	Ratio of hypothetical PDCCH RE energy to average SSS RE energy	dB	0	
	Ratio of hypothetical PDCCH DMRS energy to average SSS RE energy	dB	0	
	DMRS precoder granularity		REG bundle size	
	REG bundle size		6	
DRX			DRX.7	A.3.3.7
Gap pattern ID			N.A.	
rlmInSyncOutOfSyncThreshold			absent	When the field is absent, the UE applies the value 0. (Table 8.1.1-1).
rsrp-ThresholdSSB	Config 1, 2, 4, 5	dBm/SCS kHz	-98	Threshold used for $Q_{in\_LR\_SSB}$
	Config 3, 6		-95	
powerControlOffsetSS			db0	Used for deriving rsrp-ThresholdCSI-RS
beamFailureInstanceMaxCount			n1	see TS 38.321 [7], clause 5.17
beamFailureDetectionTimer			pbfd4	see TS 38.321 [7], clause 5.17
CSI-RS configuration for CSI reporting	Config 1, 4		CSI-RS.1.1 FDD	
	Config 2, 5		CSI-RS.1.1 TDD	
	Config 3, 6		CSI-RS.2.1 TDD	
CSI-RS for tracking	Config 1, 4		TRS.1.1 FDD	
	Config 2, 5		TRS.1.1 TDD	
	Config 3, 6		TRS.1.2 TDD	
SSB Index assigned as RLM RS			0,1	
T310 Timer		ms	1000	
N310			2	

T1	s	1	During this time the the UE shall be fully synchronized to cell 1
T2	s	5.17	
T3	s	3.24	
T4	s	0	
T5	s	1.97	
D1	s	1.93	
<p>Note 1: All configurations are assigned to the UE prior to the start of time period T1.</p> <p>Note 2: UE-specific PDCCH is not transmitted after T1 starts.</p> <p>Note 3: E-UTRAN is in non-DRX mode under test.</p>			

**Table A.4.5.2.1-3: Cell specific test parameters for FR1 PSCell for SSB-based beam failure detection and link recovery testing in DRX mode**

Parameter		Unit	Test 1				
			T1	T2	T3	T4	T5
EPRE ratio of PDCCH DMRS to SSS		dB	0				
EPRE ratio of PDCCH to PDCCH DMRS		dB					
EPRE ratio of PBCH DMRS to SSS		dB					
EPRE ratio of PBCH to PBCH DMRS		dB					
EPRE ratio of PSS to SSS		dB					
EPRE ratio of PDSCH DMRS to SSS		dB					
EPRE ratio of PDSCH to PDSCH DMRS		dB					
EPRE ratio of OCNG DMRS to SSS		dB					
EPRE ratio of OCNG to OCNG DMRS		dB					
SNR_SSB of set $q_0$	Config 1, 4	dB	5	-3	-12	-12	-12
	Config 2, 5		5	-3	-12	-12	-12
	Config 3, 6		5	-3	-12	-12	-12
SNR_SSB of set $q_1$	Config 1, 4	dB	-10	-10	10	10	10
	Config 2, 5		-10	-10	10	10	10
	Config 3, 6		-10	-10	10	10	10
SSB_RP of set $q_1$	Config 1, 4	dBm/SCS kHz	-108	-108	-88	-88	-88
	Config 2, 5		-108	-108	-88	-88	-88
	Config 3, 6		-105	-105	-85	-85	-85
$N_{oc}$	Config 1, 4	dBm/15 KHz	-98				
	Config 2, 5		-98				
	Config 3, 6		-98				
Propagation condition			TDL-C 300ns 100Hz				
<p>Note 1: OCNG shall be used such that the resources in Cell 1 are fully allocated and a constant total transmitted power spectral density is achieved for all OFDM symbols.</p> <p>Note 2: The uplink resources for CSI reporting are assigned to the UE prior to the start of time period T1.</p> <p>Note 3: NZP CSI-RS resource set configuration for CSI reporting are assigned to the UE prior to the start of time period T1.</p> <p>Note 4: Void</p> <p>Note 5: The timers and layer 3 filtering related parameters are configured prior to the start of time period T1.</p> <p>Note 6: The signal contains PDCCH for UEs other than the device under test as part of OCNG.</p> <p>Note 7: SNR levels correspond to the signal to noise ratio over the SSS REs.</p> <p>Note 8: The SNR in time periods T1, T2, T3, T4 and T5 is denoted as SNR1, SNR2 and SNR3 respectively in figure A.4.5.5.1.1-1.</p> <p>Note 9: The SNR values are specified for testing a UE which supports 2RX on at least one band. For testing of a UE which supports 4RX on all bands, the SNR during T3 is modified as specified in clause A.3.6.</p>							

Table A.4.5.5.2.1-4: Void

Table A.4.5.5.2.1-5: Void

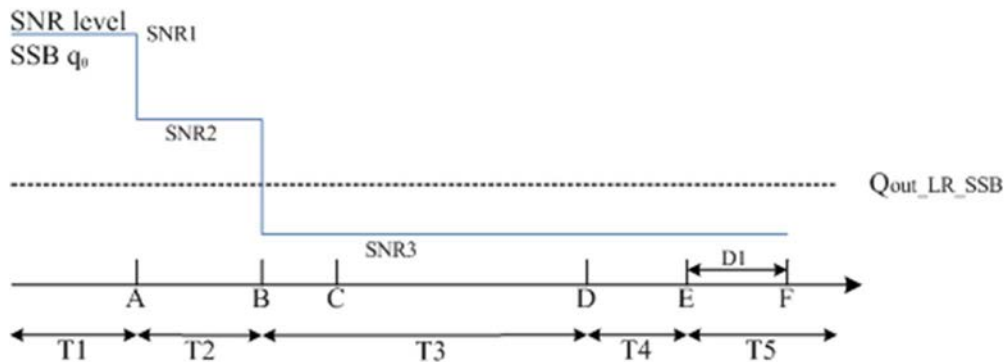

Figure A.4.5.5.2.1-1: SNR variation for SSB-based beam failure detection and link recovery testing in DRX mode

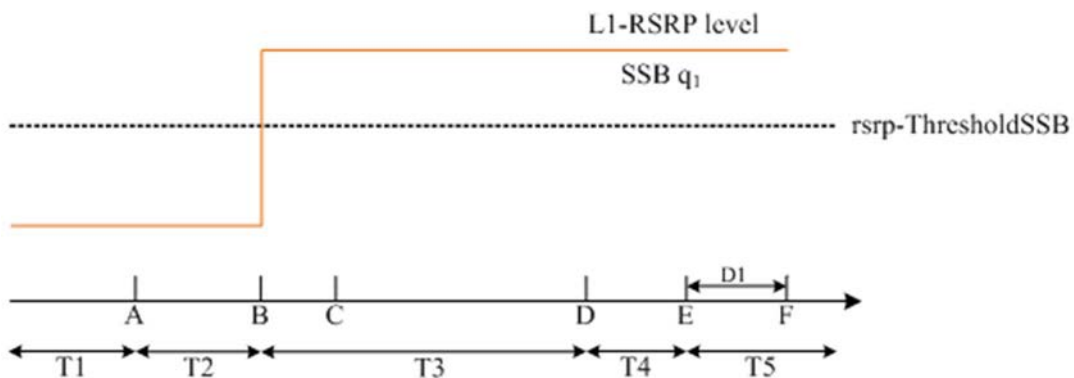

Figure A.4.5.5.2.1-2: L1-RSRP level variation for SSB-based beam failure detection and link recovery testing in DRX mode

A.4.5.5.2.2 Test Requirements

The UE behaviour during time durations T1, T2, T3, T4 and T5 shall be as follows:

During the time duration T1 and T2, the UE shall transmit uplink signal at least in all subframes configured for CSI transmission on Cell 1.

During the period from time point A to time point B the UE shall transmit uplink signal in Cell 1 in all uplink slots configured for CSI transmission according to the configured periodic CSI reporting for Cell 1.

During T3 the UE shall detect beam failure and initiate link recovery. During T4 and T5 the UE measures and evaluates beam candidate from beam candidate set  $q_1$ .

No later than time point F occurring no later than  $D1 = 1920 + 10$  ms after the start of T5, the UE shall transmit preamble on a beam associated with the candidate beam set  $q_1$ . The UE shall not transmit preamble on a beam associated with the candidate beam set  $q_1$  earlier than time point B.

Test is concluded once the test equipment has received the initial preamble transmission from the UE. The rate of correct events observed during repeated tests shall be at least 90%.

### A.4.5.5.3 EN-DC Beam Failure Detection and Link Recovery Test for FR1 PSCell configured with CSI-RS-based BFD and LR in non-DRX mode

#### A.4.5.5.3.1 Test Purpose and Environment

The purpose of this test is to verify that the UE properly detects CSI-RS-based beam failure in the set  $q_0$  configured for a serving PSCell and that the UE performs correct CSI-RS-based link recovery based on beam candidate set  $q_1$ . The purpose is to test the downlink monitoring for beam failure detection within the UEs active DL BWP of the PSCell, during the evaluation period, and link recovery, when no DRX is used. This test will partly verify the CSI-RS based beam failure detection and link recovery for an FR1 serving cell requirements in clause 8.5.

The test parameters are given in Tables A.4.5.5.3.1-1, A.4.5.5.3.1-2, and A.4.5.5.3.1-3 below. There are two cells, cell 1 is the E-UTRAN PCell, and cell 2 is the PSCell, in the test. The test consists of five successive time periods, with time duration of T1, T2, T3, T4 and T5 respectively. Figure A.4.5.5.3.1-1 shows the variation of the downlink SNR of the PSCell and the SNR of the CSI-RS in set  $q_0$  in the active PSCell to emulate CSI-RS based beam failure. Figure A.4.5.5.3.1-2 shows the variation of the downlink L1-RSRP of the CSI-RS in set  $q_1$  of the candidate beam used for link recovery. Prior to the start of the time duration T1, the UE shall be fully synchronized to cell 1 and cell 2. The UE shall be configured for periodic CSI reporting with a reporting periodicity of 5 ms. In the test, DRX configuration is not enabled.

**Table A.4.5.5.3.1-1: Supported test configurations for FR1 PSCell**

Configuration	Description
1	LTE FDD, NR 15 kHz SSB SCS, 10 MHz bandwidth, FDD duplex mode
2	LTE FDD, NR 15 kHz SSB SCS, 10 MHz bandwidth, TDD duplex mode
3	LTE FDD, NR 30 kHz SSB SCS, 40 MHz bandwidth, TDD duplex mode
4	LTE TDD, NR 15 kHz SSB SCS, 10 MHz bandwidth, FDD duplex mode
5	LTE TDD, NR 15 kHz SSB SCS, 10 MHz bandwidth, TDD duplex mode
6	LTE TDD, NR 30 kHz SSB SCS, 40 MHz bandwidth, TDD duplex mode
Note:	The UE is only required to pass in one of the supported test configurations in FR1

**Table A.4.5.5.3.1-2: General test parameters for FR1 PSCell for CSI-RS-based beam failure detection and link recovery testing in non-DRX mode**

Parameter	Unit	Value	Comment
		Test 1	
Active PCell		Cell 1	
RF Channel Number		1	
Active PSCell		Cell 2	
RF Channel Number		2	
Duplex mode	Config 1, 4	FDD	
	Config 2, 3, 5, 6	TDD	
BWchannel	Config 1, 4	10: NRB,c = 52	
	Config 2, 5	10: NRB,c = 52	
	Config 3, 6	40: NRB,c = 106	
DL initial BWP configuration	Config 1, 2, 3, 4, 5, 6	DLBWP.0.1	
DL dedicated BWP configuration	Config 1, 2, 3, 4, 5, 6	DLBWP.1.1	
UL initial BWP configuration	Config 1, 2, 3, 4, 5, 6	ULBWP.0.1	
UL dedicated BWP configuration	Config 1, 2, 3, 4, 5, 6	ULBWP.1.1	
TDD Configuration	Config 1, 4	Not Applicable	
	Config 2, 5	TDDConf.1.1	
	Config 3, 6	TDDConf.2.1	
RMSI CORESET Reference Channel	Config 1, 4	CR.1.1 FDD	A.3.1.2
	Config 2, 5	CR.1.1 TDD	
	Config 3, 6	CR.2.1 TDD	
Dedicated CORESET	Config 1, 4	CCR.1.1 FDD	A.3.1.3

Reference Channel	Config 2, 5		CCR.1.1 TDD	
	Config 3, 6		CCR.2.1 TDD	
SSB Configuration	Config 1, 4		SSB.3 FR1	A.3.10
	Config 2, 5		SSB.3 FR1	
	Config 3, 6		SSB.4 FR1	
SMTC Configuration	Config 1, 2, 4, 5		SMTC.1	A.3.11
	Config 3, 6		SMTC.1	
PDSCH/PDCCH subcarrier spacing	Config 1, 2, 4, 5		15 KHz	
	Config 3, 6		30 KHz	
PRACH Configuration	Config 1, 2, 4, 5		FR1 PRACH configuration 4	A.3.8.2
	Config 3, 6		FR1 PRACH configuration 4	A.3.8.2
csi-RS-Index assigned as beam failure detection RS in set $q_0$			0	
OCNG parameters			OP.1	A.3.2.1
CP length			Normal	
Correlation Matrix and Antenna Configuration			2x2 Low	
Beam failure detection transmission parameters	DCI format		1-0	
	Number of Control OFDM symbols		2	
	Aggregation level	CCE	8	
	Ratio of hypothetical PDCCH RE energy to average CSI-RS RE energy	dB	0	
	Ratio of hypothetical PDCCH DMRS energy to average CSI-RS RE energy	dB	0	
	DMRS precoder granularity		REG bundle size	
	REG bundle size		6	
DRX			OFF	
Gap pattern ID			N.A.	
csi-RS-Index assigned as candidate beam detection RS in set $q_1$			1	
rlmInSyncOutOfSyncThreshold			absent	When the field is absent, the UE applies the value 0. (Table 8.1.1-1).
rsrp-ThresholdCSI-RS	Config 1, 2, 4, 5	dBm/SCS	-98	Threshold used for $Q_{in\_LR\_CSI-RS}$
	Config 3, 6	kHz	-95	
powerControlOffsetSS			db0	Used for deriving rsrp-ThresholdCSI-RS
beamFailureInstanceMaxCount			n1	see TS 38.321 [7], clause 5.17
beamFailureDetectionTimer			pbfd4	see TS 38.321 [7], clause 5.17
CSI-RS configuration for $q_0$ and $q_1$	Config 1, 4		CSI-RS.1.2 FDD	A.3.14
	Config 2, 5		CSI-RS.1.2 TDD	
	Config 3, 6		CSI-RS.2.2 TDD	
CSI-RS configuration for CSI reporting	Config 1, 4		CSI-RS.1.1 FDD	A.3.14
	Config 2, 5		CSI-RS.1.1 TDD	
	Config 3, 6		CSI-RS.2.1 TDD	
TRS configuration	Config 1, 4		TRS.1.1 FDD	
	Config 2, 5		TRS.1.1 TDD	
	Config 3, 6		TRS.1.2 TDD	

csi-RS-Index assigned as RLM RS	Config 1, 4		CSI-RS.1.2 FDD	A.3.14
	Config 2, 5		CSI-RS.1.2 TDD	
	Config 3, 6		CSI-RS.2.2 TDD	
T310 Timer		ms	1000	
N310			2	
T1		s	1	During this time the the UE shall be fully synchronized to cell 1
T2		s	0.18	
T3		s	0.14	
T4		s	0	
T5		s	0.08	
D1		s	0.04	
Note 1: UE-specific PDCCH is not transmitted after T1 starts.				

**Table A.4.5.5.3.1-3: Cell specific test parameters for FR1 PSCell for CSI-RS-based beam failure detection and link recovery testing in non-DRX mode**

Parameter	Unit	Test 1				
		T1	T2	T3	T4	T5
EPRE ratio of PDCCH DMRS to SSS	dB	0				
EPRE ratio of PDCCH to PDCCH DMRS						
EPRE ratio of PBCH DMRS to SSS						
EPRE ratio of PBCH to PBCH DMRS						
EPRE ratio of PSS to SSS						
EPRE ratio of PDSCH DMRS to SSS						
EPRE ratio of PDSCH to PDSCH DMRS						
EPRE ratio of OCNG DMRS to SSS						
EPRE ratio of OCNG to OCNG DMRS						
SNR_CSI-RS of set q <sub>0</sub>	Config 1, 4	5	-3	-12	-12	-12
	Config 2, 5	5	-3	-12	-12	-12
	Config 3, 6	5	-3	-12	-12	-12
SNR_CSI-RS of set q <sub>1</sub>	Config 1, 4	-10	-10	10	10	10
	Config 2, 5	-10	-10	10	10	10
	Config 3, 6	-10	-10	10	10	10
CSI-RS_RP of set q <sub>1</sub>	Config 1, 4	-108	-108	-88	-88	-88
	Config 2, 5	-108	-108	-88	-88	-88
	Config 3, 6	-105	-105	-85	-85	-85
$N_{oc}$	Config 1, 4	-98				
	Config 2, 5	-98				
	Config 3, 6	-98				
Propagation condition		TDL-C 300ns 100Hz				
<p>Note 1: OCNG shall be used such that the resources in Cell 1 are fully allocated and a constant total transmitted power spectral density is achieved for all OFDM symbols.</p> <p>Note 2: The uplink resources for CSI reporting are assigned to the UE prior to the start of time period T1.</p> <p>Note 3: NZP CSI-RS resource set configuration for CSI reporting are assigned to the UE prior to the start of time period T1.</p> <p>Note 4: Void</p> <p>Note 5: The timers and layer 3 filtering related parameters are configured prior to the start of time period T1.</p> <p>Note 6: The signal contains PDCCH for UEs other than the device under test as part of OCNG.</p> <p>Note 7: SNR levels correspond to the signal to noise ratio over the REs carrying CSI-RS.</p> <p>Note 8: The SNR in time periods T1, T2, T3, T4 and T5 is denoted as SNR1, SNR2 and SNR3 respectively in figure A.4.5.5.1.1-1.</p> <p>Note 9: The SNR values are specified for testing a UE which supports 2RX on at least one band. For testing of a UE which supports 4RX on all bands, the SNR during T3 is modified as specified in clause A.3.6.</p>						

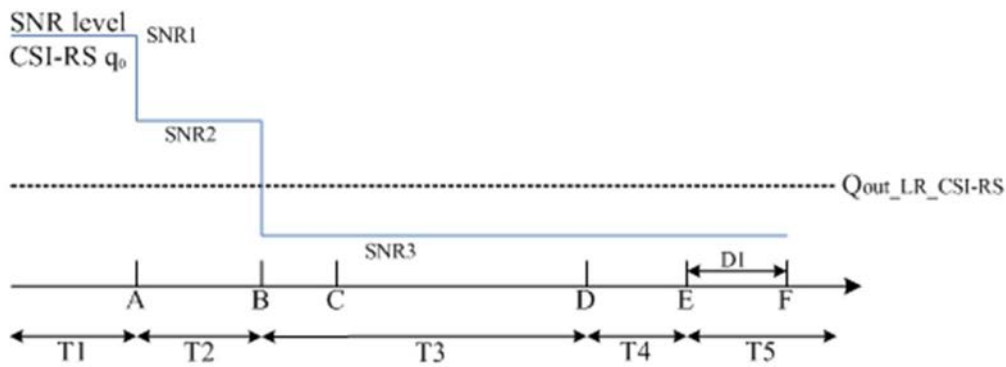

Figure A.4.5.5.3.1-1: SNR variation for CSI-RS-based beam failure detection and link recovery testing in non-DRX mode

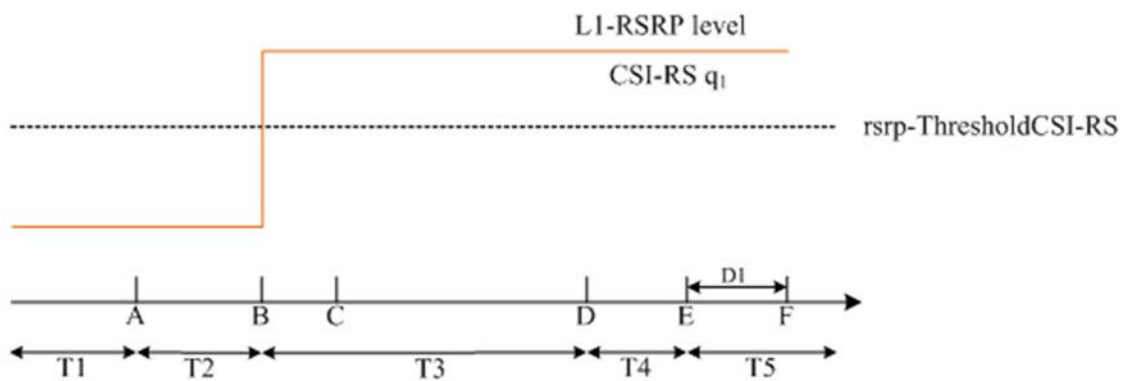

Figure A.4.5.5.3.1-2: L1-RSRP level variation for CSI-RS based beam failure detection and link recovery testing in non-DRX mode

### A.4.5.5.3.2 Test Requirements

The UE behaviour during time durations T1, T2, T3, T4 and T5 shall be as follows:

During the time duration T1 and T2, the UE shall transmit uplink signal at least in all subframes configured for CSI transmission on Cell 1.

During the period from time point A to time point B the UE shall transmit uplink signal in Cell 1 in all uplink slots configured for CSI transmission according to the configured periodic CSI reporting for Cell 1.

During T3 the UE shall detect beam failure and initiate link recovery. During T4 and T5 the UE measures and evaluates beam candidate from beam candidate set  $q_1$ .

No later than time point F occurring no later than  $D1 = 30+10$  ms after the start of T5, the UE shall transmit preamble on a beam associated with the candidate beam set  $q_1$ . The UE shall not transmit preamble on a beam associated with the candidate beam set  $q_1$  earlier than time point B.

Test is concluded once the test equipment has received the initial preamble transmission from the UE. The rate of correct events observed during repeated tests shall be at least 90%.

#### A.4.5.5.4 EN-DC Beam Failure Detection and Link Recovery Test for FR1 PSCell configured with CSI-RS-based BFD and LR in DRX mode

##### A.4.5.5.4.1 Test Purpose and Environment

The purpose of this test is to verify that the UE properly detects CSI-RS-based beam failure in the set  $q_0$  configured for a serving PSCell and that the UE performs correct CSI-RS-based link recovery based on beam candidate set  $q_1$ . The purpose is to test the downlink monitoring for beam failure detection within the UEs active DL BWP of the PSCell, during the evaluation period, and link recovery, when DRX is used. This test will partly verify the CSI-RS based beam failure detection and link recovery for an FR1 serving cell requirements in clause 8.5.

The test parameters are given in Tables A.4.5.5.4.1-1, A.4.5.5.4.1-2, A.4.5.5.4.1-3, and A.4.5.5.4.1-4 below. There are two cells, cell 1 is the E-UTRAN PCell, and cell 2 is the PSCell, in the test. The test consists of five successive time periods, with time duration of T1, T2, T3, T4 and T5 respectively. Figure A.4.5.5.4.1-1 shows the variation of the downlink SNR of the PSCell and the SNR of the CSI-RS in set  $q_0$  in the active PSCell to emulate CSI-RS based beam failure. Figure A.4.5.5.4.1-2 shows the variation of the downlink L1-RSRP of the CSI-RS in set  $q_1$  of the candidate beam used for link recovery. Prior to the start of the time duration T1, the UE shall be fully synchronized to cell 1 and cell 2. The UE shall be configured for periodic CSI reporting with a reporting periodicity of 5 ms. In the test, DRX configuration is enabled in PSCell and DRX inactivity timer has already been expired, i.e. UE tries to decode PDCCH and to send periodic CQI during the period when On-duration timer is running. Time alignment timers shall be set to "infinity" so that UL timing alignment is maintained during the test.

**Table A.4.5.5.4.1-1: Supported test configurations for FR1 PSCell**

Configuration	Description
1	LTE FDD, NR 15 kHz SSB SCS, 10 MHz bandwidth, FDD duplex mode
2	LTE FDD, NR 15 kHz SSB SCS, 10 MHz bandwidth, TDD duplex mode
3	LTE FDD, NR 30 kHz SSB SCS, 40 MHz bandwidth, TDD duplex mode
4	LTE TDD, NR 15 kHz SSB SCS, 10 MHz bandwidth, FDD duplex mode
5	LTE TDD, NR 15 kHz SSB SCS, 10 MHz bandwidth, TDD duplex mode
6	LTE TDD, NR 30 kHz SSB SCS, 40 MHz bandwidth, TDD duplex mode
Note:	The UE is only required to pass in one of the supported test configurations in FR1

**Table A.4.5.5.4.1-2: General test parameters for FR1 PSCell for CSI-RS-based beam failure detection and link recovery testing in DRX mode**

Parameter	Unit	Value	Comment
		Test 1	
Active PCell		Cell 1	
RF Channel Number		1	
Active PSCell		Cell 2	
RF Channel Number		2	
Duplex mode	Config 1, 4	FDD	
	Config 2, 3, 5, 6	TDD	
BWchannel	Config 1, 4	10: NRB,c = 52	
	Config 2, 5	10: NRB,c = 52	
	Config 3, 6	40: NRB,c = 106	
DL initial BWP configuration	Config 1, 2, 3, 4, 5, 6	DLBWP.0.1	
DL dedicated BWP configuration	Config 1, 2, 3, 4, 5, 6	DLBWP.1.1	
UL initial BWP configuration	Config 1, 2, 3, 4, 5, 6	ULBWP.0.1	
UL dedicated BWP configuration	Config 1, 2, 3, 4, 5, 6	ULBWP.1.1	
TDD Configuration	Config 1, 4	Not Applicable	
	Config 2, 5	TDDConf.1.1	
	Config 3, 6	TDDConf.2.1	



RMSI CORESET Reference Channel	Config 1, 4		CR.1.1 FDD	A.3.1.2
	Config 2, 5		CR.1.1 TDD	
	Config 3, 6		CR.2.1 TDD	
Dedicated CORESET Reference Channel	Config 1, 4		CCR.1.1 FDD	A.3.1.3
	Config 2, 5		CCR.1.1 TDD	
	Config 3, 6		CCR.2.1 TDD	
SSB Configuration	Config 1, 4		SSB.3 FR1	A.3.10
	Config 2, 5		SSB.3 FR1	
	Config 3, 6		SSB.4 FR1	
SMTC Configuration	Config 1, 2, 4, 5		SMTC.1	A.3.11
	Config 3, 6		SMTC.1	
PDSCH/PDCCH subcarrier spacing	Config 1, 2, 4, 5		15 KHz	
	Config 3, 6		30 KHz	
PRACH Configuration	Config 1, 2, 4, 5		FR1 PRACH configuration 4	A.3.8.2
	Config 3, 6		FR1 PRACH configuration 4	A.3.8.2
csi-RS-Index assigned as beam failure detection RS in set $q_0$			0	
OCNG parameters			OP.1	A.3.2.1
CP length			Normal	
Correlation Matrix and Antenna Configuration			2x2 Low	
Beam failure detection transmission parameters	DCI format		1-0	
	Number of Control OFDM symbols		2	
	Aggregation level	CCE	8	
	Ratio of hypothetical PDCCH RE energy to average CSI-RS RE energy	dB	0	
	Ratio of hypothetical PDCCH DMRS energy to average CSI-RS RE energy	dB	0	
	DMRS precoder granularity		REG bundle size	
	REG bundle size		6	
DRX			DRX.7	A.3.3.7
Gap pattern ID			N.A.	
csi-RS-Index assigned as candidate beam detection RS in set $q_1$			1	
rlmInSyncOutOfSyncThreshold			absent	When the field is absent, the UE applies the value 0. (Table 8.1.1-1).
rsrp-ThresholdCSI-RS	Config 1, 2, 4, 5	dBm/SCS kHz	-98	Threshold used for $Q_{in\_LR\_CSI-RS}$
	Config 3, 6		-95	

powerControlOffsetSS			db0	Used for deriving rsrp-ThresholdCSI-RS
beamFailureInstanceMaxCount			n1	see TS 38.321 [7], clause 5.17
beamFailureDetectionTimer			pbfd4	see TS 38.321 [7], clause 5.17
CSI-RS configuration for q <sub>0</sub> and q <sub>1</sub>	Config 1, 4		CSI-RS.1.2 FDD	A.3.14
	Config 2, 5		CSI-RS.1.2 TDD	
	Config 3, 6		CSI-RS.2.2 TDD	
CSI-RS configuration for CSI reporting	Config 1, 4		CSI-RS.1.1 FDD	A.3.14
	Config 2, 5		CSI-RS.1.1 TDD	
	Config 3, 6		CSI-RS.2.1 TDD	
TRS configuration	Config 1, 4		TRS.1.1 FDD	
	Config 2, 5		TRS.1.1 TDD	
	Config 3, 6		TRS.1.2 TDD	
csi-RS-Index assigned as RLM RS	Config 1, 4		CSI-RS.1.2 FDD	A.3.14
	Config 2, 5		CSI-RS.1.2 TDD	
	Config 3, 6		CSI-RS.2.2 TDD	
T310 Timer		ms	1000	
N310			2	
T1		s	1	During this time the the UE shall be fully synchronized to cell 1
T2		s	8.37	
T3		s	6.44	
T4		s	0	
T5		s	1.97	
D1		s	1.93	
Note 1: UE-specific PDCCH is not transmitted after T1 starts.				

**Table A.4.5.4.1-3: Cell specific test parameters for FR1 PSCell for CSI-RS-based beam failure detection and link recovery testing in DRX mode**

Parameter	Unit	Test 1					
		T1	T2	T3	T4	T5	
EPRE ratio of PDCCH DMRS to SSS	dB	0					
EPRE ratio of PDCCH to PDCCH DMRS	dB						
EPRE ratio of PBCH DMRS to SSS	dB						
EPRE ratio of PBCH to PBCH DMRS	dB						
EPRE ratio of PSS to SSS	dB						
EPRE ratio of PDSCH DMRS to SSS	dB						
EPRE ratio of PDSCH to PDSCH DMRS	dB						
EPRE ratio of OCNG DMRS to SSS	dB						
EPRE ratio of OCNG to OCNG DMRS	dB						
SNR_CSI-RS of set q <sub>0</sub>	Config 1, 4	dB	5	-3	-12	-12	-12
	Config 2, 5		5	-3	-12	-12	-12
	Config 3, 6		5	-3	-12	-12	-12
SNR_CSI-RS of set q <sub>1</sub>	Config 1, 4	dB	-10	-10	10	10	10
	Config 2, 5		-10	-10	10	10	10
	Config 3, 6		-10	-10	10	10	10

CSI-RS_RP of set $q_1$	Config 1, 4	dBm/SCS kHz	-108	-108	-88	-88	-88
	Config 2, 5		-108	-108	-88	-88	-88
	Config 3, 6		-105	-105	-85	-85	-85
$N_{oc}$	Config 1, 4	dBm/15 KHz	-98				
	Config 2, 5		-98				
	Config 3, 6		-98				
Propagation condition			TDL-C 300ns 100Hz				
<p>Note 1: OCNG shall be used such that the resources in Cell 1 are fully allocated and a constant total transmitted power spectral density is achieved for all OFDM symbols.</p> <p>Note 2: The uplink resources for CSI reporting are assigned to the UE prior to the start of time period T1.</p> <p>Note 3: NZP CSI-RS resource set configuration for CSI reporting are assigned to the UE prior to the start of time period T1.</p> <p>Note 4: Void</p> <p>Note 5: The timers and layer 3 filtering related parameters are configured prior to the start of time period T1.</p> <p>Note 6: The signal contains PDCCH for UEs other than the device under test as part of OCNG.</p> <p>Note 7: SNR levels correspond to the signal to noise ratio over the REs carrying CSI-RS.</p> <p>Note 8: The SNR in time periods T1, T2, T3, T4 and T5 is denoted as SNR1, SNR2 and SNR3 respectively in figure A.4.5.5.1.1-1.</p> <p>Note 9: The SNR values are specified for testing a UE which supports 2RX on at least one band. For testing of a UE which supports 4RX on all bands, the SNR during T3 is modified as specified in clause A.3.6.</p>							

Table A.4.5.5.4.1-4: Void

Table A.4.5.5.4.1-5: Void

Table A.4.5.5.4.1-6: Void

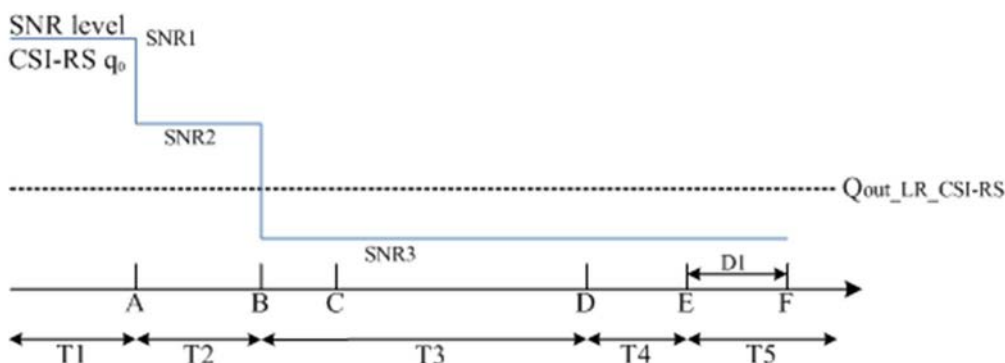

Figure A.4.5.5.4.1-1: SNR variation for CSI-RS-based beam failure detection and link recovery testing in DRX mode

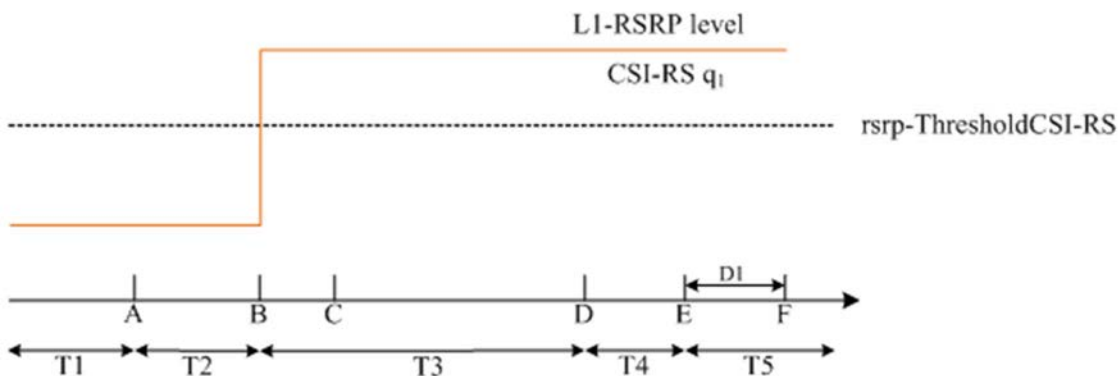

Figure A.4.5.5.4.1-2: L1-RSRP level variation for CSI-RS based beam failure detection and link recovery testing in DRX mode

#### A.4.5.5.4.2 Test Requirements

The UE behaviour during time durations T1, T2, T3, T4 and T5 shall be as follows:

During the time duration T1 and T2, the UE shall transmit uplink signal at least in all subframes configured for CSI transmission on Cell 1.

During the period from time point A to time point B the UE shall transmit uplink signal in Cell 1 in all uplink slots configured for CSI transmission according to the configured periodic CSI reporting for Cell 1.

During T3 the UE shall detect beam failure and initiate link recovery. During T4 and T5 the UE measures and evaluate beam candidate from beam candidate set  $q_1$ .

No later than time point F occurring no later than  $D1 = 1920+10$  ms after the start of T5, the UE shall transmit preamble on a beam associated with the candidate beam set  $q_1$ . The UE shall not transmit preamble on a beam associated with the candidate beam set  $q_1$  earlier than time point B.

Test is concluded once the test equipment has received the initial preamble transmission from the UE. The rate of correct events observed during repeated tests shall be at least 90%.

#### A.4.5.5.5 EN-DC Beam Failure Detection and Link Recovery Test for FR1 SCell configured with CSI-RS-based BFD and SSB-based LR in non-DRX mode

##### A.4.5.5.5.1 Test Purpose and Environment

The purpose of this test is to verify that the UE properly detects CSI-RS-based beam failure in the set  $q_0$  configured for a serving SCell and that the UE performs correct SSB-based link recovery based on beam candidate set  $q_1$ . The purpose is to test the downlink monitoring for beam failure detection within the UEs active DL BWP of the SCell without *schedulingRequestID-BFR-SCell-r16* configuration, during the evaluation period, and link recovery, when no DRX is used. This test will partly verify the beam failure detection and link recovery for an FR1 serving cell requirements in clause 8.5.

The test parameters are given in Tables A.4.5.5.5.1-1, A.4.5.5.5.1-2, and A.4.5.5.5.1-3 below. There are three cells, cell 1 is the E-UTRAN PCell, cell 2 is the PCell and cell 3 is the SCell, in the test. UE is not provided by *schedulingRequestID-BFR-SCell-r16*, i.e., no configuration for PUCCH transmission resources, and UE shall perform the random access procedure to recover the beam failure. The test consists of five successive time periods, with time duration of T1, T2, T3, T4 and T5 respectively. Figure A.4.5.5.5.1-1 shows the SNR of the CSI-RS in set  $q_0$  in the active SCell to emulate beam failure. Figure A.4.5.5.5.1-2 shows the variation of the downlink L1-RSRP of the SSB in set  $q_1$  of the candidate beam used for link recovery. Prior to the start of the time duration T1, the UE shall be fully synchronized to cell 1, cell 2 and cell3. The UE shall be configured for periodic CSI reporting with a reporting periodicity of 5 ms. In the test, DRX configuration is not enabled.

**Table A.4.5.5.5.1-1: Supported test configurations for FR1 PCell and SCell**

Configuration	Description
1	LTE FDD, NR 15 kHz SSB SCS, 10 MHz bandwidth, FDD duplex mode
2	LTE FDD, NR 15 kHz SSB SCS, 10 MHz bandwidth, TDD duplex mode
3	LTE FDD, NR 30 kHz SSB SCS, 40 MHz bandwidth, TDD duplex mode
4	LTE TDD, NR 15 kHz SSB SCS, 10 MHz bandwidth, FDD duplex mode
5	LTE TDD, NR 15 kHz SSB SCS, 10 MHz bandwidth, TDD duplex mode
6	LTE TDD, NR 30 kHz SSB SCS, 40 MHz bandwidth, TDD duplex mode

Note: The UE is only required to pass in one of the supported test configurations in FR1

**Table A.4.5.5.5.1-2: General test parameters for FR1 SCell for beam failure detection and link recovery testing in non-DRX mode**

Parameter	Unit	Value	Comment
		Test 1	
Active PCell		Cell 1	

E-UTRA RF Channel Number			1	
Active PSCell			Cell 2	
RF Channel Number for PSCell			2	
Active SCell			Cell 3	
RF Channel Number for SCell			3	
Duplex mode	Config 1, 4		FDD	
	Config 2, 3, 5, 6		TDD	
BW channel	Config 1, 4	MHz	10: NRB,c = 52	
	Config 2, 5		10: NRB,c = 52	
	Config 3, 6		40: NRB,c = 106	
DL initial BWP configuration	Config 1, 2, 3, 4, 5, 6		DLBWP.0.1	
DL dedicated BWP configuration	Config 1, 2, 3, 4, 5, 6		DLBWP.1.1	
UL initial BWP configuration	Config 1, 2, 3, 4, 5, 6		ULBWP.0.1	
UL dedicated BWP configuration	Config 1, 2, 3, 4, 5, 6		ULBWP.1.1	
TDD Configuration	Config 1, 4		Not Applicable	
	Config 2, 5		TDDConf.1.1	
	Config 3, 6		TDDConf.2.1	
CORESET Reference Channel	Config 1, 4		CR.1.1 FDD	A.3.1.2
	Config 2, 5		CR.1.1 TDD	
	Config 3, 6		CR.2.1 TDD	
SSB Configuration	Config 1, 4		SSB.1 FR1	A.3.10
	Config 2, 5		SSB.1 FR1	
	Config 3, 6		SSB.2 FR1	
SMTTC Configuration	Config 1, 2, 3, 4, 5, 6		SMTTC.1	A.3.11
PDSCH/PDCCH subcarrier spacing	Config 1, 2, 4, 5	kHz	15	
	Config 3, 6		30	
PRACH Configuration	Config 1, 2, 4, 5		Table A.3.8.2.2-1	
	Config 3, 6		Table A.3.8.2.2-1	
csi-RS-Index assigned as beam failure detection RS in set $q_0$ in activated SCell			0	
OCNG parameters			OP.1	A.3.2.1
CP length			Normal	
Correlation Matrix and Antenna Configuration			2x2 Low	
Beam failure detection transmission parameters	DCI format		1-0	
	Number of Control OFDM symbols		2	
	Aggregation level	CCE	8	
	Ratio of hypothetical PDCCH RE energy to average CSI-RS RE energy	dB	0	
	Ratio of hypothetical PDCCH DMRS energy to average CSI-RS RE energy	dB	0	
	DMRS precoder granularity		REG bundle size	
	REG bundle size		6	
DRX			OFF	
Gap pattern ID			N.A.	
schedulingRequestID-BFR-SCell-r16			absent	When the field is absent, the random access procedure will be

				triggered for SCell BFR
SSB Index assigned as CBD RS (q1) in activated SCell			0	
rlmInSyncOutOfSyncThreshold			absent	When the field is absent, the UE applies the value 0. (Table 8.1.1-1).
rsrp-ThresholdBFR	Config 1, 2, 4, 5	dBm/SCS	-98	Threshold used for $Q_{in\_LR\_SSB}$
	Config 3, 6		-95	
powerControlOffsetSS			db0	Used for deriving rsrp-ThresholdCSI-RS
beamFailureInstanceMaxCount			n1	see TS 38.321 [7], clause 5.17
beamFailureDetectionTimer			pbfd4	see TS 38.321 [7], clause 5.17
CSI-RS configuration for $q_0$ in activated SCell	Config 1, 4		CSI-RS.1.2 FDD	A.3.14
	Config 2, 5		CSI-RS.1.2 TDD	
	Config 3, 6		CSI-RS.2.2 TDD	
CSI-RS configuration for CSI reporting	Config 1, 4		CSI-RS.1.1 FDD	A.3.14
	Config 2, 5		CSI-RS.1.1 TDD	
	Config 3, 6		CSI-RS.2.1 TDD	
TRS configuration	Config 1, 4		TRS.1.1 FDD	
	Config 2, 5		TRS.1.1 TDD	
	Config 3, 6		TRS.1.2 TDD	
csi-RS-Index assigned as RLM RS in PSCell	Config 1, 4		CSI-RS.1.2 FDD	A.3.14
	Config 2, 5		CSI-RS.1.2 TDD	
	Config 3, 6		CSI-RS.2.2 TDD	
T310 Timer		ms	1000	
N310			2	
T1		s	1	During this time the the UE shall be fully synchronized to cell 1
T2		s	0.18	
T3		s	0.14	
T4		s	0	
T5		s	0.17	
D1		s	0.13	
Note 1: UE-specific PDCCH is not transmitted after T1 starts.				

**Table A.4.5.5.1-3: Cell specific test parameters for FR1 PSCell and SCell for beam failure detection and link recovery testing in non-DRX mode**

Parameter	Unit	Cell2	Test 1 Cell3				
		T1 to T5	T1	T2	T3	T4	T5
EPRE ratio of PDCCH DMRS to SSS	dB	0	0				
EPRE ratio of PDCCH to PDCCH DMRS	dB						
EPRE ratio of PBCH DMRS to SSS	dB						
EPRE ratio of PBCH to PBCH DMRS	dB						
EPRE ratio of PSS to SSS	dB						
EPRE ratio of PDSCH DMRS to SSS	dB						
EPRE ratio of PDSCH to PDSCH DMRS	dB						
EPRE ratio of OCNB DMRS to SSS	dB						
EPRE ratio of OCNB to OCNB DMRS	dB						
SNR_CSI-RS of set $q_0$	Config 1, 4	5	5	-3	-12	-12	-12
	Config 2, 5	5	5	-3	-12	-12	-12

SNR_SSB of set $q_1$	Config 3, 6	dB	5	5	-3	-12	-12	-12
	Config 1, 4		-10	-10	-10	10	10	10
	Config 2, 5		-10	-10	-10	10	10	10
	Config 3, 6		-10	-10	-10	10	10	10
SSB_RP of set $q_1$	Config 1, 4	dBm/SCS kHz	-108	-108	-108	-88	-88	-88
	Config 2, 5		-108	-108	-108	-88	-88	-88
	Config 3, 6		-105	-105	-105	-85	-85	-85
$N_{oc}$	Config 1, 4	dBm/15 kHz	-98	-98				
	Config 2, 5		-98	-98				
	Config 3, 6		-98	-98				
Propagation condition			TDL-C 300ns 100Hz	TDL-C 300ns 100Hz				

- Note 1: OCNG shall be used such that the resources in Cell 1 are fully allocated and a constant total transmitted power spectral density is achieved for all OFDM symbols.
- Note 2: The uplink resources for CSI reporting are assigned to the UE prior to the start of time period T1.
- Note 3: NZP CSI-RS resource set configuration for CSI reporting are assigned to the UE prior to the start of time period T1.
- Note 4: Void
- Note 5: The timers and layer 3 filtering related parameters are configured prior to the start of time period T1.
- Note 6: The signal contains PDCCH for UEs other than the device under test as part of OCNG.
- Note 7: SNR levels correspond to the signal to noise ratio over the REs carrying CSI-RS.
- Note 8: The SNR in time periods T1, T2, T3, T4 and T5 is denoted as SNR1, SNR2 and SNR3 respectively in figure A.4.5.5.1.1-1.
- Note 9: The SNR values are specified for testing a UE which supports 2RX on at least one band. For testing of a UE which supports 4RX on all bands, the SNR during T3 is modified as specified in clause [A.3.6].

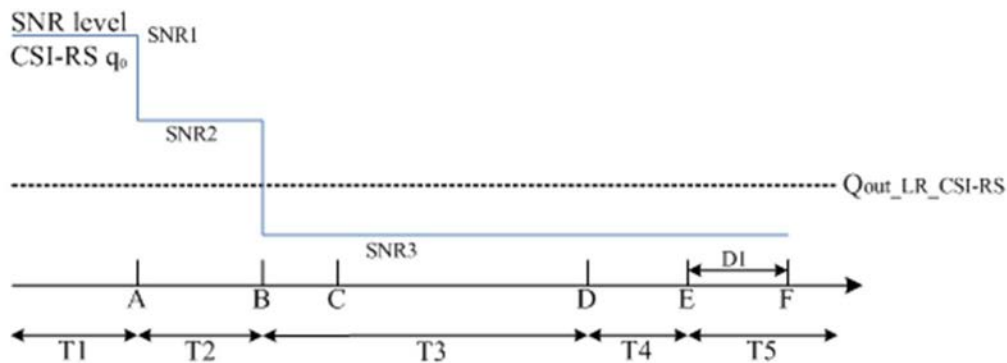

Figure A.4.5.5.1-1: SNR variation for beam failure detection and link recovery testing for SCell in non-DRX mode

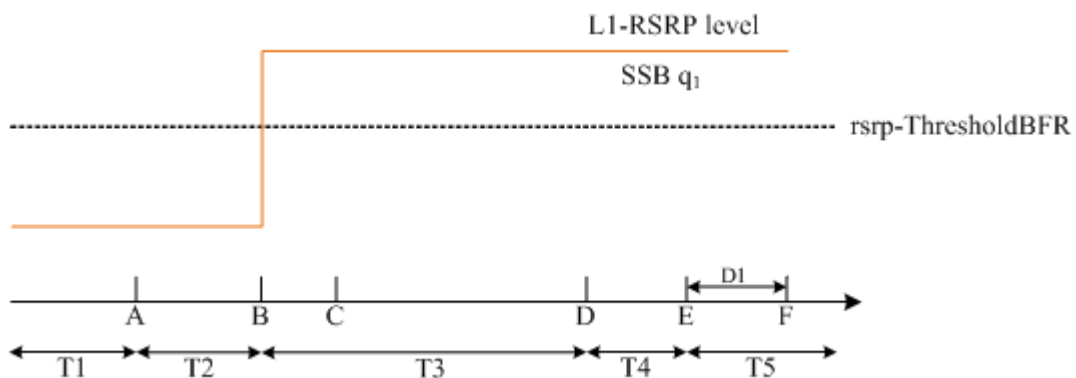

Figure A.4.5.5.1-2: L1-RSRP level variation for beam failure detection and link recovery testing for SCell in non-DRX mode

#### A.4.5.5.2 Test Requirements

The UE behaviour during time durations T1, T2, T3, T4 and T5 shall be as follows:

During the time duration T1 and T2, the UE shall transmit uplink signal at least in all subframes configured for CSI transmission on Cell 2.

During the period from time point A to time point B the UE shall transmit uplink signal in Cell 2 in all uplink slots configured for CSI transmission according to the configured periodic CSI reporting for Cell 2.

During T3 the UE shall detect beam failure and initiate link recovery. During T4 and T5 the UE measures and evaluate beam candidate from beam candidate set  $q_1$ .

No later than time point F occurring no later than  $D1 = 120+10$  ms after the start of T5, the UE shall transmit preamble for UL-SCH resource application, followed by MAC-CE on the assigned uplink resources containing a beam associated with the candidate beam set  $q_1$ . The UE shall not transmit preamble earlier than time point B.

During T5, the System Simulator shall transmit a Random Access Response to UE after the System Simulator receives the preamble from UE. The UE shall transmit the msg.3 containing candidate beam set  $q_1$  for SCell BFR if UE receives the Random Access Response.

Test is concluded once the test equipment has received the initial preamble transmission from the UE. The rate of correct events observed during repeated tests shall be at least 90%.

#### A.4.5.5.6 EN-DC Beam Failure Detection and Link Recovery Test for FR1 SCell configured with CSI-RS-based BFD and SSB-based LR in DRX mode

##### A.4.5.5.6.1 Test Purpose and Environment

The purpose of this test is to verify that the UE properly detects CSI-RS based beam failure in the set  $q_0$  configured for a serving SCell and that the UE performs correct SSB-based link recovery based on beam candidate set  $q_1$ . The purpose is to test the downlink monitoring for beam failure detection within the UEs active DL BWP of the SCell without *schedulingRequestID-BFR-SCell-r16* configuration, during the evaluation period, and link recovery, when DRX is used. This test will partly verify the beam failure detection and link recovery for an FR1 serving cell requirements in clause 8.5.

The test parameters are given in Tables A.4.5.5.6.1-1, A.4.5.5.6.1-2, and A.4.5.5.6.1-3 below. There are three cells, cell 1 is the E-UTRAN PCell, cell 2 is the PSCell and cell 3 is the SCell, in the test. UE is not provided by *schedulingRequestID-BFR-SCell-r16*, i.e., no configuration for PUCCH transmission resources, and UE shall perform the random access procedure to recover the beam failure. The test consists of five successive time periods, with time duration of T1, T2, T3, T4 and T5 respectively. Figure A.4.5.5.6.1-1 shows the SNR of the CSI-RS in set  $q_0$  in the active SCell to emulate beam failure. Figure A.4.5.5.6.1-2 shows the variation of the downlink L1-RSRP of the CSI-RS in set  $q_1$  of the candidate beam used for link recovery. Prior to the start of the time duration T1, the UE shall be fully synchronized to cell 1, cell 2 and cell 3. The UE shall be configured for periodic CSI reporting with a reporting periodicity of 5 ms. In the test, DRX configuration is enabled in SCell and DRX inactivity timer has already been expired, i.e. UE tries to decode PDCCH and to send periodic CQI during the period when On-duration timer is running. Time alignment timers shall be set to "infinity" so that UL timing alignment is maintained during the test.

**Table A.4.5.5.6.1-1: Supported test configurations for FR1 PCell and SCell**

Configuration	Description
1	LTE FDD, NR 15 kHz SSB SCS, 10 MHz bandwidth, FDD duplex mode
2	LTE FDD, NR 15 kHz SSB SCS, 10 MHz bandwidth, TDD duplex mode
3	LTE FDD, NR 30 kHz SSB SCS, 40 MHz bandwidth, TDD duplex mode
4	LTE TDD, NR 15 kHz SSB SCS, 10 MHz bandwidth, FDD duplex mode
5	LTE TDD, NR 15 kHz SSB SCS, 10 MHz bandwidth, TDD duplex mode
6	LTE TDD, NR 30 kHz SSB SCS, 40 MHz bandwidth, TDD duplex mode
Note:	The UE is only required to pass in one of the supported test configurations in FR1



**Table A.4.5.5.6.1-2: General test parameters for FR1 SCell for beam failure detection and link recovery testing in DRX mode**

Parameter		Unit	Value	Comment
			Test 1	
Active PCell			Cell 1	
E-UTRA RF Channel Number			1	
Active PSCell			Cell 2	
RF Channel Number for PSCell			2	
Active SCell			Cell 3	
RF Channel Number for SCell			3	
Duplex mode	Config 1, 4		FDD	
	Config 2, 3, 5, 6		TDD	
BW channel	Config 1, 4	MHz	10: NRB,c = 52	
	Config 2, 5		10: NRB,c = 52	
	Config 3, 6		40: NRB,c = 106	
DL initial BWP configuration	Config 1, 2, 3, 4, 5, 6		DLBWP.0.1	
DL dedicated BWP configuration	Config 1, 2, 3, 4, 5, 6		DLBWP.1.1	
UL initial BWP configuration	Config 1, 2, 3, 4, 5, 6		ULBWP.0.1	
UL dedicated BWP configuration	Config 1, 2, 3, 4, 5, 6		ULBWP.1.1	
TDD Configuration	Config 1, 4		Not Applicable	
	Config 2, 5		TDDConf.1.1	
	Config 3, 6		TDDConf.2.1	
CORESET Reference Channel	Config 1, 4		CR.1.1 FDD	A.3.1.2
	Config 2, 5		CR.1.1 TDD	
	Config 3, 6		CR.2.1 TDD	
SSB Configuration	Config 1, 4		SSB.1 FR1	A.3.10
	Config 2, 5		SSB.1 FR1	
	Config 3, 6		SSB.2 FR1	
SMTC Configuration	Config 1, 2, 3, 4, 5, 6		SMTC.1	A.3.11
PDSCH/PDCCH subcarrier spacing	Config 1, 2, 4, 5	kHz	15	
	Config 3, 6		30	
PRACH Configuration	Config 1, 2, 4, 5		Table A.3.8.2.2-1	
	Config 3, 6		Table A.3.8.2.2-1	
csi-RS-Index assigned as beam failure detection RS in set $q_0$ in activated SCell			0	
OCNG parameters			OP.1	A.3.2.1
CP length			Normal	
Correlation Matrix and Antenna Configuration			2x2 Low	
Beam failure detection transmission parameters	DCI format		1-0	
	Number of Control OFDM symbols		2	
	Aggregation level	CCE	8	
	Ratio of hypothetical PDCCH RE energy to average CSI-RS RE energy	dB	0	

	Ratio of hypothetical PDCCH DMRS energy to average CSI-RS RE energy	dB	0	
	DMRS precoder granularity		REG bundle size	
	REG bundle size		6	
DRX			DRX.7	A.3.3.7
Gap pattern ID			N.A.	
schedulingRequestID-BFR-SCell-r16			absent	When the field is absent, the random access procedure will be triggered for SCell BFR
SSB Index assigned as CBD RS (q1) in activated SCell			1	
rlmInSyncOutOfSyncThreshold			absent	When the field is absent, the UE applies the value 0. (Table 8.1.1-1).
rsrp-ThresholdBFR	Config 1, 2, 4, 5	dBm/SCS	-98	Threshold used for $Q_{in\_LR\_SSB}$
	Config 3, 6		-95	
powerControlOffsetSS			db0	Used for deriving rsrp-ThresholdCSI-RS
beamFailureInstanceMaxCount			n1	see TS 38.321 [7], clause 5.17
beamFailureDetectionTimer			pbfd4	see TS 38.321 [7], clause 5.17
CSI-RS configuration for $q_0$ in activated SCell	Config 1, 4		CSI-RS.1.2 FDD	A.3.14
	Config 2, 5		CSI-RS.1.2 TDD	
	Config 3, 6		CSI-RS.2.2 TDD	
CSI-RS configuration for CSI reporting	Config 1, 4		CSI-RS.1.1 FDD	A.3.14
	Config 2, 5		CSI-RS.1.1 TDD	
	Config 3, 6		CSI-RS.2.1 TDD	
TRS configuration	Config 1, 4		TRS.1.1 FDD	
	Config 2, 5		TRS.1.1 TDD	
	Config 3, 6		TRS.1.2 TDD	
csi-RS-Index assigned as RLM RS in PSCell	Config 1, 4		CSI-RS.1.2 FDD	A.3.14
	Config 2, 5		CSI-RS.1.2 TDD	
	Config 3, 6		CSI-RS.2.2 TDD	
T310 Timer		ms	1000	
N310			2	
T1		s	1	During this time the the UE shall be fully synchronized to cell 1

T2	s	8.37	
T3	s	6.44	
T4	s	0	
T5	s	1.97	
D1	s	1.93	
Note 1: UE-specific PDCCH is not transmitted after T1 starts.			

**Table A.4.5.5.6.1-3: Cell specific test parameters for FR1 SCell for beam failure detection and link recovery testing in DRX mode**

Parameter		Unit	Cell2	Test 1 Cell3				
			T1 to T5	T1	T2	T3	T4	T5
EPRE ratio of PDCCH DMRS to SSS		dB	0	0				
EPRE ratio of PDCCH to PDCCH DMRS								
EPRE ratio of PBCH DMRS to SSS								
EPRE ratio of PBCH to PBCH DMRS								
EPRE ratio of PSS to SSS								
EPRE ratio of PDSCH DMRS to SSS								
EPRE ratio of PDSCH to PDSCH DMRS								
EPRE ratio of OCNG DMRS to SSS								
EPRE ratio of OCNG to OCNG DMRS		dB	5	5	-3	-12	-12	-12
SNR_CSI-RS of set $q_0$	Config 1, 4							
	Config 2, 5							
	Config 3, 6							
SNR_SSB of set $q_1$	Config 1, 4	dB	-10	-10	-10	10	10	10
	Config 2, 5							
	Config 3, 6							
SSB_RP of set $q_1$	Config 1, 4	dBm/SCS kHz	-108	-108	-108	-88	-88	-88
	Config 2, 5							
	Config 3, 6							
$N_{oc}$	Config 1, 4	dBm/ 15 kHz	-98	-98				
	Config 2, 5							
	Config 3, 6							
Propagation condition			TDL-C 300ns 100Hz	TDL-C 300ns 100Hz				
<p>Note 1: OCNG shall be used such that the resources in Cell 1 are fully allocated and a constant total transmitted power spectral density is achieved for all OFDM symbols.</p> <p>Note 2: The uplink resources for CSI reporting are assigned to the UE prior to the start of time period T1.</p> <p>Note 3: NZP CSI-RS resource set configuration for CSI reporting are assigned to the UE prior to the start of time period T1.</p> <p>Note 4: Void</p> <p>Note 5: The timers and layer 3 filtering related parameters are configured prior to the start of time period T1.</p> <p>Note 6: The signal contains PDCCH for UEs other than the device under test as part of OCNG.</p> <p>Note 7: SNR levels correspond to the signal to noise ratio over the REs carrying CSI-RS.</p> <p>Note 8: The SNR in time periods T1, T2, T3, T4 and T5 is denoted as SNR1, SNR2 and SNR3 respectively in figure A.4.5.5.1.1-1.</p> <p>Note 9: The SNR values are specified for testing a UE which supports 2RX on at least one band. For testing of a UE which supports 4RX on all bands, the SNR during T3 is modified as specified in clause A.3.6.</p>								

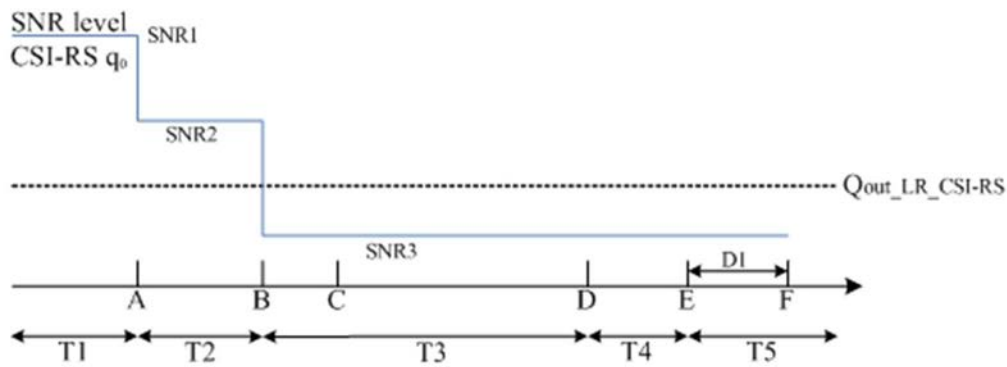

Figure A.4.5.5.6.1-1: SNR variation for beam failure detection and LR testing for SCell in DRX mode

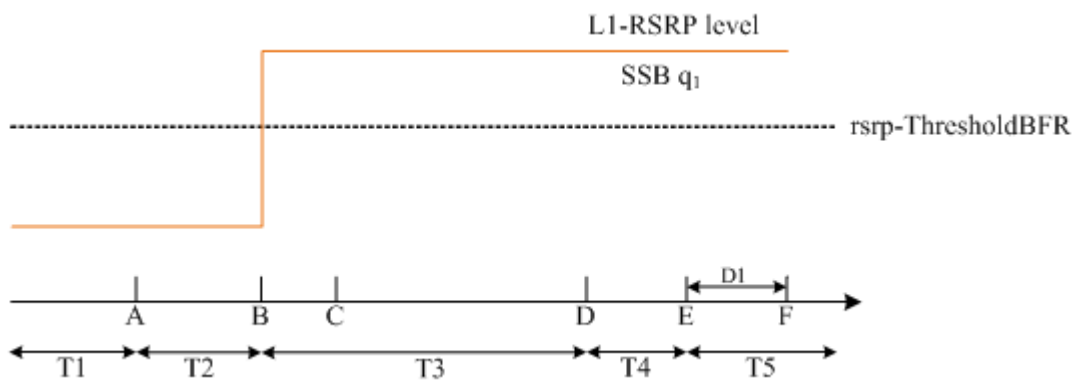

Figure A.4.5.5.6.1-2: L1-RSRP level variation for beam failure detection and link recovery testing for SCell in DRX mode

A.4.5.5.6.2 Test Requirements

The UE behaviour during time durations T1, T2, T3, T4 and T5 shall be as follows:

During the time duration T1 and T2, the UE shall transmit uplink signal at least in all subframes configured for CSI transmission on Cell 2.

During the period from time point A to time point B the UE shall transmit uplink signal in Cell 2 in all uplink slots configured for CSI transmission according to the configured periodic CSI reporting for Cell 2.

During T3 the UE shall detect beam failure and initiate link recovery. During T4 and T5 the UE measures and evaluate beam candidate from beam candidate set  $q_1$ .

No later than time point F occurring no later than  $D1 = 120+10$  ms after the start of T5, the UE shall transmit preamble for UL-SCH resource application, followed by MAC-CE on the assigned uplink resources containing a beam associated with the candidate beam set  $q_1$ . The UE shall not transmit preamble earlier than time point B.

During T5, the System Simulator shall transmit a Random Access Response to UE after the System Simulator receives the preamble from UE. The UE shall transmit the msg.3 containing candidate beam set  $q_1$  for SCell BFR if UE receives the Random Access Response.

Test is concluded once the test equipment has received the initial preamble transmission from the UE. The rate of correct events observed during repeated tests shall be at least 90%.

## A.4.5.6 Active BWP switch

### A.4.5.6.1 DCI-based and Timer-based Active BWP Switch

#### A.4.5.6.1.1 E-UTRAN – NR PSCell FR1 DL active BWP switch in non-DRX in synchronous EN-DC

##### A.4.5.6.1.1.1 Test Purpose and Environment

The purpose of this test is to verify the DL BWP switch delay requirement defined in TS38.133 clause 8.6, and interruption requirement for E-UTRA victim cell defined in TS36.133 clause 7.32.2.7. Supported test configurations are shown in Table A.4.5.6.1.1.1-1.

The test scenario comprises of one E-UTRA PCell (Cell 1), and one NR PSCell (Cell 2) as given in Table A.4.5.6.1.1.1-2. Cell-specific parameters of E-UTRA PCell are specified in Table A.3.7.2.1-1 and Cell-specific parameters of NR PSCell is specified in Table A.4.5.6.1.1.1-3 below.

PDCCHs indicating new transmissions shall be sent continuously on PCell (Cell 1) to ensure that the UE will have ACK/NACK sending.

PDCCHs indicating new transmissions shall be sent continuously on PSCell (Cell 2) to ensure that the UE would have ACK/NACK sending except for the time duration when BWP is switching on Cell 2 and the time duration of T2.

Before the test starts,

- UE is connected to Cell 1 (PCell) on radio channel 1 (PCC), and Cell 2 (PSCell) on radio channel 2 (PSCC).
- UE is configured with 2 different UE-specific downlink bandwidth parts for PSCell, BWP-1 and BWP-2, in Cell 2 before starting the test. BWP-1 and BWP-2 always include bandwidth of the initial DL BWP and SSB.
- UE is indicated in *firstActiveDownlinkBWP-Id* that the active DL BWP is BWP-1 in PSCell.
- UE is configured with a *bwp-InactivityTimer* timer value for PSCell.

All cells have constant signal levels throughout the test.

The test consists of 3 successive time periods, with durations of T1, T2, and T3, respectively.

During T1,

Time period T1 starts when a DCI format 1\_1 command for PSCell DL BWP switch, sent from the test equipment to the UE, is received at the UE side in PSCell's slot # denoted  $i$ . The UE shall switch its bandwidth part from BWP-1 to BWP-2.

The UE shall be able to receive PDSCH at the beginning of the DL slot right after PSCell's DL slot ( $i+T_{BWPswitchDelay}$ ) as defined in clause 8.6 and starts to report valid ACK/NACK for the PSCell no later than at the beginning of the DL slot right after DL slot ( $i+T_{BWPswitchDelay}+kI$ ). The UE shall be continuously scheduled on PSCell's BWP-2 starting from the beginning of the DL slot right after DL slot ( $i+T_{BWPswitchDelay}$ ).

The starting time of PCell(Cell 1) interruption due to BWP switch on PSCell shall occur within the BWP switch delay.

During T2, the test equipment won't transmit DCI format for PDSCH reception on PSCell(Cell 2).

During T3,

The time period T3 starts from the slot # $j$ , where  $j$  is the beginning slot of the DL subframe immediately after the *bwp-InactivityTimer* timer expires. The UE shall switch its bandwidth part from BWP-2 back to the default bandwidth part – BWP-1.

The UE shall be able to receive PDSCH at the beginning of the DL slot right after PSCell's DL slot ( $j+T_{BWPswitchDelay}$ ) as defined in clause 8.6 and starts to report valid ACK/NACK for the PSCell at latest at the beginning of the DL slot right after DL slot ( $j+T_{BWPswitchDelay}+kI$ ). The UE shall be continuously scheduled on PSCell's BWP-1 starting from the beginning of the DL slot right after DL slot ( $j+T_{BWPswitchDelay}$ ).

The starting time of PCell(Cell 1) interruption due to BWP switch of PSCell shall occur within the BWP switch delay.

The test equipment verifies the DL BWP switch time in PSCell by counting the slots from the time when the BWP switch command is received or *bwp-InactivityTimer* timer expires till an ACK is received.

The test equipment verifies that potential interruption to E-UTRA PCell is carried out in the correct time span by monitoring ACK/NACK sent in PCell during BWP switch of PSCell, respectively.

**Table A.4.5.6.1.1.1-1: DL BWP switch supported test configurations**

Config	Description
1	LTE FDD, NR 15 kHz SSB SCS, 10 MHz bandwidth, FDD duplex mode
2	LTE FDD, NR 15 kHz SSB SCS, 10 MHz bandwidth, TDD duplex mode
3	LTE FDD, NR 30kHz SSB SCS, 40 MHz bandwidth, TDD duplex mode
4	LTE TDD, NR 15 kHz SSB SCS, 10 MHz bandwidth, FDD duplex mode
5	LTE TDD, NR 15 kHz SSB SCS, 10 MHz bandwidth, TDD duplex mode
6	LTE TDD, NR 30kHz SSB SCS, 40 MHz bandwidth, TDD duplex mode
Note 1: The UE is only required to be tested in one of the supported test configurations.	
Note 2: A UE which fulfils the requirements in test case A.4.5.6.1.2 can skip the test cases in A.4.5.6.1.1.	

**Table A.4.5.6.1.1.1-2: General test parameters for DL BWP switch in synchronous EN-DC**

Parameter	Unit	Value	Comment
E-UTRA RF Channel Number		1	One E-UTRA radio channel is used for this test
NR RF Channel Number		2	One NR radio channel is used for this test
Active PCell		Cell 1	PCell on RF channel number 1.
Active PSCell		Cell 2	PSCell on RF channel number 2.
CP length		Normal	
DRX		OFF	For both PCell and PSCell
<i>bwp-InactivityTimer</i>	ms	[200]	
PDCCH and PDSCH maximum number of HARQ transmission		1	For both PCell and PSCell
Cell-individual offset for cells on RF channel number 1	dB	0	Individual offset for cells on PCC.
Cell-individual offset for cells on RF channel number 2	dB	0	Individual offset for cells on PSCC.
Cell2 timing offset to cell1	μs	3	Synchronous EN-DC
T1	s	[0.2]	
T2	s	[0.2]	
T3	s	[0.2]	

**Table A.4.5.6.1.1.1-3.: NR Cell specific test parameters for DL BWP switch in synchronous EN-DC**

Parameter	Unit	Cell 2
Frequency Range		FR1
Duplex mode	Config 1,4	FDD
	Config 2,3,5,6	TDD
TDD configuration	Config 1,4	Not Applicable
	Config 2,5	TDDConf.1.1
	Config 3,6	TDDConf.2.1
BW <sub>channel</sub>	Config 1,4	10 MHz: N <sub>RB,c</sub> = 52
	Config 2,5	10 MHz: N <sub>RB,c</sub> = 52
	Config 3,6	40 MHz: N <sub>RB,c</sub> = 106
Active BWP ID		1, 2
Initial DL BWP Configuration	Config 1,4	DLBWP.0.2 <sup>Note 4</sup>
	Config 2,5	
	Config 3,6	
Active DL BWP-1 Configuration	Config 1,4	DLBWP.1.1 <sup>Note 4</sup>
	Config 2,5	
	Config 3,6	
Active DL BWP-2	Config 1,4	DLBWP.1.3 <sup>Note 4</sup>

Configuration	Config 2,5		
	Config 3,6		
Initial UL BWP Configuration	Config 1,4		ULBWP.0.2 <sup>Note 4</sup>
	Config 2,5		
	Config 3,6		
Active UL BWP-1 Configuration	Config 1,4		ULBWP.1.1 <sup>Note 4</sup>
	Config 2,5		
	Config 3,6		
Active UL BWP-2 Configuration	Config 1,4		N/A
	Config 2,5		ULBWP.1.3 <sup>Note 4</sup>
	Config 3,6		ULBWP.1.3 <sup>Note 4</sup>
PDSCH Reference measurement channel	Config 1,4		SR.1.1 FDD
	Config 2,5		SR.1.1 TDD
	Config 3,6		SR.2.1 TDD
RMSI CORESET parameters	Config 1,4		CR.1.1 FDD
	Config 2,5		CR.1.1 TDD
	Config 3,6		CR.2.1 TDD
Dedicated CORESET parameters	Config 1,4		CCR.1.2 FDD
	Config 2,5		CCR.1.2 TDD
	Config 3,6		CCR.2.4TDD
OCNG Patterns			OP.1
SSB Configuration	Config 1,2,4,5		SSB.1 FR1
	Config 3,6		SSB.2 FR1
SMTc Configuration			SMTc.1
Correlation Matrix and Antenna Configuration			1x2 Low
TRS Configuration	Config 1,4		TRS.1.1 FDD
	Config 2,5		TRS.1.1 TDD
	Config 3,6		TRS.1.2 TDD
EPRE ratio of PSS to SSS		dB	0
EPRE ratio of PBCH DMRS to SSS			
EPRE ratio of PBCH to PBCH DMRS			
EPRE ratio of PDCCH DMRS to SSS			
EPRE ratio of PDCCH to PDCCH DMRS			
EPRE ratio of PDSCH DMRS to SSS			
EPRE ratio of PDSCH to PDSCH			
EPRE ratio of OCNG DMRS to SSS(Note 1)			
EPRE ratio of OCNG to OCNG DMRS (Note 1)			
N <sub>oc</sub> <sup>Note 2</sup>	Config 1,2,4,5	dBm/SCS	[-104]
	Config 3,6		[-101]
N <sub>oc</sub> <sup>Note 2</sup>		dBm/15kHz	-104
SS-RSRP <sup>Note 3</sup>	Config 1,2,4,5	dBm/SCS	[-87]
	Config 3,6		[-90]
$\hat{E}_s/I_{ot}$		dB	17
$\hat{E}_s/N_{oc}$		dB	17
I <sub>o</sub> <sup>Note3</sup>	Config 1,2,4,5	dBm/9.36MHz	[-59]
	Config 3,6	dBm/38.16MHz	[-61.9]
Propagation Condition			AWGN
<p>Note 1: OCNG shall be used such that both cells are fully allocated and a constant total transmitted power spectral density is achieved for all OFDM symbols.</p> <p>Note 2: Interference from other cells and noise sources not specified in the test is assumed to be constant over subcarriers and time and shall be modelled as AWGN of appropriate power for N<sub>oc</sub> to be fulfilled.</p> <p>Note 3: SS-RSRP and I<sub>o</sub> levels have been derived from other parameters for information purposes. They are not settable parameters themselves.</p> <p>Note 4: For unpaired spectrum, a DL BWP is linked with an UL BWP. DLBWP.0.2 is linked with ULBWP.0.2; DLBWP.1.1 is linked with ULBWP.1.1; DLBWP.1.3 is linked with ULBWP.1.3 defined in clause 12 of TS 38.213 [3].</p>			

A.4.5.6.1.1.2 Test Requirements

During T1, the UE shall start to send the ACK for PSCell from the first UL slot that occurs after the beginning of DL slot ( $i+T_{BWPswitchDelay}+kI$ ).

During T3, the UE shall start to send the ACK for PSCell from the first UL slot that occurs after the beginning of DL slot  $(j+T_{BWPswitchDelay+kI})$ .

Where,  $kI$  is the timing between DL data receiving and acknowledgement as specified in [7].

Depending on UE capability *bwp-SwitchingDelay* [2], UE shall finish BWP switch within the time duration  $T_{BWPswitchDelay}$  defined in Table 8.6.2-1.

All of the above test requirements shall be fulfilled in order for the observed PSCell active BWP switch delay to be counted as correct.

The rate of correct events observed during repeated tests shall be at least 90%.

During T1, the start time of PCell interruption during PSCell active BWP switch shall not happen outside the BWP switch delay.

During T3, the start time of PCell interruption of during PSCell active BWP switch shall not happen outside the BWP switch delay.

The interruption of PCell shall not be longer than the interruption duration specified for active BWP switch in TS36.133 Clause 7.32.2.7.

All of the above test requirements shall be fulfilled in order for the observed PCell active BWP switch interruption to be counted as correct.

The rate of correct events observed during repeated tests shall be at least 90%.

NOTE: During T1, T3 if there are no uplink resources for reporting the ACK in the DL slot right after DL slot  $(i+T_{BWPswitchDelay+kI})$ ,  $(j+T_{BWPswitchDelay+kI})$ , then the UE shall use the next available uplink resource for reporting the corresponding ACK.

#### A.4.5.6.1.2 E-UTRAN – NR PSCell FR1 DL active BWP switch with FR1 SCell in non-DRX in synchronous EN-DC

##### A.4.5.6.1.2.1 Test Purpose and Environment

The purpose of this test is to verify the DL BWP switch delay requirement defined in clause 8.6, and interruption requirements for NR victim cell defined in clause 8.2.1.2.7 and interruption requirement for E-UTRA victim cell defined in clause 7.32.2.7 of TS 36.133 [15]. Supported test configurations for LTE PCell and NR PSCell are shown in Table A.4.5.6.1.2.1-1. Supported test configurations for NR SCell are shown in table A.4.5.6.1.2.1-1A. Test configuration for LTE PCell and NR PSCell and test configuration for NR SCell are chosen independently.

The test scenario comprises of one E-UTRA PCell (Cell 1), one PSCell (Cell 2) and one SCell (Cell 3) as given in Table A.4.5.6.1.2.1-2. Cell-specific parameters of E-UTRA PCell are specified in Table A.3.7.2.1-1 and Cell-specific parameters of PSCell and SCell are specified in Table A.4.5.6.1.2.1-3 and Table A.4.5.6.1.2.1-4 below.

PDCCHs indicating new transmissions shall be sent continuously on E-UTRA PCell (Cell 1) and PSCell (Cell 2) to ensure that the UE will have ACK/NACK sending.

PDCCHs indicating new transmissions shall be sent continuously on SCell (Cell 3) to ensure that the UE would have ACK/NACK sending except for the time duration when BWP is switching on Cell 3 and the time duration of T2.

Before the test starts,

- UE is connected to Cell 1 (E-UTRA PCell) on radio channel 1 (PCC), Cell 2 (PSCell) on radio channel 2 (PSCC) and Cell 3 (SCell) on radio channel 3 (SCC).
- UE is configured with 2 different UE-specific downlink bandwidth parts for SCell, BWP-1 and BWP-2, in Cell 3 before starting the test. BWP-1 and BWP-2 always include bandwidth of the initial DL BWP and SSB.
- UE is configured with 1 UE-specific downlink bandwidth parts the same as initial BWP for PSCell, BWP-0 in Cell 2 before starting the test.
- UE is indicated in *firstActiveDownlinkBWP-Id* that the active DL BWP is BWP-1 in SCell.
- UE is indicated in *firstActiveDownlinkBWP-Id* that the active DL BWP is BWP-0 in PSCell.



- UE is configured with a *bwp-InactivityTimer* timer value for SCell.

All cells have constant signal levels throughout the test.

The test consists of 3 successive time periods, with durations of T1, T2, and T3, respectively.

During T1,

Time period T1 starts when a DCI format 1\_1 command for SCell DL BWP switch, sent from the test equipment to the UE, is received at the UE side in SCell’s slot # denoted *i*. The UE shall switch its bandwidth part from BWP-1 to BWP-2.

The UE shall be able to receive PDSCH on the first DL slot that occurs after the beginning of SCell’s DL slot ( $i+T_{BWPswitchDelay}$ ) as defined in clause 8.6 and starts to report valid ACK/NACK for the SCell on PSCell no later than on the first UL slot that occurs after the beginning of slot ( $i+T_{BWPswitchDelay}+k_1$ ). The UE shall be continuously scheduled on SCell’s BWP-2 starting from the first DL slot that occurs after the beginning of slot ( $i+T_{BWPswitchDelay}$ ).

E-UTRA PCell(Cell 1) interruption due to BWP switch on PSCell shall occur within the BWP switch delay.

PSCell(Cell 2) interruption due to BWP switch on SCell shall occur within the BWP switch delay.

During T2, the test equipment won’t transmit DCI format for PDSCH reception on PSCell(Cell 2).

During T3,

The time period T3 starts from the slot #*j*, where *j* is the beginning slot of the DL subframe immediately after the slot wherein *bwp-InactivityTimer* timer expires. The UE shall switch its bandwidth part from BWP-2 back to the default bandwidth part – BWP-1.

The UE shall be able to receive PDSCH on the first DL slot that occurs after the beginning of SCell’s DL slot ( $j+T_{BWPswitchDelay}$ ) as defined in clause 8.6 and starts to report valid ACK/NACK for the SCell on PSCell no later than on the first UL slot that occurs after the beginning of slot ( $j+T_{BWPswitchDelay}+k_1$ ). The UE shall be continuously scheduled on SCell’s BWP-1 starting from the first DL slot that occurs after the beginning of slot ( $j+T_{BWPswitchDelay}$ ).

E-UTRA PCell(Cell 1) interruption due to BWP switch of SCell shall occur within the BWP switch delay.

PSCell(Cell 2) interruption due to BWP switch of SCell shall occur within the BWP switch delay.

The test equipment verifies the DL BWP switch time in SCell by counting the slots from the time when the BWP switch command is received or *bwp-InactivityTimer* timer expires till an ACK is received.

The test equipment verifies that potential interruption to E-UTRA PCell and NR PSCell is carried out in the correct time span by monitoring ACK/NACK sent in E-UTRA PCell and PSCell during BWP switch of SCell, respectively.

**Table A.4.5.6.1.2.1-1: DL BWP switch supported test configurations for LTE PCell and NR PSCell**

Config	Description
1	LTE FDD, NR 15 kHz SSB SCS, ≥10 MHz bandwidth, FDD duplex mode
2	LTE FDD, NR 15 kHz SSB SCS, ≥10 MHz bandwidth, TDD duplex mode
3	LTE FDD, NR 30kHz SSB SCS, ≥40 MHz bandwidth, TDD duplex mode
4	LTE TDD, NR 15 kHz SSB SCS, ≥10 MHz bandwidth, FDD duplex mode
5	LTE TDD, NR 15 kHz SSB SCS, ≥10 MHz bandwidth, TDD duplex mode
6	LTE TDD, NR 30kHz SSB SCS, ≥40 MHz bandwidth, TDD duplex mode
Note 1:	The UE is only required to be tested in one of the supported test configurations
Note 2:	A UE which fulfils the requirements in test case A.4.5.6.1.2 can skip the test cases in A.4.5.6.1.1.
Note 3:	Void
Note 4:	The UE is only required to be tested in one with smallest aggregated channel bandwidth from supported band combinations which is composed of CCs ≥ the bandwidth ( $BW_{channel}$ ) defined in each test configuration

**Table A.4.5.6.1.2.1-1A: DL BWP switch supported test configurations for NR SCell**

Configs <sub>Cell</sub>	Description
1	NR 15 kHz SSB SCS, ≥10 MHz bandwidth, FDD duplex mode

2	NR 15 kHz SSB SCS, $\geq 10$ MHz bandwidth, TDD duplex mode
3	NR 30 kHz SSB SCS, $\geq 40$ MHz bandwidth, TDD duplex mode
Note 1:	The UE is only required to be tested in one of the supported test configurations
Note 2:	A UE which fulfils the requirements in test case A.4.5.6.1.2 can skip the test cases in A.4.5.6.1.1.
Note 3:	The UE is only required to be tested in one with smallest aggregated channel bandwidth from supported band combinations which is composed of CCs $\geq$ the bandwidth ( $BW_{\text{channel}}$ ) defined in each test configuration

**Table A.4.5.6.1.2.1-2: General test parameters for DL BWP switch in synchronous EN-DC**

Parameter	Unit	Value	Comment
E-UTRA RF Channel Number		1	One E-UTRA radio channel is used for this test
NR RF Channel Number		2, 3	Two NR radio channel is used for this test
Active PCell		Cell 1	PCell on RF channel number 1.
Active PSCell		Cell 2	PSCell on RF channel number 2.
Active SCell		Cell 3	SCell on RF channel number 3.
CP length		Normal	
DRX		OFF	
<i>bwp-InactivityTimer</i>	ms	[200]	
PDCCH and PDSCH maximum number of HARQ transmission		1	For PCell, PSCell and SCell
Cell-individual offset for cells on RF channel number 1	dB	0	Individual offset for cells on PCC.
Cell-individual offset for cells on RF channel number 2	dB	0	Individual offset for cells on PSCC.
Cell-individual offset for cells on RF channel number 3	dB	0	Individual offset for cells on SCC.
Cell2 timing offset to cell1	$\mu\text{s}$	3	Synchronous EN-DC
Cell3 timing offset to cell2	$\mu\text{s}$	3	Synchronous cells
T1	s	[0.2]	
T2	s	[0.2]	
T3	s	[0.2]	

**Table A.4.5.6.1.2.1-3: NR Cell specific test parameters for NR PSCell for DL BWP switch in synchronous EN-DC**

Parameter	Unit	Cell 2
Frequency Range		FR1
Duplex mode	Config 1,4	FDD
	Config 2,3,5,6	TDD
TDD configuration	Config 1,4	Not Applicable
	Config 2,5	TDDConf.1.1
	Config 3,6	TDDConf.2.1
$BW_{\text{channel}}$	Config 1,2,3,4,5,6	Note 7
$BW_{\text{occupied}}$	Config 1,2,4,5	52 <sup>Note 5</sup>
	Config 3,6	106 <sup>Note 6</sup>
Active BWP ID		0
Initial DL BWP Configuration	Config 1,2,3,4,5,6	DLBWP.0.2
Active DL BWP-0 Configuration	Config 1,2,3,4,5,6	DLBWP.0.2
Active DL BWP-1 Configuration	Config 1,2,3,4,5,6	N.A.
Active DL BWP-2 Configuration	Config 1,2,3,4,5,6	N.A.
Initial UL BWP Configuration	Config 1,2,3,4,5,6	ULBWP.0.2
Active UL BWP-0 Configuration	Config 1,2,3,4,5,6	ULBWP.0.2
Active UL BWP-1 Configuration	Config 1,2,3,4,5,6	N.A.

Active UL BWP-2 Configuration	Config 1,2,3,4,5,6		N.A.
PDSCH Reference measurement channel	Config 1,4		SR.1.1 FDD
	Config 2,5		SR.1.1 TDD
	Config 3,6		SR.2.1 TDD
RMSI CORESET parameters	Config 1,4		CR.1.1 FDD
	Config 2,5		CR.1.1 TDD
	Config 3,6		CR.2.1 TDD
Dedicated CORESET parameters	Config 1,4		CCR.1.2 FDD
	Config 2,5		CCR.1.2 TDD
	Config 3,6		CCR.2.4 TDD
OCNG Patterns	Config 1,2,4,5		OP.1 <sup>Note 5</sup>
	Config 3,6		OP.1 <sup>Note 6</sup>
SSB Configuration	Config 1,2,4,5		SSB.1 FR1
	Config 3,6		SSB.2 FR1
SMTC Configuration			SMTC.1
TRS Configuration	Config 1,4		TRS.1.1 FDD
	Config 2,5		TRS.1.1 TDD
	Config 3,6		TRS.1.2 TDD
Antenna Configuration			1x2
Propagation Condition			AWGN
EPRE ratio of PSS to SSS		dB	0
EPRE ratio of PBCH DMRS to SSS			
EPRE ratio of PBCH to PBCH DMRS			
EPRE ratio of PDCCH DMRS to SSS			
EPRE ratio of PDCCH to PDCCH DMRS			
EPRE ratio of PDSCH DMRS to SSS			
EPRE ratio of PDSCH to PDSCH			
EPRE ratio of OCNG DMRS to SSS <sup>Note 1</sup>			
EPRE ratio of OCNG to OCNG DMRS <sup>Note 1</sup>			
$N_{oc}$ <sup>Note 2</sup>			
SS-RSRP <sup>Note 3</sup>		dBm/15 kHz	-87
$\bar{E}_s/I_{ot}$		dB	17
$\bar{E}_s/N_{oc}$		dB	17
$I_o$ <sup>Note 3</sup>	Config 1,2,4,5	dBm/9.36MHz	-58.96
	Config 3,6	dBm/38.16MHz	-52.86
<p>Note 1: OCNG shall be used such that both cells are fully allocated and a constant total transmitted power spectral density is achieved for all OFDM symbols.</p> <p>Note 2: Interference from other cells and noise sources not specified in the test is assumed to be constant over subcarriers and time and shall be modelled as AWGN of appropriate power for <math>N_{oc}</math> to be fulfilled within <math>BW_{occupied}</math>.</p> <p>Note 3: SS-RSRP and <math>I_o</math> levels have been derived from other parameters for information purposes. They are not settable parameters themselves.</p> <p>Note 4: For unpaired spectrum, a DL BWP is linked with an UL BWP. DLBWP.0.2 is linked with ULBWP.0.2; DLBWP.1.1 is linked with ULBWP.1.1; DLBWP.1.3 is linked with ULBWP.1.3 defined in clause 12 of TS 38.213 [3].</p> <p>Note 5: All UL/DL transmission shall be confined within <math>BW_{occupied}</math> (i.e. 10 MHz, 52 RBs) from <math>F_{C,low}</math>, and <math>I_o</math> is independent of the <math>BW_{channel}</math> configured.</p> <p>Note 6: All UL/DL transmission shall be confined within <math>BW_{occupied}</math> (i.e. 40 MHz, 106 RBs) from <math>F_{C,low}</math>, and <math>I_o</math> is independent of the <math>BW_{channel}</math> configured.</p> <p>Note 7: NRB,c is derived from Table 5.3.2-1 in TS38.101-1[2] with configured <math>BW_{channel}</math>.</p>			

**Table A.4.5.6.1.2.1-4: NR Cell specific test parameters for NR SCell for DL BWP switch in synchronous EN-DC**

Parameter		Unit	Cell 3
Frequency Range			FR1
Duplex mode	Config <sub>SCell</sub> 1		FDD
	Config <sub>SCell</sub> 2,3		TDD
TDD configuration	Config <sub>SCell</sub> 1		Not Applicable
	Config <sub>SCell</sub> 2		TDDConf.1.1
	Config <sub>SCell</sub> 3		TDDConf.2.1
$BW_{channel}$	Config <sub>SCell</sub> 1,2,3		Note 7

BW <sub>occupied</sub>	Config <sub>SCell</sub> 1,2	RB	52 <sup>Note 5</sup>
	Config <sub>SCell</sub> 3		106 <sup>Note 6</sup>
Active BWP ID			1,2
Initial DL BWP Configuration	Config <sub>SCell</sub> 1,2,3		DLBWP.0.2
Active DL BWP-0 Configuration	Config <sub>SCell</sub> 1,2,3		N.A.
Active DL BWP-1 Configuration	Config <sub>SCell</sub> 1,2,3		DLBWP.1.3
Active DL BWP-2 Configuration	Config <sub>SCell</sub> 1,2,3		DLBWP.1.1
Initial UL BWP Configuration	Config <sub>SCell</sub> 1,2,3		N.A.
Active UL BWP-0 Configuration	Config <sub>SCell</sub> 1,2,3		N.A.
Active UL BWP-1 Configuration	Config <sub>SCell</sub> 1,2,3		N.A.
Active UL BWP-2 Configuration	Config <sub>SCell</sub> 1,2,3		N.A.
PDSCH Reference measurement channel	Config <sub>SCell</sub> 1		SR.1.1 FDD
	Config <sub>SCell</sub> 2		SR.1.1 TDD
	Config <sub>SCell</sub> 3		SR.2.1 TDD
RMSI CORESET parameters	Config <sub>SCell</sub> 1		CR.1.1 FDD
	Config <sub>SCell</sub> 2		CR.1.1 TDD
	Config <sub>SCell</sub> 3		CR.2.1 TDD
Dedicated CORESET parameters	Config <sub>SCell</sub> 1		CCR.1.2 FDD
	Config <sub>SCell</sub> 2		CCR.1.2 TDD
	Config <sub>SCell</sub> 3		CCR.2.4 TDD
OCNG Patterns	Config <sub>SCell</sub> 1,2		OP.1 <sup>Note 5</sup>
	Config <sub>SCell</sub> 3		OP.1 <sup>Note 6</sup>
SSB Configuration	Config <sub>SCell</sub> 1,2		SSB.1 FR1
	Config <sub>SCell</sub> 3		SSB.2 FR1
SMTC Configuration			SMTC.1
TRS Configuration	Config <sub>SCell</sub> 1		TRS.1.1 FDD
	Config <sub>SCell</sub> 2		TRS.1.1 TDD
	Config <sub>SCell</sub> 3		TRS.1.2 TDD
Antenna Configuration			1x2
Propagation Condition			AWGN
EPRE ratio of PSS to SSS		dB	0
EPRE ratio of PBCH DMRS to SSS			
EPRE ratio of PBCH to PBCH DMRS			
EPRE ratio of PDCCH DMRS to SSS			
EPRE ratio of PDCCH to PDCCH DMRS			
EPRE ratio of PDSCH DMRS to SSS			
EPRE ratio of PDSCH to PDSCH			
EPRE ratio of OCNG DMRS to SSS <sup>Note 1</sup>			
EPRE ratio of OCNG to OCNG DMRS <sup>Note 1</sup>			
N <sub>oc</sub> <sup>Note 2</sup>			
SS-RSRP <sup>Note 3</sup>		dBm/15 kHz	-87
E <sub>s</sub> /I <sub>ot</sub>		dB	17
E <sub>s</sub> /N <sub>oc</sub>		dB	17
I <sub>o</sub> <sup>Note 3</sup>	Config <sub>SCell</sub> 1,2	dBm/9.36MHz	-58.96
	Config <sub>SCell</sub> 3	dBm/38.16MHz	-52.86

Note 1:	OCNG shall be used such that both cells are fully allocated and a constant total transmitted power spectral density is achieved for all OFDM symbols.
Note 2:	Interference from other cells and noise sources not specified in the test is assumed to be constant over subcarriers and time and shall be modelled as AWGN of appropriate power for $N_{oc}$ to be fulfilled within $BW_{occupied}$ .
Note 3:	SS-RSRP and $I_o$ levels have been derived from other parameters for information purposes. They are not settable parameters themselves.
Note 4:	For unpaired spectrum, a DL BWP is linked with an UL BWP. DLBWP.0.2 is linked with ULBWP.0.2; DLBWP.1.1 is linked with ULBWP.1.1; DLBWP.1.3 is linked with ULBWP.1.3 defined in clause 12 of TS 38.213 [3].
Note 5:	All UL/DL transmission shall be confined within $BW_{occupied}$ (i.e. 10 MHz, 52 RBs) from $F_{C,low}$ , and $I_o$ is independent of the $BW_{channel}$ configured.
Note 6:	All UL/DL transmission shall be confined within $BW_{occupied}$ (i.e. 40 MHz, 106 RBs) from $F_{C,low}$ , and $I_o$ is independent of the $BW_{channel}$ configured.
Note 7:	NRB,c. is derived from Table 5.3.2-1 in TS38.101-1[2] with configured $BW_{channel}$ .

#### A.4.5.6.1.2.2 Test Requirements

During T1, the UE shall start to send the ACK/NACK for SCell from the first UL slot that occurs after the beginning of DL slot  $(i+T_{BWPswitchDelay}+kI)$ .

During T3, the UE shall start to send the ACK/NACK for SCell from the first UL slot that occurs after the beginning of DLslot  $(j+T_{BWPswitchDelay}+kI)$ .

All of the above test requirements shall be fulfilled in order for the observed SCell active BWP switch delay to be counted as correct.

The rate of correct events observed during repeated tests shall be at least 90%.

During T1, the start of the interruption of PCell during SCell active BWP switch shall not happen outside the BWP switch delay.

During T3, the start of the interruption of PCell during SCell active BWP switch shall not happen outside the BWP switch delay.

The interruption of PCell shall not be longer than the interruption duration specified for active BWP switch in clause 7.32.2.7 of TS 36.133 [15].

During T1, the start of the interruption of PSCell during SCell active BWP switch shall not happen outside the BWP switch delay.

During T3, the start of the interruption of PSCell during SCell active BWP switch shall not happen outside the BWP switch delay.

The interruption of PSCell shall not be longer than the interruption duration specified for active BWP switch in clause 8.6.2.

All of the above test requirements shall be fulfilled in order for the observed PCell active BWP switch interruption to be counted as correct.

The rate of correct events observed during repeated tests shall be at least 90%.

**NOTE:** During T1, T3 if there are no uplink resources for reporting the ACK in the first UL slot that occurs after the beginning of DL slot  $(i+T_{BWPswitchDelay}+kI)$ ,  $(j+T_{BWPswitchDelay}+kI)$ , then the UE shall use the next available uplink resource for reporting the corresponding ACK.

*Editor's note: FFS value of  $kI$  for type 1 and type 2 UE.*

## A.4.5.6.2 RRC-based Active BWP Switch

### A.4.5.6.2.1 E-UTRAN – NR PSCell FR1 DL active BWP switch in non-DRX in synchronous EN-DC

#### A.4.5.6.2.1.1 Test Purpose and Environment

The purpose of this test is to verify the DL BWP switch delay requirement for RRC-based BWP switch defined in clause 8.6.3. Supported test configurations are shown in Table A.4.5.6.2.1.1-1.

The test scenario comprises of one E-UTRA PCell (Cell 1) and one NR PSCell (Cell 2) as given in Table A.4.5.6.2.1.1-2. Cell-specific parameters of E-UTRA PCell are specified in Table A.3.7.2.1-1 and Cell-specific parameters of NR PSCell are specified in Table A.4.5.6.2.1.1-3 below.

PDCCHs indicating new transmissions shall be sent continuously on PCell (Cell 1) to ensure that the UE will have ACK/NACK sending.

PDCCHs indicating new transmissions shall be sent continuously on PSCell (Cell 2) to ensure that the UE would have ACK/NACK sending except for the time duration when BWP is switching on Cell 2.

Before the test starts,

- UE is connected to Cell 1 (PCell) on radio channel 1 (PCC) and to Cell 2 (PSCell) on radio channel 2 (PSCC).
- UE has bandwidth part BWP-1 in its RRC-configuration for Cell 1 (PSCell).
- UE is indicated in *firstActiveDownlinkBWP-Id* that the active DL BWP is BWP-1 of initial condition in PSCell.

All cells have constant signal levels throughout the test.

The test consists of 1 time period, with duration of T1.

During T1,

If the *RRCReconfiguration* is embedded in E-UTRA RRC message, time period T1 starts when a E-UTRA RRC message *RRCConnectionReconfiguration* with updated bandwidth part configuration, sent from the test equipment to the UE, is completely received at the UE side from PCell in PSCell's slot # denoted *i*. Otherwise, i.e., if the *RRCReconfiguration* is not embedded in E-UTRA RRC message, time period T1 starts when a *RRCReconfiguration* with updated bandwidth part configuration, sent from the test equipment to the UE, is completely received at the UE side in from PSCell in PSCell's slot # denoted *i*. The UE shall reconfigure its bandwidth part with the updated bandwidth part BWP-1 of final condition.

The UE shall be able to receive PDSCH at the beginning of the DL slot right after PSCell's DL slot ( $i+T_{RRCprocessingDelay}+T_{BWPswitchDelayRRC}$ ) as defined in clause 8.6.3 and be ready for the reception of uplink grant for the PSCell no later than at the beginning of the DL slot right after slot ( $i+T_{RRCprocessingDelay}+T_{BWPswitchDelayRRC}$ ). The UE shall be continuously scheduled on PSCell's BWP-1 starting from the beginning of the DL slot right after slot ( $i+T_{RRCprocessingDelay}+T_{BWPswitchDelayRRC}$ ).

$T_{RRCprocessingDelay}$  and  $T_{BWPswitchDelayRRC}$  are defined in clause 8.6.3.

The test equipment verifies the DL BWP switch time in PSCell by counting the time from the time when the RRC Reconfiguration message including updated BWP configuration is sent till the time when RRC Reconfiguration Complete message is received.

**Table A.4.5.6.2.1.1-1: DL BWP switch supported test configurations**

Config	Description
1	LTE FDD, NR 15 kHz SSB SCS, 10 MHz bandwidth, FDD duplex mode
2	LTE FDD, NR 15 kHz SSB SCS, 10 MHz bandwidth, TDD duplex mode
3	LTE FDD, NR 30kHz SSB SCS, 40 MHz bandwidth, TDD duplex mode
4	LTE TDD, NR 15 kHz SSB SCS, 10 MHz bandwidth, FDD duplex mode
5	LTE TDD, NR 15 kHz SSB SCS, 10 MHz bandwidth, TDD duplex mode
6	LTE TDD, NR 30kHz SSB SCS, 40 MHz bandwidth, TDD duplex mode
Note 1: The UE is only required to be tested in one of the supported test configurations	

Table A.4.5.6.2.1.1-2: General test parameters for DL BWP switch in synchronous EN-DC

Parameter	Unit	Value	Comment
E-UTRA RF Channel Number		1	One E-UTRA radio channel is used for this test
NR RF Channel Number		2	One NR radio channel is used for this test
Active PCell		Cell 1	PCell on RF channel number 1.
Active PSCell		Cell 2	PSCell on RF channel number 2.
CP length		Normal	
DRX		OFF	
PDCCH and PDSCH maximum number of HARQ transmission		1	For both PCell and PSCell
Cell-individual offset for cells on RF channel number 1	dB	0	Individual offset for cells on PCC.
Cell-individual offset for cells on RF channel number 2	dB	0	Individual offset for cells on PSCC.
Cell2 timing offset to cell1	μs	3	Synchronous EN-DC
T1	s	[0.2]	

Table A.4.5.6.2.1.1-3: NR Cell specific test parameters for DL BWP switch in synchronous EN-DC

Parameter		Unit	Cell 2
<b>Frequency Range</b>			<b>FR1</b>
Duplex mode	Config 1,4		FDD
	Config 2,3,5,6		TDD
TDD configuration	Config 1,4		Not Applicable
	Config 2,5		TDDConf.1.1
	Config 3,6		TDDConf.2.1
BW <sub>channel</sub>	Config 1,4		10 MHz: N <sub>RB,c</sub> = 52
	Config 2,5		10 MHz: N <sub>RB,c</sub> = 52
	Config 3,6		40 MHz: N <sub>RB,c</sub> = 106
Active DL BWP ID			1, 2
Initial DL BWP Configuration	Config 1,4		DLBWP.0.2
	Config 2,5		
	Config 3,6		
Initial UL BWP Configuration	Config 1,4		ULBWP.0.2
	Config 2,5		
	Config 3,6		
Initial Condition	Active DL BWP-1 Configuration	Config 1,4	DLBWP.1.3
		Config 2,5	
		Config 3,6	
	Active UL BWP-1 Configuration	Config 1,4	ULBWP.1.3
		Config 2,5	
		Config 3,6	
Final Condition	Active DL BWP-1 Configuration	Config 1,4	DLBWP.1.1
		Config 2,5	
		Config 3,6	
	Active UL BWP-1 Configuration	Config 1,4	ULBWP.1.1
		Config 2,5	
		Config 3,6	
Initial UL BWP Configuration	Config 1,4	ULBWP.0.2	
	Config 2,5		
	Config 3,6		
Active UL BWP-1 Configuration	Config 1,4	ULBWP.1.3	
	Config 2,5		
	Config 3,6		
Active UL BWP-2	Config 1,4	ULBWP.1.1	

Configuration	Config 2,5		
	Config 3,6		
PDSCH Reference measurement channel	Config 1,4		SR.1.1 FDD
	Config 2,5		SR.1.1 TDD
	Config 3,6		SR2.1 TDD
RMSI CORESET parameters	Config 1,4		CR.1.1 FDD
	Config 2,5		CR.1.1 TDD
	Config 3,6		CR2.1 TDD
Dedicated CORESET parameters	Config 1,4		CCR.1.2 FDD
	Config 2,5		CCR.1.2 TDD
	Config 3,6		CCR.2.4 TDD
OCNG Patterns			OP.1
SSB Configuration	Config 1,2,4,5		SSB.1 FR1
	Config 3,6		SSB.2 FR1
SMTC Configuration			SMTC.1
TRS Configuration	Config 1,4		TRS.1.1 FDD
	Config 2,5		TRS.1.1 TDD
	Config 3,6		TRS.1.2 TDD
Antenna Configuration			1x2
Propagation Condition			AWGN
EPRE ratio of PSS to SSS			0
EPRE ratio of PBCH DMRS to SSS			
EPRE ratio of PBCH to PBCH DMRS			
EPRE ratio of PDCCH DMRS to SSS			
EPRE ratio of PDCCH to PDCCH DMRS			
EPRE ratio of PDSCH DMRS to SSS			
EPRE ratio of PDSCH to PDSCH			
EPRE ratio of OCNG DMRS to SSS(Note 1)			
EPRE ratio of OCNG to OCNG DMRS (Note 1)			
N <sub>oc</sub> <sup>Note 2</sup>			
SS-RSRP <sup>Note 3</sup>			dBm/15 kHz
E <sub>s</sub> /I <sub>ot</sub>			dB
E <sub>s</sub> /N <sub>oc</sub>			dB
I <sub>o</sub> <sup>Note 3</sup>	Config 1,2,4,5	dBm/9.36MHz	[-59]
	Config 3,6	dBm/38.16MHz	[-61.9]
<p>Note 1: OCNG shall be used such that both cells are fully allocated and a constant total transmitted power spectral density is achieved for all OFDM symbols.</p> <p>Note 2: Interference from other cells and noise sources not specified in the test is assumed to be constant over subcarriers and time and shall be modelled as AWGN of appropriate power for N<sub>oc</sub> to be fulfilled.</p> <p>Note 3: SS-RSRP and I<sub>o</sub> levels have been derived from other parameters for information purposes. They are not settable parameters themselves.</p> <p>Note 4: For unpaired spectrum, a DL BWP is linked with an UL BWP. DLBWP.0.2 is linked with ULBWP.0.2; DLBWP.1.1 is linked with ULBWP.1.1; DLBWP.1.3 is linked with ULBWP.1.3 defined in clause 12 of TS 38.213 [3].</p>			

A.4.5.6.2.1.2 Test Requirements

During T1, the UE shall be ready for the reception of uplink grant for PSCell in the beginning of the DL slot right after slot ( $i + T_{RRCprocessingDelay} + T_{BWPswitchDelayRRC}$ ).

All of the above test requirements shall be fulfilled in order for the observed PSCell active BWP switch delay to be counted as correct.

The rate of correct events observed during repeated tests shall be at least 90%.



### A.4.5.6.3 Simultaneous DCI-based and Timer-based Active BWP Switch on multiple CCs

#### A.4.5.6.3.1 Simultaneous E-UTRAN – NR PSCell FR1 DL active BWP switch in non-DRX in EN-DC on multiple CCs

##### A.4.5.6.3.1.1 Test Purpose and Environment

The purpose of this test is to verify the requirement of DL BWP switch delay on multiple CCs in TS38.133 clause 8.6.2A.1, and interruption requirement for E-UTRA victim cell defined in TS36.133 clause 7.32.2.7. Supported test configurations for LTE PCell and NR PSCell are shown in Table A.4.5.6.3.1.1-1. Supported test configurations for NR SCell are shown in table A.4.5.6.3.1.1-1A. Test configuration for LTE PCell and NR PSCell and test configuration for NR SCell are chosen independently.

The test scenario comprises of one E-UTRA PCell (Cell 1), one NR PSCell (Cell 2) and one NR SCell (Cell 3) as given in Table A.4.5.6.3.1.1-2. Cell-specific parameters of E-UTRA PCell are specified in Table A.3.7.2.1-1 and Cell-specific parameters of NR PSCell and NR SCell are specified in Table A.4.5.6.3.1.1-3 and Table A.4.5.6.3.1.1-4 below.

PDCCHs indicating new transmissions shall be sent continuously on PCell (Cell 1) to ensure that the UE will have ACK/NACK sending.

PDCCHs indicating new transmissions shall be sent continuously on PSCell (Cell 2) and SCell (Cell 3) to ensure that the UE would have ACK/NACK sending except for the time duration T2 when BWPs are switching on Cell 2 and Cell 3.

Before the test starts,

- UE is connected to Cell 1 (PCell) on radio channel 1 (PCC), Cell 2 (PSCell) on radio channel 2 (PSCC) and Cell 3 (SCell) on radio channel 3.
- UE is configured with 2 different UE-specific downlink bandwidth parts for PSCell, BWP-1 and BWP-2, before starting the test. BWP-1 and BWP-2 always include bandwidth of the initial DL BWP and SSB.
- UE is configured with 2 different UE-specific downlink bandwidth parts for SCell, BWP-1 and BWP-2, before starting the test. BWP-1 and BWP-2 always include bandwidth of the initial DL BWP and SSB.
- UE is indicated in *firstActiveDownlinkBWP-Id* that the active DL BWP is BWP-1 in PSCell
- UE is indicated in *firstActiveDownlinkBWP-Id* that the active DL BWP is BWP-1 in SCell
- UE is configured with a *bwp-InactivityTimer* timer value for PSCell and SCell.

All cells have constant signal levels throughout the test.

The test consists of 3 successive time periods, with durations of T1, T2, and T3, respectively.

During T1,

Time period T1 starts when a DCI format 1\_1 command for PSCell DL BWP switch, sent from the test equipment to the UE, is received at the UE side in PSCell's slot # denoted  $i$ . The UE shall switch its PSCell bandwidth part from BWP-1 to BWP-2. On the same slot on Cell 3 test equipment shall send a DCI format 1\_1 command for SCell DL BWP switch. The UE shall switch its SCell bandwidth part from BWP-1 to BWP-2.

The UE shall be able to receive PDSCH on PSCell and SCell at the beginning of the DL slot right after DL slot ( $i + T_{MultipleBWPswitchDelay}$ ) as defined in clause 8.6.2A.1 and starts to report valid ACK/NACK for the PSCell and SCell no later than at the beginning of the DL slot right after DL slot ( $i + T_{MultipleBWPswitchDelay} + kI$ ). The UE shall be continuously scheduled on both PCell's and SCell's BWP-2 starting from the beginning of the DL slot right after DL slot ( $i + T_{MultipleBWPswitchDelay}$ ).

The starting time of PCell(Cell 1) interruption due to BWP switch on PSCell and SCell shall occur within the BWP switch delay.

During T2, the test equipment won't transmit DCI format for PDSCH reception on PSCell(Cell 2) and SCell(Cell 3).

During T3,

The time period T3 starts from the slot # $j$ , where  $j$  is the beginning slot of the DL subframe immediately after the *bwp-InactivityTimer* timer expires on PSCell. *bwp-InactivityTimer* timer on SCell shall also expire on slot # $j$ . The UE shall switch its bandwidth part from BWP-2 back to the default bandwidth part – BWP-1 on both PSCell and SCell. The UE shall be able to receive PDSCH on both PSCell and SCell at the beginning of the DL slot right after DL slot ( $j + T_{MultipleBWPswitchDelay}$ ) as defined in clause 8.6.2B.1 and starts to report valid ACK/NACK for the PSCell and SCell at latest at the beginning of the DL slot right after DL slot ( $j + T_{MultipleBWPswitchDelay} + kI$ ). The UE shall be continuously scheduled on both PSCell's and SCell's BWP-1 starting from the beginning of the DL slot right after DL slot ( $j + T_{MultipleBWPswitchDelay}$ ).

The starting time of PCell(Cell 1) interruption due to BWP switch of PSCell shall occur within the BWP switch delay.

The test equipment verifies the DL BWP switch time in PSCell and SCell by counting the slots from the time when the BWP switch command is received or *bwp-InactivityTimer* timer expires till an ACK is received.

The test equipment verifies that potential interruption to E-UTRA PCell is carried out in the correct time span by monitoring ACK/NACK sent in PCell during BWP switch of PSCell and SCell.

**Table A.4.5.6.3.1.1-1: DL BWP switch supported test configurations for LTE PCell and NR PSCell**

Config	Description
1	LTE FDD, NR 15 kHz SSB SCS, $\geq 10$ MHz bandwidth, FDD duplex mode
2	LTE FDD, NR 15 kHz SSB SCS, $\geq 10$ MHz bandwidth, TDD duplex mode
3	LTE FDD, NR 30 kHz SSB SCS, $\geq 40$ MHz bandwidth, TDD duplex mode
4	LTE TDD, NR 15 kHz SSB SCS, $\geq 10$ MHz bandwidth, FDD duplex mode
5	LTE TDD, NR 15 kHz SSB SCS, $\geq 10$ MHz bandwidth, TDD duplex mode
6	LTE TDD, NR 30 kHz SSB SCS, $\geq 40$ MHz bandwidth, TDD duplex mode
Note 1:	The UE is only required to be tested in one of the supported test configurations.
Note 2:	The UE is only required to be tested in one with smallest aggregated channel bandwidth from supported band combinations which is composed of CCs $\geq$ the bandwidth ( $BW_{channel}$ ) defined in each test configuration.

**Table A.4.5.6.3.1.1-1A: DL BWP switch supported test configurations for NR SCell**

Config <sub>SCell</sub>	Description
1	NR 15 kHz SSB SCS, $\geq 10$ MHz bandwidth, FDD duplex mode
2	NR 15 kHz SSB SCS, $\geq 10$ MHz bandwidth, TDD duplex mode
3	NR 30 kHz SSB SCS, $\geq 40$ MHz bandwidth, TDD duplex mode
Note 1:	The UE is only required to be tested in one of the supported test configurations
Note 2:	The UE is only required to be tested in one with smallest aggregated channel bandwidth from supported band combinations which is composed of CCs $\geq$ the bandwidth ( $BW_{channel}$ ) defined in each test configuration

**Table A.4.5.6.3.1.1-2: General test parameters for DL BWP switch in synchronous EN-DC**

Parameter	Unit	Value	Comment
E-UTRA RF Channel Number		1	One E-UTRA radio channel is used for this test
NR RF Channel Number		2,3	Two NR radio channels are used for this test
Active PCell		Cell 1	PCell on RF channel number 1.
Active PSCell		Cell 2	PSCell on RF channel number 2.
Active SCell		Cell 3	SCell on RF channel number 3.
CP length		Normal	
DRX		OFF	For both PCell and PSCell
<i>bwp-InactivityTimer</i>	ms	[200]	For both PSCell and SCell
Cell-individual offset for cells on RF channel number 1	dB	0	Individual offset for cells on PCC.
Cell-individual offset for cells on RF channel number 2	dB	0	Individual offset for cells on PSCC.
Cell-individual offset for cells on RF channel number 3	dB	0	Individual offset for cells on SCC.
Cell2 timing offset to cell1	$\mu$ s	3	Synchronous EN-DC
Cell3 timing offset to cell2	$\mu$ s	3	Synchronous cells

T1	s	0.2	
T2	s	0.2	
T3	s	0.2	

**Table A.4.5.6.3.1.1-3: NR Cell specific test parameters for NR PSCell for DL BWP switch in synchronous EN-DC**

Parameter		Unit	Cell 2
Frequency Range			FR1
Duplex mode	Config 1,4		FDD
	Config 2,3,5,6		TDD
TDD configuration	Config 1,4		Not Applicable
	Config 2,5		TDDConf.1.1
	Config 3,6		TDDConf.2.1
BW <sub>channel</sub>	Config 1,4		10 MHz: N <sub>RB,c</sub> = 52
	Config 2,5		10 MHz: N <sub>RB,c</sub> = 52
	Config 3,6		40 MHz: N <sub>RB,c</sub> = 106
Active BWP ID			1,2
Initial DL BWP Configuration	Config 1,4		DLBWP.0.2 <sup>Note 4</sup>
	Config 2,5		
	Config 3,6		
Active DL BWP-1 Configuration	Config 1,4		DLBWP.1.1 <sup>Note 4</sup>
	Config 2,5		
	Config 3,6		
Active DL BWP-2 Configuration	Config 1,4		DLBWP.1.3 <sup>Note 4</sup>
	Config 2,5		
	Config 3,6		
Initial UL BWP Configuration	Config 1,4		ULBWP.0.2 <sup>Note 4</sup>
	Config 2,5		
	Config 3,6		
Active UL BWP-1 Configuration	Config 1,4		ULBWP.1.1 <sup>Note 4</sup>
	Config 2,5		
	Config 3,6		
Active UL BWP-2 Configuration	Config 1,4		ULBWP.1.3 <sup>Note 4</sup>
	Config 2,5		
	Config 3,6		
PDSCH Reference measurement channel	Config 1,4		SR.1.1 FDD
	Config 2,5		SR.1.1 TDD
	Config 3,6		SR.2.1 TDD
RMSI CORESET parameters	Config 1,4		CR.1.1 FDD
	Config 2,5		CR.1.1 TDD
	Config 3,6		CR.2.1 TDD
Dedicated CORESET parameters	Config 1,4		CCR.1.1 FDD
	Config 2,5		CCR.1.1 TDD
	Config 3,6		CCR.2.1 TDD
OCNG Patterns			OP.1
SSB Configuration	Config 1,2,4,5		SSB.1 FR1
	Config 3,6		SSB.2 FR1
SMTC Configuration			SMTC.1
Correlation Matrix and Antenna Configuration			1x2 Low
TRS Configuration	Config 1,4		TRS.1.1 FDD
	Config 2,5		TRS.1.1 TDD
	Config 3,6		TRS.1.2 TDD
EPRE ratio of PSS to SSS		dB	0
EPRE ratio of PBCH DMRS to SSS			
EPRE ratio of PBCH to PBCH DMRS			
EPRE ratio of PDCCH DMRS to SSS			
EPRE ratio of PDCCH to PDCCH DMRS			
EPRE ratio of PDSCH DMRS to SSS			
EPRE ratio of PDSCH to PDSCH			
EPRE ratio of OCNG DMRS to SSS <sup>Note 1</sup>			
EPRE ratio of OCNG to OCNG DMRS <sup>Note 1</sup>			
N <sub>oc</sub> <sup>Note 2</sup>	Config 1,2,4,5	dBm/SCS	-104

	Config 3,6		-101
$N_{oc}$ <sup>Note 2</sup>		dBm/15kHz	[-104]
SS-RSRP <sup>Note 3</sup>	Config 1,2,4,5	dBm/SCS	-87
	Config 3,6		-90
$\bar{E}_s/I_{ot}$		dB	[17]
$\bar{E}_s/N_{oc}$		dB	[17]
$I_o$ <sup>Note3</sup>	Config 1,2,4,5	dBm/ 9.36MHz	-59
	Config 3,6	dBm/ 38.16MHz	-61.9
Propagation Condition			AWGN
<p>Note 1: OCNB shall be used such that both cells are fully allocated and a constant total transmitted power spectral density is achieved for all OFDM symbols.</p> <p>Note 2: Interference from other cells and noise sources not specified in the test is assumed to be constant over subcarriers and time and shall be modelled as AWGN of appropriate power for <math>N_{oc}</math> to be fulfilled.</p> <p>Note 3: SS-RSRP and <math>I_o</math> levels have been derived from other parameters for information purposes. They are not settable parameters themselves.</p> <p>Note 4: For unpaired spectrum, a DL BWP is linked with an UL BWP. DLBWP.0.2 is linked with ULBWP.0.2; DLBWP.1.1 is linked with ULBWP.1.1; DLBWP.1.3 is linked with ULBWP.1.3 defined in clause 12 of TS 38.213 [3].</p>			

**Table A.4.5.6.3.1.1-4: NR Cell specific test parameters for NR SCell for DL BWP switch in synchronous EN-DC**

Parameter		Unit	Cell 3
Frequency Range			FR1
Duplex mode	Config <sub>SCell</sub> 1		FDD
	Config <sub>SCell</sub> 2,3		TDD
TDD configuration	Config <sub>SCell</sub> 1		Not Applicable
	Config <sub>SCell</sub> 2		TDDConf.1.1
	Config <sub>SCell</sub> 3		TDDConf.2.1
$BW_{channel}$	Config <sub>SCell</sub> 1		10 MHz: $N_{RB,c} = 52$
	Config <sub>SCell</sub> 2		10 MHz: $N_{RB,c} = 52$
	Config <sub>SCell</sub> 3		40 MHz: $N_{RB,c} = 106$
Active BWP ID			1,2
Initial DL BWP Configuration	Config <sub>SCell</sub> 1		DLBWP.0.2 <sup>Note 4</sup>
	Config <sub>SCell</sub> 2		
	Config <sub>SCell</sub> 3		
Active DL BWP-1 Configuration	Config <sub>SCell</sub> 1		DLBWP.1.1 <sup>Note 4</sup>
	Config <sub>SCell</sub> 2		
	Config <sub>SCell</sub> 3		
Active DL BWP-2 Configuration	Config <sub>SCell</sub> 1		DLBWP.1.3 <sup>Note 4</sup>
	Config <sub>SCell</sub> 2		
	Config <sub>SCell</sub> 3		
Initial UL BWP Configuration	Config <sub>SCell</sub> 1		ULBWP.0.2 <sup>Note 4</sup>
	Config <sub>SCell</sub> 2		
	Config <sub>SCell</sub> 3		
Active UL BWP-1 Configuration	Config <sub>SCell</sub> 1		ULBWP.1.1 <sup>Note 4</sup>
	Config <sub>SCell</sub> 2		
	Config <sub>SCell</sub> 3		
Active UL BWP-2 Configuration	Config <sub>SCell</sub> 1		ULBWP.1.3 <sup>Note 4</sup>
	Config <sub>SCell</sub> 2		
	Config <sub>SCell</sub> 3		
PDSCH Reference measurement channel	Config <sub>SCell</sub> 1		SR.1.1 FDD
	Config <sub>SCell</sub> 2		SR.1.1 TDD
	Config <sub>SCell</sub> 3		SR.2.1 TDD
RMSI CORESET parameters	Config <sub>SCell</sub> 1		CR.1.1 FDD
	Config <sub>SCell</sub> 2		CR.1.1 TDD
	Config <sub>SCell</sub> 3		CR.2.1 TDD
Dedicated CORESET parameters	Config <sub>SCell</sub> 1		CCR.1.1 FDD
	Config <sub>SCell</sub> 2		CCR.1.1 TDD
	Config <sub>SCell</sub> 3		CCR.2.1 TDD
OCNB Patterns			OP.1

SSB Configuration	Config <sub>SCell</sub> 1,2		SSB.1 FR1
	Config <sub>SCell</sub> 3		SSB.2 FR1
SMTC Configuration			SMTC.1
Correlation Matrix and Antenna Configuration			1x2 Low
TRS Configuration	Config <sub>SCell</sub> 1		TRS.1.1 FDD
	Config <sub>SCell</sub> 2		TRS.1.1 TDD
	Config <sub>SCell</sub> 3		TRS.1.2 TDD
EPRE ratio of PSS to SSS		dB	0
EPRE ratio of PBCH DMRS to SSS			
EPRE ratio of PBCH to PBCH DMRS			
EPRE ratio of PDCCH DMRS to SSS			
EPRE ratio of PDCCH to PDCCH DMRS			
EPRE ratio of PDSCH DMRS to SSS			
EPRE ratio of PDSCH to PDSCH			
EPRE ratio of OCNG DMRS to SSS <sup>Note 1</sup>			
EPRE ratio of OCNG to OCNG DMRS <sup>Note 1</sup>			
N <sub>oc</sub> <sup>Note 2</sup>	Config <sub>SCell</sub> 1,2	dBm/SCS	-104
	Config <sub>SCell</sub> 3		-101
N <sub>oc</sub> <sup>Note 2</sup>		dBm/15kHz	[-104]
SS-RSRP <sup>Note 3</sup>	Config <sub>SCell</sub> 1,2	dBm/SCS	-87
	Config <sub>SCell</sub> 3		-90
$\hat{E}_s/I_{ot}$		dB	[17]
$\hat{E}_s/N_{oc}$		dB	[17]
I <sub>o</sub> <sup>Note 3</sup>	Config <sub>SCell</sub> 1,2	dBm/ 9.36MHz	-59
	Config <sub>SCell</sub> 3	dBm/ 38.16MHz	-61.9
Propagation Condition			AWGN
<p>Note 1: OCNG shall be used such that both cells are fully allocated and a constant total transmitted power spectral density is achieved for all OFDM symbols.</p> <p>Note 2: Interference from other cells and noise sources not specified in the test is assumed to be constant over subcarriers and time and shall be modelled as AWGN of appropriate power for N<sub>oc</sub> to be fulfilled.</p> <p>Note 3: SS-RSRP and I<sub>o</sub> levels have been derived from other parameters for information purposes. They are not settable parameters themselves.</p> <p>Note 4: For unpaired spectrum, a DL BWP is linked with an UL BWP. DLBWP.0.2 is linked with ULBWP.0.2; DLBWP.1.1 is linked with ULBWP.1.1; DLBWP.1.3 is linked with ULBWP.1.3 defined in clause 12 of TS 38.213 [3].</p>			

#### A.4.5.6.3.1.2 Test Requirements

During T1, the UE shall start to send the ACK for PSCell and SCell from the first UL slot that occurs after the beginning of DL slot ( $i + T_{MultipleBWPswitchDelay} + kI$ ).

During T3, the UE shall start to send the ACK for PSCell and SCell from the first UL slot that occurs after the beginning of DL slot ( $j + T_{MultipleBWPswitchDelay} + kI$ ).

Where,  $kI$  is the timing between DL data receiving and acknowledgement as specified in [7].

Depending on UE capability, UE shall finish BWP switch within the time duration  $T_{MultipleBWPswitchDelay}$  defined in 8.6.2A.1.

All of the above test requirements shall be fulfilled in order for the observed PSCell and SCell active BWP switch delay to be counted as correct.

The rate of correct events observed during repeated tests shall be at least 90%.

During T1, the start time of PCell interruption during PSCell and SCell active BWP switch shall not happen outside the BWP switch delay.

During T3, the start time of PCell interruption of during PSCell and SCell active BWP switch shall not happen outside the BWP switch delay.

The interruption of PCell shall not be longer than the interruption duration specified for active BWP switch in TS 36.133 Clause 7.32.2.7.

All of the above test requirements shall be fulfilled in order for the observed PCell active BWP switch interruption to be counted as correct.

The rate of correct events observed during repeated tests shall be at least 90%.

NOTE: During T1, T3 if there are no uplink resources for reporting the ACK in the DL slot right after DL slot ( $i + T_{MultipleBWPswitchDelay} + kI$ ), ( $j + T_{MultipleBWPswitchDelay} + kI$ ), then the UE shall use the next available uplink resource for reporting the corresponding ACK.

#### A.4.5.6.4 SCell dormancy switch

##### A.4.5.6.4.1 E-UTRAN – NR FR1 PSCell SCell dormancy switch of single FR1 SCell outside active time

###### A.4.5.6.4.1.1 Test Purpose and Environment

The purpose of this test is to verify the DL dormant BWP switch delay requirement defined in clause 8.6, and interruption requirements for NR victim cell defined in clause 8.2.1.2.15 and interruption requirement for E-UTRA victim cell defined in clause 7.32 of TS 36.133 [15]. Supported test configurations for LTE PCell and NR PSCell are shown in Table A.4.5.6.4.1.1-1. Supported test configurations for NR SCell are shown in Table A.4.5.6.4.1.1-1A. Test configuration for LTE PCell and NR PSCell and test configuration for NR SCell are chosen independently.

The test scenario comprises of one E-UTRA PCell (Cell 1), one NR PSCell (Cell 2) and one NR SCell (Cell 3) as given in Table A.4.5.6.4.1.1-2. Cell-specific parameters of E-UTRA PCell are specified in Table A.3.7.2.1-1 and Cell-specific parameters of NR PSCell and SCell are specified in Table A.4.5.6.4.1.1-3 and Table A.4.5.6.4.1.1-4 below.

PDCCHs indicating new transmissions shall be sent continuously on PCell (Cell 1) and PSCell (Cell 2) to ensure that the UE will have ACK/NACK sending.

PDCCHs indicating new transmissions shall be sent continuously on SCell (Cell 3) to ensure that the UE would have ACK/NACK sending except for the time duration when the SCell is in dormancy during T2.

The UE is configured to monitor PDCCH for DCI format 2\_6 at *ps-Offset* before the start of *onDuration*. Two tests are specified, where a UE that only supports triggering within the first three OFDM symbols of a slot shall undergo Test1 only, and a UE that supports triggering also in remaining OFDM symbols of a slot shall undergo both Test1 and Test2. In the tested scenario, *ps-Offset* is selected to correspond to the dormancy switching time specified in clause 8.6.2A.

Before the test starts,

- UE is connected to Cell 1 (PCell) on radio channel 1 (PCC), Cell 2 (PSCell) on radio channel 2 (PSCC) and Cell 3 (SCell) on radio channel 3 (SCC).
- UE is configured with 1 UE-specific downlink bandwidth parts the same as initial BWP for PSCell, BWP-1 in Cell 3 before starting the test.
- UE is configured with 2 different UE-specific downlink bandwidth parts for SCell, BWP-1 and BWP-2, in Cell 3 before starting the test. BWP-1 and BWP-2 always include bandwidth of the initial DL BWP and SSB. BWP-1 is configured in *OutsideActiveTimeConfig* as *firstOutsideActiveTimeBWP*. BWP-2 is configured as *dormantBWP*.
- UE is configured with RRM measurement on SCC.
- UE is indicated in *firstActiveDownlinkBWP-Id* that the active DL BWP is BWP-1 in PSCell.
- UE is indicated in *firstActiveDownlinkBWP-Id* that the active DL BWP is BWP-1 in SCell.
- UE is configured to monitor DCI format 2\_6, and to be active during *onDuration* even when no DCI format 2\_6 is detected (*ps-WakeUp*).

All cells have constant signal levels throughout the test.

The test consists of 3 successive time periods, with durations of T1, T2, and T3, respectively.

Time period T1 starts when a DCI format 2\_6 command for SCell switch from non-dormancy to dormancy, sent from the test equipment to the UE, is received at the UE side at *ps-Offset* before *onDuration*. The UE shall switch its SCell bandwidth part from BWP-1 to BWP-2 into dormancy. During T1, test equipment verifies that:

The UE shall be able to receive CSI-RS on SCell BWP-2 at the beginning of the DL slot right after SCell's DL slot ( $i+T_{dormantBWPswitchDelay}$ ) as defined in clause 8.6. TE shall observe the periodic reporting of CQI for SCell starting from slot ( $i+T_{dormantBWPswitchDelay}$ ).

PCell (Cell 1) interruption due to dormancy switch on SCell shall occur within the dormancy switch delay.

PSCell (Cell 2) interruption due to dormancy switch on SCell shall occur within the dormancy switch delay.

Time period T2 starts when T1 is completed. During T2, the test equipment continues to schedule the UE continuously in PCell and PSCell. The UE shall carry out CSI and RRM measurements on the dormant SCells. The UE shall report ACK/NACK in PCell and PSCell in response to scheduled PDSCH, with the maximum loss of transmitted ACK/NACKs fulfilling the requirement in clause 8.2.1.2.15. The test equipment verifies that the loss of ACK/NACKs is no larger than 1.5%.

Time period T3 starts when T2 is completed. During T3, the test equipment does not schedule the UE, by which the inactivity timer expires and the UE stops monitoring PDCCH except for signalling using DCI format 2\_6 at wake-up signalling occasions.

Time period T4 starts when the UE at *ps-Offset* before *onDuration* detects a DCI format 2\_6 carrying dormancy indication that indicates that SCell1 and SCell2 are to be switched from dormancy to non-dormancy. During T4, the test equipment schedules the UE with new data indication in PCell, PSCell and SCell during *onDuration*. The test equipment verifies that:

The UE shall be able to receive PDSCH at the beginning of the DL slot right after PSCell's DL slot ( $j+T_{dormantBWPswitchDelay}$ ) as defined in clause 8.6 and starts to report valid ACK/NACK for the SCell at latest at the beginning of the DL slot right after slot ( $j+T_{dormantBWPswitchDelay}+kI$ ). The UE shall be continuously scheduled on SCell's BWP-1 starting from the beginning of the DL slot right after slot ( $j+T_{dormantBWPswitchDelay}$ ).

PCell (Cell 1) interruption due to dormancy switch on SCell shall occur within the dormancy switch delay.

PSCell (Cell 2) interruption due to dormancy switch on SCell shall occur within the dormancy switch delay.

**Table A.4.5.6.4.1-1: DL BWP switch supported test configurations for LTE PCell and NR PSCell**

Config	Description
1	LTE FDD, NR 15 kHz SSB SCS, $\geq 10$ MHz bandwidth, FDD duplex mode
2	LTE FDD, NR 15 kHz SSB SCS, $\geq 10$ MHz bandwidth, TDD duplex mode
3	LTE FDD, NR 30 kHz SSB SCS, $\geq 40$ MHz bandwidth, TDD duplex mode
4	LTE TDD, NR 15 kHz SSB SCS, $\geq 10$ MHz bandwidth, FDD duplex mode
5	LTE TDD, NR 15 kHz SSB SCS, $\geq 10$ MHz bandwidth, TDD duplex mode
6	LTE TDD, NR 30 kHz SSB SCS, $\geq 40$ MHz bandwidth, TDD duplex mode
Note 1:	The UE is only required to be tested in one of the supported test configurations
Note 2:	A UE which fulfils the requirements in the test case in clause A.4.5.6.4.2 can skip the test cases in current clause A.4.5.6.4.1.
Note 3:	Void
Note 4:	The UE is only required to be tested in one with smallest aggregated channel bandwidth from supported band combinations which is composed of CCs $\geq$ the bandwidth ( $BW_{channel}$ ) defined in each test configuration

**Table A.4.5.6.4.1.1-1A: DL BWP switch supported test configurations for NR SCell**

Config <sub>SCell</sub>	Description
1	NR 15 kHz SSB SCS, $\geq 10$ MHz bandwidth, FDD duplex mode
2	NR 15 kHz SSB SCS, $\geq 10$ MHz bandwidth, TDD duplex mode
3	NR 30 kHz SSB SCS, $\geq 40$ MHz bandwidth, TDD duplex mode
Note 1:	The UE is only required to be tested in one of the supported test configurations
Note 2:	A UE which fulfils the requirements in the test case in clause A.4.5.6.4.2 can skip the test cases in current clause A.4.5.6.4.1.
Note 3:	The UE is only required to be tested in one with smallest aggregated channel bandwidth from supported band combinations which is composed of CCs $\geq$ the bandwidth ( $BW_{channel}$ ) defined in each test configuration

Table A.4.5.6.4.1.1-2: General test parameters for DL BWP switch in synchronous EN-DC

Parameter	Unit	Value		Comment
		Test1	Test2	
E-UTRA RF Channel Number		1		One E-UTRA radio channel is used for this test
NR RF Channel Number		2, 3		Two NR radio channel is used for this test
Active PCell		Cell 1		PCell on RF channel number 1.
Active PSCell		Cell 2		PSCell on RF channel number 2.
Active SCell		Cell 3		SCell on RF channel number 3.
CP length		Normal		
CSI reporting periodicity, Non-dormant BWP	ms	2		CSI reporting periodicity for periodic reporting of CQI for PCell and non-dormant SCCells
CSI reporting periodicity, Dormant BWP	ms	40		CSI reporting periodicity for periodic reporting of CQI for dormant SCCells
ps-Offset		Depending on UE capability		Monitoring of DCI 2_6 ahead of start of drx-onDurationTimer. Value of ps-Offset shall correspond to SCell dormancy switching time for switching of two SCCells, as specified in clause 8.6.2A. Actual value depends on reported UE capabilities.
ps-WakeUp		true		Wake up for onDuration in case DCI format 2_6 is not detected.
DRX		DRX.1		
<i>'bwp-InactivityTimer</i>	ms	200		
Cell-individual offset for cells on RF channel number 1	dB	0		Individual offset for cells on PCC.
Cell-individual offset for cells on RF channel number 2	dB	0		Individual offset for cells on PSCC.
Cell-individual offset for cells on RF channel number 3	dB	0		Individual offset for cells on SCC.
Cell2 timing offset to cell1	μs	3		Synchronous EN-DC
Cell3 timing offset to cell2	μs	3		Synchronous cells
Number of CSI-RS ports		4		The number of CSI-RS ports in a single resource without CRI report
OFDM symbol range in slot for transmission of DCI with dormancy indication		0 – 2	3 – 11	Test1 is based on that triggering DCI is received within the first three OFDM symbols of a slot. Test2 is based on that the triggering DCI is received later than within the first three OFDM symbols of a slot.
T1	s	0.2		
T2	s	10		
T3	s	0.2		
T4	s	0.2		

Table A.4.5.6.4.1.1-3: NR Cell specific test parameters for NR PSCell for DL BWP switch in synchronous EN-DC

Parameter		Unit	Cell 2
Frequency Range			FR1
Duplex mode	Config 1,4		FDD
	Config 2,3,5,6		TDD
TDD configuration	Config 1,4		Not Applicable
	Config 2,5		TDDConf.1.1
	Config 3,6		TDDConf.1.2
BW <sub>channel</sub>	Config 1,4		10 MHz: N <sub>RB,c</sub> = 52
	Config 2,5		10 MHz: N <sub>RB,c</sub> = 52



	Config 3,6		40 MHz: $N_{RB,c} = 106$
Active BWP ID			1,2
Initial BWP Configuration	Config 1,4		DLBWP.0.2
	Config 2,5		
	Config 3,6		
Active BWP-0 Configuration	Config 1,4		N/A
	Config 2,5		
	Config 3,6		
Active BWP-1 Configuration	Config 1,4		DLBWP.1.3
	Config 2,5		
	Config 3,6		
Active BWP-2 Configuration	Config 1,4		DLBWP.1.1
	Config 2,5		
	Config 3,6		
PDSCH Reference measurement channel	Config 1,4		SR.1.1 FDD
	Config 2,5		SR.1.1 TDD
	Config 3,6		SR.2.1 TDD
RMSI CORESET parameters	Config 1,4		CR.1.1 FDD
	Config 2,5		CR.1.1 TDD
	Config 3,6		CR.2.1 TDD
Dedicated CORESET parameters, Test 1	Config 1,4		CCR.1.1 FDD
	Config 2,5		CCR.1.1 TDD
	Config 3,6		CCR.2.1 TDD
Dedicated CORESET parameters, Test 2	Config 1,4		CCR.1.5 FDD
	Config 2,5		CCR.1.5 TDD
	Config 3,6		CCR.2.3 TDD
OCNG Patterns			OP.1
SSB Configuration	Config 1,2,4,5		SSB.1 FR1
	Config 3,6		SSB.2 FR1
SMTC Configuration			SMTC.1
TRS Configuration	Config 1,4		TRS.1.1 FDD
	Config 2,5		TRS.1.1 TDD
	Config 3,6		TRS.1.2 TDD
Antenna Configuration			1x2
Propagation Condition			AWGN
EPRE ratio of PSS to SSS		dB	0
EPRE ratio of PBCH DMRS to SSS			
EPRE ratio of PBCH to PBCH DMRS			
EPRE ratio of PDCCH DMRS to SSS			
EPRE ratio of PDCCH to PDCCH DMRS			
EPRE ratio of PDSCH DMRS to SSS			
EPRE ratio of PDSCH to PDSCH			
EPRE ratio of OCNG DMRS to SSS <sup>Note 1</sup>			
EPRE ratio of OCNG to OCNG DMRS <sup>Note 1</sup>			

$N_{oc}$ <sup>Note 2</sup>		dBm/15 kHz	-104
SS-RSRP <sup>Note 3</sup>		dBm/15 kHz	-87
$\bar{E}_s/I_{ot}$		dB	17
$\bar{E}_s/N_{oc}$		dB	17
$I_o$ <sup>Note3</sup>	Config 1,2,4,5	dBm/9.36MHz	-59
	Config 3,6	dBm/38.16MHz	-61.9
Note 1:	OCNG shall be used such that both cells are fully allocated and a constant total transmitted power spectral density is achieved for all OFDM symbols.		
Note 2:	Interference from other cells and noise sources not specified in the test is assumed to be constant over subcarriers and time and shall be modelled as AWGN of appropriate power for $N_{oc}$ to be fulfilled.		
Note 3:	SS-RSRP and $I_o$ levels have been derived from other parameters for information purposes. They are not settable parameters themselves.		
Note 4:	For unpaired spectrum, a DL BWP is linked with an UL BWP. DLBWP.0.2 is linked with ULBWP.0.2; DLBWP.1.1 is linked with ULBWP.1.1; DLBWP.1.3 is linked with ULBWP.1.3 defined in clause 12 of TS 38.213 [3].		

**Table A.4.5.6.4.1.1-4: NR Cell specific test parameters for NR SCell for DL BWP switch in synchronous EN-DC**

Parameter		Unit	Cell 3
Frequency Range			FR1
Duplex mode	Config <sub>SCell</sub> 1		FDD
	Config <sub>SCell</sub> 2,3		TDD
TDD configuration	Config <sub>SCell</sub> 1		Not Applicable
	Config <sub>SCell</sub> 2		TDDConf.1.1
	Config <sub>SCell</sub> 3		TDDConf.1.2
BW <sub>channel</sub>	Config <sub>SCell</sub> 1		10 MHz: $N_{RB,c} = 52$
	Config <sub>SCell</sub> 2		10 MHz: $N_{RB,c} = 52$
	Config <sub>SCell</sub> 3		40 MHz: $N_{RB,c} = 106$
Active BWP ID			0
Initial BWP Configuration	Config <sub>SCell</sub> 1		DLBWP.0.2
	Config <sub>SCell</sub> 2		
	Config <sub>SCell</sub> 3		
Active BWP-0 Configuration	Config <sub>SCell</sub> 1		DLBWP.0.2
	Config <sub>SCell</sub> 2		
	Config <sub>SCell</sub> 3		
Active BWP-1 Configuration	Config <sub>SCell</sub> 1		N/A
	Config <sub>SCell</sub> 2		
	Config <sub>SCell</sub> 3		
Active BWP-2 Configuration	Config <sub>SCell</sub> 1		N/A
	Config <sub>SCell</sub> 2		
	Config <sub>SCell</sub> 3		
PDSCH Reference measurement channel	Config <sub>SCell</sub> 1		SR.1.1 FDD
	Config <sub>SCell</sub> 2		SR.1.1 TDD
	Config <sub>SCell</sub> 3		SR.2.1 TDD
RMSI CORESET parameters	Config <sub>SCell</sub> 1		CR.1.1 FDD
	Config <sub>SCell</sub> 2		CR.1.1 TDD
	Config <sub>SCell</sub> 3		CR.2.1 TDD
Dedicated CORESET parameters, Test 1	Config <sub>SCell</sub> 1		CCR.1.1 FDD
	Config <sub>SCell</sub> 2		CCR.1.1 TDD
	Config <sub>SCell</sub> 3		CCR.2.1 TDD
Dedicated CORESET parameters, Test 2	Config <sub>SCell</sub> 1		CCR.1.5 FDD
	Config <sub>SCell</sub> 2		CCR.1.5 TDD
	Config <sub>SCell</sub> 3		CCR.2.3 TDD
OCNG Patterns			OP.1
SSB Configuration	Config <sub>SCell</sub> 1,2		SSB.1 FR1
	Config <sub>SCell</sub> 3		SSB.2 FR1
SMTC Configuration			SMTC.1
TRS Configuration	Config <sub>SCell</sub> 1		TRS.1.1 FDD
	Config <sub>SCell</sub> 2		TRS.1.1 TDD
	Config <sub>SCell</sub> 3		TRS.1.2 TDD
Antenna Configuration			1x2
Propagation Condition			AWGN

EPRE ratio of PSS to SSS		dB	0
EPRE ratio of PBCH DMRS to SSS			
EPRE ratio of PBCH to PBCH DMRS			
EPRE ratio of PDCCH DMRS to SSS			
EPRE ratio of PDCCH to PDCCH DMRS			
EPRE ratio of PDSCH DMRS to SSS			
EPRE ratio of PDSCH to PDSCH			
EPRE ratio of OCNG DMRS to SSS <sup>Note 1</sup>			
EPRE ratio of OCNG to OCNG DMRS <sup>Note 1</sup>			
$N_{oc}$ <sup>Note 2</sup>		dBm/15 kHz	-104
SS-RSRP <sup>Note 3</sup>		dBm/15 kHz	-87
$\bar{E}_s/I_{ot}$		dB	17
$\bar{E}_s/N_{oc}$		dB	17
$I_o$ <sup>Note 3</sup>	Config <sub>SCell 1,2</sub>	dBm/9.36MHz	[-59]
	Config <sub>SCell 3</sub>	dBm/38.16MHz	[-61.9]

#### A.4.5.6.4.1.2 Test Requirements

During T1, any interruption on PCell and PSCell due to dormancy switching of SCell shall be within the requirement specified in in clause 8.2.1.2.15.1 for NR victim cell, and clause 7.32.2.14.1 of 36.133 [15] for E-UTRA victim cell. Starting from *onDuration* in time period T1, the UE shall transmit ACK/NACK in response to scheduling in PCell and PSCell. There shall be no loss of ACK/NACK.

During time period T2, the UE shall transmit ACK/NACKs in response to scheduling in PCell and the rate of missed ACK/NACKs shall be no more than 1.5%.

During T1, any interruption on PCell and PSCell due to dormancy switching of SCell shall be within the requirement specified in in clause 8.2.1.2.15.1 for NR victim cell, and clause 7.32.2.14.1 of 36.133 [15] for E-UTRA victim cell. Starting from *onDuration* in time period T4, the UE shall transmit ACK/NACK in response to scheduling in PCell, SCell1 and SCell2. There shall be no loss of ACK/NACK.

The rate of correct events observed during repeated tests shall be at least 90%.

#### A.4.5.6.4.2 E-UTRAN – NR FR1 PSCell SCell dormancy switch of two FR1 SCells inside active time

##### A.4.5.6.4.2.1 Test Purpose and Environment

The purpose of this test is to verify the delay requirement of BWP switching from dormancy to non-dormancy and from non-dormancy to dormancy on SCell defined in clause 8.6.2, and interruption requirements for NR victim cell defined in clause 8.2.1.2.15 and interruption requirement for E-UTRA victim cell defined in clause 7.32.2.7 of TS 36.133 [15]. Supported test configurations for LTE PCell and NR PSCell are shown in Table A.4.5.6.4.2.1-1. Supported test configurations for NR SCells are shown in Table A.4.5.6.4.2.1-1A. Test configuration for LTE PCell and NR PSCell and test configuration for NR SCells are chosen independently. Test configurations for two NR SCells are chosen independently.

The test scenario comprises of one E-UTRA PCell (Cell 1), one NR PSCell (Cell 2) and two NR SCells (Cell 3, and Cell 4) as given in Table A.4.5.6.4.2.1-2. Cell-specific parameters of E-UTRA PCell are specified in Table A.3.7.2.1-1 and Cell-specific parameters of NR PSCell and SCells are specified in Table A.4.5.6.4.2.1-3, Table A.4.5.6.4.2.1-4 and Table A.4.5.6.4.2.1-5 below.

PDCCHs indicating new transmissions shall be sent continuously on PCell (Cell 1) and PSCell (Cell 2) to ensure that the UE will have ACK/NACK sending.

PDCCHs indicating new transmissions shall be sent continuously on SCell (Cell 3, and Cell 4) to ensure that the UE would have ACK/NACK sending except for the time duration when SCell (Cell2) performs the dormancy switching and stays in the dormant BWP.

Before the test starts,

- UE is connected to Cell 1 (PCell) on radio channel 1 (PCC), Cell 2 (PSCell) on radio channel 2 (PSCC), Cell 3 (SCell) on radio channel 3 (SCC) and Cell 4 (SCell) on radio channel 4 (SCC).

- UE is configured with 1 UE-specific downlink bandwidth parts the same as initial BWP for PSCell, BWP-0, in Cell 2 before starting the test. BWP-0 always include bandwidth of the initial DL BWP and SSB.
- UE is configured with 2 UE-specific downlink bandwidth parts for SCell, BWP-1 and BWP-2 in Cell 3 and Cell 4 before starting the test.
- UE is indicated in *firstActiveDownlinkBWP-Id* that the active DL BWP is BWP-0 in PSCell.
- UE is indicated in *firstActiveDownlinkBWP-Id* that the active DL BWP is BWP-1 in all SCells.
- UE is indicated in *dormantBWP -Id* that the dormant BWP is BWP-2 in all SCells.

All cells have constant signal levels throughout the test.

The test consists of 3 successive time periods, with durations of T1, T2, and T3, respectively.

During T1,

Time period T1 starts when a DCI format 1\_1 command for entering dormant BWP in SCell, sent from the test equipment to the UE, is received at the UE side in PCell's slot # denoted *i*. Upon reception of the PDCCH indicating entering dormant BWP in PCell, UE shall switch the DL BWP-1 to DL BWP-2 in all SCells, i.e., switching from non-dormant BWP to dormant BWP.

The UE shall be able to receive PDSCH and report valid ACK/NACK on the PCell and PSCell all the time except interruption.

The starting time of PCell (Cell 1) interruption due to dormancy switching on SCells shall occur within the dormant BWP switch delay.

The starting time of PSCell (Cell 2) interruption due to dormancy switching on SCells shall occur within the dormant BWP switch delay.

During T2, the test equipment won't transmit DCI format for PDSCH reception on all SCells.

The UE shall be able to receive PDSCH and report valid ACK/NACK on the PCell and PSCell all the time except interruption.

During T3,

Time period T3 starts when a DCI format 1\_1 command for leaving dormant BWP in SCells, sent from the test equipment to the UE, is received at the UE side in PSCell's slot # denoted *j*. Upon reception of the PDCCH indicating leaving dormant BWP in PSCell, UE shall switch the DL BWP-2 to DL BWP-1 in SCells, i.e., switching from dormant BWP to non-dormant BWP.

The UE shall be able to receive PDSCH on all SCells no later than the first DL slot that occurs after the beginning of PSCell's DL slot ( $j + T_{\text{multipleDormantBWPSwitchDelay}}$ ) as defined in clause 8.6 and starts to report valid ACK/NACK on all SCells no later than the first UL slot that occurs after the beginning of slot ( $j+N$ ) as defined in clause 10.3 in TS38.213.

The UE shall be able to receive PDSCH and report valid ACK/NACK on the PCell and PSCell all the time except interruption.

The starting time of PCell (Cell 1) interruption due to dormancy switching on SCells shall occur within the dormant BWP switch delay.

The starting time of PSCell (Cell 2) interruption due to dormancy switching on SCells shall occur within the dormant BWP switch delay.

The test equipment verifies that potential interruption to E-UTRA PCell and NR PSCell is carried out in the correct time span by monitoring ACK/NACK sent in PCell and PSCell during dormant BWP switch of SCells, respectively.

**Table A.4.5.6.4.2.1-1: Dormant BWP switch supported test configurations for LTE PCell and NR PSCell**

Config	Description
--------	-------------

1	LTE FDD, NR 15 kHz SSB SCS, $\geq 10$ MHz bandwidth, FDD duplex mode
2	LTE FDD, NR 15 kHz SSB SCS, $\geq 10$ MHz bandwidth, TDD duplex mode
3	LTE FDD, NR 30 kHz SSB SCS, $\geq 40$ MHz bandwidth, TDD duplex mode
4	LTE TDD, NR 15 kHz SSB SCS, $\geq 10$ MHz bandwidth, FDD duplex mode
5	LTE TDD, NR 15 kHz SSB SCS, $\geq 10$ MHz bandwidth, TDD duplex mode
6	LTE TDD, NR 30 kHz SSB SCS, $\geq 40$ MHz bandwidth, TDD duplex mode
Note 1:	The UE is only required to be tested in one of the supported test configurations
Note 2:	A UE which fulfils the requirements in the test case in current clause A.4.5.6.4.2 can skip the test cases in clause A.4.5.6.4.1
Note 3:	Void.
Note 4:	The UE is only required to be tested in one with smallest aggregated channel bandwidth from supported band combinations which is composed of CCs $\geq$ the bandwidth ( $BW_{\text{channel}}$ ) defined in each test configuration

**Table A.4.5.6.4.2.1-1A: Dormant BWP switch supported test configurations for NR SCells**

Config <sub>SCell</sub>	Description
1	NR 15 kHz SSB SCS, $\geq 10$ MHz bandwidth, FDD duplex mode
2	NR 15 kHz SSB SCS, $\geq 10$ MHz bandwidth, TDD duplex mode
3	NR 30 kHz SSB SCS, $\geq 40$ MHz bandwidth, TDD duplex mode
Note 1:	The UE is only required to be tested in one of the supported test configurations
Note 2:	A UE which fulfils the requirements in the test case in current clause A.4.5.6.4.2 can skip the test cases in clause A.4.5.6.4.1
Note 3:	The UE is only required to be tested in one with smallest aggregated channel bandwidth from supported band combinations which is composed of CCs $\geq$ the bandwidth ( $BW_{\text{channel}}$ ) defined in each test configuration
Note 4:	Test configurations for two NR SCells are chosen independently.

**Table A.4.5.6.4.2.1-2: General test parameters for Dormant BWP switch in synchronous EN-DC**

Parameter	Unit	Value		Comment
		Test 1	Test 2	
E-UTRA RF Channel Number		1		One E-UTRA radio channel is used for this test
NR RF Channel Number		2, 3, 4		Three NR radio channels are used for this test
Active PCell		Cell 1		PCell on RF channel number 1.
Active PSCell		Cell 2		PSCell on RF channel number 2.
Active SCell		Cell 3		SCell on RF channel number 3.
Active SCell		Cell 4		SCell on RF channel number 4.
CP length		Normal		
DRX		OFF		
<i>bwp-InactivityTimer</i>	ms	200		
Cell-individual offset for cells on RF channel number 1	dB	0		Individual offset for cells on PCC.
Cell-individual offset for cells on RF channel number 2	dB	0		Individual offset for cells on PSCC.
Cell-individual offset for cells on RF channel number 3	dB	0		Individual offset for cells on SCC.
Cell2 timing offset to cell1	$\mu\text{s}$	3		Synchronous EN-DC
Cell3 timing offset to cell2	$\mu\text{s}$	3		Synchronous cells
Cell4 timing offset to cell2	$\mu\text{s}$	3		Synchronous cells
OFDM symbol range in slot for transmission of DCI with dormancy indication		0 – 2	3 – 11	
T1	s	0.2		
T2	s	0.2		
T3	s	0.2		

**Table A.4.5.6.4.2.1-3: NR Cell specific test parameters for NR PSCell for Dormant BWP switch in synchronous EN-DC**

Parameter	Unit	Cell 2
-----------	------	--------

Frequency Range			FR1
Duplex mode	Config 1,4		FDD
	Config 2,3,5,6		TDD
TDD configuration	Config 1,4		Not Applicable
	Config 2,5		TDDConf.1.1
	Config 3,6		TDDConf.1.2
BW <sub>channel</sub>	Config 1,4		10 MHz: N <sub>RB,c</sub> = 52
	Config 2,5		10 MHz: N <sub>RB,c</sub> = 52
	Config 3,6		40 MHz: N <sub>RB,c</sub> = 106
Active BWP ID			0
Initial BWP Configuration	Config 1,4		DLBWP.0.2
	Config 2,5		
	Config 3,6		
Active BWP-0 Configuration	Config 1,4		DLBWP.0.2
	Config 2,5		
	Config 3,6		
Active BWP-1 Configuration	Config 1,4		N/A
	Config 2,5		
	Config 3,6		
Active BWP-2 Configuration	Config 1,4		N/A
	Config 2,5		
	Config 3,6		
PDSCH Reference measurement channel	Config 1,4		SR.1.1 FDD
	Config 2,5		SR.1.1 TDD
	Config 3,6		SR.2.1 TDD
RMSI CORESET parameters	Config 1,4		CR.1.1 FDD
	Config 2,5		CR.1.1 TDD
	Config 3,6		CR.2.1 TDD
Dedicated CORESET parameters, Test 1	Config 1,4		CCR.1.1 FDD
	Config 2,5		CCR.1.1 TDD
	Config 3,6		CCR.2.1 TDD
Dedicated CORESET parameters, Test 2	Config 1,4		CCR.1.5 FDD
	Config 2,5		CCR.1.5 TDD
	Config 3,6		CCR.2.3 TDD
OCNG Patterns			OP.1
SSB Configuration	Config 1,2,4,5		SSB.1 FR1
	Config 3,6		SSB.2 FR1
SMTC Configuration			SMTC.1
TRS Configuration	Config 1,4		TRS.1.1 FDD
	Config 2,5		TRS.1.1 TDD
	Config 3,6		TRS.1.2 TDD
Antenna Configuration			1x2
Propagation Condition			AWGN
EPRE ratio of PSS to SSS		dB	0
EPRE ratio of PBCH DMRS to SSS			
EPRE ratio of PBCH to PBCH DMRS			
EPRE ratio of PDCCH DMRS to SSS			
EPRE ratio of PDCCH to PDCCH DMRS			
EPRE ratio of PDSCH DMRS to SSS			
EPRE ratio of PDSCH to PDSCH			
EPRE ratio of OCNG DMRS to SSS <sup>Note 1</sup>			
EPRE ratio of OCNG to OCNG DMRS <sup>Note 1</sup>			
N <sub>oc</sub> <sup>Note 2</sup>			
SS-RSRP <sup>Note 3</sup>		dBm/15 kHz	-87
Ē <sub>s</sub> /I <sub>ot</sub>		dB	17
Ē <sub>s</sub> /N <sub>oc</sub>		dB	17
I <sub>o</sub> <sup>Note 3</sup>	Config 1,2,4,5	dBm/9.36MHz	-59
	Config 3,6	dBm/38.16MHz	-61.9

Note 1:	OCNG shall be used such that both cells are fully allocated and a constant total transmitted power spectral density is achieved for all OFDM symbols.
Note 2:	Interference from other cells and noise sources not specified in the test is assumed to be constant over subcarriers and time and shall be modelled as AWGN of appropriate power for $N_{oc}$ to be fulfilled.
Note 3:	SS-RSRP and $I_o$ levels have been derived from other parameters for information purposes. They are not settable parameters themselves.
Note 4:	For unpaired spectrum, a DL BWP is linked with an UL BWP. DLBWP.0.2 is linked with ULBWP.0.2; DLBWP.1.1 is linked with ULBWP.1.1; DLBWP.1.3 is linked with ULBWP.1.3 defined in clause 12 of TS 38.213 [3].

**Table A.4.5.6.4.2.1-4: NR Cell specific test parameters for NR SCells (Cell 3) for Dormant BWP switch in synchronous EN-DC**

Parameter		Unit	Cell 3
Frequency Range			FR1
Duplex mode	Config <sub>SCell3</sub> 1		FDD
	Config <sub>SCell3</sub> 2,3		TDD
TDD configuration	Config <sub>SCell3</sub> 1		Not Applicable
	Config <sub>SCell3</sub> 2		TDDConf.1.1
	Config <sub>SCell3</sub> 3		TDDConf.1.2
BW <sub>channel</sub>	Config <sub>SCell3</sub> 1		10 MHz: $N_{RB,c} = 52$
	Config <sub>SCell3</sub> 2		10 MHz: $N_{RB,c} = 52$
	Config <sub>SCell3</sub> 3		40 MHz: $N_{RB,c} = 106$
Active BWP ID			1,2
Initial BWP Configuration	Config <sub>SCell3</sub> 1		N/A
	Config <sub>SCell3</sub> 2		
	Config <sub>SCell3</sub> 3		
Active BWP-0 Configuration	Config <sub>SCell3</sub> 1		N/A
	Config <sub>SCell3</sub> 2		
	Config <sub>SCell3</sub> 3		
Active BWP-1 Configuration	Config <sub>SCell3</sub> 1		DLBWP.1.1
	Config <sub>SCell3</sub> 2		
	Config <sub>SCell3</sub> 3		
Active BWP-2 Configuration	Config <sub>SCell3</sub> 1		DLBWP.1.3
	Config <sub>SCell3</sub> 2		
	Config <sub>SCell3</sub> 3		
PDSCH Reference measurement channel	Config <sub>SCell3</sub> 1		SR.1.1 FDD
	Config <sub>SCell3</sub> 2		SR.1.1 TDD
	Config <sub>SCell3</sub> 3		SR.2.1 TDD
RMSI CORESET parameters	Config <sub>SCell3</sub> 1		CR.1.1 FDD
	Config <sub>SCell3</sub> 2		CR.1.1 TDD
	Config <sub>SCell3</sub> 3		CR.2.1 TDD
Dedicated CORESET parameters, Test 1	Config <sub>SCell3</sub> 1		CCR.1.1 FDD
	Config <sub>SCell3</sub> 2		CCR.1.1 TDD
	Config <sub>SCell3</sub> 3		CCR.2.1 TDD
Dedicated CORESET parameters, Test 2	Config <sub>SCell3</sub> 1		CCR.1.5 FDD
	Config <sub>SCell3</sub> 2		CCR.1.5 TDD
	Config <sub>SCell3</sub> 3		CCR.2.3 TDD
OCNG Patterns			OP.1
SSB Configuration	Config <sub>SCell3</sub> 1,2		SSB.1 FR1
	Config <sub>SCell3</sub> 3		SSB.2 FR1
SMTTC Configuration			SMTTC.1
TRS Configuration	Config <sub>SCell3</sub> 1		TRS.1.1 FDD
	Config <sub>SCell3</sub> 2		TRS.1.1 TDD
	Config <sub>SCell3</sub> 3		TRS.1.2 TDD
Antenna Configuration			1x2
Propagation Condition			AWGN
EPRE ratio of PSS to SSS		dB	0
EPRE ratio of PBCH DMRS to SSS			
EPRE ratio of PBCH to PBCH DMRS			
EPRE ratio of PDCCH DMRS to SSS			
EPRE ratio of PDCCH to PDCCH DMRS			
EPRE ratio of PDSCH DMRS to SSS			
EPRE ratio of PDSCH to PDSCH			

EPRE ratio of OCNG DMRS to SSS <sup>Note 1</sup>			
EPRE ratio of OCNG to OCNG DMRS <sup>Note 1</sup>			
$N_{oc}$ <sup>Note 2</sup>		dBm/15 kHz	-104
SS-RSRP <sup>Note 3</sup>		dBm/15 kHz	-87
$\bar{E}_s/I_{ot}$		dB	17
$\bar{E}_s/N_{oc}$		dB	17
$I_o$ <sup>Note3</sup>	Config <sub>SCell3</sub> 1,2	dBm/9.36MHz	-59
	Config <sub>SCell3</sub> 3	dBm/38.16MHz	-61.9
<p>Note 1: OCNG shall be used such that both cells are fully allocated and a constant total transmitted power spectral density is achieved for all OFDM symbols.</p> <p>Note 2: Interference from other cells and noise sources not specified in the test is assumed to be constant over subcarriers and time and shall be modelled as AWGN of appropriate power for <math>N_{oc}</math> to be fulfilled.</p> <p>Note 3: SS-RSRP and <math>I_o</math> levels have been derived from other parameters for information purposes. They are not settable parameters themselves.</p> <p>Note 4: For unpaired spectrum, a DL BWP is linked with an UL BWP. DLBWP.0.2 is linked with ULBWP.0.2; DLBWP.1.1 is linked with ULBWP.1.1; DLBWP.1.3 is linked with ULBWP.1.3 defined in clause 12 of TS 38.213 [3].</p>			

**Table A.4.5.6.4.2.1-5: NR Cell specific test parameters for NR SCells (Cell 4) for Dormant BWP switch in synchronous EN-DC**

Parameter		Unit	Cell 3
Frequency Range			FR1
Duplex mode	Config <sub>SCell4</sub> 1		FDD
	Config <sub>SCell4</sub> 2,3		TDD
TDD configuration	Config <sub>SCell4</sub> 1		Not Applicable
	Config <sub>SCell4</sub> 2		TDDConf.1.1
	Config <sub>SCell4</sub> 3		TDDConf.1.2
BW <sub>channel</sub>	Config <sub>SCell4</sub> 1		10 MHz: $N_{RB,c} = 52$
	Config <sub>SCell4</sub> 2		10 MHz: $N_{RB,c} = 52$
	Config <sub>SCell4</sub> 3		40 MHz: $N_{RB,c} = 106$
Active BWP ID			1,2
Initial BWP Configuration	Config <sub>SCell4</sub> 1		N/A
	Config <sub>SCell4</sub> 2		
	Config <sub>SCell4</sub> 3		
Active BWP-0 Configuration	Config <sub>SCell4</sub> 1		N/A
	Config <sub>SCell4</sub> 2		
	Config <sub>SCell4</sub> 3		
Active BWP-1 Configuration	Config <sub>SCell4</sub> 1		DLBWP.1.1
	Config <sub>SCell4</sub> 2		
	Config <sub>SCell4</sub> 3		
Active BWP-2 Configuration	Config <sub>SCell4</sub> 1		DLBWP.1.3
	Config <sub>SCell4</sub> 2		
	Config <sub>SCell4</sub> 3		
PDSCH Reference measurement channel	Config <sub>SCell4</sub> 1		SR.1.1 FDD
	Config <sub>SCell4</sub> 2		SR.1.1 TDD
	Config <sub>SCell4</sub> 3		SR.2.1 TDD
RMSI CORESET parameters	Config <sub>SCell4</sub> 1		CR.1.1 FDD
	Config <sub>SCell4</sub> 2		CR.1.1 TDD
	Config <sub>SCell4</sub> 3		CR.2.1 TDD
Dedicated CORESET parameters, Test 1	Config <sub>SCell4</sub> 1		CCR.1.1 FDD
	Config <sub>SCell4</sub> 2		CCR.1.1 TDD
	Config <sub>SCell4</sub> 3		CCR.2.1 TDD
Dedicated CORESET parameters, Test 2	Config <sub>SCell4</sub> 1		CCR.1.5 FDD
	Config <sub>SCell4</sub> 2		CCR.1.5 TDD
	Config <sub>SCell4</sub> 3		CCR.2.3 TDD
OCNG Patterns			OP.1
SSB Configuration	Config <sub>SCell4</sub> 1,2		SSB.1 FR1
	Config <sub>SCell4</sub> 3		SSB.2 FR1
SMTC Configuration			SMTC.1
TRS Configuration	Config <sub>SCell4</sub> 1		TRS.1.1 FDD
	Config <sub>SCell4</sub> 2		TRS.1.1 TDD
	Config <sub>SCell4</sub> 3		TRS.1.2 TDD
Antenna Configuration			1x2



Propagation Condition			AWGN
EPRE ratio of PSS to SSS		dB	0
EPRE ratio of PBCH DMRS to SSS			
EPRE ratio of PBCH to PBCH DMRS			
EPRE ratio of PDCCH DMRS to SSS			
EPRE ratio of PDCCH to PDCCH DMRS			
EPRE ratio of PDSCH DMRS to SSS			
EPRE ratio of PDSCH to PDSCH			
EPRE ratio of OCNG DMRS to SSS <sup>Note 1</sup>			
EPRE ratio of OCNG to OCNG DMRS <sup>Note 1</sup>			
$N_{oc}$ <sup>Note 2</sup>			
SS-RSRP <sup>Note 3</sup>		dBm/15 kHz	-87
$\hat{E}_s/I_{ot}$		dB	17
$\hat{E}_s/N_{oc}$		dB	17
$I_o$ <sup>Note 3</sup>	Config <sub>SCell4</sub> 1,2	dBm/9.36MHz	-59
	Config <sub>SCell4</sub> 3	dBm/38.16MHz	-61.9
<p>Note 1: OCNG shall be used such that both cells are fully allocated and a constant total transmitted power spectral density is achieved for all OFDM symbols.</p> <p>Note 2: Interference from other cells and noise sources not specified in the test is assumed to be constant over subcarriers and time and shall be modelled as AWGN of appropriate power for <math>N_{oc}</math> to be fulfilled.</p> <p>Note 3: SS-RSRP and <math>I_o</math> levels have been derived from other parameters for information purposes. They are not settable parameters themselves.</p> <p>Note 4: For unpaired spectrum, a DL BWP is linked with an UL BWP. DLBWP.0.2 is linked with ULBWP.0.2; DLBWP.1.1 is linked with ULBWP.1.1; DLBWP.1.3 is linked with ULBWP.1.3 defined in clause 12 of TS 38.213 [3].</p>			

#### A.4.5.6.4.2.2 Test Requirements

During T1, the UE shall be able to send the ACK/NACK for all SCells before UE PDCCH indicating entering dormant BWP is received in PSCell's slot # denoted.

During T3, the UE shall start to send the ACK/NACK for all SCells from the first UL slot that occurs after the beginning of DL slot ( $j+N$ ).

Where,  $N$  is the timing that UE provide HARQ-ACK information in response to a detection of a DCI format 1\_1 indicating SCell dormancy as specified in [3].

All of the above test requirements shall be fulfilled in order for the observed SCell dormant BWP switch delay to be counted as correct.

The rate of correct events observed during repeated tests shall be at least 90%.

During T1, the start of the interruption of PCell during SCell active BWP switch shall not happen outside the BWP switch delay.

During T3, the start of the interruption of PCell during SCell active BWP switch shall not happen outside the BWP switch delay.

During T1, the start of the interruption of PSCell during SCell active BWP switch shall not happen outside the BWP switch delay.

During T3, the start of the interruption of PSCell during SCell active BWP switch shall not happen outside the BWP switch delay.

The interruption of PCell shall not be longer than the interruption duration specified for active BWP switch in clause 7.32.2.7 of TS 36.133 [15].

The interruption of PSCell shall not be longer than the interruption duration specified for dormant BWP switch in clause 8.6.

**NOTE:** During T1, T3 if there are no uplink resources for reporting the ACK/NACK in the first DL slot that occurs after the beginning of DL slot ( $i+N$ ), ( $j+N$ ), then the UE shall use the next available uplink resource for reporting the corresponding ACK/NACK.

### A.4.5.6.5 Simultaneous RRC-based Active BWP Switch on multiple CCs

#### A.4.5.6.5.1 E-UTRAN – NR PSCell FR1 DL active BWP switch in non-DRX in synchronous EN-DC on multiple CCs

##### A.4.5.6.5.1.1 Test Purpose and Environment

The purpose of this test is to verify the DL BWP switch delay requirement on multiple CCs for RRC-based BWP switch defined in clause 8.6.3A.1. Supported test configurations for LTE PCell and NR PSCell are shown in Table A.4.5.6.5.1.1-1. Supported test configurations for NR SCell are shown in Table A.4.5.6.5.1.1-1A. Test configuration for LTE PCell and NR PSCell and test configuration for NR SCell are chosen independently.

The test scenario comprises of one E-UTRA PCell (Cell 1), one NR PSCell (Cell 2) and one NR SCell (Cell 3) as given in Table A.4.5.6.5.1.1-2. Cell-specific parameters of E-UTRA PCell are specified in Table A.3.7.2.1-1 and Cell-specific parameters of NR PSCell and NR SCell are specified in Table A.4.5.6.5.1.1-3 and Table A.4.5.6.5.1.1-4 below.

PDCCHs indicating new transmissions shall be sent continuously on PCell (Cell 1) to ensure that the UE will have ACK/NACK sending.

Before the test starts,

- UE is connected to Cell 1 (PCell) on radio channel 1 (PCC), PSCell (Cell 2) on radio channel 2 (PSCC) and SCell (Cell 3) on radio channel 3 (SCC).
- UE has bandwidth part BWP-1 in its RRC-configuration for PSCell (Cell 2) and SCell (Cell 3)
- UE is indicated in *firstActiveDownlinkBWP-Id* that the active DL BWP is BWP-1 in PSCell (Cell 2) and SCell (Cell 3).

All cells have constant signal levels throughout the test.

The test consists of 1 time period, with duration of T1.

During T1,

Time period T1 starts when a *RRCReconfiguration* with updated bandwidth part configuration for both PSCell (Cell 2) and SCell (Cell 3), sent from the test equipment to the UE, is completely received at the UE side in PSCell's slot # denoted *i*. The UE shall reconfigure its bandwidth part with the updated bandwidth part configuration on PSCell (Cell 2) and SCell (Cell 3).

The UE shall be able to receive PDSCH at the beginning of the DL slot right after PSCell's DL slot ( $i + \frac{T_{RRCprocessingDelay} + T_{BWPswitchDelayRRC} + D_{RRC}}{NR\ slot\ length}$ ) as defined in clause 8.6.3A.1 and be ready for the reception of uplink grant for the PSCell (Cell 2) and SCell (Cell 3) no later than at the beginning of the DL slot right after slot ( $i + \frac{T_{RRCprocessingDelay} + T_{BWPswitchDelayRRC} + D_{RRC}}{NR\ slot\ length}$ ). The UE shall be continuously scheduled on PSCell's BWP-1 and SCell's BWP-1 starting from the beginning of the DL slot right after slot ( $i + \frac{T_{RRCprocessingDelay} + T_{BWPswitchDelayRRC} + D_{RRC}}{NR\ slot\ length}$ ).

$T_{RRCprocessingDelay}$ ,  $T_{BWPswitchDelayRRC}$ ,  $D_{RRC}$  are defined in clause 8.6.3A.1 .

The test equipment verifies the DL BWP switch time in PSCell (Cell 2) and SCell (Cell 3) by counting the time from the time when the RRC Reconfiguration message including updated BWP configuration sent till the time when RRC Reconfiguration Complete message is received.

**Table A.4.5.6.5.1.1-1: DL BWP switch supported test configurations for LTE PCell and NR PSCell**

Config	Description
1	LTE FDD, NR 15 kHz SSB SCS, ≥10 MHz bandwidth, FDD duplex mode
2	LTE FDD, NR 15 kHz SSB SCS, ≥10 MHz bandwidth, TDD duplex mode
3	LTE FDD, NR 30 kHz SSB SCS, ≥40 MHz bandwidth, TDD duplex mode
4	LTE TDD, NR 15 kHz SSB SCS, ≥10 MHz bandwidth, FDD duplex mode
5	LTE TDD, NR 15 kHz SSB SCS, ≥10 MHz bandwidth, TDD duplex mode
6	LTE TDD, NR 30 kHz SSB SCS, ≥40 MHz bandwidth, TDD duplex mode

Note 1: The UE is only required to be tested in one of the supported test configurations  
 Note 2: The UE is only required to be tested in one with smallest aggregated channel bandwidth from supported band combinations which is composed of CCs  $\geq$  the bandwidth ( $BW_{channel}$ ) defined in each test configuration

**Table A.4.5.6.5.1.1-1A: DL BWP switch supported test configurations for NR SCell**

Config <sub>SCell</sub>	Description
1	NR 15 kHz SSB SCS, $\geq 10$ MHz bandwidth, FDD duplex mode
2	NR 15 kHz SSB SCS, $\geq 10$ MHz bandwidth, TDD duplex mode
3	NR 30 kHz SSB SCS, $\geq 40$ MHz bandwidth, TDD duplex mode
Note 1: The UE is only required to be tested in one of the supported test configurations	
Note 2: The UE is only required to be tested in one with smallest aggregated channel bandwidth from supported band combinations which is composed of CCs $\geq$ the bandwidth ( $BW_{channel}$ ) defined in each test configuration	

**Table A.4.5.6.5.1.1-2: General test parameters for DL BWP switch in synchronous EN-DC**

Parameter	Unit	Value	Comment
E-UTRA RF Channel Number		1	One E-UTRA radio channel is used for this test
NR RF Channel Number		2,3	Two NR radio channel is used for this test
Active PCell		Cell 1	Pcell on RF channel number 1.
Active PSCell		Cell 2	PSCell on RF channel number 2.
Active SCell		Cell 3	SCell on RF channel number 3.
CP length		Normal	
DRX		OFF	
Cell-individual offset for cells on RF channel number 1	dB	0	Individual offset for cells on PCC.
Cell-individual offset for cells on RF channel number 2	dB	0	Individual offset for cells on PSCC.
Cell-individual offset for cells on RF channel number 3	dB	0	Individual offset for cells on SCC.
Cell2 timing offset to cell1	$\mu$ s	3	Synchronous EN-DC
Cell3 timing offset to cell2	$\mu$ s	3	Synchronous cells
T1	s	0.2	

**Table A.4.5.6.5.1.1-3: NR Cell specific test parameters for NR PSCell for DL BWP switch in synchronous EN-DC**

Parameter		Unit	Cell 2
Frequency Range			FR1
Duplex mode	Config 1,4		FDD
	Config 2,3,5,6		TDD
TDD configuration	Config 1,4		Not Applicable
	Config 2,5		TDDConf.1.1
	Config 3,6		TDDConf.1.2
$BW_{channel}$	Config 1,4		10 MHz: $N_{RB,c} = 52$
	Config 2,5		10 MHz: $N_{RB,c} = 52$
	Config 3,6		40 MHz: $N_{RB,c} = 106$
Active DL BWP ID			1
Initial DL BWP Configuration	Config 1,4		DLBWP.0.2
	Config 2,5		
	Config 3,6		
Initial UL BWP Configuration	Config 1,4		ULBWP.0.2
	Config 2,5		
	Config 3,6		
Initial Condition	Active DL BWP-1 Configuration	Config 1,4	DLBWP.1.3
		Config 2,5	
		Config 3,6	
		Config 1,4	ULBWP.1.3

	Active UL BWP-1 Configuration	Config 2,5 Config 3,6		
Final Condition	Active DL BWP-1 Configuration	Config 1,4		DLBWP.1.1
		Config 2,5		
		Config 3,6		
	Active UL BWP-1 Configuration	Config 1,4		ULBWP.1.1
		Config 2,5		
		Config 3,6		
PDSCH Reference measurement channel		Config 1,4		SR.1.1 FDD
		Config 2,5		SR.1.1 TDD
		Config 3,6		SR2.1 TDD
RMSI CORESET parameters		Config 1,4		CR.1.1 FDD
		Config 2,5		CR.1.1 TDD
		Config 3,6		CR2.1 TDD
Dedicated CORESET parameters		Config 1,4		CCR.1.1 FDD
		Config 2,5		CCR.1.1 TDD
		Config 3,6		CCR.2.1 TDD
OCNG Patterns				OP.1
SSB Configuration		Config 1,2,4,5		SSB.1 FR1
		Config 3,6		SSB.2 FR1
SMTTC Configuration				SMTTC.1
TRS Configuration		Config 1,4		TRS.1.1 FDD
		Config 2,5		TRS.1.1 TDD
		Config 3,6		TRS.1.2 TDD
Antenna Configuration				1x2
Propagation Condition				AWGN
EPRE ratio of PSS to SSS			dB	0
EPRE ratio of PBCH DMRS to SSS				
EPRE ratio of PBCH to PBCH DMRS				
EPRE ratio of PDCCH DMRS to SSS				
EPRE ratio of PDCCH to PDCCH DMRS				
EPRE ratio of PDSCH DMRS to SSS				
EPRE ratio of PDSCH to PDSCH				
EPRE ratio of OCNG DMRS to SSS <sup>Note 1</sup>				
EPRE ratio of OCNG to OCNG DMRS <sup>Note 1</sup>				
$N_{oc}$ <sup>Note 2</sup>		dBm/15 kHz		
SS-RSRP <sup>Note 3</sup>		dBm/15 kHz	-87	
$\bar{E}_s/I_{ot}$		dB	17	
$\bar{E}_s/N_{oc}$		dB	17	
$I_o$ <sup>Note 3</sup>		Config 1,2,4,5	dBm/ 9.36MHz	-59
		Config 3,6	dBm/ 38.16MHz	-61.9
<p>Note 1: OCNG shall be used such that both cells are fully allocated and a constant total transmitted power spectral density is achieved for all OFDM symbols.</p> <p>Note 2: Interference from other cells and noise sources not specified in the test is assumed to be constant over subcarriers and time and shall be modelled as AWGN of appropriate power for <math>N_{oc}</math> to be fulfilled.</p> <p>Note 3: SS-RSRP and <math>I_o</math> levels have been derived from other parameters for information purposes. They are not settable parameters themselves.</p> <p>Note 4: For unpaired spectrum, a DL BWP is linked with an UL BWP. DLBWP.0.2 is linked with ULBWP.0.2; DLBWP.1.1 is linked with ULBWP.1.1; DLBWP.1.3 is linked with ULBWP.1.3 defined in clause 12 of TS 38.213 [3].</p>				

**Table A.4.5.6.5.1.1-4: NR Cell specific test parameters for NR SCell for DL BWP switch in synchronous EN-DC**

Parameter	Unit	Cell 3
Frequency Range		FR1
Duplex mode	Config <sub>SCell</sub> 1	FDD
	Config <sub>SCell</sub> 2,3	TDD
TDD configuration	Config <sub>SCell</sub> 1	Not Applicable
	Config <sub>SCell</sub> 2	TDDConf.1.1
	Config <sub>SCell</sub> 3	TDDConf.1.2
$BW_{channel}$	Config <sub>SCell</sub> 1	10 MHz: $N_{RB,c} = 52$

		Config <sub>SCell</sub> 2		10 MHz: N <sub>RB,c</sub> = 52
		Config <sub>SCell</sub> 3		40 MHz: N <sub>RB,c</sub> = 106
Active DL BWP ID				1
Initial DL BWP Configuration		Config <sub>SCell</sub> 1		DLBWP.0.2
		Config <sub>SCell</sub> 2		
		Config <sub>SCell</sub> 3		
Initial UL BWP Configuration		Config <sub>SCell</sub> 1		ULBWP.0.2
		Config <sub>SCell</sub> 2		
		Config <sub>SCell</sub> 3		
Initial Condition	Active DL BWP-1 Configuration	Config <sub>SCell</sub> 1		DLBWP.1.3
		Config <sub>SCell</sub> 2		
		Config <sub>SCell</sub> 3		
	Active UL BWP-1 Configuration	Config <sub>SCell</sub> 1		ULBWP.1.3
		Config <sub>SCell</sub> 2		
		Config <sub>SCell</sub> 3		
Final Condition	Active DL BWP-1 Configuration	Config <sub>SCell</sub> 1		DLBWP.1.1
		Config <sub>SCell</sub> 2		
		Config <sub>SCell</sub> 3		
	Active UL BWP-1 Configuration	Config <sub>SCell</sub> 1		ULBWP.1.1
		Config <sub>SCell</sub> 2		
		Config <sub>SCell</sub> 3		
PDSCH Reference measurement channel		Config <sub>SCell</sub> 1		SR.1.1 FDD
		Config <sub>SCell</sub> 2		SR.1.1 TDD
		Config <sub>SCell</sub> 3		SR2.1 TDD
RMSI CORESET parameters		Config <sub>SCell</sub> 1		CR.1.1 FDD
		Config <sub>SCell</sub> 2		CR.1.1 TDD
		Config <sub>SCell</sub> 3		CR2.1 TDD
Dedicated CORESET parameters		Config <sub>SCell</sub> 1		CCR.1.1 FDD
		Config <sub>SCell</sub> 2		CCR.1.1 TDD
		Config <sub>SCell</sub> 3		CCR.2.1 TDD
OCNG Patterns				OP.1
SSB Configuration		Config <sub>SCell</sub> 1,2		SSB.1 FR1
		Config <sub>SCell</sub> 3		SSB.2 FR1
SMTC Configuration				SMTC.1
TRS Configuration		Config <sub>SCell</sub> 1		TRS.1.1 FDD
		Config <sub>SCell</sub> 2		TRS.1.1 TDD
		Config <sub>SCell</sub> 3		TRS.1.2 TDD
Antenna Configuration				1x2
Propagation Condition				AWGN
EPRE ratio of PSS to SSS		dB		0
EPRE ratio of PBCH DMRS to SSS				
EPRE ratio of PBCH to PBCH DMRS				
EPRE ratio of PDCCH DMRS to SSS				
EPRE ratio of PDCCH to PDCCH DMRS				
EPRE ratio of PDSCH DMRS to SSS				
EPRE ratio of PDSCH to PDSCH				
EPRE ratio of OCNG DMRS to SSS <sup>Note 1</sup>				
EPRE ratio of OCNG to OCNG DMRS <sup>Note 1</sup>				
N <sub>oc</sub> <sup>Note 2</sup>				
SS-RSRP <sup>Note 3</sup>		dBm/15 kHz		-87
E <sub>s</sub> /I <sub>ot</sub>		dB		17
E <sub>s</sub> /N <sub>oc</sub>		dB		17
I <sub>o</sub> <sup>Note 3</sup>		Config <sub>SCell</sub> 1,2	dBm/ 9.36MHz	-59
		Config <sub>SCell</sub> 3	dBm/ 38.16MHz	-61.9
<p>Note 1: OCNG shall be used such that both cells are fully allocated and a constant total transmitted power spectral density is achieved for all OFDM symbols.</p> <p>Note 2: Interference from other cells and noise sources not specified in the test is assumed to be constant over subcarriers and time and shall be modelled as AWGN of appropriate power for N<sub>oc</sub> to be fulfilled.</p> <p>Note 3: SS-RSRP and I<sub>o</sub> levels have been derived from other parameters for information purposes. They are not settable parameters themselves.</p> <p>Note 4: For unpaired spectrum, a DL BWP is linked with an UL BWP. DLBWP.0.2 is linked with ULBWP.0.2; DLBWP.1.1 is linked with ULBWP.1.1; DLBWP.1.3 is linked with ULBWP.1.3 defined in clause 12 of TS 38.213 [3].</p>				

#### A.4.5.6.5.1.2 Test Requirements

During T1, the UE shall be ready for the reception of uplink grant for PSCell and SCell in the beginning of the DL slot right after slot  $(i + \frac{T_{RRC\text{processingDelay}} + T_{BWP\text{switchDelayRRC}} + D_{RRC}}{NR\text{slot length}})$ .

All of the above test requirements shall be fulfilled in order for the observed PSCell and SCell active BWP switch delay to be counted as correct.

The rate of correct events observed during repeated tests shall be at least 90%.

### A.4.5.7 PSCell addition and release delay

#### A.4.5.7.1 Addition and Release Delay of known NR PSCell

##### A.4.5.7.1.1 Test purpose and environment

The purpose of this test is to verify that the NR PSCell addition and release delays under EN-DC are within the requirements stated in clause 7.31.2 [15] for the case when the PSCell is known by the UE at the time of addition.

Supported test configurations are shown in A.4.5.7.1.1-1. The test parameters for the E-UTRA cell are given in Table A.3.7.2.1-1. The E-UTRA cell once set up is not changed across time.

The test parameters for NR cell are given in Tables A.4.5.7.1.1-2 and cell-specific parameters in A.4.5.7.1.1-3 below. The test consists of six successive time periods with duration of T1, T2, T3, T4, T5 and T6 respectively. There are two carriers each with one cell. Before the test starts the UE is connected to Cell 1 (E-UTRA PCell) on radio channel 1 (PCC) but is not aware of Cell 2 (NR PSCell) on radio channel 2. The UE is only monitoring the PCC. During T1 only Cell1 is known to the UE.

Before the start of T2, the UE in the measurement control information that event-triggered reporting with Event B1 is configured for neighbour cell (Cell2). Before the start of T2 the UE is configured with the measurement gaps (gap pattern Id # 0). The Cell2 becomes known to the UE during T2. Therefore, during T2 the UE shall report Event B1. The point in time at which the RRC message to release measurement gap is transmitted from the test system defines the start of period T3. During T3, after measurement gap is released, the test system transmits the RRC message to the UE to add PSCell on radio channel 2.

The RRC message (to add PSCell) also includes a request for the UE to start periodic CSI reporting for the PSCell after the PSCell has been successfully added. The point in time at which the RRC message to add PSCell (Cell2) is received at the UE antenna connector defines the start of period T4.

The test system shall observe the periodic reporting of CSI for PSCell during T5. The point in time at which the UE has sent PRACH to the PSCell (Cell 2) defines the start of period T5.

The test system shall send a RRC message to the UE to release PSCell (Cell 2) on radio channel 2. The RRC message to release PSCell (Cell2) shall be sent to the UE during period T5, after the UE has sent at least one CQI report with non-zero CQI index for PSCell (Cell 2). The point in time at which the RRC message to release PSCell (Cell2) is received at the UE antenna connector defines the start of period T6.

**Table A.4.5.7.1.1-1: Supported test configurations for FR1 PSCell**

Configuration	Description
1	LTE FDD, NR SCS 15 kHz, BW 10 MHz, FDD
2	LTE FDD, NR SCS 15 kHz, BW 10 MHz, TDD
3	LTE FDD, NR SCS 30 kHz, BW 40 MHz, TDD
4	LTE TDD, NR SCS 15 kHz, BW 10 MHz, FDD
5	LTE TDD, NR SCS 15 kHz, BW 10 MHz, TDD
6	LTE TDD, NR SCS 30 kHz, BW 40 MHz, TDD
Note:	The UE is only required to pass in one of the supported test configurations in FR1

**Table A.4.5.7.1.1-2: General Test Parameters for PSCell Addition and Release**

Parameter		Unit	Value	Comment
RF Channel Number			1, 2	Two radio channels are used for this test. One for E-UTRA cell and second for NR Cell
Initial	Active PCell		Cell1	PCell on RF channel number 1.
	Neighbour cell		Cell2	Neighbour cell on RF channel number 2.
Final Condition	Active PCell		Cell1	PCell on RF channel number 1.
	Neighbour Cell		Cell2	PSCell released on RF channel number 2.
B1	Hysteresis	dB	0	Hysteresis for evaluation of event B1.
	Threshold RSRP (Config 1,2,4,5)	dBm	-96	Actual RSRP threshold for event B1. Needs to take absolute accuracy tolerance in clause 9.11.1 of TS 36.133 [15] into account plus margin.
	Threshold RSRP (Config 3,6)	dBm	-93	Actual RSRP threshold for event B1. Needs to take absolute accuracy tolerance in clause 9.11.1 of TS 36.133 [15] into account plus margin.
	Time to Trigger	S	0	
DRX			OFF	Continuous monitoring of primary cell
Measurement gap pattern Id			0	Gaps are configured before T2 and released before T3.
PRACH configuration on cell2			FR1 PRACH configuration 1	Captured in A.3.8.2.1
Cell-individual offset for cells on RF channel number 1		dB	0	Individual offset for cells on primary component carrier.
Cell-individual offset for cells on RF channel number 2		dB	0	Individual offset for cells on carrier frequency of cell2.
T1		s	1	During this time the PCell shall be known and cell2 shall be unknown.
T2		s	1.5	During this time the UE shall identify neighbour cell (cell2) and report event B1.
T3		s	3	During this time the test system transmits the RRC messages to release measurement gap and add PSCell.
T4		s	0.5	During this time the UE adds the PSCell.
T5		s	0.5	During this time the UE sends CSI reports for PSCell.
T6		s	0.5	During this time the UE releases the PSCell.

**Table A.4.5.7.1.1-3: Cell Specific Parameters for PSCell Addition and Release**

Parameter	Unit	Config	Test					
			T1	T2	T3	T4	T5	T6
E-UTRA RF Channel Number		1,2,3,4,5,6	1					
NR RF Channel Number		1,2,3,4,5,6	2					
TDD configuration		1,4	Not Applicable					
		2,5	TDDConf.1.1					
		3,6	TDDConf.2.1					
BW <sub>channel</sub>	MHz	1,4	10: N <sub>RB,c</sub> = 52					
		2,5	10: N <sub>RB,c</sub> = 52					
		3,6	40: N <sub>RB,c</sub> = 106					
Initial BWP Configuration		1,2,3	DLBWP.0.1 ULBWP.0.1					
Dedicated BWP Configuration		1,2,3	DLBWP.1.1 ULBWP.1.1					
PDSCH Reference measurement channel		1,4	SR.1.1 FDD					
		2,5	SR.1.1 TDD					
		3,6	SR.2.1 TDD					
RMSI CORESET Reference Channel		1,4	CR.1.1 FDD					
		2,5	CR.1.1 TDD					
		3,6	CR.2.1 TDD					

Dedicated CORESET Reference Channel		1,4	CCR.1.1 FDD	
		2,5	CCR.1.1 TDD	
		3,6	CCR.2.1 TDD	
OCNG Patterns		1,2,3,4,5,6	OP.1	
SSB configuration		1,2,4,5	SSB.1 FR1	
		3,6	SSB.2 FR1	
SMTC configuration		1,2,4,5	SMTC.1	
		3,6	SMTC.1	
TRS Configuration		1,4	TRS.1.1 FDD	
		2,5	TRS.1.1 TDD	
		3,6	TRS.1.2 TDD	
CSI-RS configuration for CSI reporting		1,4	CSI-RS.1.1 FDD	
		2,5	CSI-RS.1.1 TDD	
		3,6	CSI-RS.2.1 TDD	
reportConfigType		1,2,3,4,5,6	periodic	
reportQuantity		1,2,3,4,5,6	cri-RI-PMI-CQI	
CSI reporting periodicity	slot	1,2,4,5	5	
		3,6	10	
CSI reporting offset	slot	1,2,4,5	2	
		3,6	4	
EPRE ratio of PSS to SSS	dB	1,2,3,4,5,6	0	
EPRE ratio of PBCH DMRS to SSS				
EPRE ratio of PBCH to PBCH DMRS				
EPRE ratio of PDCCH DMRS to SSS				
EPRE ratio of PDCCH to PDCCH DMRS				
EPRE ratio of PDSCH DMRS to SSS				
EPRE ratio of PDSCH to PDSCH				
EPRE ratio of OCNG DMRS to SSS(Note 1)				
EPRE ratio of OCNG to OCNG DMRS (Note 1)				
$N_{oc}$ <sup>Note2</sup>				
$N_{oc}$ <sup>Note2</sup>	dBm/SCS	1,2,4,5	N/A	-88
		3,6	N/A	-85
$\hat{E}_s/I_{ot}$		1,2,3,4,5,6	-infinity	0
$\hat{E}_s/N_{oc}$		1,2,3,4,5,6	-infinity	0
SS-RSRP <sup>Note3</sup>	dBm/SCS	1,2,4,5	-infinity	-88
		3,6	-infinity	-85
$I_o$ <sup>Note3</sup>	dBm/9.36MHz	1,2,4,5	N/A	-57
	dBm/38.1MHz	3,6	N/A	-51
Propagation condition		1,2,3,4,5,6	AWGN	
<p>Note 1: OCNG shall be used such that both cells are fully allocated and a constant total transmitted power spectral density is achieved for all OFDM symbols.</p> <p>Note 2: Interference from other cells and noise sources not specified in the test is assumed to be constant over subcarriers and time and shall be modelled as AWGN of appropriate power for <math>N_{oc}</math> to be fulfilled.</p> <p>Note 3: SS-RSRP and <math>I_o</math> levels have been derived from other parameters for information purposes. They are not settable parameters themselves.</p> <p>Note 4: SS-RSRP minimum requirements are specified assuming independent interference and noise at each receiver antenna port.</p>				



#### A.4.5.7.1.2 Test Requirements

The UE shall transmit the PRACH to PSCell no later than 82 ms<sup>Note1</sup> from the start of T4.

The UE shall send at least one CSI report for PSCell with non-zero CQI index during T5.

The UE shall periodically send CSI reports for PSCell after the UE has sent first CQI report with non-zero CQI index during T5

The UE shall stop sending CSI reports for PSCell no later than 20ms from the start of T6.

All the above test requirements shall be fulfilled in order for the observed PSCell addition delay and PSCell release delay to be counted as correct. The rate of correct observed PSCell addition delay and PSCell release delay during repeated tests shall be at least 90%.

Note1: The PSCell addition delay can be expressed as follows as specified in clause 7.31.2 [15]:

$$T_{\text{config\_PSCell}} = T_{\text{RRC\_delay}} + T_{\text{processing}} + T_{\text{search}} + T_{\Delta} + T_{\text{PSCell\_DU}} + 2\text{ms}$$

Where:

$$T_{\text{RRC\_delay}} = 20\text{ms}$$

$$T_{\text{processing}} = 20\text{ms}$$

$$T_{\text{search}} = 0$$

$$T_{\Delta} = 20\text{ms}$$

$$T_{\text{PSCell\_DU}} = 1 \cdot 10 + 10 = 20\text{ms}$$

### A.4.5.8 DL Interruptions at switching between two uplink carriers

#### A.4.5.8.1 Test Purpose and Environment

The purpose of this test is to verify DL interruption requirements during UE dynamic switching between two uplink carriers defined in clause 8.2.1.2.14. The test case is applicable for an uplink band pair of an inter-band EN-DC configuration when the capability *uplinkTxSwitchingPeriod* is present.

There are two cells: E-UTRAN FDD PCell (Cell 1), FR1 PSCell (Cell 2). The test parameters for PSCell are given in Table A. 4.5.8.1-1, Table A. 4.5.8.1-2 and Table A. 4.5.8.1-3 below.

Aperiodic CSI-RS for L1-RSRP reporting is triggered with power boosting 6dB on following symbol on the special slot on NR TDD carrier (Cell 2):

- symbol#10 if UE does not report *uplinkTxSwitching-DL-Interruption-r16*;
- otherwise,
  - symbol#5 if UE capability *uplinkTxSwitchingPeriod* is 140us or
  - symbol #8 if UE capability *uplinkTxSwitchingPeriod* is 35us.

The test parameters and applicability for E-UTRAN FDD PCell are defined in A.3.7.2. The test consists of one time period, with duration of T1. Prior to the start of the time duration T1, *uplinkTxSwitching* is indicated to UE. This test verifies that the UE correctly report the L1-RSRP reporting.

**Table A. 4.5.8.1-1: Supported test configurations**

Configuration	PSCell (Cell2)
1	30 kHz SSB SCS, 40 MHz bandwidth, TDD duplex mode

**Table A. 4.5.8.1-2: General test parameters for DL Interruptions at switching between two uplink carriers in EN-DC**

Parameter	Unit	Test configuration	Value	Comment
RF Channel Number		Config 1	1, 2	Two radio channels are used for the test.
Active cell		Config 1	Cell 1: E-UTRAN FDD PCell Cell 2: FR1 PSCell	E-UTRAN FDD PCell on RF channel number 1 FR1 PSCell on RF channel number 2
CP length		Config 1	Normal	
DRX		Config 1	OFF	
Measurement gap pattern Id		Config 1	OFF	
Filter coefficient		Config 1	0	L3 filtering is not used
CSI-RS configuration for L1-RSRP reporting		Config 1	CSI-RS.2.5 TDD	
T1	s	Config 1	5	

**Table A. 4.5.8.1-3: NR Cell specific test parameters for DL Interruptions at switching between two uplink carriers in EN-DC (Cell 2)**

Parameter	Unit	Cell2
Frequency Range		FR1
Duplex mode	Config 1	TDD
TDD configuration	Config 1	TDDConf.2.1 except that: S='11DL:1GP:2UL'; nrofDownlinkSymbols:11 nrofUplinkSymbols: 2
BW <sub>channel</sub>	Config 1	40 MHz; N <sub>RB,c</sub> = 106
Initial BWP Configuration	Config 1	DLBWP.0.1
DL dedicated BWP configuration	Config 1	DLBWP.1.1
UL dedicated BWP configuration		ULBWP.1.1
SRS configuration		SRSCnf.4 in Table A.4.5.8.1-4
PDSCH Reference measurement channel	Config 1	SR.2.1 TDD
RMSI CORESET parameters	Config 1	CR.2.1 TDD
Dedicated CORESET parameters	Config 1	CCR.2.1 TDD
OCNG Patterns		OP.1
SMTC Configuration		SMTc.1
SSB Configuration	Config 1	SSB.2 FR1
Correlation Matrix and Antenna Configuration		2x2 low
EPRE ratio of PSS to SSS	dB	0
EPRE ratio of PBCH DMRS to SSS		
EPRE ratio of PBCH to PBCH DMRS		
EPRE ratio of PDCCH DMRS to SSS		
EPRE ratio of PDCCH to PDCCH DMRS		
EPRE ratio of PDSCH DMRS to SSS		
EPRE ratio of PDSCH to PDSCH		
EPRE ratio of OCNG DMRS to SSS(Note 1)		
EPRE ratio of OCNG to OCNG DMRS (Note 1)		
N <sub>oc</sub> <sup>Note 2</sup>	dBm/15 kHz	-104

SS-RSRP <sup>Note 3</sup>		dBm/SSB SCS	-84
CSI-RS RSRP <sup>Note 6</sup>		dBm/SCS	-78
$\bar{E}_s/I_{ot}$		dB	17
$\bar{E}_s/N_{oc}$		dB	17
$N_{oc}$ <sup>Note 2</sup>	Config 1	dBm/SCS	-101
$I_o$ <sup>Note 3</sup> on symbols without CSI-RS	Config 1	dBm/ 38.16MHz	-52.86
$I_o$ <sup>Note 6</sup> on symbols with CSI-RS	Config 1	dBm/ 38.16MHz	-50.5
Time offset to Cell1 <sup>Note 5</sup>		$\mu$ s	0
Propagation Condition			AWGN
<p>Note 1: OCNG shall be used such that both cells are fully allocated and a constant total transmitted power spectral density is achieved for all OFDM symbols.</p> <p>Note 2: Interference from other cells and noise sources not specified in the test is assumed to be constant over subcarriers and time and shall be modelled as AWGN of appropriate power for <math>N_{oc}</math> to be fulfilled.</p> <p>Note 3: SS-RSRP and <math>I_o</math> levels have been derived from other parameters for information purposes. They are not settable parameters themselves.</p> <p>Note 4: Void</p> <p>Note 5: Receive time difference between slot boundaries of signals received from the two cells at the UE antenna connector including time alignment error between the two cells.</p> <p>Note 6: CSI-RS RSRP and <math>I_o</math> levels have been derived from other parameters for information purposes. They are not settable parameters themselves.</p>			

Table A.4.5.8.1-4: SRS Configuration for DL Interruptions at switching between two uplink carriers

	Field	SRSConf.4	Comments
SRS-ResourceSet	srs-ResourceSetId	0	
	srs-ResourceIdList	0	
	resourceType	Periodic	
	Usage	Codebook	
SRS-Resource	SRS-ResourceId	0	
	nrofSRS-Ports	Port2	
	transmissionComb	n2	
	combOffset-n2	0	
	cyclicShift-n2	0	
	resourceMapping startPosition	1	
	resourceMapping nrofSymbols	n2	
	resourceMapping repetitionFactor	n1	
	freqDomainPosition	0	
	freqDomainShift	0	
	freqHopping c-SRS	0	Matches $N_{RB,c}$
	freqHopping b-SRS	0	
	freqHopping b-hop	0	
	groupOrSequenceHopping	Neither	
	resourceType	Periodic	
	periodicityAndOffset-p	sl8, 3	Offset to align with DRx periodicity
sequenceId	0	Any 10 bit number	

### A.4.5.8.2 Test Requirements

The UE behaviour follows the requirements defined in clause 8.2.1.2.14.

UE shall send L1-RSRP report while meeting the accuracy requirements defined in clause 10.1.19.2.

The rate of correct events observed during repeated tests shall be at least 90%.

### A.4.5.9 UE specific CBW change

#### A.4.5.9.1 UE specific CBW change on FR1 NR PSCell with non-DRX in synchronous EN- DC

##### A.4.5.9.1.1 Test Purpose and Environment

The purpose of this test is to verify the UE specific CBW change delay requirement defined in clause 8.13.1. Supported test configurations are shown in Table A.4.5.9.1.1-1.

The test scenario comprises of one E-UTRA PCell (Cell 1) and one NR PSCell (Cell 2) as given in Table A.4.5.9.1.1-2. Cell-specific parameters of E-UTRA PCell are specified in Table A.3.7.2.1-1 and Cell-specific parameters of NR PSCell are specified in Table A.4.5.9.1.1-3 below.

PDCCHs indicating new transmissions shall be sent continuously on PCell (Cell 1) to ensure that the UE will have ACK/NACK sending.

Before the test starts,

- UE is connected to Cell 1 (PCell) on radio channel 1 (PCC) and to Cell 2 (PSCell) on radio channel 2 (PSCC).
- UE has bandwidth part BWP-1 in its RRC-configuration for Cell 1 (PSCell).
- UE is indicated in *firstActiveDownlinkBWP-Id* that the active DL BWP is BWP-1 of initial condition in PSCell.
- UE is indicated in *SCS-SpecificCarrier* that the active CBW is CBW-1 of initial condition in PSCell.

All cells have constant signal levels throughout the test.

The test consists of 1 time period, with duration of T1.

During T1,

Time period T1 starts when a *RRCReconfiguration* with updated CBW configuration, sent from the test equipment to the UE, is completely received at the UE side in PSCell's slot # denoted *i*. The UE shall reconfigure its CBW with the updated CBW of final condition (CBW-2).

The UE shall be able to receive PDSCH at the beginning of the DL slot right after PSCell's DL slot ( $i + \frac{T_{RRCprocessingDelay} + T_{CBWchangeDelayRRC}}{NR\ Slot\ length}$ ) as defined in clause 8.13.1 and be ready for the reception of uplink grant for the PSCell no later than at the beginning of the DL slot right after slot ( $i + \frac{T_{RRCprocessingDelay} + T_{CBWchangeDelayRRC}}{NR\ Slot\ length}$ ). The UE shall be continuously scheduled on PSCell's BWP-1 of CBW-2 starting from the beginning of the DL slot right after slot ( $i + \frac{T_{RRCprocessingDelay} + T_{CBWchangeDelayRRC}}{NR\ Slot\ length}$ ).

$T_{RRCprocessingDelay}$  and  $T_{CBWchangeDelayRRC}$  are defined in clause 8.13.1.

The test equipment verifies the UE specific CBW change time in PSCell by counting the time from the time when the RRC Reconfiguration message including updated CBW configuration is sent till the time when RRC Reconfiguration Complete message is received.

**Table A.4.5.9.1.1-1: UE specific CBW change supported test configurations**

Config	Description
1	LTE FDD, NR 15 kHz SSB SCS, 10 MHz bandwidth, FDD duplex mode
2	LTE FDD, NR 15 kHz SSB SCS, 10 MHz bandwidth, TDD duplex mode
3	LTE FDD, NR 30kHz SSB SCS, 40 MHz bandwidth, TDD duplex mode
4	LTE TDD, NR 15 kHz SSB SCS, 10 MHz bandwidth, FDD duplex mode

5	LTE TDD, NR 15 kHz SSB SCS, 10 MHz bandwidth, TDD duplex mode
6	LTE TDD, NR 30kHz SSB SCS, 40 MHz bandwidth, TDD duplex mode
Note 1: The UE is only required to be tested in one of the supported test configurations	

**Table A.4.5.9.1.1-2: General test parameters for UE specific CBW change in synchronous EN-DC**

Parameter	Unit	Value	Comment
E-UTRA RF Channel Number		1	One E-UTRA radio channel is used for this test
NR RF Channel Number		2	One NR radio channel is used for this test
Active PCell		Cell 1	PCell on RF channel number 1.
Active PSCell		Cell 2	PSCell on RF channel number 2.
CP length		Normal	
DRX		OFF	
Cell-individual offset for cells on RF channel number 1	dB	0	Individual offset for cells on PCC.
Cell-individual offset for cells on RF channel number 2	dB	0	Individual offset for cells on PSCC.
Cell2 timing offset to cell1	μs	3	Synchronous EN-DC
T1	s	0.2	

**Table A.4.5.9.1.1-3: NR Cell specific test parameters for UE specific CBW change in synchronous EN-DC**

Parameter		Unit	Cell 2
<b>Frequency Range</b>			<b>FR1</b>
Duplex mode	Config 1,4		FDD
	Config 2,3,5,6		TDD
TDD configuration	Config 1,4		Not Applicable
	Config 2,5		TDDConf.1.1
	Config 3,6		TDDConf.1.2
BW <sub>channel</sub>	Config 1,4		10 MHz: N <sub>RB,c</sub> = 52
	Config 2,5		10 MHz: N <sub>RB,c</sub> = 52
	Config 3,6		40 MHz: N <sub>RB,c</sub> = 106
Active DL BWP ID			0
Initial DL BWP Configuration (BWP-1) before and after UE specific CBW change	Config 1,4		DLBWP.0.2
	Config 2,5		
	Config 3,6		
Initial UL BWP (BWP-1) Configuration before and after UE specific CBW change	Config 1,4		ULBWP.0.2
	Config 2,5		
	Config 3,6		
Initial Condition	Active DL CBW Configuration (CBW-1)	Config 1,4	DLCBW.1.1
		Config 2,5	
		Config 3,6	
	Active UL CBW Configuration (CBW-1)	Config 1,4	ULCBW.1.1
		Config 2,5	
		Config 3,6	
Final Condition	Active DL CBW Configuration (CBW-2)	Config 1,4	DLCBW.1.2
		Config 2,5	
		Config 3,6	
	Active UL CBW	Config 1,4	ULCBW.1.2
		Config 2,5	
		Config 3,6	

	Configurat ion (CBW- 2)	Config 3,6		
PDSCH Reference measurement channel		Config 1,4		SR.1.1 FDD
		Config 2,5		SR.1.1 TDD
		Config 3,6		SR2.1 TDD
RMSI CORESET parameters		Config 1,4		CR.1.1 FDD
		Config 2,5		CR.1.1 TDD
		Config 3,6		CR2.1 TDD
Dedicated CORESET parameters		Config 1,4		CCR.1.1 FDD
		Config 2,5		CCR.1.1 TDD
		Config 3,6		CCR.2.1 TDD
OCNG Patterns				OP.1
SSB Configuration		Config 1,2,4,5		SSB.1 FR1
		Config 3,6		SSB.2 FR1
SMTC Configuration				SMTC.1
TRS Configuration		Config 1,4		TRS.1.1 FDD
		Config 2,5		TRS.1.1 TDD
		Config 3,6		TRS.1.2 TDD
Antenna Configuration				1x2 low
Propagation Condition				AWGN
EPRE ratio of PSS to SSS			dB	0
EPRE ratio of PBCH DMRS to SSS				
EPRE ratio of PBCH to PBCH DMRS				
EPRE ratio of PDCCH DMRS to SSS				
EPRE ratio of PDCCH to PDCCH DMRS				
EPRE ratio of PDSCH DMRS to SSS				
EPRE ratio of PDSCH to PDSCH				
EPRE ratio of OCNG DMRS to SSS(Note 1)				
EPRE ratio of OCNG to OCNG DMRS (Note 1)				
$N_{oc}$ <sup>Note 2</sup>		dBm/15 kHz		-104
SS-RSRP <sup>Note 3</sup>		dBm/15 kHz		-87
$\bar{E}_s/I_{ot}$		dB		17
$\bar{E}_s/N_{oc}$		dB		17
$I_o$ <sup>Note 3</sup>	Config 1,2,4,5	dBm/9.36MHz		-58.96
	Config 3,6	dBm/38.16MH z		-52.86
<p>Note 1: OCNG shall be used such that both cells are fully allocated and a constant total transmitted power spectral density is achieved for all OFDM symbols.</p> <p>Note 2: Interference from other cells and noise sources not specified in the test is assumed to be constant over subcarriers and time and shall be modelled as AWGN of appropriate power for <math>N_{oc}</math> to be fulfilled.</p> <p>Note 3: SS-RSRP and <math>I_o</math> levels have been derived from other parameters for information purposes. They are not settable parameters themselves.</p> <p>Note 4: For unpaired spectrum, a DL BWP is linked with an UL BWP. DLBWP.0.2 is linked with ULBWP.0.2; DLBWP.1.1 is linked with ULBWP.1.1; DLBWP.1.3 is linked with ULBWP.1.3 defined in clause 12 of TS 38.213 [3].</p>				

### A.4.5.9.1.2 Test Requirements

During T1, the UE shall be ready for the reception of uplink grant for PSCell in the beginning of the DL slot right after slot ( $i + \frac{T_{RRCprocessingDelay} + T_{CBWchangeDelayRRC}}{NR\ Slot\ length}$ ).

All of the above test requirements shall be fulfilled in order for the observed PSCell UE specific CBW change delay to be counted as correct.

The rate of correct events observed during repeated tests shall be at least 90%.

## A.4.6 Measurement procedure

### A.4.6.1 Intra-frequency Measurements

#### A.4.6.1.1 EN-DC event triggered reporting tests without gap under non-DRX

##### A.4.6.1.1.1 Test purpose and Environment

The purpose of this test is to verify that the UE makes correct reporting of an event. This test will partly verify the intra-frequency cell search requirements in clause 9.2.5.1 and 9.2.5.2.

##### A.4.6.1.1.2 Test parameters

Three cells are deployed in the test, which are E-UTRAN PCell (Cell 1), FR1 PCell (Cell 2) and a FR1 neighbour cell (Cell 3) on the same frequency as the PCell. The test parameters for PCell are given in Table A.4.6.1.1.2-1, A.4.6.1.1.2-2, A.4.6.1.1.2-3 below and the test parameters and applicability for the E-UTRAN cell are defined in A.3.7.2. In the measurement control information, a measurement object is configured for the frequency of the PCell, and it is indicated to the UE that event-triggered reporting with Event A3 is used. The test consists of two successive time periods, with time duration of T1, and T2 respectively. During time duration T1, the UE shall not have any timing information of cell 3.

**Table A.4.6.1.1.2-1: Supported test configurations**

Config	Description
1	LTE FDD, NR 15 kHz SSB SCS, 10 MHz bandwidth, FDD duplex mode
2	LTE FDD, NR 15 kHz SSB SCS, 10 MHz bandwidth, TDD duplex mode
3	LTE FDD, NR 30 kHz SSB SCS, 40 MHz bandwidth, TDD duplex mode
4	LTE TDD, NR 15 kHz SSB SCS, 10 MHz bandwidth, FDD duplex mode
5	LTE TDD, NR 15 kHz SSB SCS, 10 MHz bandwidth, TDD duplex mode
6	LTE TDD, NR 30 kHz SSB SCS, 40 MHz bandwidth, TDD duplex mode

Note 1: The UE is only required to be tested in one of the supported test configurations  
Note 2: Target NR Cell 3 has the same SCS, BW and duplex mode as NR serving Cell 2

**Table A.4.6.1.1.2-2: General test parameters for EN-DC intra-frequency event triggered reporting without gap for PCell in FR1**

Parameter	Unit	Test configuration	Value	Comment
Active cell		1, 2, 3, 4, 5, 6	E-UTRAN Cell 1 and NR Cell 2	
Neighbour cell		1, 2, 3, 4, 5, 6	NR Cell 3	Cell to be identified.
RF Channel Number		1, 2, 3, 4, 5, 6	1: Cell 1 2: Cell 2 and Cell 3	
SSB configuration		1, 4	SSB.1 FR1	
		2, 5	SSB.1 FR1	
		3, 6	SSB.2 FR1	
SMTC configuration		1, 4	SMTC.2	
		2, 5	SMTC.1	
		3, 6	SMTC.1	
A3-Offset	dB	1, 2, 3, 4, 5, 6	-4.5	
CP length		1, 2, 3, 4, 5, 6	Normal	
Hysteresis	dB	1, 2, 3, 4, 5, 6	0	
Time To Trigger	s	1, 2, 3, 4, 5, 6	0	
Filter coefficient		1, 2, 3, 4, 5, 6	0	L3 filtering is not used
DRX		1, 2, 3, 4, 5, 6	N/A	OFF
Time offset between PCell and PSCell		1, 2, 3, 4, 5, 6	3 $\mu$ s	Synchronous EN-DC
Time offset between serving and neighbour cells		1, 4	3 ms	Asynchronous cells. The timing of Cell 3 is 3ms later than the timing of Cell 2.
		2, 5	3 $\mu$ s	Synchronous cells
		3, 6	3 $\mu$ s	Synchronous cells
T1	s	1, 2, 3, 4, 5, 6	5	

T2	s	1, 2, 3, 4, 5, 6	5	
----	---	------------------	---	--

**Table A.4.6.1.1.2-3: NR Cell specific test parameters for EN-DC intra-frequency event triggered reporting without gap for PSCell in FR1**

Parameter	Unit	Test configuration	Cell 2		Cell 3	
			T1	T2	T1	T2
TDD configuration		1, 4	N/A		N/A	
		2, 5	TDDConf.1.1		TDDConf.1.1	
		3, 6	TDDConf.2.1		TDDConf.2.1	
PDSCH RMC configuration		1, 4	SR.1.1 FDD		N/A	
		2, 5	SR.1.1 TDD			
		3, 6	SR.2.1 TDD			
RMSI CORESET RMC configuration		1, 4	CR.1.1 FDD		N/A	
		2, 5	CR.1.1 TDD		N/A	
		3, 6	CR.2.1 TDD		N/A	
Dedicated CORESET RMC configuration		1, 4	CCR.1.1 FDD		N/A	
		2, 5	CCR.1.1 TDD		N/A	
		3, 6	CCR.2.1 TDD		N/A	
OCNG Patterns		1, 2, 3, 4, 5, 6	OP.1		OP.1	
TRS configuration		1, 4	TRS.1.1 FDD		N/A	
		2, 5	TRS.1.1 TDD		N/A	
		3, 6	TRS.1.2 TDD		N/A	
Initial BWP configuration		1, 2, 3, 4, 5, 6	DLBWP.0.1 ULBWP.0.1		DLBWP.0.1 ULBWP.0.1	
Active DL BWP configuration		1, 2, 3, 4, 5, 6	DLBWP.1.1		DLBWP.1.1	
Active UL BWP configuration		1, 2, 3, 4, 5, 6	ULBWP.1.1		ULBWP.1.1	
RLM-RS		1, 2, 3, 4, 5, 6	SSB		SSB	
$N_{oc}$ <sup>Note 2</sup>	dBm/SCS	1, 4	-98			
		2, 5	-98			
		3, 6	-95			
$N_{oc}$ <sup>Note 2</sup>	dBm/15 kHz	1, 4	-98			
		2, 5				
		3, 6				
$\hat{E}_s/I_{ot}$	dB	1, 4	4	-1.46	-Infinity	-1.46
		2, 5				
		3, 6				
$\hat{E}_s/N_{oc}$	dB	1, 4	4	4	-Infinity	4
		2, 5				
		3, 6				
SS-RSRP <sup>Note 3</sup>	dBm/SCS kHz	1, 4	-94	-94	-Infinity	-94
		2, 5	-94	-94	-Infinity	-94
		3, 6	-91	-91	-Infinity	-91
I <sub>o</sub>	dBm/9.36 MHz	1, 4	-64.60	-62.25	-64.60	-62.25
	dBm/9.36 MHz	2, 5	-64.60	-62.25	-64.60	-62.25
	dBm/38.16 MHz	3, 6	-58.50	-56.16	-58.50	-56.16
Propagation Condition		1, 2, 3, 4, 5, 6	AWGN			
<p>Note 1: The resources for uplink transmission are assigned to the UE prior to the start of time period T2.</p> <p>Note 2: Interference from other cells and noise sources not specified in the test is assumed to be constant over subcarriers and time and shall be modelled as AWGN of appropriate power for <math>N_{oc}</math> to be fulfilled.</p> <p>Note 3: SS-RSRP levels have been derived from other parameters for information purposes. They are not settable parameters themselves.</p>						



### A.4.6.1.1.3 Test Requirements

The UE shall send one Event A3 triggered measurement report, with a measurement reporting delay less than 800 ms from the beginning of time period T2. The UE is not required to read the neighbour cell SSB index in this test.

The UE shall not send event triggered measurement reports, as long as the reporting criteria are not fulfilled.

The rate of correct events observed during repeated tests shall be at least 90%.

NOTE: The actual overall delays measured in the test may be up to  $2xTTI_{DCCH}$  higher than the measurement reporting delays above because of TTI insertion uncertainty of the measurement report in DCCH.

### A.4.6.1.2 EN-DC event triggered reporting tests without gap under DRX

#### A.4.6.1.2.1 Test purpose and Environment

The purpose of this test is to verify that the UE makes correct reporting of an event. This test will partly verify the TDD intra-frequency cell search requirements in clause 9.2.5.1 and 9.2.5.2.

#### A.4.6.1.2.2 Test parameters

Three cells are deployed in the test, which are E-UTRAN PCell (Cell 1), FR1 PSCell (Cell 2) and a FR1 neighbour cell (Cell 3) on the same frequency as the PSCell. The test parameters for PSCell are given in Table A.4.6.1.2.1-1, A.4.6.1.2.1-2, A.4.6.1.2.1-3 and A.4.6.1.2.1-4 below and the test parameters and applicability for the E-UTRAN cell are defined in A.3.7.2. In the measurement control information, a measurement object is configured for the frequency of the PSCell, and it is indicated to the UE that event-triggered reporting with Event A3 is used. The test consists of two successive time periods, with time duration of T1, and T2 respectively. During time duration T1, the UE shall not have any timing information of cell 3.

UE needs to be provided with new Timing Advance Command MAC control element at least once during each time alignment timer period to maintain uplink time alignment. Furthermore UE is allocated with PUSCH resource at every DRX cycle.

**Table A.4.6.1.2.2-1: Supported test configurations**

Config	Description
1	LTE FDD, NR 15 kHz SSB SCS, 10 MHz bandwidth, FDD duplex mode
2	LTE FDD, NR 15 kHz SSB SCS, 10 MHz bandwidth, TDD duplex mode
3	LTE FDD, NR 30 kHz SSB SCS, 40 MHz bandwidth, TDD duplex mode
4	LTE TDD, NR 15 kHz SSB SCS, 10 MHz bandwidth, FDD duplex mode
5	LTE TDD, NR 15 kHz SSB SCS, 10 MHz bandwidth, TDD duplex mode
6	LTE TDD, NR 30 kHz SSB SCS, 40 MHz bandwidth, TDD duplex mode
Note 1:	The UE is only required to be tested in one of the supported test configurations
Note 2:	Target NR Cell 3 has the same SCS, BW and duplex mode as NR serving Cell 2

**Table A.4.6.1.2.2-2: General test parameters for EN-DC intra-frequency event triggered reporting without gap for PSCell in FR1 with DRX**

Parameter	Unit	Test configuration	Value		Comment
			Test 1	Test 2	
Active cell		1, 2, 3, 4, 5, 6	E-UTRAN Cell 1 and NR Cell 2		
Neighbour cell		1, 2, 3, 4, 5, 6	NR Cell 3		Cell to be identified.
RF Channel Number		1, 2, 3, 4, 5, 6	1: Cell 1 2: Cell 2 and Cell 3		
SSB configuration		1, 4	SSB.1 FR1		
		2, 5	SSB.1 FR1		
		3, 6	SSB.2 FR1		
SMTC configuration		1, 4	SMTC.2		
		2, 5	SMTC.1		
		3, 6	SMTC.1		

A3-Offset	dB	1, 2, 3, 4, 5, 6	-4.5		
CP length		1, 2, 3, 4, 5, 6	Normal		
Hysteresis	dB	1, 2, 3, 4, 5, 6	0		
Time To Trigger	s	1, 2, 3, 4, 5, 6	0		
Filter coefficient		1, 2, 3, 4, 5, 6	0		L3 filtering is not used
DRX		1, 2, 3, 4, 5, 6	DRX.1	DRX.7	
Time offset between PCell and PSCell		1, 2, 3, 4, 5, 6	3 μs		Synchronous EN-DC
Time offset between serving and neighbour cells		1, 4	3 ms		Asynchronous cells. The timing of Cell 3 is 3ms later than the timing of Cell 2.
		2, 5	3 μs		Synchronous cells
		3, 6	3 μs		Synchronous cells
T1	s	1, 2, 3, 4, 5, 6	5		
T2	s	1, 2, 3, 4, 5, 6	5	10	

**Table A.4.6.1.2.2-3: NR Cell specific test parameters for EN-DC intra-frequency event triggered reporting without gap for PSCell in FR1 with DRX**

Parameter	Unit	Test configuration	Cell 2		Cell 3	
			T1	T2	T1	T2
TDD configuration		1, 4	N/A		N/A	
		2, 5	TDDConf.1.1		TDDConf.1.1	
		3, 6	TDDConf.2.1		TDDConf.2.1	
PDSCH RMC configuration		1, 4	SR.1.1 FDD		N/A	
		2, 5	SR.1.1 TDD			
		3, 6	SR.2.1 TDD			
RMSI CORESET RMC configuration		1, 4	CR.1.1 FDD		N/A	
		2, 5	CR.1.1 TDD		N/A	
		3, 6	CR.2.1 TDD		N/A	
Dedicated CORESET RMC configuration		1, 4	CCR.1.1 FDD		N/A	
		2, 5	CCR.1.1 TDD		N/A	
		3, 6	CCR.2.1 TDD		N/A	
OCNG Patterns		1, 2, 3, 4, 5, 6	OP.1		OP.1	
TRS configuration		1, 4	TRS.1.1 FDD		N/A	
		2, 5	TRS.1.1 TDD		N/A	
		3, 6	TRS.1.2 TDD		N/A	
Initial BWP configuration		1, 2, 3, 4, 5, 6	DLBWP.0.1 ULBWP.0.1		DLBWP.0.1 ULBWP.0.1	
Active DL BWP configuration		1, 2, 3, 4, 5, 6	DLBWP.1.1		DLBWP.1.1	
Active UL BWP configuration		1, 2, 3, 4, 5, 6	ULBWP.1.1		ULBWP.1.1	
RLM-RS		1, 2, 3, 4, 5, 6	SSB		SSB	
$N_{oc}$ <sup>Note 2</sup>	dBm/SCS	1, 4	-98			
		2, 5	-98			
		3, 6	-95			
$N_{oc}$ <sup>Note 2</sup>	dBm/15 kHz	1, 4	-98			
		2, 5				
		3, 6				
$\hat{E}_s/I_{ot}$	dB	1, 4	4	-1.46	-Infinity	-1.46
		2, 5				

$\hat{E}_s/N_{oc}$	dB	3, 6	4	4	-Infinity	4
		1, 4				
		2, 5				
		3, 6				
SS-RSRP <sup>Note 3</sup>	dBm/SCS kHz	1, 4	-94	-94	-Infinity	-94
		2, 5	-94	-94	-Infinity	-94
		3, 6	-91	-91	-Infinity	-91
Io	dBm/9.36 MHz	1, 4	-64.60	-62.25	-64.60	-62.25
	dBm/9.36 MHz	2, 5	-64.60	-62.25	-64.60	-62.25
	dBm/38.16 MHz	3	-58.50	-56.16	-58.50	-56.16
Propagation Condition		1, 2, 3, 4, 5, 6	AWGN			
Note 1:	The resources for uplink transmission are assigned to the UE prior to the start of time period T2.					
Note 2:	Interference from other cells and noise sources not specified in the test is assumed to be constant over subcarriers and time and shall be modelled as AWGN of appropriate power for $N_{oc}$ to be fulfilled.					
Note 3:	SS-RSRP levels have been derived from other parameters for information purposes. They are not settable parameters themselves.					

#### A.4.6.1.2.2 Test Requirements

In test 1, the UE shall send one Event A3 triggered measurement report, with a measurement reporting delay less than 920 ms from the beginning of time period T2. The UE is not required to read the neighbour cell SSB index in this test.

In test 2, the UE shall send one Event A3 triggered measurement report, with a measurement reporting delay less than 6400 ms from the beginning of time period T2. The UE is not required to read the neighbour cell SSB index in this test.

The UE shall not send event triggered measurement reports, as long as the reporting criteria are not fulfilled.

The rate of correct events observed during repeated tests shall be at least 90%.

NOTE: The actual overall delays measured in the test may be up to  $2 \times TTI_{DCCH}$  higher than the measurement reporting delays above because of TTI insertion uncertainty of the measurement report in DCCH.

#### A.4.6.1.3 EN-DC event triggered reporting tests with per-UE gaps under non-DRX

##### A.4.6.1.3.1 Test purpose and Environment

The purpose of this test is to verify that the UE makes correct reporting of an event. This test will partly verify the TDD intra-frequency cell search requirements in clause 9.2.6.2 and 9.2.6.3.

##### A.4.6.1.3.2 Test parameters

Three cells are deployed in the test, which are E-UTRAN PCell (Cell 1), FR1 PSCell (Cell 2) and a FR1 neighbour cell (Cell 3) on the same frequency as the PSCell. The test parameters for PSCell are given in Table A.4.6.1.3.1-1 and A.4.6.1.3.1-2 below and the test parameters and applicability for the E-UTRAN cell are defined in A.3.7.2. In the measurement control information, a measurement object is configured for the frequency of the PSCell, and it is indicated to the UE that event-triggered reporting with Event A3 is used. The test consists of two successive time periods, with time duration of T1, and T2 respectively. During time duration T1, the UE shall not have any timing information of cell 3.

There are two BWPs configured in Cell 2, BWP1 which contains the cell defining SSB, and BWP2 which does not contain any SSB of Cell 2. During the whole test, BWP2 is always scheduled as the active BWP for the UE.

**Table A.4.6.1.3.2-1: Supported test configurations**

Config	Description
1	LTE FDD, NR 15 kHz SSB SCS, 10 MHz bandwidth, FDD duplex mode
2	LTE FDD, NR 15 kHz SSB SCS, 10 MHz bandwidth, TDD duplex mode
3	LTE FDD, NR 30 kHz SSB SCS, 40 MHz bandwidth, TDD duplex mode
4	LTE TDD, NR 15 kHz SSB SCS, 10 MHz bandwidth, FDD duplex mode
5	LTE TDD, NR 15 kHz SSB SCS, 10 MHz bandwidth, TDD duplex mode

6	LTE TDD, NR 30 kHz SSB SCS, 40 MHz bandwidth, TDD duplex mode
Note 1: The UE is only required to be tested in one of the supported test configurations	
Note 2: Target NR Cell 3 has the same SCS, BW and duplex mode as NR serving Cell 2	

**Table A.4.6.1.3.2-2: General test parameters for EN-DC intra-frequency event triggered reporting with per-UE gaps for PSCell in FR1**

Parameter	Unit	Test configuration	Value	Comment
Active cell		1, 2, 3, 4, 5, 6	E-UTRAN Cell 1 and NR Cell 2	
Neighbour cell		1, 2, 3, 4, 5, 6	NR Cell 3	Cell to be identified.
RF Channel Number		1, 2, 3, 4, 5, 6	1: Cell 1 2: Cell 2 and Cell 3	
Measurement gap type		1, 2, 3, 4, 5, 6	Per-UE gaps	
Measurement gap repetition periodicity	ms	1, 2, 3, 4, 5, 6	40	
Measurement gap length	ms	1, 2, 3, 4, 5, 6	6	
Measurement gap offset	ms	1, 2, 3, 4, 5, 6	39	
SSB configuration		1, 4	SSB.1 FR1	
		2, 5	SSB.1 FR1	
		3, 6	SSB.2 FR1	
SMTC configuration		1, 4	SMTC.2	
		2, 5	SMTC.1	
		3, 6	SMTC.1	
CSI-RS parameters		1, 4	CSI-RS.1.2 FDD resource #0	
		2, 5	CSI-RS.1.2 TDD resource #0	
		3, 6	CSI-RS.2.2 TDD resource #0	
A3-Offset	dB	1, 2, 3, 4, 5, 6	-4.5	
CP length		1, 2, 3, 4, 5, 6	Normal	
Hysteresis	dB	1, 2, 3, 4, 5, 6	0	
Time To Trigger	s	1, 2, 3, 4, 5, 6	0	
Filter coefficient		1, 2, 3, 4, 5, 6	0	L3 filtering is not used
DRX		1, 2, 3, 4, 5, 6	N/A	OFF
Time offset between PCell and PSCell		1, 2, 3, 4, 5, 6	3 $\mu$ s	Synchronous EN-DC
Time offset between serving and neighbour cells		1, 4	3 ms	Asynchronous cells. The timing of Cell 3 is 3ms later than the timing of Cell 2.
		2, 5	3 $\mu$ s	Synchronous cells
		3, 6	3 $\mu$ s	Synchronous cells
T1	s	1, 2, 3, 4, 5, 6	5	
T2	s	1, 2, 3, 4, 5, 6	5	

**Table A.4.6.1.3.2-3: NR Cell specific test parameters for EN-DC intra-frequency event triggered reporting with per-UE gaps for PSCell in FR1**

Parameter	Unit	Test	Cell 2	Cell 3
-----------	------	------	--------	--------

		configuration	T1	T2	T1	T2
TDD configuration		1, 4	N/A		N/A	
		2, 5	TDDConf.1.1		TDDConf.1.1	
		3, 6	TDDConf.2.1		TDDConf.2.1	
PDSCH RMC configuration		1, 4	SR.1.1 FDD		N/A	
		2, 5	SR.1.1 TDD			
		3, 6	SR.2.1 TDD			
RMSI CORESET RMC configuration		1, 4	CR.1.1 FDD		N/A	
		2, 5	CR.1.1 TDD		N/A	
		3, 6	CR.2.1 TDD		N/A	
Dedicated CORESET RMC configuration		1, 4	CCR.1.2 FDD		N/A	
		2, 5	CCR.1.2 TDD		N/A	
		3, 6	CCR.2.1 TDD		N/A	
OCNG Patterns		1, 2, 3, 4, 5, 6	OP.1		OP.1	
TRS configuration		1, 4	TRS.1.1 FDD		N/A	
		2, 5	TRS.1.1 TDD		N/A	
		3, 6	TRS.1.2 TDD		N/A	
Initial BWP configuration		1, 2, 3, 4, 5, 6	DLBWP.0.1 ULBWP.0.1		DLBWP.0.1 ULBWP.0.1	
Active DL BWP configuration		1, 2, 3, 4, 5, 6	DLBWP.1.2		DLBWP.1.1	
Active UL BWP configuration		1, 2, 3, 4, 5, 6	ULBWP.1.2		ULBWP.1.1	
RLM-RS		1, 2, 3, 4, 5, 6	CSI-RS		SSB	
$N_{oc}$ <sup>Note 2</sup>	dBm/SCS	1, 4	-98			
		2, 5	-98			
		3, 6	-95			
$N_{oc}$ <sup>Note 2</sup>	dBm/15 kHz	1, 4	-98			
		2, 5				
		3, 6				
$\hat{E}_s/I_{ot}$	dB	1, 4	4	-1.46	-Infinity	-1.46
		2, 5				
		3, 6				
$\hat{E}_s/N_{oc}$	dB	1, 4	4	4	-Infinity	4
		2, 5				
		3, 6				
SS-RSRP <sup>Note 3</sup>	dBm/SCS kHz	1, 4	-94	-94	-Infinity	-94
		2, 5	-94	-94	-Infinity	-94
		3, 6	-91	-91	-Infinity	-91
Io	dBm/9.36 MHz	1, 4	-64.60	-62.25	-64.60	-62.25
	dBm/9.36 MHz	2, 5	-64.60	-62.25	-64.60	-62.25
	dBm/38.16 MHz	3, 6	-58.50	-56.16	-58.50	-56.16
Propagation Condition		1, 2, 3, 4, 5, 6	AWGN			
<p>Note 1: The resources for uplink transmission are assigned to the UE prior to the start of time period T2.</p> <p>Note 2: Interference from other cells and noise sources not specified in the test is assumed to be constant over subcarriers and time and shall be modelled as AWGN of appropriate power for <math>N_{oc}</math> to be fulfilled.</p> <p>Note 3: SS-RSRP levels have been derived from other parameters for information purposes. They are not settable parameters themselves.</p>						

#### A.4.6.1.3.3 Test Requirements

The UE shall send one Event A3 triggered measurement report, with a measurement reporting delay less than 800 ms from the beginning of time period T2. The UE is not required to read the neighbour cell SSB index in this test.

The UE shall not send event triggered measurement reports, as long as the reporting criteria are not fulfilled.

The rate of correct events observed during repeated tests shall be at least 90%.

NOTE: The actual overall delays measured in the test may be up to  $2 \times TTI_{DCCH}$  higher than the measurement reporting delays above because of TTI insertion uncertainty of the measurement report in DCCH.

#### A.4.6.1.4 EN-DC event triggered reporting tests with per-UE gaps under DRX

##### A.4.6.1.4.1 Test purpose and Environment

The purpose of this test is to verify that the UE makes correct reporting of an event. This test will partly verify the intra-frequency cell search requirements in clause 9.2.6.2 and 9.2.6.3.

##### A.4.6.1.4.2 Test parameters

Three cells are deployed in the test, which are E-UTRAN PCell (Cell 1), FR1 PSCell (Cell 2) and a FR1 neighbour cell (Cell 3) on the same frequency as the PSCell. The test parameters for PSCell are given in Table A.4.6.1.4.2-1, A.4.6.1.4.2-2, A.4.6.1.4.2-3 A.4.6.1.4.2-4 and A.4.6.1.4.2-5 below and the test parameters and applicability for the E-UTRAN cell are defined in A.3.7.2. In the measurement control information, a measurement object is configured for the frequency of the PSCell, and it is indicated to the UE that event-triggered reporting with Event A3 is used. The test consists of two successive time periods, with time duration of T1, and T2 respectively. During time duration T1, the UE shall not have any timing information of cell 3.

There are two BWPs configured in Cell 2, BWP1 which contains the cell defining SSB, and BWP2 which does not contain any SSB of Cell 2. During the whole test, BWP2 is always scheduled as the active BWP for the UE.

UE needs to be provided with new Timing Advance Command MAC control element at least once during each time alignment timer period to maintain uplink time alignment. Furthermore UE is allocated with PUSCH resource at every DRX cycle.

**Table A.4.6.1.4.2-1: Supported test configurations**

Config	Description
1	LTE FDD, NR 15 kHz SSB SCS, 10 MHz bandwidth, FDD duplex mode
2	LTE FDD, NR 15 kHz SSB SCS, 10 MHz bandwidth, TDD duplex mode
3	LTE FDD, NR 30 kHz SSB SCS, 40 MHz bandwidth, TDD duplex mode
4	LTE TDD, NR 15 kHz SSB SCS, 10 MHz bandwidth, FDD duplex mode
5	LTE TDD, NR 15 kHz SSB SCS, 10 MHz bandwidth, TDD duplex mode
6	LTE TDD, NR 30 kHz SSB SCS, 40 MHz bandwidth, TDD duplex mode

Note 1: The UE is only required to be tested in one of the supported test configurations  
Note 2: Target NR Cell 3 has the same SCS, BW and duplex mode as NR serving Cell 2

**Table A.4.6.1.4.2-2: General test parameters for EN-DC intra-frequency event triggered reporting with per-UE gaps for PSCell in FR1 with DRX**

Parameter	Unit	Test configuration	Value		Comment
			Test 1	Test 2	
Active cell		1, 2, 3, 4, 5, 6	E-UTRAN Cell 1 and NR Cell 2		
Neighbour cell		1, 2, 3, 4, 5, 6	NR Cell 3		Cell to be identified.
RF Channel Number		1, 2, 3, 4, 5, 6	1: Cell 1 2: Cell 2 and Cell 3		
Measurement gap type		1, 2, 3, 4, 5, 6	Per-UE gaps		
Measurement gap repetition periodicity	ms	1, 2, 3, 4, 5, 6	40		
Measurement gap length	ms	1, 2, 3, 4, 5, 6	6		
Measurement gap offset	ms	1, 2, 3, 4, 5, 6	39		
SSB configuration		1, 4	SSB.1 FR1		

		2, 5	SSB.1 FR1		
		3, 6	SSB.2 FR1		
SMTC configuration		1, 4	SMTC.2		
		2, 5	SMTC.1		
		3, 6	SMTC.1		
CSI-RS parameters		1, 4	CSI-RS.1.2 FDD resource #0		
		2, 5	CSI-RS.1.2 TDD resource #0		
		3, 6	CSI-RS.2.2 TDD resource #0		
A3-Offset	dB	1, 2, 3, 4, 5, 6	-4.5		
CP length		1, 2, 3, 4, 5, 6	Normal		
Hysteresis	dB	1, 2, 3, 4, 5, 6	0		
Time To Trigger	s	1, 2, 3, 4, 5, 6	0		
Filter coefficient		1, 2, 3, 4, 5, 6	0		L3 filtering is not used
DRX		1, 2, 3, 4, 5, 6	DRX.1	DRX.7	
Time offset between PCell and PSCell		1, 2, 3, 4, 5, 6	3 $\mu$ s		Synchronous EN-DC
Time offset between serving and neighbour cells		1, 4	3 ms		Asynchronous cells. The timing of Cell 3 is 3ms later than the timing of Cell 2.
		2, 5	3 $\mu$ s		Synchronous cells
		3, 6	3 $\mu$ s		Synchronous cells
T1	s	1, 2, 3, 4, 5, 6	5		
T2	s	1, 2, 3, 4, 5, 6	5	10	

**Table A.4.6.1.4.2-3: NR Cell specific test parameters for EN-DC intra-frequency event triggered reporting with per-UE gaps for PSCell in FR1 with DRX**

Parameter	Unit	Test configuration	Cell 2		Cell 3	
			T1	T2	T1	T2
TDD configuration		1, 4	N/A		N/A	
		2, 5	TDDConf.1.1		TDDConf.1.1	
		3, 6	TDDConf.2.1		TDDConf.2.1	
PDSCH RMC configuration		1, 4	SR.1.1 FDD		N/A	
		2, 5	SR.1.1 TDD			
		3, 6	SR.2.1 TDD			
RMSI CORESET RMC configuration		1, 4	CR.1.1 FDD		N/A	
		2, 5	CR.1.1 TDD		N/A	
		3, 6	CR.2.1 TDD		N/A	
Dedicated CORESET RMC configuration		1, 4	CCR.1.2 FDD		N/A	
		2, 5	CCR.1.2 TDD		N/A	
		3, 6	CCR.2.1 TDD		N/A	
OCNG Patterns		1, 2, 3, 4, 5, 6	OP.1		OP.1	
TRS configuration		1, 4	TRS.1.1 FDD		N/A	
		2, 5	TRS.1.1 TDD		N/A	
		3, 6	TRS.1.2 TDD		N/A	
Initial BWP configuration		1, 2, 3, 4, 5, 6	DLBWP.0.1 ULBWP.0.1	DLBWP.0.1 ULBWP.0.1		
Active DL BWP configuration		1, 2, 3, 4, 5, 6	DLBWP.1.2	DLBWP.1.1		
Active UL BWP configuration		1, 2, 3, 4, 5, 6	ULBWP.1.2	ULBWP.1.1		
RLM-RS		1, 2, 3, 4, 5, 6	CSI-RS		SSB	

$N_{oc}$ Note 2	dBm/SCS	1, 4	-98			
		2, 5	-98			
		3, 6	-95			
$N_{oc}$ Note 2	dBm/15 KHz	1, 4	-98			
		2, 5				
		3, 6				
$\hat{E}_s/I_{ot}$	dB	1, 4	4	-1.46	-Infinity	-1.46
		2, 5				
		3, 6				
$\hat{E}_s/N_{oc}$	dB	1, 4	4	4	-Infinity	4
		2, 5				
		3, 6				
SS-RSRP Note 3	dBm/SCS KHz	1, 4	-94	-94	-Infinity	-94
		2, 5	-94	-94	-Infinity	-94
		3, 6	-91	-91	-Infinity	-91
Io	dBm/9.36 MHz	1, 4	-64.60	-62.25	-64.60	-62.25
	dBm/9.36 MHz	2, 5	-64.60	-62.25	-64.60	-62.25
	dBm/38.16 MHz	3, 6	-58.50	-56.16	-58.50	-56.16
Propagation Condition		1, 2, 3, 4, 5, 6	AWGN			
<p>Note 1: The resources for uplink transmission are assigned to the UE prior to the start of time period T2.</p> <p>Note 2: Interference from other cells and noise sources not specified in the test is assumed to be constant over subcarriers and time and shall be modelled as AWGN of appropriate power for <math>N_{oc}</math> to be fulfilled.</p> <p>Note 3: SS-RSRP levels have been derived from other parameters for information purposes. They are not settable parameters themselves.</p>						

#### A.4.6.1.4.3 Test Requirements

In test 1, the UE shall send one Event A3 triggered measurement report, with a measurement reporting delay less than 920 ms from the beginning of time period T2. The UE is not required to read the neighbour cell SSB index in this test.

In test 2, the UE shall send one Event A3 triggered measurement report, with a measurement reporting delay less than 6400 ms from the beginning of time period T2. The UE is not required to read the neighbour cell SSB index in this test.

The UE shall not send event triggered measurement reports, as long as the reporting criteria are not fulfilled.

The rate of correct events observed during repeated tests shall be at least 90%.

NOTE: The actual overall delays measured in the test may be up to  $2xTTI_{DCC}$  higher than the measurement reporting delays above because of TTI insertion uncertainty of the measurement report in DCC.

#### A.4.6.1.5 EN-DC event triggered reporting tests without gap under non-DRX with SSB index reading

##### A.4.6.1.5.1 Test purpose and Environment

The purpose of this test is to verify that the UE makes correct reporting of an event. This test will partly verify the FDD intra-frequency cell search requirements in clause 9.2.5.1 and 9.2.5.2.

##### A.4.6.1.5.2 Test parameters

Three cells are deployed in the test, which are E-UTRAN PCell (Cell 1), FR1 PSCell (Cell 2) and a FR1 neighbour cell (Cell 3) on the same frequency as the PSCell. The test parameters for FDD PSCell are given in Table A.4.6.1.5.1-1 and A.4.6.1.5.1-2 below and the test parameters and applicability for the E-UTRAN cell are defined in A.3.7.2. In the measurement control information, a measurement object is configured for the frequency of the PSCell, and it is indicated to the UE that event-triggered reporting with Event A3 is used. The test consists of two successive time periods, with time duration of T1, and T2 respectively. During time duration T1, the UE shall not have any timing information of cell 3.



Table A.4.6.1.5.2-1: Supported test configurations

Config	Description
1	LTE FDD, NR 15 kHz SSB SCS, 10 MHz bandwidth, FDD duplex mode
2	LTE TDD, NR 15 kHz SSB SCS, 10 MHz bandwidth, FDD duplex mode
Note 1: The UE is only required to be tested in one of the supported test configurations	
Note 2: Target NR Cell 3 has the same SCS, BW and duplex mode as NR serving Cell 2	

Table A.4.6.1.5.2-2: General test parameters for EN-DC intra-frequency event triggered reporting without gap for FDD PSCell in FR1 with SSB index reading

Parameter	Unit	Test configuration	Value	Comment
Active cell		1, 2	E-UTRAN Cell 1 and NR Cell 2	
Neighbour cell		1, 2	NR Cell 3	Cell to be identified.
RF Channel Number		1, 2	1: Cell 1 2: Cell 2 and Cell 3	
SSB configuration		1, 2	SSB.1 FR1	
SMTC configuration		1, 2	SMTC.2	
A3-Offset	dB	1, 2	-4.5	
CP length		1, 2	Normal	
Hysteresis	dB	1, 2	0	
Time To Trigger	s	1, 2	0	
Filter coefficient		1, 2	0	L3 filtering is not used
DRX		1, 2	N/A	OFF
Time offset between PCell and PSCell		1, 2	3 $\mu$ s	Synchronous EN-DC
Time offset between serving and neighbour cells		1, 2	3 ms	Asynchronous cells. The timing of Cell 3 is 3ms later than the timing of Cell 2.
T1	s	1, 2	5	
T2	s	1, 2	5	

Table A.4.6.1.5.1-3: NR Cell specific test parameters for EN-DC intra-frequency event triggered reporting without gap for FDD PSCell in FR1 with SSB index reading

Parameter	Unit	Test configuration	Cell 2		Cell 3	
			T1	T2	T1	T2
TDD configuration		1, 2	N/A		N/A	
PDSCH RMC configuration		1, 2	SR.1.1 FDD		N/A	
RMSI CORESET RMC configuration		1, 2	CR.1.1 FDD		N/A	
Dedicated CORESET RMC configuration		1, 2	CCR.1.1 FDD		N/A	
OCNG Patterns		1, 2	OP.1		OP.1	
TRS configuration		1, 2	TRS.1.1 FDD		N/A	
Initial BWP configuration		1, 2	DLBWP.0.1 ULBWP.0.1		DLBWP.0.1 ULBWP.0.1	
Active DL BWP configuration		1, 2	DLBWP.1.1		DLBWP.1.1	
Active UL BWP configuration		1, 2	ULBWP.1.1		ULBWP.1.1	
RLM-RS		1, 2	SSB		SSB	
$N_{oc}$ <small>Note 2</small>	dBm/SCS	1, 2	-98			

$N_{oc}$ <sup>Note 2</sup>	dBm/15 kHz	1, 2	-98			
$\hat{E}_s/I_{ot}$	dB	1, 2	4	-1.46	-Infinity	-1.46
$\hat{E}_s/N_{oc}$	dB	1, 2	4	4	-Infinity	4
SS-RSRP <sup>Note 3</sup>	dBm/SCS kHz	1, 2	-94	-94	-Infinity	-94
Io	dBm/9.36 MHz	1, 2	-64.60	-62.25	-64.60	-62.25
Propagation Condition		1, 2	AWGN			
<p>Note 1: The resources for uplink transmission are assigned to the UE prior to the start of time period T2.</p> <p>Note 2: Interference from other cells and noise sources not specified in the test is assumed to be constant over subcarriers and time and shall be modelled as AWGN of appropriate power for <math>N_{oc}</math> to be fulfilled.</p> <p>Note 3: SS-RSRP levels have been derived from other parameters for information purposes. They are not settable parameters themselves.</p>						

#### A.4.6.1.5.3 Test Requirements

The UE shall send one Event A3 triggered measurement report, with a measurement reporting delay less than 920 ms from the beginning of time period T2. The UE is required to read the neighbour cell SSB index and report the acquired SSB index in this test.

The UE shall not send event triggered measurement reports, as long as the reporting criteria are not fulfilled.

The rate of correct events observed during repeated tests shall be at least 90%.

NOTE: The actual overall delays measured in the test may be up to  $2 \times TTI_{DCCCH}$  higher than the measurement reporting delays above because of TTI insertion uncertainty of the measurement report in DCCCH.

#### A.4.6.1.6 EN-DC event triggered reporting tests with SSB index reading with per-UE gaps

##### A.4.6.1.6.1 Test purpose and Environment

The purpose of this test is to verify that the UE makes correct reporting of an event. This test will partly verify the intra-frequency cell search requirements in clause 9.2.6.2 and 9.2.6.3.

##### A.4.6.1.6.2 Test parameters

Three cells are deployed in the test, which are E-UTRAN PCell (Cell 1), FR1 PSCell (Cell 2) and a FR1 neighbour cell (Cell 3) on the same frequency as the PSCell. The test parameters for PSCell are given in Table A.4.6.1.6.2-1 A.4.6.1.6.2-2 and A.4.6.1.6.2-3 below and the test parameters and applicability for the E-UTRAN cell are defined in A.3.7.2. In the measurement control information, a measurement object is configured for the frequency of the PSCell, and it is indicated to the UE that event-triggered reporting with Event A3 is used. The test consists of two successive time periods, with time duration of T1, and T2 respectively. During time duration T1, the UE shall not have any timing information of cell 3.

There are two BWPs configured in Cell 2, BWP1 which contains the cell defining SSB, and BWP2 which does not contain any SSB of Cell 2. During the whole test, BWP2 is always scheduled as the active BWP for the UE.

**Table A.4.6.1.6.2-1: Supported test configurations**

Config	Description
1	LTE FDD, NR 15 kHz SSB SCS, 10 MHz bandwidth, FDD duplex mode
2	LTE TDD, NR 15 kHz SSB SCS, 10 MHz bandwidth, FDD duplex mode
Note 1: The UE is only required to be tested in one of the supported test configurations	
Note 2: Target NR Cell 3 has the same SCS, BW and duplex mode as NR serving Cell 2	

**Table A.4.6.1.6.2-2: General test parameters for EN-DC intra-frequency event triggered reporting with gap for PSCell in FR1 with SSB index reading**

Parameter	Unit	Test configuration	Value	Comment
Active cell		1, 2	E-UTRAN Cell 1 and NR Cell 2	
Neighbour cell		1, 2	NR Cell 3	Cell to be identified.
RF Channel Number		1, 2	1: Cell 1 2: Cell 2 and Cell 3	
Measurement gap type		1, 2	Per-UE gaps	
Measurement gap repetition periodicity	ms	1, 2	40	
Measurement gap length	ms	1, 2	6	
Measurement gap offset	ms	1, 2	39	
SSB configuration		1, 2	SSB.1 FR1	
SMTTC configuration		1, 2	SMTTC.2	
CSI-RS parameters		1, 2	CSI-RS.1.2 FDD resource #0	
A3-Offset	dB	1, 2	-4.5	
CP length		1, 2	Normal	
Hysteresis	dB	1, 2	0	
Time To Trigger	s	1, 2	0	
Filter coefficient		1, 2	0	L3 filtering is not used
DRX		1, 2	N/A	OFF
Time offset between PCell and PSCell		1, 2	3 $\mu$ s	Synchronous EN-DC
Time offset between serving and neighbour cells		1, 2	3 ms	Asynchronous cells. The timing of Cell 3 is 3ms later than the timing of Cell 2.
T1	s	1, 2	5	
T2	s	1, 2	5	

**Table A.4.6.1.6.2-3: NR Cell specific test parameters for EN-DC intra-frequency event triggered reporting with gap for PSCell in FR1 with SSB index reading**

Parameter	Unit	Test configuration	Cell 2		Cell 3	
			T1	T2	T1	T2
TDD configuration		1, 2	N/A		N/A	
PDSCH RMC configuration		1, 2	SR.1.1 FDD		N/A	
RMSI CORESET RMC configuration		1, 2	CR.1.1 FDD		N/A	
Dedicated CORESET RMC configuration		1, 2	CCR.1.2 FDD		N/A	
OCNG Patterns		1, 2	OP.1		OP.1	
TRS configuration		1, 2	TRS.1.1 FDD		N/A	
Initial BWP configuration		1, 2	DLBWP.0.1 ULBWP.0.1		DLBWP.0.1 ULBWP.0.1	
Active DL BWP configuration		1, 2	DLBWP.1.2		DLBWP.1.1	
Active UL BWP configuration		1, 2	ULBWP.1.2		ULBWP.1.1	
RLM-RS		1, 2	CSI-RS		SSB	
$N_{oc}$ <small>Note 2</small>	dBm/SCS	1, 2	-98			
$N_{oc}$ <small>Note 2</small>	dBm/15 kHz	1, 2	-98			

$\hat{E}_s / I_{ot}$	dB	1, 2	4	-1.46	-Infinity	-1.46
$\hat{E}_s / N_{oc}$	dB	1, 2	4	4	-Infinity	4
SS-RSRP <sup>Note 3</sup>	dBm/SCS kHz	1, 2	-94	-94	-Infinity	-94
Io	dBm/9.36 MHz	1, 2	-64.60	-62.25	-64.60	-62.25
Propagation Condition		1, 2	AWGN			
Note 1:	The resources for uplink transmission are assigned to the UE prior to the start of time period T2.					
Note 2:	Interference from other cells and noise sources not specified in the test is assumed to be constant over subcarriers and time and shall be modelled as AWGN of appropriate power for $N_{oc}$ to be fulfilled.					
Note 3:	SS-RSRP levels have been derived from other parameters for information purposes. They are not settable parameters themselves.					

#### A.4.6.1.6.3 Test Requirements

The UE shall send one Event A3 triggered measurement report, with a measurement reporting delay less than 920 ms from the beginning of time period T2. The UE is required to read the neighbour cell SSB index and report the acquired SSB index in this test.

The UE shall not send event triggered measurement reports, as long as the reporting criteria are not fulfilled.

The rate of correct events observed during repeated tests shall be at least 90%.

NOTE: The actual overall delays measured in the test may be up to  $2 \times TTI_{DCCH}$  higher than the measurement reporting delays above because of TTI insertion uncertainty of the measurement report in DCCH.

#### A.4.6.1.7 EN-DC event triggered reporting tests under DRX for UE configured with highSpeedMeasFlag-r16

##### A.4.6.1.7.1 Test purpose and Environment

The purpose of this test is to verify that the UE makes correct reporting of an event for UE configured with highSpeedMeasFlag-r16. This test will partly verify the intra-frequency cell search requirements in clause 9.2.5.1 and 9.2.5.2.

##### A.4.6.1.7.2 Test parameters

Three cells are deployed in the test, which are E-UTRAN PCell (Cell 1), FR1 PSCell (Cell 2) and a FR1 neighbour cell (Cell 3) on the same frequency as the PSCell. The test parameters for PSCell are given in Table A.4.6.1.7.1-1, A.4.6.1.7.1-2, A.4.6.1.7.1-3 and A.4.6.1.7.1-4 below and the test parameters and applicability for the E-UTRAN cell are defined in A.3.7.2. In the measurement control information, a measurement object is configured for the frequency of the PSCell, and it is indicated to the UE that event-triggered reporting with Event A3 is used. The test consists of two successive time periods, with time duration of T1, and T2 respectively. During time duration T1, the UE shall not have any timing information of cell 3.

UE needs to be provided with new Timing Advance Command MAC control element at least once during each time alignment timer period to maintain uplink time alignment. Furthermore UE is allocated with PUSCH resource at every DRX cycle.

**Table A.4.6.1.7.2-1: Supported test configurations**

Configuration	Description
1	LTE FDD, NR 15 kHz SSB SCS, 10 MHz bandwidth, FDD duplex mode
2	LTE FDD, NR 15 kHz SSB SCS, 10 MHz bandwidth, TDD duplex mode
3	LTE FDD, NR 30 kHz SSB SCS, 40 MHz bandwidth, TDD duplex mode
4	LTE TDD, NR 15 kHz SSB SCS, 10 MHz bandwidth, FDD duplex mode
5	LTE TDD, NR 15 kHz SSB SCS, 10 MHz bandwidth, TDD duplex mode
6	LTE TDD, NR 30 kHz SSB SCS, 40 MHz bandwidth, TDD duplex mode

Note 1: The UE is only required to be tested in one of the supported test configurations.  
 Note 2: Target NR Cell 3 has the same SCS, BW and duplex mode as NR serving Cell 2

**Table A.4.6.1.7.2-2: General test parameters for EN-DC intra-frequency event triggered reporting without gap for PSCell in FR1 with DRX for UE configured with highSpeedMeasFlag-r16**

Parameter	Unit	Test configuration	Value	Comment
<i>highSpeedMeasFlag-r16</i>		1,2,3,4,5,6	Present	To enable high speed measurement enhancements
Active cell		1, 2, 3,4,5,6	E-UTRAN Cell 1 and NR Cell 2	
Neighbour cell		1, 2, 3,4,5,6	NR Cell 3	Cell to be identified.
RF Channel Number		1, 2, 3,4,5,6	1: Cell 1 2: Cell 2 and Cell 3	
SSB configuration		1,4	SSB.1 FR1	
		2,5	SSB.1 FR1	
		3,6	SSB.2 FR1	
SMTC configuration		1,4	SMTC.2	
		2,5	SMTC.1	
		3,6	SMTC.1	
A3-Offset	dB	1, 2, 3,4,5,6	-4.5	
CP length		1, 2, 3,4,5,6	Normal	
Hysteresis	dB	1, 2, 3,4,5,6	0	
Time To Trigger	s	1, 2, 3,4,5,6	0	
Filter coefficient		1, 2, 3,4,5,6	0	L3 filtering is not used
DRX		1, 2, 3,4,5,6	DRX.7.	640ms DRX cycle
Time offset between PCell and PSCell		1, 2, 3,4,5,6	3 $\mu$ s	Synchronous EN-DC
Time offset between serving and neighbour cells		1,4	3 ms	Asynchronous cells. The timing of Cell 3 is 3ms later than the timing of Cell 2.
		2,5	3 $\mu$ s	Synchronous cells
		3,6	3 $\mu$ s	Synchronous cells
T1	s	1, 2, 3,4,5,6	5	
T2	s	1, 2, 3,4,5,6	6	

**Table A.4.6.1.7.2-3: NR Cell specific test parameters for EN-DC intra-frequency event triggered reporting without gap for PSCell in FR1 with DRX for UE configured with highSpeedMeasFlag-r16**

Parameter	Unit	Test configuration	Cell 2		Cell 3	
			T1	T2	T1	T2
TDD configuration		1,4	N/A		N/A	
		2,5	TDDConf.1.1		TDDConf.1.1	
		3,6	TDDConf.2.1		TDDConf.2.1	
PDSCH RMC configuration		1,4	SR.1.1 FDD		N/A	
		2,5	SR.1.1 TDD			
		3,6	SR.2.1 TDD			
		1,4	CR.1.1 FDD		CR.1.1 FDD	
		2,5	CR.1.1 TDD		CR.1.1 TDD	

RMSI CORESET RMC configuration		3,6	CR.2.1 TDD		CR.2.1 TDD	
Dedicated CORESET RMC configuration		1,4	CCR.1.1 FDD		CCR.1.1 FDD	
		2,5	CCR.1.1 TDD		CCR.1.1 TDD	
		3,6	CCR.2.1 TDD		CCR.2.1 TDD	
OCNG Patterns		1, 2, 3,4,5,6	OP.1		OP.1	
TRS configuration		1,4	TRS.1.1 FDD		N/A	
		2,5	TRS.1.1 TDD		N/A	
		3,6	TRS.1.2 TDD		N/A	
Initial BWP configuration		1, 2, 3,4,5,6	DLBWP.0.1 ULBWP.0.1		DLBWP.0.1 ULBWP.0.1	
Active DL BWP configuration		1, 2, 3,4,5,6	DLBWP.1.1		DLBWP.1.1	
Active UL BWP configuration		1, 2, 3,4,5,6	ULBWP.1.1		ULBWP.1.1	
RLM-RS		1, 2, 3,4,5,6	SSB		SSB	
$N_{oc}$ Note 2	dBm/SCS	1,4	-98			
		2,5	-98			
		3,6	-95			
$N_{oc}$ Note 2	dBm/15 kHz	1,4	-98			
		2,5				
		3,6				
$\hat{E}_s/I_{ot}$	dB	1,4	4	-1.46	-Infinity	-1.46
		2,5				
		3,6				
$\hat{E}_s/N_{oc}$	dB	1,4	4	4	-Infinity	4
		2,5				
		3,6				
SS-RSRP Note 3	dBm/SCS kHz	1,4	-94	-94	-Infinity	-94
		2,5	-94	-94	-Infinity	-94
		3,6	-91	-91	-Infinity	-91
I <sub>o</sub>	dBm/9.36 MHz	1,4	-64.60	-62.25	-64.60	-62.25
	dBm/9.36 MHz	2,5	-64.60	-62.25	-64.60	-62.25
	dBm/38.16 MHz	3,6	-58.50	-56.16	-58.50	-56.16
Propagation Condition		1, 2,4,5	AWGN		AWGN 1944 Hz Note 4	
		3,6	AWGN		AWGN 3334 Hz Note 5	
<p>Note 1: The resources for uplink transmission are assigned to the UE prior to the start of time period T2.</p> <p>Note 2: Interference from other cells and noise sources not specified in the test is assumed to be constant over subcarriers and time and shall be modelled as AWGN of appropriate power for <math>N_{oc}</math> to be fulfilled.</p> <p>Note 3: SS-RSRP levels have been derived from other parameters for information purposes. They are not settable parameters themselves.</p> <p>Note 4: The AWGN 1944 Hz condition is a non fading propagation channel with one tap. Doppler shift is a constant 1944Hz.</p> <p>Note 5: The AWGN 3334 Hz condition is a non fading propagation channel with one tap. Doppler shift is a constant 3334Hz.</p>						

#### A.4.6.1.7.3 Test Requirements

The UE shall send one Event A3 triggered measurement report, with a measurement reporting delay less than 5120 ms from the beginning of time period T2. The UE is not required to read the neighbour cell SSB index in this test.

The UE shall not send event triggered measurement reports, as long as the reporting criteria are not fulfilled.

The rate of correct events observed during repeated tests shall be at least 90%.

NOTE: The actual overall delays measured in the test may be up to  $2 \times TTI_{DCCH}$  higher than the measurement reporting delays above because of TTI insertion uncertainty of the measurement report in DCCH.

## A.4.6.2 Inter-frequency Measurements

### A.4.6.2.1 EN-DC event triggered reporting tests for FR1 cell without SSB time index detection when DRX is not used

#### A.4.6.2.1.1 Test Purpose and Environment

The purpose of this test is to verify that the UE makes correct reporting of an event. This test will partly verify the EN-DC inter-frequency NR cell search requirements in clause 9.3.4.

In this test, there are three cells: LTE cell 1 as PCell on E-UTRA RF channel 1, NR cell 2 as PCell in FR1 on NR RF channel 1 and NR cell 3 as neighbour cell in FR1 on NR RF channel 2. The test parameters and configurations are given in Tables A.4.6.2.1.1-1, A.4.6.2.1.1-2, and A.4.6.2.1.1-3.

Measurement gap pattern configuration is defined in Table A.4.6.2.1.1-2.

In the measurement control information, it is indicated to the UE that event-triggered reporting with Event A3 is used. The test consists of two successive time periods, with time duration of T1, and T2 respectively. During time duration T1, the UE shall not have any timing information of NR cell 3.

The configuration of LTE cell 1 is defined in table A.3.7.2.1-1. Supported test configurations are shown in table A.4.6.2.1.1-1.

**Table A.4.6.2.1.1-1: EN-DC event triggered reporting tests without SSB index reading for FR1-FR1**

Config	Description
1	LTE FDD, NR 15 kHz SSB SCS, 10 MHz bandwidth, FDD duplex mode
2	LTE FDD, NR 15 kHz SSB SCS, 10 MHz bandwidth, TDD duplex mode
3	LTE FDD, NR 30 kHz SSB SCS, 40 MHz bandwidth, TDD duplex mode
4	LTE TDD, NR 15 kHz SSB SCS, 10 MHz bandwidth, FDD duplex mode
5	LTE TDD, NR 15 kHz SSB SCS, 10 MHz bandwidth, TDD duplex mode
6	LTE TDD, NR 30 kHz SSB SCS, 40 MHz bandwidth, TDD duplex mode
Note 1:	The UE is only required to be tested in one of the supported test configurations
Note 2:	target NR cell3 has the same SCS, BW and duplex mode as NR serving cell2

**Table A.4.6.2.1.1-2: General test parameters for EN-DC inter-frequency event triggered reporting without SSB time index detection**

Parameter	Unit	Test configuration	Value	Comment
E-UTRA RF Channel Number		Config 1,2,3,4,5,6	1	One E-UTRAN carrier frequencies is used.
NR RF Channel Number		Config 1,2,3,4,5,6	1, 2	Two FR1 NR carrier frequencies is used.
Active cell		Config 1,2,3,4,5,6	LTE Cell 1 (PCell) and NR cell 2 (PScell)	LTE Cell 1 is on E-UTRA RF channel number 1. NR Cell 2 is on NR RF channel number 1.
Neighbour cell		Config 1,2,3,4,5,6	NR cell 3	NR cell 3 is on NR RF channel number 2.
Gap Pattern Id		Config 1,2,3,4,5,6	0	As specified in clause 9.1.2-1.
Measurement gap offset		Config 1,2,3,4,5,6	9	
A3-Offset	dB	Config 1,2,3,4,5,6	-6	
Hysteresis	dB	Config 1,2,3,4,5,6	0	
CP length		Config 1,2,3,4,5,6	Normal	

TimeToTrigger	s	Config 1,2,3,4,5,6	0	
Filter coefficient		Config 1,2,3,4,5,6	0	L3 filtering is not used
DRX		Config 1,2,3,4,5,6	OFF	DRX is not used
Time offset between PCell and PSCell		Config 1,2,3,4,5,6	3 $\mu$ s	Synchronous EN-DC
Time offset between serving and neighbour cells		Config 1,4	3 ms	Asynchronous cells. The timing of Cell 3 is 3ms later than the timing of Cell 2.
		Config 2,3,5,6	3 $\mu$ s	Synchronous cells.
T1	s	Config 1,2,3,4,5,6	5	
T2	s	Config 1,2,3,4,5,6	1	

**Table A.4.6.2.1.1-3: Cell specific test parameters for EN-DC inter-frequency event triggered reporting without SSB time index detection**

Parameter	Unit	Test configuration	Cell 2		Cell 3	
			T1	T2	T1	T2
NR RF Channel Number		Config 1,2,3,4,5,6	1		2	
Duplex mode		Config 1,4	FDD			
		Config 2,3,5,6	TDD			
BW <sub>channel</sub>	MHz	Config 1,4	10: N <sub>RB,c</sub> = 52			
		Config 2,5	10: N <sub>RB,c</sub> = 52			
		Config 3,6	40: N <sub>RB,c</sub> = 106			
BWP BW	MHz	Config 1,4	10: N <sub>RB,c</sub> = 52			
		Config 2,5	10: N <sub>RB,c</sub> = 52			
		Config 3,6	40: N <sub>RB,c</sub> = 106			
TDD configuration		Config 2,5	TDDConf.1.1		TDDConf.1.1	
		Config 3,6	TDDConf.2.1		TDDConf.2.1	
Initial DL BWP		Config 1,2,3,4,5,6	DLBWP.0.1		NA	
Initial UL BWP		Config 1,2,3,4,5,6	ULBWP.0.1		NA	
Dedicated DL BWP		Config 1,2,3,4,5,6	DLBWP.1.1		NA	
Dedicated UL BWP		Config 1,2,3,4,5,6	ULBWP.1.1		NA	
TRS configuration		Config 1,4	TRS.1.1 FDD		NA	
		Config 2,5	TRS.1.1 TDD		NA	
		Config 3,6	TRS.1.2 TDD		NA	
OCNG Patterns defined in A.3.2.1.1 (OP.1)		Config 1,2,3,4,5,6	OP.1		OP.1	
PDSCH Reference measurement channel		Config 1,4	SR.1.1 FDD		-	
		Config 2,5	SR.1.1 TDD			
		Config 3,6	SR2.1 TDD			
RMSI CORESET Reference Channel		Config 1,4	CR.1.1 FDD		-	
		Config 2,5	CR.1.1 TDD			
		Config 3,6	CR2.1 TDD			
Dedicated CORESET Reference Channel		Config 1,4	CCR.1.1 FDD			
		Config 2,5	CCR.1.1 TDD			
		Config 3,6	CCR.2.1 TDD			
SSB parameters		Config 1,4	SSB.1 FR1		SSB.5 FR1	
		Config 2,5	SSB.1 FR1		SSB.5 FR1	
		Config 3,6	SSB.2 FR1		SSB.6 FR1	
SMTC configuration defined in A.3.11		Config 1,4	SMTC.2		SMTC.5	
		Config 2,3,5,6	SMTC.1		SMTC.4	
PDSCH/PDCCH subcarrier spacing	kHz	Config 1,2,4,5	15			
		Config 3,6	30			



EPRE ratio of PSS to SSS		Config 1,2,3,4,5,6	0	0		
EPRE ratio of PBCH DMRS to SSS						
EPRE ratio of PBCH to PBCH DMRS						
EPRE ratio of PDCCH DMRS to SSS						
EPRE ratio of PDCCH to PDCCH DMRS						
EPRE ratio of PDSCH DMRS to SSS						
EPRE ratio of PDSCH to PDSCH						
EPRE ratio of OCNB DMRS to SSS(Note 1)						
EPRE ratio of OCNB to OCNB DMRS (Note 1)						
$N_{oc}^{Note2}$	dBm/15k Hz		-98		-98	
$N_{oc}^{Note2}$	dBm/SC S	Config 1,2,4,5	-98		-98	
		Config 3,6	-95		-95	
SS-RSRP <sup>Note 3</sup>	dBm/SC S	Config 1,2,4,5	-94	-94	-Infinity	-91
		Config 3,6	-91	-91	-Infinity	-88
$\hat{E}_s / I_{ot}$	dB	Config 1,2,3,4,5,6	4	4	-Infinity	7
$\hat{E}_s / N_{oc}$	dB	Config 1,2,3,4,5,6	4	4	-Infinity	7
$I_o^{Note3}$	dBm/9.36 MHz	Config 1,2,4,5	-64.59	-64.59	-70.05	-62.26
	dBm/38.1 6MHz	Config 3,6	-58.49	-58.49	-63.94	-56.15
Propagation Condition		Config 1,2,3,4,5,6	AWGN			
<p>Note 1: OCNB shall be used such that both cells are fully allocated and a constant total transmitted power spectral density is achieved for all OFDM symbols.</p> <p>Note 2: Interference from other cells and noise sources not specified in the test is assumed to be constant over subcarriers and time and shall be modelled as AWGN of appropriate power for <math>N_{oc}</math> to be fulfilled.</p> <p>Note 3: SS-RSRP and <math>I_o</math> levels have been derived from other parameters for information purposes. They are not settable parameters themselves.</p> <p>Note 4: SS-RSRP minimum requirements are specified assuming independent interference and noise at each receiver antenna port.</p>						

#### A.4.6.2.1.2 Test Requirements

The UE shall send one Event A3 triggered measurement report, with a measurement reporting delay less than 920 ms from the beginning of time period T2. The UE shall not send event triggered measurement reports, as long as the reporting criteria are not fulfilled. The rate of correct events observed during repeated tests shall be at least 90%.

UE is not required to report SSB time index.

NOTE: The actual overall delays measured in the test may be up to  $2 \times TTI_{DCCH}$  higher than the measurement reporting delays above because of TTI insertion uncertainty of the measurement report in DCCH.

#### A.4.6.2.2 EN-DC event triggered reporting tests for FR1 cell without SSB time index detection when DRX is used

##### A.4.6.2.2.1 Test Purpose and Environment

The purpose of this test is to verify that the UE makes correct reporting of an event. This test will partly verify the EN-DC inter-frequency NR cell search requirements in clause 9.3.4.

In this test, there are three cells: LTE cell 1 as PCell on E-UTRA RF channel 1, NR cell 2 as PSCell in FR1 on NR RF channel 1 and NR cell 3 as neighbour cell in FR1 on NR RF channel 2. The test parameters and configurations are given in Tables A.4.6.2.2.1-1, A.4.6.2.2.1-2, and A.4.6.2.2.1-3.

Measurement gap pattern configuration is defined in Table A.4.6.2.2.1-2.

In the measurement control information, it is indicated to the UE that event-triggered reporting with Event A3 is used. The test consists of two successive time periods, with time duration of T1, and T2 respectively. During time duration T1, the UE shall not have any timing information of NR cell 3.

The configuration of LTE cell 1 is defined in table A.3.7.2.1-1. Supported test configurations are shown in table A.4.6.2.2.1-1.

UE needs to be provided with new Timing Advance Command MAC control element at least once during each time alignment timer period to maintain uplink time alignment. Furthermore, UE is allocated with PUSCH resource at every DRX cycle.

**Table A.4.6.2.2.1-1: EN-DC event triggered reporting tests without SSB index reading for FR1-FR1**

Config	Description
1	LTE FDD, NR 15 kHz SSB SCS, 10 MHz bandwidth, FDD duplex mode
2	LTE FDD, NR 15 kHz SSB SCS, 10 MHz bandwidth, TDD duplex mode
3	LTE FDD, NR 30 kHz SSB SCS, 40 MHz bandwidth, TDD duplex mode
4	LTE TDD, NR 15 kHz SSB SCS, 10 MHz bandwidth, FDD duplex mode
5	LTE TDD, NR 15 kHz SSB SCS, 10 MHz bandwidth, TDD duplex mode
6	LTE TDD, NR 30 kHz SSB SCS, 40 MHz bandwidth, TDD duplex mode

Note 1: The UE is only required to be tested in one of the supported test configurations  
Note 2: target NR cell3 has the same SCS, BW and duplex mode as NR serving cell2

**Table A.4.6.2.2.1-2: General test parameters for EN-DC inter-frequency event triggered reporting without SSB time index detection**

Parameter	Unit	Test configuration	Value		Comment
			Test 1	Test 2	
E-UTRA RF Channel Number		Config 1,2,3,4,5,6	1		One E-UTRAN carrier frequencies is used.
NR RF Channel Number		Config 1,2,3,4,5,6	1, 2		Two FR1 NR carrier frequencies is used.
Active cell		Config 1,2,3,4,5,6	LTE Cell 1 (PCell) and NR cell 2 (PScell)		LTE Cell 1 is on E-UTRA RF channel number 1. NR Cell 2 is on NR RF channel number 1.
Neighbour cell		Config 1,2,3,4,5,6	NR cell 3		NR cell 3 is on NR RF channel number 2.
Gap Pattern Id		Config 1,2,3,4,5,6	0		As specified in clause 9.1.2-1.
Measurement gap offset		Config 1,2,3,4,5,6	9		
A3-Offset	dB	Config 1,2,3,4,5,6	-6		
Hysteresis	dB	Config 1,2,3,4,5,6	0		
CP length		Config 1,2,3,4,5,6	Normal		
TimeToTrigger	s	Config 1,2,3,4,5,6	0		
Filter coefficient		Config 1,2,3,4,5,6	0		L3 filtering is not used
DRX	ms	Config 1,2,3,4,5,6	DRX.1	DRX.7	As specified in clause A.3.3

Time offset between PCell and PSCell		Config 1,2,3,4,5,6	3 $\mu$ s		Synchronous EN-DC
Time offset between serving and neighbour cells		Config 1,4	3ms		Asynchronous cells. The timing of Cell 3 is 3ms later than the timing of Cell 2.
		Config 2,3,5,6	3 $\mu$ s		Synchronous cells.
T1	s	Config 1,2,3,4,5,6	5		
T2	s	Config 1,2,3,4,5,6	1.1	11	

**Table A.4.6.2.2.1-3: Cell specific test parameters for EN-DC inter-frequency event triggered reporting without SSB time index detection**

Parameter	Unit	Test configuration	Cell 2		Cell 3	
			T1	T2	T1	T2
NR RF Channel Number		Config 1,2,3,4,5,6	1		2	
Duplex mode		Config 1,4	FDD			
		Config 2,3,5,6	TDD			
BW <sub>channel</sub>	MHz	Config 1,4	10: N <sub>RB,c</sub> = 52			
		Config 2,5	10: N <sub>RB,c</sub> = 52			
		Config 3,6	40: N <sub>RB,c</sub> = 106			
BWP BW	MHz	Config 1,4	10: N <sub>RB,c</sub> = 52			
		Config 2,5	10: N <sub>RB,c</sub> = 52			
		Config 3,6	40: N <sub>RB,c</sub> = 106			
TDD configuration		Config 2,5	TDDConf.1.1			
		Config 3,6	TDDConf.2.1			
Initial DL BWP		Config 1,2,3,4,5,6	DLBWP.0.1		NA	
Initial UL BWP		Config 1,2,3,4,5,6	ULBWP.0.1		NA	
Dedicated DL BWP		Config 1,2,3,4,5,6	DLBWP.1.1		NA	
Dedicated UL BWP		Config 1,2,3,4,5,6	ULBWP.1.1		NA	
TRS configuration		Config 1,4	TRS.1.1 FDD		NA	
		Config 2,5	TRS.1.1 TDD		NA	
		Config 3,6	TRS.1.2 TDD		NA	
OCNG Patterns defined in A.3.2.1.1 (OP.1)		Config 1,2,3,4,5,6	OP.1		OP.1	
PDSCH Reference measurement channel		Config 1,4	SR.1.1 FDD		-	
		Config 2,5	SR.1.1 TDD			
		Config 3,6	SR2.1 TDD			
RMSI CORESET Reference Channel		Config 1,4	CR.1.1 FDD		-	
		Config 2,5	CR.1.1 TDD			
		Config 3,6	CR2.1 TDD			
Dedicated CORESET Reference Channel		Config 1,4	CCR.1.1 FDD			
		Config 2,5	CCR.1.1 TDD			
		Config 3,6	CCR.2.1 TDD			
SSB parameters		Config 1,4	SSB.1 FR1		SSB.5 FR1	
		Config 2,5	SSB.1 FR1		SSB.5 FR1	
		Config 3,6	SSB.2 FR1		SSB.6 FR1	
SMTC configuration defined in A.3.11		Config 1,4	SMTC.2		SMTC.5	
		Config 2,3,5,6	SMTC.1		SMTC.4	
PDSCH/PDCCH subcarrier spacing	kHz	Config 1,2,4,5	15			
		Config 3,6	30			
EPRE ratio of PSS to SSS						

EPRE ratio of PBCH DMRS to SSS		Config 1,2,3,4,5,6	0		0	
EPRE ratio of PBCH to PBCH DMRS						
EPRE ratio of PDCCH DMRS to SSS						
EPRE ratio of PDCCH to PDCCH DMRS						
EPRE ratio of PDSCH DMRS to SSS						
EPRE ratio of PDSCH to PDSCH						
EPRE ratio of OCNG DMRS to SSS(Note 1)						
EPRE ratio of OCNG to OCNG DMRS (Note 1)						
$N_{oc}^{Note2}$	dBm/15kHz		-98		-98	
$N_{oc}^{Note2}$	dBm/SCS	Config 1,2,4,5	-98		-98	
		Config 3,6	-95		-95	
SS-RSRP <sup>Note 3</sup>	dBm/SCS	Config 1,2,4,5	-94	-94	-Infinity	-91
		Config 3,6	-91	-91	-Infinity	-88
$\hat{E}_s / I_{ot}$	dB	Config 1,2,3,4,5,6	4	4	-Infinity	7
$\hat{E}_s / N_{oc}$	dB	Config 1,2,3,4,5,6	4	4	-Infinity	7
$I_o^{Note3}$	dBm/9.36 MHz	Config 1,2,4,5	-64.59	-64.59	-70.05	-62.26
	dBm/38.16 MHz	Config 3,6	-58.49	-58.49	-63.94	-56.15
Propagation Condition		Config 1,2,3,4,5,6	AWGN			
<p>Note 1: OCNG shall be used such that both cells are fully allocated and a constant total transmitted power spectral density is achieved for all OFDM symbols.</p> <p>Note 2: Interference from other cells and noise sources not specified in the test is assumed to be constant over subcarriers and time and shall be modelled as AWGN of appropriate power for <math>N_{oc}</math> to be fulfilled.</p> <p>Note 3: SS-RSRP and <math>I_o</math> levels have been derived from other parameters for information purposes. They are not settable parameters themselves.</p> <p>Note 4: SS-RSRP minimum requirements are specified assuming independent interference and noise at each receiver antenna port.</p>						

#### A.4.6.2.2.2 Test Requirements

In test 1 with per-UE gap, the UE shall send one Event A3 triggered measurement report, with a measurement reporting delay less than 1080 ms from the beginning of time period T2. The UE shall not send event triggered measurement reports, as long as the reporting criteria are not fulfilled. The rate of correct events observed during repeated tests shall be at least 90%.

In test 2 with per-UE gap, the UE shall send one Event A3 triggered measurement report, with a measurement reporting delay less than 10240 ms from the beginning of time period T2. The UE shall not send event triggered measurement reports, as long as the reporting criteria are not fulfilled. The rate of correct events observed during repeated tests shall be at least 90%.

In test 1 and 2, UE is not required to report SSB time index.

NOTE: The actual overall delays measured in the test may be up to  $2 \times TTI_{DCCH}$  higher than the measurement reporting delays above because of TTI insertion uncertainty of the measurement report in DCCH.

A.4.6.2.3 Void

A.4.6.2.4 Void

A.4.6.2.5 EN-DC event triggered reporting tests for FR1 cell with SSB time index detection when DRX is not used

A.4.6.2.5.1 Test Purpose and Environment

The purpose of this test is to verify that the UE makes correct reporting of an event. This test will partly verify the EN-DC inter-frequency NR cell search requirements in clause 9.3.4.

In this test, there are three cells: LTE cell 1 as PCell on E-UTRA RF channel 1, NR cell 2 as PCell in FR1 on NR RF channel 1 and NR cell 3 as neighbour cell in FR1 on NR RF channel 2. The test parameters and configurations are given in Tables A.4.6.2.5.1-1, A.4.6.2.5.1-2, and A.4.6.2.5.1-3.

Measurement gap pattern configuration is defined in Table A.4.6.2.5.1-2.

In the measurement control information, it is indicated to the UE that event-triggered reporting with Event A3 is used. The test consists of two successive time periods, with time duration of T1, and T2 respectively. During time duration T1, the UE shall not have any timing information of NR cell 3.

The configuration of LTE cell 1 is defined in table A.3.7.2.1-1. Supported test configurations are shown in table A.4.6.2.5.1-1.

**Table A.4.6.2.5.1-1: EN-DC event triggered reporting tests without SSB index reading for FR1-FR1**

Config	Description
1	LTE FDD, NR 15 kHz SSB SCS, 10 MHz bandwidth, FDD duplex mode
2	LTE FDD, NR 15 kHz SSB SCS, 10 MHz bandwidth, TDD duplex mode
3	LTE FDD, NR 30 kHz SSB SCS, 40 MHz bandwidth, TDD duplex mode
4	LTE TDD, NR 15 kHz SSB SCS, 10 MHz bandwidth, FDD duplex mode
5	LTE TDD, NR 15 kHz SSB SCS, 10 MHz bandwidth, TDD duplex mode
6	LTE TDD, NR 30 kHz SSB SCS, 40 MHz bandwidth, TDD duplex mode

Note 1: The UE is only required to be tested in one of the supported test configurations  
Note 2: target NR cell3 has the same SCS, BW and duplex mode as NR serving cell2

**Table A.4.6.2.5.1-2: General test parameters for EN-DC inter-frequency event triggered reporting with SSB time index detection**

Parameter	Unit	Test configuration	Value	Comment
E-UTRA RF Channel Number		Config 1,2,3,4,5,6	1	One E-UTRAN carrier frequencies is used.
NR RF Channel Number		Config 1,2,3,4,5,6	1, 2	Two FR1 NR carrier frequencies is used.
Active cell		Config 1,2,3,4,5,6	LTE Cell 1 (PCell) and NR cell 2 (PScell)	LTE Cell 1 is on E-UTRA RF channel number 1. NR Cell 2 is on NR RF channel number 1.
Neighbour cell		Config 1,2,3,4,5,6	NR cell 3	NR cell 3 is on NR RF channel number 2.
Gap Pattern Id		Config 1,2,3,4,5,6	0	As specified in clause 9.1.2-1.
Measurement gap offset		Config 1,2,3,4,5,6	9	
A3-Offset	dB	Config 1,2,3,4,5,6	-6	
Hysteresis	dB	Config 1,2,3,4,5,6	0	

CP length		Config 1,2,3,4,5,6	Normal	
TimeToTrigger	s	Config 1,2,3,4,5,6	0	
Filter coefficient		Config 1,2,3,4,5,6	0	L3 filtering is not used
DRX		Config 1,2,3,4,5,6	OFF	DRX is not used
Time offset between PCell and PSCell		Config 1,2,3,4,5,6	3 $\mu$ s	Synchronous EN-DC
Time offset between serving and neighbour cells		Config 1,4	3ms	Asynchronous cells. The timing of Cell 3 is 3ms later than the timing of Cell 2.
		Config 2,3,5,6	3 $\mu$ s	Synchronous cells.
T1	s	Config 1,2,3,4,5,6	5	
T2	s	Config 1,2,3,4,5,6	1.1	

**Table A.4.6.2.5.1-3: Cell specific test parameters for EN-DC inter-frequency event triggered reporting with SSB time index detection**

Parameter	Unit	Test configuration n	Cell 2		Cell 3	
			T1	T2	T1	T2
NR RF Channel Number		Config 1,2,3,4,5,6	1		2	
Duplex mode		Config 1,4	FDD			
		Config 2,3,5,6	TDD			
BW <sub>channel</sub>	MHz	Config 1,4	10: N <sub>RB,c</sub> = 52			
		Config 2,5	10: N <sub>RB,c</sub> = 52			
		Config 3,6	40: N <sub>RB,c</sub> = 106			
BWP BW	MHz	Config 1,4	10: N <sub>RB,c</sub> = 52			
		Config 2,5	10: N <sub>RB,c</sub> = 52			
		Config 3,6	40: N <sub>RB,c</sub> = 106			
TDD configuration		Config 2,5	TDDConf.1.1			
		Config 3,6	TDDConf.2.1			
Initial DL BWP		Config 1,2,3,4,5,6	DLBWP.0.1		NA	
Initial UL BWP		Config 1,2,3,4,5,6	ULBWP.0.1		NA	
Dedicated DL BWP		Config 1,2,3,4,5,6	DLBWP.1.1		NA	
Dedicated UL BWP		Config 1,2,3,4,5,6	ULBWP.1.1		NA	
TRS configuration		Config 1,4	TRS.1.1 FDD		NA	
		Config 2,5	TRS.1.1 TDD		NA	
		Config 3,6	TRS.1.2 TDD		NA	
OCNG Patterns defined in A.3.2.1.1 (OP.1)		Config 1,2,3,4,5,6	OP.1		OP.1	
PDSCH Reference measurement channel		Config 1,4	SR.1.1 FDD			
		Config 2,5	SR.1.1 TDD			
		Config 3,6	SR2.1 TDD			
RMSI CORESET Reference Channel		Config 1,4	CR.1.1 FDD		-	
		Config 2,5	CR.1.1 TDD			
		Config 3,6	CR2.1 TDD			
Dedicated CORESET Reference Channel		Config 1,4	CCR.1.1 FDD			
		Config 2,5	CCR.1.1 TDD			
		Config 3,6	CCR.2.1 TDD			
SSB parameters		Config 1,4	SSB.1 FR1		SSB.5 FR1	

		Config 2,5	SSB.1 FR1		SSB.5 FR1	
		Config 3,6	SSB.2 FR1		SSB.6 FR1	
SMTC configuration defined in A.3.11		Config 1,4	SMTC.2		SMTC.5	
		Config 2,3,5,6	SMTC.1		SMTC.4	
PDSCH/PDCCH subcarrier spacing	kHz	Config 1,2,4,5	15			
		Config 3,6	30			
EPRE ratio of PSS to SSS		Config 1,2,3,4,5,6	0		0	
EPRE ratio of PBCH DMRS to SSS						
EPRE ratio of PBCH to PBCH DMRS						
EPRE ratio of PDCCH DMRS to SSS						
EPRE ratio of PDCCH to PDCCH DMRS						
EPRE ratio of PDSCH DMRS to SSS						
EPRE ratio of PDSCH to PDSCH						
EPRE ratio of OCNG DMRS to SSS(Note 1)						
EPRE ratio of OCNG to OCNG DMRS (Note 1)						
$N_{oc}^{Note2}$	dBm/15 kHz		-98		-98	
$N_{oc}^{Note2}$	dBm/S CS	Config 1,2,4,5	-98		-98	
		Config 3,6	-95		-95	
SS-RSRP <sup>Note 3</sup>	dBm/S CS	Config 1,2,4,5	-94	-94	-Infinity	-91
		Config 3,6	-91	-91	-Infinity	-88
$\hat{E}_s / I_{ot}$	dB	Config 1,2,3,4,5,6	4	4	-Infinity	7
$\hat{E}_s / N_{oc}$	dB	Config 1,2,3,4,5,6	4	4	-Infinity	7
$I_o^{Note3}$	dBm/9.36MHz	Config 1,2,4,5	-64.59	-64.59	-70.05	-62.26
	dBm/38.16MHz	Config 3,6	-58.49	-58.49	-63.94	-56.15
Propagation Condition		Config 1,2,3,4,5,6	AWGN			
<p>Note 1: OCNG shall be used such that both cells are fully allocated and a constant total transmitted power spectral density is achieved for all OFDM symbols.</p> <p>Note 2: Interference from other cells and noise sources not specified in the test is assumed to be constant over subcarriers and time and shall be modelled as AWGN of appropriate power for <math>N_{oc}</math> to be fulfilled.</p> <p>Note 3: SS-RSRP and <math>I_o</math> levels have been derived from other parameters for information purposes. They are not settable parameters themselves.</p> <p>Note 4: SS-RSRP minimum requirements are specified assuming independent interference and noise at each receiver antenna port.</p>						

### A.4.6.2.5.2 Test Requirements

The UE shall send one Event A3 triggered measurement report, with a measurement reporting delay less than 1040 ms from the beginning of time period T2. The UE shall not send event triggered measurement reports, as long as the reporting criteria are not fulfilled. The rate of correct events observed during repeated tests shall be at least 90%.

UE is required to report SSB time index.

NOTE: The actual overall delays measured in the test may be up to  $2 \times TTI_{DCCH}$  higher than the measurement reporting delays above because of TTI insertion uncertainty of the measurement report in DCCH.

### A.4.6.2.6 EN-DC event triggered reporting tests for FR1 cell with SSB time index detection when DRX is used

#### A.4.6.2.6.1 Test Purpose and Environment

The purpose of this test is to verify that the UE makes correct reporting of an event. This test will partly verify the EN-DC inter-frequency NR cell search requirements in clause 9.3.4.

In this test, there are three cells: LTE cell 1 as PCell on E-UTRA RF channel 1, NR cell 2 as PSCell in FR1 on NR RF channel 1 and NR cell 3 as neighbour cell in FR1 on NR RF channel 2. The test parameters and configurations are given in Tables A.4.6.2.6.1-1, A.4.6.2.6.1-2, and A.4.6.2.6.1-3.

Measurement gap pattern configuration is defined in Table A.4.6.2.6.1-2.

In the measurement control information, it is indicated to the UE that event-triggered reporting with Event A3 is used. The test consists of two successive time periods, with time duration of T1, and T2 respectively. During time duration T1, the UE shall not have any timing information of NR cell 3.

The configuration of LTE cell 1 is defined in table A.3.7.2.1-1. Supported test configurations are shown in table A.4.6.2.6.1-1.

UE needs to be provided with new Timing Advance Command MAC control element at least once during each time alignment timer period to maintain uplink time alignment. Furthermore, UE is allocated with PUSCH resource at every DRX cycle.

**Table A.4.6.2.6.1-1: EN-DC event triggered reporting tests without SSB index reading for FR1-FR1**

Config	Description
1	LTE FDD, NR 15 kHz SSB SCS, 10 MHz bandwidth, FDD duplex mode
2	LTE FDD, NR 15 kHz SSB SCS, 10 MHz bandwidth, TDD duplex mode
3	LTE FDD, NR 30 kHz SSB SCS, 40 MHz bandwidth, TDD duplex mode
4	LTE TDD, NR 15 kHz SSB SCS, 10 MHz bandwidth, FDD duplex mode
5	LTE TDD, NR 15 kHz SSB SCS, 10 MHz bandwidth, TDD duplex mode
6	LTE TDD, NR 30 kHz SSB SCS, 40 MHz bandwidth, TDD duplex mode

Note 1: The UE is only required to be tested in one of the supported test configurations  
Note 2: target NR cell3 has the same SCS, BW and duplex mode as NR serving cell2

**Table A.4.6.2.6.1-2: General test parameters for EN-DC inter-frequency event triggered reporting with SSB time index detection**

Parameter	Unit	Test configuration	Value		Comment
			Test 1	Test 2	
E-UTRA RF Channel Number		Config 1,2,3,4,5,6	1		One E-UTRAN carrier frequencies is used.
NR RF Channel Number		Config 1,2,3,4,5,6	1, 2		Two FR1 NR carrier frequencies is used.
Active cell		Config 1,2,3,4,5,6	LTE Cell 1 (PCell) and NR cell 2 (PScell)		LTE Cell 1 is on E-UTRA RF channel number 1. NR Cell 2 is on NR RF channel number 1.
Neighbour cell		Config 1,2,3,4,5,6	NR cell 3		NR cell 3 is on NR RF channel number 2.
Gap Pattern Id		Config 1,2,3,4,5,6	0		As specified in clause 9.1.2-1.
Measurement gap offset		Config 1,2,3,4,5,6	9		
A3-Offset	dB	Config 1,2,3,4,5,6	-6		



Hysteresis	dB	Config 1,2,3,4,5,6	0		
CP length		Config 1,2,3,4,5,6	Normal		
TimeToTrigger	s	Config 1,2,3,4,5,6	0		
Filter coefficient		Config 1,2,3,4,5,6	0		L3 filtering is not used
DRX	ms	Config 1,2,3,4,5,6	DRX.1	DRX.7	As specified in clause A.3.3
Time offset between PCell and PSCell		Config 1,2,3,4,5,6	3 $\mu$ s		Synchronous EN-DC
Time offset between serving and neighbour cells		Config 1,4	3ms		Asynchronous cells. The timing of Cell 3 is 3ms later than the timing of Cell 2.
		Config 2,3,5,6	3 $\mu$ s		Synchronous cells.
T1	s	Config 1,2,3,4,5,6	5		
T2	s	Config 1,2,3,4,5,6	1.3	13.5	

**Table A.4.6.2.6.1-3: Cell specific test parameters for EN-DC inter-frequency event triggered reporting with SSB time index detection**

Parameter	Unit	Test configuration	Cell 2		Cell 3	
			T1	T2	T1	T2
NR RF Channel Number		Config 1,2,3,4,5,6	1		2	
Duplex mode		Config 1,4	FDD			
		Config 2,3,5,6	TDD			
BW <sub>channel</sub>	MHz	Config 1,4	10: N <sub>RB,c</sub> = 52			
		Config 2,5	10: N <sub>RB,c</sub> = 52			
		Config 3,6	40: N <sub>RB,c</sub> = 106			
BWP BW	MHz	Config 1,4	10: N <sub>RB,c</sub> = 52			
		Config 2,5	10: N <sub>RB,c</sub> = 52			
		Config 3,6	40: N <sub>RB,c</sub> = 106			
OCNG Patterns defined in A.3.2.1.1 (OP.1)		Config 1,2,3,4,5,6	OP.1		OP.1	
PDSCH Reference measurement channel		Config 1,4	SR.1.1 FDD		-	
		Config 2,5	SR.1.1 TDD			
		Config 3,6	SR2.1 TDD			
RMSI CORESET Reference Channel		Config 1,4	CR.1.1 FDD		-	
		Config 2,5	CR.1.1 TDD			
		Config 3,6	CR2.1 TDD			
Dedicated CORESET Reference Channel		Config 1,4	CCR.1.1 FDD			
		Config 2,5	CCR.1.1 TDD			
		Config 3,6	CCR.2.1 TDD			
TDD configuration		Config 2,5	TDDConf.1.1			
		Config 3,6	TDDConf.2.1			
Initial DL BWP		Config 1,2,3,4,5,6	DLBWP.0.1			
TRS configuration		Config 1,4	TRS.1.1 FDD		N/A	
		Config 2,5	TRS.1.1 TDD		N/A	
		Config 3,6	TRS.1.2 TDD		N/A	
Initial UL BWP		Config 1,2,3,4,5,6	ULBWP.0.1			
Dedicated DL BWP		Config 1,2,3,4,5,6	DLBWP.1.1			
Dedicated UL BWP		Config 1,2,3,4,5,6	ULBWP.1.1			

SSB parameters		Config 1,4	SSB.1 FR1			
		Config 2,5	SSB.1 FR1			
		Config 3,6	SSB.2 FR1			
SMTC configuration defined in A.3.11		Config 1,4	SMTC.2			
		Config 2,3,5,6	SMTC.1			
PDSCH/PDCCH subcarrier spacing	kHz	Config 1,2,4,5	15			
		Config 3,6	30			
EPRE ratio of PSS to SSS		Config 1,2,3,4,5,6	0	0		
EPRE ratio of PBCH DMRS to SSS						
EPRE ratio of PBCH to PBCH DMRS						
EPRE ratio of PDCCH DMRS to SSS						
EPRE ratio of PDCCH to PDCCH DMRS						
EPRE ratio of PDSCH DMRS to SSS						
EPRE ratio of PDSCH to PDSCH						
EPRE ratio of OCNG DMRS to SSS(Note 1)						
EPRE ratio of OCNG to OCNG DMRS (Note 1)						
$N_{oc}$ <sup>Note2</sup>	dBm/15 kHz					
$N_{oc}$ <sup>Note2</sup>	dBm/S CS	Config 1,2,4,5	-98		-98	
		Config 3,6	-95		-95	
SS-RSRP <sup>Note 3</sup>	dBm/S CS	Config 1,2,4,5	-94	-94	-Infinity	-91
		Config 3,6	-91	-91	-Infinity	-88
$\hat{E}_s/I_{ot}$	dB	Config 1,2,3,4,5,6	4	4	-Infinity	7
$\hat{E}_s/N_{oc}$	dB	Config 1,2,3,4,5,6	4	4	-Infinity	7
$I_o$ <sup>Note3</sup>	dBm/9.36MHz	Config 1,2,4,5	-64.59	-64.59	-70.05	-62.26
	dBm/38.16MHz	Config 3,6	-58.49	-58.49	-63.94	-56.15
Propagation Condition		Config 1,2,3,4,5,6	AWGN			
<p>Note 1: OCNG shall be used such that both cells are fully allocated and a constant total transmitted power spectral density is achieved for all OFDM symbols.</p> <p>Note 2: Interference from other cells and noise sources not specified in the test is assumed to be constant over subcarriers and time and shall be modelled as AWGN of appropriate power for <math>N_{oc}</math> to be fulfilled.</p> <p>Note 3: SS-RSRP and <math>I_o</math> levels have been derived from other parameters for information purposes. They are not settable parameters themselves.</p> <p>Note 4: SS-RSRP minimum requirements are specified assuming independent interference and noise at each receiver antenna port.</p>						

#### A.4.6.2.6.2 Test Requirements

In test 1 with per-UE gap, the UE shall send one Event A3 triggered measurement report, with a measurement reporting delay less than 1280 ms from the beginning of time period T2. The UE shall not send event triggered measurement reports, as long as the reporting criteria are not fulfilled. The rate of correct events observed during repeated tests shall be at least 90%.

In test 2 with per-UE gap, the UE shall send one Event A3 triggered measurement report, with a measurement reporting delay less than 12160 ms from the beginning of time period T2. The UE shall not send event triggered measurement

reports, as long as the reporting criteria are not fulfilled. The rate of correct events observed during repeated tests shall be at least 90%.

In test 1 and 2, UE is required to report SSB time index.

NOTE: The actual overall delays measured in the test may be up to  $2 \times TTI_{DCCH}$  higher than the measurement reporting delays above because of TTI insertion uncertainty of the measurement report in DCCH.

A.4.6.2.7 Void

A.4.6.2.8 Void

A.4.6.3 Void

## A.4.6.4 L1-RSRP measurement for beam reporting

A.4.6.4.1 SSB based L1-RSRP measurement when DRX is not used

A.4.6.4.1.1 Test Purpose and Environment

The purpose of this test is to verify that the UE makes correct reporting of L1-RSRP measurement. This test will partly verify the L1-RSRP measurement requirements in clause 9.5.4.1, with the testing configurations for NR cells in Table A.4.6.4.1.1-1.

**Table A.4.6.4.1.1-1: Applicable NR configurations for FR1 SSB based L1-RSRP test**

Config	Description
1	LTE FDD, NR 15 kHz SSB SCS, 10 MHz bandwidth, FDD duplex mode
2	LTE FDD, NR 15 kHz SSB SCS, 10 MHz bandwidth, TDD duplex mode
3	LTE FDD, NR 30 kHz SSB SCS, 40 MHz bandwidth, TDD duplex mode
4	LTE TDD, NR 15 kHz SSB SCS, 10 MHz bandwidth, FDD duplex mode
5	LTE TDD, NR 15 kHz SSB SCS, 10 MHz bandwidth, TDD duplex mode
6	LTE TDD, NR 30 kHz SSB SCS, 40 MHz bandwidth, TDD duplex mode

Note: The UE is only required to be tested in one of the supported test configurations

A.4.6.4.1.2 Test parameters

There are two cells in the test, E-UTRAN PCell (Cell 1) and FR1 PSCell (Cell 2). The test parameters and applicability for Cell 1 are defined in A.3.7.2. The test parameters for the Cell 2 are given in Table A.4.6.4.1.2-1 and Table A.4.6.4.1.2-2 below.

In CSI measurement configuration, UE is indicated to perform L1-RSRP measurement on the SSBs and report periodically. The test consists of two successive time periods, with time duration of T1 and T2 respectively. The test has higher layer parameter *timeRestrictionForChannelMeasurements* configured.

There is no measurement gap configured in the test. Before the test, UE is configured to perform RLM, BFD and L1-RSRP measurement based on the SSBs.

**Table A.4.6.4.1.2-1: General test parameters**

Parameter	Config	Unit	Value
SSB GSCN	1~6		freq1
Duplex mode	1,4		FDD
	2,5		TDD
	3,6		TDD
TDD Configuration	1,4		N/A
	2,5		TDDConf.1.1
	3,6		TDDConf.2.1
BW <sub>channel</sub>	1,4	MHz	10: N <sub>RB,c</sub> = 52
	2,5		10: N <sub>RB,c</sub> = 52
	3,6		40: N <sub>RB,c</sub> = 106
PDSCH Reference measurement	1,4		SR.1.1 FDD

channel	2,5		SR.1.1 TDD
	3,6		SR.2.1 TDD
RMSI CORESET Reference Channel	1,4		CR.1.1 FDD
	2,5		CR.1.1 TDD
	3,6		CR.2.1 TDD
Dedicated CORESET Reference Channel	1,4		CCR.1.1 FDD
	2,5		CCR.1.1 TDD
	3,6		CCR.2.1 TDD
SSB configuration	1,4		SSB.3 FR1
	2,5		SSB.3 FR1
	3,6		SSB.4 FR1
OCNG Patterns	1~6		OP.1
Initial BWP Configuration	1~6		DLBWP.0.1 ULBWP.0.1
Dedicated BWP configuration	1~6		DLBWP.1.1 ULBWP.1.1
SMTC configuration	1~6		SMTC.1
TRS Configuration	1,4		TRS.1.1 FDD
	2,5		TRS.1.1 TDD
	3,6		TRS.1.2 TDD
DRX configuration	1~6		Off
reportConfigType	1~6		periodic
reportQuantity	1~6		ssb-Index-RSRP
Number of reported RS	1~6		2
L1-RSRP reporting period	1~6	slot	80
T1	1~6	s	5
T2	1~6	s	1
EPRE ratio of PSS to SSS	1~6	dB	0
EPRE ratio of PBCH DMRS to SSS			
EPRE ratio of PBCH to PBCH DMRS			
EPRE ratio of PDCCH DMRS to SSS			
EPRE ratio of PDCCH to PDCCH DMRS			
EPRE ratio of PDSCH DMRS to SSS			
EPRE ratio of PDSCH to PDSCH DMRS			
EPRE ratio of OCNG DMRS to SSS <sup>Note 1</sup>			
EPRE ratio of OCNG to OCNG DMRS <sup>Note 1</sup>			
Propagation condition			
Note 1: OCNG shall be used such that both cells are fully allocated and a constant total transmitted power spectral density is achieved for all OFDM symbols.			

Table A.4.6.4.1.2-2: SSB specific test parameters

Parameter	Config	Unit	SSB#0		SSB#1	
			T1	T2	T1	T2
$N_{oc}$ <sup>Note2</sup>	1~6	dBm/15kHz	-94.65			
$N_{oc}$ <sup>Note2</sup>	1,2,4,5	dBm/SSB SCS	-94.65			
	3,6		-91.65			
$\hat{E}_s/I_{ot}$	1~6	dB	0	0	-Infinity	3
SSB RSRP <sup>Note3</sup>	1,2,4,5	dBm/SSB SCS	-94.65	-94.65	-Infinity	-91.65
	3,6		-91.65	-91.65	-Infinity	-88.65
$I_o$ <sup>Note3</sup>	1,2,4,5	dBm/9.36 MHz	-63.69	-63.69	-66.70	-61.93
	3,6		dBm/38.16 MHz	-57.59	-57.59	-60.61

$\hat{E}_s / N_{oc}$	1~6	dB	0	0	-Infinity	3
Note 1:	The resources for uplink transmission are assigned to the UE prior to the start of time period T2.					
Note 2:	Interference from other cells and noise sources not specified in the test is assumed to be constant over subcarriers and time and shall be modelled as AWGN of appropriate power for $N_{oc}$ to be fulfilled.					
Note 3:	SS-RSRP and Io levels have been derived from other parameters for information purposes. They are not settable parameters themselves.					

#### A.4.6.4.1.3 Test Requirements

The UE shall send L1-RSRP report every 80 slots. No later than 640ms plus 80 slots from the beginning of time period T2, UE shall send L1-RSRP report including results of both SSB0 and SSB1 while meeting the absolute accuracy requirement in clause 10.1.19.1.1 and relative accuracy requirement in clause 10.1.19.1.2. The rate of correct events observed during repeated tests shall be at least 90%.

NOTE: The actual overall delays measured in the test may be up to  $2xTTI_{DCC}$  higher than the measurement reporting delays above because of TTI insertion uncertainty of the measurement report in DCC.

#### A.4.6.4.2 SSB based L1-RSRP measurement when DRX is used

##### A.4.6.4.2.1 Test Purpose and Environment

The purpose of this test is to verify that the UE makes correct reporting of L1-RSRP measurement. This test will partly verify the L1-RSRP measurement requirements in clause 9.5.4.1, with the testing configurations for NR cells in Table A.4.6.4.2.1-1.

**Table A.4.6.4.2.1-1: Applicable NR configurations for FR1 SSB based L1-RSRP test**

Config	Description
1	LTE FDD, NR 15 kHz SSB SCS, 10 MHz bandwidth, FDD duplex mode
2	LTE FDD, NR 15 kHz SSB SCS, 10 MHz bandwidth, TDD duplex mode
3	LTE FDD, NR 30 kHz SSB SCS, 40 MHz bandwidth, TDD duplex mode
4	LTE TDD, NR 15 kHz SSB SCS, 10 MHz bandwidth, FDD duplex mode
5	LTE TDD, NR 15 kHz SSB SCS, 10 MHz bandwidth, TDD duplex mode
6	LTE TDD, NR 30 kHz SSB SCS, 40 MHz bandwidth, TDD duplex mode

Note: The UE is only required to be tested in one of the supported test configurations

##### A.4.6.4.2.2 Test parameters

There are two cells in the test, E-UTRAN PCell (Cell 1) and FR1 PCell (Cell 2). The test parameters and applicability for Cell 1 are defined in A.3.7.2. The test parameters for the Cell 2 are given in Table A.4.6.4.2.2-1 and Table A.4.6.4.2.2-2 below.

In CSI measurement configuration, UE is indicated to perform L1-RSRP measurement on the SSBs and report periodically. The test consists of two successive time periods, with time duration of T1 and T2 respectively. The test has higher layer parameter *timeRestrictionForChannelMeasurements* configured.

There is no measurement gap configured in the test. Before the test, UE is configured to perform RLM, BFD and L1-RSRP measurement based on the SSBs.

**Table A.4.6.4.2.2-1: General test parameters**

Parameter	Config	Unit	Value
SSB GSCN	1~6		freq1
Duplex mode	1,4		FDD
	2,5		TDD
	3,6		TDD
TDD Configuration	1,4		N/A
	2,5		TDDConf.1.1
	3,6		TDDConf.2.1

BW <sub>channel</sub>	1,4	MHz	10: N <sub>RB,c</sub> = 52
	2,5		10: N <sub>RB,c</sub> = 52
	3,6		40: N <sub>RB,c</sub> = 106
PDSCH Reference measurement channel	1,4		SR.1.1 FDD
	2,5		SR.1.1 TDD
	3,6		SR.2.1 TDD
RMSI CORESET Reference Channel	1,4		CR.1.1 FDD
	2,5		CR.1.1 TDD
	3,6		CR.2.1 TDD
Dedicated CORESET Reference Channel	1,4		CCR.1.1 FDD
	2,5		CCR.1.1 TDD
	3,6		CCR.2.1 TDD
SSB configuration	1,4		SSB.3 FR1
	2,5		SSB.3 FR1
	3,6		SSB.4 FR1
OCNG Patterns	1~6		OP.1
Initial BWP Configuration	1~6		DLBWP.0.1 ULBWP.0.1
Dedicated BWP configuration	1~6		DLBWP.1.1 ULBWP.1.1
SMTTC configuration	1~6		SMTTC.1
TRS Configuration	1,4		TRS.1.1 FDD
	2,5		TRS.1.1 TDD
	3,6		TRS.1.2 TDD
DRX configuration	1~6		DRX.3
reportConfigType	1~6		periodic
reportQuantity	1~6		ssb-index-RSRP
Number of reported RS	1~6		2
L1-RSRP reporting period	1~6	slot	80
T1	1~6	s	5
T2	1~6	s	1
EPRE ratio of PSS to SSS	1~6	dB	0
EPRE ratio of PBCH DMRS to SSS			
EPRE ratio of PBCH to PBCH DMRS			
EPRE ratio of PDCCH DMRS to SSS			
EPRE ratio of PDCCH to PDCCH DMRS			
EPRE ratio of PDSCH DMRS to SSS			
EPRE ratio of PDSCH to PDSCH DMRS			
EPRE ratio of OCNG DMRS to SSS <sup>Note 1</sup>			
EPRE ratio of OCNG to OCNG DMRS <sup>Note 1</sup>			
Propagation condition	1~6		AWGN
Note 1: OCNG shall be used such that both cells are fully allocated and a constant total transmitted power spectral density is achieved for all OFDM symbols.			

**Table A.4.6.4.2.2-2: SSB specific test parameters**

Parameter	Config	Unit	SSB#0		SSB#1	
			T1	T2	T1	T2
$N_{oc}$ <sup>Note2</sup>	1~6	dBm/15kHz	-94.65			
$N_{oc}$ <sup>Note2</sup>	1,2,4,5	dBm/SSB SCS	-94.65			
	3,6		-91.65			
$\hat{E}_s/I_{ot}$	1~6	dB	0	0	-Infinity	3
SSB RSRP <sup>Note3</sup>	1,2,4,5	dBm/SSB SCS	-94.65	-94.65	-Infinity	-91.65

	3,6		-91.65	-91.65	-Infinity	-88.65
$I_0$ <sup>Note3</sup>	1,2,4,5	dBm/9.36 MHz	-63.69	-63.69	-66.70	-61.93
	3,6	dBm/38.16 MHz	-57.59	-57.59	-60.61	-55.84
$\hat{E}_s / N_{oc}$	1~6	dB	0	0	-Infinity	3
<p>Note 1: The resources for uplink transmission are assigned to the UE prior to the start of time period T2.</p> <p>Note 2: Interference from other cells and noise sources not specified in the test is assumed to be constant over subcarriers and time and shall be modelled as AWGN of appropriate power for <math>N_{oc}</math> to be fulfilled.</p> <p>Note 3: SS-RSRP and <math>I_0</math> levels have been derived from other parameters for information purposes. They are not settable parameters themselves.</p>						

#### A.4.6.4.2.3 Test Requirements

The UE shall send L1-RSRP report every 80 slots. No later than 640ms plus 80 slots from the beginning of time period T2, UE shall send L1-RSRP report including results of both SSB0 and SSB1 while meeting absolute accuracy requirement in clause 10.1.19.1.1 and relative accuracy requirement in clause 10.1.19.1.2. The rate of correct events observed during repeated tests shall be at least 90%.

NOTE: The actual overall delays measured in the test may be up to  $2 \times TTI_{DCCH}$  higher than the measurement reporting delays above because of TTI insertion uncertainty of the measurement report in DCCH.

#### A.4.6.4.3 CSI-RS based L1-RSRP measurement when DRX is not used

##### A.4.6.4.3.1 Test Purpose and Environment

The purpose of this test is to verify that the UE makes correct reporting of L1-RSRP measurement. This test will partly verify the L1-RSRP measurement requirements in clause 9.5.4.2, with the testing configurations for NR cells in Table A.4.6.4.3.1-1.

**Table A.4.6.4.3.1-1: Applicable NR configurations for FR1 CSI-RS based L1-RSRP test**

Config	Description
1	LTE FDD, NR 15 kHz SSB SCS, 10 MHz bandwidth, FDD duplex mode
2	LTE FDD, NR 15 kHz SSB SCS, 10 MHz bandwidth, TDD duplex mode
3	LTE FDD, NR 30 kHz SSB SCS, 40 MHz bandwidth, TDD duplex mode
4	LTE TDD, NR 15 kHz SSB SCS, 10 MHz bandwidth, FDD duplex mode
5	LTE TDD, NR 15 kHz SSB SCS, 10 MHz bandwidth, TDD duplex mode
6	LTE TDD, NR 30 kHz SSB SCS, 40 MHz bandwidth, TDD duplex mode

Note: The UE is only required to be tested in one of the supported test configurations

##### A.4.6.4.3.2 Test parameters

There are two cells in the test, E-UTRAN PCell (Cell 1) and FR1 PSCell (Cell 2). The test parameters and applicability for Cell 1 are defined in A.3.7.2. The test parameters for the Cell 2 are given in Table A.4.6.4.3.2-1 and Table A.4.6.4.3.2-2 below.

In CSI measurement configuration, UE is indicated to perform L1-RSRP measurement on the CSI-RS and report aperiodically. The test consists of a single time period T1, during which the UE is triggered via DCI to report L1-RSRP on aperiodic CSI-RS resources. UE is also configured to measure L1-RSRP based on SSB. After 80ms from the beginning of the test, the DCI trigger comes in slot  $n$  (0 for Config 1,2,4,5 and 8 for Config 3,6) of a frame and UE provides the report back based on the reporting configuration as defined in Table A.4.6.4.3.2-1.

There is no measurement gap configured in the test. Before the test, UE is configured to perform RLM and BFD based on the SSBs.

Table A.4.6.4.3.2-1: General test parameters

Parameter	Config	Unit	Value
SSB GSCN	1~6		freq1
Duplex mode	1,4		FDD
	2,5		TDD
	3,6		TDD
TDD Configuration	1,4		N/A
	2,5		TDDConf.1.1
	3,6		TDDConf.2.1
BW <sub>channel</sub>	1,4	MHz	10: N <sub>RB,c</sub> = 52
	2,5		10: N <sub>RB,c</sub> = 52
	3,6		40: N <sub>RB,c</sub> = 106
PDSCH Reference measurement channel	1,4		SR.1.1 FDD
	2,5		SR.1.1 TDD
	3,6		SR.2.1 TDD
RMSI CORESET Reference Channel	1,4		CR.1.1 FDD
	2,5		CR.1.1 TDD
	3,6		CR.2.1 TDD
Dedicated CORESET Reference Channel	1,4		CCR.1.1 FDD
	2,5		CCR.1.1 TDD
	3,6		CCR.2.1 TDD
SSB configuration	1,4		SSB.3 FR1
	2,5		SSB.3 FR1
	3,6		SSB.4 FR1
CSI-RS configuration	1,4		CSI-RS 1.3 FDD
	2,5		CSI-RS 1.3 TDD
	3,6		CSI-RS 2.3 TDD
OCNG Patterns	1~6		OP.1
TRS Configuration	1,4		TRS.1.1 FDD
	2,5		TRS.1.1 TDD
	3,6		TRS.1.2 TDD
Initial BWP Configuration	1~6		DLBWP.0.1 ULBWP.0.1
Dedicated BWP configuration	1~6		DLBWP.1.1 ULBWP.1.1
SMTc configuration	1~6		SMTc.1
DRX configuration	1~6		Off
reportConfigType	1~6		aperiodic
reportQuantity	1~6		cri-RSRP
Number of reported RS	1~6		2
qcl-Info	1~6		SSB#0 for resource#0
			SSB#1 for resource#1
reportSlotOffsetList	1~6	slots	8
T1	1~6	s	5
EPRE ratio of PSS to SSS	1~6	dB	0
EPRE ratio of PBCH DMRS to SSS			
EPRE ratio of PBCH to PBCH DMRS			
EPRE ratio of PDCCH DMRS to SSS			
EPRE ratio of PDCCH to PDCCH DMRS			
EPRE ratio of PDSCH DMRS to SSS			
EPRE ratio of PDSCH to PDSCH DMRS			
EPRE ratio of OCNG DMRS to SSS <sup>Note 1</sup>			
EPRE ratio of OCNG to OCNG DMRS <sup>Note 1</sup>			
Propagation condition	1~6		AWGN
Note 1: OCNG shall be used such that both cells are fully allocated and a constant total transmitted power spectral density is achieved for all OFDM symbols.			



Table A.4.6.4.3.2-2: CSI-RS specific test parameters

Parameter	Config	Unit	CSI-RS#0	CSI-RS#1
$N_{oc}$ <sup>Note1</sup>	1~6	dBm/15kHz	-94.65	
$N_{oc}$ <sup>Note1</sup>	1,2,4,5	dBm/SSB SCS	-94.65	
	3,6		-91.65	
$\hat{E}_s / I_{ot}$	1~6	dB	0	3
CSI-RS RSRP <sup>Note2</sup>	1,2,4,5	dBm/SSB SCS	-94.65	-91.65
	3,6		-91.65	-88.65
$I_o$ <sup>Note2</sup>	1,2,4,5	dBm/9.36 MHz	-63.69	-61.93
	3,6	dBm/38.16 MHz	-57.59	-55.84
$\hat{E}_s / N_{oc}$	1~6	dB	0	3
<p>Note 2: Interference from other cells and noise sources not specified in the test is assumed to be constant over subcarriers and time and shall be modelled as AWGN of appropriate power for <math>N_{oc}</math> to be fulfilled.</p> <p>Note 3: CSI-RS RSRP and <math>I_o</math> levels have been derived from other parameters for information purposes. They are not settable parameters themselves.</p>				

#### A.4.6.4.3.3 Test Requirements

After 80ms from the beginning of the test, the UE shall send L1-RSRP report at slot 8 from the reception of DCI triggering the L1-RSRP measurement. The L1-RSRP report shall include the results for both CSI-RS#0 and CSI-RS#1 while meeting the absolute accuracy requirement in clause 10.1.20.1.1 and relative accuracy requirement in clause 10.1.20.1.2.

The rate of correct events observed during repeated tests shall be at least 90%.

NOTE: The actual overall delays measured in the test may be up to  $2 \times TTI_{DCCH}$  higher than the measurement reporting delays above because of TTI insertion uncertainty of the measurement report in DCCH.

#### A.4.6.4.4 CSI-RS based L1-RSRP measurement when DRX is used

##### A.4.6.4.4.1 Test Purpose and Environment

The purpose of this test is to verify that the UE makes correct reporting of L1-RSRP measurement. This test will partly verify the L1-RSRP measurement requirements in clause 9.5.4.2, with the testing configurations for NR cells in Table A.4.6.4.4.1-1.

Table A.4.6.4.4.1-1: Applicable NR configurations for FR1 CSI-RS based L1-RSRP test

Config	Description
1	LTE FDD, NR 15 kHz SSB SCS, 10 MHz bandwidth, FDD duplex mode
2	LTE FDD, NR 15 kHz SSB SCS, 10 MHz bandwidth, TDD duplex mode
3	LTE FDD, NR 30 kHz SSB SCS, 40 MHz bandwidth, TDD duplex mode
4	LTE TDD, NR 15 kHz SSB SCS, 10 MHz bandwidth, FDD duplex mode
5	LTE TDD, NR 15 kHz SSB SCS, 10 MHz bandwidth, TDD duplex mode
6	LTE TDD, NR 30 kHz SSB SCS, 40 MHz bandwidth, TDD duplex mode
Note: The UE is only required to be tested in one of the supported test configurations	

##### A.4.6.4.4.2 Test parameters

There are two cells in the test, E-UTRAN PCell (Cell 1) and FR1 PSCell (Cell 2). The test parameters and applicability for Cell 1 are defined in A.3.7.2. The test parameters for the Cell 2 are given in Table A.4.6.4.4.2-1 and Table A.4.6.4.4.2-2 below.

In CSI measurement configuration, UE is indicated to perform L1-RSRP measurement on the CSI-RS and report aperiodically. The test consists of a single time period T1, during which the UE is triggered via DCI to report L1-RSRP on aperiodic CSI-RS resources. UE is also configured to measure L1-RSRP based on SSB. After 80ms from the beginning of the test, the DCI trigger comes in slot n (0 for Config 1,2,4,5 and 8 for Config 3,6) of a frame and UE provides the report back based on the reporting configuration as defined in Table A.4.6.4.4.2-1.

There is no measurement gap configured in the test. Before the test, UE is configured to perform RLM and BFD based on the SSBs.

**Table A.4.6.4.4.2-1: General test parameters**

Parameter	Config	Unit	Value
SSB GSCN	1-6		freq1
Duplex mode	1,4		FDD
	2,5		TDD
	3,6		TDD
			TDD
TDD Configuration	1,4		N/A
	2,5		TDDConf.1.1
	3,6		TDDConf.2.1
BW <sub>channel</sub>	1,4	MHz	10: N <sub>RB,c</sub> = 52
	2,5		10: N <sub>RB,c</sub> = 52
	3,6		40: N <sub>RB,c</sub> = 106
PDSCH Reference measurement channel	1,4		SR.1.1 FDD
	2,5		SR.1.1 TDD
	3,6		SR.2.1 TDD
RMSI CORESET Reference Channel	1,4		CR.1.1 FDD
	2,5		CR.1.1 TDD
	3,6		CR.2.1 TDD
Dedicated CORESET Reference Channel	1,4		CCR.1.1 FDD
	2,5		CCR.1.1 TDD
	3,6		CCR.2.1 TDD
SSB configuration	1,4		SSB.3 FR1
	2,5		SSB.3 FR1
	3,6		SSB.4 FR1
CSI-RS configuration	1,4		CSI-RS 1.3 FDD
	2,5		CSI-RS 1.3 TDD
	3,6		CSI-RS 2.3 TDD
OCNG Patterns	1-6		OP.1
TRS Configuration	1,4		TRS.1.1 FDD
	2,5		TRS.1.1 TDD
	3,6		TRS.1.2 TDD
Initial BWP Configuration	1-6		DLBWP.0.1 ULBWP.0.1
Dedicated BWP configuration	1-6		DLBWP.1.1 ULBWP.1.1
SMTC configuration	1-6		SMTC.1
DRX configuration	1-6		DRX.3
reportConfigType	1-6		aperiodic
reportQuantity	1-6		cri-RSRP
Number of reported RS	1-6		2
qcl-Info	1-6		SSB#0 for resource#0
			SSB#1 for resource#1
reportSlotOffsetList	1-6	slots	8
T1	1-6	s	5
EPRE ratio of PSS to SSS	1-6	dB	0
EPRE ratio of PBCH DMRS to SSS			
EPRE ratio of PBCH to PBCH DMRS			
EPRE ratio of PDCCH DMRS to SSS			
EPRE ratio of PDCCH to PDCCH DMRS			
EPRE ratio of PDSCH DMRS to SSS			
EPRE ratio of PDSCH to PDSCH DMRS			
EPRE ratio of OCNG DMRS to SSS <sup>Note 1</sup>			
EPRE ratio of OCNG to OCNG DMRS			
Note 1			
Propagation condition	1-6		AWGN

Note 1: OCNB shall be used such that both cells are fully allocated and a constant total transmitted power spectral density is achieved for all OFDM symbols.

**Table A.4.6.4.4.2-2: CSI-RS specific test parameters**

Parameter	Config	Unit	CSI-RS#0	CSI-RS#1
$N_{oc}$ <sup>Note1</sup>	1~6	dBm/15kHz	-94.65	
$N_{oc}$ <sup>Note1</sup>	1,2,4,5	dBm/SSB SCS	-94.65	
	3,6		-91.65	
$\hat{E}_s / I_{ot}$	1~6	dB	0	3
CSI-RS RSRP <sup>Note2</sup>	1,2,4,5	dBm/SSB SCS	-94.65	-91.65
	3,6		-91.65	-88.65
$I_o$ <sup>Note2</sup>	1,2,4,5	dBm/9.36 MHz	-63.69	-61.93
	3,6	dBm/38.16 MHz	-57.59	-55.84
$\hat{E}_s / N_{oc}$	1~6	dB	0	3
<p>Note 2: Interference from other cells and noise sources not specified in the test is assumed to be constant over subcarriers and time and shall be modelled as AWGN of appropriate power for <math>N_{oc}</math> to be fulfilled.</p> <p>Note 3: CSI-RS RSRP and <math>I_o</math> levels have been derived from other parameters for information purposes. They are not settable parameters themselves.</p>				

#### A.4.6.4.4.3 Test Requirements

After 80ms from the beginning of the test, the UE shall send L1-RSRP report at slot 8 from the reception of DCI triggering the L1-RSRP measurement. The L1-RSRP report shall include the results for both CSI-RS#0 and CSI-RS#1 while meeting absolute accuracy requirement in clause 10.1.20.1.1 and relative accuracy requirement in clause 10.1.20.1.2.

The rate of correct events observed during repeated tests shall be at least 90%.

NOTE: The actual overall delays measured in the test may be up to  $2 \times TTI_{DCCH}$  higher than the measurement reporting delays above because of TTI insertion uncertainty of the measurement report in DCCH.

#### A.4.6.4.5 SSB based L1-RSRP measurement when DRX is used for UE configured with *highSpeedMeasFlag-r16*

##### A.4.6.4.5.1 Test Purpose and Environment

The purpose of this test is to verify that the UE makes correct reporting of L1-RSRP measurement when UE is configured with *highSpeedMeasFlag-r16*. This test will partly verify the L1-RSRP measurement requirements for UE configured with *highSpeedMeasFlag-r16* in clause 9.5.4.1, with the testing configurations for NR cells in Table A.4.6.4.5.1-1.

**Table A.4.6.4.5.1-1: Applicable NR configurations for FR1 SSB based L1-RSRP test**

Config	Description
1	LTE FDD, NR 15 kHz SSB SCS, 10 MHz bandwidth, FDD duplex mode
2	LTE FDD, NR 15 kHz SSB SCS, 10 MHz bandwidth, TDD duplex mode
3	LTE FDD, NR 30 kHz SSB SCS, 40 MHz bandwidth, TDD duplex mode
4	LTE TDD, NR 15 kHz SSB SCS, 10 MHz bandwidth, FDD duplex mode
5	LTE TDD, NR 15 kHz SSB SCS, 10 MHz bandwidth, TDD duplex mode
6	LTE TDD, NR 30 kHz SSB SCS, 40 MHz bandwidth, TDD duplex mode

Note: The UE is only required to be tested in one of the supported test configurations

#### A.4.6.4.5.2 Test parameters

There are two cells in the test, E-UTRAN PCell (Cell 1) and FR1 PSCell (Cell 2). The test parameters and applicability for Cell 1 are defined in A.3.7.2. The test parameters for the Cell 2 are given in Table A.4.6.4.5.2-1 and Table A.4.6.4.5.2-2 below.

In CSI measurement configuration, UE is indicated to perform L1-RSRP measurement on the SSBs and report periodically. The test consists of two successive time periods, with time duration of T1 and T2 respectively. The test has higher layer parameter *timeRestrictionForChannelMeasurements* configured.

There is no measurement gap configured in the test. Before the test, UE is configured to perform RLM, BFD and L1-RSRP measurement based on the SSBs.

**Table A.4.6.4.5.2-1: General test parameters for UE configured with *highSpeedMeasFlag-r16***

Parameter	Config	Unit	Value
SSB GSCN	1~6		freq1
Duplex mode	1,4		FDD
	2,5		TDD
	3,6		TDD
TDD Configuration	1,4		N/A
	2,5		TDDConf.1.1
	3,6		TDDConf.2.1
BW <sub>channel</sub>	1,4	MHz	10: N <sub>RB,c</sub> = 52
	2,5		10: N <sub>RB,c</sub> = 52
	3,6		40: N <sub>RB,c</sub> = 106
PDSCH Reference measurement channel	1,4		SR.1.1 FDD
	2,5		SR.1.1 TDD
	3,6		SR.2.1 TDD
RMSI CORESET Reference Channel	1,4		CR.1.1 FDD
	2,5		CR.1.1 TDD
	3,6		CR.2.1 TDD
Dedicated CORESET Reference Channel	1,4		CCR.1.1 FDD
	2,5		CCR.1.1 TDD
	3,6		CCR.2.1 TDD
SSB configuration	1,4		SSB.3 FR1
	2,5		SSB.3 FR1
	3,6		SSB.4 FR1
OCNG Patterns	1~6		OP.1
Initial BWP Configuration	1~6		DLBWP.0.1 ULBWP.0.1
Dedicated BWP configuration	1~6		DLBWP.1.1 ULBWP.1.1
SMTC configuration	1~6		SMTC.1
TRS Configuration	1,4		TRS.1.1 FDD
	2,5		TRS.1.1 TDD
	3,6		TRS.1.2 TDD
DRX configuration	1~6		DRX.3
reportConfigType	1~6		periodic
reportQuantity	1~6		ssb-Index-RSRP
Number of reported RS	1~6		2
L1-RSRP reporting period	1~6	slot	80
T1	1~6	s	5
T2	1~6	s	2
EPRE ratio of PSS to SSS	1~6	dB	0
EPRE ratio of PBCH DMRS to SSS			
EPRE ratio of PBCH to PBCH DMRS			
EPRE ratio of PDCCH DMRS to SSS			

EPRE ratio of PDCCH to PDCCH DMRS			
EPRE ratio of PDSCH DMRS to SSS			
EPRE ratio of PDSCH to PDSCH DMRS			
EPRE ratio of OCNG DMRS to SSS <sup>Note 1</sup>			
EPRE ratio of OCNG to OCNG DMRS <sup>Note 1</sup>			
Note 1: OCNG shall be used such that both cells are fully allocated and a constant total transmitted power spectral density is achieved for all OFDM symbols.			

**Table A.4.6.4.5.2-2: SSB specific test parameters for UE configured with *highSpeedMeasFlag-r16***

Parameter	Config	Unit	SSB#0		SSB#1	
			T1	T2	T1	T2
$N_{oc}$ <sup>Note2</sup>	1~6	dBm/15kHz	-94.65			
$N_{oc}$ <sup>Note2</sup>	1,2,4,5	dBm/SSB SCS	-94.65			
	3,6		-91.65			
$\hat{E}_s / I_{ot}$	1~6	dB	0	0	-Infinity	3
SSB RSRP <sup>Note3</sup>	1,2,4,5	dBm/SSB SCS	-94.65	-94.65	-Infinity	-91.65
	3,6		-91.65	-91.65	-Infinity	-88.65
$I_o$ <sup>Note3</sup>	1,2,4,5	dBm/9.36 MHz	-63.69	-63.69	-66.70	-61.93
	3,6	dBm/38.16 MHz	-57.59	-57.59	-60.61	-55.84
$\hat{E}_s / N_{oc}$	1~6	dB	0	0	-Infinity	3
Propagation condition	1,2,4,5		AWGN		AWGN 1944Hz	
	3,6		AWGN		AWGN 3334Hz	
Note 1: The resources for uplink transmission are assigned to the UE prior to the start of time period T2.						
Note 2: Interference from other cells and noise sources not specified in the test is assumed to be constant over subcarriers and time and shall be modelled as AWGN of appropriate power for $N_{oc}$ to be fulfilled.						
Note 3: SS-RSRP and $I_o$ levels have been derived from other parameters for information purposes. They are not settable parameters themselves.						

**A.4.6.4.5.3 Test Requirements**

The UE shall send L1-RSRP report every 80 slots. No later than 640ms plus 80 slots from the beginning of time period T2, UE shall send L1-RSRP report including results of both SSB0 and SSB1 while meeting absolute accuracy requirement in clause 10.1.19.1.1 and relative accuracy requirement in clause 10.1.19.1.2. The rate of correct events observed during repeated tests shall be at least 90%.

NOTE: The actual overall delays measured in the test may be up to  $2 \times TTI_{DCCH}$  higher than the measurement reporting delays above because of TTI insertion uncertainty of the measurement report in DCCH.

**A.4.6.5 CLI measurements**

**A.4.6.5.1 SRS-RSRP measurement with non-DRX**

**A.4.6.5.1.1 Test Purpose and Environment**

The purpose of this test is to verify that the UE makes correct reporting of SRS-RSRP measurement. This test will verify the SRS-RSRP measurement requirements in clause 9.7.2.5 with the testing configurations for NR cells in Table A.4.6.5.1.1-1.

**Table A.4.6.5.1.1-1: Applicable NR configurations for FR1 SRS-RSRP test**

Configuration	Description
---------------	-------------

1	NR 15 kHz SRS SCS, 10 MHz bandwidth, TDD duplex mode
2	NR 30 kHz SRS SCS, 40 MHz bandwidth, TDD duplex mode
Note:	The UE is only required to be tested in one of the supported test configurations

#### A.4.6.5.1.2 Test Parameters

Two cells are deployed in the test, which are E-UTRAN PCell (Cell 1) and FR1 PCell (Cell 2). The test parameters for PCell is given in Table A.4.6.5.1.2-1 and A.4.6.5.1.2-2 below and applicability for the E-UTRAN cell are defined in A.3.7.2. In the measurement control information, a measurement object is configured for the frequency of the PCell, and it is indicated to the UE that event-triggered reporting with Event I1 is used. The test consists of two successive time periods, with time duration of T1 and T2, respectively.

During the test, the test system transmits SRS resource for measurement in the DL slot according to the SRS configuration in Table A.4.6.5.1.2-4 and the test parameters for the (virtual) neighbour cell UE in Table A.4.6.5.1.2-3. During the test, the test system does not transmit PDCCH/PDSCH/OCNG on SRS symbol to be transmitted and on 1 data symbol before SRS to be transmitted.

**Table A.4.6.5.1.2-1: General test parameters for SRS-RSRP event triggered reporting for PCell in FR1**

Parameter	Unit	Test configuration	Value	Comment
Active cell		1, 2	E-UTRAN Cell 1 and NR Cell 2	
RF Channel Number		1, 2	1: Cell 1 2: Cell 2	
SSB configuration		1	SSB.1 FR1	
		2	SSB.2 FR1	
SMTC configuration		1	SMTC.1	
		2	SMTC.1	
SRS configuration		1	SRSCConf.1	Table A.4.6.5.1.2-3
		2	SRSCConf.2	
CP length		1, 2	Normal	
i1-Threshold	dBm	1	-97	
		2	-95	
Hysteresis	dB	1, 2	0	
Time To Trigger	s	1, 2	0	
Filter coefficient		1, 2	0	L3 filtering is not used
DRX		1, 2	OFF	Non-DRX
Time offset between DL from serving cell and SRS from test system	µs	1,2	17.67	
T1	s	1, 2	5	
T2	s	1, 2	1	

**Table A.4.6.5.1.2-2: NR Cell specific test parameters for SRS-RSRP event triggered reporting for PCell in FR1**

Parameter	Unit	Test configuration	Cell 2	
			T1	T2
TDD configuration		1	TDDConf.1.1	
		2	TDDConf.2.1	
PDSCH RMC configuration		1	SR.1.1 TDD	
		2	SR.2.1 TDD	
RMSI CORESET RMC configuration		1	CR.1.1 TDD	
		2	CR.2.1 TDD	
Dedicated CORESET RMC configuration		1	CCR.1.1 TDD	
		2	CCR.2.1 TDD	
OCNG Patterns		1, 2	OP.1	
TRS Configuration		1	TRS.1.1 TDD	
		2	TRS.1.2 TDD	
Initial BWP configuration		1, 2	DLBWP.0.1 ULBWP.0.1	
Active DL BWP configuration		1, 2	DLBWP.1.1	

Active UL BWP configuration		1, 2	ULBWP.1.1
$N_{oc}$ Note 2	dBm/15 kHz	1	-98
		2	
$N_{oc}$ Note 2	dBm/SCS	1	-98
		2	-95
Propagation Condition		1, 2	AWGN
<p>Note 1: The resources for uplink transmission are assigned to the UE prior to the start of time period T2.</p> <p>Note 2: Interference from other cells and noise sources not specified in the test is assumed to be constant over subcarriers and time and shall be modelled as AWGN of appropriate power for <math>N_{oc}</math> to be fulfilled.</p>			

**Table A.4.6.5.1.2-3: NR Cell specific test parameters for SRS-RSRP event triggered reporting for neighbour cell UE**

Parameter	Unit	Test configuration	Neighbour cell UE	
			T1	T2
$N_{oc}$ Note 2	dBm/15 kHz	1	-98	
		2		
$N_{oc}$ Note 2	dBm/SCS	1	-98	
		2	-95	
$\hat{E}_s / I_{ot}$	dB	1	-infinity	4
		2		
$\hat{E}_s / N_{oc}$	dB	1	-infinity	4
		2		
SRS-RSRP Note 3	dBm/SCS kHz	1	-infinity	-94
		2	-infinity	-91
Io	dBm/9.36 MHz	1	-70.05	-64.59
	dBm/38.16 MHz	2	-63.96	-58.50
Propagation Condition		1, 2	AWGN	
<p>Note 1: The resources for uplink transmission are assigned to the UE prior to the start of time period T2.</p> <p>Note 2: Interference from other cells and noise sources not specified in the test is assumed to be constant over subcarriers and time and shall be modelled as AWGN of appropriate power for <math>N_{oc}</math> to be fulfilled.</p> <p>Note 3: SRS-RSRP levels have been derived from other parameters for information purposes. They are not settable parameters themselves.</p>				

**Table A.4.6.5.1.2-4: SRS configuration for measurement reporting**

	Field	SRSCnf.1	SRSCnf.2	Comments
SRS-ResourceSet	srs-ResourceSetId	0	0	
	srs-ResourceIdList	0	0	
	resourceType	Periodic	Periodic	
	Usage	Codebook	Codebook	
SRS-Resource	SRS-ResourceId	0	0	
	nrofSRS-Ports	Port1	Port1	
	transmissionComb	n2	n2	
	combOffset-n2	0	0	
	cyclicShift-n2	0	0	
	resourceMapping startPosition	0	0	
	resourceMapping nrofSymbols	n1	n1	
resourceMapping repetitionFactor	n1	n1		

freqDomainPosition	0	0	
freqDomainShift	0	0	
freqHopping c-SRS	12	12	
freqHopping b-SRS	0	0	
freqHopping b-hop	0	0	
groupOrSequenceHopping	Neither	Neither	
resourceType	Periodic	Periodic	
periodicityAndOffset	sl20, 9	sl40, 19	
sequenceId	0	0	Any 10 bit number

### A.4.6.5.1.3 Test Requirements

The UE shall send one Event I1 triggered measurement report, with a measurement reporting delay less than 60 ms from the beginning of time period T2.

The UE shall not send event triggered measurement reports, as long as the reporting criteria are not fulfilled.

The rate of correct events observed during repeated tests shall be at least 90%.

NOTE: The actual overall delays measured in the test may be up to  $2 \times TTI_{DCC}$  higher than the measurement reporting delays above because of TTI insertion uncertainty of the measurement report in DCC.

### A.4.6.5.2 CLI-RSSI measurement with non-DRX

#### A.4.6.5.2.1 Test Purpose and Environment

The purpose of this test is to verify that the UE makes correct reporting of CLI-RSSI measurement. This test will verify the CLI-RSSI measurement requirements in clause 9.7.3.5 with the testing configurations for NR cells in Table A.4.6.5.2.1-1.

**Table A.4.6.5.2.1-1: Applicable NR configurations for FR1 CLI-RSSI test**

Configuration	Description
1	NR 15 kHz SCS, 10 MHz bandwidth, TDD duplex mode
2	NR 30 kHz SCS, 40 MHz bandwidth, TDD duplex mode
Note:	The UE is only required to be tested in one of the supported test configurations

#### A.4.6.5.2.2 Test Parameters

Two cells are deployed in the test, which are E-UTRAN PCell (Cell 1) and FR1 PCell (Cell 2). The test parameters for PCell is given in Table A.4.6.5.2.2-1 and A.4.6.5.2.2-2 below and applicability for the E-UTRAN cell are defined in A.3.7.2. In the measurement control information, a measurement object is configured for the frequency of the PCell, and it is indicated to the UE that event-triggered reporting with Event I1 is used. The test consists of two successive time periods, with time duration of T1 and T2, respectively.

During the test, the test system does not transmit PDCCH/PDSCH/OCNG on symbols for CLI-RSSI measurement resource and on 1 data symbol before. The CLI-RSSI measurement resource configuration is in Table A.4.6.5.2.2-3.

**Table A.4.6.5.2.2-1: General test parameters for CLI-RSSI event triggered reporting for PCell in FR1**

Parameter	Unit	Test configuration	Value	Comment
Active cell		1, 2	E-UTRAN Cell 1 and NR Cell 2	
RF Channel Number		1, 2	1: Cell 1 2: Cell 2	
SSB configuration		1	SSB.1 FR1	
		2	SSB.2 FR1	



SMTC configuration		1	SMTC.1	
		2	SMTC.1	
CLI-RSSI configuration		1	CLI-RSSICnf.1	Table A.4.6.5.2.2-3
		2	CLI-RSSICnf.2	
CP length		1, 2	Normal	
i1-Threshold	dBm	1	-93	
		2	-93	
Hysteresis	dB	1, 2	0	
Time To Trigger	s	1, 2	0	
Filter coefficient		1, 2	0	L3 filtering is not used
DRX		1, 2	OFF	Non-DRX
Time offset between DL from serving cell and OCNG from test system	$\mu$ s	1,2	17.67	
T1	s	1, 2	5	
T2	s	1, 2	1	

**Table A.4.6.5.2.2-2: NR Cell specific test parameters for CLI-RSSI event triggered reporting for PSCell in FR1**

Parameter	Unit	Test configuration	Cell 2	
			T1	T2
TDD configuration		1	TDDConf.1.1	
		2	TDDConf.2.1	
PDSCH RMC configuration		1	SR.1.1 TDD	
		2	SR.2.1 TDD	
RMSI CORESET RMC configuration		1	CR.1.1 TDD	
		2	CR.2.1 TDD	
Dedicated CORESET RMC configuration		1	CCR.1.1 TDD	
		2	CCR.2.1 TDD	
OCNG Patterns <sup>Note 3</sup>		1, 2	OP.1	
TRS Configuration		1	TRS.1.1 TDD	
		2	TRS.1.2 TDD	
Initial BWP configuration		1, 2	DLBWP.0.1 ULBWP.0.1	
Active DL BWP configuration		1, 2	DLBWP.1.1	
Active UL BWP configuration		1, 2	ULBWP.1.1	
$N_{oc}$ on CLI-RSSI measurement resource <sup>Note 2</sup>	dBm/15 kHz	1	-116	-108
		2		
$N_{oc}$ on CLI-RSSI measurement resource <sup>Note 2</sup>	dBm/SCS	1	-116	-108
		2	-113	-105
Io on CLI-RSSI measurement resource	dBm/9.36 MHz	1	-88.05	-80.05
	dBm/38.16 MHz	2	-81.96	-74.00
Io on CLI-RSSI measurement resource	dBm/1.08 MHz	1	-97.43	-89.43
	dBm/1.08 MHz	2	-97.44	-89.44
Propagation Condition		1, 2	AWGN	
Note 1: The resources for uplink transmission are assigned to the UE prior to the start of time period T2.				
Note 2: Interference from other cells and noise sources not specified in the test is assumed to be constant over subcarriers and time and shall be modelled as AWGN of appropriate power for $N_{oc}$ to be fulfilled.				
Note 3: OCNG is not transmitted in the CLI-RSSI measurement resources.				

**Table A.4.6.5.2.2-3: CLI-RSSI measurement resource configuration for measurement reporting**

	Field	CLI-RSSICnf.1	CLI-RSSICnf.2
RSSI-Resource	rssI-ResourceId	0	0
	rssI-SCS	15	30
	startPRB	0	0
	nrofPRBs	52	106
	startPosition	3	3

nrofSymbols	11	11
rsi-PeriodicityAndOffset	s120, 9	s140, 19

#### A.4.6.5.2.3 Test Requirements

The UE shall send one Event I1 triggered measurement report, with a measurement reporting delay less than 20 ms from the beginning of time period T2. The nominal RSSI used to evaluate the requirement shall be based on  $I_o$ .

The UE shall not send event triggered measurement reports, as long as the reporting criteria are not fulfilled.

The rate of correct events observed during repeated tests shall be at least 90%.

NOTE: The actual overall delays measured in the test may be up to  $2 \times TTI_{DCCH}$  higher than the measurement reporting delays above because of TTI insertion uncertainty of the measurement report in DCCH.

### A.4.6.6 Measurements with autonomous gaps

#### A.4.6.6.1 EN-DC-intra-frequency CGI identification of NR FR1 cell with autonomous gaps in synchronous EN-DC

##### A.4.6.6.1.1 Test Purpose and Environment

The purpose of this test is to verify the requirements for intra-frequency identification of a new CGI of NR FR1 cell with autonomous gaps in clause 9.11 for EN-DC.

The test scenario comprises of one E-UTRA carrier and one NR FR1 carrier. Three cells are deployed in the test, which are E-UTRAN PCell (Cell 1) on E-UTRA RF channel 1, NR FR1 PCell (Cell 2) and NR FR1 neighbour cell (Cell 3) on NR RF channel 1. The supported test configurations are shown in table A.4.6.6.1.1-1 below. The test parameters for NR Cells are given in Table A.4.6.6.1.2-2, A.4.6.6.1.2-3 below. The test parameters and applicability for the E-UTRAN PCell are defined in A.3.7.2.1. The test consists of three successive time periods, with time durations of T1, T2 and T3 respectively. At the start of time duration T1, the UE does not have any timing information of Cell 3. Starting T2, Cell 3 becomes detectable and the UE is expected to detect and send a measurement report.

An RRC message implying SI reading shall be sent to the UE during period T2, after the UE has reported Event A3. The RRC message shall create a measurement report configuration with purpose *reportCGI* which *cellForWhichToReportCGI* set to the physical cell identity of Cell 3. The start of T3 is the instant when the last TTI containing the RRC message implying SI reading of the neighbour cell (Cell 3) using autonomous gap is sent to the UE.

**Table A.4.6.6.1.1-1: intra-frequency CGI identification of NR FR1 cell with autonomous gaps in synchronous EN-DC**

Config	Description
1	LTE FDD, NR 15 kHz SSB SCS, 10 MHz bandwidth, FDD duplex mode
2	LTE FDD, NR 15 kHz SSB SCS, 10 MHz bandwidth, TDD duplex mode
3	LTE FDD, NR 30 kHz SSB SCS, 40 MHz bandwidth, TDD duplex mode
4	LTE TDD, NR 15 kHz SSB SCS, 10 MHz bandwidth, FDD duplex mode
5	LTE TDD, NR 15 kHz SSB SCS, 10 MHz bandwidth, TDD duplex mode
6	LTE TDD, NR 30 kHz SSB SCS, 40 MHz bandwidth, TDD duplex mode

Note 1: The UE is only required to be tested in one of the supported test configurations  
Note 2: target NR Cell 3 has the same SCS, BW and duplex mode as NR serving Cell 2

**Table A.4.6.6.1.1-2: General test parameters for intra-frequency CGI identification of NR FR1 cell with autonomous gaps in synchronous EN-DC**

Parameter	Unit	Test configuration	Value	Comment
E-UTRA RF Channel Number		Config 1,2,3,4,5,6	1	One E-UTRAN radio channel is used.
NR RF Channel Number		Config 1,2,3,4,5,6	1	One NR FR1 radio channel is used.

Active cell		Config 1,2,3,4,5,6	LTE Cell 1 (PCell) and NR Cell 2 (PScell)	LTE Cell 1 is on E-UTRA RF channel number 1. NR Cell 2 is on NR RF channel number 1.
Neighbour cell		Config 1,2,3,4,5,6	NR Cell 3	NR Cell 3 is on NR RF channel number 1.
A3-Offset	dB	Config 1,2,3,4,5,6	-4.5	
Hysteresis	dB	Config 1,2,3,4,5,6	0	
CP length		Config 1,2,3,4,5,6	Normal	
TimeToTrigger	s	Config 1,2,3,4,5,6	0	
Filter coefficient		Config 1,2,3,4,5,6	0	L3 filtering is not used
DRX		Config 1,2,3,4,5,6	OFF	DRX is not used
Time offset between PCell and PScell		Config 1,2,3,4,5,6	3 $\mu$ s	Synchronous EN-DC
Time offset between serving and neighbour cells		Config 1,4	3 ms	Asynchronous cells. The timing of Cell 3 is 3ms later than the timing of Cell 2.
		Config 2,3,5,6	3 $\mu$ s	Synchronous cells.
T1	s	Config 1,2,3,4,5,6	5	
T2	s	Config 1,2,3,4,5,6	$\leq 10$	
T3	s	Config 1,2,3,4,5,6	5	

**Table A.4.6.1.1-3: Cell specific test parameters for intra-frequency CGI identification of NR FR1 cell with autonomous gaps in synchronous EN-DC**

Parameter	Unit	Test configuration	Cell 2		Cell 3	
			T1	T2	T1	T2
Duplex mode		Config 1,4	FDD			
		Config 2,3,5,6	TDD			
BW <sub>channel</sub>	MHz	Config 1,4	10: N <sub>RB,c</sub> = 52			
		Config 2,5	10: N <sub>RB,c</sub> = 52			
		Config 3,6	40: N <sub>RB,c</sub> = 106			
BWP BW	MHz	Config 1,4	10: N <sub>RB,c</sub> = 52			
		Config 2,5	10: N <sub>RB,c</sub> = 52			
		Config 3,6	40: N <sub>RB,c</sub> = 106			
TDD configuration		Config 1,4	N/A		N/A	
		Config 2,5	TDDConf.1.1		TDDConf.1.1	
		Config 3,6	TDDConf.2.1		TDDConf.2.1	
Initial DL BWP		Config 1,2,3,4,5,6	DLBWP.0.1		NA	
Initial UL BWP		Config 1,2,3,4,5,6	ULBWP.0.1		NA	
Dedicated DL BWP		Config 1,2,3,4,5,6	DLBWP.1.1		NA	
Dedicated UL BWP		Config 1,2,3,4,5,6	ULBWP.1.1		NA	
TRS configuration		Config 1,4	TRS.1.1 FDD		NA	
		Config 2,5	TRS.1.1 TDD			
		Config 3,6	TRS.1.2 TDD			
OCNG Patterns defined in A.3.2.1.1 (OP.1)		Config 1,2,3,4,5,6	OP.1		OP.1	
PDSCH Reference measurement channel		Config 1,4	SR.1.1 FDD		NA	
		Config 2,5	SR.1.1 TDD			
		Config 3,6	SR.2.1 TDD			
RMSI CORESET Reference Channel		Config 1,4	CR.1.1 FDD		NA	
		Config 2,5	CR.1.1 TDD			
		Config 3,6	CR.2.1 TDD			
RMC CORESET Reference Channel		Config 1, 4	CCR.1.1 FDD		NA	
		Config 2, 5	CCR.1.1 TDD			

		Config 3, 6	CCR.2.1 TDD		NA	
SSB parameters		Config 1,2,4,5	SSB.1 FR1			
		Config 3,6	SSB.2 FR1			
SMTC configuration defined in A.3.11		Config 1,4	SMTC.2			
		Config 2,3,5,6	SMTC.1			
RMSI scheduling periodicity	ms	Config 1,2,3,4,5,6	20ms			
PDSCH/PDCCH subcarrier spacing	kHz	Config 1,2,4,5	15			
		Config 3,6	30			
RLM-RS		Config 1,2,3,4,5,6	SSB		SSB	
EPRE ratio of PSS to SSS		Config 1,2,3,4,5,6	0	0		
EPRE ratio of PBCH DMRS to SSS						
EPRE ratio of PBCH to PBCH DMRS						
EPRE ratio of PDCCH DMRS to SSS						
EPRE ratio of PDCCH to PDCCH DMRS						
EPRE ratio of PDSCH DMRS to SSS						
EPRE ratio of PDSCH to PDSCH						
EPRE ratio of OCNG DMRS to SSS(Note 1)						
EPRE ratio of OCNG to OCNG DMRS (Note 1)						
$N_{oc}^{Note2}$	dBm/15 kHz					
$N_{oc}^{Note2}$	dBm/S CS	Config 1,2,4,5	-98		-98	
		Config 3,6	-95		-95	
SS-RSRP <sup>Note 3</sup>	dBm/S CS	Config 1,2,4,5	-94	-94	-Infinity	-94
		Config 3,6	-91	-91	-Infinity	-91
$\hat{E}_s / I_{ot}$	dB	Config 1,2,3,4,5,6	4	-1.46	-Infinity	-1.46
$\hat{E}_s / N_{oc}$	dB	Config 1,2,3,4,5,6	4	4	-Infinity	4
$I_o^{Note3}$	dBm/9.36MHz	Config 1,2,4,5	-64.60	-62.25	-64.60	-62.25
	dBm/38.16MHz	Config 3,6	-58.50	-56.16	-58.50	-56.16
Propagation Condition		Config 1,2,3,4,5,6	AWGN			
Note 1:	OCNG shall be used such that both cells are fully allocated and a constant total transmitted power spectral density is achieved for all OFDM symbols.					
Note 2:	Interference from other cells and noise sources not specified in the test is assumed to be constant over subcarriers and time and shall be modelled as AWGN of appropriate power for $N_{oc}$ to be fulfilled.					
Note 3:	SS-RSRP and $I_o$ levels have been derived from other parameters for information purposes. They are not settable parameters themselves.					
Note 4:	SS-RSRP minimum requirements are specified assuming independent interference and noise at each receiver antenna port.					

#### A.4.6.6.1.2 Test Requirements

The UE shall transmit a measurement report containing the cell global identifier of Cell 3 within 260 ms from the start of T3.

Test requirement = RRC Procedure delay +  $T_{identify\_CGL\_NR}$  + TTI insertion uncertainty

$$= 15 + 240 + 2$$

$$= 257 \text{ ms, allow 260 ms.}$$

The UE shall be scheduled continuously throughout the test, and from the start of T3 until 260 ms the number of interrupted slots shall not exceed the allowed number specified in 8.2.1.2.16.

The rate of correct events observed during repeated tests shall be at least 90%.

NOTE: The actual overall delays measured in the test may be up to  $2 \times TTI_{DCCH}$  higher than the measurement reporting delays above because of TTI insertion uncertainty of the measurement report in DCCH.

## A.4.6.7 L1-SINR measurement for beam reporting

### A.4.6.7.1 L1-SINR measurement with CSI-RS based CMR and no dedicated IMR when DRX is not used

#### A.4.6.7.1.1 Test Purpose and Environment

The purpose of this test is to verify that the UE makes correct reporting of L1-SINR measurement based on CSI-RS CMR without dedicated IMR. This test will partly verify the L1-SINR measurement requirements in clause 9.8.4.1, with the testing configurations for NR cells in Table A.4.6.7.1.1-1.

**Table A.4.6.7.1.1-1: Applicable NR configurations for FR1 CSI-RS based L1-SINR test**

Config	Description
1	LTE FDD, NR 15 kHz SSB SCS, 10 MHz bandwidth, FDD duplex mode
2	LTE FDD, NR 15 kHz SSB SCS, 10 MHz bandwidth, TDD duplex mode
3	LTE FDD, NR 30 kHz SSB SCS, 40 MHz bandwidth, TDD duplex mode
4	LTE TDD, NR 15 kHz SSB SCS, 10 MHz bandwidth, FDD duplex mode
5	LTE TDD, NR 15 kHz SSB SCS, 10 MHz bandwidth, TDD duplex mode
6	LTE TDD, NR 30 kHz SSB SCS, 40 MHz bandwidth, TDD duplex mode

Note: The UE is only required to be tested in one of the supported test configurations

#### A.4.6.7.1.2 Test parameters

There are two cells in the test, E-UTRAN PCell (Cell 1) and FR1 PSCell (Cell 2). The test parameters and applicability for Cell 1 are defined in A.3.7.2. The test parameters for the Cell 2 are given in Table A.4.6.7.1.2-1 and Table A.4.6.7.1.2-2 below.

In CSI measurement configuration, UE is indicated to perform L1-SINR measurement on the CSI-RS and report aperiodically. The test consists of a single time period T1, during which the UE is triggered via DCI to report L1-SINR on aperiodic CSI-RS resources. After 80ms from the beginning of the test, the DCI trigger comes in slot n (1 Config 1,2,4,5 and 8 for Config 3,6) of a frame and UE provides the report back based on the reporting configuration as defined in Table A.4.6.7.1.2-1.

There is no measurement gap configured in the test. Before the test, UE is configured to perform RLM and BFD based on the SSBs.

**Table A.4.6.7.1.2-1: General test parameters**

Parameter	Config	Unit	Value
SSB GSCN	1~6		freq1
Duplex mode	1,4		FDD
	2,5		TDD
	3,6		TDD
TDD Configuration	1,4		N/A
	2,5		TDDConf.1.1
	3,6		TDDConf.2.1
BW <sub>channel</sub>	1,4	MHz	10: N <sub>RB,c</sub> = 52
	2,5		10: N <sub>RB,c</sub> = 52
	3,6		40: N <sub>RB,c</sub> = 106
PDSCH Reference measurement channel	1,4		SR.1.1 FDD
	2,5		SR.1.1 TDD
	3,6		SR.2.1 TDD
RMSI CORESET Reference Channel	1,4		CR.1.1 FDD
	2,5		CR.1.1 TDD

	3,6		CR.2.1 TDD
Dedicated CORESET Reference Channel	1,4		CCR.1.1 FDD
	2,5		CCR.1.1 TDD
	3,6		CCR.2.1 TDD
	1,4		SSB.3 FR1
SSB configuration	2,5		SSB.3 FR1
	3,6		SSB.4 FR1
	1,4		CSI-RS.1.3 FDD
CSI-RS configuration	2,5		CSI-RS.1.3 TDD
	3,6		CSI-RS.2.3 TDD
	1~6		OP.1
OCNG Patterns	1~6		OP.1
TRS Configuration	1,4		TRS.1.1 FDD
	2,5		TRS.1.1 TDD
	3,6		TRS.1.2 TDD
Initial BWP Configuration	1~6		DLBWP.0.1 ULBWP.0.1
Dedicated BWP configuration	1~6		DLBWP.1.1 ULBWP.1.1
SMTc configuration	1~6		SMTc.1
DRX configuration	1~6		Off
reportConfigType	1~6		aperiodic
reportQuantity-r16	1~6		cri-SINR-r16
Number of reported RS	1~6		2
qcl-Info	1~6		SSB#0 for resource#0
			SSB#1 for resource#1
reportSlotOffsetList	1~6	slots	26
T1	1~6	s	5
EPRE ratio of PSS to SSS	1~6	dB	0
EPRE ratio of PBCH DMRS to SSS			
EPRE ratio of PBCH to PBCH DMRS			
EPRE ratio of PDCCH DMRS to SSS			
EPRE ratio of PDCCH to PDCCH DMRS			
EPRE ratio of PDSCH DMRS to SSS			
EPRE ratio of PDSCH to PDSCH DMRS			
EPRE ratio of OCNG DMRS to SSS <sup>Note 1</sup>			
EPRE ratio of OCNG to OCNG DMRS <sup>Note 1</sup>			
Propagation condition	1~6		AWGN
Note 1: OCNG shall be used such that both cells are fully allocated and a constant total transmitted power spectral density is achieved for all OFDM symbols.			

Table A.4.6.7.1.2-2: CSI-RS specific test parameters

Parameter	Config	Unit	CSI-RS#0	CSI-RS#1
$N_{oc}$ <sup>Note1</sup>	1~6	dBm/15kHz	-94.65	
$N_{oc}$ <sup>Note1</sup>	1,2,4,5	dBm/SSB SCS	-94.65	
	3,6		-91.65	
$\hat{E}_s / I_{ot}$	1~6	dB	0	3
CSI-RS RSRP <sup>Note3</sup>	1,2,4,5	dBm/SSB SCS	-94.65	-91.65
	3,6		-91.65	-88.65
$I_o$ <sup>Note2</sup>	1,2,4,5	dBm/9.36 MHz	-63.69	-61.93
	3,6	dBm/38.16 MHz	-57.59	-55.84

$\hat{E}_s / N_{oc}$	1~6	dB	0	3
Note 2:	Interference from other cells and noise sources not specified in the test is assumed to be constant over subcarriers and time and shall be modelled as AWGN of appropriate power for $N_{oc}$ to be fulfilled.			
Note 3:	CSI-RS RSRP and $I_0$ levels have been derived from other parameters for information purposes. They are not settable parameters themselves.			

#### A.4.6.7.1.3 Test Requirements

After 80ms from the beginning of the test, the UE shall send L1-SINR report at slot 26 from the reception of DCI triggering the L1-SINR measurement. The L1-SINR report shall include the results for both CSI-RS#0 and CSI-RS#1 while meeting the absolute accuracy requirement in clause 10.1.27.1.1 and relative accuracy requirement in clause 10.1.27.1.2.

The rate of correct events observed during repeated tests shall be at least 90%.

NOTE: The actual overall delays measured in the test may be up to  $2 \times TTI_{DCCH}$  higher than the measurement reporting delays above because of TTI insertion uncertainty of the measurement report in DCCH.

#### A.4.6.7.2 L1-SINR measurement with SSB based CMR and dedicated IMR when DRX is used

##### A.4.6.7.2.1 Test Purpose and Environment

The purpose of this test is to verify that the UE makes correct reporting of L1-SINR measurement. This test will partly verify the L1-SINR measurement requirements with SSB based CMR and CSI-IM based IMR in clause 9.8.4.2, with the testing configurations for NR cells in Table A.4.6.7.2.1-1.

**Table A.4.6.7.2.1-1: Applicable NR configurations for FR1 L1-SINR measurement test with SSB based CMR and CSI-IM based IMR**

Config	Description
1	LTE FDD, NR 15 kHz SSB SCS, 10 MHz bandwidth, FDD duplex mode
2	LTE FDD, NR 15 kHz SSB SCS, 10 MHz bandwidth, TDD duplex mode
3	LTE FDD, NR 30 kHz SSB SCS, 40 MHz bandwidth, TDD duplex mode
4	LTE TDD, NR 15 kHz SSB SCS, 10 MHz bandwidth, FDD duplex mode
5	LTE TDD, NR 15 kHz SSB SCS, 10 MHz bandwidth, TDD duplex mode
6	LTE TDD, NR 30 kHz SSB SCS, 40 MHz bandwidth, TDD duplex mode

Note: The UE is only required to be tested in one of the supported test configurations

##### A.4.6.7.2.2 Test parameters

There are two cells in the test, E-UTRAN PCell (Cell 1) and FR1 PSCell (Cell 2). The test parameters and applicability for Cell 1 are defined in A.3.7.2. The test parameters for the Cell 2 are given in Table A.4.6.7.2.2-1 and Table A.4.6.7.2.2-2 below.

In CSI measurement configuration, UE is indicated to perform L1-SINR measurement on the SSBs and the associated CSI-IM resources, and report periodically. The test consists of two successive time periods, with time duration of T1 and T2 respectively. The test has higher layer parameter *timeRestrictionForChannelMeasurements* configured.

There is no measurement gap configured in the test. Before the test, UE is configured to perform RLM and BFD measurements based on the SSBs, and UE is configured to perform L1-SINR measurement based on the SSBs as CMR and the CSI-IM resources as IMR.

**Table A.4.6.7.2.2-1: General test parameters**

Parameter	Config	Unit	Value
SSB GSCN	1~6		freq1
Duplex mode	1,4		FDD

	2,5		TDD
	3,6		TDD
TDD Configuration	1,4		N/A
	2,5		TDDConf.1.1
	3,6		TDDConf.2.1
	1,4	MHz	10: $N_{RB,c} = 52$
2,5	10: $N_{RB,c} = 52$		
3,6	40: $N_{RB,c} = 106$		
PDSCH Reference measurement channel	1,4		SR.1.1 FDD
	2,5		SR.1.1 TDD
	3,6		SR.2.1 TDD
RMSI CORESET Reference Channel	1,4		CR.1.1 FDD
	2,5		CR.1.1 TDD
	3,6		CR.2.1 TDD
Dedicated CORESET Reference Channel	1,4		CCR.1.1 FDD
	2,5		CCR.1.1 TDD
	3,6		CCR.2.1 TDD
SSB configuration	1,4		SSB.3 FR1
	2,5		SSB.3 FR1
	3,6		SSB.4 FR1
CSI-IM configuration	1,4		CSI-IM.1.1 FDD
	2,5		CSI-IM.1.1 TDD
	3,6		CSI-IM.2.1 TDD
OCNG Patterns	1~6		OP.1
Initial BWP Configuration	1~6		DLBWP.0.1 ULBWP.0.1
Dedicated BWP configuration	1~6		DLBWP.1.1 ULBWP.1.1
SMTC configuration	1~6		SMTC.1
TRS Configuration	1,4		TRS.1.1 FDD
	2,5		TRS.1.1 TDD
	3,6		TRS.1.2 TDD
DRX configuration	1~6		DRX.3
reportConfigType	1~6		periodic
reportQuantity-r16	1~6		ssb-Index-SINR-r16
Number of reported RS	1~6		2
L1-SINR reporting period	1~6	slot	80
T1	1~6	s	5
T2	1~6	s	1
EPRE ratio of PSS to SSS	1~6	dB	0
EPRE ratio of PBCH DMRS to SSS			
EPRE ratio of PBCH to PBCH DMRS			
EPRE ratio of PDCCH DMRS to SSS			
EPRE ratio of PDCCH to PDCCH DMRS			
EPRE ratio of PDSCH DMRS to SSS			
EPRE ratio of PDSCH to PDSCH DMRS			
EPRE ratio of OCNG DMRS to SSS <sup>Note 1</sup>			
EPRE ratio of OCNG to OCNG DMRS <sup>Note 1</sup>			
Propagation condition	1~6		AWGN
Note 1: OCNG shall be used such that both cells are fully allocated and a constant total transmitted power spectral density is achieved for all OFDM symbols.			

**Table A.4.6.7.2.2-2: SSB specific test parameters**

Parameter	Config	Unit	SSB#0	SSB#1
-----------	--------	------	-------	-------



			T1	T2	T1	T2
$N_{oc}$ <sup>Note2</sup>	1~6	dBm/15kHz	-94.65			
$N_{oc}$ <sup>Note2</sup>	1,2,4,5	dBm/SSB SCS	-94.65			
	3,6		-91.65			
$\hat{E}_s/I_{ot}$	1~6	dB	0	0	-Infinity	3
SS-RSRP <sup>Note3</sup>	1,2,4,5	dBm/SSB SCS	-94.65	-94.65	-Infinity	-91.65
	3,6		-91.65	-91.65	-Infinity	-88.65
$I_o$ <sup>Note3</sup>	1,2,4,5	dBm/9.36 MHz	-63.69	-63.69	-66.70	-61.93
	3,6	dBm/38.16 MHz	-57.59	-57.59	-60.61	-55.84
$\hat{E}_s/N_{oc}$	1~6	dB	0	0	-Infinity	3
<p>Note 1: The resources for uplink transmission are assigned to the UE prior to the start of time period T2.</p> <p>Note 2: Interference from other cells and noise sources not specified in the test is assumed to be constant over subcarriers and time and shall be modelled as AWGN of appropriate power for <math>N_{oc}</math> to be fulfilled.</p> <p>Note 3: SS-RSRP and <math>I_o</math> levels have been derived from other parameters for information purposes. They are not settable parameters themselves.</p>						

#### A.4.6.7.2.3 Test Requirements

The UE shall send L1-SINR report every 80 slots. No later than 640ms plus 80 slots from the beginning of time period T2, UE shall send L1-SINR report including results of both SSB#0+CSI-IM#0 and SSB#1+CSI-IM#1 while meeting the accuracy requirement in clause 10.1.27.2. The rate of correct events observed during repeated tests shall be at least 90%.

NOTE: The actual overall delays measured in the test may be up to  $2 \times TTI_{DCCH}$  higher than the measurement reporting delays above because of TTI insertion uncertainty of the measurement report in DCCH.

#### A.4.6.7.3 L1-SINR measurement with CSI-RS based CMR and dedicated IMR configured when DRX is used

##### A.4.6.7.3.1 Test Purpose and Environment

The purpose of this test is to verify that the UE makes correct reporting of L1-SINR measurement. This test will partly verify the L1-SINR measurement requirements with CSI-RS based CMR and dedicated IMR configured in clause 9.8.4.3, with the testing configurations for NR cells in Table A.4.6.7.3.1-1.

**Table A.4.6.7.3.1-1: Applicable NR configurations for FR1 L1-SINR test with CMR and dedicated IMR**

Config	Description
1	LTE FDD, NR 15 kHz SSB SCS, 10 MHz bandwidth, FDD duplex mode
2	LTE FDD, NR 15 kHz SSB SCS, 10 MHz bandwidth, TDD duplex mode
3	LTE FDD, NR 30 kHz SSB SCS, 40 MHz bandwidth, TDD duplex mode
4	LTE TDD, NR 15 kHz SSB SCS, 10 MHz bandwidth, FDD duplex mode
5	LTE TDD, NR 15 kHz SSB SCS, 10 MHz bandwidth, TDD duplex mode
6	LTE TDD, NR 30 kHz SSB SCS, 40 MHz bandwidth, TDD duplex mode

Note: The UE is only required to be tested in one of the supported test configurations

##### A.4.6.7.3.2 Test parameters

There are two cells in the test, E-UTRAN PCell (Cell 1) and FR1 PCell (Cell 2). The test parameters and applicability for Cell 1 are defined in A.3.7.2. The test parameters for the Cell 2 are given in Table A.4.6.7.3.2-1 and Table A.4.6.7.3.2-2 below.

In CSI measurement configuration, UE is indicated to perform L1-SINR measurement on the configured CSI-RS as CMR and an associated CSI-RS as IMR, and report aperiodically. The test consists of a single time period T1, during which the UE is triggered via DCI to report L1-SINR on aperiodic CSI-RS resources and the associated IMR. After 80ms from the beginning of the test, the DCI trigger comes in slot n (1 Config 1,2,4,5 and 8 for Config 3,6) of a frame and UE provides the report back based on the reporting configuration as defined in Table A.4.6.7.3.2-1.

There is no measurement gap configured in the test. Before the test, UE is configured to perform RLM and BFD based on the SSBs, and UE is configured to perform L1-SINR measurement based on the CSI-RS as CMR and the CSI-RS as IMR.

**Table A.4.6.7.3.2-1: General test parameters**

Parameter	Config	Unit	Value
SSB GSCN	1~6		freq1
Duplex mode	1,4		FDD
	2,5		TDD
	3,6		TDD
TDD Configuration	1,4		N/A
	2,5		TDDConf.1.1
	3,6		TDDConf.2.1
BW <sub>channel</sub>	1,4	MHz	10: N <sub>RB,c</sub> = 52
	2,5		10: N <sub>RB,c</sub> = 52
	3,6		40: N <sub>RB,c</sub> = 106
PDSCH Reference measurement channel	1,4		SR.1.1 FDD
	2,5		SR.1.1 TDD
	3,6		SR.2.1 TDD
RMSI CORESET Reference Channel	1,4		CR.1.1 FDD
	2,5		CR.1.1 TDD
	3,6		CR.2.1 TDD
Dedicated CORESET Reference Channel	1,4		CCR.1.1 FDD
	2,5		CCR.1.1 TDD
	3,6		CCR.2.1 TDD
SSB configuration	1,4		SSB.3 FR1
	2,5		SSB.3 FR1
	3,6		SSB.4 FR1
CSI-RS configuration as CMR	1,4		CSI-RS.1.3 FDD
	2,5		CSI-RS.1.3 TDD
	3,6		CSI-RS.2.3 TDD
CSI-RS configuration as IMR	1,4		CSI-RS.1.2A FDD
	2,5		CSI-RS.1.2A TDD
	3,6		CSI-RS.2.2A TDD
OCNG Patterns	1~6		OP.1
TRS Configuration	1,4		TRS.1.1 FDD
	2,5		TRS.1.1 TDD
	3,6		TRS.1.2 TDD
Initial BWP Configuration	1~6		DLBWP.0.1 ULBWP.0.1
Dedicated BWP configuration	1~6		DLBWP.1.1 ULBWP.1.1
SMTc configuration	1~6		SMTc.1
DRX configuration	1~6		DRX.3
reportConfigType	1~6		aperiodic
reportQuantity-r16	1~6		cri-SINR-r16
Number of reported RS	1~6		2
qcl-Info	1~6		SSB#0 for resource#0
			SSB#1 for resource#1
reportSlotOffsetList	1~6	slots	26
T1	1~6	s	5
EPRE ratio of PSS to SSS	1~6	dB	0
EPRE ratio of PBCH DMRS to SSS			
EPRE ratio of PBCH to PBCH DMRS			
EPRE ratio of PDCCH DMRS to SSS			
EPRE ratio of PDCCH to PDCCH DMRS			

EPRE ratio of PDSCH DMRS to SSS			
EPRE ratio of PDSCH to PDSCH DMRS			
EPRE ratio of OCNG DMRS to SSS <sup>Note 1</sup>			
EPRE ratio of OCNG to OCNG DMRS <sup>Note 1</sup>			
Propagation condition	1~6		AWGN
Note 1: OCNG shall be used such that both cells are fully allocated and a constant total transmitted power spectral density is achieved for all OFDM symbols.			

Table A.4.6.7.3.2-2: CSI-RS specific test parameters

Parameter	Config	Unit	CSI-RS#0	CSI-RS#1
$N_{oc}$ <sup>Note1</sup>	1~6	dBm/15kHz	-94.65	
$N_{oc}$ <sup>Note1</sup>	1,2,4,5	dBm/SSB SCS	-94.65	
	3,6		-91.65	
$\hat{E}_s/I_{ot}$	1~6	dB	0	3
$\hat{E}_s/N_{oc}$	1~6	dB	0	3
CSI-RS RSRP <sup>Note2</sup>	1,2,4,5	dBm/SSB SCS	-94.65	-91.65
	3,6		-91.65	-88.65
$I_o$ <sup>Note2</sup>	1,2,4,5	dBm/9.36 MHz	-63.69	-61.93
	3,6	dBm/38.16 MHz	-57.59	-55.84
Note 1: Interference from other cells and noise sources not specified in the test is assumed to be constant over subcarriers and time and shall be modelled as AWGN of appropriate power for $N_{oc}$ to be fulfilled.				
Note 2: CSI-RS RSRP and $I_o$ levels have been derived from other parameters for information purposes. They are not settable parameters themselves.				

### A.4.6.7.3.3 Test Requirements

After 80ms from the beginning of the test, the UE shall send L1-SINR report at slot 26 from the reception of DCI triggering the L1-SINR measurement. The L1-SINR report shall include the results for both CSI-RS#0 as CMR + CSI-RS#0 as IMR and CSI-RS#1 as CMR + CSI-RS#1 as IMR while meeting the accuracy requirement in clause 10.1.27.3.

The rate of correct events observed during repeated tests shall be at least 90%.

NOTE: The actual overall delays measured in the test may be up to  $2xTTI_{DCCH}$  higher than the measurement reporting delays above because of TTI insertion uncertainty of the measurement report in DCCH.

## A.4.6.8 CSI-RS based intra-frequency Measurement

### A.4.6.8.1 EN-DC event triggered reporting tests without gap under DRX

#### A.4.6.8.1.1 Test purpose and Environment

The purpose of this test is to verify that the UE makes correct reporting of an event. This test will partly verify the CSI-RS based L3 intra-frequency requirements in clause 9.10.2.

Three cells are deployed in the test, which are E-UTRAN PCell (Cell 1), FR1 PCell (Cell 2) and a FR1 neighbour cell (Cell 3) on the same frequency as the PCell. The test parameters for PCell are given in Table A.4.6.8.1.1-1, A.4.6.8.1.1-2, A.4.6.8.1.1-3 and A.4.6.8.1.1-4 below and the test parameters and applicability for the E-UTRAN cell are defined in A.3.7.2. In the measurement control information, a measurement object is configured for the frequency of the PCell, and it is indicated to the UE that event-triggered reporting with Event A3 is used for the CSI-RS based L3 intra-

frequency measurements. The test consists of two successive time periods, with time duration of T1, and T2 respectively. During time duration T1, the UE shall not have any timing information of cell 3.

UE needs to be provided at least once every 500ms with new Timing Advance Command MAC control element to restart the Time alignment timer to keep UE uplink time alignment. Furthermore UE is allocated with PUSCH resource at every DRX cycle.

**Table A.4.6.8.1.1-1: Supported test configurations**

Config	Description
1	LTE FDD, NR 15 kHz SSB and CSI-RS SCS, 10 MHz bandwidth, FDD duplex mode
2	LTE FDD, NR 15 kHz SSB and CSI-RS SCS, 10 MHz bandwidth, TDD duplex mode
3	LTE FDD, NR 30 kHz SSB and CSI-RS SCS, 40 MHz bandwidth, TDD duplex mode
4	LTE TDD, NR 15 kHz SSB and CSI-RS SCS, 10 MHz bandwidth, FDD duplex mode
5	LTE TDD, NR 15 kHz SSB and CSI-RS SCS, 10 MHz bandwidth, TDD duplex mode
6	LTE TDD, NR 30 kHz SSB and CSI-RS SCS, 40 MHz bandwidth, TDD duplex mode

Note 1: The UE is only required to be tested in one of the supported test configurations  
Note 2: Target NR Cell 3 has the same SCS, BW and duplex mode as NR serving Cell 2

**Table A.4.6.8.1.1-2: General test parameters for EN-DC intra-frequency event triggered reporting without gap for PSCell in FR1 with DRX**

Parameter	Unit	Test configuration	Value	Comment
			Test 1	
Active cell		1, 2, 3, 4, 5, 6	E-UTRAN Cell 1 and NR Cell 2	
Neighbour cell		1, 2, 3, 4, 5, 6	NR Cell 3	Cell to be identified.
RF Channel Number		1, 2, 3, 4, 5, 6	1: Cell 1 2: Cell 2 and Cell 3	
SMTC configuration		1, 4	SMTC.2	
		2, 5	SMTC.1	
		3, 6	SMTC.1	
A3-Offset	dB	1, 2, 3, 4, 5, 6	-4.5	
CP length		1, 2, 3, 4, 5, 6	Normal	
Hysteresis	dB	1, 2, 3, 4, 5, 6	0	
Time To Trigger	s	1, 2, 3, 4, 5, 6	0	
Filter coefficient		1, 2, 3, 4, 5, 6	0	L3 filtering is not used
DRX		1, 2, 3, 4, 5, 6	DRX.5	
Time offset between PCell and PSCell	μs	1, 2, 3, 4, 5, 6	3	Synchronous EN-DC
Time offset between serving and neighbour cells	μs	1, 4	4.7	Asynchronous cells. The timing of Cell 3 is CP later than the timing of Cell 2.
		2, 5	4.7	Synchronous cells
		3, 6	2.35	Synchronous cells
T1	s	1, 2, 3, 4, 5, 6	5	
T2	s	1, 2, 3, 4, 5, 6	7	

**Table A.4.6.8.1.1-3: NR Cell specific test parameters for EN-DC intra-frequency event triggered reporting without gap for PSCell in FR1 with DRX**

Parameter	Unit	Test configuration	Cell 2		Cell 3	
			T1	T2	T1	T2
TDD configuration		1, 4	N/A		N/A	
		2, 5	TDDConf.1.1		TDDConf.1.1	
		3, 6	TDDConf.2.1		TDDConf.2.1	
PDSCH RMC configuration		1, 4	SR.1.1 FDD		N/A	
		2, 5	SR.1.1 TDD			
		3, 6	SR.2.1 TDD			
RMSI CORESET RMC configuration		1, 4	CR.1.1 FDD		CR.1.1 FDD	
		2, 5	CR.1.1 TDD		CR.1.1 TDD	
		3, 6	CR.2.1 TDD		CR.2.1 TDD	
Dedicated CORESET RMC configuration		1, 4	CCR.1.1 FDD		CCR.1.1 FDD	
		2, 5	CCR.1.1 TDD		CCR.1.1 TDD	
		3, 6	CCR.2.1 TDD		CCR.2.1 TDD	
OCNG Patterns		1, 2, 3, 4, 5, 6	OP.1		OP.1	
TRS configuration		1, 4	TRS.1.1 FDD		N/A	
		2, 5	TRS.1.1 TDD		N/A	
		3, 6	TRS.1.2 TDD		N/A	
Initial BWP configuration		1, 2, 3, 4, 5, 6	DLBWP.0.1 ULBWP.0.1		DLBWP.0.1 ULBWP.0.1	
Active DL BWP configuration		1, 2, 3, 4, 5, 6	DLBWP.1.1		DLBWP.1.1	
Active UL BWP configuration		1, 2, 3, 4, 5, 6	ULBWP.1.1		ULBWP.1.1	
SSB parameters		1,4	SSB.1 FR1		SSB.5 FR1	
		2,5	SSB.1 FR1		SSB.5 FR1	
		3,6	SSB.2 FR1		SSB.6 FR1	
CSI-RS configuration for RRM		1,4	CSI-RS.RRM.FR1.1 FDD			
		2,5	CSI-RS.RRM.FR1.1 TDD			
		3,6	CSI-RS.RRM.FR1.2 TDD			
RLM-RS		1, 2, 3, 4, 5, 6	SSB		SSB	
$N_{oc}$ <sup>Note 2</sup>	dBm/SCS	1,2,4,5	-98			
		3, 6	-95			
$N_{oc}$ <sup>Note 2</sup>	dBm/15 kHz	1, 2, 3, 4, 5, 6	-98			
$\hat{E}_s/I_{ot}$ for SSB	dB	1, 2, 3, 4, 5, 6	4	-1.46	-Infinity	-1.46
$\hat{E}_s/I_{ot}$ for CSI-RS	dB	1, 2, 3, 4, 5, 6	4	-1.46	-Infinity	-1.46
$\hat{E}_s/N_{oc}$ for SSB	dB	1, 2, 3, 4, 5, 6	4	4	-Infinity	4
$\hat{E}_s/N_{oc}$ for CSI-RS	dB	1, 2, 3, 4, 5, 6	4	4	-Infinity	4

SS-RSRP <sup>Note 3</sup>	dBm/SCS kHz	1, 4	-94	-94	-Infinity	-94
		2, 5	-94	-94	-Infinity	-94
		3, 6	-91	-91	-Infinity	-91
CSI-RSRP <sup>Note 3</sup>	dBm/SCS kHz	1, 4	-94	-94	-Infinity	-94
		2, 5	-94	-94	-Infinity	-94
		3, 6	-91	-91	-Infinity	-91
Io	dBm/9.36 MHz	1, 4	-64.60	-62.25	-64.60	-62.25
	dBm/9.36 MHz	2, 5	-64.60	-62.25	-64.60	-62.25
	dBm/38.16 MHz	3	-58.50	-56.16	-58.50	-56.16
Propagation Condition		1, 2, 3, 4, 5, 6	AWGN			
<p>Note 1: The resources for uplink transmission are assigned to the UE prior to the start of time period T2.</p> <p>Note 2: Interference from other cells and noise sources not specified in the test is assumed to be constant over subcarriers and time and shall be modelled as AWGN of appropriate power for <math>N_{oc}</math> to be fulfilled.</p> <p>Note 3: SS-RSRP and CSI-RSRP levels have been derived from other parameters for information purposes. They are not settable parameters themselves.</p>						

#### A.4.6.8.1.2 Test Requirements

In test 1, the UE shall send one Event A3 triggered measurement report, with a measurement reporting delay less than 9280 ms from the beginning of time period T2. The UE is not required to read the SSB index indicated by associatedSSB in the neighbour cell in this test.

The UE shall not send event triggered measurement reports, as long as the reporting criteria are not fulfilled.

The rate of correct events observed during repeated tests shall be at least 90%.

NOTE: The actual overall delays measured in the test may be up to  $2 \times TTI_{DCCH}$  higher than the measurement reporting delays above because of TTI insertion uncertainty of the measurement report in DCCH.

### A.4.6.9 CSI-RS based inter-frequency Measurement

#### A.4.6.9.1 EN-DC event triggered reporting tests for FR1 cell when non-DRX is used

##### A.4.6.9.1.1 Test Purpose and Environment

The purpose of this test is to verify that the UE makes correct reporting of an event. This test will partly verify the EN-DC inter-frequency NR cell measurement requirements in clause 9.10.3.

In this test, there are three cells: LTE cell 1 as PCell on E-UTRA RF channel 1, NR cell 2 as PSCell in FR1 on NR RF channel 1 and NR cell 3 as neighbour cell in FR1 on NR RF channel 2. The test parameters and configurations are given in Tables A.4.6.9.1.1-1, A.4.6.9.1.1-2, and A.4.6.9.1.1-3.

In test 1&2 measurement gap pattern configuration # 0 as defined in Table A.4.6.9.1.1-2 is provided for a UE that does not support per-FR gap and in test 3&4 measurement gap pattern configuration #4 as defined in Table A.4.6.2.2.1-2 is provided for UE that support per-FR gap. If a UE supports per-FR gap and gap pattern configuration #4, it is only required to pass test 3&4. Otherwise it is only required to pass test 1&2.

In the measurement control information, it is indicated to the UE that event-triggered reporting with Event A3 is used. The test consists of two successive time periods, with time duration of T1, and T2 respectively. During time duration T1, the UE shall not have any timing information of NR cell 3.

The configuration of LTE cell 1 is defined in table A.3.7.2.1-1. Supported test configurations are shown in table A.4.6.9.1.1-1.

**Table A.4.6.9.1.1-1: EN-DC event triggered reporting tests with SSB index reading for FR1-FR1**

Config	Description
1	LTE FDD, NR 15 kHz SSB and CSI-RS SCS, 10 MHz bandwidth, FDD duplex mode
2	LTE FDD, NR 15 kHz SSB and CSI-RS SCS, 10 MHz bandwidth, TDD duplex mode
3	LTE FDD, NR 30 kHz SSB and CSI-RS SCS, 40 MHz bandwidth, TDD duplex mode
4	LTE TDD, NR 15 kHz SSB and CSI-RS SCS, 10 MHz bandwidth, FDD duplex mode
5	LTE TDD, NR 15 kHz SSB and CSI-RS SCS, 10 MHz bandwidth, TDD duplex mode
6	LTE TDD, NR 30 kHz SSB and CSI-RS SCS, 40 MHz bandwidth, TDD duplex mode

Note 1: The UE is only required to be tested in one of the supported test configurations  
Note 2: target NR cell3 has the same SCS, BW and duplex mode as NR serving cell2

**Table A.4.6.9.1.1-2: General test parameters for EN-DC inter-frequency event triggered reporting**

Parameter	Unit	Test configuration	Value		Comment
			Test 1	Test 2	
E-UTRA RF Channel Number		Config 1,2,3,4,5,6	1		One E-UTRAN TDD carrier frequencies is used.
NR RF Channel Number		Config 1,2,3,4,5,6	1, 2		Two FR1 NR carrier frequencies are used.
Active cell		Config 1,2,3,4,5,6	LTE Cell 1 (PCell) and NR cell 2 (PScell)		LTE Cell 1 is on E-UTRA RF channel number 1. NR Cell 2 is on NR RF channel number 1.
Neighbour cell		Config 1,2,3,4,5,6	NR cell 3		NR cell 3 is on NR RF channel number 2.
Gap Pattern Id		Config 1,2,3,4,5,6	0	4	As specified in clause 9.1.2-1.
Measurement gap offset		Config 1,2,3,4,5,6	39	19	
A3-Offset	dB	Config 1,2,3,4,5,6	-6		
Hysteresis	dB	Config 1,2,3,4,5,6	0		
CP length		Config 1,2,3,4,5,6	Normal		
TimeToTrigger	s	Config 1,2,3,4,5,6	0		
Filter coefficient		Config 1,2,3,4,5,6	0		L3 filtering is not used
DRX	ms	Config 1,2,3,4,5,6	OFF		DRX is not used
Time offset between PCell and PScell	μs	Config 1,2,3,4,5,6	3		Synchronous EN-DC
Time offset between serving and neighbour cells	μs	Config 1,4	4.7		Asynchronous cells. The timing of Cell 3 is CP later than the timing of Cell 2.
		Config 2,5	4.7		Synchronous EN-DC
		Config 3,6	2.35		Synchronous EN-DC
T1	s	Config 1,2,3,4,5,6	5		
T2	s	Config 1,2,3,4,5,6	1.1	1.1	

**Table A.4.6.9.1.1-3: Cell specific test parameters for EN-DC inter-frequency event triggered reporting**

Parameter	Unit	Test	Cell 2	Cell 3
-----------	------	------	--------	--------

		configurat ion	T1	T2	T1	T2
NR RF Channel Number		Config 1,2,3,4,5,6	1		2	
Duplex mode		Config 1,4	FDD			
		Config 2,3,5,6	TDD			
BW <sub>channel</sub>	MHz	Config 1,4	10: N <sub>RB,c</sub> = 52			
		Config 2,5	10: N <sub>RB,c</sub> = 52			
		Config 3,6	40: N <sub>RB,c</sub> = 106			
BWP BW	MHz	Config 1,4	10: N <sub>RB,c</sub> = 52			
		Config 2,5	10: N <sub>RB,c</sub> = 52			
		Config 3,6	40: N <sub>RB,c</sub> = 106			
TDD configuration		Config 2,5	TDDConf.1.1			
		Config 3,6	TDDConf.2.1			
Initial DL BWP		Config 1,2,3,4,5,6	DLBWP.0.1		NA	
Initial UL BWP		Config 1,2,3,4,5,6	ULBWP.0.1		NA	
Dedicated DL BWP		Config 1,2,3,4,5,6	DLBWP.1.1		NA	
Dedicated UL BWP		Config 1,2,3,4,5,6	ULBWP.1.1		NA	
TRS configuration		Config 1,4	TRS.1.1 FDD		NA	
		Config 2,5	TRS.1.1 TDD		NA	
		Config 3,6	TRS.1.2 TDD		NA	
OCNG Patterns defined in A.3.2.1.1 (OP.1)		Config 1,2,3,4,5,6	OP.1		OP.1	
PDSCH Reference measurement channel		Config 1,4	SR.1.1 FDD		-	
		Config 2,5	SR.1.1 TDD			
		Config 3,6	SR.2.1 TDD			
CORESET Reference Channel		Config 1,4	CR.1.1 FDD		-	
		Config 2,5	CR.1.1 TDD			
		Config 3,6	CR.2.1 TDD			
SSB parameters		Config 1,4	SSB.1 FR1		SSB.5 FR1	
		Config 2,5	SSB.1 FR1		SSB.5 FR1	
		Config 3,6	SSB.2 FR1		SSB.6 FR1	
SMTC configuration		Config 1,4	SMTC.2			
		Config 2,3,5,6	SMTC.1			
CSI-RS configuration for RRM		Config 1,4	CSI-RS.RRM.FR1.1 FDD			
		Config 2,5	CSI-RS.RRM.FR1.1 TDD			
		Config 3,6	CSI-RS.RRM.FR1.2 TDD			
PDSCH/PDCCH subcarrier spacing	kHz	Config 1,2,4,5	15			
		Config 3,6	30			
EPRE ratio of PSS to SSS						
EPRE ratio of PBCH DMRS to SSS						



EPRE ratio of PBCH to PBCH DMRS		Config 1,2,3,4,5,6	0		0	
EPRE ratio of PDCCH DMRS to SSS						
EPRE ratio of PDCCH to PDCCH DMRS						
EPRE ratio of PDSCH DMRS to SSS						
EPRE ratio of PDSCH to PDSCH						
EPRE ratio of OCNG DMRS to SSS(Note 1)						
EPRE ratio of OCNG to OCNG DMRS (Note 1)						
$N_{oc}^{Note2}$	dBm/15kHz		-98		-98	
$N_{oc}^{Note2}$	dBm/SCS	Config 1,2,4,5	-98		-98	
		Config 3,6	-95		-95	
SS-RSRP <sup>Note 3</sup>	dBm/SCS	Config 1,2,4,5	-94	-94	-Infinity	-91
		Config 3,6	-91	-91	-Infinity	-88
CSI-RSRP <sup>Note 3</sup>	dBm/SCS	Config 1,2,4,5	-94	-94	-Infinity	-91
		Config 3,6	-91	-91	-Infinity	-88
$\hat{E}_s / I_{ot}$	dB	Config 1,2,3,4,5,6	4	4	-Infinity	7
$\hat{E}_s / N_{oc}$	dB	Config 1,2,3,4,5,6	4	4	-Infinity	7
$I_o^{Note3}$	dBm/9.36 MHz	Config 1,2,4,5	-64.59	-64.59	-70.05	-62.26
	dBm/38.16 MHz	Config 3,6	-58.49	-58.49	-63.94	-56.15
Propagation Condition		Config 1,2,3,4,5,6	AWGN			
<p>Note 1: OCNG shall be used such that both cells are fully allocated and a constant total transmitted power spectral density is achieved for all OFDM symbols.</p> <p>Note 2: Interference from other cells and noise sources not specified in the test is assumed to be constant over subcarriers and time and shall be modelled as AWGN of appropriate power for <math>N_{oc}</math> to be fulfilled.</p> <p>Note 3: SS-RSRP, CSI-RSRP and <math>I_o</math> levels have been derived from other parameters for information purposes. They are not settable parameters themselves.</p> <p>Note 4: SS-RSRP minimum requirements are specified assuming independent interference and noise at each receiver antenna port.</p>						

#### A.4.6.9.1.2 Test Requirements

In test 1 with per-UE gap, the UE shall send one Event A3 triggered measurement report, with a measurement reporting delay less than 1040 ms from the beginning of time period T2. The UE shall not send event triggered measurement reports, as long as the reporting criteria are not fulfilled. The rate of correct events observed during repeated tests shall be at least 90%.

In test 2 with per-FR gap, the UE shall send one Event A3 triggered measurement report, with a measurement reporting delay less than 920 ms from the beginning of time period T2. The UE shall not send event triggered measurement reports, as long as the reporting criteria are not fulfilled. The rate of correct events observed during repeated tests shall be at least 90%.

In test 1 and 2 UE is required to report SSB time index.

NOTE: The actual overall delays measured in the test may be up to  $2 \times \text{TTIDCCH}$  higher than the measurement reporting delays above because of TTI insertion uncertainty of the measurement report in DCCH.

## A.4.7 Measurement Performance requirements

Unless explicitly stated otherwise:

- Reported measurements shall be within defined range of accuracy limits defined in Clause 10 for at least 90 % of the reported cases. If multiple measurement performance requirements are verified in the same test, the reported measurements for each requirement shall be within defined range of accuracy limits of the corresponding requirement defined in Clause 10 for at least 90% of the reported cases.
- Measurements are performed in RRC\_CONNECTED state.
- The reference channels assume transmission of PDSCH with a maximum number of 5 HARQ transmissions unless otherwise specified.

### A.4.7.1 SS-RSRP

#### A.4.7.1.1 EN-DC Intra-frequency measurement accuracy with FR1 serving cell and FR1 target cell

##### A.4.7.1.1.1 Test Purpose and Environment

The purpose of this test is to verify that the SS-RSRP measurement accuracy is within the specified limits. This test will verify the requirements in Clauses 10.1.2.1.1 and 10.1.2.1.2 for intra-frequency measurements.

##### A.4.7.1.1.2 Test parameters

In this set of test cases all NR cells are on the same carrier frequency. Supported test configurations are shown in table A.4.7.1.1.2-1. Both absolute and relative accuracy of SS-RSRP intra-frequency measurements are tested by using the parameters in A.4.7.1.1.2-2. The configuration of cell 1 (E-UTRA PCell) is specified in clause A.3.7.2.1 In all test cases, Cell 2 is the PCell, and Cell 3 is the target cell.

**Table A.4.7.1.1.2-1: SS-RSRP Intra frequency SS-RSRP supported test configurations**

Config	Description
1	LTE FDD, NR 15 kHz SSB SCS, 10 MHz bandwidth, FDD duplex mode
2	LTE FDD, NR 15 kHz SSB SCS, 10 MHz bandwidth, TDD duplex mode
3	LTE FDD, NR 30kHz SSB SCS, 40 MHz bandwidth, TDD duplex mode
4	LTE TDD, NR 15 kHz SSB SCS, 10 MHz bandwidth, FDD duplex mode
5	LTE TDD, NR 15 kHz SSB SCS, 10 MHz bandwidth, TDD duplex mode
6	LTE TDD, NR 30kHz SSB SCS, 40 MHz bandwidth, TDD duplex mode

Note: The UE is only required to be tested in one of the supported test configurations for each supported band

**Table A.4.7.1.1.2-2: SS-RSRP Intra frequency test parameters**

Parameter	Unit	Test 1		Test 2		Test 3	
		Cell 2	Cell 3	Cell 2	Cell 3	Cell 2	Cell 3
Physical cell ID		489	0	489	0	489	0
SSB ARFCN		freq1		freq1		freq1	
Duplex mode	Config 1,4	FDD					
	Config 2,3,5,6	TDD					
TDD configuration	Config 1,4	Not Applicable					
	Config 2,5	TDDConf.1.1					
	Config 3,6	TDDConf.2.1					
BW <sub>channel</sub>	Config 1,4	10: N <sub>RB,c</sub> = 52					
	Config 2,5	10: N <sub>RB,c</sub> = 52					
	Config 3,6	40: N <sub>RB,c</sub> = 106					
Downlink initial BWP configuration		DLBWP.0.1					
Downlink dedicated BWP configuration		DLBWP.1.1					

Uplink initial BWP configuration			ULBWP.0.1						
Uplink dedicated BWP configuration			ULBWP.1.1						
TRS configuration	Config 1,4		TRS.1.1 FDD	NA	TRS.1.1 FDD	NA	TRS.1.1 FDD	NA	
	Config 2,5		TRS.1.1 TDD	NA	TRS.1.1 TDD	NA	TRS.1.1 TDD	NA	
	Config 3,6		TRS.1.2 TDD	NA	TRS.1.2 TDD	NA	TRS.1.2 TDD	NA	
DRX Cycle		ms	Not Applicable						
PDSCH Reference measurement channel	Config 1,4		SR.1.1 FDD	-	SR.1.1 FDD	-	SR.1.1 FDD	-	
	Config 2,5		SR.1.1 TDD		SR.1.1 TDD		SR.1.1 TDD		
	Config 3,6		SR2.1 TDD		SR2.1 TDD		SR2.1 TDD		
RMSI CORESET Reference Channel	Config 1,4		CR.1.1 FDD	-	CR.1.1 FDD	-	CR.1.1 FDD	-	
	Config 2,5		CR.1.1 TDD		CR.1.1 TDD		CR.1.1 TDD		
	Config 3,6		CR2.1 TDD		CR2.1 TDD		CR2.1 TDD		
Control Channel RMC	Config 1,4		CCR.1.1 FDD	-	CCR.1.1 FDD	-	CCR.1.1 FDD	-	
	Config 2,5		CCR.1.1 TDD		CCR.1.1 TDD		CCR.1.1 TDD		
	Config 3,6		CCR2.1 TDD		CCR2.1 TDD		CCR2.1 TDD		
SSB configuration	Config 1,4		SSB.1 FR1	SSB.1 FR1	SSB.1 FR1	SSB.1 FR1	SSB.1 FR1	SSB.1 FR1	
	Config 2,5		SSB.1 FR1	SSB.1 FR1	SSB.1 FR1	SSB.1 FR1	SSB.1 FR1	SSB.1 FR1	
	Config 3,6		SSB.2 FR1	SSB.2 FR1	SSB.2 FR1	SSB.2 FR1	SSB.2 FR1	SSB.2 FR1	
Time offset with Cell 2	Config 1,4	ms	-	3	-	3	-	3	
	Config 2,3,5,6	µs	-	3	-	3	-	3	
SMTC configuration	Config 1,4		SMTC.2						
	Config 2,3,5,6		SMTC.1						
OCNG Patterns			OP.1						
PDSCH/PDCCH subcarrier spacing	Config 1,2,4,5	kHz	15 kHz						
	Config 3,6		30kHz						
EPRE ratio of PSS to SSS		dB	0	0	0	0	0	0	
EPRE ratio of PBCH DMRS to SSS									
EPRE ratio of PBCH to PBCH DMRS									
EPRE ratio of PDCCH DMRS to SSS									
EPRE ratio of PDCCH to PDCCH DMRS									
EPRE ratio of PDSCH DMRS to SSS									
EPRE ratio of PDSCH to PDSCH									
EPRE ratio of OCNG DMRS to SSS(Note 1)									
EPRE ratio of OCNG to OCNG DMRS (Note 1)									
$N_{oc}$ <small>Note2</small>	Config 1,2,4,5	NR_FDD_FR1_A, NR_TDD_FR1_A <small>NOTE 6</small>	-106			-88		-114	
		NR_FDD_FR1_B						-113.5	
		NR_TDD_FR1_C						-113	
		NR_FDD_FR1_D, NR_TDD_FR1_D						-112.5	
		NR_FDD_FR1_E, NR_TDD_FR1_E						-112	
		NR_FDD_FR1_F						-111.5	
		NR_FDD_FR1_G						-111	
		NR_FDD_FR1_H						-110.5	
	Config 3,6	NR_FDD_FR1_A, NR_TDD_FR1_A <small>NOTE 6</small>	Not applicable <small>Note 5</small>			-94		-114	
		NR_FDD_FR1_B						-113.5	
		NR_TDD_FR1_C						-113	
		NR_FDD_FR1_D, NR_TDD_FR1_D						-112.5	
		NR_FDD_FR1_E, NR_TDD_FR1_E						-112	
		NR_FDD_FR1_F						-111.5	
NR_FDD_FR1_G						-111			
NR_FDD_FR1_H						-110.5			

$N_{oc}$ <sup>Note2</sup>	Config 1,2,4,5		dBm/SCS	-106		-88		Same as Noc/15kHz		
	Config 3,6	NR_FDD_FR1_A, NR_TDD_FR1_A <sup>NOTE 6</sup>		Not applicable <sup>Note 5</sup>		-91		-111		
		NR_FDD_FR1_B						-110.5		
		NR_TDD_FR1_C						-110		
		NR_FDD_FR1_D, NR_TDD_FR1_D						-109.5		
		NR_FDD_FR1_E, NR_TDD_FR1_E						-109		
		NR_FDD_FR1_F						-108.5		
		NR_FDD_FR1_G						-108		
		NR_FDD_FR1_H						-107.5		
$\hat{E}_s/I_{ot}$			dB	2.46	-5.97	2.46	-5.97	-0.01	-4.76	
$\hat{E}_s/N_{oc}$			dB	6	1	6	1	3	0	
SS-RSRP <sup>Note3</sup>	Config 1,2,4,5	NR_FDD_FR1_A, NR_TDD_FR1_A <sup>NOTE 6</sup>	dBm/SCS	-100	-105	-82	-87	-111.00	-114.00	
		NR_FDD_FR1_B						-110.50	-113.50	
		NR_TDD_FR1_C						-110.00	-113.00	
		NR_FDD_FR1_D, NR_TDD_FR1_D						-109.50	-112.50	
		NR_FDD_FR1_E, NR_TDD_FR1_E						-109.00	-112.00	
		NR_FDD_FR1_F						-108.50	-111.50	
		NR_FDD_FR1_G						-108.00	-111.00	
		NR_FDD_FR1_H						-107.50	-110.50	
		Config 3,6						NR_FDD_FR1_A, NR_TDD_FR1_A <sup>NOTE 6</sup>	- Not applicable <sup>Note 5</sup>	Not applicable <sup>Note 5</sup>
	NR_FDD_FR1_B						-107.50	-110.50		
	NR_TDD_FR1_C						-107.00	-110.00		
	NR_FDD_FR1_D, NR_TDD_FR1_D						-106.50	-109.50		
	NR_FDD_FR1_E, NR_TDD_FR1_E						-106.00	-109.00		
	NR_FDD_FR1_F						-105.50	-108.50		
	NR_FDD_FR1_G						-105.00	-108.00		
	NR_FDD_FR1_H						-104.50	-107.50		
	$I_o$ <sup>Note3</sup>		Config 1,2,4,5	NR_FDD_FR1_A, NR_TDD_FR1_A <sup>NOTE 6</sup>	dBm/ 9.36MHz	-70.09		-52.09		-80.03
		NR_FDD_FR1_B		-79.53						
NR_TDD_FR1_C		-79.03								
NR_FDD_FR1_D, NR_TDD_FR1_D		-78.53								
NR_FDD_FR1_E, NR_TDD_FR1_E		-78.03								
NR_FDD_FR1_F		-77.53								
NR_FDD_FR1_G		-77.03								
NR_FDD_FR1_H		-76.53								
Config 3,6		NR_FDD_FR1_A, NR_TDD_FR1_A <sup>NOTE 6</sup>		dBm/ 38.16MHz						Not applicable <sup>Note 5</sup>
		NR_FDD_FR1_B	-73.44							
		NR_TDD_FR1_C	-72.94							
		NR_FDD_FR1_D, NR_TDD_FR1_D	-72.44							
		NR_FDD_FR1_E, NR_TDD_FR1_E	-71.94							
		NR_FDD_FR1_F	-71.44							
		NR_FDD_FR1_G	-70.94							
		NR_FDD_FR1_H	-70.44							
		Propagation condition			-	AWGN				
Antenna configuration				1x2						
<p>Note 1: OCNG shall be used such that both cells are fully allocated and a constant total transmitted power spectral density is achieved for all OFDM symbols.</p> <p>Note 2: Interference from other cells and noise sources not specified in the test is assumed to be constant over subcarriers and time and shall be modelled as AWGN of appropriate power for <math>N_{oc}</math> to be fulfilled.</p>										

Note 3:	SS-RSRP and Io levels have been derived from other parameters for information purposes. They are not settable parameters themselves.
Note 4:	SS-RSRP minimum requirements are specified assuming independent interference and noise at each receiver antenna port.
Note 5:	Subtest 1 is not used when testing with 30kHz SSB SCS
Note 6:	The test configuration excludes support for band n51 and it is not required to run this test on band n51 in this release of the specification

#### A.4.7.1.1.3 Test Requirements

The SS-RSRP measurement accuracy for cell 2 and cell 3 shall fulfil absolute requirement in clause 10.1.2.1.1 and relative requirement in clause 10.1.2.1.2.

#### A.4.7.1.2 EN-DC inter-frequency measurement accuracy with FR1 serving cell and FR1 target cell

##### A.4.7.1.2.1 Test Purpose and Environment

The purpose of this test is to verify that the SS-RSRP measurement accuracy is within the specified limits. This test will verify the requirements in Clauses 10.1.4.1.1 and 10.1.4.1.2 for inter-frequency measurements with the testing configurations in Table A.4.7.1.2.1-1.

**Table A.4.7.1.2.1-1: Applicable NR configurations for FR1 inter-frequency SS-RSRP accuracy test**

Config	Description
1	LTE FDD, NR 15 kHz SSB SCS, 10 MHz bandwidth, FDD duplex mode
2	LTE FDD, NR 15 kHz SSB SCS, 10 MHz bandwidth, TDD duplex mode
3	LTE FDD, NR 30 kHz SSB SCS, 40 MHz bandwidth, TDD duplex mode
4	LTE TDD, NR 15 kHz SSB SCS, 10 MHz bandwidth, FDD duplex mode
5	LTE TDD, NR 15 kHz SSB SCS, 10 MHz bandwidth, TDD duplex mode
6	LTE TDD, NR 30 kHz SSB SCS, 40 MHz bandwidth, TDD duplex mode

Note: The UE is only required to be tested in one of the supported test configurations on each supported band

##### A.4.7.1.2.2 Test parameters

In this set of test cases there are three cells in the test, E-UTRAN PCell (Cell 1), FR1 PCell (Cell 2) and a FR1 neighbour cell (Cell 3) on a different frequency than the PCell. The test parameters and applicability for Cell 1 are defined in A.3.7.2. The test parameters for the Cell 2 and Cell 3 are given in Table A.4.7.1.2.2-1 below. Both absolute and relative accuracy of RSRP inter-frequency measurements are tested by using the parameters in Table A.4.7.1.2.2-1. The inter-frequency measurements are supported by a measurement gap.

**Table A.4.7.1.2.2-1: SS-RSRP inter-frequency test parameters**

Parameter	Config	Unit	Test 1		Test 2	
			Cell 2	Cell 3	Cell 2	Cell 3
SSB ARFCN	1~6		freq1	freq2	freq1	freq2
BW <sub>channel</sub>	1,4	MHz	10: N <sub>RB,c</sub> = 52		10: N <sub>RB,c</sub> = 52	
	2,5		10: N <sub>RB,c</sub> = 52		10: N <sub>RB,c</sub> = 52	
	3,6		40: N <sub>RB,c</sub> = 106		40: N <sub>RB,c</sub> = 106	
Gap pattern ID			0		0	
Duplex mode	1,4		FDD		FDD	
	2,5		TDD		TDD	
	3,6		TDD		TDD	
TDD configuration	1,4		N/A		N/A	
	2,5		TDDConf.1.1		TDDConf.1.1	
	3,6		TDDConf.2.1		TDDConf.2.1	
PDSCH Reference measurement channel	1,4		SR.1.1 FDD	-	SR.1.1 FDD	-
	2,5		SR.1.1 TDD		SR.1.1 TDD	
	3,6		SR.2.1 FDD		SR.2.1 FDD	
RMSI CORESET Reference Channel	1,4		CR.1.1 FDD	-	CR.1.1 FDD	-

		2,5		CR.1.1 TDD	-	CR.1.1 TDD	-
		3,6		CR.2.1 FDD	-	CR.2.1 FDD	-
Dedicated CORESET Reference Channel		1,4		CCR.1.1 FDD	-	CCR.1.1 FDD	-
		2,5		CCR.1.1 TDD	-	CCR.1.1 TDD	-
		3,6		CCR.2.1 TDD	-	CCR.2.1 TDD	-
SSB configuration		1,4		SSB.1 FR1		SSB.1 FR1	
		2,5		SSB.1 FR1		SSB.1 FR1	
		3,6		SSB.2 FR1		SSB.2 FR1	
OCNG Patterns		1~6		OP.1		OP.1	
TRS configuration		1,4		TRS.1.1 FDD	-	TRS.1.1 FDD	-
		2,5		TRS.1.1 TDD		TRS.1.1 TDD	
		3,6		TRS.1.2 TDD		TRS.1.2 TDD	
Initial BWP Configuration		1~6		DLBWP.0.1 ULBWP.0.1		DLBWP.0.1 ULBWP.0.1	
Dedicated BWP configuration		1~6		DLBWP.1.1 ULBWP.1.1		DLBWP.1.1 ULBWP.1.1	
Time offset with Cell 2		1,4	ms	-	3	-	3
		2,3,5,6	µs	-	3	-	3
SMTC configuration		1,4		SMTC.2		SMTC.2	
		2,3,5,6		SMTC.1		SMTC.1	
EPRE ratio of PSS to SSS							
EPRE ratio of PBCH DMRS to SSS							
EPRE ratio of PBCH to PBCH DMRS							
EPRE ratio of PDCCH DMRS to SSS							
EPRE ratio of PDCCH to PDCCH DMRS		1~6	dB	0	0	0	0
EPRE ratio of PDSCH DMRS to SSS							
EPRE ratio of PDSCH to PDSCH DMRS							
EPRE ratio of OCNG DMRS to SSS <sup>Note 1</sup>							
EPRE ratio of OCNG to OCNG DMRS <sup>Note 1</sup>							
$N_{oc}$ <sup>Note 2</sup>	NR_FDD_FR1_A, NR_TDD_FR1_A <sup>NOTE 5</sup>	1~6	dBm/15 kHz	-94.65	$(N_{oc}$ for Cell 3 +8dB)	-115	
	NR_FDD_FR1_B					-114.5	
	NR_TDD_FR1_C					-114	
	NR_FDD_FR1_D, NR_TDD_FR1_D					-113.5	
	NR_FDD_FR1_E, NR_TDD_FR1_E					-113	
	NR_FDD_FR1_F					-112.5	
	NR_FDD_FR1_G					-112	
	NR_FDD_FR1_H					-111.5	
$N_{oc}$ <sup>Note 2</sup>	NR_FDD_FR1_A, NR_TDD_FR1_A <sup>NOTE 5</sup>	1,2,4,5	dBm/SS B SCS	-94.65	$(N_{oc}$ for Cell 3 +8dB)	-115	
	NR_FDD_FR1_B					-114.5	
	NR_TDD_FR1_C					-114	
	NR_FDD_FR1_D, NR_TDD_FR1_D					-113.5	
	NR_FDD_FR1_E, NR_TDD_FR1_E					-113	
	NR_FDD_FR1_F					-112.5	
	NR_FDD_FR1_G					-112	
	NR_FDD_FR1_H					-111.5	
	NR_FDD_FR1_A, NR_TDD_FR1_A <sup>NOTE 5</sup> , NR_SDL_FR1_A	3,6	-91.65	$(N_{oc}$ for C 3 +8dB)	-112.00		

	NR_FDD_FR1_B						-111.50
	NR_TDD_FR1_C						-111.00
	NR_FDD_FR1_D, NR_TDD_FR1_D						-110.50
	NR_FDD_FR1_E, NR_TDD_FR1_E						-110.00
	NR_FDD_FR1_F						-109.00
	NR_FDD_FR1_G						-108.50
	NR_FDD_FR1_H						-112.00
$\hat{E}_s/I_{ot}$		1~6	dB	10	10	13	-3
SS- RSRP <sup>Note3</sup>	NR_FDD_FR1_A, NR_TDD_FR1_A <small>NOTE 5</small>	1,2,4,5	dBm/SC S	-84.65	(RSRP for Cell 3 +25dB)	-118.00	
	NR_FDD_FR1_B					-117.50	
	NR_TDD_FR1_C					-117.00	
	NR_FDD_FR1_D, NR_TDD_FR1_D					-116.50	
	NR_FDD_FR1_E, NR_TDD_FR1_E					-116.00	
	NR_FDD_FR1_F					-115.50	
	NR_FDD_FR1_G					-115.00	
	NR_FDD_FR1_H					-114.50	
	NR_FDD_FR1_A, NR_TDD_FR1_A <small>NOTE 5</small>	3,6	-81.65	(RSRP for Cell 3 +25dB)	-115.00		
	NR_FDD_FR1_B				-114.50		
	NR_TDD_FR1_C				-114.00		
	NR_FDD_FR1_D, NR_TDD_FR1_D				-113.50		
	NR_FDD_FR1_E, NR_TDD_FR1_E				-113.00		
	NR_FDD_FR1_F				-112.50		
	NR_FDD_FR1_G				-112.00		
	NR_FDD_FR1_H				-111.50		
$I_o$ <sup>Note3</sup>	NR_FDD_FR1_A, NR_TDD_FR1_A <small>NOTE 6</small>	1,2,4,5	dBm/ 9.36MH z	-56.28	(I <sub>o</sub> for Channel 3 +19.75dB)	-85.28	
	NR_FDD_FR1_B					-84.78	
	NR_TDD_FR1_C					-84.28	
	NR_FDD_FR1_D, NR_TDD_FR1_D					-83.78	
	NR_FDD_FR1_E, NR_TDD_FR1_E					-83.28	
	NR_FDD_FR1_F					-82.78	
	NR_FDD_FR1_G					-82.28	
	NR_FDD_FR1_H					-81.78	
	NR_FDD_FR1_A, NR_TDD_FR1_A <small>NOTE 6</small>	3,6	dBm/ 38.16M Hz	-50.19	(I <sub>o</sub> for Channel 3 +19.75dB)	-79.19	
	NR_FDD_FR1_B					-78.69	
	NR_TDD_FR1_C					-78.19	
	NR_FDD_FR1_D, NR_TDD_FR1_D					-77.69	
	NR_FDD_FR1_E, NR_TDD_FR1_E					-77.19	
	NR_FDD_FR1_F					-76.69	
	NR_FDD_FR1_G					-76.19	
	NR_FDD_FR1_H					-75.69	
$\hat{E}_s/N_{oc}$		1~6	dB	10	10	13	-3
Propagation condition		1~6	-	AWGN		AWGN	
Antenna configuration				1x2		1x2	
<p>Note 1: OCNG shall be used such that both cells are fully allocated and a constant total transmitted power spectral density is achieved for all OFDM symbols.</p> <p>Note 2: Interference from other cells and noise sources not specified in the test is assumed to be constant over subcarriers and time and shall be modelled as AWGN of appropriate power for <math>N_{oc}</math> to be fulfilled.</p>							

Note 3:	RSRP and Io levels have been derived from other parameters for information purposes. They are not settable parameters themselves.
Note 4:	RSRP minimum requirements are specified assuming independent interference and noise at each receiver antenna port.
Note 5:	The test configuration excludes support for band n51 and it is not required to run this test on band n51 in this release of the specification

#### A.4.7.1.2.3 Test Requirements

The SS-RSRP measurement accuracy for Cell 2 and Cell 3 shall fulfil the Absolute requirement in clause 10.1.4.1.1 and Relative requirement in clause 10.1.4.1.2.

#### A.4.7.1.3 Void

### A.4.7.2 SS-RSRQ

#### A.4.7.2.1 EN-DC Intra-frequency measurement accuracy with FR1 serving cell and FR1 target cell

##### A.4.7.2.1.1 Test Purpose and Environment

The purpose of this test is to verify that the SS-RSRQ measurement accuracy is within the specified limits. This test will verify the requirements in Clause 10.1.7.1.1.

##### A.4.7.2.1.2 Test Parameters

In this test case all cells are on the same carrier frequency. Supported test configuration are shown in Table A.4.7.2.1.2-1. The absolute accuracy of SS-RSRQ intra-frequency measurement is test by using the parameters in Table A.4.7.2.1.2-2. The configuration of cell 1 (E-UTRA PCell) is specified in clause A.3.7.2.1. In all test cases, Cell 2 is the PSCell and Cell 3 is the target cell.

**Table A.4.7.2.1.2-1: SS-RSRQ Intra frequency SS-RSRQ supported test configurations**

Config	Description
1	LTE FDD, NR 15 kHz SSB SCS, 10MHz bandwidth, FDD duplex mode
2	LTE FDD, NR 15 kHz SSB SCS, 10MHz bandwidth, TDD duplex mode
3	LTE FDD, NR 30kHz SSB SCS, 40MHz bandwidth, TDD duplex mode
4	LTE TDD, NR 15 kHz SSB SCS, 10MHz bandwidth, FDD duplex mode
5	LTE TDD, NR 15 kHz SSB SCS, 10MHz bandwidth, TDD duplex mode
6	LTE TDD, NR 30kHz SSB SCS, 40MHz bandwidth, TDD duplex mode

Note: The UE is only required to be tested in one of the supported test configurations in each supported band

**Table A.4.7.2.1.2-2: SS-RSRQ Intra frequency test parameters**

Parameter		Unit	Test 1		Test 2		Test 3	
			Cell 2	Cell 3	Cell 2	Cell 3	Cell 2	Cell 3
Cell ID			489	0	489	0	489	0
SSB ARFCN			freq1		freq1		freq1	
Duplex mode	Config 1,4		FDD					
	Config 2,3,5,6		TDD					
TDD configuration	Config 1,4		Not Applicable					
	Config 2,5		TDDConf.1.1					
	Config 3,6		TDDConf.2.1					
BW <sub>channel</sub>	Config 1,4	MHz	10: N <sub>RB,c</sub> = 52					
	Config 2,5		10: N <sub>RB,c</sub> = 52					
	Config 3,6		40: N <sub>RB,c</sub> = 106					
BWP configuration	Initial DL BWP		DLBWP.0.1					
	Dedicated DL BWP		DLBWP.1.1					
	Initial UL BWP		ULBWP.0.1					
	Dedicated UL BWP		ULBWP.1.1					
DRX Cycle		ms	Not Applicable					



PDSCH Reference measurement channel	Config 1,4		SR.1.1 FDD	-	SR.1.1 FDD	-	SR.1.1 FDD	-
	Config 2,5		SR.1.1 TDD		SR.1.1 TDD		SR.1.1 TDD	
	Config 3,6		SR2.1 TDD		SR2.1 TDD		SR2.1 TDD	
RMSI CORESET Reference Channel	Config 1,4		CR.1.1 FDD	-	CR.1.1 FDD	-	CR.1.1 FDD	
	Config 2,5		CR.1.1 TDD		CR.1.1 TDD		CR.1.1 TDD	
	Config 3,6		CR.2.1 TDD		CR.2.1 TDD		CR.2.1 TDD	
Control Channel RMC	Config 1,4		CCR.1.1 FDD	-	CCR.1.1 FDD	-	CCR.1.1 FDD	-
	Config 2,5		CCR.1.1 TDD		CCR.1.1 TDD		CCR.1.1 TDD	
	Config 3,6		CCR.2.1 TDD		CCR.2.1 TDD		CCR.2.1 TDD	
TRS configuration	Config 1,4		TRS.1.1 FDD	-	TRS.1.1 FDD	-	TRS.1.1 FDD	-
	Config 2,5		TRS.1.1 TDD		TRS.1.1 TDD		TRS.1.1 TDD	
	Config 3,6		TRS.1.2 TDD		TRS.1.2 TDD		TRS.1.2 TDD	
OCNG Patterns			OP. 1					
SS-RSSI-Measurement			Not Applicable					
Time offset with Cell 2	Config 1,4	ms	-	3	-	3	-	3
	Config 2,3,5,6	µs	-	3	-	3	-	3
SMTC configuration	Config 1,4		SMTC.2					
	Config 2,3,5,6		SMTC.1					
SSB configuration	Config 1,2,4,5		SSB.1 FR1					
	Config 3,6		SSB.2 FR1					
PDSCH/PDCCH subcarrier spacing	Config 1,2,4,5	kHz	15 kHz					
	Config 3,6		30kHz					
EPRE ratio of PSS to SSS		dB	0	0	0	0	0	0
EPRE ratio of PBCH DMRS to SSS								
EPRE ratio of PBCH to PBCH DMRS								
EPRE ratio of PDCCH DMRS to SSS								
EPRE ratio of PDCCH to PDCCH DMRS								
EPRE ratio of PDSCH DMRS to SSS								
EPRE ratio of PDSCH to PDSCH								
EPRE ratio of OCNG DMRS to SSS(Note 1)								
EPRE ratio of OCNG to OCNG DMRS (Note 1)								
$N_{oc}$ Note2	Config 1,2,4,5	NR_FDD_FR1_A, NR_TDD_FR1_A NOTE 7	dBm/15k Hz	-85	-101	-114		
		NR_FDD_FR1_B					-113.5	
		NR_TDD_FR1_C					-113	
		NR_FDD_FR1_D, NR_TDD_FR1_D					-112.5	
		NR_FDD_FR1_E, NR_TDD_FR1_E					-112	
		NR_FDD_FR1_F					-111.5	
		NR_FDD_FR1_G					-111	
		NR_FDD_FR1_H					-110.5	
	Config 3,6	NR_FDD_FR1_A, NR_TDD_FR1_A NOTE 7	-91	-	-114			
		NR_FDD_FR1_B				-113.5		
		NR_TDD_FR1_C				-113		
		NR_FDD_FR1_D, NR_TDD_FR1_D				-112.5		
		NR_FDD_FR1_E, NR_TDD_FR1_E				-112		
		NR_FDD_FR1_F				-111.5		
NR_FDD_FR1_G	-111							

$N_{oc}$ Note2	Config 1,2,4,5	NR_FDD_FR1_H	dBm/SC S	-85		-101		-110.5		
		NR_FDD_FR1_A, NR_TDD_FR1_A NOTE 7						-114		
		NR_FDD_FR1_B						-113.5		
		NR_TDD_FR1_C						-113		
		NR_FDD_FR1_D, NR_TDD_FR1_D						-112.5		
		NR_FDD_FR1_E, NR_TDD_FR1_E						-112		
		NR_FDD_FR1_F						-111.5		
		NR_FDD_FR1_G						-111		
		NR_FDD_FR1_H						-110.5		
	Config 3,6	NR_FDD_FR1_A, NR_TDD_FR1_A NOTE 7	-88		-		-111			
		NR_FDD_FR1_B					-110.5			
		NR_TDD_FR1_C					-110			
		NR_FDD_FR1_D, NR_TDD_FR1_D					-109.5			
		NR_FDD_FR1_E, NR_TDD_FR1_E					-109			
		NR_FDD_FR1_F					-108.5			
		NR_FDD_FR1_G					-108			
		NR_FDD_FR1_H					-107.5			
		$\hat{E}_s/I_{ot}$					dB	-1.76		-4.7
$\hat{E}_s/N_{oc}$			dB	3	3	-2.9	-2.9	-4	-4	
SS-RSRP Note3	Config 1,2,4,5	NR_FDD_FR1_A, NR_TDD_FR1_A NOTE 7	dBm/SC S	-82		-103.9		-118		
		NR_FDD_FR1_B						-117.5		
		NR_TDD_FR1_C						-117		
		NR_FDD_FR1_D, NR_TDD_FR1_D						-116.5		
		NR_FDD_FR1_E, NR_TDD_FR1_E						-116		
		NR_FDD_FR1_F						-115.5		
		NR_FDD_FR1_G						-115		
		NR_FDD_FR1_H						-114.5		
		Config 3,6						NR_FDD_FR1_A, NR_TDD_FR1_A NOTE 7	-85	
	NR_FDD_FR1_B		-114.5							
	NR_TDD_FR1_C		-114							
	NR_FDD_FR1_D, NR_TDD_FR1_D		-113.5							
	NR_FDD_FR1_E, NR_TDD_FR1_E		-113							
	NR_FDD_FR1_F		-112.5							
	NR_FDD_FR1_G		-112							
	NR_FDD_FR1_H		-111.5							
	SS-RSRQ Note3			dB	-14.77	-14.77	-16.76	-16.76		
	NR_FDD_FR1_A, NR_TDD_FR1_A NOTE 7									
NR_FDD_FR1_B										
NR_TDD_FR1_C										
NR_FDD_FR1_D, NR_TDD_FR1_D										
NR_FDD_FR1_E, NR_TDD_FR1_E										
NR_FDD_FR1_F										
NR_FDD_FR1_G										
NR_FDD_FR1_H										

Io <sup>Note3</sup>	Config 1,2,4,5	NR_FDD_FR1_A, NR_TDD_FR1_A NOTE 7	dBm/ 9.36MHz z	-50	-70	-83.5			
		NR_FDD_FR1_B				-83			
		NR_TDD_FR1_C				-82.5			
		NR_FDD_FR1_D, NR_TDD_FR1_D				-82			
		NR_FDD_FR1_E, NR_TDD_FR1_E				-81.5			
		NR_FDD_FR1_F				-81			
		NR_FDD_FR1_G				-80.5			
		NR_FDD_FR1_H				-80			
	Config 3,6	NR_FDD_FR1_A, NR_TDD_FR1_A NOTE 7	dBm/ 38.16M Hz	-50	-	-77.4			
		NR_FDD_FR1_B				-76.9			
		NR_TDD_FR1_C				-76.4			
		NR_FDD_FR1_D, NR_TDD_FR1_D				-75.9			
		NR_FDD_FR1_E, NR_TDD_FR1_E				-75.4			
		NR_FDD_FR1_F				-74.9			
NR_FDD_FR1_G		-74.4							
NR_FDD_FR1_H		-73.9							
Propagation condition			-	AWGN	AWGN	AWGN	AWGN	AWGN	AWGN
Antenna configuration				1x2	1x2	1x2	1x2	1x2	1x2
<p>Note 1: OCNG shall be used such that both cells are fully allocated and a constant total transmitted power spectral density is achieved for all OFDM symbols.</p> <p>Note 2: Interference from other cells and noise sources not specified in the test is assumed to be constant over subcarriers and time and shall be modelled as AWGN of appropriate power for <math>N_{oc}</math> to be fulfilled.</p> <p>Note 3: SS-RSRQ, SS-RSRP, and Io levels have been derived from other parameters for information purposes. They are not settable parameters themselves.</p> <p>Note 4: SS-RSRQ, SS-RSRP minimum requirements are specified assuming independent interference and noise at each receiver antenna port.</p> <p>Note 5: NR operating band groups are as defined in Clause 3.5.2.</p> <p>Note 6: Subtest 2 is not used when testing with 30kHz SSB SCS</p> <p>Note 7: The test configuration excludes support for band n51 and it is not required to run this test on band n51 in this release of the specification</p>									

A.4.7.2.1.3 Test Requirements

The SS-RSRQ measurement accuracy shall fulfil the requirements in clause 10.1.7.1.1.

A.4.7.2.2 EN-DC Inter-frequency measurement accuracy with FR1 serving cell and FR1 target cell

A.4.7.2.2.1 Test Purpose and Environment

The purpose of this test is to verify that the SS-RSRQ measurement accuracy is within the specified limits. This test will verify the requirements in clause 10.1.9.1.1 and 10.1.9.1.2 for inter frequency measurement.

A.4.7.2.2.2 Test Parameters

In this test case the two NR cells (i.e., Cell 2 and Cell 3) are on different carrier frequencies and measurement gaps are provided. Supported test configurations are shown in Table A.4.7.2.2.2-1. Both absolute accuracy and relative accuracy requirements of SS-RSRQ inter-frequency measurement are tested by using test parameters in Table A.4.7.2.2.2-2. In all test cases, Cell 2 is the PSCell and Cell 3 is target cell. Cell 1 is the E-UTRA cell which specific test parameters for this test case are specified in Table A.3.7.2.1-1.

**Table A.4.7.2.2.2-1: SS-RSRQ Inter frequency SS-RSRQ supported test configurations**

Config	Description
1	LTE FDD, NR 15 kHz SSB SCS, 10 MHz bandwidth, FDD duplex mode

2	LTE FDD, NR 15 kHz SSB SCS, 10 MHz bandwidth, TDD duplex mode
3	LTE FDD, NR 30kHz SSB SCS, 40 MHz bandwidth, TDD duplex mode
4	LTE TDD, NR 15 kHz SSB SCS, 10 MHz bandwidth, FDD duplex mode
5	LTE TDD, NR 15 kHz SSB SCS, 10 MHz bandwidth, TDD duplex mode
6	LTE TDD, NR 30kHz SSB SCS, 40 MHz bandwidth, TDD duplex mode
Note: The UE is only required to be tested in one of the supported test configurations	

**Table A.4.7.2.2-2: SS-RSRQ Inter frequency test parameters**

Parameter		Unit	Test 1		Test 2		Test 3	
			Cell 2	Cell 3	Cell 2	Cell 3	Cell 2	Cell 3
SSB ARFCN			freq1	freq2	freq1	freq2	freq1	freq2
Duplex mode	Config 1,4		FDD					
	Config 2,3,5,6		TDD					
TDD configuration	Config 1,4		Not Applicable					
	Config 2,5		TDDConf.1.1					
	Config 3,6		TDDConf.2.1					
BW <sub>channel</sub>	Config 1,4	MHz	10: N <sub>RB,c</sub> = 52					
	Config 2,5		10: N <sub>RB,c</sub> = 52					
	Config 3,6		40: N <sub>RB,c</sub> = 106					
BWP BW	Config 1,4	MHz	10: N <sub>RB,c</sub> = 52					
	Config 2,5		10: N <sub>RB,c</sub> = 52					
	Config 3,6		40: N <sub>RB,c</sub> = 106					
DRX Cycle		ms	Not Applicable					
PDSCH Reference measurement channel	Config 1,4		SR.1.1 FDD	-	SR.1.1 FDD	-	SR.1.1 FDD	-
	Config 2,5		SR.1.1 TDD		SR.1.1 TDD		SR.1.1 TDD	
	Config 3,6		SR.2.1 TDD		SR.2.1 TDD		SR.2.1 TDD	
RMSI CORESET Reference Channel	Config 1,4		CR.1.1 FDD	-	CR.1.1 FDD	-	CR.1.1 FDD	-
	Config 2,5		CR.1.1 TDD		CR.1.1 TDD		CR.1.1 TDD	
	Config 3,6		CR.2.1 TDD		CR.2.1 TDD		CR.2.1 TDD	
Dedicated CORESET Reference Channel	Config 1,4		CCR.1.1 FDD	-	CCR.1.1 FDD	-	CCR.1.1 FDD	-
	Config 2,5		CCR.1.1 TDD		CCR.1.1 TDD		CCR.1.1 TDD	
	Config 3,6		CCR.2.1 TDD		CCR.2.1 TDD		CCR.2.1 TDD	
TRS configuration	Config 1,4		TRS.1.1 FDD	-	TRS.1.1 FDD	-	TRS.1.1 FDD	-
	Config 2,5		TRS.1.1 TDD		TRS.1.1 TDD		TRS.1.1 TDD	
	Config 3,6		TRS.1.2 TDD		TRS.1.2 TDD		TRS.1.2 TDD	
OCNG Patterns			OCNG pattern 1					
Time offset with Cell 2	Config 1,4	ms	-	3	-	3	-	3
	Config 2,3,5,6	µs	-	3	-	3	-	3
SMTC configuration	Config 1,4		SMTC pattern 2					
	Config 2,3,5,6		SMTC pattern 1					
SSB configuration	Config 1,2,4,5		SSB pattern 1 in FR1					
	Config 3,6		SSB pattern 2 in FR1					

PDSCH/PDCCH subcarrier spacing		Config 1,2,4,5	kHz	15 kHz							
		Config 3,6		30 kHz							
EPRE ratio of PSS to SSS			dB	0	0	0	0	0	0		
EPRE ratio of PBCH DMRS to SSS											
EPRE ratio of PBCH to PBCH DMRS											
EPRE ratio of PDCCH DMRS to SSS											
EPRE ratio of PDCCH to PDCCH DMRS											
EPRE ratio of PDSCH DMRS to SSS											
EPRE ratio of PDSCH to PDSCH											
EPRE ratio of OCNM DMRS to SSS(Note 1)											
EPRE ratio of OCNM to OCNM DMRS (Note 1)											
$N_{oc}^{Note2}$	Config 1,2,4,5	NR_FDD_FR1_A		dBm/15kHz	-80.18	-80.18	-106	-106	-116	-116	
		NR_TDD_FR1_A									
		NR_SDL_FR1_A									
		NR_FDD_FR1_B	-115.5								-115.5
		NR_TDD_FR1_C	-115								-115
		NR_FDD_FR1_D	-114.5								-114.5
		NR_TDD_FR1_D									
		NR_FDD_FR1_E	-114								-114
	NR_TDD_FR1_E										
	NR_FDD_FR1_G	-113	-113								
	NR_TDD_FR1_G	-112.5	-112.5								
	NR_FDD_FR1_H	-112.5	-112.5								
	Config 3,6	NR_FDD_FR1_A	dBm/15kHz	-86.27	-86.27	-113	-113	-116	-116		
		NR_TDD_FR1_A									
		NR_SDL_FR1_A									
		NR_FDD_FR1_B								-115.5	-115.5
NR_TDD_FR1_C		-115								-115	
NR_FDD_FR1_D		-114.5								-114.5	
NR_TDD_FR1_D											
NR_FDD_FR1_E		-114								-114	
NR_TDD_FR1_E											
NR_FDD_FR1_G	-113	-113									
NR_TDD_FR1_G	-112.5	-112.5									
NR_FDD_FR1_H	-112.5	-112.5									
$N_{oc}^{Note2}$	Config 1,2,4,5	NR_FDD_FR1_A	dBm/SCS	-80.18	-80.18	-106	-106	-116	-116		
		NR_TDD_FR1_A									
		NR_SDL_FR1_A									
		NR_FDD_FR1_B								-115.5	-115.5
		NR_TDD_FR1_C								-115	-115
		NR_FDD_FR1_D								-114.5	-114.5
		NR_TDD_FR1_D									
		NR_FDD_FR1_E								-114	-114
	NR_TDD_FR1_E										
	NR_FDD_FR1_G	-113	-113								
	NR_TDD_FR1_G	-112.5	-112.5								
	NR_FDD_FR1_H	-112.5	-112.5								
	Config 3,6	NR_FDD_FR1_A	dBm/SCS	-83.27	-83.27	-110	-110	-113	-113		
		NR_TDD_FR1_A									
		NR_SDL_FR1_A									
		NR_FDD_FR1_B								-112.5	-112.5
NR_TDD_FR1_C		-112								-112	
NR_FDD_FR1_D		-111.5								-111.5	
NR_TDD_FR1_D											
NR_FDD_FR1_E		-111								-111	
NR_TDD_FR1_E											
NR_FDD_FR1_G	-110	-110									
NR_TDD_FR1_G	-109.5	-109.5									
NR_FDD_FR1_H	-109.5	-109.5									
$\hat{E}_s / I_{ot}$			dB	-1.75	-1.75	-1.75	-1.75	3	-1.75		
$\hat{E}_s / N_{oc}$			dB	-1.75	-1.75	-1.75	-1.75	3	-1.75		
SS-RSRP <sup>Note3</sup>	Config 1,2,4,5	NR_FDD_FR1_A	dBm/SCS	-81.93	-81.93	-107.75	-107.75	-113	-		
		NR_TDD_FR1_A							117.75		
		NR_SDL_FR1_A									
		NR_FDD_FR1_B							-112.5	-	
		NR_TDD_FR1_C							-112	-	
		NR_FDD_FR1_D							-111.5	-	
		NR_TDD_FR1_D							-111.5	116.25	
		NR_FDD_FR1_E							-111	-	
NR_TDD_FR1_E	-111	115.75									
NR_FDD_FR1_G	-110	-									
NR_TDD_FR1_G	-110	114.75									
NR_FDD_FR1_H	-109.5	-									
NR_TDD_FR1_H	-109.5	114.25									

	Config 3,6	NR_FDD_FR1_A		-85.02	-85.02	-111.75	-111.75	-110	-		
		NR_TDD_FR1_A						-	114.75		
		NR_SDL_FR1_A									
		NR_FDD_FR1_B						-109.5	-		
									114.25		
		NR_TDD_FR1_C						-109	-		
									113.75		
		NR_FDD_FR1_D						-108.5	-		
NR_TDD_FR1_D											
NR_FDD_FR1_E	-108	-									
NR_TDD_FR1_E											
NR_FDD_FR1_G	-107	-									
		111.75									
NR_FDD_FR1_H	-106.5	-									
		111.25									
SS-RSRQ <sup>Note3</sup>		NR_FDD_FR1_A	dB	-14.77	-14.77	-40.59	-40.59	-12.56	-14.76		
		NR_TDD_FR1_A									
		NR_FDD_FR1_B									
		NR_TDD_FR1_C									
		NR_FDD_FR1_D									
		NR_TDD_FR1_D									
		NR_FDD_FR1_E									
		NR_TDD_FR1_E									
NR_FDD_FR1_G											
NR_FDD_FR1_H											
Io <sup>Note3</sup>	Config 1,2,4,5	NR_FDD_FR1_A	dBm/ 9.36MHz	-50	-50	-75.83	-75.83	-83.28	-85.83		
		NR_TDD_FR1_A									
		NR_SDL_FR1_A									
		NR_FDD_FR1_B								-82.78	-85.33
		NR_TDD_FR1_C								-82.28	-84.83
		NR_FDD_FR1_D								-81.78	-84.33
		NR_TDD_FR1_D									
		NR_FDD_FR1_E								-81.28	-83.83
	NR_TDD_FR1_E										
	NR_FDD_FR1_G	-80.28	-82.83								
	NR_FDD_FR1_H	-79.78	-82.33								
	Config 3,6	NR_FDD_FR1_A	dBm/ 38.16MHz	-50	-50	-76.73	-76.73	-77.19	-79.73		
		NR_TDD_FR1_A									
		NR_SDL_FR1_A									
		NR_FDD_FR1_B								-76.69	-79.23
		NR_TDD_FR1_C								-76.19	-78.73
NR_FDD_FR1_D		-75.69								-78.23	
NR_TDD_FR1_D											
NR_FDD_FR1_E		-75.19								-77.73	
NR_TDD_FR1_E											
NR_FDD_FR1_G	-74.19	-76.73									
NR_FDD_FR1_H	-73.69	-76.53									
Propagation condition				AWGN	AWGN	AWGN	AWGN	AWGN	AWGN		
<p>Note 1: OCNG shall be used such that both cells are fully allocated and a constant total transmitted power spectral density is achieved for all OFDM symbols.</p> <p>Note 2: Interference from other cells and noise sources not specified in the test is assumed to be constant over subcarriers and time and shall be modelled as AWGN of appropriate power for <math>N_{oc}</math> to be fulfilled.</p> <p>Note 3: SS-RSRQ, SS-RSRP, and Io levels have been derived from other parameters for information purposes. They are not settable parameters themselves.</p> <p>Note 4: SS-RSRQ, SS-RSRP minimum requirements are specified assuming independent interference and noise at each receiver antenna port.</p> <p>Note 5: NR operating band groups are as defined in Clause 3.5.2.</p>											

### A.4.7.2.2.3 Test Requirements

The SS-RSRQ measurement accuracy shall fulfil the requirements in clause 10.1.9.1.1 and 10.1.9.1.2.

### A.4.7.3 SS-SINR

#### A.4.7.3.1 EN-DC Intra-frequency measurement accuracy with FR1 serving cell and FR1 target cell

##### A.4.7.3.1.1 Test Purpose and Environment

The purpose of this test is to verify that the SS-SINR measurement accuracy is within the specified limits. This test will verify the requirements in clause 10.1.12.1.1.

##### A.4.7.3.1.2 Test Parameters

In this test case all cells are on the same carrier frequency. Supported test configuration are shown in Table A.4.7.3.1.2-1. The absolute accuracy of SS-SINR intra-frequency measurement is tested by using the parameters in Table A.4.7.3.1.2-2. The configuration of cell 1 (E-UTRA PCell) is specified in clause A.3.7.2.1. In all test cases, Cell 2 is the PSCell and Cell 3 is the target cell.

**Table A.4.7.3.1.2-1: SS-SINR Intra frequency SS-SINR supported test configurations**

Config	Description
1	LTE FDD, NR 15 kHz SSB SCS, 10 MHz bandwidth, FDD duplex mode
2	LTE FDD, NR 15 kHz SSB SCS, 10 MHz bandwidth, TDD duplex mode
3	LTE FDD, NR 30 kHz SSB SCS, 40 MHz bandwidth, TDD duplex mode
4	LTE TDD, NR 15 kHz SSB SCS, 10 MHz bandwidth, FDD duplex mode
5	LTE TDD, NR 15 kHz SSB SCS, 10 MHz bandwidth, TDD duplex mode
6	LTE TDD, NR 30 kHz SSB SCS, 40 MHz bandwidth, TDD duplex mode

Note: The UE is only required to be tested in one of the supported test configurations

**Table A.4.7.3.1.2-2: SS-SINR Intra frequency test parameters**

Parameter		Unit	Test 1		Test 2	
			Cell 2	Cell 3	Cell 2	Cell 3
Cell ID			489	0	489	0
SSB ARFCN			freq1		freq1	
Duplex mode	Config 1,4		FDD			
	Config 2,3,5,6		TDD			
TDD configuration	Config 1,4		Not Applicable			
	Config 2,5		TDDConf.1.1			
	Config 3,6		TDDConf.2.1			
Downlink initial BWP configuration			DLBWP.0.1			
Downlink dedicated BWP configuration			DLBWP.1.1			
Uplink initial BWP configuration			ULBWP.0.1			
Uplink dedicated BWP configuration			ULBWP.1.1			
DRX Cycle configuration		ms	Not Applicable			
TRS Configuration	Config 1,4		TRS.1.1 FDD	-	TRS.1.1 FDD	-
	Config 2,5		TRS.1.1 TDD		TRS.1.1 TDD	
	Config 3,6		TRS.1.2 TDD		TRS.1.2 TDD	
PDSCH Reference measurement channel	Config 1,4		SR.1.1 FDD	-	SR.1.1 FDD	-
	Config 2,5		SR.1.1 TDD		SR.1.1 TDD	
	Config 3,6		SR.2.1 TDD		SR.2.1 TDD	
RMSI CORESET Reference Channel	Config 1,4		CR.1.1 FDD	-	CR.1.1 FDD	
	Config 2,5		CR.1.1 TDD		CR.1.1 TDD	
	Config 3,6		CR.2.1 TDD		CR.2.1 TDD	
Dedicated CORESET Reference Channel	Config 1,4		CCR.1.1 FDD	-	CCR.1.1 FDD	-
	Config 2,5		CCR.1.1 TDD		CCR.1.1 TDD	

		Config 3,6		CCR.2.1 TDD		CCR.2.1 TDD		
OCNG Patterns				OP.1				
SS-RSSI-Measurement				Not Applicable				
Time offset with Cell 2	Config 1,4	ms	-	3	-	3		
	Config 2,3,5,6	µs	-	3	-	3		
SMTc configuration	Config 1,4		SMTc.2					
	Config 2,3,5,6		SMTc.1					
SSB configuration	Config 1,2,4,5		SSB.1 FR1					
	Config 3,6		SSB.2 FR1					
PDSCH/PDCCH subcarrier spacing	Config 1,2,4,5	kHz	15					
	Config 3,6		30					
EPRE ratio of PSS to SSS			0	0	0	0		
EPRE ratio of PBCH DMRS to SSS								
EPRE ratio of PBCH to PBCH DMRS								
EPRE ratio of PDCCH DMRS to SSS								
EPRE ratio of PDCCH to PDCCH DMRS								
EPRE ratio of PDSCH DMRS to SSS								
EPRE ratio of PDSCH to PDSCH								
EPRE ratio of OCNG DMRS to SSS(Note 1)								
EPRE ratio of OCNG to OCNG DMRS (Note 1)								
$N_{oc}$ <sup>Note2</sup>	NR_FDD_FR1_A, NR_TDD_FR1_A NOTE 6		dBm/15kHz z	-93		-116		
		NR_FDD_FR1_B						-115.5
		NR_TDD_FR1_C						-115
		NR_FDD_FR1_D, NR_TDD_FR1_D						-114.5
		NR_FDD_FR1_E, NR_TDD_FR1_E						-114
		NR_FDD_FR1_F						-113.5
		NR_FDD_FR1_G						-113
		NR_FDD_FR1_H						-112.5
$N_{oc}$ <sup>Note2</sup>	Config 1,2,4,5		dBm/SCS	-93		Same as $N_{oc}$ for 15kHz		
		Config 3,6						-113
	NR_FDD_FR1_A, NR_TDD_FR1_A NOTE 6	-112.5						
	NR_FDD_FR1_B	-112						
	NR_TDD_FR1_C	-111.5						
	NR_FDD_FR1_D, NR_TDD_FR1_D	-111						
	NR_FDD_FR1_E, NR_TDD_FR1_E	-110.5						
	NR_FDD_FR1_F	-110						
NR_FDD_FR1_G	-109.5							
$\hat{E}_s / I_{ot}$			dB	0	-3.19	-5.46	-5.46	
$\hat{E}_s / N_{oc}$			dB	4.54	2.66	-4	-4	
SS-RSRP <sup>Note 3</sup>	Config 1,2,4,5	NR_FDD_FR1_A, NR_TDD_FR1_A	dBm/SCS	-88.46	-90.34	-120	-120	
		NR_FDD_FR1_B				-119.5	-119.5	
		NR_TDD_FR1_C				-119	-119	
		NR_FDD_FR1_D, NR_TDD_FR1_D				-118.5	-118.5	
		NR_FDD_FR1_E, NR_TDD_FR1_E				-118	-118	
		NR_FDD_FR1_F				-117.5	-117.5	
		NR_FDD_FR1_G				-117	-117	
		NR_FDD_FR1_H				-116.5	-116.5	



	Config 3,6	NR_FDD_FR1_A, NR_TDD_FR1_A NOTE 6		-85.46	-87.34	-117	-117
		NR_FDD_FR1_B				-116.5	-116.5
		NR_TDD_FR1_C				-116	-116
		NR_FDD_FR1_D, NR_TDD_FR1_D				-115.5	-115.5
		NR_FDD_FR1_E, NR_TDD_FR1_E				-115	-115
		NR_FDD_FR1_F				-114.5	-114.5
		NR_FDD_FR1_G				-114	-114
		NR_FDD_FR1_H				-113.5	-113.5
SS-SINR <sup>Note3</sup>		NR_FDD_FR1_A, NR_TDD_FR1_A NOTE 6	dB	0	-3.19	-5.46	-5.46
		NR_FDD_FR1_B					
		NR_TDD_FR1_C					
		NR_FDD_FR1_D, NR_TDD_FR1_D					
		NR_FDD_FR1_E, NR_TDD_FR1_E					
		NR_FDD_FR1_F					
		NR_FDD_FR1_G					
		NR_FDD_FR1_H					
Io <sup>Note3</sup>	Config 1,2,4,5	NR_FDD_FR1_A, NR_TDD_FR1_A NOTE 6	dBm/ 9.36MHz	-57.5			-85.51
		NR_FDD_FR1_B					-85.01
		NR_TDD_FR1_C					-84.51
		NR_FDD_FR1_D, NR_TDD_FR1_D					-84.01
		NR_FDD_FR1_E, NR_TDD_FR1_E					-83.51
		NR_FDD_FR1_F					-83.01
		NR_FDD_FR1_G					-82.51
		NR_FDD_FR1_H					-82.01
	Config 3,6	NR_FDD_FR1_A, NR_TDD_FR1_A NOTE 6	dBm/ 38.16MHz	-51.41			-79.41
		NR_FDD_FR1_B					-78.91
		NR_TDD_FR1_C					-78.41
		NR_FDD_FR1_D, NR_TDD_FR1_D					-77.91
		NR_FDD_FR1_E, NR_TDD_FR1_E					-77.41
		NR_FDD_FR1_F					-76.91
		NR_FDD_FR1_G					-76.41
		NR_FDD_FR1_H					-75.91
Propagation condition			-	AWGN			
Antenna configuration			-	1x2			
<p>Note 1: OCNG shall be used such that both cells are fully allocated and a constant total transmitted power spectral density is achieved for all OFDM symbols.</p> <p>Note 2: Interference from other cells and noise sources not specified in the test is assumed to be constant over subcarriers and time and shall be modelled as AWGN of appropriate power for <math>N_{oc}</math> to be fulfilled.</p> <p>Note 3: SS-SINR, SS-RSRP, and Io levels have been derived from other parameters for information purposes. They are not settable parameters themselves.</p> <p>Note 4: SS-SINR, SS-RSRP minimum requirements are specified assuming independent interference and noise at each receiver antenna port.</p> <p>Note 5: NR operating band groups are as defined in Clause 3.5.2.</p> <p>Note 6: The test configuration excludes support for band n51 and it is not required to run this test on band n51 in this release of the specification</p>							

### A.4.7.3.1.3 Test Requirements

The SS-SINR measurement accuracy shall fulfil the requirements in clause 10.1.12.1.1.

### A.4.7.3.2 EN-DC Inter-frequency measurement accuracy with FR1 serving cell and FR1 target cell

#### A.4.7.3.2.1 Test Purpose and Environment

The purpose of this test is to verify that the SS-SINR measurement accuracy is within the specified limits. This test will verify the requirements in clause 10.1.14.1.1 and 10.1.14.1.2 for interfrequency measurement.

#### A.4.7.3.2.2 Test Parameters

In this test case the two NR cells (i.e., Cell 2 and Cell 3) are on different carrier frequencies and measurement gaps are provided. Supported test configurations are shown in Table A.4.7.3.2.2-1. Both absolute accuracy and relative accuracy requirements of SS-SINR inter-frequency measurement are tested by using test parameters in Table A.4.7.3.2.2-2. In all test cases, Cell 2 is the PSCell and Cell 3 is target cell. Cell 1 is the E-UTRA cell of which specific test parameters for this test case are specified in Table A.3.7.2.1-1.

**Table A.4.7.3.2.2-1: SS-SINR Inter frequency SS-SINR supported test configurations**

Config	Description
1	LTE FDD, NR 15 kHz SSB SCS, 10 MHz bandwidth, FDD duplex mode
2	LTE FDD, NR 15 kHz SSB SCS, 10 MHz bandwidth, TDD duplex mode
3	LTE FDD, NR 30 kHz SSB SCS, 40 MHz bandwidth, TDD duplex mode
4	LTE TDD, NR 15 kHz SSB SCS, 10 MHz bandwidth, FDD duplex mode
5	LTE TDD, NR 15 kHz SSB SCS, 10 MHz bandwidth, TDD duplex mode
6	LTE TDD, NR 30 kHz SSB SCS, 40 MHz bandwidth, TDD duplex mode

Note: The UE is only required to be tested in one of the supported test configurations

**Table A.4.7.3.2.2-2: SS-SINR Inter frequency test parameters**

Parameter		Unit	Test 1		Test 2		Test 3	
			Cell 2	Cell 3	Cell 2	Cell 3	Cell 2	Cell 3
SSB ARFCN			freq1	freq2	freq1	freq2	freq1	freq2
Duplex mode	Config 1,4		FDD					
	Config 2,3,5,6		TDD					
TDD configuration	Config 1,4		Not Applicable					
	Config 2,5		TDDConf.1.1					
	Config 3,6		TDDConf.2.1					
Downlink initial BWP configuration			DLBWP.0.1					
Downlink dedicated BWP configuration			DLBWP.1.1					
Uplink initial BWP configuration			ULBWP.0.1					
Uplink dedicated BWP configuration			ULBWP.1.1					
DRX Cycle configuration		ms	Not Applicable					
Gap pattern ID			0	-	0	-	0	-
TRS configuration	Config 1,4		TRS.1.1 FDD	-	TRS.1.1 FDD	-	TRS.1.1 FDD	-
	Config 2,5		TRS.1.1 TDD		TRS.1.1 TDD		TRS.1.1 TDD	
	Config 3,6		TRS.1.2 TDD		TRS.1.2 TDD		TRS.1.2 TDD	
PDSCH Reference measurement channel	Config 1,4		SR.1.1 FDD	-	SR.1.1 FDD	-	SR.1.1 FDD	-
	Config 2,5		SR.1.1 TDD		SR.1.1 TDD		SR.1.1 TDD	
	Config 3,6		SR.2.1 TDD		SR.2.1 TDD		SR.2.1 TDD	
RMSI CORESET Reference Channel	Config 1,4		CR.1.1 FDD	-	CR.1.1 FDD	-	CR.1.1 FDD	-
	Config 2,5		CR.1.1 TDD		CR.1.1 TDD		CR.1.1 TDD	

	Config 3,6		CR.2.1 TDD		CR.2.1 TDD		CR.2.1 TDD	
Dedicated CORESET Reference Channel	Config 1,4		CCR.1. 1 FDD	-	CCR.1. 1 FDD	-	CCR.1. 1 FDD	-
	Config 2,5		CCR.1. 1 TDD		CCR.1. 1 TDD		CCR.1. 1 TDD	
	Config 3,6		CCR.2. 1 TDD		CCR.2. 1 TDD		CCR.2. 1 TDD	
OCNG Patterns			OP.1					
SS-RSSI-Measurement			Not Applicable					
Time offset with Cell 2	Config 1,4	ms	-	3	-	3	-	3
	Config 2,3,5,6	µs	-	3	-	3	-	3
SMTC configuration	Config 1,4		SMTC.2					
	Config 2,3,5,6		SMTC.1					
SSB configuration	Config 1,2,4,5		SSB.1 FR1					
	Config 3,6		SSB.2 FR1					
PDSCH/PDCCH subcarrier spacing	Config 1,2,4,5	kHz	15					
	Config 3,6		30					
EPRE ratio of PSS to SSS		dB	0	0	0	0	0	0
EPRE ratio of PBCH DMRS to SSS								
EPRE ratio of PBCH to PBCH DMRS								
EPRE ratio of PDCCH DMRS to SSS								
EPRE ratio of PDCCH to PDCCH DMRS								
EPRE ratio of PDSCH DMRS to SSS								
EPRE ratio of PDSCH to PDSCH								
EPRE ratio of OCNG DMRS to SSS(Note 1)								
EPRE ratio of OCNG to OCNG DMRS (Note 1)								
$N_{oc}$ Note2	Config 1,2,4,5	NR_FDD_FR1_A	dBm/15k Hz	-88	-108.5	-119.5		
		NR_TDD_FR1_A						
		NOTE 6						
		NR_FDD_FR1_B						-119
		NR_TDD_FR1_C						-118.5
		NR_FDD_FR1_D						-118
		NR_TDD_FR1_D						
		NR_FDD_FR1_E						-117.5
		NR_TDD_FR1_E						
NR_FDD_FR1_F		-117						
NR_FDD_FR1_G		-116.5						
NR_FDD_FR1_H		-116						
$N_{oc}$ Note2	Config 1,2,4,5		dBm/SC S	-88	-108.5	Same as $N_{oc}$ for 15kHz		
	Config 3,6	NR_FDD_FR1_A	dBm/SC S	-85	-105.5	-116.5		
		NR_TDD_FR1_A						
		NOTE 6						
		NR_FDD_FR1_B						-116
		NR_TDD_FR1_C						-115.5
NR_FDD_FR1_D		-115						
NR_TDD_FR1_D								
NR_FDD_FR1_E		-114.5						
NR_TDD_FR1_E								
NR_FDD_FR1_F		-114						
NR_FDD_FR1_G		-114.5						
NR_FDD_FR1_H		-113						
$\hat{E}_s / I_{ot}$		dB	-1.75	20	-4.0			
$\hat{E}_s / N_{oc}$		dB	-1.75	20	-4.0			
SS-RSRP <sup>Not e3</sup>	Config 1,2,4,5	NR_FDD_FR1_A	dBm/SC S	-89.75	-88.5	-123.5		
		NR_TDD_FR1_A						
		NOTE 6						
		NR_FDD_FR1_B						-123
NR_TDD_FR1_C		-122.5						
NR_FDD_FR1_D		-122						

	Config 3,6	NR_TDD_FR1_D					
		NR_FDD_FR1_E				-121.5	
		NR_TDD_FR1_E					
		NR_FDD_FR1_F					-121
		NR_FDD_FR1_G					-120.5
		NR_FDD_FR1_H					-120
		NR_FDD_FR1_A	-86.75	-85.5		-120.5	
		NR_TDD_FR1_A NOTE 6					
		NR_FDD_FR1_B				-120	
		NR_TDD_FR1_C				-119.5	
		NR_FDD_FR1_D				-119	
		NR_TDD_FR1_D					
		NR_FDD_FR1_E				-118.5	
NR_TDD_FR1_E							
NR_FDD_FR1_F				-118			
NR_FDD_FR1_G				-117.5			
NR_FDD_FR1_H				-117			
SS-SINR <sup>Note3</sup>		NR_FDD_FR1_A NR_TDD_FR1_A NOTE 6	dB	-1.75	20	-4.0	
		NR_FDD_FR1_B					
		NR_TDD_FR1_C					
		NR_FDD_FR1_D					
		NR_TDD_FR1_D					
		NR_FDD_FR1_E					
		NR_TDD_FR1_E					
		NR_FDD_FR1_F					
		NR_FDD_FR1_G					
		NR_FDD_FR1_H					
Io <sup>Note3</sup>	Config 1,2,4,5	NR_FDD_FR1_A	dBm/ 9.36MHz	-57.83	-60.5	-90.09	
		NR_TDD_FR1_A NOTE 6					
		NR_FDD_FR1_B					-89.59
		NR_TDD_FR1_C					-89.09
		NR_FDD_FR1_D					-88.59
		NR_TDD_FR1_D					
		NR_FDD_FR1_E					-88.09
		NR_TDD_FR1_E					
		NR_FDD_FR1_F					-87.59
	NR_FDD_FR1_G	-87.09					
	NR_FDD_FR1_H	-86.59					
	Config 3,6	NR_FDD_FR1_A	dBm/ 38.16MH Z	-51.73	-54.41	-84	
		NR_TDD_FR1_A NOTE 6					
		NR_FDD_FR1_B					-83.5
		NR_TDD_FR1_C					-83
		NR_FDD_FR1_D					-82.5
		NR_TDD_FR1_D					
		NR_FDD_FR1_E					-82
		NR_TDD_FR1_E					
NR_FDD_FR1_F		-81.5					
NR_FDD_FR1_G	-81						
NR_FDD_FR1_H	-80.5						
Propagation condition			-	AWGN			
Antenna configuration			-	1x2			
<p>Note 1: OCNG shall be used such that both cells are fully allocated and a constant total transmitted power spectral density is achieved for all OFDM symbols.</p> <p>Note 2: Interference from other cells and noise sources not specified in the test is assumed to be constant over subcarriers and time and shall be modelled as AWGN of appropriate power for <math>N_{oc}</math> to be fulfilled.</p> <p>Note 3: SS-SINR, SS-RSRP, and Io levels have been derived from other parameters for information purposes. They are not settable parameters themselves.</p> <p>Note 4: SS-SINR, SS-RSRP minimum requirements are specified assuming independent interference and noise at each receiver antenna port.</p> <p>Note 5: NR operating band groups are as defined in Clause 3.5.2.</p>							

Note 6: The test configuration excludes support for band n51 and it is not required to run this test on band n51 in this release of the specification

#### A.4.7.3.2.3 Test Requirements

The SS-SINR measurement accuracy shall fulfil the requirements in clause 10.1.14.1.1 and 10.1.14.1.2.

### A.4.7.4 L1-RSRP measurement for beam reporting

#### A.4.7.4.1 SSB based L1-RSRP measurement

##### A.4.7.4.1.1 Test Purpose and Environment

The purpose of this test is to verify that the L1-RSRP measurement accuracy is within the specified limits. This test will verify the requirements in Clauses 9.5.2 and clause 10.1.19.1 for L1-RSRP measurements based on SSB with the testing configurations for NR cells in Table A.4.7.4.1.1-1.

**Table A.4.7.4.1.1-1: Applicable NR configurations for FR1 SSB based L1-RSRP test**

Config	Description
1	LTE FDD, NR 15 kHz SSB SCS, 10 MHz bandwidth, FDD duplex mode
2	LTE FDD, NR 15 kHz SSB SCS, 10 MHz bandwidth, TDD duplex mode
3	LTE FDD, NR 30kHz SSB SCS, 40 MHz bandwidth, TDD duplex mode
4	LTE TDD, NR 15 kHz SSB SCS, 10 MHz bandwidth, FDD duplex mode
5	LTE TDD, NR 15 kHz SSB SCS, 10 MHz bandwidth, TDD duplex mode
6	LTE TDD, NR 30kHz SSB SCS, 40 MHz bandwidth, TDD duplex mode

Note: The UE is only required to be tested in one of the supported test configurations in each supported band

##### A.4.7.4.1.2 Test parameters

In this set of test cases there are two cells in the test, E-UTRAN PCell (Cell 1), FR1 PSCell (Cell 2). The test parameters and applicability for Cell 1 are defined in A.3.7.2. The test parameters for the Cell 2 are given in Table A.4.7.4.1.2-1 below. The absolute and relative accuracy of L1-RSRP measurements are tested by using the parameters in Table A.4.7.4.1.2-1.

There is no measurement gap configured in the test. Before the test, UE is configured one SSB resource set with two SSB resources. UE is configured to perform RLM, BFD and L1-RSRP measurement based on the SSB resources 0 and 1.

**Table A.4.7.4.1.2-1: FR1 SSB based L1-RSRP test parameters**

Parameter	Config	Unit	Test 1	Test 2
SSB GSCN	1~6		freq1	freq1
Duplex mode	1,4		FDD	FDD
	2,5		TDD	TDD
	3,6		TDD	TDD
TDD Configuration	1,4		N/A	N/A
	2,5		TDDConf.1.1	TDDConf.1.1
	3,6		TDDConf.2.1	TDDConf.2.1
BW <sub>channel</sub>	1,4	MHz	10: N <sub>RB,c</sub> = 52	10: N <sub>RB,c</sub> = 52
	2,5		10: N <sub>RB,c</sub> = 52	10: N <sub>RB,c</sub> = 52
	3,6		40: N <sub>RB,c</sub> = 106	40: N <sub>RB,c</sub> = 106
PDSCH Reference measurement channel	1,4		SR.1.1 FDD	SR.1.1 FDD
	2,5		SR.1.1 TDD	SR.1.1 TDD
	3,6		SR.2.1 TDD	SR.2.1 TDD
RMSI CORESET Reference Channel	1,4		CR.1.1 FDD	CR.1.1 FDD
	2,5		CR.1.1 TDD	CR.1.1 TDD
	3,6		CR.2.1 TDD	CR.2.1 TDD
Dedicated CORESET Reference Channel	1,4		CCR.1.1 FDD	CCR.1.1 FDD
	2,5		CCR.1.1 TDD	CCR.1.1 TDD
	3,6		CCR.2.1 TDD	CCR.2.1 TDD

SSB configuration	1,4		SSB.3 FR1	SSB.3 FR1		
	2,5		SSB.3 FR1	SSB.3 FR1		
	3,6		SSB.4 FR1	SSB.4 FR1		
OCNG Patterns	1~6		OP.1	OP.1		
TRS configuration	1,4		TRS.1.1 FDD	TRS.1.1 FDD		
	2,5		TRS.1.1 TDD	TRS.1.1 TDD		
	3,6		TRS.1.2 TDD	TRS.1.2 TDD		
Initial BWP Configuration	1~6		DLBWP.0.1 ULBWP.0.1	DLBWP.0.1 ULBWP.0.1		
Dedicated BWP configuration	1~6		DLBWP.1.1 ULBWP.1.1	DLBWP.1.1 ULBWP.1.1		
SMTC configuration	1~6		SMTC.1	SMTC.1		
reportConfigType	1~6		periodic	periodic		
reportQuantity	1~6		ssb-Index-RSRP	ssb-Index-RSRP		
Number of reported RS	1~6		2	2		
L1-RSRP reporting period	1~6		slot80	slot80		
EPRE ratio of PSS to SSS	1~6	dB	0	0		
EPRE ratio of PBCH DMRS to SSS						
EPRE ratio of PBCH to PBCH DMRS						
EPRE ratio of PDCCH DMRS to SSS						
EPRE ratio of PDCCH to PDCCH DMRS						
EPRE ratio of PDSCH DMRS to SSS						
EPRE ratio of PDSCH to PDSCH DMRS						
EPRE ratio of OCNG DMRS to SSS <sup>Note 1</sup>						
EPRE ratio of OCNG to OCNG DMRS <sup>Note 1</sup>						
$N_{oc}$ <sup>Note2</sup>					NR_FDD_FR1_A, NR_TDD_FR1_A <sup>NOTE 5</sup>	1~6
	NR_FDD_FR1_B	-116.5				
	NR_TDD_FR1_C	-116				
	NR_FDD_FR1_D, NR_TDD_FR1_D	-115.5				
	NR_FDD_FR1_E, NR_TDD_FR1_E	-115				
	NR_FDD_FR1_F	-114.5				
	NR_FDD_FR1_G	-114				
	NR_FDD_FR1_H	-113.5				
$N_{oc}$ <sup>Note2</sup>	NR_FDD_FR1_A, NR_TDD_FR1_A <sup>NOTE 5</sup>	1,2,4,5	dBm/SSB SCS	-94.65	-117	
	NR_FDD_FR1_B					-116.5
	NR_TDD_FR1_C					-116
	NR_FDD_FR1_D, NR_TDD_FR1_D					-115.5
	NR_FDD_FR1_E, NR_TDD_FR1_E					-115
	NR_FDD_FR1_F					-114.5
	NR_FDD_FR1_G					-114
	NR_FDD_FR1_H	-113.5				
	NR_FDD_FR1_A, NR_TDD_FR1_A <sup>NOTE 5</sup>	3,6		-91.65	-114	
	NR_FDD_FR1_B					-113.5
	NR_TDD_FR1_C					-114
	NR_FDD_FR1_D, NR_TDD_FR1_D					-112.5
	NR_FDD_FR1_E, NR_TDD_FR1_E					-112

	NR_FDD_FR1_F				-111.5		
	NR_FDD_FR1_G				-111		
	NR_FDD_FR1_H				-110.5		
$\hat{E}_s/I_{ot}$		1~6	dB	10	-3		
SSB RSRP Note3	NR_FDD_FR1_A, NR_TDD_FR1_A NOTE 5	1,2,4,5	dBm/SSB SCS	-84.65	-120		
	NR_FDD_FR1_B				-119.5		
	NR_TDD_FR1_C				-119		
	NR_FDD_FR1_D, NR_TDD_FR1_D				-118.5		
	NR_FDD_FR1_E, NR_TDD_FR1_E				-118		
	NR_FDD_FR1_F				-117.5		
	NR_FDD_FR1_G				-117		
	NR_FDD_FR1_H				-116.5		
	NR_FDD_FR1_A, NR_TDD_FR1_A NOTE 5	3,6		-81.65	-117		
	NR_FDD_FR1_B				-116.5		
	NR_TDD_FR1_C				-116		
	NR_FDD_FR1_D, NR_TDD_FR1_D				-115.5		
	NR_FDD_FR1_E, NR_TDD_FR1_E				-115		
	NR_FDD_FR1_F				-114.5		
	NR_FDD_FR1_G				-114		
	NR_FDD_FR1_H				-113.5		
	I <sub>o</sub> Note3	NR_FDD_FR1_A, NR_TDD_FR1_A NOTE 5		1,2,4,5	dBm/9.36 MHz	-56.28	-87.28
		NR_FDD_FR1_B					-86.78
		NR_TDD_FR1_C					-86.28
		NR_FDD_FR1_D, NR_TDD_FR1_D					-85.78
NR_FDD_FR1_E, NR_TDD_FR1_E		-85.28					
NR_FDD_FR1_F		-84.78					
NR_FDD_FR1_G		-84.28					
NR_FDD_FR1_H		-83.78					
NR_FDD_FR1_A, NR_TDD_FR1_A NOTE 5		3,6	-50.19	-81.19			
NR_FDD_FR1_B				-80.69			
NR_TDD_FR1_C				-80.19			
NR_FDD_FR1_D, NR_TDD_FR1_D				-79.69			
NR_FDD_FR1_E, NR_TDD_FR1_E				-79.19			
NR_FDD_FR1_F				-78.69			
NR_FDD_FR1_G				-78.19			
NR_FDD_FR1_H				-77.69			
$\hat{E}_s/N_{oc}$		1~6	dB	10	-3		
Propagation condition		1~6		AWGN	AWGN		
Antenna configuration		1~6		1x2	1x2		
<p>Note 1: OCNB shall be used such that both cells are fully allocated and a constant total transmitted power spectral density is achieved for all OFDM symbols.</p> <p>Note 2: Interference from other cells and noise sources not specified in the test is assumed to be constant over subcarriers and time and shall be modelled as AWGN of appropriate power for <math>N_{oc}</math> to be fulfilled.</p> <p>Note 3: RSRP and I<sub>o</sub> levels have been derived from other parameters for information purposes. They are not settable parameters themselves.</p> <p>Note 4: RSRP minimum requirements are specified assuming independent interference and noise at each receiver antenna port.</p>							

Note 5: The test configuration excludes support for band n51 and it is not required to run this test on band n51 in this release of the specification

#### A.4.7.4.1.3 Test Requirements

The L1-RSRP measurement accuracy for SSB resource reported by UE in L1-RSRP report (SSB#0 or SSB#1) of Cell 2 shall fulfil the requirements in clauses 10.1.19.1.

#### A.4.7.4.2 CSI-RS based L1-RSRP measurement on resource set with repetition off

##### A.4.7.4.2.1 Test Purpose and Environment

The purpose of this test is to verify that the L1-RSRP measurement accuracy is within the specified limits. This test will verify the requirements in Clauses 9.5.3 and clause 10.1.19.2 for L1-RSRP measurements based on CSI-RS with the testing configurations for NR cells in Table A.4.7.4.2.1-1.

**Table A.4.7.4.2.1-1: Applicable NR configurations for FR1 CSI-RS based L1-RSRP test**

Config	Description
1	LTE FDD, NR 15 kHz CSI-RS SCS, 10 MHz bandwidth, FDD duplex mode
2	LTE FDD, NR 15 kHz CSI-RS SCS, 10 MHz bandwidth, TDD duplex mode
3	LTE FDD, NR 30kHz CSI-RS SCS, 40 MHz bandwidth, TDD duplex mode
4	LTE TDD, NR 15 kHz CSI-RS SCS, 10 MHz bandwidth, FDD duplex mode
5	LTE TDD, NR 15 kHz CSI-RS SCS, 10 MHz bandwidth, TDD duplex mode
6	LTE TDD, NR 30kHz CSI-RS SCS, 40 MHz bandwidth, TDD duplex mode

Note: The UE is only required to be tested in one of the supported test configurations in each supported band

##### A.4.7.4.2.2 Test parameters

In this set of test cases there are two cells in the test, E-UTRAN PCell (Cell 1), FR1 PSCell (Cell 2). The test parameters and applicability for Cell 1 are defined in A.3.7.2. The test parameters for the Cell 2 are given in Table A.4.7.4.2.2-1 below. The absolute and relative accuracy of L1-RSRP measurements are tested by using the parameters in Table A.4.7.4.2.2-1.

There is no measurement gap configured in the test. Before the test, UE is configured one CSI-RS resource set with two CSI-RS resources. UE is configured to perform RLM and BFD based on SSB 0 and 1. CSI-RS is not transmitted in the same OFDM symbols as SSB.

**Table A.4.7.4.2.2-1: FR1 CSI-RS based L1-RSRP test parameters**

Parameter	Config	Unit	Test 1	Test 2
SSB GSCN	1~6		freq1	freq1
Duplex mode	1,4		FDD	FDD
	2,5		TDD	TDD
	3,6		TDD	TDD
TDD Configuration	1,4		N/A	N/A
	2,5		TDDConf.1.1	TDDConf.1.1
	3,6		TDDConf.2.1	TDDConf.2.1
BW <sub>channel</sub>	1,4	MHz	10: N <sub>RB,c</sub> = 52	10: N <sub>RB,c</sub> = 52
	2,5		10: N <sub>RB,c</sub> = 52	10: N <sub>RB,c</sub> = 52
	3,6		40: N <sub>RB,c</sub> = 106	40: N <sub>RB,c</sub> = 106
PDSCH Reference measurement channel	1,4		SR.1.1 FDD	SR.1.1 FDD
	2,5		SR.1.1 TDD	SR.1.1 TDD
	3,6		SR.2.1 TDD	SR.2.1 TDD
RMSI CORESET Reference Channel	1,4		CR.1.1 FDD	CR.1.1 FDD
	2,5		CR.1.1 TDD	CR.1.1 TDD
	3,6		CR.2.1 TDD	CR.2.1 TDD
Dedicated CORESET Reference Channel	1,4		CCR.1.1 FDD	CCR.1.1 FDD
	2,5		CCR.1.1 TDD	CCR.1.1 TDD
	3,6		CCR.2.1 TDD	CCR.2.1 TDD
SSB configuration	1,4		SSB.3 FR1	SSB.3 FR1



		2,5		SSB.3 FR1	SSB.3 FR1
		3,6		SSB.4 FR1	SSB.4 FR1
OCNG Patterns		1~6		OP.1	OP.1
TRS configuration		1,4		TRS.1.1 FDD	TRS.1.1 FDD
		2,5		TRS.1.1 TDD	TRS.1.1 TDD
		3,6		TRS.1.2 TDD	TRS.1.2 TDD
Initial BWP Configuration		1~6	DLBWP.0.1 ULBWP.0.1	DLBWP.0.1 ULBWP.0.1	
Dedicated BWP configuration		1~6	DLBWP.1.1 ULBWP.1.1	DLBWP.1.1 ULBWP.1.1	
SMTC configuration		1~6	SMTC.1	SMTC.1	
CSI-RS		1,4		CSI-RS 1.2 FDD	CSI-RS 1.2 FDD
		2,5		CSI-RS 1.2 TDD	CSI-RS 1.2 TDD
		3,6		CSI-RS 2.2 TDD	CSI-RS 2.2 FDD
reportConfigType		1~6	periodic	periodic	
reportQuantity		1~6	cri-RSRP	cri-RSRP	
Number of reported RS		1~6	2	2	
L1-RSRP reporting period		1~6	slot80	slot80	
EPRE ratio of PSS to SSS		1~6	dB	0	0
EPRE ratio of PBCH DMRS to SSS					
EPRE ratio of PBCH to PBCH DMRS					
EPRE ratio of PDCCH DMRS to SSS					
EPRE ratio of PDCCH to PDCCH DMRS					
EPRE ratio of PDSCH DMRS to SSS					
EPRE ratio of PDSCH to PDSCH DMRS					
EPRE ratio of OCNG DMRS to SSS <sup>Note 1</sup>					
EPRE ratio of OCNG to OCNG DMRS <sup>Note 1</sup>					
$N_{oc}$ Note2	NR_FDD_FR1_A, NR_TDD_FR1_A NOTE 5	1~6	dBm/15kHz	-94.65	-117
	NR_FDD_FR1_B				-116.5
	NR_TDD_FR1_C				-116
	NR_FDD_FR1_D, NR_TDD_FR1_D				-115.5
	NR_FDD_FR1_E, NR_TDD_FR1_E				-115
	NR_FDD_FR1_F				-114.5
	NR_FDD_FR1_G				-114
	NR_FDD_FR1_H				-113.5
$N_{oc}$ Note2	NR_FDD_FR1_A, NR_TDD_FR1_A NOTE 5	1,2,4,5	dBm/CSI-RS SCS	-94.65	-117
	NR_FDD_FR1_B				-116.5
	NR_TDD_FR1_C				-116
	NR_FDD_FR1_D, NR_TDD_FR1_D				-115.5
	NR_FDD_FR1_E, NR_TDD_FR1_E				-115
	NR_FDD_FR1_F				-114.5
	NR_FDD_FR1_G				-114
	NR_FDD_FR1_H				-113.5
	NR_FDD_FR1_A, NR_TDD_FR1_A NOTE 5	3,6		-91.65	-114
	NR_FDD_FR1_B				-113.5
	NR_TDD_FR1_C				-114
	NR_FDD_FR1_D, NR_TDD_FR1_D				-112.5

	NR_FDD_FR1_E, NR_TDD_FR1_E				-112	
	NR_FDD_FR1_F				-111.5	
	NR_FDD_FR1_G				-111	
	NR_FDD_FR1_H				-110.5	
$\hat{E}_s/I_{ot}$		1~6	dB	10	10	
CSI-RS RSRP Note3	NR_FDD_FR1_A, NR_TDD_FR1_A NOTE 5	1,2,4,5	dBm/CSI-RS SCS	-84.65	-120	
	NR_FDD_FR1_B				-119.5	
	NR_TDD_FR1_C				-119	
	NR_FDD_FR1_D, NR_TDD_FR1_D				-118.5	
	NR_FDD_FR1_E, NR_TDD_FR1_E				-118	
	NR_FDD_FR1_F				-117.5	
	NR_FDD_FR1_G				-117	
	NR_FDD_FR1_H				-116.5	
	NR_FDD_FR1_A, NR_TDD_FR1_A NOTE 5	3,6	dBm/CSI-RS SCS	-81.65	-117	
	NR_FDD_FR1_B				-116.5	
	NR_TDD_FR1_C				-116	
	NR_FDD_FR1_D, NR_TDD_FR1_D				-115.5	
	NR_FDD_FR1_E, NR_TDD_FR1_E				-115	
	NR_FDD_FR1_F				-114.5	
	NR_FDD_FR1_G				-114	
	NR_FDD_FR1_H				-113.5	
	I <sub>o</sub> Note3	NR_FDD_FR1_A, NR_TDD_FR1_A NOTE 5	1,2,4,5	dBm/9.36 MHz	-56.28	-87.28
		NR_FDD_FR1_B				-86.78
NR_TDD_FR1_C		-86.28				
NR_FDD_FR1_D, NR_TDD_FR1_D		-85.78				
NR_FDD_FR1_E, NR_TDD_FR1_E		-85.28				
NR_FDD_FR1_F		-84.78				
NR_FDD_FR1_G		-84.28				
NR_FDD_FR1_H		-83.78				
NR_FDD_FR1_A, NR_TDD_FR1_A NOTE 5		3,6	dBm/38.16 MHz	-50.19	-81.19	
NR_FDD_FR1_B					-80.69	
NR_TDD_FR1_C					-80.19	
NR_FDD_FR1_D, NR_TDD_FR1_D					-79.69	
NR_FDD_FR1_E, NR_TDD_FR1_E					-79.19	
NR_FDD_FR1_F					-78.69	
NR_FDD_FR1_G					-78.19	
NR_FDD_FR1_H					-77.69	
$\hat{E}_s/N_{oc}$			1~6	dB	10	-3
Propagation condition			1~6		AWGN	AWGN
Antenna configuration		1~6		1x2	1x2	
<p>Note 1: OCNB shall be used such that both cells are fully allocated and a constant total transmitted power spectral density is achieved for all OFDM symbols.</p> <p>Note 2: Interference from other cells and noise sources not specified in the test is assumed to be constant over subcarriers and time and shall be modelled as AWGN of appropriate power for <math>N_{oc}</math> to be fulfilled.</p> <p>Note 3: RSRP and I<sub>o</sub> levels have been derived from other parameters for information purposes. They are not settable parameters themselves.</p>						

Note 4:	RSRP minimum requirements are specified assuming independent interference and noise at each receiver antenna port.
Note 5:	The test configuration excludes support for band n51 and it is not required to run this test on band n51 in this release of the specification

#### A.4.7.4.2.3 Test Requirements

The L1-RSRP measurement accuracy for CSI-RS resource reported by UE in L1-RSRP report (CSI-RS#0 or CSI-RS#1) of Cell 2 shall fulfil the requirements in clauses 10.1.19.2.

### A.4.7.5 SFTD accuracy

#### A.4.7.5.1 SFTD accuracy

##### A.4.7.5.1.1 Test Purpose and Environment

The purpose of this set of tests is to verify that the SFTD measurement accuracy is within the specified limits. This test will verify the requirements as specified in clause 9.1.27 in TS 36.133 [15] for EN-DC SFTD measurements.

##### A.4.7.5.1.2 Test Parameters

Supported test configurations are shown in Table A.4.7.5.1.2-1. In this set of test cases there are two cells on different carriers. Cell 1 is E-UTRAN PCell and Cell 2 is NR FR1 PCell. The test parameters of cell 1 are given in clause A.3.7.2.1. The test parameters of cell 2 are given in Table A.4.7.5.1.2-2. The SFTD between PCell and PCell shall be set by the test equipment to one of the time differences in Table A.4.7.5.1.2-3.

**Table A.4.7.5.1.2-1: Supported test configurations for SFTD accuracy**

Configuration	Description
1	NR 15 kHz SSB SCS, 10 MHz bandwidth, FDD duplex mode, LTE FDD
2	NR 15 kHz SSB SCS, 10 MHz bandwidth, TDD duplex mode, LTE FDD
3	NR 30 kHz SSB SCS, 40 MHz bandwidth, TDD duplex mode, LTE FDD
4	NR 15 kHz SSB SCS, 10 MHz bandwidth, FDD duplex mode, LTE TDD
5	NR 15 kHz SSB SCS, 10 MHz bandwidth, TDD duplex mode, LTE TDD
6	NR 30kHz SSB SCS, 40 MHz bandwidth, TDD duplex mode, LTE TDD

Note: The UE is only required to be tested in one of the supported test configurations

**Table A.4.7.5.1.2-2: Test parameters for SFTD accuracy**

Parameter	Config	Unit	Test 1
SSB GSCN	1~6		freq1
Duplex mode	1,4		FDD
	2,5		TDD
	3,6		TDD
TDD Configuration	1,4		N/A
	2,5		TDDConf.1.1
	3,6		TDDConf.2.1
BW <sub>channel</sub>	1,4	MHz	10: N <sub>RB,c</sub> = 52
	2,5		10: N <sub>RB,c</sub> = 52
	3,6		40: N <sub>RB,c</sub> = 106
PDSCH Reference measurement channel	1,4		SR.1.1 FDD
	2,5		SR.1.1 TDD
	3,6		SR.2.1 TDD
RMSI CORESET Reference Channel	1,4		CR.1.1 FDD
	2,5		CR.1.1 TDD
	3,6		CR.2.1 TDD
RMC CORESET Reference Channel	1,4		CCR.1.1 FDD
	2,5		CCR.1.1 TDD
	3,6		CCR.2.1 TDD
SSB configuration	1,4		SSB.1 FR1
	2,5		SSB.1 FR1
	3,6		SSB.2 FR1
SMTc configuration	1~6		SMTc.1

DL BWP configuration		1~6		DLBWP.1.1
UL BWP configuration		1~6		ULBWP.1.1
CSI-RS for tracking		1,4		TRS.1.1 FDD
		2,5		TRS.1.1 TDD
		3,6		TRS.1.2 TDD
OCNG Patterns		1~6		OP.1
EPRE ratio of PSS to SSS		1~6	dB	0
EPRE ratio of PBCH DMRS to SSS				
EPRE ratio of PBCH to PBCH DMRS				
EPRE ratio of PDCCH DMRS to SSS				
EPRE ratio of PDCCH to PDCCH DMRS				
EPRE ratio of PDSCH DMRS to SSS				
EPRE ratio of PDSCH to PDSCH DMRS				
EPRE ratio of OCNG DMRS to SSS <sup>Note 1</sup>				
EPRE ratio of OCNG to OCNG DMRS <sup>Note 1</sup>				
$N_{oc}$ <sup>Note2</sup>	NR_FDD_FR1_A, NR_TDD_FR1_A <sup>NOTE 5</sup>			
	NR_FDD_FR1_B			
	NR_TDD_FR1_C			
	NR_FDD_FR1_D, NR_TDD_FR1_D			
	NR_FDD_FR1_E, NR_TDD_FR1_E			
	NR_FDD_FR1_F			
	NR_FDD_FR1_G			
	NR_FDD_FR1_H			
$N_{oc}$ <sup>Note2</sup>	NR_FDD_FR1_A, NR_TDD_FR1_A <sup>NOTE 5</sup>	1,2,4,5	dBm/SSB SCS	-104
	NR_FDD_FR1_B			
	NR_TDD_FR1_C			
	NR_FDD_FR1_D, NR_TDD_FR1_D			
	NR_FDD_FR1_E, NR_TDD_FR1_E			
	NR_FDD_FR1_F			
	NR_FDD_FR1_G			
	NR_FDD_FR1_H			
	NR_FDD_FR1_A, NR_TDD_FR1_A <sup>NOTE 5</sup>	3,6		-101
	NR_FDD_FR1_B			
	NR_TDD_FR1_C			
	NR_FDD_FR1_D, NR_TDD_FR1_D			
	NR_FDD_FR1_E, NR_TDD_FR1_E			
	NR_FDD_FR1_F			
	NR_FDD_FR1_G			
	NR_FDD_FR1_H			
$\hat{E}_s/I_{ot}$		1~6	dB	-3
$\hat{E}_s/N_{oc}$		1~6	dB	-3
SS-RSRP <sup>Note3</sup>	NR_FDD_FR1_A, NR_TDD_FR1_A <sup>NOTE 5</sup>	1,2,4,5	dBm/SCS	-107
	NR_FDD_FR1_B			
	NR_TDD_FR1_C			
	NR_FDD_FR1_D, NR_TDD_FR1_D			
	NR_FDD_FR1_E, NR_TDD_FR1_E			
	NR_FDD_FR1_F			
	NR_FDD_FR1_G			
	NR_FDD_FR1_G			

	NR_FDD_FR1_H			
	NR_FDD_FR1_A, NR_TDD_FR1_A <sup>NOTE 5</sup>	3,6		-104
	NR_FDD_FR1_B			
	NR_TDD_FR1_C			
	NR_FDD_FR1_D, NR_TDD_FR1_D			
	NR_FDD_FR1_E, NR_TDD_FR1_E			
	NR_FDD_FR1_F			
	NR_FDD_FR1_G			
	NR_FDD_FR1_H			
I <sub>o</sub> <sup>Note3</sup>	NR_FDD_FR1_A, NR_TDD_FR1_A <sup>NOTE 5</sup>	1,2,4,5	dBm/9.36 MHz	-74.28
	NR_FDD_FR1_B			
	NR_TDD_FR1_C			
	NR_FDD_FR1_D, NR_TDD_FR1_D			
	NR_FDD_FR1_E, NR_TDD_FR1_E			
	NR_FDD_FR1_F			
	NR_FDD_FR1_G			
	NR_FDD_FR1_H			
	NR_FDD_FR1_A, NR_TDD_FR1_A <sup>NOTE 5</sup>	3,6	dBm/38.16 MHz	-68.18
	NR_FDD_FR1_B			
	NR_TDD_FR1_C			
	NR_FDD_FR1_D, NR_TDD_FR1_D			
	NR_FDD_FR1_E, NR_TDD_FR1_E			
	NR_FDD_FR1_F			
	NR_FDD_FR1_G			
	NR_FDD_FR1_H			
Propagation condition		1~6		AWGN
Antenna configuration		1~6		1x2
<p>Note 1: OCNG shall be used such that both cells are fully allocated and a constant total transmitted power spectral density is achieved for all OFDM symbols.</p> <p>Note 2: Interference from other cells and noise sources not specified in the test is assumed to be constant over subcarriers and time and shall be modelled as AWGN of appropriate power for <math>N_{oc}</math> to be fulfilled.</p> <p>Note 3: SS-RSRP and I<sub>o</sub> levels have been derived from other parameters for information purposes. They are not settable parameters themselves.</p> <p>Note 4: SS-RSRP minimum requirements are specified assuming independent interference and noise at each receiver antenna port.</p> <p>Note 5: The test configuration excludes support for band n51 and it is not required to run this test on band n51 in this release of the specification</p>				

**Table A.4.7.5.1.2-3: Timing offsets for SFTD accuracy test**

Condition	SFN offset between PCell and PSCell	Frame boundary offset between PCell and PSCell (Ts)
1	100	-122000
2	300	-60540
3	500	1000
4	700	62540
5	900	124000

**A.4.7.5.1.3 Test Requirements**

The SFTD reported by the UE consists of 2 elements, SFN offset and frame boundary offset between PCell and PSCell. The reported SFTD accuracy shall fulfil the requirement in clause 9.1.27 in TS 36.133 [15].

A.4.7.5.2 Void

A.4.7.5.3 Void

## A.4.7.6 CLI measurements

### A.4.7.6.1 EN-DC SRS-RSRP measurement accuracy with FR1 serving cell

#### A.4.7.6.1.1 Test Purpose and Environment

The purpose of this test is to verify that the SRS-RSRP measurement accuracy is within the specified limits. This test will verify the requirements in Clauses 10.1.22.1.1 with the testing configurations for NR cells in Table A.4.7.6.1.1-1.

**Table A.4.7.6.1.1-1: Applicable NR configurations for FR1 SRS-RSRP accuracy test**

Config	Description
1	LTE FDD, NR 15 kHz SRS SCS, 10 MHz bandwidth, TDD duplex mode
2	LTE FDD, NR 30kHz SRS SCS, 40 MHz bandwidth, TDD duplex mode
3	LTE TDD, NR 15 kHz SRS SCS, 10 MHz bandwidth, TDD duplex mode
4	LTE TDD, NR 30kHz SRS SCS, 40 MHz bandwidth, TDD duplex mode

Note: The UE is only required to be tested in one of the supported test configurations in each supported band

#### A.4.7.6.1.2 Test parameters

In this set of test cases there are two cells in the test, E-UTRAN PCell (Cell 1), FR1 PCell (Cell 2). The test parameters and applicability for Cell 1 are defined in A.3.7.2. The test parameters for the Cell 2 are given in Table A.4.7.6.1.2-1 below. The test parameter for the (virtual) neighbor cell UE transmitting SRS are given in Table A.4.7.6.1.2-2.

Before the test UE is configured to perform SRS-RSRP measurement. During the test, the test system transmits SRS resources for measurement in the DL slots according to the SRS configuration in Table A.4.7.6.1.2-3. There is no measurement gap configured in the test. During the test, the test system does not transmit PDCCH/PDSCH/OCNG on SRS symbol to be transmitted and on 1 data symbol before SRS to be transmitted.

**Table A.4.7.6.1.2-1: FR1 test parameters for SRS-RSRP accuracy for PCell**

Parameter	Config	Unit	Test 1	Test 2	Test 3
SSB GSCN	1~4		freq1	freq1	freq1
Duplex mode	1~4		TDD	TDD	TDD
TDD configuration	1,3		TDDConf.1.1	TDDConf.1.1	TDDConf.1.1
	2,4		TDDConf.2.1	TDDConf.2.1	TDDConf.2.1
BW <sub>channel</sub>	1,3	MHz	10: N <sub>RB,c</sub> = 52	10: N <sub>RB,c</sub> = 52	10: N <sub>RB,c</sub> = 52
	2,4		40: N <sub>RB,c</sub> = 106	40: N <sub>RB,c</sub> = 106	40: N <sub>RB,c</sub> = 106
PDSCH Reference measurement channel	1,3		SR.1.1 TDD	SR.1.1 TDD	SR.1.1 TDD
	2,4		SR.2.1 TDD	SR.2.1 TDD	SR.2.1 TDD
RMSI CORESET Reference Channel	1,3		CR.1.1 TDD	CR.1.1 TDD	CR.1.1 TDD
	2,4		CR.2.1 TDD	CR.2.1 TDD	CR.2.1 TDD
Dedicated CORESET Reference Channel	1,3		CCR.1.1 TDD	CCR.1.1 TDD	CCR.1.1 TDD
	2,4		CCR.2.1 TDD	CCR.2.1 TDD	CCR.2.1 TDD
SSB configuration	1,3		SSB.1 FR1	SSB.1 FR1	SSB.1 FR1
	2,4		SSB.2 FR1	SSB.2 FR1	SSB.2 FR1
OCNG Patterns	1~4		OP.1	OP.1	OP.1
TRS configuration	1,3		TRS.1.1 TDD	TRS.1.1 TDD	TRS.1.1 TDD
	2,4		TRS.1.2 TDD	TRS.1.2 TDD	TRS.1.2 TDD
Initial BWP Configuration	1~4		DLBWP.0.1 ULBWP.0.1	DLBWP.0.1 ULBWP.0.1	DLBWP.0.1 ULBWP.0.1
Dedicated BWP configuration	1~4		DLBWP.1.1 ULBWP.1.1	DLBWP.1.1 ULBWP.1.1	DLBWP.1.1 ULBWP.1.1
SMTC configuration	1~4		SMTC.1	SMTC.1	SMTC.1
Time offset between DL from serving cell and SRS from test system	1~4	μs	17.67	17.67	17.67
EPRE ratio of PSS to SSS	1~4	dB	0	0	0

EPRE ratio of PBCH DMRS to SSS								
EPRE ratio of PBCH to PBCH DMRS								
EPRE ratio of PDCCH DMRS to SSS								
EPRE ratio of PDCCH to PDCCH DMRS								
EPRE ratio of PDSCH DMRS to SSS								
EPRE ratio of PDSCH to PDSCH DMRS								
EPRE ratio of OCNG DMRS to SSS <sup>Note 1</sup>								
EPRE ratio of OCNG to OCNG DMRS <sup>Note 1</sup>								
$N_{oc}$ Note2	NR_TDD_FR1_A <sup>Note3</sup>	1,3	dBm/15kHz	-106	-88	-114		
	NR_TDD_FR1_C					-113		
	NR_TDD_FR1_D					-112.5		
	NR_TDD_FR1_E					-112		
	NR_TDD_FR1_A <sup>Note3</sup>	2,4				Not applicable <sup>Note4</sup>	-91	-114
	NR_TDD_FR1_C						-113	
	NR_TDD_FR1_D						-112.5	
NR_TDD_FR1_E			-112					
$N_{oc}$ Note2	NR_TDD_FR1_A <sup>Note3</sup>	1,3	dBm/SRS SCS	-106	-88	-114		
	NR_TDD_FR1_C					-113		
	NR_TDD_FR1_D					-112.5		
	NR_TDD_FR1_E					-112		
	NR_TDD_FR1_A <sup>Note3</sup>	2,4				Not applicable <sup>Note4</sup>	-88	-111
	NR_TDD_FR1_C						-110	
	NR_TDD_FR1_D						-109.5	
NR_TDD_FR1_E			-109					
<p>Note 1: OCNG shall be used such that a constant total transmitted power spectral density is achieved for all OFDM symbols.</p> <p>Note 2: Interference from other cells and noise sources not specified in the test is assumed to be constant over subcarriers and time and shall be modelled as AWGN of appropriate power for <math>N_{oc}</math> to be fulfilled.</p> <p>Note 3: The test configuration excludes support for band n51 and it is not required to run this test on band n51 in this release of the specification</p> <p>Note 4: Test 1 is not used when testing with 30kHz SSB SCS</p>								

**Table A.4.7.6.1.2-2: FR1 test parameters for SRS-RSRP accuracy for neighbour cell UE**

	Parameter	Config	Unit	Test 1	Test 2	Test 3		
$N_{oc}$ Note2	NR_TDD_FR1_A <sup>NOTE 3</sup>	1,3	dBm/15kHz	-106	-88	-114		
	NR_TDD_FR1_C					-113		
	NR_TDD_FR1_D					-112.5		
	NR_TDD_FR1_E					-112		
	NR_TDD_FR1_A <sup>NOTE 5</sup>	2,4				Not applicable <sup>Note 6</sup>	-91	-114
	NR_TDD_FR1_C						-113	
	NR_TDD_FR1_D						-112.5	
NR_TDD_FR1_E			-112					
$N_{oc}$ Note2	NR_TDD_FR1_A <sup>NOTE 5</sup>	1,3	dBm/SRS SCS	-106	-88	-114		
	NR_TDD_FR1_C					-113		
	NR_TDD_FR1_D					-112.5		

	NR_TDD_FR1_E					-112	
	NR_TDD_FR1_A NOTE 5	2,4		Not applicable <sup>Note 6</sup>	-88	-111	
	NR_TDD_FR1_C					-110	
	NR_TDD_FR1_D					-109.5	
	NR_TDD_FR1_E					-109	
$\hat{E}_s / I_{ot}$ on SRS		1~4	dB	1	1	1	
SRS RSRP Note3	NR_TDD_FR1_A NOTE 5	1,3	dBm/SRS SCS	-105	-87	-113	
	NR_TDD_FR1_C					-112	
	NR_TDD_FR1_D					-111.5	
	NR_TDD_FR1_E			-111			
	NR_TDD_FR1_A NOTE 5	2,4		Not applicable <sup>Note 6</sup>	-87	-110	
	NR_TDD_FR1_C			-109			
	NR_TDD_FR1_D			-108.5			
	NR_TDD_FR1_E		-108				
$I_o$ <sup>Note3</sup>	NR_TDD_FR1_A NOTE 5	1,3	dBm/9.36 MHz	-74.51	-56.51	-82.51	
	NR_TDD_FR1_C					-81.51	
	NR_TDD_FR1_D					-81.01	
	NR_TDD_FR1_E			-79.51			
	NR_TDD_FR1_A NOTE 5	2,4		dBm/38.16 MHz	Not applicable <sup>Note 6</sup>	-53.42	-76.42
	NR_TDD_FR1_C			-75.42			
	NR_TDD_FR1_D			-74.92			
	NR_TDD_FR1_E		-74.42				
$\hat{E}_s / N_{oc}$ on SRS		1~4	dB	1	1	1	
Propagation condition		1~4		AWGN	AWGN	AWGN	
Antenna configuration		1~4		1x2	1x2	1x2	
SRS configuration		1,3		SRSCConf.1	SRSCConf.1	SRSCConf.1	
		2,4		SRSCConf.2	SRSCConf.2	SRSCConf.2	
<p>Note 1: The resources for uplink transmission are assigned to the UE prior to the start of the test.</p> <p>Note 2: Interference from other cells and noise sources not specified in the test is assumed to be constant over subcarriers and time and shall be modelled as AWGN of appropriate power for <math>N_{oc}</math> to be fulfilled.</p> <p>Note 3: RSRP and <math>I_o</math> levels have been derived from other parameters for information purposes. They are not settable parameters themselves.</p> <p>Note 4: RSRP minimum requirements are specified assuming independent interference and noise at each receiver antenna port.</p> <p>Note 5: The test configuration excludes support for band n51 and it is not required to run this test on band n51 in this release of the specification</p> <p>Note 6: Test 1 is not used when testing with 30kHz SSB SCS</p>							

**Table A.4.7.6.1.2-3: SRS configuration parameters for FR1 SRS-RSRP accuracy**

	Field	SRSCConf.1	SRSCConf.2
SRS-ResourceSet	srs-ResourceSetId	0	0
	srs-ResourceIdList	0	0
	resourceType	Periodic	Periodic
	Usage	Codebook	Codebook
SRS-Resource	SRS-ResourceId	0	0
	nrofSRS-Ports	Port1	Port1
	transmissionComb	n2	n2
	combOffset-n2	0	0
	cyclicShift-n2	0	0
	resourceMapping startPosition	0	0
	resourceMapping nrofSymbols	n1	n1
	resourceMapping repetitionFactor	n1	n1
	freqDomainPosition	0	0



freqDomainShift	0	0
freqHopping c-SRS	12	12
freqHopping b-SRS	0	0
freqHopping b-hop	0	0
groupOrSequenceHopping	Neither	Neither
resourceType	Periodic	Periodic
periodicityAndOffset-p	sl20, 9	sl40, 19
sequenceld	0	0

#### A.4.7.6.1.3 Test Requirements

The SRS-RSRP measurement accuracy shall fulfil the requirements in clauses 10.1.22.1.1.

#### A.4.7.6.2 EN-DC CLI-RSSI measurement accuracy with FR1 serving cell

##### A.4.7.6.2.1 Test Purpose and Environment

The purpose of this test is to verify that the CLI-RSSI measurement accuracy is within the specified limits. This test will verify the requirements in Clauses 10.1.22.2.1 with the testing configurations for NR cells in Table A.4.7.6.2.1-1.

**Table A.4.7.6.2.1-1: Applicable NR configurations for FR1 CLI-RSSI accuracy test**

Config	Description
1	LTE FDD, NR 15 kHz SRS SCS, 10 MHz bandwidth, TDD duplex mode
2	LTE FDD, NR 30kHz SRS SCS, 40 MHz bandwidth, TDD duplex mode
3	LTE TDD, NR 15 kHz SRS SCS, 10 MHz bandwidth, TDD duplex mode
4	LTE TDD, NR 30kHz SRS SCS, 40 MHz bandwidth, TDD duplex mode
Note:	The UE is only required to be tested in one of the supported test configurations in each supported band

##### A.4.7.6.2.2 Test parameters

In this set of test cases there are two cells in the test, E-UTRAN PCell (Cell 1), FR1 PSCell (Cell 2). The test parameters and applicability for Cell 1 are defined in A.3.7.2. The test parameters for the Cell 2 are given in Table A.4.7.6.2.2-1 below.

Before the test UE is configured to perform CLI-RSSI measurement. There is no measurement gap configured in the test. During the test, the test system does not transmit PDCCH/PDSCH/OCNG on symbols for CLI-RSSI resource and on 1 data symbol before. The CLI-RSSI measurement resource configuration is in Table A.4.7.6.2.2-2.

**Table A.4.7.6.2.2-1: FR1 test parameters for CLI-RSSI accuracy**

Parameter	Config	Unit	Value
SSB GSCN	1~4		freq1
Duplex mode	1~4		TDD
TDD configuration	1,3		TDDConf.1.1
	2,4		TDDConf.2.1
BW <sub>channel</sub>	1,3	MHz	10: N <sub>RB,c</sub> = 52
	2,4		40: N <sub>RB,c</sub> = 106
PDSCH Reference measurement channel	1,3		SR.1.1 TDD
	2,4		SR.2.1 TDD
RMSI CORESET Reference Channel	1,3		CR.1.1 TDD
	2,4		CR.2.1 TDD
Dedicated CORESET Reference Channel	1,3		CCR.1.1 TDD
	2,4		CCR.2.1 TDD
SSB configuration	1,3		SSB.1 FR1
	2,4		SSB.2 FR1
OCNG Patterns <sup>Note6</sup>	1~4		OP.1
TRS configuration	1,3		TRS.1.1 TDD
	2,4		TRS.1.2 TDD

Initial BWP Configuration	1~4		DLBWP.0.1 ULBWP.0.1
Dedicated BWP configuration	1~4		DLBWP.1.1 ULBWP.1.1
SMTC configuration	1~4		SMTC.1
Time offset between DL from serving cell and OCNG from test system	1~4	$\mu\text{s}$	17.67
EPRE ratio of PSS to SSS	1~4	dB	0
EPRE ratio of PBCH DMRS to SSS			
EPRE ratio of PBCH to PBCH DMRS			
EPRE ratio of PDCCH DMRS to SSS			
EPRE ratio of PDCCH to PDCCH DMRS			
EPRE ratio of PDSCH DMRS to SSS			
EPRE ratio of PDSCH to PDSCH DMRS			
EPRE ratio of OCNG DMRS to SSS <sup>Note 1</sup>			
EPRE ratio of OCNG to OCNG DMRS <sup>Note 1</sup>			
$N_{oc}$ on CLI-RSSI measurement resource <sup>Note2</sup>	1,3	dBm/15kHz	-106
	2,4		-106
$N_{oc}$ on CLI-RSSI measurement resource <sup>Note2</sup>	1,3	dBm/ BWP SCS	-106
	2,4		-103
$\hat{E}_s/I_{ot}$ on CLI-RSSI measurement resource	1~4	dB	-Infinity
RSRP on CLI-RSSI measurement resource <sup>Note3</sup>	1~4	dBm/ BWP SCS	-Infinity
$I_o$ on CLI-RSSI measurement resource <sup>Note3</sup>	1,3	dBm/9.36 MHz	-78.05
	2,4	dBm/38.16 MHz	-71.96
$I_o$ on CLI-RSSI measurement resource <sup>Note3</sup>	1,3	dBm/1.08 MHz	-87.43
	2,4		-87.44
$\hat{E}_s/N_{oc}$ on CLI-RSSI measurement resource	1~4	dB	-Infinity
Propagation condition	1~4		AWGN
Antenna configuration	1~4		1x2
<p>Note 1: OCNG shall be used such that a constant total transmitted power spectral density is achieved for all OFDM symbols.</p> <p>Note 2: Interference from other cells and noise sources not specified in the test is assumed to be constant over subcarriers and time and shall be modelled as AWGN of appropriate power for <math>N_{oc}</math> to be fulfilled.</p> <p>Note 3: RSRP and <math>I_o</math> levels have been derived from other parameters for information purposes. They are not settable parameters themselves.</p> <p>Note 4: RSRP minimum requirements are specified assuming independent interference and noise at each receiver antenna port.</p> <p>Note 5: The test configuration excludes support for band n51 and it is not required to run this test on band n51 in this release of the specification</p> <p>Note 6: OCNG is not transmitted in the CLI-RSSI measurement resources.</p>			

**Table A.4.7.6.2.2-2: CLI-RSSI measurement resource configuration for FR1 CLI-RSSI accuracy**

	Field	Config	SRSCConf.1
CLI-RSSI measurement resource	rss-ResourceId	1~4	0
	rss-SCS	1,3	15kHz
		2,4	30kHz
	startPRB	1~4	0
	nrofPRBs	1,3	52
		2,4	106
	startPosition	1~4	3
	nrofSymbols	1~4	11
rss-PeriodicityAndOffset	1,3	sl20, 9	
	2,4	sl40, 19	

### A.4.7.6.2.3 Test Requirements

The CLI-RSSI measurement accuracy shall fulfil the requirements in clauses 10.1.22.2.1.

## A.4.7.7 L1-SINR measurement for beam reporting

### A.4.7.7.1 L1-SINR measurement with CSI-RS based CMR and no dedicated IMR configured and CSI-RS resource set with repetition off

#### A.4.7.7.1.1 Test Purpose and Environment

The purpose of this test is to verify that the L1-SINR measurement accuracy is within the specified limits. This test will verify the requirements in clauses 9.8.4.1 and clause 10.1.27.1 for FR1 L1-SINR measurements based on CSI-RS with the testing configurations for NR cells in Table A.4.7.7.1.1-1, which configures the measurement resources for the CSI-RS based CMR and no dedicated IMR.

**Table A.4.7.7.1.1-1: Applicable NR configurations for FR1 L1-SINR test with CSI-RS based CMR and no dedicated IMR configured**

Config	Description
1	LTE FDD, NR 15 kHz CSI-RS SCS, 10 MHz bandwidth, FDD duplex mode
2	LTE FDD, NR 15 kHz CSI-RS SCS, 10 MHz bandwidth, TDD duplex mode
3	LTE FDD, NR 30kHz CSI-RS SCS, 40 MHz bandwidth, TDD duplex mode
4	LTE TDD, NR 15 kHz CSI-RS SCS, 10 MHz bandwidth, FDD duplex mode
5	LTE TDD, NR 15 kHz CSI-RS SCS, 10 MHz bandwidth, TDD duplex mode
6	LTE TDD, NR 30kHz CSI-RS SCS, 40 MHz bandwidth, TDD duplex mode

Note: The UE is only required to be tested in one of the supported test configurations in each supported band

#### A.4.7.7.1.2 Test parameters

In this set of test cases there are two cells in the test, E-UTRAN PCell (Cell 1), FR1 PSCell (Cell 2). The test parameters and applicability for Cell 1 are defined in A.3.7.2. The test parameters for the Cell 2 are given in Table A.4.7.7.1.2-1 below. The absolute and relative accuracy of L1-SINR measurements are tested by using the parameters in Table A.4.7.7.1.2-1.

There is no measurement gap configured in the test. Before the test, UE is configured one CSI-RS resource set with two CSI-RS resources. UE is configured to perform RLM and BFD based on SSB 0 and 1. CSI-RS is not transmitted in the same OFDM symbols as SSB.

**Table A.4.7.7.1.2-1: FR1 CSI-RS based L1-SINR test parameters**

Parameter	Config	Unit	Test 1	Test 2
SSB GSCN	1~6		freq1	freq1
Duplex mode	1,4		FDD	FDD
	2,5		TDD	TDD
	3,6		TDD	TDD
TDD Configuration	1,4		N/A	N/A

	2,5		TDDConf.1.1	TDDConf.1.1	
	3,6		TDDConf.2.1	TDDConf.2.1	
BW <sub>channel</sub>	1,4	MHz	10: N <sub>RB,c</sub> = 52	10: N <sub>RB,c</sub> = 52	
	2,5		10: N <sub>RB,c</sub> = 52	10: N <sub>RB,c</sub> = 52	
	3,6		40: N <sub>RB,c</sub> = 106	40: N <sub>RB,c</sub> = 106	
PDSCH Reference measurement channel	1,4		SR.1.1 FDD	SR.1.1 FDD	
	2,5		SR.1.1 TDD	SR.1.1 TDD	
	3,6		SR.2.1 TDD	SR.2.1 TDD	
RMSI CORESET Reference Channel	1,4		CR.1.1 FDD	CR.1.1 FDD	
	2,5		CR.1.1 TDD	CR.1.1 TDD	
	3,6		CR.2.1 TDD	CR.2.1 TDD	
Dedicated CORESET Reference Channel	1,4		CCR.1.1 FDD	CCR.1.1 FDD	
	2,5		CCR.1.1 TDD	CCR.1.1 TDD	
	3,6		CCR.2.1 TDD	CCR.2.1 TDD	
SSB configuration	1,4		SSB.1 FR1	SSB.1 FR1	
	2,5		SSB.1 FR1	SSB.1 FR1	
	3,6		SSB.2 FR1	SSB.2 FR1	
OCNG Patterns	1~6		OP.1	OP.1	
TRS configuration	1,4		TRS.1.1 FDD	TRS.1.1 FDD	
	2,5		TRS.1.1 TDD	TRS.1.1 TDD	
	3,6		TRS.1.2 TDD	TRS.1.2 TDD	
Initial BWP Configuration	1~6		DLBWP.0.1 ULBWP.0.1	DLBWP.0.1 ULBWP.0.1	
Dedicated BWP configuration	1~6		DLBWP.1.1 ULBWP.1.1	DLBWP.1.1 ULBWP.1.1	
SMTc configuration	1~6		SMTc.1	SMTc.1	
CSI-RS	1,4		CSI-RS 1.2 FDD	CSI-RS 1.2 FDD	
	2,5		CSI-RS 1.2 TDD	CSI-RS 1.2 TDD	
	3,6		CSI-RS 2.2 TDD	CSI-RS 2.2 FDD	
reportConfigType	1~6		periodic	periodic	
reportQuantity-r16	1~6		cri-SINR-r16	cri-SINR-r16	
nrofReportedRS	1~6		2	2	
L1-RSRP reporting period	1~6		slot80	slot80	
EPRE ratio of PSS to SSS	1~6	dB	0	0	
EPRE ratio of PBCH DMRS to SSS					
EPRE ratio of PBCH to PBCH DMRS					
EPRE ratio of PDCCH DMRS to SSS					
EPRE ratio of PDCCH to PDCCH DMRS					
EPRE ratio of PDSCH DMRS to SSS					
EPRE ratio of PDSCH to PDSCH DMRS					
EPRE ratio of OCNG DMRS to SSS <sup>Note 1</sup>					
EPRE ratio of OCNG to OCNG DMRS <sup>Note 1</sup>					
N <sub>oc</sub> <sup>Note2</sup>					NR_FDD_FR1_A, NR_TDD_FR1_A <sup>NOTE 5</sup>
	NR_FDD_FR1_B	-116.5			
	NR_TDD_FR1_C	-116			
	NR_FDD_FR1_D, NR_TDD_FR1_D	-115.5			
	NR_FDD_FR1_E, NR_TDD_FR1_E	-115			
	NR_FDD_FR1_F	-114.5			
	NR_FDD_FR1_G	-114			
	NR_FDD_FR1_H	-113.5			

$N_{oc}$ Note2	NR_FDD_FR1_A, NR_TDD_FR1_A NOTE 5	1,2,4,5	dBm/CSI-RS SCS	-94.65	-117	
	NR_FDD_FR1_B				-116.5	
	NR_TDD_FR1_C				-116	
	NR_FDD_FR1_D, NR_TDD_FR1_D				-115.5	
	NR_FDD_FR1_E, NR_TDD_FR1_E				-115	
	NR_FDD_FR1_F				-114.5	
	NR_FDD_FR1_G				-114	
	NR_FDD_FR1_H				-113.5	
	NR_FDD_FR1_A, NR_TDD_FR1_A NOTE 5	3,6		-91.65	-114	
	NR_FDD_FR1_B				-113.5	
	NR_TDD_FR1_C				-114	
	NR_FDD_FR1_D, NR_TDD_FR1_D				-112.5	
	NR_FDD_FR1_E, NR_TDD_FR1_E				-112	
	NR_FDD_FR1_F				-111.5	
	NR_FDD_FR1_G				-111	
	NR_FDD_FR1_H				-110.5	
$\hat{E}_s/I_{ot}$	1~6	dB	10	-3		
CSI-RS RSRP Note3	NR_FDD_FR1_A, NR_TDD_FR1_A NOTE 5	1,2,4,5	dBm/CSI-RS SCS	-84.65	-120	
	NR_FDD_FR1_B				-119.5	
	NR_TDD_FR1_C				-119	
	NR_FDD_FR1_D, NR_TDD_FR1_D				-118.5	
	NR_FDD_FR1_E, NR_TDD_FR1_E				-118	
	NR_FDD_FR1_F				-117.5	
	NR_FDD_FR1_G				-117	
	NR_FDD_FR1_H				-116.5	
	NR_FDD_FR1_A, NR_TDD_FR1_A NOTE 5	3,6		-81.65	-117	
	NR_FDD_FR1_B				-116.5	
	NR_TDD_FR1_C				-116	
	NR_FDD_FR1_D, NR_TDD_FR1_D				-115.5	
	NR_FDD_FR1_E, NR_TDD_FR1_E				-115	
	NR_FDD_FR1_F				-114.5	
	NR_FDD_FR1_G				-114	
	NR_FDD_FR1_H				-113.5	
$I_o$ Note3	NR_FDD_FR1_A, NR_TDD_FR1_A NOTE 5	1,2,4,5	dBm/9.36 MHz	-56.28	-87.28	
	NR_FDD_FR1_B				-86.78	
	NR_TDD_FR1_C				-86.28	
	NR_FDD_FR1_D, NR_TDD_FR1_D				-85.78	
	NR_FDD_FR1_E, NR_TDD_FR1_E				-85.28	
	NR_FDD_FR1_F				-84.78	
	NR_FDD_FR1_G				-84.28	
	NR_FDD_FR1_H				-83.78	
	NR_FDD_FR1_A, NR_TDD_FR1_A NOTE 5	3,6		dBm/38.16 MHz	-50.19	-81.19
	NR_FDD_FR1_B					-80.69
	NR_TDD_FR1_C					-80.19

	NR_FDD_FR1_D, NR_TDD_FR1_D				-79.69
	NR_FDD_FR1_E, NR_TDD_FR1_E				-79.19
	NR_FDD_FR1_F				-78.69
	NR_FDD_FR1_G				-78.19
	NR_FDD_FR1_H				-77.69
	$\hat{E}_s / N_{oc}$	1~6	dB	10	-3
	Propagation condition	1~6		AWGN	AWGN
	Antenna configuration	1~6		1x2	1x2
<p>Note 1: OCNG shall be used such that both cells are fully allocated and a constant total transmitted power spectral density is achieved for all OFDM symbols.</p> <p>Note 2: Interference from other cells and noise sources not specified in the test is assumed to be constant over subcarriers and time and shall be modelled as AWGN of appropriate power for <math>N_{oc}</math> to be fulfilled.</p> <p>Note 3: RSRP and <math>I_0</math> levels have been derived from other parameters for information purposes. They are not settable parameters themselves.</p> <p>Note 4: RSRP minimum requirements are specified assuming independent interference and noise at each receiver antenna port.</p> <p>Note 5: The test configuration excludes support for band n51 and it is not required to run this test on band n51 in this release of the specification</p>					

#### A.4.7.7.1.3 Test Requirements

The L1-SINR measurement accuracy for CSI-RS#0 and CSI-RS#1 of Cell 2 shall fulfil the requirements in clauses 10.1.27.1.

#### A.4.7.7.2 L1-SINR measurement with SSB based CMR and dedicated IMR

##### A.4.7.7.2.1 Test Purpose and Environment

The purpose of this test is to verify that the L1-SINR measurement accuracy is within the specified limits. This test will verify the requirements in Clauses 9.8.4.2 and clause 10.1.27.2 for L1-SINR measurements with SSB based CMR and CSI-IM based IMR, with the testing configurations for NR cells in Table A.4.7.7.2.1-1.

**Table A.4.7.7.2.1-1: Applicable NR configurations for FR1 L1-SINR measurement test with SSB based CMR and CSI-IM based IMR**

Config	Description
1	LTE FDD, NR 15 kHz SSB SCS, 10 MHz bandwidth, FDD duplex mode
2	LTE FDD, NR 15 kHz SSB SCS, 10 MHz bandwidth, TDD duplex mode
3	LTE FDD, NR 30kHz SSB SCS, 40 MHz bandwidth, TDD duplex mode
4	LTE TDD, NR 15 kHz SSB SCS, 10 MHz bandwidth, FDD duplex mode
5	LTE TDD, NR 15 kHz SSB SCS, 10 MHz bandwidth, TDD duplex mode
6	LTE TDD, NR 30kHz SSB SCS, 40 MHz bandwidth, TDD duplex mode
Note:	The UE is only required to be tested in one of the supported test configurations in each supported band

##### A.4.7.7.2.2 Test parameters

In this set of test cases there are two cells in the test, E-UTRAN PCell (Cell 1), FR1 PSCell (Cell 2). The test parameters and applicability for Cell 1 are defined in A.3.7.2. The test parameters for the Cell 2 are given in Table A.4.7.7.2.2-1 below. The absolute accuracy of L1-SINR measurements are tested by using the parameters in Table A.4.7.7.2.2-1.

There is no measurement gap configured in the test. Before the test, UE is configured one SSB resource set with two SSB resources and one CSI-IM resource set with two CSI-IM resource. UE is configured to perform RLM and BFD measurement based on the SSB resources 0 and 1. UE is configured to perform L1-SINR measurement based on the SSBs as CMR and the CSI-IM resources as IMR.

Table A.4.7.7.2.2-1: FR1 L1-SINR measurement test parameters with SSB based CMR and CSI-IM based IMR

Parameter	Config	Unit	Test 1	Test 2
SSB GSCN	1~6		freq1	freq1
Duplex mode	1,4		FDD	FDD
	2,5		TDD	TDD
	3,6		TDD	TDD
TDD Configuration	1,4		N/A	N/A
	2,5		TDDConf.1.1	TDDConf.1.1
	3,6		TDDConf.2.1	TDDConf.2.1
BW <sub>channel</sub>	1,4	MHz	10: N <sub>RB,c</sub> = 52	10: N <sub>RB,c</sub> = 52
	2,5		10: N <sub>RB,c</sub> = 52	10: N <sub>RB,c</sub> = 52
	3,6		40: N <sub>RB,c</sub> = 106	40: N <sub>RB,c</sub> = 106
PDSCH Reference measurement channel	1,4		SR.1.1 FDD	SR.1.1 FDD
	2,5		SR.1.1 TDD	SR.1.1 TDD
	3,6		SR.2.1 TDD	SR.2.1 TDD
RMSI CORESET Reference Channel	1,4		CR.1.1 FDD	CR.1.1 FDD
	2,5		CR.1.1 TDD	CR.1.1 TDD
	3,6		CR.2.1 TDD	CR.2.1 TDD
Dedicated CORESET Reference Channel	1,4		CCR.1.1 FDD	CCR.1.1 FDD
	2,5		CCR.1.1 TDD	CCR.1.1 TDD
	3,6		CCR.2.1 TDD	CCR.2.1 TDD
SSB configuration	1,4		SSB.3 FR1	SSB.3 FR1
	2,5		SSB.3 FR1	SSB.3 FR1
	3,6		SSB.4 FR1	SSB.4 FR1
CSI-IM configuration	1,4		CSI-IM 1.1 FDD	CSI-IM 1.1 FDD
	2,5		CSI-IM 1.1 TDD	CSI-IM 1.1 TDD
	3,6		CSI-IM 2.1 TDD	CSI-IM 2.1 TDD
OCNG Patterns	1~6		OP.1	OP.1
TRS configuration	1,4		TRS.1.1 FDD	TRS.1.1 FDD
	2,5		TRS.1.1 TDD	TRS.1.1 TDD
	3,6		TRS.1.2 TDD	TRS.1.2 TDD
Initial BWP Configuration	1~6		DLBWP.0.1 ULBWP.0.1	DLBWP.0.1 ULBWP.0.1
Dedicated BWP configuration	1~6		DLBWP.1.1 ULBWP.1.1	DLBWP.1.1 ULBWP.1.1
SMTC configuration	1~6		SMTC.1	SMTC.1
reportConfigType	1~6		periodic	periodic
reportQuantity-r16	1~6		ssb-Index-SINR-r16	ssb-Index-SINR-r16
Number of reported RS	1~6		2	2
L1-SINR reporting period	1~6		slot80	slot80
EPRE ratio of PSS to SSS	1~6	dB	0	0
EPRE ratio of PBCH DMRS to SSS				
EPRE ratio of PBCH to PBCH DMRS				
EPRE ratio of PDCCH DMRS to SSS				
EPRE ratio of PDCCH to PDCCH DMRS				
EPRE ratio of PDSCH DMRS to SSS				
EPRE ratio of PDSCH to PDSCH DMRS				
EPRE ratio of OCNG DMRS to SSS <sup>Note 1</sup>				
EPRE ratio of OCNG to OCNG DMRS <sup>Note 1</sup>				
$N_{oc}$ <sup>Note 2</sup>				
	NR_FDD_FR1_B	-117		
				-116.5

	NR_TDD_FR1_C				-116
	NR_FDD_FR1_D, NR_TDD_FR1_D				-115.5
	NR_FDD_FR1_E, NR_TDD_FR1_E				-115
	NR_FDD_FR1_F				-114.5
	NR_FDD_FR1_G				-114
	NR_FDD_FR1_H				-113.5
$N_{oc}$ Note2	NR_FDD_FR1_A, NR_TDD_FR1_A NOTE 5	1,2,4,5	dBm/SSB SCS	-94.65	-117
	NR_FDD_FR1_B				-116.5
	NR_TDD_FR1_C				-116
	NR_FDD_FR1_D, NR_TDD_FR1_D				-115.5
	NR_FDD_FR1_E, NR_TDD_FR1_E				-115
	NR_FDD_FR1_F				-114.5
	NR_FDD_FR1_G	-114			
	NR_FDD_FR1_H	-113.5			
	NR_FDD_FR1_A, NR_TDD_FR1_A NOTE 5	3,6		-91.65	-114
	NR_FDD_FR1_B				-113.5
	NR_TDD_FR1_C				-114
	NR_FDD_FR1_D, NR_TDD_FR1_D				-112.5
	NR_FDD_FR1_E, NR_TDD_FR1_E				-112
	NR_FDD_FR1_F				-111.5
NR_FDD_FR1_G	-111				
NR_FDD_FR1_H	-110.5				
$\hat{E}_s/I_{ot}$	1~6	dB	10	-3	
SSB RSRP Note3	NR_FDD_FR1_A, NR_TDD_FR1_A NOTE 5	1,2,4,5	dBm/SSB SCS	-84.65	-120
	NR_FDD_FR1_B				-119.5
	NR_TDD_FR1_C				-119
	NR_FDD_FR1_D, NR_TDD_FR1_D				-118.5
	NR_FDD_FR1_E, NR_TDD_FR1_E				-118
	NR_FDD_FR1_F				-117.5
	NR_FDD_FR1_G	-117			
	NR_FDD_FR1_H	-116.5			
	NR_FDD_FR1_A, NR_TDD_FR1_A NOTE 5	3,6		-81.65	-117
	NR_FDD_FR1_B				-116.5
	NR_TDD_FR1_C				-116
	NR_FDD_FR1_D, NR_TDD_FR1_D				-115.5
	NR_FDD_FR1_E, NR_TDD_FR1_E				-115
	NR_FDD_FR1_F				-114.5
NR_FDD_FR1_G	-114				
NR_FDD_FR1_H	-113.5				
$I_o$ Note3	NR_FDD_FR1_A, NR_TDD_FR1_A NOTE 5	1,2,4,5	dBm/9.36 MHz	-56.28	-87.28
	NR_FDD_FR1_B				-86.78
	NR_TDD_FR1_C				-86.28
	NR_FDD_FR1_D, NR_TDD_FR1_D				-85.78
	NR_FDD_FR1_E, NR_TDD_FR1_E				-85.28



	NR_FDD_FR1_F				-84.78			
	NR_FDD_FR1_G				-84.28			
	NR_FDD_FR1_H				-83.78			
	NR_FDD_FR1_A, NR_TDD_FR1_A NOTE 5	3,6	dBm/38.16 MHz	-50.19	-81.19			
	NR_FDD_FR1_B				-80.69			
	NR_TDD_FR1_C				-80.19			
	NR_FDD_FR1_D, NR_TDD_FR1_D				-79.69			
	NR_FDD_FR1_E, NR_TDD_FR1_E				-79.19			
	NR_FDD_FR1_F				-78.69			
	NR_FDD_FR1_G				-78.19			
	NR_FDD_FR1_H				-77.69			
	$\hat{E}_s / N_{oc}$				1~6	dB	10	-3
	Propagation condition				1~6		AWGN	AWGN
	Antenna configuration	1~6		1x2	1x2			
<p>Note 1: OCNG shall be used such that both cells are fully allocated and a constant total transmitted power spectral density is achieved for all OFDM symbols.</p> <p>Note 2: Interference from other cells and noise sources not specified in the test is assumed to be constant over subcarriers and time and shall be modelled as AWGN of appropriate power for <math>N_{oc}</math> to be fulfilled.</p> <p>Note 3: RSRP and <math>I_o</math> levels have been derived from other parameters for information purposes. They are not settable parameters themselves.</p> <p>Note 4: RSRP minimum requirements are specified assuming independent interference and noise at each receiver antenna port.</p> <p>Note 5: The test configuration excludes support for band n51 and it is not required to run this test on band n51 in this release of the specification</p>								

A.4.7.7.2.3 Test Requirements

The L1-SINR measurement accuracy for SSB#0+CSI-IM#0 and SSB#1+CSI-IM#1 of Cell 2 shall fulfil the requirements in clauses 10.1.27.2.

A.4.7.7.3 L1-SINR measurement with CSI-RS based CMR and dedicated IMR

A.4.7.7.3.1 Test Purpose and Environment

The purpose of this test is to verify that the L1-SINR measurement accuracy is within the specified limits. This test will partly verify the requirements in Clauses 9.8.4.3 and clause 10.1.27.3 for L1-SINR measurements based on CSI-RS as both CMR and IMR with the testing configurations for NR cells in Table A.4.7.7.3.1-1.

**Table A.4.7.7.3.1-1: Applicable NR configurations for FR1 L1-SINR measurement test with CSI-RS based both CMR based IMR**

Config	Description
1	LTE FDD, NR 15 kHz CSI-RS SCS, 10 MHz bandwidth, FDD duplex mode
2	LTE FDD, NR 15 kHz CSI-RS SCS, 10 MHz bandwidth, TDD duplex mode
3	LTE FDD, NR 30kHz CSI-RS SCS, 40 MHz bandwidth, TDD duplex mode
4	LTE TDD, NR 15 kHz CSI-RS SCS, 10 MHz bandwidth, FDD duplex mode
5	LTE TDD, NR 15 kHz CSI-RS SCS, 10 MHz bandwidth, TDD duplex mode
6	LTE TDD, NR 30kHz CSI-RS SCS, 40 MHz bandwidth, TDD duplex mode
Note:	The UE is only required to be tested in one of the supported test configurations in each supported band.

A.4.7.7.3.2 Test parameters

In this set of test cases there are two cells in the test, E-UTRAN PCell (Cell 1), FR1 PSCell (Cell 2). The test parameters and applicability for Cell 1 are defined in A.3.7.2. The test parameters for the Cell 2 are given in Table

A.4.7.7.3.2-1 below. The absolute and relative accuracy of L1-SINR measurements are tested by using the parameters in Table A.4.7.7.3.2-1.

There is no measurement gap configured in the test. Before the test, UE is configured two CSI-RS resource sets with two CSI-RS resources for each set. UE is configured to perform RLM and BFD based on SSB 0 and 1. CSI-RS is not transmitted in the same OFDM symbols as SSB. UE is configured to perform L1-SINR measurement based on the configured CSI-RS as both CMR and IMR.

**Table A.4.7.7.3.2-1: FR1 L1-SINR measurement test with CSI-RS based both CMR and IMR**

Parameter	Config	Unit	Test 1	Test 2
SSB GSCN	1~6		freq1	freq1
Duplex mode	1,4		FDD	FDD
	2,5		TDD	TDD
	3,6		TDD	TDD
TDD Configuration	1,4		N/A	N/A
	2,5		TDDConf.1.1	TDDConf.1.1
	3,6		TDDConf.2.1	TDDConf.2.1
BW <sub>channel</sub>	1,4	MHz	10: N <sub>RB,c</sub> = 52	10: N <sub>RB,c</sub> = 52
	2,5		10: N <sub>RB,c</sub> = 52	10: N <sub>RB,c</sub> = 52
	3,6		40: N <sub>RB,c</sub> = 106	40: N <sub>RB,c</sub> = 106
PDSCH Reference measurement channel	1,4		SR.1.1 FDD	SR.1.1 FDD
	2,5		SR.1.1 TDD	SR.1.1 TDD
	3,6		SR.2.1 TDD	SR.2.1 TDD
RMSI CORESET Reference Channel	1,4		CR.1.1 FDD	CR.1.1 FDD
	2,5		CR.1.1 TDD	CR.1.1 TDD
	3,6		CR.2.1 TDD	CR.2.1 TDD
Dedicated CORESET Reference Channel	1,4		CCR.1.1 FDD	CCR.1.1 FDD
	2,5		CCR.1.1 TDD	CCR.1.1 TDD
	3,6		CCR.2.1 TDD	CCR.2.1 TDD
SSB configuration	1,4		SSB.1 FR1	SSB.1 FR1
	2,5		SSB.1 FR1	SSB.1 FR1
	3,6		SSB.2 FR1	SSB.2 FR1
OCNG Patterns	1~6		OP.1	OP.1
TRS configuration	1,4		TRS.1.1 FDD	TRS.1.1 FDD
	2,5		TRS.1.1 TDD	TRS.1.1 TDD
	3,6		TRS.1.2 TDD	TRS.1.2 TDD
Initial BWP Configuration	1~6		DLBWP.0.1 ULBWP.0.1	DLBWP.0.1 ULBWP.0.1
Dedicated BWP configuration	1~6		DLBWP.1.1 ULBWP.1.1	DLBWP.1.1 ULBWP.1.1
SMTc configuration	1~6		SMTc.1	SMTc.1
CSI-RS configuration as CMR	1,4		CSI-RS 1.2 FDD	CSI-RS 1.2 FDD
	2,5		CSI-RS 1.2 TDD	CSI-RS 1.2 TDD
	3,6		CSI-RS 2.2 TDD	CSI-RS 2.2 FDD
CSI-RS configuration as IMR	1,4		CSI-RS 1.3A FDD	CSI-RS 1.3A FDD
	2,5		CSI-RS 1.3A TDD	CSI-RS 1.3A TDD
	3,6		CSI-RS 2.3A TDD	CSI-RS 2.3A TDD
reportConfigType	1~6		periodic	periodic
reportQuantity-r16	1~6		cri-SINR-r16	cri-SINR-r16
nrofReportedRS	1~6		2	2
L1-RSRP reporting period	1~6		slot80	slot80
EPRE ratio of PSS to SSS	1~6	dB	0	0
EPRE ratio of PBCH DMRS to SSS				
EPRE ratio of PBCH to PBCH DMRS				
EPRE ratio of PDCCH DMRS to SSS				
EPRE ratio of PDCCH to PDCCH DMRS				
EPRE ratio of PDSCH DMRS to SSS				

EPRE ratio of PDSCH to PDSCH DMRS					
EPRE ratio of OCNG DMRS to SSS <sup>Note 1</sup>					
EPRE ratio of OCNG to OCNG DMRS <sup>Note 1</sup>					
$N_{oc}$ Note2	NR_FDD_FR1_A, NR_TDD_FR1_A NOTE 5	1~6	dBm/15kHz	-94.65	-117
	NR_FDD_FR1_B				-116.5
	NR_TDD_FR1_C				-116
	NR_FDD_FR1_D, NR_TDD_FR1_D				-115.5
	NR_FDD_FR1_E, NR_TDD_FR1_E				-115
	NR_FDD_FR1_F				-114.5
	NR_FDD_FR1_G				-114
	NR_FDD_FR1_H				-113.5
$N_{oc}$ Note2	NR_FDD_FR1_A, NR_TDD_FR1_A NOTE 5	1,2,4,5	dBm/CSI-RS SCS	-94.65	-117
	NR_FDD_FR1_B				-116.5
	NR_TDD_FR1_C				-116
	NR_FDD_FR1_D, NR_TDD_FR1_D				-115.5
	NR_FDD_FR1_E, NR_TDD_FR1_E				-115
	NR_FDD_FR1_F				-114.5
	NR_FDD_FR1_G				-114
	NR_FDD_FR1_H				-113.5
	NR_FDD_FR1_A, NR_TDD_FR1_A NOTE 5	3,6	-91.65	-114	
	NR_FDD_FR1_B		-113.5		
	NR_TDD_FR1_C		-114		
	NR_FDD_FR1_D, NR_TDD_FR1_D		-112.5		
	NR_FDD_FR1_E, NR_TDD_FR1_E		-112		
	NR_FDD_FR1_F		-111.5		
	NR_FDD_FR1_G		-111		
	NR_FDD_FR1_H		-110.5		
$\hat{E}_s/I_{ot}$		1~6	dB	10	0
CSI-RS RSRP Note3	NR_FDD_FR1_A, NR_TDD_FR1_A NOTE 5	1,2,4,5	dBm/CSI-RS SCS	-84.65	-117
	NR_FDD_FR1_B				-116.5
	NR_TDD_FR1_C				-116
	NR_FDD_FR1_D, NR_TDD_FR1_D				-115.5
	NR_FDD_FR1_E, NR_TDD_FR1_E				-115
	NR_FDD_FR1_F				-114.5
	NR_FDD_FR1_G				-114
	NR_FDD_FR1_H				-113.5
	NR_FDD_FR1_A, NR_TDD_FR1_A NOTE 5	3,6	-81.65	-114	
	NR_FDD_FR1_B		-113.5		
	NR_TDD_FR1_C		-114		
	NR_FDD_FR1_D, NR_TDD_FR1_D		-112.5		
	NR_FDD_FR1_E, NR_TDD_FR1_E		-112		
	NR_FDD_FR1_F		-111.5		
	NR_FDD_FR1_G		-111		

I <sub>o</sub> <sup>Note3</sup>	NR_FDD_FR1_H	1,2,4,5	dBm/9.36 MHz	-56.28	-110.5
	NR_FDD_FR1_A, NR_TDD_FR1_A NOTE 5				-87.28
	NR_FDD_FR1_B				-86.78
	NR_TDD_FR1_C				-86.28
	NR_FDD_FR1_D, NR_TDD_FR1_D				-85.78
	NR_FDD_FR1_E, NR_TDD_FR1_E				-85.28
	NR_FDD_FR1_F				-84.78
	NR_FDD_FR1_G	-84.28			
	NR_FDD_FR1_H	-83.78			
	NR_FDD_FR1_A, NR_TDD_FR1_A NOTE 5	3,6	dBm/38.16 MHz	-50.19	-81.19
	NR_FDD_FR1_B				-80.69
	NR_TDD_FR1_C				-80.19
	NR_FDD_FR1_D, NR_TDD_FR1_D				-79.69
	NR_FDD_FR1_E, NR_TDD_FR1_E				-79.19
	NR_FDD_FR1_F				-78.69
	NR_FDD_FR1_G				-78.19
	NR_FDD_FR1_H	-77.69			
$\hat{E}_s / N_{oc}$	1-6	dB	10	0	
Propagation condition	1-6		AWGN	AWGN	
Antenna configuration	1-6		1x2	1x2	
<p>Note 1: OCNG shall be used such that both cells are fully allocated and a constant total transmitted power spectral density is achieved for all OFDM symbols.</p> <p>Note 2: Interference from other cells and noise sources not specified in the test is assumed to be constant over subcarriers and time and shall be modelled as AWGN of appropriate power for <math>N_{oc}</math> to be fulfilled.</p> <p>Note 3: RSRP and I<sub>o</sub> levels have been derived from other parameters for information purposes. They are not settable parameters themselves.</p> <p>Note 4: RSRP minimum requirements are specified assuming independent interference and noise at each receiver antenna port.</p> <p>Note 5: The test configuration excludes support for band n51 and it is not required to run this test on band n51 in this release of the specification</p>					

### A.4.7.7.3.3 Test Requirements

The L1-SINR measurement accuracy for CSI-RS#0+CSI-RS#2 and CSI-RS#1+CSI-RS#3 of Cell 2 shall fulfil the requirements in clauses 10.1.27.3.

## A.4.7.8 CSI-RSRP

### A.4.7.8.1 EN-DC Intra-frequency measurement accuracy with FR1 serving cell and FR1 target cell

#### A.4.7.8.1.1 Test Purpose and Environment

The purpose of this test is to verify that the CSI-RSRP measurement accuracy is within the specified limits. This test will verify the requirements in Clauses 10.1.2.3.1 and 10.1.2.3.2 for intra-frequency CSI-RS based L3 measurements.

#### A.4.7.8.1.2 Test parameters

In this set of test cases all NR cells are on the same carrier frequency. Supported test configurations are shown in table A.4.7.8.1.2-1. Both absolute and relative accuracy of CSI-RSRP intra-frequency measurements are tested by using the parameters in A.4.7.8.1.2-2. The configuration of cell 1 (E-UTRA PCell) is specified in clause A.3.7.2.1. In all test cases, Cell 2 is the PCell and Cell 3 is the target cell.

**Table A.4.7.8.1.2-1: CSI-RSRP Intra frequency CSI-RSRP supported test configurations**

Config	Description
1	LTE FDD, NR 15 kHz SSB and CSI-RS SCS, 10 MHz bandwidth, FDD duplex mode
2	LTE FDD, NR 15 kHz SSB and CSI-RS SCS, 10 MHz bandwidth, TDD duplex mode
3	LTE FDD, NR 30kHz SSB and CSI-RS SCS, 40 MHz bandwidth, TDD duplex mode
4	LTE TDD, NR 15 kHz SSB and CSI-RS SCS, 10 MHz bandwidth, FDD duplex mode
5	LTE TDD, NR 15 kHz SSB and CSI-RS SCS, 10 MHz bandwidth, TDD duplex mode
6	LTE TDD, NR 30kHz SSB and CSI-RS SCS, 40 MHz bandwidth, TDD duplex mode

Note: The UE is only required to be tested in one of the supported test configurations for each supported band

**Table A.4.7.8.1.2-2: CSI-RSRP Intra frequency test parameters**

Parameter		Unit	Test 1		Test 2		Test 3	
			Cell 2	Cell 3	Cell 2	Cell 3	Cell 2	Cell 3
Physical cell ID			489	0	489	0	489	0
SSB ARFCN			freq1		freq1		freq1	
Duplex mode	Config 1,4		FDD					
	Config 2,3,5,6		TDD					
TDD configuration	Config 1,4		Not Applicable					
	Config 2,5		TDDConf.1.1					
	Config 3,6		TDDConf.2.1					
BW <sub>channel</sub>	Config 1,4	MHz	10: N <sub>RB,c</sub> = 52					
	Config 2,5		10: N <sub>RB,c</sub> = 52					
	Config 3,6		40: N <sub>RB,c</sub> = 106					
Downlink initial BWP configuration			DLBWP.0.1					
Downlink dedicated BWP configuration			DLBWP.1.1					
Uplink initial BWP configuration			ULBWP.0.1					
Uplink dedicated BWP configuration			ULBWP.1.1					
TRS configuration	Config 1,4		TRS.1.1 FDD	NA	TRS.1.1 FDD	NA	TRS.1.1 FDD	NA
	Config 2,5		TRS.1.1 TDD	NA	TRS.1.1 TDD	NA	TRS.1.1 TDD	NA
	Config 3,6		TRS.1.2 TDD	NA	TRS.1.2 TDD	NA	TRS.1.2 TDD	NA
DRX Cycle		ms	Not Applicable					
PDSCH Reference measurement channel	Config 1,4		SR.1.1 FDD	-	SR.1.1 FDD	-	SR.1.1 FDD	-
	Config 2,5		SR.1.1 TDD	-	SR.1.1 TDD	-	SR.1.1 TDD	-
	Config 3,6		SR2.1 TDD	-	SR2.1 TDD	-	SR2.1 TDD	-
RMSI CORESET Reference Channel	Config 1,4		CR.1.1 FDD	-	CR.1.1 FDD	-	CR.1.1 FDD	-
	Config 2,5		CR.1.1 TDD	-	CR.1.1 TDD	-	CR.1.1 TDD	-
	Config 3,6		CR2.1 TDD	-	CR2.1 TDD	-	CR2.1 TDD	-
Control Channel RMC	Config 1,4		CCR.1.1 FDD	-	CCR.1.1 FDD	-	CCR.1.1 FDD	-
	Config 2,5		CCR.1.1 TDD	-	CCR.1.1 TDD	-	CCR.1.1 TDD	-
	Config 3,6		CCR2.1 TDD	-	CCR2.1 TDD	-	CCR2.1 TDD	-

SSB configuration	Config 1,4			SSB.1 FR1	SSB.1 FR1	SSB.1 FR1	SSB.1 FR1	SSB.1 FR1	SSB.1 FR1
	Config 2,5			SSB.1 FR1	SSB.1 FR1	SSB.1 FR1	SSB.1 FR1	SSB.1 FR1	SSB.1 FR1
	Config 3,6			SSB.2 FR1	SSB.2 FR1	SSB.2 FR1	SSB.2 FR1	SSB.2 FR1	SSB.2 FR1
CSI-RS configuration for RRM	Config 1,4			CSI-RS.RRM.FR1.1 FDD					
	Config 2,5			CSI-RS.RRM.FR1.1 TDD					
	Config 3,6			CSI-RS.RRM.FR1.2 TDD					
Time offset with Cell 2	Config 1,2,4,5		μs	-	4.7	-	4.7	-	4.7
	Config 3,6		μs	-	2.35	-	2.35	-	2.35
SMTC configuration	Config 1,4			SMTC.2					
	Config 2,3,5,6			SMTC.1					
OCNG Patterns				OP.1					
PDSCH/PDCCH subcarrier spacing	Config 1,2,4,5		kHz	15 kHz					
	Config 3,6			30kHz					
EPRE ratio of PSS to SSS			dB	0	0	0	0	0	0
EPRE ratio of PBCH DMRS to SSS									
EPRE ratio of PBCH to PBCH DMRS									
EPRE ratio of PDCCH DMRS to SSS									
EPRE ratio of PDCCH to PDCCH DMRS									
EPRE ratio of PDSCH DMRS to SSS									
EPRE ratio of PDSCH to PDSCH									
EPRE ratio of OCNG DMRS to SSS(Note 1)									
EPRE ratio of OCNG to OCNG DMRS (Note 1)									
$N_{oc}$ Note2	Config 1,2,4,5	NR_FDD_FR1_A, NR_TDD_FR1_A NOTE 6	dBm/15Kh Z	-106		-88		-114	
		NR_FDD_FR1_B						-113.5	
		NR_TDD_FR1_C						-113	
		NR_FDD_FR1_D, NR_TDD_FR1_D						-112.5	
		NR_FDD_FR1_E, NR_TDD_FR1_E						-112	
		NR_FDD_FR1_F						-111.5	
		NR_FDD_FR1_G						-111	
		NR_FDD_FR1_H						-110.5	
	Config 3,6	NR_FDD_FR1_A, NR_TDD_FR1_A NOTE 6		Not applicable <sup>Note 5</sup>		-94		-114	
		NR_FDD_FR1_B						-113.5	
		NR_TDD_FR1_C						-113	
		NR_FDD_FR1_D, NR_TDD_FR1_D						-112.5	
		NR_FDD_FR1_E, NR_TDD_FR1_E						-112	
		NR_FDD_FR1_F						-111.5	
		NR_FDD_FR1_G						-111	

		NR_FDD_FR1_H							-110.5			
$N_{oc}$ Note2	Config 1,2,4,5		dBm/SCS	-106		-88		Same as Noc/15kHz				
	Config 3,6	NR_FDD_FR1_A, NR_TDD_FR1_A NOTE 6		Not applicable <sup>Note 5</sup>		-91		-111				
		NR_FDD_FR1_B						-110.5				
		NR_TDD_FR1_C						-110				
		NR_FDD_FR1_D, NR_TDD_FR1_D						-109.5				
		NR_FDD_FR1_E, NR_TDD_FR1_E						-109				
		NR_FDD_FR1_F						-108.5				
		NR_FDD_FR1_G						-108				
		NR_FDD_FR1_H						-107.5				
$\hat{E}_s/I_{ot}$			dB	2.46	-5.97	2.46	-5.97	-0.01	-4.76			
$\hat{E}_s/N_{oc}$			dB	6	1	6	1	3	0			
CSI-RSRP <sup>Not e3</sup>	Config 1,2,4,5	NR_FDD_FR1_A, NR_TDD_FR1_A NOTE 6	dBm/SCS	-100	-105	-82	-87	-	-			
		NR_FDD_FR1_B						111.00	114.00			
		NR_TDD_FR1_C						-	-			
		NR_FDD_FR1_D, NR_TDD_FR1_D						110.50	113.50			
		NR_FDD_FR1_E, NR_TDD_FR1_E						-	-			
		NR_FDD_FR1_F						110.00	113.00			
		NR_FDD_FR1_G						-	-			
		NR_FDD_FR1_H						109.50	112.50			
								-	-			
		109.00	112.00									
		-	-									
		108.50	111.50									
		-	-									
		108.00	111.00									
		-	-									
		107.50	110.50									
	Config 3,6	NR_FDD_FR1_A, NR_TDD_FR1_A NOTE 6		- Not applicable <sup>Note 5</sup>		Not applicable <sup>Note 5</sup>		-85		-90		
		NR_FDD_FR1_B										-
NR_TDD_FR1_C		108.00										111.00
NR_FDD_FR1_D, NR_TDD_FR1_D		-										-
NR_FDD_FR1_E, NR_TDD_FR1_E		107.50										110.50
NR_FDD_FR1_F		-										-
NR_FDD_FR1_G		107.00										110.00
NR_FDD_FR1_H		-										-
		106.50										109.50
	-	-										
	106.00	109.00										
	-	-										
	105.50	108.50										
	-	-										
	105.00	108.00										
	-	-										
	104.50	107.50										
$I_o$ <sup>Note3</sup>	Config 1,2,4,5	NR_FDD_FR1_A, NR_TDD_FR1_A NOTE 6	dBm/ 9.36MHz	-70.09		-52.09		-80.03				

		NR_FDD_FR1_B				-79.53
		NR_TDD_FR1_C				-79.03
		NR_FDD_FR1_D, NR_TDD_FR1_D				-78.53
		NR_FDD_FR1_E, NR_TDD_FR1_E				-78.03
		NR_FDD_FR1_F				-77.53
		NR_FDD_FR1_G				-77.03
		NR_FDD_FR1_H				-76.53
	Config 3,6	NR_FDD_FR1_A, NR_TDD_FR1_A NOTE 6	dBm/ 38.16MHz	Not applicable <sup>Note 5</sup>	-51.99	-73.94
		NR_FDD_FR1_B				-73.44
		NR_TDD_FR1_C				-72.94
		NR_FDD_FR1_D, NR_TDD_FR1_D				-72.44
		NR_FDD_FR1_E, NR_TDD_FR1_E				-71.94
		NR_FDD_FR1_F				-71.44
		NR_FDD_FR1_G				-70.94
		NR_FDD_FR1_H				-70.44
Propagation condition			-	AWGN		
Antenna configuration				1x2		
<p>Note 1: OCNG shall be used such that both cells are fully allocated and a constant total transmitted power spectral density is achieved for all OFDM symbols.</p> <p>Note 2: Interference from other cells and noise sources not specified in the test is assumed to be constant over subcarriers and time and shall be modelled as AWGN of appropriate power for <math>N_{oc}</math> to be fulfilled.</p> <p>Note 3: CSI-RSRP and <math>I_o</math> levels have been derived from other parameters for information purposes. They are not settable parameters themselves.</p> <p>Note 4: CSI-RSRP minimum requirements are specified assuming independent interference and noise at each receiver antenna port.</p> <p>Note 5: Subtest 1 is not used when testing with 30kHz SSB SCS</p> <p>Note 6: The test configuration excludes support for band n51 and it is not required to run this test on band n51 in this release of the specification</p>						

A.4.7.8.1.3 Test Requirements

The CSI-RSRP measurement accuracy for cell 2 and cell 3 shall fulfill absolute requirement in clause 10.1.2.3.1 and relative requirement in clause 10.1.2.3.2.

A.4.7.8.2 EN-DC inter-frequency measurement accuracy with FR1 serving cell and FR1 target cell

A.4.7.8.2.1 Test Purpose and Environment

The purpose of this test is to verify that the CSI-RSRP measurement accuracy is within the specified limits. This test will verify the requirements in Clauses 10.1.4.3.1 and 10.1.4.3.2 for inter-frequency measurements with the testing configurations in Table A.4.7.8.2.1-1.

**Table A.4.7.8.2.1-1: Applicable NR configurations for FR1 inter-frequency CSI-RSRP accuracy test**

Config	Description
1	LTE FDD, NR 15 kHz SSB and CSI-RS SCS, 10 MHz bandwidth, FDD duplex mode
2	LTE FDD, NR 15 kHz SSB and CSI-RS SCS, 10 MHz bandwidth, TDD duplex mode
3	LTE FDD, NR 30 kHz SSB and CSI-RS SCS, 40 MHz bandwidth, TDD duplex mode



4	LTE TDD, NR 15 kHz SSB and CSI-RS SCS, 10 MHz bandwidth, FDD duplex mode
5	LTE TDD, NR 15 kHz SSB and CSI-RS SCS, 10 MHz bandwidth, TDD duplex mode
6	LTE TDD, NR 30 kHz SSB and CSI-RS SCS, 40 MHz bandwidth, TDD duplex mode
Note: The UE is only required to be tested in one of the supported test configurations on each supported band	

#### A.4.7.8.2.2 Test parameters

In this set of test cases there are three cells in the test, E-UTRAN PCell (Cell 1), FR1 PCell (Cell 2) and a FR1 neighbour cell (Cell 3) on a different frequency than the PCell. The test parameters and applicability for Cell 1 are defined in A.3.7.2. The test parameters for the Cell 2 and Cell 3 are given in Table A.4.7.8.2.2-1 below. Both absolute and relative accuracy of CSI-RSRP inter-frequency measurements are tested by using the parameters in Table A.4.7.8.2.2-1. The inter-frequency measurements are supported by a measurement gap.

**Table A.4.7.8.2.2-1: CSI-RSRP inter-frequency test parameters**

Parameter	Config	Unit	Test 1		Test 2	
			Cell 2	Cell 3	Cell 2	Cell 3
SSB ARFCN	1~6		freq1	freq2	freq1	freq2
$BW_{\text{channel}}$	1,4	MHz	10: $N_{RB,c} = 52$		10: $N_{RB,c} = 52$	
	2,5		10: $N_{RB,c} = 52$		10: $N_{RB,c} = 52$	
	3,6		40: $N_{RB,c} = 106$		40: $N_{RB,c} = 106$	
Gap pattern ID			0		0	
Duplex mode	1,4		FDD		FDD	
	2,5		TDD		TDD	
	3,6		TDD		TDD	
TDD configuration	1,4		N/A		N/A	
	2,5		TDDConf.1.1		TDDConf.1.1	
	3,6		TDDConf.2.1		TDDConf.2.1	
PDSCH Reference measurement channel	1,4		SR.1.1 FDD	-	SR.1.1 FDD	-
	2,5		SR.1.1 TDD	-	SR.1.1 TDD	-
	3,6		SR.2.1 FDD	-	SR.2.1 FDD	-
RMSI CORESET Reference Channel	1,4		CR.1.1 FDD	-	CR.1.1 FDD	-
	2,5		CR.1.1 TDD	-	CR.1.1 TDD	-
	3,6		CR.2.1 FDD	-	CR.2.1 FDD	-
Dedicated CORESET Reference Channel	1,4		CCR.1.1 FDD	-	CCR.1.1 FDD	-
	2,5		CCR.1.1 TDD	-	CCR.1.1 TDD	-
	3,6		CCR.2.1 TDD	-	CCR.2.1 TDD	-
SSB configuration	1,4		SSB.1 FR1		SSB.1 FR1	
	2,5		SSB.1 FR1		SSB.1 FR1	
	3,6		SSB.2 FR1		SSB.2 FR1	
CSI-RS configuration for RRM	1,4		CSI-RS.RRM.FR1.1 FDD			
	2,5		CSI-RS.RRM.FR1.1 TDD			
	3,6		CSI-RS.RRM.FR1.2 TDD			
OCNG Patterns	1~6		OP.1		OP.1	
TRS configuration	1,4		TRS.1.1 FDD	-	TRS.1.1 FDD	-

		2,5		TRS.1.1 TDD	TRS.1.1 TDD		
		3,6		TRS.1.2 TDD	TRS.1.2 TDD		
Initial BWP Configuration		1~6		DLBWP.0.1 ULBWP.0.1		DLBWP.0.1 ULBWP.0.1	
Dedicated BWP configuration		1~6		DLBWP.1.1 ULBWP.1.1		DLBWP.1.1 ULBWP.1.1	
Time offset with Cell 2		1,2,4,5	$\mu$ s	-	4.7	-	4.7
		3,6	$\mu$ s	-	2.35	-	2.35
SMTTC configuration		1,4		SMTTC.2		SMTTC.2	
		2,3,5,6		SMTTC.1		SMTTC.1	
EPRE ratio of PSS to SSS		1~6	dB	0	0	0	0
EPRE ratio of PBCH DMRS to SSS							
EPRE ratio of PBCH to PBCH DMRS							
EPRE ratio of PDCCH DMRS to SSS							
EPRE ratio of PDCCH to PDCCH DMRS							
EPRE ratio of PDSCH DMRS to SSS							
EPRE ratio of PDSCH to PDSCH DMRS							
EPRE ratio of OCNG DMRS to SSS Note 1							
EPRE ratio of OCNG to OCNG DMRS Note 1							
$N_{oc}$ <sup>Note2</sup>	NR_FDD_FR1_A						
	, NR_TDD_FR1_A						
	NOTE 5,						
	NR_FDD_FR1_B	-114.5					
	NR_TDD_FR1_C	-114					
	NR_FDD_FR1_D	-113.5					
	, NR_TDD_FR1_D						
	NR_FDD_FR1_E	-113					
	, NR_TDD_FR1_E						
	NF_FDD_FR1_F	-112.5					
NR_FDD_FR1_G	-112						
NR_FDD_FR1_H	-111.5						
$N_{oc}$ <sup>Note2</sup>	NR_FDD_FR1_A	1,2,4,5	dBm/SS B SCS	-94.65		$(N_{oc}$ for Cell 3 +8dB)	-115
	, NR_TDD_FR1_A						
	NOTE 5,						
	NR_FDD_FR1_B						-114.5
	NR_TDD_FR1_C						-114
	NR_FDD_FR1_D						-113.5
	, NR_TDD_FR1_D						
	NR_FDD_FR1_E						-113
, NR_TDD_FR1_E							
NR_FDD_FR1_F	-112.5						

	NR_FDD_FR1_G					-112	
	NR_FDD_FR1_H					-111.5	
	NR_FDD_FR1_A , NR_TDD_FR1_A NOTE 5, NR_SDL_FR1_A NR_FDD_FR1_B	3,6		-91.65	( $N_{oc}$ for C 3 +8dB)	-112.00	
	NR_TDD_FR1_C					-112.50	
	NR_TDD_FR1_C					-112.00	
	NR_FDD_FR1_D , NR_TDD_FR1_D					-112.00	
	NR_FDD_FR1_D					-111.50	
	NR_TDD_FR1_D					-111.50	
	NR_FDD_FR1_E , NR_TDD_FR1_E					-111.00	
	NR_FDD_FR1_E					-111.00	
	NR_TDD_FR1_E					-111.00	
	NR_FDD_FR1_F					-110.50	
	NR_FDD_FR1_G					-110.00	
	NR_FDD_FR1_H					-110.50	
	$\hat{E}_s/I_{ot}$	1~6	dB	10	10	13	-3
CSI- RSRP <sup>Note3</sup>	NR_FDD_FR1_A , NR_TDD_FR1_A NOTE 5	1,2,4,5	dBm/SC S	-84.65	(RSRP for Cell 3 +25dB)	-118.00	
	NR_FDD_FR1_B					-117.50	
	NR_TDD_FR1_C					-117.00	
	NR_FDD_FR1_D , NR_TDD_FR1_D					-116.50	
	NR_FDD_FR1_D					-116.50	
	NR_TDD_FR1_D					-116.50	
	NR_FDD_FR1_E , NR_TDD_FR1_E					-116.00	
	NR_FDD_FR1_E					-116.00	
	NR_TDD_FR1_E					-116.00	
	NR_FDD_FR1_F					-115.50	
NR_FDD_FR1_G	-115.00						
NR_FDD_FR1_H	-114.50						
CSI- RSRP <sup>Note3</sup>	NR_FDD_FR1_A , NR_TDD_FR1_A NOTE 5	3,6	dBm/SC S	-81.65	(RSRP for Cell 3 +25dB)	-115.00	
	NR_FDD_FR1_B					-114.50	
	NR_TDD_FR1_C					-114.00	
	NR_FDD_FR1_D , NR_TDD_FR1_D					-113.50	
	NR_FDD_FR1_D					-113.50	
	NR_TDD_FR1_D					-113.50	
	NR_FDD_FR1_E , NR_TDD_FR1_E					-113.00	
	NR_FDD_FR1_E					-113.00	
	NR_TDD_FR1_E					-113.00	
	NR_FDD_FR1_F					-112.50	
NR_FDD_FR1_G	-112.00						
NR_FDD_FR1_H	-111.50						

I <sub>o</sub> <sup>Note3</sup>	NR_FDD_FR1_A , NR_TDD_FR1_A NOTE 6	1,2,4,5	dBm/ 9.36MHz	-56.28		(I <sub>o</sub> for Channel 3 +19.75dB)	-85.28
	NR_FDD_FR1_B						-84.78
	NR_TDD_FR1_C						-84.28
	NR_FDD_FR1_D , NR_TDD_FR1_D						-83.78
	NR_FDD_FR1_E , NR_TDD_FR1_E						-83.28
	NR_FDD_FR1_F						-82.78
	NR_FDD_FR1_G						-82.28
	NR_FDD_FR1_H						-81.78
	NR_FDD_FR1_A , NR_TDD_FR1_A NOTE 6	3,6	dBm/ 38.16M Hz	-50.19		(I <sub>o</sub> for Channel 3 +19.75dB)	-79.19
	NR_FDD_FR1_B						-78.69
	NR_TDD_FR1_C						-78.19
	NR_FDD_FR1_D , NR_TDD_FR1_D						-77.69
	NR_FDD_FR1_E , NR_TDD_FR1_E						-77.19
	NR_FDD_FR1_F						-76.69
	NR_FDD_FR1_G						-76.19
	NR_FDD_FR1_H						-75.69
$\hat{E}_s / N_{oc}$	1~6	dB	10	10	13	-3	
Propagation condition	1~6	-	AWGN		AWGN		
Antenna configuration			1x2		1x2		
<p>Note 1: OCNG shall be used such that both cells are fully allocated and a constant total transmitted power spectral density is achieved for all OFDM symbols.</p> <p>Note 2: Interference from other cells and noise sources not specified in the test is assumed to be constant over subcarriers and time and shall be modelled as AWGN of appropriate power for <math>N_{oc}</math> to be fulfilled.</p> <p>Note 3: CSI-RSRP and I<sub>o</sub> levels have been derived from other parameters for information purposes. They are not settable parameters themselves.</p> <p>Note 4: CSI-RSRP minimum requirements are specified assuming independent interference and noise at each receiver antenna port.</p> <p>Note 5: The test configuration excludes support for band n51 and it is not required to run this test on band n51 in this release of the specification</p>							

### A.4.7.8.2.3 Test Requirements

The CSI-RSRP measurement accuracy for Cell 2 and Cell 3 shall fulfil the Absolute requirement in clause 10.1.4.2.1 and Relative requirement in clause 10.1.4.2.2.

### A.4.7.9 CSI-RSRQ

#### A.4.7.9.1 EN-DC Intra-frequency measurement accuracy with FR1 serving cell and FR1 target cell

##### A.4.7.9.1.1 Test Purpose and Environment

The purpose of this test is to verify that the CSI-RSRQ measurement accuracy is within the specified limits. This test will verify the requirements in Clause 10.1.7.

##### A.4.7.9.1.2 Test Parameters

In this test case all cells are on the same carrier frequency. Supported test configuration are shown in Table A.4.7.9.1.2-1. The absolute accuracy of CSI-RSRQ intra-frequency measurement is test by using the parameters in Table A.4.7.9.1.2-2. The configuration of cell 1 (E-UTRA PCell) is specified in clause A.3.7.2.1. In all test cases, Cell 2 is the PSCell and Cell 3 is the target cell.

**Table A.4.7.9.1.2-1: CSI-RSRQ Intra frequency CSI-RSRQ supported test configurations**

Config	Description
1	LTE FDD, NR 15 kHz SSB and CSI-RS SCS, 10MHz bandwidth, FDD duplex mode
2	LTE FDD, NR 15 kHz SSB and CSI-RS SCS, 10MHz bandwidth, TDD duplex mode
3	LTE FDD, NR 30kHz SSB and CSI-RS SCS, 40MHz bandwidth, TDD duplex mode
4	LTE TDD, NR 15 kHz SSB and CSI-RS SCS, 10MHz bandwidth, FDD duplex mode
5	LTE TDD, NR 15 kHz SSB and CSI-RS SCS, 10MHz bandwidth, TDD duplex mode
6	LTE TDD, NR 30kHz SSB and CSI-RS SCS, 40MHz bandwidth, TDD duplex mode

Note: The UE is only required to be tested in one of the supported test configurations in each supported band

**Table A.4.7.9.1.2-2: CSI-RSRQ Intra frequency test parameters**

Parameter		Unit	Test 1		Test 2		Test 3	
			Cell 2	Cell 3	Cell 2	Cell 3	Cell 2	Cell 3
SSB ARFCN			freq1		freq1		freq1	
Duplex mode	Config 1,4	MHz	FDD					
	Config 2,3,5,6		TDD					
TDD configuration	Config 1,4		Not Applicable					
	Config 2,5		TDDConf.1.1					
	Config 3,6		TDDConf.2.1					
BW <sub>channel</sub>	Config 1,4		10: N <sub>RB,c</sub> = 52					
	Config 2,5	10: N <sub>RB,c</sub> = 52						
	Config 3,6	40: N <sub>RB,c</sub> = 106						
BWP configuration	Initial DL BWP	DLBWP.0.1						
	Dedicated DL BWP	DLBWP.1.1						
	Initial UL BWP	ULBWP.0.1						
	Dedicated UL BWP	ULBWP.1.1						
DRX Cycle		ms	Not Applicable					
PDSCH Reference measurement channel	Config 1,4		SR.1.1 FDD	-	SR.1.1 FDD	-	SR.1.1 FDD	-
	Config 2,5		SR.1.1 TDD		SR.1.1 TDD		SR.1.1 TDD	
	Config 3,6		SR.2.1 TDD		SR.2.1 TDD		SR.2.1 TDD	
RMSI CORESET Reference Channel	Config 1,4		CR.1.1 FDD	-	CR.1.1 FDD	-	CR.1.1 FDD	
	Config 2,5		CR.1.1 TDD		CR.1.1 TDD		CR.1.1 TDD	
	Config 3,6		CR.2.1 TDD		CR.2.1 TDD		CR.2.1 TDD	
Control Channel RMC	Config 1,4		CCR.1.1 FDD	-	CCR.1.1 FDD	-	CCR.1.1 FDD	-
	Config 2,5		CCR.1.1 TDD		CCR.1.1 TDD		CCR.1.1 TDD	

	Config 3,6		CCR.2.1 TDD		CCR.2.1 TDD		CCR.2.1 TDD	
TRS configuration	Config 1,4		TRS.1.1 FDD	-	TRS.1.1 FDD	-	TRS.1.1 FDD	-
	Config 2,5		TRS.1.1 TDD		TRS.1.1 TDD		TRS.1.1 TDD	
	Config 3,6		TRS.1.2 TDD		TRS.1.2 TDD		TRS.1.2 TDD	
OCNG Patterns			OP. 1					
Time offset with Cell 2	Config 1,2,4,5	µs	-	4.7	-	4.7	-	4.7
	Config 3,6	µs	-	2.35	-	2.35	-	2.35
SMTc configuration	Config 1,4		SMTc.2					
	Config 2,3,5,6		SMTc.1					
SSB configuration	Config 1,2,4,5		SSB.1 FR1					
	Config 3,6		SSB.2 FR1					
CSI-RS configuration for RRM	Config 1,4		CSI-RS.RRM.FR1.1 FDD					
	Config 2, 5		CSI-RS.RRM.FR1.1 TDD					
	Config 3, 6		CSI-RS.RRM.FR1.2 TDD					
PDSCH/PDCCH subcarrier spacing	Config 1,2,4,5	kHz	15 kHz					
	Config 3,6		30kHz					
EPRE ratio of PSS to SSS		dB	0	0	0	0	0	0
EPRE ratio of PBCH DMRS to SSS								
EPRE ratio of PBCH to PBCH DMRS								
EPRE ratio of PDCCH DMRS to SSS								
EPRE ratio of PDCCH to PDCCH DMRS								
EPRE ratio of PDSCH DMRS to SSS								
EPRE ratio of PDSCH to PDSCH								
EPRE ratio of OCNG DMRS to SSS(Note 1)								
EPRE ratio of OCNG to OCNG DMRS (Note 1)								
$N_{oc}$ Note2	Config 1,2,4,5	NR_FDD_FR1_A, NR_TDD_FR1_A NOTE 7	dBm/15k Hz	-85	-101	-114		
		NR_FDD_FR1_B					-113.5	
		NR_TDD_FR1_C					-113	
		NR_FDD_FR1_D, NR_TDD_FR1_D					-112.5	
		NR_FDD_FR1_E, NR_TDD_FR1_E					-112	
		NR_FDD_FR1_F					-111.5	
		NR_FDD_FR1_G					-111	
		NR_FDD_FR1_H					-110.5	
	Config 3,6	NR_FDD_FR1_A, NR_TDD_FR1_A NOTE 7	-91	-	-114			
		NR_FDD_FR1_B				-113.5		
		NR_TDD_FR1_C				-113		
		NR_FDD_FR1_D, NR_TDD_FR1_D				-112.5		
		NR_FDD_FR1_E, NR_TDD_FR1_E				-112		
		NR_FDD_FR1_F				-111.5		
		NR_FDD_FR1_G				-111		
		NR_FDD_FR1_H				-110.5		
$N_{oc}$ Note2	Config 1,2,4,5	NR_FDD_FR1_A, NR_TDD_FR1_A NOTE 7	dBm/SC S	-85	-101	-114		
		NR_FDD_FR1_B					-113.5	
		NR_TDD_FR1_C					-113	
		NR_FDD_FR1_D, NR_TDD_FR1_D					-112.5	
		NR_FDD_FR1_E, NR_TDD_FR1_E					-112	
		NR_FDD_FR1_F					-111.5	
		NR_FDD_FR1_G					-111	
		NR_FDD_FR1_H					-110.5	

	Config 3,6	NR_FDD_FR1_A, NR_TDD_FR1_A NOTE 7		-88		-		-111			
		NR_FDD_FR1_B								-110.5	
		NR_TDD_FR1_C								-110	
		NR_FDD_FR1_D, NR_TDD_FR1_D								-109.5	
		NR_FDD_FR1_E, NR_TDD_FR1_E								-109	
		NR_FDD_FR1_F								-108.5	
		NR_FDD_FR1_G								-108	
		NR_FDD_FR1_H								-107.5	
$\hat{E}_s/I_{ot}$			dB	-1.76		-4.7		-5.46	-5.46		
$\hat{E}_s/N_{oc}$			dB	3	3	-2.9	-2.9	-4	-4		
CSI-RSRP Note3	Config 1,2,4,5	NR_FDD_FR1_A, NR_TDD_FR1_A NOTE 7	dBm/SC S	-82	-82	-103.9	-103.9	-118			
		NR_FDD_FR1_B								-117.5	-117.5
		NR_TDD_FR1_C								-117	-117
		NR_FDD_FR1_D, NR_TDD_FR1_D								-116.5	-116.5
		NR_FDD_FR1_E, NR_TDD_FR1_E								-116	-116
		NR_FDD_FR1_F								-115.5	-115.5
		NR_FDD_FR1_G								-115	-115
		NR_FDD_FR1_H								-114.5	-114.5
	Config 3,6	NR_FDD_FR1_A, NR_TDD_FR1_A NOTE 7	-85	-85	-	-	-115				
		NR_FDD_FR1_B							-114.5	-114.5	
		NR_TDD_FR1_C							-114	-114	
		NR_FDD_FR1_D, NR_TDD_FR1_D							-113.5	-113.5	
		NR_FDD_FR1_E, NR_TDD_FR1_E							-113	-113	
		NR_FDD_FR1_F							-112.5	-112.5	
		NR_FDD_FR1_G							-112	-112	
		NR_FDD_FR1_H							-111.5	-111.5	
CSI-RSRQ Note3		NR_FDD_FR1_A, NR_TDD_FR1_A NOTE 7	dB	-14.77	-14.77	-16.76	-16.76	-17.34	-17.34		
Io <sup>Note3</sup>	Config 1,2,4,5	NR_FDD_FR1_A, NR_TDD_FR1_A NOTE 7	dBm/ 9.36MH z	-50		-70		-83.5			
		NR_FDD_FR1_B								-83	
		NR_TDD_FR1_C								-82.5	
		NR_FDD_FR1_D, NR_TDD_FR1_D								-82	
		NR_FDD_FR1_E, NR_TDD_FR1_E								-81.5	
		NR_FDD_FR1_F								-81	
		NR_FDD_FR1_G								-80.5	
		NR_FDD_FR1_H								-80	
	Config 3,6	NR_FDD_FR1_A, NR_TDD_FR1_A NOTE 7	dBm/ 38.16M Hz	-50		-		-77.4			

	NR_FDD_FR1_B								-76.9
	NR_TDD_FR1_C								-76.4
	NR_FDD_FR1_D, NR_TDD_FR1_D								-75.9
	NR_FDD_FR1_E, NR_TDD_FR1_E								-75.4
	NR_FDD_FR1_F								-74.9
	NR_FDD_FR1_G								-74.4
	NR_FDD_FR1_H								-73.9
Propagation condition		-	AWGN	AWGN	AWGN	AWGN	AWGN	AWGN	AWGN
Antenna configuration			1x2	1x2	1x2	1x2	1x2	1x2	1x2
Note 1:	OCNG shall be used such that both cells are fully allocated and a constant total transmitted power spectral density is achieved for all OFDM symbols.								
Note 2:	Interference from other cells and noise sources not specified in the test is assumed to be constant over subcarriers and time and shall be modelled as AWGN of appropriate power for $N_{oc}$ to be fulfilled.								
Note 3:	CSI-RSRQ, CSI-RSRP, and $I_o$ levels have been derived from other parameters for information purposes. They are not settable parameters themselves.								
Note 4:	CSI-RSRQ, CSI-RSRP minimum requirements are specified assuming independent interference and noise at each receiver antenna port.								
Note 5:	NR operating band groups are as defined in Clause 3.5.2.								
Note 6:	Subtest 2 is not used when testing with 30kHz SSB and CSI-RS SCS								
Note 7:	The test configuration excludes support for band n51 and it is not required to run this test on band n51 in this release of the specification								

A.4.7.9.1.3 Test Requirements

The CSI-RSRQ measurement accuracy shall fulfil the requirements in clause 10.1.7.

A.4.7.9.2 EN-DC Inter-frequency measurement accuracy with FR1 serving cell and FR1 target cell

A.4.7.9.2.1 Test Purpose and Environment

The purpose of this test is to verify that the CSI-RSRQ measurement accuracy is within the specified limits. This test will verify the requirements in clause 10.1.9.1.1 and 10.1.9.1.2 for inter frequency measurement.

A.4.7.9.2.2 Test Parameters

In this test case the two NR cells (i.e., Cell 2 and Cell 3) are on different carrier frequencies and measurement gaps are provided. Supported test configurations are shown in Table A.4.7.9.2.2-1. Both absolute accuracy and relative accuracy requirements of CSI-RSRQ inter-frequency measurement are tested by using test parameters in Table A.4.7.9.2.2-2. In all test cases, Cell 2 is the PSCell and Cell 3 is target cell. Cell 1 is the E-UTRA cell which specific test parameters for this test case are specified in Table A.3.7.2.1-1.

**Table A.4.7.9.2.2-1: CSI-RSRQ Inter frequency CSI-RSRQ supported test configurations**

Config	Description
1	LTE FDD, NR 15 kHz SSB and CSI-RS SCS, 10 MHz bandwidth, FDD duplex mode
2	LTE FDD, NR 15 kHz SSB and CSI-RS SCS, 10 MHz bandwidth, TDD duplex mode
3	LTE FDD, NR 30kHz SSB and CSI-RS SCS, 40 MHz bandwidth, TDD duplex mode
4	LTE TDD, NR 15 kHz SSB and CSI-RS SCS, 10 MHz bandwidth, FDD duplex mode
5	LTE TDD, NR 15 kHz SSB and CSI-RS SCS, 10 MHz bandwidth, TDD duplex mode
6	LTE TDD, NR 30kHz SSB and CSI-RS SCS, 40 MHz bandwidth, TDD duplex mode

Note: The UE is only required to be tested in one of the supported test configurations

**Table A.4.7.9.2.2-2: CSI-RSRQ Inter frequency test parameters**

Parameter	Unit	Test 1		Test 2		Test 3	
		Cell 2	Cell 3	Cell 2	Cell 3	Cell 2	Cell 3
SSB ARFCN		freq1	freq2	freq1	freq2	freq1	freq2
Duplex mode	Config 1,4	FDD					
	Config 2,3,5,6	TDD					
TDD configuration	Config 1,4	Not Applicable					



	Config 2,5		TDDConf.1.1					
	Config 3,6		TDDConf.2.1					
BW <sub>channel</sub>	Config 1,4	MHz	10: N <sub>RB,c</sub> = 52					
	Config 2,5		10: N <sub>RB,c</sub> = 52					
	Config 3,6		40: N <sub>RB,c</sub> = 106					
BWP BW	Config 1,4	MHz	10: N <sub>RB,c</sub> = 52					
	Config 2,5		10: N <sub>RB,c</sub> = 52					
	Config 3,6		40: N <sub>RB,c</sub> = 106					
DRX Cycle		ms	Not Applicable					
PDSCH Reference measurement channel	Config 1,4		SR.1.1 FDD	-	SR.1.1 FDD	-	SR.1.1 FDD	-
	Config 2,5		SR.1.1 TDD		SR.1.1 TDD		SR.1.1 TDD	
	Config 3,6		SR.2.1 TDD		SR.2.1 TDD		SR.2.1 TDD	
RMSI CORESET Reference Channel	Config 1,4		CR.1.1 FDD	-	CR.1.1 FDD	-	CR.1.1 FDD	-
	Config 2,5		CR.1.1 TDD		CR.1.1 TDD		CR.1.1 TDD	
	Config 3,6		CR.2.1 TDD		CR.2.1 TDD		CR.2.1 TDD	
Dedicated CORESET Reference Channel	Config 1,4		CCR.1.1 FDD	-	CCR.1.1 FDD	-	CCR.1.1 FDD	-
	Config 2,5		CCR.1.1 TDD		CCR.1.1 TDD		CCR.1.1 TDD	
	Config 3,6		CCR.2.1 TDD		CCR.2.1 TDD		CCR.2.1 TDD	
TRS configuration	Config 1,4		TRS.1.1 FDD	-	TRS.1.1 FDD	-	TRS.1.1 FDD	-
	Config 2,5		TRS.1.1 TDD		TRS.1.1 TDD		TRS.1.1 TDD	
	Config 3,6		TRS.1.2 TDD		TRS.1.2 TDD		TRS.1.2 TDD	
CSI-RS configuration for RRM	Config 1,4		CSI-RS.RRM.FR1.1 FDD					
	Config 2,5		CSI-RS.RRM.FR1.1 TDD					
	Config 3,6		CSI-RS.RRM.FR1.2 TDD					
OCNG Patterns			OCNG pattern 1					
Time offset with Cell 2	Config 1,2,4,5	μs	-	4.7	-	4.7	-	4.7
	Config 3,6	μs	-	2.35	-	2.35	-	2.35
SMTC configuration	Config 1,4		SMTC.2					
	Config 2,3,5,6		SMTC.1					
SSB configuration	Config 1,2,4,5		SSB.1 FR1					
	Config 3,6		SSB.2 FR1					
PDSCH/PDCCH	Config 1,2,4,5	kHz	15 kHz					

subcarrier spacing		Config 3,6	30 kHz								
EPRE ratio of PSS to SSS			dB	0	0	0	0	0	0		
EPRE ratio of PBCH DMRS to SSS											
EPRE ratio of PBCH to PBCH DMRS											
EPRE ratio of PDCCH DMRS to SSS											
EPRE ratio of PDCCH to PDCCH DMRS											
EPRE ratio of PDSCH DMRS to SSS											
EPRE ratio of PDSCH to PDSCH											
EPRE ratio of OCNB DMRS to SSS(Note 1)											
EPRE ratio of OCNB to OCNB DMRS (Note 1)											
$N_{oc}$ Note2	Config 1,2,4,5	NR_FDD_FR1_A		dBm/15 kHz	-80.18	-80.18	-106	-106	-116	-116	
		NR_TDD_FR1_A									
		NR_SDL_FR1_A									
		NR_FDD_FR1_B	-								-115.5
		NR_TDD_FR1_C	-								-115.5
		NR_FDD_FR1_D	-								-114.5
		NR_TDD_FR1_D	114.5								-114.5
		NR_FDD_FR1_E	-								-114
	NR_TDD_FR1_E	-114	-114								
	NR_FDD_FR1_G	-	-113								
	NR_TDD_FR1_G	-113	-113								
	NR_FDD_FR1_H	-	-112.5								
	NR_TDD_FR1_H	112.5	-112.5								
	Config 3,6	NR_FDD_FR1_A	dBm/15 kHz	-86.27	-86.27	-113	-113	-116	-116		
		NR_TDD_FR1_A									
		NR_SDL_FR1_A									
NR_FDD_FR1_B		-								-115.5	
NR_TDD_FR1_C		-								-115.5	
NR_FDD_FR1_D		-								-114.5	
NR_TDD_FR1_D		114.5								-114.5	
NR_FDD_FR1_E		-								-114	
NR_TDD_FR1_E	-114	-114									
NR_FDD_FR1_G	-	-113									
NR_TDD_FR1_G	-113	-113									
NR_FDD_FR1_H	-	-112.5									
NR_TDD_FR1_H	112.5	-112.5									
$N_{oc}$ Note2	Config 1,2,4,5	NR_FDD_FR1_A	dBm/S CS	-80.18	-80.18	-106	-106	-116	-116		
		NR_TDD_FR1_A									
		NR_SDL_FR1_A									
		NR_FDD_FR1_B								-	-115.5
		NR_TDD_FR1_C								-	-115.5
		NR_FDD_FR1_D								-	-114.5
		NR_TDD_FR1_D								114.5	-114.5
		NR_FDD_FR1_E								-	-114
	NR_TDD_FR1_E	-114	-114								
	NR_FDD_FR1_G	-	-113								
	NR_TDD_FR1_G	-113	-113								
	NR_FDD_FR1_H	-	-112.5								
	NR_TDD_FR1_H	112.5	-112.5								
	Config 3,6	NR_FDD_FR1_A	dBm/S CS	-83.27	-83.27	-110	-110	-113	-113		
		NR_TDD_FR1_A									
		NR_SDL_FR1_A									
NR_FDD_FR1_B		-								-112.5	
NR_TDD_FR1_C		-								-112.5	
NR_FDD_FR1_D		-								-112	
NR_TDD_FR1_D		111.5								-112	
NR_FDD_FR1_E		-								-111	
NR_TDD_FR1_E	-111	-111									
NR_FDD_FR1_G	-	-110									
NR_TDD_FR1_G	-110	-110									
NR_FDD_FR1_H	-	-109.5									
NR_TDD_FR1_H	109.5	-109.5									
$\hat{E}_s / I_{ot}$			dB	-1.75	-1.75	-1.75	-1.75	3	-1.75		

$\hat{E}_s / N_{oc}$			dB	-1.75	-1.75	-1.75	-1.75	3	-1.75
CSI-RSRP <sup>Note3</sup>	Config 1,2,4,5	NR_FDD_FR1_A	dBm/S CS	-81.93	-81.93	-107.75	-107.75	-113	-117.75
		NR_TDD_FR1_A						-	-117.25
		NR_SDL_FR1_A						112.5	-
		NR_FDD_FR1_B						-112	-116.75
		NR_TDD_FR1_C						-	-116.25
		NR_FDD_FR1_D						111.5	-
		NR_TDD_FR1_D						-111	-115.75
		NR_FDD_FR1_E						-110	-114.75
	NR_TDD_FR1_E	-		-114.25					
	NR_FDD_FR1_G	109.5		-					
	NR_FDD_FR1_H	-		-					
	Config 3,6	NR_FDD_FR1_A		-85.02	-85.02	-111.75	-111.75	-110	-114.75
		NR_TDD_FR1_A		-	-	-	-	-	-
		NR_SDL_FR1_A		-	-	-	-	-	-
		NR_FDD_FR1_B		-	-	-	-	-	-
		NR_TDD_FR1_C		109.5	-	-	-	-	-
NR_FDD_FR1_D		-109	-113.75	-	-	-	-		
NR_TDD_FR1_D		-	-113.25	108.5	-	-	-		
NR_FDD_FR1_E		-108	-112.75	-	-	-	-		
NR_TDD_FR1_E	-107	-111.75	-	-	-	-			
NR_FDD_FR1_G	-	-111.25	106.5	-	-	-			
NR_FDD_FR1_H	-	-	-	-	-	-			
CSI-RSRQ <sup>Note3</sup>		dB	-14.77	-14.77	-40.59	-40.59	-	-14.76	
							12.56		
Io <sup>Note3</sup>	Config 1,2,4,5	NR_FDD_FR1_A	dBm/ 9.36MHz	-50	-50	-75.83	-75.83	-	-85.83
		NR_TDD_FR1_A						83.28	-
		NR_SDL_FR1_A						-	-85.33
		NR_FDD_FR1_B						82.78	-
		NR_TDD_FR1_C						-	-84.83
		NR_FDD_FR1_D						82.28	-
		NR_TDD_FR1_D						-	-84.33
		NR_FDD_FR1_E						81.78	-
	NR_TDD_FR1_E	-		-83.83					
	NR_FDD_FR1_G	81.28		-					
	NR_FDD_FR1_H	-		-82.83					
	Config 3,6	NR_FDD_FR1_A		-50	-50	-76.73	-76.73	-	-79.73
		NR_TDD_FR1_A		-	-	-	-	77.19	-
		NR_SDL_FR1_A		-	-	-	-	-	-79.23
		NR_FDD_FR1_B		-	-	-	-	76.69	-
		NR_TDD_FR1_C		-	-	-	-	76.19	-78.73
NR_FDD_FR1_D		-	-	-	-	-	-78.23		
NR_TDD_FR1_D		75.69	-	-	-	-	-77.73		
NR_FDD_FR1_E		-	-	-	-	75.19	-		
NR_TDD_FR1_E	-	-	-	-	-	-76.73			
NR_FDD_FR1_G	74.19	-	-	-	-	-			

	NR_FDD_FR1_H							-73.69	-76.53
Propagation condition			AWGN	AWGN	AWGN	AWGN		AWGN	AWGN
Note 1:	OCNG shall be used such that both cells are fully allocated and a constant total transmitted power spectral density is achieved for all OFDM symbols.								
Note 2:	Interference from other cells and noise sources not specified in the test is assumed to be constant over subcarriers and time and shall be modelled as AWGN of appropriate power for $N_{oc}$ to be fulfilled.								
Note 3:	CSI-RSRQ, CSI-RSRP, and $I_o$ levels have been derived from other parameters for information purposes. They are not settable parameters themselves.								
Note 4:	CSI-RSRQ, CSI-RSRP minimum requirements are specified assuming independent interference and noise at each receiver antenna port.								
Note 5:	NR operating band groups are as defined in Section 3.5.2.								

A.4.7.2.2.3 Test Requirements

The CSI-RSRQ measurement accuracy shall fulfil the requirements in section 10.1.9.

A.4.7.10 CSI-SINR

A.4.7.10.1 EN-DC Intra-frequency measurement accuracy with FR1 serving cell and FR1 target cell

A.4.7.10.1.1 Test Purpose and Environment

The purpose of this test is to verify that the CSI-SINR measurement accuracy is within the specified limits. This test will verify the requirements in clause 10.1.12.

A.4.7.10.1.2 Test Parameters

In this test case all cells are on the same carrier frequency. Supported test configuration are shown in Table A.4.7.10.1.2-1. The absolute accuracy of CSI-SINR intra-frequency measurement is tested by using the parameters in Table A.4.7.10.1.2-2. The configuration of cell 1 (E-UTRA PCell) is specified in clause A.3.7.2.1. In all test cases, Cell 2 is the PSCell and Cell 3 is the target cell. CSI-RS for mobility configured for Cell 2 is associated to the SSB of Cell 2, and CSI-RS for mobility configured for Cell 3 is associated to the SSB of Cell 3.

**Table A.4.7.10.1.2-1: CSI-SINR Intra frequency CSI-SINR supported test configurations**

Config	Description
1	LTE FDD, NR 15 kHz SSB and CSI-RS SCS, 10 MHz bandwidth, FDD duplex mode
2	LTE FDD, NR 15 kHz SSB and CSI-RS SCS, 10 MHz bandwidth, TDD duplex mode
3	LTE FDD, NR 30 kHz SSB and CSI-RS SCS, 40 MHz bandwidth, TDD duplex mode
4	LTE TDD, NR 15 kHz SSB and CSI-RS SCS, 10 MHz bandwidth, FDD duplex mode
5	LTE TDD, NR 15 kHz SSB and CSI-RS SCS, 10 MHz bandwidth, TDD duplex mode
6	LTE TDD, NR 30 kHz SSB and CSI-RS SCS, 40 MHz bandwidth, TDD duplex mode
Note:	The UE is only required to be tested in one of the supported test configurations

**Table A.4.7.10.1.2-2: CSI-SINR Intra frequency test parameters**

Parameter		Unit	Test 1		Test 2	
			Cell 2	Cell 3	Cell 2	Cell 3
SSB ARFCN			freq1		freq1	
Duplex mode	Config 1,4		FDD			
	Config 2,3,5,6		TDD			
TDD configuration	Config 1,4		Not Applicable			
	Config 2,5		TDDConf.1.1			
	Config 3,6		TDDConf.2.1			

Downlink initial BWP configuration			DLBWP.0.1			
Downlink dedicated BWP configuration			DLBWP.1.1			
Uplink initial BWP configuration			ULBWP.0.1			
Uplink dedicated BWP configuration			ULBWP.1.1			
DRX Cycle configuration		ms	Not Applicable			
TRS configuration	Config 1, 4		TRS.1.1 FDD			
	Config 2, 5		TRS.1.1 TDD			
	Config 3, 6		TRS.1.2 TDD			
PDSCH Reference measurement channel	Config 1,4		SR.1.1 FDD	-	SR.1.1 FDD	-
	Config 2,5		SR.1.1 TDD		SR.1.1 TDD	
	Config 3,6		SR.2.1 TDD		SR.2.1 TDD	
RMSI CORESET Reference Channel	Config 1,4		CR.1.1 FDD	-	CR.1.1 FDD	
	Config 2,5		CR.1.1 TDD		CR.1.1 TDD	
	Config 3,6		CR.2.1 TDD		CR.2.1 TDD	
Dedicated CORESET Reference Channel	Config 1,4		CCR.1.1 FDD	-	CCR.1.1 FDD	-
	Config 2,5		CCR.1.1 TDD		CCR.1.1 TDD	
	Config 3,6		CCR.2.1 TDD		CCR.2.1 TDD	
OCNG Patterns			OP.1			
SS-RSSI-Measurement			Not Applicable			
Time offset with Cell 2	Config 1,2,4,5	μs	2.35	2.35	2.35	2.35
	Config 3,6	μs	1.17	1.17	1.17	1.17
SMTC configuration	Config 1,4		SMTC.2			
	Config 2,3,5,6		SMTC.1			
SSB configuration	Config 1,2,4,5		SSB.1 FR1			
	Config 3,6		SSB.2 FR1			
CSI-RS configuration for RRM	Config 1,4		CSI-RS.RRM.FR1.1 FDD			
	Config 2,5		CSI-RS.RRM.FR1.1 TDD			
	Config 3,6		CSI-RS.RRM.FR1.2 TDD			
PDSCH/PDCCH subcarrier spacing	Config 1,2,4,5	kHz	15			
	Config 3,6		30			
EPRE ratio of PSS to SSS		dB	0	0	0	0
EPRE ratio of PBCH DMRS to SSS						
EPRE ratio of PBCH to PBCH DMRS						
EPRE ratio of PDCCH DMRS to SSS						
EPRE ratio of PDCCH to PDCCH DMRS						
EPRE ratio of PDSCH DMRS to SSS						
EPRE ratio of PDSCH to PDSCH						
EPRE ratio of OCNG DMRS to SSS(Note 1)						
EPRE ratio of OCNG to OCNG DMRS (Note 1)						
$N_{oc}$ <sup>Note2</sup>	NR_FDD_FR1_A, NR_TDD_FR1_A NOTE 6					
	NR_FDD_FR1_B	-115.5				
	NR_TDD_FR1_C	-115				

		NR_FDD_FR1_D, NR_TDD_FR1_D				-114.5		
		NR_FDD_FR1_E, NR_TDD_FR1_E				-114		
		NR_FDD_FR1_F				-113.5		
		NR_FDD_FR1_G				-113		
		NR_FDD_FR1_H				-112.5		
$N_{oc}$ <sup>Note2</sup>	Config 1,2,4,5		dBm /SC S	-93	Same as $N_{oc}$ for 15kHz			
	Config 3,6	NR_FDD_FR1_A, NR_TDD_FR1_A <small>NOTE 6</small>			-90		-113	
		NR_FDD_FR1_B					-112.5	
		NR_TDD_FR1_C					-112	
		NR_FDD_FR1_D, NR_TDD_FR1_D					-111.5	
		NR_FDD_FR1_E, NR_TDD_FR1_E					-111	
		NR_FDD_FR1_F					-110.5	
		NR_FDD_FR1_G					-110	
		NR_FDD_FR1_H					-109.5	
$\hat{E}_s / I_{ot}$			dB	0	-3.19	-5.46	-5.46	
$\hat{E}_s / N_{oc}$			dB	4.54	2.66	-4	-4	
CSI-RSRP <sup>Note3</sup>	Config 1,2,4,5	NR_FDD_FR1_A, NR_TDD_FR1_A	dBm /SC S	-88.46	-90.34	-120	-120	
		NR_FDD_FR1_B				-119.5	-119.5	
		NR_TDD_FR1_C				-119	-119	
		NR_FDD_FR1_D, NR_TDD_FR1_D				-118.5	-118.5	
		NR_FDD_FR1_E, NR_TDD_FR1_E				-118	-118	
		NR_FDD_FR1_F				-117.5	-117.5	
		NR_FDD_FR1_G				-117	-117	
		NR_FDD_FR1_H				-116.5	-116.5	
	Config 3,6	NR_FDD_FR1_A, NR_TDD_FR1_A <small>NOTE 6</small>		-85.46	-87.34	-117	-117	
		NR_FDD_FR1_B				-116.5	-116.5	
		NR_TDD_FR1_C				-116	-116	
		NR_FDD_FR1_D, NR_TDD_FR1_D				-115.5	-115.5	
		NR_FDD_FR1_E, NR_TDD_FR1_E				-115	-115	
		NR_FDD_FR1_F				-114.5	-114.5	
		NR_FDD_FR1_G				-114	-114	
		NR_FDD_FR1_H				-113.5	-113.5	
CSI-SINR <sup>Note3</sup>		NR_FDD_FR1_A, NR_TDD_FR1_A <small>NOTE 6</small>	dB	0	-3.19	-5.46	-5.46	

		NR_FDD_FR1_B			
		NR_TDD_FR1_C			
		NR_FDD_FR1_D, NR_TDD_FR1_D			
		NR_FDD_FR1_E, NR_TDD_FR1_E			
		NR_FDD_FR1_F			
		NR_FDD_FR1_G			
		NR_FDD_FR1_H			
I <sub>o</sub> <sup>Note3</sup>	Config 1,2,4,5	NR_FDD_FR1_A, NR_TDD_FR1_A NOTE 6	dBm / 9.36 MHz	-57.5	-85.51
		NR_FDD_FR1_B			-85.01
		NR_TDD_FR1_C			-84.51
		NR_FDD_FR1_D, NR_TDD_FR1_D			-84.01
		NR_FDD_FR1_E, NR_TDD_FR1_E			-83.51
		NR_FDD_FR1_F			-83.01
		NR_FDD_FR1_G			-82.51
		NR_FDD_FR1_H			-82.01
	Config 3,6	NR_FDD_FR1_A, NR_TDD_FR1_A NOTE 6	dBm / 38.1 6MHz z	-51.41	-79.41
		NR_FDD_FR1_B			-78.91
		NR_TDD_FR1_C			-78.41
		NR_FDD_FR1_D, NR_TDD_FR1_D			-77.91
		NR_FDD_FR1_E, NR_TDD_FR1_E			-77.41
		NR_FDD_FR1_F			-76.91
		NR_FDD_FR1_G			-76.41
NR_FDD_FR1_H		-75.91			
Propagation condition		-	AWGN		
Antenna configuration		-	1x2		
<p>Note 1: OCNG shall be used such that both cells are fully allocated and a constant total transmitted power spectral density is achieved for all OFDM symbols.</p> <p>Note 2: Interference from other cells and noise sources not specified in the test is assumed to be constant over subcarriers and time and shall be modelled as AWGN of appropriate power for <math>N_{oc}</math> to be fulfilled.</p> <p>Note 3: CSI-SINR, CSI-RSRP, and I<sub>o</sub> levels have been derived from other parameters for information purposes. They are not settable parameters themselves.</p> <p>Note 4: CSI-SINR, CSI-RSRP minimum requirements are specified assuming independent interference and noise at each receiver antenna port.</p> <p>Note 5: NR operating band groups are as defined in Clause 3.5.2.</p> <p>Note 6: The test configuration excludes support for band n51 and it is not required to run this test on band n51 in this release of the specification</p>					

A.4.7.10.1.3 Test Requirements

The CSI-SINR measurement accuracy shall fulfil the requirements in clause 10.1.12.

## A.4.7.10.2 EN-DC Inter-frequency measurement accuracy with FR1 serving cell and FR1 target cell

### A.4.7.10.2.1 Test Purpose and Environment

The purpose of this test is to verify that the CSI-SINR measurement accuracy is within the specified limits. This test will verify the requirements in clause 10.1.14.2.1 and 10.1.14.2.2 for inter-frequency measurement.

### A.4.7.10.2.2 Test Parameters

In this test case the two NR cells (i.e., Cell 2 and Cell 3) are on different carrier frequencies and measurement gaps are provided. Supported test configurations are shown in Table A.4.7.10.2.2-1. Both absolute accuracy and relative accuracy requirements of CSI-SINR inter-frequency measurement are tested by using test parameters in Table A.4.7.10.2.2-2. In all test cases, Cell 2 is the PSCell and Cell 3 is target cell. Cell 1 is the E-UTRA cell of which specific test parameters for this test case are specified in Table A.3.7.2.1-1. CSI-RS for mobility configured for Cell 2 is associated to the SSB of Cell 2, and CSI-RS for mobility configured for Cell 3 is associated to the SSB of Cell 3.

**Table A.4.7.10.2.2-1: CSI-SINR Inter frequency CSI-SINR supported test configurations**

Config	Description
1	LTE FDD, NR 15 kHz SSB and CSI-RS SCS, 10 MHz bandwidth, FDD duplex mode
2	LTE FDD, NR 15 kHz SSB and CSI-RS SCS, 10 MHz bandwidth, TDD duplex mode
3	LTE FDD, NR 30 kHz SSB and CSI-RS SCS, 40 MHz bandwidth, TDD duplex mode
4	LTE TDD, NR 15 kHz SSB and CSI-RS SCS, 10 MHz bandwidth, FDD duplex mode
5	LTE TDD, NR 15 kHz SSB and CSI-RS SCS, 10 MHz bandwidth, TDD duplex mode
6	LTE TDD, NR 30 kHz SSB and CSI-RS SCS, 40 MHz bandwidth, TDD duplex mode

Note: The UE is only required to be tested in one of the supported test configurations

**Table A.4.7.10.2.2-1: CSI-SINR Inter frequency test parameters**

Parameter	Unit	Test 1		Test 2		Test 3	
		Cell 2	Cell 3	Cell 2	Cell 3	Cell 2	Cell 3
<b>SSB ARFCN</b>		freq1	freq2	freq1	freq2	freq1	freq2
Duplex mode	Config 1,4	FDD					
	Config 2,3,5,6	TDD					
TDD configuration	Config 1,4	Not Applicable					
	Config 2,5	TDDConf.1.1					
	Config 3,6	TDDConf.2.1					
Downlink initial BWP configuration		DLBWP.0.1					
Downlink dedicated BWP configuration		DLBWP.1.1					
Uplink initial BWP configuration		ULBWP.0.1					
Uplink dedicated BWP configuration		ULBWP.1.1					
DRX Cycle configuration		ms		Not Applicable			
TRS configuration	Config 1, 4	TRS.1.1 FDD					
	Config 2, 5	TRS.1.1 TDD					
	Config 3, 6	TRS.1.2 TDD					
PDSCH Reference measurement channel	Config 1,4	SR.1.1 FDD	-	SR.1.1 FDD	-	SR.1.1 FDD	-
	Config 2,5	SR.1.1 TDD		SR.1.1 TDD		SR.1.1 TDD	
	Config 3,6	SR.2.1 TDD		SR.2.1 TDD		SR.2.1 TDD	
RMSI CORESET Reference Channel	Config 1,4	CR.1.1 FDD	-	CR.1.1 FDD	-	CR.1.1 FDD	-



	Config 2,5		CR.1.1 TDD		CR.1.1 TDD		CR.1.1 TDD	
	Config 3,6		CR.2.1 TDD		CR.2.1 TDD		CR.2.1 TDD	
Dedicated CORESET Reference Channel	Config 1,4		CCR.1. 1 FDD	-	CCR.1. 1 FDD	-	CCR.1. .1 FDD	-
	Config 2,5		CCR.1. 1 TDD		CCR.1. 1 TDD		CCR.1. .1 TDD	
	Config 3,6		CCR.2. 1 TDD		CCR.2. 1 TDD		CCR.2. .1 TDD	
OCNG Patterns			OP.1					
SS-RSSI-Measurement			Not Applicable					
Time offset with Cell 2	Config 1,2,4,5	µs	-	2.35	-	2.35	-	2.35
	Config 3,6	µs	-	1.17	-	1.17	-	1.17
SMTC configuration	Config 1,4		SMTC.2					
	Config 2,3,5,6		SMTC.1					
SSB configuration	Config 1,2,4,5		SSB.1 FR1					
	Config 3,6		SSB.2 FR1					
CSI-RS configuration for RRM	Config 1,4		CSI-RS.RRM.FR1.1 FDD					
	Config 2,5		CSI-RS.RRM.FR1.1 TDD					
	Config 3,6		CSI-RS.RRM.FR1.2 TDD					
PDSCH/PDCCH subcarrier spacing	Config 1,2,4,5	kHz	15					
	Config 3,6		30					
EPRE ratio of PSS to SSS		dB	0	0	0	0	0	0
EPRE ratio of PBCH DMRS to SSS								
EPRE ratio of PBCH to PBCH DMRS								
EPRE ratio of PDCCH DMRS to SSS								
EPRE ratio of PDCCH to PDCCH DMRS								
EPRE ratio of PDSCH DMRS to SSS								
EPRE ratio of PDSCH to PDSCH								
EPRE ratio of OCNG DMRS to SSS(Note 1)								
EPRE ratio of OCNG to OCNG DMRS (Note 1)								
$N_{oc}$ Note2	Config 1,2,4,5		NR_FDD_FR1_A NR_TDD_FR1_A NOTE 6	dBm/15k Hz	-88	-108.5	-119.5	
		NR_FDD_FR1_B	-119					
		NR_TDD_FR1_C	-118.5					
		NR_FDD_FR1_D NR_TDD_FR1_D	-118					
		NR_FDD_FR1_E NR_TDD_FR1_E	-117.5					
		NR_FDD_FR1_F NR_FDD_FR1_G	-117					
			-116.5					
		NR_FDD_FR1_H	-116					
$N_{oc}$ Note2	Config 1,2,4,5	dBm/SC S	-88	-108.5	Same as Noc for 15kHz			

	Config 3,6	NR_FDD_FR1_A NR_TDD_FR1_A NOTE 6		-85	-105.5	-116.5	
		NR_FDD_FR1_B				-116	
		NR_TDD_FR1_C				-115.5	
		NR_FDD_FR1_D NR_TDD_FR1_D				-115	
		NR_FDD_FR1_E NR_TDD_FR1_E				-114.5	
		NR_FDD_FR1_F				-114	
		NR_FDD_FR1_G				-114.5	
		NR_FDD_FR1_H				-113	
		$\hat{E}_s / I_{ot}$				dB	-1.75
$\hat{E}_s / N_{oc}$			dB	-1.75	20	-4.0	
CSI-RSRP <sup>Not e3</sup>	Config 1,2,4,5	NR_FDD_FR1_A NR_TDD_FR1_A NOTE 6	dBm/SC S	-89.75	-88.5	-123.5	
		NR_FDD_FR1_B				-123	
		NR_TDD_FR1_C				-122.5	
		NR_FDD_FR1_D NR_TDD_FR1_D				-122	
		NR_FDD_FR1_E NR_TDD_FR1_E				-121.5	
		NR_FDD_FR1_F				-121	
		NR_FDD_FR1_G				-120.5	
		NR_FDD_FR1_H				-120	
		Config 3,6				NR_FDD_FR1_A NR_TDD_FR1_A NOTE 6	
	NR_FDD_FR1_B		-120				
	NR_TDD_FR1_C		-119.5				
	NR_FDD_FR1_D NR_TDD_FR1_D		-119				
	NR_FDD_FR1_E NR_TDD_FR1_E		-118.5				
	NR_FDD_FR1_F		-118				
	NR_FDD_FR1_G		-117.5				
	NR_FDD_FR1_H		-117				
	CSI-SINR <sup>Note3</sup>			dB	-1.75	20	
	NR_FDD_FR1_A NR_TDD_FR1_A NOTE 6						
NR_FDD_FR1_B							
NR_TDD_FR1_C							
NR_FDD_FR1_D NR_TDD_FR1_D							
NR_FDD_FR1_E NR_TDD_FR1_E							
NR_FDD_FR1_F							
NR_FDD_FR1_G							
NR_FDD_FR1_H							

I <sub>o</sub> <sup>Note3</sup>	Config 1,2,4,5	NR_FDD_FR1_A NR_TDD_FR1_A NOTE 6	dBm/ 9.36MHz	-57.83	-60.5	-90.09
		NR_FDD_FR1_B				-89.59
		NR_TDD_FR1_C				-89.09
		NR_FDD_FR1_D NR_TDD_FR1_D				-88.59
		NR_FDD_FR1_E NR_TDD_FR1_E				-88.09
		NR_FDD_FR1_F				-87.59
		NR_FDD_FR1_G				-87.09
		NR_FDD_FR1_H				-86.59
	Config 3,6	NR_FDD_FR1_A NR_TDD_FR1_A NOTE 6	dBm/ 38.16MH z	-51.73	-54.41	-84
		NR_FDD_FR1_B				-83.5
		NR_TDD_FR1_C				-83
		NR_FDD_FR1_D NR_TDD_FR1_D				-82.5
		NR_FDD_FR1_E NR_TDD_FR1_E				-82
		NR_FDD_FR1_F				-81.5
		NR_FDD_FR1_G				-81
		NR_FDD_FR1_H				-80.5
Propagation condition			-	AWGN		
Antenna configuration			-	1x2		
<p>Note 1: OCNG shall be used such that both cells are fully allocated and a constant total transmitted power spectral density is achieved for all OFDM symbols.</p> <p>Note 2: Interference from other cells and noise sources not specified in the test is assumed to be constant over subcarriers and time and shall be modelled as AWGN of appropriate power for <math>N_{oc}</math> to be fulfilled.</p> <p>Note 3: CSI-SINR, CSI-RSRP, and I<sub>o</sub> levels have been derived from other parameters for information purposes. They are not setttable parameters themselves.</p> <p>Note 4: CSI-SINR, CSI-RSRP minimum requirements are specified assuming independent interference and noise at each receiver antenna port.</p> <p>Note 5: NR operating band groups are as defined in Clause 3.5.2.</p> <p>Note 6: The test configuration excludes support for band n51 and it is not required to run this test on band n51 in this release of the specification</p>						

#### A.4.7.10.2.3 Test Requirements

The CSI-SINR measurement accuracy shall fulfil the requirements in clause 10.1.14.2.1 and 10.1.14.2.2.

### A.4.8 Void

## A.4A NE-DC test with all NR cells in FR1

### A.4A.1 Signaling characteristics

#### A.4A.1.1 E-UTRAN PSCell addition

##### A.4A.1.1.1 Test purpose and environment

The purpose of this test is to verify that the LTE PSCell addition/release delay and interruption under NE-DC are within the requirements stated in clause 8.8 and clause 8.2.3.2.3 for the case when the PSCell is known by the UE at the time of addition.

Supported test configurations are shown in A.4A.1.1.1-1. The test parameters for the E-UTRA cell are given in Table A.3.7.2.1-1.

The test parameters for NR cell are given in Tables A.4A.1.1.1-2 and cell-specific parameters in A.4A.1.1.1-3 below. The test consists of six successive time periods with duration of T1, T2, T3, T4, T5 and T6 respectively. There are two carriers each with one cell. Before the test starts the UE is connected to Cell 1 (NR PCell) on radio channel 1 (PCC) but is not aware of Cell 2 (E-UTRAN PSCell) on radio channel 2. The UE is only monitoring the PCC. During T1 only Cell1 is known to the UE.

Before the start of T2, the UE in the measurement control information that event-triggered reporting with Event B1 is configured for neighbour cell (Cell2). Before the start of T2 the UE is configured with the measurement gaps (gap pattern Id # 0). The Cell2 becomes known to the UE during T2. Therefore, during T2 the UE shall report Event B1. The point in time at which the RRC message to release measurement gap is transmitted from the test system defines the start of period T3. During T3, after measurement gap is released, the test system transmits the RRC message to the UE to add PSCell on radio channel 2.

The RRC message (to add PSCell) also includes a request for the UE to start periodic CSI reporting for the PSCell after the PSCell has been successfully added. The point in time at which the RRC message to add PSCell (Cell2) is received at the UE antenna connector defines the start of period T4.

The test system shall observe the periodic reporting of CSI for PSCell during T5. The point in time at which the UE has sent PRACH to the PSCell (Cell 2) defines the start of period T5.

The test system shall send a RRC message to the UE to release PSCell (Cell 2) on radio channel 2. The RRC message to release PSCell (Cell2) shall be sent to the UE during period T5, after the UE has sent at least one CQI report with non-zero CQI index for PSCell (Cell 2). The point in time at which the RRC message to release PSCell (Cell2) is received at the UE antenna connector defines the start of period T6.

**Table A.4A.1.1.1-1: Applicable E-UTRA and NR configurations for NE-DC PSCell addition and Release test**

Config	Description
1	LTE FDD, NR 15 kHz SSB SCS, 10 MHz bandwidth, FDD duplex mode
2	LTE FDD, NR 15 kHz SSB SCS, 10 MHz bandwidth, TDD duplex mode
3	LTE FDD, NR 30 kHz SSB SCS, 40 MHz bandwidth, TDD duplex mode
4	LTE TDD, NR 15 kHz SSB SCS, 10 MHz bandwidth, FDD duplex mode
5	LTE TDD, NR 15 kHz SSB SCS, 10 MHz bandwidth, TDD duplex mode
6	LTE TDD, NR 30 kHz SSB SCS, 40 MHz bandwidth, TDD duplex mode
Note:	The UE is only required to be tested in one of the supported test configurations

**Table A.4A.1.1.1-2: General Test Parameters for PSCell Addition and Release**

Parameter	Unit	Value	Comment	
RF Channel Number		1, 2	Two radio channels are used for this test. One for NR cell and second for E-UTRAN Cell	
Initial	Active PCell	Cell1	PCell on RF channel number 1.	
	Neighbour cell	Cell2	Neighbour cell on RF channel number 2.	
Final Condition	Active PCell	Cell1	PCell on RF channel number 1.	
	Neighbour Cell	Cell2	PSCell released on RF channel number 2.	
B1	Hysteresis	dB	0	Hysteresis for evaluation of event B1.

	Threshold RSRP (Config 1,2,4,5)	dBm	-96	Actual RSRP threshold for event B1.
	Threshold RSRP (Config 3,6)	dBm	-93	Actual RSRP threshold for event B1.
	Time to Trigger	S	0	
DRX			OFF	Continuous monitoring of primary cell
Measurement gap pattern Id			0	Gaps are configured before T2 and released before T3.
Cell-individual offset for cells on RF channel number 1	dB		0	Individual offset for cells on primary component carrier.
Cell-individual offset for cells on RF channel number 2	dB		0	Individual offset for cells on carrier frequency of cell2.
T1	s		1	During this time the PCell shall be known and cell2 shall be unknown.
T2	s		1	During this time the UE shall identify neighbour cell (cell2) and report event B1.
T3	s		3.5	During this time the test system transmits the RRC messages to release measurement gap and add PSCell.
T4	s		0.5	During this time the UE adds the PSCell.
T5	s		0.5	During this time the UE sends CSI reports for PSCell.
T6	s		0.5	During this time the UE releases the PSCell.

Table A.4A.1.1.1-3: NR Cell Specific Parameters for PSCell Addition and Release

Parameter	Unit	Config	Test
NR RF Channel Number		1,2,3,4,5,6	1
E-UTRA RF Channel Number		1,2,3,4,5,6	2
TDD configuration		1,4	Not Applicable
		2,5	TDDConf.1.1
		3,6	TDDConf.2.1
BW <sub>channel</sub>	MHz	1,4	10: N <sub>RB,c</sub> = 52
		2,5	10: N <sub>RB,c</sub> = 52
		3,6	40: N <sub>RB,c</sub> = 106
Initial BWP Configuration		1,2,3	DLBWP.0.1 ULBWP.0.1
Dedicated BWP Configuration		1,2,3	DLBWP.1.1 ULBWP.1.1
PDSCH Reference measurement channel		1,4	SR.1.1 FDD
		2,5	SR.1.1 TDD
		3,6	SR.2.1 TDD
RMSI CORESET Reference Channel		1,4	CR.1.1 FDD
		2,5	CR.1.1 TDD
		3,6	CR.2.1 TDD
Dedicated CORESET Reference Channel		1,4	CCR.1.1 FDD
		2,5	CCR.1.1 TDD
		3,6	CCR.2.1 TDD
OCNG Patterns		1,2,3,4,5,6	OP.1
SSB configuration		1,2,4,5	SSB.1 FR1
		3,6	SSB.2 FR1
SMTC configuration		1,2,4,5	SMTC.1
		3,6	SMTC.1
TRS Configuration		1,4	TRS.1.1 FDD
		2,5	TRS.1.1 TDD
		3,6	TRS.1.2 TDD

CSI-RS configuration for CSI reporting		1,4	CSI-RS.1.1 FDD
		2,5	CSI-RS.1.1 TDD
		3,6	CSI-RS.2.1 TDD
reportConfigType		1,2,3,4,5,6	periodic
reportQuantity		1,2,3,4,5,6	cri-RI-PMI-CQI
CSI reporting periodicity	slot	1,2,4,5	5
		3,6	10
CSI reporting offset	slot	1,2,4,5	2
		3,6	4
EPRE ratio of PSS to SSS	dB	1,2,3,4,5,6	0
EPRE ratio of PBCH DMRS to SSS			
EPRE ratio of PBCH to PBCH DMRS			
EPRE ratio of PDCCH DMRS to SSS			
EPRE ratio of PDCCH to PDCCH DMRS			
EPRE ratio of PDSCH DMRS to SSS			
EPRE ratio of PDSCH to PDSCH			
EPRE ratio of OCNG DMRS to SSS(Note 1)			
EPRE ratio of OCNG to OCNG DMRS (Note 1)			
$N_{oc}$ Note2	dBm/15 kHz	1,2,3,4,5,6	-88
$N_{oc}$ Note2	dBm/SCS	1,2,4,5	-88
		3,6	-85
$\hat{E}_s/I_{ot}$		1,2,3,4,5,6	0
$\hat{E}_s/N_{oc}$		1,2,3,4,5,6	0
SS-RSRP>Note3	dBm/SCS	1,2,4,5	-88
		3,6	-85
$I_o$ Note3	dBm/9.36MHz	1,2,4,5	-57
	dBm/38.1MHz	3,6	-51
Propagation condition		1,2,3,4,5,6	AWGN
<p>Note 1: OCNG shall be used such that both cells are fully allocated and a constant total transmitted power spectral density is achieved for all OFDM symbols.</p> <p>Note 2: Interference from other cells and noise sources not specified in the test is assumed to be constant over subcarriers and time and shall be modelled as AWGN of appropriate power for <math>N_{oc}</math> to be fulfilled.</p> <p>Note 3: SS-RSRP and <math>I_o</math> levels have been derived from other parameters for information purposes. They are not settable parameters themselves.</p> <p>Note 4: SS-RSRP minimum requirements are specified assuming independent interference and noise at each receiver antenna port.</p>			

**Table A.4A.1.1-4: E-UTRAN cell specific test parameters for PSCell Addition and Release tests**

Parameter	Unit	E-UTRAN Cell					
		T1	T2	T3	T4	T5	T6
Duplex mode		FDD or TDD					
TDD special subframe configuration>Note1		6					
TDD uplink-downlink configuration>Note1		1					
BW <sub>channel</sub>		5 MHz: $N_{RB,c} = 25$ 10 MHz: $N_{RB,c} = 50$ 20 MHz: $N_{RB,c} = 100$					

PDSCH parameters: DL Reference Measurement Channel <sup>Note2</sup>			5 MHz: R.7 FDD 10 MHz: R.3 FDD 20 MHz: R.6 FDD 5 MHz: R.4 TDD 10 MHz: R.0 TDD 20 MHz: R.3 TDD
PCFICH/PDCCH/PHICH parameters: DL Reference Measurement Channel <sup>Note2</sup>			5 MHz: R.11 FDD 10 MHz: R.6 FDD 20 MHz: R.10 FDD 5 MHz: R.11 TDD 10 MHz: R.6 TDD 20 MHz: R.10 TDD
OCNG Patterns <sup>Note2</sup>			5 MHz: OP.20 FDD 10 MHz: OP.10 FDD 20 MHz: OP.17 FDD 5 MHz: OP.9 TDD 10 MHz: OP.1 TDD 20 MHz: OP.7 TDD
PBCH_RA	dB	0	
PBCH_RB	dB		
PSS_RA	dB		
SSS_RA	dB		
PCFICH_RB	dB		
PHICH_RA	dB		
PHICH_RB	dB		
PDCCH_RA	dB		
PDCCH_RB	dB		
PDSCH_RA	dB		
PDSCH_RB	dB		
OCNG_RA <sup>Note3</sup>	dB		
OCNG_RB <sup>Note3</sup>	dB		
N <sub>oc</sub> <sup>Note4</sup>	dBm/15 kHz		N/A
E <sub>s</sub> /N <sub>oc</sub>	dB	-infinite	17
E <sub>s</sub> /I <sub>ot</sub>	dB	-infinite	17
RSRP <sup>Note5</sup>	dBm/15 kHz	-infinite	-87
SCH_RP <sup>Note5</sup>	dBm/15 kHz	-infinite	-87
I <sub>o</sub> <sup>Note5</sup>	dBm/Ch BW	N/A	-59.13+10log(N <sub>RB,c</sub> /50)
Propagation Condition		AWGN	
Antenna Configuration		1x2	
<p>Note 1: Special subframe and uplink-downlink configurations are specified in table 4.2-1 in TS 36.211.</p> <p>Note 2: DL RMCs and OCNG patterns are specified in clauses A 3.1 and A 3.2 of TS 36.133 respectively.</p> <p>Note 3: OCNG shall be used such that all cells are fully allocated and a constant total transmitted power spectral density is achieved for all OFDM symbols.</p> <p>Note 4: Interference from other cells and noise sources not specified in the test is assumed to be constant over subcarriers and time and shall be modelled as AWGN of appropriate power for N<sub>oc</sub> to be fulfilled.</p> <p>Note 5: E<sub>s</sub>/I<sub>ot</sub>, RSRP, SCH_RP and I<sub>o</sub> levels have been derived from other parameters for information purposes. They are not settable parameters themselves.</p>			

### A.4A.1.1.2 Test Requirements

The UE shall transmit the PRACH to PSCell at latest 120 ms<sup>Note1</sup> into T4.

The UE shall send at least one CSI report for PSCell with non-zero CQI index during T5.

The UE shall periodically send CSI reports for PSCell after the UE has sent first CQI report with non-zero CQI index during T5

The UE shall stop sending CSI reports for PSCell in at latest 20ms into T6.

Interruption on PCell during PSCell addition and release shall not exceed the values specified for NE-DC in Clause 8.2.3.2.3.

All the above test requirements shall be fulfilled in order for the observed PSCell addition delay and PSCell release delay to be counted as correct. The rate of correct observed PSCell addition delay and PSCell release delay during repeated tests shall be at least 90%.

Note1: The PSCell addition delay can be expressed as follows as specified in clause 8.8 [15]:

$$T_{\text{config\_EUTRAN-PSCell}} = 20\text{ms} + T_{\text{activation\_time}} + 50\text{ms} + T_{\text{PCell\_DU}} + T_{\text{E-UTRAN-PSCell\_DU}}$$

Where:

$$T_{\text{activation\_time}} = 20\text{ms}$$

$$T_{\text{PCell\_DU}} = 0\text{ms}$$

$$T_{\text{E-UTRAN-PSCell\_DU}} = 30\text{ms}$$

## A.4A.1.2 Active BWP switch

### A.4A.1.2.1 E-UTRAN PSCell – NR PCell FR1 DCI-based and Timer-based DL active BWP switch in non-DRX in synchronous NE-DC

#### A.4A.1.2.1.1 Test Purpose and Environment

The purpose of this test is to verify the DL BWP switch delay requirement defined in TS38.133 clause 8.6, and interruption requirement for E-UTRA victim cell defined in TS36.133 clause 7.36.2.6. Supported test configurations are shown in Table A.4A.1.2.1.1-1.

The test scenario comprises of one NR PCell (Cell 1), and one E-UTRA PSCell (Cell 2) as given in Table A.4A.1.2.1.1-2. Cell-specific parameters of NR PCell is specified in Table A.4A.1.2.1.1-3. below, and cell-specific parameters of E-UTRA PSCell are specified in Table A.3.7.2.1-1.

PDCCHs indicating new transmissions shall be sent continuously on PCell (Cell 1) to ensure that the UE would have ACK/NACK sending except for the time duration when BWP is switching on Cell 1 and the time duration of T2.

PDCCHs indicating new transmissions shall be sent continuously on PSCell (Cell 2) to ensure that the UE will have ACK/NACK sending.

Before the test starts,

- UE is connected to Cell 1 (PCell) on radio channel 1 (PCC), and Cell 2 (PSCell) on radio channel 2 (PSCC).
- UE is configured with 2 different UE-specific downlink bandwidth parts for PCell, BWP-1 and BWP-2, in Cell 1 before starting the test. BWP-1 and BWP-2 always include bandwidth of the initial DL BWP and SSB.
- UE is indicated in *firstActiveDownlinkBWP-Id* that the active DL BWP is BWP-1 in PCell.
- UE is configured with a *bwp-InactivityTimer* timer value for PCell.

All cells have constant signal levels throughout the test.

The test consists of 3 successive time periods, with durations of T1, T2, and T3, respectively.

During T1,

Time period T1 starts when a DCI format 1\_1 command for PCell DL BWP switch, sent from the test equipment to the UE, is received at the UE side in PCell's slot # denoted  $i$ . The UE shall switch its bandwidth part from BWP-1 to BWP-2.

The UE shall be able to receive PDSCH at the beginning of the DL slot right after PCell's DL slot ( $i+T_{BWPswitchDelay}$ ) as defined in clause 8.6 and starts to report valid ACK/NACK for the PCell no later than at the beginning of the DL slot right after DL slot ( $i+T_{BWPswitchDelay}+kI$ ). The UE shall be continuously scheduled on PCell's BWP-2 starting from the beginning of the DL slot right after DL slot ( $i+T_{BWPswitchDelay}$ ).

The starting time of PSCell(Cell 2) interruption due to BWP switch on PCell shall occur within the BWP switch delay.

During T2, the test equipment won't transmit DCI format for PDSCH reception on PCell(Cell 1).



During T3,

The time period T3 starts from the slot # $j$ , where  $j$  is the beginning slot of the DL subframe immediately after the *bwp-InactivityTimer* timer expires. The UE shall switch its bandwidth part from BWP-2 back to the default bandwidth part – BWP-1.

The UE shall be able to receive PDSCH at the beginning of the DL slot right after PCell's DL slot ( $j+T_{BWPswitchDelay}$ ) as defined in clause 8.6 and starts to report valid ACK/NACK for the PCell at latest at the beginning of the DL slot right after DL slot ( $j+T_{BWPswitchDelay}+kI$ ). The UE shall be continuously scheduled on PCell's BWP-1 starting from the beginning of the DL slot right after DL slot ( $j+T_{BWPswitchDelay}$ ).

The starting time of PSCell(Cell 2) interruption due to BWP switch of PCell shall occur within the BWP switch delay.

The test equipment verifies the DL BWP switch time in PCell by counting the slots from the time when the BWP switch command is received or *bwp-InactivityTimer* timer expires till an ACK is received.

The test equipment verifies that potential interruption to E-UTRA PSCell is carried out in the correct time span by monitoring ACK/NACK sent in PSCell during BWP switch of PCell, respectively.

**Table A.4A.1.2.1.1-1: DL BWP switch supported test configurations**

Config	Description
1	LTE FDD, NR 15 kHz SSB SCS, 10 MHz bandwidth, FDD duplex mode
2	LTE FDD, NR 15 kHz SSB SCS, 10 MHz bandwidth, TDD duplex mode
3	LTE FDD, NR 30kHz SSB SCS, 40 MHz bandwidth, TDD duplex mode
4	LTE TDD, NR 15 kHz SSB SCS, 10 MHz bandwidth, FDD duplex mode
5	LTE TDD, NR 15 kHz SSB SCS, 10 MHz bandwidth, TDD duplex mode
6	LTE TDD, NR 30kHz SSB SCS, 40 MHz bandwidth, TDD duplex mode

Note 1: The UE is only required to be tested in one of the supported test configurations.

**Table A.4A.1.2.1.1-2: General test parameters for DL BWP switch in synchronous NE-DC**

Parameter	Unit	Value	Comment
NR RF Channel Number		1	One NR radio channel is used for this test
E-UTRA RF Channel Number		2	One E-UTRA radio channel is used for this test
Active PCell		Cell 1	PCell on RF channel number 1.
Active PSCell		Cell 2	PSCell on RF channel number 2.
CP length		Normal	
DRX		OFF	For both PCell and PSCell
<i>bwp-InactivityTimer</i>	ms	[200]	
Cell-individual offset for cells on RF channel number 1	dB	0	Individual offset for cells on PCC.
Cell-individual offset for cells on RF channel number 2	dB	0	Individual offset for cells on PSCC.
Cell2 timing offset to cell1	$\mu$ s	3	Synchronous NE-DC
T1	s	[0.2]	
T2	s	[0.2]	
T3	s	[0.2]	

**Table A.4A.1.2.1.1-3: NR Cell specific test parameters for DL BWP switch in synchronous NE-DC**

Parameter	Unit	Cell 1
Frequency Range		FR1
Duplex mode	Config 1,4	FDD
	Config 2,3,5,6	TDD
TDD configuration	Config 1,4	Not Applicable
	Config 2,5	TDDConf.1.1
	Config 3,6	TDDConf.2.1
$BW_{channel}$	Config 1,4	10 MHz: $N_{RB,C} = 52$
	Config 2,5	10 MHz: $N_{RB,C} = 52$
	Config 3,6	40 MHz: $N_{RB,C} = 106$

Active BWP ID			1, 2
Initial DL BWP Configuration	Config 1,4		DLBWP.0.2 <sup>Note 4</sup>
	Config 2,5		
	Config 3,6		
Active DL BWP-1 Configuration	Config 1,4		DLBWP.1.1 <sup>Note 4</sup>
	Config 2,5		
	Config 3,6		
Active DL BWP-2 Configuration	Config 1,4		DLBWP.1.3 <sup>Note 4</sup>
	Config 2,5		
	Config 3,6		
Initial UL BWP Configuration	Config 1,4		ULBWP.0.2 <sup>Note 4</sup>
	Config 2,5		
	Config 3,6		
Active UL BWP-1 Configuration	Config 1,4		ULBWP.1.1 <sup>Note 4</sup>
	Config 2,5		
	Config 3,6		
Active UL BWP-2 Configuration	Config 1,4		ULBWP.1.3 <sup>Note 4</sup>
	Config 2,5		
	Config 3,6		
PDSCH Reference measurement channel	Config 1,4		SR.1.1 FDD
	Config 2,5		SR.1.1 TDD
	Config 3,6		SR.2.1 TDD
RMSI CORESET parameters	Config 1,4		CR.1.1 FDD
	Config 2,5		CR.1.1 TDD
	Config 3,6		CR.2.1 TDD
Dedicated CORESET parameters	Config 1,4		CCR.1.1 FDD
	Config 2,5		CCR.1.1 TDD
	Config 3,6		CCR.2.3 TDD
OCNG Patterns			OP.1
SSB Configuration	Config 1,2,4,5		SSB.1 FR1
	Config 3,6		SSB.2 FR1
SMTC Configuration			SMTC.1
Correlation Matrix and Antenna Configuration			1x2 Low
TRS Configuration	Config 1,4		TRS.1.1 FDD
	Config 2,5		TRS.1.1 TDD
	Config 3,6		TRS.1.2 TDD
EPRE ratio of PSS to SSS		dB	0
EPRE ratio of PBCH DMRS to SSS			
EPRE ratio of PBCH to PBCH DMRS			
EPRE ratio of PDCCH DMRS to SSS			
EPRE ratio of PDCCH to PDCCH DMRS			
EPRE ratio of PDSCH DMRS to SSS			
EPRE ratio of PDSCH to PDSCH			
EPRE ratio of OCNG DMRS to SSS(Note 1)			
EPRE ratio of OCNG to OCNG DMRS (Note 1)			
N <sub>oc</sub> <sup>Note 2</sup>	Config 1,2,4,5	dBm/SCS	[-104]
	Config 3,6		[-101]
N <sub>oc</sub> <sup>Note 2</sup>		dBm/15kHz	-104
SS-RSRP <sup>Note 3</sup>	Config 1,2,4,5	dBm/SCS	[-87]
	Config 3,6		[-90]
Ē <sub>s</sub> /I <sub>ot</sub>		dB	17
Ē <sub>s</sub> /N <sub>oc</sub>		dB	17
I <sub>o</sub> <sup>Note 3</sup>	Config 1,2,4,5	dBm/9.36MHz	[-59]
	Config 3,6		[-61.9]
Propagation Condition			AWGN

Note 1:	OCNG shall be used such that both cells are fully allocated and a constant total transmitted power spectral density is achieved for all OFDM symbols.
Note 2:	Interference from other cells and noise sources not specified in the test is assumed to be constant over subcarriers and time and shall be modelled as AWGN of appropriate power for Noc to be fulfilled.
Note 3:	SS-RSRP and $I_0$ levels have been derived from other parameters for information purposes. They are not settable parameters themselves.
Note 4:	For unpaired spectrum, a DL BWP is linked with an UL BWP. DLBWP.0.2 is linked with ULBWP.0.2; DLBWP.1.1 is linked with ULBWP.1.1; DLBWP.1.3 is linked with ULBWP.1.3 defined in clause 12 of TS 38.213 [3].

### A.4A.1.2.1.2 Test Requirements

During T1, the UE shall start to send the ACK for PCell in the DL slot right after DL slot  $(i+T_{BWPswitchDelay}+kI)$ .

During T3, the UE shall start to send the ACK for PCell in the DL slot right after DL slot  $(j+T_{BWPswitchDelay}+kI)$ .

Where,  $kI$  is the timing between DL data receiving and acknowledgement as specified in [7].

Depending on UE capability *bwp-SwitchingDelay* [2], UE shall finish BWP switch within the time duration  $T_{BWPswitchDelay}$  defined in Table 8.6.2-1.

All of the above test requirements shall be fulfilled in order for the observed PCell active BWP switch delay to be counted as correct.

The rate of correct events observed during repeated tests shall be at least 90%.

During T1, the start time of PSCell interruption during PCell active BWP switch shall not happen outside the BWP switch delay.

During T3, the start time of PSCell interruption of during PCell active BWP switch shall not happen outside the BWP switch delay.

The interruption of PSCell shall not be longer than the interruption duration specified for active BWP switch in TS36.133 Clause 7.36.2.6.

All of the above test requirements shall be fulfilled in order for the observed PSCell active BWP switch interruption to be counted as correct.

The rate of correct events observed during repeated tests shall be at least 90%.

NOTE: During T1, T3 if there are no uplink resources for reporting the ACK in the DL slot right after DL slot  $(i+T_{BWPswitchDelay}+kI)$ ,  $(j+T_{BWPswitchDelay}+kI)$ , then the UE shall use the next available uplink resource for reporting the corresponding ACK.

## A.4A.2 Measurement performance

### A.4A.2.1 SFTD accuracy

#### A.4A.2.1.1 SFTD accuracy

##### A.4A.2.1.1.1 Test Purpose

The purpose of this set of tests is to verify that the SFTD measurement accuracy is within the specified limits. This test will verify the requirements as specified in clause 10.21.1.1 for NE-DC SFTD measurements.

##### A.4A.2.1.1.2 Test Environment

Supported test configurations are shown in Table A.4A.2.1.1.2-1. In this set of test cases there are two cells on different carriers. Cell 1 is NR FR1 PCell and Cell 2 is E-UTRAN target cell. The test parameters of cell 1 are given in clause A.4A.2.1.1.2-2. The test parameters of cell 2 are given in Table A.3.7.2.1. The SFTD between PCell and target cell shall be set by the test equipment to one of the time differences in Table A.4A.2.1.1.2-3.

**Table A.4A.2.1.1.2-1: Supported test configurations for SFTD accuracy**

Configuration	Description
1	NR 15 kHz SSB SCS, 10 MHz bandwidth, FDD duplex mode, LTE FDD
2	NR 15 kHz SSB SCS, 10 MHz bandwidth, TDD duplex mode, LTE FDD
3	NR 30 kHz SSB SCS, 40 MHz bandwidth, TDD duplex mode, LTE FDD
4	NR 15 kHz SSB SCS, 10 MHz bandwidth, FDD duplex mode, LTE TDD
5	NR 15 kHz SSB SCS, 10 MHz bandwidth, TDD duplex mode, LTE TDD
6	NR 30kHz SSB SCS, 40 MHz bandwidth, TDD duplex mode, LTE TDD

Note 1: The UE is only required to be tested in one of the supported test configurations

**Table A.4A.2.1.1.2-2: Test parameters for SFTD accuracy (Cell 1)**

Parameter	Config	Unit	Test 1	
SSB GSCN	1~6		freq1	
Duplex mode	1,4		FDD	
	2,5		TDD	
	3,6		TDD	
TDD Configuration	1,4		N/A	
	2,5		TDDConf.1.1	
	3,6		TDDConf.2.1	
BW <sub>channel</sub>	1,4	MHz	10: N <sub>RB,c</sub> = 52	
	2,5		10: N <sub>RB,c</sub> = 52	
	3,6		40: N <sub>RB,c</sub> = 106	
PDSCH Reference measurement channel	1,4		SR.1.1 FDD	
	2,5		SR.1.1 TDD	
	3,6		SR.2.1 TDD	
RMSI CORESET Reference Channel	1,4		CR.1.1 FDD	
	2,5		CR.1.1 TDD	
	3,6		CR.2.1 TDD	
RMC CORESET Reference Channel	1,4		CCR.1.1 FDD	
	2,5		CCR.1.1 TDD	
	3,6		CCR.2.1 TDD	
SSB configuration	1,4		SSB.1 FR1	
	2,5		SSB.1 FR1	
	3,6		SSB.2 FR1	
SMTc configuration	1~6		SMTc.1	
DL BWP configuration	1~6		DLBWP.1.1	
UL BWP configuration	1~6		ULBWP.1.1	
OCNG Patterns	1~6		OP.1	
EPRE ratio of PSS to SSS	1~6	dB	0	
EPRE ratio of PBCH DMRS to SSS				
EPRE ratio of PBCH to PBCH DMRS				
EPRE ratio of PDCCH DMRS to SSS				
EPRE ratio of PDCCH to PDCCH DMRS				
EPRE ratio of PDSCH DMRS to SSS				
EPRE ratio of PDSCH to PDSCH DMRS				
EPRE ratio of OCNG DMRS to SSS <sup>Note 1</sup>				
EPRE ratio of OCNG to OCNG DMRS <sup>Note 1</sup>				
$N_{oc}$ <sup>Note 2</sup>				NR_FDD_FR1_A, NR_TDD_FR1_A <sup>NOTE 5</sup>
	NR_FDD_FR1_B			
	NR_TDD_FR1_C			
	NR_FDD_FR1_D, NR_TDD_FR1_D			

	NR_FDD_FR1_E, NR_TDD_FR1_E			
	NR_FDD_FR1_F			
	NR_FDD_FR1_G			
	NR_FDD_FR1_H			
$N_{oc}$ <small>Note2</small>	NR_FDD_FR1_A, NR_TDD_FR1_A <small>NOTE 5</small>	1,2,4,5	dBm/SSB SCS	-104
	NR_FDD_FR1_B			
	NR_TDD_FR1_C			
	NR_FDD_FR1_D, NR_TDD_FR1_D			
	NR_FDD_FR1_E, NR_TDD_FR1_E			
	NR_FDD_FR1_F			
	NR_FDD_FR1_G			
	NR_FDD_FR1_H			
	NR_FDD_FR1_A, NR_TDD_FR1_A <small>NOTE 5</small>	3,6		-101
	NR_FDD_FR1_B			
	NR_TDD_FR1_C			
	NR_FDD_FR1_D, NR_TDD_FR1_D			
	NR_FDD_FR1_E, NR_TDD_FR1_E			
	NR_FDD_FR1_F			
	NR_FDD_FR1_G			
	NR_FDD_FR1_H			
$\hat{E}_s / I_{ot}$		1~6	dB	-3
$\hat{E}_s / N_{oc}$		1~6	dB	-3
SS-RSRP <small>Note3</small>	NR_FDD_FR1_A, NR_TDD_FR1_A <small>NOTE 5</small>	1,2,4,5	dBm/SCS	-107
	NR_FDD_FR1_B			
	NR_TDD_FR1_C			
	NR_FDD_FR1_D, NR_TDD_FR1_D			
	NR_FDD_FR1_E, NR_TDD_FR1_E			
	NR_FDD_FR1_F			
	NR_FDD_FR1_G			
	NR_FDD_FR1_H			
	NR_FDD_FR1_A, NR_TDD_FR1_A <small>NOTE 5</small>	3,6		-104
	NR_FDD_FR1_B			
	NR_TDD_FR1_C			
	NR_FDD_FR1_D, NR_TDD_FR1_D			
	NR_FDD_FR1_E, NR_TDD_FR1_E			
	NR_FDD_FR1_F			
	NR_FDD_FR1_G			
	NR_FDD_FR1_H			
$I_o$ <small>Note3</small>	NR_FDD_FR1_A, NR_TDD_FR1_A <small>NOTE 5</small>	1,2,4,5	dBm/9.36 MHz	-74.28
	NR_FDD_FR1_B			
	NR_TDD_FR1_C			

NR_FDD_FR1_D, NR_TDD_FR1_D			
NR_FDD_FR1_E, NR_TDD_FR1_E			
NR_FDD_FR1_F			
NR_FDD_FR1_G			
NR_FDD_FR1_H			
NR_FDD_FR1_A, NR_TDD_FR1_A <sup>NOTE 5</sup>	3,6	dBm/38.16 MHz	-68.18
NR_FDD_FR1_B			
NR_TDD_FR1_C			
NR_FDD_FR1_D, NR_TDD_FR1_D			
NR_FDD_FR1_E, NR_TDD_FR1_E			
NR_FDD_FR1_F			
NR_FDD_FR1_G			
NR_FDD_FR1_H			
Propagation condition	1~6		AWGN
Antenna configuration	1~6		1x2
<p>Note 1: OCNG shall be used such that both cells are fully allocated and a constant total transmitted power spectral density is achieved for all OFDM symbols.</p> <p>Note 2: Interference from other cells and noise sources not specified in the test is assumed to be constant over subcarriers and time and shall be modelled as AWGN of appropriate power for <math>N_{oc}</math> to be fulfilled.</p> <p>Note 3: SS-RSRP and <math>I_o</math> levels have been derived from other parameters for information purposes. They are not settable parameters themselves.</p> <p>Note 4: SS-RSRP minimum requirements are specified assuming independent interference and noise at each receiver antenna port.</p> <p>Note 5: The test configuration excludes support for band n51 and it is not required to run this test on band n51 in this release of the specification</p>			

**Table A.4A.2.1.1.2-3: Timing offsets for SFTD accuracy test**

Configuration	SFN offset between PCell and PSCell	Frame boundary offset between PCell and PSCell (Ts)
1	100	-122000
2	300	-60540
3	500	1000
4	700	62540
5	900	124000

**A.4A.2.1.1.3 Test Requirements**

The SFTD reported by the UE consists of 2 elements, SFN offset and frame boundary offset between PCell and E-UTRAN target cell. The reported SFTD accuracy shall fulfil the requirement in clause 10.1.21.1.

## A.5 EN-DC tests with one or more NR cells in FR2

### A.5.1 Void

### A.5.2 Void

### A.5.3 RRC\_CONNECTED state mobility

#### A.5.3.1 Void

#### A.5.3.2 RRC Connection Mobility Control

##### A.5.3.2.1 Void

##### A.5.3.2.2 Random Access

##### A.5.3.2.2.1 4-step RA type contention based random access test in FR2 for PSCell/SCell in EN-DC

###### A.5.3.2.2.1.1 Test Purpose and Environment

The purpose of this test is to verify that the behavior of the random access procedure is according to the requirements and that the PRACH power settings and timing are within specified limits. This test will verify the requirements in clause 6.2.2.2 and clause 7.1.2 in an AWGN model.

For this test two cells are used, with the configuration of Cell 1 (E-UTRA PCell) specified in clause A.3.7.2.1 and Cell 2 configured as PSCell or SCell in FR2. Supported test parameters are shown in Table A.5.3.2.2.1.1-1. UE capable of EN-DC with PSCell or SCell in FR2 needs to be tested by using the parameters in Table A.5.3.2.2.1.1-2 and Table A.5.3.2.2.1.1-3.

**Table A.5.3.2.2.1.1-1: Supported test configurations for non-contention based random access test in FR2 for PSCell/SCell in EN-DC**

Config	Description
1	LTE FDD, NR PSCell/SCell 120 kHz SSB SCS, 100 MHz bandwidth, TDD duplex mode
2	LTE TDD, NR PSCell/SCell 120 kHz SSB SCS, 100 MHz bandwidth, TDD duplex mode

Note: The UE is only required to be tested in one of the supported test configurations depending on UE capability

**Table A.5.3.2.2.1.1-2: General test parameters for contention based random access test in FR2 for PSCell/SCell in EN-DC**

Parameter	Unit	Test-1	Comments
SSB Configuration	Config 1,2	SSB.1 FR2	As defined in A.3.10
CSI-RS for tracking	Config 1,2	TRS.2.1 TDD	
Duplex Mode for Cell 2	Config 1,2	TDD	
TDD Configuration	Config 1,2	TDDConf.3.1	
BW <sub>channel</sub>	Config 1	MHz	100: N <sub>RB,c</sub> = 24
OCNG Pattern <sup>Note 1</sup>		OP.3	As defined in A.3.2.1.
PDSCH Reference Channel <sup>Note 2</sup>	Config 1,2	SR.3.1 TDD	As defined in A.3.1.1.
RMSI CORESET Reference Channel	Config 1,2	CR.3.1 TDD	As defined in A.3.1.2
Dedicated CORESET Reference Channel	Config 1,2	CCR.3.1 TDD	
NR RF Channel Number		1	
EPRE ratio of PSS to SSS	dB	0	
EPRE ratio of PBCH_DMRS to SSS	dB		
EPRE ratio of PBCH to PBCH_DMRS	dB		
EPRE ratio of PDCCH_DMRS to SSS	dB		
EPRE ratio of PDCCH to PDCCH_DMRS	dB		

EPRE ratio of PDSCH_DMRS to SSS	dB		
EPRE ratio of PDSCH to PDSCH_DMRS	dB		
ss-PBCH-BlockPower	dBm/ SCS	+20 + $\Delta_{UL}$	As defined in TS 38.331 [2]. $\Delta_{UL}$ is derived from the uplink calibration process Note 3
Configured UE transmitted power ( $P_{CMAX, f, c}$ )	dBm	maximum value configurable for certain power class	As defined in clause 6.2.4 in TS 38.101-2 [19]
PRACH Configuration		FR2 PRACH configuration 1	As defined in A.3.8.3, with exceptions as defined below.
rsrp-ThresholdSSB	dBm	RSRP_69 + $\Delta_{DL}$	RSRP_69 corresponds to -88dBm. $\Delta_{DL}$ is derived from the downlink calibration process Note 4
preambleReceivedTargetPower	dBm	-100	As defined in TS 38.331 [2]
<p>Note 1: OCNG shall be used such that a constant total transmitted power spectral density is achieved for all OFDM symbols. The OCNG pattern is chosen during the test according to the presence of a DL reference measurement channel.</p> <p>Note 2: The DL PDSCH reference measurement channel is used in the test only when a downlink transmission dedicated to the UE under test is required.</p> <p>Note 3: The <math>\Delta_{UL}</math> value is calculated as <math>-\text{ROUND}(\text{PPRACH0} - 1)</math>, where PPRACH0 is the measured first PRACH power with -80.6dBm/SCS applied, <math>\text{preambleReceivedTargetPower} = -100\text{dBm}</math> and <math>\text{ss-PBCH-BlockPower} = 20\text{dBm}</math>. These values are used during the uplink calibration process carried out before the test case is run, with the UE configured to send PRACH.</p> <p>Note 4: The <math>\Delta_{DL}</math> value is calculated as <math>(\text{RSRP}_{\text{REP}} - \text{RSRP}_{76})</math>, where RSRP_REP is the SS-RSRP Reported value in Table 10.1.6.1-1 with -80.6dBm/SCS applied. These values are used during the downlink calibration process carried out before the test case is run, with the UE configured to report SS-RSRP. For a Reported value RSRP_x, x is treated as a positive integer value.</p>			

**Table A.5.3.2.1.1-3: OTA-related test parameters for contention based random access test in FR2 for PSCell/SCell in EN-DC**

Parameter		Unit	Test-1	Comments
AoA setup			Setup 1	As defined in A.3.15.1
Assumption for UE beams <sup>Note 3</sup>			Rough	
SSB with index 0	$E_s$ <sup>Note1</sup>	dBm/SCS	-80.6	Power of SSB with index 0 is set to be above configured $\text{rsrp-ThresholdSSB}$
	SSB_RP	dBm/SCS	-80.6	
	$E_s/\text{lot}_{\text{BB}}$	dB	21.09	
	lo	dBm/95.04 MHz	-56.01	
SSB with index 1	$E_s$ <sup>Note1</sup>	dBm/SCS	-95.0	Power of SSB with index 1 is set to be below configured $\text{rsrp-ThresholdSSB}$
	SSB_RP	dBm/SCS	-95.0	
	$E_s/\text{lot}_{\text{BB}}$	dB	6.69	
	lo	dBm/95.04 MHz	-70.41	
Propagation Condition		-	No external noise (Note 4)	
<p>Note 1: No artificial noise is applied in this test.</p> <p>Note 2: Void.</p> <p>Note 3: Information about types of UE beam is given in B.2.1.3, and does not limit UE implementation or test system implementation</p> <p>Note 4: The downlink connection between the System Simulator and the UE is without Additive White Gaussian Noise, and has no fading or multipath effects as specified in TS 38.521-2 B.0 [37].</p>				

#### A.5.3.2.2.1.2 Test Requirements

Contention based random access is triggered by *not* explicitly assigning a random access preamble via dedicated signalling in the downlink.



#### A.5.3.2.2.1.2.1 Random Access Preamble Transmission

To test the UE behavior specified in Clause 6.2.2.2.1.1 the System Simulator shall receive the Random Access Preamble which belongs to one of the Random Access Preambles associated with the SSB with index 0, which has SS-RSRP above the configured *rsrp-ThresholdSSB*.

In addition, the power applied to all preambles shall be in accordance with what is specified in Clause 6.2.2.2. The power of the first preamble shall be 0.6 dBm to be received at TE with an accuracy specified in clause 6.3.4.2 of TS 38.101-2 [19]. The relative power applied to additional preambles shall have an accuracy specified in clause 6.3.4.3 of TS 38.101-2 [19].

The transmit timing of all PRACH transmissions shall be within the accuracy specified in Clause 7.1.2.

#### A.5.3.2.2.1.2.2 Random Access Response Reception

To test the UE behavior specified in Clause 6.2.2.2.1.2 the System Simulator shall transmit a Random Access Response containing a Random Access Preamble identifier corresponding to the transmitted Random Access Preamble after 5 preambles have been received by the System Simulator. In response to the first 2 preambles, the System Simulator shall transmit a Random Access Response *not* corresponding to the transmitted Random Access Preamble.

The UE may stop monitoring for Random Access Response(s) and shall transmit the msg3 if the Random Access Response contains a Random Access Preamble identifier corresponding to the transmitted Random Access Preamble.

The UE shall again perform the Random Access Resource selection procedure specified in clause 5.1.2 in TS38.321 [7], and transmit with the calculated PRACH transmission power when the backoff time expires if all received Random Access Responses contain Random Access Preamble identifiers that do not match the transmitted Random Access Preamble.

In addition, the power applied to all preambles shall be in accordance with what is specified in Clause 6.2.2.2. The power of the first preamble shall be 0.6 dBm to be received at TE with an accuracy specified in clause 6.3.4.2 of TS 38.101-2 [19]. The relative power applied to additional preambles shall have an accuracy specified in clause 6.3.4.3 of TS 38.101-2 [19].

The transmit timing of all PRACH transmissions shall be within the accuracy specified in Clause 7.1.2.

#### A.5.3.2.2.1.2.3 No Random Access Response Reception

To test the UE behavior specified in clause 6.2.2.2.1.3 the System Simulator shall transmit a Random Access Response containing a Random Access Preamble identifier corresponding to the transmitted Random Access Preamble after 3 preambles have been received by the System Simulator. The System Simulator shall *not* respond to the first 2 preambles.

The UE shall again perform the Random Access Resource selection procedure specified in clause 5.1.2 in TS38.321 [7], and transmit with the calculated PRACH transmission power when the backoff time expires if no Random Access Response is received within the RA Response window.

In addition, the power applied to all preambles shall be in accordance with what is specified in Clause 6.2.2.2. The power of the first preamble shall be 0.6 dBm to be received at TE with an accuracy specified in clause 6.3.4.2 of TS 38.101-2 [19]. The relative power applied to additional preambles shall have an accuracy specified in clause 6.3.4.3 of TS 38.101-2 [19].

The transmit timing of all PRACH transmissions shall be within the accuracy specified in Clause 7.1.2.

#### A.5.3.2.2.1.2.4 Receiving an UL grant for msg3 retransmission

To test the UE behavior specified in clause 6.2.2.2.1.4 the System Simulator shall provide an UL grant for msg3 retransmission following a successful Random Access Response.

The UE shall re-transmit the msg3 upon the reception of an UL grant for msg3 retransmission.

A.5.3.2.2.1.2.5 Void

A.5.3.2.2.1.2.6 Void

A.5.3.2.2.1.2.7 Contention Resolution Timer expiry

To test the UE behavior specified in Clause 6.2.2.2.1.6 the System Simulator shall *not* send a response to a msg3.

The UE shall again perform the Random Access Resource selection procedure specified in clause 5.1.2 in TS38.321 [7], and transmit with the calculated PRACH transmission power when the backoff time expires if the Contention Resolution Timer expires.

#### A.5.3.2.2.2 4-step RA type non-contention based random access test in FR2 for PSCell/SCell in EN-DC

##### A.5.3.2.2.2.1 Test Purpose and Environment

The purpose of this test is to verify that the behavior of the random access procedure is according to the requirements and that the PRACH power settings and timing are within specified limits. This test will verify the requirements in clause 6.2.2.2 and clause 7.1.2 in an AWGN model.

For this test two cells are used, with the configuration of Cell 1 (E-UTRA PCell) specified in clause A.3.7.2.1 and Cell 2 configured as PSCell or SCell in FR2. Supported test parameters are shown in Table A.5.3.2.2.2.1-1. UE capable of EN-DC with PSCell or SCell in FR2 needs to be tested by using the parameters in Table A.5.3.2.2.2.1-2 and Table A.5.3.2.2.2.1-3 for SSB-based non-contention based random access test (Test 1) and CSI-RS-based non-contention based random access test (Test 2). Test 2 is only applicable to UE which supports csi-RSRP-AndRSRQ-MeasWithSSB or csi-RSRP-AndRSRQ-MeasWithoutSSB.

**Table A.5.3.2.2.2.1-1: Supported test configurations for non-contention based random access test in FR2 for PSCell/SCell in EN-DC**

Config	Description
1	LTE FDD, NR PSCell/SCell 120 kHz SSB SCS, 100 MHz bandwidth, TDD duplex mode
2	LTE TDD, NR PSCell/SCell 120 kHz SSB SCS, 100 MHz bandwidth, TDD duplex mode

Note: The UE is only required to be tested in one of the supported test configurations depending on UE capability

**Table A.5.3.2.2.2.1-2: General test parameters for non-contention based random access test in FR2 for PSCell/SCell in EN-DC**

Parameter	Unit	Test-1	Test-2	Comments	
SSB Configuration	Config 1,2	SSB.1 FR2	SSB.1 FR2	As defined in A.3.10	
CSI-RS Configuration	Config 1,2	N/A	CSI-RS.3.1 TDD	As defined in A.3.1.4	
CSI-RS for tracking	Config 1,2	TRS.2.1 TDD	TRS.2.1 TDD		
Duplex Mode for Cell 2	Config 1,2	TDD	TDD		
TDD Configuration	Config 1,2	TDDConf.3.1	TDDConf.3.1		
BW <sub>channel</sub>	Config 1,2	MHz	100: N <sub>RB,c</sub> = 24	100: N <sub>RB,c</sub> = 24	
OCNG Pattern <sup>Note 1</sup>			OCNG pattern 1	OCNG pattern 1	As defined in A.3.2.1.
PDSCH Reference Channel <sup>Note 2</sup>	Config 1,2		SR3.1 TDD	SR3.1 TDD	As defined in A.3.1.1.
RMSI CORESET Reference Channel	Config 1,2		CR.3.1 TDD	CR.3.1 TDD	As defined in A.3.1.2
Dedicated CORESET Reference Channel	Config 1,2		CCR.3.1 TDD	CCR.3.1 TDD	
NR RF Channel Number			1	1	
EPRE ratio of PSS to SSS	dB		0	0	
EPRE ratio of PBCH_DMRS to SSS	dB				
EPRE ratio of PBCH to PBCH_DMRS	dB				
EPRE ratio of PDCCH_DMRS to SSS	dB				

EPRE ratio of PDCCH to PDCCH_DMRS	dB			
EPRE ratio of PDSCH_DMRS to SSS	dB			
EPRE ratio of PDSCH to PDSCH_DMRS	dB			
ss-PBCH-BlockPower	dBm/ SCS	+20 + $\Delta_{UL}$	+20 + $\Delta_{UL}$	As defined in TS 38.331 [2]. $\Delta_{UL}$ is derived from the uplink calibration process <sup>Note 3</sup>
Configured UE transmitted power ( $P_{CMAX, f, c}$ )	dBm	maximum value configurable for certain power class	maximum value configurable for certain power class	As defined in clause 6.2.4 in TS 38.101-2 [19]
PRACH Configuration		FR2 PRACH configuration 2	FR2 PRACH configuration 3	As defined in A.3.8.3, with exceptions as defined below
rsrp-ThresholdSSB	dBm	RSRP_69 + $\Delta_{DL}$	RSRP_69 + $\Delta_{DL}$	RSRP_69 corresponds to -88dBm. $\Delta_{DL}$ is derived from the downlink calibration process <sup>Note 4</sup>
preambleReceivedTargetPower	dBm	-100	-100	As defined in TS 38.331 [2]
<p>Note 1: OCNG shall be used such that a constant total transmitted power spectral density is achieved for all OFDM symbols. The OCNG pattern is chosen during the test according to the presence of a DL reference measurement channel.</p> <p>Note 2: The DL PDSCH reference measurement channel is used in the test only when a downlink transmission dedicated to the UE under test is required.</p> <p>Note 3: The <math>\Delta_{UL}</math> value is calculated as <math>-\text{ROUND}(\text{PPRACH0} - 1)</math>, where PPRACH0 is the measured first PRACH power with -80.6dBm/SCS applied, <math>\text{preambleReceivedTargetPower} = -100\text{dBm}</math> and <math>\text{ss-PBCH-BlockPower} = 20\text{dBm}</math>. These values are used during the uplink calibration process carried out before the test case is run, with the UE configured to send PRACH.</p> <p>Note 4: The <math>\Delta_{DL}</math> value is calculated as <math>(\text{RSRP}_{\text{REP}} - \text{RSRP}_{76})</math>, where <math>\text{RSRP}_{\text{REP}}</math> is the SS-RSRP Reported value in Table 10.1.6.1-1 with -80.6dBm/SCS applied. These values are used during the downlink calibration process carried out before the test case is run, with the UE configured to report SS-RSRP. For a Reported value <math>\text{RSRP}_x</math>, x is treated as a positive integer value.</p>				

**Table A.5.3.2.2.1-3: OTA-related test parameters for non-contention based random access test in FR2 for PSCell/SCell in EN-DC**

Parameter		Unit	Test-1	Test-2	Comments
AoA setup			Setup 1	Setup 1	As defined in A.3.15.1
Assumption for UE beams <sup>Note 3</sup>			Rough	Rough	
SSB with index 0	$E_s$ <sup>Note1</sup>	dBm/SCS	-80.6	-80.6	Power of SSB with index 0 is set to be above configured $\text{rsrp-ThresholdSSB}$
	SSB_RP	dBm/SCS	-80.6	-80.6	
	$E_s/I_{otBB}$	dB	21.09	21.09	
	$I_o$	dBm/95.04 MHz	-56.01	-56.01	$I_o$ in symbols containing SSB index 0
SSB with index 1	$E_s$ <sup>Note1</sup>	dBm/SCS	-95.0	-95.0	Power of SSB with index 1 is set to be below configured $\text{rsrp-ThresholdSSB}$
	SSB_RP	dBm/SCS	-95.0	-95.0	
	$E_s/I_{otBB}$	dB	6.69	6.69	
	$I_o$	dBm/95.04 MHz	-70.41	-70.41	$I_o$ in symbols containing SSB index 1
Propagation Condition		-	No external noise (Note 4)	No external noise (Note 4)	
<p>Note 1: No artificial noise is applied in this test.</p> <p>Note 2: void.</p> <p>Note 3: Information about types of UE beam is given in B.2.1.3, and does not limit UE implementation or test system implementation</p>					

Note 4: The downlink connection between the System Simulator and the UE is without Additive White Gaussian Noise, and has no fading or multipath effects as specified in TS 38.521-2 B.0 [37].

#### A.5.3.2.2.2.2 Test Requirements

Non-Contention based random access is triggered by explicitly assigning a random access preamble via dedicated signalling in the downlink. In the test, the non-contention based random access procedure is not initialized for Other SI requested from UE or beam failure recovery.

##### A.5.3.2.2.2.2.1 SSB-based Random Access Preamble Transmission

In Test-1, to test the UE behavior specified in Clause 6.2.2.2.2.1 for SSB-based Random Access Preamble transmission, with the contention-free Random Access Resources and the contention-free PRACH occasions associated with SSBs configured, the System Simulator shall receive the Random Access Preamble which has the Preamble Index associated with the SSB with index 0.

In addition, the System Simulator shall receive the Random Access Preamble on the PRACH occasion which belongs to the PRACH occasions corresponding to the SSB with index 0, and the selected PRACH occasion shall belong to the PRACH occasions permitted by the restrictions given by the *ra-ssb-OccasionMaskIndex*.

In addition, the power applied to all preambles shall be in accordance with what is specified in Clause 6.2.2.2. The power of the first preamble shall be 0.6 dBm to be received at TE with an accuracy specified in clause 6.3.4.2 of TS 38.101-2 [19]. The relative power applied to additional preambles shall have an accuracy specified in clause 6.3.4.3 of TS 38.101-2 [19].

The transmit timing of all PRACH transmissions shall be within the accuracy specified in Clause 7.1.2.

##### A.5.3.2.2.2.2.2 CSI-RS-based Random Access Preamble Transmission

In Test-2, to test the UE behavior specified in Clause 6.2.2.2.2.1 for CSI-RS-based Random Access Preamble transmission, with the contention-free Random Access Resources and the contention-free PRACH occasions associated with CSI-RSs configured, the System Simulator shall receive the Random Access Preamble which has the Preamble Index associated with the CSI-RS configured.

In addition, the System Simulator shall receive the Random Access Preamble on the PRACH occasion which belongs to the PRACH occasions corresponding to the CSI-RS configured, and the selected PRACH occasion shall belong to the PRACH occasions permitted by the restrictions given by the *ra-OccasionList*.

In addition, the power applied to all preambles shall be in accordance with what is specified in Clause 6.2.2.2. The power of the first preamble shall be 0.6 dBm to be received at TE with an accuracy specified in clause 6.3.4.2 of TS 38.101-2 [19]. The relative power applied to additional preambles shall have an accuracy specified in clause 6.3.4.3 of TS 38.101-2 [19].

The transmit timing of all PRACH transmissions shall be within the accuracy specified in Clause 7.1.2.

##### A.5.3.2.2.2.2.3 Random Access Response Reception

To test the UE behavior specified in Clause 6.2.2.2.2.2 the System Simulator shall transmit a Random Access Response containing a Random Access Preamble identifier corresponding to the transmitted Random Access Preamble after 3 preambles have been received by the System Simulator. In response to the first 2 preambles, the System Simulator shall transmit a Random Access Response *not* corresponding to the transmitted Random Access Preamble.

The UE may stop monitoring for Random Access Response(s) if the Random Access Response contains a Random Access Preamble identifier corresponding to the transmitted Random Access Preamble.

The UE shall again perform the Random Access Resource selection procedure specified in clause 5.1.2 in TS38.321 [7], and transmit with the calculated PRACH transmission power if all received Random Access Responses contain Random Access Preamble identifiers that do not match the transmitted Random Access Preamble.

In addition, the power applied to all preambles shall be in accordance with what is specified in Clause 6.2.2.2. The power of the first preamble shall be 0.6 dBm to be received at TE with an accuracy specified in clause 6.3.4.2 of TS 38.101-2 [19]. The relative power applied to additional preambles shall have an accuracy specified in clause 6.3.4.3 of TS 38.101-2 [19].

The transmit timing of all PRACH transmissions shall be within the accuracy specified in Clause 7.1.2.

#### A.5.3.2.2.2.4 No Random Access Response Reception

To test the UE behavior specified in clause 6.2.2.2.3 the System Simulator shall transmit a Random Access Response containing a Random Access Preamble identifier corresponding to the transmitted Random Access Preamble after 5 preambles have been received by the System Simulator. The System Simulator shall *not* respond to the first 4 preambles.

The UE shall again perform the Random Access Resource selection procedure specified in clause 5.1.2 in TS38.321 [7], and transmit with the calculated PRACH transmission power when the backoff time expires if no Random Access Response is received within the RA Response window configured in *RACH-ConfigCommon*.

In addition, the power applied to all preambles shall be in accordance with what is specified in Clause 6.2.2.2. The power of the first preamble shall be 0.6 dBm to be received at TE with an accuracy specified in clause 6.3.4.2 of TS 38.101-2 [19]. The relative power applied to additional preambles shall have an accuracy specified in clause 6.3.4.3 of TS 38.101-2 [19].

The transmit timing of all PRACH transmissions shall be within the accuracy specified in Clause 7.1.2.

#### A.5.3.2.2.3 2-step RA type contention based random access test in FR2 for PSCell/SCell in EN-DC

##### A.5.3.2.2.3.1 Test Purpose and Environment

The purpose of this test is to verify that the behavior of the random access procedure is according to the requirements and that the MsgA power settings and timing are within specified limits. This test will verify the requirements in clause 6.2.2.3 and clause 7.1.2 in an AWGN model.

For this test two cells are used, with the configuration of Cell 1 (E-UTRA PCell) specified in clause A.3.7.2.1 and Cell 2 configured as PSCell or SCell in FR2. Supported test parameters are shown in Table A.5.3.2.2.3.1-1. UE capable of EN-DC with PSCell or SCell in FR2 needs to be tested by using the parameters in Table A.5.3.2.2.3.1-2 and Table A.5.3.2.2.3.1-3.

**Table A.5.3.2.2.3.1-1: Supported test configurations for 2-step RA type contention based random access test in FR2 for PSCell/SCell in EN-DC**

Config	Description
1	LTE FDD, NR PSCell/SCell 120 kHz SSB SCS, 100 MHz bandwidth, TDD duplex mode
2	LTE TDD, NR PSCell/SCell 120 kHz SSB SCS, 100 MHz bandwidth, TDD duplex mode

Note: The UE is only required to be tested in one of the supported test configurations depending on UE capability

**Table A.5.3.2.2.3.1-2: General test parameters for 2-step RA type contention based random access test in FR2 for PSCell/SCell in EN-DC**

Parameter	Unit	Test-1	Comments
SSB Configuration	Config 1,2	SSB.1 FR2	As defined in A.3.10
Duplex Mode for Cell 2	Config 1,2	TDD	
TDD Configuration	Config 1,2	TDDConf.3.1	
BW <sub>channel</sub>	Config 1	MHz	100: NRB,c = 24
OCNG Pattern <sup>Note 1</sup>			OP.3
PDSCH Reference Channel <sup>Note 2</sup>	Config 1,2		SR.3.1 TDD
RMSI CORESET Reference Channel	Config 1,2		CR.3.1 TDD
RMC CORESET Reference Channel	Config 1,2		CCR.3.1 TDD
NR RF Channel Number			1
EPRE ratio of PSS to SSS	dB		0
EPRE ratio of PBCH_DMRS to SSS	dB		
EPRE ratio of PBCH to PBCH_DMRS	dB		
EPRE ratio of PDCCH_DMRS to SSS	dB		
EPRE ratio of PDCCH to PDCCH_DMRS	dB		
EPRE ratio of PDSCH_DMRS to SSS	dB		

EPRE ratio of PDSCH to PDSCH_DMRS	dB		
ss-PBCH-BlockPower	dBm/ SCS	+20 + $\Delta$ UL	As defined in TS 38.331 [2]. $\Delta$ UL is derived from the uplink calibration process Note 3
Configured UE transmitted power ( $P_{CMAX, f, c}$ )	dBm	maximum value configurable for certain power class	As defined in clause 6.2.4 in TS 38.101-2 [19]
MsgA Configuration		FR2 MsgA configuration 1	As defined in A.3.20.3.1, with exceptions as defined below.
<i>msgA-RSRP-ThresholdSSB</i>	dBm	RSRP_69 + $\Delta$ DL	RSRP_69 corresponds to -88dBm. $\Delta$ DL is derived from the downlink calibration process Note 4
msgA-PreambleReceivedTargetPower	dBm	-100	As defined in TS 38.331 [2]
<p>Note 1: OCNB shall be used such that a constant total transmitted power spectral density is achieved for all OFDM symbols. The OCNB pattern is chosen during the test according to the presence of a DL reference measurement channel.</p> <p>Note 2: The DL PDSCH reference measurement channel is used in the test only when a downlink transmission dedicated to the UE under test is required.</p> <p>Note 3: The <math>\Delta</math>UL value is calculated as <math>-\text{ROUND}(\text{PMsgA0} - 1)</math>, where PMsgA0 is the measured first MsgA PRACH power with -80.6dBm/SCS applied, <i>msgA-PreambleReceivedTargetPower</i> = -100dBm and <i>ss-PBCH-BlockPower</i> = 20dBm. These values are used during the uplink calibration process carried out before the test case is run, with the UE configured to send MsgA.</p> <p>Note 4: The <math>\Delta</math>DL value is calculated as <math>(\text{RSRP}_{\text{REP}} - \text{RSRP}_{76})</math>, where RSRP_REP is the SS-RSRP Reported value in Table 10.1.6.1-1 with -80.6dBm/SCS applied. These values are used during the downlink calibration process carried out before the test case is run, with the UE configured to report SS-RSRP. For a Reported value RSRP_x, x is treated as a positive integer value.</p>			

**Table A.5.3.2.3.1-3: OTA-related test parameters for 2-step RA type contention based random access test in FR2 for PSCell/SCell in EN-DC**

Parameter		Unit	Test-1	Comments
AoA setup			Setup 1	As defined in A.3.15.1
Assumption for UE beams <sup>Note 2</sup>			Rough	
SSB with index 0	$E_s$ <sup>Note 1</sup>	dBm/SCS	-80.6	Power of SSB with index 0 is set to be above configured <i>msgA-RSRP-ThresholdSSB</i>
	SSB_RP	dBm/SCS	-80.6	
	$E_s/\text{lot}_{\text{BB}}$	dB	21.09	
	lo	dBm/95.04 MHz	-56.01	
SSB with index 1	$E_s$ <sup>Note 1</sup>	dBm/SCS	-95.0	Power of SSB with index 1 is set to be below configured <i>msgA-RSRP-ThresholdSSB</i>
	SSB_RP	dBm/SCS	-95.0	
	$E_s/\text{lot}_{\text{BB}}$	dB	6.69	
	lo	dBm/95.04 MHz	-70.41	
Propagation Condition		-	AWGN	
<p>Note 1: No artificial noise is applied in this test.</p> <p>Note 2: Information about types of UE beam is given in B.2.1.3, and does not limit UE implementation or test system implementation</p>				

#### A.5.3.2.3.2 Test Requirements

Contention based random access is triggered by *not* explicitly assigning a random access preamble via dedicated signalling in the downlink.

#### A.5.3.2.2.3.2.1 MsgA Transmission

To test the UE behaviour specified in Clause 6.2.2.3.1.1 the System Simulator shall receive the Random Access Preamble which belongs to one of the Random Access Preambles associated with the SSB with index 0, which has SS-RSRP above the configured *msgA-RSRP-ThresholdSSB*.

In addition, the power applied to all MsgA transmissions shall be in accordance with what is specified in Clause 6.2.2.3. The power of the first MsgA preamble transmission shall be 0.6 dBm to be received at TE with an accuracy specified in clause 6.3.4.2 of TS 38.101-2 [19]. The power of the first MsgA PUSCH transmission shall be  $0.6 + 3(\mu + 2)$  dBm with an accuracy specified in clause 6.3.4.2 of TS 38.101-2 [19], where  $\mu$  indicates the MsgA PUSCH numerology. The relative power applied to additional preambles shall have an accuracy specified in clause 6.3.4.3 of TS 38.101-2 [19].

The transmit timing of all MsgA PRACH and MsgA PUSCH transmissions shall be within the accuracy specified in Clause 7.1.2.

#### A.5.3.2.2.3.2.2 MsgB Reception

To test the UE behaviour specified in Clause 6.2.2.3.1.2 the System Simulator shall transmit a MsgB with successRAR containing a Random Access Preamble identifier corresponding to the transmitted Random Access Preamble after 5 preambles have been received by the System Simulator. In response to the first 2 preambles, the System Simulator shall transmit a MsgB *not* corresponding to the transmitted Random Access Preamble.

The UE may stop monitoring for MsgB(s) and shall transmit an ACK if the MsgB with a successRAR contains a Random Access Preamble identifier corresponding to the transmitted Random Access Preamble and if the Contention Resolution is successful.

The UE shall again perform the Random Access Resource selection procedure specified in clause 5.1.2a in TS38.321 [7], and transmit with the calculated MsgA PRACH and MsgA PUSCH transmission power when the backoff time expires if all received MsgBs contain Random Access Preamble identifiers that do not match the transmitted Random Access Preamble.

In addition, the power applied to all MsgA transmissions shall be in accordance with what is specified in Clause 6.2.2.3. The power of the first MsgA preamble transmission shall be 0.6 dBm to be received at TE with an accuracy specified in clause 6.3.4.2 of TS 38.101-2 [19]. The power of the first MsgA PUSCH transmission shall be  $0.6 + 3(\mu + 2)$  dBm with an accuracy specified in clause 6.3.4.2 of TS 38.101-2 [19], where  $\mu$  indicates the MsgA PUSCH numerology. The relative power applied to additional preambles shall have an accuracy specified in clause 6.3.4.3 of TS 38.101-2 [19].

The transmit timing of all MsgA transmissions shall be within the accuracy specified in Clause 7.1.2.

#### A.5.3.2.2.3.2.3 No MsgB Reception

To test the UE behaviour specified in clause 6.2.2.3.1.3 the System Simulator shall transmit a MsgB with successRAR containing a Random Access Preamble identifier corresponding to the transmitted Random Access Preamble after 3 preambles have been received by the System Simulator. The System Simulator shall *not* respond to the first 2 preambles.

The UE shall again perform the Random Access Resource selection procedure specified in clause 5.1.2a in TS38.321 [7], and transmit with the calculated MsgA PRACH and MsgA PUSCH transmission power when the backoff time expires if no MsgB is received within the RA Response window.

In addition, the power applied to all MsgA transmissions shall be in accordance with what is specified in Clause 6.2.2.3. The power of the first MsgA preamble transmission shall be 0.6 dBm to be received at TE with an accuracy specified in clause 6.3.4.2 of TS 38.101-2 [19]. The power of the first MsgA PUSCH transmission shall be  $0.6 + 3(\mu + 2)$  dBm with an accuracy specified in clause 6.3.4.2 of TS 38.101-2 [19], where  $\mu$  indicates the MsgA PUSCH numerology. The relative power applied to additional preambles shall have an accuracy specified in clause 6.3.4.3 of TS 38.101-2 [19].

The transmit timing of all MsgA PRACH and MsgA PUSCH transmissions shall be within the accuracy specified in Clause 7.1.2.

#### A.5.3.2.2.4 2-step RA type non-contention based random access test in FR2 for PSCell/SCell in EN-DC

##### A.5.3.2.2.4.1 Test Purpose and Environment

The purpose of this test is to verify that the behavior of the random access procedure is according to the requirements and that the MsgA power settings and timing are within specified limits. This test will verify the requirements in clause 6.2.2.3 and clause 7.1.2 in an AWGN model.

For this test two cells are used, with the configuration of Cell 1 (E-UTRA PCell) specified in clause A.3.7.2.1 and Cell 2 configured as PSCell or SCell in FR2. Supported test parameters are shown in Table A.5.3.2.2.4.1-1. UE capable of EN-DC with PSCell or SCell in FR2 needs to be tested by using the parameters in Table A.5.3.2.2.4.1-2 and Table A.5.3.2.2.4.1-3 for SSB-based non-contention based random access test.

**Table A.5.3.2.2.4.1-1: Supported test configurations for non-contention based random access test in FR2 for PSCell/SCell in EN-DC**

Config	Description
1	LTE TDD, NR PSCell/SCell 120 kHz SSB SCS, 100 MHz bandwidth, TDD duplex mode
Note:	The UE is only required to be tested in one of the supported test configurations depending on UE capability

**Table A.5.3.2.2.4.1-2: General test parameters for non-contention based random access test in FR2 for PSCell/SCell in EN-DC**

Parameter	Unit	Test-1	Comments
SSB Configuration	Config 1	SSB.1 FR2	As defined in A.3.10
Duplex Mode for Cell 2	Config 1	TDD	
TDD Configuration	Config 1	TDDConf.3.1	
BW <sub>channel</sub>	Config 1	MHz	100: N <sub>RB,c</sub> = 24
OCNG Pattern <sup>Note 1</sup>		OCNG pattern 1	As defined in A.3.2.1.
PDSCH Reference Channel <sup>Note 2</sup>	Config 1	SR3.1 TDD	As defined in A.3.1.1.
RMSI CORESET Reference Channel	Config 1	CR.3.1 TDD	As defined in A.3.1.2
RMC CORESET Reference Channel	Config 1	CCR.3.1 TDD	
NR RF Channel Number		1	
EPRE ratio of PSS to SSS	dB	0	
EPRE ratio of PBCH_DMRS to SSS	dB		
EPRE ratio of PBCH to PBCH_DMRS	dB		
EPRE ratio of PDCCH_DMRS to SSS	dB		
EPRE ratio of PDCCH to PDCCH_DMRS	dB		
EPRE ratio of PDSCH_DMRS to SSS	dB		
EPRE ratio of PDSCH to PDSCH_DMRS	dB		
ss-PBCH-BlockPower	dBm/ SCS	+20 + $\Delta_{UL}$	As defined in TS 38.331 [2]. $\Delta_{UL}$ is derived from the uplink calibration process <sup>Note 3</sup>
Configured UE transmitted power ( $P_{CMAX, f, c}$ )	dBm	maximum value configurable for certain power class	As defined in clause 6.2.4 in TS 38.101-2 [19]
MsgA Configuration		FR2 MsgA configuration 2	As defined in A.3.20.3.2, with exceptions as defined below
msgA-RSRP-ThresholdSSB	dBm	RSRP <sub>69</sub> + $\Delta_{DL}$	RSRP <sub>69</sub> corresponds to -88dBm. $\Delta_{DL}$ is derived from the



			downlink calibration process <sup>Note 4</sup>
preambleReceivedTargetPower	dBm	-100	As defined in TS 38.331 [2]
Note 1:	OCNG shall be used such that a constant total transmitted power spectral density is achieved for all OFDM symbols. The OCNG pattern is chosen during the test according to the presence of a DL reference measurement channel.		
Note 2:	The DL PDSCH reference measurement channel is used in the test only when a downlink transmission dedicated to the UE under test is required.		
Note 3:	The $\Delta_{UL}$ value is calculated as $-\text{ROUND}(\text{PmsgA0} - 1)$ , where PmsgA0 is the measured first MsgA PRACH power with -80.6dBm/SCS applied, $\text{msgA-PreambleReceivedTargetPower} = -100\text{dBm}$ and $\text{ss-PBCH-BlockPower} = 20\text{dBm}$ . These values are used during the uplink calibration process carried out before the test case is run, with the UE configured to send MsgA.		
Note 4:	The $\Delta_{DL}$ value is calculated as $(\text{RSRP}_{\text{REP}} - \text{RSRP}_{76})$ , where $\text{RSRP}_{\text{REP}}$ is the SS-RSRP Reported value in Table 10.1.6.1-1 with -80.6dBm/SCS applied. These values are used during the downlink calibration process carried out before the test case is run, with the UE configured to report SS-RSRP. For a Reported value $\text{RSRP}_x$ , x is treated as a positive integer value.		

**Table A.5.3.2.4.1-3: OTA-related test parameters for non-contention based random access test in FR2 for PSCell/SCell in EN-DC**

Parameter		Unit	Test-1	Comments
AoA setup			Setup 1	As defined in A.3.15.1
Assumption for UE beams <sup>Note 2</sup>			Rough	
SSB with index 0	$E_s$ <sup>Note1</sup>	dBm/SCS	-80.6	Power of SSB with index 0 is set to be above configured $\text{msgA-RSRP-ThresholdSSB}$
	SSB_RP	dBm/SCS	-80.6	
	$E_s/\text{lot}_{\text{BB}}$	dB	21.09	
	$l_o$	dBm/95.04 MHz	-56.01	$l_o$ in symbols containing SSB index 0
SSB with index 1	$E_s$ <sup>Note1</sup>	dBm/SCS	-95.0	Power of SSB with index 1 is set to be below configured $\text{msgA-RSRP-ThresholdSSB}$
	SSB_RP	dBm/SCS	-95.0	
	$E_s/\text{lot}_{\text{BB}}$	dB	6.69	
	$l_o$	dBm/95.04 MHz	-70.41	$l_o$ in symbols containing SSB index 1
Propagation Condition		-	AWGN	
Note 1: No artificial noise is applied in this test.				
Note 2: Information about types of UE beam is given in B.2.1.3, and does not limit UE implementation or test system implementation				

#### A.5.3.2.4.2 Test Requirements

Non-Contention based random access is triggered by explicitly assigning a random access preamble via dedicated signalling in the downlink. In the test, the non-contention based random access procedure is not initialized for Other SI requested from UE or beam failure recovery.

##### A.5.3.2.4.2.1 MsgA Transmission

To test the UE behavior specified in Clause 6.2.2.3.2.1, with the contention-free Random Access Resources and the contention-free PRACH occasions associated with SSBs configured, the System Simulator shall receive the MsgA with a preamble which belongs to one of the Random Access Preambles associated with the SSB with index 0.

In addition, the System Simulator shall receive the MsgA PRACH on the PRACH occasion which belongs to the PRACH occasions corresponding to the SSB with index 0, and the selected PRACH occasion shall belong to the PRACH occasions permitted by the restrictions given first by the  $\text{msgA-SSB-SharedRO-MaskIndex}$  if configured, or next by the  $\text{ra-ssb-OccasionMaskIndex}$  if configured.

In addition, the power applied to all preambles shall be in accordance with what is specified in Clause 6.2.2.3. The power of the first preamble shall be 0.6 dBm to be received at TE with an accuracy specified in clause 6.3.4.2 of TS

38.101-2 [19]. The power of the first MsgA PUSCH transmission shall be  $0.6 + 3(\mu + 2)$  dBm with an accuracy specified in clause 6.3.4.2 of TS 38.101-2 [19], where  $\mu$  indicates the MsgA PUSCH numerology. The relative power applied to additional preambles shall have an accuracy specified in clause 6.3.4.3 of TS 38.101-2 [19].

The transmit timing of all PRACH transmissions shall be within the accuracy specified in Clause 7.1.2.

#### A.5.3.2.2.4.2.3 MsgB Reception

To test the UE behavior specified in Clause 6.2.2.3.2.2 the System Simulator shall transmit a MsgB containing a fallbackRAR MAC subPDU.

The UE shall fallback to the 4-step RA type by transmitting the msg3 containing the payload of MsgA PUSCH and monitoring contention resolution as described in clause 8.2A in TS 38.213 [3].

In addition, the power applied to all preambles shall be in accordance with what is specified in Clause 6.2.2.3. The power of the first preamble shall be 0.6 dBm to be received at TE with an accuracy specified in clause 6.3.4.2 of TS 38.101-2 [19]. The power of the first MsgA PUSCH transmission shall be  $0.6 + 3(\mu + 2)$  dBm with an accuracy specified in clause 6.3.4.2 of TS 38.101-2 [19], where  $\mu$  indicates the MsgA PUSCH numerology. The relative power applied to additional preambles shall have an accuracy specified in clause 6.3.4.3 of TS 38.101-2 [19].

The transmit timing of all MsgA and msg3 transmissions shall be within the accuracy specified in Clause 7.1.2.

#### A.5.3.2.2.4.2.4 No MsgB Reception

To test the UE behavior specified in clause 6.2.2.3.2.3 the System Simulator shall transmit a MsgB containing a successRAR message and a Random Access Preamble identifier corresponding to the transmitted Random Access Preamble after 5 preambles have been received by the System Simulator. The System Simulator shall *not* respond to the first 4 preambles.

The UE shall again perform the Random Access Resource selection procedure specified in clause 5.1.2a in TS 38.321 [7], and transmit with the calculated MsgA transmission power when the backoff time expires if no MsgB is received within the MsgB Response window.

In addition, the power applied to all preambles shall be in accordance with what is specified in Clause 6.2.2.3. The power of the first preamble shall be 0.6 dBm to be received at TE with an accuracy specified in clause 6.3.4.2 of TS 38.101-2 [19]. The power of the first MsgA PUSCH transmission shall be  $0.6 + 3(\mu + 2)$  dBm with an accuracy specified in clause 6.3.4.2 of TS 38.101-2 [19], where  $\mu$  indicates the MsgA PUSCH numerology. The relative power applied to additional preambles shall have an accuracy specified in clause 6.3.4.3 of TS 38.101-2 [19].

The transmit timing of all PRACH transmissions shall be within the accuracy specified in Clause 7.1.2.

#### A.5.3.2.3 Void

## A.5.4 Timing

### A.5.4.1 UE transmit timing

#### A.5.4.1.1 NR UE Transmit Timing Test for FR2

##### A.5.4.1.1.1 Test Purpose and environment

The purpose of this test is to verify that the UE can follow frame timing change of the connected gNodeB and that the UE initial transmit timing accuracy, maximum amount of timing change in one adjustment, minimum and maximum adjustment rate are within the specified limits. This test will verify the requirements in clause 7.1.2.

Supported test configurations are shown in Table 5.4.1.1.1-1.

**Table A.5.4.1.1.1-1: Supported test configurations for FR2 PSCell**

Configuration	Description
1	LTE FDD, NR TDD, SSB SCS 240 kHz, data SCS 120 kHz, BW 100 MHz
2	LTE TDD, NR TDD, SSB SCS 240 kHz, data SCS 120 kHz, BW 100 MHz

The test consists of E-UTRA PCell and NR PSCell. The configuration for E-UTRA is given in A.3.7.2.1. Tables A.5.4.1.1.1-2 and A.5.4.1.1.1-2A define the parameters to be configured and strength of the transmitted signals. The transmit timing is verified by the UE transmitting SRS using the configuration defined in Table A.5.4.1.1.1-3.

**Table A.5.4.1.1.1-2: Cell Specific Test Parameters for UL Transmit Timing test**

Parameter	Unit	Config	Test1	Test2	Band Group
SSB ARFCN		1,2	Freq1	Freq1	
Duplex Mode		1,2	TDD		
TDD configuration		1,2	TDDConf.3.1		
BW <sub>channel</sub>	MHz	1,2	100: N <sub>RB,c</sub> = 66		
Data RBs allocated		1,2	66		
Initial BWP Configuration		1,2	DLBWP.0.1 ULBWP.0.1		
Dedicated BWP Configuration		1,2	DLBWP.1.1 ULBWP.1.1		
TRS Configuration		1,2	TRS.2.1 TDD		
PDSCH/PDCCH TCI state		1,2	TCI.State.2		
DRx Cycle	ms	1,2	N/A	DRX.8 <sup>Note5</sup>	
PDSCH Reference measurement channel		1,2	SR.3.3 TDD		
RMSI CORESET Reference Channel		1,2	CR.3.2 TDD		
Dedicated CORESET Reference Channel		1,2	CCR.3.7 TDD		
OCNG Patterns		1,2	O P.1		
SSB Configuration		1,2	SSB.4 FR2		
SMTC Configuration		1,2	SMTC.1		
PDSCH/PDCCH subcarrier spacing	kHz	1,2	120		
EPRE ratio of PSS to SSS	dB	1,2	0	0	
EPRE ratio of PBCH DMRS to SSS					
EPRE ratio of PBCH to PBCH DMRS					
EPRE ratio of PDCCH DMRS to SSS					
EPRE ratio of PDCCH to PDCCH DMRS					
EPRE ratio of PDSCH DMRS to SSS					
EPRE ratio of PDSCH to PDSCH					
EPRE ratio of OCNG DMRS to SSS(Note 1)					
EPRE ratio of OCNG to OCNG DMRS (Note 1)					
Propagation condition					
SRS Config		1,2	SRSCConf.1 <sup>Note6</sup>	SRSCConf.2 <sup>Note6</sup>	
Note 1:	OCNG shall be used such that both cells are fully allocated and a constant total transmitted power spectral density is achieved for all OFDM symbols.				
Note 2:	Void				
Note 3:	Void				
Note 4:	Void				
Note 5:	DRx related parameters are given in Table A.3.3.8-1				
Note 6:	SRS configs are given in Table A.5.4.1.1.1-3				

**Table A.5.4.1.1.1-2A: OTA related test parameters**

Parameter	Unit	Test 1	Test 2
Angle of arrival configuration		Setup 1 according to clause A.3.15.1	

Assumption for UE beams <sup>Note 6</sup>		Fine
$N_{oc}$ <sup>Note1</sup>	dBm/15kHz <sup>Note4</sup>	-112
$N_{oc}$ <sup>Note1</sup>	dBm/SCS <sup>Note3</sup>	-100
$\hat{E}_s/N_{oc}$	dB	4
SS-RSRP <sup>Note2</sup>	dBm/SCS <sup>Note4</sup>	-96
$\hat{E}_s/I_{ot}$	dB	4
$I_o$ <sup>Note2</sup>	dBm/95.04 MHz <sup>Note4</sup>	-68.5
<p>Note 1: Interference from other cells and noise sources not specified in the test is assumed to be constant over subcarriers and time and shall be modelled as AWGN of appropriate power for <math>N_{oc}</math> to be fulfilled.</p> <p>Note 2: SSB_RP and <math>I_o</math> levels have been derived from other parameters for information purposes. They are not settable parameters themselves.</p> <p>Note 3: Void</p> <p>Note 4: Equivalent power received by an antenna with 0dBi gain at the centre of the quiet zone</p> <p>Note 5: As observed with 0dBi gain antenna at the centre of the quiet zone</p> <p>Note 6: Information about types of UE beam is given in B.2.1.3, and does not limit UE implementation or test system implementation</p>		

**Table A.5.4.1.1.1-3: SRS Configuration for Timing Accuracy Test**

	Field	SRSCConf.1	SRSCConf.2	Comments
SRS-ResourceSet	srs-ResourceSetId	0	0	
	srs-ResourceIdList	0	0	
	resourceType	Periodic	Periodic	
	Usage	Codebook	Codebook	
SRS-Resource	SRS-ResourceId	0	0	
	nrofSRS-Ports	Port1	Port1	
	transmissionComb	n2	n2	
	combOffset-n2	0	0	
	cyclicShift-n2	0	0	
	resourceMapping startPosition	0	0	
	resourceMapping nrofSymbols	n1	n1	
	resourceMapping repetitionFactor	n1	n1	
	freqDomainPosition	0	0	
	freqDomainShift	0	0	
	freqHopping c-SRS	17	17	Matches $N_{RB,c}$
	freqHopping b-SRS	0	0	
	freqHopping b-hop	0	0	
	groupOrSequenceHopping	Neither	Neither	
	resourceType	Periodic	Periodic	
	periodicityAndOffset-p	sl1,0	sl2560,4	Offset to align with DRx periodicity
sequenceId	0	0	Any 10 bit number	

**Table A.5.4.1.1.1-4: Void**

**A.5.4.1.1.2 Test requirements**

The test sequence shall be carried out in RRC\_CONNECTED for every test case.

Following will be the test sequence for this test

- 1) Set up E-UTRA PCell according to parameters given in Table A.3.7.2.2-1 and setup NR PCell according to parameters given in Table A.5.4.1.1.1-1.
- 2) After connection set up with the cell, the test equipment will verify that the timing of the NR cell is within  $(N_{TA} + N_{TA\_offset}) \times T_c \pm T_e$  of the first detected path of DL SSB.
  - a. The  $N_{TA}$  offset value (in  $T_c$  units) is 13792
  - b. The  $T_e$  values depend on the DL and UL SCS for which the test is being run and are given in Table 7.1.2-1
- 3) The test system shall adjust the timing of the DL path by values given in Table A.5.4.1.1.2-1

**Table A.5.4.1.1.2-1 Adjustment Value for DL Timing**

SCS of SSB signals (kHz)	Adjustment Value	
	Test1	Test2
240	+8*64T <sub>c</sub>	+4*64T <sub>c</sub>

- 4) The test system shall verify that the adjustment step size and the adjustment rate shall be according to requirements specified in Clause 7.1.2 Table 7.1.2.1-1 until the UE transmit timing offset is within  $(N_{TA} + N_{TA\_offset}) \times T_c \pm T_e$  respective to the first detected path (in time) of DL SSB. Skip this step for test 2 with DRX configured.
- 5) The test system shall verify that the UE transmit timing offset stays within  $(N_{TA} + N_{TA\_offset}) \times T_c \pm T_e$  of the first detected path of DL SSB. For Test 2 the UE transmit timing offset shall be verified for the first transmission in the DRX cycle immediately after DL timing adjustment

## A.5.4.2 UE timer accuracy

## A.5.4.3 Timing advance

### A.5.4.3.1 EN-DC FR2 timing advance adjustment accuracy

#### A.5.4.3.1.1 Test Purpose and Environment

The purpose of the test is to verify UE Timing Advance adjustment delay and accuracy requirement defined in clause 7.3.

#### A.5.4.3.1.2 Test Parameters

Supported test configurations are shown in table A.5.4.3.1.2-1. Both timing advance adjustment delay and accuracy are tested by using the parameters in table A.5.4.3.1.2-2, A.5.4.3.1.2-3, A.5.4.3.1.2-3A and A.5.4.3.1.2-4. The configuration of Cell 1 (LTE PCell) is specified in clause A.3.7.2.1.

In all test cases, two cells are used. Cell 1 is the PCell in the primary Timing Advance Group (pTAG) and cell 2 is the PSCell in the secondary Timing Advance Group (sTAG). Each test consists of two successive time periods, with time duration of T1 and T2 respectively. In each time period, timing advance commands for sTAG are sent to the UE and Sounding Reference Signals (SRS), as specified in table A.5.4.3.1.2-3, are sent from the UE and received by the test equipment. By measuring the reception of the SRS, the transmit timing, and hence the timing advance adjustment accuracy, can be measured for PSCell in sTAG.

During time period T1, the test equipment shall send one message with a Timing Advance Command MAC Control Element for sTAG, as specified in clause 6.1.3.4 in TS 38.321 [7]. The Timing Advance Command value shall be set to 31, which according to clause 4.2 in TS 38.213 [3] results in zero adjustment of the Timing Advance. In this way, a reference value for the timing advance for sTAG used by the UE is established.

During time period T2, the test equipment shall send a sequence of messages with Timing Advance Command MAC Control Elements for sTAG, with Timing Advance Command value specified in table A.5.4.3.1.2-2. This value shall result in changes of the timing advance for sTAG used by the UE, and the accuracy of the change shall then be measured, using the SRS sent from the UE.

As specified in clause 7.3.2.1, the UE adjusts its uplink timing at slot  $n+k$  for a timing advance command received in slot  $n$ . This delay must be taken into account when measuring the timing advance adjustment accuracy, via the SRS sent from the UE.

The UE Time Alignment Timer, described in clause 5.2 in TS 38.321, shall be configured so that it does not expire in the duration of the test.

**Table A.5.4.3.1.2-1: Timing advance supported test configurations**

Config	Description
1	LTE FDD, NR 120 kHz SSB SCS, 100 MHz bandwidth, TDD duplex mode
2	LTE TDD, NR 120 kHz SSB SCS, 100 MHz bandwidth, TDD duplex mode
Note: The UE is only required to be tested in one of the supported test configurations	

**Table A.5.4.3.1.2-2: General test parameters for timing advance**

Parameter	Unit	Value	Comment
RF channel number		Cell 1: 1 Cell 2: 2	1 for E-UTRAN PCell 2 for NR PSCell
Initial DL BWP		DLBWP.0.1	As specified in Table A.3.9.2.1-1
Dedicated DL BWP		DLBWP.1.1	As specified in Table A.3.9.2.2-1
Initial UL BWP		ULBWP.0.1	As specified in Table A.3.9.3.1-1
Dedicated UL BWP		ULBWP.1.1	As specified in Table A.3.9.3.2-1
Timing Advance Command ( $T_A$ ) value during T1		31	$N_{TA\_new} = N_{TA\_old}$ for the purpose of establishing a reference value from which the timing advance adjustment accuracy can be measured during T2
Timing Advance Command ( $T_A$ ) value during T2		39	For 120 kHz SCS $N_{TA\_new} = N_{TA\_old} + 1024 \cdot T_c$ (based on equation in clause 4.2 of TS 38.213 [3])
T1	s	5	
T2	s	5	

**Table A.5.4.3.1.2-3: Cell specific test parameters for timing advance**

Parameter	Unit	Test1	
		T1	T2
Duplex mode		TDD	
TDD configuration		TDDConf.3.1	
$BW_{channel}$	MHz	100: $N_{RB,c} = 66$	
BWP BW	MHz	100: $N_{RB,c} = 66$	
DRx Cycle	ms	Not Applicable	
PDSCH Reference measurement channel		SR.3.1 TDD	
RMSI CORESET Reference Channel		CR.3.1 TDD	
Dedicated CORESET Reference Channel		CCR.3.1 TDD	
TRS configuration		TRS.2.1 TDD	
PDSCH/PDCCH TCI state		TCI.State.2	
OCNG Patterns		OCNG pattern 1	
SMTC configuration		SMTC.1 FR2	
SSB configuration		SSB.3 FR2	
PDSCH/PDCCH subcarrier spacing	kHz	120 kHz	
PUCCH/PUSCH subcarrier spacing	kHz	120 kHz	
EPRE ratio of PSS to SSS	dB	0	
EPRE ratio of PBCH DMRS to SSS			
EPRE ratio of PBCH to PBCH DMRS			
EPRE ratio of PDCCH DMRS to SSS			
EPRE ratio of PDCCH to PDCCH DMRS			
EPRE ratio of PDSCH DMRS to SSS			
EPRE ratio of PDSCH to PDSCH			
EPRE ratio of OCNG DMRS to SSS(Note 1)			
EPRE ratio of OCNG to OCNG DMRS (Note 1)			
Propagation condition			

Note 1: OCNG shall be used such that both cells are fully allocated and a constant total transmitted power spectral density is achieved for all OFDM symbols.

**Table A.5.4.3.1.2-3A: OTA related test parameters**

Parameter	Unit	Test 1	
		T1	T2
Angle of arrival configuration		Setup 1 according to clause A.3.15.1	
Assumption for UE beams <sup>Note 6</sup>		Fine	
$N_{oc}$ <sup>Note1</sup>	dBm/15kHz <sup>Note4</sup>	-112	
$N_{oc}$ <sup>Note1</sup>	dBm/SCS <sup>Note3</sup>	-103	
$\hat{E}_s / N_{oc}$	dB	4	
SS-RSRP <sup>Note2</sup>	dBm/SCS <sup>Note4</sup>	-99	
$\hat{E}_s / I_{ot}$	dB	4	
$I_o$ <sup>Note2</sup>	dBm/95.04 MHz <sup>Note4</sup>	-68.5	
<p>Note 1: Interference from other cells and noise sources not specified in the test is assumed to be constant over subcarriers and time and shall be modelled as AWGN of appropriate power for <math>N_{oc}</math> to be fulfilled.</p> <p>Note 2: SS-RSRP and <math>I_o</math> levels have been derived from other parameters for information purposes. They are not settable parameters themselves.</p> <p>Note 3: SS-RSRP minimum requirements are specified assuming independent interference and noise at each receiver antenna port.</p> <p>Note 4: Equivalent power received by an antenna with 0dBi gain at the centre of the quiet zone</p> <p>Note 5: As observed with 0dBi gain antenna at the centre of the quiet zone</p> <p>Note 6: Information about types of UE beam is given in B.2.1.3, and does not limit UE implementation or test system implementation</p>			

**Table A.5.4.3.1.2-4: Sounding Reference Symbol Configuration for timing advance**

Field	Value	Comment
c-SRS	16	Frequency hopping is disabled
b-SRS	0	
b-hop	0	
freqDomainPosition	0	Frequency domain position of SRS
freqDomainShift	0	
groupOrSequenceHopping	neither	No group or sequence hopping
SRS-PeriodicityAndOffset	sl5=4	Once every 5 slots
pathlossReferenceRS	ssb-Index=0	SSB #0 is used for SRS path loss estimation
usage	Codebook	Codebook based UL transmission
startPosition	0	resourceMapping setting. SRS on last symbol of slot, and 1symbols for SRS without repetition.
nrofSymbols	n1	
repetitionFactor	n1	transmissionComb setting
combOffset-n2	0	
cyclicShift-n2	0	
nrofSRS-Ports	port1	Number of antenna ports used for SRS transmission

Note: For further information see clause 6.3.2 in TS 38.331 [2].

### A.5.4.3.1.3 Test Requirements

The UE shall apply the signalled Timing Advance value for PSCell in sTAG to the transmission timing at the designated activation time i.e.  $k+1$  slots after the reception of the timing advance command, where  $k = 11$ .

The Timing Advance adjustment accuracy for PSCell in sTAG shall be within the limits specified in clause 7.3.2.2.

The rate of correct Timing Advance adjustments observed during repeated tests shall be at least 90%.

## A.5.5 Signaling characteristics

### A.5.5.1 Radio link Monitoring

In the following clause, any uplink signal transmitted by the UE is used for detecting the In-/Out-of-Sync state of the UE. In terms of measurement, the uplink signal is verified on the basis of the UE output power:

*Editor note: The metric for the detection of the UE UL transmitted signal by the TE is FFS.*

#### A.5.5.1.1 Radio Link Monitoring Out-of-sync Test for FR2 PSCell configured with SSB-based RLM RS in non-DRX mode

##### A.5.5.1.1.1 Test Purpose and Environment

The purpose of this test is to verify that the UE properly detects the out of sync and in sync for the purpose of monitoring downlink radio link quality of the PSCell. This test will partly verify the FR2 radio link monitoring requirements in clause 8.1.

In the test, UE is configured to perform RLM on SSB, with *detectionResource* included in *RadioLinkMonitoringRS* set to SSB#0 and SSB#1, and *purpose* set to 'rlf'. Supported test configurations are shown in table A.5.5.1.1.1-1. The test parameters are given in Tables A.5.5.1.1.1-2, A.5.5.1.1.1-3, and A.5.5.1.1.1-4 below. There are two cells, Cell 1 is the E-UTRAN PCell, and Cell 2 is the PSCell, in the test. The E-UTRAN PCell setting refers to Table A.3.7.2.1-2. The test consists of three successive time periods, with time duration of T1, T2 and T3 respectively. Figure A.5.5.1.1.1-1 shows the variation of the downlink SNR in the active cell to emulate out-of-sync and in-sync states, and Figure A.5.5.1.1.1-2 shows the Time multiplexed downlink transmissions from each Angle of Arrival. Prior to the start of the time duration T1, the UE shall be fully synchronized to Cell 1 and Cell 2. The UE shall be configured for periodic CSI reporting with a reporting periodicity of 5 ms. UE is configured to perform inter-frequency measurements using Gap Pattern ID #0 (40ms) in test 1.

**Table A.5.5.1.1.1-1: Supported test configurations for FR2 PSCell**

Configuration	Description
1	FDD LTE PCell, NR 120 KHz SSB SCS, 100 MHz bandwidth, TDD duplex mode
2	TDD LTE PCell, NR 120 KHz SSB SCS, 100 MHz bandwidth, TDD duplex mode
Note:	The UE is only required to pass in one of the supported test configurations in FR2

**Table A.5.5.1.1.1-2: General test parameters for FR2 out-of-sync testing in non-DRX mode**

Parameter		Unit	Value
			Test 1
Active E-UTRA PCell			Cell 1
E-UTRA RF Channel Number			1
Active PSCell			Cell 2
RF Channel Number			2
Duplex mode	Config 1, 2		TDD
BW <sub>channel</sub>	Config 1, 2		100: N <sub>RB,c</sub> = 66
Data RBs allocated	Config 1, 2		24
DL initial BWP configuration	Config 1, 2		DLBWP.0.1
DL dedicated BWP configuration	Config 1, 2		DLBWP.1.1
UL initial BWP configuration	Config 1, 2		ULBWP.0.1
UL dedicated BWP configuration	Config 1, 2		ULBWP.1.1



TDD Configuration	Config 1, 2		TDDConf.3.1
RMSI CORESET Reference Channel	Config 1, 2		CR.3.1 TDD
Dedicated CORESET Reference Channel	Config 1, 2		CCR.3.4 TDD
SSB Configuration	Config 1, 2		SSB.1 FR2
SMTC Configuration	Config 1, 2		SMTC.1
PDSCH/PDCCH subcarrier spacing	Config 1, 2		120 KHz
PRACH Configuration	Config 1, 2		Table A.3.8.3.1
SSB index assigned as RLM RS	Config 1, 2		0,1
OCNG parameters			OP.5
CP length			Normal
Out of sync transmission parameters	DCI format		1-0
	Number of Control OFDM symbols		2
	Aggregation level	CCE	8
	Ratio of hypothetical PDCCH RE energy to average SSS RE energy	dB	4
	Ratio of hypothetical PDCCH DMRS energy to average SSS RE energy	dB	4
	DMRS precoder granularity		REG bundle size
	REG bundle size		6
DRX			OFF
Gap pattern ID			gp0
Layer 3 filtering			Enabled
T310 timer		ms	0
T311 timer		ms	1000
N310			1
N311			1
CSI-RS for CSI reporting	Config 1, 2		CSI-RS.3.1 TDD
reportConfigType			periodic
reportQuantity			cri-RI-PMI-CQI
CSI reporting periodicity		slot	40
CSI reporting offset		slot	4
TCI states for PDCCH/PDSCH			TCI.State.2
CSI-RS for tracking	Config 1, 2		TRS.2.1 TDD
T1		s	0.2
T2		s	9.68
T3		s	9.68
D1		s	9.64
Note 1: All configurations are assigned to the UE prior to the start of time period T1.			
Note 2: UE-specific PDCCH is not transmitted after T1 starts.			
Note 3: E-UTRAN is in non-DRX mode under test.			

**Table A.5.5.1.1-3: OTA related cell specific test parameters for FR2 (Cell 2) for out-of-sync radio link monitoring tests in non-DRX mode**

Parameter	Unit	Test 1					
		T1	T2	T3	T1	T2	T3
AoA setup		Setup 3 defined in A.3.15					
		AoA1			AoA2		
Assumption for UE beams <sup>Note 5</sup>		Rough			Rough		
EPRE ratio of PDCCH DMRS to SSS	dB	4			Not sent		
EPRE ratio of PDCCH to PDCCH DMRS	dB	0					
EPRE ratio of PBCH DMRS to SSS	dB						
EPRE ratio of PBCH to PBCH DMRS	dB						
EPRE ratio of PSS to SSS	dB						
EPRE ratio of PDSCH DMRS to SSS	dB						
EPRE ratio of PDSCH to PDSCH DMRS	dB						
EPRE ratio of OCNG DMRS to SSS	dB						
EPRE ratio of OCNG to OCNG DMRS	dB						

ssb-Index 0 SNR	Config 1, 2	dB	2 <sup>Note 6</sup>	-6 <sup>Note 6</sup>	-15
ssb-Index 1 SNR	Config 1, 2		Not sent		2 <sup>Note 6</sup> -15   -15
$N_{oc}$	Config 1, 2	dBm/ 15kHz	-92.1		-92.1
Time multiplexing of the downlink transmissions from each AoA			Defined in Figure A.5.5.1.1.1-2		
Propagation condition			TDL-A 30ns 75Hz		TDL-A 30ns 75Hz
<p>Note 1: OCNG shall be used such that a constant total transmitted power spectral density is achieved for all OFDM symbols.</p> <p>Note 2: The signal contains PDCCH for UEs other than the device under test as part of OCNG.</p> <p>Note 3: SNR levels correspond to the signal to noise ratio over the SSS REs.</p> <p>Note 4: The SNR values are specified for testing a UE which supports 2RX on at least one band. For testing of a UE which supports 4RX on all bands, the SNR during T3 is A.3.6.</p> <p>Note 5: Information about types of UE beam is given in B.2.1.3, and does not limit UE implementation or test system implementation</p> <p>Note 6: This value allows up to 1dB degradation from applied SNR to UE baseband</p>					

**Table A.5.5.1.1.1-4: Measurement gap configuration for out-of-sync tests in non-DRX mode**

Field	Test 1
	Value
gapOffset	0
<p>Note 1: E-UTRAN PCell and PSCell are SFN-synchronous and frame boundary aligned. (Ensure that RLM RS is partially overlapped with measurement gap).</p>	

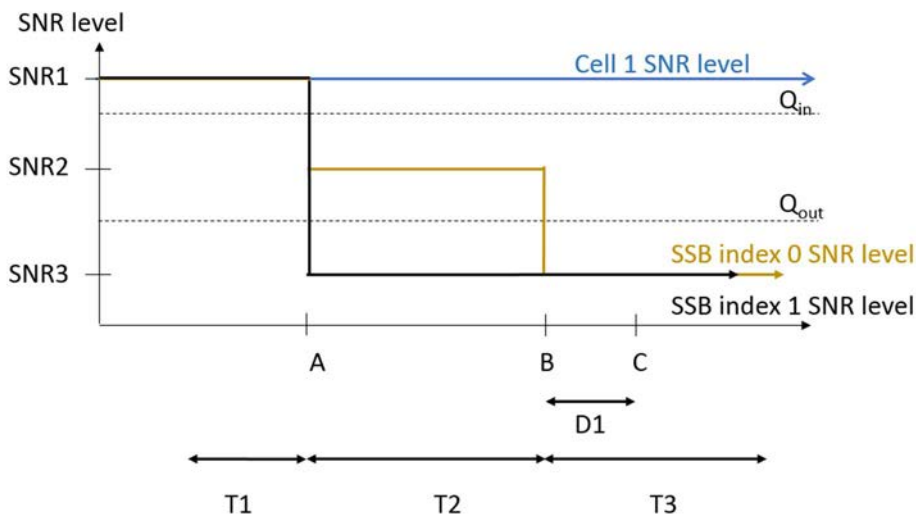

**Figure A.5.5.1.1.1-1: SNR variation for out-of-sync testing**

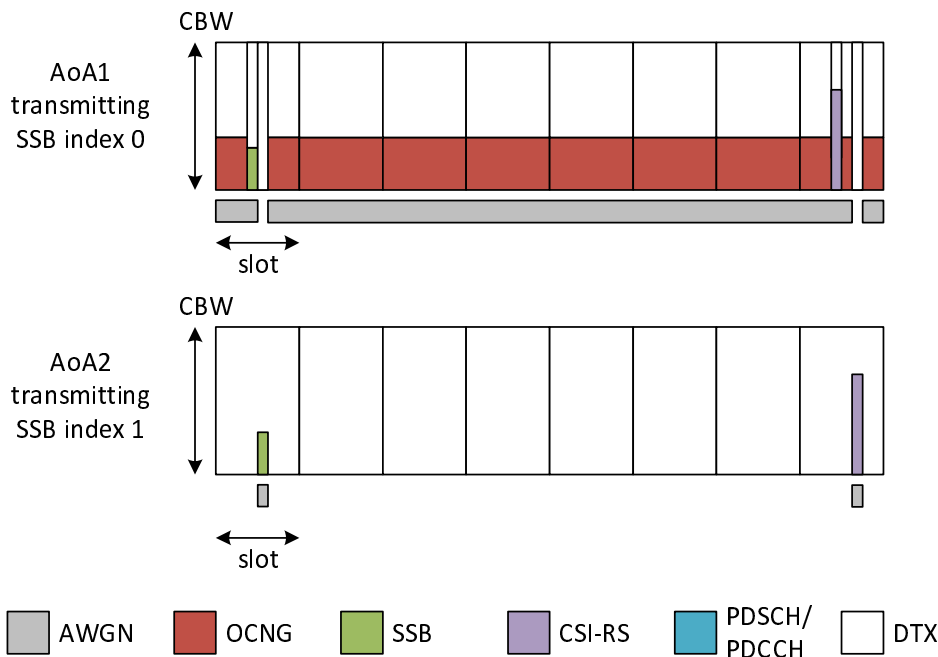

Figure A.5.5.1.1-2: Time multiplexed downlink transmissions

A.5.5.1.1.2 Test Requirements

The UE behavior in each test during time durations T1, T2 and T3 shall be as follows:

During the period from time point A to time point B the UE shall transmit uplink signal at least in all uplink slots configured for CSI transmission according to the configured periodic CSI reporting.

The UE shall stop transmitting uplink signal in Cell 2 no later than time point C (D1 second after the start of the time duration T3).

The rate of correct events observed during repeated tests shall be at least 90%.

A.5.5.1.2 Radio Link Monitoring In-sync Test for FR2 PSCell configured with SSB-based RLM RS in non-DRX mode

A.5.5.1.2.1 Test Purpose and Environment

The purpose of this test is to verify that the UE properly detects the out of sync and in sync for the purpose of monitoring downlink radio link quality of the PSCell. This test will partly verify the FR2 radio link monitoring requirements in clause 8.1.

In the test, UE is configured to perform RLM on SSB, with *detectionResource* included in *RadioLinkMonitoringRS* set to SSB#0 and SSB#1, and *purpose* set to 'rlf'. Supported test configurations are shown in table A.5.5.1.2.1-1. The test parameters are given in Tables A.5.5.1.2.1-2, and A.5.5.1.2.1-3 below. There are two cells, Cell 1 is the E-UTRAN PCell, and Cell 2 is the PSCell, in the test. The E-UTRAN PCell setting refers to Table A.3.7.2.1-2. The test consists of five successive time periods, with time duration of T1, T2, T3, T4 and T5 respectively. Figure A.5.5.1.2.1-1 shows the variation of the downlink SNR in the active cell to emulate out-of-sync and in-sync states, and Figure A.5.5.1.2.1-2 shows the Time multiplexed downlink transmissions from each Angle of Arrival. Prior to the start of the time duration T1, the UE shall be fully synchronized to Cell 1 and Cell 2. The UE shall be configured for periodic CSI reporting with a reporting periodicity of 5ms.

Table A.5.5.1.2.1-1: Supported test configurations for FR2 PSCell

Configuration	Description
1	FDD LTE PCell, NR 120 KHz SSB SCS, 100 MHz bandwidth, TDD duplex mode
2	TDD LTE PCell, NR 120 KHz SSB SCS, 100 MHz bandwidth, TDD duplex mode

Note: The UE is only required to pass in one of the supported test configurations in FR2

**Table A.5.5.1.2.1-2: General test parameters for FR2 in-sync testing in non-DRX mode**

Parameter		Unit	Value
			Test 1
Active E-UTRA PCell			Cell 1
E-UTRA RF Channel Number			1
Active PSCell			Cell 2
RF Channel Number			2
Duplex mode	Config 1, 2		TDD
BW <sub>channel</sub>	Config 1, 2		100: N <sub>RB,c</sub> = 66
Data RBs allocated	Config 1, 2		24
DL initial BWP configuration	Config 1, 2		DLBWP.0.1
DL dedicated BWP configuration	Config 1, 2		DLBWP.1.1
UL initial BWP configuration	Config 1, 2		ULBWP.0.1
UL dedicated BWP configuration	Config 1, 2		ULBWP.1.1
TDD Configuration	Config 1, 2		TDDConf.3.1
RMSI CORESET Reference Channel	Config 1, 2		CR.3.1 TDD
Dedicated CORESET Reference Channel	Config 1, 2		CCR.3.1 TDD
SSB Configuration	Config 1, 2		SSB.1 FR2
SMTC Configuration	Config 1, 2		SMTC.3
PDSCH/PDCCH subcarrier spacing	Config 1, 2		120 KHz
PRACH Configuration	Config 1, 2		Table A.3.8.3.1
SSB index assigned as RLM RS	Config 1, 2		0,1
OCNG parameters			OP.5
CP length			Normal
In sync transmission parameters	DCI format		1-0
	Number of Control OFDM symbols		2
	Aggregation level	CCE	4
	Ratio of hypothetical PDCCH RE energy to average SSS RE energy	dB	0
	Ratio of hypothetical PDCCH DMRS energy to average SSS RE energy	dB	0
	DMRS precoder granularity		REG bundle size
	REG bundle size		6
Out of sync transmission parameters	DCI format		1-0
	Number of Control OFDM symbols		2
	Aggregation level	CCE	8
	Ratio of hypothetical PDCCH RE energy to average SSS RE energy	dB	4
	Ratio of hypothetical PDCCH DMRS energy to average SSS RE energy	dB	4
	DMRS precoder granularity		REG bundle size
	REG bundle size		6
DRX			OFF
Gap pattern ID			N.A.
Layer 3 filtering			Enabled
T310 timer		ms	4000
T311 timer		ms	1000
N310			1
N311			1
CSI-RS for CSI reporting	Config 1, 2		CSI-RS.3.1 TDD
reportConfigType			periodic
reportQuantity			cri-RI-PMI-CQI
CSI reporting periodicity		slot	40
CSI reporting offset		slot	4
TCI states for PDCCH/PDSCH			TCI.State.2

CSI-RS for tracking	Config 1, 2		TRS.2.1 TDD
T1		s	0.2
T2		s	0.2
T3		s	1.88
T4		s	0.2
T5		s	3.84
D1		s	3.8
Note 1: All configurations are assigned to the UE prior to the start of time period T1.			
Note 2: UE-specific PDCCH is not transmitted after T1 starts.			
Note 3: E-UTRAN is in non-DRX mode under test.			

**Table A.5.5.1.2.1-3: OTA related cell specific test parameters for FR2 (Cell 2) for in-sync radio link monitoring tests in non-DRX mode**

Parameter	Unit	Test 1										
		T1	T2	T3	T4	T5	T1	T2	T3	T4	T5	
AoA setup		Setup 3 defined in A.3.15										
		AoA1					AoA2					
Assumption for UE beams <sup>Note 5</sup>		Rough					Rough					
EPRE ratio of PDCCH DMRS to SSS	dB	0					Not sent					
EPRE ratio of PDCCH to PDCCH DMRS	dB	0										
EPRE ratio of PBCH DMRS to SSS	dB											
EPRE ratio of PBCH to PBCH DMRS	dB											
EPRE ratio of PSS to SSS	dB											
EPRE ratio of PDSCH DMRS to SSS	dB											
EPRE ratio of PDSCH to PDSCH DMRS	dB											
EPRE ratio of OCNG DMRS to SSS	dB											
EPRE ratio of OCNG to OCNG DMRS	dB											
ssb-Index 0 SNR	Config 1, 2											dB
ssb-Index 1 SNR	Config 1, 2		Not sent					2 <sup>Note 6</sup>	-15	-15	-4.5	2 <sup>Note 6</sup>
$N_{oc}$	Config 1, 2	dBm/15KH z	-92.1					-92.1				
Time multiplexing of the downlink transmissions from each AoA		Defined in Figure A.5.5.1.2.1-2										
Propagation condition		TDL-A 30ns 75Hz					TDL-A 30ns 75Hz					
Note 1: OCNG shall be used such that a constant total transmitted power spectral density is achieved for all OFDM symbols.												
Note 2: The signal contains PDCCH for UEs other than the device under test as part of OCNG.												
Note 3: SNR levels correspond to the signal to noise ratio over the SSS REs.												
Note 4: The SNR values are specified for testing a UE which supports 2RX on at least one band. For testing of a UE which supports 4RX on all bands, the SNR during T3 is A.3.6.												
Note 5: Information about types of UE beam is given in B.2.1.3, and does not limit UE implementation or test system implementation												
Note 6: This value allows up to 1dB degradation from applied SNR to UE baseband												

Table A.5.5.1.2.1-4: Void

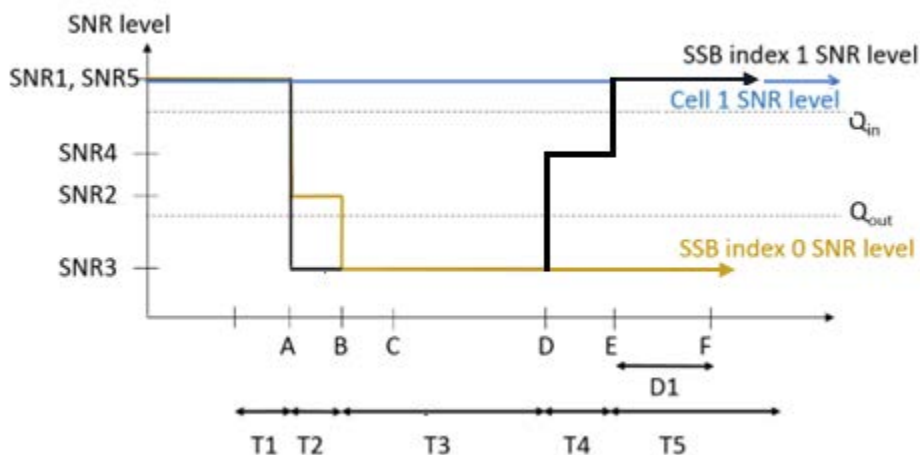

Figure A.5.5.1.2.1-1: SNR variation for in-sync testing

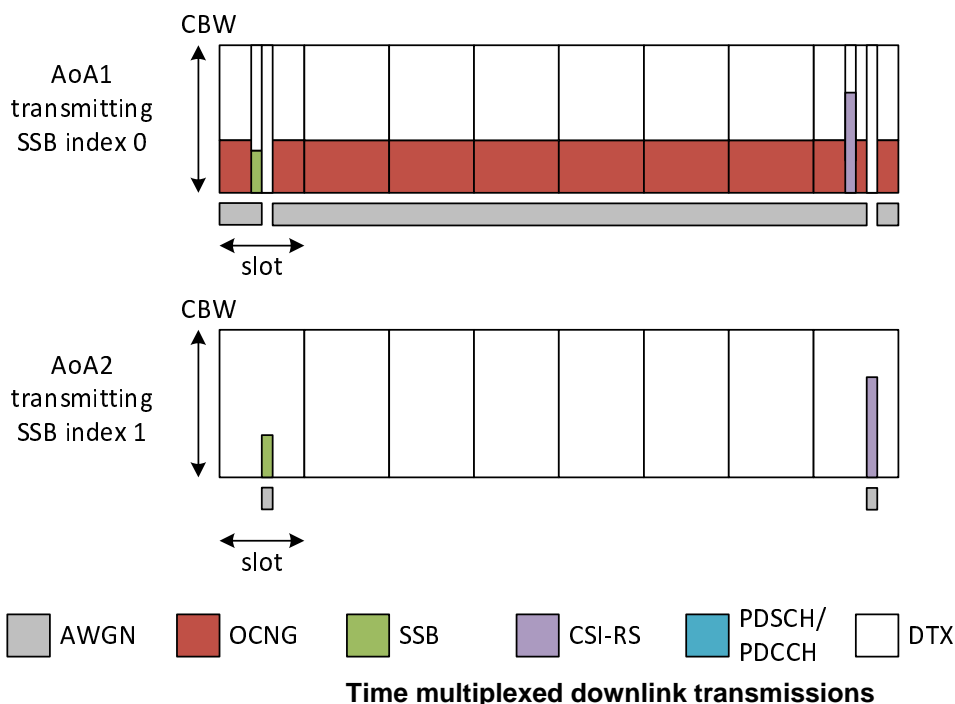

Figure A.5.5.1.2.1-2:

A.5.5.1.2.2 Test Requirements

The UE behaviour in each test during time durations T1, T2, T3, T4 and T5 shall be as follows:

During the period from time point A to time point F (D1 second after the start of time duration T5) the UE shall transmit uplink signal at least in all uplink slots configured for CSI transmission according to the configured periodic CSI reporting.

The rate of correct events observed during repeated tests shall be at least 90%.

### A.5.5.1.3 Radio Link Monitoring Out-of-sync Test for FR2 PSCell configured with SSB-based RLM RS in DRX mode

#### A.5.5.1.3.1 Test Purpose and Environment

The purpose of this test is to verify that the UE properly detects the out of sync and in sync for the purpose of monitoring downlink radio link quality of the PSCell when DRX is used. This test will partly verify the FR2 radio link monitoring requirements in clause 8.1.

In the test, UE is configured to perform RLM on SSB, with *detectionResource* included in *RadioLinkMonitoringRS* set to SSB#0 and SSB#1, and *purpose* set to 'rlf'. Supported test configurations are shown in table A.5.5.1.3.1-1. The test parameters are given in Tables A.5.5.1.3.1-2, and A.5.5.1.3.1-3. There are two cells, Cell 1 is the E-UTRAN PCell, and Cell 2 is the PSCell, in the test. The E-UTRAN PCell setting refers to Table A.3.7.2.1-2. The test consists of three successive time periods, with time duration of T1, T2 and T3 respectively. Figure A.5.5.1.3.1-1 shows the variation of the downlink SNR in the active cell to emulate out-of-sync and in-sync states. Prior to the start of the time duration T1, the UE shall be fully synchronized to Cell 1 and Cell 2. The UE shall be configured for periodic CSI reporting with a reporting periodicity of 5 ms. In the test, DRX configuration is enabled and DRX inactivity timer has already been expired, i.e. UE tries to decode PDCCH and to send periodic CSI during the period when On-duration timer is running. Time alignment timers shall be set to "infinity" so that UL timing alignment is maintained during the test.

**Table A.5.5.1.3.1-1: Supported test configurations for FR2 PSCell**

Configuration	Description
1	FDD LTE PCell, NR 120 KHz SSB SCS, 100 MHz bandwidth, TDD duplex mode
2	TDD LTE PCell, NR 120 KHz SSB SCS, 100 MHz bandwidth, TDD duplex mode
Note: The UE is only required to pass in one of the supported test configurations in FR2	

**Table A.5.5.1.3.1-2: General test parameters for FR2 out-of-sync testing in DRX mode**

Parameter		Unit	Value
			Test 1
Active E-UTRA PCell			Cell 1
E-UTRA RF Channel Number			1
Active PSCell			Cell 2
RF Channel Number			2
Duplex mode	Config 1, 2		TDD
BW <sub>channel</sub>	Config 1, 2		100: N <sub>RB,c</sub> = 66
Data RBs allocated	Config 1, 2		66
DL initial BWP configuration	Config 1, 2		DLBWP.0.1
DL dedicated BWP configuration	Config 1, 2		DLBWP.1.1
UL initial BWP configuration	Config 1, 2		ULBWP.0.1
UL dedicated BWP configuration	Config 1, 2		ULBWP.1.1
TDD Configuration	Config 1, 2		TDDConf.3.1
RMSI CORESET Reference Channel	Config 1, 2		CR.3.1 TDD
Dedicated CORESET Reference Channel	Config 1, 2		CCR.3.4 TDD
SSB Configuration	Config 1, 2		SSB.1 FR2
SMTC Configuration	Config 1, 2		SMTC.1
PDSCH/PDCCH subcarrier spacing	Config 1, 2		120 KHz
PRACH Configuration	Config 1, 2		Table A.3.8.3.1
SSB index assigned as RLM RS	Config 1, 2		0,1
OCNG parameters			OP.1
CP length			Normal
Out of sync transmission parameters	DCI format		1-0
	Number of Control OFDM symbols		2
	Aggregation level	CCE	8
	Ratio of hypothetical PDCCH RE energy to average SSS RE energy	dB	4

	Ratio of hypothetical PDCCH DMRS energy to average SSS RE energy	dB	4
	DMRS precoder granularity		REG bundle size
	REG bundle size		6
DRX Configuration			DRX.3
Gap pattern ID			N.A.
Layer 3 filtering			<i>Enabled</i>
T310 timer		ms	0
T311 timer		ms	1000
N310			1
N311			1
CSI-RS for CSI reporting	Config 1, 2		CSI-RS.3.1 TDD
reportConfigType			periodic
reportQuantity			cri-RI-PMI-CQI
CSI reporting periodicity		slot	40
CSI reporting offset		slot	4
TCI states for PDCCH/PDSCH			TCI.State.2
CSI-RS for tracking	Config 1, 2		TRS.2.1 TDD
T1		s	0.2
T2		s	14.48
T3		s	14.48
D1		s	14.44
Note 1: All configurations are assigned to the UE prior to the start of time period T1.			
Note 2: UE-specific PDCCH is not transmitted after T1 starts.			
Note 3: E-UTRAN is in non-DRX mode under test.			

**Table A.5.5.1.3.1-3: OTA related cell specific test parameters for FR2 (Cell 2) for out-of-sync radio link monitoring tests in DRX mode**

Parameter	Unit	Test 1			
		T1	T2	T3	
AoA setup		Setup 1 defined in A.3.15			
Assumption for UE beams <sup>Note 5</sup>		Rough			
EPRE ratio of PDCCH DMRS to SSS	dB	4			
EPRE ratio of PDCCH to PDCCH DMRS	dB	0			
EPRE ratio of PBCH DMRS to SSS	dB	0			
EPRE ratio of PBCH to PBCH DMRS	dB				
EPRE ratio of PSS to SSS	dB				
EPRE ratio of PDSCH DMRS to SSS	dB				
EPRE ratio of PDSCH to PDSCH DMRS	dB				
EPRE ratio of OCNG DMRS to SSS	dB				
EPRE ratio of OCNG to OCNG DMRS	dB				
ssb-Index 0 SNR	Config 1, 2	dB	2 <sup>Note 6</sup>	-6 <sup>Note 6</sup>	-15
ssb-Index 1 SNR	Config 1, 2		2 <sup>Note 6</sup>	-15	-15
$N_{oc}$	Config 1, 2	dBm/15K Hz	-104.7dBm		
Propagation condition			TDL-A 30ns 75Hz		
Note 1: OCNG shall be used such that the resources in Cell 2 are fully allocated and a constant total transmitted power spectral density is achieved for all OFDM symbols.					
Note 2: The signal contains PDCCH for UEs other than the device under test as part of OCNG.					
Note 3: SNR levels correspond to the signal to noise ratio over the SSS REs.					
Note 4: The SNR values are specified for testing a UE which supports 2RX on at least one band. For testing of a UE which supports 4RX on all bands, the SNR during T3 is A.3.6.					
Note 5: Information about types of UE beam is given in B.2.1.3, and does not limit UE implementation or test system implementation					
Note 6: This value allows up to 1dB degradation from applied SNR to UE baseband					



Table A.5.5.1.3.1-4: Void

Table A.5.5.1.3.1-5: Void

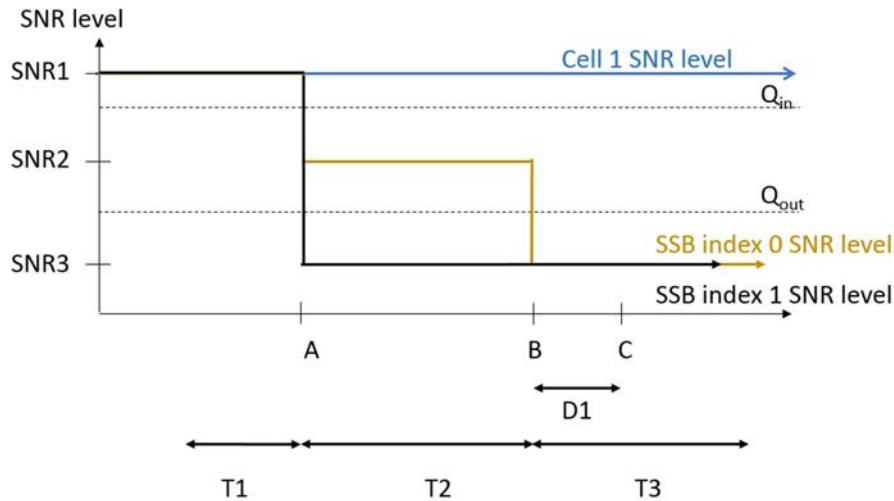

Figure A.5.5.1.3.1-1: SNR variation for out-of-sync testing

#### A.5.5.1.3.2 Test Requirements

The UE behavior in each test during time durations T1, T2 and T3 shall be as follows:

During the period from time point A to time point B the UE shall transmit uplink signal at least in all uplink slots configured for CSI transmission according to the configured periodic CSI reporting.

The UE shall stop transmitting uplink signal in Cell 2 no later than time point C (D1 second after the start of the time duration T3).

The rate of correct events observed during repeated tests shall be at least 90%.

#### A.5.5.1.4 Radio Link Monitoring In-sync Test for FR2 PSCell configured with SSB-based RLM RS in DRX mode

##### A.5.5.1.4.1 Test Purpose and Environment

The purpose of this test is to verify that the UE properly detects the out of sync and in sync for the purpose of monitoring downlink radio link quality of the PSCell when DRX is used. This test will partly verify the FR2 radio link monitoring requirements in clause 8.1.

In the test, UE is configured to perform RLM on SSB, with *detectionResource* included in *RadioLinkMonitoringRS* set to SSB#0 and SSB#1, and *purpose* set to 'rlf'. Supported test configurations are shown in table A.5.5.1.4.1-1. The test parameters are given in Tables A.5.5.1.4.1-2, and A.5.5.1.4.1-3. There are two cells, Cell 1 is the E-UTRAN PCell, and Cell 2 is the PSCell, in the test. The E-UTRAN PCell setting refers to Table A.3.7.2.1-2. The test consists of five successive time periods, with time duration of T1, T2, T3, T4 and T5 respectively. Figure A.5.5.1.4.1-1 shows the variation of the downlink SNR in the active cell to emulate out-of-sync and in-sync states. Prior to the start of the time duration T1, the UE shall be fully synchronized to Cell 1 and Cell 2. The UE shall be configured for periodic CSI reporting with a reporting periodicity of 5 ms. In the test, DRX configuration is enabled and DRX inactivity timer has already been expired, i.e. UE tries to decode PDCCH and to send periodic CSI during the period when On-duration timer is running. Time alignment timers shall be set to "infinity" so that UL timing alignment is maintained during the test.

Table A.5.5.1.4.1-1: Supported test configurations for FR2 PSCell

Configuration	Description
1	FDD LTE PCell, NR 120 KHz SSB SCS, 100 MHz bandwidth, TDD duplex mode
2	TDD LTE PCell, NR 120 KHz SSB SCS, 100 MHz bandwidth, TDD duplex mode
Note: The UE is only required to pass in one of the supported test configurations in FR2	

Table A.5.5.1.4.1-2: General test parameters for FR2 in-sync testing in DRX mode

Parameter		Unit	Value Test 1
Active E-UTRA PCell			Cell 1
E-UTRA RF Channel Number			1
Active PSCell			Cell 2
RF Channel Number			2
Duplex mode		Config 1, 2	TDD
BW <sub>channel</sub>		Config 1, 2	100: N <sub>RB,c</sub> = 66
Data RBs allocated		Config 1, 2	66
DL initial BWP configuration		Config 1, 2	DLBWP.0.1
DL dedicated BWP configuration		Config 1, 2	DLBWP.1.1
UL initial BWP configuration		Config 1, 2	ULBWP.0.1
UL dedicated BWP configuration		Config 1, 2	ULBWP.1.1
TDD Configuration		Config 1, 2	TDDConf.3.1
RMSI CORESET Reference Channel		Config 1, 2	CR.3.1 TDD
Dedicated CORESET Reference Channel		Config 1, 2	CCR.3.1 TDD
SSB Configuration		Config 1, 2	SSB.1 FR2
SMTTC Configuration		Config 1, 2	SMTTC.3
PDSCH/PDCCH subcarrier spacing		Config 1, 2	120 KHz
PRACH Configuration		Config 1, 2	Table A.3.8.3.1
SSB index assigned as RLM RS		Config 1, 2	0,1
OCNG parameters			OP.1
CP length			Normal
In sync transmission parameters	DCI format		1-0
	Number of Control OFDM symbols		2
	Aggregation level	CCE	4
	Ratio of hypothetical PDCCH RE energy to average SSS RE energy	dB	0
	Ratio of hypothetical PDCCH DMRS energy to average SSS RE energy	dB	0
	DMRS precoder granularity		REG bundle size
Out of sync transmission parameters	DCI format		1-0
	Number of Control OFDM symbols		2
	Aggregation level	CCE	8
	Ratio of hypothetical PDCCH RE energy to average SSS RE energy	dB	4
	Ratio of hypothetical PDCCH DMRS energy to average SSS RE energy	dB	4
	DMRS precoder granularity		REG bundle size
REG bundle size			6
DRX Configuration			DRX.11
Gap pattern ID			N.A.
Layer 3 filtering			Enabled
T310 timer		ms	4000
T311 timer		ms	1000
N310			1

N311			1
CSI-RS for CSI reporting	Config 1, 2		CSI-RS.3.1 TDD
reportConfigType			periodic
reportQuantity			cri-RI-PMI-CQI
CSI reporting periodicity		slot	40
CSI reporting offset		slot	4
TCI states for PDCCH/PDSCH			TCI.State.2
CSI-RS for tracking	Config 1, 2		TRS.2.1 TDD
T1		s	0.2
T2		s	0.2
T3		s	2.8
T4		s	0.2
T5		s	3.88
D1		s	3.84
Note 1: All configurations are assigned to the UE prior to the start of time period T1. Note 2: UE-specific PDCCH is not transmitted after T1 starts. Note 3: E-UTRAN is in non-DRX mode under test.			

**Table A.5.5.1.4.1-3: OTA related cell specific test parameters for FR2 (Cell 2) for in-sync radio link monitoring test in DRX mode**

Parameter		Unit	Test 1				
			T1	T2	T3	T4	T5
AoA setup			Setup 1 defined in A.3.15				
Assumption for UE beams <sup>Note 5</sup>			Rough				
EPRE ratio of PDCCH DMRS to SSS		dB	0				
EPRE ratio of PDCCH to PDCCH DMRS		dB	0				
EPRE ratio of PBCH DMRS to SSS		dB	0				
EPRE ratio of PBCH to PBCH DMRS		dB					
EPRE ratio of PSS to SSS		dB					
EPRE ratio of PDSCH DMRS to SSS		dB					
EPRE ratio of PDSCH to PDSCH DMRS		dB					
EPRE ratio of OCNG DMRS to SSS		dB					
EPRE ratio of OCNG to OCNG DMRS		dB					
ssb-Index 0 SNR	Config 1, 2	dB	<sup>2</sup> Note 6	- <sup>6</sup> Note 6	-15	-4.5	<sup>2</sup> Note 6
ssb-Index 1 SNR	Config 1, 2		<sup>2</sup> Note 6	-15	-15	-15	-15
$N_{oc}$	Config 1, 2	dBm/1 5KHz	-104.7dBm				
Propagation condition			TDL-A 30ns 75Hz				
Note 1: OCNG shall be used such that the resources in Cell 2 are fully allocated and a constant total transmitted power spectral density is achieved for all OFDM symbols. Note 2: The signal contains PDCCH for UEs other than the device under test as part of OCNG.3 Note 3: SNR levels correspond to the signal to noise ratio over the SSS REs. Note 4: The SNR values are specified for testing a UE which supports 2RX on at least one band. For testing of a UE which supports 4RX on all bands, the SNR during T3 is A.3.6. Note 5: Information about types of UE beam is given in B.2.1.3, and does not limit UE implementation or test system implementation Note 6: This value allows up to 1dB degradation from applied SNR to UE baseband							

**Table A.5.5.1.4.1-4: Void**

**Table A.5.5.1.4.1-5: Void**

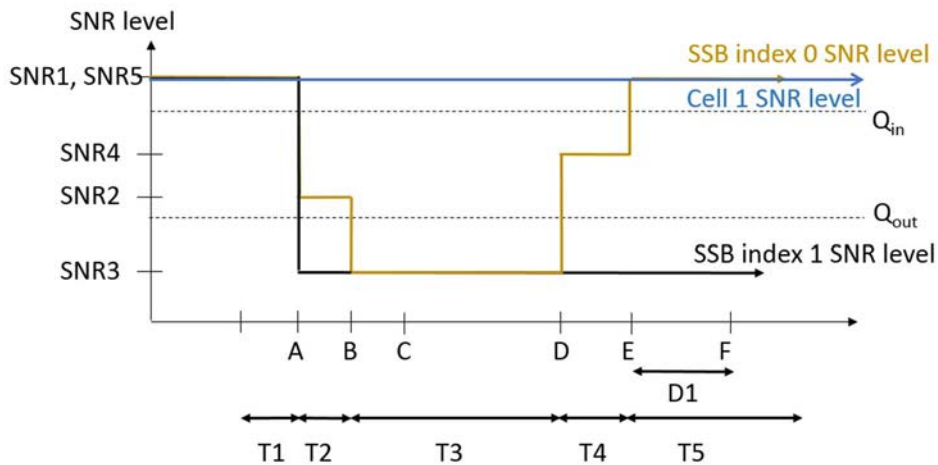

Figure A.5.5.1.4.1-1: SNR variation for in-sync testing.

A.5.5.1.4.2 Test Requirements

The UE behaviour in each test during time durations T1, T2, T3, T4 and T5 shall be as follows:

During the period from time point A to time point F (D1 second after the start of time duration T5) the UE shall transmit uplink signal at least in all uplink slots configured for CSI transmission according to the configured periodic CSI reporting.

The rate of correct events observed during repeated tests shall be at least 90%.

A.5.5.1.5 EN-DC Radio Link Monitoring Out-of-sync Test for FR2 PSCell configured with CSI-RS-based RLM in non-DRX mode

A.5.5.1.5.1 Test Purpose and Environment

The purpose of this test is to verify that the UE properly detects the out of sync for the purpose of monitoring downlink CSI-RS based radio link quality of the PSCell when no DRX is used. This test will partly verify the FR2 TDD PSCell CSI-RS Out-of-sync radio link monitoring requirements in clause 8.1.

The test parameters are given in Tables A.5.5.1.5.1-1, A.5.5.1.5.1-2, A.5.5.1.5.1-3 and A.5.5.1.5.1-3A below. There are two cells, cell 1 is the E-UTRAN PCell, and cell 2 is the PSCell, in the test. The test consists of three successive time periods, with time duration of T1, T2 and T3 respectively. Figure A.5.5.1.5.1-1 shows the variation of the downlink SNR in the E-UTRAN PCell and the PSCell to emulate out-of-sync and in-sync states. Prior to the start of the time duration T1, the UE shall be fully synchronized to cell 1 and cell 2. The UE shall be configured for periodic CSI reporting with a reporting periodicity of 5ms. In the test, DRX configuration is not enabled. The UE is configured to perform inter-frequency measurements using GP ID #0 (40ms). In the test, SSB0 and SSB1 are configured as BFD-RS.

Table A.5.5.1.5.1-1: Supported test configurations for FR2 PSCell

Configuration	Description
1	LTE FDD, NR 120 kHz SSB SCS, 100 MHz bandwidth, TDD duplex mode
2	LTE TDD, NR 120 kHz SSB SCS, 100 MHz bandwidth, TDD duplex mode
Note:	The UE is only required to pass in one of the supported test configurations in FR2

Table A.5.5.1.5.1-2: General test parameters for FR2 PSCell for CSI-RS out-of-sync testing in non-DRX mode

Parameter	Unit	Value
-----------	------	-------

			Test 1
Active E-UTRA PCell			Cell 1
E-UTRA RF Channel Number			1
Active PSCell			Cell 2
RF Channel Number			2
Duplex Mode			TDD
BW <sub>channel</sub>	Config 1, 2		100: N <sub>RB,c</sub> = 66
Data RBs allocated	Config 1, 2		24
BW <sub>occupied</sub>	Config 1, 2		24
TDD Configuration	Config 1		TDDConf.3.1
	Config 2		TDDConf.3.1
DL initial BWP configuration	Config 1, 2		DLBWP.0.1
DL dedicated BWP configuration	Config 1, 2		DLBWP.1.4
UL initial BWP configuration	Config 1, 2		ULBWP.0.1
UL dedicated BWP configuration	Config 1, 2		ULBWP.1.4
RMSI CORESET Reference Channel	Config 1		CR.3.1 TDD
	Config 2		CR.3.1 TDD
Dedicated CORESET Reference Channel	Config 1		CCR.3.4 TDD CCR.3.6 TDD
	Config 2		CCR.3.4 TDD CCR.3.6 TDD
SSB Configuration	Config 1		SSB.1 FR2
	Config 2		SSB.1 FR2
SMTTC Configuration	Config 1		SMTTC.1
	Config 2		SMTTC.1
PDSCH/PDCCH subcarrier spacing	Config 1		120 KHz
	Config 2		120 KHz
CSI-RS for RLM	Config 1, 2		Resource #4 in TRS.2.1 TDD Resource #4 in TRS.2.2 TDD
TRS configuration			TRS.2.1 TDD TRS.2.2 TDD
TCI configuration for PDCCH#1/PDSCH			TCI.State.2
TCI configuration for PDCCH#2			TCI.State.3
OCNG parameters			OP.5
CP length			Normal
Out of sync transmission parameters	DCI format		1-0
	Number of Control OFDM symbols		2
	Aggregation level	CCE	8
	Ratio of hypothetical PDCCH RE energy to average CSI-RS RE energy	dB	4
	Ratio of hypothetical PDCCH DMRS energy to average CSI-RS RE energy	dB	4
	DMRS precoder granularity		REG bundle size
	REG bundle size		6
DRX			OFF
Gap pattern ID			gp0
Layer 3 filtering			Enabled
T310 timer		ms	0
T311 timer		ms	1000
N310			1
N311			1

CSI-RS for CSI reporting	Config 1		CSI-RS.3.1 TDD
	Config 2		CSI-RS.3.1 TDD
reportConfigType			periodic
reportQuantity			cri-RI-PMI-CQI
CSI reporting periodicity		slot	40
CSI reporting offset		slot	4
T1		s	0.2
T2		s	0.35
T3		s	0.35
D1		s	0.31
Note 1: UE-specific PDCCH is not transmitted after T1 starts.			
Note 2: E-UTRAN is in non-DRX mode under test.			

**Table A.5.5.1.5.1-3: Cell specific test parameters for FR2 for CSI-RS out-of-sync radio link monitoring in non-DRX mode**

Parameter	Unit	Test 1					
		T1	T2	T3	T1	T2	T3
AoA setup		Setup 3 defined in A.3.15					
Assumption for UE beams <sup>Note 10</sup>		AoA1			AoA2		
		Rough			Rough		
EPRE ratio of PDCCH DMRS to SSS	dB	4			Not sent		
EPRE ratio of PDCCH to PDCCH DMRS	dB	0					
EPRE ratio of PBCH DMRS to SSS	dB						
EPRE ratio of PBCH to PBCH DMRS	dB						
EPRE ratio of PSS to SSS	dB						
EPRE ratio of PDSCH DMRS to SSS	dB						
EPRE ratio of PDSCH to PDSCH DMRS	dB						
EPRE ratio of OCNG DMRS to SSS	dB						
EPRE ratio of OCNG to OCNG DMRS	dB						
SNR on RLM-RS1	Config 1, 2 dB	2 <sup>Note 11</sup>	-6 <sup>Note 11</sup>	-15			
SNR on RLM-RS2	Config 1, 2 dB	Not sent			2 <sup>Note 11</sup>	-15	-15
$N_{OC}$	Config 1, 2 dBm/15kHz	-92.1			-92.1		
Propagation condition		TDL-A 30ns 75Hz			TDL-A 30ns 75Hz		
<p>Note 1: OCNG shall be used such that the resources in Cell 2 are fully allocated and a constant total transmitted power spectral density is achieved for all OFDM symbols.</p> <p>Note 2: The uplink resources for CSI reporting are assigned to the UE prior to the start of time period T1.</p> <p>Note 3: NZP CSI-RS resource set configuration for CSI reporting are assigned to the UE prior to the start of time period T1.</p> <p>Note 4: Measurement gap configuration is assigned to the UE prior to the start of time period T1.</p> <p>Note 5: The timers and layer 3 filtering related parameters are configured prior to the start of time period T1.</p> <p>Note 6: The signal contains PDCCH for UEs other than the device under test as part of OCNG.</p> <p>Note 7: SNR levels correspond to the signal to noise ratio over the SSS REs.</p> <p>Note 8: The SNR in time periods T1, T2 and T3 is denoted as SNR1, SNR2 and SNR3 respectively in figure A.5.5.1.5.1-1.</p> <p>Note 9: The SNR values are specified for testing a UE which supports 2RX on at least one band. For testing of a UE which supports 4RX on all bands, the SNR during T3 is A.3.6.</p> <p>Note 10: Information about types of UE beam is given in B.2.1.3, and does not limit UE implementation or test system implementation</p> <p>Note 11: This value allows up to 1dB degradation from applied SNR to UE baseband</p>							

**Table A.5.5.1.5.1-3A: Measurement gap configuration for FR2 CSI-RS out-of-sync radio link monitoring in non-DRX mode**

Field	Test 1
	Value
gapOffset	0
Note 1: E-UTRAN PCell and PSCell are SFN-synchronous and frame boundary	

aligned. (Ensure that RLM RS is partially overlapped with measurement gap)

**Table A.5.5.1.5.1-4: Void**

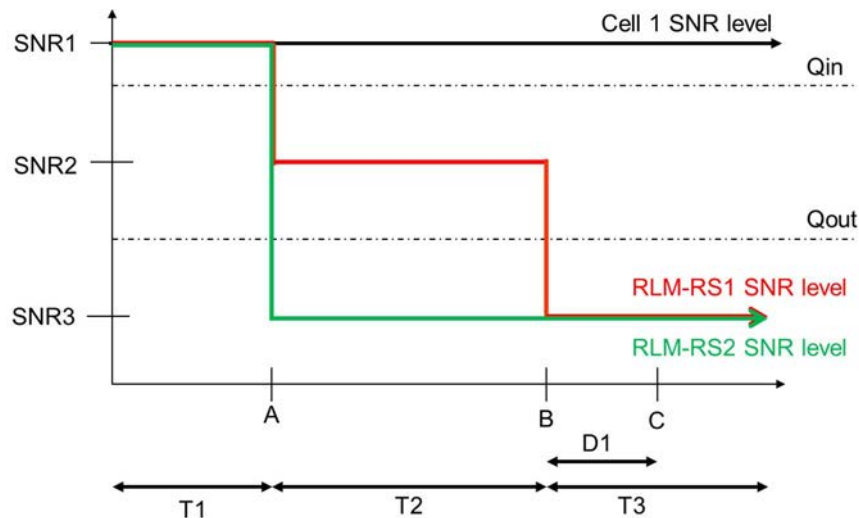

**Figure A.5.5.1.5.1-1: SNR variation for CSI-RS out-of-sync testing**

**A.5.5.1.5.2 Test Requirements**

The UE behaviour during time durations T1, T2, and T3 shall be as follows:

During the period from time point A to time point B the UE shall transmit uplink signal in Cell 2 (PSCell) at least in all uplink slots configured for CSI transmission according to the configured periodic CSI reporting for Cell 2.

The UE shall stop transmitting uplink signal in Cell 2 (PSCell) no later than time point C ( $D_1$  after the start of the time duration T3) on the PSCell.

The rate of correct events observed during repeated tests shall be at least 90%.

**A.5.5.1.6 EN-DC Radio Link Monitoring In-sync Test for FR2 PSCell configured with CSI-RS-based RLM in non-DRX mode**

**A.5.5.1.6.1 Test Purpose and Environment**

The purpose of this test is to verify that the UE properly detects the in sync for the purpose of monitoring downlink CSI-RS based radio link quality of the PSCell when no DRX is used. This test will partly verify the FR2 TDD PSCell CSI-RS In-sync radio link monitoring requirements in clause 8.1.

The test parameters are given in Tables A.5.5.1.6.1-1, A.5.5.1.6.1-2, and A.5.5.1.6.1-3 below. There are two cells, cell 1 which is the E-UTRAN PCell, and cell 2 is the PSCell, in the test. The test consists of five successive time periods, with time duration of T1, T2, T3, T4 and T5 respectively. Figure A.5.5.1.6.1-1 shows the variation of the downlink SNR in the PSCell to emulate out-of-sync and in-sync states. Prior to the start of the time duration T1, the UE shall be fully synchronized to cell 1 and cell 2. The UE shall be configured for periodic CSI reporting with a reporting periodicity of 5ms. In the test, DRX configuration is not enabled. In the test, SSB0 and SSB1 are configured as BFD-RS.

Table A.5.5.1.6.1-1: Supported test configurations for FR2 PSCell

Configuration	Description
1	LTE FDD, NR 120 kHz SSB SCS, 100 MHz bandwidth, TDD duplex mode
2	LTE TDD, NR 120 kHz SSB SCS, 100 MHz bandwidth, TDD duplex mode
Note: The UE is only required to pass in one of the supported test configurations in FR2	

Table A.5.5.1.6.1-2: General test parameters for FR2 PSCell for CSI-RS in-sync testing in non-DRX mode

Parameter		Unit	Value Test 1
Active E-UTRA PCell			Cell 1
E-UTRA RF Channel Number			1
Active PSCell			Cell 2
RF Channel Number			2
Duplex Mode			TDD
BW <sub>channel</sub>	Config 1, 2		100: N <sub>RB,C</sub> = 66
Data RBs allocated	Config 1, 2		24
BW <sub>occupied</sub>	Config 1, 2		24
TDD Configuration	Config 1		TDDConf.3.1
	Config 2		TDDConf.3.1
DL initial BWP configuration	Config 1, 2		DLBWP.0.1
DL dedicated BWP configuration	Config 1, 2		DLBWP.1.4
UL initial BWP configuration	Config 1, 2		ULBWP.0.1
UL dedicated BWP configuration	Config 1, 2		ULBWP.1.4
RMSI CORESET Reference Channel	Config 1		CR.3.1 TDD
	Config 2		CR.3.1 TDD
Dedicated CORESET Reference Channel	Config 1		CCR.3.1 TDD CCR.3.3 TDD
	Config 2		CCR.3.1 TDD CCR.3.3 TDD
SSB Configuration	Config 1		SSB.1 FR2
	Config 2		SSB.1 FR2
SMTc Configuration	Config 1		SMTc.1
	Config 2		SMTc.1
PDSCH/PDCCH subcarrier spacing	Config 1		120 KHz
	Config 2		120 KHz
CSI-RS for RLM	Config 1, 2		Resource #4 in TRS.2.1 TDD Resource #4 in TRS.2.2 TDD
OCNG parameters			OP.5
TRS configuration			TRS.2.1 TDD TRS.2.2 TDD
TCI configuration for PDCCH#1/PDSCH			TCI.State.2
TCI configuration for PDCCH#2			TCI.State.3
CP length			Normal
Out of sync transmission parameters	DCI format		1-0
	Number of Control OFDM symbols		2
	Aggregation level	CCE	8



	Ratio of hypothetical PDCCH RE energy to average CSI-RS RE energy	dB	4
	Ratio of hypothetical PDCCH DMRS energy to average CSI-RS RE energy	dB	4
	DMRS precoder granularity		REG bundle size
	REG bundle size		6
In sync transmission parameters	DCI format		1-0
	Number of Control OFDM symbols		2
	Aggregation level	CCE	4
	Ratio of hypothetical PDCCH RE energy to average CSI-RS RE energy	dB	0
	Ratio of hypothetical PDCCH DMRS energy to average CSI-RS RE energy	dB	0
	DMRS precoder granularity		REG bundle size
	REG bundle size		6
DRX			OFF
Gap pattern ID			N.A.
Layer 3 filtering			Enabled
T310 timer		ms	1000
T311 timer		ms	1000
N310			1
N311			1
CSI-RS for CSI reporting	Config 1		CSI-RS.3.1 TDD
	Config 2		CSI-RS.3.1 TDD
reportConfigType			periodic
reportQuantity			cri-RI-PMI-CQI
CSI reporting periodicity		slot	40
CSI reporting offset		slot	4
T1		s	0.2
T2		s	0.2
T3		s	0.24
T4		s	0.2
T5		s	0.88
D1		s	0.84
Note 1: UE-specific PDCCH is not transmitted after T1 starts.			
Note 2: E-UTRAN is in non-DRX mode under test.			

**Table A.5.5.1.6.1-3: Cell specific test parameters for FR2 for CSI-RS in-sync radio link monitoring in non-DRX mode**

Parameter	Unit	Test 1									
		T1	T2	T3	T4	T5	T1	T2	T3	T4	T5
AoA setup		Setup 3 defined in A.3.15									
Assumption for UE beams <sup>Note 10</sup>		AoA1					AoA2				
		Rough					Rough				
EPRE ratio of PDCCH DMRS to SSS	dB	0					Not sent				
EPRE ratio of PDCCH to PDCCH DMRS	dB	0									

EPRE ratio of PBCH DMRS to SSS		dB										
EPRE ratio of PBCH to PBCH DMRS		dB										
EPRE ratio of PSS to SSS		dB										
EPRE ratio of PDSCH DMRS to SSS		dB										
EPRE ratio of PDSCH to PDSCH DMRS		dB										
EPRE ratio of OCNG DMRS to SSS		dB										
EPRE ratio of OCNG to OCNG DMRS		dB										
SNR on RLM-RS1	Config 1, 2	dB	2 <sup>Note 11</sup>	-6 <sup>Note 11</sup>	-15	-15	-15					
SNR on RLM-RS2	Config 1, 2	dB	Not sent					2 <sup>Note 11</sup>	-15	-15	-4.5	2 <sup>Note 6</sup>
$N_{oc}$	Config 1, 2	dBm/15KHz	-92.1					-92.1				
Propagation condition			TDL-A 30ns 75Hz					TDL-A 30ns 75Hz				
<p>Note 1: OCNG shall be used such that the resources in Cell 2 are fully allocated and a constant total transmitted power spectral density is achieved for all OFDM symbols.</p> <p>Note 2: The uplink resources for CSI reporting are assigned to the UE prior to the start of time period T1.</p> <p>Note 3: NZP CSI-RS resource set configuration for CSI reporting are assigned to the UE prior to the start of time period T1.</p> <p>Note 4: Measurement gap configuration is assigned to the UE prior to the start of time period T1.</p> <p>Note 5: The timers and layer 3 filtering related parameters are configured prior to the start of time period T1.</p> <p>Note 6: The signal contains PDCCH for UEs other than the device under test as part of OCNG.</p> <p>Note 7: SNR levels correspond to the signal to noise ratio over the SSS REs.</p> <p>Note 8: The SNR in time periods T1, T2, T3, T4 and T5 is denoted as SNR1, SNR2, SNR3, SNR4 and SNR5 respectively in figure A.5.5.1.6.1-1.</p> <p>Note 9: The SNR values are specified for testing a UE which supports 2RX on at least one band. For testing of a UE which supports 4RX on all bands, the SNR during T3 is A.3.6.</p> <p>Note 10: Information about types of UE beam is given in B.2.1.3, and does not limit UE implementation or test system implementation.</p> <p>Note 11: This value allows up to 1dB degradation from applied SNR to UE baseband</p>												

**Table A.5.5.1.6.1-3A: Void**

**Table A.5.5.1.6.1-4: Void**

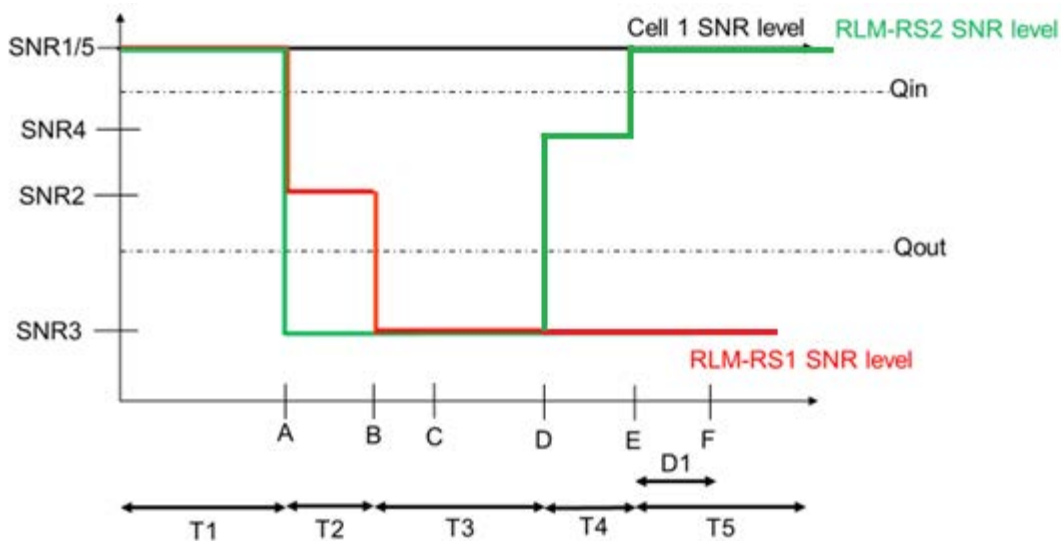

Figure A.5.5.1.6.1-1: SNR variation for CSI-RS in-sync testing

A.5.5.1.6.2 Test Requirements

The UE behaviour in each test during time durations T1, T2, T3, T4 and T5 shall be as follows:

During the period from time point A to time point F (D1 second after the start of time duration T5) the UE shall transmit uplink signal at least in all uplink slots configured for CSI transmission according to the configured periodic CSI reporting on the PSCell.

The rate of correct events observed during repeated tests shall be at least 90%.

A.5.5.1.7 EN-DC Radio Link Monitoring Out-of-sync Test for FR2 PSCell configured with CSI-RS-based RLM in DRX mode

A.5.5.1.7.1 Test Purpose and Environment

The purpose of this test is to verify that the UE properly detects the out of sync for the purpose of monitoring downlink CSI-RS based radio link quality of the PSCell when DRX is used. This test will partly verify the FR2 TDD PSCell CSI-RS Out-of-sync radio link monitoring requirements in clause 8.1.

The test parameters are given in Tables A.5.5.1.7.1-1, A.5.5.1.7.1-2, and A.5.5.1.7.1-3 below. There are two cells, cell 1 is the E-UTRAN PCell, and cell 2 is the PSCell, in the test. The test consists of three successive time periods, with time duration of T1, T2 and T3 respectively. Figure A.5.5.1.7.1-1 shows the variation of the downlink SNR in the E-UTRAN PCell and the PSCell to emulate out-of-sync and in-sync states. Prior to the start of the time duration T1, the UE shall be fully synchronized to cell 1 and cell 2. The UE shall be configured for periodic CSI reporting with a reporting periodicity of 5ms. In the test, DRX configuration is enabled in PSCell and DRX inactivity timer has already been expired, i.e. UE tries to decode PDCCH and to send periodic CQI during the period when On-duration timer is running. Time alignment timers shall be set to “infinity” so that UL timing alignment is maintained during the test. In the test, SSB0 and SSB1 are configured as BFD-RS and are not same as RLM-RS to avoid triggering the beam failure during the RLM test.

Table A.5.5.1.7.1-1: Supported test configurations for FR2 PSCell

Configuration	Description
1	LTE FDD, NR 120 kHz SSB SCS, 100 MHz bandwidth, TDD duplex mode
2	LTE TDD, NR 120 kHz SSB SCS, 100 MHz bandwidth, TDD duplex mode
Note:	The UE is only required to pass in one of the supported test configurations in FR2

**Table A.5.5.1.7.1-2: General test parameters for FR2 PSCell for CSI-RS out-of-sync testing in DRX mode**

Parameter		Unit	Value
			Test 1
Active E-UTRA PCell			Cell 1
E-UTRA RF Channel Number			1
Active PSCell			Cell 2
RF Channel Number			2
Duplex Mode			TDD
TDD Configuration	Config 1		TDDConf.3.1
	Config 2		TDDConf.3.1
DL initial BWP configuration	Config 1, 2		DLBWP.0.1
DL dedicated BWP configuration	Config 1, 2		DLBWP.1.1
UL initial BWP configuration	Config 1, 2		ULBWP.0.1
UL dedicated BWP configuration	Config 1, 2		ULBWP.1.1
RMSI CORESET Reference Channel	Config 1		CR. 3.1 TDD
	Config 2		CR. 3.1 TDD
Dedicated CORESET Reference Channel	Config 1		CCR. 3.4 TDD CCR.3.6 TDD
	Config 2		CCR. 3.4 TDD CCR.3.6 TDD
SSB Configuration	Config 1		SSB.1 FR2
	Config 2		SSB.1 FR2
SMTTC Configuration	Config 1		SMTTC.1
	Config 2		SMTTC.1
PDSCH/PDCC H subcarrier spacing	Config 1		120 KHz
	Config 2		120 KHz
CSI-RS for RLM	Config 1, 2		Resource #4 in TRS.2.1 TDD Resource #4 in TRS.2.2 TDD
SSB index for BFD-RS	Config 1, 2		0, 1
TRS configuration			TRS.2.1 TDD TRS.2.2 TDD
TCI configuration for PDCCH#1/PDSCH			TCI.State.2
TCI configuration for PDCCH#2			TCI.State.3
OCNG parameters			OP.1
CP length			Normal
Out of sync transmission parameters	DCI format		1-0
	Number of Control OFDM symbols		2
	Aggregation level	CCE	8
	Ratio of hypothetical PDCCH RE energy to average CSI-RS RE energy	dB	4
	Ratio of hypothetical PDCCH DMRS energy to average CSI-RS RE energy	dB	4
	DMRS precoder granularity		REG bundle size
	REG bundle size		6
DRX			DRX.3
Gap pattern ID			N.A.

Layer 3 filtering		<i>Enabled</i>
T310 timer	ms	0
T311 timer	ms	1000
N310		1
N311		1
CSI-RS for CSI reporting	Config 1	CSI-RS.3.1 TDD
	Config 2	CSI-RS.3.1 TDD
reportConfigType		periodic
reportQuantity		cri-RI-PMI-CQI
CSI reporting periodicity	slot	40
CSI reporting offset	slot	4
T1	s	0.2
T2	s	1.28
T3	s	1.28
D1	s	1.24
Note 1: UE-specific PDCCH is not transmitted after T1 starts.		
Note 2: E-UTRAN is in non-DRX mode under test.		

**Table A.5.5.1.7.1-3: Cell specific test parameters for FR2 for CSI-RS out-of-sync radio link monitoring in DRX mode**

Parameter	Unit	Test 1			
		T1	T2	T3	
AoA setup		Setup 1 defined in A.3.15			
Assumption for UE beams <sup>Note 10</sup>		Rough			
EPRE ratio of PDCCH DMRS to SSS	dB	4			
EPRE ratio of PDCCH to PDCCH DMRS	dB	0			
EPRE ratio of PBCH DMRS to SSS	dB				
EPRE ratio of PBCH to PBCH DMRS	dB				
EPRE ratio of PSS to SSS	dB				
EPRE ratio of PDSCH DMRS to SSS	dB				
EPRE ratio of PDSCH to PDSCH DMRS	dB				
EPRE ratio of OCNG DMRS to SSS	dB				
EPRE ratio of OCNG to OCNG DMRS	dB				
SNR on RLM-RS1	Config 1, 2	dB	2 <sup>Note 11</sup>	-6 <sup>Note 11</sup>	-15
SNR on RLM-RS2	Config 1, 2	dB	2 <sup>Note 11</sup>	-15	-15
$N_{oc}$	Config 1	dBm/15KHz	-104.7		
	Config 2		-104.7		
Propagation condition			TDL-A 30ns 75Hz		

- Note 1: OCNG shall be used such that the resources in Cell 2 are fully allocated and a constant total transmitted power spectral density is achieved for all OFDM symbols.
- Note 2: The uplink resources for CSI reporting are assigned to the UE prior to the start of time period T1.
- Note 3: NZP CSI-RS resource set configuration for CSI reporting are assigned to the UE prior to the start of time period T1.
- Note 4: Void
- Note 5: The timers and layer 3 filtering related parameters are configured prior to the start of time period T1.
- Note 6: The signal contains PDCCH for UEs other than the device under test as part of OCNG.
- Note 7: SNR levels correspond to the signal to noise ratio over the SSS REs.
- Note 8: The SNR in time periods T1, T2 and T3 is denoted as SNR1, SNR2 and SNR3 respectively in figure A.5.5.1.7.1-1.
- Note 9: The SNR values are specified for testing a UE which supports 2RX on at least one band. For testing of a UE which supports 4RX on all bands, the SNR during T3 is A.3.6.
- Note 10: Information about types of UE beam is given in B.2.1.3, and does not limit UE implementation or test system implementation.
- Note 11: This value allows up to 1dB degradation from applied SNR to UE baseband.

**Table A.5.5.1.7.1-3A: Void**

**Table A.5.5.1.7.1-4: Void**

**Table A.5.5.1.7.1-5: Void**

**Table A.5.5.1.7.1-6: Void**

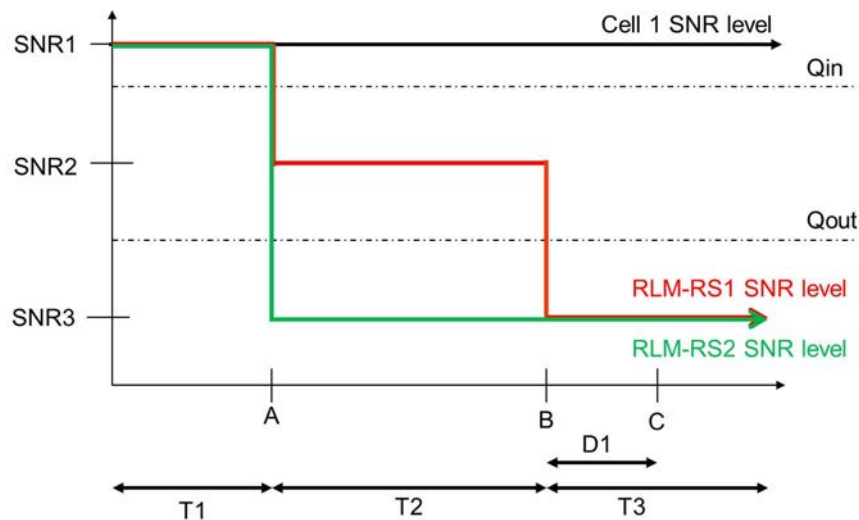

**Figure A.5.5.1.7.1-1: SNR variation for CSI-RS out-of-sync testing**

**A.5.5.1.7.2 Test Requirements**

The UE behaviour during time durations T1, T2, and T3 shall be as follows:

During the period from time point A to time point B the UE shall transmit uplink signal in Cell 2 (PSCell) at least in all uplink slots configured for CSI transmission according to the configured periodic CSI reporting for Cell 2.

The UE shall stop transmitting uplink signal in Cell 2 (PSCell) no later than time point C ( $D_1$  after the start of the time duration T3) on the PSCell.

The rate of correct events observed during repeated tests shall be at least 90%.

### A.5.5.1.8 EN-DC Radio Link Monitoring In-sync Test for FR2 PSCell configured with CSI-RS-based RLM in DRX mode

#### A.5.5.1.8.1 Test Purpose and Environment

The purpose of this test is to verify that the UE properly detects the in sync for the purpose of monitoring downlink CSI-RS based radio link quality of the PSCell when DRX is used. This test will partly verify the FR2 TDD PSCell CSI-RS In-sync radio link monitoring requirements in clause 8.1.

The test parameters are given in Tables A.5.5.1.8.1-1, A.5.5.1.8.1-2, A.5.5.1.8.1-3 and A.5.5.1.8.1-3A below. There are two cells, cell 1 which is the E-UTRAN PCell, and cell 2 is the NR PSCell, in the test. The test consists of five successive time periods, with time duration of T1, T2, T3, T4 and T5 respectively. Figure A.5.5.1.8.1-1 shows the variation of the downlink SNR in the PSCell to emulate out-of-sync and in-sync states. Prior to the start of the time duration T1, the UE shall be fully synchronized to cell 1 and cell 2. The UE shall be configured for periodic CSI reporting with a reporting periodicity of 5ms. In the test, DRX configuration is enabled. The UE is configured to perform inter-frequency measurements using GP ID #0 (40ms). In the test, SSB0 and SSB1 are configured as BFD-RS and are not same as RLM-RS to avoid triggering the beam failure during the RLM test.

**Table A.5.5.1.8.1-1: Supported test configurations for FR2 PSCell**

Configuration	Description
1	LTE FDD, NR 120 kHz SSB SCS, 100 MHz bandwidth, TDD duplex mode
2	LTE TDD, NR 120 kHz SSB SCS, 100 MHz bandwidth, TDD duplex mode
Note: The UE is only required to pass in one of the supported test configurations in FR2	

**Table A.5.5.1.8.1-2: General test parameters for FR2 PSCell for CSI-RS in-sync testing in non-DRX mode**

Parameter		Unit	Value
			Test 1
Active E-UTRA PCell			Cell 1
E-UTRA RF Channel Number			1
Active PSCell			Cell 2
RF Channel Number			2
Duplex Mode			TDD
TDD Configuration	Config 1		TDDConf.3.1
	Config 2		TDDConf.3.1
DL initial BWP configuration	Config 1, 2		DLBWP.0.1
DL dedicated BWP configuration	Config 1, 2		DLBWP.1.1
UL initial BWP configuration	Config 1, 2		ULBWP.0.1
UL dedicated BWP configuration	Config 1, 2		ULBWP.1.1
RMSI CORESET Reference Channel	Config 1		CR.3.1 TDD
	Config 2		CR.3.1 TDD
Dedicated CORESET Reference Channel	Config 1		CCR.3.1 TDD CCR.3.3 TDD
	Config 2		CCR.3.1 TDD CCR.3.3 TDD
SSB Configuration	Config 1		SSB.1 FR2
	Config 2		SSB.1 FR2
SMTc Configuration	Config 1		SMTc.1
	Config 2		SMTc.1

PDSCH/PDCCH subcarrier spacing	Config 1		120 KHz
	Config 2		120 KHz
CSI-RS for RLM	Config 1, 2		Resource #4 in TRS.2.1 TDD Resource #4 in TRS.2.2 TDD
SSB index for BFD-RS	Config 1, 2		0, 1
TRS configuration			TRS.2.1 TDD TRS.2.2 TDD
TCI configuration for PDCCH#1/PDSCH			TCI.State.2
TCI configuration for PDCCH#2			TCI.State.3
OCNG parameters			OP.1
CP length			Normal
Out of sync transmission parameters	DCI format		1-0
	Number of Control OFDM symbols		2
	Aggregation level	CCE	8
	Ratio of hypothetical PDCCH RE energy to average CSI-RS RE energy	dB	4
	Ratio of hypothetical PDCCH DMRS energy to average CSI-RS RE energy	dB	4
	DMRS precoder granularity		REG bundle size
	REG bundle size		6
In sync transmission parameters	DCI format		1-0
	Number of Control OFDM symbols		2
	Aggregation level	CCE	4
	Ratio of hypothetical PDCCH RE energy to average CSI-RS RE energy	dB	0
	Ratio of hypothetical PDCCH DMRS energy to average CSI-RS RE energy	dB	0
	DMRS precoder granularity		REG bundle size
	REG bundle size		6
DRX			DRX.3
Gap pattern ID			<i>gp0</i>
Layer 3 filtering			<i>Enabled</i>
T310 timer		ms	2000
T311 timer		ms	1000
N310			1
N311			1
CSI-RS for CSI reporting	Config 1		CSI-RS.3.1 TDD
	Config 2		CSI-RS.3.1 TDD
reportConfigType			periodic
reportQuantity			cri-RI-PMI-CQI
CSI reporting periodicity		slot	40
CSI reporting offset		slot	4
T1		s	0.2
T2		s	0.2
T3		s	1.64
T4		s	0.2
T5		s	1.88
D1		s	1.84
Note 1: UE-specific PDCCH is not transmitted after T1 starts.			
Note 2: E-UTRAN is in non-DRX mode under test.			



**Table A.5.5.1.8.1-3: Cell specific test parameters for FR2 for CSI-RS in-sync radio link monitoring in DRX mode**

Parameter		Unit	Test 1				
			T1	T2	T3	T4	T5
AoA setup			Setup 1 defined in A.3.15				
Assumption for UE beams <sup>Note 10</sup>			Rough				
EPRE ratio of PDCCH DMRS to SSS		dB	0				
EPRE ratio of PDCCH to PDCCH DMRS		dB	0				
EPRE ratio of PBCH DMRS to SSS		dB					
EPRE ratio of PBCH to PBCH DMRS		dB					
EPRE ratio of PSS to SSS		dB					
EPRE ratio of PDSCH DMRS to SSS		dB					
EPRE ratio of PDSCH to PDSCH DMRS		dB					
EPRE ratio of OCNB DMRS to SSS		dB					
EPRE ratio of OCNB to OCNB DMRS		dB					
SNR on RLM-RS1	Config 1, 2	dB	<sup>2</sup> Note 11	-6 <sup>Note 11</sup>	-15	-4.5	<sup>2</sup> Note 11
SNR on RLM-RS2	Config 1, 2	dB	<sup>2</sup> Note 11	-15	-15	-15	-15
$N_{oc}$	Config 1, 2	dBm/15KHz	-104.7				
Propagation condition			TDL-A 30ns 75Hz				
<p>Note 1: OCNB shall be used such that the resources in Cell 2 are fully allocated and a constant total transmitted power spectral density is achieved for all OFDM symbols.</p> <p>Note 2: The uplink resources for CSI reporting are assigned to the UE prior to the start of time period T1.</p> <p>Note 3: NZP CSI-RS resource set configuration for CSI reporting are assigned to the UE prior to the start of time period T1.</p> <p>Note 4: Measurement gap configuration is assigned to the UE prior to the start of time period T1.</p> <p>Note 5: The timers and layer 3 filtering related parameters are configured prior to the start of time period T1.</p> <p>Note 6: The signal contains PDCCH for UEs other than the device under test as part of OCNB.</p> <p>Note 7: SNR levels correspond to the signal to noise ratio over the SSS REs.</p> <p>Note 8: The SNR in time periods T1, T2, T3, T4 and T5 is denoted as SNR1, SNR2, SNR3, SNR4 and SNR5 respectively in figure A.5.5.1.8.1-1.</p> <p>Note 9: The SNR values are specified for testing a UE which supports 2RX on at least one band. For testing of a UE which supports 4RX on all bands, the SNR during T3 is A.3.6.</p> <p>Note 10: Information about types of UE beam is given in B.2.1.3, and does not limit UE implementation or test system implementation.</p> <p>Note 11: This value allows up to 1dB degradation from applied SNR to UE baseband</p>							

**Table A.5.5.1.8.1-3A: Measurement gap configuration for FR2 CSI-RS in-sync radio link monitoring in DRX mode**

Field	Test 1
	Value
gapOffset	0
<p>Note 1: E-UTRAN PCell and PSCell are SFN-synchronous and frame boundary aligned. (Ensure that RLM RS is partially overlapped with measurement gap)</p>	

Table A.5.5.1.8.1-4: Void

Table A.5.5.1.8.1-5: Void

Table A.5.5.1.8.1-6: Void

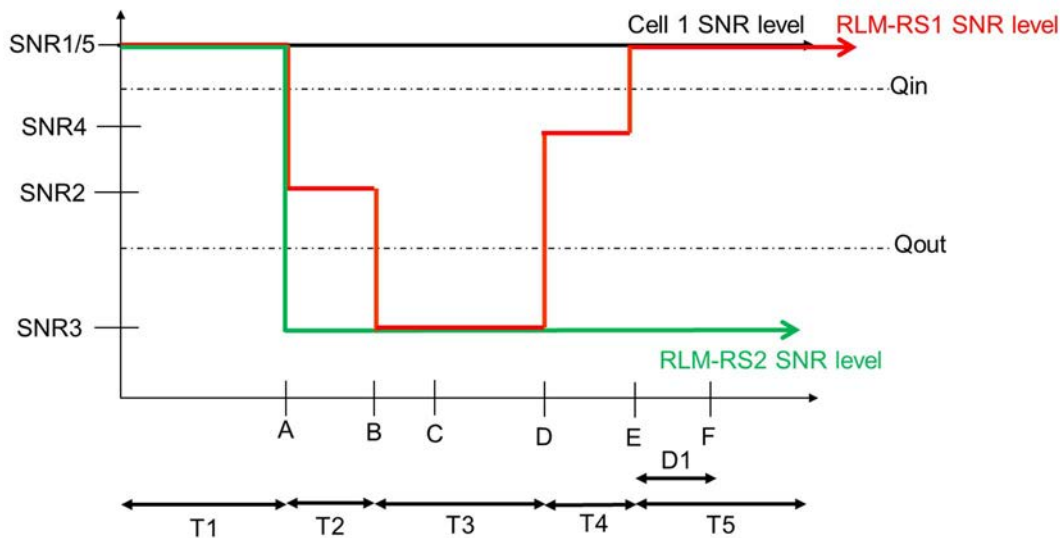

Figure A.5.5.1.8.1-1: SNR variation for CSI-RS in-sync testing

A.5.5.1.8.2 Test Requirements

The UE behaviour in each test during time durations T1, T2, T3, T4 and T5 shall be as follows:

During the period from time point A to time point F (D1 second after the start of time duration T5) the UE shall transmit uplink signal at least in all uplink slots configured for CSI transmission according to the configured periodic CSI reporting on the PSCell.

The rate of correct events observed during repeated tests shall be at least 90%.

A.5.5.1.9 EN-DC Radio Link Monitoring UE Scheduling Restrictions on FR2

A.5.5.1.9.1 Test Purpose and Environment

The purpose is to verify that the NR UE correctly follows the RLM scheduling restrictions requirements defined in clause 8.1.7. This test verifies that the UE correctly receive the PDCCH scheduled on the symbols right before the RLM SSB symbols without overlap so that it sends ACK/NACK correctly. The test case is only applicable to UE which supports pdccch-MonitoringAnyOccasions or pdccch-MonitoringAnyOccasionsWithSpanGap.

Two cells are deployed in the test, which are E-UTRAN PCell (Cell 1) and NR FR2 PSCell (Cell 2). The test parameters for NR PSCell are given in table A.5.5.1.9.1-1, table A.5.5.1.9.1-2 and table A.5.5.1.9.1-3 below and the parameters and applicability for the E-UTRAN cell are defined in A.3.7.2. The UE is required during time period T1 to transmit ACK/NACK correctly upon scheduling of PDSCH.

Table A.5.5.1.9.1-1: Supported test configurations

Configuration	Description
1	FDD LTE, 120 kHz SSB SCS, 120 kHz RMC SCS, 100 MHz bandwidth, TDD duplex mode
2	TDD LTE, 120 kHz SSB SCS, 120 kHz RMC SCS, 100 MHz bandwidth, TDD duplex mode

Note: The UE is only required to be tested in one of the supported test configurations.

**Table A.5.5.1.9.1-2: General test parameters for RLM scheduling restriction test case in FR2**

Parameter	Unit	Test configuration	Value	Comment
RF Channel Number		1, 2	1 and 2	1 for NR PSCell and 2 for LTE PCell
SSB configuration		1, 2	SSB.1 FR2	
SMTC configuration		1, 2	SMTC pattern 1	
DRX cycle length	s	1, 2	OFF	
T1	s	1, 2	5	During T1 the UE is required to correctly transmit ACK/NACK

**Table A.5.5.1.9.1-3: Cell specific test parameters for RLM scheduling restriction test case in FR2**

Parameter	Unit	Test configuration	Cell 2	
			AoA1	AoA2
AoA setup		1, 2	Setup 3 defined in A.3.15.3	
Assumption for UE beams <sup>Note 1</sup>			Rough	Rough
TDD configuration		1, 2	TDDConf.3.1	
$BW_{\text{channel}}$	MHz	1, 2	100: $N_{\text{RB},c} = 66$	
Data RBs allocated		1, 2	24	
PDSCH Reference measurement channel		1, 2	SR.3.2 TDD	Not sent
RMSI CORESET RMC configuration		1, 2	CR.3.1 TDD	Not sent
Dedicated CORESET RMC configuration		1, 2	CCR.3.2 TDD	Not sent
TRS configuration		1, 2	TRS.2.1 TDD	TRS.2.2 TDD
PDCCH/PDSCH TCI state		1, 2	TCI.State.2	Not sent
OCNG Pattern		1, 2	OP.5 defined in A.3.2.1	Not sent
Initial DL BWP configuration		1, 2	DLBWP.0.1	
Initial UL BWP configuration		1, 2	ULBWP.0.1	
RLM-RS		1, 2	SSB with index 0	SSB with index 1
$N_{oc}$	dBm/15kHz	1, 2	-92.1	-92.1
$N_{oc}$ <sup>Note2</sup>	dBm/SCS	1, 2	-83.1	-83.1
$\hat{E}_s / N_{oc}$	dB	1, 2	2	2
$\hat{E}_s / I_{\text{ot BB}}$ <sup>Note 4</sup>	dB	1, 2	1	1
SSB_RP <sup>Note3</sup>	dBm/SCS	1, 2	-81.1	-81.1
$I_o$	dBm/95.04 MHz	1, 2	-54.35	-54.35
Time multiplexing of the downlink transmissions from each AoA		1, 2	Defined in Figure A.5.5.1.9.1-1	
Propagation Condition		1, 2	AWGN	AWGN

Note 1: Information about types of UE beam is given in B.2.1.3, and does not limit UE implementation or test system implementation

Note 2: Interference from other cells and noise sources not specified in the test is assumed to be constant over subcarriers and time and shall be modelled as AWGN of appropriate power for  $N_{oc}$  to be fulfilled.

Note 3: Es/lot, SSB\_RP and lo levels have been derived from other parameters for information purposes. They are not settable parameters themselves.

Note 4: Calculation of Es/lot<sub>BB</sub> includes the effect of UE internal noise up to the value assumed for the associated Refsens requirement in clause 7.3.2 of TS 38.101-2 [19], and an allowance of 1dB for UE multi-band relaxation factor  $\Delta MB_s$  from TS 38.101-2 [19] Table 6.2.1.3-4.

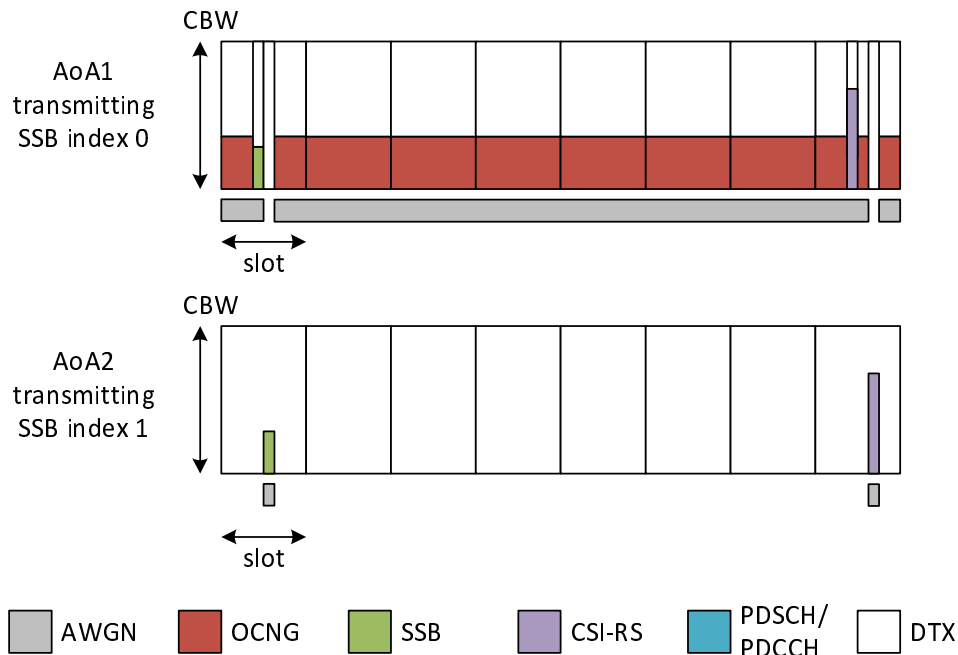

Figure A.5.5.1.9.1-1: Time multiplexed downlink transmissions

### A.5.5.1.9.2 Test Requirements

The UE behaviour follows the requirements defined in clause 8.1.7.3.

## A.5.5.2 Interruption

### A.5.5.2.1 E-UTRAN – NR FR2 interruptions at transitions between active and non-active during DRX in synchronous EN-DC

#### A.5.5.2.1.1 Test Purpose and Environment

The purpose of this test is to verify that when E-UTRA PCell is in DRX and NR PSCell is in non-DRX, NR PSCell interruptions due to transitions from active to non-active and from non-active to active during LTE PCell DRX the UE missed ACK/NACK does not exceed the limits. This test will verify the missed ACK/NACK rate for NR PSCell in EN-DC specified in clause 8. 2.1.2. Supported test configurations are shown in table A.5.5.2.1.1-1.

The general test parameters are given in Table A.5.5.2.1.1-2, and NR cell specific test parameters are given in Table A.5.5.2.1.1-3 and A.5.5.2.1.1-4. The E-UTRAN PCell DRX configuration parameters are given in Table A.5.5.2.1.1-5 below. And the E-UTRAN cell specific test parameters can refer to Table A.3.7.2.2-1. In the test there are two cells: Cell1 and Cell2. Cell1 is LTE PCell on and Cell2 is NR FR2 PSCell. The test consists of one time period, with duration of T1. During T1, NR PSCell is continuously scheduled in DL while LTE PCell is not scheduled and has DRX configured. Prior to the start of the time duration T1, Cell1 shall be configured as LTE PCell and Cell2 shall be

configured as NR PSCell. Prior to start of T1 the DRX inactivity timer for the LTE PCell has already expired. During T1 the UE shall be continuously scheduled on NR PSCell while not scheduled on LTE PCell. PDCCH indicating a new transmission on PSCell shall be sent continuously during the entire time duration to ensure UE would not enter DRX state on PSCell.

**Table A.5.5.2.1.1-1: Interruption at transitions between active and non-active during DRX supported test configurations**

Config	Description
1	LTE FDD, NR 120 kHz SSB SCS, 100 MHz bandwidth, TDD duplex mode
2	LTE TDD, NR 120 kHz SSB SCS, 100 MHz bandwidth, TDD duplex mode

Note: The UE is only required to be tested in one of the supported test configurations

**Table A.5.5.2.1.1-2: General test parameters for E-UTRAN – NR FR2 interruptions at transitions between active and non-active during DRX in synchronous EN-DC**

Parameter	Unit	Value	Comment
RF Channel Number		1, 2	One is E-UTRAN RF channel and the other is NR RF channel
Active PCell		Cell1	PCell on E-UTRAN RF channel number 1.
Configured PSCell		Cell2	PSCell on NR RF channel number 2.
CP length		Normal	Applicable to cell1 and cell 2
DRX		DRX.4	DRX related parameters are defined in Table A.3.3.4-1
Measurement gap pattern Id		OFF	
T1	s	6.25	

**Table A.5.5.2.1.1-3: NR cell specific test parameters for E-UTRAN – NR FR2 interruptions at transitions between active and non-active during DRX in synchronous EN-DC**

Parameter	Unit	Cell 2
Frequency Range		FR2
Duplex mode	Config 1,2	TDD
TDD configuration	Config 1,2	TDDConf.3.1
BW <sub>channel</sub>	Config 1,2	MHz
Data RBs allocated	Config 1,2	100: N <sub>RB,c</sub> = 66
Downlink initial BWP Configuration	Config 1,2	66
Downlink dedicated BWP Configuration	Config 1,2	DLBWP.0.1
Uplink initial BWP configuration	Config 1,2	DLBWP.1.1
Uplink dedicated BWP configuration	Config 1,2	ULBWP.0.1
ULBWP.1.1	Config 1,2	ULBWP.1.1
TRS configuration	Config 1,2	TRS.2.1 TDD
TCI state	Config 1,2	TCI.State.0
PDSCH Reference measurement channel	Config 1,2	SR.3.1 TDD
RMSI CORESET Reference Channel	Config 1,2	CR.3.1 TDD
RMC CORESET Reference Channel	Config 1,2	CCR.3.1 TDD
OCNG Patterns		OP.1
SSB Configuration		SSB.3 FR2
SMTC Configuration	Config 1,2	SMTC.1
EPRE ratio of PSS to SSS	dB	0
EPRE ratio of PBCH DMRS to SSS		
EPRE ratio of PBCH to PBCH DMRS		
EPRE ratio of PDCCH DMRS to SSS		
EPRE ratio of PDCCH to PDCCH DMRS		
EPRE ratio of PDSCH DMRS to SSS		
EPRE ratio of PDSCH to PDSCH		

EPRE ratio of OCNG DMRS to SSS(Note 1)		
EPRE ratio of OCNG to OCNG DMRS (Note 1)		
$\hat{E}_s/N_{oc}$	dB	17
Propagation Condition		AWGN
Time offset to cell1 <sup>Note 2</sup>	$\mu$ s	3
Note 1: OCNG shall be used such that both cells are fully allocated and a constant total transmitted power spectral density is achieved for all OFDM symbols.		
Note 2: Receive time difference of signals received between subframe timing boundary of E-UTRA PCell and slot timing boundary of PSCell including time alignment error between the two cells		

**Table A.5.5.2.1.1-4: NR cell specific OTA related test parameters for E-UTRAN – NR FR2 interruptions at transitions between active and non-active during DRX in synchronous EN-DC**

Parameter	Unit	Cell2
Angle of arrival configuration		Setup 1 according to clause A.3.15.1
Assumption for UE beams <sup>Note 6</sup>		Fine
$N_{oc}$ <sup>Note1</sup>	dBm/15kHz <sup>Note4</sup>	-112
$N_{oc}$ <sup>Note1</sup>	dBm/SCS <sup>Note3</sup>	-102.97
$\hat{E}_s/N_{oc}$	dB	17
SSB_RP <sup>Note2</sup>	dBm/SCS <sup>Note4</sup>	-85.97
$\hat{E}_s/I_{ot}$	dB	17
$I_o$ <sup>Note2</sup>	dBm/95.04 MHz <sup>Note4</sup>	-56.90
<p>Note 1: Interference from other cells and noise sources not specified in the test is assumed to be constant over subcarriers and time and shall be modelled as AWGN of appropriate power for <math>N_{oc}</math> to be fulfilled.</p> <p>Note 2: SSB_RP and <math>I_o</math> levels have been derived from other parameters for information purposes. They are not settable parameters themselves.</p> <p>Note 3: SS-RSRP minimum requirements are specified assuming independent interference and noise at each receiver antenna port.</p> <p>Note 4: Equivalent power received by an antenna with 0dBi gain at the centre of the quiet zone</p> <p>Note 5: As observed with 0dBi gain antenna at the centre of the quiet zone</p> <p>Note 6: Information about types of UE beam is given in B.2.1.3, and does not limit UE implementation or test system implementation</p>		

**Table A.5.5.2.1.1-5: Void**

#### A.5.5.2.1.2 Test Requirements

The UE shall be continuously scheduled in NR PSCell during the entire length of T1. UE shall not be scheduled in LTE PCell during T1. During the time duration T1 the UE shall transmit at least 99% of ACK/NACK on NR PSCell.

Interruption on NR PSCell shall not exceed 0.625ms (5 slots) as defined in clause 8. 2.1.

The rate of correct events observed during repeated tests shall be at least 90%.

## A.5.5.2.2 E-UTRAN – NR FR2 interruptions at transitions between active and non-active during DRX in asynchronous EN-DC

### A.5.5.2.2.1 Test Purpose and Environment

The purpose of this test is to verify that when LTE PCell is in DRX and NR PSCell is in non-DRX, NR PSCell interruptions due to transitions from active to non-active and from non-active to active during LTE PCell DRX the UE missed ACK/NACK does not exceed the limits. This test will verify the missed ACK/NACK rate for NR PSCell in EN-DC specified in clause 8. 2.1.2. Supported test configurations are shown in table A.5.5.2.2.1-1.

The general test parameters are given in Table A.5.5.2.2.1-2, and NR cell specific test parameters are given in Table A.5.5.2.2.1-3 and A.5.5.2.2.1-4. The E-UTRAN PCell DRX configuration parameters are given in Table A.5.5.2.2.1-5 below. And the E-UTRAN cell specific test parameters can refer to Table A.3.7.2.2-1. In the test there are two cells: Cell1 and Cell2. Cell1 is LTE PCell and Cell2 is NR PSCell. The test consists of one time period, with duration of T1. During T1, NR PSCell is continuously scheduled in DL while LTE PCell is not scheduled and has DRX configured. Prior to the start of the time duration T1, Cell1 shall be configured as LTE PCell and Cell2 shall be configured as NR PSCell. Prior to start of T1 the DRX inactivity timer for the LTE PCell has already expired. During T1 the UE shall be continuously scheduled on NR PSCell while not scheduled on LTE PCell. PDCCH indicating a new transmission on PSCell shall be sent continuously during the entire time duration to ensure UE would not enter DRX state on PSCell.

**Table A.5.5.2.2.1-1: Interruption at transitions between active and non-active during DRX supported test configurations**

Config	Description
1	LTE FDD, NR 120 kHz SSB SCS, 100 MHz bandwidth, TDD duplex mode
2	LTE TDD, NR 120 kHz SSB SCS, 100 MHz bandwidth, TDD duplex mode
Note: The UE is only required to be tested in one of the supported test configurations	

**Table A.5.5.2.2.1-2: General test parameters for E-UTRAN – NR FR2 interruptions at transitions between active and non-active during DRX in asynchronous EN-DC**

Parameter	Unit	Value	Comment
RF Channel Number		1, 2	One is E-UTRAN RF channel and the other is NR RF channel
Active PCell		Cell1	PCell on E-UTRAN RF channel number 1.
Configured PSCell		Cell2	PSCell on NR RF channel number 2.
CP length		Normal	Applicable to cell1 and cell 2
DRX		DRX.6	DRX related parameters are defined in Table A.3.3.6-1
Measurement gap pattern Id		OFF	
T1	s	6.25	

**Table A.5.5.2.2.1-3: NR cell specific test parameters for E-UTRAN – NR FR2 interruptions at transitions between active and non-active during DRX in asynchronous EN-DC**

Parameter	Unit	Cell 2
Frequency Range		FR2
Duplex mode	Config 1,2	TDD
TDD configuration	Config 1,2	TDDConf.3.1
BW <sub>channel</sub>	Config 1,2	100: N <sub>RB,c</sub> = 66
Data RBs allocated	Config 1,2	66
Downlink initial BWP Configuration	Config 1,2	DLBWP.0.1
Downlink dedicated BWP Configuration	Config 1,2	DLBWP.1.1
Uplink initial BWP configuration	Config 1,2	ULBWP.0.1
Uplink dedicated BWP configuration	Config 1,2	ULBWP.1.1
TRS configuration	Config 1,2	TRS.2.1 TDD
TCI state	Config 1,2	TCI.State.0

PDSCH Reference measurement channel	Config 1,2		SR.3.1 TDD
RMSI CORESET Reference Channel	Config 1,2		CR.3.1 TDD
RMC CORESET Reference Channel	Config 1,2		CCR.3.1 TDD
OCNG Patterns			OP.1
SSB Configuration			SSB.3 FR2
SMTC Configuration	Config 1,2		SMTC.1
EPRE ratio of PSS to SSS		dB	0
EPRE ratio of PBCH DMRS to SSS			
EPRE ratio of PBCH to PBCH DMRS			
EPRE ratio of PDCCH DMRS to SSS			
EPRE ratio of PDCCH to PDCCH DMRS			
EPRE ratio of PDSCH DMRS to SSS			
EPRE ratio of PDSCH to PDSCH			
EPRE ratio of OCNG DMRS to SSS(Note 1)			
EPRE ratio of OCNG to OCNG DMRS (Note 1)			
$\hat{E}_s/N_{oc}$			
Propagation Condition			AWGN
Time offset to cell1 <sup>Note 2</sup>		$\mu$ s	62.5
<p>Note 1: OCNG shall be used such that both cells are fully allocated and a constant total transmitted power spectral density is achieved for all OFDM symbols.</p> <p>Note 2: Receive time difference of signals received between subframe timing boundary of E-UTRA PCell and slot timing boundary of PSCell including time alignment error between the two cells</p>			

**Table A.5.5.2.2.1-4: NR cell specific OTA related test parameters for E-UTRAN – NR FR2 interruptions at transitions between active and non-active during DRX in asynchronous EN-DC**

Parameter	Unit	Cell2
Angle of arrival configuration		Setup 1 according to clause A.3.15.1
Assumption for UE beams <sup>Note 6</sup>		Fine
$N_{oc}$ <sup>Note1</sup>	dBm/15kHz <sup>Note4</sup>	-112
$N_{oc}$ <sup>Note1</sup>	dBm/SCS <sup>Note3</sup>	-102.97
$\hat{E}_s/N_{oc}$	dB	17
SSB_RP <sup>Note2</sup>	dBm/SCS <sup>Note4</sup>	-85.97
$\hat{E}_s/I_{ot}$	dB	17
$I_o$ <sup>Note2</sup>	dBm/95.04 MHz <sup>Note4</sup>	-56.90
<p>Note 1: Interference from other cells and noise sources not specified in the test is assumed to be constant over subcarriers and time and shall be modelled as AWGN of appropriate power for <math>N_{oc}</math> to be fulfilled.</p> <p>Note 2: SSB_RP and <math>I_o</math> levels have been derived from other parameters for information purposes. They are not settable parameters themselves.</p> <p>Note 3: SS-RSRP minimum requirements are specified assuming independent interference and noise at each receiver antenna port.</p> <p>Note 4: Equivalent power received by an antenna with 0dBi gain at the centre of the quiet zone</p> <p>Note 5: As observed with 0dBi gain antenna at the centre of the quiet zone</p> <p>Note 6: Information about types of UE beam is given in B.2.1.3, and does not limit UE implementation or test system implementation</p>		

**Table A.5.5.2.2.1-5: Void**



### A.5.5.2.2.2 Test Requirements

The UE shall be continuously scheduled in NR PSCell during the entire length of T1. UE shall not be scheduled in LTE PCell during T1. During the time duration T1 the UE shall transmit at least 99% of ACK/NACK on NR PSCell.

Interruption on NR PSCell shall not exceed 0.625ms (5 slots) as defined in clause 8. 2.1.

The rate of correct events observed during repeated tests shall be at least 90%.

### A.5.5.2.3 E-UTRAN – NR FR2 interruptions during measurements on deactivated NR SCC in synchronous EN-DC

#### A.5.5.2.3.1 Test Purpose and Environment

The purpose of this test is to verify that for NR PSCell interruptions during the measurement on the deactivated NR SCC, the UE missed ACK/NACK does not exceed the limits. This test will verify the missed ACK/NACK rate for NR PSCell in EN-DC specified in clause 8. 2.1.2. Supported test configurations are shown in table A.5.5.2.3.1-1.

The general test parameters are given in Table A.5.5.2.3.1-2, and NR cell specific test parameters are given in Table A.5.5.2.3.1-3 and A.5.5.2.3.1-4 below. The E-UTRAN cell specific test parameters can be found in Table A.3.7.2.1-2. In the test there are three cells: Cell1, Cell2 and Cell3. Cell1 is LTE PCell, Cell2 and Cell 3 are NR FR2 PSCell and NR FR2 deactivated SCell, respectively. Cell1 shall be configured as LTE PCell and Cell2 shall be configured as NR PSCell. The test consists of one time period, with duration of T1. Prior to the start of the time duration T1, the UE is connected to Cell1 and Cell2. The point in time at which the RRC message including *measCycleSCell* for the deactivated NR SCells is received by the UE, defines the start of time period T1. During T1, LTE PCell and NR PSCell are continuously scheduled in DL.

**Table A.5.5.2.3.1-1: Interruption during measurements on deactivated NR SCC supported test configurations**

Config	Description
1	LTE FDD, NR 120 kHz SSB SCS, 100 MHz bandwidth, TDD duplex mode
2	LTE TDD, NR 120 kHz SSB SCS, 100 MHz bandwidth, TDD duplex mode

Note: The UE is only required to be tested in one of the supported test configurations

**Table A.5.5.2.3.1-2: General test parameters for E-UTRAN – NR FR2 interruptions during measurements on deactivated NR SCC in synchronous EN-DC**

Parameter	Unit	Value	Comment
RF Channel Number		1, 2, 3	One is E-UTRAN RF channel and the other two are NR RF channels
Active PCell		Cell1	PCell on E-UTRAN RF channel number 1.
Configured PSCell		Cell2	PSCell on NR RF channel number 2.
Configured deactivated SCell		Cell3	Deactivated SCell on NR RF channel number 3.
CP length		Normal	Applicable to cell1, cell 2 and cell3
DRX		OFF	
Measurement gap pattern Id		OFF	
SCell measurement cycle ( <i>measCycleSCell</i> )	Ms	640	
T1	S	10	

**Table A.5.5.2.3.1-3: NR cell specific test parameters for E-UTRAN – NR FR2 interruptions during measurements on deactivated NR SCC in synchronous EN-DC**

Parameter		Unit	Cell 2	Cell 3
Frequency Range			FR2	FR2
Duplex mode	Config 1,2		TDD	TDD
TDD configuration	Config 1,2		TDDConf.3.1	TDDConf.3.1
BW <sub>channel</sub>	Config 1,2	MHz	100: N <sub>RB,c</sub> = 66	100: N <sub>RB,c</sub> = 66
Data RBs allocated	Config 1,2		66	66
Downlink initial BWP Configuration	Config 1,2		DLBWP.0.1	DLBWP.0.1

Downlink dedicated BWP Configuration	Config 1,2		DLBWP.1.1	DLBWP.1.1
Uplink initial BWP configuration	Config 1,2		ULBWP.0.1	ULBWP.0.1
Uplink dedicated BWP configuration	Config 1,2		ULBWP.1.1	ULBWP.1.1
PDSCH Reference measurement channel	Config 1,2		SR.3.1 TDD	-
RMSI CORESET Reference Channel	Config 1,2		CR.3.1 TDD	CR.3.1 TDD
PDCCH CORESET parameters	Config 1,2		CCR 3.1 TDD	CCR 3.1 TDD
OCNG Patterns			OP.1	OP.1
SSB Configuration	Config 1,2		SSB.1 FR2	SSB.1 FR2
SMTC Configuration	Config 1,2		SMTC.1	SMTC.1
TRS configuration	Config 1,2		TRS.2.1 TDD	TRS.2.1 TDD
TCI state	Config 1,2		TCI.State.0	TCI.State.0
EPRE ratio of PSS to SSS		dB	0	0
EPRE ratio of PBCH DMRS to SSS				
EPRE ratio of PBCH to PBCH DMRS				
EPRE ratio of PDCCH DMRS to SSS				
EPRE ratio of PDCCH to PDCCH DMRS				
EPRE ratio of PDSCH DMRS to SSS				
EPRE ratio of PDSCH to PDSCH				
EPRE ratio of OCNG DMRS to SSS(Note 1)				
EPRE ratio of OCNG to OCNG DMRS (Note 1)				
Propagation Condition			AWGN	AWGN
Time offset to cell1 <sup>Note 2</sup>		µs	3	3 + Time offset to cell2
Time offset to cell2 <sup>Note 3</sup>		µs	-	3
<p>Note 1: OCNG shall be used such that both cells are fully allocated and a constant total transmitted power spectral density is achieved for all OFDM symbols.</p> <p>Note 2: Receive time difference of signals received between subframe timing boundary of E-UTRA PCell and slot timing boundary of PSCell including time alignment error between the two cells</p> <p>Note 3: Receive time difference of signals received between slot timing boundary from two NR Cells including time alignment error between the two cells</p>				

**Table A.5.5.2.3.1-4: NR cell specific OTA related test parameters for E-UTRAN – NR FR2 interruptions during measurements on deactivated NR SCC in synchronous EN-DC**

Parameter		Unit	Cell 2	Cell 3
Angle of arrival configuration			Setup 1 defined in clause A.3.15.1	
Assumption for UE beams <sup>Note 6</sup>			Fine	Rough
$N_{oc}$ <sup>Note1</sup>	NR_TDD_FR2_A	dBm/15kHz	-111.7	-104.7
	NR_TDD_FR2_B			
	NR_TDD_FR2_F			
	NR_TDD_FR2_G			
	NR_TDD_FR2_T			
$N_{oc}$ <sup>Note1</sup>	NR_TDD_FR2_Y	dBm/SCS <sup>Note3</sup>	-102.7	-95.7
	NR_TDD_FR2_A			
	NR_TDD_FR2_B			
	NR_TDD_FR2_F			
	NR_TDD_FR2_G			
SSB_RP <sup>Note2</sup>	NR_TDD_FR2_T	dBm/SCS <sup>Note4</sup>	-90.7	-90.7
	NR_TDD_FR2_Y			
	NR_TDD_FR2_A			
	NR_TDD_FR2_B			
	NR_TDD_FR2_F			
$\hat{E}_s / I_{ot}$	NR_TDD_FR2_G	dB	12	5
	NR_TDD_FR2_T			

	NR_TDD_FR2_F			
	NR_TDD_FR2_G			
	NR_TDD_FR2_T			
	NR_TDD_FR2_Y			
$\hat{E}_s/N_{oc}$	NR_TDD_FR2_A	dB	12	5
	NR_TDD_FR2_B			
	NR_TDD_FR2_F			
	NR_TDD_FR2_G			
	NR_TDD_FR2_T			
	NR_TDD_FR2_Y			
$I_o^{Note2}$	NR_TDD_FR2_A	dBm/95.04 MHz Note4	-61.45	-61.45
	NR_TDD_FR2_B			
	NR_TDD_FR2_F			
	NR_TDD_FR2_G			
	NR_TDD_FR2_T			
	NR_TDD_FR2_Y			
<p>Note 1: Interference from other cells and noise sources not specified in the test is assumed to be constant over subcarriers and time and shall be modelled as AWGN of appropriate power for <math>N_{oc}</math> to be fulfilled.</p> <p>Note 2: SSB_RP and <math>I_o</math> levels have been derived from other parameters for information purposes. They are not settable parameters themselves.</p> <p>Note 3: SS-RSRP minimum requirements are specified assuming independent interference and noise at each receiver antenna port.</p> <p>Note 4: Equivalent power received by an antenna with 0dBi gain at the centre of the quiet zone</p> <p>Note 5: As observed with 0dBi gain antenna at the centre of the quiet zone</p> <p>Note 6: Information about types of UE beam is given in B.2.1.3, and does not limit UE implementation or test system implementation</p>				

A.5.5.2.3.2 Test Requirements

The UE shall be continuously scheduled in LTE PCell and NR PSCell during the entire length of T1. During the time duration T1 the UE shall transmit at least 99.5% of ACK/NACK on NR PSCell.

If the NR PSCell is not in the same band as the deactivated SCell, the UE is only allowed to cause interruptions on NR PSCell immediately before and immediately after an SMTC. Each interruption on NR PSCell shall not exceed the value defined in Table A.5.5.2.3.2-1.

If the NR PSCell is in the same band as the deactivated SCell, the UE is only allowed to cause an interruption on PSCell no earlier than 4 slot before an SMTC and no later than 4 slot after the SMTC. the interruption on NR PSCell shall not exceed the value defined in Table A.5.5.2.3.2-2.

**Table A.5.5.2.3.2-1: Interruption duration if the NR PSCell is not in the same band as the deactivated SCell**

$\mu$	NR Slot length (ms)	Interruption length (slot)
3	0.125	4

**Table A.5.5.2.3.2-2: Interruption duration if the NR PSCell is in the same band as the deactivated SCell**

$\mu$	NR Slot length (ms)	Interruption length (slot)
3	0.125	8 + SMTC duration

The rate of correct events observed during repeated tests shall be at least 90%.

#### A.5.5.2.4 E-UTRAN – NR FR2 interruptions during measurements on deactivated NR SCC in asynchronous EN-DC

##### A.5.5.2.4.1 Test Purpose and Environment

The purpose of this test is to verify that for NR PSCell interruptions during the measurement on the deactivated NR SCC, the UE missed ACK/NACK does not exceed the limits. This test will verify the missed ACK/NACK rate for NR PSCell in EN-DC specified in clause 8. 2.1.2. Supported test configurations are shown in table A.5.5.2.4.1-1.

The general test parameters are given in Table A.5.5.2.4.1-2, and NR cell specific test parameters are given in Table A.5.5.2.4.1-3 and A.5.5.2.4.1-4 below. The E-UTRAN cell specific test parameters can be found in Table A.3.7.2.1-2. In the test there are three cells: Cell1, Cell2 and Cell3. Cell1 is LTE PCell, Cell2 and Cell 3 are NR FR2 PSCell and NR FR2 deactivated SCell, respectively. Cell1 shall be configured as LTE PCell and Cell2 shall be configured as NR PSCell. The test consists of one time period, with duration of T1. Prior to the start of the time duration T1, the UE is connected to Cell1 and Cell2. The point in time at which the RRC message including *measCycleSCell* for the deactivated NR SCells is received by the UE, defines the start of time period T1. During T1, LTE PCell and NR PSCell are continuously scheduled in DL.

**Table A.5.5.2.4.1-1: Interruption during measurements on deactivated NR SCC supported test configurations**

Config	Description
1	LTE FDD, NR 120 kHz SSB SCS, 100 MHz bandwidth, TDD duplex mode
2	LTE TDD, NR 120 kHz SSB SCS, 100 MHz bandwidth, TDD duplex mode
Note:	The UE is only required to be tested in one of the supported test configurations

**Table A.5.5.2.4.1-2: General test parameters for E-UTRAN – NR interruptions during measurements on deactivated NR SCC in asynchronous EN-DC**

Parameter	Unit	Value	Comment
RF Channel Number		1, 2, 3	One is E-UTRAN RF channel and the other two are NR RF channels
Active PCell		Cell1	PCell on E-UTRAN RF channel number 1.
Configured PSCell		Cell2	PSCell on NR RF channel number 2.
Configured deactivated SCell		Cell3	Deactivated SCell on NR RF channel number 3.
CP length		Normal	Applicable to cell1, cell 2 and cell3
AoA number		1	Applicable to cell2 and cell3
DRX		OFF	
Measurement gap pattern Id		OFF	
SCell measurement cycle ( <i>measCycleSCell</i> )	ms	640	
T1	s	10	

**Table A.5.5.2.4.1-3: NR cell specific test parameters for E-UTRAN – NR interruptions during measurements on deactivated NR SCC in asynchronous EN-DC**

Parameter		Unit	Cell 2	Cell 3
Frequency Range			FR2	FR2
Duplex mode	Config 1,2		TDD	TDD
TDD configuration	Config 1,2		TDDConf.3.1	TDDConf.3.1
BW <sub>channel</sub>	Config 1,2	MHz	100: N <sub>RB,c</sub> = 66	100: N <sub>RB,c</sub> = 66
Data RBs allocated	Config 1,2		66	66
Downlink initial BWP Configuration	Config 1,2		DLBWP.0.1	
Downlink dedicated BWP Configuration	Config 1,2		DLBWP.1.1	
Uplink initial BWP configuration	Config 1,2		ULBWP.0.1	
Uplink dedicated BWP configuration	Config 1,2		ULBWP.1.1	

PDSCH Reference measurement channel	Config 1,2		SR.3.1 TDD	-
RMSI CORESET Reference Channel	Config 1,2		CR.3.1 TDD	CR.3.1 TDD
PDCCH CORESET parameters	Config 1,2		CCR.3.1 TDD	CCR.3.1 TDD
OCNG Patterns			OP.1	OP.1
SSB Configuration			SSB.1 FR2	SSB.1 FR2
SMTC Configuration	Config 1,2		SMTC.1 FR2	SMTC.1 FR2
TRS configuration	Config 1,2		TRS.2.1 TDD	TRS.2.1 TDD
TCI state	Config 1,2		TCI.State.0	TCI.State.0
EPRE ratio of PSS to SSS		dB	0	0
EPRE ratio of PBCH DMRS to SSS				
EPRE ratio of PBCH to PBCH DMRS				
EPRE ratio of PDCCH DMRS to SSS				
EPRE ratio of PDCCH to PDCCH DMRS				
EPRE ratio of PDSCH DMRS to SSS				
EPRE ratio of PDSCH to PDSCH				
EPRE ratio of OCNG DMRS to SSS(Note 1)				
EPRE ratio of OCNG to OCNG DMRS (Note 1)				
Propagation Condition			AWGN	AWGN
Time offset to cell1 <sup>Note 2</sup>		µs	62.5	62.5+ Time offset to cell2
Time offset to cell2 <sup>Note 3</sup>		µs	-	3
<p>Note 1: OCNG shall be used such that both cells are fully allocated and a constant total transmitted power spectral density is achieved for all OFDM symbols.</p> <p>Note 2: Receive time difference of signals received between subframe timing boundary of E-UTRA PCell and slot timing boundary of PSCell including time alignment error between the two cells</p> <p>Note 3: Receive time difference of signals received between slot timing boundary from two NR Cells including time alignment error between the two cells</p>				

**Table A.5.5.2.4.1-4: NR cell specific OTA related test parameters for E-UTRAN – NR FR2 interruptions during measurements on deactivated NR SCC in asynchronous EN-DC**

Parameter		Unit	Cell 2	Cell 3
Angle of arrival configuration			Setup 1 defined in clause A.3.15.1	
Assumption for UE beams <sup>Note 6</sup>			Fine	Rough
$N_{oc}$ <sup>Note1</sup>	NR_TDD_FR2_A	dBm/15kHz	-111.7	-104.7
	NR_TDD_FR2_B			
	NR_TDD_FR2_F			
	NR_TDD_FR2_G			
	NR_TDD_FR2_T			
	NR_TDD_FR2_Y			
$N_{oc}$ <sup>Note1</sup>	NR_TDD_FR2_A	dBm/SCS <sup>Note3</sup>	-102.7	-95.7
	NR_TDD_FR2_B			
	NR_TDD_FR2_F			
	NR_TDD_FR2_G			
	NR_TDD_FR2_T			
	NR_TDD_FR2_Y			
SSB_RP <sup>Note2</sup>	NR_TDD_FR2_A	dBm/SCS <sup>Note4</sup>	-90.7	-90.7
	NR_TDD_FR2_B			
	NR_TDD_FR2_F			
	NR_TDD_FR2_G			
	NR_TDD_FR2_T			
	NR_TDD_FR2_Y			
$\hat{E}_s/I_{ot}$		dB	12	5
$\hat{E}_s/N_{oc}$		dB	12	5
$I_o$ <sup>Note2</sup>	NR_TDD_FR2_A	dBm/95.04 MHz <sup>Note4</sup>	-61.45	-60.52
	NR_TDD_FR2_B			
	NR_TDD_FR2_F			
	NR_TDD_FR2_G			
	NR_TDD_FR2_T			
	NR_TDD_FR2_Y			

NR_TDD_FR2_Y	
Note 1:	Interference from other cells and noise sources not specified in the test is assumed to be constant over subcarriers and time and shall be modelled as AWGN of appropriate power for $N_{oc}$ to be fulfilled.
Note 2:	SSB_RP and Io levels have been derived from other parameters for information purposes. They are not settable parameters themselves.
Note 3:	SS-RSRP minimum requirements are specified assuming independent interference and noise at each receiver antenna port.
Note 4:	Equivalent power received by an antenna with 0dBi gain at the centre of the quiet zone
Note 5:	As observed with 0dBi gain antenna at the centre of the quiet zone
Note 6:	Information about types of UE beam is given in B.2.1.3, and does not limit UE implementation or test system implementation

**A.5.5.2.4.2 Test Requirements**

The UE shall be continuously scheduled in LTE PCell and NR PSCell during the entire length of T1. During the time duration T1 the UE shall transmit at least 99.5% of ACK/NACK on NR PSCell.

If the NR PSCell is not in the same band as the deactivated SCell, the UE is only allowed to cause interruptions on NR PSCell immediately before and immediately after an SMTC. Each interruption on NR PSCell shall not exceed the value defined in Table A.5.5.2.4.2-1.

If the NR PSCell is in the same band as the deactivated SCell, the UE is only allowed to cause an interruption on PSCell no earlier than 4 slot before an SMTC and no later than 4 slot after the SMTC. the interruption on NR PSCell shall not exceed the value defined in Table A.5.5.2.4.2-2.

**Table A.5.5.2.4.2-1: Interruption duration if the NR PSCell is not in the same band as the deactivated SCell**

$\mu$	NR Slot length (ms)	Interruption length (slot)
3	0.125	4

**Table A.5.5.2.4.2-2: Interruption duration if the NR PSCell is in the same band as the deactivated SCell**

$\mu$	NR Slot length (ms)	Interruption length (slot)
3	0.125	8 + SMTC duration

The rate of correct events observed during repeated tests shall be at least 90%.

**A.5.5.2.5 E-UTRAN – NR FR2 interruptions during measurements on deactivated E-UTRAN SCC in synchronous EN-DC**

**A.5.5.2.5.1 Test Purpose and Environment**

The purpose of this test is to verify that for NR PSCell interruptions during the measurement on the deactivated E-UTRAN SCC, the UE missed ACK/NACK does not exceed the limits. This test will verify the missed ACK/NACK rate for NR PSCell in EN-DC specified in clause 8.2.1.2. Supported test configurations are shown in table A.5.5.2.5.1-1.

The general test parameters are given in Table A.5.5.2.5.1-2, and NR cell specific test parameters are given in Table A.5.5.2.5.1-3 and A.5.5.2.5.1-4 below. The E-UTRAN cell specific test parameters can be found in Table A.3.7.2.1-2. In the test there are three cells: Cell1, Cell2 and Cell3. Cell1 and Cell3 are LTE PCell and LTE deactivated SCell, respectively, and Cell2 is NR FR2 PSCell. Cell1 shall be configured as LTE PCell and Cell2 shall be configured as NR PSCell. The test consists of one time period, with duration of T1. Prior to the start of the time duration T1, the UE is

connected to Cell1 and Cell2. The point in time at which the RRC message including *measCycleSCell* or *allowInterruptions* for the deactivated E-UTRA SCell is received by the UE, defines the start of time period T1. During T1, LTE PCell and NR PSCell are continuously scheduled in DL.

**Table A.5.5.2.5.1-1: Interruption during measurements on deactivated E-UTRAN SCC supported test configurations**

Config	Description
1	LTE FDD, NR 120 kHz SSB SCS, 100 MHz bandwidth, TDD duplex mode
2	LTE TDD, NR 120 kHz SSB SCS, 100 MHz bandwidth, TDD duplex mode

Note: The UE is only required to be tested in one of the supported test configurations

**Table A.5.5.2.5.1-2: General test parameters for E-UTRAN – NR FR2 interruptions during measurements on deactivated E-UTRAN SCC in synchronous EN-DC**

Parameter	Unit	Value	Comment
RF Channel Number		1, 2, 3	One is NR RF channel and two are E-UTRAN RF channels
Active PCell		Cell1	PCell on E-UTRAN RF channel number 1.
Configured PSCell		Cell2	PSCell on NR RF channel number 2.
Configured deactivated SCell		Cell3	Deactivated SCell on E-UTRAN RF channel number 3.
CP length		Normal	Applicable to cell1, cell 2 and cell3
DRX		OFF	
Measurement gap pattern Id		OFF	
SCell measurement cycle ( <i>measCycleSCell</i> )	ms	640	
T1	s	10	

**Table A.5.5.2.5.1-3: NR cell specific test parameters for E-UTRAN – NR FR2 interruptions during measurements on deactivated E-UTRAN SCC in synchronous EN-DC**

Parameter		Unit	Cell 2
Frequency Range			FR2
Duplex mode	Config 1,2		TDD
TDD configuration	Config 1,2		TDDConf.3.1
BW <sub>channel</sub>	Config 1,2	MHz	100: N <sub>RB,c</sub> = 66
Data RBs allocated	Config 1,2		66
Downlink initial BWP Configuration	Config 1,2		DLBWP.0.1
Downlink dedicated BWP Configuration	Config 1,2		DLBWP.1.1
Uplink initial BWP configuration	Config 1,2		ULBWP.0.1
Uplink dedicated BWP configuration	Config 1,2		ULBWP.1.1
PDSCH Reference measurement channel	Config 1,2		SR.3.1 TDD
RMSI CORESET Reference Channel	Config 1,2		CR.3.1 TDD
PDCCH CORESET parameters	Config 1,2		CCR.3.1 TDD
OCNG Patterns			OP.1
SMTc Configuration	Config 1,2		SMTc.1 FR2
SSB Configuration	Config 1,2		SSB.1 FR2
TRS configuration	Config 1,2		TRS.2.1 TDD
TCI state	Config 1,2		TCI.State.0
EPRE ratio of PSS to SSS		dB	0
EPRE ratio of PBCH DMRS to SSS			
EPRE ratio of PBCH to PBCH DMRS			
EPRE ratio of PDCCH DMRS to SSS			
EPRE ratio of PDCCH to PDCCH DMRS			
EPRE ratio of PDSCH DMRS to SSS			

EPRE ratio of PDSCH to PDSCH		
EPRE ratio of OCNG DMRS to SSS(Note 1)		
EPRE ratio of OCNG to OCNG DMRS (Note 1)		
Propagation Condition		AWGN
Time offset to cell1 <sup>Note 2</sup>	μs	3
Note 1: OCNG shall be used such that both cells are fully allocated and a constant total transmitted power spectral density is achieved for all OFDM symbols.		
Note 2: Receive time difference of signals received between subframe timing boundary of E-UTRA PCell and slot timing boundary of PSCell including time alignment error between the two cells		

**Table A.5.5.2.5.1-4: NR cell specific OTA related test parameters for E-UTRAN – NR FR2 interruptions during measurements on deactivated E\_UTRAN SCC in synchronous EN-DC**

Parameter	Unit	Cell2
Angle of arrival configuration		Setup 1 according to clause A.3.15.1
Assumption for UE beams <sup>Note 6</sup>		Fine
$N_{oc}$ <sup>Note1</sup>	dBm/15kHz <sup>Note4</sup>	-112
$N_{oc}$ <sup>Note1</sup>	dBm/SCS <sup>Note3</sup>	-102.97
$\hat{E}_s / N_{oc}$	dB	17
SSB_RP <sup>Note2</sup>	dBm/SCS <sup>Note4</sup>	-85.97
$\hat{E}_s / I_{ot}$	dB	17
$I_o$ <sup>Note2</sup>	dBm/95.04 MHz <sup>Note4</sup>	-56.90
<p>Note 1: Interference from other cells and noise sources not specified in the test is assumed to be constant over subcarriers and time and shall be modelled as AWGN of appropriate power for <math>N_{oc}</math> to be fulfilled.</p> <p>Note 2: SSB_RP and <math>I_o</math> levels have been derived from other parameters for information purposes. They are not settable parameters themselves.</p> <p>Note 3: SS-RSRP minimum requirements are specified assuming independent interference and noise at each receiver antenna port.</p> <p>Note 4: Equivalent power received by an antenna with 0dBi gain at the centre of the quiet zone</p> <p>Note 5: As observed with 0dBi gain antenna at the centre of the quiet zone</p> <p>Note 6: Information about types of UE beam is given in B.2.1.3, and does not limit UE implementation or test system implementation</p>		

**A.5.5.2.5.2 Test Requirements**

The UE shall be continuously scheduled in LTE PCell and NR PSCell during the entire length of T1. During the time duration T1 the UE shall transmit at least 99.5% of ACK/NACK on NR PSCell. The UE is only allowed to cause interruptions immediately before and immediately after an SMTC. Each interruption on NR PSCell shall not exceed the value defined in Table A.5.5.2.5.2-1.

**Table A.5.5.2.5.2-1: Interruption duration if the NR PSCell is not in the same band as the deactivated SCell**

$\mu$	NR Slot length (ms)	Interruption length (slot)
3	0.125	5

**Table A.5.5.2.5.2-2: Void**

The rate of correct events observed during repeated tests shall be at least 90%.



## A.5.5.2.6 E-UTRAN – NR FR2 interruptions during measurements on deactivated E-UTRAN SCC in asynchronous EN-DC

### A.5.5.2.6.1 Test Purpose and Environment

The purpose of this test is to verify that for NR PSCell interruptions during the measurement on the deactivated E-UTRAN SCC, the UE missed ACK/NACK does not exceed the limits. This test will verify the missed ACK/NACK rate for NR PSCell in EN-DC specified in clause 8. 2.1.2. Supported test configurations are shown in table A.5.5.2.6.1-1.

The general test parameters are given in Table A.5.5.2.6.1-2, and NR cell specific test parameters are given in Table A.5.5.2.6.1-3 and A.5.5.2.6.1-4 below. The E-UTRAN cell specific test parameters can be found in Table A.3.7.2.1-2. In the test there are three cells: Cell1, Cell2 and Cell3. Cell1 and Cell3 are LTE PCell and LTE deactivated SCell, respectively, and Cell2 is NR FR2 PSCell. Cell1 shall be configured as LTE PCell and Cell2 shall be configured as NR PSCell. The test consists of one time period, with duration of T1. Prior to the start of the time duration T1, the UE is connected to Cell1 and Cell2. The point in time at which the RRC message including *measCycleSCell* or *allowInterruptions* for the deactivated E-UTRA SCell is received by the UE, defines the start of time period T1. During T1, LTE PCell and NR PSCell are continuously scheduled in DL.

**Table A.5.5.2.6.1-1: Interruption during measurements on deactivated E-UTRAN SCC supported test configurations**

Config	Description
1	LTE FDD, NR 120 kHz SSB SCS, 100 MHz bandwidth, TDD duplex mode
2	LTE TDD, NR 120 kHz SSB SCS, 100 MHz bandwidth, TDD duplex mode

Note: The UE is only required to be tested in one of the supported test configurations

**Table A.5.5.2.6.1-2: General test parameters for E-UTRAN – NR FR2 interruptions during measurements on deactivated E-UTRAN SCC in asynchronous EN-DC**

Parameter	Unit	Value	Comment
RF Channel Number		1, 2, 3	One is NR RF channel and two are E-UTRAN RF channels
Active PCell		Cell1	PCell on E-UTRAN RF channel number 1.
Configured PSCell		Cell2	PSCell on NR RF channel number 2.
Configured deactivated SCell		Cell3	Deactivated SCell on E-UTRAN RF channel number 3.
CP length		Normal	Applicable to cell1, cell 2 and cell3
DRX		OFF	
Measurement gap pattern Id		OFF	
SCell measurement cycle ( <i>measCycleSCell</i> )	ms	640	
T1	s	10	

**Table A.5.5.2.6.1-3: NR cell specific test parameters for E-UTRAN – NR FR2 interruptions during measurements on deactivated E-UTRAN SCC in asynchronous EN-DC**

Parameter		Unit	Cell 2
Frequency Range			FR2
Duplex mode	Config 1,2		TDD
TDD configuration	Config 1,2		TDDConf.3.1
BW <sub>channel</sub>	Config 1,2	MHz	100: N <sub>RB,c</sub> = 66
Data RBs allocated	Config 1,2		66
Downlink initial BWP Configuration	Config 1,2		DLBWP.0.1
Downlink dedicated BWP Configuration	Config 1,2		DLBWP.1.1
Uplink initial BWP configuration	Config 1,2		ULBWP.0.1
Uplink dedicated BWP configuration	Config 1,2		ULBWP.1.1

PDSCH Reference measurement channel	Config 1,2		SR.3.1 TDD
RMSI CORESET Reference Channel	Config 1,2		CR.3.1 TDD
PDCCH CORESET parameters	Config 1,2		CCR.3.1 TDD
OCNG Patterns			OP.1
SMTTC Configuration	Config 1,2		SMTTC.1 FR2
SSB Configuration	Config 1,2		SSB.1 FR2
TRS configuration	Config 1,2		TRS.2.1 TDD
TCI state	Config 1,2		TCI.State.0
EPRE ratio of PSS to SSS		dB	0
EPRE ratio of PBCH DMRS to SSS			
EPRE ratio of PBCH to PBCH DMRS			
EPRE ratio of PDCCH DMRS to SSS			
EPRE ratio of PDCCH to PDCCH DMRS			
EPRE ratio of PDSCH DMRS to SSS			
EPRE ratio of PDSCH to PDSCH			
EPRE ratio of OCNG DMRS to SSS(Note 1)			
EPRE ratio of OCNG to OCNG DMRS (Note 1)			
Propagation Condition			
Time offset to cell1 <sup>Note 2</sup>		µs	62.5
Note 1: OCNG shall be used such that both cells are fully allocated and a constant total transmitted power spectral density is achieved for all OFDM symbols.			
Note 2: Receive time difference of signals received between subframe timing boundary of E-UTRA PCell and slot timing boundary of PSCell including time alignment error between the two cells			

**Table A.5.5.2.6.1-4: NR cell specific OTA related test parameters for E-UTRAN – NR FR2 interruptions during measurements on deactivated E\_UTRAN SCC in asynchronous EN-DC**

Parameter	Unit	Cell2
Angle of arrival configuration		Setup 1 according to clause A.3.15.1
Assumption for UE beams <sup>Note 6</sup>		Fine
$N_{oc}$ <sup>Note1</sup>	dBm/15kHz <sup>Note4</sup>	-112
$N_{oc}$ <sup>Note1</sup>	dBm/SCS <sup>Note3</sup>	-102.97
$\hat{E}_s / N_{oc}$	dB	17
SSB_RP <sup>Note2</sup>	dBm/SCS <sup>Note4</sup>	-85.97
$\hat{E}_s / I_{ot}$	dB	17
$I_o$ <sup>Note2</sup>	dBm/95.04 MHz <sup>Note4</sup>	-56.90
<p>Note 1: Interference from other cells and noise sources not specified in the test is assumed to be constant over subcarriers and time and shall be modelled as AWGN of appropriate power for <math>N_{oc}</math> to be fulfilled.</p> <p>Note 2: SSB_RP and <math>I_o</math> levels have been derived from other parameters for information purposes. They are not settable parameters themselves.</p> <p>Note 3: SS-RSRP minimum requirements are specified assuming independent interference and noise at each receiver antenna port.</p> <p>Note 4: Equivalent power received by an antenna with 0dBi gain at the centre of the quiet zone</p> <p>Note 5: As observed with 0dBi gain antenna at the centre of the quiet zone</p> <p>Note 6: Information about types of UE beam is given in B.2.1.3, and does not limit UE implementation or test system implementation</p>		

**A.5.5.2.6.2 Test Requirements**

The UE shall be continuously scheduled in LTE PCell and NR PSCell during the entire length of T1. During the time duration T1 the UE shall transmit at least 99.5% of ACK/NACK on NR PSCell. The UE is only allowed to cause

interruptions immediately before and immediately after an SMTC. Each interruption on NR PSCell shall not exceed the value defined in Table A.5.5.2.6.2-1.

**Table A.5.5.2.6.2-1: Interruption duration if the NR PSCell is not in the same band as the deactivated SCell**

$\mu$	NR Slot length (ms)	Interruption length (slot)
3	0.125	5

**Table A.5.5.2.6.2-2: Void**

The rate of correct events observed during repeated tests shall be at least 90%.

### A.5.5.2.7 E-UTRAN – NR FR2 interruptions at E-UTRA SRS carrier based switching

#### A.5.5.2.7.1 Test Purpose and Environment

The purpose of this test is to verify that when a UE needs to transmit aperiodic SRS on a PUSCH-less carrier of SCell, the UE can perform carrier based switching to one PUSCH-less SCCs from a CC with PUSCH. The test will verify the interruption requirements on active serving cell in SCG in clause 8.2.1.2.13. Supported test configurations are shown in table A.5.5.2.7.1-1.

In the test there are three cells: cell1, cell2 and cell3. Cell1 is E-UTRAN PCell on the primary component carrier. Cell3 is E-UTRAN SCell on the TDD secondary component carrier which operates in downlink without PUCCH/PUSCH. Cell2 is NR FR2 PSCell. The UE is configured with the SRS switching between E-UTRAN PCell and E-UTRAN SCell. The general test parameters and NR cell specific test parameters are given in Table A.5.5.2.8.1-2, A.5.5.2.8.1-3. And the E-UTRAN cell specific test parameters (for cell1 and cell3) can refer to Table A.3.7.2.1-1. The test consists of two successive time periods, with duration of T1 and T2, respectively. During T1 LTE PCell and NR PSCell are continuously scheduled in DL. Immediately at the beginning of T2, the UE is triggered for SRS switching by DCI 2\_3 scheduling. After T2, the UE is expected to transmit aperiodic SRS on a special slot in the configured TDD UL/DL configuration, as scheduled by DCI 2\_3.

**Table A.5.5.2.7.1-1: E-UTRAN – NR FR2 interruptions at E-UTRA SRS carrier based switching supported test configurations**

Config	Description
1	LTE FDD(cell1), LTE TDD (cell3), NR 120 kHz SSB SCS, 100 MHz bandwidth, TDD duplex mode
2	LTE TDD(cell1), LTE TDD (cell3), NR 120 kHz SSB SCS, 100 MHz bandwidth, TDD duplex mode

Note: The UE is only required to be tested in one of the supported test configurations

**Table A.5.5.2.7.1-2: General test parameters for E-UTRAN – NR FR2 interruptions at E-UTRA SRS carrier based switching**

Parameter	Unit	Value	Comment
RF Channel Number		1, 2, 3	One is NR RF channel and the other two are E-UTRAN RF channels
Active PCell		Cell1	PCell on E-UTRAN RF channel number 1.
Active PSCell		Cell2	PSCell on NR RF channel number 2.
Activated SCell		Cell3	SCell on E-UTRAN RF channel number 3.
CP length		Normal	Applicable to Cell1, Cell2 and Cell3
DRX		OFF	
Measurement gap pattern Id		OFF	
T1	s	0.2	
T2	s	0.2	UE shall perform SRS switching during T2

**Table A.5.5.2.7.1-3: NR cell specific test parameters for E-UTRAN – NR FR2 interruptions at E-UTRA SRS carrier based switching**

Parameter		Unit	Cell 2
Frequency Range			FR2
Duplex mode	Config 1,2		TDD
TDD configuration	Config 1,2		TDDConf.3.1
BW <sub>channel</sub>	Config 1,2	MHz	100: N <sub>RB,c</sub> = 66
Downlink initial BWP Configuration	Config 1,2		DLBWP.0.1
Downlink dedicated BWP Configuration	Config 1,2		DLBWP.1.1
Uplink initial BWP configuration	Config 1,2		ULBWP.0.1
Uplink dedicated BWP configuration	Config 1,2		ULBWP.1.1
TRS configuration	Config 1,2		TRS.2.1 TDD
TCI state	Config 1,2		TCI.State.0
PDSCH Reference measurement channel	Config 1,2		SR.3.1 TDD
RMSI CORESET Reference Channel	Config 1,2		CR.3.1 TDD
RMC CORESET Reference Channel	Config 1,2		CCR.3.1 TDD
OCNG Patterns			OP.1
SSB Configuration			SSB.1 FR2
SMTC Configuration	Config 1,2		SMTC.1
EPRE ratio of PSS to SSS		dB	0
EPRE ratio of PBCH DMRS to SSS			
EPRE ratio of PBCH to PBCH DMRS			
EPRE ratio of PDCCH DMRS to SSS			
EPRE ratio of PDCCH to PDCCH DMRS			
EPRE ratio of PDSCH DMRS to SSS			
EPRE ratio of PDSCH to PDSCH			
EPRE ratio of OCNG DMRS to SSS(Note 1)			
EPRE ratio of OCNG to OCNG DMRS (Note 1)			
$\hat{E}_s/N_{oc}$			
Propagation Condition			AWGN
Time offset to cell1 <sup>Note 2</sup>		ms	3
Note 1: OCNG shall be used such that both cells are fully allocated and a constant total transmitted power spectral density is achieved for all OFDM symbols.			
Note 2: Receive time difference of signals received between subframe timing boundary of E-UTRA PCell and slot timing boundary of PSCell including time alignment error between the two cells			

**Table A.5.5.2.7.1-4: NR cell specific OTA related test parameters for E-UTRAN – NR FR2 interruptions at transitions between active and non-active during DRX in asynchronous EN-DC**

Parameter	Unit	Cell2
Angle of arrival configuration		Setup 1 according to clause A.3.15.1
Assumption for UE beams <sup>Note 6</sup>		Fine
$N_{oc}$ <sup>Note1</sup>	$\text{dBm}/15\text{kHz}$ <sup>Note4</sup>	-112
$N_{oc}$ <sup>Note1</sup>	$\text{dBm}/\text{SCS}$ <sup>Note3</sup>	-102.97
$\hat{E}_s/N_{oc}$	dB	17
SS-RSRP <sup>Note2</sup>	$\text{dBm}/\text{SCS}$ <sup>Note4</sup>	-85.97
$\hat{E}_s/I_{ot}$	dB	17
$I_o$ <sup>Note2</sup>	$\text{dBm}/95.04\text{ MHz}$ <sup>Note4</sup>	-56.90

Note 1:	Interference from other cells and noise sources not specified in the test is assumed to be constant over subcarriers and time and shall be modelled as AWGN of appropriate power for $N_{oc}$ to be fulfilled.
Note 2:	SS-RSRP and Io levels have been derived from other parameters for information purposes. They are not settable parameters themselves.
Note 3:	SS-RSRP minimum requirements are specified assuming independent interference and noise at each receiver antenna port.
Note 4:	Equivalent power received by an antenna with 0dBi gain at the centre of the quiet zone
Note 5:	As observed with 0dBi gain antenna at the centre of the quiet zone
Note 6:	Information about types of UE beam is given in B.2.1.3, and does not limit UE implementation or test system implementation

**Table A.5.5.2.7.1-5: Sounding Reference Symbol Configuration for E-UTRAN – NR FR2 interruptions at E-UTRA SRS carrier based switching**

Field	Value	Comment
srsBandwidthConfiguration	bw5	
srsSubframeConfiguration	Sc8	Once every 5 subframes
ackNackSrsSimultaneousTransmission	FALSE	
srsMaxUpPTS	N/A	Not applicable
srsBandwidth	0	No hopping
srsHoppingBandwidth	hbw0	
frequencyDomainPosition	0	
Duration	TRUE	Indefinite duration
Srs-ConfigIndexAp	17	SRS periodicity of 10ms. See Table 8.2-5 in TS 36.213 for aperiodic SRS transmission.
transmissionComb	0	
cyclicShift	cs0	No cyclic shift
SRS-AntennaPort	an1	Number of antenna ports used for SRS transmission
Note:	For further information see clause 6.3.2 in TS 36.331.	

#### A.5.5.2.7.2 Test Requirements

The UE shall be continuously scheduled in NR FR2 PSCell throughout the test. During T2 two interruption time periods are allowed on Cell2 and Cell1, each interruption due to SRS carrier based switching on Cell2 shall not exceed X defined in Table A.5.5.2.7.2-1.

**Table A.5.5.2.7.2-1: Interruption length X (slot) E-UTRAN – NR at E-UTRA SRS carrier based switching**

$\mu$	NR Slot length (ms)	Interruption length X (slots)
2	0.25	5
3	0.125	9

The rate of correct events observed during repeated tests shall be at least 90%.

#### A.5.5.2.8 E-UTRAN – NR FR2 interruptions at NR SRS carrier based switching

##### A.5.5.2.8.1 Test Purpose and Environment

The purpose of the test is to verify interruptions at NR SRS carrier based switching requirements defined in TS38.133 clause 8.2.1.2.12 and TS36.133 clause 7.32.2.13. The general test parameters are given in Table A.5.5.2.8.1-2, and NR cell specific test parameters are given in Table A.5.5.2.8.1-3. And the E-UTRAN cell specific test parameters can refer to Table A.3.7.2.2-1.

In the test there are three cells: Cell1, Cell2 and Cell3. Cell1 is LTE PCell, Cell2 is NR FR2 PSCell and Cell3 is NR FR2 SCell. Cell3 is not configured with PUCCH/PUSCH transmission. The test consists of two time periods, with duration of T1 and T2, respectively. During T1 and T2, Cell1, Cell2 and Cell3 are continuously scheduled in DL. Prior

to the start of the time duration T1, Cell1 shall be configured as LTE PCell, Cell2 shall be configured as NR PSCell and Cell3 shall be configured as NR SCell.

At the beginning of T2, the UE is triggered for SRS switching by DCI 2\_3 scheduling. After T2, the UE is expected to transmit aperiodic SRS on a special slot in the configured TDD UL/DL configuration, as scheduled by DCI 2\_3. TE shall trigger aperiodic SRS transmission on Cell3.

**Table A.5.5.2.8.1-1: Interruption at transitions between active and non-active during DRX supported test configurations**

Config	Description
1	LTE FDD, NR 120 kHz SSB SCS, 100 MHz bandwidth, TDD duplex mode
2	LTE TDD, NR 120 kHz SSB SCS, 100 MHz bandwidth, TDD duplex mode
Note: The UE is only required to be tested in one of the supported test configurations	

**Table A.5.5.2.8.1-2: General test parameters for E-UTRAN – NR FR2 interruptions at transitions between active and non-active during DRX in asynchronous EN-DC**

Parameter	Unit	Value	Comment
RF Channel Number		1, 2	One is E-UTRAN RF channel and the other is NR RF channel
Active PCell		Cell1	PCell on E-UTRAN RF channel number 1.
Configured PSCell		Cell2	PSCell on NR RF channel number 2.
Configured SCell		Cell3	SCell on NR RF channel number 3.
CP length		Normal	Applicable to cell1 and cell 2
DRX		OFF	
Measurement gap pattern Id		OFF	
T1	s	5	
T2	s	0.1	

**Table A.5.5.2.8.1-3: NR cell specific test parameters for E-UTRAN – NR FR2 interruptions at transitions between active and non-active during DRX in asynchronous EN-DC**

Parameter		Unit	Cell 2	Cell 3
Frequency Range			FR2	
Duplex mode	Config 1,2		TDD	
TDD configuration	Config 1,2		TDDConf.3.1	
BW <sub>channel</sub>	Config 1,2	MHz	100: N <sub>RB,c</sub> = 66	
Downlink initial BWP Configuration	Config 1,2		DLBWP.0.1	
Downlink dedicated BWP Configuration	Config 1,2		DLBWP.1.1	
Uplink initial BWP configuration	Config 1,2		ULBWP.0.1	
Uplink dedicated BWP configuration	Config 1,2		ULBWP.1.1	
TRS configuration	Config 1,2		TRS.2.1 TDD	
SRS configuration	Config 1,2		SRS.6 TDD	
TCI state	Config 1,2		TCI.State.0	
PDSCH Reference measurement channel	Config 1,2		SR.3.1 TDD	
RMSI CORESET Reference Channel	Config 1,2		CR.3.1 TDD	
RMC CORESET Reference Channel	Config 1,2		CCR.3.1 TDD	
OCNG Patterns			OP.1	
SSB Configuration			SSB.1 FR2	
SMTC Configuration	Config 1,2		SMTC.1	
EPRE ratio of PSS to SSS		dB	0	
EPRE ratio of PBCH DMRS to SSS				
EPRE ratio of PBCH to PBCH DMRS				
EPRE ratio of PDCCH DMRS to SSS				
EPRE ratio of PDCCH to PDCCH DMRS				

EPRE ratio of PDSCH DMRS to SSS		
EPRE ratio of PDSCH to PDSCH		
EPRE ratio of OCNG DMRS to SSS(Note 1)		
EPRE ratio of OCNG to OCNG DMRS (Note 1)		
$\hat{E}_s/N_{oc}$	dB	17
Propagation Condition		AWGN
Time offset to cell1 <sup>Note 2</sup>	$\mu$ s	33
Note 1: OCNG shall be used such that both cells are fully allocated and a constant total transmitted power spectral density is achieved for all OFDM symbols.		
Note 2: Receive time difference of signals received between subframe timing boundary of E-UTRA PCell and slot timing boundary of PSCell including time alignment error between the two cells		

**Table A.5.5.2.8.1-3A: OTA related test parameters**

Parameter	Unit	Test 1	
		T1	T2
Angle of arrival configuration		Setup 1 according to clause A.3.15.1	
Assumption for UE beams <sup>Note 6</sup>		Fine	
$N_{oc}$ <sup>Note1</sup>	dBm/15kHz <sup>Note4</sup>	-112	
$N_{oc}$ <sup>Note1</sup>	dBm/SCS <sup>Note3</sup>	-103	
$\hat{E}_s/N_{oc}$	dB	4	
SS-RSRP <sup>Note2</sup>	dBm/SCS <sup>Note4</sup>	-99	
$\hat{E}_s/I_{ot}$	dB	4	
$I_o$ <sup>Note2</sup>	dBm/95.04 MHz <sup>Note4</sup>	-68.5	
<p>Note 1: Interference from other cells and noise sources not specified in the test is assumed to be constant over subcarriers and time and shall be modelled as AWGN of appropriate power for <math>N_{oc}</math> to be fulfilled.</p> <p>Note 2: SS-RSRP and <math>I_o</math> levels have been derived from other parameters for information purposes. They are not settable parameters themselves.</p> <p>Note 3: SS-RSRP minimum requirements are specified assuming independent interference and noise at each receiver antenna port.</p> <p>Note 4: Equivalent power received by an antenna with 0dBi gain at the centre of the quiet zone</p> <p>Note 5: As observed with 0dBi gain antenna at the centre of the quiet zone</p> <p>Note 6: Information about types of UE beam is given in B.2.1.3, and does not limit UE implementation or test system implementation</p>			

**Table A.5.5.2.8.1-4: Void**

### A.5.5.2.8.3 Test Requirements

In T2 UE shall transmit SRS on Cell3 as requested. During T2 interruption on Cell2 due to SRS carrier based switching from Cell2 to Cell3 shall not exceed the requirements defined in TS38.133 clause 8.2.1.2.12.

The rate of correct events observed during repeated tests shall be at least 90%.

## A.5.5.3 SCell Activation and Deactivation Delay

### A.5.5.3.1 SCell Activation and deactivation of SCell in FR2 intra-band

#### A.5.5.3.1.1 Test Purpose and Environment

The purpose of this test case is the same as for the test defined in clause A.4.5.3.1.1 except the SCell is in FR2 intra-band.

The supported test configurations are shown in table A.5.5.3.1.1-1 below. The general and cell specific test parameters are the same except those described in the following clause. The listed parameter values in Tables A.5.5.3.1.1-2 and A.5.5.3.1.1-3 will replace the values of corresponding parameters in Tables A.4.5.3.1.1-2 and A.4.5.3.1.1-3. In this case, OTA related test parameters are shown in table A.5.5.3.1.1-4 below.

In this test it is assumed that the UE is receiving RRC messages pertaining to the SCell in SCG via signaling on SRB3.

**Table A.5.5.3.1.1-1: Supported test configurations for FR2 SCell activation case with FR2 PSCell**

Configuration	Description
1	FDD LTE PCell, Cell 2&3 120 kHz SSB SCS, 100 MHz bandwidth, TDD duplex mode
2	TDD LTE PCell, Cell 2&3 120 kHz SSB SCS, 100 MHz bandwidth, TDD duplex mode

Note: The UE is only required to pass in one of the supported test configurations

**Table A.5.5.3.1.1-2: General test parameters for FR2 SCell activation case with FR2 PSCell**

Parameter	Unit	Value	Comment
Active PCell		Cell 1	Primary cell on E-UTRAN RF channel number 1. As specified in clause A.3.7.2.2

**Table A.5.5.3.1.1-3: Cell specific test parameters for FR2 SCell activation case with FR2 PSCell**

Parameter <sup>Note 5</sup>	Unit	Cell 2			Cell 3		
		T1	T2	T3	T1	T2	T3
SSB ARFCN		freq1			freq2		
Duplex mode		TDD			TDD		
TDD configuration		TDDConf.3.1			TDDConf.3.1		
BW <sub>channel</sub>	MHz	100: N <sub>RB,c</sub> = 66			100: N <sub>RB,c</sub> = 66		
Data RBs allocated		66			66		
PDSCH Reference measurement channel		SR.3.1 TDD			SR.3.1 TDD		
RMSI CORESET Reference Channel		CR.3.1 TDD			CR.3.1 TDD		
RMC CORESET Reference Channel		CCR.3.1 TDD			CCR.3.1 TDD		
DL initial BWP configuration		DLBWP.0.1					
DL dedicated BWP configuration		DLBWP.1.1					
UL initial BWP configuration		ULBWP.0.1					
UL dedicated BWP configuration		ULBWP.1.1					
OCNG Patterns		OP.1					
SMTTC configuration		SMTTC.1					
SSB configuration		SSB.1 FR2					
TCI state		TCI.State.0					
TRS configuration		TRS.2.1 TDD					
CSI-RS configuration for CSI reporting		CSI-RS.3.1 TDD					
reportConfigType		periodic			N/A		
reportQuantity		cri-RI-PMI-CQI			N/A		
CSI reporting periodicity	slot	40			N/A		
CSI reporting offset	slot	4			N/A		
PDSCH/PDCCH subcarrier spacing	kHz	120					
EPRE ratio of PSS to SSS	dB	0					
EPRE ratio of PBCH_DMRS to SSS							
EPRE ratio of PBCH to PBCH_DMRS							
EPRE ratio of PDCCH_DMRS to SSS							



EPRE ratio of PDCCH to PDCCH_DMRS	
EPRE ratio of PDSCH_DMRS to SSS	
EPRE ratio of PDSCH to PDSCH_DMRS	
EPRE ratio of OCNG DMRS to SSS <sup>Note 1</sup>	
EPRE ratio of OCNG to OCNG DMRS <sup>Note 1</sup>	
Propagation conditions	AWGN
<p>Note 1: OCNG shall be used such that both cells are fully allocated and a constant total transmitted power spectral density is achieved for all OFDM symbols.</p> <p>Note 2: Void</p> <p>Note 3: Void</p> <p>Note 4: Void</p> <p>Note 5: All parameters apply for configuration 1 and 2.</p>	

**Table A.5.5.3.1.1-4: OTA related test parameters for FR2 SCell activation case with FR2 PSCell**

Parameter <sup>Note 6</sup>	Unit	Cell 2			Cell 3		
		T1	T2	T3	T1	T2	T3
Angle of arrival configuration		Setup 1 according to A.3.15.1					
Assumption for UE beams <sup>Note 7</sup>		Rough			Rough		
$N_{oc}$ <sup>Note1</sup>	dBm/15kHz <sup>Note4</sup>	-104.7			-104.7		
$N_{oc}$ <sup>Note1</sup>	dBm/SCS <sup>Note3</sup>	-95.7			-95.7		
$\hat{E}_s / N_{oc}$	dB	7			7		
SSB_RP <sup>Note2</sup>	dBm/SCS <sup>Note4</sup>	-88.7			-88.7		
$\hat{E}_s / I_{ot}$	dB	7			7		
$I_o$ <sup>Note2</sup>	dBm/95.04 MHz <sup>Note4</sup>	-58.92			-58.92		
<p>Note 1: Interference from other cells and noise sources not specified in the test is assumed to be constant over subcarriers and time and shall be modelled as AWGN of appropriate power for <math>N_{oc}</math> to be fulfilled.</p> <p>Note 2: <math>E_s/I_{ot}</math>, SSB_RP and <math>I_o</math> levels have been derived from other parameters for information purposes. They are not settable parameters themselves.</p> <p>Note 3: Void</p> <p>Note 4: Equivalent power received by an antenna with 0dBi gain at the centre of the quiet zone</p> <p>Note 5: Void</p> <p>Note 6: All parameters apply for configuration 1 and 2</p> <p>Note 7: Information about types of UE beam is given in B.2.1.3, and does not limit UE implementation or test system implementation</p>							

**A.5.5.3.1.2 Test Requirements**

The test requirements defined in clause A.4.5.3.1.2 shall apply to this test case, with the following exception:

- Placement of interruptions is only verified in NR PSCell.

**A.5.5.3.2 SCell Activation and deactivation of known SCell in FR1 for 160ms SCell measurement cycle**

**A.5.5.3.2.1 Test Purpose and Environment**

The purpose of this test case is the same as for the test defined in clause A.4.5.3.1.1, except PSCell is in FR2.

The supported test configurations are shown in table A.5.5.3.2.1-1 below. The general test parameters are the same in Tables A.4.5.3.1.1-2. The cell specific test parameters are given in Tables A.5.5.3.2.1-2. In this case, OTA related test parameters are the same as in table A.5.5.3.2.1-3.

**Table A.5.5.3.2.1-1: Supported test configurations for FR1 SCell activation case with PSCell is FR2**

Configuration	Description
---------------	-------------

1	FDD LTE PCell, Cell 2 NR 120 kHz SSB SCS, 100 MHz bandwidth, TDD duplex mode Cell 3 NR 15 kHz SSB SCS, 10 MHz bandwidth, FDD duplex mode
2	FDD LTE PCell, Cell 2 NR 120 kHz SSB SCS, 100 MHz bandwidth, TDD duplex mode Cell 3 NR 15 kHz SSB SCS, 10 MHz bandwidth, TDD duplex mode
3	FDD LTE PCell, Cell 2 NR 120 kHz SSB SCS, 100 MHz bandwidth, TDD duplex mode Cell 3 NR 30 kHz SSB SCS, 40 MHz bandwidth, TDD duplex mode
4	TDD LTE PCell, Cell 2 NR 120 kHz SSB SCS, 100 MHz bandwidth, TDD duplex mode Cell 3 NR 15 kHz SSB SCS, 10 MHz bandwidth, FDD duplex mode
5	TDD LTE PCell, Cell 2 NR 120 kHz SSB SCS, 100 MHz bandwidth, TDD duplex mode Cell 3 NR 15 kHz SSB SCS, 10 MHz bandwidth, TDD duplex mode
6	TDD LTE PCell, Cell 2 NR 120 kHz SSB SCS, 100 MHz bandwidth, TDD duplex mode Cell 3 NR 30 kHz SSB SCS, 40 MHz bandwidth, TDD duplex mode
Note: The UE is only required to pass in one of the supported test configurations	

Table A.5.5.3.2.1-2: Cell specific test parameters for FR1 SCell activation case with FR2 PSCell

Parameter		Unit	Cell 2			Cell 3		
			T1	T2	T3	T1	T2	T3
SSB ARFCN			freq2			freq1		
Duplex mode	Config 1,4		TDD			FDD		
	Config 2,3,5,6		TDD			TDD		
TDD configuration	Config 1,4		TDDConf.3.1			Not Applicable		
	Config 2,5					TDDConf.1.1		
	Config 3,6					TDDConf.2.1		
BW <sub>channel</sub>	Config 1,4	MHz	100: N <sub>RB,c</sub> = 66			10: N <sub>RB,c</sub> = 52		
	Config 2,5					10: N <sub>RB,c</sub> = 52		
	Config 3,6					40: N <sub>RB,c</sub> = 106		
Data RBs allocated	Config 1,4		66			52		
	Config 2,5					52		
	Config 3,6					106		
DL initial BWP configuration	Config 1,2,3,4,5,6		DLBWP.0.1					
DL dedicated BWP configuration	Config 1,2,3,4,5,6		DLBWP.1.1					
UL initial BWP configuration	Config 1,2,3,4,5,6		ULBWP.0.1					
UL dedicated BWP configuration	Config 1,2,3,4,5,6		ULBWP.1.1					
DRX Cycle		ms	Not Applicable					
PDSCH Reference measurement channel	Config 1,4		SR.3.1 TDD			SR.1.1 FDD		
	Config 2,5					SR.1.1 TDD		
	Config 3,6					SR.2.1 TDD		
RMSI CORESET Reference Channel	Config 1,4		CR.3.1 TDD			CR.1.1 FDD		
	Config 2,5					CR.1.1 TDD		
	Config 3,6					CR.2.1 TDD		
RMC CORESET Reference Channel	Config 1,4		CCR.3.1 TDD			CCR.1.1 FDD		
	Config 2,5					CCR.1.1 TDD		
	Config 3,6					CCR.2.1 TDD		
OCNG Patterns			OP.1					
SMTC configuration			SMTC.1					
TCI state			TCI.State.0			NA		
TRS configuration	Config 1,4		TRS.2.1 TDD			TRS.1.1 FDD		
	Config 2,5					TRS.1.1 TDD		
	Config 3,6					TRS.1.2 TDD		
SSB configuration	Config 1,2,4,5		SSB.1 FR2			SSB.1 FR1		
	Config 3,6					SSB.2 FR1		
CSI-RS configuration for CSI reporting	Config 1,4		CSI-RS.3.1 TDD			CSI-RS.1.1 FDD		
	Config 2,5					CSI-RS.1.1 TDD		
	Config 3,6					CSI-RS.2.1 TDD		
PDSCH/PDCCH subcarrier spacing	Config 1,2,4,5	kHz	120kHz			15kHz		
	Config 3,6					30kHz		
reportConfigType	Config 1-6		periodic			N/A		
reportQuantity	Config 1-6		cri-RI-PMI-CQI			N/A		

CSI reporting periodicity	Config 1,2,3,4,5,6	slot	40	N/A
CSI reporting offset	Config 1,2,3,4,5,6	slot	4	N/A
EPRE ratio of PSS to SSS		dB	0	
EPRE ratio of PBCH DMRS to SSS				
EPRE ratio of PBCH to PBCH DMRS				
EPRE ratio of PDCCH DMRS to SSS				
EPRE ratio of PDCCH to PDCCH DMRS				
EPRE ratio of PDSCH DMRS to SSS				
EPRE ratio of PDSCH to PDSCH				
EPRE ratio of OCNG DMRS to SSS(Note 1)				
EPRE ratio of OCNG to OCNG DMRS (Note 1)				
Propagation condition			AWGN	NA Link only, see clause A.3.7A
<p>Note 1: OCNG shall be used such that both cells are fully allocated and a constant total transmitted power spectral density is achieved for all OFDM symbols.</p> <p>Note 2: Void</p> <p>Note 3: Void</p> <p>Note 4: The uplink resources for CSI reporting are assigned to the UE prior to the start of time period T2.]</p>				

**Table A.5.5.3.2.1-3: OTA related test parameters for FR1 SCell activation case with FR2 PSCell**

Parameter	Unit	Cell 2			Cell 3		
		T1	T2	T3	T1	T2	T3
Angle of arrival configuration		Setup 1 according to clause A.3.15.1			NA Link only, see clause A.3.7A		
Assumption for UE beams <sup>Note 7</sup>		Rough					
$N_{oc}$ <sup>Note1</sup>	dBm/15kHz	-104.7					
$N_{oc}$ <sup>Note1</sup>	Config 1,2,4,5	-95.7					
	Config 3,6						
SSB_RP <sup>Note2</sup>	Config 1,2,4,5	-88.7					
	Config 3,6						
$\hat{E}_s / N_{oc}$	dB	7					
$\hat{E}_s / I_{ot}$	dB	7					
$I_o$ <sup>Note2</sup>	Config 1,2,4,5	-58.92					
	Config 3,6						

Note 1: Interference from other cells and noise sources not specified in the test is assumed to be constant over subcarriers and time and shall be modelled as AWGN of appropriate power for  $N_{oc}$  to be fulfilled.

Note 2:  $E_s/I_{ot}$ , SSB\_RP and  $I_o$  levels have been derived from other parameters for information purposes. They are not settable parameters themselves.

Note 3: Void

Note 4: Equivalent power received by an antenna with 0dBi gain at the centre of the quiet zone

Note 5: Void

Note 6: ChBW is 94.04 MHz for Cell2, 9.36 MHz for Cell 3 in configurations 1,2,4,5, 38.1 MHz in configurations 3,6

Note 7: Information about types of UE beam is given in B.2.1.3, and does not limit UE implementation or test system implementation

**A.5.5.3.2.2 Test Requirements**

The test requirements defined in clause A.4.5.3.1.2 shall apply to this test case.

A.5.5.3.3 Void

A.5.5.3.4 Void

A.5.5.3.5 SCell Activation and deactivation of SCell in FR2

A.5.5.3.5.1 Test Purpose and Environment

The purpose of this test is to verify that the SCell activation and deactivation times are within the requirements stated in clause 8.3, when the SCell is in FR2.

The supported test configurations are shown in table A.5.5.3.5.1-1 below. The test parameters are the same as in clause A.4.5.3.3.1 except those described in the following clause. The listed parameter values in Tables A.5.5.3.5.1-2 will replace the values of corresponding parameters in Tables A.4.5.3.3.1-2. The listed parameter values in Tables A.5.5.3.5.1-3 will replace the values of corresponding parameters in Tables A.4.5.3.3.1-3. In this case, OTA related test parameters are shown in table A.5.5.3.5.1-4 below.

The test consists of three successive time periods, with duration of T1, T2 and T3, respectively. There are three carriers, E-UTRA has one cell (Cell 1), NR has two cells, PSCell (Cell 2) in FR1 and SCell (Cell 3) in FR2. Cell 1 and Cell 2 have constant signal levels throughout the test. Before the test starts the UE is connected to Cell 1 (PCell) on E-UTRAN and Cell 2 (PSCell) on NR, but is not aware of Cell 3 (SCell) on NR. The UE is monitoring the PCell and PSCell. The UE shall be continuously scheduled in the PCell and PSCell throughout the whole test.

At the beginning of T1 the UE receives an RRC message by which the SCell (Cell 3) becomes configured on NR. During T1 the SCell is powered off and UE is not aware of SCell.

A MAC message for activation of SCell is sent by the test equipment 100ms after the RRC message, in a slot # denoted m. The point in time at which the MAC message for activation of SCell is received at the UE antenna connector defines the start of time period T2.

During T2, the test equipment monitors the L1-RSRP measurement reporting for the SCell. The time when test equipment receives a valid L1-RSRP report is denoted as slot  $m+T_{L1-RSRP}$ . In the next DL slot after slot  $m+T_{L1-RSRP}$ , the test equipment sends a MAC message for the activation of the TCI state of the RMC CORESET of the SCell. In the same slot, the test equipment also sends an RRC message to configure the CSI-RS resources for SCell.

Time period T3 starts when a MAC message for deactivation of the SCell, sent from the test equipment to the UE in a slot # denoted n, is received at the UE antenna connector.

The test equipment verifies that potential interruption is carried out in the correct time span by monitoring ACK/NACK sent in PCell and PSCell during activation of SCell, respectively.

The test equipment verifies the activation time by counting the slots from the time when the SCell activation command is sent until a CSI report with other than CQI index 0 is received.

The test equipment verifies the deactivation time by counting the slots from the time when the SCell1 deactivation command is sent until CSI reporting for SCell1 is discontinued.

**Table A.5.5.3.5.1-1: FR2 SCell activation in non-DRX test configurations with FR1 PSCell**

Configuration	Description
1	LTE FDD PCell, Cell 2 NR 15 kHz SSB SCS, 10 MHz bandwidth, FDD duplex mode Cell 3 NR 120 kHz SSB SCS, 100 MHz bandwidth, TDD duplex mode
2	LTE FDD PCell, Cell 2 NR 15 kHz SSB SCS, 10 MHz bandwidth, TDD duplex mode Cell 3 NR 120 kHz SSB SCS, 100 MHz bandwidth, TDD duplex mode
3	LTE FDD PCell, Cell 2 NR 30 kHz SSB SCS, 40 MHz bandwidth, TDD duplex mode Cell 3 NR 120 kHz SSB SCS, 100 MHz bandwidth, TDD duplex mode
4	LTE TDD PCell, Cell 2 NR 15 kHz SSB SCS, 10 MHz bandwidth, FDD duplex mode Cell 3 NR 120 kHz SSB SCS, 100 MHz bandwidth, TDD duplex mode
5	LTE TDD PCell, Cell 2 NR 15 kHz SSB SCS, 10 MHz bandwidth, TDD duplex mode Cell 3 NR 120 kHz SSB SCS, 100 MHz bandwidth, TDD duplex mode
6	LTE TDD PCell, Cell 2 NR 30 kHz SSB SCS, 40 MHz bandwidth, TDD duplex mode Cell 3 NR 120 kHz SSB SCS, 100 MHz bandwidth, TDD duplex mode
Note:	The UE is only required to be tested in one of the supported test configurations

**Table A.5.5.3.5.1-2: General test parameters for FR2 SCell activation case with FR1 PSCell**

Parameter	Unit	Value	Comment
Active PCell		Cell 1	Primary cell on E-UTRAN RF channel number 1. As specified in clause A.3.7.2.2
T2	s	2	During this time the UE shall activate the SCell.

**Table A.5.5.3.5.1-3: Cell specific test parameters for FR2 SCell activation case with FR1 PSCell**

Parameter		Unit	Cell 2			Cell 3		
			T1	T2	T3	T1	T2	T3
SSB ARFCN			freq1			freq2		
Duplex mode	Config 1,4		FDD			TDD		
	Config 2,3,5,6		TDD			TDD		
TDD configuration	Config 1,4		Not Applicable			TDDConf.3.1		
	Config 2,5		TDDConf.1.1					
	Config 3,6		TDDConf.2.1					
BW <sub>channel</sub>	Config 1,4	MHz	10: N <sub>RB,c</sub> = 52			100: N <sub>RB,c</sub> = 66		
	Config 2,5		10: N <sub>RB,c</sub> = 52					
	Config 3,6		40: N <sub>RB,c</sub> = 106					
Data RBs allocated	Config 1,4		52			66		
	Config 2,5		52					
	Config 3,6		106					
BWP BW	Config 1,4		10: N <sub>RB,c</sub> = 52			100: N <sub>RB,c</sub> = 66		
	Config 2,5		10: N <sub>RB,c</sub> = 52					
	Config 3,6		40: N <sub>RB,c</sub> = 106					
DRx Cycle		ms	Not Applicable					
PDSCH Reference measurement channel	Config 1,4		SR.1.1 FDD			SR.3.1 TDD		
	Config 2,5		SR.1.1 TDD					
	Config 3,6		SR.2.1 TDD					
RMSI CORESET Reference Channel	Config 1,4		CR.1.1 FDD			CR.3.1 TDD		
	Config 2,5		CR.1.1 TDD					
	Config 3,6		CR.2.1 TDD					
RMC CORESET Reference Channel	Config 1,4		CCR.1.1 FDD			CCR.3.1 TDD		
	Config 2,5		CCR.1.1 TDD					
	Config 3,6		CCR.2.1 TDD					
OCNG Patterns			OP.1					
SMTC configuration			SMTC.1					
TCI state			NA			TCI.State.0		
TRS configuration	Config 1,4		TRS.2.1 TDD			TRS.2.1 TDD		
	Config 2,5		TRS.1.1 TDD					
	Config 3,6		TRS.1.2 TDD					
SSB configuration	Config 1,2,4,5		SSB.1 FR1			SSB.1 FR2		
	Config 3,6		SSB.2 FR1					
PDSCH/PDCCH subcarrier spacing	Config 1,2,4,5	kHz	15 kHz			120 kHz		
	Config 3,6		30 kHz					
CSI-RS configuration	Config 1~6		NA			NA	CSI-RS.3.1 TDD <small>Note 5</small>	
reportConfigType	Config 1~6		periodic			NA		
reportQuantity	Config 1~6		cri-RI-PMI-CQI			NA		
CSI reporting periodicity <small>Note 6</small>	Config 1~6	slot	40			NA		
CSI reporting offset	Config 1~6	slot	4			NA		
EPRE ratio of PSS to SSS		dB	0					
EPRE ratio of PBCH DMRS to SSS								
EPRE ratio of PBCH to PBCH DMRS								
EPRE ratio of PDCCH DMRS to SSS								
EPRE ratio of PDCCH to PDCCH DMRS								
EPRE ratio of PDSCH DMRS to SSS								

EPRE ratio of PDSCH to PDSCH			
EPRE ratio of OCNG DMRS to SSS(Note 1)			
EPRE ratio of OCNG to OCNG DMRS (Note 1)			
Propagation condition	-	N/A Link only, see clause A.3.7A	AWGN
<p>Note 1: OCNG shall be used such that both cells are fully allocated and a constant total transmitted power spectral density is achieved for all OFDM symbols.</p> <p>Note 2: Void</p> <p>Note 3: Void</p> <p>Note 4: The uplink resources for CSI reporting are assigned to the UE prior to the start of time period T2.</p> <p>Note 5: CSI-RS for CSI measurement is (re)configured in the next DL slot after slot <math>m+T_{L1-RSRP}</math> during T2.</p> <p>Note 6: L1-RSRP measurement and reporting are configured to the the UE prior to the start of time period T1.</p>			

**Table A.5.5.3.5.1-4: OTA related test parameters for FR2 SCell activation case with FR1 PSCell**

Parameter	Unit	Cell 2			Cell 3					
		T1	T2	T3	T1	T2	T3			
Angle of arrival configuration		NA			Setup 1 according to clause A.3.15.1					
Assumption for UE beams <sup>Note 7</sup>		NA			Rough					
$N_{oc}$ <sup>Note1</sup>	dBm/15kHz	Link only, see clause A.3.7A			-104.7					
$N_{oc}$ <sup>Note1</sup>	Config 1,2,4,5				-95.7					
	Config 3,6									
SSB_RP <sup>Note2</sup>	Config 1,2,4,5				-∞			-88.7	-88.7	
	Config 3,6									
$\hat{E}_s/N_{oc}$	dB							-∞	7	7
$\hat{E}_s/I_{ot}$	dB							-∞	7	7
$I_o$ <sup>Note2, Note 4</sup>	Config 1,2,4,5							-66.68	-58.92	-58.92
	Config 3,6									
<p>Note 1: Interference from other cells and noise sources not specified in the test is assumed to be constant over subcarriers and time and shall be modelled as AWGN of appropriate power for <math>N_{oc}</math> to be fulfilled.</p> <p>Note 2: <math>E_s/I_{ot}</math>, SSB_RP and <math>I_o</math> levels have been derived from other parameters for information purposes. They are not settable parameters themselves.</p> <p>Note 3: Void</p> <p>Note 4: Equivalent power received by an antenna with 0dBi gain at the centre of the quiet zone</p> <p>Note 5: Void</p> <p>Note 6: Void</p> <p>Note 7: Information about types of UE beam is given in B.2.1.3, and does not limit UE implementation or test system implementation.</p>										

**A.5.5.3.5.2 Test Requirements**

During T2 the UE shall send the first CSI report for SCell in the first available uplink resource after slot (m+k). UE is allowed to postpone CSI report to next available UL resource if an available uplink resource is subject to interruption. Whether CSI report in a slot was interrupted is checked by monitoring ACK/NACK sent in PSCell in the slot.

During T2 the UE shall start sending valid L1-RSRP report for the SCell in the configured slots for CSI reporting after slot (m+ $T_{L1-RSRP}$ ), where  $T_{L1-RSRP}$  is no larger than

$$3ms + T_{FirstSSB\_MAX} + 15 * T_{SMTc\_MAX} + 8 * T_{Ts} + T_{L1-RSRP, measure} + T_{L1-RSRP, report}$$

as defined in clause 8.3.2. For this test case,  $T_{FirstSSB\_MAX}=T_{SMTc\_MAX}=T_{Ts}=20ms$ ;  $T_{L1-RSRP, measure}=480ms$  and  $T_{L1-RSRP, measure}=5ms$ , which allows  $T_{L1-RSRP}$  1000ms.

During T2 the UE shall start sending CSI reports for the SCell with non-zero CQI index in the configured slots for CSI reporting no later than slot  $m + \frac{T_{\text{HARQ}} + T_{\text{activation\_time}} + T_{\text{CSI\_Reporting}}}{\text{NR slot length}}$ , where

-  $T_{\text{HARQ}}$  is defined in Table A.5.5.3.1.1-2

-  $T_{\text{activation\_time}} = 3\text{ms} + T_{\text{FirstSSB\_MAX}} + 15 * T_{\text{SMTc\_MAX}} + 8 * T_{\text{rs}} + T_{\text{LI-RSRP, measure}} + T_{\text{LI-RSRP, report}} + \max \{ (T_{\text{HARQ}} + T_{\text{uncertainty\_MAC}} + 5\text{ms} + T_{\text{FineTiming}}), (T_{\text{uncertainty\_RRC}} + T_{\text{RRC\_delay}}) \}$ , which allows 1030ms

-  $T_{\text{CSI\_Reporting}} = 10\text{ms}$

- NR slot length is 0.125ms for this test case.

During T3 the UE shall stop sending CSI reports for both SCells no later than slot  $n + \frac{T_{\text{HARQ}} + 3\text{ms}}{\text{NR slot length}}$ , as defined in clause 8.3.

During T2 interruption of PSCell during SCell activation shall not happen outside the slot  $m + 1 + \frac{T_{\text{HARQ}}}{\text{NR slot length}}$  to  $m + 1 + \frac{T_{\text{HARQ}} + 3\text{ms} + T_{\text{X}}}{\text{NR slot length}}$ , and interruption of E-UTRA PCell during SCell activation shall not happen outside the subframe  $m_1 + 1 + \frac{T_{\text{HARQ}}}{\text{EUTRA slot length}}$  to subframe  $m_2 + 1 + \frac{T_{\text{HARQ}} + 3\text{ms} + T_{\text{X}}}{\text{EUTRA slot length}}$ , as defined in clause 8.3, where  $T_{\text{X}} = 20\text{ms}$ , and  $m_1$  and  $m_2$  are the index of the first and last subframe of E-UTRA PCell which overlaps with slot  $m$ .

During T3 the starting point of interruption of PSCell during SCell deactivation shall not happen outside the slot  $n + 1 + \frac{T_{\text{HARQ}}}{\text{NR slot length}}$  to  $n + 1 + \frac{T_{\text{HARQ}} + 3\text{ms}}{\text{NR slot length}}$ , as defined in clause 8.3 and the starting point of interruption of E-UTRA PCell during SCell deactivation shall not happen outside the subframe  $n_1 + 1 + \frac{T_{\text{HARQ}}}{\text{EUTRA subframe length}}$  to subframe  $n_2 + 1 + \frac{T_{\text{HARQ}} + 3\text{ms}}{\text{EUTRA subframe length}}$ , where  $n_1$  and  $n_2$  are the index of the first and last subframe of E-UTRA PCell which overlaps with slot  $n$ .

The interruption of PSCell due to activation of SCell1 and SCell2 shall not be more than the values specified for EN-DC in Clause 8.2.1.2.10.

The interruption of PCell due to activation of SCell1 and SCell2 shall not be more than the values specified for EN-DC in Clause 7.32.2.5 of TS 36.133 [50].

### A.5.5.3.6 Multiple SCell Activation and deactivation of one unknown SCell and one known SCell in FR2

#### A.5.5.3.6.1 Test Purpose and Environment

The purpose of this test is to verify that the multiple SCell activation and deactivation delay and interruption are within the requirements stated in clause 8.3, when the two SCells to be activated are in FR2 and one SCell is known and the other SCell is unknown by the UE at the time of activation.

The supported test configurations are shown in Table A.5.5.3.6.1-1 below. The general test parameters are given in Table A.5.5.3.6.1-2 and cell-specific test parameters in Table A.5.5.3.6.1-3 below. OTA related test parameters are shown in table A.5.5.3.6.1-4.

The test consists of three successive time periods, with duration of T1, T2 and T3, respectively. There are four carriers, one E-UTRA cell, and three NR cells. Before the test starts the UE is connected to Cell 1 (PCell) on the E-UTRA carrier and Cell 2 (PSCell) on the NR carrier in FR1, but is not aware of Cell 3 (SCell1) or Cell 4 (SCell2) on the NR carriers both in FR2. Cell 1, Cell 2 and Cell 3 have constant signal levels throughout the test. The UE is monitoring the PCell and PSCell. The UE shall be continuously scheduled in the PCell and PSCell throughout the whole test.

At the beginning of T1 the UE receives an RRC message by which the Cell 3 (SCell1) and Cell 4 (SCell2) are configured on NR. The test equipment sends a single MAC message for activation of both SCells within 3s for UE power class 2/3/4 or 4s for UE power class 1 after RRM reports is sent for SCell1.

The point in time at which the MAC message is received at the UE antenna connector, in a slot # denoted  $m$ , defines the start of time period T2. In the same MAC PDU, the test equipment activates the TCI state of RMC CORESET. In slot # $m$ , the test equipment also sends an RRC message to configure the CSI-RS resources for SCell1 and SCell2.

Time period T3 starts when a MAC message for deactivation of SCell, sent from the test equipment to the UE in a slot # denoted n, is received at the UE antenna connector.

The test equipment verifies the activation time by counting the slots from the time when the SCell activation command is sent until a CSI report with other than CQI index 0 is received.

The test equipment verifies the deactivation time by counting the slots from the time when the SCell deactivation command is sent until CSI reporting for SCell is discontinued.

**Table A.5.5.3.6.1-1: Supported test configurations**

Configuration	Description
1	LTE FDD, NR 120 kHz SSB SCS, 100 MHz bandwidth, TDD duplex mode
2	LTE TDD, NR 120 kHz SSB SCS, 100 MHz bandwidth, TDD duplex mode

Note: The UE is only required to be tested in one of the supported test configurations

**Table A.5.5.3.6.1-2: General test parameters**

Parameter	Unit	Value	Comment
RF Channel Number		1,2,3,4	One E-UTRAN radio channel (1) and three NR radio channels (2,3,4) are used for this test
Active PCell		Cell 1	Primary cell on E-UTRAN RF channel number 1. As specified in clause A.3.7.2.2
Active PSCell		Cell 2	Primary secondary cell on NR RF channel number 2 in FR1.
Configured deactivated SCells		Cell 3, Cell 4	Configured deactivated secondary cell on NR RF channel number 3 and RF channel number 4, both in FR2
CP length		Normal	
DRX		OFF	Continuous monitoring of primary cell
SCell measurement cycle (measCycleSCell)	ms	160	For both Cell 3 and Cell 4
T1	s	7	During this time the PSCell shall be known and the SCells configured, SCell1 detected but SCell2 not detected.
T2	s	1	During this time the UE shall activate the SCell.
T3	s	1	During this time the UE shall deactivate the SCell.
$T_{\text{HARQ}}$	ms	$k_1 \times \text{NR slot length}$	$k_1$ is a number of slots indicated by the PDSCH-to-HARQ feedback timing indicator field in a corresponding DCI format or provided by <i>dl-DataToUL-ACK</i> if the PDSCH-to-HARQ feedback timing field is not present in the DCI format, the value is defined in 38.213 [3]
k	slot	$k_1 + 3 \cdot N_{\text{slot}}^{\text{subframe}} + 1$	As specified in clause 4.3 of TS 38.213 [3]

**Table A.5.5.3.6.1-3: Cell specific test parameters**

Parameter	Unit	Cell 2			Cell 3			Cell 4			
		T1	T2	T3	T1	T2	T3	T1	T2	T3	
<b>SSB ARFCN</b>		<b>freq1</b>			<b>freq2</b>			<b>freq3</b>			
Duplex mode	Config 1,2	TDD									
TDD configuration	Config 1,2	TDDConf.3.1									
BW <sub>channel</sub>	Config 1,2	MHz	100: N <sub>RB,c</sub> = 66								
DL initial BWP configuration	Config 1,2	DLBWP.0.1									



DL dedicated BWP configuration	Config 1,2		DLBWP.1.1			
UL initial BWP configuration	Config 1,2		ULBWP.0.1			
UL dedicated BWP configuration	Config 1,2		ULBWP.1.1			
Timing offset to Cell 2		ms	Not Applicable	0	0	
PDSCH Reference measurement channel	Config 1,2		SR.3.1 TDD	SR.3.1 TDD	SR.3.1 TDD	
RMSI CORESET Reference Channel	Config 1,2		CR.3.1 TDD	CR.3.1 TDD	CR.3.1 TDD	
RMC CORESET Reference Channel	Config 1,2		CCR.3.1 TDD	CCR.3.1 TDD	CCR.3.1 TDD	
TRS configuration	Config 1,2		TRS.2.1 TDD	TRS.2.1 TDD	TRS.2.1 TDD	
CSI-RS configuration	Config 1,2		CSI-RS.3.1 TDD	N/A	CSI-RS.3.1 TDD	N/A
CSI reporting periodicity	Config 1,2	ms	5	5	5	
OCNG Patterns			OP.1			
SMTc configuration			SMTc.1			
SSB configuration	Config 1,2		SSB.1 FR2	SSB.1 FR2	N/A	SSB.1 FR2
EPRE ratio of PSS to SSS		dB	0			
EPRE ratio of PBCH DMRS to SSS						
EPRE ratio of PBCH to PBCH DMRS						
EPRE ratio of PDCCH DMRS to SSS						
EPRE ratio of PDCCH to PDCCH DMRS						
EPRE ratio of PDSCH DMRS to SSS						
EPRE ratio of PDSCH to PDSCH						
EPRE ratio of OCNG DMRS to SSS(Note 1)						
EPRE ratio of OCNG to OCNG DMRS (Note 1)						
Propagation condition		-	AWGN			
Note 1: OCNG shall be used such that both cells are fully allocated and a constant total transmitted power spectral density is achieved for all OFDM symbols.						

Table A.5.5.3.6.1-4: OTA related test parameters

Parameter <sup>Note 6</sup>	Unit	Cell 3			Cell 4		
		T1	T2	T3	T1	T2	T3
Angle of arrival configuration		Setup 1 according to A.3.15.1					
Assumption for UE beams <sup>Note 7</sup>		Rough			Rough		
$N_{oc}$ <sup>Note1</sup>	dBm/15kHz <sup>Note4</sup>	-112			-112		
$N_{oc}$ <sup>Note1</sup>	dBm/SCS <sup>Note3</sup>	-102.97			-102.97		
$\hat{E}_s/N_{oc}$	dB	14			N/A	14	14
SS-RSRP <sup>Note2</sup>	dBm/SCS <sup>Note4</sup>	-88.97			N/A	-88.97	-88.97
$\hat{E}_s/I_{ot}$	dB	14			N/A	14	14
$I_o$ <sup>Note2</sup>	dBm/95.04 MHz <sup>Note4</sup>	-59.81			-73.98	-59.81	-59.81

Note 1:	Interference from other cells and noise sources not specified in the test is assumed to be constant over subcarriers and time and shall be modelled as AWGN of appropriate power for $N_{oc}$ to be fulfilled.
Note 2:	SS-RSRP and Io levels have been derived from other parameters for information purposes. They are not settable parameters themselves.
Note 3:	SS-RSRP minimum requirements are specified assuming independent interference and noise at each receiver antenna port.
Note 4:	Equivalent power received by an antenna with 0dBi gain at the centre of the quiet zone
Note 5:	As observed with 0dBi gain antenna at the centre of the quiet zone
Note 6:	All parameters apply for configuration 1 and 2
Note 7:	Information about types of UE beam is given in B.2.1.3, and does not limit UE implementation or test system implementation

### A.5.5.3.6.2 Test Requirements

During T2 the UE shall send the first CSI report for SCell in the first available uplink resource after slot (m+k). UE is allowed to postpone CSI report to next available UL resource if an available uplink resource is subject to interruption. Whether CSI report in a slot was interrupted is checked by monitoring ACK/NACK sent in PSCell in the slot.

During T2 the UE shall start sending CSI reports for SCell1 and SCell2 with non-zero CQI index in the configured slots for CSI reporting no later than slot  $m + \frac{T_{HARQ} + T_{activation\_time} + T_{CSI\_Reporting}}{NR\ slot\ length}$ , where

- $T_{HARQ}$  is defined in Table A.5.5.3.Y.1-2
- $T_{activation\_time} = 5ms + T_{FineTiming} = 25ms$ ,
- $T_{CSI\_Reporting} = 10ms$
- NR slot length is 0.125ms.

During T3 the UE shall stop sending CSI reports for both SCells no later than slot  $n + \frac{T_{HARQ} + 3ms}{NR\ slot\ length}$ , as defined in clause 8.3.

All of the above test requirements shall be fulfilled in order for the observed SCell activation delay to be counted as correct. The rate of correct observed SCell activation delay and SCell deactivation delay during repeated tests shall be at least 90%.

NOTE: During T2 if there are no uplink resources for reporting the valid CSI in a slot  $m + \frac{T_{HARQ} + T_{activation\_time} + T_{CSI\_Reporting}}{NR\ slot\ length}$  as defined in clause 8.3 then the UE shall use the next available uplink resource for reporting the corresponding valid CSI.

## A.5.5.3.7 Direct SCell activation at SCell addition of known SCell in FR2

### A.5.5.3.7.1 Test Purpose and Environment

The purpose of this test case is the same as for the test defined in clause A.4.5.3.5 except the SCell is in FR2 intra-band.

The supported test configurations are shown in table A.5.5.3.7.1-1 below. The general and cell specific test parameters are the same except those described in the following clause. The listed parameter values in Tables A.5.5.3.7.1-2 and A.5.5.3.7.1-3 will replace the values of corresponding parameters in Tables A.4.5.3.5.1-2 and A.4.5.3.5.1-3. In this case, OTA related test parameters are shown in table A.5.5.3.7.1-4 below.

The test consists of three successive time periods, with duration of T1, T2 and T3, respectively. There are three carriers, each with one cell. Cell 1 operates in either FDD or TDD duplex mode according to test configuration. Cell 2 and Cell 3 operate in TDD duplex mode. All cells have constant signal levels throughout the test. Before the test starts the UE is connected to Cell 1 (PCell) on radio channel 1 (PCC) and Cell 2 (PSCell) on radio channel 2 (PSCC), but is not aware of Cell 3 (SCell1) on radio channel 3 (SCC). The UE is only monitoring the PCC/PSCC. The UE shall be continuously scheduled in the PCell/PSCell throughout the whole test.

At the beginning of T1, the UE is configured to measure radio channel 3 and starts detecting the Cell 3 (SCell) on radio channel 3 (SCC). During T1 Cell 3 is detected and measured and measurement report is sent by the UE to the test equipment.

Time period T2 starts when test equipment sends the RRCConnectionReconfiguration message for the activation of the SCell within time period specified in clause 8.3.2 for known cell definition to ensure the configured SCell is known. The NR shall be use an RRCConnectionReconfigurationComplete message with parameter *sCellState* set to *activated* for the SCell (Cell 3), which causes the SCell to become configured and activated on radio channel 3 (SCC). The message is sent from the test equipment to the UE and is received in a subframe # denoted *m* at the UE antenna connector. The UE shall accomplish the activation of the SCell no later than subframe  $(m + N_{direct})$ .

Time period T3 starts at  $(m + N_{direct})$ , at which point UE shall be reporting a valid CQI for PCell/PSCell and SCell.

During T3, the UE shall be continuously scheduled in the SCell.

The test equipment verifies the activation time by counting the subframes from the time when the direct SCell activation is sent and until a CSI report with other than CQI index 0 is received.

The test equipment verifies the CSI report from the direct activated SCell after the activation procedure is completed contains CQI index other than 0.

**Table A.5.5.3.7.1-1: Supported test configurations for FR2 SCell activation case with FR2 PSCell**

Configuration	Description
1	FDD LTE PCell, Cell 2&3 120 kHz SSB SCS, 100 MHz bandwidth, TDD duplex mode
2	TDD LTE PCell, Cell 2&3 120 kHz SSB SCS, 100 MHz bandwidth, TDD duplex mode

Note: The UE is only required to pass in one of the supported test configurations

**Table A.5.5.3.7.1-2: General test parameters for FR2 SCell activation case with FR2 PSCell**

Parameter	Unit	Value	Comment
RF Channel Number		1, 2, 3	Two radio channels are used for this test. One for E-UTRA cell and two for NR Cell
Active PCell		Cell1	PCell on RF channel number 1. As specified in clause A.3.7.2.2
Active PSCell		Cell2	PSCell on RF channel number 2.
Deconfigured deactivated SCell		Cell3	Deconfigured deactivated secondary cell on RF channel number 3
DRX		OFF	Continuous monitoring of PCell/PSCell
PRACH configuration on cell2		FR2 configuration 2	Captured in A.3.8.3.2
PSCell CQI/PMI periodicity and offset configuration index		slot5	CQI reporting for PSCell every uplink slot
Cell-individual offset for cells on RF channel number 1	dB	0	Individual offset for cells on carrier frequency of cell1.
Cell-individual offset for cells on RF channel number 2	dB	0	Individual offset for cells on carrier frequency of cell2.
Cell-individual offset for cells on RF channel number 3	dB	0	Individual offset for cells on carrier frequency of cell3.
T1	s	7	During this time the PCell/PSCell shall be known and cell3 is detected, and UE shall report a valid CQI for PCell/PSCell.
T2	s	$N_{direct}$	During this time the UE shall be configured with directly activated SCell1.
T3	s	1	During this time the UE shall report a valid CQI for PCell/PSCell and SCell.

**Table A.5.5.3.7.1-3: Cell specific test parameters for FR2 SCell activation case with FR2 PSCell**

Parameter <sup>Note 5</sup>	Unit	Cell 2			Cell 3		
		T1	T2	T3	T1	T2	T3
SSB ARFCN		freq1			freq2		

Duplex mode		TDD	TDD
TDD configuration		TDDConf.3.1	TDDConf.3.1
BW <sub>channel</sub>	MHz	100: N <sub>RB,c</sub> = 66	100: N <sub>RB,c</sub> = 66
PDSCH Reference measurement channel		SR.3.1 TDD	SR.3.1 TDD
RMSI CORESET Reference Channel		CR.3.1 TDD	CR.3.1 TDD
RMC CORESET Reference Channel		CCR.3.1 TDD	CCR.3.1 TDD
DL initial BWP configuration		DLBWP.0.1	
DL dedicated BWP configuration		DLBWP.1.1	
UL initial BWP configuration		ULBWP.0.1	
UL dedicated BWP configuration		ULBWP.1.1	
OCNG Patterns		OP.1	
SMTC configuration		SMTC.1	
SSB configuration		SSB.1 FR2	
TCI state		TCI.State.0	
TRS configuration		TRS.2.1 TDD	
CSI-RS configuration for CSI reporting		CSI-RS.3.1 TDD	
reportConfigType		periodic	N/A
reportQuantity		cri-RI-PMI-CQI	N/A
CSI reporting periodicity	slot	40	N/A
CSI reporting offset	slot	4	N/A
PDSCH/PDCCH subcarrier spacing	kHz	120	
EPRE ratio of PSS to SSS	dB	0	
EPRE ratio of PBCH_DMRS to SSS			
EPRE ratio of PBCH to PBCH_DMRS			
EPRE ratio of PDCCH_DMRS to SSS			
EPRE ratio of PDCCH to PDCCH_DMRS			
EPRE ratio of PDSCH_DMRS to SSS			
EPRE ratio of PDSCH to PDSCH_DMRS			
EPRE ratio of OCNG DMRS to SSS <sup>Note 1</sup>			
EPRE ratio of OCNG to OCNG DMRS <sup>Note 1</sup>			
Propagation conditions			
<p>Note 1: OCNG shall be used such that both cells are fully allocated and a constant total transmitted power spectral density is achieved for all OFDM symbols.</p> <p>Note 2: Interference from other cells and noise sources not specified in the test is assumed to be constant over subcarriers and time and shall be modelled as AWGN of appropriate power for <math>N_{oc}</math> to be fulfilled.</p> <p>Note 3: SS-RSRP and <math>I_o</math> levels have been derived from other parameters for information purposes. They are not settable parameters themselves.</p> <p>Note 4: SS-RSRP minimum requirements are specified assuming independent interference and noise at each receiver antenna port.</p> <p>Note 5: All parameters apply for configuration 1 and 2.</p>			

**Table A.5.5.3.7.1-4: OTA related test parameters for FR2 SCell activation case with FR2 PSCell**

Parameter <sup>Note 6</sup>	Unit	Cell 2			Cell 3		
		T1	T2	T3	T1	T2	T3
Angle of arrival configuration		Setup 1 according to A.3.15.1					
Assumption for UE beams <sup>Note 7</sup>		Rough			Rough		
$N_{oc}$ <sup>Note1</sup>	dBm/15kHz <sup>Note4</sup>	-104.7			-104.7		
$N_{oc}$ <sup>Note1</sup>	dBm/SCS <sup>Note3</sup>	-95.7			-95.7		
$\hat{E}_s/N_{oc}$	dB	7			7		
SS-RSRP <sup>Note2</sup>	dBm/SCS <sup>Note4</sup>	-88.7			-88.7		
$\hat{E}_s/I_{ot}$	dB	7			7		
$I_o$ <sup>Note2</sup>	dBm/95.04 MHz <sup>Note4</sup>	-58.92			-58.92		

Note 1:	Interference from other cells and noise sources not specified in the test is assumed to be constant over subcarriers and time and shall be modelled as AWGN of appropriate power for $N_{oc}$ to be fulfilled.
Note 2:	SS-RSRP and Io levels have been derived from other parameters for information purposes. They are not settable parameters themselves.
Note 3:	SS-RSRP minimum requirements are specified assuming independent interference and noise at each receiver antenna port.
Note 4:	Equivalent power received by an antenna with 0dBi gain at the centre of the quiet zone
Note 5:	As observed with 0dBi gain antenna at the centre of the quiet zone
Note 6:	All parameters apply for configuration 1 and 2
Note 7:	Information about types of UE beam is given in B.2.1.3, and does not limit UE implementation or test system implementation

#### A.5.5.3.7.2 Test Requirements

The UE shall accomplish the activation of the SCell no later than subframe  $m+N_{direct}$  as defined in clause 8.3.4.

Time period T3 starts at  $(m+ N_{direct})$ , at which point UE shall be reporting a valid CQI for both PSCell and SCell.

During T3 the UE shall send CSI reports for SCell with non-zero CQI index and continue to send CSI reports for SCell 1 with non-zero CQI index until the end of T3. All of the above test requirements shall be fulfilled in order for the observed SCell1 direct activation delay to be counted as correct. The rate of correct observed SCell1 direct activation delay during repeated tests shall be at least 90%.

### A.5.5.4 Void

### A.5.5.5 Beam Failure Detection and Link recovery procedures

#### A.5.5.5.1 EN-DC Beam Failure Detection and Link Recovery Test for FR2 PSCell configured with SSB-based BFD and LR in non-DRX mode

##### A.5.5.5.1.1 Test Purpose and Environment

The purpose of this test is to verify that the UE properly detects SSB-based beam failure in the set  $q_0$  configured for a serving PSCell and that the UE performs correct SSB-based link recovery based on beam candidate set  $q_1$ . The purpose is to test the downlink monitoring for beam failure detection within the UEs active DL BWP of the PSCell, during the evaluation period, and link recovery, when no DRX is used. This test will partly verify the SSB based beam failure detection and link recovery for an FR2 serving cell requirements in clause 8.5.

The test parameters are given in Tables A.5.5.5.1.1-1, A.5.5.5.1.1-2, A.5.5.5.1.1-3 and A.5.5.5.1.1-4 below. There are two cells, cell 1 is the E-UTRAN PCell, and cell 2 is the PSCell, in the test. The test consists of five successive time periods, with time duration of T1, T2, T3, T4 and T5 respectively. Figure A.5.5.5.1.1-1 shows the variation of the downlink SNR of the PCell and the SNR of the SSB in set  $q_0$  in the active PSCell to emulate SSB based beam failure. Figure A.5.5.5.1.1-2 shows the variation of the downlink L1-RSRP of the SSB in set  $q_1$  of the candidate beam used for link recovery. Prior to the start of the time duration T1, the UE shall be fully synchronized to cell 1 and cell 2. The UE shall be configured for periodic CSI reporting with a reporting periodicity of 5 ms. In the test, DRX configuration is not enabled. The UE is configured to perform inter-frequency measurements using GP ID #0 (40ms) in test 1.

**Table A.5.5.5.1.1-1: Supported test configurations for FR2 PSCell**

Configuration	Description
1	LTE FDD, TDD duplex mode, 120 kHz SSB SCS, 100 MHz bandwidth
2	LTE TDD, TDD duplex mode, 120 kHz SSB SCS, 100 MHz bandwidth
3	LTE FDD, TDD duplex mode, 240 kHz SSB SCS, 100 MHz bandwidth
4	LTE TDD, TDD duplex mode, 240 kHz SSB SCS, 100 MHz bandwidth
Note:	The UE is only required to pass in one of the supported test configurations in FR2

**Table A.5.5.1.1-2: General test parameters for FR2 PCell for SSB-based beam failure detection and link recovery testing in non-DRX mode**

Parameter		Test Config.	Unit	Value	Comment
<b>Test 1</b>					
Active E-UTRA PCell		1-4		Cell 1	
E-UTRA RF Channel Number		1-4		1	
Active PCell		1-4		Cell 2	
RF Channel Number		1-4		2	
Duplex mode		1-4		TDD	
TDD Configuration		1-4		TDDConf.3.1	
BW <sub>channel</sub>		1-4	MHz	100: N <sub>RB,c</sub> = 66	
Data RBs allocated		1-4		66	
PDSCH/PDCCH subcarrier spacing		1-4	kHz	120	
DL initial BWP configuration		1-4		DLBWP.0.1	
DL dedicated BWP configuration		1-4		DLBWP.1.1	
UL initial BWP configuration		1-4		ULBWP.0.1	
UL dedicated BWP configuration		1-4		ULBWP.1.1	
PDSCH Reference Channel		1-2		SR.3.2 TDD	
		3-4		SR.3.3 TDD	
RMSI CORESET Reference Channel		1-2		CR.3.1 TDD	
		3-4		CR.3.2 TDD	
Dedicated CORESET Reference Channel		1-2		CCR.3.1 TDD	
		3-4		CCR.3.7 TDD	
OCNG parameters		1-4		OP.1	
CP length		1-4		Normal	
PDSCH/PDCCH TCI state		1-4		TCI.State.0	
CSI-RS for tracking		1-4		TRS.2.1 TDD	
SSB Configuration		1-2		SSB.1 FR2	
		3-4		SSB.2 FR2	
SMTC Configuration		1-4		SMTC.3	
PRACH Configuration		1-4		FR2 PRACH configuration 2	A.3.8.3.2
DRX configuration		1-4		OFF	
SSB index assigned as BFD RS (q <sub>0</sub> )		1-4		0	
SSB index assigned as CBD RS (q <sub>1</sub> )		1-4		1	
SSB index assigned as RLM RS		1-4		0,1	
Beam failure detection transmission parameters	DCI format	1-4		1-0	
	Number of Control OFDM symbols	1-4		2	
	Aggregation level	1-4	CCE	8	
	Ratio of hypothetical PDCCH RE energy to average SSS RE energy	1-4	dB	0	
	Ratio of hypothetical PDCCH DMRS energy to average SSS RE energy	1-4	dB	0	
	DMRS precoder granularity	1-4		REG bundle size	
	REG bundle size	1-4		6	
Gap pattern ID		1-4		gp0	
gapOffset		1-4	ms	0	
rlmInSyncOutOfSyncThreshold		1-4		absent	Value 0 is applied. (Table 8.1.1-1).
rsrp-ThresholdSSB		1-2	dBm/SCS	-95	Threshold used for Q <sub>in_LR_SSB</sub>
		3-4		-92	
powerControlOffsetSS		1-4		db0	Used for deriving rsrp-ThresholdCSI-RS
beamFailureInstanceMaxCount		1-4		n1	see TS 38.321 [7], clause 5.17
beamFailureDetectionTimer		1-4		pbfd4	see TS 38.321 [7], clause 5.17
CSI-RS configuration for CSI reporting		1-4		CSI-RS.3.1 TDD	

reportConfigType	1-4		periodic	
reportQuantity	1-4		cri-RI-PMI-CQI	
CSI reporting periodicity	1-4	slot	40	
CSI reporting offset	1-4	slot	4	
T310	1-4	ms	1000	
N310	1-4		2	
T1	1-4	s	1	The UE shall be fully synchronized to cell 1 during T1
T2	1-4	s	2.61	
T3	1-4	s	1.64	
T4	1-4	s	0	
T5	1-4	s	1.01	
D1	1-4	s	0.97	
Note 1: All configurations are assigned to the UE prior to the start of time period T1.				
Note 2: UE-specific PDCCH is not transmitted after T1 starts.				

**Table A.5.5.1.1-3: Cell specific test parameters for FR2 PSCell for SSB-based beam failure detection and link recovery testing in non-DRX mode**

Parameter		Unit	Test 1				
			T1	T2	T3	T4	T5
AoA setup			Setup 1 defined in A.3.15				
Assumption for UE beams <sup>Note 10</sup>			Rough				
EPRE ratio of PDCCH DMRS to SSS		dB	0				
EPRE ratio of PDCCH to PDCCH DMRS		dB					
EPRE ratio of PBCH DMRS to SSS		dB					
EPRE ratio of PBCH to PBCH DMRS		dB					
EPRE ratio of PSS to SSS		dB					
EPRE ratio of PDSCH DMRS to SSS		dB					
EPRE ratio of PDSCH to PDSCH DMRS		dB					
EPRE ratio of OCNG DMRS to SSS		dB					
EPRE ratio of OCNG to OCNG DMRS		dB					
SNR_SSB of set q <sub>0</sub>	Config 1-4	dB	5 <sup>Note 11</sup>	-3 <sup>Note 11</sup>	-12	-12	-12
SNR_SSB of set q <sub>1</sub>	Config 1-4	dB	0.2	0.2	20.2	20.2	20.2
SSB_RP of set q <sub>1</sub>	Config 1-2	dBm/SCS	-104.5	-104.5	-84.5	-84.5	-84.5
	Config 3-4		-101.5	-101.5	-81.5	-81.5	-81.5
N <sub>oc</sub>	Config 1-4	dBm/120 KHz	-104.7				
Propagation condition			TDL-A 30ns 75Hz				

- Note 1: OCNG shall be used such that the resources in Cell 1 are fully allocated and a constant total transmitted power spectral density is achieved for all OFDM symbols.
- Note 2: The uplink resources for CSI reporting are assigned to the UE prior to the start of time period T1.
- Note 3: NZP CSI-RS resource set configuration for CSI reporting are assigned to the UE prior to the start of time period T1.
- Note 4: Measurement gap configuration is assigned to the UE prior to the start of time period T1.
- Note 5: The timers and layer 3 filtering related parameters are configured prior to the start of time period T1.
- Note 6: The signal contains PDCCH for UEs other than the device under test as part of OCNG.
- Note 7: SNR levels correspond to the signal to noise ratio over the SSS REs.
- Note 8: The SNR in time periods T1, T2, T3, T4 and T5 is denoted as SNR1, SNR2 and SNR3 respectively in figure A.5.5.5.1.1-1.
- Note 9: The SNR values are specified for testing a UE which supports 2RX on at least one band. For testing of a UE which supports 4RX on all bands, the SNR during T3 is modified as specified in clause A.3.6.
- Note 10: Information about types of UE beam is given in B.2.1.3, and does not limit UE implementation or test system implementation
- Note 11: This value allows up to 1dB degradation from applied SNR to UE baseband

Table A.5.5.5.1.1-4: Void

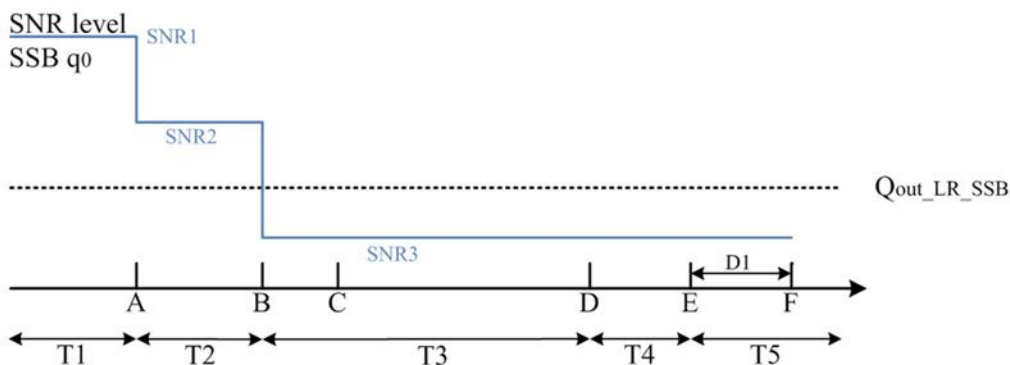

Figure A.5.5.5.1.1-1: SNR variation for SSB-based beam failure detection and link recovery testing in non-DRX mode

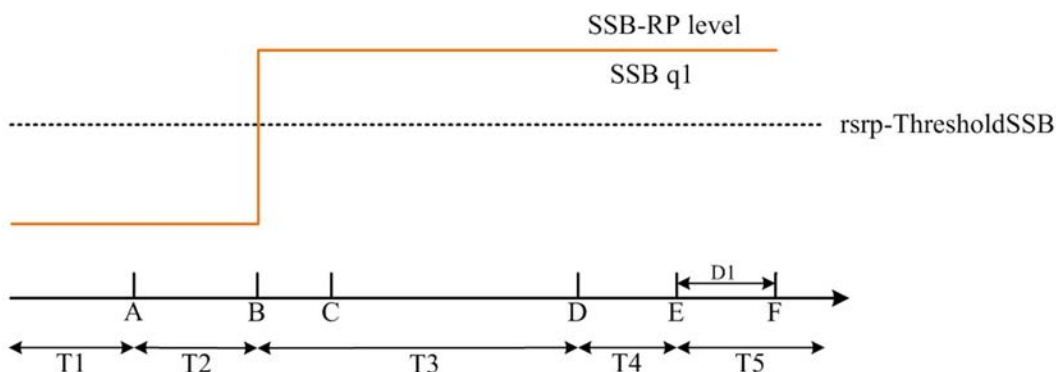

Figure A.5.5.5.1.1-2: SSB\_RP level variation for SSB-based beam failure detection and link recovery testing in non-DRX mode



### A.5.5.5.1.2 Test Requirements

The UE behaviour during time durations T1, T2, T3, T4 and T5 shall be as follows:

During the time duration T1 and T2, the UE shall transmit uplink signal at least in all subframes configured for CSI transmission on Cell 1.

During the period from time point A to time point B the UE shall transmit uplink signal in Cell 1 in all uplink slots configured for CSI transmission according to the configured periodic CSI reporting for Cell 1.

During T3 the UE shall detect beam failure and initiate link recovery. During T4 and T5 the UE measures and evaluate beam candidate from beam candidate set  $q_1$ .

No later than time point F occurring no later than  $D1 = 960 + 10$  ms after the start of T5, the UE shall transmit preamble on a beam associated with the candidate beam set  $q_1$ . The UE shall not transmit preamble on a beam associated with the candidate beam set  $q_1$  earlier than time point B.

Test is concluded once the test equipment has received the initial preamble transmission from the UE. The rate of correct events observed during repeated tests shall be at least 90%.

### A.5.5.5.2 EN-DC Beam Failure Detection and Link Recovery Test for FR2 PSCell configured with SSB-based BFD and LR in DRX mode

#### A.5.5.5.2.1 Test Purpose and Environment

The purpose of this test is to verify that the UE properly detects SSB-based beam failure in the set  $q_0$  configured for a serving PSCell and that the UE performs correct SSB-based link recovery based on beam candidate set  $q_1$ . The purpose is to test the downlink monitoring for beam failure detection within the UEs active DL BWP of the PSCell, during the evaluation period, and link recovery, when DRX is used. This test will partly verify the SSB based beam failure detection and link recovery for an FR2 serving cell requirements in clause 8.5.

The test parameters are given in Tables A.5.5.5.2.1-1, A.5.5.5.2.1-2, A.5.5.5.2.1-3, A.5.5.5.2.1-4 and A.5.5.5.2.1-5 below. There are two cells, cell 1 is the E-UTRAN PCell, and cell 2 is the PSCell, in the test. The test consists of five successive time periods, with time duration of T1, T2, T3, T4 and T5 respectively. Figure A.5.5.5.2.1-1 shows the variation of the downlink SNR of the PCell and the SNR of the SSB in set  $q_0$  in the active PSCell to emulate SSB based beam failure. Figure A.5.5.5.2.1-2 shows the variation of the downlink L1-RSRP of the SSB in set  $q_1$  of the candidate beam used for link recovery. Prior to the start of the time duration T1, the UE shall be fully synchronized to cell 1 and cell 2. The UE shall be configured for periodic CSI reporting with a reporting periodicity of 5 ms. In the test, DRX configuration is enabled in PSCell and DRX inactivity timer has already been expired, i.e. UE tries to decode PDCCH and to send periodic CQI during the period when On-duration timer is running. Time alignment timers shall be set to "infinity" so that UL timing alignment is maintained during the test.

**Table A.5.5.5.2.1-1: Supported test configurations for FR2 PSCell**

Configuration	Description
1	LTE FDD, TDD duplex mode, 120 kHz SSB SCS, 100 MHz bandwidth
2	LTE TDD, TDD duplex mode, 240 kHz SSB SCS, 100 MHz bandwidth
3	LTE FDD, TDD duplex mode, 240 kHz SSB SCS, 100 MHz bandwidth
4	LTE TDD, TDD duplex mode, 240 kHz SSB SCS, 100 MHz bandwidth
Note:	The UE is only required to pass in one of the supported test configurations in FR2

**Table A.5.5.5.2.1-2: General test parameters for FR2 PSCell for SSB-based beam failure detection and link recovery testing in DRX mode**

Parameter	Test Config.	Unit	Value	Comment
			<b>Test 1</b>	
Active E-UTRA PCell	1-4		Cell 1	
E-UTRA RF Channel Number	1-4		1	
Active PCell	1-4		Cell 2	
RF Channel Number	1-4		2	
Duplex mode	1-4		TDD	

TDD Configuration		1-4		TDDConf.3.1	
BW <sub>channel</sub>		1-4	MHz	100: N <sub>RB,c</sub> = 66	
Data RBs allocated		1-4		66	
PDSCH/PDCCH subcarrier spacing		1-4	kHz	120	
DL initial BWP configuration		1-4		DLBWP.0.1	
DL dedicated BWP configuration		1-4		DLBWP.1.1	
UL initial BWP configuration		1-4		ULBWP.0.1	
UL dedicated BWP configuration		1-4		ULBWP.1.1	
PDSCH Reference Channel		1-2		SR.3.2 TDD	
		3-4		SR.3.3 TDD	
RMSI CORESET Reference Channel		1-2		CR.3.1 TDD	
		3-4		CR.3.2 TDD	
Dedicated CORESET Reference Channel		1-2		CCR.3.1 TDD	
		3-4		CCR.3.7 TDD	
OCNG parameters		1-4		OP.1	
CP length		1-4		Normal	
PDSCH/PDCCH TCI state		1-4		TCI.State.0	
CSI-RS for tracking		1-4		TRS.2.1 TDD	
SSB Configuration		1-2		SSB.1 FR2	
		3-4		SSB.2 FR2	
SMTC Configuration		1-4		SMTC.3	
PRACH Configuration		1-4		FR2 PRACH configuration 2	A.3.8.3.2
DRX configuration		1-4		DRX.3	A.3.3.3
SSB index assigned as BFD RS (q <sub>0</sub> )		1-4		0	
SSB index assigned as CBD RS (q <sub>1</sub> )		1-4		1	
SSB index assigned as RLM RS		1-4		0,1	
Beam failure detection transmission parameters	DCI format	1-4		1-0	
	Number of Control OFDM symbols	1-4		2	
	Aggregation level	1-4	CCE	8	
	Ratio of hypothetical PDCCH RE energy to average SSS RE energy	1-4	dB	0	
	Ratio of hypothetical PDCCH DMRS energy to average SSS RE energy	1-4	dB	0	
	DMRS precoder granularity	1-4		REG bundle size	
	REG bundle size	1-4		6	
Gap pattern ID		1-4		N/A	
rlmInSyncOutOfSyncThreshold		1-4		absent	Value 0 is applied. (Table 8.1.1-1).
rsrp-ThresholdSSB		1-2	dBm/SCS	-95	Threshold used for Q <sub>in_LR_SSB</sub>
		3-4		-92	
powerControlOffsetSS		1-4		db0	Used for deriving rsrp-ThresholdCSI-RS
beamFailureInstanceMaxCount		1-4		n1	see TS 38.321 [7], clause 5.17
beamFailureDetectionTimer		1-4		pbfd4	see TS 38.321 [7], clause 5.17
CSI-RS configuration for CSI reporting		1-4		CSI-RS.3.1 TDD	
reportConfigType		1-4		periodic	
reportQuantity		1-4		cri-RI-PMI-CQI	
CSI reporting periodicity		1-4	slot	40	
CSI reporting offset		1-4	slot	4	
T310		1-4	ms	1000	
N310		1-4		2	
T1		1-4	s	1	The UE shall be fully synchronized to cell 1 during T1
T2		1-4	s	3.37	
T3		1-4	s	2.8	
T4		1-4	s	0	

T5	1-4	s	0.61	
D1	1-4	s	0.57	
Note 1: UE-specific PDCCH is not transmitted after T1 starts.				

**Table A.5.5.2.1-3: Cell specific test parameters for FR2 PSCell for SSB-based beam failure detection and link recovery testing in DRX mode**

Parameter		Unit	Test 1				
			T1	T2	T3	T4	T5
AoA setup			Setup 1 defined in A.3.15				
Assumption for UE beams <sup>Note 10</sup>			Rough				
EPRE ratio of PDCCH DMRS to SSS		dB	0				
EPRE ratio of PDCCH to PDCCH DMRS		dB					
EPRE ratio of PBCH DMRS to SSS		dB					
EPRE ratio of PBCH to PBCH DMRS		dB					
EPRE ratio of PSS to SSS		dB					
EPRE ratio of PDSCH DMRS to SSS		dB					
EPRE ratio of PDSCH to PDSCH DMRS		dB					
EPRE ratio of OCNG DMRS to SSS		dB					
EPRE ratio of OCNG to OCNG DMRS		dB					
SNR_SSB of set q <sub>0</sub>	Config 1-4	dB	<sup>5</sup> Note 11	<sup>-3</sup> Note 11	-12	-12	-12
SNR_SSB of set q <sub>1</sub>	Config 1-4	dB	0.2	0.2	20.2	20.2	20.2
SSB_RP of set q <sub>1</sub>	Config 1-2	dBm/	-104.5	-104.5	-84.5	-84.5	-84.5
	Config 3-4	SCS	-101.5	-101.5	-81.5	-81.5	-81.5
$N_{oc}$	Config 1-4	dBm/120 KHz	-104.7				
Propagation condition			TDL-A 30ns 75Hz				
<p>Note 1: OCNG shall be used such that the resources in Cell 1 are fully allocated and a constant total transmitted power spectral density is achieved for all OFDM symbols.</p> <p>Note 2: The uplink resources for CSI reporting are assigned to the UE prior to the start of time period T1.</p> <p>Note 3: NZP CSI-RS resource set configuration for CSI reporting are assigned to the UE prior to the start of time period T1.</p> <p>Note 4: Void</p> <p>Note 5: The timers and layer 3 filtering related parameters are configured prior to the start of time period T1.</p> <p>Note 6: The signal contains PDCCH for UEs other than the device under test as part of OCNG.</p> <p>Note 7: SNR levels correspond to the signal to noise ratio over the SSS REs.</p> <p>Note 8: The SNR in time periods T1, T2, T3, T4 and T5 is denoted as SNR1, SNR2 and SNR3 respectively in figure A.5.5.2.1-1.</p> <p>Note 9: The SNR values are specified for testing a UE which supports 2RX on at least one band. For testing of a UE which supports 4RX on all bands, the SNR during T3 is modified as specified in clause A.3.6.</p> <p>Note 10: Information about types of UE beam is given in B.2.1.3, and does not limit UE implementation or test system implementation</p> <p>Note 11: This value allows up to 1dB degradation from applied SNR to UE baseband</p>							

**Table A.5.5.2.1-4: Void**

**Table A.5.5.2.1-5: Void**

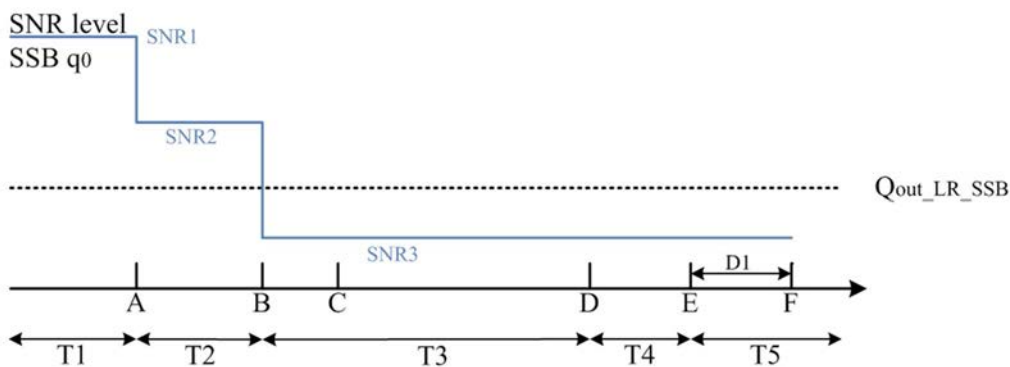

**Figure A.5.5.2.1-1: SNR variation for SSB-based beam failure detection and link recovery testing in DRX mode**

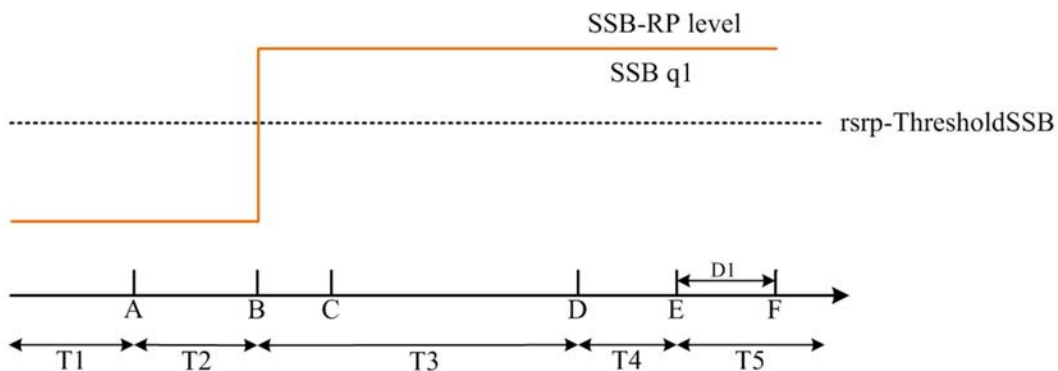

**Figure A.5.5.2.1-2: SSB\_RP level variation for SSB-based beam failure detection and link recovery testing in DRX mode**

**A.5.5.5.2.2 Test Requirements**

The UE behaviour during time durations T1, T2, T3, T4 and T5 shall be as follows:

During the time duration T1 and T2, the UE shall transmit uplink signal at least in all subframes configured for CSI transmission on Cell 1.

During the period from time point A to time point B the UE shall transmit uplink signal in Cell 1 in all uplink slots configured for CSI transmission according to the configured periodic CSI reporting for Cell 1.

During T3 the UE shall detect beam failure and initiate link recovery. During T4 and T5 the UE measures and evaluate beam candidate from beam candidate set q<sub>1</sub>.

No later than time point F occurring no later than D1 = 560+10 ms after the start of T5, the UE shall transmit preamble on a beam associated with the candidate beam set q<sub>1</sub>. The UE shall not transmit preamble on a beam associated with the candidate beam set q<sub>1</sub> earlier than time point B.

Test is concluded once the test equipment has received the initial preamble transmission from the UE. The rate of correct events observed during repeated tests shall be at least 90%.

### A.5.5.5.3 EN-DC Beam Failure Detection and Link Recovery Test for FR2 PSCell configured with CSI-RS-based BFD and LR in non-DRX mode

#### A.5.5.5.3.1 Test Purpose and Environment

The purpose of this test is to verify that the UE properly detects CSI-RS-based beam failure in the set  $q_0$  configured for a serving PSCell and that the UE performs correct CSI-RS-based link recovery based on beam candidate set  $q_1$ . The purpose is to test the downlink monitoring for beam failure detection within the UEs active DL BWP of the PSCell, during the evaluation period, and link recovery, when no DRX is used. This test will partly verify the CSI-RS based beam failure detection and link recovery for an FR2 serving cell requirements in clause 8.5.

The test parameters are given in Tables A.5.5.5.3.1-1, A.5.5.5.3.1-2, and A.5.5.5.3.1-3 below. There are two cells, cell 1 is the E-UTRAN PCell, and cell 2 is the PSCell, in the test. The test consists of five successive time periods, with time duration of T1, T2, T3, T4 and T5 respectively. Figure A.5.5.5.3.1-1 shows the variation of the downlink SNR of the PCell and the SNR of the CSI-RS in set  $q_0$  in the active PSCell to emulate CSI-RS based beam failure. Figure A.5.5.5.3.1-2 shows the variation of the downlink L1-RSRP of the CSI-RS in set  $q_1$  of the candidate beam used for link recovery. Prior to the start of the time duration T1, the UE shall be fully synchronized to cell 1 and cell 2. The UE shall be configured for periodic CSI reporting with a reporting periodicity of 5 ms. In the test, DRX configuration is not enabled.

**Table A.5.5.5.3.1-1: Supported test configurations for FR2 PSCell**

Configuration	Description
1	LTE FDD, TDD duplex mode, 120 kHz SSB SCS, 100 MHz bandwidth
2	LTE TDD, TDD duplex mode, 120 kHz SSB SCS, 100 MHz bandwidth

**Table A.5.5.5.3.1-2: General test parameters for FR2 PSCell for CSI-RS-based beam failure detection and link recovery testing in non-DRX mode**

Parameter	Test Config.	Unit	Value	Comment
			<b>Test 1</b>	
Active E-UTRA PCell	1-2		Cell 1	
E-UTRA RF Channel Number	1-2		1	
Active PCell	1-2		Cell 2	
RF Channel Number	1-2		2	
Duplex mode	1-2		TDD	
TDD Configuration	1-2		TDDConf.3.1	
$BW_{channel}$	1-2		100: $N_{RB,c} = 66$	
Data RBs allocated	1-2		66	
PDSCH/PDCCH subcarrier spacing	1-2	kHz	120	
DL initial BWP configuration	1-2		DLBWP.0.1	
DL dedicated BWP configuration	1-2		DLBWP.1.1	
UL initial BWP configuration	1-2		ULBWP.0.1	
UL dedicated BWP configuration	1-2		ULBWP.1.1	
PDSCH Reference Channel	1-2		SR.3.2 TDD	
RMSI CORESET Reference Channel	1-2		CR.3.1 TDD	
Dedicated CORESET Reference Channel	1-2		CCR.3.1 TDD	
OCNG parameters	1-2		OP.1	
CP length	1-2		Normal	
PDSCH/PDCCH TCI state	1-2		TCI.State.0	
CSI-RS for tracking	1-2		TRS.2.1 TDD	
SSB Configuration	1-2		SSB.1 FR2	
SMTc Configuration	1-2		SMTc.3	
PRACH Configuration	1-2		FR2 PRACH configuration 4	A.3.8.3.4
DRX configuration	1-2		OFF	
CSI-RS configuration for BFD/CBD/RLM	1-2		CSI-RS.3.2 TDD	A.3.14.2
CSI-RS index assigned as BFD RS ( $q_0$ )	1-2		0	
CSI-RS index assigned as CBD RS ( $q_1$ )	1-2		1	
CSI-RS index assigned as RLM RS	1-2		0,1	

Beam failure detection transmission parameters	DCI format	1-2		1-0	
	Number of Control OFDM symbols	1-2		2	
	Aggregation level	1-2	CCE	8	
	Ratio of hypothetical PDCCH RE energy to average SSS RE energy	1-2	dB	0	
	Ratio of hypothetical PDCCH DMRS energy to average SSS RE energy	1-2	dB	0	
	DMRS precoder granularity	1-2		REG bundle size	
	REG bundle size	1-2		6	
Gap pattern ID		1-2		N/A	
rimInSyncOutOfSyncThreshold		1-2		absent	Value 0 is applied. (Table 8.1.1-1).
rsrp-ThresholdSSB		1-2	dBm/SCS	-95	Threshold used for $Q_{in\_LR\_SSB}$
powerControlOffsetSS		1-2		db0	Used for deriving rsrp-ThresholdCSI-RS
beamFailureInstanceMaxCount		1-2		n1	see TS 38.321 [7], clause 5.17
beamFailureDetectionTimer		1-2		pbfd4	see TS 38.321 [7], clause 5.17
CSI-RS configuration for CSI reporting		1-2		CSI-RS.3.1 TDD	A.3.14.2
reportConfigType		1-2		periodic	
reportQuantity		1-2		cri-RI-PMI-CQI	
CSI reporting periodicity		1-2	slot	40	
CSI reporting offset		1-2	slot	4	
T310		1-2	ms	1000	
N310		1-2		2	
T1		1-2	s	1	The UE shall be fully synchronized to cell 1 during T1
T2		1-2	s	1.17	
T3		1-2	s	0.9	
T4		1-2	s	0	
T5		1-2	s	0.31	
D1		1-2	s	0.27	
Note 1: UE-specific PDCCH is not transmitted after T1 starts.					

**Table A.5.5.3.1-3: Cell specific test parameters for FR2 PSCell for CSI-RS-based beam failure detection and link recovery testing in non-DRX mode**

Parameter	Unit	Test 1					
		T1	T2	T3	T4	T5	
AoA setup		Setup 1 defined in A.3.15					
Assumption for UE beams <sup>Note 10</sup>		Rough					
EPRE ratio of PDCCH DMRS to SSS	dB	0					
EPRE ratio of PDCCH to PDCCH DMRS	dB						
EPRE ratio of PBCH DMRS to SSS	dB						
EPRE ratio of PBCH to PBCH DMRS	dB						
EPRE ratio of PSS to SSS	dB						
EPRE ratio of PDSCH DMRS to SSS	dB						
EPRE ratio of PDSCH to PDSCH DMRS	dB						
EPRE ratio of OCNG DMRS to SSS	dB						
EPRE ratio of OCNG to OCNG DMRS	dB						
SNR_CSI-RS of set $q_0$	Config 1-2	dB	<sup>5</sup> Note 11	<sup>-3</sup> Note 11	-12	-12	-12
SNR_CSI-RS of set $q_1$	Config 1-2	dB	0.2	0.2	20.2	20.2	20.2
CSI-RS_RP of set $q_1$	Config 1-2	dBm/SCS	-104.5	-104.5	-84.5	-84.5	-84.5
$N_{oc}$	Config 1-2	dBm/120 KHz	-104.7				

Propagation condition	TDL-A 30ns 75Hz
Note 1:	OCNG shall be used such that the resources in Cell 1 are fully allocated and a constant total transmitted power spectral density is achieved for all OFDM symbols.
Note 2:	The uplink resources for CSI reporting are assigned to the UE prior to the start of time period T1.
Note 3:	NZP CSI-RS resource set configuration for CSI reporting are assigned to the UE prior to the start of time period T1.
Note 4:	Void
Note 5:	The timers and layer 3 filtering related parameters are configured prior to the start of time period T1.
Note 6:	The signal contains PDCCH for UEs other than the device under test as part of OCNG.
Note 7:	SNR levels correspond to the signal to noise ratio over the REs carrying CSI-RS.
Note 8:	The SNR in time periods T1, T2, T3, T4 and T5 is denoted as SNR1, SNR2 and SNR3 respectively in figure A.5.5.3.1-1.
Note 9:	The SNR values are specified for testing a UE which supports 2RX on at least one band. For testing of a UE which supports 4RX on all bands, the SNR during T3 is modified as specified in clause A.3.6.
Note 10:	Information about types of UE beam is given in B.2.1.3, and does not limit UE implementation or test system implementation
Note 11:	This value allows up to 1dB degradation from applied SNR to UE baseband

**Table A.5.5.3.1-4: Void**

**Table A.5.5.3.1-5: Void**

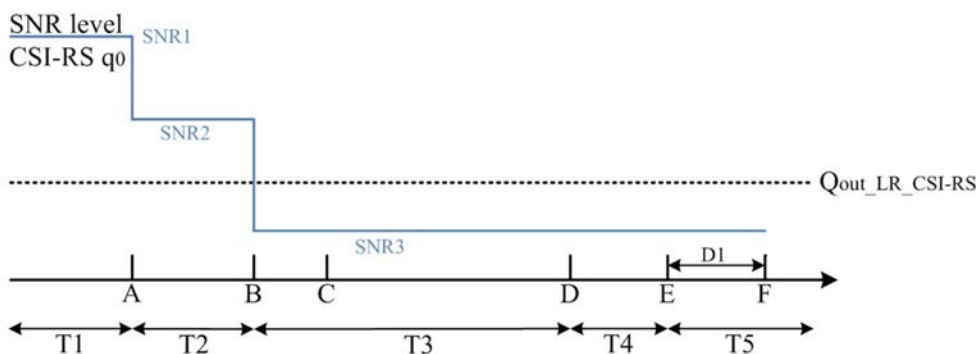

**Figure A.5.5.3.1-1: SNR variation for CSI-RS based beam failure detection and link recovery testing in non-DRX mode**

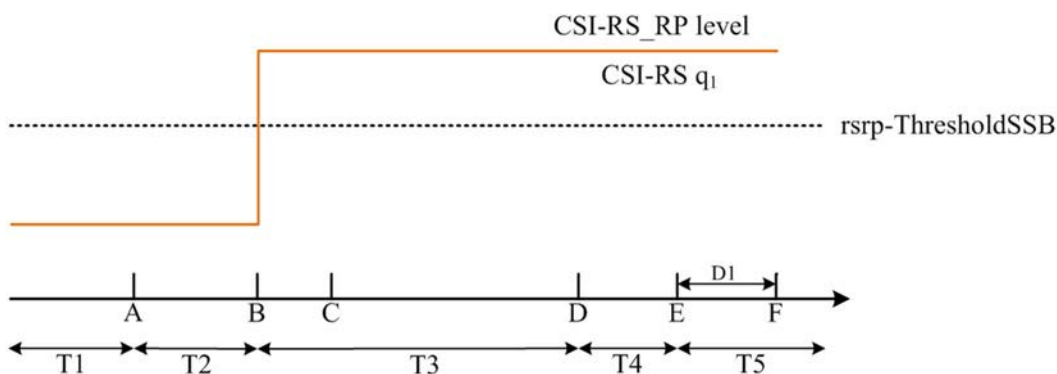

**Figure A.5.5.3.1-2: CSI-RS\_RP level variation for CSI-RS based beam failure detection and link recovery testing in non-DRX mode**

### A.5.5.5.3.2 Test Requirements

The UE behaviour during time durations T1, T2, T3, T4 and T5 shall be as follows:

During the time duration T1 and T2, the UE shall transmit uplink signal at least in all subframes configured for CSI transmission on Cell 1.

During the period from time point A to time point B the UE shall transmit uplink signal in Cell 1 in all uplink slots configured for CSI transmission according to the configured periodic CSI reporting for Cell 1.

During T3 the UE shall detect beam failure and initiate link recovery. During T4 and T5 the UE measures and evaluate beam candidate from beam candidate set  $q_1$ .

No later than time point F occurring no later than  $D1 = 260 + 10$  ms after the start of T5, the UE shall transmit preamble on a beam associated with the candidate beam set  $q_1$ . The UE shall not transmit preamble on a beam associated with the candidate beam set  $q_1$  earlier than time point B.

Test is concluded once the test equipment has received the initial preamble transmission from the UE. The rate of correct events observed during repeated tests shall be at least 90%.

### A.5.5.5.4 EN-DC Beam Failure Detection and Link Recovery Test for FR2 PSCell configured with CSI-RS-based BFD and LR in DRX mode

#### A.5.5.5.4.1 Test Purpose and Environment

The purpose of this test is to verify that the UE properly detects CSI-RS-based beam failure in the set  $q_0$  configured for a serving PSCell and that the UE performs correct CSI-RS-based link recovery based on beam candidate set  $q_1$ . The purpose is to test the downlink monitoring for beam failure detection within the UEs active DL BWP of the PSCell, during the evaluation period, and link recovery, when DRX is used. This test will partly verify the CSI-RS based beam failure detection and link recovery for an FR2 serving cell requirements in clause 8.5.

The test parameters are given in Tables A.5.5.5.4.1-1, A.5.5.5.4.1-2, A.5.5.5.4.1-3, and A.5.5.5.4.1-4 below. There are two cells, cell 1 is the E-UTRAN PCell, and cell 2 is the PSCell, in the test. The test consists of five successive time periods, with time duration of T1, T2, T3, T4 and T5 respectively. Figure A.5.5.5.4.1-1 shows the variation of the downlink SNR of the PCell and the SNR of the CSI-RS in set  $q_0$  in the active PSCell to emulate CSI-RS based beam failure. Figure A.5.5.5.4.1-2 shows the variation of the downlink L1-RSRP of the CSI-RS in set  $q_1$  of the candidate beam used for link recovery. Prior to the start of the time duration T1, the UE shall be fully synchronized to cell 1 and cell 2. The UE shall be configured for periodic CSI reporting with a reporting periodicity of 5 ms. In the test, DRX configuration is enabled in PCell and DRX inactivity timer has already been expired, i.e. UE tries to decode PDCCH and to send periodic CQI during the period when On-duration timer is running. Time alignment timers shall be set to "infinity" so that UL timing alignment is maintained during the test.

**Table A.5.5.5.4.1-1: Supported test configurations for FR2 PSCell**

Configuration	Description
1	LTE FDD, TDD duplex mode, 120 kHz SSB SCS, 100 MHz bandwidth
2	LTE TDD, FDD duplex mode, 120 kHz SSB SCS, 100 MHz bandwidth

**Table A.5.5.5.4.1-2: General test parameters for FR2 PSCell for CSI-RS-based beam failure detection and link recovery testing in DRX mode**

Parameter	Test Config.	Unit	Value	Comment
			<b>Test 1</b>	
Active E-UTRA PCell	1-2		Cell 1	
E-UTRA RF Channel Number	1-2		1	
Active PCell	1-2		Cell 2	
RF Channel Number	1-2		2	
Duplex mode	1-2		TDD	
TDD Configuration	1-2		TDDConf.3.1	
BW <sub>channel</sub>	1-2		100: $N_{RB,c} = 66$	
Data RBs allocated	1-2		66	
PDSCH/PDCCH subcarrier spacing	1-2	kHz	120	



DL initial BWP configuration	1-2		DLBWP.0.1		
DL dedicated BWP configuration	1-2		DLBWP.1.1		
UL initial BWP configuration	1-2		ULBWP.0.1		
UL dedicated BWP configuration	1-2		ULBWP.1.1		
PDSCH Reference Channel	1-2		SR.3.2 TDD		
RMSI CORESET Reference Channel	1-2		CR.3.1 TDD		
Dedicated CORESET Reference Channel	1-2		CCR.3.1 TDD		
OCNG parameters	1-2		OP.1		
CP length	1-2		Normal		
PDSCH/PDCCH TCI state	1-2		TCI.State.0		
CSI-RS for tracking	1-2		TRS.2.1 TDD		
SSB Configuration	1-2		SSB.1 FR2		
SMTC Configuration	1-2		SMTC.3		
PRACH Configuration	1-2		FR2 PRACH configuration 4	A.3.8.3.4	
DRX configuration	1-2		DRX.3	A.3.3.3	
CSI-RS configuration for BFD/CBD/RLM	1-2		CSI-RS.3.2 TDD	A.3.14.2	
CSI-RS index assigned as BFD RS ( $q_0$ )	1-2		0		
CSI-RS index assigned as CBD RS ( $q_1$ )	1-2		1		
CSI-RS index assigned as RLM RS	1-2		0,1		
Beam failure detection transmission parameters	DCI format	1-2	1-0		
	Number of Control OFDM symbols	1-2	2		
	Aggregation level	1-2	CCE	8	
	Ratio of hypothetical PDCCH RE energy to average SSS RE energy	1-2	dB	0	
	Ratio of hypothetical PDCCH DMRS energy to average SSS RE energy	1-2	dB	0	
	DMRS precoder granularity	1-2		REG bundle size	
REG bundle size	1-2		6		
Gap pattern ID	1-2		N/A		
rlmInSyncOutOfSyncThreshold	1-2		absent	Value 0 is applied. (Table 8.1.1-1).	
rsrp-ThresholdSSB	1-2	dBm/SCS	-95	Threshold used for $Q_{in,LR,SSB}$	
powerControlOffsetSS	1-2		db0	Used for deriving rsrp-ThresholdCSI-RS	
beamFailureInstanceMaxCount	1-2		n1	see TS 38.321 [7], clause 5.17	
beamFailureDetectionTimer	1-2		pbfd4	see TS 38.321 [7], clause 5.17	
CSI-RS configuration for CSI reporting	1-2		CSI-RS.3.1 TDD	A.3.14.2	
reportConfigType	1-2		periodic		
reportQuantity	1-2		cri-RI-PMI-CQI		
CSI reporting periodicity	1-2	slot	40		
CSI reporting offset	1-2	slot	4		
T310	1-2	ms	1000		
N310	1-2		2		
T1	1-2	s	1	The UE shall be fully synchronized to cell 1 during T1	
T2	1-2	s	5.43		
T3	1-2	s	5.16		
T4	1-2	s	0		
T5	1-2	s	0.31		
D1	1-2	s	0.27		
Note 1: UE-specific PDCCH is not transmitted after T1 starts.					

**Table A.5.5.4.1-3: Cell specific test parameters for FR2 PSCell for CSI-RS-based beam failure detection and link recovery testing in DRX mode**

Parameter		Unit	Test 1				
			T1	T2	T3	T4	T5
AoA setup			Setup 1 defined in A.3.155				
Assumption for UE beams <sup>Note 10</sup>			Rough				
EPRE ratio of PDCCH DMRS to SSS		dB	0				
EPRE ratio of PDCCH to PDCCH DMRS		dB					
EPRE ratio of PBCH DMRS to SSS		dB					
EPRE ratio of PBCH to PBCH DMRS		dB					
EPRE ratio of PSS to SSS		dB					
EPRE ratio of PDSCH DMRS to SSS		dB					
EPRE ratio of PDSCH to PDSCH DMRS		dB					
EPRE ratio of OCNG DMRS to SSS		dB					
EPRE ratio of OCNG to OCNG DMRS		dB					
SNR_CSI-RS of set $q_0$	Config 1-2	dB					
SNR_CSI-RS of set $q_1$	Config 1-2	dB	0.2	0.2	20.2	20.2	20.2
CSI-RS_RP of set $q_1$	Config 1-2	dBm/S CS	-104.5	-104.5	-84.5	-84.5	-84.5
$N_{oc}$	Config 1-2	dBm/12 0 KHz	-104.7				
Propagation condition			TDL-A 30ns 75Hz				
<p>Note 1: OCNG shall be used such that the resources in Cell 1 are fully allocated and a constant total transmitted power spectral density is achieved for all OFDM symbols.</p> <p>Note 2: The uplink resources for CSI reporting are assigned to the UE prior to the start of time period T1.</p> <p>Note 3: NZP CSI-RS resource set configuration for CSI reporting are assigned to the UE prior to the start of time period T1.</p> <p>Note 4: Void</p> <p>Note 5: The timers and layer 3 filtering related parameters are configured prior to the start of time period T1.</p> <p>Note 6: The signal contains PDCCH for UEs other than the device under test as part of OCNG.</p> <p>Note 7: SNR levels correspond to the signal to noise ratio over the SSS REs.</p> <p>Note 8: The SNR in time periods T1, T2, T3, T4 and T5 is denoted as SNR1, SNR2 and SNR3 respectively in figure A.5.5.4.1-1.</p> <p>Note 9: The SNR values are specified for testing a UE which supports 2RX on at least one band. For testing of a UE which supports 4RX on all bands, the SNR during T3 is modified as specified in clause A.3.6.</p> <p>Note 10: Information about types of UE beam is given in B.2.1.3, and does not limit UE implementation or test system implementation</p> <p>Note 11: This value allows up to 1dB degradation from applied SNR to UE baseband</p>							

Table A.5.5.4.1-4: Void

Table A.5.5.4.1-5: Void

Table A.5.5.4.1-6: Void

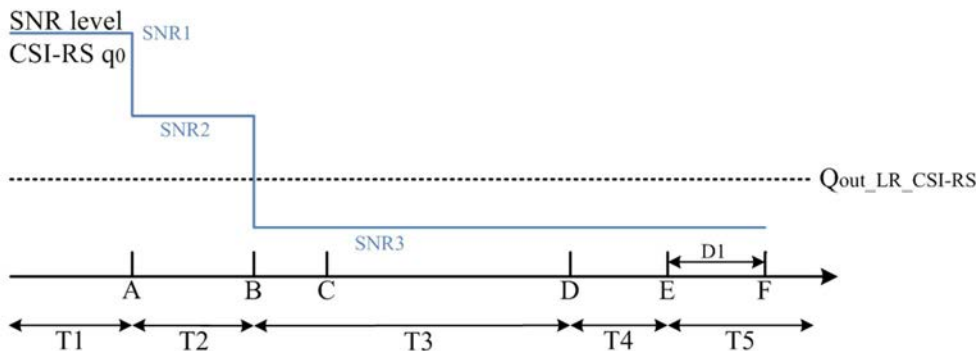

Figure A.5.5.4.1-1: SNR variation for CSI-RS-based beam failure detection and link recovery testing in DRX mode

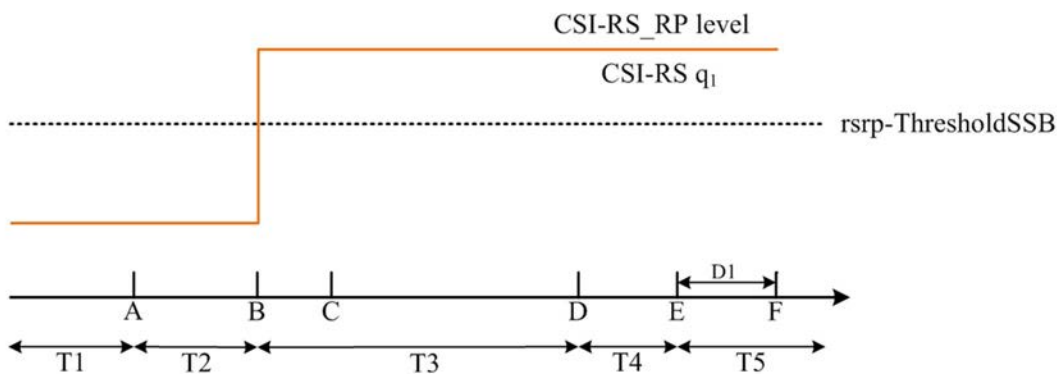

Figure A.5.5.4.1-2: CSI-RS\_RP level variation for CSI-RS based beam failure detection and link recovery testing in DRX mode

#### A.5.5.5.4.2 Test Requirements

The UE behaviour during time durations T1, T2, T3, T4 and T5 shall be as follows:

During the time duration T1 and T2, the UE shall transmit uplink signal at least in all subframes configured for CSI transmission on Cell 1.

During the period from time point A to time point B the UE shall transmit uplink signal in Cell 1 in all uplink slots configured for CSI transmission according to the configured periodic CSI reporting for Cell 1.

During T3 the UE shall detect beam failure and initiate link recovery. During T4 and T5 the UE measures and evaluates beam candidate from beam candidate set  $q_1$ .

No later than time point F occurring no later than  $D1 = 260 + 10$  ms after the start of T5, the UE shall transmit preamble on a beam associated with the candidate beam set  $q_1$ . The UE shall not transmit preamble on a beam associated with the candidate beam set  $q_1$  earlier than time point B.

Test is concluded once the test equipment has received the initial preamble transmission from the UE. The rate of correct events observed during repeated tests shall be at least 90%.

### A.5.5.5.5 EN-DC scheduling availability restriction during Beam Failure Detection and Link Recovery for FR2 PSCell configured with SSB-based BFD and LR in non-DRX mode

#### A.5.5.5.5.1 Test Purpose and Environment

The purpose is to test scheduling availability restrictions when the UE is performing beam failure detection or when the UE is performing L1-RSRP measurement for candidate beam detection, when no DRX is used. This test will verify the scheduling availability restriction requirements for SSB based beam failure detection and link recovery for an FR2 serving cell in clause 8.5.7 and 8.5.8.

The test parameters are given in Tables A.5.5.5.5.1-1, A.5.5.5.5.1-2 and A.5.5.5.5.1-3 below. There are two cells, cell 1 is the E-UTRAN PCell, and cell 2 is the PSCell, in the test. The test consists of five successive time periods, with time duration of T1, T2, T3, T4 and T5 respectively. Figure A.5.5.5.5.1-1 shows the variation of the downlink SNR of the PCell and the SNR of the SSB in set  $q_0$  in the active PSCell to emulate SSB based beam failure. Figure A.5.5.5.5.1-2 shows the variation of the downlink L1-RSRP of the SSB in set  $q_1$  of the candidate beam used for link recovery. Prior to the start of the time duration T1, the UE shall be fully synchronized to cell 1 and cell 2. The UE shall be configured for periodic CSI reporting with a reporting periodicity of 5ms. This test will focus on the scheduling availability during beam failure detection and candidate beam detection. In the test, DRX configuration is not enabled. Test is to test the scheduling availability restriction of UE performing beam failure detection and candidate beam detection when SSB RS configured for Beam failure detection and candidate beam detection. During the test the UE is scheduled to transmit continuously in UL.

**Table A.5.5.5.5.1-1: Supported test configurations for FR2 PSCell**

Configuration	Description
1	LTE FDD, NR 120 kHz SSB SCS, 100MHz bandwidth, TDD duplex mode
2	LTE TDD, NR 120 kHz SSB SCS, 100MHz bandwidth, TDD duplex mode
3	LTE FDD, NR 240 kHz SSB SCS, 100MHz bandwidth, TDD duplex mode
4	LTE TDD, NR 240 kHz SSB SCS, 100MHz bandwidth, TDD duplex mode

Note: The UE is only required to be tested in one of the supported test configurations

**Table A.5.5.5.5.1-2: General test parameters for FR2 PSCell for SSB-based beam failure detection and link recovery testing in non-DRX mode**

Parameter	Test Config.	Unit	Value	Comment
			<b>Test 1</b>	
Active E-UTRA PCell	1-4		Cell 1	
E-UTRA RF Channel Number	1-4		1	
Active PCell	1-4		Cell 2	
RF Channel Number	1-4		2	
Duplex mode	1-4		TDD	
TDD Configuration	1-4		TDDConf.3.1	
BW <sub>channel</sub>	1-4		100: N <sub>RB,c</sub> = 66	
Data RBs allocated	1-4		66	
PDSCH/PDCCH subcarrier spacing	1-4	kHz	120	
DL initial BWP configuration	1-4		DLBWP.0.1	
DL dedicated BWP configuration	1-4		DLBWP.1.1	
UL initial BWP configuration	1-4		ULBWP.0.1	
UL dedicated BWP configuration	1-4		ULBWP.1.1	
PDSCH Reference Channel	1-2		SR.3.2 TDD	
	3-4		SR.3.3 TDD	
RMSI CORESET Reference Channel	1-2		CR.3.1 TDD	
	3-4		CR.3.2 TDD	
Dedicated CORESET Reference Channel	1-2		CCR.3.1 TDD	
	3-4		CCR.3.7 TDD	
OCNG parameters	1-4		OP.1	
CP length	1-4		Normal	
PDSCH/PDCCH TCI state	1-4		TCI.State.0	
CSI-RS for tracking	1-4		TRS.2.1 TDD	
SSB Configuration	1-2		SSB.1 FR2	
	3-4		SSB.2 FR2	

SMTC Configuration		1-4		SMTC.1	
PRACH Configuration		1-4		FR2 PRACH configuration 2	A.3.8.3.2
DRX configuration		1-4		OFF	
SSB index assigned as BFD RS ( $q_0$ )		1-4		0	
SSB index assigned as CBD RS ( $q_1$ )		1-4		1	
Beam failure detection transmission parameters	DCI format	1-4		1-0	
	Number of Control OFDM symbols	1-4		2	
	Aggregation level	1-4	CCE	8	
	Ratio of hypothetical PDCCH RE energy to average SSS RE energy	1-4	dB	0	
	Ratio of hypothetical PDCCH DMRS energy to average SSS RE energy	1-4	dB	0	
	DMRS precoder granularity	1-4		REG bundle size	
	REG bundle size	1-4		6	
Gap pattern ID		1-4		N/A	No measurement gap is configured
rlmInSyncOutOfSyncThreshold		1-4		absent	Value 0 is applied. (Table 8.1.1-1).
rsrp-ThresholdSSB		1-2	dBm/SCS	-95	Threshold used for $Q_{in\_LR\_SSB}$
		3-4		-92	
powerControlOffsetSS		1-4		db0	Used for deriving rsrp-ThresholdCSI-RS
beamFailureInstanceMaxCount		1-4		n1	see TS 38.321 [7], clause 5.17
beamFailureDetectionTimer		1-4		pbfd4	see TS 38.321 [7], clause 5.17
CSI-RS configuration for CSI reporting		1-4		CSI-RS.3.1 TDD	
reportConfigType		1-4		periodic	
reportQuantity		1-4		cri-RI-PMI-CQI	
CSI reporting periodicity		1-4	slot	40	
CSI reporting offset		1-4	slot	4	
T310		1-4	ms	1000	
N310		1-4		2	
T1		1-4	s	1	The UE shall be fully synchronized to cell 1 during T1
T2		1-4	s	2.6	
T3		1-4	s	1.64	
T4		1-4	s	0	
T5		1-4	s	1.01	
D1		1-4	s	0.97	
Note 1: All configurations are assigned to the UE prior to the start of time period T1.					
Note 2: UE-specific PDCCH is not transmitted after T1 starts.					

**Table A.5.5.5.1-3: Cell specific test parameters for FR2 PSCell for SSB-based beam failure detection and link recovery testing in non-DRX mode**

Parameter	Unit	Test 1				
		T1	T2	T3	T4	T5
AoA setup		Setup 1 defined in A.3.15				
Assumption for UE beams <sup>Note 10</sup>		Rough				
EPRE ratio of PDCCH DMRS to SSS	dB	0				
EPRE ratio of PDCCH to PDCCH DMRS	dB					
EPRE ratio of PBCH DMRS to SSS	dB					
EPRE ratio of PBCH to PBCH DMRS	dB					

EPRE ratio of PSS to SSS		dB					
EPRE ratio of PDSCH DMRS to SSS		dB					
EPRE ratio of PDSCH to PDSCH DMRS		dB					
EPRE ratio of OCNG DMRS to SSS		dB					
EPRE ratio of OCNG to OCNG DMRS		dB					
SNR_SSB of set $q_0$	Config 1-4	dB	5 <sup>Note 11</sup>	-3 <sup>Note 11</sup>	-12	-12	-12
SNR_SSB of set $q_1$ SSB_RP of set $q_1$	Config 1-4	dB	0.2	0.2	20.2	20.2	20.2
	Config 1-2	dBm/	-104.5	-104.5	-84.5	-84.5	-84.5
	Config 3-4	SCS	-101.5	-101.5	-81.5	-81.5	-81.5
$N_{oc}$	Config 1-4	dBm/120 kHz	-104.7				
Propagation condition			TDL-A 30ns 75Hz				
<p>Note 1: OCNG shall be used such that the resources in Cell 1 are fully allocated and a constant total transmitted power spectral density is achieved for all OFDM symbols.</p> <p>Note 2: The uplink resources for CSI reporting are assigned to the UE prior to the start of time period T1.</p> <p>Note 3: NZP CSI-RS resource set configuration for CSI reporting are assigned to the UE prior to the start of time period T1.</p> <p>Note 4: Void</p> <p>Note 5: The timers and layer 3 filtering related parameters are configured prior to the start of time period T1.</p> <p>Note 6: The signal contains PDCCH for UEs other than the device under test as part of OCNG.</p> <p>Note 7: SNR levels correspond to the signal to noise ratio over the SSS REs.</p> <p>Note 8: The SNR in time periods T1, T2, T3, T4 and T5 is denoted as SNR1, SNR2 and SNR3 respectively in figure A.5.5.5.1-1.</p> <p>Note 9: The SNR values are specified for testing a UE which supports 2RX on at least one band. For testing of a UE which supports 4RX on all bands, the SNR during T3 is modified as specified in clause A.3.6.</p> <p>Note 10: Information about types of UE beam is given in B.2.1.3, and does not limit UE implementation or test system implementation</p> <p>Note 11: This value allows up to 1dB degradation from applied SNR to UE baseband</p>							

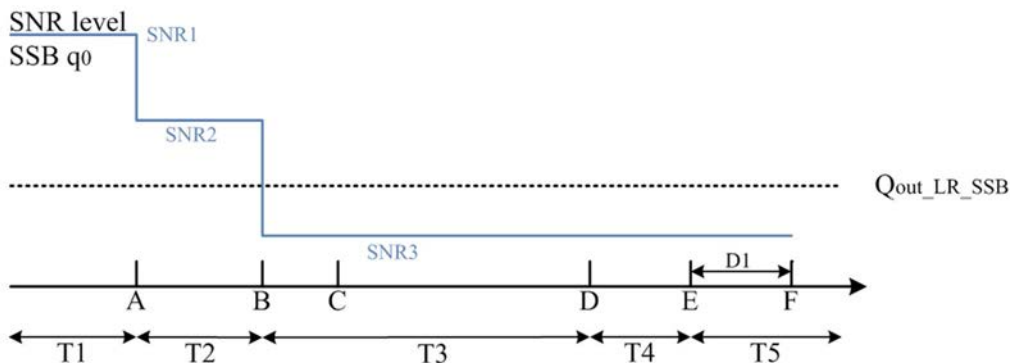
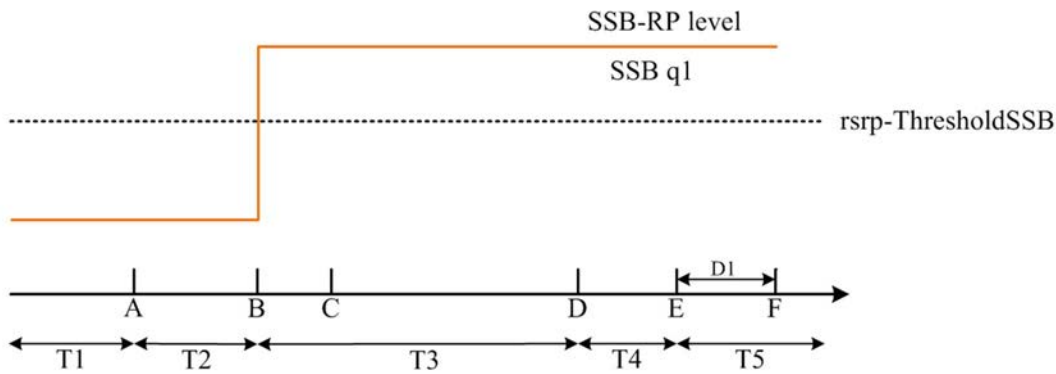

Figure A.5.5.5.1-1: SNR variation for SSB-based beam failure detection and link recovery testing in non-DRX mode



**Figure A.5.5.5.1-2: SSB\_RP level variation for SSB-based beam failure detection and link recovery testing in non-DRX mode**

**A.5.5.5.2 Test Requirements**

The UE behaviour during time duration T3 follows the requirements defined in clause 8.5.7.3:

- The UE is not expected to transmit PUCCH/PUSCH/SRS or receive PDCCH/PDSCH/CSI-RS for tracking/CSI-RS for CQI on BFD-RS symbols to be measured for beam failure detection.

The UE behaviour during time durations T4 and T5 follows the requirements defined in clause 8.5.8.3:

- The UE is not expected to transmit PUCCH/PUSCH or receive PDCCH/PDSCH on reference symbols to be measured for candidate beam detection.

**A.5.5.5.6 EN-DC Beam Failure Detection and Link Recovery Test for FR2 SCell configured with CSI-RS-based BFD and LR in non-DRX mode**

**A.5.5.5.6.1 Test Purpose and Environment**

The purpose of this test is to verify that the UE properly detects CSI-RS-based beam failure in the set  $q_0$  configured for an active SCell and that the UE performs correct CSI-RS-based link recovery based on beam candidate set  $q_1$ . The purpose is to test the downlink monitoring for beam failure detection within the UEs active DL BWP of the SCell with *schedulingRequestID-BFR-SCell-r16* configuration, during the evaluation period, and link recovery, when no DRX is used. This test will partly verify the CSI-RS based beam failure detection and link recovery for an FR2 SCell requirements in clause 8.5.

The test parameters are given in Tables A.5.5.5.6.1-1, A.5.5.5.6.1-2 and A.5.5.5.6.1-3. There are three cells, cell 1 is the E-UTRAN PCell, cell 2 is the PSCell, and cell 3 is the SCell, in the test. The test consists of five successive time periods, with time duration of T1, T2, T3, T4 and T5 respectively. Figure A.5.5.5.6.1-1 shows the variation of the downlink SNR of the active SCell and the SNR of the CSI-RS in set  $q_0$  in the active SCell to emulate CSI-RS based beam failure. Figure A.5.5.5.6.1-2 shows the variation of the downlink L1-RSRP of the CSI-RS in set  $q_1$  of the candidate beam used for link recovery. Prior to the start of the time duration T1, the UE shall be fully synchronized to cell 1, cell 2, and cell 3. The UE shall be configured for periodic CSI reporting with a reporting periodicity of 2 ms. In the test, DRX configuration is not enabled.

**Table A.5.5.5.6.1-1: Supported test configurations for FR2 PSCell and SCell**

Configuration	Description
1	LTE FDD, TDD duplex mode, 120 kHz SSB SCS, 100 MHz bandwidth
2	LTE TDD, TDD duplex mode, 120 kHz SSB SCS, 100 MHz bandwidth

**Table A.5.5.5.6.1-2: General test parameters for FR2 SCell for beam failure detection and link recovery testing in non-DRX mode**

Parameter	Test	Unit	Value	Comment
-----------	------	------	-------	---------

		Config.		Test 1	
Active E-UTRA PCell		1-2		Cell 1	
E-UTRA RF Channel Number		1-2		1	
Active PCell		1-2		Cell 2	
RF Channel Number for PSCell		1-2		2	
Active SCell		1-2		Cell 3	
RF Channel Number for SCell		1-2		3	
Duplex mode		1-2		TDD	
TDD Configuration		1-2		TDDConf.3.1	
BW <sub>channel</sub>		1-2	MHz	100: N <sub>RB,c</sub> = 66	
Data RBs allocated		1-2		66	
PDSCH/PDCCH subcarrier spacing		1-2	kHz	120	
DL initial BWP configuration		1-2		DLBWP.0.1	
DL dedicated BWP configuration		1-2		DLBWP.1.1	
UL initial BWP configuration		1-2		ULBWP.0.1	
UL dedicated BWP configuration		1-2		ULBWP.1.1	
PDSCH Reference Channel		1-2		SR.3.2 TDD	
RMSI CORESET Reference Channel		1-2		CR.3.1 TDD	A.3.1.2
Dedicated CORESET Reference Channel		1-2		CCR.3.1 TDD	
OCNG parameters		1-2		OP.1	A.3.2.1
CP length		1-2		Normal	
PDSCH/PDCCH TCI state		1-2		TCI.State.0	
CSI-RS for tracking		1-2		TRS.2.1 TDD	
SSB Configuration		1-2		SSB.3 FR2	A.3.10
SMTC Configuration		1-2		SMTC.3	A.3.11
PRACH Configuration		1-2		FR2 PRACH configuration 4	Table A.3.8.3.4-1
DRX configuration		1-2		OFF	
CSI-RS configuration for BFD/CBD in activated SCell		1-2		CSI-RS.3.2 TDD	A.3.14.2
CSI-RS index assigned as BFD RS (q <sub>0</sub> ) in activated SCell		1-2		0	
CSI-RS index assigned as CBD RS (q <sub>1</sub> ) in activated SCell		1-2		1	
CSI-RS configuration for RLM in PSCell		1-2		CSI-RS.3.2 TDD	A.3.14.2
Beam failure detection transmission parameters	DCI format	1-2		1-0	
	Number of Control OFDM symbols	1-2		2	
	Aggregation level	1-2	CCE	8	
	Ratio of hypothetical PDCCH RE energy to average SSS RE energy	1-2	dB	0	
	Ratio of hypothetical PDCCH DMRS energy to average SSS RE energy	1-2	dB	0	
	DMRS precoder granularity	1-2		REG bundle size	
	REG bundle size	1-2		6	
Gap pattern ID		1-2		N/A	
schedulingRequestID-BFR-SCell-r16		1-2		Configured	
Periodicity of PUCCH for SR configuration for BFR on SCell		1-2	slot	40	5ms
Offset of PUCCH for SR configuration for BFR on SCell		1-2	slot	4	
PUCCH parameters for SR configuration for BFR on SCell		1-2		Table 8.3.3.1.2-1 in [13]	
rlmInSyncOutOfSyncThreshold		1-2		absent	Value 0 is applied. (Table 8.1.1-1).
rsrp-ThresholdSSB		1-2	dBm/SCS	-95	Threshold used for Q <sub>in_LR_SSB</sub>
powerControlOffsetSS		1-2		db0	Used for deriving rsrp-ThresholdCSI-RS
beamFailureInstanceMaxCount		1-2		n1	see TS 38.321 [7], clause 5.17



beamFailureDetectionTimer	1-2		pbfd4	see TS 38.321 [7], clause 5.17
CSI-RS configuration for CSI reporting	1-2		CSI-RS.3.1 TDD	A.3.14.2
reportConfigType	1-2		periodic	
reportQuantity	1-2		cri-RI-PMI-CQI	
CSI reporting periodicity	1-2	slot	40	
CSI reporting offset	1-2	slot	4	
T310	1-2	ms	1000	
N310	1-2		2	
T1	1-2	s	1	The UE shall be fully synchronized to cell 1 during T1
T2	1-2	s	1.17	
T3	1-2	s	0.9	
T4	1-2	s	0	
T5	1-2	s	0.31	
D1	1-2	s	0.27	
Note 1: UE-specific PDCCH is not transmitted after T1 starts.				

**Table A.5.5.6.1-3: Cell specific test parameters for FR2 SCell for beam failure detection and link recovery testing in non-DRX mode**

Parameter		Unit	Cell2 T1 to T5	Cell3 Test 1				
				T1	T2	T3	T4	T5
AoA setup			Setup 1 defined in A.3.15	Setup 1 defined in A.3.15				
Assumption for UE beams <sup>Note 10</sup>			Rough	Rough				
EPRE ratio of PDCCH DMRS to SSS		dB	0	0				
EPRE ratio of PDCCH to PDCCH DMRS		dB						
EPRE ratio of PBCH DMRS to SSS		dB						
EPRE ratio of PBCH to PBCH DMRS		dB						
EPRE ratio of PSS to SSS		dB						
EPRE ratio of PDSCH DMRS to SSS		dB						
EPRE ratio of PDSCH to PDSCH DMRS		dB						
EPRE ratio of OCNG DMRS to SSS		dB						
EPRE ratio of OCNG to OCNG DMRS		dB						
SNR_CSI-RS of set q <sub>0</sub>	Config 1,2	dB	5	5	-3	-12	-12	-12
SNR_CSI-RS of set q <sub>1</sub>	Config 1,2	dB	0.2	0.2	0.2	20.2	20.2	20.2
CSI-RS_RP of set q <sub>1</sub>	Config 1,2	dBm/S CS kHz	-104.5	-104.5	-104.5	-84.5	-84.5	-84.5
N <sub>oc</sub>	Config 1,2	dBm/12 0kHz	-104.7	-104.7				
Propagation condition			TDL-A 30ns 75Hz	TDL-A 30ns 75Hz				

- Note 1: OCNG shall be used such that the resources in Cell 1 are fully allocated and a constant total transmitted power spectral density is achieved for all OFDM symbols.
- Note 2: The uplink resources for CSI reporting are assigned to the UE prior to the start of time period T1.
- Note 3: NZP CSI-RS resource set configuration for CSI reporting are assigned to the UE prior to the start of time period T1.
- Note 4: Void
- Note 5: The timers and layer 3 filtering related parameters are configured prior to the start of time period T1.
- Note 6: The signal contains PDCCH for UEs other than the device under test as part of OCNG.
- Note 7: SNR levels correspond to the signal to noise ratio over the REs carrying CSI-RS.
- Note 8: The SNR in time periods T1, T2, T3, T4 and T5 is denoted as SNR1, SNR2 and SNR3 respectively in figure A.5.5.5.6.1-1.
- Note 9: The SNR values are specified for testing a UE which supports 2RX on at least one band. For testing of a UE which supports 4RX on all bands, the SNR during T3 is modified as specified in clause A.3.6.
- Note 10: Information about types of UE beam is given in B.2.1.3, and does not limit UE implementation or test system implementation

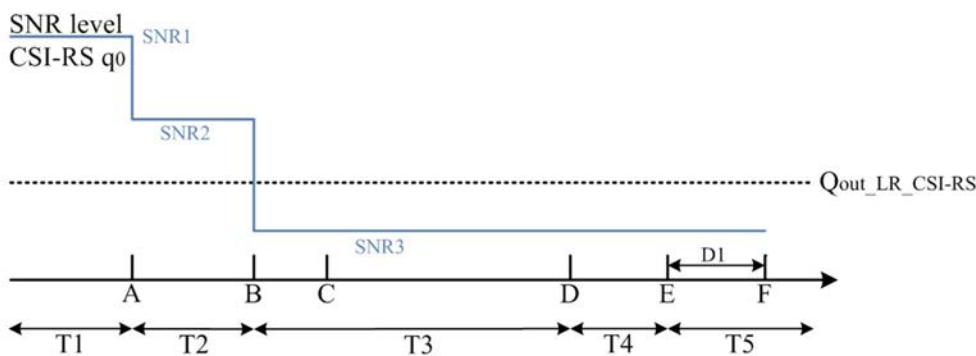

Figure A.5.5.5.6.1-1: SNR variation for CSI-RS based beam failure detection and link recovery testing for SCell in non-DRX mode

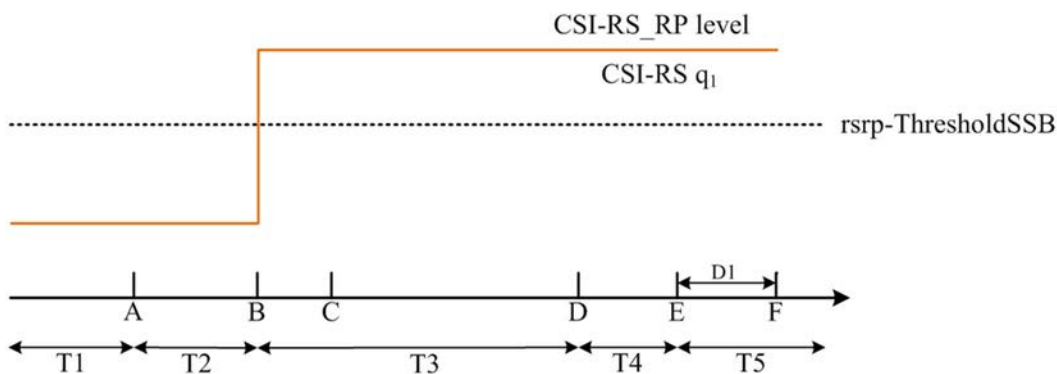

Figure A.5.5.5.6.1-2: CSI-RS\_RP level variation for CSI-RS based beam failure detection and link recovery testing for SCell in non-DRX mode

### A.5.5.5.6.2 Test Requirements

The UE behaviour during time durations T1, T2, T3, T4 and T5 in A.5.5.5.6.1 shall be as follows:

During the time duration T1 and T2, the UE shall transmit uplink signal at least in all subframes configured for CSI transmission on Cell 2.

During the period from time point A to time point B the UE shall transmit uplink signal in Cell 2 in all uplink slots configured for CSI transmission according to the configured periodic CSI reporting for Cell 2.

During T3 the UE shall detect beam failure and initial link recovery. During T4 and T5 the UE measures and evaluates beam candidate from beam candidate set  $q_1$ .

No later than time point F occurring no later than  $D1 = 260+10$  ms after the start of T5, the UE shall transmit PUCCH with LRR, followed by BFR MAC CE containing a beam associated with the candidate beam set  $q_1$ . The UE shall not transmit PUCCH with an LRR with the candidate beam set  $q_1$  earlier than time point B.

Test is concluded once the test equipment has received the initial preamble transmission from the UE. The rate of correct events observed during repeated tests shall be at least 90%.

#### A.5.5.5.7 EN-DC Beam Failure Detection and Link Recovery Test for FR2 SCell configured with CSI-RS-based BFD and LR in DRX mode

##### A.5.5.5.7.1 Test Purpose and Environment

The purpose of this test is to verify that the UE properly detects CSI-RS-based beam failure in the set  $q_0$  configured for an active SCell and that the UE performs correct CSI-RS-based link recovery based on beam candidate set  $q_1$ . The purpose is to test the downlink monitoring for beam failure detection within the UEs active DL BWP of the SCell with *schedulingRequestID-BFR-SCell-r16* configuration, during the evaluation period, and link recovery, when DRX is used. This test will partly verify the CSI-RS based beam failure detection and link recovery for an FR2 SCell requirements in clause 8.5.

The test parameters are given in Tables A.5.5.5.7.1-1, A.5.5.5.7.1-2 and A.5.5.5.7.1-3. There are three cells, cell 1 is the E-UTRAN PCell, cell 2 is the PCell, and cell 3 is the SCell, in the test. The test consists of five successive time periods, with time duration of T1, T2, T3, T4 and T5 respectively. Figure A.5.5.5.7.1-1 shows the variation of the downlink SNR of the active SCell and the SNR of the CSI-RS in set  $q_0$  in the active SCell to emulate CSI-RS based beam failure. Figure A.5.5.5.7.1-2 shows the variation of the downlink L1-RSRP of the CSI-RS in set  $q_1$  of the candidate beam used for link recovery. Prior to the start of the time duration T1, the UE shall be fully synchronized to cell 1, cell 2, and cell 3. The UE shall be configured for periodic CSI reporting with a reporting periodicity of 5 ms. In the test, DRX configuration is enabled in PCell and DRX inactivity timer has already been expired, i.e. UE tries to decode PDCCH and to send periodic CQI during the period when On-duration timer is running. Time alignment timers shall be set to “infinity” so that UL timing alignment is maintained during the test.

**Table A.5.5.5.7.1-1: Supported test configurations for FR2 PCell and SCell**

Configuration	Description
1	LTE FDD, TDD duplex mode, 120 kHz SSB SCS, 100 MHz bandwidth
2	LTE TDD, TDD duplex mode, 120 kHz SSB SCS, 100 MHz bandwidth

**Table A.5.5.5.7.1-2: General test parameters for FR2 SCell for beam failure detection and link recovery testing in DRX mode**

Parameter	Test Config.	Unit	Value	Comment
			Test 1	
Active E-UTRA PCell	1-2		Cell 1	
E-UTRA RF Channel Number	1-2		1	
Active PCell	1-2		Cell 2	
RF Channel Number for PCell	1-2		2	
Active SCell	1-2		Cell 3	
RF Channel Number for SCell	1-2		3	
Duplex mode	1-2		TDD	
TDD Configuration	1-2		TDDConf.3.1	
$BW_{channel}$	1-2	MHz	100: $N_{RB,c} = 66$	
Data RBs allocated	1-2		66	
PDSCH/PDCCH subcarrier spacing	1-2	kHz	120	
DL initial BWP configuration	1-2		DLBWP.0.1	
DL dedicated BWP configuration	1-2		DLBWP.1.1	
UL initial BWP configuration	1-2		ULBWP.0.1	

UL dedicated BWP configuration		1-2		ULBWP.1.1	
PDSCH Reference Channel		1-2		SR.3.2 TDD	
RMSI CORESET Reference Channel		1-2		CR.3.1 TDD	A.3.1.2
Dedicated CORESET Reference Channel		1-2		CCR.3.1 TDD	
OCNG parameters		1-2		OP.1	A.3.2.1
CP length		1-2		Normal	
PDSCH/PDCCH TCI state		1-2		TCI.State.0	
CSI-RS for tracking		1-2		TRS.2.1 TDD	
SSB Configuration		1-2		SSB.3 FR2	A.3.10
SMTC Configuration		1-2		SMTC.3	A.3.11
PRACH Configuration		1-2		FR2 PRACH configuration 4	Table A.3.8.3.4-1
DRX configuration		1-2		DRX.3	A.3.3.3
CSI-RS configuration for BFD/CBD in activated SCell		1-2		CSI-RS.3.2 TDD	A.3.14.2
CSI-RS index assigned as BFD RS ( $q_0$ ) in activated SCell		1-2		0	
CSI-RS index assigned as CBD RS ( $q_1$ ) in activated SCell		1-2		1	
CSI-RS configuration for RLM in PSCell		1-2		CSI-RS.3.2 TDD	A.3.14.2
Beam failure detection transmission parameters	DCI format	1-2		1-0	
	Number of Control OFDM symbols	1-2		2	
	Aggregation level	1-2	CCE	8	
	Ratio of hypothetical PDCCH RE energy to average SSS RE energy	1-2	dB	0	
	Ratio of hypothetical PDCCH DMRS energy to average SSS RE energy	1-2	dB	0	
	DMRS precoder granularity	1-2		REG bundle size	
	REG bundle size	1-2		6	
Gap pattern ID		1-2		N/A	
schedulingRequestID-BFR-SCell-r16		1-2		Configured	
Periodicity of PUCCH for SR configuration for BFR on SCell		1-2	slot	40	5ms
Offset of PUCCH for SR configuration for BFR on SCell		1-2	slot	4	
PUCCH parameters for SR configuration for BFR on SCell		1-2		Table 8.3.3.1.2-1 in [13]	
rlmInSyncOutOfSyncThreshold		1-2		absent	Value 0 is applied. (Table 8.1.1-1).
rsrp-ThresholdSSB		1-2	dBm/SCS	-95	Threshold used for $Q_{in\_LR\_SSB}$
powerControlOffsetSS		1-2		db0	Used for deriving rsrp-ThresholdCSI-RS
beamFailureInstanceMaxCount		1-2		n1	see TS 38.321 [7], clause 5.17
beamFailureDetectionTimer		1-2		pbfd4	see TS 38.321 [7], clause 5.17
CSI-RS configuration for CSI reporting		1-2		CSI-RS.3.1 TDD	A.3.14.2
reportConfigType		1-2		periodic	
reportQuantity		1-2		cri-RI-PMI-CQI	
CSI reporting periodicity		1-2	slot	40	
CSI reporting offset		1-2	slot	4	
T310		1-2	ms	1000	
N310		1-2		2	
T1		1-2	s	1	The UE shall be fully synchronized to cell 1 during T1
T2		1-2	s	5.43	
T3		1-2	s	5.16	
T4		1-2	s	0	

T5	1-2	s	0.31	
D1	1-2	s	0.27	
Note 1: UE-specific PDCCH is not transmitted after T1 starts.				

**Table A.5.5.7.1-3: Cell specific test parameters for FR2 SCell for beam failure detection and link recovery testing in DRX mode**

Parameter	Unit	Cell2	Cell3 Test 1					
			T1	T2	T3	T4	T5	
AoA setup		Setup 1 defined in A.3.155	Setup 1 defined in A.3.155					
Assumption for UE beams <sup>Note 10</sup>		Rough	Rough					
EPRE ratio of PDCCH DMRS to SSS	dB	0	0					
EPRE ratio of PDCCH to PDCCH DMRS	dB							
EPRE ratio of PBCH DMRS to SSS	dB							
EPRE ratio of PBCH to PBCH DMRS	dB							
EPRE ratio of PSS to SSS	dB							
EPRE ratio of PDSCH DMRS to SSS	dB							
EPRE ratio of PDSCH to PDSCH DMRS	dB							
EPRE ratio of OCNB DMRS to SSS	dB							
EPRE ratio of OCNB to OCNB DMRS	dB							
SNR_CSI-RS of set q <sub>0</sub>	Config 1,2	dB	5	5	-3	-12	-12	-12
SNR_CSI-RS of set q <sub>1</sub>	Config 1,2	dB	0.2	0.2	0.2	20.2	20.2	20.2
CSI-RS_RP of set q <sub>1</sub>	Config 1,2	dBm/SCS kHz	-104.5	-104.5	-104.5	-84.5	-84.5	-84.5
N <sub>oc</sub>	Config 1,2	dBm/120 kHz	-104.7	-104.7				
Propagation condition		TDL-A 30ns 75Hz	TDL-A 30ns 75Hz					
<p>Note 1: OCNB shall be used such that the resources in Cell 1 are fully allocated and a constant total transmitted power spectral density is achieved for all OFDM symbols.</p> <p>Note 2: The uplink resources for CSI reporting are assigned to the UE prior to the start of time period T1.</p> <p>Note 3: NZP CSI-RS resource set configuration for CSI reporting are assigned to the UE prior to the start of time period T1.</p> <p>Note 4: Void</p> <p>Note 5: The timers and layer 3 filtering related parameters are configured prior to the start of time period T1.</p> <p>Note 6: The signal contains PDCCH for UEs other than the device under test as part of OCNB.</p> <p>Note 7: SNR levels correspond to the signal to noise ratio over the SSS REs.</p> <p>Note 8: The SNR in time periods T1, T2, T3, T4 and T5 is denoted as SNR1, SNR2 and SNR3 respectively in figure A.5.5.7.1-1.</p> <p>Note 9: The SNR values are specified for testing a UE which supports 2RX on at least one band. For testing of a UE which supports 4RX on all bands, the SNR during T3 is modified as specified in clause A.3.6.</p> <p>Note 10: Information about types of UE beam is given in B.2.1.3, and does not limit UE implementation or test system implementation</p>								

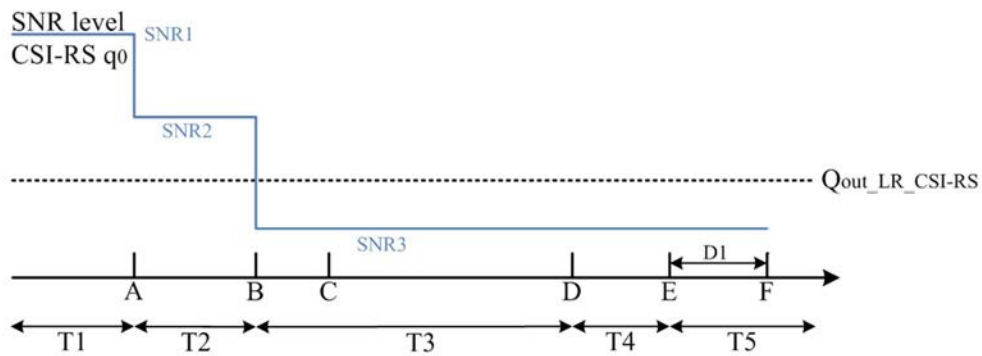

Figure A.5.5.7.1-1: SNR variation for CSI-RS-based beam failure detection and link recovery testing for SCell in DRX mode

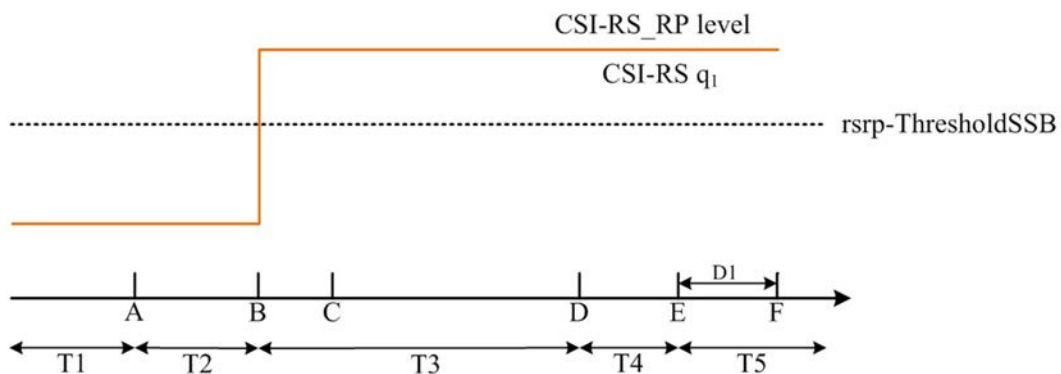

Figure A.5.5.7.1-2: CSI-RS\_RP level variation for CSI-RS based beam failure detection and link recovery testing for SCell in DRX mode

### A.5.5.5.7.2 Test Requirements

The UE behaviour during time durations T1, T2, T3, T4 and T5 in A.5.5.5.7.1 shall be as follows:

During the time duration T1 and T2, the UE shall transmit uplink signal at least in all subframes configured for CSI transmission on Cell 2.

During the period from time point A to time point B the UE shall transmit uplink signal in Cell 1 in all uplink slots configured for CSI transmission according to the configured periodic CSI reporting for Cell 2.

During T3 the UE shall detect beam failure and initial link recovery. During T4 and T5 the UE measures and evaluates beam candidate from beam candidate set  $q_1$ .

No later than time point F occurring no later than  $D1 = 260+10$  ms after the start of T5, the UE shall transmit PUCCH with LRR, followed by BFR MAC CE containing a beam associated with the candidate beam set  $q_1$ . The UE shall not transmit PUCCH with an LRR with the candidate beam set  $q_1$  earlier than time point B.

Test is concluded once the test equipment has received the initial preamble transmission from the UE. The rate of correct events observed during repeated tests shall be at least 90%.

## A.5.5.6 Active BWP switch

### A.5.5.6.1 DCI-based and Timer-based Active BWP Switch

#### A.5.5.6.1.1 E-UTRAN – NR PSCell FR2 DL active BWP switch with non-DRX in synchronous EN-DC

##### A.5.5.6.1.1.1 Test Purpose and Environment

The purpose of this test is to verify the DL BWP switch delay requirement defined in clause 8.6. Supported test configurations are shown in Table A.5.5.6.1.1.1-1.

The test scenario comprises of one E-UTRA PCell (Cell 1), and one NR PSCell (Cell 2) as given in Table A.5.5.6.1.1.1-2. Cell-specific parameters of E-UTRA PCell are specified in Table A.3.7.2.1-1 and Cell-specific parameters of NR PSCell is specified in Table A.5.5.6.1.1.1-3 below. The OTA related test parameters for FR2 is shown in Table A.5.5.6.1.1.1-4.

PDCCHs indicating new transmissions shall be sent continuously on PCell (Cell 1) to ensure that the UE will have ACK/NACK sending.

PDCCHs indicating new transmissions shall be sent continuously on PSCell (Cell 2) to ensure that the UE would have ACK/NACK sending except for the time duration when BWP is switching on Cell 2 and the time duration of T2.

Before the test starts,

- UE is connected to Cell 1 (PCell) on radio channel 1 (PCC), and Cell 2 (PSCell) on radio channel 2 (PSCC).
- UE is configured with 2 different UE-specific downlink bandwidth parts for PSCell, BWP-1 and BWP-2, in Cell 2 before starting the test. BWP-1 and BWP-2 always include bandwidth of the initial DL BWP and SSB.
- UE is indicated in *firstActiveDownlinkBWP-Id* that the active DL BWP is BWP-1 in PSCell.
- UE is configured with a *bwp-InactivityTimer* timer value for PSCell.

All cells have constant signal levels throughout the test.

The test consists of 3 successive time periods, with durations of T1, T2, and T3, respectively.

During T1,

Time period T1 starts when a DCI format 1\_1 command for PSCell DL BWP switch, sent from the test equipment to the UE, is received at the UE side in PSCell's slot # denoted  $i$ . The UE should switch its bandwidth part from BWP-1 to BWP-2.

The UE shall be able to receive PDSCH at the beginning of the DL slot right after PSCell's DL slot ( $i+T_{BWPswitchDelay}$ ) as defined in clause 8.6 and starts to report valid ACK/NACK for the PSCell no later than at the beginning of the DL slot right after slot ( $i+T_{BWPswitchDelay}+kI$ ). The UE shall be continuously scheduled on PSCell's BWP-2 starting from the beginning of the DL slot right after slot ( $i+T_{BWPswitchDelay}$ ).

During T2, the test equipment won't transmit DCI format for PDSCH reception on PSCell(Cell 2).

During T3,

The time period T3 starts from the slot # $j$ , where  $j$  is the beginning slot of the DL subframe immediately after the slot wherein *bwp-InactivityTimer* timer expires. The UE should switch its bandwidth part from BWP-2 back to the default bandwidth part – BWP-1.

The UE shall be able to receive PDSCH at the beginning of the DL slot right after PSCell's DL slot ( $j+T_{BWPswitchDelay}$ ) as defined in clause 8.6 and starts to report valid ACK/NACK for the PSCell at latest at the beginning of the DL slot right after slot ( $j+T_{BWPswitchDelay}+kI$ ). The UE shall be continuously scheduled on PSCell's BWP-1 starting from the beginning of the DL slot right after slot ( $j+T_{BWPswitchDelay}$ ).

The test equipment verifies the DL BWP switch time in PSCell by counting the slots from the time when the BWP switch command is received or *bwp-InactivityTimer* timer expires till an ACK is received.

Table A.5.5.6.1.1.1-1: DL BWP switch supported test configurations

Config	Description
1	LTE FDD, NR 120 kHz SSB SCS, 100 MHz bandwidth, TDD duplex mode
2	LTE TDD, NR 120 kHz SSB SCS, 100 MHz bandwidth, TDD duplex mode
Note 1: The UE is only required to be tested in one of the supported test configurations	
Note 2: A UE which fulfils the requirements in test case A.5.5.2.2 can skip the test cases in A.5.5.2.1.	

Table A.5.5.6.1.1.1-2: General test parameters for DL BWP switch in synchronous EN-DC

Parameter	Unit	Value	Comment
E-UTRA RF Channel Number		1	One E-UTRA radio channel is used for this test
NR RF Channel Number		2	One NR radio channel is used for this test
Active PCell		Cell 1	PCell on RF channel number 1.
Active PSCell		Cell 2	PSCell on RF channel number 2.
CP length		Normal	
DRX		OFF	For both PCell and PSCell
<i>bwp-InactivityTimer</i>	ms	[200]	
PDCCH and PDSCH maximum number of HARQ transmission		1	For both PCell and PSCell
Cell-individual offset for cells on RF channel number 1	dB	0	Individual offset for cells on PCC.
Cell-individual offset for cells on RF channel number 2	dB	0	Individual offset for cells on PSCC.
Cell2 timing offset to cell1	μs	3	Synchronous EN-DC
T1	s	[0.2]	
T2	s	[0.2]	
T3	s	[0.2]	

Table A.5.5.6.1.1.1-3: NR Cell specific test parameters for DL BWP switch in synchronous EN-DC

Parameter	Unit	Cell 2
Frequency Range		FR2
Duplex mode		TDD
TDD configuration		TDDConf.3.1
$BW_{channel}$		100 MHz: $N_{RB,C} = 66$
Active BWP ID		1, 2
Initial DL BWP Configuration		DLBWP.0.2 <sup>Note 2</sup>
Active DL BWP-1 Configuration		DLBWP.1.1 <sup>Note 2</sup>
Active DL BWP-2 Configuration		DLBWP.1.3 <sup>Note 2</sup>
Initial UL BWP Configuration		ULBWP.0.2 <sup>Note 2</sup>
Active UL BWP-1 Configuration		ULBWP.1.1 <sup>Note 2</sup>
Active UL BWP-2 Configuration		ULBWP.1.3 <sup>Note 2</sup>
PDSCH Reference measurement channel		SR.3.1 TDD
RMSI CORESET parameters		CR.3.1 TDD
Dedicated CORESET parameters		CCR.3.1 TDD
OCNG Patterns		OP.1
SSB Configuration		SSB.1 FR2
SMTC Configuration		SMTC.1
TCI State		TCI.State.0
TRS Configuration		TRS.2.1 TDD
Correlation Matrix and Antenna Configuration		1x2 Low
EPRE ratio of PSS to SSS	dB	0
EPRE ratio of PBCH DMRS to SSS		
EPRE ratio of PBCH to PBCH DMRS		
EPRE ratio of PDCCH DMRS to SSS		



EPRE ratio of PDCCH to PDCCH DMRS		
EPRE ratio of PDSCH DMRS to SSS		
EPRE ratio of PDSCH to PDSCH		
EPRE ratio of OCNG DMRS to SSS(Note 1)		
EPRE ratio of OCNG to OCNG DMRS (Note 1)		
Propagation Condition		AWGN
Note 1: OCNG shall be used such that both cells are fully allocated and a constant total transmitted power spectral density is achieved for all OFDM symbols.		
Note 2: For unpaired spectrum, a DL BWP is linked with an UL BWP. DLBWP.0.2 is linked with ULBWP.0.2; DLBWP.1.1 is linked with ULBWP.1.1; DLBWP.1.3 is linked with ULBWP.1.3 defined in clause 12 of TS 38.213 [3].		

**Table A.5.5.6.1.1.1-4: OTA related test parameters for DL BWP switch in synchronous EN-DC**

Parameter	Unit	Cell 2
Angle of arrival configuration		Setup 1 according to clause A.3.15.1
Assumption for UE beams <sup>Note 6</sup>		Fine
$N_{oc}$ <sup>Note 1</sup>	dBm/15 kHz	-112
$N_{oc}$ <sup>Note 1</sup>	dBm/SCS	-103
SS-RSRP <sup>Note 2</sup>	dBm/120 kHz <sup>Note 3</sup>	-85
$\bar{E}_s/I_{ot}$	dB	18
$I_o$ <sup>Note 2</sup>	dBm/95.04 MHz <sup>Note 4</sup>	-56
<p>Note 1: Interference from other cells and noise sources not specified in the test is assumed to be constant over subcarriers and time and shall be modelled as AWGN of appropriate power for <math>N_{oc}</math> to be fulfilled.</p> <p>Note 2: SS-RSRP and <math>I_o</math> levels have been derived from other parameters for information purposes. They are not settable parameters themselves.</p> <p>Note 3: SS-RSRP minimum requirements are specified assuming independent interference and noise at each receiver antenna port.</p> <p>Note 4: Equivalent power received by an antenna with 0 dBi gain at the centre of the quiet zone</p> <p>Note 5: As observed with 0dBi gain antenna at the centre of the quiet zone.</p> <p>Note 6: Information about types of UE beam is given in B.2.1.3, and does not limit UE implementation or test system implementation</p>		

#### A.5.5.6.1.1.2 Test Requirements

During T1, the UE shall start to send the ACK for PSCell from the first UL slot that occurs after the beginning of DL slot  $(i+T_{BWPswitchDelay}+kI)$ .

During T3, the UE shall start to send the ACK for PSCell from the first UL slot that occurs after the beginning of DL slot  $(j+T_{BWPswitchDelay}+kI)$ .

Where,  $kI$  is the timing between DL data receiving and acknowledgement as specified in [7].

Depending on UE capability *bwp-SwitchingDelay* [2], UE shall finish BWP switch within the time duration  $T_{BWPswitchDelay}$  defined in Table 8.6.2-1.

All of the above test requirements shall be fulfilled in order for the observed PSCell active BWP switch delay to be counted as correct.

The rate of correct events observed during repeated tests shall be at least 90%.

NOTE: During T1, T3 if there are no uplink resources for reporting the ACK in the DL slot right after DL slot  $(i+YI)$ ,  $(j+Y2)$ , then the UE shall use the next available uplink resource for reporting the corresponding ACK.

### A.5.5.6.1.2 E-UTRAN – NR PSCell FR2 with FR2 SCell DL active BWP switch in non-DRX in synchronous EN-DC

#### A.5.5.6.1.2.1 Test Purpose and Environment

The purpose of this test is to verify the DL BWP switch delay requirement defined in clause 8.6.2, and interruption requirements for NR victim cell defined in clause 8.2.1.2.7 . Supported test configurations are shown in Table A.5.5.6.1.2.1-1.

The test scenario comprises of one E-UTRA PCell (Cell 1), one PSCell (Cell 2) and one SCell (Cell 3) as given in Table A.5.5.6.1.2.1-2. Cell-specific parameters of E-UTRA PCell are specified in Table A.3.7.2.1-1 and Cell-specific parameters of PSCell and SCell are specified in Table A.5.5.6.1.2.1-3 below.

PDCCHs indicating new transmissions shall be sent continuously on E-UTRA PCell (Cell 1) to ensure that the UE will have ACK/NACK sending.

PDCCHs indicating new transmissions shall be sent continuously on PSCell (Cell 2) and SCell (Cell 3) to ensure that the UE would have ACK/NACK sending except for the time duration when BWP is switching on Cell 3 and the time duration of T2.

Before the test starts,

- UE is connected to Cell 1 (E-UTRA PCell) on radio channel 1 (PCC), Cell 2 (PSCell) on radio channel 2 (PSCC) and Cell 3 (SCell) on radio channel 3 (SCC).
- UE is configured with 2 different UE-specific downlink bandwidth parts for SCell, BWP-1 and BWP-2, in Cell 3 before starting the test. BWP-1 and BWP-2 always include bandwidth of the initial DL BWP and SSB.
- UE is configured with 1 UE-specific downlink bandwidth parts the same as initial BWP for PSCell, BWP-0 in Cell 2 before starting the test.
- UE is indicated in *firstActiveDownlinkBWP-Id* that the active DL BWP is BWP-1 in SCell.
- UE is indicated in *firstActiveDownlinkBWP-Id* that the active DL BWP is BWP-0 in PSCell.
- UE is configured with a *bwp-InactivityTimer* timer value for SCell.

All cells have constant signal levels throughout the test.

The test consists of 3 successive time periods, with durations of T1, T2, and T3, respectively.

During T1,

Time period T1 starts when a DCI format 1\_1 command for PSCell DL BWP switch, sent from the test equipment to the UE, is received at the UE side in PSCell's slot # denoted  $i$ . The UE shall switch its bandwidth part from BWP-1 to BWP-2.

The UE shall be able to receive PDSCH at the beginning of the DL slot right after PSCell's DL slot ( $i+T_{BWPswitchDelay}$ ) as defined in clause 8.6 and starts to report valid ACK/NACK for the PSCell no later than at the beginning of the DL slot right after slot ( $i+T_{BWPswitchDelay}+kI$ ). The UE shall be continuously scheduled on SCell's BWP-2 starting from the beginning of the DL slot right after slot ( $i+T_{BWPswitchDelay}$ ).

PCell(Cell 1) interruption due to BWP switch on PSCell shall occur within the BWP switch delay.

PSCell(Cell 2) interruption due to BWP switch on SCell shall occur within the BWP switch delay.

During T2, the test equipment won't transmit DCI format for PDSCH reception on SCell(Cell 3).

During T3,

The time period T3 starts from the slot # $j$ , where  $j$  is the first slot of the subframe immediately after the slot wherein *bwp-InactivityTimer* timer expires. The UE shall switch its bandwidth part from BWP-2 back to the default bandwidth part – BWP-1.

The UE shall be able to receive PDSCH on the first DL slot that occurs after the beginning of SCell's DL slot ( $j+T_{BWPswitchDelay}$ ) as defined in clause 8.6 and starts to report valid ACK/NACK for the SCell on PSCell at latest

on the first UL slot that occurs after the beginning of slot  $(j+T_{BWPswitchDelay}+k_1)$ . The UE shall be continuously scheduled on SCell's BWP-1 starting from the first DL slot that occurs after the beginning of slot  $(j+T_{BWPswitchDelay})$ .

PCell(Cell 1) interruption due to BWP switch of PSCell shall occur within the BWP switch delay.

PSCell(Cell 2) interruption due to BWP switch of SCell shall occur within the BWP switch delay.

The test equipment verifies the DL BWP switch time in PSCell by counting the slots from the time when the BWP switch command is received or *bwpi-InactivityTimer* timer expires till an ACK is received.

The test equipment verifies that potential interruption to NR PSCell is carried out in the correct time span by monitoring ACK/NACK sent in PSCell during BWP switch of SCell.

**Table A.5.5.6.1.2.1-1: DL BWP switch supported test configurations**

Config	Description
1	LTE FDD, NR 120 kHz SSB SCS, 100 MHz bandwidth, TDD duplex mode
2	LTE TDD, NR 120 kHz SSB SCS, 100 MHz bandwidth, TDD duplex mode
Note 1: The UE is only required to be tested in one of the supported test configurations	
Note 2: A UE which fulfils the requirements in test case A.5.5.6.1.2 can skip the test cases in A.5.5.6.1.1.	
Note 3: NR configuration is the same for PSCell and SCells.	

**Table A.5.5.6.1.2.1-2: General test parameters for DL BWP switch in synchronous EN-DC**

Parameter	Unit	Value	Comment
E-UTRA RF Channel Number		1	One E-UTRA radio channel is used for this test
NR RF Channel Number		2, 3	Two NR radio channel is used for this test
Active PCell		Cell 1	PCell on RF channel number 1.
Active PSCell		Cell 2	PSCell on RF channel number 2.
Active SCell		Cell 3	SCell on RF channel number 3.
CP length		Normal	
DRX		OFF	
<i>bwpi-InactivityTimer</i>	ms	[200]	
PDCCH and PDSCH maximum number of HARQ transmission		1	For PCell, PSCell and SCell
Cell-individual offset for cells on RF channel number 1	dB	0	Individual offset for cells on PCC.
Cell-individual offset for cells on RF channel number 2	dB	0	Individual offset for cells on PSCC.
Cell-individual offset for cells on RF channel number 3	dB	0	Individual offset for cells on SCC.
Cell2 timing offset to cell1	μs	3	Synchronous EN-DC
Cell3 timing offset to cell2	μs	3	Synchronous cells
T1	s	0.2	
T2	s	0.2	
T3	s	0.2	

**Table A.5.5.6.1.2.1-3: NR Cell specific test parameters for DL BWP switch in synchronous EN-DC**

Parameter	Unit	Cell 2	Cell 3
Frequency Range		FR2	
Duplex mode		TDD	
TDD configuration		TDDConf.3.1	
BW <sub>channel</sub>		100 MHz: N <sub>RB,c</sub> = 66	
Active BWP ID		0	1,2
Initial DL BWP Configuration		DLBWP.0.2	DLBWP.0.2
Active DL BWP-0 Configuration		DLBWP.0.2	N.A.
Active DL BWP-1 Configuration		N.A.	DLBWP.1.3
Active DL BWP-2 Configuration		N.A.	DLBWP.1.1
Initial UL BWP Configuration		ULBWP.0.2	N.A.

Active UL BWP-0 Configuration		ULBWP.0.2	N.A.
Active UL BWP-1 Configuration		N.A.	N.A.
Active UL BWP-2 Configuration		N.A.	N.A.
PDSCH Reference measurement channel		SR.3.1 TDD	
RMSI CORESET parameters		CR.3.1 TDD	
Dedicated CORESET parameters		CCR.3.1 TDD	
OCNG Patterns		OP.1	
SSB Configuration		SSB.1 FR2	
SMTTC Configuration		SMTTC.1	
TCI State		TRS.2.1 TDD	
TRS Configuration		TCI.State.0	
Antenna Configuration		1x2	
Propagation Condition		AWGN	
EPRE ratio of PSS to SSS	dB	0	0
EPRE ratio of PBCH DMRS to SSS			
EPRE ratio of PBCH to PBCH DMRS			
EPRE ratio of PDCCH DMRS to SSS			
EPRE ratio of PDCCH to PDCCH DMRS			
EPRE ratio of PDSCH DMRS to SSS			
EPRE ratio of PDSCH to PDSCH			
EPRE ratio of OCNG DMRS to SSS(Note 1)			
EPRE ratio of OCNG to OCNG DMRS (Note 1)			
<p>Note 1: OCNG shall be used such that both cells are fully allocated and a constant total transmitted power spectral density is achieved for all OFDM symbols.</p> <p>Note 2: Interference from other cells and noise sources not specified in the test is assumed to be constant over subcarriers and time and shall be modelled as AWGN of appropriate power for <math>N_{oc}</math> to be fulfilled.</p> <p>Note 3: SS-RSRP and <math>I_o</math> levels have been derived from other parameters for information purposes. They are not settable parameters themselves.</p> <p>Note 4: For unpaired spectrum, a DL BWP is linked with an UL BWP. DLBWP.0.2 is linked with ULBWP.0.2; DLBWP.1.1 is linked with ULBWP.1.1; DLBWP.1.3 is linked with ULBWP.1.3.</p>			

**Table A.5.5.6.1.2.1-4: OTA related test parameters for DL BWP switch in synchronous EN-DC**

Parameter	Unit	Cell 2	Cell 3
Angle of arrival configuration		Setup 1 according to clause A.3.15	
Assumption for UE beams <sup>Note 6</sup>		Fine	Fine
$N_{oc}$ <sup>Note 1</sup>	dBm/15 kHz	-112	-112
SS-RSRP <sup>Note 2</sup>	dBm/120 kHz <sup>Note 3</sup>	-85	-85
$\bar{E}_s/I_{ot}$	dB	18	18
$I_o$ <sup>Note 2</sup>	dBm/95.04 MHz <sup>Note 4</sup>	-56	-56
<p>Note 1: Interference from other cells and noise sources not specified in the test is assumed to be constant over subcarriers and time and shall be modelled as AWGN of appropriate power for <math>N_{oc}</math> to be fulfilled.</p> <p>Note 2: SS-RSRP and <math>I_o</math> levels have been derived from other parameters for information purposes. They are not settable parameters themselves.</p> <p>Note 3: SS-RSRP minimum requirements are specified assuming independent interference and noise at each receiver antenna port.</p> <p>Note 4: Equivalent power received by an antenna with 0dBi gain at the centre of the quiet zone</p> <p>Note 5: As observed with 0dBi gain antenna at the centre of the quiet zone.</p> <p>Note 6: Information about types of UE beam is given in B.2.1.3, and does not limit UE implementation or test system implementation</p>			

**A.5.5.6.1.2.2 Test Requirements**

During T1, the UE shall start to send the ACK for PSCell from the first UL slot that occurs after the beginning of DL after slot  $(i + T_{BWPswitchDelay} + kI)$ .

During T3, the UE shall start to send the ACK for PSCell from the first UL slot that occurs after the beginning of DL after slot  $(j + T_{BWPswitchDelay} + kI)$ .

All of the above test requirements shall be fulfilled in order for the observed PSCell active BWP switch delay to be counted as correct.

The rate of correct events observed during repeated tests shall be at least 90%.

During T1, the start of the interruption of PCell during PSCell active BWP switch shall not happen outside the BWP switch delay.

During T3, the start of the interruption of PCell during PSCell active BWP switch shall not happen outside the BWP switch delay.

The interruption of PCell shall not be longer than the interruption duration specified for active BWP switch in TS36.133 Clause 7.32.2.7.

During T1, the start of the interruption of SCell during PSCell active BWP switch shall not happen outside the BWP switch delay.

During T3, the start of the interruption of SCell during PSCell active BWP switch shall not happen outside the BWP switch delay.

The interruption of SCell shall not be longer than the interruption duration specified for active BWP switch in Clause 8.6.2.

All of the above test requirements shall be fulfilled in order for the observed PCell active BWP switch interruption to be counted as correct.

The rate of correct events observed during repeated tests shall be at least 90%.

NOTE: During T1, T3 if there are no uplink resources for reporting the ACK in the DL slot right after slot  $(i+T_{BWPswitchDelay}+kI)$ ,  $(j+T_{BWPswitchDelay}+kI)$ , then the UE shall use the next available uplink resource for reporting the corresponding ACK.

*Editor's note: FFS value of  $kI$  for type 1 and type 2 UE.*

## A.5.5.6.2 RRC-based Active BWP Switch

### A.5.5.6.2.1 E-UTRAN – NR PSCell FR2 DL active BWP switch with non-DRX in synchronous EN-DC

#### A.5.5.6.2.1.1 Test Purpose and Environment

The purpose of this test is to verify the DL BWP switch delay requirement for RRC-based BWP switch defined in clause 8.6.3. Supported test configurations are shown in Table A.5.5.6.2.1.1-1.

The test scenario comprises of one E-UTRA PCell (Cell 1) and one PSCell (Cell 2) as given in Table A.5.5.6.2.1.1-2. Cell-specific parameters of E-UTRA PCell are specified in Table A.3.7.2.1-1 and Cell-specific parameters of PSCell are specified in Table A.5.5.6.2.1.1-3 below.

PDCCHs indicating new transmissions shall be sent continuously on E-UTRA PCell (Cell 1) to ensure that the UE will have ACK/NACK sending.

PDCCHs indicating new transmissions shall be sent continuously on PSCell (Cell 2) to ensure that the UE would have ACK/NACK sending except for the time duration when BWP is switching on Cell 2.

Before the test starts,

- UE is connected to Cell 1 (E-UTRA PCell) on radio channel 1 (PCC) and to Cell 2 (PSCell) on radio channel 2 (PSCC).
- UE has bandwidth part BWP-1 in its RRC-configuration for Cell 2 (PSCell).
- UE is indicated in *firstActiveDownlinkBWP-Id* that the active DL BWP is BWP-1 of initial condition in PSCell.

All cells have constant signal levels throughout the test.

The test consists of 1 time period, with duration of T1.

During T1,

If the *RRCReconfiguration* is embedded in E-UTRA RRC message, time period T1 starts when a E-UTRA RRC message *RRConnectionReconfiguration* with updated bandwidth part configuration, sent from the test

equipment to the UE, is completely received at the UE side from PCell in PSCell’s slot # denoted *i*. Otherwise, i.e., if the *RRCReconfiguration* is not embedded in E-UTRA RRC message, time period T1 starts when a *RRCReconfiguration* with updated bandwidth part configuration, sent from the test equipment to the UE, is completely received at the UE side in from PSCell in PSCell’s slot # denoted *i*. The UE shall reconfigure its bandwidth part with the updated bandwidth part BWP-1 of final condition.

The UE shall be able to completely receive PDSCH on PSCell from the first DL slot occurs right after the beginning of PSCell’s DL slot  $i + \frac{T_{RRCprocessingDelay} + T_{BWPswitchDelayRRC}}{NR\ Slot\ length}$  as defined in clause 8.6.3 and starts to report valid ACK/NACK for the PSCell from the first UL slot that occurs after the beginning of DL slot  $i + \frac{T_{RRCprocessingDelay} + T_{BWPswitchDelayRRC}}{NR\ Slot\ length} + k1$ . The UE shall be continuously scheduled on PSCell’s BWP-1 starting from the first DL slot that occurs right after

the beginning of DL slot  $i + \frac{T_{RRCprocessingDelay} + T_{BWPswitchDelayRRC}}{NR\ Slot\ length}$ .

$T_{RRCprocessingDelay}$  and  $T_{BWPswitchDelayRRC}$  are defined in clause 8.6.3.

The test equipment verifies the DL BWP switch time in PSCell by counting the time from the time when the RRC Reconfiguration message including updated BWP configuration is sent till the time when a valid ACK/NACK is received.

**Table A.5.5.6.2.1.1-1: DL BWP switch supported test configurations**

Config	Description
1	LTE FDD, NR 120 kHz SSB SCS, 100 MHz bandwidth, TDD duplex mode
2	LTE TDD, NR 120 kHz SSB SCS, 100 MHz bandwidth, TDD duplex mode

Note 1: The UE is only required to be tested in one of the supported test configurations

**Table A.5.5.6.2.1.1-2: General test parameters for DL BWP switch in synchronous EN-DC**

Parameter	Unit	Value	Comment
E-UTRA RF Channel Number		1	One E-UTRA radio channel is used for this test
NR RF Channel Number		2	One NR radio channel is used for this test
Active PCell		Cell 1	PCell on RF channel number 1.
Active PSCell		Cell 2	PSCell on RF channel number 2.
CP length		Normal	
DRX		OFF	
PDCCH and PDSCH maximum number of HARQ transmission		1	For both PCell and PSCell
Cell-individual offset for cells on RF channel number 1	dB	0	Individual offset for cells on PCC.
Cell-individual offset for cells on RF channel number 2	dB	0	Individual offset for cells on PSCC.
Cell2 timing offset to cell1	μs	3	Synchronous EN-DC
T1	s	0.2	

**Table A.5.5.6.2.1.1-3: NR Cell specific test parameters for DL BWP switch in synchronous EN-DC**

Parameter	Unit	Cell 2
Frequency Range		FR2
Duplex mode		TDD
TDD configuration		TDDConf.3.1
BW <sub>channel</sub>		100 MHz: N <sub>RB,c</sub> = 66
Active BWP ID		1
Initial DL BWP Configuration		DLBWP.0.2
Initial UL BWP Configuration		ULBWP.0.2
Initial Condition	Active DL BWP-1 Configuration	DLBWP.1.3
	Active UL BWP-1 Configuration	ULBWP.1.3

Final Condition	Active DL BWP-1 Configuration		DLBWP.1.1
	Active UL BWP-1 Configuration		ULBWP.1.1
PDSCH Reference measurement channel			SR.3.1 TDD
RMSI CORESET parameters			CR.3.1 TDD
Dedicated CORESET parameters			CCR.3.1 TDD
OCNG Patterns			OP.1
SSB Configuration			SSB.1 FR2
SMTTC Configuration			SMTTC.1
TCI State			TCI.State.0
TRS Configuration			TRS.2.1 TDD
Antenna Configuration			1x2
Propagation Condition			AWGN
EPRE ratio of PSS to SSS		dB	0
EPRE ratio of PBCH DMRS to SSS			
EPRE ratio of PBCH to PBCH DMRS			
EPRE ratio of PDCCH DMRS to SSS			
EPRE ratio of PDCCH to PDCCH DMRS			
EPRE ratio of PDSCH DMRS to SSS			
EPRE ratio of PDSCH to PDSCH			
EPRE ratio of OCNG DMRS to SSS(Note 1)			
EPRE ratio of OCNG to OCNG DMRS (Note 1)			
<p>Note 1: OCNG shall be used such that both cells are fully allocated and a constant total transmitted power spectral density is achieved for all OFDM symbols.</p> <p>Note 2: Interference from other cells and noise sources not specified in the test is assumed to be constant over subcarriers and time and shall be modelled as AWGN of appropriate power for <math>N_{oc}</math> to be fulfilled.</p> <p>Note 3: SS-RSRP and <math>I_o</math> levels have been derived from other parameters for information purposes. They are not settable parameters themselves.</p> <p>Note 4: For unpaired spectrum, a DL BWP is linked with an UL BWP. DLBWP.0.2 is linked with ULBWP.0.2; DLBWP.1.1 is linked with ULBWP.1.1; DLBWP.1.3 is linked with ULBWP.1.3 defined in clause 12 of TS 38.213 [3].</p>			

**Table A.5.5.6.2.1.1-4: OTA related test parameters for BWP switching test case**

Parameter		Unit	Cell 2
Angle of arrival configuration			Setup 1 according to table A.3.15
Assumption for UE beams <sup>Note 5</sup>			Fine
$N_{oc}$ <sup>Note1</sup>	NR_TDD_FR2_A	dBm/15kHz	-112
	NR_TDD_FR2_B		
	NR_TDD_FR2_F		
	NR_TDD_FR2_G		
	NR_TDD_FR2_T		
$N_{oc}$ <sup>Note1</sup>	NR_TDD_FR2_Y	dBm/SCS	-103
	NR_TDD_FR2_A		
	NR_TDD_FR2_B		
	NR_TDD_FR2_F		
	NR_TDD_FR2_G		
SS-RSRP <sup>Note2</sup>	NR_TDD_FR2_T	dBm/SCS <sup>Note3</sup>	-85
	NR_TDD_FR2_Y		
	NR_TDD_FR2_A		
	NR_TDD_FR2_B		
	NR_TDD_FR2_F		
$\hat{E}_s / I_{ot}$		dB	18
$I_o$ <sup>Note2</sup>	NR_TDD_FR2_T	dBm/95.04 MHz <sup>Note4</sup>	-56
	NR_TDD_FR2_Y		
	NR_TDD_FR2_A		

	NR_TDD_FR2_G	
	NR_TDD_FR2_T	
	NR_TDD_FR2_Y	
Note 1:	Interference from other cells and noise sources not specified in the test is assumed to be constant over subcarriers and time and shall be modelled as AWGN of appropriate power for $N_{oc}$ to be fulfilled.	
Note 2:	SS-RSRP and $I_0$ levels have been derived from other parameters for information purposes. They are not settable parameters themselves.	
Note 3:	SS-RSRP minimum requirements are specified assuming independent interference and noise at each receiver antenna port.	
Note 4:	Equivalent power received by an antenna with 0dBi gain at the centre of the quiet zone	
Note 5:	Information about types of UE beam is given in B.2.1.3, and does not limit UE implementation or test system implementation	

#### A.5.5.6.2.1.2 Test Requirements

During T1, the UE shall be ready for the reception of uplink grant for PSCell

from the first DL slot that occurs right after the beginning of DL slot  $i + \frac{T_{\text{RRCprocessingDelay}} + T_{\text{BWPswitchDelayRRC}}}{\text{NR Slot length}}$  and starts to report valid ACK/NACK for the PSCell from the first UL slot that occurs after the beginning of DL slot  $i + \frac{T_{\text{RRCprocessingDelay}} + T_{\text{BWPswitchDelayRRC}}}{\text{NR Slot length}} + k1$ .

Where,  $k1$  is the timing between DL data receiving and acknowledgement as specified in [7].

All of the above test requirements shall be fulfilled in order for the observed PSCell active BWP switch delay to be counted as correct.

The rate of correct events observed during repeated tests shall be at least 90%.

#### A.5.5.6.3 Simultaneous DCI-based and Timer-based Active BWP Switch on multiple CCs

##### A.5.5.6.3.1 E-UTRAN – NR PSCell FR2 and NR SCell FR2 DL active BWP switch on multiple CCs in synchronous EN-DC

###### A.5.5.6.3.1.1 Test Purpose and Environment

The purpose of this test is to verify the DL BWP switch on multiple CCs delay requirement defined in clause 8.6. Supported test configurations are shown in Table A.5.5.6.3.1.1-1.

The test scenario comprises of one E-UTRA PCell (Cell 1), and one NR PSCell (Cell 2) and one NR SCell (Cell 3) as given in Table A.5.5.6.3.1.1-2. Cell-specific parameters of E-UTRA PCell are specified in Table A.3.7.2.1-1 and Cell-specific parameters of NR PSCell and NR SCell is specified in Table A.5.5.6.3.1.1-3 below. The OTA related test parameters for FR2 is shown in Table A.5.5.6.3.1.1-4.

PDCCHs indicating new transmissions shall be sent continuously on PCell (Cell 1) to ensure that the UE will have ACK/NACK sending.

PDCCHs indicating new transmissions shall be sent continuously on PSCell (Cell 2) and SCell (Cell 3) to ensure that the UE would have ACK/NACK sending except for the time duration when BWP is switching on Cell 2 and Cell 3 and the time duration of T2.

Before the test starts,

- UE is connected to Cell 1 (PCell) on radio channel 1 (PCC), Cell 2 (PSCell) on radio channel 2 (PSCC) and Cell 3 (SCell) on radio channel 3 (SCC).
- UE is configured with 2 different UE-specific downlink bandwidth parts for PSCell and SCell, BWP-1 and BWP-2, in Cell 2 and Cell 3 before starting the test. BWP-1 and BWP-2 always include bandwidth of the initial DL BWP and SSB.
- UE is indicated in *firstActiveDownlinkBWP-Id* that the active DL BWP is BWP-1 in PSCell and SCell.



- UE is configured with a *bwp-InactivityTimer* timer value for PSCell and SCell.

All cells have constant signal levels throughout the test.

The test consists of 3 successive time periods, with durations of T1, T2, and T3, respectively.

During T1,

Time period T1 starts when a DCI format 1\_1 command for PSCell DL BWP switch and a DCI format 1\_1 command for SCell DL BWP switch, sent from the test equipment to the UE simultaneously, are received at the UE side in PSCell and SCell slot # denoted  $i$ . The UE should switch its bandwidth part from BWP-1 to BWP-2 in PSCell and SCell.

The UE shall be able to receive PDSCH at the beginning of the DL slot right after PSCell's DL slot ( $i+T_{MultipleBWPswitchDelay}$ ) as defined in clause 8.6 and starts to report valid ACK/NACK for the PSCell no later than at the beginning of the DL slot right after slot ( $i+T_{MultipleBWPswitchDelay}+kI$ ). The UE shall be continuously scheduled on PSCell's BWP-2 starting from the beginning of the DL slot right after slot ( $i+T_{MultipleBWPswitchDelay}$ ).

The UE shall be able to receive PDSCH at the beginning of the DL slot right after SCell's DL slot ( $i+T_{BWPswitchDelay}$ ) as defined in clause 8.6 and starts to report valid ACK/NACK for the PSCell no later than at the beginning of the DL slot right after slot ( $i+T_{MultipleBWPswitchDelay}+kI$ ). The UE shall be continuously scheduled on PSCell's BWP-2 starting from the beginning of the DL slot right after slot ( $i+T_{MultipleBWPswitchDelay}$ ).

During T2, the test equipment won't transmit DCI format for PDSCH reception on PSCell (Cell 2) and SCell (Cell 3).

During T3,

The time period T3 starts from the slot # $j$ , where  $j$  is the beginning slot of the DL subframe immediately after the slot wherein *bwp-InactivityTimer* timer expires in PSCell and SCell. The UE should switch its bandwidth part from BWP-2 back to the default bandwidth part – BWP-1 in both PSCell and SCell.

The UE shall be able to receive PDSCH on PSCell at the beginning of the DL slot right after PSCell's DL slot ( $j+T_{MultipleBWPswitchDelay}$ ) as defined in clause 8.6 and starts to report valid ACK/NACK for the PSCell at latest at the beginning of the DL slot right after slot ( $j+T_{MultipleBWPswitchDelay}+kI$ ). The UE shall be continuously scheduled on PSCell's BWP-1 starting from the beginning of the DL slot right after slot ( $j+T_{MultipleBWPswitchDelay}$ ).

The UE shall be able to receive PDSCH on SCell at the beginning of the DL slot right after SCell's DL slot ( $j+T_{MultipleBWPswitchDelay}$ ) as defined in clause 8.6 and starts to report valid ACK/NACK for the SCell at latest at the beginning of the DL slot right after slot ( $j+T_{MultipleBWPswitchDelay}+kI$ ). The UE shall be continuously scheduled on SCell's BWP-1 starting from the beginning of the DL slot right after slot ( $j+T_{MultipleBWPswitchDelay}$ ).

The test equipment verifies the DL BWP switch time in PSCell and SCell by counting the slots from the time when the BWP switch command is received or *bwp-InactivityTimer* timer expires till an ACK is received.

**Table A.5.5.6.3.1.1-1: DL BWP switch supported test configurations**

Config	Description
1	LTE FDD, NR 120 kHz SSB SCS, 100 MHz bandwidth, TDD duplex mode
2	LTE TDD, NR 120 kHz SSB SCS, 100 MHz bandwidth, TDD duplex mode
Note 1: The UE is only required to be tested in one of the supported test configurations	

**Table A.5.5.6.3.1.1-2: General test parameters for DL BWP switch in synchronous EN-DC**

Parameter	Unit	Value	Comment
E-UTRA RF Channel Number		1	One E-UTRA radio channel is used for this test
NR RF Channel Number		2, 3	Two NR radio channel is used for this test for PSCell and SCell
Active PCell		Cell 1	PCell on RF channel number 1.
Active PSCell		Cell 2	PSCell on RF channel number 2.
Active SCell		Cell 3	SCell on RF channel number 3.

CP length		Normal	
DRX		OFF	For both PCell, PSCell and SCell
<i>bwp-InactivityTimer</i>	ms	200	
Cell-individual offset for cells on RF channel number 1	dB	0	Individual offset for cells on PCC.
Cell-individual offset for cells on RF channel number 2	dB	0	Individual offset for cells on PSCC.
Cell-individual offset for cells on RF channel number 3	dB	0	Individual offset for cells on SCC.
Cell2 timing offset to cell1	μs	3	Synchronous EN-DC
Cell3 timing offset to cell2	μs	0	Synchronous Cells
T1	s	0.2	
T2	s	0.2	
T3	s	0.2	

**Table A.5.5.6.3.1.1-3: NR Cell specific test parameters for DL BWP switch in synchronous EN-DC**

Parameter	Unit	Cell 2	Cell 3
Frequency Range		FR2	FR2
Duplex mode		TDD	TDD
TDD configuration		TDDConf.3.1	TDDConf.3.1
$BW_{channel}$		100 MHz: $N_{RB,c} = 66$	100 MHz: $N_{RB,c} = 66$
Active BWP ID		1, 2	1, 2
Initial DL BWP Configuration		DLBWP.0.2 <sup>Note 2</sup>	DLBWP.0.2 <sup>Note 2</sup>
Active DL BWP-1 Configuration		DLBWP.1.1 <sup>Note 2</sup>	DLBWP.1.1 <sup>Note 2</sup>
Active DL BWP-2 Configuration		DLBWP.1.3 <sup>Note 2</sup>	DLBWP.1.3 <sup>Note 2</sup>
Initial UL BWP Configuration		ULBWP.0.2 <sup>Note 2</sup>	ULBWP.0.2 <sup>Note 2</sup>
Active UL BWP-1 Configuration		ULBWP.1.1 <sup>Note 2</sup>	ULBWP.1.1 <sup>Note 2</sup>
Active UL BWP-2 Configuration		ULBWP.1.3 <sup>Note 2</sup>	ULBWP.1.3 <sup>Note 2</sup>
PDSCH Reference measurement channel		SR.3.1 TDD	SR.3.1 TDD
RMSI CORESET parameters		CR.3.1 TDD	CR.3.1 TDD
Dedicated CORESET parameters		CCR.3.1 TDD	CCR.3.1 TDD
OCNG Patterns		OP.1	OP.1
SSB Configuration		SSB.1 FR2	SSB.1 FR2
SMTC Configuration		SMTC.1	SMTC.1
TCI State		TCI.State.0	TCI.State.0
TRS Configuration		TRS.2.1 TDD	TRS.2.1 TDD
Correlation Matrix and Antenna Configuration		1x2 Low	1x2 Low
EPRE ratio of PSS to SSS	dB	0	0
EPRE ratio of PBCH DMRS to SSS			
EPRE ratio of PBCH to PBCH DMRS			
EPRE ratio of PDCCH DMRS to SSS			
EPRE ratio of PDCCH to PDCCH DMRS			
EPRE ratio of PDSCH DMRS to SSS			
EPRE ratio of PDSCH to PDSCH			
EPRE ratio of OCNG DMRS to SSS(Note 1)			
EPRE ratio of OCNG to OCNG DMRS (Note 1)			
Propagation Condition		AWGN	AWGN
<p>Note 1: OCNG shall be used such that both cells are fully allocated and a constant total transmitted power spectral density is achieved for all OFDM symbols.</p> <p>Note 2: For unpaired spectrum, a DL BWP is linked with an UL BWP. DLBWP.0.2 is linked with ULBWP.0.2; DLBWP.1.1 is linked with ULBWP.1.1; DLBWP.1.3 is linked with ULBWP.1.3 defined in clause 12 of TS 38.213 [3].</p>			

**Table A.5.5.6.3.1.1-4: OTA related test parameters for DL BWP switch in synchronous EN-DC**

Parameter	Unit	Cell 2	Cell 3
Angle of arrival configuration		Setup 1 according to clause A.3.15.1	Setup 1 according to clause A.3.15.1
Assumption for UE beams <sup>Note 6</sup>		Fine	Fine
$N_{oc}$ <sup>Note 1</sup>	dBm/15 kHz	-112	-112
$N_{oc}$ <sup>Note 1</sup>	dBm/SCS	-103	-103
SS-RSRP <sup>Note 2</sup>	dBm/120 kHz <sup>Note 3</sup>	-85	-85
$\bar{E}_s/I_{ot}$	dB	18	18
$I_o$ <sup>Note 2</sup>	dBm/95.04 MHz <sup>Note 4</sup>	-56	-56
Note 1:	Interference from other cells and noise sources not specified in the test is assumed to be constant over subcarriers and time and shall be modelled as AWGN of appropriate power for $N_{oc}$ to be fulfilled.		
Note 2:	SS-RSRP and $I_o$ levels have been derived from other parameters for information purposes. They are not settable parameters themselves.		
Note 3:	SS-RSRP minimum requirements are specified assuming independent interference and noise at each receiver antenna port.		
Note 4:	Equivalent power received by an antenna with 0 dBi gain at the centre of the quiet zone		
Note 5:	As observed with 0dBi gain antenna at the centre of the quiet zone.		
Note 6:	Information about types of UE beam is given in B.2.1.3, and does not limit UE implementation or test system implementation		

#### A.5.5.6.3.1.2 Test Requirements

During T1, the UE shall start to send the ACK for PSCell and SCell from the first UL slot that occurs after the beginning of DL slot ( $i+T_{MultipleBWPswitchDelay}+kI$ ).

During T3, the UE shall start to send the ACK for PSCell and SCell from the first UL slot that occurs after the beginning of DL slot ( $j+T_{MultipleBWPswitchDelay}+kI$ ).

Where,  $kI$  is the timing between DL data receiving and acknowledgement as specified in [7].

Depending on UE capability *bwp-SwitchingDelay* and *bwp-SwitchingMultiCCs-r16* [2], UE shall finish BWP switch within the time duration  $T_{MultipleBWPswitchDelay}$  defined in TS 38.133 clause 8.6.2A and 8.6.2B

All of the above test requirements shall be fulfilled in order for the observed PSCell and SCell active BWP switch delay to be counted as correct.

The rate of correct events observed during repeated tests shall be at least 90%.

NOTE: During T1, T3 if there are no uplink resources for reporting the ACK in the DL slot right after DL slot ( $i+Y1$ ), ( $j+Y2$ ), then the UE shall use the next available uplink resource for reporting the corresponding ACK.

#### A.5.5.6.4 SCell dormancy switch

##### A.5.5.6.4.1 E-UTRAN – NR FR2 PSCell SCell dormancy switch of single FR2 SCell inside active time

###### A.5.5.6.4.1.1 Test Purpose and Environment

The purpose of this test is to verify

- 1) the interruption due to RRM and CSI measurement during SCell dormancy on spCell is within the limits specified in clause 8.2.1.2.15.2 and 8.2.1.2.15.3 for NR victim cell, and
- 2) the SCell dormancy switch delay is within the requirement defined in clause 8.6.2, and the SCell dormancy switch interruption is within the limits defined in clause 8.2.1.2.15.1 for NR victim cell.

Supported test configurations are shown in Table A.5.5.6.4.1.1-1.

The test scenario comprises of one E-UTRA PCell (Cell 1), one NR PSCell (Cell 2) and one NR SCell (Cell 3) as given in Table A.5.5.6.4.1.1-2. Cell-specific parameters of E-UTRA PCell are specified in Table A.3.7.2.1-1 and Cell-specific parameters of NR PSCell and SCell are specified in Table A.5.5.6.4.1.1-3 below.

The tests consist of three consecutive time periods T1, T2, and T3, respectively. All cells have constant signal levels throughout the test. The UE is continuously scheduled in PCell and PSCell throughout the test

Before the test starts,

- UE is connected to Cell 1 (PCell), Cell 2 (PSCell) and Cell 3 (SCell).
- UE is configured with a single UE-specific downlink bandwidth part, BWP-0, for Cell 2. BWP-0 includes the bandwidth of the initial DL BWP and SSB.
- UE is configured with one non-dormant and one dormant UE-specific downlink bandwidth part, BWP-0 and BWP-1, respectively, for Cell 3. BWP-0 includes the bandwidth of the initial DL BWP and SSB.
- UE is indicated in *firstActiveDownlinkBWP-Id* that the active DL BWP in Cell 3 is BWP-0.
- UE is indicated that *firstOutsideActiveTimeBWP-Id* that the active DL BWP after when switching from dormant BWP in Cell 3 is BWP-0

T1 starts at the point in time at which the UE receives a DCI with dormancy indication on PDCCH in PSCell at the antenna connector, in a slot # denoted  $m$ , pertaining to dormancy indication for switching SCell from non-dormancy to dormancy. The UE shall complete switching of the SCells to dormancy by the end of slot  $m + \text{ceil}(T_{\text{BWPswitchDelay}}/\text{NR slot length}) + 1$  in Test1, and slot  $m + \text{ceil}(T_{\text{BWPswitchDelay}}/\text{NR slot length}) + 2$  in Test2, as specified in clause 8.6.2. Any PSCell interruptions due to the switching between non-dormant and dormant BWPs shall fulfill requirements in clause 8.2.1.2.15.1 for NR victim cell. The test equipment verifies that interruptions due to switching from non-dormancy to dormancy are within the requirements by analysing HARQ feedback transmitted in PSCell for PSCell.

During T2, the UE is carrying out CSI and RRM measurements on dormant SCell. Any interruptions due to CSI and RRM measurements shall fulfill requirements in clause 8.2.1.2.15.2 and 8.2.1.2.15.3 for NR victim cell. The test equipment verifies that the interruptions are within the allowed percentages by counting ACK/NACKs in PSCell. At the end of T2, the test equipment transmits a DCI with dormancy indication on PDCCH in PSCell carrying a dormancy indication for switching SCell from dormancy to non-dormancy.

T3 starts at the point in time at which the UE receives a DCI with dormancy indication on PDCCH in PSCell at the antenna connector, in a slot # denoted  $n$ , pertaining to dormancy indication for switching SCell from dormancy to non-dormancy. The UE shall complete switching of the SCell to non-dormancy by the end of slot  $n + \text{ceil}(T_{\text{BWPswitchDelay}}/\text{NR slot length}) + 1$  in Test1, and slot  $n + \text{ceil}(T_{\text{BWPswitchDelay}}/\text{NR slot length}) + 2$  in Test2, as specified in clause 8.6.2. Any PSCell interruptions due to the switching between non-dormant and dormant BWPs shall fulfill requirements in clause 8.2.1.2.15.1 for NR victim cell. The test equipment verifies that interruptions due to switching from dormancy to non-dormancy are within the requirements by analysing HARQ feedback transmitted in PSCell for PSCell. PDCCHs indicating new transmissions shall be sent continuously on SCell from the slot right after  $n + \text{ceil}(T_{\text{BWPswitchDelay}}/\text{NR slot length}) + 1$  in Test1, and slot  $n + \text{ceil}(T_{\text{BWPswitchDelay}}/\text{NR slot length}) + 2$  in Test2. The test equipment verifies the SCell dormancy switch delay by counting the slots from slot  $n$  till an ACK/NACK for SCell is received.

There are two subtests in this test. In Subtest 1 the DCI format 1\_1 command for SCell dormancy switch is transmitted within the first 3 OFDM symbols in a slot, and in Subtest 2 the DCI format 1\_1 command for SCell dormancy switch is transmitted after the first 3 OFDM symbols in a slot. A UE that only supports triggering during within the first three OFDM symbols of a slot shall only undergo Test1, whereas a UE that supports triggering also in remaining OFDM symbols of a slot shall undergo Test1 and Test2.

**Table A.5.5.6.4.1.1-1: Dormancy switch supported test configurations**

Config	Description
1	LTE FDD, NR 120 kHz SSB SCS, 100 MHz bandwidth, TDD duplex mode
2	LTE TDD, NR 120 kHz SSB SCS, 100 MHz bandwidth, TDD duplex mode
Note 1:	The UE is only required to be tested in one of the supported test configurations
Note 2:	A UE which fulfils the requirements in test case in clause A.5.5.6.4.2 can skip the test cases in current clause A.5.5.6.4.1.
Note 3:	NR configuration is the same for PSCell and SCells.

Table A.5.5.6.4.1.1-2: General test parameters for Dormancy switch in synchronous EN-DC

Parameter	Unit	Value		Comment
		Subtest 1	Subtest 2	
E-UTRA RF Channel Number		1		One E-UTRA radio channel is used for this test
NR RF Channel Number		2, 3		Two NR radio channel is used for this test
Active PCell		Cell 1		PCell on RF channel number 1.
Active PSCell		Cell 2		PSCell on RF channel number 2.
Active SCell		Cell 3		SCell on RF channel number 3.
CP length		Normal		
DRX		OFF		
Measurement gap pattern Id		OFF		
<i>bwp-InactivityTimer</i>	ms	500		
Cell-individual offset for cells on RF channel number 1	dB	0		Individual offset for cells on PCC.
Cell-individual offset for cells on RF channel number 2	dB	0		Individual offset for cells on PSCC.
Cell-individual offset for cells on RF channel number 3	dB	0		Individual offset for cells on SCC.
Cell2 timing offset to cell1	μs	3		Synchronous EN-DC
Cell3 timing offset to cell2	μs	0		Synchronous cells
Triggering DCI format		DCI 1_1		Triggering DCI format for triggering during active time
OFDM symbol range in slot for transmission of DCI with dormancy indication		0 – 2	3 – 11	Test1 is based on that triggering DCI is received within the first three OFDM symbols of a slot. Test2 is based on that the triggering DCI is received later than within the first three OFDM symbols of a slot.
T1	s	0.2		
T2	s	5		
T3	s	0.2		

Table A.5.5.6.4.1.1-3: NR Cell specific test parameters for Dormancy switch in synchronous EN-DC

Parameter	Unit	Subtest 1		Subtest 2	
		Cell 2	Cell 3	Cell 2	Cell 3
Frequency Range		FR2		FR2	
Duplex mode		TDD		TDD	
TDD configuration		TDDConf.3.1		TDDConf.3.1	
BW <sub>channel</sub>		100 MHz: N <sub>RB,c</sub> = 66		100 MHz: N <sub>RB,c</sub> = 66	
Active BWP ID		0	0	0	0
Initial DL BWP Configuration		DLBWP.0.2	DLBWP.0.2	DLBWP.0.2	DLBWP.0.2
Active DL BWP-0 Configuration		DLBWP.1.1	DLBWP.1.1	DLBWP.1.1	DLBWP.1.1
Active DL BWP-1 Configuration		NA	DLBWP.1.2	NA	DLBWP.1.2
Initial UL BWP Configuration		ULBWP.0.2	ULBWP.0.2	ULBWP.0.2	ULBWP.0.2
Active UL BWP-0 Configuration		ULBWP.1.1	ULBWP.1.1	ULBWP.1.1	ULBWP.1.1
Active UL BWP-1 Configuration		NA	ULBWP.1.2	NA	ULBWP.1.2
PDSCH Reference measurement channel		SR.3.1 TDD		SR.3.1 TDD	
RMSI CORESET parameters		CR.3.1 TDD		CR.3.1 TDD	
Dedicated CORESET parameters		CCR.3.1 TDD		CCR.3.2 TDD	CCR.3.1 TDD
OCNG Patterns		OP.1		OP.1	
SSB Configuration		SSB.1 FR2		SSB.1 FR2	
SMTC Configuration		SMTC.1		SMTC.1	
TCI State		TCI.State.0		TCI.State.0	
TRS Configuration		TRS.2.1 TDD		TRS.2.1 TDD	
CSI-RS for CSI reporting		CSI-RS.3.1 TDD		CSI-RS.3.1 TDD	
CSI reporting periodicity	slots	640		640	
SCell measurement cycle (measCycleSCell)	ms	640		640	
Antenna Configuration		1x2		1x2	
Propagation Condition		AWGN		AWGN	

EPRE ratio of PSS to SSS	dB	0	0	0	0
EPRE ratio of PBCH DMRS to SSS					
EPRE ratio of PBCH to PBCH DMRS					
EPRE ratio of PDCCH DMRS to SSS					
EPRE ratio of PDCCH to PDCCH DMRS					
EPRE ratio of PDSCH DMRS to SSS					
EPRE ratio of PDSCH to PDSCH					
EPRE ratio of OCNG DMRS to SSS(Note 1)					
EPRE ratio of OCNG to OCNG DMRS (Note 1)					
<p>Note 1: OCNG shall be used such that both cells are fully allocated and a constant total transmitted power spectral density is achieved for all OFDM symbols.</p> <p>Note 2: Interference from other cells and noise sources not specified in the test is assumed to be constant over subcarriers and time and shall be modelled as AWGN of appropriate power for <math>N_{oc}</math> to be fulfilled.</p> <p>Note 3: SS-RSRP and <math>I_o</math> levels have been derived from other parameters for information purposes. They are not settable parameters themselves.</p> <p>Note 4: For unpaired spectrum, a DL BWP is linked with an UL BWP. DLBWP.0.2 is linked with ULBWP.0.2; DLBWP.1.1 is linked with ULBWP.1.1; DLBWP.1.3 is linked with ULBWP.1.3.</p>					

**Table A.5.5.6.4.1.1-4: OTA related test parameters for Dormancy switch in synchronous EN-DC**

Parameter	Unit	Cell 2	Cell 3
Angle of arrival configuration		Setup 1 according to clause A.3.15	
$N_{oc}$ <sup>Note 1</sup>	dBm/15 kHz	-112	-112
SS-RSRP <sup>Note 2</sup>	dBm/120 kHz <sup>Note 3</sup>	-85	-85
$\dot{E}_s/I_{ot}$	dB	18	18
$I_o$ <sup>Note 2</sup>	dBm/95.04 MHz <sup>Note 4</sup>	-56	-56
<p>Note 1: Interference from other cells and noise sources not specified in the test is assumed to be constant over subcarriers and time and shall be modelled as AWGN of appropriate power for <math>N_{oc}</math> to be fulfilled.</p> <p>Note 2: SS-RSRP and <math>I_o</math> levels have been derived from other parameters for information purposes. They are not settable parameters themselves.</p> <p>Note 3: SS-RSRP minimum requirements are specified assuming independent interference and noise at each receiver antenna port.</p> <p>Note 4: Equivalent power received by an antenna with 0dBi gain at the centre of the quiet zone</p> <p>Note 5: As observed with 0dBi gain antenna at the centre of the quiet zone.</p>			

**A.5.5.6.4.1.2 Test Requirements**

During T1, any interruption on PSCell due to dormancy switching of SCell shall be within the requirement specified in clause 8.2.1.2.15.1 for NR victim cell.

During T2, interruptions on PSCell due to CSI and RRM measurements on dormant SCell shall be within the interruption rate requirements specified in 8.2.1.2.15.1 for NR victim cell.

During T3, any interruption on PSCell due to dormancy switching of SCell shall be within the requirement specified in clause 8.2.1.2.15.1 for NR victim cell. Monitoring of PDCCH for SCell in PSCell shall be resumed within the dormancy switching time specified in clause 8.6.2A.

For an event to be considered to be correct, all requirements above have to be fulfilled.

The rate of correct events observed during repeated tests shall be at least 90%.

#### A.5.5.6.4.2 E-UTRAN – NR FR1 PSCell SCell dormancy switch of two FR2 SCells outside active time

##### A.5.5.6.4.2.1 Test Purpose and Environment

The purpose of this test is to verify the NR SCell dormant BWP switch delay requirement defined in clause 8.6.2A.1, interruption requirements due to the NR SCell dormant BWP switch defined in clause 8.2.1.2.15.1 for NR victim cells and in clause 7.32.2.14.1 of TS36.133 for E-UTRA victim cell, respectively, and interruption requirements due to CSI and RRM measurements on the NR dormant SCells defined in clauses 8.2.1.2.15.2 and 8.2.1.2.15.3 for NR victim cells and in clause 7.32.2.14.2 of TS36.133 for E-UTRA victim cell, respectively. Supported test configurations are shown in Table Table A.5.5.6.4.2.1-1.

The general test parameters are given in Table A.5.5.6.4.2.1-2, and NR cell specific test parameters are given in Table A.5.5.6.4.2.1-3 and Table A.5.5.6.4.2.1-4 below. And the E-UTRAN cell specific test parameters can refer to Table A.3.7.2.1-1.

The test scenario comprises of one E-UTRA PCell (Cell 1), one NR FR1 PSCell (Cell 2), and three NR FR2 SCells (Cell 3-5) as given in Table A.5.5.6.4.2.1-2. Cell-specific parameters of E-UTRA PCell are specified in Table A.3.7.2.1-1 and Cell-specific parameters of NR PSCell and SCell are specified in Table A.5.5.6.4.2.1-3 and Table A.5.5.6.4.2.1-4 below.

PDCCHs indicating new transmissions shall be sent continuously on PCell (Cell 1), PSCell (Cell 2), and SCell (Cell 5) to ensure that the UE will have ACK/NACK sending except the time before T1 and during T3. PDCCHs indicating new transmissions shall be sent continuously on SCells (Cell 3,4) to ensure that the UE would have ACK/NACK sending except for the time duration when BWP is switching on the cells and the time duration of when active BWP of the cell is dormant.

Before the test starts,

- UE is connected to Cell 1 (PCell) on radio channel 1 (PCC), Cell 2 (PSCell) on radio channel 2 (PSCC), and Cell 3-5 (SCells) on radio channels 3-5 (SCCs), respectively.
- UE is configured with 2 different UE-specific downlink BWPs for Cell 3 and Cell 4, BWP-1 and BWP-2. BWP-1 and BWP-2 always include bandwidth of the initial DL BWP and SSB. Here, BWP-2 on Cell 3 and Cell 4 is configured as dormant BWP.
- UE is configured with 1 UE-specific downlink BWP the same as initial BWP for Cell 3 and Cell 4.
- UE is indicated in *firstActiveDownlinkBWP-Id* that the active DL BWP is BWP-1 in Cell 3 and Cell 4.
- UE is configured with DRX.
- UE is configured to monitor PDCCH for DCI format 2\_6 from Cell 2 at *ps-Offset* before the start of *onDuration*. *ps-Offset* is selected to correspond to the dormancy switching time specified in clause 8.6.2A.

All cells have constant signal levels throughout the test.

The test consists of 3 successive time periods, with durations of T1, T2, T3, and T4, respectively.

During T1,

Time period T1 starts when a DCI format 2\_6 command for Cell 3 and Cell 4 DL BWP switch to BWP-2, sent from the test equipment to the UE, is received at the UE side in PSCell's slot # denoted  $i$ . The UE shall switch its bandwidth part from BWP-1 to BWP-2.

The UE shall be able to receive PDSCH at the beginning of the DL slot right after PSCell's DL slot ( $i + T_{\text{MultipleBWPswitchDelay}} + X$ ) as defined in clause 8.6.2A.2. The UE shall be continuously scheduled on the cell starting from the beginning of the DL slot right after slot ( $i + T_{\text{MultipleBWPswitchDelay}} + X$ ).

The UE shall be able to receive PDSCH at the beginning of the DL slot right after SCell(Cell 5)'s DL slot ( $i + T_{\text{MultipleBWPswitchDelay}} + X$ ) as defined in clause 8.6.2A.2. The UE shall be continuously scheduled on the cell starting from the beginning of the DL slot right after slot ( $i + T_{\text{MultipleBWPswitchDelay}} + X$ ).

PCell(Cell 1) interruption due to dormant BWP switch on PSCell shall occur within the dormant BWP switch delay.

SCell(Cell 5) interruption due to dormant BWP switch on SCell(Cell 5) shall occur within the dormant BWP switch delay.

During T2,

Time period T2 starts when dormant BWP switch latency requirement test is completed. The test equipment shall schedule PDSCH every slot.

The UE shall be able to report ACK/NACK corresponding to the scheduled PDSCH to PCell except for the allowed times as defined in clauses 8.2.1.2.15.2 and 8.2.1.2.15.3.

The UE shall be able to report ACK/NACK corresponding to the scheduled PDSCH to PCell except for the allowed times as defined in clause 7.32.2.14.2 of TS36.133.

During T3,

Time period T3 starts when interruption due to SSB based RRM measurement and CSI measurement requirements test is completed. Test equipment shall not transmit PDCCH, hence, the UE doesn't monitor PDCCH except DCI format 2\_6 based PDCCH.

During T4,

Time period T4 starts when a DCI format 2\_6 command for Cell 3 and Cell 4 DL BWP switch to BWP-1, sent from the test equipment to the UE, is received at the UE side in PCell's slot # denoted  $j$ . The UE shall switch its bandwidth part from BWP-2 to BWP-1.

The UE shall be able to receive PDSCH at the beginning of the DL slot right after PCell's DL slot ( $j + T_{\text{MultipleBWPswitchDelay}} + X$ ) as defined in clause 8.6.2A.2. The UE shall be continuously scheduled on the cell starting from the beginning of the DL slot right after slot ( $j + T_{\text{MultipleBWPswitchDelay}} + X$ ).

The UE shall be able to receive PDSCH at the beginning of the DL slot right after all SCell's (Cell 3,4,5) DL slot ( $j + T_{\text{MultipleBWPswitchDelay}} + X$ ) as defined in clause 8.6.2A.2. The UE shall be continuously scheduled on the cells starting from the beginning of the DL slot right after slot ( $j + T_{\text{MultipleBWPswitchDelay}} + X$ ).

PCell(Cell 1) interruption due to dormant BWP switch on PCell shall occur within the dormant BWP switch delay.

SCell(Cell 5) interruption due to dormant BWP switch on SCell(Cell 5) shall occur within the dormant BWP switch delay.

**Table A.5.5.6.4.2.1-1: Supported test configurations for EN-DC DCI 2\_6 based Domant BWP Switch on Multiple NR FR2 SCells**

Config	Cell 1	Cell 2	Cell 3, Cell 4, Cell 5	DCI 2_6 of Cell 2
1	LTE FDD	15kHz SSB SCS, FDD	120kHz SSB SCS, TDD	within 3 OFDM symbols
2	LTE FDD	15kHz SSB SCS, TDD	120kHz SSB SCS, TDD	within 3 OFDM symbols
3	LTE FDD	30kHz SSB SCS, TDD	120kHz SSB SCS, TDD	within 3 OFDM symbols
4	LTE TDD	15kHz SSB SCS, FDD	120kHz SSB SCS, TDD	within 3 OFDM symbols
5	LTE TDD	15kHz SSB SCS, TDD	120kHz SSB SCS, TDD	within 3 OFDM symbols
6	LTE TDD	30kHz SSB SCS, TDD	120kHz SSB SCS, TDD	within 3 OFDM symbols
7	LTE FDD	15kHz SSB SCS, FDD	120kHz SSB SCS, TDD	after 3 OFDM symbols
8	LTE FDD	15kHz SSB SCS, TDD	120kHz SSB SCS, TDD	after 3 OFDM symbols
9	LTE FDD	30kHz SSB SCS, TDD	120kHz SSB SCS, TDD	after 3 OFDM symbols
10	LTE TDD	15kHz SSB SCS, FDD	120kHz SSB SCS, TDD	after 3 OFDM symbols
11	LTE TDD	15kHz SSB SCS, TDD	120kHz SSB SCS, TDD	after 3 OFDM symbols
12	LTE TDD	30kHz SSB SCS, TDD	120kHz SSB SCS, TDD	after 3 OFDM symbols

Note 1: 10 MHz bandwidth for Cell 2 with 15kHz SSB SCS.  
Note 2: 40 MHz bandwidth for Cell 2 with 30kHz SSB SCS.  
Note 3: 100 MHz bandwidth for Cell 3,4,5.  
Note 4: The UE is only required to be tested in one of the supported test configurations.



**Table A.5.5.6.4.2.1-2: General test parameters for EN-DC DCI 2\_6 based Domant BWP Switch on Multiple NR FR2 SCells**

Parameter	Unit	Value	Comment
E-UTRA RF Channel Number		1	One E-UTRAN carrier frequency is used.
NR RF Channel Number		2,3,4,5	Four NR radio channels are used for this test. RF channel number 2 is in FR 1 and RF channel numbers 3,4,5 are in a band where intra-band FR2 CA is allowed.
Active PCell		Cell 1	Primary cell on NR RF channel number 1.
Active PSCell		Cell 2	Primary SCG cell on NR RF channel number 2.
Configured activated SCell		Cell 3,4,5	Configured activated secondary cell on NR RF channel numbers 3,4,5.
CP length		Normal	
DRX		DRX.3	As specified in clause A.3.3
ps-Offset		Depending on UE capability	Monitoring of DCI 2_6 ahead of start of drx-onDurationTimer. Value of ps-Offset shall correspond to SCell dormancy switching time for switching of two SCells, as specified in clause 8.6.2A. Actual value depends on reported UE capabilities.
ps-WakeUp		true	Wake up for onDuration in case DCI format 2_6 is not detected.
SCell measurement cycle (measCycleSCell)	ms	160	
Cell2 timing offset to cell1	μs	3	
Cell3,4,5 timing offset to cell1	μs	3	
Timing offset among cell3,4,5	μs	0	
T1	s	0.2	During this time cell 3,4 switch to dormancy from non-dormancy.
T2	s	10	During this time cell 3,4 are dormant.
T3	S	0.1	During this time PDCCH is not transmitted from all cells.
T4	s	0.2	During this time cell 3,4 switch to non-dormancy from dormancy.

**Table A.5.5.6.4.2.1-3: Cell specific test parameters for EN-DC DCI 2\_6 based Domant BWP Switch on Multiple NR FR2 SCells**

Parameter	Unit	Cell 2	Cell 3,4	Cell 5
Frequency range		FR1	FR2	FR2
Duplex mode		FDD	TDD	TDD
TDD configuration	Config 1,4,7,10	NA	TDDConf.3.1	TDDConf.3.1
	Config 2,5,8,11	TDDConf.1.1	TDDConf.3.1	TDDConf.3.1
	Config 3,6,9,12	TDDConf.2.1	TDDConf.3.1	TDDConf.3.1
BW <sub>channel</sub>	Config 1,2,4,5,7,8,10,11	MHz	10: N <sub>RB,c</sub> = 52	100: N <sub>RB,c</sub> = 66
	Config 3,6,9,12	MHz	40: N <sub>RB,c</sub> = 106	100: N <sub>RB,c</sub> = 66
SSB Configuration	Config 1,2,4,5,7,8,10,11		SSB.1 FR1	SSB.1 FR2
	Config 3,6,9,12		SSB.2 FR1	SSB.1 FR2
Downlink initial BWP Configuration			DLBWP.0.2	DLBWP.0.2
Active (non-dormant) DL BWP-1 Configuration			NA	DLBWP.1.1

Active (dormant) DL BWP-2 Configuration			NA	DLBWP.1.1	NS
Uplink initial BWP Configuration			ULBWP.0.2	ULBWP.0.2	ULBWP.0.2
Active Uplink BWP-1 Configuration			NA	ULBWP.1.1	NA
Active Uplink BWP-2 Configuration			NA	ULBWP.1.1	NA
SMTTC Configuration			SMTTC.1	SMTTC.1	SMTTC.1
TRS configuration	Config 1,4,7,10		TRS.1.1 FDD	TRS.2.1 TDD	TRS.2.1 TDD
	Config 2,5,8,11		TRS.1.1 TDD	TRS.2.1 TDD	TRS.2.1 TDD
	Config 3,6,9,12		TRS.1.2 TDD	TRS.2.1 TDD	TRS.2.1 TDD
TCI state			TCI.State.0	TCI.State.0	TCI.State.0
PDSCH Reference measurement channel	Config 1,4,7,10		SR.1.1 FDD	SR.3.1 TDD	SR.3.1 TDD
	Config 2,5,8,11		SR.1.1 TDD	SR.3.1 TDD	SR.3.1 TDD
	Config 3,6,9,12		SR.2.1 TDD	SR.3.1 TDD	SR.3.1 TDD
RMSI CORESET Parameters	Config 1,4,7,10		CR.1.1 FDD	CR.3.1 TDD	CR.3.1 TDD
	Config 2,5,8,11		CR.1.1 TDD	CR.3.1 TDD	CR.3.1 TDD
	Config 3,6,9,12		CR.2.1 TDD	CR.3.1 TDD	CR.3.1 TDD
Dedicated CORESET Parameters for scheduling PDCCH	Config 1,4		CCR.1.1 FDD	CCR.3.1 TDD	CCR.3.1 TDD
	Config 7,10		CCR.1.5 FDD	CCR.3.1 TDD	CCR.3.1 TDD
	Config 2,5		CCR.1.1 TDD	CCR.3.1 TDD	CCR.3.1 TDD
	Config 8,11		CCR.1.5 TDD	CCR.3.1 TDD	CCR.3.1 TDD
	Config 3,6		CCR.2.1 TDD	CCR.3.1 TDD	CCR.3.1 TDD
	Config 9,12		CCR.2.3 TDD	CCR.3.1 TDD	CCR.3.1 TDD
Dedicated CORESET Parameters for DCI 2_6	Config 1,4		CCR.1.1 FDD	NA	NA
	Config 7,10		CCR.1.5 FDD	NA	NA
	Config 2,5		CCR.1.1 TDD	NA	NA
	Config 8,11		CCR.1.5 TDD	NA	NA
	Config 3,6		CCR.2.1 TDD	NA	NA
	Config 9,12		CCR.2.3 TDD	NA	NA
CSI-RS configuration			NA	CSI-RS.3.1 TDD	NA
OCNG Patterns			OP.1		
EPRE ratio of PSS to SSS		dB	0	0	0
EPRE ratio of PBCH_DMRS to SSS					
EPRE ratio of PBCH to PBCH_DMRS					
EPRE ratio of PDCCH_DMRS to SSS					
EPRE ratio of PDCCH to PDCCH_DMRS					
EPRE ratio of PDSCH_DMRS to SSS					
EPRE ratio of PDSCH to PDSCH_DMRS					
EPRE ratio of OCNG DMRS to SSS <sup>Note 1</sup>					
EPRE ratio of OCNG to OCNG DMRS <sup>Note 1</sup>					
Propagation conditions					
Note 1: OCNG shall be used such that both cells are fully allocated and a constant total transmitted power spectral density is achieved for all OFDM symbols.					

**Table A.5.5.6.4.2.1-4: OTA related test parameters for EN-DC DCI 2\_6 based Dormant BWP Switch on Multiple NR FR2 SCells**

Parameter <sup>Note 6</sup>	Unit	Cell 2	Cell 3,4	Cell 5
Angle of arrival configuration		N/A Link only, see clause A.3.7A	Setup 1 defined in clause A.3.15.1	
Assumption for UE beams <sup>Note 7</sup>			Fine	Fine
$N_{oc}$ <sup>Note1</sup>	dBm/15kHz <sup>Note4</sup>		-111.7	-111.7
$N_{oc}$ <sup>Note1</sup>	dBm/SCS <sup>Note3</sup>		-102.7	-102.7
$\hat{E}_s / N_{oc}$	dB		7	7
SS-RSRP <sup>Note2</sup>	dBm/SCS <sup>Note4</sup>		-95.7	-95.7
$\hat{E}_s / I_{ot}$	dB		7	7
$I_o$ <sup>Note2</sup>	dBm/95.04 MHz <sup>Note4</sup>		-65.9	-65.9
<p>Note 1: Interference from other cells and noise sources not specified in the test is assumed to be constant over subcarriers and time and shall be modelled as AWGN of appropriate power for <math>N_{oc}</math> to be fulfilled.</p> <p>Note 2: SS-RSRP and <math>I_o</math> levels have been derived from other parameters for information purposes. They are not settable parameters themselves.</p> <p>Note 3: SS-RSRP minimum requirements are specified assuming independent interference and noise at each receiver antenna port.</p> <p>Note 4: Equivalent power received by an antenna with 0dBi gain at the centre of the quiet zone</p> <p>Note 5: As observed with 0dBi gain antenna at the centre of the quiet zone</p> <p>Note 6: All parameters apply for configuration 1 and 2</p> <p>Note 7: Information about types of UE beam is given in B.2.1.3 and does not limit UE implementation or test system implementation.</p>				

#### A.5.5.6.4.2.2 Test Requirements

During T1, the UE shall start to send the ACK for PSCell from the first UL slot that occurs after the beginning of PSCell's DL slot ( $i + T_{\text{MultipleBWPswitchDelay}} + X$ ) as defined in clause 8.6.2A.2.

During T2, the UE shall transmit at least 98.5% of ACK/NACK on NR PCell.

During T4, the UE shall start to send the ACK for PSCell from the first UL slot that occurs after the beginning of PSCell's DL slot ( $j + T_{\text{MultipleBWPswitchDelay}} + X$ ) as defined in clause 8.6.2A.2.

The rate of correct events observed during repeated tests shall be at least 90%.

During T1, the start of the interruption of PCell and SCell (Cell 5) during dormant BWP switch on SCells (Cell 3,4) shall not happen outside the dormant BWP switch delay.

During T1, the start of the interruption of PCell and SCells (Cell 3,4,5) during dormant BWP switch on SCells (Cell 3,4) shall not happen outside the dormant BWP switch delay.

#### A.5.5.6.5 Simultaneous RRC-based Active BWP Switch on multiple CCs

A.5.5.6.5.1 E-UTRAN – NR PSCell FR2 and NR SCell FR2 DL active BWP switch on multiple CCs with non-DRX in synchronous EN-DC

##### A.5.5.6.5.1.1 Test Purpose and Environment

The purpose of this test is to verify the DL BWP switch delay requirement for simultaneous RRC-based BWP switch on multiple CCs defined in clause 8.6.3A. Supported test configurations are shown in Table A.5.5.6.5.1.1-1.

The test scenario comprises of one E-UTRA PCell (Cell 1) and one NR PSCell (Cell 2) and one NR SCell (Cell 3) as given in Table A.5.5.6.5.1.1-2. Cell-specific parameters of E-UTRA PCell are specified in Table A.3.7.2.1-1 and Cell-specific parameters of NR PSCell and NR SCell are specified in Table A.5.5.6.5.1.1-3 below.

PDCCHs indicating new transmissions shall be sent continuously on PCell (Cell 1) to ensure that the UE will have ACK/NACK sending.

Before the test starts,

- UE is connected to Cell 1 (PCell) on radio channel 1 (PCC), to Cell 2 (PSCell) on radio channel 2 (PSCC) and to Cell 3 (SCell) on radio channel 3.
- UE has bandwidth part BWP-1 in its RRC-configuration for Cell 2 (PSCell) and Cell 3 (SCell).
- UE is indicated in *firstActiveDownlinkBWP-Id* that the active DL BWP is BWP-1 of initial condition in Cell 2 (PSCell) and Cell 3 (SCell).

All cells have constant signal levels throughout the test.

The test consists of 1 time period, with duration of T1.

During T1,

Time period T1 starts when a *RRCReconfiguration* with updated bandwidth part configuration in Cell 2 and Cell3, sent from the test equipment to the UE, is received at the UE side in PSCell's slot # denoted *i*. The UE shall reconfigure its bandwidth part with the updated bandwidth part BWP-1 of final condition in Cell 2 and Cell 3.

The UE shall be able to completely receive PDSCH on Cell 2 and Cell 3 at the beginning of the DL slot right after PSCell's DL slot ( $i + \frac{T_{RRCprocessingDelay} + T_{BWPswitchDelayRRC} + D_{RRC}}{NR\ slot\ length}$ ) as defined in clause 8.6.3A and be ready for the reception of uplink grant for the PSCell no later than at the beginning of the DL slot right after slot ( $i + \frac{T_{RRCprocessingDelay} + T_{BWPswitchDelayRRC} + D_{RRC}}{NR\ slot\ length}$ ). The UE shall be continuously scheduled on Cell 2's BWP-1 and Cell 3's BWP-1 starting from the beginning of the DL slot right after slot ( $i + \frac{T_{RRCprocessingDelay} + T_{BWPswitchDelayRRC} + D_{RRC}}{NR\ slot\ length}$ ).

$T_{RRCprocessingDelay}$ ,  $T_{BWPswitchDelayRRC}$  and  $D_{RRC}$  are defined in clause 8.6.3A.

The test equipment verifies the DL BWP switch time in Cell 2 and Cell 3 by counting the time from the time when the RRC Reconfiguration message including updated BWP configuration is sent till the time when RRC Reconfiguration Complete message is received.

**Table A.5.5.6.5.1.1-1: DL BWP switch supported test configurations**

Config	Description
1	LTE FDD, NR 120 kHz SSB SCS, 100 MHz bandwidth, TDD duplex mode
2	LTE TDD, NR 120 kHz SSB SCS, 100 MHz bandwidth, TDD duplex mode

Note 1: The UE is only required to be tested in one of the supported test configurations

**Table A.5.5.6.5.1.1-2: General test parameters for DL BWP switch in synchronous EN-DC**

Parameter	Unit	Value	Comment
E-UTRA RF Channel Number		1	One E-UTRA radio channel is used for this test
NR RF Channel Number		2, 3	Two NR radio channel is used for this test
Active PCell		Cell 1	PCell on RF channel number 1
Active PSCell		Cell 2	PSCell on RF channel number 2
Active SCell		Cell 3	SCell on RF channel number 3
CP length		Normal	
DRX		OFF	
Cell-individual offset for cells on RF channel number 1	dB	0	Individual offset for cells on PCC.
Cell-individual offset for cells on RF channel number 2	dB	0	Individual offset for cells on PSCC.
Cell-individual offset for cells on RF channel number 3	dB	0	Individual offset for cells on SCC.
Cell2 timing offset to cell1	μs	3	Synchronous EN-DC
Cell3 timing offset to cell2	μs	0	Synchronous Cells
T1	s	0.2	

Table A.5.6.5.1.1-3: NR Cell specific test parameters for DL BWP switch in synchronous EN-DC

Parameter		Unit	Cell 2	Cell 3
Frequency Range			FR2	FR2
Duplex mode			TDD	TDD
TDD configuration			TDDConf.3.1	TDDConf.3.1
$BW_{\text{channel}}$			100 MHz: $N_{\text{RB},c} = 66$	100 MHz: $N_{\text{RB},c} = 66$
Active BWP ID			1	1
Initial DL BWP Configuration			DLBWP.0.2	DLBWP.0.2
Initial UL BWP Configuration			ULBWP.0.2	ULBWP.0.2
Initial Condition	Active DL BWP-1 Configuration		DLBWP.1.3	DLBWP.1.3
	Active UL BWP-1 Configuration		ULBWP.1.3	ULBWP.1.3
Final Condition	Active DL BWP-1 Configuration		DLBWP.1.1	DLBWP.1.1
	Active UL BWP-1 Configuration		ULBWP.1.1	ULBWP.1.1
PDSCH Reference measurement channel			SR.3.1 TDD	SR.3.1 TDD
RMSI CORESET parameters			CR.3.1 TDD	CR.3.1 TDD
Dedicated CORESET parameters			CCR.3.1 TDD	CCR.3.1 TDD
OCNG Patterns			OP.1	OP.1
SSB Configuration			SSB.1 FR2	SSB.1 FR2
SMTc Configuration			SMTc.1	SMTc.1
TCI State			TCI.State.0	TCI.State.0
TRS Configuration			TRS.2.1 TDD	TRS.2.1 TDD
Antenna Configuration			1x2	1x2
Propagation Condition			AWGN	AWGN
EPRE ratio of PSS to SSS		dB	0	0
EPRE ratio of PBCH DMRS to SSS				
EPRE ratio of PBCH to PBCH DMRS				
EPRE ratio of PDCCH DMRS to SSS				
EPRE ratio of PDCCH to PDCCH DMRS				
EPRE ratio of PDSCH DMRS to SSS				
EPRE ratio of PDSCH to PDSCH				
EPRE ratio of OCNG DMRS to SSS(Note 1)				
EPRE ratio of OCNG to OCNG DMRS (Note 1)				
<p>Note 1: OCNG shall be used such that both cells are fully allocated and a constant total transmitted power spectral density is achieved for all OFDM symbols.</p> <p>Note 2: Interference from other cells and noise sources not specified in the test is assumed to be constant over subcarriers and time and shall be modelled as AWGN of appropriate power for <math>N_{oc}</math> to be fulfilled.</p> <p>Note 3: SS-RSRP and <math>I_o</math> levels have been derived from other parameters for information purposes. They are not settable parameters themselves.</p> <p>Note 4: For unpaired spectrum, a DL BWP is linked with an UL BWP. DLBWP.0.2 is linked with ULBWP.0.2; DLBWP.1.1 is linked with ULBWP.1.1; DLBWP.1.3 is linked with ULBWP.1.3 defined in clause 12 of TS 38.213 [3].</p>				

Table A.5.6.5.1.1-4: OTA related test parameters for BWP switching test case

Parameter	Unit	Cell 2	Cell 3
Angle of arrival configuration		Setup 1 according to table A.3.15	Setup 1 according to table A.3.15
Assumption for UE beams <sup>Note 5</sup>		Fine	Fine
$N_{oc}$ <sup>Note1</sup>	dBm/15kHz	-112	-112
$N_{oc}$ <sup>Note1</sup>	dBm/SCS	-103	-103

SS-RSRP <sup>Note2</sup>	dBm/SCS <sup>Note3</sup>	-85	-85
$\hat{E}_s / I_{ot}$	dB	18	18
$I_o$ <sup>Note2</sup>	dBm/95.04 MHz <sup>Note4</sup>	-56	-56
<p>Note 1: Interference from other cells and noise sources not specified in the test is assumed to be constant over subcarriers and time and shall be modelled as AWGN of appropriate power for <math>N_{oc}</math> to be fulfilled.</p> <p>Note 2: SS-RSRP and <math>I_o</math> levels have been derived from other parameters for information purposes. They are not settable parameters themselves.</p> <p>Note 3: SS-RSRP minimum requirements are specified assuming independent interference and noise at each receiver antenna port.</p> <p>Note 4: Equivalent power received by an antenna with 0dBi gain at the centre of the quiet zone</p> <p>Note 5: Information about types of UE beam is given in B.2.1.3, and does not limit UE implementation or test system implementation</p>			

#### A.5.5.6.5.1.2 Test Requirements

During T1, the UE shall be ready for the reception of uplink grant for PSCell and SCell in the beginning of the DL slot right after slot  $(i + \frac{T_{RRC\text{processingDelay}} + T_{BWP\text{switchDelayRRC}} + D_{RRC}}{NR\text{ slot length}})$ .

All of the above test requirements shall be fulfilled in order for the observed PSCell and SCell active BWP switch delay to be counted as correct.

The rate of correct events observed during repeated tests shall be at least 90%.

### A.5.5.7 PSCell addition and release delay

#### A.5.5.7.1 Addition and Release Delay of NR PSCell

##### A.5.5.7.1.1 Test purpose and environment

The purpose of this test is to verify that the NR PSCell addition and release delays under EN-DC are within the requirements stated in clause 7.31.2 of TS 36.133 [15] for the case when the PSCell is unknown by the UE at the time of addition.

Supported test configurations are shown in A.5.5.7.1.1-1. The test parameters for the E-UTRA cell are given in Table A.3.7.2.2-1. The E-UTRA cell once set up is not changed across time.

The test parameters for NR cell are given in Tables A.5.5.7.1.1-2, cell-specific parameters in A.5.5.7.1.1-3 and OTA parameters in A.5.5.7.1.1-4 below. The test consists of four successive time periods with duration of T1, T2, T3 and T4. There are two carriers each with one cell. Before the test starts the UE is connected to Cell 1 (E-UTRA PCell) on radio channel 1 (PCC) but is not aware of Cell 2 (NR PSCell) on radio channel 2. The UE is only monitoring the PCC. During T1 only Cell1 is known to the UE.

The test system shall send a RRC message to the UE to add PSCell (Cell 2) on radio channel 2. The RRC message (to add PSCell) also includes a request for the UE to start periodic CSI reporting for the PSCell after the PSCell has been successfully added. The RRC message to add PSCell shall be sent to the UE during period T1. The point in time at which the RRC message to add PSCell (Cell2) is received at the UE antenna connector defines the start of period T2.

The test system shall observe the periodic reporting of CSI for PSCell during T3. The point in time at which the UE has sent PRACH to the PSCell (Cell 2) defines the start of period T3.

The test system shall send a RRC message to the UE to release PSCell (Cell 2) on radio channel 2. The RRC message to release PSCell (Cell2) shall be sent to the UE during period T3, after the UE has sent at least one CQI report with non-zero CQI index for PSCell (Cell 2). The point in time at which the RRC message to release PSCell (Cell2) is received at the UE antenna connector defines the start of period T4.

**Table A.5.5.7.1.1-1: Supported test configurations for FR2 PSCell**

Configuration	Description
1	LTE FDD, NR TDD, SSB SCS 240 kHz, data SCS 120 kHz, BW 100 MHz
2	LTE TDD, NR TDD, SSB SCS 240 kHz, data SCS 120 kHz, BW 100 MHz
Note: The UE is only required to be tested in one of the supported test configurations	

**Table A.5.5.7.1.1-2: General Test Parameters for PSCell Addition and Release**

Parameter	Unit	Value	Comment	
RF Channel Number		1, 2	Two radio channels are used for this test. One for E-UTRA cell and second for NR Cell	
Initial Condition	Active PCell	Cell1	PCell on RF channel number 1.	
	Neighbour cell	Cell2	Neighbour cell on RF channel number 2.	
Final Condition	Active PCell	Cell1	PCell on RF channel number 1.	
	Neighbour Cell	Cell2	PSCell released on RF channel number 2.	
B1	Hysteresis	dB	0	Hysteresis for evaluation of event B1.
	Threshold RSRP	dBm	-118	Actual RSRP threshold for event B1. Needs to take absolute accuracy tolerance in clause 9.1.11.1 into account plus margin.
	Time to Trigger	s	0	
DRX		OFF	Continuous monitoring of primary cell	
PRACH configuration on cell2		FR2 configuration 2	Captured in A.3.8.3.2	
Cell-individual offset for cells on RF channel number 1	dB	0	Individual offset for cells on primary component carrier.	
Cell-individual offset for cells on RF channel number 2	dB	0	Individual offset for cells on carrier frequency of cell2.	
T1	s	1	During this time the PCell shall be known and cell2 shall be unknown.	
T2	s	1	During this time the UE adds the PSCell.	
T3	s	1	During this time the UE sends CSI reports for PSCell.	
T4	s	1	During this time the UE releases the PSCell.	

**Table A.5.5.7.1.1-3: Cell Specific Parameters for PSCell Addition and Release**

Parameter	Unit	Config	Test			
			T1	T2	T3	T4
E-UTRA Channel Number		1,2	1			
NR Channel Number		1,2	2			
Duplex Mode		1,2	TDD			
TDD configuration		1,2	TDDConf.3.1			
BW <sub>channel</sub>	MHz	1,2	100: NRB,c = 66			
Data RBs allocated		1,2	48			
Initial BWP Configuration		1,2	DLBWP.0.1 ULBWP.0.1			
Dedicated BWP Configuration		1,2	DLBWP.1.1 ULBWP.1.1			
TRS Configuration		1	TRS.2.1 TDD			
PDSCH/PDCCH TCI state		1	TCI.State.2			
PDSCH Reference measurement channel		1,2	SR.3.3 TDD			
RMSI CORESET Reference Channel		1,2	CR.3.2 TDD			

Dedicated CORESET Reference Channel		1,2	CCR.3.7 TDD
OCNG Patterns		1,2	OP.3
SSB configuration		1,2	SSB.2 FR2
SMTC configuration		1,2	SMTC.2
PDSCH/PDCCH subcarrier spacing	kHz	1,2	120
TRS Configuration		1,2	TRS.2.1 TDD
CSI-RS configuration for CSI reporting		1,2	CSI-RS.3.1 TDD
reportConfigType		1,2	periodic
reportQuantity		1,2	cri-RI-PMI-CQI
CSI reporting periodicity	slot	1,2	40
CSI reporting offset	slot	1,2	4
EPRE ratio of PSS to SSS	dB	1,2	0
EPRE ratio of PBCH DMRS to SSS			
EPRE ratio of PBCH to PBCH DMRS			
EPRE ratio of PDCCH DMRS to SSS			
EPRE ratio of PDCCH to PDCCH DMRS			
EPRE ratio of PDSCH DMRS to SSS			
EPRE ratio of PDSCH to PDSCH			
EPRE ratio of OCNG DMRS to SSS(Note 1)			
EPRE ratio of OCNG to OCNG DMRS (Note 1)			
Propagation condition			
Note 1: The downlink connection between the System Simulator and the UE is without Additive White Gaussian Noise, and has no fading or multipath effects as specified in TS 38.521-2 B.0 [37].			

**Table A.5.5.7.1.1-4: OTA related test parameters**

Parameter	Unit	Cell 2			
		T1	T2	T3	T4
Angle of arrival configuration		Setup 2a according to clause A.3.15.2.1			
Assumption for UE beams <sup>Note 6</sup>		Rough			
$\hat{E}_s$ <sup>Note 2</sup>	dBm/SCS	$-\infty$		-81	
SSB_RP <sup>Note 2, Note 4</sup>	dBm/SCS	$-\infty$		-81	
$\hat{E}_s / I_{ot\_BB}$ <sup>Note 2, Note 7</sup>	dB	$-\infty$		4.88	
$I_o$ <sup>Note 2, Note 4</sup>	dBm/95.04 MHz	N/A		-56.41	
<p>Note 1: Void</p> <p>Note 2: <math>E_s/I_{ot}</math>, SSB_RP and <math>I_o</math> levels have been derived from other parameters for information purposes. They are not settable parameters themselves.</p> <p>Note 3: Void</p> <p>Note 4: Equivalent power received by an antenna with 0dBi gain at the centre of the quiet zone</p> <p>Note 5: Void</p> <p>Note 6: Information about types of UE beam is given in B.2.1.3, and does not limit UE implementation or test system implementation</p> <p>Note 7: Calculation of <math>E_s/I_{ot\_BB}</math> includes the effect of UE internal noise up to the value assumed for the associated Refsens requirement in clause 7.3.2 of TS 38.101-2 [19], and an allowance of 1dB for UE multi-band relaxation factor <math>\Delta MB_s</math> from TS 38.101-2 [19] Table 6.2.1.3-4.</p>					

**A.5.5.7.1.2 Test Requirements**

The UE shall transmit the PRACH to PSCell at latest 582 ms<sup>Note 1</sup> into T2.

The UE shall send at least one CSI report for PSCell with non-zero CQI index during T3.

The UE shall periodically send CSI reports for PSCell after the UE has sent first CQI report with non-zero CQI index during T3

The UE shall stop sending CSI reports for PSCell in at latest 20 ms into T4.



All the above test requirements shall be fulfilled for the observed PSCell addition delay and PSCell release delay to be counted as correct. The rate of correct observed PSCell addition delay and PSCell release delay during repeated tests shall be at least 90%.

Note1: The PSCell addition delay can be expressed as follows as specified in clause 7.31.2 of TS 36.133 [15]:

$$T_{\text{config\_PSCell}} = T_{\text{RRC\_delay}} + T_{\text{processing}} + T_{\text{search}} + T_{\Delta} + T_{\text{PSCell\_DU}} + 2\text{ms}$$

Where:

$$T_{\text{RRC\_delay}} = 20\text{ms}$$

$$T_{\text{processing}} = 40\text{ms}$$

$$T_{\text{search}} = 8 \times 3 \times 20 = 480 \text{ ms}$$

$$T_{\Delta} = 20\text{ms}$$

$$T_{\text{PSCell\_DU}} = 1 \times 10 + 10 = 20 \text{ ms}$$

## A.5.5.8 Active TCI state switch delay

### A.5.5.8.1 MAC-CE based active TCI state switch

#### A.5.5.8.1.1 E-UTRAN – NR PSCell FR2 active TCI state switch for a known TCI state

##### A.5.5.8.1.1.1 Test Purpose and Environment

The purpose of this test is to verify the active TCI state switch delay requirement defined in clause 8.10.3. Supported test configurations are shown in Table A.5.5.8.1.1.1-1.

The test scenario comprises of one E-UTRA PCell (Cell 1), and one NR PSCell (Cell 2) as given in Table A.5.5.8.1.1.1-2. Cell-specific parameters of E-UTRA PCell are specified in Table A.3.7.2.1-1 and Cell-specific parameters of NR PSCell is specified in Table A.5.5.8.1.1.1-3 below. The OTA related test parameters for FR2 is shown in Table A.5.5.8.1.1.1-4.

PDCCHs indicating new transmissions shall be sent continuously on PSCell (Cell 2) to ensure that the UE would have ACK/NACK sending.

Before the test starts,

- UE is connected to Cell 1 (PCell) on radio channel 1 (PCC), and Cell 2 (PSCell) on radio channel 2 (PSCC).
- UE is configured with 2 different TCI states for PSCell, PDCCH TCI state 0 (QCL'd to SSB0) and TCIstate 1 (QCL'd to SSB1), in Cell 2 before starting the test.
- UE is indicated in TCI state 0 as the active PDCCH TCI state

The test consists of two time periods, T1 and T2. Figure A.5.5.8.1.1.1-1 and Figure A.5.5.8.1.1.1-2 show the Time multiplexed (allocation in Frequency is symbolic) downlink transmissions from each Angle of Arrival. During T1 only SSB to which PDCCH-TCI-state0 is QCL'd is transmitted. At the beginning of T2, the SSB corresponding to TCI state 1 starts transmitting. The UE is configured to provide periodic L1-RSRP reports. In slot n which is within 1280ms of UE providing L1-RSRP report with results for both SSB0 and SSB1, UE receives a MAC-CE command indicating a switch to TCI state 1. *tcI-PresentInDCI* is not configured in the PDSCH configuration, i.e. TCI state for the PDSCH is identical to the PDCCH TCI state.

The test equipment verifies that UE can be scheduled on PSCell on TCI state 0 till  $n + T_{\text{HARQ}} + 3 \text{ ms}$ . The test equipment also verifies the TCI state switch time in PSCell by scheduling the UE on TCI state 1 after  $n + T_{\text{HARQ}} + 3 \text{ ms} + (T_{\text{first-SSB}} + T_{\text{SSB-proc}})$ .

**Table A.5.5.8.1.1.1-1: Supported test configurations**

Config	Description
1	LTE FDD, NR 120 kHz SSB SCS, 100 MHz bandwidth, TDD duplex mode

2	LTE TDD, NR 120 kHz SSB SCS, 100 MHz bandwidth, TDD duplex mode
Note 1: The UE is only required to be tested in one of the supported test configurations	

**Table A.5.5.8.1.1-2: General test parameters for TCI state switch**

Parameter	Unit	Value	Comment
E-UTRA RF Channel Number		1	One E-UTRA radio channel is used for this test
NR RF Channel Number		2	One NR radio channel is used for this test
Active PCell		Cell 1	PCell on RF channel number 1.
Active PSCell		Cell 2	PSCell on RF channel number 2.
CP length		Normal	
DRX		OFF	For both PCell and PSCell
Cell-individual offset for cells on RF channel number 1	dB	0	Individual offset for cells on PCC.
Cell-individual offset for cells on RF channel number 2	dB	0	Individual offset for cells on PSCC.
Cell2 timing offset to cell1	μs	3	Synchronous EN-DC
T1	s	0.2	
T2	s	0.2	

**Table A.5.5.8.1.1-3: NR Cell specific test parameters for TCI state switch**

Parameter	Unit	Cell 2
Frequency Range		FR2
Duplex mode		TDD
TDD configuration		TDDConf.3.1
BW <sub>channel</sub>		100 MHz: N <sub>RB,c</sub> = 66
Initial DL BWP Configuration		DLBWP.0.2
Dedicated DL BWP Configuration		DLBWP.1.1
Initial UL BWP Configuration		ULBWP.0.2
Dedicated UL BWP Configuration		ULBWP.1.1
PDSCH Reference measurement channel		SR.3.2 TDD
RMSI CORESET parameters		CR.3.1 TDD
Dedicated CORESET parameters		CCR.3.1 TDD
OCNG Patterns		OP.5
SSB Configuration		SSB.1 FR2
SMTC Configuration		SMTC.1
TCI State 0		TCI.State.2
TCI State 1		TCI.State.3
TRS Configuration		TRS.2.1 TDD TRS.2.2 TDD
Correlation Matrix and Antenna Configuration		1x2 Low
EPRE ratio of PSS to SSS	dB	0
EPRE ratio of PBCH DMRS to SSS		
EPRE ratio of PBCH to PBCH DMRS		
EPRE ratio of PDCCH DMRS to SSS		
EPRE ratio of PDCCH to PDCCH DMRS		
EPRE ratio of PDSCH DMRS to SSS		
EPRE ratio of PDSCH to PDSCH		
EPRE ratio of OCNG DMRS to SSS(Note 1)		
EPRE ratio of OCNG to OCNG DMRS (Note 1)		
Propagation Condition		No external noise (Note 2)
Note 1: OCNG shall be used such that and a constant total transmitted power spectral density is achieved for all OFDM symbols.		
Note 2: The downlink connection between the System Simulator and the UE is without Additive White Gaussian Noise, and has no fading or multipath effects as specified in TS 38.521-2 B.0 [37].		

Table A.5.5.8.1.1-4: OTA related test parameters for TCI state switch

Parameter	Unit	Cell 2			
		SSB0		SSB1	
		T1	T2	T1	T2
Angle of arrival configuration		Setup 3 according to clause A.3.15.3			
		AoA1		AoA2	
Assumption for UE beams <sup>Note 6</sup>		Rough		Rough	
$\bar{E}_s$	dBm/SCS	-80.6	-80.6	-Infinity	-80.6
SS B_RP <sup>Note 2</sup>	dBm/SCS	-80.6	-80.6	-Infinity	-80.6
$\hat{E}_s / I_{ot\_BB}$ <sup>Note 7</sup>	dB	8.3	8.3	-Infinity	8.3
$I_o$ <sup>Note 2</sup>	dBm/95.04 MHz <sup>Note 4</sup>	-56.0	-56.0	-Infinity	-56.0
Note 1: Void Note 2: SS B_RP and $I_o$ levels have been derived from other parameters for information purposes. They are not settable parameters themselves. Note 3: Void Note 4: Equivalent power received by an antenna with 0 dBi gain at the centre of the quiet zone Note 5: As observed with 0dBi gain antenna at the center of the quiet zone. Note 6: Information about types of UE beam is given in B.2.1.3, and does not limit UE implementation or test system implementation Note 7: Calculation of $E_s/I_{ot\_BB}$ includes the effect of UE internal noise up to the value assumed for the associated Refsens requirement in clause 7.3.2 of TS 38.101-2 [19], and an allowance of 1dB for UE multi-band relaxation factor $\Delta MB_P$ from TS 38.101-2 [19] Table 6.2.1.3-4.					

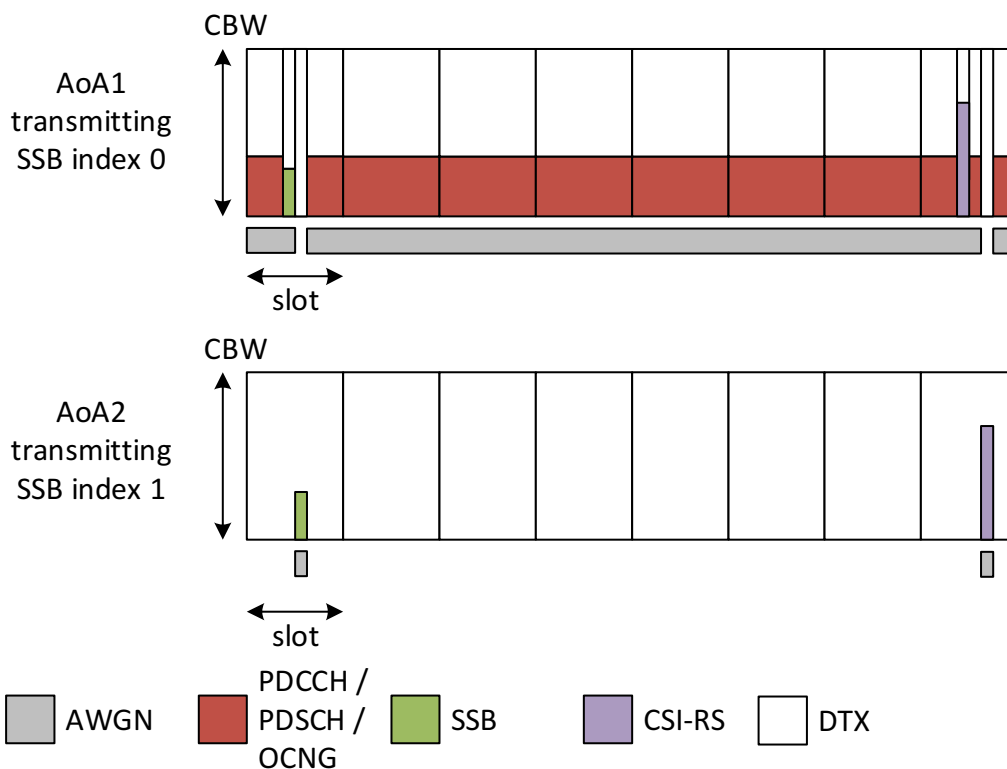
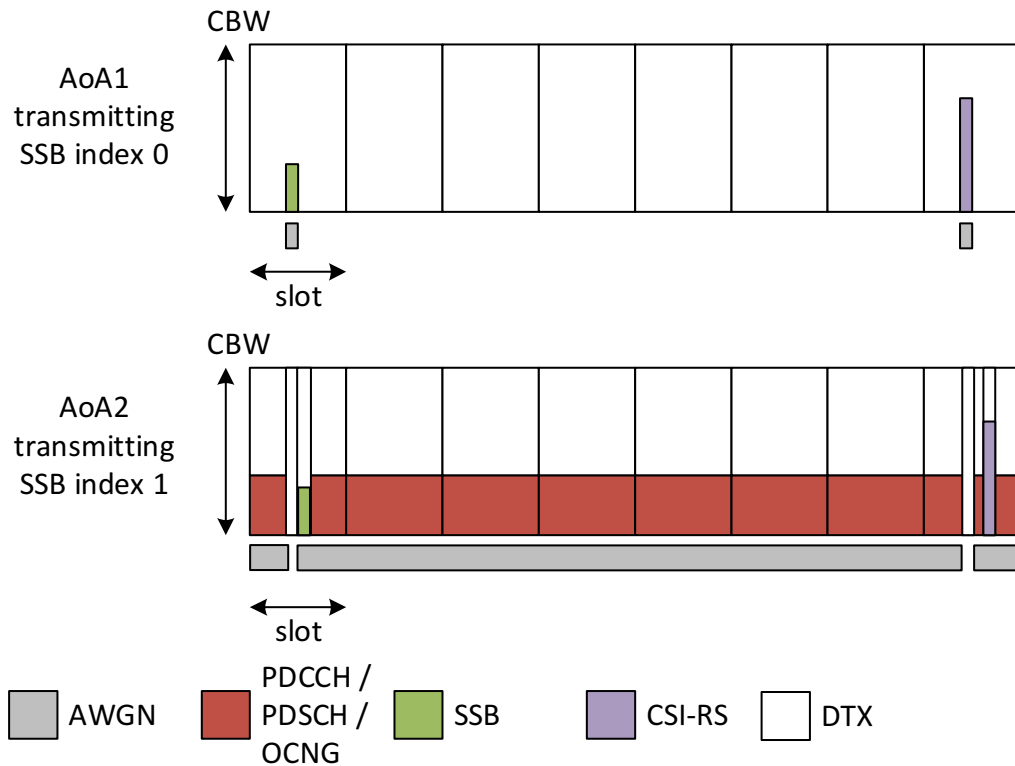

Figure A.5.5.8.1.1-1: Time multiplexed downlink transmissions during T1



**Figure A.5.5.8.1.1-2: Time multiplexed downlink transmissions during T2**

**A.5.5.8.1.1.2 Test Requirements**

During T2, UE shall send L1-RSRP report with results for both SSB0 and SSB1.

After receiving MAC-CE command in slot  $n$ , UE shall:

- be able to continue to receive on TCI state 0 till  $n + T_{\text{HARQ}} + 3 \text{ ms}$
- be able to start receiving on TCI state 1 after  $n + T_{\text{HARQ}} + 5 \text{ ms} + T_{\text{first-SSB}}$

The rate of correct events observed during repeated tests shall be at least 90%.

**A.5.5.8.2 RRC based active TCI state switch**

**A.5.5.8.2.1 E-UTRAN – NR PSCell FR2 active TCI state switch for a known TCI state**

**A.5.5.8.2.1.1 Test Purpose and Environment**

The purpose of this test is to verify the active TCI state switch delay requirement defined in clause 8.10.3 Supported test configurations are shown in Table A.5.5.8.2.1.1-1.

The test scenario comprises of one E-UTRA PCell (Cell 1), and one NR PSCell (Cell 2) as given in Table A.5.5.8.2.1.1-2. Cell-specific parameters of E-UTRA PCell are specified in Table A.3.7.2.1-1 and Cell-specific parameters of NR PSCell is specified in Table A.5.5.8.2.1.1-3 below. The OTA related test parameters for FR2 is shown in Table A.5.5.8.2.1.1-4.

PDCCHs indicating new transmissions shall be sent continuously on PSCell (Cell 2) to ensure that the UE would have ACK/NACK sending.

Before the test starts,

- UE is connected to Cell 1 (PCell) on radio channel 1 (PCC), and Cell 2 (PSCell) on radio channel 2 (PSCC).

- UE is configured with 1 TCI state for PSCell, PDCCH-TCI-state0 (QCL'd to SSB0)
- UE is indicated in TCI state0 as the active TCI state

The test consists of two time periods, T1 and T2. Figure A.5.5.8.2.1.1-1 and Figure A.5.5.8.2.1.1-2 show the Time multiplexed (allocation in Frequency is symbolic) downlink transmissions from each Angle of Arrival. During T1 only SSB to which TCI-state0 is QCL'd is transmitted. At the beginning of T2, the SSB corresponding to TCI-state1 starts transmitting. The UE is configured to provide periodic L1-RSRP reports. In slot n which is within 1280 ms of UE providing L1-RSRP report with results for both SSB0 and SSB1, UE receives a RRC command indicating a switch to TCI-state1.

The test equipment verifies the TCI state switch time in PSCell by scheduling the UE on TCI state 1 after  $n + T_{\text{RRC\_processing}} + T_{\text{first-SSB}} + 2\text{ms}$ .

**Table A.5.5.8.2.1.1-1: Supported test configurations**

Config	Description
1	LTE FDD, NR 120 kHz SSB SCS, 100 MHz bandwidth, TDD duplex mode
2	LTE TDD, NR 120 kHz SSB SCS, 100 MHz bandwidth, TDD duplex mode

Note 1: The UE is only required to be tested in one of the supported test configurations

**Table A.5.5.8.2.1.1-2: General test parameters for TCI state switch**

Parameter	Unit	Value	Comment
E-UTRA RF Channel Number		1	One E-UTRA radio channel is used for this test
NR RF Channel Number		2	One NR radio channel is used for this test
Active PCell		Cell 1	PCell on RF channel number 1.
Active PSCell		Cell 2	PSCell on RF channel number 2.
CP length		Normal	
DRX		OFF	For both PCell and PSCell
Cell-individual offset for cells on RF channel number 1	dB	0	Individual offset for cells on PCC.
Cell-individual offset for cells on RF channel number 2	dB	0	Individual offset for cells on PSCC.
Cell2 timing offset to cell1	μs	3	Synchronous EN-DC
T1	s	0.2	
T2	s	0.2	

**Table A.5.5.8.2.1.1-3: NR Cell specific test parameters for TCI state switch**

Parameter	Unit	Cell 2
Frequency Range		FR2
Duplex mode		TDD
TDD configuration		TDDConf.3.1
BW <sub>channel</sub>		100 MHz: N <sub>RB,c</sub> = 66
Initial DL BWP Configuration		DLBWP.0.2
Dedicated DL BWP Configuration		DLBWP.1.1
Initial UL BWP Configuration		ULBWP.0.2
Dedicated UL BWP Configuration		ULBWP.1.1
PDSCH Reference measurement channel		SR.3.2 TDD
RMSI CORESET parameters		CR.3.1 TDD
Dedicated CORESET parameters		CCR.3.1 TDD
OCNG Patterns		OP.5
SSB Configuration		SSB.1 FR2
SMTC Configuration		SMTC.1
TCI State 0		TC. State.2
TCI State 1		TCI.State.3
TRS Configuration		TRS.2.1 TDD TRS.2.2 TDD
reportConfigType		ssb-Index-RSRP

reportConfigType		periodic		
Number of reported RS		2		
L1-RSRP reporting period	slot	640		
timeRestrictionForChannelMeasurements		configured		
Correlation Matrix and Antenna Configuration		1x2 Low		
EPRE ratio of PSS to SSS	dB	0		
EPRE ratio of PBCH DMRS to SSS				
EPRE ratio of PBCH to PBCH DMRS				
EPRE ratio of PDCCH DMRS to SSS				
EPRE ratio of PDCCH to PDCCH DMRS				
EPRE ratio of PDSCH DMRS to SSS				
EPRE ratio of PDSCH to PDSCH				
EPRE ratio of OCNG DMRS to SSS(Note 1)				
EPRE ratio of OCNG to OCNG DMRS (Note 1)				
Propagation Condition				No external noise (Note 2)
<p>Note 1: OCNG shall be used such that a constant total transmitted power spectral density is achieved for all OFDM symbols.</p> <p>Note 2: The downlink connection between the System Simulator and the UE is without Additive White Gaussian Noise, and has no fading or multipath effects as specified in TS 38.521-2 B.0 [37].</p>				

**Table A.5.5.8.2.1-4: OTA related test parameters for TCI state switch**

Parameter	Unit	Cell 2			
		SSB0		SSB1	
		T1	T2	T1	T2
Angle of arrival configuration		Setup 3 according to clause A.3.15.3			
		AoA1		AoA2	
Assumption for UE beams <sup>Note 6</sup>		Rough		Rough	
$\hat{E}_s$	dBm/SCS	-80.6	-80.6	-Infinity	-80.6
SSB <sub>RP</sub> <sup>Note 2</sup>	dBm/ SCS	-80.6	-80.6	-Infinity	-80.6
$\hat{E}_s/I_{ot, BB}$ <sup>Note 7</sup>	dB	8.3	8.3	-Infinity	8.3
$I_o$ <sup>Note2</sup>	dBm/95.04 MHz <sup>Note4</sup>	-56.0	-56.0	-Infinity	-56.0
<p>Note 1: Void</p> <p>Note 2: SS<sub>B</sub>_RP and I<sub>o</sub> levels have been derived from other parameters for information purposes. They are not settable parameters themselves.</p> <p>Note 3: Void</p> <p>Note 4: Equivalent power received by an antenna with 0 dBi gain at the centre of the quiet zone</p> <p>Note 5: As observed with 0dBi gain antenna at the center of the quiet zone.</p> <p>Note 6: Information about types of UE beam is given in B.2.1.3, and does not limit UE implementation or test system implementation</p> <p>Note 7: Calculation of <math>E_s/I_{ot, BB}</math> includes the effect of UE internal noise up to the value assumed for the associated Refsens requirement in clause 7.3.2 of TS 38.101-2 [19], and an allowance of 1dB for UE multi-band relaxation factor <math>\Delta MB_P</math> from TS 38.101-2 [19] Table 6.2.1.3-4.</p>					

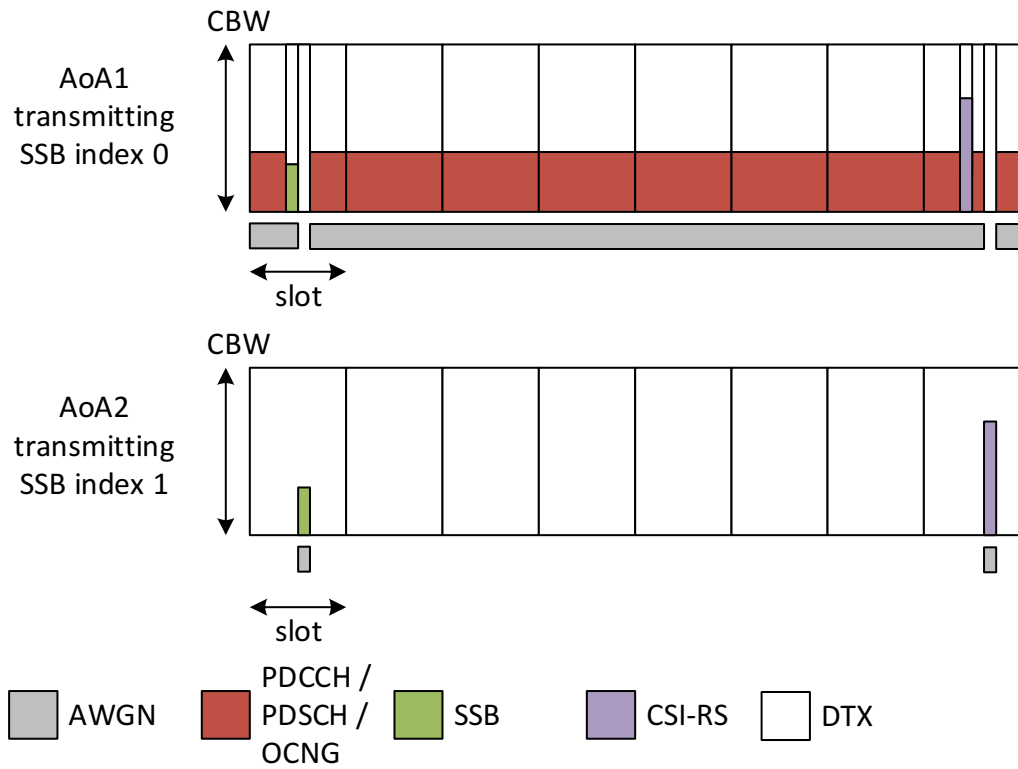

Figure A.5.5.8.2.1.1-1: Time multiplexed downlink transmissions during T1

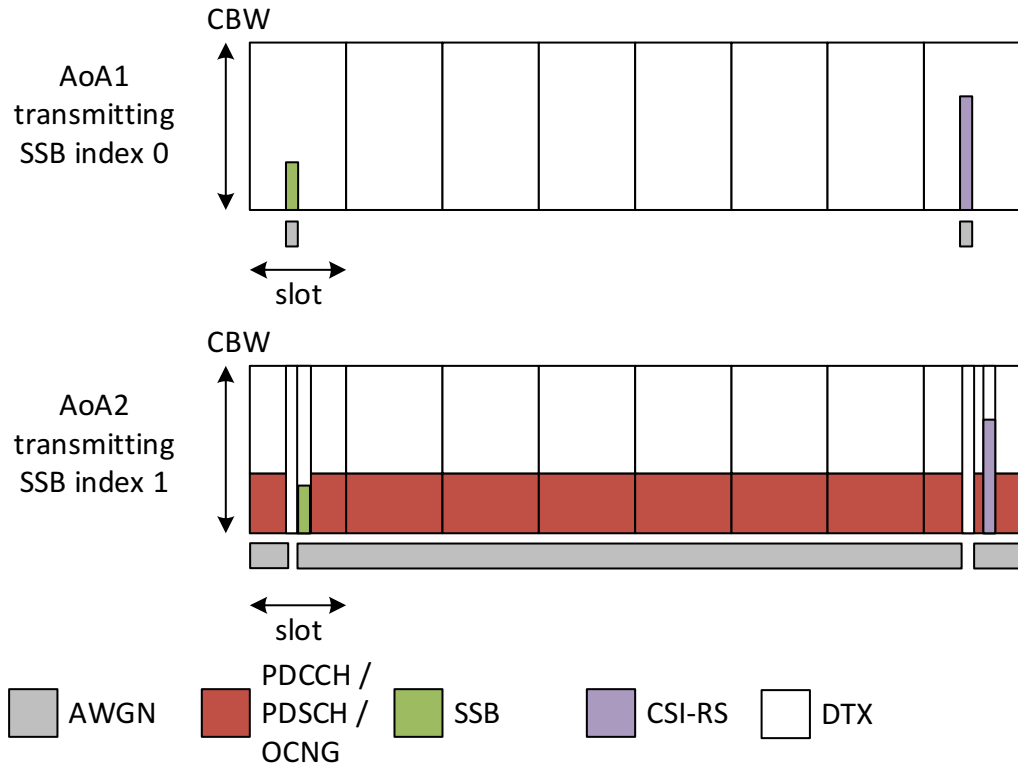

Figure A.5.5.8.2.1.1-2: Time multiplexed downlink transmissions during T2

### A.5.5.8.2.1.2 Test Requirements

During T2, UE shall send L1-RSRP report with both SSB0 and SSB1.

After receiving RRC command in slot  $n$ , UE shall be able to start receiving on TCI state 1 after  $n + T_{\text{RRC\_processing}} + T_{\text{first-SSB}} + 2\text{ms}$ .

The rate of correct events observed during repeated tests shall be at least 90%.

## A.5.5.9 Uplink spatial relation switch delay

### A.5.5.9.1 MAC-CE based uplink spatial relation switch

#### A.5.5.9.1.1 E-UTRAN – NR PSCell FR2 uplink spatial relation switch for a known spatial relation

##### A.5.5.9.1.1.1 Test Purpose and Environment

The purpose of this test is to verify the uplink spatial relation switch delay requirement defined in clause 8.12.3 by a UE capable of beam correspondence without the need for UL beam sweeping. Supported test configurations are shown in Table A.5.5.9.1.1.1-1.

The test scenario comprises of one E-UTRA PCell (Cell 1), and one NR PSCell (Cell 2) as given in Table A.5.5.9.1.1.1-2. Cell-specific parameters of E-UTRA PCell are specified in Table A.3.7.2.1-1 and Cell-specific parameters of NR PSCell is specified in Table A.5.5.9.1.1.1-3 below. The OTA related test parameters for FR2 is shown in Table A.5.5.9.1.1.1-4.

PDCCHs indicating new transmissions shall be sent continuously on PSCell (Cell 2) to ensure that the UE would have continuous ACK/NACK sending by PUCCH.

Before the test starts,

- UE is connected to Cell 1 (PCell) on radio channel 1 (PCC), and Cell 2 (PSCell) on radio channel 2 (PSCC).
- UE is configured with 2 different spatial relations for PSCell, PUCCH spatial relation 0 (QCL'd to SSB0) and spatial relation 1 (QCL'd to SSB1), in Cell 2 before starting the test.
- UE is indicated in spatial relation 0 as the active PUCCH spatial relation

The test consists of two time periods, T1 and T2. During T1 only SSB to which PUCCH spatial relation 0 QCLed is transmitted. At the beginning of T2, the SSB corresponding to spatial relation 1 starts transmitting. The UE is configured to provide periodic L1-RSRP reports. The test has higher layer parameter *timeRestrictionForChannelMeasurements* configured. In slot  $n$  which is within 1280ms of UE providing L1-RSRP report with results for both SSB0 and SSB1, UE receives a MAC-CE command indicating a switch to transmit PUCCH with spatial relation 1.

The test equipment verifies that UE can be scheduled on PSCell on spatial relation 0 till  $n + T_{\text{HARQ}}/\text{NR slot length} + 3N_{\text{slot}}^{\text{subframe},\mu}$ . The test equipment also verifies the spatial relation switch time in PSCell by scheduling the UE on spatial relation 1 from slot  $n + T_{\text{HARQ}}/\text{NR slot length} + 3N_{\text{slot}}^{\text{subframe},\mu} + 1$  and onwards.

**Table A.5.5.9.1.1.1-1: Supported test configurations**

Config	Description
1	LTE FDD, NR 120 kHz SSB SCS, 100 MHz bandwidth, TDD duplex mode
2	LTE TDD, NR 120 kHz SSB SCS, 100 MHz bandwidth, TDD duplex mode

Note 1: The UE is only required to be tested in one of the supported test configurations

**Table A.5.5.9.1.1.1-2: General test parameters for spatial relation switch**

Parameter	Unit	Value	Comment
E-UTRA RF Channel Number		1	One E-UTRA radio channel is used for this test
NR RF Channel Number		2	One NR radio channel is used for this test



Active PCell		Cell 1	PCell on RF channel number 1.
Active PSCell		Cell 2	PSCell on RF channel number 2.
CP length		Normal	
DRX		OFF	For both PCell and PSCell
Cell-individual offset for cells on RF channel number 1	dB	0	Individual offset for cells on PCC.
Cell-individual offset for cells on RF channel number 2	dB	0	Individual offset for cells on PSCC.
Cell2 timing offset to cell1	$\mu$ s	3	Synchronous EN-DC
L1-RSRP reporting period	slot	160	Periodic L1-RSRP reporting configured
L1-RSRP measured RS		SSB0, SSB1	L1-RSRP measurements of SSB0 and SSB1.
Number of reported RS		2	L1-RSRP reporting of measurements on SSB0 and SSB1.
T1	s	0.2	
T2	s	2	

Table A.5.5.9.1.1.1-3: NR Cell specific test parameters for spatial relation switch

Parameter	Unit	Cell 2
Frequency Range		FR2
Duplex mode		TDD
TDD configuration		TDDConf.3.1
BW <sub>channel</sub>		100 MHz: N <sub>RB,c</sub> = 66
Initial DL BWP Configuration		DLBWP.0.2
Dedicated DL BWP Configuration		DLBWP.1.1
Initial UL BWP Configuration		ULBWP.0.2
Dedicated UL BWP Configuration		ULBWP.1.1
PDSCH Reference measurement channel		SR.3.1 TDD
RMSI CORESET parameters		CR.3.1 TDD
Dedicated CORESET parameters		CCR.3.1 TDD
OCNG Patterns		OP.1
SSB Configuration		SSB.1 FR2
SMTC Configuration		SMTC.1
Spatial Relation 0		PUCCH. SRI.0
Spatial Relation 1		PUCCH. SRI.1
TRS Configuration		TRS.2.1 TDD
reportConfigType		ssb-Index-RSRP
reportConfigType		periodic
timeRestrictionForChannelMeasurements		configured
Correlation Matrix and Antenna Configuration		1x2 Low
EPRE ratio of PSS to SSS	dB	0
EPRE ratio of PBCH DMRS to SSS		
EPRE ratio of PBCH to PBCH DMRS		
EPRE ratio of PDCCH DMRS to SSS		
EPRE ratio of PDCCH to PDCCH DMRS		
EPRE ratio of PDSCH DMRS to SSS		
EPRE ratio of PDSCH to PDSCH		
EPRE ratio of OCNG DMRS to SSS (Note 1)		
EPRE ratio of OCNG to OCNG DMRS (Note 1)		
Propagation Condition		AWGN
Note 1: OCNG shall be used such that both cells are fully allocated and a constant total transmitted power spectral density is achieved for all OFDM symbols.		

Table A.5.5.9.1.1.1-4: OTA related test parameters for uplink spatial relation switch

Parameter	Unit	Cell 2			
		SSB0		SSB1	
		T1	T2	T1	T2
Setup 3 according to clause A.3.15.3					

Angle of arrival configuration		AoA1		AoA2	
Assumption for UE beams <sup>Note 6</sup>		Rough			
$N_{oc}$ <sup>Note 1</sup>	dBm/15 kHz	-92.1			
$N_{oc}$ <sup>Note 1</sup>	dBm/SCS	-83.1			
$\hat{E}_s/N_{oc}$	dB	1	1	-Infinity	1
SS-RSRP <sup>Note 2</sup>	dBm/120 kHz <sup>Note 3</sup>	-82.1	-82.1	-Infinity	-82.1
$I_o$ <sup>Note 2, Note 6</sup>	dBm/95.04 MHz <sup>Note 4</sup>	-50.6	-50.6	-54.1	-50.6
Note 1:	Interference from other cells and noise sources not specified in the test is assumed to be constant over subcarriers and time and shall be modelled as AWGN of appropriate power for $N_{oc}$ to be fulfilled.				
Note 2:	SS-RSRP and $I_o$ levels have been derived from other parameters for information purposes. They are not settable parameters themselves.				
Note 3:	SS-RSRP minimum requirements are specified assuming independent interference and noise at each receiver antenna port.				
Note 4:	Equivalent power received by an antenna with 0 dBi gain at the centre of the quiet zone				
Note 5:	As observed with 0dBi gain antenna at the center of the quiet zone.				
Note 6:	Information about types of UE beam is given in B.2.1.3 and does not limit UE implementation or test system implementation.				

#### A.5.5.9.1.1.2 Test Requirements

During T2, UE shall send L1-RSRP report with results for SSB1.

After receiving MAC-CE command in slot  $n$ , UE shall:

- be able to continue to transmit PUCCH on spatial relation 0 till  $n + T_{HARQ}/NR$  slot length +  $3N_{slot}^{subframe,\mu}$ ;
- be able to start transmitting PUCCH on spatial relation 1 from slot  $n + T_{HARQ}/NR$  slot length +  $3N_{slot}^{subframe,\mu} + 1$ .

The rate of correct events observed during repeated tests shall be at least 90%.

#### A.5.5.9.2 RRC based spatial relation switch

##### A.5.5.9.2.1 E-UTRAN – NR PSCell FR2 spatial relation switch associated with a known DL-RS

###### A.5.5.9.2.1.1 Test Purpose and Environment

The purpose of this test is to verify the RRC based spatial relation switch delay requirement defined in clause 8.12.5 by a UE capable of beam correspondence without the need for UL beam sweeping. Supported test configurations are shown in Table A.5.5.9.2.1.1-1.

The test scenario comprises of one E-UTRA PCell (Cell 1), and one NR PSCell (Cell 2) as given in Table A.5.5.9.2.1.1-2. Cell-specific parameters of E-UTRA PCell are specified in Table A.3.7.2.1-1 and Cell-specific parameters of NR PSCell is specified in Table A.5.5.9.2.1.1-3 below. The OTA related test parameters for FR2 is shown in Table A.5.5.9.2.1.1-4.

Periodic SRS is transmitted on NR PSCell (Cell2), and the SRS configuration is SRSCConf.1 given in Table A.5.4.1.1.1-3.

Before the test starts,

- UE is connected to Cell 1 (PCell) on radio channel 1 (PCC), and Cell 2 (PSCell) on radio channel 2 (PSCC).
- UE is configured with 1 SRS-SpatialRelation0 associated with SSB0.
- UE is indicated SRS-SpatialRelation0 as the active SRS spatial relation.

The test consists of two time periods, T1 and T2. During T1 only SSB0 to which SRS-SpatialRelation0 associated is transmitted. UE shall transmit periodic SRS with SRS-SpatialRelation0 of PSCell. At the beginning of T2, the SSB1

corresponding to SRS-SpatialRelation1 starts transmitting. The UE is configured to provide periodic L1-RSRP reports. The test has higher layer parameter *timeRestrictionForChannelMeasurements* configured. In slot *n* which is within 1280 ms of UE providing L1-RSRP report with results for both SSB0 and SSB1, UE receives a RRC command indicating a switch to transmit periodic SRS with target SRS-SpatialRelation1. The test equipment verifies that UE shall be able to transmit periodic SRS with target spatial relation (SRS-SpatialRelation1) on PCell in the slot  $n + T_{\text{RRC\_processing}}/\text{NR slot length} + 1$ .

**Table A.5.5.9.2.1.1-1: Supported test configurations**

Config	Description
1	LTE FDD, NR 120 kHz SSB SCS, 100 MHz bandwidth, TDD duplex mode
2	LTE TDD, NR 120 kHz SSB SCS, 100 MHz bandwidth, TDD duplex mode

Note 1: The UE is only required to be tested in one of the supported test configurations.

**Table A.5.5.9.2.1.1-2: General test parameters for spatial relation switch associated with a known DL-RS**

Parameter	Unit	Value	Comment
E-UTRA RF Channel Number		1	One E-UTRA radio channel is used for this test
NR RF Channel Number		2	One NR radio channel is used for this test
Active PCell		Cell 1	PCell on RF channel number 1.
Active PSCell		Cell 2	PSCell on RF channel number 2.
CP length		Normal	
DRX		OFF	For both PCell and PSCell
Cell-individual offset for cells on RF channel number 1	dB	0	Individual offset for cells on PCC.
Cell-individual offset for cells on RF channel number 2	dB	0	Individual offset for cells on PSCC.
T1	s	0.2	
T2	s	2	

**Table A.5.5.9.2.1.1-3: NR Cell specific test parameters for spatial relation switch associated with a known DL-RS**

Parameter	Unit	Cell 2
Frequency Range		FR2
Duplex mode		TDD
TDD configuration		TDDConf.3.1
BW <sub>channel</sub>		100 MHz: N <sub>RB,c</sub> = 66
Initial DL BWP Configuration		DLBWP.0.2
Dedicated DL BWP Configuration		DLBWP.1.1
Initial UL BWP Configuration		ULBWP.0.2
Dedicated UL BWP Configuration		ULBWP.1.1
PDSCH Reference measurement channel		SR.3.1 TDD
RMSI CORESET parameters		CR.3.1 TDD
Dedicated CORESET parameters		CCR.3.1 TDD
OCNG Patterns		OP.1
SSB Configuration		SSB.1 FR2
SMTC Configuration		SMTC.1
SRS-SpatialRelation0		SRS.SRI0
SRS-SpatialRelation1		SRS.SRI1
TRS Configuration		TRS.2.1 TDD
reportConfigType		ssb-Index-RSRP
reportConfigType		periodic
Number of reported RS		2
L1-RSRP reporting period	slot	160
timeRestrictionForChannelMeasurements		configured
Correlation Matrix and Antenna Configuration		1x2 Low
EPRE ratio of PSS to SSS	dB	0

EPRE ratio of PBCH DMRS to SSS		
EPRE ratio of PBCH to PBCH DMRS		
EPRE ratio of PDCCH DMRS to SSS		
EPRE ratio of PDCCH to PDCCH DMRS		
EPRE ratio of PDSCH DMRS to SSS		
EPRE ratio of PDSCH to PDSCH		
EPRE ratio of OCNG DMRS to SSS (Note 1)		
EPRE ratio of OCNG to OCNG DMRS (Note 1)		
Propagation Condition		AWGN
Note 1: OCNG shall be used such that both cells are fully allocated and a constant total transmitted power spectral density is achieved for all OFDM symbols.		

**Table A.5.5.9.2.1.1-4: OTA related test parameters for spatial relation switch associated with a known DL-RS**

Parameter	Unit	Cell 2			
		SSB0		SSB1	
		T1	T2	T1	T2
Angle of arrival configuration		Setup 3 according to clause A.3.15.3			
		<b>AoA1</b>		<b>AoA2</b>	
Assumption for UE beams <sup>Note 6</sup>		Rough		Rough	
$N_{oc}$ <sup>Note 1</sup>	dBm/15 kHz	-92.1			
$N_{oc}$ <sup>Note 1</sup>	dBm/SCS	-83.1			
$\hat{E}_s/N_{oc}$	dB	1	1	-Infinity	1
SS-RSRP <sup>Note 2</sup>	dBm/120 kHz <sup>Note 3</sup>	-82.1	-82.1	-Infinity	-82.1
$I_o$ <sup>Note 2, Note 6</sup>	dBm/95.04 MHz <sup>Note 4</sup>	-50.6	-50.6	-54.1	-50.6
<p>Note 1: Interference from other cells and noise sources not specified in the test is assumed to be constant over subcarriers and time and shall be modelled as AWGN of appropriate power for <math>N_{oc}</math> to be fulfilled.</p> <p>Note 2: SS-RSRP and <math>I_o</math> levels have been derived from other parameters for information purposes. They are not settable parameters themselves.</p> <p>Note 3: SS-RSRP minimum requirements are specified assuming independent interference and noise at each receiver antenna port.</p> <p>Note 4: Equivalent power received by an antenna with 0 dBi gain at the centre of the quiet zone</p> <p>Note 5: As observed with 0dBi gain antenna at the center of the quiet zone.</p> <p>Note 6: Information about types of UE beam is given in B.2.1.3, and does not limit UE implementation or test system implementation</p>					

**A.5.5.9.2.1.2 Test Requirements**

During T2, UE shall send L1-RSRP report with SSB1 to which SRS-SpatialRelation1 is associated.

After receiving RRC command in slot  $n$ , UE shall be able to transmit target periodic SRS with SRS-SpatialRelation1 on PSCell in the slot  $n + T_{RRC\_processing}/NR\ slot\ length + 1$ .

The rate of correct events observed during repeated tests shall be at least 90%.

**A.5.5.10 UE specific CBW change**

**A.5.5.10.1 UE specific CBW change on FR2 NR PSCell**

**A.5.5.10.1.1 Test Purpose and Environment**

The purpose of this test is to verify the UE specific CBW change delay requirement defined in clause 8.13. Supported test configurations are shown in Table A.5.5.10.1.1-1.

The test scenario comprises of one E-UTRA PCell (Cell 1) and one NR PSCell (Cell 2) as given in Table A.5.5.10.1.1-2. Cell-specific parameters of E-UTRA PCell are specified in Table A.3.7.2.1-1 and Cell-specific parameters of NR PSCell are specified in Table A.5.5.10.1.1-3 below.

PDCCHs indicating new transmissions shall be sent continuously on PCell (Cell 1) to ensure that the UE will have ACK/NACK sending.

Before the test starts,

- UE is connected to Cell 1 (PCell) on radio channel 1 (PCC) and to Cell 2 (PSCell) on radio channel 2 (PSCC).
- UE has bandwidth part BWP-1 in its RRC-configuration for Cell 2 (PSCell).
- UE is indicated in *firstActiveDownlinkBWP-Id* that the active DL BWP is BWP-1 of initial condition in PSCell.
- UE is indicated in *SCS-SpecificCarrier* that the active CBW is CBW-1 of initial condition in PSCell.

All cells have constant signal levels throughout the test.

The test consists of 1 time period, with duration of T1.

During T1,

Time period T1 starts when a *RRCReconfiguration* which reconfigure the UE specific CBW parameter, sent from the test equipment to the UE, is received at the UE side in PSCell's slot # denoted *i*. The UE shall reconfigure its UE specific CBW with the updated UE specific CBW of final condition (CBW-2).

The UE shall be able to completely receive PDSCH at the beginning of the DL slot right after PSCell's DL slot ( $i + \frac{T_{RRCprocessingDelay} + T_{CBWchangeDelayRRC}}{NR\ Slot\ length}$ ) as defined in clause 8.13 and be ready for the reception of uplink grant for the PSCell no later than at the beginning of the DL slot right after slot ( $i + \frac{T_{RRCprocessingDelay} + T_{CBWchangeDelayRRC}}{NR\ Slot\ length}$ ). The UE shall be continuously scheduled on PSCell's BWP-1 of CBW-2 starting from the beginning of the DL slot right after slot ( $i + \frac{T_{RRCprocessingDelay} + T_{CBWchangeDelayRRC}}{NR\ Slot\ length}$ ).

$T_{RRCprocessingDelay}$  and  $T_{CBWchangeDelayRRC}$  are defined in clause 8.13.

The test equipment verifies the UE specific CBW change switch time in PSCell by counting the time from the time when the RRC Reconfiguration message including updated UE specific CBW configuration is sent till the time when RRC Reconfiguration Complete message is received.

**Table A.5.5.10.1.1-1: UE specific CBW change supported test configurations**

Config	Description
1	LTE FDD, NR 120 kHz SSB SCS, 100 MHz bandwidth, TDD duplex mode
2	LTE TDD, NR 120 kHz SSB SCS, 100 MHz bandwidth, TDD duplex mode

Note 1: The UE is only required to be tested in one of the supported test configurations

**Table A.5.5.10.1.1-2: General test parameters for UE specific CBW change in synchronous EN-DC**

Parameter	Unit	Value	Comment
E-UTRA RF Channel Number		1	One E-UTRA radio channel is used for this test
NR RF Channel Number		2	One NR radio channel is used for this test
Active PCell		Cell 1	PCell on RF channel number 1.
Active PSCell		Cell 2	PSCell on RF channel number 2.
CP length		Normal	
DRX		OFF	
Cell-individual offset for cells on RF channel number 1	dB	0	Individual offset for cells on PCC.
Cell-individual offset for cells on RF channel number 2	dB	0	Individual offset for cells on PSCC.
Cell2 timing offset to cell1	μs	3	Synchronous EN-DC
T1	s	0.2	

**Table A.5.5.10.1.1-3: NR Cell specific test parameters for UE specific CBW change in synchronous EN-DC**

Parameter	Unit	Cell 2
Frequency Range		FR2
Duplex mode		TDD

TDD configuration			TDDConf.3.1
BW <sub>channel</sub>			100 MHz: N <sub>RB,c</sub> = 66
Active BWP ID			0
Initial DL BWP Configuration (BWP-1)			DLBWP.0.2
Initial UL BWP Configuration (BWP-1)			ULBWP.0.2
Initial Condition	Active DL CBW Configuration (CBW-1)		DLCBW.1.1
	Active UL CBW Configuration (CBW-1)		ULCBW.1.1
Final Condition	Active DL CBW Configuration (CBW-2)		DLCBW.1.2
	Active UL CBW Configuration (CBW-2)		ULCBW.1.2
PDSCH Reference measurement channel			SR.3.1 TDD
RMSI CORESET parameters			CR.3.1 TDD
Dedicated CORESET parameters			CCR.3.1 TDD
OCNG Patterns			OP.1
SSB Configuration			SSB.1 FR2
SMTC Configuration			SMTC.1
TCI State			TCI.State.0
TRS Configuration			TRS.2.1 TDD
Antenna Configuration			1x2
Propagation Condition			AWGN
EPRE ratio of PSS to SSS		dB	0
EPRE ratio of PBCH DMRS to SSS			
EPRE ratio of PBCH to PBCH DMRS			
EPRE ratio of PDCCH DMRS to SSS			
EPRE ratio of PDCCH to PDCCH DMRS			
EPRE ratio of PDSCH DMRS to SSS			
EPRE ratio of PDSCH to PDSCH			
EPRE ratio of OCNG DMRS to SSS(Note 1)			
EPRE ratio of OCNG to OCNG DMRS (Note 1)			
<p>Note 1: OCNG shall be used such that both cells are fully allocated and a constant total transmitted power spectral density is achieved for all OFDM symbols.</p> <p>Note 2: Interference from other cells and noise sources not specified in the test is assumed to be constant over subcarriers and time and shall be modelled as AWGN of appropriate power for N<sub>oc</sub> to be fulfilled.</p> <p>Note 3: SS-RSRP and I<sub>o</sub> levels have been derived from other parameters for information purposes. They are not settable parameters themselves.</p> <p>Note 4: For unpaired spectrum, a DL BWP is linked with an UL BWP. DLBWP.0.2 is linked with ULBWP.0.2; DLBWP.1.1 is linked with ULBWP.1.1; DLBWP.1.3 is linked with ULBWP.1.3 defined in clause 12 of TS 38.213 [3].</p>			

**Table A.5.10.1.1-4: OTA related test parameters for UE specific CBW change test case**

Parameter		Unit	Cell 2
Angle of arrival configuration			Setup 1 according to table A.3.15
Assumption for UE beams <sup>Note 5</sup>			Fine
N <sub>oc</sub> <sup>Note1</sup>	NR_TDD_FR2_A	dBm/15kHz	-112
	NR_TDD_FR2_B		
	NR_TDD_FR2_F		
	NR_TDD_FR2_G		
	NR_TDD_FR2_T		
	NR_TDD_FR2_Y		
N <sub>oc</sub> <sup>Note1</sup>	NR_TDD_FR2_A	dBm/SCS	-103

	NR_TDD_FR2_B NR_TDD_FR2_F NR_TDD_FR2_G NR_TDD_FR2_T NR_TDD_FR2_Y		
SS-RSRP <sup>Note2</sup>	NR_TDD_FR2_A NR_TDD_FR2_B NR_TDD_FR2_F NR_TDD_FR2_G NR_TDD_FR2_T NR_TDD_FR2_Y	dBm/SCS <sup>Note3</sup>	-85
$\hat{E}_s/I_{ot}$		dB	18
$I_o$ <sup>Note2</sup>	NR_TDD_FR2_A NR_TDD_FR2_B NR_TDD_FR2_F NR_TDD_FR2_G NR_TDD_FR2_T NR_TDD_FR2_Y	dBm/95.04 MHz <sup>Note4</sup>	-56
<p>Note 1: Interference from other cells and noise sources not specified in the test is assumed to be constant over subcarriers and time and shall be modelled as AWGN of appropriate power for <math>N_{oc}</math> to be fulfilled.</p> <p>Note 2: SS-RSRP and <math>I_o</math> levels have been derived from other parameters for information purposes. They are not settable parameters themselves.</p> <p>Note 3: SS-RSRP minimum requirements are specified assuming independent interference and noise at each receiver antenna port.</p> <p>Note 4: Equivalent power received by an antenna with 0dBi gain at the centre of the quiet zone</p> <p>Note 5: Information about types of UE beam is given in B.2.1.3, and does not limit UE implementation or test system implementation</p>			

### A.5.5.10.1.2 Test Requirements

During T1, the UE shall be ready for the reception of uplink grant for PSCell in the beginning of the DL slot right after slot  $(i + \frac{T_{RRCprocessingDelay} + T_{CBWchangeDelayRRC}}{NR\ Slot\ length})$ .

All of the above test requirements shall be fulfilled in order for the observed PSCell UE specific CBW change switch delay to be counted as correct.

The rate of correct events observed during repeated tests shall be at least 90%.

## A.5.6 Measurement procedure

### A.5.6.1 Intra-frequency Measurements

#### A.5.6.1.1 EN-DC event triggered reporting test without gap under non-DRX

##### A.5.6.1.1.1 Test purpose and Environment

The purpose of this test is to verify that the UE makes correct reporting of an event. This test will partly verify the TDD intra-frequency cell search requirements in clause 9.2.5.1 and 9.2.5.2. Supported test configurations are shown in table A.5.6.1.1.1-1.

**Table A.5.6.1.1.1-1: supported test configurations**

Configuration	Description
1	LTE FDD, 120 kHz SSB SCS, 100 MHz bandwidth, TDD duplex mode
2	LTE TDD, 120 kHz SSB SCS, 100 MHz bandwidth, TDD duplex mode
3	LTE FDD, 240 kHz SSB SCS, 100 MHz bandwidth, TDD duplex mode
4	LTE TDD, 240 kHz SSB SCS, 100 MHz bandwidth, TDD duplex mode
Note:	The UE is only required to be tested in one of the supported test configurations.

There are three cells in the test, E-UTRAN PCell (Cell 1), FR2 PSCell (Cell 2) and a FR2 neighbour cell (Cell 3) on the same frequency as the PSCell. The test parameters and applicability for Cell 1 are defined in A.3.7.2. The test parameters for the Cell 2 and Cell 3 are given in Table A.5.6.1.1.1-2, A.5.6.1.1.1-3 and A.5.6.1.1.1-4 below.

In the measurement control information, a measurement object is configured for the frequency of the PSCell, and it is indicated to the UE that event-triggered reporting with Event A3 is used.

The test consists of two successive time periods, with time duration of T1, and T2 respectively. During time duration T1, the UE shall not have any timing information of cell 3.

**Table A.5.6.1.1.1-2: General test parameters for intra-frequency event triggered reporting for EN-DC with TDD PSCell in FR2 without gap without DRX**

Parameter	Unit	Config	Value	Comment
Active cell		1~4	E-UTRAN PCell (Cell 1) PSCell (Cell 2)	
Neighbour cell		1~4	Cell 3	Cell to be identified.
RF Channel Number		1~4	1: Cell 1 2: Cell 2 and Cell 3	One TDD carrier frequency is used for the NR cells and one TDD or FDD carrier frequency is used for E-UTRAN cell.
SMTc configuration		1~4	SMTc.1	
A3-Offset	dB	1~4	-11	
CP length		1~4	Normal	
Hysteresis	dB	1~4	0	
Time To Trigger	s	1~4	0	
Filter coefficient		1~4	0	L3 filtering is not used
DRX		1~4	OFF	
Time offset between Cell 1 and Cell 2		1~4	3 $\mu$ s	Synchronous EN-DC
Time offset between Cell 2 and Cell 3		1~4	3 $\mu$ s	Synchronous cells
T1	s	1~4	5	
T2	s	1~4	5	

**Table A.5.6.1.1.1-3: NR Cell specific test parameters for intra-frequency event triggered reporting for EN-DC with TDD PSCell in FR2 without gap without DRX**

Parameter	Unit	Config	Cell 2		Cell 3	
			T1	T2	T1	T2
TDD configuration		1~4	TDDConf.3.1		TDDConf.3.1	
$BW_{channel}$	MHz	1~4	100: $N_{RB,c} = 66$		100: $N_{RB,c} = 66$	
Data RBs allocated		1,2	24		24	
		3,4	48		48	
Initial BWP configuration		1~4	DLBWP.0.1 ULBWP.0.1		DLBWP.0.1 ULBWP.0.1	
Active DL BWP configuration		1~4	DLBWP.1.1		DLBWP.1.1	
Active UL BWP configuration		1~4	ULBWP.1.1		ULBWP.1.1	
RLM-RS		1~4	SSB		SSB	
PDSCH RMC configuration		1,2	SR.3.2 TDD		N/A	
		3,4	SR.3.3 TDD		N/A	
RMSI CORESET RMC configuration		1,2	CR.3.1 TDD		N/A	
		3,4	CR.3.2 TDD		N/A	
Dedicated CORESET RMC configuration		1,2	CCR.3.1 TDD		N/A	
		3,4	CCR.3.7 TDD		N/A	
PDSCH/PDCCH subcarrier spacing	kHz	1~4	120		120	
OCNG Patterns		1~4	OP.5		N/A	
TRS configuration		1~4	TRS.2.1 TDD		N/A	



PDSCH/PDCCH TCI state		1~4	TCI.State.2	N/A
cellIndividualOffset	dB	1~4	N/A	16
SSB configuration		1, 2	SSB.3 FR2	SSB.7 FR2
		3, 4	SSB.4 FR2	SSB.8 FR2
Propagation Condition		1~4	No external noise (Note 1)	No external noise (Note 1)
Note 1: The downlink connection between the System Simulator and the UE is without Additive White Gaussian Noise, and has no fading or multipath effects as specified in TS 38.521-2 B.0 [37].				

**Table A.5.6.1.1.1-4: NR OTA Cell specific test parameters for intra-frequency event triggered reporting for EN-DC with TDD PSCell in FR2 without gap without DRX**

Parameter	Unit	Config	Cell 2		Cell 3	
			T1	T2	T1	T2
AoA setup		1~4	Setup 3 defined in A.3.15.3			
			AoA1		AoA2	
Assumption for UE beams <sup>Note 4</sup>		1~4	Rough		Rough	
$E_s$	dBm/SCS	1, 2	-89	-89	-Infinity	-89
		3, 4	-86	-86	-Infinity	-86
$\hat{E}_s / I_{ot\_BB}$ <sup>Note 5</sup>	dB	1~4	-0.12	-0.12	-Infinity	-0.12
SSB_RP	dBm/SCS	1, 2	-89	-89	-Infinity	-89
		3, 4	-86	-86	-Infinity	-86
$I_o$	dBm/95.04MHz	1,2	-64.41	-64.41	-Infinity	-64.41
		3,4	-61.41	-61.41	-Infinity	-61.41
Time multiplexing of the downlink transmissions from each AoA		1~4	Defined in Figure A.5.6.1.1.1-1			
<p>Note 1: The resources for uplink transmission are assigned to the UE prior to the start of time period T2.</p> <p>Note 2: Void</p> <p>Note 3: <math>E_s/I_{ot}</math>, SSB_RP and <math>I_o</math> levels have been derived from other parameters for information purposes. They are not settable parameters themselves.</p> <p>Note 4: Information about types of UE beam is given in B.2.1.3, and does not limit UE implementation or test system implementation.</p> <p>Note 5: Calculation of <math>E_s/I_{ot\_BB}</math> includes the effect of UE internal noise up to the value assumed for the associated Refsens requirement in clause 7.3.2 of TS 38.101-2 [19], and an allowance of 1dB for UE multi-band relaxation factor <math>\Delta MB_P</math> from TS 38.101-2 [19] Table 6.2.1.3-4.</p>						

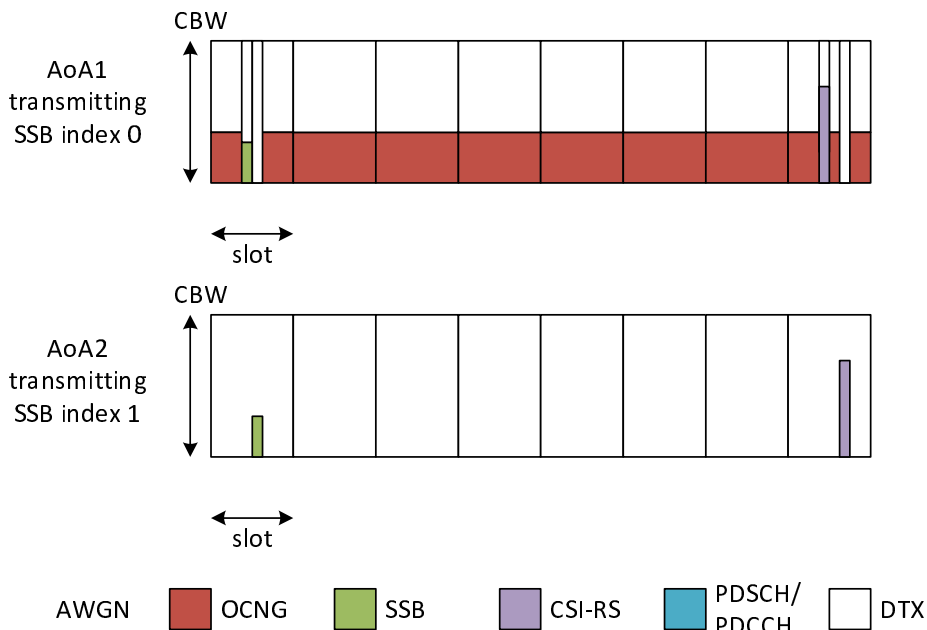

Figure A.5.6.1.1-1: Time multiplexed downlink transmissions (Config 1,2 example)

A.5.6.1.1.2 Test Requirements

In the test, the UE shall send one Event A3 triggered measurement report, with a measurement reporting delay less than X ms from the beginning of time period T2, where X is

- 2.4s for a UE supporting power class 1,
- 1.44s for a UE supporting power class 2, 3 and 4

The UE is not required to read the neighbour cell SSB index in this test.

The UE shall not send event triggered measurement reports, as long as the reporting criteria are not fulfilled.

The rate of correct events observed during repeated tests shall be at least 90%.

NOTE: The actual overall delays measured in the test may be up to 2xTTIDCCH higher than the measurement reporting delays above because of TTI insertion uncertainty of the measurement report in DCCH.

A.5.6.1.2 EN-DC event triggered reporting test without gap under DRX

A.5.6.1.2.1 Test purpose and Environment

The purpose of this test is to verify that the UE makes correct reporting of an event. This test will partly verify the TDD intra-frequency cell search requirements in clause 9.2.5.1 and 9.2.5.2. Supported test configurations are shown in table A.5.6.1.2.1-1.

Table A.5.6.1.2.1-1: supported test configurations

Configuration	Description
1	LTE FDD, 120 kHz SSB SCS, 100 MHz bandwidth, TDD duplex mode
2	LTE TDD, 120 kHz SSB SCS, 100 MHz bandwidth, TDD duplex mode
3	LTE FDD, 240 kHz SSB SCS, 100 MHz bandwidth, TDD duplex mode
4	LTE TDD, 240 kHz SSB SCS, 100 MHz bandwidth, TDD duplex mode
Note:	The UE is only required to be tested in one of the supported test configurations.

There are three cells in the test, E-UTRAN PCell (Cell 1), FR2 PSCell (Cell 2) and a FR2 neighbour cell (Cell 3) on the same frequency as the PSCell. The test parameters and applicability for Cell 1 are defined in A.3.7.2. The test parameters for the Cell 2 and Cell 3 are given in Table A.5.6.1.2.1-2 ~ Table A.5.6.1.2.1-6 below.

In the measurement control information, a measurement object is configured for the frequency of the PSCell, and it is indicated to the UE that event-triggered reporting with Event A3 is used.

The test consists of two successive time periods, with time duration of T1, and T2 respectively. During time duration T1, the UE shall not have any timing information of cell 3.

UE needs to be provided with new Timing Advance Command MAC control element at least once during each time alignment timer period to maintain uplink time alignment. Furthermore UE is allocated with PUSCH resource at every DRX cycle.

**Table A.5.6.1.2.1-2: General test parameters for intra-frequency event triggered reporting for EN-DC with TDD PSCell in FR2 without gap with DRX**

Parameter	Unit	Config	Value		Comment
			Test 1	Test 2	
Active cell		1~4	E-UTRAN PCell (Cell 1) PSCell (Cell 2)		
Neighbour cell		1~4	Cell 3		Cell to be identified.
RF Channel Number		1~4	1: Cell 1 2: Cell 2 and Cell 3		One TDD carrier frequency is used for the NR cells and one TDD or FDD carrier frequency is used for E-UTRAN cell.
SMTC configuration		1~4	SMTC.1		
A3-Offset	dB	1~4	-6		
CP length		1~4	Normal		
Hysteresis	dB	1~4	0		
Time To Trigger	s	1~4	0		
Filter coefficient		1~4	0		L3 filtering is not used
DRX		1~4	DRX.1	DRX.7	DRX related parameters are defined in Table A.5.6.1.2.1-4
Time offset between Cell 1 and Cell 2		1~4	3 $\mu$ s		Synchronous EN-DC
Time offset between Cell 2 and Cell 3		1~4	3 $\mu$ s		Synchronous cells
T1	s	1~4	5		
T2	s	1~4	10	52	

**Table A.5.6.1.2.1-3: NR Cell specific test parameters for intra-frequency event triggered reporting for EN-DC with TDD PSCell in FR2 without gap with DRX**

Parameter	Unit	Config	Cell 2		Cell 3	
			T1	T2	T1	T2
TDD configuration		1~4	TDDConf.3.1		TDDConf.3.1	
BW <sub>channel</sub>	MHz	1~4	100: N <sub>RB,c</sub> = 66		100: N <sub>RB,c</sub> = 66	
Data RBs allocated		1~4	66		66	
Initial BWP configuration		1~4	DLBWP.0.1 ULBWP.0.1		DLBWP.0.1 ULBWP.0.1	
Active DL BWP configuration		1~4	DLBWP.1.1		DLBWP.1.1	
Active UL BWP configuration		1~4	ULBWP.1.1		ULBWP.1.1	
RLM-RS		1~4	SSB		SSB	
PDSCH RMC configuration		1,2	SR.3.2 TDD		N/A	
		3,4	SR.3.3 TDD			
RMSI CORESET RMC configuration		1,2	CR.3.1 TDD		N/A	
		3,4	CR.3.2 TDD		N/A	

Dedicated CORESET RMC configuration		1,2	CCR.3.1 TDD	N/A
		3,4	CCR.3.7 TDD	N/A
PDSCH/PDCCH subcarrier spacing	kHz	1~4	120	120
OCNG Patterns		1~4	OP.1	OP.1
PDSCH/PDCCH TCI state		1~4	TCI.State.2	N/A
CSI-RS for tracking			TRS.2.1 TDD	N/A
			TRS.2.1 TDD	N/A
SSB configuration		1, 2	SSB.3 FR2	SSB.3 FR2
		3, 4	SSB.4 FR2	SSB.4 FR2
Propagation Condition		1~4	AWGN	AWGN

**Table A.5.6.1.2.1-4: NR OTA Cell specific test parameters for intra-frequency event triggered reporting for EN-DC with TDD PSCell in FR2 without gap with DRX**

Parameter	Unit	Config	Cell 2		Cell 3	
			T1	T2	T1	T2
AoA setup		1~4	Setup 1 defined in A.3.15.1			
Assumption for UE beams <sup>Note 4</sup>		1~4	Rough		Rough	
$\hat{E}_s/I_{ot}^{BB}$ <sup>Note 5</sup>	dB	1~4	3.77	-1.52	-Infinity	-1.52
$N_{oc}$ <sup>Note 2</sup>	dBm/15 KHz	1~4	-98			
$N_{oc}$ <sup>Note 2</sup>	dBm/SCS	1, 2	-89			
		3, 4	-86			
SSB_RP	dBm/SCS	1, 2	-85	-85	-Infinity	-85
		3, 4	-82	-82	-Infinity	-82
$\hat{E}_s/N_{oc}$	dB	1~4	4	4	-Infinity	4
$I_o$	dBm/95.04MHz	1~4	-54.53	-52.18	See Cell 2 columns	
Note 1:	The resources for uplink transmission are assigned to the UE prior to the start of time period T2.					
Note 2:	Interference from other cells and noise sources not specified in the test is assumed to be constant over subcarriers and time and shall be modelled as AWGN of appropriate power for $N_{oc}$ to be fulfilled.					
Note 3:	$E_s/I_{ot}$ , SSB_RP and $I_o$ levels have been derived from other parameters for information purposes. They are not settable parameters themselves.					
Note 4:	Information about types of UE beam is given in B.2.1.3, and does not limit UE implementation or test system implementation.					
Note 5:	Calculation of $E_s/I_{ot}^{BB}$ includes the effect of UE internal noise up to the value assumed for the associated Refsens requirement in clause 7.3.2 of TS 38.101-2 [19], and an allowance of 1dB for UE multi-band relaxation factor $\Delta MB_P$ from TS 38.101-2 [19] Table 6.2.1.3-4.					

#### A.5.6.1.2.2 Test Requirements

In test 1, the UE shall send one Event A3 triggered measurement report, with a measurement reporting delay less than X ms from the beginning of time period T2, where X is

- 7.2s for a UE supporting power class 1,
- 4.32s for a UE supporting power class 2, 3 and 4

In test 2, the UE shall send one Event A3 triggered measurement report, with a measurement reporting delay less than X ms from the beginning of time period T2, where X is

- 51.2s for a UE supporting power class 1,
- 30.72s for a UE supporting power class 2, 3 and 4

The UE is not required to read the neighbour cell SSB index in this test.

The UE shall not send event triggered measurement reports, as long as the reporting criteria are not fulfilled.

The rate of correct events observed during repeated tests shall be at least 90%.

NOTE: The actual overall delays measured in the test may be up to  $2 \times TTI_{DCCCH}$  higher than the measurement reporting delays above because of TTI insertion uncertainty of the measurement report in DCCCH.

### A.5.6.1.3 EN-DC event triggered reporting test with per-UE gaps under non-DRX

#### A.5.6.1.3.1 Test purpose and Environment

The purpose of this test is to verify that the UE makes correct reporting of an event. This test will partly verify the TDD intra-frequency cell search requirements in clause 9.2.5.1 and 9.2.5.2. Supported test configurations are shown in table A.5.6.1.3.1-1.

**Table A.5.6.1.3.1-1: supported test configurations**

Configuration	Description
1	LTE FDD, 120 kHz SSB SCS, 100 MHz bandwidth, TDD duplex mode
2	LTE TDD, 120 kHz SSB SCS, 100 MHz bandwidth, TDD duplex mode
3	LTE FDD, 240 kHz SSB SCS, 100 MHz bandwidth, TDD duplex mode
4	LTE TDD, 240 kHz SSB SCS, 100 MHz bandwidth, TDD duplex mode
Note: The UE is only required to be tested in one of the supported test configurations.	

There are three cells in the test, E-UTRAN PCell (Cell 1), FR2 PSCell (Cell 2) and a FR2 neighbour cell (Cell 3) on the same frequency as the PSCell. The test parameters and applicability for Cell 1 are defined in A.3.7.2. The test parameters for the Cell 2 and Cell 3 are given in Table A.5.6.1.3.1-2 ~ 4 below.

There are two BWPs configured in Cell 2, BWP1 which contains the cell defining SSB, and BWP2 which does not contain any SSB of Cell 2. During the whole test, BWP2 is always scheduled as the active BWP for the UE.

In the measurement control information, a measurement object is configured for the frequency of the PSCell, and it is indicated to the UE that event-triggered reporting with Event A3 is used.

The test consists of two successive time periods, with time duration of T1, and T2 respectively. During time duration T1, the UE shall not have any timing information of cell 3.

**Table A.5.6.1.3.1-2: General test parameters for intra-frequency event triggered reporting for EN-DC with TDD PSCell in FR2 with per-UE gaps without DRX**

Parameter	Unit	Config	Value	Comment
Active cell		1~4	E-UTRAN PCell (Cell 1) PSCell (Cell 2)	
Neighbour cell		1~4	Cell 3	Cell to be identified.
RF Channel Number		1~4	1: Cell 1 2: Cell 2 and Cell 3	One TDD carrier frequency is used for the NR cells and one TDD or FDD carrier frequency is used for E-UTRAN cell.
Gap type		1~4	Per-UE gaps	
Measurement gap repetition periodicity	ms	1~4	40	
Measurement gap length	ms	1~4	6	
Measurement gap offset	ms	1~4	39	
SMT-C configuration		1~4	SMT-C.1	
CSI-RS parameters		1~4	CSI-RS.3.2 TDD resource #0	Resource #1 is not used
A3-Offset	dB	1~4	-11	
CP length		1~4	Normal	
Hysteresis	dB	1~4	0	
Time To Trigger	s	1~4	0	
Filter coefficient		1~4	0	L3 filtering is not used

DRX		1~4	OFF	
Time offset between Cell 1 and Cell 2		1~4	3 $\mu$ s	Synchronous EN-DC
Time offset between Cell 2 and Cell 3		1~4	3 $\mu$ s	Synchronous cells
T1	s	1~4	5	
T2	s	1~4	5	

**Table A.5.6.1.3.1-3: NR Cell specific test parameters for intra-frequency event triggered reporting for EN-DC with TDD PSCell in FR2 with per-UE gaps without DRX**

Parameter	Unit	Config	Cell 2		Cell 3	
			T1	T2	T1	T2
TDD configuration		1~4	TDDConf.3.1		TDDConf.3.1	
BW <sub>channel</sub>	MHz	1~4	100: N <sub>RB,c</sub> = 66		100: N <sub>RB,c</sub> = 66	
Data RBs allocated		1,2	24		24	
		3,4	48		48	
Initial BWP configuration		1~4	DLBWP.0.1 ULBWP.0.1		DLBWP.0.1 ULBWP.0.1	
Active DL BWP configuration		1,2	DLBWP.1.2		DLBWP.1.1	
		3,4	DLBWP.1.7		DLBWP.1.1	
Active UL BWP configuration		1,2	ULBWP.1.2		ULBWP.1.1	
		3,4	ULBWP.1.7		ULBWP.1.1	
RLM-RS		1~4	CSI-RS		SSB	
PDSCH RMC configuration		1,2	SR.3.2 TDD		N/A	
		3,4	SR.3.3 TDD		N/A	
RMSI CORESET RMC configuration		1,2	CR.3.1 TDD		N/A	
		3,4	CR.3.2 TDD		N/A	
Dedicated CORESET RMC configuration		1,2	CCR.3.1 TDD		N/A	
		3,4	CCR.3.7 TDD		N/A	
TRS configuration		1~4	TRS.2.1 TDD		N/A	
PDSCH/PDCCH TCI state		1~4	TCI.State.2		N/A	
PDSCH/PDCCH subcarrier spacing	kHz	1~4	120		120	
OCNG Patterns		1~4	OP.5		N/A	
cellIndividualOffset	dB	1~4	N/A		16	
SSB		1, 2	SSB.3 FR2		SSB.7 FR2	
		3, 4	SSB.4 FR2		SSB.8 FR2	
Propagation Condition		1~4	No external noise (Note 1)		No external noise (Note 1)	
Note 1: The downlink connection between the System Simulator and the UE is without Additive White Gaussian Noise, and has no fading or multipath effects as specified in TS 38.521-2 B.0 [37].						

**Table A.5.6.1.3.1-4: NR OTA Cell specific test parameters for intra-frequency event triggered reporting for EN-DC with TDD PSCell in FR2 with per-UE gaps without DRX**

Parameter	Unit	Config	Cell 2		Cell 3	
			T1	T2	T1	T2
AoA setup		1~4	Setup 3 defined in A.3.15.3			
			AoA1		AoA2	
Assumption for UE beams <sup>Note 4</sup>		1~4	Rough		Rough	
E <sub>s</sub>	dBm/SCS	1, 2	-89	-89	-Infinity	-89
		3, 4	-86	-86	-Infinity	-86
$\hat{E}_s / I_{ot\_BB}$ <sup>Note 5</sup>	dB	1~4	-0.12	-0.12	-Infinity	-0.12
SSB_RP	dBm/SCS	1, 2	-89	-89	-Infinity	-89
		3, 4	-86	-86	-Infinity	-86

<i>I<sub>o</sub></i>	dBm/95.04MHz	1,2	-64.41	-64.41	-Infinity	-64.41
		3,4	-61.41	-61.41	-Infinity	-61.41
Time multiplexing of the downlink transmissions from each AoA		1~4	Defined in Figure A.5.6.1.3.1-1			
<p>Note 1: The resources for uplink transmission are assigned to the UE prior to the start of time period T2.</p> <p>Note 2: Void</p> <p>Note 3: Es/I<sub>ot</sub>, SSB_RP and I<sub>o</sub> levels have been derived from other parameters for information purposes. They are not settable parameters themselves.</p> <p>Note 4: Information about types of UE beam is given in B.2.1.3, and does not limit UE implementation or test system implementation.</p> <p>Note 5: Calculation of Es/I<sub>ot<sub>BB</sub></sub> includes the effect of UE internal noise up to the value assumed for the associated Refsens requirement in clause 7.3.2 of TS 38.101-2 [19], and an allowance of 1dB for UE multi-band relaxation factor ΔMB<sub>P</sub> from TS 38.101-2 [19] Table 6.2.1.3-4.</p>						

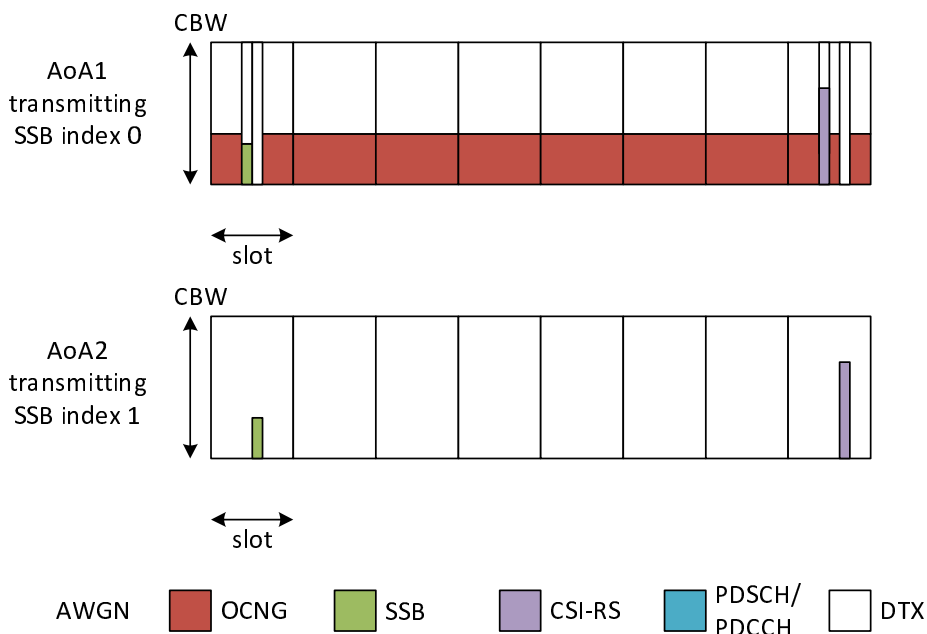

Figure A.5.6.1.3.1-1: Time multiplexed downlink transmissions (Config 1,2 example)

A.5.6.1.3.2 Test Requirements

In the test, the UE shall send one Event A3 triggered measurement report, with a measurement reporting delay less than X ms from the beginning of time period T2, where X is

- 3.2s for a UE supporting power class 1,
- 1.92s for a UE supporting power class 2, 3 and 4

The UE is not required to read the neighbour cell SSB index in this test.

The UE shall not send event triggered measurement reports, as long as the reporting criteria are not fulfilled.

The rate of correct events observed during repeated tests shall be at least 90%.

NOTE: The actual overall delays measured in the test may be up to 2xTTI<sub>DCCCH</sub> higher than the measurement reporting delays above because of TTI insertion uncertainty of the measurement report in DCCCH.

## A.5.6.1.4 EN-DC event triggered reporting test with per-UE gaps under DRX

### A.5.6.1.4.1 Test purpose and Environment

The purpose of this test is to verify that the UE makes correct reporting of an event. This test will partly verify the TDD intra-frequency cell search requirements in clause 9.2.5.1 and 9.2.5.2. Supported test configurations are shown in table A.5.6.1.4.1-1.

**Table A.5.6.1.4.1-1: supported test configurations**

Configuration	Description
1	LTE FDD, 120 kHz SSB SCS, 100 MHz bandwidth, TDD duplex mode
2	LTE TDD, 120 kHz SSB SCS, 100 MHz bandwidth, TDD duplex mode
3	LTE FDD, 240 kHz SSB SCS, 100 MHz bandwidth, TDD duplex mode
4	LTE TDD, 240 kHz SSB SCS, 100 MHz bandwidth, TDD duplex mode
Note:	The UE is only required to be tested in one of the supported test configurations.

There are three cells in the test, E-UTRAN PCell (Cell 1), FR2 PCell (Cell 2) and a FR2 neighbour cell (Cell 3) on the same frequency as the PCell. The test parameters and applicability for Cell 1 are defined in A.3.7.2. The test parameters for the Cell 2 and Cell 3 are given in Table A.5.6.1.4.1-2 ~ 6.

During the test, Cell 2 and Cell 3 are transmitted from the direction determined according to A3.8.

There are two BWPs configured in Cell 2, BWP1 which contains the cell defining SSB, and BWP2 which does not contain any SSB of Cell 2. During the whole test, BWP2 is always scheduled as the active BWP for the UE.

In the measurement control information, a measurement object is configured for the frequency of the PCell, and it is indicated to the UE that event-triggered reporting with Event A3 is used.

The test consists of two successive time periods, with time duration of T1, and T2 respectively. During time duration T1, the UE shall not have any timing information of cell 3.

UE needs to be provided with new Timing Advance Command MAC control element at least once during each time alignment timer period to maintain uplink time alignment. Furthermore UE is allocated with PUSCH resource at every DRX cycle.

**Table A.5.6.1.4.1-2: General test parameters for intra-frequency event triggered reporting for EN-DC with TDD PCell in FR2 with per-UE gaps with DRX**

Parameter	Unit	Config	Value		Comment
			Test 1	Test 2	
Active cell		1~4	E-UTRAN PCell (Cell 1) PCell (Cell 2)		
Neighbour cell		1~4	Cell 3		Cell to be identified.
RF Channel Number		1~4	1: Cell 1 2: Cell 2 and Cell 3		One TDD carrier frequency is used for the NR cells and one TDD or FDD carrier frequency is used for E-UTRAN cell.
Gap type		1~4	Per-UE gaps		
Measurement gap repetition periodicity	ms	1~4	40		
Measurement gap length	ms	1~4	6		
Measurement gap offset	ms	1~4	39		
SMTC configuration		1~4	SMTC.1		
CSI-RS parameters		1~4	CSI-RS.3.2 TDD resource #0		Resource #1 is not used
A3-Offset	dB	1~4	-6		
CP length		1~4	Normal		
Hysteresis	dB	1~4	0		
Time To Trigger	s	1~4	0		
Filter coefficient		1~4	0		L3 filtering is not used
DRX		1~4	DRX.1	DRX.7	DRX related parameters are defined in Table A.5.6.1.4.1-5



Time offset between Cell 1 and Cell 2		1~4	3 $\mu$ s		Synchronous EN-DC
Time offset between Cell 2 and Cell 3		1~4	3 $\mu$ s		Synchronous cells
T1	s	1~4	5		
T2	s	1~4	10	52	

**Table A.5.6.1.4.1-3: NR Cell specific test parameters for intra-frequency event triggered reporting for EN-DC with TDD PSCell in FR2 with per-UE gaps with DRX**

Parameter	Unit	Config	Cell 2		Cell 3	
			T1	T2	T1	T2
TDD configuration		1~4	TDDConf.3.1		TDDConf.3.1	
$BW_{channel}$	MHz	1~4	100: $N_{RB,c} = 66$		100: $N_{RB,c} = 66$	
Data RBs allocated		1~4	66		66	
Initial BWP configuration		1~4	DLBWP.0.1 ULBWP.0.1	DLBWP.0.1 ULBWP.0.1		
Active DL BWP configuration		1,2	DLBWP.1.2		DLBWP.1.1	
		3,4	DLBWP.1.7		DLBWP.1.1	
Active UL BWP configuration		1~4	ULBWP.1.2		ULBWP.1.1	
		3,4	ULBWP.1.7		ULBWP.1.1	
RLM-RS		1~4	CSI-RS		SSB	
PDSCH RMC configuration		1,2	SR.3.2 TDD		N/A	
		3,4	SR.3.3 TDD		N/A	
RMSI CORESET RMC configuration		1,2	CR.3.1 TDD		N/A	
		3,4	CR.3.2 TDD		N/A	
Dedicated CORESET RMC configuration		1,2	CCR.3.1 TDD		N/A	
		3,4	CCR.3.7 TDD		N/A	
TRS configuration		1~4	TRS.2.1 TDD		N/A	
PDSCH/PDCCH TCI state		1~4	TCI.State.2		N/A	
PDSCH/PDCCH subcarrier spacing	kHz	1~4	120		120	
OCNG Patterns		1~4	OP.1		OP.1	
SSB		1, 2	SSB.3 FR2		SSB.3 FR2	
		3, 4	SSB.4 FR2		SSB.4 FR2	
Propagation Condition		1~4	AWGN		AWGN	

**Table A.5.6.1.4.1-4: NR Cell specific test parameters for intra-frequency event triggered reporting for EN-DC with TDD PSCell in FR2 with per-UE gaps with DRX**

Parameter	Unit	Config	Cell 2		Cell 3	
			T1	T2	T1	T2
AoA setup		1~4	Setup 1 defined in A.3.15.1			
Assumption for UE beams <sup>Note 4</sup>		1~4	Rough		Rough	
$\hat{E}_s / I_{ot}^{BB}$ <sup>Note 5</sup>	dB	1~4	3.77	-1.52	-Infinity	-1.52
$N_{oc}$ <sup>Note 2</sup>	dBm/15 KHz	1~4	-98			
$N_{oc}$ <sup>Note 2</sup>	dBm/SCS	1, 2	-89			
		3, 4	-86			
SS-RSRP	dBm/SCS	1, 2	-85	-85	-Infinity	-85
		3, 4	-82	-82	-Infinity	-82
$\hat{E}_s / N_{oc}$	dB	1~4	4	4	-Infinity	4

$I_o$	dBm/95.04MHz	1~4	-54.53	-52.18	See Cell 2 columns
Note 1:	The resources for uplink transmission are assigned to the UE prior to the start of time period T2.				
Note 2:	Interference from other cells and noise sources not specified in the test is assumed to be constant over subcarriers and time and shall be modelled as AWGN of appropriate power for $N_{oc}$ to be fulfilled.				
Note 3:	Es/Iot, SSB_RP and I <sub>o</sub> levels have been derived from other parameters for information purposes. They are not settable parameters themselves.				
Note 4:	Information about types of UE beam is given in B.2.1.3, and does not limit UE implementation or test system implementation.				
Note 5:	Calculation of Es/Iot <sub>BB</sub> includes the effect of UE internal noise up to the value assumed for the associated Refsens requirement in clause 7.3.2 of TS 38.101-2 [19], and an allowance of 1dB for UE multi-band relaxation factor $\Delta MB_P$ from TS 38.101-2 [19] Table 6.2.1.3-4.				

**Table A.5.6.1.4.1-5: Void****Table A.5.6.1.4.1-6: Void**

### A.5.6.1.4.2 Test Requirements

In test 1, the UE shall send one Event A3 triggered measurement report, with a measurement reporting delay less than X ms from the beginning of time period T2, where X is

- 7.2s for a UE supporting power class 1,
- 4.32s for a UE supporting power class 2, 3 and 4

In test 2, the UE shall send one Event A3 triggered measurement report, with a measurement reporting delay less than X ms from the beginning of time period T2, where X is

- 51.20s for a UE supporting power class 1,
- 30.72s for a UE supporting power class 2, 3 and 4

The UE is not required to read the neighbour cell SSB index in this test.

The UE shall not send event triggered measurement reports, as long as the reporting criteria are not fulfilled.

The rate of correct events observed during repeated tests shall be at least 90%.

NOTE: The actual overall delays measured in the test may be up to  $2 \times TTI_{DCCH}$  higher than the measurement reporting delays above because of TTI insertion uncertainty of the measurement report in DCCH.

## A.5.6.2 Inter-frequency Measurements

### A.5.6.2.1 EN-DC event triggered reporting tests for FR2 cell without SSB time index detection when DRX is not used

#### A.5.6.2.1.1 Test Purpose and Environment

The purpose of this test is to verify that the UE makes correct reporting of an event. This test will partly verify the EN-DC inter-frequency NR cell search requirements in clause 9.3.4.

In this test, there are three cells: LTE cell 1 as PCell on E-UTRA RF channel 1, NR cell 2 as PSCell in FR2 on NR RF channel 1 and NR cell 3 as neighbour cell in FR2 on NR RF channel 2. The test parameters and configurations are given in Tables A.5.6.2.1.1-1, A.5.6.2.1.1-2, and A.5.6.2.1.1-3.

In test 1 measurement gap pattern configuration # 0 as defined in Table A.5.6.2.1.1-2 is provided for UE that does not support per-FR gap and in test 2 measurement gap pattern configuration #13 as defined in Table A.5.6.2.1.1-2 is provided for UE that supports per-FR gap. If a UE supports per-FR gap and gap pattern configuration #4, it is only required to pass test 2. Otherwise it is only required to pass test 1.

In the measurement control information, it is indicated to the UE that event-triggered reporting with Event A3 is used. The test consists of two successive time periods, with time duration of T1, and T2 respectively. During time duration T1, the UE shall not have any timing information of NR cell 3.

The configuration of LTE cell 1 is defined in table A.3.7.2.2-1. Supported test configurations are shown in table A.5.6.2.1.1-1.

**Table A.5.6.2.1.1-1 EN-DC event triggered reporting tests without SSB index reading for FR2-FR2**

Config	Description
1	LTE FDD, 120 kHz SSB SCS, 100 MHz bandwidth, TDD duplex mode
2	LTE TDD, 120 kHz SSB SCS, 100 MHz bandwidth, TDD duplex mode
Note 1: The UE is only required to be tested in one of the supported test configurations	
Note 2: target NR cell has the same SCS, BW and duplex mode as NR serving cell	

**Table A.5.6.2.1.1-2: General test parameters for EN-DC inter-frequency event triggered reporting without SSB time index detection**

Parameter	Unit	Test configuration	Value		Comment
			Test 1	Test 2	
E-UTRA RF Channel Number		Config 1,2	1		One E-UTRAN TDD carrier frequency is used.
NR RF Channel Number		Config 1,2	1, 2		Two FR2 NR carrier frequencies are used.
Active cell		Config 1,2	LTE Cell 1 (PCell) and NR cell 2 (PScell)		LTE Cell 1 is on E-UTRA RF channel number 1. NR Cell 2 is on NR RF channel number 1.
Neighbour cell		Config 1,2	NR cell 3		NR cell 3 is on NR RF channel number 2.
Gap Pattern Id		Config 1,2	0	13	As specified in clause 9.1.2-1.
Measurement gap offset		Config 1,2	39	39	
SMTC-SSB parameters		Config 1,2	SSB.3 FR2		As specified in clause A.3.10.2
offsetMO	dB	Config 1,2	16		Applied to NR Cell 3 measurement object
A3-Offset	dB	Config 1,2	-11		
Hysteresis	dB	Config 1,2	0		
CP length		Config 1,2	Normal		
TimeToTrigger	s	Config 1,2	0		
Filter coefficient		Config 1,2	0		L3 filtering is not used
DRX		Config 1,2	OFF		DRX is not used
Time offset between PCell and PScell		Config 1,2	3 μs		Synchronous EN-DC
Time offset between serving and neighbour cells		Config 1,2	3μs		Synchronous cells.
T1	s	Config 1,2	5		
T2	s	Config 1,2	5.2 for PC1; 3.5 for other PC	5.2 for PC1; 3.5 for other PC	

**Table A.5.6.2.1.1-3: Cell specific test parameters for EN-DC inter-frequency event triggered reporting without SSB time index detection**

Parameter	Unit	Test configuration	Cell 2		Cell 3	
			T1	T2	T1	T2
AoA setup		Config 1,2	Setup 3 as specified in clause A.3.15			

			AoA1		AoA2	
Assumption for UE beams <sup>Note 7</sup>		Config 1,2	Rough		Rough	
NR RF Channel Number		Config 1,2	1		2	
Duplex mode		Config 1,2	TDD		TDD	
BW <sub>channel</sub>	MHz	Config 1,2	100: N <sub>RB,c</sub> = 66		100: N <sub>RB,c</sub> = 66	
Data RBs allocated		Config 1,2	66		66	
BWP BW	MHz	Config 1,2	100: N <sub>RB,c</sub> = 66		100: N <sub>RB,c</sub> = 66	
TDD configuration		Config 1,2	TDDConf.3.1		TDDConf.3.1	
Initial DL BWP		Config 1,2	DLBWP.0.1		NA	
Initial UL BWP		Config 1,2	ULBWP.0.1		NA	
Dedicated DL BWP		Config 1,2	DLBWP.1.1		NA	
Dedicated UL BWP		Config 1,2	ULBWP.1.1		NA	
OCNG Patterns defined in A.3.2.1.1		Config 1,2	OP.1		OP.1	
TRS configuration		Config 1,2	TRS.2.1 TDD		NA	
PDSCH/PDCCH TCI state		Config 1,2	TCI.State.2		NA	
PDSCH Reference measurement channel		Config 1,2	SR.3.1 TDD		-	
RMSI CORESET Reference Channel		Config 1,2	CR.3.1 TDD		-	
Dedicated CORESET Reference Channel		Config 1,2	CCR.3.1 TDD		-	
SMTTC configuration defined in A.3.11		Config 1,2	SMTTC.1		SMTTC.1	
PDSCH/PDCCH subcarrier spacing	kHz	Config 1,2	120		120	
EPRE ratio of PSS to SSS		Config 1,2	0		0	
EPRE ratio of PBCH DMRS to SSS						
EPRE ratio of PBCH to PBCH DMRS						
EPRE ratio of PDCCH DMRS to SSS						
EPRE ratio of PDCCH to PDCCH DMRS						
EPRE ratio of PDSCH DMRS to SSS						
EPRE ratio of PDSCH to PDSCH						
EPRE ratio of OCNG DMRS to SSS(Note 1)						
EPRE ratio of OCNG to OCNG DMRS (Note 1)						
$\hat{E}_s$	dBm/SC S		Config 1,2	-87		-87
SSB-RP <sup>Note 3</sup>	dBm/SC S <sup>Note5</sup>	Config 1,2	-87	-87	-Infinity	-87
$\hat{E}_s / I_{ot\ BB}$ <sup>Note 8</sup>	dB	Config 1,2	1.89	1.89	-Infinity	1.89
$I_o$ <sup>Note3</sup>	dBm/95.04 MHz <sup>Note5</sup>	Config 1,2	-58.01	-58.01	-Infinity	-58.01
Propagation Condition		Config 1,2	No external noise (Note 9)		No external noise (Note 9)	

Note 1:	OCNG shall be used such that both cells are fully allocated and a constant total transmitted power spectral density is achieved for all OFDM symbols.
Note 2:	Void
Note 3:	SSB-RP, Es/lot and lo levels have been derived from other parameters for information purposes. They are not settable parameters themselves.
Note 4:	Void
Note 5:	Equivalent power received by an antenna with 0dBi gain at the centre of the quiet zone
Note 6:	As observed with 0dBi gain antenna at the centre of the quiet zone.
Note 7:	Information about types of UE beam is given in B.2.1.3, and does not limit UE implementation or test system implementation.
Note 8:	Calculation of Es/lot <sub>BB</sub> includes the effect of UE internal noise up to the value assumed for the associated Refsens requirement in clause 7.3.2 of TS 38.101-2 [19], and an allowance of 1dB for UE multi-band relaxation factor $\Delta MB_S$ from TS 38.101-2 [19] Table 6.2.1.3-4.
Note 9:	The downlink connection between the System Simulator and the UE is without Additive White Gaussian Noise, and has no fading or multipath effects as specified in TS 38.521-2 B.0 [37].

### A.5.6.2.1.2 Test Requirements

In test 1 with per-UE gap and in test 2 with per-FR gap, the UE shall send one Event A3 triggered measurement report, with a measurement reporting delay less than X ms from the beginning of time period T2, where X is

5120 for UE supporting power class 1, or

3200 for UE supporting other power class.

In test 1 and 2 UE is not required to report SSB time index. The UE shall not send event triggered measurement reports, as long as the reporting criteria are not fulfilled. The rate of correct events observed during repeated tests shall be at least 90%.

NOTE: The actual overall delays measured in the test may be up to  $2xTTI_{DCCH}$  higher than the measurement reporting delays above because of TTI insertion uncertainty of the measurement report in DCCH.

### A.5.6.2.2 EN-DC event triggered reporting tests for FR2 cell without SSB time index detection when DRX is used

#### A.5.6.2.2.1 Test Purpose and Environment

The purpose of this test is to verify that the UE makes correct reporting of an event. This test will partly verify the EN-DC inter-frequency NR cell search requirements in clause 9.3.4.

In this test, there are three cells: LTE cell 1 as PCell on E-UTRA RF channel 1, NR cell 2 as PSCell in FR2 on NR RF channel 1 and NR cell 3 as neighbour cell in FR2 on NR RF channel 2. The test parameters and configurations are given in Tables A.5.6.2.2.1-1, A.5.6.2.2.1-2, and A.5.6.2.2.1-3.

In test 1&2 measurement gap pattern configuration # 0 as defined in Table A.5.6.2.2.1-2 is provided for UE that does not support per-FR gap and in test 3&4 measurement gap pattern configuration #13 as defined in Table A.5.6.2.2.1-2 is provided for UE that supports per-FR gap. If a UE supports per-FR gap and gap pattern configuration #13, it is only required to pass test 3&4. Otherwise it is only required to pass test 1&2.

In the measurement control information, it is indicated to the UE that event-triggered reporting with Event A3 is used. The test consists of two successive time periods, with time duration of T1, and T2 respectively. During time duration T1, the UE shall not have any timing information of NR cell 3.

The configuration of LTE cell 1 is defined in table A.3.7.2.2-1. Supported test configurations are shown in table A.5.6.2.2.1-1.

UE needs to be provided with new Timing Advance Command MAC control element at least once during each time alignment timer period to maintain uplink time alignment. Furthermore UE is allocated with PUSCH resource at every DRX cycle.

**Table A.5.6.2.2.1-1 EN-DC event triggered reporting tests without SSB index reading for FR2-FR2**

Config	Description
--------	-------------

1	LTE FDD, 120 kHz SSB SCS, 100 MHz bandwidth, TDD duplex mode
2	LTE TDD, 120 kHz SSB SCS, 100 MHz bandwidth, TDD duplex mode
Note 1: The UE is only required to be tested in one of the supported test configurations	
Note 2: target NR cell has the same SCS, BW and duplex mode as NR serving cell	

**Table A.5.6.2.2.1-2: General test parameters for EN-DC inter-frequency event triggered reporting without SSB time index detection**

Parameter	Unit	Test configuration	Value				Comment
			Test 1	Test 2	Test 3	Test 4	
E-UTRA RF Channel Number		Config 1,2	1				One E-UTRAN TDD carrier frequency is used.
NR RF Channel Number		Config 1,2	1, 2				Two FR2 NR carrier frequencies are used.
Active cell		Config 1,2	LTE Cell 1 (PCell) and NR cell 2 (PScell)				LTE Cell 1 is on E-UTRA RF channel number 1. NR Cell 2 is on NR RF channel number 1.
Neighbour cell		Config 1,2	NR cell 3				NR cell 3 is on NR RF channel number 2.
Gap Pattern Id		Config 1,2	0		13		As specified in clause 9.1.2-1.
Measurement gap offset		Config 1,2	39		39		
SMTC-SSB parameters		Config 1,2	SSB.3 FR2				As specified in clause A.3.10.2
A3-Offset	dB	Config 1,2	-6				
Hysteresis	dB	Config 1,2	0				
CP length		Config 1,2	Normal				
TimeToTrigger	s	Config 1,2	0				
Filter coefficient		Config 1,2	0				L3 filtering is not used
DRX		Config 1,2	DRX .1	DRX .7	DRX .1	DRX .7	As specified in clause A.3.3
Time offset between PCell and PScell		Config 1,2	3 $\mu$ s				Synchronous EN-DC
Time offset between serving and neighbour cells		Config 1,2	3 $\mu$ s				Synchronous cells.
T1	s	Config 1,2	5				
T2	s	Config 1,2	8 for PC1; 5 for other PC	82 for PC1; 52 for other PC	8 for PC1; 5 for other PC	82 for PC1; 52 for other PC	

**Table A.5.6.2.2.1-3: Cell specific test parameters for EN-DC inter-frequency event triggered reporting without SSB time index detection**

Parameter	Unit	Test configuration	Cell 2		Cell 3	
			T1	T2	T1	T2
AoA setup		Config 1,2	Setup 1 as specified in clause A.3.15			
Assumption for UE beams <sup>Note 7</sup>		Config 1,2	Rough		Rough	
NR RF Channel Number		Config 1,2	1		2	
Duplex mode		Config 1,2	TDD		TDD	
BW <sub>channel</sub>	MHz	Config 1,2	100: N <sub>RB,c</sub> = 66		100: N <sub>RB,c</sub> = 66	
Data RBs allocated		Config 1,2	66		66	
BWP BW	MHz	Config 1,2	100: N <sub>RB,c</sub> = 66		100: N <sub>RB,c</sub> = 66	
TDD configuration		Config 1,2	TDDConf.3.1		TDDConf.3.1	

Initial DL BWP		Config 1,2	DLBWP.0.1		NA	
Initial UL BWP		Config 1,2	ULBWP.0.1			
Dedicated DL BWP		Config 1,2	DLBWP.1.1		NA	
Dedicated UL BWP		Config 1,2	ULBWP.1.1		NA	
OCNG Patterns defined in A.3.2.1.1 (OP.1)		Config 1,2	OP.1		OP.1	
TRS configuration		Config 1,2	TRS.2.1 TDD		NA	
PDSCH/PDCCH TCI state		Config 1,2	TCI.State.2		NA	
PDSCH Reference measurement channel		Config 1,2	SR.3.1 TDD		-	
RMSI CORESET Reference Channel		Config 1,2	CR.3.1 TDD		-	
Dedicated CORESET Reference Channel		Config 1,2	CCR.3.1 TDD		-	
SMTC configuration defined in A.3.11		Config 1,2	SMTC.1		SMTC.1	
PDSCH/PDCCH subcarrier spacing	kHz	Config 1,2	120		120	
EPRE ratio of PSS to SSS		Config 1,2	0		0	
EPRE ratio of PBCH DMRS to SSS						
EPRE ratio of PBCH to PBCH DMRS						
EPRE ratio of PDCCH DMRS to SSS						
EPRE ratio of PDCCH to PDCCH DMRS						
EPRE ratio of PDSCH DMRS to SSS						
EPRE ratio of PDSCH to PDSCH						
EPRE ratio of OCNG DMRS to SSS(Note 1)						
EPRE ratio of OCNG to OCNG DMRS (Note 1)						
$N_{oc}$ <sup>Note2</sup>	dBm/15k Hz <sup>Note5</sup>					
$N_{oc}$ <sup>Note2</sup>	dBm/SC S <sup>Note4</sup>	Config 1,2	-95.7		-95.7	
SS-RSRP <sup>Note 3</sup>	dBm/SC S <sup>Note5</sup>	Config 1,2	-89.7	-89.7	-Infinity	-86.7
$\hat{E}_s / I_{ot}$	dB	Config 1,2	6	6	-Infinity	9
$\hat{E}_s / N_{oc}$	dB	Config 1,2	6	6	-Infinity	9
$I_o$ <sup>Note3</sup>	dBm/95.0 4 MHz <sup>Note5</sup>	Config 1,2	-59.7	-59.7	-66.7	-57.2
Propagation Condition		Config 1,2	AWGN		AWGN	

Note 1:	OCNG shall be used such that both cells are fully allocated and a constant total transmitted power spectral density is achieved for all OFDM symbols.
Note 2:	Interference from other cells and noise sources not specified in the test is assumed to be constant over subcarriers and time and shall be modelled as AWGN of appropriate power for $N_{oc}$ to be fulfilled.
Note 3:	SSB_RP and $I_0$ levels have been derived from other parameters for information purposes. They are not settable parameters themselves.
Note 4:	Void
Note 5:	Equivalent power received by an antenna with 0 dBi gain at the centre of the quiet zone
Note 6:	As observed with 0 dBi gain antenna at the centre of the quiet zone
Note 7:	Information about types of UE beam is given in B.2.1.3, and does not limit UE implementation or test system implementation

#### A.5.6.2.2.2 Test Requirements

In test 1 with per-UE gap and in test 3 with per-FR gap, the UE shall send one Event A3 triggered measurement report, with a measurement reporting delay less than  $X1$  ms from the beginning of time period T2, where  $X1$  is

- 7680 for UE supporting power class 1, or
- 4800 for UE supporting other power class.

In test 2 with per-UE gap and in test 4 with per-FR gap, the UE shall send one Event A3 triggered measurement report, with a measurement reporting delay less than  $X2$  ms from the beginning of time period T2, where  $X2$  is

- 81920 for UE supporting power class 1, or
- 51200 for UE supporting other power class.

In test 1, 2, 3 and 4 UE is not required to report SSB time index. The UE shall not send event triggered measurement reports, as long as the reporting criteria are not fulfilled. The rate of correct events observed during repeated tests shall be at least 90%.

NOTE: The actual overall delays measured in the test may be up to  $2 \times TTI_{DCCCH}$  higher than the measurement reporting delays above because of TTI insertion uncertainty of the measurement report in DCCCH.

#### A.5.6.2.3 EN-DC event triggered reporting tests for FR2 cell with SSB time index detection when DRX is not used

##### A.5.6.2.3.1 Test Purpose and Environment

The purpose of this test is to verify that the UE makes correct reporting of an event. This test will partly verify the EN-DC inter-frequency NR cell search requirements in clause 9.3.4.

In this test, there are three cells: LTE cell 1 as PCell on E-UTRA RF channel 1, NR cell 2 as PSCell in FR2 on NR RF channel 1 and NR cell 3 as neighbour cell in FR2 on NR RF channel 2. The test parameters and configurations are given in Tables A.5.6.2.3.1-1, A.5.6.2.3.1-2, and A.5.6.2.3.1-3.

In test 1 measurement gap pattern configuration # 0 as defined in Table A.5.6.2.3.1-1 is provided for UE that does not support per-FR gap and in test 2 measurement gap pattern configuration #13 as defined in Table A.5.6.2.3.1-1 is provided for UE that supports per-FR gap. If a UE supports per-FR gap and gap pattern configuration #13, it is only required to pass test 2. Otherwise it is only required to pass test 1.

In the measurement control information, it is indicated to the UE that event-triggered reporting with Event A3 is used. The test consists of two successive time periods, with time duration of T1, and T2 respectively. During time duration T1, the UE shall not have any timing information of NR cell 3.

The configuration of LTE cell 1 is defined in table A.3.7.2.2-1. Supported test configurations are shown in table A.5.6.2.3.1-1.

**Table A.5.6.2.3.1-1 EN-DC event triggered reporting tests with SSB index reading for FR2-FR2**

Config	Description
1	LTE FDD, 120 kHz SSB SCS, 100 MHz bandwidth, TDD duplex mode
2	LTE TDD, 120 kHz SSB SCS, 100 MHz bandwidth, TDD duplex mode



Note 1: The UE is only required to be tested in one of the supported test configurations  
 Note 2: target NR cell has the same SCS, BW and duplex mode as NR serving cell

**Table A.5.6.2.3.1-2: General test parameters for EN-DC inter-frequency event triggered reporting with SSB time index detection**

Parameter	Unit	Test configuration	Value		Comment
			Test 1	Test 2	
E-UTRA RF Channel Number		Config 1,2	1		One E-UTRAN TDD carrier frequency is used.
NR RF Channel Number		Config 1,2	1, 2		Two FR2 NR carrier frequencies are used.
Active cell		Config 1,2	LTE Cell 1 (PCell) and NR cell 2 (PScell)		LTE Cell 1 is on E-UTRA RF channel number 1. NR Cell 2 is on NR RF channel number 1.
Neighbour cell		Config 1,2	NR cell 3		NR cell 3 is on NR RF channel number 2.
Gap Pattern Id		Config 1,2	0	13	As specified in clause 9.1.2-1.
Measurement gap offset		Config 1,2	39	39	
SMTC-SSB parameters		Config 1,2	SSB.3 FR2		As specified in clause A.3.10.2
offsetMO	dB	Config 1,2	16		Applied to NR Cell 3 measurement object
A3-Offset	dB	Config 1,2	-11		
Hysteresis	dB	Config 1,2	0		
CP length		Config 1,2	Normal		
TimeToTrigger	s	Config 1,2	0		
Filter coefficient		Config 1,2	0		L3 filtering is not used
DRX		Config 1,2	OFF		DRX is not used
Time offset between PCell and PScell		Config 1,2	3 $\mu$ s		Synchronous EN-DC
Time offset between serving and neighbour cells		Config 1,2	3 $\mu$ s		Synchronous cells.
T1	s	Config 1,2	5		
T2	s	Config 1,2	7 for PC1; 4.5 for other PC	7 for PC1; 4.5 for other PC	

**Table A.5.6.2.3.1-3: Cell specific test parameters for EN-DC inter-frequency event triggered reporting with SSB time index detection**

Parameter	Unit	Test configuration	Cell 2		Cell 3	
			T1	T2	T1	T2
AoA setup		Config 1,2	Setup 3 as specified in clause A.3.15			
			AoA1		AoA2	
Assumption for UE beams <sup>Note 7</sup>		Config 1,2	Rough		Rough	
NR RF Channel Number		Config 1,2	1		2	
Duplex mode		Config 1,2	TDD		TDD	
BW <sub>channel</sub>	MHz	Config 1,2	100: N <sub>RB,c</sub> = 66		100: N <sub>RB,c</sub> = 66	
Data RBs allocated		Config 1,2	66		66	
BWP BW	MHz	Config 1,2	100: N <sub>RB,c</sub> = 66		100: N <sub>RB,c</sub> = 66	
TDD configuration		Config 1,2	TDDConf.3.1		TDDConf.3.1	
Initial DL BWP		Config 1,2	DLBWP.0.1		NA	

Initial UL BWP		Config 1,2	DLBWP.0.1	N/A		
Dedicated DL BWP		Config 1,2	DLBWP.1.1	NA		
Dedicated UL BWP		Config 1,2	ULBWP.1.1	NA		
OCNG Patterns defined in A.3.2.1.1 (OP.1)		Config 1,2	OP.1	OP.1		
PDSCH Reference measurement channel		Config 1,2	SR.3.1 TDD	-		
RMSI CORESET Reference Channel		Config 1,2	CR.3.1 TDD	-		
Dedicated CORESET Reference Channel		Config 1,2	CCR.3.1 TDD	-		
TRS configuration		Config 1,2	TRS.2.1 TDD	NA		
PDSCH/PDCCH TCI state		Config 1,2	TCI.State.2	NA		
SMTTC configuration defined in A.3.11		Config 1,2	SMTTC.1	SMTTC.1		
PDSCH/PDCCH subcarrier spacing	kHz	Config 1,2	120	120		
EPRE ratio of PSS to SSS		Config 1,2	0	0		
EPRE ratio of PBCH DMRS to SSS						
EPRE ratio of PBCH to PBCH DMRS						
EPRE ratio of PDCCH DMRS to SSS						
EPRE ratio of PDCCH to PDCCH DMRS						
EPRE ratio of PDSCH DMRS to SSS						
EPRE ratio of PDSCH to PDSCH						
EPRE ratio of OCNG DMRS to SSS(Note 1)						
EPRE ratio of OCNG to OCNG DMRS (Note 1)						
$\hat{E}_s$	dBm/SC S					Config 1
SSB-RP <sup>Note 3</sup>	dBm/SC S <sup>Note5</sup>	Config 1,2	-87	-87	-Infinity	-87
$\hat{E}_s / I_{ot}$ <sup>BB Note 8</sup>	dB	Config 1,2	1.89	1.89	-Infinity	1.89
$I_o$ <sup>Note3</sup>	dBm/95.0 4 MHz <sup>Note5</sup>	Config 1,2	-58.01	-58.01	-Infinity	-58.01
Propagation Condition		Config 1,2	No external noise (Note 9)		No external noise (Note 9)	

Note 1:	OCNG shall be used such that both cells are fully allocated and a constant total transmitted power spectral density is achieved for all OFDM symbols.
Note 2:	Void
Note 3:	SSB-RP, Es/lot and lo levels have been derived from other parameters for information purposes. They are not settable parameters themselves.
Note 4:	Void
Note 5:	Equivalent power received by an antenna with 0dBi gain at the centre of the quiet zone
Note 6:	As observed with 0dBi gain antenna at the centre of the quiet zone
Note 7:	Information about types of UE beam is given in B.2.1.3, and does not limit UE implementation or test system implementation
Note 8:	Calculation of Es/lot <sub>BB</sub> includes the effect of UE internal noise up to the value assumed for the associated Refsens requirement in clause 7.3.2 of TS 38.101-2 [19], and an allowance of 1dB for UE multi-band relaxation factor $\Delta MB_S$ from TS 38.101-2 [19] Table 6.2.1.3-4.
Note 9:	The downlink connection between the System Simulator and the UE is without Additive White Gaussian Noise, and has no fading or multipath effects as specified in TS 38.521-2 B.0 [37].

#### A.5.6.2.3.2 Test Requirements

In test 1 with per-UE gap and in test 2 with per-FR gap, the UE shall send one Event A3 triggered measurement report, with a measurement reporting delay less than X ms from the beginning of time period T2, where X is

6720 for UE supporting power class 1, or

4160 for UE supporting other power class.

In test 1 and 2 UE is required to report SSB time index. The UE shall not send event triggered measurement reports, as long as the reporting criteria are not fulfilled. The rate of correct events observed during repeated tests shall be at least 90%.

NOTE: The actual overall delays measured in the test may be up to  $2xTTI_{DCCH}$  higher than the measurement reporting delays above because of TTI insertion uncertainty of the measurement report in DCCH.

#### A.5.6.2.4 EN-DC event triggered reporting tests for FR2 cell with SSB time index detection when DRX is used

##### A.5.6.2.4.1 Test Purpose and Environment

The purpose of this test is to verify that the UE makes correct reporting of an event. This test will partly verify the EN-DC inter-frequency NR cell search requirements in clause 9.3.4.

In this test, there are three cells: LTE cell 1 as PCell on E-UTRA RF channel 1, NR cell 2 as PSCell in FR2 on NR RF channel 1 and NR cell 3 as neighbour cell in FR2 on NR RF channel 2. The test parameters and configurations are given in Tables A.5.6.2.4.1-1, A.5.6.2.4.1-2, and A.5.6.2.4.1-3.

In test 1&2 measurement gap pattern configuration # 0 as defined in Table A.5.6.2.4.1-2 is provided for UE that does not support per-FR gap and in test 3&4 measurement gap pattern configuration #13 as defined in Table A.5.6.2.4.1-2 is provided for UE that supports per-FR gap. If a UE supports per-FR gap and gap pattern configuration #13, it is only required to pass test 3&4. Otherwise it is only required to pass test 1&2.

In the measurement control information, it is indicated to the UE that event-triggered reporting with Event A3 is used. The test consists of two successive time periods, with time duration of T1, and T2 respectively. During time duration T1, the UE shall not have any timing information of NR cell 3.

The configuration of LTE cell 1 is defined in table A.3.7.2.2-1. Supported test configurations are shown in table A.5.6.2.4.1-1.

UE needs to be provided with new Timing Advance Command MAC control element at least once during each time alignment timer period to maintain uplink time alignment. Furthermore UE is allocated with PUSCH resource at every DRX cycle.

**Table A.5.6.2.4.1-1: EN-DC event triggered reporting tests with SSB index reading for FR2-FR2**

Config	Description
--------	-------------

1	LTE FDD, 120 kHz SSB SCS, 100 MHz bandwidth, TDD duplex mode
2	LTE TDD, 120 kHz SSB SCS, 100 MHz bandwidth, TDD duplex mode
Note 1: The UE is only required to be tested in one of the supported test configurations	
Note 2: target NR cell has the same SCS, BW and duplex mode as NR serving cell	

**Table A.5.6.2.4.1-2: General test parameters for EN-DC inter-frequency event triggered reporting with SSB time index detection**

Parameter	Unit	Test configuration	Value				Comment
			Test 1	Test 2	Test 3	Test 4	
E-UTRA RF Channel Number		Config 1,2	1				One E-UTRAN TDD carrier frequency is used.
NR RF Channel Number		Config 1,2	1, 2				Two FR2 NR carrier frequencies are used.
Active cell		Config 1,2	LTE Cell 1 (PCell) and NR cell 2 (PScell)				LTE Cell 1 is on E-UTRA RF channel number 1. NR Cell 2 is on NR RF channel number 1.
Neighbour cell		Config 1,2	NR cell 3				NR cell 3 is on NR RF channel number 2.
Gap Pattern Id		Config 1,2	0		13		As specified in clause 9.1.2-1.
Measurement gap offset		Config 1,2	39		39		
SMTC-SSB parameters		Config 1,2	SSB.3 FR2				As specified in clause A.3.10.2
A3-Offset	dB	Config 1,2	-6				
Hysteresis	dB	Config 1,2	0				
CP length		Config 1,2	Normal				
TimeToTrigger	s	Config 1,2	0				
Filter coefficient		Config 1,2	0				L3 filtering is not used
DRX		Config 1,2	DRX .1	DRX .7	DRX .1	DRX .7	As specified in clause A.3.3
Time offset between PCell and PScell		Config 1,2	3 μs				Synchronous EN-DC
Time offset between serving and neighbour cells		Config 1,2	3μs				Synchronous cells.
T1	s	Config 1,2	5				
T2	s	Config 1,2	11 for PC1; 6.5 for othe r PC	108 for PC1; 67 for othe r PC	11 for PC1; 6.5 for othe r PC	108 for PC1; 67 for othe r PC	

**Table A.5.6.2.4.1-3: Cell specific test parameters for EN-DC inter-frequency event triggered reporting with SSB time index detection**

Parameter	Unit	Test configuration	Cell 2		Cell 3	
			T1	T2	T1	T2
AoA setup		Config 1,2	Setup 1 as specified in clause A.3.15			
Assumption for UE beams <sup>Note 7</sup>		Config 1,2	Rough		Rough	
NR RF Channel Number		Config 1,2	1		2	
Duplex mode		Config 1,2	TDD		TDD	
BW <sub>channel</sub>	MHz	Config 1,2	100: N <sub>RB,c</sub> = 66		100: N <sub>RB,c</sub> = 66	
Data RBs allocated		Config 1,2	66		66	
BWP BW	MHz	Config 1,2	100: N <sub>RB,c</sub> = 66		100: N <sub>RB,c</sub> = 66	
TDD configuration		Config 1,2	TDDConf.3.1		TDDConf.3.1	
Initial DL BWP		Config 1,2	DLBWP.0.1		NA	
Initial UL BWP		Config 1,2	ULBWP.0.1			
Dedicated DL BWP		Config 1,2	DLBWP.1.1		NA	

Dedicated UL BWP		Config 1,2	ULBWP.1.1	NA		
OCNG Patterns defined in A.3.2.1.1 (OP.1)		Config 1,2	OP.1	OP.1		
PDSCH Reference measurement channel		Config 1,2	SR.3.1 TDD	-		
RMSI CORESET Reference Channel		Config 1,2	CR.3.1 TDD	-		
Dedicated CORESET Reference Channel		Config 1,2	CCR.3.1 TDD	-		
TRS configuration		Config 1,2	TRS.2.1 TDD	NA		
PDSCH/PDCCH TCI state		Config 1,2	TCI.State.2	NA		
SMTC configuration defined in A.3.11		Config 1,2	SMTC.1	SMTC.1		
PDSCH/PDCCH subcarrier spacing	kHz	Config 1,2	120	120		
EPRE ratio of PSS to SSS		Config 1,2	0	0		
EPRE ratio of PBCH DMRS to SSS						
EPRE ratio of PBCH to PBCH DMRS						
EPRE ratio of PDCCH DMRS to SSS						
EPRE ratio of PDCCH to PDCCH DMRS						
EPRE ratio of PDSCH DMRS to SSS						
EPRE ratio of PDSCH to PDSCH						
EPRE ratio of OCNG DMRS to SSS(Note 1)						
EPRE ratio of OCNG to OCNG DMRS (Note 1)						
$N_{oc}$ <sup>Note2</sup>	dBm/15 kHz Note5					
$N_{oc}$ <sup>Note2</sup>	dBm/S CS Note4	Config 1,2	-95.7	-95.7		
SSB_RP <sup>Note 3</sup>	dBm/S CS Note5	Config 1,2	-89.7	-89.7	-Infinity	-86.7
$\hat{E}_s / I_{ot}$	dB	Config 1,2	6	6	-Infinity	9
$\hat{E}_s / N_{oc}$	dB	Config 1,2	6	6	-Infinity	9
$I_o$ <sup>Note3</sup>	dBm/95.04 MHz Note5	Config 1,2	-59.7	-59.7	-66.7	-57.2
Propagation Condition		Config 1,2	AWGN		AWGN	
<p>Note 1: OCNG shall be used such that both cells are fully allocated and a constant total transmitted power spectral density is achieved for all OFDM symbols.</p> <p>Note 2: Interference from other cells and noise sources not specified in the test is assumed to be constant over subcarriers and time and shall be modelled as AWGN of appropriate power for <math>N_{oc}</math> to be fulfilled.</p> <p>Note 3: SSB_RP and <math>I_o</math> levels have been derived from other parameters for information purposes. They are not settable parameters themselves.</p> <p>Note 4: Void</p> <p>Note 5: Equivalent power received by an antenna with 0dBi gain at the centre of the quiet zone</p> <p>Note 6: As observed with 0dBi gain antenna at the centre of the quiet zone</p> <p>Note 7: Information about types of UE beam is given in B.2.1.3, and does not limit UE implementation or test system implementation</p>						

#### A.5.6.2.4.2 Test Requirements

In test 1 with per-UE gap and in test 3 with per-FR gap, the UE shall send one Event A3 triggered measurement report, with a measurement reporting delay less than X1 ms from the beginning of time period T2, where X1 is

10080 for UE supporting power class 1, or

6240 for UE supporting other power class.

In test 2 with per-UE gap and in test 4 with per-FR gap, the UE shall send one Event A3 triggered measurement report, with a measurement reporting delay less than X2 ms from the beginning of time period T2, where X2 is

107520 for UE supporting power class 1, or

66560 for UE supporting other power class.

In test 1, 2, 3 and 4 UE is required to report SSB time index. The UE shall not send event triggered measurement reports, as long as the reporting criteria are not fulfilled. The rate of correct events observed during repeated tests shall be at least 90%.

NOTE: The actual overall delays measured in the test may be up to  $2xTTI_{DCCH}$  higher than the measurement reporting delays above because of TTI insertion uncertainty of the measurement report in DCCH.

#### A.5.6.2.5 EN-DC event triggered reporting tests for FR2 cell without SSB time index detection when DRX is not used

##### A.5.6.2.5.1 Test Purpose and Environment

The purpose of this test is to verify that the UE makes correct reporting of an event. This test will partly verify the EN-DC inter-frequency NR cell search requirements in clause 9.3.4.

In this test, there are three cells: LTE cell 1 as PCell on E-UTRA RF channel 1, NR cell 2 as PSCell in FR1 on NR RF channel 1 and NR cell 3 as neighbour cell in FR2 on NR RF channel 2. The test parameters and configurations are given in Tables A.5.6.2.5.1-1, A.5.6.2.5.1-2, and A.5.6.2.5.1-3.

In test 1 measurement gap pattern configuration # 0 as defined in Table A.5.6.2.5.1-2 is provided for a UE that does not support per-FR gap and in test 2 measurement gap pattern configuration #13 as defined in Table A.5.6.2.5.1-2 is provided for UE that support per-FR gap. If a UE supports per-FR gap and gap pattern configuration #13, it is only required to pass test 2. Otherwise it is only required to pass test 1.

In the measurement control information, it is indicated to the UE that event-triggered reporting with Event A4 is used. The test consists of two successive time periods, with time duration of T1, and T2 respectively. During time duration T1, the UE shall not have any timing information of NR cell 3.

The configuration of LTE cell 1 is defined in table A.3.7.2.1-1. Supported test configurations are shown in table A.5.6.2.5.1-1.

**Table A.5.6.2.5.1-1: EN-DC event triggered reporting tests without SSB index reading for FR1-FR2**

Config	Description of serving cell	Description of target cell
1	LTE FDD, NR 15 kHz SSB SCS, 10 MHz bandwidth, FDD duplex mode	120 kHz SSB SCS, 100 MHz bandwidth, TDD duplex mode
2	LTE FDD, NR 15 kHz SSB SCS, 10 MHz bandwidth, TDD duplex mode	
3	LTE FDD, NR 30 kHz SSB SCS, 40 MHz bandwidth, TDD duplex mode	
4	LTE TDD, NR 15 kHz SSB SCS, 10 MHz bandwidth, FDD duplex mode	
5	LTE TDD, NR 15 kHz SSB SCS, 10 MHz bandwidth, TDD duplex mode	
6	LTE TDD, NR 30 kHz SSB SCS, 40 MHz bandwidth, TDD duplex mode	
Note: The UE is only required to be tested in one of the supported test configurations		

**Table A.5.6.2.5.1-2: General test parameters for EN-DC inter-frequency event triggered reporting without SSB time index detection**

Parameter	Unit	Test configuration	Value		Comment
			Test 1	Test 2	
E-UTRA RF Channel Number		Config 1,2,3,4,5,6	1		One E-UTRAN TDD carrier frequency is used.
NR RF Channel Number		Config 1,2,3,4,5,6	1, 2		One FR1 and one FR2 NR carrier frequency is used.
Active cell		Config 1,2,3,4,5,6	LTE Cell 1 (PCell) and NR cell 2 (PScell)		LTE Cell 1 is on E-UTRA RF channel number 1. NR Cell 2 is on NR RF channel number 1.
Neighbour cell		Config 1,2,3,4,5,6	NR cell 3		NR cell 3 is on NR RF channel number 2.
Gap Pattern Id		Config 1,2,3,4,5,6	0	13	As specified in clause 9.1.2-1.
Measurement gap offset		Config 1,2,3,4,5,6	39	39	
SMTC-SSB parameters on NR RF Channel 1		Config 1,4	SSB.1 FR1		As specified in clause A.3.10.1
		Config 2,5	SSB.1 FR1		As specified in clause A.3.10.1
		Config 3,6	SSB.2 FR1		As specified in clause A.3.10.1
SMTC-SSB parameters on NR RF Channel 2		Config 1,2,3,4,5,6	SSB.3 FR2		As specified in clause A.3.10.2
CSI-RS for tracking		Config 1,4	TRS.1.1 FDD		
		Config 2,5	TRS.1.1 TDD		
		Config 3,6	TRS.1.2 TDD		
<i>offsetMO</i>	dB	Config 1,2,3,4,5,6	6		
Hysteresis	dB	Config 1,2,3,4,5,6	0		
<i>a4-Threshold</i>	dBm	Config 1,2,3,4,5,6	-105		
CP length		Config 1,2,3,4,5,6	Normal		
TimeToTrigger	s	Config 1,2,3,4,5,6	0		
Filter coefficient		Config 1,2,3,4,5,6	0		L3 filtering is not used
DRX		Config 1,2,3,4,5,6	OFF		DRX is not used
Time offset between PCell and PSCell		Config 1,2,3,4,5,6	3 $\mu$ s		Synchronous EN-DC
Time offset between serving and neighbour cells		Config 1,4	3ms		Asynchronous cells. The timing of Cell 3 is 3ms later than the timing of Cell 2.
		Config 2,3,5,6	3 $\mu$ s		Synchronous cells.
T1	s	Config 1,2,3,4,5,6	5		
T2	s	Config 1,2,3,4,5,6	5.2 for PC1; 3.5 for other PC	5.2 for PC1; 3.5 for other PC	

**Table A.5.6.2.5.1-3: Cell specific test parameters for EN-DC inter-frequency event triggered reporting without SSB time index detection**

Parameter	Unit	Test configuration	Cell 2		Cell 3	
			T1	T2	T1	T2
AoA setup		Config 1,2,3,4,5,6	NA		Setup 1 as specified in clause A.3.15	
Assumption for UE beams <sup>Note 7</sup>		Config 1,2,3,4,5,6	N/A		Rough	

NR RF Channel Number		Config 1,2,3,4,5,6	1	2	
Duplex mode		Config 1,4	FDD	TDD	
		Config 2,3,5,6	TDD	TDD	
BW <sub>channel</sub>	MHz	Config 1,4	10: N <sub>RB,c</sub> = 52	100: N <sub>RB,c</sub> = 66	
		Config 2,5	10: N <sub>RB,c</sub> = 52	100: N <sub>RB,c</sub> = 66	
		Config 3,6	40: N <sub>RB,c</sub> = 106	100: N <sub>RB,c</sub> = 66	
BWP BW	MHz	Config 1,4	10: N <sub>RB,c</sub> = 52	100: N <sub>RB,c</sub> = 66	
		Config 2,5	10: N <sub>RB,c</sub> = 52	100: N <sub>RB,c</sub> = 66	
		Config 3,6	40: N <sub>RB,c</sub> = 106	100: N <sub>RB,c</sub> = 66	
Data RBs allocated		Config 1,4	52	66	
		Config 2,5	52	66	
		Config 3,6	106	66	
TDD configuration		Config 2,5	TDDConf.1.1	TDDConf.3.1	
		Config 3,6	TDDConf.2.1	TDDConf.3.1	
Initial DL BWP		Config 1,2,3,4,5,6	DLBWP.0.1	NA	
Initial UL BWP		Config 1,2,3,4,5,6	ULBWP.0.1	NA	
Dedicated DL BWP		Config 1,2,3,4,5,6	DLBWP.1.1	NA	
Dedicated UL BWP		Config 1,2,3,4,5,6	ULBWP.1.1	NA	
OCNG Patterns defined in A.3.2.1.1 (OP.1)		Config 1,2,3,4,5,6	OP.1	OP.1	
PDSCH Reference measurement channel		Config 1,4	SR.1.1 FDD	-	
		Config 2,5	SR.1.1 TDD		
		Config 3,6	SR2.1 TDD		
RMSI CORESET Reference Channel		Config 1,4	CR.1.1 FDD	-	
		Config 2,5	CR.1.1 TDD		
		Config 3,6	CR2.1 TDD		
Dedicated CORESET Reference Channel		Config 1,4	CCR.1.1 FDD	-	
		Config 2,5	CCR.1.1 TDD		
		Config 3,6	CCR.2.1 TDD		
SMTc configuration defined in A.3.11		Config 1,4	SMTc.2	SMTc.2	
		Config 2,3,5,6	SMTc.1	SMTc.1	
PDSCH/PDCCH subcarrier spacing	kHz	Config 1,2,4,5	15	120	
		Config 3,6	30	120	
EPRE ratio of PSS to SSS		Config	0	0	
EPRE ratio of PBCH DMRS to SSS		1,2,3,4,5,6			
EPRE ratio of PBCH to PBCH DMRS					
EPRE ratio of PDCCH DMRS to SSS					
EPRE ratio of PDCCH to PDCCH DMRS					
EPRE ratio of PDSCH DMRS to SSS					
EPRE ratio of PDSCH to PDSCH					
EPRE ratio of OCNG DMRS to SSS(Note 1)					
EPRE ratio of OCNG to OCNG DMRS (Note 1)					
E <sub>s</sub>	dBm/S CS	Config 1,2,3,4,5,6		-Infinity	-87
SSB_RP <sup>Note 3</sup>	dBm/S CS Note5	Config 1,2,3,4,5,6		-Infinity	-87



$\hat{E}_s / I_{ot\_BB}$ <sup>Note 8</sup>	dB	Config 1,2,3,4,5,6	Link only, see clause A.3.7A	-Infinity	14.69
$I_o$ <sup>Note 3</sup>	dBm/95 .04 MHz Note 5	Config 1,2,3,4,5,6		-Infinity	-58.01
Propagation Condition		Config 1,2,3,4,5,6		No external noise (Note 9)	
<p>Note 1: OCNG shall be used such that both cells are fully allocated and a constant total transmitted power spectral density is achieved for all OFDM symbols.</p> <p>Note 2: Void</p> <p>Note 3: SSB<sub>RP</sub>, <math>E_s/I_{ot}</math> and <math>I_o</math> levels have been derived from other parameters for information purposes. They are not settable parameters themselves.</p> <p>Note 4: Void.</p> <p>Note 5: Equivalent power received by an antenna with 0dBi gain at the centre of the quiet zone</p> <p>Note 6: As observed with 0dBi gain antenna at the centre of the quiet zone</p> <p>Note 7: Information about types of UE beam is given in B.2.1.3, and does not limit UE implementation or test system implementation</p> <p>Note 8: Calculation of <math>E_s/I_{ot\_BB}</math> includes the effect of UE internal noise up to the value assumed for the associated Refsens requirement in clause 7.3.2 of TS 38.101-2 [19], and an allowance of 1dB for UE multi-band relaxation factor <math>\Delta MB_s</math> from TS 38.101-2 [19] Table 6.2.1.3-4.</p> <p>Note 9: The downlink connection between the System Simulator and the UE is without Additive White Gaussian Noise, and has no fading or multipath effects as specified in TS 38.521-2 B.0 [37].</p>					

#### A.5.6.2.5.2 Test Requirements

In test 1 with per-UE gap and in test 2 with per-FR gap, the UE shall send one Event A4 triggered measurement report, with a measurement reporting delay less than X ms from the beginning of time period T2, where X is

5120 for UE supporting power class 1, or

3200 for UE supporting other power class.

In test 1 and 2 UE is not required to report SSB time index. The UE shall not send event triggered measurement reports, as long as the reporting criteria are not fulfilled. The rate of correct events observed during repeated tests shall be at least 90%.

NOTE: The actual overall delays measured in the test may be up to  $2 \times TTI_{DCCH}$  higher than the measurement reporting delays above because of TTI insertion uncertainty of the measurement report in DCCH.

#### A.5.6.2.6 EN-DC event triggered reporting tests for FR2 cell without SSB time index detection when DRX is used

##### A.5.6.2.6.1 Test Purpose and Environment

The purpose of this test is to verify that the UE makes correct reporting of an event. This test will partly verify the EN-DC inter-frequency NR cell search requirements in clause 9.3.4.

In this test, there are three cells: LTE cell 1 as PCell on E-UTRA RF channel 1, NR cell 2 as PCell in FR1 on NR RF channel 1 and NR cell 3 as neighbour cell in FR2 on NR RF channel 2. The test parameters and configurations are given in Tables A.5.6.2.6.1-1, A.5.6.2.6.1-2, and A.5.6.2.6.1-3.

In test 1&2 measurement gap pattern configuration # 0 as defined in Table A.5.6.2.6.1-2 is provided for a UE that does not support per-FR gap and in test 3&4 measurement gap pattern configuration #13 as defined in Table A.5.6.2.6.1-2 is provided for UE that support per-FR gap. If a UE supports per-FR gap and gap pattern configuration #13, it is only required to pass test 3&4. Otherwise it is only required to pass test 1&2.

In the measurement control information, it is indicated to the UE that event-triggered reporting with Event A4 is used. The test consists of two successive time periods, with time duration of T1, and T2 respectively. During time duration T1, the UE shall not have any timing information of NR cell 3.

The configuration of LTE cell 1 is defined in table A.3.7.2.1-1. Supported test configurations are shown in table A.5.6.2.6.1-1.

UE needs to be provided with new Timing Advance Command MAC control element at least once during each time alignment timer period to maintain uplink time alignment. Furthermore UE is allocated with PUSCH resource at every DRX cycle.

**Table A.5.6.2.6.1-1: EN-DC event triggered reporting tests without SSB index reading for FR1-FR2**

Config	Description of serving cell	Description of target cell
1	LTE FDD, NR 15 kHz SSB SCS, 10 MHz bandwidth, FDD duplex mode	120 kHz SSB SCS, 100 MHz bandwidth, TDD duplex mode
2	LTE FDD, NR 15 kHz SSB SCS, 10 MHz bandwidth, TDD duplex mode	
3	LTE FDD, NR 30 kHz SSB SCS, 40 MHz bandwidth, TDD duplex mode	
4	LTE TDD, NR 15 kHz SSB SCS, 10 MHz bandwidth, FDD duplex mode	
5	LTE TDD, NR 15 kHz SSB SCS, 10 MHz bandwidth, TDD duplex mode	
6	LTE TDD, NR 30 kHz SSB SCS, 40 MHz bandwidth, TDD duplex mode	
Note: The UE is only required to be tested in one of the supported test configurations		

**Table A.5.6.2.6.1-2: General test parameters for EN-DC inter-frequency event triggered reporting without SSB time index detection**

Parameter	Unit	Test configuration	Value				Comment
			Test 1	Test 2	Test 3	Test 4	
E-UTRA RF Channel Number		Config 1,2,3,4,5,6	1				One E-UTRAN TDD carrier frequency is used.
NR RF Channel Number		Config 1,2,3,4,5,6	1, 2				One FR1 and one Fr2 NR carrier frequency is used.
Active cell		Config 1,2,3,4,5,6	LTE Cell 1 (PCell) and NR cell 2 (PScell)				LTE Cell 1 is on E-UTRA RF channel number 1. NR Cell 2 is on NR RF channel number 1.
Neighbour cell		Config 1,2,3,4,5,6	NR cell 3				NR cell 3 is on NR RF channel number 2.
Gap Pattern Id		Config 1,2,3,4,5,6	0	13			As specified in clause 9.1.2-1.
Measurement gap offset		Config 1,2,3,4,5,6	39	39			
SMTC-SSB parameters on NR RF Channel 1		Config 1,4	SSB.1 FR1				As specified in clause A.3.10.1
		Config 2,5	SSB.1 FR1				As specified in clause A.3.10.1
		Config 3,6	SSB.2 FR1				As specified in clause A.3.10.1
SMTC-SSB parameters on NR RF Channel 2		Config 1,2,3,4,5,6	SSB.3 FR2				As specified in clause A.3.10.2
CSI-RS for tracking		Config 1,4	TRS.1.1 FDD				
		Config 2,5	TRS.1.1 TDD				
		Config 3,6	TRS.1.2 TDD				
offset <sub>MO</sub>	dB	Config 1,2,3,4,5,6	6				
Hysteresis	dB	Config 1,2,3,4,5,6	0				
a4-Threshold	dBm	Config 1,2,3,4,5,6	-105				
CP length		Config 1,2,3,4,5,6	Normal				
TimeToTrigger	s	Config 1,2,3,4,5,6	0				
Filter coefficient		Config 1,2,3,4,5,6	0				L3 filtering is not used
DRX		Config 1,2,3,4,5,6	DRX .1	DRX .7	DRX .1	DRX .7	As specified in clause A.3.3

Time offset between PCell and PSCell		Config 1,2,3,4,5,6	3 μs				Synchronous EN-DC
Time offset between serving and neighbour cells		Config 1,4	3ms				Asynchronous cells. The timing of Cell 3 is 3ms later than the timing of Cell 2.
		Config 2,3,5,6	3μs				Synchronous cells.
T1	s	Config 1,2,3,4,5,6	5				
T2	s	Config 1,2,3,4,5,6	8 for PC1; 5 for other PC	82 for PC1; 52 for other PC	8 for PC1; 5 for other PC	82 for PC1; 52 for other PC	

**Table A.5.6.2.6.1-3: Cell specific test parameters for EN-DC inter-frequency event triggered reporting without SSB time index detection**

Parameter	Unit	Test configuration	Cell 2		Cell 3	
			T1	T2	T1	T2
AoA setup		Config 1,2,3,4,5,6	NA		Setup 1 as specified in clause A.3.15	
Assumption for UE beams <sup>Note 7</sup>		Config 1,2,3,4,5,6	N/A		Rough	
NR RF Channel Number		Config 1,2,3,4,5,6	1		2	
Duplex mode		Config 1,4	FDD		TDD	
		Config 2,3,5,6	TDD		TDD	
BW <sub>channel</sub>	MHz	Config 1,4	10: N <sub>RB,c</sub> = 52		100: N <sub>RB,c</sub> = 66	
		Config 2,5	10: N <sub>RB,c</sub> = 52		100: N <sub>RB,c</sub> = 66	
		Config 3,6	40: N <sub>RB,c</sub> = 106		100: N <sub>RB,c</sub> = 66	
BWP BW	MHz	Config 1,4	10: N <sub>RB,c</sub> = 52		100: N <sub>RB,c</sub> = 66	
		Config 2,5	10: N <sub>RB,c</sub> = 52		100: N <sub>RB,c</sub> = 66	
		Config 3,6	40: N <sub>RB,c</sub> = 106		100: N <sub>RB,c</sub> = 66	
Data RBs allocated		Config 1,4	52		66	
		Config 2,5	52		66	
		Config 3,6	106		66	
TDD configuration		Config 2,5	TDDConf.1.1		TDDConf.3.1	
		Config 3,6	TDDConf.2.1		TDDConf.3.1	
Initial DL BWP		Config 1,2,3,4,5,6	DLBWP.0.1		NA	
Initial UL BWP		Config 1,2,3,4,5,6	ULBWP.0.1		NA	
Dedicated DL BWP		Config 1,2,3,4,5,6	DLBWP.1.1		NA	
Dedicated UL BWP		Config 1,2,3,4,5,6	ULBWP.1.1		NA	
OCNG Patterns defined in A.3.2.1.1 (OP.1)		Config 1,2,3,4,5,6	OP.1		OP.1	
PDSCH Reference measurement channel		Config 1,4	SR.1.1 FDD		-	
		Config 2,5	SR.1.1 TDD			
		Config 3,6	SR2.1 TDD			
RMSI CORESET Reference Channel		Config 1,4	CR.1.1 FDD		-	
		Config 2,5	CR.1.1 TDD			
		Config 3,6	CR2.1 TDD			
Dedicated CORESET Reference Channel		Config 1,4	CCR.1.1 FDD		-	
		Config 2,5	CCR.1.1 TDD			
		Config 3,6	CCR.2.1 TDD			
SMTc configuration defined		Config 1,4	SMTc.2		SMTc.2	

in A.3.11		Config 2,3,5,6	SMTC.1	SMTC.1	
PDSCH/PDCCH subcarrier spacing	kHz	Config 1,2,4,5	15	120	
		Config 3,6	30	120	
EPRE ratio of PSS to SSS		Config 1,2,3,4,5,6	0	0	
EPRE ratio of PBCH DMRS to SSS					
EPRE ratio of PBCH to PBCH DMRS					
EPRE ratio of PDCCH DMRS to SSS					
EPRE ratio of PDCCH to PDCCH DMRS					
EPRE ratio of PDSCH DMRS to SSS					
EPRE ratio of PDSCH to PDSCH					
EPRE ratio of OCNG DMRS to SSS(Note 1)					
EPRE ratio of OCNG to OCNG DMRS (Note 1)					
$N_{oc}$ <sup>Note2</sup>	dBm/15 kHz Note5				
$N_{oc}$ <sup>Note2</sup>	dBm/S CS Note4	Config 1,2,4,5		-95.7	
		Config 3,6		-95.7	
SSB_RP <sup>Note 3</sup>	dBm/S CS Note5	Config 1,2,4,5		-Infinity	-86.7
		Config 3,6		-Infinity	-86.7
$\hat{E}_s / I_{ot}$	dB	Config 1,2,3,4,5,6	NA Link only, see clause A.3.7A	-Infinity	9
$\hat{E}_s / N_{oc}$	dB	Config 1,2,3,4,5,6		-Infinity	9
$I_o$ <sup>Note3</sup>	dBm/9.36MHz	Config 1,2,4,5		-	-
	dBm/38.16MHz	Config 3,6		-	-
	dBm/95.04 MHz Note5	Config 1,2,3,4,5,6		-66.7	-57.2
Propagation Condition		Config 1,2,3,4,5,6		AWGN	
<p>Note 1: OCNG shall be used such that both cells are fully allocated and a constant total transmitted power spectral density is achieved for all OFDM symbols.</p> <p>Note 2: Interference from other cells and noise sources not specified in the test is assumed to be constant over subcarriers and time and shall be modelled as AWGN of appropriate power for <math>N_{oc}</math> to be fulfilled.</p> <p>Note 3: SSB_RP and <math>I_o</math> levels have been derived from other parameters for information purposes. They are not settable parameters themselves.</p> <p>Note 4: SSB_RP minimum requirements are specified assuming independent interference and noise at each receiver antenna port.</p> <p>Note 5: Equivalent power received by an antenna with 0 dBi gain at the centre of the quiet zone</p> <p>Note 6: As observed with 0 dBi gain antenna at the centre of the quiet zone</p> <p>Note 7: Information about types of UE beam is given in B.2.1.3, and does not limit UE implementation or test system implementation</p>					

A.5.6.2.6.2 Test Requirements

In test 1 with per-UE gap and in test 3 with per-FR gap, the UE shall send one Event A4 triggered measurement report, with a measurement reporting delay less than X1 ms from the beginning of time period T2, where X1 is

7680 for UE supporting power class 1, or

4800 for UE supporting other power class.

In test 2 with per-UE gap and in test 4 with per-FR gap, the UE shall send one Event A4 triggered measurement report, with a measurement reporting delay less than  $X2$  ms from the beginning of time period T2, where  $X2$  is

81920 for UE supporting power class 1, or

51200 for UE supporting other power class.

In test 1, 2, 3 and 4 UE is not required to report SSB time index. The UE shall not send event triggered measurement reports, as long as the reporting criteria are not fulfilled. The rate of correct events observed during repeated tests shall be at least 90%.

NOTE: The actual overall delays measured in the test may be up to  $2xTTI_{DCCH}$  higher than the measurement reporting delays above because of TTI insertion uncertainty of the measurement report in DCCH.

### A.5.6.2.7 EN-DC event triggered reporting tests for FR2 cell with SSB time index detection when DRX is not used

#### A.5.6.2.7.1 Test Purpose and Environment

The purpose of this test is to verify that the UE makes correct reporting of an event. This test will partly verify the EN-DC inter-frequency NR cell search requirements in clause 9.3.4.

In this test, there are three cells: LTE cell 1 as PCell on E-UTRA RF channel 1, NR cell 2 as PCell in FR1 on NR RF channel 1 and NR cell 3 as neighbour cell in FR2 on NR RF channel 2. The test parameters and configurations are given in Tables A.5.6.2.7.1-1, A.5.6.2.7.1-2, and A.5.6.2.7.1-3.

In test 1 measurement gap pattern configuration # 0 as defined in Table A.5.6.2.7.1-2 is provided for a UE that does not support per-FR gap and in test 2 measurement gap pattern configuration #13 as defined in Table A.5.6.2.7.1-2 is provided for UE that support per-FR gap. If a UE supports per-FR gap and gap pattern configuration #13, it is only required to pass test 2. Otherwise it is only required to pass test 1.

In the measurement control information, it is indicated to the UE that event-triggered reporting with Event A4 is used. The test consists of two successive time periods, with time duration of T1, and T2 respectively. During time duration T1, the UE shall not have any timing information of NR cell 3.

The configuration of LTE cell 1 is defined in table A.3.7.2.1-1. Supported test configurations are shown in table A.5.6.2.7.1-1.

**Table A.5.6.2.7.1-1: EN-DC event triggered reporting tests with SSB index reading for FR1-FR2**

Config	Description of serving cell	Description of target cell
1	LTE FDD, NR 15 kHz SSB SCS, 10 MHz bandwidth, FDD duplex mode	120 kHz SSB SCS, 100 MHz bandwidth, TDD duplex mode
2	LTE FDD, NR 15 kHz SSB SCS, 10 MHz bandwidth, TDD duplex mode	
3	LTE FDD, NR 30 kHz SSB SCS, 40 MHz bandwidth, TDD duplex mode	
4	LTE TDD, NR 15 kHz SSB SCS, 10 MHz bandwidth, FDD duplex mode	
5	LTE TDD, NR 15 kHz SSB SCS, 10 MHz bandwidth, TDD duplex mode	
6	LTE TDD, NR 30 kHz SSB SCS, 40 MHz bandwidth, TDD duplex mode	
Note: The UE is only required to be tested in one of the supported test configurations		

**Table A.5.6.2.7.1-2: General test parameters for EN-DC inter-frequency event triggered reporting with SSB time index detection**

Parameter	Unit	Test configuration	Value		Comment
			Test 1	Test 2	
E-UTRA RF Channel Number		Config 1,2,3,4,5,6	1		One E-UTRAN TDD carrier frequency is used.

NR RF Channel Number		Config 1,2,3,4,5,6	1, 2		One FR1 and one FR2 NR carrier frequency is used.
Active cell		Config 1,2,3,4,5,6	LTE Cell 1 (PCell) and NR cell 2 (PScell)		LTE Cell 1 is on E-UTRA RF channel number 1. NR Cell 2 is on NR RF channel number 1.
Neighbour cell		Config 1,2,3,4,5,6	NR cell 3		NR cell 3 is on NR RF channel number 2.
Gap Pattern Id		Config 1,2,3,4,5,6	0	13	As specified in clause 9.1.2-1.
Measurement gap offset		Config 1,2,3,4,5,6	39	39	
SMTC-SSB parameters on NR RF Channel 1		Config 1,4	SSB.1 FR1		As specified in clause A.3.10.1
		Config 2,5	SSB.1 FR1		As specified in clause A.3.10.1
		Config 3,6	SSB.2 FR1		As specified in clause A.3.10.1
SMTC-SSB parameters on NR RF Channel 2		Config 1,2,3,4,5,6	SSB.3 FR2		As specified in clause A.3.10.2
CSI-RS for tracking		Config 1,4	TRS.1.1 FDD		
		Config 2,5	TRS.1.1 TDD		
		Config 3,6	TRS.1.2 TDD		
<i>offsetMO</i>	dB	Config 1,2,3,4,5,6	6		
Hysteresis	dB	Config 1,2,3,4,5,6	0		
<i>a4-Threshold</i>	dBm	Config 1,2,3,4,5,6	-105		
CP length		Config 1,2,3,4,5,6	Normal		
TimeToTrigger	s	Config 1,2,3,4,5,6	0		
Filter coefficient		Config 1,2,3,4,5,6	0		L3 filtering is not used
DRX		Config 1,2,3,4,5,6	OFF		DRX is not used
Time offset between PCell and PSCell		Config 1,2,3,4,5,6	3 $\mu$ s		Synchronous EN-DC
Time offset between serving and neighbour cells		Config 1,4	3ms		Asynchronous cells. The timing of Cell 3 is 3ms later than the timing of Cell 2.
		Config 2,3,5,6	3 $\mu$ s		Synchronous cells.
T1	s	Config 1,2,3,4,5,6	5		
T2	s	Config 1,2,3,4,5,6	7 for PC1; 4.5 for other PC	7 for PC1; 4.5 for other PC	

**Table A.5.6.2.7.1-3: Cell specific test parameters for EN-DC inter-frequency event triggered reporting with SSB time index detection**

Parameter	Unit	Test configuration	Cell 2		Cell 3	
			T1	T2	T1	T2
AoA setup		Config 1,2,3,4,5,6	NA		Setup 1 as specified in clause A.3.15	
Assumption for UE beams <sup>Note 7</sup>		Config 1,2,3,4,5,6	N/A		Rough	
NR RF Channel Number		Config 1,2,3,4,5,6	1		2	
Duplex mode		Config 1,4	FDD		TDD	
		Config 2,3,5,6	TDD		TDD	
BW <sub>channel</sub>	MHz	Config 1,4	10: N <sub>RB,c</sub> = 52		100: N <sub>RB,c</sub> = 66	
		Config 2,5	10: N <sub>RB,c</sub> = 52		100: N <sub>RB,c</sub> = 66	
		Config 3,6	40: N <sub>RB,c</sub> = 106		100: N <sub>RB,c</sub> = 66	
BWP BW	MHz	Config 1,4	10: N <sub>RB,c</sub> = 52		100: N <sub>RB,c</sub> = 66	

		Config 2,5	10: $N_{RB,c} = 52$	100: $N_{RB,c} = 66$	
		Config 3,6	40: $N_{RB,c} = 106$	100: $N_{RB,c} = 66$	
Data RBs allocated		Config 1,4	52	66	
		Config 2,5	52	66	
		Config 3,6	106	66	
OCNG Patterns defined in A.3.2.1.1 (OP.1)		Config 1,2,3,4,5,6	OP.1	OP.1	
PDSCH Reference measurement channel		Config 1,4	SR.1.1 FDD	-	
		Config 2,5	SR.1.1 TDD		
		Config 3,6	SR2.1 TDD		
RMSI CORESET Reference Channel		Config 1,4	CR.1.1 FDD	-	
		Config 2,5	CR.1.1 TDD		
		Config 3,6	CR2.1 TDD		
Dedicated CORESET Reference Channel		Config 1,4	CCR.1.1 FDD	-	
		Config 2,5	CCR.1.1 TDD		
		Config 3,6	CCR.2.1 TDD		
TDD configuration		Config 2,5	TDDConf.1.1	TDDConf.3.1	
		Config 3,6	TDDConf.2.1	TDDConf.3.1	
Initial DL BWP		Config 1,2,3,4,5,6	DLBWP.0.1	NA	
Initial UL BWP		Config 1,2,3,4,5,6	ULBWP.0.1	NA	
Dedicated DL BWP		Config 1,2,3,4,5,6	DLBWP.1.1	NA	
Dedicated UL BWP		Config 1,2,3,4,5,6	ULBWP.1.1	NA	
SMTC configuration defined in A.3.11		Config 1,4	SMTC.2	SMTC.2	
		Config 2,3,5,6	SMTC.1	SMTC.1	
PDSCH/PDCCH subcarrier spacing	kHz	Config 1,2,4,5	15	120	
		Config 3,6	30	120	
EPRE ratio of PSS to SSS		Config 1,2,3,4,5,6	0	0	
EPRE ratio of PBCH DMRS to SSS					
EPRE ratio of PBCH to PBCH DMRS					
EPRE ratio of PDCCH DMRS to SSS					
EPRE ratio of PDCCH to PDCCH DMRS					
EPRE ratio of PDSCH DMRS to SSS					
EPRE ratio of PDSCH to PDSCH					
EPRE ratio of OCNG DMRS to SSS(Note 1)					
EPRE ratio of OCNG to OCNG DMRS (Note 1)					
$\hat{E}_s$	dBm/S CS				
SSB_RP <sup>Note 3</sup>	dBm/S CS Note5	Config 1,2,3,4,5,6	-Infinity	-87	
$\hat{E}_s / I_{ot\_BB}$ <sup>Note 8</sup>	dB	Config 1,2,3,4,5,6	-Infinity	14.69	
$I_o$ <sup>Note3</sup>	dBm/95.04 MHz Note5	Config 1,2,3,4,5,6	-Infinity	-58.01	
Propagation Condition		Config 1,2,3,4,5,6	No external noise (Note 9)		

Note 1:	OCNG shall be used such that both cells are fully allocated and a constant total transmitted power spectral density is achieved for all OFDM symbols.
Note 2:	Void
Note 3:	SS-RP, Es/lot and lo levels have been derived from other parameters for information purposes. They are not settable parameters themselves.
Note 4:	Void
Note 5:	Equivalent power received by an antenna with 0dBi gain at the centre of the quiet zone
Note 6:	As observed with 0dBi gain antenna at the centre of the quiet zone
Note 7:	Information about types of UE beam is given in B.2.1.3, and does not limit UE implementation or test system implementation
Note 8:	Calculation of Es/lot <sub>BB</sub> includes the effect of UE internal noise up to the value assumed for the associated Refsens requirement in clause 7.3.2 of TS 38.101-2 [19], and an allowance of 1dB for UE multi-band relaxation factor $\Delta MB_S$ from TS 38.101-2 [19] Table 6.2.1.3-4.
Note 9:	The downlink connection between the System Simulator and the UE is without Additive White Gaussian Noise, and has no fading or multipath effects as specified in TS 38.521-2 B.0 [37].

#### A.5.6.2.7.2 Test Requirements

In test 1 with per-UE gap and in test 2 with per-FR gap, the UE shall send one Event A4 triggered measurement report, with a measurement reporting delay less than X ms from the beginning of time period T2, where X is

- 6720 for UE supporting power class 1, or
- 4160 for UE supporting other power class.

In test 1 and 2 UE is required to report SSB time index. The UE shall not send event triggered measurement reports, as long as the reporting criteria are not fulfilled. The rate of correct events observed during repeated tests shall be at least 90%.

NOTE: The actual overall delays measured in the test may be up to  $2xTTI_{DCCH}$  higher than the measurement reporting delays above because of TTI insertion uncertainty of the measurement report in DCCH.

#### A.5.6.2.8 EN-DC event triggered reporting tests for FR2 cell with SSB time index detection when DRX is used

##### A.5.6.2.8.1 Test Purpose and Environment

The purpose of this test is to verify that the UE makes correct reporting of an event. This test will partly verify the EN-DC inter-frequency NR cell search requirements in clause 9.3.4.

In this test, there are three cells: LTE cell 1 as PCell on E-UTRA RF channel 1, NR cell 2 as PCell in FR1 on NR RF channel 1 and NR cell 3 as neighbour cell in FR2 on NR RF channel 2. The test parameters and configurations are given in Tables A.5.6.2.8.1-1, A.5.6.2.8.1-2, and A.5.6.2.8.1-3.

In test 1&2 measurement gap pattern configuration # 0 as defined in Table A.5.6.2.8.1-2 is provided for a UE that does not support per-FR gap and in test 3&4 measurement gap pattern configuration #13 as defined in Table A.5.6.2.8.1-2 is provided for UE that support per-FR gap. If a UE supports per-FR gap and gap pattern configuration #13, it is only required to pass test 3&4. Otherwise it is only required to pass test 1&2.

In the measurement control information, it is indicated to the UE that event-triggered reporting with Event A4 is used. The test consists of two successive time periods, with time duration of T1, and T2 respectively. During time duration T1, the UE shall not have any timing information of NR cell 3.

The configuration of LTE cell 1 is defined in table A.3.7.2.1-1. Supported test configurations are shown in table A.5.6.2.8.1-1.

UE needs to be provided with new Timing Advance Command MAC control element at least once during each time alignment timer period to maintain uplink time alignment. Furthermore UE is allocated with PUSCH resource at every DRX cycle.

**Table A.5.6.2.8.1-1: EN-DC event triggered reporting tests without SSB index reading for FR1-FR2**

Config	Description of serving cell	Description of target cell
--------	-----------------------------	----------------------------



1	LTE FDD, NR 15 kHz SSB SCS, 10 MHz bandwidth, FDD duplex mode	120 kHz SSB SCS, 100 MHz bandwidth, TDD duplex mode
2	LTE FDD, NR 15 kHz SSB SCS, 10 MHz bandwidth, TDD duplex mode	
3	LTE FDD, NR 30 kHz SSB SCS, 40 MHz bandwidth, TDD duplex mode	
4	LTE TDD, NR 15 kHz SSB SCS, 10 MHz bandwidth, FDD duplex mode	
5	LTE TDD, NR 15 kHz SSB SCS, 10 MHz bandwidth, TDD duplex mode	
6	LTE TDD, NR 30 kHz SSB SCS, 40 MHz bandwidth, TDD duplex mode	
Note: The UE is only required to be tested in one of the supported test configurations		

**Table A.5.6.2.8.1-2: General test parameters for EN-DC inter-frequency event triggered reporting with SSB time index detection**

Parameter	Unit	Test configuration	Value				Comment
			Test 1	Test 2	Test 3	Test 4	
E-UTRA RF Channel Number		Config 1,2,3,4,5,6	1				One E-UTRAN TDD carrier frequency is used.
NR RF Channel Number		Config 1,2,3,4,5,6	1, 2				One FR1 and one FR2 NR carrier frequency is used.
Active cell		Config 1,2,3,4,5,6	LTE Cell 1 (PCell) and NR cell 2 (PScell)				LTE Cell 1 is on E-UTRA RF channel number 1. NR Cell 2 is on NR RF channel number 1.
Neighbour cell		Config 1,2,3,4,5,6	NR cell 3				NR cell 3 is on NR RF channel number 2.
Gap Pattern Id		Config 1,2,3,4,5,6	0	13			As specified in clause 9.1.2-1.
Measurement gap offset		Config 1,2,3,4,5,6	39		39		
SMTC-SSB parameters on NR RF Channel 1		Config 1,4	SSB.1 FR1				As specified in clause A.3.10.1
		Config 2,5	SSB.1 FR1				As specified in clause A.3.10.1
		Config 3,6	SSB.2 FR1				As specified in clause A.3.10.1
SMTC-SSB parameters on NR RF Channel 2		Config 1,2,3,4,5,6	SSB.3 FR2				As specified in clause A.3.10.2
CSI-RS for tracking		Config 1,4	TRS.1.1 FDD				
		Config 2,5	TRS.1.1 TDD				
		Config 3,6	TRS.1.2 TDD				
<i>offsetMO</i>	dB	Config 1,2,3,4,5,6	6				
Hysteresis	dB	Config 1,2,3,4,5,6	0				
<i>a4-Threshold</i>	dBm	Config 1,2,3,4,5,6	-105				
CP length		Config 1,2,3,4,5,6	Normal				
TimeToTrigger	s	Config 1,2,3,4,5,6	0				
Filter coefficient		Config 1,2,3,4,5,6	0				L3 filtering is not used
DRX		Config 1,2,3,4,5,6	DRX .1	DRX .7	DRX .1	DRX .7	As specified in clause A.3.3
Time offset between PCell and PSCell		Config 1,2,3,4,5,6	3 μs				Synchronous EN-DC
Time offset between serving and neighbour cells		Config 1,4	3ms				Asynchronous cells. The timing of Cell 3 is 3ms later than the timing of Cell 2.
		Config 2,3,5,6	3μs				Synchronous cells.

T1	s	Config 1,2,3,4,5,6	5			
T2	s	Config 1,2,3,4,5,6	11 for PC1; 6.5 for other PC	108 for PC1; 67 for other PC	11 for PC1; 6.5 for other PC	108 for PC1; 67 for other PC

**Table A.5.6.2.8.1-3: Cell specific test parameters for EN-DC inter-frequency event triggered reporting with SSB time index detection**

Parameter	Unit	Test configuration	Cell 2		Cell 3	
			T1	T2	T1	T2
AoA setup		Config 1,2,3,4,5,6	NA		Setup 1 as specified in clause A.3.15	
Assumption for UE beams <sup>Note 7</sup>		Config 1,2,3,4,5,6	N/A		Rough	
NR RF Channel Number		Config 1,2,3,4,5,6	1		2	
Duplex mode		Config 1,4	FDD		TDD	
		Config 2,3,5,6	TDD		TDD	
BW <sub>channel</sub>	MHz	Config 1,4	10: N <sub>RB,c</sub> = 52		100: N <sub>RB,c</sub> = 66	
		Config 2,5	10: N <sub>RB,c</sub> = 52		100: N <sub>RB,c</sub> = 66	
		Config 3,6	40: N <sub>RB,c</sub> = 106		100: N <sub>RB,c</sub> = 66	
BWP BW	MHz	Config 1,4	10: N <sub>RB,c</sub> = 52		100: N <sub>RB,c</sub> = 66	
		Config 2,5	10: N <sub>RB,c</sub> = 52		100: N <sub>RB,c</sub> = 66	
		Config 3,6	40: N <sub>RB,c</sub> = 106		100: N <sub>RB,c</sub> = 66	
Data RBs allocated		Config 1,4	52		66	
		Config 2,5	52		66	
		Config 3,6	106		66	
OCNG Patterns defined in A.3.2.1.1 (OP.1)		Config 1,2,3,4,5,6	OP.1		OP.1	
PDSCH Reference measurement channel		Config 1,4	SR.1.1 FDD		-	
		Config 2,5	SR.1.1 TDD			
		Config 3,6	SR2.1 TDD			
RMSI CORESET Reference Channel		Config 1,4	CR.1.1 FDD		-	
		Config 2,5	CR.1.1 TDD			
		Config 3,6	CR2.1 TDD			
Dedicated CORESET Reference Channel		Config 1,4	CCR.1.1 FDD		-	
		Config 2,5	CCR.1.1 TDD			
		Config 3,6	CCR.2.1 TDD			
TDD configuration		Config 2,5	TDDConf.1.1		TDDConf.3.1	
		Config 3,6	TDDConf.2.1		TDDConf.3.1	
Initial DL BWP		Config 1,2,3,4,5,6	DLBWP.0.1		NA	
Initial UL BWP		Config 1,2,3,4,5,6	ULBWP.0.1		NA	
Dedicated DL BWP		Config 1,2,3,4,5,6	DLBWP.1.1		NA	
Dedicated UL BWP		Config 1,2,3,4,5,6	ULBWP.1.1		NA	
SMTc configuration defined in A.3.11		Config 1,4	SMTc.2		SMTc.2	

		Config 2,3,5,6	SMTC.1	SMTC.1
PDSCH/PDCCH subcarrier spacing	kHz	Config 1,2,4,5	15	120
		Config 3,6	30	120
EPRE ratio of PSS to SSS		Config 1,2,3,4,5,6	0	0
EPRE ratio of PBCH DMRS to SSS				
EPRE ratio of PBCH to PBCH DMRS				
EPRE ratio of PDCCH DMRS to SSS				
EPRE ratio of PDCCH to PDCCH DMRS				
EPRE ratio of PDSCH DMRS to SSS				
EPRE ratio of PDSCH to PDSCH				
EPRE ratio of OCNG DMRS to SSS(Note 1)				
EPRE ratio of OCNG to OCNG DMRS (Note 1)				
$N_{oc}$ <sup>Note2</sup>	dBm/15 kHz Note5			
$N_{oc}$ <sup>Note2</sup>	dBm/S CS Note4	Config 1,2,4,5	-95.7	
		Config 3,6	-95.7	
SSB_RP <sup>Note 3</sup>	dBm/S CS Note5	Config 1,2,4,5	-Infinity	-86.7
		Config 3,6	-Infinity	-86.7
$\hat{E}_s / I_{ot}$	dB	Config 1,2,3,4,5,6	-Infinity	9
$\hat{E}_s / N_{oc}$	dB	Config 1,2,3,4,5,6	-Infinity	9
$I_o$ <sup>Note3</sup>	dBm/9.36MHz	Config 1,2,4,5	-	-
	dBm/38.16MHz	Config 3,6	-	-
	dBm/95.04 MHz Note5	Config 1,2,3,4,5,6	-66.7	-57.2
Propagation Condition		Config 1,2,3,4,5,6	AWGN	
<p>Note 1: OCNG shall be used such that both cells are fully allocated and a constant total transmitted power spectral density is achieved for all OFDM symbols.</p> <p>Note 2: Interference from other cells and noise sources not specified in the test is assumed to be constant over subcarriers and time and shall be modelled as AWGN of appropriate power for <math>N_{oc}</math> to be fulfilled.</p> <p>Note 3: SSB_RP and <math>I_o</math> levels have been derived from other parameters for information purposes. They are not settable parameters themselves.</p> <p>Note 4: SSB_RP minimum requirements are specified assuming independent interference and noise at each receiver antenna port.</p> <p>Note 5: Equivalent power received by an antenna with 0dBi gain at the centre of the quiet zone</p> <p>Note 6: As observed with 0dBi gain antenna at the centre of the quiet zone</p> <p>Note 7: Information about types of UE beam is given in B.2.1.3, and does not limit UE implementation or test system implementation</p>				

### A.5.6.2.8.2 Test Requirements

In test 1 with per-UE gap and in test 3 with per-FR gap, the UE shall send one Event A4 triggered measurement report, with a measurement reporting delay less than X1 ms from the beginning of time period T2, where X1 is

10080 for UE supporting power class 1, or

6240 for UE supporting other power class.

In test 2 with per-UE gap and in test 4 with per-FR gap, the UE shall send one Event A4 triggered measurement report, with a measurement reporting delay less than X2 ms from the beginning of time period T2, where X2 is

107520 for UE supporting power class 1, or

66560 for UE supporting other power class.

In test 1, 2, 3 and 4 UE is required to report SSB time index. The UE shall not send event triggered measurement reports, as long as the reporting criteria are not fulfilled. The rate of correct events observed during repeated tests shall be at least 90%.

NOTE: The actual overall delays measured in the test may be up to  $2 \times TTI_{DCCH}$  higher than the measurement reporting delays above because of TTI insertion uncertainty of the measurement report in DCCH.

## A.5.6.3 L1-RSRP measurement for beam reporting

### A.5.6.3.1 SSB based L1-RSRP measurement when DRX is not used

#### A.5.6.3.1.1 Test Purpose and Environment

The purpose of this test is to verify that the UE makes correct reporting of L1-RSRP measurement. This test will partly verify the L1-RSRP measurement requirements in clause 9.5.4.1, with the testing configurations for NR cells in Table A.5.6.3.1.1-1.

The AoA setup for this test is Setup 1 as defined in clause A.3.15

**Table A.5.6.3.1.1-1: Applicable NR configurations for FR2 SSB based L1-RSRP test**

Config	Description
1	LTE FDD, NR 120 kHz SSB SCS, 100 MHz bandwidth, TDD duplex mode
2	LTE TDD, NR 120 kHz SSB SCS, 100 MHz bandwidth, TDD duplex mode
3	LTE FDD, NR 240 kHz SSB SCS, 100 MHz bandwidth, TDD duplex mode
4	LTE TDD, NR 240 kHz SSB SCS, 100 MHz bandwidth, TDD duplex mode

Note: The UE is only required to be tested in one of the supported test configurations

#### A.5.6.3.1.2 Test parameters

There are two cells in the test, E-UTRAN PCell (Cell 1) and FR1 PSCell (Cell 2). The test parameters and applicability for Cell 1 are defined in A.3.7.2. The test parameters for the Cell 2 are given in Table A.5.6.3.1.2-1 and Table A.5.6.3.1.2-2 below.

In CSI measurement configuration, UE is indicated to perform L1-RSRP measurement on the SSBs and report periodically. The test consists of two successive time periods, with time duration of T1 and T2 respectively. The test has higher layer parameter *timeRestrictionForChannelMeasurements* configured.

There is no measurement gap configured in the test. Before the test, UE is configured to perform RLM, BFD and L1-RSRP measurement based on the SSBs.

**Table A.5.6.3.1.2-1: General test parameters**

Parameter	Config	Unit	Value
SSB GSCN	1~4		freq1
Duplex mode	1~4		TDD
TDD Configuration	1~4		TDDConf.3.1
BW <sub>channel</sub>	1~4	MHz	100: N <sub>RB,c</sub> = 66

Data RBs allocated	1~4		66			
PDSCH Reference measurement channel	1,2		SR.3.2 TDD			
	3,4		SR.3.3 TDD			
RMSI CORESET Reference Channel	1,2		CR.3.1 TDD			
	3,4		CR.3.2 TDD			
Dedicated CORESET Reference Channel	1,2		CCR.3.1 TDD			
	3,4		CCR.3.7 TDD			
SSB configuration	1,2		SSB.1 FR2			
	3,4		SSB.2 FR2			
OCNG Patterns	1~4		OP.1			
Initial BWP Configuration	1~4		DLBWP.0.1 ULBWP.0.1			
Dedicated BWP configuration	1~4		DLBWP.1.3 ULBWP.1.3			
SMTC configuration	1~4		SMTC.1			
TRS Configuration	1~4		TRS.2.1 TDD			
PDCCH/PDSCH TCI Configuration	1~4		TCI.State.2			
DRX configuration	1~4		Off			
reportConfigType	1~4		periodic			
reportQuantity	1~4		ssb-Index-RSRP			
Number of reported RS	1~4		2			
L1-RSRP reporting period	1~4	slot	320			
T1	1~4	s	5			
T2	1~4	s	2			
EPRE ratio of PSS to SSS	1~4	dB	0			
EPRE ratio of PBCH DMRS to SSS						
EPRE ratio of PBCH to PBCH DMRS						
EPRE ratio of PDCCH DMRS to SSS						
EPRE ratio of PDCCH to PDCCH DMRS						
EPRE ratio of PDSCH DMRS to SSS						
EPRE ratio of PDSCH to PDSCH DMRS						
EPRE ratio of OCNG DMRS to SSS <sup>Note 1</sup>						
EPRE ratio of OCNG to OCNG DMRS <sup>Note 1</sup>						
Propagation condition				1~4		AWGN
Note 1: OCNG shall be used such that both cells are fully allocated and a constant total transmitted power spectral density is achieved for all OFDM symbols.						

**Table A.5.6.3.1.2-2: SSB specific test parameters**

Parameter	Config	Unit	SSB#0		SSB#1	
			T1	T2	T1	T2
Angle of arrival configuration			Setup 1 according to A.3.15.1			
Assumption for UE beams <sup>Note 4</sup>	1~4		Rough			
$N_{oc}$ <sup>Note2</sup>	1~4	dBm/15kHz	-105			
$N_{oc}$ <sup>Note2</sup>	1,2	dBm/SSB SCS	-96			
	3,4		-93			
$\hat{E}_s/I_{ot}$	1~4	dB	0	0	-Infinity	9

SSB RSRP <sup>Note3</sup>	1,2	dBm/SSB SCS	-96	-96	-Infinity	-87
	3,4		-93	-93	-Infinity	-84
I <sub>0</sub> <sup>Note3</sup>	1,2	dBm/95.04MHz	-63.97	-63.97	-66.98	-57.47
	3,4		-63.97	-63.97	-66.98	-57.47
$\hat{E}_s / N_{oc}$	1~4	dB	0	0	-Infinity	9
<p>Note 1: The resources for uplink transmission are assigned to the UE prior to the start of time period T2.</p> <p>Note 2: Interference from other cells and noise sources not specified in the test is assumed to be constant over subcarriers and time and shall be modelled as AWGN of appropriate power for <math>N_{oc}</math> to be fulfilled.</p> <p>Note 3: SSB_RP and I<sub>0</sub> levels have been derived from other parameters for information purposes. They are not settable parameters themselves.</p> <p>Note 4: Information about types of UE beam is given in B.2.1.3, and does not limit UE implementation or test system implementation</p>						

### A.5.6.3.1.3 Test Requirements

The UE shall send L1-RSRP report every 320 slots. No later than X ms plus 320 slots from the beginning of time period T2, UE shall send L1-RSRP report including the results for both SSB#0 and SSB#1 while meeting the accuracy requirements defined in clause 10.1.20.1, where X is

- 1680 for UE supporting power class 1
- 1200 for UE supporting power class 2,3 or 4.

The reported L1-RSRP value shall include the Rx antenna gain in the range of -10 to +20 dB.

The rate of correct events observed during repeated tests shall be at least 90%.

### A.5.6.3.2 SSB based L1-RSRP measurement when DRX is used

#### A.5.6.3.2.1 Test Purpose and Environment

The purpose of this test is to verify that the UE makes correct reporting of L1-RSRP measurement. This test will partly verify the L1-RSRP measurement requirements in clause 9.5.4.1, with the testing configurations for NR cells in Table A.5.6.3.2.1-1.

The AoA setup for this test is Setup 1 as defined in clause A.3.15

**Table A.5.6.3.2.1-1: Applicable NR configurations for FR2 SSB based L1-RSRP test**

Config	Description
1	LTE FDD, NR 120 kHz SSB SCS, 100 MHz bandwidth, TDD duplex mode
2	LTE TDD, NR 120 kHz SSB SCS, 100 MHz bandwidth, TDD duplex mode
3	LTE FDD, NR 240 kHz SSB SCS, 100 MHz bandwidth, TDD duplex mode
4	LTE TDD, NR 240 kHz SSB SCS, 100 MHz bandwidth, TDD duplex mode
Note:	The UE is only required to be tested in one of the supported test configurations

#### A.5.6.3.2.2 Test parameters

There are two cells in the test, E-UTRAN PCell (Cell 1) and FR2 PCell (Cell 2). The test parameters and applicability for Cell 1 are defined in A.3.7.2. The test parameters for the Cell 2 are given in Table A.5.6.3.2.2-1 and Table A.5.6.3.2.2-2 below.

In CSI measurement configuration, UE is indicated to perform L1-RSRP measurement on the SSBs and report periodically. The test consists of two successive time periods, with time duration of T1 and T2 respectively. The test has higher layer parameter *timeRestrictionForChannelMeasurements* configured.

There is no measurement gap configured in the test. Before the test, UE is configured to perform RLM, BFD and L1-RSRP measurement based on the SSBs.

**Table A.5.6.3.2.2-1: General test parameters**

Parameter	Config	Unit	Value
SSB GSCN	1~4		freq1
Duplex mode	1~4		TDD
TDD Configuration	1~4		TDDConf.3.1
BW <sub>channel</sub>	1~4	MHz	100: N <sub>RB,c</sub> = 66
Data RBs allocated	1~4		66
PDSCH Reference measurement channel	1,2		SR.3.2 TDD
	3,4		SR.3.3 TDD
RMSI CORESET Reference Channel	1,2		CR.3.1 TDD
	3,4		CR.3.2 TDD
Dedicated CORESET Reference Channel	1,2		CCR.3.1 TDD
	3,4		CCR.3.7 TDD
SSB configuration	1,2		SSB.1 FR2
	3,4		SSB.2 FR2
OCNG Patterns	1~4		OP.1
Initial BWP Configuration	1~4		DLBWP.0.1 ULBWP.0.1
Dedicated BWP configuration	1~4		DLBWP.1.3 ULBWP.1.3
SMTC configuration	1~4		SMTC.1
TRS Configuration	1~4		TRS.2.1 TDD
PDCCH/PDSCH TCI Configuration	1~4		TCI.State.2
DRX configuration	1~4		DRX.3
reportConfigType	1~4		periodic
reportQuantity	1~4		ssb-Index-RSRP
Number of reported RS	1~4		2
L1-RSRP reporting period	1~4	slot	320
T1	1~4	s	5
T2	1~4	s	3
EPRE ratio of PSS to SSS	1~4	dB	0
EPRE ratio of PBCH DMRS to SSS			
EPRE ratio of PBCH to PBCH DMRS			
EPRE ratio of PDCCH DMRS to SSS			
EPRE ratio of PDCCH to PDCCH DMRS			
EPRE ratio of PDSCH DMRS to SSS			
EPRE ratio of PDSCH to PDSCH DMRS			
EPRE ratio of OCNG DMRS to SSS <sup>Note 1</sup>			
EPRE ratio of OCNG to OCNG DMRS <sup>Note 1</sup>			
Propagation condition			
Note 1: OCNG shall be used such that both cells are fully allocated and a constant total transmitted power spectral density is achieved for all OFDM symbols.			

**Table A.5.6.3.2.2-2: SSB specific test parameters**

Parameter	Config	Unit	SSB#0		SSB#1	
			T1	T2	T1	T2

Angle of arrival configuration			Setup 1 according to A.3.15.1			
Assumption for UE beams <sup>Note 4</sup>	1~4		Rough			
$N_{oc}$ <sup>Note2</sup>	1~4	dBm/15kHz	-105			
$N_{oc}$ <sup>Note2</sup>	1,2	dBm/SSB SCS	-96			
	3,4		-93			
$\hat{E}_s / I_{ot}$	1~4	dB	0	0	-Infinity	9
SSB RSRP <sup>Note3</sup>	1,2	dBm/SSB SCS	-96	-96	-Infinity	-87
	3,4		-93	-93	-Infinity	-84
$I_o$ <sup>Note3</sup>	1,2	dBm/95.04MHz	-63.97	-63.97	-66.98	-57.47
	3,4		-63.97	-63.97	-66.98	-57.47
$\hat{E}_s / N_{oc}$	1~4	dB	0	0	-Infinity	9
<p>Note 1: The resources for uplink transmission are assigned to the UE prior to the start of time period T2.</p> <p>Note 2: Interference from other cells and noise sources not specified in the test is assumed to be constant over subcarriers and time and shall be modelled as AWGN of appropriate power for <math>N_{oc}</math> to be fulfilled.</p> <p>Note 3: SSB_RP and <math>I_o</math> levels have been derived from other parameters for information purposes. They are not settable parameters themselves.</p> <p>Note 4: Information about types of UE beam is given in B.2.1.3, and does not limit UE implementation or test system implementation.</p>						

**A.5.6.3.2.3 Test Requirements**

The UE shall send L1-RSRP report every 320 slots. No later than X ms plus 320 slots from the beginning of time period T2, UE shall send L1-RSRP report including the results for both SSB#0 and SSB#1 while meeting the accuracy requirements defined in clause 10.1.20.1, where X is

- 2880 for UE supporting power class 1
- 1920 for UE supporting power class 2,3 or 4.

The reported L1-RSRP value shall include the Rx antenna gain in the range of -10 to +20 dB.

The rate of correct events observed during repeated tests shall be at least 90%.

**A.5.6.3.3 CSI-RS based L1-RSRP measurement when DRX is not used**

**A.5.6.3.3.1 Test Purpose and Environment**

The purpose of this test is to verify that the UE makes correct reporting of L1-RSRP measurement. This test will partly verify the L1-RSRP measurement requirements in clause 9.5.4.2, with the testing configurations for NR cells in Table A.5.6.3.3.1-1.

**Table A.5.6.3.3.1-1: Applicable NR configurations for FR2 CSI-RS based L1-RSRP test**

Config	Description
1	LTE FDD, NR 120 kHz SSB SCS, 100 MHz bandwidth, TDD duplex mode
2	LTE TDD, NR 120 kHz SSB SCS, 100 MHz bandwidth, TDD duplex mode
Note: The UE is only required to be tested in one of the supported test configurations	



### A.5.6.3.3.2 Test parameters

There are two cells in the test, E-UTRAN PCell (Cell 1) and FR1 PSCell (Cell 2). The test parameters and applicability for Cell 1 are defined in A.3.7.2. The test parameters for the Cell 2 are given in Table A.5.6.3.3.2-1 and Table A.5.6.3.3.2-2 below.

In CSI measurement configuration, UE is indicated to perform L1-RSRP measurement on the CSI-RS and report aperiodically. The test consists of a single time period T1, during which the UE is triggered via DCI to report L1-RSRP on aperiodic CSI-RS resources. UE is also configured to measure L1-RSRP based on SSB. After 480ms from the beginning of the test, the DCI trigger comes in slot 1 of a frame and UE provides the report back based on the reporting configuration as defined in Table A.5.6.3.3.2-1.

There is no measurement gap configured in the test. Before the test, UE is configured to perform RLM and BFD based on the SSBs.

**Table A.5.6.3.3.2-1: General test parameters**

Parameter	Config	Unit	Value
SSB GSCN	1~2		freq1
Duplex mode	1~2		TDD
TDD Configuration	1~2		TDDConf.3.1
BW <sub>channel</sub>	1~2	MHz	100: N <sub>RB,C</sub> = 66
Data RBs allocated	1~2		66
PDSCH Reference measurement channel	1~2		SR.3.3 TDD
RMSI CORESET Reference Channel	1~2		CR.3.2 TDD
Dedicated CORESET Reference Channel	1~2		CCR.3.7 TDD
SSB configuration	1~2		SSB.1 FR2
CSI-RS configuration	1~2		CSI-RS.3.3 TDD
OCNG Patterns	1~2		OP.1
Initial BWP Configuration	1~2		DLBWP.0.1 ULBWP.0.1
Dedicated BWP configuration	1~2		DLBWP.1.1 ULBWP.1.1
SMTc configuration	1~2		SMTc.1
TRS Configuration	1~2		TRS.2.1 TDD
PDCCH/PDSCH TCI Configuration	1~2		TCI.State.2
DRX configuration	1~2		Off
reportConfigType	1~2		aperiodic
reportQuantity	1~2		cri-RSRP
Number of reported RS	1~2		2
qcl-Info	1~2		SSB#0 for resource#0 SSB#1 for resource#1
reportSlotOffsetList	1~2		8
Propagation condition	1~2		AWGN
T1	1~2	s	5
EPRE ratio of PSS to SSS	1~2	dB	0
EPRE ratio of PBCH DMRS to SSS			
EPRE ratio of PBCH to PBCH DMRS			
EPRE ratio of PDCCH DMRS to SSS			
EPRE ratio of PDCCH to PDCCH DMRS			
EPRE ratio of PDSCH DMRS to SSS			
EPRE ratio of PDSCH to PDSCH DMRS			
EPRE ratio of OCNG DMRS to SSS <sup>Note 1</sup>			
EPRE ratio of OCNG to OCNG DMRS <sup>Note 1</sup>			

Note 1: OCNG shall be used such that both cells are fully allocated and a constant total transmitted power spectral density is achieved for all OFDM symbols.

**Table A.5.6.3.3.2-1: CSI-RS specific test parameters**

Parameter	Config	Unit	CSI-RS#0	CSI-RS#1
Angle of arrival configuration	1~2		Setup 1 according to A.3.15.1	
Assumption for UE beams <sup>Note 4</sup>	1~2		Rough	
$N_{oc}$ <sup>Note1</sup>	1~2	dBm/15kHz	-105	
$N_{oc}$ <sup>Note1</sup>	1~2	dBm/SSB SCS	-95.97	
$\hat{E}_s / I_{ot}$	1~2	dB	0	9
CSI-RS RSRP <sup>Note2</sup>	1~2	dBm/SSB SCS	-95.97	-86.97
$I_o$ <sup>Note2</sup>	1~2	dBm/95.04MHz	-63.97	-57.47
$\hat{E}_s / N_{oc}$	1~2	dB	0	9
<p>Note 2: Interference from other cells and noise sources not specified in the test is assumed to be constant over subcarriers and time and shall be modelled as AWGN of appropriate power for <math>N_{oc}</math> to be fulfilled.</p> <p>Note 3: CSI-RS RSRP and <math>I_o</math> levels have been derived from other parameters for information purposes. They are not settable parameters themselves.</p> <p>Note 4: Information about types of UE beam is given in B.2.1.3, and does not limit UE implementation or test system implementation</p>				

### A.5.6.3.3.3 Test Requirements

After 480ms from the beginning of the test, the UE shall send L1-RSRP report at slot 8 from the reception of DCI triggering the L1-RSRP measurement. The L1-RSRP report shall include the results for both CSI-RS#0 and CSI-RS#1 while meeting the accuracy requirements defined in clause 10.1.20.1. The reported L1-RSRP value shall include the Rx antenna gain in the range of -10 to +20 dB.

For absolute accuracy of CSI-RS0 and absolute accuracy of CSI-RS1, the UE is deemed to meet the requirement if the reported L1-RSRP is in the range shown in Table A.5.6.3.3.3-1.

For relative accuracy of CSI-RS0 compared with CSI-RS1, the UE is deemed to meet the requirement if the difference in reported L1-RSRP meets the requirements in Table 10.1.20.2.2-1.

**Table A.5.6.3.3.3-1: L1-RSRP absolute accuracy test requirement**

	Test requirement <sup>Notes1,2,3</sup>
CSI-RS0	$CSI-RS\_RP0 - \delta + G_{min} \leq \text{Reported RSRP(dBm)} \leq CSI-RS\_RP0 + \delta + G_{max}$
CSI-RS1	$CSI-RS\_RP1 - \delta + G_{min} \leq \text{Reported RSRP(dBm)} \leq CSI-RS\_RP1 + \delta + G_{max}$
Note 1:	CSI-RS_RPn is the equivalent power received by an antenna with 0dBi gain at the centre of the quiet zone configured in the test for the CSI-RS n under consideration
Note 2:	$\delta$ is the RSRP absolute accuracy requirement from Table 10.1.20.2.1-1, selected according to the $I_o$ used in the test
Note 3:	$G_{min}$ and $G_{max}$ are the minimum and maximum UE gain values from Table B.2.1.5.1-1, selected according to the UE power class

### A.5.6.3.4 CSI-RS based L1-RSRP measurement when DRX is used

#### A.5.6.3.4.1 Test Purpose and Environment

The purpose of this test is to verify that the UE makes correct reporting of L1-RSRP measurement. This test will partly verify the L1-RSRP measurement requirements in clause 9.5.4.2, with the testing configurations for NR cells in Table A.5.6.3.4.1-1.

**Table A.5.6.3.4.1-1: Applicable NR configurations for FR2 CSI-RS based L1-RSRP test**

Config	Description
1	LTE FDD, NR 120 kHz SSB SCS, 100 MHz bandwidth, TDD duplex mode
2	LTE TDD, NR 120 kHz SSB SCS, 100 MHz bandwidth, TDD duplex mode
Note: The UE is only required to be tested in one of the supported test configurations	

#### A.5.6.3.4.2 Test parameters

There are two cells in the test, E-UTRAN PCell (Cell 1) and FR1 PSCell (Cell 2). The test parameters and applicability for Cell 1 are defined in A.3.7.2. The test parameters for the Cell 2 are given in Table A.5.6.3.4.2-1 and Table A.5.6.3.4.2-2 below.

In CSI measurement configuration, UE is indicated to perform L1-RSRP measurement on the CSI-RS and report aperiodically. The test consists of a single time period T1, during which the UE is triggered via DCI to report L1-RSRP on aperiodic CSI-RS resources. UE is also configured to measure L1-RSRP based on SSB. After 1440ms from the beginning of the test, the DCI trigger comes in slot 1 of a frame and UE provides the report back based on the reporting configuration as defined in Table A.5.6.3.4.2-1.

There is no measurement gap configured in the test. Before the test, UE is configured to perform RLM and BFD based on the SSBs.

**Table A.5.6.3.4.2-1: General test parameters**

Parameter	Config	Unit	Value
SSB GSCN	1~2		freq1
Duplex mode	1~2		TDD
TDD Configuration	1~2		TDDConf.3.1
BW <sub>channel</sub>	1~2	MHz	100: N <sub>RB,c</sub> = 66
Data RBs allocated	1~2		66
PDSCH Reference measurement channel	1~2		SR.3.3 TDD
RMSI CORESET Reference Channel	1~2		CR.3.2 TDD
Dedicated CORESET Reference Channel	1~2		CCR.3.7 TDD
SSB configuration	1~2		SSB.1 FR2
CSI-RS configuration	1~2		CSI-RS.3.3 TDD
OCNG Patterns	1~2		OP.1
Initial BWP Configuration	1~2		DLBWP.0.1 ULBWP.0.1
Dedicated BWP configuration	1~2		DLBWP.1.1 ULBWP.1.1
SMTc configuration	1~2		SMTc.1
TRS Configuration	1~2		TRS.2.1 TDD
PDCCH/PDSCH TCI Configuration	1~2		TCI.State.2
DRX configuration	1~2		DRX.3
reportConfigType	1~2		aperiodic
reportQuantity	1~2		cri-RSRP
Number of reported RS	1~2		2
qcl-Info	1~2		SSB#0 for resource#0 SSB#1 for resource#1
reportSlotOffsetList	1~2		8
Propagation condition	1~2		AWGN
T1	1~2	s	5
EPRE ratio of PSS to SSS	1~2	dB	0
EPRE ratio of PBCH DMRS to SSS			
EPRE ratio of PBCH to PBCH DMRS			
EPRE ratio of PDCCH DMRS to SSS			
EPRE ratio of PDCCH to PDCCH DMRS			

EPRE ratio of PDSCH DMRS to SSS			
EPRE ratio of PDSCH to PDSCH DMRS			
EPRE ratio of OCNG DMRS to SSS <sup>Note 1</sup>			
EPRE ratio of OCNG to OCNG DMRS <sup>Note 1</sup>			
Note 1: OCNG shall be used such that both cells are fully allocated and a constant total transmitted power spectral density is achieved for all OFDM symbols.			

**Table A.5.6.3.4.2-1: CSI-RS specific test parameters**

Parameter	Config	Unit	CSI-RS#0	CSI-RS#1
Angle of arrival configuration	1~2		Setup 1 according to A.3.15.1	
Assumption for UE beams <sup>Note 4</sup>	1~2		Rough	
$N_{oc}$ <sup>Note1</sup>	1~2	dBm/15kHz	-105	
$N_{oc}$ <sup>Note1</sup>	1~2	dBm/SSB SCS	-95.97	
$\hat{E}_s / I_{ot}$	1~2	dB	0	9
CSI-RS RSRP <sup>Note2</sup>	1~2	dBm/SSB SCS	-95.97	-86.97
$I_o$ <sup>Note2</sup>	1~2	dBm/95.04MHz	-63.97	-57.47
$\hat{E}_s / N_{oc}$	1~2	dB	0	9
<p>Note 2: Interference from other cells and noise sources not specified in the test is assumed to be constant over subcarriers and time and shall be modelled as AWGN of appropriate power for <math>N_{oc}</math> to be fulfilled.</p> <p>Note 3: CSI-RS RSRP and <math>I_o</math> levels have been derived from other parameters for information purposes. They are not settable parameters themselves.</p> <p>Note 4: Information about types of UE beam is given in B.2.1.3, and does not limit UE implementation or test system implementation</p>				

**A.5.6.3.4.3 Test Requirements**

After 1440ms from the beginning of the test, the UE shall send L1-RSRP report at slot 8 from the reception of DCI triggering the L1-RSRP measurement. The L1-RSRP report shall include the results for both CSI-RS#0 and CSI-RS#1 while meeting the accuracy requirements defined in clause 10.1.20.1. The reported L1-RSRP value shall include the Rx antenna gain in the range of [-10 ~ +20] dB.

For absolute accuracy of CSI-RS0 and absolute accuracy of CSI-RS1, the UE is deemed to meet the requirement if the reported L1-RSRP is in the range shown in Table A.5.6.3.4.3-1.

For relative accuracy of CSI-RS0 compared with CSI-RS1, the UE is deemed to meet the requirement if the difference in reported L1-RSRP meets the requirements in Table 10.1.20.2.2-1.

**Table A.5.6.3.4.3-1: L1-RSRP absolute accuracy test requirement**

	Test requirement <sup>Notes1,2,3</sup>
CSI-RS0	$CSI-RS\_RP0 - \delta + G_{min} \leq \text{Reported RSRP(dBm)} \leq CSI-RS\_RP0 + \delta + G_{max}$
CSI-RS1	$CSI-RS\_RP1 - \delta + G_{min} \leq \text{Reported RSRP(dBm)} \leq CSI-RS\_RP1 + \delta + G_{max}$
<p>Note 1: CSI-RS_RPn is the equivalent power received by an antenna with 0dBi gain at the centre of the quiet zone configured in the test for the CSI-RS n under consideration</p> <p>Note 2: <math>\delta</math> is the RSRP absolute accuracy requirement from Table 10.1.20.2.1-1, selected according to the <math>I_o</math> used in the test</p> <p>Note 3: <math>G_{min}</math> and <math>G_{max}</math> are the minimum and maximum UE gain values from Table B.2.1.5.1-1, selected according to the UE power class</p>	

## A.5.6.4 CLI measurements

### A.5.6.4.1 SRS-RSRP measurement with DRX

#### A.5.6.4.1.1 Test Purpose and Environment

The purpose of this test is to verify that the UE makes correct reporting of SRS-RSRP measurement. This test will verify the SRS-RSRP measurement requirements in clause 9.7.2.5 with the testing configurations for NR cells in Table A.5.6.4.1.1-1.

**Table A.5.6.4.1.1-1: Applicable NR configurations for FR2 SRS-RSRP test**

Configuration	Description
1	NR 120 kHz SRS SCS, 100 MHz bandwidth, TDD duplex mode

#### A.5.6.4.1.2 Test Parameters

Two cells are deployed in the test, which are E-UTRAN PCell (Cell 1) and FR2 PSCell (Cell 2). The test parameters for PSCell is given in Table A.5.6.4.1.2-1 ~ A.5.6.4.1.2-3 below and applicability for the E-UTRAN cell are defined in A.3.7.2. In the measurement control information, a measurement object is configured for the frequency of the PSCell, and it is indicated to the UE that event-triggered reporting with Event I1 is used. The test consists of two successive time periods, with time duration of T1 and T2, respectively.

During the test, the test system transmits SRS resource for measurement in the DL slot according to the SRS configuration in Table A.5.6.4.1.2-4 and the test parameters for the (virtual) neighbour cell UE in Table A.5.6.4.1.2-3. During the test, the test system does not transmit PDCCH/PDSCH/OCNG on SRS symbol to be transmitted and on 2 data symbols before SRS to be transmitted.

**Table A.5.6.4.1.2-1: General test parameters for SRS-RSRP event triggered reporting for PSCell in FR2**

Parameter	Unit	Test configuration	Value	Comment
Active cell		1	E-UTRAN Cell 1 and NR Cell 2	
RF Channel Number		1	1: Cell 1 2: Cell 2	
SSB configuration		1	SSB.1 FR2	
SMTC configuration		1	SMTC.1	
SRS configuration		1	SRSCnf.1	Table A.5.6.4.1.2-4
CP length		1	Normal	
i1-Threshold	dBm	1	-103	
Hysteresis	dB	1	0	
Time To Trigger	s	1	0	
Filter coefficient		1	0	L3 filtering is not used
DRX	ms	1	DRX.11	
Time offset between DL from serving cell and SRS from test system	µs	1,2	10.67	
T1	s	1	5	
T2	s	1	1	

**Table A.5.6.4.1.2-2: NR Cell specific test parameters for SRS-RSRP event triggered reporting for PSCell in FR2**

Parameter	Unit	Test configuration	Cell 2	
			T1	T2
TDD configuration		1	TDDConf.3.1	
PDSCH RMC configuration		1	SR.3.1 TDD	

RMSI CORESET RMC configuration		1	CR.3.1 TDD
Dedicated CORESET RMC configuration		1	CCR.3.1 TDD
OCNG Patterns		1	OP.1
TRS configuration			TRS.2.1. TDD
PDSCH/PDCCH TCI state		1	TCI.State.2
Initial BWP configuration		1	DLBWP.0.1 ULBWP.0.1
Active DL BWP configuration		1	DLBWP.1.1
Active UL BWP configuration		1	ULBWP.1.1
Propagation Condition		1	AWGN

**Table A.5.6.4.1.2-3: NR OTA Cell specific test parameters for SRS-RSRP event triggered reporting for PSCell and Neighbour cell UE in FR2**

Parameter	Unit	Test configuration	Cell 2		Neighbour cell UE	
			T1	T2	T1	T2
AoA setup		1	Setup 1 defined A.3.15.1			
Beam assumption Note 4		1	Fine			
$N_{oc}$ Note 2	dBm/15 kHz	1	-98		-98	
$N_{oc}$ Note 2	dBm/SCS	1	-89		-89	
$\hat{E}_s / I_{ot}$	dB	1	-	-	-infinity	4
$\hat{E}_s / N_{oc}$	dB	1	4	4	-infinity	4
SRS-RSRP Note 3	dBm/SCS kHz	1	-	-	-infinity	-94
$I_o$	dBm/95.04 MHz	1	-61.36	-55.91	-70.01	-68.82
<p>Note 1: The resources for uplink transmission are assigned to the UE prior to the start of time period T2.</p> <p>Note 2: Interference from other cells and noise sources not specified in the test is assumed to be constant over subcarriers and time and shall be modelled as AWGN of appropriate power for <math>N_{oc}</math> to be fulfilled.</p> <p>Note 3: SRS-RSRP levels have been derived from other parameters for information purposes. They are not settable parameters themselves.</p> <p>Note 4: Information about types of UE beam is given in B.2.1.3, and does not limit UE implementation or test system implementation</p> <p>Note 5: Cell 2 doesn't transmit during the SRS and the 2 previous symbols. Es/NoC is not applied to those symbols.</p>						

**Table A.5.6.4.1.2-4: SRS configuration for measurement reporting**

	Field	SRSConf.1	Comments
SRS-ResourceSet	srs-ResourceSetId	0	
	srs-ResourceIdList	0	
	resourceType	Periodic	
	Usage	Codebook	
SRS-Resource	SRS-ResourceId	0	
	nrofSRS-Ports	Port1	
	transmissionComb	n2	
	combOffset-n2	0	
	cyclicShift-n2	0	
	resourceMapping startPosition	0	
resourceMapping	n1		

nrofSymbols		
resourceMapping repetitionFactor	n1	
freqDomainPosition	0	
freqDomainShift	0	
freqHopping c-SRS	12	
freqHopping b-SRS	0	
freqHopping b-hop	0	
groupOrSequenceHopping	Neither	
resourceType	Periodic	
periodicityAndOffset	sl160, 25	
sequenceId	0	Any 10 bit number

#### A.5.6.4.1.3 Test Requirements

The UE shall send one Event I1 triggered measurement report, with a measurement reporting delay less than 60 ms from the beginning of time period T2.

The UE shall not send event triggered measurement reports, as long as the reporting criteria are not fulfilled.

The rate of correct events observed during repeated tests shall be at least 90%.

NOTE: The actual overall delays measured in the test may be up to  $2 \times TTI_{DCCH}$  higher than the measurement reporting delays above because of TTI insertion uncertainty of the measurement report in DCCH.

#### A.5.6.4.2 CLI-RSSI measurement with DRX

##### A.5.6.4.2.1 Test Purpose and Environment

The purpose of this test is to verify that the UE makes correct reporting of CLI-RSSI measurement. This test will verify the CLI-RSSI measurement requirements in clause 9.7.3.5 with the testing configurations for NR cells in Table A.5.6.4.2.1-1.

**Table A.5.6.4.2.1-1: Applicable NR configurations for FR2 CLI-RSSI test**

Configuration	Description
1	NR 120 kHz SCS, 100 MHz bandwidth, TDD duplex mode

##### A.5.6.4.2.2 Test Parameters

Two cells are deployed in the test, which are E-UTRAN PCell (Cell 1) and FR2 PSCell (Cell 2). The test parameters for PSCell is given in Table A.5.6.4.2.2-1 ~ A.5.6.4.2.2-3 below and applicability for the E-UTRAN cell are defined in A.3.7.2. In the measurement control information, a measurement object is configured for the frequency of the PSCell, and it is indicated to the UE that event-triggered reporting with Event I1 is used. The test consists of two successive time periods, with time duration of T1 and T2, respectively.

During the test, the test system does not transmit PDCCH/PDSCH/OCNG on symbols for CLI-RSSI measurement resource and on 2 data symbols before. The CLI-RSSI measurement resource configuration is in Table A.5.6.4.2.2-4.

**Table A.5.6.4.2.2-1: General test parameters for CLI-RSSI event triggered reporting for PSCell in FR2**

Parameter	Unit	Test configuration	Value	Comment
Active cell		1	E-UTRAN Cell 1 and NR Cell 2	
RF Channel Number		1	1: Cell 1 2: Cell 2	
SSB configuration		1	SSB.1 FR2	
SMTC configuration		1	SMTC.1	
CLI-RSSI configuration		1	CLI-RSSICnf.1	Table A.5.6.4.2.2-4

CP length		1	Normal	
i1-Threshold	dBm	1	-94.5	
Hysteresis	dB	1	0	
Time To Trigger	s	1	0	
Filter coefficient		1	0	L3 filtering is not used
DRX		1	DRX.11	
Time offset between DL from serving cell and OCNG from test system	$\mu$ s	1	10.67	
T1	s	1	5	
T2	s	1	1	

**Table A.5.6.4.2.2-2: NR Cell specific test parameters for CLI-RSSI event triggered reporting for PSCell in FR2**

Parameter	Unit	Test configuration	Cell 2	
			T1	T2
TDD configuration		1	TDDConf.3.1	
PDSCH RMC configuration		1	SR.3.1 TDD	
PUSCH parameters		1	N/A	
RMSI CORESET RMC configuration		1	CR.3.1 TDD	
Dedicated CORESET RMC configuration		1	CCR.3.1 TDD	
OCNG Patterns <sup>Note 1</sup>		1	OP.1	
TRS configuration			TRS.2.1. TDD	
PDSCH/PDCCH TCI state		1	TCI.State.2	
Initial BWP configuration		1	DLBWP.0.1 ULBWP.0.1	
Active DL BWP configuration		1	DLBWP.1.1	
Active UL BWP configuration		1	ULBWP.1.1	
Propagation Condition		1	AWGN	
Note 1: OCNG is not transmitted in the CLI-RSSI measurement resources.				

**Table A.5.6.4.2.2-3: NR OTA Cell specific test parameters for CLI-RSSI event triggered reporting for PSCell in FR2**

Parameter	Unit	Test configuration	Cell 2	
			T1	T2
AoA setup		1	Setup 1 defined in A.3.15.1	
Beam assumption <sup>Note 3</sup>		1	Fine	
$N_{oc}$ on CLI-RSSI measurement resource <sup>Note 2</sup>	dBm/15 kHz	1	-119	-108
$N_{oc}$ on CLI-RSSI measurement resource <sup>Note 2</sup>	dBm/SCS	1	-110	-99
$I_o$ on CLI-RSSI measurement resource	dBm/95.04 MHz	1	-81.01	-70.01
$I_o$ on CLI-RSSI measurement resource	dBm/1.08 MHz	1	-100.46	-89.46
<p>Note 1: The resources for uplink transmission are assigned to the UE prior to the start of time period T2.</p> <p>Note 2: Interference from other cells and noise sources not specified in the test is assumed to be constant over subcarriers and time and shall be modelled as AWGN of appropriate power for <math>N_{oc}</math> to be fulfilled.</p> <p>Note 3: Information about types of UE beam is given in B.2.1.3, and does not limit UE implementation or test system implementation.</p>				



**Table A.5.6.4.2.2-4: CLI-RSSI measurement resource configuration for measurement reporting**

	Field	CLI-RSSICnf.1
RSSI-Resource	rssI-ResourceId	0
	rssI-SCS	120
	startPRB	0
	nrofPRBs	66
	startPosition	3
	nrofSymbols	11
	rssI-PeriodicityAndOffset	sl160, 25

### A.5.6.4.2.3 Test Requirements

The UE shall send one Event I1 triggered measurement report, with a measurement reporting delay less than 20 ms from the beginning of time period T2. The nominal RSSI used to evaluate the requirement shall be based on  $I_o$ .

The UE shall not send event triggered measurement reports, as long as the reporting criteria are not fulfilled.

The rate of correct events observed during repeated tests shall be at least 90%.

NOTE: The actual overall delays measured in the test may be up to  $2xTTI_{DCCH}$  higher than the measurement reporting delays above because of TTI insertion uncertainty of the measurement report in DCCH.

## A.5.6.5 Measurements with autonomous gaps

### A.5.6.5.1 EN-DC inter-frequency CGI identification of NR neighbor cell in FR2

#### A.5.6.5.1.1 Test Purpose and Environment

This test is to verify the requirement for identification of a new CGI of NR cell with autonomous gaps in clause 9.11.

In this test, there are three cells: LTE cell 1 as PCell on E-UTRA RF channel 1, NR cell 2 as PSCell in FR2 on NR RF channel 1 and NR cell 3 as neighbour cell in FR2 on NR RF channel 2. The test parameters and configurations are given in Tables A.5.6.5.1.1-1, A.5.6.5.1.1-2, and A.5.6.5.1.1-3.

The test consists of three successive time periods, with time durations of T1, T2 and T3 respectively. At the start of time duration T1, the UE does not have any timing information of cell 3. Starting T2, cell 3 becomes detectable and the UE is expected to detect and send a measurement report with SSB index. In the measurement control information, it is indicated to the UE that event-triggered reporting with Event A3 is used. Gap pattern configuration with id #0 is configured before T2 begins to enable inter-frequency monitoring.

A RRC message implying SI reading with autonomous gap shall be sent to the UE during period T2, within 3s after the UE has reported Event A3. The RRC message shall create a measurement report configuration with *reportCGI* and *useAutonomousGaps-r16* setup. The start of T3 is the instant when the last TTI containing the RRC message implying SI reading is sent to the UE. Measurement gaps shall be deconfigured before the start of T3.

PDCCHs indicating new transmissions shall be sent continuously to ensure that the UE would have ACK/NACK sending during identifying a new CGI of NR cell.

The configuration of LTE cell 1 is defined in table A.3.7.2.2-1. Supported test configurations are shown in table A.5.6.5.1.1-1.

**Table A.5.6.5.1.1-1 Supported test configurations for EN-DC inter-frequency CGI identification of NR neighbor cell in FR2**

Config	Description
1	LTE FDD, 120 kHz SSB SCS, 100 MHz bandwidth, TDD duplex mode
2	LTE TDD, 120 kHz SSB SCS, 100 MHz bandwidth, TDD duplex mode
Note 1:	The UE is only required to be tested in one of the supported test configurations
Note 2:	target NR cell has the same SCS, BW and duplex mode as NR serving cell

**Table A.5.6.5.1.1-2: General test parameters for EN-DC inter-frequency CGI identification of NR neighbor cell in FR2**

Parameter	Unit	Test configuration	Value	Comment
E-UTRA RF Channel Number		Config 1,2	1	One E-UTRAN TDD carrier frequencies is used.
NR RF Channel Number		Config 1,2	1, 2	Two FR1 NR carrier frequencies is used.
Active cell		Config 1,2	LTE Cell 1 (PCell) and NR cell 2 (PScell)	LTE Cell 1 is on E-UTRA RF channel number 1. NR Cell 2 is on NR RF channel number 1.
Neighbour cell		Config 1,2	NR cell 3	NR cell 3 is on NR RF channel number 2.
Gap Pattern Id		Config 1,2	0	As specified in clause 9.1.2-1.
Measurement gap offset		Config 1,2	39	
SMTC-SSB parameters		Config 1,2	SSB.3 FR2	As specified in clause A.3.10.2
A3-Offset	dB	Config 1,2	-15	
Hysteresis	dB	Config 1,2	0	
CP length		Config 1,2	Normal	
TimeToTrigger	s	Config 1,2	0	
Filter coefficient		Config 1,2	0	L3 filtering is not used
DRX		Config 1,2	OFF	DRX is not used
Time offset between PCell and PScell		Config 1,2	3 $\mu$ s	Synchronous EN-DC
Time offset between serving and neighbour cells		Config 1,2	3 $\mu$ s	Synchronous cells.
T1	s	Config 1,2	5	
T2	s	Config 1,2	7 for PC1; 4.5 for other PC	
T3	s	Config 1,2	5	

**Table A.5.6.5.1.1-3: Cell specific test parameters for EN-DC inter-frequency CGI identification of NR neighbor cell in FR2**

Parameter	Unit	Test configuration	Cell 2		Cell 3	
			T1	T2, T3	T1	T2, T3
NR RF Channel Number		Config 1,2	1		2	
Duplex mode		Config 1,2	TDD		TDD	
BW <sub>channel</sub>	MHz	Config 1,2	100: N <sub>RB,c</sub> = 66		100: N <sub>RB,c</sub> = 66	
BWP BW	MHz	Config 1,2	100: N <sub>RB,c</sub> = 66		100: N <sub>RB,c</sub> = 66	
TDD configuration		Config 1,2	TDDConf.3.1		TDDConf.3.1	
Initial DL BWP		Config 1,2	DLBWP.0.1		NA	
Initial UL BWP		Config 1,2	DLBWP.0.1			
Dedicated DL BWP		Config 1,2	DLBWP.1.1		NA	
Dedicated UL BWP		Config 1,2	ULBWP.1.1		NA	
OCNG Patterns defined in A.3.2.1.1 (OP.1)		Config 1,2	OP.1		OP.1	
PDSCH Reference measurement channel		Config 1,2	SR.3.1 TDD		-	
CORESET Reference Channel		Config 1,2	CR.3.1 TDD		-	

RMSI scheduling periodicity	ms	Config 1,2	NA	20
TRS configuration		Config 1,2	TRS.2.1 TDD	NA
TCI configuration		Config 1,2	CSI-RS.Config.0	NA
SMTC configuration defined in A.3.11		Config 1,2	SMTC.1	SMTC.1
PDSCH/PDCCH subcarrier spacing	kHz	Config 1,2	120	120
EPRE ratio of PSS to SSS		Config 1,2	0	0
EPRE ratio of PBCH DMRS to SSS				
EPRE ratio of PBCH to PBCH DMRS				
EPRE ratio of PDCCH DMRS to SSS				
EPRE ratio of PDCCH to PDCCH DMRS				
EPRE ratio of PDSCH DMRS to SSS				
EPRE ratio of PDSCH to PDSCH				
EPRE ratio of OCNG DMRS to SSS (Note 1)				
EPRE ratio of OCNG to OCNG DMRS (Note 1)				
Propagation Condition				
Note 1: OCNG shall be used such that both cells are fully allocated and a constant total transmitted power spectral density is achieved for all OFDM symbols.				

**Table A.5.6.5.1.1-4: OTA cell specific test parameters for EN-DC inter-frequency CGI identification of NR neighbor cell in FR2**

Parameter	Unit	Config	Cell 2		Cell 3	
			T1	T2, T3	T1	T2, T3
AoA setup		Config 1,2	Setup 1 defined in A.3.15.1			
Assumption for UE beams <sup>Note 4</sup>		Config 1,2	Rough		Rough	
$\hat{E}_s / I_{ot}$	dB	Config 1,2	4	4	-Infinity	-3
$N_{oc}$ <sup>Note 2</sup>	dBm/15 KHz	Config 1,2	-102			
$N_{oc}$ <sup>Note 2</sup>	dBm/SCS	1, 2	-93			
SS-RSRP	dBm/SCS	1, 2	-89	-89	-Infinity	-96
$\hat{E}_s / N_{oc}$	dB	1~4	4	4	-Infinity	-3
$I_o$	dBm/95.04MHz	1~4	-58.56		-62.25	
<p>Note 1: The resources for uplink transmission are assigned to the UE prior to the start of time period T2.</p> <p>Note 2: Interference from other cells and noise sources not specified in the test is assumed to be constant over subcarriers and time and shall be modelled as AWGN of appropriate power for <math>N_{oc}</math> to be fulfilled.</p> <p>Note 3: SS-RSRP levels have been derived from other parameters for information purposes. They are not settable parameters themselves.</p> <p>Note 4: Information about types of UE beam is given in B.2.1.3, and does not limit UE implementation or test system implementation.</p> <p>Note 5: As observed with 0dBi gain antenna at the centre of the quiet zone</p>						

### A.5.6.5.1.2 Test Requirements

The UE shall transmit a measurement report containing the cell global identifier of cell 3 within 775 milliseconds from the start of T3.

$$\begin{aligned} \text{Test requirement} &= \text{RRC Procedure delay} + T_{\text{identify\_CGI}} + \text{additional margin for FR2} + \text{TTI insertion uncertainty} \\ &= 15 + (25 \cdot 20 + 6 \cdot 20) + 20 + 2 \text{ms from the start of T3} \\ &= 657 \text{ ms, allow 660 ms.} \end{aligned}$$

The UE shall be scheduled continuously throughout the test, and from the start of T3 until 660 ms the number of interrupted slots shall not exceed the allowed number as defined in clause 8.2.1.2.16.

The maximum number of interrupted slots allowed is  $25 \cdot 48 + 6 \cdot 49 = 1494$ .

The rate of correct events observed during repeated tests shall be at least 90%.

NOTE: The actual overall delays measured in the test may be up to  $2 \cdot T_{\text{TTI}_{\text{DCCH}}}$  higher than the measurement reporting delays above because of TTI insertion uncertainty of the measurement report in DCCH.

## A.5.6.6 L1-SINR measurement for beam reporting

### A.5.6.6.1 L1-SINR measurement with CSI-RS based CMR and no dedicated IMR configured when DRX is used

#### A.5.6.6.1.1 Test Purpose and Environment

The purpose of this test is to verify that the UE makes correct reporting of L1-SINR measurement. This test will partly verify the L1-SINR measurement requirements in clause 9.8.4.1, with the testing configurations for NR cells in Table A.5.6.6.1.1-1.

**Table A.5.6.6.1.1-1: Applicable NR configurations for FR2 CSI-RS based L1-SINR test**

Config	Description
1	LTE FDD, NR 120 kHz CSI-RS SCS, 100 MHz bandwidth, TDD duplex mode
2	LTE TDD, NR 120 kHz CSI-RS SCS, 100 MHz bandwidth, TDD duplex mode
Note: The UE is only required to be tested in one of the supported test configurations	

#### A.5.6.6.1.2 Test parameters

There are two cells in the test, E-UTRAN PCell (Cell 1) and FR1 PCell (Cell 2). The test parameters and applicability for Cell 1 are defined in A.3.7.2. The test parameters for the Cell 2 are given in Table A.5.6.6.1.2-1 and Table A.5.6.6.1.2-2 below.

In CSI measurement configuration, UE is indicated to perform L1-SINR measurement on the CSI-RS and report aperiodically. The test consists of a single time period T1, during which the UE is triggered via DCI to report L1-SINR on aperiodic CSI-RS resources. After 480ms from the beginning of the test, the DCI trigger comes in slot 8 of a frame and UE provides the report back based on the reporting configuration as defined in Table A.5.6.6.1.2-1.

There is no measurement gap configured in the test. Before the test, UE is configured to perform RLM and BFD based on the SSBs.

**Table A.5.6.6.1.2-1: General test parameters**

Parameter	Config	Unit	Value
SSB GSCN	1~2		freq1
Duplex mode	1~2		TDD
TDD Configuration	1~2		TDDConf.3.1
BW <sub>channel</sub>	1~2	MHz	100: N <sub>RB,C</sub> = 66
PDSCH Reference measurement channel	1~2		SR.3.1 TDD

RMSI CORESET Reference Channel	1~2		CR.3.1 TDD
Dedicated CORESET Reference Channel	1~2		CCR.3.1 TDD
SSB configuration	1~2		SSB.1 FR2
CSI-RS configuration	1~2		CSI-RS.3.3 TDD
OCNG Patterns	1~2		OP.1
Initial BWP Configuration	1~2		DLBWP.0.1 ULBWP.0.1
Dedicated BWP configuration	1~2		DLBWP.1.3 ULBWP.1.3
SMTC configuration	1~2		SMTC.1
TRS Configuration	1~2		TRS.2.1 TDD
PDCCH/PDSCH TCI Configuration	1~2		TCI.State.2
DRX configuration	1~2		DRX.3
reportConfigType	1~2		aperiodic
reportQuantity-r16	1~2		cri-SINR-r16
Number of reported RS	1~2		2
qcl-Info	1~2		SSB#0 for resource#0 SSB#1 for resource#1
reportSlotOffsetList	1~2		26
Propagation condition	1~2		AWGN
T1	1~2	s	5
EPRE ratio of PSS to SSS	1~2	dB	0
EPRE ratio of PBCH DMRS to SSS			
EPRE ratio of PBCH to PBCH DMRS			
EPRE ratio of PDCCH DMRS to SSS			
EPRE ratio of PDCCH to PDCCH DMRS			
EPRE ratio of PDSCH DMRS to SSS			
EPRE ratio of PDSCH to PDSCH DMRS			
EPRE ratio of OCNG DMRS to SSS <sup>Note 1</sup>			
EPRE ratio of OCNG to OCNG DMRS <sup>Note 1</sup>			
Note 1: OCNG shall be used such that both cells are fully allocated and a constant total transmitted power spectral density is achieved for all OFDM symbols.			

**Table A.5.6.6.1.2-1: CSI-RS specific test parameters**

Parameter	Config	Unit	CSI-RS#0	CSI-RS#1
Angle of arrival configuration	1~2		Setup 1 according to A.3.15.1	
Beam assumption <sup>Note 3</sup>	1~2		Rough	
$N_{oc}$ <sup>Note 1</sup>	1~2	dBm/15kHz	-105	
$N_{oc}$ <sup>Note 1</sup>	1~2	dBm/SSB SCS	-95.97	
$\hat{E}_s / I_{ot}$	1~2	dB	0	9
CSI-RS RSRP <sup>Note 2</sup>	1~2	dBm/SSB SCS	-95.97	-86.97
$I_o$ <sup>Note 2</sup>	1~2	dBm/95.04MHz	-63.97	-57.47
$\hat{E}_s / N_{oc}$	1~2	dB	0	9
Note 1: Interference from other cells and noise sources not specified in the test is assumed to be constant over subcarriers and time and shall be modelled as AWGN of appropriate power for $N_{oc}$ to be fulfilled.				
Note 2: CSI-RS RSRP and $I_o$ levels have been derived from other parameters for information purposes. They are not settable parameters themselves.				

Note 3: Information about types of UE beam is given in B.2.1.3, and does not limit UE implementation or test system implementation

### A.5.6.6.1.3 Test Requirements

After 480ms from the beginning of the test, the UE shall send L1-SINR report at slot 26 from the reception of DCI triggering the L1-SINR measurement. The L1-SINR report shall include the results for both CSI-RS#0 and CSI-RS#1 while meeting the accuracy requirements defined in clause 10.1.28.1.

The rate of correct events observed during repeated tests shall be at least 90%.

NOTE: The actual overall delays measured in the test may be up to  $2xTTI_{DCCH}$  higher than the measurement reporting delays above because of TTI insertion uncertainty of the measurement report in DCCH.

### A.5.6.6.2 L1-SINR measurement with SSB based CMR and dedicated IMR when DRX is not used

#### A.5.6.6.2.1 Test Purpose and Environment

The purpose of this test is to verify that the UE makes correct reporting of L1-SINR measurement. This test will partly verify the L1-SINR measurement requirements in clause 9.8.4.2, with the testing configurations for NR cells in Table A.5.6.6.2.1-1.

The AoA setup for this test is Setup 1 as defined in clause A.3.15

**Table A.5.6.6.2.1-1: Applicable NR configurations for FR2 L1-SINR measurement test with SSB based CMR and CSI-RS based IMR**

Config	Description
1	LTE FDD, NR 120 kHz SSB SCS, 100 MHz bandwidth, TDD duplex mode
2	LTE TDD, NR 120 kHz SSB SCS, 100 MHz bandwidth, TDD duplex mode
3	LTE FDD, NR 240 kHz SSB SCS, 100 MHz bandwidth, TDD duplex mode
4	LTE TDD, NR 240 kHz SSB SCS, 100 MHz bandwidth, TDD duplex mode
Note:	The UE is only required to be tested in one of the supported test configurations

#### A.5.6.6.2.2 Test parameters

There are two cells in the test, E-UTRAN PCell (Cell 1) and FR1 PSCell (Cell 2). The test parameters and applicability for Cell 1 are defined in A.3.7.2. The test parameters for the Cell 2 are given in Table A.5.6.6.2.2-1 and Table A.5.6.6.2.2-2 below.

In CSI measurement configuration, UE is indicated to perform L1-SINR measurement on the SSBs and the associated CSI-RS resources, and report periodically. The test consists of two successive time periods, with time duration of T1 and T2 respectively. The test has higher layer parameter *timeRestrictionForChannelMeasurements* configured.

There is no measurement gap configured in the test. Before the test, UE is configured to perform RLM and BFD measurements based on the SSBs, and UE is configured to perform L1-SINR measurement based on the SSBs as CMR and the CSI-RS resources as IMR.

**Table A.5.6.6.2.2-1: General test parameters**

Parameter	Config	Unit	Value
SSB GSCN	1~4		freq1
Duplex mode	1~4		TDD
TDD Configuration	1~4		TDDConf.3.1
$BW_{channel}$	1~4	MHz	100: $N_{RB,c} = 66$
PDSCH Reference measurement channel	1~4		SR.3.1 TDD
RMSI CORESET Reference Channel	1~4		CR.3.1 TDD
Dedicated CORESET Reference Channel	1~4		CCR.3.1 TDD

SSB configuration	1,2		SSB.1 FR2
	3,4		SSB.2 FR2
CSI-RS configuration	1~4		CSI-RS.3.1A TDD
OCNG Patterns	1~4		OP.1
Initial BWP Configuration	1~4		DLBWP.0.1 ULBWP.0.1
Dedicated BWP configuration	1~4		DLBWP.1.3 ULBWP.1.3
SMTTC configuration	1~4		SMTTC.1
TRS Configuration	1~4		TRS.2.1 TDD
PDCCH/PDSCH TCI Configuration	1~4		TCI.State.2
DRX configuration	1~4		off
reportConfigType	1~4		periodic
reportQuantity-r16	1~4		ssb-Index-SINR-r16
Number of reported RS	1~4		2
L1-SINR reporting period	1~4	slot	640
T1	1~4	s	5
T2	1~4	s	3
EPRE ratio of PSS to SSS	1~4	dB	0
EPRE ratio of PBCH DMRS to SSS			
EPRE ratio of PBCH to PBCH DMRS			
EPRE ratio of PDCCH DMRS to SSS			
EPRE ratio of PDCCH to PDCCH DMRS			
EPRE ratio of PDSCH DMRS to SSS			
EPRE ratio of PDSCH to PDSCH DMRS			
EPRE ratio of OCNG DMRS to SSS <sup>Note 1</sup>			
EPRE ratio of OCNG to OCNG DMRS <sup>Note 1</sup>			
Propagation condition			
Note 1: OCNG shall be used such that both cells are fully allocated and a constant total transmitted power spectral density is achieved for all OFDM symbols.			

**Table A.5.6.6.2.2-2: SSB specific test parameters**

Parameter	Config	Unit	SSB#0		SSB#1	
			T1	T2	T1	T2
Angle of arrival configuration			Setup 1 according to A.3.15.1			
Beam assumption <sup>Note 4</sup>			Rough			
$N_{oc}$ <sup>Note2</sup>	1~4	dBm/15kHz	-105			
$N_{oc}$ <sup>Note2</sup>	1,2	dBm/SSB SCS	-96			
	3,4		-93			
$\hat{E}_s / I_{ot}$	1~4	dB	0	0	-Infinity	9
SSB RSRP <sup>Note3</sup>	1,2	dBm/SSB SCS	-96	-96	-Infinity	-87
	3,4		-93	-93	-Infinity	-84
$I_o$ <sup>Note3</sup>	1,2	dBm/95.04MHz	-63.97	-63.97	-67	-57.5
	3,4		-63.97	-63.97	-67	-57.5
$\hat{E}_s / N_{oc}$	1~4	dB	0	0	-Infinity	9

Note 1:	The resources for uplink transmission are assigned to the UE prior to the start of time period T2.
Note 2:	Interference from other cells and noise sources not specified in the test is assumed to be constant over subcarriers and time and shall be modelled as AWGN of appropriate power for $N_{oc}$ to be fulfilled.
Note 3:	SSB RSRP and $I_o$ levels have been derived from other parameters for information purposes. They are not settable parameters themselves.
Note 4:	Information about types of UE beam is given in B.2.1.3, and does not limit UE implementation or test system implementation

**Table A.5.6.6.2.2-3: CSI-RS specific test parameters**

Parameter	Config	Unit	CSI-RS#0		CSI-RS#1	
			T1	T2	T1	T2
Angle of arrival configuration			Setup 1 according to A.3.15.1			
Beam assumption <sup>Note 4</sup>			Rough			
$N_{oc}$ <sup>Note2</sup>	1~4	dBm/15kHz	-105			
$N_{oc}$ <sup>Note2</sup>	1~4	dBm/CSI-RS SCS	-96			
$\hat{E}_s / I_{ot}$	1~4	dB	0	0	-Infinity	9
$\hat{E}_s / N_{oc}$	1~4	dB	0	0	-Infinity	9
CSI-RS RSRP <sup>Note3</sup>	1~4	dBm/ CSI-RS SCS	-96	-96	-Infinity	-87
$I_o$ <sup>Note3</sup>	1~4	dBm/95.04MHz	-63.97	-63.97	-67	-57.5
Note 1:	The resources for uplink transmission are assigned to the UE prior to the start of time period T2.					
Note 2:	Interference from other cells and noise sources not specified in the test is assumed to be constant over subcarriers and time and shall be modelled as AWGN of appropriate power for $N_{oc}$ to be fulfilled.					
Note 3:	CSI-RS RSRP and $I_o$ levels have been derived from other parameters for information purposes. They are not settable parameters themselves.					
Note 4:	Information about types of UE beam is given in B.2.1.3, and does not limit UE implementation or test system implementation					

**A.5.6.6.2.3 Test Requirements**

The UE shall send L1-SINR report every 640 slots. No later than X ms plus 640 slots from the beginning of time period T2, UE shall send L1-SINR report including the results for both SSB#0+CSI-RS#0 and SSB#1+CSI-RS#1 while meeting the accuracy requirements defined in clause 10.1.28.2, where X is

- 2880 for UE supporting power class 1
- 1920 for UE supporting power class 2, 3 or 4.

The rate of correct events observed during repeated tests shall be at least 90%.

NOTE: The actual overall delays measured in the test may be up to  $2xTTI_{DCC}$  higher than the measurement reporting delays above because of TTI insertion uncertainty of the measurement report in DCC.



### A.5.6.6.3 L1-SINR measurement with CSI-RS based CMR and dedicated IMR configured when DRX is not used

#### A.5.6.6.3.1 Test Purpose and Environment

The purpose of this test is to verify that the UE makes correct reporting of L1-SINR measurement. This test will partly verify the L1-SINR measurement requirements with CSI-RS based CMR and dedicated IMR configured in clause 9.8.4.3, with the testing configurations for NR cells in Table A.5.6.6.3.1-1.

**Table A.5.6.6.3.1-1: Applicable NR configurations for FR2 L1-SINR test with CMR and dedicated IMR**

Config	Description
1	LTE FDD, NR 120 kHz SSB SCS, 100 MHz bandwidth, TDD duplex mode
2	LTE TDD, NR 120 kHz SSB SCS, 100 MHz bandwidth, TDD duplex mode
Note: The UE is only required to be tested in one of the supported test configurations	

#### A.5.6.6.3.2 Test parameters

There are two cells in the test, E-UTRAN PCell (Cell 1) and FR2 PCell (Cell 2). The test parameters and applicability for Cell 1 are defined in A.3.7.2. The test parameters for the Cell 2 are given in Table A.5.6.6.3.2-1 and Table A.5.6.6.3.2-2 below.

In CSI measurement configuration, UE is indicated to perform L1-SINR measurement on the configured CSI-RS as CMR and an associated CSI-IM as IMR, and report aperiodically. The test consists of a single time period T1, during which the UE is triggered via DCI to report L1-SINR on aperiodic CSI-RS resources and the associated IMR. UE is also configured to measure L1-SINR based on SSB. After 480ms from the beginning of the test, the DCI trigger comes in slot 8 of a frame and UE provides the report back based on the reporting configuration as defined in Table A.5.6.6.3.2-1.

There is no measurement gap configured in the test. Before the test, UE is configured to perform RLM and BFD based on the SSBs, and UE is configured to perform L1-SINR measurement based on the CSI-RS as CMR and the CSI-IM as IMR.

**Table A.5.6.6.3.2-1: General test parameters**

Parameter	Config	Unit	Value
SSB GSCN	1~2		freq1
Duplex mode	1~2		TDD
TDD Configuration	1~2		TDDConf.3.1
BW <sub>channel</sub>	1~2	MHz	100: N <sub>RB,c</sub> = 66
PDSCH Reference measurement channel	1~2		SR.3.1 TDD
RMSI CORESET Reference Channel	1~2		CR.3.1 TDD
Dedicated CORESET Reference Channel	1~2		CCR.3.1 TDD
SSB configuration	1~2		SSB.1 FR2
CSI-RS configuration	1~2		CSI-RS.3.3 TDD
CSI-IM configuration	1~2		CSI-IM.3.2 TDD
OCNG Patterns	1~2		OP.1
Initial BWP Configuration	1~2		DLBWP.0.1 ULBWP.0.1
Dedicated BWP configuration	1~2		DLBWP.1.3 ULBWP.1.3
SMTc configuration	1~2		SMTc.1
TRS Configuration	1~2		TRS.2.1 TDD
PDCCH/PDSCH TCI Configuration	1~2		TCI.State.2
DRX configuration	1~2		Off
reportConfigType	1~2		aperiodic
reportQuantity-r16	1~2		cri-SINR-r16
Number of reported RS	1~2		2

qcl-Info	1~2		SSB#0 for resource#0
			SSB#1 for resource#1
reportSlotOffsetList	1~2		26
T1	1~2	s	5
EPRE ratio of PSS to SSS	1~2	dB	0
EPRE ratio of PBCH DMRS to SSS			
EPRE ratio of PBCH to PBCH DMRS			
EPRE ratio of PDCCH DMRS to SSS			
EPRE ratio of PDCCH to PDCCH DMRS			
EPRE ratio of PDSCH DMRS to SSS			
EPRE ratio of PDSCH to PDSCH DMRS			
EPRE ratio of OCNG DMRS to SSS <sup>Note 1</sup>			
EPRE ratio of OCNG to OCNG DMRS <sup>Note 1</sup>			
Propagation condition	1~2		AWGN
Note 1: OCNG shall be used such that both cells are fully allocated and a constant total transmitted power spectral density is achieved for all OFDM symbols.			

**Table A.5.6.6.3.2-2: CSI-RS specific test parameters**

Parameter	Config	Unit	CSI-RS#0	CSI-RS#1
Angle of arrival configuration	1~2		Setup 1 according to A.3.15.1	
Assumption for UE beams <sup>Note 3</sup>	1~2		Rough	
$N_{oc}$ <sup>Note1</sup>	1~2	dBm/15kHz	-105	
$N_{oc}$ <sup>Note1</sup>	1~2	dBm/SSB SCS	-95.97	
$\hat{E}_s / I_{ot}$	1~2	dB	0	9
CSI-RS RSRP <sup>Note2</sup>	1~2	dBm/SSB SCS	-95.97	-86.97
$I_o$ <sup>Note2</sup>	1~2	dBm/95.04MHz	-63.97	-57.47
$\hat{E}_s / N_{oc}$	1~2	dB	0	9
Note 1: Interference from other cells and noise sources not specified in the test is assumed to be constant over subcarriers and time and shall be modelled as AWGN of appropriate power for $N_{oc}$ to be fulfilled. Note 2: CSI-RS RSRP and $I_o$ levels have been derived from other parameters for information purposes. They are not settable parameters themselves. Note 3: Information about types of UE beam is given in B.2.1.3, and does not limit UE implementation or test system implementation				

**A.5.6.6.3.3 Test Requirements**

After 480ms from the beginning of the test, the UE shall send L1-SINR report at slot 26 from the reception of DCI triggering the L1-SINR measurement. The L1-SINR report shall include the results for both CSI-RS#0 as CMR + CSI-IM#0 as IMR and CSI-RS#1 as CMR + CSI-IM#1 as IMR while meeting the accuracy requirements defined in clause 10.1.28.3. The reported L1-SINR value shall consider the Rx antenna gain in the range of [-10 ~ +20] dB when calculated.

The rate of correct events observed during repeated tests shall be at least 90%.

NOTE: The actual overall delays measured in the test may be up to  $2xTTI_{DCCH}$  higher than the measurement reporting delays above because of TTI insertion uncertainty of the measurement report in DCCH.

## A.5.6.7 CSI-RS based Intra-frequency Measurements

### A.5.6.7.1 EN-DC event triggered reporting test without gap under non-DRX

#### A.5.6.7.1.1 Test purpose and Environment

The purpose of this test is to verify that the UE makes correct reporting of an event. This test will partly verify the intra-frequency cell identification requirements in clause e. Supported test configurations are shown in table A.5.6.7.1.1-1.

**Table 5.6.7.1.1-1: supported test configurations**

Configuration	Description
1	LTE FDD, 120 kHz SSB SCS, 120KHz CSI-RS SCS, 100 MHz bandwidth, TDD duplex mode
2	LTE TDD, 120 kHz SSB SCS, 120KHz CSI-RS SCS, 100 MHz bandwidth, TDD duplex mode
Note: The UE is only required to be tested in one of the supported test configurations.	

There are three cells in the test, E-UTRAN PCell (Cell 1), FR2 PSCell (Cell 2) and a FR2 neighbour cell (Cell 3) on the same frequency as the PSCell. The test parameters and applicability for Cell 1 are defined in A.3.7.2. The test parameters for the Cell 2 and Cell 3 are given in Table A.5.6.7.1.1-2, A.5.6.7.1.1-3 and A.5.6.7.1.1-4 below.

In the measurement control information, a measurement object is configured for the frequency of the PSCell, and it is indicated to the UE that event-triggered reporting with Event A3 is used.

The test consists of two successive time periods, with time duration of T1, and T2 respectively. During time duration T1, the UE shall not have any timing information of cell 3.

**Table A.5.6.7.1.1-2: General test parameters for intra-frequency event triggered reporting for EN-DC with PSCell in FR2 without gap without DRX**

Parameter	Unit	Config	Value	Comment
Active cell		1,2	E-UTRAN PCell (Cell 1) PSCell (Cell 2)	
Neighbour cell		1,2	Cell 3	Cell to be identified.
RF Channel Number		1,2	1: Cell 1 2: Cell 2 and Cell 3	One TDD carrier frequency is used for the NR cells and one TDD or FDD carrier frequency is used for E-UTRAN cell.
SMTc configuration		1,2	SMTc.1	
A3-Offset	dB	1,2	-6	
CP length		1,2	Normal	
Hysteresis	dB	1,2	0	
Time To Trigger	s	1,2	0	
Filter coefficient		1,2	0	L3 filtering is not used
DRX		1,2	OFF	
Time offset between Cell 1 and Cell 2	μs	1,2	3	Synchronous EN-DC
Time offset between Cell 2 and Cell 3	μs	1,2	0.58	Synchronous cells
T1	s	1,2	5	
T2	s	1,2	5	

**Table A.5.6.7.1.1-3: NR Cell specific test parameters for intra-frequency event triggered reporting for EN-DC with PSCell in FR2 without gap without DRX**

Parameter	Unit	Config	Cell 2		Cell 3	
			T1	T2	T1	T2
TDD configuration		1,2	TDDConf.3.1		TDDConf.3.1	
BW <sub>channel</sub>	MHz	1,2	100: N <sub>RB,c</sub> = 66		100: N <sub>RB,c</sub> = 66	
Initial BWP configuration		1,2	DLBWP.0.1 ULBWP.0.1		DLBWP.0.1 ULBWP.0.1	
Active DL BWP configuration		1,2	DLBWP.1.1		DLBWP.1.1	

Active UL BWP configuration		1,2	ULBWP.1.1	ULBWP.1.1
RLM-RS		1,2	SSB	SSB
PDSCH RMC configuration		1,2	SR.3.1 TDD	N/A
RMSI CORESET RMC configuration		1,2	CR.3.1 TDD	CR.3.1 TDD
Dedicated CORESET RMC configuration		1,2	CCR.3.1 TDD	CCR.3.1 TDD
OCNG Patterns		1,2	OP.1	OP.1
TRS configuration		1,2	TRS.2.1 TDD	N/A
PDSCH/PDCCH TCI state		1,2	TCI.State.2	N/A
SMTTC configuration		1, 2	SMTTC.1	SMTTC.1
SSB configuration		1,2	SSB.3 FR2	SSB.3 FR2
CSI-RS RRM configuration		1,2	CSI-RS.RRM.FR2.1 TDD	CSI-RS.RRM.FR2.1 TDD
Propagation Condition		1,2	AWGN	

**Table A.5.6.7.1.1-4: NR OTA Cell specific test parameters for intra-frequency event triggered reporting for EN-DC with PSCell in FR2 without gap without DRX**

Parameter	Unit	Config	Cell 2		Cell 3	
			T1	T2	T1	T2
AoA setup		1,2	Setup 3 defined in A.3.15.3			
			AoA1		AoA2	
Assumption for UE beams <sup>Note 4</sup>		1,2	Rough		Rough	
$\hat{E}_s/I_{ot}$	dB	1,2	4	4	-Infinity	8
$N_{oc}$ <sup>Note 2</sup>	dBm/15 KHz	1,2	-102			
$N_{oc}$ <sup>Note 2</sup>	dBm/SCS	1,2	-93			
SS-RSRP	dBm/SCS	1,2	-89	-89	-Infinity	-85
CSI-RSRP	dBm/SCS	1,2	-89	-89	-Infinity	-85
$\hat{E}_s/N_{oc}$	dB	1,2	4	4	-Infinity	8
$I_o$	dBm/95.04MHz	1,2	-58.56		-55.38	
Note 1:	The resources for uplink transmission are assigned to the UE prior to the start of time period T2.					
Note 2:	Interference from other cells and noise sources not specified in the test is assumed to be constant over subcarriers and time and shall be modelled as AWGN of appropriate power for $N_{oc}$ to be fulfilled.					
Note 3:	SS-RSRP levels have been derived from other parameters for information purposes. They are not settable parameters themselves.					
Note 4:	Information about types of UE beam is given in B.2.1.3, and does not limit UE implementation or test system implementation.					

### A.5.6.7.1.2 Test Requirements

In the test, the UE shall send one Event A3 triggered measurement report, with a measurement reporting delay less than X ms from the beginning of time period T2, where X is

- 3.2s for a UE supporting power class 1,
- 2.16s for a UE supporting power class 2, 3 and 4

The UE is not required to read the neighbour cell SSB index in this test in order to detect associated SSB for the CSI-RS resource of Cell 3.

The UE shall not send event triggered measurement reports, as long as the reporting criteria are not fulfilled.

The rate of correct events observed during repeated tests shall be at least 90%.

NOTE: The actual overall delays measured in the test may be up to  $2xTTIDCCH$  higher than the measurement reporting delays above because of TTI insertion uncertainty of the measurement report in DCCH.

## A.5.6.8 CSI-RS based Inter-frequency Measurements

### A.5.6.8.1 EN-DC event triggered reporting tests for NR FR2 cell when DRX is used

#### A.5.6.8.1.1 Test Purpose and Environment

The purpose of this test is to verify that the UE makes correct reporting of an event. This test will partly verify the EN-DC inter-frequency NR cell search requirements in clause 9.10.3.

In this test, there are three cells: LTE cell 1 as PCell on E-UTRA RF channel 1, NR cell 2 as PSCell in FR2 on NR RF channel 1 and NR cell 3 as neighbour cell in FR2 on NR RF channel 2. The test parameters and configurations are given in Tables A.5.6.8.1.1-1, A. 5.6.5.1.1-2, and A.5.6.8.1.1-3.

In test 1&2 measurement gap pattern configuration # 0 as defined in Table A.5.6.8.1.1-2 is provided for UE that does not support per-FR gap and in test 3&4 measurement gap pattern configuration #13 as defined in Table A. 5.6.5.1.1-2 is provided for UE that supports per-FR gap. If a UE supports per-FR gap and gap pattern configuration #4, it is only required to pass test 3&4. Otherwise it is only required to pass test 1&2.

In the measurement control information, it is indicated to the UE that event-triggered reporting with Event A4 is used. The test consists of two successive time periods, with time duration of T1, and T2 respectively. During time duration T1, the UE shall not have any timing information of NR cell 3.

The configuration of LTE cell 1 is defined in table A.3.7.2.2-1. Supported test configurations are shown in table A.5.6.8.1.1-1.

**Table A.5.6.8.1.1-1 EN-DC event triggered reporting tests for FR2-FR2**

Config	Description
1	LTE FDD, 120 kHz SSB SCS, 120 kHz CSI-RS SCS, 100 MHz bandwidth, TDD duplex mode
2	LTE TDD, 120 kHz SSB SCS, 120 kHz CSI-RS SCS, 100 MHz bandwidth, TDD duplex mode
Note 1: The UE is only required to be tested in one of the supported test configurations	
Note 2: target NR cell has the same SCS, BW and duplex mode as NR serving cell	

UE needs to be provided at least once every 500ms with new Timing Advance Command MAC control element to restart the Time alignment timer to keep UE uplink time alignment. Furthermore UE is allocated with PUSCH resource at every DRX cycle.

**Table A.5.6.8.1.1-2: General test parameters for EN-DC inter-frequency event triggered reporting with SSB time index detection with DRX**

Parameter	Unit	Test configuration	Value		Comment
			Test 1	Test 3	
E-UTRA RF Channel Number		Config 1,2	1		One E-UTRAN TDD carrier frequencies is used.
NR RF Channel Number		Config 1,2	1, 2		Two FR2 NR carrier frequencies is used.
Active cell		Config 1,2	LTE Cell 1 (PCell) and NR cell 2 (PSCell)		LTE Cell 1 is on E-UTRA RF channel number 1. NR Cell 2 is on NR RF channel number 1.
Neighbour cell		Config 1,2	NR cell 3		NR cell 3 is on NR RF channel number 2.
Gap Pattern Id		Config 1,2	0	13	As specified in clause 9.1.2-1.

Measurement gap offset		Config 1,2	39	39	
SMTC-SSB parameters		Config 1,2	SSB.3 FR2		As specified in clause A.3.10.2
A3-Offset	dB	Config 1,2	-6		
Hysteresis	dB	Config 1,2	0		
CP length		Config 1,2	Normal		
TimeToTrigger	s	Config 1,2	0		
Filter coefficient		Config 1,2	0		L3 filtering is not used
DRX		Config 1,2	DRX.1		As specified in clause A.3.3.3
Time offset between PCell and PSCell	$\mu$ s	Config 1,2	3		Synchronous EN-DC
Time offset between serving and neighbour cells	$\mu$ s	Config 1,2	0.58		Synchronous cells
T1	s	Config 1,2	5		
T2	s	Config 1,2	11 for PC1; 6.5 for other PC	11 for PC1; 6.5 for other PC	

**Table A.5.6.8.1.1-3: Cell specific test parameters for EN-DC inter-frequency event triggered reporting with SSB time index detection**

Parameter	Unit	Test configuration	Cell 2		Cell 3	
			T1	T2	T1	T2
AoA setup		Config 1,2	Setup 1 as specified in clause A.3.15			
Assumption for UE beams <sup>Note 7</sup>		Config 1,2	Rough		Rough	
NR RF Channel Number		Config 1,2	1		2	
Duplex mode		Config 1,2	TDD		TDD	
BW <sub>channel</sub>	MHz	Config 1,2	10: N <sub>RB,c</sub> = 66		100: N <sub>RB,c</sub> = 66	
BWP BW	MHz	Config 1,2	10: N <sub>RB,c</sub> = 66		100: N <sub>RB,c</sub> = 66	
TDD configuration		Config 1,2	TDDConf.3.1		TDDConf.3.1	
Initial DL BWP		Config 1,2	DLBWP.0.1		NA	
Initial UL BWP		Config 1,2	ULBWP.0.1			
Dedicated DL BWP		Config 1,2	DLBWP.1.1		NA	
Dedicated UL BWP		Config 1,2	ULBWP.1.1		NA	
OCNG Patterns defined in A.3.2.1.1 (OP.1)		Config 1,2	OP.1		OP.1	
PDSCH Reference measurement channel		Config 1,2	SR.3.1 TDD		-	
PDSCH/PDCCH subcarrier spacing	kHz	Config 1,2	120		120	
CORESET Reference Channel		Config 1,2	CR.3.1 TDD		-	
TRS configuration		Config 1,2	TRS.2.1 TDD		NA	
TCI configuration		Config 1,2	CSI-RS.Config.0		NA	
SMTC configuration defined in A.3.11		Config 1,2	SMTC.1		SMTC.1	
CSI-RS RRM configuration		Config 1,2	CSI-RS.RRM.FR2.1 TDD		CSI-RS.RRM.FR2.1 TDD	
firstOFDMSymbolInTimeDomain		Config 1,2	7		12	
$N_{oc}$ <sup>Note2</sup>	dBm/1 5kHz <sup>Note5</sup>		-104.7		-104.7	
$N_{oc}$ <sup>Note2</sup>	dBm/S CS <sup>Note4</sup>	Config 1,2	-95.7		-95.7	
CSI-RSRP <sup>Note 3</sup>	dBm/S CS <sup>Note5</sup>	Config 1,2	-89.7	-89.7	-Infinity	-86.7

SS-RSRP <sup>Note 3</sup>	dBm/S CS <sup>Note5</sup>	Config 1,2	-89.7	-89.7	-Infinity	-86.7
$\hat{E}_s / I_{ot}$	dB	Config 1,2	6	6	-Infinity	9
$\hat{E}_s / N_{oc}$	dB	Config 1,2	6	6	-Infinity	9
$I_o$ <sup>Note3</sup>	dBm/9 5.04 MHz <sup>Note5</sup>	Config 1,2	-59.7	-59.7	-66.7	-57.2
Propagation Condition		Config 1,2,3,4,5,6	AWGN			
<p>Note 1: OCNG shall be used such that both cells are fully allocated and a constant total transmitted power spectral density is achieved for all OFDM symbols.</p> <p>Note 2: Interference from other cells and noise sources not specified in the test is assumed to be constant over subcarriers and time and shall be modelled as AWGN of appropriate power for <math>N_{oc}</math> to be fulfilled.</p> <p>Note 3: SS-RSRP, CSI-RSRP and <math>I_o</math> levels have been derived from other parameters for information purposes. They are not settable parameters themselves.</p> <p>Note 4: SS-RSRP and CSI-RSRP minimum requirements are specified assuming independent interference and noise at each receiver antenna port.</p> <p>Note 5: Equivalent power received by an antenna with 0dBi gain at the centre of the quiet zone</p> <p>Note 6: As observed with 0dBi gain antenna at the centre of the quiet zone</p> <p>Note 7: Information about types of UE beam is given in B.2.1.3, and does not limit UE implementation or test system implementation</p>						

#### A.5.6.8.1.2 Test Requirements

In test 1 with per-UE gap and in test 3 with per-FR gap, the UE shall send one Event A3 triggered measurement report, with a measurement reporting delay less than  $X1$  ms from the beginning of time period T2, where  $X1$  is

10080 ms for UE supporting power class 1, or

6240 ms for UE supporting other power class.

In test 1, and 2 UE is required to report SSB time index. The UE is required to read the neighbour cell SSB index in this test in order to detect associated SSB for the CSI-RS resource of Cell 3.

The UE shall not send event triggered measurement reports, as long as the reporting criteria are not fulfilled. The rate of correct events observed during repeated tests shall be at least 90%.

NOTE: The actual overall delays measured in the test may be up to  $2 \times TTI_{DCCH}$  higher than the measurement reporting delays above because of TTI insertion uncertainty of the measurement report in DCCH.

### A.5.7 Measurement Performance requirements

Unless explicitly stated otherwise:

- Reported measurements shall be within defined range of accuracy limits defined in Clause 10 for at least 90 % of the reported cases. If multiple measurement performance requirements are verified in the same test, the reported measurements for each requirement shall be within defined range of accuracy limits of the corresponding requirement defined in Clause 10 for at least 90% of the reported cases.
- Measurements are performed in RRC\_CONNECTED state.
- The reference channels assume transmission of PDSCH with a maximum number of 5 HARQ transmissions unless otherwise specified.

## A.5.7.1 SS-RSRP

### A.5.7.1.1 EN-DC intra-frequency case measurement accuracy with FR2 serving cell and FR2 target cell

#### A.5.7.1.1.1 Test Purpose and Environment

The purpose of this test is to verify that the SS-RSRP measurement accuracy is within the specified limits. This test will verify the requirements in Clauses 10.1.3.1.1 and 10.1.3.1.2 for intra-frequency measurements.

#### A.5.7.1.1.2 Test parameters

In this set of test cases, all NR cells are on the same carrier frequency. Supported test configurations are shown in Table A.5.7.1.1.2-1. Both absolute and relative accuracy of SS-RSRP intra-frequency measurements are tested by using the parameters in Table A.5.7.1.1.2-2 and A.5.7.1.1.2-3. The E-UTRA PCell is configured as specified in clause A.3.7.2.2. In all test cases, Cell 1 is the PCell, cell 2 is the PSCell and Cell 3 is the target cell. The test consists of two time phases T1 and T2.

**Table A.5.7.1.1.2-1: SS-RSRP Intra frequency SS-RSRP supported test configurations**

Configuration	Description
1	FDD LTE PCell, Cell 2&3 120 kHz SSB SCS, 100 MHz bandwidth, TDD duplex mode
2	TDD LTE PCell, Cell 2&3 120 kHz SSB SCS, 100 MHz bandwidth, TDD duplex mode
Note:	The UE is only required to pass in one of the supported test configurations

**Table A.5.7.1.1.2-2: SS-RSRP Intra frequency general test parameters**

Parameter <sup>Note 5</sup>	Unit	T1		T2	
		Cell 2	Cell 3	Cell 2	Cell 3
Physical cell ID		489	0	489	0
SSB ARFCN		freq1		freq1	
Duplex mode		TDD		TDD	
TDD configuration		TDDConf.3.1		TDDConf.3.1	
BW <sub>channel</sub>	MHz	100: N <sub>RB,c</sub> = 66		100: N <sub>RB,c</sub> = 66	
Data RBs allocated		24		24	
BWP configuration	Initial DL BWP	DLBWP.0.1			
	Dedicated DL BWP	DLBWP.1.1			
	Initial UL BWP	ULBWP.0.1			
	Dedicated UL BWP	ULBWP.1.1			
TRS configuration		TRS.2.1 TDD	-	TRS.2.1 TDD	-
TCI state		TCI.State.0	-	TCI.State.0	-
PDSCH Reference measurement channel		SR.3.2 TDD	-	SR.3.2 TDD	-
RMSI CORESET Reference Channel		CR.3.1 TDD	-	CR.3.1 TDD	-
Dedicated CORESET Reference Channel		CCR.3.1 TDD	-	CCR.3.1 TDD	-
OCNG Patterns		OP.3	OP.3	OP.3	OP.3
SSB configuration		SSB.3 FR2	SSB.3 FR2	SSB.3 FR2	SSB.3 FR2
SMTc configuration		SMTc.1	SMTc.1	SMTc.1	SMTc.1
Time offset with Cell 2	μs	-	3	-	3
PDSCH/PDCCH subcarrier spacing	kHz	120	120	120	120
EPRE ratio of PSS to SSS	dB	0	0	0	0
EPRE ratio of PBCH_DMRS to SSS					
EPRE ratio of PBCH to PBCH_DMRS					
EPRE ratio of PDCCH_DMRS to SSS					



EPRE ratio of PDCCH to PDCCH_DMRS					
EPRE ratio of PDSCH_DMRS to SSS					
EPRE ratio of PDSCH to PDSCH_DMRS					
EPRE ratio of OCNG DMRS to SSS <sup>Note 1</sup>					
EPRE ratio of OCNG to OCNG DMRS <sup>Note 1</sup>					
Propagation conditions		AWGN		AWGN	
Antenna configuration		1x2	1x2	1x2	1x2
Note 1:	OCNG shall be used such that both cells are fully allocated and a constant total transmitted power spectral density is achieved for all OFDM symbols.				
Note 2:	Void				
Note 3:	Void				
Note 4:	Void				
Note 5:	All parameters apply for configuration 1 and 2				
Note 6:	Void				

**Table A.5.7.1.1.2-3: SS-RSRP Intra frequency OTA related test parameters**

Parameter	Unit	T1		T2	
		Cell 2	Cell 3	Cell 2	Cell 3
Angle of arrival configuration		Setup 1 according to clause A.3.15.1			
Assumption for UE beams <sup>Note 8</sup>		Rough			
$N_{oc}$ <sup>Note1</sup>	dBm/15kHz <sub>z</sub> <sup>Note4</sup>	-91.6		N/A	
$N_{oc}$ <sup>Note1</sup>	dBm/SCS <sup>Note4</sup>	-82.6		N/A	
$\hat{E}_s/N_{oc}$	dB	6.0	1.0	N/A	N/A
$E_s$	dBm/SCS <sup>Note4</sup>			(Table B.2.2-2 Rx Beam Peak +2.1dB)	(Table B.2.2-2 Rx Beam Peak +2.1dB)
SSB_RP <sup>Note2</sup>	dBm/SCS	-76.6	-81.6	(Table B.2.2-2 Rx Beam Peak +2.1dB)	(Table B.2.2-2 Rx Beam Peak +2.1dB)
$\hat{E}_s/I_{otBB}$ <sup>Note6</sup>	dB	2.44	-5.98	-5.98	-5.98
$I_o$ <sup>Note2</sup>	dBm/95.04 MHz <sup>Note4</sup>	-50.05		(Table B.2.2-2 Rx Beam Peak +29.70dB)	
Note 1:	Where used, interference from other cells and noise sources not specified in the test is assumed to be constant over subcarriers and time and shall be modelled as AWGN of appropriate power for $N_{oc}$ to be fulfilled.				
Note 2:	SSB_RP, $E_s/I_{ot}$ and $I_o$ levels have been derived from other parameters for information purposes. They are not settable parameters themselves.				
Note 3:	Void				
Note 4:	Equivalent power received by an antenna with 0 dBi gain at the centre of the quiet zone				
Note 5:	Void				
Note 6:	Calculation of $E_s/I_{otBB}$ includes the effect of UE internal noise up to the value assumed for the associated Refsens requirement in clause 7.3.2 of TS 38.101-2 [19], and an allowance of 1dB for UE multi-band relaxation factor $\Delta MB_P$ from TS 38.101-2 [19] Table 6.2.1.3-4.				
Note 7:	All parameters apply for configurations 1 and 2				
Note 8:	Information about types of UE beam is given in B.2.1.3, and does not limit UE implementation or test system implementation				

### A.5.7.1.1.3 Test Requirements

The SS-RSRP measurement accuracy shall fulfil the absolute accuracy requirements in clauses 10.1.3.1.1 and relative accuracy requirements in clause 10.1.3.1.2. The following requirements are to be verified:

During T1:

Absolute accuracy of Cell 2 and absolute accuracy of Cell 3. The UE is deemed to meet the requirement if the reported SS-RSRP is in the range shown in table A.5.7.1.1.3-1.

Relative accuracy of Cell 3 compared with Cell 2. The UE is deemed to meet the requirement if the difference in reported SS-RSRP meets the requirements in Table 10.1.3.1.2-1.

During T2:

Absolute accuracy of Cell 2 and absolute accuracy of Cell 3. The UE is deemed to meet the requirement if the reported SS-RSRP is in the range shown in table A.5.7.1.1.3-1.

Relative accuracy of Cell 3 compared with Cell 2. The UE is deemed to meet the requirement if the difference in reported SS-RSRP meets the requirements in Table 10.1.3.1.2-1.

During T1 and T2:

Relative accuracy of Cell 2 during T2 compared with Cell 2 during T1. The UE is deemed to meet the requirement if the difference in reported SS-RSRP meets the requirements in Table 10.1.3.1.2-1

Relative accuracy of Cell 3 during T2 compared with Cell 3 during T1. The UE is deemed to meet the requirement if the difference in reported SS-RSRP meets the requirements in Table 10.1.3.1.2-1.

**Table A.5.7.1.1.3-1: SS-RSRP absolute accuracy test requirement**

	Test requirement <sup>Notes1,2,3</sup>
Cell 2	$SSB\_RP2 - \delta + G_{min} \leq \text{Reported RSRP(dBm)} \leq SSB\_RP2 + \delta + G_{max}$
Cell 3	$SSB\_RP3 - \delta + G_{min} \leq \text{Reported RSRP(dBm)} \leq SSB\_RP3 + \delta + G_{max}$
Note 1:	SSB_RPn is the equivalent power received by an antenna with 0dBi gain at the centre of the quiet zone configured in the test for the cell n under consideration
Note 2:	$\delta$ is the RSRP absolute accuracy requirement from Table 10.1.3.1.1-1, selected according to the $\delta$ used in the test
Note 3:	$G_{min}$ and $G_{max}$ are the minimum and maximum UE gain values from Table B.2.1.5.1-1, selected according to the UE power class

### A.5.7.1.2 EN-DC inter-frequency case measurement accuracy with FR2 serving cell and FR2 target cell

#### A.5.7.1.2.1 Test Purpose and Environment

The purpose of this test is to verify that the SS-RSRP measurement accuracy is within the specified limits. This test will verify the requirements in Clauses 10.1.5.1.1 and 10.1.5.1.2 for inter-frequency measurements with the testing configurations for NR cells in Table A.5.7.1.2.1-1.

**Table A.5.7.1.2.1-1: Applicable NR configurations for FR2 inter-frequency SS-RSRP accuracy test**

Configuration	Description
1	FDD LTE PCell, cells 2&3 120 kHz SSB SCS, 100 MHz bandwidth, TDD duplex mode
2	TDD LTE PCell, cells 2&3 120 kHz SSB SCS, 100 MHz bandwidth, TDD duplex mode
3	FDD LTE PCell, cells 2&3 240 kHz SSB SCS, 100 MHz bandwidth, TDD duplex mode
4	TDD LTE PCell, cells 2&3 240 kHz SSB SCS, 100 MHz bandwidth, TDD duplex mode

#### A.5.7.1.2.2 Test parameters

In this set of test cases, there are three cells in the test, E-UTRAN PCell (Cell 1), FR2 PSCell (Cell 2) and a FR2 neighbour cell (Cell 3) on a different frequency than the PSCell. The test parameters and applicability for Cell 1 are defined in A.3.7.2. The test parameters for the Cell 2 and Cell 3 are given in Table A.5.7.1.2.2-1 and Table A.5.7.1.2.2-2 below. Both absolute and relative accuracy of RSRP intrer-frequency measurements are tested by using the

parameters in Table A.5.7.1.2.2-1 and Table A.5.7.1.2.2-2. The inter-frequency measurements are supported by a measurement gap.

**Table A.5.7.1.2.2-1: SS-RSRP inter-frequency test parameters**

Parameter	Config	Unit	Test 1		Test 2	
			Cell 2	Cell 3	Cell 2	Cell 3
SSB ARFCN	1~4		freq1	freq2	freq1	freq2
BW <sub>channel</sub>	1~4		100: N <sub>RB,c</sub> = 66		100: N <sub>RB,c</sub> = 66	
Data RBs allocated	1,2 3,4		24 48		24 48	
Duplex mode	1~4		TDD		TDD	
TDD configuration	1~4		TDDConf.3.1		TDDConf.3.1	
PDSCH Reference measurement channel	1,2 3,4		SR.3.2 TDD SR.3.3 TDD	-	SR.3.2 TDD SR.3.3 TDD	-
RMSI CORESET Reference Channel	1,2 3,4		CR.3.1 TDD CR.3.2 TDD	-	CR.3.1 TDD CR.3.2 TDD	-
Dedicated CORESET Reference Channel	1,2 3,4		CCR.3.1 TDD CCR.3.7 TDD	-	CCR.3.1 TDD CCR.3.7 TDD	-
SSB configuration	1,2 3,4		SSB.3 FR2 SSB.4 FR2		SSB.3 FR2 SSB.4 FR2	
PDSCH/PDCCH subcarrier spacing	1~4	kHz	120		120	
OCNG Patterns	1~4		OP.3		OP.3	
Initial BWP Configuration	1~4		DLBWP.0.1 ULBWP.0.1		DLBWP.0.1 ULBWP.0.1	
Dedicated BWP configuration	1~4		DLBWP.1.3 ULBWP.1.3		DLBWP.1.3 ULBWP.1.3	
TRS Configuration	1~4		TRS.2.1 TDD		TRS.2.1 TDD	
PDCCH/PDSCH TCI Configuration	1~4		TCI.State.2		TCI.State.2	
SMTC configuration	1~4		SMTC.1		SMTC.1	
Time offset between Cell 2 and Cell 3	1~4	µs	3		3	
EPRE ratio of PSS to SSS	1~4	dB	0	0	0	0
EPRE ratio of PBCH DMRS to SSS						
EPRE ratio of PBCH to PBCH DMRS						
EPRE ratio of PDCCH DMRS to SSS						
EPRE ratio of PDCCH to PDCCH DMRS						
EPRE ratio of PDSCH DMRS to SSS						
EPRE ratio of PDSCH to PDSCH DMRS						
EPRE ratio of OCNG DMRS to SSS <sup>Note 1</sup>						
EPRE ratio of OCNG to OCNG DMRS <sup>Note 1</sup>						
Propagation condition						
Antenna configuration	1~4	-	1x2	1x2	1x2	1x2
Note 1: OCNG shall be used such that a constant total transmitted power spectral density is achieved for all OFDM symbols.						
Note 2: Void						

**Table A.5.7.1.2.2-2: SS-RSRP inter frequency OTA related test parameters**

Parameter	Config	Unit	Test 1		Test 2	
			Cell 2	Cell 3	Cell 2	Cell 3

Angle of arrival configuration	1~4		Setup 4b according to clause A.3.15.4.2		Setup 4b according to clause A.3.15.4.2	
			AoA1 Spherical coverage	AoA2 Rx Beam Peak	AoA1 Spherical coverage	AoA2 Rx Beam Peak
Assumption for UE beams <sup>Note 7</sup>	1~4		Rough		Rough	
$N_{oc}$ <sup>Note1</sup>	1, 2	dBm/15kHz <sup>Note4</sup>	-90.6	-90.6	(Table B.2.3-2 Rx Beam Peak <sup>Note 8</sup> +1.97dB)	(Table B.2.3-2 Rx Beam Peak <sup>Note 8</sup> -3.03dB)
	3, 4		-93.7	-93.7		
$N_{oc}$ <sup>Note1</sup>	1, 2	dBm/SCS <sup>Note4</sup>	-81.6	-81.6	(Table B.2.3-2 Rx Beam Peak <sup>Note 8</sup> +11.0dB)	(Table B.2.3-2 Rx Beam Peak <sup>Note 8</sup> +6.0dB)
	3, 4		-81.7	-81.7	(Table B.2.3-2 Rx Beam Peak <sup>Note 8</sup> +14.0dB)	(Table B.2.3-2 Rx Beam Peak <sup>Note 8</sup> +9.0dB)
$\hat{E}_s/N_{oc}$	1~4	dB	6.0	6.0	17.0	-1.0
SSB_RP <sup>Note2</sup>	1, 2	dBm/SCS	-75.6	-75.6	(Table B.2.3-2 Rx Beam Peak <sup>Note 8</sup> +28.0dB)	(Table B.2.3-2 Rx Beam Peak <sup>Note 8</sup> +5.0dB)
	3, 4		-75.7	-75.7	(Table B.2.3-2 Rx Beam Peak <sup>Note 8</sup> +31.0dB)	(Table B.2.3-2 Rx Beam Peak <sup>Note 8</sup> +8.0dB)
(SSB_RP <sub>Cell 2</sub> – SSB_RP <sub>Cell 3</sub> )	1~4	dB	0		23.00	
$\hat{E}_s/I_{otBB}$ <sup>Note6</sup>	1, 2	dB	5.26	5.96	9.53	-3.46
	3, 4		4.61	5.91		
$I_o$ <sup>Note2</sup>	1, 2	dBm/95.04 MHz <sup>Note4</sup>	-50.00	-50.00	(Table B.2.3-2 Rx Beam Peak <sup>Note 8</sup> +52.68dB)	(Table B.2.3-2 Rx Beam Peak <sup>Note 8</sup> +33.13dB)
	3, 4		-50.09	-50.09	(Table B.2.3-2 Rx Beam Peak <sup>Note 8</sup> +55.69dB)	(Table B.2.3-2 Rx Beam Peak <sup>Note 8</sup> +36.14dB)
( $I_{ofreq 1} - I_{ofreq 2}$ )	1~4	dB	0		19.55	

Note 1: Where used, interference from other cells and noise sources not specified in the test is assumed to be constant over subcarriers and time and shall be modelled as AWGN of appropriate power for  $N_{oc}$  to be fulfilled.

Note 2: SSB\_RP,  $E_s/I_{ot}$ ,  $I_o$ , (SSB\_RP<sub>Cell 3</sub> – SSB\_RP<sub>Cell 2</sub>) and ( $I_{ofreq 2} - I_{ofreq 1}$ ) levels have been derived from other parameters for information purposes. They are not settable parameters themselves.

Note 3: Void

Note 4: Equivalent power received by an antenna with 0 dBi gain at the centre of the quiet zone

Note 5: Void

Note 6: Calculation of  $E_s/I_{otBB}$  includes the effect of UE internal noise up to the value assumed for the associated Refsens requirement in clause 7.3.2 of TS 38.101-2 [19], and an allowance of 1dB for UE multi-band relaxation factor  $\Delta MB_P$  or  $\Delta MB_S$  from TS 38.101-2 [19] Table 6.2.1.3-4.

Note 7: Information about types of UE beam is given in B.2.1.3, and does not limit UE implementation or test system implementation

Note 8: The value in Table B.2.3-2 is the Minimum SSB\_RP for  $SCS_{SSB} = 120$  kHz, selected according to the operating band of Cell 3 and UE power class, without  $\Delta MB_{P,n}$  adjustment.

### A.5.7.1.2.3 Test Requirements

The SS-RSRP measurement accuracy for Cell 2 and Cell 3 shall fulfil the absolute requirements in clause 10.1.5.1.1 and the relative requirements in clause 10.1.5.1.2.

Absolute accuracy of Cell 2 and absolute accuracy of Cell 3. The UE is deemed to meet the requirement if the reported SS-RSRP is in the range shown in Table A.5.7.1.2.3-1.

Relative accuracy of Cell 3 compared with Cell 2. The UE is deemed to meet the requirement if the difference in reported SS-RSRP meets the requirements in A.5.7.1.2.3-2.

Test 2:

Absolute accuracy of Cell 2 and absolute accuracy of Cell 3. The UE is deemed to meet the requirement if the reported SS-RSRP is in the range shown in Table A.5.7.1.2.3-1.

Relative accuracy of Cell 3 compared with Cell 2. The UE is deemed to meet the requirement if the difference in reported SS-RSRP meets the requirements in A.5.7.1.2.3-2.

**Table A.5.7.1.2.3-1: SS-RSRP absolute accuracy test requirement**

	<b>Test requirement</b> <sup>Notes1,2,3,4</sup>
Cell 2	$SSB\_RP2 - \delta + G_{min} + X \leq \text{Reported RSRP(dBm)} \leq SSB\_RP2 + \delta + G_{max}$
Cell 3	$SSB\_RP3 - \delta + G_{min} \leq \text{Reported RSRP(dBm)} \leq SSB\_RP3 + \delta + G_{max}$
Note 1:	SSB_RP <sub>n</sub> is the equivalent power received by an antenna with 0dBi gain at the centre of the quiet zone configured in the test for the cell n under consideration
Note 2:	$\delta$ is the RSRP absolute accuracy requirement from Table 10.1.5.1.1-1, selected according to the $l_0$ used in the test
Note 3:	$G_{min}$ and $G_{max}$ are the minimum and maximum UE gain values from Table B.2.1.5.1-1, selected according to the UE power class
Note 4:	X is the Spherical coverage gain difference in dB, derived as (UE Refsens - UE Spherical coverage) from TS 38.101-2 [19] clauses 7.3.2 and 7.3.4, selected according to the UE power class and operating band. X is always a negative value.

**Table A.5.7.1.2.3-2: SS-RSRP relative accuracy test requirement**

	<b>Test requirement</b> <sup>Notes1,2,3,4, 5, 6, 7</sup>
Cell 3 – Cell 2	$SSB\_RP3 - SSB\_RP2 - \delta - D - G_{inter} \leq \text{Reported RSRP(dB)} \leq SSB\_RP3 - SSB\_RP2 + \delta + G_{inter} - (X) + E$
Note 1:	SSB_RP <sub>n</sub> is the equivalent power received by an antenna with 0dBi gain at the centre of the quiet zone configured in the test for the cell n under consideration
Note 2:	$\delta$ is the RSRP relative accuracy requirement from Table 10.1.5.1.2-1
Note 3:	Void
Note 4:	X is the Spherical coverage gain difference in dB, derived as (UE Refsens - UE Spherical coverage) from TS 38.101-2 [19] clauses 7.3.2 and 7.3.4, selected according to the UE power class and operating band. X is always a negative value.
Note 5:	D is the margin due to mis-alignment between fine beam and rough beam. D is the Rough Beam gain reduction in Rx beam peak direction from Table B.2.1.5.3-1, selected according to the UE power class. D is always a positive value.
Note 6:	$G_{inter}$ is the margin due to different antenna gain caused by frequency separation. $G_{inter}$ is from Table B.2.1.5.2-1, selected according to the UE power class, and is always a positive value.
Note 7:	E = 3 (dB) is an additional margin to account for the actual gain difference between peak direction and spherical coverage using rough beams.

### A.5.7.1.3 EN-DC inter-frequency measurement accuracy with FR1 serving cell and FR2 target cell

#### A.5.7.1.3.1 Test Purpose and Environment

The purpose of this test is to verify that the SS-RSRP measurement accuracy is within the specified limits. This test will verify the requirements in Clauses 10.1.5.1.1 for inter-frequency measurements with the testing configurations in Table A.5.7.1.3.1-1.

**Table A.5.7.1.3.1-1: Applicable NR configurations for FR2 inter-frequency SS-RSRP accuracy test**

Config	Description of serving cell	Description of target cell
1	LTE FDD, NR 15 kHz SSB SCS, 10 MHz bandwidth, FDD duplex mode	120 kHz SSB SCS, 100 MHz bandwidth, TDD duplex mode
2	LTE FDD, NR 15 kHz SSB SCS, 10 MHz bandwidth, TDD duplex mode	
3	LTE FDD, NR 30 kHz SSB SCS, 40 MHz bandwidth, TDD duplex mode	
4	LTE TDD, NR 15 kHz SSB SCS, 10 MHz bandwidth, FDD duplex mode	
5	LTE TDD, NR 15 kHz SSB SCS, 10 MHz bandwidth, TDD duplex mode	
6	LTE TDD, NR 30 kHz SSB SCS, 40 MHz bandwidth, TDD duplex mode	
Note: The UE is only required to be tested in one of the supported test configurations		

#### A.5.7.1.3.2 Test parameters

In this set of test cases there are three cells in the test, E-UTRAN PCell (Cell 1), FR1 PCell (Cell 2) and a FR2 neighbour cell (Cell 3) on a different frequency than the PCell. The test parameters and applicability for Cell 1 are defined in A.3.7.2. The test parameters for the Cell 2 and Cell 3 are given in Table A.5.7.1.3.2-1 and Table A.5.7.1.3.2-2 below. Absolute accuracy of RSRP inter-frequency measurements are tested by using the parameters in Table A.5.7.1.3.2-1 and Table A.5.7.1.3.2-2. The inter-frequency measurements are supported by a measurement gap.

**Table A.5.7.1.3.2-1: SS-RSRP inter-frequency test parameters**

Parameter	Config	Unit	Test 1		Test 2	
			Cell 2	Cell 3	Cell 2	Cell 3
SSB ARFCN	1~6		freq1	freq2	freq1	freq2
BW <sub>channel</sub>	1,4	MHz	10: N <sub>RB,c</sub> = 52	100: N <sub>RB,c</sub> = 66	10: N <sub>RB,c</sub> = 52	100: N <sub>RB,c</sub> = 66
	2,5		10: N <sub>RB,c</sub> = 52		10: N <sub>RB,c</sub> = 52	
	3,6		40: N <sub>RB,c</sub> = 106		40: N <sub>RB,c</sub> = 106	
Data RBs allocated	1,2,4,5 3,6		52 106	24	52 106	66
Gap pattern ID			0		0	
Duplex mode	1,4		FDD	TDD	FDD	TDD
	2,5		TDD		TDD	
	3,6		TDD		TDD	
TDD configuration	1,4		N/A	TDDConf. 3.1	N/A	TDDConf. 3.1
	2,5		TDDConf. 1.1		TDDConf. 1.1	
	3,6		TDDConf. 2.1		TDDConf. 2.1	
PDSCH Reference measurement channel	1,4		SR.1.1 FDD	-	SR.1.1 FDD	-
	2,5		SR.1.1 TDD		SR.1.1 TDD	
	3,6		SR.2.1 FDD		SR.2.1 FDD	
RMSI CORESET Reference Channel	1,4		CR.1.1 FDD	-	CR.1.1 FDD	-
	2,5		CR.1.1 TDD	-	CR.1.1 TDD	-
	3,6		CR.2.1 FDD	-	CR.2.1 FDD	-
Dedicated CORESET Reference Channel	1,4		CCR.1.1 FDD	-	CCR.1.1 FDD	-
	2,5		CCR.1.1 TDD	-	CCR.1.1 TDD	-
	3,6		CCR.2.1 TDD	-	CCR.2.1 TDD	-

SSB configuration	1,4		SSB.1 FR1	SSB.3 FR2	SSB.1 FR1	SSB.3 FR2
	2,5		SSB.1 FR1		SSB.1 FR1	
	3,6		SSB.2 FR1		SSB.2 FR1	
OCNG Patterns	1~6		OP.1	OP.3	OP.1	OP.1
Initial BWP Configuration	1~6		DLBWP.0.1 ULBWP.0.1		DLBWP.0.1 ULBWP.0.1	
Dedicated BWP configuration	1~6		DLBWP.1.3 ULBWP.1.3		DLBWP.1.3 ULBWP.1.3	
TRS Configuration	1~6		TRS.2.1 TDD		TRS.2.1 TDD	
PDCCH/PDSCH TCI Configuration	1~6		TCI.State.2		TCI.State.2	
SMTc configuration	1~6		SMTc.1		SMTc.1	
Time offset between Cell 2 and Cell 3	1~6	µs	3		3	
EPRE ratio of PSS to SSS	1~6	dB	0	0	0	0
EPRE ratio of PBCH DMRS to SSS						
EPRE ratio of PBCH to PBCH DMRS						
EPRE ratio of PDCCH DMRS to SSS						
EPRE ratio of PDCCH to PDCCH DMRS						
EPRE ratio of PDSCH DMRS to SSS						
EPRE ratio of PDSCH to PDSCH DMRS						
EPRE ratio of OCNG DMRS to SSS <sup>Note 1</sup>						
EPRE ratio of OCNG to OCNG DMRS <sup>Note 1</sup>						
Propagation condition						
Antenna configuration	1~6	-	Link only, see clause A.3.7A	1x2	Link only, see clause A.3.7A	1x2
<p>Note 1: OCNG shall be used such that both cells are fully allocated and a constant total transmitted power spectral density is achieved for all OFDM symbols.</p> <p>Note 2: Void</p>						

**Table A.5.7.1.3.2-2: SS-RSRP inter-frequency OTA related test parameters**

Parameter	Config	Unit	Test 1		Test 2 <sup>NOTE 3</sup>	
			Cell 2	Cell 3	Cell 2	Cell 3
Angle of arrival configuration according to clause A.3.15			NA	Setup 2b	NA	Setup 2b
Assumption for UE beams <sup>Note 4</sup>			N/A	Rough	N/A	Rough
$N_{oc}$	1~6	dBm/15 kHz	Link only, see clause A.3.7A	-90	Link only, see clause A.3.7A	NA
$N_{oc}$	1~6	dBm/SS B SCS		-80.97		NA
$\hat{E}_s / N_{oc}$	1~6	dB		5		NA
$E_s$	1~6	dBm/SC S				Table B.2.3-2 Spherical coverage +1dB)
SSB_RP <sup>Note1</sup>	1~6	dBm/SC S		-76.0		(Table B.2.3-2 Spherical coverage +1dB)

$\hat{E}_s/I_{ot\ BB}^{Note6}$	1~6	dB	4.35	-3.81
$I_o^{Note1}$	1~6	dBm/ 95.04M Hz	-50.18	SSB_R P+28.9 8
<p>Note 1: <math>E_s/I_{ot}</math>, SSB_RP and <math>I_o</math> levels have been derived from other parameters for information purposes. They are not settable parameters themselves.</p> <p>Note 2: Void</p> <p>Note 3: No additional noise is added by the test system in Test 2.</p> <p>Note 4: Information about types of UE beam is given in B.2.1.3, and does not limit UE implementation or test system implementation</p> <p>Note 5: Where used, interference from other cells and noise sources not specified in the test is assumed to be constant over subcarriers and time and shall be modelled as AWGN of appropriate power for <math>N_{oc}</math> to be fulfilled.</p> <p>Note 6: Calculation of <math>E_s/I_{ot\ BB}</math> includes the effect of UE internal noise up to the value assumed for the associated Refsens requirement in clause 7.3.2 of TS 38.101-2 [19], and an allowance of 1dB for UE multi-band relaxation factor <math>\Delta MB_s</math> from TS 38.101-2 [19] Table 6.2.1.3-4.</p>				

### A.5.7.1.3.3 Test Requirements

The SS-RSRP measurement accuracy for Cell 3 shall fulfil the Absolute requirement in clause 10.1.5.1.1.

Test 1:

Absolute accuracy of Cell 3. The UE is deemed to meet the requirement if the reported SS-RSRP is in the range shown in Table A.5.7.1.3.3.

Test 2:

Absolute accuracy of Cell 3. The UE is deemed to meet the requirement if the reported SS-RSRP is in the range shown in Table A.5.7.1.3.3.

**Table A.5.7.1.3.3: SS-RSRP absolute accuracy test requirement**

	Test requirement <sup>Notes1,2,3,4</sup>
Cell 3	$SSB\_RP2 - \delta + G_{min} + X \leq \text{Reported RSRP(dBm)} \leq SSB\_RP2 + \delta + G_{max}$
Note 1:	SSB_RPn is the equivalent power received by an antenna with 0dBi gain at the centre of the quiet zone configured in the test for the cell n under consideration
Note 2:	$\delta$ is the RSRP absolute accuracy requirement from Table 10.1.5.1.1-1, selected according to the $I_o$ used in the test
Note 3:	$G_{min}$ and $G_{max}$ are the minimum and maximum UE gain values from Table B.2.1.5.1-1, selected according to the UE power class
Note 4:	X is the Spherical coverage gain difference in dB, derived as (UE Refsens - UE Spherical coverage) from TS 38.101-2 [19] clauses 7.3.2 and 7.3.4, selected according to the UE power class and operating band. X is always a negative value.

### A.5.7.2 SS-RSRQ

#### A.5.7.2.1 EN-DC Intra-frequency measurement accuracy with FR2 serving cell and FR2 TDD target cell

##### A.5.7.2.1.1 Test Purpose and Environment

The purpose of this test is to verify that the SS-RSRQ measurement accuracy is within the specified limits. This test will verify the requirements in clause 10.1.8.1.1.

##### A.5.7.2.1.2 Test Parameters

In this test case all cells are on the same carrier frequency. Supported test configurations are shown in Table A.5.7.2.1.2-1. The absolute accuracy of SS-RSRQ intra-frequency measurement is test by using the parameters in Table



A.5.7.2.1.2-2 and Table A.5.7.2.1.2-3. The configuration of cell 1 (E-UTRA PCell) is specified in clause A.3.7.2.1. In all test cases, Cell 2 is the PSCell and Cell 3 is the target cell.

**Table A.5.7.2.1.2-1: SS-RSRQ Intra frequency SS-RSRQ supported test configurations**

Configuration	Description
1	FDD LTE PCell, Cell 2&3 120 kHz SSB SCS, 100 MHz bandwidth, TDD duplex mode
2	TDD LTE PCell, Cell 2&3 120 kHz SSB SCS, 100 MHz bandwidth, TDD duplex mode
Note: The UE is only required to pass in one of the supported test configurations	

**Table A.5.7.2.1.2-2: SS-RSRQ Intra frequency test parameters**

Parameter	Unit	Test 1		Test 2	
		Cell 2	Cell 3	Cell 2	Cell 3
Cell ID		489	0	489	0
SSB ARFCN		Freq1		Freq1	
Duplex mode		TDD		TDD	
TDD configuration		TDDConf.3.1		TDDConf.3.1	
BW <sub>channel</sub>	MHz	100: N <sub>RB,c</sub> = 66		100: N <sub>RB,c</sub> = 66	
Data RBs allocated		66		66	
BWP configuration	Initial DL BWP	DLBWP.0.1			
	Dedicated DL BWP	DLBWP.1.1			
	Initial UL BWP	ULBWP.0.1			
	Dedicated UL BWP	ULBWP.1.1			
TRS configuration		TRS.2.1 TDD		TRS.2.1 TDD	
TCI state		TCI.State .0		TCI.State .0	
PDSCH Reference measurement channel		SR.3.1 TDD		SR.3.1 TDD	
RMSI CORESET Reference Channel		CR.3.1 TDD	-	CR.3.1 TDD	-
Control channel RMC		CCR.3.1 TDD	-	CCR.3.1 TDD	-
OCNG Patterns		OP.1	OP.1	OP.1	OP.1
SMTC configuration		SMTC.1			
SSB configuration		SSB.3 FR2	SSB.3 FR2	SSB.3 FR2	SSB.3 FR2
PDSCH/PDCCH subcarrier spacing	kHz	120	120	120	120
SS-RSSI-Measurement		Not Applicable			
EPRE ratio of PSS to SSS	dB	0	0	0	0
EPRE ratio of PBCH_DMRS to SSS					
EPRE ratio of PBCH to PBCH_DMRS					
EPRE ratio of PDCCH_DMRS to SSS					
EPRE ratio of PDCCH to PDCCH_DMRS					
EPRE ratio of PDSCH_DMRS to SSS					
EPRE ratio of PDSCH to PDSCH_DMRS					
EPRE ratio of OCNG DMRS to SSS <sup>Note 1</sup>					
EPRE ratio of OCNG to OCNG DMRS <sup>Note 1</sup>					
Propagation condition		AWGN		AWGN	
Antenna Configuration		1x2	1x2	1x2	1x2
Note 1: OCNG shall be used such that both cells are fully allocated and a constant total transmitted power spectral density is achieved for all OFDM symbols. Note 2: Void Note 3: Void Note 4: Void Note 5: Void					

**Table A.5.7.2.1.2-3: SS-RSRQ Intra frequency OTA related test parameters**

Parameter	Unit	Test 1		Test 2	
		Cell 2	Cell 3	Cell 2	Cell 3

Angle of arrival configuration		Setup 1 according to clause A.3.15.1		Setup 1 according to clause A.3.15.1	
Assumption for UE beams <sup>Note 9</sup>		Rough			
$N_{oc}$ <sup>Note1</sup>	dBm/15kHz <sup>Note4</sup>	-95		-95	
$N_{oc}$ <sup>Note1</sup>	dBm/SCS <sup>Note3</sup>	-86		-86	
$\hat{E}_s / N_{oc}$	dB	3	3	-3	-3
SSB_RP <sup>Note2</sup>	dBm/SCS <sup>Note4</sup>	-83	-83	-89	-89
SS-RSRQ <sup>Note2</sup>	dB	-14.77	-14.77	-16.81	-16.81
$\hat{E}_s / I_{ot}$	dB	-1.76	-1.76	-4.76	-4.76
$I_o$ <sup>Note2</sup>	dBm/95.04 MHz <sup>Note4</sup>	-50		-54	
<p>Note 1: Interference from other cells and noise sources not specified in the test is assumed to be constant over subcarriers and time and shall be modelled as AWGN of appropriate power for <math>N_{oc}</math> to be fulfilled.</p> <p>Note 2: SS-RSRQ, SSB_RP, and <math>I_o</math> levels have been derived from other parameters for information purposes. They are not settable parameters themselves.</p> <p>Note 3: SS-RSRQ and SS-RSRP minimum requirements are specified assuming independent interference and noise at each receiver antenna port.</p> <p>Note 4: Equivalent power received by an antenna with 0dBi gain at the centre of the quiet zone</p> <p>Note 5: As observed with 0dBi gain antenna at the centre of the quiet zone</p> <p>Note 6: Void</p> <p>Note 7: Void</p> <p>Note 8: Void</p> <p>Note 9: Information about types of UE beam is given in B.2.1.3, and does not limit UE implementation or test system implementation</p>					

### A.5.7.2.1.3 Test Requirements

The SS-RSRQ absolute measurement accuracy in test 1 shall be within the range Nominal SS-RSRQ+2.5dB to Nominal SS-RSRQ -2.5dB and the SS-RSRQ measurement accuracy in test 2 shall be within the range Nominal SS-RSRQ +3.5dB to Nominal SS-RSRQ -3.5dB according to the requirements in clause 10.1.8.1.1. Nominal SS-RSRQ is the value shown in table A.5.7.2.1.2-3.

### A.5.7.2.2 EN-DC Inter-frequency measurement accuracy with FR2 serving cell and FR2 TDD target cell

#### A.5.7.2.2.1 Test Purpose and Environment

The purpose of this test is to verify that the SS-RSRQ measurement accuracy is within the specified limits. This test will verify the requirements in clause 10.1.9.1.1 and 10.1.9.1.2 for inter-frequency measurement.

A.5.7.2.2.2 Test Parameters

In this test case the two NR cells (i.e., Cell 2 and Cell 3) are on different carrier frequencies and measurement gaps are provided. Supported test configurations are shown in Table A.5.7.2.2.2-1. Both absolute accuracy and relative accuracy requirements of SS-RSRQ inter-frequency measurement are tested by using test setup in Table A.5.7.2.2.2-2 and Table A.5.7.2.2.2-3. In all test cases, Cell 2 is the PSCell and Cell 3 is target cell. Cell 1 is the E-UTRA cell which specific test parameters for this test case are specified in Table A.3.7.2.1-1.

**Table A.5.7.2.2.2-1: SS-RSRQ Inter frequency SS-RSRQ supported test configurations**

Configuration	Description
1	LTE FDD, NR 120 kHz SSB SCS, 100 MHz bandwidth, TDD duplex mode
2	LTE TDD, NR 120 kHz SSB SCS, 100 MHz bandwidth, TDD duplex mode

**Table A.5.7.2.2.2-2: SS-RSRQ Inter frequency general test parameters**

Parameter	Unit	Test 1		Test 2	
		Cell 2	Cell 3	Cell 2	Cell 3
SSB ARFCN		Freq1	freq2	freq1	Freq2
Duplex mode		TDD		TDD	
TDD configuration		TDDConf.3.1		TDDConf.3.1	
BW <sub>channel</sub>	MHz	100: N <sub>RB,c</sub> = 66		100: N <sub>RB,c</sub> = 66	
Data RBs allocated		66		66	
BWP configuration	Initial DL BWP	DLBWP.0.1			
	Dedicated DL BWP	DLBWP.1.1			
	Initial UL BWP	ULBWP.0.1			
	Dedicated UL BWP	ULBWP.1.1			
TRS configuration		TRS.2.1 TDD	-	TRS.2.1 TDD	-
TCI state		TCI.State.0	-	TCI.State.0	-
PDSCH Reference measurement channel		SR.3.1 TDD	-	SR.3.1 TDD	-
RMSI CORESET Reference Channel		CR.3.1 TDD	-	CR.3.1 TDD	-
OCNG Patterns		OP.1	OP.1	OP.1	OP.1
SSB configuration		SSB.3 FR2	SSB.3 FR2	SSB.3 FR2	SSB.3 FR2
SMTc configuration		SMTc.1 FR2	SMTc.1 FR2	SMTc.1 FR2	SMTc.1 FR2
PDSCH/PDCCH subcarrier spacing	kHz	120	120	120	120
EPRE ratio of PSS to SSS	dB	0	0	0	0
EPRE ratio of PBCH_DMRS to SSS					
EPRE ratio of PBCH to PBCH_DMRS					
EPRE ratio of PDCCH_DMRS to SSS					
EPRE ratio of PDCCH to PDCCH_DMRS					
EPRE ratio of PDSCH_DMRS to SSS					
EPRE ratio of PDSCH to PDSCH_DMRS					
EPRE ratio of OCNG DMRS to SSS <sup>Note 1</sup>					
EPRE ratio of OCNG to OCNG DMRS <sup>Note 1</sup>					
Propagation conditions		AWGN	AWGN	AWGN	AWGN
Antenna configuration		1x2	1x2	1x2	1x2
Note 1:	OCNG shall be used such that both cells are fully allocated and a constant total transmitted power spectral density is achieved for all OFDM symbols.				
Note 2:	Void				
Note 3:	Void				
Note 4:	Void				

Table A.5.7.2.2.2-3: SS-RSRQ Inter frequency OTA related test parameters

Parameter	Unit	Test 1		Test 2	
		Cell 2	Cell 3	Cell 2	Cell 3
AoA setup		Setup 1 in clause A.3.15		Setup 1 in clause A.3.15	
Assumption for UE beams <sup>Note 8</sup>		Rough		Rough	
$N_{oc}$ <sup>Note1</sup>	dBm/15kHz <sup>Note4</sup>	-94.03	-94.03	-94.03	-94.03
$N_{oc}$ <sup>Note1</sup>	dBm/SCS <sup>Note3</sup>	-85.0	-85.0	-85.0	-85.0
$\hat{E}_s/N_{oc}$	dB	-1.75	-1.75	-3	-3
SSB_RP <sup>Note2</sup>	dBm/SCS <sup>Note4</sup>	-86.75	-86.75	-88	-88
SS-RSRQ <sup>Note2</sup>	dB	-14.75	-14.75	-15.56	-15.56
$\hat{E}_s/I_{ot}$	dB	-1.75	-1.75	-3	-3
$I_o$ <sup>Note2</sup>	dBm/95.04 MHz <sup>Note4</sup>	-53.8	-53.8	-54.25	-54.25
<p>Note 1: Interference from other cells and noise sources not specified in the test is assumed to be constant over subcarriers and time and shall be modelled as AWGN of appropriate power for <math>N_{oc}</math> to be fulfilled.</p> <p>Note 2: SS-RSRQ, SSB_RP, and <math>I_o</math> levels have been derived from other parameters for information purposes. They are not settable parameters themselves.</p> <p>Note 3: SS-RSRQ and SS-RSRP minimum requirements are specified assuming independent interference and noise at each receiver antenna port.</p> <p>Note 4: Equivalent power received by an antenna with 0dBi gain at the centre of the quiet zone</p> <p>Note 5: As observed with 0dBi gain antenna at the centre of the quiet zone</p> <p>Note 6: Void</p> <p>Note 7: Void</p> <p>Note 8: Information about types of UE beam is given in B.2.1.3, and does not limit UE implementation or test system implementation</p>					

### A.5.7.2.2.3 Test Requirements

The SS-RSRQ absolute measurement accuracy in test 1 shall be within the range Nominal SS-RSRQ+2.5dB to Nominal SS-RSRQ-2.5dB and the SS-RSRQ measurement accuracy in test 2 shall be within the range Nominal SS-RSRQ+3.5dB to Nominal SS-RSRQ-3.5dB according to the requirements in clause 10.1.10.1.1.

The SS-RSRQ relative measurement accuracy shall fulfil the requirements in clause 10.1.10.1.2.

## A.5.7.3 SS-SINR

### A.5.7.3.1 EN-DC Intra-frequency measurement accuracy with FR2 serving cell and FR2 TDD target cell

#### A.5.7.3.1.1 Test Purpose and Environment

The purpose of this test is to verify that the SS-SINR measurement accuracy is within the specified limits. This test will verify the requirements in clause 10.1.13.1.1.

#### A.5.7.3.1.2 Test Parameters

In this test case all cells are on the same carrier frequency. Supported test configurations are shown in Table A.5.7.3.1.2-1. The absolute accuracy of SS-SINR intra-frequency measurement is test by using the parameters in Table A.5.7.3.1.2-2 and Table A.5.7.3.1.2-3. The configuration of cell 1 (E-UTRA PCell) is specified in clause A.3.7.2.1. In all test cases, Cell 2 is the PCell and Cell 3 is the target cell.

**Table A.5.7.3.1.2-1: SS-SINR Intra frequency SS-SINR supported test configurations**

Configuration	Description
1	FDD LTE PCell, Cell 2&3 120 kHz SSB SCS, 100 MHz bandwidth, TDD duplex mode
2	TDD LTE PCell, Cell 2&3 120 kHz SSB SCS, 100 MHz bandwidth, TDD duplex mode

Note: The UE is only required to pass in one of the supported test configurations

**Table A.5.7.3.1.2-2: SS-SINR Intra frequency test parameters**

Parameter	Unit	Test 1		Test 2	
		Cell 2	Cell 3	Cell 2	Cell 3
Cell ID		489	0	489	0
SSB ARFCN		Freq2		Freq2	
Duplex mode		TDD		TDD	
TDD configuration		TDDConf.3.1		TDDConf.3.1	
BW <sub>channel</sub>	MHz	100: N <sub>RB,c</sub> = 66		100: N <sub>RB,c</sub> = 66	
Data RBs allocated		66		66	
Downlink initial BWP configuration		DLBWP.0.1			
Downlink dedicated BWP configuration		DLBWP.1.1			
Uplink initial BWP configuration		ULBWP.0.1			
Uplink dedicated BWP configuration		ULBWP.1.1			
DRX cycle configuration	ms	Not applicable			
TRS configuration		TRS.2.1 TDD			
TCI state		TCI.State.0			
PDSCH Reference measurement channel		SR.3.1 TDD		SR.3.1 TDD	
RMSI CORESET Reference Channel		CR.3.1 TDD	-	CR.3.1 TDD	-
Dedicated RMSI CORESET Reference Channel		CCR.3.1 TDD	-	CCR.3.1 TDD	-
OCNG Patterns		OP.1	OP.1	OP.1	OP.1
SMTC configuration		SMTC.1			
SSB configuration		SSB.1 FR2	SSB.1 FR2	SSB.1 FR2	SSB.1 FR2
PDSCH/PDCCH subcarrier spacing	kHz	120	120	120	120
SS-RSSI-Measurement		Not Applicable			
EPRE ratio of PSS to SSS	dB	0	0	0	0
EPRE ratio of PBCH_DMRS to SSS					
EPRE ratio of PBCH to PBCH_DMRS					
EPRE ratio of PDCCH_DMRS to SSS					
EPRE ratio of PDCCH to PDCCH_DMRS					
EPRE ratio of PDSCH_DMRS to SSS					
EPRE ratio of PDSCH to PDSCH_DMRS					
EPRE ratio of OCNG DMRS to SSS <sup>Note 1</sup>					
EPRE ratio of OCNG to OCNG DMRS <sup>Note 1</sup>					
Propagation conditions		AWGN		AWGN	
Antenna configuration		1x2	1x2	1x2	1x2
Note 1: OCNG shall be used such that both cells are fully allocated and a constant total transmitted power spectral density is achieved for all OFDM symbols. Note 2: Void Note 3: Void Note 4: Void					

**Table A.5.7.3.1.2-3: SS-SINR Intra frequency OTA related test parameters**

Parameter	Unit	Test 1		Test 2	
		Cell 2	Cell 3	Cell 2	Cell 3
Angle of arrival configuration		Setup 1 according to clause A.3.15.1		Setup 1 according to clause A.3.15.1	
Assumption for UE beams <sup>Note 9</sup>		Rough		Rough	
$N_{oc}$ <sup>Note1</sup>	dBm/15kHz <sup>Note4</sup>	-105		-105	

$N_{oc}$ Note1	dBm/SCS Note3	-96		-96	
$\hat{E}_s / N_{oc}$	dB	4.54	2.66	-3	-3
SS-RSRP Note2	dBm/SCS Note4	-91.46	-93.34	-99	-99
SS-SINR Note2	dB	0	-3.2	-4.76	-4.76
$\hat{E}_s / I_{ot}$	dB	0	-3.2	-4.76	-4.76
$I_o$ Note2	dBm/95.04 MHz Note4	-59.43		-64	
<p>Note 1: Interference from other cells and noise sources not specified in the test is assumed to be constant over subcarriers and time and shall be modelled as AWGN of appropriate power for <math>N_{oc}</math> to be fulfilled.</p> <p>Note 2: SS-SINR, SSB_RP, and <math>I_o</math> levels have been derived from other parameters for information purposes. They are not settable parameters themselves.</p> <p>Note 3: SS-SINR and SS-RSRP minimum requirements are specified assuming independent interference and noise at each receiver antenna port.</p> <p>Note 4: Equivalent power received by an antenna with 0dBi gain at the centre of the quiet zone</p> <p>Note 5: As observed with 0dBi gain antenna at the centre of the quiet zone</p> <p>Note 6: Void</p> <p>Note 7: Void</p> <p>Note 8: Void</p> <p>Note 9: Information about types of UE beam is given in B.2.1.3, and does not limit UE implementation or test system implementation</p>					

**A.5.7.3.1.3 Test Requirements**

The SS-SINR absolute measurement accuracy in test 1 shall be within the range Nominal SS-SINR+3B to Nominal SS-SINR -3dB and the SS-SINR measurement accuracy in test 2 shall be within the range Nominal SS-SINR +3.5dB to Nominal SS-SINR -3.5dB according to the requirements in clause 10.1.10.13.1. Nominal SS-SINR is the value shown in table A.5.7.3.1.2-3.

The SS-SINR relative measurement accuracy shall fulfil the requirements in clause 10.1.13.1.1.

**A.5.7.3.2 EN-DC Inter-frequency measurement accuracy with FR2 serving cell and FR2 TDD target cell**

**A.5.7.3.2.1 Test Purpose and Environment**

The purpose of this test is to verify that the SS-SINR measurement accuracy is within the specified limits. This test will verify the requirements in clause 10.1.15.1.1 and 10.1.15.1.2 for inter-frequency measurement.

**A.5.7.3.2.2 Test Parameters**

In this test case the two NR cells (i.e., Cell 2 and Cell 3) are on different carrier frequencies and measurement gaps are provided. Supported test configurations are shown in Table A.5.7.3.2.2-1. Both absolute accuracy and relative accuracy requirements of SS-SINR inter-frequency measurement are tested by using test setup in Table A.5.7.3.2.2-2 and Table A.5.7.3.2.2-3. In all test cases, Cell 2 is the PSCell and Cell 3 is target cell. Cell 1 is the E-UTRA cell which specific test parameters for this test case are specified in Table A.3.7.2.1-1. The TCI status for Cell 1 is defined in Table A.3.16.2-1 and TRS configuration for Cell 1 is defined in Table A.3.17.2.1-1.

**Table A.5.7.3.2.2-1: SS-SINR Inter frequency SS-SINR supported test configurations**

Configuration	Description
1	LTE FDD, NR 120 kHz SSB SCS, 100 MHz bandwidth, TDD duplex mode
2	LTE TDD, NR 120 kHz SSB SCS, 100 MHz bandwidth, TDD duplex mode

**Table A.5.7.3.2.2-2: SS-SINR Inter frequency general test parameters**

Parameter	Unit	Test 1		Test 2		Test 3	
		Cell 2	Cell 3	Cell 2	Cell 3	Cell 2	Cell 3
SSB ARFCN		Freq1	freq2	freq1	Freq2	freq1	Freq2
Duplex mode		TDD		TDD		TDD	
TDD configuration		TDDConf.3.1		TDDConf.3.1		TDDConf.3.1	
BW <sub>channel</sub>	MHz	100: N <sub>RB,c</sub> = 66		100: N <sub>RB,c</sub> = 66		100: N <sub>RB,c</sub> = 66	
Data RBs allocated		66		66		66	
Downlink initial BWP configuration		DLBWP.0.1					
Downlink dedicated BWP configuration		DLBWP.1.1					
Uplink initial BWP configuration		ULBWP.0.1					
Uplink dedicated BWP configuration		ULBWP.1.1					
DRX cycle configuration	ms	Not applicable					
TRS configuration		TRS.2.1 TDD					
TCI state		TCI.State.0					
PDSCH Reference measurement channel		SR.3.1 TDD	-	SR.3.1 TDD	-	SR.3.1 TDD	-
RMSI CORESET Reference Channel		CR.3.1 TDD	-	CR.3.1 TDD	-	CR.3.1 TDD	-
OCNG Patterns		OP.1	OP.1	OP.1	OP.1	OP.1	OP.1
SMTC configuration		SMTC. 1 FR2	SMTC. 1 FR2	SMTC. 1 FR2	SMTC. 1 FR2	SMTC. 1 FR2	SMTC. 1 FR2
SSB configuration		SSB.3 FR2	SSB.3 FR2	SSB.3 FR2	SSB.3 FR2	SSB.3 FR2	SSB.3 FR2
PDSCH/PDCCH subcarrier spacing	kHz	120	120	120	120	120	120
EPRE ratio of PSS to SSS	dB	0	0	0	0	0	0
EPRE ratio of PBCH_DMRS to SSS							
EPRE ratio of PBCH to PBCH_DMRS							
EPRE ratio of PDCCH_DMRS to SSS							
EPRE ratio of PDCCH to PDCCH_DMRS							
EPRE ratio of PDSCH_DMRS to SSS							
EPRE ratio of PDSCH to PDSCH_DMRS							
EPRE ratio of OCNG DMRS to SSS <sup>Note 1</sup>							
EPRE ratio of OCNG to OCNG DMRS <sup>Note 1</sup>							
Propagation conditions		AWGN	AWGN	AWGN	AWGN	AWGN	AWGN
Antenna configuration		1x2	1x2	1x2	1x2	1x2	1x2
Note 1: OCNG shall be used such that both cells are fully allocated and a constant total transmitted power spectral density is achieved for all OFDM symbols. Note 2: Void Note 3: Void Note 4: Void							

**Table A.5.7.3.2.2-3: SS-SINR Inter frequency OTA related test parameters**

Parameter	Unit	Test 1		Test 2		Test 3	
		Cell 2	Cell 3	Cell 2	Cell 3	Cell 2	Cell 3
Angle of arrival configuration	degrees	Setup 1 according to A.3.15.1		Setup 1 according to A.3.15.1		Setup 1 according to A.3.15.1	
Assumption for UE beams <sup>Note 10</sup>		Rough		Rough		Rough	
$N_{oc}$ <sup>Note1</sup>	$\frac{dBm}{15kHz}$ <sup>Note4</sup>	-105	-105	-105	-105	-105	-105
$N_{oc}$ <sup>Note1</sup>	$\frac{dBm}{SCS}$ <sup>Note3</sup>	-96	-96	-96	-96	-96	-96
$\hat{E}_s / N_{oc}$	dB	-0.5	-0.5	11	11.	-3.0	-3.0
SS-RSRP <sup>Note2</sup>	$\frac{dBm}{SCS}$ <sup>Note4</sup>	-96.5	-96.5	-85	-85	-99	-99
SS-SINR <sup>Note2</sup>	dB	-0.5	-0.5	11	11	-3.0	-3.0
$\hat{E}_s / I_{ot}$	dB	-0.5	-0.5	11	11	-3.0	-3.0

$I_0$ <sup>Note2</sup>	dBm/95.04 MHz <sup>Note4</sup>	-69.3	-69.3	-55.4	-55.4	-65.24	-65.24
<p>Note 1: Interference from other cells and noise sources not specified in the test is assumed to be constant over subcarriers and time and shall be modelled as AWGN of appropriate power for <math>N_{oc}</math> to be fulfilled.</p> <p>Note 2: SS-SINR, SSB_RP, and <math>I_0</math> levels have been derived from other parameters for information purposes. They are not settable parameters themselves.</p> <p>Note 3: SS-SINR and SS-RSRP minimum requirements are specified assuming independent interference and noise at each receiver antenna port.</p> <p>Note 4: Equivalent power received by an antenna with 0dBi gain at the centre of the quiet zone</p> <p>Note 5: As observed with 0dBi gain antenna at the centre of the quiet zone</p> <p>Note 6: Void</p> <p>Note 7: Void</p> <p>Note 8: Void</p> <p>Note 9: Void</p> <p>Note 10: Information about types of UE beam is given in B.2.1.3, and does not limit UE implementation or test system implementation</p>							

### A.5.7.3.2.3 Test Requirements

The SS-SINR absolute measurement accuracy in test 1 shall be within the range Nominal SS-SINR+3dB to Nominal SS-SINR -3dB and the SS-SINR measurement accuracy in test 2 shall be within the range Nominal SS-SINR+3.5dB to Nominal SS-SINR -3.5dB according to the requirements in clause 10.1.15.1.1. Nominal SS-SINR is the value shown in table A.5.7.2.2.2-3

The SS-SINR relative measurement accuracy shall fulfil the requirements in clause 10.1.15.1.2.

## A.5.7.4 L1-RSRP measurement for beam reporting

### A.5.7.4.1 SSB based L1-RSRP measurement

#### A.5.7.4.1.1 Test Purpose and Environment

The purpose of this test is to verify that the L1-RSRP measurement accuracy is within the specified limits. This test will verify the requirements in Clauses 9.5.2 and clause 10.1.20.1 for L1-RSRP measurements based on SSB with the testing configurations for NR cells in Table A.5.7.4.1.1-1.

The AoA setup for this test is Setup 1 as defined in clause A.3.15.

**Table A.5.7.4.1.1-1: Applicable NR configurations for FR2 SSB based L1-RSRP test**

Config	Description
1	LTE FDD, NR 120 kHz SSB SCS, 100 MHz bandwidth, TDD duplex mode
2	LTE TDD, NR 120 kHz SSB SCS, 100 MHz bandwidth, TDD duplex mode
3	LTE FDD, NR 240 kHz SSB SCS, 100 MHz bandwidth, TDD duplex mode
4	LTE TDD, NR 240 kHz SSB SCS, 100 MHz bandwidth, TDD duplex mode
Note:	The UE is only required to be tested in one of the supported test configurations in each supported band

#### A.5.7.4.1.2 Test parameters

In this set of test cases there are two cells in the test, E-UTRAN PCell (Cell 1), FR1 PSCell (Cell 2). The test parameters and applicability for Cell 1 are defined in A.3.7.2. The test parameters for the Cell 2 are given in Table A.5.7.4.1.2-1 and Table A.5.7.4.1.2-2 below. The absolute and relative accuracy of L1-RSRP measurements are tested by using the parameters in Table A.5.7.4.1.2-1 and Table A.5.7.4.1.2-2.

There is no measurement gap configured in the test. Before the test, UE is configured one SSB resource set with two SSB resources. UE is configured to perform RLM, BFD and L1-RSRP measurement based on the SSB resources 0 and 1.

**Table A.5.7.4.1.2-1: FR2 SSB based L1-RSRP general test parameters**

Parameter	Config	Unit	Test 1	Test 2
-----------	--------	------	--------	--------



SSB GSCN	1~4		freq1	freq1
Duplex mode	1~4		TDD	TDD
TDD Configuration	1~4		TDDConf.3.1	TDDConf.3.1
BW <sub>channel</sub>	1~4	MHz	100: N <sub>RB,c</sub> = 66	100: N <sub>RB,c</sub> = 66
Data RBs allocated	1~4		66	66
PDSCH Reference measurement channel	1,2		SR.3.2 TDD	SR.3.2 TDD
	3,4		SR.3.3 TDD	SR.3.3 TDD
RMSI CORESET Reference Channel	1,2		CR.3.1 TDD	CR.3.1 TDD
	3,4		CR.3.2 TDD	CR.3.2 TDD
Dedicated CORESET Reference Channel	1,2		CCR.3.1 TDD	CCR.3.1 TDD
	3,4		CCR.3.7 TDD	CCR.3.7 TDD
SSB configuration	1,2		SSB.1 FR2	SSB.1 FR2
	3,4		SSB.2 FR2	SSB.2 FR2
OCNG Patterns	1~4		OP.1	OP.1
Initial BWP Configuration	1~4		DLBWP.0.1 ULBWP.0.1	DLBWP.0.1 ULBWP.0.1
Dedicated BWP configuration	1~4		DLBWP.1.3 ULBWP.1.3	DLBWP.1.3 ULBWP.1.3
TRS Configuration	1~4		TRS.2.1 TDD	TRS.2.1 TDD
PDCCH/PDSCH TCI Configuration	1~4		TCI.State.2	TCI.State.2
SMTC configuration	1~4		SMTC.1	SMTC.1
reportConfigType	1~4		periodic	periodic
reportQuantity	1~4		ssb-Index-RSRP	ssb-Index-RSRP
Number of reported RS	1~4		2	2
L1-RSRP reporting period	1~4		slot320	slot320
Propagation condition	1~4		AWGN	AWGN
Antenna configuration			1x2	1x2
EPRE ratio of PSS to SSS	1~4	dB	0	0
EPRE ratio of PBCH DMRS to SSS				
EPRE ratio of PBCH to PBCH DMRS				
EPRE ratio of PDCCH DMRS to SSS				
EPRE ratio of PDCCH to PDCCH DMRS				
EPRE ratio of PDSCH DMRS to SSS				
EPRE ratio of PDSCH to PDSCH DMRS				
EPRE ratio of OCNG DMRS to SSS <sup>Note 1</sup>				
EPRE ratio of OCNG to OCNG DMRS <sup>Note 1</sup>				
<p>Note 1: OCNG shall be used such that both cells are fully allocated and a constant total transmitted power spectral density is achieved for all OFDM symbols.</p> <p>Note 2: Interference from other cells and noise sources not specified in the test is assumed to be constant over subcarriers and time and shall be modelled as AWGN of appropriate power for <math>N_{oc}</math> to be fulfilled.</p>				

**Table A.5.7.4.1.2-2: FR2 SSB based L1-RSRP OTA related test parameters**

Parameter	Config	Unit	Test 1		Test 2 <sup>NOTE 3</sup>	
			SSB0	SSB1	SSB0	SSB1
Angle of arrival configuration			Setup 1 according to A.3.15.1		Setup 1 according to A.3.15.1	
Assumption for UE beams <sup>Note 4</sup>			Rough		Rough	
$N_{oc}$	1~4	dBm/15 kHz	-100		n.a.	

$N_{oc}$	1,2	dBm/SS B SCS	-91		n.a.
	3,4		-88		n.a.
$\hat{E}_s / I_{ot}$	1~4	dB	10	-2	n.a.
SSB_RP <sup>Note1</sup>	1,2	dBm/SC S	-81	-93	As in Table B.2.4-2
	3,4		-78	-90	As in Table B.2.4-2
$I_o$ <sup>Note1</sup>	1~4	dBm/ 95.04M Hz	-51.57		SSB_RP+28.98
$\hat{E}_s / N_{oc}$	1~4	dB	10	-2	n.a.
<p>Note 1: SSB_RP and <math>I_o</math> levels have been derived from other parameters for information purposes. They are not settable parameters themselves.</p> <p>Note 2: Void</p> <p>Note 3: No additional noise is added by the test system in Test 2.</p> <p>Note 4: Information about types of UE beam is given in B.2.1.3, and does not limit UE implementation or test system implementation</p>					

**A.5.7.4.1.3 Test Requirements**

After 320ms from the beginning of the test, the L1-RSRP measurement accuracy for SSB#0 and SSB#1 of Cell 2 shall fulfil the requirements in clauses 10.1.20.1. The following requirements are to be verified:

For Test 1:

Absolute accuracy of SSB0. The UE is deemed to meet the requirement if the reported L1-RSRP is in the range shown in Table A.5.7.4.1.3-1.

Relative accuracy of SSB0 compared with SSB1. The UE is deemed to meet the requirement if the difference in reported L1-RSRP meets the requirements in Table 10.1.20.1.2-1.

For Test 2:

Absolute accuracy of SSB resource reported by UE in L1-RSRP report (SSB0 or SSB1). The UE is deemed to meet the requirement if the reported L1-RSRP is in the range shown in Table A.5.7.4.1.3-1.

Relative accuracy of SSB0 compared with SSB1. The UE is deemed to meet the requirement if the difference in reported L1-RSRP meets the requirements in Table 10.1.20.1.2-1.

**Table A.5.7.4.1.3-1: L1-RSRP absolute accuracy test requirement**

	Test requirement <sup>Notes1,2,3</sup>
SSB0	$SSB\_RP0 - \delta + G_{min} \leq \text{Reported RSRP(dBm)} \leq SSB\_RP0 + \delta + G_{max}$
SSB1	$SSB\_RP1 - \delta + G_{min} \leq \text{Reported RSRP(dBm)} \leq SSB\_RP1 + \delta + G_{max}$
<p>Note 1: SSB_RPn is the equivalent power received by an antenna with 0dBi gain at the centre of the quiet zone configured in the test for the SSB n under consideration</p> <p>Note 2: <math>\delta</math> is the RSRP absolute accuracy requirement from Table 10.1.20.1.1-1, selected according to the <math>I_o</math> used in the test</p> <p>Note 3: <math>G_{min}</math> and <math>G_{max}</math> are the minimum and maximum UE gain values from Table B.2.1.5.1-1, selected according to the UE power class</p>	

**A.5.7.4.2 CSI-RS based L1-RSRP measurement on resource set with repetition off**

**A.5.7.4.2.1 Test Purpose and Environment**

The purpose of this test is to verify that the L1-RSRP measurement accuracy is within the specified limits. This test will verify the requirements in Clauses 9.5.3 and clause 10.1.20.2 for L1-RSRP measurements based on CSI-RS with the testing configurations for NR cells in Table A.5.7.4.2.1-1.

The AoA setup for this test is Setup 1 as defined in clause A.3.15.

**Table A.5.7.4.2.1-1: Applicable NR configurations for FR2 CSI-RS based L1-RSRP test**

Config	Description
1	LTE FDD, NR 120 kHz CSI-RS SCS, 100 MHz bandwidth, TDD duplex mode
2	LTE TDD, NR 120 kHz CSI-RS SCS, 100 MHz bandwidth, TDD duplex mode
Note: The UE is only required to be tested in one of the supported test configurations in each supported band	

### A.5.7.4.2.2 Test parameters

In this set of test cases there are two cells in the test, E-UTRAN PCell (Cell 1), FR1 PCell (Cell 2). The test parameters and applicability for Cell 1 are defined in A.3.7.2. The test parameters for the Cell 2 are given in Table A.5.7.4.2.2-1 and Table A.5.7.4.2.2-2 below. The absolute and relative accuracy of L1-RSRP measurements are tested by using the parameters in Table A.5.7.4.2.2-1 and Table A.5.7.4.2.2-2.

There is no measurement gap configured in the test. Before the test, UE is configured one CSI-RS resource set with two CSI-RS resources. UE is configured to perform RLM and BFD based on SSB 0 and 1. CSI-RS is not transmitted in the same OFDM symbols as SSB.

**Table A.5.7.4.2.2-1: FR2 CSI-RS based L1-RSRP general test parameters**

Parameter	Config	Unit	Test 1	Test 2
SSB GSCN	1~2		freq1	freq1
Duplex mode	1~2		TDD	TDD
TDD Configuration	1~2		TDDConf.3.1	TDDConf.3.1
BW <sub>channel</sub>	1~2	MHz	100: N <sub>RB,c</sub> = 66	100: N <sub>RB,c</sub> = 66
PDSCH Reference measurement channel	1~2		SR.3.1 TDD	SR.3.1 TDD
RMSI CORESET Reference Channel	1~2		CR.3.1 TDD	CR.3.1 TDD
Dedicated CORESET Reference Channel	1~2		CCR.3.1 TDD	CCR.3.1 TDD
SSB configuration	1~2		SSB.1 FR2	SSB.1 FR2
OCNG Patterns	1~2		OP.1	OP.1
Initial BWP Configuration	1~2		DLBWP.0.1 ULBWP.0.1	DLBWP.0.1 ULBWP.0.1
Dedicated BWP configuration	1~2		DLBWP.1.1 ULBWP.1.1	DLBWP.1.1 ULBWP.1.1
TRS Configuration	1~2		TRS.2.1 TDD	TRS.2.1 TDD
PDCCH/PDSCH TCI Configuration	1~2		TCI.State.2	TCI.State.2
SMTc configuration	1~2		SMTc.1	SMTc.1
CSI-RS	1~2		CSI-RS.3.2 TDD	CSI-RS.3.2 TDD
reportConfigType	1~2		periodic	periodic
reportQuantity	1~2		cri-RSRP	cri-RSRP
Number of reported RS	1~2		2	2
L1-RSRP reporting period	1~2		slot320	slot320
Propagation condition	1~2		AWGN	AWGN
Antenna configuraion	1~2		1x2	1x2
EPRE ratio of PSS to SSS	1~2	dB	0	0
EPRE ratio of PBCH DMRS to SSS				
EPRE ratio of PBCH to PBCH DMRS				
EPRE ratio of PDCCH DMRS to SSS				
EPRE ratio of PDCCH to PDCCH DMRS				
EPRE ratio of PDSCH DMRS to SSS				
EPRE ratio of PDSCH to PDSCH DMRS				
EPRE ratio of OCNG DMRS to SSS <sup>Note 1</sup>				
EPRE ratio of OCNG to OCNG DMRS <sup>Note 1</sup>				
Note 1: OCNG shall be used such that both cells are fully allocated and a constant total transmitted power spectral density is achieved for all OFDM symbols.				

Note 2: Interference from other cells and noise sources not specified in the test is assumed to be constant over subcarriers and time and shall be modelled as AWGN of appropriate power for  $N_{oc}$  to be fulfilled.

**Table A.5.7.4.2.2-2: FR2 CSI-RS based L1-RSRP OTA related test parameters**

Parameter	Config	Unit	Test 1		Test 2 <sup>NOTE 3</sup>	
			CSI-RS0	CSI-RS1	CSI-RS0	CSI-RS1
Angle of arrival configuration			Setup 1 according to A.3.15.1		Setup 1 according to A.3.15.1	
Assumption for UE beams <sup>Note 4</sup>			Rough		Rough	
$N_{oc}$	1~2	dBm/15 kHz	-100		n.a.	
$N_{oc}$	1~2	dBm/SS B SCS	-91		n.a. n.a.	
$\hat{E}_s / I_{ot}$	1~2	dB	10	-2	n.a.	
CSI-RS-RSRP <sup>Note1</sup>	1~2	dBm/SC S	-81	-93	As in Table B.2.4-2	
$I_o$ <sup>Note1</sup>	1~2	dBm/95.04M Hz	-59.86		SS-RSRP+28.98	
$\hat{E}_s / N_{oc}$	1~2	dB	-51.57	-2	n.a.	
Note 1: RSRP and $I_o$ levels have been derived from other parameters for information purposes. They are not settable parameters themselves. Note 2: RSRP minimum requirements are specified assuming independent interference and noise at each receiver antenna port. Note 3: No additional noise is added by the test system in Test 2. Note 4: Information about types of UE beam is given in B.2.1.3, and does not limit UE implementation or test system implementation						

**A.5.7.4.2.3 Test Requirements**

After 320ms from the beginning of the test, the L1-RSRP measurement accuracy for CSI-RS#0 and CSI-RS#1 of Cell 2 shall fulfil the requirements in clauses 10.1.20.2. The following requirements are to be verified:

For Test 1:

Absolute accuracy of CSI-RS0. The UE is deemed to meet the requirement if the reported L1-RSRP is in the range shown in Table A.5.7.4.2.3-1.

Relative accuracy of CSI-RS0 compared with CSI-RS1. The UE is deemed to meet the requirement if the difference in reported L1-RSRP meets the requirements in Table 10.1.20.2.2-1.

For Test 2:

Absolute accuracy of CSI-RS resource reported by UE in L1-RSRP report (CSI-RS0 or CSI-RS1). The UE is deemed to meet the requirement if the reported L1-RSRP is in the range shown in Table A.5.7.4.2.3-1.

Relative accuracy of CSI-RS0 compared with CSI-RS1. The UE is deemed to meet the requirement if the difference in reported L1-RSRP meets the requirements in Table 10.1.20.2.2-1.

**Table A.5.7.4.2.3-1: L1-RSRP absolute accuracy test requirement**

	Test requirement <sup>Notes1,2,3</sup>
CSI-RS0	$CSI-RS\_RP0 - \delta + G_{min} \leq \text{Reported RSRP(dBm)} \leq CSI-RS\_RP0 + \delta + G_{max}$
CSI-RS1	$CSI-RS\_RP1 - \delta + G_{min} \leq \text{Reported RSRP(dBm)} \leq CSI-RS\_RP1 + \delta + G_{max}$
Note 1: CSI-RS_RPn is the equivalent power received by an antenna with 0dBi gain at the centre of the quiet zone configured in the test for the CSI-RS n under consideration Note 2: $\delta$ is the RSRP absolute accuracy requirement from Table 10.1.20.2.1-1, selected according to the $I_o$ used in the test Note 3: $G_{min}$ and $G_{max}$ are the minimum and maximum UE gain values from Table B.2.1.5.1-1, selected according to the UE power class	

## A.5.7.5 CLI measurements

### A.5.7.5.1 EN-DC SRS-RSRP measurement accuracy with FR2 serving cell

#### A.5.7.5.1.1 Test Purpose and Environment

The purpose of this test is to verify that the SRS-RSRP measurement accuracy is within the specified limits. This test will verify the requirements in Clauses 10.1.22.1.1 with the testing configurations for NR cells in Table A.5.7.5.1.1-1.

**Table A.5.7.5.1.1-1: Applicable NR configurations for FR2 SRS-RSRP accuracy test**

Config	Description
1	LTE FDD, NR 120 kHz SRS SCS, 100 MHz bandwidth, TDD duplex mode
2	LTE TDD, NR 120 kHz SRS SCS, 100 MHz bandwidth, TDD duplex mode
Note:	The UE is only required to be tested in one of the supported test configurations in each supported band

#### A.5.7.5.1.2 Test parameters

In this set of test cases there are two cells in the test, E-UTRAN PCell (Cell 1), FR2 PSCell (Cell 2). The test parameters and applicability for Cell 1 are defined in A.3.7.2. The test parameters for the Cell 2 are given in Table A.5.7.5.1.2-1 and A.5.7.5.1.2-2 below. The test parameter for the (virtual) neighbor cell UE transmitting SRS are given in Table A.5.7.5.1.2-2.

Before the test UE is configured to perform SRS-RSRP measurement. During the test, the test system transmits SRS resources for measurement in the DL slots according to the SRS configuration in Table A.5.7.5.1.2-3. There is no measurement gap configured in the test. During the test, the test system does not transmit PDCCH/PDSCH/OCNG on SRS symbol to be transmitted and on 2 data symbols before SRS to be transmitted.

**Table A.5.7.5.1.2-1: FR2 test parameters for SRS-RSRP accuracy**

Parameter	Config	Unit	Test 1	Test 2
SSB GSCN	1~2		freq1	freq1
Duplex mode	1~2		TDD	TDD
TDD configuration	1~2		TDDConf.3.1	TDDConf.3.1
BW <sub>channel</sub>	1~2	MHz	100: N <sub>RB,c</sub> = 66	100: N <sub>RB,c</sub> = 66
PDSCH Reference measurement channel	1~2		SR.3.1 TDD	SR.3.1 TDD
RMSI CORESET Reference Channel	1~2		CR.3.1 TDD	CR.3.1 TDD
Dedicated CORESET Reference Channel	1~2		CCR.3.1 TDD	CCR.3.1 TDD
SSB configuration	1~2		SSB.3 FR2	SSB.3 FR2
OCNG Patterns	1~2		OP.1	OP.1
TRS configuration	1~2		TRS.2.1 TDD	TRS.2.1 TDD
Initial BWP Configuration	1~2		DLBWP.0.1 ULBWP.0.1	DLBWP.0.1 ULBWP.0.1
Dedicated BWP configuration	1~2		DLBWP.1.3 ULBWP.1.3	DLBWP.1.3 ULBWP.1.3
SMTC configuration	1~2		SMTC.1	SMTC.1
Time offset between DL from serving cell and SRS from test system	1~2	µs	10.76	10.67
EPRE ratio of PSS to SSS	1~2	dB	0	0
EPRE ratio of PBCH DMRS to SSS				
EPRE ratio of PBCH to PBCH DMRS				
EPRE ratio of PDCCH DMRS to SSS				
EPRE ratio of PDCCH to PDCCH DMRS				
EPRE ratio of PDSCH DMRS to SSS				
EPRE ratio of PDSCH to PDSCH DMRS				
EPRE ratio of OCNG DMRS to SSS <sup>Note 1</sup>				

EPRE ratio of OCNG to OCNG DMRS <sup>Note 1</sup>				
Propagation condition	1~2		AWGN	AWGN
Antenna configuration	1~2		1x2	1x2
SRS configuration	1~2		SRSCConf.1	SRSCConf.1
Note 1: OCNG shall be used such that a constant total transmitted power spectral density is achieved for all OFDM symbols.				

**Table A.5.7.5.1.2-2: SRS-RSRP accuracy OTA related test parameters for PSCell and Neighbour cell UE in FR2**

Parameter	Unit	T1	T2
Angle of arrival configuration		Setup 1 defined A.3.15.1	Setup 1 defined A.3.15.1
Beam assumption <sup>Note 5</sup>		Fine	Fine
$N_{oc}$ <sup>Note1</sup>	dBm/15kHz <sub><sup>z</sup>Note3</sub>	-100	N/A
$N_{oc}$ <sup>Note1</sup>	dBm/SCS <sub>Note3</sub>	-91	N/A
$\hat{E}_s/N_{oc}$	dB	2	N/A
$E_s$	dBm/SCS <sub>Note3</sub>		(Table B.2.7-2 Rx Beam Peak)
SRS_RP <sup>Note2</sup>	dBm/SCS	-89	(Table B.2.7-2 Rx Beam Peak)
$\hat{E}_s/I_{ot\ BB}$ <sup>Note4</sup>	dB	>1	1
$I_o$ <sup>Note2</sup>	dBm/95.04 MHz <sub>Note3</sub>	-57.89	(Table B.2.7-2 Rx Beam Peak +50.79dB)
<p>Note 1: Where used, interference from other cells and noise sources not specified in the test is assumed to be constant over subcarriers and time and shall be modelled as AWGN of appropriate power for <math>N_{oc}</math> to be fulfilled.</p> <p>Note 2: SRS_RP, <math>E_s/I_{ot}</math> and <math>I_o</math> levels have been derived from other parameters for information purposes. They are not settable parameters themselves.</p> <p>Note 3: Equivalent power received by an antenna with 0 dBi gain at the centre of the quiet zone</p> <p>Note 4: Calculation of <math>E_s/I_{ot\ BB}</math> includes the effect of UE internal noise up to the value assumed for the associated Refsens requirement in clause 7.3.2 of TS 36.101-2 [19], and an allowance of 2dB for UE multi-band relaxation factor <math>\sum MB_P</math> from TS 38.101-2 [19] Table 6.2.1.3-4.</p> <p>Note 5: Information about types of UE beam is given in B.2.1.3, and does not limit UE implementation or test system implementation.</p>			

**Table A.5.7.5.1.2-3: SRS configuration parameters for FR2 SRS-RSRP accuracy**

	Field	SRSCConf.1
SRS-ResourceSet	srs-ResourceSetId	0
	srs-ResourceIdList	0
	resourceType	Periodic
	Usage	Codebook
SRS-Resource	SRS-ResourceId	0
	nrofSRS-Ports	Port1
	transmissionComb	n2
	combOffset-n2	0
	cyclicShift-n2	0
	resourceMapping startPosition	0
	resourceMapping	n1
	nrofSymbols	n1

repetitionFactor	
freqDomainPosition	0
freqDomainShift	0
freqHopping c-SRS	12
freqHopping b-SRS	0
freqHopping b-hop	0
groupOrSequenceHopping	Neither
resourceType	Periodic
periodicityAndOffset-p	sl160,25
sequenceId	0

### A.5.7.5.1.3 Test Requirements

The SRS-RSRP measurement accuracy shall fulfil the absolute accuracy requirements in clauses 10.1.22.1.1. The following requirements are to be verified:

During T1:

The UE is deemed to meet the requirement if the reported SRS-RSRP is in the range shown in table A.5.7.5.1.3-1.

During T2:

The UE is deemed to meet the requirement if the reported SRS-RSRP is in the range shown in table A.5.7.5.1.3-1.

**Table A.5.7.5.1.3-1: SRS-RSRP absolute accuracy test requirement**

	Test requirement <sup>Notes1,2,3</sup>
SRS	$SRS\_RP - \delta + G_{min} \leq \text{Reported SRS-RSRP(dBm)} \leq SRS\_RP + \delta + G_{max}$
Note 1:	SRS_RP is the equivalent power received by an antenna with 0dBi gain at the centre of the quiet zone configured in the test
Note 2:	$\delta$ is the RSRP absolute accuracy requirement from Table 10.1.22.1.1-2, selected according to the $I_o$ used in the test
Note 3:	$G_{min}$ and $G_{max}$ are the minimum and maximum UE gain values from Table B.2.1.5.1-1, selected according to the UE power class

### A.5.7.5.2 EN-DC CLI-RSSI measurement accuracy with FR2 serving cell

#### A.5.7.5.2.1 Test Purpose and Environment

The purpose of this test is to verify that the CLI-RSSI measurement accuracy is within the specified limits. This test will verify the requirements in Clauses 10.1.22.2.1 with the testing configurations for NR cells in Table A.5.7.5.2.1-1.

**Table A.5.7.5.2.1-1: Applicable NR configurations for FR2 CLI-RSSI accuracy test**

Config	Description
1	LTE FDD, NR 120 kHz SRS SCS, 100 MHz bandwidth, TDD duplex mode
2	LTE TDD, NR 120 kHz SRS SCS, 100 MHz bandwidth, TDD duplex mode
Note:	The UE is only required to be tested in one of the supported test configurations in each supported band

#### A.5.7.5.2.2 Test parameters

In this set of test cases there are two cells in the test, E-UTRAN PCell (Cell 1), FR2 PSCell (Cell 2). The test parameters and applicability for Cell 1 are defined in A.3.7.2. The test parameters for the Cell 2 are given in Table A.5.7.5.2.2-1 and A.5.7.5.2.2-2 below.

Before the test UE is configured to perform CLI-RSSI measurement. There is no measurement gap configured in the test. During the test, the test system does not transmit PDCCH/PDSCH/OCNG on symbols for CLI-RSSI resource and on 2 data symbol before. The CLI-RSSI measurement resource configuration is in Table A.5.7.5.2.2-3.

Table A.5.7.5.2.2-1: FR2 test parameters for CLI-RSSI accuracy

Parameter	Config	Unit	Test 1	Test 2
SSB GSCN	1~2		freq1	freq1
Duplex mode	1~2		TDD	TDD
TDD configuration	1~2		TDDConf.3.1	TDDConf.3.1
BW <sub>channel</sub>	1~2	MHz	100: N <sub>RB,c</sub> = 66	100: N <sub>RB,c</sub> = 66
PDSCH Reference measurement channel	1~2		SR.3.1 TDD	SR.3.1 TDD
RMSI CORESET Reference Channel	1~2		CR.3.1 TDD	CR.3.1 TDD
Dedicated CORESET Reference Channel	1~2		CCR.3.1 TDD	CCR.3.1 TDD
SSB configuration	1~2		SSB.3 FR2	SSB.3 FR2
OCNG Patterns <sup>Note2</sup>	1~2		OP.1	OP.1
TRS configuration	1~2		TRS.2.1 TDD	TRS.2.1 TDD
Initial BWP Configuration	1~2		DLBWP.0.1 ULBWP.0.1	DLBWP.0.1 ULBWP.0.1
Dedicated BWP configuration	1~2		DLBWP.1.3 ULBWP.1.3	DLBWP.1.3 ULBWP.1.3
SMTc configuration	1~2		SMTc.1	SMTc.1
Time offset between DL from serving cell and OCNG from test system	1~2	µs	10.67	10.67
EPRE ratio of PSS to SSS	1~2	dB	0	0
EPRE ratio of PBCH DMRS to SSS				
EPRE ratio of PBCH to PBCH DMRS				
EPRE ratio of PDCCH DMRS to SSS				
EPRE ratio of PDCCH to PDCCH DMRS				
EPRE ratio of PDSCH DMRS to SSS				
EPRE ratio of PDSCH to PDSCH DMRS				
EPRE ratio of OCNG DMRS to SSS <sup>Note 1</sup>				
EPRE ratio of OCNG to OCNG DMRS <sup>Note 1</sup>				
Propagation condition				
Antenna configuration	1~2		1x2	1x2
Note 1: OCNG shall be used such that a constant total transmitted power spectral density is achieved for all OFDM symbols.				
Note 2: OCNG is not transmitted in the CLI-RSSI measurement resources.				

Table A.5.7.5.2.2-2: CLI-RSSI accuracy OTA related test parameters

Parameter	Unit	T1	T2
Angle of arrival configuration		Setup 1 defined A.3.15.1	
Beam assumption <sup>Note 5</sup>		Fine	
$N_{oc}$ on CLI-RSSI measurement resource <sup>Note1</sup>	$\text{dBm}/15\text{kHz}$ $z^{\text{Note3}}$	-100	
$N_{oc}$ on CLI-RSSI measurement resource <sup>Note1</sup>	$\text{dBm}/\text{SCS}^{\text{N}}$ $ote3$	-91	
$\hat{E}_s/N_{oc}$ on CLI-RSSI measurement resource	dB	-Infinity	
RSRP on CLI-RSSI measurement resource <sup>Note2</sup>	$\text{dBm}/\text{SCS}$	-Infinity	



$\hat{E}_s/I_{ot}$ BB on CLI-RSSI measurement resource <sup>Note4</sup>	dB	-Infinity
Io on CLI-RSSI measurement resource <sup>Note2</sup>	dBm/95.04 MHz <sup>Note3</sup>	-62.01
Io on CLI-RSSI measurement resource <sup>Note2</sup>	dBm/1.08 MHz	-81.46
<p>Note 1: Where used, interference from other cells and noise sources not specified in the test is assumed to be constant over subcarriers and time and shall be modelled as AWGN of appropriate power for <math>N_{oc}</math> to be fulfilled.</p> <p>Note 2: SRS_RP, Es/Iot and Io levels have been derived from other parameters for information purposes. They are not settable parameters themselves.</p> <p>Note 3: Equivalent power received by an antenna with 0 dBi gain at the centre of the quiet zone</p> <p>Note 4: Calculation of Es/Iot<sub>BB</sub> includes the effect of UE internal noise up to the value assumed for the associated Refsens requirement in clause 7.3.2 of TS 36.101-2 [19], and an allowance of 2dB for UE multi-band relaxation factor <math>\sum MBP</math> from TS 38.101-2 [19] Table 6.2.1.3-4.</p> <p>Note 5: Information about types of UE beam is given in B.2.1.3, and does not limit UE implementation or test system implementation.</p>		

**Table A.5.7.5.2.2-3: CLI-RSSI measurement resource configuration for FR2 CLI-RSSI accuracy**

	Field	SRSCConf.1
CLI-RSSI measurement resource	rsi-ResourceId	0
	rsi-SCS	120kHz
	startPRB	0
	nrofPRBs	66
	startPosition	3
	nrofSymbols	11
	rsi-PeriodicityAndOffset	sl160, 25

**A.5.7.5.2.3 Test Requirements**

The CLI-RSSI measurement accuracy shall fulfil the absolute accuracy requirements in clauses 10.1.22.2.1. The following requirements are to be verified:

During T1:

The UE is deemed to meet the requirement if the reported CLI-RSSI is in the range shown in table A.5.7.5.2.3-1.

During T2:

The UE is deemed to meet the requirement if the reported CLI-RSSI is in the range shown in table A.5.7.5.2.3-1..

**Table A.5.7.5.2.3-1: CLI-RSSI absolute accuracy test requirement**

	Test requirement <sup>Notes1,2,3</sup>
	$I_o - \delta + G_{min} \leq \text{Reported CLI-RSSI(dBm)} \leq I_o + \delta + G_{max}$
Note 1:	$I_o$ is the equivalent power received by an antenna with 0dBi gain at the centre of the quiet zone configured in the test for 1.08MHz
Note 2:	$\delta$ is the RSRP absolute accuracy requirement from Table 10.1.22.1.1-2, selected according to the $I_o$ used in the test
Note 3:	$G_{min}$ and $G_{max}$ are the minimum and maximum UE gain values from Table B.2.1.5.1-1, selected according to the UE power class

## A.5.7.6 L1-SINR measurement for beam reporting

### A.5.7.6.1 L1-SINR measurement with CSI-RS based CMR and no dedicated IMR configured and CSI-RS resource set with repetition off

#### A.5.7.6.1.1 Test Purpose and Environment

The purpose of this test is to verify that the L1-SINR measurement accuracy is within the specified limits. This test will verify the requirements in Clauses 9.8.4.1 and clause 10.1.28.1 for FR2 L1-SINR measurements based on CSI-RS with the testing configurations for NR cells in Table A.5.7.6.1.1-1, which configures the measurement resources for the CSI-RS based CMR and no dedicated IMR.

The AoA setup for this test is Setup 1 as defined in clause A.3.15.

**Table A.5.7.6.1.1-1: Applicable NR configurations for FR2 L1-SINR test with CSI-RS based CMR and no dedicated IMR configured**

Config	Description
1	LTE FDD, NR 120 kHz CSI-RS SCS, 100 MHz bandwidth, TDD duplex mode
2	LTE TDD, NR 120 kHz CSI-RS SCS, 100 MHz bandwidth, TDD duplex mode
Note:	The UE is only required to be tested in one of the supported test configurations in each supported band

#### A.5.7.6.1.2 Test parameters

In this set of test cases there are two cells in the test, E-UTRAN PCell (Cell 1), FR2 PSCell (Cell 2). The test parameters and applicability for Cell 1 are defined in A.3.7.2. The test parameters for the Cell 2 are given in Table A.5.7.6.1.2-1 and Table A.5.7.6.1.2-2 below. The absolute and relative accuracy of L1-SINR measurements are tested by using the parameters in Table A.5.7.6.1.2-1 and Table A.5.7.6.1.2-2.

There is no measurement gap configured in the test. Before the test, UE is configured one CSI-RS resource set with two CSI-RS resources. UE is configured to perform RLM and BFD based on SSB 0 and 1. CSI-RS is not transmitted in the same OFDM symbols as SSB.

**Table A.5.7.6.1.2-1: FR2 CSI-RS based L1-SINR general test parameters**

Parameter	Config	Unit	Test 1
SSB GSCN	1~2		freq1
Duplex mode	1~2		TDD
TDD Configuration	1~2		TDDConf.3.1
BW <sub>channel</sub>	1~2	MHz	100: N <sub>RB,c</sub> = 66
PDSCH Reference measurement channel	1~2		SR.3.1 TDD
RMSI CORESET Reference Channel	1~2		CR.3.1 TDD
Dedicated CORESET Reference Channel	1~2		CCR.3.1 TDD
SSB configuration	1~2		SSB.1 FR2
OCNG Patterns	1~2		OP.1
Initial BWP Configuration	1~2		DLBWP.0.1 ULBWP.0.1
Dedicated BWP configuration	1~2		DLBWP.1.1 ULBWP.1.1
TRS Configuration	1~2		TRS.2.1 TDD
PDCCH/PDSCH TCI Configuration	1~2		TCI.State.2
SMTC configuration	1~2		SMTC.1
CSI-RS	1~2		CSI-RS.3.2 TDD
reportConfigType	1~2		periodic
reportQuantity-r16	1~2		cri-SINR-r16
nrofReportedRS	1~2		2
L1-SINR reporting period	1~2		slot640
Propagation condition	1~2		AWGN

Antenna configuration	1~2		1x2
EPRE ratio of PSS to SSS	1~2	dB	0
EPRE ratio of PBCH DMRS to SSS			
EPRE ratio of PBCH to PBCH DMRS			
EPRE ratio of PDCCH DMRS to SSS			
EPRE ratio of PDCCH to PDCCH DMRS			
EPRE ratio of PDSCH DMRS to SSS			
EPRE ratio of PDSCH to PDSCH DMRS			
EPRE ratio of OCNG DMRS to SSS <sup>Note 1</sup>			
EPRE ratio of OCNG to OCNG DMRS <sup>Note 1</sup>			
<p>Note 1: OCNG shall be used such that both cells are fully allocated and a constant total transmitted power spectral density is achieved for all OFDM symbols.</p> <p>Note 2: Interference from other cells and noise sources not specified in the test is assumed to be constant over subcarriers and time and shall be modelled as AWGN of appropriate power for <math>N_{oc}</math> to be fulfilled.</p>			

**Table A.5.7.6.1.2-2: FR2 CSI-RS based L1-SINR OTA related test parameters**

Parameter	Config	Unit	Test 1	
			CSI-RS0	CSI-RS1
Angle of arrival configuration			Setup 1 according to A.3.15.1	
Assumption for UE beams <sup>Note 4</sup>			Rough	
$N_{oc}$	1~2	dBm/15 kHz	-100	
$N_{oc}$	1~2	dBm/SS B SCS	-91	
$\hat{E}_s / I_{ot}$	1~2	dB	10	-2
CSI-RS-RSRP <sup>Note1</sup>	1~2	dBm/SC S	-81	-93
$I_o$ <sup>Note1</sup>	1~2	dBm/95.04M Hz	-51.57	-59.86
$\hat{E}_s / N_{oc}$	1~2	dB	10	-2
<p>Note 1: RSRP and <math>I_o</math> levels have been derived from other parameters for information purposes. They are not settable parameters themselves.</p> <p>Note 2: RSRP minimum requirements are specified assuming independent interference and noise at each receiver antenna port.</p> <p>Note 3: Void.</p> <p>Note 4: Information about types of UE beam is given in B.2.1.3, and does not limit UE implementation or test system implementation</p>				

**A.5.7.6.1.3 Test Requirements**

After 640ms from the beginning of the test, the L1-SINR measurement accuracy for CSI-RS#0 and CSI-RS#1 of Cell 2 shall fulfil the requirements in clauses 10.1.28.1. The following requirements are to be verified:

For Test 1:

Absolute accuracy of CSI-RS0. The UE is deemed to meet the requirement if the reported L1-SINR is in the range shown in Table A.5.7.6.1.3-1.

Relative accuracy of CSI-RS0 compared with CSI-RS1. The UE is deemed to meet the requirement if the reported differential L1-SINR meets is in the range shown in Table A.5.7.6.1.3-2.

**Table A.5.7.6.1.3-1: L1-SINR absolute accuracy test requirement**

	Test requirement <sup>Notes1,2</sup>
CSI-RS0	$L1-SINR0 - \delta \leq \text{Reported SINR (dB)} \leq L1-SINR0 + \delta$
Note 1:	L1-SINR0 is the equivalent SINR received by an antenna with 0dBi gain at the centre of the quiet zone configured in the test for the CSI-RS 0 under consideration
Note 2:	$\delta$ is the SINR absolute accuracy requirement from Table 10.1.28.1.1-1, selected according to the $I_o$ used in the test

**Table A.5.7.6.1.3-2: L1-SINR relative accuracy test requirement**

	Test requirement <sup>Notes1,2</sup>
CSI-RS0 - CSI-RS1	$L1-SINR0 - L1-SINR1 - \sigma \leq \text{Reported DIFFSINR (dB)} \leq L1-SINR0 - L1-SINR1 + \sigma$
Note 1:	L1-SINRn is the equivalent SINR received by an antenna with 0dBi gain at the centre of the quiet zone configured in the test for the CSI-RS n under consideration
Note 2:	$\sigma$ is the SINR relative requirement from Table 10.1.28.1.2-1, selected according to the $I_o$ used in the test

## A.5.7.6.2 L1-SINR measurement with SSB based CMR and dedicated IMR

### A.5.7.6.2.1 Test Purpose and Environment

The purpose of this test is to verify that the L1-SINR measurement accuracy is within the specified limits. This test will verify the requirements in Clauses 9.8.4.2 and clause 10.1.28.2 for L1-SINR measurements with SSB based CMR and dedicated CSI-RS based IMR, with the testing configurations for NR cells in Table A.5.7.6.2.1-1.

The AoA setup for this test is Setup 1 as defined in clause A.3.15.

**Table A.5.7.6.2.1-1: Applicable NR configurations for FR2 L1-SINR measurement test with SSB based CMR and CSI-RS based IMR**

Config	Description
1	LTE FDD, NR 120 kHz SSB SCS, 100 MHz bandwidth, TDD duplex mode
2	LTE TDD, NR 120 kHz SSB SCS, 100 MHz bandwidth, TDD duplex mode
3	LTE FDD, NR 240 kHz SSB SCS, 100 MHz bandwidth, TDD duplex mode
4	LTE TDD, NR 240 kHz SSB SCS, 100 MHz bandwidth, TDD duplex mode
Note:	The UE is only required to be tested in one of the supported test configurations in each supported band

### A.5.7.6.2.2 Test parameters

In this set of test cases there are two cells in the test, E-UTRAN PCell (Cell 1), FR1 PSCell (Cell 2). The test parameters and applicability for Cell 1 are defined in A.3.7.2. The test parameters for the Cell 2 are given in Table A.5.7.6.2.2-1 and Table A.5.7.6.2.2-2 below. The absolute accuracy of L1-SINR measurements are tested by using the parameters in Table A.5.7.6.2.2-1 and Table A.5.7.6.2.2-2.

There is no measurement gap configured in the test. Before the test, UE is configured one SSB resource set with two SSB resources and one CSI-RS resource set with two CSI-RS resource. UE is configured to perform RLM and BFD measurement based on the SSB resources 0 and 1. UE is configured to perform L1-SINR measurement based on the SSBs as CMR and the CSI-RS resources as IMR.

**Table A.5.7.6.2.2-1: FR2 L1-SINR measurement test parameters with SSB based CMR and CSI-RS based IMR**

Parameter	Config	Unit	Test 1
SSB GSCN	1~4		freq1
Duplex mode	1~4		TDD
TDD Configuration	1~4		TDDConf.3.1
BW <sub>channel</sub>	1~4	MHz	100: N <sub>RB,c</sub> = 66

PDSCH Reference measurement channel	1~4		SR.3.1 TDD
RMSI CORESET Reference Channel	1~4		CR.3.1 TDD
Dedicated CORESET Reference Channel	1~4		CCR.3.1 TDD
SSB configuration	1,2		SSB.1 FR2
	3,4		SSB.2 FR2
CSI-RS configuration	1~4		CSI-RS 3.1A TDD
OCNG Patterns	1~4		OP.1
Initial BWP Configuration	1~4		DLBWP.0.1 ULBWP.0.1
Dedicated BWP configuration	1~4		DLBWP.1.3 ULBWP.1.3
TRS Configuration	1~4		TRS.2.1 TDD
PDCCH/PDSCH TCI Configuration	1~4		TCI.State.2
SMTTC configuration	1~4		SMTTC.1
reportConfigType	1~4		periodic
reportQuantity-r16	1~4		ssb-Index-SINR-r16
Number of reported RS	1~4		2
L1-SINR reporting period	1~4		slot640
Propagation condition	1~4		AWGN
Antenna configuration	1~4		1x2
EPRE ratio of PSS to SSS	1~4	dB	0
EPRE ratio of PBCH DMRS to SSS			
EPRE ratio of PBCH to PBCH DMRS			
EPRE ratio of PDCCH DMRS to SSS			
EPRE ratio of PDCCH to PDCCH DMRS			
EPRE ratio of PDSCH DMRS to SSS			
EPRE ratio of PDSCH to PDSCH DMRS			
EPRE ratio of OCNG DMRS to SSS <sup>Note 1</sup>			
EPRE ratio of OCNG to OCNG DMRS <sup>Note 1</sup>			
<p>Note 1: OCNG shall be used such that both cells are fully allocated and a constant total transmitted power spectral density is achieved for all OFDM symbols.</p> <p>Note 2: Interference from other cells and noise sources not specified in the test is assumed to be constant over subcarriers and time and shall be modelled as AWGN of appropriate power for <math>N_{oc}</math> to be fulfilled.</p>			

Table A.5.7.6.2.2-2: FR2 SSB specific test parameters

Parameter	Config	Unit	Test 1	
			SSB#0	SSB#1
Angle of arrival configuration			Setup 1 according to A.3.15.1	
Assumption for UE beams <sup>Note 4</sup>			Rough	
$N_{oc}$	1~4	dBm/15 kHz	-100	
$N_{oc}$	1,2	dBm/SS	-91	
	3,4	B SCS	-88	
$\hat{E}_s / I_{oc}$	1~4	dB	10	0
SSB RSRP <sup>Note1</sup>	1,2	dBm/SC	-81	-91
	3,4	S	-78	-88
$I_0$ <sup>Note1</sup>	1~4	dBm/95.04M Hz	-51.57	-58.97
$\hat{E}_s / N_{oc}$	1~4	dB	10	0

Note 1:	RSRP and $I_o$ levels have been derived from other parameters for information purposes. They are not settable parameters themselves.
Note 2:	RSRP minimum requirements are specified assuming independent interference and noise at each receiver antenna port.
Note 3:	Information about types of UE beam is given in B.2.1.3, and does not limit UE implementation or test system implementation

**Table A.5.7.6.2.2-3: FR2 CSI-RS specific test parameters**

Parameter	Config	Unit	Test 1	
			CSI-RS#0	CSI-RS#1
Angle of arrival configuration			Setup 1 according to A.3.15.1	
Assumption for UE beams <sup>Note 4</sup>			Rough	
$N_{oc}$	1~4	dBm/15k Hz	-100	
$N_{oc}$	1~4	dBm/CSI-RS SCS	-91	
$\hat{E}_s / I_{ot}$	1~4	dB	10	0
CSI-RS RSRP <sup>Note1</sup>	1~4	dBm/SCS	-81	-91
$I_o$ <sup>Note1</sup>	1~4	dBm/95.04MHz	-51.57	-58.97
$\hat{E}_s / N_{oc}$	1~4	dB	10	0
Note 1:	RSRP and $I_o$ levels have been derived from other parameters for information purposes. They are not settable parameters themselves.			
Note 2:	RSRP minimum requirements are specified assuming independent interference and noise at each receiver antenna port.			
Note 3:	Information about types of UE beam is given in B.2.1.3, and does not limit UE implementation or test system implementation			

**A.5.7.6.2.3 Test Requirements**

After 640ms from the beginning of the test, the L1-SINR measurement accuracy for SSB#0+CSI-RS#0 and SSB#1+CSI-RS#1 of Cell 2 shall fulfil the requirements in clauses 10.1.28.2. The following requirements are to be verified:

For Test 1:

Absolute accuracy of SSB#0+CSI-RS#0. The UE is deemed to meet the requirement if the reported L1-SINR is in the range shown in Table A.5.7.6.2.3-1.

Relative accuracy of SSB#0+CSI-RS#0 compared with SSB#1+CSI-RS#1. The UE is deemed to meet the requirement if the reported differential L1-SINR is in the range shown in Table A.5.7.6.2.3-2.

**Table A.5.7.6.2.3-1: L1-SINR absolute accuracy test requirement**

	Test requirement <sup>Notes1,2</sup>
SSB#0+CSI-RS#0	$L1\_SINR0 - \delta + \leq \text{Reported SINR (dB)} \leq L1\_SINR0 + \delta$
Note 1:	L1_SINR0 is the equivalent SINR received by an antenna with 0dBi gain at the centre of the quiet zone configured in the test for the SSB#0+CSI-RS#0 under consideration
Note 2:	$\delta$ is the SINR absolute accuracy requirement from Table 10.1.28.2.1-1, selected according to the $I_o$ used in the test

**Table A.5.7.6.2.3-2: L1-SINR relative accuracy test requirement**

	Test requirement <sup>Notes1,2</sup>
SSB#0+CSI-RS#0 - SSB#1+CSI-RS#1	$L1\_SINR0 - L1\_SINR1 - \sigma \leq \text{Reported DIFFSINR (dB)} \leq L1\_SINR0 - L1\_SINR1 + \sigma$
Note 1:	L1-SINRn is the equivalent SINR received by an antenna with 0dBi gain at the centre of the quiet zone configured in the test for the SSB#n+CSI-RS#n under consideration
Note 2:	$\sigma$ is the SINR relative requirement from Table 10.1.28.2.2-1, selected according to the $I_o$ used in the test

### A.5.7.6.3 L1-SINR measurement with CSI-RS based CMR and dedicated IMR

#### A.5.7.6.3.1 Test Purpose and Environment

The purpose of this test is to verify that the L1-SINR measurement accuracy is within the specified limits. This test will partly verify the requirements in Clauses 9.8.4.3 and clause 10.1.28.3 for L1-SINR measurements based on CSI-RS as CMR and CSI-IM as IMR with the testing configurations for NR cells in Table A.5.7.6.3.1-1.

The AoA setup for this test is Setup 1 as defined in clause A.3.15.

**Table A.5.7.6.3.1-1: Applicable NR configurations for FR2 L1-SINR measurement test with CSI-RS based CMR and CSI-IM based IMR**

Config	Description
1	LTE FDD, NR 120 kHz CSI-RS SCS, 100 MHz bandwidth, TDD duplex mode
2	LTE TDD, NR 120 kHz CSI-RS SCS, 100 MHz bandwidth, TDD duplex mode
Note:	The UE is only required to be tested in one of the supported test configurations in each supported band

#### A.5.7.6.3.2 Test parameters

In this set of test cases there are two cells in the test, E-UTRAN PCell (Cell 1), FR1 PSCell (Cell 2). The test parameters and applicability for Cell 1 are defined in A.3.7.2. The test parameters for the Cell 2 are given in Table A.5.7.6.3.2-1 and A.5.7.6.3.2-2 below. The absolute and relative accuracy of L1-SINR measurements are tested by using the parameters in Table A.5.7.6.3.2-1 and A.5.7.6.3.2-2.

There is no measurement gap configured in the test. Before the test, UE is configured one CSI-RS resource set with two CSI-RS resources and one CSI-IM resource set with two CSI-IM resources. UE is configured to perform RLM and BFD based on SSB 0 and 1. CSI-RS is not transmitted in the same OFDM symbols as SSB. UE is configured to perform L1-SINR measurement based on the configured CSI-RS as CMR and CSI-IM as IMR.

**Table A.5.7.6.3.2-1: FR2 L1-SINR measurement test with CSI-RS based CMR and CSI-IM based IMR**

Parameter	Config	Unit	Test 1
SSB GSCN	1~2		freq1
Duplex mode	1~2		TDD
TDD Configuration	1~2		TDDConf.3.1
BW <sub>channel</sub>	1~2	MHz	100: N <sub>RB,c</sub> = 66
PDSCH Reference measurement channel	1~2		SR.3.1 TDD
RMSI CORESET Reference Channel	1~2		CR.3.1 TDD
Dedicated CORESET Reference Channel	1~2		CCR.3.1 TDD
SSB configuration	1~2		SSB.1 FR2
OCNG Patterns	1~2		OP.1
Initial BWP Configuration	1~2		DLBWP.0.1 ULBWP.0.1
Dedicated BWP configuration	1~2		DLBWP.1.1 ULBWP.1.1
TRS Configuration	1~2		TRS.2.1 TDD
PDCCH/PDSCH TCI Configuration	1~2		TCI.State.2
SMTC configuration	1~2		SMTC.1
CSI-RS configuration as CMR	1~2		CSI-RS.3.2 TDD
CSI-IM configuration as IMR	1~2		CSI-IM.3.3 TDD
reportConfigType	1~2		periodic
reportQuantity-r16	1~2		cri-SINR-r16
nrofReportedRS	1~2		2
L1-SINR reporting period	1~2		slot640
Propagation condition	1~2		AWGN
Antenna configuraion	1~2		1x2
EPRE ratio of PSS to SSS	1~2	dB	0

EPRE ratio of PBCH DMRS to SSS			
EPRE ratio of PBCH to PBCH DMRS			
EPRE ratio of PDCCH DMRS to SSS			
EPRE ratio of PDCCH to PDCCH DMRS			
EPRE ratio of PDSCH DMRS to SSS			
EPRE ratio of PDSCH to PDSCH DMRS			
EPRE ratio of OCNG DMRS to SSS <sup>Note 1</sup>			
EPRE ratio of OCNG to OCNG DMRS <sup>Note 1</sup>			
<p>Note 1: OCNG shall be used such that both cells are fully allocated and a constant total transmitted power spectral density is achieved for all OFDM symbols.</p> <p>Note 2: Interference from other cells and noise sources not specified in the test is assumed to be constant over subcarriers and time and shall be modelled as AWGN of appropriate power for <math>N_{oc}</math> to be fulfilled.</p>			

**Table A.5.7.6.3.2-2: FR2 CSI-RS based L1-SINR measurement OTA related test parameters**

Parameter	Config	Unit	Test 1	
			CSI-RS0	CSI-RS1
Angle of arrival configuration			Setup 1 according to A.3.15.1	
Assumption for UE beams <sup>Note 4</sup>			Rough	
$N_{oc}$	1~2	dBm/15 kHz	-100	
$N_{oc}$	1~2	dBm/SS B SCS	-91	
$\hat{E}_s / I_{ot}$	1~2	dB	10	-2
CSI-RS-RSRP <sup>Note1</sup>	1~2	dBm/SC S	-81	-93
$I_o$ <sup>Note1</sup>	1~2	dBm/95.04M Hz	-51.57	-59.86
$\hat{E}_s / N_{oc}$	1~2	dB	10	-2
<p>Note 1: RSRP and <math>I_o</math> levels have been derived from other parameters for information purposes. They are not settable parameters themselves.</p> <p>Note 2: RSRP minimum requirements are specified assuming independent interference and noise at each receiver antenna port.</p> <p>Note 3: No additional noise is added by the test system in Test 2.</p> <p>Note 4: Information about types of UE beam is given in B.2.1.3, and does not limit UE implementation or test system implementation</p>				

**A.5.7.6.3.3 Test Requirements**

After 640ms from the beginning of the test, the L1-SINR measurement accuracy for CSI-RS#0+CSI-IM#0 and CSI-RS#1+CSI-IM#1 of Cell 2 shall fulfil the requirements in clauses 10.1.28.3. The following requirements are to be verified:

Absolute accuracy of CSI-RS#0+CSI-IM#0. The UE is deemed to meet the requirement if the reported L1-SINR is in the range shown in Table A.5.7.6.3.3-1.

Relative accuracy of CSI-RS#0+CSI-IM#0 compared with CSI-RS#1+CSI-IM#1. The UE is deemed to meet the requirement if the reported differential L1-SINR is in the range shown in Table A.5.7.6.3.3-2.

**Table A.5.7.6.3.3-1: L1-SINR absolute accuracy test requirement**

	Test requirement <sup>Notes1,2</sup>
CSI-RS#0+CSI-IM#0	L1-SINR0 -δ ≤ Reported SINR(dBm) ≤ L1-SINR 0 +δ



- Note 1: L1-SINR0 is the equivalent SINR received by an antenna with 0dBi gain at the centre of the quiet zone configured in the test for the CSI-RS#0 under consideration
- Note 2:  $\delta$  is the SINR absolute accuracy requirement from Table 10.1.28.3.1-2.

**Table A.5.7.6.3.3-2: L1-SINR relative accuracy test requirement**

	Test requirement <sup>Notes1,2</sup>
CSI-RS#0+CSI-IM#0 - CSI-RS#1+CSI-IM#1	$L1-SINR0 - L1-SINR1 - \sigma \leq \text{Reported DIFFSINR (dB)} \leq L1-SINR0 - L1-SINR1 + \sigma$
Note 1:	L1-SINRn is the equivalent SINR received by an antenna with 0dBi gain at the centre of the quiet zone configured in the test for the CSI-RS#n+CSI-IM#n under consideration
Note 2:	$\sigma$ is the SINR relative requirement from Table 10.1.28.3.2-2, selected according to the $I_0$ used in the test

## A.5.7.7 CSI-RSRP

### A.5.7.7.1 EN-DC intra-frequency case measurement accuracy with FR2 serving cell and FR2 target cell

#### A.5.7.7.1.1 Test Purpose and Environment

The purpose of this test is to verify that the CSI-RS based RSRP measurement accuracy is within the specified limits. This test will verify the requirements in Clauses 10.1.3.1.1 and 10.1.3.1.2 for intra-frequency measurements.

#### A.5.7.7.1.2 Test parameters

In this set of test cases, all NR cells are on the same carrier frequency. Supported test configurations are shown in Table A.5.7.7.1.2-1. Both absolute and relative accuracy of SS-RSRP intra-frequency measurements are tested by using the parameters in Table A.5.7.7.1.2-2 and A.5.7.7.1.2-3. The E-UTRA PCell is configured as specified in clause A.3.7.2.2. In all test cases, cell 1 is the PCell, cell 2 is the PSCell and cell 3 is the target cell. The test consists of two time phases T1 and T2.

**Table A.5.7.7.1.2-1: SS-RSRP Intra frequency SS-RSRP supported test configurations**

Configuration	Description
1	FDD LTE PCell, Cell 2&3 120 kHz SSB SCS, 120KHz CSI-RS SCS, 100 MHz bandwidth, TDD duplex mode
2	TDD LTE PCell, Cell 2&3 120 kHz SSB SCS, 120KHz CSI-RS SCS, 100 MHz bandwidth, TDD duplex mode

Note: The UE is only required to pass in one of the supported test configurations

**Table A.5.7.7.1.2-2: CSI-RSRP Intra frequency general test parameters**

Parameter <sup>Note 5</sup>	Unit	T1		T2	
		Cell 2	Cell 3	Cell 2	Cell 3
Physical cell ID		489	0	489	0
SSB ARFCN		freq1		freq1	
Duplex mode		TDD		TDD	
TDD configuration		TDDConf.3.1		TDDConf.3.1	
$BW_{\text{channel}}$	MHz	100: $N_{RB,C} = 66$		100: $N_{RB,C} = 66$	
PDSCH Reference measurement channel		SR.3.1 TDD	-	SR.3.1 TDD	-
RMSI CORESET Reference Channel		CR.3.1 TDD	-	CR.3.1 TDD	-
Dedicated CORESET Reference Channel		CCR.3. 1 TDD	-	CCR.3. 1 TDD	-
OCNG Patterns		OP.3	OP.3	OP.3	OP.3
SSB configuration		SSB.3 FR2	SSB.3 FR2	SSB.3 FR2	SSB.3 FR2

SMTC configuration		SMTC. 1	SMTC. 1	SMTC. 1	SMTC. 1
CSI-RS configuration for RRM		CSI-RS.RR M.FR2. 1 TDD	CSI-RS.RR M.FR2. 1 TDD	CSI-RS.RR M.FR2. 1 TDD	CSI-RS.RR M.FR2. 1 TDD
Time offset with Cell 2	μs	-	0.58	-	0.58
PDSCH/PDCCH subcarrier spacing	kHz	120	120	120	120
EPRE ratio of PSS to SSS	dB	0	0	0	0
EPRE ratio of PBCH_DMRS to SSS					
EPRE ratio of PBCH to PBCH_DMRS					
EPRE ratio of PDCCH_DMRS to SSS					
EPRE ratio of PDCCH to PDCCH_DMRS					
EPRE ratio of PDSCH_DMRS to SSS					
EPRE ratio of PDSCH to PDSCH_DMRS					
EPRE ratio of OCNG DMRS to SSS <sup>Note 1</sup>					
EPRE ratio of OCNG to OCNG DMRS <sup>Note 1</sup>					
Propagation conditions		AWGN	AWGN	AWGN	AWGN
Antenna configuration		1x2	1x2	1x2	1x2
<p>Note 1: OCNG shall be used such that both cells are fully allocated and a constant total transmitted power spectral density is achieved for all OFDM symbols.</p> <p>Note 2: Void</p> <p>Note 3: Void</p> <p>Note 4: Void</p> <p>Note 5: All parameters apply for configuration 1 and 2</p> <p>Note 6: Void</p>					

**Table A.5.7.7.1.2-3: CSI-RSRP Intra frequency OTA related test parameters**

Parameter	Unit	T1		T2	
		Cell 2	Cell 3	Cell 2	Cell 3
Angle of arrival configuration		Setup 1 according to clause A.3.15.1			
Assumption for UE beams <sup>Note 8</sup>		Rough			
$N_{oc}$ <sup>Note1</sup>	dBm/15kHz <sub>z</sub> <sup>Note4</sup>	-91.6		N/A	
$N_{oc}$ <sup>Note1</sup>	dBm/SCS <sup>Note4</sup>	-82.6		N/A	
$\hat{E}_s / N_{oc}$	dB	6.0	1.0	N/A	N/A
$E_s$	dBm/SCS <sup>Note4</sup>			(Table B.2.2-2 Rx Beam Peak +2.1dB)	(Table B.2.2-2 Rx Beam Peak +2.1dB)
SSB_RP <sup>Note2</sup>	dBm/SCS	-76.6	-81.6	(Table B.2.2-2 Rx Beam Peak +2.1dB)	(Table B.2.2-2 Rx Beam Peak +2.1dB)
$\hat{E}_s / I_{ot\_BB}$ <sup>Note6</sup>	dB	2.44	-5.98	-5.98	-5.98
CSI_RP	dBm/SCS	-76.6	-81.6	(Table B.2.2-2 Rx Beam Peak +2.1dB)	(Table B.2.2-2 Rx Beam Peak +2.1dB)
$I_o$ <sup>Note2</sup>	dBm/95.04 MHz <sup>Note4</sup>	-50.05		(Table B.2.2-2 Rx Beam Peak +29.70dB)	
<p>Note 1: Where used, interference from other cells and noise sources not specified in the test is assumed to be constant over subcarriers and time</p>					

	and shall be modelled as AWGN of appropriate power for $N_{oc}$ to be fulfilled.
Note 2:	SSB_RP, Es/lot and lo levels have been derived from other parameters for information purposes. They are not settable parameters themselves.
Note 3:	Void
Note 4:	Equivalent power received by an antenna with 0 dBi gain at the centre of the quiet zone
Note 5:	Void
Note 6:	Calculation of Es/lot <sub>BB</sub> includes the effect of UE internal noise up to the value assumed for the associated Refsens requirement in clause 7.3.2 of TS 36.101-2 [19], and an allowance of 1dB for UE multi-band relaxation factor $\Delta MB_P$ from TS 38.101-2 [19] Table 6.2.1.3-4.
Note 7:	All parameters apply for configurations 1 and 2
Note 8:	Information about types of UE beam is given in B.2.1.3, and does not limit UE implementation or test system implementation

### A.5.7.7.1.3 Test Requirements

The CSI-RSRP measurement accuracy shall fulfil the absolute accuracy requirements in clauses 10.1.3.1.1 and relative accuracy requirements in clause 10.1.3.1.2. The following requirements are to be verified:

During T1:

Absolute accuracy of Cell 2 and absolute accuracy of Cell 3. The UE is deemed to meet the requirement if the reported CSI-RSRP is in the range shown in table A.5.7.7.1.3-1.

Relative accuracy of Cell 3 compared with Cell 2. The UE is deemed to meet the requirement if the difference in reported CSI-RSRP meets the requirements in Table 10.1.3.1.2-1.

During T2:

Absolute accuracy of Cell 2 and absolute accuracy of Cell 3. The UE is deemed to meet the requirement if the reported CSI-RSRP is in the range shown in table A.5.7.7.1.3-1.

Relative accuracy of Cell 3 compared with Cell 2. The UE is deemed to meet the requirement if the difference in reported CSI-RSRP meets the requirements in Table 10.1.3.1.2-1.

During T1 and T2:

Relative accuracy of Cell 2 during T2 compared with Cell 2 during T1. The UE is deemed to meet the requirement if the difference in reported CSI-RSRP meets the requirements in Table 10.1.3.1.2-1

Relative accuracy of Cell 3 during T2 compared with Cell 3 during T1. The UE is deemed to meet the requirement if the difference in reported CSI-RSRP meets the requirements in Table 10.1.3.1.2-1.

**Table A.5.7.7.1.3-1: CSI-RSRP absolute accuracy test requirement**

	<b>Test requirement</b> <small>Notes1,2,3</small>
Cell 2	$CSI\_RP2 - \delta + G_{min} \leq \text{Reported RSRP(dBm)} \leq CSI\_RP2 + \delta + G_{max}$
Cell 3	$CSI\_RP3 - \delta + G_{min} \leq \text{Reported RSRP(dBm)} \leq CSI\_RP3 + \delta + G_{max}$
Note 1:	CSI_RPn is the equivalent power received by an antenna with 0dBi gain at the centre of the quiet zone configured in the test for the cell n under consideration
Note 2:	$\delta$ is the RSRP absolute accuracy requirement from Table 10.1.3.1.1-1, selected according to the lo used in the test
Note 3:	$G_{min}$ and $G_{max}$ are the minimum and maximum UE gain values from Table B.2.1.5.1-1, selected according to the UE power class

## A.5.7.7.2 EN-DC inter-frequency case measurement accuracy with FR2 serving cell and FR2 target cell

### A.5.7.7.2.1 Test Purpose and Environment

The purpose of this test is to verify that the CSI-RS based RSRP measurement accuracy is within the specified limits. This test will verify the requirements in Clauses 10.1.5.3.1 and 10.1.5.3.2 for inter-frequency measurements with the testing configurations for NR cells in Table A.5.7.7.2.1-1.

**Table A.5.7.7.2.1-1: Applicable NR configurations for FR2 inter-frequency CSI-RSRP accuracy test**

Configuration	Description
1	FDD LTE PCell, cells 2&3 120 kHz SSB SCS, 120KHz CSI-RS SCS, 100 MHz bandwidth, TDD duplex mode
2	TDD LTE PCell, cells 2&3 120 kHz SSB SCS, 120KHz CSI-RS SCS, 100 MHz bandwidth, TDD duplex mode

### A.5.7.7.2.2 Test parameters

In this set of test cases, there are three cells in the test, E-UTRAN PCell (Cell 1), FR2 PCell (Cell 2) and a FR2 neighbour cell (Cell 3) on a different frequency than the PCell. The test parameters and applicability for Cell 1 are defined in A.3.7.2. The test parameters for the Cell 2 and Cell 3 are given in Table A.5.7.7.2.2-1 and Table A.5.7.7.2.2-2 below. Both absolute and relative accuracy of RSRP intrer-frequency measurements are tested by using the parameters in Table A.5.7.7.2.2-1 and Table A.5.7.7.2.2-2. The inter-frequency measurements are supported by a measurement gap.

**Table A.5.7.7.2.2-1: CSI-RSRP inter-frequency general test parameters**

Parameter	Config	Unit	Test 1		Test 2	
			Cell 2	Cell 3	Cell 2	Cell 3
Physical cell ID			489	0	489	0
SSB ARFCN	1,2		freq1	freq2	freq1	freq2
BW <sub>channel</sub>	1,2		100: N <sub>RB,c</sub> = 66		100: N <sub>RB,c</sub> = 66	
Gap pattern ID			0		0	
Duplex mode	1,2		TDD	TDD	TDD	TDD
TDD configuration	1,2		TDDConf.3.1		TDDConf.3.1	
PDSCH Reference measurement channel	1,2		SR.3.1 TDD	-	SR.3.1 TDD	-
RMSI CORESET Reference Channel	1,2		CR.3.1 TDD	-	CR.3.1 TDD	-
Dedicated CORESET Reference Channel	1,2		CCR.3.1 TDD	-	CCR.3.1 TDD	-
SSB configuration	1,2		SSB.3 FR2		SSB.3 FR2	
OCNG Patterns	1,2		OP.3		OP.3	
Initial BWP Configuration	1,2		DLBWP.0.1 ULBWP.0.1		DLBWP.0.1 ULBWP.0.1	
Dedicated BWP configuration	1,2		DLBWP.1.3 ULBWP.1.3		DLBWP.1.3 ULBWP.1.3	
TRS Configuration	1,2		TRS.2.1 TDD		TRS.2.1 TDD	
PDCCH/PDSCH TCI Configuration	1,2		TCI.State.2		TCI.State.2	
SMTTC configuration	1,2		SMTTC.1		SMTTC.1	
CSI-RS configuration for RRM	1,2		CSI- RS.RRM.3 .1 TDD	CSI- RS.RRM.3 .2 TDD	CSI- RS.RRM.3 .1 TDD	CSI- RS.RRM.3 .2 TDD
Time offset between Cell 2 and Cell 3	1,2	µs	0.58		0.58	
EPRE ratio of PSS to SSS	1,2	dB	0	0	0	0
EPRE ratio of PBCH DMRS to SSS						
EPRE ratio of PBCH to PBCH DMRS						

EPRE ratio of PDCCH DMRS to SSS						
EPRE ratio of PDCCH to PDCCH DMRS						
EPRE ratio of PDSCH DMRS to SSS						
EPRE ratio of PDSCH to PDSCH DMRS						
EPRE ratio of OCNG DMRS to SSS <sup>Note 1</sup>						
EPRE ratio of OCNG to OCNG DMRS <sup>Note 1</sup>						
Propagation condition	1,2	-	AWGN	AWGN	AWGN	AWGN
Antenna configuration	1,2	-	1x2	1x2	1x2	1x2
Note 1: OCNG shall be used such that both cells are fully allocated and a constant total transmitted power spectral density is achieved for all OFDM symbols.						
Note 2: Void						

**Table A.5.7.7.2.2-2: CSI-RSRP inter-frequency OTA related test parameters**

Parameter	Unit	Test 1		Test 2	
		Cell 2	Cell 3	Cell 2	Cell 3
Angle of arrival configuration		Setup 4b according to clause A.3.15.4.2		Setup 4b according to clause A.3.15.4.2	
		AoA1 Spherical coverage	AoA2 Rx Beam Peak	AoA1 Spherical coverage	AoA2 Rx Beam Peak
Assumption for UE beams <sup>Note 7</sup>		Rough	Rough	Assumption for UE beams <sup>Note 7</sup>	
$N_{oc}$ <sup>Note1</sup>	dBm/15kHz <sub>z</sub> <sup>Note4</sup>	-90.6	-90.6	(Table B.2.3-2 Rx Beam Peak +1.97dB)	(Table B.2.3-2 Rx Beam Peak -3.03dB)
$N_{oc}$ <sup>Note1</sup>	dBm/SCS <sub>Note4</sub>	-81.6	-81.6	(Table B.2.3-2 Rx Beam Peak +11.0dB)	(Table B.2.3-2 Rx Beam Peak +6.0dB)
$\hat{E}_s/N_{oc}$	dB	6.0	6.0	17.0	-1.0
SSB_RP <sup>Note2</sup>	dBm/SCS	-75.60	-75.60	(Table B.2.3-2 Rx Beam Peak +28.0dB)	(Table B.2.3-2 Rx Beam Peak +5.0dB)
(SSB_RP <sub>Cell 1</sub> – SSB_RP <sub>Cell 2</sub> )	dB	0		23.00	
$\hat{E}_s/I_{ot\ BB}$ <sup>Note6</sup>	dB	5.29	5.96	8.86	-3.92
CSI_RP	dBm/SCS	-75.60	-75.60	(Table B.2.2-2 Rx Beam Peak +2.1dB)	(Table B.2.2-2 Rx Beam Peak +2.1dB)
$I_o$ <sup>Note2</sup>	dBm/95.04 MHz <sub>Note4</sub>	-50.03	-50.03	(Table B.2.3-2 Rx Beam Peak +52.68dB)	(Table B.2.3-2 Rx Beam Peak +33.13dB)
( $I_{o\ freq\ 1} - I_{o\ freq\ 2}$ )	dB	0		19.55	
Note 1: Where used, interference from other cells and noise sources not specified in the test is assumed to be constant over subcarriers and time					

	and shall be modelled as AWGN of appropriate power for $N_{oc}$ to be fulfilled.
Note 2:	SSB_RP, Es/lot, lo, (SSB_RP <sub>Cell 2</sub> – SSB_RP <sub>Cell 1</sub> ) and (I <sub>ofreq 2</sub> – I <sub>ofreq 1</sub> ) levels have been derived from other parameters for information purposes. They are not settable parameters themselves.
Note 3:	Void
Note 4:	Equivalent power received by an antenna with 0 dBi gain at the centre of the quiet zone
Note 5:	Void
Note 6:	Calculation of Es/lot <sub>BB</sub> includes the effect of UE internal noise up to the value assumed for the associated Refsens requirement in clause 7.3.2 of TS 36.101-2 [19], and an allowance of 1dB for UE multi-band relaxation factor ΔMB <sub>P</sub> or ΔMB <sub>S</sub> from TS 38.101-2 [19] Table 6.2.1.3-4.
Note 7:	Information about types of UE beam is given in B.2.1.3, and does not limit UE implementation or test system implementation

**A.5.7.7.2.3 Test Requirements**

The CSI-RSRP measurement accuracy for Cell 2 and Cell 3 shall fulfil the absolute requirements in clause 10.1.5.3.1 and the relative requirements in clause 10.1.5.3.2.

Test 1:

Absolute accuracy of Cell 2 and absolute accuracy of Cell 3. The UE is deemed to meet the requirement if the reported CSI-RSRP is in the range shown in Table A.5.7.7.2.3-1.

Relative accuracy of Cell 3 compared with Cell 2. The UE is deemed to meet the requirement if the difference in reported CSI -RSRP meets the requirements in Table A.5.7.7.2.3-2.

Test 2:

Absolute accuracy of Cell 2 and absolute accuracy of Cell 3. The UE is deemed to meet the requirement if the reported CSI -RSRP is in the range shown in Table A.5.7.7.2.3-1.

Relative accuracy of Cell 3 compared with Cell 2. The UE is deemed to meet the requirement if the difference in reported CSI -RSRP meets the requirements in Table A.5.7.7.2.3-2.

**Table A.5.7.7.2.3-1: CSI-RSRP absolute accuracy test requirement**

	<b>Test requirement</b> <sup>Notes1,2,3,4</sup>
Cell 2	$CSI\_RP2 - \delta + G_{min} + X \leq \text{Reported RSRP(dBm)} \leq CSI\_RP2 + \delta + G_{max}$
Cell 3	$CSI\_RP3 - \delta + G_{min} \leq \text{Reported RSRP(dBm)} \leq CSI\_RP3 + \delta + G_{max}$
Note 1:	CSI_RP <sub>n</sub> is the equivalent power received by an antenna with 0dBi gain at the centre of the quiet zone configured in the test for the cell n under consideration
Note 2:	δ is the RSRP absolute accuracy requirement from Table 10.1.5.1.1-1, selected according to the lo used in the test
Note 3:	G <sub>min</sub> and G <sub>max</sub> are the minimum and maximum UE gain values from Table B.2.1.5.1-1, selected according to the UE power class
Note 4:	X is the Spherical coverage gain difference in dB, derived as (UE Refsens - UE Spherical coverage) from TS 38.101-2 [19] clauses 7.3.2 and 7.3.4, selected according to the UE power class and operating band. X is always a negative value.

**Table A.5.7.7.2.3-2: CSI-RSRP relative accuracy test requirement**

	<b>Test requirement</b> <sup>Notes1,2,3,4</sup>
Cell 3 – Cell 2	$CSI\_RP3 - CSI\_RP2 - \delta - D - G_{inter} \leq \text{Reported RSRP(dB)} \leq CSI\_RP3 - CSI\_RP2 + \delta + G_{inter} - (X) + E$
Note 1:	CSI_RP <sub>n</sub> is the equivalent power received by an antenna with 0dBi gain at the centre of the quiet zone configured in the test for the cell n under consideration
Note 2:	δ is the RSRP relative accuracy requirement from Table 10.1.5.1.2-1
Note 3:	Void
Note 4:	X is the Spherical coverage gain difference in dB, derived as (UE Refsens - UE Spherical coverage) from TS 38.101-2 [19] clauses 7.3.2 and 7.3.4, selected according to the UE power class and operating band. X is always a negative value.

Note 5:	D is the margin due to mis-alignment between fine beam and rough beam. D is the Rough Beam gain reduction in Rx beam peak direction from Table B.2.1.5.3-1, selected according to the UE power class. D is always a positive value.
Note 6:	$G_{inter}$ is the margin due to different antenna gain caused by frequency separation. $G_{inter}$ is from Table B.2.1.5.2-1, selected according to the UE power class, and is always a positive value.
Note 7:	$E = 3$ (dB) is an additional margin to account for the actual gain difference between peak direction and spherical coverage using rough beams.

### A.5.7.8 CSI-RSRQ

#### A.5.7.8.1 EN-DC Intra-frequency measurement accuracy with FR2 serving cell and FR2 target cell

##### A.5.7.8.1.1 Test Purpose and Environment

The purpose of this test is to verify that the CSI-RSRQ measurement accuracy is within the specified limits. This test will verify the requirements in Clause 10.1.8 for inter-frequency measurement.

##### A.5.7.8.1.2 Test Parameters

In this test case all cells are on the same carrier frequency. Supported test configuration are shown in Table A.5.7.8.1.2-1. The absolute accuracy of CSI-RSRQ intra-frequency measurement is test by using the parameters in Table A.5.7.8.1.2-2. In all test cases, Cell 2 is the PSCell and Cell 3 is the target cell. The configuration of cell 1 (E-UTRA PCell) is specified in clause A.3.7.2.1.

**Table A.5.7.8.1.2-1: CSI-RSRQ Intra frequency CSI-RSRQ supported test configurations**

Config	Description
1	FDD LTE PCell, Cell 2&3 120 kHz SSB&CSI-RS SCS, 100 MHz bandwidth, TDD duplex mode
2	TDD LTE PCell, Cell 2&3 120 kHz SSB&CSI-RS SCS, 100 MHz bandwidth, TDD duplex mode
Note:	The UE is only required to be tested in one of the supported test configurations in each supported band

**Table A.5.7.8.1.2-2: CSI-RSRQ Intra frequency test parameters**

Parameter	Unit	Test 1		Test 2	
		Cell 2	Cell 3	Cell 2	Cell 3
SSB ARFCN		Freq1		Freq1	
Duplex mode		TDD		TDD	
TDD configuration		TDDConf.3.1		TDDConf.3.1	
BW <sub>channel</sub>	MHz	100: N <sub>RB,c</sub> = 66		100: N <sub>RB,c</sub> = 66	
BWP configuration	Initial DL BWP	DLBWP.0.1			
	Dedicated DL BWP	DLBWP.1.1			
	Initial UL BWP	ULBWP.0.1			
	Dedicated UL BWP	ULBWP.1.1			
TRS configuration		TRS.2.1 TDD		TRS.2.1 TDD	
CSI-RS configuration for RRM		CSI-RS.RRM.FR2.1 TDD			
TCI state		TCI.State .0		TCI.State .0	
PDSCH Reference measurement channel		SR.3.1 TDD		SR.3.1 TDD	
RMSI CORESET Reference Channel		CR.3.1 TDD	-	CR.3.1 TDD	-
Control channel RMC		CCR.3.1 TDD	-	CCR.3.1 TDD	-
OCNG Patterns		OP.1	OP.1	OP.1	OP.1
SMTc configuration		SMTc.1			
SSB configuration		SSB.1 FR2	SSB.1 FR2	SSB.1 FR2	SSB.1 FR2
Time offset with Cell 2	μs	-	0.58	-	0.58

PDSCH/PDCCH subcarrier spacing	kHz	120	120	120	120
SS-RSSI-Measurement		Not Applicable			
EPRE ratio of PSS to SSS					
EPRE ratio of PBCH_DMRS to SSS					
EPRE ratio of PBCH to PBCH_DMRS					
EPRE ratio of PDCCH_DMRS to SSS					
EPRE ratio of PDCCH to PDCCH_DMRS					
EPRE ratio of PDSCH_DMRS to SSS	dB	0	0	0	0
EPRE ratio of PDSCH to PDSCH_DMRS					
EPRE ratio of OCNG DMRS to SSS <sup>Note 1</sup>					
EPRE ratio of OCNG to OCNG DMRS <sup>Note 1</sup>					
$\hat{E}_s / N_{oc}$					
	dB	3	3	-3	-3
<p>Note 1: OCNG shall be used such that both cells are fully allocated and a constant total transmitted power spectral density is achieved for all OFDM symbols.</p> <p>Note 2: Interference from other cells and noise sources not specified in the test is assumed to be constant over subcarriers and time and shall be modelled as AWGN of appropriate power for <math>N_{oc}</math> to be fulfilled.</p> <p>Note 3: CSI-RSRQ, CSI-RSRP, and <math>I_o</math> levels have been derived from other parameters for information purposes. They are not settable parameters themselves.</p> <p>Note 4: CSI-RSRQ and CSI-RSRP minimum requirements are specified assuming independent interference and noise at each receiver antenna port.</p> <p>Note 5: Void</p>					

**Table A.5.7.8.1.2-3: CSI-RSRQ Intra frequency OTA related test parameters**

Parameter	Unit	Test 1		Test 2	
		Cell 2	Cell 3	Cell 2	Cell 3
Angle of arrival configuration		Setup 1 according to clause A.3.15.1			
Assumption for UE beams <sup>Note 9</sup>		Rough			
$N_{oc}$ <sup>Note1</sup>	dBm/15kHz <sup>Note4</sup>	-95		-95	
$N_{oc}$ <sup>Note1</sup>	dBm/SCS <sup>Note3</sup>	-86		-86	
CSI-RSRP <sup>Note2</sup>	dBm/SCS <sup>Note4</sup>	-83	-83	-89	-89
CSI-RSRQ <sup>Note2</sup>	dB	-14.77	-14.77	-16.81	-16.81
$\hat{E}_s / I_{ot}$	dB	-1.76	-1.76	-4.76	-4.76
$I_o$ <sup>Note2</sup>	dBm/95.04 MHz <sup>Note4</sup>	-50		-54	-54
<p>Note 1: Interference from other cells and noise sources not specified in the test is assumed to be constant over subcarriers and time and shall be modelled as AWGN of appropriate power for <math>N_{oc}</math> to be fulfilled.</p> <p>Note 2: CSI-RSRQ, CSI-RSRP, and <math>I_o</math> levels have been derived from other parameters for information purposes. They are not settable parameters themselves.</p> <p>Note 3: CSI-RSRQ and CSI-RSRP minimum requirements are specified assuming independent interference and noise at each receiver antenna port.</p> <p>Note 4: Equivalent power received by an antenna with 0dBi gain at the centre of the quiet zone</p> <p>Note 5: As observed with 0dBi gain antenna at the centre of the quiet zone</p> <p>Note 6: NR operating band groups are as defined in Clause 3.5.2.</p> <p>Note 7: Void</p> <p>Note 8: Void</p> <p>Note 9: Information about types of UE beam is given in B.2.1.3, and does not limit UE implementation or test system implementation</p>					

**A.5.7.8.1.3 Test Requirements**

The CSI-RSRQ absolute measurement accuracy in test 1 shall be within the range Nominal CSI-RSRQ +2.5dB to Nominal CSI-RSRQ -3.5dB and the CSI-RSRQ measurement accuracy in test 2 shall be within the range Nominal CSI-RSRQ +3.5dB to Nominal CSI-RSRQ -4.5dB according to the requirements in clause 10.1.8 with an additional -1dB margin reflecting the possible impact of UE self-noise in the test. Nominal CSI-RSRQ is the value shown in table A.5.7.8.1.2-3.



## A.5.7.8.2 EN-DC Inter-frequency measurement accuracy with FR2 serving cell and FR2 TDD target cell

### A.5.7.8.2.1 Test Purpose and Environment

The purpose of this test is to verify that the CSI-RSRQ measurement accuracy is within the specified limits. This test will verify the requirements in clause 10.1.10 for inter-frequency measurement.

### A.5.7.8.2.2 Test Parameters

In this test case the two NR cells (i.e., Cell 2 and Cell 3) are on different carrier frequencies and measurement gaps are provided. Supported test configurations are shown in Table A.5.7.8.2.2-1. Both absolute accuracy and relative accuracy requirements of CSI-RSRQ inter-frequency measurement are tested by using test setup in Table A.5.7.8.2.2-2 and Table A.5.7.8.2.2-3. In all test cases, Cell 2 is the PSCell and Cell 3 is target cell. Cell 1 is the E-UTRA cell which specific test parameters for this test case are specified in Table A.3.7.2.1-1.

**Table A.5.7.8.2.2-1: CSI-RSRQ Inter frequency CSI-RSRQ supported test configurations**

Configuration	Description
1	LTE FDD, NR 120 kHz SSB&CSI-RS SCS, 100 MHz bandwidth, TDD duplex mode
2	LTE TDD, NR 120 kHz SSB&CSI-RS SCS, 100 MHz bandwidth, TDD duplex mode

**Table A.5.7.8.2.2-2: CSI-RSRQ Inter frequency general test parameters**

Parameter	Unit	Test 1		Test 2	
		Cell 2	Cell 3	Cell 2	Cell 3
SSB ARFCN		Freq1	freq2	freq1	Freq2
Duplex mode		TDD		TDD	
TDD configuration		TDDConf.3.1		TDDConf.3.1	
BW <sub>channel</sub>	MHz	100: N <sub>RB,C</sub> = 66		100: N <sub>RB,C</sub> = 66	
PDSCH Reference measurement channel		SR.3.1 TDD	-	SR.3.1 TDD	-
RMSI CORESET Reference Channel		CR.3.1 TDD	-	CR.3.1 TDD	-
OCNG Patterns		OP.1	OP.1	OP.1	OP.1
SMTC configuration		SMTC. 1 FR2	SMTC. 1 FR2	SMTC. 1 FR2	SMTC. 1 FR2
CSI-RS configuration for RRM		CSI-RS.RRM.FR2.1 TDD			
PDSCH/PDCCH subcarrier spacing	kHz	120	120	120	120
Time offset with Cell 2	µs	-	0.58	-	0.58
EPRE ratio of PSS to SSS	dB	0	0	0	0
EPRE ratio of PBCH_DMRS to SSS					
EPRE ratio of PBCH to PBCH_DMRS					
EPRE ratio of PDCCH_DMRS to SSS					
EPRE ratio of PDCCH to PDCCH_DMRS					
EPRE ratio of PDSCH_DMRS to SSS					
EPRE ratio of PDSCH to PDSCH_DMRS					
EPRE ratio of OCNG DMRS to SSS <sup>Note 1</sup>					
$\hat{E}_s / N_{oc}$	dB	-1.75	-1.75	-3	-3
Note 1:	OCNG shall be used such that both cells are fully allocated and a constant total transmitted power spectral density is achieved for all OFDM symbols.				
Note 2:	Interference from other cells and noise sources not specified in the test is assumed to be constant over subcarriers and time and shall be modelled as AWGN of appropriate power for $N_{oc}$ to be fulfilled.				
Note 3:	CSI-RSRQ, CSI-RSRP and Io levels have been derived from other parameters for information purposes. They are not settable parameters themselves.				
Note 4:	CSI-RSRQ and CSI-RSRP minimum requirements are specified assuming independent interference and noise at each receiver antenna port.				

Table A.5.7.8.2.2-3: CSI-RSRQ Inter frequency OTA related test parameters

Parameter	Unit	Test 1		Test 2	
		Cell 2	Cell 3	Cell 2	Cell 3
AoA setup		Setup 1 in clause A.3.15		Setup 1 in clause A.3.15	
Assumption for UE beams <sup>Note 8</sup>		Rough		Rough	
$N_{oc}$ <sup>Note1</sup>	dBm/15kHz <sup>Note4</sup>	-94.03		-94.03	
$N_{oc}$ <sup>Note1</sup>	dBm/SCS <sup>Note3</sup>	-85.0		-85.0	
CSI-RP <sup>Note2</sup>	dBm/SCS <sup>Note4</sup>	-86.75	-86.75	-88	-88
CSI-RSRQ <sup>Note2</sup>	dB	-14.75	-14.75	-15.56	-15.56
$\hat{E}_s/I_{ot}$	dB	-1.75	-1.75	-3	-3
$I_o$ <sup>Note2</sup>	dBm/95.04 MHz <sup>Note4</sup>	-53.8	-53.8	-54.25	-54.25
Note 1:	Interference from other cells and noise sources not specified in the test is assumed to be constant over subcarriers and time and shall be modelled as AWGN of appropriate power for $N_{oc}$ to be fulfilled.				
Note 2:	CSI-RSRQ, CSI-RP, and $I_o$ levels have been derived from other parameters for information purposes. They are not settable parameters themselves.				
Note 3:	CSI-RSRQ and CSI-RP minimum requirements are specified assuming independent interference and noise at each receiver antenna port.				
Note 4:	Equivalent power received by an antenna with 0dBi gain at the centre of the quiet zone				
Note 5:	As observed with 0dBi gain antenna at the centre of the quiet zone				
Note 6:	Void				
Note 7:	Void				
Note 8:	Information about types of UE beam is given in B.2.1.3, and does not limit UE implementation or test system implementation				

### A.5.7.8.2.3 Test Requirements

The CSI-RSRQ absolute measurement accuracy in test 1 shall be within the range Nominal CSI-RSRQ +2.5dB to Nominal CSI-RSRQ -3.5dB and the CSI-RSRQ measurement accuracy in test 2 shall be within the range Nominal CSI-RSRQ +3.5dB to Nominal CSI-RSRQ -4.5dB according to the requirements in clause 10.1.10 with an additional -1dB margin reflecting the possible impact of UE self-noise in the test.

The CSI-RSRQ relative measurement accuracy shall fulfil the requirements in clause 10.1.10.

## A.5.7.9 CSI-SINR

### A.5.7.9.1 EN-DC Intra-frequency measurement accuracy with FR2 serving cell and FR2 TDD target cell

#### A.5.7.9.1.1 Test Purpose and Environment

The purpose of this test is to verify that the CSI-SINR measurement accuracy is within the specified limits. This test will verify the requirements in clause 10.1.13.2.1.

#### A.5.7.9.1.2 Test Parameters

In this test case all cells are on the same carrier frequency. Supported test configurations are shown in Table A.5.7.9.1.2-1. The absolute accuracy of CSI-SINR intra-frequency measurement is test by using the parameters in Table A.5.7.9.1.2-2 and Table A.5.7.9.1.2-3. The configuration of cell 1 (E-UTRA PCell) is specified in clause A.3.7.2.1. In all test cases, Cell 2 is the PSCell and Cell 3 is the target cell.

Table A.5.7.9.1.2-1: CSI-SINR Intra frequency CSI-SINR supported test configurations

Configuration	Description
1	FDD LTE PCell, Cell 2&3 120 kHz SSB and CSI-RS SCS, 100 MHz bandwidth, TDD duplex mode
2	TDD LTE PCell, Cell 2&3 120 kHz SSB and CSI-RS SCS, 100 MHz bandwidth, TDD duplex mode

Note: The UE is only required to pass in one of the supported test configurations

Table A.5.7.9.1.2-2: CSI-SINR Intra frequency test parameters

Parameter	Unit	Test 1		Test 2	
		Cell 2	Cell 3	Cell 2	Cell 3
SSB ARFCN		Freq2		Freq2	
Duplex mode		TDD		TDD	
TDD configuration		TDDConf.3.1		TDDConf.3.1	
BW <sub>channel</sub>	MHz	100: N <sub>RB,c</sub> = 66		100: N <sub>RB,c</sub> = 66	
Downlink initial BWP configuration		DLBWP.0.1			
Downlink dedicated BWP configuration		DLBWP.1.1			
Uplink initial BWP configuration		ULBWP.0.1			
Uplink dedicated BWP configuration		ULBWP.1.1			
DRX cycle configuration	ms	Not applicable			
TRS configuration		TRS.2.1 TDD			
TCI state		TCI.State.0			
PDSCH Reference measurement channel		SR.3.1 TDD		SR.3.1 TDD	
RMSI CORESET Reference Channel		CR.3.1 TDD	-	CR.3.1 TDD	-
Dedicated RMSI CORESET Reference Channel		CCR.3.1 TDD	-	CCR.3.1 TDD	-
OCNG Patterns		OP.1	OP.1	OP.1	OP.1
SMTC configuration		SMTC.1			
SSB configuration		SSB.1 FR2	SSB.1 FR2	SSB.1 FR2	SSB.1 FR2
CSI-RS for mobility		-	CSI-RS.RR M.FR2.1 TDD	-	CSI-RS.RR M.FR2.1 TDD
PDSCH/PDCCH subcarrier spacing	kHz	120	120	120	120
Time offset with Cell 2	μs	-	0.29	-	0.29
CSI-RSSI-Measurement		Not Applicable			
EPRE ratio of PSS to SSS	dB	0	0	0	0
EPRE ratio of PBCH_DMRS to SSS					
EPRE ratio of PBCH to PBCH_DMRS					
EPRE ratio of PDCCH_DMRS to SSS					
EPRE ratio of PDCCH to PDCCH_DMRS					
EPRE ratio of PDSCH_DMRS to SSS					
EPRE ratio of PDSCH to PDSCH_DMRS					
EPRE ratio of OCNG DMRS to SSS <sup>Note 1</sup>					
EPRE ratio of OCNG to OCNG DMRS <sup>Note 1</sup>					
$\hat{E}_s / N_{oc}$	dB	4.54	2.66	-3	-3
<p>Note 1: OCNG shall be used such that both cells are fully allocated and a constant total transmitted power spectral density is achieved for all OFDM symbols.</p> <p>Note 2: Interference from other cells and noise sources not specified in the test is assumed to be constant over subcarriers and time and shall be modelled as AWGN of appropriate power for <math>N_{oc}</math> to be fulfilled.</p> <p>Note 3: CSI-SINR, CSI-RSRP, and I<sub>o</sub> levels have been derived from other parameters for information purposes. They are not settable parameters themselves.</p> <p>Note 4: CSI-SINR and CSI-RSRP minimum requirements are specified assuming independent interference and noise at each receiver antenna port.</p>					

**Table A.5.7.9.1.2-3: CSI-SINR Intra frequency OTA related test parameters**

Parameter	Unit	Test 1		Test 2	
		Cell 2	Cell 3	Cell 2	Cell 3
Angle of arrival configuration		Setup 1 according to clause A.3.15.1		Setup 1 according to clause A.3.15.1	
Assumption for UE beams <sup>Note 7</sup>		Rough		Rough	
$N_{oc}$ <sup>Note1</sup>	dBm/15kHz <sup>Note4</sup>	-105		N/A	
$N_{oc}$ <sup>Note1</sup>	dBm/SCS <sup>Note3</sup>	-96		N/A	
$\hat{E}_s / N_{oc}$	dB	4.54	2.66	-3	-3
CSI-RSRP <sup>Note2</sup>	dBm/SCS <sup>Note4</sup>	-91.46	-93.34	-99	-99
CSI-SINR <sup>Note2</sup>	dB	0	-3.2	-4.76	-4.76
$\hat{E}_s / I_{ot}$	dB	0	-3.2	-4.76	-4.76
$I_o$ <sup>Note2</sup>	dBm/95.04 MHz <sup>Note4</sup>	-59.2		-64	
<p>Note 1: Interference from other cells and noise sources not specified in the test is assumed to be constant over subcarriers and time and shall be modelled as AWGN of appropriate power for <math>N_{oc}</math> to be fulfilled.</p> <p>Note 2: CSI-SINR, CSI-RSRP, and <math>I_o</math> levels have been derived from other parameters for information purposes. They are not settable parameters themselves.</p> <p>Note 3: CSI-SINR and CSI-RSRP minimum requirements are specified assuming independent interference and noise at each receiver antenna port.</p> <p>Note 4: Equivalent power received by an antenna with 0dBi gain at the centre of the quiet zone</p> <p>Note 5: As observed with 0dBi gain antenna at the centre of the quiet zone</p> <p>Note 6: NR operating band groups are as defined in Clause 3.5.2.</p> <p>Note 7: Information about types of UE beam is given in B.2.1.3, and does not limit UE implementation or test system implementation</p>					

### A.5.7.9.1.3 Test Requirements

The CSI-SINR absolute measurement accuracy in test 1 shall be within the range Nominal CSI-SINR+3dB to Nominal CSI-SINR -4dB and the CSI-SINR measurement accuracy in test 2 shall be within the range Nominal CSI-SINR +3.5dB to Nominal CSI-SINR -4.5dB according to the requirements in clause 10.13.2 with an additional -1dB margin reflecting the possible impact of UE self noise in the test. Nominal CSI-SINR is the value shown in table A.5.7.9.1.2-3.

### A.5.7.9.2 EN-DC Inter-frequency measurement accuracy with FR2 serving cell and FR2 TDD target cell

#### A.5.7.9.2.1 Test Purpose and Environment

The purpose of this test is to verify that the CSI-SINR measurement accuracy is within the specified limits. This test will verify the requirements in clause 10.1.15.2.1 and 10.1.15.2.2 for inter-frequency measurement.

#### A.5.7.9.2.2 Test Parameters

In this test case the two NR cells (i.e., Cell 2 and Cell 3) are on different carrier frequencies and measurement gaps are provided. Supported test configurations are shown in Table A.5.7.9.2.2-1. Both absolute accuracy and relative accuracy requirements of CSI-SINR inter-frequency measurement are tested by using test setup in Table A.5.7.9.2.2-2 and Table A.5.7.9.2.2-3. In all test cases, Cell 2 is the PSCell and Cell 3 is target cell. Cell 1 is the E-UTRA cell which specific test parameters for this test case are specified in Table A.3.7.2.1-1. The TCI status for Cell 1 is defined in Table A.3.16.2-1 and TRS configuration for Cell 1 is defined in Table A.3.17.2.1-1.

**Table A.5.7.9.2.2-1: CSI-SINR Inter frequency CSI-SINR supported test configurations**

Configuration	Description
1	LTE FDD, NR 120 kHz SSB and CSI-RS SCS, 100 MHz bandwidth, TDD duplex mode

2	LTE TDD, NR 120 kHz SSB and CSI-RS SCS, 100 MHz bandwidth, TDD duplex mode
---	--

Table A.5.7.9.2.2-2: CSI-SINR Inter frequency general test parameters

Parameter	Unit	Test 1		Test 2		Test 3	
		Cell 2	Cell 3	Cell 2	Cell 3	Cell 2	Cell 3
SSB ARFCN		Freq1	freq2	freq1	Freq2	freq1	Freq2
Duplex mode		TDD		TDD		TDD	
TDD configuration		TDDConf.3.1		TDDConf.3.1		TDDConf.3.1	
BW <sub>channel</sub>	MHz	100: N <sub>RB,c</sub> = 66		100: N <sub>RB,c</sub> = 66		100: N <sub>RB,c</sub> = 66	
Downlink initial BWP configuration		DLBWP.0.1					
Downlink dedicated BWP configuration		DLBWP.1.1					
Uplink initial BWP configuration		ULBWP.0.1					
Uplink dedicated BWP configuration		ULBWP.1.1					
DRX cycle configuration	ms	Not applicable					
TRS configuration		TRS.2.1 TDD					
TCI state		TCI.State.0					
PDSCH Reference measurement channel		SR.3.1 TDD	-	SR.3.1 TDD	-	SR.3. 1 TDD	-
RMSI CORESET Reference Channel		CR.3.1 TDD	-	CR.3.1 TDD	-	CR.3. 1 TDD	-
OCNG Patterns		OP.1	OP.1	OP.1	OP.1	OP.1	OP.1
Time offset with cell 2	μs	-	0.29	-	0.29	-	0.29
SMTC configuration		SMTC. 1 FR2	SMTC. 1 FR2	SMTC. 1 FR2	SMTC. 1 FR2	SMTC .1 FR2	SMTC. 1 FR2
CSI-RS for mobility		-	CSI- RS.RR M.FR2. 1 TDD	-	CSI- RS.RR M.FR2. 1 TDD	-	CSI- RS.RR M.FR2. 1 TDD
PDSCH/PDCCH subcarrier spacing	kHz	120	120	120	120	120	120
EPRE ratio of PSS to SSS	dB	0	0	0	0	0	0
EPRE ratio of PBCH_DMRS to SSS							
EPRE ratio of PBCH to PBCH_DMRS							
EPRE ratio of PDCCH_DMRS to SSS							
EPRE ratio of PDCCH to PDCCH_DMRS							
EPRE ratio of PDSCH_DMRS to SSS							
EPRE ratio of PDSCH to PDSCH_DMRS							
EPRE ratio of OCNG DMRS to SSS <sup>Note 1</sup>							
$\hat{E}_s / N_{oc}$	dB	-0.5	-0.5	11.0	11.0	-3.0	-3.0
Note 1:	OCNG shall be used such that both cells are fully allocated and a constant total transmitted power spectral density is achieved for all OFDM symbols.						
Note 2:	Interference from other cells and noise sources not specified in the test is assumed to be constant over subcarriers and time and shall be modelled as AWGN of appropriate power for $N_{oc}$ to be fulfilled.						
Note 3:	CSI-SINR, CSI-RSRP and $I_0$ levels have been derived from other parameters for information purposes. They are not settable parameters themselves.						
Note 4:	CSI-SINR and CSI-RSRP minimum requirements are specified assuming independent interference and noise at each receiver antenna port.						

Table A.5.7.9.2.2-3: CSI-SINR Inter frequency OTA related test parameters

Parameter	Unit	Test 1		Test 2		Test 3	
		Cell 2	Cell 3	Cell 2	Cell 3	Cell 2	Cell 3
Angle of arrival configuration	degrees	Setup 1 according to A.3.15.1		Setup 1 according to A.3.15.1		Setup 1 according to A.3.15.1	
Assumption for UE beams <sup>Note 7</sup>		Rough		Rough		Rough	
$N_{oc}$ <sup>Note1</sup>	dBm/15kHz <sup>Note4</sup>	-105		-105		-105	
$N_{oc}$ <sup>Note1</sup>	dBm/SCS <sup>Note3</sup>	-96		-96		-96	

$\hat{E}_s / N_{oc}$	dB	-0.5	-0.5	11.0	11.0	-3.0	-3.0
CSI-RSRP <sup>Note2</sup>	dBm/SCS <small>Note4</small>	-96.5	-96.5	-85	-85	-99	-99
CSI-SINR <sup>Note2</sup>	dB	-0.5	-0.5	11	11	-3.0	-3.0
$\hat{E}_s / I_{ot}$	dB	-0.5	-0.5	11	11	-3.0	-3.0
$I_o$ <sup>Note2</sup>	dBm/95.04 MHz <sup>Note4</sup>	-69.3		-55.4		-65.24	
<p>Note 1: Interference from other cells and noise sources not specified in the test is assumed to be constant over subcarriers and time and shall be modelled as AWGN of appropriate power for <math>N_{oc}</math> to be fulfilled.</p> <p>Note 2: CSI-SINR, CSI-RSRP, and <math>I_o</math> levels have been derived from other parameters for information purposes. They are not settable parameters themselves.</p> <p>Note 3: CSI-SINR and CSI-RSRP minimum requirements are specified assuming independent interference and noise at each receiver antenna port.</p> <p>Note 4: Equivalent power received by an antenna with 0dBi gain at the centre of the quiet zone</p> <p>Note 5: As observed with 0dBi gain antenna at the centre of the quiet zone</p> <p>Note 6: NR operating band groups are as defined in Clause 3.5.2.</p> <p>Note 7: Information about types of UE beam is given in B.2.1.3, and does not limit UE implementation or test system implementation</p>							

### A.5.7.9.2.3 Test Requirements

The CSI-SINR absolute measurement accuracy in test 1 shall be within the range Nominal CSI-SINR+3dB to Nominal CSI-SINR -4dB and the CSI-SINR measurement accuracy in test 2 shall be within the range Nominal CSI-SINR+3.5dB to Nominal CSI-SINR -4.5dB according to the requirements in clause 10.1.15.2.1 with an additional -1dB margin reflecting the possible impact of UE self noise in the test. Nominal CSI-SINR is the value shown in table A.5.7.2.2.2-3

The CSI-SINR relative measurement accuracy shall fulfil the requirements in clause 10.1.15.2.2.

## A.5.8 Void

## A.6 NR standalone tests with all NR cells in FR1

### A.6.1 SA: RRC\_IDLE state mobility

#### A.6.1.1 Cell re-selection to NR

##### A.6.1.1.1 Cell reselection to FR1 intra-frequency NR case

###### A.6.1.1.1.1 Test Purpose and Environment

This test is to verify the requirement for the intra frequency NR cell reselection requirements specified in clause 4.2.2.3.

###### A.6.1.1.1.2 Test Parameters

The test scenario comprises of 1 NR carrier and 2 cells as given in tables A.6.1.1.1.2-1, A.6.1.1.1.2-2 and A.6.1.1.1.2-3. The test consists of three successive time periods, with time duration of T1, T2, and T3 respectively. Only cell 1 is already identified by the UE prior to the start of the test. Cell 1 and cell 2 belong to different tracking areas. Furthermore, UE has not registered with network for the tracking area containing cell 2.

**Table A.6.1.1.1.2-1: Supported test configurations**

Configuration	Description
1	15 kHz SSB SCS, 10 MHz bandwidth, FDD duplex mode
2	15 kHz SSB SCS, 10 MHz bandwidth, TDD duplex mode
3	30 kHz SSB SCS, 40 MHz bandwidth, TDD duplex mode
Note:	The UE is only required to be tested in one of the supported test configurations.

**Table A.6.1.1.1.2-2: General test parameters for intra frequency NR cell re-selection test case**

Parameter		Unit	Test configuration	Value	Comment
Initial condition	Active cell		1, 2, 3	Cell1	
T2 end condition	Active cell		1, 2, 3	Cell2	
	Neighbour cells		1, 2, 3	Cell1	
Final condition	Active cell		1, 2, 3	Cell1	
	Neighbour cells		1, 2, 3	Cell2	
RF Channel Number			1, 2, 3	1	
Time offset between cells			1	3 ms	Asynchronous cells
			2	3 $\mu$ s	Synchronous cells
			3	3 $\mu$ s	Synchronous cells
Access Barring Information		-	1, 2, 3	Not Sent	No additional delays in random access procedure.
SSB configuration			1	SSB.1 FR1	
			2	SSB.1 FR1	
			3	SSB.2 FR1	
SMTC configuration			1	SMTC.2	Configured in SIB2 of Cell 1
				SMTC.6	Configured in SIB2 of Cell 2
			2	SMTC.1	
	3	SMTC.1			
DRX cycle length		s	1, 2, 3	1.28	The value shall be used for all cells in the test.
PRACH configuration index			1, 2, 3	102	The detailed configuration is specified in TS 38.211 clause 6.3.3.2
rangeToBestCell			1, 2, 3	Not configured	

T1	s	1, 2, 3	>7	During T1, Cell 2 shall be powered off, and during the off time the physical cell identity shall be changed, The intention is to ensure that Cell 2 has not been detected by the UE prior to the start of period T2
T2	s	1, 2, 3	40	T2 needs to be defined so that cell re-selection reaction time is taken into account.
T3	s	1, 2, 3	15	T3 needs to be defined so that cell re-selection reaction time is taken into account.

**Table A.6.1.1.2-3: Cell specific test parameters for intra frequency NR cell re-selection test case in AWGN**

Parameter	Unit	Test configuration	Cell 1			Cell 2		
			T1	T2	T3	T1	T2	T3
TDD configuration		1	N/A			N/A		
		2	TDDConf.1.1			TDDConf.1.1		
		3	TDDConf.2.1			TDDConf.2.1		
PDSCH RMC configuration		1	SR.1.1 FDD			SR.1.1 FDD		
		2	SR.1.1 TDD			SR.1.1 TDD		
		3	SR.2.1 TDD			SR.2.1 TDD		
RMSI CORESET RMC configuration		1	CR.1.1 FDD			CR.1.1 FDD		
		2	CR.1.1 TDD			CR.1.1 TDD		
		3	CR.2.1 TDD			CR.2.1 TDD		
Dedicated CORESET RMC configuration		1	CCR.1.1 FDD			CCR.1.1 FDD		
		2	CCR.1.1 TDD			CCR.1.1 TDD		
		3	CCR.2.1 TDD			CCR.2.1 TDD		
OCNG Pattern		1, 2, 3	OP.1 defined in A.3.2.1			OP.1 defined in A.3.2.1		
Initial DL BWP configuration		1, 2, 3	DLBWP.0.1			DLBWP.0.1		
Initial UL BWP configuration		1, 2, 3	ULBWP.0.1			ULBWP.0.1		
RLM-RS		1, 2, 3	SSB			SSB		
Qrxlevmin	dBm/SCS	1, 2	-130			-130		
		3	-127			-127		
Pcompensation	dB	1, 2, 3	0			0		
Qhysts	dB	1, 2, 3	0			0		
Qoffsets <sub>s, n</sub>	dB	1, 2, 3	0			0		
Cell_selection_and_reselection_quality_measurement		1, 2, 3	SS-RSRP			SS-RSRP		
$\hat{E}_s / I_{ot}$	dB	1	16	-3.11	2.79	-infinity	2.79	-3.11
		2						
		3						
$N_{oc}$ <sup>Note2</sup>	dBm/SCS	1	-98					
		2	-98					
		3	-95					
$N_{oc}$ <sup>Note2</sup>	dBm/15 kHz	1	-98					
		2						
		3						
$\hat{E}_s / N_{oc}$	dB	1	16	13	16	-infinity	16	13
		2						
		3						
SS-RSRP <sup>Note3</sup>	dBm/SCS	1	-82	-85	-82	-infinity	-82	-85
		2	-82	-85	-82	-infinity	-82	-85
		3	-79	-82	-79	-infinity	-79	-82



I <sub>o</sub>	dBm/9.36 MHz	1	-53.94	-52.21	-52.21	Same as parameters specified in Cell 1 columns-		
	dBm/9.36 MHz	2	-53.94	-52.21	-52.21			
	dBm/38.16 MHz	3	-47.85	-46.12	-46.12			
Treselection	s	1, 2, 3	0	0	0	0	0	0
SintrasearchP	dB	1, 2, 3	60			60		
Propagation Condition		1, 2, 3	AWGN					
Note 1:	OCNG shall be used such that both cells are fully allocated and a constant total transmitted power spectral density is achieved for all OFDM symbols.							
Note 2:	Interference from other cells and noise sources not specified in the test is assumed to be constant over subcarriers and time and shall be modelled as AWGN of appropriate power for $N_{oc}$ to be fulfilled.							
Note 3:	SS-RSRP levels have been derived from other parameters for information purposes. They are not settable parameters themselves.							

### A.6.1.1.1.3 Test Requirements

The cell reselection delay to a newly detectable cell is defined as the time from the beginning of time period T<sub>2</sub>, to the moment when the UE camps on Cell 2, and starts to send preambles on the PRACH for sending the *RRCSetupRequest* message to perform a Registration procedure for mobility and periodic registration update on Cell 2.

The cell re-selection delay to a newly detectable cell shall be less than 34 s.

The cell reselection delay to an already detected cell is defined as the time from the beginning of time period T<sub>3</sub>, to the moment when the UE camps on cell 1, and starts to send preambles on the PRACH for sending the *RRCSetupRequest* message to perform a Registration procedure for mobility and periodic registration update on cell 1.

The cell re-selection delay to an already detected cell shall be less than 8 s.

The rate of correct cell reselections observed during repeated tests shall be at least 90%.

NOTE: The cell re-selection delay to a newly detectable cell can be expressed as:  $T_{\text{detect, NR\_Intra}} + T_{\text{SI-NR}}$ , and to an already detected cell can be expressed as:  $T_{\text{evaluate, NR\_intra}} + T_{\text{SI-NR}}$ ,

Where:

$T_{\text{detect, NR\_Intra}}$  See Table 4.2.2.3-1 in clause 4.2.2.3

$T_{\text{evaluate, NR\_intra}}$  See Table 4.2.2.3-1 in clause 4.2.2.3

$T_{\text{SI-NR}}$  Maximum repetition period of relevant system info blocks that needs to be received by the UE to camp on a cell; 1280ms is assumed in this test case.

This gives a total of 33.28 s, allow 34 s for the cell re-selection delay to a newly detectable cell and 7.68 s for the cell re-selection delay to an already detected cell in the test case, which we allow 8 s.

### A.6.1.1.2 Cell reselection to FR1 inter-frequency NR case

#### A.6.1.1.2.1 Test Purpose and Environment

This test is to verify the requirement for the inter frequency NR cell reselection requirements specified in clause 4.2.2.4.

#### A.6.1.1.2.2 Test Parameters

The test scenario comprises of 2 cells on 2 different NR carriers respectively as given in tables A.6.1.1.2.2-1, A.6.1.1.2.2-2 and A.6.1.1.2.2-3. The test consists of three successive time periods, with time duration of T<sub>1</sub>, T<sub>2</sub>, and T<sub>3</sub> respectively. Both cell 1 and cell 2 are already identified by the UE prior to the start of the test. Cell 1 and cell 2 belong to different tracking areas and cell 2 is of higher priority than cell 1.

**Table A.6.1.1.2.2-1: Supported test configurations**

Configuration	Description of serving cell	Description of target cell
1	15 kHz SSB SCS, 10 MHz bandwidth, FDD duplex mode	15 kHz SSB SCS, 10 MHz bandwidth, FDD duplex mode

2	15 kHz SSB SCS, 10 MHz bandwidth, TDD duplex mode	15 kHz SSB SCS, 10 MHz bandwidth, TDD duplex mode
3	30 kHz SSB SCS, 40 MHz bandwidth, TDD duplex mode	30 kHz SSB SCS, 40 MHz bandwidth, TDD duplex mode
Note: The UE is only required to be tested in one of the supported test configurations.		

**Table A.6.1.1.2.2-2: General test parameters for FR1 inter frequency NR cell re-selection test case**

Parameter		Unit	Test configuration	Value	Comment
Initial condition	Active cell		1, 2, 3	Cell2	The UE camps on cell 2 in the initial phase and during T1 period the UE reselects to cell 1
	Neighbour cell		1, 2, 3	Cell 1	
T1 end condition	Active cell		1, 2, 3	Cell1	The UE shall perform reselection to cell 1 during T1
	Neighbour cells		1, 2, 3	Cell2	
T3 end condition	Active cell		1, 2, 3	Cell2	The UE shall perform reselection to cell 2 with higher priority during T3
	Neighbour cell		1, 2, 3	Cell 1	
RF Channel Number			1, 2, 3	1, 2	
Time offset between cells			1	3 ms	Asynchronous cells
			2	3 $\mu$ s	Synchronous cells
			3	3 $\mu$ s	Synchronous cells
Access Barring Information		-	1, 2, 3	Not Sent	No additional delays in random access procedure.
SSB configuration			1	SSB.1 FR1	
			2	SSB.1 FR1	
			3	SSB.2 FR1	
SMTTC configuration			1	SMTTC.2	Configured in SIB4 of Cell 1
				SMTTC.6	Configured in SIB4 of Cell 2
			2	SMTTC.1	
	3	SMTTC.1			
DRX cycle length		s	1, 2, 3	1.28	The value shall be used for all cells in the test.
PRACH configuration index			1, 2, 3	102	The detailed configuration is specified in TS 38.211 clause 6.3.3.2
rangeToBestCell			1, 2, 3	Not configured	
T1		s	1, 2, 3	15	T1 needs to be defined so that cell re-selection reaction time is taken into account.
T2		s	1, 2, 3	>7	During T2, cell 2 shall be powered off, and during the off time the physical cell identity shall be changed. The intention is to ensure that cell 2 has not been detected by the UE prior to the start of period T3.
T3		s	1, 2, 3	75	T3 needs to be defined so that cell re-selection reaction time is taken into account.

**Table A.6.1.1.2.2-3: Cell specific test parameters for FR1 inter frequency NR cell re-selection test case in AWGN**

Parameter	Unit	Test configuration	Cell 1			Cell 2		
			T1	T2	T3	T1	T2	T3
TDD configuration		1	N/A			N/A		
		2	TDDConf.1.1			TDDConf.1.1		
		3	TDDConf.2.1			TDDConf.2.1		
PDSCH RMC configuration		1	SR.1.1 FDD			SR.1.1 FDD		
		2	SR.1.1 TDD			SR.1.1 TDD		
		3	SR.2.1 TDD			SR.2.1 TDD		
RMSI CORESET		1	CR.1.1 FDD			CR.1.1 FDD		

RMC configuration		2	CR.1.1 TDD			CR.1.1 TDD		
		3	CR.2.1 TDD			CR.2.1 TDD		
	Dedicated CORESET RMC configuration	1	CCR.1.1 FDD			CCR.1.1 FDD		
2		CCR.1.1 TDD			CCR.1.1 TDD			
3		CCR.2.1 TDD			CCR.2.1 TDD			
OCNG Pattern		1, 2, 3	OP.1 defined in A.3.2.1			OP.1 defined in A.3.2.1		
Initial DL BWP configuration		1, 2, 3	DLBWP.0.1			DLBWP.0.1		
Initial UL BWP configuration		1, 2, 3	ULBWP.0.1			ULBWP.0.1		
RLM-RS		1, 2, 3	SSB			SSB		
Qrxlevmin	dBm/SCS	1, 2	-140			-140		
		3	-137			-137		
Pcompensation	dB	1, 2, 3	0			0		
Cell_selection_and_reselection_quality_measurement		1, 2, 3	SS-RSRP			SS-RSRP		
$\hat{E}_s / I_{\alpha}$	dB	1	14	14	14	-4	-infinity	12
		2						
		3						
$N_{oc}$ Note2	dBm/SCS	1	-98					
		2	-98					
		3	-95					
$N_{oc}$ Note2	dBm/15 kHz	1	-98					
		2						
		3						
$\hat{E}_s / N_{oc}$	dB	1	14	14	14	-4	-infinity	12
		2						
		3						
SS-RSRP Note3	dBm/SCS	1	-84	-84	-84	-102	-infinity	-86
		2	-84	-84	-84	-102	-infinity	-86
		3	-81	-81	-81	-99	-infinity	-83
I <sub>o</sub>	dBm/9.36 MHz	1	-55.88	-55.88	-55.88	-68.60	-70.05	-57.78
	dBm/9.36 MHz	2	-55.88	-55.88	-55.88	-68.60	-70.05	-57.78
	dBm/38.16 MHz	3	-49.79	-49.79	-49.79	-62.50	-63.96	-51.69
Treselection	s	1, 2, 3	0	0	0	0	0	0
SnonintrasearchP	dB	1, 2, 3	50			50		
Thresh <sub>x, highP</sub>	dB	1, 2, 3	48			48		
Thresh <sub>serv, lowP</sub>	dB	1, 2, 3	44			44		
Thresh <sub>x, lowP</sub>	dB	1, 2, 3	50			50		
Propagation Condition		1, 2, 3	AWGN					
<p>Note 1: OCNG shall be used such that both cells are fully allocated and a constant total transmitted power spectral density is achieved for all OFDM symbols.</p> <p>Note 2: Interference from other cells and noise sources not specified in the test is assumed to be constant over subcarriers and time and shall be modelled as AWGN of appropriate power for <math>N_{oc}</math> to be fulfilled.</p> <p>Note 3: SS-RSRP levels have been derived from other parameters for information purposes. They are not settable parameters themselves.</p>								

### A.6.1.1.2.3 Test Requirements

The cell reselection delay to a higher priority cell is defined as the time from the beginning of time period T3, to the moment when the UE camps again on cell 2, and starts to send preambles on the PRACH for sending the *RRCSetupRequest* message to perform a Registration procedure for mobility and periodic registration update on cell 2.

The cell re-selection delay to a higher priority cell shall be less than 68 s.

The cell reselection delay to a lower priority cell is defined as the time from the beginning of time period T1, to the moment when the UE camps on cell 1, and starts to send preambles on the PRACH for sending the *RRCSetupRequest* message to perform a Registration procedure for mobility and periodic registration update on cell 1.

The cell re-selection delay to a lower priority cell shall be less than 8 s.

The rate of correct cell reselections observed during repeated tests shall be at least 90%.

NOTE: The cell re-selection delay to a higher priority cell can be expressed as:  $T_{\text{higher\_priority\_search}} + T_{\text{evaluate, NR\_inter}} + T_{\text{SI-NR}}$ , and to a lower priority cell can be expressed as:  $T_{\text{evaluate, NR\_inter}} + T_{\text{SI-NR}}$ .

Where:

$T_{\text{higher\_priority\_search}}$  See clause 4.2.2.7

$T_{\text{evaluate, NR\_inter}}$  See Table 4.2.2.4-1 in clause 4.2.2.4

$T_{\text{SI-NR}}$  Maximum repetition period of relevant system info blocks that needs to be received by the UE to camp on a cell; 1280 ms is assumed in this test case.

This gives a total of 67.68 s, allow 68 s for the cell re-selection delay to a higher priority cell and 7.68 s for the cell re-selection delay to a lower priority cell in the test case, which we allow 8 s.

### A.6.1.1.3 Cell reselection to FR1 intra-frequency NR case for UE fulfilling low mobility relaxed measurement criterion

#### A.6.1.1.3.1 Test Purpose and Environment

This test is to verify the requirement for the intra frequency NR cell reselection requirements for UE fulfilling low mobility criterion specified in clause 4.2.2.9.2

#### A.6.1.1.3.2 Test Parameters

The test scenario comprises of 1 NR carrier and 2 cells as given in tables A.6.1.1.3.2-1, A.6.1.1.3.2-2 and A.6.1.1.3.2-3. The test consists of two successive time periods, with time duration of T1 and T2 respectively. Both cell 1 and cell 2 are already identified by the UE prior to the start of the test. Cell 1 and cell 2 belong to different tracking areas. Furthermore, UE has not registered with network for the tracking area containing cell 2.

**Table A.6.1.1.3.2-1: Supported test configurations**

Configuration	Description
1	15 kHz SSB SCS, 10 MHz bandwidth, FDD duplex mode
2	15 kHz SSB SCS, 10 MHz bandwidth, TDD duplex mode
3	30 kHz SSB SCS, 40 MHz bandwidth, TDD duplex mode
Note: The UE is only required to be tested in one of the supported test configurations.	

**Table A.6.1.1.3.2-2: General test parameters for FR1 intra frequency NR cell re-selection test case for UE fulfilling low mobility criterion**

Parameter	Unit	Test configuration	Value	Comment
Initial condition	Active cell	1, 2, 3	Cell1	The UE camps on cell 1 in the initial phase
	Neighbour cells	1, 2, 3	Cell2	
T1 end condition	Active cell	1, 2, 3	Cell2	The UE reselects to cell 2 during T1 period
	Neighbour cells	1, 2, 3	Cell1	
Final condition	Active cell	1, 2, 3	Cell1	The UE reselects to cell 1 during T2 period
	Neighbour cells	1, 2, 3	Cell2	
RF Channel Number		1, 2, 3	1	
Time offset between cells		1	3 ms	Asynchronous cells

		2	3 $\mu$ s	Synchronous cells
		3	3 $\mu$ s	Synchronous cells
Access Barring Information	-	1, 2, 3	Not Sent	No additional delays in random access procedure.
SSB configuration		1	SSB.1 FR1	
		2	SSB.1 FR1	
		3	SSB.2 FR1	
SMTC configuration		1	SMTC pattern 2	Configured in SIB2 of Cell 1
			SMTC pattern 6	Configured in SIB2 of Cell 2
		2	SMTC pattern 1	
		3	SMTC pattern 1	
DRX cycle length	s	1, 2, 3	0.64	The value shall be used for all cells in the test.
PRACH configuration index		1, 2, 3	102	The detailed configuration is specified in TS 38.211 clause 6.3.3.2
rangeToBestCell		1, 2, 3	Not configured	
T1	s	1, 2, 3	25	T1 needs to be defined so that cell re-selection reaction time is taken into account.
T2	s	1, 2, 3	25	T2 needs to be defined so that cell re-selection reaction time is taken into account.

**Table A.6.1.1.3.2-3: Cell specific test parameters for FR1 intra frequency NR cell re-selection test case in AWGN for UE fulfilling low mobility criterion**

Parameter	Unit	Test configuration	Cell 1		Cell 2	
			T1	T2	T1	T2
TDD configuration		1	N/A		N/A	
		2	TDDConf.1.1		TDDConf.1.1	
		3	TDDConf.2.1		TDDConf.2.1	
PDSCH RMC configuration		1	SR.1.1 FDD		N/A	
		2	SR.1.1 TDD			
		3	SR.2.1 TDD			
RMSI CORESET RMC configuration		1	CR.1.1 FDD		CR.1.1 FDD	
		2	CR.1.1 TDD		CR.1.1 TDD	
		3	CR.2.1 TDD		CR.2.1 TDD	
Dedicated CORESET RMC configuration		1	CCR.1.1 FDD		CCR.1.1 FDD	
		2	CCR.1.1 TDD		CCR.1.1 TDD	
		3	CCR.2.1 TDD		CCR.2.1 TDD	
OCNG Pattern		1, 2, 3	OP.1 defined in A.3.2.1		OP.1 defined in A.3.2.1	
Initial DL BWP configuration		1, 2, 3	DLBWP.0.1		DLBWP.0.1	
Initial UL BWP configuration		1, 2, 3	ULBWP.0.1		ULBWP.0.1	
RLM-RS		1, 2, 3	SSB		SSB	
Qrxlevmin	dBm/SCS	1, 2	-140		-140	
		3	-137		-137	
Pcompensation	dB	1, 2, 3	0		0	

Qhysts	dB	1, 2, 3	0		0	
Qoffsets, n	dB	1, 2, 3	0		0	
S <sub>SearchDeltaP</sub>	dB	1, 2, 3	3		3	
T <sub>SearchDeltaP</sub>	s	1, 2, 3	5		5	
Cell_selection_and_reselection_quality_measurement		1, 2, 3	SS-RSRP		SS-RSRP	
$\hat{E}_s / I_{ot}$	dB	1, 2, 3	-3.11	2.79	2.79	-3.11
$N_{oc}$ <sup>Note2</sup>	dBm/SCS	1	-98			
		2	-98			
		3	-95			
$N_{oc}$ <sup>Note2</sup>	dBm/15 kHz	1, 2, 3	-98			
$\hat{E}_s / N_{oc}$	dB	1, 2, 3	13	16	16	13
SS-RSRP <sup>Note3</sup>	dBm/SCS	1	-85	-82	-82	-85
		2	-85	-82	-82	-85
		3	-82	-79	-79	-82
I <sub>o</sub>	dBm/9.36 MHz	1	-52.21	-52.21	specified in Cell 1 columns-	
	dBm/9.36 MHz	2	-52.21	-52.21		
	dBm/38.16 MHz	3	-46.12	-46.12		
T <sub>reselection</sub>	s	1, 2, 3	0	0	0	0
S <sub>intrasearchP</sub>	dB	1, 2, 3	60		60	
Propagation Condition		1, 2, 3	AWGN			
Note 1: OCNG shall be used such that both cells are fully allocated and a constant total transmitted power spectral density is achieved for all OFDM symbols.						
Note 2: Interference from other cells and noise sources not specified in the test is assumed to be constant over subcarriers and time and shall be modelled as AWGN of appropriate power for $N_{oc}$ to be fulfilled.						
Note 3: SS-RSRP levels have been derived from other parameters for information purposes. They are not settable parameters themselves.						

### A.6.1.1.3.3 Test Requirements

The cell reselection delay to an already detected cell is defined as the time from the beginning of time period T1, to the moment when the UE camps on Cell 2, and starts to send preambles on the PRACH for sending the *RRCSetupRequest* message to perform a Tracking Area Update procedure on Cell 2.

The cell re-selection delay to an already detected cell shall be less than 17 s.

The cell reselection delay to an already detected cell is defined as the time from the beginning of time period T2, to the moment when the UE camps on cell 1, and starts to send preambles on the PRACH for sending the *RRCSetupRequest* message to perform a Tracking Area Update procedure on cell 1.

The cell re-selection delay to an already detected cell shall be less than 17 s.

The rate of correct cell reselections observed during repeated tests shall be at least 90%.

NOTE: The cell re-selection delay to an already detected cell can be expressed as:  $T_{\text{evaluate,NR\_Intra}} + T_{\text{SI-NR}}$ ,

Where:

$T_{\text{evaluate,NR\_Intra}}$  See Table 4.2.2.9.2-1 in clause 4.2.2.9.2 for reselection to Cell 2 during T1 with UE fulfilling low mobility criterion. 15.36s.

$T_{\text{SI-NR}}$  Maximum repetition period of relevant system info blocks that needs to be received by the UE to camp on a cell; 1280 ms is assumed in this test case.

This gives a total of 16.64 s, allow 17 s for the cell re-selection delay to an already detected cell for UE fulfilling low mobility criterion in the test case.

#### A.6.1.1.4 Cell reselection to FR1 intra-frequency NR case for UE fulfilling not-at-cell edge relaxed measurement criterion

##### A.6.1.1.4.1 Test Purpose and Environment

This test is to verify the relaxed cell re-selection requirement for UEs configured with not-at-cell edge criterion specified in clause 4.2.2.9.3.

##### A.6.1.1.4.2 Test Parameters

The test scenario comprises of 1 NR carrier and 2 cells as given in tables A.6.1.1.4.2-1, A.6.1.1.4.2-2 and A.6.1.1.4.2-3. The test consists of two successive time periods, with time duration of T1 and T2 respectively. Both Cell 1 and Cell 2 are already identified by the UE prior to the start of the test. Cell 1 and Cell 2 belong to different tracking areas.

**Table A.6.1.1.4.2-1: Supported test configurations**

Configuration	Description
1	15 kHz SSB SCS, 10 MHz bandwidth, FDD duplex mode
2	15 kHz SSB SCS, 10 MHz bandwidth, TDD duplex mode
3	30 kHz SSB SCS, 40 MHz bandwidth, TDD duplex mode
Note:	The UE is only required to be tested in one of the supported test configurations.

**Table A.6.1.1.4.2-2: General test parameters for FR1 intra frequency NR cell re-selection test case for UE fulfilling not-at-cell edge criterion**

Parameter		Unit	Test configuration	Value	Comment
Initial condition	Active Cell		1, 2, 3	Cell1	The UE camps on Cell 1 in the initial phase
	Neighbour Cells		1, 2, 3	Cell2	
T1 end condition	Active Cell		1, 2, 3	Cell2	The UE shall fulfil the not-at-cell edge criterion and reselect to cell 2 during T1 period during T1.
	Neighbour Cells		1, 2, 3	Cell1	
T2 end condition	Active Cell		1, 2, 3	Cell1	The UE shall perform reselection to Cell 1 during T2
	Neighbour Cells		1, 2, 3	Cell2	
RF Channel Number			1, 2, 3	1	
Time offset between Cells			1	3 ms	Asynchronous Cells
			2	3 $\mu$ s	Synchronous Cells
			3	3 $\mu$ s	Synchronous Cells
Access Barring Information		-	1, 2, 3	Not Sent	No additional delays in random access procedure.
SSB configuration			1	SSB.1 FR1	
			2	SSB.1 FR1	
			3	SSB.2 FR1	
SMTC configuration			1	SMTC pattern 2	Configured in SIB2 of Cell 1
				SMTC pattern 6	Configured in SIB2 of Cell 2
			2	SMTC pattern 1	
				3	SMTC pattern 1
DRX cycle length		s	1, 2, 3	0.64	The value shall be used for all Cells in the test.
PRACH configuration index			1, 2, 3	102	The detailed configuration is specified in TS 38.211 clause 6.3.3.2
rangeToBestCell			1, 2, 3	Not configured	
T1		s	1, 2, 3	20	T1 needs to be defined so that Cell re-selection reaction time is taken into account.

T2	s	1, 2, 3	20	T2 needs to be defined so that Cell re-selection reaction time is taken into account.
----	---	---------	----	---

**Table A.6.1.1.4.2-3: Cell specific test parameters for FR1 intra frequency NR cell re-selection test case in AWGN for UE fulfilling not-at-cell edge criterion**

Parameter	Unit	Test configuration	Cell 1		Cell 2	
			T1	T2	T1	T2
TDD configuration		1	N/A		N/A	
		2	TDDConf.1.1		TDDConf.1.1	
		3	TDDConf.2.1		TDDConf.2.1	
PDSCH RMC configuration		1	SR.1.1 FDD		N/A	
		2	SR.1.1 TDD			
		3	SR.2.1 TDD			
RMSI CORESET RMC configuration		1	CR.1.1 FDD		CR.1.1 FDD	
		2	CR.1.1 TDD		CR.1.1 TDD	
		3	CR.2.1 TDD		CR.2.1 TDD	
Dedicated CORESET RMC configuration		1	CCR.1.1 FDD		CCR.1.1 FDD	
		2	CCR.1.1 TDD		CCR.1.1 TDD	
		3	CCR.2.1 TDD		CCR.2.1 TDD	
OCNG Pattern		1, 2, 3	OP.1 defined in A.3.2.1		OP.1 defined in A.3.2.1	
Initial DL BWP configuration		1, 2, 3	DLBWP.0.1		DLBWP.0.1	
Initial UL BWP configuration		1, 2, 3	ULBWP.0.1		ULBWP.0.1	
RLM-RS		1, 2, 3	SSB		SSB	
Qrxlevmin	dBm/SCS	1, 2	-140		-140	
		3	-137		-137	
Pcompensation	dB	1, 2, 3	0		0	
Qhysts	dB	1, 2, 3	0		0	
Qoffsets <sub>s, n</sub>	dB	1, 2, 3	0		0	
Cell_selection_and_reselection_quality_measurement		1, 2, 3	SS-RSRP		SS-RSRP	
$\hat{E}_s / I_{ot}$	dB	1	-3.11	2.79	2.79	-3.11
		2				
		3				
$N_{oc}$ Note2	dBm/SCS	1	-98			
		2	-98			
		3	-95			
$N_{oc}$ Note2	dBm/15 kHz	1	-98			
		2				
		3				
$\hat{E}_s / N_{oc}$	dB	1	13	16	16	13
		2				
		3				
SS-RSRP Note3	dBm/SCS	1	-85	-82	-82	-85
		2	-85	-82	-82	-85
		3	-82	-79	-79	-82
I <sub>o</sub>	dBm/9.36 MHz	1	-52.21	-52.21	-52.21	-52.21
	dBm/9.36 MHz	2	-52.21	-52.21	-52.21	-52.21
	dBm/38.16 MHz	3	-46.12	-46.12	-46.12	-46.12
Treselection	s	1, 2, 3	0	0	0	0
SintrasearchP	dB	1, 2, 3	60		60	
S <sub>searchThresholdP</sub>	dB	1, 2, 3	50		50	
Propagation Condition		1, 2, 3	AWGN			



Note 1:	OCNG shall be used such that both Cells are fully allocated and a constant total transmitted power spectral density is achieved for all OFDM symbols.
Note 2:	Interference from other Cells and noise sources not specified in the test is assumed to be constant over subcarriers and time and shall be modelled as AWGN of appropriate power for $N_{oc}$ to be fulfilled.
Note 3:	SS-RSRP levels have been derived from other parameters for information purposes. They are not settable parameters themselves.

#### A.6.1.1.4.3 Test Requirements

The cell re-selection delay to an already detected cell for UE configured with *cellEdgeEvaluation* criterion is defined as the time from the beginning of time period T1, to the moment when the UE camps on Cell 2, and starts to send preambles on the PRACH for sending the *RRCSetupRequest* message to perform a Tracking Area Update procedure on Cell 2.

The cell re-selection delay to an already detected cell for UE configured with *cellEdgeEvaluation* criterion shall be less than 17s.

The rate of correct cell reselections observed during repeated tests shall be at least 90%.

NOTE: The cell re-selection delay to an already detected cell for UE configured with relaxed measurement criterion can be expressed as:  $T_{\text{evaluate,NR\_Intra}} + T_{\text{SI-NR}}$ ,

Where:

$T_{\text{evaluate,NR\_Intra}}$  See Table 4.2.2.9.3-1 for UE fulfilling not-at-cell edge criterion in clause 4.2.2.9.3.

$T_{\text{SI-NR}}$  Maximum repetition period of relevant system info blocks that needs to be received by the UE to camp on a Cell; 1280ms is assumed in this test case.

This gives a total of 16.64s, allow 17s for the cell re-selection delay to an already detected cell for UE fulfilling not-at-cell edge criterion in the test case.

#### A.6.1.1.5 Cell reselection to FR1 inter-frequency NR case for UE fulfilling low mobility relaxed measurement criterion

##### A.6.1.1.5.1 Test Purpose and Environment

This test is to verify the requirement for the inter frequency NR cell reselection requirements specified in clause 4.2.2.10.2, for UE fulfilling low mobility relaxed measurement criterion.

##### A.6.1.1.5.2 Test Parameters

The test scenario comprises of 2 cells on 2 different NR carriers respectively as given in tables A.6.1.1.5.2-1, A.6.1.1.5.2-2 and A.6.1.1.5.2-3. The test consists of two successive time periods, with time duration of T1 and T2 respectively. Both cell 1 and cell 2 are already identified by the UE prior to the start of the test. Cell 1 and cell 2 belong to different tracking areas and cell 2 is of higher priority than cell 1.

As specified in the Test Purpose, the UE is configured with the relaxed measurement criterion for UE with low mobility defined in clause 5.2.4.9.1 in [1]. So, Cell 2 and Cell 1 configure the UE as follows:

*lowMobilityEvaluation* [2] criterion is configured according to the parameters listed in Table A.6.1.1.5.2-3;

*cellEdgeEvaluation* [2] criterion is not configured;

*combineRelaxedMeasCondition* [2] is not configured;

**Table A.6.1.1.5.2-1: Supported test configurations**

Configuration	Description of serving cell	Description of target cell
1	15 kHz SSB SCS, 10 MHz bandwidth, FDD duplex mode	15 kHz SSB SCS, 10 MHz bandwidth, FDD duplex mode
2	15 kHz SSB SCS, 10 MHz bandwidth, TDD duplex mode	15 kHz SSB SCS, 10 MHz bandwidth, TDD duplex mode

3	30 kHz SSB SCS, 40 MHz bandwidth, TDD duplex mode	30 kHz SSB SCS, 40 MHz bandwidth, TDD duplex mode
Note: The UE is only required to be tested in one of the supported test configurations.		

**Table A.6.1.1.5.2-2: General test parameters for FR1 inter frequency NR cell re-selection test case for UE fulfilling low mobility criterion**

Parameter		Unit	Test configuration	Value	Comment
Initial condition	Active cell		1, 2, 3	Cell2	The UE camps on cell 2 in the initial phase, it fulfills Low Mobility relaxation measurements criterion, and during T1 period the UE reselects to cell 1
	Neighbour cells		1, 2, 3	Cell1	
T1 end condition	Active cell		1, 2, 3	Cell1	The UE shall perform reselection to cell 1 during T1
	Neighbour cells		1, 2, 3	Cell2	
T2 end condition	Active cell		1, 2, 3	Cell2	The UE shall perform reselection to cell 2 with higher priority during T2
	Neighbour cells		1, 2, 3	Cell1	
RF Channel Number			1, 2, 3	1, 2	
Time offset between cells			1	3 ms	Asynchronous cells
			2	3 $\mu$ s	Synchronous cells
			3	3 $\mu$ s	Synchronous cells
Access Barring Information		-	1, 2, 3	Not Sent	No additional delays in random access procedure.
SSB Configuration			1	SSB.1 FR1	
			2	SSB.1 FR1	
			3	SSB.2 FR1	
SMTC configuration			1	SMTC pattern 2	Configured in SIB4 of Cell 1
				SMTC pattern 6	Configured in SIB4 of Cell 2
			2	SMTC pattern 1	
				3	SMTC pattern 1
DRX cycle length		s	1, 2, 3	0.64	The value shall be used for all cells in the test.
PRACH configuration index			1, 2, 3	102	The detailed configuration is specified in TS 38.211 clause 6.3.3.2
rangeToBestCell			1, 2, 3	Not configured	
T1		s	1, 2, 3	25 s	T1 is defined so that cell re-selection reaction time is taken into account.
T2		s	1, 2, 3	25 s	T2 is defined so that cell re-selection reaction time is taken into account.

**Table A.6.1.1.5.2-3: Cell specific test parameters for FR1 inter frequency NR cell re-selection test case in AWGN for UE fulfilling low mobility criterion**

Parameter	Unit	Test configuration	Cell 1		Cell 2	
			T1	T2	T1	T2
TDD configuration		1	N/A		N/A	
		2	TDDConf.1.1		TDDConf.1.1	
		3	TDDConf.2.1		TDDConf.2.1	
PDSCH RMC configuration		1	SR.1.1 FDD		SR.1.1 FDD	
		2	SR.1.1 TDD		SR.1.1 TDD	
		3	SR.2.1 TDD		SR.2.1 TDD	
RMSI CORESET RMC configuration		1	CR.1.1 FDD		CR.1.1 FDD	
		2	CR.1.1 TDD		CR.1.1 TDD	
		3	CR.2.1 TDD		CR.2.1 TDD	
Dedicated CORESET RMC configuration		1	CCR.1.1 FDD		CCR.1.1 FDD	
		2	CCR.1.1 TDD		CCR.1.1 TDD	
		3	CCR.2.1 TDD		CCR.2.1 TDD	
OCNG Pattern		1, 2, 3	OP.1 defined in A.3.2.1		OP.1 defined in A.3.2.1	
Initial DL BWP configuration		1, 2, 3	DLBWP.0.1		DLBWP.0.1	
Initial UL BWP configuration		1, 2, 3	ULBWP.0.1		ULBWP.0.1	
RLM-RS		1, 2, 3	SSB		SSB	
Qrxlevmin	dBm/SCS	1, 2	-140		-140	
		3	-137		-137	
Pcompensation	dB	1, 2, 3	0		0	
Qhysts	dB	1, 2, 3	0		0	
Qoffsets, n	dB	1, 2, 3	0		0	
Cell_selection_and_reselection_quality_measurement		1, 2, 3	SS-RSRP		SS-RSRP	
$\hat{E}_s / I_{ot}$	dB	1	14	14	-4	12
		2				
		3				
$N_{oc}$ Note2	dBm/SCS	1	-98			
		2	-98			
		3	-95			
$N_{oc}$ Note2	dBm/15 kHz	1	-98			
		2				
		3				
$\hat{E}_s / N_{oc}$	dB	1	14	14	-4	12
		2				
		3				
SS-RSRP Note3	dBm/SCS	1	-84	-84	-102	-86
		2	-84	-84	-102	-86
		3	-81	-81	-99	-83
Io	dBm/9.36 MHz	1	-55.88	-55.88	-68.60	-57.78
	dBm/9.36 MHz	2	-55.88	-55.88	-68.60	-57.78
	dBm/38.16 MHz	3	-49.79	-49.79	-62.50	-51.69
Treselection	s	1, 2, 3	0	0	0	0
SnonintrasearchP	dB	1, 2, 3	Not sent		Not sent	
Thresh <sub>x, highP</sub>	dB	1, 2, 3	48		48	
Thresh <sub>serv, lowP</sub>	dB	1, 2, 3	44		44	
Thresh <sub>x, lowP</sub>	dB	1, 2, 3	50		50	
S <sub>SearchDeltaP</sub>	dB	1, 2, 3	3		3	

$T_{SearchDeltaP}$	s	1, 2, 3	5	5
Propagation Condition		1, 2, 3	AWGN	
Note 1:	OCNG shall be used such that both cells are fully allocated and a constant total transmitted power spectral density is achieved for all OFDM symbols.			
Note 2:	Interference from other cells and noise sources not specified in the test is assumed to be constant over subcarriers and time and shall be modelled as AWGN of appropriate power for $N_{oc}$ to be fulfilled.			
Note 3:	SS-RSRP levels have been derived from other parameters for information purposes. They are not settable parameters themselves.			

### A.6.1.1.5.3 Test Requirements

The cell reselection delay to an already detected lower priority cell for UE fulfilling low mobility relaxed measurements is defined as the time from the beginning of time period T1, to the moment when the UE camps on cell 1, and starts to send preambles on the PRACH for sending the *RRCSetupRequest* message to perform a Tracking Area Update procedure on cell 1.

The cell re-selection delay to a lower priority cell for UE fulfilling low mobility relaxed measurements shall be less than 17 s.

The cell reselection delay to an already detected higher priority cell for UE fulfilling low mobility relaxed measurements is defined as the time from the beginning of time period T2, to the moment when the UE camps on cell 2, and starts to send preambles on the PRACH for sending the *RRCSetupRequest* message to perform a Tracking Area Update procedure on cell 2.

The cell re-selection delay to an already detected higher priority cell for UE fulfilling low mobility relaxed measurements shall be less than 17 s.

The rate of correct cell reselections observed during repeated tests shall be at least 90%.

NOTE: The cell re-selection delay to a known lower priority cell can be expressed as:  $T_{evaluate, NR\_inter} + T_{SI-NR}$ ,

Where:

$T_{evaluate, NR\_inter}$  See Table 4.2.2.10.2-1 in clause 4.2.2.10.2

$T_{SI-NR}$  Maximum repetition period of relevant system info blocks that needs to be received by the UE to camp on a cell; 1280 ms is assumed in this test case.

This gives a total of 16.64 s, allow 17s for the cell re-selection delay to an already detected lower priority cell and 16.64s for the cell re-selection delay to an already detected higher priority cell, which we allow 17s for UE fulfilling low mobility relaxed measurements in the test case.

### A.6.1.1.6 Cell reselection to FR1 inter-frequency NR case for UE fulfilling not-at-cell edge relaxed measurement criterion

#### A.6.1.1.6.1 Test Purpose and Environment

This test is to verify the requirement for the inter frequency NR cell reselection requirements specified in clause 4.2.2.10.3, for UE fulfilling not-at-cell edge relaxed measurement criterion.

#### A.6.1.1.6.2 Test Parameters

The test scenario comprises of 2 cells on 2 different NR carriers respectively as given in tables A.6.1.1.6.2-1, A.6.1.1.6.2-2 and A.6.1.1.6.2-3. The test consists of two successive time periods, with time duration of T1 and T2 respectively. Both cell 1 and cell 2 are already identified by the UE prior to the start of the test. Cell 1 and cell 2 belong to different tracking areas and cell 2 is of higher priority than cell 1.

As specified in the Test Purpose, the UE is configured with the relaxed measurement criterion for UE not-at-cell edge as defined in clause 5.2.4.9.2 in [1]. So, Cell 2 and Cell 1 configures the UE as follows:

*cellEdgeEvaluation* [2] criterion is configured according to the parameters listed in Table A.6.1.1.5.2-3;

*lowMobilityEvaluation* [2] criterion is not configured;

*combineRelaxedMeasCondition* [2] is not configured;

**Table A.6.1.1.6.2-1: Supported test configurations**

Configuration	Description of serving cell	Description of target cell
1	15 kHz SSB SCS, 10 MHz bandwidth, FDD duplex mode	15 kHz SSB SCS, 10 MHz bandwidth, FDD duplex mode
2	15 kHz SSB SCS, 10 MHz bandwidth, TDD duplex mode	15 kHz SSB SCS, 10 MHz bandwidth, TDD duplex mode
3	30 kHz SSB SCS, 40 MHz bandwidth, TDD duplex mode	30 kHz SSB SCS, 40 MHz bandwidth, TDD duplex mode
Note: The UE is only required to be tested in one of the supported test configurations.		

**Table A.6.1.1.6.2-2: General test parameters for FR1 inter frequency NR cell re-selection test case for UE fulfilling not-at-cell edge criterion**

Parameter		Unit	Test configuration	Value	Comment
Initial condition	Active cell		1, 2, 3	Cell2	The UE camps on cell 2 in the initial phase, it fulfills Not-at-cell edge relaxation measurements criterion, and during T1 period the UE reselects to cell 1
	Neighbour cells		1, 2, 3	Cell1	
T1 end condition	Active cell		1, 2, 3	Cell1	The UE shall perform reselection to cell 1 during T1
	Neighbour cells		1, 2, 3	Cell2	
T2 end condition	Active cell		1, 2, 3	Cell2	The UE shall perform reselection to cell 2 with higher priority during T2
	Neighbour cells		1, 2, 3	Cell1	
RF Channel Number			1, 2, 3	1, 2	
Time offset between cells			1	3 ms	Asynchronous cells
			2	3 $\mu$ s	Synchronous cells
			3	3 $\mu$ s	Synchronous cells
Access Barring Information		-	1, 2, 3	Not Sent	No additional delays in random access procedure.
SSB Configuration			1	SSB.1 FR1	
			2	SSB.1 FR1	
			3	SSB.2 FR1	
SMTC configuration			1	SMTC pattern 2	Configured in SIB4 of Cell 1
				SMTC pattern 6	Configured in SIB4 of Cell 2
			2	SMTC pattern 1	
				SMTC pattern 1	
DRX cycle length		s	1, 2, 3	0.64	The value shall be used for all cells in the test.
PRACH configuration index			1, 2, 3	102	The detailed configuration is specified in TS 38.211 clause 6.3.3.2
rangeToBestCell			1, 2, 3	Not configured	
T1		s	1, 2, 3	20 s	T1 is defined so that cell re-selection reaction time is taken into account.
T2		s	1, 2, 3	20 s	T2 is defined so that cell re-selection reaction time is taken into account.

**Table A.6.1.1.6.2-3: Cell specific test parameters for FR1 inter frequency NR cell re-selection test case in AWGN for UE fulfilling not-at-cell edge criterion**

Parameter	Unit	Test configuration	Cell 1		Cell 2	
			T1	T2	T1	T2
TDD configuration		1	N/A		N/A	
		2	TDDConf.1.1		TDDConf.1.1	
		3	TDDConf.2.1		TDDConf.2.1	
PDSCH RMC configuration		1	SR.1.1 FDD		SR.1.1 FDD	
		2	SR.1.1 TDD		SR.1.1 TDD	
		3	SR.2.1 TDD		SR.2.1 TDD	
RMSI CORESET RMC configuration		1	CR.1.1 FDD		CR.1.1 FDD	
		2	CR.1.1 TDD		CR.1.1 TDD	
		3	CR.2.1 TDD		CR.2.1 TDD	
Dedicated CORESET RMC configuration		1	CCR.1.1 FDD		CCR.1.1 FDD	
		2	CCR.1.1 TDD		CCR.1.1 TDD	
		3	CCR.2.1 TDD		CCR.2.1 TDD	
OCNG Pattern		1, 2, 3	OP.1 defined in A.3.2.1		OP.1 defined in A.3.2.1	
Initial DL BWP configuration		1, 2, 3	DLBWP.0.1		DLBWP.0.1	
Initial UL BWP configuration		1, 2, 3	ULBWP.0.1		ULBWP.0.1	
RLM-RS		1, 2, 3	SSB		SSB	
Qrxlevmin	dBm/SCS	1, 2	-140		-140	
		3	-137		-137	
Pcompensation	dB	1, 2, 3	0		0	
Qhyst <sub>s</sub>	dB	1, 2, 3	0		0	
Qoffset <sub>s, n</sub>	dB	1, 2, 3	0		0	
Cell_selection_and_reselection_quality_measurement		1, 2, 3	SS-RSRP		SS-RSRP	
$\hat{E}_s / I_{ot}$	dB	1	14	14	-4	12
		2				
		3				
$N_{oc}$ Note2	dBm/SCS	1	-98			
		2	-98			
		3	-95			
$N_{oc}$ Note2	dBm/15 kHz	1	-98			
		2				
		3				
$\hat{E}_s / N_{oc}$	dB	1	14	14	-4	12
		2				
		3				
SS-RSRP Note3	dBm/SCS	1	-84	-84	-102	-86
		2	-84	-84	-102	-86
		3	-81	-81	-99	-83
I <sub>o</sub>	dBm/9.36 MHz	1	-55.88	-55.88	-68.60	-57.78
	dBm/9.36 MHz	2	-55.88	-55.88	-68.60	-57.78
	dBm/38.16 MHz	3	-49.79	-49.79	-62.50	-51.69
Treselection	s	1, 2, 3	0	0	0	0
SnonintrasearchP	dB	1, 2, 3	Not sent		Not sent	
Thresh <sub>x, highP</sub>	dB	1, 2, 3	48		48	
Thresh <sub>serv, lowP</sub>	dB	1, 2, 3	44		44	
Thresh <sub>x, lowP</sub>	dB	1, 2, 3	50		50	
S <sub>SearchThresholdP</sub>	dB	1, 2, 3	50		50	



$S_{\text{SearchThresholdQ}}$	s	1, 2, 3	Not Configured
Propagation Condition		1, 2, 3	AWGN
Note 1:	OCNG shall be used such that both cells are fully allocated and a constant total transmitted power spectral density is achieved for all OFDM symbols.		
Note 2:	Interference from other cells and noise sources not specified in the test is assumed to be constant over subcarriers and time and shall be modelled as AWGN of appropriate power for $N_{oc}$ to be fulfilled.		
Note 3:	SS-RSRP levels have been derived from other parameters for information purposes. They are not settable parameters themselves.		

### A.6.1.1.6.3 Test Requirements

The cell reselection delay to an already detected lower priority cell for UE fulfilling not-at-cell edge relaxed measurements is defined as the time from the beginning of time period T1, to the moment when the UE camps on cell 1, and starts to send preambles on the PRACH for sending the *RRCSetupRequest* message to perform a Tracking Area Update procedure on cell 1.

The cell re-selection delay to an already detected lower priority cell for UE fulfilling not-at-cell edge relaxed measurements shall be less than 17 s.

The cell reselection delay to an already detected higher priority cell for UE fulfilling not-at-cell-edge relaxed measurements is defined as the time from the beginning of time period T2, to the moment when the UE camps on cell 2, and starts to send preambles on the PRACH for sending the *RRCSetupRequest* message to perform a Tracking Area Update procedure on cell 2.

The cell re-selection delay to an already detected higher priority cell for UE fulfilling not-at-cell-edge relaxed measurements shall be less than 17 s.

The rate of correct cell reselections observed during repeated tests shall be at least 90%.

NOTE: The cell re-selection delay to a lower priority cell can be expressed as:  $T_{\text{evaluate, NR\_inter}} + T_{\text{SI-NR}}$ ,

Where:

$T_{\text{evaluate, NR\_inter}}$  See Table 4.2.2.10.3-1 in clause 4.2.2.10

$T_{\text{SI-NR}}$  Maximum repetition period of relevant system info blocks that needs to be received by the UE to camp on a cell; 1280 ms is assumed in this test case.

This gives a total of 16.64 s, allow 17s for the cell re-selection delay to an already detected lower priority cell and 16.64s for the cell re-selection delay to an already higher priority cell, which we allow 17s for UE fulfilling not-at-cell edge relaxed measurements in the test case.

### A.6.1.1.7 Cell reselection to FR1 intra-frequency NR case for UE configured with *highSpeedMeasFlag-r16*

#### A.6.1.1.7.1 Test Purpose and Environment

This test is to verify the requirement for the intra frequency NR cell reselection requirements for UE configured with *highSpeedMeasFlag-r16* specified in clause 4.2.2.3.

#### A.6.1.1.7.2 Test Parameters

The test scenario comprises of 1 NR carrier and 2 cells as given in tables A.6.1.1.7.2-1, A.6.1.1.7.2-2 and A.6.1.1.7.2-3. The test consists of three successive time periods, with time duration of T1, T2, and T3 respectively. Only cell 1 is already identified by the UE prior to the start of the test. Cell 1 and cell 2 belong to different tracking areas. Furthermore, UE h

Table A.6.1.1.7.2-1: Supported test configurations

Configuration	Description
1	15 kHz SSB SCS, 10 MHz bandwidth, FDD duplex mode
2	15 kHz SSB SCS, 10 MHz bandwidth, TDD duplex mode
3	30 kHz SSB SCS, 40 MHz bandwidth, TDD duplex mode
Note: The UE is only required to be tested in one of the supported test configurations.	

Table A.6.1.1.7.2-2: General test parameters for intra frequency NR cell re-selection test case for UE configured with highSpeedMeasFlag-r16

Parameter		Unit	Test configuration	Value	Comment
Initial condition	Active cell		1, 2, 3	Cell1	
	Neighbour cells		1, 2, 3	Cell2	
T2 end condition	Active cell		1, 2, 3	Cell2	
	Neighbour cells		1, 2, 3	Cell1	
Final condition	Active cell		1, 2, 3	Cell1	
	Neighbour cells		1, 2, 3	Cell2	
RF Channel Number			1, 2, 3	1	
Time offset between cells			1	3 ms	Asynchronous cells
			2	3 $\mu$ s	Synchronous cells
			3	3 $\mu$ s	Synchronous cells
Access Barring Information		-	1, 2, 3	Not Sent	No additional delays in random access procedure.
SSB configuration			1	SSB.1 FR1	
			2	SSB.1 FR1	
			3	SSB.2 FR1	
SMTC configuration			1	SMTC pattern 2	Configured in SIB2 of Cell 1
				SMTC pattern 6	Configured in SIB2 of Cell 2
			2	SMTC pattern 1	
				3	SMTC pattern 1
DRX cycle length		s	1, 2, 3	0.32	The value shall be used for all cells in the test.
PRACH configuration index			1, 2, 3	102	The detailed configuration is specified in TS 38.211 clause 6.3.3.2
rangeToBestCell			1, 2, 3	Not configured	
T1		s	1, 2, 3	>7	During T1, Cell 2 shall be powered off, and during the off time the physical cell identity shall be changed, The intention is to ensure that Cell 2 has not been detected by the UE prior to the start of period T2
T2		s	1, 2, 3	10	T2 needs to be defined so that cell re-selection reaction time is taken into account. Note: This value includes 6sec to allow Tracking Area Update procedure to be completed.
T3		s	1, 2, 3	9	T3 needs to be defined so that cell re-selection reaction time is taken into account. Note: This value includes 6sec to allow Tracking Area Update procedure to be completed.

**Table A.6.1.1.7.2-3: Cell specific test parameters for intra frequency NR cell re-selection test case for UE configured with highSpeedMeasFlag-r16**

Parameter	Unit	Test configuration	Cell 1			Cell 2		
			T1	T2	T3	T1	T2	T3
TDD configuration		1	N/A			N/A		
		2	TDDConf.1.1			TDDConf.1.1		
		3	TDDConf.2.1			TDDConf.2.1		
PDSCH RMC configuration		1	SR.1.1 FDD			SR.1.1 FDD		
		2	SR.1.1 TDD			SR.1.1 TDD		
		3	SR.2.1 TDD			SR.2.1 TDD		
RMSI CORESET RMC configuration		1	CR.1.1 FDD			CR.1.1 FDD		
		2	CR.1.1 TDD			CR.1.1 TDD		
		3	CR.2.1 TDD			CR.2.1 TDD		
Dedicated CORESET RMC configuration		1	CCR.1.1 FDD			CCR.1.1 FDD		
		2	CCR.1.1 TDD			CCR.1.1 TDD		
		3	CCR.2.1 TDD			CCR.2.1 TDD		
OCNG Pattern		1, 2, 3	OP.1 defined in A.3.2.1			OP.1 defined in A.3.2.1		
Initial DL BWP configuration		1, 2, 3	DLBWP.0.1			DLBWP.0.1		
Initial UL BWP configuration		1, 2, 3	ULBWP.0.1			ULBWP.0.1		
RLM-RS		1, 2, 3	SSB			SSB		
Qrxlevmin	dBm/SCS	1, 2	-140			-140		
		3	-137			-137		
Pcompensation	dB	1, 2, 3	0			0		
Qhyst <sub>s</sub>	dB	1, 2, 3	0			0		
Qoffset <sub>s, n</sub>	dB	1, 2, 3	0			0		
Cell_selection_and_reselection_quality_measurement		1, 2, 3	SS-RSRP			SS-RSRP		
$\hat{E}_s / I_{\alpha}$	dB	1	16	-3.11	2.79	-infinity	2.79	-3.11
		2						
		3						
$N_{oc}$ <sup>Note2</sup>	dBm/SCS	1	-98					
		2	-98					
		3	-95					
$N_{oc}$ <sup>Note2</sup>	dBm/15 kHz	1	-98					
		2						
		3						
$\hat{E}_s / N_{oc}$	dB	1	16	13	16	-infinity	16	13
		2						
		3						
SS-RSRP <sup>Note3</sup>	dBm/SCS	1	-82	-85	-82	-infinity	-82	-85
		2	-82	-85	-82	-infinity	-82	-85
		3	-79	-82	-79	-infinity	-79	-82
I <sub>o</sub>	dBm/9.36 MHz	1	-53.94	-52.21	-52.21	Same as parameters specified in Cell 1 columns		
	dBm/9.36 MHz	2	-53.94	-52.21	-52.21			
	dBm/38.16 MHz	3	-47.85	-46.12	-46.12			
Treselection	s	1, 2, 3	0	0	0	0	0	0
SintrasearchP	dB	1, 2, 3	60			60		
Propagation Condition		1, 2	AWGN			AWGN 1944Hz <sup>Note4</sup>		
Propagation Condition		3	AWGN			AWGN 3334Hz <sup>Note5</sup>		

Note 1:	OCNG shall be used such that both cells are fully allocated and a constant total transmitted power spectral density is achieved for all OFDM symbols.
Note 2:	Interference from other cells and noise sources not specified in the test is assumed to be constant over subcarriers and time and shall be modelled as AWGN of appropriate power for $N_{oc}$ to be fulfilled.
Note 3:	SS-RSRP levels have been derived from other parameters for information purposes. They are not settable parameters themselves.
Note 4:	The AWGN 1944 Hz condition is a non fading propagation channel with one tap. Doppler shift is a constant 1944 Hz.
Note 5:	The AWGN 3334 Hz condition is a non fading propagation channel with one tap. Doppler shift is a constant 3334 Hz.

### A.6.1.1.7.3 Test Requirements

The cell reselection delay to a newly detectable cell is defined as the time from the beginning of time period T2, to the moment when the UE camps on Cell 2, and starts to send preambles on the PRACH for sending the *RRCSetupRequest* message to perform a Tracking Area Update procedure on Cell 2.

The cell re-selection delay to a newly detectable cell shall be less than 4 s.

The cell reselection delay to an already detected cell is defined as the time from the beginning of time period T3, to the moment when the UE camps on cell 1, and starts to send preambles on the PRACH for sending the *RRCSetupRequest* message to perform a Tracking Area Update procedure on cell 1.

The cell re-selection delay to an already detected cell shall be less than 3 s.

The rate of correct cell reselections observed during repeated tests shall be at least 90%.

NOTE: The cell re-selection delay to a newly detectable cell can be expressed as:  $T_{\text{detect, NR\_Intra}} + T_{\text{SI-NR}}$ , and to an already detected cell can be expressed as:  $T_{\text{evaluate, NR\_intra}} + T_{\text{SI-NR}}$ ,

Where:

$T_{\text{detect, NR\_Intra}}$  See Table 4.2.2.3-2 in clause 4.2.2.3

$T_{\text{evaluate, NR\_intra}}$  See Table 4.2.2.3-2 in clause 4.2.2.3

$T_{\text{SI-NR}}$  Maximum repetition period of relevant system info blocks that needs to be received by the UE to camp on a cell; 1280ms is assumed in this test case.

This gives a total of 3.84s, allow 4s for the cell re-selection delay to a newly detectable cell and 2.24 s for the cell re-selection delay to an already detected cell in the test case, which we allow 3 s.

## A.6.1.2 Inter-RAT E-UTRAN cell re-selection

### A.6.1.2.1 Cell reselection to higher priority E-UTRAN

#### A.6.1.2.1.1 Test Purpose and Environment

This test is to verify the requirement for the NR to E-UTRAN inter-RAT cell reselection requirements specified in clause 4.2.2.5 when the E-UTRAN cell is of higher priority.

#### A.6.1.2.1.2 Test Parameters

The test scenario comprises of one NR cell and one E-UTRAN cell as given in tables A.6.1.2.1.2-1, A.6.1.2.1.2-2, A.6.1.2.1.2-3 and A.6.1.2.1.2-4. The test consists of three successive time periods, with time duration of T1, T2, and T3 respectively. NR cell 1 is already identified by the UE prior to the start of the test. E-UTRAN cell 2 is of higher priority than cell 1.

**Table A.6.1.2.1.2-1: Supported test configurations**

Configuration	Description of serving cell	Description of target cell
1	NR 15 kHz SSB SCS, 10 MHz bandwidth, FDD duplex mode	LTE 10 MHz bandwidth, TDD duplex mode

2	NR 15 kHz SSB SCS, 10 MHz bandwidth, TDD duplex mode	LTE 10 MHz bandwidth, TDD duplex mode
3	NR 30 kHz SSB SCS, 40 MHz bandwidth, TDD duplex mode	LTE 10 MHz bandwidth, TDD duplex mode
4	NR 15 kHz SSB SCS, 10 MHz bandwidth, FDD duplex mode	LTE 10 MHz bandwidth, FDD duplex mode
5	NR 15 kHz SSB SCS, 10 MHz bandwidth, TDD duplex mode	LTE 10 MHz bandwidth, FDD duplex mode
6	NR 30 kHz SSB SCS, 40 MHz bandwidth, TDD duplex mode	LTE 10 MHz bandwidth, FDD duplex mode
Note: The UE is only required to be tested in one of the supported test configurations.		

**Table A.6.1.2.1.2-2: General test parameters for NR to E-UTRAN cell re-selection test case**

Parameter		Unit	Test configuration	Value	Comment
Initial condition	Active cell		1, 2, 3, 4, 5, 6	Cell1	The UE camps on cell 1 in the initial phase and during T2 period the UE reselects to cell 2.
T2 end condition	Active cell		1, 2, 3, 4, 5, 6	Cell2	The UE shall perform reselection to cell 2 during T2.
	Neighbour cell		1, 2, 3, 4, 5, 6	Cell1	
T3 end condition	Active cell		1, 2, 3, 4, 5, 6	Cell1	The UE shall perform reselection to cell 1 during T3 for iteration of the tests.
	Neighbour cell		1, 2, 3, 4, 5, 6	Cell2	
Access Barring Information		-	1, 2, 3, 4, 5, 6	Not Sent	No additional delays in random access procedure.
DRX cycle length		s	1, 2, 3, 4, 5, 6	1.28	The value shall be used for all cells in the test.
NR PRACH configuration index			1, 2, 3, 4, 5, 6	102	The detailed configuration is specified in TS 38.211 clause 6.3.3.2
E-UTRAN PRACH configuration index			1, 2, 3	53	As specified in table 5.7.1-2 in TS 36.211 [23]
			4, 5, 6	4	
E-UTRAN PRACH configuration index			1, 2, 3	53	As specified in table 5.7.1-2 in TS 36.211 [23]
			4, 5, 6	4	
T1		s	1, 2, 3, 4, 5, 6	>7	During T1, cell 2 shall be powered off, and during the off time the physical cell identity shall be changed. The intention is to ensure that cell 2 has not been detected by the UE prior to the start of period T2.
T2		s	1, 2, 3, 4, 5, 6	75	T2 needs to be defined so that cell re-selection reaction time is taken into account.
T3		s	1, 2, 3, 4, 5, 6	15	T3 needs to be defined so that cell re-selection reaction time is taken into account.

**Table A.6.1.2.1.2-3: Cell specific test parameters for NR cell 1**

Parameter	Unit	Test configuration	Cell 1		
			T1	T2	T3
TDD configuration		1, 4	N/A		
		2, 5	TDDConf.1.1		
		3, 6	TDDConf.2.1		
PDSCH parameters		1, 4	SR.1.1 FDD		
		2, 5	SR.1.1 TDD		
		3, 6	SR.2.1 TDD		
RMSI CORESET parameters		1, 4	CR.1.1 FDD		
		2, 5	CR.1.1 TDD		
		3, 6	CR.2.1 TDD		
Dedicated CORESET parameters		1, 4	CCR.1.1 FDD		
		2, 5	CCR.1.1 TDD		
		3, 6	CCR.2.1 TDD		
SSB parameters		1, 4	SSB.1 FR1		

		2, 5	SSB.1 FR1		
		3, 6	SSB.2 FR1		
NR SMTC parameters		1, 4	SMTC.2		
		2, 5	SMTC.1		
		3, 6	SMTC.1		
OCNG Pattern		1, 2, 3, 4, 5, 6	OP.1 defined in A.3.2.1		
Initial DL BWP configuration		1, 2, 3, 4, 5, 6	DLBWP.0.1		
Initial UL BWP configuration		1, 2, 3, 4, 5, 6	ULBWP.0.1		
RLM-RS		1, 2, 3, 4, 5, 6	SSB		
Qrxlevmin	dBm/SCS	1, 2, 4, 5	-140		
		3, 6	-137		
$N_{oc}$	dBm/SCS	1, 4	-98		
		2, 5	-98		
		3, 6	-95		
$N_{oc}$	dBm/15 kHz	1, 2, 3, 4, 5, 6	-98		
SS-RSRP	dBm/SCS	1, 4	-84	-84	-84
		2, 5	-84	-84	-84
		3, 6	-81	-81	-81
$\hat{E}_s / I_{ot}$	dB	1, 4	14	14	14
		2, 5			
		3, 6			
$\hat{E}_s / N_{oc}$	dB	1, 4	14	14	14
		2, 5			
		3, 6			
Io	dBm/9.36 MHz	1, 4	-55.88	-55.88	-55.88
	dBm/9.36 MHz	2, 5	-55.88	-55.88	-55.88
	dBm/38.16 MHz	3, 6	-49.79	-49.79	-49.79
Treselection	S	1, 2, 3, 4, 5, 6	0		
SnonintrasearchP	dB	1, 2, 3, 4, 5, 6	50		
Thresh <sub>x, highP</sub> (Note 2)	dB	1, 2, 3, 4, 5, 6	48		
Thresh <sub>serv, lowP</sub>	dB	1, 2, 3, 4, 5, 6	44		
Thresh <sub>x, lowP</sub>	dB	1, 2, 3, 4, 5, 6	50		
Propagation Condition		1, 2, 3, 4, 5, 6	AWGN		
<p>Note 1: OCNG shall be used such that both cells are fully allocated and a constant total transmitted power spectral density is achieved for all OFDM symbols.</p> <p>Note 2: This refers to the value of Thresh<sub>x, high</sub> which is included in NR system information, and is a threshold for the E-UTRA target cell</p>					

**Table A.6.1.2.1.2-4: Cell specific test parameters for E-UTRA cell 2**

Parameter	Unit	Cell 2		
		T1	T2	T3
E-UTRA RF Channel number		1		
BW <sub>channel</sub>	MHz	10		
OCNG Patterns defined in TS 36.133 [15] clause A.3.2		OP.2 TDD for test configuration 1, 2, 3; OP.2 FDD for test configuration 4, 5, 6		
PBCH_RA	dB	0		
PBCH_RB	dB			
PSS_RA	dB			
SSS_RA	dB			
PCFICH_RB	dB			
PHICH_RA	dB			
PHICH_RB	dB			
PDCCH_RA	dB			
PDCCH_RB	dB			
PDSCH_RA	dB			
PDSCH_RB	dB			
OCNG_RA <sup>Note 1</sup>	dB			

OCNG_RB <sup>Note 1</sup>	dB			
Qrxlevmin	dBm	-140		
$N_{oc}$	dBm/15 kHz	-98		
RSRP	dBm/15 KHz	-infinity	-86	-102
$\hat{E}_s / I_{ot}$	dB	-infinity	12	-4
$\hat{E}_s / N_{oc}$	dB	-infinity	12	-4
Treselection <sub>EUTRAN</sub>	S	0		
SnonintrasearchP	dB	Not sent		
Thresh <sub>x, highP</sub>	dB	48		
Thresh <sub>serv, lowP</sub>	dB	44		
Thresh <sub>x, lowP</sub> (Note 2)	dB	50		
Propagation Condition		AWGN		
Note 1: OCNG shall be used such that both cells are fully allocated and a constant total transmitted power spectral density is achieved for all OFDM symbols.				
Note 2: This refers to the value of Thresh <sub>x, Low</sub> which is included in E-UTRA system information, and is a threshold for the NR target cell				

### A.6.1.2.1.3 Test Requirements

The cell reselection delay to a higher priority E-UTRAN cell is defined as the time from the beginning of time period T2, to the moment when the UE camps on cell 2, and starts to send preambles on the PRACH for sending the *RRCSetupRequest* message to perform a Tracking Area Update procedure on cell 2.

The cell re-selection delay to a higher priority cell shall be less than 68 s.

The rate of correct cell reselections observed during repeated tests shall be at least 90%.

NOTE: The cell re-selection delay to a higher priority cell can be expressed as:  $T_{\text{higher\_priority\_search}} + T_{\text{evaluate, E-UTRAN}} + T_{\text{SI-E-UTRA}}$

Where:

$T_{\text{higher\_priority\_search}}$  See clause 4.2.2.7

$T_{\text{evaluate, E-UTRAN}}$  See Table 4.2.2.5-1 in clause 4.2.2.5

$T_{\text{SI-E-UTRA}}$  Maximum repetition period of relevant system info blocks that needs to be received by the UE to camp on a cell; 1280 ms is assumed in this test case.

This gives a total of 67.68 s, allow 68 s for the cell re-selection delay to a higher priority E-UTRAN cell.

### A.6.1.2.2 Cell reselection to lower priority E-UTRAN

#### A.6.1.2.2.1 Test Purpose and Environment

This test is to verify the requirement for the NR to E-UTRAN inter-RAT cell reselection requirements specified in clause 4.2.2.5 when the E-UTRAN cell is of lower priority.

#### A.6.1.2.2.2 Test Parameters

The test scenario comprises of one NR cell and one E-UTRAN cell as given in tables A.6.1.2.2.2-1, A.6.1.2.2.2-2, A.6.1.2.2.2-3 and A.6.1.2.2.2-4. The test consists of two successive time periods, with time duration of T1 and T2 respectively. Both NR cell 1 and E-UTRAN cell 2 are already identified by the UE prior to the start of the test. E-UTRAN cell 2 is of lower priority than cell 1.

**Table A.6.1.2.2.2-1: Supported test configurations**

Configuration	Description of serving cell	Description of target cell
1	NR 15 kHz SSB SCS, 10 MHz bandwidth, FDD duplex mode	LTE 10 MHz bandwidth, TDD duplex mode
2	NR 15 kHz SSB SCS, 10 MHz bandwidth, TDD duplex mode	LTE 10 MHz bandwidth, TDD duplex mode

3	NR 30 kHz SSB SCS, 40 MHz bandwidth, TDD duplex mode	LTE 10 MHz bandwidth, TDD duplex mode
4	NR 15 kHz SSB SCS, 10 MHz bandwidth, FDD duplex mode	LTE 10 MHz bandwidth, FDD duplex mode
5	NR 15 kHz SSB SCS, 10 MHz bandwidth, TDD duplex mode	LTE 10 MHz bandwidth, FDD duplex mode
6	NR 30 kHz SSB SCS, 40 MHz bandwidth, TDD duplex mode	LTE 10 MHz bandwidth, FDD duplex mode
Note: The UE is only required to be tested in one of the supported test configurations.		

Table A.6.1.2.2-2: General test parameters for NR to E-UTRAN cell re-selection test case

Parameter		Unit	Test configuration	Value	Comment
Initial condition	Active cell		1, 2, 3, 4, 5, 6	Cell1	The UE camps on cell 1 in the initial phase.
	Neighbour cell		1, 2, 3, 4, 5, 6	Cell2	
T1 end condition	Active cell		1, 2, 3, 4, 5, 6	Cell2	The UE shall perform reselection to cell 2 during T1.
	Neighbour cell		1, 2, 3, 4, 5, 6	Cell1	
T2 end condition	Active cell		1, 2, 3, 4, 5, 6	Cell1	The UE shall perform reselection to cell 1 during T2 for iteration of the tests.
	Neighbour cell		1, 2, 3, 4, 5, 6	Cell2	
Access Barring Information		-	1, 2, 3, 4, 5, 6	Not Sent	No additional delays in random access procedure.
DRX cycle length		s	1, 2, 3, 4, 5, 6	1.28	The value shall be used for all cells in the test.
NR PRACH configuration index			1, 2, 3, 4, 5, 6	102	The detailed configuration is specified in TS 38.211 clause 6.3.3.2
E-UTRAN PRACH configuration index			1, 2, 3	53	As specified in table 5.7.1-2 in TS 36.211 [23]
			4, 5, 6	4	
T1		s	1, 2, 3, 4, 5, 6	15	T1 needs to be defined so that cell re-selection reaction time is taken into account.
T2		s	1, 2, 3, 4, 5, 6	75	T2 needs to be defined so that cell re-selection reaction time is taken into account.

Table A.6.1.2.2-3: Cell specific test parameters for NR cell 1

Parameter	Unit	Test configuration	Cell 1	
			T1	T2
TDD configuration		1, 4	N/A	
		2, 5	TDDConf.1.1	
		3, 6	TDDConf.2.1	
PDSCH RMC configuration		1, 4	SR.1.1 FDD	
		2, 5	SR.1.1 TDD	
		3, 6	SR.2.1 TDD	
RMSI CORESET RMC configuration		1, 4	CR.1.1 FDD	
		2, 5	CR.1.1 TDD	
		3, 6	CR.2.1 TDD	
Dedicated CORESET RMC configuration		1, 4	CCR.1.1 FDD	
		2, 5	CCR.1.1 TDD	
		3, 6	CCR.2.1 TDD	
SSB configuration		1, 4	SSB.1 FR1	
		2, 5	SSB.1 FR1	
		3, 6	SSB.2 FR1	
SMTC configuration		1, 4	SMTC.2	
		2, 5	SMTC.1	
		3, 6	SMTC.1	
OCNG Pattern		1, 2, 3, 4, 5, 6	OP.1 defined in A.3.2.1	
Initial DL BWP configuration		1, 2, 3, 4, 5, 6	DLBWP.0.1	
Initial UL BWP configuration		1, 2, 3, 4, 5, 6	ULBWP.0.1	



RLM-RS		1, 2, 3, 4, 5, 6	SSB	
Qrxlevmin	dBm/SCS	1, 2, 4, 5	-140	
		3, 6	-137	
$N_{oc}$	dBm/SCS	1, 4	-98	
		2, 5	-98	
		3, 6	-95	
$N_{oc}$	dBm/15 kHz	1, 2, 3, 4, 5, 6	-98	
SS-RSRP	dBm/SCS	1, 4	-102	-86
		2, 5	-102	-86
		3, 6	-99	-83
$\hat{E}_s / I_{ot}$	dB	1, 4	-4	12
		2, 5		
		3, 6		
$\hat{E}_s / N_{oc}$	dB	1, 4	-4	12
		2, 5		
		3, 6		
Io	dBm/9.36 MHz	1, 4	-68.60	-57.78
	dBm/9.36 MHz	2, 5	-68.60	-57.78
	dBm/38.16 MHz	3, 6	-62.50	-51.69
Treselection	S	1, 2, 3, 4, 5, 6	0	
SnonintrasearchP	dB	1, 2, 3, 4, 5, 6	Not sent	
Thresh <sub>x, highP</sub>	dB	1, 2, 3, 4, 5, 6	48	
Thresh <sub>serv, lowP</sub>	dB	1, 2, 3, 4, 5, 6	44	
Thresh <sub>x, lowP</sub> (Note 2)	dB	1, 2, 3, 4, 5, 6	50	
Propagation Condition		1, 2, 3, 4, 5, 6	AWGN	
Note 1: OCNG shall be used such that both cells are fully allocated and a constant total transmitted power spectral density is achieved for all OFDM symbols.				
Note 2: This refers to the value of Thresh <sub>x, high</sub> which is included in NR system information, and is a threshold for the E-UTRA target cell				

Table A.6.1.2.2.2-4: Cell specific test parameters for E-UTRA cell 2

Parameter	Unit	Cell 2	
		T1	T2
E-UTRA RF Channel number		1	
BW <sub>channel</sub>	MHz	10	
OCNG Patterns defined in TS 36.133 [15] clause A.3.2		OP.2 TDD for test configuration 1, 2, 3; OP.2 FDD for test configuration 4, 5, 6	
PBCH_RA	dB	0	
PBCH_RB	dB		
PSS_RA	dB		
SSS_RA	dB		
PCFICH_RB	dB		
PHICH_RA	dB		
PHICH_RB	dB		
PDCCH_RA	dB		
PDCCH_RB	dB		
PDSCH_RA	dB		
PDSCH_RB	dB		
OCNG_RA <sup>Note 1</sup>	dB		
OCNG_RB <sup>Note 1</sup>	dB		
Qrxlevmin	dBm		
$N_{oc}$	dBm/15 kHz	-98	
RSRP	dBm/15 KHz	-84	-84
$\hat{E}_s / I_{ot}$	dB	14	14
$\hat{E}_s / N_{oc}$	dB	14	14

Treselection <sub>EUTRAN</sub>	S	0
SnonintraSearchP	dB	Not sent
Thresh <sub>x, highP</sub> (Note 2)	dB	48
Thresh <sub>serv, lowP</sub>	dB	44
Thresh <sub>x, lowP</sub>	dB	50
Propagation Condition		AWGN
Note 1:	OCNG shall be used such that both cells are fully allocated and a constant total transmitted power spectral density is achieved for all OFDM symbols.	
Note 2:	This refers to the value of Thresh <sub>x, high</sub> which is included in E-UTRA system information, and is a threshold for the NR target cell	

### A.6.1.2.2.3 Test Requirements

The cell reselection delay to a lower priority E-UTRAN cell is defined as the time from the beginning of time period T1, to the moment when the UE camps on cell 2, and starts to send preambles on the PRACH for sending the *RRCSetupRequest* message to perform a Tracking Area Update procedure on cell 2.

The cell re-selection delay to a lower priority cell shall be less than 8 s.

The rate of correct cell reselections observed during repeated tests shall be at least 90%.

NOTE: The cell re-selection delay to a lower priority cell can be expressed as:  $T_{\text{evaluate, E-UTRAN}} + T_{\text{SI-E-UTRA}}$ ,

Where:

$T_{\text{evaluate, E-UTRAN}}$  See Table 4.2.2.5-1 in clause 4.2.2.5

$T_{\text{SI-E-UTRA}}$  Maximum repetition period of relevant system info blocks that needs to be received by the UE to camp on a cell; 1280 ms is assumed in this test case.

This gives a total of 7.68 s, allow 8 s for the cell re-selection delay to a lower priority E-UTRAN cell.

### A.6.1.2.3 Cell reselection to lower priority E-UTRAN for UE fulfilling low mobility relaxed measurement criterion

#### A.6.1.2.3.1 Test Purpose and Environment

This test is to verify the requirement for the NR to E-UTRAN inter-RAT cell reselection when UE fulfills the low mobility criterion specified in clause 4.2.2.11.2 and the E-UTRAN cell is of lower priority.

#### A.6.1.2.3.2 Test Parameters

The test scenario comprises of one NR cell and one E-UTRAN cell as given in tables A.6.1.2.3.2-1, A.6.1.2.3.2-2, A.6.1.2.3.2-3 and A.6.1.2.3.2-4. The test consists of two successive time periods, with time duration of T1 and T2 respectively. Both NR cell 1 and E-UTRAN cell 2 are already identified by the UE prior to the start of the test. E-UTRAN cell 2 is of lower priority than cell 1.

As specified in the Test Purpose, the UE is configured with the relaxed measurement criterion for UE with low mobility defined in clause 5.2.4.9.1 in [1]. So, Cell 1 configures the UE as follows:

- *lowMobilityEvaluation* [2] criterion is configured according to the parameters listed in Table A.6.1.2.3.2-3;
- *cellEdgeEvaluation* [2] criterion is not configured;
- *combineRelaxedMeasCondition* [2] is not configured

**Table A.6.1.2.3.2-1: Supported test configurations**

Configuration	Description of serving cell	Description of target cell
1	NR 15 kHz SSB SCS, 10 MHz bandwidth, FDD duplex mode	LTE 10 MHz bandwidth, TDD duplex mode
2	NR 15 kHz SSB SCS, 10 MHz bandwidth, TDD duplex mode	LTE 10 MHz bandwidth, TDD duplex mode

3	NR 30 kHz SSB SCS, 40 MHz bandwidth, TDD duplex mode	LTE 10 MHz bandwidth, TDD duplex mode
4	NR 15 kHz SSB SCS, 10 MHz bandwidth, FDD duplex mode	LTE 10 MHz bandwidth, FDD duplex mode
5	NR 15 kHz SSB SCS, 10 MHz bandwidth, TDD duplex mode	LTE 10 MHz bandwidth, FDD duplex mode
6	NR 30 kHz SSB SCS, 40 MHz bandwidth, TDD duplex mode	LTE 10 MHz bandwidth, FDD duplex mode
Note: The UE is only required to be tested in one of the supported test configurations.		

**Table A.6.1.2.3.2-2: General test parameters for NR to E-UTRAN cell re-selection test case for UE fulfilling low mobility criterion**

Parameter		Unit	Test configuration	Value	Comment
Initial condition	Active cell		1, 2, 3, 4, 5, 6	Cell1	The UE camps on cell 1 in the initial phase, it fulfills Low Mobility relaxation measurements criterion, and during T1 period the UE reselects to cell 2
	Neighbour cells		1, 2, 3, 4, 5, 6	Cell2	
T1 end condition	Active cell		1, 2, 3, 4, 5, 6	Cell2	The UE shall perform reselection to cell 2 during T1
	Neighbour cells		1, 2, 3, 4, 5, 6	Cell1	
T2 end condition	Active cell		1, 2, 3, 4, 5, 6	Cell1	The UE shall perform reselection to cell 1 with higher priority during T2 for iteration of the tests.
	Neighbour cells		1, 2, 3, 4, 5, 6	Cell2	
Access Barring Information		-	1, 2, 3, 4, 5, 6	Not Sent	No additional delays in random access procedure.
DRX cycle length		s	1, 2, 3, 4, 5, 6	0.64	The value shall be used for all cells in the test.
NR PRACH configuration index			1, 2, 3, 4, 5, 6	102	The detailed configuration is specified in TS 38.211 clause 6.3.3.2
E-UTRAN PRACH configuration index			1, 2, 3	53	As specified in table 5.7.1-2 in TS 36.211 [23]
			4, 5, 6	4	
T1		s	1, 2, 3, 4, 5, 6	24	T1 needs to be defined so that cell re-selection reaction time is taken into account.
T2		s	1, 2, 3, 4, 5, 6	24	T2 needs to be defined so that cell re-selection reaction time is taken into account.

**Table A.6.1.2.3.2-3: Cell specific test parameters for NR cell 1**

Parameter	Unit	Test configuration	Cell 1	
			T1	T2
TDD configuration		1, 4	N/A	
		2, 5	TDDConf.1.1	
		3, 6	TDDConf.2.1	
PDSCH RMC configuration		1, 4	SR.1.1 FDD	
		2, 5	SR.1.1 TDD	
		3, 6	SR.2.1 TDD	
RMSI CORESET RMC configuration		1, 4	CR.1.1 FDD	
		2, 5	CR.1.1 TDD	
		3, 6	CR.2.1 TDD	
Dedicated CORESET RMC configuration		1, 4	CCR.1.1 FDD	
		2, 5	CCR.1.1 TDD	
		3, 6	CCR.2.1 TDD	
SSB configuration		1, 4	SSB.1 FR1	
		2, 5	SSB.1 FR1	
		3, 6	SSB.2 FR1	
SMTC configuration		1, 4	SMTC pattern 2	
		2, 5	SMTC pattern 1	
		3, 6	SMTC pattern 1	
OCNG Pattern		1, 2, 3, 4, 5, 6	OP.1 defined in A.3.2.1	
Initial DL BWP configuration		1, 2, 3, 4, 5, 6	DLBWP.0.1	

Initial UL BWP configuration		1, 2, 3, 4, 5, 6	ULBWP.0.1	
RLM-RS		1, 2, 3, 4, 5, 6	SSB	
Qrxlevmin	dBm/SCS	1, 2, 4, 5	-140	
		3, 6	-137	
$N_{oc}$	dBm/SCS	1, 4	-98	
		2, 5	-98	
		3, 6	-95	
$N_{oc}$	dBm/15 kHz	1, 2, 3, 4, 5, 6	-98	
SS-RSRP	dBm/SCS	1, 4	-102	-86
		2, 5	-102	-86
		3, 6	-99	-83
$\hat{E}_s / I_{ot}$	dB	1, 4	-4	12
		2, 5		
		3, 6		
$\hat{E}_s / N_{oc}$	dB	1, 4	-4	12
		2, 5		
		3, 6		
Io	dBm/9.36 MHz	1, 4	-68.60	-57.78
	dBm/9.36 MHz	2, 5	-68.60	-57.78
	dBm/38.16 MHz	3, 6	-62.50	-51.69
Treselection	S	1, 2, 3, 4, 5, 6	0	
SnonintrasearchP	dB	1, 2, 3, 4, 5, 6	50	
Thresh <sub>x, highP</sub>	dB	1, 2, 3, 4, 5, 6	48	
Thresh <sub>serv, lowP</sub>	dB	1, 2, 3, 4, 5, 6	44	
Thresh <sub>x, lowP</sub> (Note 2)	dB	1, 2, 3, 4, 5, 6	50	
S <sub>SearchDeltaP</sub>	dB	1, 2, 3, 4, 5, 6	3	
T <sub>SearchDeltaP</sub>	s	1, 2, 3, 4, 5, 6	5	
Propagation Condition		1, 2, 3, 4, 5, 6	AWGN	
Note 1: OCNG shall be used such that both cells are fully allocated and a constant total transmitted power spectral density is achieved for all OFDM symbols.				
Note 2: This refers to the value of Thresh <sub>x, low</sub> which is included in NR system information, and is a threshold for the E-UTRA target cell				

**Table A.6.1.2.3.2-4: Cell specific test parameters for E-UTRA cell 2**

Parameter	Unit	Cell 2			
		T1	T2		
E-UTRA RF Channel number		1			
BW <sub>channel</sub>	MHz	10			
OCNG Patterns defined in TS 36.133 [15] clause A.3.2		OP.2 TDD for test configuration 1, 2, 3; OP.2 FDD for test configuration 4, 5, 6			
PBCH_RA	dB	0			
PBCH_RB	dB				
PSS_RA	dB				
SSS_RA	dB				
PCFICH_RB	dB				
PHICH_RA	dB				
PHICH_RB	dB				
PDCCH_RA	dB				
PDCCH_RB	dB				
PDSCH_RA	dB				
PDSCH_RB	dB				
OCNG_RA <sup>Note 1</sup>	dB				
OCNG_RB <sup>Note 1</sup>	dB				
Qrxlevmin	dBm			-140	
$N_{oc}$	dBm/15 kHz			-98	
RSRP	dBm/15 KHz	-84	-84		

$\hat{E}_s / I_{ot}$	dB	14	14
$\hat{E}_s / N_{oc}$	dB	14	14
Treselection <sub>EUTRAN</sub>	S	0	
Snonintrasearch	dB	Not sent	
Thresh <sub>x, high</sub> (Note 2)	dB	48	
Thresh <sub>serv, low</sub>	dB	44	
Thresh <sub>x, low</sub>	dB	50	
Propagation Condition		AWGN	
Note 1:	OCNG shall be used such that both cells are fully allocated and a constant total transmitted power spectral density is achieved for all OFDM symbols.		
Note 2:	This refers to the value of Thresh <sub>x, high</sub> which is included in E-UTRA system information, and is a threshold for the NR target cell		

### A.6.1.2.3.3 Test Requirements

time from the beginning of time period T1, to the moment when the UE camps on cell 2, and starts to send preambles on the PRACH for sending the *RRConnectionRequest* message to perform a Tracking Area Update procedure on cell 2.

The cell re-selection delay to a lower priority cell shall be less than 17 s.

The rate of correct cell reselections observed during repeated tests shall be at least 90%.

NOTE: The cell re-selection delay to a lower priority cell can be expressed as:  $T_{\text{evaluate, E-UTRAN}} + T_{\text{SI-E-UTRA}}$ ,

Where:

$T_{\text{evaluate, E-UTRAN}}$  See Table 4.2.2.11.2-1 in clause 4.2.2.11.2

$T_{\text{SI-E-UTRA}}$  Maximum repetition period of relevant system info blocks that needs to be received by the UE to camp on a cell; 1280 ms is assumed in this test case.

This gives a total of  $15.36 (T_{\text{evaluate, E-UTRAN}}) + 1.28 (T_{\text{SI-E-UTRA}}) = 16.64$  s, allow 17 s for the cell re-selection delay to a lower priority E-UTRAN cell for UE fulfilling low mobility criterion.

### A.6.1.2.4 Cell reselection to lower priority E-UTRAN for UE fulfilling not-at-cell edge relaxed measurement criterion

#### A.6.1.2.4.1 Test Purpose and Environment

This test is to verify the requirement for the NR to E-UTRAN inter-RAT cell reselection requirements when UE fulfills not-at-cell edge criterion specified in clause 4.2.2.11.3 when the E-UTRAN cell is of lower priority.

#### A.6.1.2.4.2 Test Parameters

The test scenario comprises of one NR cell and one E-UTRAN cell as given in tables A.6.1.2.4.2-1, A.6.1.2.4.2-2, A.6.1.2.4.2-3 and A.6.1.2.4.2-4. The test consists of two successive time periods, with time duration of T1 and T2 respectively. Both NR cell 1 and E-UTRAN cell 2 are already identified by the UE prior to the start of the test. E-UTRAN cell 2 is of lower priority than cell 1.

As specified in the Test Purpose, the UE is configured with the relaxed measurement criterion for UE with not-at-cell edge defined in clause 5.2.4.9.2 in [1]. So, Cell 1 configures the UE as follows:

- *lowMobilityEvaluation* [2] criterion is not configured;
- *cellEdgeEvaluation* [2] criterion is configured according to the parameters listed in Table A.6.1.2.4.2-3;
- *combineRelaxedMeasCondition* [2] is not configured

**Table A.6.1.2.4.2-1: Supported test configurations**

Configuration	Description of serving cell	Description of target cell
---------------	-----------------------------	----------------------------

1	NR 15 kHz SSB SCS, 10 MHz bandwidth, FDD duplex mode	LTE 10 MHz bandwidth, TDD duplex mode
2	NR 15 kHz SSB SCS, 10 MHz bandwidth, TDD duplex mode	LTE 10 MHz bandwidth, TDD duplex mode
3	NR 30 kHz SSB SCS, 40 MHz bandwidth, TDD duplex mode	LTE 10 MHz bandwidth, TDD duplex mode
4	NR 15 kHz SSB SCS, 10 MHz bandwidth, FDD duplex mode	LTE 10 MHz bandwidth, FDD duplex mode
5	NR 15 kHz SSB SCS, 10 MHz bandwidth, TDD duplex mode	LTE 10 MHz bandwidth, FDD duplex mode
6	NR 30 kHz SSB SCS, 40 MHz bandwidth, TDD duplex mode	LTE 10 MHz bandwidth, FDD duplex mode
Note: The UE is only required to be tested in one of the supported test configurations.		

**Table A.6.1.2.4.2-2: General test parameters for NR to E-UTRAN cell re-selection test case for UE fulfilling not-at-cell edge criterion**

Parameter		Unit	Test configuration	Value	Comment
Initial condition	Active cell		1, 2, 3, 4, 5, 6	Cell1	The UE camps on cell 1 in the initial phase and fulfill the not at the cell edge criteria.
	Neighbour cells		1, 2, 3, 4, 5, 6	Cell2	
T1 end condition	Active cell		1, 2, 3, 4, 5, 6	Cell2	The UE shall perform reselection to cell 2 during T1.
	Neighbour cells		1, 2, 3, 4, 5, 6	Cell1	
T2 end condition	Active cell		1, 2, 3, 4, 5, 6	Cell1	The UE shall perform reselection to cell 1 during T2 for iteration of the tests.
	Neighbour cells		1, 2, 3, 4, 5, 6	Cell2	
Access Barring Information		-	1, 2, 3, 4, 5, 6	Not Sent	No additional delays in random access procedure.
DRX cycle length		s	1, 2, 3, 4, 5, 6	0.64	The value shall be used for all cells in the test.
NR PRACH configuration index			1, 2, 3, 4, 5, 6	102	The detailed configuration is specified in TS 38.211 clause 6.3.3.2
E-UTRAN PRACH configuration index			1, 2, 3	53	As specified in table 5.7.1-2 in TS 36.211 [23]
			4, 5, 6	4	
T1		s	1, 2, 3, 4, 5, 6	24	T1 needs to be defined so that cell re-selection reaction time is taken into account.
T2		s	1, 2, 3, 4, 5, 6	24	T2 needs to be defined so that cell re-selection reaction time is taken into account.

**Table A.6.1.2.4.2-3: Cell specific test parameters for NR cell 1**

Parameter	Unit	Test configuration	Cell 1	
			T1	T2
TDD configuration		1, 4	N/A	
		2, 5	TDDConf.1.1	
		3, 6	TDDConf.2.1	
PDSCH RMC configuration		1, 4	SR.1.1 FDD	
		2, 5	SR.1.1 TDD	
		3, 6	SR.2.1 TDD	
RMSI CORESET RMC configuration		1, 4	CR.1.1 FDD	
		2, 5	CR.1.1 TDD	
		3, 6	CR.2.1 TDD	
Dedicated CORESET RMC configuration		1, 4	CCR.1.1 FDD	
		2, 5	CCR.1.1 TDD	
		3, 6	CCR.2.1 TDD	
SSB configuration		1, 4	SSB.1 FR1	
		2, 5	SSB.1 FR1	
		3, 6	SSB.2 FR1	
SMTC configuration		1, 4	SMTC pattern 2	
		2, 5	SMTC pattern 1	
		3, 6	SMTC pattern 1	

OCNG Pattern		1, 2, 3, 4, 5, 6	OP.1 defined in A.3.2.1	
Initial DL BWP configuration		1, 2, 3, 4, 5, 6	DLBWP.0.1	
Initial UL BWP configuration		1, 2, 3, 4, 5, 6	ULBWP.0.1	
RLM-RS		1, 2, 3, 4, 5, 6	SSB	
Qrxlevmin	dBm/SCS	1, 2, 4, 5	-140	
		3, 6	-137	
$N_{oc}$	dBm/SCS	1, 4	-98	
		2, 5	-98	
		3, 6	-95	
$N_{oc}$	dBm/15 kHz	1, 2, 3, 4, 5, 6	-98	
SS-RSRP	dBm/SCS	1, 4	-102	-86
		2, 5	-102	-86
		3, 6	-99	-83
$\hat{E}_s / I_{ot}$	dB	1, 4	-4	12
		2, 5		
		3, 6		
$\hat{E}_s / N_{oc}$	dB	1, 4	-4	12
		2, 5		
		3, 6		
S <sub>SearchThresholdP</sub>	dB	1, 2, 3, 4, 5, 6	32	32
I <sub>o</sub>	dBm/9.36 MHz	1, 4	-68.60	-57.78
	dBm/9.36 MHz	2, 5	-68.60	-57.78
	dBm/38.16 MHz	3, 6	-62.50	-51.69
Treselection	S	1, 2, 3, 4, 5, 6	0	
SnointrasearchP	dB	1, 2, 3, 4, 5, 6	60	
Thresh <sub>x, highP</sub> (Note 2)	dB	1, 2, 3, 4, 5, 6	48	
Thresh <sub>serv, lowP</sub>	dB	1, 2, 3, 4, 5, 6	44	
Thresh <sub>x, lowP</sub>	dB	1, 2, 3, 4, 5, 6	50	
Propagation Condition		1, 2, 3, 4, 5, 6	AWGN	
Note 1: OCNG shall be used such that both cells are fully allocated and a constant total transmitted power spectral density is achieved for all OFDM symbols.				
Note 2: This refers to the value of Thresh <sub>x, high</sub> which is included in NR system information, and is a threshold for the E-UTRA target cell				

**Table A.6.1.2.4.2-4: Cell specific test parameters for E-UTRA cell 2**

Parameter	Unit	Cell 2	
		T1	T2
E-UTRA RF Channel number		1	
BW <sub>channel</sub>	MHz	10	
OCNG Patterns defined in TS 36.133 [15] clause A.3.2		OP.2 TDD for test configuration 1, 2, 3; OP.2 FDD for test configuration 4, 5, 6	
PBCH_RA	dB	0	
PBCH_RB	dB		
PSS_RA	dB		
SSS_RA	dB		
PCFICH_RB	dB		
PHICH_RA	dB		
PHICH_RB	dB		
PDCCH_RA	dB		
PDCCH_RB	dB		
PDSCH_RA	dB		
PDSCH_RB	dB		
OCNG_RA <sup>Note 1</sup>	dB		
OCNG_RB <sup>Note 1</sup>	dB		
Qrxlevmin	dBm	-140	
$N_{oc}$	dBm/15 kHz	-98	

RSRP	dBm/15 KHz	-84	-84
$\hat{E}_s / I_{ot}$	dB	14	14
$\hat{E}_s / N_{oc}$	dB	14	14
Treselection <sub>EUTRAN</sub>	S	0	
S <sub>nonintra</sub> search	dB	Not sent	
Thresh <sub>x, high</sub> (Note 2)	dB	48	
Thresh <sub>serv, low</sub>	dB	44	
Thresh <sub>x, low</sub>	dB	50	
Propagation Condition		AWGN	
<p>Note 1: OCNG shall be used such that both cells are fully allocated and a constant total transmitted power spectral density is achieved for all OFDM symbols.</p> <p>Note 2: This refers to the value of Thresh<sub>x, high</sub> which is included in E-UTRA system information, and is a threshold for the NR target cell</p>			

#### A.6.1.2.4.3 Test Requirements

The cell reselection delay to a lower priority E-UTRAN cell is defined as the time from the beginning of time period T1, to the moment when the UE camps on cell 2, and starts to send preambles on the PRACH for sending the *RRCCConnectionRequest* message to perform a Tracking Area Update procedure on cell 2.

The cell re-selection delay to a lower priority cell shall be less than 17s.

The rate of correct cell reselections observed during repeated tests shall be at least 90%.

NOTE: The cell re-selection delay to a lower priority cell can be expressed as:  $T_{\text{evaluate, E-UTRAN}} + T_{\text{SI-E-UTRA}}$ ,

Where:

$T_{\text{evaluate, E-UTRAN}}$  See Table 4.2.2.11.3-1 in clause 4.2.2.11.3

$T_{\text{SI-E-UTRA}}$  Maximum repetition period of relevant system info blocks that needs to be received by the UE to camp on a cell; 1280 ms is assumed in this test case.

This gives a total of 16.64 s, allow 17 s for the cell re-selection delay to a lower priority E-UTRAN cell for UE fulfilling not-at-cell edge criterion.

#### A.6.1.2.5 Cell reselection to lower priority E-UTRAN cell for UE configured with highSpeedMeasFlag-r16

##### A.6.1.2.5.1 Test Purpose and Environment

This test is to verify the requirement for the NR to E-UTRAN inter-RAT cell reselection requirements for UE configured with *highSpeedMeasFlag-r16* specified in clause 4.2.2.5 when the E-UTRAN cell is of lower priority.

##### A.6.1.2.5.2 Test Parameters

The test scenario comprises of one NR cell and one E-UTRAN cell as given in tables A.6.1.2.5.2-1, A.6.1.2.5.2-2, A.6.1.2.5.2-3 and A.6.1.2.5.2-4. The test consists of two successive time periods, with time duration of T1 and T2 respectively. Both NR cell 1 and E-UTRAN cell 2 are already identified by the UE prior to the start of the test. E-UTRAN cell 2 is of lower priority than cell 1. The E-UTRAN cell 2 is indicated by NR cell 1 as an HST cell.

**Table A.6.1.2.5.2-1: Supported test configurations**

Configuration	Description of serving cell	Description of target cell
1	NR 15 kHz SSB SCS, 10 MHz bandwidth, FDD duplex mode	LTE 10 MHz bandwidth, TDD duplex mode
2	NR 15 kHz SSB SCS, 10 MHz bandwidth, TDD duplex mode	LTE 10 MHz bandwidth, TDD duplex mode
3	NR 30 kHz SSB SCS, 40 MHz bandwidth, TDD duplex mode	LTE 10 MHz bandwidth, TDD duplex mode
4	NR 15 kHz SSB SCS, 10 MHz bandwidth, FDD duplex mode	LTE 10 MHz bandwidth, FDD duplex mode



5	NR 15 kHz SSB SCS, 10 MHz bandwidth, TDD duplex mode	LTE 10 MHz bandwidth, FDD duplex mode
6	NR 30 kHz SSB SCS, 40 MHz bandwidth, TDD duplex mode	LTE 10 MHz bandwidth, FDD duplex mode
Note: The UE is only required to be tested in one of the supported test configurations.		

**Table A.6.1.2.5.2-2: General test parameters for NR to E-UTRAN cell re-selection test case**

Parameter		Unit	Test configuration	Value	Comment
Initial condition	Active cell		1, 2, 3, 4, 5, 6	Cell1	The UE camps on cell 1 in the initial phase.
T1 end condition	Active cell		1, 2, 3, 4, 5, 6	Cell2	The UE shall perform reselection to cell 2 during T1.
	Neighbour cells		1, 2, 3, 4, 5, 6	Cell1	
T2 end condition	Active cell		1, 2, 3, 4, 5, 6	Cell1	The UE shall perform reselection to cell 1 during T2 for iteration of the tests.
	Neighbour cells		1, 2, 3, 4, 5, 6	Cell2	
Access Barring Information		-	1, 2, 3, 4, 5, 6	Not Sent	No additional delays in random access procedure.
DRX cycle length		s	1, 2, 3, 4, 5, 6	0.32	The value shall be used for all cells in the test.
NR PRACH configuration index			1, 2, 3, 4, 5, 6	102	The detailed configuration is specified in TS 38.211 clause 6.3.3.2
E-UTRAN PRACH configuration index			1, 2, 3	53	As specified in table 5.7.1-2 in TS 36.211 [23]
			4, 5, 6	4	
T1		s	1, 2, 3, 4, 5, 6	15	T1 needs to be defined so that cell re-selection reaction time is taken into account.
T2		s	1, 2, 3, 4, 5, 6	75	T2 needs to be defined so that cell re-selection reaction time is taken into account.

**Table A.6.1.2.5.2-3: Cell specific test parameters for NR cell 1**

Parameter	Unit	Test configuration	Cell 1	
			T1	T2
TDD configuration		1, 4	N/A	
		2, 5	TDDConf.1.1	
		3, 6	TDDConf.2.1	
PDSCH RMC configuration		1, 4	SR.1.1 FDD	
		2, 5	SR.1.1 TDD	
		3, 6	SR.2.1 TDD	
RMSI CORESET RMC configuration		1, 4	CR.1.1 FDD	
		2, 5	CR.1.1 TDD	
		3, 6	CR.2.1 TDD	
Dedicated CORESET RMC configuration		1, 4	CCR.1.1 FDD	
		2, 5	CCR.1.1 TDD	
		3, 6	CCR.2.1 TDD	
SSB configuration		1, 4	SSB.1 FR1	
		2, 5	SSB.1 FR1	
		3, 6	SSB.2 FR1	
SMTC configuration		1, 4	SMTC pattern 2	
		2, 5	SMTC pattern 1	
		3, 6	SMTC pattern 1	
OCNG Pattern		1, 2, 3, 4, 5, 6	OP.1 defined in A.3.2.1	
Initial DL BWP configuration		1, 2, 3, 4, 5, 6	DLBWP.0.1	
Initial UL BWP configuration		1, 2, 3, 4, 5, 6	ULBWP.0.1	
RLM-RS		1, 2, 3, 4, 5, 6	SSB	
Qrxlevmin	dBm/SCS	1, 2, 4, 5	-140	
		3, 6	-137	

$N_{oc}$	dBm/SCS	1, 4	-98	
		2, 5	-98	
		3, 6	-95	
$N_{oc}$	dBm/15 kHz	1, 2, 3, 4, 5, 6	-98	
SS-RSRP	dBm/SCS	1, 4	-102	-86
		2, 5	-102	-86
		3, 6	-99	-83
$\hat{E}_s/I_{ot}$	dB	1, 4	-4	12
		2, 5		
		3, 6		
$\hat{E}_s/N_{oc}$	dB	1, 4	-4	12
		2, 5		
		3, 6		
Io	dBm/9.36 MHz	1, 4	-68.60	-57.78
	dBm/9.36 MHz	2, 5	-68.60	-57.78
	dBm/38.16 MHz	3, 6	-62.50	-51.69
Treselection	S	1, 2, 3, 4, 5, 6	0	
S <sub>nonintrasearchP</sub>	dB	1, 2, 3, 4, 5, 6	50	
Thresh <sub>x, highP</sub> (Note 2)	dB	1, 2, 3, 4, 5, 6	48	
Thresh <sub>serv, lowP</sub>	dB	1, 2, 3, 4, 5, 6	44	
Thresh <sub>x, lowP</sub>	dB	1, 2, 3, 4, 5, 6	50	
Propagation Condition		1, 2, 3, 4, 5, 6	AWGN	
Note 1: OCNG shall be used such that both cells are fully allocated and a constant total transmitted power spectral density is achieved for all OFDM symbols.				
Note 2: This refers to the value of Thresh <sub>x, highP</sub> which is included in NR system information, and is a threshold for the E-UTRA target cell.				
Note 3: Void.				

**Table A.6.1.2.5.2-4: Cell specific test parameters for E-UTRA cell 2**

Parameter	Unit	Cell 2	
		T1	T2
E-UTRA RF Channel number		1	
BW <sub>channel</sub>	MHz	10	
OCNG Patterns defined in TS 36.133 [15] clause A.3.2		OP.2 TDD for test configuration 1, 2, 3; OP.2 FDD for test configuration 4, 5, 6	
PBCH_RA	dB	0	
PBCH_RB	dB		
PSS_RA	dB		
SSS_RA	dB		
PCFICH_RB	dB		
PHICH_RA	dB		
PHICH_RB	dB		
PDCCH_RA	dB		
PDCCH_RB	dB		
PDSCH_RA	dB		
PDSCH_RB	dB		
OCNG_RA <sup>Note 1</sup>	dB		
OCNG_RB <sup>Note 1</sup>	dB		
Qrxlevmin	dBm	-140	
$N_{oc}$	dBm/15 kHz	-98	
RSRP	dBm/15 KHz	-84	-84
$\hat{E}_s/I_{ot}$	dB	14	14
$\hat{E}_s/N_{oc}$	dB	14	14
Treselection <sub>EUTRAN</sub>	S	0	

$S_{nonintraSearchP}$	dB	Not sent
$Thresh_{x, highP}$ (Note 2)	dB	48
$Thresh_{serving, lowP}$	dB	44
$Thresh_{x, lowP}$	dB	50
Propagation Condition		AWGN 1944Hz <sup>Note3</sup>
Note 1:	OCNG shall be used such that both cells are fully allocated and a constant total transmitted power spectral density is achieved for all OFDM symbols.	
Note 2:	This refers to the value of $Thresh_{x, highP}$ which is included in E-UTRA system information, and is a threshold for the NR target cell	
Note 3:	The AWGN 1944 Hz condition is a non fading propagation channel with one tap. Doppler shift is a constant 1944 Hz.	

### A.6.1.2.5.3 Test Requirements

The cell reselection delay to a lower priority E-UTRAN cell is defined as the time from the beginning of time period T1, to the moment when the UE camps on cell 2, and starts to send preambles on the PRACH for sending the *RRCSetupRequest* message to perform a Tracking Area Update procedure on cell 2.

The cell re-selection delay to a lower priority cell shall be less than 3 s.

The rate of correct cell reselections observed during repeated tests shall be at least 90%.

NOTE: The cell re-selection delay to a lower priority cell can be expressed as:  $T_{evaluate, E-UTRAN\_HST} + T_{SI-E-UTRA}$ ,

Where:

$T_{evaluate, E-UTRAN\_HST}$  See Table 4.2.2.5-2 in clause 4.2.2.5

$T_{SI-E-UTRA}$  Maximum repetition period of relevant system info blocks that needs to be received by the UE to camp on a cell; 1280 ms is assumed in this test case.

This gives a total of 2.24 s, allow 3 s for the cell re-selection delay to a lower priority E-UTRAN cell.

## A.6.2 SA: RRC\_INACTIVE state mobility

## A.6.3 RRC\_CONNECTED state mobility

### A.6.3.1 Handover

#### A.6.3.1.1 Intra-frequency handover from FR1 to FR1; known target cell

##### A.6.3.1.1.1 Test Purpose and Environment

This test is to verify the requirement for the NR FR1-NR FR1 intra frequency handover requirements specified in clause 6.1.1.2.

##### A.6.3.1.1.2 Test Parameters

Supported test configurations are shown in table A.6.3.1.1.2-1. Both handover delay and interruption length are tested by using the parameters in table A.6.3.1.1.2-2, and A.6.3.1.1.2-3.

The test consists of three successive time periods, with time durations of T1, T2 and T3 respectively. At the start of time duration T1, the UE may not have any timing information of cell 2.

NR shall send a RRC message implying handover to cell 2. The RRC message implying handover shall be sent to the UE during period T2, after the UE has reported Event A3. T3 is defined as the end of the last TTI containing the RRC message implying handover.

**Table A.6.3.1.1.2-1: Intra-frequency handover from FR1 to FR1 test configurations**

Config	Description
1	Source cell: NR 15 kHz SSB SCS, 10 MHz bandwidth, FDD duplex mode Target cell: NR 15 kHz SSB SCS, 10 MHz bandwidth, FDD duplex mode
2	Source cell: NR 15 kHz SSB SCS, 10 MHz bandwidth, TDD duplex mode Target cell: NR 15 kHz SSB SCS, 10 MHz bandwidth, TDD duplex mode
3	Source cell: NR 30 kHz SSB SCS, 40 MHz bandwidth, TDD duplex mode Target cell: NR 30 kHz SSB SCS, 40 MHz bandwidth, TDD duplex mode
Note: The UE is only required to be tested in one of the supported test configurations	

**Table A.6.3.1.1.2-2: General test parameters Intra-frequency handover from FR1 to FR1**

Parameter	Unit	Value	Comment
Initial conditions	Active cell	Cell 1	
	Neighbouring cell	Cell 2	
Final condition	Active cell	Cell 2	
A3-Offset	dB	0	
Hysteresis	dB	0	
Time To Trigger	s	0	
Filter coefficient		0	L3 filtering is not used
Access Barring Information	-	Not Sent	No additional delays in random access procedure.
Time offset between cells		3 $\mu$ s	Synchronous cells
T1	s	5	
T2	s	$\leq 5$	
T3	s	1	

**Table A.6.3.1.1.2-3: Cell specific test parameters for NR FR1-FR1 Intra frequency handover test case**

Parameter	Unit	Cell 1			Cell 2		
		T1	T2	T3	T1	T2	T3
NR RF Channel Number		1			1		
Duplex mode	Config 1	FDD					
	Config 2,3	TDD					
TDD configuration	Config 1	Not Applicable					
	Config 2	TDDConf.1.1					
	Config 3	TDDConf.2.1					
BW <sub>channel</sub>	Config 1	MHz					
	Config 2	10: N <sub>RB,c</sub> = 52					
	Config 3	40: N <sub>RB,c</sub> = 106					
BWP BW	Config 1	MHz					
	Config 2	10: N <sub>RB,c</sub> = 52					
	Config 3	40: N <sub>RB,c</sub> = 106					
DRx Cycle	ms	Not Applicable					
PDSCH Reference measurement channel	Config 1	SR.1.1 FDD					
	Config 2	SR.1.1 TDD					
	Config 3	SR2.1 TDD					
CORESET Reference Channel	Config 1	CR.1.1 FDD					
	Config 2	CR.1.1 TDD					
	Config 3	CR2.1 TDD					
TRS configuration	Config 1	TRS.1.1 FDD					
	Config 2	TRS.1.1 TDD					
	Config 3	TRS.1.2 TDD					
OCNG Patterns		OP.1					
SMTc Configuration		SMTc.1					
SSB Configuration	Config 1,2	SSB.1 FR1					
	Config 3	SSB.2 FR1					
PDSCH/PDCCH subcarrier spacing	Config 1,2	kHz					
	Config 3	30 kHz					
PUCCH/PUSCH subcarrier spacing	Config 1,2	kHz					
		15 kHz					

	Config 3		30 kHz					
PRACH configuration			FR1 PRACH configuration 1					
BWP configuration	Initial DL BWP		DLBWP.0.1					
	Dedicated DL BWP		DLBWP.1.1					
	Initial UL BWP		ULBWP.0.1					
	Dedicated UL BWP		ULBWP.1.1					
EPRE ratio of PSS to SSS	dB	0						
EPRE ratio of PBCH DMRS to SSS								
EPRE ratio of PBCH to PBCH DMRS								
EPRE ratio of PDCCH DMRS to SSS								
EPRE ratio of PDCCH to PDCCH DMRS								
EPRE ratio of PDSCH DMRS to SSS								
EPRE ratio of PDSCH to PDSCH								
EPRE ratio of OCNG DMRS to SSS(Note 1)								
EPRE ratio of OCNG to OCNG DMRS (Note 1)								
$N_{oc}^{Note2}$		dBm/15kHz z						
$N_{oc}^{Note2}$	Config 1,2	dBm/SCS	-98					
	Config 3		-95					
$\hat{E}_s / I_{ot}$		dB	8	-3.3	-3.3	-	2.36	2.36
$\hat{E}_s / N_{oc}$		dB	8	8	8	-	11	11
SSB_RP	Config 1,2	dBm/SCS	-90	-90	-90	-	-87	-87
	Config 3	dBm/SCS	-87	-87	-87	-	-84	-84
$I_o^{Note3}$	Config 1,2	dBm/ 9.36MHz	-61.41	-57.06	-57.06	-61.41	-57.06	-57.06
	Config 3	dBm/ 38.16MHz	-55.31	-50.96	-50.96	-55.31	-50.96	-50.96
Propagation condition		-	AWGN			AWGN		
Note 1:	OCNG shall be used such that both cells are fully allocated and a constant total transmitted power spectral density is achieved for all OFDM symbols.							
Note 2:	Interference from other cells and noise sources not specified in the test is assumed to be constant over subcarriers and time and shall be modelled as AWGN of appropriate power for $N_{oc}$ to be fulfilled.							
Note 3:	$I_o$ levels have been derived from other parameters for information purposes. They are not settable parameters themselves.							

### A.6.3.1.1.3 Test Requirements

The UE shall start to transmit the PRACH to Cell 2 less than 72 ms from the beginning of time period T3. The rate of correct handovers observed during repeated tests shall be at least 90%.

NOTE: The handover delay can be expressed as: RRC procedure delay +  $T_{interrupt}$ , where:

RRC procedure delay = 10 ms and is specified in clause 12 in TS 38.331 [2].

$T_{interrupt}$  = 62 ms in the test.  $T_{interrupt}$  is defined in clause 6.1.1.2.2.

This gives a total of 72 ms.

### A.6.3.1.2 Intra-frequency handover from FR1 to FR1; unknown target cell

#### A.6.3.1.2.1 Test Purpose and Environment

This test is to verify the requirement for the NR FR1-NR FR1 intra frequency handover requirements specified in clause 6.1.1.2.

## A.6.3.1.2.2 Test Parameters

Supported test configurations are shown in table A.6.3.1.2.2-1. Both handover delay and interruption length are tested by using the parameters in table A.6.3.1.2.2-2, and A.6.3.1.2.2-3.

The test scenario comprises of two carriers and one cell on each carrier. No gap patterns are configured in the test case. The test consists of two successive time periods, with time durations of T1, T2 respectively. At the start of time duration T1, the UE does not have any timing information of cell 2. Starting T2, cell 2 becomes detectable and the UE receives a RRC handover command from the network. The start of T2 is the instant when the last TTI containing the RRC message implying handover is sent to the UE.

**Table A.6.3.1.2.2-1: Intra-frequency handover from FR1 to FR1 test configurations**

Config	Description
1	Source cell: NR 15 kHz SSB SCS, 10 MHz bandwidth, FDD duplex mode Target cell: NR 15 kHz SSB SCS, 10 MHz bandwidth, FDD duplex mode
2	Source cell: NR 15 kHz SSB SCS, 10 MHz bandwidth, TDD duplex mode Target cell: NR 15 kHz SSB SCS, 10 MHz bandwidth, TDD duplex mode
3	Source cell: NR 30 kHz SSB SCS, 40 MHz bandwidth, TDD duplex mode Target cell: NR 30 kHz SSB SCS, 40 MHz bandwidth, TDD duplex mode
Note: The UE is only required to be tested in one of the supported test configurations	

**Table A.6.3.1.2.2-2: General test parameters Intra-frequency handover from FR1 to FR1**

Parameter	Unit	Value	Comment
Initial conditions	Active cell	Cell 1	
	Neighbouring cell	Cell 2	
Final condition	Active cell	Cell 2	
Access Barring Information	-	Not Sent	No additional delays in random access procedure.
Time offset between cells		3 $\mu$ s	Synchronous cells
T1	s	5	
T2	s	$\leq 5$	

**Table A.6.3.1.2.2-3: Cell specific test parameters for NR FR1-FR1 Intra frequency handover test case**

Parameter	Unit	Cell 1		Cell 2	
		T1	T2	T1	T2
NR RF Channel Number		1		1	
Duplex mode	Config 1	FDD			
	Config 2,3	TDD			
TDD configuration	Config 1	Not Applicable			
	Config 2	TDDConf.1.1			
	Config 3	TDDConf. 2.1			
BW <sub>channel</sub>	Config 1	MHz	10: N <sub>RB,c</sub> = 52		
	Config 2		10: N <sub>RB,c</sub> = 52		
	Config 3		40: N <sub>RB,c</sub> = 106		
BWP BW	Config 1	MHz	10: N <sub>RB,c</sub> = 52		
	Config 2		10: N <sub>RB,c</sub> = 52		
	Config 3		40: N <sub>RB,c</sub> = 106		
DRx Cycle	ms	Not Applicable			
PDSCH Reference measurement channel	Config 1	SR.1.1 FDD			
	Config 2	SR.1.1 TDD			
	Config 3	SR2.1 TDD			
CORESET Reference Channel	Config 1	CR.1.1 FDD			
	Config 2	CR.1.1 TDD			
	Config 3	CR2.1 TDD			
TRS configuration	Config 1	TRS.1.1 FDD			
	Config 2	TRS.1.1 TDD			
	Config 3	TRS.1.2 TDD			
OCNG Patterns		OP.1			
SMTTC Configuration		SMTTC.1			

SSB Configuration	Config 1,2		SSB.1 FR1			
	Config 3		SSB.2 FR1			
PDSCH/PDCCH subcarrier spacing	Config 1,2	kHz	15 kHz			
	Config 3		30 kHz			
PUCCH/PUSCH subcarrier spacing	Config 1,2	kHz	15 kHz			
	Config 3		30 kHz			
PRACH configuration			FR1 PRACH configuration 1			
BWP configuration	Initial DL BWP		DLBWP.0.1			
	Dedicated DL BWP		DLBWP.1.1			
	Initial UL BWP		ULBWP.0.1			
	Dedicated UL BWP		ULBWP.1.1			
EPRE ratio of PSS to SSS		dB	0			
EPRE ratio of PBCH DMRS to SSS						
EPRE ratio of PBCH to PBCH DMRS						
EPRE ratio of PDCCH DMRS to SSS						
EPRE ratio of PDCCH to PDCCH DMRS						
EPRE ratio of PDSCH DMRS to SSS						
EPRE ratio of PDSCH to PDSCH						
EPRE ratio of OCNG DMRS to SSS(Note 1)						
EPRE ratio of OCNG to OCNG DMRS (Note 1)						
$N_{oc}^{Note2}$		dBm/15kHz	-98			
$N_{oc}^{Note2}$	Config 1,2	dBm/SCS	-98			
	Config 3		-95			
$\hat{E}_s / I_{ot}$		dB	8	-0.64	-Infinity	-0.64
$\hat{E}_s / N_{oc}$		dB	8	8	-Infinity	8
SSB_RP	Config 1,2	dBm/SCS	-90	-90	-Infinity	-90
	Config 3	dBm/SCS	-87	-87	-Infinity	-87
$I_o^{Note3}$	Config 1,2	dBm/9.36MHz	-61.41	-58.71	-61.41	-58.71
	Config 3	dBm/38.16MHz	-55.31	-52.60	-55.31	-52.60
Propagation condition		-	AWGN		AWGN	
Note 1: OCNG shall be used such that both cells are fully allocated and a constant total transmitted power spectral density is achieved for all OFDM symbols.						
Note 2: Interference from other cells and noise sources not specified in the test is assumed to be constant over subcarriers and time and shall be modelled as AWGN of appropriate power for $N_{oc}$ to be fulfilled.						
Note 3: $I_o$ levels have been derived from other parameters for information purposes. They are not settable parameters themselves.						

### A.6.3.1.2.3 Test Requirements

The UE shall start to transmit the PRACH to Cell 2 less than 92 ms from the beginning of time period T2. The rate of correct handovers observed during repeated tests shall be at least 90%.

NOTE: The handover delay can be expressed as: RRC procedure delay +  $T_{interrupt}$ , where:

RRC procedure delay = 10 ms and is specified in clause 12 in TS 38.331 [2].

$T_{interrupt}$  = 82 ms in the test.  $T_{interrupt}$  is defined in clause 6.1.1.2.2.

This gives a total of 92 ms.

### A.6.3.1.3 Inter-frequency handover from FR1 to FR1; unknown target cell

#### A.6.3.1.3.1 Test Purpose and Environment

This test is to verify the requirement for the NR FR1-NR FR1 inter frequency handover requirements specified in clause 6.1.1.2.

### A.6.3.1.3.2 Test Parameters

Supported test configurations are shown in table A.6.3.1.3.2-1. Both handover delay and interruption length are tested by using the parameters in table A.6.3.1.3.2-2, and A.6.3.1.3.2-3.

The test scenario comprises of two carriers and one cell on each carrier. No gap patterns are configured in the test case. The test consists of two successive time periods, with time durations of T1, T2 respectively. At the start of time duration T1, the UE does not have any timing information of cell 2. Starting T2, cell 2 becomes detectable and the UE receives a RRC handover command from the network. The start of T2 is the instant when the last TTI containing the RRC message implying handover is sent to the UE.

**Table A.6.3.1.3.2-1: Inter-frequency handover from FR1 to FR1 test configurations**

Config	Description
1	Source cell: NR 15 kHz SSB SCS, 10 MHz bandwidth, FDD duplex mode Target cell: NR 15 kHz SSB SCS, 10 MHz bandwidth, FDD duplex mode
2	Source cell: NR 15 kHz SSB SCS, 10 MHz bandwidth, TDD duplex mode Target cell: NR 15 kHz SSB SCS, 10 MHz bandwidth, TDD duplex mode
3	Source cell: NR 30 kHz SSB SCS, 40 MHz bandwidth, TDD duplex mode Target cell: NR 30 kHz SSB SCS, 40 MHz bandwidth, TDD duplex mode
Note: The UE is only required to be tested in one of the supported test configurations	

**Table A.6.3.1.3.2-2: General test parameters Inter-frequency handover from FR1 to FR1**

Parameter	Unit	Value	Comment
Initial conditions	Active cell	Cell 1	
	Neighbouring cell	Cell 2	
Final condition	Active cell	Cell 2	
Access Barring Information	-	Not Sent	No additional delays in random access procedure.
T1	s	5	
T2	s	≤5	

**Table A.6.3.1.3.2-3: Cell specific test parameters for NR FR1-FR1 Inter frequency handover test case**

Parameter	Unit	Cell 1		Cell 2	
		T1	T2	T1	T2
NR RF Channel Number		1		2	
Duplex mode	Config 1	FDD			
	Config 2,3	TDD			
TDD configuration	Config 1	Not Applicable			
	Config 2	TDDConf.1.1			
	Config 3	TDDConf.2.1			
BW <sub>channel</sub>	Config 1	MHz			
	Config 2	10: N <sub>RB,c</sub> = 52			
	Config 3	40: N <sub>RB,c</sub> = 106			
BWP BW	Config 1	MHz			
	Config 2	10: N <sub>RB,c</sub> = 52			
	Config 3	40: N <sub>RB,c</sub> = 106			
TRS configuration	Config 1	TRS.1.1 FDD			
	Config 2	TRS.1.1 TDD			
	Config 3	TRS.1.2 TDD			
DRx Cycle	ms	Not Applicable			
PDSCH Reference measurement channel	Config 1	SR.1.1 FDD			
	Config 2	SR.1.1 TDD			
	Config 3	SR2.1 TDD			
CORESET Reference Channel	Config 1	CR.1.1 FDD			
	Config 2	CR.1.1 TDD			
	Config 3	CR2.1 TDD			
OCNG Patterns		OP.1			
SMTTC Configuration		SMTTC.1			
SSB Configuration	Config 1,2	SSB.1 FR1			



	Config 3		SSB.2 FR1			
PDSCH/PDCCH subcarrier spacing	Config 1,2	kHz	15 kHz			
	Config 3		30 kHz			
PUCCH/PUSCH subcarrier spacing	Config 1,2	kHz	15 kHz			
	Config 3		30 kHz			
PRACH configuration			FR1 PRACH configuration 1			
BWP	Initial DL BWP		DLBWP.0.1			
	Dedicated DL BWP		DLBWP.1.1			
	Initial UL BWP		ULBWP.0.1			
	Dedicated UL BWP		ULBWP.1.1			
EPRE ratio of PSS to SSS		dB	0			
EPRE ratio of PBCH DMRS to SSS						
EPRE ratio of PBCH to PBCH DMRS						
EPRE ratio of PDCCH DMRS to SSS						
EPRE ratio of PDCCH to PDCCH DMRS						
EPRE ratio of PDSCH DMRS to SSS						
EPRE ratio of PDSCH to PDSCH						
EPRE ratio of OCNG DMRS to SSS(Note 1)						
EPRE ratio of OCNG to OCNG DMRS (Note 1)						
$N_{oc}^{Note2}$						
$N_{oc}^{Note2}$	Config 1,2	dBm/SCS	-98		-98	
	Config 3		-95		-95	
$\hat{E}_s / I_{\alpha}$		dB	4	4	-Infinity	5
$\hat{E}_s / N_{oc}$		dB	4	4	-Infinity	5
SSB_RP	Config 1,2	dBm/SCS	-94	-94	-Infinity	-93
	Config 3	dBm/SCS	-91	-91	-Infinity	-90
$I_o^{Note3}$	Config 1,2	dBm/9.36MHz	-64.59	-64.59	-70.05	-63.85
	Config 3	dBm/38.16MHz	-58.49	-58.49	-63.94	-57.75
Propagation condition		-	AWGN		AWGN	
<p>Note 1: OCNG shall be used such that both cells are fully allocated and a constant total transmitted power spectral density is achieved for all OFDM symbols.</p> <p>Note 2: Interference from other cells and noise sources not specified in the test is assumed to be constant over subcarriers and time and shall be modelled as AWGN of appropriate power for <math>N_{oc}</math> to be fulfilled.</p> <p>Note 3: <math>I_o</math> levels have been derived from other parameters for information purposes. They are not settable parameters themselves.</p>						

### A.6.3.1.3.3 Test Requirements

The UE shall start to transmit the PRACH to Cell 2 less than 132 ms from the beginning of time period T2. The rate of correct handovers observed during repeated tests shall be at least 90%.

NOTE: The handover delay can be expressed as: RRC procedure delay +  $T_{interrupt}$ , where:

RRC procedure delay = 10 ms and is specified in clause 12 in TS 38.331 [2].

$T_{interrupt}$  = 122 ms in the test.  $T_{interrupt}$  is defined in clause 6.1.1.2.2.

This gives a total of 132 ms.

### A.6.3.1.4 SA NR - E-UTRAN handover

#### A.6.3.1.4.1 Test Purpose and Environment

The purpose of this set of tests is to verify that the UE can make correct inter-RAT E-UTRAN handover when operating in standalone (SA) operation with PCell in FR1. This test shall verify the NR to E-UTRAN handover requirements as specified in clause 6.1.2.1.

The test comprises of one NR carrier and one E-UTRA carrier. There are two cells and one cell on each carrier. Cell 1 is the NR PCell and Cell 2 is an inter-RAT E-UTRAN neighbour cell. The test consists of three successive time periods, with time durations of T1, T2 and T3 respectively. At the start of time duration T1, the UE does not have any timing information of Cell 2. Starting T2, Cell 2 becomes detectable and the UE is expected to detect and send a measurement report. Gap pattern configuration with id #0 as specified in Table 9.1.2-1 is configured before T2 begins to enable inter-RAT frequency monitoring.

A RRC message implying handover shall be sent to the UE during period T2 after the UE has reported Event B2. The start of T3 is the next instant after the last TTI containing the RRC message implying handover is sent to the UE. The handover message shall contain Cell 2 as the target cell.

Supported test configurations are shown in table A.6.3.1.4-1. General test parameters are provided in Table A.6.3.1.4-2. Cell specific test parameters for Cell 1 and Cell 2 are provided in Tables A.6.3.1.4-3 and A.6.3.1.4-4 respectively.

**Table A.6.3.1.4-1: Supported test configurations for SA inter-RAT E-UTRAN handover tests**

Configuration	Description
1	NR 15 kHz SSB SCS, 10 MHz bandwidth, FDD duplex mode, LTE FDD
2	NR 15 kHz SSB SCS, 10 MHz bandwidth, TDD duplex mode, LTE FDD
3	NR 30 kHz SSB SCS, 40 MHz bandwidth, TDD duplex mode, LTE FDD
4	NR 15 kHz SSB SCS, 10 MHz bandwidth, FDD duplex mode, LTE TDD
5	NR 15 kHz SSB SCS, 10 MHz bandwidth, TDD duplex mode, LTE TDD
6	NR 30 kHz SSB SCS, 40 MHz bandwidth, TDD duplex mode, LTE TDD
Note: The UE is only required to be tested in one of the supported test configurations	

**Table A.6.3.1.4-2: General test parameters for SA inter-RAT E-UTRAN handover**

Parameter	Unit	Value	Comment
NR RF Channel Number		1	1 NR carrier frequency is used in the test
LTE RF Channel Number		2	1 E-UTRAN carrier frequency is used in the test
Initial conditions	Active cell	Cell 1	NR cell
	Neighbouring cell	Cell 2	E-UTRAN cell
Final condition	Active cell	Cell 2	
NR measurement quantity		SS-RSRP	
E-UTRAN measurement quantity		RSRP	
b2-Threshold1	dBm	As specified in Table A.6.3.1.4-3	Absolute NR SS-RSRP threshold for event B2
b2-Threshold2EUTRAN	dBm	-98	Absolute E-UTRAN RSRP threshold for event B2
Hysteresis	dB	0	
TimeToTrigger	s	0	
Filter coefficient		0	L3 filtering is not used
DRX		OFF	Non-DRX test
Access Barring Information	-	Not sent	No additional delays in random access procedure
Time offset between cells		3 ms	Asynchronous cells
Gap pattern configuration Id		0	As specified in Table 9.1.2-1 started before T2 starts
T1	s	5	
T2	s	≤5	
T3	s	1	

**Table A.6.3.1.4-3: Cell specific test parameters for SA inter-RAT E-UTRA handover (Cell 1)**

Parameter	Unit	Configuration	Cell 1		
			T1	T2	T3
RF channel number		1, 2, 3, 4, 5, 6	1		
Duplex mode		1, 4	FDD		
		2, 3, 5, 6	TDD		
TDD Configuration		2, 5	TDDConf.1.1		
		3, 6	TDDConf.2.1		
BW <sub>channel</sub>	MHz	1, 4	10: N <sub>RB,c</sub> = 52 (FDD)		

		2, 5	10: $N_{RB,c} = 52$ (TDD)							
		3, 6	40: $N_{RB,c} = 106$ (TDD)							
PDSCH reference measurement channel		1, 4	SR.1.1 FDD							
		2, 5	SR.1.1 TDD							
		3, 6	SR.2.1 TDD							
CORSET reference channel		1, 4	CR.1.1 FDD							
		2, 5	CR.1.1 TDD							
		3, 6	CR.2.1 TDD							
TRS configuration		1, 4	TRS.1.1 FDD							
		2, 5	TRS.1.1 TDD							
		3, 6	TRS.1.2 TDD							
OCNG pattern <sup>Note1</sup>		1, 2, 3, 4, 5, 6	OP.1							
BWP	Initial DL BWP	1, 2, 3, 4, 5, 6	DLBWP.0.1							
	Dedicated DL BWP		DLBWP.1.1							
	Initial UL BWP		ULBWP.0.1							
	Dedicated UL BWP		ULBWP.1.1							
SMTC configuration		1, 2, 3, 4, 5, 6	SMTC.1							
SSB configuration		1, 2, 4, 5	SSB.1 FR1							
		3, 6	SSB.2 FR1							
b2-Threshold1	dBm	1, 2, 4, 5	-96							
		3, 6	-93							
EPRE ratio of PSS to SSS	dB	1, 2, 3, 4, 5, 6	0							
EPRE ratio of PBCH_DMRS to SSS										
EPRE ratio of PBCH to PBCH_DMRS										
EPRE ratio of PDCCH_DMRS to SSS										
EPRE ratio of PDCCH to PDCCH_DMRS										
EPRE ratio of PDSCH_DMRS to SSS										
EPRE ratio of PDSCH to PDSCH_DMRS										
EPRE ratio of OCNG DMRS to SSS										
EPRE ratio of OCNG to OCNG DMRS										
$N_{oc}$ <sup>Note2</sup>						dBm/15 KHz	1, 2, 3, 4, 5, 6	-100	-104	-100
$N_{oc}$ <sup>Note2</sup>						dBm/SCS	1, 2, 4, 5	-100	-104	-100
							3, 6	-97	-101	-97
$\hat{E}_s/N_{oc}$						dB	1, 2, 3, 4, 5, 6	12	0	0
$\hat{E}_s/I_{ot}$ <sup>Note3</sup>	dB	1, 2, 3, 4, 5, 6	12	0	0					
SS-RSRP <sup>Note3</sup>	dBm/SCS	1, 2, 4, 5	-88	-104	-104					
		3, 6	-85	-101	-101					
$I_o$ <sup>Note3</sup>	dBm/9.36 MHz	1, 2, 4, 5	-59.78	-73.04	-69.04					
	dBm/38.16 MHz	3, 6	-53.68	-66.9448	-64.19					
Propagation condition		1, 2, 3, 4, 5, 6	AWGN							
Antenna Configuration and Correlation Matrix		1, 2, 3, 4, 5, 6	1x2 Low							
<p>Note 1: OCNG shall be used such that both cells are fully allocated and a constant total transmitted power spectral density is achieved for all OFDM symbols.</p> <p>Note 2: Interference from other cells and noise sources not specified in the test is assumed to be constant over subcarriers and time and shall be modelled as AWGN of appropriate power for <math>N_{oc}</math> to be fulfilled.</p> <p>Note 3: <math>\hat{E}_s/I_{ot}</math>, SS-RSRP, and <math>I_o</math> levels have been derived from other parameters for information purposes. They are not settable parameters themselves.</p>										

Table A.6.3.1.4-4: Cell specific test parameters for SA inter-RAT E-UTRA handover (Cell 2)

Parameter	Unit	Configuration	Cell 2		
			T1	T2	T3

RF channel number		1, 2, 3, 4, 5, 6	2		
Duplex mode		1, 2, 3	FDD		
		4, 5, 6	TDD		
TDD special subframe configuration <sup>Note1</sup>		4, 5, 6	6		
TDD uplink-downlink configuration <sup>Note1</sup>		4, 5, 6	1		
BW <sub>channel</sub>	MHz	1, 2, 3, 4, 5, 6	5 MHz: N <sub>RB,c</sub> = 25 10 MHz: N <sub>RB,c</sub> = 50 20 MHz: N <sub>RB,c</sub> = 100		
PRACH Configuration <sup>Note2</sup>		1, 2, 3	4		
		4, 5, 6	53		
PDSCH parameters: DL Reference Measurement Channel <sup>Note3</sup>		1, 2, 3	5 MHz: R.7 FDD 10 MHz: R.3 FDD 20 MHz: R.6 FDD		
		4, 5, 6	5 MHz: R.4 TDD 10 MHz: R.0 TDD 20 MHz: R.3 TDD		
PCFICH/PDCCH/PHICH parameters: DL Reference Measurement Channel <sup>Note3</sup>		1, 2, 3	5 MHz: R.11 FDD 10 MHz: R.6 FDD 20 MHz: R.10 FDD		
		4, 5, 6	5 MHz: R.11 TDD 10 MHz: R.6 TDD 20 MHz: R.10 TDD		
OCNG Patterns <sup>Note3</sup>		1, 2, 3	5 MHz: OP.20 FDD 10 MHz: OP.10 FDD 20 MHz: OP.17 FDD		
		4, 5, 6	5 MHz: OP.9 TDD 10 MHz: OP.1 TDD 20 MHz: OP.7 TDD		
PBCH_RA	dB	1, 2, 3, 4, 5, 6	0		
PBCH_RB					
PSS_RA					
SSS_RA					
PCFICH_RB					
PHICH_RA					
PHICH_RB					
PDCCH_RA					
PDCCH_RB					
PDSCH_RA					
PDSCH_RB					
OCNG_RA <sup>Note4</sup>					
OCNG_RB <sup>Note4</sup>					
N <sub>oc</sub> <sup>Note5</sup>					
$\hat{E}_s/N_{oc}$	dB	1, 2, 3, 4, 5, 6	-Infinity	8	78
$\hat{E}_s/I_{ot}$ <sup>Note6</sup>	dB	1, 2, 3, 4, 5, 6	-Infinity	78	78
RSRP <sup>Note6</sup>	dBm/15kHz	1, 2, 3, 4, 5, 6	-Infinity	-90	-90
SCH_RP <sup>Note6</sup>	dBm/15kHz	1, 2, 3, 4, 5, 6	-Infinity	-90	-90
I <sub>o</sub> <sup>Note6</sup>	dBm/9MHz	1, 2, 3, 4, 5, 6	-67.21 +10log(N <sub>RB,c</sub> /100)	-58.57 +10log(N <sub>RB,c</sub> /100)	-58.57 +10log(N <sub>RB,c</sub> /100)
Propagation Condition		1, 2, 3, 4, 5, 6	AWGN		
Antenna Configuration and Correlation Matrix <sup>Note7</sup>		1, 2, 3, 4, 5, 6	1x2 Low		
<p>Note 1: Special subframe and uplink-downlink configurations are specified in table 4.2-1 in TS 36.211 [23].</p> <p>Note 2: PRACH configurations are specified in table 5.7.1-2 and table 5.7.1-3 in TS 36.211 [23].</p> <p>Note 3: DL RMCs and OCNG patterns are specified in clauses A 3.1 and A 3.2 of TS 36.133 [15] respectively.</p> <p>Note 4: OCNG shall be used such that all cells are fully allocated and a constant total transmitted power spectral density is achieved for all OFDM symbols.</p> <p>Note 5: Interference from other cells and noise sources not specified in the test is assumed to be constant over subcarriers and time and shall be modelled as AWGN of appropriate power for N<sub>oc</sub> to be fulfilled.</p> <p>Note 6: <math>\hat{E}_s/I_{ot}</math>, RSRP, SCH_RP and I<sub>o</sub> levels have been derived from other parameters for information purposes. They are not settable parameters themselves.</p>					

Note 7: Propagation condition and correlation matrix are defined in clause B.2 in TS 36.101 [25].
---

#### A.6.3.1.4.2 Test Requirements

The UE shall start to transmit the PRACH to Cell 2 less than 85 ms from the beginning of time period T3.

The rate of correct handovers observed during repeated tests shall be at least 90%.

NOTE: The handover delay can be expressed as: RRC procedure delay +  $T_{\text{interrupt}}$ , where:

RRC procedure delay = 50 ms and is specified in clause 6.1.2.1.

$T_{\text{interrupt}}$  = 35 ms in the test;  $T_{\text{interrupt}}$  is defined in clause 6.1.2.1.

This gives a total of 85 ms.

#### A.6.3.1.5 SA NR - E-UTRAN handover with unknown target cell

##### A.6.3.1.5.1 Test Purpose and Environment

The purpose of this set of tests is to verify that the UE can make correct inter-RAT E-UTRAN handover when operating in standalone (SA) operation with PCell in FR1. This test shall verify the NR to E-UTRAN handover requirements for the case when the target E-UTRAN cell is unknown as specified in clause 6.1.2.1.

The test comprises of one NR carrier and one E-UTRA carrier. There are two cells and one cell on each carrier. Cell 1 is the NR PCell and Cell 2 is an inter-RAT E-UTRAN neighbour cell. The test consists of two successive time periods, with time durations of T1 and T2 respectively. At the start of time duration T1, the UE does not have any timing information of Cell 2. Starting T2, Cell 2 becomes detectable. No Gap pattern shall be configured.

A RRC message implying handover shall be sent to the UE during period T1. The start of T2 is the instant when the last TTI containing the RRC message implying handover is sent to the UE. The handover message shall contain Cell 2 as the target cell.

Supported test configurations are shown in table A.6.3.1.5-1. General test parameters are provided in Table A.6.3.1.5-2. Cell specific test parameters for Cell 1 and Cell 2 are provided in Tables A.6.3.1.5-3 and A.6.3.1.5-4 respectively.

**Table A.6.3.1.5-1: Supported test configurations for SA inter-RAT E-UTRAN handover tests**

Configuration	Description
1	NR 15 kHz SSB SCS, 10 MHz bandwidth, FDD duplex mode, LTE FDD
2	NR 15 kHz SSB SCS, 10 MHz bandwidth, TDD duplex mode, LTE FDD
3	NR 30 kHz SSB SCS, 40 MHz bandwidth, TDD duplex mode, LTE FDD
4	NR 15 kHz SSB SCS, 10 MHz bandwidth, FDD duplex mode, LTE TDD
5	NR 15 kHz SSB SCS, 10 MHz bandwidth, TDD duplex mode, LTE TDD
6	NR 30kHz SSB SCS, 40 MHz bandwidth, TDD duplex mode, LTE TDD

Note: The UE is only required to be tested in one of the supported test configurations

**Table A.6.3.1.5-2: General test parameters for SA inter-RAT E-UTRAN handover**

Parameter	Unit	Value	Comment
NR RF Channel Number		1	1 NR carrier frequency is used in the test
LTE RF Channel Number		2	1 E-UTRAN carrier frequency is used in the test
Initial conditions	Active cell	Cell 1	NR cell
	Neighbouring cell	Cell 2	E-UTRAN cell
Final condition	Active cell	Cell 2	
NR measurement quantity		SS-RSRP	
DRX		OFF	Non-DRX test
Access Barring Information	-	Not sent	No additional delays in random access procedure
Time offset between cells		3 ms	Asynchronous cells
T1	s	≤5	
T2	s	1	

Table A.6.3.1.5-3: Cell specific test parameters for SA inter-RAT E-UTRA handover (Cell 1)

Parameter		Unit	Configuration	Cell 1	
				T1	T2
RF channel number			1, 2, 3, 4, 5, 6	1	
Duplex mode			1, 4	FDD	
			2, 3, 5, 6	TDD	
TDD Configuration			2, 5	TDDConf.1.1	
			3, 6	TDDConf.2.1	
BW <sub>channel</sub>		MHz	1, 4	10: N <sub>RB,c</sub> = 52 (FDD)	
			2, 5	10: N <sub>RB,c</sub> = 52 (TDD)	
			3, 6	40: N <sub>RB,c</sub> = 106 (TDD)	
PDSCH reference measurement channel			1, 4	SR.1.1 FDD	
			2, 5	SR.1.1 TDD	
			3, 6	SR.2.1 TDD	
CORSET reference channel			1, 4	CR.1.1 FDD	
			2, 5	CR.1.1 TDD	
			3, 6	CR.2.1 TDD	
TRS configuration			1, 4	TRS.1.1 FDD	
			2, 5	TRS.1.1 TDD	
			3, 6	TRS.1.2 TDD	
OCNG pattern <sup>Note1</sup>			1, 2, 3, 4, 5, 6	OP.1	
BWP	Initial DL BWP		1, 2, 3, 4, 5, 6	DLBWP.0.1	
	Dedicated DL BWP			DLBWP.1.1	
	Initial UL BWP			ULBWP.0.1	
	Dedicated UL BWP			ULBWP.1.1	
SMTC configuration			1, 2, 3, 4, 5, 6	SMTC.1	
SSB configuration			1, 2, 4, 5	SSB.1 FR1	
			3, 6	SSB.2 FR1	
EPRE ratio of PSS to SSS		dB	1, 2, 3, 4, 5, 6	0	
EPRE ratio of PBCH_DMRS to SSS					
EPRE ratio of PBCH to PBCH_DMRS					
EPRE ratio of PDCCH_DMRS to SSS					
EPRE ratio of PDCCH to PDCCH_DMRS					
EPRE ratio of PDSCH_DMRS to SSS					
EPRE ratio of PDSCH to PDSCH_DMRS					
EPRE ratio of OCNG DMRS to SSS					
EPRE ratio of OCNG to OCNG DMRS					
N <sub>oc</sub> <sup>Note2</sup>					
N <sub>oc</sub> <sup>Note2</sup>		dBm/SCS	1, 2, 4, 5	-98	
			3, 6	-95	
E <sub>s</sub> /N <sub>oc</sub>		dB	1, 2, 3, 4, 5, 6	0	0
E <sub>s</sub> /I <sub>ot</sub> <sup>Note3</sup>		dB	1, 2, 3, 4, 5, 6	0	0
SS-RSRP <sup>Note3</sup>		dBm/SCS	1, 2, 4, 5	-98	-98
			3, 6	-95	-95
I <sub>o</sub> <sup>Note3</sup>		dBm/9.36 MHz	1, 2, 4, 5	-67.04	-67.04
			dBm/38.16 MHz	3, 6	-60.94
Propagation condition			1, 2, 3, 4, 5, 6	AWGN	
Antenna Configuration and Correlation Matrix			1, 2, 3, 4, 5, 6	1x2 Low	

Note 1: OCNG shall be used such that both cells are fully allocated and a constant total transmitted power spectral density is achieved for all OFDM symbols.  
 Note 2: Interference from other cells and noise sources not specified in the test is assumed to be constant over subcarriers and time and shall be modelled as AWGN of appropriate power for  $N_{oc}$  to be fulfilled.  
 Note 3:  $\hat{E}_s/I_{ot}$ , SS-RSRP, and  $I_o$  levels have been derived from other parameters for information purposes. They are not settable parameters themselves.

**Table A.6.3.1.5-4: Cell specific test parameters for SA inter-RAT E-UTRA handover (Cell 2)**

Parameter	Unit	Configuration	Cell 2	
			T1	T2
RF channel number		1, 2, 3, 4, 5, 6	2	
Duplex mode		1, 2, 3	FDD	
		4, 5, 6	TDD	
TDD special subframe configuration <sup>Note1</sup>		4, 5, 6	6	
TDD uplink-downlink configuration <sup>Note1</sup>		4, 5, 6	1	
BW <sub>channel</sub>	MHz	1, 2, 3, 4, 5, 6	5 MHz: N <sub>RB,c</sub> = 25 10 MHz: N <sub>RB,c</sub> = 50 20 MHz: N <sub>RB,c</sub> = 100	
PRACH Configuration <sup>Note2</sup>		1, 2, 3	4	
		4, 5, 6	53	
PDSCH parameters: DL Reference Measurement Channel <sup>Note3</sup>		1, 2, 3	5 MHz: R.7 FDD 10 MHz: R.3 FDD 20 MHz: R.6 FDD	
		4, 5, 6	5 MHz: R.4 TDD 10 MHz: R.0 TDD 20 MHz: R.3 TDD	
PCFICH/PDCCH/PHICH parameters: DL Reference Measurement Channel <sup>Note3</sup>		1, 2, 3	5 MHz: R.11 FDD 10 MHz: R.6 FDD 20 MHz: R.10 FDD	
		4, 5, 6	5 MHz: R.11 TDD 10 MHz: R.6 TDD 20 MHz: R.10 TDD	
OCNG Patterns <sup>Note3</sup>		1, 2, 3	5 MHz: OP.20 FDD 10 MHz: OP.10 FDD 20 MHz: OP.17 FDD	
		4, 5, 6	5 MHz: OP.9 TDD 10 MHz: OP.1 TDD 20 MHz: OP.7 TDD	
PBCH_RA	dB	1, 2, 3, 4, 5, 6	0	
PBCH_RB				
PSS_RA				
SSS_RA				
PCFICH_RB				
PHICH_RA				
PHICH_RB				
PDCCH_RA				
PDCCH_RB				
PDSCH_RA				
PDSCH_RB				
OCNG_RA <sup>Note4</sup>				
OCNG_RB <sup>Note4</sup>				
N <sub>oc</sub> <sup>Note5</sup>				
$\hat{E}_s/N_{oc}$	dB	1, 2, 3, 4, 5, 6	-Infinity	7
$\hat{E}_s/I_{ot}$ <sup>Note6</sup>	dB	1, 2, 3, 4, 5, 6	-Infinity	7
RSRP <sup>Note6</sup>	dBm/15kHz	1, 2, 3, 4, 5, 6	-Infinity	-91
SCH_RP <sup>Note6</sup>	dBm/15kHz	1, 2, 3, 4, 5, 6	-Infinity	-91
I <sub>o</sub> <sup>Note6</sup>	dBm/9MHz	1, 2, 3, 4, 5, 6	-70.22	-62.43
Propagation Condition		1, 2, 3, 4, 5, 6	AWGN	
Antenna Configuration and Correlation Matrix <sup>Note7</sup>		1, 2, 3, 4, 5, 6	1x2 Low	
Note 1: Special subframe and uplink-downlink configurations are specified in table 4.2-1 in TS 36.211 [23].				

Note 2:	PRACH configurations are specified in table 5.7.1-2 and table 5.7.1-3 in TS 36.211 [23].
Note 3:	DL RMCs and OCNG patterns are specified in clauses A 3.1 and A 3.2 of TS 36.133 [15] respectively.
Note 4:	OCNG shall be used such that all cells are fully allocated and a constant total transmitted power spectral density is achieved for all OFDM symbols.
Note 5:	Interference from other cells and noise sources not specified in the test is assumed to be constant over subcarriers and time and shall be modelled as AWGN of appropriate power for $N_{oc}$ to be fulfilled.
Note 6:	$\hat{E}_s/I_{ot}$ , RSRP, SCH_RP and $I_o$ levels have been derived from other parameters for information purposes. They are not settable parameters themselves.
Note 7:	Propagation condition and correlation matrix are defined in clause B.2 in TS 36.101 [25].

### A.6.3.1.5.2 Test Requirements

The UE shall start to transmit the PRACH to Cell 2 less than 165 ms from the beginning of time period T2.

The rate of correct handovers observed during repeated tests shall be at least 90%.

NOTE: The handover delay can be expressed as: RRC procedure delay +  $T_{interrupt}$ , where:

RRC procedure delay = 50 ms and is specified in clause 6.1.2.1.

$T_{interrupt}$  = 115 ms in the test;  $T_{interrupt}$  is defined in clause 6.1.2.1.

This gives a total of 165 ms.

### A.6.3.1.6 SA NR - UTRAN FDD handover

#### A.6.3.1.6.1 Test Purpose and Environment

The purpose of this set of tests is to verify that the UE can make correct inter-RAT UTRAN FDD handover when operating in standalone (SA) operation with PCell in FR1. This test shall verify the NR to UTRAN FDD handover requirements as specified in clause 6.1.2.2.1.

The test comprises of one NR carrier and one UTRA FDD carrier. There are two cells and one cell on each carrier. Cell 1 is the NR PCell and Cell 2 is an inter-RAT UTRAN FDD neighbour cell. The test consists of three successive time periods, with time durations of T1, T2 and T3 respectively. At the start of time duration T1, the UE does not have any timing information of Cell 2. Starting T2, Cell 2 becomes detectable and the UE is expected to detect and send a measurement report. Gap pattern configuration with id #0 as specified in Table 9.1.2-1 is configured before T2 begins to enable inter-RAT frequency monitoring.

A RRC message implying handover shall be sent to the UE during period T2 after the UE has reported Event B2. The start of T3 is the instant when the last TTI containing the RRC message implying handover is sent to the UE. The handover message shall contain Cell 2 as the target cell.

Supported test configurations are shown in table A.6.3.1.6-1. General test parameters are provided in Table A.6.3.1.6-2. Cell specific test parameters for Cell 1 and Cell 2 are provided in Tables A.6.3.1.6-3 and A.6.3.1.6-4 respectively.

**Table A.6.3.1.6-1: Supported test configurations for SA inter-RAT UTRAN FDD handover tests**

Configuration	Description
1	NR 15 kHz SSB SCS, 10 MHz bandwidth, FDD duplex mode, UTRAN FDD
2	NR 15 kHz SSB SCS, 10 MHz bandwidth, TDD duplex mode, UTRAN FDD
3	NR 30 kHz SSB SCS, 40 MHz bandwidth, TDD duplex mode, UTRAN FDD

Note: The UE is only required to be tested in one of the supported test configurations

**Table A.6.3.1.6-2: General test parameters for SA inter-RAT UTRAN FDD handover**

Parameter	Unit	Value	Comment
NR RF Channel Number		1	1 NR carrier frequency is used in the test
UTRA RF Channel Number		2	1 UTRAN carrier frequency is used in the test
Initial conditions	Active cell	Cell 1	NR cell
	Neighbouring cell	Cell 2	UTRAN cell
Final condition	Active cell	Cell 2	
NR measurement quantity		SS-RSRP	



Inter-RAT (UTRAN FDD) measurement quantity		CPICH Ec/N0	
b2-Threshold1	dBm	As specified in Table A.6.3.1.6-3	Absolute NR SS-RSRP threshold for event B2
b2-Threshold2UTRA-FDD	dB	-18	Absolute UTRAN CPICH Ec/Io threshold for event B2
Hysteresis	dB	0	
TimeToTrigger	s	0	
Filter coefficient		0	L3 filtering is not used
DRX		OFF	Non-DRX test
Access Barring Information	-	Not sent	No additional delays in random access procedure
Time offset between cells		3 ms	Asynchronous cells
Gap pattern configuration Id		0	As specified in Table 9.1.2-1 started before T2 starts
T1	s	5	
T2	s	≤5	
T3	s	1	

**Table A.6.3.1.6-3: Cell specific test parameters for SA inter-RAT UTRAN FDD handover (Cell 1)**

Parameter		Unit	Configuration	Cell 1		
				T1	T2	T3
RF channel number			1, 2, 3	1		
Duplex mode			1	FDD		
			2, 3	TDD		
TDD Configuration			2	TDDConf.1.1		
			3	TDDConf.2.1		
BW <sub>channel</sub>		MHz	1	10: N <sub>RB,c</sub> = 52 (FDD)		
			2	10: N <sub>RB,c</sub> = 52 (TDD)		
			3	40: N <sub>RB,c</sub> = 106 (TDD)		
PDSCH reference measurement channel			1	SR.1.1 FDD		
			2	SR.1.1 TDD		
			3	SR.2.1 TDD		
CORSET reference channel			1	CR.1.1 FDD		
			2	CR.1.1 TDD		
			3	CR.2.1 TDD		
TRS configuration			1	TRS.1.1 FDD		
			2	TRS.1.1 TDD		
			3	TRS.1.2 TDD		
OCNG pattern <sup>Note1</sup>			1, 2, 3	OP.1		
BWP	Initial DL BWP		1, 2, 3	DLBWP.0.1		
	Dedicated DL BWP			DLBWP.1.1		
	Initial UL BWP			ULBWP.0.1		
	Dedicated UL BWP			ULBWP.1.1		
SMTc configuration			1, 2, 3	SMTc.1		
SSB configuration			1, 2	SSB.1 FR1		
			3	SSB.2 FR1		
b2-Threshold1		dBm	1, 2	-96		
			3	-93		
EPRE ratio of PSS to SSS		dB	1, 2, 3	0		
EPRE ratio of PBCH_DMRS to SSS						
EPRE ratio of PBCH to PBCH_DMRS						
EPRE ratio of PDCCH_DMRS to SSS						
EPRE ratio of PDCCH to PDCCH_DMRS						
EPRE ratio of PDSCH_DMRS to SSS						
EPRE ratio of PDSCH to PDSCH_DMRS						

EPRE ratio of OCNG DMRS to SSS					
EPRE ratio of OCNG to OCNG DMRS					
$N_{oc}$ <sup>Note2</sup>	dBm/15 KHz	1, 2, 3			-100
$N_{oc}$ <sup>Note2</sup>	dBm/SCS	1, 2,			-100
		3			-97
$\hat{E}_s/N_{oc}$	dB	1, 2, 3	12	-4	-4
$\hat{E}_s/I_{ot}$ <sup>Note3</sup>	dB	1, 2, 3	12	-4	-4
SS-RSRP <sup>Note3</sup>	dBm/SCS	1, 2	-88	-104	-104
		3	-85	-101	-101
$I_{o}$ <sup>Note3</sup>	dBm/9.36 MHz	1, 2	-59.78	-70.59	-70.59
	dBm/38.16 MHz	3	-53.68	-64.49	-64.49
Propagation condition		1, 2, 3	AWGN		
Antenna Configuration and Correlation Matrix		1, 2, 3	1x2 Low		
Note 1: OCNG shall be used such that both cells are fully allocated and a constant total transmitted power spectral density is achieved for all OFDM symbols.					
Note 2: Interference from other cells and noise sources not specified in the test is assumed to be constant over subcarriers and time and shall be modelled as AWGN of appropriate power for $N_{oc}$ to be fulfilled.					
Note 3: $\hat{E}_s/I_{ot}$ , SS-RSRP, and $I_o$ levels have been derived from other parameters for information purposes. They are not settable parameters themselves.					

Table A.6.3.1.6-4: Cell specific test parameters for SA inter-RAT UTRAN FDD handover (Cell 2)

Parameter	Unit	Cell 2 (UTRA)		
		T1	T2	T3
UTRA RF Channel Number		2		
CPICH_Ec/lor	dB	-10		
PCCPCH_Ec/lor	dB	-12		
SCH_Ec/lor	dB	-12		
PICH_Ec/lor	dB	-15		
DCH_Ec/lor	dB	N/A	N/A	Note 1
OCNS_Ec/lor	dB	-0.941	0.941	Note 2
$\hat{I}_{or}/I_{oc}$	dB	-infinity	-1.8	-1.8
$I_{oc}$	dBm/3,84 MHz	-70	-70	-70
CPICH_Ec/lo	dB	-infinity	-14	-14
Propagation Condition		AWGN		
Note 1: The DPCH level is controlled by the power control loop				
Note 2: The power of the OCNS channel that is added shall make the total power from the cell to be equal to $I_{or}$ .				

#### A.6.3.1.6.2 Test Requirements

The UE shall start to transmit the UL DPCCCH to Cell 2 less than 190 ms from the beginning of time period T3.

The rate of correct handovers observed during repeated tests shall be at least 90%.

NOTE: The handover delay can be expressed as: RRC procedure delay +  $T_{interrupt}$ , where:

RRC procedure delay = 50 ms, which is specified in clause 5.3.1.1.1.

$T_{interrupt}$  = 140 ms in the test;  $T_{interrupt}$  is defined in clause 5.3.1.1.2. This gives a total of 190 ms.

#### A.6.3.1.7 Intra-frequency synchronous DAPS handover in FR1

##### A.6.3.1.7.1 Test Purpose and Environment

This test is to verify the requirement for the NR FR1-NR FR1 intra frequency DAPS handover requirements in synchronous scenario specified in clause 6.1.3.2.

### A.6.3.1.7.2 Test Parameters

Supported test configurations are shown in Table A.6.3.1.7.2-1. Both handover delay and interruption length are tested by using the parameters in Table A.6.3.1.7.2-2, and A.6.3.1.7.2-3. The test consists of five successive time periods, with time durations of T1, T2, T3, T4, and T5 respectively.

Before the start of T1, the UE is connected to the cell1 and not aware of the cell2. The UE shall be configured with periodic CSI reporting for cell1. During T1, the UE does not have any timing information of the cell2.

Starting T2, the cell2 becomes detectable. During T2, the UE performs cell detection and measurements on the cell2 and shall send event report to the network. After receiving the event report A3, the network sends a RRC message implying DAPS handover to the UE.

The start of T3 is the instant when the last TTI containing DAPS handover command is sent to the UE. During T3, UE shall be able to perform random access, DL reception or UL transmission in the cell2 while the DL scheduling and UL feedback in the cell1 shall be avoided. After successful RACH procedure of the cell2, UE is scheduled with PDSCH from cell1 and cell2 in alternative TTIs where both cell1 and cell2 belong to the same TAG. In the end the network sends a RRC message implying cell1 release to the UE. During T3, the handover delay  $D_{handover1}$  for target cell addition need to be verified.

The start of T4 is the instant when the last TTI containing cell1 release command is sent to the UE. During T4, the UE shall accomplish the release actions within  $D_{handover2}$ .

Starting T5, the UE stops sending the periodical CSI report to the cell1.

**Table A.6.3.1.7.2-1: Intra-frequency DAPS handover in FR1 test configurations**

Config	Description
1	Source cell: NR 15 kHz SSB SCS, 10 MHz bandwidth, FDD duplex mode Target cell: NR 15 kHz SSB SCS, 10 MHz bandwidth, FDD duplex mode
2	Source cell: NR 15 kHz SSB SCS, 10 MHz bandwidth, TDD duplex mode Target cell: NR 15 kHz SSB SCS, 10 MHz bandwidth, TDD duplex mode
3	Source cell: NR 30 kHz SSB SCS, 40 MHz bandwidth, TDD duplex mode Target cell: NR 30 kHz SSB SCS, 40 MHz bandwidth, TDD duplex mode

Note: The UE is only required to be tested in one of the supported test configurations

**Table A.6.3.1.7.2-2: General test parameters synchronous Intra-frequency DAPS handover in FR1**

Parameter	Unit	Value	Comment
Initial conditions	Active cell	Cell 1	
	Neighbouring cell	Cell 2	
Final condition	Active cell	Cell 2	
A3-Offset	dB	0	
Hysteresis	dB	0	
Time To Trigger	s	0	
Filter coefficient		0	L3 filtering is not used
Access Barring Information	-	Not Sent	No additional delays in random access procedure.
Time offset between cells		3 $\mu$ s	Synchronous cells
T1	s	5	
T2	s	$\leq 5$	
T3	s	1	
T4	ms	$D_{handover2}$	$D_{handover2}$ is defined in clause 6.1.3.2.1
T5	ms	100	

**Table A.6.3.1.7.2-3: Cell specific test parameters for NR FR1-FR1 Intra frequency DAPS handover test case**

Parameter	Unit	Cell 1		Cell 2	
		T1	T2 - T5	T1	T2 - T5
NR RF Channel Number		1		1	
Duplex mode	Config 1			FDD	
	Config 2,3			TDD	

TDD configuration	Config 1		Not Applicable			
	Config 2		TDDConf.1.1			
	Config 3		TDDConf.2.1			
BW <sub>channel</sub>	Config 1	MHz	10: N <sub>RB,c</sub> = 52			
	Config 2		10: N <sub>RB,c</sub> = 52			
	Config 3		40: N <sub>RB,c</sub> = 106			
BWP BW	Config 1	MHz	10: N <sub>RB,c</sub> = 52			
	Config 2		10: N <sub>RB,c</sub> = 52			
	Config 3		40: N <sub>RB,c</sub> = 106			
DRX Cycle		ms	Not Applicable			
PDSCH Reference measurement channel	Config 1		SR.1.1 FDD			
	Config 2		SR.1.1 TDD			
	Config 3		SR.2.1 TDD			
CORESET Reference Channel	Config 1		CR.1.1 FDD			
	Config 2		CR.1.1 TDD			
	Config 3		CR.2.1 TDD			
TRS configuration	Config 1		TRS.1.1 FDD			
	Config 2		TRS.1.1 TDD			
	Config 3		TRS.1.2 TDD			
OCNG Patterns			OP.1			
CSI-RS configuration for CSI reporting	Config 1		CSI-RS.1.1 FDD			
	Config 2		CSI-RS.1.1 TDD			
	Config 3		CSI-RS.2.1 TDD			
reportConfigType			periodic	N/A		
reportQuantity			cri-RI-PMI-CQI	N/A		
CSI reporting periodicity	Config 1,2	slot	5	N/A		
	Config 3		10	N/A		
CSI reporting offset	Config 1,2	slot	3	N/A		
	Config 3		5	N/A		
SMTC Configuration			SMTC.1			
SSB Configuration	Config 1,2		SSB.1 FR1			
	Config 3		SSB.2 FR1			
PDSCH/PDCCH subcarrier spacing	Config 1,2	kHz	15 kHz			
	Config 3		30 kHz			
PUCCH/PUSCH subcarrier spacing	Config 1,2	kHz	15 kHz			
	Config 3		30 kHz			
PRACH configuration			FR1 PRACH configuration 1			
BWP configuration	Initial DL BWP		DLBWP.0.1			
	Dedicated DL BWP		DLBWP.1.1			
	Initial UL BWP		ULBWP.0.1			
	Dedicated UL BWP		ULBWP.1.1			
EPRE ratio of PSS to SSS		dB	0			
EPRE ratio of PBCH DMRS to SSS						
EPRE ratio of PBCH to PBCH DMRS						
EPRE ratio of PDCCH DMRS to SSS						
EPRE ratio of PDCCH to PDCCH DMRS						
EPRE ratio of PDSCH DMRS to SSS						
EPRE ratio of PDSCH to PDSCH						
EPRE ratio of OCNG DMRS to SSS(Note 1)						
EPRE ratio of OCNG to OCNG DMRS (Note 1)						
$N_{oc}^{Note2}$		dBm/15kHz	-98			
$N_{oc}^{Note2}$	Config 1,2	dBm/SCS	-98			
	Config 3		-95			
$\hat{E}_s / I_{ot}$		dB	8	-1.5	-Infinity	0.36
$\hat{E}_s / N_{oc}$		dB	8	8	-Infinity	9
SSB_RP	Config 1,2	dBm/SCS	-90	-90	-Infinity	-89
	Config 3	dBm/SCS	-87	-87	-Infinity	-86
I <sub>o</sub> <sup>Note3</sup>	Config 1,2	dBm/ 9.36MHz	-61.41	-58.21	-61.41	-58.21
	Config 3	dBm/ 38.16MHz	-55.31	-52.11	-55.31	-52.11
Propagation condition			AWGN			
Note 1: OCNG shall be used such that both cells are fully allocated and a constant total transmitted power spectral density is achieved for all OFDM symbols.						

Note 2:	Interference from other cells and noise sources not specified in the test is assumed to be constant over subcarriers and time and shall be modelled as AWGN of appropriate power for $N_{oc}$ to be fulfilled.
Note 3:	lo levels have been derived from other parameters for information purposes. They are not settable parameters themselves.

### A.6.3.1.7.3 Test Requirements

The UE shall start to transmit the PRACH to cell 2 less than 72 ms from the beginning of time period T3.

The rate of correct handovers observed during repeated tests shall be at least 90%.

NOTE: The target cell add delay  $D_{handover1}$  can be expressed as:  $T_{RRC\_procedure} + T_{search} + T_{IU} + T_{processing} + T_{\Delta} + T_{margin}$ , where:

$T_{RRC\_procedure} = 10$  ms and is specified in clause 12 in TS 38.331 [2].

$T_{search}$ ,  $T_{IU}$ ,  $T_{processing}$ ,  $T_{\Delta}$  and  $T_{margin}$  are defined in clause 6.1.1.2.2.

If the target cell is known, then  $T_{search} = 0$  ms

$T_{IU} = 20$  ms in the test.  $T_{IU}$  is defined in clause 6.1.1.2.2.

$T_{\Delta} = 20$  ms in the test.  $T_{\Delta}$  is defined in clause 6.1.1.2.2.

$T_{processing} = 20$  ms in the test.  $T_{processing}$  is defined in clause 6.1.1.2.2.

$T_{margin} = 2$  ms in the test.  $T_{margin}$  is defined in clause 6.1.1.2.2.

This gives a total of 72 ms.

After successful RACH to cell 2 and until the start of time period T4, UE shall be able to receive PDSCH alternatively from cell 1 and cell 2. UE is not expected to transmit UL to both cell 1 and cell 2 in the same TTI.

The UE shall release cell 1 less than  $D_{handover2} = (T_{RRC\_procedure} + T_{interrupt2})$  from the beginning of time period T4.

NOTE:  $D_{handover2}$  is defined in clause 6.1.3.2.1.

$T_{RRC\_procedure} = 10$  ms and is specified in clause 12 in TS 38.331 [2].

$T_{interrupt2}$  is defined in clause 6.1.3.2.2.

UE shall not report CSI to cell 1 during T5.

## A.6.3.1.8 Intra-frequency asynchronous DAPS handover in FR1

### A.6.3.1.8.1 Test Purpose and Environment

This test is to verify the requirement for the NR FR1-NR FR1 intra frequency DAPS handover requirements in asynchronous scenario specified in clause 6.1.3.2.

### A.6.3.1.8.2 Test Parameters

Supported test configurations are shown in Table A.6.3.1.8.2-1. Both handover delay and interruption length are tested by using the parameters in Table A.6.3.1.8.2-2, and A.6.3.1.8.2-3.

The test consists of five successive time periods, with time durations of T1, T2, T3, T4, and T5 respectively.

Before the start of T1, the UE is connected to the cell1 and not aware of the cell2. The UE shall be configured with periodic CSI reporting for cell1. During T1, the UE does not have any timing information of the cell2.

Starting T2, the cell2 becomes detectable. During T2, the UE performs cell detection and measurements on the cell2 and shall send event report to the network. After receiving the event report A3, the network sends a RRC message implying DAPS handover to the UE.

The start of T3 is the instant when the last TTI containing DAPS handover command is sent to the UE. During T3, UE shall be able to perform random access, DL reception or UL transmission in the cell2 while the DL scheduling and UL

feedback in the cell1 shall be avoided. After successful RACH procedure of the cell2, UE is scheduled with PDSCH from cell1 and cell2 in alternative TTIs where both cell1 and cell2 belong to the same TAG. In the end the network sends a RRC message implying cell1 release to the UE. During T3, the handover delay  $D_{handover1}$  for target cell addition needs to be verified.

The start of T4 is the instant when the last TTI containing cell1 release command is sent to the UE by cell2. During T4, the UE shall accomplish the release actions within  $D_{handover2}$ .

Starting T5, the UE stops sending the periodical CSI report to the cell1.

**Table A.6.3.1.8.2-1: Intra-frequency DAPS handover in FR1 test configurations**

Config	Description
1	Source cell: NR 15 kHz SSB SCS, 10 MHz bandwidth, FDD duplex mode Target cell: NR 15 kHz SSB SCS, 10 MHz bandwidth, FDD duplex mode
2	Source cell: NR 15 kHz SSB SCS, 10 MHz bandwidth, TDD duplex mode Target cell: NR 15 kHz SSB SCS, 10 MHz bandwidth, TDD duplex mode
3	Source cell: NR 30 kHz SSB SCS, 40 MHz bandwidth, TDD duplex mode Target cell: NR 30 kHz SSB SCS, 40 MHz bandwidth, TDD duplex mode
Note: The UE is only required to be tested in one of the supported test configurations	

**Table A.6.3.1.8.2-2: General test parameters Intra-frequency asynchronous DAPS handover in FR1**

Parameter	Unit	Value	Comment
Initial conditions	Active cell	Cell 1	
	Neighbouring cell	Cell 2	
Final condition	Active cell	Cell 2	
A3-Offset	dB	0	
Hysteresis	dB	0	
Time To Trigger	s	0	
Filter coefficient		0	L3 filtering is not used
Access Barring Information	-	Not Sent	No additional delays in random access procedure.
Time offset between cells		7 $\mu$ s	Asynchronous cells
T1	s	5	
T2	s	$\leq 5$	
T3	s	1	
T4	ms	$D_{handover2}$	$D_{Handover2}$ is defined in clause 6.1.3.2.1
T5	ms	100	

**Table A.6.3.1.8.2-3: Cell specific test parameters for NR FR1-FR1 Intra frequency DAPS handover test case**

Parameter	Unit	Cell 1		Cell 2	
		T1	T2 - T5	T1	T2 - T5
NR RF Channel Number		1		1	
Duplex mode	Config 1	FDD			
	Config 2,3	TDD			
TDD configuration	Config 1	Not Applicable			
	Config 2	TDDConf.1.1			
	Config 3	TDDConf.2.1			
BW <sub>channel</sub>	Config 1,2	MHz	10: N <sub>RB,c</sub> = 52		
	Config 3		40: N <sub>RB,c</sub> = 106		
BWP BW	Config 1,2	MHz	10: N <sub>RB,c</sub> = 52		
	Config 3		40: N <sub>RB,c</sub> = 106		
DRX Cycle		ms	Not Applicable		
PDSCH Reference measurement channel	Config 1		SR.1.1 FDD		
	Config 2		SR.1.1 TDD		
	Config 3		SR.2.1 TDD		
CORESET Reference Channel	Config 1		CR.1.1 FDD		
	Config 2		CR.1.1 TDD		
	Config 3		CR.2.1 FDD		
TRS configuration	Config 1		TRS.1.1 FDD		

	Config 2		TRS.1.1 TDD			
	Config 3		TRS.1.2 TDD			
OCNG Patterns			OP.1			
CSI-RS configuration for CSI reporting	Config 1		CSI-RS.1.1 FDD			
	Config 2		CSI-RS.1.1 TDD			
	Config 3		CSI-RS.2.1 TDD			
reportConfigType			periodic	N/A		
reportQuantity			cri-RI-PMI-CQI	N/A		
CSI reporting periodicity	Config 1,2	slot	5	N/A		
	Config 3		10	N/A		
CSI reporting offset	Config 1,2	slot	3	N/A		
	Config 3		5	N/A		
SMT C Configuration			SMT C.1			
SSB Configuration	Config 1,2		SSB.1 FR1			
	Config 3		SSB.2 FR1			
PDSCH/PDCCH subcarrier spacing	Config 1,2	kHz	15			
	Config 3		30			
PUCCH/PUSCH subcarrier spacing	Config 1,2	kHz	15			
	Config 3		30			
PRACH configuration			FR1 PRACH configuration 1			
BWP configuration	Initial DL BWP		DLBWP.0.1			
	Dedicated DL BWP		DLBWP.1.1			
	Initial UL BWP		ULBWP.0.1			
	Dedicated UL BWP		ULBWP.1.1			
EPRE ratio of PSS to SSS		dB	0			
EPRE ratio of PBCH DMRS to SSS						
EPRE ratio of PBCH to PBCH DMRS						
EPRE ratio of PDCCH DMRS to SSS						
EPRE ratio of PDCCH to PDCCH DMRS						
EPRE ratio of PDSCH DMRS to SSS						
EPRE ratio of PDSCH to PDSCH						
EPRE ratio of OCNG DMRS to SSS(Note 1)						
EPRE ratio of OCNG to OCNG DMRS (Note 1)						
$N_{oc}^{Note2}$						
$N_{oc}^{Note2}$	Config 1,2	dBm/SCS	-98			
	Config 3		-95			
$\hat{E}_s / I_{ot}$		dB	8	-1.5	-Infinity	0.36
$\hat{E}_s / N_{oc}$		dB	8	8	-Infinity	9
SSB_RP	Config 1,2	dBm/SCS	-90	-90	-Infinity	-89
	Config 3		-87	-87	-Infinity	-86
$I_o^{Note3}$	Config 1,2	dBm/9.36MHz	-61.41	-58.21	-61.41	-58.21
	Config 3	dBm/38.16MHz	-55.31	-52.11	-55.31	-52.11
Propagation condition			AWGN			
<p>Note 1: OCNG shall be used such that both cells are fully allocated and a constant total transmitted power spectral density is achieved for all OFDM symbols.</p> <p>Note 2: Interference from other cells and noise sources not specified in the test is assumed to be constant over subcarriers and time and shall be modelled as AWGN of appropriate power for <math>N_{oc}</math> to be fulfilled.</p> <p>Note 3: <math>I_o</math> levels have been derived from other parameters for information purposes. They are not settable parameters themselves.</p>						

### A.6.3.1.8.3 Test Requirements

The UE shall start to transmit the PRACH to cell 2 less than 72 ms from the beginning of time period T3.

The rate of correct handovers observed during repeated tests shall be at least 90%.

NOTE: The target cell add delay  $D_{handover1}$  can be expressed as:  $T_{RRC\_procedure} + T_{search} + T_{IU} + T_{processing} + T_{\Delta} + T_{margin}$ , where:

$T_{RRC\_procedure} = 10$  ms and is specified in clause 12 in TS 38.331 [2].

$T_{\text{search}}$ ,  $T_{\text{IU}}$ ,  $T_{\text{processing}}$ ,  $T_{\Delta}$  and  $T_{\text{margin}}$  are defined in clause 6.1.1.2.2.

If the target cell is known, then  $T_{\text{search}} = 0$  ms

$T_{\text{IU}} = 20$  ms in the test.  $T_{\text{IU}}$  is defined in clause 6.1.1.2.2.

$T_{\Delta} = 20$  ms in the test.  $T_{\Delta}$  is defined in clause 6.1.1.2.2.

$T_{\text{processing}} = 20$  ms in the test.  $T_{\text{processing}}$  is defined in clause 6.1.1.2.2.

$T_{\text{margin}} = 2$  ms in the test.  $T_{\text{margin}}$  is defined in clause 6.1.1.2.2.

This gives a total of 72 ms.

After successful RACH to cell 2 and until the start of time period T4, UE shall be able to receive PDSCH alternatively from cell 1 and cell 2. UE is not expected to transmit UL to both cell 1 and cell 2 in the same TTI.

The UE shall release cell 1 less than  $D_{\text{handover2}} = (T_{\text{RRC\_procedure}} + T_{\text{interrupt2}})$  from the beginning of time period T4.

NOTE:  $D_{\text{handover2}}$  is defined in clause 6.1.3.2.1.

$T_{\text{RRC\_procedure}} = 10$  ms and is specified in clause 12 in TS 38.331 [2].

$T_{\text{interrupt2}}$  is defined in clause 6.1.3.2.2.

UE shall not report CSI to cell 1 during T5.

### A.6.3.1.9 Intra-band inter-frequency synchronous DAPS handover test in SA for FR1

#### A.6.3.1.9.1 Test Purpose and Environment

This test is to verify the requirement for the NR FR1-NR FR1 intra-band inter-frequency synchronous DAPS handover requirements specified in clause 6.1.3.2.

#### A.6.3.1.9.2 Test Parameters

Supported test configurations are shown in table A.6.3.1.9.2-1. Both handover delay and interruption length are tested by using the parameters in table A.6.3.1.9.2-2, and A.6.3.1.9.2-3.

The test consists of five successive time periods, with time durations of T1, T2, T3, T4 and T5 respectively. At the start of time duration T1, the UE may not have any timing information of cell 2. The UE shall be configured with periodic CSI reporting for cell1. The test scenario comprises of two carriers and one cell on each carrier. Gap pattern ID gp0 as specified in Table 9.1.2-1 is configured before T2 in the test case.

Starting T2, Cell 2 becomes known to the UE. During T2, the UE shall report Event A3. After receiving the Event A3, the test system shall send a RRC message implying DAPS handover to the UE.

T3 is defined as the end of the last TTI containing the RRC message implying DAPS handover. During T3 UE shall be able to perform random access to cell 2. Cell 1 is continuously scheduled in DL during T3. DL schedule and UL feedback to cell 1 shall be avoided when UE is required to perform DL reception or UL transmission in PRACH procedure in cell 2, except preamble transmission. At the end of T3 cell 2 shall send an RRC message implying cell 1 release command.

T4 is defined as the end of the last TTI containing the RRC message implying DAPS handover. Cell 2 is continuously scheduled in DL during T4. During T4, the UE shall perform source cell release.

Starting T5, the UE shall stop sending CSI report to the source cell. And the test system shall observe the periodic reporting of CSI for cell 1 during T5.

**Table A.6.3.1.9.2-1: Intra-band inter-frequency synchronous DAPS handover in SA for FR1 test configurations**

Config	Description
1	Source cell: NR 15 kHz SSB SCS, 10 MHz bandwidth, FDD duplex mode Target cell: NR 15 kHz SSB SCS, 10 MHz bandwidth, FDD duplex mode
2	Source cell: NR 15 kHz SSB SCS, 10 MHz bandwidth, TDD duplex mode



	Target cell: NR 15 kHz SSB SCS, 10 MHz bandwidth, TDD duplex mode
3	Source cell: NR 30 kHz SSB SCS, 40 MHz bandwidth, TDD duplex mode Target cell: NR 30 kHz SSB SCS, 40 MHz bandwidth, TDD duplex mode
Note:	The UE is only required to be tested in one of the supported test configurations

**Table A.6.3.1.9.2-2: General test parameters for intra-band inter-frequency synchronous DAPS handover test in SA for FR1**

Parameter	Unit	Value	Comment
Initial conditions	Active cell	Cell 1	
	Neighbouring cell	Cell 2	
Final condition	Active cell	Cell 2	
A3-Offset	dB	0	
Hysteresis	dB	0	
Time To Trigger	s	0	
Filter coefficient		0	L3 filtering is not used
Access Barring Information	-	Not Sent	No additional delays in random access procedure.
Time offset between cells		0 $\mu$ s	Synchronous cells
T1	s	5	
T2	s	$\leq 5$	
T3	s	1	
T4	ms	10 + T <sub>interrupt2</sub>	T <sub>interrupt2</sub> is defined in clause 6.1.3.2.2 Table 6.1.3.2.2-5
T5	ms	100	

**Table A.6.3.1.9.2-3: Cell specific test parameters for intra-band inter-frequency synchronous DAPS handover test in SA for FR1**

Parameter	Unit	Cell 1		Cell 2	
		T1	T2 - T5	T1	T2 - T5
NR RF Channel Number		1		2	
Duplex mode	Config 1	FDD			
	Config 2,3	TDD			
TDD configuration	Config 1	Not Applicable			
	Config 2	TDDConf.1.1			
	Config 3	TDDConf.2.1			
BW <sub>channel</sub>	Config 1	10: N <sub>RB,c</sub> = 52			
	Config 2	10: N <sub>RB,c</sub> = 52			
	Config 3	40: N <sub>RB,c</sub> = 106			
BWP BW	Config 1	10: N <sub>RB,c</sub> = 52			
	Config 2	10: N <sub>RB,c</sub> = 52			
	Config 3	40: N <sub>RB,c</sub> = 106			
DRX Cycle	ms	Not Applicable			
PDSCH Reference measurement channel	Config 1	SR.1.1 FDD			
	Config 2	SR.1.1 TDD			
	Config 3	SR.2.1 TDD			
CORESET Reference Channel	Config 1	CR.1.1 FDD			
	Config 2	CR.1.1 TDD			
	Config 3	CR.2.1 TDD			
TRS configuration	Config 1	TRS.1.1 FDD			
	Config 2	TRS.1.1 TDD			
	Config 3	TRS.1.2 TDD			
OCNG Patterns		OP.1			
CSI-RS configuration for CSI reporting	Config 1	CSI-RS.1.1 FDD			
	Config 2	CSI-RS.1.1 TDD			
	Config 3	CSI-RS.2.1 TDD			
reportConfigType		periodic		N/A	
reportQuantity		cri-RI-PMI-CQI		N/A	
CSI reporting periodicity	Config 1,2	slot		5	
	Config 3	slot		10	
CSI reporting offset	Config 1,2	slot		3	
	Config 3	slot		5	
SMTTC Configuration		SMTTC.1			

SSB Configuration	Config 1,2		SSB.1 FR1			
	Config 3		SSB.2 FR1			
PDSCH/PDCCH subcarrier spacing	Config 1,2	kHz	15 kHz			
	Config 3		30 kHz			
PUCCH/PUSCH subcarrier spacing	Config 1,2	kHz	15 kHz			
	Config 3		30 kHz			
PRACH configuration			FR1 PRACH configuration 1			
BWP configuration	Initial DL BWP		DLBWP.0.1			
	Dedicated DL BWP		DLBWP.1.1			
	Initial UL BWP		ULBWP.0.1			
	Dedicated UL BWP		ULBWP.1.1			
EPRE ratio of PSS to SSS		dB	0			
EPRE ratio of PBCH DMRS to SSS						
EPRE ratio of PBCH to PBCH DMRS						
EPRE ratio of PDCCH DMRS to SSS						
EPRE ratio of PDCCH to PDCCH DMRS						
EPRE ratio of PDSCH DMRS to SSS						
EPRE ratio of PDSCH to PDSCH						
EPRE ratio of OCNG DMRS to SSS(Note 1)						
EPRE ratio of OCNG to OCNG DMRS (Note 1)						
$N_{oc}^{Note2}$		dBm/15kHz	-98			
$N_{oc}^{Note2}$	Config 1,2	dBm/SCS	-98			
	Config 3		-95			
$\hat{E}_s / I_{ot}$		dB	8	8	-Infinity	8
$\hat{E}_s / N_{oc}$		dB	8	8	-Infinity	8
SSB_RP	Config 1,2	dBm/SCS	-90	-90	-Infinity	-90
	Config 3	dBm/SCS	-87	-87	-Infinity	-87
$I_o^{Note3}$	Config 1,2	dBm/ 9.36MHz	-61.41	-61.41	-70.05	-61.41
	Config 3	dBm/ 38.16MHz	-55.31	-55.31	-63.94	-55.31
Propagation condition			AWGN			
<p>Note 1: OCNG shall be used such that both cells are fully allocated and a constant total transmitted power spectral density is achieved for all OFDM symbols.</p> <p>Note 2: Interference from other cells and noise sources not specified in the test is assumed to be constant over subcarriers and time and shall be modelled as AWGN of appropriate power for <math>N_{oc}</math> to be fulfilled.</p> <p>Note 3: <math>I_o</math> levels have been derived from other parameters for information purposes. They are not settable parameters themselves.</p>						

### A.6.3.1.9.3 Test Requirements

The UE shall start to transmit the PRACH to cell 2 less than 72 ms from the beginning of time period T3.

During T3 UE is allowed to cause  $T_{interrupt1}$  interruption to cell 1.  $T_{interrupt1}$  is defined in clause 6.1.3.2.2 Table 6.1.3.2.2-2. When UE is transmitting PRACH preamble to cell 2, interruption to cell 1 is allowed.

During T4 UE is allowed to cause  $T_{interrupt2}$  interruption to cell 1.  $T_{interrupt2}$  is defined in clause 6.1.3.2.2 Table 6.1.3.2.2-5.

UE shall finish cell 1 release in T4 and shall not send any CSI reports to cell 1 during T5.

The rate of correct handovers observed during repeated tests shall be at least 90%.

### A.6.3.1.10 Intra-band inter-frequency asynchronous DAPS handover test in SA for FR1

#### A.6.3.1.10.1 Test Purpose and Environment

This test is to verify the requirement for the NR FR1-NR FR1 intra-band inter-frequency asynchronous DAPS handover requirements specified in clause 6.1.3.2.

### A.6.3.1.10.2 Test Parameters

Supported test configurations are shown in table A.6.3.1.10.2-1. Both handover delay and interruption length are tested by using the parameters in table A.6.3.1.10.2-2, and A.6.3.1.10.2-3.

The test consists of five successive time periods, with time durations of T1, T2, T3, T4 and T5 respectively. At the start of time duration T1, the UE may not have any timing information of cell 2. The UE shall be configured with periodic CSI reporting for cell1. The test scenario comprises of two carriers and one cell on each carrier. Gap pattern ID gp0 as specified in Table 9.1.2-1 is configured before T2 in the test case.

Starting T2, Cell 2 becomes known to the UE. During T2, the UE shall report Event A3. After receiving the Event A3, the test system shall send a RRC message implying DAPS handover to the UE.

T3 is defined as the end of the last TTI containing the RRC message implying DAPS handover. During T3 UE shall be able to perform random access to cell 2. Cell 1 is continuously scheduled in DL during T3. DL schedule and UL feedback to cell 1 shall be avoided when UE is required to perform DL reception or UL transmission in PRACH procedure in cell 2, except preamble transmission. At the end of T3 cell 2 shall send an RRC message implying cell 1 release command.

T4 is defined as the end of the last TTI containing the RRC message implying DAPS handover. Cell 2 is continuously scheduled in DL during T4. During T4, the UE shall perform source cell release.

Starting T5, the UE shall stop sending CSI report to the source cell. And the test system shall observe the periodic reporting of CSI for cell 1 during T5.

**Table A.6.3.1.10.2-1: Intra-band inter-frequency asynchronous DAPS handover in SA for FR1 test configurations**

Config	Description
1	Source cell: NR 15 kHz SSB SCS, 10 MHz bandwidth, FDD duplex mode Target cell: NR 15 kHz SSB SCS, 10 MHz bandwidth, FDD duplex mode
Note: The UE is only required to be tested in one of the supported test configurations	

**Table A.6.3.1.10.2-2: General test parameters for intra-band inter-frequency asynchronous DAPS handover test in SA for FR1**

Parameter	Unit	Value	Comment
Initial conditions	Active cell	Cell 1	
	Neighbouring cell	Cell 2	
Final condition	Active cell	Cell 2	
A3-Offset	dB	0	
Hysteresis	dB	0	
Time To Trigger	s	0	
Filter coefficient		0	L3 filtering is not used
Access Barring Information	-	Not Sent	No additional delays in random access procedure.
Time offset between cells		10 $\mu$ s	Asynchronous cells
T1	s	5	
T2	s	$\leq 5$	
T3	s	1	
T4	ms	10 + T <sub>interrupt2</sub>	T <sub>interrupt2</sub> is defined in clause 6.1.3.2.2 Table 6.1.3.2.2-5
T5	ms	100	

**Table A.6.3.1.10.2-3: Cell specific test parameters for intra-band inter-frequency asynchronous DAPS handover test in SA for FR1**

Parameter	Unit	Cell 1		Cell 2	
		T1	T2 - T5	T1	T2 - T5
NR RF Channel Number		1		2	
Duplex mode	Config 1	FDD			
TDD configuration	Config 1	Not Applicable			
BW <sub>channel</sub>	Config 1	MHz 10: N <sub>RB,c</sub> = 52			

BWP BW	Config 1	MHz	10: $N_{RB,c} = 52$			
DRX Cycle		ms	Not Applicable			
PDSCH Reference measurement channel	Config 1		SR.1.1 FDD			
CORESET Reference Channel	Config 1		CR.1.1 FDD			
TRS configuration	Config 1		TRS.1.1 FDD			
OCNG Patterns			OP.1			
CSI-RS configuration for CSI reporting	Config 1		CSI-RS.1.1 FDD			
reportConfigType			periodic	N/A		
reportQuantity			cri-RI-PMI-CQI	N/A		
CSI reporting periodicity	Config 1	slot	5	N/A		
CSI reporting offset	Config 1	slot	3	N/A		
SMTC Configuration			SMTC.1			
SSB Configuration	Config 1		SSB.1 FR1			
PDSCH/PDCCH subcarrier spacing	Config 1	kHz	15 kHz			
PUCCH/PUSCH subcarrier spacing	Config 1	kHz	15 kHz			
PRACH configuration			FR1 PRACH configuration 1			
BWP configuration	Initial DL BWP		DLBWP.0.1			
	Dedicated DL BWP		DLBWP.1.1			
	Initial UL BWP		ULBWP.0.1			
	Dedicated UL BWP		ULBWP.1.1			
EPRE ratio of PSS to SSS		dB	0			
EPRE ratio of PBCH DMRS to SSS						
EPRE ratio of PBCH to PBCH DMRS						
EPRE ratio of PDCCH DMRS to SSS						
EPRE ratio of PDCCH to PDCCH DMRS						
EPRE ratio of PDSCH DMRS to SSS						
EPRE ratio of PDSCH to PDSCH						
EPRE ratio of OCNG DMRS to SSS(Note 1)						
EPRE ratio of OCNG to OCNG DMRS (Note 1)						
$N_{oc}$ <sup>Note2</sup>		dBm/15kHz	-98			
$N_{oc}$ <sup>Note2</sup>	Config 1	dBm/SCS	-98			
$\hat{E}_s / I_{\alpha}$		dB	8	8	-Infinity	8
$\hat{E}_s / N_{oc}$		dB	8	8	-Infinity	8
SSB_RP	Config 1	dBm/SCS	-90	-90	-Infinity	-90
$I_0$ <sup>Note3</sup>	Config 1	dBm/9.36MHz	-61.41	-61.41	-70.05	-61.41
Propagation condition			AWGN			
<p>Note 1: OCNG shall be used such that both cells are fully allocated and a constant total transmitted power spectral density is achieved for all OFDM symbols.</p> <p>Note 2: Interference from other cells and noise sources not specified in the test is assumed to be constant over subcarriers and time and shall be modelled as AWGN of appropriate power for <math>N_{oc}</math> to be fulfilled.</p> <p>Note 3: <math>I_0</math> levels have been derived from other parameters for information purposes. They are not settable parameters themselves.</p>						

### A.6.3.1.10.3 Test Requirements

The UE shall start to transmit the PRACH to cell 2 less than 72 ms from the beginning of time period T3.

During T3 UE is allowed to cause  $T_{interrupt1}$  interruption to cell 1.  $T_{interrupt1}$  is defined in clause 6.1.3.2.2 Table 6.1.3.2.2-2. When UE is transmitting PRACH preamble to cell 2, interruption to cell 1 is allowed.

During T4 UE is allowed to cause  $T_{interrupt2}$  interruption to cell 1.  $T_{interrupt2}$  is defined in clause 6.1.3.2.2 Table 6.1.3.2.2-5.

UE shall finish cell 1 release in T4 and shall not send any CSI reports to cell 1 during T5.

The rate of correct handovers observed during repeated tests shall be at least 90%.

### A.6.3.1.11 Inter-band inter-frequency synchronous DAPS handover from FR1 to FR1

#### A.6.3.1.11.1 Test Purpose and Environment

This test is to verify the requirement for the FR1-to-FR1 inter-band inter-frequency synchronous DAPS handover requirements specified in clause 6.1.3.2.

#### A.6.3.1.11.2 Test Parameters

Supported test configurations are shown in table A.6.3.1.11.2-1. Both handover delay and interruption length are tested by using the parameters in table A.6.3.1.11.2-2, A.6.3.1.11.2-3 and A.6.3.1.11.2-4.

The test scenario comprises of two bands each with one cell. The test consists of five successive time periods, with time durations of T1, T2, T3, T4 and T5 respectively.

Before the start of T1, the UE is connected to Cell 1 (source PCell) on radio channel 1 but is not aware of Cell 2 (neighbour cell) on radio channel 2. The UE shall be configured with periodic CSI reporting for cell1. During T1, the UE shall not have any timing information of Cell 2.

Before the start of T2, the UE in the measurement control information that event-triggered reporting with Event A3 is configured for neighbour cell (Cell 2), and the UE is configured with the measurement gaps (gap pattern ID # 0). Starting T2, Cell 2 becomes known to the UE. During T2, the UE shall report Event A3. After receiving the Event A3, the test system shall send a RRC message implying DAPS handover to the UE.

The start of T3 is the instant when the last TTI containing the RRC message implying DAPS handover to Cell 2 (target PCell) is sent to the UE. During T3, the UE shall be able to perform random access to Cell 2. DL schedule and UL feedback to cell 1 shall be avoided when UE is required to perform DL reception or UL transmission in PRACH procedure in cell 2, except preamble transmission. After the RACH procedure is completed, the test system shall send a RRC message to the UE to release Cell 1 (source cell) on radio channel 1.

The start of T4 is the instant when the last TTI containing the RRC message implying source cell release is sent to the UE. During T4, the UE shall perform source cell release.

Starting T5, the UE shall stop sending CSI report to the source cell.

**Table A.6.3.1.11.2-1: Inter-band inter-frequency synchronous DAPS handover from FR1 to FR1 test configurations**

Config	Description
1	Source cell: NR 15 kHz SSB SCS, 10 MHz bandwidth, FDD duplex mode Target cell: NR 15 kHz SSB SCS, 10 MHz bandwidth, FDD duplex mode
2	Source cell: NR 15 kHz SSB SCS, 10 MHz bandwidth, TDD duplex mode Target cell: NR 15 kHz SSB SCS, 10 MHz bandwidth, FDD duplex mode
3	Source cell: NR 30 kHz SSB SCS, 40 MHz bandwidth, TDD duplex mode Target cell: NR 15 kHz SSB SCS, 10 MHz bandwidth, FDD duplex mode
4	Source cell: NR 15 kHz SSB SCS, 10 MHz bandwidth, FDD duplex mode Target cell: NR 15 kHz SSB SCS, 10 MHz bandwidth, TDD duplex mode
5	Source cell: NR 15 kHz SSB SCS, 10 MHz bandwidth, TDD duplex mode Target cell: NR 15 kHz SSB SCS, 10 MHz bandwidth, TDD duplex mode
6	Source cell: NR 30 kHz SSB SCS, 40 MHz bandwidth, TDD duplex mode Target cell: NR 15 kHz SSB SCS, 10 MHz bandwidth, TDD duplex mode
7	Source cell: NR 15 kHz SSB SCS, 10 MHz bandwidth, FDD duplex mode Target cell: NR 30 kHz SSB SCS, 40 MHz bandwidth, TDD duplex mode
8	Source cell: NR 15 kHz SSB SCS, 10 MHz bandwidth, TDD duplex mode Target cell: NR 30 kHz SSB SCS, 40 MHz bandwidth, TDD duplex mode
9	Source cell: NR 30 kHz SSB SCS, 40 MHz bandwidth, TDD duplex mode Target cell: NR 30 kHz SSB SCS, 40 MHz bandwidth, TDD duplex mode
Note:	The UE is only required to be tested in one of the supported test configurations

**Table A.6.3.1.11.2-2: General test parameters for inter-band inter-frequency synchronous DAPS handover from FR1 to FR1**

Parameter	Unit	Value	Comment
Initial conditions	Active cell	Cell 1	PCell on RF channel number 1

	Neighbouring cell		Cell 2	Neighbour cell on RF channel number 2
Final condition	Active cell		Cell 2	PCell on RF channel number 2
	Neighbouring cell		Cell 1	Neighbour cell on RF channel number 1
A3-Offset		dB	-6	
Hysteresis		dB	0	
Time To Trigger		s	0	
Filter coefficient			0	L3 filtering is not used
Access Barring Information		-	Not Sent	No additional delays in random access procedure.
Time offset between cells		µs	33	Synchronous cells
DRX			OFF	
Measurement gap pattern Id			#0	Gaps are configured before T2.
T1		s	5	
T2		s	<5	
T3		s	<0.5	
T4		ms	10+T <sub>interrupt2</sub>	T <sub>interrupt2</sub> as defined in Table 6.1.3.2.2-6 for synchronous DAPS HO
T5		ms	100	

**Table A.6.3.1.11.2-3: Cell specific test parameters for inter-band inter-frequency synchronous DAPS handover from FR1 to FR1 (Cell 1)**

Parameter		Unit	Cell 1	
			T1	T2 – T5
NR RF Channel Number			1	
Duplex mode	Config 1,4,7		FDD	
	Config 2,3,5,6,8,9		TDD	
TDD configuration	Config 1,4,7		Not Applicable	
	Config 2,5,8		TDDConf.1.1	
	Config 3,6,9		TDDConf.2.1	
BW <sub>channel</sub>	Config 1,4,7	MHz	10: N <sub>RB,c</sub> = 52	
	Config 2,5,8		10: N <sub>RB,c</sub> = 52	
	Config 3,6,9		40: N <sub>RB,c</sub> = 106	
BWP BW	Config 1,4,7	MHz	10: N <sub>RB,c</sub> = 52	
	Config 2,5,8		10: N <sub>RB,c</sub> = 52	
	Config 3,6,9		40: N <sub>RB,c</sub> = 106	
TRS configuration	Config 1,4,7		TRS.1.1 FDD	
	Config 2,5,8		TRS.1.1 TDD	
	Config 3,6,9		TRS.1.2 TDD	
DRX Cycle		ms	Not Applicable	
PDSCH Reference measurement channel	Config 1,4,7		SR.1.1 FDD	
	Config 2,5,8		SR.1.1 TDD	
	Config 3,6,9		SR.2.1 TDD	
CORESET Reference Channel	Config 1,4,7		CR.1.1 FDD	
	Config 2,5,8		CR.1.1 TDD	
	Config 3,6,9		CR.2.1 TDD	
OCNG Patterns			OP.1	
CSI-RS configuration for CSI reporting	Config 1,4,7		CSI-RS.1.1 FDD	
	Config 2,5,8		CSI-RS.1.1 TDD	
	Config 3,6,9		CSI-RS.2.1 TDD	
reportConfigType			periodic	
reportQuantity			cri-RI-PMI-CQI	
CSI reporting periodicity	Config 1,2,4,5,7,8	slot	5	
	Config 3,6,9		10	
CSI reporting offset	Config 1,2,4,5,7,8	slot	3	
	Config 3,6,9		5	
SMTc Configuration			SMTc.1	
SSB Configuration	Config 1,2,4,5,7,8		SSB.1 FR1	
	Config 3,6,9		SSB.2 FR1	
PDSCH/PDCCH subcarrier spacing	Config 1,2,4,5,7,8	kHz	15 kHz	
	Config 3,6,9		30 kHz	
	Config 1,2,4,5,7,8	kHz	15 kHz	

PUCCH/PUSCH subcarrier spacing	Config 3,6,9		30 kHz	
PRACH configuration			FR1 PRACH configuration 2	
BWP	Initial DL BWP		DLBWP.0.1	
	Dedicated DL BWP		DLBWP.1.3	
	Initial UL BWP		ULBWP.0.1	
	Dedicated UL BWP		ULBWP.1.3	
EPRE ratio of PSS to SSS		dB	0	
EPRE ratio of PBCH DMRS to SSS				
EPRE ratio of PBCH to PBCH DMRS				
EPRE ratio of PDCCH DMRS to SSS				
EPRE ratio of PDCCH to PDCCH DMRS				
EPRE ratio of PDSCH DMRS to SSS				
EPRE ratio of PDSCH to PDSCH				
EPRE ratio of OCNG DMRS to SSS(Note 1)				
EPRE ratio of OCNG to OCNG DMRS (Note 1)				
$N_{oc}$ <sup>Note2</sup>		dBm/15kHz	-98	-98
$N_{oc}$ <sup>Note2</sup>	Config 1,2,4,5,7,8	dBm/SCS	-98	-98
	Config 3,6,9		-95	-95
$\hat{E}_s / I_{at}$		dB	4	4
$\hat{E}_s / N_{oc}$		dB	4	4
SSB_RP	Config 1,2,4,5,7,8	dBm/SCS	-94	-94
	Config 3,6,9	dBm/SCS	-91	-91
$I_o$ <sup>Note3</sup>	Config 1,2,4,5,7,8	dBm/9.36MHz	-64.59	-64.59
	Config 3,6,9	dBm/38.16MHz	-58.49	-58.49
Propagation condition		-	AWGN	
<p>Note 1: OCNG shall be used such that the cell is fully allocated and a constant total transmitted power spectral density is achieved for all OFDM symbols.</p> <p>Note 2: Interference from other cells and noise sources not specified in the test is assumed to be constant over subcarriers and time and shall be modelled as AWGN of appropriate power for <math>N_{oc}</math> to be fulfilled.</p> <p>Note 3: <math>I_o</math> levels have been derived from other parameters for information purposes. They are not settable parameters themselves.</p>				

**Table A.6.3.1.11.2-4: Cell specific test parameters for inter-band inter-frequency synchronous DAPS handover from FR1 to FR1 (Cell 2)**

Parameter		Unit	Cell 2	
			T1	T2-T5
NR RF Channel Number			2	
Duplex mode	Config 1,2,3		FDD	
	Config 4,5,6,7,8,9		TDD	
TDD configuration	Config 1,2,3		Not Applicable	
	Config 4,5,6		TDDConf.1.1	
	Config 7,8,9		TDDConf.2.1	
$BW_{channel}$	Config 1,2,3	MHz	10: $N_{RB,c} = 52$	
	Config 4,5,6		10: $N_{RB,c} = 52$	
	Config 7,8,9		40: $N_{RB,c} = 106$	
BWP BW	Config 1,2,3	MHz	10: $N_{RB,c} = 52$	
	Config 4,5,6		10: $N_{RB,c} = 52$	
	Config 7,8,9		40: $N_{RB,c} = 106$	
TRS configuration	Config 1,2,3		TRS.1.1 FDD	
	Config 4,5,6		TRS.1.1 TDD	
	Config 7,8,9		TRS.1.2 TDD	
DRx Cycle		ms	Not Applicable	
PDSCH Reference measurement channel	Config 1,2,3		SR.1.1 FDD	
	Config 4,5,6		SR.1.1 TDD	
	Config 7,8,9		SR2.1 TDD	
CORESET Reference Channel	Config 1,2,3		CR.1.1 FDD	
	Config 4,5,6		CR.1.1 TDD	
	Config 7,8,9		CR2.1 TDD	
OCNG Patterns			OCNG pattern 1	

CSI-RS configuration for CSI reporting	Config 1,2,3		CSI-RS.1.1 FDD	
	Config 4,5,6		CSI-RS.1.1 TDD	
	Config 7,8,9		CSI-RS.2.1 TDD	
SMTC Configuration			SMTC pattern 1	
SSB Configuration	Config 1,2,3,4,5,6		SSB.1 FR1	
	Config 7,8,9		SSB.2 FR1	
PDSCH/PDCCH subcarrier spacing	Config 1,2,3,4,5,6	kHz	15 kHz	
	Config 7,8,9		30 kHz	
PUCCH/PUSCH subcarrier spacing	Config 1,2,3,4,5,6	kHz	15 kHz	
	Config 7,8,9		30 kHz	
PRACH configuration			FR1 PRACH configuration 2	
BWP	Initial DL BWP		DLBWP.0.1	
	Dedicated DL BWP		DLBWP.1.3	
	Initial UL BWP		ULBWP.0.1	
	Dedicated UL BWP		ULBWP.1.3	
EPRE ratio of PSS to SSS		dB	0	
EPRE ratio of PBCH DMRS to SSS				
EPRE ratio of PBCH to PBCH DMRS				
EPRE ratio of PDCCH DMRS to SSS				
EPRE ratio of PDCCH to PDCCH DMRS				
EPRE ratio of PDSCH DMRS to SSS				
EPRE ratio of PDSCH to PDSCH				
EPRE ratio of OCNG DMRS to SSS(Note 1)				
EPRE ratio of OCNG to OCNG DMRS (Note 1)				
$N_{oc}$ <sup>Note2</sup>		dBm/15kHz	-98	-98
$N_{oc}$ <sup>Note2</sup>	Config 1,2,3,4,5,6	dBm/SCS	-98	-98
	Config 7,8,9		-95	-95
$\hat{E}_s / I_{\alpha}$		dB	-Infinity	4
$\hat{E}_s / N_{oc}$		dB	-Infinity	4
SSB_RP	Config 1,2,3,4,5,6	dBm/SCS	-Infinity	-94
	Config 7,8,9	dBm/SCS	-Infinity	-91
$I_0$ <sup>Note3</sup>	Config 1,2,3,4,5,6	dBm/ 9.36MHz	-70.05	-64.59
	Config 7,8,9	dBm/ 38.16MHz	-63.94	-58.49
Propagation condition		-	AWGN	
Note 1: OCNG shall be used such that the cell is fully allocated and a constant total transmitted power spectral density is achieved for all OFDM symbols.				
Note 2: Interference from other cells and noise sources not specified in the test is assumed to be constant over subcarriers and time and shall be modelled as AWGN of appropriate power for $N_{oc}$ to be fulfilled.				
Note 3: $I_0$ levels have been derived from other parameters for information purposes. They are not settable parameters themselves.				

### A.6.3.1.11.3 Test Requirements

The UE shall start to transmit the PRACH to Cell 2 less than 72 ms from the beginning of time period T3. During  $D_{handover1}$ , the interruption on Cell 1 shall not exceed  $T_{interrupt1}$  as defined in Table 6.1.3.2.2-3 for synchronous DAPS HO.

The rate of correct handovers observed during repeated tests shall be at least 90%.

NOTE: The handover delay  $D_{handover1}$  can be expressed as:  $T_{RRC\_procedure} + T_{IU} + T_{processing} + T_{\Delta} + T_{margin}$ , where:

$T_{RRC\_procedure} = 10$  ms and is specified in clause 12 in TS 38.331 [2].

$T_{IU} = 20$  ms in the test.  $T_{IU}$  is defined in clause 6.1.1.2.2.

$T_{\Delta} = 20$  ms in the test.  $T_{\Delta}$  is defined in clause 6.1.1.2.2.

$T_{processing} = 20$  ms in the test.  $T_{processing}$  is defined in clause 6.1.1.2.2.

$T_{margin} = 2$  ms in the test.  $T_{margin}$  is defined in clause 6.1.1.2.2.

This gives a total of 72 ms.



The UE shall complete to release Cell 1 less than  $(10 \text{ ms} + T_{\text{interrupt}2})$  from the beginning of time period T4. During  $D_{\text{handover}2}$ , the interruption on Cell 2 shall not exceed  $T_{\text{interrupt}2}$  as defined in Table 6.1.3.2.2-6 for synchronous DAPS HO.

The rate of correct handovers observed during repeated tests shall be at least 90%.

NOTE: The handover delay  $D_{\text{handover}2}$  can be expressed as:  $T_{\text{RRC\_procedure}} + T_{\text{interrupt}2}$ , where:

$T_{\text{RRC\_procedure}} = 10 \text{ ms}$  and is specified in clause 12 in TS 38.331 [2].

### A.6.3.1.12 Inter-band inter-frequency asynchronous DAPS handover from FR1 to FR1

#### A.6.3.1.12.1 Test Purpose and Environment

This test is to verify the requirement for the FR1-to-FR1 inter-band inter-frequency asynchronous DAPS handover requirements specified in clause 6.1.3.2.

#### A.6.3.1.12.2 Test Parameters

Supported test configurations are shown in table A.6.3.1.12.2-1. Both handover delay and interruption length are tested by using the parameters in table A.6.3.1.12.2-2, A.6.3.1.12.2-3 and A.6.3.1.12.2-4.

The test scenario comprises of two bands each with one cell. The test consists of five successive time periods, with time durations of T1, T2, T3, T4 and T5 respectively.

Before the start of T1, the UE is connected to Cell 1 (source PCell) on radio channel 1 but is not aware of Cell 2 (neighbour cell) on radio channel 2. The UE shall be configured with periodic CSI reporting for cell1. During T1, the UE shall not have any timing information of Cell 2.

Before the start of T2, the UE in the measurement control information that event-triggered reporting with Event A3 is configured for neighbour cell (Cell 2), and the UE is configured with the measurement gaps (gap pattern ID # 0). Starting T2, Cell 2 becomes known to the UE. During T2, the UE shall report Event A3. After receiving the Event A3, the test system shall send a RRC message implying DAPS handover to the UE.

The start of T3 is the instant when the last TTI containing the RRC message implying DAPS handover to Cell 2 (target PCell) is sent to the UE. During T3, the UE shall be able to perform random access to Cell 2. DL schedule and UL feedback to cell 1 shall be avoided when UE is required to perform DL reception or UL transmission in PRACH procedure in cell 2, except preamble transmission. After the RACH procedure is completed, the test system shall send a RRC message to the UE to release Cell 1 (source cell) on radio channel 1.

The start of T4 is the instant when the last TTI containing the RRC message implying source cell release is sent to the UE. During T4, the UE shall perform source cell release.

Starting T5, the UE shall stop sending CSI report to the source cell.

**Table A.6.3.1.12.2-1: Inter-band inter-frequency asynchronous DAPS handover from FR1 to FR1 test configurations**

Config	Description
1	Source cell: NR 15 kHz SSB SCS, 10 MHz bandwidth, FDD duplex mode Target cell: NR 15 kHz SSB SCS, 10 MHz bandwidth, FDD duplex mode
2	Source cell: NR 15 kHz SSB SCS, 10 MHz bandwidth, TDD duplex mode Target cell: NR 15 kHz SSB SCS, 10 MHz bandwidth, FDD duplex mode
3	Source cell: NR 30 kHz SSB SCS, 40 MHz bandwidth, TDD duplex mode Target cell: NR 15 kHz SSB SCS, 10 MHz bandwidth, FDD duplex mode
4	Source cell: NR 15 kHz SSB SCS, 10 MHz bandwidth, FDD duplex mode Target cell: NR 15 kHz SSB SCS, 10 MHz bandwidth, TDD duplex mode
5	Source cell: NR 15 kHz SSB SCS, 10 MHz bandwidth, TDD duplex mode Target cell: NR 15 kHz SSB SCS, 10 MHz bandwidth, TDD duplex mode
6	Source cell: NR 30 kHz SSB SCS, 40 MHz bandwidth, TDD duplex mode Target cell: NR 15 kHz SSB SCS, 10 MHz bandwidth, TDD duplex mode
7	Source cell: NR 15 kHz SSB SCS, 10 MHz bandwidth, FDD duplex mode Target cell: NR 30 kHz SSB SCS, 40 MHz bandwidth, TDD duplex mode
8	Source cell: NR 15 kHz SSB SCS, 10 MHz bandwidth, TDD duplex mode Target cell: NR 30 kHz SSB SCS, 40 MHz bandwidth, TDD duplex mode

9	Source cell: NR 30 kHz SSB SCS, 40 MHz bandwidth, TDD duplex mode Target cell: NR 30 kHz SSB SCS, 40 MHz bandwidth, TDD duplex mode
Note: The UE is only required to be tested in one of the supported test configurations	

**Table A.6.3.1.12.2-2: General test parameters for inter-band inter-frequency asynchronous DAPS handover from FR1 to FR1**

Parameter		Unit	Value	Comment
Initial conditions	Active cell		Cell 1	
	Neighbouring cell		Cell 2	
Final condition	Active cell		Cell 2	
A3-Offset		dB	-4	
Hysteresis		dB	0	
Time To Trigger		s	0	
Filter coefficient			0	L3 filtering is not used
Access Barring Information		-	Not Sent	No additional delays in random access procedure.
Time offset between cells	Config 1,2,4,5	ms	0.5	Asynchronous cells
	Config3,6,7,8,9	ms	0.25	
DRX			OFF	
Measurement gap pattern Id			#0	Gaps are configured before T2.
T1		s	5	
T2		s	<5	
T3		s	<0.5	
T4		ms	10+T <sub>interrupt2</sub>	T <sub>interrupt2</sub> as defined in Table 6.1.3.2.2-6 for asynchronous DAPS HO.
T5		ms	100	

**Table A.6.3.1.12.2-3: Cell specific test parameters for inter-band inter-frequency asynchronous DAPS handover from FR1 to FR1 (Cell 1)**

Parameter		Unit	Cell 1	
			T1	T2 – T5
NR RF Channel Number			1	
Duplex mode	Config 1,4,7		FDD	
	Config 2,3,5,6,8,9		TDD	
TDD configuration	Config 1,4,7		Not Applicable	
	Config 2,5,8		TDDConf.1.1	
	Config 3,6,9		TDDConf.2.1	
BW <sub>channel</sub>	Config 1,4,7	MHz	10: N <sub>RB,c</sub> = 52	
	Config 2,5,8		10: N <sub>RB,c</sub> = 52	
	Config 3,6,9		40: N <sub>RB,c</sub> = 106	
BWP BW	Config 1,4,7	MHz	10: N <sub>RB,c</sub> = 52	
	Config 2,5,8		10: N <sub>RB,c</sub> = 52	
	Config 3,6,9		40: N <sub>RB,c</sub> = 106	
TRS configuration	Config 1,4,7		TRS.1.1 FDD	
	Config 2,5,8		TRS.1.1 TDD	
	Config 3,6,9		TRS.1.2 TDD	
DRX Cycle		ms	Not Applicable	
PDSCH Reference measurement channel	Config 1,4,7		SR.1.1 FDD	
	Config 2,5,8		SR.1.1 TDD	
	Config 3,6,9		SR.2.1 TDD	
CORESET Reference Channel	Config 1,4,7		CR.1.1 FDD	
	Config 2,5,8		CR.1.1 TDD	
	Config 3,6,9		CR.2.1 TDD	
OCNG Patterns			OP.1	
CSI-RS configuration for CSI reporting	Config 1,4,7		CSI-RS.1.1 FDD	
	Config 2,5,8		CSI-RS.1.1 TDD	
	Config 3,6,9		CSI-RS.2.1 TDD	
reportConfigType			periodic	
reportQuantity			cri-RI-PMI-CQI	
CSI reporting periodicity	Config 1,2,4,5,7,8	slot	5	

	Config 3,6,9		10	
CSI reporting offset	Config 1,2,4,5,7,8	slot	3	
	Config 3,6,9		5	
SMTc Configuration			SMTc.1	
SSB Configuration	Config 1,2,4,5,7,8		SSB.1 FR1	
	Config 3,6,9		SSB.2 FR1	
PDSCH/PDCCH subcarrier spacing	Config 1,2,4,5,7,8	kHz	15 kHz	
	Config 3,6,9		30 kHz	
PUCCH/PUSCH subcarrier spacing	Config 1,2,4,5,7,8	kHz	15 kHz	
	Config 3,6,9		30 kHz	
PRACH configuration			FR1 PRACH configuration 2	
BWP	Initial DL BWP		DLBWP.0.1	
	Dedicated DL BWP		DLBWP.1.3	
	Initial UL BWP		ULBWP.0.1	
	Dedicated UL BWP		ULBWP.1.3	
EPRE ratio of PSS to SSS		dB	0	
EPRE ratio of PBCH DMRS to SSS				
EPRE ratio of PBCH to PBCH DMRS				
EPRE ratio of PDCCH DMRS to SSS				
EPRE ratio of PDCCH to PDCCH DMRS				
EPRE ratio of PDSCH DMRS to SSS				
EPRE ratio of PDSCH to PDSCH				
EPRE ratio of OCNcG DMRS to SSS(Note 1)				
EPRE ratio of OCNcG to OCNcG DMRS (Note 1)				
$N_{oc}^{Note2}$				
$N_{oc}^{Note2}$	Config 1,2,4,5,7,8	dBm/SCS	-98	-98
	Config 3,6,9		-95	-95
$\hat{E}_s / I_{at}$		dB	4	4
$\hat{E}_s / N_{oc}$		dB	4	4
SSB_RP	Config 1,2,4,5,7,8	dBm/SCS	-94	-94
	Config 3,6,9	dBm/SCS	-91	-91
$I_0^{Note3}$	Config 1,2,4,5,7,8	dBm/ 9.36MHz	-64.59	-64.59
	Config 3,6,9	dBm/ 38.16MHz	-58.49	-58.49
Propagation condition		-	AWGN	
<p>Note 1: OCNcG shall be used such that the cell is fully allocated and a constant total transmitted power spectral density is achieved for all OFDM symbols.</p> <p>Note 2: Interference from other cells and noise sources not specified in the test is assumed to be constant over subcarriers and time and shall be modelled as AWGN of appropriate power for <math>N_{oc}</math> to be fulfilled.</p> <p>Note 3: <math>I_0</math> levels have been derived from other parameters for information purposes. They are not settable parameters themselves.</p>				

**Table A.6.3.1.12.2-4: Cell specific test parameters for inter-band inter-frequency asynchronous DAPS handover from FR1 to FR1 (Cell 2)**

Parameter		Unit	Cell 2	
			T1	T2-T5
NR RF Channel Number			2	
Duplex mode	Config 1,2,3		FDD	
	Config 4,5,6,7,8,9		TDD	
TDD configuration	Config 1,2,3		Not Applicable	
	Config 4,5,6		TDDConf.1.1	
	Config 7,8,9		TDDConf.2.1	
BW <sub>channel</sub>	Config 1,2,3	MHz	10: N <sub>RB,c</sub> = 52	
	Config 4,5,6		10: N <sub>RB,c</sub> = 52	
	Config 7,8,9		40: N <sub>RB,c</sub> = 106	
BWP BW	Config 1,2,3	MHz	10: N <sub>RB,c</sub> = 52	
	Config 4,5,6		10: N <sub>RB,c</sub> = 52	
	Config 7,8,9		40: N <sub>RB,c</sub> = 106	
TRS configuration	Config 1,2,3		TRS.1.1 FDD	
	Config 4,5,6		TRS.1.1 TDD	
	Config 7,8,9		TRS.1.2 TDD	

DRx Cycle		ms	Not Applicable	
PDSCH Reference measurement channel	Config 1,2,3		SR.1.1 FDD	
	Config 4,5,6		SR.1.1 TDD	
	Config 7,8,9		SR2.1 TDD	
CORESET Reference Channel	Config 1,2,3		CR.1.1 FDD	
	Config 4,5,6		CR.1.1 TDD	
	Config 7,8,9		CR2.1 TDD	
OCNG Patterns			OCNG pattern 1	
CSI-RS configuration for CSI reporting	Config 1,2,3		CSI-RS.1.1 FDD	
	Config 4,5,6		CSI-RS.1.1 TDD	
	Config 7,8,9		CSI-RS.2.1 TDD	
SMTC Configuration			SMTC pattern 1	
SSB Configuration	Config 1,2,3,4,5,6		SSB.1 FR1	
	Config 7,8,9		SSB.2 FR1	
PDSCH/PDCCH subcarrier spacing	Config 1,2,3,4,5,6	kHz	15 kHz	
	Config 7,8,9		30 kHz	
PUCCH/PUSCH subcarrier spacing	Config 1,2,3,4,5,6	kHz	15 kHz	
	Config 7,8,9		30 kHz	
PRACH configuration			FR1 PRACH configuration 2	
BWP	Initial DL BWP		DLBWP.0.1	
	Dedicated DL BWP		DLBWP.1.3	
	Initial UL BWP		ULBWP.0.1	
	Dedicated UL BWP		ULBWP.1.3	
EPRE ratio of PSS to SSS		dB	0	
EPRE ratio of PBCH DMRS to SSS				
EPRE ratio of PBCH to PBCH DMRS				
EPRE ratio of PDCCH DMRS to SSS				
EPRE ratio of PDCCH to PDCCH DMRS				
EPRE ratio of PDSCH DMRS to SSS				
EPRE ratio of PDSCH to PDSCH				
EPRE ratio of OCNG DMRS to SSS(Note 1)				
EPRE ratio of OCNG to OCNG DMRS (Note 1)				
$N_{oc}$ <sup>Note2</sup>		dBm/15kHz	-98	-98
$N_{oc}$ <sup>Note2</sup>	Config 1,2,3,4,5,6	dBm/SCS	-98	-98
	Config 7,8,9		-95	-95
$\hat{E}_s / I_{ot}$		dB	-Infinity	4
$\hat{E}_s / N_{oc}$		dB	-Infinity	4
SSB_RP	Config 1,2,3,4,5,6	dBm/SCS	-Infinity	-94
	Config 7,8,9	dBm/SCS	-Infinity	-91
$I_o$ <sup>Note3</sup>	Config 1,2,3,4,5,6	dBm/ 9.36MHz	-70.05	-64.59
	Config 7,8,9	dBm/ 38.16MHz	-63.94	-58.49
Propagation condition		-	AWGN	
<p>Note 1: OCNG shall be used such that the cell is fully allocated and a constant total transmitted power spectral density is achieved for all OFDM symbols.</p> <p>Note 2: Interference from other cells and noise sources not specified in the test is assumed to be constant over subcarriers and time and shall be modelled as AWGN of appropriate power for <math>N_{oc}</math> to be fulfilled.</p> <p>Note 3: <math>I_o</math> levels have been derived from other parameters for information purposes. They are not settable parameters themselves.</p>				

### A.6.3.1.12.3 Test Requirements

The UE shall start to transmit the PRACH to Cell 2 less than 72 ms from the beginning of time period T3. During  $D_{handover1}$ , the interruption on Cell 1 shall not exceed  $T_{interrupt1}$  as defined in Table 6.1.3.2.2-3 for asynchronous DAPS HO.

The rate of correct handovers observed during repeated tests shall be at least 90%.

NOTE: The handover delay  $D_{handover1}$  can be expressed as:  $T_{RRC\_procedure} + T_{IU} + T_{processing} + T_{\Delta} + T_{margin}$ , where:

$T_{\text{RRC\_procedure}} = 10$  ms and is specified in clause 12 in TS 38.331 [2].

$T_{\text{IU}} = 20$  ms in the test.  $T_{\text{IU}}$  is defined in clause 6.1.1.2.2.

$T_{\Delta} = 20$  ms in the test.  $T_{\Delta}$  is defined in clause 6.1.1.2.2.

$T_{\text{processing}} = 20$  ms in the test.  $T_{\text{processing}}$  is defined in clause 6.1.1.2.2.

$T_{\text{margin}} = 2$  ms in the test.  $T_{\text{margin}}$  is defined in clause 6.1.1.2.2.

This gives a total of 72 ms.

The UE shall complete to release Cell 1 less than  $(10 \text{ ms} + T_{\text{interrupt}2})$  from the beginning of time period T4. During  $D_{\text{handover}2}$ , the interruption on Cell 2 shall not exceed  $T_{\text{interrupt}2}$  as defined in Table 6.1.3.2.2-6 for asynchronous DAPS HO.

The rate of correct handovers observed during repeated tests shall be at least 90%.

NOTE: The handover delay  $D_{\text{handover}2}$  can be expressed as:  $T_{\text{RRC\_procedure}} + T_{\text{interrupt}2}$ , where:

$T_{\text{RRC\_procedure}} = 10$  ms and is specified in clause 12 in TS 38.331 [2].

## A.6.3.2 RRC Connection Mobility Control

### A.6.3.2.1 SA: RRC Re-establishment

#### A.6.3.2.1.1 Intra-frequency RRC Re-establishment in FR1

##### A.6.3.2.1.1.1 Test Purpose and Environment

The purpose is to verify that the NR intra-frequency RRC re-establishment delay in FR1 with known target cell is within the specified limits. These tests will verify the requirements in clause 6.2.1.

The test parameters are given in table A.6.3.2.1.1.1-1, table A.6.3.2.1.1.1-2 and table A.6.3.2.1.1.1-3 below. The test consists of 3 successive time periods, with time duration of T1, T2 and T3 respectively. At the start of time period T2, cell 1, which is the active cell, is deactivated. The time period T3 starts after the occurrence of the radio link failure.

**Table A.6.3.2.1.1.1-1: Supported test configurations**

Configuration	Description
1	15 kHz SSB SCS, 10 MHz bandwidth, FDD duplex mode
2	15 kHz SSB SCS, 10 MHz bandwidth, TDD duplex mode
3	30 kHz SSB SCS, 40 MHz bandwidth, TDD duplex mode

Note: The UE is only required to be tested in one of the supported test configurations.

**Table A.6.3.2.1.1.1-2: General test parameters for NR intra-frequency RRC Re-establishment test case in FR1**

Parameter		Unit	Test configuration	Value	Comment
Initial condition	Active cell		1, 2, 3	Cell1	
	Neighbour cells		1, 2, 3	Cell2	
Final condition	Active cell		1, 2, 3	Cell2	
RF Channel Number			1, 2, 3	1	
Time offset between cells			1	3 ms	Asynchronous cells
			2	3 $\mu$ s	Synchronous cells
			3	3 $\mu$ s	Synchronous cells
N310		-	1, 2, 3	1	Maximum consecutive out-of-sync indications from lower layers
N311		-	1, 2, 3	1	Minimum consecutive in-sync indications from lower layers
T310		ms	1, 2, 3	0	Radio link failure timer;

T311	ms	1, 2, 3	3000	RRC re-establishment timer
Access Barring Information	-	1, 2, 3	Not Sent	No additional delays in random access procedure.
SSB configuration		1	SSB.1 FR1	
		2	SSB.1 FR1	
		3	SSB.2 FR1	
SMTC configuration		1	SMTC.2	
		2	SMTC.1	
		3	SMTC.1	
DRX cycle length	s	1, 2, 3	OFF	
PRACH configuration		1, 2, 3	FR1 PRACH configuration 1	Table A.3.8.2.1-1
T1	s	1, 2, 3	5	
T2	ms	1, 2, 3	240	Time for the UE to detect RLF (Summation of T <sub>Evaluate_out_SSB</sub> defined in clause 8.1 in TS 38.133, T310 and the period for UE turns off transmitter defined in clause 8.1.5 in TS 38.133 )
T3	s	1, 2, 3	2	

**Table A.6.3.2.1.1.1-3: Cell specific test parameters for NR intra-frequency RRC Re-establishment test case in FR1**

Parameter	Unit	Test configuration	Cell 1			Cell 2		
			T1	T2	T3	T1	T2	T3
TDD configuration		1	N/A			N/A		
		2	TDDConf.1.1			TDDConf.1.1		
		3	TDDConf.2.1			TDDConf.2.1		
PDSCH RMC configuration		1	SR.1.1 FDD			SR.1.1 FDD		
		2	SR.1.1 TDD			SR.1.1 TDD		
		3	SR.2.1 TDD			SR.2.1 TDD		
RMSI CORESET RMC configuration		1	CR.1.1 FDD			CR.1.1 FDD		
		2	CR.1.1 TDD			CR.1.1 TDD		
		3	CR.2.1 TDD			CR.2.1 TDD		
Dedicated CORESET RMC configuration		1	CCR.1.1 FDD			CCR.1.1 FDD		
		2	CCR.1.1 TDD			CCR.1.1 TDD		
		3	CCR.2.1 TDD			CCR.2.1 TDD		
OCNG Pattern		1, 2, 3	OP.1 defined in A.3.2.1			OP.1 defined in A.3.2.1		
TRS configuration		1	TRS.1.1 FDD			TRS.1.1 FDD		
		2	TRS.1.1 TDD			TRS.1.1 TDD		
		3	TRS.1.2 TDD			TRS.1.2 TDD		
Initial DL BWP configuration		1, 2, 3	DLBWP.0.1			DLBWP.0.1		
Initial UL BWP configuration		1, 2, 3	ULBWP.0.1			ULBWP.0.1		
Active DL BWP configuration		1, 2, 3	DLBWP.1.1	N/A	N/A	N/A	N/A	DLBW P.1.1
Active UL BWP configuration		1, 2, 3	ULBWP.1.1	N/A	N/A	N/A	N/A	ULBW P.1.1
RLM-RS		1, 2, 3	SSB			SSB		
$\hat{E}_s/I_{\alpha}$	dB	1	1.54	-infinity	-infinity	-3.79	4	4
		2						
		3						

$N_{oc}$ Note2	dBm/SCS	1	-98					
		2	-98					
		3	-95					
$N_{oc}$ Note2	dBm/15 kHz	1	-98					
		2						
		3						
$\hat{E}_s / N_{oc}$	dB	1	7	-infinity	-infinity	4	4	4
		2						
		3						
SS-RSRP Note3	dBm/SCS	1	-91	-infinity	-infinity	-94	-94	-94
		2	-91	-infinity	-infinity	-94	-94	-94
		3	-88	-infinity	-infinity	-91	-91	-91
Io	dBm/9.36 MHz	1	-60.74	-64.59	-64.59	-60.74	-64.59	-64.59
	dBm/9.36 MHz	2	-60.74	-64.59	-64.59	-60.74	-64.59	-64.59
	dBm/38.16 MHz	3	-54.65	-58.50	-58.50	-54.65	-58.50	-58.50
Propagation Condition		1, 2, 3	AWGN					
<p>Note 1: OCNG shall be used such that both cells are fully allocated and a constant total transmitted power spectral density is achieved for all OFDM symbols.</p> <p>Note 2: Interference from other cells and noise sources not specified in the test is assumed to be constant over subcarriers and time and shall be modelled as AWGN of appropriate power for <math>N_{oc}</math> to be fulfilled.</p> <p>Note 3: SS-RSRP levels have been derived from other parameters for information purposes. They are not settable parameters themselves.</p>								

#### A.6.3.2.1.1.2 Test Requirements

The RRC re-establishment delay is defined as the time from the start of time period T3, to the moment when the UE starts to send PRACH preambles to cell 2 for sending the *RRCReestablishmentRequest* message to cell 2.

The RRC re-establishment delay to a known NR intra frequency cell shall be less than 1.6 s.

The rate of correct RRC re-establishments observed during repeated tests shall be at least 90%.

NOTE: The RRC re-establishment delay in the test is derived from the following expression:

$$T_{\text{re-establish\_delay}} = T_{\text{UL\_grant}} + T_{\text{UE\_re-establish\_delay}}$$

Where:

$T_{\text{UL\_grant}}$  = It is the time required to acquire and process uplink grant from the target cell. The PRACH reception at the system simulator is used as a trigger for the completion of the test; hence  $T_{\text{UL\_grant}}$  is not used.

$$T_{\text{UE\_re-establish\_delay}} = 50 \text{ ms} + T_{\text{identify\_intra\_NR}} + \sum_{i=1}^{N_{\text{freq}}-1} T_{\text{identify\_inter\_NR},i} + T_{\text{SI-NR}} + T_{\text{PRACH}}$$

$$N_{\text{freq}} = 1$$

$$T_{\text{identify\_intra\_NR}} = 200 \text{ ms}$$

$T_{\text{SI}} = 1280 \text{ ms}$ ; it is the time required for receiving all the relevant system information as defined in TS 38.331 for the target intra-frequency NR cell.

$T_{\text{PRACH}} = 15 \text{ ms}$ ; it is the additional delay caused by the random access procedure.

This gives a total of 1545 ms, allow 1.6 s in the test case.

#### A.6.3.2.1.2 Inter-frequency RRC Re-establishment in FR1

##### A.6.3.2.1.2.1 Test Purpose and Environment

The purpose is to verify that the NR inter-frequency RRC re-establishment delay in FR1 without known target cell is within the specified limits. These tests will verify the requirements in clause 6.2.1.

The test parameters are given in table A.6.3.2.1.2.1-1, table A.6.3.2.1.2.1-2 and table A.6.3.2.1.2.1-3 below. The test consists of 3 successive time periods, with time duration of T1, T2 and T3 respectively. At the start of time period T2, cell 1, which is the active cell, becomes inactive. The time period T3 starts after the occurrence of the radio link failure. During T1, the UE shall be configured with the carrier frequency of cell 2 (with RF Channel Number #2) to ensure that the UE has the context of the carrier frequency of cell 2 by the end of T1.

**Table A.6.3.2.1.2.1-1: Supported test configurations**

Configuration	Description of serving cell	Description of target cell
1	15 kHz SSB SCS, 10 MHz bandwidth, FDD duplex mode	15 kHz SSB SCS, 10 MHz bandwidth, FDD duplex mode
2	15 kHz SSB SCS, 10 MHz bandwidth, TDD duplex mode	15 kHz SSB SCS, 10 MHz bandwidth, TDD duplex mode
3	30 kHz SSB SCS, 40 MHz bandwidth, TDD duplex mode	30 kHz SSB SCS, 40 MHz bandwidth, TDD duplex mode

Note: The UE is only required to be tested in one of the supported test configurations.

**Table A.6.3.2.1.2.1-2: General test parameters for NR inter-frequency RRC Re-establishment test case in FR1**

Parameter		Unit	Test configuration	Value	Comment
Initial condition	Active cell		1, 2, 3	Cell1	
	Neighbour cells		1, 2, 3	Cell2	
Final condition	Active cell		1, 2, 3	Cell2	
RF Channel Number			1, 2, 3	1, 2	
Time offset between cells			1	3 ms	Asynchronous cells
			2	3 $\mu$ s	Synchronous cells
			3	3 $\mu$ s	Synchronous cells
N310		-	1, 2, 3	1	Maximum consecutive out-of-sync indications from lower layers
N311		-	1, 2, 3	1	Minimum consecutive in-sync indications from lower layers
T310		ms	1, 2, 3	0	Radio link failure timer;
T311		ms	1, 2, 3	5000	RRC re-establishment timer
Access Barring Information		-	1, 2, 3	Not Sent	No additional delays in random access procedure.
SSB configuration			1	SSB.1 FR1	
			2	SSB.1 FR1	
			3	SSB.2 FR1	
SMTC configuration			1	SMTC.2	
			2	SMTC.1	
			3	SMTC.1	
DRX cycle length		s	1, 2, 3	OFF	
PRACH configuration			1, 2, 3	FR1 PRACH configuration on 1	Table A.3.8.2.1-1
T1		s	1, 2, 3	5	
T2		ms	1, 2, 3	240	Time for the UE to detect RLF (Summation of $T_{Evaluate\_out\_SSB}$ defined in clause 8.1 in TS 38.133, T310 and the period for UE turns off transmitter defined in clause 8.1.5 in TS 38.133 )
T3		s	1, 2, 3	5	

**Table A.6.3.2.1.2.1-3: Cell specific test parameters for NR inter-frequency RRC Re-establishment test case in FR1**

Parameter	Unit	Test configuration	Cell 1	Cell 2
-----------	------	--------------------	--------	--------



			T1	T2	T3	T1	T2	T3
RF Channel Number		1, 2, 3	1			2		
TDD configuration		1	N/A			N/A		
		2	TDDConf.1.1			TDDConf.1.1		
		3	TDDConf.2.1			TDDConf.2.1		
PDSCH RMC configuration		1	SR.1.1 FDD			SR.1.1 FDD		
		2	SR.1.1 TDD			SR.1.1 TDD		
		3	SR.2.1 TDD			SR.2.1 TDD		
RMSI CORESET RMC configuration		1	CR.1.1 FDD			CR.1.1 FDD		
		2	CR.1.1 TDD			CR.1.1 TDD		
		3	CR.2.1 TDD			CR.2.1 TDD		
Dedicated CORESET RMC configuration		1	CCR.1.1 FDD			CCR.1.1 FDD		
		2	CCR.1.1 TDD			CCR.1.1 TDD		
		3	CCR.2.1 TDD			CCR.2.1 TDD		
OCNG Pattern		1, 2, 3	OP.1 defined in A.3.2.1			OP.1 defined in A.3.2.1		
TRS configuration		1	TRS.1.1 FDD			TRS.1.1 FDD		
		2	TRS.1.1 TDD			TRS.1.1 TDD		
		3	TRS.1.2 TDD			TRS.1.2 TDD		
Initial DL BWP configuration		1, 2, 3	DLBWP.0.1			DLBWP.0.1		
Initial UL BWP configuration		1, 2, 3	ULBWP.0.1			ULBWP.0.1		
Active DL BWP configuration		1, 2, 3	DLBWP.1.1	N/A	N/A	N/A	N/A	DLBW P.1.1
Active UL BWP configuration		1, 2, 3	ULBWP.1.1	N/A	N/A	N/A	N/A	ULBW P.1.1
RLM-RS		1, 2, 3	SSB			SSB		
$\hat{E}_s / I_{ot}$	dB	1	4	-infinity	-infinity	-infinity	-infinity	7
		2						
		3						
$N_{oc}$ Note2	dBm/SCS	1	-98					
		2	-98					
		3	-95					
$N_{oc}$ Note2	dBm/15 kHz	1	-98					
		2						
		3						
$\hat{E}_s / N_{oc}$	dB	1	4	-infinity	-infinity	-infinity	-infinity	7
		2						
		3						
SS-RSRP Note3	dBm/SCS	1	-94	-infinity	-infinity	-infinity	-infinity	-91
		2	-94	-infinity	-infinity	-infinity	-infinity	-91
		3	-91	-infinity	-infinity	-infinity	-infinity	-88
I <sub>o</sub>	dBm/9.36 MHz	1	-64.59	-70.05	-70.05	-70.05	-70.05	-62.26
	dBm/9.36 MHz	2	-64.59	-70.05	-70.05	-70.05	-70.05	-62.26
	dBm/38.16 MHz	3	-58.50	-63.94	-63.94	-63.94	-63.94	-56.15
Propagation Condition		1, 2, 3	AWGN					
<p>Note 1: OCNG shall be used such that both cells are fully allocated and a constant total transmitted power spectral density is achieved for all OFDM symbols.</p> <p>Note 2: Interference from other cells and noise sources not specified in the test is assumed to be constant over subcarriers and time and shall be modelled as AWGN of appropriate power for <math>N_{oc}</math> to be fulfilled.</p> <p>Note 3: SS-RSRP levels have been derived from other parameters for information purposes. They are not settable parameters themselves.</p>								

A.6.3.2.1.2.2 Test Requirements

The RRC re-establishment delay is defined as the time from the start of time period T3, to the moment when the UE starts to send PRACH preambles to cell 2 for sending the *RRCReestablishmentRequest* message to cell 2.

The RRC re-establishment delay to an unknown NR inter frequency cell shall be less than 3 s.

The rate of correct RRC re-establishments observed during repeated tests shall be at least 90%.

NOTE: The RRC re-establishment delay in the test is derived from the following expression:

$$T_{\text{re-establish\_delay}} = T_{\text{UL\_grant}} + T_{\text{UE\_re-establish\_delay}}$$

Where:

$T_{\text{UL\_grant}}$  = It is the time required to acquire and process uplink grant from the target cell. The PRACH reception at the system simulator is used as a trigger for the completion of the test; hence  $T_{\text{UL\_grant}}$  is not used.

$$T_{\text{UE\_re-establish\_delay}} = 50 \text{ ms} + T_{\text{identify\_intra\_NR}} + \sum_{i=1}^{N_{\text{freq}}-1} T_{\text{identify\_inter\_NR},i} + T_{\text{SI-NR}} + T_{\text{PRACH}}$$

$$N_{\text{freq}} = 2$$

$$T_{\text{identify\_intra\_NR}} = 800 \text{ ms}$$

$$T_{\text{identify\_inter\_NR}} = 800 \text{ ms}$$

$T_{\text{SI}} = 1280 \text{ ms}$ ; it is the time required for receiving all the relevant system information as defined in TS 38.331 for the target inter-frequency NR cell.

$T_{\text{PRACH}} = 15 \text{ ms}$ ; it is the additional delay caused by the random access procedure.

This gives a total of 2945 ms, allow 3 s in the test case.

### A.6.3.2.1.3 Intra-frequency RRC Re-establishment in FR1 without serving cell timing

#### A.6.3.2.1.3.1 Test Purpose and Environment

The purpose is to verify that the NR intra-frequency RRC re-establishment delay in FR1 without serving cell timing is within the specified limits. These tests will verify the requirements in clause 6.2.1.

The test parameters are given in table A.6.3.2.1.3.1-1, table A.6.3.2.1.3.1-2 and table A.6.3.2.1.3.1-3 below. The test consists of 3 successive time periods, with time duration of T1, T2 and T3 respectively. At the start of time period T2, cell 1, which is the active cell, is deactivated. The time period T3 starts after the occurrence of the radio link failure.

**Table A.6.3.2.1.3.1-1: Supported test configurations**

Configuration	Description
1	15 kHz SSB SCS, 10 MHz bandwidth, FDD duplex mode
2	15 kHz SSB SCS, 10 MHz bandwidth, TDD duplex mode
3	30 kHz SSB SCS, 40 MHz bandwidth, TDD duplex mode

Note: The UE is only required to be tested in one of the supported test configurations.

**Table A.6.3.2.1.3.1-2: General test parameters for NR intra-frequency RRC Re-establishment test case in FR1**

Parameter	Unit	Test configuration	Value	Comment
Initial condition	Active cell	1, 2, 3	Cell1	
	Neighbour cells	1, 2, 3	Cell2	
Final condition	Active cell	1, 2, 3	Cell2	
RF Channel Number		1, 2, 3	1	
Time offset between cells		1	3 ms	Asynchronous cells
		2	3 $\mu$ s	Synchronous cells
		3	3 $\mu$ s	Synchronous cells
N310	-	1, 2, 3	1	Maximum consecutive out-of-sync indications from lower layers
N311	-	1, 2, 3	1	Minimum consecutive in-sync indications from lower layers

T310	ms	1, 2, 3	6000	Radio link failure timer configured by <i>RLF-TimersAndConstants</i>
T311	ms	1, 2, 3	3000	RRC re-establishment timer
Access Barring Information	-	1, 2, 3	Not Sent	No additional delays in random access procedure.
SSB configuration		1	SSB.1 FR1	
		2	SSB.1 FR1	
		3	SSB.2 FR1	
SMTC configuration		1	SMTC.2	
		2	SMTC.1	
		3	SMTC.1	
DRX cycle length	s	1, 2, 3	OFF	
PRACH configuration		1, 2, 3	FR1 PRACH configuration 1	Table A.3.8.2.1-1
T1	s	1, 2, 3	5	
T2	s	1, 2, 3	6.24	Time for the UE to detect RLF (Summation of $T_{Evaluate\_out\_SSB}$ defined in clause 8.1 in TS 38.133, T310 and the period for UE turns off transmitter defined in clause 8.1.5 in TS 38.133 )
T3	s	1, 2, 3	3	

**Table A.6.3.2.1.3.1-3: Cell specific test parameters for NR intra-frequency RRC Re-establishment test case in FR1**

Parameter	Unit	Test configuration	Cell 1			Cell 2		
			T1	T2	T3	T1	T2	T3
TDD configuration		1	N/A			N/A		
		2	TDDConf.1.1			TDDConf.1.1		
		3	TDDConf.2.1			TDDConf.2.1		
PDSCH RMC configuration		1	SR.1.1 FDD			SR.1.1 FDD		
		2	SR.1.1 TDD			SR.1.1 TDD		
		3	SR.2.1 TDD			SR.2.1 TDD		
RMSI CORESET RMC configuration		1	CR.1.1 FDD			CR.1.1 FDD		
		2	CR.1.1 TDD			CR.1.1 TDD		
		3	CR.2.1 TDD			CR.2.1 TDD		
Dedicated CORESET RMC configuration		1	CCR.1.1 FDD			CCR.1.1 FDD		
		2	CCR.1.1 TDD			CCR.1.1 TDD		
		3	CCR.2.1 TDD			CCR.2.1 TDD		
OCNG Pattern		1, 2, 3	OP.1 defined in A.3.2.1			OP.1 defined in A.3.2.1		
Initial DL BWP configuration		1, 2, 3	DLBWP.0.1			DLBWP.0.1		
TRS Configuration		1	TRS.1.1 FDD			TRS.1.1 FDD		
		2	TRS.1.1 TDD			TRS.1.1 TDD		
		3	TRS.1.2 TDD			TRS.1.2 TDD		
Initial UL BWP configuration		1, 2, 3	ULBWP.0.1			ULBWP.0.1		
RLM-RS		1, 2, 3	SSB			SSB		
$\hat{E}_s/I_{\alpha}$	dB	1	4	-infinity	-infinity	-infinity	-infinity	4
		2						
		3						
$N_{oc}$ Note2	dBm/SCS	1	-98					
		2	-98					
		3	-95					
$N_{oc}$ Note2	dBm/15 kHz	1	-98					

		2						
		3						
$\hat{E}_s / N_{oc}$	dB	1	4	-infinity	-infinity	-infinity	-infinity	4
		2						
		3						
SS-RSRP <sup>Note3</sup>	dBm/SCS	1	-94	-infinity	-infinity	-infinity	-infinity	-94
		2	-94	-infinity	-infinity	-infinity	-infinity	-94
		3	-91	-infinity	-infinity	-infinity	-infinity	-91
I <sub>o</sub>	dBm/9.36 MHz	1	-64.59	-infinity	-infinity	-infinity	-infinity	-64.59
	dBm/9.36 MHz	2	-64.59	-infinity	-infinity	-infinity	-infinity	-64.59
	dBm/38.16 MHz	3	-58.50	-infinity	-infinity	-infinity	-infinity	-58.50
Propagation Condition		1, 2, 3	AWGN					
<p>Note 1: OCNG shall be used such that both cells are fully allocated and a constant total transmitted power spectral density is achieved for all OFDM symbols.</p> <p>Note 2: Interference from other cells and noise sources not specified in the test is assumed to be constant over subcarriers and time and shall be modelled as AWGN of appropriate power for <math>N_{oc}</math> to be fulfilled.</p> <p>Note 3: SS-RSRP levels have been derived from other parameters for information purposes. They are not settable parameters themselves.</p>								

#### A.6.3.2.1.3.2 Test Requirements

The RRC re-establishment delay is defined as the time from the start of time period T3, to the moment when the UE starts to send PRACH preambles to cell 2 for sending the *RRCReestablishmentRequest* message to cell 2.

The RRC re-establishment delay to an unknown NR intra frequency cell without serving cell timing shall be less than 2.2 s.

The rate of correct RRC re-establishments observed during repeated tests shall be at least 90%.

NOTE: The RRC re-establishment delay in the test is derived from the following expression:

$$T_{\text{re-establish\_delay}} = T_{\text{UL\_grant}} + T_{\text{UE\_re-establish\_delay}}$$

Where:

$T_{\text{UL\_grant}}$  = It is the time required to acquire and process uplink grant from the target cell. The PRACH reception at the system simulator is used as a trigger for the completion of the test; hence  $T_{\text{UL\_grant}}$  is not used.

$$T_{\text{UE\_re-establish\_delay}} = 50 \text{ ms} + T_{\text{identify\_intra\_NR}} + \sum_{i=1}^{N_{\text{freq}}-1} T_{\text{identify\_inter\_NR},i} + T_{\text{SI-NR}} + T_{\text{PRACH}}$$

$$N_{\text{freq}} = 1$$

$$T_{\text{identify\_intra\_NR}} = 800 \text{ ms}$$

$T_{\text{SI}} = 1280 \text{ ms}$ ; it is the time required for receiving all the relevant system information as defined in TS 38.331 [2] for the target intra-frequency NR cell.

$T_{\text{PRACH}} = 15 \text{ ms}$ ; it is the additional delay caused by the random access procedure.

This gives a total of 2145 ms, allow 2.2 s in the test case.

#### A.6.3.2.2 Random Access

##### A.6.3.2.2.1 4-step RA type contention based random access test in FR1 for NR standalone

###### A.6.3.2.2.1.1 Test Purpose and Environment

The purpose of this test is to verify that the behavior of the random access procedure is according to the requirements and that the PRACH power settings and timing are within specified limits. This test will verify the requirements in Clause 6.2.2.2 and Clause 7.1.2 in an AWGN model.

For this test one cell is used and configured as PCell in FR1. Supported test parameters are shown in Table A.6.3.2.2.1.1-1. UE capable of SA with PCell in FR1 needs to be tested by using the parameters in Table A.6.3.2.2.1.1-2.

**Table A.6.3.2.2.1.1-1: Supported test configurations for contention based random access test in FR1 for NR standalone**

Config	Description
1	NR 15 kHz SSB SCS, 10 MHz bandwidth, FDD duplex mode
2	NR 30 kHz SSB SCS, 40 MHz bandwidth, TDD duplex mode

Note: The UE is only required to be tested in one of the supported test configurations depending on UE capability

**Table A.6.3.2.2.1.1-2: General test parameters for contention based random access test in FR1 for NR Standalone**

Parameter		Unit	Test-1	Comments	
SSB Configuration	Config 1		SSB pattern 1 in FR1	As defined in A.3.10, except for number of SSBs per SS-burst and SS/PBCH block index as below	
	Config 2		SSB pattern 2 in FR1		
Number of SSBs per SS-burst			2	Different from the definition in A.3.10	
SS/PBCH block index			0,1	Different from the definition in A.3.10	
Duplex Mode for Cell 1	Config 1		FDD		
	Config 2		TDD		
TDD Configuration	Config 2		TDDConf.2.1		
CSI-RS for tracking	Config 1		TRS.1.1 FDD		
	Config 2		TRS.1.2 TDD		
OCNG Pattern <sup>Note 1</sup>			OP.1	As defined in A.3.2.1.	
PDSCH parameters <sup>Note 4</sup>	Config 1		SR.1.1 FDD	As defined in A.3.1.1.	
	Config 2		SR.2.1 TDD		
RMSI CORESET Reference Channel	Config 1		CR.1.1 FDD		
	Config 2		CR.2.1 TDD		
Dedicated CORESET Reference Channel	Config 1		CCR.1.1 FDD		
	Config 2		CCR.2.1 TDD		
NR RF Channel Number			1		
EPRE ratio of PSS to SSS		dB	0		
EPRE ratio of PBCH_DMRS to SSS		dB			
EPRE ratio of PBCH to PBCH_DMRS		dB			
EPRE ratio of PDCCH_DMRS to SSS		dB			
EPRE ratio of PDCCH to PDCCH_DMRS		dB			
EPRE ratio of PDSCH_DMRS to SSS		dB			
EPRE ratio of PDSCH to PDSCH_DMRS		dB			
SSB with index 0	$\hat{E}_s / I_{ot}$		dB	3	Power of SSB with index 0 is set to be above configured <i>rsrp-ThresholdSSB</i>
	$N_{oc}$	Config 1	dBm/15kHz	-98	
		Config 2		-101	
	$\hat{E}_s / N_{oc}$		dB	3	
SS-RSRP <sup>Note 3</sup>		dBm/ SCS	-95		
SSB with index 1	$\hat{E}_s / I_{ot}$		dB	-17	Power of SSB with index 1 is set to be below configured <i>rsrp-ThresholdSSB</i>
		Config 1	dBm/15kHz	-98	

	$N_{oc}$	Config 2		-101	
	$\hat{E}_s / N_{oc}$		dB	-17	
	SS-RSRP	Note 3	dBm/ SCS	-115	
$I_0$ Note 2	Config 1		dBm	-65.3/9.36MHz	For symbols without SSB index 1
	Config 2			-62.2/38.16MHz	
ss-PBCH-BlockPower			dBm/ SCS	-5	As defined in clause 6.3.2 in TS 38.331 [2].
Configured UE transmitted power ( $P_{CMAX, f.c}$ )			dBm	23	As defined in clause 6.2.4 in TS 38.101-1.
PRACH Configuration				FR1 PRACH configuration 1	As defined in A.3.8.
Propagation Condition			-	AWGN	
<p>Note 1: OCNG shall be used such that the cell is fully allocated and a constant total transmitted power spectral density is achieved for all OFDM symbols. The OCNG pattern is chosen during the test according to the presence of a DL reference measurement channel.</p> <p>Note 2: SS-RSRP, <math>E_s/I_0</math> and <math>I_0</math> levels have been derived from other parameters for information purpose. They are not settable parameters.</p> <p>Note 3: Void</p> <p>Note 4: The DL PDSCH reference measurement channel is used in the test only when a downlink transmission dedicated to the UE under test is required.</p>					

#### A.6.3.2.2.1.2 Test Requirements

Contention based random access is triggered by *not* explicitly assigning a random access preamble via dedicated signalling in the downlink.

##### A.6.3.2.2.1.2.1 Random Access Preamble Transmission

To test the UE behavior specified in Clause 6.2.2.2.1.1 the System Simulator shall receive the Random Access Preamble which belongs to one of the Random Access Preambles associated with the SSB with index 0, which has SS-RSRP above the configured *rsrp-ThresholdSSB*.

In addition, the power applied to all preambles shall be in accordance with what is specified in Clause 6.2.2.2. The power of the first preamble shall be -22 dBm with an accuracy specified in clause 6.3.4.2 of TS 38.101-1 [18]. The relative power applied to additional preambles shall have an accuracy specified in clause 6.3.4.3 of TS 38.101-1 [18].

The transmit timing of all PRACH transmissions shall be within the accuracy specified in Clause 7.1.2.

##### A.6.3.2.2.1.2.2 Random Access Response Reception

To test the UE behavior specified in Clause 6.2.2.2.1.2 the System Simulator shall transmit a Random Access Response containing a Random Access Preamble identifier corresponding to the transmitted Random Access Preamble after 5 preambles have been received by the System Simulator. In response to the first 4 preambles, the System Simulator shall transmit a Random Access Response *not* corresponding to the transmitted Random Access Preamble.

The UE may stop monitoring for Random Access Response(s) and shall transmit the msg3 if the Random Access Response contains a Random Access Preamble identifier corresponding to the transmitted Random Access Preamble.

The UE shall again perform the Random Access Resource selection procedure specified in clause 5.1.2 in TS 38.321 [7], and transmit with the calculated PRACH transmission power when the backoff time expires if all received Random Access Responses contain Random Access Preamble identifiers that do not match the transmitted Random Access Preamble.

In addition, the power applied to all preambles shall be in accordance with what is specified in Clause 6.2.2.2. The power of the first preamble shall be -22 dBm with an accuracy specified in clause 6.3.4.2 of TS 38.101-1 [18]. The relative power applied to additional preambles shall have an accuracy specified in clause 6.3.4.3 of TS 38.101-1 [18].

The transmit timing of all PRACH transmissions shall be within the accuracy specified in Clause 7.1.2.

#### A.6.3.2.2.1.2.3 No Random Access Response Reception

To test the UE behavior specified in clause 6.2.2.2.1.3 the System Simulator shall transmit a Random Access Response containing a Random Access Preamble identifier corresponding to the transmitted Random Access Preamble after 5 preambles have been received by the System Simulator. The System Simulator shall *not* respond to the first 4 preambles.

The UE shall again perform the Random Access Resource selection procedure specified in clause 5.1.2 in TS 38.321 [7], and transmit with the calculated PRACH transmission power when the backoff time expires if no Random Access Response is received within the RA Response window.

In addition, the power applied to all preambles shall be in accordance with what is specified in Clause 6.2.2.2. The power of the first preamble shall be -22 dBm with an accuracy specified in clause 6.3.4.2 of TS 38.101-1 [18]. The relative power applied to additional preambles shall have an accuracy specified in clause 6.3.4.3 of TS 38.101-1 [18].

The transmit timing of all PRACH transmissions shall be within the accuracy specified in Clause 7.1.2.

#### A.6.3.2.2.1.2.4 Receiving an UL grant for msg3 retransmission

To test the UE behavior specified in clause 6.2.2.2.1.4 the System Simulator shall provide an UL grant for msg3 retransmission following a successful Random Access Response.

The UE shall re-transmit the msg3 upon the reception of an UL grant for msg3 retransmission.

#### A.6.3.2.2.1.2.5 Reception of an Incorrect Message over Temporary C-RNTI

To test the UE behavior specified in Clause 6.2.2.2.1.5 the System Simulator shall send a message addressed to the temporary C-RNTI with a UE Contention Resolution Identity included in the MAC control element *not* matching the CCCH SDU transmitted in msg3 uplink message.

The UE shall again perform the Random Access Resource selection procedure specified in clause 5.1.2 in TS 38.321 [7], and transmit with the calculated PRACH transmission power when the backoff time expires unless the received message includes a UE Contention Resolution Identity MAC control element and the UE Contention Resolution Identity included in the MAC control element matches the CCCH SDU transmitted in the uplink message.

#### A.6.3.2.2.1.2.6 Reception of a Correct Message over Temporary C-RNTI

To test the UE behavior specified in Clause 6.2.2.2.1.5 the System Simulator shall send a message addressed to the temporary C-RNTI with a UE Contention Resolution Identity included in the MAC control element matching the CCCH SDU transmitted in the msg3 uplink message.

The UE shall send ACK if the Contention Resolution is successful.

#### A.6.3.2.2.1.2.7 Contention Resolution Timer expiry

To test the UE behavior specified in Clause 6.2.2.2.1.6 the System Simulator shall *not* send a response to a msg3.

The UE shall again perform the Random Access Resource selection procedure specified in clause 5.1.2 in TS 38.321 [7], and transmit with the calculated PRACH transmission power when the backoff time expires if the Contention Resolution Timer expires.

### A.6.3.2.2.2 4-step RA type non-contention based random access test in FR1 for NR standalone

#### A.6.3.2.2.2.1 Test Purpose and Environment

The purpose of this test is to verify that the behavior of the random access procedure is according to the requirements and that the PRACH power settings and timing are within specified limits. This test will verify the requirements in Clause 6.2.2.2 and Clause 7.1.2 in an AWGN model.

For this test one cell is used and configured as PCell in FR1. Supported test parameters are shown in Table A.6.3.2.2.2.1-1. UE capable of SA with PCell in FR1 needs to be tested by using the parameters in Table A.6.3.2.2.2.1-2 for SSB-based non-contention based random access test (Test 1) and CSI-RS-based non-contention based random access test (Test 2). Test 2 is only applicable to UE which supports csi-RSRP-AndRSRQ-MeasWithSSB or csi-RSRP-AndRSRQ-MeasWithoutSSB.

**Table A.6.3.2.2.1-1: Supported test configurations for non-contention based random access test in FR1 for NR standalone**

Config	Description
1	NR 15 kHz SSB SCS, 10 MHz bandwidth, FDD duplex mode
2	NR 30 kHz SSB SCS, 40 MHz bandwidth, TDD duplex mode

Note: The UE is only required to be tested in one of the supported test configurations depending on UE capability

**Table A.6.3.2.2.1-2: General test parameters for non-contention based random access test in FR1 for NR Standalone**

Parameter		Unit	Test-1	Test-2	Comments	
SSB Configuration	Config 1		SSB pattern 1 in FR1	SSB pattern 1 in FR1	As defined in A.3.10, except for number of SSBs per SS-burst and SS/PBCH block index as below	
	Config 2		SSB pattern 2 in FR1	SSB pattern 2 in FR1		
Number of SSBs per SS-burst			2	2	Different from the definition in A.3.10	
SS/PBCH block index			0,1	0,1	Different from the definition in A.3.10	
CSI-RS Configuration	Config 1		N/A	CSI-RS.1.1 FDD	As defined in A.3.1.4	
	Config 2			CSI-RS.2.1 TDD		
Duplex Mode for Cell 1	Config 1		FDD	FDD		
	Config 2		TDD	TDD		
TDD Configuration	Config 2		TDDConf.2.1	TDDConf.2.1		
CSI-RS for tracking	Config 1		TRS.1.1 FDD	TRS.1.1 FDD		
	Config 2		TRS.1.2 TDD	TRS.1.2 TDD		
OCNG Pattern <sup>Note 1</sup>			OP.1	OP.1	As defined in A.3.2.1.	
PDSCH parameters <sup>Note 4</sup>	Config 1		SR.1.1 FDD	SR.1.1 FDD	As defined in A.3.1.1.	
	Config 2		SR.2.1 TDD	SR.2.1 TDD		
RMSI CORESET Reference Channel	Config 1		CR.1.1 TDD	CR.1.1 TDD		
	Config 2		CR.2.1 TDD	CR.2.1 TDD		
Dedicated CORESET Reference Channel	Config 1		CCR.1.1 TDD	CCR.1.1 TDD		
	Config 2		CCR.2.1 TDD	CCR.2.1 TDD		
NR RF Channel Number			1	1		
EPRE ratio of PSS to SSS		dB	0	0		
EPRE ratio of PBCH_DMRS to SSS		dB				
EPRE ratio of PBCH to PBCH_DMRS		dB				
EPRE ratio of PDCCH_DMRS to SSS		dB				
EPRE ratio of PDCCH to PDCCH_DMRS		dB				
EPRE ratio of PDSCH_DMRS to SSS		dB				
EPRE ratio of PDSCH to PDSCH_DMRS		dB				
SSB with index 0	$\hat{E}_s / I_{ot}$		dB	3	3	Power of SSB with index 0 is set to be above configured <i>rsrp-ThresholdSSB</i>
	$N_{oc}$	Config 1	dBm/15kHz	-98	-98	
		Config 2		-101	-101	
	$\hat{E}_s / N_{oc}$		dB	3	3	
SS-RSRP <sup>Note 3</sup>		dBm/ SCS	-95	-95		
SSB with index 1	$\hat{E}_s / I_{ot}$		dB	-17	-17	Power of SSB with index 1 is set to be below configured <i>rsrp-ThresholdSSB</i>
	$N_{oc}$	Config 1	dBm/15kHz	-98	-98	



	Config 2		-101	-101	
	$\hat{E}_s/N_{oc}$	dB	-17	-17	
	SS-RSRP <sup>Note 3</sup>	dBm/ SCS	-115	-115	
$I_0$ <sup>Note 2</sup>	Config 1	dBm	-65.3/9.36MHz	-65.3/9.36MHz	For symbols without SSB index 1
	Config 2		-62.2/38.16MHz	-62.2/38.16MHz	
ss-PBCH-BlockPower		dBm/ SCS	-5	-5	As defined in clause 6.3.2 in TS 38.331 [2].
Configured UE transmitted power ( $P_{CMAX, f, c}$ )		dBm	23	23	As defined in clause 6.2.4 in TS 38.101-1.
PRACH Configuration			FR1 PRACH configuration 2	FR1 PRACH configuration 3	As defined in A.3.8.2.
Propagation Condition		-	AWGN	AWGN	
<p>Note 1: OCNG shall be used such that the cell is fully allocated and a constant total transmitted power spectral density is achieved for all OFDM symbols. The OCNG pattern is chosen during the test according to the presence of a DL reference measurement channel.</p> <p>Note 2: SS-RSRP, <math>E_s/I_0</math> and <math>I_0</math> levels have been derived from other parameters for information purpose. They are not settable parameters.</p> <p>Note 3: Void</p> <p>Note 4: The DL PDSCH reference measurement channel is used in the test only when a downlink transmission dedicated to the UE under test is required.</p>					

#### A.6.3.2.2.2.2 Test Requirements

Non-Contention based random access is triggered by explicitly assigning a random access preamble via dedicated signalling in the downlink. In the test, the non-contention based random access procedure is not initialized for Other SI requested from UE or beam failure recovery.

##### A.6.3.2.2.2.2.1 SSB-based Random Access Preamble Transmission

In Test-1, to test the UE behavior specified in Clause 6.2.2.2.2.1 for SSB-based Random Access Preamble transmission, with the contention-free Random Access Resources and the contention-free PRACH occasions associated with SSBs configured, the System Simulator shall receive the Random Access Preamble which has the Preamble Index associated with the SSB with index 0.

In addition, the System Simulator shall receive the Random Access Preamble on the PRACH occasion which belongs to the PRACH occasions corresponding to the SSB with index 0, and the selected PRACH occasion shall belong to the PRACH occasions permitted by the restrictions given by the *ra-ssb-OccasionMaskIndex*.

In addition, the power applied to all preambles shall be in accordance with what is specified in Clause 6.2.2.2. The power of the first preamble shall be -22 dBm with an accuracy specified in clause 6.3.4.2 of TS 38.101-1 [18]. The relative power applied to additional preambles shall have an accuracy specified in clause 6.3.4.3 of TS 38.101-1 [18].

The transmit timing of all PRACH transmissions shall be within the accuracy specified in Clause 7.1.2.

##### A.6.3.2.2.2.2.2 CSI-RS-based Random Access Preamble Transmission

In Test-2, to test the UE behavior specified in Clause 6.2.2.2.2.1 for CSI-RS-based Random Access Preamble transmission, with the contention-free Random Access Resources and the contention-free PRACH occasions associated with CSI-RSs configured, the System Simulator shall receive the Random Access Preamble which has the Preamble Index associated with the CSI-RS configured.

In addition, the System Simulator shall receive the Random Access Preamble on the PRACH occasion which belongs to the PRACH occasions corresponding to the CSI-RS configured, and the selected PRACH occasion shall belong to the PRACH occasions permitted by the restrictions given by the *ra-OccasionList*.

In addition, the power applied to all preambles shall be in accordance with what is specified in Clause 6.2.2.2. The power of the first preamble shall be -22 dBm with an accuracy specified in clause 6.3.4.2 of TS 38.101-1 [18]. The relative power applied to additional preambles shall have an accuracy specified in clause 6.3.4.3 of TS 38.101-1 [18].

The transmit timing of all PRACH transmissions shall be within the accuracy specified in Clause 7.1.2.

### A.6.3.2.2.2.3 Random Access Response Reception

To test the UE behavior specified in Clause 6.2.2.2.2 the System Simulator shall transmit a Random Access Response containing a Random Access Preamble identifier corresponding to the transmitted Random Access Preamble after 5 preambles have been received by the System Simulator. In response to the first 4 preambles, the System Simulator shall transmit a Random Access Response *not* corresponding to the transmitted Random Access Preamble.

The UE may stop monitoring for Random Access Response(s) if the Random Access Response contains a Random Access Preamble identifier corresponding to the transmitted Random Access Preamble.

The UE shall again perform the Random Access Resource selection procedure specified in clause 5.1.2 in TS 38.321 [7], and transmit with the calculated PRACH transmission power if all received Random Access Responses contain Random Access Preamble identifiers that do not match the transmitted Random Access Preamble.

In addition, the power applied to all preambles shall be in accordance with what is specified in Clause 6.2.2.2. The power of the first preamble shall be -22 dBm with an accuracy specified in clause 6.3.4.2 of TS 38.101-1 [18]. The relative power applied to additional preambles shall have an accuracy specified in clause 6.3.4.3 of TS 38.101-1 [18].

The transmit timing of all PRACH transmissions shall be within the accuracy specified in Clause 7.1.2.

### A.6.3.2.2.2.4 No Random Access Response Reception

To test the UE behavior specified in clause 6.2.2.2.3 the System Simulator shall transmit a Random Access Response containing a Random Access Preamble identifier corresponding to the transmitted Random Access Preamble after 5 preambles have been received by the System Simulator. The System Simulator shall *not* respond to the first 4 preambles.

The UE shall again perform the Random Access Resource selection procedure specified in clause 5.1.2 in TS 38.321 [7], and transmit with the calculated PRACH transmission power when the backoff time expires if no Random Access Response is received within the RA Response window configured in *RACH-ConfigCommon*.

In addition, the power applied to all preambles shall be in accordance with what is specified in Clause 6.2.2.2. The power of the first preamble shall be -22 dBm with an accuracy specified in clause 6.3.4.2 of TS 38.101-1 [18]. The relative power applied to additional preambles shall have an accuracy specified in clause 6.3.4.3 of TS 38.101-1 [18].

The transmit timing of all PRACH transmissions shall be within the accuracy specified in Clause 7.1.2.

### A.6.3.2.2.3 2-step RA type contention based random access test in FR1 for NR standalone

#### A.6.3.2.2.3.1 Test Purpose and Environment

The purpose of this test is to verify that the behavior of the 2-step RA type random access procedure is according to the requirements and that the MsgA PRACH, MsgA PUSCH power settings and timing are within specified limits. This test will verify the requirements in Clause 6.2.2.3 and Clause 7.1.2 in an AWGN model.

For this test one cell is used and configured as PCell in FR1. Supported test parameters are shown in Table A.6.3.2.2.3.1-1. UE capable of SA with PCell in FR1 needs to be tested by using the parameters in Table A.6.3.2.2.3.1-2.

**Table A.6.3.2.2.3.1-1: Supported test configurations for 2-step RA type contention based random access with successRAR test in FR1 for NR standalone**

Config	Description
1	NR 15 kHz SSB SCS, 10 MHz bandwidth, FDD duplex mode
2	NR 30 kHz SSB SCS, 40 MHz bandwidth, TDD duplex mode
Note:	The UE is only required to be tested in one of the supported test configurations depending on UE capability

**Table A.6.3.2.2.3.1-2: General test parameters for 2-step RA type contention based random access with successRAR test in FR1 for NR standalone**

Parameter	Unit	Test-1	Comments
SSB Configuration	Config 1	SSB pattern 1 in FR1	As defined in A.3.10, except for number of SSBs per SS-burst and
	Config 2	SSB pattern 2 in FR1	

				SS/PBCH block index as below	
Number of SSBs per SS-burst			2	Different from the definition in A.3.10	
SS/PBCH block index			0,1	Different from the definition in A.3.10	
Duplex Mode for Cell 2	Config 1		FDD		
	Config 2		TDD		
TDD Configuration	Config 2		TDDConf.2.1		
OCNG Pattern <sup>Note 1</sup>			OP.1	As defined in A.3.2.1.	
PDSCH parameters <sup>Note 3</sup>	Config 1		SR.1.1 FDD	As defined in A.3.1.1.	
	Config 2		SR.2.1 TDD		
NR RF Channel Number			1		
EPRE ratio of PSS to SSS		dB	0		
EPRE ratio of PBCH_DMRS to SSS		dB			
EPRE ratio of PBCH to PBCH_DMRS		dB			
EPRE ratio of PDCCH_DMRS to SSS		dB			
EPRE ratio of PDCCH to PDCCH_DMRS		dB			
EPRE ratio of PDSCH_DMRS to SSS		dB			
EPRE ratio of PDSCH to PDSCH_DMRS		dB			
SSB with index 0	$\hat{E}_s / I_{ot}$		dB	3	Power of SSB with index 0 is set to be above configured <i>msgA-RSRP-ThresholdSSB</i>
	$N_{oc}$	Config 1	dBm/15kHz	-98	
		Config 2		-101	
	$\hat{E}_s / N_{oc}$		dB		
SS-RSRP		dBm/ SCS		-95	
SSB with index 1	$\hat{E}_s / I_{ot}$		dB	-17	Power of SSB with index 1 is set to be below configured <i>msgA-RSRP-ThresholdSSB</i>
	$N_{oc}$	Config 1	dBm/15kHz	-98	
		Config 2		-101	
	$\hat{E}_s / N_{oc}$		dB		
SS-RSRP		dBm/ SCS		-115	
$I_o$ <sup>Note 2</sup>	Config 1	dBm		-65.3/9.36MHz	For symbols without SSB index 1
	Config 2			-62.2/38.16MHz	
ss-PBCH-BlockPower		dBm/ SCS		-5	As defined in clause 6.3.2 in TS 38.331 [2].
Configured UE transmitted power ( $P_{CMAX, f,c}$ )		dBm		23	As defined in clause 6.2.4 in TS 38.101-1.
MsgA Configuration				FR1 MsgA configuration 1	As defined in A.3.20.2.1.
<i>msgA-RSRP-ThresholdSSB</i>		dBm		RSRP_51	The actual value of the threshold is -105dBm, as defined in TS 38.331 [2].
Propagation Condition		-		AWGN	
<p>Note 1: OCNG shall be used such that the cell is fully allocated and a constant total transmitted power spectral density is achieved for all OFDM symbols. The OCNG pattern is chosen during the test according to the presence of a DL reference measurement channel.</p> <p>Note 2: SS-RSRP, <math>E_s/I_{ot}</math> and <math>I_o</math> levels have been derived from other parameters for information purpose. They are not settable parameters.</p> <p>Note 3: The DL PDSCH reference measurement channel is used in the test only when a downlink transmission dedicated to the UE under test is required.</p>					

A.6.3.2.2.3.2 Test Requirements

Contention based random access is triggered by *not* explicitly assigning a random access preamble via dedicated signalling in the downlink.

#### A.6.3.2.2.3.2.1 MsgA Transmission

To test the UE behavior specified in Clause 6.2.2.3.1.1 the System Simulator shall receive the MsgA with a preamble which belongs to one of the Random Access Preambles associated with the SSB with index 0, which has SS-RSRP above the configured *msgA-RSRP-ThresholdSSB*.

In addition, the power applied to all MsgA transmissions shall be in accordance with what is specified in Clause 6.2.2.3. The power of the first MsgA preamble transmission shall be -22 dBm with an accuracy specified in clause 6.3.4.2 of TS 38.101-1 [18]. The power of the first MsgA PUSCH transmission shall be  $0.6 + 3(\mu + 2)$  dBm with an accuracy specified in clause 6.3.4.2 of TS 38.101-1 [18], where  $\mu$  indicates the MsgA PUSCH numerology. The relative power applied to additional MsgA transmissions shall have an accuracy specified in clause 6.3.4.3 of TS 38.101-1 [18].

The transmit timing of all MsgA transmissions shall be within the accuracy specified in Clause 7.1.2.

#### A.6.3.2.2.3.2.2 MsgB Reception

To test the UE behavior specified in Clause 6.2.2.3.1.2 the System Simulator shall transmit a MsgB containing a Random Access Preamble identifier corresponding to the transmitted Random Access Preamble after 5 preambles have been received by the System Simulator. In response to the first 4 preambles, the System Simulator shall transmit a MsgB *not* corresponding to the transmitted Random Access Preamble.

The UE may stop monitoring for MsgB(s) and shall transmit an ACK if the MsgB with a successRAR contains a Random Access Preamble identifier corresponding to the transmitted Random Access Preamble and if the Contention Resolution is successful.

The UE may stop monitoring for MsgB(s) and shall transmit the msg3 if the MsgB with a fallbackRAR contains a Random Access Preamble identifier corresponding to the transmitted Random Access Preamble.

The UE shall again perform the Random Access Resource selection procedure specified in clause 5.1.2a in TS 38.321 [7], and transmit with the calculated MsgA PRACH and MsgA PUSCH transmission power when the backoff time expires if all received MsgB(s) contain Random Access Preamble identifiers that do not match the transmitted Random Access Preamble.

In addition, the power applied to all MsgA transmissions shall be in accordance with what is specified in Clause 6.2.2.3. The power of the first preamble shall be -22 dBm with an accuracy specified in clause 6.3.4.2 of TS 38.101-1 [18]. The power of the first MsgA PUSCH transmission shall be  $0.6 + 3(\mu + 2)$  dBm with an accuracy specified in clause 6.3.4.2 of TS 38.101-1 [18], where  $\mu$  indicates the MsgA PUSCH numerology. The relative power applied to additional MsgA transmissions shall have an accuracy specified in clause 6.3.4.3 of TS 38.101-1 [18].

The transmit timing of all MsgA transmissions shall be within the accuracy specified in Clause 7.1.2.

#### A.6.3.2.2.3.2.3 No MsgB Reception

To test the UE behavior specified in clause 6.2.2.3.1.3 the System Simulator shall transmit a MsgB containing a successRAR message and a Random Access Preamble identifier corresponding to the transmitted Random Access Preamble after 5 preambles have been received by the System Simulator. The System Simulator shall *not* respond to the first 4 preambles.

The UE shall again perform the Random Access Resource selection procedure specified in clause 5.1.2a in TS 38.321 [7], and transmit with the calculated MsgA PRACH and MsgA PUSCH transmission power when the backoff time expires if no MsgB is received within the MsgB Response window.

In addition, the power applied to all MsgA transmissions shall be in accordance with what is specified in Clause 6.2.2.3. The power of the first preamble shall be -22 dBm with an accuracy specified in clause 6.3.4.2 of TS 38.101-1 [18]. The power of the first MsgA PUSCH transmission shall be  $0.6 + 3(\mu + 2)$  dBm with an accuracy specified in clause 6.3.4.2 of TS 38.101-1 [18], where  $\mu$  indicates the MsgA PUSCH numerology. The relative power applied to additional MsgA transmissions shall have an accuracy specified in clause 6.3.4.3 of TS 38.101-1 [18].

The transmit timing of all MsgA transmissions shall be within the accuracy specified in Clause 7.1.2.

## A.6.3.2.2.4 2-step RA type non-contention based test in FR1 for NR standalone

## A.6.3.2.2.4.1 Test Purpose and Environment

The purpose of this test is to verify that the behavior of the random access procedure is according to the requirements and that the MsgA PRACH, MsgA PUSCH power settings and timing are within specified limits. This test will verify the requirements in Clause 6.2.2.3 and Clause 7.1.2 in an AWGN model.

For this test one cell is used and configured as PCell in FR1. Supported test parameters are shown in Table

A.6.3.2.2.4.1-1. UE capable of SA with PCell in FR1 needs to be tested by using the parameters in Table A.6.3.2.2.4.1-2.

**Table A.6.3.2.2.4.1-1: Supported test configurations for non-contention based random access test in FR1 for NR standalone**

Config	Description
1	NR 30 kHz SSB SCS, 40 MHz bandwidth, TDD duplex mode
Note:	The UE is only required to be tested in one of the supported test configurations depending on UE capability

**Table A.6.3.2.2.4.1-2: General test parameters for non-contention based random access test in FR1 for NR Standalone**

Parameter		Unit	Test-1	Comments	
SSB Configuration	Config 1		SSB pattern 2 in FR1	As defined in A.3.10, except for number of SSBs per SS-burst and SS/PBCH block index as below	
Number of SSBs per SS-burst			2	Different from the definition in A.3.10	
SS/PBCH block index			0,1	Different from the definition in A.3.10	
Duplex Mode for Cell 1	Config 1		TDD		
TDD Configuration	Config 1		TDDConf.2.1		
OCNG Pattern <sup>Note 1</sup>			OP.1	As defined in A.3.2.1.	
PDSCH parameters <sup>Note 4</sup>	Config 1		SR.2.1 TDD	As defined in A.3.1.1.	
NR RF Channel Number			1		
EPRE ratio of PSS to SSS		dB	0		
EPRE ratio of PBCH_DMRS to SSS		dB			
EPRE ratio of PBCH to PBCH_DMRS		dB			
EPRE ratio of PDCCH_DMRS to SSS		dB			
EPRE ratio of PDCCH to PDCCH_DMRS		dB			
EPRE ratio of PDSCH_DMRS to SSS		dB			
EPRE ratio of PDSCH to PDSCH_DMRS		dB			
msgA-RSRP-ThresholdSSB		dBm	RSRP_51	The actual value of the threshold is -105dBm, as defined in TS 38.331 [2].	
SSB with index 0	$\hat{E}_s / I_{ot}$		dB	Power of SSB with index 0 is set to be above configured msgA-RSRP-ThresholdSSB	
	$N_{oc}$	Config 1	dBm/15kHz		
	$\hat{E}_s / N_{oc}$		dB		3
	SS-RSRP <sup>Note 3</sup>		dBm/ SCS		-95
SSB with index 1	$\hat{E}_s / I_{ot}$		dB	Power of SSB with index 1 is set to be below configured	
	$N_{oc}$	Config 1	dBm/15kHz		-101

	$\hat{E}_s / N_{oc}$	dB	-17	msgA-RSRP-ThresholdSSB
	SS-RSRP <sup>Note 3</sup>	dBm/ SCS	-115	
$I_0$ <sup>Note 2</sup>	Config 1	dBm	-62.2/38.16MHz	For symbols without SSB index 1
ss-PBCH-BlockPower		dBm/ SCS	-5	As defined in clause 6.3.2 in TS 38.331 [2].
Configured UE transmitted power ( $P_{CMAX, f, c}$ )		dBm	23	As defined in clause 6.2.4 in TS 38.101-1.
MsgA Configuration			FR1 MsgA configuration 2	As defined in A.3.20.2.2.
Propagation Condition		-	AWGN	
<p>Note 1: OCNG shall be used such that the cell is fully allocated and a constant total transmitted power spectral density is achieved for all OFDM symbols. The OCNG pattern is chosen during the test according to the presence of a DL reference measurement channel.</p> <p>Note 2: SS-RSRP, <math>E_s/I_0</math> and <math>I_0</math> levels have been derived from other parameters for information purpose. They are not settable parameters.</p> <p>Note 3: The DL PDSCH reference measurement channel is used in the test only when a downlink transmission dedicated to the UE under test is required.</p>				

#### A.6.3.2.2.4.2 Test Requirements

Non-Contention based random access is triggered by explicitly assigning a random access preamble via dedicated signalling in the downlink. In the test, the non-contention based random access procedure is not initialized for Other SI requested from UE or beam failure recovery.

##### A.6.3.2.2.4.2.1 MsgA Transmission

To test the UE behavior specified in Clause 6.2.2.3.2.1, with the contention-free Random Access Resources and the contention-free PRACH occasions associated with SSBs configured, the System Simulator shall receive the MsgA with a preamble which belongs to one of the Random Access Preambles associated with the SSB with index 0.

In addition, the System Simulator shall receive the MsgA PRACH on the PRACH occasion which belongs to the PRACH occasions corresponding to the SSB with index 0, and the selected PRACH occasion shall belong to the PRACH occasions permitted by the restrictions given first by the *msgA-SSB-SharedRO-MaskIndex* if configured, or next by the *ra-ssb-OccasionMaskIndex* if configured.

In addition, the power applied to all preambles shall be in accordance with what is specified in Clause 6.2.2.3. The power of the first preamble shall be -22 dBm with an accuracy specified in clause 6.3.4.2 of TS 38.101-1 [18]. The power of the first MsgA PUSCH transmission shall be  $0.6 + 3(\mu + 2)$  dBm with an accuracy specified in clause 6.3.4.2 of TS 38.101-1 [18], where  $\mu$  indicates the MsgA PUSCH numerology. The relative power applied to additional MsgA transmissions shall have an accuracy specified in clause 6.3.4.3 of TS 38.101-1 [18].

The transmit timing of all MsgA transmissions shall be within the accuracy specified in Clause 7.1.2.

##### A.6.3.2.2.4.2.2 MsgB Reception

To test the UE behavior specified in Clause 6.2.2.3.2.2 the System Simulator shall transmit a MsgB containing a fallbackRAR containing a Random Access Preamble identifier corresponding to the transmitted Random Access Preamble after 5 preambles have been received by the System Simulator. In response to the first 4 preambles, the System Simulator shall transmit a MsgB *not* corresponding to the transmitted Random Access Preamble.

The UE may stop monitoring for MsgB(s) and shall transmit the msg3 containing the payload of MsgA PUSCH if the MsgB with a fallbackRAR contains a Random Access Preamble identifier corresponding to the transmitted Random Access Preamble. The UE shall monitor contention resolution as described in clause 8.2A in TS 38.213 [3].

The UE shall again perform the Random Access Resource selection procedure specified in clause 5.1.2a in TS 38.321 [7], and transmit with the calculated MsgA PRACH and MsgA PUSCH transmission power when the backoff time expires if all received MsgB's contain Random Access Preamble identifiers that do not match the transmitted Random Access Preamble.

In addition, the power applied to all preambles shall be in accordance with what is specified in Clause 6.2.2.3. The power of the first preamble shall be -22 dBm with an accuracy specified in clause 6.3.4.2 of TS 38.101-1 [18]. The

power of the first MsgA PUSCH transmission shall be  $0.6 + 3(\mu + 2)$  dBm with an accuracy specified in clause 6.3.4.2 of TS 38.101-1 [18], where  $\mu$  indicates the MsgA PUSCH numerology. The relative power applied to additional preambles shall have an accuracy specified in clause 6.3.4.3 of TS 38.101-1 [18].

The transmit timing of all MsgA and msg3 transmissions shall be within the accuracy specified in Clause 7.1.2.

#### A.6.3.2.2.4.2.3 No MsgB Reception

To test the UE behavior specified in clause 6.2.2.3.2.3 the System Simulator shall transmit a MsgB containing a successRAR message and a Random Access Preamble identifier corresponding to the transmitted Random Access Preamble after 5 preambles have been received by the System Simulator. The System Simulator shall *not* respond to the first 4 preambles.

The UE shall again perform the Random Access Resource selection procedure specified in clause 5.1.2a in TS 38.321 [7], and transmit with the calculated MsgA transmission power when the backoff time expires if no MsgB is received within the MsgB Response window.

In addition, the power applied to all MsgA transmissions shall be in accordance with what is specified in Clause 6.2.2.3. The power of the first preamble shall be -22 dBm with an accuracy specified in clause 6.3.4.2 of TS 38.101-1 [18]. The power of the first MsgA PUSCH transmission shall be  $0.6 + 3(\mu + 2)$  dBm with an accuracy specified in clause 6.3.4.2 of TS 38.101-1 [18], where  $\mu$  indicates the MsgA PUSCH numerology. The relative power applied to additional MsgA transmissions shall have an accuracy specified in clause 6.3.4.3 of TS 38.101-1 [18].

The transmit timing of all MsgA transmissions shall be within the accuracy specified in Clause 7.1.2.

### A.6.3.2.3 SA: RRC Connection Release with Redirection

#### A.6.3.2.3.1 Redirection from NR in FR1 to NR in FR1

##### A.6.3.2.3.1.1 Test Purpose and Environment

This test is to verify RRC connection release with redirection from NR to NR requirements specified in clause 6.2.3.2.1.

##### A.6.3.2.3.1.2 Test Parameters

Supported test configurations are shown in table A.6.3.2.3.1.2-1. The time delay is tested by using the parameters in table A.6.3.2.3.1.2-2, and A.6.3.2.3.1.2-3.

The test consists of two successive time periods, with time duration of T1, and T2 respectively. The *RRCRelease* message shall be sent to the UE during period T1 and the start of T2 is the instant when the last TTI containing the RRC message is sent to the UE. Prior to time duration T2, the UE shall not have any timing information of Cell 2. Cell 2 is powered up at the beginning of the T2. Cell 1 and Cell 2 belong to different tracking areas.

**Table A.6.3.2.3.1.2-1: Redirection from NR to NR test configurations**

Config	Description
1	Source cell: NR 15 kHz SSB SCS, 10 MHz bandwidth, FDD duplex mode Target cell: NR 15 kHz SSB SCS, 10 MHz bandwidth, FDD duplex mode
2	Source cell: NR 15 kHz SSB SCS, 10 MHz bandwidth, TDD duplex mode Target cell: NR 15 kHz SSB SCS, 10 MHz bandwidth, TDD duplex mode
3	Source cell: NR 30 kHz SSB SCS, 40 MHz bandwidth, TDD duplex mode Target cell: NR 30 kHz SSB SCS, 40 MHz bandwidth, TDD duplex mode
Note:	The UE is only required to be tested in one of the supported test configurations

**Table A.6.3.2.3.1.2-2: General test parameters for Redirection from NR to NR test case**

Parameter	Unit	Value	Comment
Initial conditions	Active cell	Cell 1	
	Neighbouring cell	Cell 2	
Final condition	Active cell	Cell 2	
Filter coefficient		0	L3 filtering is not used
Access Barring Information	-	Not Sent	No additional delays in random access procedure.
Time offset between cells		3 $\mu$ s	Synchronous cells
T1	s	5	

T2	s	2.3	
----	---	-----	--

**Table A.6.3.2.3.1.2-3: Cell specific test parameters for Redirection from NR to NR test case**

Parameter		Unit	Cell 1		Cell 2	
			T1	T2	T1	T2
NR RF Channel Number			1		2	
Duplex mode	Config 1		FDD			
	Config 2,3		TDD			
SSB Configuration	Config 1		SSB.1 FR1			
	Config 2		SSB.1 FR1			
	Config 3		SSB.2 FR1			
CSI-RS for tracking	Config 1		TRS.1.1 FDD			
	Config 2		TRS.1.1 TDD			
	Config 3		TRS.1.2 TDD			
TDD configuration	Config 1		Not Applicable			
	Config 2		TDDConf.1.1			
	Config 3		TDDConf.2.1			
BW <sub>channel</sub>	Config 1	MHz	10: N <sub>RB,c</sub> = 52			
	Config 2		10: N <sub>RB,c</sub> = 52			
	Config 3		40: N <sub>RB,c</sub> = 106			
BWP BW	Config 1	MHz	10: N <sub>RB,c</sub> = 52			
	Config 2		10: N <sub>RB,c</sub> = 52			
	Config 3		40: N <sub>RB,c</sub> = 106			
DRx Cycle		ms	Not Applicable			
PDSCH Reference measurement channel	Config 1		SR.1.1 FDD			
	Config 2		SR.1.1 TDD			
	Config 3		SR2.1 TDD			
CORESET Reference Channel	Config 1		CR.1.1 FDD			
	Config 2		CR.1.1 TDD			
	Config 3		CR2.1 TDD			
OCNG Patterns			OCNG pattern 1			
SMTC configuration	Config 1,2		SMTC.1 FR1			
	Config 3		SMTC.2 FR1			
PDSCH/PDCCH subcarrier spacing	Config 1,2	kHz	15 kHz			
	Config 3		30 kHz			
PUCCH/PUSCH subcarrier spacing	Config 1,2	kHz	15 kHz			
	Config 3		30 kHz			
PRACH configuration			FR1 PRACH configuration 1			
BWP configuration	Initial DL BWP		DLBWP.0.1			
	Dedicated DL BWP		DLBWP.1.1			
	Initial UL BWP		ULBWP.0.1			
	Dedicated UL BWP		ULBWP.1.1			
EPRE ratio of PSS to SSS		dB	0			
EPRE ratio of PBCH DMRS to SSS						
EPRE ratio of PBCH to PBCH DMRS						
EPRE ratio of PDCCH DMRS to SSS						
EPRE ratio of PDCCH to PDCCH DMRS						
EPRE ratio of PDSCH DMRS to SSS						
EPRE ratio of PDSCH to PDSCH						
EPRE ratio of OCNG DMRS to SSS(Note 1)						
EPRE ratio of OCNG to OCNG DMRS (Note 1)						
$N_{oc}$ <sup>Note2</sup>		dBm/15kHz	-98			
$N_{oc}$ <sup>Note2</sup>	Config 1,2	dBm/SCS	-98			
	Config 3		-95			



$\hat{E}_s/I_{ot}$		dB	4	4	-infinity	4
$\hat{E}_s/N_{oc}$		dB	4	4	-infinity	4
I <sub>o</sub> <sup>Note3</sup>	Config 1,2	dBm/ 9.36MHz	-64.59	-64.59	-70.05	-64.59
	Config 3	dBm/ 38.16MHz	-58.49	-58.49	-63.94	-58.49
Propagation condition		-	AWGN			
Note 1: OCNG shall be used such that both cells are fully allocated and a constant total transmitted power spectral density is achieved for all OFDM symbols.						
Note 2: Interference from other cells and noise sources not specified in the test is assumed to be constant over subcarriers and time and shall be modelled as AWGN of appropriate power for $N_{oc}$ to be fulfilled.						
Note 3: I <sub>o</sub> levels have been derived from other parameters for information purposes. They are not settable parameters themselves.						

### A.6.3.2.3.1.3 Test Requirements

The UE shall start to transmit the PRACH to Cell 2 less than 2240 ms from the beginning of time period T2. The rate of correct RRC connection release redirection to NR observed during repeated tests shall be at least 90%.

NOTE: The redirection delay can be expressed as:

$$T_{\text{connection\_release\_redirect\_NR}} = T_{\text{RRC\_procedure\_delay}} + T_{\text{identify-NR}} + T_{\text{SI-NR}} + T_{\text{RACH}},$$

where:

$T_{\text{RRC\_procedure\_delay}} = 110$  ms in the test.

$T_{\text{identify-NR}} = 680$  ms in the test.

$T_{\text{SI-NR}} = 1280$  ms, it is the time required for receiving all the relevant system information as defined in TS 38.331 for the target NR cell.

$T_{\text{RACH}} = 170$  ms in the test.

This gives a total of 2240 ms.

### A.6.3.2.3.2 Redirection from NR in FR1 to E-UTRAN

#### A.6.3.2.3.2.1 Test Purpose and Environment

This test is to verify RRC connection release with redirection from NR to E-UTRAN requirements specified in clause 6.2.3.2.2.

#### A.6.3.2.3.2.2 Test Parameters

Supported test configurations are shown in table A.6.3.2.3.2.2-1. The time delay is tested by using the parameters in table A.6.3.2.3.2.2-2, A.6.3.2.3.2.2-3 and A.6.3.2.3.2.2-4.

The test consists of two successive time periods, with time duration of T1, and T2 respectively. The *RRCRelease* message shall be sent to the UE during period T1 and the start of T2 is the instant when the last TTI containing the RRC message is sent to the UE. Prior to time duration T2, the UE shall not have any timing information of Cell 2. Cell 2 is powered up at the beginning of the T2.

**Table A.6.3.2.3.2.2-1: Redirection from NR to E-UTRAN test configurations**

Configuration	Description
1	NR 15 kHz SSB SCS, 10 MHz bandwidth, FDD duplex mode, LTE FDD
2	NR 15 kHz SSB SCS, 10 MHz bandwidth, TDD duplex mode, LTE FDD
3	NR 30 kHz SSB SCS, 40 MHz bandwidth, TDD duplex mode, LTE FDD
4	NR 15 kHz SSB SCS, 10 MHz bandwidth, FDD duplex mode, LTE TDD
5	NR 15 kHz SSB SCS, 10 MHz bandwidth, TDD duplex mode, LTE TDD
6	NR 30kHz SSB SCS, 40 MHz bandwidth, TDD duplex mode, LTE TDD
Note:	The UE is only required to be tested in one of the supported test configurations

**Table A.6.3.2.3.2.2-2: General test parameters for Redirection from NR to E-UTRAN test case**

Parameter		Unit	Value	Comment
Initial conditions	Active cell		Cell 1	
	Neighbouring cell		Cell 2	
Final condition	Active cell		Cell 2	
Filter coefficient			0	L3 filtering is not used
Access Barring Information		-	Not Sent	No additional delays in random access procedure.
Time offset between cells			3 $\mu$ s	Synchronous cells
T1		s	5	
T2		s	2.3	

**Table A.6.3.2.3.2.2-3: Cell specific test parameters for Redirection from NR to E-UTRAN (cell 1)**

Parameter		Unit	Cell 1	
			T1	T2
RF Channel Number			1	
Duplex mode	Config 1,4		FDD	
	Config 2,3,5,6		TDD	
SSB Configuration	Config 1,4		SSB.1 FR1	
	Config 2,5		SSB.1 FR1	
	Config 3,6		SSB.2 FR1	
CSI-RS for tracking	Config 1,4		TRS.1.1 FDD	
	Config 2,5		TRS.1.1 TDD	
	Config 3,6		TRS.1.2 TDD	
TDD configuration	Config 1,4		Not Applicable	
	Config 2,5		TDDConf.1.1	
	Config 3,6		TDDConf.2.1	
BW <sub>channel</sub>	Config 1,4	MHz	10: N <sub>RB,c</sub> = 52	
	Config 2,5		10: N <sub>RB,c</sub> = 52	
	Config 3,6		40: N <sub>RB,c</sub> = 106	
BWP BW	Config 1,4	MHz	10: N <sub>RB,c</sub> = 52	
	Config 2,5		10: N <sub>RB,c</sub> = 52	
	Config 3,6		40: N <sub>RB,c</sub> = 106	
DRx Cycle		ms	Not Applicable	
PDSCH Reference measurement channel	Config 1,4		SR.1.1 FDD	
	Config 2,5		SR.1.1 TDD	
	Config 3,6		SR2.1 TDD	
CORESET Reference Channel	Config 1,4		CR.1.1 FDD	
	Config 2,5		CR.1.1 TDD	
	Config 3,6		CR2.1 TDD	
OCNG Patterns			OCNG pattern 1	
SMTC configuration	Config 1,2,4,5		SMTC.1 FR1	
	Config 3,6		SMTC.2 FR1	
PDSCH/PDCCH subcarrier spacing	Config 1,2,4,5	kHz	15 kHz	
	Config 3,6		30 kHz	
PUCCH/PUSCH subcarrier spacing	Config 1,2,4,5	kHz	15 kHz	
	Config 3,6		30 kHz	
PRACH configuration			FR1 PRACH configuration 1	
BWP configuration	Initial DL BWP		DLBWP.0.1	
	Dedicated DL BWP		DLBWP.1.1	
	Initial UL BWP		ULBWP.0.1	
	Dedicated UL BWP		ULBWP.1.1	
EPRE ratio of PSS to SSS		dB	0	
EPRE ratio of PBCH DMRS to SSS				
EPRE ratio of PBCH to PBCH DMRS				

EPRE ratio of PDCCH DMRS to SSS				
EPRE ratio of PDCCH to PDCCH DMRS				
EPRE ratio of PDSCH DMRS to SSS				
EPRE ratio of PDSCH to PDSCH				
EPRE ratio of OCNG DMRS to SSS(Note 1)				
EPRE ratio of OCNG to OCNG DMRS (Note 1)				
$N_{oc}$ Note2		dBm/15kHz z		-98
$N_{oc}$ Note2	Config 1,2,4,5	dBm/SCS		-98
	Config 3,6			-95
$\hat{E}_s/I_{ot}$		dB	4	4
$\hat{E}_s/N_{oc}$		dB	4	4
$I_o$ Note3	Config 1,2,4,5	dBm/ 9.36MHz	-64.59	-64.59
	Config 3,6	dBm/ 38.16MHz	-58.49	-58.49
Propagation condition		-	AWGN	
<p>Note 1: OCNG shall be used such that both cells are fully allocated and a constant total transmitted power spectral density is achieved for all OFDM symbols.</p> <p>Note 2: Interference from other cells and noise sources not specified in the test is assumed to be constant over subcarriers and time and shall be modelled as AWGN of appropriate power for <math>N_{oc}</math> to be fulfilled.</p> <p>Note 3: <math>I_o</math> levels have been derived from other parameters for information purposes. They are not settable parameters themselves.</p>				

**Table A.6.3.2.3.2-4: Cell specific test parameters for Redirection from NR to E-UTRAN (cell 2)**

Parameter	Unit	Configuration	Cell 2	
			T1	T2
RF channel number		1, 2, 3, 4, 5, 6	2	
Duplex mode		1, 2, 3	FDD	
		4, 5, 6	TDD	
TDD special subframe configuration <sup>Note1</sup>		4, 5, 6	6	
TDD uplink-downlink configuration <sup>Note1</sup>		4, 5, 6	1	
$BW_{channel}$	MHz	1, 2, 3, 4, 5, 6	5 MHz: $N_{RB,c} = 25$ 10 MHz: $N_{RB,c} = 50$ 20 MHz: $N_{RB,c} = 100$	
PRACH Configuration <sup>Note2</sup>		1, 2, 3	4	
		4, 5, 6	53	
PDSCH parameters: DL Reference Measurement Channel <sup>Note3</sup>		1, 2, 3	5 MHz: R.7 FDD 10 MHz: R.3 FDD 20 MHz: R.6 FDD	
		4, 5, 6	5 MHz: R.4 TDD 10 MHz: R.0 TDD 20 MHz: R.3 TDD	
PCFICH/PDCCH/PHICH parameters: DL Reference Measurement Channel <sup>Note3</sup>		1, 2, 3	5 MHz: R.11 FDD 10 MHz: R.6 FDD 20 MHz: R.10 FDD	
		4, 5, 6	5 MHz: R.11 TDD 10 MHz: R.6 TDD 20 MHz: R.10 TDD	
OCNG Patterns <sup>Note3</sup>		1, 2, 3	5 MHz: OP.20 FDD 10 MHz: OP.10 FDD 20 MHz: OP.17 FDD	
		4, 5, 6	5 MHz: OP.9 TDD 10 MHz: OP.1 TDD 20 MHz: OP.7 TDD	
PBCH_RA	dB	1, 2, 3, 4, 5, 6	0	
PBCH_RB				

PSS_RA				
SSS_RA				
PCFICH_RB				
PHICH_RA				
PHICH_RB				
PDCCH_RA				
PDCCH_RB				
PDSCH_RA				
PDSCH_RB				
OCNG_RA <sup>Note4</sup>				
OCNG_RB <sup>Note4</sup>				
$N_{oc}$ <sup>Note5</sup>	dBm/15kHz	1, 2, 3, 4, 5, 6	-98	
$\hat{E}_s/N_{oc}$	dB	1, 2, 3, 4, 5, 6	-Infinity	4
$\hat{E}_s/I_{ot}$ <sup>Note6</sup>	dB	1, 2, 3, 4, 5, 6	-Infinity	4
RSRP <sup>Note6</sup>	dBm/15kHz	1, 2, 3, 4, 5, 6	-Infinity	-94
SCH_RP <sup>Note6</sup>	dBm/15kHz	1, 2, 3, 4, 5, 6	-Infinity	-94
$I_o$ <sup>Note6</sup>	dBm/9MHz	1, 2, 3, 4, 5, 6	-70.22	-64.76
Propagation Condition		1, 2, 3, 4, 5, 6	AWGN	
Note 1:	Special subframe and uplink-downlink configurations are specified in table 4.2-1 in TS 36.211 [23].			
Note 2:	PRACH configurations are specified in table 5.7.1-2 and table 5.7.1-3 in TS 36.211 [23].			
Note 3:	DL RMCs and OCNG patterns are specified in clauses A 3.1 and A 3.2 of TS 36.133 [15] respectively.			
Note 4:	OCNG shall be used such that all cells are fully allocated and a constant total transmitted power spectral density is achieved for all OFDM symbols.			
Note 5:	Interference from other cells and noise sources not specified in the test is assumed to be constant over subcarriers and time and shall be modelled as AWGN of appropriate power for $N_{oc}$ to be fulfilled.			
Note 6:	$\hat{E}_s/I_{ot}$ , RSRP, SCH_RP and $I_o$ levels have been derived from other parameters for information purposes. They are not settable parameters themselves.			
Note 7:	Propagation condition and correlation matrix are defined in clause B.2 in TS 36.101 [25].			

#### A.6.3.2.3.2.3 Test Requirements

The UE shall start to transmit the PRACH to Cell 2 less than 2205 ms from the beginning of time period T2. The rate of correct RRC connection release redirection to E-UTRAN observed during repeated tests shall be at least 90%.

NOTE: The redirection delay can be expressed as:

$$T_{\text{connection\_release\_redirect\_E-UTRA}} = T_{\text{RRC\_procedure\_delay}} + T_{\text{identify-E-UTRA}} + T_{\text{SI-E-UTRA}} + T_{\text{RACH}},$$

where:

$T_{\text{RRC\_procedure\_delay}} = 110$  ms in the test.

$T_{\text{identify-E-UTRA}} = 800$  ms in the test.

$T_{\text{SI-E-UTRA}} = 1280$  ms, it is the time required for receiving all the relevant system information as defined in TS 36.331 for the target E-UTRA cell.

$T_{\text{RACH}} = 15$  ms in the test.

This gives a total of 2205 ms.

### A.6.3.3 Conditional handover

#### A.6.3.3.1 Intra-frequency conditional handover from FR1 to FR1

##### A.6.3.3.1.1 Test Purpose and Environment

This test is to verify the requirement for the NR FR1-NR FR1 intra frequency conditional handover requirements specified in clause 6.1.4.2.

##### A.6.3.3.1.2 Test Parameters

Supported test configurations are shown in table A.6.3.3.1.2-1. Both conditional handover delay and interruption length are tested by using the parameters in table A.6.3.3.1.2-2, and A.6.3.3.1.2-3.

The test consists of two successive time periods, with time durations of T1 and T2 respectively. At the start of time duration T1, the UE may not have any timing information of cell 2.

NR shall configure a condition implying handover to cell 2 during T1, at a time earlier than  $T_{RRC}$  before the beginning of T2.

**Table A.6.3.3.1.2-1: Intra-frequency conditional handover from FR1 to FR1 test configurations**

Config	Description
1	Source cell: NR 15 kHz SSB SCS, 10 MHz bandwidth, FDD duplex mode Target cell: NR 15 kHz SSB SCS, 10 MHz bandwidth, FDD duplex mode
2	Source cell: NR 15 kHz SSB SCS, 10 MHz bandwidth, TDD duplex mode Target cell: NR 15 kHz SSB SCS, 10 MHz bandwidth, TDD duplex mode
3	Source cell: NR 30 kHz SSB SCS, 40 MHz bandwidth, TDD duplex mode Target cell: NR 30 kHz SSB SCS, 40 MHz bandwidth, TDD duplex mode
Note: The UE is only required to be tested in one of the supported test configurations	

**Table A.6.3.3.1.2-2: General test parameters Intra-frequency conditional handover from FR1 to FR1**

Parameter	Unit	Value	Comment
Initial conditions	Active cell	Cell 1	
	Neighbouring cell	Cell 2	
Final condition	Active cell	Cell 2	
A3-Offset in condition	dB	0	
Hysteresis	dB	0	
Time To Trigger	s	0	
Filter coefficient		0	L3 filtering is not used
Access Barring Information	-	Not Sent	No additional delays in random access procedure.
PRACH configuration index		FR1 PRACH configuration 1	As specified in table Table 6.3.3.2-3 in TS 38.211 [6]
Time offset between cells		3 $\mu$ s	Synchronous cells
T1	s	5	
T2	s	$\leq 2$	

**Table A.6.3.3.1.2-3: Cell specific test parameters for NR FR1-FR1 Intra frequency conditional handover test case**

Parameter		Unit	Cell 1		Cell 2	
			T1	T2	T1	T2
NR RF Channel Number			1		1	
Duplex mode	Config 1		FDD			
	Config 2,3		TDD			
TDD configuration	Config 1		Not Applicable			
	Config 2		TDDConf.1.1			
	Config 3		TDDConf.2.1			
$BW_{channel}$	Config 1	MHz	10: $N_{RB,c} = 52$			
	Config 2		10: $N_{RB,c} = 52$			
	Config 3		40: $N_{RB,c} = 106$			
BWP BW	Config 1	MHz	10: $N_{RB,c} = 52$			
	Config 2		10: $N_{RB,c} = 52$			
	Config 3		40: $N_{RB,c} = 106$			
DRx Cycle		ms	Not Applicable			
PDSCH Reference measurement channel	Config 1		SR.1.1 FDD			
	Config 2		SR.1.1 TDD			
	Config 3		SR2.1 TDD			
CORESET Reference Channel	Config 1		CR.1.1 FDD			
	Config 2		CR.1.1 TDD			
	Config 3		CR2.1 TDD			
TRS configuration	Config 1		TRS.1.1 FDD			
	Config 2		TRS.1.1 TDD			

	Config 3		TRS.1.2 TDD			
OCNG Patterns			OCNG pattern 1			
SMTC Configuration			SMTC pattern 1			
SSB Configuration	Config 1,2		SSB.1 FR1			
	Config 3		SSB.2 FR1			
PDSCH/PDCCH subcarrier spacing	Config 1,2	kHz	15 kHz			
	Config 3		30 kHz			
PUCCH/PUSCH subcarrier spacing	Config 1,2	kHz	15 kHz			
	Config 3		30 kHz			
PRACH configuration			FR1 PRACH configuration 1			
BWP configuration	Initial DL BWP		DLBWP.0.1			
	Dedicated DL BWP		DLBWP.1.1			
	Initial UL BWP		ULBWP.0.1			
	Dedicated UL BWP		ULBWP.1.1			
EPRE ratio of PSS to SSS		dB	0			
EPRE ratio of PBCH DMRS to SSS						
EPRE ratio of PBCH to PBCH DMRS						
EPRE ratio of PDCCH DMRS to SSS						
EPRE ratio of PDCCH to PDCCH DMRS						
EPRE ratio of PDSCH DMRS to SSS						
EPRE ratio of PDSCH to PDSCH						
EPRE ratio of OCNG DMRS to SSS(Note 1)						
EPRE ratio of OCNG to OCNG DMRS (Note 1)						
$N_{oc}^{Note2}$		dBm/15kHz	-98			
$N_{oc}^{Note2}$	Config 1,2	dBm/SCS	-98			
	Config 3		-95			
$\hat{E}_s / I_{ot}$		dB	8	-3.3	-	2.36
$\hat{E}_s / N_{oc}$		dB	8	8	-	11
SSB_RP	Config 1,2	dBm/SCS	-90	-90	-	-87
	Config 3	dBm/SCS	-87	-87	-	-84
$I_o^{Note3}$	Config 1,2	dBm/9.36MHz	-61.41	-57.06	-61.41	-57.06
	Config 3	dBm/38.16MHz	-55.31	-50.96	-55.31	-50.96
Propagation condition		-	AWGN			AWGN
<p>Note 1: OCNG shall be used such that both cells are fully allocated and a constant total transmitted power spectral density is achieved for all OFDM symbols.</p> <p>Note 2: Interference from other cells and noise sources not specified in the test is assumed to be constant over subcarriers and time and shall be modelled as AWGN of appropriate power for <math>N_{oc}</math> to be fulfilled.</p> <p>Note 3: <math>I_o</math> levels have been derived from other parameters for information purposes. They are not settable parameters themselves.</p>						

A.6.3.3.1.3 Test Requirements

$T_{RRC} + T_{Event\_DU}$  occurs during T1 as the handover condition becomes satisfied at the start of T2. The test shall verify that there are no interruptions during T1.

The UE shall start to transmit the PRACH to Cell 2 less than  $T_{measure} + T_{interrupt} + T_{CHO\_execution} = 800 + 62 + 10 = 872ms$  from the start of T2 and the interruption during T2 shall not exceed  $T_{interrupt} = T_{processing} + T_{IU} + T_{\Delta} + T_{margin} = 40 + 20 + 2 = 62ms$

### A.6.3.3.2 Inter-frequency conditional handover from FR1 to FR1

#### A.6.3.3.2.1 Test Purpose and Environment

This test is to verify the requirement for the NR conditional FR1-NR FR1 inter frequency conditional handover requirements specified in clause 6.1.4.2.

#### A.6.3.3.2.2 Test Parameters

Supported test configurations are shown in table A.6.3.3.2.2-1. Both conditional handover delay and interruption length are tested by using the parameters in table A.6.3.3.2.2-2, and A.6.3.3.2.2-3.

The test scenario comprises of two carriers and one cell on each carrier Gap pattern ID gp0 is configured in the test case. The test consists of two successive time periods, with time durations of T1, T2 respectively. At the start of time duration T1, the UE does not have any timing information of cell 2. NR shall configure a condition implying handover to cell 2 during T1, at a time earlier than  $T_{RRC}$  before the beginning of T2. At the start of T2, cell 2 becomes detectable and meets the handover condition.

**Table A.6.3.3.2.2-1: Inter-frequency handover from FR1 to FR1 test configurations**

Config	Description
1	Source cell: NR 15 kHz SSB SCS, 10 MHz bandwidth, FDD duplex mode Target cell: NR 15 kHz SSB SCS, 10 MHz bandwidth, FDD duplex mode
2	Source cell: NR 15 kHz SSB SCS, 10 MHz bandwidth, TDD duplex mode Target cell: NR 15 kHz SSB SCS, 10 MHz bandwidth, TDD duplex mode
3	Source cell: NR 30 kHz SSB SCS, 40 MHz bandwidth, TDD duplex mode Target cell: NR 30 kHz SSB SCS, 40 MHz bandwidth, TDD duplex mode
Note: The UE is only required to be tested in one of the supported test configurations	

**Table A.6.3.3.2.2-2: General test parameters Inter-frequency handover from FR1 to FR1**

Parameter	Unit	Value	Comment
Initial conditions	Active cell	Cell 1	
	Neighbouring cell	Cell 2	
Final condition	Active cell	Cell 2	
A3-Offset in handover condition	dB	-4	
Hysteresis	dB	0	
Time To Trigger	s	0	
Filter coefficient		0	L3 filtering is not used
Access Barring Information	-	Not Sent	No additional delays in random access procedure.
T1	s	5	
T2	s	$\leq 2$	

**Table A.6.3.3.2.2-3: Cell specific test parameters for NR FR1-FR1 Inter frequency handover test case**

Parameter	Unit	Cell 1		Cell 2	
		T1	T2	T1	T2
NR RF Channel Number		1		2	
Duplex mode	Config 1	FDD			
	Config 2,3	TDD			
TDD configuration	Config 1	Not Applicable			
	Config 2	TDDConf.1.1			
	Config 3	TDDConf.2.1			
BW <sub>channel</sub>	Config 1	10: N <sub>RB,c</sub> = 52			
	Config 2	10: N <sub>RB,c</sub> = 52			
	Config 3	40: N <sub>RB,c</sub> = 106			
BWP BW	Config 1	10: N <sub>RB,c</sub> = 52			
	Config 2	10: N <sub>RB,c</sub> = 52			
	Config 3	40: N <sub>RB,c</sub> = 106			
TRS configuration	Config 1	TRS.1.1 FDD			
	Config 2	TRS.1.1 TDD			

	Config 3		TRS.1.2 TDD			
DRx Cycle		ms	Not Applicable			
Gap pattern ID			gp0			
PDSCH Reference measurement channel	Config 1		SR.1.1 FDD			
	Config 2		SR.1.1 TDD			
	Config 3		SR2.1 TDD			
CORESET Reference Channel	Config 1		CR.1.1 FDD			
	Config 2		CR.1.1 TDD			
	Config 3		CR2.1 TDD			
OCNG Patterns			OCNG pattern 1			
SMTTC Configuration			SMTTC pattern 1			
SSB Configuration	Config 1,2		SSB.1 FR1			
	Config 3		SSB.2 FR1			
PDSCH/PDCCH subcarrier spacing	Config 1,2	kHz	15 kHz			
	Config 3		30 kHz			
PUCCH/PUSCH subcarrier spacing	Config 1,2	kHz	15 kHz			
	Config 3		30 kHz			
PRACH configuration			FR1 PRACH configuration 1			
BWP	Initial DL BWP		DLBWP.0.1			
	Dedicated DL BWP		DLBWP.1.1			
	Initial UL BWP		ULBWP.0.1			
	Dedicated UL BWP		ULBWP.1.1			
EPRE ratio of PSS to SSS		dB	0			
EPRE ratio of PBCH DMRS to SSS						
EPRE ratio of PBCH to PBCH DMRS						
EPRE ratio of PDCCH DMRS to SSS						
EPRE ratio of PDCCH to PDCCH DMRS						
EPRE ratio of PDSCH DMRS to SSS						
EPRE ratio of PDSCH to PDSCH						
EPRE ratio of OCNG DMRS to SSS(Note 1)						
EPRE ratio of OCNG to OCNG DMRS (Note 1)						
$N_{oc}^{Note2}$						
$N_{oc}^{Note2}$	Config 1,2	dBm/SCS	-98		-98	
	Config 3		-95		-95	
$\hat{E}_s/I_{ot}$		dB	4	4	-Infinity	5
$\hat{E}_s/N_{oc}$		dB	4	4	-Infinity	5
SSB_RP	Config 1,2	dBm/SCS	-94	-94	-Infinity	-93
	Config 3	dBm/SCS	-91	-91	-Infinity	-90
$I_o^{Note3}$	Config 1,2	dBm/9.36MHz	-64.59	-64.59	-70.05	-63.85
	Config 3	dBm/38.16MHz	-58.49	-58.49	-63.94	-57.75
Propagation condition		-	AWGN		AWGN	
Note 1:	OCNG shall be used such that both cells are fully allocated and a constant total transmitted power spectral density is achieved for all OFDM symbols.					
Note 2:	Interference from other cells and noise sources not specified in the test is assumed to be constant over subcarriers and time and shall be modelled as AWGN of appropriate power for $N_{oc}$ to be fulfilled.					
Note 3:	$I_o$ levels have been derived from other parameters for information purposes. They are not settable parameters themselves.					

A.6.3.3.2.3 Test Requirements

$T_{RRC} + T_{Event\_DU}$  occurs during T1 as the handover condition becomes satisfied at the start of T2. The test shall verify that there are no interruptions during T1.



The UE shall start to transmit the PRACH to Cell 2 less than  $T_{\text{measure}} + T_{\text{interrupt}} + T_{\text{CHO\_execution}} = 920 + 62 + 10 = 992$  ms from the start of T2 and the interruption during T2 shall not exceed  $T_{\text{interrupt}} = T_{\text{processing}} + T_{\text{IU}} + T_{\Delta} + T_{\text{margin}} = 40 + 20 + 2 = 62$  ms excluding any transmissions which do not occur due to measurement gaps.

Inter-frequency CHO FR1-FR1  $920 (T_{\text{measure}}) + 62 (T_{\text{interrupt}}) + 10 (T_{\text{CHO\_execution}}) = 992$  ms

## A.6.4 Timing

### A.6.4.1 UE transmit timing

#### A.6.4.1.1 NR UE Transmit Timing Test for FR1

##### A.6.4.1.1.1 Test Purpose and environment

The purpose of this test is to verify that the UE can follow frame timing change of the connected gNodeB and that the UE initial transmit timing accuracy, maximum amount of timing change in one adjustment, minimum and maximum adjustment rate are within the specified limits. This test will verify the requirements in clause 7.1.2.

Supported test configurations are shown in Table A.6.4.1.1.1-1.

**Table A.6.4.1.1.1-1: Supported test configurations for FR1 PCell**

Configuration	Description
1	NR FDD, SSB SCS 15 kHz, data SCS 15 kHz, BW 10 MHz
2	NR TDD, SSB SCS 15 kHz, data SCS 15 kHz, BW 10 MHz
3	NR TDD, SSB SCS 30 kHz, data SCS 30 kHz, BW 40 MHz
Note:	The UE is only required to be tested in one of the supported test configurations

For this test a single NR cell is used. Table A.6.4.1.1.1-2 defines the parameters to be configured and strength of the transmitted signals. The transmit timing is verified by the UE transmitting SRS using the configuration defined in Table A.6.4.1.1.1-3.

**Table A.6.4.1.1.1-2: Cell Specific Test Parameters for UL Transmit Timing test**

Parameter	Unit	Config	Test1	Test2
SSB ARFCN		1,2,3	1	1
TDD configuration		1	Not Applicable	
		2	TDDConf.1.1	
		3	TDDConf.2.1	
BW <sub>channel</sub>	MHz	1	10: N <sub>RB,c</sub> = 52	
		2	10: N <sub>RB,c</sub> = 52	
		3	40: N <sub>RB,c</sub> = 106	
Initial BWP Configuration		1,2,3	DLBWP.0.1 ULBWP.0.1	
Dedicated BWP Configuration		1,2,3	DLBWP.1.1 ULBWP.1.1	
DRx Cycle	ms	1,2,3	N/A	DRX.8 <sup>Note5</sup>
PDSCH Reference measurement channel		1	SR.1.1 FDD	
		2	SR.1.1 TDD	
		3	SR.2.1 TDD	
RMSI CORESET Reference Channel		1	CR.1.1 FDD	
		2	CR.1.1 TDD	
		3	CR.2.1 TDD	
Dedicated CORESET Reference Channel		1	CCR.1.1 FDD	
		2	CCR.1.1 TDD	
		3	CCR.2.1 TDD	
OCNG Patterns		1,2,3	OP.1	
SSB configuration		1,2	SSB.1 FR1	
		3	SSB.2 FR1	

SMTC Configuration		1,2	SMTC.1	
		3	SMTC.2	
TRS configuration		1	TRS.1.1 FDD	
		2	TRS.1.1 TDD	
		3	TRS.1.2 TDD	
EPRE ratio of PSS to SSS	dB	1,2,3	0	0
EPRE ratio of PBCH DMRS to SSS				
EPRE ratio of PBCH to PBCH DMRS				
EPRE ratio of PDCCH DMRS to SSS				
EPRE ratio of PDCCH to PDCCH DMRS				
EPRE ratio of PDSCH DMRS to SSS				
EPRE ratio of PDSCH to PDSCH				
EPRE ratio of OCNG DMRS to SSS(Note 1)				
EPRE ratio of OCNG to OCNG DMRS (Note 1)				
$N_{oc}$ <sup>Note2</sup>	dBm/15 kHz	1,2,3	-98	-98
$N_{oc}$ <sup>Note2</sup>	dBm/SCS	1,2	-98	-98
		3	-95	-95
$\hat{E}_s / I_{ot}$		1,2,3	3	3
$\hat{E}_s / N_{oc}$		1,2,3	3	3
SS-RSRP <sup>Note3</sup>	dBm/SCS	1,2	-95	-95
		3	-92	-92
$I_o$ <sup>Note3</sup>	dBm/9.36MHz	1,2	-65.2	-65.2
	dBm/38.1MHz	3	-59.2	-59.2
Propagation condition		1,2,3	AWGN	
SRS Config		1,2	SRSCConf.1 <sup>Note6</sup>	SRSCConf.3 <sup>Note6</sup>
		3	SRSCConf.1 <sup>Note6</sup>	SRSCConf.2 <sup>Note6</sup>
<p>Note 1: OCNG shall be used such that both cells are fully allocated and a constant total transmitted power spectral density is achieved for all OFDM symbols.</p> <p>Note 2: Interference from other cells and noise sources not specified in the test is assumed to be constant over subcarriers and time and shall be modelled as AWGN of appropriate power for <math>N_{oc}</math> to be fulfilled.</p> <p>Note 3: SS-RSRP and <math>I_o</math> levels have been derived from other parameters for information purposes. They are not settable parameters themselves.</p> <p>Note 4: SS-RSRP minimum requirements are specified assuming independent interference and noise at each receiver antenna port.</p> <p>Note 5: DRx related parameters are given in Table A.3.3.8-1</p> <p>Note 6: SRS configs are given in Table A.6.4.1.1.1-3</p>				

**Table A.6.4.1.1.1-3: SRS Configuration for Timing Accuracy Test**

	Field	SRSCConf.1	SRSCConf.2	SRSCConf.3	Comments
SRS-ResourceSet	srs-ResourceSetId	0	0	0	
	srs-ResourceIdList	0	0	0	
	resourceType	Periodic	Periodic	Periodic	
	Usage	Codebook	Codebook	Codebook	
SRS-Resource	SRS-ResourceId	0	0	0	
	nrofSRS-Ports	Port1	Port1	Port1	
	transmissionComb	n2	n2	n2	
	combOffset-n2	0	0	0	
	cyclicShift-n2	0	0	0	
	resourceMapping startPosition	0	0	0	
	resourceMapping	n1	n1	n1	

nrofSymbols				
resourceMapping repetitionFactor	n1	n1	n1	
freqDomainPosition	0	0	0	
freqDomainShift	0	0	0	
freqHopping c-SRS	14 for test configuration 1,2 25 for test configuration 3	25	14	Matches N <sub>RB,c</sub>
freqHopping b-SRS	0	0	0	
freqHopping b-hop	0	0	0	
groupOrSequenceHopping	Neither	Neither	Neither	
resourceType	Periodic	Periodic	Periodic	
periodicityAndOffset-p	sl1, 0	sl640, 0	sl320, 0	Offset to align with DRx periodicity
sequenceId	0	0	0	Any 10 bit number

Table A.6.4.1.1.1-4: Void

## A.6.4.1.1.2 Test requirements

The test sequence shall be carried out in RRC\_CONNECTED for every test case.

Following will be the test sequence for this test

- 1) Setup NR PCell according to parameters given in Table A.6.4.1.1.1-1.
- 2) After connection set up with the cell, the test equipment will verify that the timing of the NR cell is within  $(N_{TA} + N_{TA\_offset}) \times T_c \pm T_e$  of the first detected path of DL SSB.
  - a. The  $N_{TA}$  offset value (in  $T_c$  units) is 25600
  - b. The  $T_e$  values depend on the DL and UL SCS for which the test is being run and are given in Table 7.1.2-1
- 3) The test system shall adjust the timing of the DL path by values given in Table A.6.4.1.1.2-1

Table A.6.4.1.1.2-1: Adjustment Value for DL Timing

SCS of SSB signals (KHz)	Adjustment Value	
	Test1	Test2
15	+64*64T <sub>c</sub>	+32*64T <sub>c</sub>
30	+32*64T <sub>c</sub>	+16*64T <sub>c</sub>

- 4) The test system shall verify that the adjustment step size and the adjustment rate shall be according to requirements specified in clause 7.1.2 Table 7.1.2.1-1 until the UE transmit timing offset is within  $(N_{TA} + N_{TA\_offset}) \times T_c \pm T_e$  respective to the first detected path (in time) of DL SSB. Skip this step for test 2 with DRX configured.
- 5) The test system shall verify that the UE transmit timing offset stays within  $(N_{TA} + N_{TA\_offset}) \times T_c \pm T_e$  of the first detected path of DL SSB. For Test 2 the UE transmit timing offset shall be verified for the first transmission in the DRX cycle immediately after DL timing adjustment

## A.6.4.2 UE timer accuracy

## A.6.4.3 Timing advance

### A.6.4.3.1 SA FR1 timing advance adjustment accuracy

#### A.6.4.3.1.1 Test Purpose and Environment

The purpose of the test is to verify UE Timing Advance adjustment delay and accuracy requirement defined in clause 7.3.

#### A.6.4.3.1.2 Test Parameters

Supported test configurations are shown in table A.6.4.3.1.2-1. Both timing advance adjustment delay and accuracy are tested by using the parameters in table A.6.4.3.1.2-2, A.6.4.3.1.2-3 and A.6.4.3.1.2-4.

In all test cases, single cell is used. Each test consists of two successive time periods, with time duration of T1 and T2 respectively. In each time period, timing advance commands are sent to the UE and Sounding Reference Signals (SRS), as specified in table A.6.4.3.1.2-3, are sent from the UE and received by the test equipment. By measuring the reception of the SRS, the transmit timing, and hence the timing advance adjustment accuracy, can be measured.

During time period T1, the test equipment shall send one message with a Timing Advance Command MAC Control Element, as specified in Clause 6.1.3.4 in TS 38.321 [7]. The Timing Advance Command value shall be set to 31, which according to Clause 4.2 in TS 38.213 [3] results in zero adjustment of the Timing Advance. In this way, a reference value for the timing advance used by the UE is established.

During time period T2, the test equipment shall send a sequence of messages with Timing Advance Command MAC Control Elements, with Timing Advance Command value specified in table A.6.4.3.1.2-2. This value shall result in changes of the timing advance used by the UE, and the accuracy of the change shall then be measured, using the SRS sent from the UE.

As specified in Clause 7.3.2.1, the UE adjusts its uplink timing at slot  $n+k+1$  for a timing advance command received in slot  $n$ . This delay must be taken into account when measuring the timing advance adjustment accuracy, via the SRS sent from the UE.

The UE Time Alignment Timer, described in Clause 5.2 in TS 38.321 [7], shall be configured so that it does not expire in the duration of the test.

**Table A.6.4.3.1.2-1: Timing advance supported test configurations**

Config	Description
1	NR 15 kHz SSB SCS, 10 MHz bandwidth, FDD duplex mode
2	NR 15 kHz SSB SCS, 10 MHz bandwidth, TDD duplex mode
3	NR 30 kHz SSB SCS, 40 MHz bandwidth, TDD duplex mode
Note:	The UE is only required to be tested in one of the supported test configurations

**Table A.6.4.3.1.2-2: General test parameters for timing advance**

Parameter	Unit	Value	Comment
RF channel number		1	
Initial DL BWP		DLBWP.0.1	As specified in Table A.3.9.2.1-1
Dedicated DL BWP		DLBWP.1.1	As specified in Table A.3.9.2.2-1
Initial UL BWP		ULBWP.0.1	As specified in Table A.3.9.3.1-1
Dedicated UL BWP		ULBWP.1.1	As specified in Table A.3.9.3.2-1
Timing Advance Command ( $T_A$ ) value during T1		31	$N_{TA\_new} = N_{TA\_old}$ for the purpose of establishing a reference value from which the timing advance adjustment accuracy can be measured during T2
Timing Advance Command ( $T_A$ ) value during T2		39	For 15 kHz SCS $N_{TA\_new} = N_{TA\_old} + 8192 * T_c$ For 30 kHz SCS $N_{TA\_new} = N_{TA\_old} + 4096 * T_c$ (based on equation in clause 4.2 of TS 38.213 [3])

T1	s	5	
T2	s	5	

**Table A.6.4.3.1.2-3: Cell specific test parameters for timing advance**

Parameter		Unit	Test1	
			T1	T2
Duplex mode	Config 1		FDD	
	Config 2,3		TDD	
TDD configuration	Config 1		Not Applicable	
	Config 2		TDDConf.1.1	
	Config 3		TDDConf.2.1	
BW <sub>channel</sub>	Config 1	MHz	10: N <sub>RB,c</sub> = 52	
	Config 2		10: N <sub>RB,c</sub> = 52	
	Config 3		40: N <sub>RB,c</sub> = 106	
BWP BW	Config 1	MHz	10: N <sub>RB,c</sub> = 52	
	Config 2		10: N <sub>RB,c</sub> = 52	
	Config 3		40: N <sub>RB,c</sub> = 106	
DRx Cycle		ms	Not Applicable	
PDSCH Reference measurement channel	Config 1		SR.1.1 FDD	
	Config 2		SR.1.1 TDD	
	Config 3		SR.2.1 TDD	
RMSI CORESET Reference Channel	Config 1		CR.1.1 FDD	
	Config 2		CR.1.1 TDD	
	Config 3		CR.2.1 TDD	
CORESET Reference Channel	Config 1		CCR.1.1 FDD	
	Config 2		CCR.1.1 TDD	
	Config 3		CCR.2.1 TDD	
TRS configuration	Config 1		TRS.1.1 FDD	
	Config 2		TRS.1.1 TDD	
	Config 3		TRS.1.2 TDD	
OCNG Patterns			OCNG pattern 1	
SMTc configuration	Config 1,2		SMTc.1 FR1	
	Config 3		SMTc.2 FR1	
SSB configuration	Config 1,2		SSB.1 FR1	
	Config 3		SSB.2 FR1	
PDSCH/PDCCH subcarrier spacing	Config 1,2	kHz	15 kHz	
	Config 3		30 kHz	
PUCCH/PUSCH subcarrier spacing	Config 1,2	kHz	15 kHz	
	Config 3		30 kHz	
EPRE ratio of PSS to SSS		dB	0	
EPRE ratio of PBCH DMRS to SSS				
EPRE ratio of PBCH to PBCH DMRS				
EPRE ratio of PDCCH DMRS to SSS				
EPRE ratio of PDCCH to PDCCH DMRS				
EPRE ratio of PDSCH DMRS to SSS				
EPRE ratio of PDSCH to PDSCH				
EPRE ratio of OCNG DMRS to SSS(Note 1)				
EPRE ratio of OCNG to OCNG DMRS (Note 1)				
$N_{oc}$ <sup>Note2</sup>			dBm/15kHz	-98
$N_{oc}$ <sup>Note2</sup>	Config 1,2	dBm/SCS	-98	
	Config 3		-95	
$\hat{E}_s / I_{ot}$		dB	3	
$\hat{E}_s / N_{oc}$		dB	3	

I <sub>o</sub> <sup>Note3</sup>	Config 1,2	dBm/ 9.36MHz	-67.57
	Config 3	dBm/ 38.16MHz	-62.58
Propagation condition		-	AWGN
Note 1: OCNG shall be used such that both cells are fully allocated and a constant total transmitted power spectral density is achieved for all OFDM symbols.			
Note 2: Interference from other cells and noise sources not specified in the test is assumed to be constant over subcarriers and time and shall be modelled as AWGN of appropriate power for $N_{oc}$ to be fulfilled.			
Note 3: I <sub>o</sub> levels have been derived from other parameters for information purposes. They are not settable parameters themselves.			

**Table A.6.4.3.1.2-4: Sounding Reference Symbol Configuration for timing advance**

Field		Value	Comment
c-SRS	Config 1,2	12	Frequency hopping is disabled
	Config 3	24	
b-SRS		0	
b-hop		0	
freqDomainPosition		0	Frequency domain position of SRS
freqDomainShift		0	
groupOrSequenceHopping		neither	No group or sequence hopping
SRS-PeriodicityAndOffset		sI5=2 for SCS 15kHz sI5=4 for SCS 30kHz	Once every 5 slots
pathlossReferenceRS		ssb-Index=0	SSB #0 is used for SRS path loss estimation
usage		Codebook	Codebook based UL transmission resourceMapping setting. SRS on last symbol of slot, and 1symbols for SRS without repetition.
startPosition		0	
nrofSymbols		n1	
repetitionFactor		n1	
combOffset-n2		0	transmissionComb setting
cyclicShift-n2		0	
nrofSRS-Ports		port1	Number of antenna ports used for SRS transmission
Note: For further information see clause 6.3.2 in TS 38.331 [2].			

### A.6.4.3.1.3 Test Requirements

The UE shall apply the signalled Timing Advance value to the transmission timing at the designated activation time i.e.  $k+1$  slots after the reception of the timing advance command, where  $k=5$ .

The Timing Advance adjustment accuracy shall be within the limits specified in clause 7.3.2.2.

The rate of correct Timing Advance adjustments observed during repeated tests shall be at least 90%.

## A.6.5 Signalling characteristics

### A.6.5.1 Radio link Monitoring

In the following clause, any uplink signal transmitted by the UE is used for detecting the In-/Out-of-Sync state of the UE. In terms of measurement, the uplink signal is verified on the basis of the UE output power:

For intra-band contiguous carrier aggregation, transmit OFF power is measured as the mean power per component carrier.

For UE with multiple transmit antennas, transmit OFF power is measured as the mean power at each transmit connector.

- UE output power higher than Transmit OFF power -50 dBm (as defined in TS 38.101-1 [18]) means uplink signal
- UE output power equal to or less than Transmit OFF power -50 dBm (as defined in TS 38.101-1 [18]) means no uplink signal.

### A.6.5.1.1 Radio Link Monitoring Out-of-sync Test for FR1 PCell configured with SSB-based RLM RS in non-DRX mode

#### A.6.5.1.1.1 Test Purpose and Environment

The purpose of this test is to verify that the UE properly detects the out of sync and in sync for the purpose of monitoring downlink radio link quality of the PCell. This test will partly verify the FR1 radio link monitoring requirements in clause 8.1.

In the test, UE is configured to perform RLM on SSB, with *detectionResource* included in *RadioLinkMonitoringRS* set to SSB#0, and *purpose* set to 'rlf'. Supported test configurations are shown in table A.6.5.1.1.1-1. The test parameters are given in Tables A.6.5.1.1.1-2, A.6.5.1.1.1-3, and A.6.5.1.1.1-4 below. There is one cell (Cell 1), which is the active NR cell, in the test. The test consists of three successive time periods, with time duration of T1, T2 and T3 respectively. Figure A.6.5.1.1.1-1 shows the variation of the downlink SNR in the active cell to emulate out-of-sync and in-sync states. Prior to the start of the time duration T1, the UE shall be fully synchronized to Cell 1. The UE shall be configured for periodic CSI reporting with a reporting periodicity of 5 ms. The UE is configured to perform inter-frequency measurements using Gap Pattern ID #0 (40ms) in test 1.

**Table A.6.5.1.1.1-1: Supported test configurations for FR1 PCell**

Configuration	Description
1	FDD, SSB SCS 15 kHz, data SCS 15 kHz, BW 10 MHz
2	TDD, SSB SCS 15 kHz, data SCS 15 kHz, BW 10 MHz
3	TDD, SSB SCS 30 kHz, data SCS 30 kHz, BW 40 MHz
Note:	The UE is only required to pass in one of the supported test configurations in FR1

**Table A.6.5.1.1.1-2: General test parameters for FR1 out-of-sync testing in non-DRX mode**

Parameter	Unit	Value
		Test 1
Active PCell		Cell 1
RF Channel Number		1
Duplex mode	Config 1	FDD
	Config 2, 3	TDD
BW <sub>channel</sub>	Config 1	10: N <sub>RB,c</sub> = 52
	Config 2	10: N <sub>RB,c</sub> = 52
	Config 3	40: N <sub>RB,c</sub> = 106
DL initial BWP configuration	Config 1, 2, 3	DLBWP.0.1
DL dedicated BWP configuration	Config 1, 2, 3	DLBWP.1.1
UL initial BWP configuration	Config 1, 2, 3	ULBWP.0.1
UL dedicated BWP configuration	Config 1, 2, 3	ULBWP.1.1
TDD Configuration	Config 1	Not Applicable
	Config 2	TDDConf.1.1
	Config 3	TDDConf.2.1
RMSI CORESET Reference Channel	Config 1	CR.1.1 FDD
	Config 2	CR.1.1 TDD
	Config 3	CR.2.1 TDD
Dedicated CORESET Reference Channel	Config 1	CCR.1.3 FDD
	Config 2	CCR.1.3 TDD
	Config 3	CCR.2.2 TDD
SSB Configuration	Config 1	SSB.1 FR1
	Config 2	SSB.1 FR1
	Config 3	SSB.2 FR1

SMTC Configuration	Config 1, 2		SMTC.1
	Config 3		SMTC.1
PDSCH/PDCCH subcarrier spacing	Config 1, 2		15 kHz
	Config 3		30 kHz
PRACH Configuration	Config 1, 2		Table A.3.8.2.1-1
	Config 3		Table A.3.8.2.1-1
SSB index assigned as RLM RS			0
OCNG parameters			OP.1
CP length			Normal
Correlation Matrix and Antenna Configuration			2x2 Low
Out of sync transmission parameters	DCI format		1-0
	Number of Control OFDM symbols		2
	Aggregation level	CCE	8
	Ratio of hypothetical PDCCH RE energy to average SSS RE energy	dB	4
	Ratio of hypothetical PDCCH DMRS energy to average SSS RE energy	dB	4
	DMRS precoder granularity		REG bundle size
	REG bundle size		6
DRX			OFF
Gap pattern ID			gp0
Layer 3 filtering			Enabled
T310 timer	ms		0
T311 timer	ms		1000
N310			1
N311			1
CSI-RS configuration for CSI reporting	Config 1		CSI-RS.1.1 FDD
	Config 2		CSI-RS.1.1 TDD
	Config 3		CSI-RS.2.1 TDD
CSI-RS for tracking	Config 1		TRS.1.1 FDD
	Config 2		TRS.1.1 TDD
	Config 3		TRS.1.2 TDD
T1	s		0.2
T2	s		0.48
T3	s		0.48
D1	s		0.44
Note 1: All configurations are assigned to the UE prior to the start of time period T1.			
Note 2: UE-specific PDCCH is not transmitted after T1 starts.			

**Table A.6.5.1.1.1-3: Cell specific test parameters for FR1 (Cell 1) for out-of-sync radio link monitoring tests in non-DRX mode**

Parameter	Unit	Test 1		
		T1	T2	T3
EPRE ratio of PDCCH DMRS to SSS	dB		4	
EPRE ratio of PDCCH to PDCCH DMRS	dB		0	
EPRE ratio of PBCH DMRS to SSS	dB		0	
EPRE ratio of PBCH to PBCH DMRS	dB			
EPRE ratio of PSS to SSS	dB			
EPRE ratio of PDSCH DMRS to SSS	dB			
EPRE ratio of PDSCH to PDSCH DMRS	dB			
EPRE ratio of OCNG DMRS to SSS	dB			



EPRE ratio of OCNG to OCNG DMRS		dB			
SNR on RLM-RS	Config 1	dB	1	-7	-15
	Config 2		1	-7	-15
	Config 3		1	-7	-15
$N_{oc}$	Config 1	dBm/ 15kHz z	-98		
	Config 2		-98		
	Config 3		-98		
$N_{oc}$	Config 1	dBm/ SCS	-98		
	Config 2		-98		
	Config 3		-95		
Propagation condition			TDL-C 300ns 100Hz		
<p>Note 1: OCNG shall be used such that the resources in Cell 1 are fully allocated and a constant total transmitted power spectral density is achieved for all OFDM symbols.</p> <p>Note 2: The signal contains PDCCH for UEs other than the device under test as part of OCNG.</p> <p>Note 3: SNR levels correspond to the signal to noise ratio over the SSS REs.</p> <p>Note 4: The SNR in time periods T1, T2 and T3 is denoted as SNR1, SNR2 and SNR3 respectively in Figure A.6.5.1.1.1-1.</p> <p>Note 5: The SNR values are specified for testing a UE which supports 2RX on at least one band. For testing of a UE which supports 4RX on all bands, the SNR during T3 is A.3.6.</p>					

Table A.6.5.1.1.1-4: Measurement gap configuration for out-of-sync tests in non-DRX mode

Field	Test 1
	Value
gapOffset	0
Note: Ensure that RLM RS is partially overlapped with measurement gap	

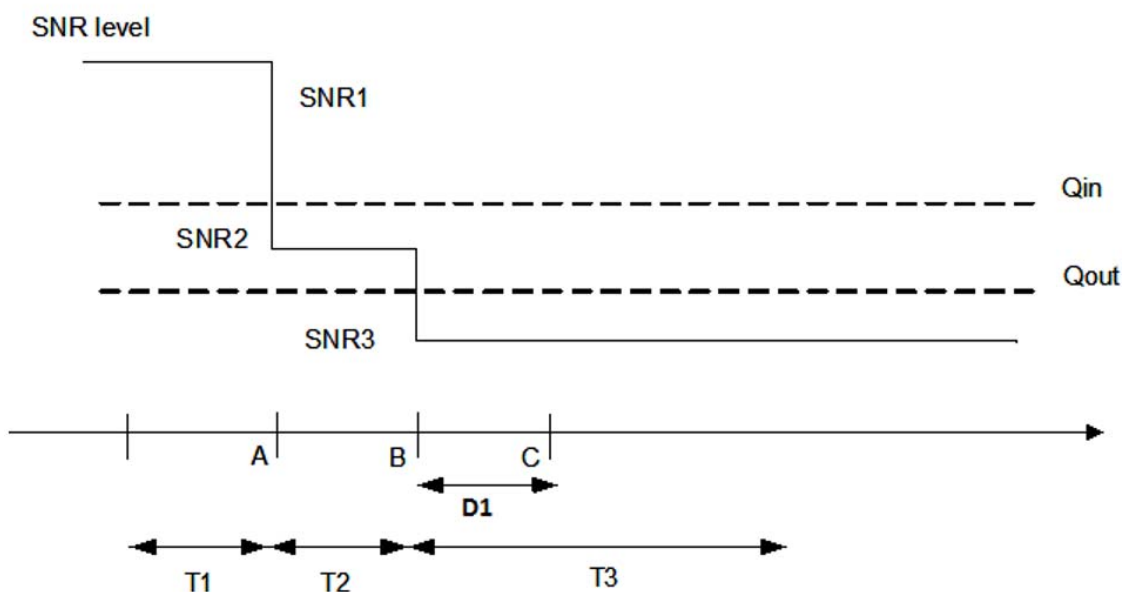

Figure A.6.5.1.1.1-1: SNR variation for out-of-sync testing

A.6.5.1.1.2 Test Requirements

The UE behaviour in each test during time durations T1, T2 and T3 shall be as follows:

During the period from time point A to time point B the UE shall transmit uplink signal at least in all uplink slots configured for CSI transmission according to the configured periodic CSI reporting.

The UE shall stop transmitting uplink signal no later than time point C (D1 second after the start of the time duration T3).

The rate of correct events observed during repeated tests shall be at least 90%.

### A.6.5.1.2 Radio Link Monitoring In-sync Test for FR1 PCell configured with SSB-based RLM RS in non-DRX mode

#### A.6.5.1.2.1 Test Purpose and Environment

The purpose of this test is to verify that the UE properly detects the out of sync and in sync for the purpose of monitoring downlink radio link quality of the PCell. This test will partly verify the FR1 radio link monitoring requirements in clause 8.1.

In the test, UE is configured to perform RLM on SSB, with *detectionResource* included in *RadioLinkMonitoringRS* set to SSB#0, and *purpose* set to 'rlf'. Supported test configurations are shown in table A.6.5.1.2.1-1. The test parameters are given in Tables A.6.5.1.2.1-2, and A.6.5.1.2.1-3 below. There is one cell (Cell 1), which is the active cell, in the test. The test consists of five successive time periods, with time duration of T1, T2, T3, T4 and T5 respectively. Figure A.6.5.1.2.1-1 shows the variation of the downlink SNR in the active cell to emulate out-of-sync and in-sync states. Prior to the start of the time duration T1, the UE shall be fully synchronized to Cell 1. Prior to the start of the time duration T1, the UE shall be fully synchronized to Cell 1. The UE shall be configured for periodic CSI reporting with a reporting periodicity of 5 ms.

**Table A.6.5.1.2.1-1: Supported test configurations for FR1 PCell**

Configuration	Description
1	FDD, SSB SCS 15 kHz, data SCS 15 kHz, BW 10 MHz
2	TDD, SSB SCS 15 kHz, data SCS 15 kHz, BW 10 MHz
3	TDD, SSB SCS 30 kHz, data SCS 30 kHz, BW 40 MHz
Note:	The UE is only required to pass in one of the supported test configurations in FR1

**Table A.6.5.1.2.1-2: General test parameters for FR1 in-sync testing in non-DRX mode**

Parameter	Unit	Value
		Test 1
Active PCell		Cell 1
RF Channel Number		1
Duplex mode	Config 1	FDD
	Config 2, 3	TDD
BW <sub>channel</sub>	Config 1	10: N <sub>RB,c</sub> = 52
	Config 2	10: N <sub>RB,c</sub> = 52
	Config 3	40: N <sub>RB,c</sub> = 106
DL initial BWP configuration	Config 1, 2, 3	DLBWP.0.1
DL dedicated BWP configuration	Config 1, 2, 3	DLBWP.1.1
UL initial BWP configuration	Config 1, 2, 3	ULBWP.0.1
UL dedicated BWP configuration	Config 1, 2, 3	ULBWP.1.1
TDD Configuration	Config 1	Not Applicable
	Config 2	TDDConf.1.1
	Config 3	TDDConf.2.1
RMSI CORESET Reference Channel	Config 1	CR.1.1 FDD
	Config 2	CR.1.1 TDD
	Config 3	CR.2.1 TDD
Dedicated CORESET Reference Channel	Config 1	CCR.1.1 FDD
	Config 2	CCR.1.1 TDD
	Config 3	CCR.2.1 TDD
SSB Configuration	Config 1	SSB.1 FR1

	Config 2		SSB.1 FR1
	Config 3		SSB.2 FR1
SMTC Configuration	Config 1, 2		SMTC.1
	Config 3		SMTC.1
PDSCH/PDCCH subcarrier spacing	Config 1, 2		15 kHz
	Config 3		30 kHz
PRACH Configuration	Config 1, 2		Table A.3.8.2.1-1
	Config 3		Table A.3.8.2.1-1
SSB index assigned as RLM RS			0
OCNG parameters			OP.1
CP length			Normal
Correlation Matrix and Antenna Configuration			2x2 Low
In sync transmission parameters	DCI format		1-0
	Number of Control OFDM symbols		2
	Aggregation level	CCE	4
	Ratio of hypothetical PDCCH RE energy to average SSS RE energy	dB	0
	Ratio of hypothetical PDCCH DMRS energy to average SSS RE energy	dB	0
	DMRS precoder granularity		REG bundle size
	REG bundle size		6
Out of sync transmission parameters	DCI format		1-0
	Number of Control OFDM symbols		2
	Aggregation level	CCE	8
	Ratio of hypothetical PDCCH RE energy to average SSS RE energy	dB	4
	Ratio of hypothetical PDCCH DMRS energy to average SSS RE energy	dB	4
	DMRS precoder granularity		REG bundle size
	REG bundle size		6
DRX			<i>OFF</i>
Gap pattern ID			N.A.
Layer 3 filtering			<i>Enabled</i>
T310 timer		ms	1000
T311 timer		ms	1000
N310			1
N311			1
CSI-RS configuration for CSI reporting	Config 1		CSI-RS.1.1 FDD
	Config 2		CSI-RS.1.1 TDD
	Config 3		CSI-RS.2.1 TDD
CSI-RS for tracking	Config 1, 4		TRS.1.1 FDD
	Config 2, 5		TRS.1.1 TDD
	Config 3, 6		TRS.1.2 TDD
T1		s	0.2

T2	s	0.2
T3	s	0.24
T4	s	0.2
T5	s	0.88
D1	s	0.84
Note 1: All configurations are assigned to the UE prior to the start of time period T1.		
Note 2: UE-specific PDCCH is not transmitted after T1 starts.		

**Table A.6.5.1.2.1-3: Cell specific test parameters for FR1 (Cell 1) for in-sync radio link monitoring tests in non-DRX mode**

Parameter		Unit	Test 1				
			T1	T2	T3	T4	T5
EPRE ratio of PDCCH DMRS to SSS		dB	0				
EPRE ratio of PDCCH to PDCCH DMRS		dB	0				
EPRE ratio of PBCH DMRS to SSS		dB	0				
EPRE ratio of PBCH to PBCH DMRS		dB	0				
EPRE ratio of PSS to SSS		dB	0				
EPRE ratio of PDSCH DMRS to SSS		dB	0				
EPRE ratio of PDSCH to PDSCH DMRS		dB	0				
EPRE ratio of OCNG DMRS to SSS		dB	0				
EPRE ratio of OCNG to OCNG DMRS		dB	0				
SNR on RLM-RS	Config 1	dB	1	-7	-15	-4.5	1
	Config 2	dB	1	-7	-15	-4.5	1
	Config 3	dB	1	-7	-15	-4.5	1
$N_{oc}$	Config 1	dBm/ 15 kHz	-98				
	Config 2	dBm/ 15 kHz	-98				
	Config 3	dBm/ 15 kHz	-98				
$N_{oc}$	Config 1	dBm/ SCS	-98				
	Config 2	dBm/ SCS	-98				
	Config 3	dBm/ SCS	-95				
Propagation condition			TDL-C 300ns 100Hz				
Note 1: OCNG shall be used such that the resources in Cell 1 are fully allocated and a constant total transmitted power spectral density is achieved for all OFDM symbols.							
Note 2: The signal contains PDCCH for UEs other than the device under test as part of OCNG.							
Note 3: SNR levels correspond to the signal to noise ratio over the SSS REs.							
Note 4: The SNR in time periods T1, T2, T3, T4 and T5 is denoted as SNR1, SNR2, SNR3, SNR4 and SNR5 respectively in Figure A.6.5.1.2.1-1.							
Note 5: The SNR values are specified for testing a UE which supports 2RX on at least one band. For testing of a UE which supports 4RX on all bands, the SNR during T3 and T4 is modified as specified in clause A.3.6.							

Table A.6.5.1.2.1-4: Void

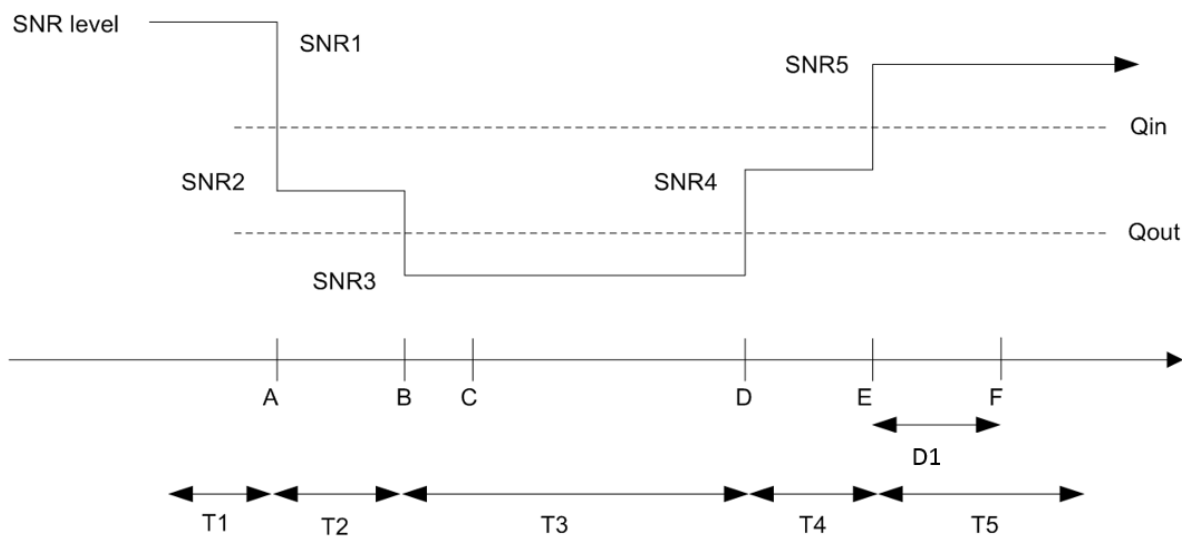

Figure A.6.5.1.2.1-1: SNR variation for in-sync testing

A.6.5.1.2.2 Test Requirements

The UE behaviour in each test during time durations T1, T2, T3, T4 and T5 shall be as follows:

During the period from time point A to time point F (D1 second after the start of time duration T5) the UE shall transmit uplink signal at least in all uplink slots configured for CSI transmission according to the configured periodic CSI reporting.

The rate of correct events observed during repeated tests shall be at least 90%.

A.6.5.1.3 Radio Link Monitoring Out-of-sync Test for FR1 PCell configured with SSB-based RLM RS in DRX mode

A.6.5.1.3.1 Test Purpose and Environment

The purpose of this test is to verify that the UE properly detects the out of sync and in sync for the purpose of monitoring downlink radio link quality of the PCell when DRX is used. This test will partly verify the FR1 radio link monitoring requirements in clause 8.1.

In the test, UE is configured to perform RLM on SSB, with *detectionResource* included in *RadioLinkMonitoringRS* set to SSB#0, and *purpose* set to ‘*rlf*’. Supported test configurations are shown in table A.6.5.1.3.1-1. The test parameters are given in Tables A.6.5.1.3.1-2, and A.6.5.1.3.1-3. There is one cell (Cell 1), which is the active NR cell, in the test. The test consists of three successive time periods, with time duration of T1, T2 and T3 respectively. Figure A.6.5.1.3.1-1 shows the variation of the downlink SNR in the active cell to emulate out-of-sync and in-sync states. Prior to the start of the time duration T1, the UE shall be fully synchronized to Cell 1. The UE shall be configured for periodic CSI reporting with a reporting periodicity of 5 ms. In the test, DRX configuration is enabled and DRX inactivity timer has already been expired, i.e. UE tries to decode PDCCH and to send periodic CSI during the period when On-duration timer is running. Time alignment timers shall be set to “infinity” so that UL timing alignment is maintained during the test.

Table A.6.5.1.3.1-1: Supported test configurations for FR1 PCell

Configuration	Description
1	FDD, SSB SCS 15 kHz, data SCS 15 kHz, BW 10 MHz
2	TDD, SSB SCS 15 kHz, data SCS 15 kHz, BW 10 MHz
3	TDD, SSB SCS 30 kHz, data SCS 30 kHz, BW 40 MHz
Note:	The UE is only required to pass in one of the supported test configurations in FR1

Table A.6.5.1.3.1-2: General test parameters for FR1 out-of-sync testing in DRX mode

Parameter		Unit	Value
			Test 1
Active PCell			Cell 1
RF Channel Number			1
Duplex mode	Config 1		FDD
	Config 2, 3		TDD
BW <sub>channel</sub>	Config 1	MHz	10: N <sub>RB,c</sub> = 52
	Config 2		10: N <sub>RB,c</sub> = 52
	Config 3		40: N <sub>RB,c</sub> = 106
DL initial BWP configuration	Config 1, 2, 3		DLBWP.0.1
DL dedicated BWP configuration	Config 1, 2, 3		DLBWP.1.1
UL initial BWP configuration	Config 1, 2, 3		ULBWP.0.1
UL dedicated BWP configuration	Config 1, 2, 3		ULBWP.1.1
TDD Configuration	Config 1		Not Applicable
	Config 2		TDDConf.1.1
	Config 3		TDDConf.2.1
RMSI CORESET Reference Channel	Config 1		CR.1.1 FDD
	Config 2		CR.1.1 TDD
	Config 3		CR.2.1 TDD
Dedicated CORESET Reference Channel	Config 1		CCR.1.3 FDD
	Config 2		CCR.1.3 TDD
	Config 3		CCR.2.2 TDD
SSB Configuration	Config 1		SSB.1 FR1
	Config 2		SSB.1 FR1
	Config 3		SSB.2 FR1
SMTC Configuration	Config 1, 2		SMTC.1
	Config 3		SMTC.1
PDSCH/PDCCH subcarrier spacing	Config 1, 2		15 kHz
	Config 3		30 kHz
PRACH Configuration	Config 1, 2		Table A.3.8.2.1-1
	Config 3		Table A.3.8.2.1-1
SSB index assigned as RLM RS			0
OCNG parameters			OP.1
CP length			Normal
Correlation Matrix and Antenna Configuration			2x2 Low
Out of sync transmission parameters	DCI format		1-0
	Number of Control OFDM symbols		2
	Aggregation level	CCE	8
	Ratio of hypothetical PDCCH RE energy to average SSS RE energy	dB	4
	Ratio of hypothetical PDCCH DMRS	dB	4

		energy to average SSS RE energy	
		DMRS precoder granularity	REG bundle size
		REG bundle size	6
DRX Configuration			DRX.3
Gap pattern ID			N.A.
Layer 3 filtering			<i>Enabled</i>
T310 timer	ms		0
T311 timer	ms		1000
N310			1
N311			1
CSI-RS configuration for CSI reporting	Config 1		CSI-RS.1.1 FDD
	Config 2		CSI-RS.1.1 TDD
	Config 3		CSI-RS.2.1 TDD
CSI-RS for tracking	Config 1		TRS.1.1 FDD
	Config 2		TRS.1.1 TDD
	Config 3		TRS.1.2 TDD
T1	s		0.2
T2	s		0.68
T3	s		0.68
D1	s		0.64
Note 1: All configurations are assigned to the UE prior to the start of time period T1.			
Note 2: UE-specific PDCCH is not transmitted after T1 starts.			

**Table A.6.5.1.3.1-3: Cell specific test parameters for FR1 (Cell 1) for out-of-sync radio link monitoring tests in DRX mode**

Parameter	Unit	Test 1		
		T1	T2	T3
EPRE ratio of PDCCH DMRS to SSS	dB	4		
EPRE ratio of PDCCH to PDCCH DMRS	dB	0		
EPRE ratio of PBCH DMRS to SSS	dB	0		
EPRE ratio of PBCH to PBCH DMRS	dB			
EPRE ratio of PSS to SSS	dB			
EPRE ratio of PDSCH DMRS to SSS	dB			
EPRE ratio of PDSCH to PDSCH DMRS	dB			
EPRE ratio of OCNG DMRS to SSS	dB			
EPRE ratio of OCNG to OCNG DMRS	dB			
SNR on RLM-RS	Config 1	1	-7	-15
	Config 2	1	-7	-15
	Config 3	1	-7	-15
$N_{oc}$	Config 1	-98		
	Config 2	-98		
	Config 3	-98		
$N_{oc}$	Config 1	-98		
	Config 2	-98		
	Config 3	-95		
Propagation condition		TDL-C 300ns 100Hz		

Note 1: OCNG shall be used such that the resources in Cell 1 are fully allocated and a constant total transmitted power spectral density is achieved for all OFDM symbols.  
 Note 2: The signal contains PDCCH for UEs other than the device under test as part of OCNG.  
 Note 3: SNR levels correspond to the signal to noise ratio over the SSS REs.  
 Note 4: The SNR in time periods T1, T2 and T3 is denoted as SNR1, SNR2 and SNR3 respectively in Figure A.6.5.1.3.1-1.  
 Note 5: The SNR values are specified for testing a UE which supports 2RX on at least one band. For testing of a UE which supports 4RX on all bands, the SNR during T3 is A.3.6.

**Table A.6.5.1.3.1-4: Void**

**Table A.6.5.1.3.1-5: Void**

**Table A.6.5.1.3.1-6: Void**

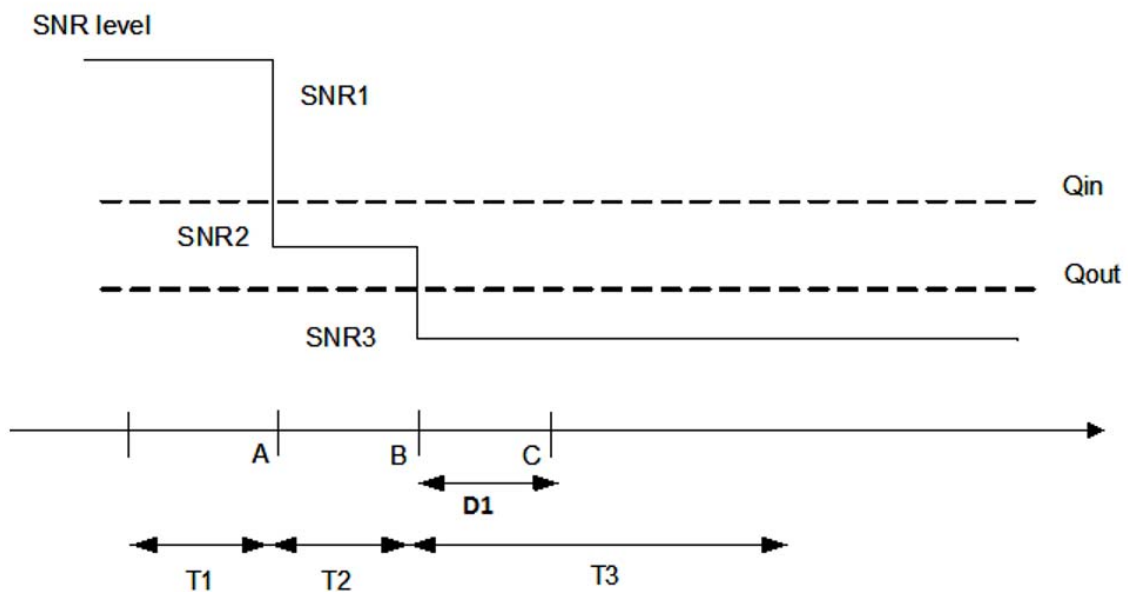

**Figure A.6.5.1.3.1-1: SNR variation for out-of-sync testing**

**A.6.5.1.3.2 Test Requirements**

The UE behaviour in each test during time durations T1, T2 and T3 shall be as follows:

During the period from time point A to time point B the UE shall transmit uplink signal at least in all uplink slots configured for CSI transmission according to the configured periodic CSI reporting.

The UE shall stop transmitting uplink signal no later than time point C (D1 second after the start of the time duration T3).

The rate of correct events observed during repeated tests shall be at least 90%.

**A.6.5.1.4 Radio Link Monitoring In-sync Test for FR1 PCell configured with SSB-based RLM RS in DRX mode**

**A.6.5.1.4.1 Test Purpose and Environment**

The purpose of this test is to verify that the UE properly detects the out of sync and in sync for the purpose of monitoring downlink radio link quality of the PCell when DRX is used. This test will partly verify the FR1 radio link monitoring requirements in clause 8.1.



In the test, UE is configured to perform RLM on SSB, with *detectionResource* included in *RadioLinkMonitoringRS* set to SSB#, and *purpose* set to 'rlf'. Supported test configurations are shown in table A.6.5.1.4.1-1. The test parameters are given in Tables A.6.5.1.4.1-2, and A.6.5.1.4.1-3. There is one cell (Cell 1), which is the active NR cell, in the test. The test consists of five successive time periods, with time duration of T1, T2, T3, T4 and T5 respectively. Figure A.6.5.1.4.1-1 shows the variation of the downlink SNR in the active cell to emulate out-of-sync and in-sync states. Prior to the start of the time duration T1, the UE shall be fully synchronized to Cell 1. The UE shall be configured for periodic CSI reporting with a reporting periodicity of 5 ms. In the test, DRX configuration is enabled and DRX inactivity timer has already been expired, i.e. UE tries to decode PDCCH and to send periodic CSI during the period when On-duration timer is running. Time alignment timers shall be set to "infinity" so that UL timing alignment is maintained during the test.

**Table A.6.5.1.4.1-1: Supported test configurations for FR1 PCell**

Configuration	Description
1	FDD, SSB SCS 15 kHz, data SCS 15 kHz, BW 10 MHz
2	TDD, SSB SCS 15 kHz, data SCS 15 kHz, BW 10 MHz
3	TDD, SSB SCS 30 kHz, data SCS 30 kHz, BW 40 MHz
Note:	The UE is only required to pass in one of the supported test configurations in FR1

**Table A.6.5.1.4.1-2: General test parameters for FR1 in-sync testing in DRX mode**

Parameter		Unit	Value
			Test 1
Active PCell			Cell 1
RF Channel Number			1
Duplex mode	Config 1		FDD
	Config 2, 3		TDD
BW <sub>channel</sub>	Config 1	MHz	10: N <sub>RB,c</sub> = 52
	Config 2		10: N <sub>RB,c</sub> = 52
	Config 3		40: N <sub>RB,c</sub> = 106
DL initial BWP configuration	Config 1, 2, 3		DLBWP.0.1
DL dedicated BWP configuration	Config 1, 2, 3		DLBWP.1.1
UL initial BWP configuration	Config 1, 2, 3		ULBWP.0.1
UL dedicated BWP configuration	Config 1, 2, 3		ULBWP.1.1
TDD Configuration	Config 1		Not Applicable
	Config 2		TDDConf.1.1
	Config 3		TDDConf.2.1
RMSI CORESET Reference Channel	Config 1		CR.1.1 FDD
	Config 2		CR.1.1 TDD
	Config 3		CR.2.1 TDD
Dedicated CORESET Reference Channel	Config 1		CCR.1.1 FDD
	Config 2		CCR.1.1 TDD
	Config 3		CCR.2.1 TDD
SSB Configuration	Config 1		SSB.1 FR1
	Config 2		SSB.1 FR1
	Config 3		SSB.2 FR1
SMTTC Configuration	Config 1, 2		SMTTC.1
	Config 3		SMTTC.1
PDSCH/PDCCH subcarrier spacing	Config 1, 2		15 kHz
	Config 3		30 kHz
PRACH Configuration	Config 1, 2		Table A.3.8.2.1-1
	Config 3		Table A.3.8.2.1-1
SSB index assigned as RLM RS			0
OCNG parameters			OP.1
CP length			Normal
Correlation Matrix and Antenna Configuration			2x2 Low
In sync transmission parameters	DCI format		1-0
	Number of Control OFDM symbols		2

	Aggregation level	CCE	4
	Ratio of hypothetical PDCCH RE energy to average SSS RE energy	dB	0
	Ratio of hypothetical PDCCH DMRS energy to average SSS RE energy	dB	0
	DMRS precoder granularity		REG bundle size
	REG bundle size		6
Out of sync transmission parameters	DCI format		1-0
	Number of Control OFDM symbols		2
	Aggregation level	CCE	8
	Ratio of hypothetical PDCCH RE energy to average SSS RE energy	dB	4
	Ratio of hypothetical PDCCH DMRS energy to average SSS RE energy	dB	4
	DMRS precoder granularity		REG bundle size
	REG bundle size		6
DRX Configuration			DRX.3
Gap pattern ID			N.A.
Layer 3 filtering			<i>Enabled</i>
T310 timer	ms		2000
T311 timer	ms		1000
N310			1
N311			1
CSI-RS configuration for CSI reporting	Config 1		CSI-RS.1.1 FDD
	Config 2		CSI-RS.1.1 TDD
	Config 3		CSI-RS.2.1 TDD
CSI-RS for tracking	Config 1		TRS.1.1 FDD
	Config 2		TRS.1.1 TDD
	Config 3		TRS.1.2 TDD
T1	s		0.2
T2	s		0.2
T3	s		0.64
T4	s		0.2
T5	s		0.88
D1	s		0.84
Note 1: All configurations are assigned to the UE prior to the start of time period T1.			
Note 2: UE-specific PDCCH is not transmitted after T1 starts.			

**Table A.6.5.1.4.1-3: Cell specific test parameters for FR1 (Cell 1) for in-sync radio link monitoring tests in DRX mode**

Parameter		Unit	Test 1				
			T1	T2	T3	T4	T5
EPRE ratio of PDCCH DMRS to SSS		dB	0				
EPRE ratio of PDCCH to PDCCH DMRS		dB	0				
EPRE ratio of PBCH DMRS to SSS		dB	0				
EPRE ratio of PBCH to PBCH DMRS		dB					
EPRE ratio of PSS to SSS		dB					
EPRE ratio of PDSCH DMRS to SSS		dB					
EPRE ratio of PDSCH to PDSCH DMRS		dB					
EPRE ratio of OCNG DMRS to SSS		dB					
EPRE ratio of OCNG to OCNG DMRS		dB					
SNR on RLM-RS	Config 1	dB	1	-7	-15	-4.5	1
	Config 2		1	-7	-15	-4.5	1
	Config 3		1	-7	-15	-4.5	1
$N_{oc}$	Config 1	dBm/15 kHz	-98				

$N_{oc}$	Config 2	dBm/S CS	-98
	Config 3		-98
	Config 1		-98
	Config 2		-98
	Config 3		-95
Propagation condition			TDL-C 300ns 100Hz
<p>Note 1: OCNG shall be used such that the resources in Cell 1 are fully allocated and a constant total transmitted power spectral density is achieved for all OFDM symbols.</p> <p>Note 2: The signal contains PDCCH for UEs other than the device under test as part of OCNG.</p> <p>Note 3: SNR levels correspond to the signal to noise ratio over the SSS REs.</p> <p>Note 4: The SNR in time periods T1, T2, T3, T4 and T5 is denoted as SNR1, SNR2, SNR3, SNR4 and SNR5 respectively in Figure A.6.5.1.4.1-1.</p> <p>Note 5: The SNR values are specified for testing a UE which supports 2RX on at least one band. For testing of a UE which supports 4RX on all bands, the SNR during T3 and T4 is modified as specified in clause A.3.6.</p>			

Table A.6.5.1.4.1-4: Void

Table A.6.5.1.4.1-5: Void

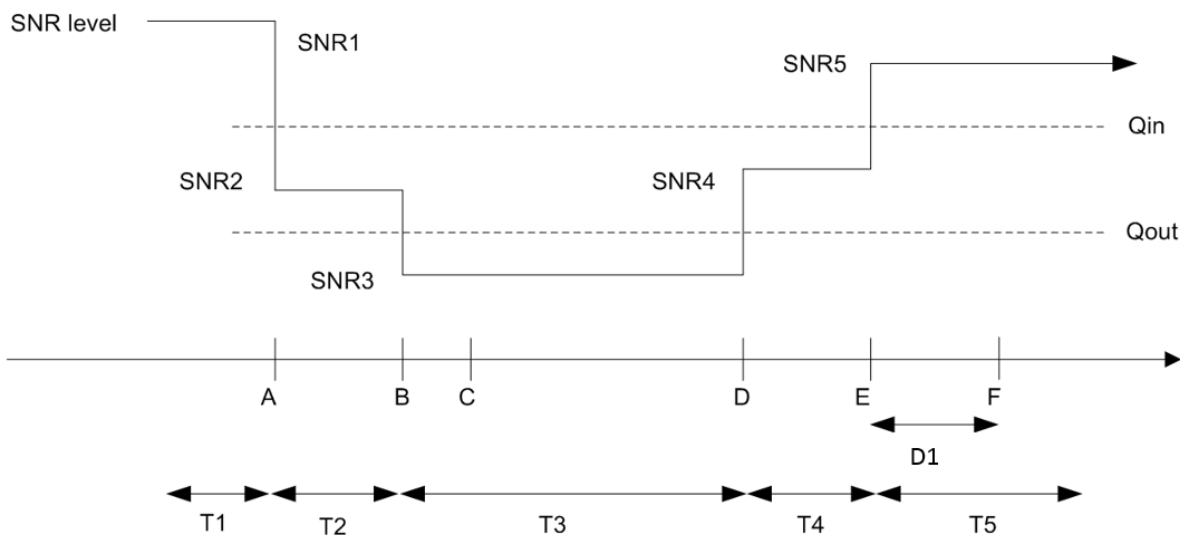

Figure A.6.5.1.4.1-1: SNR variation for in-sync testing.

A.6.5.1.4.2 Test Requirements

The UE behaviour in each test during time durations T1, T2, T3, T4 and T5 shall be as follows:

During the period from time point A to time point F (D1 second after the start of time duration T5) the UE shall transmit uplink signal at least in all uplink slots configured for CSI transmission according to the configured periodic CSI reporting.

The rate of correct events observed during repeated tests shall be at least 90%.

A.6.5.1.5 Radio Link Monitoring Out-of-sync Test for FR1 PCell configured with CSI-RS-based RLM in non-DRX mode

A.6.5.1.5.1 Test Purpose and Environment

The purpose of this test is to verify that the UE properly detects the out of sync for the purpose of monitoring downlink CSI-RS based radio link quality of the PCell when no DRX is used. This test will partly verify the FR1 PCell CSI-RS Out-of-sync radio link monitoring requirements in clause 8.1.

The test parameters are given in Tables A.6.5.1.5.1-1, A.6.5.1.5.1-2, A.6.5.1.5.1-3, and A.6.5.1.5.1-3A below. There is one cell, cell 1 which is the PCell, in the test. The test consists of three successive time periods, with time duration of T1, T2 and T3 respectively. Figure A.6.5.1.5.1-1 shows the variation of the downlink SNR in the PCell to emulate out-of-sync and in-sync states. Prior to the start of the time duration T1, the UE shall be fully synchronized to cell 1. The UE shall be configured for periodic CSI reporting of 5ms. In the test, DRX configuration is not enabled. The UE is configured to perform inter-frequency measurements using GP ID #0 (40ms) in test. In the test, SSB0 is configured as the BFD-RS.

**Table A.6.5.1.5.1-1: Supported test configurations for FR1 PCell**

Configuration	Description
1	FDD duplex mode, 15 kHz SSB SCS, 10 MHz bandwidth
2	TDD duplex mode, 15 kHz SSB SCS, 10 MHz bandwidth
3	TDD duplex mode, 30 kHz SSB SCS, 40 MHz bandwidth
Note: The UE is only required to pass in one of the supported test configurations in FR1	

**Table A.6.5.1.5.1-2: General test parameters for FR1 PCell for CSI-RS out-of-sync testing in non-DRX mode**

Parameter	Unit	Value
		Test 1
Active PCell		Cell 1
RF Channel Number		1
Duplex mode	Config 1	FDD
	Config 2, 3	TDD
TDD Configuration	Config 1	Not Applicable
	Config 2	TDDConf.1.1
	Config 3	TDDConf.2.1
DL initial BWP configuration	Config 1, 2, 3	DLBWP.0.1
DL dedicated BWP configuration	Config 1, 2, 3	DLBWP.1.1
UL initial BWP configuration	Config 1, 2, 3	ULBWP.0.1
UL dedicated BWP configuration	Config 1, 2, 3	ULBWP.1.1
RMSI CORESET Reference Channel	Config 1	CR.1.1 FDD
	Config 2	CR.1.1 TDD
	Config 3	CR.2.1 TDD
Dedicated CORESET Reference Channel	Config 1	CCR.1.3 FDD
	Config 2	CCR.1.3 TDD
	Config 3	CCR.2.2 TDD
SSB Configuration	Config 1	SSB.1 FR1
	Config 2	SSB.1 FR1
	Config 3	SSB.2 FR1
SMTC Configuration	Config 1, 2	SMTC.1
	Config 3	SMTC.1
PDSCH/PDCCH subcarrier spacing	Config 1, 2	15 kHz
	Config 3	30 kHz
TRS configuration	Config 1	TRS.1.1 FDD
	Config 2	TRS.1.1 TDD
	Config 3	TRS.1.2 TDD
CSI-RS for RLM	Config 1	Resource #4 in TRS.1.1 FDD
	Config 2	Resource #4 in TRS.1.1 TDD
	Config 3	Resource #4 in TRS.1.2 TDD
TCI configuration for PDCCH/PDSCH		TCI.State.2
OCNG parameters		OP.1
CP length		Normal
Correlation Matrix and Antenna Configuration		2x2 Low

Out of sync transmission parameters	DCI format		1-0
	Number of Control OFDM symbols		2
	Aggregation level	CCE	8
	Ratio of hypothetical PDCCH RE energy to average CSI-RS RE energy	dB	4
	Ratio of hypothetical PDCCH DMRS energy to average CSI-RS RE energy	dB	4
	DMRS precoder granularity		REG bundle size
	REG bundle size		6
DRX			OFF
Gap pattern ID			gp0
Layer 3 filtering			Enabled
T310 timer	ms		0
T311 timer	ms		1000
N310			1
N311			1
CSI-RS configuration for CSI reporting	Config 1		CSI-RS.1.1 FDD
	Config 2		CSI-RS.1.1 TDD
	Config 3		CSI-RS.2.1 TDD
T1	s		0.2
T2	s		0.88
T3	s		0.88
D1	s		0.84
Note 1: UE-specific PDCCH is not transmitted after T1 starts.			

**Table A.6.5.1.5.1-3: Cell specific test parameters for FR1 for CSI-RS out-of-sync radio link monitoring in non-DRX mode**

Parameter		Unit	Test 1		
			T1	T2	T3
EPRE ratio of PDCCH DMRS to SSS		dB	4		
EPRE ratio of PDCCH to PDCCH DMRS		dB	0		
EPRE ratio of PBCH DMRS to SSS		dB			
EPRE ratio of PBCH to PBCH DMRS		dB			
EPRE ratio of PSS to SSS		dB			
EPRE ratio of PDSCH DMRS to SSS		dB			
EPRE ratio of PDSCH to PDSCH DMRS		dB			
EPRE ratio of OCNG DMRS to SSS		dB			
EPRE ratio of OCNG to OCNG DMRS		dB			
SNR on RLM-RS	Config 1	dB	1	-7	-15
	Config 2		1	-7	-15
	Config 3		1	-7	-15
$N_{oc}$	Config 1	dBm/15kHz	-98		
	Config 2		-98		
	Config 3		-98		
Propagation condition			TDL-C 300ns 100Hz		

- Note 1: OCNG shall be used such that the resources in Cell 1 are fully allocated and a constant total transmitted power spectral density is achieved for all OFDM symbols.
- Note 2: The uplink resources for CSI reporting are assigned to the UE prior to the start of time period T1.
- Note 3: NZP CSI-RS resource set configuration for CSI reporting are assigned to the UE prior to the start of time period T1.
- Note 4: Measurement gap configuration is assigned to the UE prior to the start of time period T1.
- Note 5: The timers and layer 3 filtering related parameters are configured prior to the start of time period T1.
- Note 6: The signal contains PDCCH for UEs other than the device under test as part of OCNG.
- Note 7: SNR levels correspond to the signal to noise ratio over the SSS REs.
- Note 8: The SNR in time periods T1, T2 and T3 is denoted as SNR1, SNR2 and SNR3 respectively in figure A.6.5.1.5.1-1.
- Note 9: The SNR values are specified for testing a UE which supports 2RX on at least one band. For testing of a UE which supports 4RX on all bands, the SNR during T3 is [A.3.6].

**Table A.6.5.1.5.1-3A: Measurement gap configuration for FR1 CSI-RS out-of-sync radio link monitoring in non-DRX mode**

Field	Test 1
	Value
gapOffset	0
Note 1:	Void

**Table A.6.5.1.5.1-4: Void**

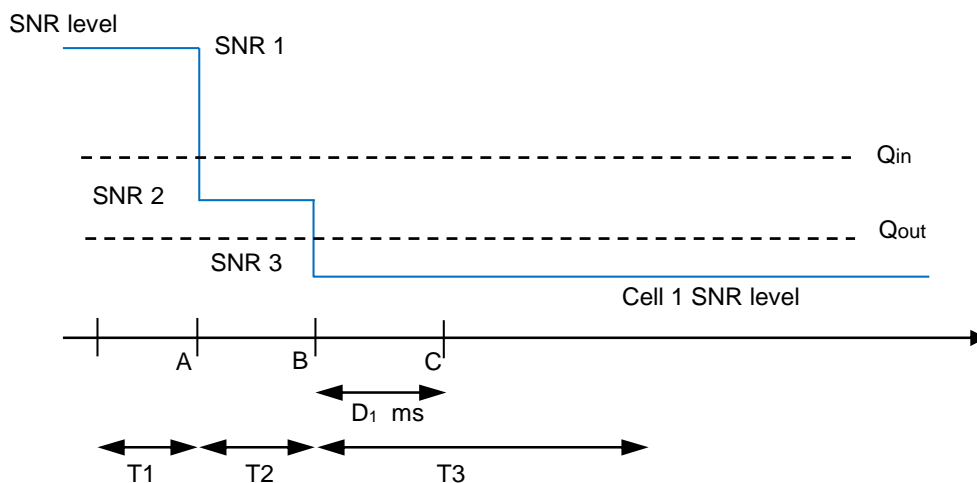

**Figure A.6.5.1.5.1-1: SNR variation for CSI-RS out-of-sync testing**

**A.6.5.1.5.2 Test Requirements**

The UE behaviour during time durations T1, T2, and T3 shall be as follows:

During the period from time point A to time point B the UE shall transmit uplink signal in Cell 1 at least in all uplink slots configured for CSI transmission according to the configured periodic CSI reporting for Cell 1.

The UE shall stop transmitting uplink signal in Cell 1 no later than time point C (D<sub>1</sub> ms after the start of the time duration T3) on the PCell.

The rate of correct events observed during repeated tests shall be at least 90%.

## A.6.5.1.6 Radio Link Monitoring In-sync Test for FR1 PCell configured with CSI-RS-based RLM in non-DRX mode

### A.6.5.1.6.1 Test Purpose and Environment

The purpose of this test is to verify that the UE properly detects the in sync for the purpose of monitoring downlink CSI-RS based radio link quality of the PCell when no DRX is used. This test will partly verify the FR1 PCell CSI-RS In-sync radio link monitoring requirements in clause 8.1.

The test parameters are given in Tables A.6.5.1.6.1-1, A.6.5.1.6.1-2, and A.6.5.1.6.1-3 below. There is one cells, cell 1 which is the PCell, in the test. The test consists of five successive time periods, with time duration of T1, T2, T3, T4 and T5 respectively. Figure A.6.5.1.6.1-1 shows the variation of the downlink SNR in the PCell to emulate out-of-sync and in-sync states. Prior to the start of the time duration T1, the UE shall be fully synchronized to cell 1. The UE shall be configured for periodic CSI reporting with a reporting periodicity of 5ms. In the test, DRX configuration is not enabled. In the test, SSB0 is configured as the BFD-RS.

**Table A.6.5.1.6.1-1: Supported test configurations for FR1 PCell**

Configuration	Description
1	FDD duplex mode, 15 kHz SSB SCS, 10 MHz bandwidth
2	TDD duplex mode, 15 kHz SSB SCS, 10 MHz bandwidth
3	TDD duplex mode, 30kHz SSB SCS, 40 MHz bandwidth
Note:	The UE is only required to pass in one of the supported test configurations in FR1

**Table A.6.5.1.6.1-2: General test parameters for FR1 PCell for CSI-RS in-sync testing in non-DRX mode**

Parameter		Unit	Value
			Test 1
Active PCell			Cell 1
RF Channel Number			1
Duplex mode	Config 1		FDD
	Config 2, 3		TDD
TDD Configuration	Config 1		Not Applicable
	Config 2		TDDConf.1.1
	Config 3		TDDConf.2.1
DL initial BWP configuration	Config 1, 2, 3		DLBWP.0.1
DL dedicated BWP configuration	Config 1, 2, 3		DLBWP.1.1
UL initial BWP configuration	Config 1, 2, 3		ULBWP.0.1
UL dedicated BWP configuration	Config 1, 2, 3		ULBWP.1.1
RMSI CORESET Reference Channel	Config 1		CR.1.1 FDD
	Config 2		CR.1.1 TDD
	Config 3		CR.2.1 TDD
Dedicated CORESET Reference Channel	Config 1		CCR.1.1 FDD
	Config 2		CCR.1.1 TDD
	Config 3		CCR.2.1 TDD
SSB Configuration	Config 1		SSB.1 FR1
	Config 2		SSB.1 FR1
	Config 3		SSB.2 FR1
SMTC Configuration	Config 1, 2		SMTC.1
	Config 3		SMTC.1
PDSCH/PDCCH subcarrier spacing	Config 1, 2		15 kHz
	Config 3		30 kHz
TRS configuration	Config 1		TRS.1.1 FDD
	Config 2		TRS.1.1 TDD
	Config 3		TRS.1.2 TDD
CSI-RS for RLM	Config 1		Resource #4 in TRS.1.1 FDD

	Config 2		Resource #4 in TRS.1.1 TDD
	Config 3		Resource #4 in TRS.1.2 TDD
TCI configuration for PDCCH/PDSCH			TCI.State.2
OCNG parameters			OP.1
CP length			Normal
Correlation Matrix and Antenna Configuration			2x2 Low
Out of sync transmission parameters	DCI format		1-0
	Number of Control OFDM symbols		2
	Aggregation level	CCE	8
	Ratio of hypothetical PDCCH RE energy to average CSI-RS RE energy	dB	4
	Ratio of hypothetical PDCCH DMRS energy to average CSI-RS RE energy	dB	4
	DMRS precoder granularity		REG bundle size
	REG bundle size		6
In sync transmission parameters	DCI format		1-0
	Number of Control OFDM symbols		2
	Aggregation level	CCE	4
	Ratio of hypothetical PDCCH RE energy to average CSI-RS RE energy	dB	0
	Ratio of hypothetical PDCCH DMRS energy to average CSI-RS RE energy	dB	0
	DMRS precoder granularity		REG bundle size
	REG bundle size		6
DRX			OFF
Gap pattern ID			N.A.
Layer 3 filtering			Enabled
T310 timer	ms		1000
T311 timer	ms		1000
N310			1
N311			1
CSI-RS configuration for CSI reporting	Config 1		CSI-RS.1.1 FDD
	Config 2		CSI-RS.1.1 TDD
	Config 3		CSI-RS.2.1 TDD
T1	s		0.2
T2	s		0.2
T3	s		0.44
T4	s		0.2
T5	s		0.88
T6	S		0.84
Note 1: UE-specific PDCCH is not transmitted after T1 starts.			

**Table A.6.5.1.6.1-3: Cell specific test parameters for FR1 for CSI-RS in-sync radio link monitoring in non-DRX mode**

Parameter	Unit	Test 1				
		T1	T2	T3	T4	T5
EPRE ratio of PDCCH DMRS to SSS	dB	0				
EPRE ratio of PDCCH to PDCCH DMRS	dB	0				
EPRE ratio of PBCH DMRS to SSS	dB					
EPRE ratio of PBCH to PBCH DMRS	dB					
EPRE ratio of PSS to SSS	dB					



EPRE ratio of PDSCH DMRS to SSS		dB					
EPRE ratio of PDSCH to PDSCH DMRS		dB					
EPRE ratio of OCNG DMRS to SSS		dB					
EPRE ratio of OCNG to OCNG DMRS		dB					
SNR on RLM-RS	Config 1	dB	1	-7	-15	-4.5	1
	Config 2		1	-7	-15	-4.5	1
	Config 3		1	-7	-15	-4.5	1
$N_{oc}$	Config 1	dBm/15kHz	-98				
	Config 2		-98				
	Config 3		-98				
Propagation condition			TDL-C 300ns 100Hz				
<p>Note 1: OCNG shall be used such that the resources in Cell 1 are fully allocated and a constant total transmitted power spectral density is achieved for all OFDM symbols.</p> <p>Note 2: The uplink resources for CSI reporting are assigned to the UE prior to the start of time period T1.</p> <p>Note 3: NZP CSI-RS resource set configuration for CSI reporting are assigned to the UE prior to the start of time period T1.</p> <p>Note 4: Measurement gap configuration is assigned to the UE prior to the start of time period T1.</p> <p>Note 5: The timers and layer 3 filtering related parameters are configured prior to the start of time period T1.</p> <p>Note 6: The signal contains PDCCH for UEs other than the device under test as part of OCNG.</p> <p>Note 7: SNR levels correspond to the signal to noise ratio over the SSS REs.</p> <p>Note 8: The SNR in time periods T1, T2, T3, T4 and T5 is denoted as SNR1, SNR2, SNR3, SNR4 and SNR5 respectively in figure A.6.5.1.6.1-1.</p> <p>Note 9: The SNR values are specified for testing a UE which supports 2RX on at least one band. For testing of a UE which supports 4RX on all bands, the SNR during T3 is specified in clause A.3.6.1.1.</p>							

Table A.6.5.1.6.1-4: Void

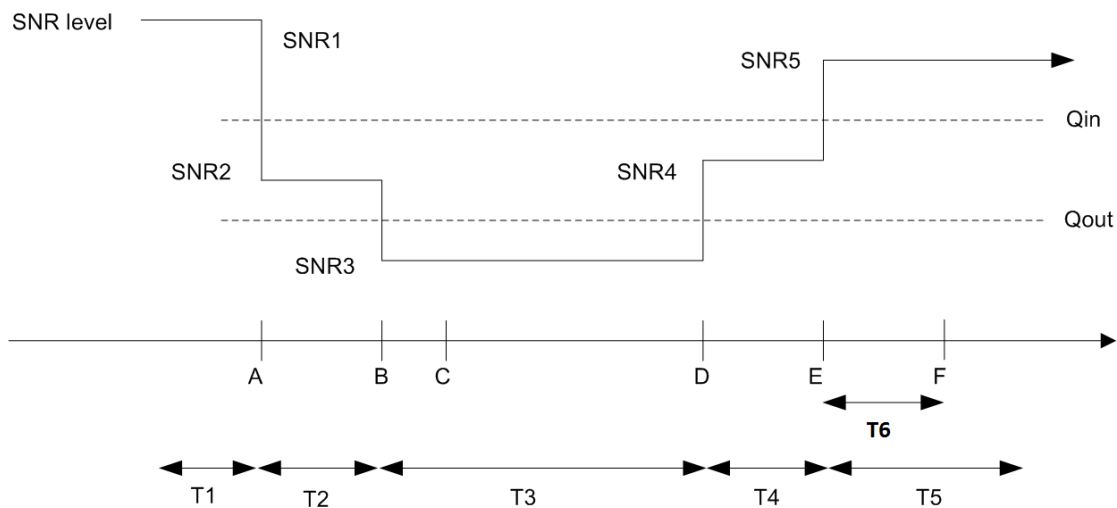

Figure A.6.5.1.6.1-1: SNR variation for CSI-RS in-sync testing

A.6.5.1.6.2 Test Requirements

The UE behaviour in each test during time durations T1, T2, T3, T4 and T5 shall be as follows:

During the period from time point A to time point F ( $T_6$  second after the start of time duration T5) the UE shall transmit uplink signal at least in all uplink slots configured for CSI transmission according to the configured periodic CSI reporting on the PCell.

The rate of correct events observed during repeated tests shall be at least 90%.

### A.6.5.1.7 Radio Link Monitoring Out-of-sync Test for FR1 PCell configured with CSI-RS-based RLM in DRX mode

#### A.6.5.1.7.1 Test Purpose and Environment

The purpose of this test is to verify that the UE properly detects the out of sync for the purpose of monitoring downlink CSI-RS based radio link quality of the PCell when DRX is used. This test will partly verify the FR1 PCell CSI-RS Out-of-sync radio link monitoring requirements in clause 8.1.

The test parameters are given in Tables A.6.5.1.7.1-1, A.6.5.1.7.1-2, and A.6.5.1.7.1-3 below. There is one cell, cell 1 is the PCell, in the test. The test consists of three successive time periods, with time duration of T1, T2 and T3 respectively. Figure A.6.5.1.7.1-1 shows the variation of the downlink SNR in the PCell to emulate out-of-sync and in-sync states. Prior to the start of the time duration T1, the UE shall be fully synchronized to cell 1. The UE shall be configured for periodic CSI reporting with a reporting periodicity of 5ms. In the test, DRX configuration is enabled in PCell and DRX inactivity timer has already been expired, i.e. UE tries to decode PDCCH and to send periodic CQI during the period when On-duration timer is running. Time alignment timers shall be set to “infinity” so that UL timing alignment is maintained during the test. In the test, SSB0 is configured as the BFD-RS.

**Table A.6.5.1.7.1-1: Supported test configurations for FR1 PCell**

Configuration	Description
1	FDD duplex mode, 15 kHz SSB SCS, 10 MHz bandwidth
2	TDD duplex mode, 15 kHz SSB SCS, 10 MHz bandwidth
3	TDD duplex mode, 30 kHz SSB SCS, 40 MHz bandwidth
Note:	The UE is only required to pass in one of the supported test configurations in FR1

**Table A.6.5.1.7.1-2: General test parameters for FR1 PCell for CSI-RS out-of-sync testing in DRX mode**

Parameter		Unit	Value
			Test 1
Active PCell			Cell 1
RF Channel Number			1
Duplex mode	Config 1		FDD
	Config 2, 3		TDD
TDD Configuration	Config 1		Not Applicable
	Config 2		TDDConf.1.1
	Config 3		TDDConf.2.1
DL initial BWP configuration	Config 1, 2, 3		DLBWP.0.1
DL dedicated BWP configuration	Config 1, 2, 3		DLBWP.1.1
UL initial BWP configuration	Config 1, 2, 3		ULBWP.0.1
UL dedicated BWP configuration	Config 1, 2, 3		ULBWP.1.1
RMSI CORESET Reference Channel	Config 1		CR.1.1 FDD
	Config 2		CR.1.1 TDD
	Config 3		CR.2.1 TDD
Dedicated CORESET Reference Channel	Config 1		CCR.1.3 FDD
	Config 2		CCR.1.3 TDD
	Config 3		CCR.2.2 TDD
SSB Configuration	Config 1		SSB.1 FR1
	Config 2		SSB.1 FR1
	Config 3		SSB.2 FR1
SMTTC Configuration	Config 1, 2		SMTTC.1
	Config 3		SMTTC.1
PDSCH/PDCCH subcarrier spacing	Config 1, 2		15 kHz
	Config 3		30 kHz
TRS configuration	Config 1		TRS.1.1 FDD
	Config 2		TRS.1.1 TDD
	Config 3		TRS.1.2 TDD
CSI-RS for RLM	Config 1		Resource #4 in TRS.1.1 FDD

	Config 2		Resource #4 in TRS.1.1 TDD
	Config 3		Resource #4 in TRS.1.2 TDD
TCI configuration for PDCCH/PDSCH			TCI.State.2
OCNG parameters			OP.1
CP length			Normal
Correlation Matrix and Antenna Configuration			2x2 Low
Out of sync transmission parameters	DCI format		1-0
	Number of Control OFDM symbols		2
	Aggregation level	CCE	8
	Ratio of hypothetical PDCCH RE energy to average CSI-RS RE energy	dB	4
	Ratio of hypothetical PDCCH DMRS energy to average CSI-RS RE energy	dB	4
	DMRS precoder granularity		REG bundle size
	REG bundle size		6
DRX			DRX.3
Gap pattern ID			N.A.
Layer 3 filtering			Enabled
T310 timer		ms	0
T311 timer		ms	1000
N310			1
N311			1
CSI-RS configuration for CSI reporting	Config 1		CSI-RS.1.1 FDD
	Config 2		CSI-RS.1.1 TDD
	Config 3		CSI-RS.2.1 TDD
T1		s	0.2
T2		s	1.28
T3		s	1.28
D1		s	1.24
Note 1: UE-specific PDCCH is not transmitted after T1 starts.			

**Table A.6.5.1.7.1-3: Cell specific test parameters for FR1 for CSI-RS out-of-sync radio link monitoring in DRX mode**

Parameter		Unit	Test 1					
			T1	T2	T3			
EPRE ratio of PDCCH DMRS to SSS		dB	4					
EPRE ratio of PDCCH to PDCCH DMRS		dB	0					
EPRE ratio of PBCH DMRS to SSS		dB						
EPRE ratio of PBCH to PBCH DMRS		dB						
EPRE ratio of PSS to SSS		dB						
EPRE ratio of PDSCH DMRS to SSS		dB						
EPRE ratio of PDSCH to PDSCH DMRS		dB						
EPRE ratio of OCNG DMRS to SSS		dB						
EPRE ratio of OCNG to OCNG DMRS		dB	-98					
SNR on RLM-RS	Config 1	dB				1	-7	-15
	Config 2					1	-7	-15
	Config 3		1	-7	-15			
$N_{oc}$	Config 1	dBm/15kHz	-98					
	Config 2		-98					

	Config 3	-98
Propagation condition	TDL-C 300ns 100Hz	
Note 1:	OCNG shall be used such that the resources in Cell 1 are fully allocated and a constant total transmitted power spectral density is achieved for all OFDM symbols.	
Note 2:	The uplink resources for CSI reporting are assigned to the UE prior to the start of time period T1.	
Note 3:	NZP CSI-RS resource set configuration for CSI reporting are assigned to the UE prior to the start of time period T1.	
Note 4:	Measurement gap configuration is assigned to the UE prior to the start of time period T1.	
Note 5:	The timers and layer 3 filtering related parameters are configured prior to the start of time period T1.	
Note 6:	The signal contains PDCCH for UEs other than the device under test as part of OCNG.	
Note 7:	SNR levels correspond to the signal to noise ratio over the SSS REs.	
Note 8:	The SNR in time periods T1, T2 and T3 is denoted as SNR1, SNR2 and SNR3 respectively in figure A.6.5.1.7.1-1.	
Note 9:	The SNR values are specified for testing a UE which supports 2RX on at least one band. For testing of a UE which supports 4RX on all bands, the SNR during T3 is specified in clause A.3.6.1.1.	

**Table A.6.5.1.7.1-4: Void**

**Table A.6.5.1.7.1-5: Void**

**Table A.6.5.1.7.1-6: Void**

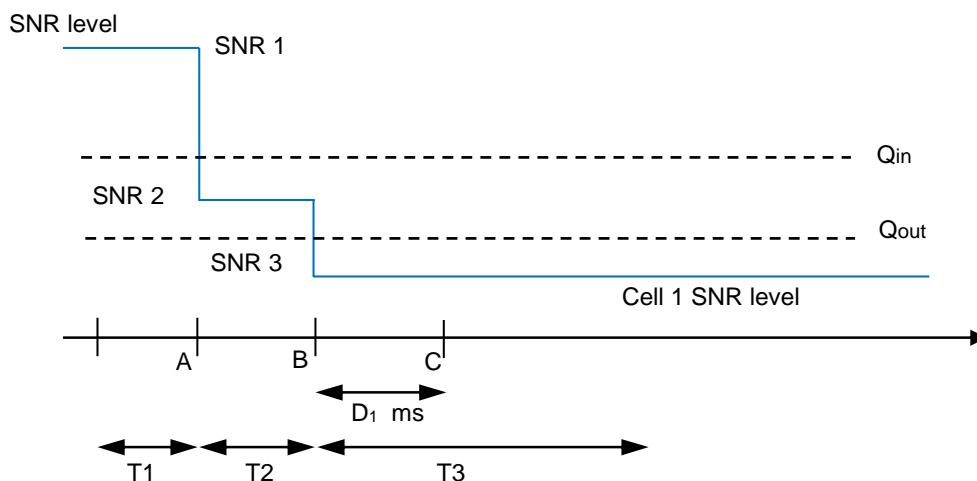

**Figure A.6.5.1.7.1-1: SNR variation for CSI-RS out-of-sync testing**

**A.6.5.1.7.2 Test Requirements**

The UE behaviour during time durations T1, T2, and T3 shall be as follows:

During the period from time point A to time point B the UE shall transmit uplink signal in Cell 1 (PCell) at least in all uplink slots configured for CSI transmission according to the configured periodic CSI reporting for Cell 1.

The UE shall stop transmitting uplink signal in Cell 1 (PCell) no later than time point C (D<sub>1</sub> ms after the start of the time duration T3) on the PCell.

The rate of correct events observed during repeated tests shall be at least 90%.

**A.6.5.1.8 Radio Link Monitoring In-sync Test for FR1 PCell configured with CSI-RS-based RLM in DRX mode**

**A.6.5.1.8.1 Test Purpose and Environment**

The purpose of this test is to verify that the UE properly detects the in sync for the purpose of monitoring downlink CSI-RS based radio link quality of the PCell when DRX is used. This test will partly verify the FR1 PCell CSI-RS In-sync radio link monitoring requirements in clause 8.1.

The test parameters are given in Tables A.6.5.1.8.1-1, A.6.5.1.8.1-2, A.6.5.1.8.1-3 and A.6.5.1.8.1-3A below. There is one cells, cell 1 which is the PCell, in the test. The test consists of five successive time periods, with time duration of T1, T2, T3, T4 and T5 respectively. Figure A.6.5.1.8.1-1 shows the variation of the downlink SNR in the PCell to emulate out-of-sync and in-sync states. Prior to the start of the time duration T1, the UE shall be fully synchronized to cell 1. The UE shall be configured for periodic CSI reporting with a reporting periodicity of 5ms. The UE is configured to perform inter-frequency measurements using GP ID #0 (40ms) in test. In the test, SSB0 is configured as the BFD-RS.

**Table A.6.5.1.8.1-1: Supported test configurations for FR1 PSCell**

Configuration	Description
1	FDD duplex mode, 15 kHz SSB SCS, 10 MHz bandwidth
2	TDD duplex mode, 15 kHz SSB SCS, 10 MHz bandwidth
3	TDD duplex mode, 30kHz SSB SCS, 40 MHz bandwidth
Note: The UE is only required to pass in one of the supported test configurations in FR1	

**Table A.6.5.1.8.1-2: General test parameters for FR1 PCell for CSI-RS in-sync testing in non-DRX mode**

Parameter	Unit	Value
		Test 1
Active PCell		Cell 1
RF Channel Number		1
Duplex mode	Config 1	FDD
	Config 2, 3	TDD
TDD Configuration	Config 1	Not Applicable
	Config 2	TDDConf.1.1
	Config 3	TDDConf.2.1
DL initial BWP configuration	Config 1, 2, 3	DLBWP.0.1
DL dedicated BWP configuration	Config 1, 2, 3	DLBWP.1.1
UL initial BWP configuration	Config 1, 2, 3	ULBWP.0.1
UL dedicated BWP configuration	Config 1, 2, 3	ULBWP.1.1
RMSI CORESET Reference Channel	Config 1	CR.1.1 FDD
	Config 2	CR.1.1 TDD
	Config 3	CR.2.1 TDD
Dedicated CORESET Reference Channel	Config 1	CCR.1.1 FDD
	Config 2	CCR.1.1 TDD
	Config 3	CCR.2.1 TDD
SSB Configuration	Config 1	SSB.1 FR1
	Config 2	SSB.1 FR1
	Config 3	SSB.2 FR1
SMTC Configuration	Config 1, 2	SMTC.1
	Config 3	SMTC.1
PDSCH/PDCCH subcarrier spacing	Config 1, 2	15 kHz
	Config 3	30 kHz
TRS configuration	Config 1	TRS.1.1 FDD
	Config 2	TRS.1.1 TDD
	Config 3	TRS.1.2 TDD
CSI-RS for RLM	Config 1	Resource #4 in TRS.1.1 FDD
	Config 2	Resource #4 in TRS.1.1 TDD
	Config 3	Resource #4 in TRS.1.2 TDD
TCI configuration for PDCCH/PDSCH		TCI.State.2
OCNG parameters		OP.1
CP length		Normal
Correlation Matrix and Antenna Configuration		2x2 Low
Out of sync transmission parameters	DCI format	1-0

	Number of Control OFDM symbols		2
	Aggregation level	CCE	8
	Ratio of hypothetical PDCCH RE energy to average CSI-RS RE energy	dB	4
	Ratio of hypothetical PDCCH DMRS energy to average CSI-RS RE energy	dB	4
	DMRS precoder granularity		REG bundle size
	REG bundle size		6
In sync transmission parameters	DCI format		1-0
	Number of Control OFDM symbols		2
	Aggregation level	CCE	4
	Ratio of hypothetical PDCCH RE energy to average CSI-RS RE energy	dB	0
	Ratio of hypothetical PDCCH DMRS energy to average CSI-RS RE energy	dB	0
	DMRS precoder granularity		REG bundle size
	REG bundle size		6
DRX			DRX.3
Gap pattern ID			gp0
Layer 3 filtering			Enabled
T310 timer	ms		4000
T311 timer	ms		1000
N310			1
N311			1
CSI-RS configuration for CSI reporting	Config 1		CSI-RS.1.1 FDD
	Config 2		CSI-RS.1.1 TDD
	Config 3		CSI-RS.2.1 TDD
T1	s		0.2
T2	s		0.2
T3	s		1.24
T4	s		0.2
T5	s		4
T6	s		3.88
Note 1: UE-specific PDCCH is not transmitted after T1 starts.			

**Table A.6.5.1.8.1-3: Cell specific test parameters for FR1 for CSI-RS in-sync radio link monitoring in non-DRX mode**

Parameter		Unit	Test 1				
			T1	T2	T3	T4	T5
EPRE ratio of PDCCH DMRS to SSS		dB	0				
EPRE ratio of PDCCH to PDCCH DMRS		dB	0				
EPRE ratio of PBCH DMRS to SSS		dB					
EPRE ratio of PBCH to PBCH DMRS		dB					
EPRE ratio of PSS to SSS		dB					
EPRE ratio of PDSCH DMRS to SSS		dB					
EPRE ratio of PDSCH to PDSCH DMRS		dB					
EPRE ratio of OCNG DMRS to SSS		dB					
EPRE ratio of OCNG to OCNG DMRS		dB					
SNR on RLM-RS	Config 1	dB					

$N_{oc}$	Config 2	dBm/15kHz	1	-7	-15	-4.5	1
	Config 3		1	-7	-15	-4.5	1
	Config 1		-98				
	Config 2		-98				
	Config 3		-98				
Propagation condition		TDL-C 300ns 100Hz					
Note 1:	OCNG shall be used such that the resources in Cell 1 are fully allocated and a constant total transmitted power spectral density is achieved for all OFDM symbols.						
Note 2:	The uplink resources for CSI reporting are assigned to the UE prior to the start of time period T1.						
Note 3:	NZP CSI-RS resource set configuration for CSI reporting are assigned to the UE prior to the start of time period T1.						
Note 4:	Measurement gap configuration is assigned to the UE prior to the start of time period T1.						
Note 5:	The timers and layer 3 filtering related parameters are configured prior to the start of time period T1.						
Note 6:	The signal contains PDCCH for UEs other than the device under test as part of OCNG.						
Note 7:	SNR levels correspond to the signal to noise ratio over the SSS REs.						
Note 8:	The SNR in time periods T1, T2, T3, T4 and T5 is denoted as SNR1, SNR2, SNR3, SNR4 and SNR5 respectively in figure A.6.5.1.8.1-1.						
Note 9:	The SNR values are specified for testing a UE which supports 2RX on at least one band. For testing of a UE which supports 4RX on all bands, the SNR during T3 is specified in clause A.3.6.1.1.						

**Table A.6.5.1.8.1-3A: Measurement gap configuration for FR1 CSI-RS in-sync radio link monitoring in non-DRX mode**

Field	Test 1 Value
gapOffset	0
Note 1: Void	

**Table A.6.5.1.8.1-4: Void**

**Table A.6.5.1.8.1-5: Void**

**Table A.6.5.1.8.1-6: Void**

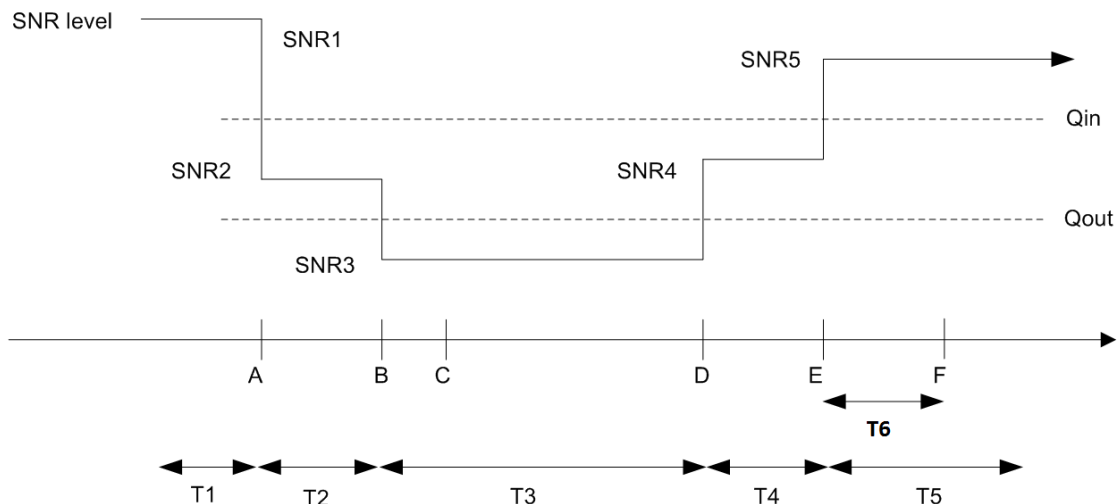

**Figure A.6.5.1.8.1-1: SNR variation for CSI-RS in-sync testing**

**A.6.5.1.8.2 Test Requirements**

The UE behaviour in each test during time durations T1, T2, T3, T4 and T5 shall be as follows:

During the period from time point A to time point F (T6 second after the start of time duration T5) the UE shall transmit uplink signal at least in all uplink slots configured for CSI transmission according to the configured periodic CSI reporting on the PCell.

The rate of correct events observed during repeated tests shall be at least 90%.

## A.6.5.2 Interruption

### A.6.5.2.1 Interruptions during measurements on deactivated NR SCC in FR1

#### A.6.5.2.1.1 Test Purpose and Environment

The purpose of this test is to verify that the UE missed ACK/NACK rate does not exceed the limits at NR PSCell interruptions during the measurement on the deactivated NR SCC. This test will verify the missed ACK/NACK rate for PCell in standalone NR specified in clause 8.2.2.2. Supported test configurations for NR PCell are shown in table A.6.5.2.1.1-1. Supported test configurations for NR SCell are shown in table A.6.5.2.1.1-1A. Test configuration for NR PCell and test configuration for NR SCell are chosen independently.

The general test parameters and NR cell specific test parameters are given in Table A.6.5.2.1.1-2, A.6.5.2.1.1-3 and A.6.5.2.1.1-4 below. In the test there are two cells: Cell1 and Cell2. Cell1 is PCell, Cell2 is an NR deactivated SCell. Cell1 shall be configured as PCell and Cell2 shall be configured as SCell.

The test consists of one time period, with duration of T1. Prior to the start of the time duration T1, the UE is connected to Cell1 and Cell2 and the RRC message including *measCycleSCell* or *allowInterruptions* for the deactivated NR SCells is received at the UE antenna connector. During T1, PCell is continuously scheduled in DL.

**Table A.6.5.2.1.1-1: Interruptions during measurements on deactivated NR SCC supported test configurations for NR Pcell**

Config	Description
1	NR 15 kHz SSB SCS, $\geq 10$ MHz bandwidth, FDD duplex mode
2	NR 15 kHz SSB SCS, $\geq 10$ MHz bandwidth, TDD duplex mode
3	NR 30 kHz SSB SCS, $\geq 40$ MHz bandwidth, TDD duplex mode
Note 1:	The UE is only required to be tested in one of the supported test configurations
Note 2:	The UE is only required to be tested in one with smallest aggregated channel bandwidth from supported band combinations which is composed of CCs $\geq$ the bandwidth ( $BW_{channel}$ ) defined in each test configuration,

**Table A.6.5.2.1.1-1A: Interruptions during measurements on deactivated NR SCC supported test configurations for NR SCell**

Config <sub>SCell</sub>	Description
1	NR 15 kHz SSB SCS, $\geq 10$ MHz bandwidth, FDD duplex mode
2	NR 15 kHz SSB SCS, $\geq 10$ MHz bandwidth, TDD duplex mode
3	NR 30 kHz SSB SCS, $\geq 40$ MHz bandwidth, TDD duplex mode
Note 1:	The UE is only required to be tested in one of the supported test configurations
Note 2:	The UE is only required to be tested in one with smallest aggregated channel bandwidth from supported band combinations which is composed of CCs $\geq$ the bandwidth ( $BW_{channel}$ ) defined in each test configuration,

**Table A.6.5.2.1.1-2: General test parameters for interruptions during measurements on deactivated NR SCC in standalone NR**

Parameter	Unit	Value	Comment
RF Channel Number		1, 2	Two NR RF channels
Active PCell		Cell1	PCell on NR RF channel number 1.
Configured deactivated SCell		Cell2	Deactivated SCell on NR RF channel number 2.
CP length		Normal	Applicable to Cell1 and Cell2
DRX		OFF	
Measurement gap pattern Id		OFF	
SCell measurement cycle (measCycleSCell)	ms	640	



T1	s	10	
----	---	----	--

**Table A.6.5.2.1.1-3: NR cell specific test parameters for NR PCell for interruptions during measurements on deactivated NR SCC in standalone NR**

Parameter		Unit	Cell1
Frequency Range			FR1
Duplex mode	Config 1		FDD
	Config 2,3		TDD
TDD configuration	Config 1		Not Applicable
	Config 2		TDDConf.1.1
	Config 3		TDDConf.2.1
BW <sub>channel</sub>	Config 1,2		Note 9
	Config 3		Note 9
BW <sub>occupied</sub>	Config 1,2	RB	52 <sup>Note 7</sup>
	Config 3		106 <sup>Note 8</sup>
Initial DL BWP Configuration	Config 1,2,3		DLBWP.0.1
Dedicated DL BWP Configuration	Config 1,2,3		DLBWP.1.1
Initial UL BWP Configuration	Config 1,2,3		ULBWP.0.1
Dedicated UL BWP Configuration	Config 1,2,3		ULBWP.1.1
PDSCH Reference measurement channel	Config 1		SR.1.1 FDD
	Config 2		SR.1.2 TDD
	Config 3		SR.2.1 TDD
CSI-RS for tracking	Config 1		TRS.1.1 FDD
	Config 2		TRS.1.1 TDD
	Config 3		TRS.1.2 TDD
RMSI CORESET parameters	Config 1		CR.1.1 FDD
	Config 2		CR.1.1 TDD
	Config 3		CR.2.1 TDD
Dedicated CORESET parameters	Config 1		CCR.1.1 FDD
	Config 2		CCR.1.1 TDD
	Config 3		CCR.2.1 TDD
OCNG Patterns	Config 1,2		OP.1 <sup>Note 7</sup>
	Config 3		OP.1 <sup>Note 8</sup>
SMTC Configuration			SMTC.1
SSB Configuration	Config 1,2		SSB.1 FR1
	Config 3		SSB.2 FR1
Correlation Matrix and Antenna Configuration			1x2 Low
EPRE ratio of PSS to SSS		dB	0
EPRE ratio of PBCH DMRS to SSS			
EPRE ratio of PBCH to PBCH DMRS			
EPRE ratio of PDCCH DMRS to SSS			
EPRE ratio of PDCCH to PDCCH DMRS			
EPRE ratio of PDSCH DMRS to SSS			
EPRE ratio of PDSCH to PDSCH			
EPRE ratio of OCNG DMRS to SSS <sup>Note 1</sup>			
EPRE ratio of OCNG to OCNG DMRS <sup>Note 1</sup>			
N <sub>oc</sub> <sup>Note 2</sup>		dBm/15 kHz	-104
SS-RSRP <sup>Note 3</sup>		dBm/15 kHz	-87
$\bar{E}_s/I_{ot}$		dB	17
$\bar{E}_s/N_{oc}$		dB	17
N <sub>oc</sub> <sup>Note 2</sup>	Config 1,2	dBm/SCS	-104
	Config 3		-101
I <sub>o</sub> <sup>Note 3</sup>	Config 1,2	dBm/9.36MHz	-58.96
	Config 3	dBm/38.16MHz	-52.86
Time offset to Cell1 <sup>Note 5</sup>		μs	-
Propagation Condition			AWGN

Note 1:	OCNG shall be used such that both cells are fully allocated and a constant total transmitted power spectral density is achieved for all OFDM symbols.
Note 2:	Interference from other cells and noise sources not specified in the test is assumed to be constant over subcarriers and time and shall be modeled as AWGN of appropriate power for $N_{oc}$ to be fulfilled within $BW_{occupied}$ .
Note 3:	SS-RSRP and $I_o$ levels have been derived from other parameters for information purposes. They are not settable parameters themselves.
Note 4:	Void
Note 5:	Receive time difference between slot boundaries of signals received from the two cells at the UE antenna connector including time alignment error between the two cells.
Note 6:	For unpaired spectrum, a DL BWP is linked with an UL BWP. DLBWP.0.2 is linked with ULBWP.0.2 defined in clause 12 of TS 38.213 [3].
Note 7:	All UL/DL transmission shall be confined within $BW_{occupied}$ (i.e. 10 MHz, 52 RBs) from $F_{C,low}$ , and $I_o$ is independent of the $BW_{channel}$ configured.
Note 8:	All UL/DL transmission shall be confined within $BW_{occupied}$ (i.e. 40 MHz, 106 RBs) from $F_{C,low}$ , and $I_o$ is independent of the $BW_{channel}$ configured.
Note 9:	$N_{RB,C}$ is derived from Table 5.3.2-1 in TS38.101-1[2] with configured $BW_{channel}$ .

**Table A.6.5.2.1.1-4: NR cell specific test parameters for NR SCell for interruptions during measurements on deactivated NR SCC in standalone NR**

Parameter		Unit	Cell2
Frequency Range			FR1
Duplex mode	Config <sub>SCell 1</sub>		FDD
	Config <sub>SCell 2,3</sub>		TDD
TDD configuration	Config <sub>SCell 1</sub>		Not Applicable
	Config <sub>SCell 2</sub>		TDDConf.1.1
	Config <sub>SCell 3</sub>		TDDConf.2.1
$BW_{channel}$	Config <sub>SCell 1,2</sub>		Note 9
	Config <sub>SCell 3</sub>		Note 9
$BW_{occupied}$	Config <sub>SCell 1,2</sub>	RB	52 <sup>Note 7</sup>
	Config <sub>SCell 3</sub>		106 <sup>Note 8</sup>
Initial DL BWP Configuration	Config <sub>SCell 1,2,3</sub>		DLBWP.0.1
Dedicated DL BWP Configuration	Config <sub>SCell 1,2,3</sub>		DLBWP.1.1
Initial UL BWP Configuration	Config <sub>SCell 1,2,3</sub>		N/A
Dedicated UL BWP Configuration	Config 1,2,3		N/A
PDSCH Reference measurement channel	Config <sub>SCell 1</sub>		SR.1.1 FDD
	Config <sub>SCell 2</sub>		SR.1.2 TDD
	Config <sub>SCell 3</sub>		SR.2.1 TDD
CSI-RS for tracking	Config <sub>SCell 1</sub>		TRS.1.1 FDD
	Config <sub>SCell 2</sub>		TRS.1.1 TDD
	Config <sub>SCell 3</sub>		TRS.1.2 TDD
RMSI CORESET parameters	Config <sub>SCell 1</sub>		CR.1.1 FDD
	Config <sub>SCell 2</sub>		CR.1.1 TDD
	Config <sub>SCell 3</sub>		CR.2.1 TDD
Dedicated CORESET parameters	Config <sub>SCell 1</sub>		CCR.1.1 FDD
	Config <sub>SCell 2</sub>		CCR.1.1 TDD
	Config <sub>SCell 3</sub>		CCR.2.1 TDD
OCNG Patterns	Config <sub>SCell 1,2</sub>		OP.1 <sup>Note 7</sup>
	Config <sub>SCell 3</sub>		OP.1 <sup>Note 8</sup>
SMTC Configuration			SMTC.4
SSB Configuration	Config <sub>SCell 1,2</sub>		SSB.5 FR1
	Config <sub>SCell 3</sub>		SSB.6 FR1
Correlation Matrix and Antenna Configuration			1x2 Low
EPRE ratio of PSS to SSS		dB	0
EPRE ratio of PBCH DMRS to SSS			
EPRE ratio of PBCH to PBCH DMRS			
EPRE ratio of PDCCH DMRS to SSS			
EPRE ratio of PDCCH to PDCCH DMRS			
EPRE ratio of PDSCH DMRS to SSS			
EPRE ratio of PDSCH to PDSCH			

EPRE ratio of OCNG DMRS to SSS <sup>Note 1</sup>			
EPRE ratio of OCNG to OCNG DMRS <sup>Note 1</sup>			
$N_{oc}$ <sup>Note 2</sup>		dBm/15 kHz	-104
SS-RSRP <sup>Note 3</sup>		dBm/15 kHz	-87
$\bar{E}_s/I_{ot}$		dB	17
$\bar{E}_s/N_{oc}$		dB	17
$N_{oc}$ <sup>Note 2</sup>	Config <sub>SCell</sub> 1,2	dBm/SCS	-104
	Config <sub>SCell</sub> 3		-101
$I_o$ <sup>Note 3</sup>	Config <sub>SCell</sub> 1,2	dBm/9.36MHz	-58.96
	Config <sub>SCell</sub> 3	dBm/38.16MHz	-52.86
Time offset to Cell1 <sup>Note 5</sup>		$\mu$ s	3
Propagation Condition			AWGN
<p>Note 1: OCNG shall be used such that both cells are fully allocated and a constant total transmitted power spectral density is achieved for all OFDM symbols.</p> <p>Note 2: Interference from other cells and noise sources not specified in the test is assumed to be constant over subcarriers and time and shall be modeled as AWGN of appropriate power for <math>N_{oc}</math> to be fulfilled within <math>BW_{occupied}</math>.</p> <p>Note 3: SS-RSRP and <math>I_o</math> levels have been derived from other parameters for information purposes. They are not settable parameters themselves.</p> <p>Note 4: Void</p> <p>Note 5: Receive time difference between slot boundaries of signals received from the two cells at the UE antenna connector including time alignment error between the two cells.</p> <p>Note 6: For unpaired spectrum, a DL BWP is linked with an UL BWP. DLBWP.0.2 is linked with ULBWP.0.2 defined in clause 12 of TS 38.213 [3].</p> <p>Note 7: All UL/DL transmission shall be confined within <math>BW_{occupied}</math> (i.e. 10 MHz, 52 RBs) from <math>F_{C,low}</math>, and <math>I_o</math> is independent of the <math>BW_{channel}</math> configured.</p> <p>Note 8: All UL/DL transmission shall be confined within <math>BW_{occupied}</math> (i.e. 40 MHz, 106 RBs) from <math>F_{C,low}</math>, and <math>I_o</math> is independent of the <math>BW_{channel}</math> configured.</p> <p>Note 9: <math>N_{RB,c}</math> is derived from Table 5.3.2-1 in TS38.101-1[2] with configured <math>BW_{channel}</math>.</p>			

A.6.5.2.1.2 Test Requirements

The UE shall be continuously scheduled on PCell during the entire length of T1. During the time duration T1 the UE shall transmit at least 99.5% of ACK/NACK on PCell.

If the NR PCell is not in the same band as the deactivated SCell, the UE is only allowed to cause interruptions on NR PCell immediately before and immediately after an SMTC. Each interruption on NR PCell shall not exceed the value defined in Table A.6.5.2.1.2-1.

If the NR PCell is in the same band as the deactivated SCell, the UE is only allowed to cause an interruption on PCell no earlier than 1 slot before an SMTC and no later than 1 slot after the SMTC. the interruption on NR PCell shall not exceed the value defined in Table A.6.5.2.1.2-2.

Table A.6.5.2.1.2-1: Interruption duration if the PCell is not in the same band as the deactivated SCell

$\mu$	NR Slot length (ms)	Interruption length
0	1	1
1	0.5	1

Table A.6.5.2.1.2-2: Interruption duration if the PCell is in the same band as the deactivated SCell

$\mu$	NR Slot length (ms)	Interruption length
0	1	2 + SMTC duration
1	0.5	2 + SMTC duration

The rate of correct events observed during repeated tests shall be at least 90%.

## A.6.5.2.2 SA interruptions at NR SRS carrier based switching

### A.6.5.2.2.1 Test Purpose and Environment

The purpose of this test is to verify that when a UE needs to transmit aperiodic SRS, the UE can perform carrier based switching to one carrier not configured for PUCCH/PUSCH transmission from a carrier with PUCCH/PUSCH transmission. The test will partly verify the interruption requirements on PCell in clause 8.2.2.2.9.

### A.6.5.2.2.2 Test Parameters

In each test there are two cells: Cell 1 and Cell 2. Cell 1 is the FR1 PCell and Cell 2 is activated SCell on the TDD SCC which operates in downlink without PUCCH/PUSCH. The UE is configured with the SRS switching between PCell and SCell. The test parameters for PCell and SCell are given in Table A.6.5.2.2.2-2 and A.6.5.2.2.2-3 below. The test consists of two successive time periods, with duration of T1 and T2, respectively. Immediately at the beginning of T2, the UE is triggered for SRS switching by DCI 2\_3 scheduling. After T2, the UE is expected to transmit aperiodic SRS on a special slot in the configured TDD UL/DL configuration, as scheduled by DCI 2\_3.

The test equipment verifies that potential interruption is carried out correctly by monitoring ACK/NACK sent in PCell.

**Table A.6.5.2.2-1: Supported test configurations**

Configuration	Description
1	15 kHz SSB SCS, 10 MHz bandwidth, FDD – TDD duplex mode
2	15 kHz SSB SCS, 10 MHz bandwidth, TDD – TDD duplex mode
3	30 kHz SSB SCS, 40 MHz bandwidth, TDD – TDD duplex mode
Note: The UE is only required to be tested in one of the supported test configurations.	

**Table A.6.5.2.2-2: General test parameters for SA interruptions at NR SRS carrier based switching**

Parameter	Unit	Value	Comment
RF Channel Number		1,2	Two NR radio channel (1, 2) are used for this test
Active PCell		Cell 1	Primary cell on NR RF channel number 1
Configured SCell		Cell 2	Activated secondary cell on NR RF channel number 2
CP length		Normal	
DRX		OFF	Continuous monitoring of primary cell
Cell2 timing offset to cell1	μs	0	
Time alignment error between cell2 and cell1	μs	≤ Time alignment error as specified in TS 38.104 [13] clause 6.5.3.1.	The value of time alignment error depends upon the type of carrier aggregation.
T1	s	5	
T2	ms	40	UE shall perform SRS switching during T2

**Table A.6.5.2.2-3: Cell specific test parameters for SA interruptions at NR SRS carrier based switching**

Parameter		Unit	T1		T2	
			Cell 1	Cell 2	Cell 1	Cell 2
Duplex mode	Config 1		FDD	TDD	FDD	TDD
	Config 2,3		TDD			
TDD configuration	Config 1		N/A	TDDConf.1.1	N/A	TDDConf.1.1
	Config 2		TDDConf.1.1			
	Config 3		TDDConf.2.1			
BW <sub>channel</sub>	Config 1,2	MHz	10: N <sub>RB,c</sub> = 52			
	Config 3		40: N <sub>RB,c</sub> = 106			
Downlink initial BWP Configuration			DLBWP.0.1			
Downlink dedicated BWP Configuration			DLBWP.1.1			

Uplink initial BWP configuration			ULBWP.0.1			
Uplink dedicated BWP configuration			ULBWP.1.1			
TCI state			TCI.State.0			
TRS Configuration			TRS.1.1 TDD			
PDSCH Reference measurement channel	Config 1		SR.1.1 FDD	SR.1.1 TDD	SR.1.1 FDD	SR.1.1 TDD
	Config 2		SR.1.1 TDD	SR.1.1 TDD	SR.1.1 TDD	SR.1.1 TDD
	Config 3		SR2.1 TDD	SR2.1 TDD	SR2.1 TDD	SR2.1 TDD
Dedicated CORESET parameters	Config 1		CCR.1.1 FDD	CCR.1.1 TDD	CCR.1.1 FDD	CCR.1.1 TDD
	Config 2		CCR.1.1 TDD	CCR.1.1 TDD	CCR.1.1 TDD	CCR.1.1 TDD
	Config 3		CCR.2.1 TDD	CCR.2.1 TDD	CCR.2.1 TDD	CCR.2.1 TDD
RMSI CORESET parameters	Config 1		CR.1.1 FDD	CR.1.1 TDD	CR.1.1 FDD	CR.1.1 TDD
	Config 2		CR.1.1 TDD	CR.1.1 TDD	CR.1.1 TDD	CR.1.1 TDD
	Config 3		CR2.1 TDD	CR2.1 TDD	CR2.1 TDD	CR2.1 TDD
OCNG Patterns			OP.1			
SRS Configuration	Config 1,2		SRS.4 TDD			
	Config 3		SRS.5 TDD			
SSB Configuration	Config 1,2		SSB.1 FR1			
	Config 3		SSB.2 FR1			
SMTC configuration			SMTC.1			
EPRE ratio of PSS to SSS		dB	0			
EPRE ratio of PBCH DMRS to SSS						
EPRE ratio of PBCH to PBCH DMRS						
EPRE ratio of PDCCH DMRS to SSS						
EPRE ratio of PDCCH to PDCCH DMRS						
EPRE ratio of PDSCH DMRS to SSS						
EPRE ratio of PDSCH to PDSCH						
EPRE ratio of OCNG DMRS to SSS(Note 1)						
EPRE ratio of OCNG to OCNG DMRS (Note 1)						
$N_{oc}$ <sup>Note2</sup>	Config 1,2,4,5	dBm/15kHz	-104			
	Config 3,6		-101			
$\hat{E}_s/I_{ot}$		dB	17			
$\hat{E}_s/N_{oc}$		dB	17			
SS-RSRP <sup>Note3</sup>	Config 1,2,4,5	dBm/SCS	-87			
	Config 3,6		-84			
SCH_RP <sup>Note 3</sup>		dBm/15 kHz	-87			
Propagation condition		-	AWGN			
<p>Note 1: OCNG shall be used such that both cells are fully allocated and a constant total transmitted power spectral density is achieved for all OFDM symbols.</p> <p>Note 2: Interference from other cells and noise sources not specified in the test is assumed to be constant over subcarriers and time and shall be modelled as AWGN of appropriate power for <math>N_{oc}</math> to be fulfilled.</p> <p>Note 3: SS-RSRP and SCH_RP levels have been derived from other parameters for information purposes. They are not settable parameters themselves.</p>						

Note 4: The uplink resources for CSI reporting are assigned to the UE prior to the start of time period T2.

**Table A.6.5.2.2-4: Void**

### A.6.5.2.2.3 Test Requirements

The UE shall be scheduled on PCell continuously throughout the test. During the time duration T2, the interruption on PCell shall not be more than the values specified for SA in clause 8.2.2.2.9.

The rate of correct events observed during repeated tests shall be at least 90%.

## A.6.5.3 SCell Activation and Deactivation Delay

### A.6.5.3.1 SCell Activation and deactivation of known SCell in FR1 in non-DRX for 160ms SCell measurement cycle

#### A.6.5.3.1.1 Test Purpose and Environment

The purpose of this test is to verify that the SCell activation and deactivation times are within the requirements stated in clause 8.3, when the SCell in FR1 is known by the UE at the time of activation.

The supported test configurations for NR PCell are shown in table A.6.5.3.1.1-1 below. Supported test configurations for NR SCell are shown in table A.6.5.3.1.1-1A. Test configuration for NR PCell and test configuration for NR SCell are chosen independently. The test parameters are given in Tables A.6.5.3.1.1-2 and cell-specific parameters in A.6.5.3.1.1-3 and A.6.5.3.1.1-4 below. The test consists of three successive time periods, with duration of T1, T2 and T3, respectively. There are two NR carriers, each with one cell. Both cells have constant signal levels throughout the test. Before the test starts the UE is connected to Cell 1, but is not aware of Cell2. The UE is only monitoring the PCC. The UE shall be continuously scheduled in the PCell throughout the whole test.

At the beginning of T1 the UE receives an RRC message by which the SCell (Cell 2) becomes configured on radio channel 2. The UE now starts monitoring the SCC. The test equipment sends a MAC message for activation of the SCell.

The point in time at which the MAC message is received at the UE antenna connector, in slot # denoted  $n$ , defines the start of time period T2. The UE shall be able to report valid CSI in PCell for the activated SCell at latest in slot  $n + \frac{T_{\text{HARQ}} + T_{\text{activation\_time}} + T_{\text{CSI\_Reporting}}}{\text{NR slot length}}$ , as defined in clause 8.3. The UE shall start reporting CSI in PCell after at least one

CSI-RS transmission occasion for channel measurement and reporting after slot  $n + \frac{T_{\text{HARQ}} + 3\text{ms}}{\text{NR slot length}}$  and shall report CQI index 0 (out-of-range) until the SCell activation has been completed. Any PCell interruption due to activation of SCell shall occur in the slot  $n + 1 + \frac{T_{\text{HARQ}}}{\text{NR slot length}}$  to  $n + 1 + \frac{T_{\text{HARQ}} + 3\text{ms} + T_X}{\text{NR slot length}} + N_{\text{interruption}}$ , as defined in clause 8.3, where  $N_{\text{interruption}}$  is the interruption length given in clause 8.2.

Time period T3 starts when a MAC message for deactivation of SCell, sent from the test equipment to the UE in a slot # denoted  $m$ , is received at the UE antenna connector. The UE shall carry out deactivation of the SCell in a slot  $m + \frac{T_{\text{HARQ}} + 3\text{ms}}{\text{NR slot length}}$ , as defined in clause 8.3, and The starting point of any PCell interruption due to the deactivation shall occur in the slot  $m + 1 + \frac{T_{\text{HARQ}}}{\text{NR slot length}}$  to  $m + 1 + \frac{T_{\text{HARQ}} + 3\text{ms}}{\text{NR slot length}}$ , as defined in clause 8.3.

The test equipment verifies that potential interruption is carried out in the correct time span by monitoring ACK/NACK sent in PCell during activation and deactivation of SCell, respectively.

The test equipment verifies the activation time by counting the slots from the time when the SCell activation command is sent until a CSI report with other than CQI index 0 is received.

The test equipment verifies the deactivation time by counting the slots from the time when the SCell deactivation command is sent until CQI reporting for SCell is discontinued.

**Table A.6.5.3.1.1-1: known FR1 SCell activation in non-DRX for 160ms SCell measurement cycle supported test configurations for NR PCell**

Config	Description
1	NR 15 kHz SSB SCS, $\geq 10$ MHz bandwidth, FDD duplex mode
2	NR 15 kHz SSB SCS, $\geq 10$ MHz bandwidth, TDD duplex mode
3	NR 30kHz SSB SCS, $\geq 40$ MHz bandwidth, TDD duplex mode
Note 1: The UE is only required to be tested in one of the supported test configurations	
Note 2: The UE is only required to be tested in one with smallest aggregated channel bandwidth from supported band combinations which is composed of CCs $\geq$ the bandwidth ( $BW_{\text{channel}}$ ) defined in each test configuration,	

**Table A.6.5.3.1.1-1A: known FR1 SCell activation in non-DRX for 160ms SCell measurement cycle supported test configurations for NR SCell**

Config <sub>SCell</sub>	Description
1	NR 15 kHz SSB SCS, $\geq 10$ MHz bandwidth, FDD duplex mode
2	NR 15 kHz SSB SCS, $\geq 10$ MHz bandwidth, TDD duplex mode
3	NR 30kHz SSB SCS, $\geq 40$ MHz bandwidth, TDD duplex mode
Note 1: The UE is only required to be tested in one of the supported test configurations	
Note 2: The UE is only required to be tested in one with smallest aggregated channel bandwidth from supported band combinations which is composed of CCs $\geq$ the bandwidth ( $BW_{\text{channel}}$ ) defined in each test configuration,	

**Table A.6.5.3.1.1-2: General test parameters for known FR1 SCell activation case, 160ms SCell measurement cycle**

Parameter	Unit	Value	Comment
RF Channel Number		1,2	Two NR radio channel (1, 2) are used for this test
Active PCell		Cell 1	Primary cell on NR RF channel number 1.
Configured deactivated SCell		Cell 2	Configured deactivated secondary cell on NR RF channel number 2
CP length		Normal	
DRX		OFF	Continuous monitoring of primary cell
Cell-individual offset for cells on NR channel number	dB	0	Individual offset for cells on primary component carrier.
SCell measurement cycle (measCycleSCell)	ms	160	
Cell2 timing offset to cell1	$\mu\text{s}$	0	
Time alignment error between cell2 and cell1	$\mu\text{s}$	$\leq$ Time alignment error as specified in TS 38.104 [13] clause 6.5.3.1.	The value of time alignment error depends upon the type of carrier aggregation.
T1	s	7	During this time the PCell shall be known and the SCell configured and detected.
T2	s	1	During this time the UE shall activate the SCell.
T3	s	1	During this time the UE shall deactivate the SCell.
A3-offset	dB	-15	
$T_{\text{HARQ}}$	ms	Config 1: 2 Config 2: 3 Config 3: 2.5	$k_1 \times \text{NR slot length}$  $k_1$ is a number of slots and is indicated by the PDSCH-to-HARQ-timing-indicator field in the DCI format, if present, or provided by <i>dl-DataToUL-ACK</i> , the value of $k$ should be the minimum value defined in TS 38.213 [3] that will meet the timing constraints of this test case.

T <sub>CSI_Reporting</sub>	ms	15	The delay (in ms) including uncertainty in acquiring the first available downlink CSI reference resource, UE processing time for CSI reporting (clause 5.2.2.5 in TS 38.214) and uncertainty in acquiring the first available CSI reporting resources as specified in TS 38.331 [2]
----------------------------	----	----	---

**Table A.6.5.3.1.1-3: Cell specific test parameters for NR PCell for known FR1 SCell activation case, 160ms SCell measurement cycle**

Parameter		Unit	Cell 1		
			T1	T2	T3
Duplex mode	Config 1		FDD		
	Config 2,3		TDD		
TDD configuration	Config 1		Not applicable		
	Config 2		TDDConf.1.1		
	Config 3		TDDConf.2.1		
BW <sub>channel</sub>	Config 1,2	MHz	Note 7		
	Config 3		Note 7		
BW <sub>occupied</sub>	Config 1,2	RB	52 <sup>Note 5</sup>		
	Config 3		106 <sup>Note 6</sup>		
Initial BWP configuration			DLBWP.0.1		
TCI state			TCI.State.0		
TRS Configuration	Config 1		TRS.1.1 FDD		
	Config 2		TRS.1.1 TDD		
	Config 3		TRS.1.2 TDD		
PDSCH Reference measurement channel	Config 1		SR.1.1 FDD		
	Config 2		SR.1.1 TDD		
	Config 3		SR.2.1 TDD		
Dedicated CORESET parameters	Config 1		CCR.1.1 FDD		
	Config 2		CCR.1.1 TDD		
	Config 3		CCR.2.1 TDD		
RMSI CORESET parameters	Config 1		CR.1.1 FDD		
	Config 2		CR.1.1 TDD		
	Config 3		CR.2.1 TDD		
OCNG Patterns	Config 1,2		OP.1 <sup>Note 5</sup>		
	Config 3,		OP.1 <sup>Note 6</sup>		
SSB Configuration	Config 1,2		SSB.1 FR1		
	Config 3		SSB.2 FR1		
CSI-RS configuration for CSI reporting (Note 8)	Config 1		CSI-RS.1.1 FDD		
	Config 2		CSI-RS.1.1 TDD		
	Config 3		CSI-RS.2.1 TDD		
SMTC configuration			SMTC.1		
reportConfigType			periodic		
reportQuantity			cri-RI-PMI-CQI		
CSI reporting periodicity	Config 1,2	slot	5		
	Config 3		10		
CSI reporting offset	Config 1,2	slot	3		
	Config 3		5		
EPRE ratio of PSS to SSS		dB	0		
EPRE ratio of PBCH DMRS to SSS					
EPRE ratio of PBCH to PBCH DMRS					
EPRE ratio of PDCCH DMRS to SSS					
EPRE ratio of PDCCH to PDCCH DMRS					
EPRE ratio of PDSCH DMRS to SSS					
EPRE ratio of PDSCH to PDSCH					
EPRE ratio of OCNG DMRS to SSS <sup>Note 1</sup>					
EPRE ratio of OCNG to OCNG DMRS <sup>Note 1</sup>					
$N_{oc}$ <sup>Note2</sup>	Config 1,2	dBm/SCS	-104		
	Config 3		-101		



$\hat{E}_s/I_{ot}$		dB	17
$\hat{E}_s/N_{oc}$		dB	17
SS-RSRP <sup>Note3</sup>	Config 1,2	dBm/SCS	-87
	Config 3		-84
SCH_RP <sup>Note 3</sup>		dBm/15 kHz	-87
I <sub>o</sub> <sup>Note3</sup>	Config 1,2	dBm/ 9.36MHz	-58.96
	Config 3	dBm/ 38.16MHz	-52.87
Propagation condition		-	AWGN
Correlation Matrix and Antenna Configuration		-	2x2 Low
<p>Note 1: OCNG shall be used such that both cells are fully allocated and a constant total transmitted power spectral density is achieved for all OFDM symbols.</p> <p>Note 2: Interference from other cells and noise sources not specified in the test is assumed to be constant over subcarriers and time and shall be modelled as AWGN of appropriate power for <math>N_{oc}</math> to be fulfilled within <math>BW_{occupied}</math>.</p> <p>Note 3: SS-RSRP and SCH_RP levels have been derived from other parameters for information purposes. They are not settable parameters themselves.</p> <p>Note 4: The uplink resources for CSI reporting are assigned to the UE prior to the start of time period T2.</p> <p>Note 5: All UL/DL transmission shall be confined within <math>BW_{occupied}</math> (i.e. 10 MHz, 52 RBs) from <math>F_{C,low}</math>, and I<sub>o</sub> is independent of the <math>BW_{channel}</math> configured.</p> <p>Note 6: All UL/DL transmission shall be confined within <math>BW_{occupied}</math> (i.e. 40 MHz, 106 RBs) from <math>F_{C,low}</math>, and I<sub>o</sub> is independent of the <math>BW_{channel}</math> configured.</p> <p>Note 7: <math>N_{RB,c}</math> is derived from Table 5.3.2-1 in TS38.101-1[2] with configured <math>BW_{channel}</math>.</p> <p>Note 8: On top of the reference configurations, CSI-RS offset should be set to meet the CSI reference resource timing definition in TS 38.214 cl. 5.2.2.5.</p>			

**Table A.6.5.3.1.1-4: Cell specific test parameters for NR SCell for known FR1 SCell activation case, 160ms SCell measurement cycle**

Parameter		Unit	Cell 2		
			T1	T2	T3
Duplex mode	Config <sub>SCell</sub> 1		FDD		
	Config <sub>SCell</sub> 2,3		TDD		
TDD configuration	Config <sub>SCell</sub> 1		Not applicable		
	Config <sub>SCell</sub> 2		TDDConf.1.1		
	Config <sub>SCell</sub> 3		TDDConf.2.1		
BW <sub>channel</sub>	Config <sub>SCell</sub> 1,2	MHz	Note 7		
	Config <sub>SCell</sub> 3		Note 7		
BW <sub>occupied</sub>	Config <sub>SCell</sub> 1,2	RB	52 <sup>Note 5</sup>		
	Config <sub>SCell</sub> 3		106 <sup>Note 6</sup>		
Initial BWP configuration			DLBWP.0.1		
TCI state			TCI.State.0		
TRS Configuration	Config <sub>SCell</sub> 1		TRS.1.1 FDD		
	Config <sub>SCell</sub> 2		TRS.1.1 TDD		
	Config <sub>SCell</sub> 3		TRS.1.2 TDD		
PDSCH Reference measurement channel	Config <sub>SCell</sub> 1		N/A		
	Config <sub>SCell</sub> 2		N/A		
	Config <sub>SCell</sub> 3		N/A		
Dedicated CORESET parameters	Config <sub>SCell</sub> 1		N/A		
	Config <sub>SCell</sub> 2		N/A		
	Config <sub>SCell</sub> 3		N/A		
RMSI CORESET parameters	Config <sub>SCell</sub> 1		N/A		
	Config <sub>SCell</sub> 2		N/A		
	Config <sub>SCell</sub> 3		N/A		
OCNG Patterns	Config <sub>SCell</sub> 1,2		OP.1 <sup>Note 5</sup>		
	Config <sub>SCell</sub> 3,		OP.1 <sup>Note 6</sup>		
SSB Configuration	Config <sub>SCell</sub> 1,2		SSB.1 FR1		
	Config <sub>SCell</sub> 3		SSB.2 FR1		
	Config <sub>SCell</sub> 1		CSI-RS.1.1 FDD		

CSI-RS configuration for CSI reporting <sup>Note 8</sup>	Config <sub>SCell</sub> 2		CSI-RS.1.1 TDD
	Config <sub>SCell</sub> 3		CSI-RS.2.1 TDD
SMTC configuration			SMTC.1
reportConfigType			N/A
reportQuantity			N/A
CSI reporting periodicity	Config <sub>SCell</sub> 1,2	slot	N/A
	Config <sub>SCell</sub> 3		N/A
CSI reporting offset	Config <sub>SCell</sub> 1,2	slot	N/A
	Config <sub>SCell</sub> 3		N/A
EPRE ratio of PSS to SSS		dB	0
EPRE ratio of PBCH DMRS to SSS			
EPRE ratio of PBCH to PBCH DMRS			
EPRE ratio of PDCCH DMRS to SSS			
EPRE ratio of PDCCH to PDCCH DMRS			
EPRE ratio of PDSCH DMRS to SSS			
EPRE ratio of PDSCH to PDSCH			
EPRE ratio of OCNG DMRS to SSS <sup>Note 1</sup>			
EPRE ratio of OCNG to OCNG DMRS <sup>Note 1</sup>			
$N_{oc}$ <sup>Note 2</sup>	Config <sub>SCell</sub> 1,2	dBm/SCS	-104
	Config <sub>SCell</sub> 3		-101
$\hat{E}_s/I_{ot}$		dB	17
$\hat{E}_s/N_{oc}$		dB	17
SS-RSRP <sup>Note 3</sup>	Config <sub>SCell</sub> 1,2	dBm/SCS	-87
	Config <sub>SCell</sub> 3		-84
SCH_RP <sup>Note 3</sup>		dBm/15 kHz	-87
$I_o$ <sup>Note 3</sup>	Config <sub>SCell</sub> 1,2	dBm/ 9.36MHz	-58.96
	Config <sub>SCell</sub> 3	dBm/ 38.16MHz	-52.87
Propagation condition		-	AWGN
Correlation Matrix and Antenna Configuration			2x2 Low
<p>Note 1: OCNG shall be used such that both cells are fully allocated and a constant total transmitted power spectral density is achieved for all OFDM symbols.</p> <p>Note 2: Interference from other cells and noise sources not specified in the test is assumed to be constant over subcarriers and time and shall be modelled as AWGN of appropriate power for <math>N_{oc}</math> to be fulfilled within <math>BW_{occupied}</math>.</p> <p>Note 3: SS-RSRP and SCH_RP levels have been derived from other parameters for information purposes. They are not settable parameters themselves.</p> <p>Note 4: The uplink resources for CSI reporting are assigned to the UE prior to the start of time period T2.</p> <p>Note 5: All UL/DL transmission shall be confined within <math>BW_{occupied}</math> (i.e. 10 MHz, 52 RBs) from <math>F_{C,low}</math>, and <math>I_o</math> is independent of the <math>BW_{channel}</math> configured.</p> <p>Note 6: All UL/DL transmission shall be confined within <math>BW_{occupied}</math> (i.e. 40 MHz, 106 RBs) from <math>F_{C,low}</math>, and <math>I_o</math> is independent of the <math>BW_{channel}</math> configured.</p> <p>Note 7: <math>N_{RB,c}</math> is derived from Table 5.3.2-1 in TS38.101-1[2] with configured <math>BW_{channel}</math>.</p> <p>Note 8: On top of the reference configurations, CSI-RS offset should be set to meet the CSI reference resource timing definition in TS 38.214 cl. 5.2.2.5.</p>			

### A.6.5.3.1.2 Test Requirements

During T2 the UE shall send the first CSI report for SCell in the first available uplink resource after at least one CSI-RS transmission occasion for channel measurement and reporting after slot  $(n + 1 + \frac{T_{HARQ} + 3ms}{NR\ slot\ length})$ . UE is allowed to postpone CSI report to next available uplink resource if an available uplink resource is subject to interruption.

During T2 the UE shall start sending CSI reports for SCell with non-zero CQI index at latest in a slot  $n + \frac{T_{HARQ} + T_{activation\_time} + T_{CSI\_Reporting}}{NR\ slot\ length}$ ,  $T_{activation\_time} = T_{FirstSSB} + 5ms$ , as defined in clause 8.3.

During T3 the UE shall stop sending CSI reports for SCell at latest in a slot  $m + \frac{T_{\text{HARQ}}+3\text{ms}}{\text{NR slot length}}$ , as defined in clause 8.3.

During T2 interruption of PCell during SCell activation shall not happen outside the slot  $n + 1 + \frac{T_{\text{HARQ}}}{\text{NR slot length}}$  to  $n + 1 + \frac{T_{\text{HARQ}}+3\text{ms}+T_X}{\text{NR slot length}} + N_{\text{interruption}}$ , as defined in clause 8.3.

During T3 the starting point of interruption of PCell during SCell deactivation shall not happen outside the slot  $m + 1 + \frac{T_{\text{HARQ}}}{\text{NR slot length}}$  to  $m + 1 + \frac{T_{\text{HARQ}}+3\text{ms}}{\text{NR slot length}}$ , as defined in clause 8.3.

The interruption on any activated serving cell shall not be more than the values specified for SA in clause 8.2.2.2.2.

All of the above test requirements shall be fulfilled in order for the observed SCell activation delay and SCell deactivation delay to be counted as correct. The rate of correct observed SCell activation delay and SCell deactivation delay during repeated tests shall be at least 90%.

NOTE: During T2 if there are no uplink resources for reporting the valid CSI in a slot  $\frac{T_{\text{HARQ}}+T_{\text{activation\_time}}+T_{\text{CSI\_Reporting}}}{\text{NR slot length}}$  as defined in clause 8.3 then the UE shall use the next available uplink resource for reporting the corresponding valid CSI.

### A.6.5.3.2 SCell Activation and deactivation of known SCell in FR1 in non-DRX for 640 ms SCell measurement cycle

#### A.6.5.3.2.1 Test Purpose and Environment

The purpose of this test case is the same as for the test defined in clause A.6.5.3.1.1. The supported test configurations are the same as defined in clause A.6.5.3.1.1. The test parameters are the same except those described in the following clause. The listed parameter values in Tables A.6.5.3.2.1-1 will replace the values of corresponding parameters in Tables A.4.5.3.1.1-1.

**Table A.6.5.3.2.1-1: General test parameters for known FR1 SCell activation case, 640 ms SCell measurement cycle**

Parameter	Unit	Value	Comment
SCell measurement cycle (measCycleSCell)	ms	640	

#### A.6.5.3.2.2 Test Requirements

The test requirements defined in clause A.6.5.3.1.2 shall apply to this test case, except  $T_{\text{activation\_time}}$  will be replaced with the value  $T_{\text{FirstSSB\_MAX}} + T_{\text{rs}} + 5\text{ms}$ .

### A.6.5.3.3 SCell Activation and deactivation of unknown SCell in FR1 in non-DRX

#### A.6.5.3.3.1 Test Purpose and Environment

The purpose of this test is to verify that the SCell activation and deactivation times are within the requirements stated in clause 8.3, when the SCell in FR1 is known by the UE at the time of activation.

The supported test configurations are shown in table A.6.5.3.1.1-1 below. The test parameters are given in Tables A.6.5.3.1.1-2 and cell-specific parameters in A.6.5.3.1.1-3 below. The test consists of three successive time periods, with duration of T1, T2 and T3, respectively. There are two NR carriers, each with one cell. Both cells have constant signal levels throughout the test. Before the test starts the UE is connected to Cell 1, but is not aware of Cell2. The UE is only monitoring the PCC. The UE shall be continuously scheduled in the PCell throughout the whole test.

At the beginning of T1 the UE receives an RRC message by which the SCell (Cell 2) becomes configured on radio channel 2. The UE now starts monitoring the SCC. The test equipment sends a MAC message for activation of the SCell.

The point in time at which the MAC message is received at the UE antenna connector, in slot # denoted n, defines the start of time period T2. The UE shall be able to report valid CSI in PCell for the activated SCell at latest in slot  $n + \frac{T_{\text{HARQ}}+T_{\text{activation\_time}}+T_{\text{CSI\_Reporting}}}{\text{NR slot length}}$ , as defined in clause 8.3. The UE shall start reporting CSI in PCell after at least one

CSI-RS transmission occasion for channel measurement and reporting after slot  $n + \frac{T_{\text{HARQ}} + 3\text{ms}}{\text{NR slot length}}$  and shall report CQI index 0 (out-of-range) until the SCell activation has been completed. Any PCell interruption due to activation of SCell shall occur in the slot  $n + 1 + \frac{T_{\text{HARQ}}}{\text{NR slot length}}$  to  $n + 1 + \frac{T_{\text{HARQ}} + 3\text{ms} + T_X}{\text{NR slot length}} + N_{\text{interruption}}$ , as defined in clause 8.3, where  $N_{\text{interruption}}$  is the interruption length given in clause 8.2.

Time period T3 starts when a MAC message for deactivation of SCell, sent from the test equipment to the UE in a slot # denoted m, is received at the UE antenna connector. The UE shall carry out deactivation of the SCell in a slot  $m + \frac{T_{\text{HARQ}} + 3\text{ms}}{\text{NR slot length}}$ , as defined in clause 8.3, and The starting point of any PCell interruption due to the deactivation shall occur in the slot  $m + 1 + \frac{T_{\text{HARQ}}}{\text{NR slot length}}$  to  $m + 1 + \frac{T_{\text{HARQ}} + 3\text{ms}}{\text{NR slot length}}$ , as defined in clause 8.3.

The test equipment verifies that potential interruption is carried out in the correct time span by monitoring ACK/NACK sent in PCell during activation and deactivation of SCell, respectively.

The test equipment verifies the activation time by counting the slots from the time when the SCell activation command is sent until a CSI report with other than CQI index 0 is received.

The test equipment verifies the deactivation time by counting the slots from the time when the SCell deactivation command is sent until CQI reporting for SCell is discontinued.

**Table A.6.5.3.3.1-1: General test parameters for unknown FR1 SCell activation case, 160ms SCell measurement cycle**

Parameter	Unit	Value	Comment
T1	ms	100	During this time the PCell shall be known and the SCell configured, but not detected.

#### A.6.5.3.3.2 Test Requirements

The test requirements defined in clause A.6.5.3.1.2 shall apply to this test case, except  $T_{\text{activation\_time}}$  will be replaced with the value  $T_{\text{FirstSSB\_MAX}} + T_{\text{SMTC\_MAX}} + 2 * T_{\text{rs}} + 5\text{ms}$  as defined in clause 8.3.

#### A.6.5.3.4 Direct SCell activation at SCell addition of known SCell in FR1

##### A.6.5.3.4.1 Test Purpose and Environment

The purpose of this test is to verify fulfillment of direct SCell activation delay and interruption requirements at SCell addition as defined in clause 8.3.4 and 8.2.2, respectively. The supported test configurations for NR PCell are shown in Table A.6.5.3.4.1-1. The supported test configurations for NR SCell are shown in Table A.6.5.3.4.1-1A. Test configuration for NR PCell and test configuration for NR SCell are chosen independently.

The test scenario comprises one PCell (Cell 1) and one SCell (Cell 2) as outlined in Table A.6.5.3.4.1-2. Cell-specific parameters are provided in Table A.6.5.3.4.1-3 and Table A.6.5.3.4.1-4.

The test consists of two successive time periods with duration T1 and T2, respectively. There are two carriers, each with one cell. Cell 1 (PCell) is on RF channel 1 (PCC), and Cell 2 (SCell) is on RF channel 2 (SCC). Cell 1 and Cell 2 both operate according to one of the configurations in Table A.6.5.3.4.1-1.

Before the test starts the UE is connected to Cell 1 on RF channel 1. The UE is only monitoring RF channel 1 and is not aware of Cell 2 on RF channel 2.

The UE is continuously scheduled in PCell throughout the test.

At the beginning of T1 the UE is configured to measure RF channel 2 in measurement gaps. During T1, the UE detects and measures Cell 2 on RF channel 2, and sends a measurement report containing Cell 2 to the test equipment. After having received a measurement report containing Cell 2, the test equipment deconfigures the measurement gaps and thereafter sends a RRC connection reconfiguration message to the UE by which it configures the SCell (Cell 2) in activated state (*sCellState* is set to *activated*). The time between reception of the last measurement report carrying SCell and transmission of the RRC connection reconfiguration message directly activating SCell is kept short enough to allow the SCell to remain known to the UE.

Time period T2 starts when the UE receives the RRC connection reconfiguration message at the UE antenna connector. The corresponding slot at which the message is received at the UE antenna connector is denoted  $n$ . The UE shall complete activation of the SCell no later than in slot  $n + \frac{N_{\text{direct}}}{\text{NR slot length}}$ , as specified in clause 8.3.4. From slot  $n + \frac{N_{\text{direct}}}{\text{NR slot length}}$  and onwards the UE shall report valid CSI both for PCell and SCell.

The test equipment verifies the activation time by counting the slots between the RRC connection reconfiguration message is sent and until CSI report with non-zero CQI for both PCell and SCell is received.

The test equipment verifies that interruptions on other serving cells are within the requirements by counting ACK/NACKs transmitted in PCell.

**Table A.6.5.3.4.1-1: Supported test configurations for NR PCell**

Config	Description
1	NR 15 kHz SSB SCS, $\geq 10$ MHz bandwidth, FDD duplex mode
2	NR 15 kHz SSB SCS, $\geq 10$ MHz bandwidth, TDD duplex mode
3	NR 30 kHz SSB SCS, $\geq 40$ MHz bandwidth, TDD duplex mode
Note 1:	The UE is only required to be tested in one of the supported test configurations
Note 2:	The UE is only required to be tested in one with smallest aggregated channel bandwidth from supported band combinations which is composed of CCs $\geq$ the bandwidth ( $BW_{\text{channel}}$ ) defined in each test configuration,

**Table A.6.5.3.4.1-1A: Supported test configurations for NR SCell**

Config <sub>SCell</sub>	Description
1	NR 15 kHz SSB SCS, $\geq 10$ MHz bandwidth, FDD duplex mode
2	NR 15 kHz SSB SCS, $\geq 10$ MHz bandwidth, TDD duplex mode
3	NR 30 kHz SSB SCS, $\geq 40$ MHz bandwidth, TDD duplex mode
Note 1:	The UE is only required to be tested in one of the supported test configurations
Note 2:	The UE is only required to be tested in one with smallest aggregated channel bandwidth from supported band combinations which is composed of CCs $\geq$ the bandwidth ( $BW_{\text{channel}}$ ) defined in each test configuration,

**Table A.6.5.3.4.1-2: General test parameters**

Parameter	Unit	Value	Comment
NR RF Channel Number		1, 2	Two NR radio channels are used for this test
Active PCell		Cell 1	Primary cell on NR RF channel number 1.
Inter-frequency neighbor cell (SCell to-be)		Cell 2	Inter-frequency neighbor cell on NR RF channel number 2
CP length		Normal	
DRX		OFF	Continuous monitoring of primary cell
Measurement gap pattern		gp0	Measurement gap is used during parts of time period T1 for detection of Cell 2.
CSI reporting periodicity	ms	2	CSI reporting periodicity for periodic reporting of CQI for PCell and, when added, SCell.
SCell measurement cycle (measCycleSCell)	ms	160	Measurement cycle for SCell does not come into effect in direct activation at SCell addition.
Timing offset between Cell 1 and Cell 2	$\mu\text{s}$	$\leq \text{MRTD}$	The value of maximum timing offset depends upon the carrier aggregation scenario.
T1	s	7	During this time period the PCell shall be known and Cell 2 shall be detected as an inter-frequency neighbor cell.
T2	s	1	During this time period Cell 2 shall be configured and directly activated as SCell.
A3-offset	dB	-15	

$T_{HARQ}$	ms	$k_1 \times \text{NR slot length}$	$k_1$ is a number of slots indicated by the PDSCH-to-HARQ_feedback timing indicator field in a corresponding DCI format or provided by <i>dl-DataToUL-ACK</i> if the PDSCH-to-HARQ feedback timing field is not present in the DCI format, the value is defined in 38.213 [3]
$T_{CSI\_Reporting}$	ms	2	the delay uncertainty in acquiring the first available CSI reporting resources as specified in TS 38.331 [2]
$k$	ms	$k_1 + 3 \cdot N_{\text{slot}}^{\text{subframe}, \mu} + 1$	As specified in clause 4.3 of TS 38.213 [3]

**Table A.6.5.3.4.1-3: NR Cell specific test parameters for NR Pcell**

Parameter		Unit	Cell 1	
			T1	T2
Duplex mode	Config 1		FDD	
	Config 2,3		TDD	
TDD configuration	Config 2		TDDConf.1.1	
	Config 3		TDDConf.2.1	
$BW_{\text{channel}}$	Config 1,2	MHz	10: $N_{RB,C} = 52$	
	Config 3		40: $N_{RB,C} = 106$	
BWP configuration	Initial DL		DLBWP.0.1	
	Initial UL		ULBWP.0.1	
	Dedicated DL		DLBWP.1.1	
	Dedicated UL		ULBWP.1.1	
TCI state			TCI.State.0	
CSI-RS configuration for CSI reporting	Config 1		CSI-RS.1.1 FDD	
	Config 2		CSI-RS.1.1 TDD	
	Config 3		CSI-RS.2.1 TDD	
TRS Configuration	Config 1		TRS.1.1 FDD	
	Config 2		TRS.1.1 TDD	
	Config 3		TRS.1.2 TDD	
PDSCH Reference measurement channel	Config 1		SR.1.1 FDD	
	Config 2		SR.1.1 TDD	
	Config 3		SR.2.1 TDD	
Dedicated CORESET parameters	Config 1		CCR.1.1 FDD	
	Config 2		CCR.1.1 TDD	
	Config 3		CCR.2.1 TDD	
RMSI CORESET parameters	Config 1		CR.1.1 FDD	
	Config 2		CR.1.1 TDD	
	Config 3		CR.2.1 TDD	
OCNG Pattern			OP.1	
SSB Configuration	Config 1,2		SSB.1 FR1	
	Config 3		SSB.2 FR1	
SMTC configuration			SMTC.1	
reportConfigType			periodic	
reportQuantity			cri-RI-PMI-CQI	
CSI reporting periodicity	Config 1,2	slot	5	
	Config 3		10	
CSI reporting offset	Config 1,2	slot	3	
	Config 3		5	
EPRE ratio of PSS to SSS		dB	0	
EPRE ratio of PBCH DMRS to SSS				
EPRE ratio of PBCH to PBCH DMRS				
EPRE ratio of PDCCH DMRS to SSS				
EPRE ratio of PDCCH to PDCCH DMRS				
EPRE ratio of PDSCH DMRS to SSS				
EPRE ratio of PDSCH to PDSCH				
EPRE ratio of OCNG DMRS to SSS <sup>Note1</sup>				
EPRE ratio of OCNG to OCNG DMRS <sup>Note1</sup>				
$N_{oc}$ <sup>Note2</sup>	Config 1,2	dBm/SCS	-104	
	Config 3		-101	

$\hat{E}_s/I_{ot}$		dB	17
$\hat{E}_s/N_{oc}$		dB	17
SS-RSRP <sup>Note3</sup>	Config 1,2	dBm/SCS	-87
	Config 3		-84
I <sub>o</sub> <sup>Note3</sup>	Config 1,2	dBm/9.36 MHz	-59.0
	Config 3	dBm/38.16 MHz	-52.9
Propagation condition			AWGN
Correlation Matrix and Antenna Configuration			1x2 Low
<p>Note 1: OCNG shall be used such that both cells are fully allocated and a constant total transmitted power spectral density is achieved for all OFDM symbols.</p> <p>Note 2: Interference from other cells and noise sources not specified in the test is assumed to be constant over subcarriers and time and shall be modelled as AWGN of appropriate power for <math>N_{oc}</math> to be fulfilled.</p> <p>Note 3: SS-RSRP, SCH_RP, and I<sub>o</sub> levels have been derived from other parameters for information purpose. They are not settable parameters themselves.</p>			

**Table A.6.5.3.4.1-4: NR Cell specific test parameters for NR Scell**

Parameter		Unit	Cell 2	
			T1	T2
Duplex mode	Config <sub>SCell</sub> 1		FDD	
	Config <sub>SCell</sub> 2,3		TDD	
TDD configuration	Config <sub>SCell</sub> 2		TDDConf.1.1	
	Config <sub>SCell</sub> 3		TDDConf.2.1	
BW <sub>channel</sub>	Config <sub>SCell</sub> 1,2	MHz	10: N <sub>RB,c</sub> = 52	
	Config <sub>SCell</sub> 3		40: N <sub>RB,c</sub> = 106	
BWP configuration	Initial DL	N/A	DLBWP.0.1	
	Initial UL		N/A	
	Dedicated DL		DLBWP.1.1	
	Dedicated UL		N/A	
TCI state		N/A	TCI.State.0	
CSI-RS configuration for CSI reporting	Config <sub>SCell</sub> 1	N/A	CSI-RS.1.1 FDD	
	Config <sub>SCell</sub> 2		CSI-RS.1.1 TDD	
	Config <sub>SCell</sub> 3		CSI-RS.2.1 TDD	
TRS Configuration	Config <sub>SCell</sub> 1	N/A	TRS.1.1 FDD	
	Config <sub>SCell</sub> 2		TRS.1.1 TDD	
	Config <sub>SCell</sub> 3		TRS.1.2 TDD	
PDSCH Reference measurement channel	Config <sub>SCell</sub> 1	N/A	SR.1.1 FDD	
	Config <sub>SCell</sub> 2		SR.1.1 TDD	
	Config <sub>SCell</sub> 3		SR.2.1 TDD	
Dedicated CORESET parameters	Config <sub>SCell</sub> 1	N/A	CCR.1.1 FDD	
	Config <sub>SCell</sub> 2		CCR.1.1 TDD	
	Config <sub>SCell</sub> 3		CCR.2.1 TDD	
RMSI CORESET parameters	Config <sub>SCell</sub> 1 Config <sub>SCell</sub> 2 Config <sub>SCell</sub> 3		N/A	
OCNG Pattern			OP.1	
SSB Configuration	Config <sub>SCell</sub> 1,2		SSB.1 FR1	
	Config <sub>SCell</sub> 3		SSB.2 FR1	
SMTC configuration			SMTC.1	
reportConfigType			N/A	
reportQuantity			N/A	
CSI reporting periodicity	Config <sub>SCell</sub> 1,2	slot	N/A	
	Config <sub>SCell</sub> 3		N/A	
CSI reporting offset	Config <sub>SCell</sub> 1,2	slot	N/A	
	Config <sub>SCell</sub> 3		N/A	
EPRE ratio of PSS to SSS		dB	0	
EPRE ratio of PBCH DMRS to SSS				
EPRE ratio of PBCH to PBCH DMRS				
EPRE ratio of PDCCH DMRS to SSS				

EPRE ratio of PDCCH to PDCCH DMRS			
EPRE ratio of PDSCH DMRS to SSS			
EPRE ratio of PDSCH to PDSCH			
EPRE ratio of OCNG DMRS to SSS <sup>Note1</sup>			
EPRE ratio of OCNG to OCNG DMRS <sup>Note1</sup>			
$N_{oc}$ <sup>Note2</sup>	Config <sub>SCell</sub> 1,2	dBm/15kHz	-104
	Config <sub>SCell</sub> 3		-101
$\hat{E}_s/I_{ot}$		dB	17
$\hat{E}_s/N_{oc}$		dB	17
SS-RSRP <sup>Note3</sup>	Config <sub>SCell</sub> 1,2	dBm/SCS	-87
	Config <sub>SCell</sub> 3		-84
$I_o$ <sup>Note3</sup>	Config <sub>SCell</sub> 1,2	dBm/9.36 MHz	-59.0
	Config <sub>SCell</sub> 3	dBm/38.16 MHz	-52.9
Propagation condition			AWGN
Correlation Matrix and Antenna Configuration			1x2 Low
<p>Note 1: OCNG shall be used such that both cells are fully allocated and a constant total transmitted power spectral density is achieved for all OFDM symbols.</p> <p>Note 2: Interference from other cells and noise sources not specified in the test is assumed to be constant over subcarriers and time and shall be modelled as AWGN of appropriate power for <math>N_{oc}</math> to be fulfilled.</p> <p>Note 3: SS-RSRP, SCH_RP, and <math>I_o</math> levels have been derived from other parameters for information purpose. They are not settable parameters themselves.</p>			

#### A.6.5.3.4.2 Test Requirements

The UE shall complete the direct activation of the SCell no later than at slot  $n + \frac{N_{direct}}{NR \text{ slot length}}$ .

The UE shall report non-zero CQI for SCell from slot  $n + \frac{N_{direct}}{NR \text{ slot length}}$  and onwards throughout time period T2.

The interruption on PCell during direct activation of the SCell shall occur within the interruption window specified in clause 8.3.4 and shall not exceed the length specified in clause 8.2.2.2.11.

The rate of correct events observed during repeated tests shall be at least 90%.

#### A.6.5.3.5 Direct SCell activation at handover with known SCell in FR1

##### A.6.5.3.5.1 Test Purpose and Environment

This test is to verify the requirement for the FDD-FDD and TDD-TDD intra frequency handover with direct SCell activation requirements specified in subclause 8.3.5.

Supported test configurations for NR PCell are shown in table A.6.5.3.5.1-1. Supported test configurations for NR SCell are shown in table A.6.5.3.5.1-1A. Test configuration for NR PCell and test configuration for NR SCell are chosen independently. Both handover with direct SCell activation requirements are tested by using the parameters in table A.6.5.3.5.1-2, A.6.5.3.5.1-3 and A.6.5.3.5.1-4.

The test scenario comprises of two NR carriers and 3 cells as given in tables A.6.5.3.5.1-1 and A.6.5.3.5.1-2. The test consists of three successive time periods, with time durations of T1, T2, and T3 respectively.

At the start of time duration T1, the UE is in connected mode with PCell and SCell1 (cell 2) is in activated state and UE is reporting CQI for both PCell and SCell1.

Time period T2 starts when UE receives a handover command to Cell 3 that also activates SCell1 (Cell2). This is done using an *RRCReconfiguration* message with parameter *sCellState* set to *activated* for the SCell1 (Cell 2). The message is sent from the test equipment to the UE and is received in a subframe # denoted n at the UE antenna connector. The UE shall accomplish the activation of the SCell no later than subframe  $(n + N_{direct})$ .

Time period T3 starts at  $(n + N_{direct})$ , at which point UE shall be reporting a valid CQI for both PCell and SCell1.



**Table A.6.5.3.5.1-1: Intra-frequency handover with direct SCell activation from FR1 to FR1 test configurations for NR PCell**

Config	Description
1	Source PCell: NR 15 kHz SSB SCS, $\geq 10$ MHz bandwidth, FDD duplex mode Target PCell: NR 15 kHz SSB SCS, $\geq 10$ MHz bandwidth, FDD duplex mode
2	Source PCell: NR 15 kHz SSB SCS, $\geq 10$ MHz bandwidth, TDD duplex mode Target PCell: NR 15 kHz SSB SCS, $\geq 10$ MHz bandwidth, TDD duplex mode
3	Source PCell: NR 30 kHz SSB SCS, $\geq 40$ MHz bandwidth, TDD duplex mode Target PCell: NR 30 kHz SSB SCS, $\geq 40$ MHz bandwidth, TDD duplex mode
Note 1:	The UE is only required to be tested in one of the supported test configurations
Note 2:	The UE is only required to be tested in one with smallest aggregated channel bandwidth from supported band combinations which is composed of CCs $\geq$ the bandwidth ( $BW_{channel}$ ) defined in each test configuration,

**Table A.6.5.3.5.1-1A: Intra-frequency handover with direct SCell activation from FR1 to FR1 test configurations for NR SCell**

Config <sub>SCell</sub>	Description
1	NR 15 kHz SSB SCS, $\geq 10$ MHz bandwidth, FDD duplex mode
2	NR 15 kHz SSB SCS, $\geq 10$ MHz bandwidth, TDD duplex mode
3	NR 30 kHz SSB SCS, $\geq 40$ MHz bandwidth, TDD duplex mode
Note 1:	The UE is only required to be tested in one of the supported test configurations
Note 2:	The UE is only required to be tested in one with smallest aggregated channel bandwidth from supported band combinations which is composed of CCs $\geq$ the bandwidth ( $BW_{channel}$ ) defined in each test configuration.

**Table A.6.5.3.5.1-2: General test parameters Intra-frequency handover with direct SCell activation from FR1 to FR1**

Parameter	Unit	Value	Comment
Initial conditions	PCell	Cell 1	
	SCell	Cell 2	
	Target cell	Cell 3	
Final condition	PCell	Cell 3	
	SCell	Cell 2	
	neighbour cell	Cell 1	
Access Barring Information	-	Not Sent	No additional delays in random access procedure.
PRACH configuration index		FR1 PRACH configuration 1	As specified in table Table 6.3.3.2-3 in TS 38.211 [6]
Time offset between cells		3 $\mu$ s	Synchronous cells
T1	s	5	UE is in connected mode with PCell and SCell1 (cell 2) is in activated state. UE receives a handover command
T2	s	$N_{direct}$	UE shall accomplish the activation of the SCell
T3	s	1	
A3-offset	dB	-15	
$T_{HARQ}$	slot	k	k is a number of slots indicated by the PDSCH-to-HARQ_feedback timing indicator field in a corresponding DCI format or provided by <i>dl-DataToUL-ACK</i> if the PDSCH-to-HARQ feedback timing field is not present in the DCI format, the value is defined in 38.213 [3]
$T_{CSI\_Reporting}$	ms	2	the delay uncertainty in acquiring the first available CSI reporting resources as specified in TS 38.331 [2]

k	ms	$k_1 + 3 \cdot N_{\text{slot}}^{\text{subframe}, \mu} + 1$	As specified in clause 4.3 of TS 38.213 [3]
---	----	--	---

**Table A.6.5.3.5.1-3: Cell specific test parameters for NR PCell for NR FR1-FR1 Intra frequency handover with direct SCell activation test case**

Parameter	Unit	Cell 1			Cell 3		
		T1	T2	T3	T1	T2	T3
NR RF Channel Number		1			1		
Duplex mode	Config 1	FDD					
	Config 2,3	TDD					
TDD configuration	Config 1	Not Applicable					
	Config 2	TDDConf.1.1					
	Config 3	TDDConf.2.1					
BW <sub>channel</sub>	Config 1	10: N <sub>RB,c</sub> = 52					
	Config 2	10: N <sub>RB,c</sub> = 52					
	Config 3	40: N <sub>RB,c</sub> = 106					
BWP BW	Config 1	10: N <sub>RB,c</sub> = 52					
	Config 2	10: N <sub>RB,c</sub> = 52					
	Config 3	40: N <sub>RB,c</sub> = 106					
DRx Cycle	ms	Not Applicable					
PDSCH Reference measurement channel	Config 1	SR.1.1 FDD					
	Config 2	SR.1.1 TDD					
	Config 3	SR.2.1 TDD					
CORESET Reference Channel	Config 1	CR.1.1 FDD					
	Config 2	CR.1.1 TDD					
	Config 3	CR.2.1 TDD					
TRS configuration	Config 1	TRS.1.1 FDD					
	Config 2	TRS.1.1 TDD					
	Config 3	TRS.1.2 TDD					
OCNG Patterns		OCNG pattern 1					
SMTTC Configuration		SMTTC pattern 1					
SSB Configuration	Config 1,2	SSB.1 FR1					
	Config 3	SSB.2 FR1					
PDSCH/PDCCH subcarrier spacing	Config 1,2	15 kHz					
	Config 3	30 kHz					
PUCCH/PUSCH subcarrier spacing	Config 1,2	15 kHz					
	Config 3	30 kHz					
PRACH configuration		FR1 PRACH configuration 1					
BWP configuraiton	Initial DL BWP	DLBWP.0.1					
	Dedicated DL BWP	DLBWP.1.1					
	Initial UL BWP	ULBWP.0.1					
	Dedicated UL BWP	ULBWP.1.1					
CSI-RS configuration for CSI reporting	Config 1	CSI-RS.1.1 FDD					
	Config 2	CSI-RS.1.1 TDD					
	Config 3	CSI-RS.2.1 TDD					
reportConfigType		periodic					
reportQuantity		cri-RI-PMI-CQI					
CSI reporting periodicity	Config 1,2	5					
	Config 3	10					
CSI reporting offset	Config 1,2	3					
	Config 3	5					
EPRE ratio of PSS to SSS	dB	0					

EPRE ratio of PBCH DMRS to SSS								
EPRE ratio of PBCH to PBCH DMRS								
EPRE ratio of PDCCH DMRS to SSS								
EPRE ratio of PDCCH to PDCCH DMRS								
EPRE ratio of PDSCH DMRS to SSS								
EPRE ratio of PDSCH to PDSCH								
EPRE ratio of OCNG DMRS to SSS(Note 1)								
EPRE ratio of OCNG to OCNG DMRS (Note 1)								
$N_{oc}^{Note2}$		dBm/15kHz	-98					
$N_{oc}^{Note2}$	Config 1,2	dBm/SCS	-98					
	Config 3		-95					
$\hat{E}_s/I_{ot}$		dB	8	8	8	8	8	8
$\hat{E}_s/N_{oc}$		dB	8	8	8	8	8	8
SSB_RP	Config 1,2	dBm/SCS	-90	-90	-90	-90	-90	-90
	Config 3	dBm/SCS	-87	-87	-87	-87	-87	-87
$I_o^{Note3}$	Config 1,2	dBm/9.36MHz	-58.71	-58.71	-58.71	-58.71	-58.71	-58.71
	Config 3	dBm/38.16MHz	-52.60	-52.60	-52.60	-52.60	-52.60	-52.60
Propagation condition		-	AWGN			AWGN		
<p>Note 1: OCNG shall be used such that both cells are fully allocated and a constant total transmitted power spectral density is achieved for all OFDM symbols.</p> <p>Note 2: Interference from other cells and noise sources not specified in the test is assumed to be constant over subcarriers and time and shall be modelled as AWGN of appropriate power for <math>N_{oc}</math> to be fulfilled.</p> <p>Note 3: <math>I_o</math> levels have been derived from other parameters for information purposes. They are not settable parameters themselves.</p>								

**Table A.6.5.3.5.1-4: Cell specific test parameters for NR SCell for NR FR1-FR1 Intra frequency handover with direct SCell activation test case**

Parameter		Unit	Cell 2		
			T1	T2	T3
NR RF Channel Number			2		
Duplex mode	Config <sub>SCell</sub> 1		FDD		
	Config <sub>SCell</sub> 2,3		TDD		
TDD configuration	Config <sub>SCell</sub> 1		Not Applicable		
	Config <sub>SCell</sub> 2		TDDConf.1.1		
	Config <sub>SCell</sub> 3		TDDConf.2.1		
BW <sub>channel</sub>	Config <sub>SCell</sub> 1	MHz	10: N <sub>RB,c</sub> = 52		
	Config <sub>SCell</sub> 2		10: N <sub>RB,c</sub> = 52		
	Config <sub>SCell</sub> 3		40: N <sub>RB,c</sub> = 106		
BWP BW	Config <sub>SCell</sub> 1	MHz	10: N <sub>RB,c</sub> = 52		
	Config <sub>SCell</sub> 2		10: N <sub>RB,c</sub> = 52		
	Config <sub>SCell</sub> 3		40: N <sub>RB,c</sub> = 106		
DRx Cycle		ms	Not Applicable		
PDSCH Reference measurement channel	Config <sub>SCell</sub> 1		SR.1.1 FDD		
	Config <sub>SCell</sub> 2		SR.1.1 TDD		
	Config <sub>SCell</sub> 3		SR.2.1 TDD		
	Config <sub>SCell</sub> 1		CR.1.1 FDD		

CORESET Reference Channel	Config <sub>sCell</sub> 2		CR.1.1 TDD		
	Config <sub>sCell</sub> 3		CR.2.1 TDD		
TRS configuration	Config <sub>sCell</sub> 1		TRS.1.1 FDD		
	Config <sub>sCell</sub> 2		TRS.1.1 TDD		
	Config <sub>sCell</sub> 3		TRS.1.2 TDD		
OCNG Patterns			OCNG pattern 1		
SMTC Configuration			SMTC pattern 1		
SSB Configuration	Config <sub>sCell</sub> 1,2		SSB.1 FR1		
	Config <sub>sCell</sub> 3		SSB.2 FR1		
PDSCH/PDCCH subcarrier spacing	Config <sub>sCell</sub> 1,2	kHz	15 kHz		
	Config <sub>sCell</sub> 3		30 kHz		
PUCCH/PUSCH subcarrier spacing	Config <sub>sCell</sub> 1,2	kHz	15 kHz		
	Config <sub>sCell</sub> 3		30 kHz		
PRACH configuration			FR1 PRACH configuration 1		
BWP configuraiton	Initial DL BWP		DLBWP.0.1		
	Dedicated DL BWP		DLBWP.1.1		
	Initial UL BWP		ULBWP.0.1		
	Dedicated UL BWP		ULBWP.1.1		
EPRE ratio of PSS to SSS		dB	0		
EPRE ratio of PBCH DMRS to SSS					
EPRE ratio of PBCH to PBCH DMRS					
EPRE ratio of PDCCH DMRS to SSS					
EPRE ratio of PDCCH to PDCCH DMRS					
EPRE ratio of PDSCH DMRS to SSS					
EPRE ratio of PDSCH to PDSCH					
EPRE ratio of OCNG DMRS to SSS(Note 1)					
EPRE ratio of OCNG to OCNG DMRS (Note 1)					
$N_{oc}^{Note2}$		dBm/15kHz	-98		
$N_{oc}^{Note2}$	Config <sub>sCell</sub> 1,2	dBm/SCS	-98		
	Config <sub>sCell</sub> 3		-95		
$\hat{E}_s / I_{ot}$		dB	8	8	8
$\hat{E}_s / N_{oc}$		dB	8	8	8
SSB <sub>RP</sub>	Config <sub>sCell</sub> 1,2	dBm/SCS	-90	-90	-90
	Config <sub>sCell</sub> 3	dBm/SCS	-87	-87	-87
$I_o^{Note3}$	Config <sub>sCell</sub> 1,2	dBm/ 9.36MHz	-61.41	-61.41	-61.41
	Config <sub>sCell</sub> 3	dBm/ 38.16MHz	-55.31	-55.31	-55.31
Propagation condition		-	AWGN		
<p>Note 1: OCNG shall be used such that both cells are fully allocated and a constant total transmitted power spectral density is achieved for all OFDM symbols.</p> <p>Note 2: Interference from other cells and noise sources not specified in the test is assumed to be constant over subcarriers and time and shall be modelled as AWGN of appropriate power for <math>N_{oc}</math> to be fulfilled.</p> <p>Note 3: <math>I_o</math> levels have been derived from other parameters for information purposes. They are not settable parameters themselves.</p>					

A.6.5.3.5.2 Test Requirements

The UE shall be capable to transmit valid CSI report for the directly activated SCell1 no later than in subframe  $n+N_{direct}$ .

The rate of correct observed SCell1 direct activation delay during repeated tests shall be at least 90%.

NOTE: The SCell activation delay,  $N_{direct}$ , can be expressed as:  $N_{direct} = T_{RRC\_process} + T_{interrupt} + T_2 + T_3 + T_{activation\_time} + T_{CSI\_Reporting} - 3ms$ , where:

$T_{RRC\_Process}$ : RRC procedure delay defined in clause 12 of TS 38.331 [2],

$T_{\text{interrupt}}$ : Interruption time during handover as specified in clause 6.1.1,

$T_2$ : Delay from slot  $n + \frac{T_{\text{RRC\_Process}} + T_{\text{interrupt}}}{\text{NR slot length}}$  until UE has obtained a valid TA command for the target PCell,

$T_3$ : Delay for applying the received TA for uplink transmission in the target PCell, and greater than or equal to  $k+1$  slot, where  $k$  is defined in clause 4.2 in TS 38.213,

$T_{\text{activation\_time}}$  and  $T_{\text{CSI\_Reporting}}$  are specified in clause 8.3.2, where the following definitions of  $T_{\text{FirstSSB}}$  and  $T_{\text{FirstSSB\_MAX}}$  as defined in section 8.3.5 shall apply:

-  $T_{\text{FirstSSB}}$ : the time to the end of the first complete SSB burst indicated by the SMTC after slot  $n + \frac{(T_{\text{RRC\_Process}} + T_{\text{interrupt}} + T_2 + T_3)}{\text{NR slot length}}$

-  $T_{\text{FirstSSB\_MAX}}$ : the time to the end of the first complete SSB burst indicated by the SMTC after slot  $n + \frac{(T_{\text{RRC\_Process}} + T_{\text{interrupt}} + T_2 + T_3)}{\text{NR slot length}}$

This gives a total of  $N_{\text{direct}} = 10 + 52 + T_{\text{IU}} + T_2 + T_3 + T_{\text{activation\_time}} + T_{\text{CSI\_Reporting}} - 3 \text{ ms} = 62 + 10 + 13 + 6 + 20 + 2 - 3 = 94 \text{ ms}$  for test configurations 1 and 2.

This gives a total of  $N_{\text{direct}} = 10 + 52 + T_{\text{IU}} + T_2 + T_3 + T_{\text{activation\_time}} + T_{\text{CSI\_Reporting}} - 3 \text{ ms} = 62 + 10 + 13 + 6 + 20 + 2 - 3 = 94 \text{ ms}$  for test configuration 3.

During  $T_3$  the UE shall send valid CSI reports for PCell and SCell1 with non-zero CQI index and continue to send CSI reports for PCell and SCell1 (Cell 2) with non-zero CQI index until the end of  $T_3$ .

All of the above test requirements shall be fulfilled in order for the observed SCell1 direct activation delay to be counted as correct.

## A.6.5.4 UE UL carrier RRC reconfiguration Delay

### A.6.5.4.1 UE UL carrier RRC reconfiguration Delay

**Table A.6.5.4.1-1 - Table A.6.5.4.1-4 : Void**

#### A.6.5.4.1.1 Test Purpose and Environment

The purpose of this test is to verify that when the UE receives a RRC message implying NR UL or Supplementary UL carrier configuration, the UE shall be ready to start transmission on the newly configured carrier within the time limits specified in clause 8.4.2 and 8.4.3 for configuring and deconfiguring, respectively.

There are two cells: FR1 PCell (cell 1) and FR1 SCell (cell 2). Both NR uplink and supplementary uplink are broadcast by *ServingCellConfigCommonSIB*. The test parameters for PCell and SCell are given in Table A. 6.5.4.1.1-1, Table A.6.5.4.1.1-2, Table A.6.5.4.1.1-3 and Table A.6.5.4.1.1-4 below. In test 1, the test consists of three time periods, with duration of  $T_1$ ,  $T_2$  and  $T_3$  respectively. During time duration  $T_1$ , NR uplink of cell 2 is configured to UE. At the start of  $T_2$ , a supplementary uplink of cell 2 is configured to UE through *RRCReconfiguration*, then UE shall start transmission both on the NR uplink and supplementary uplink. At the start of  $T_3$ , the supplementary uplink is released through *RRCReconfiguration*.

In test 2, the test consists of three time periods, with duration of  $T_1$ ,  $T_2$  and  $T_3$  respectively. During time duration  $T_1$ , supplementary uplink on cell 2 is configured to UE. At the start of  $T_2$ , a NR uplink is configured to UE through *RRCReconfiguration*, then UE shall start transmission both on the NR uplink and supplementary uplink. At the start of  $T_3$ , the NR uplink is released through *RRCReconfiguration*.

**Table A.6.5.4.1.1-1: Supported test configurations**

Configuration	PCell (Cell 1)	SCell (Cell 2)
1	15 kHz SSB SCS, $\geq 10$ MHz bandwidth, FDD duplex mode	DL and UL: 15 kHz SSB SCS, $\geq 10$ MHz bandwidth, FDD duplex mode; SUL: 15 kHz SCS, $\geq 10$ MHz bandwidth, SUL duplex mode
2	15 kHz SSB SCS, $\geq 10$ MHz bandwidth, FDD duplex mode	DL and UL: 15 kHz SSB SCS, $\geq 10$ MHz bandwidth, TDD duplex mode; SUL: 15 kHz SCS, $\geq 10$ MHz bandwidth, SUL duplex mode

3	15 kHz SSB SCS, $\geq 10$ MHz bandwidth, FDD duplex mode	DL and UL: 30kHz SSB SCS, $\geq 40$ MHz bandwidth, TDD duplex mode; SUL: 30kHz SCS, $\geq 40$ MHz bandwidth, SUL duplex mode
4	15 kHz SSB SCS, $\geq 10$ MHz bandwidth, TDD duplex mode	DL and UL: 15 kHz SSB SCS, $\geq 10$ MHz bandwidth, FDD duplex mode; SUL: 15 kHz SCS, $\geq 10$ MHz bandwidth, SUL duplex mode
5	15 kHz SSB SCS, $\geq 10$ MHz bandwidth, TDD duplex mode	DL and UL: 15 kHz SSB SCS, $\geq 10$ MHz bandwidth, TDD duplex mode; SUL: 15 kHz SCS, $\geq 10$ MHz bandwidth, SUL duplex mode
6	15 kHz SSB SCS, $\geq 10$ MHz bandwidth, TDD duplex mode	DL and UL: 30kHz SSB SCS, $\geq 40$ MHz bandwidth, TDD duplex mode; SUL: 30kHz SCS, $\geq 40$ MHz bandwidth, SUL duplex mode
7	30 kHz SSB SCS, $\geq 40$ MHz bandwidth, TDD duplex mode	DL and UL: 15 kHz SSB SCS, $\geq 10$ MHz bandwidth, FDD duplex mode; SUL: 15 kHz SCS, $\geq 10$ MHz bandwidth, SUL duplex mode
8	30 kHz SSB SCS, $\geq 40$ MHz bandwidth, TDD duplex mode	DL and UL: 15 kHz SSB SCS, $\geq 10$ MHz bandwidth, TDD duplex mode; SUL: 15 kHz SCS, $\geq 10$ MHz bandwidth, SUL duplex mode
9	30 kHz SSB SCS, $\geq 40$ MHz bandwidth, TDD duplex mode	DL and UL: 30kHz SSB SCS, $\geq 40$ MHz bandwidth, TDD duplex mode; SUL: 30kHz SCS, $\geq 40$ MHz bandwidth, SUL duplex mode
Note 1: The UE is only required to be tested in one of the supported test configurations		
Note 2: The UE is only required to be tested in one with smallest aggregated channel bandwidth from supported band combinations which is composed of CCs $\geq$ the bandwidth ( $BW_{channel}$ ) defined in each test configuration,		

**Table A.6.5.4.1.1-2: General test parameters for NR standalone UE UL carrier RRC reconfiguration Delay on Pcell**

Parameter	Unit	Test configuration	Value	Comment
RF Channel Number		Config 1,2,3, 4, 5, 6, 7, 8, 9	1, 2	Two radio channels are used for these two tests.
Active cell		Config 1,2,3, 4, 5, 6, 7, 8, 9	Cell 1: FR1 PCell Cell 2: FR1 SCell	PCell on RF channel number 1 FR1 SCell on RF channel number 2
CP length		Config 1,2,3, 4, 5, 6, 7, 8, 9	Normal	
DRX		Config 1,2,3, 4, 5, 6, 7, 8, 9	OFF	
Measurement gap pattern Id		Config 1,2,3, 4, 5, 6, 7, 8, 9	OFF	
Filter coefficient		Config 1,2,3, 4, 5, 6, 7, 8, 9	0	L3 filtering is not used
T1	s	Config 1,2,3, 4, 5, 6, 7, 8, 9	5	
T2	s	Config 1,2,3, 4, 5, 6, 7, 8, 9	5	
T3	s	Config 1,2,3, 4, 5, 6, 7, 8, 9	5	

**Table A.6.5.4.1.1-3: NR Cell specific test parameters for NR standalone UE UL carrier RRC reconfiguration Delay on PCell (Cell 1)**

Parameter	Unit	Test Configuration	Test 1			Test 2		
			T1	T2	T3	T1	T2	T3
Channel number		Conf 1, 2, 3, 4, 5, 6, 7, 8, 9	1			1		
TDD configuration		Conf 1, 2, 3	N/A			N/A		
		Conf 4, 5, 6	TDD Conf.1.1			TDD Conf.1.1		
		Conf 7, 8, 9	TDD Conf.2.1			TDD Conf.2.1		
BW <sub>channel</sub>	MHz	Conf 1, 2, 3	Note 6			Note 6		
		Conf 4, 5, 6	Note 6			Note 6		
		Conf 7, 8, 9	Note 6			Note 6		
BW <sub>occupied</sub>	RB	Conf 1, 2, 3	52 <sup>Note 4</sup>			52 <sup>Note 4</sup>		
		Conf 4, 5, 6	52 <sup>Note 4</sup>			52 <sup>Note 4</sup>		
		Conf 7, 8, 9	106 <sup>Note 5</sup>			106 <sup>Note 5</sup>		
PDSCH reference measurement channel as defined in A.3.1.1		Conf 1, 2, 3	SR.1.1 FDD			SR.1.1 FDD		
		Conf 4, 5, 6	SR.1.1 TDD			SR.1.1 TDD		
		Conf 7, 8, 9	SR.2.1 TDD			SR.2.1 TDD		
RMSI CORESET reference measurement channel as defined in A.3.1.2		Conf 1, 2, 3	CR.1.1 FDD			CR.1.1 FDD		
		Conf 4, 5, 6	CR.1.1 TDD			CR.1.1 TDD		
		Conf 7, 8, 9	CR.2.1 TDD			CR.2.1 TDD		
RMC CORESET reference measurement channel as defined in A.3.1.3		Conf 1, 2, 3	CCR.1.1 FDD			CCR.1.1 FDD		
		Conf 4, 5, 6	CCR.1.1 TDD			CCR.1.1 TDD		
		Conf 7, 8, 9	CCR.2.1 TDD			CCR.2.1 TDD		
OCNG Pattern <sup>Note 1</sup>		Conf 1, 2, 3, 4, 5, 6	OP.1 <sup>Note 4</sup>			OP.1 <sup>Note 4</sup>		
		Config 7, 8, 9	OP.1 <sup>Note 5</sup>			OP.1 <sup>Note 5</sup>		
SSB configuration		Conf 1, 2, 3, 4, 5, 6	SSB.1 FR1			SSB.1 FR1		
		Conf 7, 8, 9	SSB.2 FR1			SSB.2 FR1		
SMTC configuration		Conf 1, 2, 3, 4, 5, 6, 7, 8, 9	SMTC.1			SMTC.1		
CSI-RS for tracking		Conf 1	TRS.1.1 FDD			TRS.1.1 FDD		
		Conf 2	TRS.1.1 FDD			TRS.1.1 FDD		
		Conf 3	TRS.1.1 FDD			TRS.1.1 FDD		
		Conf 4	TRS.1.1 TDD			TRS.1.1 TDD		
		Conf 5	TRS.1.1 TDD			TRS.1.1 TDD		
		Conf 6	TRS.1.1 TDD			TRS.1.1 TDD		
		Conf 7	TRS.1.2 TDD			TRS.1.2 TDD		
		Conf 8	TRS.1.2 TDD			TRS.1.2 TDD		
DL initial BWP configuration		Conf 1, 2, 3, 4, 5, 6, 7, 8, 9	DLBWP.0.1			DLBWP.0.1		
		Conf 1, 2, 3, 4, 5, 6, 7, 8, 9	DLBWP.1.1			DLBWP.1.1		
UL dedicated BWP configuration		Conf 1, 2, 3, 4, 5, 6, 7, 8, 9	ULBWP.1.1			ULBWP.1.1		
EPRE ratio of PSS to SSS	dB	Conf 1, 2, 3, 4, 5, 6, 7, 8, 9	0			0		
EPRE ratio of PBCH_DMRS to SSS								

EPRE ratio of PBCH to PBCH_DMRS								
EPRE ratio of PDCCH_DMRS to SSS								
EPRE ratio of PDCCH to PDCCH_DMRS								
EPRE ratio of PDSCH_DMRS to SSS								
EPRE ratio of PDSCH to PDSCH_DMRS								
EPRE ratio of OCNG DMRS to SSS								
EPRE ratio of OCNG to OCNG DMRS								
$N_{ot}$ <sup>Note 2</sup>	dBm / 15kHz	Conf 1, 2, 3, 4, 5, 6, 7, 8, 9	-102			-102		
	dBm/ SCS	Conf 1,2,3,4,5,6	-102			-102		
		Conf 7,8,9	-99			-99		
$\hat{E}_s / N_{oc}$	dB	Conf 1, 2, 3, 4, 5, 6, 7, 8, 9	16	16	16	16	16	16
$\hat{E}_s / I_{ot}$ <sup>Note 3</sup>	dB	Conf 1, 2, 3, 4, 5, 6, 7, 8, 9	16	16	16	16	16	16
SS-RSRP <sup>Note 3</sup>	dBm/ SCS	Conf 1,2,3,4,5,6	-86	-86	-86	-86	-86	-86
		Conf 7,8,9	-83	-83	-83	-83	-83	-83
$I_o$ <sup>Note 3</sup>	dBm/ 9.36 MHz	Conf 1,2,3,4,5,6	-57.9	-57.9	-57.9	-57.9	-57.9	-57.9
	dBm/ 38.16 MHz	Conf 7,8,9	-51.8	-51.8	-51.8	-51.8	-51.8	-51.8
Propagation Condition		Conf 1, 2, 3, 4, 5, 6, 7, 8, 9	AWGN			AWGN		
Antenna configuration		Conf 1, 2, 3, 4, 5, 6, 7, 8, 9	1 x 2			1 x 2		

NOTE 1: OCNG shall be used such that both cells are fully allocated, and a constant total transmitted power spectral density is achieved for all OFDM symbols.

NOTE 2: Interference from other cells and noise sources not specified in the test is assumed to be constant over subcarriers and time and shall be modelled as AWGN of appropriate power for  $N_{ot}$  to be fulfilled within  $BW_{occupied}$ .

NOTE 3:  $\hat{E}_s / I_{ot}$ ,  $I_o$ , and SS-RSRP levels have been derived from other parameters for information purposes. They are not settable parameters themselves.

NOTE 4: All UL/DL transmission shall be confined within  $BW_{occupied}$  (i.e. 10 MHz, 52 RBs) from  $F_{c,low}$ , and  $I_o$  is independent of the  $BW_{channel}$  configured.

NOTE 5: All UL/DL transmission shall be confined within  $BW_{occupied}$  (i.e. 40 MHz, 106 RBs) from  $F_{c,low}$ , and  $I_o$  is independent of the  $BW_{channel}$  configured.

NOTE 6:  $N_{RB,c}$  is derived from Table 5.3.2-1 in TS38.101-1[2] with configured  $BW_{channel}$ .



**Table A.6.5.4.1.1-4: NR Cell specific test parameters for NR standalone UE UL carrier RRC reconfiguration Delay on SCell (Cell 2)**

Parameter	Unit	Test Configuration	Test 1			Test 2		
			T1	T2	T3	T1	T2	T3
Channel number		Conf 1, 2, 3, 4, 5, 6, 7, 8, 9	2			2		
TDD configuration		Conf 1, 4, 7	N/A			N/A		
		Conf 2, 5, 8	TDDConf.1.1			TDDConf.1.1		
		Conf 3, 6, 9	TDDConf.2.1			TDDConf.2.1		
BW <sub>channel</sub>	MHz	Conf 1, 4, 7	Note 6			Note 6		
		Conf 2, 5, 8	Note 6			Note 6		
		Conf 3, 6, 9	Note 6			Note 6		
BW <sub>occupied</sub>	RB	Conf 1, 4, 7	52 <sup>Note 4</sup>			52 <sup>Note 4</sup>		
		Conf 2, 5, 8	52 <sup>Note 4</sup>			52 <sup>Note 4</sup>		
		Conf 3, 6, 9	106 <sup>Note 5</sup>			106 <sup>Note 5</sup>		
PUSCH parameters for NR UL carrier		Conf 1, 4, 7	G-FR1-A3-10 in [13]	G-FR1-A3-10 in [13]	G-FR1-A3-10 in [13]	N/A	G-FR1-A3-10 in [13]	N/A
		Conf 2, 5, 8	G-FR1-A3-10 in [13]	G-FR1-A3-10 in [13]	G-FR1-A3-10 in [13]	N/A	G-FR1-A3-10 in [13]	N/A
		Conf 3, 6, 9	G-FR1-A3-14 in [13]	G-FR1-A3-14 in [13]	G-FR1-A3-14 in [13]	N/A	G-FR1-A3-14 in [13]	N/A
PUCCH parameters For NR UL carrier		Conf 1, 4, 7	Table 8.3.3.1.2-1 in [13]	Table 8.3.3.1.2-1 in [13]	Table 8.3.3.1.2-1 in [13]	N/A	N/A	N/A
		Conf 2, 5, 8	Table 8.3.3.1.2-1 in [13]	Table 8.3.3.1.2-1 in [13]	Table 8.3.3.1.2-1 in [13]	N/A	N/A	N/A
		Conf 3, 6, 9	Table 8.3.3.1.2-2 in [13]	Table 8.3.3.1.2-2 in [13]	Table 8.3.3.1.2-2 in [13]	N/A	N/A	N/A
PUSCH parameters for supplementary UL		Conf 1, 4, 7	N/A	G-FR1-A3-10 in [13]	N/A	G-FR1-A3-10 in [13]	G-FR1-A3-10 in [13]	G-FR1-A3-10 in [13]
		Conf 2, 5, 8	N/A	G-FR1-A3-10 in [13]	N/A	G-FR1-A3-10 in [13]	G-FR1-A3-10 in [13]	G-FR1-A3-10 in [13]
		Conf 3, 6, 9	N/A	G-FR1-A3-14 in [13]	N/A	G-FR1-A3-14 in [13]	G-FR1-A3-14 in [13]	G-FR1-A3-14 in [13]
PUCCH parameters for supplementary UL		Conf 1, 4, 7	N/A	N/A	N/A	Table 8.3.3.1.2-1 in [13]	Table 8.3.3.1.2-1 in [13]	Table 8.3.3.1.2-1 in [13]
		Conf 2, 5, 8	N/A	N/A	N/A	Table 8.3.3.1.2-1 in [13]	Table 8.3.3.1.2-1 in [13]	Table 8.3.3.1.2-1 in [13]
		Conf 3, 6, 9	N/A	N/A	N/A	Table 8.3.3.1.2-2 in [13]	Table 8.3.3.1.2-2 in [13]	Table 8.3.3.1.2-2 in [13]
PDSCH reference measurement channel as defined in A.3.1.1		Conf 1, 4, 7	SR.1.1 FDD			SR.1.1 FDD		
		Conf 2, 5, 8	SR.1.1 TDD			SR.1.1 TDD		
		Conf 3, 6, 9	SR.2.1 TDD			SR.2.1 TDD		

RMSI CORESET reference measurement channel as defined in A.3.1.2		Conf 1, 4, 7	CR.1.1 FDD	CR.1.1 FDD
		Conf 2, 5, 8	CR.1.1 TDD	CR.1.1 TDD
		Conf 3, 6, 9	CR.2.1 TDD	CR.2.1 TDD
RMC CORESET reference measurement channel as defined in A.3.1.3		Conf 1, 4, 7	CCR.1.1 FDD	CCR.1.1 FDD
		Conf 2, 5, 8	CCR.1.1 TDD	CCR.1.1 TDD
		Conf 3, 6, 9	CCR.2.1 TDD	CCR.2.1 TDD
OCNG Pattern <sup>Note 1</sup>		Conf 1, 2, 4, 5, 7, 8	OP.1 <sup>Note 4</sup>	OP.1 <sup>Note 4</sup>
		Conf 3, 6, 9	OP.1 <sup>Note 5</sup>	OP.1 <sup>Note 5</sup>
SSB configuration		Conf 1, 2, 4, 5, 7, 8	SSB.1 FR1	SSB.1 FR1
		Conf 3, 6, 9	SSB.2 FR1	SSB.2 FR1
SMTC configuration		Conf 1, 2, 3, 4, 5, 6, 7, 8, 9	SMTC.1	SMTC.1
CSI-RS for tracking		Conf 1	TRS.1.1 FDD	TRS.1.1 FDD
		Conf 2	TRS.1.1 TDD	TRS.1.1 TDD
		Conf 3	TRS.1.2 TDD	TRS.1.2 TDD
		Conf 4	TRS.1.1 FDD	TRS.1.1 FDD
		Conf 5	TRS.1.1 TDD	TRS.1.1 TDD
		Conf 6	TRS.1.2 TDD	TRS.1.2 TDD
		Conf 7	TRS.1.1 FDD	TRS.1.1 FDD
		Conf 8	TRS.1.1 TDD	TRS.1.1 TDD
		Conf 9	TRS.1.2 TDD	TRS.1.2 TDD
DL initial BWP configuration		Conf 1, 2, 3, 4, 5, 6, 7, 8, 9	DLBWP.0.1	DLBWP.0.1
DL dedicated BWP configuration		Conf 1, 2, 3, 4, 5, 6, 7, 8, 9	DLBWP.1.1	DLBWP.1.1
UL dedicated BWP configuration		Conf 1, 2, 3, 4, 5, 6, 7, 8, 9	ULBWP.1.1	ULBWP.1.1
EPRE ratio of PSS to SSS	dB	Conf 1, 2, 3, 4, 5, 6, 7, 8, 9	0	0
EPRE ratio of PBCH_DMRS to SSS				
EPRE ratio of PBCH to PBCH_DMRS				
EPRE ratio of PDCCH_DMRS to SSS				
EPRE ratio of PDCCH to PDCCH_DMRS				
EPRE ratio of PDSCH_DMRS to SSS				
EPRE ratio of PDSCH to PDSCH_DMRS				
EPRE ratio of OCNG DMRS to SSS				
EPRE ratio of OCNG to OCNG DMRS				
$N_{\alpha}$ <sup>Note 2</sup>				
	dBm/SCS	Conf 1, 2, 4, 5, 7, 8	-102	-102
		Conf 3, 6, 9	-99	-99

$\hat{E}_s / N_{oc}$	dB	Conf 1, 2, 3, 4, 5, 6, 7, 8, 9	16	16	16	16	16	16
$\hat{E}_s / I_{ot}$ <sup>Note 3</sup>	dB	Conf 1, 2, 3, 4, 5, 6, 7, 8, 9	16	16	16	16	16	16
SS-RSRP <sup>Note 3</sup>	dBm/SCS	Conf 1, 2, 4, 5, 7, 8	-86	-86	-86	-86	-86	-86
		Conf 3, 6, 9	-83	-83	-83	-83	-83	-83
$I_o$ <sup>Note 3</sup>	dBm/9.36 MHz	Conf 1, 2, 4, 5, 7, 8	-57.9	-57.9	-57.9	-57.9	-57.9	-57.9
	dBm/38.16 MHz	Conf 3, 6, 9	-51.8	-51.8	-51.8	-51.8	-51.8	-51.8
Propagation Condition		Conf 1, 2, 3, 4, 5, 6, 7, 8, 9	AWGN			AWGN		
Antenna configuration		Conf 1, 2, 3, 4, 5, 6, 7, 8, 9	1 x 2			1 x 2		
<p>NOTE 1: OCNB shall be used such that both cells are fully allocated, and a constant total transmitted power spectral density is achieved for all OFDM symbols.</p> <p>NOTE 2: Interference from other cells and noise sources not specified in the test is assumed to be constant over subcarriers and time and shall be modelled as AWGN of appropriate power for <math>N_{ot}</math> to be fulfilled within <math>BW_{occupied}</math>.</p> <p>NOTE 3: <math>\hat{E}_s / I_{ot}</math>, <math>I_o</math>, and SS-RSRP levels have been derived from other parameters for information purposes. They are not settable parameters themselves.</p> <p>NOTE 4: All UL/DL transmission shall be confined within <math>BW_{occupied}</math> (i.e. 10 MHz, 52 RBs) from <math>F_{C,low}</math>, and <math>I_o</math> is independent of the <math>BW_{channel}</math> configured.</p> <p>NOTE 5: All UL/DL transmission shall be confined within <math>BW_{occupied}</math> (i.e. 40 MHz, 106 RBs) from <math>F_{C,low}</math>, and <math>I_o</math> is independent of the <math>BW_{channel}</math> configured.</p> <p>NOTE 6: <math>N_{RB,c}</math> is derived from Table 5.3.2-1 in TS38.101-1[2] with configured <math>BW_{channel}</math>.</p>								

#### A.6.5.4.1.2 Test Requirements

In test 1 the UE shall be ready to start transmission on the supplementary uplink carrier on SCell within 20ms from the start of T2.

In test 1 the UE shall stop the transmission on the supplementary uplink carrier on SCell within 20ms from the start of T3.

In test 2 the UE shall be ready to start transmission on the NR uplink carrier on SCell within 20ms from the start of T2.

In test 2 the UE shall stop the transmission on the NR uplink carrier on SCell within 20ms from the start of T3.

All of the above test requirements shall be fulfilled in order for the observed UE UL carrier configuration delay and UE UL carrier release delay to be counted as correct. The rate of correct observed UE UL carrier configuration delay and UE UL carrier release delay during repeated tests shall be at least 90%.

#### A.6.5.4.2 Void

### A.6.5.5 Beam Failure Detection and Link recovery procedures

#### A.6.5.5.1 Beam Failure Detection and Link Recovery Test for FR1 PCell configured with SSB-based BFD and LR in non-DRX mode

##### A.6.5.5.1.1 Test Purpose and Environment

The purpose of this test is to verify that the UE properly detects SSB-based beam failure in the set  $q_0$  configured for a serving cell and that the UE performs correct SSB-based link recovery based on beam candidate set  $q_1$ . The purpose is to test the downlink monitoring for beam failure detection within the UEs active DL BWP, during the evaluation period, and link recovery, when no DRX is used. This test will partly verify the SSB based beam failure detection and link recovery for an FR1 serving cell requirements in clause 8.5.

The test parameters are given in Tables A.6.5.5.1.1-1, A.6.5.5.1.1-2, A.6.5.5.1.1-3 and A.6.5.5.1.1-4 below. There is one cell, cell 1 which is the active cell, in the test. The test consists of five successive time periods, with time duration of T1, T2, T3, T4 and T5 respectively. Figure A.6.5.5.1.1-1 shows the variation of the downlink SNR of the SSB in set  $q_0$  in the active cell to emulate SSB based beam failure. Figure A.6.5.5.1.1-2 shows the variation of the downlink L1-RSRP of the SSB in set  $q_1$  of the candidate beam used for link recovery. Prior to the start of the time duration T1, the UE shall be fully synchronized to cell 1. The UE shall be configured for periodic CSI reporting with a reporting periodicity of 5 ms. In the test, DRX configuration is not enabled. The UE is configured to perform inter-frequency measurements using GP ID #0 (40ms) in test 1.

**Table A.6.5.5.1.1-1: Supported test configurations for FR1 PCell**

Configuration	Description
1	FDD duplex mode, 15 kHz SSB SCS, 10 MHz bandwidth
2	TDD duplex mode, 15 kHz SSB SCS, 10 MHz bandwidth
3	TDD duplex mode, 30 kHz SSB SCS, 40 MHz bandwidth
Note: The UE is only required to pass in one of the supported test configurations in FR1	

**Table A.6.5.5.1.1-2: General test parameters for FR1 PCell for SSB-based beam failure detection and link recovery testing in non-DRX mode**

Parameter		Unit	Value	Comment
			Test 1	
Active PSCell			Cell 1	
RF Channel Number			1	
Duplex mode	Config 1		FDD	
	Config 2, 3		TDD	
BWchannel	Config 1	MHz	10: NRB,c = 52	
	Config 2		10: NRB,c = 52	
	Config 3		40: NRB,c = 106	
DL initial BWP configuration	Config 1, 2, 3		DLBWP.0.1	
DL dedicated BWP configuration	Config 1, 2, 3		DLBWP.1.1	
UL initial BWP configuration	Config 1, 2, 3		ULBWP.0.1	
UL dedicated BWP configuration	Config 1, 2, 3		ULBWP.1.1	
TDD Configuration	Config 1		Not Applicable	
	Config 2		TDDConf.1.1	
	Config 3		TDDConf.2.1	
RMSI CORESET Reference Channel	Config 1		CR.1.1 FDD	
	Config 2		CR.1.1 TDD	
	Config 3		CR.2.1 TDD	
Dedicated CORESET Reference Channel	Config 1		CCR.1.1 FDD	
	Config 2		CCR.1.1 TDD	
	Config 3		CCR.2.1 TDD	
SSB Configuration	Config 1		SSB.3 FR1	
	Config 2		SSB.3 FR1	
	Config 3		SSB.4 FR1	
SMTC Configuration	Config 1, 2		SMTC.1	
	Config 3		SMTC.1	
PDSCH/PDCCH subcarrier spacing	Config 1, 2		15 KHz	
	Config 3		30 KHz	
PRACH Configuration	Config 1, 2		Table A.3.8.2.2-1	
	Config 3		Table A.3.8.2.2-1	
SSB Index assigned as BFD RS ( $q_0$ )			0	
SSB Index assigned as CBD RS ( $q_1$ )			1	
OCNG parameters			OP.1	
CP length			Normal	
Correlation Matrix and Antenna Configuration			2x2 Low	

Beam failure detection transmission parameters	DCI format		1-0	
	Number of Control OFDM symbols		2	
	Aggregation level	CCE	8	
	Ratio of hypothetical PDCCH RE energy to average SSS RE energy	dB	0	
	Ratio of hypothetical PDCCH DMRS energy to average SSS RE energy	dB	0	
	DMRS precoder granularity		REG bundle size	
	REG bundle size		6	
	DRX			OFF
Gap pattern ID			gp0	
gapOffset			0	
rlmInSyncOutOfSyncThreshold			absent	When the field is absent, the UE applies the value 0. (Table 8.1.1-1).
rsrp-ThresholdSSB	Config 1, 2	dBm/SCS kHz	-98	Threshold used for $Q_{in\_LR\_SSB}$
	Config 3		-95	
powerControlOffsetSS			db0	Used for deriving rsrp-ThresholdCSI-RS
beamFailureInstanceMaxCount			n1	see clause 5.17 of TS 38.321 [7]
beamFailureDetectionTimer			pbfd4	see clause 5.17 of TS 38.321 [7]
CSI-RS configuration for CSI reporting	Config 1		CSI-RS.1.1 FDD	
	Config 2		CSI-RS.1.1 TDD	
	Config 3		CSI-RS.2.1 TDD	
CSI-RS for tracking	Config 1		TRS.1.1 FDD	
	Config 2		TRS.1.1 TDD	
	Config 3		TRS.1.2 TDD	
SSB Index assigned as RLM RS			0, 1	
T310 Timer		ms	1000	
N310			2	
T1		s	0.2	During this time the the UE shall be fully

			synchronized to cell 1
T2	s	0.37	
T3	s	0.24	
T4	s	0	
T5	s	0.17	
D1	s	0.13	
Note 1: All configurations are assigned to the UE prior to the start of time period T1.			
Note 2: UE-specific PDCCH is not transmitted after T1 starts.			

**Table A.6.5.5.1.1-3: Cell specific test parameters for FR1 PCell for SSB-based beam failure detection and link recovery testing in non-DRX mode**

Parameter		Unit	Test 1				
			T1	T2	T3	T4	T5
EPRE ratio of PDCCH DMRS to SSS		dB	0				
EPRE ratio of PDCCH to PDCCH DMRS							
EPRE ratio of PBCH DMRS to SSS							
EPRE ratio of PBCH to PBCH DMRS							
EPRE ratio of PSS to SSS							
EPRE ratio of PDSCH DMRS to SSS							
EPRE ratio of PDSCH to PDSCH DMRS							
EPRE ratio of OCNG DMRS to SSS							
EPRE ratio of OCNG to OCNG DMRS							
SNR_SSB of set $q_0$	Config 1	dB	5	-3	-12	-12	-12
	Config 2		5	-3	-12	-12	-12
	Config 3		5	-3	-12	-12	-12
SNR_SSB of set $q_1$	Config 1	dB	-10	-10	10	10	10
	Config 2		-10	-10	10	10	10
	Config 3		-10	-10	10	10	10
SSB_RP of set $q_1$	Config 1	dBm/S CS kHz	-108	-108	-88	-88	-88
	Config 2		-108	-108	-88	-88	-88
	Config 3		-105	-105	-85	-85	-85
$N_{oc}$	Config 1	dBm/15 KHz	-98				
	Config 2						
	Config 3						
Propagation condition			TDL-C 300ns 100Hz				
<p>Note 1: OCNG shall be used such that the resources in Cell 1 are fully allocated and a constant total transmitted power spectral density is achieved for all OFDM symbols.</p> <p>Note 2: The uplink resources for CSI reporting are assigned to the UE prior to the start of time period T1.</p> <p>Note 3: NZP CSI-RS resource set configuration for CSI reporting are assigned to the UE prior to the start of time period T1.</p> <p>Note 4: Measurement gap configuration is assigned to the UE prior to the start of time period T1.</p> <p>Note 5: The timers and layer 3 filtering related parameters are configured prior to the start of time period T1.</p> <p>Note 6: The signal contains PDCCH for UEs other than the device under test as part of OCNG.</p> <p>Note 7: SNR levels correspond to the signal to noise ratio over the SSS REs.</p> <p>Note 8: The SNR in time periods T1, T2, T3, T4 and T5 is denoted as SNR1, SNR2 and SNR3 respectively in figure A.4.5.5.1.1-1.</p> <p>Note 9: The SNR values are specified for testing a UE which supports 2RX on at least one band. For testing of a UE which supports 4RX on all bands, the SNR during T3 is modified as specified in clause A.3.6.</p>							

**Table A.6.5.5.1.1-4: Void**

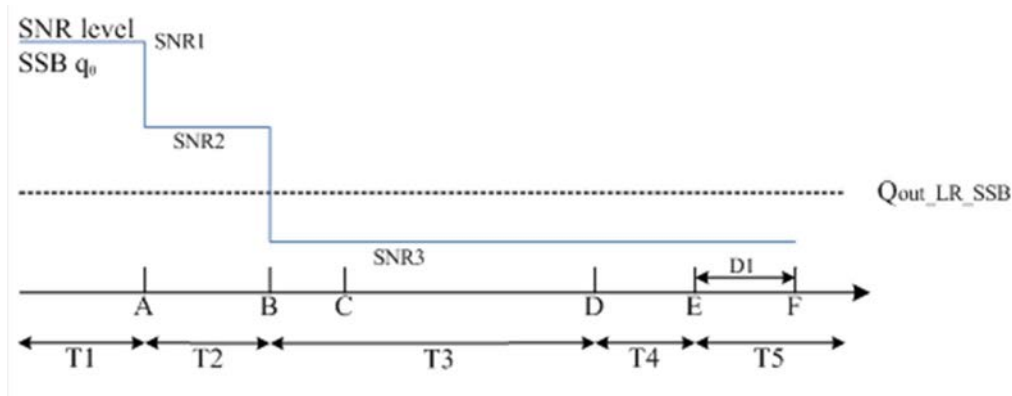

Figure A.6.5.5.1.1-1: SNR variation for SSB-based beam failure detection and link recovery testing in non-DRX mode

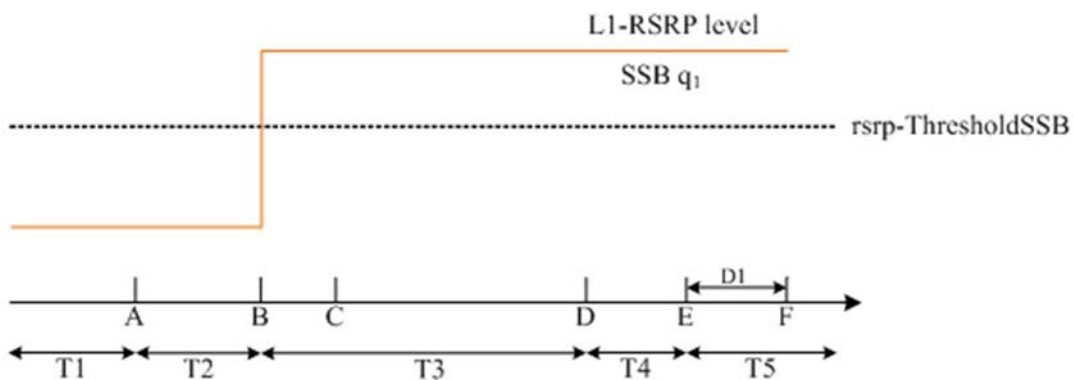

Figure A.6.5.5.1.1-2: L1-RSRP level variation for SSB-based beam failure detection and link recovery testing in non-DRX mode

### A.6.5.5.1.2 Test Requirements

The UE behaviour during time durations T1, T2, T3, T4 and T5 shall be as follows:

During the time duration T1 and T2, the UE shall transmit uplink signal at least in all subframes configured for CSI transmission on Cell 1.

During the period from time point A to time point B the UE shall transmit uplink signal in Cell 1 in all uplink slots configured for CSI transmission according to the configured periodic CSI reporting for Cell 1.

During T3 the UE shall detect beam failure and initiate link recovery. During T4 and T5 the UE measures and evaluate beam candidate from beam candidate set  $q_1$ .

No later than time point F occurring no later than  $D1 = 120+10$  ms after the start of T5, the UE shall transmit preamble on a beam associated with the candidate beam set  $q_1$ . The UE shall not transmit preamble on a beam associated with the candidate beam set  $q_1$  earlier than time point B.

Test is concluded once the test equipment has received the initial preamble transmission from the UE. The rate of correct events observed during repeated tests shall be at least 90%.

## A.6.5.5.2 Beam Failure Detection and Link Recovery Test for FR1 PCell configured with SSB-based BFD and LR in DRX mode

### A.6.5.5.2.1 Test Purpose and Environment

The purpose of this test is to verify that the UE properly detects SSB-based beam failure in the set  $q_0$  configured for a serving cell and that the UE performs correct SSB-based link recovery based on beam candidate set  $q_1$ . The purpose is to test the downlink monitoring for beam failure detection within the UEs active DL BWP, during the evaluation period, and link recovery, when DRX is used. This test will partly verify the SSB based beam failure detection and link recovery for an FR1 serving cell requirements in clause 8.5.

The test parameters are given in Tables A.6.5.5.2.1-1, A.6.5.5.2.1-2, A.6.5.5.2.1-3, A.6.5.5.2.1-4 and A.6.5.5.2.1-5 below. There is one cell, cell 1 which is the active cell, in the test. The test consists of five successive time periods, with time duration of T1, T2, T3, T4 and T5 respectively. Figure A.6.5.5.2.1-1 shows the variation of the downlink SNR of the SSB in set  $q_0$  in the active cell to emulate SSB based beam failure. Figure A.6.5.5.2.1-2 shows the variation of the downlink L1-RSRP of the SSB in set  $q_1$  of the candidate beam used for link recovery. Prior to the start of the time duration T1, the UE shall be fully synchronized to cell 1. The UE shall be configured for periodic CSI reporting with a reporting periodicity of 5 ms. In the test, DRX configuration is enabled in PCell and DRX inactivity timer has already been expired, i.e. UE tries to decode PDCCH and to send periodic CQI during the period when On-duration timer is running. Time alignment timers shall be set to “infinity” so that UL timing alignment is maintained during the test.

**Table A.6.5.5.2.1-1: Supported test configurations for FR1 PCell**

Configuration	Description
1	FDD duplex mode, 15 kHz SSB SCS, 10 MHz bandwidth
2	TDD duplex mode, 15 kHz SSB SCS, 10 MHz bandwidth
3	TDD duplex mode, 30 kHz SSB SCS, 40 MHz bandwidth
Note: The UE is only required to pass in one of the supported test configurations in FR1	

**Table A.6.5.5.2.1-2: General test parameters for FR1 PCell for SSB-based beam failure detection and link recovery testing in DRX mode**

Parameter		Unit	Value	Comment
			Test 1	
Active PCell			Cell 1	
RF Channel Number			1	
Duplex mode	Config 1		FDD	
	Config 2, 3		TDD	
BW/channel	Config 1	MHz	10: NRB,c = 52	
	Config 2		10: NRB,c = 52	
	Config 3		40: NRB,c = 106	
DL initial BWP configuration	Config 1, 2, 3		DLBWP.0.1	
DL dedicated BWP configuration	Config 1, 2, 3		DLBWP.1.1	
UL initial BWP configuration	Config 1, 2, 3		ULBWP.0.1	
UL dedicated BWP configuration	Config 1, 2, 3		ULBWP.1.1	
TDD Configuration	Config 1		Not Applicable	
	Config 2		TDDConf.1.1	
	Config 3		TDDConf.2.1	
RMSI CORESET Reference Channel	Config 1		CR.1.1 FDD	
	Config 2		CR.1.1 TDD	
	Config 3		CR.2.1 TDD	
Dedicated CORESET Reference Channel	Config 1		CCR.1.1 FDD	
	Config 2		CCR.1.1 TDD	
	Config 3		CCR.2.1 TDD	
SSB Configuration	Config 1		SSB.3 FR1	



	Config 2		SSB.3 FR1	
	Config 3		SSB.4 FR1	
SMTC Configuration	Config 1, 2		SMTC.1	
	Config 3		SMTC.1	
PDSCH/PDCCH subcarrier spacing	Config 1, 2		15 KHz	
	Config 3		30 KHz	
PRACH Configuration	Config 1, 2		Table A.3.8.2.2-1	
	Config 3		Table A.3.8.2.2-1	
SSB Index assigned as BFD RS ( $q_0$ )			0	
SSB Index assigned as CBD RS ( $q_1$ )			1	
OCNG parameters			OP.1	
CP length			Normal	
Correlation Matrix and Antenna Configuration			2x2 Low	
Beam failure detection transmission parameters	DCI format		1-0	
	Number of Control OFDM symbols		2	
	Aggregation level	CCE	8	
	Ratio of hypothetical PDCCH RE energy to average SSS RE energy	dB	0	
	Ratio of hypothetical PDCCH DMRS energy to average SSS RE energy	dB	0	
	DMRS precoder granularity		REG bundle size	
	REG bundle size		6	
DRX			DRX.7	A.3.3.7
Gap pattern ID			N.A.	
rimInSyncOutOfSyncThreshold			Absent	When the field is absent, the UE applies the value 0. (Table 8.1.1-1).
rsrp-ThresholdSSB	Config 1, 2	dBm/SCS kHz	-98	Threshold used for $Q_{in\_LR\_SSB}$
	Config 3		-95	
powerControlOffsetSS			db0	Used for deriving rsrp-ThresholdC SI-RS

beamFailureInstanceMaxCount			n1	see clause 5.17 of TS 38.321 [7]
beamFailureDetectionTimer			pbfd4	see clause 5.17 of TS 38.321 [7]
CSI-RS configuration for CSI reporting	Config 1		CSI-RS.1.1 FDD	
	Config 2		CSI-RS.1.1 TDD	
	Config 3		CSI-RS.2.1 TDD	
CSI-RS for tracking	Config 1		TRS.1.1 FDD	
	Config 2		TRS.1.1 TDD	
	Config 3		TRS.1.2 TDD	
SSB Index assigned as RLM RS			0, 1	
T310 Timer		ms	1000	
N310			2	
T1		s	1	During this time the the UE shall be fully synchronized to cell 1
T2		s	5.17	
T3		s	3.24	
T4		s	0	
T5		s	1.97	
D1		s	1.93	
Note 1: All configurations are assigned to the UE prior to the start of time period T1.				
Note 2: UE-specific PDCCH is not transmitted after T1 starts.				

**Table A.6.5.5.2.1-3: Cell specific test parameters for FR1 PCell for SSB-based beam failure detection and link recovery testing in DRX mode**

Parameter		Unit	Test 1				
			T1	T2	T3	T4	T5
EPRE ratio of PDCCH DMRS to SSS		dB	0				
EPRE ratio of PDCCH to PDCCH DMRS							
EPRE ratio of PBCH DMRS to SSS							
EPRE ratio of PBCH to PBCH DMRS							
EPRE ratio of PSS to SSS							
EPRE ratio of PDSCH DMRS to SSS							
EPRE ratio of PDSCH to PDSCH DMRS							
EPRE ratio of OCNG DMRS to SSS							
EPRE ratio of OCNG to OCNG DMRS							
SNR_SSB of set q <sub>0</sub>	Config 1	dB	5	-3	-12	-12	-12
	Config 2		5	-3	-12	-12	-12
	Config 3		5	-3	-12	-12	-12
SNR_SSB of set q <sub>1</sub>	Config 1	dB	-10	-10	10	10	10
	Config 2		-10	-10	10	10	10
	Config 3		-10	-10	10	10	10

SSB_RP of set $q_1$	Config 1	dBm/S CS kHz	-108	-108	-88	-88	-88
	Config 2		-108	-108	-88	-88	-88
	Config 3		-105	-105	-85	-85	-85
$N_{oc}$	Config 1	dBm/15 KHz	-98				
	Config 2		-98				
	Config 3		-98				
Propagation condition			TDL-C 300ns 100Hz				
<p>Note 1: OCNG shall be used such that the resources in Cell 1 are fully allocated and a constant total transmitted power spectral density is achieved for all OFDM symbols.</p> <p>Note 2: The uplink resources for CSI reporting are assigned to the UE prior to the start of time period T1.</p> <p>Note 3: NZP CSI-RS resource set configuration for CSI reporting are assigned to the UE prior to the start of time period T1.</p> <p>Note 4: Void</p> <p>Note 5: The timers and layer 3 filtering related parameters are configured prior to the start of time period T1.</p> <p>Note 6: The signal contains PDCCH for UEs other than the device under test as part of OCNG.</p> <p>Note 7: SNR levels correspond to the signal to noise ratio over the SSS REs.</p> <p>Note 8: The SNR in time periods T1, T2, T3, T4 and T5 is denoted as SNR1, SNR2 and SNR3 respectively in figure A.4.5.5.1.1-1.</p> <p>Note 9: The SNR values are specified for testing a UE which supports 2RX on at least one band. For testing of a UE which supports 4RX on all bands, the SNR during T3 is modified as specified in clause A.3.6.</p>							

Table A.6.5.5.2.1-4: Void

Table A.6.5.5.2.1-5: Void

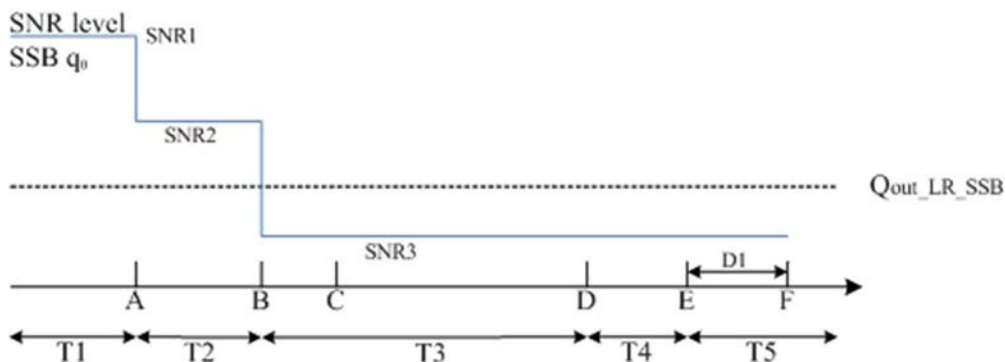
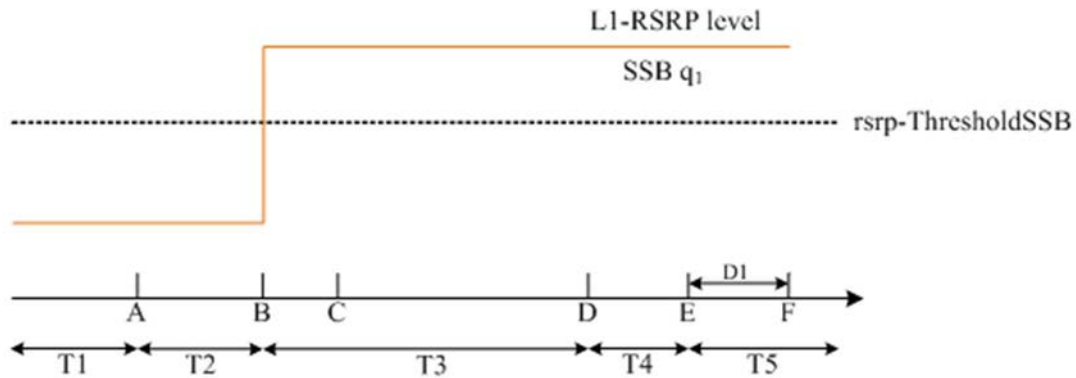

Figure A.6.5.5.2.1-1: SNR variation for SSB-based beam failure detection and link recovery testing in DRX mode



**Figure A.6.5.5.2.1-2: L1-RSRP level variation for SSB-based beam failure detection and link recovery testing in DRX mode**

**A.6.5.5.2.2 Test Requirements**

The UE behaviour during time durations T1, T2, T3, T4 and T5 shall be as follows:

During the time duration T1 and T2, the UE shall transmit uplink signal at least in all subframes configured for CSI transmission on Cell 1.

During the period from time point A to time point B the UE shall transmit uplink signal in Cell 1 in all uplink slots configured for CSI transmission according to the configured periodic CSI reporting for Cell 1.

During T3 the UE shall detect beam failure and initiate link recovery. During T4 and T5 the UE measures and evaluate beam candidate from beam candidate set  $q_1$ .

No later than time point F occurring no later than  $D1 = 1920+10$  ms after the start of T5, the UE shall transmit preamble on a beam associated with the candidate beam set  $q_1$ . The UE shall not transmit preamble on a beam associated with the candidate beam set  $q_1$  earlier than time point B.

Test is concluded once the test equipment has received the initial preamble transmission from the UE. The rate of correct events observed during repeated tests shall be at least 90%.

**A.6.5.5.3 Beam Failure Detection and Link Recovery Test for FR1 PCell configured with CSI-RS-based BFD and LR in non-DRX mode**

**A.6.5.5.3.1 Test Purpose and Environment**

The purpose of this test is to verify that the UE properly detects CSI-RS-based beam failure in the set  $q_0$  configured for a serving cell and that the UE performs correct CSI-RS-based link recovery based on beam candidate set  $q_1$ . The purpose is to test the downlink monitoring for beam failure detection within the UEs active DL BWP, during the evaluation period, and link recovery, when no DRX is used. This test will partly verify the CSI-RS based beam failure detection and link recovery for an FR1 serving cell requirements in clause 8.5.

The test parameters are given in Tables A.6.5.5.3.1-1, A.6.5.5.3.1-2, and below. There is one cell, cell 1 which is the active cell, in the test. The test consists of five successive time periods, with time duration of T1, T2, T3, T4 and T5 respectively. Figure A.6.5.5.3.1-1 shows the variation of the downlink SNR of the CSI-RS in set  $q_0$  in the active cell to emulate CSI-RS based beam failure. Figure A.6.5.5.3.1-2 shows the variation of the downlink L1-RSRP of the CSI-RS in set  $q_1$  of the candidate beam used for link recovery. Prior to the start of the time duration T1, the UE shall be fully synchronized to cell 1. The UE shall be configured for periodic CSI reporting with a reporting periodicity of 3 ms. In the test, DRX configuration is not enabled.

**Table A.6.5.5.3.1-1: Supported test configurations for FR1 PCell**

Configuration	Description
1	FDD duplex mode, 15 kHz SSB SCS, 10 MHz bandwidth
2	TDD duplex mode, 15 kHz SSB SCS, 10 MHz bandwidth
3	TDD duplex mode, 30 kHz SSB SCS, 40 MHz bandwidth

Note: The UE is only required to pass in one of the supported test configurations in FR1
--

**Table A.6.5.5.3.1-2: General test parameters for FR1 PCell for CSI-RS-based beam failure detection and link recovery testing in non-DRX mode**

Parameter		Unit	Value	Comment
			Test 1	
Active PCell			Cell 1	
RF Channel Number			1	
Duplex mode	Config 1		FDD	
	Config 2, 3		TDD	
TDD Configuration	Config 1		Not Applicable	
	Config 2		TDDConf.1.1	
	Config 3		TDDConf.2.1	
RMSI CORESET Reference Channel	Config 1		CR.1.1 FDD	A.3.1.2
	Config 2		CR.1.1 TDD	
	Config 3		CR.2.1 TDD	
Dedicated CORESET Reference Channel	Config 1		CCR.1.1 FDD	A.3.1.3
	Config 2		CCR.1.1 TDD	
	Config 3		CCR.2.1 TDD	
SSB Configuration	Config 1		SSB.3 FR1	A.3.10
	Config 2		SSB.3 FR1	
	Config 3		SSB.4 FR1	
SMT-C Configuration	Config 1, 2		SMT-C.1	A.3.11
	Config 3		SMT-C.1	
PDSCH/PDCCH subcarrier spacing	Config 1, 2		15 KHz	
	Config 3		30 KHz	
PRACH Configuration	Config 1, 2		FR1 PRACH configuration 4	A.3.8.2
	Config 3		FR1 PRACH configuration 4	A.3.8.2
csi-RS-Index assigned as beam failure detection RS in set $q_0$			0	
OCNG parameters			OP.1	A.3.2.1
CP length			Normal	
Correlation Matrix and Antenna Configuration			2x2 Low	
Beam failure detection transmission parameters	DCI format		1-0	
	Number of Control OFDM symbols		2	
	Aggregation level	CCE	8	
	Ratio of hypothetical PDCCH RE energy to average CSI-RS RE energy	dB	0	
	Ratio of hypothetical PDCCH DMRS energy to average CSI-RS RE energy	dB	0	
	DMRS precoder granularity		REG bundle size	

REG bundle size			6	
DRX			OFF	
Gap pattern ID			N.A.	
csi-RS-Index assigned as candidate beam detection RS in set $q_1$			1	N
rlmInSyncOutOfSyncThreshold			absent	When the field is absent, the UE applies the value 0. (Table 8.1.1.1-1).
rsrp-ThresholdCSI-RS	Config 1, 2	dBm/SCS kHz	-98	Threshold used for $Q_{in\_LR\_CSI-RS}$
	Config 3		-95	
powerControlOffsetSS			db0	Used for deriving rsrp-ThresholdCSI-RS
beamFailureInstanceMaxCount			n1	see clause 5.17 of TS 38.321 [7]
beamFailureDetectionTimer			pbfd4	see clause 5.17 of TS 38.321 [7]
CSI-RS configuration for $q_0$ and $q_1$	Config 1		CSI-RS.1.2 FDD	A.3.14
	Config 2		CSI-RS.1.2 TDD	
	Config 3		CSI-RS.2.2 TDD	
CSI-RS configuration for CSI reporting	Config 1		CSI-RS.1.1 FDD	A.3.14
	Config 2		CSI-RS.1.1 TDD	
	Config 3		CSI-RS.2.1 TDD	
TRS configuration	Config 1		TRS.1.1 FDD	
	Config 2		TRS.1.1 TDD	
	Config 3		TRS.1.2 TDD	
CSI-RS-Index assigned as RLM RS	Config 1		CSI-RS.1.2 FDD	A.3.14
	Config 2		CSI-RS.1.2 TDD	
	Config 3		CSI-RS.2.2 TDD	
T310 Timer		ms	1000	
N310			2	
T1		s	0.2	During this time the the UE shall be fully synchronized to cell 1
T2		s	0.18	
T3		s	0.14	
T4		s	0	
T5		s	0.08	
D1		s	0.04	
Note 1: UE-specific PDCCH is not transmitted after T1 starts.				

**Table A.6.5.5.3.1-3: Cell specific test parameters for FR1 PCell for CSI-RS-based beam failure detection and link recovery testing in non-DRX mode**

Parameter	Unit	Test 1				
		T1	T2	T3	T4	T5
EPRE ratio of PDCCH DMRS to SSS	dB	0				
EPRE ratio of PDCCH to PDCCH DMRS						
EPRE ratio of PBCH DMRS to SSS						
EPRE ratio of PBCH to PBCH DMRS						
EPRE ratio of PSS to SSS						
EPRE ratio of PDSCH DMRS to SSS						
EPRE ratio of PDSCH to PDSCH DMRS						
EPRE ratio of OCNG DMRS to SSS						
EPRE ratio of OCNG to OCNG DMRS						
SNR_CSI-RS of set $q_0$	Config 1	5	-3	-12	-12	-12
	Config 2	5	-3	-12	-12	-12

	Config 3		5	-3	-12	-12	-12
SNR_CSI-RS of set $q_1$	Config 1	dB	-10	-10	10	10	10
	Config 2		-10	-10	10	10	10
	Config 3		-10	-10	10	10	10
CSI-RS_RP of set $q_1$	Config 1	dBm/S CS kHz	-108	-108	-88	-88	-88
	Config 2		-108	-108	-88	-88	-88
	Config 3		-105	-105	-85	-85	-85
$N_{oc}$	Config 1	dBm/15 KHz	-98				
	Config 2		-98				
	Config 3		-98				
Propagation condition			TDL-C 300ns 100Hz				
<p>Note 1: OCNG shall be used such that the resources in Cell 1 are fully allocated and a constant total transmitted power spectral density is achieved for all OFDM symbols.</p> <p>Note 2: The uplink resources for CSI reporting are assigned to the UE prior to the start of time period T1.</p> <p>Note 3: NZP CSI-RS resource set configuration for CSI reporting are assigned to the UE prior to the start of time period T1.</p> <p>Note 4: Void</p> <p>Note 5: The timers and layer 3 filtering related parameters are configured prior to the start of time period T1.</p> <p>Note 6: The signal contains PDCCH for UEs other than the device under test as part of OCNG.</p> <p>Note 7: SNR levels correspond to the signal to noise ratio over the REs carrying CSI-RS.</p> <p>Note 8: The SNR in time periods T1, T2, T3, T4 and T5 is denoted as SNR1, SNR2 and SNR3 respectively in figure A.4.5.5.1.1-1.</p> <p>Note 9: The SNR values are specified for testing a UE which supports 2RX on at least one band. For testing of a UE which supports 4RX on all bands, the SNR during T3 is modified as specified in clause A.3.6.</p>							

Table A.6.5.5.3.1-4: Void

Table A.6.5.5.3.1-5: Void

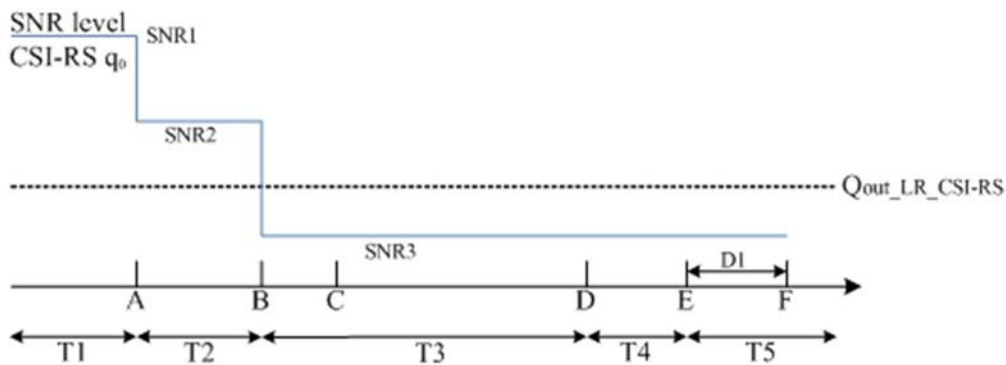
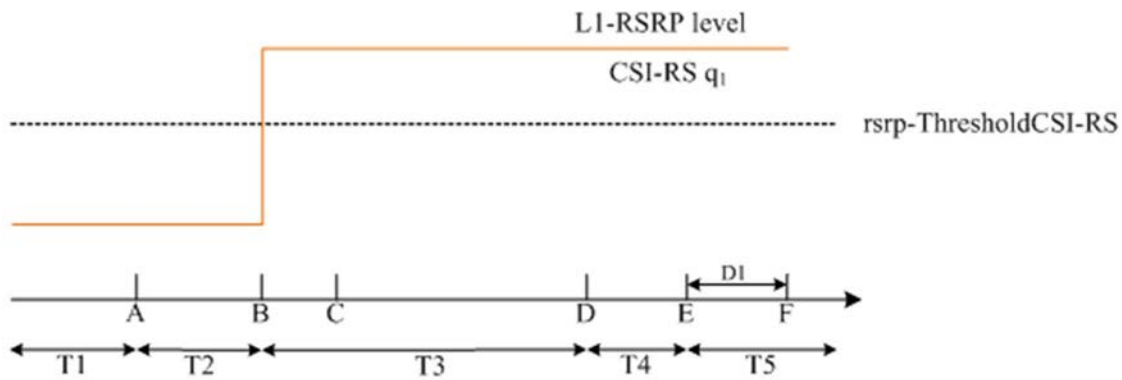

Figure A.6.5.5.3.1-1: SNR variation for CSI-RS-based beam failure detection and link recovery testing in non-DRX mode



**Figure A.6.5.5.3.1-2: L1-RSRP level variation for CSI-RS based beam failure detection and link recovery testing in non-DRX mode**

**A.6.5.5.3.2 Test Requirements**

The UE behaviour during time durations T1, T2, T3, T4 and T5 shall be as follows:

During the time duration T1 and T2, the UE shall transmit uplink signal at least in all subframes configured for CSI transmission on Cell 1.

During the period from time point A to time point B the UE shall transmit uplink signal in Cell 1 in all uplink slots configured for CSI transmission according to the configured periodic CSI reporting for Cell 1.

During T3 the shall detect beam failure and initiat link recovery. During T4 and T5 the UE measures and evaluate beam candidate from beam candidate set  $q_1$ .

No later than time point F occurring no later than  $D1 = 30+10$  ms after the start of T5, the UE shall transmit preamble on a beam associated with the candidate beam set  $q_1$ . The UE shall not transmit preamble on a beam associated with the candidate beam set  $q_1$  earlier than time point B.

Test is concluded once the test equipment has received the initial preamble transmission from the UE. The rate of correct events observed during repeated tests shall be at least 90%.

**A.6.5.5.4 Beam Failure Detection and Link Recovery Test for FR1 PCell configured with CSI-RS-based BFD and LR in DRX mode**

**A.6.5.5.4.1 Test Purpose and Environment**

The purpose of this test is to verify that the UE properly detects CSI-RS-based beam failure in the set  $q_0$  configured for a serving cell and that the UE performs correct CSI-RS-based link recovery based on beam candicate set  $q_1$ . The purpose is to test the downlink monitoring for beam failure detection within the UEs active DL BWP, during the evaluation period, and link recovery, when DRX is used. This test will partly verify the CSI-RS based beam failure detection and link recovery for an FR1 serving cell requirements in clause 8.5.

The test parameters are given in Tables A.6.5.5.4.1-1, A.6.5.5.4.1-2, A.6.5.5.4.1-3, and A.6.5.5.4.1-4 below. There is one cell, cell 1 which is the active cell, in the test. The test consists of five successive time periods, with time duration of T1, T2, T3, T4 and T5 respectively. Figure A.6.5.5.4.1-1 shows the variation of the downlink SNR of the CSI-RS in set  $q_0$  in the active cell to emulate CSI-RS based beam failure. Figure A.6.5.5.4.1-2 shows the variation of the downlink L1-RSRP of the CSI-RS in set  $q_1$  of the candidate beam used for link recovery. Prior to the start of the time duration T1, the UE shall be fully synchronized to cell 1. The UE shall be configured for periodic CSI reporting with a reporting periodicity of 5 ms. In the test, DRX configuration is enabled in PCell and DRX inactivity timer has already been expired, i.e. UE tries to decode PDCCH and to send periodic CQI during the period when On-duration timer is running. Time alignment timers shall be set to “infinity” so that UL timing alignment is maintained during the test.

**Table A.6.5.5.4.1-1: Supported test configurations for FR1 PCell**

Configuration	Description
1	FDD duplex mode, 15 kHz SSB SCS, 10 MHz bandwidth
2	TDD duplex mode, 15 kHz SSB SCS, 10 MHz bandwidth
3	TDD duplex mode, 30 kHz SSB SCS, 40 MHz bandwidth



Note: The UE is only required to pass in one of the supported test configurations in FR1
--

**Table A.6.5.5.4.1-2: General test parameters for FR1 PCell for CSI-RS-based beam failure detection and link recovery testing in DRX mode**

Parameter		Unit	Value	Comment
			Test 1	
Active PCell			Cell 1	
RF Channel Number			1	
Duplex mode	Config 1		FDD	
	Config 2, 3		TDD	
TDD Configuration	Config 1		Not Applicable	
	Config 2		TDDConf.1.1	
	Config 3		TDDConf..21	
RMSI CORESET Reference Channel	Config 1		CR.1.1 FDD	A.3.1.2
	Config 2		CR.1.1 TDD	
	Config 3		CR.2.1 TDD	
SSB Configuration	Config 1		SSB.3 FR1	A.3.10
	Config 2		SSB.3 FR1	
	Config 3		SSB.4 FR1	
Dedicated CORESET Reference Channel	Config 1		CCR.1.1 FDD	A.3.1.3
	Config 2		CCR.1.1 TDD	
	Config 3		CCR.2.1 TDD	
SMTC Configuration	Config 1, 2		SMTC.1	A.3.11
	Config 3		SMTC.1	
PDSCH/PDCCH subcarrier spacing	Config 1, 2		15 KHz	
	Config 3		30 KHz	
PRACH Configuration	Config 1, 2		FR1 PRACH configuration 4	A.3.8.2
	Config 3		FR1 PRACH configuration 4	A.3.8.2
csi-RS-Index assigned as beam failure detection RS in set $q_0$			0	
OCNG parameters			OP.1	A.3.2.1
CP length			Normal	
Correlation Matrix and Antenna Configuration			2x2 Low	
Beam failure detection transmission parameters	DCI format		1-0	
	Number of Control OFDM symbols		2	
	Aggregation level	CCE	8	
	Ratio of hypothetical PDCCH RE energy to average CSI-RS RE energy	dB	0	
	Ratio of hypothetical PDCCH DMRS energy to average CSI-RS RE energy	dB	0	
	DMRS precoder granularity		REG bundle size	

REG bundle size			6	
DRX			DRX.7	A.3.3.7
Gap pattern ID			N.A.	
csi-RS-Index assigned as candidate beam detection RS in set $q_1$			1	
rlmInSyncOutOfSyncThreshold			absent	When the field is absent, the UE applies the value 0. (Table 8.1.1-1).
rsrp-ThresholdCSI-RS	Config 1, 2	dBm/SCS kHz	-98	Threshold used for $Q_{in\_LR\_CSI-RS}$
	Config 3		-95	
powerControlOffsetSS			db0	Used for deriving rsrp-ThresholdCSI-RS
beamFailureInstanceMaxCount			n1	see clause 5.17 of TS 38.321 [7]
beamFailureDetectionTimer			pbfd4	see clause 5.17 of TS 38.321 [7]
CSI-RS configuration for $q_0$ and $q_1$	Config 1		CSI-RS.1.2 FDD	A.3.14.1
	Config 2		CSI-RS.1.2 TDD	
	Config 3		CSI-RS.2.2 TDD	
CSI-RS configuration for CSI reporting	Config 1		CSI-RS.1.1 FDD	A.3.14.1
	Config 2		CSI-RS.1.1 TDD	
	Config 3		CSI-RS.2.1 TDD	
TRS configuration	Config 1		TRS.1.1 FDD	
	Config 2		TRS.1.1 TDD	
	Config 3		TRS.1.2 TDD	
CSI-RS-Index assigned as RLM RS	Config 1		CSI-RS.1.2 FDD	
	Config 2		CSI-RS.1.2 TDD	
	Config 3		CSI-RS.2.2 TDD	
T310 Timer		ms	1000	
N310			2	
T1		s	1	During this time the the UE shall be fully synchronized to cell 1
T2		s	8.37	
T3		s	6.44	
T4		s	0	
T5		s	1.97	
D1		s	1.93	
Note 1: UE-specific PDCCH is not transmitted after T1 starts.				

**Table A.6.5.5.4.1-3: Cell specific test parameters for FR1 PCell for CSI-RS-based beam failure detection and link recovery testing in DRX mode**

Parameter	Unit	Test 1					
		T1	T2	T3	T4	T5	
EPRE ratio of PDCCH DMRS to SSS	dB	0					
EPRE ratio of PDCCH to PDCCH DMRS	dB						
EPRE ratio of PBCH DMRS to SSS	dB						
EPRE ratio of PBCH to PBCH DMRS	dB						
EPRE ratio of PSS to SSS	dB						
EPRE ratio of PDSCH DMRS to SSS	dB						
EPRE ratio of PDSCH to PDSCH DMRS	dB						
EPRE ratio of OCNG DMRS to SSS	dB						
EPRE ratio of OCNG to OCNG DMRS	dB						
SNR_CSI-RS of set $q_0$	Config 1	dB	5	-3	-12	-12	-12

	Config 2		5	-3	-12	-12	-12
	Config 3		5	-3	-12	-12	-12
SNR_CSI-RS of set $q_1$	Config 1	dB	-10	-10	10	10	10
	Config 2		-10	-10	10	10	10
	Config 3		-10	-10	10	10	10
CSI-RS_RP of set $q_1$	Config 1	dB/SCS kHz	-108	-108	-88	-88	-88
	Config 2		-108	-108	-88	-88	-88
	Config 3		-105	-105	-85	-85	-85
$N_{oc}$	Config 1	dBm/15 kHz	-98				
	Config 2		-98				
	Config 3		-98				
Propagation condition			TDL-C 300ns 100Hz				
<p>Note 1: OCNG shall be used such that the resources in Cell 1 are fully allocated and a constant total transmitted power spectral density is achieved for all OFDM symbols.</p> <p>Note 2: The uplink resources for CSI reporting are assigned to the UE prior to the start of time period T1.</p> <p>Note 3: NZP CSI-RS resource set configuration for CSI reporting are assigned to the UE prior to the start of time period T1.</p> <p>Note 4: Void</p> <p>Note 5: The timers and layer 3 filtering related parameters are configured prior to the start of time period T1.</p> <p>Note 6: The signal contains PDCCH for UEs other than the device under test as part of OCNG.</p> <p>Note 7: SNR levels correspond to the signal to noise ratio over the REs carrying CSI-RS.</p> <p>Note 8: The SNR in time periods T1, T2, T3, T4 and T5 is denoted as SNR1, SNR2 and SNR3 respectively in figure A.4.5.5.1.1-1.</p> <p>Note 9: The SNR values are specified for testing a UE which supports 2RX on at least one band. For testing of a UE which supports 4RX on all bands, the SNR during T3 is modified as specified in clause A.3.6.</p>							

**Table A.6.5.5.4.1-4: Void**

**Table A.6.5.5.4.1-5: Void**

**Table A.6.5.5.4.1-6: Void**

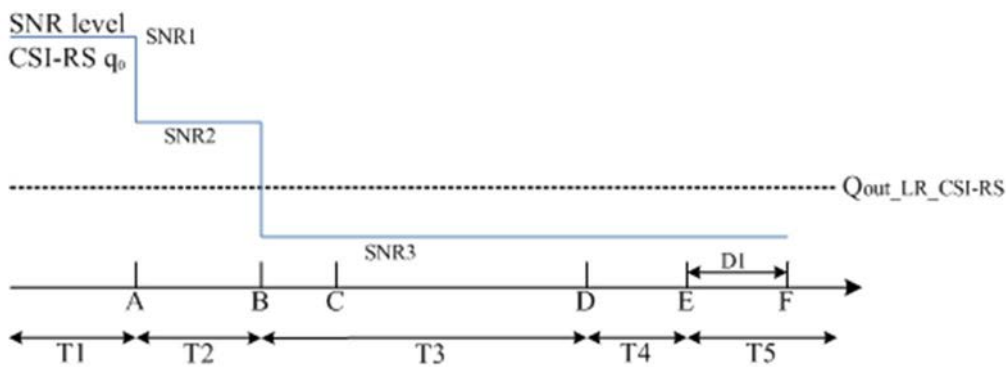

**Figure A.6.5.5.4.1-1: SNR variation for CSI-RS-based beam failure detection and link recovery testing in DRX mode**

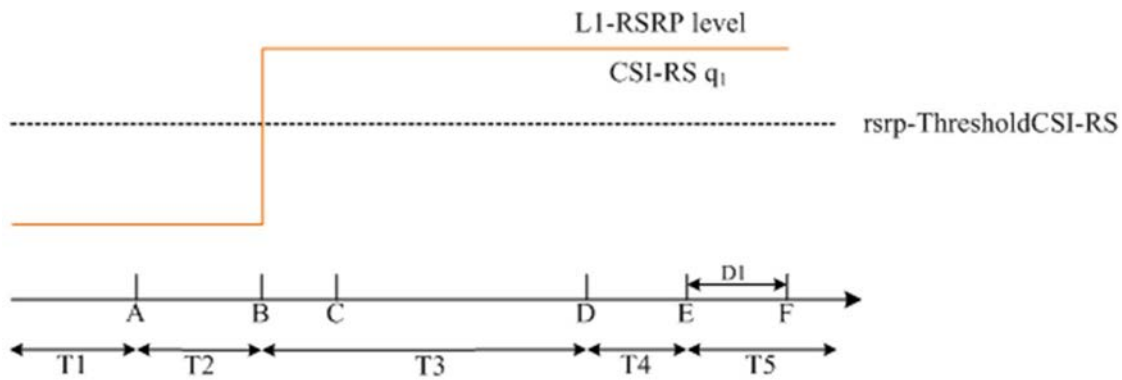

**Figure A.6.5.5.4.1-2: L1-RSRP level variation for CSI-RS based beam failure detection and link recovery testing in DRX mode**

**A.6.5.5.4.2 Test Requirements**

The UE behaviour during time durations T1, T2, T3, T4 and T5 shall be as follows:

During the time duration T1 and T2, the UE shall transmit uplink signal at least in all subframes configured for CSI transmission on Cell 1.

During the period from time point A to time point B the UE shall transmit uplink signal in Cell 1 in all uplink slots configured for CSI transmission according to the configured periodic CSI reporting for Cell 1.

During T3 the shall detect beam failure and initiat link recovery. During T4 and T5 the UE measures and evaluate beam candidate from beam candidate set  $q_1$ .

No later than time point F occurring no later than  $D1 = 1920+10$  ms after the start of T5, the UE shall transmit preamble on a beam associated with the candidate beam set  $q_1$ . The UE shall not transmit preamble on a beam associated with the candidate beam set  $q_1$  earlier than time point B.

Test is concluded once the test equipment has received the initial preamble transmission from the UE. The rate of correct events observed during repeated tests shall be at least 90%.

**A.6.5.5.5 Beam Failure Detection and Link Recovery Test for FR1 SCell configured with CSI-RS-based BFD and SSB-based LR in non-DRX mode**

**A.6.5.5.5.1 Test Purpose and Environment**

The purpose of this test is to verify that the UE properly detects CSI-RS-based beam failure in the set  $q_0$  configured for a serving cell and that the UE performs correct SSB-based link recovery based on beam candidate set  $q_1$ . The purpose is to test the downlink monitoring for beam failure detection within the UEs active DL BWP without *schedulingRequestID-BFR-SCell-r16* configuration, during the evaluation period, and link recovery, when no DRX is used. This test will partly verify the beam failure detection and link recovery for an FR1 serving cell requirements in clause 8.5.

The test parameters are given in Tables A.6.5.5.5.1-1, A.6.5.5.5.1-2, and below. There are two cells, cell 1 is the PCell and cell 2 is the SCell, in the test. UE is not provided by *schedulingRequestID-BFR-SCell-r16*, i.e., no configuration for PUCCH transmission resources, and UE shall perform the random access procedure to recover the beam failure. The test consists of five successive time periods, with time duration of T1, T2, T3, T4 and T5 respectively. Figure A.6.5.5.5.1-1 shows the SNR of the CSI-RS in set  $q_0$  in the active SCell to emulate beam failure. Figure A.6.5.5.5.1-2 shows the variation of the downlink L1-RSRP of the SSB in set  $q_1$  of the candidate beam used for link recovery. Prior to the start of the time duration T1, the UE shall be fully synchronized to cell 1 and cell 2. The UE shall be configured for periodic CSI reporting with a reporting periodicity of 5 ms. In the test, DRX configuration is not enabled.

**Table A.6.5.5.5.1-1: Supported test configurations for FR1 PCell and SCell**

Configuration	Description
1	FDD duplex mode, 15 kHz SSB SCS, 10 MHz bandwidth
2	TDD duplex mode, 15 kHz SSB SCS, 10 MHz bandwidth
3	TDD duplex mode, 30 kHz SSB SCS, 40 MHz bandwidth

Note: The UE is only required to pass in one of the supported test configurations in FR1

**Table A.6.5.5.1-2: General test parameters for FR1 SCell for beam failure detection and link recovery testing in non-DRX mode**

Parameter		Unit	Value	Comment
			Test 1	
Active PCell			Cell 1	
RF Channel Number for PCell			1	
Active SCell			Cell 2	
RF Channel Number for SCell			2	
Duplex mode	Config 1		FDD	
	Config 2, 3		TDD	
BW channel	Config 1	MHz	10: NRB,c = 52	
	Config 2		10: NRB,c = 52	
	Config 3		40: NRB,c = 106	
TDD Configuration	Config 1		Not Applicable	
	Config 2		TDDConf.1.1	
	Config 3		TDDConf.2.1	
CORESET Reference Channel	Config 1		CR.1.1 FDD	A.3.1.2
	Config 2		CR.1.1 TDD	
	Config 3		CR.2.1 TDD	
SSB Configuration	Config 1		SSB.1 FR1	A.3.10
	Config 2		SSB.1 FR1	
	Config 3		SSB.2 FR1	
SMTC Configuration	Config 1, 2		SMTC.1	A.3.11
	Config 3		SMTC.1	
PDSCH/PDCCH subcarrier spacing	Config 1, 2	kHz	15	
	Config 3		30	
PRACH Configuration	Config 1, 2		Table A.3.8.2.2-1	
	Config 3		Table A.3.8.2.2-1	
csi-RS-Index assigned as beam failure detection RS in set $q_0$ in activated SCell			0	
OCNG parameters			OP.1	A.3.2.1
CP length			Normal	
Correlation Matrix and Antenna Configuration			2x2 Low	
Beam failure detection transmission parameters	DCI format		1-0	
	Number of Control OFDM symbols		2	
	Aggregation level	CCE	8	
	Ratio of hypothetical PDCCH RE energy to average CSI-RS RE energy	dB	0	
	Ratio of hypothetical PDCCH DMRS energy to average CSI-RS RE energy	dB	0	
	DMRS precoder granularity		REG bundle size	
	REG bundle size		6	
DRX			OFF	
Gap pattern ID			N.A.	
schedulingRequestID-BFR-SCell-r16			absent	When the field is absent, the random access procedure

				will be triggered for SCell BFR
SSB Index assigned as CBD RS (q1) in activated SCell			0	
rimInSyncOutOfSyncThreshold			absent	When the field is absent, the UE applies the value 0. (Table 8.1.1-1).
rsrp-ThresholdBFR	Config 1, 2	dBm/SCS kHz	-98	Threshold used for $Q_{in\_LR\_SSB}$
	Config 3		-95	
powerControlOffsetSS			db0	Used for deriving rsrp-ThresholdCSI-RS
beamFailureInstanceMaxCount			n1	see clause 5.17 of TS 38.321 [7]
beamFailureDetectionTimer			pbfd4	see clause 5.17 of TS 38.321 [7]
CSI-RS configuration for $q_0$ in activated SCell	Config 1		CSI-RS.1.2 FDD	A.3.14
	Config 2		CSI-RS.1.2 TDD	
	Config 3		CSI-RS.2.2 TDD	
CSI-RS configuration for CSI reporting	Config 1		CSI-RS.1.1 FDD	A.3.14
	Config 2		CSI-RS.1.1 TDD	
	Config 3		CSI-RS.2.1 TDD	
TRS configuration	Config 1		TRS.1.1 FDD	
	Config 2		TRS.1.1 TDD	
	Config 3		TRS.1.2 TDD	
CSI-RS-Index assigned as RLM RS in PCell	Config 1		CSI-RS.1.2 FDD	A.3.14
	Config 2		CSI-RS.1.2 TDD	
	Config 3		CSI-RS.2.2 TDD	
T310 Timer		ms	1000	
N310			2	
T1		s	0.2	During this time the the UE shall be fully synchronized to cell 1
T2		s	0.18	
T3		s	0.14	
T4		s	0	
T5		s	0.17	
D1		s	0.13	
Note 1: UE-specific PDCCH is not transmitted after T1 starts.				

**Table A.6.5.5.1-3: Cell specific test parameters for FR1 SCell for CSI-RS-based beam failure detection and link recovery testing in non-DRX mode**

Parameter	Unit	Cell1 T1 to T5	Test 1 Cell2				
			T1	T2	T3	T4	T5
EPRE ratio of PDCCH DMRS to SSS	dB	0	0	0	0	0	0
EPRE ratio of PDCCH to PDCCH DMRS	dB						
EPRE ratio of PBCH DMRS to SSS	dB						
EPRE ratio of PBCH to PBCH DMRS	dB						
EPRE ratio of PSS to SSS	dB						
EPRE ratio of PDSCH DMRS to SSS	dB						
EPRE ratio of PDSCH to PDSCH DMRS	dB						

EPRE ratio of OCNG DMRS to SSS		dB						
EPRE ratio of OCNG to OCNG DMRS		dB						
SNR_CSI-RS of set $q_0$	Config 1	dB	5	5	-3	-12	-12	-12
	Config 2		5	5	-3	-12	-12	-12
	Config 3		5	5	-3	-12	-12	-12
SNR_SSB of set $q_1$	Config 1	dB	-10	-10	-10	10	10	10
	Config 2		-10	-10	-10	10	10	10
	Config 3		-10	-10	-10	10	10	10
SSB_RP of set $q_1$	Config 1	dBm/ SCS kHz	-108	-108	-108	-88	-88	-88
	Config 2		-108	-108	-108	-88	-88	-88
	Config 3		-105	-105	-105	-85	-85	-85
$N_{oc}$	Config 1	dBm/ 15kHz	-98	-98				
	Config 2		-98	-98				
	Config 3		-98	-98				
Propagation condition			TDL-C 300ns 100Hz	TDL-C 300ns 100Hz				
<p>Note 1: OCNG shall be used such that the resources in Cell 1 are fully allocated and a constant total transmitted power spectral density is achieved for all OFDM symbols.</p> <p>Note 2: The uplink resources for CSI reporting are assigned to the UE prior to the start of time period T1.</p> <p>Note 3: NZP CSI-RS resource set configuration for CSI reporting are assigned to the UE prior to the start of time period T1.</p> <p>Note 4: Void</p> <p>Note 5: The timers and layer 3 filtering related parameters are configured prior to the start of time period T1.</p> <p>Note 6: The signal contains PDCCH for UEs other than the device under test as part of OCNG.</p> <p>Note 7: SNR levels correspond to the signal to noise ratio over the REs carrying CSI-RS.</p> <p>Note 8: The SNR in time periods T1, T2, T3, T4 and T5 is denoted as SNR1, SNR2 and SNR3 respectively in figure A.4.5.5.1.1-1.</p> <p>Note 9: The SNR values are specified for testing a UE which supports 2RX on at least one band. For testing of a UE which supports 4RX on all bands, the SNR during T3 is modified as specified in clause A.3.6.</p>								

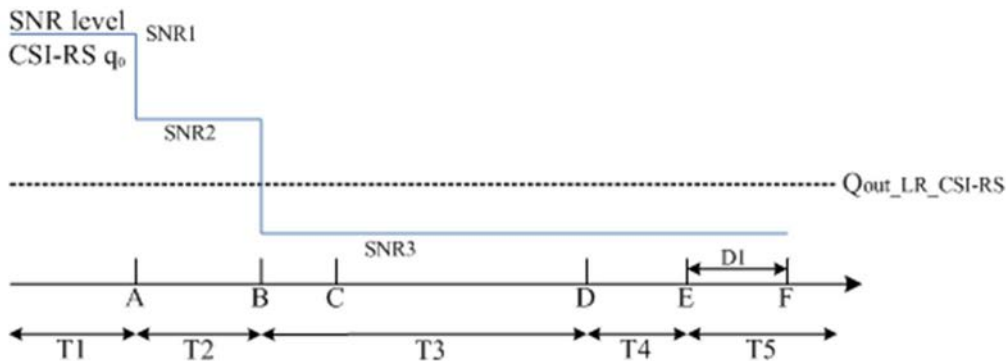
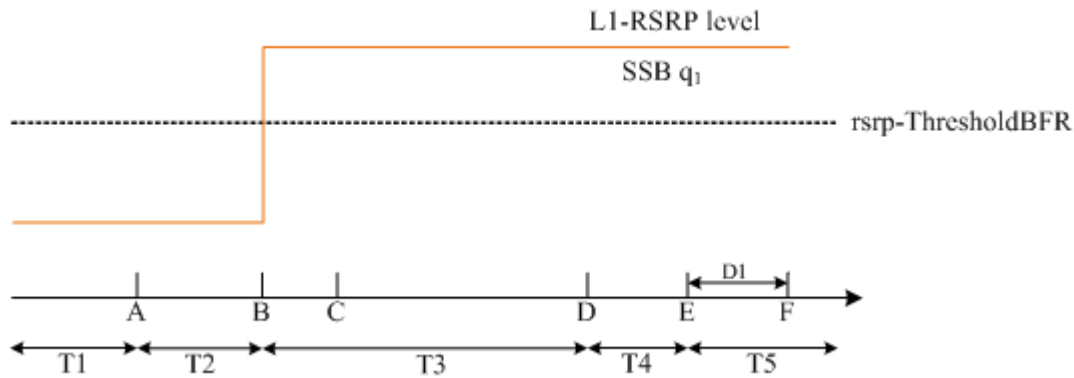

Figure A.6.5.5.1-1: SNR variation for beam failure detection and link recovery testing in for SCell non-DRX mode



**Figure A.6.5.5.1-2: L1-RSRP level variation for beam failure detection and link recovery testing for SCell in non-DRX mode**

#### A.6.5.5.5.2 Test Requirements

The UE behaviour during time durations T1, T2, T3, T4 and T5 shall be as follows:

During the time duration T1 and T2, the UE shall transmit uplink signal at least in all subframes configured for CSI transmission on Cell 1.

During the period from time point A to time point B the UE shall transmit uplink signal in Cell 1 in all uplink slots configured for CSI transmission according to the configured periodic CSI reporting for Cell 1.

During T3 the UE shall detect beam failure and initiate link recovery. During T4 and T5 the UE measures and evaluates beam candidate from beam candidate set  $q_1$ .

No later than time point F occurring no later than  $D1 = 120 + 10$  ms after the start of T5, the UE shall transmit preamble for UL-SCH resource application, followed by MAC-CE on the assigned uplink resources containing a beam associated with the candidate beam set  $q_1$ . The UE shall not transmit preamble earlier than time point B.

During T5, the System Simulator shall transmit a Random Access Response to UE after the System Simulator receives the preamble from UE. The UE shall transmit the msg.3 containing candidate beam set  $q_1$  for SCell BFR if UE receives the Random Access Response.

Test is concluded once the test equipment has received the initial preamble transmission from the UE. The rate of correct events observed during repeated tests shall be at least 90%.

#### A.6.5.5.6 Beam Failure Detection and Link Recovery Test for FR1 SCell configured with CSI-RS-based BFD and SSB-based LR in DRX mode

##### A.6.5.5.6.1 Test Purpose and Environment

The purpose of this test is to verify that the UE properly detects CSI-RS-based beam failure in the set  $q_0$  configured for a serving cell and that the UE performs correct SSB-based link recovery based on beam candidate set  $q_1$ . The purpose is to test the downlink monitoring for beam failure detection within the UE's active DL BWP without *schedulingRequestID-BFR-SCell-r16* configuration, during the evaluation period, and link recovery, when DRX is used. This test will partly verify the beam failure detection and link recovery for an FR1 serving cell requirements in clause 8.5.

The test parameters are given in Tables A.6.5.5.6.1-1, A.6.5.5.6.1-2, A.6.5.5.6.1-3, and A.6.5.5.6.1-4 below. There are two cells, cell 1 is the PCell and cell 2 is the SCell, in the test. UE is not provided by *schedulingRequestID-BFR-SCell-r16*, i.e., no configuration for PUCCH transmission resources, and UE shall perform the random access procedure to recover the beam failure. The test consists of five successive time periods, with time duration of T1, T2, T3, T4 and T5 respectively. Figure A.6.5.5.6.1-1 shows the SNR of the CSI-RS in set  $q_0$  in the active SCell to emulate beam failure. Figure A.6.5.5.6.1-2 shows the variation of the downlink L1-RSRP of the SSB in set  $q_1$  of the candidate beam used for link recovery. Prior to the start of the time duration T1, the UE shall be fully synchronized to cell 1 and cell 2. The UE shall be configured for periodic CSI reporting with a reporting periodicity of 5 ms. In the test, DRX configuration is enabled in SCell and DRX inactivity timer has already been expired, i.e. UE tries to decode PDCCH and to send periodic CQI during the period when On-duration timer is running. Time alignment timers shall be set to "infinity" so that UL timing alignment is maintained during the test.



**Table A.6.5.5.6.1-1: Supported test configurations for FR1 PCell and SCell**

Configuration	Description
1	FDD duplex mode, 15 kHz SSB SCS, 10 MHz bandwidth
2	TDD duplex mode, 15 kHz SSB SCS, 10 MHz bandwidth
3	TDD duplex mode, 30 kHz SSB SCS, 40 MHz bandwidth
Note:	The UE is only required to pass in one of the supported test configurations in FR1

**Table A.6.5.5.6.1-2: General test parameters for FR1 SCell for beam failure detection and link recovery testing in DRX mode**

Parameter		Unit	Value Test 1	Comment
Active PCell			Cell 1	
RF Channel Number for PCell			1	
Active SCell			Cell 2	
RF Channel Number for SCell			2	
Duplex mode	Config 1		FDD	
	Config 2, 3		TDD	
BW channel	Config 1	MHz	10: NRB,c = 52	
	Config 2		10: NRB,c = 52	
	Config 3		40: NRB,c = 106	
TDD Configuration	Config 1		Not Applicable	
	Config 2		TDDConf.1.1	
	Config 3		TDDConf..21	
CORESET Reference Channel	Config 1		CR.1.1 FDD	A.3.1.2
	Config 2		CR.1.1 TDD	
	Config 3		CR.2.1 TDD	
SSB Configuration	Config 1		SSB.1 FR1	A.3.10
	Config 2		SSB.1 FR1	
	Config 3		SSB.2 FR1	
SMTC Configuration	Config 1, 2		SMTC.1	A.3.11
	Config 3		SMTC.1	
PDSCH/PDCCH subcarrier spacing	Config 1, 2	kHz	15	
	Config 3		30	
PRACH Configuration	Config 1, 2		Table A.3.8.2.2-1	
	Config 3		Table A.3.8.2.2-1	
csi-RS-Index assigned as beam failure detection RS in set $q_0$ in activated SCell			0	
OCNG parameters			OP.1	A.3.2.1
CP length			Normal	
Correlation Matrix and Antenna Configuration			2x2 Low	
Beam failure detection transmission parameters	DCI format		1-0	
	Number of Control OFDM symbols		2	
	Aggregation level	CCE	8	
	Ratio of hypothetical PDCCH RE energy to average CSI-RS RE energy	dB	0	
	Ratio of hypothetical PDCCH DMRS energy to average CSI-RS RE energy	dB	0	
	DMRS precoder granularity		REG bundle size	
	REG bundle size		6	

DRX			DRX.7	A.3.3.7
Gap pattern ID			N.A.	
schedulingRequestID-BFR-SCell-r16			absent	When the field is absent, the random access procedure will be triggered for SCell BFR
SSB Index assigned as CBD RS (q1) in activated SCell			0	
rlmInSyncOutOfSyncThreshold			absent	When the field is absent, the UE applies the value 0. (Table 8.1.1-1).
rsrp-ThresholdBFR	Config 1, 2	dBm/SCS kHz	-98	Threshold used for $Q_{in\_LR\_SSB}$
	Config 3		-95	
powerControlOffsetSS			db0	Used for deriving rsrp-ThresholdCSI-RS
beamFailureInstanceMaxCount			n1	see clause 5.17 of TS 38.321 [7]
beamFailureDetectionTimer			pbfd4	see clause 5.17 of TS 38.321 [7]
CSI-RS configuration for qoin activated SCell	Config 1		CSI-RS.1.2 FDD	A.3.14.1
	Config 2		CSI-RS.1.2 TDD	
	Config 3		CSI-RS.2.2 TDD	
CSI-RS configuration for CSI reporting	Config 1		CSI-RS.1.1 FDD	A.3.14.1
	Config 2		CSI-RS.1.1 TDD	
	Config 3		CSI-RS.2.1 TDD	
TRS configuration	Config 1		TRS.1.1 FDD	
	Config 2		TRS.1.1 TDD	
	Config 3		TRS.1.2 TDD	
CSI-RS-Index assigned as RLM RS in PCell	Config 1		CSI-RS.1.2 FDD	
	Config 2		CSI-RS.1.2 TDD	
	Config 3		CSI-RS.2.2 TDD	
T310 Timer		ms	1000	
N310			2	
T1		s	1	During this time the the UE shall be fully synchronized to cell 1
T2		s	8.37	
T3		s	6.44	
T4		s	0	
T5		s	1.97	
D1		s	1.93	
Note 1: UE-specific PDCCH is not transmitted after T1 starts.				

**Table A.6.5.5.6.1-3: Cell specific test parameters for FR1 SCell for beam failure detection and link recovery testing in DRX mode**

Parameter	Unit	Cell 1 T1 to T5	Test 1 Cell2				
			T1	T2	T3	T4	T5
EPRE ratio of PDCCH DMRS to SSS	dB		0				
EPRE ratio of PDCCH to PDCCH DMRS	dB						
EPRE ratio of PBCH DMRS to SSS	dB						

EPRE ratio of PBCH to PBCH DMRS		dB	0					
EPRE ratio of PSS to SSS		dB						
EPRE ratio of PDSCH DMRS to SSS		dB						
EPRE ratio of PDSCH to PDSCH DMRS		dB						
EPRE ratio of OCNG DMRS to SSS		dB						
EPRE ratio of OCNG to OCNG DMRS		dB						
SNR_CSI-RS of set $q_0$	Config 1	dB	5	5	-3	-12	-12	-12
	Config 2	dB	5	5	-3	-12	-12	-12
	Config 3	dB	5	5	-3	-12	-12	-12
SNR_SSB of set $q_1$	Config 1	dB	-10	-10	-10	10	10	10
	Config 2	dB	-10	-10	-10	10	10	10
	Config 3	dB	-10	-10	-10	10	10	10
SSB_RP of set $q_1$	Config 1	dBm/ SCS kHz	-108	-108	-108	-88	-88	-88
	Config 2		-108	-108	-108	-88	-88	-88
	Config 3		-105	-105	-105	-85	-85	-85
$N_{oc}$	Config 1	dBm/15	-98	-98				
	Config 2	kHz	-98	-98				
	Config 3		-98	-98				
Propagation condition			TDL-C 300ns 100Hz	TDL-C 300ns 100Hz				
<p>Note 1: OCNG shall be used such that the resources in Cell 1 are fully allocated and a constant total transmitted power spectral density is achieved for all OFDM symbols.</p> <p>Note 2: The uplink resources for CSI reporting are assigned to the UE prior to the start of time period T1.</p> <p>Note 3: NZP CSI-RS resource set configuration for CSI reporting are assigned to the UE prior to the start of time period T1.</p> <p>Note 4: Void</p> <p>Note 5: The timers and layer 3 filtering related parameters are configured prior to the start of time period T1.</p> <p>Note 6: The signal contains PDCCH for UEs other than the device under test as part of OCNG.</p> <p>Note 7: SNR levels correspond to the signal to noise ratio over the REs carrying CSI-RS.</p> <p>Note 8: The SNR in time periods T1, T2, T3, T4 and T5 is denoted as SNR1, SNR2 and SNR3 respectively in figure A.4.5.5.1.1-1.</p> <p>Note 9: The SNR values are specified for testing a UE which supports 2RX on at least one band. For testing of a UE which supports 4RX on all bands, the SNR during T3 is modified as specified in clause A.3.6.</p>								

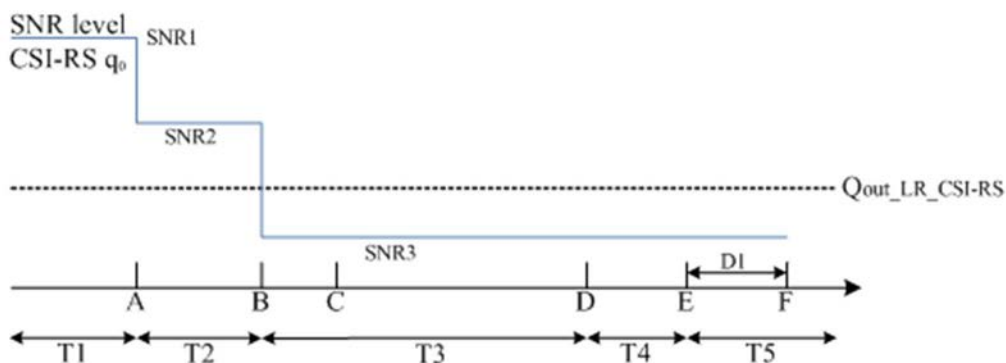
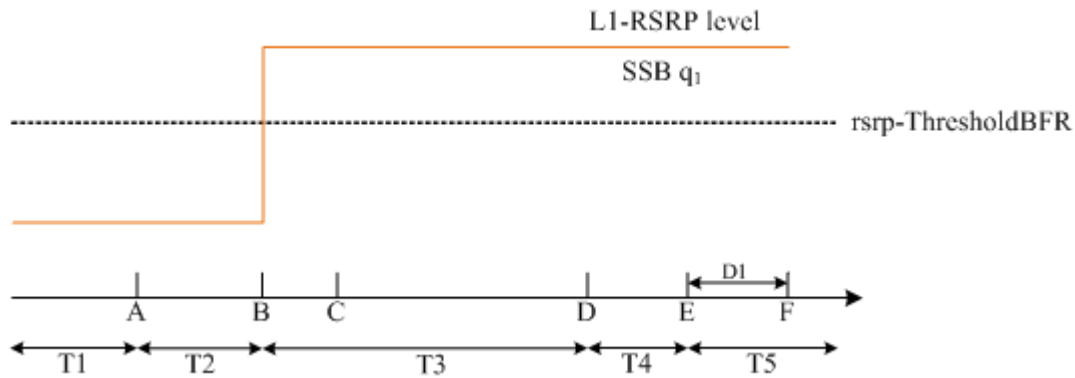

Figure A.6.5.5.6.1-1: SNR variation for beam failure detection and link recovery testing for SCell in DRX mode



**Figure A.6.5.5.6.1-2: L1-RSRP level variation for beam failure detection and link recovery testing for SCell in DRX mode**

### A.6.5.5.6.2 Test Requirements

The UE behaviour during time durations T1, T2, T3, T4 and T5 shall be as follows:

During the time duration T1 and T2, the UE shall transmit uplink signal at least in all subframes configured for CSI transmission on Cell 1.

During the period from time point A to time point B the UE shall transmit uplink signal in Cell 1 in all uplink slots configured for CSI transmission according to the configured periodic CSI reporting for Cell 1.

During T3 the UE shall detect beam failure and initiate link recovery. During T4 and T5 the UE measures and evaluates beam candidate from beam candidate set  $q_1$ .

No later than time point F occurring no later than  $D1 = 120 + 10$  ms after the start of T5, the UE shall transmit preamble for UL-SCH resource application, followed by MAC-CE on the assigned uplink resources containing a beam associated with the candidate beam set  $q_1$ . The UE shall not transmit preamble earlier than time point B.

During T5, the System Simulator shall transmit a Random Access Response to UE after the System Simulator receives the preamble from UE. The UE shall transmit the msg.3 containing candidate beam set  $q_1$  for SCell BFR if UE receives the Random Access Response.

Test is concluded once the test equipment has received the initial preamble transmission from the UE. The rate of correct events observed during repeated tests shall be at least 90%.

## A.6.5.6 Active BWP switch

### A.6.5.6.1 DCI-based and Timer-based Active BWP Switch

#### A.6.5.6.1.1 NR FR1- NR FR1 DL active BWP switch of SCell with non-DRX in SA

##### A.6.5.6.1.1.1 Test Purpose and Environment

The purpose of this test is to verify the DL BWP switch delay requirement defined in clause 8.6, and interruption requirement on other active serving cell defined in clause 8.2.2.2.5.

The supported test configurations for PCell are shown in Table A.6.5.6.1.1.1-1 below. Supported test configurations for NR SCell are shown in table A.6.5.6.1.1.1-1A below. Test configuration for NR PCell and test configuration for NR SCell are chosen independently. The test scenario comprises of one NR PCell (Cell 1) and one SCell (Cell 2) as given in Table A.6.5.6.1.1.1-2. NR Cell-specific parameters are specified in Table A.6.5.6.1.1.1-3 and Table A.6.5.6.1.1.1-4 below.

PDCCHs indicating new transmissions shall be sent continuously on SCell (Cell 2) to ensure that the UE would have ACK/NACK sending except for the time duration when BWP is switching on Cell 2 and the time duration of T2.

PDCCHs indicating new transmissions shall be sent continuously on PCell (Cell 1) to ensure that the UE will have ACK/NACK sending.

Before the test starts,

- UE is connected to Cell 1 (PCell) on radio channel 1 (PCC), and Cell 2 (SCell) on radio channel 2 (SCC).  
UE is configured with 2 different UE-specific downlink bandwidth parts for SCell, BWP-1 and BWP-2, in Cell 2 before starting the test. BWP-1 and BWP-2 always include bandwidth of the initial DL BWP and SSB.
- UE is configured with 1 UE-specific downlink bandwidth parts the same as initial BWP for PCell, BWP-0 in Cell 1 before starting the test.
- UE is indicated in *firstActiveDownlinkBWP-Id* that the active DL BWP is BWP-1 in SCell.
- UE is indicated in *firstActiveDownlinkBWP-Id* that the active DL BWP is BWP-0 in PCell.
- UE is configured with a *bwp-InactivityTimer* timer value for SCell.

All cells have constant signal levels throughout the test.

The test consists of 3 successive time periods, with durations of T1, T2, and T3, respectively.

During T1,

Time period T1 starts when a DCI format 1\_1 command for SCell DL BWP switch, sent from the test equipment to the UE, is received at the UE side in SCell's slot # denoted  $i$ . The UE shall switch its bandwidth part from BWP-1 to BWP-2.

The UE shall be able to receive PDSCH no later than the first DL slot that occurs after the beginning of SCell's DL slot ( $i+T_{\text{BWPswitchDelay}}$ ) as defined in clause 8.6 and starts to report valid ACK/NACK for the SCell on PCell no later than the first UL slot that occurs after the beginning of slot ( $i+T_{\text{BWPswitchDelay}}+k_1$ ). The UE shall be continuously scheduled on SCell's BWP-2 no later than the first DL slot that occurs after the beginning of slot ( $i+T_{\text{BWPswitchDelay}}$ ).

The starting time of PCell (Cell 1) interruption due to BWP switch on SCell shall occur within the BWP switch delay.

During T2, the test equipment won't transmit DCI format for PDSCH reception on SCell (Cell 2).

During T3,

The time period T3 starts from the slot # $j$ , where  $j$  is the first slot of the subframe immediately after *bwp-InactivityTimer* timer expires. The UE should switch its bandwidth part from BWP-2 back to the default bandwidth part – BWP-1.

The UE shall be able to receive PDSCH no later than the first DL slot that occurs after the beginning of SCell's slot ( $j+T_{\text{BWPswitchDelay}}$ ) as defined in clause 8.6 and starts to report valid ACK/NACK for the SCell on PCell at latest on the first UL slot that occurs after the beginning of slot ( $j+T_{\text{BWPswitchDelay}}+k_1$ ). The UE shall be continuously scheduled on SCell's BWP-1 no later than the first DL slot that occurs after the beginning of slot ( $j+T_{\text{BWPswitchDelay}}$ ).

The starting time of PCell (Cell 1) interruption due to BWP switch of SCell shall occur within the BWP switch delay.

The test equipment verifies the DL BWP switch time in SCell by counting the slots from the time when the BWP switch command is received or *bwp-InactivityTimer* timer expires till an ACK/NACK is received.

The test equipment verifies that potential interruption to PCell is carried out in the correct time span by monitoring ACK/NACK sent in PCell during BWP switch of SCell, respectively.

**Table A.6.5.6.1.1-1: DL BWP switch supported test configurations for NR PCell**

Config	Description
1	NR 15 kHz SSB SCS, $\geq 10$ MHz bandwidth, FDD duplex mode
2	NR 15 kHz SSB SCS, $\geq 10$ MHz bandwidth, TDD duplex mode
3	NR 30 kHz SSB SCS, $\geq 40$ MHz bandwidth, TDD duplex mode
Note 1:	The UE is only required to be tested in one of the supported test configurations
Note 2:	The UE is only required to be tested in one with smallest aggregated channel bandwidth from supported band combinations which is composed of CCs $\geq$ the bandwidth ( $BW_{\text{channel}}$ ) defined in each test configuration,

**Table A.6.5.6.1.1.1-1A: DL BWP switch supported test configurations for NR SCell**

Config <sub>SCell</sub>	Description
1	NR 15 kHz SSB SCS, ≥10 MHz bandwidth, FDD duplex mode
2	NR 15 kHz SSB SCS, ≥10 MHz bandwidth, TDD duplex mode
3	NR 30 kHz SSB SCS, ≥40 MHz bandwidth, TDD duplex mode
Note 1: The UE is only required to be tested in one of the supported test configurations	
Note 2: The UE is only required to be tested in one with smallest aggregated channel bandwidth from supported band combinations which is composed of CCs ≥ the bandwidth ( $BW_{channel}$ ) defined in each test configuration,	

**Table A.6.5.6.1.1.1-2: General test parameters for DL BWP switch in SA**

Parameter	Unit	Value	Comment
NR RF Channel Number		1, 2	Two NR radio channels are used for this test
Active PCell		Cell 1	PCell on RF channel number 1.
Active SCell		Cell 2	SCell on RF channel number 2.
CP length		Normal	
DRX		OFF	For both PCell and SCell
<i>bwp-InactivityTimer</i>	ms	200	
PDCCH and PDSCH maximum number of HARQ transmission		1	For both PCell and SCell
Cell-individual offset for cells on RF channel number 1	dB	0	Individual offset for cells on PCC.
Cell-individual offset for cells on RF channel number 2	dB	0	Individual offset for cells on SCC.
Cell2 timing offset to cell1	μs	3	Time alignment error as specified in TS 38.104 [13] clause 6.5.3.1.
T1	s	0.2	
T2	s	0.2	
T3	s	0.2	

**Table A.6.5.6.1.1.1-3: NR Cell specific test parameters for NR PCell for DL BWP switch in SA**

Parameter	Unit	Cell 1
Frequency Range		FR1
Duplex mode	Config 1	FDD
	Config 2,3	TDD
TDD configuration	Config 1	Not Applicable
	Config 2	TDDConf.1.1
	Config 3	TDDConf.1.2
$BW_{channel}$	Config 1,2	Note 7
	Config 3	Note 7
$BW_{occupied}$	Config 1,2	52 <sup>Note 5</sup>
	Config 3	106 <sup>Note 6</sup>
Active BWP ID		0
Initial DL BWP Configuration		DLBWP.0.2 <sup>Note4</sup>
Initial UL BWP Configuration		ULBWP.0.2 <sup>Note4</sup>
Active DL BWP-0 Configuration		DLBWP.0.2 <sup>Note4</sup>
Active DL BWP-1 Configuration		N.A.
Active DL BWP-2 Configuration		N.A.
Active UL BWP-0 Configuration		ULBWP.0.2 <sup>Note4</sup>
Active UL BWP-1 Configuration		N.A.
Active UL BWP-2 Configuration		N.A.
PDSCH Reference measurement channel	Config 1	SR.1.1 FDD
	Config 2	SR.1.1 TDD
	Config 3	SR.2.1 TDD
RMSI CORESET parameters	Config 1	CR.1.1 FDD
	Config 2	CR.1.1 TDD
	Config 3	CR.2.1 TDD

Dedicated CORESET parameters	Config 1		CCR.1.2 FDD
	Config 2		CCR.1.2 TDD
	Config 3		CCR.2.4 TDD
TRS Configuration	Config 1		TRS.1.1 FDD
	Config 2		TRS.1.1 TDD
	Config 3		TRS.1.2 TDD
OCNG Patterns	Config 1,2		OP.1 <sup>Note 5</sup>
	Config 3		OP.1 <sup>Note 6</sup>
SSB Configuration	Config 1,2		SSB.1 FR1
	Config 3		SSB.2 FR1
SMTc Configuration			SMTc.1
Correlation Matrix and Antenna Configuration			1x2 Low
EPRE ratio of PSS to SSS		dB	0
EPRE ratio of PBCH DMRS to SSS			
EPRE ratio of PBCH to PBCH DMRS			
EPRE ratio of PDCCH DMRS to SSS			
EPRE ratio of PDCCH to PDCCH DMRS			
EPRE ratio of PDSCH DMRS to SSS			
EPRE ratio of PDSCH to PDSCH			
EPRE ratio of OCNG DMRS to SSS(Note 1)			
EPRE ratio of OCNG to OCNG DMRS (Note 1)			
N <sub>oc</sub> <sup>Note 2</sup>	Config 1,2	dBm/SCS	-104
	Config 3		-101
N <sub>oc</sub> <sup>Note 2</sup>		dBm/15KHz	-104
SS-RSRP <sup>Note 3</sup>	Config 1,2	dBm/SCS	-87
	Config 3		-84
Ē <sub>s</sub> /I <sub>ot</sub>		dB	17
Ē <sub>s</sub> /N <sub>oc</sub>		dB	17
I <sub>o</sub> <sup>Note 3</sup>	Config 1,2	dBm/ 9.36MHz	-58.96
	Config 3	dBm/ 38.16MHz	-52.86
Propagation Condition			AWGN
<p>Note 1: OCNG shall be used such that both cells are fully allocated and a constant total transmitted power spectral density is achieved for all OFDM symbols.</p> <p>Note 2: Interference from other cells and noise sources not specified in the test is assumed to be constant over subcarriers and time and shall be modelled as AWGN of appropriate power for N<sub>oc</sub> to be fulfilled within BW<sub>occupied</sub>.</p> <p>Note 3: SS-RSRP and I<sub>o</sub> levels have been derived from other parameters for information purposes. They are not settable parameters themselves.</p> <p>Note 4: For unpaired spectrum, a DL BWP is linked with an UL BWP. DLBWP.0.2 is linked with ULBWP.0.2; DLBWP.1.1 is linked with ULBWP.1.1; DLBWP.1.3 is linked with ULBWP.1.3 defined in clause 12 of TS 38.213 [3].</p> <p>Note 5: All UL/DL transmission shall be confined within BW<sub>occupied</sub> (i.e. 10 MHz, 52 RBs) from F<sub>C,low</sub>, and I<sub>o</sub> is independent of the BW<sub>channel</sub> configured.</p> <p>Note 6: All UL/DL transmission shall be confined within BW<sub>occupied</sub> (i.e. 40 MHz, 106 RBs) from F<sub>C,low</sub>, and I<sub>o</sub> is independent of the BW<sub>channel</sub> configured.</p> <p>Note 7: N<sub>RB,c</sub> is derived from Table 5.3.2-1 in TS38.101-1[2] with configured BW<sub>channel</sub>.</p>			

**Table A.6.5.6.1.1-4: NR Cell specific test parameters for NR SCell for DL BWP switch in SA**

Parameter	Unit	Cell2
Frequency Range		FR1
Duplex mode	Config <sub>SCell</sub> 1	FDD
	Config <sub>SCell</sub> 2,3	TDD
TDD configuration	Config <sub>SCell</sub> 1	Not Applicable
	Config <sub>SCell</sub> 2	TDDConf.1.1
	Config <sub>SCell</sub> 3	TDDConf.1.2

BW <sub>channel</sub>	Config <sub>SCell</sub> 1,2	RB	Note 7
	Config <sub>SCell</sub> 3		Note 7
BW <sub>occupied</sub>	Config <sub>SCell</sub> 1,2	RB	52 <sup>Note 5</sup>
	Config <sub>SCell</sub> 3		106 <sup>Note 6</sup>
Active BWP ID			1, 2
Initial DL BWP Configuration			DLBWP.0.2 <sup>Note4</sup>
Initial UL BWP Configuration			N.A.
Active DL BWP-0 Configuration			N.A.
Active DL BWP-1 Configuration			DLBWP.1.1 <sup>Note4</sup>
Active DL BWP-2 Configuration			DLBWP.1.3 <sup>Note4</sup>
Active UL BWP-0 Configuration			N.A.
Active UL BWP-1 Configuration			N.A.
Active UL BWP-2 Configuration			N.A.
PDSCH Reference measurement channel	Config <sub>SCell</sub> 1		SR.1.1 FDD
	Config <sub>SCell</sub> 2		SR.1.1 TDD
	Config <sub>SCell</sub> 3		SR.2.1 TDD
RMSI CORESET parameters	Config <sub>SCell</sub> 1		CR.1.1 FDD
	Config <sub>SCell</sub> 2		CR.1.1 TDD
	Config <sub>SCell</sub> 3		CR.2.1 TDD
Dedicated CORESET parameters	Config <sub>SCell</sub> 1		CCR.1.2 FDD
	Config <sub>SCell</sub> 2		CCR.1.2 TDD
	Config <sub>SCell</sub> 3		CCR.2.4 TDD
TRS Configuration	Config <sub>SCell</sub> 1		TRS.1.1 FDD
	Config <sub>SCell</sub> 2		TRS.1.1 TDD
	Config <sub>SCell</sub> 3		TRS.1.2 TDD
OCNG Patterns	Config <sub>SCell</sub> 1,2		OP.1 <sup>Note 5</sup>
	Config <sub>SCell</sub> 3		OP.1 <sup>Note 6</sup>
SSB Configuration	Config <sub>SCell</sub> 1,2		SSB.1 FR1
	Config <sub>SCell</sub> 3		SSB.2 FR1
SMTC Configuration			SMTC.1
Correlation Matrix and Antenna Configuration			1x2 Low
EPRE ratio of PSS to SSS		dB	0
EPRE ratio of PBCH DMRS to SSS			
EPRE ratio of PBCH to PBCH DMRS			
EPRE ratio of PDCCH DMRS to SSS			
EPRE ratio of PDCCH to PDCCH DMRS			
EPRE ratio of PDSCH DMRS to SSS			
EPRE ratio of PDSCH to PDSCH			
EPRE ratio of OCNG DMRS to SSS <sup>Note 1</sup>			
EPRE ratio of OCNG to OCNG DMRS <sup>Note 1</sup>			
N <sub>oc</sub> <sup>Note 2</sup>	Config <sub>SCell</sub> 1,2		
	Config <sub>SCell</sub> 3	-101	
N <sub>oc</sub> <sup>Note 2</sup>		dBm/15KHz	-104
SS-RSRP <sup>Note 3</sup>	Config <sub>SCell</sub> 1,2	dBm/SCS	-87
	Config <sub>SCell</sub> 3		-84
E <sub>s</sub> /I <sub>ot</sub>		dB	17
E <sub>s</sub> /N <sub>oc</sub>		dB	17
I <sub>o</sub> <sup>Note3</sup>	Config <sub>SCell</sub> 1,2	dBm/ 9.36MHz	-58.96
	Config <sub>SCell</sub> 3	dBm/ 38.16MHz	-52.86
Propagation Condition			AWGN



Note 1:	OCNG shall be used such that both cells are fully allocated and a constant total transmitted power spectral density is achieved for all OFDM symbols.
Note 2:	Interference from other cells and noise sources not specified in the test is assumed to be constant over subcarriers and time and shall be modelled as AWGN of appropriate power for $N_{oc}$ to be fulfilled within $BW_{occupied}$ .
Note 3:	SS-RSRP and $I_0$ levels have been derived from other parameters for information purposes. They are not settable parameters themselves.
Note 4:	For unpaired spectrum, a DL BWP is linked with an UL BWP. DLBWP.0.2 is linked with ULBWP.0.2; DLBWP.1.1 is linked with ULBWP.1.1; DLBWP.1.3 is linked with ULBWP.1.3 defined in clause 12 of TS 38.213 [3].
Note 5:	All UL/DL transmission shall be confined within $BW_{occupied}$ (i.e. 10 MHz, 52 RBs) from $F_{C,low}$ , and $I_0$ is independent of the $BW_{channel}$ configured.
Note 6:	All UL/DL transmission shall be confined within $BW_{occupied}$ (i.e. 40 MHz, 106 RBs) from $F_{C,low}$ , and $I_0$ is independent of the $BW_{channel}$ configured.
Note 7:	$N_{RB,c}$ is derived from Table 5.3.2-1 in TS38.101-1[2] with configured $BW_{channel}$ .

#### A.6.5.6.1.1.2 Test Requirements

During T1, the UE shall start to send the ACK/NACK for SCell on PCell from the first UL slot that occurs after the beginning of DL slot ( $i+T_{BWPswitchDelay}+k_1$ ).

During T3, the UE shall start to send the ACK/NACK for SCell on PCell from the first UL slot that occurs after the beginning of DL slot ( $j+T_{BWPswitchDelay}+k_1$ ).

Where,  $k_1$  is the timing between DL data receiving and acknowledgement as specified in [7].

Depending on UE capability *bwp-SwitchingDelay* [2], UE shall finish BWP switch within the time duration  $T_{BWPswitchDelay}$  defined in Table 8.6.2-1.

All of the above test requirements shall be fulfilled in order for the observed SCell active BWP switch delay to be counted as correct.

The rate of correct events observed during repeated tests shall be at least 90%.

During T1 and T3, the start time of PCell interruption during SCell active BWP switch shall not happen outside the BWP switch delay.

The interruption of PCell shall not be longer than the interruption duration specified for active BWP switch in clause 8.2.2.2.5.

All of the above test requirements shall be fulfilled in order for the observed SCell active BWP switch interruption to be counted as correct.

The rate of correct events observed during repeated tests shall be at least 90%.

NOTE: During T1, T3 if there are no uplink resources for reporting the ACK/NACK in the first UL slot that occurs after the beginning of DL slot ( $i+T_{BWPswitchDelay}+k_1$ ), ( $j+T_{BWPswitchDelay}+k_1$ ), then the UE shall use the next available uplink resource for reporting the corresponding ACK/NACK.

#### A.6.5.6.1.2 NR FR1 DL active BWP switch with non-DRX in SA

##### A.6.5.6.1.2.1 Test Purpose and Environment

The purpose of this test is to verify the DL BWP switch delay requirement defined in clause 8.6.

The supported test configurations are shown in Table A.6.5.6.1.2.1-1. The test scenario comprises of one cell (Cell 1) as given in Table A.6.5.6.1.2.1-2. Cell-specific parameters of the cell are specified in Table A.6.5.6.1.2.1-3 below.

PDCCHs indicating new transmissions shall be sent continuously on Cell 1 to ensure that the UE will have ACK/NACK sending.

Before the test starts,

- UE is connected to Cell 1 on radio channel 1.
- UE is configured with 2 different UE-specific downlink bandwidth parts, BWP-1 and BWP-2 before starting the test. BWP-1 and BWP-2 always include bandwidth of the initial DL BWP and SSB.
- UE is indicated in *firstActiveDownlinkBWP-Id* that the active DL BWP is BWP-1.
- UE is configured with a *bwp-InactivityTimer* timer value for Cell1.

The cell has constant signal levels throughout the test.

The test consists of 3 successive time periods, with durations of T1, T2, and T3, respectively.

During T1,

Time period T1 starts when a DCI format 1\_1 command for DL BWP switch, sent from the test equipment to the UE, is received at the UE side in Cell1's slot # denoted  $i$ . The UE shall switch its bandwidth part from BWP-1 to BWP-2.

The UE shall be able to receive PDSCH on the first DL slot that occurs after the beginning of Cell1's DL slot ( $i+T_{BWPswitchDelay}$ ) as defined in clause 8.6 and starts to report valid ACK/NACK for the Cell1 no later than the first UL slot that occurs after the beginning of slot ( $i+T_{BWPswitchDelay}+kI$ ). The UE shall be continuously scheduled on Cell1's BWP-2 starting from the first DL slot that occurs after the beginning of slot ( $i+T_{BWPswitchDelay}$ ).

During T2, the test equipment won't transmit DCI format for PDSCH reception on Cell1.

During T3,

The time period T3 starts from the slot # $j$ , where  $j$  is the first slot of the subframe immediately after *bwp-InactivityTimer* timer expires. The UE shall switch its bandwidth part from BWP-2 back to the default bandwidth part – BWP-1.

The UE shall be able to receive PDSCH on the first DL slot that occurs after the beginning of Cell1's slot ( $j+T_{BWPswitchDelay}$ ) as defined in clause 8.6 and starts to report valid ACK/NACK for the Cell1 at latest on the first UL slot that occurs after the beginning of slot ( $j+T_{BWPswitchDelay}+kI$ ). The UE shall be continuously scheduled on Cell1's BWP-1 starting from the first DL slot that occurs after the beginning of slot ( $j+T_{BWPswitchDelay}$ ).

The test equipment verifies the DL BWP switch time by counting the slots from the time when the BWP switch command is received or *bwp-InactivityTimer* timer expires till an ACK/NACK is received.

**Table A.6.5.6.1.2.1-1: DL BWP switch supported test configurations**

Config	Description
1	NR 15 kHz SSB SCS, 10 MHz bandwidth, FDD duplex mode
2	NR 15 kHz SSB SCS, 10 MHz bandwidth, TDD duplex mode
3	NR 30 kHz SSB SCS, 40 MHz bandwidth, TDD duplex mode
Note 1:	The UE is only required to be tested in one of the supported test configurations.
Note 2:	A UE which fulfils the requirements in test case A.6.5.6.1.1 can skip the test cases in A.6.5.6.1.2.

**Table A.6.5.6.1.2.1-2: General test parameters for DL BWP switch in SA**

Parameter	Unit	Value	Comment
NR RF Channel Number		1	One NR radio channel is used for this test
Active Cell		Cell 1	Cell1 on RF channel number 1.
CP length		Normal	
DRX		OFF	
<i>bwp-InactivityTimer</i>	ms	200	
PDCCH and PDSCH maximum number of HARQ transmission		1	
T1	s	0.2	
T2	s	0.2	
T3	s	0.2	

Table A.6.5.6.1.2.1-3: NR Cell specific test parameters for DL BWP switch in SA

Parameter		Unit	Cell 1
Frequency Range			FR1
Duplex mode	Config 1		FDD
	Config 2,3		TDD
TDD configuration	Config 1		Not Applicable
	Config 2		TDDConf.1.1
	Config 3		TDDConf.2.1
$BW_{\text{channel}}$	Config 1		10 MHz: $N_{RB,c} = 52$
	Config 2		10 MHz: $N_{RB,c} = 52$
	Config 3		40 MHz: $N_{RB,c} = 106$
Active BWP ID			1, 2
Initial DL BWP Configuration	Config 1,2,3		DLBWP.0.2 <sup>Note 4</sup>
Active DL BWP-1 Configuration	Config 1,2,3		DLBWP.1.1 <sup>Note 4</sup>
Active DL BWP-2 Configuration	Config 1,2,3		DLBWP.1.3 <sup>Note 4</sup>
Initial UL BWP Configuration	Config 1,2,3		ULBWP.0.2 <sup>Note 4</sup>
Active UL BWP-1 Configuration	Config 1,2,3		ULBWP.1.1 <sup>Note 4</sup>
Active UL BWP-2 Configuration	Config 1		N/A
	Config 2,3		ULBWP.1.3 <sup>Note 4</sup>
PDSCH Reference measurement channel	Config 1		SR.1.1 FDD
	Config 2		SR.1.1 TDD
	Config 3		SR.2.1 TDD
RMSI CORESET parameters	Config 1		CR.1.1 FDD
	Config 2		CR.1.1 TDD
	Config 3		CR.2.1 TDD
Dedicated CORESET parameters	Config 1		CCR.1.2 FDD
	Config 2		CCR.1.2 TDD
	Config 3		CCR.2.4 TDD
OCNG Patterns			OP.1
SSB Configuration	Config 1,2		SSB.1 FR1
	Config 3		SSB.2 FR1
SMTc Configuration			SMTc.1
Correlation Matrix and Antenna Configuration			1x2 Low
TRS Configuration	Config 1,4		TRS.1.1 FDD
	Config 2,5		TRS.1.1 TDD
	Config 3,6		TRS.1.2 TDD
EPRE ratio of PSS to SSS		dB	0
EPRE ratio of PBCH DMRS to SSS			
EPRE ratio of PBCH to PBCH DMRS			
EPRE ratio of PDCCH DMRS to SSS			
EPRE ratio of PDCCH to PDCCH DMRS			
EPRE ratio of PDSCH DMRS to SSS			
EPRE ratio of PDSCH to PDSCH			
EPRE ratio of OCNG DMRS to SSS(Note 1)			
EPRE ratio of OCNG to OCNG DMRS (Note 1)			
$N_{oc}$ <sup>Note 2</sup>	Config 1,2	dBm/SCS	-104
	Config 3		-101
$N_{oc}$ <sup>Note 2</sup>		dBm/15kHz	-104
SS-RSRP <sup>Note 3</sup>	Config 1,2	dBm/SCS	-87
	Config 3		-84
$\tilde{E}_s/I_{ot}$		dB	17
$\tilde{E}_s/N_{oc}$		dB	17

$I_{o}^{\text{Note3}}$	Config 1,2	dBm/ 9.36MHz	-58.96
	Config 3	dBm/ 38.16MHz	-52.86
Propagation Condition			AWGN
Note 1:	OCNG shall be used such that the resources in Cell 1 are fully allocated and a constant total transmitted power spectral density is achieved for all OFDM symbols.		
Note 2:	Interference from other cells and noise sources not specified in the test is assumed to be constant over subcarriers and time and shall be modelled as AWGN of appropriate power for $N_{oc}$ to be fulfilled.		
Note 3:	SS-RSRP and $I_o$ levels have been derived from other parameters for information purposes. They are not settable parameters themselves.		
Note 4:	For unpaired spectrum, a DL BWP is linked with an UL BWP. DLBWP.0.2 is linked with ULBWP.0.2; DLBWP.1.1 is linked with ULBWP.1.1; DLBWP.1.3 is linked with ULBWP.1.3 defined in clause 12 of TS 38.213 [3].		

#### A.6.5.6.1.2.2 Test Requirements

During T1, the UE shall start to send the ACK/NACK for PCell from the first UL slot that occurs after the beginning of DL slot ( $i+T_{BWPswitchDelay}+kI$ ).

During T3, the UE shall start to send the ACK/NACK for PCell from the first UL slot that occurs after the beginning of DL slot ( $j+T_{BWPswitchDelay}+kI$ ).

Where,  $kI$  is the timing between DL data receiving and acknowledgement as specified in [7].

Depending on UE capability *bwp-SwitchingDelay* [2], UE shall finish BWP switch within the time duration  $T_{BWPswitchDelay}$  defined in Table 8.6.2-1.

All of the above test requirements shall be fulfilled in order for the observed Cell1 active BWP switch delay to be counted as correct.

The rate of correct events observed during repeated tests shall be at least 90%.

NOTE: During T1, T3 if there are no uplink resources for reporting the ACK/NACK in the first UL slot that occurs after beginning of DL slot ( $i+T_{BWPswitchDelay}+kI$ ), ( $j+T_{BWPswitchDelay}+kI$ ), then the UE shall use the next available uplink resource for reporting the corresponding ACK/NACK.

#### A.6.5.6.2 RRC-based Active BWP Switch

##### A.6.5.6.2.1 NR FR1 DL active BWP switch of Cell with non-DRX in SA

##### A.6.5.6.2.1.1 Test Purpose and Environment

The purpose of this test is to verify the DL BWP switch delay requirement for RRC-based BWP switch defined in clause 8.6.

The supported test configurations are shown in Table A.6.5.6.2.1.1-1. The test scenario comprises of one Cell (Cell 1) as given in Table A.6.5.6.2.1.1-2. Cell-specific parameters of Cell are specified in Table A.6.5.6.2.1.1-3 below.

PDCCHs indicating new transmissions shall be sent continuously on Cell 1 to ensure that the UE will have ACK/NACK sending.

Before the test starts,

- UE is connected to Cell 1 on radio channel 1.
- UE has bandwidth part BWP-1 in its RRC-configuration for Cell 1.
- UE is indicated in *firstActiveDownlinkBWP-Id* that the active DL BWP is BWP-1 of initial condition in Cell 1.

All cells have constant signal levels throughout the test.

The test consists of 1 time period, with duration of T1.

During T1,

Time period T1 starts when a *RRCReconfiguration* with updated bandwidth part configuration, sent from the test equipment to the UE, is completely received at the UE side in PCell’s slot # denoted *i*. The UE shall reconfigure its bandwidth part with the updated bandwidth part BWP-1 of final condition.

The UE shall be able to receive PDSCH on PCell from the first DL slot that occurs after the beginning of DL slot  $i + \frac{T_{RRCprocessingDelay} + T_{BWPswitchDelayRRC}}{NR\ Slot\ length}$  as defined in clause 8.6.3 and starts to report valid ACK/NACK for the PCell from the first UL slot that occurs after the beginning of DL slot  $i + \frac{T_{RRCprocessingDelay} + T_{BWPswitchDelayRRC}}{NR\ Slot\ length} + k1$  on BWP-1 of final condition. The UE shall be continuously scheduled on PCell’s BWP-1 of final condition starting from the first DL slot right after slot  $i + \frac{T_{RRCprocessingDelay} + T_{BWPswitchDelayRRC}}{NR\ Slot\ length}$ .

$T_{RRCprocessingDelay}$  and  $T_{BWPswitchDelayRRC}$  are defined in clause 8.6.3.

The test equipment verifies the DL BWP switch time in Cell by counting the time from the time when the RRC Reconfiguration message including updated BWP configuration is sent till the time when a valid ACK/NACK is received is received.

**Table A.6.5.6.2.1.1-1: DL BWP switch supported test configurations in SA scenario**

Config	Description
1	NR 15 kHz SSB SCS, 10 MHz bandwidth, FDD duplex mode
2	NR 15 kHz SSB SCS, 10 MHz bandwidth, TDD duplex mode
3	NR 30kHz SSB SCS, 40 MHz bandwidth, TDD duplex mode
Note 1: The UE is only required to be tested in one of the supported test configurations	

**Table A.6.5.6.2.1.1-2: General test parameters for DL BWP switch in SA scenario**

Parameter	Unit	Value	Comment
NR RF Channel Number		1	One NR radio channel is used for this test
Active Cell		Cell 1	Cell on RF channel number 1.
CP length		Normal	
DRX		OFF	
PDCCH and PDSCH maximum number of HARQ transmission		1	
T1	s	0.2	

**Table A.6.5.6.2.1.1-3: NR Cell specific test parameters for DL BWP switch in SA scenario**

Parameter		Unit	Cell 1
Frequency Range			FR1
Duplex mode	Config 1		FDD
	Config 2,3		TDD
TDD configuration	Config 1		Not Applicable
	Config 2		TDDConf.1.1
	Config 3		TDDConf.2.1
BW <sub>channel</sub>	Config 1		10 MHz: N <sub>RB,c</sub> = 52
	Config 2		10 MHz: N <sub>RB,c</sub> = 52
	Config 3		40 MHz: N <sub>RB,c</sub> = 106
Active BWP ID			1
Initial DL BWP Configuration	Config 1,2, 3		DLBWP.0.2
Initial UL BWP Configuration	Config 1,2, 3		ULBWP.0.2
Initial Condition	Active DL BWP-1 Configuration	Config 1, 2, 3	DLBWP.1.3

	Active UL BWP-1 Configuration	Config 1, 2, 3		ULBWP.1.3
Final Condition	Active DL BWP-1 Configuration	Config 1, 2, 3		DLBWP.1.1
	Active UL BWP-1 Configuration	Config 1, 2, 3		ULBWP.1.1
PDSCH Reference measurement channel		Config 1		SR.1.1 FDD
		Config 2		SR.1.1 TDD
		Config 3		SR2.1 TDD
RMSI CORESET parameters		Config 1		CR.1.1 FDD
		Config 2		CR.1.1 TDD
		Config 3		CR2.1 TDD
Dedicated CORESET parameters		Config 1		CCR.1.2 FDD
		Config 2		CCR.1.2 TDD
		Config 3		CCR.2.4 TDD
OCNG Patterns				OP.1
SSB Configuration		Config 1,2		SSB.1 FR1
		Config 3		SSB.2 FR1
SMTC Configuration				SMTC.1
TRS Configuration		Config 1		TRS.1.1 FDD
		Config 2		TRS.1.1 TDD
		Config 3		TRS.1.2 TDD
Antenna Configuration				1x2 Low
Propagation Condition				AWGN
EPRE ratio of PSS to SSS			dB	0
EPRE ratio of PBCH DMRS to SSS				
EPRE ratio of PBCH to PBCH DMRS				
EPRE ratio of PDCCH DMRS to SSS				
EPRE ratio of PDCCH to PDCCH DMRS				
EPRE ratio of PDSCH DMRS to SSS				
EPRE ratio of PDSCH to PDSCH				
EPRE ratio of OCNG DMRS to SSS <sup>(Note 1)</sup>				
EPRE ratio of OCNG to OCNG DMRS <sup>(Note 1)</sup>				
N <sub>oc</sub> <sup>Note 2</sup>		Config 1,2		
		Config 3	-101	
SS-RSRP <sup>Note 3</sup>		Config 1,2	dBm/SCS	-87
		Config 3		-84
Ē <sub>s</sub> /I <sub>ot</sub>			dB	17
Ē <sub>s</sub> /N <sub>oc</sub>			dB	17
I <sub>o</sub> <sup>Note3</sup>		Config 1,2	dBm/ 9.36MHz	-58.96
		Config 3		dBm/ 38.16MHz
<p>Note 1: OCNG shall be used such that both cells are fully allocated and a constant total transmitted power spectral density is achieved for all OFDM symbols.</p> <p>Note 2: Interference from other cells and noise sources not specified in the test is assumed to be constant over subcarriers and time and shall be modelled as AWGN of appropriate power for N<sub>oc</sub> to be fulfilled.</p> <p>Note 3: SS-RSRP and I<sub>o</sub> levels have been derived from other parameters for information purposes. They are not settable parameters themselves.</p> <p>Note 4: For unpaired spectrum, a DL BWP is linked with an UL BWP. DLBWP.0.2 is linked with ULBWP.0.2; DLBWP.1.1 is linked with ULBWP.1.1; DLBWP.1.3 is linked with ULBWP.1.3 defined in clause 12 of TS 38.213 [3].</p>				

### A.6.5.6.2.1.2 Test Requirements

During T1, the UE shall be ready for the reception of uplink grant for the Cell from the first DL slot that occurs right after the beginning of slot  $i + \frac{T_{\text{RRCprocessingDelay}} + T_{\text{BWPswitchDelayRRC}}}{\text{NR Slot length}}$  and starts to report valid ACK/NACK for PCell from the first UL slot that occurs after the beginning of DL slot  $i + \frac{T_{\text{RRCprocessingDelay}} + T_{\text{BWPswitchDelayRRC}}}{\text{NR Slot length}} + k1$ .

Where,  $k1$  is the timing between DL data receiving and acknowledgement as specified in [7].

All of the above test requirements shall be fulfilled in order for the observed Cell active BWP switch delay to be counted as correct.

The rate of correct events observed during repeated tests shall be at least 90%.

### A.6.5.6.3 Simultaneous DCI-based and Timer-based Active BWP Switch on multiple CCs

#### A.6.5.6.3.1 NR FR1- NR FR1 DL active BWP switch on multiple CCs with non-DRX in SA

##### A.6.5.6.3.1.1 Test Purpose and Environment

The purpose of this test is to verify requirements on the DL BWP switch delay on multiple CCs and interruption requirement for NR victim cell, both defined in clause 8.6.

The supported test configurations for NR PCell are shown in Table A.6.5.6.3.1.1-1 below. The supported test configurations for NR SCells are shown in Table A.6.5.6.3.1.1-1A below. Test configuration for NR PCell and test configuration for NR SCells are chosen independently. Test configuration for two NR SCells are chosen independently. The test scenario comprises of one NR PCell (Cell 1) and two NR SCells (Cell 2 and Cell 3) as given in Table A.6.5.6.3.1.1-2. NR Cell-specific parameters are specified in Table A.6.5.6.3.1.1-3, Table A.6.5.6.3.1.1-4 and Table A.6.5.6.3.1.1-5 below.

PDCCHs indicating new transmissions shall be sent continuously on SCell (Cell 2) and SCell (Cell 3) to ensure that the UE would have ACK/NACK sending except for the time duration when BWP is switching on Cell 2 and Cell 3 and the time duration of T2.

PDCCHs indicating new transmissions shall be sent continuously on SCell (Cell 3) to ensure that the UE will have ACK/NACK sending. Before the test starts,

- UE is connected to PCell (Cell 1) on radio channel 1 (PCC), and SCell (Cell 2) on radio channel 2 (SCC) and SCell (Cell 3) on radio channel 3(SCC).
- UE is configured with 2 different UE-specific downlink bandwidth parts for SCell (Cell 2) and SCell (Cell 3), BWP-1 and BWP-2, in Cell 2 and Cell 3 before starting the test. BWP-1 and BWP-2 always include bandwidth of the initial DL BWP and SSB.
- UE is configured with a single UE-specific downlink bandwidth part, BWP-0, for PCell (Cell 1). BWP-0 includes the bandwidth of the initial DL BWP and SSB.
- UE is indicated in *firstActiveDownlinkBWP-Id* that the active DL BWP is BWP-1 in SCell (Cell 2) and SCell (Cell 3).
- UE is indicated in *firstActiveDownlinkBWP-Id* that the active DL BWP is BWP-0 in PCell (Cell 1).
- UE is configured with a *bwp-InactivityTimer* timer value for SCell (Cell 2) and SCell (Cell 3).

All cells have constant signal levels throughout the test.

The test consists of 3 successive time periods, with durations of T1, T2, and T3, respectively.

During T1,

Time period T1 starts when a DCI format 1\_1 command for both SCell (Cell 2) and SCell (Cell 3) DL BWP switch, sent from the test equipment to the UE, is received at the UE side in both SCell (Cell 2)'s and SCell (Cell 3)'s slot # denoted  $i$ . The UE shall switch its bandwidth part from BWP-1 to BWP-2 at both SCell (Cell 2) and SCell (Cell 3).

The UE shall be able to receive PDSCH no later than the first DL slot that occurs after the beginning of SCell (Cell 2)'s and SCell (Cell 3)'s DL slot ( $i + T_{MultipleBWPswitchDelay}$ ) as defined in clause 8.6.2A.1 and starts to report valid ACK/NACK for the both SCell (Cell 2) and SCell (Cell 3) no later than the first UL slot that occurs after the beginning of slot ( $i + T_{MultipleBWPswitchDelay} + kI$ ). The UE shall be continuously scheduled on both SCell (Cell 2)'s and SCell (Cell 3)'s BWP-2 no later than the first DL slot that occurs after the beginning of slot ( $i + T_{MultipleBWPswitchDelay}$ ).

The starting time of PCell interruption due to BWP switch on SCell (Cell 2) and SCell (Cell 3) shall occur within the BWP switch delay.

During T2, the test equipment won't transmit DCI format for PDSCH reception on SCell (Cell 2) and SCell (Cell 3).

During T3,

The time period T3 starts from the slot # $j$ , where  $j$  is the first slot of the subframe immediately after *bwp-InactivityTimer* timer expires. The UE should switch its bandwidth part from BWP-2 back to the default bandwidth part – BWP-1 on both SCell (Cell 2) and SCell (Cell 3).

The UE shall be able to receive PDSCH no later than the first DL slot that occurs after the beginning of SCell (Cell 2)'s and SCell (Cell 3)'s slot ( $j + T_{MultipleBWPswitchDelay}$ ) as defined in clause 8.6.2A.1 and starts to report valid ACK/NACK for the SCell (Cell 2) and SCell (Cell 3) no later than the first UL slot that occurs after the beginning of slot ( $j + T_{MultipleBWPswitchDelay} + kI$ ). The UE shall be continuously scheduled on SCell (Cell 2)'s and SCell (Cell 3)'s BWP-1 no later than the first DL slot that occurs after the beginning of slot ( $j + T_{MultipleBWPswitchDelay}$ ).

The starting time of PCell interruption due to BWP switch of SCell (Cell 2) and SCell (Cell 3) shall occur within the BWP switch delay.

The test equipment verifies the DL BWP switch time in SCells by counting the slots from the time when the BWP switch command is received or *bwp-InactivityTimer* timer expires till an ACK/NACK is received.

The test equipment verifies that potential interruption to PCell is carried out in the correct time span by monitoring ACK/NACK sent in PCell during BWP switch of SCells, respectively.

**Table A.6.5.6.3.1.1-1: DL BWP switch supported test configurations for NR PCell**

Config	Description
1	NR 15 kHz SSB SCS, $\geq 10$ MHz bandwidth, FDD duplex mode
2	NR 15 kHz SSB SCS, $\geq 10$ MHz bandwidth, TDD duplex mode
3	NR 30 kHz SSB SCS, $\geq 40$ MHz bandwidth, TDD duplex mode
Note 1:	The UE is only required to be tested in one of the supported test configurations
Note 2:	The UE is only required to be tested in one with smallest aggregated channel bandwidth from supported band combinations which is composed of CCs $\geq$ the bandwidth ( $BW_{channel}$ ) defined in each test configuration

**Table A.6.5.6.3.1.1-1A: DL BWP switch supported test configurations for NR SCells**

Config <sub>SCell</sub>	Description
1	NR 15 kHz SSB SCS, $\geq 10$ MHz bandwidth, FDD duplex mode
2	NR 15 kHz SSB SCS, $\geq 10$ MHz bandwidth, TDD duplex mode
3	NR 30 kHz SSB SCS, $\geq 40$ MHz bandwidth, TDD duplex mode
Note 1:	The UE is only required to be tested in one of the supported test configurations
Note 2:	The UE is only required to be tested in one with smallest aggregated channel bandwidth from supported band combinations which is composed of CCs $\geq$ the bandwidth ( $BW_{channel}$ ) defined in each test configuration
Note 3:	Test configurations of two NR SCells are selected independently.

**Table A.6.5.6.3.1.1-2: General test parameters for DL BWP switch in SA**

Parameter	Unit	Value	Comment
NR RF Channel Number		1, 2	Two NR radio channels are used for this test
Active PCell		Cell 1	PCell on RF channel number 1.
Active SCell		Cell 2; Cell 3	SCell on RF channel number 2 and number 3.
CP length		Normal	



DRX		OFF	For both PCell and SCells (Cell 2 and Cell 3)
<i>bwp-InactivityTimer</i>	ms	200	
Cell-individual offset for cells on RF channel number 1	dB	0	Individual offset for cells on PCC.
Cell-individual offset for cells on RF channel number 2	dB	0	Individual offset for Cell 1 on SCC.
Cell-individual offset for cells on RF channel number 3	dB	0	Individual offset for Cell 2 on SCC.
Cell2 and Cell 3 timing offset to cell1	$\mu$ s	3	Time alignment error as specified in TS 38.104 [13] clause 6.5.3.1.
T1	s	0.2	
T2	s	0.2	
T3	s	0.2	

Table A.6.5.6.3.1.1-3: NR Cell specific test parameters for NR PCell for DL BWP switch in SA

Parameter		Unit	Cell 1
Frequency Range			FR1
Duplex mode	Config 1		FDD
	Config 2,3		TDD
TDD configuration	Config 1		Not Applicable
	Config 2		TDDConf.1.1
	Config 3		TDDConf.2.1
BW <sub>channel</sub>	Config 1,2		10 MHz: N <sub>RB,c</sub> = 52
	Config 3		40 MHz: N <sub>RB,c</sub> = 106
Active BWP ID			0
Initial DL BWP Configuration			DLBWP.0.2 <sup>Note4</sup>
Initial UL BWP Configuration			ULBWP.0.2 <sup>Note4</sup>
Active DL BWP-0 Configuration			DLBWP.0.2 <sup>Note4</sup>
Active DL BWP-1 Configuration			N.A.
Active DL BWP-2 Configuration			N.A.
Active UL BWP-0 Configuration			ULBWP.0.2 <sup>Note4</sup>
Active UL BWP-1 Configuration			N.A.
Active UL BWP-2 Configuration			N.A.
PDSCH Reference measurement channel	Config 1		SR.1.1 FDD
	Config 2		SR.1.1 TDD
	Config 3		SR.2.1 TDD
RMSI CORESET parameters	Config 1		CR.1.1 FDD
	Config 2		CR.1.1 TDD
	Config 3		CR.2.1 TDD
Dedicated CORESET parameters	Config 1		CCR.1.1 FDD
	Config 2		CCR.1.1 TDD
	Config 3		CCR.2.1 TDD
OCNG Patterns			OP.1
SSB Configuration	Config 1,2		SSB.1 FR1
	Config 3		SSB.2 FR1
SMTC Configuration			SMTC.1
Correlation Matrix and Antenna Configuration			1x2 Low
EPRE ratio of PSS to SSS		dB	0
EPRE ratio of PBCH DMRS to SSS			
EPRE ratio of PBCH to PBCH DMRS			
EPRE ratio of PDCCH DMRS to SSS			
EPRE ratio of PDCCH to PDCCH DMRS			
EPRE ratio of PDSCH DMRS to SSS			
EPRE ratio of PDSCH to PDSCH			
EPRE ratio of OCNG DMRS to SSS(Note 1)			
EPRE ratio of OCNG to OCNG DMRS (Note 1)			
N <sub>oc</sub> <sup>Note 2</sup>	Config 1,2		
	Config 3	-101	
N <sub>oc</sub> <sup>Note 2</sup>		dBm/15KH z	-104

SS-RSRP <sup>Note 3</sup>	Config 1,2	dBm/SCS	-87
	Config 3		-84
$\bar{E}_s/I_{ot}$		dB	17
$\bar{E}_s/N_{oc}$		dB	17
$I_o$ <sup>Note3</sup>	Config 1,2	dBm/ 9.36MHz	-58.96
	Config 3	dBm/ 38.16MHz	-52.86
Propagation Condition			AWGN
<p>Note 1: OCNG shall be used such that both cells are fully allocated and a constant total transmitted power spectral density is achieved for all OFDM symbols.</p> <p>Note 2: Interference from other cells and noise sources not specified in the test is assumed to be constant over subcarriers and time and shall be modelled as AWGN of appropriate power for <math>N_{oc}</math> to be fulfilled.</p> <p>Note 3: SS-RSRP and <math>I_o</math> levels have been derived from other parameters for information purposes. They are not settable parameters themselves.</p> <p>Note 4: For unpaired spectrum, a DL BWP is linked with an UL BWP. DLBWP.0.2 is linked with ULBWP.0.2; DLBWP.1.1 is linked with ULBWP.1.1; DLBWP.1.3 is linked with ULBWP.1.3 defined in clause 12 of TS 38.213 [3].</p>			

Table A.6.5.6.3.1.1-4: NR Cell specific test parameters for SCell (NR Cell 2) for DL BWP switch in SA

Parameter		Unit	Cell 2
Frequency Range			FR1
Duplex mode	Config <sub>SCell2</sub> 1		FDD
	Config <sub>SCell2</sub> 2,3		TDD
TDD configuration	Config <sub>SCell2</sub> 1		Not Applicable
	Config <sub>SCell2</sub> 2		TDDConf.1.1
	Config <sub>SCell2</sub> 3		TDDConf.2.1
BW <sub>channel</sub>	Config <sub>SCell2</sub> 1,2		10 MHz: $N_{RB,c} = 52$
	Config <sub>SCell2</sub> 3		40 MHz: $N_{RB,c} = 106$
Active BWP ID			1, 2
Initial DL BWP Configuration			DLBWP.0.2 <sup>Note4</sup>
Initial UL BWP Configuration			ULBWP.0.2 <sup>Note4</sup>
Active DL BWP-0 Configuration			N.A.
Active DL BWP-1 Configuration			DLBWP.1.1 <sup>Note4</sup>
Active DL BWP-2 Configuration			DLBWP.1.3 <sup>Note4</sup>
Active UL BWP-0 Configuration			N.A.
Active UL BWP-1 Configuration			ULBWP.1.1 <sup>Note4</sup>
Active UL BWP-2 Configuration			ULBWP.1.3 <sup>Note4</sup>
PDSCH Reference measurement channel	Config <sub>SCell2</sub> 1		SR.1.1 FDD
	Config <sub>SCell2</sub> 2		SR.1.1 TDD
	Config <sub>SCell2</sub> 3		SR.2.1 TDD
RMSI CORESET parameters	Config <sub>SCell2</sub> 1		CR.1.1 FDD
	Config <sub>SCell2</sub> 2		CR.1.1 TDD
	Config <sub>SCell2</sub> 3		CR.2.1 TDD
Dedicated CORESET parameters	Config <sub>SCell2</sub> 1		CCR.1.1 FDD
	Config <sub>SCell2</sub> 2		CCR.1.1 TDD
	Config <sub>SCell2</sub> 3		CCR.2.1 TDD
OCNG Patterns			OP.1
SSB Configuration	Config <sub>SCell2</sub> 1,2		SSB.1 FR1
	Config <sub>SCell2</sub> 3		SSB.2 FR1
SMTc Configuration			SMTc.1
Correlation Matrix and Antenna Configuration			1x2 Low
EPRE ratio of PSS to SSS		dB	0
EPRE ratio of PBCH DMRS to SSS			
EPRE ratio of PBCH to PBCH DMRS			
EPRE ratio of PDCCH DMRS to SSS			
EPRE ratio of PDCCH to PDCCH DMRS			
EPRE ratio of PDSCH DMRS to SSS			
EPRE ratio of PDSCH to PDSCH			
EPRE ratio of OCNG DMRS to SSS(Note 1)			

EPRE ratio of OCNG to OCNG DMRS (Note 1)			
$N_{oc}$ <sup>Note 2</sup>	Config <sub>SCell2</sub> 1,2	dBm/SCS	-104
	Config <sub>SCell2</sub> 3		-101
$N_{oc}$ <sup>Note 2</sup>		dBm/15KH z	-104
SS-RSRP <sup>Note 3</sup>	Config <sub>SCell2</sub> 1,2	dBm/SCS	-87
	Config <sub>SCell2</sub> 3		-84
$\bar{E}_s/I_{ot}$		dB	17
$\bar{E}_s/N_{oc}$		dB	17
$I_o$ <sup>Note3</sup>	Config <sub>SCell2</sub> 1,2	dBm/ 9.36MHz	-58.96
	Config <sub>SCell2</sub> 3	dBm/ 38.16MHz	-52.86
Propagation Condition			AWGN
<p>Note 1: OCNG shall be used such that both cells are fully allocated and a constant total transmitted power spectral density is achieved for all OFDM symbols.</p> <p>Note 2: Interference from other cells and noise sources not specified in the test is assumed to be constant over subcarriers and time and shall be modelled as AWGN of appropriate power for <math>N_{oc}</math> to be fulfilled.</p> <p>Note 3: SS-RSRP and <math>I_o</math> levels have been derived from other parameters for information purposes. They are not settable parameters themselves.</p> <p>Note 4: For unpaired spectrum, a DL BWP is linked with an UL BWP. DLBWP.0.2 is linked with ULBWP.0.2; DLBWP.1.1 is linked with ULBWP.1.1; DLBWP.1.3 is linked with ULBWP.1.3 defined in clause 12 of TS 38.213 [3].</p>			

**Table A.6.5.6.3.1.1-5: NR Cell specific test parameters for SCell (NR Cell 3) for DL BWP switch in SA**

Parameter		Unit	Cell 3
Frequency Range			FR1
Duplex mode	Config <sub>SCell3</sub> 1		FDD
	Config <sub>SCell3</sub> 2,3		TDD
TDD configuration	Config <sub>SCell3</sub> 1		Not Applicable
	Config <sub>SCell3</sub> 2		TDDConf.1.1
	Config <sub>SCell3</sub> 3		TDDConf.2.1
BW <sub>channel</sub>	Config <sub>SCell3</sub> 1,2		10 MHz: $N_{RB,c} = 52$
	Config <sub>SCell3</sub> 3		40 MHz: $N_{RB,c} = 106$
Active BWP ID			1,2
Initial DL BWP Configuration			DLBWP.0.2 <sup>Note4</sup>
Initial UL BWP Configuration			ULBWP.0.2 <sup>Note4</sup>
Active DL BWP-0 Configuration			N.A.
Active DL BWP-1 Configuration			DLBWP.1.1 <sup>Note4</sup>
Active DL BWP-2 Configuration			DLBWP.1.3 <sup>Note4</sup>
Active UL BWP-0 Configuration			N.A.
Active UL BWP-1 Configuration			ULBWP.1.1 <sup>Note4</sup>
Active UL BWP-2 Configuration			ULBWP.1.3 <sup>Note4</sup>
PDSCH Reference measurement channel	Config <sub>SCell3</sub> 1		SR.1.1 FDD
	Config <sub>SCell3</sub> 2		SR.1.1 TDD
	Config <sub>SCell3</sub> 3		SR.2.1 TDD
RMSI CORESET parameters	Config <sub>SCell3</sub> 1		CR.1.1 FDD
	Config <sub>SCell3</sub> 2		CR.1.1 TDD
	Config <sub>SCell3</sub> 3		CR.2.1 TDD
Dedicated CORESET parameters	Config <sub>SCell3</sub> 1		CCR.1.1 FDD
	Config <sub>SCell3</sub> 2		CCR.1.1 TDD
	Config <sub>SCell3</sub> 3		CCR.2.1 TDD
OCNG Patterns			OP.1
SSB Configuration	Config <sub>SCell3</sub> 1,2		SSB.1 FR1
	Config <sub>SCell3</sub> 3		SSB.2 FR1
SMTC Configuration			SMTC.1
Correlation Matrix and Antenna Configuration			1x2 Low
EPRE ratio of PSS to SSS		dB	0
EPRE ratio of PBCH DMRS to SSS			
EPRE ratio of PBCH to PBCH DMRS			

EPRE ratio of PDCCH DMRS to SSS			
EPRE ratio of PDCCH to PDCCH DMRS			
EPRE ratio of PDSCH DMRS to SSS			
EPRE ratio of PDSCH to PDSCH			
EPRE ratio of OCNG DMRS to SSS(Note 1)			
EPRE ratio of OCNG to OCNG DMRS (Note 1)			
$N_{oc}$ <sup>Note 2</sup>	Config <sub>SCell3</sub> 1,2	dBm/SCS	-104
	Config <sub>SCell3</sub> 3		-101
$N_{oc}$ <sup>Note 2</sup>		dBm/15KHz	-104
SS-RSRP <sup>Note 3</sup>	Config <sub>SCell3</sub> 1,2	dBm/SCS	-87
	Config <sub>SCell3</sub> 3		-84
$\hat{E}_s/I_{ot}$		dB	17
$\hat{E}_s/N_{oc}$		dB	17
$I_o$ <sup>Note3</sup>	Config <sub>SCell3</sub> 1,2	dBm/ 9.36MHz	-58.96
	Config <sub>SCell3</sub> 3	dBm/ 38.16MHz	-52.86
Propagation Condition			AWGN
<p>Note 1: OCNG shall be used such that both cells are fully allocated and a constant total transmitted power spectral density is achieved for all OFDM symbols.</p> <p>Note 2: Interference from other cells and noise sources not specified in the test is assumed to be constant over subcarriers and time and shall be modelled as AWGN of appropriate power for <math>N_{oc}</math> to be fulfilled.</p> <p>Note 3: SS-RSRP and <math>I_o</math> levels have been derived from other parameters for information purposes. They are not settable parameters themselves.</p> <p>Note 4: For unpaired spectrum, a DL BWP is linked with an UL BWP. DLBWP.0.2 is linked with ULBWP.0.2; DLBWP.1.1 is linked with ULBWP.1.1; DLBWP.1.3 is linked with ULBWP.1.3 defined in clause 12 of TS 38.213 [3].</p>			

#### A.6.5.6.3.1.2 Test Requirements

During T1, the UE shall start to send the ACK/NACK for both SCell (Cell 2) and SCell (Cell 3) from the first UL slot that occurs after the beginning of DL slot  $(i + T_{MultipleBWPswitchDelay} + kI)$ .

During T3, the UE shall start to send the ACK/NACK for both SCell (Cell 2) and SCell (Cell 3) from the first UL slot that occurs after the beginning of DL slot  $(j + T_{MultipleBWPswitchDelay} + kI)$ .

Where,  $kI$  is the timing between DL data receiving and acknowledgement as specified in [7].

Depending on UE capability *bwp-SwitchingDelay* [2], UE shall finish BWP switch within the time duration  $T_{MultipleBWPswitchDelay}$  defined in 8.6.2A.1.

All of the above test requirements shall be fulfilled in order for the observed Cell 2 and Cell 3 active BWP switch delay to be counted as correct.

The rate of correct events observed during repeated tests shall be at least 90%.

During T1 and T3, the start time of PCell interruption during SCell (Cell 2) and SCell (Cell 3) active BWP switch shall not happen outside the BWP switch delay.

The interruption of PCell shall not be longer than the interruption duration specified for active BWP switch in clause 8.2.2.2.5.

All of the above test requirements shall be fulfilled in order for the observed SCell (Cell 2) and SCell (Cell 3) active BWP switch interruption to be counted as correct.

The rate of correct events observed during repeated tests shall be at least 90%.

NOTE: During T1, T3 if there are no uplink resources for reporting the ACK/NACK in the first UL slot that occurs after beginning of DL slot  $(i + T_{MultipleBWPswitchDelay} + kI)$ ,  $(j + T_{MultipleBWPswitchDelay} + kI)$ , then the UE shall use the next available uplink resource for reporting the corresponding ACK/NACK.

#### A.6.5.6.4 SCell dormancy switch

##### A.6.5.6.4.1 NR FR1 PCell SCell dormancy switch of single FR1 SCell outside active time

###### A.6.5.6.4.1.1 Test Purpose and Environment

The purpose of this test is to verify the SCell dormancy switch delay requirements defined in clause 8.6 when the UE is triggered to switch between dormancy to non-dormancy and non-dormancy to dormancy outside the DRX active time. Further the test purpose is to verify the interruption rate on other serving cells when the UE performing CSI and RRM measurements on dormant SCell(s) as defined in clause 8.2.2.2.12 and also to verify the interruption requirement on other active serving cell defined in clause 8.2.2.2.5.

In the test scenario UE is connected to one PCell (Cell 1) in FR1 and one SCell in FR1. In the test the SCell is switched from non-dormancy to dormancy, and vice versa, at a point in time before start of *onDuration*. The UE is configured to monitor PDCCH for DCI format 2\_6 at *ps-Offset* before the start of *onDuration*. Two tests are specified, where a UE that only supports triggering within the first three OFDM symbols of a slot shall undergo Test1 only, and a UE that supports triggering also in remaining OFDM symbols of a slot shall undergo both Test1 and Test2. In the tested scenario, *ps-Offset* is selected to correspond to the dormancy switching time specified in clause 8.6.

The supported test configurations for NR PCell are shown in Table A.6.5.6.4.1.1-1, The supported test configurations for NR SCell are shown in Table A.6.5.6.4.1.1-1A. Test configuration for NR PCell and test configuration for NR SCell are chosen independently. The general test parameters are given in Table A.6.5.6.4.1.1-2. NR Cell-specific parameters are specified in Table A.6.5.6.4.1.1-3 and Table A.6.5.6.4.1.1-4.

Before the test starts,

- UE is connected to Cell 1 (PCell) on radio channel 1 (PCC), and Cell 2 (SCell) on radio channel 2 (SCC).
- UE is configured with 1 UE-specific downlink bandwidth parts the same as initial BWP for PCell, BWP-0 in Cell 1 before starting the test.
- UE is configured with 2 different UE-specific downlink bandwidth parts for SCell, BWP-1 and BWP-2, in Cell 2 before starting the test. BWP-1 and BWP-2 always include bandwidth of the initial DL BWP and SSB.
- UE is indicated in *firstActiveDownlinkBWP-Id* that the active DL BWP is BWP-0 in PCell.
- UE is indicated in *firstActiveDownlinkBWP-Id* that the active DL BWP is BWP-1 in SCell.
- UE is indicated in *dormantBWP-Id* that the active DL BWP is BWP-2 in the SCell.
- UE is configured with DRX.
- UE is configured to monitor DCI format 2\_6, and to be active during *onDuration* even when no DCI format 2\_6 is detected (*ps-WakeUp*).

All cells have constant signal levels throughout the test.

The test consists of 4 successive time periods, with durations of T1, T2, T3 and T4, respectively.

During T1,

Time period T1 starts when a DCI format 2\_6 command intended for dormant BWP switch in a SCell from non-dormancy to dormancy, sent from the test equipment to the UE, is received at the UE side in PCell's slot # denoted *i* (at *ps-Offset* before *onDuration*). Upon reception of the PDCCH indicating entering dormant BWP in PCell (i.e. through cross-carrier scheduling), UE shall switch the DL BWP-1 to DL BWP-2 in SCell, i.e., switching from non-dormant BWP to dormant BWP and the UE shall complete the switching before the start of *onDuration*.

The UE shall be able to receive PDCCH on PCell no later than the first DL slot that occurs after the beginning of PCell's DL slot ( $i + T_{\text{dormantBWPswitchDelay}}$ ) as defined in clause 8.6 and starts to report valid ACK/NACK on the PCell no later than the first UL slot that occurs after the beginning of slot ( $i+N$ ) as defined in clause 10.3 in TS38.213. The UE shall be continuously scheduled on PCell's BWP-0 no later than the first DL slot that occurs after the beginning of slot ( $i + T_{\text{dormantBWPswitchDelay}}$ ).

The starting time of PCell (Cell 1) interruption due to dormancy switching on SCell shall occur within the dormant BWP switch delay, i.e. before start of *onDuration*.

The UE shall not transmit signals on SCell after the beginning of PCell's DL slot ( $i + T_{\text{dormantBWPswitchDelay}}$ ) as defined in clause 8.6. The UE shall not be scheduled on SCells BWP-1 no later than the first DL slot that occurs after the beginning of slot ( $i + T_{\text{dormantBWPswitchDelay}}$ ).

Time period T2 starts when T1 is completed. During T2, the test equipment continues to schedule the UE continuously in PCell. The UE shall carry out CSI and RRM measurements on the dormant SCells. The UE shall report ACK/NACK in PCell in response to scheduled PDSCH, with the maximum loss of transmitted ACK/NACKs fulfilling the requirement in clause 8.2.2.2.12. The test equipment verifies that the loss of ACK/NACKs is no larger than 1.5%.

Time period T3 starts when T2 is completed. During T3, the test equipment does not schedule the UE, by which the inactivity timer expires and the UE stops monitoring PDCCH except for signalling using DCI format 2\_6 at wake-up signalling occasions.

During T4,

Time period T4 starts when a DCI format 2\_6 command for leaving dormant BWP in SCell, sent from the test equipment to the UE, is received at the UE side in PCell's slot # denoted  $j$  (at *ps-Offset* before *onDuration*). Upon reception of the PDCCH indicating leaving dormant BWP in PCell (i.e. through cross-carrier scheduling), UE shall switch the DL BWP-2 to DL BWP-1 in SCell, i.e., switching from dormant BWP to non-dormant BWP.

The UE shall be able to receive PDSCH on PCell and SCell no later than the first DL slot that occurs after the beginning of PCell's DL slot ( $j + T_{\text{dormantBWPswitchDelay}}$ ) as defined in clause 8.6 and starts to report valid ACK/NACK on the PCell (for both PCell and SCell) no later than the first UL slot that occurs after the beginning of slot ( $j + N$ ) as defined in clause 10.3 in TS 38.213. The UE shall be continuously scheduled on PCell's BWP-0 no later than the first DL slot that occurs after the beginning of slot ( $j + T_{\text{dormantBWPswitchDelay}}$ ).

The starting time of PCell (Cell 1) interruption due to dormancy switching on SCell shall occur within the dormant BWP switch delay.

The UE shall be ready to transmit signals on SCell no later than the first DL slot that occurs after the beginning of PCell's DL slot ( $j + T_{\text{dormantBWPswitchDelay}}$ ) as defined in clause 8.6. The UE shall be ready to continuously scheduled on SCell's BWP-1 no later than the first DL slot that occurs after the beginning of slot ( $j + T_{\text{dormantBWPswitchDelay}}$ ).

The test equipment verifies the DL dormant BWP switch time in SCell by counting the slots from the time when the dormant BWP switch command is received till an ACK/NACK on PCell is received.

The test equipment verifies that potential interruption to PCell is carried out in the correct time span by monitoring ACK/NACK sent in PCell during dormant BWP switch of SCell (i.e. before start of *onDuration*), respectively.

**Table A.6.5.6.4.1.1-1: SCell dormancy switch supported test configurations for NR PCell**

Config	Description
1	NR 15 kHz SSB SCS, $\geq 10$ MHz bandwidth, FDD duplex mode
2	NR 15 kHz SSB SCS, $\geq 10$ MHz bandwidth, TDD duplex mode
3	NR 30 kHz SSB SCS, $\geq 40$ MHz bandwidth, TDD duplex mode
Note 1:	The UE is only required to be tested in one of the supported test configurations
Note 2:	The UE is only required to be tested in one with smallest aggregated channel bandwidth from supported band combinations which is composed of CCs $\geq$ the bandwidth ( $BW_{\text{channel}}$ ) defined in each test configuration

**Table A.6.5.6.4.1.1-1A: SCell dormancy switch supported test configurations for NR SCell**

Config <sub>SCell</sub>	Description
1	NR 15 kHz SSB SCS, $\geq 10$ MHz bandwidth, FDD duplex mode
2	NR 15 kHz SSB SCS, $\geq 10$ MHz bandwidth, TDD duplex mode
3	NR 30 kHz SSB SCS, $\geq 40$ MHz bandwidth, TDD duplex mode
Note 1:	The UE is only required to be tested in one of the supported test configurations
Note 2:	The UE is only required to be tested in one with smallest aggregated channel bandwidth from supported band combinations which is composed of CCs $\geq$ the bandwidth ( $BW_{\text{channel}}$ ) defined in each test configuration

Table A.6.5.6.4.1.1-2: General test parameters for SCell dormancy switch in SA

Parameter	Unit	Value		Comment
		Test 1	Test 2	
NR RF Channel Number		1, 2		Two NR radio channels are used for this test
Active PCell		Cell 1		PCell on RF channel number 1.
Active SCell		Cell 2		SCell on RF channel number 2.
CP length		Normal		
DRX		ON		For both PCell and SCell
Cell-individual offset for cells on RF channel number 1	dB	0		Individual offset for cells on PCC.
Cell-individual offset for cells on RF channel number 2	dB	0		Individual offset for cells on SCC.
Cell2 timing offset to cell1	μs	3		Time alignment error as specified in TS 38.104 [13] clause 6.5.3.1.
OFDM symbol range in slot for transmission of DCI with dormancy indication		0 – 2	3 – 11	
T1	s	0.2		
T2	s	0.2		

Table A.6.5.6.4.1.1-3: NR Cell specific test parameters for NR PCell for SCell dormancy switch in SA

Parameter		Unit	Cell 1
Frequency Range			FR1
Duplex mode	Config 1		FDD
	Config 2,3		TDD
TDD configuration	Config 1		Not Applicable
	Config 2		TDDConf.1.1
	Config 3		TDDConf.2.1
BW <sub>channel</sub>	Config 1,2		10 MHz: N <sub>RB,c</sub> = 52
	Config 3		40 MHz: N <sub>RB,c</sub> = 106
Active BWP ID			0
Initial DL BWP Configuration			DLBWP.0.2 <sup>Note4</sup>
Initial UL BWP Configuration			ULBWP.0.2 <sup>Note4</sup>
Active DL BWP-0 Configuration			DLBWP.0.2 <sup>Note4</sup>
Active DL BWP-1 Configuration			N.A.
Active DL BWP-2 Configuration			N.A.
Active UL BWP-0 Configuration			ULBWP.0.2 <sup>Note4</sup>
Active UL BWP-1 Configuration			N.A.
Active UL BWP-2 Configuration			N.A.
PDSCH Reference measurement channel	Config 1		SR.1.1 FDD
	Config 2		SR.1.1 TDD
	Config 3		SR.2.1 TDD
RMSI CORESET parameters	Config 1		CR.1.1 FDD
	Config 2		CR.1.1 TDD
	Config 3		CR.2.1 TDD
Dedicated CORESET parameters, Test 1	Config 1		CCR.1.1 FDD
	Config 2		CCR.1.1 TDD
	Config 3		CCR.2.1 TDD
Dedicated CORESET parameters, Test 2	Config 1		CCR.1.5 FDD
	Config 2		CCR.1.5 TDD
	Config 3		CCR.2.3 TDD
OCNG Patterns			OP.1
SSB Configuration	Config 1,2		SSB.1 FR1
	Config 3		SSB.2 FR1
SMTc Configuration			SMTc.1
Correlation Matrix and Antenna Configuration			1x2 Low
EPRE ratio of PSS to SSS		dB	0
EPRE ratio of PBCH DMRS to SSS			
EPRE ratio of PBCH to PBCH DMRS			
EPRE ratio of PDCCH DMRS to SSS			

EPRE ratio of PDCCH to PDCCH DMRS			
EPRE ratio of PDSCH DMRS to SSS			
EPRE ratio of PDSCH to PDSCH			
EPRE ratio of OCNG DMRS to SSS(Note 1)			
EPRE ratio of OCNG to OCNG DMRS (Note 1)			
$N_{oc}^{Note 2}$	Config 1,2	dBm/SCS	-104
	Config 3		-101
$N_{oc}^{Note 2}$		dBm/15KHz	-104
SS-RSRP <sup>Note 3</sup>	Config 1,2	dBm/SCS	-87
	Config 3		-84
$\hat{E}_s/I_{ot}$		dB	17
$\hat{E}_s/N_{oc}$		dB	17
$I_o^{Note3}$	Config 1,2	dBm/ 9.36MHz	-58.96
	Config 3	dBm/ 38.16MHz	-52.86
Propagation Condition			AWGN
<p>Note 1: OCNG shall be used such that both cells are fully allocated and a constant total transmitted power spectral density is achieved for all OFDM symbols.</p> <p>Note 2: Interference from other cells and noise sources not specified in the test is assumed to be constant over subcarriers and time and shall be modelled as AWGN of appropriate power for <math>N_{oc}</math> to be fulfilled.</p> <p>Note 3: SS-RSRP and <math>I_o</math> levels have been derived from other parameters for information purposes. They are not settable parameters themselves.</p> <p>Note 4: For unpaired spectrum, a DL BWP is linked with an UL BWP. DLBWP.0.2 is linked with ULBWP.0.2; DLBWP.1.1 is linked with ULBWP.1.1; DLBWP.1.3 is linked with ULBWP.1.3 defined in clause 12 of TS 38.213 [3].</p>			

Table A.6.5.6.4.1.1-4: NR Cell specific test parameters for NR SCell for SCell dormancy switch in SA

Parameter		Unit	Cell2
Frequency Range			FR1
Duplex mode	Config <sub>SCell</sub> 1		FDD
	Config <sub>SCell</sub> 2,3		TDD
TDD configuration	Config <sub>SCell</sub> 1		Not Applicable
	Config <sub>SCell</sub> 2		TDDConf.1.1
	Config <sub>SCell</sub> 3		TDDConf.2.1
$BW_{channel}$	Config <sub>SCell</sub> 1,2		10 MHz: $N_{RB,c} = 52$
	Config <sub>SCell</sub> 3		40 MHz: $N_{RB,c} = 106$
Active BWP ID			1
Initial DL BWP Configuration			DLBWP.0.2 <sup>Note4</sup>
Initial UL BWP Configuration			ULBWP.0.2 <sup>Note4</sup>
Active DL BWP-0 Configuration			N.A.
Active DL BWP-1 Configuration			DLBWP.1.1 <sup>Note4</sup>
Active DL BWP-2 Configuration			DLBWP.1.3 <sup>Note4</sup>
Active UL BWP-0 Configuration			N.A.
Active UL BWP-1 Configuration			ULBWP.1.1 <sup>Note4</sup>
Active UL BWP-2 Configuration			ULBWP.1.3 <sup>Note4</sup>
PDSCH Reference measurement channel	Config <sub>SCell</sub> 1		SR.1.1 FDD
	Config <sub>SCell</sub> 2		SR.1.1 TDD
	Config <sub>SCell</sub> 3		SR.2.1 TDD
RMSI CORESET parameters	Config <sub>SCell</sub> 1		CR.1.1 FDD
	Config <sub>SCell</sub> 2		CR.1.1 TDD
	Config <sub>SCell</sub> 3		CR.2.1 TDD
Dedicated CORESET parameters, Test 1	Config <sub>SCell</sub> 1		CCR.1.1 FDD
	Config <sub>SCell</sub> 2		CCR.1.1 TDD
	Config <sub>SCell</sub> 3		CCR.2.1 TDD
Dedicated CORESET parameters, Test 2	Config <sub>SCell</sub> 1		CCR.1.1 FDD
	Config <sub>SCell</sub> 2		CCR.1.1 TDD
	Config <sub>SCell</sub> 3		CCR.2.3 TDD
OCNG Patterns			OP.1
SSB Configuration	Config <sub>SCell</sub> 1,2		SSB.1 FR1



	Config <sub>SCell 3</sub>		SSB.2 FR1
SMTC Configuration			SMTC.1
Correlation Matrix and Antenna Configuration			1x2 Low
EPRE ratio of PSS to SSS		dB	0
EPRE ratio of PBCH DMRS to SSS			
EPRE ratio of PBCH to PBCH DMRS			
EPRE ratio of PDCCH DMRS to SSS			
EPRE ratio of PDCCH to PDCCH DMRS			
EPRE ratio of PDSCH DMRS to SSS			
EPRE ratio of PDSCH to PDSCH			
EPRE ratio of OCNG DMRS to SSS(Note 1)			
EPRE ratio of OCNG to OCNG DMRS (Note 1)			
N <sub>oc</sub> <sup>Note 2</sup>	Config <sub>SCell 1,2</sub>	dBm/SCS	-104
	Config <sub>SCell 3</sub>		-101
N <sub>oc</sub> <sup>Note 2</sup>		dBm/15KHz	-104
SS-RSRP <sup>Note 3</sup>	Config <sub>SCell 1,2</sub>	dBm/SCS	-87
	Config <sub>SCell 3</sub>		-84
$\dot{E}_s/I_{ot}$		dB	17
$\dot{E}_s/N_{oc}$		dB	17
I <sub>o</sub> <sup>Note3</sup>	Config <sub>SCell 1,2</sub>	dBm/ 9.36MHz	-58.96
	Config <sub>SCell 3</sub>	dBm/ 38.16MHz	-52.86
Propagation Condition			AWGN
<p>Note 1: OCNG shall be used such that both cells are fully allocated and a constant total transmitted power spectral density is achieved for all OFDM symbols.</p> <p>Note 2: Interference from other cells and noise sources not specified in the test is assumed to be constant over subcarriers and time and shall be modelled as AWGN of appropriate power for N<sub>oc</sub> to be fulfilled.</p> <p>Note 3: SS-RSRP and I<sub>o</sub> levels have been derived from other parameters for information purposes. They are not settable parameters themselves.</p> <p>Note 4: For unpaired spectrum, a DL BWP is linked with an UL BWP. DLBWP.0.2 is linked with ULBWP.0.2; DLBWP.1.1 is linked with ULBWP.1.1; DLBWP.1.3 is linked with ULBWP.1.3 defined in clause 12 of TS 38.213 [3].</p>			

#### A.6.5.6.4.1.2 Test Requirements

During T1, the UE shall start to send the ACK/NACK for PCell from the first UL slot that occurs after the beginning of DL slot ( $i+N$ ) (i.e. from the start of *onDuration*).

During time period T2, the UE shall transmit ACK/NACKs in response to scheduling in PCell and the rate of missed ACK/NACKs shall be no more than 1.5%.

During T4, the UE shall start to send the ACK/NACK for PCell and SCell from the first UL slot that occurs after the beginning of DL slot ( $j+N$ ) (i.e. from the start of *onDuration*).

Where,  $N$  is the timing that UE provide HARQ-ACK information in response to a detection of a DCI format 2\_6 indicating SCell dormancy as specified in [3].

All of the above test requirements shall be fulfilled in order for the observed SCell dormant BWP switch delay to be counted as correct.

The rate of correct events observed during repeated tests shall be at least 90%.

During T1 and T4, the start time of PCell interruption during SCell dormant BWP switch shall not happen outside the dormant BWP switch delay.

The interruption of PCell shall not be longer than the interruption duration specified for dormant BWP switch in clause 8.6.

NOTE: During T1, T4 if there are no uplink resources for reporting the ACK/NACK in the first DL slot that occurs after the beginning of DL slot  $(i + N)$ ,  $(j + N)$ , then the UE shall use the next available uplink resource for reporting the corresponding ACK/NACK.

## A.6.5.6.4.2 NR FR1 PCell SCell dormancy switch of two FR1 SCells inside active time

### A.6.5.6.4.2.1 Test Purpose and Environment

The purpose of this test is to verify fulfillment of SCell dormancy switching delay requirements in clause 8.6.2A, requirements on interruptions due to SCell dormancy switching in clause 8.2.2.2.12.1, and requirements on interruptions due to CSI and RRM measurements on dormant SCells in clauses 8.2.2.2.12.2 and 8.2.2.2.12.3, respectively. In the tested scenario, the UE is connected to PCell and two SCells in FR1, and the SCells are switched from non-dormancy to dormancy, and back, during active time. Depending on UE capability on whether DCI for dormancy switching can be received also later than within the initial three OFDM symbols of a slot, the UE may have to undergo one or two sets of tests. A UE that only supports triggering during within the first three OFDM symbols of a slot shall only undergo Test1 and Test2, whereas a UE that supports triggering also in remaining OFDM symbols of a slot shall undergo Test1 through Test4.

The supported test configurations for NR PCell are provided in Table A.6.5.6.4.2.1-1 below. The supported test configurations for NR SCells are provided in Table A.6.5.6.4.2.1-1A below. Test configuration for NR PCell and test configuration for NR SCells are chosen independently. Test configurations for two NR SCells are chosen independently. General test parameters are provided in Table A.6.5.6.4.2.1-2, and cell-specific parameters are provided in Table A.6.5.6.4.2.1-3, Table A.6.5.6.4.2.1-4 and Table A.6.5.6.4.2.1-5 below.

The tests consist of three consecutive time periods T1, T2, and T3, respectively.

Three carriers are used in the test, each within FR1 and each with one cell. Cell 1 (PCell) is on RF channel 1 (PCC), Cell 2 (SCell1) is on RF channel 2 (SCC1), and Cell 3 (SCell2) is on RF channel 3 (SCC2). All three cells have constant signal levels throughout the test. The UE is continuously scheduled in PCell throughout the test.

Before the test starts,

UE is connected to Cell 1 (PCell), Cell 2 (SCell1) and Cell 3 (SCell2).

UE is configured with a single UE-specific downlink bandwidth part, BWP-0, for Cell 1. BWP-0 includes the bandwidth of the initial DL BWP and SSB.

UE is configured with one non-dormant and one dormant UE-specific downlink bandwidth part, BWP-0 and BWP-1, respectively, for Cell 2 and Cell 3. BWP-0 includes the bandwidth of the initial DL BWP and SSB.

UE is indicated in *firstActiveDownlinkBWP-Id* that the active DL BWP in Cell 1 is BWP-0.

UE is indicated in *firstActiveDownlinkBWP-Id* that the active DL BWP in Cell 2 is BWP-0.

UE is indicated in *firstActiveDownlinkBWP-Id* that the active DL BWP in Cell 3 is BWP-0.

UE is continuously scheduled in PCell, SCell1 and SCell2.

T1 starts at the point in time at which the UE receives a DCI with dormancy indication on PDCCH in PCell at the antenna connector, in a slot # denoted  $m$ , pertaining to dormancy indication for switching SCell1 and SCell2 from non-dormancy to dormancy. The UE shall complete switching of the SCells to dormancy by the end of slot  $m + \text{ceil}(T_{\text{MultipleBWPswitchDelay}}/\text{NR slot length}) + 1$  in Test1 and Test2, and slot  $m + \text{ceil}(T_{\text{MultipleBWPswitchDelay}}/\text{NR slot length}) + 2$  in Test3 and Test4, as specified in clause 8.6.2A. Any PCell interruptions due to the switching between non-dormant and dormant BWPs shall fulfill requirements in clause 8.2.2.2.12.1. The test equipment verifies that interruptions due to switching from non-dormancy to dormancy are within the requirements by analysing HARQ feedback transmitted in PCell for PCell.

During T2, the UE is carrying out CSI and RRM measurements on dormant SCell1 and SCell2. Any PCell interruptions due to CSI and RRM measurements shall fulfill requirements in clauses 8.2.2.2.12.2 and 8.2.2.2.12.3, respectively. The test equipment verifies that the interruptions are within the allowed percentages by counting ACK/NACKs in PCell. At the end of T2, the test equipment transmits a DCI with dormancy indication on PDCCH in PCell carrying a dormancy indication for switching SCell1 and SCell2 from dormancy to non-dormancy.

T3 starts at the point in time at which the UE receives a DCI with dormancy indication on PDCCH in PCell at the antenna connector, in a slot # denoted  $n$ , pertaining to dormancy indication for switching SCell1 and SCell2 from dormancy to non-dormancy. The UE shall complete switching of the SCells to non-dormancy by the end of slot  $n + \text{ceil}(T_{\text{MultipleBWPs}}/\text{NR slot length}) + 1$  in Test1 and Test2, and slot  $n + \text{ceil}(T_{\text{MultipleBWPs}}/\text{NR slot length}) + 2$  in Test3 and test4, as specified in clause 8.6.2A. Any PCell interruptions due to the switching between dormant and non-dormant BWPs shall fulfill requirements in clause 8.2.2.2.12.1. The test equipment verifies that interruptions due to switching from dormancy to non-dormancy are within the requirements by analysing HARQ feedback transmitted in PCell for PCell. The test equipment verifies the switching delay by analysing HARQ feedback transmitted in PCell for SCells.

**Table A.6.5.6.4.2.1-1: Supported test configurations for NR PCell**

Config	Description
1	NR 15 kHz SSB SCS, $\geq 10$ MHz bandwidth, FDD duplex mode
2	NR 15 kHz SSB SCS, $\geq 10$ MHz bandwidth, TDD duplex mode
3	NR 30 kHz SSB SCS, $\geq 40$ MHz bandwidth, TDD duplex mode
Note 1:	The UE is only required to be tested in one of the supported test configurations
Note 2:	The UE is only required to be tested in one with smallest aggregated channel bandwidth from supported band combinations which is composed of CCs $\geq$ the bandwidth ( $BW_{\text{channel}}$ ) defined in each test configuration.

**Table A.6.5.6.4.2.1-1A: Supported test configurations for NR SCells**

Config <sub>SCell</sub>	Description
1	NR 15 kHz SSB SCS, $\geq 10$ MHz bandwidth, FDD duplex mode
2	NR 15 kHz SSB SCS, $\geq 10$ MHz bandwidth, TDD duplex mode
3	NR 30 kHz SSB SCS, $\geq 40$ MHz bandwidth, TDD duplex mode
Note 1:	The UE is only required to be tested in one of the supported test configurations
Note 2:	The UE is only required to be tested in one with smallest aggregated channel bandwidth from supported band combinations which is composed of CCs $\geq$ the bandwidth ( $BW_{\text{channel}}$ ) defined in each test configuration.
Note 3:	Test configurations for two NR SCells are selected independently.

**Table A.6.5.6.4.2.1-2: General test parameters**

Parameter	Unit	Value				Comment
		Test1	Test2	Test3	Test4	
NR RF Channel Number		1, 2, 3				Three NR radio channels are used for this test
Active PCell		Cell 1				Primary cell on NR RF channel number 1 in FR1
SCell1		Cell 2				SCell1 on NR RF channel number 2 in FR1
SCell2		Cell 3				SCell2 on NR RF channel number 3 in FR1
CP length		Normal				
DRX		OFF				Continuous monitoring of primary cell
CSI reporting periodicity, Non-dormant BWP	ms	2				CSI reporting periodicity for periodic reporting of CQI for PCell and non-dormant SCells
CSI reporting periodicity, Dormant BWP	ms	40				CSI reporting periodicity for periodic reporting of CQI for dormant SCells
Timing offset between Cell 1 and Cell 2	ns	0				
Timing offset between Cell 1 and Cell 3	ns	0				
Triggering DCI format		1 <sub>1</sub>	0 <sub>1</sub>	1 <sub>1</sub>	0 <sub>1</sub>	Triggering DCI format for triggering during active time
OFDM symbol range in slot for transmission of DCI with dormancy indication		0 – 2		3 – 11		Test1 and Test3 are based on that triggering DCI is received within the first three OFDM symbols of a slot. Test2 and Test4 are based on that the triggering DCI is received later than within the first three OFDM symbols of a slot.

T1	s	0.2	
T2	s	5	
T3	s	0.2	

**Table A.6.5.6.4.2.1-3: NR Cell specific test parameters for NR PCell**

Parameter		Unit	Cell 1
Frequency range			FR1
NR RF channel			1
Duplex mode	Config 1		FDD
	Config 2,3		TDD
TDD configuration	Config 2		TDDConf.1.1
	Config 3		TDDConf.2.1
BW <sub>channel</sub>	Config 1,2	MHz	10: N <sub>RB,c</sub> = 52
	Config 3		40: N <sub>RB,c</sub> = 106
Downlink initial BWP configuration			DLBWP.0.1
Uplink initial BWP configuration			ULBWP.0.1
Downlink active non-dormant BWP-0 configuration			DLBWP.1.1
Downlink active dormant BWP-1 configuration			---
Uplink active BWP-0 configuration			ULBWP.1.1
TCI state			TCI.State.0
CSI-RS configuration for CSI reporting, Non-dormant BWP	Config 1		CSI-RS.1.1 FDD
	Config 2		CSI-RS.1.1 TDD
	Config 3		CSI-RS.2.1 TDD
CSI-RS configuration for CSI reporting, Dormant BWP	Config 1		---
	Config 2		
	Config 3		
TRS Configuration	Config 1		TRS.1.1 FDD
	Config 2		TRS.1.1 TDD
	Config 3		TRS.1.2 TDD
PDSCH Reference measurement channel	Config 1		SR.1.1 FDD
	Config 2		SR.1.1 TDD
	Config 3		SR.2.1 TDD
Dedicated CORESET parameters, Test 1,2	Config 1		CCR.1.1 FDD
	Config 2		CCR.1.1 TDD
	Config 3		CCR.2.1 TDD
Dedicated CORESET parameters, Test 3,4	Config 1		CCR.1.5 FDD
	Config 2		CCR.1.5 TDD
	Config 3		CCR.2.3 TDD
RMSI CORESET parameters	Config 1		CR.1.1 FDD
	Config 2		CR.1.1 TDD
	Config 3		CR.2.1 TDD
OCNG Pattern			OP.1
SSB Configuration	Config 1,2		SSB.1 FR1
	Config 3		SSB.2 FR1
SMTc configuration			SMTc.1
EPRE ratio of PSS to SSS		dB	0
EPRE ratio of PBCH DMRS to SSS			
EPRE ratio of PBCH to PBCH DMRS			
EPRE ratio of PDCCH DMRS to SSS			
EPRE ratio of PDCCH to PDCCH DMRS			
EPRE ratio of PDSCH DMRS to SSS			
EPRE ratio of PDSCH to PDSCH			
EPRE ratio of OCNG DMRS to SSS <sup>Note1</sup>			
EPRE ratio of OCNG to OCNG DMRS <sup>Note1</sup>			
N <sub>oc</sub> <sup>Note2</sup>	Config 1,2		
	Config 3	-101	
Ē <sub>s</sub> /I <sub>ot</sub>		dB	17

$\hat{E}_s/N_{oc}$		dB	17
SS-RSRP <sup>Note3</sup>	Config 1,2	dBm/SCS	-87
	Config 3		-84
I <sub>o</sub> <sup>Note3</sup>	Config 1,2	dBm/9.36 MHz	-59.0
	Config 3	dBm/38.16 MHz	-52.9
Propagation condition			AWGN
Correlation Matrix and Antenna Configuration			1x2 Low
<p>Note 1: OCNG shall be used such that the cells are fully allocated and a constant total transmitted power spectral density is achieved for all OFDM symbols.</p> <p>Note 2: Interference from other cells and noise sources not specified in the test is assumed to be constant over subcarriers and time and shall be modelled as AWGN of appropriate power for <math>N_{oc}</math> to be fulfilled.</p> <p>Note 3: SS-RSRP, SCH_RP, and I<sub>o</sub> levels have been derived from other parameters for information purpose. They are not settable parameters themselves.</p>			

**Table A.6.5.6.4.2.1-4: NR Cell specific test parameters for NR SCell (Cell 2)**

Parameter		Unit	Cell 2
Frequency range			FR1
NR RF channel			2
Duplex mode	Config <sub>SCell2</sub> 1		FDD
	Config <sub>SCell2</sub> 2,3		TDD
TDD configuration	Config <sub>SCell2</sub> 2		TDDConf.1.1
	Config <sub>SCell2</sub> 3		TDDConf.2.1
BW <sub>channel</sub>	Config <sub>SCell2</sub> 1,2	MHz	10: N <sub>RB,c</sub> = 52
	Config <sub>SCell2</sub> 3		40: N <sub>RB,c</sub> = 106
Downlink initial BWP configuration			DLBWP.0.1
Uplink initial BWP configuration			N/A
Downlink active non-dormant BWP-0 configuration			DLBWP.1.1
Downlink active dormant BWP-1 configuration			DLBWP.1.1
Uplink active BWP-0 configuration			N/A
TCI state			TCI.State.0
CSI-RS configuration for CSI reporting, Non-dormant BWP	Config <sub>SCell2</sub> 1		CSI-RS.1.1 FDD
	Config <sub>SCell2</sub> 2		CSI-RS.1.1 TDD
	Config <sub>SCell2</sub> 3		CSI-RS.2.1 TDD
CSI-RS configuration for CSI reporting, Dormant BWP	Config <sub>SCell2</sub> 1		CSI-RS.1.6 FDD
	Config <sub>SCell2</sub> 2		CSI-RS.1.5 TDD
	Config <sub>SCell2</sub> 3		CSI-RS.2.6 TDD
TRS Configuration	Config <sub>SCell2</sub> 1		TRS.1.1 FDD
	Config <sub>SCell2</sub> 2		TRS.1.1 TDD
	Config <sub>SCell2</sub> 3		TRS.1.2 TDD
PDSCH Reference measurement channel	Config <sub>SCell2</sub> 1		SR.1.1 FDD
	Config <sub>SCell2</sub> 2		SR.1.1 TDD
	Config <sub>SCell2</sub> 3		SR.2.1 TDD
Dedicated CORESET parameters, Test 1,2	Config <sub>SCell2</sub> 1		CCR.1.1 FDD
	Config <sub>SCell2</sub> 2		CCR.1.1 TDD
	Config <sub>SCell2</sub> 3		CCR.2.1 TDD
Dedicated CORESET parameters, Test 3,4	Config <sub>SCell2</sub> 1		CCR.1.1 FDD
	Config <sub>SCell2</sub> 2		CCR.1.1 TDD
	Config <sub>SCell2</sub> 3		CCR.2.1 TDD
RMSI CORESET parameters	Config <sub>SCell2</sub> 1		N/A
	Config <sub>SCell2</sub> 2		
	Config <sub>SCell2</sub> 3		
OCNG Pattern			OP.1
SSB Configuration	Config <sub>SCell2</sub> 1,2		SSB.1 FR1
	Config <sub>SCell2</sub> 3		SSB.2 FR1
SMTC configuration			SMTC.1
EPRE ratio of PSS to SSS		dB	0

EPRE ratio of PBCH DMRS to SSS			
EPRE ratio of PBCH to PBCH DMRS			
EPRE ratio of PDCCH DMRS to SSS			
EPRE ratio of PDCCH to PDCCH DMRS			
EPRE ratio of PDSCH DMRS to SSS			
EPRE ratio of PDSCH to PDSCH			
EPRE ratio of OCNB DMRS to SSS <sup>Note1</sup>			
EPRE ratio of OCNB to OCNB DMRS <sup>Note1</sup>			
$N_{oc}$ <sup>Note2</sup>	Config <sub>SCell2</sub> 1,2	dBm/15kHz	-104
	Config <sub>SCell2</sub> 3		-101
$\hat{E}_s/I_{ot}$		dB	17
$\hat{E}_s/N_{oc}$		dB	17
SS-RSRP <sup>Note3</sup>	Config <sub>SCell2</sub> 1,2	dBm/SCS	-87
	Config <sub>SCell2</sub> 3		-84
$I_o$ <sup>Note3</sup>	Config <sub>SCell2</sub> 1,2	dBm/9.36 MHz	-59.0
	Config <sub>SCell2</sub> 3	dBm/38.16 MHz	-52.9
Propagation condition			AWGN
Correlation Matrix and Antenna Configuration			1x2 Low
<p>Note 1: OCNB shall be used such that the cells are fully allocated and a constant total transmitted power spectral density is achieved for all OFDM symbols.</p> <p>Note 2: Interference from other cells and noise sources not specified in the test is assumed to be constant over subcarriers and time and shall be modelled as AWGN of appropriate power for <math>N_{oc}</math> to be fulfilled.</p> <p>Note 3: SS-RSRP, SCH_RP, and <math>I_o</math> levels have been derived from other parameters for information purpose. They are not settable parameters themselves.</p>			

**Table A.6.5.6.4.2.1-4: NR Cell specific test parameters for NR SCells**

Parameter	Unit	Cell 3
Frequency range		FR1
NR RF channel		3
Duplex mode	Config <sub>SCell3</sub> 1	FDD
	Config <sub>SCell3</sub> 2,3	TDD
TDD configuration	Config <sub>SCell3</sub> 2	TDDConf.1.1
	Config <sub>SCell3</sub> 3	TDDConf.2.1
BW <sub>channel</sub>	Config <sub>SCell3</sub> 1,2	10: $N_{RB,c} = 52$
	Config <sub>SCell3</sub> 3	40: $N_{RB,c} = 106$
Downlink initial BWP configuration		DLBWP.0.1
Uplink initial BWP configuration		N/A
Downlink active non-dormant BWP-0 configuration		DLBWP.1.1
Downlink active dormant BWP-1 configuration		DLBWP.1.1
Uplink active BWP-0 configuration		N/A
TCI state		TCI.State.0
CSI-RS configuration for CSI reporting, Non-dormant BWP	Config <sub>SCell3</sub> 1	CSI-RS.1.1 FDD
	Config <sub>SCell3</sub> 2	CSI-RS.1.1 TDD
	Config <sub>SCell3</sub> 3	CSI-RS.2.1 TDD
CSI-RS configuration for CSI reporting, Dormant BWP	Config <sub>SCell3</sub> 1	CSI-RS.1.6 FDD
	Config <sub>SCell3</sub> 2	CSI-RS.1.5 TDD
	Config <sub>SCell3</sub> 3	CSI-RS.2.6 TDD
TRS Configuration	Config <sub>SCell3</sub> 1	TRS.1.1 FDD
	Config <sub>SCell3</sub> 2	TRS.1.1 TDD
	Config <sub>SCell3</sub> 3	TRS.1.2 TDD
PDSCH Reference measurement channel	Config <sub>SCell3</sub> 1	SR.1.1 FDD
	Config <sub>SCell3</sub> 2	SR.1.1 TDD
	Config <sub>SCell3</sub> 3	SR.2.1 TDD
Dedicated CORESET parameters, Test 1,2	Config <sub>SCell3</sub> 1	CCR.1.1 FDD
	Config <sub>SCell3</sub> 2	CCR.1.1 TDD

	Config <sub>SCell3</sub> 3		CCR.2.1 TDD
Dedicated CORESET parameters, Test 3,4	Config <sub>SCell3</sub> 1		CCR.1.1 FDD
	Config <sub>SCell3</sub> 2		CCR.1.1 TDD
	Config <sub>SCell3</sub> 3		CCR.2.1 TDD
	Config <sub>SCell3</sub> 1		N/A
RMSI CORESET parameters	Config <sub>SCell3</sub> 2		N/A
	Config <sub>SCell3</sub> 3		N/A
			N/A
OCNG Pattern			OP.1
SSB Configuration	Config <sub>SCell3</sub> 1,2		SSB.1 FR1
	Config <sub>SCell3</sub> 3		SSB.2 FR1
SMTc configuration			SMTc.1
EPRE ratio of PSS to SSS		dB	0
EPRE ratio of PBCH DMRS to SSS			
EPRE ratio of PBCH to PBCH DMRS			
EPRE ratio of PDCCH DMRS to SSS			
EPRE ratio of PDCCH to PDCCH DMRS			
EPRE ratio of PDSCH DMRS to SSS			
EPRE ratio of PDSCH to PDSCH			
EPRE ratio of OCNG DMRS to SSS <sup>Note1</sup>			
EPRE ratio of OCNG to OCNG DMRS <sup>Note1</sup>			
$N_{oc}$ <sup>Note2</sup>	Config <sub>SCell3</sub> 1,2		
	Config <sub>SCell3</sub> 3	-101	
$\hat{E}_s/I_{ot}$		dB	17
$\hat{E}_s/N_{oc}$		dB	17
SS-RSRP <sup>Note3</sup>	Config <sub>SCell3</sub> 1,2	dBm/SCS	-87
	Config <sub>SCell3</sub> 3		-84
$I_o$ <sup>Note3</sup>	Config <sub>SCell3</sub> 1,2	dBm/9.36 MHz	-59.0
	Config <sub>SCell3</sub> 3	dBm/38.16 MHz	-52.9
Propagation condition			AWGN
Correlation Matrix and Antenna Configuration			1x2 Low
<p>Note 1: OCNG shall be used such that the cells are fully allocated and a constant total transmitted power spectral density is achieved for all OFDM symbols.</p> <p>Note 2: Interference from other cells and noise sources not specified in the test is assumed to be constant over subcarriers and time and shall be modelled as AWGN of appropriate power for <math>N_{oc}</math> to be fulfilled.</p> <p>Note 3: SS-RSRP, SCH_RP, and <math>I_o</math> levels have been derived from other parameters for information purpose. They are not settable parameters themselves.</p>			

#### A.6.5.6.4.2.2 Test Requirements

During T1, any interruption on PCell due to dormancy switching of SCells shall be within the requirement specified in clause 8.2.2.2.12.1.

During T2, interruptions on PCell due to CSI and RRM measurements on dormant SCells shall be within the interruption rate requirements specified in clauses 8.2.2.2.12.2 and 8.2.2.2.12.3, respectively.

During T3, any interruption on PCell due to dormancy switching of SCells shall be within the requirement specified in clause 8.2.2.2.12.1. Monitoring of PDCCH for SCell in SCell shall be resumed within the dormancy switching time specified in clause 8.6.2A.

For an event to be considered to be correct, all requirements above have to be fulfilled.

The rate of correct events observed during repeated tests shall be at least 90%.

### A.6.5.6.5 Simultaneous RRC-based Active BWP Switch on multiple CCs

#### A.6.5.6.5.1 NR FR1- NR FR1 DL active BWP switch on multiple CCs with non-DRX in SA

##### A.6.5.6.5.1.1 Test Purpose and Environment

The purpose of this test is to verify requirements on the RRC-based DL BWP switch delay on multiple CCs defined in clause 8.6.

The supported test configurations for NR PCell are shown in Table A.6.5.6.5.1.1-1 below. The supported test configurations for NR SCell are shown in Table A.6.5.6.5.1.1-1A below. Test configuration for NR PCell and test configuration for NR SCell are chosen independently. The test scenario comprises of one NR PCell (Cell 1) and one NR SCell (Cell 2) as given in Table A.6.5.6.5.1.1-2. NR Cell-specific parameters are specified in Table A.6.5.6.5.1.1-3 and A.6.5.6.5.1.1-4 below.

PDCCHs indicating new transmissions shall be sent continuously on PCell (Cell 1) and SCell (Cell 2) to ensure that the UE would have ACK/NACK sending.

Before the test starts,

- UE is connected to Cell 1 (PCell) on radio channel 1 (PCC), Cell 2 (SCell) on radio channel 2 (SCC).
- UE has bandwidth part BWP-1 in its RRC-configuration for PCell and SCell (Cell 2).
- UE is indicated in *firstActiveDownlinkBWP-Id* that the active DL BWP is BWP-1 of initial condition in PCell and SCell (Cell 2).

All cells have constant signal levels throughout the test.

The test consists of 1 time period, with duration of T1.

During T1,

Time period T1 starts when a *RRCReconfiguration* with updated bandwidth part configuration for both PCell and SCell (Cell 2), sent from the test equipment to the UE, is completely received at the UE side in PCell's and SCell's slot # denoted *i*. The UE shall reconfigure its bandwidth part with the updated bandwidth part BWP-1 of final condition for both PCell and SCell (Cell 2).

The UE shall be able to receive PDSCH on PCell and SCell (Cell 2) from the first DL slot that occurs after the beginning of DL slot  $i + \frac{T_{RRCprocessingDelay} + T_{BWPswitchDelayRRC} + D_{RRC}}{NR\ slot\ length}$  as defined in clause 8.6.3A.1 and starts to report valid ACK/NACK for the PCell and SCell (Cell 2) from the first UL slot that occurs after the beginning of DL slot  $i + \frac{T_{RRCprocessingDelay} + T_{BWPswitchDelayRRC} + D_{RRC}}{NR\ slot\ length} + k1$  on BWP-1 of final condition. The UE shall be continuously scheduled on PCell's and SCell (Cell 2)'s BWP-1 of final condition starting from the first DL slot right after slot  $i + \frac{T_{RRCprocessingDelay} + T_{BWPswitchDelayRRC} + D_{RRC}}{NR\ slot\ length}$ .

$T_{RRCprocessingDelay}$ ,  $T_{BWPswitchDelayRRC}$  and  $D_{RRC}$  are defined in clause 8.6.3A.1,  $N=2$  in this test case.

The test equipment verifies the DL BWP switch time in PCell and SCell by counting the slots from the time when the RRC Reconfiguration message including updated BWP configuration is sent till the time when a valid ACK/NACK is received.

**Table A.6.5.6.5.1.1-1: DL BWP switch supported test configurations for NR PCell**

Config	Description
1	NR 15 kHz SSB SCS, $\geq 10$ MHz bandwidth, FDD duplex mode
2	NR 15 kHz SSB SCS, $\geq 10$ MHz bandwidth, TDD duplex mode
3	NR 30 kHz SSB SCS, $\geq 40$ MHz bandwidth, TDD duplex mode
Note 1:	The UE is only required to be tested in one of the supported test configurations
Note 2:	The UE is only required to be tested in one with smallest aggregated channel bandwidth from supported band combinations which is composed of CCs $\geq$ the bandwidth ( $BW_{channel}$ ) defined in each test configuration



Table A.6.5.6.5.1.1-1A: DL BWP switch supported test configurations for NR SCell

Config <sub>SCell</sub>	Description
1	NR 15 kHz SSB SCS, ≥10 MHz bandwidth, FDD duplex mode
2	NR 15 kHz SSB SCS, ≥10 MHz bandwidth, TDD duplex mode
3	NR 30 kHz SSB SCS, ≥40 MHz bandwidth, TDD duplex mode
Note 1:	The UE is only required to be tested in one of the supported test configurations
Note 2:	The UE is only required to be tested in one with smallest aggregated channel bandwidth from supported band combinations which is composed of CCs ≥ the bandwidth ( $BW_{channel}$ ) defined in each test configuration

Table A.6.5.6.5.1.1-2: General test parameters for DL BWP switch in SA

Parameter	Unit	Value	Comment
NR RF Channel Number		1, 2	Two NR radio channels are used for this test
Active PCell		Cell 1	PCell on RF channel number 1.
Active SCell		Cell 2	SCell on RF channel number 2.
CP length		Normal	
DRX		OFF	For both PCell and SCell (Cell 2)
Cell-individual offset for cells on RF channel number 1	dB	0	Individual offset for cell on PCC.
Cell-individual offset for cells on RF channel number 2	dB	0	Individual offset for cell on SCC.
Cell 2 timing offset to Cell 1	μs	3	Time alignment error as specified in TS 38.104 [13] clause 6.5.3.1.
T1	s	0.2	

Table A.6.5.6.5.1.1-3: NR Cell specific test parameters for NR PCell for DL BWP switch in SA

Parameter		Unit	Cell 1
Frequency Range			FR1
Duplex mode	Config 1		FDD
	Config 2,3		TDD
TDD configuration	Config 1		Not Applicable
	Config 2		TDDConf.1.1
	Config 3		TDDConf.2.1
$BW_{channel}$	Config 1,2		10 MHz: $N_{RB,c} = 52$
	Config 3		40 MHz: $N_{RB,c} = 106$
Active BWP ID			1
Initial DL BWP Configuration			DLBWP.0.2 <sup>Note4</sup>
Initial UL BWP Configuration			ULBWP.0.2 <sup>Note4</sup>
Initial Condition	Active DL BWP-1 Configuration		DLBWP.1.3 <sup>Note4</sup>
	Active UL BWP-1 Configuration		ULBWP.1.3 <sup>Note4</sup>
Final Condition	Active DL BWP-1 Configuration		DLBWP.1.1 <sup>Note4</sup>
	Active UL BWP-1 Configuration		ULBWP.1.1 <sup>Note4</sup>
PDSCH Reference measurement channel	Config 1		SR.1.1 FDD
	Config 2		SR.1.1 TDD
	Config 3		SR.2.1 TDD
RMSI CORESET parameters	Config 1		CR.1.1 FDD
	Config 2		CR.1.1 TDD
	Config 3		CR.2.1 TDD
Dedicated CORESET parameters	Config 1		CCR.1.1 FDD
	Config 2		CCR.1.1 TDD
	Config 3		CCR.2.1 TDD
OCNG Patterns			OP.1
SSB Configuration	Config 1,2		SSB.1 FR1
	Config 3		SSB.2 FR1
SMTTC Configuration			SMTTC.1
TRS Configuration	Config 1		TRS.1.1 FDD
	Config 2		TRS.1.1 TDD

	Config 3		TRS.1.2 TDD
Correlation Matrix and Antenna Configuration			1x2 Low
Propagation Condition			AWGN
EPRE ratio of PSS to SSS		dB	0
EPRE ratio of PBCH DMRS to SSS			
EPRE ratio of PBCH to PBCH DMRS			
EPRE ratio of PDCCH DMRS to SSS			
EPRE ratio of PDCCH to PDCCH DMRS			
EPRE ratio of PDSCH DMRS to SSS			
EPRE ratio of PDSCH to PDSCH			
EPRE ratio of OCNB DMRS to SSS(Note 1)			
EPRE ratio of OCNB to OCNB DMRS (Note 1)			
$N_{oc}$ <sup>Note 2</sup>	Config 1,2	dBm/SCS	-104
	Config 3		-101
SS-RSRP <sup>Note 3</sup>	Config 1,2	dBm/SCS	-87
	Config 3		-84
$\bar{E}_s/I_{ot}$		dB	17
$\bar{E}_s/N_{oc}$		dB	17
$I_o$ <sup>Note3</sup>	Config 1,2	dBm/ 9.36MHz	-58.96
	Config 3	dBm/ 38.16MHz	-52.86
<p>Note 1: OCNB shall be used such that both cells are fully allocated and a constant total transmitted power spectral density is achieved for all OFDM symbols.</p> <p>Note 2: Interference from other cells and noise sources not specified in the test is assumed to be constant over subcarriers and time and shall be modelled as AWGN of appropriate power for <math>N_{oc}</math> to be fulfilled.</p> <p>Note 3: SS-RSRP and <math>I_o</math> levels have been derived from other parameters for information purposes. They are not settable parameters themselves.</p> <p>Note 4: For unpaired spectrum, a DL BWP is linked with an UL BWP. DLBWP.0.2 is linked with ULBWP.0.2; DLBWP.1.1 is linked with ULBWP.1.1; DLBWP.1.3 is linked with ULBWP.1.3 defined in clause 12 of TS 38.213 [3].</p>			

**Table A.6.5.6.5.1.1-4: NR Cell specific test parameters for NR SCell for DL BWP switch in SA**

Parameter		Unit	Cell 2
Frequency Range			FR1
Duplex mode	Config <sub>SCell</sub> 1		FDD
	Config <sub>SCell</sub> 2,3		TDD
TDD configuration	Config <sub>SCell</sub> 1		Not Applicable
	Config <sub>SCell</sub> 2		TDDConf.1.1
	Config <sub>SCell</sub> 3		TDDConf.2.1
BW <sub>channel</sub>	Config <sub>SCell</sub> 1,2		10 MHz: $N_{RB,c} = 52$
	Config <sub>SCell</sub> 3		40 MHz: $N_{RB,c} = 106$
Active BWP ID			1
Initial DL BWP Configuration			DLBWP.0.2 <sup>Note4</sup>
Initial UL BWP Configuration			ULBWP.0.2 <sup>Note4</sup>
Initial Condition	Active DL BWP-1 Configuration		DLBWP.1.3 <sup>Note4</sup>
	Active UL BWP-1 Configuration		ULBWP.1.3 <sup>Note4</sup>
Final Condition	Active DL BWP-1 Configuration		DLBWP.1.1 <sup>Note4</sup>
	Active UL BWP-1 Configuration		ULBWP.1.1 <sup>Note4</sup>
PDSCH Reference measurement channel	Config <sub>SCell</sub> 1		SR.1.1 FDD
	Config <sub>SCell</sub> 2		SR.1.1 TDD
	Config <sub>SCell</sub> 3		SR.2.1 TDD
RMSI CORESET parameters	Config <sub>SCell</sub> 1		CR.1.1 FDD
	Config <sub>SCell</sub> 2		CR.1.1 TDD
	Config <sub>SCell</sub> 3		CR.2.1 TDD
Dedicated CORESET parameters	Config <sub>SCell</sub> 1		CCR.1.1 FDD
	Config <sub>SCell</sub> 2		CCR.1.1 TDD
	Config <sub>SCell</sub> 3		CCR.2.1 TDD
OCNB Patterns			OP.1

SSB Configuration	Config <sub>SCell</sub> 1,2		SSB.1 FR1
	Config <sub>SCell</sub> 3		SSB.2 FR1
SMTC Configuration			SMTC.1
TRS Configuration	Config <sub>SCell</sub> 1		TRS.1.1 FDD
	Config <sub>SCell</sub> 2		TRS.1.1 TDD
	Config <sub>SCell</sub> 3		TRS.1.2 TDD
Correlation Matrix and Antenna Configuration			1x2 Low
Propagation Condition			AWGN
EPRE ratio of PSS to SSS		dB	0
EPRE ratio of PBCH DMRS to SSS			
EPRE ratio of PBCH to PBCH DMRS			
EPRE ratio of PDCCH DMRS to SSS			
EPRE ratio of PDCCH to PDCCH DMRS			
EPRE ratio of PDSCH DMRS to SSS			
EPRE ratio of PDSCH to PDSCH			
EPRE ratio of OCNG DMRS to SSS(Note 1)			
EPRE ratio of OCNG to OCNG DMRS (Note 1)			
N <sub>oc</sub> <sup>Note 2</sup>	Config <sub>SCell</sub> 1,2	dBm/SCS	-104
	Config <sub>SCell</sub> 3		-101
SS-RSRP <sup>Note 3</sup>	Config <sub>SCell</sub> 1,2	dBm/SCS	-87
	Config <sub>SCell</sub> 3		-84
$\hat{E}_s/I_{ot}$		dB	17
$\hat{E}_s/N_{oc}$		dB	17
I <sub>o</sub> <sup>Note3</sup>	Config <sub>SCell</sub> 1,2	dBm/ 9.36MHz	-58.96
	Config <sub>SCell</sub> 3	dBm/ 38.16MHz	-52.86
<p>Note 1: OCNG shall be used such that both cells are fully allocated and a constant total transmitted power spectral density is achieved for all OFDM symbols.</p> <p>Note 2: Interference from other cells and noise sources not specified in the test is assumed to be constant over subcarriers and time and shall be modelled as AWGN of appropriate power for N<sub>oc</sub> to be fulfilled.</p> <p>Note 3: SS-RSRP and I<sub>o</sub> levels have been derived from other parameters for information purposes. They are not settable parameters themselves.</p> <p>Note 4: For unpaired spectrum, a DL BWP is linked with an UL BWP. DLBWP.0.2 is linked with ULBWP.0.2; DLBWP.1.1 is linked with ULBWP.1.1; DLBWP.1.3 is linked with ULBWP.1.3 defined in clause 12 of TS 38.213 [3].</p>			

#### A.6.5.6.5.1.2 Test Requirements

During T1, the UE shall be ready for the reception of uplink grant for both PCell and SCell (Cell 2) from the first DL slot that occurs right after the beginning of slot  $(i + \frac{T_{RRCprocessingDelay} + T_{BWPswitchDelayRRC} + D_{RRC}}{NR\ slot\ length})$  and starts to report valid ACK/NACK for both PCell and SCell (Cell 2) from the first UL slot that occurs after the beginning of DL slot  $(i + \frac{T_{RRCprocessingDelay} + T_{BWPswitchDelayRRC} + D_{RRC}}{NR\ slot\ length} + k1)$ .

Where,  $k1$  is the timing between DL data receiving and acknowledgement as specified in [7].

Depending on UE capability  $bwp-SwitchingDelay$  [2], UE shall finish BWP switch on PCell and SCell (Cell 2) within the time duration  $T_{RRCprocessingDelay} + T_{BWPswitchDelayRRC} + D_{RRC}$  defined in 8.6.3A.1.

All of the above test requirements shall be fulfilled in order for the observed PCell and SCell (Cell 2) active BWP switch delay to be counted as correct.

The rate of correct events observed during repeated tests shall be at least 90%.

NOTE: During T1 if there are no uplink resources for reporting the ACK/NACK in the first UL slot that occurs after beginning of DL slot  $(i + \frac{T_{RRCprocessingDelay} + T_{BWPswitchDelayRRC} + D_{RRC}}{NR\ slot\ length} + k1)$ , then the UE shall use the next available uplink resource for reporting the corresponding ACK/NACK.

## A.6.5.7 DL interruptions at switching between two uplink carriers

### A.6.5.7.1 DL interruptions at switching between two uplink carriers in FDD-TDD CA

#### A.6.5.7.1.1 Test Purpose and Environment

The purpose of this test is to verify DL interruption requirements during UE dynamic switching between two uplink carriers defined in clause 8.2.2.2.10. The test case is applicable for an uplink band pair of an inter-band FDD-TDD CA configuration when the capability *uplinkTxSwitchingPeriod* is present.

There are two cells: FR1 FDD PCell (Cell 1), FR1 TDD SCell (Cell 2). The test parameters for the two cells are given in Table A.6.5.7.1.1-1, Table A.6.5.7.1.1-2 and Table A.6.5.7.1.1-3 below.

For NR FDD carrier (Cell 1), aperiodic CSI-RS for L1-RSRP reporting is triggered with power boosting 6dB on the following symbol in the slot overlapping with the special slot of the NR TDD carrier (Cell 2):

- symbol#12 if UE does not report *uplinkTxSwitching-DL-Interruption-r16*;
- otherwise,
  - symbol #8 if UE capability *uplinkTxSwitchingPeriod* is 210us or
  - symbol #9 if UE capability *uplinkTxSwitchingPeriod* is 140us or
  - symbol #10 if UE capability *uplinkTxSwitchingPeriod* is 35us.

For NR TDD carrier (Cell 2), aperiodic CSI-RS for L1-RSRP reporting is configured with power boosting [6dB] on the following symbol in the special slot:

- symbol#10 if UE does not report *uplinkTxSwitching-DL-Interruption-r16*;
- otherwise,
  - symbol #4 if UE capability *uplinkTxSwitchingPeriod* is 210us or
  - symbol #5 if UE capability *uplinkTxSwitchingPeriod* is 140us or
  - symbol #8 if UE capability *uplinkTxSwitchingPeriod* is 35us.

This test verifies that the UE correctly report the L1-RSRP reporting. The test consists of one time period, with duration of T1. Prior to the start of the time duration T1, *uplinkTxSwitching* is indicated to UE.

**Table A.6.5.7.1.1-1: Supported test configurations**

Configuration	Description
1	NR Cell 1: 15 kHz SSB SCS, 10 MHz bandwidth, FDD duplex mode NR Cell 2: 30 kHz SSB SCS, 40 MHz bandwidth, TDD duplex mode

**Table A.6.5.7.1.1-2: General test parameters for DL interruptions at switching between two uplink carriers in FDD-TDD CA**

Parameter	Unit	Test configuration	Value	Comment
RF Channel Number		Config 1	1, 2	Two radio channels are used for this test.
Active cell		Config 1	Cell 1: FR1 PCell Cell 2: FR1 SCell	FR1 PCell on RF channel number 1 FR1 SCell on RF channel number 2
CP length		Config 1	Normal	
DRX		Config 1	OFF	
Measurement gap pattern Id		Config 1	OFF	
Filter coefficient		Config 1	0	L3 filtering is not used
CSI-RS configuration for L1-RSRP reporting		Config 1	Cell 1: CSI-RS.1.5 FDD Cell 2: CSI-RS.2.5 TDD	

T1	s	Config 1	5	
----	---	----------	---	--

**Table A.6.5.7.1.1-3: Cell specific test parameters for DL interruptions at switching between two uplink carriers in FDD-TDD CA**

Parameter		Unit	Cell1	Cell2
Frequency Range			FR1	FR1
Duplex mode	Config 1		FDD	TDD
TDD configuration	Config 1		N/A	TDDConf.2.1 except that: S='11DL:1GP:2UL'; nrofDownlinkSymbols:11 nrofUplinkSymbols: 2
BW <sub>channel</sub>	Config 1		10 MHz: N <sub>RB,c</sub> = 52	40 MHz: N <sub>RB,c</sub> = 106
Initial BWP Configuration	Config 1		DLBWP.0.1	DLBWP.0.1
DL dedicated BWP configuration	Config 1		DLBWP.1.1	DLBWP.1.1
UL dedicated BWP configuration	Config 1		ULBWP.1.1	ULBWP.1.1
SRS configuration	Config 1		SRS configuration in Table A.4.4.1.1.1-3 is applied except that: resourceMappingstartPosition: 0 resourceMappingnrofSymbols: n2	SRS configuration in Table A.4.4.1.1.1-3 is applied except that: resourceMappingstartPosition: 0 resourceMappingnrofSymbols: n2
PDSCH Reference measurement channel	Config 1		SR.1.1 FDD	SR.2.1 TDD
RMSI CORESET parameters	Config 1		CR.1.1 FDD	CR.2.1 TDD
Dedicated CORESET parameters	Config 1		CCR.1.1 FDD	CCR.2.1 TDD
OCNG Patterns			OP.1	OP.1
SMTTC Configuration			SMTTC.1	SMTTC.1
SSB Configuration	Config 1		SSB.1 FR1	SSB.2 FR1
Correlation Matrix and Antenna Configuration			1x2 Low	2x2 Low
EPRE ratio of PSS to SSS		dB	0	0
EPRE ratio of PBCH DMRS to SSS				
EPRE ratio of PBCH to PBCH DMRS				
EPRE ratio of PDCCH DMRS to SSS				
EPRE ratio of PDCCH to PDCCH DMRS				
EPRE ratio of PDSCH DMRS to SSS				
EPRE ratio of PDSCH to PDSCH				
EPRE ratio of OCNG DMRS to SSS(Note 1)				
EPRE ratio of OCNG to OCNG DMRS (Note 1)				
N <sub>oc</sub> <sup>Note 2</sup>		dBm/15 kHz	-104	-104
SS-RSRP <sup>Note 3</sup>		dBm/SSB SCS	-87	-84
CSI-RS RSRP <sup>Note 6</sup>		dBm/SCS	-81	-78
$\hat{E}_s/I_{ot}$		dB	17	17
$\hat{E}_s/N_{oc}$		dB	17	17
N <sub>oc</sub> <sup>Note 2</sup>		dBm/SCS	-104	-101
I <sub>o</sub> <sup>Note 3</sup> on symbols without CSI-RS	Config 1	dBm/9.36 MHz	-58.96	-
		dBm/38.16MHz	-	-52.86
I <sub>o</sub> <sup>Note 6</sup> on symbols with CSI-RS	Config 1	dBm/9.36 MHz	-56.58	-
		dBm/38.16MHz	-	-50.5
Time offset to Cell1 <sup>Note 5</sup>		μs	-	0

Propagation Condition		AWGN	AWGN
Note 1:	OCNG shall be used such that both cells are fully allocated and a constant total transmitted power spectral density is achieved for all OFDM symbols.		
Note 2:	Interference from other cells and noise sources not specified in the test is assumed to be constant over subcarriers and time and shall be modelled as AWGN of appropriate power for $N_{oc}$ to be fulfilled.		
Note 3:	SS-RSRP and $l_0$ levels have been derived from other parameters for information purposes. They are not settable parameters themselves.		
Note 4:	Void		
Note 5:	Receive time difference between slot boundaries of signals received from the two cells at the UE antenna connector including time alignment error between the two cells.		
Note 6:	CSI-RS RSRP and $l_0$ levels have been derived from other parameters for information purposes. They are not settable parameters themselves.		

#### A.6.5.7.1.2 Test Requirements

The UE behaviour follows the requirements defined in clause 8.2.2.2.10.

UE shall send L1-RSRP report while meeting the accuracy requirements defined in clause 10.1.19.1.

The rate of correct events observed during repeated tests shall be at least 90%.

#### A.6.5.7.2 DL interruptions at switching between two uplink carriers in TDD-TDD CA

##### A.6.5.7.2.1 Test Purpose and Environment

The purpose of this test is to verify DL interruption requirements during UE dynamic switching between two uplink carriers defined in clause 8.2.2.2.10. The test case is applicable for an uplink band pair of an inter-band TDD-TDD CA configuration when the capability *uplinkTxSwitchingPeriod* is present.

There are two cells: FR1 TDD PCell (Cell 1), FR1 TDD SCell (Cell 2). The test parameters for the two cells are given in Table A.6.5.7.2.1-1, Table A.6.5.7.2.1-2 and Table A.6.5.7.2.1-3 below.

For NR TDD PCell (Cell 1), aperiodic CSI-RS for L1-RSRP reporting is triggered with power boosting 6dB on the following symbol in the special slot:

- symbol#10 if UE does not report *uplinkTxSwitching-DL-Interruption-r16*;
- otherwise,
  - symbol #4 if UE capability *uplinkTxSwitchingPeriod* is 210us or
  - symbol #5 if UE capability *uplinkTxSwitchingPeriod* is 140us or
  - symbol #8 if UE capability *uplinkTxSwitchingPeriod* is 35us.

For NR TDD SCell (Cell 2), aperiodic CSI-RS for L1-RSRP reporting is configured with power boosting 6dB [6dB] on the following symbol on the 2<sup>nd</sup> special slot of every 8 slots:

- symbol#10 if UE does not report *uplinkTxSwitching-DL-Interruption-r16*;
- otherwise,
  - symbol #4 if UE capability *uplinkTxSwitchingPeriod* is 210us or
  - symbol #5 if UE capability *uplinkTxSwitchingPeriod* is 140us or
  - symbol #8 if UE capability *uplinkTxSwitchingPeriod* is 35us.

This test verifies that the UE correctly report the L1-RSRP reporting. The test case is only applicable to UE which supports *simultaneousRxTxInterBandCA*.

The test consists of one time period, with duration of T1. Prior to the start of the time duration T1, *uplinkTxSwitching* is indicated to UE.

**Table A.6.5.7.2.1-1: Supported test configurations**

Configuration	Description
---------------	-------------

1	NR Cell 1: 30 kHz SSB SCS, 40 MHz bandwidth, TDD duplex mode NR Cell 2: 30 kHz SSB SCS, 40 MHz bandwidth, TDD duplex mode
---	--

**Table A.6.5.7.2.1-2: General test parameters for DL interruptions at switching between two uplink carriers in TDD-TDD CA**

Parameter	Unit	Test configuration	Value	Comment
RF Channel Number		Config 1	1, 2	Two radio channels are used for this test.
Active cell		Config 1	Cell 1: FR1 PCell Cell 2: FR1 SCell	FR1 PCell on RF channel number 1 FR1 SCell on RF channel number 2
CP length		Config 1	Normal	
DRX		Config 1	OFF	
Measurement gap pattern Id		Config 1	OFF	
Filter coefficient		Config 1	0	L3 filtering is not used
CSI-RS configuration for L1-RSRP reporting		Config 1	Cell 1: CSI-RS.2.5 TDD Cell 2: CSI-RS.2.5 TDD	
T1	s	Config 1	5	

**Table A.6.5.7.2.1-3: Cell specific test parameters for DL interruptions at switching between two uplink carriers in TDD-TDD CA**

Parameter		Unit	Cell1	Cell2
Frequency Range			FR1	FR1
Duplex mode	Config 1		TDD	TDD
TDD configuration	Config 1		TDDConf.2.1 except that S='11DL:1GP:2UL'; nrofDownlinkSymbols:11 nrofUplinkSymbols: 2	TDDConf.2.2
BW <sub>channel</sub>	Config 1		40 MHz: N <sub>RB,c</sub> = 106	40 MHz: N <sub>RB,c</sub> = 106
Initial BWP Configuration	Config 1		DLBWP.0.1	DLBWP.0.1
DL dedicated BWP configuration	Config 1		DLBWP.1.1	DLBWP.1.1
UL dedicated BWP configuration	Config 1		ULBWP.1.1	ULBWP.1.1
SRS configuration	Config 1		SRS configuration in Table A.4.4.1.1.1-3 is applied except that: resourceMappingstartPosition: 0 resourceMappingnrofSymbols: n2	SRS configuration in Table A.4.4.1.1.1-3 is applied except that: resourceMappingstartPosition: 0 resourceMappingnrofSymbols: n2
PDSCH Reference measurement channel	Config 1		SR.2.1 TDD	SR.2.1 TDD
RMSI CORESET parameters	Config 1		CR.2.1 TDD	CR.2.1 TDD
Dedicated CORESET parameters	Config 1		CCR.2.1 TDD	CCR.2.1 TDD
OCNG Patterns			OP.1	OP.1
SMTTC Configuration			SMTTC.1	SMTTC.1
SSB Configuration	Config 1		SSB.2 FR1	SSB.2 FR1
Correlation Matrix and Antenna Configuration			1x2 Low	2x2 Low
EPRE ratio of PSS to SSS		dB	0	0
EPRE ratio of PBCH DMRS to SSS				
EPRE ratio of PBCH to PBCH DMRS				
EPRE ratio of PDCCH DMRS to SSS				
EPRE ratio of PDCCH to PDCCH DMRS				
EPRE ratio of PDSCH DMRS to SSS				
EPRE ratio of PDSCH to PDSCH				

EPRE ratio of OCNG DMRS to SSS(Note 1)				
EPRE ratio of OCNG to OCNG DMRS (Note 1)				
$N_{oc}$ <sup>Note 2</sup>		dBm/15 kHz	-104	-104
SS-RSRP <sup>Note 3</sup>		dBm/SSB SCS	-84	-84
CSI-RS RSRP <sup>Note 6</sup>		dBm/SCS	-78	-78
$\bar{E}_s/I_{ot}$		dB	17	17
$\bar{E}_s/N_{oc}$		dB	17	17
$N_{oc}$ <sup>Note 2</sup>	Config 1	dBm/SCS	-101	-101
$I_o$ <sup>Note 3</sup> on symbols without CSI-RS	Config 1	dBm/38.16MHz	-52.86	-52.86
$I_o$ <sup>Note 6</sup> on symbols with CSI-RS	Config 1	dBm/38.16MHz	-50.5	-50.5
Time offset to Cell1 <sup>Note 5</sup>		$\mu$ s	-	0
Propagation Condition			AWGN	AWGN
<p>Note 1: OCNG shall be used such that both cells are fully allocated and a constant total transmitted power spectral density is achieved for all OFDM symbols.</p> <p>Note 2: Interference from other cells and noise sources not specified in the test is assumed to be constant over subcarriers and time and shall be modelled as AWGN of appropriate power for <math>N_{oc}</math> to be fulfilled.</p> <p>Note 3: SS-RSRP and <math>I_o</math> levels have been derived from other parameters for information purposes. They are not settable parameters themselves.</p> <p>Note 4: Void</p> <p>Note 5: Receive time difference between slot boundaries of signals received from the two cells at the UE antenna connector including time alignment error between the two cells.</p> <p>Note 6: CSI-RS RSRP and <math>I_o</math> levels have been derived from other parameters for information purposes. They are not settable parameters themselves.</p>				

### A.6.5.7.2.2 Test Requirements

The UE behaviour follows the requirements defined in clause 8.2.2.2.10.

UE shall send L1-RSRP report while meeting the accuracy requirements defined in clause 10.1.19.1.

The rate of correct events observed during repeated tests shall be at least 90%.

## A.6.5.8 UE specific CBW change

### A.6.5.8.1 UE specific CBW change on PCell in FR1 in non-DRX

#### A.6.5.8.1.1 Test Purpose and Environment

The purpose of this test is to verify the UE specific CBW change delay requirement defined in clause 8.13.

The supported test configurations are shown in Table A.6.5.8.1.1-1. The test scenario comprises of one Cell (Cell 1), which is PCell as given in Table A.6.5.8.1.1-2. Cell-specific parameters are specified in Table A.6.5.8.1.1-3.

PDCCHs indicating new transmissions shall be sent continuously on Cell 1 to ensure that the UE sends ACK/NACK during the test.

Before the test starts:

- UE is connected to Cell 1 (PCell) on radio channel 1.
- UE has bandwidth part BWP-1 in its RRC-configuration for Cell 1 (PCell).
- UE is indicated in *firstActiveDownlinkBWP-Id* that the active DL BWP is BWP-1 of initial condition in PCell.
- UE has been configured with UE specific CBW (CBW-1).
- UE is indicated in *SCS-SpecificCarrier* [2] that the UE specific CBW is CBW-1 as the initial condition in Cell 1 (PCell).



Cell1 (PCell) has constant signal levels throughout the test.

The test consists of 1 time period, with duration of T1.

During T1,

Time period T1 starts when a *RRCReconfiguration* containing *SCS-SpecificCarrier* with updated UE specific CBW, sent from the test equipment to the UE, is completely received at the UE side in PCell's slot # denoted *i*. The UE shall reconfigure its UE specific CBW with the updated CBW-2 for the final condition.

The UE shall be able to receive PDSCH on PCell from the first DL slot that occurs after the beginning of DL slot  $i + \frac{T_{RRCprocessingDelay} + T_{CBWchangeDelayRRC}}{NR\ Slot\ length}$  as defined in clause 8.13 and starts to report valid ACK/NACK for

PCell from the first UL slot that occurs after the beginning of DL slot  $i + \frac{T_{RRCprocessingDelay} + T_{CBWchangeDelayRRC}}{NR\ Slot\ length} + k1$  on the PCell's BWP-1 on CBW-2 for the final condition. The UE shall be continuously scheduled on the PCell's BWP-1 on CBW-2 for the final condition starting from the first DL slot right after slot  $i + \frac{T_{RRCprocessingDelay} + T_{CBWchangeDelayRRC}}{NR\ Slot\ length}$ .

$T_{RRCprocessingDelay}$  and  $T_{CBWchangeDelayRRC}$  are defined in clause 8.13.

The test equipment verifies the UE specific CBW switching delay in PCell by estimating the time from the moment the RRC Reconfiguration message including updated UE specific CBW configuration is sent until the moment a valid ACK/NACK is received.

**Table A.6.5.8.1.1-1: Supported test configurations for UE specific CBW change in SA scenario**

Configuration	Description
1	NR 15 kHz SSB SCS, 10 MHz bandwidth, FDD duplex mode
2	NR 15 kHz SSB SCS, 10 MHz bandwidth, TDD duplex mode
3	NR 30kHz SSB SCS, 40 MHz bandwidth, TDD duplex mode
Note 1: The UE is only required to be tested in one of the supported test configurations	

**Table A.6.5.8.1.1-2: General test parameters for UE specific CBW change in SA scenario**

Parameter	Unit	Value	Comment
NR RF Channel Number		1	One NR radio channel is used for this test
Active Cell		Cell 1	Cell on RF channel number 1.
CP length		Normal	
DRX		OFF	
T1	s	0.2	

**Table A.6.5.8.1.1-3: NR Cell specific test parameters for UE specific CBW change in SA scenario**

Parameter		Unit	Cell 1
Frequency Range			FR1
Duplex mode	Config 1		FDD
	Config 2,3		TDD
TDD configuration	Config 1		Not Applicable
	Config 2		TDDConf.1.1
	Config 3		TDDConf.2.1
BW <sub>channel</sub>	Config 1		10 MHz: N <sub>RB,c</sub> = 52
	Config 2		10 MHz: N <sub>RB,c</sub> = 52
	Config 3		40 MHz: N <sub>RB,c</sub> = 106
Active DL BWP ID	Config 1,2, 3		1
Initial DL BWP Configuration (BWP-1)	Config 1,2, 3		DLBWP.0.2
Initial UL BWP Configuration	Config 1,2, 3		ULBWP.0.2
Initial Condition	Active DL CBW-1 Configuration	Config 1, 2, 3	DLCBW.1.1

	Active UL CBW-1 Configuration	Config 1, 2, 3		ULCBW.1.1
Final Condition	Active DL CBW-2 Configuration	Config 1, 2, 3		DLCBW.1.2
	Active UL CBW-2 Configuration	Config 1, 2, 3		ULCBW.1.2
PDSCH Reference measurement channel		Config 1		SR.1.1 FDD
		Config 2		SR.1.1 TDD
		Config 3		SR2.1 TDD
RMSI CORESET parameters		Config 1		CR.1.1 FDD
		Config 2		CR.1.1 TDD
		Config 3		CR2.1 TDD
Dedicated CORESET parameters		Config 1		CCR.1.1 FDD
		Config 2		CCR.1.1 TDD
		Config 3		CCR.2.1 TDD
OCNG Patterns				OP.1
SSB Configuration		Config 1,2		SSB.1 FR1
		Config 3		SSB.2 FR1
SMTC Configuration				SMTC.1
TRS Configuration		Config 1		TRS.1.1 FDD
		Config 2		TRS.1.1 TDD
		Config 3		TRS.1.2 TDD
Antenna Configuration				1x2 Low
Propagation Condition				AWGN
EPRE ratio of PSS to SSS			dB	0
EPRE ratio of PBCH DMRS to SSS				
EPRE ratio of PBCH to PBCH DMRS				
EPRE ratio of PDCCH DMRS to SSS				
EPRE ratio of PDCCH to PDCCH DMRS				
EPRE ratio of PDSCH DMRS to SSS				
EPRE ratio of PDSCH to PDSCH				
EPRE ratio of OCNG DMRS to SSS <sup>(Note 1)</sup>				
EPRE ratio of OCNG to OCNG DMRS <sup>(Note 1)</sup>				
N <sub>oc</sub> <sup>Note 2</sup>		Config 1,2	dBm/SCS	-104
		Config 3		-101
SS-RSRP <sup>Note 3</sup>		Config 1,2	dBm/SCS	-87
		Config 3		-84
E <sub>s</sub> /I <sub>ot</sub>			dB	17
E <sub>s</sub> /N <sub>oc</sub>			dB	17
I <sub>o</sub> <sup>Note3</sup>		Config 1,2	dBm/ 9.36MHz	-58.96
		Config 3		dBm/ 38.16MHz
<p>Note 1: OCNG shall be used such that both cells are fully allocated and a constant total transmitted power spectral density is achieved for all OFDM symbols.</p> <p>Note 2: Interference from other cells and noise sources not specified in the test is assumed to be constant over subcarriers and time and shall be modelled as AWGN of appropriate power for N<sub>oc</sub> to be fulfilled.</p> <p>Note 3: SS-RSRP and I<sub>o</sub> levels have been derived from other parameters for information purposes. They are not settable parameters themselves.</p> <p>Note 4: For unpaired spectrum, a DL BWP is linked with an UL BWP. DLBWP.0.1 is linked with ULBWP.0.1; DLBWP.1.1 is linked with ULBWP.1.1; as defined in clause 12 of TS 38.213 [3].</p>				

### A.6.5.8.1.2 Test Requirements

During T1, the UE shall be ready for the reception of uplink grant for the PCell from the first DL slot that occurs right after the beginning of slot  $i + \frac{T_{RRCprocessingDelay} + T_{CBWchangeDelayRRC}}{NR\ Slot\ length}$  and starts to report valid ACK/NACK for PCell from the first UL slot that occurs after the beginning of DL slot  $i + \frac{T_{RRCprocessingDelay} + T_{CBWchangeDelayRRC}}{NR\ Slot\ length} + k1$ .

Where,  $kI$  is the timing between DL data receiving and acknowledgement as specified in [7].

All of the above test requirements shall be fulfilled in order for the observed UE specific CBW change delay on the PCell to be counted as correct.

The rate of correct events observed during repeated tests shall be at least 90%.

## A.6.5.9 Pathloss reference signal switching delay

### A.6.5.9.1 MAC-CE based pathloss reference signal switch delay

#### A.6.5.9.1.1 Test Purpose and Environment

The purpose of this test is to verify the MAC-CE based pathloss reference signal switch delay requirement defined in clause 8.14.

The supported test configurations are shown in Table A.6.5.9.1.1-1. The test scenario comprises of one cell (Cell 1) as given in Table A.6.5.9.1.1-2. Cell-specific parameters of the cell are specified in Table A.6.5.9.1.1-3 below.

The test consists of 3 successive time periods, with duration of T1, T2 and T3, respectively.

Prior to the start of the time duration T1,

- UE is connected to Cell 1 on radio channel 1.
- UE shall be fully synchronized to SSB #0.

During T1,

- The UE shall track SSB #1 so that SSB #1 as a pathloss reference signal is known to the UE.

Time period T2 starts when the UE is configured of the power headroom reporting functionality by upper layers by the test equipment and the UE shall transmit a PHR during T2.

During T2,

- UE is configured with a *phr-ProhibitTimer* timer value for Cell 1.
- UE is configured with a *phr-Tx-PowerFactorChange* value for Cell 1.

During T3,

Time period T3 starts when a PDSCH carrying MAC-CE activation for pathloss reference signal switch, sent from the test equipment to the UE to switch the pathloss reference signal from SSB 0 to SSB 1, is received at the UE side in Cell1's slot # denoted  $i$ . The UE shall switch its pathloss reference signal to the target one and send PHR.

The UE shall be able to apply the target pathloss reference signal of the serving cell on which pathloss reference signal switch occurs no later than the slot  $i + T_{HARQ} + \left\lceil \frac{3\text{ms} + 5 * T_{target\_PL-RS} + 2\text{ms}}{NR\ slot\ length} \right\rceil$  as defined in clause 8.14. The UE shall be able to apply old pathloss reference signals until the slot  $i + T_{HARQ} + 3N_{slot}^{subframe,\mu}$  as defined in clause 8.14.

The test equipment verifies the pathloss RS switch time by counting the slots from the time when the pathloss RS switch command is transmitted till a PHR is received during T3.

**Table A.6.5.9.1.1-1: MAC-CE based pathloss reference signal switch supported test configurations**

Config	Description
1	NR 15 kHz SSB SCS, 10 MHz bandwidth, FDD duplex mode
2	NR 15 kHz SSB SCS, 10 MHz bandwidth, TDD duplex mode
3	NR 30 kHz SSB SCS, 40 MHz bandwidth, TDD duplex mode
Note 1: The UE is only required to be tested in one of the supported test configurations.	

**Table A.6.5.9.1.1-2: General test parameters for MAC-CE based pathloss reference signal switch in SA**

Parameter		Unit	Value	Comment
Active PCell			Cell 1	
RF Channel Number			1	
Duplex mode	Config 1		FDD	
	Config 2, 3		TDD	
DL initial BWP configuration	Config 1, 2, 3		DLBWP.0.1	
DL dedicated BWP configuration	Config 1, 2, 3		DLBWP.1.1	
UL initial BWP configuration	Config 1, 2, 3		ULBWP.0.1	
UL dedicated BWP configuration	Config 1, 2, 3		ULBWP.1.1	
TDD Configuration	Config 1		Not Applicable	
	Config 2		TDDConf.1.1	
	Config 3		TDDConf.2.1	
CORESET Reference Channel	Config 1		CR.1.1 FDD	
	Config 2		CR.1.1 TDD	
	Config 3		CR.2.1 TDD	
SSB Configuration	Config 1		SSB.1 FR1	
	Config 2		SSB.1 FR1	
	Config 3		SSB.2 FR1	
SMTTC Configuration	Config 1, 2		SMTTC.1	
	Config 3		SMTTC.1	
PDSCH/PDCCH subcarrier spacing	Config 1, 2		15 kHz	
	Config 3		30 kHz	
SSB index assigned as pathloss RS			0 in T1, 0 in T2, 1 in T3	
OCNG parameters			OP.1	
CP length			Normal	
Correlation Matrix and Antenna Configuration			1x2 Low	
DRX			OFF	
Gap pattern ID			gp0	
<i>phr-ProhibitTimer</i>	sub frame		0	
<i>phr-Tx-PowerFactorChange</i>	dB		5	
<i>phr-PeriodicTimer</i>	sub frame		infinity	
Filter coefficient			0	L3 filtering is not used
T1	s		[2]	
T2	s		[2]	
T3	s		0.2	

**Table A.6.5.9.1.1-3: NR Cell specific test parameters for MAC-CE based pathloss reference signal switch in SA**

Parameter	Unit	Test 1		
		T1	T2	T3
EPRE ratio of PDCCH DMRS to SSS	dB	4		
EPRE ratio of PDCCH to PDCCH DMRS	dB	0		
EPRE ratio of PBCH DMRS to SSS	dB	0		
EPRE ratio of PBCH to PBCH DMRS	dB			
EPRE ratio of PSS to SSS	dB			
EPRE ratio of PDSCH DMRS to SSS	dB			
EPRE ratio of PDSCH to PDSCH DMRS	dB			
EPRE ratio of OCNG DMRS to SSS	dB			
EPRE ratio of OCNG to OCNG DMRS	dB			
$\hat{E}_s / I_{ot}$	dB			

SSB with index 0	$N_{oc}$	Config 1, 2, 3	dBm/15kHz	[-101]
	$\hat{E}_s / N_{oc}$		dB	[7]
	SS-RSRP Note 4	Config 1, 2	dBm/SCS	[-94]
		Config 3		[-91]
SSB with index 1	$\hat{E}_s / I_{ot}$		dB	[-3]
	$N_{oc}$	Config 1, 2, 3	dBm/15kHz	[-101]
	$\hat{E}_s / N_{oc}$		dB	[-3]
	SS-RSRP Note 4	Config 1, 2	dBm/SCS	[-104]
		Config 3		[-101]
$l_0$ Note 5	Config 1, 2		dBm	-65.3/9.36MHz
	Config 3			-59.2/38.16MHz
Propagation condition				AWGN
<p>Note 1: OCNG shall be used such that the resources in Cell 1 are fully allocated and a constant total transmitted power spectral density is achieved for all OFDM symbols.</p> <p>Note 2: The signal contains PDCCH for UEs other than the device under test as part of OCNG.</p> <p>Note 3: SNR levels correspond to the signal to noise ratio over the SSS REs.</p> <p>Note 4: The DL PDSCH reference measurement channel is used in the test only when a downlink transmission dedicated to the UE under test is required.</p> <p>Note 5: SS-RSRP, <math>E_s/I_{ot}</math> and <math>l_0</math> levels have been derived from other parameters for information purpose. They are not settable parameters.</p>				

### A.6.5.9.1.2 Test Requirements

During T3, the UE shall start to send the PHR for PCell no later than the slot  $i + T_{HARQ} + \left\lceil \frac{3ms + 5 * T_{target\_PL-RS} + 2ms}{NR\ slot\ length} \right\rceil$ .

During T3, the UE shall start to send the PHR for PCell no earlier than the slot  $i + T_{HARQ} + 3N_{slot}^{subframe,\mu}$ .

Where,  $T_{HARQ}$  is the timing between pathloss reference MAC-CE activation command and acknowledgement as specified in [7],  $T_{target\_PL-RS}$  is the periodicity of the target pathloss reference signal which is SSB in this test.

During T3, UE shall send L1-RSRP report with measurement results for both SSB0 and SSB1.

All of the above test requirements shall be fulfilled in order for the observed pathloss RS switch delay to be counted as correct.

The rate of correct events observed during repeated tests shall be at least 90%.

Note: The UE shall be given proper uplink transmission grant during T2 and T3.

## A.6.6 Measurement procedure

### A.6.6.1 Intra-frequency Measurements

#### A.6.6.1.1 SA event triggered reporting tests without gap under non-DRX

##### A.6.6.1.1.1 Test purpose and Environment

The purpose of this test is to verify that the UE makes correct reporting of an event. This test will partly verify the intra-frequency cell search requirements in clauses 9.2.5.1 and 9.2.5.2.

## A.6.6.1.1.2 Test parameters

Two cells are deployed in the test, which are FR1 PCell (Cell 1) and a FR1 neighbour cell (Cell 2) on the same frequency as the PCell. The test parameters for PCell and neighbour cell are given in Table A.6.6.1.1.1-1 and A.6.6.1.1.1-2 below. In the measurement control information, a measurement object is configured for the frequency of the PCell, and it is indicated to the UE that event-triggered reporting with Event A3 is used. The test consists of two successive time periods, with time duration of T1, and T2 respectively. During time duration T1, the UE shall not have any timing information of Cell 2.

**Table A.6.6.1.1.1.2-1: Supported test configurations**

Configuration	Description
1	15 kHz SSB SCS, 10 MHz bandwidth, FDD duplex mode
2	15 kHz SSB SCS, 10 MHz bandwidth, TDD duplex mode
3	30 kHz SSB SCS, 40 MHz bandwidth, TDD duplex mode
Note: The UE is only required to be tested in one of the supported test configurations.	

**Table A.6.6.1.1.2-2: General test parameters for SA intra-frequency event triggered reporting without gap for FR1**

Parameter	Unit	Test configuration	Value	Comment
Active cell		1, 2, 3	Cell 1	
Neighbour cell		1, 2, 3	Cell 2	Cell to be identified.
RF Channel Number		1, 2, 3	1: Cell 1 and Cell 2	
SSB configuration		1	SSB.1 FR1	
		2	SSB.1 FR1	
		3	SSB.2 FR1	
SMTC configuration		1	SMTC.2	
		2	SMTC.1	
		3	SMTC.1	
A3-Offset	dB	1, 2, 3	-4.5	
CP length		1, 2, 3	Normal	
Hysteresis	dB	1, 2, 3	0	
Time To Trigger	s	1, 2, 3	0	
Filter coefficient		1, 2, 3	0	L3 filtering is not used
DRX		1, 2, 3		OFF
Time offset between serving and neighbour cells		1	3 ms	Asynchronous cells. The timing of Cell 2 is 3ms later than the timing of Cell 1.
		2	3 $\mu$ s	Synchronous cells
		3	3 $\mu$ s	Synchronous cells
T1	s	1, 2, 3	5	
T2	s	1, 2, 3	5	

**Table A.6.6.1.1.2-3: NR Cell specific test parameters for SA intra-frequency event triggered reporting without gap for FR1**

Parameter	Unit	Test configuration	Cell 1		Cell 2	
			T1	T2	T1	T2
TDD configuration		1	TN/A		TN/A	
		2	TDDConf.1.1		TDDConf.1.1	
		3	TDDConf.2.1		TDDConf.2.1	
PDSCH RMC configuration		1	SR.1.1 FDD		N/A	
		2	SR.1.1 TDD			
		3	SR.2.1 TDD			
RMSI CORESET RMC configuration		1	CR.1.1 FDD		N/A	
		2	CR.1.1 TDD		N/A	
		3	CR.2.1 TDD		N/A	

Dedicated CORESET RMC configuration		1	CCR.1.1 FDD		N/A	
		2	CCR.1.1 TDD		N/A	
		3	CCR.2.1 TDD		N/A	
OCNG Patterns		1, 2, 3	OP.1		OP.1	
TRS Configuration		1	TRS.1.1 FDD		N/A	
		2	TRS.1.1 TDD		N/A	
		3	TRS.1.2 TDD		N/A	
Initial BWP configuration		1, 2, 3	DLBWP.0.1 ULBWP.0.1		DLBWP.0.1 ULBWP.0.1	
Active DL BWP configuration		1, 2, 3	DLBWP.1.1		DLBWP.1.1	
Active UL BWP configuration		1, 2, 3	ULBWP.1.1		ULBWP.1.1	
RLM-RS		1, 2, 3	SSB		SSB	
$N_{oc}$ <sup>Note 2</sup>	dBm/SCS	1	-98			
		2	-98			
		3	-95			
$N_{oc}$ <sup>Note 2</sup>	dBm/15 kHz	1	-98			
		2				
		3				
$\hat{E}_s/I_{ot}$	dB	1	4	-1.46	-Infinity	-1.46
		2				
		3				
$\hat{E}_s/N_{oc}$	dB	1	4	4	-Infinity	4
		2				
		3				
SS-RSRP <sup>Note 3</sup>	dBm/SCS kHz	1	-94	-94	-Infinity	-94
		2	-94	-94	-Infinity	-94
		3	-91	-91	-Infinity	-91
I <sub>o</sub>	dBm/9.36 MHz	1	-64.60	-62.25	--64.60	-62.25
	dBm/9.36 MHz	2	-64.60	-62.25	--64.60	-62.25
	dBm/38.16 MHz	3	-58.50	-56.16	--58.50	-56.16
Propagation Condition		1, 2, 3	AWGN			
<p>Note 1: The resources for uplink transmission are assigned to the UE prior to the start of time period T2.</p> <p>Note 2: Interference from other cells and noise sources not specified in the test is assumed to be constant over subcarriers and time and shall be modelled as AWGN of appropriate power for <math>N_{oc}</math> to be fulfilled.</p> <p>Note 3: SS-RSRP levels have been derived from other parameters for information purposes. They are not settable parameters themselves.</p>						

### A.6.6.1.1.3 Test Requirements

The UE shall send one Event A3 triggered measurement report, with a measurement reporting delay less than 800 ms from the beginning of time period T2. The UE is not required to read the neighbour cell SSB index in this test.

The UE shall not send event triggered measurement reports, as long as the reporting criteria are not fulfilled.

The rate of correct events observed during repeated tests shall be at least 90%.

NOTE: The actual overall delays measured in the test may be up to  $2 \times TTI_{DCC}$  higher than the measurement reporting delays above because of TTI insertion uncertainty of the measurement report in DCC.

## A.6.6.1.2 SA event triggered reporting tests without gap under DRX

### A.6.6.1.2.1 Test purpose and Environment

The purpose of this test is to verify that the UE makes correct reporting of an event. This test will partly verify the intra-frequency cell search requirements in clauses 9.2.5.1 and 9.2.5.2.

### A.6.6.1.2.2 Test parameters

Two cells are deployed in the test, which are FR1 PCell (Cell 1) and a FR1 neighbour cell (Cell 2) on the same frequency as the PCell. The test parameters for PCell are given in Table A.6.6.1.2.2-1, A.6.6.1.2.2-2 and A.6.6.1.2.2-3 below. In the measurement control information, a measurement object is configured for the frequency of the PCell, and it is indicated to the UE that event-triggered reporting with Event A3 is used. The test consists of two successive time periods, with time duration of T1, and T2 respectively. During time duration T1, the UE shall not have any timing information of Cell 2.

UE needs to be provided with new Timing Advance Command MAC control element at least once during each time alignment timer period to maintain uplink time alignment. Furthermore UE is allocated with PUSCH resource at every DRX cycle.

**Table A.6.6.1.2.2-1: Supported test configurations**

Configuration	Description
1	15 kHz SSB SCS, 10 MHz bandwidth, FDD duplex mode
2	15 kHz SSB SCS, 10 MHz bandwidth, TDD duplex mode
3	30 kHz SSB SCS, 40 MHz bandwidth, TDD duplex mode
Note:	The UE is only required to be tested in one of the supported test configurations.

**Table A.6.6.1.2.2-2: General test parameters for SA intra-frequency event triggered reporting without gap for PCell in FR1 with DRX**

Parameter	Unit	Test configuration	Value		Comment
			Test 1	Test 2	
Active cell		1, 2, 3	Cell 1		
Neighbour cell		1, 2, 3	Cell 2		Cell to be identified.
RF Channel Number		1, 2, 3	1: Cell 1 and Cell 2		
SSB configuration		1	SSB.1 FR1		
		2	SSB.1 FR1		
		3	SSB.2 FR1		
SMTC configuration		1	SMTC.2		
		2	SMTC.1		
		3	SMTC.1		
A3-Offset	dB	1, 2, 3	-4.5		
CP length		1, 2, 3	Normal		
Hysteresis	dB	1, 2, 3	0		
Time To Trigger	s	1, 2, 3	0		
Filter coefficient		1, 2, 3	0		L3 filtering is not used
DRX		1, 2, 3	DRX.1	DRX.7	
Time offset between serving and neighbour cells		1	3 ms		Asynchronous cells. The timing of Cell 2 is 3ms later than the timing of Cell 1.
		2	3 μs		Synchronous cells
		3	3 μs		Synchronous cells
T1	s	1, 2, 3	5		
T2	s	1, 2, 3	5	10	



**Table A.6.6.1.2.2-3: NR Cell specific test parameters for SA intra-frequency event triggered reporting without gap for PCell in FR1 with DRX**

Parameter	Unit	Test configuration	Cell 1		Cell 2	
			T1	T2	T1	T2
TDD configuration		1	TN/A		TN/A	
		2	TDDConf.1.1		TDDConf.1.1	
		3	TDDConf.2.1		TDDConf.2.1	
PDSCH RMC configuration		1	SR.1.1 FDD		N/A	
		2	SR.1.1 TDD			
		3	SR.2.1 TDD			
RMSI CORESET RMC configuration		1	CR.1.1 FDD		N/A	
		2	CR.1.1 TDD		N/A	
		3	CR.2.1 TDD		N/A	
Dedicated CORESET RMC configuration		1	CCR.1.1 FDD		N/A	
		2	CCR.1.1 TDD		N/A	
		3	CCR.2.1 TDD		N/A	
OCNG Patterns		1, 2, 3	OP.1		OP.1	
TRS configuration		1	TRS.1.1 FDD		N/A	
		2	TRS.1.1 TDD		N/A	
		3	TRS.1.2 TDD		N/A	
Initial BWP configuration		1, 2, 3	DLBWP.0.1 ULBWP.0.1		DLBWP.0.1 ULBWP.0.1	
Active DL BWP configuration		1, 2, 3	DLBWP.1.1		DLBWP.1.1	
Active UL BWP configuration		1, 2, 3	ULBWP.1.1		ULBWP.1.1	
RLM-RS		1, 2, 3	SSB		SSB	
$N_{oc}$ <small>Note 2</small>	dBm/SCS	1	-98			
		2	-98			
		3	-95			
$N_{oc}$ <small>Note 2</small>	dBm/15 kHz	1	-98			
		2				
		3				
$\hat{E}_s/I_{ot}$	dB	1	4	-1.46	-Infinity	-1.46
		2				
		3				
$\hat{E}_s/N_{oc}$	dB	1	4	4	-Infinity	4
		2				
		3				
SS-RSRP <small>Note 3</small>	dBm/SCS kHz	1	-94	-94	-Infinity	-94
		2	-94	-94	-Infinity	-94
		3	-91	-91	-Infinity	-91
I <sub>o</sub>	dBm/9.36 MHz	1	-64.60	-62.25	--64.60	-62.25
	dBm/9.36 MHz	2	-64.60	-62.25	--64.60	-62.25
	dBm/38.16 MHz	3	-58.50	-56.16	--58.50	-56.16
Propagation Condition		1, 2, 3	AWGN			
<p>Note 1: The resources for uplink transmission are assigned to the UE prior to the start of time period T2.</p> <p>Note 2: Interference from other cells and noise sources not specified in the test is assumed to be constant over subcarriers and time and shall be modelled as AWGN of appropriate power for <math>N_{oc}</math> to be fulfilled.</p> <p>Note 3: SS-RSRP levels have been derived from other parameters for information purposes. They are not settable parameters themselves.</p>						

### A.6.6.1.2.3 Test Requirements

In test 1, the UE shall send one Event A3 triggered measurement report, with a measurement reporting delay less than 920 ms from the beginning of time period T2. The UE is not required to read the neighbour cell SSB index in this test.

In test 2, the UE shall send one Event A3 triggered measurement report, with a measurement reporting delay less than 6400 ms from the beginning of time period T2. The UE is not required to read the neighbour cell SSB index in this test.

The UE shall not send event triggered measurement reports, as long as the reporting criteria are not fulfilled.

The rate of correct events observed during repeated tests shall be at least 90%.

NOTE: The actual overall delays measured in the test may be up to  $2 \times TTI_{DCCH}$  higher than the measurement reporting delays above because of TTI insertion uncertainty of the measurement report in DCCH.

### A.6.6.1.3 SA event triggered reporting tests with per-UE gaps under non-DRX

#### A.6.6.1.3.1 Test purpose and Environment

The purpose of this test is to verify that the UE makes correct reporting of an event. This test will partly verify the intra-frequency cell search requirements in clause 9.2.6.2 and 9.2.6.3.

#### A.6.6.1.3.2 Test parameters

Two cells are deployed in the test, which are FR1 PCell (Cell 1) and a FR1 neighbour cell (Cell 2) on the same frequency as the PCell. The test parameters for PCell are given in Table A.6.6.1.3.1-1 and A.6.6.1.3.1-2 below. In the measurement control information, a measurement object is configured for the frequency of the PCell, and it is indicated to the UE that event-triggered reporting with Event A3 is used. The test consists of two successive time periods, with time duration of T1, and T2 respectively. During time duration T1, the UE shall not have any timing information of Cell 2.

There are two BWPs configured in Cell 1, BWP1 which contains the cell defining SSB, and BWP2 which does not contain any SSB of Cell 1. During the whole test, BWP2 is always scheduled as the active BWP for the UE.

**Table A.6.6.1.3.2-1: Supported test configurations**

Configuration	Description
1	15 kHz SSB SCS, 10 MHz bandwidth, FDD duplex mode
2	15 kHz SSB SCS, 10 MHz bandwidth, TDD duplex mode
3	30 kHz SSB SCS, 40 MHz bandwidth, TDD duplex mode
Note: The UE is only required to be tested in one of the supported test configurations.	

**Table A.6.6.1.3.2-2: General test parameters for SA intra-frequency event triggered reporting with per-UE gaps for PCell in FR1**

Parameter	Unit	Test configuration	Value	Comment
Active cell		1, 2, 3	Cell 1	
Neighbour cell		1, 2, 3	Cell 2	Cell to be identified.
RF Channel Number		1, 2, 3	1: Cell 1 and Cell 2	
Measurement gap type		1, 2, 3	Per-UE gaps	
Measurement gap repetition periodicity	ms	1, 2, 3	40	
Measurement gap length	ms	1, 2, 3	6	
Measurement gap offset	ms	1, 2, 3	39	
SSB configuration		1	SSB.1 FR1	
		2	SSB.1 FR1	
		3	SSB.2 FR1	
SMTTC configuration		1	SMTTC.2	
		2	SMTTC.1	
		3	SMTTC.1	
CSI-RS parameters		1	CSI-RS.1.2 FDD resource #0	

		2	CSI-RS.1.2 TDD resource #0	
		3	CSI-RS.2.2 TDD resource #0	
A3-Offset	dB	1, 2, 3	-4.5	
CP length		1, 2, 3	Normal	
Hysteresis	dB	1, 2, 3	0	
Time To Trigger	s	1, 2, 3	0	
Filter coefficient		1, 2, 3	0	L3 filtering is not used
DRX	ms	1, 2, 3		OFF
Time offset between serving and neighbour cells		1	3 ms	Asynchronous cells. The timing of Cell 2 is 3ms later than the timing of Cell 1.
		2	3 μs	Synchronous cells
		3	3 μs	Synchronous cells
T1	s	1, 2, 3	5	
T2	s	1, 2, 3	5	

**Table A.6.6.1.3.2-3: NR Cell specific test parameters for SA intra-frequency event triggered reporting with per-UE gaps for PCell in FR1**

Parameter	Unit	Test configuration	Cell 1		Cell 2	
			T1	T2	T1	T2
TDD configuration		1	TN/A		TN/A	
		2	TDDConf.1.1		TDDConf.1.1	
		3	TDDConf.2.1		TDDConf.2.1	
PDSCH RMC configuration		1	SR.1.1 FDD		N/A	
		2	SR.1.1 TDD			
		3	SR.2.1 TDD			
RMSI CORESET RMC configuration		1	CR.1.1 FDD		N/A	
		2	CR.1.1 TDD		N/A	
		3	CR.2.1 TDD		N/A	
Dedicated CORESET RMC configuration		1	CCR.1.2 FDD		N/A	
		2	CCR.1.2 TDD		N/A	
		3	CCR.2.1 TDD		N/A	
OCNG Patterns		1, 2, 3	OP.1		OP.1	
TRS configuration		1	TRS.1.1 FDD		N/A	
		2	TRS.1.1 TDD		N/A	
		3	TRS.1.2 TDD		N/A	
Initial BWP configuration		1, 2, 3	DLBWP.0.1 ULBWP.0.1		DLBWP.0.1 ULBWP.0.1	
Active DL BWP configuration		1, 2, 3	DLBWP.1.2		DLBWP.1.1	
Active UL BWP configuration		1, 2, 3	ULBWP.1.2		ULBWP.1.1	
RLM-RS		1, 2, 3	CSI-RS		SSB	
$N_{oc}$ Note 2	dBm/SCS	1	-98			
		2	-98			
		3	-95			
$N_{oc}$ Note 2	dBm/15 kHz	1	-98			
		2				
		3				
$\hat{E}_s/I_{ot}$	dB	1	4	-1.46	-Infinity	-1.46
		2				
		3				
$\hat{E}_s/N_{oc}$	dB	1	4	4	-Infinity	4

		2				
		3				
SS-RSRP <sup>Note 3</sup>	dBm/SCS kHz	1	-94	-94	-Infinity	-94
		2	-94	-94	-Infinity	-94
		3	-91	-91	-Infinity	-91
I <sub>o</sub>	dBm/9.36 MHz	1	-64.60	-62.25	--64.60	-62.25
		2	-64.60	-62.25	--64.60	-62.25
		3	-58.50	-56.16	--58.50	-56.16
Propagation Condition		1, 2, 3	AWGN			
<p>Note 1: The resources for uplink transmission are assigned to the UE prior to the start of time period T2.</p> <p>Note 2: Interference from other cells and noise sources not specified in the test is assumed to be constant over subcarriers and time and shall be modelled as AWGN of appropriate power for <math>N_{oc}</math> to be fulfilled.</p> <p>Note 3: SS-RSRP levels have been derived from other parameters for information purposes. They are not settable parameters themselves.</p>						

### A.6.6.1.3.3 Test Requirements

The UE shall send one Event A3 triggered measurement report, with a measurement reporting delay less than 800 ms from the beginning of time period T2. The UE is not required to read the neighbour cell SSB index in this test.

The UE shall not send event triggered measurement reports, as long as the reporting criteria are not fulfilled.

The rate of correct events observed during repeated tests shall be at least 90%.

NOTE: The actual overall delays measured in the test may be up to  $2 \times TTI_{DCCH}$  higher than the measurement reporting delays above because of TTI insertion uncertainty of the measurement report in DCCH.

### A.6.6.1.4 SA event triggered reporting tests with per-UE gaps under DRX

#### A.6.6.1.4.1 Test purpose and Environment

The purpose of this test is to verify that the UE makes correct reporting of an event. This test will partly verify the intra-frequency cell search requirements in clause 9.2.6.2 and 9.2.6.3.

#### A.6.6.1.4.2 Test parameters

Two cells are deployed in the test, which are FR1 PCell (Cell 1) and a FR1 neighbour cell (Cell 2) on the same frequency as the PCell. The test parameters for PCell are given in Table A.6.6.1.4.2-1, A.6.6.1.4.2-2 and A.6.6.1.4.2-3 below. In the measurement control information, a measurement object is configured for the frequency of the PCell, and it is indicated to the UE that event-triggered reporting with Event A3 is used. The test consists of two successive time periods, with time duration of T1, and T2 respectively. During time duration T1, the UE shall not have any timing information of Cell 2.

There are two BWPs configured in Cell 1, BWP1 which contains the cell defining SSB, and BWP2 which does not contain any SSB of Cell 1. During the whole test, BWP2 is always scheduled as the active BWP for the UE.

UE needs to be provided with new Timing Advance Command MAC control element at least once during each time alignment timer period to maintain uplink time alignment. Furthermore UE is allocated with PUSCH resource at every DRX cycle.

**Table A.6.6.1.4.2-1: Supported test configurations**

Configuration	Description
1	15 kHz SSB SCS, 10 MHz bandwidth, FDD duplex mode
2	15 kHz SSB SCS, 10 MHz bandwidth, TDD duplex mode
3	30 kHz SSB SCS, 40 MHz bandwidth, TDD duplex mode
Note:	The UE is only required to be tested in one of the supported test configurations.

**Table A.6.6.1.4.2-2: General test parameters for SA intra-frequency event triggered reporting with per-UE gaps for PCell in FR1 with DRX**

Parameter	Unit	Test configuration	Value		Comment
			Test 1	Test 2	
Active cell		1, 2, 3	Cell 1		
Neighbour cell		1, 2, 3	Cell 2		Cell to be identified.
RF Channel Number		1, 2, 3	1: Cell 1 and Cell 2		
Measurement gap type		1, 2, 3	Per-UE gaps		
Measurement gap repetition periodicity	ms	1, 2, 3	40		
Measurement gap length	ms	1, 2, 3	6		
Measurement gap offset	ms	1, 2, 3	39		
SSB configuration		1	SSB.1 FR1		
		2	SSB.1 FR1		
		3	SSB.2 FR1		
SMTC configuration		1	SMTC.2		
		2	SMTC.1		
		3	SMTC.1		
CSI-RS parameters		1	CSI-RS.1.2 FDD resource #0		
		2	CSI-RS.1.2 TDD resource #0		
		3	CSI-RS.2.2 TDD resource #0		
A3-Offset	dB	1, 2, 3	-4.5		
CP length		1, 2, 3	Normal		
Hysteresis	dB	1, 2, 3	0		
Time To Trigger	s	1, 2, 3	0		
Filter coefficient		1, 2, 3	0		L3 filtering is not used
DRX		1, 2, 3	DRX.1	DRX.7	
Time offset between serving and neighbour cells		1	3 ms		Asynchronous cells. The timing of Cell 2 is 3ms later than the timing of Cell 1..
		2	3 $\mu$ s		Synchronous cells
		3	3 $\mu$ s		Synchronous cells
T1	s	1, 2, 3	5		
T2	s	1, 2, 3	5	10	

**Table A.6.6.1.4.2-3: NR Cell specific test parameters for SA intra-frequency event triggered reporting with per-UE gaps for PCell in FR1 with DRX**

Parameter	Unit	Test configuration	Cell 1		Cell 2	
			T1	T2	T1	T2
TDD configuration		1	TN/A		TN/A	
		2	TDDConf.1.1		TDDConf.1.1	
		3	TDDConf.2.1		TDDConf.2.1	
PDSCH RMC configuration		1	SR.1.1 FDD		N/A	
		2	SR.1.1 TDD			
		3	SR.2.1 TDD			
RMSI CORESET RMC configuration		1	CR.1.1 FDD		N/A	
		2	CR.1.1 TDD		N/A	
		3	CR.2.1 TDD		N/A	
Dedicated CORESET RMC configuration		1	CCR.1.2 FDD		N/A	
		2	CCR.1.2 TDD		N/A	
		3	CCR.2.1 TDD		N/A	
OCNG Patterns		1, 2, 3	OP.1		OP.1	

TRS configuration		1	TRS.1.1 FDD	N/A		
		2	TRS.1.1 TDD	N/A		
		3	TRS.1.2 TDD	N/A		
Initial BWP configuration		1, 2, 3	DLBWP.0.1 ULBWP.0.1	DLBWP.0.1 ULBWP.0.1		
Active DL BWP configuration		1, 2, 3	DLBWP.1.2	DLBWP.1.1		
Active UL BWP configuration		1, 2, 3	ULBWP.1.2	ULBWP.1.1		
RLM-RS		1, 2, 3	CSI-RS	SSB		
$N_{oc}$ <sup>Note 2</sup>	dBm/SCS	1	-98			
		2	-98			
		3	-95			
$N_{oc}$ <sup>Note 2</sup>	dBm/15 kHz	1	-98			
		2				
		3				
$\hat{E}_s/I_{ot}$	dB	1	4	-1.46	-Infinity	-1.46
		2				
		3				
$\hat{E}_s/N_{oc}$	dB	1	4	4	-Infinity	4
		2				
		3				
SS-RSRP <sup>Note 3</sup>	dBm/SCS kHz	1	-94	-94	-Infinity	-94
		2	-94	-94	-Infinity	-94
		3	-91	-91	-Infinity	-91
I <sub>o</sub>	dBm/9.36 MHz	1	-64.60	-62.25	--64.60	-62.25
	dBm/9.36 MHz	2	-64.60	-62.25	-64.60	-62.25
	dBm/38.16 MHz	3	-58.50	-56.16	--58.50	-56.16
Propagation Condition		1, 2, 3	AWGN			
<p>Note 1: Table A.6.6.1.4.2-1 The resources for uplink transmission are assigned to the UE prior to the start of time period T2.</p> <p>Note 2: Table A.6.6.1.4.2-1 Interference from other cells and noise sources not specified in the test is assumed to be constant over subcarriers and time and shall be modelled as AWGN of appropriate power for <math>N_{oc}</math> to be fulfilled.</p> <p>Note 3: Table A.6.6.1.4.2-1 SS-RSRP levels have been derived from other parameters for information purposes. They are not settable parameters themselves.</p>						

Table A.6.6.1.4.2-4: Void

Table A.6.6.1.4.2-5: Void

### A.6.6.1.4.3 Test Requirements

In test 1, the UE shall send one Event A3 triggered measurement report, with a measurement reporting delay less than 920 ms from the beginning of time period T2. The UE is not required to read the neighbour cell SSB index in this test.

In test 2, the UE shall send one Event A3 triggered measurement report, with a measurement reporting delay less than 6400 ms from the beginning of time period T2. The UE is not required to read the neighbour cell SSB index in this test.

The UE shall not send event triggered measurement reports, as long as the reporting criteria are not fulfilled.

The rate of correct events observed during repeated tests shall be at least 90%.

NOTE: The actual overall delays measured in the test may be up to  $2 \times TTI_{DCCH}$  higher than the measurement reporting delays above because of TTI insertion uncertainty of the measurement report in DCCH.

### A.6.6.1.5 SA event triggered reporting tests without gap under non-DRX with SSB index reading

#### A.6.6.1.5.1 Test purpose and Environment

The purpose of this test is to verify that the UE makes correct reporting of an event. This test will partly verify the FDD intra-frequency cell search requirements in clause 9.2.5.1 and 9.2.5.2.

#### A.6.6.1.5.2 Test parameters

Two cells are deployed in the test, which are FR1 PCell (Cell 1) and a FR1 neighbour cell (Cell 2) on the same frequency as the PCell. The test parameters for FDD PCell and neighbour cell are given in Table A.6.6.1.5.2-1 and A.6.6.1.5.2-2 below. In the measurement control information, a measurement object is configured for the frequency of the PCell, and it is indicated to the UE that event-triggered reporting with Event A3 is used. The test consists of two successive time periods, with time duration of T1, and T2 respectively. During time duration T1, the UE shall not have any timing information of Cell 2.

**Table A.6.6.1.5.2-1: Supported test configurations**

Configuration	Description
1	15 kHz SSB SCS, 10 MHz bandwidth, FDD duplex mode

**Table A.6.6.1.5.2-2: General test parameters for SA intra-frequency event triggered reporting without gap for FDD PCell in FR1 with SSB index reading**

Parameter	Unit	Test configuration	Value	Comment
Active cell		1	Cell 1	
Neighbour cell		1	Cell 2	Cell to be identified.
RF Channel Number		1	1: Cell 1 and Cell 2	
SSB configuration		1	SSB.1 FR1	
SMTC configuration		1	SMTC.2	
A3-Offset	dB	1	-4.5	
CP length		1	Normal	
Hysteresis	dB	1	0	
Time To Trigger	s	1	0	
Filter coefficient		1	0	L3 filtering is not used
DRX	ms	1		OFF
Time offset between serving and neighbour cells		1	3 ms	Asynchronous cells. The timing of Cell 2 is 3ms later than the timing of Cell 1.
T1	s	1	5	
T2	s	1	5	

**Table A.6.6.1.5.2-3: NR Cell specific test parameters for SA intra-frequency event triggered reporting without gap for FDD PCell in FR1 with SSB index reading**

Parameter	Unit	Test configuration	Cell 1		Cell 2	
			T1	T2	T1	T2
TDD configuration		1	N/A		N/A	
PDSCH RMC configuration		1	SR.1.1 FDD		N/A	
RMSI CORESET RMC configuration		1	CR.1.1 FDD		N/A	
Dedicated CORESET RMC configuration		1	CCR.1.1 FDD		N/A	
OCNG Patterns		1	OP.1		OP.1	
TRS configuration		1	TRS.1.1 FDD		N/A	
Initial BWP configuration		1	DLBWP.0,1	ULBWP.0.1	DLBWP.0.1	ULBWP.0.1

Active DL BWP configuration		1	DLBWP.1.1		DLBWP.1.1	
Active UL BWP configuration		1	ULBWP.1.1		ULBWP.1.1	
RLM-RS		1	SSB		SSB	
$N_{oc}$ Note 2	dBm/SCS	1	-98			
$N_{oc}$ Note 2	dBm/15 kHz	1	-98			
$\hat{E}_s/I_{ot}$	dB	1	4	-1.46	-Infinity	-1.46
$\hat{E}_s/N_{oc}$	dB	1	4	4	-Infinity	4
SS-RSRP Note 3	dBm/SCS kHz	1	-94	-94	-Infinity	-94
Io	dBm/9.36 MHz	1	-64.60	-62.25	--64.60	-62.25
Propagation Condition		1	AWGN			
Note 1:	The resources for uplink transmission are assigned to the UE prior to the start of time period T2.					
Note 2:	Interference from other cells and noise sources not specified in the test is assumed to be constant over subcarriers and time and shall be modelled as AWGN of appropriate power for $N_{oc}$ to be fulfilled.					
Note 3:	SS-RSRP levels have been derived from other parameters for information purposes. They are not settable parameters themselves.					

#### A.6.6.1.5.3 Test Requirements

The UE shall send one Event A3 triggered measurement report, with a measurement reporting delay less than 920 ms from the beginning of time period T2. The UE is required to read the neighbour cell SSB index and report the acquired SSB index in this test.

The UE shall not send event triggered measurement reports, as long as the reporting criteria are not fulfilled.

The rate of correct events observed during repeated tests shall be at least 90%.

NOTE: The actual overall delays measured in the test may be up to  $2xTTI_{DCC}$  higher than the measurement reporting delays above because of TTI insertion uncertainty of the measurement report in DCC.

#### A.6.6.1.6 SA event triggered reporting tests with per-UE gaps under non-DRX with SSB index reading

##### A.6.6.1.6.1 Test purpose and Environment

The purpose of this test is to verify that the UE makes correct reporting of an event. This test will partly verify the FDD intra-frequency cell search requirements in clause 9.2.6.2 and 9.2.6.3.

##### A.6.6.1.6.2 Test parameters

Two cells are deployed in the test, which are FR1 PCell (Cell 1) and a FR1 neighbour cell (Cell 2) on the same frequency as the PCell. The test parameters for FDD PCell and neighbour cell are given in Table A.6.6.1.6.2-1 and A.6.6.1.6.2-2 below. In the measurement control information, a measurement object is configured for the frequency of the PCell, and it is indicated to the UE that event-triggered reporting with Event A3 is used. The test consists of two successive time periods, with time duration of T1, and T2 respectively. During time duration T1, the UE shall not have any timing information of Cell 2.

There are two BWPs configured in Cell 1, BWP1 which contains the cell defining SSB, and BWP2 which does not contain any SSB of Cell 1. During the whole test, BWP2 is always scheduled as the active BWP for the UE.

**Table A.6.6.1.6.2-1: Supported test configurations**

Configuration	Description
1	15 kHz SSB SCS, 10 MHz bandwidth, FDD duplex mode



**Table A.6.6.1.6.2-2: General test parameters for SA intra-frequency event triggered reporting with gap for FDD PCell in FR1 with SSB index reading**

Parameter	Unit	Test configuration	Value	Comment
Active cell		1	Cell 1	
Neighbour cell		1	Cell 2	Cell to be identified.
RF Channel Number		1	1: Cell 1 and Cell 2	
Measurement gap type		1	Per-UE gaps	
Measurement gap repetition periodicity	ms	1	40	
Measurement gap length	ms	1	6	
Measurement gap offset	ms	1	39	
SSB configuration		1	SSB.1 FR1	
SMTC configuration		1	SMTC.2	
CSI-RS parameters		1	CSI-RS.1.2 FDD resource #0	
A3-Offset	dB	1	-4.5	
CP length		1	Normal	
Hysteresis	dB	1	0	
Time To Trigger	s	1	0	
Filter coefficient		1	0	L3 filtering is not used
DRX	ms	1		OFF
Time offset between serving and neighbour cells		1	3 ms	Asynchronous cells. The timing of Cell 2 is 3ms later than the timing of Cell 1.
T1	s	1	5	
T2	s	1	5	

**Table A.6.6.1.6.2-3: NR Cell specific test parameters for SA intra-frequency event triggered reporting with gap for FDD PCell in FR1 with SSB index reading**

Parameter	Unit	Test configuration	Cell 1		Cell 2	
			T1	T2	T1	T2
TDD configuration		1	N/A		N/A	
PDSCH RMC configuration		1	SR.1.1 FDD		N/A	
RMSI CORESET RMC configuration		1	CR.1.1 FDD		N/A	
Dedicated CORESET RMC configuration		1	CCR.1.2 FDD		N/A	
OCNG Patterns		1	OP.1		OP.1	
TRS configuration		1	TRS.1.1 FDD		N/A	
Initial BWP configuration		1	DLBWP.0.1 ULBWP.0.1		DLBWP.0.1 ULBWP.0.1	
Active DL BWP configuration		1	DLBWP.1.2		DLBWP.1.1	
Active UL BWP configuration		1	ULBWP.1.2		ULBWP.1.1	
RLM-RS		1	CSI-RS		SSB	
$N_{oc}$ <sup>Note 2</sup>	dBm/SCS	1	-98			
$N_{oc}$ <sup>Note 2</sup>	dBm/15 kHz	1	-98			
$\hat{E}_s/I_{ot}$	dB	1	4	-1.46	-Infinity	-1.46
$\hat{E}_s/N_{oc}$	dB	1	4	4	-Infinity	4
SS-RSRP <sup>Note 3</sup>	dBm/SCS kHz	1	-94	-94	-Infinity	-94
Io	dBm/9.36 MHz	1	-64.60	-62.25	--64.60	-62.25
Propagation Condition		1	AWGN			

Note 1:	The resources for uplink transmission are assigned to the UE prior to the start of time period T2.
Note 2:	Interference from other cells and noise sources not specified in the test is assumed to be constant over subcarriers and time and shall be modelled as AWGN of appropriate power for $N_{oc}$ to be fulfilled.
Note 3:	SS-RSRP levels have been derived from other parameters for information purposes. They are not settable parameters themselves.

### A.6.6.1.6.3 Test Requirements

The UE shall send one Event A3 triggered measurement report, with a measurement reporting delay less than 920 ms from the beginning of time period T2. The UE is required to read the neighbour cell SSB index and report the acquired SSB index in this test.

The UE shall not send event triggered measurement reports, as long as the reporting criteria are not fulfilled.

The rate of correct events observed during repeated tests shall be at least 90%.

NOTE: The actual overall delays measured in the test may be up to  $2 \times TTI_{DCCH}$  higher than the measurement reporting delays above because of TTI insertion uncertainty of the measurement report in DCCH.

### A.6.6.1.7 SA event triggered reporting tests under DRX for UE configured with highSpeedMeasFlag-r16

#### A.6.6.1.7.1 Test purpose and Environment

The purpose of this test is to verify that the UE makes correct reporting of an event for UE configured with highSpeedMeasFlag-r16. This test will partly verify the intra-frequency cell search requirements in clauses 9.2.5.1 and 9.2.5.2.

#### A.6.6.1.7.2 Test parameters

Two cells are deployed in the test, which are FR1 PCell (Cell 1) and a FR1 neighbour cell (Cell 2) on the same frequency as the PCell. The test parameters for PCell are given in Table A.6.6.1.7.2-1, A.6.6.1.7.2-2 and A.6.6.1.7.2-3 below. In the measurement control information, a measurement object is configured for the frequency of the PCell, and it is indicated to the UE that event-triggered reporting with Event A3 is used. The test consists of two successive time periods, with time duration of T1, and T2 respectively. During time duration T1, the UE shall not have any timing information of Cell 2.

UE needs to be provided at least once every 500ms with new Timing Advance Command MAC control element to restart the Time alignment timer to keep UE uplink time alignment. Furthermore UE is allocated with PUSCH resource at every DRX cycle.

UE needs to be provided with new Timing Advance Command MAC control element at least once during each time alignment timer period to maintain uplink time alignment. Furthermore UE is allocated with PUSCH resource at every DRX cycle.

**Table A.6.6.1.7.2-1: Supported test configurations**

Configuration	Description
1	15 kHz SSB SCS, 10 MHz bandwidth, FDD duplex mode
2	15 kHz SSB SCS, 10 MHz bandwidth, TDD duplex mode
3	30 kHz SSB SCS, 40 MHz bandwidth, TDD duplex mode
Note:	The UE is only required to be tested in one of the supported test configurations.

**Table A.6.6.1.7.2-2: General test parameters for SA intra-frequency event triggered reporting without gap for PCell in FR1 with DRX for UE configured with highSpeedMeasFlag-r16**

Parameter	Unit	Test configuration	Value	Comment

<i>highSpeedMeasFlag-r16</i>		1,2,3	Present	To enable high speed measurement enhancements
Active cell		1, 2, 3	Cell 1	
Neighbour cell		1, 2, 3	Cell 2	Cell to be identified.
RF Channel Number		1, 2, 3	1: Cell 1 and Cell 2	
SSB configuration		1	SSB.1 FR1	
		2	SSB.1 FR1	
		3	SSB.2 FR1	
SMTC configuration		1	SMTC.2	
		2	SMTC.1	
		3	SMTC.1	
A3-Offset	dB	1, 2, 3	-4.5	
CP length		1, 2, 3	Normal	
Hysteresis	dB	1, 2, 3	0	
Time To Trigger	s	1, 2, 3	0	
Filter coefficient		1, 2, 3	0	L3 filtering is not used
DRX		1, 2, 3	DRX.7	640ms DRX cycle
Time offset between serving and neighbour cells		1	3 ms	Asynchronous cells. The timing of Cell 2 is 3ms later than the timing of Cell 1.
		2	3 $\mu$ s	Synchronous cells
		3	3 $\mu$ s	Synchronous cells
T1	s	1, 2, 3	5	
T2	s	1, 2, 3	6	

**Table A.6.6.1.7.2-3: NR Cell specific test parameters for SA intra-frequency event triggered reporting without gap for PCell in FR1 with DRX for UE configured with highSpeedMeasFlag-r16**

Parameter	Unit	Test configuration	Cell 1		Cell 2	
			T1	T2	T1	T2
TDD configuration		1	TN/A		TN/A	
		2	TDDConf.1.1		TDDConf.1.1	
		3	TDDConf.2.1		TDDConf.2.1	
PDSCH RMC configuration		1	SR.1.1 FDD		N/A	
		2	SR.1.1 TDD			
		3	SR.2.1 TDD			
RMSI CORESET RMC configuration		1	CR.1.1 FDD		CR.1.1 FDD	
		2	CR.1.1 TDD		CR.1.1 TDD	
		3	CR.2.1 TDD		CR.2.1 TDD	
Dedicated CORESET RMC configuration		1	CCR.1.1 FDD		CCR.1.1 FDD	
		2	CCR.1.1 TDD		CCR.1.1 TDD	
		3	CCR.2.1 TDD		CCR.2.1 TDD	
OCNG Patterns		1, 2, 3	OP.1		OP.1	
TRS configuration		1	TRS.1.1 FDD		N/A	
		2	TRS.1.1 TDD		N/A	
		3	TRS.1.2 TDD		N/A	
Initial BWP configuration		1, 2, 3	DLBWP.0.1 ULBWP.0.1		DLBWP.0.1 ULBWP.0.1	
Active DL BWP configuration		1, 2, 3	DLBWP.1.1		DLBWP.1.1	
Active UL BWP configuration		1, 2, 3	ULBWP.1.1		ULBWP.1.1	
RLM-RS		1, 2, 3	SSB		SSB	
$N_{oc}$ <small>Note 2</small>	dBm/SCS	1	-98			
		2	-98			
		3	-95			

$N_{oc}$ <small>Note 2</small>	dBm/15 kHz	1	-98			
		2				
		3				
$\hat{E}_s/I_{ot}$	dB	1	4	-1.46	-Infinity	-1.46
		2				
		3				
$\hat{E}_s/N_{oc}$	dB	1	4	4	-Infinity	4
		2				
		3				
SS-RSRP <small>Note 3</small>	dBm/SCS kHz	1	-94	-94	-Infinity	-94
		2	-94	-94	-Infinity	-94
		3	-91	-91	-Infinity	-91
I <sub>o</sub>	dBm/9.36 MHz	1	-64.60	-62.25	-64.60	-62.25
	dBm/9.36 MHz	2	-64.60	-62.25	-64.60	-62.25
	dBm/38.16 MHz	3	-58.50	-56.16	-58.50	-56.16
Propagation Condition		1, 2	AWGN		AWGN 1944Hz <small>Note 4</small>	
		3	AWGN		AWGN 3334Hz <small>Note 5</small>	
<p>Note 1: The resources for uplink transmission are assigned to the UE prior to the start of time period T2.</p> <p>Note 2: Interference from other cells and noise sources not specified in the test is assumed to be constant over subcarriers and time and shall be modelled as AWGN of appropriate power for <math>N_{oc}</math> to be fulfilled.</p> <p>Note 3: SS-RSRP levels have been derived from other parameters for information purposes. They are not settable parameters themselves.</p> <p>Note 4: The AWGN 1944 Hz condition is a non fading propagation channel with one tap. Doppler shift is a constant 1944Hz.</p> <p>Note 5: The AWGN 3334 Hz condition is a non fading propagation channel with one tap. Doppler shift is a constant 3334Hz.</p>						

### A.6.6.1.7.3 Test Requirements

The UE shall send one Event A3 triggered measurement report, with a measurement reporting delay less than 5120 ms from the beginning of time period T2. The UE is not required to read the neighbour cell SSB index in this test.

The UE shall not send event triggered measurement reports, as long as the reporting criteria are not fulfilled.

The rate of correct events observed during repeated tests shall be at least 90%.

NOTE: The actual overall delays measured in the test may be up to  $2xTTI_{DCCH}$  higher than the measurement reporting delays above because of TTI insertion uncertainty of the measurement report in DCCH.

## A.6.6.2 Inter-frequency Measurements

### A.6.6.2.1 SA event triggered reporting tests for FR1 without SSB time index detection when DRX is not used

#### A.6.6.2.1.1 Test Purpose and Environment

The purpose of this test is to verify that the UE makes correct reporting of an event. This test will partly verify the SA inter-frequency NR cell search requirements in clause 9.3.4.

In this test, there are two cells: NR cell 1 as PCell in FR1 on NR RF channel 1 and NR cell 2 as neighbour cell in FR1 on NR RF channel 2. The test parameters are given in Tables A.6.6.2.1.1-1, A.6.6.2.1.1-2 and A.6.6.2.1.1-3.

Measurement gap pattern configuration is defined in Table A.6.6.2.1.1-2.

In the measurement control information, it is indicated to the UE that event-triggered reporting with Event A3 is used. The test consists of two successive time periods, with time duration of T1, and T2 respectively. During time duration T1, the UE shall not have any timing information of NR cell 2.

**Table A.6.6.2.1.1-1: SA event triggered reporting tests without SSB index reading for FR1-FR1**

Config	Description
1	NR 15 kHz SSB SCS, 10 MHz bandwidth, FDD duplex mode
2	NR 15 kHz SSB SCS, 10 MHz bandwidth, TDD duplex mode
3	NR 30kHz SSB SCS, 40 MHz bandwidth, TDD duplex mode
Note 1: The UE is only required to be tested in one of the supported test configurations	
Note 2: target NR cell has the same SCS, BW and duplex mode as NR serving cell	

**Table A.6.6.2.1.1-2: General test parameters for SA inter-frequency event triggered reporting for FR1 without SSB time index detection**

Parameter	Unit	Test configuration	Value	Comment
NR RF Channel Number		Config 1,2,3	1, 2	Two FR1 NR carrier frequencies is used.
Active cell		Config 1,2,3	NR cell 1 (Pcell)	NR Cell 1 is on NR RF channel number 1.
Neighbour cell		Config 1,2,3	NR cell2	NR cell 2 is on NR RF channel number 2.
Gap Pattern Id		Config 1,2,3	0	As specified in clause 9.1.2-1.
Measurement gap offset		Config 1,2,3	9	
SMTC-SSB parameters		Config 1	SSB.1 FR1	As specified in clause A.3.10.1
		Config 2	SSB.1 FR1	As specified in clause A.3.10.1
		Config 3	SSB.2 FR1	As specified in clause A.3.10.1
A3-Offset	dB	Config 1,2,3	-6	
Hysteresis	dB	Config 1,2,3	0	
CP length		Config 1,2,3	Normal	
TimeToTrigger	s	Config 1,2,3	0	
Filter coefficient		Config 1,2,3	0	L3 filtering is not used
DRX		Config 1,2,3	OFF	DRX is not used
Time offset between serving and neighbour cells		Config 1	3ms	Asynchronous cells. The timing of Cell 2 is 3ms later than the timing of Cell 1.
		Config 2,3	3μs	Synchronous cells.
T1	s	Config 1,2,3	5	
T2	s	Config 1,2,3	1	

**Table A.6.6.2.1.1-3: Cell specific test parameters for SA inter-frequency event triggered reporting for FR1 without SSB time index detection**

Parameter	Unit	Test configuration	Cell 1		Cell 2	
			T1	T2	T1	T2
NR RF Channel Number		Config 1,2,3	1		2	
Duplex mode		Config 1	FDD			
		Config 2,3	TDD			
TDD configuration		Config 1	Not Applicable			
		Config 2	TDDConf.1.1			
		Config 3	TDDConf.2.1			
BW <sub>channel</sub>	MHz	Config 1,2	10: N <sub>RB,c</sub> = 52			
		Config 3	40: N <sub>RB,c</sub> = 106			

BWP BW		MHz	Config 1,2	10: $N_{RB,c} = 52$			
			Config 3	40: $N_{RB,c} = 106$			
BWP configuration	Initial DL BWP		Config 1, 2, 3	DLBWP.0.1		NA	
	Initial UL BWP			ULBWP.0.1		NA	
	Dedicated DL BWP			DLBWP.1.1		NA	
	Dedicated UL BWP			ULBWP.1.1		NA	
TRS configuration			Config 1	TRS.1.1 FDD		NA	
			Config 2	TRS.1.1 TDD		NA	
			Config 3	TRS.1.2 TDD		NA	
OCNG Patterns defined in A.3.2.1.1 (OP.1)			Config 1,2,3	OP.1		OP.1	
PDSCH Reference measurement channel			Config 1	SR.1.1 FDD			
			Config 2	SR.1.1 TDD			
			Config 3	SR2.1 TDD			
RMSI CORESET Reference Channel			Config 1	CR.1.1 FDD			
			Config 2	CR.1.1 TDD			
			Config 3	CR2.1 TDD			
Dedicated CORESET Reference Channel			Config 1	CCR.1.1 FDD			
			Config 2	CCR.1.1 TDD			
			Config 3	CCR.2.1 TDD			
SSB parameters			Config 1	SSB.1 FR1		SSB.5 FR1	
			Config 2	SSB.1 FR1		SSB.5 FR1	
			Config 3	SSB.2 FR1		SSB.6 FR1	
SMTC configuration defined in A.3.11			Config 1	SMTC.2		SMTC.5	
			Config 2, 3	SMTC.1		SMTC.4	
PDSCH/PDCCH subcarrier spacing		kHz	Config 1,2	15			
			Config 3	30			
EPRE ratio of PSS to SSS			Config 1,2,3	0		0	
EPRE ratio of PBCH DMRS to SSS							
EPRE ratio of PBCH to PBCH DMRS							
EPRE ratio of PDCCH DMRS to SSS							
EPRE ratio of PDCCH to PDCCH DMRS							
EPRE ratio of PDSCH DMRS to SSS							
EPRE ratio of PDSCH to PDSCH							
EPRE ratio of OCNG DMRS to SSS(Note 1)							
EPRE ratio of OCNG to OCNG DMRS (Note 1)							
$N_{oc}$ <sup>Note2</sup>	dBm/15 kHz				-98		-98
$N_{oc}$ <sup>Note2</sup>	dBm/S CS		Config 1,2	-98		-98	
			Config 3	-95		-95	
SS-RSRP <sup>Note 3</sup>	dBm/S CS		Config 1,2	-94	-94	-Infinity	-91
			Config 3	-91	-91	-Infinity	-88
$\hat{E}_s/I_{ot}$	dB		Config 1,2,3,4,5,6	4	4	-Infinity	7
$\hat{E}_s/N_{oc}$	dB		Config 1,2,3	4	4	-Infinity	7
$I_{o}$ <sup>Note3</sup>	dBm/9.36MHz		Config 1,2	-64.59	-64.59	-70.05	-62.26

	dBm/38 .16MHz	Config 3	-58.49	-58.49	-63.94	-56.15
Propagation Condition		Config 1,2,3	AWGN		AWGN	
Note 1:	OCNG shall be used such that both cells are fully allocated and a constant total transmitted power spectral density is achieved for all OFDM symbols.					
Note 2:	Interference from other cells and noise sources not specified in the test is assumed to be constant over subcarriers and time and shall be modelled as AWGN of appropriate power for $N_{oc}$ to be fulfilled.					
Note 3:	SS-RSRP and Io levels have been derived from other parameters for information purposes. They are not settable parameters themselves.					
Note 4:	SS-RSRP minimum requirements are specified assuming independent interference and noise at each receiver antenna port.					

#### A.6.6.2.1.2 Test Requirements

The UE shall send one Event A3 triggered measurement report, with a measurement reporting delay less than 920 ms from the beginning of time period T2. The UE shall not send event triggered measurement reports, as long as the reporting criteria are not fulfilled. The rate of correct events observed during repeated tests shall be at least 90%.

UE is not required to report SSB time index.

NOTE: The actual overall delays measured in the test may be up to  $2 \times TTI_{DCCH}$  higher than the measurement reporting delays above because of TTI insertion uncertainty of the measurement report in DCCH.

#### A.6.6.2.2 SA event triggered reporting tests for FR1 without SSB time index detection when DRX is used

##### A.6.6.2.2.1 Test Purpose and Environment

The purpose of this test is to verify that the UE makes correct reporting of an event. This test will partly verify the SA inter-frequency NR cell search requirements in clause 9.3.4.

In this test, there are two cells: NR cell 1 as PCell in FR1 on NR RF channel 1 and NR cell 2 as neighbour cell in FR1 on NR RF channel 2. The test parameters are given in Tables A.6.6.2.2.1-1, A.6.6.2.2.1-2 and A.6.6.2.2.1-3.

Measurement gap pattern configuration is defined in Table A.6.6.2.1.1-2.

In the measurement control information, it is indicated to the UE that event-triggered reporting with Event A3 is used. The test consists of two successive time periods, with time duration of T1, and T2 respectively. During time duration T1, the UE shall not have any timing information of NR cell 2.

UE needs to be provided at least once every 500ms with new Timing Advance Command MAC control element to restart the Time alignment timer to keep UE uplink time alignment. Furthermore, UE is allocated with PUSCH resource at every DRX cycle.

UE needs to be provided with new Timing Advance Command MAC control element at least once during each time alignment timer period to maintain uplink time alignment. Furthermore, UE is allocated with PUSCH resource at every DRX cycle.

**Table A.6.6.2.2.1-1: SA event triggered reporting tests without SSB index reading for FR1-FR1**

Config	Description
1	NR 15 kHz SSB SCS, 10 MHz bandwidth, FDD duplex mode
2	NR 15 kHz SSB SCS, 10 MHz bandwidth, TDD duplex mode
3	NR 30 kHz SSB SCS, 40 MHz bandwidth, TDD duplex mode
Note 1:	The UE is only required to be tested in one of the supported test configurations
Note 2:	target NR cell has the same SCS, BW and duplex mode as NR serving cell

**Table A.6.6.2.2.1-2: General test parameters for SA inter-frequency event triggered reporting for FR1 without SSB time index detection**

Parameter	Unit	Test configuration	Value		Comment
			Test 1	Test 2	
NR RF Channel Number		Config 1,2,3	1, 2		Two FR1 NR carrier frequencies is used.
Active cell		Config 1,2,3	NR cell 1 (Pcell)		NR Cell 1 is on NR RF channel number 1.
Neighbour cell		Config 1,2,3	NR cell2		NR cell 2 is on NR RF channel number 2.
Gap Pattern Id		Config 1,2,3	0		As specified in clause 9.1.2-1.
Measurement gap offset		Config 1,2,3	9		
A3-Offset	dB	Config 1,2,3	-6		
Hysteresis	dB	Config 1,2,3	0		
CP length		Config 1,2,3	Normal		
TimeToTrigger	s	Config 1,2,3	0		
Filter coefficient		Config 1,2,3	0		L3 filtering is not used
DRX		Config 1,2,3	DRX.1	DRX.7	As specified in clause A.3.3
Time offset between serving and neighbour cells		Config 1	3ms		Asynchronous cells. The timing of Cell 2 is 3ms later than the timing of Cell 1.
		Config 2,3	3µs		Synchronous cells.
T1	s	Config 1,2,3	5		
T2	s	Config 1,2,3	1.1	11	

**Table A.6.6.2.2.1-3: Cell specific test parameters for SA inter-frequency event triggered reporting for FR1 without SSB time index detection**

Parameter		Unit	Test configuration	Cell 1		Cell 2	
				T1	T2	T1	T2
NR RF Channel Number			Config 1,2,3	1		2	
Duplex mode			Config 1	FDD			
			Config 2,3	TDD			
TDD configuration			Config 1	Not Applicable			
			Config 2	TDDConf.1.1			
			Config 3	TDDConf.2.1			
BW <sub>channel</sub>		MHz	Config 1,2	10: N <sub>RB,c</sub> = 52			
			Config 3	40: N <sub>RB,c</sub> = 106			
BWP BW		MHz	Config 1,2	10: N <sub>RB,c</sub> = 52			
			Config 3	40: N <sub>RB,c</sub> = 106			
BWP configuration	Initial DL BWP		Config 1, 2, 3	DLBWP.0.1		NA	
	Initial UL BWP		Config 1, 2, 3	ULBWP.0.1		NA	
	Dedicated DL BWP			DLBWP.1.1		NA	
	Dedicated UL BWP			ULBWP.1.1		NA	
TRS configuration			Config 1	TRS.1.1 FDD		NA	
			Config 2	TRS.1.1 TDD		NA	
			Config 3	TRS.1.2 TDD		NA	



OCNG Patterns defined in A.3.2.1.1 (OP.1)		Config 1,2,3	OP.1		OP.1	
PDSCH Reference measurement channel		Config 1	SR.1.1 FDD		NA	
		Config 2	SR.1.1 TDD		NA	
		Config 3	SR2.1 TDD		NA	
RMSI CORESET Reference Channel		Config 1	CR.1.1 FDD		NA	
		Config 2	CR.1.1 TDD		NA	
		Config 3	CR2.1 TDD		NA	
Dedicated CORESET Reference Channel		Config 1	CCR.1.1 FDD		NA	
		Config 2	CCR.1.1 TDD		NA	
		Config 3	CCR.2.1 TDD		NA	
SSB parameters		Config 1	SSB.1 FR1		SSB.5 FR1	
		Config 2	SSB.1 FR1		SSB.5 FR1	
		Config 3	SSB.2 FR1		SSB.6 FR1	
SMTC configuration defined in A.3.11		Config 1	SMTC.2		SMTC.5	
		Config 2, 3	SMTC.1		SMTC.4	
PDSCH/PDCCH subcarrier spacing	kHz	Config 1,2	15			
		Config 3	30			
EPRE ratio of PSS to SSS		Config 1,2,3	0		0	
EPRE ratio of PBCH DMRS to SSS						
EPRE ratio of PBCH to PBCH DMRS						
EPRE ratio of PDCCH DMRS to SSS						
EPRE ratio of PDCCH to PDCCH DMRS						
EPRE ratio of PDSCH DMRS to SSS						
EPRE ratio of PDSCH to PDSCH						
EPRE ratio of OCNG DMRS to SSS(Note 1)						
EPRE ratio of OCNG to OCNG DMRS (Note 1)						
$N_{oc}$ <sup>Note2</sup>	dBm/15 kHz	Config 1,2,3	-98		-98	
$N_{oc}$ <sup>Note2</sup>	dBm/S CS	Config 1,2	-98		-98	
		Config 3	-95		-95	
SS-RSRP <sup>Note 3</sup>	dBm/S CS	Config 1,2	-94	-94	-Infinity	-91
		Config 3	-91	-91	-Infinity	-88
$\hat{E}_s / I_{ot}$	dB	Config 1,2,3,4,5,6	4	4	-Infinity	7
$\hat{E}_s / N_{oc}$	dB	Config 1,2,3	4	4	-Infinity	7
$I_o$ <sup>Note3</sup>	dBm/9.36MHz	Config 1,2	-64.59	-64.59	-70.05	-62.2
	dBm/38.16MHz	Config 3	-58.49	-58.49	-63.94	-56.15
Propagation Condition		Config 1,2,3	AWGN		AWGN	
<p>Note 1: OCNG shall be used such that both cells are fully allocated and a constant total transmitted power spectral density is achieved for all OFDM symbols.</p> <p>Note 2: Interference from other cells and noise sources not specified in the test is assumed to be constant over subcarriers and time and shall be modelled as AWGN of appropriate power for <math>N_{oc}</math> to be fulfilled.</p> <p>Note 3: SS-RSRP and <math>I_o</math> levels have been derived from other parameters for information purposes. They are not settable parameters themselves.</p> <p>Note 4: SS-RSRP minimum requirements are specified assuming independent interference and noise at each receiver antenna port.</p>						

**Table A.6.6.2.2.1-4: DRX-Configuration for SA inter-frequency event triggered reporting without SSB time index detection**

Field	Test1&3	Test2&4	Comment
	Value	Value	
drx-onDurationTimer	ms1	ms1	As specified in clause 6.3.2 in TS 38.331 [2]
drx-InactivityTimer	ms1	ms1	
drx-RetransmissionTimerDL	sl1	sl1	
drx-RetransmissionTimerUL	sl1	sl1	
drx-LongCycleStartOffset	ms40	Ms640	
shortDRX	disable	disable	

**Table A.6.6.2.2.1-5: TimeAlignmentTimer -Configuration SA inter-frequency event triggered reporting without SSB time index detection**

Field	Value	Comment
TimeAlignmentTimer	ms500	As specified in clause 6.3.2 in TS 38.331 [2]

#### A.6.6.2.2.2 Test Requirements

In test 1 with per-UE gap, the UE shall send one Event A3 triggered measurement report, with a measurement reporting delay less than 1080 ms from the beginning of time period T2. The UE shall not send event triggered measurement reports, as long as the reporting criteria are not fulfilled. The rate of correct events observed during repeated tests shall be at least 90%.

In test 2 with per-UE gap, the UE shall send one Event A3 triggered measurement report, with a measurement reporting delay less than 10240 ms from the beginning of time period T2. The UE shall not send event triggered measurement reports, as long as the reporting criteria are not fulfilled. The rate of correct events observed during repeated tests shall be at least 90%.

In test 1 and 2, UE is not required to report SSB time index.

NOTE: The actual overall delays measured in the test may be up to  $2xTTI_{DCCH}$  higher than the measurement reporting delays above because of TTI insertion uncertainty of the measurement report in DCCH.

#### A.6.6.2.3 Void

#### A.6.6.2.4 Void

#### A.6.6.2.5 SA event triggered reporting tests for FR1 with SSB time index detection when DRX is not used

##### A.6.6.2.5.1 Test Purpose and Environment

The purpose of this test is to verify that the UE makes correct reporting of an event. This test will partly verify the SA inter-frequency NR cell search requirements in clause 9.3.4.

In this test, there are two cells: NR cell 1 as PCell in FR1 on NR RF channel 1 and NR cell 2 as neighbour cell in FR1 on NR RF channel 2. The test parameters are given in Tables A.6.6.2.5.1-1, A.6.6.2.5.1-2 and A.6.6.2.5.1-3.

Measurement gap pattern configuration is defined in Table A.6.6.2.5.1-2.

In the measurement control information, it is indicated to the UE that event-triggered reporting with Event A3 is used. The test consists of two successive time periods, with time duration of T1, and T2 respectively. During time duration T1, the UE shall not have any timing information of NR cell 2.

**Table A.6.6.2.5.1-1: SA event triggered reporting tests with SSB index reading for FR1-FR1**

Config	Description
1	NR 15 kHz SSB SCS, 10 MHz bandwidth, FDD duplex mode

2	NR 15 kHz SSB SCS, 10 MHz bandwidth, TDD duplex mode
3	NR 30 kHz SSB SCS, 40 MHz bandwidth, TDD duplex mode
Note 1:	The UE is only required to be tested in one of the supported test configurations
Note 2:	target NR cell has the same SCS, BW and duplex mode as NR serving cell

**Table A.6.6.2.5.1-2: General test parameters for SA inter-frequency event triggered reporting for FR1 with SSB time index detection**

Parameter	Unit	Test configuration	Value	Comment
NR RF Channel Number		Config 1,2,3	1, 2	Two FR1 NR carrier frequencies is used.
Active cell		Config 1,2,3	NR cell 1 (Pcell)	NR Cell 1 is on NR RF channel number 1.
Neighbour cell		Config 1,2,3	NR cell2	NR cell 2 is on NR RF channel number 2.
Gap Pattern Id		Config 1,2,3	0	As specified in clause 9.1.2-1.
Measurement gap offset		Config 1,2,3	9	
A3-Offset	dB	Config 1,2,3	-6	
Hysteresis	dB	Config 1,2,3	0	
CP length		Config 1,2,3	Normal	
TimeToTrigger	s	Config 1,2,3	0	
Filter coefficient		Config 1,2,3	0	L3 filtering is not used
DRX		Config 1,2,3	OFF	DRX is not used
Time offset between serving and neighbour cells		Config 1	3ms	Asynchronous cells. The timing of Cell 2 is 3ms later than the timing of Cell 1.
		Config 2,3	3µs	Synchronous cells.
T1	s	Config 1,2,3	5	
T2	s	Config 1,2,3	1.1	

**Table A.6.6.2.5.1-3: Cell specific test parameters for SA inter-frequency event triggered reporting for FR1 with SSB time index detection**

Parameter		Unit	Test configuration	Cell 1		Cell 2	
				T1	T2	T1	T2
NR RF Channel Number			Config 1,2,3	1		2	
Duplex mode			Config 1	FDD			
			Config 2,3	TDD			
TDD configuration			Config 1	Not Applicable			
			Config 2	TDDConf.1.1			
			Config 3	TDDConf.2.1			
BW <sub>channel</sub>		MHz	Config 1,2	10: N <sub>RB,c</sub> = 52			
			Config 3	40: N <sub>RB,c</sub> = 106			
BWP BW		MHz	Config 1,2	10: N <sub>RB,c</sub> = 52			
			Config 3	40: N <sub>RB,c</sub> = 106			
BWP configuration	Initial DL BWP		Config 1, 2, 3	DLBWP.0.1		NA	
	Initial UL BWP			ULBWP.0.1		NA	
	Dedicated DL BWP			DLBWP.1.1		NA	
	Dedicated UL BWP			ULBWP.1.1		NA	
TRS configuration			Config 1	TRS.1.1 FDD		NA	
			Config 2	TRS.1.1 TDD		NA	
			Config 3	TRS.1.2 TDD		NA	

OCNG Patterns defined in A.3.2.1.1 (OP.1)		Config 1,2,3	OP.1		OP.1	
PDSCH Reference measurement channel		Config 1	SR.1.1 FDD			
		Config 2	SR.1.1 TDD			
		Config 3	SR2.1 TDD			
RMSI CORESET Reference Channel		Config 1	CR.1.1 FDD		-	
		Config 2	CR.1.1 TDD			
		Config 3	CR2.1 TDD			
Dedicated CORESET Reference Channel		Config 1	CCR.1.1 FDD		-	
		Config 2	CCR.1.1 TDD			
		Config 3	CCR.2.1 TDD			
SSB parameters		Config 1	SSB.1 FR1		SSB.5 FR1	
		Config 2	SSB.1 FR1		SSB.5 FR1	
		Config 3	SSB.2 FR1		SSB.6 FR1	
SMTC configuration defined in A.3.11		Config 1	SMTC.2		SMTC.5	
		Config 2, 3	SMTC.1		SMTC.4	
PDSCH/PDCCH subcarrier spacing	kHz	Config 1,2	15			
		Config 3	30			
EPRE ratio of PSS to SSS		Config 1,2,3	0		0	
EPRE ratio of PBCH DMRS to SSS						
EPRE ratio of PBCH to PBCH DMRS						
EPRE ratio of PDCCH DMRS to SSS						
EPRE ratio of PDCCH to PDCCH DMRS						
EPRE ratio of PDSCH DMRS to SSS						
EPRE ratio of PDSCH to PDSCH						
EPRE ratio of OCNG DMRS to SSS(Note 1)						
EPRE ratio of OCNG to OCNG DMRS (Note 1)						
$N_{oc}$ <sup>Note2</sup>	dBm/15 kHz		-98		-98	
$N_{oc}$ <sup>Note2</sup>	dBm/S CS	Config 1,2	-98		-98	
		Config 3	-95		-95	
SS-RSRP <sup>Note 3</sup>	dBm/S CS	Config 1,2	-94	-94	-Infinity	-91
		Config 3	-91	-91	-Infinity	-88
$\hat{E}_s/I_{ot}$	dB	Config 1,2,3	4	4	-Infinity	7
$\hat{E}_s/N_{oc}$	dB	Config 1,2,3	4	4	-Infinity	7
$I_o$ <sup>Note3</sup>	dBm/9.36MHz	Config 1,2	-64.59	-64.59	-70.05	-62.2
	dBm/38.16MHz	Config 3	-58.4	-58.49	-63.94	-56.15
Propagation Condition		Config 1,2,3	AWGN		AWGN	
<p>Note 1: OCNG shall be used such that both cells are fully allocated and a constant total transmitted power spectral density is achieved for all OFDM symbols.</p> <p>Note 2: Interference from other cells and noise sources not specified in the test is assumed to be constant over subcarriers and time and shall be modelled as AWGN of appropriate power for <math>N_{oc}</math> to be fulfilled.</p> <p>Note 3: SS-RSRP and <math>I_o</math> levels have been derived from other parameters for information purposes. They are not settable parameters themselves.</p> <p>Note 4: SS-RSRP minimum requirements are specified assuming independent interference and noise at each receiver antenna port.</p>						

### A.6.6.2.5.2 Test Requirements

The UE shall send one Event A3 triggered measurement report, with a measurement reporting delay less than 1040 ms from the beginning of time period T2. The UE shall not send event triggered measurement reports, as long as the reporting criteria are not fulfilled. The rate of correct events observed during repeated tests shall be at least 90%.

UE is required to report SSB time index.

NOTE: The actual overall delays measured in the test may be up to  $2 \times TTI_{DCCH}$  higher than the measurement reporting delays above because of TTI insertion uncertainty of the measurement report in DCCH.

### A.6.6.2.6 SA event triggered reporting tests for FR1 with SSB time index detection when DRX is used

#### A.6.6.2.6.1 Test Purpose and Environment

The purpose of this test is to verify that the UE makes correct reporting of an event. This test will partly verify the SA inter-frequency NR cell search requirements in clause 9.3.4.

In this test, there are two cells: NR cell 1 as PCell in FR1 on NR RF channel 1 and NR cell 2 as neighbour cell in FR1 on NR RF channel 2. The test parameters are given in Tables A.6.6.2.6.1-1, A.6.6.2.6.1-2 and A.6.6.2.6.1-3.

Measurement gap pattern configuration is defined in Table A.6.6.2.6.1-2.

In the measurement control information, it is indicated to the UE that event-triggered reporting with Event A3 is used. The test consists of two successive time periods, with time duration of T1, and T2 respectively. During time duration T1, the UE shall not have any timing information of NR cell 2.

UE needs to be provided with new Timing Advance Command MAC control element at least once during each time alignment timer period to maintain uplink time alignment. Furthermore, UE is allocated with PUSCH resource at every DRX cycle.

**Table A.6.6.2.6.1-1: SA event triggered reporting tests with SSB index reading for FR1-FR1**

Config	Description
1	NR 15 kHz SSB SCS, 10 MHz bandwidth, FDD duplex mode
2	NR 15 kHz SSB SCS, 10 MHz bandwidth, TDD duplex mode
3	NR 30 kHz SSB SCS, 40 MHz bandwidth, TDD duplex mode
Note 1:	The UE is only required to be tested in one of the supported test configurations
Note 2:	target NR cell has the same SCS, BW and duplex mode as NR serving cell

**Table A.6.6.2.6.1-2: General test parameters for SA inter-frequency event triggered reporting for FR1 with SSB time index detection**

Parameter	Unit	Test configuration	Value		Comment
			Test 1	Test 2	
NR RF Channel Number		Config 1,2,3	1, 2		Two FR1 NR carrier frequencies is used.
Active cell		Config 1,2,3	NR cell 1 (Pcell)		NR Cell 1 is on NR RF channel number 1.
Neighbour cell		Config 1,2,3	NR cell2		NR cell 2 is on NR RF channel number 2.
Gap Pattern Id		Config 1,2,3	0		As specified in clause 9.1.2-1.
Measurement gap offset		Config 1,2,3	9		
A3-Offset	dB	Config 1,2,3	-6		
Hysteresis	dB	Config 1,2,3	0		
CP length		Config 1,2,3	Normal		
TimeToTrigger	s	Config 1,2,3	0		
Filter coefficient		Config 1,2,3	0		L3 filtering is not used

DRX		Config 1,2,3	DRX.1 DRX.7	DRX.1 DRX.7	As specified in clause A.3.3
Time offset between serving and neighbour cells		Config 1	3 ms		Asynchronous cells. The timing of Cell 2 is 3ms later than the timing of Cell 1.
		Config 2,3	3 μs		Synchronous cells.
T1	s	Config 1,2,3	5		
T2	s	Config 1,2,3	1.3	13.5	

**Table A.6.6.2.6.1-3: Cell specific test parameters for SA inter-frequency event triggered reporting for FR1 with SSB time index detection**

Parameter		Unit	Test configuration	Cell 1		Cell 2	
				T1	T2	T1	T2
NR RF Channel Number			Config 1,2,3	1		2	
Duplex mode			Config 1	FDD			
			Config 2,3	TDD			
TDD configuration			Config 1	Not Applicable			
			Config 2	TDDConf.1.1			
			Config 3	TDDConf.2.1			
BW <sub>channel</sub>		MHz	Config 1,2	10: N <sub>RB,c</sub> = 52			
			Config 3	40: N <sub>RB,c</sub> = 106			
BWP BW		MHz	Config 1,2	10: N <sub>RB,c</sub> = 52			
			Config 3	40: N <sub>RB,c</sub> = 106			
BWP configuration	Initial DL BWP		Config 1, 2, 3	DLBWP.0.1		NA	
	Initial UL BWP			ULBWP.0.1		NA	
	Dedicated DL BWP			DLBWP.1.1		NA	
	Dedicated UL BWP			ULBWP.1.1		NA	
TRS configuration			Config 1	TRS.1.1 FDD		NA	
			Config 2	TRS.1.1 TDD		NA	
			Config 3	TRS.1.2 TDD		NA	
OCNG Patterns defined in A.3.2.1.1 (OP.1)			Config 1,2,3	OP.1		OP.1	
PDSCH Reference measurement channel			Config 1	SR.1.1 FDD		NA	
			Config 2	SR.1.1 TDD			
			Config 3	SR2.1 TDD			
RMSI CORESET Reference Channel			Config 1	CR.1.1 FDD		-	
			Config 2	CR.1.1 TDD			
			Config 3	CR2.1 TDD			
Dedicated CORESET Reference Channel			Config 1	CCR.1.1 FDD		-	
			Config 2	CCR.1.1 TDD			
			Config 3	CCR.2.1 TDD			
SSB parameters			Config 1	SSB.1 FR1		SSB.5 FR1	
			Config 2	SSB.1 FR1		SSB.5 FR1	
			Config 3	SSB.2 FR1		SSB.6 FR1	
SMTC configuration defined in A.3.11			Config 1	SMTC.2		SMTC.5	
			Config 2, 3	SMTC.1		SMTC.4	
PDSCH/PDCCH subcarrier spacing		kHz	Config 1,2	15			
			Config 3	30			
EPRE ratio of PSS to SSS			Config 1,2,3	0		0	
EPRE ratio of PBCH DMRS to SSS							

EPRE ratio of PBCH to PBCH DMRS						
EPRE ratio of PDCCH DMRS to SSS						
EPRE ratio of PDCCH to PDCCH DMRS						
EPRE ratio of PDSCH DMRS to SSS						
EPRE ratio of PDSCH to PDSCH						
EPRE ratio of OCNG DMRS to SSS(Note 1)						
EPRE ratio of OCNG to OCNG DMRS (Note 1)						
$N_{oc}$ <sup>Note2</sup>	dBm/15 kHz			-98		-98
$N_{oc}$ <sup>Note2</sup>	dBm/S CS	Config 1,2		-98		-98
		Config 3		-95		-95
SS-RSRP <sup>Note 3</sup>	dBm/S CS	Config 1,2	-94	-94	-Infinity	-91
		Config 3	-91	-91	-Infinity	-88
$\hat{E}_s / I_{ot}$	dB	Config 1,2,3	4	4	-Infinity	7
$\hat{E}_s / N_{oc}$	dB	Config 1,2,3	4	4	-Infinity	7
$I_o$ <sup>Note3</sup>	dBm/9.36MHz	Config 1,2	-64.59	-64.59	-70.05	-62.26
	dBm/38.16MHz	Config 3	-58.49	-58.49	-63.94	-56.15
Propagation Condition		Config 1,2,3	AWGN		AWGN	
<p>Note 1: OCNG shall be used such that both cells are fully allocated and a constant total transmitted power spectral density is achieved for all OFDM symbols.</p> <p>Note 2: Interference from other cells and noise sources not specified in the test is assumed to be constant over subcarriers and time and shall be modelled as AWGN of appropriate power for <math>N_{oc}</math> to be fulfilled.</p> <p>Note 3: SS-RSRP and <math>I_o</math> levels have been derived from other parameters for information purposes. They are not settable parameters themselves.</p> <p>Note 4: SS-RSRP minimum requirements are specified assuming independent interference and noise at each receiver antenna port.</p>						

A.6.6.2.6.2 Test Requirements

In test 1 with per-UE gap, the UE shall send one Event A3 triggered measurement report, with a measurement reporting delay less than 1280 ms from the beginning of time period T2. The UE shall not send event triggered measurement reports, as long as the reporting criteria are not fulfilled. The rate of correct events observed during repeated tests shall be at least 90%.

In test 2 with per-UE gap, the UE shall send one Event A3 triggered measurement report, with a measurement reporting delay less than 12160 ms from the beginning of time period T2. The UE shall not send event triggered measurement reports, as long as the reporting criteria are not fulfilled. The rate of correct events observed during repeated tests shall be at least 90%.

In test 1 and 2, UE is required to report SSB time index.

NOTE: The actual overall delays measured in the test may be up to  $2 \times TTI_{DCCH}$  higher than the measurement reporting delays above because of TTI insertion uncertainty of the measurement report in DCCH.

A.6.6.2.7 Void

A.6.6.2.8 Void

A.6.6.2.9 SA event triggered reporting tests with additional mandatory gap pattern

A.6.6.2.9.1 Test Purpose and Environment

The purpose of this test is to verify that the UE makes correct reporting of an event when mandatory gap pattern with 3ms MGL is configured.

In this test, there are two cells: NR cell 1 as PCell in FR1 on NR RF channel 1 and NR cell 2 as neighbour cell in FR1 on NR RF channel 2. The test parameters are given in Tables A.6.6.2.9.1-1, A.6.6.2.9.1-2 and A.6.6.2.9.1-3.

Measurement gap pattern configuration defined in Table A.6.6.2.9.1-2 does not depend on per-FR gap capability of UE.

In the measurement control information, it is indicated to the UE that event-triggered reporting with Event A3 is used. The test consists of two successive time periods, with time duration of T1, and T2 respectively. During time duration T1, the UE shall not have any timing information of NR cell 2.

**Table A.6.6.2.9.1-1: SA event triggered reporting tests without SSB index reading for FR1-FR1**

Config	Description
1	NR 15 kHz SSB SCS, 10 MHz bandwidth, FDD duplex mode
2	NR 15 kHz SSB SCS, 10 MHz bandwidth, TDD duplex mode
3	NR 30kHz SSB SCS, 40 MHz bandwidth, TDD duplex mode

Note 1: The UE is only required to be tested in one of the supported test configurations  
Note 2: target NR cell has the same SCS, BW and duplex mode as NR serving cell

**Table A.6.6.2.9.1-2: General test parameters for SA inter-frequency event triggered reporting with additional mandatory gap pattern**

Parameter	Unit	Test configuration	Value	Comment
NR RF Channel Number		Config 1,2,3	1, 2	Two FR1 NR carrier frequencies is used.
Active cell		Config 1,2,3	NR cell 1 (Pcell)	NR Cell 1 is on NR RF channel number 1.
Neighbour cell		Config 1,2,3	NR cell2	NR cell 2 is on NR RF channel number 2.
Gap Pattern Id		Config 1,2,3	3	As specified in clause 9.1.2-1.
Measurement gap offset		Config 1	12	
		Config 2,3	9	
SMTC-SSB parameters		Config 1	SSB.1 FR1	As specified in clause A.3.10.1
		Config 2	SSB.1 FR1	As specified in clause A.3.10.1
		Config 3	SSB.2 FR1	As specified in clause A.3.10.1
A3-Offset	dB	Config 1,2,3	-6	
Hysteresis	dB	Config 1,2,3	0	
CP length		Config 1,2,3	Normal	
TimeToTrigger	s	Config 1,2,3	0	
Filter coefficient		Config 1,2,3	0	L3 filtering is not used
DRX		Config 1,2,3	OFF	DRX is not used
Time offset between serving and neighbour cells		Config 1	3ms	Asynchronous cells. The timing of Cell 2 is 3ms later than the timing of Cell 1.



		Config 2,3	3μs	Synchronous cells.
T1	s	Config 1,2,3	5	
T2	s	Config 1,2,3	1	

**Table A.6.6.2.9.1-3: Cell specific test parameters for SA inter-frequency event triggered reporting with additional mandatory gap pattern**

Parameter		Unit	Test configuration	Cell 1		Cell 2	
				T1	T2	T1	T2
NR RF Channel Number			Config 1,2,3	1		2	
Duplex mode			Config 1	FDD			
			Config 2,3	TDD			
TDD configuration			Config 1	Not Applicable			
			Config 2	TDDConf.1.1			
			Config 3	TDDConf.2.1			
BW <sub>channel</sub>		MHz	Config 1,2	10: N <sub>RB,c</sub> = 52			
			Config 3	40: N <sub>RB,c</sub> = 106			
BWP BW		MHz	Config 1,2	10: N <sub>RB,c</sub> = 52			
			Config 3	40: N <sub>RB,c</sub> = 106			
BWP configuration	Initial DL BWP		Config 1, 2, 3	DLBWP.0.1		NA	
	Initial UL BWP			ULBWP.0.1		NA	
	Dedicated DL BWP			DLBWP.1.1		NA	
	Dedicated UL BWP			ULBWP.1.1		NA	
TRS configuration			Config 1	TRS.1.1 FDD		NA	
			Config 2	TRS.1.1 TDD		NA	
			Config 3	TRS.1.2 TDD		NA	
OCNG Patterns defined in A.3.2.1.1 (OP.1)			Config 1,2,3	OP.1		OP.1	
PDSCH Reference measurement channel			Config 1	SR.1.1 FDD			
			Config 2	SR.1.1 TDD			
			Config 3	SR2.1 TDD			
CORESET Reference Channel			Config 1	CR.1.1 FDD			
			Config 2	CR.1.1 TDD			
			Config 3	CR2.1 TDD			
SSB parameters			Config 1	SSB.1 FR1		SSB.5 FR1	
			Config 2	SSB.1 FR1		SSB.5 FR1	
			Config 3	SSB.2 FR1		SSB.6 FR1	
SMTC configuration defined in A.3.11			Config 1	SMTC.1		SMTC.9	
			Config 2, 3	SMTC.1		SMTC.4	
PDSCH/PDCCH subcarrier spacing		kHz	Config 1,2	15			
			Config 3	30			
EPRE ratio of PSS to SSS			Config 1,2,3	0		0	
EPRE ratio of PBCH DMRS to SSS							
EPRE ratio of PBCH to PBCH DMRS							
EPRE ratio of PDCCH DMRS to SSS							
EPRE ratio of PDCCH to PDCCH DMRS							
EPRE ratio of PDSCH DMRS to SSS							
EPRE ratio of PDSCH to PDSCH							

EPRE ratio of OCNG DMRS to SSS (Note 1)						
EPRE ratio of OCNG to OCNG DMRS (Note 1)						
$N_{oc}$ <sup>Note2</sup>	dBm/15 kHz			-98		-98
$N_{oc}$ <sup>Note2</sup>	dBm/S CS	Config 1,2		-98		-98
		Config 3		-95		-95
SS-RSRP <sup>Note 3</sup>	dBm/S CS	Config 1,2	-94	-94	-Infinity	-91
		Config 3	-91	-91	-Infinity	-88
$\hat{E}_s/I_{ot}$	dB	Config 1,2,3,4,5,6	4	4	-Infinity	7
$\hat{E}_s/N_{oc}$	dB	Config 1,2,3	4	4	-Infinity	7
$I_o$ <sup>Note3</sup>	dBm/9.36MHz	Config 1,2	-64.59	-64.59	-70.05	-62.26
	dBm/38.16MHz	Config 3	-58.49	-58.49	-63.94	-56.15
Propagation Condition		Config 1,2,3	AWGN		AWGN	
<p>Note 1: OCNG shall be used such that both cells are fully allocated and a constant total transmitted power spectral density is achieved for all OFDM symbols.</p> <p>Note 2: Interference from other cells and noise sources not specified in the test is assumed to be constant over subcarriers and time and shall be modelled as AWGN of appropriate power for <math>N_{oc}</math> to be fulfilled.</p> <p>Note 3: SS-RSRP and <math>I_o</math> levels have been derived from other parameters for information purposes. They are not settable parameters themselves.</p> <p>Note 4: SS-RSRP minimum requirements are specified assuming independent interference and noise at each receiver antenna port.</p>						

#### A.6.6.2.9.2 Test Requirements

The UE shall send one Event A3 triggered measurement report, with a measurement reporting delay less than 1280 ms from the beginning of time period T2. The UE shall not send event triggered measurement reports, as long as the reporting criteria are not fulfilled. The rate of correct events observed during repeated tests shall be at least 90%.

UE is not required to report SSB time index.

NOTE: The actual overall delays measured in the test may be up to  $2 \times TTI_{DCCH}$  higher than the measurement reporting delays above because of TTI insertion uncertainty of the measurement report in DCCH.

#### A.6.6.2.10 SA event triggered reporting tests for FR1 when DRX is used

##### A.6.6.2.10.1 Test Purpose and Environment

The purpose of this test is to verify that the UE which supports interFrequencyMeas-Nogap-r16 makes correct reporting of an event. This test will partly verify the SA inter-frequency NR cell search without measurement gap requirements in clause 9.3.9.

In this test, there are two cells: NR cell 1 as PCell in FR1 on NR RF channel 1 and NR cell 2 as neighbour cell in FR1 on RF channel 2. The SSB of cell 2 is completely within UE's active BWP BW. The RBs containing SSB from cell 1 and cell 2 should be different in frequency location within the cell bandwidth. The test parameters are given in Tables A.6.6.2.10.1-1, A.6.6.2.10.1-2 and A.6.6.2.10.1-3.

In the measurement control information, it is indicated to the UE that event-triggered reporting with Event A3 is used. The test consists of two successive time periods, with time duration of T1, and T2 respectively. During time duration T1, the UE shall not have any timing information of NR cell 2.

UE needs to be provided at least once every 500ms with new Timing Advance Command MAC control element to restart the Time alignment timer to keep UE uplink time alignment. Furthermore, UE is allocated with PUSCH resource at every DRX cycle.

**Table A.6.6.2.10.1-1: SA event triggered reporting tests when DRX is used for FR1-FR1**

Config	Description
1	NR 15 kHz SSB SCS, 10 MHz bandwidth, FDD duplex mode
2	NR 15 kHz SSB SCS, 10 MHz bandwidth, TDD duplex mode
3	NR 30 kHz SSB SCS, 40 MHz bandwidth, TDD duplex mode

Note 1: The UE is only required to be tested in one of the supported test configurations  
 Note 2: target NR cell has the same SCS, BW and duplex mode as NR serving cell

**Table A.6.6.2.10.1-2: General test parameters for SA inter-frequency event triggered reporting for FR1 when DRX is used**

Parameter	Unit	Test configuration	Value	Comment
NR RF Channel Number		Config 1,2,3	1, 2	Two FR1 NR carrier frequencies is used.
Active cell		Config 1,2,3	NR cell 1 (Pcell)	NR Cell 1 is on NR RF channel number 1.
Neighbour cell		Config 1,2,3	NR cell2	NR cell 2 is on NR RF channel number 2.
A3-Offset	dB	Config 1,2,3	-6	
Hysteresis	dB	Config 1,2,3	0	
CP length		Config 1,2,3	Normal	
TimeToTrigger	s	Config 1,2,3	0	
Filter coefficient		Config 1,2,3	0	L3 filtering is not used
DRX		Config 1,2,3	DRX.1	As specified in clause A.3.3
Time offset between serving and neighbour cells		Config 1	3ms	Asynchronous cells. The timing of Cell 2 is 3ms later than the timing of Cell 1.
		Config 2,3	3μs	Synchronous cells.
T1	s	Config 1,2,3	5	
T2	s	Config 1,2,3	1	

**Table A.6.6.2.10.1-3: Cell specific test parameters for SA inter-frequency event triggered reporting for FR1 when DRX is used**

Parameter		Unit	Test configuration	Cell 1		Cell 2	
				T1	T2	T1	T2
NR RF Channel Number			Config 1,2,3	1		2	
Duplex mode			Config 1	FDD			
			Config 2,3	TDD			
TDD configuration			Config 1	Not Applicable			
			Config 2	TDDConf.1.1			
			Config 3	TDDConf.2.1			
BW <sub>channel</sub>		MHz	Config 1,2	10: N <sub>RB,c</sub> = 52			
			Config 3	40: N <sub>RB,c</sub> = 106			
BWP BW		MHz	Config 1,2	10: N <sub>RB,c</sub> = 52			
			Config 3	40: N <sub>RB,c</sub> = 106			
BWP configuration	Initial DL BWP		Config 1, 2, 3	DLBWP.0.1		NA	
	Initial UL BWP		Config 1, 2, 3	ULBWP.0.1		NA	
	Dedicated DL BWP			DLBWP.1.1		NA	
	Dedicated UL BWP			ULBWP.1.1		NA	
TRS configuration			Config 1	TRS.1.1 FDD		NA	
			Config 2	TRS.1.1 TDD		NA	
			Config 3	TRS.1.2 TDD		NA	

OCNG Patterns defined in A.3.2.1.1 (OP.1)		Config 1,2,3	OP.1		OP.1	
PDSCH Reference measurement channel		Config 1	SR.1.1 FDD		NA	
		Config 2	SR.1.1 TDD		NA	
		Config 3	SR2.1 TDD		NA	
CORESET Reference Channel		Config 1	CR.1.1 FDD		NA	
		Config 2	CR.1.1 TDD		NA	
		Config 3	CR2.1 TDD		NA	
SSB parameters		Config 1	SSB.1 FR1		SSB.5 FR1	
		Config 2	SSB.1 FR1		SSB.5 FR1	
		Config 3	SSB.2 FR1		SSB.6 FR1	
SMTC configuration defined in A.3.11		Config 1	SMTC.2		SMTC.5	
		Config 2, 3	SMTC.1		SMTC.4	
PDSCH/PDCCH subcarrier spacing	kHz	Config 1,2	15			
		Config 3	30			
EPRE ratio of PSS to SSS		Config 1,2,3	0	0		
EPRE ratio of PBCH DMRS to SSS						
EPRE ratio of PBCH to PBCH DMRS						
EPRE ratio of PDCCH DMRS to SSS						
EPRE ratio of PDCCH to PDCCH DMRS						
EPRE ratio of PDSCH DMRS to SSS						
EPRE ratio of PDSCH to PDSCH						
EPRE ratio of OCNG DMRS to SSS (Note 1)						
EPRE ratio of OCNG to OCNG DMRS (Note 1)						
$N_{oc}$ <sup>Note2</sup>	dBm/15 kHz					
$N_{oc}$ <sup>Note2</sup>	dBm/S CS	Config 1,2	-98		-98	
		Config 3	-95		-95	
SS-RSRP <sup>Note 3</sup>	dBm/S CS	Config 1,2	-94	-94	-Infinity	-91
		Config 3	-91	-91	-Infinity	-88
$\hat{E}_s / I_{ot}$	dB	Config 1,2,3,4,5,6	4	4	-Infinity	7
$\hat{E}_s / N_{oc}$	dB	Config 1,2,3	4	4	-Infinity	7
$I_o$ <sup>Note3</sup>	dBm/9.36MHz	Config 1,2	-64.59	-64.59	-70.05	-62.2
	dBm/38.16MHz	Config 3	-58.49	-58.49	-63.94	-56.15
Propagation Condition		Config 1,2,3	AWGN		AWGN	
<p>Note 1: OCNG shall be used such that both cells are fully allocated and a constant total transmitted power spectral density is achieved for all OFDM symbols.</p> <p>Note 2: Interference from other cells and noise sources not specified in the test is assumed to be constant over subcarriers and time and shall be modelled as AWGN of appropriate power for <math>N_{oc}</math> to be fulfilled.</p> <p>Note 3: SS-RSRP and <math>I_o</math> levels have been derived from other parameters for information purposes. They are not settable parameters themselves.</p> <p>Note 4: SS-RSRP minimum requirements are specified assuming independent interference and noise at each receiver antenna port.</p>						

**Table A.6.6.2.10.1-4: TimeAlignmentTimer-Configuration SA inter-frequency event triggered reporting when DRX is used**

Field	Value	Comment
-------	-------	---------

TimeAlignmentTimer	ms500	As specified in clause 6.3.2 in TS 38.331 [2]
--------------------	-------	---

### A.6.6.2.10.2 Test Requirements

In test config 1, UE is required to report SSB time index. UE is not required to report SSB time index. The UE shall send one Event A3 triggered measurement report, with a measurement reporting delay less than 1080 ms from the beginning of time period T2. The UE shall not send event triggered measurement reports, as long as the reporting criteria are not fulfilled. The rate of correct events observed during repeated tests shall be at least 90%.

In test config 2 and 3, UE is not required to report SSB time index. The UE shall send one Event A3 triggered measurement report, with a measurement reporting delay less than 900 ms from the beginning of time period T2. The UE shall not send event triggered measurement reports, as long as the reporting criteria are not fulfilled. The rate of correct events observed during repeated tests shall be at least 90%.

NOTE: The actual overall delays measured in the test may be up to  $2 \times TTI_{DCCCH}$  higher than the measurement reporting delays above because of TTI insertion uncertainty of the measurement report in DCCCH.

### A.6.6.2.11 SA event triggered reporting tests for FR1 without gap when DRX is not used

#### A.6.6.2.11.1 Test Purpose and Environment

The purpose of this test is to verify that the UE makes correct reporting of an event. This test will partly verify the SA inter-frequency NR cell search requirements in clause 9.3.9.

In this test, there are two cells: NR cell 1 as PCell in FR1 on NR RF channel 1 and NR cell 2 as neighbour cell in FR1 on NR RF channel 2. The SSB of Cell 2 is completely within UE's active BWP BW. The RBs containing SSB from cell 1 and cell 2 should be different in frequency location within the cell bandwidth. The test parameters are given in Tables A.6.6.2.11.1-1, A.6.6.2.11.1-2 and A.6.6.2.11.1-3.

In the measurement control information, it is indicated to the UE that event-triggered reporting with Event A3 is used. The test consists of two successive time periods, with time duration of T1, and T2 respectively. During time duration T1, the UE shall not have any timing information of NR cell 2.

**Table A.6.6.2.11.1-1: SA event triggered reporting tests without SSB index reading for FR1-FR1**

Config	Description
1	NR 15 kHz SSB SCS, 10 MHz bandwidth, FDD duplex mode
2	NR 15 kHz SSB SCS, 10 MHz bandwidth, TDD duplex mode
3	NR 30kHz SSB SCS, 40 MHz bandwidth, TDD duplex mode
Note 1: The UE is only required to be tested in one of the supported test configurations	
Note 2: target NR cell has the same SCS, BW and duplex mode as NR serving cell	

**Table A.6.6.2.11.1-2: General test parameters for SA inter-frequency event triggered reporting for FR1 without gap**

Parameter	Unit	Test configuration	Value	Comment
NR RF Channel Number		Config 1,2,3	1, 2	Two FR1 NR carrier frequencies is used.
Active cell		Config 1,2,3	NR cell 1 (Pcell)	NR Cell 1 is on NR RF channel number 1.
Neighbour cell		Config 1,2,3	NR cell2	NR cell 2 is on NR RF channel number 2.
A3-Offset	dB	Config 1,2,3	-6	
Hysteresis	dB	Config 1,2,3	0	
CP length		Config 1,2,3	Normal	
TimeToTrigger	s	Config 1,2,3	0	
Filter coefficient		Config 1,2,3	0	L3 filtering is not used
DRX		Config 1,2,3	OFF	DRX is not used

Time offset between serving and neighbour cells		Config 1	3ms	Asynchronous cells. The timing of Cell 2 is 3ms later than the timing of Cell 1.
		Config 2,3	3μs	Synchronous cells.
T1	s	Config 1,2,3	5	
T2	s	Config 1,2,3	1	

**Table A.6.6.2.11.1-3: Cell specific test parameters for SA inter-frequency event triggered reporting for FR1 without gap**

Parameter		Unit	Test configuration	Cell 1		Cell 2	
				T1	T2	T1	T2
NR RF Channel Number			Config 1,2,3	1		2	
Duplex mode			Config 1	FDD			
			Config 2,3	TDD			
TDD configuration			Config 1	Not Applicable			
			Config 2	TDDConf.1.1			
			Config 3	TDDConf.2.1			
BW <sub>channel</sub>		MHz	Config 1,2	10: N <sub>RB,c</sub> = 52			
			Config 3	40: N <sub>RB,c</sub> = 106			
BWP BW		MHz	Config 1,2	10: N <sub>RB,c</sub> = 52			
			Config 3	40: N <sub>RB,c</sub> = 106			
BWP configuration	Initial DL BWP		Config 1, 2, 3	DLBWP.0.1		NA	
	Initial UL BWP			ULBWP.0.1		NA	
	Dedicated DL BWP			DLBWP.1.1		NA	
	Dedicated UL BWP			ULBWP.1.1		NA	
TRS configuration			Config 1	TRS.1.1 FDD		NA	
			Config 2	TRS.1.1 TDD		NA	
			Config 3	TRS.1.2 TDD		NA	
OCNG Patterns defined in A.3.2.1.1 (OP.1)			Config 1,2,3	OP.1		OP.1	
PDSCH Reference measurement channel			Config 1	SR.1.1 FDD			
			Config 2	SR.1.1 TDD			
			Config 3	SR2.1 TDD			
CORESET Reference Channel			Config 1	CR.1.1 FDD			
			Config 2	CR.1.1 TDD			
			Config 3	CR2.1 TDD			
SSB parameters			Config 1	SSB.1 FR1		SSB.5 FR1	
			Config 2	SSB.1 FR1		SSB.5 FR1	
			Config 3	SSB.2 FR1		SSB.6 FR1	
SMTC configuration defined in A.3.11			Config 1	SMTC.2		SMTC.5	
			Config 2, 3	SMTC.1		SMTC.4	
PDSCH/PDCCH subcarrier spacing		kHz	Config 1,2	15			
			Config 3	30			
EPRE ratio of PSS to SSS			Config 1,2,3	0		0	
EPRE ratio of PBCH DMRS to SSS							
EPRE ratio of PBCH to PBCH DMRS							
EPRE ratio of PDCCH DMRS to SSS							
EPRE ratio of PDCCH to PDCCH DMRS							

EPRE ratio of PDSCH DMRS to SSS						
EPRE ratio of PDSCH to PDSCH						
EPRE ratio of OCNG DMRS to SSS(Note 1)						
EPRE ratio of OCNG to OCNG DMRS (Note 1)						
$N_{oc}^{Note2}$	dBm/15 kHz			-98		-98
$N_{oc}^{Note2}$	dBm/S CS	Config 1,2		-98		-98
		Config 3		-95		-95
SS-RSRP <sup>Note 3</sup>	dBm/S CS	Config 1,2	-94	-94	-Infinity	-91
		Config 3	-91	-91	-Infinity	-88
$\hat{E}_s/I_{ot}$	dB	Config 1,2,3,4,5,6	4	4	-Infinity	7
$\hat{E}_s/N_{oc}$	dB	Config 1,2,3	4	4	-Infinity	7
$I_o^{Note3}$	dBm/9.36MHz	Config 1,2	-64.59	-64.59	-70.05	-62.26
	dBm/38.16MHz	Config 3	-58.49	-58.49	-63.94	-56.15
Propagation Condition		Config 1,2,3	AWGN		AWGN	
Note 1:	OCNG shall be used such that both cells are fully allocated and a constant total transmitted power spectral density is achieved for all OFDM symbols.					
Note 2:	Interference from other cells and noise sources not specified in the test is assumed to be constant over subcarriers and time and shall be modelled as AWGN of appropriate power for $N_{oc}$ to be fulfilled.					
Note 3:	SS-RSRP and $I_o$ levels have been derived from other parameters for information purposes. They are not settable parameters themselves.					
Note 4:	SS-RSRP minimum requirements are specified assuming independent interference and noise at each receiver antenna port.					

### A.6.6.2.11.2 Test Requirements

The UE shall send one Event A3 triggered measurement report, with a measurement reporting delay less than 800 ms from the beginning of time period T2. The UE shall not send event triggered measurement reports, as long as the reporting criteria are not fulfilled. The rate of correct events observed during repeated tests shall be at least 90%.

The UE is not required to read the neighbour cell SSB index in this test.

NOTE: The actual overall delays measured in the test may be up to  $2xTTI_{DCCH}$  higher than the measurement reporting delays above because of TTI insertion uncertainty of the measurement report in DCCH.

## A.6.6.3 Inter-RAT Measurements

### A.6.6.3.1 SA NR - E-UTRAN event-triggered reporting in non-DRX in FR1

#### A.6.6.3.1.1 Test Purpose and Environment

The purpose of this set of tests is to verify that the UE makes correct event-triggered reporting of inter-RAT E-UTRAN measurements when operating in standalone (SA) operation with PCell in FR1. This test shall partly verify the cell search and measurement requirements in Clauses 9.4.2 and 9.4.3.

In each test there are two cells: Cell 1 and Cell 2. Cell 1 is the NR PCell and Cell 2 is an inter-RAT E-UTRAN inter-RAT neighbour cell. In the measurement control information from the PCell it is indicated to the UE that event-triggered reporting with Event B2 (PCell becomes worse than threshold1 and inter RAT neighbour becomes better than threshold2) is to be used. Each test consists of two consecutive time periods, with durations T1 and T2, respectively. Prior to the start of time duration T1, the UE shall be fully synchronized to Cell 1. During T1, the UE shall not have any information on Cell 2.

Supported test configurations are shown in table A.6.6.3.1.1-1. General test parameters are provided in Table A.6.6.3.1.1-2 below. Test parameters for Cell 1 and Cell 2, valid for both time duration T1 and T2, are provided in Tables A.6.6.3.1.1-3 and A.6.6.3.1.1-4, respectively.

**Table A.6.6.3.1.1-1: Supported test configurations in SA inter-RAT E-UTRAN event triggered reporting in non-DRX with PCell in FR1**

Configuration	Description
1	NR 15 kHz SSB SCS, 10 MHz bandwidth, FDD duplex mode, LTE FDD
2	NR 15 kHz SSB SCS, 10 MHz bandwidth, TDD duplex mode, LTE FDD
3	NR 30 kHz SSB SCS, 40 MHz bandwidth, TDD duplex mode, LTE FDD
4	NR 15 kHz SSB SCS, 10 MHz bandwidth, FDD duplex mode, LTE TDD
5	NR 15 kHz SSB SCS, 10 MHz bandwidth, TDD duplex mode, LTE TDD
6	NR 30 kHz SSB SCS, 40 MHz bandwidth, TDD duplex mode, LTE TDD

Note: The UE is only required to be tested in one of the supported test configurations

**Table A.6.6.3.1.1-2: General test parameters for SA inter-RAT E-UTRAN event triggered reporting in non-DRX with PCell in FR1**

Parameter	Unit	Value	Comment
NR RF Channel Number		1	1 NR carrier frequency is used in the test
LTE RF Channel Number		1	1 LTE carrier frequency is used in the test
Channel Bandwidth	MHz	As specified in Tables A.6.6.3.1.1-2 and A.6.6.3.1.1-3.	
Active cell		Cell 1	Cell 1 is on RF channel number 1
Neighbour cell		Cell 2	Cell 2 is on RF channel number 2
Gap Pattern Id		0	As specified in Clause Table 9.1.2-1. Per-UE gap pattern.
NR measurement quantity		SS-RSRP	Measurement quantity for Cell 1
Inter-RAT E-UTRAN measurement quantity		RSRP	Measurement quantity for Cell 2
b2-Threshold1	dBm	Note 1	SS-RSRP threshold for SS-RSRP measurement on cell1 for event B2
b2-Threshold2EUTRA	dBm	-95	E-UTRAN RSRP threshold for SS-RSRP measurement on cell1 for event B2
Hysteresis	dB	0	
TimeToTrigger	s	0	
Filter coefficient		0	L3 filtering is not used
DRX		OFF	OFF
T1	s	5	
T2	s	5	

Note 1: Values are defined in Table A.6.6.3.1.1-3

**Table A.6.6.3.1.1-3: PCell specific test parameters for SA inter-RAT E-UTRA event triggered reporting in non-DRX with PCell in FR1**

Parameter		Unit	Configuration	Cell 1	
				T1	T2
RF channel number			1, 2, 3, 4, 5, 6	1	
Duplex mode			1, 2, 3	FDD	
			4, 5, 6	TDD	
TDD Configuration	SCS=15 KHz		2, 5	TDDConf.1.1	
	SCS=30 KHz		3, 6	TDDConf.2.1	
BW <sub>channel</sub>		MHz	1, 4	10: N <sub>RB,c</sub> = 52 (FDD)	
			2, 5	10: N <sub>RB,c</sub> = 52 (TDD)	
			3, 6	40: N <sub>RB,c</sub> = 106 (TDD)	
PDSCH reference measurement channel			1, 4	SR.1.1 FDD	
			2, 5	SR.1.1 TDD	
			3, 6	SR.2.1 TDD	
RMSI CORSET reference channel			1, 4	CR.1.1 FDD	
			2, 5	CR.1.1 TDD	
			3, 6	CR.2.1 TDD	
Dedicated CORSET reference channel			1, 4	CCR.1.1 FDD	
			2, 5	CCR.1.1 TDD	
			3, 6	CCR.2.1 TDD	



BWP configurations	Initial DL BWP		1, 2, 3, 4, 5, 6	DLBWP.0.1	
	Dedicated DL BWP		1, 2, 3, 4, 5, 6	DLBWP.1.1	
	Initial UL BWP		1, 2, 3, 4, 5, 6	ULBWP.0.1	
	Dedicated UL BWP		1, 2, 3, 4, 5, 6	ULBWP.1.1	
OCNG pattern <sup>Note1</sup>			1, 2, 3, 4, 5, 6	OP.1	
SMTC configuration			1, 2, 3, 4, 5, 6	SMTC.1	
SSB configuration			1, 2, 4, 5	SSB.1 FR1	
			3, 6	SSB.2 FR1	
CSI-RS for tracking			1, 4	TRS.1.1 FDD	
			2, 5	TRS.1.1 TDD	
			3, 6	TRS.1.2 TDD	
b2-Threshold1		dBm	1, 2, 4, 5	-96	
			3, 6	-93	
EPRE ratio of PSS to SSS		dB	1, 2, 3, 4, 5, 6	0	
EPRE ratio of PBCH_DMRS to SSS					
EPRE ratio of PBCH to PBCH_DMRS					
EPRE ratio of PDCCH_DMRS to SSS					
EPRE ratio of PDCCH to PDCCH_DMRS					
EPRE ratio of PDSCH_DMRS to SSS					
EPRE ratio of PDSCH to PDSCH_DMRS					
EPRE ratio of OCNG DMRS to SSS					
EPRE ratio of OCNG to OCNG DMRS					
$N_{oc}$ <sup>Note2</sup>					
$N_{oc}$ <sup>Note2</sup>		dBm/SCS	1, 2, 4, 5	-104	
			3, 6	-101	
$\hat{E}_s/N_{oc}$		dB	1, 2, 3, 4, 5, 6	16	0
$\hat{E}_s/I_{ot}$ <sup>Note3</sup>		dB	1, 2, 3, 4, 5, 6	16	0
SS-RSRP <sup>Note3</sup>		dBm/SCS	1, 2, 4, 5	-88	-104
			3, 6	-85	-101
SSB_RP <sup>Note3</sup>		dBm/SCS	1, 2, 4, 5	-88	-104
			3, 6	-85	-101
$I_o$ <sup>Note3</sup>		dBm/9.36 MHz	1, 2, 4, 5	-59.94	-73.04
			dBm/38.16 MHz	3, 6	-53.84
Propagation condition			1, 2, 3, 4, 5, 6	AWGN	
Antenna Configuration and Correlation Matrix			1, 2, 3, 4, 5, 6	1x2	
<p>Note 1: OCNG shall be used such that both cells are fully allocated and a constant total transmitted power spectral density is achieved for all OFDM symbols.</p> <p>Note 2: Interference from other cells and noise sources not specified in the test is assumed to be constant over subcarriers and time and shall be modelled as AWGN of appropriate power for <math>N_{oc}</math> to be fulfilled.</p> <p>Note 3: <math>\hat{E}_s/I_{ot}</math>, SS-RSRP, SSB_RP and <math>I_o</math> levels have been derived from other parameters for information purposes. They are not settable parameters themselves.</p>					

**Table A.6.6.3.1.1-4: E-UTRAN neighbour cell specific test parameters for SA inter-RAT E-UTRAN event triggered reporting in non-DRX with PCell in FR1**

Parameter	Unit	Configuration	Cell 2	
			T1	T2
RF channel number		1, 2, 3, 4, 5, 6	1	
Duplex mode		1, 2, 3	FDD	
		4, 5, 6	TDD	
TDD special subframe configuration <sup>Note1</sup>		4, 5, 6	6	
TDD uplink-downlink configuration <sup>Note1</sup>		4, 5, 6	1	
BW <sub>channel</sub>	MHz	1, 2, 3, 4, 5, 6	5 MHz: $N_{RB,c} = 25$	

			10 MHz: $N_{RB,c} = 50$ 20 MHz: $N_{RB,c} = 100$
PDSCH parameters: DL Reference Measurement Channel <sup>Note2</sup>		1, 2, 3	5 MHz: R.7 FDD 10 MHz: R.3 FDD 20 MHz: R.6 FDD
		4, 5, 6	5 MHz: R.4 TDD 10 MHz: R.0 TDD 20 MHz: R.3 TDD
PCFICH/PDCCH/PHICH parameters: DL Reference Measurement Channel <sup>Note2</sup>		1, 2, 3	5 MHz: R.11 FDD 10 MHz: R.6 FDD 20 MHz: R.10 FDD
		4, 5, 6	5 MHz: R.11 TDD 10 MHz: R.6 TDD 20 MHz: R.10 TDD
OCNG Patterns <sup>Note2</sup>		1, 2, 3	5 MHz: OP.20 FDD 10 MHz: OP.10 FDD 20 MHz: OP.17 FDD
		4, 5, 6	5 MHz: OP.9 TDD 10 MHz: OP.1 TDD 20 MHz: OP.7 TDD
PBCH_RA	dB	1, 2, 3, 4, 5, 6	0
PBCH_RB			
PSS_RA			
SSS_RA			
PCFICH_RB			
PHICH_RA			
PHICH_RB			
PDCCH_RA			
PDCCH_RB			
PDSCH_RA			
PDSCH_RB			
OCNG_RA <sup>Note3</sup>			
OCNG_RB <sup>Note3</sup>			
$N_{oc}$ <sup>Note4</sup>			
$\bar{E}_s/N_{oc}$	dB	1, 2, 3, 4, 5, 6	-Infinity   17
$\bar{E}_s/I_{ot}$ <sup>Note5</sup>	dB	1, 2, 3, 4, 5, 6	-Infinity   17
RSRP <sup>Note5</sup>	dBm/15kHz	1, 2, 3, 4, 5, 6	-Infinity   -87
SCH_RP <sup>Note5</sup>	dBm/15kHz	1, 2, 3, 4, 5, 6	-Infinity   -87
$I_o$ <sup>Note5</sup>	dBm/9MHz	1, 2, 3, 4, 5, 6	-73.21+10log( $N_{RB,c}/50$ )   -56.12+10log( $N_{RB,c}/50$ )
Propagation Condition		1, 2, 3, 4, 5, 6	AWGN
Antenna Configuration and Correlation Matrix		1, 2, 3, 4, 5, 6	1x2
<p>Note 1: Special subframe and uplink-downlink configurations are specified in table 4.2-1 in TS 36.211 [23].</p> <p>Note 2: DL RMCs and OCNG patterns are specified in clauses A 3.1 and A 3.2 of TS 36.133 [15] respectively.</p> <p>Note 3: OCNG shall be used such that all cells are fully allocated and a constant total transmitted power spectral density is achieved for all OFDM symbols.</p> <p>Note 4: Interference from other cells and noise sources not specified in the test is assumed to be constant over subcarriers and time and shall be modelled as AWGN of appropriate power for <math>N_{oc}</math> to be fulfilled.</p> <p>Note 5: <math>\bar{E}_s/I_{ot}</math>, RSRP, SCH_RP and <math>I_o</math> levels have been derived from other parameters for information purposes. They are not settable parameters themselves.</p>			

A.6.6.3.1.2 Test Requirements

The UE shall send one Event B2 triggered measurement report for Cell 2 to the PCell, with a measurement reporting delay less than 3.84s from the start of period T2. The measurement reporting delay is defined as the time from the beginning of time period T2 to the moment when the UE sends the measurement report on PUSCH.

The UE shall not send event-triggered measurement reports as long as the reporting criteria is not fulfilled.

The rate of correct events observed during repeated tests shall be at least 90%.

### A.6.6.3.2 SA NR - E-UTRAN event-triggered reporting in DRX in FR1

#### A.6.6.3.2.1 Test Purpose and Environment

The purpose of this set of tests is to verify that the UE makes correct event-triggered reporting of inter-RAT E-UTRAN measurements when operating in standalone (SA) operation with PCell in FR1 when DRX is used. This test shall partly verify the cell search and measurement requirements in Clauses 9.4.2 and 9.4.3. There are two test cases. In test 1 the UE shall be configured with DRX cycle of 40 ms. In test 2 the UE shall be configured with DRX cycle of 640 ms.

In each test there are two cells: Cell 1 and Cell 2. Cell 1 is the NR PCell and Cell 2 is an inter-RAT E-UTRAN inter-RAT neighbour cell. In the measurement control information from the PCell it is indicated to the UE that event-triggered reporting with Event B2 (PCell becomes worse than threshold1 and inter RAT neighbour becomes better than threshold2) is to be used. Each test consists of two consecutive time periods, with durations T1 and T2, respectively. Prior to the start of time duration T1, the UE shall be fully synchronized to Cell 1. During T1, the UE shall not have any information on Cell 2.

In each test the UE shall be provided with new Timing Advance Command MAC control element at least once during each time alignment timer period to maintain uplink time alignment. Furthermore the UE shall be allocated with PUSCH resource at every DRX cycle.

Supported test configurations are shown in table A.6.6.3.2.1-1. General test parameters are provided in Table A.6.6.3.2.1-2 below. Test parameters for Cell 1 and Cell 2, valid for both time duration T1 and T2, are provided in Tables A.6.6.3.2.1-3 and A.6.6.3.2.1-4, respectively.

**Table A.6.6.3.2.1-1: Supported test configurations in SA inter-RAT E-UTRAN event triggered reporting in DRX with PCell in FR1**

Configuration	Description
1	NR 15 kHz SSB SCS, 10 MHz bandwidth, FDD duplex mode, LTE FDD
2	NR 15 kHz SSB SCS, 10 MHz bandwidth, TDD duplex mode, LTE FDD
3	NR 30 kHz SSB SCS, 40 MHz bandwidth, TDD duplex mode, LTE FDD
4	NR 15 kHz SSB SCS, 10 MHz bandwidth, FDD duplex mode, LTE TDD
5	NR 15 kHz SSB SCS, 10 MHz bandwidth, TDD duplex mode, LTE TDD
6	NR 30 kHz SSB SCS, 40 MHz bandwidth, TDD duplex mode, LTE TDD

Note: The UE is only required to be tested in one of the supported test configurations

**Table A.6.6.3.2.1-2: General test parameters for SA inter-RAT E-UTRAN event triggered reporting in DRX with PCell in FR1**

Parameter	Unit	Test 1	Test 2	Comment
		Value		
NR RF Channel Number		1		1 NR carrier frequency is used in the test
LTE RF Channel Number		2		1 LTE carrier frequency is used in the test
Channel Bandwidth	MHz	As specified in Tables A.6.6.3.2.1-2 and A.6.6.3.2.1-3.		
Active cell		Cell 1		Cell 1 is on RF channel number 1
Neighbour cell		Cell 2		Cell 2 is on RF channel number 2
Gap Pattern Id		0		As specified in Clause Table 9.1.2-1. Per-UE gap pattern.
NR measurement quantity		SS-RSRP		Measurement quantity for Cell 1
Inter-RAT E-UTRAN measurement quantity		RSRP		Measurement quantity for Cell 2
b2-Threshold1	dBm	Note 1		SS-RSRP threshold for SS-RSRP measurement on cell1 for event B2
b2-Threshold2EUTRA	dBm	-95		E-UTRAN RSRP threshold for SS-RSRP measurement on cell1 for event B2
Hysteresis	dB	0		
TimeToTrigger	s	0		
Filter coefficient		0		L3 filtering is not used
DRX		DRX.1	DRX.7	DRX cycle configurations DRX.1 and DRX.7 are defined in Table A.3.3.1-1 and Table A.3.3.7-1 respectively.
T1	s	5		

T2	s	5	15	
Note 1: Values are defined in Table A.6.6.3.2.1-3				

**Table A.6.6.3.2.1-3: PCell specific test parameters for SA inter-RAT E-UTRA event triggered reporting in DRX with PCell in FR1**

Parameter		Unit	Configuration	Cell 1	
				T1	T2
RF channel number			1, 2, 3, 4, 5, 6	1	
Duplex mode			1, 2, 3	FDD	
			4, 5, 6	TDD	
TDD Configuration	SCS=15 KHz		2, 5	TDDConf.1.1	
	SCS=30 KHz		3, 6	TDDConf.2.1	
BW <sub>channel</sub>		MHz	1, 4	10: N <sub>RB,c</sub> = 52 (FDD)	
			2, 5	10: N <sub>RB,c</sub> = 52 (TDD)	
			3, 6	40: N <sub>RB,c</sub> = 106 (TDD)	
PDSCH reference measurement channel			1, 4	SR.1.1 FDD	
			2, 5	SR.1.1 TDD	
			3, 6	SR.2.1 TDD	
RMSI CORSET reference channel			1, 4	CR.1.1 FDD	
			2, 5	CR.1.1 TDD	
			3, 6	CR.2.1 TDD	
Dedicated CORSET reference channel			1, 4	CCR.1.1 FDD	
			2, 5	CCR.1.1 TDD	
			3, 6	CCR.2.1 TDD	
BWP configurations	Initial DL BWP		1, 2, 3, 4, 5, 6	DLBWP.0.1	
	Dedicated DL BWP		1, 2, 3, 4, 5, 6	DLBWP.1.1	
	Initial UL BWP		1, 2, 3, 4, 5, 6	ULBWP.0.1	
	Dedicated UL BWP		1, 2, 3, 4, 5, 6	ULBWP.1.1	
OCNG pattern <sup>Note1</sup>			1, 2, 3, 4, 5, 6	OP.1	
SMTc configuration			1, 2, 3, 4, 5, 6	SMTc.1	
SSB configuration			1, 2, 4, 5	SSB.1 FR1	
			3, 6	SSB.2 FR1	
CSI-RS for tracking			1, 4	TRS.1.1 FDD	
			2, 5	TRS.1.1 TDD	
			3, 6	TRS.1.2 TDD	
b2-Threshold1		dBm	1, 2, 4, 5	-96	
			3, 6	-93	
EPRE ratio of PSS to SSS		dB	1, 2, 3, 4, 5, 6	0	
EPRE ratio of PBCH_DMRS to SSS					
EPRE ratio of PBCH to PBCH_DMRS					
EPRE ratio of PDCCH_DMRS to SSS					
EPRE ratio of PDCCH to PDCCH_DMRS					
EPRE ratio of PDSCH_DMRS to SSS					
EPRE ratio of PDSCH to PDSCH_DMRS					
EPRE ratio of OCNG DMRS to SSS					
EPRE ratio of OCNG to OCNG DMRS					
N <sub>oc</sub> <sup>Note2</sup>		dBm/15 KHz	1, 2, 3, 4, 5, 6	-104	
N <sub>oc</sub> <sup>Note2</sup>		dBm/SCS	1, 2, 4, 5	-104	
			3, 6	-101	
E <sub>s</sub> /N <sub>oc</sub>		dB	1, 2, 3, 4, 5, 6	16	0
E <sub>s</sub> /I <sub>ot</sub> <sup>Note3</sup>				dB	1, 2, 3, 4, 5, 6
SS-RSRP <sup>Note3</sup>		dBm/SCS	1, 2, 4, 5		
			3, 6	-85	-101
SSB_RP <sup>Note3</sup>		dBm/SCS	1, 2, 4, 5	-88	-104
			3, 6	-85	-101
I <sub>o</sub> <sup>Note3</sup>		dBm/9.36 MHz	1, 2, 4, 5	-59.94	-73.04

	dBm/38.16 MHz	3, 6	-53.84	-66.93
Propagation condition		1, 2, 3, 4, 5, 6	AWGN	
Antenna Configuration and Correlation Matrix		1, 2, 3, 4, 5, 6	1x2	
Note 1:	OCNG shall be used such that both cells are fully allocated and a constant total transmitted power spectral density is achieved for all OFDM symbols.			
Note 2:	Interference from other cells and noise sources not specified in the test is assumed to be constant over subcarriers and time and shall be modelled as AWGN of appropriate power for $N_{oc}$ to be fulfilled.			
Note 3:	$\bar{E}_s/I_{ot}$ , SS-RSRP, SSB_RP and $I_o$ levels have been derived from other parameters for information purposes. They are not settable parameters themselves.			

**Table A.6.6.3.2.1-4: E-UTRAN neighbour cell specific test parameters for SA inter-RAT E-UTRAN event triggered reporting in DRX with PCell in FR1**

Parameter	Unit	Configuration	Cell 2	
			T1	T2
RF channel number		1, 2, 3, 4, 5, 6	2	
Duplex mode		1, 2, 3	FDD	
		4, 5, 6	TDD	
TDD special subframe configuration <sup>Note1</sup>		4, 5, 6	6	
TDD uplink-downlink configuration <sup>Note1</sup>		4, 5, 6	1	
BW <sub>channel</sub>	MHz	1, 2, 3, 4, 5, 6	5 MHz: N <sub>RB,c</sub> = 25 10 MHz: N <sub>RB,c</sub> = 50 20 MHz: N <sub>RB,c</sub> = 100	
PDSCH parameters: DL Reference Measurement Channel <sup>Note2</sup>		1, 2, 3	5 MHz: R.7 FDD 10 MHz: R.3 FDD 20 MHz: R.6 FDD	
		4, 5, 6	5 MHz: R.4 TDD 10 MHz: R.0 TDD 20 MHz: R.3 TDD	
PCFICH/PDCCH/PHICH parameters: DL Reference Measurement Channel <sup>Note2</sup>		1, 2, 3	5 MHz: R.11 FDD 10 MHz: R.6 FDD 20 MHz: R.10 FDD	
		4, 5, 6	5 MHz: R.11 TDD 10 MHz: R.6 TDD 20 MHz: R.10 TDD	
OCNG Patterns <sup>Note2</sup>		1, 2, 3	5 MHz: OP.20 FDD 10 MHz: OP.10 FDD 20 MHz: OP.17 FDD	
		4, 5, 6	5 MHz: OP.9 TDD 10 MHz: OP.1 TDD 20 MHz: OP.7 TDD	
PBCH_RA	dB	1, 2, 3, 4, 5, 6	0	
PBCH_RB				
PSS_RA				
SSS_RA				
PCFICH_RB				
PHICH_RA				
PHICH_RB				
PDCCH_RA				
PDCCH_RB				
PDSCH_RA				
PDSCH_RB				
OCNG_RA <sup>Note3</sup>				
OCNG_RB <sup>Note3</sup>				
N <sub>oc</sub> <sup>Note4</sup>				
$\bar{E}_s/N_{oc}$	dB	1, 2, 3, 4, 5, 6	-Infinity	17
$\bar{E}_s/I_{ot}$ <sup>Note5</sup>	dB	1, 2, 3, 4, 5, 6	-Infinity	17
RSRP <sup>Note5</sup>	dBm/15kHz	1, 2, 3, 4, 5, 6	-Infinity	-87
SCH_RP <sup>Note5</sup>	dBm/15kHz	1, 2, 3, 4, 5, 6	-Infinity	-87

$I_{o}^{Note5}$	dBm/9MHz	1, 2, 3, 4, 5, 6	$-73.21+10\log(N_{RB,c}/50)$	$-56.12+10\log(N_{RB,c}/50)$
Propagation Condition <sup>Note6</sup>		1, 2, 3, 4, 5, 6	AWGN	
Antenna Configuration and Correlation Matrix <sup>Note6</sup>		1, 2, 3, 4, 5, 6	1x2	
Note 1:	Special subframe and uplink-downlink configurations are specified in table 4.2-1 in TS 36.211 [23].			
Note 2:	DL RMCs and OCNG patterns are specified in clauses A 3.1 and A 3.2 of TS 36.133 [15] respectively.			
Note 3:	OCNG shall be used such that all cells are fully allocated and a constant total transmitted power spectral density is achieved for all OFDM symbols.			
Note 4:	Interference from other cells and noise sources not specified in the test is assumed to be constant over subcarriers and time and shall be modelled as AWGN of appropriate power for $N_{oc}$ to be fulfilled.			
Note 5:	$\hat{E}_s/I_{ot}$ , RSRP, SCH_RP and $I_o$ levels have been derived from other parameters for information purposes. They are not settable parameters themselves.			
Note 6:	Propagation condition and correlation matrix are defined in clause B.2 in TS 36.101 [25].			

### A.6.6.3.2.2 Test Requirements

In test 1, the UE shall send one Event B2 triggered measurement report for Cell 2 to the PCell, with a measurement reporting delay less than 3.84s from the start of period T2. The measurement reporting delay is defined as the time from the beginning of time period T2 to the moment when the UE sends the measurement report on PUSCH.

In test 2, the UE shall send one Event B2 triggered measurement report for Cell 2 to the PCell, with a measurement reporting delay less than 12.8s from the start of period T2. The measurement reporting delay is defined as the time from the beginning of time period T2 to the moment when the UE sends the measurement report on PUSCH.

The UE shall not send event-triggered measurement reports as long as the reporting criteria is not fulfilled.

The rate of correct events observed during repeated tests shall be at least 90%.

### A.6.6.3.3 SA NR - E-UTRAN event-triggered reporting in DRX in FR1 for UE configured with highSpeedMeasFlag-r16

#### A.6.6.3.3.1 Test Purpose and Environment

The purpose of this set of tests is to verify that the UE makes correct event-triggered reporting of inter-RAT E-UTRAN measurements for UE configured with highSpeedMeasFlag-r16 in standalone (SA) operation with PCell in FR1 when DRX is used. This test shall partly verify the cell search and measurement requirements in Clauses 9.4.2 and 9.4.3.

In the test there are two cells: Cell 1 and Cell 2. Cell 1 is the NR PCell and Cell 2 is an inter-RAT E-UTRAN inter-RAT neighbour cell. In the measurement control information from the PCell it is indicated to the UE that event-triggered reporting with Event B2 (PCell becomes worse than threshold1 and inter RAT neighbour becomes better than threshold2) is to be used. Each test consists of two consecutive time periods, with durations T1 and T2, respectively. Prior to the start of time duration T1, the UE shall be fully synchronized to Cell 1. During T1, the UE shall not have any information on Cell 2.

The UE shall be provided at least once every 500ms with new Timing Advance Command MAC control element to restart the Time alignment timer to keep UE uplink time alignment. Furthermore the UE shall be allocated with PUSCH resource at every DRX cycle.

Supported test configurations are shown in table A.6.6.3.3.1-1. General test parameters are provided in Table A.6.6.3.3.1-2 below. Test parameters for Cell 1 and Cell 2, valid for both time duration T1 and T2, are provided in Tables A.6.6.3.3.1-3 and A.6.6.3.3.1-4, respectively.

**Table A.6.6.3.3.1-1: Supported test configurations in SA inter-RAT E-UTRAN event triggered reporting in DRX with PCell in FR1 for UE configured with highSpeedMeasFlag-r16**

Configuration	Description
1	NR 15 kHz SSB SCS, 10 MHz bandwidth, FDD duplex mode, LTE FDD
2	NR 15 kHz SSB SCS, 10 MHz bandwidth, TDD duplex mode, LTE FDD
3	NR 30 kHz SSB SCS, 40 MHz bandwidth, TDD duplex mode, LTE FDD
4	NR 15 kHz SSB SCS, 10 MHz bandwidth, FDD duplex mode, LTE TDD
5	NR 15 kHz SSB SCS, 10 MHz bandwidth, TDD duplex mode, LTE TDD
6	NR 30 kHz SSB SCS, 40 MHz bandwidth, TDD duplex mode, LTE TDD
Note:	The UE is only required to be tested in one of the supported test configurations

**Table A.6.6.3.3.1-2: General test parameters for SA inter-RAT E-UTRAN event triggered reporting in DRX with PCell in FR1 for UE configured with highSpeedMeasFlag-r16**

Parameter	Unit	Value	Comment
NR RF Channel Number		1	1 NR carrier frequency is used in the test
LTE RF Channel Number		2	1 LTE carrier frequency is used in the test
Channel Bandwidth	MHz	As specified in Tables A.6.6.3.3.1-2 and A.6.6.3.3.1-3.	
Active cell		Cell 1	Cell 1 is on RF channel number 1
Neighbour cell		Cell 2	Cell 2 is on RF channel number 2
Gap Pattern Id		0	As specified in Clause Table 9.1.2-1. Per-UE gap pattern.
NR measurement quantity		SS-RSRP	Measurement quantity for Cell 1
Inter-RAT E-UTRAN measurement quantity		RSRP	Measurement quantity for Cell 2
b2-Threshold1	dBm	Note 1	SS-RSRP threshold for SS-RSRP measurement on cell1 for event B2
b2-Threshold2EUTRA	dBm	-97	E-UTRAN RSRP threshold for SS-RSRP measurement on cell1 for event B2
Hysteresis	dB	0	
TimeToTrigger	s	0	
Filter coefficient		0	L3 filtering is not used
DRX		DRX.6	DRX cycle configurations DRX.6 is defined in Table A.3.3.1-6.
T1	s	5	
T2	s	5	
Note 1: Values are defined in Table A.6.6.3.3.1-3			

**Table A.6.6.3.3.1-3: PCell specific test parameters for SA inter-RAT E-UTRA event triggered reporting in DRX with PCell in FR1 for UE configured with highSpeedMeasFlag-r16**

Parameter		Unit	Configuration	Cell 1	
				T1	T2
RF channel number			1, 2, 3, 4, 5, 6	1	
Duplex mode			1, 2, 3	FDD	
			4, 5, 6	TDD	
TDD Configuration	SCS=15 KHz		2, 5	TDDConf.1.1	
	SCS=30 KHz		3, 6	TDDConf.2.1	
BW <sub>channel</sub>		MHz	1, 4	10: N <sub>RB,c</sub> = 52 (FDD)	
			2, 5	10: N <sub>RB,c</sub> = 52 (TDD)	
			3, 6	40: N <sub>RB,c</sub> = 106 (TDD)	
PDSCH reference measurement channel			1, 4	SR.1.1 FDD	
			2, 5	SR.1.1 TDD	
			3, 6	SR.2.1 TDD	
RMSI CORESET reference channel			1, 4	CR.1.1 FDD	
			2, 5	CR.1.1 TDD	
			3, 6	CR.2.1 TDD	
Dedicated CORESET reference channel			1, 4	CCR.1.1 FDD	
			2, 5	CCR.1.1 TDD	
			3, 6	CCR.2.1 TDD	
BWP configurations	Initial DL BWP		1, 2, 3, 4, 5, 6	DLBWP.0.1	
	Dedicated DL BWP		1, 2, 3, 4, 5, 6	DLBWP.1.1	
	Initial UL BWP		1, 2, 3, 4, 5, 6	ULBWP.0.1	
	Dedicated UL BWP		1, 2, 3, 4, 5, 6	ULBWP.1.1	
OCNG pattern <sup>Note1</sup>			1, 2, 3, 4, 5, 6	OP.1	
SMTC configuration			1, 2, 3, 4, 5, 6	SMTC.1	
SSB configuration			1, 2, 4, 5	SSB.1 FR1	
			3, 6	SSB.2 FR1	
CSI-RS for tracking			1, 4	TRS.1.1 FDD	
			2, 5	TRS.1.1 TDD	
			3, 6	TRS.1.2 TDD	

b2-Threshold1	dBm	1, 2, 4, 5	-98	
		3, 6	-95	
EPRE ratio of PSS to SSS	dB	1, 2, 3, 4, 5, 6	0	
EPRE ratio of PBCH_DMRS to SSS				
EPRE ratio of PBCH to PBCH_DMRS				
EPRE ratio of PDCCH_DMRS to SSS				
EPRE ratio of PDCCH to PDCCH_DMRS				
EPRE ratio of PDSCH_DMRS to SSS				
EPRE ratio of PDSCH to PDSCH_DMRS				
EPRE ratio of OCNG DMRS to SSS				
EPRE ratio of OCNG to OCNG DMRS				
$N_{oc}^{Note2}$	dBm/15 KHz	1, 2, 3, 4, 5, 6	-106	
$N_{oc}^{Note2}$	dBm/SCS	1, 2, 4, 5	-106	
		3, 6	-103	
$\hat{E}_s/N_{oc}$	dB	1, 2, 3, 4, 5, 6	18	-2
$\hat{E}_s/I_{ot}^{Note3}$	dB	1, 2, 3, 4, 5, 6	18	-2
SS-RSRP <sup>Note3</sup>	dBm/SCS	1, 2, 4, 5	-88	-108
		3, 6	-85	-105
SSB_RP <sup>Note3</sup>	dBm/SCS	1, 2, 4, 5	-88	-108
		3, 6	-85	-105
$I_o^{Note3}$	dBm/9.36 MHz	1, 2, 4, 5	-59.98	-75.92
	dBm/38.16 MHz	3, 6	-53.88	-69.82
Propagation condition		1, 2, 3, 4, 5, 6	AWGN	
Antenna Configuration and Correlation Matrix		1, 2, 3, 4, 5, 6	1x2 Low	
<p>Note 1: OCNG shall be used such that both cells are fully allocated and a constant total transmitted power spectral density is achieved for all OFDM symbols.</p> <p>Note 2: Interference from other cells and noise sources not specified in the test is assumed to be constant over subcarriers and time and shall be modelled as AWGN of appropriate power for <math>N_{oc}</math> to be fulfilled.</p> <p>Note 3: <math>\hat{E}_s/I_{ot}</math>, SS-RSRP, SSB_RP and <math>I_o</math> levels have been derived from other parameters for information purposes. They are not settable parameters themselves.</p>				

**Table A.6.6.3.3.1-4: E-UTRAN neighbour cell specific test parameters for SA inter-RAT E-UTRAN event triggered reporting in DRX with PCell in FR1 for UE configured with highSpeedMeasFlag-r16**

Parameter	Unit	Configuration	Cell 2	
			T1	T2
RF channel number		1, 2, 3, 4, 5, 6	2	
Duplex mode		1, 2, 3	FDD	
		4, 5, 6	TDD	
TDD special subframe configuration <sup>Note1</sup>		4, 5, 6	6	
TDD uplink-downlink configuration <sup>Note1</sup>		4, 5, 6	1	
BW <sub>channel</sub>	MHz	1, 2, 3, 4, 5, 6	5 MHz: $N_{RB,c} = 25$ 10 MHz: $N_{RB,c} = 50$ 20 MHz: $N_{RB,c} = 100$	
PDSCH parameters: DL Reference Measurement Channel <sup>Note2</sup>		1, 2, 3	5 MHz: R.7 FDD 10 MHz: R.3 FDD 20 MHz: R.6 FDD	
		4, 5, 6	5 MHz: R.4 TDD 10 MHz: R.0 TDD 20 MHz: R.3 TDD	
PCFICH/PDCCH/PHICH parameters: DL Reference Measurement Channel <sup>Note2</sup>		1, 2, 3	5 MHz: R.11 FDD 10 MHz: R.6 FDD 20 MHz: R.10 FDD	
		4, 5, 6	5 MHz: R.11 TDD 10 MHz: R.6 TDD 20 MHz: R.10 TDD	



OCNG Patterns <sup>Note2</sup>		1, 2, 3	5 MHz: OP.20 FDD 10 MHz: OP.10 FDD 20 MHz: OP.17 FDD	
		4, 5, 6	5 MHz: OP.9 TDD 10 MHz: OP.1 TDD 20 MHz: OP.7 TDD	
PBCH_RA	dB	1, 2, 3, 4, 5, 6	0	
PBCH_RB				
PSS_RA				
SSS_RA				
PCFICH_RB				
PHICH_RA				
PHICH_RB				
PDCCH_RA				
PDCCH_RB				
PDSCH_RA				
PDSCH_RB				
OCNG_RA <sup>Note3</sup>				
OCNG_RB <sup>Note3</sup>				
$N_{oc}$ <sup>Note4</sup>				
$\bar{E}_s/N_{oc}$	dB	1, 2, 3, 4, 5, 6	-Infinity	19
$\bar{E}_s/I_{ot}$ <sup>Note5</sup>	dB	1, 2, 3, 4, 5, 6	-Infinity	19
RSRP <sup>Note5</sup>	dBm/15kHz	1, 2, 3, 4, 5, 6	-Infinity	-87
SCH_RP <sup>Note5</sup>	dBm/15kHz	1, 2, 3, 4, 5, 6	-Infinity	-87
$I_o$ <sup>Note5</sup>	dBm/9MHz	1, 2, 3, 4, 5, 6	$-78.22+10\log(N_{RB,c}/50)$	$-59.16+10\log(N_{RB,c}/50)$
Propagation Condition <sup>Note6</sup>		1, 2, 3, 4, 5, 6	AWGN1944	
Antenna Configuration and Correlation Matrix <sup>Note6</sup>		1, 2, 3, 4, 5, 6	1x2 Low	
<p>Note 1: Special subframe and uplink-downlink configurations are specified in table 4.2-1 in TS 36.211 [23].</p> <p>Note 2: DL RMCs and OCNG patterns are specified in clauses A 3.1 and A 3.2 of TS 36.133 [15] respectively.</p> <p>Note 3: OCNG shall be used such that all cells are fully allocated and a constant total transmitted power spectral density is achieved for all OFDM symbols.</p> <p>Note 4: Interference from other cells and noise sources not specified in the test is assumed to be constant over subcarriers and time and shall be modelled as AWGN of appropriate power for <math>N_{oc}</math> to be fulfilled.</p> <p>Note 5: <math>\bar{E}_s/I_{ot}</math>, RSRP, SCH_RP and <math>I_o</math> levels have been derived from other parameters for information purposes. They are not settable parameters themselves.</p> <p>Note 6: Propagation condition and correlation matrix are defined in clause B.2 in TS 36.101 [25].</p>				

A.6.6.3.3.2 Test Requirements

In the test, the UE shall send one Event B2 triggered measurement report for Cell 2 to the PCell, with a measurement reporting delay less than 4.8s from the start of period T2. The measurement reporting delay is defined as the time from the beginning of time period T2 to the moment when the UE sends the measurement report on PUSCH.

The UE shall not send event-triggered measurement reports as long as the reporting criteria is not fulfilled.

The rate of correct events observed during repeated tests shall be at least 90%.

A.6.6.4 L1-RSRP measurement for beam reporting

A.6.6.4.1 SSB based L1-RSRP measurement when DRX is not used

A.6.6.4.1.1 Test Purpose and Environment

The purpose of this test is to verify that the UE makes correct reporting of L1-RSRP measurement. This test will partly verify the L1-RSRP measurement requirements in clause 9.5.4.1, with the testing configurations for NR cells in Table A.6.6.4.1.1-1.

**Table A.6.6.4.1.1-1: Applicable NR configurations for FR1 SSB based L1-RSRP test**

Config	Description
1	NR 15 kHz SSB SCS, 10 MHz bandwidth, FDD duplex mode
2	NR 15 kHz SSB SCS, 10 MHz bandwidth, TDD duplex mode
3	NR 30 kHz SSB SCS, 40 MHz bandwidth, TDD duplex mode

Note: The UE is only required to be tested in one of the supported test configurations
--

#### A.6.6.4.1.2 Test parameters

There is one cells in the test, the FR1 PCell (Cell 1). The test parameters for the Cell 1 are given in Table A.6.6.4.1.2-1 and Table A.6.6.4.1.2-2 below.

In CSI measurement configuration, UE is indicated to perform L1-RSRP measurement on the SSBs and report periodically. The test consists of two successive time periods, with time duration of T1 and T2 respectively. The test has higher layer parameter *timeRestrictionForChannelMeasurements* configured.

There is no measurement gap configured in the test. Before the test, UE is configured to perform RLM, BFD and L1-RSRP measurement based on the SSBs.

**Table A.6.6.4.1.2-1: General test parameters**

Parameter	Config	Unit	Value
SSB GSCN	1~3		freq1
Duplex mode	1		FDD
	2		TDD
	3		TDD
TDD Configuration	1		N/A
	2		TDDConf.1.1
	3		TDDConf.2.1
BW <sub>channel</sub>	1	MHz	10: N <sub>RB,c</sub> = 52
	2		10: N <sub>RB,c</sub> = 52
	3		40: N <sub>RB,c</sub> = 106
PDSCH Reference measurement channel	1		SR.1.1 FDD
	2		SR.1.1 TDD
	3		SR.2.1 TDD
RMSI CORESET Reference Channel	1		CR.1.1 FDD
	2		CR.1.1 TDD
	3		CR.2.1 TDD
Dedicated CORESET Reference Channel	1		CCR.1.1 FDD
	2		CCR.1.1 TDD
	3		CCR.2.1 TDD
SSB configuration	1		SSB.3 FR1
	2		SSB.3 FR1
	3		SSB.4 FR1
OCNG Patterns	1~3		OP.1
Initial BWP Configuration	1~3		DLBWP.0.1 ULBWP.0.1
Dedicated BWP configuration	1~3		DLBWP.1.1 ULBWP.1.1
SMTC configuration	1~3		SMTC.1
TRS Configuration	1		TRS.1.1 FDD
	2		TRS.1.1 TDD
	3		TRS.1.2 TDD
DRX configuration	1~3		Off
reportConfigType	1~3		periodic
reportQuantity	1~3		ssb-Index-RSRP
Number of reported RS	1~3		2
L1-RSRP reporting period	1~3	slot	80
T1	1~3	s	5
T2	1~3	s	1
EPRE ratio of PSS to SSS	1~3	dB	0
EPRE ratio of PBCH DMRS to SSS			
EPRE ratio of PBCH to PBCH DMRS			
EPRE ratio of PDCCH DMRS to SSS			

EPRE ratio of PDCCH to PDCCH DMRS			
EPRE ratio of PDSCH DMRS to SSS			
EPRE ratio of PDSCH to PDSCH DMRS			
EPRE ratio of OCNG DMRS to SSS <sup>Note 1</sup>			
EPRE ratio of OCNG to OCNG DMRS <sup>Note 1</sup>			
Propagation condition	1~3		AWGN
Note 1: OCNG shall be used such that the resources in Cell 1 are fully allocated and a constant total transmitted power spectral density is achieved for all OFDM symbols.			

Table A.6.6.4.1.2-2: SSB specific test parameters

Parameter	Config	Unit	SSB#0		SSB#1	
			T1	T2	T1	T2
$N_{oc}$ <sup>Note2</sup>	1~3	dBm/15kHz	-94.65			
$N_{oc}$ <sup>Note2</sup>	1,2	dBm/SSB SCS	-94.65			
	3		-91.65			
$\hat{E}_s/I_{ot}$	1~3	dB	0	0	-Infinity	3
SSB RSRP <sup>Note3</sup>	1,2	dBm/SSB SCS	-94.65	-94.65	-Infinity	-91.65
	3		-91.65	-91.65	-Infinity	-88.65
$I_o$ <sup>Note3</sup>	1,2	dBm/9.36 MHz	-63.69	-63.69	-66.70	-61.93
	3	dBm/38.16 MHz	-57.59	-57.59	-60.61	-55.84
$\hat{E}_s/N_{oc}$	1~3	dB	0	0	-Infinity	3
Note 1: The resources for uplink transmission are assigned to the UE prior to the start of time period T2.						
Note 2: Interference from other cells and noise sources not specified in the test is assumed to be constant over subcarriers and time and shall be modelled as AWGN of appropriate power for $N_{oc}$ to be fulfilled.						
Note 3: SS-RSRP and $I_o$ levels have been derived from other parameters for information purposes. They are not settable parameters themselves.						

### A.6.6.4.1.3 Test Requirements

The UE shall send L1-RSRP report every 80 slots. No later than 640ms plus 80 slots from the beginning of time period T2, UE shall send L1-RSRP report including results of both SSB0 and SSB1 while meeting the absolute accuracy requirement in clause 10.1.19.1.1 and relative accuracy requirement in clause 10.1.19.1.2. The rate of correct events observed during repeated tests shall be at least 90%.

NOTE: The actual overall delays measured in the test may be up to  $2xTTI_{DCCH}$  higher than the measurement reporting delays above because of TTI insertion uncertainty of the measurement report in DCCH.

### A.6.6.4.2 SSB based L1-RSRP measurement when DRX is used

#### A.6.6.4.2.1 Test Purpose and Environment

The purpose of this test is to verify that the UE makes correct reporting of L1-RSRP measurement. This test will partly verify the L1-RSRP measurement requirements in clause 9.5.4.1, with the testing configurations for NR cells in Table A.6.6.4.2.1-1.

Table A.6.6.4.2.1-1: Applicable NR configurations for FR1 SSB based L1-RSRP test

Config	Description
1	NR 15 kHz SSB SCS, 10 MHz bandwidth, FDD duplex mode
2	NR 15 kHz SSB SCS, 10 MHz bandwidth, TDD duplex mode
3	NR 30 kHz SSB SCS, 40 MHz bandwidth, TDD duplex mode

Note: The UE is only required to be tested in one of the supported test configurations
--

#### A.6.6.4.2.2 Test parameters

There is one cells in the test, the FR1 PCell (Cell 1). The test parameters for the Cell 1 are given in Table A.6.6.4.2.2-1 and Table A.6.6.4.2.2-2 below.

In CSI measurement configuration, UE is indicated to perform L1-RSRP measurement on the SSBs and report periodically. The test consists of two successive time periods, with time duration of T1 and T2 respectively. The test has higher layer parameter *timeRestrictionForChannelMeasurements* configured.

There is no measurement gap configured in the test. Before the test, UE is configured to perform RLM, BFD and L1-RSRP measurement based on the SSBs.

**Table A.6.6.4.2.2-1: General test parameters**

Parameter	Config	Unit	Value
SSB GSCN	1~3		freq1
Duplex mode	1		FDD
	2		TDD
	3		TDD
TDD Configuration	1		N/A
	2		TDDConf.1.1
	3		TDDConf.2.1
BW <sub>channel</sub>	1	MHz	10: N <sub>RB,c</sub> = 52
	2		10: N <sub>RB,c</sub> = 52
	3		40: N <sub>RB,c</sub> = 106
PDSCH Reference measurement channel	1		SR.1.1 FDD
	2		SR.1.1 TDD
	3		SR.2.1 TDD
RMSI CORESET Reference Channel	1		CR.1.1 FDD
	2		CR.1.1 TDD
	3		CR.2.1 TDD
Dedicated CORESET Reference Channel	1		CCR.1.1 FDD
	2		CCR.1.1 TDD
	3		CCR.2.1 TDD
SSB configuration	1		SSB.3 FR1
	2		SSB.3 FR1
	3		SSB.4 FR1
OCNG Patterns	1~3		OP.1
Initial BWP Configuration	1~3		DLBWP.0.1 ULBWP.0.1
Dedicated BWP configuration	1~3		DLBWP.1.1 ULBWP.1.1
SMTC configuration	1~3		SMTC.1
TRS Configuration	1		TRS.1.1 FDD
	2		TRS.1.1 TDD
	3		TRS.1.2 TDD
DRX configuration	1~3		DRX.3
reportConfigType	1~3		periodic
reportQuantity	1~3		ssb-Index-RSRP
Number of reported RS	1~3		2
L1-RSRP reporting period	1~3	slot	80
T1	1~3	s	5
T2	1~3	s	1
EPRE ratio of PSS to SSS	1~3	dB	0
EPRE ratio of PBCH DMRS to SSS			
EPRE ratio of PBCH to PBCH DMRS			
EPRE ratio of PDCCH DMRS to SSS			

EPRE ratio of PDCCH to PDCCH DMRS			
EPRE ratio of PDSCH DMRS to SSS			
EPRE ratio of PDSCH to PDSCH DMRS			
EPRE ratio of OCNG DMRS to SSS <sup>Note 1</sup>			
EPRE ratio of OCNG to OCNG DMRS <sup>Note 1</sup>			
Propagation condition	1~3		AWGN
Note 1: OCNG shall be used such that the resources in Cell 1 are fully allocated and a constant total transmitted power spectral density is achieved for all OFDM symbols.			

Table A.6.6.4.2.2-2: SSB specific test parameters

Parameter	Config	Unit	SSB#0		SSB#1	
			T1	T2	T1	T2
$N_{oc}$ <sup>Note2</sup>	1~3	dBm/15kHz	-94.65			
$N_{oc}$ <sup>Note2</sup>	1,2	dBm/SSB SCS	-94.65			
	3		-91.65			
$\hat{E}_s/I_{ot}$	1~3	dB	0	0	-Infinity	3
SSB RSRP <sup>Note3</sup>	1,2	dBm/SSB SCS	-94.65	-94.65	-Infinity	-91.65
	3		-91.65	-91.65	-Infinity	-88.65
$I_o$ <sup>Note3</sup>	1,2	dBm/9.36 MHz	-63.69	-63.69	-66.70	-61.93
	3	dBm/38.16 MHz	-57.59	-57.59	-60.61	-55.84
$\hat{E}_s/N_{oc}$	1~3	dB	0	0	-Infinity	3
Note 1: The resources for uplink transmission are assigned to the UE prior to the start of time period T2.						
Note 2: Interference from other cells and noise sources not specified in the test is assumed to be constant over subcarriers and time and shall be modelled as AWGN of appropriate power for $N_{oc}$ to be fulfilled.						
Note 3: SS-RSRP and $I_o$ levels have been derived from other parameters for information purposes. They are not settable parameters themselves.						

### A.6.6.4.2.3 Test Requirements

The UE shall send L1-RSRP report every 80 slots. No later than 640ms plus 80 slots from the beginning of time period T2, UE shall send L1-RSRP report including results of both SSB0 and SSB1 while meeting the absolute accuracy requirement in clause 10.1.19.1.1 and relative accuracy requirement in clause 10.1.19.1.2. The rate of correct events observed during repeated tests shall be at least 90%.

NOTE: The actual overall delays measured in the test may be up to  $2xTTI_{DCCH}$  higher than the measurement reporting delays above because of TTI insertion uncertainty of the measurement report in DCCH.

### A.6.6.4.3 CSI-RS based L1-RSRP measurement when DRX is not used

#### A.6.6.4.3.1 Test Purpose and Environment

The purpose of this test is to verify that the UE makes correct reporting of L1-RSRP measurement. This test will partly verify the L1-RSRP measurement requirements in clause 9.5.4.2, with the testing configurations for NR cells in Table A.6.6.4.3.1-1.

Table A.6.6.4.3.1-1: Applicable NR configurations for FR1 CSI-RS based L1-RSRP test

Config	Description
1	NR 15 kHz SSB SCS, 10 MHz bandwidth, FDD duplex mode
2	NR 15 kHz SSB SCS, 10 MHz bandwidth, TDD duplex mode
3	NR 30 kHz SSB SCS, 40 MHz bandwidth, TDD duplex mode

Note: The UE is only required to be tested in one of the supported test configurations
--

### A.6.6.4.3.2 Test parameters

There is one cells in the test, the FR1 PCell (Cell 1). The test parameters for the Cell 1 are given in Table A.6.6.4.3.2-1 and Table A.6.6.4.3.2-2 below.

In CSI measurement configuration, UE is indicated to perform L1-RSRP measurement on the CSI-RS and report aperiodically. The test consists of a single time period T1, during which the UE is triggered via DCI to report L1-RSRP on aperiodic CSI-RS resources. UE is also configured to measure L1-RSRP based on SSB. After 80ms from the beginning of the test, the DCI trigger comes in slot n (0 for Config 1,2 and 8 for Config 3) of a frame and UE provides the report back based on the reporting configuration as defined in Table A.6.6.4.3.2-1.

There is no measurement gap configured in the test. Before the test, UE is configured to perform RLM and BFD based on the SSBs.

**Table A.6.6.4.3.2-1: General test parameters**

Parameter	Config	Unit	Value
SSB GSCN	1~3		freq1
Duplex mode	1		FDD
	2		TDD
	3		TDD
TDD Configuration	1		N/A
	2		TDDConf.1.1
	3		TDDConf.2.1
BW <sub>channel</sub>	1	MHz	10: N <sub>RB,c</sub> = 52
	2		10: N <sub>RB,c</sub> = 52
	3		40: N <sub>RB,c</sub> = 106
PDSCH Reference measurement channel	1		SR.1.1 FDD
	2		SR.1.1 TDD
	3		SR.2.1 TDD
RMSI CORESET Reference Channel	1		CR.1.1 FDD
	2		CR.1.1 TDD
	3		CR.2.1 TDD
Dedicated CORESET Reference Channel	1		CCR.1.1 FDD
	2		CCR.1.1 TDD
	3		CCR.2.1 TDD
SSB configuration	1		SSB.3 FR1
	2		SSB.3 FR1
	3		SSB.4 FR1
CSI-RS configuration	1		CSI-RS 1.3 FDD
	2		CSI-RS 1.3 TDD
	3		CSI-RS 2.3 TDD
OCNG Patterns	1~3		OP.1
TRS Configuration	1		TRS.1.1 FDD
	2		TRS.1.1 TDD
	3		TRS.1.2 TDD
Initial BWP Configuration	1~3		DLBWP.0.1 ULBWP.0.1
Dedicated BWP configuration	1~3		DLBWP.1.1 ULBWP.1.1
SMTc configuration	1~3		SMTc.1
DRX configuration	1~3		Off
reportConfigType	1~3		aperiodic
reportQuantity	1~3		cri-RSRP
Number of reported RS	1~3		2
qcl-Info	1~3		SSB#0 for resource#0
			SSB#1 for resource#1
reportSlotOffsetList	1~3	slots	8
T1	1~3	s	5

EPRE ratio of PSS to SSS	1~3	dB	0
EPRE ratio of PBCH DMRS to SSS			
EPRE ratio of PBCH to PBCH DMRS			
EPRE ratio of PDCCH DMRS to SSS			
EPRE ratio of PDCCH to PDCCH DMRS			
EPRE ratio of PDSCH DMRS to SSS			
EPRE ratio of PDSCH to PDSCH DMRS			
EPRE ratio of OCNG DMRS to SSS <sup>Note 1</sup>			
EPRE ratio of OCNG to OCNG DMRS <sup>Note 1</sup>			
Propagation condition	1~3		AWGN
Note 1: OCNG shall be used such that the resources in Cell 1 are fully allocated and a constant total transmitted power spectral density is achieved for all OFDM symbols.			

**Table A.6.6.4.3.2-2: CSI-RS specific test parameters**

Parameter	Config	Unit	CSI-RS#0	CSI-RS#1
$N_{oc}$ <sup>Note1</sup>	1~3	dBm/15kHz	-94.65	
$N_{oc}$ <sup>Note1</sup>	1,2	dBm/SSB SCS	-94.65	
	3		-91.65	
$\hat{E}_s / I_{ot}$	1~3	dB	0	3
CSI-RS RSRP <sup>Note2</sup>	1,2	dBm/SSB SCS	-94.65	-91.65
	3		-91.65	-88.65
$I_o$ <sup>Note2</sup>	1,2	dBm/9.36 MHz	-63.69	-61.93
	3	dBm/38.16 MHz	-57.59	-55.84
$\hat{E}_s / N_{oc}$	1~3	dB	0	3
Note 2: Interference from other cells and noise sources not specified in the test is assumed to be constant over subcarriers and time and shall be modelled as AWGN of appropriate power for $N_{oc}$ to be fulfilled.				
Note 3: CSI-RS RSRP and $I_o$ levels have been derived from other parameters for information purposes. They are not settable parameters themselves.				

**A.6.6.4.3.3 Test Requirements**

After 80ms from the beginning of the test, the UE shall send L1-RSRP report at slot 8 from the reception of DCI triggering the L1-RSRP measurement. The L1-RSRP report shall include the results for both CSI-RS#0 and CSI-RS#1 while meeting the absolute accuracy requirement in clause 10.1.20.1.1 and relative accuracy requirement in clause 10.1.20.1.2.

The rate of correct events observed during repeated tests shall be at least 90%.

NOTE: The actual overall delays measured in the test may be up to  $2 \times TTI_{DCCH}$  higher than the measurement reporting delays above because of TTI insertion uncertainty of the measurement report in DCCH.

**A.6.6.4.4 CSI-RS based L1-RSRP measurement when DRX is used**

**A.6.6.4.4.1 Test Purpose and Environment**

The purpose of this test is to verify that the UE makes correct reporting of L1-RSRP measurement. This test will partly verify the L1-RSRP measurement requirements in clause 9.5.4.2, with the testing configurations for NR cells in Table A.6.6.4.4.1-1.

**Table A.6.6.4.4.1-1: Applicable NR configurations for FR1 CSI-RS based L1-RSRP test**

Config	Description
--------	-------------

1	NR 15 kHz SSB SCS, 10 MHz bandwidth, FDD duplex mode
2	NR 15 kHz SSB SCS, 10 MHz bandwidth, TDD duplex mode
3	NR 30 kHz SSB SCS, 40 MHz bandwidth, TDD duplex mode
Note: The UE is only required to be tested in one of the supported test configurations	

#### A.6.6.4.4.2 Test parameters

There is one cells in the test, the FR1 PCell (Cell 1). The test parameters for the Cell 1 are given in Table A.6.6.4.4.2-1 and Table A.6.6.4.4.2-2 below.

In CSI measurement configuration, UE is indicated to perform L1-RSRP measurement on the CSI-RS and report aperiodically. The test consists of a single time period T1, during which the UE is triggered via DCI to report L1-RSRP on aperiodic CSI-RS resources. UE is also configured to measure L1-RSRP based on SSB. After 80ms from the beginning of the test, the DCI trigger comes in slot n (0 for Config 1,2 and 8 for Config 3) of a frame and UE provides the report back based on the reporting configuration as defined in Table A.6.6.4.4.2-1.

There is no measurement gap configured in the test. Before the test, UE is configured to perform RLM and BFD based on the SSBs.

**Table A.6.6.4.4.2-1: General test parameters**

Parameter	Config	Unit	Value
SSB GSCN	1~3		freq1
Duplex mode	1		FDD
	2		TDD
	3		TDD
TDD Configuration	1		N/A
	2		TDDConf.1.1
	3		TDDConf.2.1
BW <sub>channel</sub>	1	MHz	10: N <sub>RB,c</sub> = 52
	2		10: N <sub>RB,c</sub> = 52
	3		40: N <sub>RB,c</sub> = 106
PDSCH Reference measurement channel	1		SR.1.1 FDD
	2		SR.1.1 TDD
	3		SR.2.1 TDD
RMSI CORESET Reference Channel	1		CR.1.1 FDD
	2		CR.1.1 TDD
	3		CR.2.1 TDD
Dedicated CORESET Reference Channel	1		CCR.1.1 FDD
	2		CCR.1.1 TDD
	3		CCR.2.1 TDD
SSB configuration	1		SSB.3 FR1
	2		SSB.3 FR1
	3		SSB.4 FR1
CSI-RS configuration	1		CSI-RS 1.3 FDD
	2		CSI-RS 1.3 TDD
	3		CSI-RS 2.3 TDD
OCNG Patterns	1~3		OP.1
TRS Configuration	1		TRS.1.1 FDD
	2		TRS.1.1 TDD
	3		TRS.1.2 TDD
Initial BWP Configuration	1~3		DLBWP.0.1 ULBWP.0.1
Dedicated BWP configuration	1~3		DLBWP.1.1 ULBWP.1.1
SMTc configuration	1~3		SMTc.1
DRX configuration	1~3		DRX.3
reportConfigType	1~3		aperiodic
reportQuantity	1~3		cri-RSRP
Number of reported RS	1~3		2
qcl-Info	1~3		SSB#0 for resource#0
			SSB#1 for resource#1



reportSlotOffsetList	1~3	slots	8
T1	1~3	s	5
EPRE ratio of PSS to SSS	1~3	dB	0
EPRE ratio of PBCH DMRS to SSS			
EPRE ratio of PBCH to PBCH DMRS			
EPRE ratio of PDCCH DMRS to SSS			
EPRE ratio of PDCCH to PDCCH DMRS			
EPRE ratio of PDSCH DMRS to SSS			
EPRE ratio of PDSCH to PDSCH DMRS			
EPRE ratio of OCNG DMRS to SSS <sup>Note 1</sup>			
EPRE ratio of OCNG to OCNG DMRS <sup>Note 1</sup>			
Propagation condition	1~3		AWGN
Note 1: OCNG shall be used such that the resources in Cell 1 are fully allocated and a constant total transmitted power spectral density is achieved for all OFDM symbols.			

Table A.6.6.4.4.2-2: CSI-RS specific test parameters

Parameter	Config	Unit	CSI-RS#0	CSI-RS#1
$N_{oc}$ <sup>Note1</sup>	1~3	dBm/15kHz	-94.65	
$N_{oc}$ <sup>Note1</sup>	1,2	dBm/SSB SCS	-94.65	
	3		-91.65	
$\hat{E}_s / I_{ot}$	1~3	dB	0	3
CSI-RS RSRP <sup>Note2</sup>	1,2	dBm/SSB SCS	-94.65	-91.65
	3		-91.65	-88.65
$I_o$ <sup>Note2</sup>	1,2	dBm/9.36 MHz	-63.69	-61.93
	3	dBm/38.16 MHz	-57.59	-55.84
$\hat{E}_s / N_{oc}$	1~3	dB	0	3
Note 2: Interference from other cells and noise sources not specified in the test is assumed to be constant over subcarriers and time and shall be modelled as AWGN of appropriate power for $N_{oc}$ to be fulfilled.				
Note 3: CSI-RS RSRP and $I_o$ levels have been derived from other parameters for information purposes. They are not settable parameters themselves.				

#### A.6.6.4.4.3 Test Requirements

After 80ms from the beginning of the test, the UE shall send L1-RSRP report at slot 8 from the reception of DCI triggering the L1-RSRP measurement. The L1-RSRP report shall include the results for both CSI-RS#0 and CSI-RS#1 while meeting the absolute accuracy requirement in clause 10.1.20.1.1 and relative accuracy requirement in clause 10.1.20.1.2.

The rate of correct events observed during repeated tests shall be at least 90%.

NOTE: The actual overall delays measured in the test may be up to  $2xTTI_{DCCH}$  higher than the measurement reporting delays above because of TTI insertion uncertainty of the measurement report in DCCH.

#### A.6.6.4.5 SSB based L1-RSRP measurement when DRX is used for UE configured with *highSpeedMeasFlag-r16*

##### A.6.6.4.5.1 Test Purpose and Environment

The purpose of this test is to verify that the UE makes correct reporting of L1-RSRP measurement when UE is configured with *highSpeedMeasFlag-r16*. This test will partly verify the L1-RSRP measurement requirements for UE configured with *highSpeedMeasFlag-r16* in clause 9.5.4.1, with the testing configurations for NR cells in Table A.6.6.4.5.1-1.

**Table A.6.6.4.5.1-1: Applicable NR configurations for FR1 SSB based L1-RSRP test**

Config	Description
1	NR 15 kHz SSB SCS, 10 MHz bandwidth, FDD duplex mode
2	NR 15 kHz SSB SCS, 10 MHz bandwidth, TDD duplex mode
3	NR 30 kHz SSB SCS, 40 MHz bandwidth, TDD duplex mode
Note:	The UE is only required to be tested in one of the supported test configurations

#### A.6.6.4.5.2 Test parameters

There is one cells in the test, the FR1 PCell (Cell 1). The test parameters for the Cell 1 are given in Table A.6.6.4.5.2-1 and Table A.6.6.4.5.2-2 below.

In CSI measurement configuration, UE is indicated to perform L1-RSRP measurement on the SSBs and report periodically. The test consists of two successive time periods, with time duration of T1 and T2 respectively. The test has higher layer parameter *timeRestrictionForChannelMeasurements* configured.

There is no measurement gap configured in the test. Before the test, UE is configured to perform RLM, BFD and L1-RSRP measurement based on the SSBs.

**Table A.6.6.4.5.2-1: General test parameters for UE configured with *highSpeedMeasFlag-r16***

Parameter	Config	Unit	Value
SSB GSCN	1~3		freq1
Duplex mode	1		FDD
	2		TDD
	3		TDD
TDD Configuration	1		N/A
	2		TDDConf.1.1
	3		TDDConf.2.1
BW <sub>channel</sub>	1	MHz	10: N <sub>RB,c</sub> = 52
	2		10: N <sub>RB,c</sub> = 52
	3		40: N <sub>RB,c</sub> = 106
PDSCH Reference measurement channel	1		SR.1.1 FDD
	2		SR.1.1 TDD
	3		SR.2.1 TDD
RMSI CORESET Reference Channel	1		CR.1.1 FDD
	2		CR.1.1 TDD
	3		CR.2.1 TDD
Dedicated CORESET Reference Channel	1		CCR.1.1 FDD
	2		CCR.1.1 TDD
	3		CCR.2.1 TDD
SSB configuration	1		SSB.3 FR1
	2		SSB.3 FR1
	3		SSB.4 FR1
OCNG Patterns	1~3		OP.1
Initial BWP Configuration	1~3		DLBWP.0.1 ULBWP.0.1
Dedicated BWP configuration	1~3		DLBWP.1.1 ULBWP.1.1
SMTTC configuration	1~3		SMTTC.1
TRS Configuration	1		TRS.1.1 FDD
	2		TRS.1.1 TDD
	3		TRS.1.2 TDD
DRX configuration	1~3		DRX.3
reportConfigType	1~3		periodic
reportQuantity	1~3		ssb-Index-RSRP
Number of reported RS	1~3		2
L1-RSRP reporting period	1~3	slot	80
T1	1~3	s	5
T2	1~3	s	2
EPRE ratio of PSS to SSS	1~3	dB	0

EPRE ratio of PBCH DMRS to SSS			
EPRE ratio of PBCH to PBCH DMRS			
EPRE ratio of PDCCH DMRS to SSS			
EPRE ratio of PDCCH to PDCCH DMRS			
EPRE ratio of PDSCH DMRS to SSS			
EPRE ratio of PDSCH to PDSCH DMRS			
EPRE ratio of OCNG DMRS to SSS <sup>Note 1</sup>			
EPRE ratio of OCNG to OCNG DMRS <sup>Note 1</sup>			
Note 1: OCNG shall be used such that both cells are fully allocated and a constant total transmitted power spectral density is achieved for all OFDM symbols.			

**Table A.6.6.4.5.2-2: SSB specific test parameters for UE configured with *highSpeedMeasFlag-r16***

Parameter	Config	Unit	SSB#0		SSB#1	
			T1	T2	T1	T2
$N_{oc}$ <sup>Note2</sup>	1~3	dBm/15kHz	-94.65			
$N_{oc}$ <sup>Note2</sup>	1,2	dBm/SSB SCS	-94.65			
	3		-91.65			
$\hat{E}_s / I_{ot}$	1~3	dB	0	0	-Infinity	3
SSB RSRP <sup>Note3</sup>	1,2	dBm/SSB SCS	-94.65	-94.65	-Infinity	-91.65
	3		-91.65	-91.65	-Infinity	-88.65
$I_o$ <sup>Note3</sup>	1,2	dBm/9.36 MHz	-63.69	-63.69	-66.70	-61.93
	3	dBm/38.16 MHz	-57.59	-57.59	-60.61	-55.84
$\hat{E}_s / N_{oc}$	1~3	dB	0	0	-Infinity	3
Propagation conditions	1,2		AWGN		AWGN 1944 Hz	
	3		AWGN		AWGN 3334 Hz	
<p>Note 1: The resources for uplink transmission are assigned to the UE prior to the start of time period T2.</p> <p>Note 2: Interference from other cells and noise sources not specified in the test is assumed to be constant over subcarriers and time and shall be modelled as AWGN of appropriate power for <math>N_{oc}</math> to be fulfilled.</p> <p>Note 3: SS-RSRP and <math>I_o</math> levels have been derived from other parameters for information purposes. They are not settable parameters themselves.</p>						

**A.6.6.4.5.3 Test Requirements**

The UE shall send L1-RSRP report every 80 slots. No later than 640ms plus 80 slots from the beginning of time period T2, UE shall send L1-RSRP report including results of both SSB0 and SSB1 while meeting the absolute accuracy requirement in clause 10.1.19.1.1 and relative accuracy requirement in clause 10.1.19.1.2. The rate of correct events observed during repeated tests shall be at least 90%.

NOTE: The actual overall delays measured in the test may be up to  $2 \times TTI_{DCCH}$  higher than the measurement reporting delays above because of TTI insertion uncertainty of the measurement report in DCCH.

## A.6.6.5

### A.6.6.5.1 SA NR - UTRAN FDD event-triggered reporting in non-DRX in FR1

#### A.6.6.5.1.1 Test Purpose and Environment

The purpose of this set of tests is to verify that the UE makes correct event-triggered reporting of inter-RAT UTRAN FDD measurements when operating in standalone (SA) operation with PCell in FR1. This test shall partly verify the cell search and measurement requirements in Clause 9.4.6.

In each test there are two cells: Cell 1 and Cell 2. Cell 1 is the NR PCell and Cell 2 is an inter-RAT UTRAN FDD neighbour cell. In the measurement control information from the PCell it is indicated to the UE that event-triggered reporting with Event B1 (Inter RAT neighbour becomes better than threshold) is to be used. Each test consists of two consecutive time periods, with durations T1 and T2, respectively. Prior to the start of time duration T1, the UE shall be fully synchronized to Cell 1. During T1, the UE shall not have any information on Cell 2.

Supported test configurations are shown in table A.6.6.5.1.1-1. General test parameters are provided in Table A.6.6.5.1.1-2 below. Test parameters for Cell 1 and Cell 2, valid for both time duration T1 and T2, are provided in Tables A.6.6.5.1.1-3 and A.6.6.5.1.1-4, respectively.

**Table A.6.6.5.1.1-1: Supported test configurations in SA inter-RAT UTRAN FDD event triggered reporting in non-DRX with PCell in FR1**

Configuration	Description
1	NR 15 kHz SSB SCS, 10 MHz bandwidth, FDD duplex mode, UTRA FDD
2	NR 15 kHz SSB SCS, 10 MHz bandwidth, TDD duplex mode, UTRA FDD
3	NR 30 kHz SSB SCS, 40 MHz bandwidth, TDD duplex mode, UTRA FDD
Note: The UE is only required to be tested in one of the supported test configurations	

**Table A.6.6.5.1.1-2: General test parameters for SA inter-RAT UTRAN FDD event triggered reporting in non-DRX with PCell in FR1**

Parameter	Unit	Value	Comment
NR RF Channel Number		1	1 NR carrier frequency is used in the test
UTRA RF Channel Number		2	1 UTRA carrier frequency is used in the test
Channel Bandwidth	MHz	As specified in Tables A.6.6.5.1.1-3 and A.6.6.5.1.1-4.	
Active cell		Cell 1	Cell 1 is on RF channel number 1
Neighbour cell		Cell 2	Cell 2 is on RF channel number 2
Gap Pattern Id		0	As specified in Clause Table 9.1.2-1. Per-UE gap pattern.
Inter-RAT UTRA measurement quantity		CPICH Ec/Io	Measurement quantity for Cell 2
b1-ThresholdUTRA-FDD	dB	-16.5	CPICH Ec/Io threshold for SS-RSRP measurement on cell1 for event B1
Hysteresis	dB	0	
TimeToTrigger	s	0	
Filter coefficient		0	L3 filtering is not used
DRX		OFF	OFF
T1	s	5	
T2	s	5	
Note 1: Values are defined in Table A.6.6.5.1.1-3			

**Table A.6.6.5.1.1-3: PCell specific test parameters for SA inter-RAT UTRAN FDD event triggered reporting in non-DRX with PCell in FR1**

Parameter	Unit	Configuration	Cell 1	
			T1	T2
RF channel number		1, 2, 3	1	
Duplex mode		1, 2, 3	FDD	

TDD Configuration	SCS=15 KHz		2	TDDConf.1.1	
	SCS=30 KHz		3	TDDConf.2.1	
BW <sub>channel</sub>		MHz	1	10: N <sub>RB,c</sub> = 52 (FDD)	
			2	10: N <sub>RB,c</sub> = 52 (TDD)	
			3	40: N <sub>RB,c</sub> = 106 (TDD)	
PDSCH reference measurement channel			1	SR.1.1 FDD	
			2	SR.1.1 TDD	
			3	SR.2.1 TDD	
CORESET reference channel			1	CR.1.1 FDD	
			2	CR.1.1 TDD	
			3	CR.2.1 TDD	
BWP configurations	Initial DL BWP		1, 2, 3	DLBWP.0.1	
	Dedicated DL BWP		1, 2, 3	DLBWP.1.1	
	Initial UL BWP		1, 2, 3	ULBWP.0.1	
	Dedicated UL BWP		1, 2, 3	ULBWP.1.1	
OCNG pattern <sup>Note1</sup>			1, 2, 3	OP.1	
SMTC configuration			1, 2, 3	SMTC.1	
SSB configuration			1, 2	SSB.1 FR1	
			3	SSB.2 FR1	
CSI-RS for tracking			1	TRS.1.1 FDD	
			2	TRS.1.1 TDD	
			3	TRS.1.2 TDD	
EPRE ratio of PSS to SSS		dB	1, 2, 3	0	
EPRE ratio of PBCH_DMRS to SSS					
EPRE ratio of PBCH to PBCH_DMRS					
EPRE ratio of PDCCH_DMRS to SSS					
EPRE ratio of PDCCH to PDCCH_DMRS					
EPRE ratio of PDSCH_DMRS to SSS					
EPRE ratio of PDSCH to PDSCH_DMRS					
EPRE ratio of OCNG DMRS to SSS					
EPRE ratio of OCNG to OCNG DMRS					
N <sub>oc</sub> <sup>Note2</sup>					
N <sub>oc</sub> <sup>Note2</sup>		dBm/SCS	1, 2	-106	
			3	-103	
E <sub>s</sub> /N <sub>oc</sub>		dB	1, 2, 3	18	-2
E <sub>s</sub> /I <sub>ot</sub> <sup>Note3</sup>		dB	1, 2, 3	18	-2
SS-RSRP <sup>Note3</sup>		dBm/SCS	1, 2	-88	-108
			3	-85	-105
SSB_RP <sup>Note3</sup>		dBm/SCS	1, 2	-88	-108
			3	-85	-105
I <sub>o</sub> <sup>Note3</sup>		dBm/9.36 MHz	1, 2	-59.98	-75.92
		dBm/38.16 MHz	3	-53.88	-69.82
Propagation condition			1, 2, 3	ETDLA30	
Antenna Configuration and Correlation Matrix			1, 2, 3	1x2 Low	
<p>Note 1: OCNG shall be used such that both cells are fully allocated and a constant total transmitted power spectral density is achieved for all OFDM symbols.</p> <p>Note 2: Interference from other cells and noise sources not specified in the test is assumed to be constant over subcarriers and time and shall be modelled as AWGN of appropriate power for N<sub>oc</sub> to be fulfilled.</p> <p>Note 3: E<sub>s</sub>/I<sub>ot</sub>, SS-RSRP, SSB_RP and I<sub>o</sub> levels have been derived from other parameters for information purposes. They are not settable parameters themselves.</p>					

**Table A.6.6.5.1.1-4: UTRAN neighbour cell specific test parameters for SA inter-RAT UTRAN FDD event triggered reporting in non-DRX with PCell in FR1**

Parameter	Unit	Cell 2	
		T1	T2
UTRA RF Channel Number		2	
CPICH_Ec/I <sub>or</sub>	dB	-10	
PCCPCH_Ec/I <sub>or</sub>	dB	-12	
SCH_Ec/I <sub>or</sub>	dB	-12	
PICH_Ec/I <sub>or</sub>	dB	-15	
DPCH_Ec/I <sub>or</sub>	dB	N/A	
OCNS		-0.941	
$\hat{I}_{or}/I_{oc}$	dB	-Infinity	-1.8
$I_{oc}$	dBm/3.84 MHz	-70	
CPICH_Ec/I <sub>o</sub>	dB	-Infinity	-14
Propagation Condition		AWGN	
Note 1:	The DPCH level is controlled by the power control loop.		
Note 2:	The power of the OCNS channel that is added shall make the total power from the cell to be equal to I <sub>or</sub> .		

### A.6.6.5.1.2 Test Requirements

The UE shall send one Event B1 triggered measurement report for Cell 2 to the PCell, with a measurement reporting delay less than 2.4s from the start of period T2, i.e. when Cell 2 becomes detectable. The measurement reporting delay is defined as the time from the beginning of time period T2 to the moment when the UE sends the measurement report on PUSCH.

The UE shall not send event-triggered measurement reports as long as the reporting criteria is not fulfilled.

The rate of correct events observed during repeated tests shall be at least 90%.

## A.6.6.6 CLI measurements

### A.6.6.6.1 SRS-RSRP measurement with DRX

#### A.6.6.6.1.1 Test Purpose and Environment

The purpose of this test is to verify that the UE makes correct reporting of SRS-RSRP measurement. This test will verify the SRS-RSRP measurement requirements in clause 9.7.2.5 with the testing configurations for NR cells in Table A.6.6.6.1.1-1.

**Table A.6.6.6.1.1-1: Applicable NR configurations for FR1 SRS-RSRP test**

Configuration	Description
1	NR 15 kHz SRS SCS, 10 MHz bandwidth, TDD duplex mode
2	NR 30 kHz SRS SCS, 40 MHz bandwidth, TDD duplex mode
Note:	The UE is only required to be tested in one of the supported test configurations

#### A.6.6.6.1.2 Test Parameters

One cell is deployed in the test, which is FR1 PCell (Cell 1). The test parameters for PCell is given in Table A.6.6.6.1.2-1 and A.6.6.6.1.2-2 below. In the measurement control information, a measurement object is configured for the frequency of the PCell, and it is indicated to the UE that event-triggered reporting with Event I1 is used. The test consists of two successive time periods, with time duration of T1 and T2, respectively.

During the test, the test system transmits SRS resource for measurement in the DL slot according to the SRS configuration in Table A.6.6.6.1.2-4 and the test parameters for the (virtual) neighbour cell UE in Table A. 6.6.6.1.2-3. During the test, the test system does not transmit PDCCH/PDSCH/OCNG on SRS symbol to be transmitted and on 1 data symbol before SRS to be transmitted.

**Table A.6.6.1.2-1: General test parameters for SRS-RSRP event triggered reporting for PCell in FR1**

Parameter	Unit	Test configuration	Value	Comment
Active cell		1, 2	Cell 1	
RF Channel Number		1, 2	1: Cell 1	
SSB configuration		1	SSB.1 FR1	
		2	SSB.2 FR1	
SMTC configuration		1	SMTC.1	
		2	SMTC.1	
SRS configuration		1	SRSCConf.1	Table A.6.6.1.2-3
		2	SRSCConf.2	
CP length		1, 2	Normal	
i1-Threshold	dBm	1	-97	
		2	-95	
Hysteresis	dB	1, 2	0	
Time To Trigger	s	1, 2	0	
Filter coefficient		1, 2	0	L3 filtering is not used
DRX		1, 2	DRX.7	
Time offset between DL from serving cell and SRS from test system	μs	1,2	17.67	
T1	s	1, 2	5	
T2	s	1, 2	5	

**Table A.6.6.1.2-2: NR Cell specific test parameters for SRS-RSRP event triggered reporting for PCell in FR1**

Parameter	Unit	Test configuration	Cell 1	
			T1	T2
TDD configuration		1	TDDConf.1.1	
		2	TDDConf.2.1	
PDSCH RMC configuration		1	SR.1.1 TDD	
		2	SR.2.1 TDD	
RMSI CORESET RMC configuration		1	CR.1.1 TDD	
		2	CR.2.1 TDD	
Dedicated CORESET RMC configuration		1	CCR.1.1 TDD	
		2	CCR.2.1 TDD	
OCNG Patterns		1, 2	OP.1	
TRS Configuration		1	TRS.1.1 TDD	
		2	TRS.1.2 TDD	
Initial BWP configuration		1, 2	DLBWP.0.1 ULBWP.0.1	
Active DL BWP configuration		1, 2	DLBWP.1.1	
Active UL BWP configuration		1, 2	ULBWP.1.1	
$N_{oc}$ <sup>Note 2</sup>	dBm/15 kHz	1	-98	
		2		
$N_{oc}$ <sup>Note 2</sup>	dBm/SCS	1	-98	
		2	-95	
Propagation Condition		1, 2	AWGN	
<p>Note 1: The resources for uplink transmission are assigned to the UE prior to the start of time period T2.</p> <p>Note 2: Interference from other cells and noise sources not specified in the test is assumed to be constant over subcarriers and time and shall be modelled as AWGN of appropriate power for <math>N_{oc}</math> to be fulfilled.</p>				

**Table A.6.6.1.2-3: NR Cell specific test parameters for SRS-RSRP event triggered reporting for neighbour cell UE**

Parameter	Unit	Test configuration	Neighbour cell UE	
			T1	T2
$N_{oc}$ Note 2	dBm/15 kHz	1	-98	
		2		
$N_{oc}$ Note 2	dBm/SCS	1	-98	
		2		
$\hat{E}_s/I_{ot}$	dB	1	-infinity	4
		2		
$\hat{E}_s/N_{oc}$	dB	1	-infinity	4
		2		
SRS-RSRP Note 3	dBm/SCS kHz	1	-infinity	-94
		2	-infinity	-91
Io	dBm/9.36 MHz	1	-70.05	-64.59
	dBm/38.16 MHz	2	-63.96	-58.50
Propagation Condition		1, 2	AWGN	
<p>Note 1: The resources for uplink transmission are assigned to the UE prior to the start of time period T2.</p> <p>Note 2: Interference from other cells and noise sources not specified in the test is assumed to be constant over subcarriers and time and shall be modelled as AWGN of appropriate power for <math>N_{oc}</math> to be fulfilled.</p> <p>Note 3: SRS-RSRP levels have been derived from other parameters for information purposes. They are not settable parameters themselves.</p>				

**Table A.6.6.1.2-4: SRS configuration for measurement reporting**

	Field	SRSCnf.1	SRSCnf.2	Comments
SRS-ResourceSet	srs-ResourceSetId	0	0	
	srs-ResourceSetList	0	0	
	resourceType	Periodic	Periodic	
	Usage	Codebook	Codebook	
SRS-Resource	SRS-ResourceId	0	0	
	nrofSRS-Ports	Port1	Port1	
	transmissionComb	n2	n2	
	combOffset-n2	0	0	
	cyclicShift-n2	0	0	
	resourceMapping startPosition	0	0	
	resourceMapping nrofSymbols	n1	n1	
	resourceMapping repetitionFactor	n1	n1	
	freqDomainPosition	0	0	
	freqDomainShift	0	0	
	freqHopping c-SRS	12	12	
	freqHopping b-SRS	0	0	
	freqHopping b-hop	0	0	
	groupOrSequenceHopping	Neither	Neither	
	resourceType	Periodic	Periodic	
	periodicityAndOffset	sl640, 4	sl640, 9	
sequenceId	0	0	Any 10 bit number	



### A.6.6.6.1.3 Test Requirements

The UE shall send one Event I1 triggered measurement report, with a measurement reporting delay less than 1920 ms from the beginning of time period T2.

The UE shall not send event triggered measurement reports, as long as the reporting criteria are not fulfilled.

The rate of correct events observed during repeated tests shall be at least 90%.

NOTE: The actual overall delays measured in the test may be up to  $2xTTI_{DCCH}$  higher than the measurement reporting delays above because of TTI insertion uncertainty of the measurement report in DCCH.

### A.6.6.6.2 CLI-RSSI measurement with DRX

#### A.6.6.6.2.1 Test Purpose and Environment

The purpose of this test is to verify that the UE makes correct reporting of CLI-RSSI measurement. This test will verify the CLI-RSSI measurement requirements in clause 9.7.3.5 with the testing configurations for NR cells in Table A.6.6.6.2.1-1.

**Table A.6.6.6.2.1-1: Applicable NR configurations for FR1 CLI-RSSI test**

Configuration	Description
1	NR 15 kHz SCS, 10 MHz bandwidth, TDD duplex mode
2	NR 30 kHz SCS, 40 MHz bandwidth, TDD duplex mode
Note: The UE is only required to be tested in one of the supported test configurations	

#### A.6.6.6.2.2 Test Parameters

One cell is deployed in the test, which are FR1 PCell (Cell 1). The test parameters for PCell is given in Table A.6.6.6.2.2-1 and A.6.6.6.2.2-2 below. In the measurement control information, a measurement object is configured for the frequency of the PCell, and it is indicated to the UE that event-triggered reporting with Event I1 is used. The test consists of two successive time periods, with time duration of T1 and T2, respectively.

During the test, the test system does not transmit PDCCH/PDSCH/OCNG on symbols for CLI-RSSI measurement resource and on 1 data symbol before. The CLI-RSSI measurement resource configuration is in Table A.6.6.6.2.2-3.

**Table A.6.6.6.2.2-1: General test parameters for CLI-RSSI event triggered reporting for PCell in FR1**

Parameter	Unit	Test configuration	Value	Comment
Active cell		1, 2	NR Cell 1	
RF Channel Number		1, 2	1: Cell 1	
SSB configuration		1	SSB.1 FR1	
		2	SSB.2 FR1	
SMTC configuration		1	SMTC.1	
		2	SMTC.1	
CLI-RSSI configuration		1	CLI-RSSICConf.1	Table A.6.6.6.2.2-3
		2	CLI-RSSICConf.2	
CP length		1, 2	Normal	
i1-Threshold	dBm	1	-93	
		2	-93	
Hysteresis	dB	1, 2	0	
Time To Trigger	s	1, 2	0	
Filter coefficient		1, 2	0	L3 filtering is not used
DRX		1, 2	DRX.7	
Time offset between DL from serving cell and OCNG from test system	μs	1,2	17.67	
T1	s	1, 2	5	
T2	s	1, 2	2	

**Table A.6.6.2.2-2: NR Cell specific test parameters for CLI-RSSI event triggered reporting for PCell in FR1**

Parameter	Unit	Test configuration	Cell 1	
			T1	T2
TDD configuration		1	TDDConf.1.1	
		2	TDDConf.2.1	
PDSCH RMC configuration		1	SR.1.1 TDD	
		2	SR.2.1 TDD	
PUSCH parameters		1	N/A	
		2		
RMSI CORESET RMC configuration		1	CR.1.1 TDD	
		2	CR.2.1 TDD	
Dedicated CORESET RMC configuration		1	CCR.1.1 TDD	
		2	CCR.2.1 TDD	
OCNG Patterns <sup>Note 3</sup>		1, 2	OP.1	
TRS Configuration		1	TRS.1.1 TDD	
		2	TRS.1.2 TDD	
Initial BWP configuration		1, 2	DLBWP.0.1 ULBWP.0.1	
Active DL BWP configuration		1, 2	DLBWP.1.1	
Active UL BWP configuration		1, 2	ULBWP.1.1	
$N_{oc}$ on CLI-RSSI measurement resource <sup>Note 2</sup>	dBm/15 kHz	1	-116	-108
		2		
$N_{oc}$ on CLI-RSSI measurement resource <sup>Note 2</sup>	dBm/SCS	1	-116	-108
		2	-113	-105
Io on CLI-RSSI measurement resource	dBm/9.36 MHz	1	-88.05	-80.05
	dBm/38.16 MHz	2	-81.96	-74.00
Io on CLI-RSSI measurement resource	dBm/1.08 MHz	1	-97.43	-89.43
	dBm/1.08 MHz	2	-97.44	-89.44
Propagation Condition		1, 2	AWGN	
Note 1: The resources for uplink transmission are assigned to the UE prior to the start of time period T2.				
Note 2: Interference from other cells and noise sources not specified in the test is assumed to be constant over subcarriers and time and shall be modelled as AWGN of appropriate power for $N_{oc}$ to be fulfilled.				
Note 3: OCNG is not transmitted in the CLI-RSSI measurement resources.				

**Table A.6.6.2.2-3: CLI-RSSI measurement resource configuration for measurement reporting**

	Field	CLI-RSSIConf.1	CLI-RSSIConf.2
RSSI-Resource	rss-ResourceId	0	0
	rss-SCS	15	30
	startPRB	0	0
	nrofPRBs	52	106
	startPosition	3	3
	nrofSymbols	11	11
	rss-PeriodicityAndOffset	sl640, 4	sl640, 9

### A.6.6.2.3 Test Requirements

The UE shall send one Event I1 triggered measurement report, with a measurement reporting delay less than 640 ms from the beginning of time period T2. The nominal RSSI used to evaluate the requirement shall be based on Io.

The UE shall not send event triggered measurement reports, as long as the reporting criteria are not fulfilled.

The rate of correct events observed during repeated tests shall be at least 90%.

NOTE: The actual overall delays measured in the test may be up to  $2xTTI_{DCCH}$  higher than the measurement reporting delays above because of TTI insertion uncertainty of the measurement report in DCCH.

## A.6.6.7 NR measurements with autonomous gaps

### A.6.6.7.1 SA intra-frequency CGI identification of NR neighbor cell in FR1

#### A.6.6.7.1.1 Test Purpose and Environment

The purpose of this test is to verify that the UE makes correct reporting of intra-frequency CGI identification of an NR neighbour cell in FR1 with autonomous gaps. This test shall partly verify the measurement requirements in Clause 9.11.

#### A.6.6.7.1.2 Test Parameters

In each test there are two cells: Cell 1 and Cell 2. Cell 1 is the FR1 PCell and Cell 2 is an FR1 neighbour cell on the same frequency as the PCell. The test parameters for PCell and neighbour cell are given in Table A.6.6.7.1.1-2 and A.6.6.7.1.3-2 below. The test consists of three successive time periods, with time durations of T1, T2 and T3 respectively. At the start of time duration T1, the UE does not have any timing information of cell 2. Starting T2, cell 2 becomes detectable. A measurement object is configured for the frequency of the PCell and it is indicated to the UE that event-triggered reporting with Event A3 is used. The UE is expected to detect and send a measurement report with Event A3.

A new RRC message triggering CGI identification shall be sent to the UE during period T2, after the UE has reported Event A3. The RRC message shall create a measurement report configuration with purpose *reportCGI* and *useAutonomousGaps* set to TRUE. The start of T3 is the instant when the last TTI containing the RRC message implying CGI identification is sent to the UE.

The test equipment verifies that potential interruption is carried out correctly by monitoring ACK/NACK sent in PCell during T3 until a measurement report with CGI is sent.

**Table A.6.6.7.1.2-1: Supported test configurations**

Configuration	Description
1	15 kHz SSB SCS, 10 MHz bandwidth, FDD duplex mode
2	15 kHz SSB SCS, 10 MHz bandwidth, TDD duplex mode
3	30 kHz SSB SCS, 40 MHz bandwidth, TDD duplex mode
Note:	The UE is only required to be tested in one of the supported test configurations.

**Table A.6.6.7.1.2-2: General test parameters for SA intra-frequency CGI identification of NR neighbor cell in FR1**

Parameter	Unit	Test configuration	Value	Comment
Active cell		1, 2, 3	Cell 1	
Neighbour cell		1, 2, 3	Cell 2	Cell to be identified.
RF Channel Number		1, 2, 3	1: Cell 1 and Cell 2	
SSB configuration		1	SSB.1 FR1	
		2	SSB.1 FR1	
		3	SSB.2 FR1	
SMTC configuration		1	SMTC.2	
		2	SMTC.1	
		3	SMTC.1	
A3-Offset	dB	1, 2, 3	-4.5	
CP length		1, 2, 3	Normal	
Hysteresis	dB	1, 2, 3	0	
Time To Trigger	s	1, 2, 3	0	
Filter coefficient		1, 2, 3	0	L3 filtering is not used

DRX		1, 2, 3		OFF
Time offset between serving and neighbour cells		1	3 ms	Asynchronous cells. The timing of Cell 2 is 3ms later than the timing of Cell 1.
		2	3 μs	Synchronous cells
		3	3 μs	Synchronous cells
T1	s	1, 2, 3	5	
T2	s	1, 2, 3	5	
T3	s	1, 2, 3	5	

**Table A.6.6.7.1.2-3: NR Cell specific test parameters for SA intra-frequency CGI identification of NR neighbor cell in FR1**

Parameter	Unit	Test configuration	Cell 1		Cell 2	
			T1	T2	T1	T2
TDD configuration		1	TN/A		TN/A	
		2	TDDConf.1.1		TDDConf.1.1	
		3	TDDConf.2.1		TDDConf.2.1	
PDSCH RMC configuration		1	SR.1.1 FDD		N/A	
		2	SR.1.1 TDD			
		3	SR.2.1 TDD			
RMSI CORESET RMC configuration		1	CR.1.1 FDD		CR.1.1 FDD	
		2	CR.1.1 TDD		CR.1.1 TDD	
		3	CR.2.1 TDD		CR.2.1 TDD	
Dedicated CORESET RMC configuration		1	CCR.1.1 FDD		CCR.1.1 FDD	
		2	CCR.1.1 TDD		CCR.1.1 TDD	
		3	CCR.2.1 TDD		CCR.2.1 TDD	
OCNG Patterns		1, 2, 3	OP.1		OP.1	
TRS Configuration		1	TRS.1.1 FDD		N/A	
		2	TRS.1.1 TDD		N/A	
		3	TRS.1.2 TDD		N/A	
Initial BWP configuration		1, 2, 3	DLBWP.0.1 ULBWP.0.1		DLBWP.0.1 ULBWP.0.1	
Active DL BWP configuration		1, 2, 3	DLBWP.1.1		DLBWP.1.1	
Active UL BWP configuration		1, 2, 3	ULBWP.1.1		ULBWP.1.1	
RLM-RS		1, 2, 3	SSB		SSB	
$N_{oc}$ <small>Note 2</small>	dBm/SCS	1	-98			
		2	-98			
		3	-95			
$N_{oc}$ <small>Note 2</small>	dBm/15 kHz	1	-98			
		2				
		3				
$\hat{E}_s/I_{ot}$	dB	1	4	-1.46	-Infinity	-1.46
		2				
		3				
$\hat{E}_s/N_{oc}$	dB	1	4	4	-Infinity	4
		2				
		3				
SS-RSRP <small>Note 3</small>	dBm/SCS kHz	1	-94	-94	-Infinity	-94
		2	-94	-94	-Infinity	-94
		3	-91	-91	-Infinity	-91
Io	dBm/9.36 MHz	1	-64.60	-62.25	--64.60	-62.25
	dBm/9.36 MHz	2	-64.60	-62.25	--64.60	-62.25
	dBm/38.16 MHz	3	-58.50	-56.16	--58.50	-56.16
Propagation Condition		1, 2, 3	AWGN			

Note 1:	The resources for uplink transmission are assigned to the UE prior to the start of time period T2.
Note 2:	Interference from other cells and noise sources not specified in the test is assumed to be constant over subcarriers and time and shall be modelled as AWGN of appropriate power for $N_{oc}$ to be fulfilled.
Note 3:	SS-RSRP levels have been derived from other parameters for information purposes. They are not settable parameters themselves.

### A.6.6.7.1.3 Test Requirements

The UE shall send a measurement report containing the CGI of cell 2 within 252 ms from the start of time period T3.

$$\begin{aligned} \text{Test requirement} &= \text{RRC Procedure delay} + T_{\text{identify\_CGI}} + \text{reporting delay} \\ &= 10 + 240 + 2\text{ms from the start of T3} \\ &= 252 \text{ ms} \end{aligned}$$

The UE shall be scheduled continuously throughout the test. From the start of T3 until 252 ms, the interruption on PCell shall not be more than the values specified for SA in clause 8.2.2.2.14.

The rate of correct events observed during repeated tests shall be at least 90%.

### A.6.6.7.2 Identification of a new CGI of inter-RAT E-UTRA cell using autonomous gaps in NR SA

#### A.6.6.7.2.1 Test Purpose and Environment

This test is to verify the requirement for identification of a new CGI of E-UTRA cell with autonomous gaps in NR SA in clause 9.4.7.

The test scenario comprises of one NR carrier and an E-UTRA carrier and two cells as given in tables A.6.6.7.2.1-1, A.6.6.7.2.1-2, A.6.6.7.2.1-3 and A.6.6.7.2.1-4. PDCCHs indicating new transmissions shall be sent continuously to ensure that the UE would have ACK/NACK sending during identifying a new CGI of E-UTRAN cell. The test consists of three successive time periods, with time durations of T1, T2 and T3 respectively. At the start of time duration T1, the UE does not have any timing information of cell 2. Starting T2, cell 2 becomes detectable and the UE is expected to detect and send a measurement report.

A RRC message implying SI reading shall be sent to the UE during period T2, after the UE has reported Event B2. The RRC message shall create a measurement report configuration with purpose *reportCGI* and *useAutonomousGaps* set to TRUE. The start of T3 is the instant when the last TTI containing the RRC message implying SI reading is sent to the UE.

**Table A.6.6.7.2.1-1: Supported test configurations of inter-RAT E-UTRAN cell using autonomous gap in SA**

Configuration	Description
1	NR 15 kHz SSB SCS, 10 MHz bandwidth, FDD duplex mode, LTE FDD
2	NR 15 kHz SSB SCS, 10 MHz bandwidth, TDD duplex mode, LTE FDD
3	NR 30 kHz SSB SCS, 40 MHz bandwidth, TDD duplex mode, LTE FDD
4	NR 15 kHz SSB SCS, 10 MHz bandwidth, FDD duplex mode, LTE TDD
5	NR 15 kHz SSB SCS, 10 MHz bandwidth, TDD duplex mode, LTE TDD
6	NR 30 kHz SSB SCS, 40 MHz bandwidth, TDD duplex mode, LTE TDD
Note:	The UE is only required to be tested in one of the supported test configurations

**Table A.6.6.7.2.1-2: General test parameters for identification of a new CGI of inter-RAT E-UTRA cell using autonomous gaps in NR SA**

Parameter	Unit	Value	Comment
NR RF Channel Number		1	1 NR carrier frequency is used in the test
LTE RF Channel Number		2	1 LTE carrier frequency is used in the test

Active cell		Cell 1	
Neighbour cell		Cell 2	Cell to be identified.
LTE Channel Bandwidth	MHz	10	
LTE PDSCH/PCFICH/PDCCH/PHICH parameters			As specified in clause A.3.7.2.1
CP length		Normal	
Hysteresis	dB	0	
Time To Trigger	s	0	
Filter coefficient		0	L3 filtering is not used
DRX		OFF	
useAutonomousGaps		TRUE	As specified in clause 5.5.3.1 in TS 38.331.
Time offset between cells	ms	3	Asynchronous cells
T1	s	5	
T2	s	≤10	
T3	s	5	

**Table A.6.6.7.2.1-3: PCell specific test parameters for identification of a new CGI of inter-RAT E-UTRA cell using autonomous gaps in NR**

Parameter		Unit	Configuration	Cell 1		
				T1	T2	T3
RF channel number			1, 2, 3, 4, 5, 6	1		
Duplex mode			1, 2, 3	FDD		
			4, 5, 6	TDD		
TDD Configuration	SCS=15 KHz		2, 5	TDDConf.1.1		
	SCS=30 KHz		3, 6	TDDConf.2.1		
BW <sub>channel</sub>		MHz	1, 4	10: N <sub>RB,c</sub> = 52 (FDD)		
			2, 5	10: N <sub>RB,c</sub> = 52 (TDD)		
			3, 6	40: N <sub>RB,c</sub> = 106 (TDD)		
PDSCH reference measurement channel			1, 4	SR.1.1 FDD		
			2, 5	SR.1.1 TDD		
			3, 6	SR.2.1 TDD		
CORSET reference channel			1, 4	CR.1.1 FDD		
			2, 5	CR.1.1 TDD		
			3, 6	CR.2.1 TDD		
BWP configurations	Initial DL BWP		1, 2, 3, 4, 5, 6	DLBWP.0.1		
	Dedicated DL BWP		1, 2, 3, 4, 5, 6	DLBWP.1.1		
	Initial UL BWP		1, 2, 3, 4, 5, 6	ULBWP.0.1		
	Dedicated UL BWP		1, 2, 3, 4, 5, 6	ULBWP.1.1		
OCNG pattern <sup>Note1</sup>			1, 2, 3, 4, 5, 6	OP.1		
SMTc configuration			1, 2, 3, 4, 5, 6	SMTc.1		
SSB configuration			1, 2, 4, 5	SSB.1 FR1		
			3, 6	SSB.2 FR1		
b2-Threshold1		dBm	1, 2, 4, 5	-98		
			3, 6	-95		
b2-Threshold2EUTRA		dBm/15kHz	1, 2, 3, 4, 5, 6	-109		
EPRE ratio of PSS to SSS		dB	1, 2, 3, 4, 5, 6	0		
EPRE ratio of PBCH_DMRS to SSS						
EPRE ratio of PBCH to PBCH_DMRS						
EPRE ratio of PDCCH_DMRS to SSS						
EPRE ratio of PDCCH to PDCCH_DMRS						
EPRE ratio of PDSCH_DMRS to SSS						
EPRE ratio of PDSCH to PDSCH_DMRS						
EPRE ratio of OCNG DMRS to SSS						
EPRE ratio of OCNG to OCNG DMRS						
N <sub>oc</sub> <sup>Note2</sup>		dBm/15 KHz	1, 2, 3, 4, 5, 6	-106		
N <sub>oc</sub> <sup>Note2</sup>		dBm/SCS	1, 2, 4, 5	-106		
			3, 6	-103		
E <sub>s</sub> /N <sub>oc</sub>		dB	1, 2, 3, 4, 5, 6	18	-2	-2
E <sub>s</sub> /I <sub>ot</sub> <sup>Note3</sup>		dB	1, 2, 3, 4, 5, 6	18	-2	-2
SS-RSRP <sup>Note3</sup>		dBm/SCS	1, 2, 4, 5	-88	-108	-108
			3, 6	-85	-105	-105

SSB_RP <sup>Note3</sup>	dBm/SCS	1, 2, 4, 5	-88	-108	-108
		3, 6	-85	-105	-105
I <sub>o</sub> <sup>Note3</sup>	dBm/9.36 MHz	1, 2, 4, 5	-59.98	-75.92	-75.92
		3, 6	-53.88	-69.82	-69.82
Propagation condition		1, 2, 3, 4, 5, 6	AWGN		
Antenna Configuration and Correlation Matrix		1, 2, 3, 4, 5, 6	1x2 Low		
<p>Note 1: OCNG shall be used such that both cells are fully allocated and a constant total transmitted power spectral density is achieved for all OFDM symbols.</p> <p>Note 2: Interference from other cells and noise sources not specified in the test is assumed to be constant over subcarriers and time and shall be modelled as AWGN of appropriate power for <math>N_{oc}</math> to be fulfilled.</p> <p>Note 3: <math>\hat{E}_s/I_{ot}</math>, SS-RSRP, SSB_RP and I<sub>o</sub> levels have been derived from other parameters for information purposes. They are not settable parameters themselves.</p>					

**Table A.6.6.7.2.1-4: Cell specific test parameters for inter-RAT E-UTRAN cell for identification of a new CGI of E-UTRA cell using autonomous gaps**

Parameter	Unit	Configuration	Cell 2		
			T1	T2	T3
RF channel number		1, 2, 3, 4, 5, 6	2		
Duplex mode		1, 2, 3	FDD		
		4, 5, 6	TDD		
TDD special subframe configuration <sup>Note1</sup>		4, 5, 6	6		
TDD uplink-downlink configuration <sup>Note1</sup>		4, 5, 6	1		
BW <sub>channel</sub>	MHz	1, 2, 3, 4, 5, 6	10 MHz: N <sub>RB,c</sub> = 50		
PDSCH parameters: DL Reference Measurement Channel <sup>Note2</sup>		1, 2, 3	10 MHz: R.3 FDD		
		4, 5, 6	10 MHz: R.0 TDD		
PCFICH/PDCCH/PHICH parameters: DL Reference Measurement Channel <sup>Note2</sup>		1, 2, 3	10 MHz: R.6 FDD		
		4, 5, 6	10 MHz: R.6 TDD		
OCNG Patterns <sup>Note2</sup>		1, 2, 3	10 MHz: OP.10 FDD		
		4, 5, 6	10 MHz: OP.1 TDD		
PBCH_RA	dB	1, 2, 3, 4, 5, 6	0		
PBCH_RB					
PSS_RA					
SSS_RA					
PCFICH_RB					
PHICH_RA					
PHICH_RB					
PDCCH_RA					
PDCCH_RB					
PDSCH_RA					
PDSCH_RB					
OCNG_RA <sup>Note3</sup>					
OCNG_RB <sup>Note3</sup>					
N <sub>oc</sub> <sup>Note4</sup>					
$\hat{E}_s/N_{oc}$	dB	1, 2, 3, 4, 5, 6	-Infinity	7	7
$\hat{E}_s/I_{ot}$ <sup>Note5</sup>	dB	1, 2, 3, 4, 5, 6	-Infinity	7	7
RSRP <sup>Note5</sup>	dBm/15kHz	1, 2, 3, 4, 5, 6	-Infinity	-99	-99
SCH_RP <sup>Note5</sup>	dBm/15kHz	1, 2, 3, 4, 5, 6	-Infinity	-99	-99
Propagation Condition		1, 2, 3, 4, 5, 6	AWGN		
Antenna Configuration and Correlation Matrix		1, 2, 3, 4, 5, 6	1x2 Low		
<p>Note 1: Special subframe and uplink-downlink configurations are specified in table 4.2-1 in TS 36.211 [23].</p> <p>Note 2: DL RMCs and OCNG patterns are specified in clauses A 3.1 and A 3.2 of TS 36.133 [15] respectively.</p>					

Note 3:	OCNG shall be used such that all cells are fully allocated and a constant total transmitted power spectral density is achieved for all OFDM symbols.
Note 4:	Interference from other cells and noise sources not specified in the test is assumed to be constant over subcarriers and time and shall be modelled as AWGN of appropriate power for $N_{oc}$ to be fulfilled.
Note 5:	$\bar{E}_s/I_{ot}$ , RSRP, and SCH_RP levels have been derived from other parameters for information purposes. They are not settable parameters themselves.

### A.6.6.7.2.2 Test Requirements

The UE shall transmit a measurement report containing the cell global identifier of cell 2 within 200 milliseconds from the start of T3.

Test requirement = RRC Procedure delay with additional margin +  $T_{identify\_CGI,E-UTRAN}$  + reporting delay

$$= 15 + 30 + 150 + 2\text{ms from the start of T3}$$

$$= 197 \text{ ms, allow 200 ms.}$$

- The UE shall be scheduled continuously throughout the test, and from the start of T3 until 200 ms at least the number of ACK/NACK specified in NOTE 2 shall be detected as being transmitted by the UE.

The rate of correct events observed during repeated tests shall be at least 90%.

NOTE 1: The actual overall delays measured in the test may be up to  $2xTTI_{DCCH}$  higher than the measurement reporting delays above because of TTI insertion uncertainty of the measurement report in DCCH.

NOTE 2: The overall ACK/NACK number is caused by two parts. Firstly, at least X ACK/NACK shall be sent during identifying the cell global identifier of cell 2, where X is defined in Table 8.2.2.2.15-1. Secondly, given that continuous DL data allocation, additional 43, 14 and 34 ACK/NACK shall be sent for FDD 15 kHz, TDD 15 kHz and TDD 30 kHz, respectively, from the start of T3 until 200 ms excludes 150 ms for identifying the cell global identifier of cell 2.

## A.6.6.8 L1-SINR measurement for beam reporting

### A.6.6.8.1 L1-SINR measurement with CSI-RS based CMR and no dedicated IMR configured when DRX is used

#### A.6.6.8.1.1 Test Purpose and Environment

The purpose of this test is to verify that the UE makes correct reporting of L1-SINR measurement. This test will partly verify the L1-SINR measurement requirements in clause 9.8.4.1, with the testing configurations for NR cells in Table A.6.6.8.1.1-1.

**Table A.6.6.8.1.1-1: Applicable NR configurations for FR1 CSI-RS based L1-SINR test**

Config	Description
1	NR 15 kHz SSB SCS, 10 MHz bandwidth, FDD duplex mode
2	NR 15 kHz SSB SCS, 10 MHz bandwidth, TDD duplex mode
3	NR 30 kHz SSB SCS, 40 MHz bandwidth, TDD duplex mode

Note: The UE is only required to be tested in one of the supported test configurations

#### A.6.6.8.1.2 Test parameters

There is one cells in the test, the FR1 PCell (Cell 1). The test parameters for the Cell 1 are given in Table A.6.6.8.1.2-1 and Table A.6.6.8.1.2-2 below.

In the CSI-RS measurement configuration, UE is indicated to perform L1-SINR measurement on the CSI-RS and report aperiodically. The test consists of a single time period T1, during which the UE is triggered via DCI to report L1-SINR on aperiodic CSI-RS resources. After 80ms from the beginning of the test, the DCI trigger comes in slot n (1 Config 1,2 and 8 for Config 3) of a frame and UE provides the report back based on the reporting configuration as defined in Table A.6.6.8.1.2-1.



There is no measurement gap configured in the test. Before the test, UE is configured to perform RLM and BFD based on the SSBs.

**Table A.6.6.8.1.2-1: General test parameters**

Parameter	Config	Unit	Value
SSB GSCN	1~3		freq1
Duplex mode	1		FDD
	2		TDD
	3		TDD
TDD Configuration	1		N/A
	2		TDDConf.1.1
	3		TDDConf.2.1
BW <sub>channel</sub>	1	MHz	10: N <sub>RB,c</sub> = 52
	2		10: N <sub>RB,c</sub> = 52
	3		40: N <sub>RB,c</sub> = 106
PDSCH Reference measurement channel	1		SR.1.1 FDD
	2		SR.1.1 TDD
	3		SR.2.1 TDD
RMSI CORESET Reference Channel	1		CR.1.1 FDD
	2		CR.1.1 TDD
	3		CR.2.1 TDD
Dedicated CORESET Reference Channel	1		CCR.1.1 FDD
	2		CCR.1.1 TDD
	3		CCR.2.1 TDD
SSB configuration	1		SSB.3 FR1
	2		SSB.3 FR1
	3		SSB.4 FR1
CSI-RS configuration	1		CSI-RS.1.3 FDD
	2		CSI-RS.1.3TDD
	3		CSI-RS.2.3TDD
OCNG Patterns	1~3		OP.1
TRS Configuration	1		TRS.1.1 FDD
	2		TRS.1.1 TDD
	3		TRS.1.2 TDD
Initial BWP Configuration	1~3		DLBWP.0.1 ULBWP.0.1
Dedicated BWP configuration	1~3		DLBWP.1.1 ULBWP.1.1
SMTc configuration	1~3		SMTc.1
DRX configuration	1~3		DRX.3
reportConfigType	1~3		aperiodic
reportQuantity-r16	1~3		cri-SINR-r16
Number of reported RS	1~3		2
qcl-Info	1~3		SSB#0 for resource#0
			SSB#1 for resource#1
reportSlotOffsetList	1~3	slots	26
T1	1~3	s	5
EPRE ratio of PSS to SSS	1~3	dB	0
EPRE ratio of PBCH DMRS to SSS			
EPRE ratio of PBCH to PBCH DMRS			
EPRE ratio of PDCCH DMRS to SSS			
EPRE ratio of PDCCH to PDCCH DMRS			
EPRE ratio of PDSCH DMRS to SSS			
EPRE ratio of PDSCH to PDSCH DMRS			
EPRE ratio of OCNG DMRS to SSS <sup>Note 1</sup>			
EPRE ratio of OCNG to OCNG DMRS <sup>Note 1</sup>			
Propagation condition	1~3		AWGN
Note 1: OCNG shall be used such that both cells are fully allocated and a constant total transmitted power spectral density is achieved for all OFDM symbols.			

Table A.6.6.8.1.2-2: CSI-RS specific test parameters

Parameter	Config	Unit	CSI-RS#0	CSI-RS#1
$N_{oc}$ <sup>Note1</sup>	1~3	dBm/15kHz	-94.65	
$N_{oc}$ <sup>Note1</sup>	1,2	dBm/SSB SCS	-94.65	
	3		-91.65	
$\hat{E}_s / I_{ot}$	1~3	dB	0	3
CSI-RS RSRP <sup>Note3</sup>	1,2	dBm/SSB SCS	-94.65	-91.65
	3		-91.65	-88.65
$I_o$ <sup>Note2</sup>	1,2	dBm/9.36 MHz	-63.69	-61.93
	3	dBm/38.16 MHz	-57.59	-55.84
$\hat{E}_s / N_{oc}$	1~3	dB	0	3
<p>Note 2: Interference from other cells and noise sources not specified in the test is assumed to be constant over subcarriers and time and shall be modelled as AWGN of appropriate power for <math>N_{oc}</math> to be fulfilled.</p> <p>Note 3: CSI-RS RSRP and <math>I_o</math> levels have been derived from other parameters for information purposes. They are not settable parameters themselves.</p>				

### A.6.6.8.1.3 Test Requirements

After 80ms from the beginning of the test, the UE shall send L1-SINR report at slot 26 from the reception of DCI triggering the L1-SINR measurement. The L1-SINR report shall include the results for both CSI-RS#0 and CSI-RS#1 while meeting the absolute accuracy requirement in clause 10.1.27.1.1 and relative accuracy requirement in clause 10.1.27.1.2.

The rate of correct events observed during repeated tests shall be at least 90%.

NOTE: The actual overall delays measured in the test may be up to  $2 \times TTI_{DCCH}$  higher than the measurement reporting delays above because of TTI insertion uncertainty of the measurement report in DCCH.

### A.6.6.8.2 L1-SINR measurement with SSB based CMR and dedicated IMR when DRX is not used

#### A.6.6.8.2.1 Test Purpose and Environment

The purpose of this test is to verify that the UE makes correct reporting of L1-SINR measurement. This test will partly verify the L1-SINR measurement requirements in clause 9.8.4.2, with the testing configurations for NR cells in Table A.6.6.8.2.1-1.

**Table A.6.6.8.2.1-1: Applicable NR configurations for FR1 L1-SINR measurement test with SSB based CMR and CSI-RS based IMR**

Config	Description
1	NR 15 kHz SSB SCS, 10 MHz bandwidth, FDD duplex mode
2	NR 15 kHz SSB SCS, 10 MHz bandwidth, TDD duplex mode
3	NR 30 kHz SSB SCS, 40 MHz bandwidth, TDD duplex mode
Note: The UE is only required to be tested in one of the supported test configurations	

## A.6.6.8.2.2 Test parameters

There is one cells in the test, the FR1 PCell (Cell 1). The test parameters for the Cell 1 are given in Table A.6.6.8.2.2-1 and Table A.6.6.8.2.2-2 below.

In CSI measurement configuration, UE is indicated to perform L1-SINR measurement on the SSBs and the associated CSI-RS resources, and report periodically. The test consists of two successive time periods, with time duration of T1 and T2 respectively. The test has higher layer parameter *timeRestrictionForChannelMeasurements* configured.

There is no measurement gap configured in the test. Before the test, UE is configured to perform RLM and BFD measurements based on the SSBs, and UE is configured to perform L1-SINR measurement based on the SSBs as CMR and the CSI-RS resources as IMR.

Table A.6.6.8.2.2-1: General test parameters

Parameter	Config	Unit	Value
SSB GSCN	1~3		freq1
Duplex mode	1		FDD
	2		TDD
	3		TDD
TDD Configuration	1		N/A
	2		TDDConf.1.1
	3		TDDConf.2.1
BW <sub>channel</sub>	1	MHz	10: N <sub>RB,c</sub> = 52
	2		10: N <sub>RB,c</sub> = 52
	3		40: N <sub>RB,c</sub> = 106
PDSCH Reference measurement channel	1		SR.1.1 FDD
	2		SR.1.1 TDD
	3		SR.2.1 TDD
RMSI CORESET Reference Channel	1		CR.1.1 FDD
	2		CR.1.1 TDD
	3		CR.2.1 TDD
Dedicated CORESET Reference Channel	1		CCR.1.1 FDD
	2		CCR.1.1 TDD
	3		CCR.2.1 TDD
SSB configuration	c		SSB.3 FR1
	2		SSB.3 FR1
	3		SSB.4 FR1
CSI-RS configuration	1		CSI-RS 1.1A FDD
	2		CSI-RS 1.1A TDD
	3		CSI-RS 2.1A TDD
OCNG Patterns	1~3		OP.1
Initial BWP Configuration	1~3		DLBWP.0.1 ULBWP.0.1
Dedicated BWP configuration	1~3		DLBWP.1.1 ULBWP.1.1
SMTC configuration	1~3		SMTC.1
TRS Configuration	1		TRS.1.1 FDD
	2		TRS.1.1 TDD
	3		TRS.1.2 TDD
DRX configuration	1~3		off
reportConfigType	1~3		periodic
reportQuantity-r16	1~3		ssb-index-SINR-r16
Number of reported RS	1~3		2
L1-SINR reporting period	1~3	slot	80
T1	1~3	s	5
T2	1~3	s	1
EPRE ratio of PSS to SSS	1~3	dB	0
EPRE ratio of PBCH DMRS to SSS			
EPRE ratio of PBCH to PBCH DMRS			
EPRE ratio of PDCCH DMRS to SSS			

EPRE ratio of PDCCH to PDCCH DMRS			
EPRE ratio of PDSCH DMRS to SSS			
EPRE ratio of PDSCH to PDSCH DMRS			
EPRE ratio of OCNG DMRS to SSS <sup>Note 1</sup>			
EPRE ratio of OCNG to OCNG DMRS <sup>Note 1</sup>			
Propagation condition	1~3		AWGN
Note 1: OCNG shall be used such that both cells are fully allocated and a constant total transmitted power spectral density is achieved for all OFDM symbols.			

**Table A.6.6.8.2.2-2: SSB specific test parameters**

Parameter	Config	Unit	SSB#0		SSB#1	
			T1	T2	T1	T2
$N_{oc}$ <sup>Note2</sup>	1~3	dBm/15kHz	-94.65			
$N_{oc}$ <sup>Note2</sup>	1,2	dBm/SSB SCS	-94.65			
	3		-91.65			
$\hat{E}_s/I_{ot}$	1~3	dB	0	0	-Infinity	3
SSB RSRP <sup>Note3</sup>	1,2	dBm/SSB SCS	-94.65	-94.65	-Infinity	-91.65
	3		-91.65	-91.65	-Infinity	-88.65
$I_o$ <sup>Note3</sup>	1,2	dBm/9.36 MHz	-63.69	-63.69	-66.70	-61.93
	3	dBm/38.16 MHz	-57.59	-57.59	-60.61	-55.84
$\hat{E}_s/N_{oc}$	1~3	dB	0	0	-Infinity	3
<p>Note 1: The resources for uplink transmission are assigned to the UE prior to the start of time period T2.</p> <p>Note 2: Interference from other cells and noise sources not specified in the test is assumed to be constant over subcarriers and time and shall be modelled as AWGN of appropriate power for <math>N_{oc}</math> to be fulfilled.</p> <p>Note 3: SS-RSRP and <math>I_o</math> levels have been derived from other parameters for information purposes. They are not settable parameters themselves.</p>						

**Table A.6.6.8.2.2-3: CSI-RS specific test parameters**

Parameter	Config	Unit	CSI-RS#0		CSI-RS#1	
			T1	T2	T1	T2
$N_{oc}$ <sup>Note2</sup>	1~3	dBm/15kHz	-94.65			
$N_{oc}$ <sup>Note2</sup>	1,2	dBm/CSI-RS SCS	-94.65			
	3		-91.65			
$\hat{E}_s/I_{ot}$	1~3	dB	0	0	-Infinity	3
CSI-RS RSRP <sup>Note3</sup>	1,2	dBm/CSI-RS SCS	-94.65	-94.65	-Infinity	-91.65
	3		-91.65	-91.65	-Infinity	-88.65
$I_o$ <sup>Note3</sup>	1,2	dBm/9.36 MHz	-63.69	-63.69	-66.70	-61.93
	3	dBm/38.16 MHz	-57.59	-57.59	-60.61	-55.84
$\hat{E}_s/N_{oc}$	1~3	dB	0	0	-Infinity	3
<p>Note 1: The resources for uplink transmission are assigned to the UE prior to the start of time period T2.</p>						

Note 2:	Interference from other cells and noise sources not specified in the test is assumed to be constant over subcarriers and time and shall be modelled as AWGN of appropriate power for $N_{oc}$ to be fulfilled.
Note 3:	SS-RSRP and Io levels have been derived from other parameters for information purposes. They are not settable parameters themselves.

### A.6.6.8.2.3 Test Requirements

The UE shall send L1-SINR report every 80 slots. No later than 640ms plus 80 slots from the beginning of time period T2, UE shall send L1-SINR report including results of both SSB#0+CSI-RS#0 and SSB#1+CSI-RS#1 while meeting the accuracy requirement in clause 10.1.27.2. The rate of correct events observed during repeated tests shall be at least 90%.

NOTE: The actual overall delays measured in the test may be up to  $2 \times TTI_{DCC}$  higher than the measurement reporting delays above because of TTI insertion uncertainty of the measurement report in DCCH.

### A.6.6.8.3 L1-SINR measurement with CSI-RS based CMR and dedicated IMR configured when DRX is not used

#### A.6.6.8.3.1 Test Purpose and Environment

The purpose of this test is to verify that the UE makes correct reporting of L1-SINR measurement. This test will partly verify the L1-SINR measurement requirements with CSI-RS based CMR and dedicated IMR configured in clause 9.8.4.3, with the testing configurations for NR cells in Table A.6.6.8.3.1-1.

**Table A.6.6.8.3.1-1: Applicable NR configurations for FR1 L1-SINR test with CMR and dedicated IMR**

Config	Description
1	NR 15 kHz SSB SCS, 10 MHz bandwidth, FDD duplex mode
2	NR 15 kHz SSB SCS, 10 MHz bandwidth, TDD duplex mode
3	NR 30 kHz SSB SCS, 40 MHz bandwidth, TDD duplex mode
Note:	The UE is only required to be tested in one of the supported test configurations

#### A.6.6.8.3.2 Test parameters

There is one cells in the test, the FR1 PCell (Cell 1). The test parameters for the Cell 1 are given in Table A.6.6.8.3.2-1 and Table A.6.6.8.3.2-2 below.

In CSI measurement configuration, UE is indicated to perform L1-SINR measurement on the configured CSI-RS as CMR and an associated CSI-IM as IMR, and report aperiodically. The test consists of a single time period T1, during which the UE is triggered via DCI to report L1-SINR on aperiodic CSI-RS resources. UE is also configured to measure L1-SINR based on SSB. After 80ms from the beginning of the test, the DCI trigger comes in slot  $n$  (1 Config 1,2 and 8 for Config 3) of a frame and UE provides the report back based on the reporting configuration as defined in Table A.6.6.8.3.2-1.

There is no measurement gap configured in the test. Before the test, UE is configured to perform RLM and BFD based on the SSBs, and UE is configured to perform L1-SINR measurement based on the CSI-RS as CMR and the CSI-IM as IMR.

**Table A.6.6.8.3.2-1: General test parameters**

Parameter	Config	Unit	Value
SSB GSCN	1~3		freq1
Duplex mode	1		FDD
	2		TDD
	3		TDD
TDD Configuration	1		N/A
	2		TDDConf.1.1

	3		TDDConf.2.1
BW <sub>channel</sub>	1	MHz	10: N <sub>RB,c</sub> = 52
	2		10: N <sub>RB,c</sub> = 52
	3		40: N <sub>RB,c</sub> = 106
PDSCH Reference measurement channel	1		SR.1.1 FDD
	2		SR.1.1 TDD
	3		SR.2.1 TDD
RMSI CORESET Reference Channel	1		CR.1.1 FDD
	2		CR.1.1 TDD
	3		CR.2.1 TDD
Dedicated CORESET Reference Channel	1		CCR.1.1 FDD
	2		CCR.1.1 TDD
	3		CCR.2.1 TDD
SSB configuration	1		SSB.3 FR1
	2		SSB.3 FR1
	3		SSB.4 FR1
CSI-RS configuration	1		CSI-RS 1.3 FDD
	2		CSI-RS 1.3 TDD
	3		CSI-RS 2.3 TDD
CSI-IM configuration	1		CSI-IM.1.2 FDD
	2		CSI-IM.1.2 TDD
	3		CSI-IM.2.2 TDD
OCNG Patterns	1~3		OP.1
TRS Configuration	1		TRS.1.1 FDD
	2		TRS.1.1 TDD
	3		TRS.1.2 TDD
Initial BWP Configuration	1~3		DLBWP.0.1 ULBWP.0.1
Dedicated BWP configuration	1~3		DLBWP.1.1 ULBWP.1.1
SMTc configuration	1~3		SMTc.1
DRX configuration	1~3		Off
reportConfigType	1~3		aperiodic
reportQuantity-r16	1~3		cri-SINR-r16
Number of reported RS	1~3		2
qcl-Info	1~3		SSB#0 for resource#0
			SSB#1 for resource#1
reportSlotOffsetList	1~3	slots	26
T1	1~3	s	5
EPRE ratio of PSS to SSS	1~3	dB	0
EPRE ratio of PBCH DMRS to SSS			
EPRE ratio of PBCH to PBCH DMRS			
EPRE ratio of PDCCH DMRS to SSS			
EPRE ratio of PDCCH to PDCCH DMRS			
EPRE ratio of PDSCH DMRS to SSS			
EPRE ratio of PDSCH to PDSCH DMRS			
EPRE ratio of OCNG DMRS to SSS <sup>Note 1</sup>			
EPRE ratio of OCNG to OCNG DMRS <sup>Note 1</sup>			
Propagation condition	1~3		AWGN
Note 1: OCNG shall be used such that both cells are fully allocated and a constant total transmitted power spectral density is achieved for all OFDM symbols.			

**A.6.6.8.3.2-2: CSI-RS specific test parameters**

Parameter	Config	Unit	CSI-RS#0	CSI-RS#1
$N_{oc}$ <sup>Note1</sup>	1~3	dBm/15kHz	-94.65	
	1,2	dBm/SSB SCS	-94.65	

$N_{oc}$ <sup>Note1</sup>	3		-91.65	
$\hat{E}_s / I_{ot}$	1~3	dB	0	3
CSI-RS RSRP <sup>Note2</sup>	1,2	dBm/SSB SCS	-94.65	-91.65
	3		-91.65	-88.65
$I_o$ <sup>Note2</sup>	1,2	dBm/9.36 MHz	-63.69	-61.93
	3	dBm/38.16 MHz	-57.59	-55.84
$\hat{E}_s / N_{oc}$	1~3	dB	0	3
<p>Note 1: Interference from other cells and noise sources not specified in the test is assumed to be constant over subcarriers and time and shall be modelled as AWGN of appropriate power for <math>N_{oc}</math> to be fulfilled.</p> <p>Note 2: CSI-RS RSRP and <math>I_o</math> levels have been derived from other parameters for information purposes. They are not settable parameters themselves.</p>				

### A.6.6.8.3.3 Test Requirements

After 80ms from the beginning of the test, the UE shall send L1-SINR report at slot 26 from the reception of DCI triggering the L1-SINR measurement. The L1-SINR report shall include the results for both CSI-RS#0 as CMR + CSI-IM#0 as IMR and CSI-RS#1 as CMR + CSI-IM#1 as IMR while meeting the accuracy requirement in clause 10.1.27.3.

The rate of correct events observed during repeated tests shall be at least 90%.

NOTE: The actual overall delays measured in the test may be up to  $2 \times TTI_{DCCH}$  higher than the measurement reporting delays above because of TTI insertion uncertainty of the measurement report in DCCH.

## A.6.6.9 Idle Mode CA/DC Measurements

### A.6.6.9.1 SA Idle mode CA/DC measurement for FR1

#### A.6.6.9.1.1 Test Purpose and Environment

The purpose of this test is to verify that the UE performs the required measurements on the serving cell and the configured inter-frequency carrier for idle mode measurement reporting after the UE has entered Idle mode. This test will partly verify the Idle mode CA/DC measurements requirements in clause 4.4.

In this test, there are two cells: NR cell 1 as PCell in FR1 on NR RF channel 1 and NR cell 2 as neighbour cell in FR1 on NR RF channel 2. The test parameters are given in Tables A.6.6.9.1.1-1, A.6.6.9.1.1-2, A.6.6.9.1.1-3 and A.6.6.9.1.1-4.

The test consists of 3 successive time periods, with time duration of T1, T2 and T3 respectively. During T1, the UE is connected to cell 1 only and shall not have any timing information of cell 2. UE is configured with early measurement reporting with channel 2. Beam level reporting for early measurements is not configured. The connection is released at the end of T1. T2 starts when the connection is released. During the time periods T2 UE is in Idle mode. At T3 the UE is paged for connection setup and requested by the network to send idle mode measurements.

**Table A.6.6.9.1.1-1: supported test configuration**

Config	Description
1	NR 15 kHz SSB SCS, 10 MHz bandwidth, FDD duplex mode
2	NR 15 kHz SSB SCS, 10 MHz bandwidth, TDD duplex mode
3	NR 30kHz SSB SCS, 40 MHz bandwidth, TDD duplex mode
Note 1:	The UE is only required to be tested in one of the supported test configurations
Note 2:	target NR cell has the same SCS, BW and duplex mode as NR serving cell

**Table A.6.6.9.1.1-2: General test parameters for SA Idle mode CA/DC measurement for FR1**

Parameter	Unit	Test configuration	Value	Comment
NR RF Channel Number		Config 1,2,3	1, 2	Two FR1 NR carrier frequencies is used.
Active cell		Config 1,2,3	NR cell 1 (Pcell)	NR Cell 1 is on NR RF channel number 1.
Neighbour cell		Config 1,2,3	NR cell2	NR cell 2 is on NR RF channel number 2.
SMTC-SSB parameters		Config 1	SSB.1 FR1	As specified in clause A.3.10.1
		Config 2	SSB.1 FR1	As specified in clause A.3.10.1
		Config 3	SSB.2 FR1	As specified in clause A.3.10.1
Hysteresis	dB	Config 1,2,3	0	
PRACH configuration index		Config 1,2,3	102	The detailed configuration is specified in TS 38.211 clause 6.3.3.2
CP length		Config 1,2,3	Normal	
TimeToTrigger	s	Config 1,2,3	0	
Filter coefficient		Config 1,2,3	0	L3 filtering is not used
DRX in connected mode		Config 1,2,3	OFF	DRX is not used
DRX in idle mode	s	Config 1,2,3	0.32	The value shall be used for all cells in the test.
T331	s		300	
Time offset between serving and neighbour cells		Config 1	3ms	Asynchronous cells. The timing of Cell 2 is 3ms later than the timing of Cell 1.
		Config 2,3	3µs	Synchronous cells.
T1	s	Config 1,2,3	10	
T2	s	Config 1,2,3	11.52	
T3	s	Config 1,2,3	10	

**Table A.6.6.9.1.1-3: Cell specific test parameters for connected mode for SA Idle mode CA/DC measurement for FR1**

Parameter		Unit	Test configuration	Cell 1			Cell 2		
				T1	T2	T3	T1	T2	T3
NR RF Channel Number			Config 1,2,3	1			2		
Duplex mode			Config 1	FDD					
			Config 2,3	TDD					
TDD configuration			Config 1	Not Applicable					
			Config 2	TDDConf.1.1					
			Config 3	TDDConf.2.1					
BW <sub>channel</sub>		MHz	Config 1,2	10: N <sub>RB,c</sub> = 52					
			Config 3	40: N <sub>RB,c</sub> = 106					
BWP BW		MHz	Config 1,2	10: N <sub>RB,c</sub> = 52					
			Config 3	40: N <sub>RB,c</sub> = 106					
BWP configuration	Initial DL BWP		Config 1, 2, 3	DLBWP.0.1			NA		
	Initial UL BWP			ULBWP.0.1			NA		
	Dedicated DL BWP			DLBWP.1.1			NA		



	Dedicated UL BWP		ULBWP.1.1			NA		
TRS configuration		Config 1	TRS.1.1 FDD			NA		
		Config 2	TRS.1.1 TDD			NA		
		Config 3	TRS.1.2 TDD			NA		
OCNG Patterns defined in A.3.2.1.1 (OP.1)		Config 1,2,3	OP.1			OP.1		
PDSCH Reference measurement channel		Config 1	SR.1.1 FDD			SR.1.1 FDD		
		Config 2	SR.1.1 TDD			SR.1.1 TDD		
		Config 3	SR2.1 TDD			SR2.1 TDD		
CORESET Reference Channel		Config 1	CR.1.1 FDD			CR.1.1 FDD		
		Config 2	CR.1.1 TDD			CR.1.1 TDD		
		Config 3	CR2.1 TDD			CR2.1 TDD		
SSB parameters		Config 1	SSB.1 FR1			SSB.5 FR1		
		Config 2	SSB.1 FR1			SSB.5 FR1		
		Config 3	SSB.2 FR1			SSB.6 FR1		
SMTC configuration defined in A.3.11		Config 1	SMTC.2			SMTC.5		
		Config 2, 3	SMTC.1			SMTC.4		
PDSCH/PDCCH subcarrier spacing	kHz	Config 1,2	15					
		Config 3	30					
EPRE ratio of PSS to SSS		Config 1,2,3	0			0		
EPRE ratio of PBCH DMRS to SSS								
EPRE ratio of PBCH to PBCH DMRS								
EPRE ratio of PDCCH DMRS to SSS								
EPRE ratio of PDCCH to PDCCH DMRS								
EPRE ratio of PDSCH DMRS to SSS								
EPRE ratio of PDSCH to PDSCH								
EPRE ratio of OCNG DMRS to SSS(Note 1)								
EPRE ratio of OCNG to OCNG DMRS (Note 1)								
$N_{oc}$ <sup>Note2</sup>	dBm/15 kHz		-98			-98		
$N_{oc}$ <sup>Note2</sup>	dBm/S CS	Config 1,2	-98			-98		
		Config 3	-95			-95		
SS-RSRP <sup>Note 3</sup>	dBm/S CS	Config 1,2	-91	-91	-91	-	-98	-98
		Config 3	-88	-88	-88	-	-95	-95
$\hat{E}_s/I_{ot}$	dB	Config 1,2,3,4,5,6	7	7	7	-	0	0
$\hat{E}_s/N_{oc}$	dB	Config 1,2,3	7	7	7	infinite	0	0
$I_o$ <sup>Note3</sup>	dBm/9.36MHz	Config 1,2	-	-	-	-70.5	-67.04	-67.04
	dBm/38.16MHz	Config 3	-	-	-	-	-60.93	-60.93
Propagation Condition		Config 1,2,3	AWGN			AWGN		

Note 1: OCNG shall be used such that both cells are fully allocated and a constant total transmitted power spectral density is achieved for all OFDM symbols.  
 Note 2: Interference from other cells and noise sources not specified in the test is assumed to be constant over subcarriers and time and shall be modelled as AWGN of appropriate power for  $N_{oc}$  to be fulfilled.  
 Note 3: SS-RSRP and  $I_o$  levels have been derived from other parameters for information purposes. They are not settable parameters themselves.  
 Note 4: SS-RSRP minimum requirements are specified assuming independent interference and noise at each receiver antenna port.

**Table A.6.6.9.1.1-4: Cell specific test parameters for idle mode for SA Idle mode CA/DC measurement for FR1**

Parameter	Unit	Test configuration	Cell 1			Cell 2		
			T1	T2	T3	T1	T2	T3
NR RF Channel Number		1,2,3	1			2		
TDD configuration		1	N/A			N/A		
		2	TDDConf.1.1			TDDConf.1.1		
		3	TDDConf.2.1			TDDConf.2.1		
PDSCH RMC configuration		1	SR.1.1 FDD			SR.1.1 FDD		
		2	SR.1.1 TDD			SR.1.1 TDD		
		3	SR.2.1 TDD			SR.2.1 TDD		
RMSI CORESET RMC configuration		1	CR.1.1 FDD			CR.1.1 FDD		
		2	CR.1.1 TDD			CR.1.1 TDD		
		3	CR.2.1 TDD			CR.2.1 TDD		
Dedicated CORESET RMC configuration		1	CCR.1.1 FDD			CCR.1.1 FDD		
		2	CCR.1.1 TDD			CCR.1.1 TDD		
		3	CCR.2.1 TDD			CCR.2.1 TDD		
OCNG Pattern		1, 2, 3	OP.1 defined in A.3.2.1			OP.1 defined in A.3.2.1		
Initial DL BWP configuration		1, 2, 3	DLBWP.0.1			DLBWP.0.1		
Initial UL BWP configuration		1, 2, 3	ULBWP.0.1			ULBWP.0.1		
RLM-RS		1, 2, 3	SSB			SSB		
Qrxlevmin	dBm/SCS	1, 2	-140			-140		
		3	-137			-137		
Pcompensation	dB	1, 2, 3	0			0		
Cell_selection_and_reselection_quality_measurement		1, 2, 3	SS-RSRP			SS-RSRP		
$\hat{E}_s / I_{ot}$	dB	1	14	14	14	-infinity	12	12
		2						
		3						
$N_{oc}$ <sup>Note2</sup>	dBm/SCS	1	-98					
		2	-98					
		3	-95					
$N_{oc}$ <sup>Note2</sup>	dBm/15 kHz	1	-98					
		2						
		3						
$\hat{E}_s / N_{oc}$	dB	1	7	7	7	-infinity	0	0
		2						
		3						
$\hat{E}_s / I_{ot}$	dB	1, 2, 3	7	7	7	-infinity	0	0
SS-RSRP <sup>Note3</sup>	dBm/SCS	1	-91	-91	-91	-infinity	-98	-98
		2	-91	-91	-91	-infinity	-98	-98
		3	-88	-88	-88	-infinity	-95	-95
$I_o$	dBm/9.36 MHz	1	-62.26	-62.26	-62.26	-70.5	-67.04	-67.04
	dBm/9.36 MHz	2	-62.26	-62.26	-62.26	-70.5	-67.04	-67.04
	dBm/38.16 MHz	3	-56.15	-56.15	-56.15	-63.94	-60.93	-60.93
Treselection	s	1, 2, 3	0	0	0	0	0	0
SnonintrasearchP	dB	1, 2, 3	Not sent			Not sent		

Propagation Condition		1, 2, 3	AWGN
Note 1:	OCNG shall be used such that both cells are fully allocated and a constant total transmitted power spectral density is achieved for all OFDM symbols.		
Note 2:	Interference from other cells and noise sources not specified in the test is assumed to be constant over subcarriers and time and shall be modelled as AWGN of appropriate power for $N_{oc}$ to be fulfilled.		
Note 3:	SS-RSRP levels have been derived from other parameters for information purposes. They are not settable parameters themselves.		

### A.6.6.9.1.2 Test Requirements

The UE behaviour during time durations T2 and T3 shall be as follows:

During the time period T2 the UE is in Idle mode and the signal level of cell 2 is changed. The UE shall not perform reselection. The UE shall perform Idle Mode CA measurement according to Section 4.4.

At the start of T3 the UE is paged for connection setup. During the connection setup the UE is requested to transmit early measurement report for cell 2. The UE shall send early measurement report to the PCell.

After receiving the requested early measurement report, the test equipment verifies the accuracy of measurement reported for Cell 2 meets the requirements in Section 10.1.4B for SS-RSRP and in Section 10.1.8B for SS-RSRQ and test ends.

The rate of correct events observed during repeated tests shall be at least 90%.

## A.6.6.10 CSI-RS based intra-frequency Measurements

### A.6.6.10.1 SA event triggered reporting tests without gap under non-DRX

#### A.6.6.10.1.1 Test purpose and Environment

The purpose of this test is to verify that the UE makes correct reporting of an event. This test will partly verify the SA CSI-RS based L3 intra-frequency requirements in clauses 9.10.2.

Two cells are deployed in the test, which are FR1 PCell (Cell 1) and a FR1 neighbour cell (Cell 2) on the same frequency as the PCell. The test parameters for PCell and neighbour cell are given in Table A.6.6.10.1.1-1 and A.6.6.10.1.1-2 below. In the measurement control information, a measurement object is configured for the frequency of the PCell, and it is indicated to the UE that event-triggered reporting with Event A3 is used. The test consists of two successive time periods, with time duration of T1, and T2 respectively. During time duration T1, the UE shall not have any timing information of Cell 2.

**Table A.6.6.10.1.1-1: Supported test configurations**

Configuration	Description
1	15 kHz SSB and CSI-RS SCS, 10 MHz bandwidth, FDD duplex mode
2	15 kHz SSB and CSI-RS SCS, 10 MHz bandwidth, TDD duplex mode
3	30 kHz SSB and CSI-RS SCS, 40 MHz bandwidth, TDD duplex mode
Note:	The UE is only required to be tested in one of the supported test configurations.

**Table A.6.6.10.1.1-2: General test parameters for SA intra-frequency event triggered reporting without gap for FR1**

Parameter	Unit	Test configuration	Value	Comment
Active cell		1, 2, 3	Cell 1	
Neighbour cell		1, 2, 3	Cell 2	Cell to be identified and measured.
RF Channel Number		1, 2, 3	1: Cell 1 and Cell 2	
SSB configuration		1	SSB.1 FR1	
		2	SSB.1 FR1	

		3	SSB.2 FR1	
SMTC configuration		1	SMTC.2	
		2	SMTC.1	
		3	SMTC.1	
CSI-RS configuration for RRM		1	CSI-RS.RRM.FR1.1 FDD	
		2	CSI-RS.RRM.FR1.1 TDD	
		3	CSI-RS.RRM.FR1.2 TDD	
A3-Offset	dB	1, 2, 3	-4.5	
CP length		1, 2, 3	Normal	
Hysteresis	dB	1, 2, 3	0	
Time To Trigger	s	1, 2, 3	0	
Filter coefficient		1, 2, 3	0	L3 filtering is not used
DRX		1, 2, 3		OFF
Time offset between serving and neighbour cells	µs	1	4.7	Asynchronous cells. The timing of Cell 2 is CP later than the timing of Cell 1.
		2	4.7	Synchronous cells
		3	2.35	Synchronous cells
T1	s	1, 2, 3	5	
T2	s	1, 2, 3	1	

**Table A.6.6.10.1.1-3: NR Cell specific test parameters for SA intra-frequency event triggered reporting without gap for FR1**

Parameter	Unit	Test configuration	Cell 1		Cell 2	
			T1	T2	T1	T2
TDD configuration		1	TN/A		TN/A	
		2	TDDConf.1.1		TDDConf.1.1	
		3	TDDConf.2.1		TDDConf.2.1	
PDSCH RMC configuration		1	SR.1.1 FDD		N/A	
		2	SR.1.1 TDD			
		3	SR.2.1 TDD			
RMSI CORESET RMC configuration		1	CR.1.1 FDD		CR.1.1 FDD	
		2	CR.1.1 TDD		CR.1.1 TDD	
		3	CR.2.1 TDD		CR.2.1 TDD	
Dedicated CORESET RMC configuration		1	CCR.1.1 FDD		CCR.1.1 FDD	
		2	CCR.1.1 TDD		CCR.1.1 TDD	
		3	CCR.2.1 TDD		CCR.2.1 TDD	
OCNG Patterns		1, 2, 3	OP.1		OP.1	
TRS Configuration		1	TRS.1.1 FDD		N/A	
		2	TRS.1.1 TDD		N/A	
		3	TRS.1.2 TDD		N/A	
Initial BWP configuration		1, 2, 3	DLBWP.0.1 ULBWP.0.1		DLBWP.0.1 ULBWP.0.1	
Active DL BWP configuration		1, 2, 3	DLBWP.1.1		DLBWP.1.1	
Active UL BWP configuration		1, 2, 3	ULBWP.1.1		ULBWP.1.1	
RLM-RS		1, 2, 3	SSB		SSB	
$N_{oc}$ <small>Note 2</small>	dBm/SCS	1	-98			
		2	-98			
		3	-95			
$N_{oc}$ <small>Note 2</small>	dBm/15 kHz	1	-98			
		2				
		3				
$\hat{E}_s/I_{ot}$	dB	1	4	-1.46	-Infinity	-1.46
		2				
		3				
$\hat{E}_s/N_{oc}$	dB	1	4	4	-Infinity	4
		2				
		3				
SS-RSRP <small>Note 3</small>	dBm/SCS kHz	1	-94	-94	-Infinity	-94
		2	-94	-94	-Infinity	-94

CSI-RSRP <sup>Note 3</sup>	dBm/SCS kHz	3	-91	-91	-Infinity	-91
		1	-94	-94	-Infinity	-94
		2	-94	-94	-Infinity	-94
		3	-91	-91	-Infinity	-91
I <sub>o</sub>	dBm/9.36 MHz	1	-64.60	-62.25	--64.60	-62.25
		2	-64.60	-62.25	--64.60	-62.25
		3	-58.50	-56.16	--58.50	-56.16
Propagation Condition		1, 2, 3	AWGN			
Note 1:	The resources for uplink transmission are assigned to the UE prior to the start of time period T2.					
Note 2:	Interference from other cells and noise sources not specified in the test is assumed to be constant over subcarriers and time and shall be modelled as AWGN of appropriate power for $N_{oc}$ to be fulfilled.					
Note 3:	CSI-RSRP levels have been derived from other parameters for information purposes. They are not settable parameters themselves.					

### A.6.6.10.1.2 Test Requirements

In this test, the UE shall send one Event A3 triggered measurement report, with a measurement reporting delay less than 920 ms from the beginning of time period T2. The UE is required to read the neighbour cell SSB index and report the acquired SSB index in this test.

The UE shall not send event triggered measurement reports, as long as the reporting criteria are not fulfilled.

The rate of correct events observed during repeated tests shall be at least 90%.

NOTE: The actual overall delays measured in the test may be up to  $2 \times TTI_{DCCH}$  higher than the measurement reporting delays above because of TTI insertion uncertainty of the measurement report in DCCH.

## A.6.6.11 CSI-RS based inter-frequency Measurements

### A.6.6.11.1 SA event triggered reporting tests with gap under DRX

#### A.6.6.11.1.1 Test Purpose and Environment

The purpose of this test is to verify that the UE makes correct reporting of an event. This test will partly verify the SA CSI-RS based L3 inter-frequency measurement requirements in clause 9.10.3.

In this test, there are two cells: NR cell 1 as PCell in FR1 on NR RF channel 1 and NR cell 2 as neighbour cell in FR1 on NR RF channel 2. The test parameters are given in Tables A.6.6.11.1.1-1, A.6.6.11.1.1-2 and A.6.6.11.1.1-3.

In test 1&2 measurement gap pattern configuration # 0 as defined in Table A.6.6.11.1.1-2 is provided for UE that does not support per-FR gap and in test 3&4 measurement gap pattern configuration #4 as defined in Table A.6.6.11.1.1-2 is provided for UE that supports per-FR gap. If a UE supports per-FR gap and gap pattern configuration #4, it is only required to pass test 3&4. Otherwise it is only required to pass test 1&2.

In the measurement control information, it is indicated to the UE that event-triggered reporting with Event A3 is used. The test consists of two successive time periods, with time duration of T1, and T2 respectively. During time duration T1, the UE shall not have any timing information of NR cell 2.

UE needs to be provided at least once every 500 ms with new Timing Advance Command MAC control element to restart the Time alignment timer to keep UE uplink time alignment. Furthermore, UE is allocated with PUSCH resource at every DRX cycle.

**Table A.6.6.11.1.1-1: SA event triggered reporting tests for FR1-FR1**

Config	Description
1	NR 15 kHz SSB and CSI-RS SCS, 10 MHz bandwidth, FDD duplex mode
2	NR 15 kHz SSB and CSI-RS SCS, 10 MHz bandwidth, TDD duplex mode
3	NR 30 kHz SSB and CSI-RS SCS, 40 MHz bandwidth, TDD duplex mode
Note 1:	The UE is only required to be tested in one of the supported test configurations

Note 2: target NR cell has the same SCS, BW and duplex mode as NR serving cell
--

**Table A.6.6.11.1.1-2: General test parameters for SA inter-frequency event triggered reporting for FR1**

Parameter	Unit	Test configuration	Value		Comment
			Test 1	Test 2	
NR RF Channel Number		Config 1,2,3	1, 2		Two FR1 NR carrier frequencies is used.
Active cell		Config 1,2,3	NR cell 1 (Pcell)		NR Cell 1 is on NR RF channel number 1.
Neighbour cell		Config 1,2,3	NR cell2		NR cell 2 is on NR RF channel number 2.
Gap Pattern Id		Config 1,2,3	0	4	As specified in clause 9.1.2-1.
Measurement gap offset		Config 1,2,3	39	19	
A3-Offset	dB	Config 1,2,3	-6		
Hysteresis	dB	Config 1,2,3	0		
CP length		Config 1,2,3	Normal		
TimeToTrigger	s	Config 1,2,3	0		
Filter coefficient		Config 1,2,3	0		L3 filtering is not used
DRX		Config 1,2,3	DRX.5	DRX.5	As specified in clause A.3.3
Time offset between serving and neighbour cells	μs	Config 1	4.7		Asynchronous cells. The timing of Cell 2 is CP later than the timing of Cell 1.
		Config 2	4.7		Synchronous cells.
		Config 3	2.35		Synchronous cells.
T1	s	Config 1,2,3	5		
T2	s	Config 1,2,3	10	10	

**Table A.6.6.11.1.1-3: Cell specific test parameters for SA inter-frequency event triggered reporting for FR1 with SSB time index detection**

Parameter		Unit	Test configuration	Cell 1		Cell 2	
				T1	T2	T1	T2
NR RF Channel Number			Config 1,2,3	1		2	
Duplex mode			Config 1	FDD			
			Config 2,3	TDD			
TDD configuration			Config 1	Not Applicable			
			Config 2	TDDConf.1.1			
			Config 3	TDDConf.2.1			
BW <sub>channel</sub>		MHz	Config 1,2	10: N <sub>RB,c</sub> = 52			
			Config 3	40: N <sub>RB,c</sub> = 106			
BWP BW		MHz	Config 1,2	10: N <sub>RB,c</sub> = 52			
			Config 3	40: N <sub>RB,c</sub> = 106			
BWP configuration	Initial DL BWP		Config 1, 2, 3	DLBWP.0.1		NA	
	Initial UL BWP			ULBWP.0.1		NA	
	Dedicated DL BWP			DLBWP.1.1		NA	
	Dedicated UL BWP			ULBWP.1.1		NA	
TRS configuration			Config 1	TRS.1.1 FDD		NA	
			Config 2	TRS.1.1 TDD		NA	
			Config 3	TRS.1.2 TDD		NA	
OCNG Patterns defined in A.3.2.1.1 (OP.1)			Config 1,2,3	OP.1		OP.1	
PDSCH Reference measurement channel			Config 1	SR.1.1 FDD			
			Config 2	SR.1.1 TDD			

		Config 3	SR2.1 TDD			
CORESET Reference Channel		Config 1	CR.1.1 FDD			
		Config 2	CR.1.1 TDD			
		Config 3	CR2.1 TDD			
SSB parameters		Config 1	SSB.1 FR1		SSB.5 FR1	
		Config 2	SSB.1 FR1		SSB.5 FR1	
		Config 3	SSB.2 FR1		SSB.6 FR1	
SMTC configuration defined in A.3.11		Config 1	SMTC.2		SMTC.5	
		Config 2, 3	SMTC.1		SMTC.4	
CSI-RS configuration for RRM		Config 1	CSI-RS.RRM.FR1.1 FDD		CSI-RS.RRM.FR1.1 FDD	
		Config 2	CSI-RS.RRM.FR1.1 TDD		CSI-RS.RRM.FR1.1 TDD	
		Config 3	CSI-RS.RRM.FR1.2 TDD		CSI-RS.RRM.FR1.2 TDD	
PDSCH/PDCCH subcarrier spacing	kHz	Config 1,2	15			
		Config 3	30			
EPRE ratio of PSS to SSS		Config 1,2,3	0	0		
EPRE ratio of PBCH DMRS to SSS						
EPRE ratio of PBCH to PBCH DMRS						
EPRE ratio of PDCCH DMRS to SSS						
EPRE ratio of PDCCH to PDCCH DMRS						
EPRE ratio of PDSCH DMRS to SSS						
EPRE ratio of PDSCH to PDSCH						
EPRE ratio of OCNG DMRS to SSS(Note 1)						
EPRE ratio of OCNG to OCNG DMRS (Note 1)						
$N_{oc}$ <sup>Note2</sup>	dBm/15 kHz		-98		-98	
$N_{oc}$ <sup>Note2</sup>	dBm/S CS	Config 1,2	-98		-98	
		Config 3	-95		-95	
CSI-RSRP <sup>Note 3</sup>	dBm/S CS	Config 1,2	-94	-94	-Infinity	-91
		Config 3	-91	-91	-Infinity	-88
SS-RSRP <sup>Note 3</sup>	dBm/S CS	Config 1,2	-94	-94	-Infinity	-91
		Config 3	-91	-91	-Infinity	-88
$\hat{E}_s / I_{ot}$	dB	Config 1,2,3	4	4	-Infinity	7
$\hat{E}_s / N_{oc}$	dB	Config 1,2,3	4	4	-Infinity	7
$I_o$ <sup>Note3</sup>	dBm/9.36MHz	Config 1,2	-64.59	-64.59	-70.05	-62.26
	dBm/38.16MHz	Config 3	-58.49	-58.49	-63.94	-56.15
Propagation Condition		Config 1,2,3	AWGN		AWGN	
<p>Note 1: OCNG shall be used such that both cells are fully allocated and a constant total transmitted power spectral density is achieved for all OFDM symbols.</p> <p>Note 2: Interference from other cells and noise sources not specified in the test is assumed to be constant over subcarriers and time and shall be modelled as AWGN of appropriate power for <math>N_{oc}</math> to be fulfilled.</p> <p>Note 3: CSI-RSRP and <math>I_o</math> levels have been derived from other parameters for information purposes. They are not settable parameters themselves.</p> <p>Note 4: CSI-RSRP minimum requirements are specified assuming independent interference and noise at each receiver antenna port.</p>						

### A.6.6.11.1.2 Test Requirements

In test 1 with per-UE gap and test 2 with per-FR gap, the UE shall send one Event A3 triggered measurement report, with a measurement reporting delay less than 9280 ms from the beginning of time period T2. The UE shall not send event triggered measurement reports, as long as the reporting criteria are not fulfilled. The rate of correct events observed during repeated tests shall be at least 90%.

In test 1 and 2 UE is required to report SSB time index.

NOTE: The actual overall delays measured in the test may be up to  $2xTTIDCCH$  higher than the measurement reporting delays above because of TTI insertion uncertainty of the measurement report in DCCH.

## A.6.6.12 RSTD measurements

### A. 6.6.12.1 NR RSTD measurement reporting delay test case for single positioning frequency layer in FR1 SA

#### A. 6.6.12.1.1 Test Purpose and Environment

The purpose of the test is to verify that the RSTD measurement meets the requirements specified in Clause 9.9.2 in an environment with AWGN propagation conditions in FR1 in standalone scenario when single positioning frequency layer is configured.

The supported test configurations are specified in Table A.6.6.12.1.1-1.

**Table A.6.6.12.1.1-1: Supported test configurations**

Configuration	Description
1	15 kHz SSB SCS, 20 MHz bandwidth, FDD duplex mode
2	15 kHz SSB SCS, 20 MHz bandwidth, TDD duplex mode
3	30 kHz SSB SCS, 50 MHz bandwidth, TDD duplex mode
Note:	The UE is only required to be tested in one of the supported test configurations.

In the test there are three synchronous cells: Cell 1, Cell 2 and Cell 3. Cell 1 is the reference as well as the PCell. Cell 2 and Cell 3 are the neighbour cells. All 3 cells are on the same RF channel in FR1.

The test consists of two consecutive time intervals, with duration of T1 and T2. During time duration T1, the UE shall not have any timing information of Cell 2 and Cell 3. All three cells transmit PRS during T2.

Note: The information on when PRS is muted is conveyed to the UE using PRS muting information.

The *NR-DL-TDOA-ProvideAssistanceData* and *nr-DL-TDOA-RequestLocationInformation* as defined in TS 37.355 [34, clause 6.5.12.1], shall be provided to the UE during T1. The last TTI containing the two messages shall be provided to the UE  $\Delta T$  ms before the start of T2, where  $\Delta T = 50$  ms is the maximum processing time of the *DL-TDOA assistance* data and location information request.

The beginning of the time interval T2 shall be aligned with the beginning of the first MG instance containing the PRS resources.

The UE is configured with measurement gap pattern ID # 24 or #0 before T2.

The general test parameters are listed in Table A.6.6.12.1.1-2, and cell specific test parameters are listed in Table A.6.6.12.1.1-3.

**Table A.6.6.12.1.1-2: General test parameters for RSTD measurement reporting delay**

Parameter	Unit	Value	Comment
-----------	------	-------	---------



Reference cell			Cell 1	Reference cell is the cell in the DL-TDOA assistance data with respect to which the RSTD measurement is defined, as specified in TS 38.215 [4] and TS 37.355[34]. The reference cell is the PCell in this test case.
Neighbor cells			Cell 2 and Cell 3	Cell 2 and Cell 3 appear at the first and second places in the neighbour cell list in the DL-TDOA assistance data.
SSB configuration	Config 1		SSB.1 FR1	
	Config 2		SSB.1 FR1	
	Config 3		SSB.2 FR1	
SMTC configuration	Config 1		SMTC.2	
	Config 2		SMTC.1	
	Config 3		SMTC.1	
PDSCH RMC configuration	Config 1		SR.1.1 FDD	
	Config 2		SR.1.1 TDD	
	Config 3		SR.2.1 TDD	
RMSI CORESET RMC configuration	Config 1		CR.1.1 FDD	As specified in clause A.3.1.2.1
	Config 2		CR.1.1 TDD	
	Config 3		CR.2.1 TDD	
Dedicated CORESET RMC configuration	Config 1		CCR.1.1 FDD	
	Config 2		CCR.1.1 TDD	
	Config 3		CCR.2.1 TDD	
Initial BWP configuration	Config 1,2,3		DLBWP.0.1 ULBWP.0.1	
Active DL BWP configuration	Config 1,2,3		DLBWP.1.1	
Active UL BWP configuration	Config 1,2,3		ULBWP.1.1	
PRS Configuration	Config 1		PRS.1.1 FR1	As specified in clause A.3.31
	Config 2		PRS.1.1 FR1	
	Config 3		PRS.2.1 FR1	
Physical cell ID PCI			(PCI of Cell 1 – PCI of Cell 2) mod 6 = 0 and (PCI of Cell 1 – PCI of Cell 3) mod 6 = 0	The cell PCIs are selected such that the relative shifts of PRS patterns among cells are as given by the test parameters
CP length			Normal	
DRX			OFF	
Measurement gap			GP#24 or GP#0	GP#24 is configured if UE supports MG#24, otherwise GP#0 is configured
Radio frame receive time offset between the cells at the UE antenna connector	$\mu\text{s}$		Cell 2 to Cell 1: 0 Cell 3 to Cell 1: 3	PRS are transmitted from synchronous cells
Expected RSTD	$\mu\text{s}$		Cell 2: 3 Cell 3: 3 Other neighbour cells: randomly between -3 and 3	The expected RSTD is what is expected at the receiver. The corresponding parameter in the DL-TDOA assistance data specified in TS 37.355[34] is the expectedRSTD indicator
Expected RSTD uncertainty for all neighbour cells	$\mu\text{s}$		5	The corresponding parameter in the DL-TDOA assistance data specified in TS 37.355[34] is the expectedRSTD-Uncertainty index

Number of cells provided in DL-TDOA assistance data		4	Including the reference cell
PRS muting info		Cell 1: '10' Cell 2: '01' Cell 3: '10'	Corresponds to prs-MutingInfo defined in TS 37.355 [34]
PRS resource RE offset		Cell 1: 0 Cell 2: 0 Cell 3: 1	Cell 1 and Cell 3 are configured with different resource offsets
T1	s	3	The length of the time interval from the beginning of each test
T2	s	1.28	The length of the time interval that follows immediately after time interval T1

Table A.6.6.12.1.1-3: Cell-specific test parameters for RSTD measurement reporting delay during T1

Parameter	Unit	Cell 1	Cell 2	Cell 3	
NR RF Channel Number		1	1	1	
Positioning frequency layer		1	1	1	
Correlation Matrix and Antenna Configuration		1x2 Low	1x2 Low	1x2 Low	
OCNG patterns defined in A.3.2.1		OP.1	N/A	N/A	
EPRE ratio of PSS to SSS	dB	0	N/A	N/A	
EPRE ratio of PBCH DMRS to SSS					
EPRE ratio of PBCH to PBCH DMRS					
EPRE ratio of PDCCH DMRS to SSS					
EPRE ratio of PDCCH to PDCCH DMRS					
EPRE ratio of PDSCH DMRS to SSS					
EPRE ratio of PDSCH to PDSCH DMRS					
EPRE ratio of OCNG DMRS to SSS <sup>Note 1</sup>					
EPRE ratio of OCNG to OCNG DMRS <sup>Note 1</sup>					
$N_{oc}$ <sup>Note 3</sup>	Config 1	dBm/SCS	-98		
	Config 2	dBm/SCS	-98		
	Config 3	dBm/SCS	-95		
PRS $\hat{E}_s/N_{oc}$	dB	-Infinity	-Infinity	-Infinity	
SSB $\hat{E}_s/N_{oc}$	dB	10	-Infinity	-Infinity	
$I_0$ <sup>Note 4</sup>	Config 1	dBm/ 19.08MHz	-56.54	-56.54	-56.54
	Config 2	dBm/ 19.08MHz	-56.54	-56.54	-56.54
	Config 3	dBm/ 47.88MHz	-52.56	-52.56	-52.56
SSB RP <sup>Note4</sup>	Config 1	dBm/SCS	-88	-Infinity	-Infinity
	Config 2	dBm/SCS	-88	-Infinity	-Infinity
	Config 3	dBm/SCS	-85	-Infinity	-Infinity
Propagation Condition		AWGN			

Note 1:	OCNG shall be used such that active cell (Cell 1) is fully allocated and a constant total transmitted power spectral density is achieved for all OFDM symbols other than those in the slots with transmitted PRS.
Note 2:	The resources for uplink transmission are assigned to the UE prior to the start of time period T2.
Note 3:	Interference from other cells and noise sources not specified in the test are assumed to be constant over subcarriers and time and shall be modelled as AWGN of appropriate power for $N_{oc}$ to be fulfilled.
Note 4:	SSB RP and $I_o$ levels have been derived from other parameters and are given for information purpose. These are not settable test parameters.

**Table A.6.6.12.1.1-4: Cell-specific test parameters for RSTD measurement reporting delay during T2**

Parameter	Unit	Cell 1	Cell 2	Cell 3	
		T2	T2	T2	
NR RF Channel Number		1	1	1	
Correlation Matrix and Antenna Configuration		1x2 Low	1x2 Low	1x2 Low	
OCNG patterns defined in A.3.2.1		OP.1	OP.1	OP.1	
PRACH configuration		FR1 PRACH configuration 1	FR1 PRACH configuration 1	FR1 PRACH configuration 1	
EPRE ratio of PSS to SSS	dB	0	0	0	
EPRE ratio of PBCH DMRS to SSS					
EPRE ratio of PBCH to PBCH DMRS					
EPRE ratio of PDCCH DMRS to SSS					
EPRE ratio of PDCCH to PDCCH DMRS					
EPRE ratio of PDSCH DMRS to SSS					
EPRE ratio of PDSCH to PDSCH DMRS					
EPRE ratio of OCNG DMRS to SSS <sup>Note 1</sup>					
EPRE ratio of OCNG to OCNG DMRS <sup>Note 1</sup>					
$N_{oc}$ <sup>Note 3</sup>					Config 1
	Config 2	dBm/SCS	-98	-98	-98
	Config 3	dBm/SCS	-95	-95	-95
PRS $\hat{E}_s/N_{oc}$	Config 1	dB	-5.45	-11.67	-11.67
	Config 2	dB	-5.45	-11.67	-11.67
	Config 3	dB	-5.45	-11.67	-11.67
SSB $\hat{E}_s/N_{oc}$	Config 1~3	dB	10	3	3
$I_o$ <sup>Note 4</sup>	Config 1	dBm/19.08MHz	-65.43	-65.43	-65.43
	Config 2	dBm/19.08MHz	-65.43	-65.43	-65.43
	Config 3	dBm/47.88MHz	-61.44	-61.44	-61.44
SSB RP <sup>Note4</sup>	Config 1	dBm/SCS	-88	-95	-95
	Config 2	dBm/SCS	-88	-95	-95
	Config 3	dBm/SCS	-85	-92	-92
PRS $\hat{E}_s/I_{ot}$		dB	-6.00	-12.98	-12.98
Propagation Condition			AWGN		

Note 1:	OCNG shall be used such that active cells are fully allocated and a constant total transmitted power spectral density is achieved for all OFDM symbols other than those in the slots with transmitted PRS.
Note 2:	The resources for uplink transmission are assigned to the UE prior to the start of time period T2.
Note 3:	Interference from other cells and noise sources not specified in the test are assumed to be constant over subcarriers and time and shall be modelled as AWGN of appropriate power for $N_{oc}$ to be fulfilled.
Note 4:	SSB RP and lo levels have been derived from other parameters and are given for information purpose. These are not settable test parameters. The lo is calculated based only on the symbols in which PRS is transmitted.

### A.6.6.12.1.2 Test Requirements

The RSTD measurement time fulfils the requirements specified in Clause 9.9.2.5.

The UE shall perform and report the RSTD measurements for Cell 2 and Cell 3 with respect to the reference cell in the DL-TDOA assistance data, Cell 1, within the time duration specified in section 9.9.2.5 starting from the beginning of time interval T2.

- NOTE: The actual overall delays measured in the test may be up to  $2 \times TTI_{DCCH}$  higher than the time duration above because of TTI insertion uncertainty of the measurement report in DCCH.

The rate of the correct events for each neighbour cell observed during repeated tests shall be at least 90%, where the reported RSTD measurement for each correct event shall be within the RSTD reporting range specified in Clause 10.1.23.3, i.e., between RSTD\_0000000 and RSTD1970049

## A. 6.6.12.2 NR RSTD measurement reporting delay test case for dual positioning frequency layers in FR1 SA

### A. 6.6.12.2.1 Test Purpose and Environment

The purpose of the test is to verify that the RSTD measurement meets the requirements specified in Clause 9.9.2 in an environment with AWGN propagation conditions in FR1 in standalone scenario when dual positioning frequency layers are configured.

The supported test configurations are specified in Table A.6.6.12.2.1-1.

**Table A.6.6.12.2.1-1: Supported test configurations**

Configuration	Description
1	15 kHz SSB SCS, 20 MHz bandwidth, FDD duplex mode
2	15 kHz SSB SCS, 20 MHz bandwidth, TDD duplex mode
3	30 kHz SSB SCS, 50 MHz bandwidth, TDD duplex mode
Note:	The UE is only required to be tested in one of the supported test configurations.

In the test there are three synchronous cells: Cell 1, Cell 2 and Cell 3. Cell 1 is the reference as well as the PCell. Cell 2 and Cell 3 are the neighbour cells. Cell 3 is on a different RF channel with Cell 1 and Cell 2.

The test consists of two consecutive time intervals, with duration of T1 and T2. During time duration T1, the UE shall not have any timing information of Cell 2 and Cell 3. All three cells transmit PRS during T2.

Note: The information on when PRS is muted is conveyed to the UE using PRS muting information.

The *NR-DL-TDOA-ProvideAssistanceData* and *nr-DL-TDOA-RequestLocationInformation* as defined in TS 37.355 [34, clause 6.5.12.1], shall be provided to the UE during T1. The last TTI containing the two messages shall be provided to the UE  $\Delta T$  ms before the start of T2, where  $\Delta T = 50$  ms is the maximum processing time of the *DL-TDOA assistance* data and location information request.

The beginning of the time interval T2 shall be aligned with the beginning of the first MG instance containing the PRS resources.

The UE is configured with measurement gap pattern ID # 24 or #0 before T2.

The general test parameters are listed in Table A.6.6.12.2.1-2, and cell specific test parameters are listed in Table A.6.6.12.2.1-3.

**Table A.6.6.12.2.1-2: General test parameters for RSTD measurement reporting delay**

Parameter		Unit	Value	Comment
Reference cell			Cell 1	Reference cell is the cell in the DL-TDOA assistance data with respect to which the RSTD measurement is defined, as specified in TS 38.215 [4] and TS 37.355[34]. The reference cell is the PCell in this test case.
Neighbor cells			Cell 2 and Cell 3	Cell 2 and Cell 3 appear at the first place in the respective neighbour cell list in the DL-TDOA assistance data for two positioning frequency layers
SSB configuration	Config 1		SSB.1 FR1	
	Config 2		SSB.1 FR1	
	Config 3		SSB.2 FR1	
SMTC configuration	Config 1		SMTC.2	
	Config 2		SMTC.1	
	Config 3		SMTC.1	
PDSCH RMC configuration	Config 1		SR.1.1 FDD	
	Config 2		SR.1.1 TDD	
	Config 3		SR.2.1 TDD	
RMSI CORESET RMC configuration	Config 1		CR.1.1 FDD	As specified in clause A.3.1.2.1
	Config 2		CR.1.1 TDD	
	Config 3		CR.2.1 TDD	
Dedicated CORESET RMC configuration	Config 1		CCR.1.1 FDD	
	Config 2		CCR.1.1 TDD	
	Config 3		CCR.2.1 TDD	
Initial BWP configuration	Config 1,2,3		DLBWP.0.1 ULBWP.0.1	
Active DL BWP configuration	Config 1,2,3		DLBWP.1.1	
Active UL BWP configuration	Config 1,2,3		ULBWP.1.1	
PRS Configuration	Config 1		PRS.1.1 FR1	As specified in clause A.3. 31
	Config 2		PRS.1.1 FR1	
	Config 3		PRS.2.1 FR1	
Physical cell ID PCI			(PCI of Cell 1 – PCI of Cell 2)mod6=0 and (PCI of Cell 1 – PCI of Cell 3)mod6=0	The cell PCIs are selected such that the relative shifts of PRS patterns among cells are as given by the test parameters
CP length			Normal	
DRX			OFF	
Measurement gap			GP#24 or GP#0	GP#24 is configured if UE supports MG#24, otherwise GP#0 is configured
Radio frame receive time offset between the cells at the UE antenna connector		µs	Cell 2 to Cell 1: 0 Cell 3 to Cell 1: 3	PRS are transmitted from synchronous cells

Expected RSTD	$\mu\text{s}$	Cell 2: 3 Cell 3: 3 Other neighbour cells: randomly between -3 and 3	The expected RSTD is what is expected at the receiver. The corresponding parameter in the DL-TDOA assistance data specified in TS 37.355[34] is the expectedRSTD indicator
Expected RSTD uncertainty for all neighbour cells	$\mu\text{s}$	5	The corresponding parameter in the DL-TDOA assistance data specified in TS 37.355[34] is the expectedRSTD-Uncertainty index
Number of cells provided in DL-TDOA assistance data		4	Including the reference cell
PRS muting info		Cell 1: '10' Cell 2: '01' Cell 3: '10'	Corresponds to prs-MutingInfo defined in TS 37.355 [34]
PRS resource RE offset		Cell 1: 0 Cell 2: 0 Cell 3: 1	Cell 1 and Cell 3 are configured with different resource offsets
T1	s	3	The length of the time interval from the beginning of each test
T2	s	1.28	The length of the time interval that follows immediately after time interval T1

**Table A.6.6.12.2.1-3: Cell-specific test parameters for RSTD measurement reporting delay during T1**

Parameter		Unit	Cell 1	Cell 2	Cell 3
NR RF Channel Number			1	1	2
Positioning frequency layer			1	1	2
Correlation Matrix and Antenna Configuration			1x2 Low	1x2 Low	1x2 Low
OCNG patterns defined in A.3.2.1			OP.1	N/A	N/A
EPRE ratio of PSS to SSS		dB	0	N/A	N/A
EPRE ratio of PBCH DMRS to SSS					
EPRE ratio of PBCH to PBCH DMRS					
EPRE ratio of PDCCH DMRS to SSS					
EPRE ratio of PDCCH to PDCCH DMRS					
EPRE ratio of PDSCH DMRS to SSS					
EPRE ratio of PDSCH to PDSCH DMRS					
EPRE ratio of OCNG DMRS to SSS <sup>Note 1</sup>					
EPRE ratio of OCNG to OCNG DMRS <sup>Note 1</sup>					
$N_{oc}$ <sup>Note 3</sup>	Config 1	dBm/SCS	-98		
	Config 2	dBm/SCS	-98		
	Config 3	dBm/SCS	-95		
PRS $\hat{E}_s/N_{oc}$		dB	-Infinity	-Infinity	-Infinity
SSB $\hat{E}_s/N_{oc}$		dB	10	-Infinity	-Infinity
$I_o$ <sup>Note 4</sup>	Config 1	dBm/ 19.08MHz	-56.54	-56.54	-66.96
	Config 2	dBm/ 19.08MHz	-56.54	-56.54	-66.96
	Config 3	dBm/ 47.88MHz	-52.56	-52.56	-62.97

SSB RP Note 4	Config 1	dBm/SCS	-88	-Infinity	-Infinity
	Config 2	dBm/SCS	-88	-Infinity	-Infinity
	Config 3	dBm/SCS	-85	-Infinity	-Infinity
Propagation Condition			AWGN		
<p>Note 1: OCNG shall be used such that active cell (Cell 1) is fully allocated and a constant total transmitted power spectral density is achieved for all OFDM symbols other than those in the slots with transmitted PRS.</p> <p>Note 2: The resources for uplink transmission are assigned to the UE prior to the start of time period T2.</p> <p>Note 3: Interference from other cells and noise sources not specified in the test are assumed to be constant over subcarriers and time and shall be modelled as AWGN of appropriate power for <math>N_{oc}</math> to be fulfilled.</p> <p>Note 4: SSB RP and <math>I_o</math> levels have been derived from other parameters and are given for information purpose. These are not settable test parameters.</p>					

**Table A.6.6.12.2.1-4: Cell-specific test parameters for RSTD measurement reporting delay during T2**

Parameter	Unit	Cell 1	Cell 2	Cell 3	
		T2	T2	T2	
NR RF Channel Number		1	1	2	
Positioning frequency layer		1	1	2	
Correlation Matrix and Antenna Configuration		1x2 Low	1x2 Low	1x2 Low	
OCNG patterns defined in A.3.2.1		OP.1	OP.1	OP.1	
EPRE ratio of PSS to SSS	dB	0	0	0	
EPRE ratio of PBCH DMRS to SSS					
EPRE ratio of PBCH to PBCH DMRS					
EPRE ratio of PDCCH DMRS to SSS					
EPRE ratio of PDCCH to PDCCH DMRS					
EPRE ratio of PDSCH DMRS to SSS					
EPRE ratio of PDSCH to PDSCH DMRS					
EPRE ratio of OCNG DMRS to SSS <sup>Note 1</sup>					
EPRE ratio of OCNG to OCNG DMRS <sup>Note 1</sup>					
EPRE ratio of PRS to SSS					
PRACH configuration		FR1 PRACH configuration 1	FR1 PRACH configuration 1	FR1 PRACH configuration 1	
$N_{oc}$ Note 3	Config 1	dBm/SCS	-98	-98	-98
	Config 2	dBm/SCS	-98	-98	-98
	Config 3	dBm/SCS	-95	-95	-95
PRS $\hat{E}_s/N_{oc}$	Config 1	dB	-5.7	-11.9	-13
	Config 2	dB	-5.7	-11.9	-13
	Config 3	dB	-5.7	-11.9	-13
$I_o$ Note 4	Config 1	dBm/19.08MHz	-65.70	-65.70	-66.74
	Config 2	dBm/19.08MHz	-65.70	-65.70	-66.74
	Config 3	dBm/47.88MHz	-61.72	-61.72	-62.76
PRS $\hat{E}_s/I_{ot}$	dB	-6	-13	-13	

Propagation Condition	AWGN
Note 1:	OCNG shall be used such that active cells are fully allocated and a constant total transmitted power spectral density is achieved for all OFDM symbols other than those in the slots with transmitted PRS.
Note 2:	The resources for uplink transmission are assigned to the UE prior to the start of time period T2.
Note 3:	Interference from other cells and noise sources not specified in the test are assumed to be constant over subcarriers and time and shall be modelled as AWGN of appropriate power for $N_{oc}$ to be fulfilled.
Note 4:	SSB RP and Io levels have been derived from other parameters and are given for information purpose. These are not settable test parameters. The Io is calculated based only on the symbols in which PRS is transmitted.

### A.6.6.12.2.2 Test Requirements

The RSTD measurement time fulfils the requirements specified in Clause 9.9.2.5.

The UE shall perform and report the RSTD measurements for Cell 2 and Cell 3 with respect to the reference cell in the DL-TDOA assistance data, Cell 1, within the time duration specified in section 9.9.2.5 starting from the beginning of time interval T2.

- NOTE: The actual overall delays measured in the test may be up to  $2 \times TTI_{DCCH}$  higher than the time duration above because of TTI insertion uncertainty of the measurement report in DCCH.

The rate of the correct events for each neighbour cell observed during repeated tests shall be at least 90%, where the reported RSTD measurement for each correct event shall be within the RSTD reporting range specified in Clause 10.1.23.3, i.e., between RSTD\_0000000 and RSTD\_1970049.

## A.6.6.13 PRS-RSRP measurements

### A.6.6.13.1 PRS-RSRP reporting delay test case for single positioning frequency layer

#### A.6.6.13.1.1 Test purpose and Environment

The purpose of the test is to verify that the PRS-RSRP measurement meets the delay requirements specified in clause 9.9.3.5 in an environment with AWGN propagation conditions.

The supported test configurations are specified in Table A.6.6.13.1.1-1.

**Table A.6.6.13.1.1-1: Supported test configurations**

Configuration	Description
1	15 kHz SSB SCS, 20 MHz bandwidth, FDD duplex mode
2	15 kHz SSB SCS, 20 MHz bandwidth, TDD duplex mode
3	30 kHz SSB SCS, 50 MHz bandwidth, TDD duplex mode
Note:	The UE is only required to be tested in one of the supported test configurations.

In the test there are two synchronous cells: Cell 1 and Cell 2. Cell 1 is the reference as well as the PCell. Cell 2 is a neighbour cell. Both cells are on the same NR RF channel in FR1. The test consists of two consecutive time intervals, with duration of T1 and T2. Both cells transmit PRS during T2.

The *NR-DL-AoD-RequestLocationInformation* message and *NR-DL-AoD-ProvideAssistanceData* message as defined in TS 37.355 shall be provided to the UE during T1. The last slot containing the two messages for the assistance data and location information request is denoted as #n.

The beginning of the time interval T2 shall be aligned with the beginning of the first MG instance containing the PRS resources that is  $\Delta T$  after slot #n, where  $\Delta T = 50$  ms is the maximum processing time of the assistance data and location information request.

The general test parameters are listed in Table A.6.6.13.1.1-2, and cell specific test parameters are listed in Table A.6.6.13.1.1-3.



Table A.6.6.13.1.1-2: General test parameters

Parameter	Unit	Test configuration	Value	Comment
Reference cell		1, 2, 3	Cell 1	Cell 1 is the PCell and the DL-AoD reference cell in the positioning assistance data.
Neighbour cell		1, 2, 3	Cell 2	Cell 2 is a neighbour cell in the positioning assistance data.
RF Channel Number		1, 2, 3	1: Cell 1 and Cell 2	
BW <sub>channel</sub>	MHz	1	20: N <sub>RB,c</sub> = 106	
		2	20: N <sub>RB,c</sub> = 106	
		3	50: N <sub>RB,c</sub> = 133	
SSB configuration		1	SSB.1 FR1	
		2	SSB.1 FR1	
		3	SSB.2 FR1	
SMTC configuration		1	SMTC.2	
		2	SMTC.1	
		3	SMTC.1	
Measurement gap		1, 2, 3	GP#24 or GP#0 <sup>Note 1</sup>	
CP length		1, 2, 3	Normal	
DRX		1, 2, 3	NA	OFF
Time offset between serving and neighbour cells	μs	1, 2, 3	3	Synchronous cells
Expected RSTD	μs	1, 2, 3	3	
Expected RSTD uncertainty	μs	1, 2, 3	5	
T1	s	1, 2, 3	2	
T2	s	1, 2, 3	5	

NOTE 1: GP#24 is configured if UE supports MG#24, otherwise GP#0 is configured.

Table A.6.6.13.1.1-3: Cell specific test parameters

Parameter	Unit	Test configuration	Cell 1		Cell 2	
			T1	T2	T1	T2
TDD configuration		1	N/A		N/A	
		2	TDDConf.1.1		TDDConf.1.1	
		3	TDDConf.2.1		TDDConf.2.1	
PDSCH RMC configuration		1	SR.1.1 FDD		N/A	
		2	SR.1.1 TDD			
		3	SR.2.1 TDD			
RMSI CORESET RMC configuration		1	CR.1.1 FDD		N/A	
		2	CR.1.1 TDD			
		3	CR.2.1 TDD			
Dedicated CORESET RMC configuration		1	CCR.1.1 FDD		N/A	
		2	CCR.1.1 TDD			
		3	CCR.2.1 TDD			
OCNG Patterns		1, 2, 3	OP.1		OP.1	
EPRE ratio of PSS to SSS	dB	1, 2, 3	0		0	
EPRE ratio of PBCH DMRS to SSS						
EPRE ratio of PBCH to PBCH DMRS						
EPRE ratio of PDCCH DMRS to SSS						
EPRE ratio of PDCCH to PDCCH DMRS						
EPRE ratio of PDSCH DMRS to SSS						

EPRE ratio of PDSCH to PDSCH DMRS						
EPRE ratio of OCNG DMRS to SSS <sup>Note 1</sup>						
EPRE ratio of OCNG to OCNG DMRS <sup>Note 1</sup>						
EPRE ratio of PRS to SSS						
TRS Configuration		1	TRS.1.1 FDD	N/A		
		2	TRS.1.1 TDD			
		3	TRS.1.2 TDD			
Initial BWP configuration		1, 2, 3	DLBWP.0.1 ULBWP.0.1	N/A		
Active DL BWP configuration		1, 2, 3	DLBWP.1.1	N/A		
Active UL BWP configuration		1, 2, 3	ULBWP.1.1	N/A		
PRS configuration		1	PRS.1.4 FR1	PRS.1.4 FR1		
		2	PRS.1.4 FR1	PRS.1.4 FR1		
		3	PRS.2.4 FR1	PRS.2.4 FR1		
PRS muting info		1, 2, 3	'10'	'01'		
$N_{oc}$ <sup>Note 2</sup>	dBm/SCS	1	-98			
		2	-98			
		3	-95			
$N_{oc}$ <sup>Note 2</sup>	dBm/15 kHz	1	-98			
		2				
		3				
PRS $\hat{E}_s/I_{ot}$	dB	1	-Infinity	-2.41	-Infinity	-12.12
		2				
		3				
PRS $\hat{E}_s/N_{oc}$	dB	1	-Infinity	-2	-Infinity	-10
		2				
		3				
PRP <sup>Note 3</sup>	dBm/SCS kHz	1	-Infinity	-100	-Infinity	-108
		2	-Infinity	-100	-Infinity	-108
		3	-Infinity	-97	-Infinity	-105
Io	dBm/19.08 MHz	1	N/A	-64.57	N/A	-64.57
		2		-64.57		-64.57
		3		-60.59		-60.59
Propagation Condition		1, 2, 3	AWGN			
<p>Note 1: The resources for uplink transmission are assigned to the UE prior to the start of time period T2.</p> <p>Note 2: Interference from other cells and noise sources not specified in the test is assumed to be constant over subcarriers and time and shall be modelled as AWGN of appropriate power for <math>N_{oc}</math> to be fulfilled.</p> <p>Note 3: PRP levels have been derived from other parameters for information purposes. They are not settable parameters themselves.</p>						

### A.6.6.13.1.2 Test Requirements

The UE shall perform and report the PRS-RSRP measurements for Cell 1 and Cell 2, within the time limit specified in clause 9.9.3.5, starting from the beginning of time interval T2.

- NOTE: The actual overall delays measured in the test may be up to  $2 \times TTI_{DCCH}$  higher than the time limit above because of TTI insertion uncertainty of the measurement report in DCCH.

The rate of correct events observed during repeated tests shall be at least 90%.

### A.6.6.13.2 PRS-RSRP reporting delay test case for dual positioning frequency layer

#### A.6.6.13.2.1 Test purpose and Environment

The purpose of the test is to verify that the PRS-RSRP measurement meets the delay requirements specified in clause 9.9.3.5 in an environment with AWGN propagation conditions.

The supported test configurations are specified in Table A.6.6.13.2.1-1.

**Table A.6.6.13.2.1-1: Supported test configurations**

Configuration	Description
1	15 kHz SSB SCS, 20 MHz bandwidth, FDD duplex mode
2	15 kHz SSB SCS, 20 MHz bandwidth, TDD duplex mode
3	30 kHz SSB SCS, 50 MHz bandwidth, TDD duplex mode
Note:	The UE is only required to be tested in one of the supported test configurations.

In the test there are two synchronous cells: Cell 1 and Cell 2. Cell 1 is the reference as well as the PCell on NR RF channel #1 in FR1. Cell 2 is a neighbour cell on a different NR RF channel #2 in FR1. The test consists of two consecutive time intervals, with duration of T1 and T2. Both cells transmit PRS during T2.

The *NR-DL-AoD-RequestLocationInformation* message and *NR-DL-AoD-ProvideAssistanceData* message as defined in TS 37.355 shall be provided to the UE during T1. The last slot containing the two messages for the assistance data and location information request is denoted as #n.

The beginning of the time interval T2 shall be aligned with the beginning of the first MG instance containing the PRS resources that is  $\Delta T$  after slot #n, where  $\Delta T = 50$  ms is the maximum processing time of the assistance data and location information request.

The general test parameters are listed in Table A.6.6.13.2.1-2, and cell specific test parameters are listed in Table A.6.6.13.2.1-3.

**Table A.6.6.13.2.1-2: General test parameters**

Parameter	Unit	Test configuration	Value	Comment
Reference cell		1, 2, 3	Cell 1	Cell 1 is the PCell and the DL-AoD reference cell in the positioning assistance data.
Neighbour cell		1, 2, 3	Cell 2	Cell 2 is a neighbour cell in the positioning assistance data.
RF Channel Number		1, 2, 3	1: Cell 1 2: Cell 2	Cell 1 and Cell 2 are on different positioning frequency layers
BW <sub>channel</sub>	MHz	1	20: N <sub>RB,c</sub> = 106	
		2	20: N <sub>RB,c</sub> = 106	
		3	50: N <sub>RB,c</sub> = 133	
SSB configuration		1	SSB.1 FR1	
		2	SSB.1 FR1	
		3	SSB.2 FR1	
SMTC configuration		1	SMTC.2	
		2	SMTC.1	
		3	SMTC.1	
Measurement gap		1, 2, 3	GP#24 or GP#0 <sup>Note 1</sup>	
CP length		1, 2, 3	Normal	
DRX		1, 2, 3	NA	OFF
Time offset between serving and neighbour cells	μs	1, 2, 3	3	Synchronous cells
Expected RSTD	μs	1, 2, 3	3	
Expected RSTD uncertainty	μs	1, 2, 3	5	
T1	s	1, 2, 3	2	
T2	s	1, 2, 3	10	
NOTE 1: GP#24 is configured if UE supports MG#24, otherwise GP#0 is configured.				

Table A.6.6.13.2.1-3: Cell specific test parameters

Parameter	Unit	Test configuration	Cell 1		Cell 2							
			T1	T2	T1	T2						
TDD configuration		1	N/A		N/A							
		2	TDDConf.1.1		TDDConf.1.1							
		3	TDDConf.2.1		TDDConf.2.1							
PDSCH RMC configuration		1	SR.1.1 FDD		N/A							
		2	SR.1.1 TDD									
		3	SR.2.1 TDD									
RMSI CORESET RMC configuration		1	CR.1.1 FDD		N/A							
		2	CR.1.1 TDD									
		3	CR.2.1 TDD									
Dedicated CORESET RMC configuration		1	CCR.1.1 FDD		N/A							
		2	CCR.1.1 TDD									
		3	CCR.2.1 TDD									
OCNG Patterns		1, 2, 3	OP.1		OP.1							
EPRE ratio of PSS to SSS	dB	1, 2, 3	0		0							
EPRE ratio of PBCH DMRS to SSS												
EPRE ratio of PBCH to PBCH DMRS												
EPRE ratio of PDCCH DMRS to SSS												
EPRE ratio of PDCCH to PDCCH DMRS												
EPRE ratio of PDSCH DMRS to SSS												
EPRE ratio of PDSCH to PDSCH DMRS												
EPRE ratio of OCNG DMRS to SSS <sup>Note 1</sup>												
EPRE ratio of OCNG to OCNG DMRS <sup>Note 1</sup>												
EPRE ratio of PRS to SSS												
TRS Configuration								1	TRS.1.1 FDD		N/A	
								2	TRS.1.1 TDD			
	3	TRS.1.2 TDD										
Initial BWP configuration		1, 2, 3	DLBWP.0.1 ULBWP.0.1		N/A							
Active DL BWP configuration		1, 2, 3	DLBWP.1.1		N/A							
Active UL BWP configuration		1, 2, 3	ULBWP.1.1		N/A							
PRS configuration		1	PRS.1.4 FR1		PRS.1.4 FR1							
		2	PRS.1.4 FR1		PRS.1.4 FR1							
		3	PRS.2.4 FR1		PRS.2.4 FR1							
PRS muting info		1, 2, 3	'10'		'01'							
$N_{oc}$ <sup>Note 2</sup>	dBm/SCS	1	-98									
		2	-98									
		3	-95									
$N_{oc}$ <sup>Note 2</sup>	dBm/15 kHz	1	-98									
		2										
		3										
$PRS \hat{E}_s / I_{ot}$	dB	1	-Infinity	-3	-Infinity	-13						
		2										

PRS $\hat{E}_s / N_{oc}$	dB	3	-Infinity	-3	-Infinity	-13
		1				
		2				
		3				
PRP <sup>Note 3</sup>	dBm/SCS kHz	1	-Infinity	-101	-Infinity	-111
		2	-Infinity	-101	-Infinity	-111
		3	-Infinity	-98	-Infinity	-108
Io	dBm/19.08 MHz	1	N/A	-65.19	N/A	-66.74
		2				
		3				
dBm/19.08 MHz	1	N/A	-65.19	N/A	-66.74	
	2					
	3					
dBm/47.88 MHz	1	N/A	-61.21	N/A	-62.76	
	2					
	3					
Propagation Condition		1, 2, 3	AWGN			
<p>Note 1: The resources for uplink transmission are assigned to the UE prior to the start of time period T2.</p> <p>Note 2: Interference from other cells and noise sources not specified in the test is assumed to be constant over subcarriers and time and shall be modelled as AWGN of appropriate power for <math>N_{oc}</math> to be fulfilled.</p> <p>Note 3: PRP levels have been derived from other parameters for information purposes. They are not settable parameters themselves.</p>						

#### A.6.6.13.2.2 Test Requirements

The UE shall perform and report the PRS-RSRP measurements for Cell 1 and Cell 2, within the time limit specified in clause 9.9.3.5, starting from the beginning of time interval T2.

- NOTE: The actual overall delays measured in the test may be up to  $2 \times TTI_{DCC}$  higher than the time limit above because of TTI insertion uncertainty of the measurement report in DCCCH.

The rate of correct events observed during repeated tests shall be at least 90%.

### A.6.6.14 UE Rx-Tx time difference measurements

#### A.6.6.14.1 UE Rx-Tx time difference measurement for single positioning frequency layer in FR1 SA

##### A.6.6.14.1.1 Test purpose and environment

The purpose of the test is to verify that the UE Rx-Tx measurement meets the requirements specified in clause 9.9.4.5 in AWGN propagation condition in FR1 in standalone scenario when single positioning frequency layer is configured.

The supported test configurations are listed in Table A.6.6.14.1.1-1.

**Table A.6.6.14.1.1-1: Supported test configurations**

Configuration	Description
1	15 kHz SSB SCS, 20 MHz bandwidth, FDD duplex mode
2	15 kHz SSB SCS, 20 MHz bandwidth, TDD duplex mode
3	30 kHz SSB SCS, 50 MHz bandwidth, TDD duplex mode
Note:	The UE is only required to be tested in one of the supported test configurations.

There are two cells in the test: PCell (Cell 1) and a neighbour cell (Cell 2). Both cells are on the same RF channel in FR1.

The test consists of two consecutive time intervals, with duration of T1 and T2. Cell 1 and Cell 2 mute PRS transmission during T1 and transmit PRS during T2.

The *NR-Multi-RTT-ProvideAssistanceData* and *nr-Multi-RTT-RequestLocationInformation* as defined in TS 37.355 [34, clause 6.5.12.1], shall be provided to the UE during T1. The last TTI containing the two messages shall be provided to

the UE  $\Delta T$  ms before the start of T2, where  $\Delta T = 50$  ms is the maximum processing time of the multi-RTT assistance data and location information request.

The beginning of the time interval T2 shall be aligned with the beginning of the first MG instance containing the PRS resources.

The UE is configured with measurement gap pattern ID #0 or ID #24 before T2.

The UE is configured to transmit positioning SRS during T2.

The general test parameters and cell specific test parameters are as given in Table A.6.6.14.1.1-2 and Table A.6.6.14.1.1-3 respectively.

**Table A.6.6.14.1.1-2: General test parameters**

Parameter	Unit	Test configuration	Value	Comment
Active cell		1, 2, 3	Cell 1	Cell 1 is the PCell in <i>NR-Multi-RTT-ProvideAssistanceData</i> [34].
Neighbour cell		1, 2, 3	Cell 2	Cell 2 is a neighbour cell in <i>NR-Multi-RTT-ProvideAssistanceData</i> [34].
RF Channel Number		1, 2, 3	1	For both Cell 1 and Cell 2
BW <sub>channel</sub>	MHz	1	20: N <sub>RB,c</sub> = 106	
		2	20: N <sub>RB,c</sub> = 106	
		3	50: N <sub>RB,c</sub> = 133	
SSB configuration		1	SSB.1 FR1	
		2	SSB.1 FR1	
		3	SSB.2 FR1	
SMTC configuration		1	SMTC.2	
		2	SMTC.1	
		3	SMTC.1	
Measurement gap		1, 2, 3	GP#24 or GP#0 <sup>Note 1</sup>	
CP length		1, 2, 3	Normal	
DRX		1, 2, 3	OFF	
Time offset between serving and neighbour cells	μs	1, 2, 3	3	Synchronous cells
T1	s	1, 2, 3	5	
T2	s	1, 2, 3	10	
Note 1: GP#24 is configured if UE supports MG#24, otherwise GP#0 is configured.				

**Table A.6.6.14.1.1-3: Cell specific test parameters**

Parameter	Unit	Test configuration	Cell 1		Cell 2	
			T1	T2	T1	T2
TDD configuration		1	N/A		N/A	
		2	TDDConf.1.1		TDDConf.1.1	
		3	TDDConf.2.1		TDDConf.2.1	
PDSCH RMC configuration		1	SR.1.1 FDD		N/A	
		2	SR.1.1 TDD			
		3	SR.2.1 TDD			
RMSI CORESET RMC configuration		1	CR.1.1 FDD		N/A	
		2	CR.1.1 TDD			
		3	CR.2.1 TDD			
Dedicated CORESET RMC configuration		1	CCR.1.1 FDD		N/A	
		2	CCR.1.1 TDD			
		3	CCR.2.1 TDD			
OCNG Patterns		1, 2, 3	OP.1		OP.1	
EPRE ratio of PSS to SSS	dB	1, 2, 3	0		0	
EPRE ratio of PBCH DMRS to SSS						
EPRE ratio of PBCH to PBCH DMRS						

EPRE ratio of PDCCH DMRS to SSS						
EPRE ratio of PDCCH to PDCCH DMRS						
EPRE ratio of PDSCH DMRS to SSS						
EPRE ratio of PDSCH to PDSCH DMRS						
EPRE ratio of OCNG DMRS to SSS <sup>Note 1</sup>						
EPRE ratio of OCNG to OCNG DMRS <sup>Note 1</sup>						
EPRE ratio of PRS to SSS						
TRS Configuration		1	TRS.1.1 FDD	N/A		
		2	TRS.1.1 TDD			
		3	TRS.1.2 TDD			
Initial BWP configuration		1, 2, 3	DLBWP.0.1 ULBWP.0.1	N/A		
Active DL BWP configuration		1, 2, 3	DLBWP.1.1	N/A		
Active UL BWP configuration		1, 2, 3	ULBWP.1.1	N/A		
PRS configuration		1	PRS.1.2 FR1	PRS.1.2 FR1		
		2	PRS.1.2 FR1	PRS.1.2 FR1		
		3	PRS.2.2 FR1	PRS.2.2 FR1		
PRS muting info		1, 2, 3	'10'	'01'		
SRS configuration		1	POS-SRS.1	N/A		
		2	POS-SRS.1	N/A		
		3	POS-SRS.2	N/A		
$N_{oc}$ <sup>Note 2</sup>	dBm/SCS	1	-98			
		2	-98			
		3	-95			
$N_{oc}$ <sup>Note 2</sup>	dBm/15 kHz	1	-98			
		2				
		3				
PRS $\hat{E}_s/I_{ot}$	dB	1	-Infinity	-2.41	-Infinity	-12.12
		2				
		3				
PRS $\hat{E}_s/N_{oc}$	dB	1	-Infinity	-2	-Infinity	-10
		2				
		3				
PRP <sup>Note 3</sup>	dBm/SCS kHz	1	-Infinity	-100	-Infinity	-108
		2	-Infinity	-100	-Infinity	-108
		3	-Infinity	-97	-Infinity	-105
I <sub>o</sub>	dBm/19.08 MHz	1	N/A	-64.57	N/A	-64.57
		2		-64.57		-64.57
		3		-60.59		-60.59
Propagation Condition		1, 2, 3	AWGN			
<p>Note 1: The resources for uplink transmission are assigned to the UE prior to the start of time period T2.</p> <p>Note 2: Interference from other cells and noise sources not specified in the test is assumed to be constant over subcarriers and time and shall be modelled as AWGN of appropriate power for <math>N_{oc}</math> to be fulfilled.</p> <p>Note 3: PRP levels have been derived from other parameters for information purposes. They are not settable parameters themselves.</p>						

Table A.6.6.14.1.1-4: Void

### A.6.6.14.1.2 Test requirements

The UE Rx-Tx time difference measurement time fulfils the requirements specified in clause 9.9.4.5.

The UE shall perform and report the UE Rx-Tx time difference measurements for Cell 1 and Cell 2 within the specified UE Rx-Tx time difference measurement time starting from the beginning of time interval T2.

- NOTE: The actual overall delays measured in the test may be up to  $2 \times TTI_{DCCH}$  higher than the time duration above because of TTI insertion uncertainty of the measurement report in DCCH.

The rate of the correct events for each neighbour cell observed during repeated tests shall be at least 90%, where the reported UE Rx-Tx measurement for each correct event shall be within the UE Rx-Tx reporting range specified in clause 10.1.25.3.1.

### A.6.6.14.2 UE Rx-Tx time difference measurement for dual positioning frequency layers in FR1 SA

#### A.6.6.14.2.1 Test purpose and environment

The purpose of the test is to verify that the UE Rx-Tx measurement meets the requirements specified in clause 9.9.4.5 in AWGN propagation condition in FR1 in standalone scenario when dual positioning frequency layers are configured.

The supported test configurations are listed in Table A.6.6.14.2.1-1.

**Table A.6.6.14.2.1-1: Supported test configurations**

Configuration	Description
1	15 kHz SSB SCS, 20 MHz bandwidth, FDD duplex mode
2	15 kHz SSB SCS, 20 MHz bandwidth, TDD duplex mode
3	30 kHz SSB SCS, 50 MHz bandwidth, TDD duplex mode
Note:	The UE is only required to be tested in one of the supported test configurations.

There are two cells in the test: PCell (Cell 1) and a neighbour cell (Cell 2). Cell 1 and Cell 2 are on different RF channels in FR1.

The test consists of two consecutive time intervals, with duration of T1 and T2. Cell 1 and Cell 2 mute PRS transmission during T1 and transmit PRS during T2.

The *NR-Multi-RTT-ProvideAssistanceData* and *nr-Multi-RTT-RequestLocationInformation* as defined in TS 37.355 [34, clause 6.5.12.1], shall be provided to the UE during T1. The last TTI containing the two messages shall be provided to the UE  $\Delta T$  ms before the start of T2, where  $\Delta T = 50$  ms is the maximum processing time of the multi-RTT assistance data and location information request.

The beginning of the time interval T2 shall be aligned with the beginning of the first MG instance containing the PRS resources.

The UE is configured with measurement gap pattern ID #0 or ID #24 before T2.

The UE is configured to transmit positioning SRS during T2.

The general test parameters and cell specific test parameters are as given in Table A.6.6.14.2.1-2 and Table A.6.6.14.2.1-3 respectively.

**Table A.6.6.14.2.1-2: General test parameters**

Parameter	Unit	Test configuration	Value	Comment
Active cell		1, 2, 3	Cell 1	Cell 1 is the PCell in <i>NR-Multi-RTT-ProvideAssistanceData</i> [34].
Neighbour cell		1, 2, 3	Cell 2	Cell 2 is a neighbour cell in <i>NR-Multi-RTT-ProvideAssistanceData</i> [34].
RF Channel Number		1, 2, 3	1	For Cell 1
RF Channel Number		1, 2, 3	2	For Cell 2
BW <sub>channel</sub>	MHz	1	20: N <sub>RB,c</sub> = 106	
		2	20: N <sub>RB,c</sub> = 106	



		3	50: $N_{RB,c} = 133$	
SSB configuration		1	SSB.1 FR1	
		2	SSB.1 FR1	
		3	SSB.2 FR1	
SMTTC configuration		1	SMTTC.2	
		2	SMTTC.1	
		3	SMTTC.1	
Measurement gap		1, 2, 3	GP#24 or GP#0 <sup>Note 1</sup>	
CP length		1, 2, 3	Normal	
DRX		1, 2, 3	OFF	
Time offset between serving and neighbour cells	µs	1, 2, 3	3	Synchronous cells
T1	s	1, 2, 3	5	
T2	s	1, 2, 3	10	
Note 1: GP#24 is configured if UE supports MG#24, otherwise GP#0 is configured.				

**Table A.6.6.14.2.1-3: Cell specific test parameters**

Parameter	Unit	Test configuration	Cell 1		Cell 2	
			T1	T2	T1	T2
TDD configuration		1	N/A		N/A	
		2	TDDConf.1.1		TDDConf.1.1	
		3	TDDConf.2.1		TDDConf.2.1	
PDSCH RMC configuration		1	SR.1.1 FDD		N/A	
		2	SR.1.1 TDD			
		3	SR.2.1 TDD			
RMSI CORESET RMC configuration		1	CR.1.1 FDD		N/A	
		2	CR.1.1 TDD			
		3	CR.2.1 TDD			
Dedicated CORESET RMC configuration		1	CCR.1.1 FDD		N/A	
		2	CCR.1.1 TDD			
		3	CCR.2.1 TDD			
OCNG Patterns		1, 2, 3	OP.1		OP.1	
EPRE ratio of PSS to SSS	dB	1, 2, 3	0		0	
EPRE ratio of PBCH DMRS to SSS						
EPRE ratio of PBCH to PBCH DMRS						
EPRE ratio of PDCCH DMRS to SSS						
EPRE ratio of PDCCH to PDCCH DMRS						
EPRE ratio of PDSCH DMRS to SSS						
EPRE ratio of PDSCH to PDSCH DMRS						
EPRE ratio of OCNG DMRS to SSS <sup>Note 1</sup>						
EPRE ratio of OCNG to OCNG DMRS <sup>Note 1</sup>						
EPRE ratio of PRS to SSS						
TRS Configuration		1	TRS.1.1 FDD		N/A	
		2	TRS.1.1 TDD			
		3	TRS.1.2 TDD			
Initial BWP configuration		1, 2, 3	DLBWP.0.1 ULBWP.0.1		N/A	
Active DL BWP configuration		1, 2, 3	DLBWP.1.1		N/A	
Active UL BWP configuration		1, 2, 3	ULBWP.1.1		N/A	
PRS configuration		1	PRS.1.2 FR1		PRS.1.2 FR1	
		2	PRS.1.2 FR1		PRS.1.2 FR1	
		3	PRS.2.2 FR1		PRS.2.2 FR1	

PRS muting info		1, 2, 3	'10'	'01'		
SRS configuration		1	POS-SRS.1	N/A		
		2	POS-SRS.1	N/A		
		3	POS-SRS.2	N/A		
$N_{oc}$ Note 2	dBm/SCS	1	-98			
		2	-98			
		3	-95			
$N_{oc}$ Note 2	dBm/15 kHz	1	-98			
		2				
		3				
PRS $\hat{E}_s/I_{ot}$	dB	1	-Infinity	-3	-Infinity	-13
		2				
		3				
PRS $\hat{E}_s/N_{oc}$	dB	1	-Infinity	-3	-Infinity	-13
		2				
		3				
PRP Note 3	dBm/SCS kHz	1	-Infinity	-101	-Infinity	-111
		2	-Infinity	-101	-Infinity	-111
		3	-Infinity	-98	-Infinity	-108
Io	dBm/19.08 MHz	1	N/A	-65.19	N/A	-66.74
		2		-65.19		-66.74
		3		-61.21		-62.76
Propagation Condition		1, 2, 3	AWGN			
<p>Note 1: The resources for uplink transmission are assigned to the UE prior to the start of time period T2.</p> <p>Note 2: Interference from other cells and noise sources not specified in the test is assumed to be constant over subcarriers and time and shall be modelled as AWGN of appropriate power for <math>N_{oc}</math> to be fulfilled.</p> <p>Note 3: PRP levels have been derived from other parameters for information purposes. They are not settable parameters themselves.</p>						

Table A.6.6.14.2.1-4: Void

### A.6.6.14.2.2 Test requirements

The UE Rx-Tx time difference measurement time fulfils the requirements specified in clause 9.9.4.5.

The UE shall perform and report the UE Rx-Tx time difference measurements for Cell 1 and Cell 2 within the specified UE Rx-Tx time difference measurement time starting from the beginning of time interval T2.

- NOTE: The actual overall delays measured in the test may be up to  $2 \times TTI_{DCC}$  higher than the time duration above because of TTI insertion uncertainty of the measurement report in DCC.

The rate of the correct events for each neighbour cell observed during repeated tests shall be at least 90%, where the reported UE Rx-Tx measurement for each correct event shall be within the UE Rx-Tx reporting range specified in clause 10.1.25.3.1.

## A.6.6.15 Idle Mode measurements of inter-RAT DC candidate cells for early reporting

### A.6.6.15.1 Test Purpose and Environment

The purpose of this test is to verify that the UE properly retains the detected cell status for the idle mode CA/DC measurement when UE transitions from RRC Connected mode to Idle mode, when the UE has entered Idle mode. Additionally, test that the UE performs the required measurements on the serving cell and the configured inter-RAT carrier for idle mode measurement reporting. This test will partly verify the Idle mode CA measurements in clause 4.4. In the test, connected mode DRX configuration is not configured in either PCell or PSCell.

Additionally, the purpose of this test is to verify that the SS-RSRP, SS-RSRQ, RSRP and RSRQ measurement accuracy is within the specified limits. This test will verify the accuracy requirements in Sections 10.1.2B and 10.1.7B for intra-frequency measurements and section 10.2.2 and 10.2.3 for the inter-RAT measurements for the supported test configurations in tables A.6.6.15.1-4 and A.6.6.15.1-5.

The supported test configurations are given in Table A.6.6.15.1-1. The test parameters are given in Tables A.6.6.15.1-2, A.6.6.15.1-3, A.6.6.15.1-4 and A.6.6.15.1-5 below. In the test there are two cells, cell 1, which is the PCell in connected, and serving cell in idle mode, on radio channel 1 in FR1, and cell 2, which is the PSCell in connected, and measured LTE inter-RAT cell in idle mode, on radio channel 2 in LTE.

For the purpose of testing absolute accuracy in idle mode in this set of test cases the cells in idle mode are on different carrier frequencies (NR FR1 and LTE). The absolute accuracy of RSRP and RSRQ inter-RAT measurements are tested by using the parameters in Table A.6.6.15.1-4 and Table A.6.6.15.1-5. In all test cases, Cell 1 is the serving and Cell 2 the target cell.

The test consists of 5 successive time periods, with time duration of T1, T2, T3, T4 and T5 respectively. Prior to the start of the time duration T1, the UE shall be fully synchronized to cell 1 and cell 2. During T1 cell 2, the PSCell, shall be configured.

Time duration T2 starts when UE has transmitted random access preamble on the PSCell. During T2, the UE is configured with idle mode CA measurements with the PSCell carrier as the target carrier. The connection is released 500 ms after T2 when the UE has sent random access preamble on the PSCell.

T3 starts when the connection is released. During the time periods T3 and T4 the UE is in Idle mode with the serving cell on the FR1 carrier. The UE is configured to perform inter-RAT idle mode CA/DC measurements on Cell 2 carrier. After the connection release and during T3, 1000 ms after T3 is started, the signal level of the inter-RAT carrier configured for idle mode CA/DC measurements is changed at which time T4 starts. T5 starts 65s after T4, when the UE is paged for connection setup and UE is requested by the network to report idle mode CA/DC measurements.

**Table A.6.6.15.1-1: Supported test configurations for Idle Mode measurements of inter-RAT DC candidate cells for early reporting**

Config	Description
1	FR1 FDD SSB SCS 15kHz BW 10MHz – LTE FDD 10MHz
2	FR1 FDD SSB SCS 15kHz BW 10MHz – LTE TDD 10MHz
3	FR1 TDD SSB SCS 30kHz BW 40MHz – LTE FDD 10MHz
4	FR1 TDD SSB SCS 30kHz BW 40MHz – LTE TDD 10MHz

Note 1: The UE is only required to be tested in one of the supported test configurations

**Table A.6.6.15.1-2: General test parameters for Idle Mode measurements of inter-RAT DC candidate cells for early reporting**

Parameter	Unit	Value	Comment
RF Channel Number		1, 2	Two radio channels are used for this test
Active PCell		Cell 1	PCell on RF channel number 1 in FR1
PSCell		Cell 2	PSCell on RF channel number 2 in LTE. Cell 2 is of higher priority.
DRX		OFF	For both PCell and PSCell once configured
PRACH configuration in Cell 2		PRACH_2CE	PRACH configuration as specified in Clause A.3.16 in TS 36.133
T331	s	300	
CSI reporting periodicity and offset configuration for Cell 2	ms	2	
T1	s	0.5	During this time the PCell is known and PSCell is configured.
T2	s	0.5	PSCell access.
T3 + T4	s	66	During this time the UE is configured to perform inter-RAT measurements in idle mode on the PSCell carrier.
T5	s	0.5	UE is paged and connection is setup. Network requests measurement report from the UE.

**Table A.6.6.15.1-3: Cell specific test parameters for NR cell for Idle Mode measurements of inter-RAT DC candidate cells for early reporting**

Parameter	Unit	Config	Test 1				
			Cell 1				
			T1	T2	T3	T4	T5
AoA setup		1,2,3,4	N/A				
Assumption for UE beams <sup>Note 5</sup> R: Rough		1,2,3,4	N/A	N/A	R	R	N/A
Frequency Range		1,2,3,4	FR1				
Duplex mode		1, 2	FDD				
		3, 4	TDD				
TDD Configuration 1: TDDConf.1.1 2: TDDConf.2.1		1,2	-				
		3,4	1	1	2	2	1
BW <sub>channel</sub> 1: 10: N <sub>RB,c</sub> = 52 2: 40: N <sub>RB,c</sub> = 106	MHz	1, 2	1	1	-	-	1
		3, 4	2	2	-	-	2
Initial Downlink BWP configuration		1,2,3,4	DLBWP.0.1				
Initial Uplink BWP configuration		1,2,3,4	ULBWP.0.1				
Dedicated Downlink BWP configuration 1: DLBWP.1.1		1,2,3,4	1	1	-	-	1
Dedicated Uplink BWP configuration 1: ULBWP.1.1		1,2,3,4	1	1	-	-	1
PDSCH Reference Measurement Channel 1: SR.1.1 FDD 2: SR.2.1 TDD	FDD	1,2	1	1	1	1	1
	TDD	3,4	2	2	2	2	2
TRS configuration		1,2,3,4	-				
TCI state		1,2,3,4	-				
RMSI CORESET parameters	FDD	1,2	CR.1.1 FDD				
	TDD	3,4	CR.2.1 TDD				
Dedicated CORESET parameters	FDD	1,2	CCR.1.1 FDD				
	TDD	3,4	CCR.2.1 TDD				
OCNG Patterns <sup>Note1</sup>		1,2,3,4	OP.1 defined in A.3.2.1				
SSB configuration 1: SSB.1 FR1 2: SSB.2 FR1		1,2	1				
		3,4	2				
SMTc configuration		1,2,3,4	SMTc.2				
Correlation Matrix and Antenna config		1,2,3,4	1x2 Low				
EPRE ratio of PSS to SSS	dB	1,2,3,4	0	0	-	-	0
EPRE ratio of PBCH DMRS to SSS			0	0	-	-	0
EPRE ratio of PBCH to PBCH DMRS			0	0	-	-	0
EPRE ratio of PDCCH DMRS to SSS			0	0	-	-	0
EPRE ratio of PDCCH to PDCCH DMRS			0	0	-	-	0
EPRE ratio of PDSCH DMRS to SSS			0	0	-	-	0
EPRE ratio of PDSCH to PDSCH			0	0	-	-	0
EPRE ratio of OCNG DMRS to SSS			0	0	-	-	0
N <sub>oc</sub> <sup>Note2</sup>			dBm/ 15kHz	1,2	-98	-98	-98
	3,4						
N <sub>oc</sub> <sup>Note2</sup>	dBm/SCS	1,2	-98	-98	-98	-98	-98
		3,4	-95	-95	-95	-95	-95
$\hat{E}_s/I_{ot}$	dB	1,2,3,4	5	5	5	5	5
$\hat{E}_s/N_{oc}$	dB	1,2,3,4	5	5	5	5	5
SS-RSRP <sup>Note3,4</sup>	dBm/SCS	1,2	-93	-93	-93	-93	-93
		3,4	-90	-90	-90	-90	-90

I <sub>o</sub> Note3,4	dBm/ 9.36 MHz	1,2	-63.85	-63.85	-63.85	-63.85	-63.85
	dBm/ 38.16 MHz	3,4	-57.76	-57.76	-57.76	-57.76	-57.76
Qrxlevmin	dBm/SCS	1, 2	-	-	-140		-
		3, 4	-	-	-137		-
Pcompensation	dB	1,2,3,4	-	-	0	0	-
Qhyst <sub>s</sub>	dB	1,2,3,4	-	-	0	0	-
Qoffset <sub>s, n</sub>	dB	1,2,3,4	-	-	0	0	-
Cell_selection_and_reselection_quality_measurement		1,2,3,4	SS-RSRP				
Treselection	s	1,2,3,4	-	-	0		-
SnonintrasearchP	dB	1,2,3,4	-	-	Not Sent		-
SnonintrasearchQ	dB	1,2,3,4	-	-	Not Sent		-
Thresh <sub>x, high</sub>	dB	1,2,3,4	-	-	48		-
Thresh <sub>servicing, low</sub>	dB	1,2,3,4	-	-	44		-
Thresh <sub>x, low</sub>	dB	1,2,3,4	-	-	50		-
Propagation Condition	dB	1,2,3,4	-	-	AWGN		-
Note 1:	OCNG shall be used such that both cells are fully allocated and a constant total transmitted power spectral density is achieved for all OFDM symbols.						
Note 2:	Interference from other cells and noise sources not specified in the test is assumed to be constant over subcarriers and time and shall be modelled as AWGN of appropriate power for $N_{oc}$ to be fulfilled.						
Note 3:	SSB_RP and I <sub>o</sub> levels have been derived from other parameters for information purposes. They are not settable parameters themselves.						
Note 4:	SSB_RP minimum requirements are specified assuming independent interference and noise at each receiver antenna port.						

**Table A.6.6.15.1-4: Cell specific test parameters for LTE cell for Idle Mode measurements of inter-RAT DC candidate cells for early reporting**

Parameter	Unit	Config	Test 1				
			Cell 2				
			T1	T2	T3	T4	T5
Frequency Range		1,2,3,4	LTE				
Duplex mode		1, 3	FDD				
		2, 4	TDD				
BW <sub>channel</sub>	MHz	1,2,3,4	10	10	-	-	10
Measurement bandwidth	$n_{PRB}$	1,2,3,4	-	-	22-27	22-27	-
PDSCH Reference Measurement Channel 1: R.1 FDD 2: R.1 TDD	FDD	1,3	1	1	-	-	1
	TDD	2,4	2	2	-	-	2
PDCCH/PCFICH/PHICH Reference measurement channel defined in A.3.1.2.1 and A.3.1.2.2 in 36.133 1: R.6 FDD 2: R.6 TDD		1,3	1	1	-	-	1
		2,4	2	2	-	-	2
OCNG Patterns defined in A.3.2.1.1 (OP.2 FDD) and A.3.2.1.2 (OP.2 TDD) in 36.133 1: OP.2 FDD 2: OP.2 TDD		1,3	1				
		2,4	2				
Correlation Matrix and Antenna config		1,2,3,4	1x2 Low				
PBCH_RA	dB	1,2,3,4	N/A	N/A	0	0	N/A
PBCH_RB			N/A	N/A	0	0	N/A
PSS_RA			N/A	N/A	0	0	N/A
SSS_RA			N/A	N/A	0	0	N/A
PCFICH_RB			N/A	N/A	0	0	N/A
			N/A	N/A	0	0	N/A

PHICH_RA			N/A	N/A	0	0	N/A
PHICH_RB			N/A	N/A	0	0	N/A
PDCCH_RA			N/A	N/A	0	0	N/A
PDCCH_RB			N/A	N/A	0	0	N/A
PDSCH_RA			N/A	N/A	0	0	N/A
PDSCH_RB			N/A	N/A	0	0	N/A
OCNG_RA <sup>Note 1</sup>			N/A	N/A	0	0	N/A
OCNG_RB <sup>Note 1</sup>			N/A	N/A	0	0	N/A
$N_{oc}$ <sup>Note2</sup>	dBm/ 15kHz	1,2	-98	-98	-98	-98	-98
		3,4					
$\bar{E}_s/I_{ot}$	dB	1,2,3,4	5	5	-3	8	5
$\bar{E}_s/N_{oc}$	dB	1,2,3,4	5	5	-3	8	5
SS-RSRP <sup>Note3,4</sup>	dBm/SCS	1,2,3,4	-93	-93	-101	-90	-93
$I_o$ <sup>Note3,4</sup>	dBm/ 9.36 MHz	1,2,3, 4	-61.01	-61.01	-65.44	-58.57	-61.01
Qrxlevmin	dBm/SCS	1, 2, 3, 4	-	-	-140		-
Pcompensation	dB	1,2,3,4	-	-	0	0	-
Qhyst <sub>s</sub>	dB	1,2,3,4	-	-	0	0	-
Qoffset <sub>s, n</sub>	dB	1,2,3,4	-	-	0	0	-
Cell_selection_and_reselection_quality_measurement		1,2,3,4	RSRP and RSRQ				
Treselection	s	1,2,3,4	-	-	0		-
SnonintrasearchP	dB	1,2,3,4	-	-	Not Sent		-
SnonintrasearchQ	dB	1,2,3,4	-	-	Not Sent		-
Thresh <sub>x, high</sub>	dB	1,2,3,4	-	-	48		-
Thresh <sub>servng, low</sub>	dB	1,2,3,4	-	-	44		-
Thresh <sub>x, low</sub>	dB	1,2,3,4	-	-	50		-
Propagation Condition	dB	1,2,3,4	-	-	AWGN		-
Note 1: OCNG shall be used such that both cells are fully allocated and a constant total transmitted power spectral density is achieved for all OFDM symbols.							
Note 2: Interference from other cells and noise sources not specified in the test is assumed to be constant over subcarriers and time and shall be modelled as AWGN of appropriate power for $N_{oc}$ to be fulfilled.							
Note 3: SSB_RP and $I_o$ levels have been derived from other parameters for information purposes. They are not settable parameters themselves.							
Note 4: SSB_RP minimum requirements are specified assuming independent interference and noise at each receiver antenna port.							

**Table A.6.6.15.1-5: General idle mode test parameters for Idle Mode measurements of inter-RAT DC candidate cells for early reporting**

Parameter	Unit	Test configuration	Value	Comment
Serving cell		1, 2, 3, 4	Cell1	The UE camps on cell 1 which is the former PCell.
Neighbour cell		1, 2, 3, 4	Cell2	The UE shall perform inter-RAT measurements on cell 2 which is the former PSCell.
RF Channel Number		1, 2, 3, 4	1, 2	
Time offset between cells		1, 2, 3, 4	3 $\mu$ s	Synchronous cells
Access Barring Information	-	1, 2, 3, 4	Not Sent	No additional delays in random access procedure.
SSB configuration		1, 2	SSB.1 FR1	Serving cell
		3, 4	SSB.2 FR1	Serving cell
SMTc configuration Serving cell		1, 2, 3, 4	SMTc.2	
DRX cycle length	s	1, 2, 3, 4	1.28	The value shall be used for all cells in the test.
PRACH configuration index		1, 2, 3, 4	190	The detailed configuration is specified in TS 38.211 clause 6.3.3.2

rangeToBestCell		1, 2, 3, 4	Not configured	
T3	s	1, 2, 3, 4	0.5	T3 needs to be defined so that cell measurement time is taken into account.
T4	s	1, 2, 3, 4	65	T4 needs to be defined so that cell measurement time is taken into account.

### A.6.6.15.2 Test Requirements

The UE behaviour during time durations T1, T2, T3, T4 and T5 shall be as follows:

During time durations T1 the UE shall start transmitting preamble on PSCell. During T2 the UE perform intra-frequency measurements on the PCell and the PSCell.

During the time-period T3 the connection is released, and UE enters idle mode. During the time period T3 and T4 the UE is camped in Idle mode and at T4 the signal level of cell 2 is changed. The UE shall not perform reselection. The UE shall perform Idle Mode CA measurement according to Section 4.4.

At the start of T5 the UE is paged for connection setup. During the connection setup the UE is requested to transmit early measurement report. The UE shall send early measurement report to the PCell including idle mode CA/DC measurement from cell 2.

After receiving the requested early measurement report, the test equipment verifies that the accuracy of measurement reported for serving Cell 1 and Cell 2 meets the requirements in Sections 10.1.2B and 10.1.7B and Sections 10.2.4 and 10.2.5, respectively and test ends.

The rate of correct events observed during repeated tests shall be at least 90%.

## A.6.7 Measurement Performance requirements

Unless explicitly stated otherwise:

- Reported measurements shall be within defined range of accuracy limits defined in Clause 10 for at least 90 % of the reported cases. If multiple measurement performance requirements are verified in the same test, the reported measurements for each requirement shall be within defined range of accuracy limits of the corresponding requirement defined in Clause 10 for at least 90% of the reported cases.
- Measurements are performed in RRC\_CONNECTED state.
- The reference channels assume transmission of PDSCH with a maximum number of 5 HARQ transmissions unless otherwise specified.

### A.6.7.1 SS-RSRP

#### A.6.7.1.1 SA: intra-frequency case measurement accuracy with FR1 serving cell and FR1 target cell

##### A.6.7.1.1.1 Test Purpose and Environment

The purpose of this test is to verify that the SS-RSRP measurement accuracy is within the specified limits. This test will verify the requirements in clauses 10.1.2.1.1 and 10.1.2.1.2 for intra-frequency measurements.

##### A.6.7.1.1.2 Test parameters

In this set of test cases all cells are on the same carrier frequency. Supported test configurations are shown in table A.6.7.1.1.2-1. Both absolute and relative accuracy of SS-RSRP intra-frequency measurements are tested by using the parameters in A.6.7.1.1.2-2. In all test cases, Cell 1 is the PCell, and Cell 2 is the target cell.

**Table A.6.7.1.1.2-1: SS-RSRP Intra frequency SS-RSRP supported test configurations**

Config	Description
1	NR 15 kHz SSB SCS, 10 MHz bandwidth, FDD duplex mode
2	NR 15 kHz SSB SCS, 10 MHz bandwidth, TDD duplex mode
3	NR 30kHz SSB SCS, 40 MHz bandwidth, TDD duplex mode
Note: The UE is only required to be tested in one of the supported test configurations in each supported band	

**Table A.6.7.1.1.2-2: SS-RSRP Intra frequency test parameters**

Parameter		Unit	Test 1		Test 2		Test 3	
			Cell 1	Cell 2	Cell 1	Cell 2	Cell 1	Cell 2
Cell ID			489	0	489	0	489	0
SSB ARFCN			freq1		freq1		freq1	
Duplex mode	Config 1		FDD					
	Config 2,3		TDD					
TDD configuration	Config 1		Not Applicable					
	Config 2		TDDConf.1.1					
	Config 3		TDDConf.2.1					
BW <sub>channel</sub>	Config 1	MHz	10: N <sub>RB,c</sub> = 52					
	Config 2		10: N <sub>RB,c</sub> = 52					
	Config 3		40: N <sub>RB,c</sub> = 106					
BWP BW	Config 1		10: N <sub>RB,c</sub> = 52					
	Config 2		10: N <sub>RB,c</sub> = 52					
	Config 3		40: N <sub>RB,c</sub> = 106					
Downlink initial BWP configuration			DLBWP.0.1					
Downlink dedicated BWP configuration			DLBWP.1.1					
Uplink initial BWP configuration			ULBWP.0.1					
Uplink dedicated BWP configuration			ULBWP.1.1					
TRS configuration	Config 1		TRS.1.1 FDD	NA	TRS.1.1 FDD	NA	TRS.1.1 FDD	NA
	Config 2		TRS.1.1 TDD	NA	TRS.1.1 TDD	NA	TRS.1.1 TDD	NA
	Config 3		TRS.1.2 TDD	NA	TRS.1.2 TDD	NA	TRS.1.2 TDD	NA
DRX Cycle		ms	Not Applicable					
PDSCH Reference measurement channel	Config 1		SR.1.1 FDD	-	SR.1.1 FDD	-	SR.1.1 FDD	-
	Config 2		SR.1.1 TDD	-	SR.1.1 TDD	-	SR.1.1 TDD	-
	Config 3		SR.2.1 TDD	-	SR.2.1 TDD	-	SR.2.1 TDD	-
RMSI CORESET Reference Channel	Config 1		CR.1.1 FDD	-	CR.1.1 FDD	-	CR.1.1 FDD	-
	Config 2		CR.1.1 TDD	-	CR.1.1 TDD	-	CR.1.1 TDD	-
	Config 3		CR.2.1 TDD	-	CR.2.1 TDD	-	CR.2.1 TDD	-
Control channel RMC	Config 1		CCR.1.1 FDD	-	CCR.1.1 FDD	-	CCR.1.1 FDD	-
	Config 2		CCR.1.1 TDD	-	CCR.1.1 TDD	-	CCR.1.1 TDD	-
	Config 3		CCR.2.1 TDD	-	CCR.2.1 TDD	-	CCR.2.1 TDD	-
SSB configuration	Config 1		SSB.1 FR1	SSB.1 FR1	SSB.1 FR1	SSB.1 FR1	SSB.1 FR1	SSB.1 FR1
	Config 2		SSB.1 FR1	SSB.1 FR1	SSB.1 FR1	SSB.1 FR1	SSB.1 FR1	SSB.1 FR1
	Config 3		SSB.2 FR1	SSB.2 FR1	SSB.2 FR1	SSB.2 FR1	SSB.2 FR1	SSB.2 FR1
Time offset with Cell 1	Config 1	ms	-	3	-	3	-	3
	Config 2,3	µs	-	3	-	3	-	3
SMTC configuration	Config 1		SMTC.2					
	Config 2,3		SMTC.1					



OCNG Patterns			OCNG pattern 1						
PDSCH/PDCCH subcarrier spacing	Config 1,2	kHz	15 kHz						
	Config 3		30kHz						
EPRE ratio of PSS to SSS			0	0	0	0	0	0	
EPRE ratio of PBCH DMRS to SSS									
EPRE ratio of PBCH to PBCH DMRS									
EPRE ratio of PDCCH DMRS to SSS									
EPRE ratio of PDCCH to PDCCH DMRS									
EPRE ratio of PDSCH DMRS to SSS									
EPRE ratio of PDSCH to PDSCH									
EPRE ratio of OCNG DMRS to SSS(Note 1)									
EPRE ratio of OCNG to OCNG DMRS (Note 1)									
$N_{oc}$ <sup>Note2</sup>	Config 1,2	NR_FDD_FR1_A, NR_TDD_FR1_A <small>NOTE 6</small>	dBm/15Kh Z	-106	-88	-114			
		NR_FDD_FR1_B				-113.5			
		NR_TDD_FR1_C				-113			
		NR_FDD_FR1_D, NR_TDD_FR1_D				-112.5			
		NR_FDD_FR1_E, NR_TDD_FR1_E				-112			
		NR_FDD_FR1_F				-111.5			
		NR_FDD_FR1_G				-111			
		NR_FDD_FR1_H				-110.5			
	Config 3	NR_FDD_FR1_A, NR_TDD_FR1_A <small>NOTE 6</small>		Not applicable <sup>Note 5</sup>	-94	-114			
		NR_FDD_FR1_B				-113.5			
		NR_TDD_FR1_C				-113			
		NR_FDD_FR1_D, NR_TDD_FR1_D				-112.5			
		NR_FDD_FR1_E, NR_TDD_FR1_E				-112			
		NR_FDD_FR1_F				-111.5			
		NR_FDD_FR1_G				-111			
		NR_FDD_FR1_H				-110.5			
$N_{oc}$ <sup>Note2</sup>	Config 1,2	dBm/SCS	-106	-88	Same as Noc/15kHz				
	Config 3				NR_FDD_FR1_A, NR_TDD_FR1_A <small>NOTE 6</small>	Not applicable <sup>Note 5</sup>	-91	-111	
			NR_FDD_FR1_B	-110.5					
			NR_TDD_FR1_C	-110					
			NR_FDD_FR1_D, NR_TDD_FR1_D	-109.5					
			NR_FDD_FR1_E, NR_TDD_FR1_E	-109					
			NR_FDD_FR1_F	-108.5					
			NR_FDD_FR1_G	-108					
			NR_FDD_FR1_H	-107.5					
	$\hat{E}_s/I_{ot}$			dB	2.46	-5.97	2.46	-5.97	-0.01
$\hat{E}_s/N_{oc}$			dB	6	1	6	1	3	0
SS-RSRP <sup>Not e3</sup>	Config 1,2	NR_FDD_FR1_A, NR_TDD_FR1_A <small>NOTE 6</small>	dBm/SCS	-100	-105	-82	-87	-	-
		NR_FDD_FR1_B						111.00	114.00
		NR_TDD_FR1_C						-	-
		NR_FDD_FR1_D, NR_TDD_FR1_D						110.50	113.50
		NR_FDD_FR1_E, NR_TDD_FR1_E						110.00	113.00
		NR_FDD_FR1_F, NR_TDD_FR1_F						109.50	112.50
NR_FDD_FR1_G, NR_TDD_FR1_G	109.00	112.00							

		NR_FDD_FR1_F					-	-	
		NR_FDD_FR1_G					108.50	111.50	
		NR_FDD_FR1_H					-	-	
	Config 3	NR_FDD_FR1_A, NR_TDD_FR1_A NOTE 6		Not applicable <sup>Note 5</sup>	Not applicable <sup>Note 5</sup>	-85	-90	108.00	111.00
		NR_FDD_FR1_B					-	-	
		NR_TDD_FR1_C					107.50	110.50	
		NR_FDD_FR1_D, NR_TDD_FR1_D					-	-	
		NR_FDD_FR1_E, NR_TDD_FR1_E					107.00	110.00	
		NR_FDD_FR1_F					-	-	
		NR_FDD_FR1_G					106.50	109.50	
		NR_FDD_FR1_H					-	-	
							106.00	109.00	
							-	-	
							105.50	108.50	
							-	-	
							105.00	108.00	
							-	-	
							104.50	107.50	
$I_o$ <sup>Note3</sup>	Config 1,2	NR_FDD_FR1_A, NR_TDD_FR1_A NOTE 6	dBm/ 9.36MHz	-70.09		-52.09		-80.03	
		NR_FDD_FR1_B						-79.53	
		NR_TDD_FR1_C						-79.03	
		NR_FDD_FR1_D, NR_TDD_FR1_D						-78.53	
		NR_FDD_FR1_E, NR_TDD_FR1_E						-78.03	
		NR_FDD_FR1_F						-77.53	
		NR_FDD_FR1_G						-77.03	
		NR_FDD_FR1_H						-76.53	
	Config 3	NR_FDD_FR1_A, NR_TDD_FR1_A NOTE 6	dBm/ 38.16MHz	Not applicable <sup>Note 5.</sup>		-51.99		-73.94	
		NR_FDD_FR1_B						-73.44	
		NR_TDD_FR1_C						-72.94	
		NR_FDD_FR1_D, NR_TDD_FR1_D						-72.44	
		NR_FDD_FR1_E, NR_TDD_FR1_E						-71.94	
		NR_FDD_FR1_F						-71.44	
		NR_FDD_FR1_G						-70.94	
		NR_FDD_FR1_H						-70.44	
Propagation condition			-	AWGN					
Antenna configuration				1x2					
<p>Note 1: OCNG shall be used such that both cells are fully allocated and a constant total transmitted power spectral density is achieved for all OFDM symbols.</p> <p>Note 2: Interference from other cells and noise sources not specified in the test is assumed to be constant over subcarriers and time and shall be modelled as AWGN of appropriate power for <math>N_{oc}</math> to be fulfilled.</p> <p>Note 3: SS-RSRP and <math>I_o</math> levels have been derived from other parameters for information purposes. They are not settable parameters themselves.</p> <p>Note 4: SS-RSRP minimum requirements are specified assuming independent interference and noise at each receiver antenna port.</p> <p>Note 5: Subtest 1 is not used when testing with 30kHz SSB SCS.</p> <p>Note 6: The test configuration excludes support for band n51 and it is not required to run this test on band n51 in this release of the specification</p>									

### A.6.7.1.1.3 Test Requirements

The SS-RSRP measurement accuracy for cell 1 and cell 2 shall fulfil absolute requirement in clause 10.1.2.1.1 and relative requirement in clause 10.1.2.1.2.

### A.6.7.1.2 SA inter-frequency case measurement accuracy with FR1 serving cell and FR1 target cell

#### A.6.7.1.2.1 Test Purpose and Environment

The purpose of this test is to verify that the SS-RSRP measurement accuracy is within the specified limits. This test will verify the requirements in clauses 10.1.4.1.1 and 10.1.4.1.2 for inter-frequency measurements with the testing configurations for NR cells in Table A.6.7.1.2.1-1.

**Table A.6.7.1.2.1-1: Applicable NR configurations for FR1 inter-frequency SS-RSRP accuracy test**

Config	Description
1	NR 15 kHz SSB SCS, 10 MHz bandwidth, FDD duplex mode
2	NR 15 kHz SSB SCS, 10 MHz bandwidth, TDD duplex mode
3	NR 30kHz SSB SCS, 40 MHz bandwidth, TDD duplex mode
Note:	The UE is only required to be tested in one of the supported test configurations in each supported band

#### A.6.7.1.2.2 Test parameters

In this set of test cases there are two cells in the test, PCell (Cell 1) and a FR1 neighbour cell (Cell 2) on a different frequency than the PCell. The test parameters for the Cell 1 and Cell 2 are given in Table A.6.7.1.2.2-1 below. Both absolute and relative accuracy of RSRP inter-frequency measurements are tested by using the parameters in Table A.6.7.1.2.2-1. The inter-frequency measurements are supported by a measurement gap.

**Table A.6.7.1.2.2-1: SS-RSRP inter-frequency test parameters**

Parameter	Config	Unit	Test 1		Test 2	
			Cell 1	Cell 2	Cell 1	Cell 2
SSB ARFCN	1~3		freq1	freq2	freq1	freq2
BW <sub>channel</sub>	1	MHz	10: N <sub>RB,c</sub> = 52		10: N <sub>RB,c</sub> = 52	
	2		10: N <sub>RB,c</sub> = 52		10: N <sub>RB,c</sub> = 52	
	3		40: N <sub>RB,c</sub> = 106		40: N <sub>RB,c</sub> = 106	
Duplex mode	1		FDD		FDD	
	2		TDD		TDD	
	3		TDD		TDD	
TDD configuration	1		N/A		N/A	
	2		TDDConf.1.1		TDDConf.1.1	
	3		TDDConf.2.1		TDDConf.2.1	
PDSCH Reference measurement channel	1		SR.1.1 FDD	-	SR.1.1 FDD	-
	2		SR.1.1 TDD	-	SR.1.1 TDD	-
	3		SR.2.1 FDD	-	SR.2.1 FDD	-
RMSI CORESET Reference Channel	1		CR.1.1 FDD	-	CR.1.1 FDD	-
	2		CR.1.1 TDD	-	CR.1.1 TDD	-
	3		CR.2.1 FDD	-	CR.2.1 FDD	-
Dedicated CORESET Reference Channel	1		CCR.1.1 FDD	-	CCR.1.1 FDD	-
	2		CCR.1.1 TDD	-	CCR.1.1 TDD	-
	3		CCR.2.1 TDD	-	CCR.2.1 TDD	-
SSB configuration	1		SSB.1 FR1		SSB.1 FR1	
	2		SSB.1 FR1		SSB.1 FR1	
	3		SSB.2 FR1		SSB.2 FR1	
OCNG Patterns	1~3		OP.1		OP.1	
TRS configuration	1		TRS.1.1 FDD	-	TRS.1.1 FDD	-
	2		TRS.1.1 TDD	-	TRS.1.1 TDD	-
	3		TRS.1.2 TDD	-	TRS.1.2 TDD	-

Initial BWP Configuration		1~3		DLBWP.0.1 ULBWP.0.1		DLBWP.0.1 ULBWP.0.1	
Dedicated BWP configuration		1~3		DLBWP.1.1 ULBWP.1.1		DLBWP.1.1 ULBWP.1.1	
Time offset with Cell 1		1	ms	-	3	-	3
		2,3	μs	-	3	-	3
SMTC configuration		1		SMTC.2		SMTC.2	
		2,3		SMTC.1		SMTC.1	
EPRE ratio of PSS to SSS		1~3	dB	0	0	0	0
EPRE ratio of PBCH DMRS to SSS							
EPRE ratio of PBCH to PBCH DMRS							
EPRE ratio of PDCCH DMRS to SSS							
EPRE ratio of PDCCH to PDCCH DMRS							
EPRE ratio of PDSCH DMRS to SSS							
EPRE ratio of PDSCH to PDSCH DMRS							
EPRE ratio of OCNG DMRS to SSS <sup>Note 1</sup>							
EPRE ratio of OCNG to OCNG DMRS <sup>Note 1</sup>							
$N_{oc}$ <sup>Note2</sup>	NR_FDD_FR1_A, NR_TDD_FR1_A NOTE 5						
	NR_FDD_FR1_B	-114.5					
	NR_TDD_FR1_C	-114					
	NR_FDD_FR1_D, NR_TDD_FR1_D	-113.5					
	NR_FDD_FR1_E, NR_TDD_FR1_E	-113					
	NR_FDD_FR1_F	-112.5					
	NR_FDD_FR1_G	-112					
	NR_FDD_FR1_H	-111.5					
$N_{oc}$ <sup>Note2</sup>	NR_FDD_FR1_A, NR_TDD_FR1_A NOTE 5,	1,2,4,5	dBm/SS B SCS	-94.65		$(N_{oc}$ for Channel 2 +8dB)	-115
	NR_FDD_FR1_B						-114.5
	NR_TDD_FR1_C						-114
	NR_FDD_FR1_D, NR_TDD_FR1_D						-113.5
	NR_FDD_FR1_E, NR_TDD_FR1_E						-113
	NR_FDD_FR1_F						-112.5
	NR_FDD_FR1_G						-112
	NR_FDD_FR1_H						-111.5
	NR_FDD_FR1_A, NR_TDD_FR1_A NOTE 5,	3	-91.65		$(N_{oc}$ for Channel 2 +8dB)	-112.00	
	NR_FDD_FR1_B					-111.50	
	NR_TDD_FR1_C					-111.00	
	NR_FDD_FR1_D, NR_TDD_FR1_D					-110.50	
	NR_FDD_FR1_E, NR_TDD_FR1_E					-110.00	
	NR_FDD_FR1_F					-109.50	
	NR_FDD_FR1_G					-109.00	
NR_FDD_FR1_H	-108.50						
$\hat{E}_s/I_{ot}$		1~3	dB	10	10	13	-3
SS- RSRP <sup>Note3</sup>	NR_FDD_FR1_A, NR_TDD_FR1_A NOTE 5,	1,2,4,5	dBm/SC S	-84.65		(RSRP for Cell 2 +25dB)	-118.00
	NR_FDD_FR1_B						-117.50

	NR_TDD_FR1_C					-117.00
	NR_FDD_FR1_D, NR_TDD_FR1_D					-116.50
	NR_FDD_FR1_E, NR_TDD_FR1_E					-116.00
	NR_FDD_FR1_F					-115.50
	NR_FDD_FR1_G					-115.00
	NR_FDD_FR1_H					-114.50
	NR_FDD_FR1_A, NR_TDD_FR1_A NOTE 5,	3		-81.65	(RSRP for Cell 2 +25dB)	-115.00
	NR_FDD_FR1_B					-114.50
	NR_TDD_FR1_C					-114.00
	NR_FDD_FR1_D, NR_TDD_FR1_D					-113.50
	NR_FDD_FR1_E, NR_TDD_FR1_E					-113.00
	NR_FDD_FR1_F					-112.50
	NR_FDD_FR1_G					-112.00
	NR_FDD_FR1_H					-111.50
Io <sup>Note3</sup>	NR_FDD_FR1_A, NR_TDD_FR1_A NOTE 5,	1,2,4,5	dBm/ 9.36MH z	-56.28	Io for Channel 2 +19.75dB)T	-85.28
	NR_FDD_FR1_B					-84.78
	NR_TDD_FR1_C					-84.28
	NR_FDD_FR1_D, NR_TDD_FR1_D					-83.78
	NR_FDD_FR1_E, NR_TDD_FR1_E					-83.28
	NR_FDD_FR1_F					-82.78
	NR_FDD_FR1_G	-82.28				
	NR_FDD_FR1_H	-81.78				
	NR_FDD_FR1_A, NR_TDD_FR1_A NOTE 5,	3	dBm/ 38.16M Hz	-50.19	Io for Channel 2 +19.75dB)T	-79.19
	NR_FDD_FR1_B					-78.69
	NR_TDD_FR1_C					-78.19
	NR_FDD_FR1_D, NR_TDD_FR1_D					-77.69
	NR_FDD_FR1_E, NR_TDD_FR1_E					-77.19
	NR_FDD_FR1_F					-76.69
NR_FDD_FR1_G	-76.19					
NR_FDD_FR1_H	-75.69					
$\hat{E}_s / N_{oc}$	1~3	dB	10	10	13	-3
Propagation condition	1~3	-	AWGN		AWGN	
Antenna configuration	1~3		1x2		1x2	
<p>Note 1: OCNG shall be used such that both cells are fully allocated and a constant total transmitted power spectral density is achieved for all OFDM symbols.</p> <p>Note 2: Interference from other cells and noise sources not specified in the test is assumed to be constant over subcarriers and time and shall be modelled as AWGN of appropriate power for <math>N_{oc}</math> to be fulfilled.</p> <p>Note 3: RSRP and Io levels have been derived from other parameters for information purposes. They are not settable parameters themselves.</p> <p>Note 4: RSRP minimum requirements are specified assuming independent interference and noise at each receiver antenna port.</p> <p>Note 5: The test configuration excludes support for band n51 and it is not required to run this test on band n51 in this release of the specification.</p>						

### A.6.7.1.2.3 Test Requirements

The SS-RSRP measurement accuracy for Cell 1 and Cell 2 shall fulfil the absolute requirement in clause 10.1.4.1.1 and relative requirement in clause 10.1.4.1.2.

A.6.7.1.3 Void

A.6.7.2 SS-RSRQ

A.6.7.2.1 SA: Intra-frequency measurement accuracy with FR1 serving cell and FR1 target cell

A.6.7.2.1.1 Test Purpose and Environment

The purpose of this test is to verify that the SS-RSRQ measurement accuracy is within the specified limits. This test will verify the requirements in Clause 10.1.7.1.1.

A.6.7.2.1.2 Test Parameters

In this test case all cells are on the same carrier frequency. Supported test configuration are shown in Table A.6.7.2.1.2-1. The absolute accuracy of SS-RSRQ intra-frequency measurement is tested by using the parameters in Table A.6.7.2.1.2-2. In all test cases, Cell 1 is the PCell and Cell 2 is the target cell.

**Table A.6.7.2.1.2-1: SS-RSRQ Intra frequency SS-RSRQ supported test configurations**

Config	Description
1	NR 15 kHz SSB SCS, 10 MHz bandwidth, FDD duplex mode
2	NR 15 kHz SSB SCS, 10 MHz bandwidth, TDD duplex mode
3	NR 30 kHz SSB SCS, 40 MHz bandwidth, TDD duplex mode
Note: The UE is only required to be tested in one of the supported test configurations	

**Table A.6.7.2.1.2-2: SS-RSRQ Intra frequency test parameters**

Parameter		Unit	Test 1		Test 2		Test 3	
			Cell 1	Cell 2	Cell 1	Cell 2	Cell 1	Cell 2
Cell ID			489	0	489	0	489	0
SSB ARFCN			freq1		freq1		freq1	
Duplex mode	Config 1		FDD					
	Config 2,3		TDD					
TDD configuration	Config 1		Not Applicable					
	Config 2		TDDConf.1.1					
	Config 3		TDDConf.2.1					
BW <sub>channel</sub>	Config 1	MHz	10: N <sub>RB,c</sub> = 52					
	Config 2		10: N <sub>RB,c</sub> = 52					
	Config 3		40: N <sub>RB,c</sub> = 106					
BWP configuration	Initial DL BWP		DLBWP.0.1					
	Dedicated DL BWP		DLBWP.1.1					
	Initial UL BWP		ULBWP.0.1					
	Dedicated UL BWP		ULBWP.1.1					
DRX Cycle		ms	Not Applicable					
PDSCH Reference measurement channel	Config 1		SR.1.1 FDD	-	SR.1.1 FDD	-	SR.1.1 FDD	-
	Config 2		SR.1.1 TDD		SR.1.1 TDD		SR.1.1 TDD	
	Config 3		SR2.1 TDD		SR2.1 TDD		SR2.1 TDD	
RMSI CORESET Reference Channel	Config 1		CR.1.1 FDD	-	CR.1.1 FDD	-	CR.1.1 FDD	
	Config 2		CR.1.1 TDD		CR.1.1 TDD		CR.1.1 TDD	
	Config 3		CR.2.1 TDD		CR.2.1 TDD		CR.2.1 TDD	
Control Channel RMC	Config 1		CCR.1.1 FDD	-	CCR.1.1 FDD	-	CCR.1.1 FDD	-
	Config 2		CCR.1.1 TDD		CCR.1.1 TDD		CCR.1.1 TDD	
	Config 3		CCR.2.1 TDD		CCR.2.1 TDD		CCR.2.1 TDD	

TRS Configuration	Config 1		TRS.1.1 FDD	-	TRS.1.1 FDD	-	TRS.1.1 FDD	-
	Config 2		TRS.1.1 TDD		TRS.1.1 TDD		TRS.1.1 TDD	
	Config 3		TRS.1.2 TDD		TRS.1.2 TDD		TRS.1.2 TDD	
OCNG Patterns			OP. 1					
SS-RSSI-Measurement			Not Applicable					
Time offset with Cell 1	Config 1	ms	-	3	-	3	-	3
	Config 2,3	µs	-	3	-	3	-	3
SMTC configuration	Config 1		SMTC.2					
	Config 2,3		SMTC.1					
SSB configuration	Config 1,2		SSB.1 FR1					
	Config 3		SSB.2 FR1					
CSI-RS for tracking	Config 1		TRS.1.1 FDD					
	Config 2		TRS.1.1 TDD					
	Config 3		TRS.1.2 TDD					
PDSCH/PDCCH subcarrier spacing	Config 1,2	kHz	15 kHz					
	Config 3		30kHz					
EPRE ratio of PSS to SSS		dB	0	0	0	0	0	0
EPRE ratio of PBCH DMRS to SSS								
EPRE ratio of PBCH to PBCH DMRS								
EPRE ratio of PDCCH DMRS to SSS								
EPRE ratio of PDCCH to PDCCH DMRS								
EPRE ratio of PDSCH DMRS to SSS								
EPRE ratio of PDSCH to PDSCH								
EPRE ratio of OCNG DMRS to SSS(Note 1)								
EPRE ratio of OCNG to OCNG DMRS (Note 1)								
$N_{oc}$ <sup>Note2</sup>	Config 1,2		NR_FDD_FR1_A, NR_TDD_FR1_A NOTE 6	dBm/15kHz z	-85	-101	-114	
		NR_FDD_FR1_B	-113.5					
		NR_TDD_FR1_C	-113					
		NR_FDD_FR1_D, NR_TDD_FR1_D	-112.5					
		NR_FDD_FR1_E, NR_TDD_FR1_E	-112					
		NR_FDD_FR1_F	-111.5					
		NR_FDD_FR1_G	-111					
		NR_FDD_FR1_H	-110.5					
	Config 3	NR_FDD_FR1_A, NR_TDD_FR1_A NOTE 6	-91		-	-114		
		NR_FDD_FR1_B				-113.5		
		NR_TDD_FR1_C				-113		
		NR_FDD_FR1_D, NR_TDD_FR1_D				-112.5		
		NR_FDD_FR1_E, NR_TDD_FR1_E				-112		
		NR_FDD_FR1_F				-111.5		
		NR_FDD_FR1_G				-111		
		NR_FDD_FR1_H				-110.5		
$N_{oc}$ <sup>Note2</sup>	Config 1,2	NR_FDD_FR1_A, NR_TDD_FR1_A NOTE 6	dBm/SCS	-85	-101	-114		
						-113.5		
						-113		
						-112.5		
						-112		
						-111.5		
						-111		
						-110.5		

	Config 3	NR_FDD_FR1_A, NR_TDD_FR1_A NOTE 6	dB	-88		-		-111	
		NR_FDD_FR1_B						-110.5	
		NR_TDD_FR1_C						-110	
		NR_FDD_FR1_D, NR_TDD_FR1_D						-109.5	
		NR_FDD_FR1_E, NR_TDD_FR1_E						-109	
		NR_FDD_FR1_F						-108.5	
		NR_FDD_FR1_G						-108	
		NR_FDD_FR1_H						-107.5	
$\hat{E}_s/I_{ot}$			dB	-1.76		-4.7		-5.46	-5.46
$\hat{E}_s/N_{oc}$			dB	3	3	-2.9	-2.9	-4	-4
SS- RSRP <sup>Note 3</sup>	Config 1,2	NR_FDD_FR1_A, NR_TDD_FR1_A NOTE 6	dBm/SCS	-82	-82	-103.9	-103.9	-118	
		NR_FDD_FR1_B						-	-117.5
		NR_TDD_FR1_C						117.5	-117
		NR_FDD_FR1_D, NR_TDD_FR1_D						-	-116.5
		NR_FDD_FR1_E, NR_TDD_FR1_E						116.5	-116
		NR_FDD_FR1_F						-116	-116
		NR_FDD_FR1_G						-	-115.5
		NR_FDD_FR1_H						115.5	-115
	Config 3	NR_FDD_FR1_A, NR_TDD_FR1_A NOTE 6		-85	-85	-	-	-115	-115
		NR_FDD_FR1_B		-	-114.5				
		NR_TDD_FR1_C		114.5	-114	-114			
		NR_FDD_FR1_D, NR_TDD_FR1_D		-	-113.5				
		NR_FDD_FR1_E, NR_TDD_FR1_E		113.5	-113	-113			
		NR_FDD_FR1_F		-	-112.5				
		NR_FDD_FR1_G		112.5	-112	-112			
		NR_FDD_FR1_H		-	-111.5				
SS-RSRQ <sup>Note3</sup>		NR_FDD_FR1_A, NR_TDD_FR1_A NOTE 6	dB	-14.77	-14.77	-16.76	-16.76	-	-17.34
		NR_FDD_FR1_B						17.34	
		NR_TDD_FR1_C							
		NR_FDD_FR1_D, NR_TDD_FR1_D							
		NR_FDD_FR1_E, NR_TDD_FR1_E							
		NR_FDD_FR1_F							
		NR_FDD_FR1_G							
		NR_FDD_FR1_H							
Io <sup>Note3</sup>	Config 1,2	NR_FDD_FR1_A, NR_TDD_FR1_A NOTE 6	dBm/ 9.36MHz	-50		-70		-83.5	
		NR_FDD_FR1_B						-83	
		NR_TDD_FR1_C						-82.5	
		NR_FDD_FR1_D, NR_TDD_FR1_D						-82	
		NR_FDD_FR1_E, NR_TDD_FR1_E						-81.5	
		NR_FDD_FR1_F						-81	



Config 3	NR_FDD_FR1_G	dBm/ 38.16MHz	-50	-				-80.5
	NR_FDD_FR1_H							-80
	NR_FDD_FR1_A, NR_TDD_FR1_A NOTE 6							-77.4
	NR_FDD_FR1_B							-76.9
	NR_TDD_FR1_C							-76.4
	NR_FDD_FR1_D, NR_TDD_FR1_D							-75.9
	NR_FDD_FR1_E, NR_TDD_FR1_E							-75.4
	NR_FDD_FR1_F							-74.9
	NR_FDD_FR1_G							-74.4
	NR_FDD_FR1_H							-73.9
Propagation condition		-	AWGN	AWGN	AWGN	AWGN	AWGN	AWGN
Antenna configuration			1x2	1x2	1x2	1x2	1x2	1x2
<p>Note 1: OCNG shall be used such that both cells are fully allocated and a constant total transmitted power spectral density is achieved for all OFDM symbols.</p> <p>Note 2: Interference from other cells and noise sources not specified in the test is assumed to be constant over subcarriers and time and shall be modelled as AWGN of appropriate power for <math>N_{oc}</math> to be fulfilled.</p> <p>Note 3: SS-RSRQ, SS-RSRP, and <math>I_o</math> levels have been derived from other parameters for information purposes. They are not settable parameters themselves.</p> <p>Note 4: SS-RSRQ, SS-RSRP minimum requirements are specified assuming independent interference and noise at each receiver antenna port.</p> <p>Note 5: NR operating band groups are as defined in clause 3.5.2.</p> <p>Note 6: The test configuration excludes support for band n51 and it is not required to run this test on band n51 in this release of the specification.</p>								

A.6.7.2.1.3 Test Requirements

The SS-RSRQ measurement accuracy shall fulfil the requirements in clause 10.1.7.1.1.

A.6.7.2.2 SA Inter-frequency measurement accuracy with FR1 serving cell and FR1 target cell

A.6.7.2.2.1 Test Purpose and Environment

The purpose of this test is to verify that the SS-RSRQ measurement accuracy is within the specified limits. This test will verify the requirements in Clause 10.1.9.1.1 and 10.1.9.1.2.

A.6.7.2.2.2 Test Parameters

In this test case the two cells (i.e., Cell 1 and Cell 2) are on different carrier frequencies and measurement gaps are provided. Supported test configurations are shown in Table A.6.7.2.2.2-1. Both absolute accuracy and relative accuracy requirements of SS-RSRQ inter-frequency measurement are tested by using test parameters in Table A.6.7.2.2.2-2. In all test cases, Cell 1 is the PCell and Cell 2 is target cell.

Table A.6.7.2.2.2-1: SS-RSRQ Inter frequency SS-RSRQ supported test configurations

Config	Description
1	NR 15 kHz SSB SCS, 10 MHz bandwidth, FDD duplex mode
2	NR 15 kHz SSB SCS, 10 MHz bandwidth, TDD duplex mode
3	NR 30kHz SSB SCS, 40 MHz bandwidth, TDD duplex mode

Note: The UE is only required to be tested in one of the supported test configurations

Table A.6.7.2.2.2-2: SS-RSRQ Inter frequency test parameters

Parameter	Unit	Test 1		Test 2		Test 3	
		Cell 1	Cell 2	Cell 1	Cell 2	Cell 1	Cell 2
SSB ARFCN		freq1	freq2	freq1	freq2	freq1	freq2
Duplex mode	Config 1	FDD					
	Config 2,3	TDD					
TDD configuration	Config 1	Not Applicable					

	Config 2		TDDConf.1.1					
	Config 3		TDDConf.2.1					
BW <sub>channel</sub>	Config 1	MHz	10: N <sub>RB,c</sub> = 52					
	Config 2		10: N <sub>RB,c</sub> = 52					
	Config 3		40: N <sub>RB,c</sub> = 106					
Gap pattern ID	Config 1,2,3		0					
BWP BW	Config 1		10: N <sub>RB,c</sub> = 52					
	Config 2		10: N <sub>RB,c</sub> = 52					
	Config 3		40: N <sub>RB,c</sub> = 106					
DRX Cycle		ms	Not Applicable					
PDSCH Reference measurement channel	Config 1,4		SR.1.1 FDD	-	SR.1.1 FDD	-	SR.1.1 FDD	-
	Config 2,5		SR.1.1 TDD		SR.1.1 TDD		SR.1.1 TDD	
	Config 3,6		SR2.1 TDD		SR2.1 TDD		SR2.1 TDD	
RMSI CORESET Reference Channel	Config 1		CR.1.1 FDD	-	R.1.1 FDD	-	CR.1.1 FDD	
	Config 2		CR.1.1 TDD		CR.1.1 TDD		CR.1.1 TDD	
	Config 3		CR2.1 TDD		CR2.1 TDD		CR2.1 TDD	
Dedicated CORESET Reference Channel	Config 1		CCR.1.1 FDD	-	CCR.1.1 FDD	-	CCR.1.1 FDD	-
	Config 2		CCR.1.1 TDD		CCR.1.1 TDD		CCR.1.1 TDD	
	Config 3		CCR2.1 TDD		CCR2.1 TDD		CCR2.1 TDD	
TRS Configuration	Config 1		TRS.1.1 FDD	-	TRS.1.1 FDD	-	TRS.1.1 FDD	-
	Config 2		TRS.1.1 TDD		TRS.1.1 TDD		TRS.1.1 TDD	
	Config 3		TRS.1.2 TDD		TRS.1.2 TDD		TRS.1.2 TDD	
OCNG Patterns			OCNG pattern 1					
Time offset with Cell 1	Config 1	ms	-	3	-	3	-	3
	Config 2,3	µs	-	3	-	3	-	3
SMTC configuration	Config 1		SMTC pattern 2					
	Config 2,3		SMTC pattern 1					
SSB configuration	Config 1,2		SSB pattern 1 in FR1					
	Config 3		SSB pattern 2 in FR1					
CSI-RS for tracking	Config 1		TRS.1.1 FDD					
	Config 2		TRS.1.1 TDD					
	Config 3		TRS.1.2 TDD					
PDSCH/PDCCH subcarrier spacing	Config 1,2	kHz	15 kHz					
	Config 3		30 kHz					
EPRE ratio of PSS to SSS		dB	0	0	0	0	0	0
EPRE ratio of PBCH DMRS to SSS								
EPRE ratio of PBCH to PBCH DMRS								
EPRE ratio of PDCCH DMRS to SSS								
EPRE ratio of PDCCH to PDCCH DMRS								
EPRE ratio of PDSCH DMRS to SSS								
EPRE ratio of PDSCH to PDSCH								
EPRE ratio of OCNG DMRS to SSS(Note 1)								
EPRE ratio of OCNG to OCNG DMRS (Note 1)								
N <sub>oc</sub> <sup>Note2</sup>	Config 1,2	NR_FDD_FR1_A NR_TDD_FR1_A NOTE 6	-80.18		-106		-116	
		NR_FDD_FR1_B					-115.5	
		NR_TDD_FR1_C					-115	
		NR_FDD_FR1_D NR_TDD_FR1_D					-114.5	
		NR_FDD_FR1_E NR_TDD_FR1_E					-114	
		NR_FDD_FR1_F					-113.5	
		NR_FDD_FR1_G					-113	

$N_{oc}$ <sup>Note2</sup>	Config 3	NR_FDD_FR1_H	dBm/15kHz	-86.27	-113	-112.5			
		NR_FDD_FR1_A				-116			
		NR_TDD_FR1_A NOTE 6							
		NR_FDD_FR1_B				-115.5			
		NR_TDD_FR1_C				-115			
		NR_FDD_FR1_D				-114.5			
		NR_TDD_FR1_D							
		NR_FDD_FR1_E				-114			
		NR_TDD_FR1_E							
NR_FDD_FR1_F	-113.5								
NR_FDD_FR1_G	-113								
NR_FDD_FR1_H	-112.5								
$N_{oc}$ <sup>Note2</sup>	Config 1,2	NR_FDD_FR1_A	dBm/15kHz	-80.18	-106	-116			
		NR_TDD_FR1_A NOTE 6							
		NR_FDD_FR1_B				-115.5			
		NR_TDD_FR1_C				-115			
		NR_FDD_FR1_D				-114.5			
		NR_TDD_FR1_D							
		NR_FDD_FR1_E				-114			
		NR_TDD_FR1_E							
		NR_FDD_FR1_F				-113.5			
	NR_FDD_FR1_G	-113							
	NR_FDD_FR1_H	-112.5							
	Config 3	NR_FDD_FR1_A	dBm/15kHz	-83.27	-110	-113			
		NR_TDD_FR1_A NOTE 6							
		NR_FDD_FR1_B				-112.5			
		NR_TDD_FR1_C				-112			
		NR_FDD_FR1_D				-111.5			
		NR_TDD_FR1_D							
		NR_FDD_FR1_E				-111			
NR_TDD_FR1_E									
NR_FDD_FR1_F		-110.5							
NR_FDD_FR1_G	-110								
NR_FDD_FR1_H	-109.5								
$\hat{E}_s / I_{ot}$			dB	-1.75	-1.75	3	-1.75		
$\hat{E}_s / N_{oc}$			dB	-1.75	-1.75	3	-1.75		
SS- RSRP <sup>Not e3</sup>	Config 1,2	NR_FDD_FR1_A	dBm/SCS	-81.93	-81.93	-107.75	-	-113	-
		NR_TDD_FR1_A NOTE 6						-117.75	5
		NR_FDD_FR1_B						-112.5	-
		NR_TDD_FR1_C						-112	-
		NR_FDD_FR1_D						-111.5	-
		NR_TDD_FR1_D						-116.25	5
		NR_FDD_FR1_E						-111	-
		NR_TDD_FR1_E						-115.75	5
		NR_FDD_FR1_F						-110.5	-115.2
	NR_FDD_FR1_G	-110	-						
	NR_FDD_FR1_H	-109.5	-						
	Config 3	NR_FDD_FR1_A	dBm/SCS	-85.02	-85.02	-111.75	-	-110	-
		NR_TDD_FR1_A NOTE 6						-114.75	5

		NR_FDD_FR1_B						-109.5	-114.25
		NR_TDD_FR1_C						-109	-113.75
		NR_FDD_FR1_D NR_TDD_FR1_D						-108.5	-113.25
		NR_FDD_FR1_E NR_TDD_FR1_E						-108	-112.75
		NR_FDD_FR1_F						-107.5	-112.2
		NR_FDD_FR1_G						-107	-111.75
		NR_FDD_FR1_H						-106.5	-111.25
SS-RSRQ <sup>Note3</sup>		NR_FDD_FR1_A NR_TDD_FR1_A NOTE 6	dB	-14.77	-14.77	-40.59	-40.59	12.56 T	14.76 T
		NR_FDD_FR1_B							
		NR_TDD_FR1_C							
		NR_FDD_FR1_D NR_TDD_FR1_D							
		NR_FDD_FR1_E NR_TDD_FR1_E							
		NR_FDD_FR1_F							
		NR_FDD_FR1_G							
		NR_FDD_FR1_H							
I <sub>o</sub> <sup>Note3</sup>	Config 1,2	NR_FDD_FR1_A NR_TDD_FR1_A NOTE 6	dBm/SCS	-50		-75.83		-83.28	-85.83
		NR_FDD_FR1_B						-82.78	-85.33
		NR_TDD_FR1_C						-82.28	-84.83
		NR_FDD_FR1_D NR_TDD_FR1_D						-81.78	-84.33
		NR_FDD_FR1_E NR_TDD_FR1_E						-81.28	-83.83
		NR_FDD_FR1_F						-80.78	-83.33
		NR_FDD_FR1_G						-80.28	-82.83
		NR_FDD_FR1_H						-79.78	-82.33
	Config 3	NR_FDD_FR1_A NR_TDD_FR1_A NOTE 6		-50		-76.73	-77.19	-79.73	
		NR_FDD_FR1_B					-76.69	-79.23	
		NR_TDD_FR1_C					-76.19	-78.73	
		NR_FDD_FR1_D NR_TDD_FR1_D					-75.69	-78.23	
		NR_FDD_FR1_E NR_TDD_FR1_E					-75.19	-77.73	
		NR_FDD_FR1_F					-74.69	-77.23	
	NR_FDD_FR1_G				-74.19	-76.73			
	NR_FDD_FR1_H				-73.69	-76.53			
Propagation condition			-	AWGN	AWGN	AWGN	AWGN	AWGN	AWGN
Antenna configuration				1x2	1x2	1x2	1x2	1x2	1x2
<p>Note 1: OCNG shall be used such that both cells are fully allocated and a constant total transmitted power spectral density is achieved for all OFDM symbols.</p> <p>Note 2: Interference from other cells and noise sources not specified in the test is assumed to be constant over subcarriers and time and shall be modelled as AWGN of appropriate power for <math>N_{oc}</math> to be fulfilled.</p> <p>Note 3: SS-RSRQ, SS-RSRP, and I<sub>o</sub> levels have been derived from other parameters for information purposes. They are not settable parameters themselves.</p> <p>Note 4: SS-RSRQ, SS-RSRP minimum requirements are specified assuming independent interference and noise at each receiver antenna port.</p>									

Note 5: NR operating band groups are as defined in clause 3.5.2.  
 Note 6: The test configuration excludes support for band n51 and it is not required to run this test on band n51 in this release of the specification.

**A.6.7.2.2.3 Test Requirements**

The SS-RSRQ measurement accuracy shall fulfil the requirements in clause 10.1.9.1.1 and 10.1.9.1.2.

**A.6.7.3 SS-SINR**

**A.6.7.3.1 SA intra-frequency measurement accuracy with FR1 serving cell and FR1 target cell**

**A.6.7.3.1.1 Test Purpose and Environment**

The purpose of this test is to verify that the SS-SINR measurement accuracy is within the specified limits. This test will verify the requirements in clause 10.1.12.1.1.

**A.6.7.3.1.2 Test Parameters**

In this test case all cells are on the same carrier frequency. Supported test configuration are shown in Table A.6.7.3.1.2-1. The absolute accuracy of SS-SINR intra-frequency measurement is tested by using the parameters in Table A.6.7.3.1.2-2. In all test cases, Cell 1 is the PCell and Cell 2 is the target cell.

**Table A.6.7.3.1.2-1: SS-SINR Intra frequency SS-SINR supported test configurations**

Config	Description
1	NR 15 kHz SSB SCS, 10 MHz bandwidth, FDD duplex mode
2	NR 15 kHz SSB SCS, 10 MHz bandwidth, TDD duplex mode
3	NR 30 kHz SSB SCS, 40 MHz bandwidth, TDD duplex mode
Note:	The UE is only required to be tested in one of the supported test configurations

**Table A.6.7.3.1.2-2: SS-SINR Intra frequency test parameters**

Parameter		Unit	Test 1		Test 2	
			Cell 1	Cell 2	Cell 1	Cell 2
Cell ID			489	0	489	0
SSB ARFCN			freq1		freq1	
Duplex mode	Config 1		FDD			
	Config 2,3		TDD			
TDD configuration	Config 1		Not Applicable			
	Config 2		TDDConf.1.1			
	Config 3		TDDConf.2.1			
Downlink initial BWP configuration			DLBWP.0.1			
Downlink dedicated BWP configuration			DLBWP.1.1			
Uplink initial BWP configuration			ULBWP.0.1			
Uplink dedicated BWP configuration			ULBWP.1.1			
DRX Cycle configuration		ms	Not Applicable			
TRS configuration	Config 1		TRS.1.1 FDD		TRS.1.1 FDD	
	Config 2		TRS.1.1 TDD		TRS.1.1 TDD	
	Config 3		TRS.1.2 TDD		TRS.1.2 TDD	
PDSCH Reference measurement channel	Config 1		SR.1.1 FDD	-	SR.1.1 FDD	-
	Config 2		SR.1.1 TDD		SR.1.1 TDD	
	Config 3		SR.2.1 TDD		SR2.1 TDD	
RMSI CORESET Reference Channel	Config 1		CR.1.1 FDD	-	CR.1.1 FDD	
	Config 2		CR.1.1 TDD		CR.1.1 TDD	

	Config 3		CR.2.1 TDD		CR.2.1 TDD		
Dedicated CORESET Reference Channel	Config 1		CCR.1. 1 FDD	-	CCR.1.1 FDD	-	
	Config 2		CCR.1. 1 TDD		CCR.1.1 TDD		
	Config 3		CCR.2. 1 TDD		CCR.2.1 TDD		
OCNG Patterns			OP.1				
SS-RSSI-Measurement			Not Applicable				
SMTTC configuration	Config 1		SMTTC.2				
	Config 2,3		SMTTC.1				
Time offset with Cell 1	Config 1	ms	-	3	-	3	
	Config 2,3	µs	-	3	-	3	
SSB configuration	Config 1,2		SSB.1 FR1				
	Config 3		SSB.2 FR1				
PDSCH/PDCCH subcarrier spacing	Config 1,2	kHz	15				
	Config 3		30				
EPRE ratio of PSS to SSS		dB	0	0	0	0	
EPRE ratio of PBCH DMRS to SSS							
EPRE ratio of PBCH to PBCH DMRS							
EPRE ratio of PDCCH DMRS to SSS							
EPRE ratio of PDCCH to PDCCH DMRS							
EPRE ratio of PDSCH DMRS to SSS							
EPRE ratio of PDSCH to PDSCH							
EPRE ratio of OCNG DMRS to SSS(Note 1)							
EPRE ratio of OCNG to OCNG DMRS (Note 1)							
$N_{oc}$ <sup>Note2</sup>	NR_FDD_FR1_A, NR_TDD_FR1_A NOTE 6	dBm/15kHz	-93		-116		
							-115.5
			-115				
					-114.5		
			-114				
					-113.5		
			-113				
					-112.5		
$N_{oc}$ <sup>Note2</sup>	Config 1,2	dBm/SCS	-93				Same as $N_{oc}$ for 15 kHz
					-113		
			-112.5				
					-112		
			-111.5				
					-111		
			-110.5				
					-110		
-109.5							
		$\hat{E}_s / I_{ot}$		dB	0	-3.19	-5.46
$\hat{E}_s / N_{oc}$		dB	4.54	2.66	-4	-4	
SS- RSRP <sup>Note 3</sup>	Config 1,2	NR_FDD_FR1_A, NR_TDD_FR1_A NOTE 6	dBm/SCS	-88.46	-90.34	-120	-120
						-119.5	-119.5
						-119	-119
						-118.5	-118.5
						-118	-118
		NR_FDD_FR1_B NR_TDD_FR1_C NR_FDD_FR1_D, NR_TDD_FR1_D NR_FDD_FR1_E, NR_TDD_FR1_E NR_FDD_FR1_F NR_FDD_FR1_G NR_FDD_FR1_H					

		NR_FDD_FR1_F			-117.5	-117.5
		NR_FDD_FR1_G			-117	-117
		NR_FDD_FR1_H			-116.5	-116.5
	Config 3	NR_FDD_FR1_A, NR_TDD_FR1_A NOTE 6	-85.46	-87.34	-117	-117
		NR_FDD_FR1_B			-116.5	-116.5
		NR_TDD_FR1_C			-116	-116
		NR_FDD_FR1_D, NR_TDD_FR1_D			-115.5	-115.5
		NR_FDD_FR1_E, NR_TDD_FR1_E			-115	-115
		NR_FDD_FR1_F			-114.5	-114.5
		NR_FDD_FR1_G			-114	-114
		NR_FDD_FR1_H			-113.5	-113.5
SS-SINR <sup>Note3</sup>		NR_FDD_FR1_A, NR_TDD_FR1_A NOTE 6	dB	0	-3.19	-5.46
		NR_FDD_FR1_B				
		NR_TDD_FR1_C				
		NR_FDD_FR1_D, NR_TDD_FR1_D				
		NR_FDD_FR1_E, NR_TDD_FR1_E				
		NR_FDD_FR1_F				
		NR_FDD_FR1_G				
		NR_FDD_FR1_H				
Io <sup>Note3</sup>	Config 1,2	NR_FDD_FR1_A, NR_TDD_FR1_A NOTE 6	dBm/ 9.36MHz	-57.5	-85.51	
		NR_FDD_FR1_B			-85.01	
		NR_TDD_FR1_C			-84.51	
		NR_FDD_FR1_D, NR_TDD_FR1_D			-84.01	
		NR_FDD_FR1_E, NR_TDD_FR1_E			-83.51	
		NR_FDD_FR1_F			-83.01	
		NR_FDD_FR1_G			-82.51	
		NR_FDD_FR1_H			-82.01	
	Config 3	NR_FDD_FR1_A, NR_TDD_FR1_A NOTE 6	dBm/ 38.16MHz	-51.41	-79.41	
		NR_FDD_FR1_B			-78.91	
		NR_TDD_FR1_C			-78.41	
		NR_FDD_FR1_D, NR_TDD_FR1_D			-77.91	
		NR_FDD_FR1_E, NR_TDD_FR1_E			-77.41	
		NR_FDD_FR1_F			-76.91	
NR_FDD_FR1_G	-76.41					
NR_FDD_FR1_H	-75.91					
Propagation condition			-	AWGN		
Antenna configuration			-	1x2		
<p>Note 1: OCNG shall be used such that both cells are fully allocated and a constant total transmitted power spectral density is achieved for all OFDM symbols.</p> <p>Note 2: Interference from other cells and noise sources not specified in the test is assumed to be constant over subcarriers and time and shall be modelled as AWGN of appropriate power for <math>N_{oc}</math> to be fulfilled.</p> <p>Note 3: SS-SINR, SS-RSRP, and Io levels have been derived from other parameters for information purposes. They are not settable parameters themselves.</p> <p>Note 4: SS-SINR, SS-RSRP minimum requirements are specified assuming independent interference and noise at each receiver antenna port.</p> <p>Note 5: NR operating band groups are as defined in clause 3.5.2.</p> <p>Note 6: The test configuration excludes support for band n51 and it is not required to run this test on band n51 in this release of the specification.</p>						

### A.6.7.3.1.3 Test Requirements

The SS-SINR measurement accuracy shall fulfil the requirements in clause 10.1.12.1.1.

### A.6.7.3.2 SA Inter-frequency measurement accuracy with FR1 serving cell and FR1 target cell

#### A.6.7.3.2.1 Test Purpose and Environment

The purpose of this test is to verify that the SS-SINR measurement accuracy is within the specified limits. This test will verify the requirements in clauses 10.1.14.1.1 and 10.1.14.1.2.

#### A.6.7.3.2.2 Test Parameters

In this test case the two cells (i.e., Cell 1 and Cell 2) are on different carrier frequencies and measurement gaps are provided. Supported test configurations are shown in Table A.6.7.3.2.2-1. Both absolute accuracy and relative accuracy requirements of SS-SINR inter-frequency measurement are tested by using test parameters in Table A.6.7.3.2.2-2. In all test cases, Cell 1 is the PCell and Cell 2 is target cell.

**Table A.6.7.3.2.2-1: SS-SINR Inter frequency SS-SINR supported test configurations**

Config	Description
1	NR 15 kHz SSB SCS, 10 MHz bandwidth, FDD duplex mode
2	NR 15 kHz SSB SCS, 10 MHz bandwidth, TDD duplex mode
3	NR 30 kHz SSB SCS, 40 MHz bandwidth, TDD duplex mode
Note: The UE is only required to be tested in one of the supported test configurations	

**Table A.6.7.3.2.2-2: SS-SINR Inter frequency test parameters**

Parameter		Unit	Test 1		Test 2		Test 3	
			Cell 1	Cell 2	Cell 1	Cell 2	Cell 1	Cell 2
SSB ARFCN			freq1	freq2	freq1	freq2	freq1	freq2
Duplex mode	Config 1		FDD					
	Config 2,3		TDD					
TDD configuration	Config 1		Not Applicable					
	Config 2		TDDConf.1.1					
	Config 3		TDDConf.2.1					
Downlink initial BWP configuration			DLBWP.0.1					
Downlink dedicated BWP configuration			DLBWP.1.1					
Uplink initial BWP configuration			ULBWP.0.1					
Uplink dedicated BWP configuration			ULBWP.1.1					
DRX Cycle configuration		ms	Not Applicable					
Gap pattern ID			0	-	0	-	0	-
TRS configuration	Config 1		TRS.1.1 1 FDD		TRS.1.1 FDD		TRS.1.1 1 FDD	
	Config 2		TRS.1.1 1 TDD		TRS.1.1 TDD		TRS.1.1 1 TDD	
	Config 3		TRS.1.1 2 TDD		TRS.1.2 TDD		TRS.1.1 2 TDD	
PDSCH Reference measurement channel	Config 1		SR.1.1 FDD	-	SR.1.1 FDD	-	SR.1.1 FDD	-
	Config 2		SR.1.1 TDD		SR.1.1 TDD		SR.1.1 TDD	
	Config 3		SR2.1 TDD		SR2.1 TDD		SR2.1 TDD	
RMSI CORESET Reference Channel	Config 1		CR.1.1 FDD	-	CR.1.1 FDD	-	CR.1.1 FDD	
	Config 2		CR.1.1 TDD		CR.1.1 TDD		CR.1.1 TDD	
	Config 3		CR2.1 TDD		CR2.1 TDD		CR2.1 TDD	
Dedicated CORESET Reference Channel	Config 1		CCR.1.1 1 FDD	-	CCR.1.1 1 FDD	-	CCR.1.1 1 FDD	-
	Config 2		CCR.1.1 1 TDD		CCR.1.1 1 TDD		CCR.1.1 1 TDD	
	Config 3		CCR2.1 1 TDD		CCR2.1 TDD		CCR2.1 1 TDD	



OCNG Patterns			OP.1									
SS-RSSI-Measurement			Not Applicable									
Time offset with Cell 1	Config 1	ms	-	3	-	3	-	3				
	Config 2,3	µs	-	3	-	3	-	3				
SMTC configuration	Config 1		SMTC pattern 2									
	Config 2,3		SMTC pattern 1									
SSB configuration	Config 1,2		SSB.1 FR1									
	Config 3		SSB.2 FR1									
PDSCH/PDCCH subcarrier spacing	Config 1,2	kHz	15									
	Config 3		30									
EPRE ratio of PSS to SSS			0	0	0	0	0	0				
EPRE ratio of PBCH DMRS to SSS												
EPRE ratio of PBCH to PBCH DMRS												
EPRE ratio of PDCCH DMRS to SSS												
EPRE ratio of PDCCH to PDCCH DMRS												
EPRE ratio of PDSCH DMRS to SSS												
EPRE ratio of PDSCH to PDSCH												
EPRE ratio of OCNG DMRS to SSS(Note 1)												
EPRE ratio of OCNG to OCNG DMRS (Note 1)												
$N_{oc}$ <sup>Note2</sup>	Config 1,2	NR_FDD_FR1_A NR_TDD_FR1_A NOTE 6	dBm/15kHz	-88	-108.5	-119.5						
		NR_FDD_FR1_B				-119						
		NR_TDD_FR1_C				-118.5						
		NR_FDD_FR1_D NR_TDD_FR1_D				-118						
		NR_FDD_FR1_E NR_TDD_FR1_E				-117.5						
		NR_FDD_FR1_F				-117						
		NR_FDD_FR1_G				-116.5						
		NR_FDD_FR1_H				-116						
$N_{oc}$ <sup>Note2</sup>	Config 1,2		dBm/SCS	-88	-108.5	Same as $N_{oc}$ for 15kHz						
						Config 3	NR_FDD_FR1_A NR_TDD_FR1_A NOTE 6	-85	-105.5	-116.5		
										NR_FDD_FR1_B	-116	
										NR_TDD_FR1_C	-115.5	
										NR_FDD_FR1_D NR_TDD_FR1_D	-115	
										NR_FDD_FR1_E NR_TDD_FR1_E	-114.5	
										NR_FDD_FR1_F	-114	
	NR_FDD_FR1_G	-114.5										
	NR_FDD_FR1_H	-113										
	$\hat{E}_s / I_{ot}$			dB	-1.75	-1.75	20	20	-4.0	-4.0		
	$\hat{E}_s / N_{oc}$			dB	-1.75		20		-4.0			
	SS-RSRP <sup>Note3</sup>	Config 1,2	NR_FDD_FR1_A NR_TDD_FR1_A NOTE 6	dBm/SCS	-89.75	-88.5	-123.5					
			NR_FDD_FR1_B				-123					
			NR_TDD_FR1_C				-122.5					
NR_FDD_FR1_D NR_TDD_FR1_D			-122									
NR_FDD_FR1_E			-121.5									

		NR_TDD_FR1_E					
		NR_FDD_FR1_F				-121	
		NR_FDD_FR1_G				-120.5	
		NR_FDD_FR1_H				-120	
	Config 3	NR_FDD_FR1_A		-86.75	-85.5	-120.5	
		NR_TDD_FR1_A NOTE 6					
		NR_FDD_FR1_B					-120
		NR_TDD_FR1_C					-119.5
		NR_FDD_FR1_D					-119
		NR_TDD_FR1_D					
		NR_FDD_FR1_E					-118.5
		NR_TDD_FR1_E					
		NR_FDD_FR1_F					-118
		NR_FDD_FR1_G					-117.5
		NR_FDD_FR1_H				-117	
SS-SINR <sup>Note3</sup>		NR_FDD_FR1_A	dB	-1.75	20	-4.0	
		NR_TDD_FR1_A NOTE 6					
		NR_FDD_FR1_B					
		NR_TDD_FR1_C					
		NR_FDD_FR1_D					
		NR_TDD_FR1_D					
		NR_FDD_FR1_E					
		NR_TDD_FR1_E					
Io <sup>Note3</sup>	Config 1,2	NR_FDD_FR1_A	dBm/ 9.36MHz	-57.83	-60.5	-90.09	
		NR_TDD_FR1_A NOTE 6					
		NR_FDD_FR1_B					-89.59
		NR_TDD_FR1_C					-89.09
		NR_FDD_FR1_D					-88.59
		NR_TDD_FR1_D					
		NR_FDD_FR1_E					-88.09
		NR_TDD_FR1_E					
	NR_FDD_FR1_F	-87.59					
	NR_FDD_FR1_G	-87.09					
	NR_FDD_FR1_H	-86.59					
	Config 3	NR_FDD_FR1_A	dBm/ 38.16MHz	-51.73	-54.41	-84	
		NR_TDD_FR1_A NOTE 6					
		NR_FDD_FR1_B					-83.5
NR_TDD_FR1_C		-83					
NR_FDD_FR1_D		-82.5					
NR_TDD_FR1_D							
NR_FDD_FR1_E	-82						
NR_TDD_FR1_E							
NR_FDD_FR1_F	-81.5						
NR_FDD_FR1_G	-81						
NR_FDD_FR1_H	-80.5						
Propagation condition			-	AWGN			
Antenna configuration			-	1x2			
<p>Note 1: OCNG shall be used such that both cells are fully allocated and a constant total transmitted power spectral density is achieved for all OFDM symbols.</p> <p>Note 2: Interference from other cells and noise sources not specified in the test is assumed to be constant over subcarriers and time and shall be modelled as AWGN of appropriate power for <math>N_{oc}</math> to be fulfilled.</p> <p>Note 3: SS-SINR, SS-RSRP, and Io levels have been derived from other parameters for information purposes. They are not settable parameters themselves.</p> <p>Note 4: SS-SINR, SS-RSRP minimum requirements are specified assuming independent interference and noise at each receiver antenna port.</p> <p>Note 5: NR operating band groups are as defined in clause 3.5.2.</p> <p>Note 6: The test configuration excludes support for band n51 and it is not required to run this test on band n51 in this release of the specification.</p>							

### A.6.7.3.2.3 Test Requirements

The SS-SINR measurement accuracy shall fulfil the requirements in clause 10.1.14.1.1 and 10.1.14.1.2.

## A.6.7.4 L1-RSRP measurement for beam reporting

### A.6.7.4.1 SSB based L1-RSRP measurement

#### A.6.7.4.1.1 Test Purpose and Environment

The purpose of this test is to verify that the L1-RSRP measurement accuracy is within the specified limits. This test will verify the requirements in clause 9.5.2 and clause 10.1.19.1 for L1-RSRP measurements based on SSB with the testing configurations for NR cells in Table A.6.7.4.1.1-1.

**Table A.6.7.4.1.1-1: Applicable NR configurations for FR1 SSB based L1-RSRP test**

Config	Description
1	NR 15 kHz SSB SCS, 10 MHz bandwidth, FDD duplex mode
2	NR 15 kHz SSB SCS, 10 MHz bandwidth, TDD duplex mode
3	NR 30kHz SSB SCS, 40 MHz bandwidth, TDD duplex mode
Note:	The UE is only required to be tested in one of the supported test configurations in each supported band

#### A.6.7.4.1.2 Test parameters

In this set of test cases there one cell in the test, PCell (Cell 1). The test parameters for the Cell 1 are given in Table A.6.7.4.1.2-1 below. The absolute and relative accuracy of L1-RSRP measurements are tested by using the parameters in Table A.6.7.4.1.2-1.

There is no measurement gap configured in the test. Before the test, UE is configured one SSB resource set with two SSB resources. UE is configured to perform RLM, BFD and L1-RSRP measurement based on the SSB resources 0 and 1.

**Table A.6.7.4.1.2-1: FR1 SSB based L1-RSRP test parameters**

Parameter	Config	Unit	Test 1	Test 2
SSB GSCN	1~3		freq1	freq1
Duplex mode	1		FDD	FDD
	2		TDD	TDD
	3		TDD	TDD
TDD Configuration	1		N/A	N/A
	2		TDDConf.1.1	TDDConf.1.1
	3		TDDConf.2.1	TDDConf.2.1
BW <sub>channel</sub>	1	MHz	10: N <sub>RB,c</sub> = 52	10: N <sub>RB,c</sub> = 52
	2		10: N <sub>RB,c</sub> = 52	10: N <sub>RB,c</sub> = 52
	3		40: N <sub>RB,c</sub> = 106	40: N <sub>RB,c</sub> = 106
PDSCH Reference measurement channel	1		SR.1.1 FDD	SR.1.1 FDD
	2		SR.1.1 TDD	SR.1.1 TDD
	3		SR.2.1 TDD	SR.2.1 TDD
RMSI CORESET Reference Channel	1		CR.1.1 FDD	CR.1.1 FDD
	2		CR.1.1 TDD	CR.1.1 TDD
	3		CR.2.1 TDD	CR.2.1 TDD
Dedicated CORESET Reference Channel	1		CCR.1.1 FDD	CCR.1.1 FDD
	2		CCR.1.1 TDD	CCR.1.1 TDD
	3		CCR.2.1 TDD	CCR.2.1 TDD
SSB configuration	1		SSB.3 FR1	SSB.3 FR1
	2		SSB.3 FR1	SSB.3 FR1
	3		SSB.4 FR1	SSB.4 FR1
OCNG Patterns	1~3		OP.1	OP.1
Initial BWP Configuration	1~3		DLBWP.0.1	DLBWP.0.1
			ULBWP.0.1	ULBWP.0.1
TRS configuration	1		TRS.1.1 FDD	TRS.1.1 FDD

		2		TRS.1.1 TDD	TRS.1.1 TDD
		3		TRS.1.2 TDD	TRS.1.2 TDD
Dedicated BWP configuration		1~3		DLBWP.1.1 ULBWP.1.1	DLBWP.1.1 ULBWP.1.1
SMTC configuration		1~3		SMTC.1	SMTC.1
reportConfigType		1~3		periodic	periodic
reportQuantity		1~3		ssb-Index-RSRP	ssb-Index-RSRP
Number of reported RS		1~3		2	2
L1-RSRP reporting period		1~3		slot80	slot80
EPRE ratio of PSS to SSS		1~3	dB	0	0
EPRE ratio of PBCH DMRS to SSS					
EPRE ratio of PBCH to PBCH DMRS					
EPRE ratio of PDCCH DMRS to SSS					
EPRE ratio of PDCCH to PDCCH DMRS					
EPRE ratio of PDSCH DMRS to SSS					
EPRE ratio of PDSCH to PDSCH DMRS					
EPRE ratio of OCNG DMRS to SSS <sup>Note 1</sup>					
EPRE ratio of OCNG to OCNG DMRS <sup>Note 1</sup>					
$N_{oc}$ Note2	NR_FDD_FR1_A, NR_TDD_FR1_A NOTE 5	1~3	dBm/15kHz	-94.65	-117
	NR_FDD_FR1_B				-116.5
	NR_TDD_FR1_C				-116
	NR_FDD_FR1_D, NR_TDD_FR1_D				-115.5
	NR_FDD_FR1_E, NR_TDD_FR1_E				-115
	NR_FDD_FR1_F				-114.5
	NR_FDD_FR1_G				-114
	NR_FDD_FR1_H				-113.5
$N_{oc}$ Note2	NR_FDD_FR1_A, NR_TDD_FR1_A NOTE 5	1,2	dBm/SSB SCS	-94.65	-117
	NR_FDD_FR1_B				-116.5
	NR_TDD_FR1_C				-116
	NR_FDD_FR1_D, NR_TDD_FR1_D				-115.5
	NR_FDD_FR1_E, NR_TDD_FR1_E				-115
	NR_FDD_FR1_F				-114.5
	NR_FDD_FR1_G				-114
	NR_FDD_FR1_H				-113.5
	NR_FDD_FR1_A, NR_TDD_FR1_A NOTE 5	3		-91.65	-114
	NR_FDD_FR1_B				-113.5
	NR_TDD_FR1_C				-114
	NR_FDD_FR1_D, NR_TDD_FR1_D				-112.5
	NR_FDD_FR1_E, NR_TDD_FR1_E				-112
	NR_FDD_FR1_F				-111.5
	NR_FDD_FR1_G				-111
	NR_FDD_FR1_H				-110.5
$\hat{E}_s/I_{ot}$		1~3	dB	10	-3

SSB RSRP Note3	NR_FDD_FR1_A, NR_TDD_FR1_A NOTE 5	1,2	dBm/SSB SCS	-84.65	-120	
	NR_FDD_FR1_B				-119.5	
	NR_TDD_FR1_C				-119	
	NR_FDD_FR1_D, NR_TDD_FR1_D				-118.5	
	NR_FDD_FR1_E, NR_TDD_FR1_E				-118	
	NR_FDD_FR1_F				-117.5	
	NR_FDD_FR1_G				-117	
	NR_FDD_FR1_H				-116.5	
	NR_FDD_FR1_A, NR_TDD_FR1_A NOTE 5	3		-81.65	-117	
	NR_FDD_FR1_B				-116.5	
	NR_TDD_FR1_C				-116	
	NR_FDD_FR1_D, NR_TDD_FR1_D				-115.5	
	NR_FDD_FR1_E, NR_TDD_FR1_E				-115	
	NR_FDD_FR1_F				-114.5	
	NR_FDD_FR1_G				-114	
	NR_FDD_FR1_H				-113.5	
I <sub>o</sub> Note3	NR_FDD_FR1_A, NR_TDD_FR1_A NOTE 5	1,2	dBm/9.36 MHz	-56.28	-87.28	
	NR_FDD_FR1_B				-86.78	
	NR_TDD_FR1_C				-86.28	
	NR_FDD_FR1_D, NR_TDD_FR1_D				-85.78	
	NR_FDD_FR1_E, NR_TDD_FR1_E				-85.28	
	NR_FDD_FR1_F				-84.78	
	NR_FDD_FR1_G				-84.28	
	NR_FDD_FR1_H				-83.78	
	NR_FDD_FR1_A, NR_TDD_FR1_A NOTE 5	3		dBm/38.16 MHz	-50.19	-81.19
	NR_FDD_FR1_B					-80.69
	NR_TDD_FR1_C					-80.19
	NR_FDD_FR1_D, NR_TDD_FR1_D					-79.69
	NR_FDD_FR1_E, NR_TDD_FR1_E					-79.19
	NR_FDD_FR1_F					-78.69
	NR_FDD_FR1_G					-78.19
	NR_FDD_FR1_H					-77.69
$\hat{E}_s/N_{oc}$	1~3	dB	10	-3		
Propagation condition	1~3		AWGN	AWGN		
Antenna configuration	1~3		1x2	1x2		
<p>Note 1: OCNG shall be used such that both cells are fully allocated and a constant total transmitted power spectral density is achieved for all OFDM symbols.</p> <p>Note 2: Interference from other cells and noise sources not specified in the test is assumed to be constant over subcarriers and time and shall be modelled as AWGN of appropriate power for <math>N_{oc}</math> to be fulfilled.</p> <p>Note 3: RSRP and I<sub>o</sub> levels have been derived from other parameters for information purposes. They are not settable parameters themselves.</p> <p>Note 4: RSRP minimum requirements are specified assuming independent interference and noise at each receiver antenna port.</p> <p>Note 5: The test configuration excludes support for band n51 and it is not required to run this test on band n51 in this release of the specification.</p>						

### A.6.7.4.1.3 Test Requirements

The L1-RSRP measurement accuracy for SSB resource reported by UE in L1-RSRP report (SSB#0 or SSB#1) of Cell 2 shall fulfil the requirements in clauses 10.1.19.1.

### A.6.7.4.2 CSI-RS based L1-RSRP measurement on resource set with repetition off

#### A.6.7.4.2.1 Test Purpose and Environment

The purpose of this test is to verify that the L1-RSRP measurement accuracy is within the specified limits. This test will verify the requirements in clause 9.5.3 and clause 10.1.19.2 for L1-RSRP measurements based on CSI-RS with the testing configurations for NR cells in Table A.6.7.4.2.1-1.

**Table A.6.7.4.2.1-1: Applicable NR configurations for FR1 CSI-RS based L1-RSRP test**

Config	Description
1	NR 15 kHz CSI-RS SCS, 10 MHz bandwidth, FDD duplex mode
2	NR 15 kHz CSI-RS SCS, 10 MHz bandwidth, TDD duplex mode
3	NR 30kHz CSI-RS SCS, 40 MHz bandwidth, TDD duplex mode
Note:	The UE is only required to be tested in one of the supported test configurations in each supported band

#### A.6.7.4.2.2 Test parameters

In this set of test cases there are one cell in the test, PCell (Cell 1). The test parameters for the Cell 1 are given in Table A.6.7.4.2.2-1 below. The absolute and relative accuracy of L1-RSRP measurements are tested by using the parameters in Table A.6.7.4.2.2-1.

There is no measurement gap configured in the test. Before the test, UE is configured one CSI-RS resource set with two CSI-RS resources. UE is configured to perform RLM and BFD based on SSB 0 and 1. CSI-RS is not transmitted in the same OFDM symbols as SSB.

**Table A.6.7.4.2.2-1: FR1 CSI-RS based L1-RSRP test parameters**

Parameter	Config	Unit	Test 1	Test 2
SSB GSCN	1~3		freq1	freq1
Duplex mode	1		FDD	FDD
	2		TDD	TDD
	3		TDD	TDD
TDD Configuration	1		N/A	N/A
	2		TDDConf.1.1	TDDConf.1.1
	3		TDDConf.2.1	TDDConf.2.1
BW <sub>channel</sub>	1	MHz	10: N <sub>RB,c</sub> = 52	10: N <sub>RB,c</sub> = 52
	2		10: N <sub>RB,c</sub> = 52	10: N <sub>RB,c</sub> = 52
	3		40: N <sub>RB,c</sub> = 106	40: N <sub>RB,c</sub> = 106
PDSCH Reference measurement channel	1		SR.1.1 FDD	SR.1.1 FDD
	2		SR.1.1 TDD	SR.1.1 TDD
	3		SR.2.1 TDD	SR.2.1 TDD
RMSI CORESET Reference Channel	1		CR.1.1 FDD	CR.1.1 FDD
	2		CR.1.1 TDD	CR.1.1 TDD
	3		CR.2.1 TDD	CR.2.1 TDD
Dedicated CORESET Reference Channel	1		CCR.1.1 FDD	CCR.1.1 FDD
	2		CCR.1.1 TDD	CCR.1.1 TDD
	3		CCR.2.1 TDD	CCR.2.1 TDD
SSB configuration	1		SSB.3 FR1	SSB.3 FR1
	2		SSB.3 FR1	SSB.3 FR1
	3		SSB.4 FR1	SSB.4 FR1
OCNG Patterns	1~3		OP.1	OP.1
TRS configuration	1		TRS.1.1 FDD	TRS.1.1 FDD
	2		TRS.1.1 TDD	TRS.1.1 TDD
	3		TRS.1.2 TDD	TRS.1.2 TDD
Initial BWP Configuration	1~3		DLBWP.0.1	DLBWP.0.1
			ULBWP.0.1	ULBWP.0.1

Dedicated BWP configuration		1~3		DLBWP.1.1 ULBWP.1.1	DLBWP.1.1 ULBWP.1.1				
SMTTC configuration		1~3		SMTTC.1	SMTTC.1				
CSI-RS		1		CSI-RS 1.2 FDD	CSI-RS 1.2 FDD				
		2		CSI-RS 1.2 TDD	CSI-RS 1.2 TDD				
		3		CSI-RS 2.2 TDD	CSI-RS 2.2 FDD				
reportConfigType		1~3		periodic	periodic				
reportQuantity		1~3		cri-RSRP	cri-RSRP				
Number of reported RS		1~3		2	2				
L1-RSRP reporting period		1~3		slot80	slot80				
EPRE ratio of PSS to SSS		1~3	dB	0	0				
EPRE ratio of PBCH DMRS to SSS									
EPRE ratio of PBCH to PBCH DMRS									
EPRE ratio of PDCCH DMRS to SSS									
EPRE ratio of PDCCH to PDCCH DMRS									
EPRE ratio of PDSCH DMRS to SSS									
EPRE ratio of PDSCH to PDSCH DMRS									
EPRE ratio of OCNG DMRS to SSS <sup>Note 1</sup>									
EPRE ratio of OCNG to OCNG DMRS <sup>Note 1</sup>									
$N_{oc}$ Note2	NR_FDD_FR1_A, NR_TDD_FR1_A NOTE 5					1~3	dBm/15kHz	-94.65	-117
	NR_FDD_FR1_B								-116.5
	NR_TDD_FR1_C								-116
	NR_FDD_FR1_D, NR_TDD_FR1_D								-115.5
	NR_FDD_FR1_E, NR_TDD_FR1_E	-115							
	NR_FDD_FR1_F	-114.5							
	NR_FDD_FR1_G	-114							
	NR_FDD_FR1_H	-113.5							
$N_{oc}$ Note2	NR_FDD_FR1_A, NR_TDD_FR1_A NOTE 5	1,2	dBm/CSI-RS SCS	-94.65	-117				
	NR_FDD_FR1_B				-116.5				
	NR_TDD_FR1_C				-116				
	NR_FDD_FR1_D, NR_TDD_FR1_D				-115.5				
	NR_FDD_FR1_E, NR_TDD_FR1_E				-115				
	NR_FDD_FR1_F				-114.5				
	NR_FDD_FR1_G				-114				
	NR_FDD_FR1_H				-113.5				
	NR_FDD_FR1_A, NR_TDD_FR1_A NOTE 5	3			-91.65	-114			
	NR_FDD_FR1_B					-113.5			
	NR_TDD_FR1_C					-114			
	NR_FDD_FR1_D, NR_TDD_FR1_D					-112.5			
	NR_FDD_FR1_E, NR_TDD_FR1_E					-112			
	NR_FDD_FR1_F					-111.5			
	NR_FDD_FR1_G					-111			
	NR_FDD_FR1_H					-110.5			
	$\hat{E}_s/I_{\alpha}$				1~3	dB	10	-3	

CSI-RS RSRP Note3	NR_FDD_FR1_A, NR_TDD_FR1_A NOTE 5	1,2	dBm/CSI-RS SCS	-84.65	-120	
	NR_FDD_FR1_B				-119.5	
	NR_TDD_FR1_C				-119	
	NR_FDD_FR1_D, NR_TDD_FR1_D				-118.5	
	NR_FDD_FR1_E, NR_TDD_FR1_E				-118	
	NR_FDD_FR1_F				-117.5	
	NR_FDD_FR1_G				-117	
	NR_FDD_FR1_H				-116.5	
	NR_FDD_FR1_A, NR_TDD_FR1_A NOTE 5	3		-81.65	-117	
	NR_FDD_FR1_B				-116.5	
	NR_TDD_FR1_C				-116	
	NR_FDD_FR1_D, NR_TDD_FR1_D				-115.5	
	NR_FDD_FR1_E, NR_TDD_FR1_E				-115	
	NR_FDD_FR1_F				-114.5	
	NR_FDD_FR1_G				-114	
	NR_FDD_FR1_H				-113.5	
I <sub>o</sub> Note3	NR_FDD_FR1_A, NR_TDD_FR1_A NOTE 5	1,2	dBm/9.36 MHz	-56.28	-87.28	
	NR_FDD_FR1_B				-86.78	
	NR_TDD_FR1_C				-86.28	
	NR_FDD_FR1_D, NR_TDD_FR1_D				-85.78	
	NR_FDD_FR1_E, NR_TDD_FR1_E				-85.28	
	NR_FDD_FR1_F				-84.78	
	NR_FDD_FR1_G				-84.28	
	NR_FDD_FR1_H				-83.78	
	NR_FDD_FR1_A, NR_TDD_FR1_A NOTE 5	3		dBm/38.16 MHz	-50.19	-81.19
	NR_FDD_FR1_B					-80.69
	NR_TDD_FR1_C					-80.19
	NR_FDD_FR1_D, NR_TDD_FR1_D					-79.69
	NR_FDD_FR1_E, NR_TDD_FR1_E					-79.19
	NR_FDD_FR1_F					-78.69
	NR_FDD_FR1_G					-78.19
	NR_FDD_FR1_H					-77.69
$\hat{E}_s/N_{oc}$	1~3	dB	10	-3		
Propagation condition	1~3		AWGN	AWGN		
Antenna configuration	1~3		1x2	1x2		
<p>Note 1: OCNG shall be used such that both cells are fully allocated and a constant total transmitted power spectral density is achieved for all OFDM symbols.</p> <p>Note 2: Interference from other cells and noise sources not specified in the test is assumed to be constant over subcarriers and time and shall be modelled as AWGN of appropriate power for <math>N_{oc}</math> to be fulfilled.</p> <p>Note 3: RSRP and I<sub>o</sub> levels have been derived from other parameters for information purposes. They are not settable parameters themselves.</p> <p>Note 4: RSRP minimum requirements are specified assuming independent interference and noise at each receiver antenna port.</p> <p>Note 5: The test configuration excludes support for band n51 and it is not required to run this test on band n51 in this release of the specification.</p>						



### A.6.7.4.2.3 Test Requirements

The L1-RSRP measurement accuracy for CSI-RS resource reported by UE in L1-RSRP report (CSI-RS#0 or CSI-RS#1) of Cell 1 shall fulfil the requirements in clause 10.1.19.2.

## A.6.7.5 E-UTRAN RSRP

### A.6.7.5.1 SA: inter-RAT measurement accuracy with FR1 serving cell

#### A.6.7.5.1.1 Test Purpose and Environment

The purpose of this test is to verify that the E-UTRAN RSRP measurement accuracy is within the specified limits. This test will verify the requirements in clause 10.2.2 for SA inter-RAT E-UTRAN RSRP measurements.

#### A.6.7.5.1.2 Test parameters

In each test there are two cells: Cell 1 and Cell 2. Cell 1 is the NR PCell and Cell 2 is an E-UTRAN inter-RAT neighbour cell. Supported test configurations are shown in table A.6.7.5.1.2-1. The measurement accuracy of SA inter-RAT E-UTRAN RSRP are tested by using the parameters in A.6.7.5.1.2-2 and A.6.7.5.1.2-3.

**Table A.6.7.5.1.2-1: Inter-RAT E-UTRAN RSRP supported test configurations with FR1 serving cell**

Configuration	Description
1	NR 15 kHz SSB SCS, 10 MHz bandwidth, FDD duplex mode, E-UTRAN FDD
2	NR 15 kHz SSB SCS, 10 MHz bandwidth, TDD duplex mode, E-UTRAN FDD
3	NR 30 kHz SSB SCS, 40 MHz bandwidth, TDD duplex mode, E-UTRAN FDD
4	NR 15 kHz SSB SCS, 10 MHz bandwidth, FDD duplex mode, E-UTRAN TDD
5	NR 15 kHz SSB SCS, 10 MHz bandwidth, TDD duplex mode, E-UTRAN TDD
6	NR 30 kHz SSB SCS, 40 MHz bandwidth, TDD duplex mode, E-UTRAN TDD

Note: The UE is only required to be tested in one of the supported test configurations

**Table A.6.7.5.1.2-2: NR Cell specific test parameters for SA Inter-RAT E-UTRAN RSRP test parameters**

Parameter	Unit	Cell 1
NR RF channel number		1
Duplex mode	Config 1, 4	FDD
	Config 2, 3, 5, 6	TDD
TDD Configuration	Config 1, 4	N/A
	Config 2, 5	TDDConf.1.1
	Config 3, 6	TDDConf.2.1
BW <sub>channel</sub>	Config 1, 4	10: N <sub>RB,c</sub> = 52 (FDD)
	Config 2, 5	10: N <sub>RB,c</sub> = 52 (TDD)
	Config 3, 6	40: N <sub>RB,c</sub> = 106 (TDD)
Gap pattern Id		0
PDSCH reference measurement channel	Config 1, 4	SR.1.1 FDD
	Config 2, 5	SR.1.1 TDD
	Config 3, 6	SR.2.1 TDD
RMSI CORSET reference channel	Config 1, 4	CR.1.1 FDD
	Config 2, 5	CR.1.1 TDD
	Config 3, 6	CR.2.1 TDD
Dedicated CORSET reference channel	Config 1, 4	CCR.1.1 FDD
	Config 2, 5	CCR.1.1 TDD
	Config 3, 6	CCR.2.1 TDD
CSI-RS for tracking	Config 1, 4	TRS.1.1 FDD
	Config 2, 5	TRS.1.1 TDD
	Config 3, 6	TRS.1.2 TDD
BWP configurations	Initial DL BWP	DLBWP.0.1
	Dedicated DL BWP	DLBWP.1.1
	Initial UL BWP	ULBWP.0.1
	Dedicated UL BWP	ULBWP.1.1
OCNG pattern <sup>Note1</sup>		OP.1
SMTTC configuration		SMTTC.1

SSB configuration	Config 1, 2, 4, 5	dB	SSB.1 FR1
	Config 3, 6		SSB.2 FR1
EPRE ratio of PSS to SSS			0
EPRE ratio of PBCH_DMRS to SSS			
EPRE ratio of PBCH to PBCH_DMRS			
EPRE ratio of PDCCH_DMRS to SSS			
EPRE ratio of PDCCH to PDCCH_DMRS			
EPRE ratio of PDSCH_DMRS to SSS			
EPRE ratio of PDSCH to PDSCH_DMRS			
EPRE ratio of OCNG DMRS to SSS			
EPRE ratio of OCNG to OCNG DMRS			
$N_{oc}^{Note2}$		dBm/15 kHz	-104
$N_{oc}^{Note2}$	Config 1, 2, 4, 5	dBm/SCS	-104
	Config 3, 6		-101
$\hat{E}_s/N_{oc}$		dB	17
$\hat{E}_s/I_{ot}^{Note3}$		dB	17
SS-RSRP <sup>Note3</sup>	Config 1, 2, 4, 5	dBm/SCS	-87
	Config 3, 6		-84
SSB_RP <sup>Note3</sup>	Config 1, 2, 4, 5	dBm/SCS	-87
	Config 3, 6		-84
$I_o^{Note3}$	Config 1, 2, 4, 5	dBm/9.36 MHz	-58.96
	Config 3, 6	dBm/38.16 MHz	-52.87
Propagation condition			AWGN
Antenna Configuration and Correlation Matrix			1x2
<p>Note 1: OCNG shall be used such that both cells are fully allocated and a constant total transmitted power spectral density is achieved for all OFDM symbols.</p> <p>Note 2: Interference from other cells and noise sources not specified in the test is assumed to be constant over subcarriers and time and shall be modelled as AWGN of appropriate power for <math>N_{oc}</math> to be fulfilled.</p> <p>Note 3: <math>\hat{E}_s/I_{ot}</math>, SS-RSRP, SSB_RP and <math>I_o</math> levels have been derived from other parameters for information purposes. They are not settable parameters themselves.</p>			

**Table A.6.7.5.1.2-3: E-UTRAN Cell specific test parameters for SA Inter-RAT E-UTRAN RSRP test parameters**

Parameter	Unit	Cell 2	
		Test 1	Test 2
E-UTRA RF channel number		1	
Duplex mode	Config 1, 2, 3	FDD	
	Config 4, 5, 6	TDD	
TDD special subframe configuration <sup>Note1</sup>	Config 1, 2, 3	N/A	
	Config 4, 5, 6	6	
TDD uplink-downlink configuration <sup>Note1</sup>	Config 1, 2, 3	N/A	
	Config 4, 5, 6	1	
BW <sub>channel</sub>	MHz	5 MHz: $N_{RB,c} = 25$ 10 MHz: $N_{RB,c} = 50$ 20 MHz: $N_{RB,c} = 100$	
PDSCH parameters: DL Reference Measurement Channel <sup>Note2</sup>			
PCFICH/PDCCH/PHICH parameters: DL Reference Measurement Channel <sup>Note2</sup>	Config 1, 2, 3	5 MHz: R.11 FDD 10 MHz: R.6 FDD 20 MHz: R.10 FDD	
	Config 4, 5, 6	5 MHz: R.11 TDD 10 MHz: R.6 TDD 20 MHz: R.10 TDD	
OCNG Patterns <sup>Note2</sup>	Config 1, 2, 3	5 MHz: OP.19 FDD 10 MHz: OP.6 FDD 20 MHz: OP.14 FDD	
	Config 4, 5, 6	5 MHz: OP.10 TDD	

			10 MHz: OP.2 TDD 20 MHz: OP.8 TDD	
PBCH_RA		dB	0	
PBCH_RB				
PSS_RA				
SSS_RA				
PCFICH_RB				
PHICH_RA				
PHICH_RB				
PDCCH_RA				
PDCCH_RB				
PDSCH_RA				
PDSCH_RB				
OCNG_RA <sup>Note3</sup>				
OCNG_RB <sup>Note3</sup>				
N <sub>oc</sub> <sup>Note4</sup>	Bands FDD_A <sup>Note 9</sup> , TDD_A			
	Bands FDD_B1, FDD_B2 <sup>Note 10</sup>	-116.5		
	Bands FDD_C, TDD_C	-116		
	Bands FDD_D	-115.5		
	Bands FDD_E, FDD_F <sup>Note 7</sup> , TDD_E	-115		
	Bands FDD_G <sup>Note 8</sup>	-114		
	Bands FDD_H	-113.5		
$\bar{E}_s/N_{oc}$		dB	10	-4
$\bar{E}_s/I_{ot}$ <sup>Note5</sup>		dB	10	-4
RSRP <sup>Note5</sup>	Bands FDD_A <sup>Note 9</sup> , TDD_A	dBm/15kHz	-81.65	-121
	Bands FDD_B1, FDD_B2 <sup>Note 10</sup>			-120.5
	Bands FDD_C, TDD_C			-120
	Bands FDD_D			-119.5
	Bands FDD_E, FDD_F <sup>Note 7</sup> , TDD_E			-119
	Bands FDD_G <sup>Note 8</sup>			-118
	Bands FDD_H			-117.5
SCH_RP <sup>Note5</sup>	Bands FDD_A <sup>Note 9</sup> , TDD_A	dBm/15kHz	-81.65	-121
	Bands FDD_B1, FDD_B2 <sup>Note 10</sup>			-120.5
	Bands FDD_C, TDD_C			-120
	Bands FDD_D			-119.5
	Bands FDD_E, FDD_F <sup>Note 7</sup> , TDD_E			-119
	Bands FDD_G <sup>Note 8</sup>			-118
	Bands FDD_H			-117.5
I <sub>o</sub> <sup>Note5</sup>	Bands FDD_A <sup>Note 9</sup> , TDD_A	dBm/Ch BW	-53.45 + 10log(N <sub>RB,c</sub> /50)	-87.76 + 10log(N <sub>RB,c</sub> /50)
	Bands FDD_B1, FDD_B2 <sup>Note 10</sup>			-87.26 + 10log(N <sub>RB,c</sub> /50)
	Bands FDD_C, TDD_C			-86.76 + 10log(N <sub>RB,c</sub> /50)
	Bands FDD_D			-86.26 + 10log(N <sub>RB,c</sub> /50)
	Bands FDD_E, FDD_F <sup>Note 7</sup> , TDD_E			-85.76 + 10log(N <sub>RB,c</sub> /50)
	Bands FDD_G <sup>Note 8</sup>			-84.76 + 10log(N <sub>RB,c</sub> /50)
	Bands FDD_H			-84.26 + 10log(N <sub>RB,c</sub> /50)
Propagation Condition			AWGN	
Antenna Configuration and Correlation Matrix			1x2	
Note 1: Special subframe and uplink-downlink configurations are specified in table 4.2-1 in TS 36.211 [23].				
Note 2: DL RMCs and OCNG patterns are specified in clauses A 3.1 and A 3.2 of TS 36.133 [15] respectively.				

Note 3:	OCNG shall be used such that all cells are fully allocated and a constant total transmitted power spectral density is achieved for all OFDM symbols.
Note 4:	Interference from other cells and noise sources not specified in the test is assumed to be constant over subcarriers and time and shall be modelled as AWGN of appropriate power for $N_{oc}$ to be fulfilled.
Note 5:	$\bar{E}_s/I_{ot}$ , RSRP, SCH_RP and $I_o$ levels have been derived from other parameters for information purposes. They are not settable parameters themselves.
Note 6:	E-UTRA operating band groups are as defined in clause 3.5 of TS 36.133 [15].
Note 7:	For Band 26, the tests shall be performed with the carrier frequency of assigned E-UTRA channel bandwidth within 865-894 MHz.
Note 8:	Except Band 29.
Note 9:	Except Band 32, Band 75 and Band 76.
Note 10:	For Band 74, the tests shall be performed with the carrier frequency of the assigned E-UTRA channel bandwidth within 1475.9-1510.9 MHz.

### A.6.7.5.1.3 Test Requirements

The SA inter-RAT E-UTRAN RSRP measurement accuracy for cell 2 shall fulfil absolute requirement in clause 10.2.2.

## A.6.7.6 E-UTRAN RSRQ

### A.6.7.6.1 SA: inter-RAT measurement accuracy with FR1 serving cell

#### A.6.7.6.1.1 Test Purpose and Environment

The purpose of this test is to verify that the E-UTRAN RSRQ measurement accuracy is within the specified limits. This test will verify the requirements in clause 10.2.3 for SA inter-RAT E-UTRAN RSRQ measurements.

#### A.6.7.6.1.2 Test parameters

In each test there are two cells: Cell 1 and Cell 2. Cell 1 is the NR PCell and Cell 2 is an E-UTRAN inter-RAT neighbour cell. Supported test configurations are shown in table A.6.7.6.1.2-1. The measurement accuracy of SA inter-RAT E-UTRAN RSRQ are tested by using the parameters in A.6.7.6.1.2-2 and A.6.7.6.1.2-3.

**Table A.6.7.6.1.2-1: Inter-RAT E-UTRAN RSRQ supported test configurations with FR1 serving cell**

Configuration	Description
1	NR 15 kHz SSB SCS, 10 MHz bandwidth, FDD duplex mode, E-UTRAN FDD
2	NR 15 kHz SSB SCS, 10 MHz bandwidth, TDD duplex mode, E-UTRAN FDD
3	NR 30 kHz SSB SCS, 40 MHz bandwidth, TDD duplex mode, E-UTRAN FDD
4	NR 15 kHz SSB SCS, 10 MHz bandwidth, FDD duplex mode, E-UTRAN TDD
5	NR 15 kHz SSB SCS, 10 MHz bandwidth, TDD duplex mode, E-UTRAN TDD
6	NR 30 kHz SSB SCS, 40 MHz bandwidth, TDD duplex mode, E-UTRAN TDD

Note: The UE is only required to be tested in one of the supported test configurations

**Table A.6.7.6.1.2-2: NR Cell specific test parameters for SA Inter-RAT E-UTRAN RSRQ test parameters**

Parameter	Unit	Cell 1
NR RF channel number		1
Duplex mode	Config 1, 4	FDD
	Config 2, 3, 5, 6	TDD
TDD Configuration	Config 1, 4	N/A
	Config 2, 5	TDDConf.1.1
	Config 3, 6	TDDConf.2.1
$BW_{channel}$	Config 1, 4	10: $N_{RB,c} = 52$ (FDD)
	Config 2, 5	10: $N_{RB,c} = 52$ (TDD)
	Config 3, 6	40: $N_{RB,c} = 106$ (TDD)
Gap pattern Id		0
PDSCH reference measurement channel	Config 1, 4	SR.1.1 FDD
	Config 2, 5	SR.1.1 TDD
	Config 3, 6	SR.2.1 TDD
RMSI CORSET reference channel	Config 1, 4	CR.1.1 FDD
	Config 2, 5	CR.1.1 TDD

	Config 3, 6		CR.2.1 TDD
Dedicated CORSET reference channel	Config 1, 4		CCR.1.1 FDD
	Config 2, 5		CCR.1.1 TDD
	Config 3, 6		CCR.2.1 TDD
	Config 1, 4		TRS.1.1 FDD
CSI-RS for tracking	Config 2, 5		TRS.1.1 TDD
	Config 3, 6		TRS.1.2 TDD
	Initial DL BWP		DLBWP.0.1
BWP configurations	Dedicated DL BWP		DLBWP.1.1
	Initial UL BWP		ULBWP.0.1
	Dedicated UL BWP		ULBWP.1.1
	OCNG pattern <sup>Note1</sup>		OP.1
SMTC configuration		SMTC.1	
SSB configuration	Config 1, 2, 4, 5		SSB.1 FR1
	Config 3, 6		SSB.2 FR1
EPRE ratio of PSS to SSS		dB	0
EPRE ratio of PBCH_DMRS to SSS			
EPRE ratio of PBCH to PBCH_DMRS			
EPRE ratio of PDCCH_DMRS to SSS			
EPRE ratio of PDCCH to PDCCH_DMRS			
EPRE ratio of PDSCH_DMRS to SSS			
EPRE ratio of PDSCH to PDSCH_DMRS			
EPRE ratio of OCNG DMRS to SSS			
EPRE ratio of OCNG to OCNG DMRS			
$N_{oc}$ <sup>Note2</sup>		dBm/15 kHz	-104
$N_{oc}$ <sup>Note2</sup>	Config 1, 2, 4, 5	dBm/SCS	-104
	Config 3, 6		-101
$\bar{E}_s/N_{oc}$		dB	dB
$\bar{E}_s/I_{ot}$ <sup>Note3</sup>		dB	dB
SS-RSRQ <sup>Note3</sup>	Config 1, 2, 4, 5	dBm/SCS	-87
	Config 3, 6		-84
SSB_RP <sup>Note3</sup>	Config 1, 2, 4, 5	dBm/SCS	-87
	Config 3, 6		-84
$I_o$ <sup>Note3</sup>	Config 1, 2, 4, 5	dBm/9.36 MHz	-58.96
	Config 3, 6	dBm/38.16 MHz	-52.87
Propagation condition			AWGN
Antenna Configuration and Correlation Matrix			1x2
<p>Note 1: OCNG shall be used such that both cells are fully allocated and a constant total transmitted power spectral density is achieved for all OFDM symbols.</p> <p>Note 2: Interference from other cells and noise sources not specified in the test is assumed to be constant over subcarriers and time and shall be modelled as AWGN of appropriate power for <math>N_{oc}</math> to be fulfilled.</p> <p>Note 3: <math>\bar{E}_s/I_{ot}</math>, SS-RSRQ, SSB_RP and <math>I_o</math> levels have been derived from other parameters for information purposes. They are not settable parameters themselves.</p>			

**Table A.6.7.6.1.2-3: E-UTRAN Cell specific test parameters for SA Inter-RAT E-UTRAN RSRQ test parameters**

Parameter		Unit	Cell 2		
			Test 1	Test 2	Test 3
E-UTRA RF channel number			1		
Duplex mode	Config 1, 2, 3		FDD		
	Config 4, 5, 6		TDD		
TDD special subframe configuration <sup>Note1</sup>	Config 1, 2, 3		N/A		
	Config 4, 5, 6		6		
TDD uplink-downlink configuration <sup>Note1</sup>	Config 1, 2, 3		N/A		
	Config 4, 5, 6		1		
BW <sub>channel</sub>		MHz	5 MHz: $N_{RB,c} = 25$ 10 MHz: $N_{RB,c} = 50$		

			20 MHz: $N_{RB,c} = 100$		
PDSCH parameters: DL Reference Measurement Channel <sup>Note2</sup>			-		
PCFICH/PDCCH/PHICH parameters: DL Reference Measurement Channel <sup>Note2</sup>	Config 1, 2, 3		5 MHz: R.11 FDD 10 MHz: R.6 FDD 20 MHz: R.10 FDD		
	Config 4, 5, 6		5 MHz: R.11 TDD 10 MHz: R.6 TDD 20 MHz: R.10 TDD		
OCNG Patterns <sup>Note2</sup>	Config 1, 2, 3		5 MHz: OP.19 FDD 10 MHz: OP.6 FDD 20 MHz: OP.14 FDD		
	Config 4, 5, 6		5 MHz: OP.10 TDD 10 MHz: OP.2 TDD 20 MHz: OP.8 TDD		
PBCH_RA		dB	0		
PBCH_RB					
PSS_RA					
SSS_RA					
PCFICH_RB					
PHICH_RA					
PHICH_RB					
PDCCH_RA					
PDCCH_RB					
PDSCH_RA					
PDSCH_RB					
OCNG_RA <sup>Note3</sup>					
OCNG_RB <sup>Note3</sup>					
$N_{oc}$ <sup>Note4</sup>	Bands FDD_A <sup>Note 9</sup> , TDD_A				
	Bands FDD_B1, FDD_B2 <sup>Note 10</sup>	-119			
	Bands FDD_C, TDD_C	-118.5			
	Bands FDD_D	-118			
	Bands FDD_E, FDD_F <sup>Note 7</sup> , TDD_E	-117.5			
	Bands FDD_G <sup>Note 8</sup>	-116.5			
	Bands FDD_H	-116			
$\bar{E}_s/N_{oc}$		dB	-1.75	-4.0	-4.0
$\bar{E}_s/I_{ot}$ <sup>Note5</sup>		dB	-1.75	-4.0	-4.0
RSRP <sup>Note5</sup>	Bands FDD_A <sup>Note 9</sup> , TDD_A	dBm/15kHz	-84.75	-108.70	-123.5
	Bands FDD_B1, FDD_B2 <sup>Note 10</sup>				-123
	Bands FDD_C, TDD_C				-122.5
	Bands FDD_D				-122
	Bands FDD_E, FDD_F <sup>Note 7</sup> , TDD_E				-121.5
	Bands FDD_G <sup>Note 8</sup>				-120.5
	Bands FDD_H				-120
RSRQ <sup>Note5</sup>	Bands FDD_A <sup>Note 9</sup> , TDD_A	dB	-14.76	-16.25	-16.25
	Bands FDD_B1, FDD_B2 <sup>Note 10</sup>				
	Bands FDD_C, TDD_C				
	Bands FDD_D				
	Bands FDD_E, FDD_F <sup>Note 7</sup> , TDD_E				
	Bands FDD_G <sup>Note 8</sup>				
	Bands FDD_H				
$I_o$ <sup>Note5</sup>	Bands FDD_A <sup>Note 9</sup> , TDD_A	dBm/Ch BW	$-53 + 10\log(N_{RB,c} / 50)$	$-75.46 + 10\log(N_{RB,c} / 50)$	$-90.26 + 10\log(N_{RB,c} / 50)$

	Bands FDD_B1, FDD_B2 <sup>Note 10</sup>			-89.76 + 10log(N <sub>RB,c</sub> /50)
	Bands FDD_C, TDD_C			-89.26 + 10log(N <sub>RB,c</sub> /50)
	Bands FDD_D			-88.76 + 10log(N <sub>RB,c</sub> /50)
	Bands FDD_E, FDD_F <sup>Note 7</sup> , TDD_E			-88.26 + 10log(N <sub>RB,c</sub> /50)
	Bands FDD_G <sup>Note 8</sup>			-87.26 + 10log(N <sub>RB,c</sub> /50)
	Bands FDD_H			-86.76 + 10log(N <sub>RB,c</sub> /50)
Propagation Condition			AWGN	
Antenna Configuration and Correlation Matrix			1x2	
<p>Note 1: Special subframe and uplink-downlink configurations are specified in table 4.2-1 in TS 36.211 [23].</p> <p>Note 2: DL RMCs and OCNG patterns are specified in clauses A 3.1 and A 3.2 of TS 36.133 [15] respectively.</p> <p>Note 3: OCNG shall be used such that all cells are fully allocated and a constant total transmitted power spectral density is achieved for all OFDM symbols.</p> <p>Note 4: Interference from other cells and noise sources not specified in the test is assumed to be constant over subcarriers and time and shall be modelled as AWGN of appropriate power for N<sub>oc</sub> to be fulfilled.</p> <p>Note 5: E<sub>s</sub>/I<sub>ot</sub>, RSRP, RSRQ and I<sub>o</sub> levels have been derived from other parameters for information purposes. They are not settable parameters themselves.</p> <p>Note 6: E-UTRA operating band groups are as defined in clause 3.5 of TS 36.133 [15].</p> <p>Note 7: For Band 26, the tests shall be performed with the carrier frequency of assigned E-UTRA channel bandwidth within 865-894 MHz.</p> <p>Note 8: Except Band 29.</p> <p>Note 9: Except Band 32, Band 75 and Band 76.</p> <p>Note 10: For Band 74, the tests shall be performed with the carrier frequency of the assigned E-UTRA channel bandwidth within 1475.9-1510.9 MHz.</p>				

A.6.7.6.1.3 Test Requirements

The SA inter-RAT E-UTRAN RSRQ measurement accuracy for cell 2 shall fulfil absolute requirement in clause 10.2.3.

A.6.7.7 E-UTRAN RS-SINR

A.6.7.7.1 SA: inter-RAT measurement accuracy with FR1 serving cell

A.6.7.7.1.1 Test Purpose and Environment

The purpose of this test is to verify that the E-UTRAN RS-SINR measurement accuracy is within the specified limits. This test will verify the requirements in clause 10.2.4 for SA inter-RAT E-UTRAN RS-SINR measurements.

A.6.7.7.1.2 Test parameters

In each test there are two cells: Cell 1 and Cell 2. Cell 1 is the NR PCell and Cell 2 is an E-UTRAN inter-RAT neighbour cell. Supported test configurations are shown in table A.6.7.7.1.2-1. The measurement accuracy of SA inter-RAT E-UTRAN RS-SINR are tested by using the parameters in A.6.7.7.1.2-2 and A.6.7.7.1.2-3.

**Table A.6.7.7.1.2-1: Inter-RAT E-UTRAN RS-SINR supported test configurations with FR1 serving cell**

Configuration	Description
1	NR 15 kHz SSB SCS, 10 MHz bandwidth, FDD duplex mode, E-UTRAN FDD
2	NR 15 kHz SSB SCS, 10 MHz bandwidth, TDD duplex mode, E-UTRAN FDD
3	NR 30 kHz SSB SCS, 40 MHz bandwidth, TDD duplex mode, E-UTRAN FDD
4	NR 15 kHz SSB SCS, 10 MHz bandwidth, FDD duplex mode, E-UTRAN TDD
5	NR 15 kHz SSB SCS, 10 MHz bandwidth, TDD duplex mode, E-UTRAN TDD
6	NR 30 kHz SSB SCS, 40 MHz bandwidth, TDD duplex mode, E-UTRAN TDD
Note: The UE is only required to be tested in one of the supported test configurations	

**Table A.6.7.7.1.2-2: NR Cell specific test parameters for SA Inter-RAT E-UTRAN RS-SINR test parameters**

Parameter		Unit	Cell 1
NR RF channel number			1
Duplex mode	Config 1, 4		FDD
	Config 2, 3, 5, 6		TDD
TDD Configuration	Config 1, 4		N/A
	Config 2, 5		TDDConf.1.1
	Config 3, 6		TDDConf.2.1
BW <sub>channel</sub>	Config 1, 4	MHz	10: N <sub>RB,c</sub> = 52 (FDD)
	Config 2, 5		10: N <sub>RB,c</sub> = 52 (TDD)
	Config 3, 6		40: N <sub>RB,c</sub> = 106 (TDD)
Gap pattern Id			0
PDSCH reference measurement channel	Config 1, 4		SR.1.1 FDD
	Config 2, 5		SR.1.1 TDD
	Config 3, 6		SR.2.1 TDD
RMSI CORSET reference channel	Config 1, 4		CR.1.1 FDD
	Config 2, 5		CR.1.1 TDD
	Config 3, 6		CR.2.1 TDD
Dedicated CORSET reference channel	Config 1, 4		CCR.1.1 FDD
	Config 2, 5		CCR.1.1 TDD
	Config 3, 6		CCR.2.1 TDD
CSI-RS for tracking	Config 1, 4		TRS.1.1 FDD
	Config 2, 5		TRS.1.1 TDD
	Config 3, 6		TRS.1.2 TDD
BWP configurations	Initial DL BWP		DLBWP.0.1
	Dedicated DL BWP		DLBWP.1.1
	Initial UL BWP		ULBWP.0.1
	Dedicated UL BWP		ULBWP.1.1
OCNG pattern <sup>Note1</sup>			OP.1
SMTTC configuration			SMTTC.1
SSB configuration	Config 1, 2, 4, 5		SSB.1 FR1
	Config 3, 6		SSB.2 FR1
EPRE ratio of PSS to SSS		dB	0
EPRE ratio of PBCH_DMRS to SSS			
EPRE ratio of PBCH to PBCH_DMRS			
EPRE ratio of PDCCH_DMRS to SSS			
EPRE ratio of PDCCH to PDCCH_DMRS			
EPRE ratio of PDSCH_DMRS to SSS			
EPRE ratio of PDSCH to PDSCH_DMRS			
EPRE ratio of OCNG DMRS to SSS			
EPRE ratio of OCNG to OCNG DMRS			
N <sub>oc</sub> <sup>Note2</sup>		dBm/15 kHz	-104
N <sub>oc</sub> <sup>Note2</sup>	Config 1, 2, 4, 5	dBm/SCS	-104
	Config 3, 6		-101
E <sub>s</sub> /N <sub>oc</sub>		dB	17
E <sub>s</sub> /I <sub>ot</sub> <sup>Note3</sup>		dB	17
SS-RS-SINR <sup>Note3</sup>	Config 1, 2, 4, 5	dBm/SCS	-87
	Config 3, 6		-84
SSB_RP <sup>Note3</sup>	Config 1, 2, 4, 5	dBm/SCS	-87
	Config 3, 6		-84
I <sub>o</sub> <sup>Note3</sup>	Config 1, 2, 4, 5	dBm/9.36 MHz	-58.96
	Config 3, 6	dBm/38.16 MHz	-52.87
Propagation condition			AWGN
Antenna Configuration and Correlation Matrix			1x2
Note 1: OCNG shall be used such that both cells are fully allocated and a constant total transmitted power spectral density is achieved for all OFDM symbols.			
Note 2: Interference from other cells and noise sources not specified in the test is assumed to be constant over subcarriers and time and shall be modelled as AWGN of appropriate power for N <sub>oc</sub> to be fulfilled.			



Note 3:  $\bar{E}_s/I_{ot}$ , SS-RS-SINR, SSB\_RP and  $I_o$  levels have been derived from other parameters for information purposes. They are not settable parameters themselves.

**Table A.6.7.7.1.2-3: E-UTRAN Cell specific test parameters for SA Inter-RAT E-UTRAN RS-SINR test parameters**

Parameter		Unit	Cell 2		
			Test 1	Test 2	Test 3
E-UTRA RF channel number			1		
Duplex mode	Config 1, 2, 3		FDD		
	Config 4, 5, 6		TDD		
TDD special subframe configuration <sup>Note1</sup>	Config 1, 2, 3		N/A		
	Config 4, 5, 6		6		
TDD uplink-downlink configuration <sup>Note1</sup>	Config 1, 2, 3		N/A		
	Config 4, 5, 6		1		
BW <sub>channel</sub>		MHz	5 MHz: N <sub>RB,c</sub> = 25 10 MHz: N <sub>RB,c</sub> = 50 20 MHz: N <sub>RB,c</sub> = 100		
PDSCH parameters: DL Reference Measurement Channel <sup>Note2</sup>			-		
PCFICH/PDCCH/PHICH parameters: DL Reference Measurement Channel <sup>Note2</sup>	Config 1, 2, 3		5 MHz: R.11 FDD 10 MHz: R.6 FDD 20 MHz: R.10 FDD		
	Config 4, 5, 6		5 MHz: R.11 TDD 10 MHz: R.6 TDD 20 MHz: R.10 TDD		
OCNG Patterns <sup>Note2</sup>	Config 1, 2, 3		5 MHz: OP.19 FDD 10 MHz: OP.6 FDD 20 MHz: OP.14 FDD		
	Config 4, 5, 6		5 MHz: OP.10 TDD 10 MHz: OP.2 TDD 20 MHz: OP.8 TDD		
PBCH_RA		dB	0		
PBCH_RB					
PSS_RA					
SSS_RA					
PCFICH_RB					
PHICH_RA					
PHICH_RB					
PDCCH_RA					
PDCCH_RB					
PDSCH_RA					
PDSCH_RB					
OCNG_RA <sup>Note3</sup>					
OCNG_RB <sup>Note3</sup>					
N <sub>oc</sub> <sup>Note4</sup>	Bands FDD_A <sup>Note 9</sup> , TDD_A				
	Bands FDD_B1, FDD_B2 <sup>Note 10</sup>	-119			
	Bands FDD_C, TDD_C	-118.5			
	Bands FDD_D	-118			
	Bands FDD_E, FDD_F <sup>Note 7</sup> , TDD_E	-117.5			
	Bands FDD_G <sup>Note 8</sup> Bands FDD_H	-116.5			
	-116				
CRS $\bar{E}_s/N_{oc1}$		dB	-1.75	20.0	-4.0
CRS $\bar{E}_s/I_{ot}$ <sup>Note5</sup>		dB	-1.75	20.0	-4.0
RSRP <sup>Note5</sup>	Bands FDD_A <sup>Note 9</sup> , TDD_A	dBm/15kHz	-89.75	-88.50	-123.5

	Bands FDD_B1, FDD_B2 <sup>Note 10</sup>				-123
	Bands FDD_C, TDD_C				-122.5
	Bands FDD_D				-122
	Bands FDD_E, FDD_F <sup>Note 7</sup> , TDD_E				-121.5
	Bands FDD_G <sup>Note 8</sup>				-120.5
	Bands FDD_H				-120
RS-SINR <sup>Note 5</sup>	Bands FDD_A <sup>Note 9</sup> , TDD_A	dB	-1.75	20	-4.0
	Bands FDD_B1, FDD_B2 <sup>Note 10</sup>				
	Bands FDD_C, TDD_C				
	Bands FDD_D				
	Bands FDD_E, FDD_F <sup>Note 7</sup> , TDD_E				
	Bands FDD_G <sup>Note 8</sup>				
	Bands FDD_H				
$I_o$ <sup>Note 5</sup>	Bands FDD_A <sup>Note 9</sup> , TDD_A	dBm/Ch BW	$-53.79 + 10\log(N_{RB,c} / 50)$	$-60.56 + 10\log(N_{RB,c} / 50)$	$-93.48 + 10\log(N_{RB,c} / 50)$
	Bands FDD_B1, FDD_B2 <sup>Note 10</sup>				$-92.98 + 10\log(N_{RB,c} / 50)$
	Bands FDD_C, TDD_C				$-92.48 + 10\log(N_{RB,c} / 50)$
	Bands FDD_D				$-91.98 + 10\log(N_{RB,c} / 50)$
	Bands FDD_E, FDD_F <sup>Note 7</sup> , TDD_E				$-91.48 + 10\log(N_{RB,c} / 50)$
	Bands FDD_G <sup>Note 8</sup>				$-90.48 + 10\log(N_{RB,c} / 50)$
	Bands FDD_H				$-89.98 + 10\log(N_{RB,c} / 50)$
Propagation Condition			AWGN		
Antenna Configuration and Correlation Matrix			1x2		
<p>Note 1: Special subframe and uplink-downlink configurations are specified in table 4.2-1 in TS 36.211 [23].</p> <p>Note 2: DL RMCs and OCNG patterns are specified in clauses A 3.1 and A 3.2 of TS 36.133 [15] respectively.</p> <p>Note 3: OCNG shall be used such that all cells are fully allocated and a constant total transmitted power spectral density is achieved for all OFDM symbols.</p> <p>Note 4: Interference from other cells and noise sources not specified in the test is assumed to be constant over subcarriers and time and shall be modelled as AWGN of appropriate power for <math>N_{oc}</math> to be fulfilled.</p> <p>Note 4a: Void.</p> <p>Note 5: CRS <math>\hat{E}_s/I_{ot}</math>, RSRP, RS-SINR and <math>I_o</math> levels have been derived from other parameters for information purposes. They are not settable parameters themselves.</p> <p>Note 6: E-UTRA operating band groups are as defined in clause 3.5 of TS 36.133 [15].</p> <p>Note 7: For Band 26, the tests shall be performed with the carrier frequency of assigned E-UTRA channel bandwidth within 865-894 MHz.</p> <p>Note 8: Except Band 29.</p> <p>Note 9: Except Band 32, Band 75 and Band 76.</p> <p>Note 10: For Band 74, the tests shall be performed with the carrier frequency of the assigned E-UTRA channel bandwidth within 1475.9-1510.9 MHz.</p>					

### A.6.7.7.1.3 Test Requirements

The SA inter-RAT E-UTRAN RS-SINR measurement accuracy for cell 2 shall fulfil absolute requirement in clause 10.2.4.

## A.6.7.8 CLI measurements

### A.6.7.8.1 SA SRS-RSRP measurement accuracy with FR1 serving cell

#### A.6.7.8.1.1 Test Purpose and Environment

The purpose of this test is to verify that the SRS-RSRP measurement accuracy is within the specified limits. This test will verify the requirements in Clauses 10.1.22.1.1 with the testing configurations for NR cells in Table A.6.7.8.1.1-1.

**Table A.6.7.8.1.1-1: Applicable NR configurations for FR1 SRS-RSRP accuracy test**

Config	Description
1	15kHz SRS SCS, 10 MHz bandwidth, TDD duplex mode
2	30kHz SRS SCS, 40 MHz bandwidth, TDD duplex mode
Note: The UE is only required to be tested in one of the supported test configurations in each supported band	

#### A.6.7.8.1.2 Test parameters

In this set of test cases there is one cell in the test, FR1 PCell (Cell 1). The test parameters for the Cell 1 are given in Table A.6.7.8.1.2-1 below. The test parameter for the (virtual) neighbor cell UE transmitting SRS are given in Table A.6.7.8.1.2-2.

Before the test UE is configured to perform SRS-RSRP measurement. During the test, the test system transmits SRS resources for measurement in the DL slots according to the SRS configuration in Table A.6.7.8.1.2-3. There is no measurement gap configured in the test. During the test, the test system does not transmit PDCCH/PDSCH/OCNG on SRS symbol to be transmitted and on 1 data symbol before SRS to be transmitted.

**Table A.6.7.8.1.2-1: FR1 test parameters for SRS-RSRP accuracy for PCell**

Parameter	Config	Unit	Test 1	Test 2	Test 3
SSB GSCN	1~2		freq1	freq1	freq1
Duplex mode	1~2		TDD	TDD	TDD
TDD configuration	1		TDDConf.1.1	TDDConf.1.1	TDDConf.1.1
	2		TDDConf.2.1	TDDConf.2.1	TDDConf.2.1
BW <sub>channel</sub>	1	MHz	10: N <sub>RB,c</sub> = 52	10: N <sub>RB,c</sub> = 52	10: N <sub>RB,c</sub> = 52
	2		40: N <sub>RB,c</sub> = 106	40: N <sub>RB,c</sub> = 106	40: N <sub>RB,c</sub> = 106
PDSCH Reference measurement channel	1		SR.1.1 TDD	SR.1.1 TDD	SR.1.1 TDD
	2		SR.2.1 TDD	SR.2.1 TDD	SR.2.1 TDD
RMSI CORESET Reference Channel	1		CR.1.1 TDD	CR.1.1 TDD	CR.1.1 TDD
	2		CR.2.1 TDD	CR.2.1 TDD	CR.2.1 TDD
Dedicated CORESET Reference Channel	1		CCR.1.1 TDD	CCR.1.1 TDD	CCR.1.1 TDD
	2		CCR.2.1 TDD	CCR.2.1 TDD	CCR.2.1 TDD
SSB configuration	1		SSB.1 FR1	SSB.1 FR1	SSB.1 FR1
	2		SSB.2 FR1	SSB.2 FR1	SSB.2 FR1
OCNG Patterns	1~2		OP.1	OP.1	OP.1
TRS configuration	1		TRS.1.1 TDD	TRS.1.1 TDD	TRS.1.1 TDD
	2		TRS.1.2 TDD	TRS.1.2 TDD	TRS.1.2 TDD
Initial BWP Configuration	1~2		DLBWP.0.1 ULBWP.0.1	DLBWP.0.1 ULBWP.0.1	DLBWP.0.1 ULBWP.0.1
Dedicated BWP configuration	1~2		DLBWP.1.1 ULBWP.1.1	DLBWP.1.1 ULBWP.1.1	DLBWP.1.1 ULBWP.1.1
SMTc configuration	1~2		SMTc.1	SMTc.1	SMTc.1
Time offset between DL from serving cell and SRS from test system	1~2	μs	17.67	17.67	17.67
EPRE ratio of PSS to SSS	1~2	dB	0	0	0
EPRE ratio of PBCH DMRS to SSS					
EPRE ratio of PBCH to PBCH DMRS					
EPRE ratio of PDCCH DMRS to SSS					

EPRE ratio of PDCCH to PDCCH DMRS								
EPRE ratio of PDSCH DMRS to SSS								
EPRE ratio of PDSCH to PDSCH DMRS								
EPRE ratio of OCNG DMRS to SSS <sup>Note 1</sup>								
EPRE ratio of OCNG to OCNG DMRS <sup>Note 1</sup>								
$N_{oc}$ Note2	NR_TDD_FR1_A NOTE 3	1	dBm/15kHz	-106	-88	-114		
	NR_TDD_FR1_C					-113		
	NR_TDD_FR1_D					-112.5		
	NR_TDD_FR1_E					-112		
	NR_TDD_FR1_A NOTE 5	2				Not applicable <sup>Note 4</sup>	-91	-114
	NR_TDD_FR1_C						-113	
	NR_TDD_FR1_D						-112.5	
$N_{oc}$ Note2	NR_TDD_FR1_A NOTE 3	1	dBm/SRS SCS	-106	-88	-114		
	NR_TDD_FR1_C					-113		
	NR_TDD_FR1_D					-112.5		
	NR_TDD_FR1_E					-112		
	NR_TDD_FR1_A NOTE 3	2				Not applicable <sup>Note 4</sup>	-88	-111
	NR_TDD_FR1_C						-110	
	NR_TDD_FR1_D						-109.5	
	NR_TDD_FR1_E			-109				
<p>Note 1: OCNG shall be used such that a constant total transmitted power spectral density is achieved for all OFDM symbols.</p> <p>Note 2: Interference from other cells and noise sources not specified in the test is assumed to be constant over subcarriers and time and shall be modelled as AWGN of appropriate power for <math>N_{oc}</math> to be fulfilled.</p> <p>Note 3: The test configuration excludes support for band n51 and it is not required to run this test on band n51 in this release of the specification</p> <p>Note 4: Test 1 is not used when testing with 30kHz SSB SCS</p>								

**Table A.6.7.8.1.2-2: FR1 test parameters for SRS-RSRP accuracy for neighbour cell UE**

	Parameter	Config	Unit	Test 1	Test 2	Test 3		
$N_{oc}$ Note2	NR_TDD_FR1_A NOTE 5	1	dBm/15kHz	-106	-88	-114		
	NR_TDD_FR1_C					-113		
	NR_TDD_FR1_D					-112.5		
	NR_TDD_FR1_E					-112		
	NR_TDD_FR1_A NOTE 5	2				Not applicable <sup>Note 6</sup>	-91	-114
	NR_TDD_FR1_C						-113	
	NR_TDD_FR1_D						-112.5	
$N_{oc}$ Note2	NR_TDD_FR1_A NOTE 5	1	dBm/SRS SCS	-106	-88	-114		
	NR_TDD_FR1_C					-113		
	NR_TDD_FR1_D					-112.5		
	NR_TDD_FR1_E					-112		
	NR_TDD_FR1_A NOTE 5	2				Not applicable <sup>Note 6</sup>	-88	-111
	NR_TDD_FR1_C						-110	
	NR_TDD_FR1_D						-109.5	

	NR_TDD_FR1_E					-109
$\hat{E}_s / I_{ot}$ on SRS		1~2	dB	1	1	1
SRS RSRP Note3	NR_TDD_FR1_A NOTE 5	1	dBm/SRS SCS	-105	-87	-113
	NR_TDD_FR1_C					-112
	NR_TDD_FR1_D					-111.5
	NR_TDD_FR1_E	-111				
	NR_TDD_FR1_A NOTE 5	2		Not applicable <sup>Note 6</sup>	-87	-110
	NR_TDD_FR1_C					-109
	NR_TDD_FR1_D					-108.5
NR_TDD_FR1_E	-108					
I <sub>o</sub> <sup>Note3</sup>	NR_TDD_FR1_A NOTE 5	1	dBm/9.36 MHz	-74.51	-56.51	-82.51
	NR_TDD_FR1_C					-81.51
	NR_TDD_FR1_D					-81.01
	NR_TDD_FR1_E	-79.51				
	NR_TDD_FR1_A NOTE 5	2		Not applicable <sup>Note 6</sup>	-53.42	-76.42
	NR_TDD_FR1_C					-75.42
	NR_TDD_FR1_D					-74.92
NR_TDD_FR1_E	-74.42					
$\hat{E}_s / N_{oc}$ on SRS		1~2	dB	1	1	1
Propagation condition		1~2		AWGN	AWGN	AWGN
Antenna configuration		1~2		1x2	1x2	1x2
SRS configuration		1		SRSCConf.1	SRSCConf.1	SRSCConf.1
		2		SRSCConf.2	SRSCConf.2	SRSCConf.2
<p>Note 1: The resources for uplink transmission are assigned to the UE prior to the start of the test.</p> <p>Note 2: Interference from other cells and noise sources not specified in the test is assumed to be constant over subcarriers and time and shall be modelled as AWGN of appropriate power for <math>N_{oc}</math> to be fulfilled.</p> <p>Note 3: RSRP and I<sub>o</sub> levels have been derived from other parameters for information purposes. They are not settable parameters themselves.</p> <p>Note 4: RSRP minimum requirements are specified assuming independent interference and noise at each receiver antenna port.</p> <p>Note 5: The test configuration excludes support for band n51 and it is not required to run this test on band n51 in this release of the specification</p> <p>Note 6: Test 1 is not used when testing with 30kHz SSB SCS</p>						

**Table A.6.7.8.1.2-3: SRS configuration parameters for FR1 SRS-RSRP accuracy**

	Field	SRSCConf.1	SRSCConf.2
SRS-ResourceSet	srs-ResourceSetId	0	0
	srs-ResourceIdList	0	0
	resourceType	Periodic	Periodic
	Usage	Codebook	Codebook
SRS-Resource	SRS-ResourceId	0	0
	nrofSRS-Ports	Port1	Port1
	transmissionComb	n2	n2
	combOffset-n2	0	0
	cyclicShift-n2	0	0
	resourceMapping startPosition	0	0
	resourceMapping nrofSymbols	n1	n1
	resourceMapping repetitionFactor	n1	n1
	freqDomainPosition	0	0
	freqDomainShift	0	0
	freqHopping	12	12
	c-SRS		

freqHopping b-SRS	0	0
freqHopping b-hop	0	0
groupOrSequenceHopping	Neither	Neither
resourceType	Periodic	Periodic
periodicityAndOffset-p	sl20, 9	sl40, 19
sequenceId	0	0

### A.6.7.8.1.3 Test Requirements

The SRS-RSRP measurement accuracy shall fulfil the requirements in clauses 10.1.22.1.1.

## A.6.7.8.2 SA CLI-RSSI measurement accuracy with FR1 serving cell

### A.6.7.8.2.1 Test Purpose and Environment

The purpose of this test is to verify that the CLI-RSSI measurement accuracy is within the specified limits. This test will verify the requirements in Clauses 10.1.22.2.1 with the testing configurations for NR cells in Table A.6.7.8.2.1-1.

**Table A.6.7.8.2.1-1: Applicable NR configurations for FR1 CLI-RSSI accuracy test**

Config	Description
1	NR 15 kHz SRS SCS, 10 MHz bandwidth, TDD duplex mode
2	NR 30kHz SRS SCS, 40 MHz bandwidth, TDD duplex mode
Note:	The UE is only required to be tested in one of the supported test configurations in each supported band

### A.6.7.8.2.2 Test parameters

In this set of test cases there is one cell in the test, the FR1 PSCell (Cell 1). The test parameters for the Cell 1 are given in Table A.6.7.8.2.2-1 below.

Before the test UE is configured to perform CLI-RSSI measurement. There is no measurement gap configured in the test. During the test, the test system does not transmit PDCCH/PDSCH/OCNG on symbols for CLI-RSSI resource and on 1 data symbol before. The CLI-RSSI measurement resource configuration is in Table A.6.7.8.2.2-2.

**Table A.6.7.8.2.2-1: FR1 test parameters for CLI-RSSI accuracy**

Parameter	Config	Unit	Value
SSB GSCN	1~2		freq1
Duplex mode	1~2		TDD
TDD configuration	1		TDDConf.1.1
	2		TDDConf.2.1
BW <sub>channel</sub>	1	MHz	10: N <sub>RB,c</sub> = 52
	2		40: N <sub>RB,c</sub> = 106
PDSCH Reference measurement channel	1		SR.1.1 TDD
	2		SR.2.1 TDD
RMSI CORESET Reference Channel	1		CR.1.1 TDD
	2		CR.2.1 TDD
Dedicated CORESET Reference Channel	1		CCR.1.1 TDD
	2		CCR.2.1 TDD
SSB configuration	1		SSB.1 FR1
	2		SSB.2 FR1
OCNG Patterns <sup>Note6</sup>	1~2		OP.1
TRS configuration	1		TRS.1.1 TDD
	2		TRS.1.2 TDD
Initial BWP Configuration	1~2		DLBWP.0.1
			ULBWP.0.1
Dedicated BWP configuration	1~2		DLBWP.1.1

			ULBWP.1.1
SMTC configuration	1~2		SMTC.1
Time offset between DL from serving cell and OCNG from test system	1~2	$\mu\text{s}$	17.67
EPRE ratio of PSS to SSS	1~2	dB	0
EPRE ratio of PBCH DMRS to SSS			
EPRE ratio of PBCH to PBCH DMRS			
EPRE ratio of PDCCH DMRS to SSS			
EPRE ratio of PDCCH to PDCCH DMRS			
EPRE ratio of PDSCH DMRS to SSS			
EPRE ratio of PDSCH to PDSCH DMRS			
EPRE ratio of OCNG DMRS to SSS <sup>Note 1</sup>			
EPRE ratio of OCNG to OCNG DMRS <sup>Note 1</sup>			
$N_{oc}$ on CLI-RSSI measurement resource <sup>Note2</sup>	1	dBm/15kHz	-106
	2		-106
$N_{oc}$ on CLI-RSSI measurement resource <sup>Note2</sup>	1	dBm/ BWP SCS	-106
	2		-103
$\hat{E}_s/I_{ot}$ on CLI-RSSI measurement resource	1~2	dB	-Infinity
RSRP on CLI-RSSI measurement resource <sup>Note3</sup>	1~2	dBm/ BWP SCS	-Infinity
Io on CLI-RSSI measurement resource <sup>Note3</sup>	1	dBm/9.36 MHz	-78.05
	2	dBm/38.16 MHz	-71.96
Io on CLI-RSSI measurement resource <sup>Note3</sup>	1	dBm/1.08 MHz	-87.43
	2		-87.44
$\hat{E}_s/N_{oc}$ on CLI-RSSI measurement resource	1~2	dB	-Infinity
Propagation condition	1~2		AWGN
Antenna configuration	1~2		1x2
<p>Note 1: OCNG shall be used such that a constant total transmitted power spectral density is achieved for all OFDM symbols.</p> <p>Note 2: Interference from other cells and noise sources not specified in the test is assumed to be constant over subcarriers and time and shall be modelled as AWGN of appropriate power for <math>N_{oc}</math> to be fulfilled.</p> <p>Note 3: RSRP and Io levels have been derived from other parameters for information purposes. They are not settable parameters themselves.</p> <p>Note 4: RSRP minimum requirements are specified assuming independent interference and noise at each receiver antenna port.</p> <p>Note 5: The test configuration excludes support for band n51 and it is not required to run this test on band n51 in this release of the specification</p> <p>Note 6: OCNG is not transmitted in the CLI-RSSI measurement resources.</p>			

**Table A.6.7.8.2.2-2: CLI-RSSI measurement resource configuration for FR1 CLI-RSSI accuracy**

	Field	Config	SRSSConf.1
CLI-RSSI measurement resource	rss-ResourceId	1~2	0
	rss-SCS	1	15kHz
		2	30kHz
	startPRB	1~2	0
	nrofPRBs	1	52
		2	106
	startPosition	1~2	3
	nrofSymbols	1~2	11
rss-PeriodicityAndOffset	1	sl20, 9	
	2	sl40, 19	

### A.6.7.8.2.3 Test Requirements

The CLI-RSSI measurement accuracy shall fulfil the requirements in clauses 10.1.22.2.1.

## A.6.7.9 L1-SINR measurement for beam reporting

### A.6.7.9.1 L1-SINR measurement with CSI-RS based CMR and no dedicated IMR configured and CSI-RS resource set with repetition off

#### A.6.7.9.1.1 Test Purpose and Environment

The purpose of this test is to verify that the L1-SINR measurement accuracy is within the specified limits. This test will verify the requirements in clause 9.8.4.1 and clause 10.1.27.1 for L1-SINR measurements based on CSI-RS with the testing configurations for NR cells in Table A.6.7.9.1.1-1.

**Table A.6.7.9.1.1-1: Applicable NR configurations for FR1 L1-SINR test with CSI-RS based CMR and no dedicated IMR configured**

Config	Description
1	NR 15 kHz CSI-RS SCS, 10 MHz bandwidth, FDD duplex mode
2	NR 15 kHz CSI-RS SCS, 10 MHz bandwidth, TDD duplex mode
3	NR 30kHz CSI-RS SCS, 40 MHz bandwidth, TDD duplex mode
Note:	The UE is only required to be tested in one of the supported test configurations in each supported band

#### A.6.7.9.1.2 Test parameters

In this set of test cases there are one cell in the test, PCell (Cell 1). The test parameters for the Cell 1 are given in Table A.6.7.9.1.2-1 below. The absolute and relative accuracy of L1-SINR measurements are tested by using the parameters in Table A.6.7.9.1.2-1.

There is no measurement gap configured in the test. Before the test, UE is configured one CSI-RS resource set with two CSI-RS resources. UE is configured to perform RLM and BFD based on SSB 0 and 1. CSI-RS is not transmitted in the same OFDM symbols as SSB.

**Table A.6.7.9.1.2-1: FR1 CSI-RS based L1-SINR test parameters**

Parameter	Config	Unit	Test 1	Test 2
SSB GSCN	1~3		freq1	freq1
Duplex mode	1		FDD	FDD
	2		TDD	TDD
	3		TDD	TDD
TDD Configuration	1		N/A	N/A
	2		TDDConf.1.1	TDDConf.1.1
	3		TDDConf.2.1	TDDConf.2.1
BW <sub>channel</sub>	1	MHz	10: N <sub>RB,c</sub> = 52	10: N <sub>RB,c</sub> = 52



	2		10: $N_{RB,c} = 52$	10: $N_{RB,c} = 52$	
	3		40: $N_{RB,c} = 106$	40: $N_{RB,c} = 106$	
PDSCH Reference measurement channel	1		SR.1.1 FDD	SR.1.1 FDD	
	2		SR.1.1 TDD	SR.1.1 TDD	
	3		SR.2.1 TDD	SR.2.1 TDD	
RMSI CORESET Reference Channel	1		CR.1.1 FDD	CR.1.1 FDD	
	2		CR.1.1 TDD	CR.1.1 TDD	
	3		CR.2.1 TDD	CR.2.1 TDD	
Dedicated CORESET Reference Channel	1		CCR.1.1 FDD	CCR.1.1 FDD	
	2		CCR.1.1 TDD	CCR.1.1 TDD	
	3		CCR.2.1 TDD	CCR.2.1 TDD	
SSB configuration	1		SSB.1 FR1	SSB.1 FR1	
	2		SSB.1 FR1	SSB.1 FR1	
	3		SSB.2 FR1	SSB.2 FR1	
OCNG Patterns	1~3		OP.1	OP.1	
TRS configuration	1		TRS.1.1 FDD	TRS.1.1 FDD	
	2		TRS.1.1 TDD	TRS.1.1 TDD	
	3		TRS.1.2 TDD	TRS.1.2 TDD	
Initial BWP Configuration	1~3		DLBWP.0.1 ULBWP.0.1	DLBWP.0.1 ULBWP.0.1	
Dedicated BWP configuration	1~3		DLBWP.1.1 ULBWP.1.1	DLBWP.1.1 ULBWP.1.1	
SMTC configuration	1~3		SMTC.1	SMTC.1	
CSI-RS	1		CSI-RS 1.2 FDD	CSI-RS 1.2 FDD	
	2		CSI-RS 1.2 TDD	CSI-RS 1.2 TDD	
	3		CSI-RS 2.2 TDD	CSI-RS 2.2 FDD	
reportConfigType	1~3		periodic	periodic	
reportQuantity-r16	1~3		cri-SINR-r16	cri-SINR-r16	
nrofReportedRS	1~3		2	2	
L1-SINR reporting period	1~3		slot80	slot80	
EPRE ratio of PSS to SSS	1~3	dB	0	0	
EPRE ratio of PBCH DMRS to SSS					
EPRE ratio of PBCH to PBCH DMRS					
EPRE ratio of PDCCH DMRS to SSS					
EPRE ratio of PDCCH to PDCCH DMRS					
EPRE ratio of PDSCH DMRS to SSS					
EPRE ratio of PDSCH to PDSCH DMRS					
EPRE ratio of OCNG DMRS to SSS <sup>Note 1</sup>					
EPRE ratio of OCNG to OCNG DMRS <sup>Note 1</sup>					
$N_{oc}$ Note2					NR_FDD_FR1_A, NR_TDD_FR1_A NOTE 5
	NR_FDD_FR1_B	-116.5			
	NR_TDD_FR1_C	-116			
	NR_FDD_FR1_D, NR_TDD_FR1_D	-115.5			
	NR_FDD_FR1_E, NR_TDD_FR1_E	-115			
	NR_FDD_FR1_F	-114.5			
	NR_FDD_FR1_G	-114			
	NR_FDD_FR1_H	-113.5			
$N_{oc}$ Note2	NR_FDD_FR1_A, NR_TDD_FR1_A NOTE 5	1,2	dBm/CSI-RS SCS	-94.65	-117
	NR_FDD_FR1_B				-116.5
	NR_TDD_FR1_C				-116

	NR_FDD_FR1_D, NR_TDD_FR1_D				-115.5	
	NR_FDD_FR1_E, NR_TDD_FR1_E				-115	
	NR_FDD_FR1_F				-114.5	
	NR_FDD_FR1_G				-114	
	NR_FDD_FR1_H				-113.5	
	NR_FDD_FR1_A, NR_TDD_FR1_A NOTE 5	3			-114	
	NR_FDD_FR1_B				-113.5	
	NR_TDD_FR1_C				-114	
	NR_FDD_FR1_D, NR_TDD_FR1_D				-112.5	
	NR_FDD_FR1_E, NR_TDD_FR1_E				-112	
	NR_FDD_FR1_F				-111.5	
	NR_FDD_FR1_G				-111	
	NR_FDD_FR1_H				-110.5	
	$\hat{E}_s/I_{ot}$				1~3	dB
CSI-RS RSRP Note3	NR_FDD_FR1_A, NR_TDD_FR1_A NOTE 5	1,2	dBm/CSI-RS SCS		-120	
	NR_FDD_FR1_B				-119.5	
	NR_TDD_FR1_C				-119	
	NR_FDD_FR1_D, NR_TDD_FR1_D				-118.5	
	NR_FDD_FR1_E, NR_TDD_FR1_E				-118	
	NR_FDD_FR1_F	-117.5				
	NR_FDD_FR1_G	-117				
	NR_FDD_FR1_H	-116.5				
	NR_FDD_FR1_A, NR_TDD_FR1_A NOTE 5	3			-117	
	NR_FDD_FR1_B				-116.5	
	NR_TDD_FR1_C				-116	
	NR_FDD_FR1_D, NR_TDD_FR1_D				-115.5	
	NR_FDD_FR1_E, NR_TDD_FR1_E				-115	
	NR_FDD_FR1_F				-114.5	
NR_FDD_FR1_G	-114					
NR_FDD_FR1_H	-113.5					
I <sub>o</sub> Note3	NR_FDD_FR1_A, NR_TDD_FR1_A NOTE 5		1,2	dBm/9.36 MHz		-87.28
	NR_FDD_FR1_B	-86.78				
	NR_TDD_FR1_C	-86.28				
	NR_FDD_FR1_D, NR_TDD_FR1_D	-85.78				
	NR_FDD_FR1_E, NR_TDD_FR1_E	-85.28				
	NR_FDD_FR1_F	-84.78				
	NR_FDD_FR1_G	-84.28				
	NR_FDD_FR1_H	-83.78				
	NR_FDD_FR1_A, NR_TDD_FR1_A NOTE 5	3	dBm/38.16 MHz			-81.19
	NR_FDD_FR1_B					-80.69
	NR_TDD_FR1_C					-80.19
	NR_FDD_FR1_D, NR_TDD_FR1_D					-79.69
	NR_FDD_FR1_E, NR_TDD_FR1_E					-79.19
	NR_FDD_FR1_F					-78.69

	NR_FDD_FR1_G				-78.19
	NR_FDD_FR1_H				-77.69
$\hat{E}_s/N_{oc}$		1~3	dB	10	-3
Propagation condition		1~3		AWGN	AWGN
Antenna configuration		1~3		1x2	1x2
Note 1:	OCNG shall be used such that both cells are fully allocated and a constant total transmitted power spectral density is achieved for all OFDM symbols.				
Note 2:	Interference from other cells and noise sources not specified in the test is assumed to be constant over subcarriers and time and shall be modelled as AWGN of appropriate power for $N_{oc}$ to be fulfilled.				
Note 3:	RSRP and $I_o$ levels have been derived from other parameters for information purposes. They are not settable parameters themselves.				
Note 4:	RSRP minimum requirements are specified assuming independent interference and noise at each receiver antenna port.				
Note 5:	The test configuration excludes support for band n51 and it is not required to run this test on band n51 in this release of the specification.				

### A.6.7.9.1.3 Test Requirements

The L1-SINR measurement accuracy for CSI-RS#0 and CSI-RS#1 of Cell 1 shall fulfil the requirements in clause 10.1.27.1.

## A.6.7.9.2 L1-SINR measurement with SSB based CMR and dedicated IMR

### A.6.7.9.2.1 Test Purpose and Environment

The purpose of this test is to verify that the L1-SINR measurement accuracy is within the specified limits. This test will verify the requirements in clause 9.8.4.2 and clause 10.1.27.2 for L1-SINR measurements with SSB based CMR and dedicated CSI-RS based IMR, with the testing configurations for NR cells in Table A.6.7.9.2.1-1.

**Table A.6.7.9.2.1-1: Applicable NR configurations for FR1 L1-SINR measurement test with SSB based CMR and CSI-RS based IMR**

Config	Description
1	NR 15 kHz SSB SCS, 10 MHz bandwidth, FDD duplex mode
2	NR 15 kHz SSB SCS, 10 MHz bandwidth, TDD duplex mode
3	NR 30kHz SSB SCS, 40 MHz bandwidth, TDD duplex mode
Note:	The UE is only required to be tested in one of the supported test configurations in each supported band

### A.6.7.9.2.2 Test parameters

In this set of test cases there one cell in the test, PCell (Cell 1). The test parameters for the Cell 1 are given in Table A.6.7.9.2.2-1 below. The absolute accuracy of L1-SINR measurements are tested by using the parameters in Table A.6.7.9.2.2-1.

There is no measurement gap configured in the test. Before the test, UE is configured one SSB resource set with two SSB resources and one CSI-RS resource set with two CSI-RS resource. UE is configured to perform RLM and BFD measurement based on the SSB resources 0 and 1. UE is configured to perform L1-SINR measurement based on the SSBs as CMR and the CSI-RS resources as IMR.

**Table A.6.7.9.2.2-1: FR1 SSB based L1-SINR test parameters**

Parameter	Config	Unit	Test 1	Test 2
SSB GSCN	1~3		freq1	freq1
Duplex mode	1		FDD	FDD
	2		TDD	TDD
	3		TDD	TDD
TDD Configuration	1		N/A	N/A
	2		TDDConf.1.1	TDDConf.1.1
	3		TDDConf.2.1	TDDConf.2.1
$BW_{channel}$	1	MHz	10: $N_{RB,c} = 52$	10: $N_{RB,c} = 52$

	2		10: $N_{RB,c} = 52$	10: $N_{RB,c} = 52$	
	3		40: $N_{RB,c} = 106$	40: $N_{RB,c} = 106$	
PDSCH Reference measurement channel	1		SR.1.1 FDD	SR.1.1 FDD	
	2		SR.1.1 TDD	SR.1.1 TDD	
	3		SR.2.1 TDD	SR.2.1 TDD	
RMSI CORESET Reference Channel	1		CR.1.1 FDD	CR.1.1 FDD	
	2		CR.1.1 TDD	CR.1.1 TDD	
	3		CR.2.1 TDD	CR.2.1 TDD	
Dedicated CORESET Reference Channel	1		CCR.1.1 FDD	CCR.1.1 FDD	
	2		CCR.1.1 TDD	CCR.1.1 TDD	
	3		CCR.2.1 TDD	CCR.2.1 TDD	
SSB configuration	1		SSB.3 FR1	SSB.3 FR1	
	2		SSB.3 FR1	SSB.3 FR1	
	3		SSB.4 FR1	SSB.4 FR1	
CSI-RS configuration	1		CSI-RS 1.1A FDD	CSI-RS 1.1A FDD	
	2		CSI-RS 1.1A TDD	CSI-RS 1.1A TDD	
	3		CSI-RS 2.1A TDD	CSI-RS 2.1A TDD	
OCNG Patterns	1~3		OP.1	OP.1	
Initial BWP Configuration	1~3		DLBWP.0.1 ULBWP.0.1	DLBWP.0.1 ULBWP.0.1	
TRS configuration	1		TRS.1.1 FDD	TRS.1.1 FDD	
	2		TRS.1.1 TDD	TRS.1.1 TDD	
	3		TRS.1.2 TDD	TRS.1.2 TDD	
Dedicated BWP configuration	1~3		DLBWP.1.1 ULBWP.1.1	DLBWP.1.1 ULBWP.1.1	
SMTC configuration	1~3		SMTC.1	SMTC.1	
reportConfigType	1~3		periodic	periodic	
reportQuantity-r16	1~3		ssb-Index-SINR-r16	ssb-Index-SINR-r16	
Number of reported RS	1~3		2	2	
L1-SINR reporting period	1~3		slot80	slot80	
EPRE ratio of PSS to SSS	1~3	dB	0	0	
EPRE ratio of PBCH DMRS to SSS					
EPRE ratio of PBCH to PBCH DMRS					
EPRE ratio of PDCCH DMRS to SSS					
EPRE ratio of PDCCH to PDCCH DMRS					
EPRE ratio of PDSCH DMRS to SSS					
EPRE ratio of PDSCH to PDSCH DMRS					
EPRE ratio of OCNG DMRS to SSS <sup>Note 1</sup>					
EPRE ratio of OCNG to OCNG DMRS <sup>Note 1</sup>					
$N_{oc}$ Note2					NR_FDD_FR1_A, NR_TDD_FR1_A NOTE 5
	NR_FDD_FR1_B	-116.5			
	NR_TDD_FR1_C	-116			
	NR_FDD_FR1_D, NR_TDD_FR1_D	-115.5			
	NR_FDD_FR1_E, NR_TDD_FR1_E	-115			
	NR_FDD_FR1_F	-114.5			
	NR_FDD_FR1_G	-114			
	NR_FDD_FR1_H	-113.5			

$N_{oc}$ Note2	NR_FDD_FR1_A, NR_TDD_FR1_A NOTE 5	1,2	dBm/SSB SCS	-94.65	-117
	NR_FDD_FR1_B				-116.5
	NR_TDD_FR1_C				-116
	NR_FDD_FR1_D, NR_TDD_FR1_D				-115.5
	NR_FDD_FR1_E, NR_TDD_FR1_E				-115
	NR_FDD_FR1_F				-114.5
	NR_FDD_FR1_G				-114
	NR_FDD_FR1_H				-113.5
	NR_FDD_FR1_A, NR_TDD_FR1_A NOTE 5	3		-91.65	-114
	NR_FDD_FR1_B				-113.5
	NR_TDD_FR1_C				-114
	NR_FDD_FR1_D, NR_TDD_FR1_D				-112.5
	NR_FDD_FR1_E, NR_TDD_FR1_E				-112
	NR_FDD_FR1_F				-111.5
	NR_FDD_FR1_G				-111
	NR_FDD_FR1_H				-110.5
$\hat{E}_s/I_{ot}$	1~3	dB	10	0	
$\hat{E}_s/N_{oc}$	1~6	dB	10	0	
SSB RSRP Note3	NR_FDD_FR1_A, NR_TDD_FR1_A NOTE 5	1,2	dBm/SSB SCS	-84.65	-117
	NR_FDD_FR1_B				-116.5
	NR_TDD_FR1_C				-116
	NR_FDD_FR1_D, NR_TDD_FR1_D				-115.5
	NR_FDD_FR1_E, NR_TDD_FR1_E				-115
	NR_FDD_FR1_F				-114.5
	NR_FDD_FR1_G				-114
	NR_FDD_FR1_H				-113.5
	NR_FDD_FR1_A, NR_TDD_FR1_A NOTE 5	3		-81.65	-114
	NR_FDD_FR1_B				-113.5
	NR_TDD_FR1_C				-114
	NR_FDD_FR1_D, NR_TDD_FR1_D				-112.5
	NR_FDD_FR1_E, NR_TDD_FR1_E				-112
	NR_FDD_FR1_F				-111.5
	NR_FDD_FR1_G				-111
	NR_FDD_FR1_H				-110.5
CSI-RS RSRP Note3	NR_FDD_FR1_A, NR_TDD_FR1_A NOTE 5	1,2	dBm/CSI-RS SCS	-84.65	-117
	NR_FDD_FR1_B				-116.5
	NR_TDD_FR1_C				-116
	NR_FDD_FR1_D, NR_TDD_FR1_D				-115.5
	NR_FDD_FR1_E, NR_TDD_FR1_E				-115
	NR_FDD_FR1_F				-114.5
	NR_FDD_FR1_G				-114
	NR_FDD_FR1_H				-113.5

	NR_FDD_FR1_A, NR_TDD_FR1_A NOTE 5	3		-81.65	-114
	NR_FDD_FR1_B				-113.5
	NR_TDD_FR1_C				-113
	NR_FDD_FR1_D, NR_TDD_FR1_D				-112.5
	NR_FDD_FR1_E, NR_TDD_FR1_E				-112
	NR_FDD_FR1_F				-111.5
	NR_FDD_FR1_G				-111
	NR_FDD_FR1_H				-110.5
Io Note3	NR_FDD_FR1_A, NR_TDD_FR1_A NOTE 5	1,2	dBm/9.36 MHz	-56.28	-86.04
	NR_FDD_FR1_B				-85.54
	NR_TDD_FR1_C				-85.04
	NR_FDD_FR1_D, NR_TDD_FR1_D				-84.54
	NR_FDD_FR1_E, NR_TDD_FR1_E				-84.04
	NR_FDD_FR1_F				-83.54
	NR_FDD_FR1_G				-83.04
	NR_FDD_FR1_H				-82.54
	NR_FDD_FR1_A, NR_TDD_FR1_A NOTE 5	3	dBm/38.16 MHz	-50.19	-79.94
	NR_FDD_FR1_B				-79.44
	NR_TDD_FR1_C				-78.94
	NR_FDD_FR1_D, NR_TDD_FR1_D				-78.44
	NR_FDD_FR1_E, NR_TDD_FR1_E				-77.94
	NR_FDD_FR1_F				-77.44
	NR_FDD_FR1_G				-76.94
	NR_FDD_FR1_H				-76.44
Propagation condition		1~3		AWGN	AWGN
Antenna configuration		1~3		1x2	1x2
<p>Note 1: OCNG shall be used such that both cells are fully allocated and a constant total transmitted power spectral density is achieved for all OFDM symbols.</p> <p>Note 2: Interference from other cells and noise sources not specified in the test is assumed to be constant over subcarriers and time and shall be modelled as AWGN of appropriate power for <math>N_{oc}</math> to be fulfilled.</p> <p>Note 3: RSRP and Io levels have been derived from other parameters for information purposes. They are not settable parameters themselves.</p> <p>Note 4: RSRP minimum requirements are specified assuming independent interference and noise at each receiver antenna port.</p> <p>Note 5: The test configuration excludes support for band n51 and it is not required to run this test on band n51 in this release of the specification.</p>					

### A.6.7.9.2.3 Test Requirements

The L1-SINR measurement accuracy for SSB#0+CSI-RS#0 and SSB#1+CSI-RS#1 of Cell 1 shall fulfil the requirements in clauses 10.1.27.2.

### A.6.7.9.3 L1-SINR measurement with CSI-RS based CMR and dedicated IMR

#### A.6.7.9.3.1 Test Purpose and Environment

The purpose of this test is to verify that the L1-SINR measurement accuracy is within the specified limits. This test will partly verify the requirements in Clauses 9.8.4.3 and clause 10.1.27.3 for L1-SINR measurements based on CSI-RS as CMR and CSI-IM as IMR with the testing configurations for NR cells in Table A.6.7.9.3.1-1.

**Table A.6.7.9.3.1-1: Applicable NR configurations for FR1 L1-SINR measurement test with CSI-RS based CMR and CSI-IM based IMR**

Config	Description
1	NR 15 kHz CSI-RS SCS, 10 MHz bandwidth, FDD duplex mode
2	NR 15 kHz CSI-RS SCS, 10 MHz bandwidth, TDD duplex mode
3	NR 30kHz CSI-RS SCS, 40 MHz bandwidth, TDD duplex mode
Note:	The UE is only required to be tested in one of the supported test configurations in each supported band

### A.6.7.9.3.2 Test parameters

In this set of test cases there are one cell in the test, PCell (Cell 1). The test parameters for the Cell 1 are given in Table A.6.7.9.3.2-1 below. The absolute and relative accuracy of L1-SINR measurements are tested by using the parameters in Table A.6.7.9.3.2-1.

There is no measurement gap configured in the test. Before the test, UE is configured one CSI-RS resource set with two CSI-RS resources and one CSI-IM resource set with two CSI-IM resources. UE is configured to perform RLM and BFD based on SSB 0 and 1. CSI-RS is not transmitted in the same OFDM symbols as SSB. UE is configured to perform L1-SINR measurement based on the configured CSI-RS as CMR and CSI-IM as IMR.

**Table A.6.7.9.3.2-1: FR2 L1-SINR measurement test with CSI-RS based CMR and CSI-IM based IMR**

Parameter	Config	Unit	Test 1	Test 2
SSB GSCN	1~3		freq1	freq1
Duplex mode	1		FDD	FDD
	2		TDD	TDD
	3		TDD	TDD
TDD Configuration	1		N/A	N/A
	2		TDDConf.1.1	TDDConf.1.1
	3		TDDConf.2.1	TDDConf.2.1
BW <sub>channel</sub>	1	MHz	10: N <sub>RB,c</sub> = 52	10: N <sub>RB,c</sub> = 52
	2		10: N <sub>RB,c</sub> = 52	10: N <sub>RB,c</sub> = 52
	3		40: N <sub>RB,c</sub> = 106	40: N <sub>RB,c</sub> = 106
PDSCH Reference measurement channel	1		SR.1.1 FDD	SR.1.1 FDD
	2		SR.1.1 TDD	SR.1.1 TDD
	3		SR.2.1 TDD	SR.2.1 TDD
RMSI CORESET Reference Channel	1		CR.1.1 FDD	CR.1.1 FDD
	2		CR.1.1 TDD	CR.1.1 TDD
	3		CR.2.1 TDD	CR.2.1 TDD
Dedicated CORESET Reference Channel	1		CCR.1.1 FDD	CCR.1.1 FDD
	2		CCR.1.1 TDD	CCR.1.1 TDD
	3		CCR.2.1 TDD	CCR.2.1 TDD
SSB configuration	1		SSB.1 FR1	SSB.1 FR1
	2		SSB.1 FR1	SSB.1 FR1
	3		SSB.2 FR1	SSB.2 FR1
OCNG Patterns	1~3		OP.1	OP.1
TRS configuration	1		TRS.1.1 FDD	TRS.1.1 FDD
	2		TRS.1.1 TDD	TRS.1.1 TDD
	3		TRS.1.2 TDD	TRS.1.2 TDD
Initial BWP Configuration	1~3		DLBWP.0.1 ULBWP.0.1	DLBWP.0.1 ULBWP.0.1
Dedicated BWP configuration	1~3		DLBWP.1.1 ULBWP.1.1	DLBWP.1.1 ULBWP.1.1
SMTc configuration	1~3		SMTc.1	SMTc.1
CSI-RS configuration as CMR	1		CSI-RS 1.2 FDD	CSI-RS 1.2 FDD
	2		CSI-RS 1.2 TDD	CSI-RS 1.2 TDD
	3		CSI-RS 2.2 TDD	CSI-RS 2.2 FDD
CSI-IM configuration as IMR	1		CSI-IM 1.3 FDD	CSI-IM 1.3 FDD
	2		CSI-IM 1.3 TDD	CSI-IM 1.3 TDD
	3		CSI-IM 2.3 TDD	CSI-IM 2.3 TDD
reportConfigType	1~3		periodic	periodic
reportQuantity-r16	1~3		cri-SINR-r16	cri-SINR-r16

nrofReportedRS		1~3		2	2		
L1-RSRP reporting period		1~3		slot80	slot80		
EPRE ratio of PSS to SSS		1~3	dB	0	0		
EPRE ratio of PBCH DMRS to SSS							
EPRE ratio of PBCH to PBCH DMRS							
EPRE ratio of PDCCH DMRS to SSS							
EPRE ratio of PDCCH to PDCCH DMRS							
EPRE ratio of PDSCH DMRS to SSS							
EPRE ratio of PDSCH to PDSCH DMRS							
EPRE ratio of OCNG DMRS to SSS <sup>Note 1</sup>							
EPRE ratio of OCNG to OCNG DMRS <sup>Note 1</sup>							
$N_{oc}$ Note2	NR_FDD_FR1_A, NR_TDD_FR1_A NOTE 5					1~3	dBm/15kHz
	NR_FDD_FR1_B	-116.5					
	NR_TDD_FR1_C	-116					
	NR_FDD_FR1_D, NR_TDD_FR1_D	-115.5					
	NR_FDD_FR1_E, NR_TDD_FR1_E	-115					
	NR_FDD_FR1_F	-114.5					
	NR_FDD_FR1_G	-114					
	NR_FDD_FR1_H	-113.5					
$N_{oc}$ Note2	NR_FDD_FR1_A, NR_TDD_FR1_A NOTE 5	1,2	dBm/CSI-RS SCS	-94.65	-117		
	NR_FDD_FR1_B				-116.5		
	NR_TDD_FR1_C				-116		
	NR_FDD_FR1_D, NR_TDD_FR1_D				-115.5		
	NR_FDD_FR1_E, NR_TDD_FR1_E				-115		
	NR_FDD_FR1_F				-114.5		
	NR_FDD_FR1_G				-114		
	NR_FDD_FR1_H				-113.5		
	NR_FDD_FR1_A, NR_TDD_FR1_A NOTE 5				3	-91.65	-114
	NR_FDD_FR1_B						-113.5
	NR_TDD_FR1_C	-114					
	NR_FDD_FR1_D, NR_TDD_FR1_D	-112.5					
	NR_FDD_FR1_E, NR_TDD_FR1_E	-112					
	NR_FDD_FR1_F	-111.5					
	NR_FDD_FR1_G	-111					
	NR_FDD_FR1_H	-110.5					
	$\hat{E}_s/I_{\alpha}$			1~3	dB	10	-3
	CSI-RS RSRP Note3	NR_FDD_FR1_A, NR_TDD_FR1_A NOTE 5		1,2	dBm/CSI-RS SCS	-84.65	-120
NR_FDD_FR1_B		-119.5					
NR_TDD_FR1_C		-119					
NR_FDD_FR1_D, NR_TDD_FR1_D		-118.5					
NR_FDD_FR1_E, NR_TDD_FR1_E		-118					
NR_FDD_FR1_F		-117.5					
NR_FDD_FR1_G		-117.5					



	NR_FDD_FR1_G				-117			
	NR_FDD_FR1_H				-116.5			
	NR_FDD_FR1_A, NR_TDD_FR1_A NOTE 5	3		-81.65	-117			
	NR_FDD_FR1_B				-116.5			
	NR_TDD_FR1_C				-116			
	NR_FDD_FR1_D, NR_TDD_FR1_D				-115.5			
	NR_FDD_FR1_E, NR_TDD_FR1_E				-115			
	NR_FDD_FR1_F				-114.5			
	NR_FDD_FR1_G				-114			
	NR_FDD_FR1_H				-113.5			
Io Note3	NR_FDD_FR1_A, NR_TDD_FR1_A NOTE 5	1,2	dBm/9.36 MHz	-56.28	-87.28			
	NR_FDD_FR1_B				-86.78			
	NR_TDD_FR1_C				-86.28			
	NR_FDD_FR1_D, NR_TDD_FR1_D				-85.78			
	NR_FDD_FR1_E, NR_TDD_FR1_E				-85.28			
	NR_FDD_FR1_F				-84.78			
	NR_FDD_FR1_G				-84.28			
	NR_FDD_FR1_H				-83.78			
	NR_FDD_FR1_A, NR_TDD_FR1_A NOTE 5				3	dBm/38.16 MHz	-50.19	-81.19
	NR_FDD_FR1_B							-80.69
NR_TDD_FR1_C	-80.19							
NR_FDD_FR1_D, NR_TDD_FR1_D	-79.69							
NR_FDD_FR1_E, NR_TDD_FR1_E	-79.19							
NR_FDD_FR1_F	-78.69							
NR_FDD_FR1_G	-78.19							
NR_FDD_FR1_H	-77.69							
$\hat{E}_s/N_{oc}$	1~3	dB	10	-3				
Propagation condition	1~3		AWGN	AWGN				
Antenna configuration	1~3		1x2	1x2				
<p>Note 1: OCNG shall be used such that both cells are fully allocated and a constant total transmitted power spectral density is achieved for all OFDM symbols.</p> <p>Note 2: Interference from other cells and noise sources not specified in the test is assumed to be constant over subcarriers and time and shall be modelled as AWGN of appropriate power for <math>N_{oc}</math> to be fulfilled.</p> <p>Note 3: RSRP and Io levels have been derived from other parameters for information purposes. They are not settable parameters themselves.</p> <p>Note 4: RSRP minimum requirements are specified assuming independent interference and noise at each receiver antenna port.</p> <p>Note 5: The test configuration excludes support for band n51 and it is not required to run this test on band n51 in this release of the specification.</p>								

### A.6.7.9.3.3 Test Requirements

The L1-SINR measurement accuracy for CSI-RS#0+CSI-IM#0 and CSI-RS#1+CSI-IM# of Cell 1 shall fulfil the requirements in clause 10.1.27.3.A.7 NR standalone tests with one or more NR cells in FR2.

## A.6.7.10 CSI-RSRP

### A.6.7.10.1 SA: intra-frequency case measurement accuracy with FR1 serving cell and FR1 target cell

#### A.6.7.10.1.1 Test Purpose and Environment

The purpose of this test is to verify that the CSI-RSRP measurement accuracy is within the specified limits. This test will verify the requirements in clauses 10.1.2.3.1 and 10.1.2.3.2 for CSI-RS intra-frequency measurements.

#### A.6.7.10.1.2 Test parameters

In this set of test cases all cells are on the same carrier frequency. Supported test configurations are shown in table A.6.7.10.1.2-1. Both absolute and relative accuracy of CSI-RSRP intra-frequency measurements are tested by using the parameters in A.6.7.10.1.2-2. In all test cases, Cell 1 is the PCell, and Cell 2 is the target cell.

**Table A.6.7.10.1.2-1: CSI-RSRP intra frequency supported test configurations**

Config	Description
1	NR 15 kHz SSB and CSI-RS SCS, 10 MHz bandwidth, FDD duplex mode
2	NR 15 kHz SSB and CSI-RS SCS, 10 MHz bandwidth, TDD duplex mode
3	NR 30kHz SSB and CSI-RS SCS, 40 MHz bandwidth, TDD duplex mode
Note: The UE is only required to be tested in one of the supported test configurations in each supported band	

**Table A.6.7.10.1.2-2: CSI-RSRP intra frequency test parameters**

Parameter		Unit	Test 1		Test 2		Test 3	
			Cell 1	Cell 2	Cell 1	Cell 2	Cell 1	Cell 2
Cell ID			489	0	489	0	489	0
SSB ARFCN			freq1		freq1		freq1	
Duplex mode	Config 1		FDD					
	Config 2,3		TDD					
TDD configuration	Config 1		Not Applicable					
	Config 2		TDDConf.1.1					
	Config 3		TDDConf.2.1					
BW <sub>channel</sub>	Config 1	MHz	10: N <sub>RB,c</sub> = 52					
	Config 2		10: N <sub>RB,c</sub> = 52					
	Config 3		40: N <sub>RB,c</sub> = 106					
BWP BW	Config 1		10: N <sub>RB,c</sub> = 52					
	Config 2		10: N <sub>RB,c</sub> = 52					
	Config 3		40: N <sub>RB,c</sub> = 106					
Downlink initial BWP configuration			DLBWP.0.1					
Downlink dedicated BWP configuration			DLBWP.1.1					
Uplink initial BWP configuration			ULBWP.0.1					
Uplink dedicated BWP configuration			ULBWP.1.1					
TRS configuration	Config 1		TRS.1.1 FDD	NA	TRS.1.1 FDD	NA	TRS.1.1 FDD	NA
	Config 2		TRS.1.1 TDD	NA	TRS.1.1 TDD	NA	TRS.1.1 TDD	NA
	Config 3		TRS.1.2 TDD	NA	TRS.1.2 TDD	NA	TRS.1.2 TDD	NA
DRX Cycle		ms	Not Applicable					
PDSCH Reference measurement channel	Config 1		SR.1.1 FDD	-	SR.1.1 FDD	-	SR.1.1 FDD	-
	Config 2		SR.1.1 TDD	-	SR.1.1 TDD	-	SR.1.1 TDD	-

	Config 3		SR.2.1 TDD		SR.2. 1 TDD		SR.2.1 TDD	
RMSI CORESET Reference Channel	Config 1		CR.1.1 FDD		CR.1. 1 FDD		CR.1.1 FDD	
	Config 2		CR.1.1 TDD	-	CR.1. 1 TDD	-	CR.1.1 TDD	-
	Config 3		CR.2.1 TDD		CR.2. 1 TDD		CR.2.1 TDD	
Control channel RMC	Config 1		CCR.1. 1 FDD		CCR. 1.1 FDD		CCR.1. 1 FDD	
	Config 2		CCR.1. 1 TDD	-	CCR. 1.1 TDD	-	CCR.1. 1 TDD	-
	Config 3		CCR2. 1 TDD		CCR2 .1 TDD		CCR2. 1 TDD	
SSB configuration	Config 1		SSB.1 FR1	SSB.1 FR1	SSB.1 FR1	SSB.1 FR1	SSB.1 FR1	SSB.1 FR1
	Config 2		SSB.1 FR1	SSB.1 FR1	SSB.1 FR1	SSB.1 FR1	SSB.1 FR1	SSB.1 FR1
	Config 3		SSB.2 FR1	SSB.2 FR1	SSB.2 FR1	SSB.2 FR1	SSB.2 FR1	SSB.2 FR1
Time offset with Cell 1	Config 1,2	µs	-	4.7	-	4.7	-	4.7
	Config 3	µs	-	2.35	-	2.35	-	2.35
SMTC configuration	Config 1		SMTC.2					
	Config 2,3		SMTC.1					
CSI-RS configuration for RRM	Config 1		CSI-RS.RRM.FR1.1 FDD					
	Config 2		CSI-RS.RRM.FR1.1 TDD					
	Config 3		CSI-RS.RRM.FR1.2 TDD					
OCNG Patterns			OCNG pattern 1					
PDSCH/PDCCH subcarrier spacing	Config 1,2	kHz	15 kHz					
	Config 3		30kHz					
EPRE ratio of PSS to SSS		dB	0	0	0	0	0	0
EPRE ratio of PBCH DMRS to SSS								
EPRE ratio of PBCH to PBCH DMRS								
EPRE ratio of PDCCH DMRS to SSS								
EPRE ratio of PDCCH to PDCCH DMRS								
EPRE ratio of PDSCH DMRS to SSS								
EPRE ratio of PDSCH to PDSCH								
EPRE ratio of OCNG DMRS to SSS(Note 1)								
EPRE ratio of OCNG to OCNG DMRS (Note 1)								
$N_{oc}$ <small>Note2</small>	Config 1,2	NR_FDD_FR1_A, NR_TDD_FR1_A <small>NOTE 6</small>	-106			-88		-114
		NR_FDD_FR1_B						-113.5
		NR_TDD_FR1_C						-113
		NR_FDD_FR1_D, NR_TDD_FR1_D						-112.5
		NR_FDD_FR1_E, NR_TDD_FR1_E						-112
		NR_FDD_FR1_F						-111.5
		NR_FDD_FR1_G						-111
		NR_FDD_FR1_H						-110.5
	Config 3	NR_FDD_FR1_A, NR_TDD_FR1_A <small>NOTE 6</small>	Not applicable <sup>Note 5</sup>			-94		-114
		NR_FDD_FR1_B						-113.5
NR_TDD_FR1_C		-113						
NR_FDD_FR1_D, NR_TDD_FR1_D		-112.5						

		NR_FDD_FR1_E, NR_TDD_FR1_E						-112	
		NR_FDD_FR1_F						-111.5	
		NR_FDD_FR1_G						-111	
		NR_FDD_FR1_H						-110.5	
$N_{oc}$ <sup>Note2</sup>	Config 1,2		dBm/SCS	Not applicable <sup>Note 5</sup>	-91			Same as Noc/15kHz	
								-106	-88
	Config 3	NR_FDD_FR1_A, NR_TDD_FR1_A <small>NOTE 6</small>						-110.5	
		NR_FDD_FR1_B						-110	
		NR_TDD_FR1_C						-109.5	
		NR_FDD_FR1_D, NR_TDD_FR1_D						-109	
		NR_FDD_FR1_E, NR_TDD_FR1_E						-108.5	
		NR_FDD_FR1_F						-108	
		NR_FDD_FR1_G						-107.5	
		NR_FDD_FR1_H							
$\hat{E}_{sl}/I_{ot}$			dB	2.46	-5.97	2.46	-5.97	-0.01	-4.76
$\hat{E}_s/N_{oc}$			dB	6	1	6	1	3	0
CSI-RSRP <sup>Note e3</sup>	Config 1,2	NR_FDD_FR1_A, NR_TDD_FR1_A <small>NOTE 6</small>	dBm/SCS	-100	-105	-82	-87	-	-
								111.00	114.00
		NR_FDD_FR1_B						-	-
								110.50	113.50
		NR_TDD_FR1_C						-	-
								110.00	113.00
		NR_FDD_FR1_D, NR_TDD_FR1_D						-	-
								109.50	112.50
	NR_FDD_FR1_E, NR_TDD_FR1_E	-		-					
		109.00		112.00					
	NR_FDD_FR1_F	-		-					
		108.50		111.50					
	NR_FDD_FR1_G	-		-					
		108.00		111.00					
	NR_FDD_FR1_H	-		-					
		107.50		110.50					
Config 3	NR_FDD_FR1_A, NR_TDD_FR1_A <small>NOTE 6</small>	-	-						
		108.00	111.00						
	NR_FDD_FR1_B	-	-						
		107.50	110.50						
	NR_TDD_FR1_C	-	-						
		107.00	110.00						
	NR_FDD_FR1_D, NR_TDD_FR1_D	-	-						
		106.50	109.50						
NR_FDD_FR1_E, NR_TDD_FR1_E	-	-							
	106.00	109.00							
NR_FDD_FR1_F	-	-							
	105.50	108.50							
NR_FDD_FR1_G	-	-							
	105.00	108.00							
NR_FDD_FR1_H	-	-							
	104.50	107.50							
$I_o$ <sup>Note3</sup>	Config 1,2	NR_FDD_FR1_A, NR_TDD_FR1_A <small>NOTE 6</small>	dBm/ 9.36MHz	-70.09		-52.09		-80.03	
		NR_FDD_FR1_B						-79.53	
		NR_TDD_FR1_C						-79.03	
		NR_FDD_FR1_D, NR_TDD_FR1_D						-78.53	
		NR_FDD_FR1_E, NR_TDD_FR1_E						-78.03	

Config 3	NR_FDD_FR1_F	dBm/ 38.16MHz	Not applicable <sup>Note 5.</sup>	-51.99	-77.53
	NR_FDD_FR1_G				-77.03
	NR_FDD_FR1_H				-76.53
	NR_FDD_FR1_A, NR_TDD_FR1_A <small>NOTE 6</small>				-73.94
	NR_FDD_FR1_B				-73.44
	NR_TDD_FR1_C				-72.94
	NR_FDD_FR1_D, NR_TDD_FR1_D				-72.44
	NR_FDD_FR1_E, NR_TDD_FR1_E				-71.94
	NR_FDD_FR1_F				-71.44
	NR_FDD_FR1_G				-70.94
	NR_FDD_FR1_H				-70.44
Propagation condition		-	AWGN		
Antenna configuration			1x2		
<p>Note 1: OCNG shall be used such that both cells are fully allocated and a constant total transmitted power spectral density is achieved for all OFDM symbols.</p> <p>Note 2: Interference from other cells and noise sources not specified in the test is assumed to be constant over subcarriers and time and shall be modelled as AWGN of appropriate power for <math>N_{oc}</math> to be fulfilled.</p> <p>Note 3: CSI-RSRP and <math>I_o</math> levels have been derived from other parameters for information purposes. They are not settable parameters themselves.</p> <p>Note 4: CSI-RSRP minimum requirements are specified assuming independent interference and noise at each receiver antenna port.</p> <p>Note 5: Subtest 1 is not used when testing with 30kHz SSB and CSI-RS SCS.</p> <p>Note 6: The test configuration excludes support for band n51 and it is not required to run this test on band n51 in this release of the specification</p>					

**A.6.7.10.1.3 Test Requirements**

The CSI-RSRP measurement accuracy for cell 1 and cell 2 shall fulfil absolute requirement in clause 10.1.2.3.1 and relative requirement in clause 10.1.2.3.2.

**A.6.7.10.2 SA inter-frequency case measurement accuracy with FR1 serving cell and FR1 target cell**

**A.6.7.10.2.1 Test Purpose and Environment**

The purpose of this test is to verify that the CSI-RSRP measurement accuracy is within the specified limits. This test will verify the requirements in clauses 10.1.4.3.1 and 10.1.4.3.2 for CSI-RS inter-frequency measurements with the testing configurations for NR cells in Table A.6.7.10.2.1-1.

**Table A.6.7.10.2.1-1: Applicable NR configurations for FR1 inter-frequency CSI-RSRP accuracy test**

Config	Description
1	NR 15 kHz SSB and CSI-RS SCS, 10 MHz bandwidth, FDD duplex mode
2	NR 15 kHz SSB and CSI-RS SCS, 10 MHz bandwidth, TDD duplex mode
3	NR 30 kHz SSB and CSI-RS SCS, 40 MHz bandwidth, TDD duplex mode
Note:	The UE is only required to be tested in one of the supported test configurations in each supported band

**A.6.7.10.2.2 Test parameters**

In this set of test cases there are two cells in the test, PCell (Cell 1) and a FR1 neighbour cell (Cell 2) on a different frequency than the PCell. The test parameters for the Cell 1 and Cell 2 are given in Table A.6.7.10.2.2-1 below. Both absolute and relative accuracy of CSI-RSRP inter-frequency measurements are tested by using the parameters in Table A.6.7.10.2.2-1. The inter-frequency measurements are supported by a measurement gap.

**Table A.6.7.10.2.2-1: CSI-RSRP inter-frequency test parameters**

Parameter	Config	Unit	Test 1		Test 2	
			Cell 1	Cell 2	Cell 1	Cell 2
SSB ARFCN	1~3		freq1	freq2	freq1	freq2
BW <sub>channel</sub>	1	MHz	10: N <sub>RB,c</sub> = 52		10: N <sub>RB,c</sub> = 52	
	2		10: N <sub>RB,c</sub> = 52		10: N <sub>RB,c</sub> = 52	
	3		40: N <sub>RB,c</sub> = 106		40: N <sub>RB,c</sub> = 106	
Duplex mode	1		FDD		FDD	
	2		TDD		TDD	
	3		TDD		TDD	
TDD configuration	1		N/A		N/A	
	2		TDDConf.1.1		TDDConf.1.1	
	3		TDDConf.2.1		TDDConf.2.1	
PDSCH Reference measurement channel	1		SR.1.1 FDD	-	SR.1.1 FDD	-
	2		SR.1.1 TDD		SR.1.1 TDD	
	3		SR.2.1 FDD		SR.2.1 FDD	
RMSI CORESET Reference Channel	1		CR.1.1 FDD	-	CR.1.1 FDD	-
	2		CR.1.1 TDD		CR.1.1 TDD	
	3		CR.2.1 FDD		CR.2.1 FDD	
Dedicated CORESET Reference Channel	1		CCR.1.1 FDD	-	CCR.1.1 FDD	-
	2		CCR.1.1 TDD		CCR.1.1 TDD	
	3		CCR.2.1 FDD		CCR.2.1 FDD	
SSB configuration	1		SSB.1 FR1		SSB.1 FR1	
	2		SSB.1 FR1		SSB.1 FR1	
	3		SSB.2 FR1		SSB.2 FR1	
OCNG Patterns	1~3		OP.1		OP.1	
TRS configuration	1		TRS.1.1 FDD	-	TRS.1.1 FDD	
	2		TRS.1.1 TDD		TRS.1.1 TDD	
	3		TRS.1.2 TDD		TRS.1.2 TDD	
Initial BWP Configuration	1~3		DLBWP.0.1 ULBWP.0.1		DLBWP.0.1 ULBWP.0.1	
Dedicated BWP configuration	1~3		DLBWP.1.1 ULBWP.1.1		DLBWP.1.1 ULBWP.1.1	
Time offset with Cell 1	1,2	μs	-	4.7	-	4.7
	3	μs	-	2.35	-	2.35
SMTC configuration	1		SMTC.2		SMTC.2	
	2,3		SMTC.1		SMTC.1	
CSI-RS configuration for RRM	1		CSI-RS.RRM.FR1.1 FDD		CSI-RS.RRM.FR1.1 FDD	
	2		CSI-RS.RRM.FR1.1 TDD		CSI-RS.RRM.FR1.1 TDD	
	3		CSI-RS.RRM.FR1.2 TDD		CSI-RS.RRM.FR1.2 TDD	
EPRE ratio of PSS to SSS	1~3	dB	0	0	0	0
EPRE ratio of PBCH DMRS to SSS						
EPRE ratio of PBCH to PBCH DMRS						
EPRE ratio of PDCCH DMRS to SSS						
EPRE ratio of PDCCH to PDCCH DMRS						

EPRE ratio of PDSCH DMRS to SSS							
EPRE ratio of PDSCH to PDSCH DMRS							
EPRE ratio of OCNG DMRS to SSS>Note 1							
EPRE ratio of OCNG to OCNG DMRS Note 1							
$N_{oc}$ Note2	NR_FDD_FR1_A	1~3	dBm/15 kHz	-94.65	$(N_{oc}$ for Channel 2 +8dB)	-115	
	NR_TDD_FR1_A NOTE 5					-114.5	
	NR_FDD_FR1_B					-114	
	NR_TDD_FR1_C					-113.5	
	NR_FDD_FR1_D					-113	
	NR_TDD_FR1_D					-112.5	
	NR_FDD_FR1_E					-112	
	NR_TDD_FR1_E					-111.5	
	NR_FDD_FR1_F					-111.5	
	NR_TDD_FR1_F					-111.5	
$N_{oc}$ Note2	NR_FDD_FR1_A	1,2	dBm/SS B SCS	-94.65	$(N_{oc}$ for Channel 2 +8dB)	-115	
	NR_TDD_FR1_A NOTE 5,					-114.5	
	NR_FDD_FR1_B					-114	
	NR_TDD_FR1_C					-113.5	
	NR_FDD_FR1_D					-113	
	NR_TDD_FR1_D					-112.5	
	NR_FDD_FR1_E					-112	
	NR_TDD_FR1_E					-111.5	
	NR_FDD_FR1_F					-111.5	
	NR_TDD_FR1_F					-111.5	
	NR_FDD_FR1_G	-112.00					
	NR_TDD_FR1_G	-112.00					
	NR_FDD_FR1_H	-112.50					
	NR_TDD_FR1_H	-112.00					
	NR_FDD_FR1_A	3	dBm/SS B SCS	-91.65	$(N_{oc}$ for Channel 2 +8dB)	-111.50	
	NR_TDD_FR1_A NOTE 5,					-111.00	
	NR_FDD_FR1_B					-110.50	
	NR_TDD_FR1_C					-110.00	
	NR_FDD_FR1_D					-110.00	
	NR_TDD_FR1_D					-110.00	
NR_FDD_FR1_E	-110.00						
NR_TDD_FR1_E	-110.00						
NR_FDD_FR1_F	-110.00						
NR_TDD_FR1_F	-110.00						
NR_FDD_FR1_G	-110.00						
NR_TDD_FR1_G	-110.00						
NR_FDD_FR1_H	-110.00						
NR_TDD_FR1_H	-110.00						
$\hat{E}_s/I_{ot}$		1~3	dB	10	10	13	-3
CSI-RSRP>Note3	NR_FDD_FR1_A	1,2	dBm/SC S	-84.65	(RSRP for Cell 2 +25dB)	-118.00	
	NR_TDD_FR1_A NOTE 5,					-117.50	
	NR_FDD_FR1_B					-117.00	
	NR_TDD_FR1_C					-116.50	
	NR_FDD_FR1_D					-116.00	
	NR_TDD_FR1_D					-116.00	

	NR_FDD_FR1_F	3				(RSRP for Cell 2 +25dB)	-115.50
	NR_FDD_FR1_G						-115.00
	NR_FDD_FR1_H						-114.50
	NR_FDD_FR1_A						-115.00
	NR_TDD_FR1_A NOTE 5,						
	NR_FDD_FR1_B						-114.50
	NR_TDD_FR1_C						-114.00
	NR_FDD_FR1_D						-113.50
	NR_TDD_FR1_D						
	NR_FDD_FR1_E						-113.00
	NR_TDD_FR1_E						
	NR_FDD_FR1_F						-112.50
	NR_FDD_FR1_G						-112.00
	NR_FDD_FR1_H						-111.50
Io <sup>Note3</sup>	NR_FDD_FR1_A	1,2	dBm/ 9.36MH z			Io for Channel 2 +19.75dB	-85.28
	NR_TDD_FR1_A NOTE 5,						
	NR_FDD_FR1_B						-84.78
	NR_TDD_FR1_C						-84.28
	NR_FDD_FR1_D						-83.78
	NR_TDD_FR1_D						
	NR_FDD_FR1_E						-83.28
	NR_TDD_FR1_E						
	NR_FDD_FR1_F						-82.78
	NR_FDD_FR1_G						-82.28
	NR_FDD_FR1_H	-81.78					
	NR_FDD_FR1_A	3	dBm/ 38.16M Hz			Io for Channel 2 +19.75dB	-79.19
	NR_TDD_FR1_A NOTE 5,						
	NR_FDD_FR1_B						-78.69
	NR_TDD_FR1_C						-78.19
	NR_FDD_FR1_D						-77.69
	NR_TDD_FR1_D						
	NR_FDD_FR1_E						-77.19
	NR_TDD_FR1_E						
	NR_FDD_FR1_F						-76.69
NR_FDD_FR1_G	-76.19						
NR_FDD_FR1_H	-75.69						
$\hat{E}_s/N_{oc}$	1~3	dB	10	10	13	-3	
Propagation condition	1~3	-	AWGN		AWGN		
Antenna configuration	1~3		1x2		1x2		
<p>Note 1: OCNG shall be used such that both cells are fully allocated and a constant total transmitted power spectral density is achieved for all OFDM symbols.</p> <p>Note 2: Interference from other cells and noise sources not specified in the test is assumed to be constant over subcarriers and time and shall be modelled as AWGN of appropriate power for <math>N_{oc}</math> to be fulfilled.</p> <p>Note 3: CSI-RSRP and Io levels have been derived from other parameters for information purposes. They are not settable parameters themselves.</p> <p>Note 4: CSI-RSRP minimum requirements are specified assuming independent interference and noise at each receiver antenna port.</p> <p>Note 5: The test configuration excludes support for band n51 and it is not required to run this test on band n51 in this release of the specification.</p>							



### A.6.7.10.2.3 Test Requirements

The CSI-RSRP measurement accuracy for Cell 1 and Cell 2 shall fulfil the absolute requirement in clause 10.1.4.3.1 and relative requirement in clause 10.1.4.3.2.

## A.6.7.11 CSI-RSRQ

### A.6.7.11.1 SA: Intra-frequency measurement accuracy with FR1 serving cell and FR1 target cell

#### A.6.7.11.1.1 Test Purpose and Environment

The purpose of this test is to verify that the CSI-RSRQ measurement accuracy is within the specified limits. This test will verify the requirements in Clause 10.1.7.2.

#### A.6.7.11.1.2 Test Parameters

In this test case all cells are on the same carrier frequency. Supported test configuration are shown in Table A.6.7.11.1.2-1. The absolute accuracy of CSI-RSRQ intra-frequency measurement is tested by using the parameters in Table A.6.7.11.1.2-2. In all test cases, Cell 1 is the PCell and Cell 2 is the target cell.

**Table A.6.7.11.1.2-1: Intra frequency CSI-RSRQ supported test configurations**

Config	Description
1	NR 15 kHz SSB and CSI-RS SCS, 10 MHz bandwidth, FDD duplex mode
2	NR 15 kHz SSB and CSI-RS SCS, 10 MHz bandwidth, TDD duplex mode
3	NR 30 kHz SSB and CSI-RS SCS, 40 MHz bandwidth, TDD duplex mode

Note: The UE is only required to be tested in one of the supported test configurations

**Table A.6.7.11.1.2-2: CSI-RSRQ Intra frequency test parameters**

Parameter		Unit	Test 1		Test 2		Test 3	
			Cell 1	Cell 2	Cell 1	Cell 2	Cell 1	Cell 2
Duplex mode	Config 1		FDD					
	Config 2,3		TDD					
TDD configuration	Config 1		Not Applicable					
	Config 2		TDDConf.1.1					
	Config 3		TDDConf.2.1					
BW <sub>channel</sub>	Config 1	MHz	10: N <sub>RB,c</sub> = 52					
	Config 2		10: N <sub>RB,c</sub> = 52					
	Config 3		40: N <sub>RB,c</sub> = 106					
Gap Pattern ID			0					
BWP configuration	Initial DL BWP		DLBWP.0.1					
	Dedicated DL BWP		DLBWP.1.1					
	Initial UL BWP		ULBWP.0.1					
	Dedicated UL BWP		ULBWP.1.1					
DRX Cycle		ms	Not Applicable					
PDSCH Reference measurement channel	Config 1		SR.1.1 FDD	-	SR.1.1 FDD	-	SR.1.1 FDD	-
	Config 2		SR.1.1 TDD		SR.1.1 TDD		SR.1.1 TDD	
	Config 3		SR.2.1 TDD		SR.2.1 TDD		SR.2.1 TDD	

RMSI CORESET Reference Channel	Config 1		CR.1.1 FDD		CR.1.1 FDD		CR.1.1 FDD	
	Config 2		CR.1.1 TDD	-	CR.1.1 TDD	-	CR.1.1 TDD	
	Config 3		CR.2.1 TDD		CR.2.1 TDD		CR.2.1 TDD	
Control Channel RMC	Config 1		CCR.1.1 FDD		CCR.1.1 FDD		CCR.1.1 FDD	
	Config 2		CCR.1.1 TDD	-	CCR.1.1 TDD	-	CCR.1.1 TDD	-
	Config 3		CCR.2.1 TDD		CCR.2.1 TDD		CCR.2.1 TDD	
TRS Configuration	Config 1		TRS.1.1 FDD		TRS.1.1 FDD		TRS.1.1 FDD	
	Config 2		TRS.1.1 TDD	-	TRS.1.1 TDD	-	TRS.1.1 TDD	-
	Config 3		TRS.1.2 TDD		TRS.1.2 TDD		TRS.1.2 TDD	
OCNG Patterns			OP. 1					
Time offset with Cell 1	Config 1	$\mu$ s	-	4.7	-	4.7	-	4.7
	Config 2,3	$\mu$ s	-	2.35	-	2.35	-	2.35
CSI-RS configuration for RRM	Config 1		CSI-RS.RRM.FR1.1 FDD					
	Config 2		CSI-RS.RRM.FR1.1 TDD					
	Config 3		CSI-RS.RRM.FR1.2 TDD					
SMTC configuration	Config 1		SMTC.2					
	Config 2,3		SMTC.1					
SSB configuration	Config 1,2		SSB.1 FR1					
	Config 3		SSB.2 FR1					
PDSCH/PDCCH subcarrier spacing	Config 1,2	kHz	15 kHz					
	Config 3		30kHz					
EPRE ratio of PSS to SSS		dB	0	0	0	0	0	0
EPRE ratio of PBCH DMRS to SSS								
EPRE ratio of PBCH to PBCH DMRS								
EPRE ratio of PDCCH DMRS to SSS								
EPRE ratio of PDCCH to PDCCH DMRS								
EPRE ratio of PDSCH DMRS to SSS								
EPRE ratio of PDSCH to PDSCH								
EPRE ratio of OCNG DMRS to SSS(Note 1)								
EPRE ratio of OCNG to OCNG DMRS (Note 1)								
$N_{oc}$ Note2	Config 1,2	NR_FDD_FR1_A, NR_TDD_FR1_A NOTE 6	dBm/15kHz <sup>z</sup>	-85		-101		-114
		NR_FDD_FR1_B						-113.5
		NR_TDD_FR1_C						-113
		NR_FDD_FR1_D, NR_TDD_FR1_D						-112.5
		NR_FDD_FR1_E, NR_TDD_FR1_E						-112
		NR_FDD_FR1_F						-111.5
		NR_FDD_FR1_G						-111
		NR_FDD_FR1_H						-110.5

	Config 3	NR_FDD_FR1_A, NR_TDD_FR1_A NOTE 6		-91	-	-114			
		NR_FDD_FR1_B				-113.5			
		NR_TDD_FR1_C				-113			
		NR_FDD_FR1_D, NR_TDD_FR1_D				-112.5			
		NR_FDD_FR1_E, NR_TDD_FR1_E				-112			
		NR_FDD_FR1_F				-111.5			
		NR_FDD_FR1_G				-111			
		NR_FDD_FR1_H				-110.5			
$N_{oc}$ Note2	Config 1,2	NR_FDD_FR1_A, NR_TDD_FR1_A NOTE 6	dBm/ SCS	-85	-101	-114			
		NR_FDD_FR1_B				-113.5			
		NR_TDD_FR1_C				-113			
		NR_FDD_FR1_D, NR_TDD_FR1_D				-112.5			
		NR_FDD_FR1_E, NR_TDD_FR1_E				-112			
		NR_FDD_FR1_F				-111.5			
		NR_FDD_FR1_G				-111			
		NR_FDD_FR1_H				-110.5			
	Config 3	NR_FDD_FR1_A, NR_TDD_FR1_A NOTE 6		-88	-	-111			
		NR_FDD_FR1_B				-110.5			
		NR_TDD_FR1_C				-110			
		NR_FDD_FR1_D, NR_TDD_FR1_D				-109.5			
		NR_FDD_FR1_E, NR_TDD_FR1_E				-109			
		NR_FDD_FR1_F				-108.5			
NR_FDD_FR1_G	-108								
NR_FDD_FR1_H	-107.5								
$\hat{E}_s/I_{oc}$			dB	-1.76		-4.7		-5.46	-5.46
$\hat{E}_s/N_{oc}$			dB	3	3	-2.9	-2.9	-4	-4
SS- RSR P/ CSI- RSR p>Note3	Config 1,2	NR_FDD_FR1_A, NR_TDD_FR1_A NOTE 6	dBm/ SCS	-82	-82	-103.9	- 103.9	-118	
		NR_FDD_FR1_B						-117.5	
		NR_TDD_FR1_C						-117	
		NR_FDD_FR1_D, NR_TDD_FR1_D						-116.5	
		NR_FDD_FR1_E, NR_TDD_FR1_E						-116	
		NR_FDD_FR1_F						-115.5	
		NR_FDD_FR1_G						-115	
		NR_FDD_FR1_H						-114.5	
	Config 3	NR_FDD_FR1_A, NR_TDD_FR1_A NOTE 6		-85	-85	-	-	-115	
		NR_FDD_FR1_B						-114.5	
		NR_TDD_FR1_C						-114	
		NR_FDD_FR1_D, NR_TDD_FR1_D						-113.5	
		NR_FDD_FR1_E, NR_TDD_FR1_E						-113	
		NR_FDD_FR1_F						-112.5	
NR_FDD_FR1_G	-112								
NR_FDD_FR1_H	-111.5								
SS-RSRQ/CSI- RSRQ Note3	NR_FDD_FR1_A, NR_TDD_FR1_A NOTE 6		dB	-14.77	-14.77	-16.76	- 16.76	-17.34	-17.34
	NR_FDD_FR1_B								

		NR_TDD_FR1_C							
		NR_FDD_FR1_D, NR_TDD_FR1_D							
		NR_FDD_FR1_E, NR_TDD_FR1_E							
		NR_FDD_FR1_F							
		NR_FDD_FR1_G							
		NR_FDD_FR1_H							
Io <sup>Note3</sup>	Config 1,2	NR_FDD_FR1_A, NR_TDD_FR1_A NOTE 6	dBm/ 9.36M Hz	-50	-70			-83.5	
		NR_FDD_FR1_B						-83	
		NR_TDD_FR1_C						-82.5	
		NR_FDD_FR1_D, NR_TDD_FR1_D						-82	
		NR_FDD_FR1_E, NR_TDD_FR1_E						-81.5	
		NR_FDD_FR1_F						-81	
		NR_FDD_FR1_G						-80.5	
	NR_FDD_FR1_H	-80							
	Config 3	NR_FDD_FR1_A, NR_TDD_FR1_A NOTE 6	dBm/ 38.16 MHz	-50	-				-77.4
		NR_FDD_FR1_B							-76.9
		NR_TDD_FR1_C							-76.4
		NR_FDD_FR1_D, NR_TDD_FR1_D							-75.9
		NR_FDD_FR1_E, NR_TDD_FR1_E							-75.4
		NR_FDD_FR1_F							-74.9
NR_FDD_FR1_G		-74.4							
NR_FDD_FR1_H	-73.9								
Propagation condition			-	AWGN	AWGN	AWGN	AWGN	AWGN	
Antenna configuration				1x2	1x2	1x2	1x2	1x2	
<p>Note 1: OCNB shall be used such that both cells are fully allocated and a constant total transmitted power spectral density is achieved for all OFDM symbols.</p> <p>Note 2: Interference from other cells and noise sources not specified in the test is assumed to be constant over subcarriers and time and shall be modelled as AWGN of appropriate power for <math>N_{oc}</math> to be fulfilled.</p> <p>Note 3: SS-RSRQ/CSI-RSRQ, SS-RSRP/CSI-RSRP, and Io levels have been derived from other parameters for information purposes. They are not settable parameters themselves.</p> <p>Note 4: SS-RSRQ/CSI-RSRQ, SS-RSRP/CSI-RSRP minimum requirements are specified assuming independent interference and noise at each receiver antenna port.</p> <p>Note 5: NR operating band groups are as defined in clause 3.5.2.</p> <p>Note 6: The test configuration excludes support for band n51 and it is not required to run this test on band n51 in this release of the specification.</p>									

A.6.7.11.1.3 Test Requirements

The CSI-RSRQ measurement accuracy shall fulfil the requirements in clause 10.1.7.2.

A.6.7.11.2 SA Inter-frequency measurement accuracy with FR1 serving cell and FR1 target cell

A.6.7.11.2.1 Test Purpose and Environment

The purpose of this test is to verify that the CSI-RSRQ measurement accuracy is within the specified limits. This test will verify the requirements in Clause 10.1.9.2.1 and 10.1.9.2.2.

A.6.7.11.2.2 Test Parameters

In this test case the two cells (i.e., Cell 1 and Cell 2) are on different carrier frequencies and measurement gaps are provided. Supported test configurations are shown in Table A.6.7.11.2.2-1. Both absolute accuracy and relative accuracy requirements of CSI-RSRQ inter-frequency measurement are tested by using test parameters in Table A.6.7.11.2.2-2. In all test cases, Cell 1 is the PCell and Cell 2 is target cell.

**Table A.6.7.11.2.2-1: CSI-RSRQ Inter frequency CSI-RSRQ supported test configurations**

Config	Description
1	NR 15 kHz CSI-RS SCS, 10 MHz bandwidth, FDD duplex mode
2	NR 15 kHz CSI-RS SCS, 10 MHz bandwidth, TDD duplex mode
3	NR 30 kHz CSI-RS SCS, 40 MHz bandwidth, TDD duplex mode
Note: The UE is only required to be tested in one of the supported test configurations	

**Table A.6.7.11.2.2-2: CSI-RSRQ Inter frequency test parameters**

Parameter		Unit	Test 1		Test 2		Test 3	
			Cell 1	Cell 2	Cell 1	Cell 2	Cell 1	Cell 2
Duplex mode	Config 1		FDD					
	Config 2,3		TDD					
TDD configuration	Config 1		Not Applicable					
	Config 2		TDDConf.1.1					
	Config 3		TDDConf.2.1					
BW <sub>channel</sub>	Config 1	MHz	10: N <sub>RB,c</sub> = 52					
	Config 2		10: N <sub>RB,c</sub> = 52					
	Config 3		40: N <sub>RB,c</sub> = 106					
Gap pattern ID	Config 1,2,3		0					
BWP BW	Config 1		10: N <sub>RB,c</sub> = 52					
	Config 2		10: N <sub>RB,c</sub> = 52					
	Config 3		40: N <sub>RB,c</sub> = 106					
DRX Cycle		ms	Not Applicable					
PDSCH Reference measurement channel	Config 1,4		SR.1.1 FDD	-	SR.1.1 FDD	-	SR.1.1 FDD	-
	Config 2,5		SR.1.1 TDD		SR.1.1 TDD		SR.1.1 TDD	
	Config 3,6		SR.2.1 TDD		SR.2.1 TDD		SR.2.1 TDD	
RMSI CORESET Reference Channel	Config 1		CR.1.1 FDD	-	R.1.1 FDD	-	CR.1.1 FDD	
	Config 2		CR.1.1 TDD		CR.1.1 TDD		CR.1.1 TDD	
	Config 3		CR2.1 TDD		CR2.1 TDD		CR2.1 TDD	
Dedicated CORESET Reference Channel	Config 1		CCR.1.1 FDD	-	CCR.1.1 FDD	-	CCR.1.1 FDD	-
	Config 2		CCR.1.1 TDD		CCR.1.1 TDD		CCR.1.1 TDD	
	Config 3		CCR2.1 TDD		CCR2.1 TDD		CCR2.1 TDD	
TRS Configuration	Config 1		TRS.1.1 FDD	-	TRS.1.1 FDD	-	TRS.1.1 FDD	-
	Config 2		TRS.1.1 TDD		TRS.1.1 TDD		TRS.1.1 TDD	

		Config 3		TRS.1 .2 TDD		TRS.1 .2 TDD		TRS.1 .2 TDD	
OCNG Patterns			OCNG pattern 1						
Time offset with Cell 1	Config 1,2	$\mu$ s	-	4.7	-	4.7	-	4.7	
	Config 3	$\mu$ s	-	2.35	-	2.35	-	2.35	
CSI-RS configuration for RRM	Config 1	CSI-RS.RRM.FR1.1 FDD							
	Config 2	CSI-RS.RRM.FR1.1 TDD							
	Config 3	CSI-RS.RRM.FR1.2 TDD							
SSB configuration	Config 1,2	SSB.1 FR1							
	Config 3	SSB.2 FR1							
SMTC configuration	Config 1,2	SMTC.2							
	Config 3	SMTC.1							
PDSCH/PDCCH subcarrier spacing	Config 1,2	kHz	15 kHz						
	Config 3		30 kHz						
EPRE ratio of PSS to SSS		dB	0	0	0	0	0	0	
EPRE ratio of PBCH DMRS to SSS									
EPRE ratio of PBCH to PBCH DMRS									
EPRE ratio of PDCCH DMRS to SSS									
EPRE ratio of PDCCH to PDCCH DMRS									
EPRE ratio of PDSCH DMRS to SSS									
EPRE ratio of PDSCH to PDSCH									
EPRE ratio of OCNG DMRS to SSS(Note 1)									
EPRE ratio of OCNG to OCNG DMRS (Note 1)									
$N_{oc}$ Note2	Config 1,2	NR_FDD_FR1_A NR_TDD_FR1_A NOTE 6	dBm/15kHz	-80.18	-106			-116	
		NR_FDD_FR1_B NR_TDD_FR1_C						-115.5	
		NR_FDD_FR1_D NR_TDD_FR1_D						-115	
		NR_FDD_FR1_E NR_TDD_FR1_E						-114.5	
		NR_FDD_FR1_F NR_TDD_FR1_F						-114	
		NR_FDD_FR1_G NR_TDD_FR1_G						-113.5	
		NR_FDD_FR1_H NR_TDD_FR1_H						-113	
		NR_FDD_FR1_H NR_TDD_FR1_H						-112.5	
$N_{oc}$ Note2	Config 3	NR_FDD_FR1_A NR_TDD_FR1_A NOTE 6	dBm/15kHz	-86.27	-113			-116	
		NR_FDD_FR1_B NR_TDD_FR1_C						-115.5	
		NR_FDD_FR1_D NR_TDD_FR1_D						-115	
		NR_FDD_FR1_E NR_TDD_FR1_E						-114.5	
		NR_FDD_FR1_F NR_TDD_FR1_F						-114	
		NR_FDD_FR1_G NR_TDD_FR1_G						-113.5	
		NR_FDD_FR1_H NR_TDD_FR1_H						-113	
		NR_FDD_FR1_H NR_TDD_FR1_H						-112.5	
$N_{oc}$ Note2	Config 1,2	NR_FDD_FR1_A NR_TDD_FR1_A NOTE 6	dBm/15kHz	-80.18	-106			-116	
		NR_FDD_FR1_B NR_TDD_FR1_C						-115.5	
		NR_FDD_FR1_D NR_TDD_FR1_D						-115	
		NR_FDD_FR1_E NR_TDD_FR1_E						-114.5	
		NR_FDD_FR1_F NR_TDD_FR1_F						-114	
		NR_FDD_FR1_G NR_TDD_FR1_G						-113.5	
		NR_FDD_FR1_H NR_TDD_FR1_H						-113	
		NR_FDD_FR1_H NR_TDD_FR1_H						-112.5	
	Config 3	NR_FDD_FR1_A NR_TDD_FR1_A NOTE 6		-83.27	-110			-113	

		NR_FDD_FR1_B						-112.5	
		NR_TDD_FR1_C						-112	
		NR_FDD_FR1_D NR_TDD_FR1_D						-111.5	
		NR_FDD_FR1_E NR_TDD_FR1_E						-111	
		NR_FDD_FR1_F						-110.5	
		NR_FDD_FR1_G						-110	
		NR_FDD_FR1_H						-109.5	
$\hat{E}_s / I_{ot}$			dB	-1.75		-1.75	3	-1.75	
$\hat{E}_s / N_{oc}$			dB	-1.75		-1.75	3	-1.75	
SS-RSRP/C SI-RSRP <sup>Not e3</sup>	Config 1,2	NR_FDD_FR1_A NR_TDD_FR1_A NOTE 6	dBm/SCS	-81.93	-81.93	-	-	-113	-
		NR_FDD_FR1_B						-112.5	-
		NR_TDD_FR1_C						-112	-
		NR_FDD_FR1_D NR_TDD_FR1_D						-111.5	-
		NR_FDD_FR1_E NR_TDD_FR1_E						-111	-
		NR_FDD_FR1_F						-110.5	-
		NR_FDD_FR1_G						-110	-
		NR_FDD_FR1_H						-109.5	-
	Config 3	NR_FDD_FR1_A NR_TDD_FR1_A NOTE 6		-85.02	-85.02	-	-	-110	-
		NR_FDD_FR1_B		-85.02	-85.02	-	-	-109.5	-
		NR_TDD_FR1_C		-85.02	-85.02	-	-	-109	-
		NR_FDD_FR1_D NR_TDD_FR1_D		-85.02	-85.02	-	-	-108.5	-
		NR_FDD_FR1_E NR_TDD_FR1_E		-85.02	-85.02	-	-	-108	-
		NR_FDD_FR1_F		-85.02	-85.02	-	-	-107.5	-
		NR_FDD_FR1_G		-85.02	-85.02	-	-	-107	-
		NR_FDD_FR1_H		-85.02	-85.02	-	-	-106.5	-
SS-RSRQ/CSI-RSRQ <sup>Note3</sup>	NR_FDD_FR1_A NR_TDD_FR1_A NOTE 6	dB	-14.77	-14.77	-40.59	-40.59	12.56 T	14.76 T	
	NR_FDD_FR1_B								
	NR_TDD_FR1_C								
	NR_FDD_FR1_D NR_TDD_FR1_D								
	NR_FDD_FR1_E NR_TDD_FR1_E								
	NR_FDD_FR1_F NR_FDD_FR1_G								

		NR_FDD_FR1_H							
Io <sup>Note3</sup>	Config 1,2	NR_FDD_FR1_A NR_TDD_FR1_A NOTE 6	dBm/SCS	-50	-75.83			-83.28	-85.83
		NR_FDD_FR1_B						-82.78	-85.33
		NR_TDD_FR1_C						-82.28	-84.83
		NR_FDD_FR1_D NR_TDD_FR1_D						-81.78	-84.33
		NR_FDD_FR1_E NR_TDD_FR1_E						-81.28	-83.83
		NR_FDD_FR1_F						-80.78	-83.33
		NR_FDD_FR1_G						-80.28	-82.83
	Config 3	NR_FDD_FR1_H		-79.78	-82.33				
		NR_FDD_FR1_A NR_TDD_FR1_A NOTE 6		-77.19	-79.73				
		NR_FDD_FR1_B		-76.69	-79.23				
		NR_TDD_FR1_C		-76.19	-78.73				
		NR_FDD_FR1_D NR_TDD_FR1_D		-75.69	-78.23				
		NR_FDD_FR1_E NR_TDD_FR1_E		-75.19	-77.73				
		NR_FDD_FR1_F		-74.69	-77.23				
		NR_FDD_FR1_G						-74.19	-76.73
		NR_FDD_FR1_H						-73.69	-76.53
Propagation condition			-	AWG N	AWGN	AWGN	AWGN	AWG N	AWG N
Antenna configuration				1x2	1x2	1x2	1x2	1x2	1x2
<p>Note 1: OCNG shall be used such that both cells are fully allocated and a constant total transmitted power spectral density is achieved for all OFDM symbols.</p> <p>Note 2: Interference from other cells and noise sources not specified in the test is assumed to be constant over subcarriers and time and shall be modelled as AWGN of appropriate power for <math>N_{oc}</math> to be fulfilled.</p> <p>Note 3: SS-RSRQ/CSI-RSRQ, SS-RSRP/CSI-RSRP, and Io levels have been derived from other parameters for information purposes. They are not settable parameters themselves.</p> <p>Note 4: SS-RSRQ/CSI-RSRQ, SS-RSRP/CSI-RSRP minimum requirements are specified assuming independent interference and noise at each receiver antenna port.</p> <p>Note 5: NR operating band groups are as defined in clause 3.5.2.</p> <p>Note 6: The test configuration excludes support for band n51 and it is not required to run this test on band n51 in this release of the specification.</p>									

### A.6.7.11.2.3 Test Requirements

The CSI-RSRQ measurement accuracy shall fulfil the requirements in clause 10.1.9.2.1 and 10.1.9.2.2.

## A.6.7.12 CSI-SINR

### A.6.7.12.1 SA intra-frequency measurement accuracy with FR1 serving cell and FR1 target cell

#### A.6.7.12.1.1 Test Purpose and Environment

The purpose of this test is to verify that the CSI-SINR measurement accuracy is within the specified limits. This test will verify the requirements in clause 10.1.12.2.1.

#### A.6.7.12.1.2 Test Parameters

In this test case all cells are on the same carrier frequency. Supported test configuration are shown in Table A.6.7.12.1.2-1. The absolute accuracy of CSI-SINR intra-frequency measurement is tested by using the parameters in Table A.6.7.12.1.2-2. In all test cases, Cell 1 is the PCell and Cell 2 is the target cell.



**Table A.6.7.12.1.2-1: CSI-SINR Intra frequency CSI-SINR supported test configurations**

Config	Description
1	NR 15 kHz SSB and CSI-RS SCS, 10 MHz bandwidth, FDD duplex mode
2	NR 15 kHz SSB and CSI-RS SCS, 10 MHz bandwidth, TDD duplex mode
3	NR 30 kHz SSB and CSI-RS SCS, 40 MHz bandwidth, TDD duplex mode
Note: The UE is only required to be tested in one of the supported test configurations	

**Table A.6.7.12.1.2-2: CSI-SINR Intra frequency test parameters**

Parameter		Unit	Test 1		Test 2	
			Cell 1	Cell 2	Cell 1	Cell 2
SSB ARFCN			freq1		freq1	
Duplex mode	Config 1		FDD			
	Config 2,3		TDD			
TDD configuration	Config 1		Not Applicable			
	Config 2		TDDConf.1.1			
	Config 3		TDDConf.2.1			
Downlink initial BWP configuration			DLBWP.0.1			
Downlink dedicated BWP configuration			DLBWP.1.1			
Uplink initial BWP configuration			ULBWP.0.1			
Uplink dedicated BWP configuration			ULBWP.1.1			
DRX Cycle configuration		ms	Not Applicable			
TRS configuration	Config 1		TRS.1.1 FDD			
	Config 2		TRS.1.1 TDD			
	Config 3		TRS.1.2 TDD			
PDSCH Reference measurement channel	Config 1		SR.1.1 FDD		SR.1.1 FDD	
	Config 2		SR.1.1 TDD	-	SR.1.1 TDD	-
	Config 3		SR.2.1 TDD		SR.2.1 TDD	
RMSI CORESET Reference Channel	Config 1		CR.1.1 FDD		CR.1.1 FDD	
	Config 2		CR.1.1 TDD	-	CR.1.1 TDD	
	Config 3		CR.2.1 TDD		CR.2.1 TDD	
Dedicated CORESET Reference Channel	Config 1		CCR.1.1 FDD		CCR.1.1 FDD	
	Config 2		CCR.1.1 TDD	-	CCR.1.1 TDD	-
	Config 3		CCR.2.1 TDD		CCR.2.1 TDD	
OCNG Patterns			OP.1			
CSI-RSSI-Measurement			Not Applicable			
Time offset with Cell 1	Config 1,2	µs	-	2.35	-	2.35
	Config 3	µs	-	1.17	-	1.17
SSB configuration	Config 1,2		SSB.1 FR1			
	Config 3		SSB.2 FR1			
SMTc configuration	Config 1		SMTc.2			
	Config 2,3		SMTc.1			
CSI-RS for mobility	Config 1		CSI-RS.RRM.FR1.1 FDD			
	Config 2		CSI-RS.RRM.FR1.1 TDD			

	Config 3		CSI-RS.RRM.FR1.2 TDD				
PDSCH/PDCCH subcarrier spacing	Config 1,2	kHz	15				
	Config 3		30				
EPRE ratio of PSS to SSS		dB	0	0	0	0	
EPRE ratio of PBCH DMRS to SSS							
EPRE ratio of PBCH to PBCH DMRS							
EPRE ratio of PDCCH DMRS to SSS							
EPRE ratio of PDCCH to PDCCH DMRS							
EPRE ratio of PDSCH DMRS to SSS							
EPRE ratio of PDSCH to PDSCH							
EPRE ratio of OCNB DMRS to SSS(Note 1)							
EPRE ratio of OCNB to OCNB DMRS (Note 1)							
$N_{oc}$ Note2	NR_FDD_FR1_A, NR_TDD_FR1_A NOTE 6	dBm/15kHz z	-93			-116	
	NR_FDD_FR1_B					-115.5	
	NR_TDD_FR1_C					-115	
	NR_FDD_FR1_D, NR_TDD_FR1_D					-114.5	
	NR_FDD_FR1_E, NR_TDD_FR1_E					-114	
	NR_FDD_FR1_F					-113.5	
	NR_FDD_FR1_G					-113	
	NR_FDD_FR1_H					-112.5	
$N_{oc}$ Note2	Config 1,2	dBm/SCS	-93			Same as Noc for 15 kHz	
	Config 3			NR_FDD_FR1_A, NR_TDD_FR1_A NOTE 6			-113
				NR_FDD_FR1_B			-112.5
				NR_TDD_FR1_C			-112
				NR_FDD_FR1_D, NR_TDD_FR1_D			-111.5
				NR_FDD_FR1_E, NR_TDD_FR1_E			-111
				NR_FDD_FR1_F			-110.5
				NR_FDD_FR1_G			-110
				NR_FDD_FR1_H			-109.5
$\hat{E}_s / I_{ot}$		dB	0	-3.19	-5.46	-5.46	
$\hat{E}_s / N_{oc}$		dB	4.54	2.66	-4	-4	
CSI-RSRP <sup>Note 3</sup>	Config 1,2	dBm/SCS	-88.46	-90.34	-120	-120	
					-119.5	-119.5	
					-119	-119	
					-118.5	-118.5	
					-118	-118	
					-117.5	-117.5	
					-117	-117	
					-116.5	-116.5	
	Config 3		NR_FDD_FR1_A, NR_TDD_FR1_A NOTE 6	-117	-117		
			NR_FDD_FR1_B	-116.5	-116.5		
			NR_TDD_FR1_C	-116	-116		
			NR_FDD_FR1_D, NR_TDD_FR1_D	-115.5	-115.5		
			NR_FDD_FR1_E, NR_TDD_FR1_E	-115	-115		
			NR_FDD_FR1_F	-114.5	-114.5		
			NR_FDD_FR1_G	-114	-114		
			NR_FDD_FR1_H	-113.5	-113.5		

CSI-SINR <sup>Note3</sup>		NR_FDD_FR1_A, NR_TDD_FR1_A <small>NOTE 6</small>	dB	0	-3.19	-5.46	-5.46
		NR_FDD_FR1_B					
		NR_TDD_FR1_C					
		NR_FDD_FR1_D, NR_TDD_FR1_D					
		NR_FDD_FR1_E, NR_TDD_FR1_E					
		NR_FDD_FR1_F					
		NR_FDD_FR1_G					
		NR_FDD_FR1_H					
Io <sup>Note3</sup>	Config 1,2	NR_FDD_FR1_A, NR_TDD_FR1_A <small>NOTE 6</small>	dBm/ 9.36MHz	-57.5			-85.51
		NR_FDD_FR1_B					-85.01
		NR_TDD_FR1_C					-84.51
		NR_FDD_FR1_D, NR_TDD_FR1_D					-84.01
		NR_FDD_FR1_E, NR_TDD_FR1_E					-83.51
		NR_FDD_FR1_F					-83.01
		NR_FDD_FR1_G					-82.51
		NR_FDD_FR1_H					-82.01
	Config 3	NR_FDD_FR1_A, NR_TDD_FR1_A <small>NOTE 6</small>	dBm/ 38.16MHz	-51.41			-79.41
		NR_FDD_FR1_B					-78.91
		NR_TDD_FR1_C					-78.41
		NR_FDD_FR1_D, NR_TDD_FR1_D					-77.91
		NR_FDD_FR1_E, NR_TDD_FR1_E					-77.41
		NR_FDD_FR1_F					-76.91
		NR_FDD_FR1_G					-76.41
		NR_FDD_FR1_H					-75.91
Propagation condition			-	AWGN			
Antenna configuration			-	1x2			
<p>Note 1: OCNG shall be used such that both cells are fully allocated and a constant total transmitted power spectral density is achieved for all OFDM symbols.</p> <p>Note 2: Interference from other cells and noise sources not specified in the test is assumed to be constant over subcarriers and time and shall be modelled as AWGN of appropriate power for <math>N_{oc}</math> to be fulfilled.</p> <p>Note 3: CSI-SINR, CSI-RSRP, and Io levels have been derived from other parameters for information purposes. They are not settable parameters themselves.</p> <p>Note 4: CSI-SINR, CSI-RSRP minimum requirements are specified assuming independent interference and noise at each receiver antenna port.</p> <p>Note 5: NR operating band groups are as defined in clause 3.5.2.</p> <p>Note 6: The test configuration excludes support for band n51 and it is not required to run this test on band n51 in this release of the specification.</p>							

A.6.7.12.1.3 Test Requirements

The CSI-SINR measurement accuracy shall fulfil the requirements in clause 10.1.12.2.1.

A.6.7.12.2 SA Inter-frequency measurement accuracy with FR1 serving cell and FR1 target cell

A.6.7.12.2.1 Test Purpose and Environment

The purpose of this test is to verify that the CSI-SINR measurement accuracy is within the specified limits. This test will verify the requirements in clauses 10.1.14.2.1 and 10.1.14.2.2.

A.6.7.12.2.2 Test Parameters

In this test case the two cells (i.e., Cell 1 and Cell 2) are on different carrier frequencies and measurement gaps are provided. Supported test configurations are shown in Table A.6.7.12.2.2-1. Both absolute accuracy and relative accuracy requirements of CSI-SINR inter-frequency measurement are tested by using test parameters in Table A.6.7.12.2.2-2. In all test cases, Cell 1 is the PCell and Cell 2 is target cell.

**Table A.6.7.12.2.2-1: CSI-SINR Inter frequency CSI-SINR supported test configurations**

Config	Description
1	NR 15 kHz SSB and CSI-RS SCS, 10 MHz bandwidth, FDD duplex mode
2	NR 15 kHz SSB and CSI-RS SCS, 10 MHz bandwidth, TDD duplex mode
3	NR 30 kHz SSB and CSI-RS SCS, 40 MHz bandwidth, TDD duplex mode
Note: The UE is only required to be tested in one of the supported test configurations	

**Table A.6.7.12.2.2-2: CSI-SINR Inter frequency test parameters**

Parameter	Unit	Test 1		Test 2		Test 3		
		Cell 1	Cell 2	Cell 1	Cell 2	Cell 1	Cell 2	
SSB ARFCN		freq1	freq2	freq1	freq2	freq1	freq2	
Duplex mode	Config 1	FDD						
	Config 2,3	TDD						
TDD configuration	Config 1	Not Applicable						
	Config 2	TDDConf.1.1						
	Config 3	TDDConf.2.1						
Downlink initial BWP configuration		DLBWP.0.1						
Downlink dedicated BWP configuration		DLBWP.1.1						
Uplink initial BWP configuration		ULBWP.0.1						
Uplink dedicated BWP configuration		ULBWP.1.1						
DRX Cycle configuration	ms	Not Applicable						
TRS configuration	Config 1	TRS.1.1 FDD						
	Config 2	TRS.1.1 TDD						
	Config 3	TRS.1.2 TDD						
PDSCH Reference measurement channel	Config 1	SR.1.1 FDD	-	SR.1.1 FDD	-	SR.1.1 FDD	-	
	Config 2	SR.1.1 TDD	-	SR.1.1 TDD	-	SR.1.1 TDD	-	
	Config 3	SR.2.1 TDD	-	SR.2.1 TDD	-	SR.2.1 TDD	-	
RMSI CORESET Reference Channel	Config 1	CR.1.1 FDD	-	R.1.1 FDD	-	CR.1.1 FDD	-	
	Config 2	CR.1.1 TDD	-	CR.1.1 TDD	-	CR.1.1 TDD	-	
	Config 3	CR.2.1 TDD	-	CR.2.1 TDD	-	CR.2.1 TDD	-	
Dedicated CORESET Reference Channel	Config 1	CCR.1.1 FDD	-	CCR.1.1 FDD	-	CCR.1.1 FDD	-	
	Config 2	CCR.1.1 TDD	-	CCR.1.1 TDD	-	CCR.1.1 TDD	-	
	Config 3	CCR.2.1 TDD	-	CCR.2.1 TDD	-	CCR.2.1 TDD	-	
OCNG Patterns		OP.1						
CSI-RSSI-Measurement		Not Applicable						
Time offset with Cell 1	Config 1,2	μs	-	2.35	-	2.35	-	2.35
	Config 3	μs	-	1.17	-	1.17	-	1.17

SMT configuration	Config 1		SMT.C.2						
	Config 2,3		SMT.C.1						
SSB configuration	Config 1,2		SSB.1 FR1						
	Config 3		SSB.2 FR1						
CSI-RS for mobility	Config 1		CSI-RS.RRM.FR1.1 FDD						
	Config 2		CSI-RS.RRM.FR1.1 TDD						
	Config 3		CSI-RS.RRM.FR1.2 TDD						
PDSCH/PDCCH subcarrier spacing	Config 1,2	kHz	15						
	Config 3		30						
EPRE ratio of PSS to SSS		dB	0	0	0	0	0		
EPRE ratio of PBCH DMRS to SSS									
EPRE ratio of PBCH to PBCH DMRS									
EPRE ratio of PDCCH DMRS to SSS									
EPRE ratio of PDCCH to PDCCH DMRS									
EPRE ratio of PDSCH DMRS to SSS									
EPRE ratio of PDSCH to PDSCH									
EPRE ratio of OCNG DMRS to SSS(Note 1)									
EPRE ratio of OCNG to OCNG DMRS (Note 1)									
$N_{oc}$ Note2	Config 1,2	NR_FDD_F R1_A NR_TDD_F R1_A NOTE 6	dBm/1 5kHz	-88	-108.5	-119.5			
		NR_FDD_F R1_B				-119			
		NR_TDD_F R1_C				-118.5			
		NR_FDD_F R1_D NR_TDD_F R1_D				-118			
		NR_FDD_F R1_E NR_TDD_F R1_E				-117.5			
		NR_FDD_F R1_F				-117			
		NR_FDD_F R1_G				-116.5			
		NR_FDD_F R1_H				-116			
		$N_{oc}$ Note2				Config 1,2 N		dBm/1 5kHz	-88
Config 3	NR_FDD_F R1_A NR_TDD_F R1_A NOTE 6		-85	-105.5	-116.5				
	NR_FDD_F R1_B				-116				
	NR_TDD_F R1_C				-115.5				
	NR_FDD_F R1_D NR_TDD_F R1_D				-115				
NR_FDD_F R1_E	-114.5								

		NR_TDD_F R1_E							
		NR_FDD_F R1_F						-114	
		NR_FDD_F R1_G						-114.5	
		NR_FDD_F R1_H						-113	
$\hat{E}_s/I_{ot}$			dB	-1.75	-1.75	15	15	-4.0	-4.0
$\hat{E}_s/N_{oc}$			dB	-1.75		15		-4.0	
CSI-RSRP <sup>Note3</sup>	Config 1,2	NR_FDD_F R1_A NR_TDD_F R1_A <sup>NOTE 6</sup>	dBm/S CS	-89.75	-93.5			-123.5	
		NR_FDD_F R1_B						-123	
		NR_TDD_F R1_C						-122.5	
		NR_FDD_F R1_D NR_TDD_F R1_D						-122	
		NR_FDD_F R1_E NR_TDD_F R1_E						-121.5	
		NR_FDD_F R1_F						-121	
		NR_FDD_F R1_G						-120.5	
		NR_FDD_F R1_H						-120	
		Config 3						NR_FDD_F R1_A NR_TDD_F R1_A <sup>NOTE 6</sup>	-120.5
	NR_FDD_F R1_B			-120					
	NR_TDD_F R1_C			-119.5					
	NR_FDD_F R1_D NR_TDD_F R1_D			-119					
	NR_FDD_F R1_E NR_TDD_F R1_E			-118.5					
	NR_FDD_F R1_F			-118					
	NR_FDD_F R1_G			-117.5					
	NR_FDD_F R1_H			-117					
	CSI-SINR <sup>Note3</sup>			NR_FDD_F R1_A NR_TDD_F R1_A <sup>NOTE 6</sup>	dB	-1.75	15	-4.0	
		NR_FDD_F R1_B							
NR_TDD_F R1_C									
NR_FDD_F R1_D									

		NR_TDD_F R1_D					
		NR_FDD_F R1_E NR_TDD_F R1_E					
		NR_FDD_F R1_F					
		NR_FDD_F R1_G					
		NR_FDD_F R1_H					
Io <sup>Note3</sup>	Config 1,2	NR_FDD_F R1_A NR_TDD_F R1_A <sup>NOTE 6</sup>	dBm/ 9.36M Hz	-57.83	-65.4	-90.09	
		NR_FDD_F R1_B				-89.59	
		NR_TDD_F R1_C				-89.09	
		NR_FDD_F R1_D NR_TDD_F R1_D				-88.59	
		NR_FDD_F R1_E NR_TDD_F R1_E				-88.09	
		NR_FDD_F R1_F				-87.59	
		NR_FDD_F R1_G				-87.09	
		NR_FDD_F R1_H				-86.59	
		Config 3				NR_FDD_F R1_A NR_TDD_F R1_A <sup>NOTE 6</sup>	dBm/ 38.16 MHz
	NR_FDD_F R1_B		-83.5				
	NR_TDD_F R1_C		-83				
	NR_FDD_F R1_D NR_TDD_F R1_D		-82.5				
	NR_FDD_F R1_E NR_TDD_F R1_E		-82				
	NR_FDD_F R1_F		-81.5				
	NR_FDD_F R1_G		-81				
	NR_FDD_F R1_H		-80.5				
	Propagation condition			-	AWGN		
	Antenna configuration			-	1x2		
<p>Note 1: OCNG shall be used such that both cells are fully allocated and a constant total transmitted power spectral density is achieved for all OFDM symbols.</p> <p>Note 2: Interference from other cells and noise sources not specified in the test is assumed to be constant over subcarriers and time and shall be modelled as AWGN of appropriate power for <math>N_{oc}</math> to be fulfilled.</p> <p>Note 3: CSI-SINR, CSI-RSRP, and Io levels have been derived from other parameters for information purposes. They are not settable parameters themselves.</p> <p>Note 4: CSI-SINR, CSI-RSRP minimum requirements are specified assuming independent interference and noise at each receiver antenna port.</p> <p>Note 5: NR operating band groups are as defined in clause 3.5.2.</p>							

Note 6: The test configuration excludes support for band n51 and it is not required to run this test on band n51 in this release of the specification.

### A.6.7.12.2.3 Test Requirements

The CSI-SINR measurement accuracy shall fulfil the requirements in clause 10.1.14.2.1 and 10.1.14.2.2.

## A.6.7.13 RSTD measurements

### A.6.7.13.1 RSTD measurement accuracy test case for single positioning frequency layer

#### A.6.7.13.1.1 Test purpose and Environment

The purpose of the test is to verify that the RSTD measurement meets the accuracy requirements specified in clause 10.1.23.2 in an environment with AWGN propagation conditions.

The supported test configurations are specified in Table A.6.7.13.1.1-1.

**Table A.6.7.13.1.1-1: Supported test configurations**

Configuration	Description
1	15 kHz SSB SCS, 20 MHz bandwidth, FDD duplex mode
2	15 kHz SSB SCS, 20 MHz bandwidth, TDD duplex mode
3	30 kHz SSB SCS, 50 MHz bandwidth, TDD duplex mode
Note:	The UE is only required to be tested in one of the supported test configurations.

In the test there are two synchronous cells: Cell 1 and Cell 2. Cell 1 is the reference as well as the PCell. Cell 2 is a neighbour cells. Both cells are on the same NR RF channel in FR1. GP#24 is configured if UE supports MG#24, otherwise GP#0 is configured. The *NR-TDOA-ProvideAssistanceData* and *NR-TDOA-RequestLocationInformation* message as defined in TS 37.355 shall be provided to the UE before the start of the test. The test duration should be larger than the UE measurement period as defined in clause 9.9.2.

**Table A.6.7.13.1.1-2: RSTD accuracy test parameters**

Parameter	Config	Unit	Test 1		Test 2	
			Cell 1	Cell 2	Cell 1	Cell 2
PRS ARFCN	1~3		freq1	Freq1	freq1	Freq1
BW <sub>channel</sub>	1	MHz	20: N <sub>RB,c</sub> = 106		20: N <sub>RB,c</sub> = 106	
	2		20: N <sub>RB,c</sub> = 106		20: N <sub>RB,c</sub> = 106	
	3		50: N <sub>RB,c</sub> = 133		50: N <sub>RB,c</sub> = 133	
Duplex mode	1		FDD		FDD	
	2		TDD		TDD	
	3		TDD		TDD	
TDD configuration	1		N/A		N/A	
	2		TDDConf.1.1		TDDConf.1.1	
	3		TDDConf.2.1		TDDConf.2.1	
Measurement gap	1, 2, 3		GP#24 or GP#0		GP#24 or GP#0	
PDSCH Reference measurement channel	1		SR.1.1 FDD	-	SR.1.1 FDD	-
	2		SR.1.1 TDD		SR.1.1 TDD	
	3		SR.2.1 FDD		SR.2.1 FDD	
RMSI CORESET Reference Channel	1		CR.1.1 FDD	-	CR.1.1 FDD	-
	2		CR.1.1 TDD	-	CR.1.1 TDD	-
	3		CR.2.1 FDD	-	CR.2.1 FDD	-
Dedicated CORESET Reference Channel	1		CCR.1.1 FDD	-	CCR.1.1 FDD	-
	2		CCR.1.1 TDD	-	CCR.1.1 TDD	-
	3		CCR.2.1 TDD	-	CCR.2.1 TDD	-
SSB configuration	1		SSB.1 FR1		SSB.1 FR1	
	2		SSB.1 FR1		SSB.1 FR1	
	3		SSB.2 FR1		SSB.2 FR1	
OCNG Patterns	1~3		OP.1		OP.1	
TRS configuration	1		TRS.1.1 FDD	-	TRS.1.1 FDD	



	2		TRS.1.1 TDD		TRS.1.1 TDD	
	3		TRS.1.2 TDD		TRS.1.2 TDD	
Initial BWP Configuration	1~3		DLBWP.0.1 ULBWP.0.1		DLBWP.0.1 ULBWP.0.1	
Dedicated BWP configuration	1~3		DLBWP.1.1 ULBWP.1.1		DLBWP.1.1 ULBWP.1.1	
Time offset with Cell 1	1	$\mu$ s	-	3	-	3
	2,3		-	3	-	3
SMTC configuration	1		SMTC.2		SMTC.2	
	2,3		SMTC.1		SMTC.1	
PRS configuration	1		PRS.1.1 FR1		PRS.1.2 FR1	
	2		PRS.1.1 FR1		PRS.1.2 FR1	
	3		PRS.2.1 FR1		PRS.2.2 FR1	
PRS Resource slot offset	1, 2, 3	slot	0	4	0	4
Expected RSTD	1, 2, 3	$\mu$ s	N/A	3	N/A	3
Expected RSTD uncertainty	1, 2, 3	$\mu$ s	N/A	5	N/A	5
EPRE ratio of PSS to SSS	1~3	dB	0	0	0	0
EPRE ratio of PBCH DMRS to SSS						
EPRE ratio of PBCH to PBCH DMRS						
EPRE ratio of PDCCH DMRS to SSS						
EPRE ratio of PDCCH to PDCCH DMRS						
EPRE ratio of PDSCH DMRS to SSS						
EPRE ratio of PDSCH to PDSCH DMRS						
EPRE ratio of OCNG DMRS to SSS <sup>Note 1</sup>						
EPRE ratio of OCNG to OCNG DMRS <sup>Note 1</sup>						
EPRE ratio of PRS to SSS						
$N_{oc}$ <sup>Note2</sup>	1,2	dBm/SCS	-98		-98	
	3	SCS	-95		-95	
PRS $\hat{E}_s/I_{ot}$	1~3	dB	-6	-13	-6	-13
PRP <sup>Note3</sup>	1,2	dBm/SC	-103.7	-109.9	-103.7	-109.9
	3	S	-100.7	-106.9	-100.7	-106.9
$I_o$ <sup>Note3</sup>	1,2	dBm/19.08M Hz	-65.70	-65.70	-65.70	-65.70
	3	dBm/47.88M Hz	-61.72	-61.72	-61.72	-61.72
PRS $\hat{E}_s/N_{oc}$	1~3	dB	-5.7	-11.9	-5.7	-11.9
SSB $\hat{E}_s/N_{oc}$	1~3	dB	-5.7	-11.9	-5.7	-11.9
Propagation condition	1~3	-	AWGN		AWGN	
Antenna configuration	1~3		1x2		1x2	
<p>Note 1: OCNG shall be used such that both cells are fully allocated and a constant total transmitted power spectral density is achieved for all OFDM symbols other than those in the slots with transmitted PRS.</p> <p>Note 2: Interference from other cells and noise sources not specified in the test is assumed to be constant over subcarriers and time and shall be modelled as AWGN of appropriate power for <math>N_{oc}</math> to be fulfilled.</p> <p>Note 3: PRP and <math>I_o</math> levels have been derived from other parameters for information purposes. They are not settable parameters themselves. The <math>I_o</math> is calculated based only on the symbols in which PRS is transmitted.</p> <p>Note 4: RSRP minimum requirements are specified assuming independent interference and noise at each receiver antenna port.</p>						

Note 5: The test configuration excludes support for band n51 and it is not required to run this test on band n51 in this release of the specification.

### A.6.7.13.1.2 Test Requirements

The RSTD measurement accuracy for Cell 2 shall fulfil the absolute requirement in clause 10.1.23.2.

## A.6.7.13.2 RSTD measurement accuracy test case for dual positioning frequency layer

### A.6.7.13.2.1 Test purpose and Environment

The purpose of the test is to verify that the RSTD measurement meets the accuracy requirements specified in clause 10.1.23.2 in an environment with AWGN propagation conditions.

The supported test configurations are specified in Table A.6.7.13.2.1-1.

**Table A.6.7.13.2.1-1: Supported test configurations**

Configuration	Description
1	15 kHz SSB SCS, 20 MHz bandwidth, FDD duplex mode
2	15 kHz SSB SCS, 20 MHz bandwidth, TDD duplex mode
3	30 kHz SSB SCS, 50 MHz bandwidth, TDD duplex mode
Note:	The UE is only required to be tested in one of the supported test configurations.

In the test there are two synchronous cells: Cell 1 and Cell 2. Cell 1 is the reference as well as the PCell on NR RF channel #1 in FR1. Cell 2 is a neighbour cell on a different NR RF channel #2 in FR1. GP#24 is configured if UE supports MG#24, otherwise GP#0 is configured. The *NR-TDOA-ProvideAssistanceData* and *NR-TDOA-RequestLocationInformation* message as defined in TS 37.355 shall be provided to the UE before the start of the test. The test duration should be larger than the UE measurement period as defined in clause 9.9.2.

**Table A.6.7.13.2.1-2: RSTD accuracy test parameters**

Parameter	Config	Unit	Test 1		Test 2	
			Cell 1	Cell 2	Cell 1	Cell 2
PRS ARFCN	1~3		freq1	freq2	freq1	freq2
BW <sub>channel</sub>	1	MHz	20: N <sub>RB,c</sub> = 106		20: N <sub>RB,c</sub> = 106	
	2		20: N <sub>RB,c</sub> = 106		20: N <sub>RB,c</sub> = 106	
	3		50: N <sub>RB,c</sub> = 133		50: N <sub>RB,c</sub> = 133	
Duplex mode	1		FDD		FDD	
	2		TDD		TDD	
	3		TDD		TDD	
TDD configuration	1		N/A		N/A	
	2		TDDConf.1.1		TDDConf.1.1	
	3		TDDConf.2.1		TDDConf.2.1	
Measurement gap	1, 2, 3		GP#24 or GP#0		GP#24 or GP#0	
PDSCH Reference measurement channel	1		SR.1.1 FDD	-	SR.1.1 FDD	-
	2		SR.1.1 TDD		SR.1.1 TDD	
	3		SR.2.1 FDD		SR.2.1 FDD	
RMSI CORESET Reference Channel	1		CR.1.1 FDD	-	CR.1.1 FDD	-
	2		CR.1.1 TDD	-	CR.1.1 TDD	-
	3		CR.2.1 FDD	-	CR.2.1 FDD	-
Dedicated CORESET Reference Channel	1		CCR.1.1 FDD	-	CCR.1.1 FDD	-
	2		CCR.1.1 TDD	-	CCR.1.1 TDD	-
	3		CCR.2.1 TDD	-	CCR.2.1 TDD	-
SSB configuration	1		SSB.1 FR1		SSB.1 FR1	
	2		SSB.1 FR1		SSB.1 FR1	

	3		SSB.2 FR1		SSB.2 FR1	
OCNG Patterns	1~3		OP.1		OP.1	
TRS configuration	1		TRS.1.1 FDD	-	TRS.1.1 FDD	
	2		TRS.1.1 TDD		TRS.1.1 TDD	
	3		TRS.1.2 TDD		TRS.1.2 TDD	
Initial BWP Configuration	1~3		DLBWP.0.1 ULBWP.0.1		DLBWP.0.1 ULBWP.0.1	
Dedicated BWP configuration	1~3		DLBWP.1.1 ULBWP.1.1		DLBWP.1.1 ULBWP.1.1	
Time offset with Cell 1	1	μs	-	3	-	3
	2,3		-	3	-	3
SMTC configuration	1		SMTC.2		SMTC.2	
	2,3		SMTC.1		SMTC.1	
PRS configuration	1		PRS.1.1 FR1		PRS.1.2 FR1	
	2		PRS.1.1 FR1		PRS.1.2 FR1	
	3		PRS.2.1 FR1		PRS.2.2 FR1	
PRS Resource slot offset	1, 2, 3	slot	0	4	0	4
Expected RSTD	1, 2, 3	μs	N/A	3	N/A	3
Expected RSTD uncertainty	1, 2, 3	μs	N/A	5	N/A	5
EPRE ratio of PSS to SSS	1~3	dB	0	0	0	0
EPRE ratio of PBCH DMRS to SSS						
EPRE ratio of PBCH to PBCH DMRS						
EPRE ratio of PDCCH DMRS to SSS						
EPRE ratio of PDCCH to PDCCH DMRS						
EPRE ratio of PDSCH DMRS to SSS						
EPRE ratio of PDSCH to PDSCH DMRS						
EPRE ratio of OCNG DMRS to SSS <sup>Note 1</sup>						
EPRE ratio of OCNG to OCNG DMRS <sup>Note 1</sup>						
EPRE ratio of PRS to SSS						
$N_{oc}$ <sup>Note 2</sup>	1,2	dBm/SCS	-98		-98	
	3		-95		-95	
$PRS \hat{E}_s / I_{ot}$	1~3	dB	-6	-13	-6	-13
PRP <sup>Note 3</sup>	1,2	dBm/SCS	-104	-111	-104	-111
	3	S	-101	-108	-101	-108
$I_o$ <sup>Note 3</sup>	1,2	dBm/19.08M Hz	-65.98	-66.74	-65.98	-66.74
	3	dBm/47.88M Hz	-62.00	-62.76	-62.00	-62.76
$PRS \hat{E}_s / N_{oc}$	1~3	dB	-6	-13	-6	-13
Propagation condition	1~3	-	AWGN		AWGN	
Antenna configuration	1~3		1x2		1x2	
<p>Note 1: OCNG shall be used such that both cells are fully allocated and a constant total transmitted power spectral density is achieved for all OFDM symbols other than those in the slots with transmitted PRS.</p> <p>Note 2: Interference from other cells and noise sources not specified in the test is assumed to be constant over subcarriers and time and shall be modelled as AWGN of appropriate power for <math>N_{oc}</math> to be fulfilled.</p> <p>Note 3: PRP and <math>I_o</math> levels have been derived from other parameters for information purposes. They are not settable parameters themselves. The <math>I_o</math> is calculated based only on the symbols in which PRS is transmitted.</p> <p>Note 4: RSRP minimum requirements are specified assuming independent interference and noise at each receiver antenna port.</p> <p>Note 5: The test configuration excludes support for band n51 and it is not required to run this test on band n51 in this release of the specification.</p>						

## A.6.7.13.2.2 Test Requirements

The RSTD measurement accuracy for Cell 2 shall fulfil the absolute requirement in clause 10.1.23.2.

## A.6.7.14 PRS-RSRP measurements

## A.6.7.14.1 SA: measurement accuracy with PRS in FR1

## A.6.7.14.1.1 Test Purpose and Environment

The purpose of this test is to verify that the PRS-RSRP measurement accuracy is within the specified limits. This test will verify the requirements in clauses 10.1.24.2.1 and 10.1.24.2.2.

## A.6.7.14.1.2 Test parameters

In this set of test cases all cells are on the same carrier frequency. Supported test configurations are shown in table A.6.7.14.1.2-1. Both absolute and relative accuracy of PRS-RSRP measurements are tested by using the parameters in A.6.7.14.1.2-2. In all test cases, Cell 1 is the PCell.

Table A.6.7.14.1.2-1: PRS-RSRP supported test configurations

Config	Description
1	NR 15 kHz SSB SCS, 20 MHz bandwidth, FDD duplex mode
2	NR 15 kHz SSB SCS, 20 MHz bandwidth, TDD duplex mode
3	NR 30 kHz SSB SCS, 50 MHz bandwidth, TDD duplex mode
Note:	The UE is only required to be tested in one of the supported test configurations in each supported band

Table A.6.7.14.1.2-2: PRS-RSRP test parameters

Parameter		Unit	Test 1		Test 2	
			Cell 1	Cell 2	Cell 1	Cell 2
Cell ID			489	0	489	0
SSB ARFCN			freq1		freq1	
Duplex mode	Config 1		FDD			
	Config 2,3		TDD			
TDD configuration	Config 1		Not Applicable			
	Config 2		TDDConf.1.1			
	Config 3		TDDConf.2.1			
BW <sub>channel</sub>	Config 1	MHz	20: N <sub>RB,c</sub> = 106			
	Config 2		20: N <sub>RB,c</sub> = 106			
	Config 3		50: N <sub>RB,c</sub> = 133			
Downlink initial BWP configuration			DLBWP.0.1			
Downlink dedicated BWP configuration			DLBWP.1.1			
Uplink initial BWP configuration			ULBWP.0.1			
Uplink dedicated BWP configuration			ULBWP.1.1			
TRS configuration	Config 1		TRS.1.1 FDD	NA	TRS.1.1 FDD	NA
	Config 2		TRS.1.1 TDD	NA	TRS.1.1 TDD	NA
	Config 3		TRS.1.2 TDD	NA	TRS.1.2 TDD	NA
DRX Cycle		ms	Not Applicable			
Measurement gap			GP#24 or GP#0 <sup>Note 7</sup>			
PDSCH Reference measurement channel	Config 1		SR.1.1 FDD	-	SR.1.1 FDD	-

	Config 2		SR.1.1 TDD		SR.1.1 TDD	
	Config 3		SR2.1 TDD		SR2.1 TDD	
RMSI CORESET Reference Channel	Config 1		CR.1.1 FDD	-	CR.1.1 FDD	-
	Config 2		CR.1.1 TDD		CR.1.1 TDD	
	Config 3		CR2.1 TDD		CR2.1 TDD	
Control channel RMC	Config 1		CCR.1.1 FDD	-	CCR.1.1 FDD	-
	Config 2		CCR.1.1 TDD		CCR.1.1 TDD	
	Config 3		CCR2.1 TDD		CCR2.1 TDD	
PRS configuration	Config 1		PRS.1.3 FR1	PRS.1.3 FR1	PRS.1.4 FR1	PRS.1.4 FR1
	Config 2		PRS.1.3 FR1	PRS.1.3 FR1	PRS.1.4 FR1	PRS.1.4 FR1
	Config 3		PRS.2.3 FR1	PRS.2.3 FR1	PRS.2.4 FR1	PRS.2.4 FR1
PRS Resource slot offset (slot)	Config 1,2,3	slot	0	4	0	4
SSB configuration	Config 1		SSB.1 FR1	SSB.1 FR1	SSB.1 FR1	SSB.1 FR1
	Config 2		SSB.1 FR1	SSB.1 FR1	SSB.1 FR1	SSB.1 FR1
	Config 3		SSB.2 FR1	SSB.2 FR1	SSB.2 FR1	SSB.2 FR1
Time offset with Cell 1	Config 1	$\mu$ s	-	3	-	3
	Config 2,3		-	3	-	3
Expected RSTD	Config 1,2,3	$\mu$ s	3			
Expected RSTD uncertainty	Config 1,2,3	$\mu$ s	5			
SMTC configuration	Config 1		SMTC.2			
	Config 2,3		SMTC.1			
OCNG Patterns			OCNG pattern 1			
PDSCH/PDCCH subcarrier spacing	Config 1,2	kHz	15 kHz			
	Config 3		30 kHz			
EPRE ratio of PSS to SSS		dB	0	0	0	0
EPRE ratio of PBCH DMRS to SSS						
EPRE ratio of PBCH to PBCH DMRS						
EPRE ratio of PDCCH DMRS to SSS						
EPRE ratio of PDCCH to PDCCH DMRS						
EPRE ratio of PDSCH DMRS to SSS						
EPRE ratio of PDSCH to PDSCH						
EPRE ratio of OCNG DMRS to SSS(Note 1)						
EPRE ratio of OCNG to OCNG DMRS (Note 1)						
EPRE ratio of PRS to SSS		dB	0	0	0	0
$N_{oc}$ Note2	Config 1,2	dBm/15KhZ	-98		-98	

	Config 3			-98		-98	
$N_{oc}$ Note2	Config 1,2		dBm/SCS	-98		-98	
	Config 3			-95		-95	
PRS $\hat{E}_s/I_{ot}$			dB	-2.41	-12.12	-2.41	-12.12
PRS $\hat{E}_s/N_{oc}$			dB	-2	-10	-2	-10
PRP Note3	Config 1, 2		dBm/SCS	-100	-108	-100	-108
	Config 3			-97	-105	-97	-105
$I_o$ Note3	Config 1,2		dBm/19.08MH z	-64.57		-64.57	
	Config 3			dBm/47.88MH z	-60.59		-60.59
Propagation condition					AWGN		
Antenna configuration				1x2			
<p>Note 1: OCNG shall be used such that both cells are fully allocated and a constant total transmitted power spectral density is achieved for all OFDM symbols.</p> <p>Note 2: Interference from other cells and noise sources not specified in the test is assumed to be constant over subcarriers and time and shall be modelled as AWGN of appropriate power for <math>N_{oc}</math> to be fulfilled.</p> <p>Note 3: PRP and <math>I_o</math> levels have been derived from other parameters for information purposes. They are not settable parameters themselves.</p> <p>Note 4: PRP minimum requirements are specified assuming independent interference and noise at each receiver antenna port.</p> <p>Note 5: Void.</p> <p>Note 6: The test configuration excludes support for band n51 and it is not required to run this test on band n51 in this release of the specification</p> <p>Note 7: GP#24 is configured if UE supports MG#24, otherwise GP#0 is configured.</p>							

A.6.7.14.1.3 Test Requirements

In each test, the absolute PRS-RSRP measurement for each cell shall fulfil the absolute accuracy requirement in clause 10.1.24.2.1. The relative PRS-RSRP measurement between the two PRS resources within the same cell shall fulfil the relative accuracy requirement in clause 10.1.24.2.2.

## A.6.7.15 UE Rx-Tx time difference measurements

### A.6.7.15.1 UE Rx-Tx time difference measurement accuracy for single positioning frequency layer in FR1 SA

#### A.6.7.15.1.1 Test purpose and environment

The purpose of the test is to verify that the UE Rx-Tx time difference measurement accuracy is within the specified limits. This test will verify the requirements in clause 10.1.25.2. The test is conducted in AWGN propagation condition in FR1 in standalone scenario when single positioning frequency layer is configured.

The supported test configurations are listed in Table A.6.7.15.1.1-1.

**Table A.6.7.15.1.1-1: Supported test configurations**

Configuration	Description
1	15 kHz SSB SCS, 20 MHz bandwidth, FDD duplex mode
2	15 kHz SSB SCS, 20 MHz bandwidth, TDD duplex mode
3	30 kHz SSB SCS, 50 MHz bandwidth, TDD duplex mode
Note: The UE is only required to be tested in one of the supported test configurations.	

There are two cells in the test: PCell (Cell 1) and a neighbour cell (Cell 2). Both cells are on the same RF channel in FR1.

The *NR-Multi-RTT-ProvideAssistanceData* and *nr-Multi-RTT-RequestLocationInformation* as defined in TS 37.355 [34, clause 6.5.12.1], shall be provided to the UE before the start of the test.

The UE is configured with measurement gap pattern ID #0 or ID #24 before the test.

The UE is configured to transmit positioning SRS on Cell 1 during the test.

The test equipment measures the transmit timing of the UE using the transmitted SRS and measures the receive timing using the PRS. The test equipment then compares the difference of these two timings to the UE Rx-Tx measurement reported by the UE for each cell.

#### A.6.7.15.1.2 Test parameters

The UE Rx-Tx time difference accuracy test parameters are given in Table A.6.7.15.1.2-1.

**Table A.6.7.15.1.2-1: UE Rx-Tx time difference measurement accuracy test parameters**

Parameter	Unit	Test configuration	Test 1		Test 2	
			Cell 1	Cell 2	Cell 1	Cell 2
RF Channel Number		1,2,3	1	1	1	1
Measurement gap		1,2,3	GP#24 or GP#0 <sup>Note 4</sup>		GP#24 or GP#0 <sup>Note 4</sup>	
DRX		1,2,3	OFF		OFF	
Time offset with Cell 1	μs	1, 2, 3	N/A	3	N/A	3
TDD configuration		1	N/A	N/A	N/A	N/A
		2	TDDConf.1.1	TDDConf.1.1	TDDConf.1.1	TDDConf.1.1
		3	TDDConf.2.1	TDDConf.2.1	TDDConf.2.1	TDDConf.2.1
PDSCH RMC configuration		1	SR.1.1 FDD	N/A	SR.1.1 FDD	N/A
		2	SR.1.1 TDD		SR.1.1 TDD	
		3	SR.2.1 TDD		SR.2.1 TDD	
RMSI CORESET RMC configuration		1	CR.1.1 FDD	N/A	CR.1.1 FDD	N/A
		2	CR.1.1 TDD		CR.1.1 TDD	
		3	CR.2.1 TDD		CR.2.1 TDD	
Dedicated CORESET RMC configuration		1	CCR.1.1 FDD	N/A	CCR.1.1 FDD	N/A
		2	CCR.1.1 TDD		CCR.1.1 TDD	
		3	CCR.2.1 TDD		CCR.2.1 TDD	
OCNG Patterns		1, 2, 3	OP.1	OP.1	OP.1	OP.1
EPRE ratio of PSS to SSS	dB	1, 2, 3	0	0	0	0

EPRE ratio of PBCH DMRS to SSS						
EPRE ratio of PBCH to PBCH DMRS						
EPRE ratio of PDCCH DMRS to SSS						
EPRE ratio of PDCCH to PDCCH DMRS						
EPRE ratio of PDSCH DMRS to SSS						
EPRE ratio of PDSCH to PDSCH DMRS						
EPRE ratio of OCNG DMRS to SSS <sup>Note 1</sup>						
EPRE ratio of OCNG to OCNG DMRS <sup>Note 1</sup>						
EPRE ratio of PRS to SSS						
TRS Configuration		1	TRS.1.1 FDD	N/A	TRS.1.1 FDD	N/A
		2	TRS.1.1 TDD		TRS.1.1 TDD	
		3	TRS.1.2 TDD		TRS.1.2 TDD	
Initial BWP configuration		1, 2, 3	DLBWP.0.1 ULBWP.0.1	N/A	DLBWP.0.1 ULBWP.0.1	N/A
Active DL BWP configuration		1, 2, 3	DLBWP.1.1	N/A	DLBWP.1.1	N/A
Active UL BWP configuration		1, 2, 3	ULBWP.1.1	N/A	ULBWP.1.1	N/A
PRS configuration		1	PRS.1.1 FR1	PRS.1.1 FR1	PRS.1.2 FR1	PRS.1.2 FR1
		2	PRS.1.1 FR1	PRS.1.1 FR1	PRS.1.2 FR1	PRS.1.2 FR1
		3	PRS.2.1 FR1	PRS.2.1 FR1	PRS.2.2 FR1	PRS.2.2 FR1
PRS Resource slot offset	slot	1, 2, 3	0	4	0	4
SRS configuration		1	POS-SRS.1	N/A	POS-SRS.1	N/A
		2	POS-SRS.1	N/A	POS-SRS.1	N/A
		3	POS-SRS.2	N/A	POS-SRS.2	N/A
$N_{oc}$ <sup>Note 2</sup>	dBm/SCS	1	-98		-98	
		2	-98		-98	
		3	-95		-95	
$N_{oc}$ <sup>Note 2</sup>	dBm/15 kHz	1	-98		-98	
		2				
		3				
PRS $\hat{E}_s/I_{ot}$	dB	1	-2.41	-12.12	-2.41	-12.12
		2				
		3				
PRS $\hat{E}_s/N_{oc}$	dB	1	-2	-10	-2	-10
		2				
		3				
PRP <sup>Note 3</sup>	dBm/SCS kHz	1	-100	-108	-100	-108
		2	-100	-108	-100	-108
		3	-97	-105	-97	-105
$I_o$	dBm/19.08 MHz	1	-64.57	-64.57	-64.57	-64.57
		2	-64.57	-64.57	-64.57	-64.57
		3	-60.59	-60.59	-60.59	-60.59
Propagation Condition		1, 2, 3	AWGN		AWGN	



Note 1:	Void.
Note 2:	Interference from other cells and noise sources not specified in the test is assumed to be constant over subcarriers and time and shall be modelled as AWGN of appropriate power for $N_{oc}$ to be fulfilled.
Note 3:	PRP levels have been derived from other parameters for information purposes. They are not settable parameters themselves.
Note 4:	GP#24 is configured if UE supports MG#24, otherwise GP#0 is configured.

**Table A.6.7.15.1.2-2: Void**

### A.6.7.15.1.3 Test requirements

The UE Rx-Tx time difference measurement fulfils the UE Rx-Tx measurement accuracy requirements specified in clause 10.1.25.2 for both Cell 1 and Cell 2.

## A.7.1 SA: RRC\_IDLE state mobility

### A.7.1.1 Cell re-selection to NR

#### A.7.1.1.1 Cell reselection to FR2 intra-frequency NR case

##### A.7.1.1.1.1 Test Purpose and Environment

This test is to verify the requirement for the intra frequency NR cell reselection requirements specified in clause 4.2.2.3.

##### A.7.1.1.1.2 Test Parameters

The test scenario comprises of 1 NR carrier and 2 cells as given in tables A.7.1.1.1.2-1, A.7.1.1.1.2-2 and A.7.1.1.1.2-3. The test consists of three successive time periods, with time duration of T1, T2, and T3 respectively. Only cell 1 is already identified by the UE prior to the start of the test. Cell 1 and cell 2 belong to different tracking areas. Furthermore, UE has not registered with network for the tracking area containing cell 2.

**Table A.7.1.1.1.2-1: Supported test configurations**

Configuration	Description
1	120 kHz SSB SCS, 100 MHz bandwidth, TDD duplex mode
2	240 kHz SSB SCS, 100 MHz bandwidth, TDD duplex mode
Note: The UE is only required to be tested in one of the supported test configurations.	

**Table A.7.1.1.1.2-2: General test parameters for intra frequency NR cell re-selection test case**

Parameter		Unit	Test configuration	Value	Comment
Initial condition	Active cell		1, 2	Cell1	
T2 end condition	Active cell		1, 2	Cell2	
	Neighbour cell		1, 2	Cell1	
Final condition	Active cell		1, 2	Cell1	
	Neighbour cell		1, 2	Cell2	
RF Channel Number			1, 2	1	
Time offset between cells			1, 2	3 $\mu$ s	Synchronous cells
Access Barring Information		-	1, 2	Not Sent	No additional delays in random access procedure.
SMTC configuration			1, 2	SMTC.1	
DRX cycle length		s	1, 2	1.28	The value shall be used for all cells in the test.

PRACH configuration index		1, 2	190	The detailed configuration is specified in TS 38.211 clause 6.3.3.2
rangeToBestCell		1, 2	Not configured	
T1	s	1, 2	>7	During T1, Cell 2 shall be powered off, and during the off time the physical cell identity shall be changed, The intention is to ensure that Cell 2 has not been detected by the UE prior to the start of period T2
T2	s	1, 2	135	T2 needs to be defined so that cell re-selection reaction time is taken into account.
T3	s	1, 2	35	T3 needs to be defined so that cell re-selection reaction time is taken into account.

**Table A.7.1.1.1.2-3: Cell specific test parameters for intra frequency NR cell re-selection test case in AWGN**

Parameter	Unit	Test configuration	Cell 1			Cell 2		
			T1	T2	T3	T1	T2	T3
TDD configuration		1, 2	TDDConf.3.1			TDDConf.3.1		
PDSCH RMC configuration		1	SR.3.1 TDD			SR.3.1 TDD		
		2	SR.3.1 TDD			SR.3.1 TDD		
RMSI CORESET RMC configuration		1	CR.3.1 TDD			CR.3.1 TDD		
		2	CR.3.1 TDD			CR.3.1 TDD		
Dedicated CORESET RMC configuration		1	CCR.3.1 TDD			CCR.3.1 TDD		
		2	CCR.3.1 TDD			CCR.3.1 TDD		
SSB configuration		1	SSB.3 FR2			SSB.7 FR2		
		2	SSB.4 FR2			SSB.8 FR2		
OCNG Pattern		1, 2	OP.4			OP.4		
BW <sub>channel</sub>	MHz	1, 2	100: N <sub>RB,c</sub> = 66			100: N <sub>RB,c</sub> = 66		
Data RBs allocated		1, 2	66			66		
Initial DL BWP configuration		1, 2	DLBWP.0.1			DLBWP.0.1		
Initial UL BWP configuration		1, 2	ULBWP.0.1			ULBWP.0.1		
RLM-RS		1, 2	SSB			SSB		
Qrxlevmin	dBm/SCS	1	-138			-138		
		2	-135			-135		
Pcompensation	dB	1, 2	0			0		
Qhysts	dB	1, 2	0			0		
Qoffset <sub>s,n</sub>	dB	1, 2	0			0		
Cell_selection_and_reselection_quality_measurement		1, 2	SS-RSRP			SS-RSRP		
AoA setup		1, 2	Setup 1 defined in A.3.15.1			Setup 1 defined in A.3.15.1		
Beam assumption <sup>Note 4</sup>		1,2	Rough			Rough		
$\hat{E}_s / I_{ot\ BB}$ <sup>Note 5</sup>	dB	1	7.45	-3.55	0.95	-infinity	0.95	-3.55
		2						
$N_{oc}$ <sup>Note2</sup>	dBm/SCS	1	-93					
		2	-90					
$N_{oc}$ <sup>Note2</sup>	dBm/15 kHz	1	-102					
		2						
$\hat{E}_s / N_{oc}$	dB	1	8	-3	1.5	-infinity	1.5	-3
		2						
SS-RSRP <sup>Note3</sup>	dBm/SCS	1	-85	-96	-91.5	-infinity	-91.5	-96
		2	-82	-93	-88.5	-infinity	-88.5	-93
Io on SSB symbols of each cell	dBm/95.04 MHz	1	-60.53	-67.40	-65.34	-69.17	-65.34	-67.40
		2	-57.52	-64.39	-62.33	-66.16	-62.33	-64.39

Treselection	s	1, 2	0	0	0	0	0	0
SintrasearchP	dB	1, 2	50			50		
Propagation Condition		1, 2	AWGN					
Note 1:	OCNG shall be used such that both cells are fully allocated and a constant total transmitted power spectral density is achieved for all OFDM symbols.							
Note 2:	Interference from other cells and noise sources not specified in the test is assumed to be constant over subcarriers and time and shall be modelled as AWGN of appropriate power for $N_{oc}$ to be fulfilled.							
Note 3:	SS-RSRP levels have been derived from other parameters for information purposes. They are not settable parameters themselves.							
Note 4:	Information about types of UE beam is given in B.2.1.3, and does not limit UE implementation or test system implementation							
Note 5:	Calculation of $E_s/lot_{BB}$ includes the effect of UE internal noise up to the value assumed for the associated Refsens requirement in clause 7.3.2 of TS 38.101-2 [19], and an allowance of 1dB for UE multi-band relaxation factor $\Delta MB_P$ from TS 38.101-2 [19] Table 6.2.1.3-4.							

### A.7.1.1.1.3 Test Requirements

The cell reselection delay to a newly detectable cell is defined as the time from the beginning of time period T2, to the moment when the UE camps on Cell 2, and starts to send preambles on the PRACH for sending the *RRCSetupRequest* message to perform a Registration procedure for mobility and periodic registration update on Cell 2.

The cell re-selection delay to a newly detectable cell shall be less than 130 s.

The cell reselection delay to an already detected cell is defined as the time from the beginning of time period T3, to the moment when the UE camps on cell 1, and starts to send preambles on the PRACH for sending the *RRCSetupRequest* message to perform a Registration procedure for mobility and periodic registration update on cell 1.

The cell re-selection delay to an already detected cell shall be less than 27 s.

The rate of correct cell reselections observed during repeated tests shall be at least 90%.

NOTE: The cell re-selection delay to a newly detectable cell can be expressed as:  $T_{detect, NR\_Intra} + T_{SI-NR}$ , and to an already detected cell can be expressed as:  $T_{evaluate, NR\_intra} + T_{SI-NR}$ ,

Where:

$T_{detect, NR\_Intra}$  See Table 4.2.2.3-1 in clause 4.2.2.3

$T_{evaluate, NR\_intra}$  See Table 4.2.2.3-1 in clause 4.2.2.3

$T_{SI-NR}$  Maximum repetition period of relevant system info blocks that needs to be received by the UE to camp on a cell; 1280 ms is assumed in this test case.

This gives a total of 129.28 s, allow 130 s for the cell re-selection delay to a newly detectable cell and 26.88 s for the cell re-selection delay to an already detected cell in the test case, which we allow 27 s.

### A.7.1.1.2 Cell reselection to FR2 inter-frequency NR case

#### A.7.1.1.2.1 Test Purpose and Environment

This test is to verify the requirement for the inter frequency NR cell reselection requirements specified in clause 4.2.2.4.

#### A.7.1.1.2.2 Test Parameters

The test scenario comprises of 2 cells on 2 different NR carriers respectively as given in tables A.7.1.1.2.2-1, A.7.1.1.2.2-2 and A.7.1.1.2.2-3. The test consists of three successive time periods, with time duration of T1, T2, and T3 respectively. Both cell 1 and cell 2 are already identified by the UE prior to the start of the test. Cell 1 and cell 2 belong to different tracking areas and cell 2 is of higher priority than cell 1. Furthermore, UE has not registered with network for the tracking area containing cell 2.

**Table A.7.1.1.2.2-1: Supported test configurations**

Configuration	Description for serving cell	Description for target cell
---------------	------------------------------	-----------------------------

1	120 kHz SSB SCS, 100 MHz bandwidth, TDD duplex mode	120 kHz SSB SCS, 100 MHz bandwidth, TDD duplex mode
2	240 kHz SSB SCS, 100 MHz bandwidth, TDD duplex mode	240 kHz SSB SCS, 100 MHz bandwidth, TDD duplex mode
Note: The UE is only required to be tested in one of the supported test configurations.		

**Table A.7.1.1.2.2-2: General test parameters for FR2 inter frequency NR cell re-selection test case**

Parameter		Unit	Test configuration	Value	Comment
Initial condition	Active cell		1, 2	Cell2	The UE camps on cell 2 in the initial phase and during T1 period the UE reselects to cell 1
	Neighbour cell		1, 2	Cell1	
T1 end condition	Active cell		1, 2	Cell1	The UE shall perform reselection to cell 1 during T1
	Neighbour cells		1, 2	Cell2	
T3 end condition	Active cell		1, 2	Cell2	The UE shall perform reselection to cell 2 with higher priority during T3
	Neighbour cell		1, 2	Cell1	
RF Channel Number			1, 2	1, 2	
Time offset between cells			1, 2	3 $\mu$ s	Synchronous cells
Access Barring Information		-	1, 2	Not Sent	No additional delays in random access procedure.
SSB configuration			1	SSB.1 FR2	
			2	SSB.2 FR2	
SMTC configuration			1, 2	SMTC.1	
DRX cycle length		s	1, 2	1.28	The value shall be used for all cells in the test.
PRACH configuration index			1, 2	190	The detailed configuration is specified in TS 38.211 clause 6.3.3.2
rangeToBestCell			1, 2	Not configured	
T1		s	1, 2	35	T1 needs to be defined so that cell re-selection reaction time is taken into account.
T2		s	1, 2	>7	During T2, cell 2 shall be powered off, and during the off time the physical cell identity shall be changed. The intention is to ensure that cell 2 has not been detected by the UE prior to the start of period T3.
T3		s	1, 2	95	T3 needs to be defined so that cell re-selection reaction time is taken into account.

**Table A.7.1.1.2.2-3: Cell specific test parameters for FR2 inter frequency NR cell re-selection test case in AWGN**

Parameter	Unit	Test configuration	Cell 1			Cell 2		
			T1	T2	T3	T1	T2	T3
TDD configuration		1, 2	TDDConf.3.1			TDDConf.3.1		
PDSCH RMC configuration		1, 2	SR.3.1 TDD			SR.3.1 TDD		
RMSI CORESET parameters		1, 2	CR.3.1 TDD			CR.3.1 TDD		
RMSI CORESET RMC configuration		1, 2	CCR.3.1 TDD			CCR.3.1 TDD		
OCNG Pattern		1, 2	OP.1 defined in A.3.2.1			OP.1 defined in A.3.2.1		
Initial DL BWP configuration		1, 2	DLBWP.0.1			DLBWP.0.1		
Initial UL BWP configuration		1, 2	ULBWP.0.1			ULBWP.0.1		
RLM-RS		1, 2	SSB			SSB		

Qrxlevmin	dBm/SCS	1	-140			-140		
		2	-137			-137		
Pcompensation	dB	1, 2	0			0		
Qhysts	dB	1, 2	0			0		
Qoffset <sub>s, n</sub>	dB	1, 2	0			0		
Cell_selection_and_reselection_quality_measurement		1, 2	SS-RSRP			SS-RSRP		
AoA setup		1, 2	Setup 1 defined in A.3.15.1			Setup 1 defined in A.3.15.1		
Beam assumption <sup>Note 4</sup>		1,2	Rough			Rough		
$\hat{E}_s/I_{ot\ BB}$ <sup>Note 5</sup>	dB	1	9.95	9.95	7.45	-11.05	-infinity	7.95
		2						
$N_{oc}$ <sup>Note2</sup>	dBm/SCS	1	-93			-93		
		2	-90			-90		
$N_{oc}$ <sup>Note2</sup>	dBm/15 kHz	1	-102			-102		
		2						
$\hat{E}_s / N_{oc}$	dB	1	10.5	10.5	8	-10.5	-infinity	8.5
		2						
SS-RSRP <sup>Note3</sup>	dBm/SCS	1	-82.5	-82.5	-85	-103.5	-infinity	-84.5
		2	-79.5	-79.5	-82	-100.5	-infinity	-81.5
Io	dBm/95.04 MHz	1, 2	-53.11	-53.11	-55.34	-63.61	-63.98	-54.91
Treselection	s	1, 2	0	0	0	0	0	0
SnonintrasearchP	dB	1, 2	50			50		
Thresh <sub>x, highP</sub>	dB	1, 2	48			48		
Thresh <sub>serv, lowP</sub>	dB	1, 2	44			44		
Thresh <sub>x, lowP</sub>	dB	1, 2	50			50		
Propagation Condition		1, 2	AWGN			AWGN		
<p>Note 1: OCNB shall be used such that both cells are fully allocated and a constant total transmitted power spectral density is achieved for all OFDM symbols.</p> <p>Note 2: Interference from other cells and noise sources not specified in the test is assumed to be constant over subcarriers and time and shall be modelled as AWGN of appropriate power for <math>N_{oc}</math> to be fulfilled.</p> <p>Note 3: SS-RSRP levels have been derived from other parameters for information purposes. They are not settable parameters themselves.</p> <p>Note 4: Information about types of UE beam is given in B.2.1.3, and does not limit UE implementation or test system implementation</p> <p>Note 5: Calculation of <math>\hat{E}_s/I_{ot\ BB}</math> includes the effect of UE internal noise up to the value assumed for the associated Refsens requirement in clause 7.3.2 of TS 38.101-2 [19], and an allowance of 1dB for UE multi-band relaxation factor <math>\Delta MB_P</math> from TS 38.101-2 [19] Table 6.2.1.3-4.</p>								

### A.7.1.1.2.3 Test Requirements

The cell reselection delay to a higher priority cell is defined as the time from the beginning of time period T3, to the moment when the UE camps on cell 2, and starts to send preambles on the PRACH for sending the *RRCSetupRequest* message to perform a Registration procedure for mobility and periodic registration update on cell 2.

The cell re-selection delay to a higher priority cell shall be less than 87 s.

The cell reselection delay to a lower priority cell is defined as the time from the beginning of time period T1, to the moment when the UE camps on cell 1, and starts to send preambles on the PRACH for sending the *RRCSetupRequest* message to perform a Registration procedure for mobility and periodic registration update on cell 1.

The cell re-selection delay to a lower priority cell shall be less than 27 s.

The rate of correct cell reselections observed during repeated tests shall be at least 90%.

NOTE: The cell re-selection delay to a higher priority cell can be expressed as:  $T_{\text{higher\_priority\_search}} + T_{\text{evaluate, NR\_inter}} + T_{\text{SI-NR}}$ , and to a lower priority cell can be expressed as:  $T_{\text{evaluate, NR\_inter}} + T_{\text{SI-NR}}$ ,

Where:

$T_{\text{higher\_priority\_search}}$  See clause 4.2.2.7

$T_{\text{evaluate, NR\_inter}}$  See Table 4.2.2.4-1 in clause 4.2.2.4

$T_{SI-NR}$  Maximum repetition period of relevant system info blocks that needs to be received by the UE to camp on a cell; 1280 ms is assumed in this test case.

This gives a total of 86.88 s, allow 87 s for the cell re-selection delay to a higher priority cell and 26.88 s for the cell re-selection delay to a lower priority cell in the test case, which we allow 27 s.

### A.7.1.1.3 Cell reselection to FR2 intra-frequency NR case for UE fulfilling low mobility relaxed measurement criterion

#### A.7.1.1.3.1 Test Purpose and Environment

This test is to verify the requirement for the intra frequency NR cell reselection requirements for UE configured with relaxed measurement criterion specified in clause 4.2.2.9.2.

#### A.7.1.1.3.2 Test Parameters

The test scenario comprises of 1 NR carrier and 2 cells as given in tables A.7.1.1.3.2-1, A.7.1.1.3.2-2 and A.7.1.1.3.2-3. The test consists of two successive time periods, with time duration of T1 and T2 respectively. Both cell 1 and cell 2 are already identified by the UE prior to the start of the test. Cell 1 and cell 2 belong to different tracking areas. During T1 and T2, only criteria *lowMobilityEvaluation* is configured and fulfilled, where  $(S_{rxlev_{Ref}} - S_{rxlev}) < S_{SearchDeltaP}$ . UE has not registered with network for the tracking area containing cell2.

**Table A.7.1.1.3.2-1: Supported test configurations**

Configuration	Description
1	120 kHz SSB SCS, 100 MHz bandwidth, TDD duplex mode
2	240 kHz SSB SCS, 100 MHz bandwidth, TDD duplex mode
Note:	The UE is only required to be tested in one of the supported test configurations.

**Table A.7.1.1.3.2-2: General test parameters for FR2 intra-frequency NR cell re-selection test case for UE fulfilling low mobility criterion**

Parameter		Unit	Test configuration	Value	Comment
Initial condition	Active cell		1, 2	Cell1	The UE camps on cell 1 in the initial phase
	Neighbour cells		1, 2	Cell2	
T1 end condition	Active cell		1, 2	Cell2	The UE reselects to cell 2 during T1 period
	Neighbour cells		1, 2	Cell1	
Final condition	Active cell		1, 2	Cell1	The UE reselects to cell 1 during T2 period
	Neighbour cells		1,2	Cell2	
RF Channel Number			1, 2	1	
Time offset between cells			1, 2	3 $\mu$ s	Synchronous cells
Access Barring Information		-	1, 2	Not Sent	No additional delays in random access procedure.
SMTC configuration			1, 2	SMTC pattern 1	
DRX cycle length		s	1, 2	0.64	The value shall be used for all cells in the test.
PRACH configuration index			1, 2	190	The detailed configuration is specified in TS 38.211 clause 6.3.3.2
rangeToBestCell			1, 2	Not configured	
T1		s	1, 2	100	
T2		s	1, 2	100	

**Table A.7.1.1.3.2-3: Cell specific test parameters for FR2 intra-frequency NR cell re-selection test case in AWGN for UE fulfilling low mobility criterion**

Parameter	Unit	Test configuration	Cell 1	Cell 2

			T1	T2	T1	T2
TDD configuration		1, 2	TDDConf.3.1		TDDConf.3.1	
PDSCH RMC configuration		1	SR.3.1 TDD		SR.3.1 TDD	
		2	SR.3.1 TDD		SR.3.1 TDD	
RMSI CORESET RMC configuration		1	CR.3.1 TDD		CR.3.1 TDD	
		2	CR.3.1 TDD		CR.3.1 TDD	
Dedicated CORESET RMC configuration		1	CCR.3.1 TDD		CCR.3.1 TDD	
		2	CCR.3.1 TDD		CCR.3.1 TDD	
SSB configuration		1	SSB.3 FR2		SSB.7 FR2	
		2	SSB.4 FR2		SSB.8 FR2	
OCNG Pattern		1, 2	OP.4		OP.4	
BW <sub>channel</sub>	MHz	1, 2	100: N <sub>RB,c</sub> = 66		100: N <sub>RB,c</sub> = 66	
Data RBs allocated		1, 2	66		66	
Initial DL BWP configuration		1, 2	DLBWP.0.1		DLBWP.0.1	
Initial UL BWP configuration		1, 2	ULBWP.0.1		ULBWP.0.1	
RLM-RS		1, 2	SSB		SSB	
Qrxlevmin	dBm/SCS	1	-140		-140	
		2	-137		-137	
S <sub>SearchDeltaP</sub>	dB	1, 2	6		6	
T <sub>SearchDeltaP</sub>	s	1,2	5		5	
P <sub>compensation</sub>	dB	1, 2	0		0	
Q <sub>hysts</sub>	dB	1, 2	0		0	
Q <sub>offsets,n</sub>	dB	1, 2	0		0	
Cell selection and reselection quality measurement		1, 2	SS-RSRP		SS-RSRP	
AoA setup		1, 2	Setup 1 defined in A.3.15.1		Setup 1 defined in A.3.15.1	
Beam assumption <sup>Note 4</sup>		1,2	Rough		Rough	
$\hat{E}_s/I_{ot\ BB}$ <sup>Note 5</sup>	dB	1	-3.55	0.95	0.95	-3.55
		2				
$N_{oc}$ <sup>Note2</sup>	dBm/SCS	1	-93			
		2	-90			
$N_{oc}$ <sup>Note2</sup>	dBm/15 kHz	1	-102			
		2				
$\hat{E}_s / N_{oc}$	dB	1	-3	1.5	1.5	-3
		2				
SS-RSRP <sup>Note3</sup>	dBm/SCS	1	-96	-91.5	-91.5	-96
		2	-93	-88.5	-88.5	-93
Io on SSB symbols of each cell	dBm/95.04 MHz	1	-67.40	-65.34	-65.34	-67.40
		2	-64.40	-62.34	-62.34	-64.40
Treselection	s	1, 2	0	0	0	0
SintrasearchP	dB	1, 2	50		50	
Propagation Condition		1, 2	AWGN			

Note 1: OCNG shall be used such that both cells are fully allocated and a constant total transmitted power spectral density is achieved for all OFDM symbols.

Note 2: Interference from other cells and noise sources not specified in the test is assumed to be constant over subcarriers and time and shall be modelled as AWGN of appropriate power for  $N_{oc}$  to be fulfilled.

Note 3: SS-RSRP levels have been derived from other parameters for information purposes. They are not settable parameters themselves.

Note 4: Information about types of UE beam is given in B.2.1.3, and does not limit UE implementation or test system implementation

Note 5: Calculation of  $E_s/I_{ot\ BB}$  includes the effect of UE internal noise up to the value assumed for the associated Refsens requirement in clause 7.3.2 of TS 38.101-2 [19], and an allowance of 1dB for UE multi-band relaxation factor  $\Delta MB_P$  from TS 38.101-2 [19] Table 6.2.1.3-4.

### A.7.1.1.3.3 Test Requirements

The cell reselection delay to an already detected cell for UE fulfilling low mobility relaxed criterion is defined as the time from the beginning of time period T1, to the moment when the UE camps on Cell 2, and starts to send preambles on the PRACH for sending the *RRCSetupRequest* message to perform a Tracking Area Update procedure on Cell 2.

The cell re-selection delay to an already detected cell shall be less than 79 s.

The rate of correct cell reselections observed during repeated tests shall be at least 90%.

NOTE: The cell re-selection delay to an already detectable cell can be expressed as:  $T_{\text{evaluate, NR\_Intra}} + T_{\text{SI-NR}}$ ,

Where:

$T_{\text{evaluate, NR\_Intra}}$  See Table 4.2.2.9.1-1 in clause 4.2.2.9,

$T_{\text{SI-NR}}$  Maximum repetition period of relevant system info blocks that needs to be received by the UE to camp on a cell; 1280 ms is assumed in this test case.

This gives a total of 78.08 s, allow 79s for the cell re-selection delay to an already detected cell for UE fulfilling low mobility criterion in the test case.

### A.7.1.1.4 Cell reselection to FR2 intra-frequency NR case for UE fulfilling not-at-cell edge relaxed measurement criterion

#### A.7.1.1.4.1 Test Purpose and Environment

This test is to verify the requirement for the intra frequency NR cell reselection requirements for UE configured with relaxed measurement criterion specified in clause 4.2.2.9.3.

#### A.7.1.1.4.2 Test Parameters

The test scenario comprises of 1 NR carrier and 2 cells as given in tables A.7.1.1.4.2-1, A.7.1.1.4.2-2 and A.7.1.1.4.2-3. The test consists of two successive time periods, with time duration of T1 and T2 respectively. Both cell 1 and cell 2 are already identified by the UE prior to the start of the test. Cell 1 and cell 2 belong to different tracking areas. During T1 and T2, only criteria *cellEdgeEvaluation* is configured and fulfilled, where  $S_{\text{rxlev}} > S_{\text{SearchThresholdP}}$ . UE has not registered with network for the tracking area containing cell2.

**Table A.7.1.1.4.2-1: Supported test configurations**

Configuration	Description
1	120 kHz SSB SCS, 100 MHz bandwidth, TDD duplex mode
2	240 kHz SSB SCS, 100 MHz bandwidth, TDD duplex mode
Note:	The UE is only required to be tested in one of the supported test configurations.

**Table A.7.1.1.4.2-2: General test parameters for FR2 intra-frequency NR cell re-selection test case for UE fulfilling not-at-cell edge criterion**

Parameter	Unit	Test configuration	Value	Comment
Initial condition	Active cell	1, 2	Cell1	The UE camps on cell 1 in the initial phase
	Neighbour cells	1, 2	Cell2	
T1 end condition	Active cell	1, 2	Cell2	The UE reselects to cell 2 during T1 period
	Neighbour cells	1, 2	Cell1	
Final condition	Active cell	1, 2	Cell1	
	Neighbour cells	1, 2	Cell2	
RF Channel Number		1, 2	1	
Time offset between cells		1, 2	3 $\mu$ s	Synchronous cells
Access Barring Information	-	1, 2	Not Sent	No additional delays in random access procedure.
SMTC configuration		1, 2	SMTC pattern 1	



DRX cycle length	s	1, 2	0.64	The value shall be used for all cells in the test.
PRACH configuration index		1, 2	190	The detailed configuration is specified in TS 38.211 clause 6.3.3.2
rangeToBestCell		1, 2	Not configured	
T1	s	1, 2	100	
T2	s	1, 2	100	

**Table A.7.1.1.4.2-3: Cell specific test parameters for FR2 intra-frequency NR cell re-selection test case in AWGN for UE fulfilling not-at-cell edge criterion**

Parameter	Unit	Test configuration	Cell 1		Cell 2	
			T1	T2	T1	T2
TDD configuration		1, 2	TDDConf.3.1		TDDConf.3.1	
PDSCH RMC configuration		1	SR.3.1 TDD		SR.3.1 TDD	
		2	SR.3.1 TDD		SR.3.1 TDD	
RMSI CORESET RMC configuration		1	CR.3.1 TDD		CR.3.1 TDD	
		2	CR.3.1 TDD		CR.3.1 TDD	
Dedicated CORESET RMC configuration		1	CCR.3.1 TDD		CCR.3.1 TDD	
		2	CCR.3.1 TDD		CCR.3.1 TDD	
SSB configuration		1	SSB.3 FR2		SSB.7 FR2	
		2	SSB.4 FR2		SSB.8 FR2	
OCNG Pattern		1, 2	OP.4		OP.4	
BW <sub>channel</sub>	MHz	1, 2	100: N <sub>RB,c</sub> = 66		100: N <sub>RB,c</sub> = 66	
Data RBs allocated		1, 2	66		66	
Initial DL BWP configuration		1, 2	DLBWP.0.1		DLBWP.0.1	
Initial UL BWP configuration		1, 2	ULBWP.0.1		ULBWP.0.1	
RLM-RS		1, 2	SSB		SSB	
Qrxlevmin	dBm/SCS	1	-140		-140	
		2	-137		-137	
Pcompensation	dB	1, 2	0		0	
Qhyst <sub>s</sub>	dB	1, 2	0		0	
Qoffset <sub>s, n</sub>	dB	1, 2	0		0	
Cell_selection_and_reselection_quality_measurement		1, 2	SS-RSRP		SS-RSRP	
AoA setup		1, 2	Setup 1 defined in A.3.15.1		Setup 1 defined in A.3.15.1	
Beam assumption <sup>Note 4</sup>		1,2	Rough		Rough	
$\hat{E}_s/I_{ot\ BB}$ <sup>Note 5</sup>	dB	1	-3.55	0.95	0.95	-3.55
		2				
$N_{oc}$ <sup>Note2</sup>	dBm/SCS	1	-93			
		2	-90			
$N_{oc}$ <sup>Note2</sup>	dBm/15 kHz	1	-102			
		2				
$\hat{E}_s/N_{oc}$	dB	1	-3	1.5	1.5	-3
		2				
SS-RSRP <sup>Note3</sup>	dBm/SCS	1	-96	-91.5	-91.5	-96
		2	-93	-88.5	-88.5	-93
Io on SSB symbols of each cell	dBm/95.04 MHz	1	-67.40	-65.34	-65.34	-67.40
		2	-64.40	-62.34	-62.34	-64.40
Treselection	s	1, 2	0	0	0	0
S <sub>SearchThresholdP</sub>		1, 2	35	35	35	35
S <sub>IntrasearchP</sub>	dB	1, 2	50		50	

Propagation Condition		1, 2	AWGN
Note 1:	OCNG shall be used such that both cells are fully allocated and a constant total transmitted power spectral density is achieved for all OFDM symbols.		
Note 2:	Interference from other cells and noise sources not specified in the test is assumed to be constant over subcarriers and time and shall be modelled as AWGN of appropriate power for $N_{oc}$ to be fulfilled.		
Note 3:	SS-RSRP levels have been derived from other parameters for information purposes. They are not settable parameters themselves.		
Note 4:	Information about types of UE beam is given in B.2.1.3, and does not limit UE implementation or test system implementation		
Note 5:	Calculation of $E_s/lot_{BB}$ includes the effect of UE internal noise up to the value assumed for the associated Refsens requirement in clause 7.3.2 of TS 38.101-2 [19], and an allowance of 1dB for UE multi-band relaxation factor $\Delta MB_P$ from TS 38.101-2 [19] Table 6.2.1.3-4.		

#### A.7.1.1.4.3 Test Requirements

The cell reselection delay to an already detected cell is defined as the time from the beginning of time period T1, to the moment when the UE camps on Cell 1, and starts to send preambles on the PRACH for sending the *RRCSetupRequest* message to perform a Tracking Area Update procedure on Cell 1.

The cell re-selection delay to an already detected cell shall be less than 79 s.

The rate of correct cell reselections observed during repeated tests shall be at least 90%.

NOTE: The cell re-selection delay to an already detected cell can be expressed as:  $T_{\text{evaluate, NR\_Intra}} + T_{\text{SI-NR}}$ ,

Where:

$T_{\text{evaluate, NR\_Intra}}$  See Table 4.2.2.9.3-1 in clause 4.2.2.9,

$T_{\text{SI-NR}}$  Maximum repetition period of relevant system info blocks that needs to be received by the UE to camp on a cell; 1280 ms is assumed in this test case.

This gives a total of 78.08 s, allow 79s for the cell re-selection delay to an already detected cell for UE fulfilling not-at-cell edge criterion in the test case.

#### A.7.1.1.5 Cell reselection to FR2 inter-frequency NR case for UE fulfilling low mobility relaxed measurement criterion

##### A.7.1.1.5.1 Test Purpose and Environment

This test is to verify the requirement for the inter frequency NR cell reselection requirements for UE fulfilling low mobility criterion specified in clause 4.2.2.10.2.

##### A.7.1.1.5.2 Test Parameters

The test scenario comprises of 2 cells (Cell 1 and Cell 2) on 2 different NR carriers respectively as given in tables A.7.1.1.5.2-1, A.7.1.1.5.2-2 and A.7.1.1.5.2-3. The test consists of two successive time periods, with time duration of T1 and T2 respectively. Both cell 1 and cell 2 are already identified by the UE prior to the start of the test. Cell 1 and Cell 2 belong to different tracking areas. Furthermore, UE has not registered with network for the tracking area containing Cell 2. Cell 2 is of higher priority than Cell 1. The UE is configured with *lowMobilityEvaluation* criterion [2].

**Table A.7.1.1.5.2-1: Supported test configurations**

Configuration	Description for serving cell	Description for target cell
1	120 kHz SSB SCS, 100 MHz bandwidth, TDD duplex mode	120 kHz SSB SCS, 100 MHz bandwidth, TDD duplex mode
2	240 kHz SSB SCS, 100 MHz bandwidth, TDD duplex mode	240 kHz SSB SCS, 100 MHz bandwidth, TDD duplex mode
Note: The UE is only required to be tested in one of the supported test configurations.		

**Table A.7.1.1.5.2-2: General test parameters for FR2 inter frequency NR cell re-selection test case for UE fulfilling low mobility criterion**

Parameter		Unit	Test configuration	Value	Comment
Initial condition	Active cell		1, 2	Cell2	The UE camps on cell2 and fulfils low mobility ( <i>lowMobilityEvaluation</i> [2]) criterion.
	Neighbour cell		1, 2	Cell1	
T1 final condition	Active cell		1, 2	Cell1	The UE reselects to low priority cell1 during T1
	Neighbour cell		1, 2	Cell2	
T2 final condition	Active cell		1, 2	Cell2	The UE reselects to high priority cell2 during T2
	Neighbour cell			Cell1	
RF Channel Number			1, 2	1, 2	
Time offset between cells			1, 2	3 $\mu$ s	Synchronous cells
Access Barring Information		-	1, 2	Not Sent	No additional delays in random access procedure.
SSB configuration			1	SSB.1 FR2	
			2	SSB.2 FR2	
SMTC configuration			1, 2	SMTC pattern 1	
DRX cycle length		s	1, 2	0.64	The value shall be used for all cells in the test.
PRACH configuration index			1, 2	190	The detailed configuration is specified in TS 38.211 clause 6.3.3.2
rangeToBestCell			1, 2	Not configured	
T1		s	1, 2	85	T1 needs to be long enough to allow cell re-selection to already known cell1
T2		s	1, 2	85	T2 needs to be long enough to allow cell re-selection to already known cell2

**Table A.7.1.1.5.2-3: Cell specific test parameters for FR2 inter frequency NR cell re-selection test case in AWGN for UE fulfilling low mobility criterion**

Parameter	Unit	Test configuration	Cell 1		Cell 2	
			T1	T2	T1	T2
TDD configuration		1, 2	TDDConf.3.1		TDDConf.3.1	
PDSCH RMC configuration		1, 2	SR.3.1 TDD		SR.3.1 TDD	
RMSI CORESET parameters		1, 2	CR.3.1 TDD		CR.3.1 TDD	
RMSI CORESET RMC configuration		1, 2	CCR.3.1 TDD		CCR.3.1 TDD	
OCNG Pattern		1, 2	OP.1 defined in A.3.2.1		OP.1 defined in A.3.2.1	
BW <sub>channel</sub>	MHz	1, 2	100: N <sub>RB,c</sub> = 66		100: N <sub>RB,c</sub> = 66	
Data RBs allocated		1, 2	66		66	
Initial DL BWP configuration		1, 2	DLBWP.0.1		DLBWP.0.1	
Initial UL BWP configuration		1, 2	ULBWP.0.1		ULBWP.0.1	
RLM-RS		1, 2	SSB		SSB	
Qrxlevmin	dBm/SCS	1	-140		-140	
		2	-137		-137	
Pcompensation	dB	1, 2	0		0	
Qhysts	dB	1, 2	0		0	
Qoffsets <sub>s,n</sub>	dB	1, 2	0		0	

Cell_selection_and_reselection_quality_measurement		1, 2	SS-RSRP		SS-RSRP	
AoA setup		1, 2	Setup 1 defined in A.3.15.1		Setup 1 defined in A.3.15.1	
Beam assumption <sup>Note 4</sup>		1, 2	Rough		Rough	
$\hat{E}_s / I_{ot\ BB}$ <sup>Note 5</sup>	dB	1, 2	9.95	7.45	-11.05	7.95
$N_{oc}$ <sup>Note 2</sup>	dBm/SCS	1	-93		-93	
		2	-90		-90	
$N_{oc}$ <sup>Note 2</sup>	dBm/15 kHz	1, 2	-102		-102	
$\hat{E}_s / N_{oc}$	dB	1, 2	10.5	8	-10.5	8.5
		SS-RSRP <sup>Note 3</sup>	dBm/SCS	1	-82.5	-85
		2	-79.5	-82	-100.5	-81.5
$I_o$	dBm/95.04 MHz	1, 2	-53.14	-55.37	-63.64	-54.94
TreselectionNR	s	1, 2	0		0	
SnonintrasearchP	dB	1, 2	50		Not sent	
S <sub>SearchDeltaP</sub>	dB	1, 2	6		6	
T <sub>SearchDeltaP</sub>	s	1, 2	5		5	
Thresh <sub>x, highP</sub>	dB	1, 2	48		48	
Thresh <sub>serv, lowP</sub>	dB	1, 2	44		44	
Thresh <sub>x, lowP</sub>	dB	1, 2	50		50	
Propagation Condition		1, 2	AWGN		AWGN	
<p>Note 1: OCNG shall be used such that both cells are fully allocated and a constant total transmitted power spectral density is achieved for all OFDM symbols.</p> <p>Note 2: Interference from other cells and noise sources not specified in the test is assumed to be constant over subcarriers and time and shall be modelled as AWGN of appropriate power for <math>N_{oc}</math> to be fulfilled.</p> <p>Note 3: SS-RSRP levels have been derived from other parameters for information purposes. They are not settable parameters themselves.</p> <p>Note 4: Information about types of UE beam is given in B.2.1.3, and does not limit UE implementation or test system implementation</p> <p>Note 5: Calculation of <math>E_s / I_{ot\ BB}</math> includes the effect of UE internal noise up to the value assumed for the associated Refsens requirement in clause 7.3.2 of TS 38.101-2 [19], and an allowance of 1dB for UE multi-band relaxation factor <math>\Delta MB_P</math> from TS 38.101-2 [19] Table 6.2.1.3-4.</p>						

### A.7.1.1.5.3 Test Requirements

The cell reselection delay to an already detected low priority cell (Cell 1) for UE fulfilling low mobility criterion is defined as the time from the beginning of time period T1, to the moment when the UE camps on Cell 1, and starts to send preambles on the PRACH for sending the *RRCSetupRequest* message to perform a Tracking Area Update procedure on Cell 1.

The cell re-selection delay to an already detected low priority cell, Cell 1, shall be less than 79 s.

The cell reselection delay to an already detected high priority cell (Cell 2) for UE fulfilling low mobility criterion is defined as the time from the beginning of time period T2, to the moment when the UE camps on Cell 2, and starts to send preambles on the PRACH for sending the *RRCSetupRequest* message to perform a Tracking Area Update procedure on Cell 2.

The cell re-selection delay to an already detected high priority cell, Cell 2, shall be less than 79 s.

The rate of correct cell reselections observed during repeated tests shall be at least 90%.

NOTE 1: The cell re-selection delay to an already detected low priority cell can be expressed as:  $T_{evaluate, NR\_inter} + T_{SI-NR}$

NOTE 2: The cell re-selection delay to an already detected higher priority cell can be expressed as:  $T_{evaluate, NR\_inter} + T_{SI-NR}$

Where:

$T_{\text{evaluate, NR\_inter}}$  See Table 4.2.2.10.2-1 in clause 4.2.2.10.2

$T_{\text{SI-NR}}$  Maximum repetition period of relevant system info blocks that needs to be received by the UE to camp on a cell; 1280 ms is assumed in this test case.

This gives a total of 78.08 s, allow 79 s for the cell re-selection delay to an already detected low priority cell for UE fulfilling low mobility criterion in the test case.

This gives a total of 78.08 s, allow 79 s for the cell re-selection delay to an already detected high priority cell for UE fulfilling low mobility criterion in the test case.

### A.7.1.1.6 Cell reselection to FR2 inter-frequency NR case for UE fulfilling not-at-cell edge relaxed measurement criterion

#### A.7.1.1.6.1 Test Purpose and Environment

This test is to verify the requirement for the inter frequency NR cell reselection requirements for UE fulfilling not-at-cell edge criterion specified in clause 4.2.2.10.3.

#### A.7.1.1.6.2 Test Parameters

The test scenario comprises of 2 cells (Cell 1 and Cell 2) on 2 different NR carriers respectively as given in tables A.7.1.1.6.2-1, A.7.1.1.6.2-2 and A.7.1.1.6.2-3. The test consists of two successive time periods, with time duration of T1 and T2 respectively. Both cell 1 and cell 2 are already identified by the UE prior to the start of the test. Cell 1 and Cell 2 belong to different tracking areas. Furthermore, UE has not registered with network for the tracking area containing Cell 2. Cell 2 is of higher priority than Cell 1. The UE is configured with *cellEdgeEvaluation* criterion [2].

**Table A.7.1.1.6.2-1: Supported test configurations**

Configuration	Description for serving cell	Description for target cell
1	120 kHz SSB SCS, 100 MHz bandwidth, TDD duplex mode	120 kHz SSB SCS, 100 MHz bandwidth, TDD duplex mode
2	240 kHz SSB SCS, 100 MHz bandwidth, TDD duplex mode	240 kHz SSB SCS, 100 MHz bandwidth, TDD duplex mode
Note: The UE is only required to be tested in one of the supported test configurations.		

**Table A.7.1.1.6.2-2: General test parameters for FR2 inter frequency NR cell re-selection test case for UE fulfilling not-at-cell edge criterion**

Parameter	Unit	Test configuration	Value	Comment
Initial condition		1, 2	Cell2	The UE camps on cell2 and fulfils not-at-cell edge ( <i>cellEdgeEvaluation</i> [2]) criterion.
			Cell1	
T1 final condition		1, 2	Cell1	The UE reselects to low priority cell1 during T1
			Cell2	
T2 final condition		1, 2	Cell2	The UE reselects to high priority cell2 during T2
			Cell1	
RF Channel Number		1, 2	1, 2	
Time offset between cells		1, 2	3 $\mu$ s	Synchronous cells
Access Barring Information	-	1, 2	Not Sent	No additional delays in random access procedure.
SSB configuration		1, 2	SSB.1 FR2	
			SSB.2 FR2	
SMTTC configuration		1, 2	SMTTC pattern 1	
DRX cycle length	s	1, 2	0.64	The value shall be used for all cells in the test.
PRACH configuration index		1, 2	190	The detailed configuration is specified in TS 38.211 clause 6.3.3.2
rangeToBestCell		1, 2	Not configured	

T1	s	1, 2	85	T1 needs to be long enough to allow cell re-selection to already known cell.
T2	s	1, 2	[85]	T2 needs to be long enough to allow cell re-selection to already known cell.

**Table A.7.1.1.6.2-3: Cell specific test parameters for FR2 inter frequency NR cell re-selection test case in AWGN for UE fulfilling not-at-cell edge criterion**

Parameter	Unit	Test configuration	Cell 1		Cell 2	
			T1	T2	T1	T2
TDD configuration		1, 2	TDDConf.3.1		TDDConf.3.1	
PDSCH RMC configuration		1, 2	SR.3.1 TDD		SR.3.1 TDD	
RMSI CORESET parameters		1, 2	CR.3.1 TDD		CR.3.1 TDD	
RMSI CORESET RMC configuration		1, 2	CCR.3.1 TDD		CCR.3.1 TDD	
OCNG Pattern		1, 2	OP.1 defined in A.3.2.1		OP.1 defined in A.3.2.1	
$BW_{channel}$	MHz	1, 2	100: $N_{RB,C} = 66$		100: $N_{RB,C} = 66$	
Data RBs allocated		1, 2	66		66	
Initial DL BWP configuration		1, 2	DLBWP.0.1		DLBWP.0.1	
Initial UL BWP configuration		1, 2	ULBWP.0.1		ULBWP.0.1	
RLM-RS		1, 2	SSB		SSB	
Qrxlevmin	dBm/SCS	1	-140		-140	
		2	-137		-137	
Pcompensation	dB	1, 2	0		0	
Qhyst <sub>s</sub>	dB	1, 2	0		0	
Qoffset <sub>s,n</sub>	dB	1, 2	0		0	
Cell_selection_and_reselection_quality_measurement		1, 2	SS-RSRP		SS-RSRP	
AoA setup		1, 2	Setup 1 defined in A.3.15.1		Setup 1 defined in A.3.15.1	
Beam assumption <sup>Note 4</sup>		1, 2	Rough		Rough	
$\hat{E}_s/I_{ot\ BB}$ <sup>Note 5</sup>	dB	1, 2	9.95	7.45	-11.05	7.95
$N_{oc}$ <sup>Note 2</sup>	dBm/SCS	1	-93		-93	
		2	-90		-90	
$N_{oc}$ <sup>Note 2</sup>	dBm/15 kHz	1, 2	-102		-102	
$\hat{E}_s/N_{oc}$	dB	1, 2	10.5	8	-10.5	8.5
SS-RSRP <sup>Note 3</sup>	dBm/SCS	1	-82.5	-85	-103.5	-84.5
		2	-79.5	-82	-100.5	-81.5
$I_o$ $S_{SearchThresholdP}$	dBm/95.04 MHz	1, 2	-53.14	-55.37	-63.64	-54.94
		1, 2	35	35	29	29
TreselectionNR	s	1, 2	0		0	
SnonintrasearchP	dB	1, 2	50		Not sent	
Thresh <sub>x, highP</sub>	dB	1, 2	48		48	
Thresh <sub>serv, lowP</sub>	dB	1, 2	44		44	
Thresh <sub>x, lowP</sub>	dB	1, 2	50		50	
Propagation Condition		1, 2	AWGN		AWGN	

Note 1:	OCNG shall be used such that both cells are fully allocated and a constant total transmitted power spectral density is achieved for all OFDM symbols.
Note 2:	Interference from other cells and noise sources not specified in the test is assumed to be constant over subcarriers and time and shall be modelled as AWGN of appropriate power for $N_{oc}$ to be fulfilled.
Note 3:	SS-RSRP levels have been derived from other parameters for information purposes. They are not settable parameters themselves.
Note 4:	Information about types of UE beam is given in B.2.1.3, and does not limit UE implementation or test system implementation
Note 5:	Calculation of $E_s/lot_{BB}$ includes the effect of UE internal noise up to the value assumed for the associated Refsens requirement in clause 7.3.2 of TS 38.101-2 [19], and an allowance of 1dB for UE multi-band relaxation factor $\Delta MB_P$ from TS 38.101-2 [19] Table 6.2.1.3-4.

### A.7.1.1.6.3 Test Requirements

The cell reselection delay to an already detected low priority cell (Cell 1) for UE fulfilling not-at-cell edge criterion is defined as the time from the beginning of time period T1, to the moment when the UE camps on Cell 1, and starts to send preambles on the PRACH for sending the *RRCSetupRequest* message to perform a Tracking Area Update procedure on Cell 1.

The cell re-selection delay to an already detected low priority cell, Cell 1, shall be less than 79 s.

The cell reselection delay to an already detected high priority cell (Cell 2) for UE fulfilling not-at-cell edge criterion is defined as the time from the beginning of time period T2, to the moment when the UE camps on Cell 2, and starts to send preambles on the PRACH for sending the *RRCSetupRequest* message to perform a Tracking Area Update procedure on Cell 2.

The cell re-selection delay to an already detected high priority cell, Cell 2, shall be less than 79 s.

The rate of correct cell reselections observed during repeated tests shall be at least 90%.

NOTE 1: The cell re-selection delay to an already detected low priority cell can be expressed as:  $T_{\text{evaluate, NR\_inter}} + T_{\text{SI-NR}}$

NOTE 2: The cell re-selection delay to an already detected higher priority cell can be expressed as:  $T_{\text{evaluate, NR\_inter}} + T_{\text{SI-NR}}$

Where:

$T_{\text{evaluate, NR\_inter}}$  See Table 4.2.2.10.3-1 in clause 4.2.2.10.3

$T_{\text{SI-NR}}$  Maximum repetition period of relevant system info blocks that needs to be received by the UE to camp on a cell; 1280ms is assumed in this test case.

This gives a total of 78.8 s, allow 79 s for the cell re-selection delay to an already detected low priority cell for UE fulfilling not-at-cell edge criterion in the test case.

This gives a total of 78.08 s, allow 79 s for the cell re-selection delay to an already detected high priority cell for UE fulfilling not-at-cell edge criterion in the test case.

## A.7.2 SA: RRC\_INACTIVE state mobility

## A.7.3 RRC\_CONNECTED state mobility

### A.7.3.1 Handover

#### A.7.3.1.1 Inter-frequency handover from FR1 to FR2; unknown target cell

##### A.7.3.1.1.1 Test Purpose and Environment

This test is to verify the requirement for the NR FR1-NR FR2 inter frequency handover requirements specified in clause 6.1.1.5.

##### A.7.3.1.1.2 Test Parameters

Supported test configurations are shown in table A.7.3.1.2-1. Both handover delay and interruption length are tested by using the parameters in table A.7.3.1.1.2-2, and A.7.3.1.1.2-3.

The test scenario comprises of two carriers and one cell on each carrier. No gap patterns are configured in the test case. The test consists of two successive time periods, with time durations of T1, T2 respectively. At the start of time duration T1, the UE does not have any timing information of cell 2. Starting T2, cell 2 becomes detectable and the UE receives a RRC handover command from the network. The start of T2 is the instant when the last TTI containing the RRC message implying handover is sent to the UE.

**Table A.7.3.1.1.2-1: Inter-frequency handover from FR1 to FR2 test configurations**

Config	Description
1	Source cell: NR 15 kHz SSB SCS, 10 MHz bandwidth, FDD duplex mode Target cell: NR 120 kHz SSB SCS, 100 MHz bandwidth, TDD duplex mode
2	Source cell: NR 15 kHz SSB SCS, 10 MHz bandwidth, TDD duplex mode Target cell: NR 120 kHz SSB SCS, 100 MHz bandwidth, TDD duplex mode
3	Source cell: NR 30 kHz SSB SCS, 40 MHz bandwidth, TDD duplex mode Target cell: NR 120 kHz SSB SCS, 100 MHz bandwidth, TDD duplex mode

Note: The UE is only required to be tested in one of the supported test configurations

**Table A.7.3.1.1.2-2: General test parameters Inter-frequency handover from FR1 to FR2**

Parameter	Unit	Value	Comment
Initial conditions	Active cell	Cell 1	
	Neighbouring cell	Cell 2	
Final condition	Active cell	Cell 2	
Access Barring Information	-	Not Sent	No additional delays in random access procedure.
Time offset between cells		3 $\mu$ s	Synchronous cells
T1	s	5	
T2	s	$\leq 10$	

**Table A.7.3.1.1.2-3: Cell specific test parameters for NR FR1-FR2 Inter frequency handover test case**

Parameter	Unit	Cell 1		Cell 2	
		T1	T2	T1	T2
Assumption for UE beams <sup>Note 6</sup>		N/A		Rough	
AoA setup		NA		Setup 1 as defined in A.3.15	
NR RF Channel Number		<b>1</b>		<b>2</b>	
Duplex mode	Config 1	FDD		TDD	
	Config 2,3	TDD		TDD	
TDD configuration	Config 1	Not Applicable		TDDConf.3.1	
	Config 2	TDDConf.1.1		TDDConf.3.1	
	Config 3	TDDConf.2.1		TDDConf.3.1	
BW <sub>channel</sub>	Config 1	10: N <sub>RB,c</sub> = 52		100: N <sub>RB,c</sub> = 66	
	Config 2	10: N <sub>RB,c</sub> = 52		100: N <sub>RB,c</sub> = 66	
	Config 3	40: N <sub>RB,c</sub> = 106		100: N <sub>RB,c</sub> = 66	



BWP BW	Config 1	MHz	10: $N_{RB,c} = 52$	100: $N_{RB,c} = 66$	
	Config 2		10: $N_{RB,c} = 52$	100: $N_{RB,c} = 66$	
	Config 3		40: $N_{RB,c} = 106$	100: $N_{RB,c} = 66$	
Data RBs allocated	Config 1		52	66	
	Config 2		52	66	
	Config 3		106	66	
DRx Cycle		ms	Not Applicable		
PDSCH Reference measurement channel	Config 1		SR.1.1 FDD	SR3.1 TDD	
	Config 2		SR.1.1 TDD	SR3.1 TDD	
	Config 3		SR2.1 TDD	SR3.1 TDD	
RMSI CORESET Reference Channel	Config 1		CR.1.1 FDD	CR3.1 TDD	
	Config 2		CR.1.1 TDD	CR3.1 TDD	
	Config 3		CR2.1 TDD	CR3.1 TDD	
Control Channel RMC	Config 1		CCR.1.1 FDD	CCR.3.1 TDD	
	Config 2		CCR.1.1 TDD	CCR.3.1 TDD	
	Config 3		CCR.2.1 TDD	CCR.3.1 TDD	
OCNG Patterns			OP.1		
SSB configuration	Config 1,2		SSB.1 FR1	SSB.3 FR2	
	Config 3		SSB.2 FR1	SSB.3 FR2	
SMTC configuration	Config 1,2		SMTC.1	SMTC.1	
	Config 3		SMTC.2	SMTC.1	
SMTC configuration	Config 1,2		SMTC.1	SMTC.1	
	Config 3		SMTC.2	SMTC.1	
PDSCH/PDCCH subcarrier spacing	Config 1,2	kHz	15 kHz	120 kHz	
	Config 3		30 kHz	120 kHz	
PUCCH/PUSCH subcarrier spacing	Config 1,2	kHz	15 kHz	120 kHz	
	Config 3		30 kHz	120 kHz	
PRACH configuration			FR1 PRACH configuration 1	FR2 PRACH configuration 1	
TRS configuration	Config 1		TRS.1.1 FDD	TRS.2.1 TDD	
	Config 2		TRS.1.1 TDD	TRS.2.1 TDD	
	Config 3		TRS.1.2 TDD	TRS.2.1 TDD	
PDSCH/PDCCH TCI state			N/A	TCI.State.2	
BWP configuraiton	Initial DL BWP		DLBWP.0.1	DLBWP.0.1	
	Dedicated DL BWP		DLBWP.1.1	DLBWP.1.1	
	Initial UL BWP		ULBWP.0.1	ULBWP.0.1	
	Dedicated UL BWP		ULBWP.1.1	ULBWP.1.1	
EPRE ratio of PSS to SSS		dB	0		
EPRE ratio of PBCH DMRS to SSS			0		
EPRE ratio of PBCH to PBCH DMRS					
EPRE ratio of PDCCH DMRS to SSS					
EPRE ratio of PDCCH to PDCCH DMRS					
EPRE ratio of PDSCH DMRS to SSS					
EPRE ratio of PDSCH to PDSCH					
EPRE ratio of OCNG DMRS to SSS(Note 1)					
EPRE ratio of OCNG to OCNG DMRS (Note 1)					
$N_{oc}^{Note2}$		dBm/15kHz	Link only, see clause A.3.7A		
$N_{oc}^{Note2}$	Config 1,2	dBm/SCS	-104.7		
	Config 3		-95.7		
$\hat{E}_s / I_{ot}$		dB	-Infinity		
$\hat{E}_s / N_{oc}$			10		
$I_o^{Note3}$	Config 1,2	dBm/BW	-66.7	-56.3	
	Config 3		-66.7	-56.3	
Propagation condition		-	AWGN		

Note 1:	OCNG shall be used such that both cells are fully allocated and a constant total transmitted power spectral density is achieved for all OFDM symbols.
Note 2:	Interference from other cells and noise sources not specified in the test is assumed to be constant over subcarriers and time and shall be modelled as AWGN of appropriate power for $N_{oc}$ to be fulfilled.
Note 3:	lo levels have been derived from other parameters for information purposes. They are not settable parameters themselves.
Note 4:	Equivalent power received by an antenna with 0 dBi gain at the centre of the quiet zone
Note 5:	As observed with 0 dBi gain antenna at the centre of the quiet zone
Note 6:	Information about types of UE beam is given in B.2.1.3, and does not limit UE implementation or test system implementation

### A.7.3.1.1.3 Test Requirements

The UE shall start to transmit the PRACH to Cell 2 less than 572 ms from the beginning of time period T2. The rate of correct handovers observed during repeated tests shall be at least 90%.

NOTE: The handover delay can be expressed as: RRC procedure delay +  $T_{interrupt}$ , where:

RRC procedure delay = [10] ms and is specified in clause 12 in TS 38.331 [2].

$T_{interrupt}$  = 562 ms in the test.  $T_{interrupt}$  is defined in clause 6.1.1.5.2.

This gives a total of 572 ms.

### A.7.3.1.2 Intra-frequency handover from FR2 to FR2; unknown target cell

#### A.7.3.1.2.1 Test Purpose and Environment

This test is to verify the requirement for the NR FR2-NR FR2 intra frequency handover requirements specified in clause 6.1.1.4.

#### A.7.3.1.2.2 Test Parameters

Supported test configurations are shown in table A.7.3.1.2.2-1. Both handover delay and interruption length are tested by using the parameters in table A.7.3.1.2.2-2, and A.7.3.1.2.2-3.

The test scenario comprises of carriers and one cell on each carrier. No gap patterns are configured in the test case. The test consists of two successive time periods, with time durations of T1, T2 respectively. At the start of time duration T1, the UE does not have any timing information of cell 2. Starting T2, cell 2 becomes detectable and the UE receives a RRC handover command from the network. The start of T2 is the instant when the last TTI containing the RRC message implying handover is sent to the UE.

**Table A.7.3.1.2.2-1: Intra-frequency handover from FR2 to FR2 test configurations**

Config	Description
1	Source cell: NR 120 kHz SSB SCS, 100 MHz bandwidth, TDD duplex mode Target cell: NR 120 kHz SSB SCS, 100 MHz bandwidth, TDD duplex mode

**Table A.7.3.1.2.2-2: General test parameters Intra-frequency handover from FR2 to FR2**

Parameter	Unit	Value	Comment
Initial conditions	Active cell	Cell 1	
	Neighbouring cell	Cell 2	
Final condition	Active cell	Cell 2	
Access Barring Information	-	Not Sent	No additional delays in random access procedure.
Time offset between cells		3 $\mu$ s	Synchronous cells
T1	s	5	
T2	s	$\leq 10$	

**Table A.7.3.1.2.2-3: Cell specific test parameters for NR FR2-FR2 Intra frequency handover test case**

Parameter	Unit	Cell 1	Cell 2
-----------	------	--------	--------

			T1	T2	T1	T2
Assumption for UE beams <sup>Note 6</sup>			Rough		Rough	
AoA setup			Setup 1 as defined in A.3.15			
NR RF Channel Number			1		1	
Duplex mode			TDD			
TDD configuration			TDDConf.3.1			
BW <sub>channel</sub>		MHz	100: N <sub>RB,c</sub> = 66			
BWP BW		MHz	100: N <sub>RB,c</sub> = 66			
Data RBs allocated			66			
DRx Cycle		ms	Not Applicable			
PDSCH Reference measurement channel			SR3.1 TDD			
RMSI CORESET Reference Channel			CR3.1 TDD			
Control Channel RMC			CCR.3.1 TDD			
OCNG Patterns			OP.1			
SMTC Configuration			SMTC pattern 1			
SSB Configuration			SSB.3 FR2			
PDSCH/PDCCH subcarrier spacing		kHz	120 kHz			
PUCCH/PUSCH subcarrier spacing		kHz	120 kHz			
PRACH configuration			FR2 PRACH configuration 1			
TRS configuration			TRS.2.1 TDD			
PDSCH/PDCCH TCI state			TCI.State.2			
BWP configuraiton	Initial DL BWP		DLBWP.0.1			
	Dedicated DL BWP		DLBWP.1.1			
	Initial UL BWP		ULBWP.0.1			
	Dedicated UL BWP		ULBWP.1.1			
EPRE ratio of PSS to SSS		dB	0		0	
EPRE ratio of PBCH DMRS to SSS						
EPRE ratio of PBCH to PBCH DMRS						
EPRE ratio of PDCCH DMRS to SSS						
EPRE ratio of PDCCH to PDCCH DMRS						
EPRE ratio of PDSCH DMRS to SSS						
EPRE ratio of PDSCH to PDSCH						
EPRE ratio of OCNG DMRS to SSS(Note 1)						
EPRE ratio of OCNG to OCNG DMRS (Note 1)						
$N_{oc}$ <sup>Note2</sup>						
$N_{oc}$ <sup>Note2</sup>		dBm/SCS	-95.7			
$\hat{E}_s / I_{ot}$		dB	6	-1.8	-Infinity	0
$\hat{E}_s / N_{oc}$		dB	6	6	-Infinity	7
$I_o$ <sup>Note3</sup>		dBm/BW	-59.7	-56.7	-59.7	-56.7
Propagation condition		-	AWGN		AWGN	
<p>Note 1: OCNG shall be used such that both cells are fully allocated and a constant total transmitted power spectral density is achieved for all OFDM symbols.</p> <p>Note 2: Interference from other cells and noise sources not specified in the test is assumed to be constant over subcarriers and time and shall be modelled as AWGN of appropriate power for <math>N_{oc}</math> to be fulfilled.</p> <p>Note 3: <math>I_o</math> levels have been derived from other parameters for information purposes. They are not settable parameters themselves.</p> <p>Note 4: Equivalent power received by an antenna with 0 dBi gain at the centre of the quiet zone</p> <p>Note 5: As observed with 0 dBi gain antenna at the centre of the quiet zone</p> <p>Note 6: Information about types of UE beam is given in B.2.1.3, and does not limit UE implementation or test system implementation</p>						

A.7.3.1.2.3 Test Requirements

The UE shall start to transmit the PRACH to Cell 2 less than 232 ms from the beginning of time period T2. The rate of correct handovers observed during repeated tests shall be at least 90%.

NOTE: The handover delay can be expressed as: RRC procedure delay +  $T_{interrupt}$ , where:

RRC procedure delay = 10 ms and is specified in clause 12 in TS 38.331 [2].

$T_{\text{interrupt}} = 222$  ms in the test.  $T_{\text{interrupt}}$  is defined in clause 6.1.1.4.2.

This gives a total of 232 ms.

### A.7.3.1.3 Inter-frequency handover from FR2 to FR2; unknown target cell

#### A.7.3.1.3.1 Test Purpose and Environment

This test is to verify the requirement for the NR FR2-NR FR2 inter frequency handover requirements specified in clause 6.1.1.4.

#### A.7.3.1.3.2 Test Parameters

Supported test configurations are shown in table A.7.3.1.3.2-1. Both handover delay and interruption length are tested by using the parameters in table A.7.3.1.3.2-2, and A.7.3.1.3.2-3.

The test scenario comprises of carriers and one cell on each carrier. No gap patterns are configured in the test case. The test consists of two successive time periods, with time durations of T1, T2 respectively. At the start of time duration T1, the UE does not have any timing information of cell 2. Starting T2, cell 2 becomes detectable and the UE receives a RRC handover command from the network. The start of T2 is the instant when the last TTI containing the RRC message implying handover is sent to the UE.

**Table A.7.3.1.3.2-1: Inter-frequency handover from FR2 to FR2 test configurations**

Config	Description
1	Source cell: NR 120 kHz SSB SCS, 100 MHz bandwidth, TDD duplex mode Target cell: NR 120 kHz SSB SCS, 100 MHz bandwidth, TDD duplex mode

**Table A.7.3.1.3.2-2: General test parameters Inter-frequency handover from FR2 to FR2**

Parameter	Unit	Value	Comment
Initial conditions	Active cell	Cell 1	
	Neighbouring cell	Cell 2	
Final condition	Active cell	Cell 2	
Access Barring Information	-	Not Sent	No additional delays in random access procedure.
Time offset between cells		3 $\mu$ s	Synchronous cells
T1	s	5	
T2	s	$\leq 10$	

**Table A.7.3.1.3.2-3: Cell specific test parameters for NR FR2-FR2 Inter frequency handover test case**

Parameter	Unit	Cell 1		Cell 2	
		T1	T2	T1	T2
Assumption for UE beams <sup>Note 6</sup>		Rough		Rough	
AoA setup		Setup 1 as defined in A.3.15			
NR RF Channel Number		1		2	
Duplex mode		TDD			
TDD configuration		TDDConf.3.1			
BW <sub>channel</sub>	MHz	100: N <sub>RB,c</sub> = 66			
BWP BW	MHz	100: N <sub>RB,c</sub> = 66			
Data RBs allocated		66			
DRx Cycle	ms	Not Applicable			
PDSCH Reference measurement channel		SR3.1 TDD			
RMSI CORESET Reference Channel		CR3.1 TDD			
Control Channel RMC		CCR.3.1 TDD			
OCNG Patterns		OP.1			
SMTC Configuration		SMTC pattern 1			
SSB Configuration		SSB.3 FR2			
PDSCH/PDCCH subcarrier spacing	kHz	120 kHz			
PUCCH/PUSCH subcarrier spacing	kHz	120 kHz			
PRACH configuration		FR2 PRACH configuration 1			
TRS configuration		TRS.2.1 TDD			
PDSCH/PDCCH TCI state		TCI.State.2			

BWP configuraiton	Initial DL BWP		DLBWP.0.1			
	Dedicated DL BWP		DLBWP.1.1			
	Initial UL BWP		ULBWP.0.1			
	Dedicated UL BWP		ULBWP.1.1			
EPRE ratio of PSS to SSS	dB	0		0		
EPRE ratio of PBCH DMRS to SSS						
EPRE ratio of PBCH to PBCH DMRS						
EPRE ratio of PDCCH DMRS to SSS						
EPRE ratio of PDCCH to PDCCH DMRS						
EPRE ratio of PDSCH DMRS to SSS						
EPRE ratio of PDSCH to PDSCH						
EPRE ratio of OCNG DMRS to SSS(Note 1)						
EPRE ratio of OCNG to OCNG DMRS (Note 1)						
$N_{oc}^{Note2}$	dBm/15kHz	-104.7		-104.7		
$N_{oc}^{Note2}$	dBm/SCS	-95.7		-95.7		
$\hat{E}_s / I_{ot}$	dB	5	5	-Infinity	5	
$\hat{E}_s / N_{oc}$	dB	5	5	-Infinity	5	
$I_o^{Note3}$	dBm/BW	-60.5	-60.5	-66.7	-60.5	
Propagation condition	-	AWGN		AWGN		
Note 1:	OCNG shall be used such that both cells are fully allocated and a constant total transmitted power spectral density is achieved for all OFDM symbols.					
Note 2:	Interference from other cells and noise sources not specified in the test is assumed to be constant over subcarriers and time and shall be modelled as AWGN of appropriate power for $N_{oc}$ to be fulfilled.					
Note 3:	$I_o$ levels have been derived from other parameters for information purposes. They are not settable parameters themselves.					
Note 4:	Equivalent power received by an antenna with 0 dBi gain at the centre of the quiet zone					
Note 5:	As observed with 0 dBi gain antenna at the centre of the quiet zone					
Note 6:	Information about types of UE beam is given in B.2.1.3, and does not limit UE implementation or test system implementation					

### A.7.3.1.3.3 Test Requirements

The UE shall start to transmit the PRACH to Cell 2 less than 552 ms from the beginning of time period T2. The rate of correct handovers observed during repeated tests shall be at least 90%.

NOTE: The handover delay can be expressed as: RRC procedure delay +  $T_{interrupt}$ , where:

RRC procedure delay = 10 ms and is specified in clause 12 in TS 38.331 [2].

$T_{interrupt}$  = 542 ms in the test.  $T_{interrupt}$  is defined in clause 6.1.1.4.2.

This gives a total of 552 ms.

### A.7.3.1.4 Inter-band inter-frequency synchronous DAPS handover from FR1 to FR2

#### A.7.3.1.4.1 Test Purpose and Environment

This test is to verify the requirement for the FR1-to-FR2 Inter-band inter-frequency synchronous DAPS handover requirements specified in clause 6.1.3.4.

#### A.7.3.1.4.2 Test Parameters

Supported test configurations are shown in table A.7.3.1.4.2-1. Both handover delay and interruption length are tested by using the parameters in table A.7.3.1.4.2-2, A.7.3.1.4.2-3 and A.7.3.1.4.2-4.

The test scenario comprises of two bands each with one cell. The test consists of five successive time periods, with time durations of T1, T2, T3, T4 and T5 respectively.

Before the start of T1, the UE is connected to Cell 1 (source PCell) on radio channel 1 but is not aware of Cell 2 (neighbour cell) on radio channel 2. The UE shall be configured with periodic CSI reporting for cell1. During T1, the UE shall not have any timing information of Cell 2.

Before the start of T2, the UE in the measurement control information that event-triggered reporting with Event A4 is configured for neighbour cell (Cell 2), and the UE is configured with the measurement gaps (gap pattern ID # 0). Starting T2, Cell 2 becomes known to the UE. During T2, the UE shall report Event A4. After receiving the Event A4, the test system shall send a RRC message implying DAPS handover to the UE.

The start of T3 is the instant when the test system receives the ACK of the PDSCH corresponding to the last TTI containing the RRC message implying DAPS handover to Cell 2 (target PCell) sent to the UE. During T3, the UE shall be able to perform random access to Cell 2. DL schedule and UL feedback to cell 1 shall be avoided when UE is required to perform DL reception or UL transmission in PRACH procedure in cell 2, except preamble transmission. After the RACH procedure is completed, the test system shall send a RRC message to the UE to release Cell 1 (source cell) on radio channel 1.

The start of T4 is the instant when the test system receives the ACK of the PDSCH corresponding to the last TTI containing the RRC message implying source cell release sent to the UE. During T4, the UE shall perform source cell release.

Starting T5, the UE shall stop sending CSI report to the source cell.

**Table A.7.3.1.4.2-1: Inter-band inter-frequency synchronous DAPS handover from FR1 to FR2 test configurations**

Config	Description
1	Source cell: NR 15 kHz SSB SCS, 10 MHz bandwidth, FDD duplex mode Target cell: NR 120 kHz SSB SCS, 100 MHz bandwidth, TDD duplex mode
2	Source cell: NR 15 kHz SSB SCS, 10 MHz bandwidth, TDD duplex mode Target cell: NR 120 kHz SSB SCS, 100 MHz bandwidth, TDD duplex mode
3	Source cell: NR 30 kHz SSB SCS, 40 MHz bandwidth, TDD duplex mode Target cell: NR 120 kHz SSB SCS, 100 MHz bandwidth, TDD duplex mode
Note: The UE is only required to be tested in one of the supported test configurations	

**Table A.7.3.1.4.2-2: General test parameters for Inter-band inter-frequency synchronous DAPS handover from FR1 to FR2**

Parameter	Unit	Value	Comment
Initial conditions	Active cell	Cell 1	
	Neighbouring cell	Cell 2	
Final condition	Active cell	Cell 2	
A4-Threshold	dBm	-120	
Hysteresis	dB	0	
Time To Trigger	s	0	
Filter coefficient		0	L3 filtering is not used
Access Barring Information	-	Not Sent	No additional delays in random access procedure.
Time offset between cells	μs	33	Synchronous cells
T1	s	5	
T2	s	<5	
T3	s	<0.5	
T4	ms	10+T <sub>interrupt2</sub>	T <sub>interrupt2</sub> as defined in Table 6.1.3.4.2-2 for synchronous DAPS HO
T5	ms	100	

**Table A.7.3.1.4.2-3: Cell specific test parameters for Inter-band inter-frequency synchronous DAPS handover from FR1 to FR2 (Cell 1 in FR1)**

Parameter	Unit	Cell 1	
		T1	T2 - T5
NR RF Channel Number		1	
Duplex mode	Config 1	FDD	
	Config 2,3	TDD	

TDD configuration	Config 1		Not Applicable
	Config 2		TDDConf.1.1
	Config 3		TDDConf.2.1
BW <sub>channel</sub>	Config 1	MHz	10: N <sub>RB,c</sub> = 52
	Config 2		10: N <sub>RB,c</sub> = 52
	Config 3		40: N <sub>RB,c</sub> = 106
BWP BW	Config 1	MHz	10: N <sub>RB,c</sub> = 52
	Config 2		10: N <sub>RB,c</sub> = 52
	Config 3		40: N <sub>RB,c</sub> = 106
TRS configuration	Config 1		TRS.1.1 FDD
	Config 2		TRS.1.1 TDD
	Config 3		TRS.1.2 TDD
DRx Cycle		ms	Not Applicable
PDSCH Reference measurement channel	Config 1		SR.1.1 FDD
	Config 2		SR.1.1 TDD
	Config 3		SR.2.1 TDD
CORESET Reference Channel	Config 1		CR.1.1 FDD
	Config 2		CR.1.1 TDD
	Config 3		CR.2.1 TDD
OCNG Patterns			OP.1
CSI-RS configuration for CSI reporting	Config 1		CSI-RS.1.1 FDD
	Config 2		CSI-RS.1.1 TDD
	Config 3		CSI-RS.2.1 TDD
reportConfigType			periodic
reportQuantity			cri-RI-PMI-CQI
CSI reporting periodicity	Config 1,2	slot	5
	Config 3		10
CSI reporting offset	Config 1,2	slot	3
	Config 3		5
SSB Configuration	Config 1,2		SSB.1 FR1
	Config 3		SSB.2 FR1
SMTC Configuration	Config 1,2		SMTC.1
	Config 3		SMTC.2
PDSCH/PDCCH subcarrier spacing	Config 1,2	kHz	15 kHz
	Config 3		30 kHz
PUCCH/PUSCH subcarrier spacing	Config 1,2	kHz	15 kHz
	Config 3		30 kHz
PRACH configuration			FR1 PRACH configuration 2
BWP	Initial DL BWP		DLBWP.0.1
	Dedicated DL BWP		DLBWP.1.3
	Initial UL BWP		ULBWP.0.1
	Dedicated UL BWP		ULBWP.1.3
EPRE ratio of PSS to SSS		dB	0
EPRE ratio of PBCH DMRS to SSS			
EPRE ratio of PBCH to PBCH DMRS			
EPRE ratio of PDCCH DMRS to SSS			
EPRE ratio of PDCCH to PDCCH DMRS			
EPRE ratio of PDSCH DMRS to SSS			
EPRE ratio of PDSCH to PDSCH			
EPRE ratio of OCNG DMRS to SSS(Note 1)			
EPRE ratio of OCNG to OCNG DMRS (Note 1)			
$N_{oc}^{Note2}$		dBm/15kHz	NA Link only, see clause A.3.7A
$N_{oc}^{Note2}$	Config 1,2	dBm/SCS	
	Config 3		
$\hat{E}_s / I_{ot}$		dB	
$\hat{E}_s / N_{oc}$		dB	
$I_{o}^{Note3}$	Config 1,2	dBm/ 9.36MHz	
	Config 3	dBm/ 38.16MHz	
Propagation condition		-	AWGN

Note 1: OCNG shall be used such that the cell is fully allocated and a constant total transmitted power spectral density is achieved for all OFDM symbols.

Note 2:	Interference from other cells and noise sources not specified in the test is assumed to be constant over subcarriers and time and shall be modelled as AWGN of appropriate power for $N_{oc}$ to be fulfilled.
Note 3:	lo levels have been derived from other parameters for information purposes. They are not settable parameters themselves.

**Table A.7.3.1.4.2-4: Cell specific test parameters for Inter-band inter-frequency synchronous DAPS handover from FR1 to FR2 (Cell 2 in FR2)**

Parameter		Unit	Cell 2	
			T1	T2 - T5
Assumption for UE beams <sup>Note 6</sup>			Rough	
AoA setup			Setup 1 as defined in A.3.15	
NR RF Channel Number			2	
Duplex mode	Config 1,2,3		TDD	
TDD configuration	Config 1,2,3		TDDConf.3.1	
BW <sub>channel</sub>	Config 1,2,3	MHz	100: N <sub>RB,c</sub> = 66	
BWP BW	Config 1,2,3	MHz	100: N <sub>RB,c</sub> = 66	
TRS configuration	Config 1,2,3		TRS.2.1 TDD	
DRX Cycle		ms	Not Applicable	
PDSCH Reference measurement channel	Config 1,2,3		SR3.1 TDD	
CORESET Reference Channel	Config 1,2,3		CR3.1 TDD	
OCNG Patterns			OCNG pattern 1	
CSI-RS configuration for CSI reporting	Config 1,2,3		CSI-RS.3.1 TDD	
SSB Configuration	Config 1,2,3		SSB.1 FR2	
SMTC Configuration			SMTC.1	
PDSCH/PDCCH subcarrier spacing	Config 1,2,3	kHz	120 kHz	
PUCCH/PUSCH subcarrier spacing	Config 1,2,3	kHz	120 kHz	
PRACH configuration			FR2 PRACH configuration 2	
TCI configuration			CSI-RS.Config.0	
BWP	Initial DL BWP		DLBWP.0.1	
	Dedicated DL BWP		DLBWP.1.3	
	Initial UL BWP		ULBWP.0.1	
	Dedicated UL BWP		ULBWP.1.3	
EPRE ratio of PSS to SSS		dB	0	
EPRE ratio of PBCH DMRS to SSS				
EPRE ratio of PBCH to PBCH DMRS				
EPRE ratio of PDCCH DMRS to SSS				
EPRE ratio of PDCCH to PDCCH DMRS				
EPRE ratio of PDSCH DMRS to SSS				
EPRE ratio of PDSCH to PDSCH				
EPRE ratio of OCNG DMRS to SSS(Note 1)				
EPRE ratio of OCNG to OCNG DMRS (Note 1)				
$N_{oc}$ <sup>Note2</sup>		dBm/15kHz	-104.7	-104.7
$N_{oc}$ <sup>Note2</sup>		dBm/SCS	-95.7	-95.7
$\hat{E}_s / I_{ot}$		dB	-Infinity	10
$\hat{E}_s / N_{oc}$		dB	-Infinity	10
$I_o$ <sup>Note3</sup>		dBm/ 95.04MHz	-66.7	-55.4
Propagation condition		-	AWGN	
Note 1:	OCNG shall be used such that the cell is fully allocated and a constant total transmitted power spectral density is achieved for all OFDM symbols.			
Note 2:	Interference from other cells and noise sources not specified in the test is assumed to be constant over subcarriers and time and shall be modelled as AWGN of appropriate power for $N_{oc}$ to be fulfilled.			
Note 3:	lo levels have been derived from other parameters for information purposes. They are not settable parameters themselves.			



Note 4:	Equivalent power received by an antenna with 0 dBi gain at the centre of the quiet zone
Note 5:	As observed with 0 dBi gain antenna at the centre of the quiet zone.
Note 6:	Information about types of UE beam is given in B.2.1.3, and does not limit UE implementation or test system implementation.

### A.7.3.1.4.3 Test Requirements

The UE shall start to transmit the PRACH to Cell 2 less than 92 ms from the beginning of time period T3. During  $D_{\text{handover1}}$ , the interruption on Cell 1 shall not exceed  $T_{\text{interrupt1}}$  as defined in Table 6.1.3.4.2-1 for synchronous DAPS HO.

The rate of correct handovers observed during repeated tests shall be at least 90%.

NOTE: The handover delay  $D_{\text{handover1}}$  can be expressed as:  $T_{\text{RRC\_procedure}} + T_{\text{IU}} + T_{\text{processing}} + T_{\Delta} + T_{\text{margin}}$ , where:

$T_{\text{RRC\_procedure}} = 10$  ms and is specified in clause 12 in TS 38.331 [2].

$T_{\text{IU}} = 20$  ms in the test.  $T_{\text{IU}}$  is defined in clause 6.1.1.2.2.

$T_{\Delta} = 20$  ms in the test.  $T_{\Delta}$  is defined in clause 6.1.1.2.2.

$T_{\text{processing}} = 40$  ms in the test.  $T_{\text{processing}}$  is defined in clause 6.1.1.2.2.

$T_{\text{margin}} = 2$  ms in the test.  $T_{\text{margin}}$  is defined in clause 6.1.1.2.2.

This gives a total of 92 ms.

The UE shall complete to release Cell 1 less than  $(10 \text{ ms} + T_{\text{interrupt2}})$  from the beginning of time period T4. During  $D_{\text{handover2}}$ , the interruption on Cell 2 shall not exceed  $T_{\text{interrupt2}}$  as defined in Table 6.1.3.4.2-2 for synchronous DAPS HO.

The rate of correct handovers observed during repeated tests shall be at least 90%.

NOTE: The handover delay  $D_{\text{handover2}}$  can be expressed as:  $T_{\text{RRC\_procedure}} + T_{\text{interrupt2}}$ , where:

$T_{\text{RRC\_procedure}} = 10$  ms and is specified in clause 12 in TS 38.331 [2].

## A.7.3.1.5 Inter-band inter-frequency asynchronous DAPS handover from FR1 to FR2

### A.7.3.1.5.1 Test Purpose and Environment

This test is to verify the requirement for the FR1-to-FR2 Inter-band inter-frequency asynchronous DAPS handover requirements specified in clause 6.1.3.4.

### A.7.3.1.5.2 Test Parameters

Supported test configurations are shown in table A.7.3.1.5.2-1. Both handover delay and interruption length are tested by using the parameters in table A.7.3.1.5.2-2, A.7.3.1.5.2-3 and A.7.3.1.5.2-4.

The test scenario comprises of two bands each with one cell. The test consists of five successive time periods, with time durations of T1, T2, T3, T4 and T5 respectively.

Before the start of T1, the UE is connected to Cell 1 (source PCell) on radio channel 1 but is not aware of Cell 2 (neighbour cell) on radio channel 2. The UE shall be configured with periodic CSI reporting for cell1. During T1, the UE shall not have any timing information of Cell 2.

Before the start of T2, the UE in the measurement control information that event-triggered reporting with Event A4 is configured for neighbour cell (Cell 2), and the UE is configured with the measurement gaps (gap pattern ID # 0). Starting T2, Cell 2 becomes known to the UE. During T2, the UE shall report Event A4. After receiving the Event A4, the test system shall send a RRC message implying DAPS handover to the UE.

The start of T3 is the instant when the test system receives the ACK of the PDSCH corresponding to the last TTI containing the RRC message implying DAPS handover to Cell 2 (target PCell) sent to the UE. During T3, the UE shall be able to perform random access to Cell 2. DL schedule and UL feedback to cell 1 shall be avoided when UE is required to perform DL reception or UL transmission in PRACH procedure in cell 2, except preamble transmission.

After the RACH procedure is completed, the test system shall send a RRC message to the UE to release Cell 1 (source cell) on radio channel 1.

The start of T4 is the instant when the test system receives the ACK of the PDSCH corresponding to the last TTI containing the RRC message implying source cell release sent to the UE. During T4, the UE shall perform source cell release.

Starting T5, the UE shall stop sending CSI report to the source cell.

**Table A.7.3.1.5.2-1: Inter-band inter-frequency asynchronous DAPS handover from FR1 to FR2 test configurations**

Config	Description
1	Source cell: NR 15 kHz SSB SCS, 10 MHz bandwidth, FDD duplex mode Target cell: NR 120 kHz SSB SCS, 100 MHz bandwidth, TDD duplex mode
2	Source cell: NR 15 kHz SSB SCS, 10 MHz bandwidth, TDD duplex mode Target cell: NR 120 kHz SSB SCS, 100 MHz bandwidth, TDD duplex mode
3	Source cell: NR 30 kHz SSB SCS, 40 MHz bandwidth, TDD duplex mode Target cell: NR 120 kHz SSB SCS, 100 MHz bandwidth, TDD duplex mode
Note: The UE is only required to be tested in one of the supported test configurations	

**Table A.7.3.1.5.2-2: General test parameters for Inter-band inter-frequency asynchronous DAPS handover from FR1 to FR2**

Parameter	Unit	Value	Comment
Initial conditions	Active cell	Cell 1	
	Neighbouring cell	Cell 2	
Final condition	Active cell	Cell 2	
A4-Threshold	dBm	-120	
Hysteresis	dB	0	
Time To Trigger	s	0	
Filter coefficient		0	L3 filtering is not used
Access Barring Information	-	Not Sent	No additional delays in random access procedure.
Time offset between cells	µs	62.5	Asynchronous cells
T1	s	5	
T2	s	<5	
T3	s	<0.5	
T4	ms	10+T <sub>interrupt2</sub>	T <sub>interrupt2</sub> as defined in Table 6.1.3.4.2-2 for asynchronous DAPS HO.
T5	ms	100	

**Table A.7.3.1.5.2-3: Cell specific test parameters for Inter-band inter-frequency asynchronous DAPS handover from FR1 to FR2 (Cell 1 in FR1)**

Parameter	Unit	Cell 1	
		T1	T2 - T5
NR RF Channel Number		1	
Duplex mode	Config 1	FDD	
	Config 2,3	TDD	
TDD configuration	Config 1	Not Applicable	
	Config 2	TDDConf.1.1	
	Config 3	TDDConf.2.1	
BW <sub>channel</sub>	Config 1	10: N <sub>RB,c</sub> = 52	
	Config 2	10: N <sub>RB,c</sub> = 52	
	Config 3	40: N <sub>RB,c</sub> = 106	
BWP BW	Config 1	10: N <sub>RB,c</sub> = 52	
	Config 2	10: N <sub>RB,c</sub> = 52	
	Config 3	40: N <sub>RB,c</sub> = 106	
TRS configuration	Config 1	TRS.1.1 FDD	
	Config 2	TRS.1.1 TDD	
	Config 3	TRS.1.2 TDD	
DRx Cycle	ms	Not Applicable	

PDSCH Reference measurement channel	Config 1		SR.1.1 FDD	
	Config 2		SR.1.1 TDD	
	Config 3		SR.2.1 TDD	
CORESET Reference Channel	Config 1		CR.1.1 FDD	
	Config 2		CR.1.1 TDD	
	Config 3		CR.2.1 TDD	
OCNG Patterns			OP.1	
CSI-RS configuration for CSI reporting	Config 1		CSI-RS.1.1 FDD	
	Config 2		CSI-RS.1.1 TDD	
	Config 3		CSI-RS.2.1 TDD	
reportConfigType			periodic	
reportQuantity			cri-RI-PMI-CQI	
CSI reporting periodicity	Config 1,2	slot	5	
	Config 3		10	
CSI reporting offset	Config 1,2	slot	3	
	Config 3		5	
SSB Configuration	Config 1,2		SSB.1 FR1	
	Config 3		SSB.2 FR1	
SMTc Configuration	Config 1,2		SMTc.1	
	Config 3		SMTc.2	
PDSCH/PDCCH subcarrier spacing	Config 1,2	kHz	15 kHz	
	Config 3		30 kHz	
PUCCH/PUSCH subcarrier spacing	Config 1,2	kHz	15 kHz	
	Config 3		30 kHz	
PRACH configuration			FR1 PRACH configuration 2	
BWP	Initial DL BWP		DLBWP.0.1	
	Dedicated DL BWP		DLBWP.1.3	
	Initial UL BWP		ULBWP.0.1	
	Dedicated UL BWP		ULBWP.1.3	
EPRE ratio of PSS to SSS		dB	0	
EPRE ratio of PBCH DMRS to SSS				
EPRE ratio of PBCH to PBCH DMRS				
EPRE ratio of PDCCH DMRS to SSS				
EPRE ratio of PDCCH to PDCCH DMRS				
EPRE ratio of PDSCH DMRS to SSS				
EPRE ratio of PDSCH to PDSCH				
EPRE ratio of OCNG DMRS to SSS(Note 1)				
EPRE ratio of OCNG to OCNG DMRS (Note 1)				
$N_{oc}^{Note2}$		dBm/15kHz	NA Link only, see clause A.3.7A	
$N_{oc}^{Note2}$	Config 1,2	dBm/SCS		
	Config 3			
$\hat{E}_s / I_{ot}$		dB		
$\hat{E}_s / N_{oc}$		dB		
$I_{o}^{Note3}$	Config 1,2	dBm/ 9.36MHz		
	Config 3	dBm/ 38.16MHz		
Propagation condition		-		AWGN
<p>Note 1: OCNG shall be used such that the cell is fully allocated and a constant total transmitted power spectral density is achieved for all OFDM symbols.</p> <p>Note 2: Interference from other cells and noise sources not specified in the test is assumed to be constant over subcarriers and time and shall be modelled as AWGN of appropriate power for <math>N_{oc}</math> to be fulfilled.</p> <p>Note 3: <math>I_o</math> levels have been derived from other parameters for information purposes. They are not settable parameters themselves.</p>				

**Table A.7.3.1.5.2-4: Cell specific test parameters for Inter-band inter-frequency asynchronous DAPS handover from FR1 to FR2 (Cell 2 in FR2)**

Parameter		Unit	Cell 2	
			T1	T2 - T5
Assumption for UE beams <sup>Note 6</sup>			Rough	
AoA setup			Setup 1 as defined in A.3.15	
NR RF Channel Number			2	
Duplex mode	Config 1,2,3		TDD	
TDD configuration	Config 1,2,3		TDDConf.3.1	
BW <sub>channel</sub>	Config 1,2,3	MHz	100: N <sub>RB,c</sub> = 66	
BWP BW	Config 1,2,3	MHz	100: N <sub>RB,c</sub> = 66	
TRS configuration	Config 1,2,3		TRS.2.1 TDD	
DRX Cycle		ms	Not Applicable	
PDSCH Reference measurement channel	Config 1,2,3		SR.3.1 TDD	
CORESET Reference Channel	Config 1,2,3		CR.3.1 TDD	
OCNG Patterns			OP.1	
CSI-RS configuration for CSI reporting	Config 1,2,3		CSI-RS.3.1 TDD	
SSB Configuration	Config 1,2,3		SSB.1 FR2	
SMTC Configuration			SMTC.1	
PDSCH/PDCCH subcarrier spacing	Config 1,2,3	kHz	120 kHz	
PUCCH/PUSCH subcarrier spacing	Config 1,2,3	kHz	120 kHz	
PRACH configuration			FR2 PRACH configuration 2	
TCI configuration			CSI-RS.Config.0	
BWP	Initial DL BWP		DLBWP.0.1	
	Dedicated DL BWP		DLBWP.1.3	
	Initial UL BWP		ULBWP.0.1	
	Dedicated UL BWP		ULBWP.1.3	
EPRE ratio of PSS to SSS		dB	0	
EPRE ratio of PBCH DMRS to SSS				
EPRE ratio of PBCH to PBCH DMRS				
EPRE ratio of PDCCH DMRS to SSS				
EPRE ratio of PDCCH to PDCCH DMRS				
EPRE ratio of PDSCH DMRS to SSS				
EPRE ratio of PDSCH to PDSCH				
EPRE ratio of OCNG DMRS to SSS(Note 1)				
EPRE ratio of OCNG to OCNG DMRS (Note 1)				
$N_{oc}$ <sup>Note2</sup>		dBm/15kHz	-104.7	-104.7
$N_{oc}$ <sup>Note2</sup>		dBm/SCS	-95.7	-95.7
$\hat{E}_s / I_{ot}$		dB	-Infinity	10
$\hat{E}_s / N_{oc}$		dB	-Infinity	10
$I_o$ <sup>Note3</sup>		dBm/ 95.04MHz	-66.7	-55.4
Propagation condition		-	AWGN	
<p>Note 1: OCNG shall be used such that the cell is fully allocated and a constant total transmitted power spectral density is achieved for all OFDM symbols.</p> <p>Note 2: Interference from other cells and noise sources not specified in the test is assumed to be constant over subcarriers and time and shall be modelled as AWGN of appropriate power for <math>N_{oc}</math> to be fulfilled.</p> <p>Note 3: <math>I_o</math> levels have been derived from other parameters for information purposes. They are not settable parameters themselves.</p> <p>Note 4: Equivalent power received by an antenna with 0 dBi gain at the centre of the quiet zone</p> <p>Note 5: As observed with 0 dBi gain antenna at the centre of the quiet zone.</p> <p>Note 6: Information about types of UE beam is given in B.2.1.3, and does not limit UE implementation or test system implementation.</p>				

### A.7.3.1.5.3 Test Requirements

The UE shall start to transmit the PRACH to Cell 2 less than 92 ms from the beginning of time period T3. During  $D_{\text{handover1}}$ , the interruption on Cell 1 shall not exceed  $T_{\text{interrupt1}}$  as defined in Table 6.1.3.4.2-1 for asynchronous DAPS HO.

The rate of correct handovers observed during repeated tests shall be at least 90%.

NOTE: The handover delay  $D_{\text{handover1}}$  can be expressed as:  $T_{\text{RRC\_procedure}} + T_{\text{IU}} + T_{\text{processing}} + T_{\Delta} + T_{\text{margin}}$ , where:

$T_{\text{RRC\_procedure}} = 10$  ms and is specified in clause 12 in TS 38.331 [2].

$T_{\text{IU}} = 20$  ms in the test.  $T_{\text{IU}}$  is defined in clause 6.1.1.2.2.

$T_{\Delta} = 20$  ms in the test.  $T_{\Delta}$  is defined in clause 6.1.1.2.2.

$T_{\text{processing}} = 40$  ms in the test.  $T_{\text{processing}}$  is defined in clause 6.1.1.2.2.

$T_{\text{margin}} = 2$  ms in the test.  $T_{\text{margin}}$  is defined in clause 6.1.1.2.2.

This gives a total of 792 ms.

The UE shall complete to release Cell 1 less than  $(10 \text{ ms} + T_{\text{interrupt2}})$  from the beginning of time period T4. During  $D_{\text{handover2}}$ , the interruption on Cell 2 shall not exceed  $T_{\text{interrupt2}}$  as defined in Table 6.1.3.4.2-2 for asynchronous DAPS HO.

The rate of correct handovers observed during repeated tests shall be at least 90%.

NOTE: The handover delay  $D_{\text{handover2}}$  can be expressed as:  $T_{\text{RRC\_procedure}} + T_{\text{interrupt2}}$ , where:

$T_{\text{RRC\_procedure}} = 10$  ms and is specified in clause 12 in TS 38.331 [2].

## A.7.3.2 RRC Connection Mobility Control

### A.7.3.2.1 SA: RRC Re-establishment

#### A.7.3.2.1.1 Intra-frequency RRC Re-establishment in FR2

##### A.7.3.2.1.1.1 Test Purpose and Environment

The purpose is to verify that the NR intra-frequency RRC re-establishment delay in FR2 without known target cell is within the specified limits. These tests will verify the requirements in clause 6.2.1.

The test parameters are given in table A.7.3.2.1.1.1-1, table A.7.3.2.1.1.1-2 and table A.7.3.2.1.1.1-3 below. The test consists of 3 successive time periods, with time duration of T1, T2 and T3 respectively. At the start of time period T2, cell 1, which is the active cell, becomes inactive. The time period T3 starts after the occurrence of the radio link failure.

**Table A.7.3.2.1.1.1-1: Supported test configurations**

Config	Description
1	NR 120 kHz SSB SCS, 100 MHz bandwidth, TDD duplex mode

**Table A.7.3.2.1.1.1-2: General test parameters for NR intra-frequency RRC Re-establishment test case in FR2**

Parameter	Unit	Test configuration	Value	Comment
Initial condition	Active cell	1	Cell1	
	Neighbour cells	1	Cell2	
Final condition	Active cell	1	Cell2	
RF Channel Number		1	1	
Time offset between cells		1	3 $\mu$ s	Synchronous cells

N310	-	1	1	Maximum consecutive out-of-sync indications from lower layers
N311	-	1	1	Minimum consecutive in-sync indications from lower layers
T310	ms	1	0	Radio link failure timer; T310 is disabled
T311	ms	1	5000	RRC re-establishment timer
Access Barring Information	-	1	Not Sent	No additional delays in random access procedure.
SSB configuration		1	SSB.1 FR2	
SMTC configuration		1	SMTC pattern 1	
DRX cycle length	s	1	OFF	
PRACH configuration		1	FR2 PRACH configuration 1	Table A.3.8.3.1-1
T1	s	1	5	
T2	s	1	4.84	Time for the UE to detect RLF (Summation of $T_{\text{Evaluate\_out\_SSB}}$ defined in clause 8.1 in TS 38.133, T310 and the period for UE turns off transmitter defined in clause 8.1.5 in TS 38.133 )
T3	s	1	5	

**Table A.7.3.2.1.1-3: Cell specific test parameters for NR intra-frequency RRC Re-establishment test case in FR2**

Parameter	Unit	Test configuration	Cell 1			Cell 2		
			T1	T2	T3	T1	T2	T3
Assumption for UE beams <sup>Note 4</sup>			Rough			Rough		
TDD configuration		1	TDDConf.3.1			TDDConf.3.1		
$BW_{\text{channel}}$	MHz	1	100: $N_{\text{RB},c} = 66$			100: $N_{\text{RB},c} = 66$		
Data RBs allocated		1	24			24		
PDSCH RMC configuration		1	SR.3.1 TDD			N/A		
RMSI CORESET RMC configuration		1	CR.3.1 TDD			CR.3.1 TDD		
Dedicated CORESET RMC configuration		1	CCR.3.1 TDD			CCR.3.1 TDD		
TRS configuration		1	TRS.2.1 TDD			N/A		
PDSCH/PDCCH TCI state		1	TCI.State.2			N/A		
OCNG Pattern		1	OP.1 defined in A.3.2.1			OP.1 defined in A.3.2.1		
Initial DL BWP configuration		1	DLBWP.0.1			DLBWP.0.1		
Initial UL BWP configuration		1	ULBWP.0.1			ULBWP.0.1		
RLM-RS		1	SSB			SSB		
AoA setup		1	Setup 1 defined in A.3.15.1			Setup 1 defined in A.3.15.1		
$\hat{E}_s / I_{\text{ot}}$	dB	1	-0.12	-infinity	-infinity	-3.46	2	2
$N_{oc}$ <sup>Note2</sup>	dBm/15 kHz	1	-104.7					
$N_{oc}$ <sup>Note2</sup>	dBm/SCS	1	-95.7					
$\hat{E}_s / N_{oc}$	dB	1	4	-infinity	-infinity	2	2	2
SS-RSRP <sup>Note3</sup>	dBm/SCS	1	-91.7	-infinity	-infinity	-93.7	-93.7	-93.7
$I_o$	dBm/95.04 MHz	1	-59.64	-62.59	-62.59	-59.94	-62.59	-62.59
Propagation Condition		1	AWGN					

Note 1:	OCNG shall be used such that both cells are fully allocated and a constant total transmitted power spectral density is achieved for all OFDM symbols.
Note 2:	Interference from other cells and noise sources not specified in the test is assumed to be constant over subcarriers and time and shall be modelled as AWGN of appropriate power for $N_{oc}$ to be fulfilled.
Note 3:	SS-RSRP levels have been derived from other parameters for information purposes. They are not settable parameters themselves.
Note 4:	Information about types of UE beam is given in B.2.1.3, and does not limit UE implementation or test system implementation

A.7.3.2.1.1.2 Test Requirements

The RRC re-establishment delay is defined as the time from the start of time period T3, to the moment when the UE starts to send PRACH preambles to cell 2 for sending the *RRCReestablishmentRequest* message to cell 2.

The RRC re-establishment delay to an unknown NR intra frequency cell shall be less than 5 s.

The rate of correct RRC re-establishments observed during repeated tests shall be at least 90%.

NOTE: The RRC re-establishment delay in the test is derived from the following expression:

$$T_{re-establish\_delay} = T_{UL\_grant} + T_{UE\_re-establish\_delay}$$

Where:

$T_{UL\_grant}$  = It is the time required to acquire and process uplink grant from the target cell. The PRACH reception at the system simulator is used as a trigger for the completion of the test; hence  $T_{UL\_grant}$  is not used.

$$T_{UE\_re-establish\_delay} = 50 \text{ ms} + T_{identify\_intra\_NR} + \sum_{i=1}^{N_{freq}-1} T_{identify\_inter\_NR,i} + T_{SI-NR} + T_{PRACH}$$

$$N_{freq} = 1$$

$$T_{identify\_intra\_NR} = 3520 \text{ ms}$$

$T_{SI} = 1280 \text{ ms}$ ; it is the time required for receiving all the relevant system information as defined in TS 38.331 for the target intra-frequency NR cell.

$T_{PRACH} = 15 \text{ ms}$ ; it is the additional delay caused by the random access procedure.

This gives a total of 4865 ms, allow 5 s in the test case.

A.7.3.2.1.2 Inter-frequency RRC Re-establishment in FR2

A.7.3.2.1.2.1 Test Purpose and Environment

The purpose is to verify that the NR inter-frequency RRC re-establishment delay in FR2 without known target cell is within the specified limits. These tests will verify the requirements in clause 6.2.1.

The test parameters are given in table A.7.3.2.1.2.1-1, table A.7.3.2.1.2.1-2 and table A.7.3.2.1.2.1-3 below. The test consists of 3 successive time periods, with time duration of T1, T2 and T3 respectively. At the start of time period T2, cell 1, which is the active cell, becomes inactive. The time period T3 starts after the occurrence of the radio link failure. During T1, the UE shall be configured with the carrier frequency of cell 2 (with RF Channel Number #2) to ensure that the UE has the context of the carrier frequency of cell 2 by the end of T1.

**Table A.7.3.2.1.2.1-1: Supported test configurations**

Config	Description
1	NR 120 kHz SSB SCS, 100 MHz bandwidth, TDD duplex mode

**Table A.7.3.2.1.2.1-2: General test parameters for NR inter-frequency RRC Re-establishment test case in FR2**

Parameter	Unit	Test configuration	Value	Comment
-----------	------	--------------------	-------	---------

Initial condition	Active cell		1	Cell1	
	Neighbour cells		1	Cell2	
Final condition	Active cell		1	Cell2	
RF Channel Number			1	1, 2	
Time offset between cells			1	3 $\mu$ s	Synchronous cells
N310		-	1	1	Maximum consecutive out-of-sync indications from lower layers
N311		-	1	1	Minimum consecutive in-sync indications from lower layers
T310		ms	1	0	Radio link failure timer; T310 is disabled
T311		ms	1	5000	RRC re-establishment timer
Access Barring Information		-	1	Not Sent	No additional delays in random access procedure.
SSB configuration			1	SSB.1 FR2	
SMTC configuration			1	SMTC pattern 1	
DRX cycle length		s	1	OFF	
PRACH configuration			1	FR2 PRACH configuration 1	Table A.3.8.3.1-1
T1		s	1	5	
T2		s	1	4.84	Time for the UE to detect RLF (Summation of $T_{Evaluate\_out\_SSB}$ defined in clause 8.1 in TS 38.133, T310 and the period for UE turns off transmitter defined in clause 8.1.5 in TS 38.133)
T3		s	1	6	

**Table A.7.3.2.1.2.1-3: Cell specific test parameters for NR inter-frequency RRC Re-establishment test case in FR2**

Parameter	Unit	Test configuration	Cell 1			Cell 2		
			T1	T2	T3	T1	T2	T3
Assumption for UE beams <sup>Note 4</sup>			Rough			Rough		
AoA setup		1	Setup 3 as specified in clause A.3.15					
			AoA1			AoA2		
TDD configuration		1	TDDConf.3.1			TDDConf.3.1		
BW <sub>channel</sub>	MHz	1	100: N <sub>RB,c</sub> = 66			100: N <sub>RB,c</sub> = 66		
Data RBs allocated		1	24			24		
PDSCH RMC configuration		1	SR.3.1 TDD			N/A		
RMSI CORESET RMC configuration		1	CR.3.1 TDD			CR.3.1 TDD		
Dedicated CORESET RMC configuration		1	CCR.3.1 TDD			CCR.3.1 TDD		
TRS configuration		1	TRS.2.1 TDD			N/A		
PDSCH/PDCCH TCI state		1	TCI.State.2			N/A		
OCNG Pattern		1	OP.1 defined in A.3.2.1			OP.1 defined in A.3.2.1		
Initial DL BWP configuration		1	DLBWP.0.1			DLBWP.0.1		
Initial UL BWP configuration		1	ULBWP.0.1			ULBWP.0.1		
RLM-RS		1	SSB			SSB		
$N_{oc}$ <sup>Note2</sup>	dBm/15 kHz	1	-92.1			-92.1		
$N_{oc}$ <sup>Note2</sup>	dBm/SCS	1	-83.1			-83.1		
$\hat{E}_s / N_{oc}$	dB	1	0	-infinity	-infinity	-infinity	-infinity	0



$\hat{E}_s / I_{ot\_BB}$ Note 5	dB	1	-1.01	-infinity	-infinity	-infinity	-infinity	-1.01
SSB_RP Note3	dBm/SCS	1	-83.1	-infinity	-infinity	-infinity	-infinity	-83.1
Io	dBm/95.04 MHz	1	-55.46	-58.51	-58.51	-58.51	-58.51	-55.46
Propagation Condition		1	AWGN			AWGN		
Note 1:	OCNG shall be used such that a constant total transmitted power is achieved for all OFDM symbols.							
Note 2:	Interference from other cells and noise sources not specified in the test is assumed to be constant over subcarriers and time and shall be modelled as AWGN of appropriate power for $N_{oc}$ to be fulfilled.							
Note 3:	Es/Iot, SSB_RP and Io levels have been derived from other parameters for information purposes. They are not settable parameters themselves.							
Note 4:	Information about types of UE beam is given in B.2.1.3, and does not limit UE implementation or test system implementation							
Note 5:	Calculation of Es/Iot <sub>BB</sub> includes the effect of UE internal noise up to the value assumed for the associated Refsens requirement in clause 7.3.2 of TS 38.101-2 [19], and an allowance of 1dB for UE multi-band relaxation factor ΔMB <sub>s</sub> from TS 38.101-2 [19] Table 6.2.1.3-4.							

A.7.3.2.1.2.2 Test Requirements

The RRC re-establishment delay is defined as the time from the start of time period T3, to the moment when the UE starts to send PRACH preambles to cell 2 for sending the *RRCReestablishmentRequest* message to cell 2.

The RRC re-establishment delay to an unknown NR inter frequency cell shall be less than 6 s.

The rate of correct RRC re-establishments observed during repeated tests shall be at least 90%.

NOTE: The RRC re-establishment delay in the test is derived from the following expression:

$$T_{re-establish\_delay} = T_{UL\_grant} + T_{UE\_re-establish\_delay}$$

Where:

$T_{UL\_grant}$  = It is the time required to acquire and process uplink grant from the target cell. The PRACH reception at the system simulator is used as a trigger for the completion of the test; hence  $T_{UL\_grant}$  is not used.

$$T_{UE\_re-establish\_delay} = 50 \text{ ms} + T_{identify\_intra\_NR} + \sum_{i=1}^{N_{freq}-1} T_{identify\_inter\_NR,i} + T_{SI-NR} + T_{PRACH}$$

$$N_{freq} = 2$$

$$T_{identify\_intra\_NR} = 1600 \text{ ms}$$

$$T_{identify\_inter\_NR} = 2080 \text{ ms}$$

$T_{SI} = 1280 \text{ ms}$ ; it is the time required for receiving all the relevant system information as defined in TS 38.331 for the target inter-frequency NR cell.

$T_{PRACH} = 15 \text{ ms}$ ; it is the additional delay caused by the random access procedure.

This gives a total of 5025 ms, allow 6 s in the test case.

A.7.3.2.1.3 Intra-frequency RRC Re-establishment in FR2 without serving cell timing

A.7.3.2.1.3.1 Test Purpose and Environment

The purpose is to verify that the NR intra-frequency RRC re-establishment delay in FR2 without serving cell timing is within the specified limits. These tests will verify the requirements in clause 6.2.1.

The test parameters are given in table A.7.3.2.1.3.1-1, table A.7.3.2.1.3.1-2 and table A.7.3.2.1.3.1-3 below. The test consists of 3 successive time periods, with time duration of T1, T2 and T3 respectively. At the start of time period T2, cell 1, which is the active cell, is deactivated. The time period T3 starts after the occurrence of the radio link failure.

**Table A.7.3.2.1.3.1-1: Supported test configurations**

Configuration	Description
1	120 kHz SSB SCS, 100 MHz bandwidth, TDD duplex mode

**Table A.7.3.2.1.3.1-2: General test parameters for NR intra-frequency RRC Re-establishment test case in FR2**

Parameter		Unit	Test configuration	Value	Comment
Initial condition	Active cell		1	Cell1	
	Neighbour cells		1	Cell2	
Final condition	Active cell		1	Cell2	
RF Channel Number			1	1	
Time offset between cells			1	3 $\mu$ s	Synchronous cells
N310		-	1	1	Maximum consecutive out-of-sync indications from lower layers
N311		-	1	1	Minimum consecutive in-sync indications from lower layers
T310		ms	1	6000	Radio link failure timer configured by <i>RLF-TimersAndConstants</i>
T311		ms	1	5000	RRC re-establishment timer
Access Barring Information		-	1	Not Sent	No additional delays in random access procedure.
SSB configuration			1	SSB.1 FR2	
SMTC configuration			1	SMTC pattern 1	
DRX cycle length		s	1	OFF	
PRACH configuration			1	FR2 PRACH configuration 1	Table A.3.8.3.1-1
T1		s	1	5	
T2		s	1	10.84	Time for the UE to detect RLF (Summation of T <sub>Evaluate_out_SSB</sub> defined in clause 8.1 in TS 38.133, T310 and the period for UE turns off transmitter defined in clause 8.1.5 in TS 38.133)
T3		s	1	5	

**Table A.7.3.2.1.3.1-3: Cell specific test parameters for NR intra-frequency RRC Re-establishment test case in FR2**

Parameter	Unit	Test configuration	Cell 1			Cell 2		
			T1	T2	T3	T1	T2	T3
Assumption for UE beams <sup>Note 4</sup>			Rough			Rough		
TDD configuration		1	TDDConf.3.1			TDDConf.3.1		
PDSCH RMC configuration		1	SR.3.1 TDD			N/A		
RMSI CORESET RMC configuration		1	CR.3.1 FDD			CR.3.1 FDD		
Dedicated CORESET RMC configuration		1	CCR.3.1 FDD			CCR.3.1 FDD		
TRS configuration		1	TRS.2.1 TDD			N/A		
PDSCH/PDCCH TCI state		1	TCI.State.2			N/A		
OCNG Pattern		1	OP.1 defined in A.3.2.1			OP.1 defined in A.3.2.1		
Initial DL BWP configuration		1	DLBWP.0.1			DLBWP.0.1		
Initial UL BWP configuration		1	ULBWP.0.1			ULBWP.0.1		
RLM-RS		1	SSB			SSB		
AoA setup		1	Setup 1 defined in A.3.15.1			Setup 1 defined in A.3.15.1		

$\hat{E}_s / I_{ot}$	dB	1	5	-infinity	-infinity	-infinity	-infinity	5
$N_{oc}$ Note2	dBm/15kHz	1	-104.7					
$N_{oc}$ Note2	dBm/SCS	1	-95.7					
$\hat{E}_s / N_{oc}$	dB	1	5	-infinity	-infinity	-infinity	-infinity	5
SS-RSRP Note3	dBm/SCS	1	-90.7	-infinity	-infinity	-infinity	-infinity	-90.7
Io	dBm/95.04 MHz	1	-60.52	-66.71	-60.52	-60.52	-66.71	-60.52
Propagation Condition		1	AWGN					
<p>Note 1: OCNG shall be used such that both cells are fully allocated and a constant total transmitted power spectral density is achieved for all OFDM symbols.</p> <p>Note 2: Interference from other cells and noise sources not specified in the test is assumed to be constant over subcarriers and time and shall be modelled as AWGN of appropriate power for <math>N_{oc}</math> to be fulfilled.</p> <p>Note 3: SS-RSRP levels have been derived from other parameters for information purposes. They are not settable parameters themselves.</p> <p>Note 4: Information about types of UE beam is given in B.2.1.3, and does not limit UE implementation or test system implementation</p>								

### A.7.3.2.1.3.2 Test Requirements

The RRC re-establishment delay is defined as the time from the start of time period T3, to the moment when the UE starts to send PRACH preambles to cell 2 for sending the *RRCReestablishmentRequest* message to cell 2.

The RRC re-establishment delay to an unknown NR intra frequency cell without serving cell timing shall be less than 5 s.

The rate of correct RRC re-establishments observed during repeated tests shall be at least 90%.

NOTE: The RRC re-establishment delay in the test is derived from the following expression:

$$T_{\text{re-establish\_delay}} = T_{\text{UL\_grant}} + T_{\text{UE\_re-establish\_delay}}$$

Where:

$T_{\text{UL\_grant}}$  = It is the time required to acquire and process uplink grant from the target cell. The PRACH reception at the system simulator is used as a trigger for the completion of the test; hence  $T_{\text{UL\_grant}}$  is not used.

$$T_{\text{UE\_re-establish\_delay}} = 50 \text{ ms} + T_{\text{identify\_intra\_NR}} + \sum_{i=1}^{N_{\text{freq}}-1} T_{\text{identify\_inter\_NR},i} + T_{\text{SI-NR}} + T_{\text{PRACH}}$$

$$N_{\text{freq}} = 1$$

$$T_{\text{identify\_intra\_NR}} = 3520 \text{ ms}$$

$T_{\text{SI}} = 1280 \text{ ms}$ ; it is the time required for receiving all the relevant system information as defined in TS 38.331 [2] for the target intra-frequency NR cell.

$T_{\text{PRACH}} = 15 \text{ ms}$ ; it is the additional delay caused by the random access procedure.

This gives a total of 4865 ms, allow 5 s in the test case.

### A.7.3.2.2 Random Access

#### A.7.3.2.2.1 4-step RA type contention based random access test in FR2 for NR Standalone

##### A.7.3.2.2.1.1 Test Purpose and Environment

The purpose of this test is to verify that the behavior of the random access procedure is according to the requirements and that the PRACH power settings and timing are within specified limits. This test will verify the requirements in Clause 6.2.2.2 and Clause 7.1.2 in an AWGN model.

For this test one cell is used, with the configuration of Cell 1 configured as PCell or SCell in FR2. Supported test parameters are shown in Table A.7.3.2.2.1.1-1. UE capable of SA with PCell or SCell in FR2 needs to be tested by using the parameters in Table A.7.3.2.2.1.1-2 and Table A.7.3.2.2.1.1-3.

**Table A.7.3.2.2.1.1-1: Supported test configurations for contention based random access test in FR2 for NR Standalone**

Config	Description
1	NR PSCell/SCell 120 kHz SSB SCS, 100 MHz bandwidth, TDD duplex mode

**Table A.7.3.2.2.1.1-2: General test parameters for contention based random access test in FR2 for NR Standalone**

Parameter	Unit	Test-1	Comments
SSB Configuration	Config 1	SSB.1 FR2	As defined in A.3.10
CSI-RS for tracking	Config 1	TRS.2.1 TDD	
Duplex Mode for Cell 1	Config 1	TDD	
TDD Configuration	Config 1	TDDConf.3.1	As defined in A.3.1.4
BW <sub>channel</sub>	Config 1	MHz	100: N <sub>RB,c</sub> = 66
Data RBs allocated	Config 1		24
OCNG Pattern <sup>Note 1</sup>			OCNG pattern 1
PDSCH Reference Channel <sup>Note 2</sup>	Config 1		SR.3.1 TDD
RMSI CORESET Reference Channel	Config 1		CR.3.1 TDD
NR RF Channel Number			1
EPRE ratio of PSS to SSS	dB		0
EPRE ratio of PBCH_DMRS to SSS	dB		
EPRE ratio of PBCH to PBCH_DMRS	dB		
EPRE ratio of PDCCH_DMRS to SSS	dB		
EPRE ratio of PDCCH to PDCCH_DMRS	dB		
EPRE ratio of PDSCH_DMRS to SSS	dB		
EPRE ratio of PDSCH to PDSCH_DMRS	dB		
ss-PBCH-BlockPower	dBm/ SCS	+20 + $\Delta_{UL}$	As defined in TS 38.331 [2]. $\Delta_{UL}$ is derived from the uplink calibration process <sup>Note 3</sup>
Configured UE transmitted power ( $P_{CMAX, f, c}$ )	dBm	maximum value configurable for certain power class	As defined in clause 6.2.4 in TS 38.101-2 [19]
PRACH Configuration		FR2 PRACH configuration 1	As defined in A.3.8.3, with exceptions as defined below
rsrp-ThresholdSSB	dBm	RSRP <sub>69</sub> + $\Delta_{DL}$	RSRP <sub>69</sub> corresponds to -88dBm. $\Delta_{DL}$ is derived from the downlink calibration process <sup>Note 4</sup>
preambleReceivedTargetPower	dBm	-100	As defined in TS 38.331 [2]
Note 1:	OCNG shall be used such that a constant total transmitted power spectral density is achieved for all OFDM symbols. The OCNG pattern is chosen during the test according to the presence of a DL reference measurement channel.		
Note 2:	The DL PDSCH reference measurement channel is used in the test only when a downlink transmission dedicated to the UE under test is required.		
Note 3:	The $\Delta_{UL}$ value is calculated as $-\text{ROUND}(\text{PPRACH0} - 1)$ , where PPRACH0 is the measured first PRACH power with -80.6dBm/SCS applied, $\text{preambleReceivedTargetPower} = -100\text{dBm}$ and $\text{ss-PBCH-BlockPower} = 20\text{dBm}$ . These values are used during the uplink calibration process carried out before the test case is run, with the UE configured to send PRACH.		
Note 4:	The $\Delta_{DL}$ value is calculated as $(\text{RSRP}_{\text{REP}} - \text{RSRP}_{76})$ , where RSRP <sub>REP</sub> is the SS-RSRP Reported value in Table 10.1.6.1-1 with -80.6dBm/SCS applied. These values are used during the downlink calibration process carried out before the test case is run, with the UE configured to report SS-RSRP. For a Reported value RSRP <sub>x</sub> , x is treated as a positive integer value.		

**Table A.7.3.2.2.1.1-3: OTA-related test parameters for contention based random access test in FR2 for NR Standalone**

Parameter	Unit	Test-1	Comments
AoA setup		Setup 1	As defined in A.3.15.1

Assumption for UE beams <sup>Note 3</sup>			Rough	
SSB with index 0	Es <sup>Note1</sup>	dBm/SCS	-80.6	Power of SSB with index 0 is set to be above configured <i>rsrp-ThresholdSSB</i>
	SSB_RP	dBm/SCS	-80.6	
	Es/lot <sub>BB</sub>	dB	21.09	
	lo	dBm/95.04 MHz	-56.01	lo in symbols containing SSB index 0
SSB with index 1	Es <sup>Note1</sup>	dBm/SCS	-95.0	Power of SSB with index 1 is set to be below configured <i>rsrp-ThresholdSSB</i>
	SSB_RP	dBm/SCS	-95.0	
	Es/lot <sub>BB</sub>	dB	6.69	
	lo	dBm/95.04 MHz	-70.41	lo in symbols containing SSB index 1
Propagation Condition		-	No external noise (Note 4)	
<p>Note 1: No artificial noise is applied in this test.</p> <p>Note 2: Void.</p> <p>Note 3: Information about types of UE beam is given in B.2.1.3, and does not limit UE implementation or test system implementation</p> <p>Note 4: The downlink connection between the System Simulator and the UE is without Additive White Gaussian Noise, and has no fading or multipath effects as specified in TS 38.521-2 B.0 [37].</p>				

#### A.7.3.2.2.1.2 Test Requirements

Contention based random access is triggered by *not* explicitly assigning a random access preamble via dedicated signalling in the downlink.

##### A.7.3.2.2.1.2.1 Random Access Preamble Transmission

To test the UE behavior specified in Clause 6.2.2.2.1.1 the System Simulator shall receive the Random Access Preamble which belongs to one of the Random Access Preambles associated with the SSB with index 0, which has SS-RSRP above the configured *rsrp-ThresholdSSB*.

In addition, the power applied to all preambles shall be in accordance with what is specified in Clause 6.2.2.2. The power of the first preamble shall be 0.6 dBm to be received at TE with an accuracy specified in clause 6.3.4.2 of TS 38.101-2 [19]. The relative power applied to additional preambles shall have an accuracy specified in clause 6.3.4.3 of TS 38.101-2 [19].

The transmit timing of all PRACH transmissions shall be within the accuracy specified in Clause 7.1.2.

##### A.7.3.2.2.1.2.2 Random Access Response Reception

To test the UE behavior specified in Clause 6.2.2.2.1.2 the System Simulator shall transmit a Random Access Response containing a Random Access Preamble identifier corresponding to the transmitted Random Access Preamble after 3 preambles have been received by the System Simulator. In response to the first 2 preambles, the System Simulator shall transmit a Random Access Response *not* corresponding to the transmitted Random Access Preamble.

The UE may stop monitoring for Random Access Response(s) and shall transmit the msg3 if the Random Access Response contains a Random Access Preamble identifier corresponding to the transmitted Random Access Preamble.

The UE shall again perform the Random Access Resource selection procedure specified in clause 5.1.2 in TS 38.321 [7], and transmit with the calculated PRACH transmission power when the backoff time expires if all received Random Access Responses contain Random Access Preamble identifiers that do not match the transmitted Random Access Preamble.

In addition, the power applied to all preambles shall be in accordance with what is specified in Clause 6.2.2.2. The power of the first preamble shall be 0.6 dBm to be received at TE with an accuracy specified in clause 6.3.4.2 of TS 38.101-2 [19]. The relative power applied to additional preambles shall have an accuracy specified in clause 6.3.4.3 of TS 38.101-2 [19].

The transmit timing of all PRACH transmissions shall be within the accuracy specified in Clause 7.1.2.

#### A.7.3.2.2.1.2.3 No Random Access Response Reception

To test the UE behavior specified in clause 6.2.2.2.1.3 the System Simulator shall transmit a Random Access Response containing a Random Access Preamble identifier corresponding to the transmitted Random Access Preamble after 3 preambles have been received by the System Simulator. The System Simulator shall *not* respond to the first 2 preambles.

The UE shall again perform the Random Access Resource selection procedure specified in clause 5.1.2 in TS 38.321 [7], and transmit with the calculated PRACH transmission power when the backoff time expires if no Random Access Response is received within the RA Response window.

In addition, the power applied to all preambles shall be in accordance with what is specified in Clause 6.2.2.2. The power of the first preamble shall be 0.6 dBm to be received at TE with an accuracy specified in clause 6.3.4.2 of TS 38.101-2 [19]. The relative power applied to additional preambles shall have an accuracy specified in clause 6.3.4.3 of TS 38.101-2 [19].

The transmit timing of all PRACH transmissions shall be within the accuracy specified in Clause 7.1.2.

#### A.7.3.2.2.1.2.4 Receiving an UL grant for msg3 retransmission

To test the UE behavior specified in clause 6.2.2.2.1.4 the System Simulator shall provide an UL grant for msg3 retransmission following a successful Random Access Response.

The UE shall re-transmit the msg3 upon the reception of an UL grant for msg3 retransmission.

#### A.7.3.2.2.1.2.5 Reception of an Incorrect Message over Temporary C-RNTI

To test the UE behavior specified in Clause 6.2.2.2.1.5 the System Simulator shall send a message addressed to the temporary C-RNTI with a UE Contention Resolution Identity included in the MAC control element *not* matching the CCCH SDU transmitted in msg3 uplink message.

The UE shall again perform the Random Access Resource selection procedure specified in clause 5.1.2 in TS 38.321 [7], and transmit with the calculated PRACH transmission power when the backoff time expires unless the received message includes a UE Contention Resolution Identity MAC control element and the UE Contention Resolution Identity included in the MAC control element matches the CCCH SDU transmitted in the uplink message.

#### A.7.3.2.2.1.2.6 Reception of a Correct Message over Temporary C-RNTI

To test the UE behavior specified in Clause 6.2.2.2.1.5 the System Simulator shall send a message addressed to the temporary C-RNTI with a UE Contention Resolution Identity included in the MAC control element matching the CCCH SDU transmitted in the msg3 uplink message.

The UE shall send ACK if the Contention Resolution is successful.

#### A.7.3.2.2.1.2.7 Contention Resolution Timer expiry

To test the UE behavior specified in Clause 6.2.2.2.1.6 the System Simulator shall *not* send a response to a msg3.

The UE shall again perform the Random Access Resource selection procedure specified in clause 5.1.2 in TS 38.321 [7], and transmit with the calculated PRACH transmission power when the backoff time expires if the Contention Resolution Timer expires.

### A.7.3.2.2.2 4-step RA type non-contention based random access test in FR2 for NR Standalone

#### A.7.3.2.2.2.1 Test Purpose and Environment

The purpose of this test is to verify that the behavior of the random access procedure is according to the requirements and that the PRACH power settings and timing are within specified limits. This test will verify the requirements in Clause 6.2.2.2 and Clause 7.1.2 in an AWGN model.

For this test one cell is used, with the configuration of Cell 1 configured as PCell or SCell in FR2. Supported test parameters are shown in Table A.7.3.2.2.2.1-1. UE capable of SA with PCell or SCell in FR2 needs to be tested by using the parameters in Table A.7.3.2.2.2.1-2 and Table A.7.3.2.2.2.1-3 for SSB-based non-contention based random access test (Test 1) and CSI-RS-based non-contention based random access test (Test 2). Test 2 is only applicable to UE which supports csi-RSRP-AndRSRQ-MeasWithSSB or csi-RSRP-AndRSRQ-MeasWithoutSSB.

**Table A.7.3.2.2.1-1: Supported test configurations for non-contention based random access test in FR2 for NR Standalone**

Config	Description
1	NR PSCell/SCell 120 kHz SSB SCS, 100 MHz bandwidth, TDD duplex mode

**Table A.7.3.2.2.1-2: General test parameters for non-contention based random access test in FR2 for NR Standalone**

Parameter	Unit	Test-1	Test-2	Comments
SSB Configuration	Config 1	SSB.1 FR2	SSB.1 FR2	As defined in A.3.10
CSI-RS for tracking	Config 1	TRS.2.1 TDD	TRS.2.1 TDD	
CSI-RS Configuration	Config 1	N/A	CSI-RS.3.1 TDD	As defined in A.3.1.4
Duplex Mode for Cell 2	Config 1	TDD	TDD	
TDD Configuration	Config 1	TDDConf.3.1	TDDConf.3.1	
$BW_{channel}$	Config 1	MHz	100: $N_{RB,c} = 66$	100: $N_{RB,c} = 66$
Data RBs allocated	Config 1	24	24	
OCNG Pattern <sup>Note 1</sup>		OP.3	OP.3	As defined in A.3.2.1.
PDSCH Reference Channel <sup>Note 2</sup>	Config 1	SR3.1 TDD	SR3.1 TDD	As defined in A.3.1.1.
NR RF Channel Number		1	1	
EPRE ratio of PSS to SSS	dB	0	0	
EPRE ratio of PBCH_DMRS to SSS	dB			
EPRE ratio of PBCH to PBCH_DMRS	dB			
EPRE ratio of PDCCH_DMRS to SSS	dB			
EPRE ratio of PDCCH to PDCCH_DMRS	dB			
EPRE ratio of PDSCH_DMRS to SSS	dB			
EPRE ratio of PDSCH to PDSCH_DMRS	dB			
ss-PBCH-BlockPower	dBm/ SCS	+20 + $\Delta_{UL}$	+20 + $\Delta_{UL}$	As defined in TS 38.331 [2]. $\Delta_{UL}$ is derived from the uplink calibration process <sup>Note 3</sup>
Configured UE transmitted power ( $P_{CMAX, f,c}$ )	dBm	maximum value configurable for certain power class	maximum value configurable for certain power class	As defined in clause 6.2.4 in TS 38.101-2 [19]
PRACH Configuration		FR2 PRACH configuration 2	FR2 PRACH configuration 3	As defined in A.3.8.3, with exceptions as defined below.
rsrp-ThresholdSSB	dBm	RSRP_69 + $\Delta_{DL}$	RSRP_69 + $\Delta_{DL}$	RSRP_69 corresponds to -88dBm. $\Delta_{DL}$ is derived from the downlink calibration process <sup>Note 4</sup>
preambleReceivedTargetPower	dBm	-100	-100	As defined in TS 38.331 [2]
Note 1:	OCNG shall be used such that a constant total transmitted power spectral density is achieved for all OFDM symbols. The OCNG pattern is chosen during the test according to the presence of a DL reference measurement channel.			
Note 2:	The DL PDSCH reference measurement channel is used in the test only when a downlink transmission dedicated to the UE under test is required.			
Note 3:	The $\Delta_{UL}$ value is calculated as $-\text{ROUND}(\text{PPRACH0} - 1)$ , where PPRACH0 is the measured first PRACH power with -80.6dBm/SCS applied, $\text{preambleReceivedTargetPower} = -100\text{dBm}$ and $\text{ss-PBCH-BlockPower} = 20\text{dBm}$ . These values are used during the uplink calibration process carried out before the test case is run, with the UE configured to send PRACH.			
Note 4:	The $\Delta_{DL}$ value is calculated as $(\text{RSRP}_{\text{REP}} - \text{RSRP}_{76})$ , where $\text{RSRP}_{\text{REP}}$ is the SS-RSRP Reported value in Table 10.1.6.1-1 with -80.6dBm/SCS applied. These values are used during the downlink calibration			

process carried out before the test case is run, with the UE configured to report SS-RSRP. For a Reported value RSRP<sub>x</sub>, x is treated as a positive integer value.

**Table A.7.3.2.2.1-3: OTA-related test parameters for non-contention based random access test in FR2 for NR Standalone**

Parameter		Unit	Test-1	Test-2	Comments
AoA setup			Setup 1	Setup 1	As defined in A.3.15.1
Assumption for UE beams <sup>Note 3</sup>			Rough	Rough	
SSB with index 0	Es <sup>Note1</sup>	dBm/SC S	-80.6	-80.6	Power of SSB with index 0 is set to be above configured <i>rsrp-ThresholdSSB</i>
	SSB_RP	dBm/SC S	-80.6	-80.6	
	Es/lot <sub>BB</sub>	dB	21.09	21.09	
	lo	dBm/95.0 4 MHz	-56.01	-56.01	
SSB with index 1	Es <sup>Note1</sup>	dBm/SC S	-95.0	-95.0	Power of SSB with index 1 is set to be below configured <i>rsrp-ThresholdSSB</i>
	SSB_RP	dBm/SC S	-95.0	-95.0	
	Es/lot <sub>BB</sub>	dB	6.69	6.69	
	lo	dBm/95.0 4 MHz	-70.41	-70.41	
Propagation Condition		-	No external noise (Note 4)	No external noise (Note 4)	
Note 1: No artificial noise is applied in this test. Note 2: void. Note 3: Information about types of UE beam is given in B.2.1.3, and does not limit UE implementation or test system implementation Note 4: The downlink connection between the System Simulator and the UE is without Additive White Gaussian Noise, and has no fading or multipath effects as specified in TS 38.521-2 B.0 [37].					

#### A.7.3.2.2.2.2 Test Requirements

Non-Contention based random access is triggered by explicitly assigning a random access preamble via dedicated signalling in the downlink. In the test, the non-contention based random access procedure is not initialized for Other SI requested from UE or beam failure recovery.

##### A.7.3.2.2.2.2.1 SSB-based Random Access Preamble Transmission

In Test-1, to test the UE behavior specified in Clause 6.2.2.2.2.1 for SSB-based Random Access Preamble transmission, with the contention-free Random Access Resources and the contention-free PRACH occasions associated with SSBs configured, the System Simulator shall receive the Random Access Preamble which has the Preamble Index associated with the SSB with index 0.

In addition, the System Simulator shall receive the Random Access Preamble on the PRACH occasion which belongs to the PRACH occasions corresponding to the SSB with index 0, and the selected PRACH occasion shall belong to the PRACH occasions permitted by the restrictions given by the *ra-ssb-OccasionMaskIndex*.

In addition, the power applied to all preambles shall be in accordance with what is specified in Clause 6.2.2.2. The power of the first preamble shall be 0.6 dBm to be received at TE with an accuracy specified in clause 6.3.4.2 of TS 38.101-2 [19]. The relative power applied to additional preambles shall have an accuracy specified in clause 6.3.4.3 of TS 38.101-2 [19].

The transmit timing of all PRACH transmissions shall be within the accuracy specified in Clause 7.1.2.



#### A.7.3.2.2.2.2 CSI-RS-based Random Access Preamble Transmission

In Test-1, to test the UE behavior specified in Clause 6.2.2.2.1 for CSI-RS-based Random Access Preamble transmission, with the contention-free Random Access Resources and the contention-free PRACH occasions associated with CSI-RSs configured, the System Simulator shall receive the Random Access Preamble which has the Preamble Index associated with the CSI-RS configured.

In addition, the System Simulator shall receive the Random Access Preamble on the PRACH occasion which belongs to the PRACH occasions corresponding to the CSI-RS configured, and the selected PRACH occasion shall belong to the PRACH occasions permitted by the restrictions given by the *ra-OccasionList*.

In addition, the power applied to all preambles shall be in accordance with what is specified in Clause 6.2.2.2. The power of the first preamble shall be 0.6 dBm to be received at TE with an accuracy specified in clause 6.3.4.2 of TS 38.101-2 [19]. The relative power applied to additional preambles shall have an accuracy specified in clause 6.3.4.3 of TS 38.101-2 [19].

The transmit timing of all PRACH transmissions shall be within the accuracy specified in Clause 7.1.2.

#### A.7.3.2.2.2.3 Random Access Response Reception

To test the UE behavior specified in Clause 6.2.2.2.2 the System Simulator shall transmit a Random Access Response containing a Random Access Preamble identifier corresponding to the transmitted Random Access Preamble after 3 preambles have been received by the System Simulator. In response to the first 2 preambles, the System Simulator shall transmit a Random Access Response *not* corresponding to the transmitted Random Access Preamble.

The UE may stop monitoring for Random Access Response(s) if the Random Access Response contains a Random Access Preamble identifier corresponding to the transmitted Random Access Preamble.

The UE shall again perform the Random Access Resource selection procedure specified in clause 5.1.2 in TS 38.321 [7], and transmit with the calculated PRACH transmission power if all received Random Access Responses contain Random Access Preamble identifiers that do not match the transmitted Random Access Preamble.

In addition, the power applied to all preambles shall be in accordance with what is specified in Clause 6.2.2.2. The power of the first preamble shall be 0.6 dBm to be received at TE with an accuracy specified in clause 6.3.4.2 of TS 38.101-2 [19]. The relative power applied to additional preambles shall have an accuracy specified in clause 6.3.4.3 of TS 38.101-2 [19].

The transmit timing of all PRACH transmissions shall be within the accuracy specified in Clause 7.1.2.

#### A.7.3.2.2.2.4 No Random Access Response Reception

To test the UE behavior specified in clause 6.2.2.2.3 the System Simulator shall transmit a Random Access Response containing a Random Access Preamble identifier corresponding to the transmitted Random Access Preamble after 3 preambles have been received by the System Simulator. The System Simulator shall *not* respond to the first 2 preambles.

The UE shall again perform the Random Access Resource selection procedure specified in clause 5.1.2 in TS 38.321 [7], and transmit with the calculated PRACH transmission power when the backoff time expires if no Random Access Response is received within the RA Response window configured in *RACH-ConfigCommon*.

In addition, the power applied to all preambles shall be in accordance with what is specified in Clause 6.2.2.2. The power of the first preamble shall be 0.6 dBm to be received at TE with an accuracy specified in clause 6.3.4.2 of TS 38.101-2 [19]. The relative power applied to additional preambles shall have an accuracy specified in clause 6.3.4.3 of TS 38.101-2 [19].

The transmit timing of all PRACH transmissions shall be within the accuracy specified in Clause 7.1.2.

### A.7.3.2.2.3 2-step RA type contention based random access test in FR2 for NR Standalone

#### A.7.3.2.2.3.1 Test Purpose and Environment

The purpose of this test is to verify that the behavior of the 2-step RA type random access procedure is according to the requirements and that the MsgA PRACH, MsgA PUSCH power settings and timing are within specified limits. This test will verify the requirements in Clause 6.2.2.3 and Clause 7.1.2 in an AWGN model.

For this test one cell is used, with the configuration of Cell 1 configured as PCell or SCell in FR2. Supported test parameters are shown in Table A.7.3.2.2.3.1-1. UE capable of SA with PCell or SCell in FR2 needs to be tested by using the parameters in Table A.7.3.2.2.3.1-2 and Table A.7.3.2.2.3.1-3.

**Table A.7.3.2.2.3.1-1: Supported test configurations for 2-step RA type contention based random access test in FR2 for NR Standalone**

Config	Description
1	NR PSCell/SCell 120 kHz SSB SCS, 100 MHz bandwidth, TDD duplex mode

**Table A.7.3.2.2.3.1-2: General test parameters for 2-step RA type contention based random access test in FR2 for NR Standalone**

Parameter	Unit	Test-1	Comments
SSB Configuration	Config 1	SSB.1 FR2	As defined in A.3.10
Duplex Mode for Cell 1	Config 1	TDD	
TDD Configuration	Config 1	TDDConf.3.1	As defined in A.3.1.4
$BW_{channel}$	Config 1	MHz	100: $N_{RB,c} = 24$
OCNG Pattern <sup>Note 1</sup>			OCNG pattern 1
PDSCH Reference Channel <sup>Note 2</sup>	Config 1		SR.3.1 TDD
RMSI CORESET Reference Channel	Config 1		CR.3.1 TDD
NR RF Channel Number			1
EPRE ratio of PSS to SSS	dB		0
EPRE ratio of PBCH_DMRS to SSS	dB		
EPRE ratio of PBCH to PBCH_DMRS	dB		
EPRE ratio of PDCCH_DMRS to SSS	dB		
EPRE ratio of PDCCH to PDCCH_DMRS	dB		
EPRE ratio of PDSCH_DMRS to SSS	dB		
EPRE ratio of PDSCH to PDSCH_DMRS	dB		
ss-PBCH-BlockPower	dBm/ SCS		+20 $\Delta_{UL}$
			As defined in TS 38.331 [2]. $\Delta_{UL}$ is derived from the uplink calibration process <sup>Note 3</sup>
Configured UE transmitted power ( $P_{CMAX, f,c}$ )	dBm		maximum value configurable for certain power class
MsgA Configuration			FR2 MsgA configuration 1
<i>msgA-RSRP-ThresholdSSB</i>	dBm		RSRP_69 + $\Delta_{DL}$
			RSRP_69 corresponds to -88dBm. $\Delta_{DL}$ is derived from the downlink calibration process <sup>Note 4</sup>
preambleReceivedTargetPower	dBm		-100
			As defined in TS 38.331 [2]
Note 1:	OCNG shall be used such that a constant total transmitted power spectral density is achieved for all OFDM symbols. The OCNG pattern is chosen during the test according to the presence of a DL reference measurement channel.		
Note 2:	The DL PDSCH reference measurement channel is used in the test only when a downlink transmission dedicated to the UE under test is required.		
Note 3:	The $\Delta_{UL}$ value is calculated as $-\text{ROUND}(\text{PMsgA0} - 1)$ , where PMsgA0 is the measured first MsgA PRACH power with -80.6dBm/SCS applied, <i>msgA-PreambleReceivedTargetPower</i> = -100dBm and <i>ss-PBCH-BlockPower</i> = 20dBm. These values are used during the uplink calibration process carried out before the test case is run, with the UE configured to send MsgA.		
Note 4:	The $\Delta_{DL}$ value is calculated as $(\text{RSRP}_{\text{REP}} - \text{RSRP}_{76})$ , where RSRP_REP is the SS-RSRP Reported value in Table 10.1.6.1-1 with -80.6dBm/SCS applied. These values are used during the downlink calibration process carried out before the test case is run, with the UE configured to report SS-RSRP. For a Reported value RSRP_x, x is treated as a positive integer value.		

**Table A.7.3.2.2.3.1-3: OTA-related test parameters for 2-step RA type contention based random access test in FR2 for NR Standalone**

Parameter		Unit	Test-1	Comments
AoA setup			Setup 2b	As defined in A.3.15.1
Assumption for UE beams <sup>Note 2</sup>			Rough	
SSB with index 0	Es <sup>Note1</sup>	dBm/SCS	-80.6	Power of SSB with index 0 is set to be above configured <i>msgA-RSRP-ThresholdSSB</i>
	SSB_RP	dBm/SCS	-80.6	
	Es/lot <sub>BB</sub>	dB	21.09	
	Io	dBm/95.04 MHz	-56.01	Io in symbols containing SSB index 0
SSB with index 1	Es <sup>Note1</sup>	dBm/SCS	-95.0	Power of SSB with index 1 is set to be below configured <i>msgA-RSRP-ThresholdSSB</i>
	SSB_RP	dBm/SCS	-95.0	
	Es/lot <sub>BB</sub>	dB	6.69	
	Io	dBm/95.04 MHz	-70.41	Io in symbols containing SSB index 1
Propagation Condition		-	AWGN	
Note 1: No artificial noise is applied in this test.				
Note 2: Information about types of UE beam is given in B.2.1.3, and does not limit UE implementation or test system implementation				

#### A.7.3.2.2.3.2 Test Requirements

Contention based random access is triggered by *not* explicitly assigning a random access preamble via dedicated signalling in the downlink.

##### A.7.3.2.2.3.2.1 MsgA Transmission

To test the UE behavior specified in Clause 6.2.2.3.1.1 the System Simulator shall receive the MsgA with a preamble which belongs to one of the Random Access Preambles associated with the SSB with index 0, which has SS-RSRP above the configured *msgA-RSRP-ThresholdSSB*.

In addition, the power applied to all MsgA transmissions shall be in accordance with what is specified in Clause 6.2.2.3. The power of the first MsgA preamble shall be 0.6 dBm to be received at TE with an accuracy specified in clause 6.3.4.2 of TS 38.101-2 [19]. The power of the first MsgA PUSCH transmission shall be  $0.6 + 3(\mu + 2)$  dBm with an accuracy specified in clause 6.3.4.2 of TS 38.101-2 [19], where  $\mu$  indicates the MsgA PUSCH numerology. The relative power applied to additional MsgA transmissions shall have an accuracy specified in clause 6.3.4.3 of TS 38.101-2 [19].

The transmit timing of all MsgA transmissions shall be within the accuracy specified in Clause 7.1.2.

##### A.7.3.2.2.3.2.2 MsgB Reception

To test the UE behavior specified in Clause 6.2.2.3.1.2 the System Simulator shall transmit a MsgB containing a fallbackRAR message and a Random Access Preamble identifier corresponding to the transmitted Random Access Preamble after 3 preambles have been received by the System Simulator. In response to the first 2 preambles, the System Simulator shall transmit a MsgB *not* corresponding to the transmitted Random Access Preamble.

The UE may stop monitoring for MsgB(s) and shall transmit the msg3 if the MsgB with a fallbackRAR contains a Random Access Preamble identifier corresponding to the transmitted Random Access Preamble.

The UE shall again perform the Random Access Resource selection procedure specified in clause 5.1.2a in TS 38.321 [7], and transmit MsgA with the calculated MsgA PRACH and MsgA PUSCH transmission power when the backoff time expires if all received MsgB's contain Random Access Preamble identifiers that do not match the transmitted Random Access Preamble.

In addition, the power applied to all MsgA transmissions shall be in accordance with what is specified in Clause 6.2.2.3. The power of the first MsgA PRACH shall be 0.6 dBm to be received at TE with an accuracy specified in clause 6.3.4.2 of TS 38.101-2 [19]. The power of the first MsgA PUSCH transmission shall be  $0.6 + 3(\mu + 2)$  dBm with an accuracy specified in clause 6.3.4.2 of TS 38.101-2 [19], where  $\mu$  indicates the MsgA PUSCH numerology. The relative power applied to additional MsgA transmissions shall have an accuracy specified in clause 6.3.4.3 of TS 38.101-2 [19].

The transmit timing of all MsgA transmissions shall be within the accuracy specified in Clause 7.1.2.

#### A.7.3.2.2.3.2.3 No MsgB Reception

To test the UE behavior specified in clause 6.2.2.3.1.3 the System Simulator shall transmit a MsgB containing a fallbackRAR message and Random Access Preamble identifier corresponding to the transmitted Random Access Preamble after 3 preambles have been received by the System Simulator. The System Simulator shall *not* respond to the first 2 preambles.

The UE shall again perform the Random Access Resource selection procedure specified in clause 5.1.2a in TS 38.321 [7], and transmit with the calculated MsgA PRACH and MsgA PUSCH transmission power when the backoff time expires if no MsgB is received within the MsgB Response window.

In addition, the power applied to all MsgA transmissions shall be in accordance with what is specified in Clause 6.2.2.3. The power of the first MsgA PRACH shall be 0.6 dBm to be received at TE with an accuracy specified in clause 6.3.4.2 of TS 38.101-2 [19]. The power of the first MsgA PUSCH transmission shall be  $0.6 + 3(\mu + 2)$  dBm with an accuracy specified in clause 6.3.4.2 of TS 38.101-2 [19], where  $\mu$  indicates the MsgA PUSCH numerology. The relative power applied to additional MsgA transmissions shall have an accuracy specified in clause 6.3.4.3 of TS 38.101-2 [19].

The transmit timing of all MsgA transmissions shall be within the accuracy specified in Clause 7.1.2.

#### A.7.3.2.2.4 2-step RA type non-contention based random access test in FR2 for NR Standalone

##### A.7.3.2.2.4.1 Test Purpose and Environment

The purpose of this test is to verify that the behavior of the random access procedure is according to the requirements and that the MsgA PRACH, MsgA PUSCH power settings and timing are within specified limits. This test will verify the requirements in Clause 6.2.2.3 and Clause 7.1.2 in an AWGN model.

For this test one cell is used, with the configuration of Cell 1 configured as PCell or SCell in FR2. Supported test parameters are shown in Table A.7.3.2.2.4.1-1. UE capable of SA with PCell or SCell in FR2 needs to be tested by using the parameters in Table A.7.3.2.2.4.1-2 and Table A.7.3.2.2.4.1-3.

**Table A.7.3.2.2.4.1-1: Supported test configurations for non-contention based random access test for 2-step RA type in FR2 for NR Standalone**

Config	Description
1	NR PSCell/SCell 120 kHz SSB SCS, 100 MHz bandwidth, TDD duplex mode

**Table A.7.3.2.2.4.1-2: General test parameters for non-contention based random access test for 2-step RA type in FR2 for NR Standalone**

Parameter	Unit	Test-1	Comments
SSB Configuration	Config 1	SSB.1 FR2	As defined in A.3.10
Duplex Mode for Cell 2	Config 1	TDD	
TDD Configuration	Config 1	TDDConf.3.1	
BW <sub>channel</sub>	Config 1	MHz	100: N <sub>RB,c</sub> = 24
OCNG Pattern <sup>Note 1</sup>		OP.3	As defined in A.3.2.1.
PDSCH Reference Channel <sup>Note 2</sup>	Config 1	SR3.1 TDD	As defined in A.3.1.1.
NR RF Channel Number		1	
EPRE ratio of PSS to SSS	dB	0	
EPRE ratio of PBCH_DMRS to SSS	dB		
EPRE ratio of PBCH to PBCH_DMRS	dB		
EPRE ratio of PDCCH_DMRS to SSS	dB		
EPRE ratio of PDCCH to PDCCH_DMRS	dB		
EPRE ratio of PDSCH_DMRS to SSS	dB		
EPRE ratio of PDSCH to PDSCH_DMRS	dB		
ss-PBCH-BlockPower	dBm/SCS	+20 +Δ <sub>UL</sub>	As defined in TS 38.331 [2].

			$\Delta_{UL}$ is derived from the uplink calibration process Note 3
Configured UE transmitted power ( $P_{CMAX,f,c}$ )	dBm	maximum value configurable for certain power class	As defined in clause 6.2.4 in TS 38.101-2 [19]
MsgA Configuration		FR2 MsgA configuration 2	As defined in A.3.20.3, with exceptions as defined below.
msgA-RSRP-ThresholdSSB	dBm	$RSRP_{69} + \Delta_{DL}$	$RSRP_{69}$ corresponds to -88dBm. $\Delta_{DL}$ is derived from the downlink calibration process Note 4
msgA-PreambleReceivedTargetPower	dBm	-100	As defined in TS 38.331 [2]
<p>Note 1: OCNG shall be used such that a constant total transmitted power spectral density is achieved for all OFDM symbols. The OCNG pattern is chosen during the test according to the presence of a DL reference measurement channel.</p> <p>Note 2: The DL PDSCH reference measurement channel is used in the test only when a downlink transmission dedicated to the UE under test is required.</p> <p>Note 3: The <math>\Delta_{UL}</math> value is calculated as <math>-\text{ROUND}(P_{MsgA0} - 1)</math>, where <math>P_{MsgA0}</math> is the measured first MsgA PRACH power with -80.6dBm/SCS applied, <math>msgA-PreambleReceivedTargetPower = -100\text{dBm}</math> and <math>ss-PBCH-BlockPower = 20\text{dBm}</math>. These values are used during the uplink calibration process carried out before the test case is run, with the UE configured to send MsgA.</p> <p>Note 4: The <math>\Delta_{DL}</math> value is calculated as <math>(RSRP_{REP} - RSRP_{76})</math>, where <math>RSRP_{REP}</math> is the SS-RSRP Reported value in Table 10.1.6.1-1 with -80.6dBm/SCS applied. These values are used during the downlink calibration process carried out before the test case is run, with the UE configured to report SS-RSRP. For a Reported value <math>RSRP_x</math>, x is treated as a positive integer value.</p>			

**Table A.7.3.2.2.4.1-3: OTA-related test parameters for non-contention based random access test for 2-step RA type in FR2 for NR Standalone**

Parameter		Unit	Test-1	Comments
AoA setup			Setup 1	As defined in A.3.15.1
Assumption for UE beams <sup>Note 2</sup>			Rough	
SSB with index 0	$E_s$ <sup>Note 1</sup>	dBm/SCS	-80.6	Power of SSB with index 0 is set to be above configured <i>msgA-RSRP-ThresholdSSB</i>
	SSB_RP	dBm/SCS	-80.6	
	$E_s/lot_{BB}$	dB	21.09	
	lo	dBm/95.04 MHz	-56.01	lo in symbols containing SSB index 0
SSB with index 1	$E_s$ <sup>Note 1</sup>	dBm/SCS	-95.0	Power of SSB with index 1 is set to be below configured <i>msgA-RSRP-ThresholdSSB</i>
	SSB_RP	dBm/SCS	-95.0	
	$E_s/lot_{BB}$	dB	6.69	
	lo	dBm/95.04 MHz	-70.41	lo in symbols containing SSB index 1
Propagation Condition		-	AWGN	
<p>Note 1: No artificial noise is applied in this test.</p> <p>Note 2: Information about types of UE beam is given in B.2.1.3, and does not limit UE implementation or test system implementation</p>				

**A.7.3.2.2.4.2 Test Requirements**

Non-Contention based random access is triggered by explicitly assigning a random access preamble via dedicated signalling in the downlink. In the test, the non-contention based random access procedure is not initialized for Other SI requested from UE or beam failure recovery.

#### A.7.3.2.2.4.2.1 MsgA Transmission

In Test-1, to test the UE behavior specified in Clause 6.2.2.3.2.1 for MsgA transmission, with the contention-free Random Access Resources and the contention-free PRACH occasions associated with SSBs configured, the System Simulator shall receive the MsgA which has the Preamble Index associated with the SSB with index 0.

In addition, the System Simulator shall receive the MsgA on the PRACH occasion which belongs to the PRACH occasions corresponding to the SSB with index 0, and the selected PRACH occasion shall belong to the PRACH occasions permitted by the restrictions given first by the *msgA-SSB-SharedRO-MaskIndex* if configured, or next by the *ra-ssb-OccasionMaskIndex* if configured.

In addition, the power applied to all MsgA transmissions shall be in accordance with what is specified in Clause 6.2.2.3. The power of the first preamble shall be 0.6 dBm to be received at TE with an accuracy specified in clause 6.3.4.2 of TS 38.101-2 [19]. The power of the first MsgA PUSCH transmission shall be  $0.6 + 3(\mu + 2)$  dBm with an accuracy specified in clause 6.3.4.2 of TS 38.101-2 [19], where  $\mu$  indicates the MsgA PUSCH numerology. The relative power applied to additional MsgA transmissions shall have an accuracy specified in clause 6.3.4.3 of TS 38.101-2 [19].

The transmit timing of all MsgA transmissions shall be within the accuracy specified in Clause 7.1.2.

#### A.7.3.2.2.4.2.2 MsgB Reception

To test the UE behavior specified in Clause 6.2.2.3.2.2 the System Simulator shall transmit a MsgB containing a successRAR MAC subPDU corresponding to the transmitted Random Access Preamble after 3 MsgA transmissions have been received by the System Simulator. In response to the first 2 preambles, the System Simulator shall transmit a MsgB *not* corresponding to the transmitted Random Access Preamble.

The UE may stop monitoring for MsgB if the MsgB contains a successRAR MAC subPDU corresponding to the transmitted Random Access Preamble.

The UE shall again perform the Random Access Resource selection procedure specified in clause 5.1.2a in TS 38.321 [7], and transmit with the calculated MsgA transmission power if all received Random Access Response Reception has not been considered as successful.

In addition, the power applied to all MsgA transmissions shall be in accordance with what is specified in Clause 6.2.2.3. The power of the first preamble shall be 0.6 dBm to be received at TE with an accuracy specified in clause 6.3.4.2 of TS 38.101-2 [19]. The power of the first MsgA PUSCH transmission shall be  $0.6 + 3(\mu + 2)$  dBm with an accuracy specified in clause 6.3.4.2 of TS 38.101-2 [19], where  $\mu$  indicates the MsgA PUSCH numerology. The relative power applied to additional MsgA transmissions shall have an accuracy specified in clause 6.3.4.3 of TS 38.101-2 [19].

The transmit timing of all MsgA transmissions shall be within the accuracy specified in Clause 7.1.2.

#### A.7.3.2.2.4.2.3 No MsgB Reception

To test the UE behavior specified in clause 6.2.2.3.2.3 the System Simulator shall transmit a MsgB corresponding to the transmitted Random Access Preamble after 3 preambles have been received by the System Simulator. The System Simulator shall *not* respond to the first 2 preambles.

The UE shall again perform the Random Access Resource selection procedure specified in clause 5.1.2a in TS 38.321 [7], and transmit with the calculated MsgA transmission power when the backoff time expires if no MsgB is received within the MsgB Response window configured in *RACH-ConfigGenericTwoStepRA*.

In addition, the power applied to all MsgA transmissions shall be in accordance with what is specified in Clause 6.2.2.3. The power of the first preamble shall be 0.6 dBm to be received at TE with an accuracy specified in clause 6.3.4.2 of TS 38.101-2 [19]. The power of the first MsgA PUSCH transmission shall be  $0.6 + 3(\mu + 2)$  dBm with an accuracy specified in clause 6.3.4.2 of TS 38.101-2 [19], where  $\mu$  indicates the MsgA PUSCH numerology. The relative power applied to additional MsgA transmissions shall have an accuracy specified in clause 6.3.4.3 of TS 38.101-2 [19].

The transmit timing of all MsgA transmissions shall be within the accuracy specified in Clause 7.1.2.

### A.7.3.2.3 SA: RRC Connection Release with Redirection

#### A.7.3.2.3.1 Redirection from NR in FR2 to NR in FR2

##### A.7.3.2.3.1.1 Test Purpose and Environment

This test is to verify RRC connection release with redirection from NR to NR requirements specified in clause 6.2.3.2.1.

##### A.7.3.2.3.1.2 Test Parameters

Supported test configurations are shown in table A.7.3.2.3.1.2-1. The time delay is tested by using the parameters in table A.7.3.2.3.1.2-2, and A.7.3.2.3.1.2-3.

The test consists of two successive time periods, with time duration of T1, and T2 respectively. The *RRCRelease* message shall be sent to the UE during period T1 and the start of T2 is the instant when the last TTI containing the RRC message is sent to the UE. Prior to time duration T2, the UE shall not have any timing information of Cell 2. Cell 2 is powered up at the beginning of the T2.

**Table A.7.3.2.3.1.2-1: Redirection from NR to NR test configurations**

Config	Description
1	Source cell: NR 120 kHz SSB SCS, 100 MHz bandwidth, TDD duplex mode Target cell: NR 120 kHz SSB SCS, 100 MHz bandwidth, TDD duplex mode

**Table A.7.3.2.3.1.2-2: General test parameters for Redirection from NR to NR test case**

Parameter	Unit	Value	Comment
Initial conditions	Active cell	Cell 1	
	Neighbouring cell	Cell 2	
Final condition	Active cell	Cell 2	
Filter coefficient		0	L3 filtering is not used
Access Barring Information	-	Not Sent	No additional delays in random access procedure.
Time offset between cells		3 $\mu$ s	Synchronous cells
T1	s	5	
T2	s	3.2	

**Table A.7.3.2.3.1.2-3: Cell specific test parameters for Redirection from NR to NR test case**

Parameter	Unit	Cell 1		Cell 2	
		T1	T2	T1	T2
Assumption for UE beams <sup>Note 6</sup>		Rough		Rough	
AoA setup		Setup 1 as defined in A.3.15			
NR RF Channel Number		1		2	
Duplex mode		TDD			
TDD configuration		TDDConf.3.1			
BW <sub>channel</sub>	MHz	100: N <sub>RB,c</sub> = 66			
BWP BW	MHz	100: N <sub>RB,c</sub> = 66			
Data RBs allocated		66			
DRx Cycle	ms	Not Applicable			
PDSCH Reference measurement channel		SR3.1 TDD			
RMSI CORESET Reference Channel		CR3.1 TDD			
Control Channel RMC		CCR.3.1 TDD			
OCNG Patterns		OP.1			
SMTc configuration		SMTc.1 FR2			
SSB Configuration		SSB.3 FR2			
PDSCH/PDCCH subcarrier spacing	kHz	120 kHz			
PUCCH/PUSCH subcarrier spacing	kHz	120 kHz			
PRACH configuration		FR2 PRACH configuration 1			
TRS configuration		TRS.2.1 TDD			
PDSCH/PDCCH TCI state		TCI.State.2			
BWP configuration	Initial DL BWP	DLBWP.0.1			
	Dedicated DL BWP	DLBWP.1.1			

		Initial UL BWP	ULBWP.0.1			
		Dedicated UL BWP	ULBWP.1.1			
EPRE ratio of PSS to SSS		dB	0		0	
EPRE ratio of PBCH DMRS to SSS						
EPRE ratio of PBCH to PBCH DMRS						
EPRE ratio of PDCCH DMRS to SSS						
EPRE ratio of PDCCH to PDCCH DMRS						
EPRE ratio of PDSCH DMRS to SSS						
EPRE ratio of PDSCH to PDSCH						
EPRE ratio of OCNG DMRS to SSS(Note 1)						
EPRE ratio of OCNG to OCNG DMRS (Note 1)						
$N_{oc}$ Note2		dBm/15kHz	-104.7		-104.7	
$N_{oc}$ Note2		dBm/SCS	-95.7		-95.7	
$\hat{E}_s/I_{ot}$		dB	5	5	-Infinity	5
$\hat{E}_s/N_{oc}$		dB	5	5	-Infinity	5
$I_o$ Note3		dBm/BW	-60.5	-60.5	-66.7	-60.5
Propagation condition		-	AWGN		AWGN	
<p>Note 1: OCNG shall be used such that both cells are fully allocated and a constant total transmitted power spectral density is achieved for all OFDM symbols.</p> <p>Note 2: Interference from other cells and noise sources not specified in the test is assumed to be constant over subcarriers and time and shall be modelled as AWGN of appropriate power for <math>N_{oc}</math> to be fulfilled.</p> <p>Note 3: <math>I_o</math> levels have been derived from other parameters for information purposes. They are not settable parameters themselves.</p> <p>Note 4: Equivalent power received by an antenna with 0 dBi gain at the centre of the quiet zone</p> <p>Note 5: As observed with 0 dBi gain antenna at the centre of the quiet zone</p> <p>Note 6: Information about types of UE beam is given in B.2.1.3, and does not limit UE implementation or test system implementation</p>						

A.7.3.2.3.1.3 Test Requirements

The UE shall start to transmit the PRACH to Cell 2 less than 3160 ms from the beginning of time period T2.

The rate of correct RRC connection release redirection to NR observed during repeated tests shall be at least 90%.

NOTE: The redirection delay can be expressed as:

$$T_{\text{connection\_release\_redirect\_NR}} = T_{\text{RRC\_procedure\_delay}} + T_{\text{identify-NR}} + T_{\text{SI-NR}} + T_{\text{RACH}},$$

where:

$T_{\text{RRC\_procedure\_delay}} = 110$  ms in the test.

$T_{\text{identify-NR}} = 1760$  ms in the test.

$T_{\text{SI-NR}} = 1280$  ms, it is the time required for receiving all the relevant system information as defined in TS 38.331 for the target NR cell.

$T_{\text{RACH}} = 10$  ms in the test.

This gives a total of 3160 ms.

A.7.3.3 Conditional Handover

A.7.3.3.1 Intra-frequency conditional handover from FR2 to FR2

A.7.3.3.1.1 Test Purpose and Environment

This test is to verify the requirement for the NR FR2-NR FR2 intra frequency conditional handover requirements specified in clause 6.1.4.4.



## A.7.3.3.1.2 Test Parameters

Supported test configurations are shown in table A.7.3.3.2.2-1. Both handover delay and interruption length are tested by using the parameters in table A.7.3.3.2.2-2, and A.7.3.3.2.2-3.

The test scenario comprises of two cells. No gap patterns are configured in the test case. The test consists of two successive time periods, with time durations of T1, T2 respectively. At the start of time duration T1, the UE does not have any timing information of cell 2. NR shall configure a condition implying handover to cell 2 during T1, at a time earlier than  $T_{RRC}$  before the beginning of T2. Starting T2, cell 2 becomes detectable.

**Table A.7.3.3.1.2-1: Intra-frequency conditional handover from FR2 to FR2 test configurations**

Config	Description
1	Source cell: NR 120 kHz SSB SCS, 100 MHz bandwidth, TDD duplex mode Target cell: NR 120 kHz SSB SCS, 100 MHz bandwidth, TDD duplex mode

**Table A.7.3.3.1.2-2: General test parameters for conditional Intra-frequency handover from FR2 to FR2**

Parameter	Unit	Value	Comment
Initial conditions		Cell 1	
		Cell 2	
Final condition		Cell 2	
A3-Offset for condition	dBm	-1	Trigger HO to cell which may be measured as -1dB relative to cell 1. Actual SS-RSRP is 5dB stronger.
Hysteresis	dB	0	
Time To Trigger	s	0	
Filter coefficient		0	L3 filtering is not used
Access Barring Information	-	Not Sent	No additional delays in random access procedure.
Time offset between cells		3 $\mu$ s	Synchronous cells
T1	s	5	
T2	s	$\leq 2$	

**Table A.7.3.3.1.2-3: Cell specific test parameters for NR FR2-FR2 conditional Intra frequency handover test case**

Parameter	Unit	Cell 1		Cell 2	
		T1	T2	T1	T2
NR RF Channel Number		1		1	
AoA setup		Setup 1 as defined in A.3.15			
Assumption for UE beams <sup>Note 6</sup>		Rough			
Duplex mode		TDD			
TDD configuration		TDDConf.3.1			
BW <sub>channel</sub>	MHz	100: N <sub>RB,c</sub> = 66			
BWP BW	MHz	100: N <sub>RB,c</sub> = 66			
DRx Cycle	ms	Not Applicable			
PDSCH Reference measurement channel		SR3.1 TDD			
CORESET Reference Channel		CR3.1 TDD			
OCNG Patterns		OCNG pattern 1			
SMTc Configuration		SMTc pattern 1			
SSB Configuration		SSB.1 FR2			
PDSCH/PDCCH subcarrier spacing	kHz	120 kHz			
PUCCH/PUSCH subcarrier spacing	kHz	120 kHz			
PRACH configuration		FR2 PRACH configuration 1			
TRS configuration		TRS.2.1 TDD			
TCl configuration		CSI-RS.Config.0			
BWP configuration	Initial DL BWP	DLBWP.0.1			
	Dedicated DL BWP	DLBWP.1.1			
	Initial UL BWP	ULBWP.0.1			
	Dedicated UL BWP	ULBWP.1.1			

EPRE ratio of PSS to SSS		dB	0		0	
EPRE ratio of PBCH DMRS to SSS						
EPRE ratio of PBCH to PBCH DMRS						
EPRE ratio of PDCCH DMRS to SSS						
EPRE ratio of PDCCH to PDCCH DMRS						
EPRE ratio of PDSCH DMRS to SSS						
EPRE ratio of PDSCH to PDSCH						
EPRE ratio of OCNG DMRS to SSS(Note 1)						
EPRE ratio of OCNG to OCNG DMRS (Note 1)						
$N_{oc}^{Note2}$		dBm/15kHz	-104.7		-104.7	
$N_{oc}^{Note2}$	Config 1	dBm/SCS	-95.7		-95.7	
$\hat{E}_s/I_{otBB}^{Note8}$		dB	5.03	-5.41	-Infinity	3.81
$\hat{E}_s/N_{oc}$		dB	6	6	-Infinity	11
$Io^{Note3}$	Config 1	dBm/BW	-59.7	-54.2	-59.7	-54.2
Propagation condition		-	AWGN			
<p>Note 1: OCNG shall be used such that both cells are fully allocated and a constant total transmitted power spectral density is achieved for all OFDM symbols.</p> <p>Note 2: Interference from other cells and noise sources not specified in the test is assumed to be constant over subcarriers and time and shall be modelled as AWGN of appropriate power for <math>N_{oc}</math> to be fulfilled.</p> <p>Note 3: <math>Io</math> levels have been derived from other parameters for information purposes. They are not settable parameters themselves.</p> <p>Note 4: Equivalent power received by an antenna with 0 dBi gain at the centre of the quiet zone</p> <p>Note 5: As observed with 0 dBi gain antenna at the centre of the quiet zone</p> <p>Note 6: Information about types of UE beam is given in B.2.1.3, and does not limit UE implementation or test system implementation</p> <p>Note 7: <math>E_s/I_{ot}</math>, SSB_RP and <math>Io</math> levels have been derived from other parameters for information purposes. They are not settable parameters themselves.</p> <p>Note 8: Calculation of <math>E_s/I_{otBB}</math> includes the effect of UE internal noise up to the value assumed for the associated REFSSENS requirement in TS 38.101-2 [19] clause 7.3.2, and an allowance of 1dB for UE multi-band relaxation factor <math>\Delta_{MBS}</math> specified in TS 38.101-2 [19] Table 6.2.1.3-4.</p>						

### A.7.3.3.1.2.3 Test Requirements

$T_{RRC} + T_{Event\_DU}$  occurs during T1 as the handover condition becomes satisfied at the start of T2. The test shall verify that there are no interruptions during T1.

The UE shall start to transmit the PRACH to Cell 2 less than  $T_{measure} + T_{interrupt} + T_{CHO\_execution} = 1600 + 62 + 10 = 1672$  ms (power class 1) or  $1080 + 62 + 10 = 1152$  (PC2/3/4)  $62$  ms = 1152 ms (power classes 2,3 and 4) from the start of T2 and the interruption during T2 shall not exceed  $T_{interrupt} = T_{processing} + T_{IU} + T_{\Delta} + T_{margin} = 40 + 20 + 2 = 62$ ms excluding any transmissions which do not occur due to scheduling restrictions.

### A.7.3.3.2 Inter-frequency conditional handover from FR2 to FR2; unknown target cell

#### A.7.3.3.2.1 Test Purpose and Environment

This test is to verify the requirement for the NR FR2-NR FR2 inter frequency conditional handover requirements specified in clause 6.1.4.4.

#### A.7.3.3.2.2 Test Parameters

Supported test configurations are shown in table A.7.3.3.2-1. Both conditional handover delay and interruption length are tested by using the parameters in table A.7.3.3.2-2, and A.7.3.3.2-3.

The test scenario comprises of two carriers and one cell on each carrier. Gap pattern ID gp0 is configured in the test case. The test consists of two successive time periods, with time durations of T1, T2 respectively. At the start of time duration T1, the UE does not have any timing information of cell 2. NR shall configure a condition implying handover

to cell 2 during T1, at a time earlier than  $T_{RRC}$  before the beginning of T2. At the start of T2, cell 2 becomes detectable and meets the handover condition.

**Table A.7.3.3.2.2-1: Inter-frequency conditional handover from FR2 to FR2 test configurations**

Config	Description
1	Source cell: NR 120 kHz SSB SCS, 100 MHz bandwidth, TDD duplex mode Target cell: NR 120 kHz SSB SCS, 100 MHz bandwidth, TDD duplex mode

**Table A.7.3.3.2.2-2: General test parameters Inter-frequency conditional handover from FR2 to FR2**

Parameter	Unit	Value	Comment
Initial conditions	Active cell	Cell 1	
	Neighbouring cell	Cell 2	
Final condition	Active cell	Cell 2	
A3-Offset for handovercondition	dB	FFS	
Hysteresis	dB	0	
Time To Trigger	s	0	
Filter coefficient		0	L3 filtering is not used
Access Barring Information	-	Not Sent	No additional delays in random access procedure.
Time offset between cells		3 $\mu$ s	Synchronous cells
T1	s	5	
T2	s	$\leq 7$	

**Table A.7.3.3.2.2-3: Cell specific test parameters for NR FR2-FR2 Inter frequency conditional handover test case**

Parameter	Unit	Cell 1		Cell 2	
		T1	T2	T1	T2
NR RF Channel Number		1		2	
AoA setup		Setup 1 as defined in A.3.15			
Assumption for UE beams <sup>Note 6</sup>		Rough			
Duplex mode		TDD			
TDD configuration		TDDConf.3.1			
BW <sub>channel</sub>	MHz	100: N <sub>RB,c</sub> = 66			
BWP BW	MHz	100: N <sub>RB,c</sub> = 66			
DRx Cycle	ms	Not Applicable			
Gap pattern ID		gp0			
PDSCH Reference measurement channel		SR3.1 TDD			
CORESET Reference Channel		CR3.1 TDD			
OCNG Patterns		OCNG pattern 1			
SMTc Configuration		SMTc pattern 1			
SSB Configuration		SSB.1 FR2			
PDSCH/PDCCH subcarrier spacing	kHz	120 kHz			
PUCCH/PUSCH subcarrier spacing	kHz	120 kHz			
PRACH configuration		FR2 PRACH configuration 1			
TRS configuration		TRS.2.1 TDD			
TCI configuration		CSI-RS.Config.0			
BWP configuraiton	Initial DL BWP	DLBWP.0.1			
	Dedicated DL BWP	DLBWP.1.1			
	Initial UL BWP	ULBWP.0.1			
	Dedicated UL BWP	ULBWP.1.1			
EPRE ratio of PSS to SSS	dB	0		0	
EPRE ratio of PBCH DMRS to SSS					
EPRE ratio of PBCH to PBCH DMRS					
EPRE ratio of PDCCH DMRS to SSS					
EPRE ratio of PDCCH to PDCCH DMRS					
EPRE ratio of PDSCH DMRS to SSS					
EPRE ratio of PDSCH to PDSCH					
EPRE ratio of OCNG DMRS to SSS(Note 1)					
EPRE ratio of OCNG to OCNG DMRS (Note 1)					

$N_{oc}^{Note2}$		dBm/15kHz z	-104.7		-104.7	
$N_{oc}^{Note2}$	Config 1,2	dBm/SCS	-95.7		-95.7	
	Config 3		-95.7		-95.7	
$\hat{E}_s / I_{ot}$		dB	5	5	-Infinity	5
$\hat{E}_s / N_{oc}$		dB	5	5	-Infinity	5
$I_o^{Note3}$	Config 1,2	dBm/ BW	-60.5	-60.5	-66.7	-60.5
	Config 3	dBm/ BW	-60.5	-60.5	-66.7	-60.5
Propagation condition		-	AWGN			
<p>Note 1: OCNG shall be used such that both cells are fully allocated and a constant total transmitted power spectral density is achieved for all OFDM symbols.</p> <p>Note 2: Interference from other cells and noise sources not specified in the test is assumed to be constant over subcarriers and time and shall be modelled as AWGN of appropriate power for <math>N_{oc}</math> to be fulfilled.</p> <p>Note 3: <math>I_o</math> levels have been derived from other parameters for information purposes. They are not settable parameters themselves.</p> <p>Note 4: Equivalent power received by an antenna with 0 dBi gain at the centre of the quiet zone</p> <p>Note 5: As observed with 0 dBi gain antenna at the centre of the quiet zone</p> <p>Note 6: Information about types of UE beam is given in B.2.1.3, and does not limit UE implementation or test system implementation</p>						

### A.7.3.3.2.3 Test Requirements

$T_{RRC} + T_{Event\_DU}$  occurs during T1 as the handover condition becomes satisfied at the start of T2. The test shall verify that there are no interruptions during T1.

The UE shall start to transmit the PRACH to Cell 2 less than  $T_{measure} + T_{interrupt} + T_{CHO\_execution} = 6720+62+10ms=6792$  ms (power class 1) or  $4160+62+10ms =4232ms$  (power classes 2,3 and 4) from the start of T2 and the interruption during T2 shall not exceed  $T_{interrupt}=T_{processing} + T_{IU} + T_{\Delta} + T_{margin} =40+20+2 = 62ms$  excluding any transmissions which do not occur due to scheduling restrictions. excluding any transmissions which do not occur due to scheduling restrictions.

## A.7.4 Timing

### A.7.4.1 UE transmit timing

#### A.7.4.1.1 NR UE Transmit Timing Test for FR2

##### A.7.4.1.1.1 Test Purpose and environment

The purpose of this test is to verify that the UE can follow frame timing change of the connected gNodeB and that the UE initial transmit timing accuracy, maximum amount of timing change in one adjustment, minimum and maximum adjustment rate are within the specified limits. This test will verify the requirements in clause 7.1.2.

Supported test configurations are shown in Table 7.4.1.1.1-1.

**Table A.7.4.1.1.1-1: Supported test configurations for FR2 PCell**

Configuration	Description
1	NR TDD, SSB SCS 240 kHz, data SCS 120 kHz, BW 100 MHz

For this test a single NR cell is used. Tables A.7.4.1.1.1-2 and A.7.4.1.1.1-2A define the parameters to be configured and strength of the transmitted signals. The transmit timing is verified by the UE transmitting SRS using the configuration defined in Table A.7.4.1.1.1-3.

**Table A.7.4.1.1.1-2: Cell Specific Test Parameters for UL Transmit Timing test**

Parameter	Unit	Config	Test1	Test2
-----------	------	--------	-------	-------

SSB ARFCN		1	Freq1	Freq1
TDD configuration		1	TDDConf.3.1	
BW <sub>channel</sub>	MHz	1	100: N <sub>RB,c</sub> = 66	
Data RBs allocated		1	66	
Initial BWP Configuration		1	DLBWP.0.1 ULBWP.0.1	
Dedicated BWP Configuration		1	DLBWP.1.1 ULBWP.1.1	
TRS Configuration		1	TRS.2.1 TDD	
PDSCH/PDCCH TCI state		1	TCI.State.2	
DRx Cycle	ms	1	N/A	DRX.8 <sup>Note5</sup>
PDSCH Reference measurement channel		1	SR.3.3 TDD	
RMSI CORESET Reference Channel		1	CR.3.2 TDD	
Dedicated CORESET Reference Channel		1	CCR.3.7 TDD	
OCNG Patterns		1	OP.1	
SSB Configuration		1	SSB.4 FR2	
SMTC Configuration		1	SMTC.1	
PDSCH/PDCCH subcarrier spacing	kHz	1	120	
EPRE ratio of PSS to SSS	dB	1	0	0
EPRE ratio of PBCH DMRS to SSS				
EPRE ratio of PBCH to PBCH DMRS				
EPRE ratio of PDCCH DMRS to SSS				
EPRE ratio of PDCCH to PDCCH DMRS				
EPRE ratio of PDSCH DMRS to SSS				
EPRE ratio of PDSCH to PDSCH				
EPRE ratio of OCNG DMRS to SSS(Note 1)				
EPRE ratio of OCNG to OCNG DMRS (Note 1)				
Propagation condition				
SRS Config		1	SRSCConf.1 <sup>Note6</sup>	SRSCConf.2 <sup>Note6</sup>
<p>Note 1: OCNG shall be used such that both cells are fully allocated and a constant total transmitted power spectral density is achieved for all OFDM symbols.</p> <p>Note 2: Void</p> <p>Note 3: Void</p> <p>Note 4: Void</p> <p>Note 5: DRx related parameters are given in Table A.3.3.8-1</p> <p>Note 6: SRS configs are given in Table A.7.4.1.1.1-3</p>				

Table A.7.4.1.1.1-2A: OTA related test parameters

Parameter	Unit	Test 1	Test 2
Angle of arrival configuration		Setup 1 according to clause A.3.15.1	
Assumption for UE beams <sup>Note6</sup>		Fine	
$N_{oc}$ <sup>Note1</sup>	$\text{dBm}/15\text{kHz}$ <sup>Note4</sup>	-112	
$N_{oc}$ <sup>Note1</sup>	$\text{dBm}/\text{SCS}$ <sup>Note3</sup>	-100	
$\hat{E}_s/N_{oc}$	dB	4	
SSB_RP <sup>Note2</sup>	$\text{dBm}/\text{SCS}$ <sup>Note4</sup>	-96	

$\hat{E}_s / I_{ot}$	dB	4
$I_{o}$ <sup>Note2</sup>	dBm/95.04 MHz <sup>Note4</sup>	-68.5
Note 1:	Interference from other cells and noise sources not specified in the test is assumed to be constant over subcarriers and time and shall be modelled as AWGN of appropriate power for $N_{oc}$ to be fulfilled.	
Note 2:	SSB_RP and $I_o$ levels have been derived from other parameters for information purposes. They are not settable parameters themselves.	
Note 3:	Void	
Note 4:	Equivalent power received by an antenna with 0dBi gain at the centre of the quiet zone	
Note 5:	As observed with 0dBi gain antenna at the centre of the quiet zone	
Note 6:	Information about types of UE beam is given in B.2.1.3, and does not limit UE implementation or test system implementation	

**Table A.7.4.1.1.1-3: SRS Configuration for Timing Accuracy Test**

	Field	SRSCConf.1	SRSCConf.2	Comments
SRS-ResourceSet	srs-ResourceSetId	0	0	
	srs-ResourceSetList	0	0	
	resourceType	Periodic	Periodic	
	Usage	Codebook	Codebook	
SRS-Resource	SRS-ResourceId	0	0	
	nrofSRS-Ports	Port1	Port1	
	transmissionComb	n2	n2	
	combOffset-n2	0	0	
	cyclicShift-n2	0	0	
	resourceMapping startPosition	0	0	
	resourceMapping nrofSymbols	n1	n1	
	resourceMapping repetitionFactor	n1	n1	
	freqDomainPosition	0	0	
	freqDomainShift	0	0	
	freqHopping c-SRS	17	17	Matches $N_{RB,c}$
	freqHopping b-SRS	0	0	
	freqHopping b-hop	0	0	
	groupOrSequenceHopping	Neither	Neither	
	resourceType	Periodic	Periodic	
	periodicityAndOffset-p	sl1, 0	sl2560, 4	Offset to align with DRx periodicity
	sequenceId	0	0	Any 10 bit number

**Table A.7.4.1.1.1-4: Void****A.7.4.1.1.2 Test requirements**

The test sequence shall be carried out in RRC\_CONNECTED for every test case.

Following will be the test sequence for this test:

- 1) Setup NR PCell according to parameters given in Table A.7.4.1.1.1-1.
- 2) After connection set up with the cell, the test equipment will verify that the timing of the NR cell is within  $(N_{TA} + N_{TA\_offset}) \times T_c \pm T_e$  of the first detected path of DL SSB.
  - a. The  $N_{TA}$  offset value (in  $T_c$  units) is 13792
  - b. The  $T_e$  values depend on the DL and UL SCS for which the test is being run and are given in Table 7.1.2-1

- 3) The test system shall adjust the timing of the DL path by values given in Table A.7.4.1.1.2-1

**Table A.7.4.1.1.2-1 Adjustment Value for DL Timing**

SCS of SSB signals (kHz)	Adjustment Value	
	Test1	Test2
240	+8*64T <sub>c</sub>	+4*64T <sub>c</sub>

- 4) The test system shall verify that the adjustment step size and the adjustment rate shall be according to requirements specified in clause 7.1.2 Table 7.1.2.1-1 until the UE transmit timing offset is within  $(N_{TA} + N_{TA\_offset}) \times T_c \pm T_e$  respective to the first detected path (in time) of DL SSB. Skip this step for test 2 with DRX configured.
- 5) The test system shall verify that the UE transmit timing offset stays within  $(N_{TA} + N_{TA\_offset}) \times T_c \pm T_e$  of the first detected path of DL SSB. For Test 2 the UE transmit timing offset shall be verified for the first transmission in the DRX cycle immediately after DL timing adjustment.

## A.7.4.2 UE timer accuracy

## A.7.4.3 Timing advance

### A.7.4.3.1 SA FR2 timing advance adjustment accuracy

#### A.7.4.3.1.1 Test Purpose and Environment

The purpose of the test is to verify UE Timing Advance adjustment delay and accuracy requirement defined in clause 7.3.

#### A.7.4.3.1.2 Test Parameters

Supported test configurations are shown in table A.7.4.3.1.2-1. Both timing advance adjustment delay and accuracy are tested by using the parameters in table A.7.4.3.1.2-2, A.7.4.3.1.2-3 and A.7.4.3.1.2-4.

In all test cases, single cell is used. Each test consists of two successive time periods, with time duration of T1 and T2 respectively. In each time period, timing advance commands are sent to the UE and Sounding Reference Signals (SRS), as specified in table A.7.4.3.1.2-3, are sent from the UE and received by the test equipment. By measuring the reception of the SRS, the transmit timing, and hence the timing advance adjustment accuracy, can be measured.

During time period T1, the test equipment shall send one message with a Timing Advance Command MAC Control Element, as specified in clause 6.1.3.4 in TS 38.321 [7]. The Timing Advance Command value shall be set to 31, which according to clause 4.2 in TS 38.213 [3] results in zero adjustment of the Timing Advance. In this way, a reference value for the timing advance used by the UE is established.

During time period T2, the test equipment shall send a sequence of messages with Timing Advance Command MAC Control Elements, with Timing Advance Command value specified in table A.7.4.3.1.2-2. This value shall result in changes of the timing advance used by the UE, and the accuracy of the change shall then be measured, using the SRS sent from the UE.

As specified in Clause 7.3.2.1, the UE adjusts its uplink timing at slot n+k+1 for a timing advance command received in slot n. This delay must be taken into account when measuring the timing advance adjustment accuracy, via the SRS sent from the UE.

The UE Time Alignment Timer, described in Clause 5.2 in TS 38.321 [7], shall be configured so that it does not expire in the duration of the test.

**Table A.7.4.3.1.2-1: Timing advance supported test configurations**

Config	Description
1	NR 120 kHz SSB SCS, 100 MHz bandwidth, TDD duplex mode

**Table A.7.4.3.1.2-2: General test parameters for timing advance**

Parameter	Unit	Value	Comment
-----------	------	-------	---------

RF channel number		1	
Initial DL BWP		DLBWP.0.1	As specified in Table A.3.9.2.1-1
Dedicated DL BWP		DLBWP.1.1	As specified in Table A.3.9.2.2-1
Initial UL BWP		ULBWP.0.1	As specified in Table A.3.9.3.1-1
Dedicated UL BWP		ULBWP.1.1	As specified in Table A.3.9.3.2-1
Timing Advance Command ( $T_A$ ) value during T1		31	$N_{TA\_new} = N_{TA\_old}$ for the purpose of establishing a reference value from which the timing advance adjustment accuracy can be measured during T2
Timing Advance Command ( $T_A$ ) value during T2		39	For 120 kHz SCS $N_{TA\_new} = N_{TA\_old} + 1024 * T_c$ (based on equation in clause 4.2 of TS 38.213 [3])
T1	s	5	
T2	s	5	

**Table A.7.4.3.1.2-3: Cell specific test parameters for timing advance**

Parameter	Unit	Test1	
		T1	T2
Duplex mode		TDD	
TDD configuration		TDDConf.3.1	
$BW_{channel}$	MHz	100: $N_{RB,c} = 66$	
BWP BW	MHz	100: $N_{RB,c} = 66$	
DRx Cycle	ms	Not Applicable	
PDSCH Reference measurement channel		SR.3.1 TDD	
CORESET Reference Channel		CR.3.1 TDD	
OCNG Patterns		OCNG pattern 1	
TRS configuration		TRS.2.1 TDD	
PDSCH/PDCCH TCI state		TCI.State.2	
SMTC configuration		SMTC.1 FR2	
SSB Configuration		SSB.3 FR2	
PDSCH/PDCCH subcarrier spacing	kHz	120 kHz	
PUCCH/PUSCH subcarrier spacing	kHz	120 kHz	
EPRE ratio of PSS to SSS	dB	0	
EPRE ratio of PBCH DMRS to SSS			
EPRE ratio of PBCH to PBCH DMRS			
EPRE ratio of PDCCH DMRS to SSS			
EPRE ratio of PDCCH to PDCCH DMRS			
EPRE ratio of PDSCH DMRS to SSS			
EPRE ratio of PDSCH to PDSCH			
EPRE ratio of OCNG DMRS to SSS(Note 1)			
EPRE ratio of OCNG to OCNG DMRS (Note 1)			
Propagation condition			
<p>Note 1: OCNG shall be used such that the resources in the cell in this test are fully allocated and a constant total transmitted power spectral density is achieved for all OFDM symbols.</p> <p>Note 2: Interference from other cells and noise sources not specified in the test is assumed to be constant over subcarriers and time and shall be modelled as AWGN of appropriate power for <math>N_{oc}</math> to be fulfilled.</p> <p>Note 3: <math>l_0</math> levels have been derived from other parameters for information purposes. They are not settable parameters themselves.</p> <p>Note 4: Equivalent power received by an antenna with 0 dBi gain at the centre of the quiet zone</p> <p>Note 5: As observed with 0 dBi gain antenna at the centre of the quiet zone</p>			

**Table A.7.4.3.1.2-3A: OTA related test parameters**

Parameter	Unit	Test 1	
		T1	T2
Angle of arrival configuration		Setup 1 according to clause A.3.15.1	
Assumption for UE beams <sup>Note 6</sup>		Fine	
$N_{oc}$ <sup>Note1</sup>	dBm/15kHz <sup>Note4</sup>	-112	



$N_{oc}$ <sup>Note1</sup>	dBm/SCS <sup>Note3</sup>	-103
$\hat{E}_s/N_{oc}$	dB	4
SS-RSRP <sup>Note2</sup>	dBm/SCS <sup>Note4</sup>	-99
$\hat{E}_s/I_{ot}$	dB	4
$I_o$ <sup>Note2</sup>	dBm/95.04 MHz <sup>Note4</sup>	-68.5
<p>Note 1: Interference from other cells and noise sources not specified in the test is assumed to be constant over subcarriers and time and shall be modelled as AWGN of appropriate power for <math>N_{oc}</math> to be fulfilled.</p> <p>Note 2: SS-RSRP and <math>I_o</math> levels have been derived from other parameters for information purposes. They are not settable parameters themselves.</p> <p>Note 3: SS-RSRP minimum requirements are specified assuming independent interference and noise at each receiver antenna port.</p> <p>Note 4: Equivalent power received by an antenna with 0dBi gain at the centre of the quiet zone</p> <p>Note 5: As observed with 0dBi gain antenna at the centre of the quiet zone</p> <p>Note 6: Information about types of UE beam is given in B.2.1.3, and does not limit UE implementation or test system implementation</p>		

**Table A.7.4.3.1.2-4: Sounding Reference Symbol Configuration for timing advance**

Field	Value	Comment
c-SRS	16	Frequency hopping is disabled
b-SRS	0	
b-hop	0	
freqDomainPosition	0	Frequency domain position of SRS
freqDomainShift	0	
groupOrSequenceHopping	neither	No group or sequence hopping
SRS-PeriodicityAndOffset	sl5=4	Once every 5 slots
pathlossReferenceRS	ssb-Index=0	SSB #0 is used for SRS path loss estimation
usage	Codebook	Codebook based UL transmission
startPosition	0	resourceMapping setting. SRS on last symbol of slot, and 1symbols for SRS without repetition.
nrofSymbols	n1	
repetitionFactor	n1	
combOffset-n2	0	transmissionComb setting
cyclicShift-n2	0	
nrofSRS-Ports	port1	Number of antenna ports used for SRS transmission
Note: For further information see clause 6.3.2 in TS 38.331 [2].		

### A.7.4.3.1.3 Test Requirements

The UE shall apply the signalled Timing Advance value to the transmission timing at the designated activation time i.e.  $k+1$  slots after the reception of the timing advance command, where  $k = 11$ .

The Timing Advance adjustment accuracy shall be within the limits specified in clause 7.3.2.2.

The rate of correct Timing Advance adjustments observed during repeated tests shall be at least 90%.

## A.7.5 Signaling characteristics

### A.7.5.1 Radio link Monitoring

In the following clause, any uplink signal transmitted by the UE is used for detecting the In-/Out-of-Sync state of the UE. In terms of measurement, the uplink signal is verified on the basis of the UE output power:

*Editor note: The metric for the detection of the UE UL transmitted signal by the TE is FFS.*

## A.7.5.1.1 Radio Link Monitoring Out-of-sync Test for FR2 PCell configured with SSB-based RLM RS in non-DRX mode

### A.7.5.1.1.1 Test Purpose and Environment

The purpose of this test is to verify that the UE properly detects the out of sync and in sync for the purpose of monitoring downlink radio link quality of the PCell. This test will partly verify the FR2 radio link monitoring requirements in clause 8.1.

In the test, UE is configured to perform RLM on SSB, with *detectionResource* included in *RadioLinkMonitoringRS* set to SSB#0 and SSB#1, and *purpose* set to 'rlf'. Supported test configurations are shown in table A.7.5.1.1.1-1. The test parameters are given in Tables A.7.5.1.1.1-2, A.7.5.1.1.1-3, and A.7.5.1.1.1-4 below. There is one cell (Cell 1), which is the active NR cell, in the test. The test consists of three successive time periods, with time duration of T1, T2 and T3 respectively. Figure A.7.5.1.1.1-1 shows the variation of the downlink SNR in the active cell to emulate out-of-sync and in-sync states, and Figure A.7.5.1.1.1-2 shows the Time multiplexed downlink transmissions from each Angle of Arrival. Prior to the start of the time duration T1, the UE shall be fully synchronized to Cell 1. The UE shall be configured for periodic CSI reporting with a reporting periodicity of 5 ms. In addition to RLM-RS radio link monitoring using SSB index 0 and SSB index 1, the UE is configured to perform inter-frequency measurements using Gap Pattern ID #0 (40ms) in test 1.

**Table A.7.5.1.1.1-1: Supported test configurations for FR2 PCell**

Configuration	Description
1	TDD, SSB SCS 120 KHz, data SCS 120KHz, BW 100 MHz

**Table A.7.5.1.1.1-2: General test parameters for FR2 out-of-sync testing in non-DRX mode**

Parameter		Unit	Value
			Test 1
Active PCell			Cell 1
RF Channel Number			1
Duplex mode	Config 1		TDD
BW <sub>channel</sub>	Config 1		100: N <sub>RB,c</sub> = 66
Data RBs allocated	Config 1		24
DL initial BWP configuration	Config 1		DLBWP.0.1
DL dedicated BWP configuration	Config 1		DLBWP.1.1
UL initial BWP configuration	Config 1		ULBWP.0.1
UL dedicated BWP configuration	Config 1		ULBWP.1.1
TDD Configuration	Config 1		TDDConf.3.1
RMSI CORESET Reference Channel	Config 1		CR.3.1 TDD
Dedicated CORESET Reference Channel	Config 1		CCR.3.4 TDD
SSB Configuration	Config 1		SSB.1 FR2
SMTC Configuration	Config 1		SMTC.1
PDSCH/PDCCH subcarrier spacing	Config 1		120 KHz
PRACH Configuration	Config 1		Table A.3.8.3.1
SSB index assigned as RLM RS	Config 1		0,1
OCNG parameters			OP.5
CP length			Normal
Out of sync transmission parameters	DCI format		1-0
	Number of Control OFDM symbols		2
	Aggregation level	CCE	8
	Ratio of hypothetical PDCCH RE energy to average SSS RE energy	dB	4
	Ratio of hypothetical PDCCH DMRS energy to average SSS RE energy	dB	4
	DMRS precoder granularity		REG bundle size
	REG bundle size		6
DRX			OFF
Gap pattern ID			gp0

Layer 3 filtering		<i>Enabled</i>
T310 timer	ms	0
T311 timer	ms	1000
N310		1
N311		1
CSI-RS for CSI reporting	Config 1	CSI-RS.3.1 TDD
reportConfigType		periodic
reportQuantity		cri-RI-PMI-CQI
CSI reporting periodicity	slot	40
CSI reporting offset	slot	4
TCI states for PDCCH/PDSCH		TCI.State.2
CSI-RS for tracking	Config 1	TRS.2.1 TDD
T1	s	0.2
T2	s	9.68
T3	s	9.68
D1	s	9.64
Note 1: All configurations are assigned to the UE prior to the start of time period T1. Note 2: UE-specific PDCCH is not transmitted after T1 starts.		

**Table A.7.5.1.1.1-3: OTA related cell specific test parameters for FR2 (Cell 1) for out-of-sync radio link monitoring tests in non-DRX mode**

Parameter	Unit	Test 1						
		T1	T2	T3	T1	T2	T3	
AoA setup		Setup 3 defined in A.3.15						
Assumption for UE beams <sup>Note 5</sup>		AoA1			AoA2			
EPRE ratio of PDCCH DMRS to SSS	dB	4			Not sent			
EPRE ratio of PDCCH to PDCCH DMRS	dB	0						
EPRE ratio of PBCH DMRS to SSS	dB							
EPRE ratio of PBCH to PBCH DMRS	dB							
EPRE ratio of PSS to SSS	dB							
EPRE ratio of PDSCH DMRS to SSS	dB							
EPRE ratio of PDSCH to PDSCH DMRS	dB							
EPRE ratio of OCNG DMRS to SSS	dB							
EPRE ratio of OCNG to OCNG DMRS	dB							
ssb-Index 0 SNR	Config 1	dB	2 <sup>Note 6</sup>	-6 <sup>Note 6</sup>	-15			
ssb-Index 1 SNR	Config 1		Not sent			2 <sup>Note 6</sup>	-15	
$N_{oc}$	Config 1	dBm/15kHz	-92.1			-92.1		
Time multiplexing of the downlink transmissions from each AoA			Defined in Figure A.7.5.1.1.1-2					
Propagation condition			TDL-A 30ns 75Hz			TDL-A 30ns 75Hz		
Note 1: OCNG shall be used such that and a constant total transmitted power spectral density is achieved for all OFDM symbols. Note 2: The signal contains PDCCH for UEs other than the device under test as part of OCNG. Note 3: SNR levels correspond to the signal to noise ratio over the SSS REs. Note 4: The SNR values are specified for testing a UE which supports 2RX on at least one band. For testing of a UE which supports 4RX on all bands, the SNR during T3 is A.3.6. Note 5: Information about types of UE beam is given in B.2.1.3 and does not limit UE implementation or test system implementation. Note 6: This value allows up to 1dB degradation from applied SNR to UE baseband								

**Table A.7.5.1.1.1-4: Measurement gap configuration for out-of-sync tests in non-DRX mode**

Field	Test 1
	Value
gapOffset	0

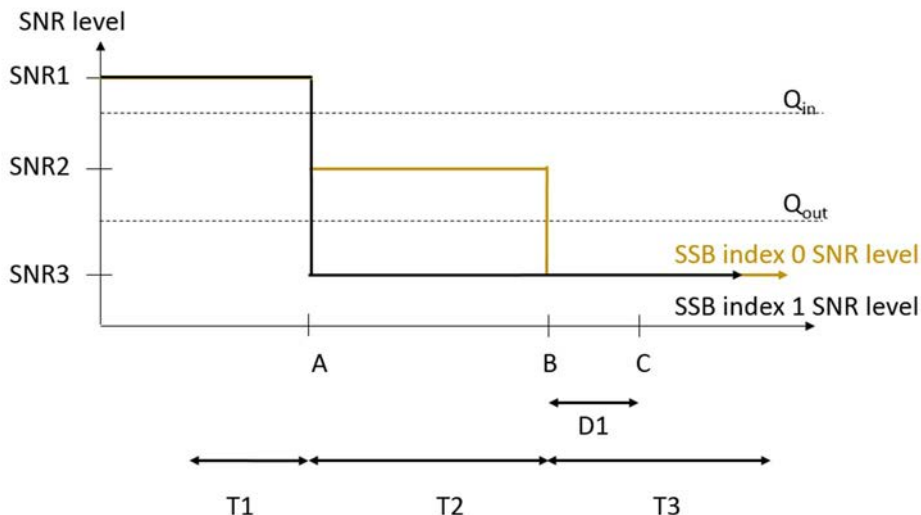

Figure A.7.5.1.1.1-1: SNR variation for out-of-sync testing

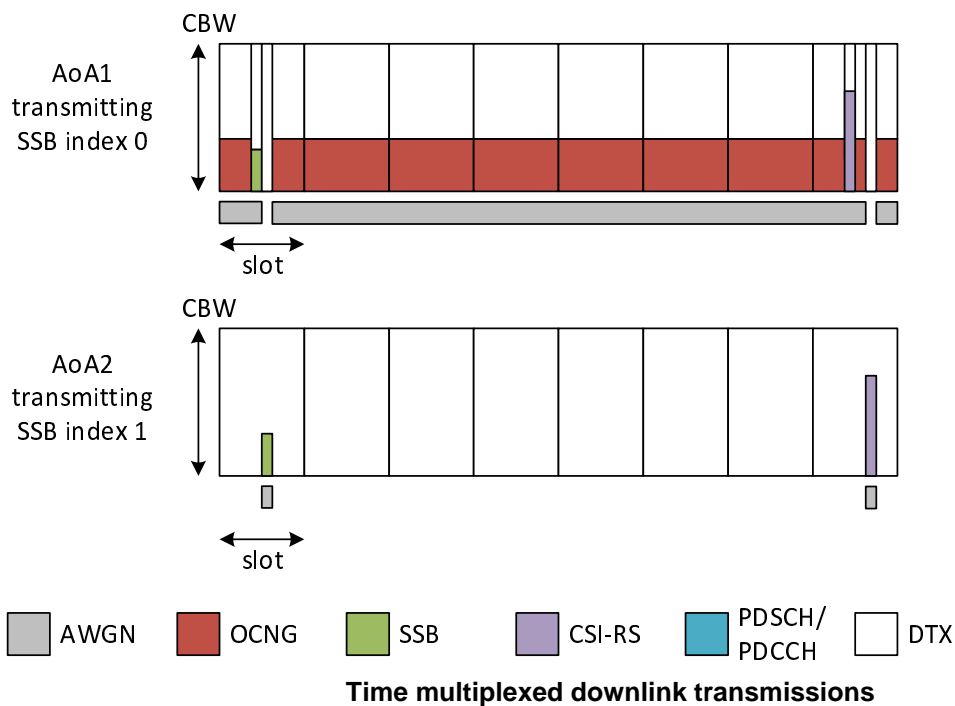

Figure A.7.5.1.1.1-2:

A.7.5.1.1.2 Test Requirements

The UE behavior in each test during time durations T1, T2 and T3 shall be as follows:

During the period from time point A to time point B the UE shall transmit uplink signal at least in all uplink slots configured for CSI transmission according to the configured periodic CSI reporting.

The UE shall stop transmitting uplink signal no later than time point C (D1 second after the start of the time duration T3).

The rate of correct events observed during repeated tests shall be at least 90%.

## A.7.5.1.2 Radio Link Monitoring In-sync Test for FR2 PCell configured with SSB-based RLM RS in non-DRX mode

### A.7.5.1.2.1 Test Purpose and Environment

The purpose of this test is to verify that the UE properly detects the out of sync and in sync for the purpose of monitoring downlink radio link quality of the PCell. This test will partly verify the FR2 radio link monitoring requirements in clause 8.1.

In the test, UE is configured to perform RLM on SSB, with *detectionResource* included in *RadioLinkMonitoringRS* set to SSB#0 and SSB#1, and *purpose* set to 'rlf'. Supported test configurations are shown in table A.7.5.1.2.1-1. The test parameters are given in Tables A.7.5.1.2.1-2, and A.7.5.1.2.1-3 below. There is one cell (Cell 1), which is the active cell, in the test. The test consists of five successive time periods, with time duration of T1, T2, T3, T4 and T5 respectively. Figure A.7.5.1.2.1-1 shows the variation of the downlink SNR in the active cell to emulate out-of-sync and in-sync states, and Figure A.7.5.1.2.1-2 shows the Time multiplexed downlink transmissions from each Angle of Arrival. Prior to the start of the time duration T1, the UE shall be fully synchronized to Cell 1. Prior to the start of the time duration T1, the UE shall be fully synchronized to Cell 1. The UE shall be configured for periodic CSI reporting with a reporting periodicity of 5 ms.

**Table A.7.5.1.2.1-1: Supported test configurations for FR2 PCell**

Configuration	Description
1	TDD, SSB SCS 120 KHz, data SCS 120KHz, BW 100 MHz

**Table A.7.5.1.2.1-2: General test parameters for FR2 in-sync testing in non-DRX mode**

Parameter		Unit	Value
			Test 1
Active PCell			Cell 1
RF Channel Number			1
Duplex mode	Config 1		TDD
BW <sub>channel</sub>	Config 1		100: N <sub>RB,c</sub> = 66
Data RBs allocated	Config 1		24
DL initial BWP configuration	Config 1		DLBWP.0.1
DL dedicated BWP configuration	Config 1		DLBWP.1.1
UL initial BWP configuration	Config 1		ULBWP.0.1
UL dedicated BWP configuration	Config 1		ULBWP.1.1
TDD Configuration	Config 1		TDDConf.3.1
RMSI CORESET Reference Channel	Config 1		CR.3.1 TDD
Dedicated CORESET Reference Channel	Config 1		CCR.3.1 TDD
SSB Configuration	Config 1		SSB.1 FR2
SMTC Configuration	Config 1		SMTC.3
PDSCH/PDCCH subcarrier spacing	Config 1		120 KHz
PRACH Configuration	Config 1		Table A.3.8.3.1
SSB index assigned as RLM RS	Config 1		0,1
OCNG parameters			OP.5
CP length			Normal
In sync transmission parameters	DCI format		1-0
	Number of Control OFDM symbols		2
	Aggregation level	CCE	4
	Ratio of hypothetical PDCCH RE energy to average SSS RE energy	dB	0
	Ratio of hypothetical PDCCH DMRS energy to average SSS RE energy	dB	0
	DMRS precoder granularity		REG bundle size
	REG bundle size		6
	DCI format		1-0

Out of sync transmission parameters	Number of Control OFDM symbols		2
	Aggregation level	CCE	8
	Ratio of hypothetical PDCCH RE energy to average SSS RE energy	dB	4
	Ratio of hypothetical PDCCH DMRS energy to average SSS RE energy	dB	4
	DMRS precoder granularity		REG bundle size
	REG bundle size		6
DRX			OFF
Gap pattern ID			N.A.
Layer 3 filtering			Enabled
T310 timer	ms		4000
T311 timer	ms		1000
N310			1
N311			1
CSI-RS for CSI reporting	Config 1		CSI-RS.3.1 TDD
reportConfigType			periodic
reportQuantity			cri-RI-PMI-CQI
CSI reporting periodicity	slot		40
CSI reporting offset	slot		4
TCI states for PDCCH/PDSCH			TCI.State.2
CSI-RS for tracking	Config 1		TRS.2.1 TDD
T1	s		0.2
T2	s		0.2
T3	s		1.88
T4	s		0.2
T5	s		3.84
D1	s		3.8
Note 1: All configurations are assigned to the UE prior to the start of time period T1.			
Note 2: UE-specific PDCCH is not transmitted after T1 starts.			

**Table A.7.5.1.2.1-3: OTA related cell specific test parameters for FR2 (Cell 1) for in-sync radio link monitoring tests in non-DRX mode**

Parameter	Unit	Test 1										
		T1	T2	T3	T4	T5	T1	T2	T3	T4	T5	
oA setup		Setup 3 defined in A.3.15										
		AoA1					AoA2					
Assumption for UE beams <sup>Note 5</sup>		Rough					Rough					
PRE ratio of PDCCH DMRS to SSS	dB	0					Not sent					
PRE ratio of PDCCH to PDCCH DMRS	dB	0					Not sent					
PRE ratio of PBCH DMRS to SSS	dB											
PRE ratio of PBCH to PBCH DMRS	dB											
PRE ratio of PSS to SSS	dB											
PRE ratio of PDSCH DMRS to SSS	dB											
PRE ratio of PDSCH to PDSCH DMRS	dB											
PRE ratio of OCNG DMRS to SSS	dB	-92.1					-92.1					
PRE ratio of OCNG to OCNG DMRS	dB											
$\Delta$ b-Index 0 SNR	Config 1	dB	<sup>2</sup> Note 6	<sup>-6</sup> Note 6	-15	-15	-15	<sup>2</sup> Note 6	-15	-15	-4.5	<sup>2</sup> Note 6
$\Delta$ b-Index 1 SNR	Config 1		Not sent					<sup>2</sup> Note 6	-15	-15	-4.5	<sup>2</sup> Note 6
$\sqrt{P_{oc}}$	Config 1	dBm/15kHz	-92.1					-92.1				
Time multiplexing of the downlink transmissions from each AoA			Defined in Figure A.7.5.1.2.1-2									
Propagation condition			TDL-A 30ns 75Hz					TDL-A 30ns 75Hz				
Note 1: OCNG shall be used such that a constant total transmitted power spectral density is achieved for all OFDM symbols. Note 2: The signal contains PDCCH for UEs other than the device under test as part of OCNG. Note 3: SNR levels correspond to the signal to noise ratio over the SSS REs. Note 4: The SNR values are specified for testing a UE which supports 2RX on at least one band. For testing of a UE which supports 4RX on a bands, the SNR during T3 is A.3.6. Note 5: Information about types of UE beam is given in B.2.1.3 and does not limit UE implementation or test system implementation. Note 6: This value allows up to 1dB degradation from applied SNR to UE baseband												

Table A.7.5.1.2.1-4: Void

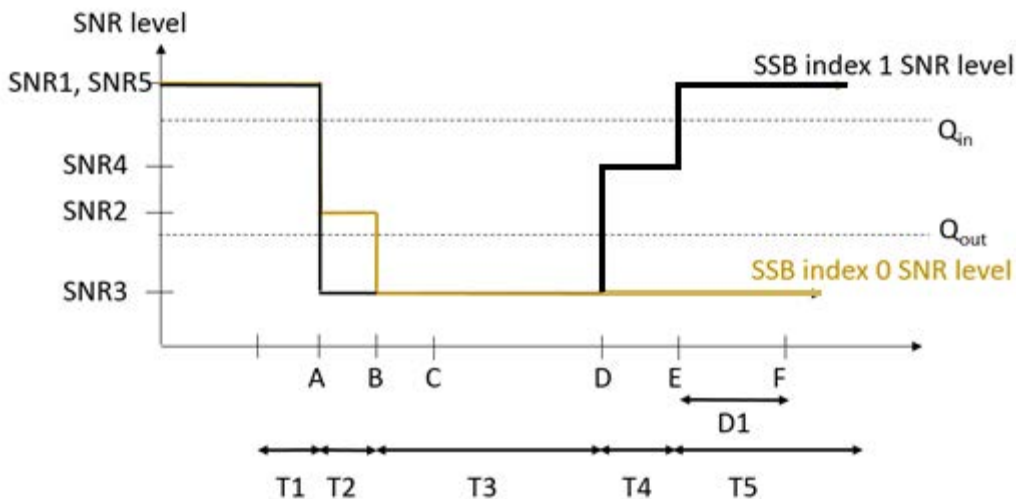

Figure A.7.5.1.2.1-1: SNR variation for in-sync testing

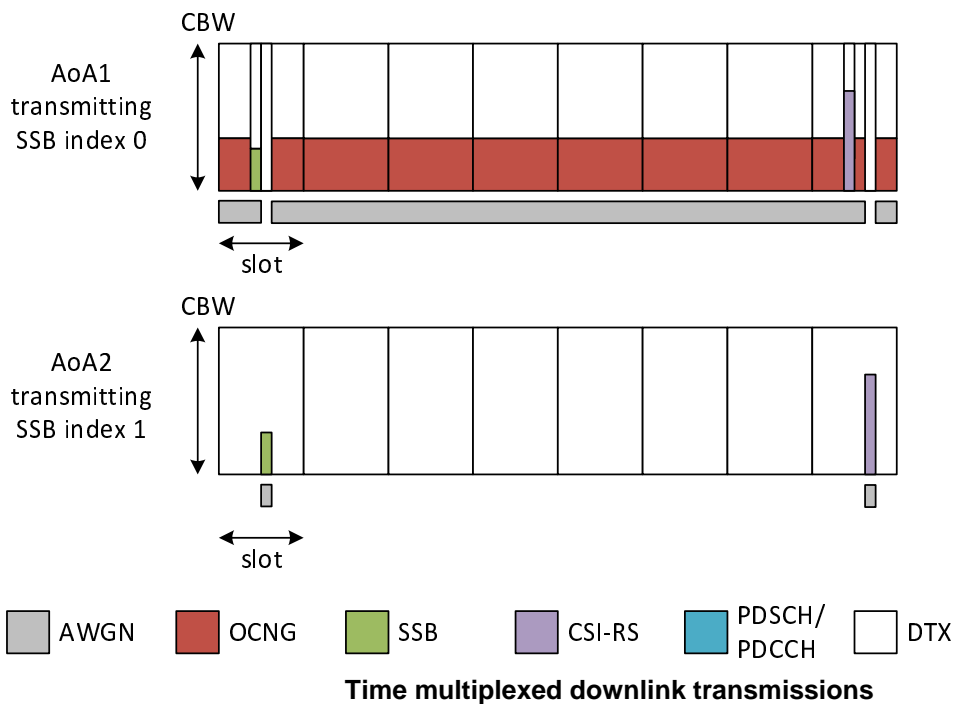

Figure A.7.5.1.2.1-2:

A.7.5.1.2.2 Test Requirements

The UE behaviour in each test during time durations T1, T2, T3, T4 and T5 shall be as follows:

During the period from time point A to time point F (D1 second after the start of time duration T5) the UE shall transmit uplink signal at least in all uplink slots configured for CSI transmission according to the configured periodic CSI reporting.

The rate of correct events observed during repeated tests shall be at least 90%.

### A.7.5.1.3 Radio Link Monitoring Out-of-sync Test for FR2 PCell configured with SSB-based RLM RS in DRX mode

#### A.7.5.1.3.1 Test Purpose and Environment

The purpose of this test is to verify that the UE properly detects the out of sync and in sync for the purpose of monitoring downlink radio link quality of the PCell when DRX is used. This test will partly verify the FR2 radio link monitoring requirements in clause 8.1.

In the test, UE is configured to perform RLM on SSB, with *detectionResource* included in *RadioLinkMonitoringRS* set to SSB#0 and SSB#1, and *purpose* set to 'rlf'. Supported test configurations are shown in table A.7.5.1.3.1-1. The test parameters are given in Tables A.7.5.1.3.1-2, and A.7.5.1.3.1-3. There is one cell (Cell 1), which is the active NR cell, in the test. The test consists of three successive time periods, with time duration of T1, T2 and T3 respectively. Figure A.7.5.1.3.1-1 shows the variation of the downlink SNR in the active cell to emulate out-of-sync and in-sync states. Prior to the start of the time duration T1, the UE shall be fully synchronized to Cell 1. The UE shall be configured for periodic CSI reporting with a reporting periodicity of 5 ms. In the test, DRX configuration is enabled and DRX inactivity timer has already been expired, i.e. UE tries to decode PDCCH and to send periodic CSI during the period when On-duration timer is running. Time alignment timers shall be set to "infinity" so that UL timing alignment is maintained during the test.

**Table A.7.5.1.3.1-1: Supported test configurations for FR2 PCell**

Configuration	Description
1	TDD, SSB SCS 120 KHz, data SCS 120KHz, BW 100 MHz

**Table A.7.5.1.3.1-2: General test parameters for FR2 out-of-sync testing in DRX mode**

Parameter		Unit	Value
			Test 1
Active PCell			Cell 1
RF Channel Number			1
Duplex mode	Config 1		TDD
BW <sub>channel</sub>	Config 1		100: N <sub>RB,c</sub> = 66
Data RBs allocated	Config 1		66
DL initial BWP configuration	Config 1		DLBWP.0.1
DL dedicated BWP configuration	Config 1		DLBWP.1.1
UL initial BWP configuration	Config 1		ULBWP.0.1
UL dedicated BWP configuration	Config 1		ULBWP.1.1
TDD Configuration	Config 1		TDDConf.3.1
RMSI CORESET Reference Channel	Config 1		CR.3.1 TDD
Dedicated CORESET Reference Channel	Config 1		CCR.3.4 TDD
SSB Configuration	Config 1		SSB.1 FR2
SMTc Configuration	Config 1		SMTc.1
PDSCH/PDCCH subcarrier spacing	Config 1		120 KHz
PRACH Configuration	Config 1		Table A.3.8.3.1
SSB index assigned as RLM RS	Config 1		0,1
OCNG parameters			OP.1
CP length			Normal
Out of sync transmission parameters	DCI format		1-0
	Number of Control OFDM symbols		2
	Aggregation level	CCE	8
	Ratio of hypothetical PDCCH RE energy to average SSS RE energy	dB	4
	Ratio of hypothetical PDCCH DMRS energy to average SSS RE energy	dB	4
DMRS precoder granularity			REG bundle size



	REG bundle size		6
DRX Configuration			DRX.3
Gap pattern ID			N.A.
Layer 3 filtering			<i>Enabled</i>
T310 timer		ms	0
T311 timer		ms	1000
N310			1
N311			1
CSI-RS for CSI reporting	Config 1		CSI-RS.3.1 TDD
reportConfigType			periodic
reportQuantity			cri-RI-PMI-CQI
CSI reporting periodicity		slot	40
CSI reporting offset		slot	4
TCI states for PDCCH/PDSCH			TCI.State.2
CSI-RS for tracking	Config 1		TRS.2.1 TDD
T1		s	0.2
T2		s	14.48
T3		s	14.48
D1		s	14.44
Note 1: All configurations are assigned to the UE prior to the start of time period T1.			
Note 2: UE-specific PDCCH is not transmitted after T1 starts.			

**Table A.7.5.1.3.1-3: OTA related cell specific test parameters for FR2 (Cell 1) for out-of-sync radio link monitoring tests in DRX mode**

Parameter	Unit	Test 1		
		T1	T2	T3
AoA setup		Setup 1 defined in A.3.15		
Assumption for UE beams <sup>Note 5</sup>		Rough		
EPRE ratio of PDCCH DMRS to SSS	dB	4		
EPRE ratio of PDCCH to PDCCH DMRS	dB	0		
EPRE ratio of PBCH DMRS to SSS	dB	0		
EPRE ratio of PBCH to PBCH DMRS	dB			
EPRE ratio of PSS to SSS	dB			
EPRE ratio of PDSCH DMRS to SSS	dB			
EPRE ratio of PDSCH to PDSCH DMRS	dB			
EPRE ratio of OCNG DMRS to SSS	dB			
EPRE ratio of OCNG to OCNG DMRS	dB			
ssb-Index 0 SNR	Config 1	2 <sup>Note 6</sup>	-6 <sup>Note 6</sup>	-15
ssb-Index 1 SNR	Config 1	2 <sup>Note 6</sup>	-15	-15
$N_{oc}$	Config 1	dBm/15K Hz	-104.7dBm	
Propagation condition		TDL-A 30ns 75Hz		
Note 1: OCNG shall be used such that the resources in Cell 1 are fully allocated and a constant total transmitted power spectral density is achieved for all OFDM symbols.				
Note 2: The signal contains PDCCH for UEs other than the device under test as part of OCNG.				
Note 3: SNR levels correspond to the signal to noise ratio over the SSS REs.				
Note 4: The SNR values are specified for testing a UE which supports 2RX on at least one band. For testing of a UE which supports 4RX on all bands, the SNR during T3 is A.3.6.				
Note 5: Information about types of UE beam is given in B.2.1.3 and does not limit UE implementation or test system implementation.				
Note 6: This value allows up to 1dB degradation from applied SNR to UE baseband.				

**Table A.7.5.1.3.1-4: Void**

**Table A.7.5.1.3.1-5: Void**

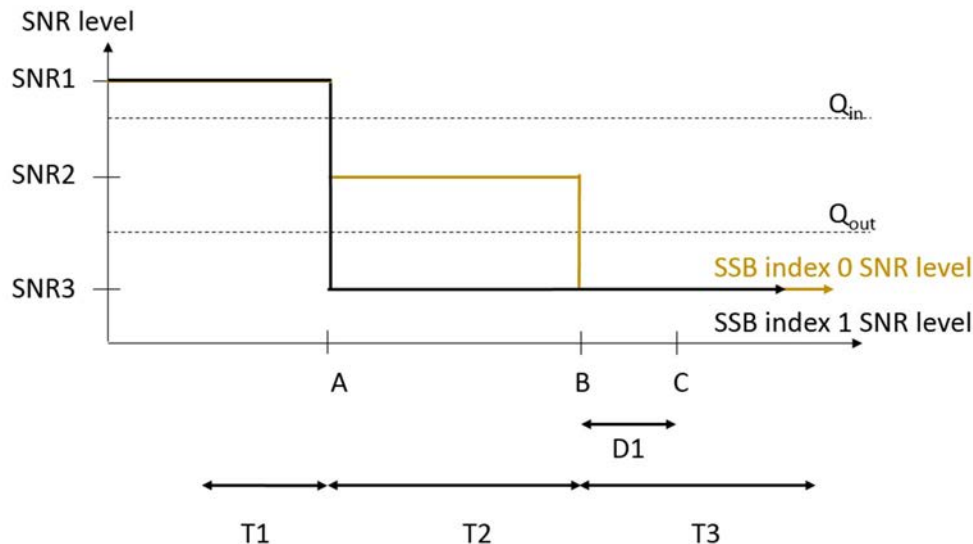

Figure A.7.5.1.3.1-1: SNR variation for out-of-sync testing

A.7.5.1.3.2 Test Requirements

The UE behavior in each test during time durations T1, T2 and T3 shall be as follows:

During the period from time point A to time point B the UE shall transmit uplink signal at least in all uplink slots configured for CSI transmission according to the configured periodic CSI reporting.

The UE shall stop transmitting uplink signal no later than time point C (D1 second after the start of the time duration T3).

The rate of correct events observed during repeated tests shall be at least 90%.

A.7.5.1.4 Radio Link Monitoring In-sync Test for FR2 PCell configured with SSB-based RLM RS in DRX mode

A.7.5.1.4.1 Test Purpose and Environment

The purpose of this test is to verify that the UE properly detects the out of sync and in sync for the purpose of monitoring downlink radio link quality of the PCell when DRX is used. This test will partly verify the FR2 radio link monitoring requirements in clause 8.1.

In the test, UE is configured to perform RLM on SSB, with *detectionResource* included in *RadioLinkMonitoringRS* set to SSB#0 and SSB#1, and *purpose* set to 'rlf'. Supported test configurations are shown in table A.7.5.1.4.1-1. The test parameters are given in Tables A.7.5.1.4.1-2, and A.7.5.1.4.1-3. There is one cell (Cell 1), which is the active NR cell, in the test. The test consists of five successive time periods, with time duration of T1, T2, T3, T4 and T5 respectively. Figure A.7.5.1.4.1-1 shows the variation of the downlink SNR in the active cell to emulate out-of-sync and in-sync states. Prior to the start of the time duration T1, the UE shall be fully synchronized to Cell 1. The UE shall be configured for periodic CSI reporting with a reporting periodicity of 5 ms. In the test, DRX configuration is enabled and DRX inactivity timer has already been expired, i.e. UE tries to decode PDCCH and to send periodic CSI during the period when On-duration timer is running. Time alignment timers shall be set to "infinity" so that UL timing alignment is maintained during the test.

Table A.7.5.1.4.1-1: Supported test configurations for FR2 PCell

Configuration	Description
1	TDD, SSB SCS 120 KHz, data SCS 120KHz, BW 100 MHz

Table A.7.5.1.4.1-2: General test parameters for FR2 in-sync testing in DRX mode

Parameter	Unit	Value
-----------	------	-------

		<b>Test 1</b>	
Active PCell		Cell 1	
RF Channel Number		1	
Duplex mode	Config 1	TDD	
BW <sub>channel</sub>	Config 1	100: N <sub>RB,c</sub> = 66	
Data RBs allocated	Config 1	66	
DL initial BWP configuration	Config 1	DLBWP.0.1	
DL dedicated BWP configuration	Config 1	DLBWP.1.1	
UL initial BWP configuration	Config 1	ULBWP.0.1	
UL dedicated BWP configuration	Config 1	ULBWP.1.1	
TDD Configuration	Config 1	TDDConf.3.1	
RMSI CORESET Reference Channel	Config 1	CR.3.1 TDD	
Dedicated CORESET Reference Channel	Config 1	CCR.3.1 TDD	
SSB Configuration	Config 1	SSB.1 FR2	
SMTTC Configuration	Config 1	SMTTC.3	
PDSCH/PDCCH subcarrier spacing	Config 1	120 KHz	
PRACH Configuration	Config 1	Table A.3.8.3.1	
SSB index assigned as RLM RS	Config 1	0,1	
OCNG parameters		OP.1	
CP length		Normal	
In sync transmission parameters	DCI format	1-0	
	Number of Control OFDM symbols	2	
	Aggregation level	CCE	4
	Ratio of hypothetical PDCCH RE energy to average SSS RE energy	dB	0
	Ratio of hypothetical PDCCH DMRS energy to average SSS RE energy	dB	0
	DMRS precoder granularity	REG bundle size	
	REG bundle size	6	
Out of sync transmission parameters	DCI format	1-0	
	Number of Control OFDM symbols	2	
	Aggregation level	CCE	8
	Ratio of hypothetical PDCCH RE energy to average SSS RE energy	dB	4
	Ratio of hypothetical PDCCH DMRS energy to average SSS RE energy	dB	4
	DMRS precoder granularity	REG bundle size	
	REG bundle size	6	
DRX Configuration		DRX.11	
Gap pattern ID		N.A.	
Layer 3 filtering		<i>Enabled</i>	
T310 timer	ms	4000	
T311 timer	ms	1000	
N310		1	
N311		1	
CSI-RS for CSI reporting	Config 1	CSI-RS.3.1 TDD	
reportConfigType		periodic	
reportQuantity		cri-RI-PMI-CQI	
CSI reporting periodicity	slot	40	
CSI reporting offset	slot	4	
TCI states for PDCCH/PDSCH		TCI.State.2	
CSI-RS for tracking	Config 1	TRS.2.1 TDD	
T1	s	0.2	
T2	s	0.2	
T3	s	2.8	
T4	s	0.2	
T5	s	3.88	
D1	s	3.84	
Note 1: All configurations are assigned to the UE prior to the start of time period T1.			
Note 2: UE-specific PDCCH is not transmitted after T1 starts.			

**Table A.7.5.1.4.1-3: OTA related cell specific test parameters for FR2 (Cell 1) for in-sync radio link monitoring test in DRX mode**

Parameter		Unit	Test 1				
			T1	T2	T3	T4	T5
AoA setup			Setup 1 defined in A.3.15				
Assumption for UE beams <sup>Note 5</sup>			Rough				
EPRE ratio of PDCCH DMRS to SSS		dB	0				
EPRE ratio of PDCCH to PDCCH DMRS		dB	0				
EPRE ratio of PBCH DMRS to SSS		dB	0				
EPRE ratio of PBCH to PBCH DMRS		dB					
EPRE ratio of PSS to SSS		dB					
EPRE ratio of PDSCH DMRS to SSS		dB					
EPRE ratio of PDSCH to PDSCH DMRS		dB					
EPRE ratio of OCNG DMRS to SSS		dB					
EPRE ratio of OCNG to OCNG DMRS		dB					
ssb-Index 0 SNR	Config 1	dB	2 <sup>Note 6</sup>	-6 <sup>Note 6</sup>	-15	-4.5	2 <sup>Note 6</sup>
ssb-Index 1 SNR	Config 1		2 <sup>Note 6</sup>	-15	-15	-15	-15
$N_{oc}$	Config 1	dBm/1 5KHz	-104.7dBm				
Propagation condition			TDL-A 30ns 75Hz				
<p>Note 1: OCNG shall be used such that the resources in Cell 1 are fully allocated and a constant total transmitted power spectral density is achieved for all OFDM symbols.</p> <p>Note 2: The signal contains PDCCH for UEs other than the device under test as part of OCNG.3</p> <p>Note 3: SNR levels correspond to the signal to noise ratio over the SSS REs.</p> <p>Note 4: The SNR values are specified for testing a UE which supports 2RX on at least one band. For testing of a UE which supports 4RX on all bands, the SNR during T3 is A.3.6.</p> <p>Note 5: Information about types of UE beam is given in B.2.1.3 and does not limit UE implementation or test system implementation.</p> <p>Note 6: This value allows up to 1dB degradation from applied SNR to UE baseband.</p>							

Table A.7.5.1.4.1-4: Void

Table A.7.5.1.4.1-5: Void

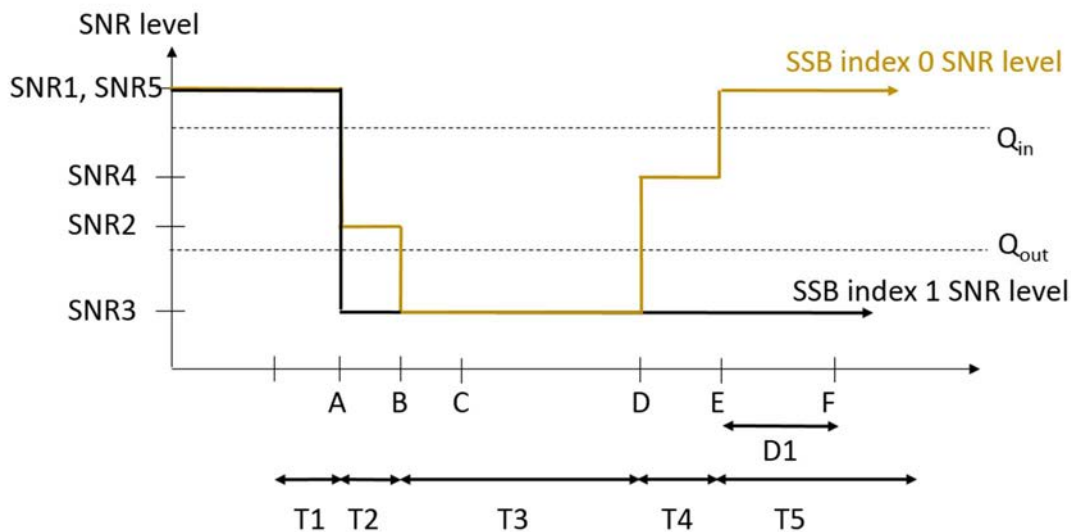

Figure A.7.5.1.4.1-1: SNR variation for in-sync testing

A.7.5.1.4.2 Test Requirements

The UE behaviour in each test during time durations T1, T2, T3, T4 and T5 shall be as follows:

During the period from time point A to time point F (D1 second after the start of time duration T5) the UE shall transmit uplink signal at least in all uplink slots configured for CSI transmission according to the configured periodic CSI reporting.

The rate of correct events observed during repeated tests shall be at least 90%.

A.7.5.1.5 Radio Link Monitoring Out-of-sync Test for FR2 PCell configured with CSI-RS-based RLM in non-DRX mode

A.7.5.1.5.1 Test Purpose and Environment

The purpose of this test is to verify that the UE properly detects the out of sync for the purpose of monitoring downlink CSI-RS based radio link quality of the PCell when no DRX is used. This test will partly verify the FR2 PCell CSI-RS Out-of-sync radio link monitoring requirements in clause 8.1.

The test parameters are given in Tables A.7.5.1.5.1-1, A.7.5.1.5.1-2, A.7.5.1.5.1-3 and A.7.5.1.5.1-4 below. There is one cell, cell 1 which is the PCell, in the test. The test consists of three successive time periods, with time duration of T1, T2 and T3 respectively. Figure A.7.5.1.5.1-1 shows the variation of the downlink SNR in the PCell to emulate out-of-sync and in-sync states. Prior to the start of the time duration T1, the UE shall be fully synchronized to cell 1. The UE shall be configured for periodic CSI reporting with a reporting periodicity of 10 ms. In the test, DRX configuration is not enabled. The UE is configured to perform inter-frequency measurements using GP ID #0 (40ms) in test. In the test, SSB0 and SSB1 are configured as BFD-RS.

Table A.7.5.1.5.1-1: Supported test configurations for FR2 PCell

Configuration	Description
1	TDD duplex mode, 120 kHz SSB SCS, 100 MHz bandwidth

**Table A.7.5.1.5.1-2: General test parameters for FR2 PCell for CSI-RS out-of-sync testing in non-DRX mode**

Parameter		Unit	Value
			Test 1
Active PCell			Cell 1
RF Channel Number			1
Duplex mode	Config 1		TDD
TDD Configuration	Config 1		TDDConf.3.1
BW <sub>channel</sub>	Config 1		100: N <sub>RB,c</sub> = 66
Data RBs allocated	Config 1		24
BW <sub>occupied</sub>	Config 1		24
DL initial BWP configuration	Config 1		DLBWP.0.1
DL dedicated BWP configuration	Config 1		DLBWP.1.4
UL initial BWP configuration	Config 1		ULBWP.0.1
UL dedicated BWP configuration	Config 1		ULBWP.1.4
RMSI CORESET Reference Channel	Config 1		CR.3.1 TDD
Dedicated CORESET Reference Channel	Config 1		CCR.3.4 TDD CCR.3.6 TDD
SSB Configuration	Config 1		SSB.1 FR2
SMTC Configuration	Config 1		SMTC.1
PDSCH/PDCCH subcarrier spacing	Config 1		120 KHz
CSI-RS for RLM	Config 1		Resource #4 in TRS.2.1 TDD Resource #4 in TRS.2.2 TDD
TRS configuration			TRS.2.1 TDD TRS.2.2 TDD
TCI configuration for PDCCH#1/PDSCH			TCI.State.2
TCI configuration for PDCCH#2			TCI.State.3
OCNG parameters			OP.5
CP length			Normal
Out of sync transmission parameters	DCI format		1-0
	Number of Control OFDM symbols		2
	Aggregation level	CCE	8
	Ratio of hypothetical PDCCH RE energy to average CSI-RS RE energy	dB	4
	Ratio of hypothetical PDCCH DMRS energy to average CSI-RS RE energy	dB	4
	DMRS precoder granularity		REG bundle size
REG bundle size			6
DRX			OFF
Gap pattern ID			*gp0
Layer 3 filtering			Enabled
T310 timer		ms	0
T311 timer		ms	1000
N310			1
N311			1
CSI-RS for CSI reporting	Config 1		CSI-RS.3.1 TDD
reportConfigType			periodic
reportQuantity			cri-RI-PMI-CQI
CSI reporting periodicity		slot	40
CSI reporting offset		slot	4
T1		s	0.2
T2		s	0.35
T3		s	0.35
D1		s	0.31
Note 1: UE-specific PDCCH is not transmitted after T1 starts.			

**Table A.7.5.1.5.1-3: Cell specific test parameters for FR2 for CSI-RS out-of-sync radio link monitoring in non-DRX mode**

Parameter		Unit	Test 1								
			T1	T2	T3	T1	T2	T3			
AoA setup			Setup 3 defined in A.3.15								
			AoA1			AoA2					
Assumption for UE beams <sup>Note 10</sup>			Rough			Rough					
EPRE ratio of PDCCH DMRS to SSS		dB	4			Not sent					
EPRE ratio of PDCCH to PDCCH DMRS		dB	0								
EPRE ratio of PBCH DMRS to SSS		dB									
EPRE ratio of PBCH to PBCH DMRS		dB									
EPRE ratio of PSS to SSS		dB									
EPRE ratio of PDSCH DMRS to SSS		dB									
EPRE ratio of PDSCH to PDSCH DMRS		dB									
EPRE ratio of OCNG DMRS to SSS		dB									
EPRE ratio of OCNG to OCNG DMRS		dB									
SNR on RLM-RS1	Config 1	dB							<sup>2</sup> Note 11	<sup>-6</sup> Note 11	-15
SNR on RLM-RS2	Config 1	dB				Not sent			<sup>2</sup> Note 11	-15	-15
$N_{oc}$	Config 1	dBm/15kHz	-92.1			-92.1					
Propagation condition			TDL-C 300ns 100Hz			TDL-C 300ns 100Hz					
<p>Note 1: OCNG shall be used such that the resources in Cell 1 are fully allocated and a constant total transmitted power spectral density is achieved for all OFDM symbols.</p> <p>Note 2: The uplink resources for CSI reporting are assigned to the UE prior to the start of time period T1.</p> <p>Note 3: NZP CSI-RS resource set configuration for CSI reporting are assigned to the UE prior to the start of time period T1.</p> <p>Note 4: Measurement gap configuration is assigned to the UE prior to the start of time period T1.</p> <p>Note 5: The timers and layer 3 filtering related parameters are configured prior to the start of time period T1.</p> <p>Note 6: The signal contains PDCCH for UEs other than the device under test as part of OCNG.</p> <p>Note 7: SNR levels correspond to the signal to noise ratio over the SSS REs.</p> <p>Note 8: The SNR in time periods T1, T2 and T3 is denoted as SNR1, SNR2 and SNR3 respectively in figure A.7.5.1.5.1-1.</p> <p>Note 9: The SNR values are specified for testing a UE which supports 2RX on at least one band. For testing of a UE which supports 4RX on all bands, the SNR during T3 is A.3.6.</p> <p>Note 10: Information about types of UE beam is given in B.2.1.3 and does not limit UE implementation or test system implementation.</p> <p>Note 11: This value allows up to 1dB degradation from applied SNR to UE baseband</p>											

**Table A.7.5.1.5.1-4: Measurement gap configuration for FR2 CSI-RS out-of-sync radio link monitoring in non-DRX mode**

Field	Test 1
	Value
gapOffset	0
Note 1: RLM RS is partially overlapped with measurement gap	

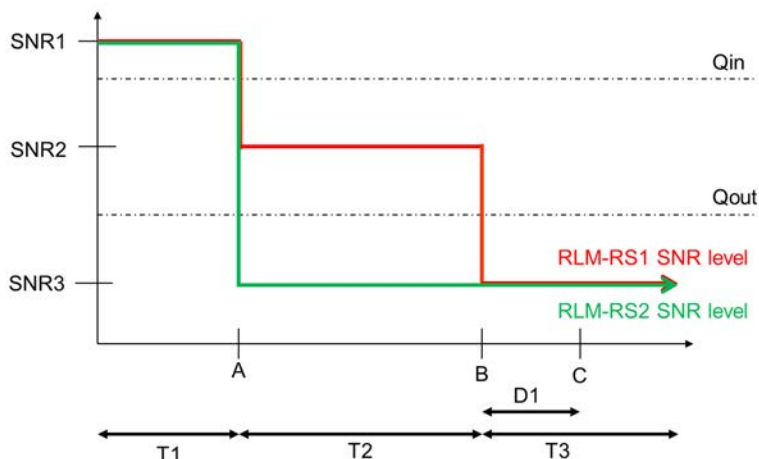

Figure A.7.5.1.5.1-1: SNR variation for CSI-RS out-of-sync testing

A.7.5.1.5.2 Test Requirements

The UE behaviour during time durations T1, T2, and T3 shall be as follows:

During the period from time point A to time point B the UE shall transmit uplink signal in Cell 1 at least in all uplink slots configured for CSI transmission according to the configured periodic CSI reporting for Cell 1.

The UE shall stop transmitting uplink signal in Cell 1 no later than time point C ( $D_1$  second after the start of the time duration T3) on the PCell.

The rate of correct events observed during repeated tests shall be at least 90%.

A.7.5.1.6 Radio Link Monitoring In-sync Test for FR2 PCell configured with CSI-RS-based RLM in non-DRX mode

A.7.5.1.6.1 Test Purpose and Environment

The purpose of this test is to verify that the UE properly detects the in sync for the purpose of monitoring downlink CSI-RS based radio link quality of the PCell when no DRX is used. This test will partly verify the FR2 PCell CSI-RS In-sync radio link monitoring requirements in clause 8.1.

The test parameters are given in Tables A.7.5.1.6.1-1, A.7.5.1.6.1-2 and A.7.5.1.6.1-3 below. There is one cells, cell 1 which is the PCell, in the test. The test consists of five successive time periods, with time duration of T1, T2, T3, T4 and T5 respectively. Figure A.7.5.1.6.1-1 shows the variation of the downlink SNR in the PCell to emulate out-of-sync and in-sync states. Prior to the start of the time duration T1, the UE shall be fully synchronized to cell 1. The UE shall be configured for periodic CSI reporting with a reporting periodicity of 10 ms. In the test, DRX configuration is not enabled. In the test, SSB0 and SSB1 are configured as BFD-RS.

Table A.7.5.1.6.1-1: Supported test configurations for FR2 PCell

Configuration	Description
1	TDD duplex mode, 120 kHz SSB SCS, 100 MHz bandwidth

Table A.7.5.1.6.1-2: General test parameters for FR2 PCell for CSI-RS in-sync testing in non-DRX mode

Parameter		Unit	Value
			Test 1
Active PCell			Cell 1
RF Channel Number			1
Duplex mode	Config 1		TDD
TDD Configuration	Config 1		TDDConf.3.1



BW <sub>channel</sub>	Config 1		100: N <sub>RB,c</sub> = 66
Data RBs allocated	Config 1		24
BW <sub>occupied</sub>	Config 1		24
DL initial BWP configuration	Config 1		DLBWP.0.1
DL dedicated BWP configuration	Config 1		DLBWP.1.4
UL initial BWP configuration	Config 1		ULBWP.0.1
UL dedicated BWP configuration	Config 1		ULBWP.1.4
RMSI CORESET Reference Channel	Config 1		CR.3.1 TDD
Dedicated CORESET Reference Channel	Config 1		CCR.3.1 TDD CCR.3.3 TDD
SSB Configuration	Config 1		SSB.1 FR2
SMTC Configuration	Config 1		SMTC.1
PDSCH/PDCCH subcarrier spacing	Config 1		120 KHz
CSI-RS for RLM	Config 1		Resource #4 in TRS.2.1 TDD Resource #4 in TRS.2.2 TDD
TRS configuration			TRS.2.1 TDD TRS.2.2 TDD
TCI configuration for PDCCH#1/PDSCH			TCI.State.2
TCI configuration for PDCCH#2			TCI.State.3
OCNG parameters			OP.5
CP length			Normal
Out of sync transmission parameters	DCI format		1-0
	Number of Control OFDM symbols		2
	Aggregation level	CCE	8
	Ratio of hypothetical PDCCH RE energy to average CSI-RS RE energy	dB	4
	Ratio of hypothetical PDCCH DMRS energy to average CSI-RS RE energy	dB	4
	DMRS precoder granularity		REG bundle size
	REG bundle size		6
In sync transmission parameters	DCI format		1-0
	Number of Control OFDM symbols		2
	Aggregation level	CCE	4
	Ratio of hypothetical PDCCH RE energy to average CSI-RS RE energy	dB	0
	Ratio of hypothetical PDCCH DMRS energy to average CSI-RS RE energy	dB	0
	DMRS precoder granularity		REG bundle size
	REG bundle size		6
DRX			OFF
Gap pattern ID			N.A.
Layer 3 filtering			Enabled
T310 timer		ms	1000
T311 timer		ms	1000
N310			1
N311			1
CSI-RS for CSI reporting	Config 1		CSI-RS.3.1 TDD
reportConfigType			periodic
reportQuantity			cri-RI-PMI-CQI
CSI reporting periodicity		slot	40
CSI reporting offset		slot	4
T1		s	0.2
T2		s	0.2
T3		s	0.24
T4		s	0.2

T5	s	0.88
D1	s	0.84
Note 1: UE-specific PDCCH is not transmitted after T1 starts.		

**Table A.7.5.1.6.1-3: Cell specific test parameters for FR2 for CSI-RS in-sync radio link monitoring in non-DRX mode**

Parameter	Unit	Test 1										
		T1	T2	T3	T4	T5	T1	T2	T3	T4	T5	
oA setup		Setup 3 defined in A.3.15										
Assumption for UE beams <sup>Note 10</sup>		AoA1					AoA2					
		Rough					Rough					
PRE ratio of PDCCH DMRS to SSS	dB	0										
PRE ratio of PDCCH to PDCCH DMRS	dB	Not sent										
PRE ratio of PBCH DMRS to SSS	dB											
PRE ratio of PBCH to PBCH DMRS	dB											
PRE ratio of PSS to SSS	dB											
PRE ratio of PDSCH DMRS to SSS	dB											
PRE ratio of PDSCH to PDSCH DMRS	dB											
PRE ratio of OCNG DMRS to SSS	dB											
PRE ratio of OCNG to OCNG DMRS	dB											
NR on RLM-RS1	Config 1	dB	2 <sup>Note 11</sup>	-6 <sup>Note 11</sup>	-15	-15	-15					
NR on RLM-RS2	Config 1	dB	Not sent					2 <sup>Note 11</sup>	-15	-15	-4.5	2 <sup>Note 11</sup>
$V_{oc}$	Config 1	dBm/15KHz	-92.1					-92.1				
Propagation condition			TDL-C 300ns 100Hz					TDL-C 300ns 100Hz				

- ote 1: OCNG shall be used such that the resources in Cell 1 are fully allocated and a constant total transmitted power spectral density is achieved for all OFDM symbols.
- ote 2: The uplink resources for CSI reporting are assigned to the UE prior to the start of time period T1.
- ote 3: NZP CSI-RS resource set configuration for CSI reporting are assigned to the UE prior to the start of time period T1.
- ote 4: Measurement gap configuration is assigned to the UE prior to the start of time period T1.
- ote 5: The timers and layer 3 filtering related parameters are configured prior to the start of time period T1.
- ote 6: The signal contains PDCCH for UEs other than the device under test as part of OCNG.
- ote 7: SNR levels correspond to the signal to noise ratio over the SSS REs.
- ote 8: The SNR in time periods T1, T2, T3, T4 and T5 is denoted as SNR1, SNR2, SNR3, SNR4 and SNR5 respectively in figure A.7.5.1.6.1-1.
- ote 9: The SNR values are specified for testing a UE which supports 2RX on at least one band. For testing of a UE which supports 4RX on a bands, the SNR during T3 is A.3.6.
- ote 10: Information about types of UE beam is given in B.2.1.3 and does not limit UE implementation or test system implementation.
- ote 11: This value allows up to 1dB degradation from applied SNR to UE baseband.

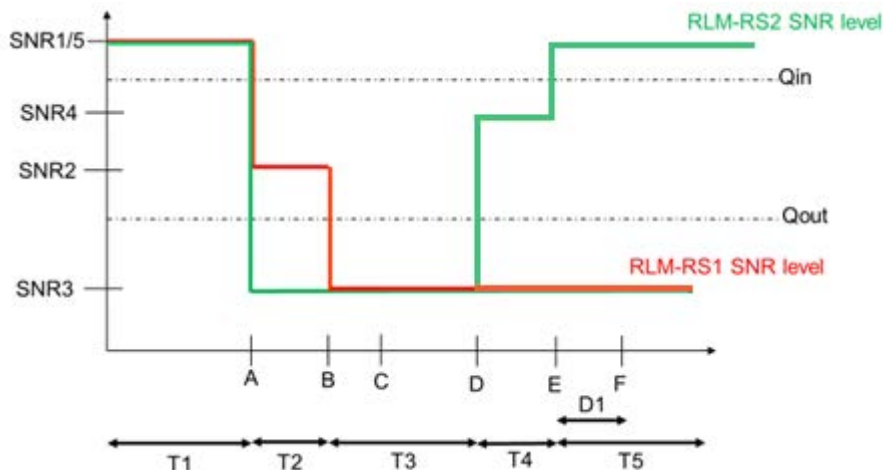

**Figure A.7.5.1.6.1-1: SNR variation for CSI-RS in-sync testing**

### A.7.5.1.6.2 Test Requirements

The UE behaviour in each test during time durations T1, T2, T3, T4 and T5 shall be as follows:

During the period from time point A to time point F (D1 second after the start of time duration T5) the UE shall transmit uplink signal at least in all uplink slots configured for CSI transmission according to the configured periodic CSI reporting on the PCell.

The rate of correct events observed during repeated tests shall be at least 90%.

### A.7.5.1.7 Radio Link Monitoring Out-of-sync Test for FR2 PCell configured with CSI-RS-based RLM in DRX mode

#### A.7.5.1.7.1 Test Purpose and Environment

The purpose of this test is to verify that the UE properly detects the out of sync for the purpose of monitoring downlink CSI-RS based radio link quality of the PCell when DRX is used. This test will partly verify the FR2 PCell CSI-RS Out-of-sync radio link monitoring requirements in clause 8.1.

The test parameters are given in Tables A.7.5.1.7.1-1, A.7.5.1.7.1-2, and A.7.5.1.7.1-3 below. There is one cell, cell 1 is the PCell, in the test. The test consists of three successive time periods, with time duration of T1, T2 and T3 respectively. Figure A.7.5.1.7.1-1 shows the variation of the downlink SNR in the PCell to emulate out-of-sync and in-sync states. Prior to the start of the time duration T1, the UE shall be fully synchronized to cell 1. The UE shall be configured for periodic CSI reporting with a reporting periodicity of 10 ms. In the test, DRX configuration is enabled in PCell and DRX inactivity timer has already been expired, i.e. UE tries to decode PDCCH and to send periodic CQI during the period when On-duration timer is running. Time alignment timers shall be set to “infinity” so that UL timing alignment is maintained during the test. In the test, SSB0 and SSB1 are configured as BFD-RS.

**Table A.7.5.1.7.1-1: Supported test configurations for FR2 PCell**

Configuration	Description
1	TDD duplex mode, 120 kHz SSB SCS, 100 MHz bandwidth

**Table A.7.5.1.7.1-2: General test parameters for FR2 PCell for CSI-RS out-of-sync testing in DRX mode**

Parameter		Unit	Value
			Test 1
Active PCell			Cell 1
RF Channel Number			1
Duplex mode	Config 1		TDD
TDD Configuration	Config 1		TDDConf.3.1
DL initial BWP configuration	Config 1		DLBWP.0.1
DL dedicated BWP configuration	Config 1		DLBWP.1.1
UL initial BWP configuration	Config 1		ULBWP.0.1
UL dedicated BWP configuration	Config 1		ULBWP.1.1
RMSI CORESET Reference Channel	Config 1		CR.3.1 TDD
Dedicated CORESET Reference Channel	Config 1		CCR.3.4 TDD CCR.3.6 TDD
SSB Configuration	Config 1		SSB.1 FR2
SMTTC Configuration	Config 1		SMTTC.1
PDSCH/PDCCH subcarrier spacing	Config 1		120 KHz
CSI-RS for RLM	Config 1		Resource #4 in TRS.2.1 TDD Resource #4 in TRS.2.2 TDD
TRS configuration			TRS.2.1 TDD TRS.2.2 TDD
TCI configuration for PDCCH#1/PDSCH			TCI.State.2
TCI configuration for PDCCH#2			TCI.State.3

OCNG parameters			OP.1
CP length			Normal
Out of sync transmission parameters	DCI format		1-0
	Number of Control OFDM symbols		2
	Aggregation level	CCE	8
	Ratio of hypothetical PDCCH RE energy to average CSI-RS RE energy	dB	4
	Ratio of hypothetical PDCCH DMRS energy to average CSI-RS RE energy	dB	4
	DMRS precoder granularity		REG bundle size
REG bundle size			6
DRX			DRX.3
Gap pattern ID			N.A.
Layer 3 filtering			Enabled
T310 timer		ms	0
T311 timer		ms	1000
N310			1
N311			1
CSI-RS for CSI reporting	Config 1		CSI-RS.3.1 TDD
reportConfigType			periodic
reportQuantity			cri-RI-PMI-CQI
CSI reporting periodicity		slot	40
CSI reporting offset		slot	4
T1		s	0.2
T2		s	1.28
T3		s	1.28
D1		s	1.24
Note 1: UE-specific PDCCH is not transmitted after T1 starts.			

**Table A.7.5.1.7.1-3: Cell specific test parameters for FR2 for CSI-RS out-of-sync radio link monitoring in DRX mode**

Parameter		Unit	Test 1		
			T1	T2	T3
AoA setup		dB	Setup 1 defined in A.3.15		
Assumption for UE beams <sup>Note 10</sup>			Rough		
EPRE ratio of PDCCH DMRS to SSS		dB	4		
EPRE ratio of PDCCH to PDCCH DMRS		dB	0		
EPRE ratio of PBCH DMRS to SSS		dB			
EPRE ratio of PBCH to PBCH DMRS		dB			
EPRE ratio of PSS to SSS		dB			
EPRE ratio of PDSCH DMRS to SSS		dB			
EPRE ratio of PDSCH to PDSCH DMRS		dB			
EPRE ratio of OCNG DMRS to SSS		dB			
EPRE ratio of OCNG to OCNG DMRS		dB			
SNR on RLM-RS1	Config 1	dB	2 <sup>Note 11</sup>	-6 <sup>Note 11</sup>	-15
SNR on RLM-RS2	Config 1	dB	2 <sup>Note 11</sup>	-15	-15
$N_{oc}$	Config 1	dBm/15KHz	-104.7		
Propagation condition			TDL-C 300ns 100Hz		

- Note 1: OCNG shall be used such that the resources in Cell 1 are fully allocated and a constant total transmitted power spectral density is achieved for all OFDM symbols.
- Note 2: The uplink resources for CSI reporting are assigned to the UE prior to the start of time period T1.
- Note 3: NZP CSI-RS resource set configuration for CSI reporting are assigned to the UE prior to the start of time period T1.
- Note 4: Measurement gap configuration is assigned to the UE prior to the start of time period T1.
- Note 5: The timers and layer 3 filtering related parameters are configured prior to the start of time period T1.
- Note 6: The signal contains PDCCH for UEs other than the device under test as part of OCNG.
- Note 7: SNR levels correspond to the signal to noise ratio over the SSS REs.
- Note 8: The SNR in time periods T1, T2 and T3 is denoted as SNR1, SNR2 and SNR3 respectively in figure A.7.5.1.7.1-1.
- Note 9: The SNR values are specified for testing a UE which supports 2RX on at least one band. For testing of a UE which supports 4RX on all bands, the SNR during T3 is specified in clause A.3.6.
- Note 10: Information about types of UE beam is given in B.2.1.3 and does not limit UE implementation or test system implementation.
- Note 11: This value allows up to 1dB degradation from applied SNR to UE baseband.

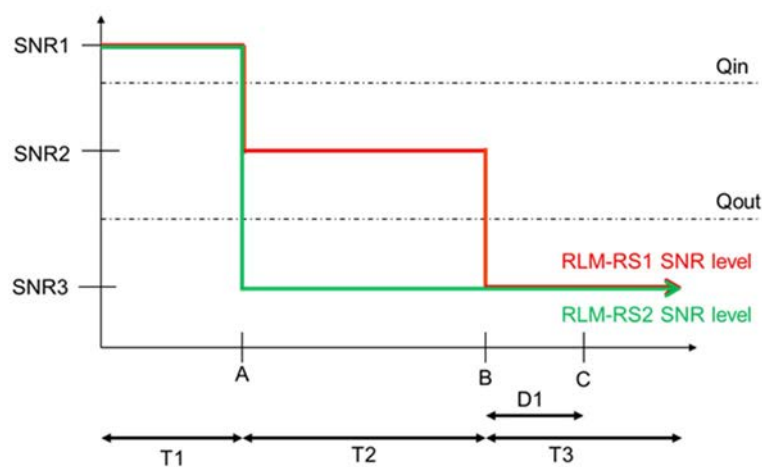

**Figure A.7.5.1.7.1-1: SNR variation for CSI-RS out-of-sync testing**

#### A.7.5.1.7.2 Test Requirements

The UE behaviour during time durations T1, T2, and T3 shall be as follows:

During the period from time point A to time point B the UE shall transmit uplink signal in Cell 1 (PCell) at least in all uplink slots configured for CSI transmission according to the configured periodic CSI reporting for Cell 1.

The UE shall stop transmitting uplink signal in Cell 1 (PCell) no later than time point C ( $D_1$  seconds after the start of the time duration T3) on the PCell.

The rate of correct events observed during repeated tests shall be at least 90%.

#### A.7.5.1.8 Radio Link Monitoring In-sync Test for FR2 PCell configured with CSI-RS-based RLM in DRX mode

##### A.7.5.1.8.1 Test Purpose and Environment

The purpose of this test is to verify that the UE properly detects the in sync for the purpose of monitoring downlink CSI-RS based radio link quality of the PCell when DRX is used. This test will partly verify the FR2 PCell CSI-RS In-sync radio link monitoring requirements in clause 8.1.

The test parameters are given in Tables A.7.5.1.8.1-1, A.7.5.1.8.1-2, A.7.5.1.8.1-3 and A.7.5.1.8.1-4 below. There is one cell, cell 1 which is the PCell, in the test. The test consists of five successive time periods, with time duration of T1, T2, T3, T4 and T5 respectively. Figure A.7.5.1.8.1-1 shows the variation of the downlink SNR in the PCell to emulate out-of-sync and in-sync states. Prior to the start of the time duration T1, the UE shall be fully synchronized to cell 1. The UE shall be configured for periodic CSI reporting with a reporting periodicity of 10 ms. The UE is configured to

perform inter-frequency measurements using GP ID #0 (40ms) in test. In the test, SSB0 and SSB1 are configured as BFD-RS.

**Table A.7.5.1.8.1-1: Supported test configurations for FR2 PSCell**

Configuration	Description
1	TDD duplex mode, 120 kHz SSB SCS, 100 MHz bandwidth

**Table A.7.5.1.8.1-2: General test parameters for FR2 PCell for CSI-RS in-sync testing in non-DRX mode**

Parameter		Unit	Value
			Test 1
Active PCell			Cell 1
RF Channel Number			1
Duplex mode	Config 1		TDD
TDD Configuration	Config 1		TDDConf.3.1
DL initial BWP configuration	Config 1		DLBWP.0.1
DL dedicated BWP configuration	Config 1		DLBWP.1.1
UL initial BWP configuration	Config 1		ULBWP.0.1
UL dedicated BWP configuration	Config 1		ULBWP.1.1
RMSI CORESET Reference Channel	Config 1		CR.3.1 TDD
Dedicated CORESET Reference Channel	Config 1		CCR.3.1 TDD CCR.3.3 TDD
SSB Configuration	Config 1		SSB.1 FR2
SMTc Configuration	Config 1		SMTc.1
PDSCH/PDCCH subcarrier spacing	Config 1		120 KHz
CSI-RS for RLM	Config 1		Resource #4 in TRS.2.1 TDD Resource #4 in TRS.2.2 TDD
TRS configuration			TRS.2.1 TDD TRS.2.2 TDD
TCI configuration for PDCCH#1/PDSCH			TCI.State.2
TCI configuration for PDCCH#2			TCI.State.3
OCNG parameters			OP.1
CP length			Normal
Out of sync transmission parameters	DCI format		1-0
	Number of Control OFDM symbols		2
	Aggregation level	CCE	8
	Ratio of hypothetical PDCCH RE energy to average CSI-RS RE energy	dB	4
	Ratio of hypothetical PDCCH DMRS energy to average CSI-RS RE energy	dB	4
	DMRS precoder granularity		REG bundle size
	REG bundle size		6
In sync transmission parameters	DCI format		1-0
	Number of Control OFDM symbols		2
	Aggregation level	CCE	4
	Ratio of hypothetical PDCCH RE energy to average CSI-RS RE energy	dB	0
	Ratio of hypothetical PDCCH DMRS energy to average CSI-RS RE energy	dB	0
	DMRS precoder granularity		REG bundle size
	REG bundle size		6
DRX			DRX.3

Gap pattern ID			<i>*gp0</i>
Layer 3 filtering			<i>Enabled</i>
T310 timer		ms	2000
T311 timer		ms	1000
N310			1
N311			1
CSI-RS for CSI reporting	Config 1		CSI-RS.3.1 TDD
reportConfigType			periodic
reportQuantity			cri-RI-PMI-CQI
CSI reporting periodicity		slot	40
CSI reporting offset		slot	4
T1		s	0.2
T2		s	0.2
T3		s	1.64
T4		s	0.2
T5		s	1.88
D1		s	1.84
Note 1: UE-specific PDCCH is not transmitted after T1 starts.			

**Table A.7.5.1.8.1-3: Cell specific test parameters for FR2 for CSI-RS in-sync radio link monitoring in non-DRX mode**

Parameter		Unit	Test 1									
			T1	T2	T3	T4	T5					
AoA setup		dB	Setup 1 defined in A.3.15									
Assumption for UE beams <sup>Note 10</sup>			Rough									
EPRE ratio of PDCCH DMRS to SSS		dB	0									
EPRE ratio of PDCCH to PDCCH DMRS		dB	0									
EPRE ratio of PBCH DMRS to SSS		dB										
EPRE ratio of PBCH to PBCH DMRS		dB										
EPRE ratio of PSS to SSS		dB										
EPRE ratio of PDSCH DMRS to SSS		dB										
EPRE ratio of PDSCH to PDSCH DMRS		dB										
EPRE ratio of OCNG DMRS to SSS		dB										
EPRE ratio of OCNG to OCNG DMRS		dB	-104.7									
SNR on RLM-RS1	Config 1	dB						2 <sup>Note 11</sup>	-6 <sup>Note 11</sup>	-15	-4.5	2 <sup>Note 11</sup>
SNR on RLM-RS2	Config 1	dB						2 <sup>Note 11</sup>	-15	-15	-15	-15
$N_{oc}$	Config 1	dBm/15KHz	-104.7									
Propagation condition			TDL-C 300ns 100Hz									

- Note 1: OCNB shall be used such that the resources in Cell 1 are fully allocated and a constant total transmitted power spectral density is achieved for all OFDM symbols.
- Note 2: The uplink resources for CSI reporting are assigned to the UE prior to the start of time period T1.
- Note 3: NZP CSI-RS resource set configuration for CSI reporting are assigned to the UE prior to the start of time period T1.
- Note 4: Measurement gap configuration is assigned to the UE prior to the start of time period T1.
- Note 5: The timers and layer 3 filtering related parameters are configured prior to the start of time period T1.
- Note 6: The signal contains PDCCH for UEs other than the device under test as part of OCNB.
- Note 7: SNR levels correspond to the signal to noise ratio over the SSS REs.
- Note 8: The SNR in time periods T1, T2, T3, T4 and T5 is denoted as SNR1, SNR2, SNR3, SNR4 and SNR5 respectively in figure A.7.5.1.8.1-1.
- Note 9: The SNR values are specified for testing a UE which supports 2RX on at least one band. For testing of a UE which supports 4RX on all bands, the SNR during T3 is A.3.6.
- Note 10: Information about types of UE beam is given in B.2.1.3 and does not limit UE implementation or test system implementation.
- Note 11: This value allows up to 1dB degradation from applied SNR to UE baseband.

**Table A.7.5.1.8.1-4: Measurement gap configuration for FR2 CSI-RS in-sync radio link monitoring in non-DRX mode**

Field	Test 1 Value
gapOffset	0
Note 1: RLM RS is partially overlapped with measurement gap	

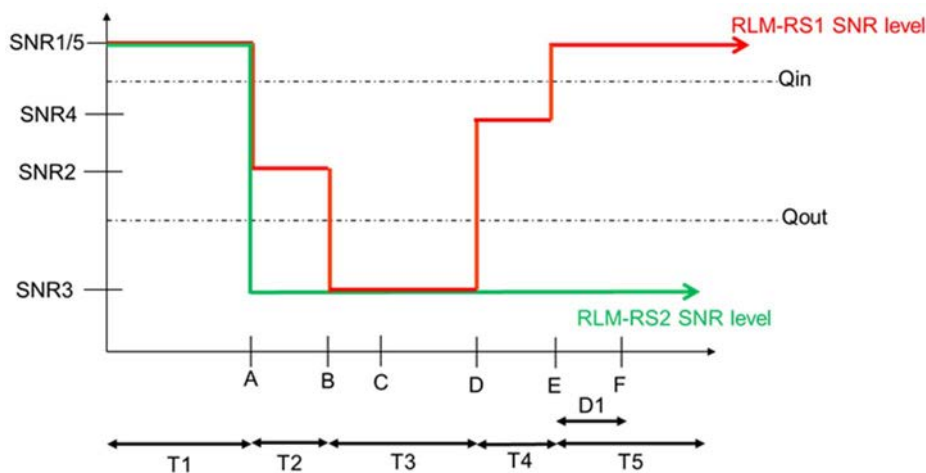

**Figure A.7.5.1.8.1-1: SNR variation for CSI-RS in-sync testing**

**A.7.5.1.8.2 Test Requirements**

The UE behaviour in each test during time durations T1, T2, T3, T4 and T5 shall be as follows:

During the period from time point A to time point F (D1 second after the start of time duration T5) the UE shall transmit uplink signal at least in all uplink slots configured for CSI transmission according to the configured periodic CSI reporting on the PCell.

The rate of correct events observed during repeated tests shall be at least 90%.

**A.7.5.1.9 UE Radio Link Monitoring Scheduling Restrictions on FR2**

**A.7.5.1.9.1 Test Purpose and Environment**

The purpose is to verify that the NR UE correctly follows the RLM scheduling restrictions requirements defined in clause 8.1.7. This test verifies that the UE correctly receive the PDCCH scheduled on the symbols right before the RLM



SSB symbols without overlap so that it sends ACK/NACK correctly. The test case is only applicable to UE which supports pdcch-MonitoringAnyOccasions or pdcch-MonitoringAnyOccasionsWithSpanGap.

The test parameters are given in table A.7.5.1.9.1-1, table A.7.5.1.9.1-2 and table A.7.5.1.9.1-3 below. The UE is required during time period T1 to transmit ACK/NACK correctly upon scheduling of PDSCH.

**Table A.7.5.1.9.1-1: Supported test configurations**

Configuration	Description
1	120 kHz SSB SCS, 120 kHz RMC SCS, 100 MHz bandwidth, TDD duplex mode

**Table A.7.5.1.9.1-2: General test parameters for NR RLM scheduling restriction test case in FR2**

Parameter	Unit	Test configuration	Value	Comment
RF Channel Number		1	1	
SSB configuration		1	SSB.1 FR2	
SMTC configuration		1	SMTC pattern 1	
DRX cycle length	s	1	OFF	
T1	s	1	5	During T1 the UE is required to correctly transmit ACK/NACK

**Table A.7.5.1.9.1-3: Cell specific test parameters for NR RLM scheduling restriction test case in FR2**

Parameter	Unit	Test configuration	Cell 1	
AoA setup		1	Setup 3 defined in A.3.15.3	
			AoA1	AoA2
Assumption for UE beams <small>Note 1</small>			Rough	Rough
TDD configuration		1	TDDConf.3.1	
BW <sub>channel</sub>	MHz	1	100: N <sub>RB,c</sub> = 66	
Data RBs allocated		1	24	
PDSCH Reference measurement channel		1	SR.3.2 TDD	Not sent
RMSI CORESET RMC configuration		1	CR.3.1 TDD	Not sent
Dedicated CORESET RMC configuration		1	CCR.3.2 TDD	Not sent
TRS configuration		1	TRS.2.1 TDD	TRS.2.2 TDD
PDCCH/PDSCH TCI state		1	TCI.State.2	N/A
OCNG Pattern		1	OP.5 defined in A.3.2.1	Not sent
Initial DL BWP configuration		1	DLBWP.0.1	
Initial UL BWP configuration		1	ULBWP.0.1	
RLM-RS		1	SSB with index 0	SSB with index 1
$N_{oc}$	dBm/15kHz	1	-92.1	-92.1
$N_{oc}$ <small>Note2</small>	dBm/SCS	1	-83.1	-83.1
$\hat{E}_s/N_{oc}$	dB	1	2	2
$\hat{E}_s/I_{ot\_BB}$ <small>Note 4</small>	dB	1	1	1
SSB_RP <small>Note3</small>	dBm/SCS	1	-81.1	-81.1
Io	dBm/95.04 MHz	1	-54.35	-54.35
Time multiplexing of the downlink transmissions from each AoA		1	Defined in Figure A.7.5.1.9.1-1	
Propagation Condition		1	AWGN	AWGN

Note 1: Information about types of UE beam is given in B.2.1.3 and does not limit UE implementation or test system implementation.

Note 2: Interference from other cells and noise sources not specified in the test is assumed to be constant over subcarriers and time and shall be modelled as AWGN of appropriate power for  $N_{oc}$  to be fulfilled.

Note 3: Es/lot, SSB\_RP and lo levels have been derived from other parameters for information purposes. They are not settable parameters themselves.

Note 4: Calculation of Es/lot<sub>BB</sub> includes the effect of UE internal noise up to the value assumed for the associated Refsens requirement in clause 7.3.2 of TS 38.101-2 [19], and an allowance of 1dB for UE multi-band relaxation factor  $\Delta MB_s$  from TS 38.101-2 [19] Table 6.2.1.3-4.

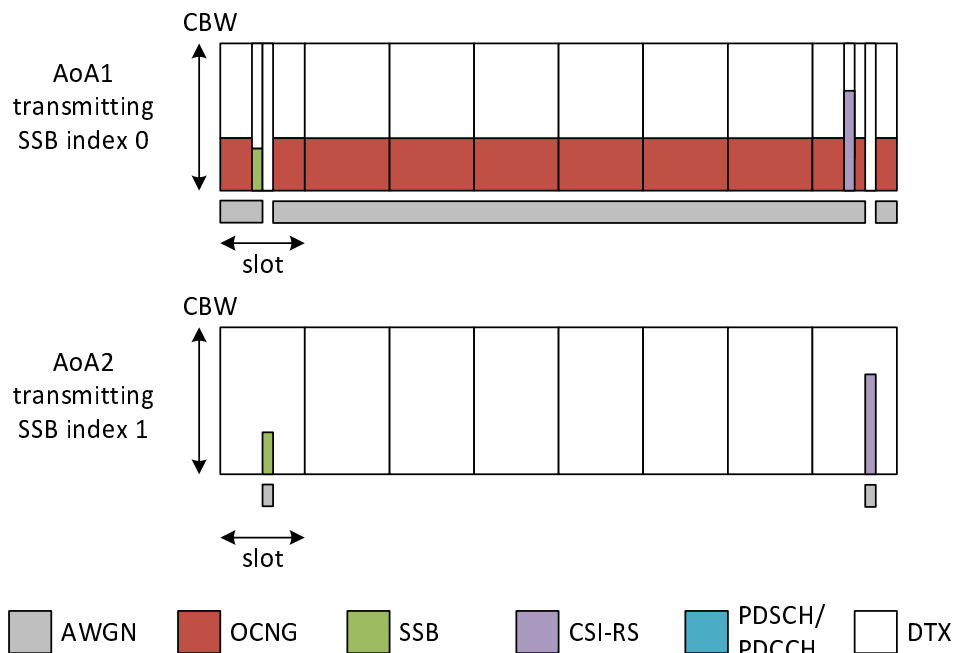

Figure A.7.5.1.9.1-1: Time multiplexed downlink transmissions

### A.7.5.1.9.2 Test Requirements

The UE behaviour follows the requirements defined in clause 8.1.7.3.

## A.7.5.2 Interruption

### A.7.5.2.1 Interruptions during measurements on deactivated NR SCC in FR2

#### A.7.5.2.1.1 Test Purpose and Environment

The purpose of this test is to verify that the UE missed ACK/NACK rate does not exceed the limits at NR PSCell interruptions during the measurement on the deactivated NR SCC. This test will verify the missed ACK/NACK rate for PCell in standalone NR specified in clause 8.2.2.2. Supported test configurations are shown in table A.7.5.2.1.1-1.

The general test parameters and NR cell specific test parameters are given in Table A.7.5.2.1.1-2 and A.7.5.2.1.1-3 below. In the test there are two cells: Cell1 and Cell2. Cell1 is PCell, Cell2 is an NR deactivated SCell. Cell1 shall be configured as PCell and Cell2 shall be configured as SCell.

The test consists of one time period, with duration of T1. Prior to the start of the time duration T1, the UE is connected to Cell1 and Cell2. The point in time at which the RRC message including *measCycleSCell* or *allowInterruptions* for the deactivated NR SCells is received at the UE antenna connector, defines the start of time period T1. During T1, PCell is continuously scheduled in DL.

**Table A.7.5.2.1.1-1: Interruptions during measurements on deactivated NR SCC supported test configurations**

Config	Description
1	NR 120 kHz SSB SCS, 100 MHz bandwidth, TDD – TDD duplex mode

**Table A.7.5.2.1.1-2: General test parameters for interruptions during measurements on deactivated NR SCC in standalone NR**

Parameter	Unit	Value	Comment
RF Channel Number		1, 2	Two NR RF channels
Active PCell		Cell1	PCell on NR RF channel number 1.
Configured deactivated SCell		Cell2	Deactivated SCell on NR RF channel number 2.
CP length		Normal	Applicable to Cell1 and Cell2
DRX		OFF	
Measurement gap pattern Id		OFF	
SCell measurement cycle (measCycleSCell)	ms	640	
T1	s	10	

**Table A.7.5.2.1.1-3: NR cell specific test parameters for interruptions during measurements on deactivated NR SCC in standalone NR**

Parameter	Unit	Cell1	Cell2
Frequency Range		FR2	
Duplex mode		TDD	
TDD configuration		TDDConf.3.1	
BW <sub>channel</sub>		100 MHz: N <sub>RB,c</sub> = 66	
Data RBs allocated		66	
Initial DL BWP Configuration		DLBWP.0.2 <sup>Note4</sup>	
Initial UL BWP Configuration		ULBWP.0.2 <sup>Note6</sup>	
Downlink dedicated BWP Configuration		DLBWP.1.1	
Uplink dedicated BWP configuration		ULBWP.1.1	
PDSCH Reference measurement channel		SR.3.1 TDD	
RMSI CORESET parameters		CR.3.1 TDD	
Dedicated CORESET parameters		CCR.3.1 TDD	
OCNG Patterns		OP.1	
SMTTC Configuration		SMTTC.1	
SSB Configuration		SSB.1 FR2	
TCI State		TCI.State.0	
TRS Configuration		TRS.2.1 TDD	
Correlation Matrix and Antenna Configuration		1x2 Low	
EPRE ratio of PSS to SSS	dB	0	0
EPRE ratio of PBCH DMRS to SSS			
EPRE ratio of PBCH to PBCH DMRS			
EPRE ratio of PDCCH DMRS to SSS			
EPRE ratio of PDCCH to PDCCH DMRS			
EPRE ratio of PDSCH DMRS to SSS			
EPRE ratio of PDSCH to PDSCH			
EPRE ratio of OCNG DMRS to SSS(Note 1)			

EPRE ratio of OCNG to OCNG DMRS (Note 1)			
Time offset to Cell1 <sup>Note 3</sup>	µs	-	3
Propagation Condition	AWGN		
Note 1:	OCNG shall be used such that both cells are fully allocated and a constant total transmitted power spectral density is achieved for all OFDM symbols.		
Note 2:	Void		
Note 3:	Receive time difference between slot boundaries of signals received from the two cells at the UE antenna connector including time alignment error between the two cells.		
Note 4:	For unpaired spectrum, a DL BWP is linked with an UL BWP. DLBWP.0.2 is linked with ULBWP.0.2 defined in clause 12 of of TS 38.213 [3].		

**Table A.7.5.2.1.1-4: OTA related test parameters for interruptions during measurements on deactivated NR SCC in standalone NR**

Parameter		Unit	Cell 1	Cell 2
Angle of arrival configuration			Setup1 according to table A.3.15.1	Setup 1according to table A.3.15.1
Assumption for UE beams <sup>Note 6</sup>			Rough	Rough
$N_{oc}$ <sup>Note1</sup>	NR_TDD_FR2_A	dBm/15kHz	-104.7	-104.7
	NR_TDD_FR2_B			
	NR_TDD_FR2_F			
	NR_TDD_FR2_G			
	NR_TDD_FR2_T			
$N_{oc}$ <sup>Note1</sup>	NR_TDD_FR2_A	dBm/SCS	-95.7	-95.7
	NR_TDD_FR2_B			
	NR_TDD_FR2_F			
	NR_TDD_FR2_G			
	NR_TDD_FR2_T			
SSB_RP <sup>Note2</sup>	NR_TDD_FR2_A	dBm/120KH <i>z</i> <sup>Note3</sup>	-88.7	-88.7
	NR_TDD_FR2_B			
	NR_TDD_FR2_F			
	NR_TDD_FR2_G			
	NR_TDD_FR2_T			
$\hat{E}_s/N_{oc}$		dB	7	7
$\hat{E}_s/I_{ot}$		dB	7	7
$I_o$ <sup>Note2</sup>	NR_TDD_FR2_A	dBm/95.04 MHz <sup>Note4</sup>	-58.92	-58.92
	NR_TDD_FR2_B			
	NR_TDD_FR2_F			
	NR_TDD_FR2_G			
	NR_TDD_FR2_T			
<p>Note 1: Interference from other cells and noise sources not specified in the test is assumed to be constant over subcarriers and time and shall be modelled as AWGN of appropriate power for <math>N_{oc}</math> to be fulfilled.</p> <p>Note 2: SSB_RP and <math>I_o</math> levels have been derived from other parameters for information purposes. They are not settable parameters themselves.</p> <p>Note 3: SSB_RP minimum requirements are specified assuming independent interference and noise at each receiver antenna port.</p> <p>Note 4: Equivalent power received by an antenna with 0 dBi gain at the centre of the quiet zone</p> <p>Note 5: As observed with 0 dBi gain antenna at the centre of the quiet zone</p> <p>Note 6: Information about types of UE beam is given in B.2.1.3 and does not limit UE implementation or test system implementation.</p>				

### A.7.5.2.1.2 Test Requirements

The UE shall be continuously scheduled on PCell during the entire length of T1. During the time duration T1 the UE shall transmit at least 99.5% of ACK/NACK on PCell.

If the NR PCell is not in the same band as the deactivated SCell, the UE is only allowed to cause interruptions on NR PCell immediately before and immediately after an SMTC. Each interruption on NR PCell shall not exceed the value defined in Table A.7.5.2.1.2-1.

If the NR PCell is in the same band as the deactivated SCell, the UE is only allowed to cause an interruption on PCell no earlier than 4 slots before an SMTC and no later than 4 slots after the SMTC. the interruption on NR PCell shall not exceed the value defined in Table A.7.5.2.1.2-2.

**Table A.7.5.2.1.2-1: Interruption duration if the PCell is not in the same band as the deactivated SCell**

$\mu$	NR Slot length (ms)	Interruption length (slot)
3	0.125	4

**Table A.7.5.2.1.2-2: Interruption duration if the PCell is in the same band as the deactivated SCell**

$\mu$	NR Slot length (ms)	Interruption length (slot)
3	0.125	8 + SMTC duration

The rate of correct events observed during repeated tests shall be at least 90%.

### A.7.5.2.2 SA interruptions at NR SRS carrier-based switching

#### A.7.5.2.2.1 Test Purpose and Environment

The purpose of this test is to verify that when a UE needs to transmit aperiodic SRS, the UE can perform SRS carrier-based switching to a carrier not configured for PUCCH/PUSCH transmission from a carrier with PUCCH/PUSCH transmission. The test will partly verify the interruption requirements on PCell in clause 8.2.2.2.9.

#### A.7.5.2.2.2 Test Parameters

In each test there are two cells: Cell 1 and Cell 2. Cell 1 is the FR2 PCell. Cell 2 is an activated FR2 SCell on the TDD SCC which operates in downlink without PUCCH/PUSCH. The UE is configured with the SRS switching between PCell and SCell. The test parameters for PCell and SCell are given in Tables A.7.5.2.2.2-2, A.7.5.2.2.2-3, and A.7.5.2.2.2-4 below. The test consists of two successive time periods, with duration of T1 and T2, respectively. Immediately at the beginning of T2, the UE is triggered for SRS switching by DCI 2\_3 scheduling. After T2, the UE is expected to transmit aperiodic SRS on a special slot in the configured TDD UL/DL configuration, as scheduled by DCI 2\_3. The UE shall be scheduled on PCell continuously throughout the test.

The test equipment verifies that potential interruption is carried out correctly by monitoring ACK/NACK sent in PCell.

**Table A.7.5.2.2.2-1: Supported test configurations**

Configuration	Description
1	120 kHz SSB SCS, 100 MHz bandwidth, TDD duplex mode
NOTE: The UE is only required to be tested in one of the supported test configurations.	

**Table A.7.5.2.2.2-2: General test parameters for SA interruptions at NR SRS carrier-based switching**

Parameter	Unit	Value	Comment
RF Channel Number		1, 2	Two NR radio channel (1, 2) are used for this test
Active PCell		Cell 1	Primary cell on NR RF channel number 1

Configured SCell		Cell 2	Activated secondary cell on NR RF channel number 2
CP length		Normal	
DRX		OFF	Continuous monitoring of PCell
T1	s	5	
T2	ms	100	UE shall perform SRS switching during T2

**Table A.7.5.2.2.2-3: Cell-specific test parameters for SA interruptions at NR SRS carrier-based switching**

Parameter		Unit	Cell 1	Cell 2
Frequency Range				FR2
Duplex mode				TDD
TDD configuration		Config 1		TDDConf.3.1
BW <sub>channel</sub>		Config 1	MHz	100: N <sub>RB,c</sub> = 66
Downlink initial BWP Configuration		Config 1		DLBWP.0.1
Downlink dedicated BWP Configuration		Config 1		DLBWP.1.1
Uplink initial BWP configuration		Config 1		ULBWP.0.1
Uplink dedicated BWP configuration		Config 1		ULBWP.1.1
SRS configuration		Config 1		SRS.6 TDD
TRS configuration		Config 1		TRS.2.1 TDD
TCI state		Config 1		TCI.State.0
PDSCH Reference measurement channel		Config 1		SR.3.1 TDD
RMSI CORESET Reference Channel		Config 1		CR.3.1 TDD
RMC CORESET Reference Channel		Config 1		CCR.3.1 TDD
OCNG Patterns				OP.1
SSB Configuration				SSB.1 FR2
SMTc Configuration		Config 1		SMTc.1
EPRE ratio of PSS to SSS			dB	0
EPRE ratio of PBCH DMRS to SSS				
EPRE ratio of PBCH to PBCH DMRS				
EPRE ratio of PDCCH DMRS to SSS				
EPRE ratio of PDCCH to PDCCH DMRS				
EPRE ratio of PDSCH DMRS to SSS				
EPRE ratio of PDSCH to PDSCH				
EPRE ratio of OCNG DMRS to SSS <sup>Note 1</sup>				
EPRE ratio of OCNG to OCNG DMRS <sup>Note 1</sup>				
$\hat{E}_s/N_{oc}$			dB	17
Propagation Condition				AWGN
NOTE 1: OCNG shall be used such that both cells are fully allocated, and a constant total transmitted power spectral density is achieved for all OFDM symbols.				

**Table A.7.5.2.2.2-4: OTA related test parameters**

Parameter	Unit	Test 1	
		T1	T2
Angle of arrival configuration		Setup 1 according to clause A.3.15.1	
Assumption for UE beams <sup>Note 6</sup>		Fine	
$N_{oc}$ <sup>Note 1</sup>	dBm/15kHz <sup>Note 4</sup>	-112	
$N_{oc}$ <sup>Note 1</sup>	dBm/SCS <sup>Note 3</sup>	-103	
$\hat{E}_s/N_{oc}$	dB	4	
SS-RSRP <sup>Note 2</sup>	dBm/SCS <sup>Note 4</sup>	-99	

$\hat{E}_s/I_{ot}$	dB	4
$I_o$ <sup>Note2</sup>	dBm/95.04 MHz <sup>Note 4</sup>	-68.5
NOTE 1: Interference from other cells and noise sources not specified in the test is assumed to be constant over subcarriers and time and shall be modelled as AWGN of appropriate power for $N_{oc}$ to be fulfilled.		
NOTE 2: SS-RSRP and $I_o$ levels have been derived from other parameters for information purposes. They are not settable parameters themselves.		
NOTE 3: SS-RSRP minimum requirements are specified assuming independent interference and noise at each receiver antenna port.		
NOTE 4: Equivalent power received by an antenna with 0 dBi gain at the centre of the quiet zone.		
NOTE 5: As observed with 0 dBi gain antenna at the centre of the quiet zone.		
NOTE 6: Information about types of UE beam is given in B.2.1.3 and does not limit UE implementation or test system implementation.		

### A.7.5.2.2.3 Test Requirements

During T2, interruption on PCell due to SRS carrier-based switching between Cell 1 and Cell 2 shall not exceed the required values specified in clause 8.2.2.2.9.

The rate of correct events observed during repeated tests shall be at least 90%.

## A.7.5.3 SCell Activation and Deactivation Delay

### A.7.5.3.1 SCell Activation and deactivation for SCell in FR2 intra-band in non-DRX

#### A.7.5.3.1.1 Test Purpose and Environment

The purpose of this test case is the same as for the test defined in clause A.6.5.3.1.1 except the PCell and SCell are in FR2 intra-band.

The supported test configurations are shown in table A.7.5.3.1.1-1 below. The general test parameters are the same as defined in Table A.6.5.3.1.1-2 except those described in Tables A.7.5.3.1.1-2, and cell specific test parameters are described in Tables A.7.5.3.1.1-3. OTA related test parameters are shown in table A.7.5.3.1.1-4 below.

**Table A.7.5.3.1.1-1: Supported test configurations for FR2 SCell activation case**

Configuration	Description
1	NR 120 kHz SSB SCS, 100MHz bandwidth, TDD duplex mode

**Table A.7.5.3.1.1-2: General test parameters for FR2 SCell activation case**

Parameter	Unit	Value	Comment
RF Channel Number		1,2	Two NR radio channels are used for this test, cell 1 and cell2 use RF channel 1 and 2, respectively.

**Table A.7.5.3.1.1-3: Cell specific test parameters for FR2 SCell activation case**

Parameter <sup>Note 5</sup>	Unit	Cell 1			Cell 2		
		T1	T2	T3	T1	T2	T3
SSB ARFCN		freq1			freq2		
Duplex mode		TDD					
TDD configuration		TDDConf.3.1					
Downlink initial BWP Configuration		DLBWP.0.1					
Downlink dedicated BWP Configuration		DLBWP.1.1					
Uplink initial BWP configuration		ULBWP.0.1					
Uplink dedicated BWP configuration		ULBWP.1.1					
TRS configuration		TRS.2.1 TDD					
TCI state		TCI.State.0					
BW <sub>channel</sub>	MHz	100: N <sub>RB,C</sub> = 66					
Data RBs allocated		66					

PDSCH Reference measurement channel		SR.3.1 TDD	-
RMSI CORESET Parameters		CR.3.1 TDD	-
Dedicated CORESET Parameters		CCR.3.1 TDD	-
OCNG Patterns		OP.1	
SSB Configuration		SSB.1 FR2	
SMTTC Configuration		SMTTC.1	
CSI-RS configuration for CSI reporting		CSI-RS.3.1 TDD	
reportConfigType		periodic	N/A
reportQuantity		cri-RI-PMI-CQI	N/A
CSI reporting periodicity	slot	40	N/A
CSI reporting offset	slot	4	N/A
EPRE ratio of PSS to SSS	dB	0	
EPRE ratio of PBCH_DMRS to SSS			
EPRE ratio of PBCH to PBCH_DMRS			
EPRE ratio of PDCCH_DMRS to SSS			
EPRE ratio of PDCCH to PDCCH_DMRS			
EPRE ratio of PDSCH_DMRS to SSS			
EPRE ratio of PDSCH to PDSCH_DMRS			
EPRE ratio of OCNG DMRS to SSS <sup>Note 1</sup>			
EPRE ratio of OCNG to OCNG DMRS <sup>Note 1</sup>			
Propagation conditions		AWGN	
<p>Note 1: OCNG shall be used such that both cells are fully allocated and a constant total transmitted power spectral density is achieved for all OFDM symbols.</p> <p>Note 2: Void</p> <p>Note 3: Void</p> <p>Note 4: Void</p> <p>Note 5: Void</p>			

**Table A.7.5.3.1.1-4: OTA related test parameters for FR2 SCell activation case**

Parameter	Unit	Cell 1			Cell 2		
		T1	T2	T3	T1	T2	T3
Angle of arrival configuration		Setup 1 according to table A.3.15.1			Setup 1 according to table A.3.15.1		
Assumption for UE beams <sup>Note 7</sup>		Rough			Rough		
$N_{oc}$ <sup>Note1</sup>	dBm/15kHz <sup>Note4</sup>	-104.7			-104.7		
$N_{oc}$ <sup>Note1</sup>	dBm/SCS <sup>Note3</sup>	-95.7			-95.7		
$\hat{E}_s / N_{oc}$	dB	7			7		
SSB_RP <sup>Note2</sup>	dBm/SCS <sup>Note4</sup>	-88.7			-88.7		
$\hat{E}_s / I_{ot}$	dB	7			7		
$I_o$ <sup>Note2</sup>	dBm/95.04 MHz <sup>Note4</sup>	-58.92			-58.92		
<p>Note 1: Interference from other cells and noise sources not specified in the test is assumed to be constant over subcarriers and time and shall be modelled as AWGN of appropriate power for <math>N_{oc}</math> to be fulfilled.</p> <p>Note 2: <math>E_s/I_{ot}</math>, SSB_RP and <math>I_o</math> levels have been derived from other parameters for information purposes. They are not settable parameters themselves.</p> <p>Note 3: Void</p> <p>Note 4: Equivalent power received by an antenna with 0dBi gain at the centre of the quiet zone</p> <p>Note 5: Void</p> <p>Note 6: Void</p> <p>Note 7: Information about types of UE beam is given in B.2.1.3 and does not limit UE implementation or test system implementation.</p>							

**A.7.5.3.1.2 Test Requirements**

The test requirements defined in clause A.6.5.3.1.2 shall apply to this test case, except  $T_{activation\_time}$  will be replaced with the value  $T_{FirstSSB} + 5ms$  as defined in clause 8.3.



### A.7.5.3.2 SCell Activation and deactivation for FR1+FR2 inter-band with target SCell in FR2

#### A.7.5.3.2.1 Test Purpose and Environment

The purpose of this test case is the same as for the test defined in clause A.7.5.3.1.1 except the PCell is in FR1 and SCell is in FR2.

The supported test configurations are defined in Table A.7.5.3.2.1-1. The general test parameters are the same as defined in Table A.6.5.3.1.1-2 except that the length of T2 is 2s. And cell specific test parameters are described in Tables A.7.5.3.2.1-2. OTA related test parameters are defined in Table A.7.5.3.2.1-3.

At the beginning of T1 the UE receives an RRC message by which the SCell (Cell 2) becomes configured on NR. During T1 the SCell is powered off and UE is not aware of SCell.

A MAC message for activation of SCell is sent by the test equipment 100ms after the RRC message, in a slot # denoted m. The point in time at which the MAC message for activation of SCell is received at the UE antenna connector defines the start of time period T2.

During T2, the test equipment monitors the L1-RSRP measurement reporting for the SCell. The time when test equipment receives a valid L1-RSRP report is denoted as slot  $m+T_{L1-RSRP}$ . In the next DL slot after slot  $m+T_{L1-RSRP}$ , the test equipment sends a MAC message for the activation of the TCI state of the RMC CORESET of the SCell. In the same slot, the test equipment also sends an RRC message to configure the CSI-RS resources for SCell.

Time period T3 starts when a MAC message for deactivation of the SCell, sent from the test equipment to the UE in a slot # denoted n, is received at the UE antenna connector.

The test equipment verifies that potential interruption is carried out in the correct time span by monitoring ACK/NACK sent in PCell and PCell during activation of SCell, respectively.

The test equipment verifies the activation time by counting the slots from the time when the SCell activation command is sent until a CSI report with other than CQI index 0 is received.

The test equipment verifies the deactivation time by counting the slots from the time when the SCell1 deactivation command is sent until CSI reporting for SCell1 is discontinued.

**Table A.7.5.3.2.1-1: Supported test configurations for FR2 SCell activation case**

Configuration	Description
1	PCell: 15 kHz SSB SCS, 10MHz bandwidth, FDD duplex mode Target SCell: 120 kHz SSB SCS, 100MHz bandwidth, TDD duplex mode
2	PCell: 15 kHz SSB SCS, 10MHz bandwidth, TDD duplex mode Target SCell: 120 kHz SSB SCS, 100MHz bandwidth, TDD duplex mode
3	PCell: 30kHz SSB SCS, 40MHz bandwidth, TDD duplex mode Target SCell: 120 kHz SSB SCS, 100MHz bandwidth, TDD duplex mode
Note:	The UE is only required to pass in one of the supported test configurations

**Table A.7.5.3.2.1-2: Cell specific test parameters for FR2 SCell activation case**

Parameter <sup>Note 5</sup>	Unit	Cell 1			Cell 2		
		T1	T2	T3	T1	T2	T3
SSB ARFCN		Freq1			Freq2		
Duplex mode	Config 1	FDD			TDD		
	Config 2,3	TDD					
TDD configuration	Config 1	Not Applicable			TDDConf.3.1		
	Config 2	TDDConf.1.1					
	Config 3	TDDConf.2.1					
Downlink initial BWP Configuration	Config 1,2,3	DLBWP.0.1					
Downlink dedicated BWP Configuration	Config 1,2,3	DLBWP.1.1					
Uplink initial BWP configuration	Config 1,2,3	ULBWP.0.1					
Uplink dedicated BWP configuration	Config 1,2,3	ULBWP.1.1					

TRS configuration	Config 1,2,3		N/A			TRS.2.1 TDD		
TCI state	Config 1,2,3		TCI.State.0					
BW <sub>channel</sub>	Config 1,2	MHz	10: N <sub>RB,c</sub> = 52			100: N <sub>RB,c</sub> = 66		
	Config 3		40: N <sub>RB,c</sub> = 106					
Data RBs allocated	Config 1,2		52			66		
	Config 3		106					
PDSCH Reference measurement channel	Config 1		SR.1.1 FDD			-		
	Config 2		SR.1.1 TDD					
	Config 3		SR.2.1 TDD					
RMSI CORESET Parameters	Config 1		CR.1.1 FDD			-		
	Config 2		CR.1.1 TDD					
	Config 3		CR.2.1 TDD					
Dedicated CORESET Parameters	Config 1		CCR.1.1 FDD			-		
	Config 2		CCR.1.1 TDD					
	Config 3		CCR.2.1 TDD					
OCNG Patterns			OP.1					
SSB configuration	Config 1,2		SSB.1 FR1			SSB.3 FR2		
	Config 3		SSB.2 FR1					
CSI-RS configuration for CSI reporting	Config 1~3		N/A			N/A	CSI-RS.3.1 TDD <small>Note 6</small>	CSI-RS.3.1 TDD
reportConfigType for CSI reporting			periodic			N/A		
reportConfigType for L1-RSRP			periodic			N/A		
reportQuantity for CSI reporting			cri-RI-PMI-CQI			N/A		
reportQuantity for L1-RSRP			ssb-Index-RSRP			N/A		
CSI reporting periodicity	Config 1,2	slot	5			N/A		
	Config 3		10					
L1-RSRP reporting periodicity <small>Note 7</small>	Config 1,2	slot	5			N/A		
	Config 3		10					
CSI reporting offset	Config 1,2	slot	2			N/A		
	Config 3		4					
L1-RSRP reporting offset	Config 1,2	slot	2			N/A		
	Config 3		4					
SMTC configuration			SMTC.1					
EPRE ratio of PSS to SSS		dB	0					
EPRE ratio of PBCH_DMRS to SSS								
EPRE ratio of PBCH to PBCH_DMRS								
EPRE ratio of PDCCH_DMRS to SSS								
EPRE ratio of PDCCH to PDCCH_DMRS								
EPRE ratio of PDSCH_DMRS to SSS								
EPRE ratio of PDSCH to PDSCH_DMRS								
EPRE ratio of OCNG DMRS to SSS <sup>Note 1</sup>								
EPRE ratio of OCNG to OCNG DMRS <sup>Note 1</sup>								
Propagation conditions			N/A Link only, see clause A.3.7A			AWGN		
<p>Note 1: OCNG shall be used such that both cells are fully allocated and a constant total transmitted power spectral density is achieved for all OFDM symbols.</p> <p>Note 2: Void</p> <p>Note 3: Void</p> <p>Note 4: Void</p> <p>Note 5: All parameters apply for configuration 1 and 2</p> <p>Note 6: CSI-RS for CSI measurement is (re)configured in the next DL slot after slot <math>m+T_{L1-RSRP}</math> during T2.</p> <p>Note 7: L1-RSRP measurement and reporting are configured to the the UE prior to the start of time period T1.</p>								

**Table A.7.5.3.2.1-3: OTA related test parameters for FR1 PCell activation case with FR2 SCell**

Parameter	Unit	Cell 1			Cell 2		
		T1	T2	T3	T1	T2	T3

Angle of arrival configuration			N/A	According to clause A.3.15.1		
Assumption for UE beams <sup>Note 7</sup>			N/A	Rough		
$N_{oc}$ <sup>Note 1</sup>	Config 1,2,3	dBm/15kHz	Link only, see clause A.3.7A	-104.7		
$N_{oc}$ <sup>Note 1</sup>	Config 1,2,3	dBm/SCS		-95.7		
$\hat{E}_s/N_{oc}$	Config 1,2,3	dB		$-\infty$	7	7
$\hat{E}_s/I_{ot}$	Config 1,2,3	dB		$-\infty$	7	7
SSB_RP <sup>Note 2, Note 4</sup>	Config 1,2,3	dBm/SCS		$-\infty$	-88.7	-88.7
$I_o$ <sup>Note 2, Note 4</sup>	Config 1,2,3	dBm/95.04 MHz		-66.68	-58.92	-58.92
<p>Note 1: Interference from other cells and noise sources not specified in the test is assumed to be constant over subcarriers and time and shall be modelled as AWGN of appropriate power for <math>N_{oc}</math> to be fulfilled.</p> <p>Note 2: <math>E_s/I_{ot}</math>, SSB_RP and <math>I_o</math> levels have been derived from other parameters for information purposes. They are not settable parameters themselves.</p> <p>Note 3: Void</p> <p>Note 4: Equivalent power received by an antenna with 0dBi gain at the centre of the quiet zone</p> <p>Note 5: Void</p> <p>Note 6: Void</p> <p>Note 7: Information about types of UE beam is given in B.2.1.3 and does not limit UE implementation or test system implementation.</p>						

### A.7.5.3.2.2 Test Requirements

During T2 the UE shall send the first CSI report for SCell in the first available uplink resource after at least one CSI-RS transmission occasion for channel measurement and reporting after slot  $(m+k)$ . UE is allowed to postpone CSI report to next available UL resource if an available uplink resource is subject to interruption. Whether CSI report in a slot was interrupted is checked by monitoring ACK/NACK sent in PCell in the slot.

During T2 the UE shall start sending valid L1-RSRP report for the SCell in the configured slots for CSI reporting after slot  $(m+T_{L1-RSRP})$ , where  $T_{L1-RSRP}$  is no larger than

$$3\text{ms} + T_{\text{FirstSSB\_MAX}} + 15 * T_{\text{SMTc\_MAX}} + 8 * T_{\text{rs}} + T_{L1-RSRP, \text{measure}} + T_{L1-RSRP, \text{report}}$$

as defined in clause 8.3.2. For this test case,  $T_{\text{FirstSSB\_MAX}}=T_{\text{SMTc\_MAX}}=T_{\text{rs}}=20\text{ms}$ ;  $T_{L1-RSRP, \text{measure}}=160\text{ms}$  and  $T_{L1-RSRP, \text{report}}=5\text{ms}$ , which allows  $T_{L1-RSRP}$  680 ms.

During T2 the UE shall start sending CSI reports for the SCell with non-zero CQI index in the configured slots for CSI reporting no later than slot  $m + \frac{T_{\text{HARQ}} + T_{\text{activation\_time}} + T_{\text{CSI\_Reporting}}}{\text{NR slot length}}$ , where

-  $T_{\text{HARQ}}$  is defined in Table A.5.5.3.1.1-2

-  $T_{\text{activation\_time}} = 3\text{ms} + T_{\text{FirstSSB\_MAX}} + 15 * T_{\text{SMTc\_MAX}} + 8 * T_{\text{rs}} + T_{L1-RSRP, \text{measure}} + T_{L1-RSRP, \text{report}} + \max \{ (T_{\text{HARQ}} + T_{\text{uncertainty\_MAC}} + 5\text{ms} + T_{\text{FineTiming}}), (T_{\text{uncertainty\_RRC}} + T_{\text{RRC\_delay}}) \}$ , which allows 710 ms

-  $T_{\text{CSI\_Reporting}} = 10\text{ms}$

- NR slot length is 0.125ms for this test case.

During T3 the UE shall stop sending CSI reports for both SCells no later than slot  $n + \frac{T_{\text{HARQ}} + 3\text{ms}}{\text{NR slot length}}$ , as defined in clause 8.3.

During T2 interruption of PCell during SCell activation shall not happen outside the slot  $m + 1 + \frac{T_{\text{HARQ}}}{\text{NR slot length}}$  to  $m + 1 + \frac{T_{\text{HARQ}} + 3\text{ms} + T_{\text{X}}}{\text{NR slot length}}$ , as defined in clause 8.3, where  $T_{\text{X}}=20\text{ms}$ .

During T3 the starting point of interruption of PCell during SCell deactivation shall not happen outside the slot  $n + 1 + \frac{T_{\text{HARQ}}}{\text{NR slot length}}$  to  $n + 1 + \frac{T_{\text{HARQ}} + 3\text{ms}}{\text{NR slot length}}$ , as defined in clause 8.3.

The interruption of PCell due to activation of SCell shall not be more than the values specified for SA in Clause 8.2.2.2.7.

### A.7.5.3.3 SCell Activation and deactivation for SCell in FR2 inter-band in non-DRX

#### A.7.5.3.3.1 Test Purpose and Environment

The purpose of this test case is the same as for the test defined in clause A.7.5.3.1.1 except the PCell and SCell are in FR2 inter-band.

The supported test configurations are shown in table A.7.5.3.3.1-1 below. The general test parameters are described in Tables A.7.5.3.3.1-2, and cell specific test parameters are described in Tables A.7.5.3.3.1-3. OTA related test parameters are shown in table A.7.5.3.3.1-4 below.

At the beginning of T1 the UE receives an RRC message by which the SCell (Cell 2) becomes configured on NR. During T1 the SCell is powered off and UE is not aware of SCell. A MAC message for activation of SCell is sent by the test equipment 100ms after the RRC message, in a slot # denoted m.

The point in time at which the MAC message for activation of SCell is received at the UE antenna connector defines the start of time period T2. Immediately at beginning of T2 the transmission power of Cell 2 is increased to same level as for cell 2. During T2, the test equipment monitors the L1-RSRP measurement reporting for the SCell. The time when test equipment receives a valid L1-RSRP report is denoted as slot  $m + T_{\text{L1-RSRP}}$ . In the next DL slot after slot  $m + T_{\text{L1-RSRP}}$ , the test equipment sends a MAC message for the activation of the TCI state of the RMC CORESET of the SCell. In the same slot, the test equipment also sends an RRC message to configure the CSI-RS resources for SCell.

Time period T3 starts when a MAC message for deactivation of the SCell, sent from the test equipment to the UE in a slot # denoted n, is received at the UE antenna connector.

The test equipment verifies that potential interruption is carried out in the correct time span by monitoring ACK/NACK sent in PCell and PSCell during activation of SCell, respectively.

The test equipment verifies the activation time by counting the slots from the time when the SCell activation command is sent until a CSI report with other than CQI index 0 is received.

The test equipment verifies the deactivation time by counting the slots from the time when the SCell1 deactivation command is sent until CSI reporting for SCell1 is discontinued.

**Table A.7.5.3.3.1-1: Supported test configurations for FR2 SCell activation in FR2 inter-band**

Configuration	Description
1	NR 120 kHz SSB SCS, 100MHz bandwidth, TDD duplex mode

**Table A.7.5.3.3.1-2: General test parameters for FR2 SCell activation in FR2 inter-band**

Parameter	Unit	Value	Comment
RF Channel Number		1,2	Two NR radio channels are used for this test. RF channel number 1 is in band 1 and RF channel number 2 is in band 2, where bands 1 and 2 are inter-band CA operating bands in FR2 as specified in Table 5.2A.2-1 in TS38.101-2.
Active PCell		Cell 1	Primary cell on NR RF channel number 1.
Configured deactivated SCell		Cell 2	Configured deactivated secondary cell on NR RF channel number 2.
CP length		Normal	
DRX		OFF	Continuous monitoring of primary cell
CQI/PMI periodicity and offset configuration index		0	CQI reporting for SCell every second subframe
Cell-individual offset for cells on NR channel number	dB	0	Individual offset for cells on primary component carrier.

SCell measurement cycle (measCycleSCell)	ms	160	
Cell2 timing offset to cell1	μs	≤8	A random value from 0μs to 8μs
T1	s	7	During this time the PCell shall be known and the SCell configured and detected.
T2	s	2	During this time the UE shall activate the SCell.
T3	s	1	During this time the UE shall deactivate the SCell.
T <sub>HARQ</sub>	ms	k <sub>1</sub> ×NR slot length	k <sub>1</sub> is a number of slots and is indicated by the PDSCH-to-HARQ-timing-indicator field in the DCI format, if present, or provided by <i>dl-DataToUL-ACK</i> , the value of k should be the minimum value defined in TS 38.213 [3] depends on UE's capability
T <sub>CSI_Reporting</sub>	ms	2	the delay uncertainty in acquiring the first available CSI reporting resources as specified in TS 38.331 [2]

**Table A.7.5.3.3.1-3: Cell specific test parameters for FR2 SCell activation in FR2 inter-band**

Parameter <sup>Note 5</sup>	Unit	T1		T2		T3	
		Cell 1	Cell 2	Cell 1	Cell 2	Cell 1	Cell 2
SSB ARFCN		freq1	freq2	freq1	freq2	freq1	freq2
Duplex mode		TDD		TDD		TDD	
TDD configuration		TDDConf.3.1		TDDConf.3.1		TDDConf.3.1	
Downlink initial BWP Configuration		DLBWP.0.1		DLBWP.0.1		DLBWP.0.1	
Downlink dedicated BWP Configuration		DLBWP.1.1		DLBWP.1.1		DLBWP.1.1	
Uplink initial BWP configuration		ULBWP.0.1		ULBWP.0.1		ULBWP.0.1	
Uplink dedicated BWP configuration		ULBWP.1.1		ULBWP.1.1		ULBWP.1.1	
TRS configuration		TRS.2.1 TDD		TRS.2.1 TDD		TRS.2.1 TDD	
TCI state		TCI.State.0		TCI.State.0		TCI.State.0	
BW <sub>channel</sub>	MHz	100: N <sub>RB,c</sub> = 66		100: N <sub>RB,c</sub> = 66		100: N <sub>RB,c</sub> = 66	
PDSCH Reference measurement channel		SR.3.1 TDD	-	SR.3.1 TDD	-	SR.3.1 TDD	-
RMSI CORESET Parameters		CR.3.1 TDD	-	CR.3.1 TDD	-	CR.3.1 TDD	-
Dedicated CORESET Parameters		CCR.3.1 TDD	-	CCR.3.1 TDD	-	CCR.3.1 TDD	-
CSI-RS configuration		NA	NA	NA	CSI-RS.3.1 TDD <sup>Note 2</sup>	NA	CSI-RS.3.1 TDD
CSI reporting periodicity <sup>Note 3</sup>		NA	5	NA	5	NA	5
OCNG Patterns		OP.1					
SSB Configuration		SSB.1 FR2					
SMTc Configuration		SMTc.1					
EPRE ratio of PSS to SSS	dB	0					
EPRE ratio of PBCH_DMRS to SSS							
EPRE ratio of PBCH to PBCH_DMRS							
EPRE ratio of PDCCH_DMRS to SSS							
EPRE ratio of PDCCH to PDCCH_DMRS							
EPRE ratio of PDSCH_DMRS to SSS							
EPRE ratio of PDSCH to PDSCH_DMRS							
EPRE ratio of OCNG DMRS to SSS <sup>Note 1</sup>							
EPRE ratio of OCNG to OCNG DMRS <sup>Note 1</sup>							
Propagation conditions		AWGN					
<p>Note 1: OCNG shall be used such that both cells are fully allocated and a constant total transmitted power spectral density is achieved for all OFDM symbols.</p> <p>Note 2: CSI-RS for CSI measurement is (re)configured in the next DL slot after slot m+T<sub>L1-RSRP</sub> during T2.</p> <p>Note 3: L1-RSRP measurement and reporting are configured to the the UE prior to the start of time period T1.</p>							

Table A.7.5.3.3.1-4: OTA related test parameters for FR2 SCell activation in FR2 inter-band

Parameter <sup>Note 6</sup>	Unit	Cell 1			Cell 2		
		T1	T2	T3	T1	T2	T3
AoA setup		Setup 3 as specified in clause A.3.15					
Assumption for UE beams <sup>Note 7</sup>		AoA1			AoA2		
		Rough			Rough		
$N_{oc}$ <sup>Note1</sup>	dBm/15kHz <sup>Note4</sup>	-92.1			-92.1		
$N_{oc}$ <sup>Note1</sup>	dBm/SCS <sup>Note3</sup>	-83.1			-83.1		
$\hat{E}_s/N_{oc}$	dB	0			0		
SS-RSRP <sup>Note2</sup>	dBm/SCS <sup>Note4</sup>	-83.1			-83.1		
$\hat{E}_s/I_{ot}$	dB	0			0		
$I_o$ <sup>Note2</sup>	dBm/95.04 MHz <sup>Note4</sup>	-51.1			-51.1		
Note 1:	Interference from other cells and noise sources not specified in the test is assumed to be constant over subcarriers and time and shall be modelled as AWGN of appropriate power for $N_{oc}$ to be fulfilled.						
Note 2:	SS-RSRP and $I_o$ levels have been derived from other parameters for information purposes. They are not settable parameters themselves.						
Note 3:	SS-RSRP minimum requirements are specified assuming independent interference and noise at each receiver antenna port.						
Note 4:	Equivalent power received by an antenna with 0dBi gain at the centre of the quiet zone						
Note 5:	As observed with 0dBi gain antenna at the centre of the quiet zone						
Note 6:	All parameters apply for configuration 1						
Note 7:	Information about types of UE beam is given in B.2.1.3 and does not limit UE implementation or test system implementation.						

### A.7.5.3.3.2 Test Requirements

During T2 the UE shall start sending CSI report for the SCell in the configured slots for CSI reporting after at least one CSI-RS transmission occasion for channel measurement and reporting after slot (m+k). UE shall send the first CSI report for SCell after receiving at least one CSI-RS transmission occasion for channel measurement and reporting after slot (m+k), or in the next available uplink resource for CSI reporting if the slot was subject to interruption. Whether CSI report in a slot was interrupted is checked by monitoring ACK/NACK sent in PCell in the slot.

During T2, the UE shall start sending valid L1-RSRP report for the SCell in the configured slots for CSI reporting after slot (m+ $T_{L1-RSRP}$ ), where  $T_{L1-RSRP}$  is no larger than  $3ms + T_{FirstSSB\_MAX} + 15 * T_{SMTC\_MAX} + 8 * T_{rs} + T_{L1-RSRP, measure} + T_{L1-RSRP, report}$  as defined in clause 8.3.2. For this test case,  $T_{FirstSSB\_MAX} = T_{SMTC\_MAX} = T_{rs} = 20ms$ ;  $T_{L1-RSRP, measure} = 480ms$  and  $T_{L1-RSRP, report} = 5ms$ , which allows  $T_{L1-RSRP} = 1000ms$ .

During T2, the UE shall start sending CSI reports for the SCell with non-zero CQI index in the configured slots for CSI reporting no later than slot  $m + \frac{T_{HARQ} + T_{activation\_time} + T_{CSI\_Reporting}}{NR\ slot\ length}$ , where

- $T_{HARQ}$  is defined in Table A.7.5.3.3.1-2
- $T_{activation\_time} = 3ms + T_{FirstSSB\_MAX} + 15 * T_{SMTC\_MAX} + 8 * T_{rs} + T_{L1-RSRP, measure} + T_{L1-RSRP, report} + \max \{ (T_{HARQ} + T_{uncertainty\_MAC} + 5ms + T_{FineTiming}), (T_{uncertainty\_RRC} + T_{RRC\_delay}) \}$ , which allows 1030ms
- $T_{CSI\_Reporting} = 10ms$
- NR slot length is 0.125ms for this test case.

During T2, the interruption of PCell during SCell activation shall not happen outside the slot  $m + 1 + \frac{T_{HARQ}}{NR\ slot\ length}$  to  $m + 1 + \frac{T_{HARQ} + 3ms + T_X}{NR\ slot\ length}$ , where  $T_X = 20ms$ .

During T3, the UE shall stop sending CSI reports for SCell no later than slot  $n + \frac{T_{HARQ} + 3ms}{NR\ slot\ length}$ , as defined in clause 8.3.

During T3, the starting point of interruption of PCell during SCell deactivation shall not happen outside the slot  $n + 1 + \frac{T_{HARQ}}{NR\ slot\ length}$  to  $n + 1 + \frac{T_{HARQ} + 3ms}{NR\ slot\ length}$  as defined in clause 8.3.

### A.7.5.3.4 Direct SCell activation at SCell addition of known SCell in FR2

#### A.7.5.3.4.1 Test Purpose and Environment

The purpose of this test is to verify that the delay and interruption for direct SCell activation delay at SCell addition are within the requirements stated in clause 8.3.4.

The supported test configurations are shown in Table A.7.5.3.4.1-1 below. The general test parameters are given in Table A.7.5.3.4.1-2 and cell-specific test parameters in Table A.7.5.3.4.1-3. OTA related test parameters are shown in Table A.7.5.3.4.1-4.

The test consists of three successive time periods, with duration of T1, T2 and T3, respectively. There are two FR2 carriers and two NR cells. Before the test starts the UE is connected to Cell 1 (PCell) on carrier #1, but is not aware of Cell 2 on NR carrier #2. Cell 1 and Cell 2 have constant signal levels throughout the test. The UE is monitoring the PCell. The UE shall be continuously scheduled in the PCell throughout the whole test.

At the beginning of T1 the UE receives an RRC message by which the Cell 2 is monitored by the UE. During T1, Cell 2 should be detected and measured by the UE such that it meets the condition for known cell defined in clause 8.3.4 for direct SCell activation.

Time period T2 starts when the *RRCReconfiguration* message for the configuration and activation of Cell 2 (the SCell), which is sent from the test equipment, is received at the UE antenna connector in a slot # denoted m. The test equipment shall set the parameter *sCellState* to *activated* for the SCell, which causes Cell 2 to become configured and activated.

Time period T3 starts at  $(m + N_{\text{direct}})$ , at which point UE shall be reporting a valid CQI for both PCell and SCell.

The test equipment verifies that potential interruption is carried out in the correct time span by monitoring ACK/NACK sent in PCell during the activation of SCell. The test equipment verifies the activation time by counting the slots from the time when the SCell activation message is sent until a CQI report with other than CQI index 0 is received.

**Table A.7.5.3.4.1-1: Supported test configurations**

Configuration	Description
1	NR 120 kHz SSB SCS, 100 MHz bandwidth, TDD duplex mode
Note:	The UE is only required to be tested in one of the supported test configurations

**Table A.7.5.3.4.1-2: General test parameters**

Parameter	Unit	Value	Comment
RF Channel Number		1,2	Two NR radio channels (1,2) in FR2 are used for this test
Active PCell		Cell 1	Primary cell on NR RF channel number 1.
Configured and activated SCell		Cell 2	Configured and activated SCell on NR RF channel number 2.
CP length		Normal	
DRX		OFF	Continuous monitoring of primary cell
SCell measurement cycle (measCycleSCell)	ms	160	
T1	s	7	During this time the measurement for Cell 2 is configured, and Cell 2 is detected.
T2	s	$N_{\text{direct}}$	During this time the UE shall configure and activate Cell 2 as SCell.
T3	ms	100	During this time the UE shall report valid CQI for both PCell and SCell.
A3 offset	dB	-15	
$T_{\text{HARQ}}$	ms	$k_1 \times \text{NR slot length}$	$k_1$ is a number of slots indicated by the PDSCH-to-HARQ_feedback timing indicator field in a corresponding DCI format or provided by <i>dl-DataToUL-ACK</i> if the PDSCH-to-HARQ feedback timing field is not present in the DCI format, the value is defined in 38.213 [3]
k	slot	$k_1 + 3 \cdot N_{\text{slot}}^{\text{subframe}, \mu} + 1$	As specified in clause 4.3 of TS 38.213 [3]

**Table A.7.5.3.4.1-3: Cell specific test parameters**

Parameter		Unit	Cell 1			Cell 2		
			T1	T2	T3	T1	T2	T3
SSB ARFCN			freq1			freq2		
Duplex mode	Config 1		TDD					
TDD configuration	Config 1		TDDConf.3.1					
BW <sub>channel</sub>	Config 1	MHz	100: N <sub>RB,c</sub> = 66					
DL initial BWP configuration	Config 1		DLBWP.0.1					
DL dedicated BWP configuration	Config 1		DLBWP.1.1					
UL initial BWP configuration	Config 1		ULBWP.0.1					
UL dedicated BWP configuration	Config 1		ULBWP.1.1					
Timing offset to Cell 1		ms	Not Applicable			0		
PDSCH Reference measurement channel	Config 1		SR.3.1 TDD			SR.3.1 TDD		
RMSI CORESET Reference Channel	Config 1		CR.3.1 TDD			CR.3.1 TDD		
RMC CORESET Reference Channel	Config 1		CCR.3.1 TDD			CCR.3.1 TDD		
TRS configuration	Config 1		TRS.2.1 TDD			TRS.2.1 TDD		
CSI-RS configuration	Config 1		CSI-RS.3.1 TDD			CSI-RS.3.1 TDD		
CSI reporting periodicity	Config 1	ms	5			5		
OCNG Patterns			OP.1					
SMTC configuration			SMTC.1					
SSB configuration	Config 1		SSB.1 FR2			SSB.1 FR2		
EPRE ratio of PSS to SSS		dB	0					
EPRE ratio of PBCH DMRS to SSS								
EPRE ratio of PBCH to PBCH DMRS								
EPRE ratio of PDCCH DMRS to SSS								
EPRE ratio of PDCCH to PDCCH DMRS								
EPRE ratio of PDSCH DMRS to SSS								
EPRE ratio of PDSCH to PDSCH								
EPRE ratio of OCNG DMRS to SSS(Note 1)								
EPRE ratio of OCNG to OCNG DMRS (Note 1)								
Propagation condition		-	AWGN					
Note 1: OCNG shall be used such that both cells are fully allocated and a constant total transmitted power spectral density is achieved for all OFDM symbols.								

**Table A.7.5.3.4.1-4: OTA related test parameters**

Parameter <sup>Note 6</sup>	Unit	Cell 1			Cell 2		
		T1	T2	T3	T1	T2	T3
Angle of arrival configuration		Setup 1 according to A.3.15.1					
Assumption for UE beams <sup>Note 7</sup>		Rough			Rough		
$N_{oc}$ <sup>Note1</sup>	$\text{dBm}/15\text{kHz}$ <sup>Note4</sup>	-112			-112		
$N_{oc}$ <sup>Note1</sup>	$\text{dBm}/\text{SCS}$ <sup>Note3</sup>	-102.97			-102.97		



$\hat{E}_s / N_{oc}$	dB	14	14
SS-RSRP <sup>Note2</sup>	dBm/SCS <small>Note4</small>	-88.97	-88.97
$\hat{E}_s / I_{ot}$	dB	14	14
Io <sup>Note2</sup>	dBm/95.04 MHz <small>Note4</small>	-59.81	-59.81
<p>Note 1: Interference from other cells and noise sources not specified in the test is assumed to be constant over subcarriers and time and shall be modelled as AWGN of appropriate power for <math>N_{oc}</math> to be fulfilled.</p> <p>Note 2: SS-RSRP and Io levels have been derived from other parameters for information purposes. They are not settable parameters themselves.</p> <p>Note 3: SS-RSRP minimum requirements are specified assuming independent interference and noise at each receiver antenna port.</p> <p>Note 4: Equivalent power received by an antenna with 0dBi gain at the centre of the quiet zone</p> <p>Note 5: As observed with 0dBi gain antenna at the centre of the quiet zone</p> <p>Note 6: All parameters apply for configuration 1</p> <p>Note 7: Information about types of UE beam is given in B.2.1.3, and does not limit UE implementation or test system implementation</p>			

#### A.7.5.3.4.2 Test Requirements

During T2 the UE shall send the first CSI report for SCell in the first available uplink resource after slot (m+k). UE is allowed to postpone CSI report to next available UL resource if an available uplink resource is subject to interruption. Whether CSI report in a slot was interrupted is checked by monitoring ACK/NACK sent in PCell in the slot.

During T2 the UE shall start sending CSI reports for SCell with non-zero CQI index in the configured slots for CSI reporting no later than slot  $m + \frac{N_{direct}}{NR\ slot\ length}$ , where

$$N_{direct} = T_{RRC\_Process} + T_1 + T_{activation\_time} + T_{CSI\_Reporting} - 3ms,$$

- $T_{RRC\_Process} = 16ms$ , which is the RRC procedure delay defined for SCell addition in clause 12 of TS 38.331 [2],
- $T_1$  is the delay from slot  $m + T_{RRC\_Process}$  until the transmission of *RRCReconfigurationComplete* message,
- $T_{activation\_time} = T_{FirstSSB} + 5ms = 25ms$ ,
- $T_{CSI\_Reporting} = 10ms$

This gives a total of  $N_{direct} = 16 + T_1 + 25 + 10 - 3 = (48 + T_1)$  ms, and NR slot length is 0.125ms.

During T3 the UE shall send CSI reports for SCell with non-zero CQI index and continue to send CSI reports for SCell with non-zero CQI index until the end of T3.

During T2 interruption of PCell during SCell activation shall not happen outside the window from slot  $m+1$  to slot  $m+1 + \frac{T_{RRC\_Process} + T_1 + T_X}{NR\ slot\ length}$  as defined in clause 8.3.4, where  $T_X = 20ms$ .

The interruption of PCell due to activation of SCell shall not be more than the values specified for NR SA in clause 8.2.2.2.11.

All of the above test requirements shall be fulfilled in order for the observed SCell activation delay to be counted as correct. The rate of correct observed SCell activation delay and SCell deactivation delay during repeated tests shall be at least 90%.

NOTE: During T2 if there are no uplink resources for reporting the valid CSI in a slot  $m + \frac{N_{direct}}{NR\ slot\ length}$  as defined in clause 8.3.4 then the UE shall use the next available uplink resource for reporting the corresponding valid CSI.

A.7.5.3.5 Direct SCell activation at handover with known SCell in FR2

A.7.5.3.5.1 Test Purpose and Environment

This test is to verify the requirements specified in sub clause 8.3.5 for the FR2 intra-frequency handover with direct SCell activation.

The test scenario comprises of three FR2 cells, one source PCell (Cell 1), one target PCell (Cell 2) and one SCell (Cell 3). The test consists of three successive time periods, with time durations of T1, T2, and T3 respectively.

At the start of time duration T1, the UE is in connected mode with PCell (Cell 1). Both Cell 2 and Cell 3 are known to UE and UE is reporting CQI for all Cell 1.

Time period T2 starts when UE receives a handover command that initiate handover of UE to Cell2 and also activates Cell 3. This is done using an *RRCConnectionReconfiguration* message with parameter *sCellState* set to *activated* for the Cell 3. The message is sent from the test equipment to the UE and is received in a slot number n at the UE antenna connector. The UE shall accomplish the handover, addition and activation of the SCell no later than slot  $(n + \frac{N_{direct}}{NR\ slot\ length})$ .

Time period T3 starts at  $(n + \frac{N_{direct}}{NR\ slot\ length})$ , at which point UE shall be reporting a valid CSI for both Cell 2 and Cell 3 as given in tables A.7.5.3.5.1-1 and A.7.5.3.5.1-2.

**Table A.7.5.3.5.1-1: Supported test configurations for FR2 handover with direct SCell activation case**

Configuration	Description
1	SCell: NR 120 kHz SSB SCS, 100MHz bandwidth, TDD duplex mode Source cell: NR 120 kHz SSB SCS, 100 MHz bandwidth, TDD duplex mode Target cell: NR 120 kHz SSB SCS, 100 MHz bandwidth, TDD duplex mode

**Table A.7.5.3.5.1-2: General test parameters for FR2 handover with direct SCell activation case**

Parameter	Unit	Value	Comment
RF Channel Number		1, 2	Two NR radio channels are used for this test, Cell 1 and Cell2 use RF channel 1 and Cell 3 uses RF channel 2 respectively.
A3-Offset	dB	-15	
Time offset between cells		3 μs	Synchronous cells
Initial conditions	Source cell	Cell 1	Source Cell
	Target cell	Cell 2	Neighbour cell
	SCell	Cell 3	SCell is not added and activated
Final condition	Source cell	Cell 2	Cell 2 is Source cell after handover
	Neighbour cell	Cell 1	Neighbour cell
	SCell	Cell 3	SCell is added and activated

**Table A.7.5.3.5.1-3: Cell specific test parameters for FR2 SCell activation case**

Parameter <sup>Note 5</sup>	Unit	T1			T2			T3		
		Cell 1	Cell 2	Cell 3	Cell 1	Cell 2	Cell 3	Cell 1	Cell 2	Cell 3
SSB ARFCN		freq1	freq1	freq 2	freq1	freq1	freq 2	freq1	freq1	freq2
Duplex mode		TDD			TDD			TDD		
TDD configuration		TDDConf.3.1			TDDConf.3.1			TDDConf.3.1		
Downlink initial BWP Configuration		DLBWP.0.1			DLBWP.0.1			DLBWP.0.1		
Downlink dedicated BWP Configuration		DLBWP.1.1			DLBWP.1.1			DLBWP.1.1		
Uplink initial BWP configuration		ULBWP.0.1			ULBWP.0.1			ULBWP.0.1		
Uplink dedicated BWP configuration		ULBWP.1.1			ULBWP.1.1			ULBWP.1.1		

TRS configuration		TRS.2.1 TDD		TRS.2.1 TDD		TRS.2.1 TDD	
TCI state		TCI.State.0		TCI.State.0		TCI.State.0	
BW <sub>channel</sub>	MHz	100: N <sub>RB,c</sub> = 66		100: N <sub>RB,c</sub> = 66		100: N <sub>RB,c</sub> = 66	
PDSCH Reference measurement channel		SR.3.1 TDD	-	SR.3.1 TDD	-	SR.3.1 TDD	
RMSI CORESET Parameters		CR.3.1 TDD	-	CR.3.1 TDD	-	CR.3.1 TDD	
Dedicated CORESET Parameters		CCR.3.1 TDD	-	CCR.3.1 TDD	-	CCR.3.1 TDD	
OCNG Patterns		OP.1					
SSB Configuration		SSB.1 FR2					
SMTC Configuration		SMTC.1					
PRACH configuration		FR2 PRACH configuration 1					
CSI-RS configuration for CSI reporting		CSI-RS.3.1 TDD					
reportConfigType		periodic	-	periodic	-	periodic	-
reportQuantity		cri-RI-PMI-CQI	-	cri-RI-PMI-CQI	-	cri-RI-PMI-CQI	-
CSI reporting periodicity	slot	40	-	40	-	40	-
CSI reporting offset	slot	4	-	4	-	4	-
EPRE ratio of PSS to SSS	dB	0					
EPRE ratio of PBCH_DMRS to SSS							
EPRE ratio of PBCH to PBCH_DMRS							
EPRE ratio of PDCCH_DMRS to SSS							
EPRE ratio of PDCCH to PDCCH_DMRS							
EPRE ratio of PDSCH_DMRS to SSS							
EPRE ratio of PDSCH to PDSCH_DMRS							
EPRE ratio of OCNG DMRS to SSS <sup>Note 1</sup>							
EPRE ratio of OCNG to OCNG DMRS <sup>Note 1</sup>							
Propagation conditions							
<p>Note 1: OCNG shall be used such that both cells are fully allocated and a constant total transmitted power spectral density is achieved for all OFDM symbols.</p> <p>Note 2: Interference from other cells and noise sources not specified in the test is assumed to be constant over subcarriers and time and shall be modelled as AWGN of appropriate power for <math>N_{oc}</math> to be fulfilled.</p> <p>Note 3: SS-RSRP and <math>I_o</math> levels have been derived from other parameters for information purposes. They are not settable parameters themselves.</p> <p>Note 4: SS-RSRP minimum requirements are specified assuming independent interference and noise at each receiver antenna port.</p> <p>Note 5: Void</p>							

**Table A.7.5.3.5.1-4: OTA related test parameters for FR2 SCell activation case**

Parameter <sup>Note 6</sup>	Unit	Cell 1			Cell 2			Cell 3		
		T1	T2	T3	T1	T2	T3	T1	T2	T3
Angle of arrival configuration		Setup 1 according to table A.3.15.1			Setup 1 according to table A.3.15.1			Setup 1 according to table A.3.15.1		
Assumption for UE beams <sup>Note 7</sup>		Rough			Rough			Rough		
$N_{oc}$ <sup>Note1</sup>	dBm/15kHz <sup>Note4</sup>	-112			-112			-112		
$N_{oc}$ <sup>Note1</sup>	dBm/SCS <sup>Note3</sup>	-102.97			-102.97			-102.97		
$\hat{E}_s / N_{oc}$	dB	14			14			14		
SS-RSRP <sup>Note2</sup>	dBm/SCS <sup>Note4</sup>	-88.97			-88.97			-88.97		
$\hat{E}_s / I_{ot}$	dB	14			14			14		

$I_0$ <sup>Note2</sup>	dBm/95.04 MHz <sup>Note4</sup>	-56.89	-56.89	-59.81
Note 1:	Interference from other cells and noise sources not specified in the test is assumed to be constant over subcarriers and time and shall be modelled as AWGN of appropriate power for $N_{oc}$ to be fulfilled.			
Note 2:	SS-RSRP and $I_0$ levels have been derived from other parameters for information purposes. They are not settable parameters themselves.			
Note 3:	SS-RSRP minimum requirements are specified assuming independent interference and noise at each receiver antenna port.			
Note 4:	Equivalent power received by an antenna with 0dBi gain at the centre of the quiet zone			
Note 5:	As observed with 0dBi gain antenna at the centre of the quiet zone			
Note 6:	Void			
Note 7:	Information about types of UE beam is given in B.2.1.3 and does not limit UE implementation or test system implementation.			

### A.7.5.3.5.2 Test Requirements

The UE shall be capable to transmit valid CSI report for PCell (Cell 2) and to the directly activated SCell1 no later than in slot  $n + N_{direct}$ .

The SCell activation delay,  $N_{direct}$ , can be expressed as:  $N_{direct} = T_{RRC\_process} + T_{interrupt} + T_2 + T_3 + T_{activation\_time} + T_{CSI\_Reporting} - 3ms$ ; Where:

$T_{RRC\_Process}$ : RRC procedure delay defined in clause 12 of TS 38.331 and it is equal to 16ms,

$T_{interrupt}$ : Interruption time during handover as specified in clause 6.1.1. The value to be verified in the test is 52 ms ( $T_{interrupt} = 0$  ms for  $T_{search} + 10ms$  for  $T_{IU} + 20$  ms for  $T_{processing} + 20ms$  for  $T_{\Delta} + 2$  ms for  $T_{margin}$  ms) by assuming known SCell and SMTC.1 configuration.

$T_2$ : Delay from slot  $n + \frac{T_{RRC\_Process} + T_{interrupt}}{NR\ slot\ length}$  until UE has obtained a valid TA command for the target PCell,

$T_3$ : Delay for applying the received TA for uplink transmission in the target PCell, and greater than or equal to  $k+1$  slot, where  $k$  is defined in clause 4.2 in TS 38.213,

$T_{activation\_time}$  and  $T_{CSI\_Reporting}$  are specified in clause 8.3.2, where the following definitions of  $T_{FirstSSB}$  and  $T_{FirstSSB\_MAX}$  as defined in section 8.3.5 shall apply:

During time period  $T_2$  of the test, the UE shall start sending CSI reports for SCell with non-zero CQI index at latest in a slot  $n + \frac{T_{HARQ} + T_{activation\_time} + T_{CSI\_Reporting}}{NR\ slot\ length}$ ,  $T_{activation\_time} = T_{SMTC\_SCell} + 5ms$ , as defined in clause 8.3.

During time period  $T_3$  of the test, the UE shall stop sending CSI reports for SCell at latest in a slot  $m + \frac{T_{HARQ} + 3ms}{NR\ slot\ length}$ , as defined in clause 8.3.

During time period  $T_2$  of the test, interruption of PCell / PSCell during SCell activation shall not happen outside the slot  $n + 1 + \frac{T_{HARQ}}{NR\ slot\ length}$  to  $n + 1 + \frac{T_{HARQ} + 3ms + T_X}{NR\ slot\ length} + N_{interruption}$ , as defined in clause 8.3.

During time period  $T_3$  of the test, the starting point of interruption of PCell during SCell deactivation shall not happen outside the slot  $m + 1 + \frac{T_{HARQ}}{NR\ slot\ length}$  to  $m + 1 + \frac{T_{HARQ} + 3ms}{NR\ slot\ length}$ , as defined in clause 8.3.

The interruption on any activated serving cell shall not be more than the values specified for SA in clause 8.2.2.2.2.

All of the above test requirements shall be fulfilled in order for the observed SCell activation delay and SCell deactivation delay to be counted as correct. The rate of correct observed SCell activation delay and SCell deactivation delay during repeated tests shall be at least 90%.

NOTE: During time period  $T_2$  of the test, if there are no uplink resources for reporting the valid CSI in a slot  $n + \frac{T_{HARQ} + T_{activation\_time} + T_{CSI\_Reporting}}{NR\ slot\ length}$  as defined in clause 8.3 then the UE shall use the next available uplink resource for reporting the corresponding valid CSI.

## A.7.5.4 Void

## A.7.5.5 Beam Failure Detection and Link recovery procedures

### A.7.5.5.1 Beam Failure Detection and Link Recovery Test for FR2 PCell configured with SSB-based BFD and LR in non-DRX mode

#### A.7.5.5.1.1 Test Purpose and Environment

The purpose of this test is to verify that the UE properly detects SSB-based beam failure in the set  $q_0$  configured for a serving cell and that the UE performs correct SSB-based link recovery based on beam candidate set  $q_1$ . The purpose is to test the downlink monitoring for beam failure detection within the UEs active DL BWP, during the evaluation period, and link recovery, when no DRX is used. This test will partly verify the SSB based beam failure detection and link recovery for an FR2 serving cell requirements in clause 8.5.

The test parameters are given in Tables A.7.5.5.1.1-1, A.7.5.5.1.1-2, A.7.5.5.1.1-3 and A.7.5.5.1.1-4 below. There is one cell, cell 1 which is the active cell, in the test. The test consists of five successive time periods, with time duration of T1, T2, T3, T4 and T5 respectively. Figure A.7.5.5.1.1-1 shows the variation of the downlink SNR of the SSB in set  $q_0$  in the active cell to emulate SSB based beam failure. Figure A.7.5.5.1.1-2 shows the variation of the downlink L1-RSRP of the SSB in set  $q_1$  of the candidate beam used for link recovery. Prior to the start of the time duration T1, the UE shall be fully synchronized to cell 1. The UE shall be configured for periodic CSI reporting with a reporting periodicity of 5 ms. In the test, DRX configuration is not enabled. The UE is configured to perform inter-frequency measurements using GP ID #0 (40ms) in test 1.

**Table A.7.5.5.1.1-1: Supported test configurations for FR2 PCell**

Configuration	Description
1	TDD duplex mode, 120 kHz SSB SCS, 100 MHz bandwidth
2	TDD duplex mode, 240 kHz SSB SCS, 100 MHz bandwidth
Note:	The UE is only required to pass in one of the supported test configurations in FR2

**Table A.7.5.5.1.1-2: General test parameters for FR2 PCell for SSB-based beam failure detection and link recovery testing in non-DRX mode**

Parameter	Test Config.	Unit	Value	Comment
			<b>Test 1</b>	
Active PCell	1-2		Cell 1	
RF Channel Number	1-2		1	
Duplex mode	1-2		TDD	
TDD Configuration	1-2		TDDConf.3.1	
BW <sub>channel</sub>	1-2		100: N <sub>RB,c</sub> = 66	
Data RBs allocated	1-2		66	
PDSCH/PDCCH subcarrier spacing	1-2	kHz	120	
DL initial BWP configuration	1-2		DLBWP.0.1	
DL dedicated BWP configuration	1-2		DLBWP.1.1	
UL initial BWP configuration	1-2		ULBWP.0.1	
UL dedicated BWP configuration	1-2		ULBWP.1.1	
PDSCH Reference Channel	1		SR.3.2 TDD	
	2		SR.3.3 TDD	
RMSI CORESET Reference Channel	1		CR.3.1 TDD	
	2		CR.3.2 TDD	
Dedicated CORESET Reference Channel	1		CCR.3.1 TDD	
	2		CCR.3.7 TDD	
OCNG parameters	1-2		OP.1	
CP length	1-2		Normal	
PDSCH/PDCCH TCI state	1-2		TCI.State.0	
CSI-RS for tracking	1-2		TRS.2.1 TDD	
SSB Configuration	1		SSB.1 FR2	
	2		SSB.2 FR2	
SMTc Configuration	1-2		SMTc.3	

PRACH Configuration		1-2		FR2 PRACH configuration 2	A.3.8.3.2
DRX configuration		1-2		OFF	
SSB index assigned as BFD RS ( $q_0$ )		1-2		0	
SSB index assigned as CBD RS ( $q_1$ )		1-2		1	
SSB index assigned as RLM RS		1-2		0,1	
Beam failure detection transmission parameters	DCI format	1-2		1-0	
	Number of Control OFDM symbols	1-2		2	
	Aggregation level	1-2	CCE	8	
	Ratio of hypothetical PDCCH RE energy to average SSS RE energy	1-2	dB	0	
	Ratio of hypothetical PDCCH DMRS energy to average SSS RE energy	1-2	dB	0	
	DMRS precoder granularity	1-2		REG bundle size	
	REG bundle size	1-2		6	
Gap pattern ID		1-2		gp0	
gapOffset		1-2	ms	0	
rlmInSyncOutOfSyncThreshold		1-2		absent	Value 0 is applied. (Table 8.1.1-1).
rsrp-ThresholdSSB	1	dBm/SCS		-95	Threshold used for $Q_{in\_LR\_SSB}$
	2			-92	
powerControlOffsetSS		1-2		db0	Used for deriving rsrp-ThresholdCSI-RS
beamFailureInstanceMaxCount		1-2		n1	see TS 38.321 [7], clause 5.17
beamFailureDetectionTimer		1-2		pbfd4	see TS 38.321 [7], clause 5.17
CSI-RS configuration for CSI reporting		1-2		CSI-RS.3.1 TDD	
reportConfigType		1-2		periodic	
reportQuantity		1-2		cri-RI-PMI-CQI	
CSI reporting periodicity		1-2	slot	40	
CSI reporting offset		1-2	slot	4	
T310		1-2	ms	1000	
N310		1-2		2	
T1		1-2	s	1	The UE shall be fully synchronized to cell 1 during T1
T2		1-2	s	2.61	
T3		1-2	s	1.64	
T4		1-2	s	0	
T5		1-2	s	1.01	
D1		1-2	s	0.97	
Note 1: All configurations are assigned to the UE prior to the start of time period T1.					
Note 2: UE-specific PDCCH is not transmitted after T1 starts.					

**Table A.7.5.5.1.1-3: Cell specific test parameters for FR2 PCell for SSB-based beam failure detection and link recovery testing in non-DRX mode**

Parameter	Unit	Test 1				
		T1	T2	T3	T4	T5
AoA setup		Setup 1 defined in A.3.15				
Assumption for UE beams <sup>Note 10</sup>		Rough				
EPRE ratio of PDCCH DMRS to SSS	dB	0				
EPRE ratio of PDCCH to PDCCH DMRS	dB					
EPRE ratio of PBCH DMRS to SSS	dB					
EPRE ratio of PBCH to PBCH DMRS	dB					

EPRE ratio of PSS to SSS		dB					
EPRE ratio of PDSCH DMRS to SSS		dB					
EPRE ratio of PDSCH to PDSCH DMRS		dB					
EPRE ratio of OCNG DMRS to SSS		dB					
EPRE ratio of OCNG to OCNG DMRS		dB					
SNR_SSB of set $q_0$	Config 1-2	dB	5 <sup>Note 11</sup>	-3 <sup>Note 11</sup>	-12	-12	-12
SNR_SSB of set $q_1$ SSB_RP of set $q_1$	Config 1-2	dB	0.2	0.2	20.2	20.2	20.2
	Config 1	dBm/ SCS	-104.5	-104.5	-84.5	-84.5	-84.5
	Config 2		-101.5	-101.5	-81.5	-81.5	-81.5
$N_{oc}$	Config 1,2	dBm/120 KHz	-104.7				
Propagation condition			TDL-A 30ns 75Hz				
<p>Note 1: OCNG shall be used such that the resources in Cell 1 are fully allocated and a constant total transmitted power spectral density is achieved for all OFDM symbols.</p> <p>Note 2: The uplink resources for CSI reporting are assigned to the UE prior to the start of time period T1.</p> <p>Note 3: NZP CSI-RS resource set configuration for CSI reporting are assigned to the UE prior to the start of time period T1.</p> <p>Note 4: Measurement gap configuration is assigned to the UE prior to the start of time period T1.</p> <p>Note 5: The timers and layer 3 filtering related parameters are configured prior to the start of time period T1.</p> <p>Note 6: The signal contains PDCCH for UEs other than the device under test as part of OCNG.</p> <p>Note 7: SNR levels correspond to the signal to noise ratio over the SSS REs.</p> <p>Note 8: The SNR in time periods T1, T2, T3, T4 and T5 is denoted as SNR1, SNR2 and SNR3 respectively in figure A.7.5.5.1.1-1.</p> <p>Note 9: The SNR values are specified for testing a UE which supports 2RX on at least one band. For testing of a UE which supports 4RX on all bands, the SNR during T3 is modified as specified in clause A.3.6.</p> <p>Note 10: Information about types of UE beam is given in B.2.1.3 and does not limit UE implementation or test system implementation.</p> <p>Note 11: This value allows up to 1dB degradation from applied SNR to UE baseband</p>							

Table A.7.5.5.1.1-4: Void

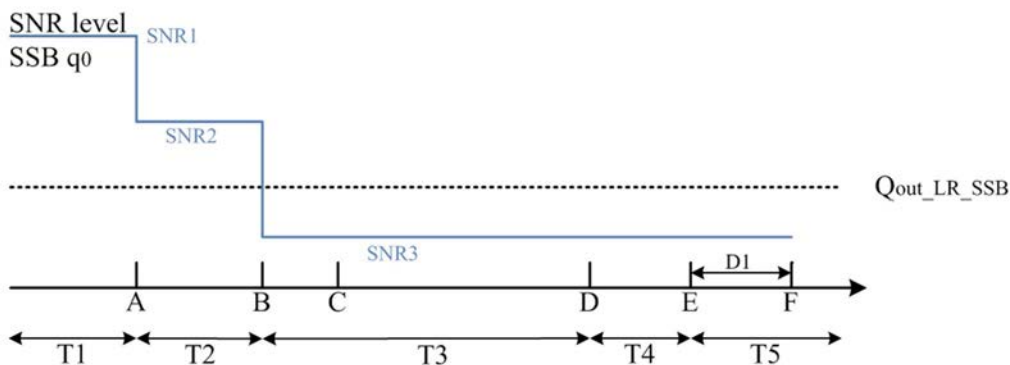
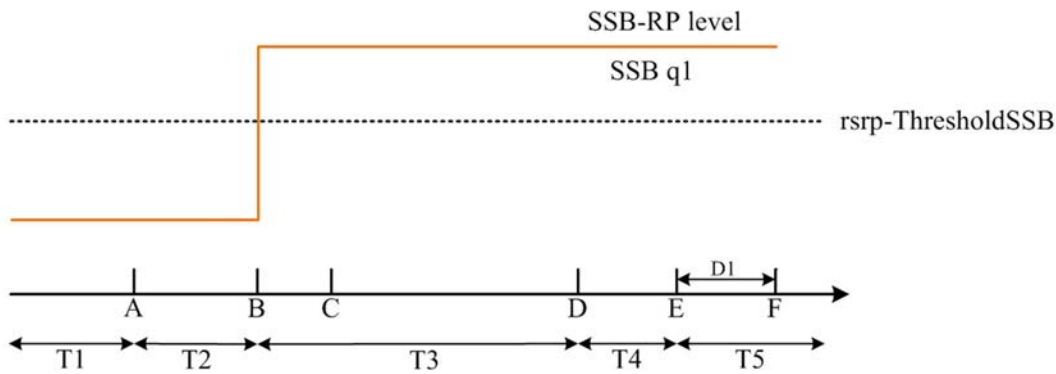

Figure A.7.5.5.1.1-1: SNR variation for SSB-based beam failure detection and link recovery testing in non-DRX mode



**Figure A.7.5.5.1.1-2: SSB\_RP level variation for SSB-based beam failure detection and link recovery testing in non-DRX mode**

**A.7.5.5.1.2 Test Requirements**

The UE behaviour during time durations T1, T2, T3, T4 and T5 shall be as follows:

During the time duration T1 and T2, the UE shall transmit uplink signal at least in all subframes configured for CSI transmission on Cell 1.

During the period from time point A to time point B the UE shall transmit uplink signal in Cell 1 in all uplink slots configured for CSI transmission according to the configured periodic CSI reporting for Cell 1.

During T3 the UE shall detect beam failure and initiate link recovery. During T4 and T5 the UE measures and evaluate beam candidate from beam candidate set  $q_1$ .

No later than time point F occurring no later than  $D1 = 960 + 10$  ms after the start of T5, the UE shall transmit preamble on a beam associated with the candidate beam set  $q_1$ . The UE shall not transmit preamble on a beam associated with the candidate beam set  $q_1$  earlier than time point B.

Test is concluded once the test equipment has received the initial preamble transmission from the UE. The rate of correct events observed during repeated tests shall be at least 90%.

**A.7.5.5.2 Beam Failure Detection and Link Recovery Test for FR2 PCell configured with SSB-based BFD and LR in DRX mode**

**A.7.5.5.2.1 Test Purpose and Environment**

The purpose of this test is to verify that the UE properly detects SSB-based beam failure in the set  $q_0$  configured for a serving cell and that the UE performs correct SSB-based link recovery based on beam candidate set  $q_1$ . The purpose is to test the downlink monitoring for beam failure detection within the UEs active DL BWP, during the evaluation period, and link recovery, when DRX is used. This test will partly verify the SSB based beam failure detection and link recovery for an FR2 serving cell requirements in clause 8.5.

The test parameters are given in Tables A.7.5.5.2.1-1, A.7.5.5.2.1-2, A.7.5.5.2.1-3, A.7.5.5.2.1-4 and A.7.5.5.2.1-5 below. There is one cell, cell 1 which is the active cell, in the test. The test consists of five successive time periods, with time duration of T1, T2, T3, T4 and T5 respectively. Figure A.7.5.5.2.1-1 shows the variation of the downlink SNR of the SSB in set  $q_0$  in the active cell to emulate SSB based beam failure. Figure A.7.5.5.2.1-2 shows the variation of the downlink L1-RSRP of the SSB in set  $q_1$  of the candidate beam used for link recovery. Prior to the start of the time duration T1, the UE shall be fully synchronized to cell 1. The UE shall be configured for periodic CSI reporting with a reporting periodicity of 5 ms. In the test, DRX configuration is enabled in PCell and DRX inactivity timer has already expired, i.e. UE tries to decode PDCCH and to send periodic CQI during the period when On-duration timer is running. Time alignment timers shall be set to “infinity” so that UL timing alignment is maintained during the test.

**Table A.7.5.5.2.1-1: Supported test configurations for FR2 PCell**

Configuration	Description
1	TDD duplex mode, 120 kHz SSB SCS, 100 MHz bandwidth



2	TDD duplex mode, 240 kHz SSB SCS, 100 MHz bandwidth
Note:	The UE is only required to pass in one of the supported test configurations in FR2

**Table A.7.5.5.2.1-2: General test parameters for FR2 PCell for SSB-based beam failure detection and link recovery testing in DRX mode**

Parameter	Test Config.	Unit	Value	Comment	
			<b>Test 1</b>		
Active PCell	1-2		Cell 1		
RF Channel Number	1-2		1		
Duplex mode	1-2		TDD		
TDD Configuration	1-2		TDDConf.3.1		
BW <sub>channel</sub>	1-2		100: N <sub>RB,c</sub> = 66		
Data RBs allocated	1-2		66		
PDSCH/PDCCH subcarrier spacing	1-2	kHz	120		
DL initial BWP configuration	1-2		DLBWP.0.1		
DL dedicated BWP configuration	1-2		DLBWP.1.1		
UL initial BWP configuration	1-2		ULBWP.0.1		
UL dedicated BWP configuration	1-2		ULBWP.1.1		
PDSCH Reference Channel	1		SR.3.2 TDD		
	2		SR.3.3 TDD		
RMSI CORESET Reference Channel	1		CR.3.1 TDD		
	2		CR.3.2 TDD		
Dedicated CORESET Reference Channel	1		CCR.3.1 TDD		
	2		CCR.3.7 TDD		
OCNG parameters	1-2		OP.1		
CP length	1-2		Normal		
PDSCH/PDCCH TCI state	1-2		TCI.State.0		
CSI-RS for tracking	1-2		TRS.2.1 TDD		
SSB Configuration	1		SSB.1 FR2		
	2		SSB.2 FR2		
SMTC Configuration	1-2		SMTC.3		
PRACH Configuration	1-2		FR2 PRACH configuration 2	A.3.8.3.2	
DRX configuration	1-2		DRX.3	A.3.3.3	
SSB index assigned as BFD RS (q <sub>0</sub> )	1-2		0		
SSB index assigned as CBD RS (q <sub>1</sub> )	1-2		1		
SSB index assigned as RLM RS	1-2		0,1		
Beam failure detection transmission parameters	DCI format	1-2	1-0		
	Number of Control OFDM symbols	1-2	2		
	Aggregation level	1-2	CCE	8	
	Ratio of hypothetical PDCCH RE energy to average SSS RE energy	1-2	dB	0	
	Ratio of hypothetical PDCCH DMRS energy to average SSS RE energy	1-2	dB	0	
	DMRS precoder granularity	1-2		REG bundle size	
REG bundle size	1-2		6		
Gap pattern ID	1-2		N/A		
rlmInSyncOutOfSyncThreshold	1-2		absent	Value 0 is applied. (Table 8.1.1-1).	
rsrp-ThresholdSSB	1	dBm/SCS	-95	Threshold used for Q <sub>in_LR_SSB</sub>	
	2		-92		
powerControlOffsetSS	1-2		db0	Used for deriving rsrp-ThresholdCSI-RS	
beamFailureInstanceMaxCount	1-2		n1	see TS 38.321 [7], clause 5.17	
beamFailureDetectionTimer	1-2		pbfd4	see TS 38.321 [7], clause 5.17	

CSI-RS configuration for CSI reporting	1-2		CSI-RS.3.1 TDD	
reportConfigType	1-2		periodic	
reportQuantity	1-2		cri-RI-PMI-CQI	
CSI reporting periodicity	1-2	slot	40	
CSI reporting offset	1-2	slot	4	
T310	1-2	ms	1000	
N310	1-2		2	
T1	1-2	s	1	The UE shall be fully synchronized to cell 1 during T1
T2	1-2	s	3.37	
T3	1-2	s	2.8	
T4	1-2	s	0	
T5	1-2	s	0.61	
D1	1-2	s	0.57	
Note 1: All configurations are assigned to the UE prior to the start of time period T1.				
Note 2: UE-specific PDCCH is not transmitted after T1 starts.				

**Table A.7.5.5.2.1-3: Cell specific test parameters for FR2 PCell for SSB-based beam failure detection and link recovery testing in DRX mode**

Parameter		Unit	Test 1				
			T1	T2	T3	T4	T5
AoA setup			Setup 1 defined in A.3.15				
Assumption for UE beams <sup>Note 10</sup>			Rough				
EPRE ratio of PDCCH DMRS to SSS		dB	0				
EPRE ratio of PDCCH to PDCCH DMRS		dB					
EPRE ratio of PBCH DMRS to SSS		dB					
EPRE ratio of PBCH to PBCH DMRS		dB					
EPRE ratio of PSS to SSS		dB					
EPRE ratio of PDSCH DMRS to SSS		dB					
EPRE ratio of PDSCH to PDSCH DMRS		dB					
EPRE ratio of OCNG DMRS to SSS		dB					
EPRE ratio of OCNG to OCNG DMRS		dB					
SNR_SSB of set q <sub>0</sub>	Config 1,2	dB	5 <sup>Note 11</sup>	-3 <sup>Note 11</sup>	-12	-12	-12
SNR_SSB of set q <sub>1</sub>	Config 1-2	dB	0.2	0.2	20.2	20.2	20.2
SSB_RP of set q <sub>1</sub>	Config 1	dBm/SCS	-104.5	-104.5	-84.5	-84.5	-84.5
	Config 2		-101.5	-101.5	-81.5	-81.5	-81.5
N <sub>oc</sub>	Config 1-2	dBm/120 KHz	-104.7				
Propagation condition			TDL-A 30ns 75Hz				
<p>Note 1: OCNG shall be used such that the resources in Cell 1 are fully allocated and a constant total transmitted power spectral density is achieved for all OFDM symbols.</p> <p>Note 2: The uplink resources for CSI reporting are assigned to the UE prior to the start of time period T1.</p> <p>Note 3: NZP CSI-RS resource set configuration for CSI reporting are assigned to the UE prior to the start of time period T1.</p> <p>Note 4: Void</p> <p>Note 5: The timers and layer 3 filtering related parameters are configured prior to the start of time period T1.</p> <p>Note 6: The signal contains PDCCH for UEs other than the device under test as part of OCNG.</p> <p>Note 7: SNR levels correspond to the signal to noise ratio over the SSS REs.</p> <p>Note 8: The SNR in time periods T1, T2, T3, T4 and T5 is denoted as SNR1, SNR2 and SNR3 respectively in figure A.7.5.5.1.1-1.</p> <p>Note 9: The SNR values are specified for testing a UE which supports 2RX on at least one band. For testing of a UE which supports 4RX on all bands, the SNR during T3 is modified as specified in clause A.3.6.</p> <p>Note 10: Information about types of UE beam is given in B.2.1.3 and does not limit UE implementation or test system implementation.</p> <p>Note 11: This value allows up to 1dB degradation from applied SNR to UE baseband.</p>							

Table A.7.5.5.2.1-4: Void

Table A.7.5.5.2.1-5: Void

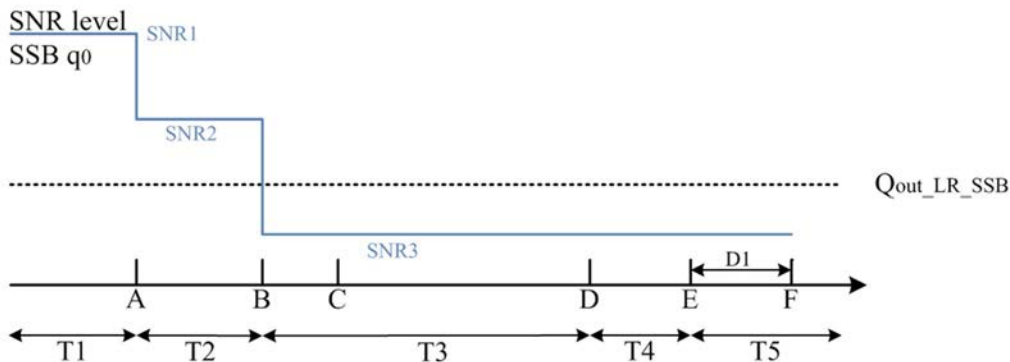

Figure A.7.5.5.2.1-1: SNR variation for SSB-based beam failure detection and link recovery testing in DRX mode

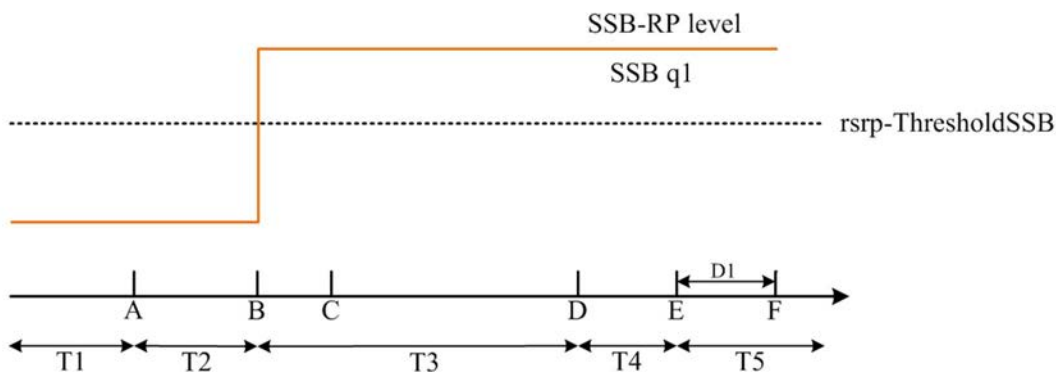

Figure A.7.5.5.2.1-2: SSB\_RP level variation for SSB-based beam failure detection and link recovery testing in DRX mode

A.7.5.5.2.2 Test Requirements

The UE behaviour during time durations T1, T2, T3, T4 and T5 shall be as follows:

During the time duration T1 and T2, the UE shall transmit uplink signal at least in all subframes configured for CSI transmission on Cell 1.

During the period from time point A to time point B the UE shall transmit uplink signal in Cell 1 in all uplink slots configured for CSI transmission according to the configured periodic CSI reporting for Cell 1.

During T3 the UE shall detect beam failure and initiate link recovery. During T4 and T5 the UE measures and evaluate beam candidate from beam candidate set q<sub>1</sub>.

No later than time point F occurring no later than D1 = 560+10 ms after the start of T5, the UE shall transmit preamble on a beam associated with the candidate beam set q<sub>1</sub>. The UE shall not transmit preamble on a beam associated with the candidate beam set q<sub>1</sub> earlier than time point B.

Test is concluded once the test equipment has received the initial preamble transmission from the UE. The rate of correct events observed during repeated tests shall be at least 90%.

### A.7.5.5.3 Beam Failure Detection and Link Recovery Test for FR2 PCell configured with CSI-RS-based BFD and LR in non-DRX mode

#### A.7.5.5.3.1 Test Purpose and Environment

The purpose of this test is to verify that the UE properly detects CSI-RS-based beam failure in the set  $q_0$  configured for a serving cell and that the UE performs correct CSI-RS-based link recovery based on beam candidate set  $q_1$ . The purpose is to test the downlink monitoring for beam failure detection within the UEs active DL BWP, during the evaluation period, and link recovery, when no DRX is used. This test will partly verify the CSI-RS based beam failure detection and link recovery for an FR2 serving cell requirements in clause 8.5.

The test parameters are given in Tables A.7.5.5.3.1-1, A.7.5.5.3.1-2, and A.7.5.5.3.1-3 below. There is one cell, cell 1 which is the active cell, in the test. The test consists of five successive time periods, with time duration of T1, T2, T3, T4 and T5 respectively. Figure A.7.5.5.3.1-1 shows the variation of the downlink SNR of the CSI-RS in set  $q_0$  in the active cell to emulate CSI-RS based beam failure. Figure A.7.5.5.3.1-2 shows the variation of the downlink L1-RSRP of the CSI-RS in set  $q_1$  of the candidate beam used for link recovery. Prior to the start of the time duration T1, the UE shall be fully synchronized to cell 1. The UE shall be configured for periodic CSI reporting with a reporting periodicity of 5 ms. In the test, DRX configuration is not enabled.

**Table A.7.5.5.3.1-1: Supported test configurations for FR2 PCell**

Configuration	Description
1	TDD duplex mode, 120 kHz SSB SCS, 100 MHz bandwidth

**Table A.7.5.5.3.1-2: General test parameters for FR2 PCell for CSI-RS-based beam failure detection and link recovery testing in non-DRX mode**

Parameter	Test Config.	Unit	Value	Comment
			<b>Test 1</b>	
Active PCell	1		Cell 1	
RF Channel Number	1		1	
Duplex mode	1		TDD	
TDD Configuration	1		TDDConf.3.1	
BW <sub>channel</sub>	1		100: N <sub>RB,c</sub> = 66	
Data RBs allocated	1		66	
PDSCH/PDCCH subcarrier spacing	1	kHz	120	
DL initial BWP configuration	1		DLBWP.0.1	
DL dedicated BWP configuration	1		DLBWP.1.1	
UL initial BWP configuration	1		ULBWP.0.1	
UL dedicated BWP configuration	1		ULBWP.1.1	
PDSCH Reference Channel	1		SR.3.2 TDD	
RMSI CORESET Reference Channel	1		CR.3.1 TDD	
Dedicated CORESET Reference Channel	1		CCR.3.1 TDD	
OCNG parameters	1		OP.1	
CP length	1		Normal	
PDSCH/PDCCH TCI state	1		TCI.State.0	
CSI-RS for tracking	1		TRS.2.1 TDD	
SSB Configuration	1		SSB.1 FR2	
SMTC Configuration	1		SMTC.3	
PRACH Configuration	1		FR2 PRACH configuration 4	A.3.8.3.4
DRX configuration	1		OFF	
CSI-RS configuration for BFD/CBD/RLM	1		CSI-RS.3.2 TDD	A.3.14.2
CSI-RS index assigned as BFD RS ( $q_0$ )	1		0	
CSI-RS index assigned as CBD RS ( $q_1$ )	1		1	
CSI-RS index assigned as RLM RS	1		0,1	
Beam failure detection transmission parameters	DCI format	1	1-0	
	Number of Control OFDM symbols	1	2	
	Aggregation level	1	CCE	8

	Ratio of hypothetical PDCCH RE energy to average SSS RE energy	1	dB	0	
	Ratio of hypothetical PDCCH DMRS energy to average SSS RE energy	1	dB	0	
	DMRS precoder granularity	1		REG bundle size	
	REG bundle size	1		6	
Gap pattern ID		1		N/A	
rimInSyncOutOfSyncThreshold		1		absent	Value 0 is applied. (Table 8.1.1-1).
rsrp-ThresholdSSB		1	dBm/SCS	-95	Threshold used for $Q_{in\_LR\_SSB}$
powerControlOffsetSS		1		db0	Used for deriving rsrp-ThresholdCSI-RS
beamFailureInstanceMaxCount		1		n1	see TS 38.321 [7], clause 5.17
beamFailureDetectionTimer		1		pbfd4	see TS 38.321 [7], clause 5.17
CSI-RS configuration for CSI reporting		1		CSI-RS.3.1 TDD	A.3.14.2
reportConfigType		1		periodic	
reportQuantity		1		cri-RI-PMI-CQI	
CSI reporting periodicity		1	slot	40	
CSI reporting offset		1	slot	4	
T310		1	ms	1000	
N310		1		2	
T1		1	s	1	The UE shall be fully synchronized to cell 1 during T1
T2		1	s	1.17	
T3		1	s	0.9	
T4		1	s	0	
T5		1	s	0.31	
D1		1	s	0.27	
Note 1: UE-specific PDCCH is not transmitted after T1 starts.					

**Table A.7.5.5.3.1-3: Cell specific test parameters for FR2 PCell for CSI-RS-based beam failure detection and link recovery testing in non-DRX mode**

Parameter	Unit	Test 1					
		T1	T2	T3	T4	T5	
AoA setup		Setup 1 defined in A.3.15					
Assumption for UE beams <sup>Note 10</sup>		Rough					
EPRE ratio of PDCCH DMRS to SSS	dB	0					
EPRE ratio of PDCCH to PDCCH DMRS	dB						
EPRE ratio of PBCH DMRS to SSS	dB						
EPRE ratio of PBCH to PBCH DMRS	dB						
EPRE ratio of PSS to SSS	dB						
EPRE ratio of PDSCH DMRS to SSS	dB						
EPRE ratio of PDSCH to PDSCH DMRS	dB						
EPRE ratio of OCNG DMRS to SSS	dB						
EPRE ratio of OCNG to OCNG DMRS	dB						
SNR_CSI-RS of set $q_0$	Config 1	dB	5 <sup>Note 11</sup>	-3 <sup>Note 11</sup>	-12	-12	-12
SNR_CSI-RS of set $q_1$	Config 1	dB	0.2	0.2	20.2	20.2	20.2
CSI-RS_RP of set $q_1$	Config 1	dBm/S CS	-104.5	-104.5	-84.5	-84.5	-84.5
$N_{oc}$	Config 1	dBm/12 0 KHz	-104.7				
Propagation condition			TDL-A 30ns 75Hz				

- Note 1: OCNG shall be used such that the resources in Cell 1 are fully allocated and a constant total transmitted power spectral density is achieved for all OFDM symbols.
- Note 2: The uplink resources for CSI reporting are assigned to the UE prior to the start of time period T1.
- Note 3: NZP CSI-RS resource set configuration for CSI reporting are assigned to the UE prior to the start of time period T1.
- Note 4: Void
- Note 5: The timers and layer 3 filtering related parameters are configured prior to the start of time period T1.
- Note 6: The signal contains PDCCH for UEs other than the device under test as part of OCNG.
- Note 7: SNR levels correspond to the signal to noise ratio over the REs carrying CSI-RS.
- Note 8: The SNR in time periods T1, T2, T3, T4 and T5 is denoted as SNR1, SNR2 and SNR3 respectively in figure A.7.5.5.3.1-1.
- Note 9: The SNR values are specified for testing a UE which supports 2RX on at least one band. For testing of a UE which supports 4RX on all bands, the SNR during T3 is modified as specified in clause A.3.6.
- Note 10: Information about types of UE beam is given in B.2.1.3 and does not limit UE implementation or test system implementation.
- Note 11: This value allows up to 1dB degradation from applied SNR to UE baseband

**Table A.7.5.5.3.1-4: Void**

**Table A.7.5.5.3.1-5: Void**

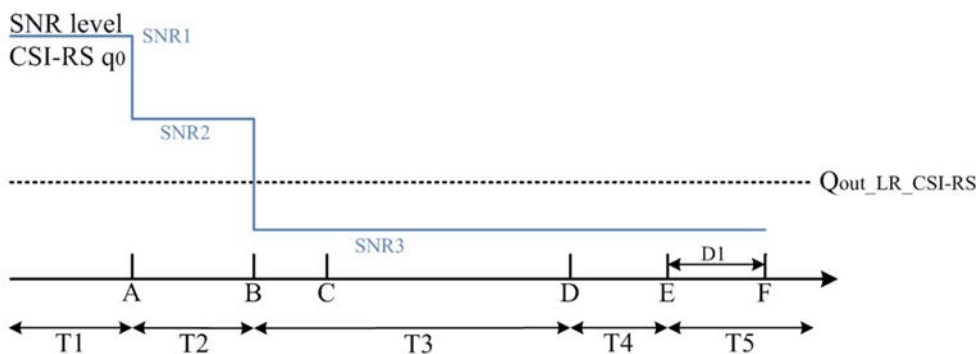

**Figure A.7.5.5.3.1-1: SNR variation for CSI-RS based beam failure detection and link recovery testing in non-DRX mode**

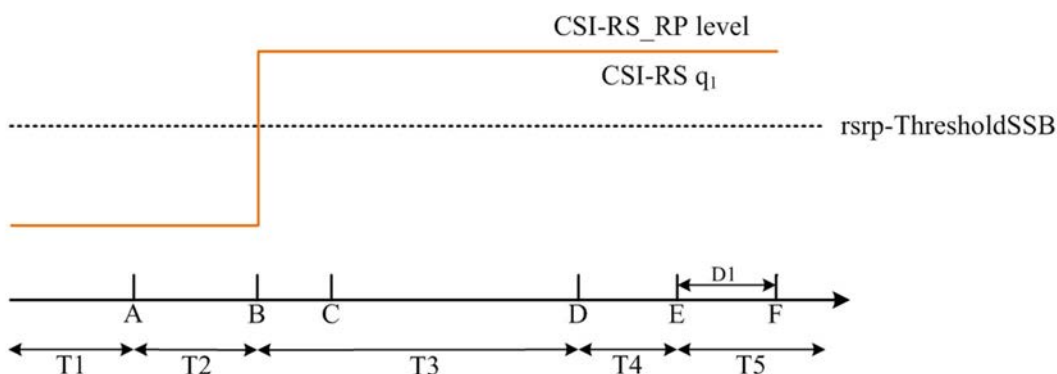

**Figure A.7.5.5.3.1-2: CSI-RS\_RP level variation for CSI-RS based beam failure detection and link recovery testing in non-DRX mode**

### A.7.5.5.3.2 Test Requirements

The UE behaviour during time durations T1, T2, T3, T4 and T5 shall be as follows:

During the time duration T1 and T2, the UE shall transmit uplink signal at least in all subframes configured for CSI transmission on Cell 1.

During the period from time point A to time point B the UE shall transmit uplink signal in Cell 1 in all uplink slots configured for CSI transmission according to the configured periodic CSI reporting for Cell 1.

During T3 the shall detect beam failure and initiat link recovery. During T4 and T5 the UE measures and evaluate beam candidate from beam candidate set  $q_1$ .

No later than time point F occurring no later than  $D1 = 260+10$  ms after the start of T5, the UE shall transmit preamble on a beam associated with the candidate beam set  $q_1$ . The UE shall not transmit preamble on a beam associated with the candidate beam set  $q_1$  earlier than time point B.

Test is concluded once the test equipment has received the initial preamble transmission from the UE. The rate of correct events observed during repeated tests shall be at least 90%.

### A.7.5.5.4 Beam Failure Detection and Link Recovery Test for FR2 PCell configured with CSI-RS-based BFD and LR in DRX mode

#### A.7.5.5.4.1 Test Purpose and Environment

The purpose of this test is to verify that the UE properly detects CSI-RS-based beam failure in the set  $q_0$  configured for a serving cell and that the UE performs correct CSI-RS-based link recovery based on beam candicate set  $q_1$ . The purpose is to test the downlink monitoring for beam failure detection within the UEs active DL BWP, during the evaluation period, and link recovery, when DRX is used. This test will partly verify the CSI-RS based beam failure detection and link recovery for an FR2 serving cell requirements in clause 8.5.

The test parameters are given in Tables A.7.5.5.4.1-1, A.7.5.5.4.1-2, A.7.5.5.4.1-3, and A.7.5.5.4.1-4 below. There is one cell, cell 1 which is the active cell, in the test. The test consists of five successive time periods, with time duration of T1, T2, T3, T4 and T5 respectively. Figure A.7.5.5.4.1-1 shows the variation of the downlink SNR of the CSI-RS in set  $q_0$  in the active cell to emulate CSI-RS based beam failure. Figure A.7.5.5.4.1-2 shows the variation of the downlink L1-RSRP of the CSI-RS in set  $q_1$  of the candidate beam used for link recovery. Prior to the start of the time duration T1, the UE shall be fully synchronized to cell 1. The UE shall be configured for periodic CSI reporting with a reporting periodicity of 5 ms. In the test, DRX configuration is enabled in PCell and DRX inactivity timer has already been expired, i.e. UE tries to decode PDCCH and to send periodic CQI during the period when On-duration timer is running. Time alignment timers shall be set to “infinity” so that UL timing alignment is maintained during the test.

**Table A.7.5.5.4.1-1: Supported test configurations for FR2 PCell**

Configuration	Description
1	TDD duplex mode, 120 kHz SSB SCS, 100 MHz bandwidth

**Table A.7.5.5.4.1-2: General test parameters for FR2 PCell for CSI-RS-based beam failure detection and link recovery testing in DRX mode**

Parameter	Test Config.	Unit	Value	Comment
			<b>Test 1</b>	
Active PCell	1		Cell 1	
RF Channel Number	1		1	
Duplex mode	1		TDD	
TDD Configuration	1		TDDConf.3.1	
BW <sub>channel</sub>	1		100: $N_{RB,c} = 66$	
Data RBs allocated	1		66	
PDSCH/PDCCH subcarrier spacing	1	kHz	120	
DL initial BWP configuration	1		DLBWP.0.1	
DL dedicated BWP configuration	1		DLBWP.1.1	
UL initial BWP configuration	1		ULBWP.0.1	
UL dedicated BWP configuration	1		ULBWP.1.1	

PDSCH Reference Channel		1		SR.3.2 TDD	
RMSI CORESET Reference Channel		1		CR.3.1 TDD	
Dedicated CORESET Reference Channel		1		CCR.3.1 TDD	
OCNG parameters		1		OP.1	
CP length		1		Normal	
PDSCH/PDCCH TCI state		1		TCI.State.0	
CSI-RS for tracking		1		TRS.2.1 TDD	
SSB Configuration		1		SSB.1 FR2	
SMTC Configuration		1		SMTC.3	
PRACH Configuration		1		FR2 PRACH configuration 4	A.3.8.3.4
DRX configuration		1		DRX.3	A.3.3.3
CSI-RS configuration for BFD/CBD/RLM		1		CSI-RS.3.2 TDD	A.3.14.2
CSI-RS index assigned as BFD RS ( $q_0$ )		1		0	
CSI-RS index assigned as CBD RS ( $q_1$ )		1		1	
CSI-RS index assigned as RLM RS		1		0,1	
Beam failure detection transmission parameters	DCI format	1		1-0	
	Number of Control OFDM symbols	1		2	
	Aggregation level	1	CCE	8	
	Ratio of hypothetical PDCCH RE energy to average SSS RE energy	1	dB	0	
	Ratio of hypothetical PDCCH DMRS energy to average SSS RE energy	1	dB	0	
	DMRS precoder granularity	1		REG bundle size	
	REG bundle size	1		6	
Gap pattern ID		1		N/A	
rlmInSyncOutOfSyncThreshold		1		absent	Value 0 is applied. (Table 8.1.1-1).
rsrp-ThresholdSSB		1	dBm/SCS	-95	Threshold used for $Q_{in\_LR\_SSB}$
powerControlOffsetSS		1		db0	Used for deriving rsrp-ThresholdCSI-RS
beamFailureInstanceMaxCount		1		n1	see TS 38.321 [7], clause 5.17
beamFailureDetectionTimer		1		pbfd4	see TS 38.321 [7], clause 5.17
CSI-RS configuration for CSI reporting		1		CSI-RS.3.1 TDD	A.3.14.2
reportConfigType		1		periodic	
reportQuantity		1		cri-RI-PMI-CQI	
CSI reporting periodicity		1	slot	40	
CSI reporting offset		1	slot	4	
T310		1	ms	1000	
N310		1		2	
T1		1	s	1	The UE shall be fully synchronized to cell 1 during T1
T2		1	s	5.43	
T3		1	s	5.16	
T4		1	s	0	
T5		1	s	0.31	
D1		1	s	0.27	
Note 1: UE-specific PDCCH is not transmitted after T1 starts.					

**Table A.7.5.5.4.1-3: Cell specific test parameters for FR2 PCell for CSI-RS-based beam failure detection and link recovery testing in DRX mode**

Parameter	Unit	Test 1
-----------	------	--------



			T1	T2	T3	T4	T5
AoA setup			Setup 1 defined in A.3.15				
Assumption for UE beams <sup>Note 10</sup>			Rough				
EPRE ratio of PDCCH DMRS to SSS		dB	0				
EPRE ratio of PDCCH to PDCCH DMRS		dB					
EPRE ratio of PBCH DMRS to SSS		dB					
EPRE ratio of PBCH to PBCH DMRS		dB					
EPRE ratio of PSS to SSS		dB					
EPRE ratio of PDSCH DMRS to SSS		dB					
EPRE ratio of PDSCH to PDSCH DMRS		dB					
EPRE ratio of OCNG DMRS to SSS		dB					
EPRE ratio of OCNG to OCNG DMRS		dB					
SNR_CSI-RS of set q <sub>0</sub>	Config 1	dB					
SNR_CSI-RS of set q <sub>1</sub>	Config 1	dB	0.2	0.2	20.2	20.2	20.2
CSI-RS_RP of set q <sub>1</sub>	Config 1	dBm/S CS	-104.5	-104.5	-84.5	-84.5	-84.5
$N_{oc}$	Config 1	dBm/12 0 KHz	-104.7				
Propagation condition			TDL-A 30ns 75Hz				
<p>Note 1: OCNG shall be used such that the resources in Cell 1 are fully allocated and a constant total transmitted power spectral density is achieved for all OFDM symbols.</p> <p>Note 2: The uplink resources for CSI reporting are assigned to the UE prior to the start of time period T1.</p> <p>Note 3: NZP CSI-RS resource set configuration for CSI reporting are assigned to the UE prior to the start of time period T1.</p> <p>Note 4: Void</p> <p>Note 5: The timers and layer 3 filtering related parameters are configured prior to the start of time period T1.</p> <p>Note 6: The signal contains PDCCH for UEs other than the device under test as part of OCNG.</p> <p>Note 7: SNR levels correspond to the signal to noise ratio over the REs carrying CSI-RS.</p> <p>Note 8: The SNR in time periods T1, T2, T3, T4 and T5 is denoted as SNR1, SNR2 and SNR3 respectively in figure A.7.5.5.4.1-1.</p> <p>Note 9: The SNR values are specified for testing a UE which supports 2RX on at least one band. For testing of a UE which supports 4RX on all bands, the SNR during T3 is modified as specified in clause A.3.6.</p> <p>Note 10: Information about types of UE beam is given in B.2.1.3 and does not limit UE implementation or test system implementation.</p> <p>Note 11: This value allows up to 1dB degradation from applied SNR to UE baseband.</p>							

Table A.7.5.5.4.1-4: Void

Table A.7.5.5.4.1-5: Void

Table A.7.5.5.4.1-6: Void

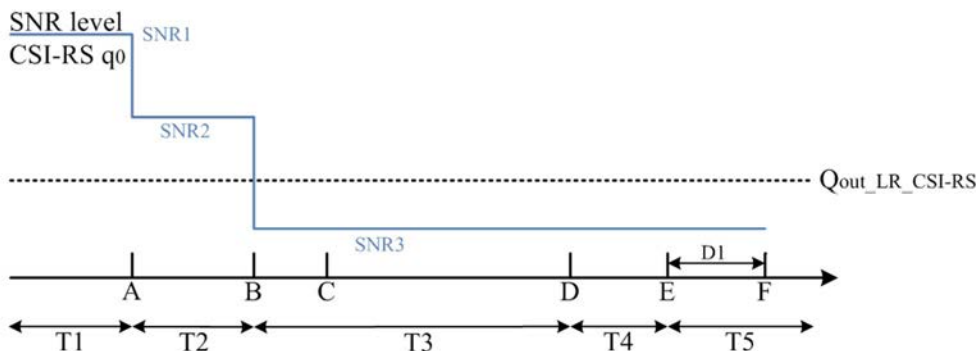
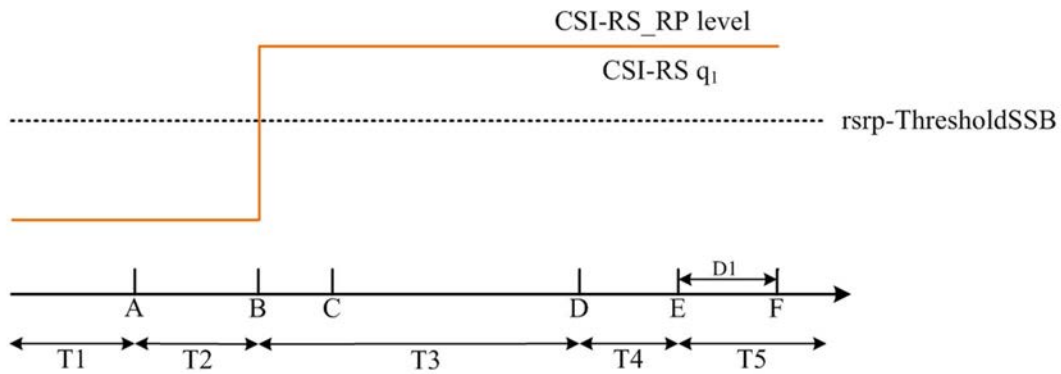

Figure A.7.5.5.4.1-1: SNR variation for CSI-RS-based beam failure detection and link recovery testing in DRX mode



**Figure A.7.5.5.4.1-2: CSI-RS\_RP level variation for CSI-RS based beam failure detection and link recovery testing in DRX mode**

**A.7.5.5.4.2 Test Requirements**

The UE behaviour during time durations T1, T2, T3, T4 and T5 shall be as follows:

During the time duration T1 and T2, the UE shall transmit uplink signal at least in all subframes configured for CSI transmission on Cell 1.

During the period from time point A to time point B the UE shall transmit uplink signal in Cell 1 in all uplink slots configured for CSI transmission according to the configured periodic CSI reporting for Cell 1.

During T3 the UE shall detect beam failure and initiate link recovery. During T4 and T5 the UE measures and evaluates beam candidate from beam candidate set  $q_1$ .

No later than time point F occurring no later than  $D1 = 260 + 10$  ms after the start of T5, the UE shall transmit preamble on a beam associated with the candidate beam set  $q_1$ . The UE shall not transmit preamble on a beam associated with the candidate beam set  $q_1$  earlier than time point B.

Test is concluded once the test equipment has received the initial preamble transmission from the UE. The rate of correct events observed during repeated tests shall be at least 90%.

**A.7.5.5.5 Scheduling availability restriction during Beam Failure Detection and Link Recovery for FR2 PCell configured with SSB-based BFD and LR in non-DRX mode**

**A.7.5.5.5.1 Test Purpose and Environment**

The purpose is to test scheduling availability restrictions when the UE is performing beam failure detection or when the UE is performing L1-RSRP measurement for candidate beam detection, when no DRX is used. This test will verify the scheduling availability restriction requirements in clause 8.5.7 and 8.5.8.

The test parameters are given in Tables A.7.5.5.5.1-1, A.7.5.5.5.1-2 and A.7.5.5.5.1-3 below. There is one cell, cell 1 which is the active cell, in the test. The test consists of five successive time periods, with time duration of T1, T2, T3, T4 and T5 respectively. Figure A.7.5.5.5.1-1 shows the variation of the downlink SNR of the SSB in set  $q_0$  in the active cell to emulate SSB based beam failure. Figure A.7.5.5.5.1-2 shows the variation of the downlink L1-RSRP of the SSB in set  $q_1$  of the candidate beam used for link recovery. Prior to the start of the time duration T1, the UE shall be fully synchronized to cell 1. The UE shall be configured for periodic CSI reporting with a reporting periodicity of 5ms. This test will focus on the scheduling availability during beam failure detection) and candidate beam detection. In the test, DRX configuration is not enabled. Test is to test the scheduling availability restriction of UE performing beam failure detection and candidate beam detection when SSB RS configured for Beam failure detection and candidate beam detection. During the test the UE is scheduled to transmit continuously in UL.

**Table A.7.5.5.5.1-1: Supported test configurations for FR2 PCell**

Configuration	Description
1	NR 120 kHz SSB SCS, 100MHz bandwidth, TDD duplex mode

2	NR 240 kHz SSB SCS, 100MHz bandwidth, TDD duplex mode
Note:	The UE is only required to be tested in one of the supported test configurations

**Table A.7.5.5.1-2: General test parameters for FR2 PCell for SSB-based beam failure detection and link recovery testing in non-DRX mode**

Parameter		Test Config.	Unit	Value	Comment
<b>Test 1</b>					
Active PCell		1-2		Cell 1	
RF Channel Number		1-2		1	
Duplex mode		1-2		TDD	
TDD Configuration		1-2		TDDConf.3.1	
BW <sub>channel</sub>		1-2		100: N <sub>RB,c</sub> = 66	
Data RBs allocated		1-2		66	
PDSCH/PDCCH subcarrier spacing		1-2	kHz	120	
DL initial BWP configuration		1-2		DLBWP.0.1	
DL dedicated BWP configuration		1-2		DLBWP.1.1	
UL initial BWP configuration		1-2		ULBWP.0.1	
UL dedicated BWP configuration		1-2		ULBWP.1.1	
PDSCH Reference Channel		1		SR.3.2 TDD	
		2		SR.3.3 TDD	
RMSI CORESET Reference Channel		1		CR.3.1 TDD	
		2		CR.3.2 TDD	
Dedicated CORESET Reference Channel		1		CCR.3.1 TDD	
		2		CCR.3.7 TDD	
OCNG parameters		1-2		OP.1	
CP length		1-2		Normal	
PDSCH/PDCCH TCI state		1-2		TCI.State.0	
CSI-RS for tracking		1-2		TRS.2.1 TDD	
SSB Configuration		1		SSB.1 FR2	
		2		SSB.2 FR2	
SMTC Configuration		1-2		SMTC.1	
PRACH Configuration		1-2		FR2 PRACH configuration 2	A.3.8.3.2
DRX configuration		1-2		OFF	
SSB index assigned as BFD RS (q <sub>0</sub> )		1-2		0	
SSB index assigned as CBD RS (q <sub>1</sub> )		1-2		1	
Beam failure detection transmission parameters	DCI format	1-2		1-0	
	Number of Control OFDM symbols	1-2		2	
	Aggregation level	1-2	CCE	8	
	Ratio of hypothetical PDCCH RE energy to average SSS RE energy	1-2	dB	0	
	Ratio of hypothetical PDCCH DMRS energy to average SSS RE energy	1-2	dB	0	
	DMRS precoder granularity	1-2		REG bundle size	
	REG bundle size	1-2		6	
Gap pattern ID		1-2		N/A	
rlmInSyncOutOfSyncThreshold		1-2		absent	Value 0 is applied. (Table 8.1.1-1).
rsrp-ThresholdSSB		1	dBm/SCS	-95	Threshold used for Q <sub>in_LR_SSB</sub>
		2		-92	
powerControlOffsetSS		1-2		db0	Used for deriving rsrp-ThresholdCSI-RS
beamFailureInstanceMaxCount		1-2		n1	see TS 38.321 [7], clause 5.17
beamFailureDetectionTimer		1-2		pbfd4	see TS 38.321 [7], clause 5.17
CSI-RS configuration for CSI reporting		1-2		CSI-RS.3.1 TDD	

reportConfigType	1-2		periodic	
reportQuantity	1-2		cri-RI-PMI-CQI	
CSI reporting periodicity	1-2	slot	40	
CSI reporting offset	1-2	slot	4	
T310	1-2	ms	1000	
N310	1-2		2	
T1	1-2	s	1	The UE shall be fully synchronized to cell 1 during T1
T2	1-2	s	2.6	
T3	1-2	s	1.64	
T4	1-2	s	0	
T5	1-2	s	1.01	
D1	1-2	s	0.97	
Note 1: All configurations are assigned to the UE prior to the start of time period T1.				
Note 2: UE-specific PDCCH is not transmitted after T1 starts.				

**Table A.7.5.5.1-3: Cell specific test parameters for FR2 PCell for SSB-based beam failure detection and link recovery testing in non-DRX mode**

Parameter		Unit	Test 1				
			T1	T2	T3	T4	T5
AoA Setup			Setup1 defined in A.3.15.1				
Assumption for UE beams <sup>Note 10</sup>			Rough				
EPRE ratio of PDCCH DMRS to SSS		dB	0				
EPRE ratio of PDCCH to PDCCH DMRS		dB					
EPRE ratio of PBCH DMRS to SSS		dB					
EPRE ratio of PBCH to PBCH DMRS		dB					
EPRE ratio of PSS to SSS		dB					
EPRE ratio of PDSCH DMRS to SSS		dB					
EPRE ratio of PDSCH to PDSCH DMRS		dB					
EPRE ratio of OCNG DMRS to SSS		dB					
EPRE ratio of OCNG to OCNG DMRS		dB					
SNR_SSB of set q <sub>0</sub>	Config 1-2	dB	<sup>5</sup> Note 11	<sup>-3</sup> Note 11	-12	-12	-12
SNR_SSB of set q <sub>1</sub>	Config 1-2	dB	0.2	0.2	20.2	20.2	20.2
SSB_RP of set q <sub>1</sub>	Config 1	dBm/S	-104.5	-104.5	-84.5	-84.5	-84.5
	Config 2	CS	-101.5	-101.5	-81.5	-81.5	-81.5
N <sub>oc</sub>	Config 1-2	dBm/12 0 kHz	-104.7				
Propagation condition			TDL-A 30ns 75Hz				
<p>Note 1: OCNG shall be used such that the resources in Cell 1 are fully allocated and a constant total transmitted power spectral density is achieved for all OFDM symbols.</p> <p>Note 2: The uplink resources for CSI reporting are assigned to the UE prior to the start of time period T1.</p> <p>Note 3: NZP CSI-RS resource set configuration for CSI reporting are assigned to the UE prior to the start of time period T1.</p> <p>Note 4: Void</p> <p>Note 5: The timers and layer 3 filtering related parameters are configured prior to the start of time period T1.</p> <p>Note 6: The signal contains PDCCH for UEs other than the device under test as part of OCNG.</p> <p>Note 7: SNR levels correspond to the signal to noise ratio over the SSS REs.</p> <p>Note 8: The SNR in time periods T1, T2, T3, T4 and T5 is denoted as SNR1, SNR2 and SNR3 respectively in figure A.7.5.5.1-1.</p> <p>Note 9: The SNR values are specified for testing a UE which supports 2RX on at least one band. For testing of a UE which supports 4RX on all bands, the SNR during T3 is modified as specified in clause A.3.6.</p> <p>Note 10: Information about types of UE beam given in B.2.1.3 and does not limit UE implementation or test system implementation</p> <p>Note 11: This value allows up to 1dB degradation from applied SNR to UE baseband.</p>							

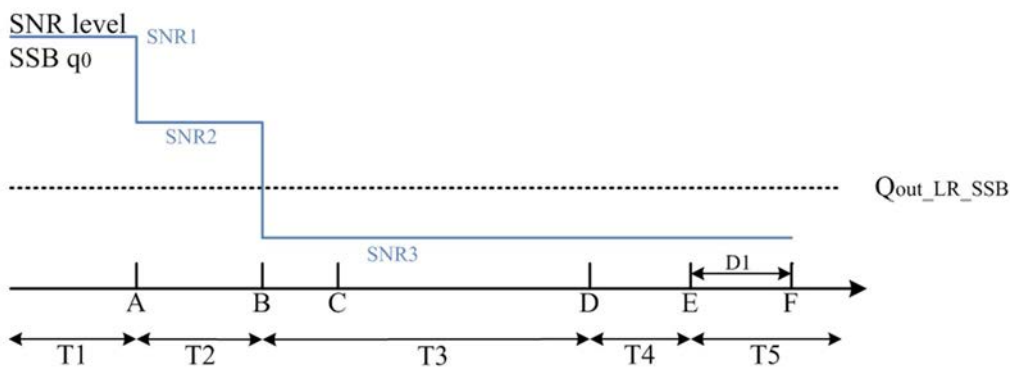

Figure A.7.5.5.1-1: SNR variation for SSB-based beam failure detection and link recovery testing in non-DRX mode

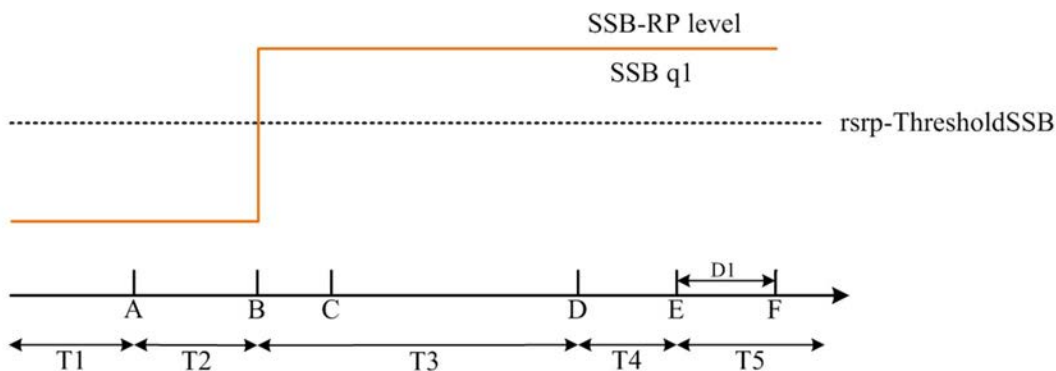

Figure A.7.5.5.1-2: SSB\_RP level variation for SSB-based beam failure detection and link recovery testing in non-DRX mode

A.7.5.5.5.2 Test Requirements

The UE behaviour during time duration T3 follows the requirements defined in clause 8.5.7.3:

- The UE is not expected to transmit PUCCH/PUSCH/SRS or receive PDCCH/PDSCH/CSI-RS for tracking/CSI-RS for CQI on BFD-RS symbols to be measured for beam failure detection.

The UE behaviour during time durations T4 and T5 follows the requirements defined in clause 8.5.8.3:

- The UE is not expected to transmit PUCCH/PUSCH or receive PDCCH/PDSCH on reference symbols to be measured for candidate beam detection.

A.7.5.5.6 Beam Failure Detection and Link Recovery Test for FR2 SCell configured with CSI-RS-based BFD and LR in non-DRX mode

A.7.5.5.6.1 Test Purpose and Environment

The purpose of this test is to verify that the UE properly detects CSI-RS-based beam failure in the set  $q_0$  configured for an active SCell and that the UE performs correct CSI-RS-based link recovery based on beam candidate set  $q_1$ . The purpose is to test the downlink monitoring for beam failure detection within the UE's active DL BWP of the SCell with *schedulingRequestID-BFR-SCell-r16* configuration, during the evaluation period, and link recovery, when no DRX is used. This test will partly verify the CSI-RS based beam failure detection and link recovery for an FR2 SCell requirements in clause 8.5.

The test parameters are given in Tables A.7.5.5.6.1-1, A.7.5.5.6.1-2 and A.7.5.5.6.1-3. There are two cells, cell 1 is the active PCell and cell 2 is the active SCell, in the test. The test consists of five successive time periods, with time duration of T1, T2, T3, T4 and T5 respectively. Figure A.7.5.5.6.1-1 shows the variation of the downlink SNR of the CSI-RS in set  $q_0$  in the active SCell to emulate CSI-RS based beam failure. Figure A.7.5.5.6.1-2 shows the variation of the downlink L1-RSRP of the CSI-RS in set  $q_1$  of the candidate beam used for link recovery. Prior to the start of the time duration T1, the UE shall be fully synchronized to cell 1 and cell 2. The UE shall be configured for periodic CSI reporting with a reporting periodicity of [2] ms. In the test, DRX configuration is not enabled.

**Table A.7.5.5.6.1-1: Supported test configurations for FR2 PCell and SCell**

Configuration	Description
1	TDD duplex mode, 120 kHz SSB SCS, 100 MHz bandwidth

**Table A.7.5.5.6.1-2: General test parameters for FR2 SCell for beam failure detection and link recovery testing in non-DRX mode**

Parameter	Test Config.	Unit	Value	Comment	
			<b>Test 1</b>		
Active PCell	1		Cell 1		
RF Channel Number for PCell	1		1		
Active SCell	1		Cell 2		
RF Channel Number for SCell	1		2		
Duplex mode	1		TDD		
TDD Configuration	1		TDDConf.3.1		
$BW_{channel}$	1	MHz	100: $N_{RB,c} = 66$		
Data RBs allocated	1		66		
PDSCH/PDCCH subcarrier spacing	1	kHz	120		
DL initial BWP configuration	1		DLBWP.0.1		
DL dedicated BWP configuration	1		DLBWP.1.1		
UL initial BWP configuration	1		ULBWP.0.1		
UL dedicated BWP configuration	1		ULBWP.1.1		
PDSCH Reference Channel	1		SR.3.2 TDD		
RMSI CORESET Reference Channel	1		CR.3.1 TDD	A.3.1.2	
Dedicated CORESET Reference Channel	1		CCR.3.1 TDD		
OCNG parameters	1		OP.1	A.3.2.1	
CP length	1		Normal		
PDSCH/PDCCH TCI state	1		TCI.State.0		
CSI-RS for tracking	1		TRS.2.1 TDD		
SSB Configuration	1		SSB.3 FR2	A.3.10	
SMTc Configuration	1		SMTc.3	A.3.11	
PRACH Configuration	1		FR2 PRACH configuration 4	Table A.3.8.3.4-1	
DRX configuration	1		OFF		
CSI-RS configuration for BFD/CBD on SCell	1		CSI-RS.3.2 TDD	A.3.14.2	
CSI-RS index assigned as BFD RS ( $q_0$ )	1		0		
CSI-RS index assigned as CBD RS ( $q_1$ )	1		1		
CSI-RS configuration for RLM on PCell	1		CSI-RS.3.2 TDD	A.3.14.2	
Beam failure detection transmission parameters	DCI format	1	1-0		
	Number of Control OFDM symbols	1	2		
	Aggregation level	1	CCE	8	
	Ratio of hypothetical PDCCH RE energy to average SSS RE energy	1	dB	0	
	Ratio of hypothetical PDCCH DMRS energy to average SSS RE energy	1	dB	0	
	DMRS precoder granularity	1		REG bundle size	
	REG bundle size	1	6		
Gap pattern ID	1		N/A		

schedulingRequestID-BFR-SCell-r16	1		Configured	
Periodicity of PUCCH for SR configuration for BFR on SCell	1	slot	40	5ms
Offset of PUCCH for SR configuration for BFR on SCell	1	slot	4	
PUCCH parameters for SR configuration for BFR on SCell	1		Table 8.3.3.1.2-1 in [13]	
rlmInSyncOutOfSyncThreshold	1		absent	Value 0 is applied. (Table 8.1.1-1).
rsrp-ThresholdSSB	1	dBm/SCS	-95	Threshold used for $Q_{in\_LR\_SSB}$
powerControlOffsetSS	1		db0	Used for deriving rsrp-ThresholdCSI-RS
beamFailureInstanceMaxCount	1		n1	see TS 38.321 [7], clause 5.17
beamFailureDetectionTimer	1		pbfd4	see TS 38.321 [7], clause 5.17
CSI-RS configuration for CSI reporting	1		CSI-RS.3.1 TDD	A.3.14.2
reportConfigType	1		periodic	
reportQuantity	1		cri-RI-PMI-CQI	
CSI reporting periodicity	1	slot	40	
CSI reporting offset	1	slot	4	
T310	1	ms	1000	
N310	1		2	
T1	1	s	1	The UE shall be fully synchronized to cell 1 during T1
T2	1	s	1.17	
T3	1	s	0.9	
T4	1	s	0	
T5	1	s	0.31	
D1	1	s	0.27	
Note 1: UE-specific PDCCH is not transmitted after T1 starts.				

**Table A.7.5.5.6.1-3: Cell specific test parameters for FR2 SCell for beam failure detection and link recovery testing in non-DRX mode**

Parameter	Unit	Cell 1 T1 to T5	Cell2 Test 1				
			T1	T2	T3	T4	T5
AoA setup		Setup 1 defined in A.3.15	Setup 1 defined in A.3.15				
Assumption for UE beams <sup>Note 10</sup>		Rough	Rough				
EPRE ratio of PDCCH DMRS to SSS	dB	0	0				
EPRE ratio of PDCCH to PDCCH DMRS	dB						
EPRE ratio of PBCH DMRS to SSS	dB						
EPRE ratio of PBCH to PBCH DMRS	dB						
EPRE ratio of PSS to SSS	dB						
EPRE ratio of PDSCH DMRS to SSS	dB						
EPRE ratio of PDSCH to PDSCH DMRS	dB						
EPRE ratio of OCNG DMRS to SSS	dB						
EPRE ratio of OCNG to OCNG DMRS	dB						
SNR_CSI-RS of set $q_0$	Config 1 dB	5	5	-3	-12	-12	-12
SNR_CSI-RS of set $q_1$	Config 1 dB	0.2	0.2	0.2	20.2	20.2	20.2
CSI-RS_RP of set $q_1$	Config 1 dBm/SCS kHz	-104.5	-104.5	-104.5	-84.5	-84.5	-84.5
$N_{oc}$	Config 1 dBm/ 120kHz	-104.7	-104.7				

Propagation condition	TDL-A 30ns 75Hz	TDL-A 30ns 75Hz
<p>Note 1: OCNG shall be used such that the resources in Cell 1 are fully allocated and a constant total transmitted power spectral density is achieved for all OFDM symbols.</p> <p>Note 2: The uplink resources for CSI reporting are assigned to the UE prior to the start of time period T1.</p> <p>Note 3: NZP CSI-RS resource set configuration for CSI reporting are assigned to the UE prior to the start of time period T1.</p> <p>Note 4: Void</p> <p>Note 5: The timers and layer 3 filtering related parameters are configured prior to the start of time period T1.</p> <p>Note 6: The signal contains PDCCH for UEs other than the device under test as part of OCNG.</p> <p>Note 7: SNR levels correspond to the signal to noise ratio over the REs carrying CSI-RS.</p> <p>Note 8: The SNR in time periods T1, T2, T3, T4 and T5 is denoted as SNR1, SNR2 and SNR3 respectively in figure A.7.5.5.6.1-1.</p> <p>Note 9: The SNR values are specified for testing a UE which supports 2RX on at least one band. For testing of a UE which supports 4RX on all bands, the SNR during T3 is modified as specified in clause A.3.6.</p> <p>Note 10: Information about types of UE beam is given in B.2.1.3 and does not limit UE implementation or test system implementation.</p>		

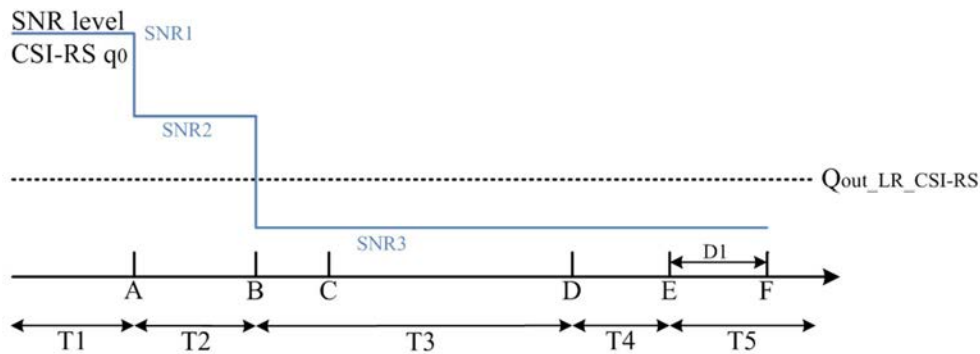

Figure A.7.5.5.6.1-1: SNR variation for beam failure detection and link recovery testing for SCell in non-DRX mode

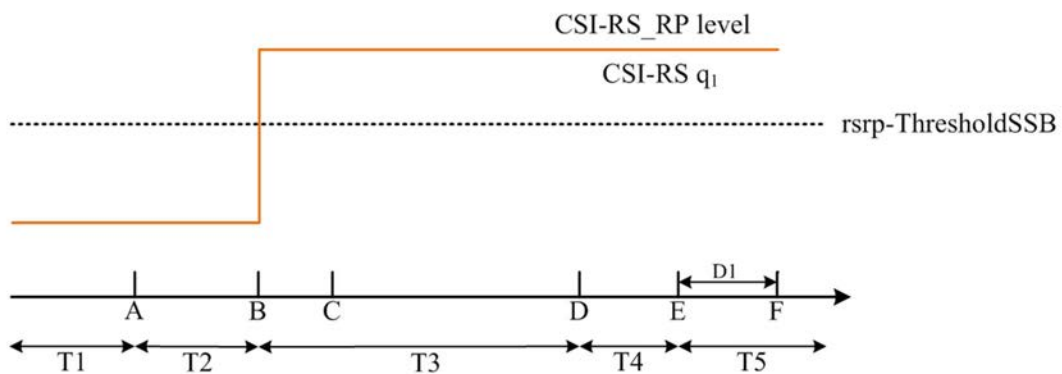

Figure A.7.5.5.6.1-2: CSI-RS\_RP level variation for CSI-RS based beam failure detection and link recovery testing for SCell in non-DRX mode

### A.7.5.5.6.2 Test Requirements

The UE behaviour during time durations T1, T2, T3, T4 and T5 in A.7.5.5.6.1 shall be as follows:

During the time duration T1 and T2, the UE shall transmit uplink signal at least in all subframes configured for CSI transmission on Cell 1.



During the period from time point A to time point B the UE shall transmit uplink signal in Cell 1 in all uplink slots configured for CSI transmission according to the configured periodic CSI reporting for Cell 1.

During T3 the UE shall detect beam failure and initial link recovery. During T4 and T5 the UE measures and evaluates beam candidate from beam candidate set  $q_1$ .

No later than time point F occurring no later than  $D1 = 260+10$  ms after the start of T5, the UE shall transmit PUCCH with LRR, followed by BFR MAC CE containing a beam associated with the candidate beam set  $q_1$ . The UE shall not transmit PUCCH with an LRR with the candidate beam set  $q_1$  earlier than time point B.

Test is concluded once the test equipment has received the initial preamble transmission from the UE. The rate of correct events observed during repeated tests shall be at least 90%.

### A.7.5.5.7 Beam Failure Detection and Link Recovery Test for FR2 SCell configured with CSI-RS-based BFD and LR in DRX mode

#### A.7.5.5.7.1 Test Purpose and Environment

The purpose of this test is to verify that the UE properly detects CSI-RS-based beam failure in the set  $q_0$  configured for an active SCell and that the UE performs correct CSI-RS-based link recovery based on beam candidate set  $q_1$ . The purpose is to test the downlink monitoring for beam failure detection within the UEs active DL BWP of the SCell with *schedulingRequestID-BFR-SCell-r16* configuration, during the evaluation period, and link recovery, when DRX is used. This test will partly verify the CSI-RS based beam failure detection and link recovery for an FR2 SCell requirements in clause 8.5.

The test parameters are given in Tables A.7.5.5.7.1-1, A.7.5.5.7.1-2 and A.7.5.5.7.1-3. There are two cell, cell 1 is the active PCell and cell 2 is the active SCell, in the test. The test consists of five successive time periods, with time duration of T1, T2, T3, T4 and T5 respectively. Figure A.7.5.5.7.1-1 shows the variation of the downlink SNR of the CSI-RS in set  $q_0$  in the active SCell to emulate CSI-RS based beam failure. Figure A.7.5.5.7.1-2 shows the variation of the downlink L1-RSRP of the CSI-RS in set  $q_1$  of the candidate beam used for link recovery. Prior to the start of the time duration T1, the UE shall be fully synchronized to cell 1 and cell 2. The UE shall be configured for periodic CSI reporting with a reporting periodicity of 5 ms. In the test, DRX configuration is enabled in PCell and DRX inactivity timer has already been expired, i.e. UE tries to decode PDCCH and to send periodic CQI during the period when On-duration timer is running. Time alignment timers shall be set to "infinity" so that UL timing alignment is maintained during the test.

**Table A.7.5.5.7.1-1: Supported test configurations for FR2 PCell and SCell**

Configuration	Description
1	TDD duplex mode, 120 kHz SSB SCS, 100 MHz bandwidth

**Table A.7.5.5.7.1-2: General test parameters for FR2 SCell for beam failure detection and link recovery testing in DRX mode**

Parameter	Test Config.	Unit	Value	Comment
			<b>Test 1</b>	
Active PCell	1		Cell 1	
RF Channel Number for PCell	1		1	
Active SCell	1		Cell 2	
RF Channel Number for SCell	1		2	
Duplex mode	1		TDD	
TDD Configuration	1		TDDConf.3.1	
BW <sub>channel</sub>	1	MHz	100: N <sub>RB,c</sub> = 66	
Data RBs allocated	1		66	
PDSCH/PDCCH subcarrier spacing	1	kHz	120	
DL initial BWP configuration	1		DLBWP.0.1	
DL dedicated BWP configuration	1		DLBWP.1.1	
UL initial BWP configuration	1		ULBWP.0.1	
UL dedicated BWP configuration	1		ULBWP.1.1	
PDSCH Reference Channel	1		SR.3.2 TDD	
RMSI CORESET Reference Channel	1		CR.3.1 TDD	A.3.1.2
Dedicated CORESET Reference Channel	1		CCR.3.1 TDD	

OCNG parameters		1		OP.1	A.3.2.1
CP length		1		Normal	
PDSCH/PDCCH TCI state		1		TCI.State.0	
CSI-RS for tracking		1		TRS.2.1 TDD	
SSB Configuration		1		SSB.3 FR2	A.3.10
SMTC Configuration		1		SMTC.3	A.3.11
PRACH Configuration		1		FR2 PRACH configuration 4	Table A.3.8.3.4-1
DRX configuration		1		DRX.3	A.3.3.3
CSI-RS configuration for BFD/CBD on SCell		1		CSI-RS.3.2 TDD	A.3.14.2
CSI-RS index assigned as BFD RS ( $q_0$ )		1		0	
CSI-RS index assigned as CBD RS ( $q_1$ )		1		1	
CSI-RS configuration for RLM on PCell		1		CSI-RS.3.2 TDD	A.3.14.2
Beam failure detection transmission parameters	DCI format	1		1-0	
	Number of Control OFDM symbols	1		2	
	Aggregation level	1	CCE	8	
	Ratio of hypothetical PDCCH RE energy to average SSS RE energy	1	dB	0	
	Ratio of hypothetical PDCCH DMRS energy to average SSS RE energy	1	dB	0	
	DMRS precoder granularity	1		REG bundle size	
	REG bundle size	1		6	
Gap pattern ID		1		N/A	
schedulingRequestID-BFR-SCell-r16		1		Configured	
Periodicity of PUCCH for SR configuration for BFR on SCell		1	slot	40	5ms
Offset of PUCCH for SR configuration for BFR on SCell		1	slot	4	
PUCCH parameters for SR configuration for BFR on SCell		1		Table 8.3.3.1.2-1 in [13]	
rimInSyncOutOfSyncThreshold		1		absent	Value 0 is applied. (Table 8.1.1-1).
rsrp-ThresholdSSB		1	dBm/SCS	-95	Threshold used for $Q_{in\_LR\_SSB}$
powerControlOffsetSS		1		db0	Used for deriving rsrp-ThresholdCSI-RS
beamFailureInstanceMaxCount		1		n1	see TS 38.321 [7], clause 5.17
beamFailureDetectionTimer		1		pbfd4	see TS 38.321 [7], clause 5.17
CSI-RS configuration for CSI reporting		1		CSI-RS.3.1 TDD	A.3.14.2
reportConfigType		1		periodic	
reportQuantity		1		cri-RI-PMI-CQI	
CSI reporting periodicity		1	slot	40	
CSI reporting offset		1	slot	4	
T310		1	ms	1000	
N310		1		2	
T1		1	s	1	The UE shall be fully synchronized to cell 1 during T1
T2		1	s	5.43	
T3		1	s	5.16	
T4		1	s	0	
T5		1	s	0.31	
D1		1	s	0.27	
Note 1: UE-specific PDCCH is not transmitted after T1 starts.					

**Table A.7.5.7.1-3: Cell specific test parameters for FR2 SCell for beam failure detection and link recovery testing in DRX mode**

Parameter	Unit	Cell1 T1 to T5	Cell2 Test 1				
			T1	T2	T3	T4	T5
AoA setup		Setup 1 defined in A.3.15	Setup 1 defined in A.3.15				
Assumption for UE beams <sup>Note 10</sup>		Rough	Rough				
EPRE ratio of PDCCH DMRS to SSS	dB	0	0				
EPRE ratio of PDCCH to PDCCH DMRS	dB						
EPRE ratio of PBCH DMRS to SSS	dB						
EPRE ratio of PBCH to PBCH DMRS	dB						
EPRE ratio of PSS to SSS	dB						
EPRE ratio of PDSCH DMRS to SSS	dB						
EPRE ratio of PDSCH to PDSCH DMRS	dB						
EPRE ratio of OCNG DMRS to SSS	dB						
EPRE ratio of OCNG to OCNG DMRS	dB						
SNR_CSI-RS of set q <sub>0</sub>	Config 1 dB						
SNR_CSI-RS of set q <sub>1</sub>	Config 1 dB	0.2	0.2	0.2	20.2	20.2	20.2
CSI-RS_RP of set q <sub>1</sub>	Config 1 dBm/ SCS kHz	-104.5	-104.5	-104.5	-84.5	-84.5	-84.5
N <sub>oc</sub>	Config 1 dBm/120 kHz	-104.7	-104.7				
Propagation condition		TDL-A 30ns 75Hz	TDL-A 30ns 75Hz				
Note 1:	OCNG shall be used such that the resources in Cell 1 are fully allocated and a constant total transmitted power spectral density is achieved for all OFDM symbols.						
Note 2:	The uplink resources for CSI reporting are assigned to the UE prior to the start of time period T1.						
Note 3:	NZP CSI-RS resource set configuration for CSI reporting are assigned to the UE prior to the start of time period T1.						
Note 4:	Void						
Note 5:	The timers and layer 3 filtering related parameters are configured prior to the start of time period T1.						
Note 6:	The signal contains PDCCH for UEs other than the device under test as part of OCNG.						
Note 7:	SNR levels correspond to the signal to noise ratio over the REs carrying CSI-RS.						
Note 8:	The SNR in time periods T1, T2, T3, T4 and T5 is denoted as SNR1, SNR2 and SNR3 respectively in figure A.7.5.7.1-1.						
Note 9:	The SNR values are specified for testing a UE which supports 2RX on at least one band. For testing of a UE which supports 4RX on all bands, the SNR during T3 is modified as specified in clause A.3.6.						
Note 10:	Information about types of UE beam is given in B.2.1.3 and does not limit UE implementation or test system implementation.						

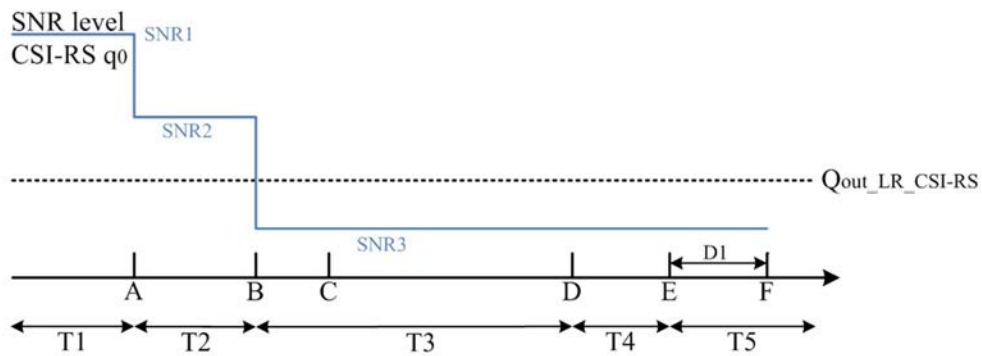

Figure A.7.5.5.7.1-1: SNR variation for beam failure detection and link recovery testing for SCell in DRX mode

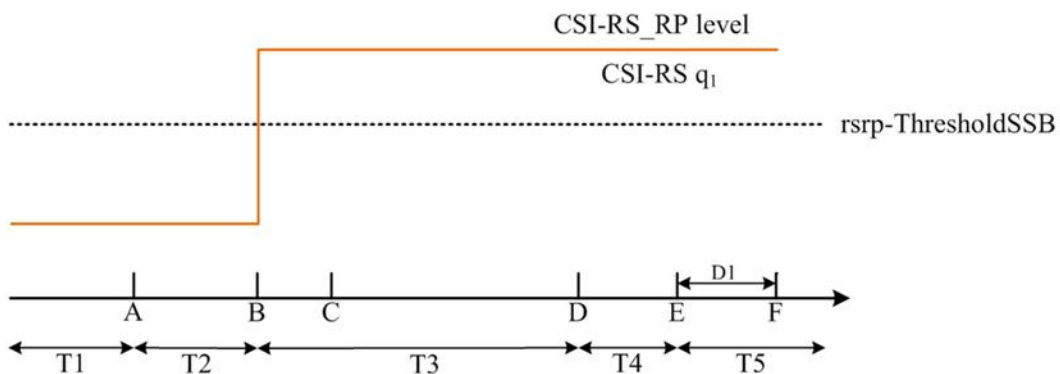

Figure A.7.5.5.7.1-2: CSI-RS\_RP level variation for CSI-RS based beam failure detection and link recovery testing for SCell in DRX mode

### A.7.5.5.7.2 Test Requirements

The UE behaviour during time durations T1, T2, T3, T4 in A.7.5.5.7.1 and T5 shall be as follows:

During the time duration T1 and T2, the UE shall transmit uplink signal at least in all subframes configured for CSI transmission on Cell 1.

During the period from time point A to time point B the UE shall transmit uplink signal in Cell 1 in all uplink slots configured for CSI transmission according to the configured periodic CSI reporting for Cell 1.

During T3 the UE shall detect beam failure and initial link recovery. During T4 and T5 the UE measures and evaluates beam candidate from beam candidate set  $q_1$ .

No later than time point F occurring no later than  $D1 = 260+10$  ms after the start of T5, the UE shall transmit PUCCH with LRR, followed by BFR MAC CE containing a beam associated with the candidate beam set  $q_1$ . The UE shall not transmit PUCCH with an LRR with the candidate beam set  $q_1$  earlier than time point B.

Test is concluded once the test equipment has received the initial preamble transmission from the UE. The rate of correct events observed during repeated tests shall be at least 90%.

## A.7.5.6 Active BWP switch

### A.7.5.6.1 DCI-based and Timer-based Active BWP Switch

#### A.7.5.6.1.1 NR FR2- NR FR2 DL active BWP switch of SCell with non-DRX in SA

##### A.7.5.6.1.1.1 Test Purpose and Environment

The purpose of this test is to verify the DL BWP switch delay requirement defined in clause 8.6, and interruption requirement on other active serving cell defined in clause 8.2.2.2.5.

The supported test configurations are shown in Table A.7.5.6.1.1.1-1 below. The test scenario comprises of one PCell (Cell 1) and one SCell (Cell 2) as given in Table A.7.5.6.1.1.1-2. NR Cell-specific parameters are specified in Table A.7.5.6.1.1.1-3 below. OTA related test parameters are shown in table A.7.5.6.1.1.1-4 below.

PDCCHs indicating new transmissions shall be sent continuously on SCell (Cell 2) to ensure that the UE would have ACK/NACK sending except for the time duration when BWP is switching on Cell 2 and the time duration of T2.

PDCCHs indicating new transmissions shall be sent continuously on PCell (Cell 1) to ensure that the UE will have ACK/NACK sending.

Before the test starts,

UE is connected to Cell 1 (PCell) on radio channel 1 (PCC), and Cell 2 (SCell) on radio channel 2 (SCC).

UE is configured with 2 different UE-specific downlink bandwidth parts for SCell, BWP-1 and BWP-2, in Cell 2 before starting the test. BWP-1 and BWP-2 always include bandwidth of the initial DL BWP and SSB.

UE is configured with 1 UE-specific downlink bandwidth parts the same as initial BWP for PCell, BWP-0 in Cell 1 before starting the test.

UE is indicated in *firstActiveDownlinkBWP-Id* that the active DL BWP is BWP-1 in SCell.

UE is indicated in *firstActiveDownlinkBWP-Id* that the active DL BWP is BWP-0 in PCell.

UE is configured with a *bwp-InactivityTimer* timer value for SCell.

All cells have constant signal levels throughout the test.

The test consists of 3 successive time periods, with durations of T1, T2, and T3, respectively.

During T1,

Time period T1 starts when a DCI format 1\_1 command for SCell DL BWP switch, sent from the test equipment to the UE, is received at the UE side in SCell's slot # denoted  $i$ . The UE shall switch its bandwidth part from BWP-1 to BWP-2.

The UE shall be able to receive PDSCH no later than the first DL slot that occurs after the beginning of SCell's DL slot ( $i+T_{\text{BWPswitchDelay}}$ ) as defined in clause 8.6 and starts to report valid ACK/NACK for the SCell on PCell no later than the first UL slot that occurs after the beginning of slot ( $i+T_{\text{BWPswitchDelay}}+k_1$ ). The UE shall be continuously scheduled on SCell's BWP-2 no later than the first DL slot that occurs after the beginning of slot ( $i+T_{\text{BWPswitchDelay}}$ ).

The starting time of PCell (Cell 1) interruption due to BWP switch on SCell shall occur within the BWP switch delay.

During T2, the test equipment won't transmit DCI format for PDSCH reception on SCell (Cell 2).

During T3,

The time period T3 starts from the slot # $j$ , where  $j$  is the first slot of the half subframe immediately after *bwp-InactivityTimer* timer expires. The UE should switch its bandwidth part from BWP-2 back to the default bandwidth part – BWP-1.

The UE shall be able to receive PDSCH no later than the first DL slot that occurs after the beginning of SCell's DL slot ( $j+T_{\text{BWPswitchDelay}}$ ) as defined in clause 8.6 and starts to report valid ACK/NACK for the SCell on PCell at

latest on the first UL slot that occurs after the beginning of slot ( $j+T_{\text{BWPswitchDelay}}+k_1$ ). The UE shall be continuously scheduled on SCell's BWP-1 no later than the first DL slot that occurs after the beginning of slot ( $j+T_{\text{BWPswitchDelay}}$ ).

The starting time of PCell (Cell 1) interruption due to BWP switch of SCell shall occur within the BWP switch delay.

The test equipment verifies the DL BWP switch time in SCell by counting the slots from the time when the BWP switch command is received or *bwp-InactivityTimer* timer expires till an ACK/NACK is received.

The test equipment verifies that potential interruption to PCell is carried out in the correct time span by monitoring ACK/NACK sent in PCell during BWP switch of SCell, respectively.

**Table A.7.5.6.1.1.1-1: DL BWP switch supported test configurations**

Config	Description
1	NR 120 kHz SSB SCS, 100 MHz bandwidth, TDD -TDD duplex mode
Note 1:	Void

**Table A.7.5.6.1.1.1-2: General test parameters for DL BWP switch in SA**

Parameter	Unit	Value	Comment
NR RF Channel Number		1, 2	Two NR radio channels are used for this test
Active PCell		Cell 1	PCell on RF channel number 1.
Active SCell		Cell 2	SCell on RF channel number 2.
CP length		Normal	
DRX		OFF	For both PCell and SCell
<i>bwp-InactivityTimer</i>	ms	200	
Cell-individual offset for cells on RF channel number 1	dB	0	Individual offset for cells on PCC.
Cell-individual offset for cells on RF channel number 2	dB	0	Individual offset for cells on PSCC.
Cell2 timing offset to cell1	$\mu$ s	3	Time alignment error as specified in TS 38.104 [13] clause 6.5.3.1.
T1	s	0.2	
T2	s	0.2	
T3	s	0.2	

**Table A.7.5.6.1.1.1-3: NR Cell specific test parameters for DL BWP switch in SA**

Parameter	Unit	Cell 1	Cell2
Frequency Range		FR2	FR2
Duplex mode		TDD	
TDD configuration		TDDConf.3.1	
$BW_{\text{channel}}$		100 MHz: $N_{\text{RB},c} = 66$	
Active BWP ID		0	1, 2
Downlink initial BWP Configuration		DLBWP.0.2	
Uplink initial BWP Configuration		ULBWP.0.2	N.A.
Downlink active BWP-0 Configuration		DLBWP.0.2	N.A.
Downlink active BWP-1 Configuration		N.A.	DLBWP.1.1
Downlink active BWP-2 Configuration		N.A.	DLBWP.1.3
Uplink active BWP-0 Configuration		ULBWP.0.2	N.A.
Uplink active BWP-1 Configuration		N.A.	N.A.
Uplink active BWP-2 Configuration		N.A.	N.A.
PDSCH Reference measurement channel		SR.3.1 TDD	
TRS configuration		TRS.2.1 TDD	
TCI state		TCI.State.0	

RMSI CORESET parameters		CR.3.1 TDD	
Dedicated CORESET parameters		CCR.3.1 TDD	
OCNG Patterns		OP.1	
SSB Configuration		SSB.1 FR2	
SMTC Configuration		SMTC.1	
Correlation Matrix and Antenna Configuration		1x2 Low	
EPRE ratio of PSS to SSS	dB	0	0
EPRE ratio of PBCH DMRS to SSS			
EPRE ratio of PBCH to PBCH DMRS			
EPRE ratio of PDCCH DMRS to SSS			
EPRE ratio of PDCCH to PDCCH DMRS			
EPRE ratio of PDSCH DMRS to SSS			
EPRE ratio of PDSCH to PDSCH			
EPRE ratio of OCNG DMRS to SSS(Note 1)			
EPRE ratio of OCNG to OCNG DMRS (Note 1)			
Propagation Condition		AWGN	AWGN
Note 1: OCNG shall be used such that both cells are fully allocated and a constant total transmitted power spectral density is achieved for all OFDM symbols.			

**Table A.7.5.6.1.1.1-4: OTA related test parameters for BWP switching test case**

Parameter	Unit	Cell 1	Cell 2
Angle of arrival configuration		Setup 1 defined in clause A.3.15.1	Setup 1 defined in clause A.3.15.1
Assumption for UE beams <sup>Note 6</sup>		Fine	Fine
$N_{oc}$ <sup>Note1</sup>	dBm/15kHz	-112	-112
$N_{oc}$ <sup>Note1</sup>	dBm/SCS	-103	-103
SS-RSRP <sup>Note2</sup>	dBm/SCS <sup>Note3</sup>	-85	-85
$\hat{E}_s / I_{ot}$	dB	18	18
$I_o$ <sup>Note4</sup>	dBm/95.04 MHz <sup>Note4</sup>	-56	-56
<p>Note 1: Interference from other cells and noise sources not specified in the test is assumed to be constant over subcarriers and time and shall be modelled as AWGN of appropriate power for <math>N_{oc}</math> to be fulfilled.</p> <p>Note 2: SS-RSRP and <math>I_o</math> levels have been derived from other parameters for information purposes. They are not settable parameters themselves.</p> <p>Note 3: SS-RSRP minimum requirements are specified assuming independent interference and noise at each receiver antenna port.</p> <p>Note 4: Equivalent power received by an antenna with 0 dBi gain at the centre of the quiet zone</p> <p>Note 5: As observed with 0 dBi gain antenna at the centre of the quiet zone.</p> <p>Note 6: Information about types of UE beam is given in B.2.1.3 and does not limit UE implementation or test system implementation.</p>			

**A.7.5.6.1.1.2 Test Requirements**

During T1, the UE shall start to send the ACK/NACK for SCell on PCell from the first UL slot that occurs after the beginning of DL slot  $(i + T_{BWPswitchDelay} + k_1)$ .

During T3, the UE shall start to send the ACK/NACK for SCell on PCell from the first UL slot that occurs after the beginning of DL slot  $(j + T_{BWPswitchDelay} + k_1)$ .

Where,  $k_1$  is the timing between DL data receiving and acknowledgement as specified in [7].

Depending on UE capability *bwp-SwitchingDelay* [2], UE shall finish BWP switch within the time duration  $T_{\text{BWPswitchDelay}}$  defined in Table 8.6.2-1.

All of the above test requirements shall be fulfilled in order for the observed SCell active BWP switch delay to be counted as correct.

The rate of correct events observed during repeated tests shall be at least 90%.

During T1 and T3, the start time of PCell interruption during SCell active BWP switch shall not happen outside the BWP switch delay.

The interruption of PCell shall not be longer than the interruption duration specified for active BWP switch in clause 8.2.2.2.5.

All of the above test requirements shall be fulfilled in order for the observed SCell active BWP switch interruption to be counted as correct.

The rate of correct events observed during repeated tests shall be at least 90%.

NOTE: During T1, T3 if there are no uplink resources for reporting the ACK in the first UL slot that occurs after the beginning of DL slot  $(i + T_{\text{BWPswitchDelay}} + k_1)$ ,  $(j + T_{\text{BWPswitchDelay}} + k_1)$ , then the UE shall use the next available uplink resource for reporting the corresponding ACK.

#### A.7.5.6.1.2 NR FR1- NR FR2 DL active BWP switch of SCell with non-DRX in SA

##### A.7.5.6.1.2.1 Test Purpose and Environment

The purpose of this test is to verify the DL BWP switch delay requirement defined in clause 8.6, and interruption requirement on other active serving cell defined in clause 8.2.2.2.5.

The supported test configurations are shown in Table A.7.5.6.1.2.1-1 below. The test scenario comprises of one NR PCell (Cell 1) and one NR SCell (Cell 2). The general parameters are given in Table A.7.5.6.1.2.1-2. NR Cell-specific parameters are specified in Table A.7.5.6.1.2.1-3 below. OTA related test parameters are shown in table A.7.5.6.1.2.1-4 below.

PDCCHs indicating new transmissions shall be sent continuously on SCell (Cell 2) to ensure that the UE would have ACK/NACK sending except for the time duration when BWP is switching on Cell 2 and the time duration of T2.

PDCCHs indicating new transmissions shall be sent continuously on PCell (Cell 1) to ensure that the UE will have ACK/NACK sending.

Before the test starts,

UE is connected to Cell 1 (PCell) on radio channel 1 (PCC), and Cell 2 (SCell) on radio channel 2 (SCC).

UE is configured with 2 different UE-specific downlink bandwidth parts for SCell, BWP-1 and BWP-2, in Cell 2 before starting the test. BWP-1 and BWP-2 always include bandwidth of the initial DL BWP and SSB.

UE is configured with 1 UE-specific downlink bandwidth parts the same as initial BWP for PCell, BWP-0 in Cell 1 before starting the test.

UE is indicated in *firstActiveDownlinkBWP-Id* that the active DL BWP is BWP-1 in SCell.

UE is indicated in *firstActiveDownlinkBWP-Id* that the active DL BWP is BWP-0 in PCell.

UE is configured with a *bwp-InactivityTimer* timer value for SCell.

All cells have constant signal levels throughout the test.

The test consists of 3 successive time periods, with durations of T1, T2, and T3, respectively.

During T1,

Time period T1 starts when a DCI format 1\_1 command for SCell DL BWP switch, sent from the test equipment to the UE, is received at the UE side in SCell's slot # denoted  $i$ . The UE shall switch its bandwidth part from BWP-1 to BWP-2.



The UE shall be able to receive PDSCH no later than the first DL slot that occurs after the beginning of SCell's DL slot ( $i+T_{\text{BWPswitchDelay}}$ ) as defined in clause 8.6 and starts to report valid ACK/NACK for the SCell on PCell no later than the first UL slot that occurs after the beginning of slot ( $i+T_{\text{BWPswitchDelay}}+k_1$ ). The UE shall be continuously scheduled on SCell's BWP-2 no later than the first DL slot that occurs after the beginning of slot ( $i+T_{\text{BWPswitchDelay}}$ ).

The starting time of PCell (Cell 1) interruption due to BWP switch on SCell shall occur within the BWP switch delay if the UE doesn't support per-FR gap, otherwise no interruption due to BWP switch on PCell is allowed.

During T2, the test equipment won't transmit DCI format for PDSCH reception on SCell (Cell 2).

During T3,

The time period T3 starts from the slot # $j$ , where  $j$  is the first slot of the half subframe immediately after *bwp-InactivityTimer* timer expires. The UE should switch its bandwidth part from BWP-2 back to the default bandwidth part – BWP-1.

The UE shall be able to receive PDSCH no later than the first DL slot that occurs after the beginning of SCell's DL slot ( $j+T_{\text{BWPswitchDelay}}$ ) as defined in clause 8.6 and starts to report valid ACK/NACK for the SCell on PCell at latest on the first UL slot that occurs after the beginning of slot ( $j+T_{\text{BWPswitchDelay}}+k_1$ ). The UE shall be continuously scheduled on SCell's BWP-1 no later than the first DL slot that occurs after the beginning of slot ( $j+T_{\text{BWPswitchDelay}}$ ).

The starting time of PCell (Cell 1) interruption due to BWP switch of SCell shall occur within the BWP switch delay if the UE doesn't support per-FR gap, otherwise no interruption due to BWP switch on PCell is allowed.

The test equipment verifies the DL BWP switch time in SCell by counting the slots from the time when the BWP switch command is received or *bwp-InactivityTimer* timer expires till an ACK/NACK is received.

The test equipment verifies that potential interruption to PCell is carried out in the correct time span by monitoring ACK/NACK sent in PCell during BWP switch of SCell, respectively.

**Table A.7.5.6.1.2.1-1: DL BWP switch supported test configurations**

Config	Description
1	PCell: NR 15 kHz SSB SCS, 10 MHz bandwidth, FDD duplex mode SCell: NR 120 kHz SSB SCS, 100 MHz bandwidth, TDD duplex mode
2	PCell: NR 15 kHz SSB SCS, 10 MHz bandwidth, TDD duplex mode SCell: NR 120 kHz SSB SCS, 100 MHz bandwidth, TDD duplex mode
3	PCell: NR 30 kHz SSB SCS, 10 MHz bandwidth, TDD duplex mode SCell: NR 120 kHz SSB SCS, 100 MHz bandwidth, TDD duplex mode
Note 1: The UE is only required to be tested in one of the supported test configurations	

**Table A.7.5.6.1.2.1-2: General test parameters for DL BWP switch in SA**

Parameter	Unit	Value	Comment
NR RF Channel Number		2	Two NR radio channel is used for this test
Active PCell		Cell 1	PCell on RF channel number 1.
Active SCell		Cell 2	SCell on RF channel number 2.
CP length		Normal	
DRX		OFF	For both PCell and SCell
<i>bwp-InactivityTimer</i>	ms	200	
Cell-individual offset for cells on RF channel number 1	dB	0	Individual offset for cells on PCC.
Cell-individual offset for cells on RF channel number 2	dB	0	Individual offset for cells on SCC.
Cell2 timing offset to cell1	μs	3	Time alignment error as specified in TS 38.104 [13] clause 6.5.3.1.
T1	s	0.2	
T2	s	0.2	
T3	s	0.2	

**Table A.7.5.6.1.2.1-3: NR Cell specific test parameters for DL BWP switch in SA**

Parameter		Unit	Cell 1	Cell2
Frequency Range			FR1	FR2
Duplex mode	Config 1		FDD	TDD
	Config 2,3		TDD	
TDD configuration	Config 1		Not Applicable	TDDConf.3.1
	Config 2		TDDConf.1.1	
	Config 3		TDDConf.2.1	
BW <sub>channel</sub>	Config 1,2	MHz	10 MHz: N <sub>RB,c</sub> = 52	100 MHz: N <sub>RB,c</sub> = 66
	Config 3		40 MHz: N <sub>RB,c</sub> = 106	
Active BWP ID			0	1, 2
Downlink initial BWP Configuration			DLBWP.0.2	
Uplink initial BWP Configuration			ULBWP.0.2	N.A.
Downlink active BWP-0 Configuration			DLBWP.0.2	N.A.
Downlink active BWP-1 Configuration			N.A.	DLBWP.1.1
Downlink active BWP-2 Configuration			N.A.	DLBWP.1.3
Uplink active BWP-0 Configuration			ULBWP.0.2	N.A.
Uplink active BWP-1 Configuration			N.A.	N.A.
Uplink active BWP-2 Configuration			N.A.	N.A.
PDSCH Reference measurement channel	Config 1		SR.1.1 FDD	SR.3.1 TDD
	Config 2		SR.1.1 TDD	
	Config 3		SR.2.1 TDD	
RMSI CORESET parameters	Config 1		CR.1.1 FDD	CR.3.1 TDD
	Config 2		CR.1.1 TDD	
	Config 3		CR.2.1 TDD	
Dedicated CORESET parameters	Config 1		CCR.1.1 FDD	CCR.3.1 TDD
	Config 2		CCR.1.1 TDD	
	Config 3		CCR.2.1 TDD	
OCNG Patterns			OP.1	
SSB Configuration	Config 1,2		SSB.1 FR1	SSB.1 FR2
	Config 3		SSB.2 FR1	
TRS configuration	Config 1,2,3		-	TRS.2.1 TDD
TCI state	Config 1,2,3		TCI.State.0	TCI.State.0
SMTC Configuration			SMTC.1	
Correlation Matrix and Antenna Configuration			NA Link only, see clause A.3.7A	1x2 Low
EPRE ratio of PSS to SSS		dB	0	0
EPRE ratio of PBCH DMRS to SSS				
EPRE ratio of PBCH to PBCH DMRS				
EPRE ratio of PDCCH DMRS to SSS				
EPRE ratio of PDCCH to PDCCH DMRS				
EPRE ratio of PDSCH DMRS to SSS				
EPRE ratio of PDSCH to PDSCH				
EPRE ratio of OCNG DMRS to SSS(Note 1)				
EPRE ratio of OCNG to OCNG DMRS (Note 1)				
Propagation Condition			NA Link only, see clause A.3.7A	AWGN
<p>Note 1: OCNG shall be used such that both cells are fully allocated and a constant total transmitted power spectral density is achieved for all OFDM symbols.</p> <p>Note 2: Interference from other cells and noise sources not specified in the test is assumed to be constant over subcarriers and time and shall be modelled as AWGN of appropriate power for <math>N_{oc}</math> to be fulfilled.</p> <p>Note 3: SS-RSRP and SCH_RP levels have been derived from other parameters for information purposes. They are not settable parameters themselves.</p>				

Table A.7.5.6.1.2.1-4: OTA related test parameters for BWP switching test case

Parameter	Unit	Cell 1	Cell 2
Angle of arrival configuration		-NA Link only, see clause A.3.7A	Setup 1 defined in clause A.3.15.1
Assumption for UE beams <sup>Note 6</sup>			Fine
$N_{oc}$ <sup>Note1</sup>	dBm/15kHz		-112
$N_{oc}$ <sup>Note1</sup>	dBm/SCS		-103
SS-RSRP <sup>Note2</sup>	dBm/SCS <sup>Note3</sup>		-85
$\hat{E}_s / I_{ot}$	dB		18
$I_o$ <sup>Note4</sup>	dBm/95.04 MHz <sup>Note4</sup>		-56
<p>Note 1: Interference from other cells and noise sources not specified in the test is assumed to be constant over subcarriers and time and shall be modelled as AWGN of appropriate power for <math>N_{oc}</math> to be fulfilled.</p> <p>Note 2: SS-RSRP and <math>I_o</math> levels have been derived from other parameters for information purposes. They are not settable parameters themselves.</p> <p>Note 3: SS-RSRP minimum requirements are specified assuming independent interference and noise at each receiver antenna port.</p> <p>Note 4: Equivalent power received by an antenna with 0 dBi gain at the centre of the quiet zone</p> <p>Note 5: As observed with 0 dBi gain antenna at the centre of the quiet zone.</p> <p>Note 6: Information about types of UE beam is given in B.2.1.3 and does not limit UE implementation or test system implementation.</p>			

#### A.7.5.6.1.2.2 Test Requirements

During T1, the UE shall start to send the ACK/NACK for PCell from the first UL slot that occurs after the beginning of DL slot ( $i + T_{BWPswitchDelay} + kI$ ).

During T3, the UE shall start to send the ACK/NACK for PCell from the first UL slot that occurs after the beginning of DL slot ( $j + T_{BWPswitchDelay} + kI$ ).

Where,  $kI$  is the timing between DL data receiving and acknowledgement as specified in [7].

Depending on UE capability *bwp-SwitchingDelay* [2], UE shall finish BWP switch within the time duration  $T_{BWPswitchDelay}$  defined in Table 8.6.2-1.

All of the above test requirements shall be fulfilled in order for the observed PCell active BWP switch delay to be counted as correct.

The rate of correct events observed during repeated tests shall be at least 90%.

If the UE doesn't support per-FR gap,

- During T1 and T3, the start time of SCell interruption during PCell active BWP switch shall not happen outside the BWP switch delay.
- The interruption of SCell shall not be longer than the interruption duration specified for active BWP switch in clause 8.2.2.2.5.

Otherwise no interruption due to BWP switch on SCell is allowed.

All of the above test requirements shall be fulfilled in order for the observed PCell active BWP switch interruption to be counted as correct.

The rate of correct events observed during repeated tests shall be at least 90%.

- NOTE: During T1, T3 if there are no uplink resources for reporting the ACK/NACK in the first UL slot that occurs after the beginning of DL slot ( $i + T_{BWPswitchDelay} + kI$ ), ( $j + T_{BWPswitchDelay} + kI$ ), then the UE shall use the next available uplink resource for reporting the corresponding ACK/NACK.

### A.7.5.6.1.3 NR FR2 DL active BWP switch with non-DRX in SA

#### A.7.5.6.1.3.1 Test Purpose and Environment

The purpose of this test is to verify the DL BWP switch delay requirement defined in clause 8.6. Supported test configurations are shown in Table A.7.5.6.1.3.1-1.

The test scenario comprises of one cell (Cell 1) as given in Table A.7.5.6.1.3.1-2. Cell-specific parameters of NR PCell is specified in Table A.7.5.6.1.3.1-3 below. The OTA related test parameters for FR2 is shown in Table A.7.5.6.1.3.1-4.

PDCCHs indicating new transmissions shall be sent continuously on PCell (Cell 1) to ensure that the UE will have ACK/NACK sending.

Before the test starts,

- UE is connected to Cell 1 on radio channel 1.
- UE is configured with 2 different UE-specific downlink bandwidth parts, BWP-1 and BWP-2 before starting the test. BWP-1 and BWP-2 always include bandwidth of the initial DL BWP and SSB.
- UE is indicated in *firstActiveDownlinkBWP-Id* that the active DL BWP is BWP-1.
- UE is configured with a *bwp-InactivityTimer* timer value for Cell1.

All cells have constant signal levels throughout the test.

The test consists of 3 successive time periods, with durations of T1, T2, and T3, respectively.

During T1,

Time period T1 starts when a DCI format 1\_1 command for DL BWP switch, sent from the test equipment to the UE, is received at the UE side in Cell 1's slot # denoted  $i$ . The UE should switch its bandwidth part from BWP-1 to BWP-2.

The UE shall be able to receive PDSCH on the first DL slot that occurs after the beginning of Cell 1's DL slot ( $i+T_{BWPswitchDelay}$ ) as defined in clause 8.6 and starts to report valid ACK/NACK for the Cell 1 no later than the first UL slot that occurs after the beginning of slot ( $i+T_{BWPswitchDelay}+kI$ ). The UE shall be continuously scheduled on Cell 1's BWP-2 starting from the first DL slot that occurs after the beginning of slot ( $i+T_{BWPswitchDelay}$ ).

During T2, the test equipment won't transmit DCI format for PDSCH reception on Cell 1.

During T3,

The time period T3 starts from the slot # $j$ , where  $j$  is the first slot of the half subframe immediately after *bwp-InactivityTimer* timer expires. The UE should switch its bandwidth part from BWP-2 back to the default bandwidth part – BWP-1.

The UE shall be able to receive PDSCH on the first DL slot that occurs after the beginning of Cell 1's DL slot ( $j+T_{BWPswitchDelay}$ ) as defined in clause 8.6 and starts to report valid ACK/NACK for the Cell 1 at latest on the first UL slot that occurs after the beginning of slot ( $j+T_{BWPswitchDelay}+kI$ ). The UE shall be continuously scheduled on Cell 1's BWP-1 starting from the first DL slot that occurs after the beginning of slot ( $j+T_{BWPswitchDelay}$ ).

The test equipment verifies the DL BWP switch time by counting the slots from the time when the BWP switch command is received or *bwp-InactivityTimer* timer expires till an ACK is received.

**Table A.7.5.6.1.3.1-1: DL BWP switch supported test configurations**

Config	Description
1	NR 120 kHz SSB SCS, 100 MHz bandwidth, TDD duplex mode
Note 1:	Void.
Note 2:	A UE which fulfils the requirements in test case A.7.5.6.1.1 or A.7.5.6.1.2 can skip the test cases in A.7.5.6.1.3.

**Table A.7.5.6.1.3.1-2: General test parameters for DL BWP switch in SA**

Parameter	Unit	Value	Comment
-----------	------	-------	---------

NR RF Channel Number		1	One NR radio channel is used for this test
Active Cell		Cell 1	Cell on RF channel number 1.
CP length		Normal	
DRX		OFF	For both PCell and PSCell
<i>bwp-InactivityTimer</i>	ms	[200]	
T1	s	[0.2]	
T2	s	[0.2]	
T3	s	[0.2]	

**Table A.7.5.6.1.3.1-3: NR Cell specific test parameters for DL BWP switch in SA**

Parameter	Unit	Cell 1
Frequency Range		FR2
Duplex mode		TDD
TDD configuration		TDDConf.3.1
$BW_{channel}$		100 MHz: $N_{RB,c} = 66$
Active BWP ID		1, 2
Initial DL BWP Configuration		DLBWP.0.2 <sup>Note 2</sup>
Active DL BWP-1 Configuration		DLBWP.1.1 <sup>Note 2</sup>
Active DL BWP-2 Configuration		DLBWP.1.3 <sup>Note 2</sup>
Initial UL BWP Configuration		ULBWP.0.2 <sup>Note 2</sup>
Active UL BWP-1 Configuration		ULBWP.1.1 <sup>Note 2</sup>
Active UL BWP-2 Configuration		ULBWP.1.3 <sup>Note 2</sup>
PDSCH Reference measurement channel		SR.3.1 TDD
RMSI CORESET parameters		CR.3.1 TDD
Dedicated CORESET parameters		CCR.3.1 TDD
OCNG Patterns		OP.1
SSB Configuration		SSB.1 FR2
SMTc Configuration		SMTc.1
TCI State		TCI.State.0
TRS Configuration		TRS.2.1 TDD
Correlation Matrix and Antenna Configuration		1x2 Low
EPRE ratio of PSS to SSS	dB	0
EPRE ratio of PBCH DMRS to SSS		
EPRE ratio of PBCH to PBCH DMRS		
EPRE ratio of PDCCH DMRS to SSS		
EPRE ratio of PDCCH to PDCCH DMRS		
EPRE ratio of PDSCH DMRS to SSS		
EPRE ratio of PDSCH to PDSCH		
EPRE ratio of OCNG DMRS to SSS(Note 1)		
EPRE ratio of OCNG to OCNG DMRS (Note 1)		
Propagation Condition		AWGN
<p>Note 1: OCNG shall be used such that the cell is fully allocated and a constant total transmitted power spectral density is achieved for all OFDM symbols.</p> <p>Note 2: For unpaired spectrum, a DL BWP is linked with an UL BWP. DLBWP.0.2 is linked with ULBWP.0.2; DLBWP.1.1 is linked with ULBWP.1.1; DLBWP.1.3 is linked with ULBWP.1.3 defined in clause 12 of TS 38.213 [3].</p>		

**Table A.7.5.6.1.3.1-4: OTA related test parameters for DL BWP switch in SA**

Parameter	Unit	Cell 2
Angle of arrival configuration		Setup 1 defined in clause A.3.15.1
Assumption for UE beams <sup>Note 6</sup>		Fine
$N_{oc}$ <sup>Note 1</sup>	dBm/15 kHz	-112
$N_{oc}$ <sup>Note 1</sup>	dBm/SCS	-103
SS-RSRP <sup>Note 2</sup>	dBm/120 kHz <sup>Note 3</sup>	-85
$\hat{E}_s/I_{ot}$	dB	18
$\hat{E}_s/N_{oc}$ <sup>Note 5</sup>	dB	18

$I_0^{\text{Note2}}$	dBm/95.04 MHz <sup>Note4</sup>	-56
<p>Note 1: Interference from other cells and noise sources not specified in the test is assumed to be constant over subcarriers and time and shall be modelled as AWGN of appropriate power for <math>N_{oc}</math> to be fulfilled.</p> <p>Note 2: SS-RSRP and <math>I_0</math> levels have been derived from other parameters for information purposes. They are not settable parameters themselves.</p> <p>Note 3: SS-RSRP minimum requirements are specified assuming independent interference and noise at each receiver antenna port.</p> <p>Note 4: Equivalent power received by an antenna with 0 dBi gain at the centre of the quiet zone</p> <p>Note 5: As observed with 0 dBi gain antenna at the centre of the quiet zone.</p> <p>Note 6: Information about types of UE beam is given in B.2.1.3 and does not limit UE implementation or test system implementation.</p>		

#### A.7.5.6.1.3.2 Test Requirements

During T1, the UE shall start to send the ACK/NACK for PCell from the first UL slot that occurs after the beginning of DL slot  $(i+T_{BWPswitchDelay}+kI)$ .

During T3, the UE shall start to send the ACK/NACK for PCell from the first UL slot that occurs after the beginning of DL slot  $(j+T_{BWPswitchDelay}+kI)$ .

Where,  $kI$  is the timing between DL data receiving and acknowledgement as specified in [7].

Depending on UE capability *bwp-SwitchingDelay* [2], UE shall finish BWP switch within the time duration  $T_{BWPswitchDelay}$  defined in Table 8.6.2-1.

All of the above test requirements shall be fulfilled in order for the observed PCell active BWP switch delay to be counted as correct.

The rate of correct events observed during repeated tests shall be at least 90%.

NOTE: During T1, T3 if there are no uplink resources for reporting the ACK/NACK in the first UL slot that occurs after the beginning of DL slot  $(i+T_{BWPswitchDelay}+kI)$ ,  $(j+T_{BWPswitchDelay}+kI)$ , then the UE shall use the next available uplink resource for reporting the corresponding ACK/NACK.

### A.7.5.6.2 RRC-based Active BWP Switch

#### A.7.5.6.2.1 NR FR2 DL active BWP switch of PCell with non-DRX in SA

##### A.7.5.6.2.1.1 Test Purpose and Environment

The purpose of this test is to verify the DL BWP switch delay requirement for RRC-based BWP switch defined in clause 8.6.3. Supported test configurations are shown in Table A.7.5.6.2.1.1-1.

The test scenario comprises of one PCell (Cell 1) as given in Table A.7.5.6.2.1.1-2. Cell-specific parameters of PCell are specified in Table A.7.5.6.2.1.1-3 below.

PDCCHs indicating new transmissions shall be sent continuously on PCell (Cell 1) to ensure that the UE will have ACK/NACK sending.

Before the test starts,

- UE is connected to Cell 1 (PCell) on radio channel 1 (PCC).
- UE has bandwidth part BWP-1 in its RRC-configuration for Cell 1 (PCell).
- UE is indicated in *firstActiveDownlinkBWP-Id* that the active DL BWP is BWP-1 of initial condition in PCell.

All cells have constant signal levels throughout the test.

The test consists of 1 time period, with duration of T1.

During T1,

Time period T1 starts when a *RRCReconfiguration* with updated bandwidth part configuration, sent from the test equipment to the UE, is received at the UE side in PCell’s slot # denoted *i*. The UE shall reconfigure its bandwidth part with the updated bandwidth part BWP-1 of final condition.

The UE shall be able to completely receive PDSCH on PCell from the first DL slot that occurs after the beginning of DL slot  $i + \frac{T_{RRCprocessingDelay} + T_{BWPswitchDelayRRC}}{NR\ Slot\ length}$  as defined in clause 8.6.3 and starts to report valid ACK/NACK for the PCell from the first UL slot that occurs after the beginning of DL slot  $i + \frac{T_{RRCprocessingDelay} + T_{BWPswitchDelayRRC}}{NR\ Slot\ length} + k1$ . The UE shall be continuously scheduled on PCell’s BWP-1 starting from the first DL slot that occurs after the beginning of DL slot  $i + \frac{T_{RRCprocessingDelay} + T_{BWPswitchDelayRRC}}{NR\ Slot\ length}$ .

$T_{RRCprocessingDelay}$  and  $T_{BWPswitchDelayRRC}$  are defined in clause 8.6.3.

The test equipment verifies the DL BWP switch time in PCell by counting the time from the time when the RRC Reconfiguration message including updated BWP configuration is sent till the time when RRC Reconfiguration Complete message is received.

**Table A.7.5.6.2.1.1-1: DL BWP switch supported test configurations**

Config	Description
1	NR 120 kHz SSB SCS, 100 MHz bandwidth, TDD duplex mode

**Table A.7.5.6.2.1.1-2: General test parameters for DL BWP switch in SA**

Parameter	Unit	Value	Comment
NR RF Channel Number		1	One NR radio channel is used for this test
Active PCell		Cell 1	PCell on RF channel number 1.
CP length		Normal	
DRX		OFF	
Cell-individual offset for cells on RF channel number 1	dB	0	Individual offset for cells on PCC.
T1	s	0.2	

**Table A.7.5.6.2.1.1-3: NR Cell specific test parameters for DL BWP switch in SA**

Parameter		Unit	Cell 1
Frequency Range			FR2
Duplex mode			TDD
TDD configuration			TDDConf.3.1
BW <sub>channel</sub>			100 MHz: N <sub>RB,c</sub> = 66
Active BWP ID			1
Initial DL BWP Configuration			DLBWP.0.2
Initial UL BWP Configuration			ULBWP.0.2
Initial Condition	Active DL BWP-1 Configuration		DLBWP.1.3
	Active UL BWP-1 Configuration		ULBWP.1.3
Final Condition	Active DL BWP-1 Configuration		DLBWP.1.1
	Active UL BWP-1 Configuration		ULBWP.1.1
PDSCH Reference measurement channel			SR.3.1 TDD
RMSI CORESET parameters			CR.3.1 TDD
Dedicated CORESET parameters			CCR.3.1 TDD
OCNG Patterns			OP.1
SSB Configuration			SSB.1 FR2
SMTc Configuration			SMTc.1
TCI State			TCI.State.0
TRS Configuration			TRS.2.1 TDD
Antenna Configuration			1x2
Propagation Condition			AWGN

EPRE ratio of PSS to SSS	dB	0
EPRE ratio of PBCH DMRS to SSS		
EPRE ratio of PBCH to PBCH DMRS		
EPRE ratio of PDCCH DMRS to SSS		
EPRE ratio of PDCCH to PDCCH DMRS		
EPRE ratio of PDSCH DMRS to SSS		
EPRE ratio of PDSCH to PDSCH		
EPRE ratio of OCNG DMRS to SSS(Note 1)		
EPRE ratio of OCNG to OCNG DMRS (Note 1)		
<p>Note 1: OCNG shall be used such that the resources in Cell 1 are fully allocated and a constant total transmitted power spectral density is achieved for all OFDM symbols.</p> <p>Note 2: Interference from other cells and noise sources not specified in the test is assumed to be constant over subcarriers and time and shall be modelled as AWGN of appropriate power for <math>N_{oc}</math> to be fulfilled.</p> <p>Note 3: SS-RSRP and <math>I_o</math> levels have been derived from other parameters for information purposes. They are not settable parameters themselves.</p> <p>Note 4: For unpaired spectrum, a DL BWP is linked with an UL BWP. DLBWP.0.2 is linked with ULBWP.0.2; DLBWP.1.1 is linked with ULBWP.1.1; DLBWP.1.3 is linked with ULBWP.1.3 defined in clause 12 of TS 38.213 [3].</p>		

**Table A.7.5.6.2.1.1-4: OTA related test parameters for BWP switching test case**

Parameter		Unit	Cell 1
Angle of arrival configuration			Setup 1 according to table A.3.15
Assumption for UE beams <sup>Note 5</sup>			Fine
$N_{oc}$ <sup>Note1</sup>	NR_TDD_FR2_A	dBm/15kHz	-112
	NR_TDD_FR2_B		
	NR_TDD_FR2_F		
	NR_TDD_FR2_G		
	NR_TDD_FR2_T		
	NR_TDD_FR2_Y		
$N_{oc}$ <sup>Note1</sup>	NR_TDD_FR2_A	dBm/SCS	-103
	NR_TDD_FR2_B		
	NR_TDD_FR2_F		
	NR_TDD_FR2_G		
	NR_TDD_FR2_T		
	NR_TDD_FR2_Y		
SS-RSRP <sup>Note2</sup>	NR_TDD_FR2_A	dBm/SCS <sup>Note3</sup>	-85
	NR_TDD_FR2_B		
	NR_TDD_FR2_F		
	NR_TDD_FR2_G		
	NR_TDD_FR2_T		
	NR_TDD_FR2_Y		
$\hat{E}_s / I_{ot}$		dB	18
$I_o$ <sup>Note2</sup>	NR_TDD_FR2_A	dBm/95.04 MHz <sup>Note4</sup>	-56
	NR_TDD_FR2_B		
	NR_TDD_FR2_F		
	NR_TDD_FR2_G		
	NR_TDD_FR2_T		
	NR_TDD_FR2_Y		



Note 1:	Interference from other cells and noise sources not specified in the test is assumed to be constant over subcarriers and time and shall be modelled as AWGN of appropriate power for $N_{oc}$ to be fulfilled.
Note 2:	SS-RSRP and $I_0$ levels have been derived from other parameters for information purposes. They are not settable parameters themselves.
Note 3:	SS-RSRP minimum requirements are specified assuming independent interference and noise at each receiver antenna port.
Note 4:	Equivalent power received by an antenna with 0 dBi gain at the centre of the quiet zone
Note 5:	Information about types of UE beam is given in B.2.1.3 and does not limit UE implementation or test system implementation.

#### A.7.5.6.2.1.2 Test Requirements

During T1, the UE shall be ready for the reception of uplink grant for PCell from the first DL slot that occurs after the beginning of slot  $i + \frac{T_{\text{RRCprocessingDelay}} + T_{\text{BWPswitchDelayRRC}}}{\text{NR Slot length}}$  and starts to report valid ACK/NACK for the PCell from the first UL slot that occurs after the beginning of DL slot  $i + \frac{T_{\text{RRCprocessingDelay}} + T_{\text{BWPswitchDelayRRC}}}{\text{NR Slot length}} + k1$ .

Where,  $k1$  is the timing between DL data receiving and acknowledgement as specified in [7].

All of the above test requirements shall be fulfilled in order for the observed PCell active BWP switch delay to be counted as correct.

The rate of correct events observed during repeated tests shall be at least 90%.

#### A.7.5.6.3 Simultaneous DCI-based and Timer-based Active BWP Switch on multiple CCs

##### A.7.5.6.3.1 Active BWP switch on multiple SCells with non-DRX in SA

###### A.7.5.6.3.1.1 Test Purpose and Environment

The purpose of this test is to verify fulfillment of DL BWP switch delay requirement defined in clauses 8.6.2A.1 and 8.6.2B.1, and interruption requirement on other active serving cell defined in clause 8.2.2.2.5.

The supported test configurations are shown in Table A.7.5.6.3.1.1-1 below. The test scenario comprises one PCell (Cell 1) and two SCells (Cell 2 and Cell 3) as given in Table A.7.5.6.3.1.1-2. NR cell-specific parameters are provided in Table A.7.5.6.3.1.1-3, and OTA related test parameters in Table A.7.5.6.3.1.1-4 below.

The test consists of three consecutive time periods with durations T1, T2 and T3, respectively.

PDCCHs indicating new transmissions shall be transmitted in PCell, SCell1 and SCell2 throughout time periods T1 and T3 to ensure that UE sends ACK/NACKs for PDSCH reception in PCell, SCell1 and SCell2. During T2, there shall be scheduling on PDSCH in PCell only.

Before the test starts,

UE is connected to Cell 1 (PCell) on radio channel 1 (PCC), Cell 2 (SCell1) on radio channel 2 (SCC1), and Cell 3 (SCell2) on radio channel 3 (SCC2).

UE is configured with a single UE-specific downlink bandwidth part, BWP-0, for Cell 1 (PCell). BWP-0 includes the bandwidth of the initial DL BWP and SSB.

UE is configured with two different UE-specific downlink bandwidth parts, BWP-1 and BWP-2, for Cell 2 (SCell1). BWP-1 and BWP-2 include the bandwidth of the initial DL BWP and SSB.

UE is configured with two different UE-specific downlink bandwidth parts, BWP-3 and BWP-4, for Cell 3 (SCell2). BWP-3 and BWP-4 include the bandwidth of the initial DL BWP and SSB.

UE is indicated in *firstActiveDownlinkBWP-Id* that the active DL BWP is BWP-0 in PCell.

UE is indicated in *firstActiveDownlinkBWP-Id* that the active DL BWP is BWP-1 in SCell1.

UE is indicated in *firstActiveDownlinkBWP-Id* that the active DL BWP is BWP-3 in SCell2.

UE is configured with a *bwp-InactivityTimer* timer value for SCell1 and SCell2, respectively.

All cells have constant signal levels throughout the test.

Time period T1 starts when the UE simultaneously receives DCI format 1\_1 commands for DL BWP switch in SCell1 and SCell2, respectively, in a slot # denoted  $m$ . The UE shall switch its SCell1 bandwidth part from BWP-1 to BWP-2, and its SCell2 bandwidth part from BWP-3 to BWP-4. The UE shall be able to receive PDSCH in SCell1 and SCell2 starting from the first DL slot that occurs after slot  $(m+T_{MultipleBWPswitchDelay})$  as defined in clause 8.6.2A.1, and to transmit ACK/NACKs in SCell1 and SCell2 from the first UL slot that occurs after  $(m+T_{BWPswitchDelay}+kI)$  where  $kI$  is specified in [7]. The UE shall be continuously scheduled in SCell1 BWP-2 and SCell2 BWP-4 no later than in the first DL slot that occurs after slot  $(m+T_{MultipleBWPswitchDelay})$ . The starting time of any interruption on PCell due to DL BWP switching of SCell1 and SCell2 shall occur within the BWP switching delay. The length of any interruption on PCell due to DL BWP switching of SCell1 and SCell2 shall fulfill requirements in clause 8.2.2.2.5.

Time period T2 starts when the test equipment ceases to schedule the UE on PDSCH in SCell1 and SCell2, thereby causing the *bwp-InactivityTimer* timers for SCell1 and SCell2 to be running until expiry.

Time period T3 starts at the beginning of the first DL half-subframe immediately after the earliest of the *bwp-InactivityTimer* timers expires, in a slot # denoted  $n$ . The UE shall switch its SCell1 bandwidth part from BWP-2 to BWP-1, and its SCell2 bandwidth part from BWP-4 to BWP-3. The UE shall be able to receive PDSCH in SCell1 and SCell2 starting from the first DL slot that occurs after slot  $(n+T_{MultipleBWPswitchDelay})$  as defined in clause 8.6.2B.1, and to transmit ACK/NACKs in SCell1 and SCell2 from the first UL slot that occurs after slot  $(n+T_{MultipleBWPswitchDelay}+kI)$ . The UE shall be continuously scheduled in SCell1 BWP-1 and SCell2 BWP-3 no later than in the first DL slot that occurs after slot  $(n+T_{MultipleBWPswitchDelay})$ . The starting time of any interruption on PCell due to DL BWP switching of SCell1 and SCell2 shall occur within the BWP switching delay. The length of any interruption on PCell due to DL BWP switching of SCell1 and SCell2 shall fulfill requirements in clause 8.2.2.2.5.

The test equipment verifies the DL BWP switch time by counting the slots from the time when the BWP switch commands are received or *bwp-InactivityTimer* timers expire until ACK/NACKs are sent in SCell1 and SCell2, respectively.

The test equipment verifies that potential interruptions of PCell due to DL BWP switching on SCell1 and SCell2 are carried out within the correct time span, and are within the correct length, by monitoring ACK/NACKs sent in PCell for PCell.

**Table A.7.5.6.3.1.1-1: DL BWP switch supported test configurations**

Config	Description
1	NR 120 kHz SSB SCS, 100 MHz bandwidth, TDD -TDD duplex mode

**Table A.7.5.6.3.1.1-2: General test parameters for DL BWP switch in SA**

Parameter	Unit	Value	Comment
NR RF Channel Number		1, 2, 3	Three NR radio channels are used for this test
Active PCell		Cell 1	PCell on RF channel number 1.
Active SCell1		Cell 2	SCell1 on RF channel number 2.
Active SCell2		Cell 3	SCell2 on RF channel number 3.
CP length		Normal	
DRX		OFF	
<i>sCellDeactivationTimer</i>	ms	---	Same value applies for SCell1 and SCell2. The value infinity is applied.
<i>bwp-InactivityTimer</i>	ms	200	Same value applies for SCell1 and SCell2.
Cell2 timing offset to Cell1	$\mu$ s	0	Time alignment error as specified in TS 38.104 [13] clause 6.5.3.1.
Cell3 timing offset to Cell1	$\mu$ s	0	
T1	s	0.2	During T1, DCI-based simultaneous BWP switching of SCell1 and SCell2 is carried out.
T2	s	0.2	During T2 <i>bwp-InactivityTimer</i> timers shall run to expiry.

T3	s	0.2	During T3, timer-based simultaneous BWP switching of SCell1 and SCell2 is carried out.
----	---	-----	--

Table A.7.5.6.3.1.1-3: NR Cell specific test parameters for DL BWP switch in SA

Parameter	Unit	Cell 1	Cell 2	Cell 3
Frequency Range		FR2		
NR RF channel		1	2	3
Duplex mode		TDD		
TDD configuration		TDDConf.3.1		
BW <sub>channel</sub>	MHz	100: N <sub>RB,c</sub> = 66		
Active Downlink BWP ID		0	1, 2	3, 4
Downlink initial BWP Configuration		DLBWP.0.2	DLBWP.0.2	DLBWP.0.2
Uplink initial BWP Configuration		ULBWP.0.2	ULBWP.0.2	ULBWP.0.2
Downlink active BWP-0 Configuration		DLBWP.1.1	---	---
Downlink active BWP-1 Configuration		---	DLBWP.1.1	---
Downlink active BWP-2 Configuration		---	DLBWP.1.3	---
Downlink active BWP-3 Configuration		---	---	DLBWP.1.1
Downlink active BWP-4 Configuration		---	---	DLBWP.1.3
Uplink active BWP-0 Configuration		ULBWP.1.1	ULBWP.1.1	ULBWP.1.1
PDSCH Reference measurement channel		SR.3.1 TDD		
TRS configuration		TRS.2.1 TDD		
TCI state		TCI.State.0		
RMSI CORESET parameters		CR.3.1 TDD		
Dedicated CORESET parameters		CCR.3.1 TDD		
OCNG Patterns		OP.1		
SSB Configuration		SSB.3 FR2		
SMTc Configuration		SMTc.1		
EPRE ratio of PSS to SSS	dB	0	0	0
EPRE ratio of PBCH DMRS to SSS				
EPRE ratio of PBCH to PBCH DMRS				
EPRE ratio of PDCCH DMRS to SSS				
EPRE ratio of PDCCH to PDCCH DMRS				
EPRE ratio of PDSCH DMRS to SSS				
EPRE ratio of PDSCH to PDSCH				
EPRE ratio of OCNG DMRS to SSS <small>Note1</small>				
EPRE ratio of OCNG to OCNG DMRS <small>Note1</small>				
Propagation Condition		AWGN	AWGN	AWGN
Correlation Matrix and Antenna Configuration		1x2 Low	1x2 Low	1x2 Low
Note 1: OCNG shall be used such that all cells are fully allocated and a constant total transmitted power spectral density is achieved for all OFDM symbols.				

Table A.7.5.6.3.1.1-4: OTA related test parameters for BWP switching test case

Parameter	Unit	Cell 1	Cell 2	Cell 3
Angle of arrival configuration		Setup 1 defined in clause A.3.15.1		
Assumption for UE beams <sup>Note4</sup>		Fine	Fine	Fine
$N_{oc}$ <sup>Note1</sup>	dBm/15kHz	-111.7	-111.7	-111.7
$N_{oc}$ <sup>Note1</sup>	dBm/SCS	[102.7	-102.7	-102.7
$\hat{E}_s/N_{oc}$	dB	7	7	7
SSB-RP <sup>Note2</sup>	dBm/SCS	-95.7	-95.7	-95.7
$\hat{E}_s/I_{ot}$	dB	7	7	7
$I_o$ <sup>Note3</sup>	dBm/95.04 MHz	-65.9	-65.9	-65.9
Note 1:	Interference from other cells and noise sources not specified in the test is assumed to be constant over subcarriers and time and shall be modelled as AWGN of appropriate power for $N_{oc}$ to be fulfilled.			
Note 2:	SSB-RP and $I_o$ levels have been derived from other parameters for information purposes. They are not settable parameters themselves.			
Note 3:	Equivalent power received by an antenna with 0 dBi gain at the centre of the quiet zone			
Note 4:	Information about types of UE beam is given in B.2.1.3 and does not limit UE implementation or test system implementation.			

#### A.7.5.6.3.1.2 Test Requirements

During T1, the UE shall start to send ACK/NACKs in SCell1 and SCell2 from the first UL slot that occurs after the beginning of DL slot ( $m+T_{MultipleBWPswitchDelay}+kI$ ).

During T3, the UE shall start to send ACK/NACKs in SCell1 and SCell2 from the first UL slot that occurs after the beginning of DL slot ( $n+T_{MultipleBWPswitchDelay}+kI$ ).

During T1 and T3, the start of any interruption on PCell due to active BWP switching on SCell1 and SCell2 shall not happen outside the BWP switching delay  $T_{MultipleBWPswitchDelay}$ , and the length of any interruption shall not exceed the length specified in clause 8.2.2.2.5.

All of the above test requirements shall be fulfilled in order for the observed active BWP switch delays in SCell1 and SCell2 to be considered correct.

The rate of correct events observed during repeated tests shall be at least 90%.

#### A.7.5.6.4 SCell dormancy switch

##### A.7.5.6.4.1 NR FR2 PCell SCell dormancy switch of single FR2 SCell inside active time

###### A.7.5.6.4.1.1 Test Purpose and Environment

The purpose of this test is to verify that the Dormant SCell BWP switch delay requirements are within the requirements stated in section 8.6 for UE configured with a single downlink SCell, when the dormancy indication is received in any of the first 3 OFDM symbols or is received after the first 3 OFDM symbols.

The Supported test configurations are given in Table A.7.5.6.4.1.1-1. The test parameters are given in Tables A.7.5.6.4.1.1-2 and cell-specific parameters in A.7.5.6.4.1.1-3 below. In the measurement control information, a measurement object is configured for the frequency of the PCell, and it is indicated to the UE that event-triggered reporting with Event A6 is used. The test consists of four successive time periods, with duration of T1, T2, T3 and T4, respectively. There are two carriers both in FR2, with one cell on the PCC and 2 cells on SCC. Cell 1, Cell 2 and Cell 3 operate in either FDD or TDD duplex mode according to test configuration. All cells have constant signal levels throughout the test. Before the test starts the UE is connected to Cell 1 (PCell) on radio channel 1 (PCC) with

configured and activated SCell (SCell1) on radio channel 2 (SCC1). The UE is not aware of Cell 3 on radio channel 2 (SCC1). The UE is reporting CSI and shall not report CQI index 0 (out-of-range) in the available uplink resources to report CQI for the SCell. The UE shall be continuously scheduled in the PCell throughout the whole test.

The UE receives a DCI-based BWP switch command by which the SCell1 (Cell 2) is requested to switch the active BWP to the dormant BWP.

The point in time at which the DCI message is received at the UE antenna connector, in a subframe # denoted  $n$ , defines the start of time period T1. The UE shall accomplish the BWP switch to the dormant BWP latest in subframe  $(n + T_{\text{BWPswitchDelay}} + X)$ . The UE shall continue to report valid CQI if the UE has available uplink resources to report CQI for the dormant SCell. The UE shall continue to report L1-RSRP if the UE has available uplink resources to report L1-RSRP for the Dormant SCell. Any PCell interruption due to BWP switch on the SCell shall occur in the subframes  $n$  to  $(n + T_{\text{BWPswitchDelay}} + X)$ .

Time T2 start at  $T1 + (T_{\text{BWPswitchDelay}} + X)$ . During T2 the UE shall continue to measure and report CQI and L1-RSRP in the available uplink resources to report CQI and L1-RSRP for the SCell.

Time T3 starts at  $T2 + 500\text{ms}$ . During T3 the UE shall continue to measure and report CQI and L1-RSRP in the available uplink resources to report CQI and L1-RSRP for the SCell.

Starting at  $T4 = T3 + 500\text{ms}$ , Cell 3 becomes detectable. During T3 the UE shall continue to measure and report CQI and L1-RSRP in the available uplink resources to report CQI and L1-RSRP for the SCell. The UE shall send one Event A6 triggered measurement report, with a measurement reporting delay less than 1000 ms from the beginning of time period T4. The UE is not required to read the neighbour cell SSB index in this test.

At time T5 starting at  $T4 + 1500\text{ms}$  a DCI-based BWP switch command by which the SCell1 (Cell 2) is requested to switch the active BWP to the non-dormant BWP.

The point in time at which the DCI message is received at the UE antenna connector, in a subframe # denoted  $n$ , defines the start of time period T6. The UE shall accomplish the BWP switch to the non-dormant BWP latest in subframe  $(n + T_{\text{BWPswitchDelay}} + X)$ . The UE shall continue to report valid CQI if the UE has available uplink resources to report CQI for the non-dormant SCell. The UE shall continue to report L1-RSRP if the UE has available uplink resources to report L1-RSRP for the non-dormant SCell. Any PCell interruption due to BWP switch on the SCell shall occur in the subframes  $n$  to  $(n + T_{\text{BWPswitchDelay}} + X)$ .

During T2, T3 and T4 the total rate of ACK/NACK feedback loss on any non-dormant serving cell resulting from CQI measurements and RRM measurements, clause 8.2.2.2.12.3, on dormant SCells, shall not exceed [0.5]%.

During T2, T3 and T4 the total rate of ACK/NACK feedback loss on any non-dormant serving cell resulting from L1-RSRP measurements and RRM measurements, clause 8.2.2.2.12.x, on dormant SCells, shall not exceed [0.5]%.

During T2, T3 and T4 the total rate of ACK/NACK feedback loss on any non-dormant serving cell resulting from RRM measurements and RRM measurements, clause 8.2.2.2.12.3, on dormant SCells, shall not exceed [0.5]%.

During T1, T2, T3, T4, T5 and T6, the UE shall be continuously scheduled in the SCell1.

**Table A.7.5.6.4.1.1-1: Supported test configurations**

Configuration	Description
1	120 kHz SSB SCS, 100 MHz bandwidth, TDD duplex mode

**Table A.7.5.6.4.1.1-2: General test parameters for dormancy SCell in NR SA with PCell and SCell in FR2**

Parameter	Unit	Test configuration	Value				Comment
			Test 1	Test 2	Test 3	Test 4	
PCell		1	Cell 1				
SCell		1	Cell 2				
Neighbour cell		1	Cell 3				Cell to be identified.
RF Channel Number		1	1				cell 1
RF Channel Number		1	2				Cell 2 and Cell 3

Measurement gap type		1		No measurement gaps configured
SSB configuration		1	SSB.1 FR2	for all cells
SMTC configuration		1	SMTC.1	all cells
CSI-RS parameters		1	CSI-RS.3.2 FDD	
CSI reporting periodicity, Non-dormant BWP	ms		2	
CSI reporting periodicity, Dormant BWP	ms		40	
Timing offset between the cells	ms		0	
Triggering DCI format			1_1   0_1   1_1   0_1	Triggering DCI format
OFDM symbol range in slot for transmission of DCI with dormancy indication			0 – 2   3 – 11	Test1 and Test3 are based on that triggering DCI is received within the first three OFDM symbols of a slot. Test2 and Test4 are based on that the triggering DCI is received after the first three OFDM symbols of a slot
A3-Offset	dB	1	-4.5	
CP length		1	Normal	
Hysteresis	dB	1	0	
Time To Trigger	s	1	0	
Filter coefficient		1	0	L3 filtering is not used
DRX		1	OFF	
T1	s	1	5	
T2	s	1	5	

**Table A.7.5.6.4.1.1-3: NR Cell specific test parameters for dormancy SCell in NR SA with PCell and SCell in FR2**

Parameter	Unit	Test configuration	Cell 1, Cell 2		Cell 3	
			T1	T2	T1	T2
TDD configuration		1	TDDConf.3.1		TDDConf.3.1	
PDSCH RMC configuration		1	SR.3.1 TDD		SR.3.1 TDD	
RMSI CORESET RMC configuration		1	CR.3.1 TDD		CR.3.1 TDD	
Dedicated CORESET RMC configuration, Test 1,2		1	CCR.3.1 TDD		CCR.3.1 TDD	
Dedicated CORESET RMC configuration, Test 3,4			CCR.3.2 TDD		CCR.3.1 TDD	
OCNG Patterns		1	OP.1		OP.1	
TRS configuration		1	TRS.2.1 TDD		N/A	
Downlink initial BWP configuration		1	DLBWP.0.1		N/A	
Uplink initial BWP configuration		1	ULBW P.0.1	N/A	N/A	
Downlink active non-dormant BWP configuration		1	N/A	DLBW P.1.2	N/A	
Downlink active dormant BWP configuration		1	DLBWP.1.2		N/A	
Active UL BWP configuration		1	ULBW P.1.1	N/A	N/A	
RLM-RS		1	CSI-RS		N/A	
EPRE ratio of PSS to SSS	dB		0			

EPRE ratio of PBCH DMRS to SSS						
EPRE ratio of PBCH to PBCH DMRS						
EPRE ratio of PDCCH DMRS to SSS						
EPRE ratio of PDCCH to PDCCH DMRS						
EPRE ratio of PDSCH DMRS to SSS						
EPRE ratio of PDSCH to PDSCH						
EPRE ratio of OCNG DMRS to SSS <sup>Note 4</sup>						
EPRE ratio of OCNG to OCNG DMRS <sup>Note 4</sup>						
$N_{oc}$ <sup>Note 2</sup>	dBm/SCS	1	-98			
$N_{oc}$ <sup>Note 2</sup>	dBm/15 kHz	1	-98			
$\hat{E}_s/I_{ot}$	dB	1	4	-1.46	-Infinity	-1.46
$\hat{E}_s/N_{oc}$	dB	1	4	4	-Infinity	4
SS-RSRP <sup>Note 3</sup>	dBm/SCS kHz	1	-94	-94	-Infinity	-94
$I_o$	dBm/9.36 MHz	1	-64.60	-62.25	-64.60	-62.25
Propagation Condition		1	AWGN			
<p>Note 1: The resources for uplink transmission are assigned to the UE prior to the start of time period T2.</p> <p>Note 2: Interference from other cells and noise sources not specified in the test is assumed to be constant over subcarriers and time and shall be modelled as AWGN of appropriate power for <math>N_{oc}</math> to be fulfilled.</p> <p>Note 3: SS-RSRP levels have been derived from other parameters for information purposes. They are not settable parameters themselves.</p> <p>Note 4: OCNG shall be used such that the cells are fully allocated and a constant total transmitted power spectral density is achieved for all OFDM symbols</p>						

A.7.5.6.4.1.2 Test Requirements

During T1 the UE shall switch to the dormant BWP.

During T2, T3, T4 and T5 the UE shall not send ACK/NACK for the PDSCH data scheduled on the SCell.

During T2, T3, T4 and T5 the UE shall continue to send CSI reports for SCell1 with non-zero CQI index.

During T2, T3, T4 and T5 the UE shall continue to send L1-RSRP reports for SCell.

During T4 the UE shall send one Event A6 triggered measurement report, with a measurement reporting delay less than 1000 ms from the beginning of time period T4.

During T2, T3, T4 and T5, the missing ACK/NACK sent in PCell shall be less than 1.5% of the total number of the expected ACK/NACK.

During T6, the UE shall send ACK/NACK for the PDSCH data scheduled after subframe  $(n + T_{BWPswitchDelay} + X)$  for the SCell1.

All of the above test requirements shall be fulfilled in order for the observed SCell1 BWP switch delays, Pcell interruption rate, correct CSI and L1-RSRP reporting and event triggeres reporting. The rate of correct observed SCell1 hibernation delay, activation delay and SCell1 deactivation delay during repeated tests shall be at least 90%.

#### A.7.5.6.4.2 NR FR1 PCell SCell dormancy switch of two FR2 SCells outside active time

##### A.7.5.6.4.2.1 Test Purpose and Environment

The purpose of this test is to verify fulfillment of SCell dormancy switching delay requirements in clause 8.6.2A when the UE is triggered to switch between non-dormancy and dormancy outside DRX active time. In the tested scenario, the UE is connected to PCell in FR1 and two SCells in FR2, and the SCells are switched from non-dormancy to dormancy, and vice versa, at a point in time before start of *onDuration*. The UE is configured to monitor PDCCH for DCI format 2\_6 at *ps-Offset* before the start of *onDuration*. Two tests are specified, where a UE that only supports triggering within the first three OFDM symbols of a slot shall undergo Test1 only, and a UE that supports triggering also in remaining OFDM symbols of a slot shall undergo both Test1 and Test2. In the tested scenario, *ps-Offset* is selected to correspond to the dormancy switching time specified in clause 8.6.2A.

The supported test configurations are provided in Table A.7.5.6.4.2.1-1 below. General test parameters are provided in Table A.7.5.6.4.2.1-2, and cell-specific parameters are provided in Table A.7.5.6.4.2.1-3 below. OTA-related test parameters are provided in Table A.7.5.6.4.2.1-4.

The tests consist of four consecutive time periods, T1, T2, T3 and T4, respectively.

Three carriers are used in the test. Cell 1 (PCell) is on RF channel 1 (PCC) in FR1, and Cell 2 (SCell1) and Cell 3 (SCell2) are on RF channels 2 (SCC1) and 3 (SCC2) in FR2, respectively. All three cells have constant signal levels throughout the test.

Before the test starts,

UE is connected to Cell 1 (PCell), Cell 2 (SCell1) and Cell 3 (SCell2).

UE is configured with a single UE-specific downlink bandwidth part, BWP-0, for Cell 1. BWP-0 includes the bandwidth of the initial DL BWP and SSB.

UE is configured with one non-dormant and one dormant UE-specific downlink bandwidth part, BWP-0 and BWP-1, respectively, for Cell 2 and Cell 3. BWP-0 includes the bandwidth of the initial DL BWP and SSB.

UE is indicated in *firstActiveDownlinkBWP-Id* that the active DL BWP in Cell 1 is BWP-0.

UE is indicated in *firstActiveDownlinkBWP-Id* that the active DL BWP in Cell 2 is BWP-0.

UE is indicated in *firstActiveDownlinkBWP-Id* that the active DL BWP in Cell 3 is BWP-0.

UE is configured with DRX.

UE is configured to monitor DCI format 2\_6, and to be active during *onDuration* even when no DCI format 2\_6 is detected (*ps-WakeUp*).

Time period T1 starts when the UE at *ps-Offset* before *onDuration* detects a DCI format 2\_6 carrying dormancy indication that indicates that SCell1 and SCell2 are to be switched from non-dormancy to dormancy. The UE shall switch active bandwidth parts for SCell1 and SCell2, respectively, from non-dormant BWP-0 to dormant BWP-1. The UE shall complete the switching before the start of *onDuration*. The test equipment schedules the UE continuously with new data indications in PCell starting from beginning of *onDuration*. The test equipment verifies that the UE is transmitting HARQ feedback for PCell from the beginning of *onDuration* and thus verifies that the UE has completed interruptions due to dormancy switching before the start of *onDuration*.

Time period T2 starts when T1 is completed. The test equipment continues to schedule the UE continuously in PCell. The UE shall carry out CSI and RRM measurements on the dormant SCells. The UE shall report ACK/NACK in PCell in response to scheduled PDSCH, with the maximum loss of transmitted ACK/NACKs fulfilling the requirement in clause 8.2.2.2.12. The test equipment verifies that the loss of ACK/NACKs is no larger than 1.5%.

Time period T3 starts when T2 is completed. During T3, the test equipment does not schedule the UE, by which the inactivity timer expires and the UE stops monitoring PDCCH except for signalling using DCI format 2\_6 at wake-up signalling occasions.



Time period T4 starts when the UE at *ps-Offset* before *onDuration* detects a DCI format 2\_6 carrying dormancy indication that indicates that SCell1 and SCell2 are to be switched from dormancy to non-dormancy. The UE shall switch active bandwidth parts for SCell1 and SCell2, respectively, from dormant BWP-1 to non-dormant BWP-0. The UE shall complete the switching before the start of *onDuration*. The test equipment schedules the UE with new data indication in PCell, SCell1 and SCell2 during *onDuration*. The UE shall receive in PCell, SCell1 and SCell2 and send HARQ feedback for PCell, SCell1 and SCell2 via PCell. The test equipment verifies that the UE is transmitting HARQ feedback for PCell, SCell1 and SCell2 from the beginning of *onDuration*, and thus verifies that the UE has completed interruptions due to dormancy switching before the start of *onDuration*.

**Table A.7.5.6.4.2.1-1: Supported test configurations**

Config	Description
1	PCell: 15kHz SSB SCS, 10MHz bandwidth, FDD duplex mode SCells: NR 120 kHz SSB SCS, 100 MHz bandwidth, TDD duplex mode
2	PCell: 15kHz SSB SCS, 10MHz bandwidth, TDD duplex mode SCells: NR 120 kHz SSB SCS, 100 MHz bandwidth, TDD duplex mode
3	PCell: 30kHz SSB SCS, 40MHz bandwidth, TDD duplex mode SCells: NR 120 kHz SSB SCS, 100 MHz bandwidth, TDD duplex mode

Note: The UE is only required to undergo test for one of the supported test configurations.

**Table A.7.5.6.4.2.1-2: General test parameters**

Parameter	Unit	Value		Comment
		Test1	Test2	
NR RF Channel Number		1, 2, 3		Three NR radio channels are used for this test
Active PCell		Cell 1		PCell on RF channel number 1 in FR1
Active SCell1		Cell 2		SCell1 on RF channel number 2 in FR2
Active SCell2		Cell 3		SCell2 on RF channel number 3 in FR2
CSI reporting periodicity, Non-dormant BWP	ms	2		CSI reporting periodicity for periodic reporting of CQI for PCell and non-dormant SCells
CSI reporting periodicity, Dormant BWP	ms	40		CSI reporting periodicity for periodic reporting of CQI for dormant SCells
CP length		Normal		
DRX		DRX.8		For both PCell and SCells. See clause A.3.3.8.
ps-Offset		Depending on UE capability		Monitoring of DCI 2_6 ahead of start of <i>drx-onDurationTimer</i> . Value of <i>ps-Offset</i> shall correspond to SCell dormancy switching time for switching of two SCells, as specified in clause 8.6.2A. Actual value depends on reported UE capabilities.
ps-WakeUp		true		Wake up for <i>onDuration</i> in case DCI format 2_6 is not detected.
Cell 2 timing offset to Cell 1	μs	<24		Timing offset shall be less than MRTD for FR1-FR2 CA, and leave margin for timing difference between Cell2 and Cell3.
Cell 3 timing offset to Cell 2	ns	<260		Timing offset shall be less than MRTD for FR2 intra-band non-contiguous CA.
OFDM symbol range in slot for transmission of DCI with dormancy indication		0 – 2	3 – 11	Test1 is based on that triggering DCI is received within the first three OFDM symbols of a slot. Test2 is based on that the triggering DCI is received later than within the first three OFDM symbols of a slot.
T1	s	0.2		During this time the SCells are switched from non-dormancy to dormancy.
T2	s	10		During this time the SCells are dormant.
T3	s	0.2		During this time the UE is not scheduled in PCell.
T4	s	0.2		During this time the SCells are switched from dormancy to non-dormancy.

Table A.7.5.6.4.2.1-3: Cell specific test parameters

Parameter		Unit	Cell 1	Cell2	Cell 3
Frequency Range			FR1	FR2	FR2
NR RF channel			1	2	3
Duplex mode	Config 1		FDD	TDD	TDD
	Config 2,3		TDD		
TDD configuration	Config 1		---	TDDConf.3.1	TDDConf.3.1
	Config 2		TDDConf.1.1		
	Config 3		TDDConf.2.1		
BW <sub>channel</sub>	Config 1,2	MHz	10: N <sub>RB,c</sub> = 52	100: N <sub>RB,c</sub> = 66	100: N <sub>RB,c</sub> = 66
	Config 3		40: N <sub>RB,c</sub> = 106		
Downlink initial BWP Configuration			DLBWP.0.2	DLBWP.0.2	DLBWP.0.2
Uplink initial BWP Configuration			ULBWP.0.2	---	---
Downlink active non-dormant BWP-0 Configuration			DLBWP.1.1	DLBWP.1.1	DLBWP.1.1
Downlink active dormant BWP-1 Configuration			---	DLBWP.1.1	DLBWP.1.1
Uplink active BWP-0 Configuration			ULBWP.0.2	---	---
PDSCH Reference measurement channel	Config 1		SR.1.1 FDD	SR.3.1 TDD	SR.3.1 TDD
	Config 2		SR.1.1 TDD		
	Config 3		SR.2.1 TDD		
CSI-RS configuration for CSI reporting, Non-dormant BWP	Config 1		CSI-RS.1.1 FDD	CSI-RS.3.1 TDD	CSI-RS.3.1 TDD
	Config 2		CSI-RS.1.1 TDD		
	Config 3		CSI-RS.2.1 TDD		
CSI-RS configuration for CSI reporting, Dormant BWP			---	CSI-RS.3.5 TDD	CSI-RS.3.5 TDD
TRS configuration	Config 1		TRS.1.1 FDD	TRS.2.1 TDD	TRS.2.1 TDD
	Config 2		TRS.1.1 TDD		
	Config 3		TRS.1.2 TDD		
TCI state			TCI.State.0	TCI.State.0	TCI.State.0
RMSI CORESET parameters	Config 1		CR.1.1 FDD	---	---
	Config 2		CR.1.1 TDD		
	Config 3		CR.2.1 TDD		
Dedicated CORESET parameters, Test 1,2	Config 1		CCR.1.1 FDD	CCR.3.1 TDD	CCR.3.1 TDD
	Config 2		CCR.1.1 TDD		
	Config 3		CCR.2.1 TDD		
Dedicated CORESET parameters, Test 3,4	Config 1		CCR.1.5 FDD	CCR.3.1 TDD	CCR.3.1 TDD
	Config 2		CCR.1.5 TDD		
	Config 3		CCR.2.3 TDD		
OCNG Patterns			OP.1	OP.1	OP.1
SSB Configuration	Config 1,2		SSB.1 FR1	SSB.1 FR2	SSB.1 FR2
	Config 3		SSB.2 FR1		
SMTc Configuration			SMTc.1	SMTc.1	SMTc.1
Correlation Matrix and Antenna Configuration			1x2 Low		
EPRE ratio of PSS to SSS		dB	0	0	0
EPRE ratio of PBCH DMRS to SSS					
EPRE ratio of PBCH to PBCH DMRS					
EPRE ratio of PDCCH DMRS to SSS					
EPRE ratio of PDCCH to PDCCH DMRS					
EPRE ratio of PDSCH DMRS to SSS					
EPRE ratio of PDSCH to PDSCH					
EPRE ratio of OCNG DMRS to SSS <sup>Note1</sup>					
EPRE ratio of OCNG to OCNG DMRS <sup>Note1</sup>					
Propagation Condition			N/A Link only, see clause A.3.7A	AWGN	AWGN
Note 1: OCNG shall be used such that the cells are fully allocated and a constant total transmitted power spectral density is achieved for all OFDM symbols.					

Table A.7.5.6.4.2.1: OTA related test parameters

Parameter	Unit	Cell 1	Cell 2	Cell 3
Angle of arrival configuration		N/A Link only, see clause A.3.7A	Setup 1 defined in clause A.3.15.1	
Assumption for UE beams Note6			Fine	Fine
$N_{oc}$ Note1	dBm/15kHz		-112	-112
$N_{oc}$ Note1	dBm/SCS		-103	-103
SS-RSRP <sup>Note2</sup>	dBm/SCS <sup>Note3</sup>		-85	-85
$\hat{E}_s/I_{ot}$	dB		18	18
$I_o$ <sup>Note4</sup>	dBm/95.04 MHz <sup>Note4</sup>		-56	-56
Note 1:	Interference from other cells and noise sources not specified in the test is assumed to be constant over subcarriers and time and shall be modelled as AWGN of appropriate power for $N_{oc}$ to be fulfilled.			
Note 2:	SS-RSRP and $I_o$ levels have been derived from other parameters for information purposes. They are not settable parameters themselves.			
Note 3:	SS-RSRP minimum requirements are specified assuming independent interference and noise at each receiver antenna port.			
Note 4:	Equivalent power received by an antenna with 0 dBi gain at the centre of the quiet zone			
Note 6:	Information about types of UE beam is given in B.2.1.3 and does not limit UE implementation or test system implementation.			

#### A.7.5.6.4.2.2 Test Requirements

Starting from *onDuration* in time period T1, the UE shall transmit ACK/NACK in response to scheduling in PCell. There shall be no loss of ACK/NACK.

During time period T2, the UE shall transmit ACK/NACKs in response to scheduling in PCell and the rate of missed ACK/NACKs shall be no more than 1.5%.

Starting from *onDuration* in time period T4, the UE shall transmit ACK/NACK in response to scheduling in PCell, SCell1 and SCell2. There shall be no loss of ACK/NACK.

The rate of correct events observed during repeated tests shall be at least 90%.

### A.7.5.6.5 Simultaneous RRC-based Active BWP Switch on multiple CCs

#### A.7.5.6.5.1 Active BWP switch on multiple SCells with non-DRX in SA

##### A.7.5.6.5.1.1 Test Purpose and Environment

The purpose of this test is to verify the DL BWP switch delay requirement for simultaneous RRC-based BWP switch on multiple CCs defined in clause 8.6.3A.

The supported test configurations are shown in Table A.7.5.6.5.1.1-1. The test scenario comprises one PCell (Cell 1) and one SCell (Cell 2) as given in Table A.7.5.6.5.1.1-2. NR cell-specific parameters are provided in Table A.7.5.6.5.1.1-3, and OTA related test parameters in Table A.7.5.6.5.1.1-4.

PDCCHs indicating new transmissions shall be transmitted in PCell and SCell throughout to ensure that UE sends ACK/NACKs for PDSCH reception in PCell, SCell.

Before the test starts,

- UE is connected to Cell 1 (PCell) on radio channel 1 (PCC), to Cell 2 (SCell) on radio channel 2 (SCC).
- UE has bandwidth part BWP-1 in its RRC-configuration for Cell1 (PCell), Cell 2 (SCell).
- UE is indicated in *firstActiveDownlinkBWP-Id* that the active DL BWP is BWP-1 of initial condition on Cell1 (PCell), Cell 2 (SCell).

All cells have constant signal levels throughout the test.

The test consists of 1 time period, with duration of T1.

During T1,

Time period T1 starts when a *RRCReconfiguration* with updated bandwidth part configuration in Cell1 and Cell2, sent from the test equipment to the UE, is received at the UE side in PCell's slot # denoted *i*. The UE shall reconfigure its bandwidth part with the updated bandwidth part BWP-1 of final condition in Cell1 and Cell2.

The UE shall be able to receive PDSCH on Cell 1 and Cell 2 at the beginning of the DL slot right after PCell's DL slot ( $i + \frac{T_{RRCprocessingDelay} + T_{BWPswitchDelayRRC} + D_{RRC}}{NR\ slot\ length}$ ) as defined in clause 8.6.3A and be ready for the reception of uplink grant for the PCell no later than at the beginning of the DL slot right after slot ( $i + \frac{T_{RRCprocessingDelay} + T_{BWPswitchDelayRRC} + D_{RRC}}{NR\ slot\ length}$ ). The UE shall be continuously scheduled on Cell 1's BWP-1 and Cell 2's BWP-1 starting from the beginning of the DL slot right after slot ( $i + \frac{T_{RRCprocessingDelay} + T_{BWPswitchDelayRRC} + D_{RRC}}{NR\ slot\ length}$ ).

$T_{RRCprocessingDelay}$ ,  $T_{BWPswitchDelayRRC}$  and  $D_{RRC}$  are defined in clause 8.6.3A.

The test equipment verifies the DL BWP switch time in Cell 1 and Cell 2 by counting the time from the time when the RRC Reconfiguration message including updated BWP configuration is sent till the time when RRC Reconfiguration Complete message is received.

**Table A.7.5.6.5.1.1-1: DL BWP switch supported test configurations**

Config	Description
1	NR 120 kHz SSB SCS, 100 MHz bandwidth, TDD -TDD duplex mode

**Table A.7.5.6.5.1.1-2: General test parameters for DL BWP switch in SA**

Parameter	Unit	Value	Comment
NR RF Channel Number		1, 2, 3	Three NR radio channels are used for this test
Active PCell		Cell 1	PCell on RF channel number 1.
Active SCell		Cell 2	SCell on RF channel number 2.
CP length		Normal	
DRX		OFF	
Cell2 timing offset to Cell1	µs	0	Time alignment error as specified in TS 38.104 [13] clause 6.5.3.1.
T1	s	0.2	During T1, RRC-based simultaneous BWP switching of PCell and SCell is carried out.

**Table A.7.5.6.5.1.1-3: NR Cell specific test parameters for DL BWP switch in SA**

Parameter	Unit	Cell 1	Cell 2
Frequency Range			FR2
NR RF channel		1	2
Duplex mode			TDD
TDD configuration			TDDConf.3.1
BW <sub>channel</sub>	MHz		100: N <sub>RB,c</sub> = 66
Active Downlink BWP ID		0	1
Downlink initial BWP Configuration		DLBWP.0.2	DLBWP.0.2
Uplink initial BWP Configuration		ULBWP.0.2	ULBWP.0.2
Initial Condition	Active DL BWP-1 Configuration	DLBWP.1.3	DLBWP.1.3
	Active UL BWP-1 Configuration	ULBWP.1.3	ULBWP.1.3
Final Condition	Active DL BWP-1 Configuration	DLBWP.1.1	DLBWP.1.1
	Active UL BWP-1 Configuration	ULBWP.1.1	ULBWP.1.1

PDSCH Reference measurement channel			SR.3.1 TDD
TRS configuration			TRS.2.1 TDD
TCI state			TCI.State.0
RMSI CORESET parameters			CR.3.1 TDD
Dedicated CORESET parameters			CCR.3.1 TDD
OCNG Patterns			OP.1
SSB Configuration			SSB.3 FR2
SMTC Configuration			SMTC.1
EPRE ratio of PSS to SSS	dB	0	0
EPRE ratio of PBCH DMRS to SSS			
EPRE ratio of PBCH to PBCH DMRS			
EPRE ratio of PDCCH DMRS to SSS			
EPRE ratio of PDCCH to PDCCH DMRS			
EPRE ratio of PDSCH DMRS to SSS			
EPRE ratio of PDSCH to PDSCH			
EPRE ratio of OCNG DMRS to SSS <small>Note1</small>			
EPRE ratio of OCNG to OCNG DMRS <small>Note1</small>			
Propagation Condition		AWGN	AWGN
Correlation Matrix and Antenna Configuration		1x2 Low	1x2 Low
<p>Note 1: OCNG shall be used such that all cells are fully allocated and a constant total transmitted power spectral density is achieved for all OFDM symbols.</p> <p>Note 2: Interference from other cells and noise sources not specified in the test is assumed to be constant over subcarriers and time and shall be modelled as AWGN of appropriate power for <math>N_{oc}</math> to be fulfilled.</p> <p>Note 3: SS-RSRP and <math>I_o</math> levels have been derived from other parameters for information purposes. They are not settable parameters themselves.</p> <p>Note 4: For unpaired spectrum, a DL BWP is linked with an UL BWP. DLBWP.0.2 is linked with ULBWP.0.2; DLBWP.1.1 is linked with ULBWP.1.1; DLBWP.1.3 is linked with ULBWP.1.3 defined in clause 12 of TS 38.213 [3].</p>			

**Table A.7.5.6.3.1.1-4: OTA related test parameters for BWP switching test case**

Parameter	Unit	Cell 1	Cell 2
Angle of arrival configuration		Setup 1 defined in clause A.3.15.1	
Assumption for UE beams <small>Note4</small>		Fine	Fine
$N_{oc}$ <small>Note1</small>	dBm/15kHz	-111.7	-111.7
$N_{oc}$ <small>Note1</small>	dBm/SCS	-102.7	-102.7
$\hat{E}_s/N_{oc}$	dB	7	7
SSB-RP <small>Note2</small>	dBm/SCS	-85	-85
$\hat{E}_s/I_o$	dB	18	18
$I_o$ <small>Note3</small>	dBm/95.04 MHz	-56	-56
<p>Note 1: Interference from other cells and noise sources not specified in the test is assumed to be constant over subcarriers and time and shall be modelled as AWGN of appropriate power for <math>N_{oc}</math> to be fulfilled.</p> <p>Note 2: SSB-RP and <math>I_o</math> levels have been derived from other parameters for information purposes. They are not settable parameters themselves.</p> <p>Note 3: Equivalent power received by an antenna with 0 dBi gain at the center of the quiet zone</p>			

Note 4: Information about types of UE beam is given in B.2.1.3 and does not limit UE implementation or test system implementation.

#### A.7.5.6.5.1.2 Test Requirements

During T1, the UE shall be ready for the reception of uplink grant for PCell and SCell in the beginning of the DL slot right after slot  $(i + \frac{T_{RRC\ processing\ Delay} + T_{BWP\ switch\ Delay\ RRC} + D_{RRC}}{NR\ slot\ length})$ .

All of the above test requirements shall be fulfilled in order for the observed PCell and SCell active BWP switch delay to be counted as correct.

The rate of correct events observed during repeated tests shall be at least 90%.

### A.7.5.7 PSCell addition and release delay

#### A.7.5.7.1 Addition and Release Delay of known NR PSCell

##### A.7.5.7.1.1 Test Purpose and Environment

The purpose of this test is to verify the PSCell addition and release delay requirements defined in clauses 8.9.2 and 8.9.3, respectively, for the case where the PSCell is known to the UE at the time of addition.

The supported test configurations are given in Table A.7.5.7.1.1-1. The test scenario comprises two NR cells, Cell 1 and Cell 2, on radio channel 1 in FR1 and radio channel 2 in FR2, respectively. Test parameters are given in Tables A.7.5.7.1.1-2, A.7.5.7.1.1-3 and A.7.5.7.1.1-4 below. The test consists of six time periods with durations T1, T2, T3, T4, T5 and T6, respectively.

At the start of T1, the UE shall be connected to Cell 1 (PCell) on radio channel 1 (PCC) and shall only monitor PCC and hence be unaware of Cell 2 (PSCell-to-be) on radio channel 2. Before the start of T2, the test system shall send measurement control information including measurement gap configuration and event-triggered reporting configuration for measurements on radio channel 2.

During T2, the Cell2 becomes known to the UE. Therefore, during T2 the UE shall report Event triggered report.

The point in time at which the RRC message to release measurement gap is transmitted from the test system defines the start of period T3. During T3, after measurement gap is released, the test system transmits the RRC message to the UE to add PSCell on radio channel 2. The RRC message (to add PSCell) also includes a request for the UE to start periodic CSI reporting for the PSCell after the PSCell has been successfully added.

The point in time at which the RRC message to add PSCell (Cell2) is received at the UE antenna connector defines the start of period T4.

During T4, the UE shall carry out random access towards the PSCell. Reception by the test system of the PRACH preamble defines the start of T5.

During T5, the UE shall send periodic CSI reports in PSCell. After having received at least one such report, the test system shall send a RRC message instructing the UE to release the PSCell. Reception by the UE of the RRC message defines the start of T6.

During T6, the UE shall release the PSCell.

**Table A.7.5.7.1.1-1: Supported test configurations for FR2 PSCell**

Config	Description
1	FR1 FDD SSB SCS 15kHz BW 10MHz – FR2 TDD SSB SCS 240kHz BW 100MHz
2	FR1 TDD SSB SCS 15kHz BW 10MHz – FR2 TDD SSB SCS 240kHz BW 100MHz
3	FR1 TDD SSB SCS 30kHz BW 40MHz – FR2 TDD SSB SCS 240kHz BW 100MHz
Note 1: The UE is only required to be tested in one of the supported test configurations	

Table A.7.5.7.1.1-2: General test parameters for PSCell addition and release delay

Parameter		Unit	Value	Comment
RF Channel Number			1, 2	Two radio channels are used for this test
Active PCell			Cell 1	PCell on RF channel number 1 in FR1
Neighbour cell			Cell 2	Neighbour cell (PSCell-to-be) on RF channel number 2 in FR2
A4	Hysteresis	dB	0	Hysteresis for event A4
	Threshold RSRP	dBm	-118	Threshold for event A4
	Time to Trigger	S	0	Time to trigger for event A4
DRX			OFF	For both PCell and PSCell once activated
Measurement gap pattern ID			0	Gaps are configured before T2 and released before T3.
PRACH configuration in Cell 2			FR2 PRACH configuration 2	PRACH configuration as specified in Clause A.3.8.3.2.
CSI reporting periodicity and offset configuration for Cell 2		ms	2	
T1		s	5	During this time the PCell is known and Cell 2 is unknown.
T2		s	1	During this time the UE shall identify neighbour cell 2 and report event B1.
T3		s	3.5	During this time the test system transmits the RRC messages to release measurement gap and add PSCell.
T4		s	1	During this time the UE adds the PSCell.
T5		s	1	During this time the UE sends CSI reports for PSCell.
T6		s	1	During this time the UE releases the PSCell.

Table A.7.5.7.1.1-3: NR Cell specific test parameters for PSCell addition and release delay

Parameter	Unit	Config	Cell 1	Cell2					
				T1	T2	T3	T4	T5	T6
Frequency Range		1,2,3	FR1	FR2					
Duplex mode		1	FDD	TDD					
TDD configuration		2,3	TDD						
		1	–	TDDConf.3.1					
		2	TDDConf.1.1						
BW <sub>channel</sub>	MHz	3	TDDConf.2.1						
		1,2	10: N <sub>RB,c</sub> = 52	100: N <sub>RB,c</sub> = 66					
Data RBs allocated		3	40: N <sub>RB,c</sub> = 106						
		1,2	52	48					
Initial Downlink BWP configuration		3	106						
Initial Downlink BWP configuration		1,2,3	DLBWP.0.1	DLBWP.0.1					
Initial Uplink BWP configuration		1,2,3	ULBWP.0.1	ULBWP.0.1					
Dedicated Downlink BWP configuration		1,2,3	DLBWP.1.1	DLBWP.1.1					
Dedicated Uplink BWP configuration		1,2,3	ULBWP.1.1	ULBWP.1.1					
PDSCH Reference Measurement Channel		1	SR.1.1 FDD	SR.3.3 TDD					
		2	SR.1.1 TDD						
		3	SR.2.1 TDD						
TRS configuration		1,2,3	–	TRS.2.1 TDD					
TCI state		1,2,3	–	TCI.State.0					
RMSI CORESET parameters		1	CR.1.1 FDD	CR.3.2 TDD					
		2	CR.1.1 TDD						
		3	CR.2.1 TDD						
Dedicated CORESET parameters		1	CCR.1.1 FDD	CCR.3.7 TDD					
		2	CCR.1.1 TDD						
		3	CCR.2.1 TDD						
OCNG Patterns <sup>Note1</sup>		1,2,3	OP.1	OP.3					
SSB configuration		1,2	SSB.1 FR1	SSB.2 FR2					
		3	SSB.2 FR1						
SMTTC configuration		1,2,3	SMTTC.2	SMTTC.1					

PDSCH/PDCCH subcarrier spacing	kHz	1,2 3	15 30	120
EPRE ratio of PSS to SSS	dB	1,2,3	0	0
EPRE ratio of PBCH DMRS to SSS				
EPRE ratio of PBCH to PBCH DMRS				
EPRE ratio of PDCCH DMRS to SSS				
EPRE ratio of PDCCH to PDCCH DMRS				
EPRE ratio of PDSCH DMRS to SSS				
EPRE ratio of PDSCH to PDSCH				
EPRE ratio of OCNG DMRS to SSS				
EPRE ratio of OCNG to OCNG DMRS				
Propagation Condition		1,2,3	N/A	No external noise (Note 6)
Note 1: OCNG shall be used such that a constant total transmitted power spectral density is achieved for all OFDM symbols.				
Note 2: Void				
Note 3: Void				
Note 4: Void				
Note 5: Void				
Note 6: The downlink connection between the System Simulator and the UE is without Additive White Gaussian Noise, and has no fading or multipath effects as specified in TS 38.521-2 B.0 [37].				

Table A.7.5.7.1.1-4: OTA related test parameters for PSCell addition and release delay

Parameter	Unit	Config	Cell 1	Cell 2					
				T1	T2	T3	T4	T5	T6
Angle of arrival configuration		1,2,3	Link only, see clause A.3.7A	Setup 2a according to clause A.3.15.2.1					
Assumption for UE beams <sup>Note 3</sup>				Rough					
$\hat{E}_s$	dBm/SCS	1,2,3		$-\infty$	-81				
SSB_RP <sup>Note 1, Note 2</sup>	dBm/SCS	1,2,3		$-\infty$	-81				
$\hat{E}_s / I_{ot\ BB}$ <sup>Note 1, Note 4</sup>	dB	1,2,3		$-\infty$	4.88				
$I_o$ <sup>Note 1, Note 2</sup>	dBm/95.04 MHz	1,2,3		N/A	-56.41				
Note 1: $E_s/I_{ot}$ , SSB_RP and $I_o$ levels have been derived from other parameters for information purposes. They are not settable parameters themselves.									
Note 2: Equivalent power received by an antenna with 0dBi gain at the centre of the quiet zone.									
Note 3: Information about types of UE beam is given in B.2.1.3 and does not limit UE implementation or test system implementation.									
Note 4: Calculation of $E_s/I_{ot\ BB}$ includes the effect of UE internal noise up to the value assumed for the associated Refsens requirement in clause 7.3.2 of TS 38.101-2 [19], and an allowance of 1dB for UE multi-band relaxation factor $\Delta MB_S$ from TS 38.101-2 [19] Table 6.2.1.3-4.									

### A.7.5.7.1.2 Test Requirements

The UE shall transmit the PRACH preamble to PSCell at latest 112 ms into T4.

The UE shall transmit at least one periodic CSI report for PSCell during T5.

The UE shall stop transmitting CSI reports for PSCell at latest 20 ms into T6.

All of the above test requirements shall be fulfilled in order for the observed PSCell addition and release delay to be counted as correct. The rate of correct events observed during repeated tests shall be at least 90%.

### A.7.5.7.2 Addition and Release Delay of unknown NR PSCell

#### A.7.5.7.2.1 Test Purpose and Environment

The purpose of this test is to verify the PSCell addition and release delay requirements defined in clauses 8.9.2 and 8.9.3, respectively, for the case where the PSCell is unknown to the UE at the time of addition.



The supported test configurations are given in Table A.7.5.7.2.1-1. The test scenario comprises two NR cells, Cell 1 and Cell 2, on radio channel 1 in FR1 and radio channel 2 in FR2, respectively. Test parameters are given in Tables A.7.5.7.2.1-2, A.7.5.7.2.1-3 and A.7.5.7.2.1-4 below. The test consists of four time periods with durations T1, T2, T3 and T4, respectively.

At the start of T1, the UE shall be connected to Cell 1 (PCell) on radio channel 1 (PCC) and shall only monitor PCC and hence be unaware of Cell 2 (PSCell-to-be) on radio channel 2. At the end of T1, the test system shall send a RRC message instructing the UE to add PSCell (Cell 2), and further instructing the UE to report CSI periodically in the PSCell once it has been added. Reception by the UE of this RRC message defines the start of T2.

During T2, the UE shall identify PSCell and carry out random access towards the PSCell. Reception by the test system of the PRACH preamble defines the start of T3.

During T3, the UE shall send periodic CSI reports in PSCell. After having received at least one such report, the test system shall send a RRC message instructing the UE to release the PSCell. Reception by the UE of the RRC message defines the start of T4.

During T4, the UE shall release the PSCell.

**Table A.7.5.7.2.1-1: Supported test configurations for FR2 PSCell**

Config	Description
1	FR1 FDD SSB SCS 15kHz BW 10MHz – FR2 TDD SSB SCS 240kHz BW 100MHz
2	FR1 TDD SSB SCS 15kHz BW 10MHz – FR2 TDD SSB SCS 240kHz BW 100MHz
3	FR1 TDD SSB SCS 30kHz BW 40MHz – FR2 TDD SSB SCS 240kHz BW 100MHz

Note 1: The UE is only required to be tested in one of the supported test configurations

**Table A.7.5.7.2.1-2: General test parameters for PSCell addition and release delay**

Parameter	Unit	Value	Comment
RF Channel Number		1, 2	Two radio channels are used for this test
Active PCell		Cell 1	PCell on RF channel number 1 in FR1
Neighbour cell		Cell 2	Neighbour cell (PSCell-to-be) on RF channel number 2 in FR2
DRX		OFF	For both PCell and PSCell once activated
PRACH configuration in Cell 2		FR2 PRACH configuration 2	PRACH configuration as specified in Clause A.3.8.3.2.
CSI reporting periodicity and offset configuration for Cell 2	ms	[2]	
T1	s	5	During this time the PCell is known and Cell 2 is unknown.
T2	s	1	During this time the UE adds the PSCell.
T3	s	1	During this time the UE sends CSI reports for PSCell.
T4	s	1	During this time the UE releases the PSCell.

**Table A.7.5.7.2.1-3: NR Cell specific test parameters for PSCell addition and release delay**

Parameter	Unit	Config	Cell 1	Cell2			
				T1	T2	T3	T4
Frequency Range		1,2,3	FR1	FR2			
Duplex mode		1	FDD	TDD			
		2,3	TDD				
TDD configuration		1	–	TDDConf.3.1			
		2	TDDConf.1.1				
		3	TDDConf.2.1				
BW <sub>channel</sub>	MHz	1,2	10: N <sub>RB,c</sub> = 52	100: N <sub>RB,c</sub> = 66			
		3	40: N <sub>RB,c</sub> = 106				
Data RBs allocated		1,2	52	48			
		3	106				
Initial Downlink BWP configuration		1,2,3	DLBWP.0.1	DLBWP.0.1			
Initial Uplink BWP configuration		1,2,3	ULBWP.0.1	ULBWP.0.1			

Dedicated Downlink BWP configuration		1,2,3	DLBWP.1.1	DLBWP.1.1
Dedicated Uplink BWP configuration		1,2,3	ULBWP.1.1	ULBWP.1.1
PDSCH Reference Measurement Channel		1	SR.1.1 FDD	SR.3.3 TDD
		2	SR.1.1 TDD	
		3	SR.2.1 TDD	
TRS configuration		1,2,3	–	TRS.2.1 TDD
TCI state		1,2,3	–	TCI.State.0
RMSI CORESET parameters		1	CR.1.1 FDD	CR.3.2 TDD
		2	CR.1.1 TDD	
		3	CR.2.1 TDD	
Dedicated CORESET parameters		1	CCR.1.1 FDD	CCR.3.7 TDD
		2	CCR.1.1 TDD	
		3	CCR.2.1 TDD	
OCNG Patterns <sup>Note1</sup>		1,2,3	OP.1	OP.3
SSB configuration		1,2	SSB.1 FR1	SSB.2 FR2
		3	SSB.2 FR1	
SMTc configuration		1,2,3	SMTc.2	SMTc.1
PDSCH/PDCCH subcarrier spacing	kHz	1,2	15	120
		3	30	
EPRE ratio of PSS to SSS	dB	1,2,3	0	0
EPRE ratio of PBCH DMRS to SSS				
EPRE ratio of PBCH to PBCH DMRS				
EPRE ratio of PDCCH DMRS to SSS				
EPRE ratio of PDCCH to PDCCH DMRS				
EPRE ratio of PDSCH DMRS to SSS				
EPRE ratio of PDSCH to PDSCH				
EPRE ratio of OCNG DMRS to SSS				
EPRE ratio of OCNG to OCNG DMRS				
Propagation Condition				
<p>Note 1: OCNG shall be used such that and a constant total transmitted power spectral density is achieved for all OFDM symbols.</p> <p>Note 2: Void</p> <p>Note 3: Void</p> <p>Note 4: Void</p> <p>Note 5: Void</p> <p>Note 6: The downlink connection between the System Simulator and the UE is without Additive White Gaussian Noise, and has no fading or multipath effects as specified in TS 38.521-2 B.0 [37].</p>				

**Table A.7.5.7.2.1-4: OTA related test parameters for PSCell addition and release delay**

Parameter	Unit	Config	Cell 1	Cell 2			
				T1	T2	T3	T4
Angle of arrival configuration		1,2,3	Link only, see clause A.3.7A	Setup 2a according to clause A.3.15.2.1			
Assumption for UE beams <sup>Note 3</sup>				Rough			
$\hat{E}_s$	dBm/SCS	1,2,3		-∞	-81		
SSB_RP <sup>Note1, Note 2</sup>	dBm/SCS	1,2,3		-∞	-81		
$\hat{E}_s / I_{ot\_BB}$ <sup>Note1, Note 4</sup>	dB	1,2,3		-∞	4.88		
$I_o$ <sup>Note 1, Note 2</sup>	dBm/95.04 MHz	1,2,3		N/A	-56.41		
<p>Note 1: <math>E_s/I_{ot}</math>, SSB_RP and <math>I_o</math> levels have been derived from other parameters for information purposes. They are not settable parameters themselves.</p> <p>Note 2: Equivalent power received by an antenna with 0dBi gain at the centre of the quiet zone.</p> <p>Note 3: Information about types of UE beam is given in B.2.1.3 and does not limit UE implementation or test system implementation.</p> <p>Note 4: Calculation of <math>E_s/I_{ot\_BB}</math> includes the effect of UE internal noise up to the value assumed for the associated Refsens requirement in clause 7.3.2 of TS 38.101-2 [19], and an allowance of 1dB for UE multi-band relaxation factor <math>\Delta MBs</math> from TS 38.101-2 [19] Table 6.2.1.3-4.</p>							

### A.7.5.7.2.2 Test Requirements

The UE shall transmit the PRACH preamble to PSCell at latest 572 ms into T2.

The UE shall transmit at least one periodic CSI report for PSCell during T3.

The UE shall stop transmitting CSI reports for PSCell at latest 20 ms into T4.

All of the above test requirements shall be fulfilled in order for the observed PSCell addition and release delay to be counted as correct. The rate of correct events observed during repeated tests shall be at least 90%.

## A.7.5.8 Active TCI state switch delay

### A.7.5.8.1 MAC-CE based active TCI state switch

#### A.7.5.8.1.1 NR PCell FR2 active TCI state switch for a known TCI state

##### A.7.5.8.1.1.1 Test Purpose and Environment

The purpose of this test is to verify the active TCI state switch delay requirement defined in clause 8.10.3. Supported test configuration is shown in Table A.7.5.8.1.1.1-1.

The test scenario comprises of one NR PCell (Cell 1) as given in Table A.7.5.8.1.1.1-2. Cell-specific parameters of NR PCell are specified in Table A.7.5.8.1.1.1-3 below. The OTA related test parameters for FR2 are shown in Table A.7.5.8.1.1.1-4.

PDCCHs indicating new transmissions shall be sent continuously on PCell to ensure that the UE would have ACK/NACK sending.

Before the test starts,

- UE is connected to Cell 1 (PCell) on radio channel 1 (PCC).
- UE is configured with 2 different TCI states for PCell, PDCCH TCI state 0 (QCL'd to SSB0) and TCIstate 1 (QCL'd to SSB1), in Cell 1 before starting the test.
- UE is indicated in TCI state 0 as the active PDCCH TCI state
- Target TCI state is not in the active TCI state list.

The test consists of two time periods, T1 and T2. Figure A.7.5.8.1.1.1-1 and Figure A.7.5.8.1.1.1-2 show the Time multiplexed (allocation in Frequency is symbolic) downlink transmissions from each Angle of Arrival. During T1 only SSB to which PDCCH-TCI-state0 is QCL'd is transmitted. At the beginning of T2, the SSB corresponding to TCI state 1 starts transmitting. The UE is configured to provide periodic L1-RSRP reports. In slot n which is within 1280ms of UE providing L1-RSRP report with results for both SSB0 and SSB1, UE receives a MAC-CE command indicating a switch to TCI state 1. *tc-PresentInDCI* is not configured in the PDSCH configuration, i.e. TCI state for the PDSCH is identical to the PDCCH TCI state.

The test equipment verifies that UE can be scheduled on PCell on TCI state 0 till  $n + T_{HARQ} + 3$  ms. The test equipment also verifies the TCI state switch time in PCell by scheduling the UE on TCI state 1 after  $n + T_{HARQ} + 3$  ms + ( $T_{\text{first-SSB}} + T_{\text{SSB-proc}}$ ).

**Table A.7.5.8.1.1.1-1: Supported test configurations**

Config	Description
1	NR 120 kHz SSB SCS, 100 MHz bandwidth, TDD duplex mode

**Table A.7.5.8.1.1.1-2: General test parameters for TCI state switch**

Parameter	Unit	Value	Comment
NR RF Channel Number		1	One NR radio channel is used for this test
Active PCell		Cell 1	PCell on RF channel number 1.
CP length		Normal	

DRX		OFF	
T1	s	0.2	
T2	s	0.2	

**Table A.7.5.8.1.1-3: NR Cell specific test parameters for TCI state switch**

Parameter	Unit	Cell 1
Frequency Range		FR2
Duplex mode		TDD
TDD configuration		TDDConf.3.1
BW <sub>channel</sub>		100 MHz: N <sub>RB,c</sub> = 66
Data RBs allocated		24
Initial DL BWP Configuration		DLBWP.0.2
Dedicated DL BWP Configuration		DLBWP.1.1
Initial UL BWP Configuration		ULBWP.0.2
Dedicated UL BWP Configuration		ULBWP.1.1
PDSCH Reference measurement channel		SR.3.2 TDD
RMSI CORESET parameters		CR.3.1 TDD
Dedicated CORESET parameters		CCR.3.1 TDD
OCNG Patterns		OP.5
SSB Configuration		SSB.1 FR2
SMTC Configuration		SMTC.1
TCI State 0		TC. State.2
TCI State 1		TCI.State.3
TRS Configuration		TRS.2.1 TDD TRS.2.2 TDD
Correlation Matrix and Antenna Configuration		1x2 Low
EPRE ratio of PSS to SSS	dB	0
EPRE ratio of PBCH DMRS to SSS		
EPRE ratio of PBCH to PBCH DMRS		
EPRE ratio of PDCCH DMRS to SSS		
EPRE ratio of PDCCH to PDCCH DMRS		
EPRE ratio of PDSCH DMRS to SSS		
EPRE ratio of PDSCH to PDSCH		
EPRE ratio of OCNG DMRS to SSS(Note 1)		
EPRE ratio of OCNG to OCNG DMRS (Note 1)		
Propagation Condition		No external noise (Note 2)
Note 1: OCNG shall be used such that a constant total transmitted power spectral density is achieved for all OFDM symbols.		
Note 2: The downlink connection between the System Simulator and the UE is without Additive White Gaussian Noise, and has no fading or multipath effects as specified in TS 38.521-2 B.0 [37].		

**Table A.7.5.8.1.1-4: OTA related test parameters for TCI state switch**

Parameter	Unit	Cell 1			
		SSB0		SSB1	
		T1	T2	T1	T2
Angle of arrival configuration		Setup 3 according to clause A.3.15.3			
		AoA1		AoA2	
Assumption for UE beams <sup>Note 6</sup>		Rough			
$\hat{E}_s$	dBm/SCS	-80.6	-80.6	-Infinity	-80.6
SSB_RP <sup>Note 2</sup>	dBm/ SCS	-80.6	-80.6	-Infinity	-80.6
$\hat{E}_s / I_{e, BB}$ <sup>Note 7</sup>	dB	8.3	8.3	-Infinity	8.3
$I_o$ <sup>Note 2</sup>	dBm/95.04 MHz <sup>Note 4</sup>	-55.41	-55.41	- Infinity	-55.41

- Note 1: Void
- Note 2: SSB\_RP and Io levels have been derived from other parameters for information purposes. They are not settable parameters themselves.
- Note 3: Void
- Note 4: Equivalent power received by an antenna with 0 dBi gain at the centre of the quiet zone
- Note 5: As observed with 0dBi gain antenna at the center of the quiet zone.
- Note 6: Information about types of UE beam is given in B.2.1.3 and does not limit UE implementation or test system implementation.
- Note 7: Calculation of  $E_s/I_{otBB}$  includes the effect of UE internal noise up to the value assumed for the associated Refsens requirement in clause 7.3.2 of TS 38.101-2 [19], and an allowance of 1 dB for UE multi-band relaxation factor  $\Delta MB_P$  from TS 38.101-2 [19] Table 6.2.1.3-4.

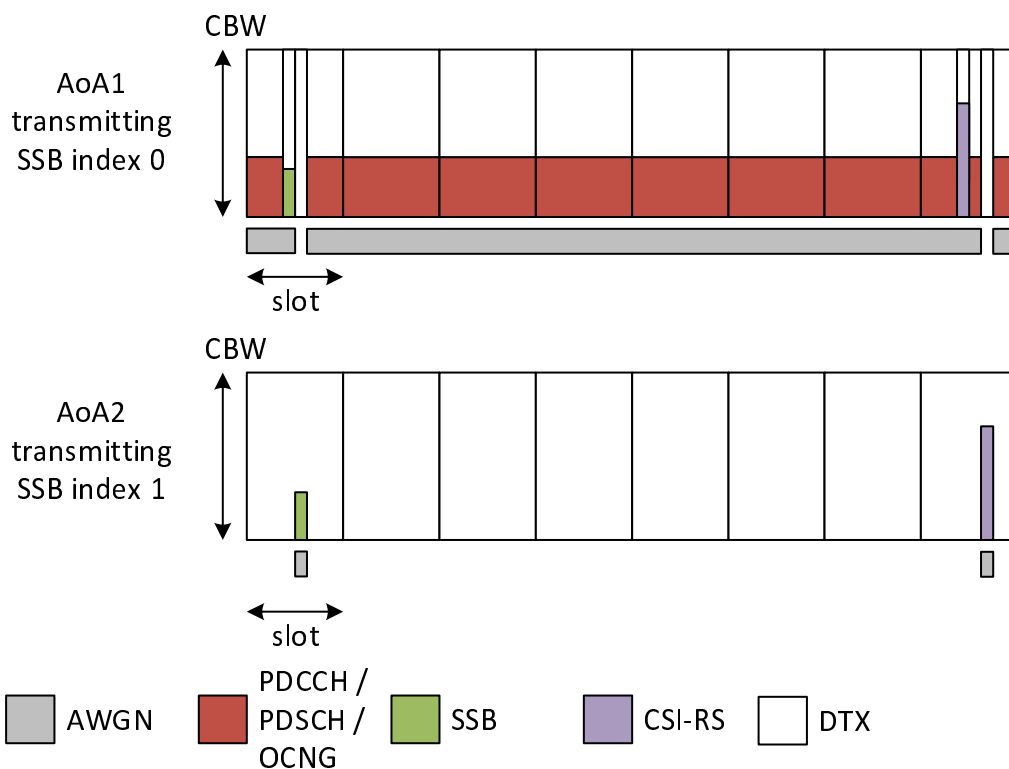
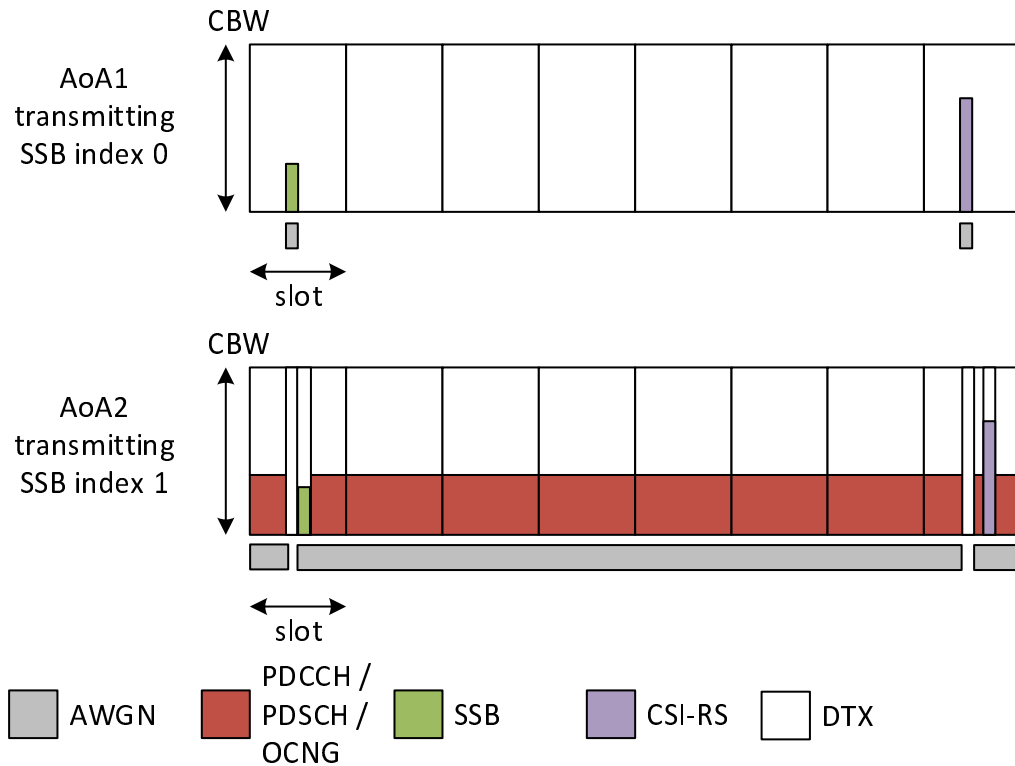

Figure A.7.5.8.1.1-1: Time multiplexed downlink transmissions during T1



**Figure A.7.5.8.1.1-2: Time multiplexed downlink transmissions during T2**

**A.7.5.8.1.1.2 Test Requirements**

During T2, UE shall send L1-RSRP report with results for both SSB0 and SSB1.

After receiving MAC-CE command in slot  $n$ , UE shall:

- be able to continue to receive on TCI state 0 till  $n + T_{\text{HARQ}} + 3 \text{ ms}$
- be able to start receiving on TCI state 1 after  $n + T_{\text{HARQ}} + 5 \text{ ms} + T_{\text{first-SSB}}$

The rate of correct events observed during repeated tests shall be at least 90%.

**A.7.5.8.2 RRC based active TCI state switch**

**A.7.5.8.2.1 NR PCell FR2 active TCI state switch for a known TCI state**

**A.7.5.8.2.1.1 Test Purpose and Environment**

The purpose of this test is to verify the active TCI state switch delay requirement defined in clause 8.10.3. Supported test configuration is shown in Table A.7.5.8.2.1.1-1.

The test scenario comprises of one NR PCell as given in Table A.7.5.8.2.1.1-2. Cell-specific parameters of NR PCell is specified in Table A.7.5.8.2.1.1-3 below. The OTA related test parameters for FR2 is shown in Table A.7.5.8.2.1.1-4.

PDCCHs indicating new transmissions shall be sent continuously on PCell to ensure that the UE would have ACK/NACK sending.

Before the test starts,

- UE is connected to Cell 1 (PCell) on radio channel 1 (PCC).
- UE is configured with 1 TCI state for PCell, PDCCH-TCI-state0 (QCL'd to SSB0)

- UE is indicated in TCI state0 as the active TCI state

The test consists of two time periods, T1 and T2. Figure A.7.5.8.2.1.1-1 and Figure A.7.5.8.2.1.1-2 show the Time multiplexed (allocation in Frequency is symbolic) downlink transmissions from each Angle of Arrival. During T1 only SSB to which TCI-state0 is QCL'd is transmitted. At the beginning of T2, the SSB corresponding to TCI-state1 starts transmitting. The UE is configured to provide periodic L1-RSRP reports. In slot n which is within 1280 ms of UE providing L1-RSRP report with results for both SSB0 and SSB1, UE receives a RRC command indicating a switch to TCI-state1.

The test equipment verifies the TCI state switch time in PCell by scheduling the UE on TCI state 1 after  $n + T_{RRC\_processing} + T_{first-SSB} + 2ms$ .

**Table A.7.5.8.2.1.1-1: Supported test configurations**

Config	Description
1	NR 120 kHz SSB SCS, 100 MHz bandwidth, TDD duplex mode

**Table A.7.5.8.2.1.1-2: General test parameters for TCI state switch**

Parameter	Unit	Value	Comment
NR RF Channel Number		1	One NR radio channel is used for this test
Active PCell		Cell 1	PCell on RF channel number 1.
CP length		Normal	
DRX		OFF	
T1	s	0.2	
T2	s	2	

**Table A.7.5.8.2.1.1-3: NR Cell specific test parameters for TCI state switch**

Parameter	Unit	Cell 1
Frequency Range		FR2
Duplex mode		TDD
TDD configuration		TDDConf.3.1
BW <sub>channel</sub>		100 MHz: N <sub>RB,c</sub> = 66
Data RBs allocated		24
Initial DL BWP Configuration		DLBWP.0.2
Dedicated DL BWP Configuration		DLBWP.1.1
Initial UL BWP Configuration		ULBWP.0.2
Dedicated UL BWP Configuration		ULBWP.1.1
PDSCH Reference measurement channel		SR.3.2 TDD
RMSI CORESET parameters		CR.3.1 TDD
Dedicated CORESET parameters		CCR.3.1 TDD
OCNG Patterns		OP.5
SSB Configuration		SSB.1 FR2
SMTc Configuration		SMTc.1
TCI State 0		TC. State.2
TCI State 1		TCI.State.3
reportConfigType		ssb-Index-RSRP
reportConfigType		periodic
Number of reported RS		2
L1-RSRP reporting period	slot	640
timeRestrictionForChannelMeasurements		configured
TRS Configuration		TRS.2.1 TDD TRS.2.2 TDD
Correlation Matrix and Antenna Configuration		1x2 Low
EPRE ratio of PSS to SSS	dB	0
EPRE ratio of PBCH DMRS to SSS		
EPRE ratio of PBCH to PBCH DMRS		
EPRE ratio of PDCCH DMRS to SSS		
EPRE ratio of PDCCH to PDCCH DMRS		
EPRE ratio of PDSCH DMRS to SSS		
EPRE ratio of PDSCH to PDSCH		

EPRE ratio of OCNG DMRS to SSS(Note 1)		
EPRE ratio of OCNG to OCNG DMRS (Note 1)		
Propagation Condition		No external noise (Note 2)
Note 1:	OCNG shall be used such that the resources in Cell 1 are fully allocated and a constant total transmitted power spectral density is achieved for all OFDM symbols.	
Note 2:	The downlink connection between the System Simulator and the UE is without Additive White Gaussian Noise, and has no fading or multipath effects as specified in TS 38.521-2 B.0 [37].	

**Table A.7.5.8.2.1-4: OTA related test parameters for TCI state switch**

Parameter	Unit	Cell 1			
		SSB0		SSB1	
		T1	T2	T1	T2
Angle of arrival configuration		Setup 3 according to clause A.3.15.3			
		AoA1		AoA2	
Assumption for UE beams <sup>Note 6</sup>		Rough			
$\hat{E}_s$	dBm/SCS	-80.6	-80.6	-Infinity	-80.6
SSB_RP <sup>Note 2</sup>	dBm/ SCS	-80.6	-80.6	-Infinity	-80.6
$\hat{E}_s/I_{\alpha, BB}$ <sup>Note 7</sup>	dB	8.3	8.3	-Infinity	8.3
$I_o$ <sup>Note2</sup>	dBm/95.04 MHz <sup>Note4</sup>	-55.41	-55.41	- Infinity	-55.41
Note 1:	Void				
Note 2:	SSB_RP and $I_o$ levels have been derived from other parameters for information purposes. They are not settable parameters themselves.				
Note 3:	Void				
Note 4:	Equivalent power received by an antenna with 0 dBi gain at the centre of the quiet zone				
Note 5:	As observed with 0dBi gain antenna at the center of the quiet zone.				
Note 6:	Information about types of UE beam is given in B.2.1.3 and does not limit UE implementation or test system implementation.				
Note 7:	Calculation of $E_s/I_{\alpha, BB}$ includes the effect of UE internal noise up to the value assumed for the associated Refsens requirement in clause 7.3.2 of TS 38.101-2 [19], and an allowance of 1dB for UE multi-band relaxation factor $\Delta MB_P$ from TS 38.101-2 [19] Table 6.2.1.3-4.				



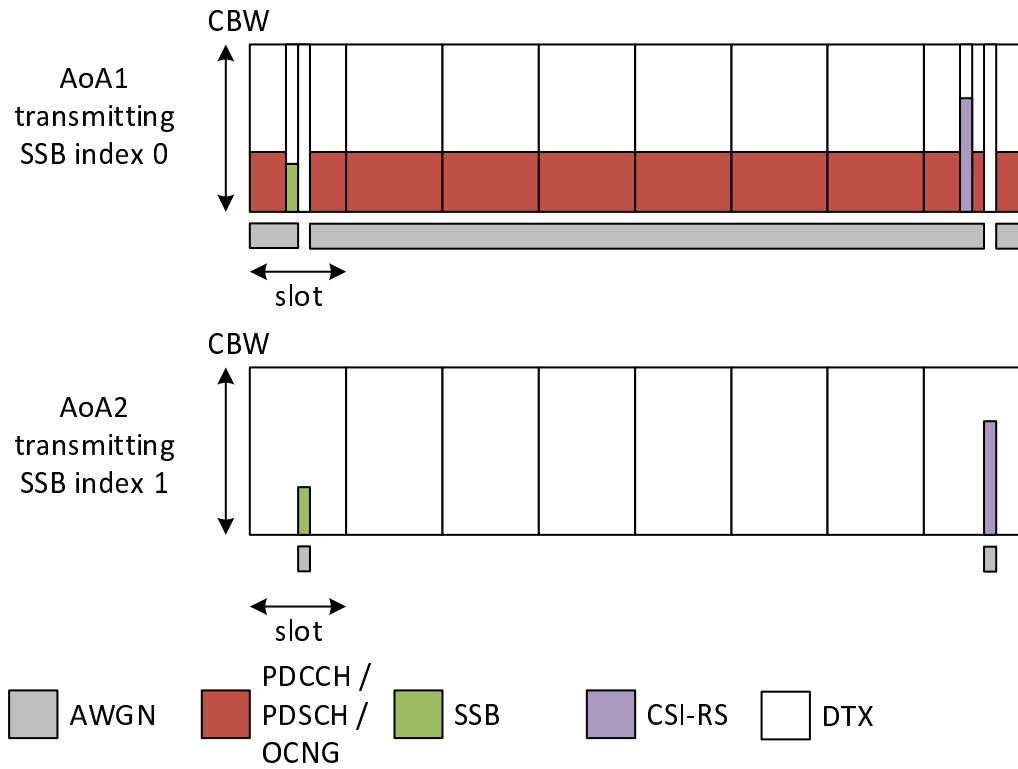

Figure A.7.5.8.2.1.1-1: Time multiplexed downlink transmissions during T1

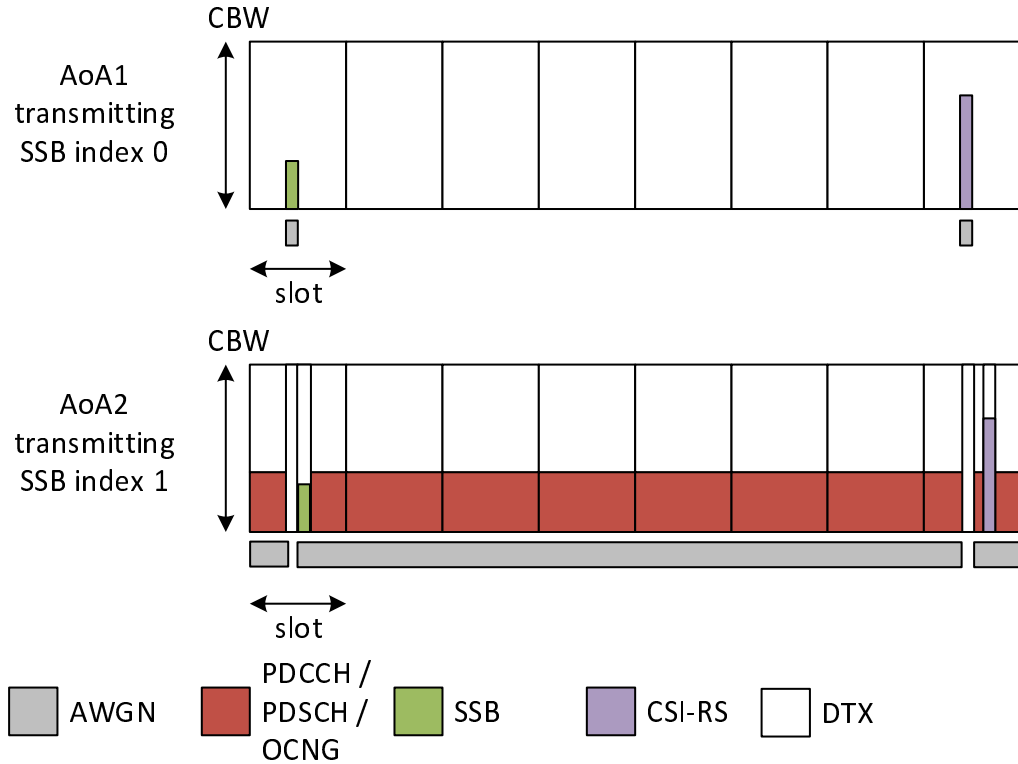

Figure A.7.5.8.2.1.1-2: Time multiplexed downlink transmissions during T2

### A.7.5.8.2.1.2 Test Requirements

During T2, UE shall send L1-RSRP report with both SSB0 and SSB1.

After receiving RRC command in slot  $n$ , UE shall be able to start receiving on TCI state 1 after  $n + T_{\text{RRC\_processing}} + T_{\text{first-SSB}} + 2\text{ms}$ .

The rate of correct events observed during repeated tests shall be at least 90%.

## A.7.5.9 Uplink spatial relation switch delay

### A.7.5.9.1 MAC-CE based Spatial Relation switch

#### A.7.5.9.1.1 NR PCell FR2 spatial relation associated with known DL-RS

##### A.7.5.9.1.1.1 Test Purpose and Environment

The purpose of this test is to verify fulfillment of the uplink spatial relation switch delay requirement defined in clause 8.12.3 by a UE capable of beam correspondence without the need for UL beam sweeping. The supported test configurations are shown in Table A.7.5.9.1.1.1-1.

The test scenario comprises one PCell (Cell 1) as outlined in Table A.7.5.9.1.1.1-2. Cell-specific parameters are provided in Table A.7.5.9.1.1.1-3. OTA-related test parameters are provided in Table A.7.5.9.1.1.1-4.

Throughout the test, PDCCH indicating new transmissions shall be sent continuously on PCell to ensure that the UE will send ACK/NACKs on PUCCH.

Before the test starts,

UE is connected to Cell 1 on radio channel 1.

UE is configured with a single TCI state, TCI State-0, which is QCLed with SSB0.

UE is configured with two spatial relation information configurations Spatial Relation Info-0 and Spatial Relation Info-1 for PUCCH, each associated with SSB0 and SSB1, respectively.

UE is indicated via MAC-CE activation of *PUCCH-SpatialRelationInfo* corresponding to Spatial Relation Info-0

UE is configured with a CSI measurement configuration indicating L1-RSRP measurements on SSB0 and SSB1 with periodic reporting. The L1-RSRP measurement period is influenced by the following: the higher layer parameter *timeRestrictionForChannelMeasurement* is configured, measured SSBs are fully overlapping with SMTC window, and there are no conflicts with measurement gaps.

The test consists of two time periods, T1 and T2. During T1 only the SSB associated with PDCCH TCI state-0 and PUCCH Spatial Relation Info-0 is transmitted. At the beginning of T2, transmission of the SSB associated with PUCCH Spatial Relation Info-1 starts. The UE conducts periodic L1-RSRP measurements and *SSB-Index-RSRP* reporting for SSB0 and SSB1. In slot  $n$ , which is within 1280ms after UE receiving both SSB0 and SSB1, and after reporting valid results for both the SSB0 and the SSB1, the UE receives a MAC-CE indicating a switch of spatial relation to PUCCH Spatial Relation Info 1

The test equipment verifies that the UE transmits according to PUCCH Spatial Relation Info 0 up until slot  $n + T_{\text{HARQ/NR slot length}} + 3N_{\text{slot}}^{\text{subframe},\mu}$ , and according to PUCCH Spatial Relation Info 1 from slot  $n + T_{\text{HARQ/NR slot length}} + 3N_{\text{slot}}^{\text{subframe},\mu} + 1$  and onwards.

**Table A.7.5.9.1.1.1-1: Supported test configurations**

Config	Description
1	NR 120 kHz SSB SCS, 100 MHz bandwidth, TDD duplex mode

**Table A.7.5.9.1.1.1-2: General test parameters**

Parameter	Unit	Value	Comment
NR RF Channel Number		1	One NR radio channel is used for this test

Active PCell		Cell 1	PCell on RF channel number 1.
CP length		Normal	
DRX		OFF	
L1-RSRP reporting period	slot	160	Periodic L1-RSRP reporting configured
L1-RSRP measured RS		SSB0, SSB1	L1-RSRP measurements of SSB0 and SSB1.
Number of reported RS		2	L1-RSRP reporting of measurements on SSB0 and SSB1.
T1	s	[0.2]	
T2	s	[2]	

**Table A.7.5.9.1.1-3: NR Cell specific test parameters**

Parameter	Unit	Cell 1
Frequency Range		FR2
Duplex mode		TDD
TDD configuration		TDDConf.3.1
BW <sub>channel</sub>		100 MHz: N <sub>RB,c</sub> = 66
Initial DL BWP Configuration		DLBWP.0.2
Dedicated DL BWP Configuration		DLBWP.1.1
Initial UL BWP Configuration		ULBWP.0.2
Dedicated UL BWP Configuration		ULBWP.1.1
PDSCH Reference measurement channel		SR.3.1 TDD
RMSI CORESET parameters		CR.3.1 TDD
Dedicated CORESET parameters		CCR.3.1 TDD
OCNG Patterns		OP.1
SSB Configuration		SSB.1 FR2
SMTC Configuration		SMTC.1
TCI State-0 Configuration		TCI.State.0
reportConfigType		ssb-Index-RSRP
reportConfigType		periodic
timeRestrictionForChannelMeasurements		configured
TRS Configuration		TRS.2.1 TDD
Spatial Relation Info-0 Configuration		PUCCH.SRI.0
Spatial Relation Info-1 Configuration		PUCCH.SRI.1
Correlation Matrix and Antenna Configuration		1x2 Low
EPRE ratio of PSS to SSS	dB	0
EPRE ratio of PBCH DMRS to SSS		
EPRE ratio of PBCH to PBCH DMRS		
EPRE ratio of PDCCH DMRS to SSS		
EPRE ratio of PDCCH to PDCCH DMRS		
EPRE ratio of PDSCH DMRS to SSS		
EPRE ratio of PDSCH to PDSCH		
EPRE ratio of OCNG DMRS to SSS <sup>Note 1</sup>		
EPRE ratio of OCNG to OCNG DMRS <sup>Note 1</sup>		
Propagation Condition		AWGN
Note 1: OCNG shall be used such that the cell is fully allocated and a constant total transmitted power spectral density is achieved for all OFDM symbols.		

**Table A.7.5.9.1.1-4: OTA related test parameters**

Parameter	Unit	Cell 1			
		SSB0		SSB1	
		T1	T2	T1	T2
Angle of arrival configuration		Setup 3 according to clause A.3.15.3			
		AoA1		AoA2	
Assumption for UE beams <sup>Note 6</sup>		Rough			
N <sub>oc</sub> <sup>Note 1</sup>	dBm/15 kHz	-92.1			
N <sub>oc</sub> <sup>Note 1</sup>	dBm/SCS	-83.1			
Ē <sub>s</sub> /N <sub>oc</sub>	dB	1		-infinity	1
SS-RSRP <sup>Note 2</sup>	dBm/120 kHz <sup>Note3</sup>	-82.1		-infinity	-82.1
I <sub>o</sub> <sup>Note2</sup>	dBm/95.04 MHz <sup>Note4</sup>	-50.6		-54.1	-50.6

Note 1:	Interference from other cells and noise sources not specified in the test is assumed to be constant over subcarriers and time and shall be modelled as AWGN of appropriate power for $N_{oc}$ to be fulfilled.
Note 2:	SS-RSRP and $I_o$ levels have been derived from other parameters for information purposes. They are not settable parameters themselves.
Note 3:	SS-RSRP minimum requirements are specified assuming independent interference and noise at each receiver antenna port.
Note 4:	Equivalent power received by an antenna with 0 dBi gain at the centre of the quiet zone
Note 5:	As observed with 0dBi gain antenna at the center of the quiet zone.
Note 6:	Information about types of UE beam is given in B.2.1.3 and does not limit UE implementation or test system implementation.

#### A.7.5.9.1.1.2 Test Requirements

During T2, the UE shall send L1-RSRP report with results for SSB0 and SSB1.

After receiving MAC-CE command in slot  $n$ , the UE shall:

Continue transmitting using PUCCH spatial relation associated with SSB0 up to and including slot  $n + T_{\text{HARQ}}/\text{NR slot length} + 3N_{\text{slot}}^{\text{subframe},\mu}$

Start transmitting using PUCCH spatial relation associated with SSB1 from slot  $n + T_{\text{HARQ}}/\text{NR slot length} + 3N_{\text{slot}}^{\text{subframe},\mu} + 1$  and onwards.

The rate of correct events observed during repeated tests shall be at least 90%.

### A.7.5.9.2 RRC based spatial relation switch

#### A.7.5.9.2.1 NR PCell FR2 spatial relation switch associated with a known DL-RS

##### A.7.5.9.2.1.1 Test Purpose and Environment

The purpose of this test is to verify the RRC based spatial relation switch delay requirement defined in clause 8.12.5 by a UE capable of beam correspondence without the need for UL beam sweeping. In the test the higher layer parameter *timeRestrictionForChannelMeasurements* is configured. Supported test configuration is shown in Table A.7.5.9.2.1.1-1.

The test scenario comprises of one PCell (Cell 1) as given in Table A.7.5.9.2.1.1-2. Cell-specific parameters of PCell is specified in Table A.7.5.9.2.1.1-3 below. The OTA related test parameters for FR2 is shown in Table A.7.5.9.2.1.1-4.

Periodic SRS is transmitted on PCell (Cell 1), and the SRS configuration is SRSConf.1 given in Table A.5.4.1.1.1-3.

Before the test starts,

- UE is connected to Cell 1 (PCell) on radio channel 1 (PCC).
- UE is configured with 1 SRS-SpatialRelation0 associated with SSB0.
- UE is indicated SRS-SpatialRelation0 as the active SRS spatial relation.

The test consists of two time periods, T1 and T2. During T1 only SSB0 to which SRS-SpatialRelation0 associated is transmitted. UE shall transmit periodic SRS with SRS-SpatialRelation0 on the UL of the PCell.

T2 start when the tester initiates transmission of SSB1 corresponding to SRS-SpatialRelation1. The UE is configured to transmit periodic L1-RSRP reports.

In slot  $n$ , which is within [1280]ms of UE providing the L1-RSRP report with results for both SSB0 and SSB1, the UE receives an RRC command indicating a switch to transmit periodic SRS with target SRS-SpatialRelation1. The UE shall be able to transmit periodic SRS with target spatial relation (SRS-SpatialRelation1) on PCell in slot  $n + T_{\text{RRC\_processing}}/\text{NR slot length} + 1$ .

**Table A.7.5.9.2.1.1-1: Supported test configurations**

Config	Description
--------	-------------

1	120 kHz SSB SCS, 100 MHz bandwidth, TDD duplex mode
---	---

**Table A.7.5.9.2.1.1-2: General test parameters for spatial relation switch associated with a known DL-RS**

Parameter	Unit	Value	Comment
NR RF Channel Number		1	One NR radio channel is used for this test
Active PCell		Cell 1	PCell on RF channel number 1.
CP length		Normal	
DRX		OFF	
Cell-individual offset for cells on RF channel number 1	dB	0	Individual offset for cells on PCC.
timeRestrictionForChannel Measurements		configured	Time domain measurement restriction for the channel (signal) measurements (see TS 38.214 [19], clause 5.2.1.1)
T1	s	0.5	
T2	s	1.5	

**Table A.7.5.9.2.1.1-3: NR Cell specific test parameters for spatial relation switch associated with a known DL-RS**

Parameter	Unit	Cell 1
Frequency Range		FR2
Duplex mode		TDD
TDD configuration		TDDConf.3.1
BW <sub>channel</sub>		100 MHz: N <sub>RB,c</sub> = 66
Initial DL BWP Configuration		DLBWP.0.2
Dedicated DL BWP Configuration		DLBWP.1.1
Initial UL BWP Configuration		ULBWP.0.2
Dedicated UL BWP Configuration		ULBWP.1.1
PDSCH Reference measurement channel		SR.3.1 TDD
RMSI CORESET parameters		CR.3.1 TDD
Dedicated CORESET parameters		CCR.3.1 TDD
OCNG Patterns		OP.1
SSB Configuration		SSB.1 FR2
SMTTC Configuration		SMTTC.1
SRS-SpatialRelation0		SRS.SRI0
SRS-SpatialRelation1		SRS.SRI1
reportConfigType		ssb-Index-RSRP
reportConfigType		periodic
Number of reported RS		2
L1-RSRP reporting period	slot	160
TRS Configuration		TRS.2.1 TDD
Correlation Matrix and Antenna Configuration		1x2 Low
EPRE ratio of PSS to SSS	dB	0
EPRE ratio of PBCH DMRS to SSS		
EPRE ratio of PBCH to PBCH DMRS		
EPRE ratio of PDCCH DMRS to SSS		
EPRE ratio of PDCCH to PDCCH DMRS		
EPRE ratio of PDSCH DMRS to SSS		
EPRE ratio of PDSCH to PDSCH		
EPRE ratio of OCNG DMRS to SSS (Note 1)		
EPRE ratio of OCNG to OCNG DMRS (Note 1)		
Propagation Condition		
Note 1: OCNG shall be used such that both cells are fully allocated and a constant total transmitted power spectral density is achieved for all OFDM symbols.		

**Table A.7.5.9.2.1.1-4: OTA related test parameters for spatial relation switch associated with a known DL-RS**

Parameter	Unit	Cell 1			
		SSB0		SSB1	
		T1	T2	T1	T2
Angle of arrival configuration		Setup 3 according to clause A.3.15.3			
		AoA1		AoA2	
Assumption for UE beams <sup>Note 6</sup>		Rough		Rough	
$N_{oc}$ <sup>Note 1</sup>	dBm/15 kHz	-92.1			
$N_{oc}$ <sup>Note 1</sup>	dBm/SCS	-83.1			
$\bar{E}_s/N_{oc}$	dB	1	1	-Infinity	1
SS-RSRP <sup>Note 2</sup>	dBm/120 kHz <sup>Note 3</sup>	-82.1	-82.1	-Infinity	-82.1
$I_o$ <sup>Note 2, Note 6</sup>	dBm/95.04 MHz <sup>Note 4</sup>	-50.6	-50.6	-54.1	-50.6
Note 1:	Interference from other cells and noise sources not specified in the test is assumed to be constant over subcarriers and time and shall be modelled as AWGN of appropriate power for $N_{oc}$ to be fulfilled.				
Note 2:	SS-RSRP and $I_o$ levels have been derived from other parameters for information purposes. They are not settable parameters themselves.				
Note 3:	SS-RSRP minimum requirements are specified assuming independent interference and noise at each receiver antenna port.				
Note 4:	Equivalent power received by an antenna with 0 dBi gain at the centre of the quiet zone				
Note 5:	As observed with 0dBi gain antenna at the center of the quiet zone.				
Note 6:	Information about types of UE beam is given in B.2.1.3, and does not limit UE implementation or test system implementation				

#### A.7.5.9.2.1.2 Test Requirements

During T1 UE shall send L1-RSRP report with SSB0 to which SRS-SpatialRelation0 is associated. During T2, UE shall send L1-RSRP report with SSB1 to which SRS-SpatialRelation1 is associated.

After receiving RRC command in slot  $n$ , UE shall be able to transmit target periodic SRS with SRS-SpatialRelation1 on the PCell in the slot  $n + T_{RRC\_processing}/NR\ slot\ length + 1$ .

The rate of correct events observed during repeated tests shall be at least 90%.

#### A.7.5.10 UE specific CBW change

##### A.7.5.10.1 NR FR2 UE specific CBW change of PCell with non-DRX in SA

###### A.7.5.10.1.1 Test Purpose and Environment

The purpose of this test is to verify the UE specific CBW change delay requirement defined in clause 8.13. Supported test configurations are shown in Table A.7.5.10.1.1-1.

The test scenario comprises of one PCell (Cell 1) as given in Table A.7.5.10.1.1-2. Cell-specific parameters of PCell are specified in Table A.7.5.10.1.1-3 below.

PDCCHs indicating new transmissions shall be sent continuously on PCell (Cell 1) to ensure that the UE will have ACK/NACK transmission.

Before the test starts,

- UE is connected to Cell 1 (PCell) on radio channel 1 (PCC).
- UE has bandwidth part BWP-1 in its RRC-configuration for Cell 1 (PCell).
- UE is indicated in firstActiveDownlinkBWP-Id that the active DL BWP is BWP-1 of initial condition in PCell.
- UE has been configured with UE-specific CBW (CBW-1)
- UE is indicated in SCS-SpecificCarrier [2] that the UE-specific CBW is CBW-1 as the initial condition in Cell 1 (PCell).

All cells have constant signal levels throughout the test.

The test consists of 1 time period, with duration of T1.

During T1,

Time period T1 starts when a *RRCReconfiguration* with updated CBW configuration, sent from the test equipment to the UE, is received at the UE side in PCell’s slot # denoted *i*. The UE shall reconfigure its CBW with the updated CBW of final condition.

The UE shall be able to completely receive PDSCH on PCell from the first DL slot that occurs after the beginning of DL slot  $i + \frac{T_{RRCprocessingDelay} + T_{CBWchangeDelayRRC}}{NR\ Slot\ length}$  as defined in clause 8.13.2 and starts to report valid ACK/NACK for the PCell from the first UL slot that occurs after the beginning of DL slot  $i + \frac{T_{RRCprocessingDelay} + T_{CBWchangeDelayRRC}}{NR\ Slot\ length} + k1$ . The UE shall be continuously scheduled on PCell’s BWP-1 on CBW-2 starting from the first DL slot that occurs after the beginning of DL slot  $i + \frac{T_{RRCprocessingDelay} + T_{CBWchangeDelayRRC}}{NR\ Slot\ length}$ .

$T_{RRCprocessingDelay}$  and  $T_{CBWchangeDelayRRC}$  are defined in clause 8.13.

The test equipment verifies the UE specific CBW switch time in PCell by counting the time from the time when the RRC Reconfiguration message including updated CBW configurations sent till the time when RRC Reconfiguration Complete message is received.

**Table A.7.5.10.1.1-1: UE specific CBW change supported test configurations**

Config	Description
1	NR 120 kHz SSB SCS, 100 MHz bandwidth, TDD duplex mode
2	NR 120 kHz SSB SCS, 100 MHz bandwidth, TDD duplex mode

Note 1: The UE is only required to be tested in one of the supported test configurations

**Table A.7.5.10.1.1-2: General test parameters for UE specific CBW change in NR SA**

Parameter	Unit	Value	Comment
NR RF Channel Number		1	One NR radio channel is used for this test
Active PCell		Cell 1	PCell on RF channel number 1.
CP length		Normal	
DRX		OFF	
Cell-individual offset for cells on RF channel number 1	dB	0	Individual offset for cells on PCC.
T1	s	[0.2]	

**Table A.7.5.10.1.1-3: NR Cell specific test parameters for UE specific CBW change in NR SA**

Parameter	Unit	Cell 1
Frequency Range		FR2
Duplex mode		TDD
TDD configuration		TDDConf.3.1
BW <sub>channel</sub>		100 MHz: N <sub>RB,c</sub> = 66
Active DL BWP ID		1
Initial DL BWP Configuration (BWP-1)		DLBWP.0.2
Initial UL BWP Configuration		ULBWP.0.2
Initial Condition	Active DL CBW-1 Configuration	DLCBW.1.1
	Active UL CBW-1 Configuration	ULCBW.1.1
Final Condition	Active DL CBW-2 Configuration	DLCBW.1.2
	Active UL CBW-2 Configuration	ULCBW.1.2
PDSCH Reference measurement channel		SR.3.1 TDD
RMSI CORESET parameters		CR.3.1 TDD
Dedicated CORESET parameters		CCR.3.1 TDD

OCNG Patterns		OP.1
SSB Configuration		SSB.1 FR2
SMTC Configuration		SMTC.1
TCI State		TCI.State.0
TRS Configuration		TRS.2.1 TDD
Antenna Configuration		1x2
Propagation Condition		AWGN
EPRE ratio of PSS to SSS	dB	0
EPRE ratio of PBCH DMRS to SSS		
EPRE ratio of PBCH to PBCH DMRS		
EPRE ratio of PDCCH DMRS to SSS		
EPRE ratio of PDCCH to PDCCH DMRS		
EPRE ratio of PDSCH DMRS to SSS		
EPRE ratio of PDSCH to PDSCH		
EPRE ratio of OCNG DMRS to SSS(Note 1)		
EPRE ratio of OCNG to OCNG DMRS (Note 1)		
Note 1:		
Note 2:	Interference from other cells and noise sources not specified in the test is assumed to be constant over subcarriers and time and shall be modelled as AWGN of appropriate power for $N_{oc}$ to be fulfilled.	
Note 3:	SS-RSRP and $I_o$ levels have been derived from other parameters for information purposes. They are not settable parameters themselves.	

**Table A.7.5.10.1.1-4: OTA related test parameters for UE specific CBW change test case**

Parameter		Unit	Cell 2
Angle of arrival configuration			Setup 1 according to table A.3.15
Assumption for UE beams <sup>Note 5</sup>			Fine
$N_{oc}$ <sup>Note1</sup>	NR_TDD_FR2_A	dBm/15kHz	-112
	NR_TDD_FR2_B		
	NR_TDD_FR2_F		
	NR_TDD_FR2_G		
	NR_TDD_FR2_T		
	NR_TDD_FR2_Y		
$N_{oc}$ <sup>Note1</sup>	NR_TDD_FR2_A	dBm/SCS	-103
	NR_TDD_FR2_B		
	NR_TDD_FR2_F		
	NR_TDD_FR2_G		
	NR_TDD_FR2_T		
	NR_TDD_FR2_Y		
SS-RSRP <sup>Note2</sup>	NR_TDD_FR2_A	dBm/SCS <sup>Note3</sup>	-85
	NR_TDD_FR2_B		
	NR_TDD_FR2_F		
	NR_TDD_FR2_G		
	NR_TDD_FR2_T		
	NR_TDD_FR2_Y		
$\hat{E}_s/I_{ot}$		dB	18
$I_o$ <sup>Note2</sup>	NR_TDD_FR2_A	dBm/95.04 MHz <sup>Note4</sup>	-56
	NR_TDD_FR2_B		
	NR_TDD_FR2_F		
	NR_TDD_FR2_G		
	NR_TDD_FR2_T		
	NR_TDD_FR2_Y		
Note 1:	Interference from other cells and noise sources not specified in the test is assumed to be constant over subcarriers and time and shall be modelled as AWGN of appropriate power for $N_{oc}$ to be fulfilled.		
Note 2:	SS-RSRP and $I_o$ levels have been derived from other parameters for information purposes. They are not settable parameters themselves.		
Note 3:	SS-RSRP minimum requirements are specified assuming independent interference and noise at each receiver antenna port.		
Note 4:	Equivalent power received by an antenna with 0 dBi gain at the centre of the quiet zone		



Note 5: Information about types of UE beam is given in B.2.1.3 and does not limit UE implementation or test system implementation.

### A.7.5.10.1.2 Test Requirements

During T1, the UE shall be ready for the reception of uplink grant for PCell from the first DL slot that occurs after the beginning of slot  $i + \frac{T_{\text{RRCprocessingDelay}} + T_{\text{CBWchangeDelayRRC}}}{\text{NR Slot length}}$  and starts to report valid ACK/NACK for the PCell from the first UL slot that occurs after the beginning of DL slot  $i + \frac{T_{\text{RRCprocessingDelay}} + T_{\text{CBWchangeDelayRRC}}}{\text{NR Slot length}} + k1$ .

Where,  $k1$  is the timing between DL data receiving and acknowledgement as specified in [7].

All of the above test requirements shall be fulfilled in order for the observed PCell UE specific CBW change delay to be counted as correct.

The rate of correct events observed during repeated tests shall be at least 90%.

## A.7.6 Measurement procedure

### A.7.6.1 Intra-frequency Measurements

#### A.7.6.1.1 SA event triggered reporting test without gap under non-DRX

##### A.7.6.1.1.1 Test purpose and Environment

The purpose of this test is to verify that the UE makes correct reporting of an event. This test will partly verify the TDD intra-frequency cell search requirements in clause 9.2.5.1 and 9.2.5.2. Supported test configurations are shown in table A.7.6.1.1.1-1.

**Table A.7.6.1.1.1-1: supported test configurations**

Configuration	Description
1	120 kHz SSB SCS, 100 MHz bandwidth, TDD duplex mode
2	240 kHz SSB SCS, 100 MHz bandwidth, TDD duplex mode
Note: The UE is only required to be tested in one of the supported test configurations.	

There are two cells in the test, PCell (Cell 1) and a FR2 neighbour cell (Cell 2) on the same frequency as the PCell. The test parameters for the Cell 1 and Cell 2 are given in Table A.7.6.1.1.1-2, A.7.6.1.1.1-3 and A.7.6.1.1.1-4 below.

In the measurement control information, a measurement object is configured for the frequency of the PCell, and it is indicated to the UE that event-triggered reporting with Event A3 is used.

The test consists of two successive time periods, with time duration of T1, and T2 respectively. During time duration T1, the UE shall not have any timing information of Cell 2.

**Table A.7.6.1.1.1-2: General test parameters for intra-frequency event triggered reporting for SA with TDD PCell in FR2 without gap without DRX**

Parameter	Unit	Config	Value	Comment
Active cell		1, 2	PCell (Cell 1)	
Neighbour cell		1, 2	Cell 2	Cell to be identified.
RF Channel Number		1, 2	1: Cell 1 and Cell 2	One TDD carrier frequency is used for the NR cells.
SMTC configuration		1, 2	SMTC.1	
A3-Offset	dB	1, 2	-11	
CP length		1, 2	Normal	
Hysteresis	dB	1, 2	0	
Time To Trigger	s	1, 2	0	
Filter coefficient		1, 2	0	L3 filtering is not used
DRX		1, 2	OFF	
Time offset between Cell 1 and Cell 2		1, 2	3 $\mu$ s	Synchronous cells
T1	s	1, 2	5	

T2	s	1, 2	5	
----	---	------	---	--

**Table A.7.6.1.1.1-3: NR Cell specific test parameters for intra-frequency event triggered reporting for SA with TDD PCell in FR2 without gap without DRX**

Parameter	Unit	Config	Cell 1		Cell 2	
			T1	T2	T1	T2
TDD configuration		1, 2	TDDConf.3.1		TDDConf.3.1	
BW <sub>channel</sub>	MHz	1, 2	100: N <sub>RB,c</sub> = 66		100: N <sub>RB,c</sub> = 66	
Data RBs allocated		1	24		24	
		2	48		48	
Initial BWP configuration		1, 2	DLBWP.0.1 ULBWP.0.1		DLBWP.0.1 ULBWP.0.1	
Active DL BWP configuration		1, 2	DLBWP.1.1		DLBWP.1.1	
Active UL BWP configuration		1, 2	ULBWP.1.1		ULBWP.1.1	
RLM-RS		1, 2	SSB		SSB	
PDSCH RMC configuration		1	SR.3.2 TDD		N/A	
		2	SR.3.3 TDD			
RMSI CORESET RMC configuration		1	CR.3.1 TDD		N/A	
		2	CR.3.2 TDD		N/A	
Dedicated CORESET RMC configuration		1	CCR.3.1 TDD		N/A	
		2	CCR.3.7 TDD		N/A	
TRS configuration		1, 2	TRS.2.1 TDD		N/A	
PDSCH/PDCCH TCI states		1, 2	TCI.State.2		N/A	
PDSCH/PDCCH subcarrier spacing	kHz	1, 2	120		120	
OCNG Patterns		1, 2	OP.5		N/A	
cellIndividualOffset	dB	1~2	N/A		16	
SSB		1	SSB.3 FR2		SSB.7 FR2	
		2	SSB.4 FR2		SSB.8 FR2	
Propagation Condition		1, 2	No external noise (Note 1)		No external noise (Note 1)	
Note 1: The downlink connection between the System Simulator and the UE is without Additive White Gaussian Noise, and has no fading or multipath effects as specified in TS 38.521-2 B.0 [37].						

**Table A.7.6.1.1.1-4: NR OTA Cell specific test parameters for intra-frequency event triggered reporting for SA with TDD PCell in FR2 without gap without DRX**

Parameter	Unit	Config	Cell 1		Cell 2	
			T1	T2	T1	T2
AoA setup		1, 2	Setup 3 defined in A.3.15.3			
			AoA1		AoA2	
Beam assumption <sup>Note 4</sup>		1,2	Rough		Rough	
E <sub>s</sub>	dBm/SCS	1	-89	-89	-Infinity	-89
		2	-86	-86	-Infinity	-86
$\hat{E}_s / I_{ot}$ BB Note 5	dB	1, 2	-0.12	-0.12	-Infinity	-0.12
SSB <sub>RP</sub>	dBm/SCS	1	-89	-89	-Infinity	-89
		2	-86	-86	-Infinity	-86
I <sub>o</sub>	dBm/95.04MHz	1	-64.41	-64.41	-Infinity	-64.41
		2	-61.41	-61.41	-Infinity	-61.41
Time multiplexing of the downlink transmissions from each AoA		1, 2	Defined in Figure A.7.6.1.1.1-1			

Note 1: The resources for uplink transmission are assigned to the UE prior to the start of time period T2.  
 Note 2: Void  
 Note 3: Es/lot, SSB\_RP and Io levels have been derived from other parameters for information purposes. They are not settable parameters themselves.  
 Note 4: Information about types of UE beam is given in B.2.1.3, and does not limit UE implementation or test system implementation  
 Note 5: Calculation of Es/lot<sub>BB</sub> includes the effect of UE internal noise up to the value assumed for the associated Refsens requirement in clause 7.3.2 of TS 38.101-2 [19], and an allowance of 1dB for UE multi-band relaxation factor ΔMB<sub>P</sub> from TS 38.101-2 [19] Table 6.2.1.3-4.

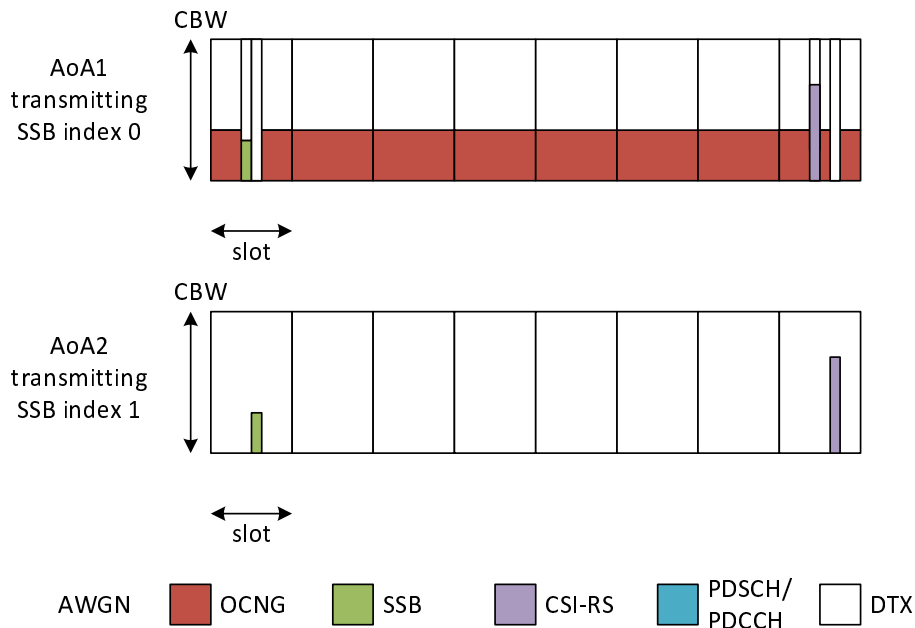

**Figure A.7.6.1.1.1-1: Time multiplexed downlink transmissions (Config 1 example)**

**A.7.6.1.1.2 Test Requirements**

In the test, the UE shall send one Event A3 triggered measurement report, with a measurement reporting delay less than X ms from the beginning of time period T2, where X is

- 2.4s for a UE supporting power class 1,
- 1.44s for a UE supporting power class 2, 3 and 4

The UE is not required to read the neighbour cell SSB index in this test.

The UE shall not send event triggered measurement reports, as long as the reporting criteria are not fulfilled.

The rate of correct events observed during repeated tests shall be at least 90%.

NOTE: The actual overall delays measured in the test may be up to 2xTTI<sub>DCCH</sub> higher than the measurement reporting delays above because of TTI insertion uncertainty of the measurement report in DCCH.

**A.7.6.1.2 SA event triggered reporting test without gap under DRX**

**A.7.6.1.2.1 Test purpose and Environment**

The purpose of this test is to verify that the UE makes correct reporting of an event. This test will partly verify the TDD intra-frequency cell search requirements in clause 9.2.5.1 and 9.2.5.2. Supported test configurations are shown in table A.7.6.1.2.1-1.

**Table A.7.6.1.2.1-1: supported test configurations**

Configuration	Description
1	120 kHz SSB SCS, 100 MHz bandwidth, TDD duplex mode
2	240 kHz SSB SCS, 100 MHz bandwidth, TDD duplex mode
Note: The UE is only required to be tested in one of the supported test configurations.	

There are two cells in the test, PCell (Cell 1) and a FR2 neighbour cell (Cell 2) on the same frequency as the PCell. The test parameters for the Cell 1 and Cell 2 are given in Table A.7.6.1.2.1-2 ~ 6.

In the measurement control information, a measurement object is configured for the frequency of the PCell, and it is indicated to the UE that event-triggered reporting with Event A3 is used.

The test consists of two successive time periods, with time duration of T1, and T2 respectively. During time duration T1, the UE shall not have any timing information of Cell 2.

UE needs to be provided with new Timing Advance Command MAC control element at least once during each time alignment timer period to maintain uplink time alignment. Furthermore UE is allocated with PUSCH resource at every DRX cycle.

**Table A.7.6.1.2.1-2: General test parameters for intra-frequency event triggered reporting for SA with TDD PCell in FR2 without gap with DRX**

Parameter	Unit	Config	Value		Comment
			Test 1	Test 2	
Active cell		1, 2	PCell (Cell 1)		
Neighbour cell		1, 2	Cell 2		Cell to be identified.
RF Channel Number		1, 2	1: Cell 1 and Cell 2		One TDD carrier frequency is used for the NR cells.
SMTC configuration		1, 2	SMTC.1		
A3-Offset	dB	1, 2	-6		
CP length		1, 2	Normal		
Hysteresis	dB	1, 2	0		
Time To Trigger	s	1, 2	0		
Filter coefficient		1, 2	0		L3 filtering is not used
DRX		1, 2	DRX.1	DRX.7	DRX related parameters are defined in Table A.7.6.1.2.1-5
Time offset between Cell 1 and Cell 2		1, 2	3 $\mu$ s		Synchronous cells
T1	s	1, 2	5		
T2	s	1, 2	10	52	

**Table A.7.6.1.2.1-3: NR Cell specific test parameters for intra-frequency event triggered reporting for SA with TDD PCell in FR2 without gap with DRX**

Parameter	Unit	Config	Cell 1		Cell 2	
			T1	T2	T1	T2
TDD configuration		1, 2	TDDConf.3.1		TDDConf.3.1	
BW <sub>channel</sub>	MHz	1, 2	100: N <sub>RB,c</sub> = 66		100: N <sub>RB,c</sub> = 66	
Data RBs allocated		1, 2	66		66	
Initial BWP configuration		1, 2	DLBWP.0.1 ULBWP.0.1	DLBWP.0.1 ULBWP.0.1		
Active DL BWP configuration		1, 2	DLBWP.1.1		DLBWP.1.1	
Active UL BWP configuration		1, 2	ULBWP.1.1		ULBWP.1.1	
RLM-RS		1, 2	SSB		SSB	
PDSCH RMC configuration		1	SR.3.2 TDD		N/A	
		2	SR.3.3 TDD			
RMSI CORESET RMC configuration		1	CR.3.1 TDD		N/A	
		2	CR.3.2 TDD			
Dedicated CORESET RMC configuration		1	CCR.3.1 TDD		N/A	
		2	CCR.3.7 TDD			
TRS configuration		1, 2	TRS.2.1 TDD		N/A	
PDSCH/PDCCH TCI states		1, 2	TCI.State.2		N/A	
PDSCH/PDCCH subcarrier spacing	kHz	1, 2	120		120	
OCNG Patterns		1, 2	OP.1		OP.1	
SSB		1	SSB.3 FR2		SSB.3 FR2	
		2	SSB.4 FR2		SSB.4 FR2	
Propagation Condition		1, 2	AWGN		AWGN	

**Table A.7.6.1.2.1-4: NR OTA Cell specific test parameters for intra-frequency event triggered reporting for SA with TDD PCell in FR2 without gap with DRX**

Parameter	Unit	Config	Cell 1		Cell 2	
			T1	T2	T1	T2
AoA setup		1, 2	Setup 1 defined in A.3.15.1			
Beam assumption <sup>Note 4</sup>		1,2	Rough		Rough	
$\hat{E}_s / I_{ot}$ <sup>BB Note 5</sup>	dB	1, 2	3.77	-1.52	-Infinity	-1.52
$N_{oc}$ <sup>Note 2</sup>	dBm/15 KHz	1, 2	-98			
$N_{oc}$ <sup>Note 2</sup>	dBm/SCS	1	-89			
		2	-86			
SSB_RP	dBm/SCS	1	-85	-85	-Infinity	-85
		2	-82	-82	-Infinity	-82
$\hat{E}_s / N_{oc}$	dB	1, 2	4	4	-Infinity	4
$I_o$	dBm/95.04MHz	1, 2	-54.53	-52.18	See Cell 1 columns	

Note 1:	The resources for uplink transmission are assigned to the UE prior to the start of time period T2.
Note 2:	Interference from other cells and noise sources not specified in the test is assumed to be constant over subcarriers and time and shall be modelled as AWGN of appropriate power for $N_{oc}$ to be fulfilled.
Note 3:	Es/lot, SSB_RP and Io levels have been derived from other parameters for information purposes. They are not settable parameters themselves.
Note 4:	Information about types of UE beam is given in B.2.1.3, and does not limit UE implementation or test system implementation.
Note 5:	Calculation of Es/lot <sub>BB</sub> includes the effect of UE internal noise up to the value assumed for the associated Refsens requirement in clause 7.3.2 of TS 38.101-2 [19], and an allowance of 1dB for UE multi-band relaxation factor $\Delta MB_P$ from TS 38.101-2 [19] Table 6.2.1.3-4.

**Table A.7.6.1.2.1-5: Void****Table A.7.6.1.2.1-6: Void****A.7.6.1.2.2 Test Requirements**

In test 1, the UE shall send one Event A3 triggered measurement report, with a measurement reporting delay less than X ms from the beginning of time period T2, where X is

- 7.2s for a UE supporting power class 1,
- 4.32s for a UE supporting power class 2, 3 and 4

In test 2, the UE shall send one Event A3 triggered measurement report, with a measurement reporting delay less than X ms from the beginning of time period T2, where X is

- 51.2s for a UE supporting power class 1,
- 30.72s for a UE supporting power class 2, 3 and 4

The UE is not required to read the neighbour cell SSB index in this test.

The UE shall not send event triggered measurement reports, as long as the reporting criteria are not fulfilled.

The rate of correct events observed during repeated tests shall be at least 90%.

NOTE: The actual overall delays measured in the test may be up to  $2xTTI_{DCCCH}$  higher than the measurement reporting delays above because of TTI insertion uncertainty of the measurement report in DCCCH.

**A.7.6.1.3 SA event triggered reporting test with per-UE gaps under non-DRX****A.7.6.1.3.1 Test purpose and Environment**

The purpose of this test is to verify that the UE makes correct reporting of an event. This test will partly verify the TDD intra-frequency cell search requirements in clause 9.2.5.1 and 9.2.5.2. Supported test configurations are shown in table A.7.6.1.3.1-1.

**Table A.7.6.1.3.1-1: supported test configurations**

Configuration	Description
1	120 kHz SSB SCS, 100 MHz bandwidth, TDD duplex mode
2	240 kHz SSB SCS, 100 MHz bandwidth, TDD duplex mode
Note:	The UE is only required to be tested in one of the supported test configurations.

There are two cells in the test, PCell (Cell 1) and a FR2 neighbour cell (Cell 2) on the same frequency as the PCell. The test parameters for the Cell 1 and Cell 2 are given in Table A.7.6.1.3.1-2 ~ 4 below.

There are two BWPs configured in Cell 1, BWP1 which contains the cell defining SSB, and BWP2 which does not contain any SSB of Cell 1. During the whole test, BWP2 is always scheduled as the active BWP for the UE.

In the measurement control information, a measurement object is configured for the frequency of the PCell, and it is indicated to the UE that event-triggered reporting with Event A3 is used.

The test consists of two successive time periods, with time duration of T1, and T2 respectively. During time duration T1, the UE shall not have any timing information of Cell 2.

**Table A.7.6.1.3.1-2: General test parameters for intra-frequency event triggered reporting for SA with TDD PCell in FR2 with per-UE gaps without DRX**

Parameter	Unit	Config	Value	Comment
Active cell		1, 2	PCell (Cell 1)	
Neighbour cell		1, 2	Cell 2	Cell to be identified.
RF Channel Number		1, 2	1: Cell 1 and Cell 2	One TDD carrier frequency is used for the NR cells.
Gap type		1, 2	Per-UE gaps	
Measurement gap repetition periodicity	ms	1, 2	40	
Measurement gap length	ms	1, 2	6	
Measurement gap offset	ms	1, 2	39	
SMTTC configuration		1, 2	SMTTC.1	
CSI-RS parameters		1, 2	CSI-RS.3.2 TDD resource #0	Resource #1 is not used
A3-Offset	dB	1, 2	-11	
CP length		1, 2	Normal	
Hysteresis	dB	1, 2	0	
Time To Trigger	s	1, 2	0	
Filter coefficient		1, 2	0	L3 filtering is not used
DRX		1, 2	OFF	
Time offset between Cell 1 and Cell 2		1, 2	3 $\mu$ s	Synchronous cells
T1	s	1, 2	5	
T2	s	1, 2	5	

**Table A.7.6.1.3.1-3: NR Cell specific test parameters for intra-frequency event triggered reporting for SA with TDD PCell in FR2 with per-UE gaps without DRX**

Parameter	Unit	Config	Cell 1		Cell 2	
			T1	T2	T1	T2
TDD configuration		1, 2	TDDConf.3.1		TDDConf.3.1	
BW <sub>channel</sub>	MHz	1, 2	100: N <sub>RB,c</sub> = 66		100: N <sub>RB,c</sub> = 66	
Data RBs allocated		1	24		24	
		2	48		48	
Initial BWP configuration		1, 2	DLBWP.0.1 ULBWP.0.1		DLBWP.0.1 ULBWP.0.1	
Active DL BWP configuration		1, 2	DLBWP.1.2		DLBWP.1.1	
Active UL BWP configuration		1, 2	ULBWP.1.2		ULBWP.1.1	
RLM-RS		1, 2	CSI-RS		SSB	
PDSCH RMC configuration		1	SR.3.2 TDD		N/A	
		2	SR.3.3 TDD			
RMSI CORESET RMC configuration		1	CR.3.1 TDD		N/A	
		2	CR.3.2 TDD		N/A	
Dedicated CORESET RMC configuration		1	CCR.3.1 TDD		N/A	
		2	CCR.3.7 TDD		N/A	
TRS configuration		1, 2	TRS.2.1 TDD		N/A	
PDSCH/PDCCH TCI states		1, 2	TCI.State.2		N/A	
PDSCH/PDCCH subcarrier spacing	kHz	1, 2	120		120	

OCNG Patterns		1, 2	OP.5	N/A
cellIndividualOffset	dB	1~2	N/A	16
SSB		1	SSB.3 FR2	SSB.7 FR2
		2	SSB.4 FR2	SSB.8 FR2
Propagation Condition		1, 2	No external noise (Note 1)	No external noise (Note 1)
Note 1: The downlink connection between the System Simulator and the UE is without Additive White Gaussian Noise, and has no fading or multipath effects as specified in TS 38.521-2 B.0 [37].				

**Table A.7.6.1.3.1-4: NR OTA Cell specific test parameters for intra-frequency event triggered reporting for SA with TDD PCell in FR2 with per-UE gaps without DRX**

Parameter	Unit	Config	Cell 1		Cell 2	
			T1	T2	T1	T2
AoA setup		1, 2	Setup 3 defined in A.3.15.3			
			AoA1		AoA2	
Beam Assumption <sup>Note 4</sup>		1,2	Rough		Rough	
$E_s$	dBm/SCS	1	-89	-89	-Infinity	-89
		2	-86	-86	-Infinity	-86
$\hat{E}_s / I_{ot\_BB}$ <sup>Note 5</sup>	dB	1, 2	-0.12	-0.12	-Infinity	-0.12
SSB_RP	dBm/SCS	1	-89	-89	-Infinity	-89
		2	-86	-86	-Infinity	-86
$I_o$	dBm/95.04MHz	1	-64.41	-64.41	-Infinity	-64.41
		2	-61.41	-61.41	-Infinity	-61.41
Time multiplexing of the downlink transmissions from each AoA		1	Defined in Figure A.7.6.1.3.1-1			
<p>Note 1: The resources for uplink transmission are assigned to the UE prior to the start of time period T2.</p> <p>Note 2: Void</p> <p>Note 3: <math>E_s/I_{ot}</math>, SSB_RP and <math>I_o</math> levels have been derived from other parameters for information purposes. They are not settable parameters themselves.</p> <p>Note 4: Information about types of UE beam is given in B.2.1.3, and does not limit UE implementation or test system implementation</p> <p>Note 5: Calculation of <math>E_s/I_{ot\_BB}</math> includes the effect of UE internal noise up to the value assumed for the associated Refsens requirement in clause 7.3.2 of TS 38.101-2 [19], and an allowance of 1dB for UE multi-band relaxation factor <math>\Delta MB_P</math> from TS 38.101-2 [19] Table 6.2.1.3-4.</p>						



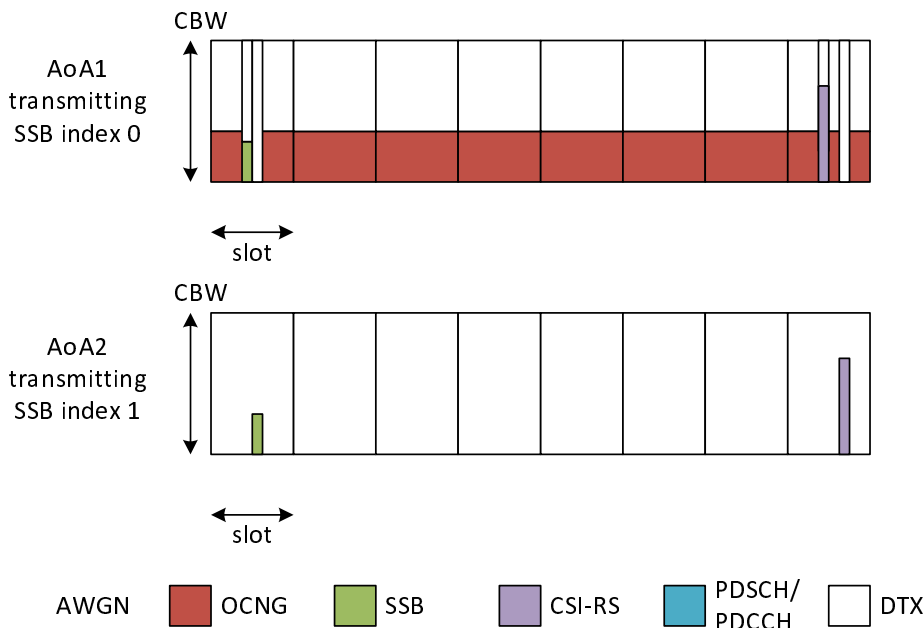

**Figure A.7.6.1.3.1-1: Time multiplexed downlink transmissions (Config 1 example)**

**A.7.6.1.3.2 Test Requirements**

In the test, the UE shall send one Event A3 triggered measurement report, with a measurement reporting delay less than X ms from the beginning of time period T2, where X is

- 3.2s for a UE supporting power class 1,
- 1.92s for a UE supporting power class 2, 3 and 4

The UE is not required to read the neighbour cell SSB index in this test.

The UE shall not send event triggered measurement reports, as long as the reporting criteria are not fulfilled.

The rate of correct events observed during repeated tests shall be at least 90%.

NOTE: The actual overall delays measured in the test may be up to  $2 \times TTI_{DCCH}$  higher than the measurement reporting delays above because of TTI insertion uncertainty of the measurement report in DCCH.

**A.7.6.1.4 SA event triggered reporting test with per-UE gaps under DRX**

**A.7.6.1.4.1 Test purpose and Environment**

The purpose of this test is to verify that the UE makes correct reporting of an event. This test will partly verify the TDD intra-frequency cell search requirements in clause 9.2.5.1 and 9.2.5.2. Supported test configurations are shown in table A.7.6.1.4.1-1.

**Table A.7.6.1.4.1-1: supported test configurations**

Configuration	Description
1	120 kHz SSB SCS, 100 MHz bandwidth, TDD duplex mode
2	240 kHz SSB SCS, 100 MHz bandwidth, TDD duplex mode
Note: The UE is only required to be tested in one of the supported test configurations.	

There are two cells in the test, PCell (Cell 1) and a FR2 neighbour cell (Cell 2) on the same frequency as the PCell. The test parameters for the Cell 1 and Cell 2 are given in Table A.7.6.1.4.1-2, A.7.6.1.4.1-3 and A.7.6.1.4.1-4 below.

There are two BWPs configured in Cell 1, BWP1 which contains the cell defining SSB, and BWP2 which does not contain any SSB of Cell 1. During the whole test, BWP2 is always scheduled as the active BWP for the UE.

In the measurement control information, a measurement object is configured for the frequency of the PCell, and it is indicated to the UE that event-triggered reporting with Event A3 is used.

The test consists of two successive time periods, with time duration of T1, and T2 respectively. During time duration T1, the UE shall not have any timing information of Cell 2.

UE needs to be provided with new Timing Advance Command MAC control element at least once during each time alignment timer period to maintain uplink time alignment. Furthermore UE is allocated with PUSCH resource at every DRX cycle.

**Table A.7.6.1.4.1-2: General test parameters for intra-frequency event triggered reporting for SA with TDD PCell in FR2 with per-UE gaps with DRX**

Parameter	Unit	Config	Value		Comment
			Test 1	Test 2	
Active cell		1, 2	PCell (Cell 1)		
Neighbour cell		1, 2	Cell 2		Cell to be identified.
RF Channel Number		1, 2	1: Cell 1 and Cell 2		One TDD carrier frequency is used for the NR cells.
Gap type		1, 2	Per-UE gaps		
Measurement gap repetition periodicity	ms	1, 2	40		
Measurement gap length	ms	1, 2	6		
Measurement gap offset	ms	1, 2	39		
SMTC configuration		1, 2	SMTC.1		
CSI-RS parameters		1, 2	CSI-RS.3.2 TDD resource #0		Resource #1 is not used
A3-Offset	dB	1, 2	-6		
CP length		1, 2	Normal		
Hysteresis	dB	1, 2	0		
Time To Trigger	s	1, 2	0		
Filter coefficient		1, 2	0		L3 filtering is not used
DRX		1, 2	DRX.1	DRX.7	DRX related parameters are defined in Table A.7.6.1.2.1-5
Time offset between Cell 1 and Cell 2		1, 2	3 $\mu$ s		Synchronous cells
T1	s	1, 2	5		
T2	s	1, 2	10	52	

**Table A.7.6.1.4.1-3: NR Cell specific test parameters for intra-frequency event triggered reporting for SA with TDD PCell in FR2 with per-UE gaps with DRX**

Parameter	Unit	Config	Cell 1		Cell 2	
			T1	T2	T1	T2
TDD configuration		1, 2	TDDConf.3.1		TDDConf.3.1	
BW <sub>channel</sub>	MHz	1, 2	100: N <sub>RB,c</sub> = 66		100: N <sub>RB,c</sub> = 66	
Data RBs allocated		1, 2	66		66	
Initial BWP configuration		1, 2	DLBWP.0.1	ULBWP.0.1	DLBWP.0.1	ULBWP.0.1
Active DL BWP configuration		1, 2	DLBWP.1.2		DLBWP.1.1	
Active UL BWP configuration		1, 2	ULBWP.1.2		ULBWP.1.1	
RLM-RS		1, 2	SCSI-RS		SSB	
PDSCH RMC configuration		1	SR.3.12TDD		N/A	
		2	SR.3.3 TDD			
RMSI CORESET RMC configuration		1	CR.3.1 TDD		N/A	
		2	CR.3.2 TDD		N/A	
Dedicated CORESET RMC configuration		1	CCR.3.1 TDD		N/A	

		2	CCR.3.7 TDD	N/A
TRS configuration		1, 2	TRS.2.1 TDD	N/A
PDSCH/PDCCH TCI state		1, 2	TCI.State.2	N/A
PDSCH/PDCCH subcarrier spacing	kHz	1, 2	120	120
OCNG Patterns		1, 2	OP.1	OP.1
SSB		1	SSB.3 FR2	SSB.3 FR2
		2	SSB.4 FR2	SSB.4 FR2
Propagation Condition		1, 2	AWGN	AWGN

**Table A.7.6.1.4.1-4: NR OTA Cell specific test parameters for intra-frequency event triggered reporting for SA with TDD PCell in FR2 with per-UE gaps with DRX**

Parameter	Unit	Config	Cell 1		Cell 2	
			T1	T2	T1	T2
AoA setup		1, 2	Setup 1 defined in A.3.15.1			
Beam Assumption <sup>Note 4</sup>		1,2	Rough			
$\hat{E}_s/I_{ot}$ <sup>BB Note 5</sup>	dB	1, 2	3.77	-1.52	-Infinity	-1.52
$N_{oc}$ <sup>Note 2</sup>	dBm/15 KHz	1, 2	-98			
$N_{oc}$ <sup>Note 2</sup>	dBm/SCS	1	-89			
		2	-86			
SSB_RP	dBm/SCS	1	-85	-85	-Infinity	-85
		2	-82	-82	-Infinity	-82
$\hat{E}_s/N_{oc}$	dB	1, 2	4	4	-Infinity	4
$I_o$	dBm/95.04MHz	1,2	-54.53	-52.18	See Cell 1 columns	
Note 1:	The resources for uplink transmission are assigned to the UE prior to the start of time period T2.					
Note 2:	Interference from other cells and noise sources not specified in the test is assumed to be constant over subcarriers and time and shall be modelled as AWGN of appropriate power for $N_{oc}$ to be fulfilled.					
Note 3:	$E_s/I_{ot}$ , SSB_RP and $I_o$ levels have been derived from other parameters for information purposes. They are not settable parameters themselves.					
Note 4:	Information about types of UE beam is given in B.2.1.3, and does not limit UE implementation or test system implementation					
Note 5:	Calculation of $E_s/I_{ot_{BB}}$ includes the effect of UE internal noise up to the value assumed for the associated Refsens requirement in clause 7.3.2 of TS 38.101-2 [19], and an allowance of 1dB for UE multi-band relaxation factor $\Delta MB_F$ from TS 38.101-2 [19] Table 6.2.1.3-4.					

**Table A.7.6.1.4.1-5: Void**

**Table A.7.6.1.4.1-6: Void**

#### A.7.6.1.4.2 Test Requirements

In test 1, the UE shall send one Event A3 triggered measurement report, with a measurement reporting delay less than X ms from the beginning of time period T2, where X is

- 7.2s for a UE supporting power class 1,
- 4.32s for a UE supporting power class 2, 3 and 4

In test 2, the UE shall send one Event A3 triggered measurement report, with a measurement reporting delay less than X ms from the beginning of time period T2, where X is

- 51.2s for a UE supporting power class 1,

- 30.72s for a UE supporting power class 2, 3 and 4

The UE is not required to read the neighbour cell SSB index in this test.

The UE shall not send event triggered measurement reports, as long as the reporting criteria are not fulfilled.

The rate of correct events observed during repeated tests shall be at least 90%.

NOTE: The actual overall delays measured in the test may be up to  $2 \times TTI_{DCC}$  higher than the measurement reporting delays above because of TTI insertion uncertainty of the measurement report in DCC.

## A.7.6.2 Inter-frequency Measurements

### A.7.6.2.1 SA event triggered reporting tests For FR2 without SSB time index detection when DRX is not used (PCell in FR2)

#### A.7.6.2.1.1 Test Purpose and Environment

The purpose of this test is to verify that the UE makes correct reporting of an event. This test will partly verify the SA inter-frequency NR cell search requirements in clause 9.3.4.

In this test, there are two cells: NR cell 1 as PCell in FR2 on NR RF channel 1 and NR cell 2 as neighbour cell in FR2 on NR RF channel 2. The test parameters and configurations are given in Tables A.7.6.2.1.1-1, A.7.6.2.1.1-2, and A.7.6.2.1.1-3.

Measurement gap pattern configuration defined in Table A.7.6.2.1.1-2 is provided for a UE that does not support per-FR gap, and no gap pattern (Gap Pattern Id and Measurement gap offset) is configured for a UE capable of per-FR gap.

In the measurement control information, it is indicated to the UE that event-triggered reporting with Event A3 is used. The test consists of two successive time periods, with time duration of T1, and T2 respectively. During time duration T1, the UE shall not have any timing information of NR cell 2.

Supported test configurations are shown in table A.7.6.2.1.1-1.

**Table A.7.6.2.1.1-1 SA event triggered reporting tests without SSB index reading for FR2-FR2**

Config	Description
1	120 kHz SSB SCS, 100 MHz bandwidth, TDD duplex mode
Note 1:	Void.

**Table A.7.6.2.1.1-2: General test parameters for SA inter-frequency event triggered reporting for FR2 without SSB time index detection**

Parameter	Unit	Test configuration	Value	Comment
NR RF Channel Number		Config 1	1, 2	Two FR2 NR carrier frequencies is used.
Active cell		Config 1	NR cell 1 (Pcell)	NR Cell 1 is on NR RF channel number 1.
Neighbour cell		Config 1	NR cell 2	NR cell 2 is on NR RF channel number 2.
Gap Pattern Id		Config 1	13	As specified in clause 9.1.2-1.
Measurement gap offset		Config 1	39	
offsetMO	dB	Config 1	16	Applied to NR Cell 2 measurement object
A3-Offset	dB	Config 1	-11	
Hysteresis	dB	Config 1	0	
CP length		Config 1	Normal	
TimeToTrigger	s	Config 1	0	

Filter coefficient		Config 1	0	L3 filtering is not used
DRX		Config 1	OFF	DRX is not used
Time offset between serving and neighbour cells		Config 1	3 $\mu$ s	Synchronous cells.
T1	s	Config 1	5	
T2	s	Config 1	5.2 for PC1; 3.5 for other PC	

**Table A.7.6.2.1.1-3: Cell specific test parameters for SA inter-frequency event triggered reporting for FR2 without SSB time index detection**

Parameter		Unit	Test configuration	Cell 1		Cell 2	
				T1	T2	T1	T2
AoA setup			Config 1	Setup 3 as specified in clause A.3.15			
				AoA1		AoA2	
Beam Assumption <sup>Note 7</sup>			1,2	Rough		Rough	
NR RF Channel Number			Config 1	1		2	
Duplex mode			Config 1	TDD		TDD	
TDD configuration			Config 1	TDDConf.3.1		TDDConf.3.1	
BW <sub>channel</sub>		MHz	Config 1	100: N <sub>RB,c</sub> = 66		100: N <sub>RB,c</sub> = 66	
Data RBs allocated			Config 1	66		66	
BWP BW		MHz	Config 1	100: N <sub>RB,c</sub> = 66		100: N <sub>RB,c</sub> = 66	
BWP configuration	Initial DL BWP		Config 1	DLBWP.0.1		N/A	
	Initial UL BWP			ULBWP.0.1		N/A	
	Dedicated DL BWP			DLBWP.1.1		N/A	
	Dedicated UL BWP			ULBWP.1.1		N/A	
OCNG Patterns defined in A.3.2.1.1 (OP.1)			Config 1	OP.1		OP.1	
PDSCH Reference measurement channel			Config 1	SR.3.1 TDD		-	
CORESET Reference Channel			Config 1	CR.3.1 TDD		-	
SMTC configuration defined in A.3.11.1 and A.3.11.2			Config 1	SMTC.1		SMTC.1	
PDSCH/PDCCH subcarrier spacing		kHz	Config 1	120		120	
TRS configuration			Config 1	TRS.2.1 TDD		N/A	
PDSCH/PDCCH TCI state			Config 1	TCI.State.2		N/A	
EPRE ratio of PSS to SSS			Config 1	0		0	
EPRE ratio of PBCH DMRS to SSS							
EPRE ratio of PBCH to PBCH DMRS							
EPRE ratio of PDCCH DMRS to SSS							
EPRE ratio of PDCCH to PDCCH DMRS							
EPRE ratio of PDSCH DMRS to SSS							
EPRE ratio of PDSCH to PDSCH							
EPRE ratio of OCNG DMRS to SSS(Note 1)							
EPRE ratio of OCNG to OCNG DMRS (Note 1)							
E <sub>s</sub>		dBm/S CS	Config 1	-87		-87	

SSB-RP <sup>Note 3</sup>	dBm/S CS <sup>Note5</sup>	Config 1	-87	-87	-Infinity	-87
$\hat{E}_s / I_{ot\_BB}$ <sup>Note 8</sup>	dB	Config 1	1.89	1.89	-Infinity	1.89
$I_o$ <sup>Note3</sup>	dBm/95 .04 MHz <sup>Note5</sup>	Config 1	-58.01	-58.01	-Infinity	-58.01
Propagation Condition		Config 1	No external noise (Note 9)		No external noise (Note 9)	
<p>Note 1: OCNG shall be used such that both cells are fully allocated and a constant total transmitted power spectral density is achieved for all OFDM symbols.</p> <p>Note 2: Void</p> <p>Note 3: SSB-RP, <math>E_s/I_{ot}</math> and <math>I_o</math> levels have been derived from other parameters for information purposes. They are not settable parameters themselves.</p> <p>Note 4: Void</p> <p>Note 5: Equivalent power received by an antenna with 0 dBi gain at the centre of the quiet zone</p> <p>Note 6: As observed with 0 dBi gain antenna at the centre of the quiet zone</p> <p>Note 7: Information about types of UE beam is given in B.2.1.3, and does not limit UE implementation or test system implementation</p> <p>Note 8: Calculation of <math>E_s/I_{ot\_BB}</math> includes the effect of UE internal noise up to the value assumed for the associated Refsens requirement in clause 7.3.2 of TS 38.101-2 [19], and an allowance of 1dB for UE multi-band relaxation factor <math>\Delta MB_s</math> from TS 38.101-2 [19] Table 6.2.1.3-4.</p> <p>Note 9: The downlink connection between the System Simulator and the UE is without Additive White Gaussian Noise, and has no fading or multipath effects as specified in TS 38.521-2 B.0 [37].</p>						

#### A.7.6.2.1.2 Test Requirements

The UE shall send one Event A3 triggered measurement report, with a measurement reporting delay less than X ms from the beginning of time period T2, where X is

- 5120 for UE supporting power class 1, or
- 3200 for UE supporting other power class.

The UE is not required to report SSB time index. The UE shall not send event triggered measurement reports, as long as the reporting criteria are not fulfilled. The rate of correct events observed during repeated tests shall be at least 90%.

NOTE: The actual overall delays measured in the test may be up to  $2 \times TTI_{DCC}$  higher than the measurement reporting delays above because of TTI insertion uncertainty of the measurement report in DCC.

#### A.7.6.2.2 SA event triggered reporting tests For FR2 without SSB time index detection when DRX is used (PCell in FR2)

##### A.7.6.2.2.1 Test Purpose and Environment

The purpose of this test is to verify that the UE makes correct reporting of an event. This test will partly verify the SA inter-frequency NR cell search requirements in clause 9.3.4.

In this test, there are two cells: NR cell 1 as PCell in FR2 on NR RF channel 1 and NR cell 2 as neighbour cell in FR2 on NR RF channel 2. The test parameters and configurations are given in Tables A.7.6.2.2.1-1, A.7.6.2.2.1-2, and A.7.6.2.2.1-3.

Measurement gap pattern configuration defined in Table A.7.6.2.2.1-2 is provided for a UE that does not support per-FR gap, and no gap pattern (Gap Pattern Id and Measurement gap offset) is configured for a UE capable of per-FR gap.

In the measurement control information, it is indicated to the UE that event-triggered reporting with Event A3 is used. The test consists of two successive time periods, with time duration of T1, and T2 respectively. During time duration T1, the UE shall not have any timing information of NR cell 2.

Supported test configurations are shown in table A.7.6.2.2.1-1.

UE needs to be provided with new Timing Advance Command MAC control element at least once during each time alignment timer period to maintain uplink time alignment. Furthermore UE is allocated with PUSCH resource at every DRX cycle.

**Table A.7.6.2.2.1-1: SA event triggered reporting tests without SSB index reading for FR2-FR2**

Config	Description
1	120 kHz SSB SCS, 100 MHz bandwidth, TDD duplex mode
Note 1: Void.	

**Table A.7.6.2.2.1-2: General test parameters for SA inter-frequency event triggered reporting for FR2 without SSB time index detection**

Parameter	Unit	Test configuration	Value		Comment
			Test 1	Test 2	
NR RF Channel Number		Config 1	1, 2		Two FR2 NR carrier frequencies is used.
Active cell		Config 1	NR cell 1 (Pcell)		NR Cell 1 is on NR RF channel number 1.
Neighbour cell		Config 1	NR cell 2		NR cell 2 is on NR RF channel number 2.
Gap Pattern Id		Config 1	13		As specified in clause 9.1.2-1.
Measurement gap offset		Config 1	39		
SMTC-SSB parameters		Config 1	SSB.3 FR2		As specified in clause A.3.10.2
A3-Offset	dB	Config 1	-6		
Hysteresis	dB	Config 1	0		
CP length		Config 1	Normal		
TimeToTrigger	s	Config 1	0		
Filter coefficient		Config 1	0		L3 filtering is not used
DRX		Config 1	DRX.1	DRX.7	As specified in clause A.3.3
Time offset between serving and neighbour cells		Config 1	3µs		Synchronous cells.
T1	s	Config 1	5		
T2	s	Config 1	8 for PC1; 5 for other PC	82 for PC1; 52 for other PC	

**Table A.7.6.2.2.1-3: Cell specific test parameters for CA inter-frequency event triggered reporting without SSB time index detection**

Parameter	Unit	Test configuration	Cell 1		Cell 2	
			T1	T2	T1	T2
AoA setup		Config 1	Setup 1 as specified in clause A.3.15			
Beam Assumption <sup>Note 7</sup>		Config 1	Rough		Rough	
NR RF Channel Number		Config 1	1		2	
TDD configuration		Config 1	TDDConf.3.1		TDDConf.3.1	
Duplex mode		Config 1	TDD		TDD	
BW <sub>channel</sub>	MHz	Config 1	100: N <sub>RB,c</sub> = 66		100: N <sub>RB,c</sub> = 66	
Data RBs allocated		Config 1	66		66	
BWP BW	MHz	Config 1	100: N <sub>RB,c</sub> = 66		100: N <sub>RB,c</sub> = 66	
BWP configuration	Initial DL BWP	Config 1	DLBWP.0.1		N/A	
	Initial UL BWP		ULBWP.0.1		N/A	
	Dedicated DL BWP		DLBWP.1.1		N/A	
	Dedicated UL BWP		ULBWP.1.1		N/A	
OCNG Patterns defined in A.3.2.1.1 (OP.1)		Config 1	OP.1		OP.1	

PDSCH Reference measurement channel		Config 1	SR.3.1 TDD	-		
CORESET Reference Channel		Config 1	CR.3.1 TDD	-		
SMTC configuration defined in A.3.11.1 and A.3.11.2		Config 1	SMTC.1	SMTC.1		
PDSCH/PDCCH subcarrier spacing	kHz	Config 1	120	120		
TRS configuration		Config 1	TRS.2.1 TDD	N/A		
PDSCH/PDCCH TCI state		Config 1	TCI.State.2	N/A		
EPRE ratio of PSS to SSS		Config 1	0	0		
EPRE ratio of PBCH DMRS to SSS						
EPRE ratio of PBCH to PBCH DMRS						
EPRE ratio of PDCCH DMRS to SSS						
EPRE ratio of PDCCH to PDCCH DMRS						
EPRE ratio of PDSCH DMRS to SSS						
EPRE ratio of PDSCH to PDSCH						
EPRE ratio of OCNG DMRS to SSS(Note 1)						
EPRE ratio of OCNG to OCNG DMRS (Note 1)						
$N_{oc}$ Note2	dBm/15 kHz Note5					
$N_{oc}$ Note2	dBm/S CS Note4	Config 1	-95.7	-95.7		
SS-RSRP Note 3	dBm/S CS Note5	Config 1	-89.7	-89.7	-Infinity	-86.7
$\hat{E}_s / I_{ot}$	dB	Config 1	6	6	-Infinity	9
$\hat{E}_s / N_{oc}$	dB	Config 1	6	6	-Infinity	9
$I_o$ Note3	dBm/95.04 MHz Note5	Config 1	-59.7	-59.7	-66.7	-57.2
Propagation Condition		Config 1	AWGN		AWGN	
<p>Note 1: OCNG shall be used such that both cells are fully allocated and a constant total transmitted power spectral density is achieved for all OFDM symbols.</p> <p>Note 2: Interference from other cells and noise sources not specified in the test is assumed to be constant over subcarriers and time and shall be modelled as AWGN of appropriate power for <math>N_{oc}</math> to be fulfilled.</p> <p>Note 3: SSB_RP and <math>I_o</math> levels have been derived from other parameters for information purposes. They are not settable parameters themselves.</p> <p>Note 4: Void</p> <p>Note 5: Equivalent power received by an antenna with 0 dBi gain at the centre of the quiet zone</p> <p>Note 6: As observed with 0 dBi gain antenna at the centre of the quiet zone</p> <p>Note 7: Information about types of UE beam is given in B.2.1.3, and does not limit UE implementation or test system implementation</p>						

A.7.6.2.2.2 Test Requirements

In test 1 the UE shall send one Event A3 triggered measurement report, with a measurement reporting delay less than X1 ms from the beginning of time period T2, where X1 is

7680 for UE supporting power class 1, or



4800 for UE supporting other power class.

In test 2 the UE shall send one Event A3 triggered measurement report, with a measurement reporting delay less than X2 ms from the beginning of time period T2, where X2 is

81920 for UE supporting power class 1, or

51200 for UE supporting other power class.

In test 1 and 2 UE is not required to report SSB time index. The UE shall not send event triggered measurement reports, as long as the reporting criteria are not fulfilled. The rate of correct events observed during repeated tests shall be at least 90%.

NOTE: The actual overall delays measured in the test may be up to  $2xTTI_{DCCH}$  higher than the measurement reporting delays above because of TTI insertion uncertainty of the measurement report in DCCH.

### A.7.6.2.3 SA event triggered reporting tests For FR2 with SSB time index detection when DRX is not used (PCell in FR2)

#### A.7.6.2.3.1 Test Purpose and Environment

The purpose of this test is to verify that the UE makes correct reporting of an event. This test will partly verify the SA inter-frequency NR cell search requirements in clause 9.3.4.

In this test, there are two cells: NR cell 1 as PCell in FR2 on NR RF channel 1 and NR cell 2 as neighbour cell in FR2 on NR RF channel 2. The test parameters and configurations are given in Tables A.7.6.2.3.1-1, A.7.6.2.3.1-2, and A.7.6.2.3.1-3.

Measurement gap pattern configuration defined in Table A.7.6.2.3.1-2 is provided for a UE that does not support per-FR gap, and no gap pattern (Gap Pattern Id and Measurement gap offset) is configured for a UE capable of per-FR gap.

In the measurement control information, it is indicated to the UE that event-triggered reporting with Event A3 is used. The test consists of two successive time periods, with time duration of T1, and T2 respectively. During time duration T1, the UE shall not have any timing information of NR cell 2.

Supported test configurations are shown in table A.7.6.2.3.1-1.

**Table A.7.6.2.3.1-1: SA event triggered reporting tests with SSB index reading for FR2-FR2**

Config	Description
1	120 kHz SSB SCS, 100 MHz bandwidth, TDD duplex mode
Note 1:	Void.

**Table A.7.6.2.3.1-2: General test parameters for SA inter-frequency event triggered reporting for FR2 with SSB time index detection**

Parameter	Unit	Test configuration	Value	Comment
NR RF Channel Number		Config 1	1, 2	Two FR2 NR carrier frequencies is used.
Active cell		Config 1	NR cell 1 (Pcell)	NR Cell 1 is on NR RF channel number 1.
Neighbour cell		Config 1	NR cell 2	NR cell 2 is on NR RF channel number 2.
Gap Pattern Id		Config 1	13	As specified in clause 9.1.2-1.
Measurement gap offset		Config 1	39	
SMTc-SSB parameters		Config 1	SSB.3 FR2	As specified in clause A.3.10.2
offsetMO	dB	Config 1	16	Applied to NR Cell 2 measurement object
A3-Offset	dB	Config 1	-11	
Hysteresis	dB	Config 1	0	
CP length		Config 1	Normal	
TimeToTrigger	s	Config 1	0	

Filter coefficient		Config 1	0	L3 filtering is not used
DRX		Config 1	OFF	DRX is not used
Time offset between serving and neighbour cells		Config 1	3 $\mu$ s	Synchronous cells.
T1	s	Config 1	5	
T2	s	Config 1	7 for PC1; 4.5 for other PC	

**Table A.7.6.2.3.1-3: Cell specific test parameters for SA inter-frequency event triggered reporting for FR2 with SSB time index detection**

Parameter		Unit	Test configuration	Cell 1		Cell 2	
				T1	T2	T1	T2
AoA setup			Config 1	Setup 3 as specified in clause A.3.15			
				AoA1	AoA2		
Beam Assumption <sup>Note 7</sup>			Config 1	Rough		Rough	
NR RF Channel Number			Config 1	1		2	
Duplex mode			Config 1	TDD		TDD	
TDD configuration			Config 1	TDDConf.3.1		TDDConf.3.1	
BW <sub>channel</sub>		MHz	Config 1	100: N <sub>RB,c</sub> = 66		100: N <sub>RB,c</sub> = 66	
Data RBs allocated			Config 1	66		66	
BWP BW		MHz	Config 1	100: N <sub>RB,c</sub> = 66		100: N <sub>RB,c</sub> = 66	
BWP configuration	Initial DL BWP		Config 1	DLBWP.0.1		N/A	
	Initial UL BWP			ULBWP.0.1		N/A	
	Dedicated DL BWP			DLBWP.1.1		N/A	
	Dedicated UL BWP			ULBWP.1.1		N/A	
OCNG Patterns defined in A.3.2.1.1			Config 1	OP.1		OP.1	
PDSCH Reference measurement channel			Config 1	SR.3.1 TDD		-	
CORESET Reference Channel			Config 1	CR.3.1 TDD		-	
SMTTC configuration defined in A.3.11.1 and A.3.11.2			Config 1	SMTTC.1		SMTTC.1	
PDSCH/PDCCH subcarrier spacing		kHz	Config 1	120		120	
TRS configuration			Config 1	TRS.2.1 TDD		N/A	
PDSCH/PDCCH TCI state			Config 1	TCI.State.2		N/A	
EPRE ratio of PSS to SSS			Config 1	0		0	
EPRE ratio of PBCH DMRS to SSS							
EPRE ratio of PBCH to PBCH DMRS							
EPRE ratio of PDCCH DMRS to SSS							
EPRE ratio of PDCCH to PDCCH DMRS							
EPRE ratio of PDSCH DMRS to SSS							
EPRE ratio of PDSCH to PDSCH							
EPRE ratio of OCNG DMRS to SSS(Note 1)							
EPRE ratio of OCNG to OCNG DMRS (Note 1)							
E <sub>s</sub>		dBm/SCS					
SSB-RP <sup>Note 3</sup>		dBm/SCS <sup>Note 5</sup>	Config 1	-87	-87	-Infinity	-87

$\hat{E}_s / I_{ot\_BB}$ Note 8	dB	Config 1	1.89	1.89	N/A	1.89
$I_o$ Note 3	dBm/95 .04 MHz Note 5	Config 1	-58.01	-58.01	-Infinity	-58.01
Propagation Condition		Config 1	No external noise (Note 9)		No external noise (Note 9)	
<p>Note 1: OCNG shall be used such that both cells are fully allocated and a constant total transmitted power spectral density is achieved for all OFDM symbols.</p> <p>Note 2: Void</p> <p>Note 3: SSB-RP, <math>E_s/I_{ot}</math> and <math>I_o</math> levels have been derived from other parameters for information purposes. They are not settable parameters themselves.</p> <p>Note 4: Void</p> <p>Note 5: Equivalent power received by an antenna with 0 dBi gain at the centre of the quiet zone</p> <p>Note 6: As observed with 0 dBi gain antenna at the centre of the quiet zone</p> <p>Note 7: Information about types of UE beam is given in B.2.1.3, and does not limit UE implementation or test system implementation</p> <p>Note 8: Calculation of <math>E_s/I_{ot\_BB}</math> includes the effect of UE internal noise up to the value assumed for the associated Refsens requirement in clause 7.3.2 of TS 38.101-2 [19], and an allowance of 1dB for UE multi-band relaxation factor <math>\Delta M B_s</math> from TS 38.101-2 [19] Table 6.2.1.3-4.</p> <p>Note 9: The downlink connection between the System Simulator and the UE is without Additive White Gaussian Noise, and has no fading or multipath effects as specified in TS 38.521-2 B.0 [37].</p>						

#### A.7.6.2.3.2 Test Requirements

In test 1 with per-UE gap and in test 2 with per-FR gap, the UE shall send one Event A3 triggered measurement report, with a measurement reporting delay less than X ms from the beginning of time period T2, where X is

6720 for UE supporting power class 1, or

4160 for UE supporting other power class.

The UE is required to report SSB time index. The UE shall not send event triggered measurement reports, as long as the reporting criteria are not fulfilled. The rate of correct events observed during repeated tests shall be at least 90%.

NOTE: The actual overall delays measured in the test may be up to  $2xTTI_{DCCH}$  higher than the measurement reporting delays above because of TTI insertion uncertainty of the measurement report in DCCH.

#### A.7.6.2.4 SA event triggered reporting tests For FR2 with SSB time index detection when DRX is used (PCell in FR2)

##### A.7.6.2.4.1 Test Purpose and Environment

The purpose of this test is to verify that the UE makes correct reporting of an event. This test will partly verify the SA inter-frequency NR cell search requirements in clause 9.3.4.

In this test, there are two cells: NR cell 1 as PCell in FR2 on NR RF channel 1 and NR cell 2 as neighbour cell in FR2 on NR RF channel 2. The test parameters and configurations are given in Tables A.7.6.2.4.1-1, A.7.6.2.4.1-2, and A.7.6.2.4.1-3.

Measurement gap pattern configuration defined in Table A.7.6.2.4.1-2 is provided for a UE that does not support per-FR gap, and no gap pattern (Gap Pattern Id and Measurement gap offset) is configured for a UE capable of per-FR gap.

In the measurement control information, it is indicated to the UE that event-triggered reporting with Event A3 is used. The test consists of two successive time periods, with time duration of T1, and T2 respectively. During time duration T1, the UE shall not have any timing information of NR cell 2.

Supported test configurations are shown in table A.7.6.2.4.1-1.

UE needs to be provided with new Timing Advance Command MAC control element at least once during each time alignment timer period to maintain uplink time alignment. Furthermore UE is allocated with PUSCH resource at every DRX cycle.

**Table A.7.6.2.4.1-1: SA event triggered reporting tests with SSB index reading for FR2-FR2**

Config	Description
1	120 kHz SSB SCS, 100 MHz bandwidth, TDD duplex mode
Note 1: Void.	

**Table A.7.6.2.4.1-2: General test parameters for SA inter-frequency event triggered reporting for FR2 with SSB time index detection**

Parameter	Unit	Test configuration	Value		Comment
			Test 1	Test 2	
NR RF Channel Number		Config 1	1, 2		Two FR2 NR carrier frequencies is used.
Active cell		Config 1	NR cell 1 (Pcell)		NR Cell 1 is on NR RF channel number 1.
Neighbour cell		Config 1	NR cell 2		NR cell 2 is on NR RF channel number 2.
Gap Pattern Id		Config 1	13		As specified in clause 9.1.2-1.
Measurement gap offset		Config 1	39		
SMTC-SSB parameters		Config 1	SSB.3 FR2		As specified in clause A.3.10.2
A3-Offset	dB	Config 1	-6		
Hysteresis	dB	Config 1	0		
CP length		Config 1	Normal		
TimeToTrigger	s	Config 1	0		
Filter coefficient		Config 1	0		L3 filtering is not used
DRX		Config 1	DRX.1	DRX.7	As specified in clause A.3.3
Time offset between serving and neighbour cells		Config 1	3µs		Synchronous cells.
T1	s	Config 1	5		
T2	s	Config 1	11 for PC1; 6.5 for other PC	108 for PC1; 67 for other PC	

**Table A.7.6.2.4.1-3: Cell specific test parameters for CA inter-frequency event triggered reporting with SSB time index detection**

Parameter		Unit	Test configuration	Cell 1		Cell 2	
				T1	T2	T1	T2
AoA setup			Config 1	Setup 1 as specified in clause A.3.15			
Beam Assumption <sup>Note 7</sup>			Config 1	Rough		Rough	
NR RF Channel Number			Config 1	1		2	
Duplex mode			Config 1	TDD		TDD	
TDD configuration			Config 1	TDDConf.3.1		TDDConf.3.1	
BW <sub>channel</sub>		MHz	Config 1	100: N <sub>RB,c</sub> = 66		100: N <sub>RB,c</sub> = 66	
Data RBs allocated			Config 1	66		66	
BWP BW		MHz	Config 1	100: N <sub>RB,c</sub> = 66		100: N <sub>RB,c</sub> = 66	
BWP configuration	Initial DL BWP		Config 1	DLBWP.0.1		N/A	
	Initial UL BWP			ULBWP.0.1		N/A	
	Dedicated DL BWP			DLBWP.1.1		N/A	
	Dedicated UL BWP			ULBWP.1.1		N/A	
OCNG Patterns defined in A.3.2.1.1 (OP.1)			Config 1	OP.1		OP.1	
PDSCH Reference measurement channel			Config 1	SR.3.1 TDD		-	

CORESET Reference Channel		Config 1	CR.3.1 TDD		-	
SMTTC configuration defined in A.3.11.1 and A.3.11.2		Config 1	SMTTC.1		SMTTC.1	
PDSCH/PDCCH subcarrier spacing	kHz	Config 1	120		120	
TRS configuration		Config 1	TRS.2.1 TDD		N/A	
PDSCH/PDCCH TCI state		Config 1	TCI.State.2		N/A	
EPRE ratio of PSS to SSS		Config 1	0		0	
EPRE ratio of PBCH DMRS to SSS						
EPRE ratio of PBCH to PBCH DMRS						
EPRE ratio of PDCCH DMRS to SSS						
EPRE ratio of PDCCH to PDCCH DMRS						
EPRE ratio of PDSCH DMRS to SSS						
EPRE ratio of PDSCH to PDSCH						
EPRE ratio of OCNG DMRS to SSS(Note 1)						
EPRE ratio of OCNG to OCNG DMRS (Note 1)						
$N_{oc}^{Note2}$	dBm/15 kHz Note5					
$N_{oc}^{Note2}$	dBm/S CS Note4	Config 1	-95.7		-95.7	
SS-RSRP <sup>Note 3</sup>	dBm/S CS Note5	Config 1	-89.7	-89.7	-Infinity	-86.7
$\hat{E}_s/I_{ot}$	dB	Config 1	6	6	-Infinity	9
$\hat{E}_s/N_{oc}$	dB	Config 1	6	6	-Infinity	9
$I_o^{Note3}$	dBm/95.04 MHz Note5	Config 1	-59.7	-59.7	-66.7	-57.2
Propagation Condition		Config 1	AWGN		AWGN	
<p>Note 1: OCNG shall be used such that both cells are fully allocated and a constant total transmitted power spectral density is achieved for all OFDM symbols.</p> <p>Note 2: Interference from other cells and noise sources not specified in the test is assumed to be constant over subcarriers and time and shall be modelled as AWGN of appropriate power for <math>N_{oc}</math> to be fulfilled.</p> <p>Note 3: SSB_RP and <math>I_o</math> levels have been derived from other parameters for information purposes. They are not settable parameters themselves.</p> <p>Note 4: Void</p> <p>Note 5: Equivalent power received by an antenna with 0 dBi gain at the centre of the quiet zone</p> <p>Note 6: As observed with 0 dBi gain antenna at the centre of the quiet zone</p> <p>Note 7: Information about types of UE beam is given in B.2.1.3, and does not limit UE implementation or test system implementation</p>						

#### A.7.6.2.4.2 Test Requirements

In test 1 the UE shall send one Event A3 triggered measurement report, with a measurement reporting delay less than  $X1$  ms from the beginning of time period T2, where  $X1$  is

10080 for UE supporting power class 1, or

6240 for UE supporting other power class.

In test 2 the UE shall send one Event A3 triggered measurement report, with a measurement reporting delay less than X2 ms from the beginning of time period T2, where X2 is

107520 for UE supporting power class 1, or

66560 for UE supporting other power class.

In test 1 and 2 UE is required to report SSB time index. The UE shall not send event triggered measurement reports, as long as the reporting criteria are not fulfilled. The rate of correct events observed during repeated tests shall be at least 90%.

NOTE: The actual overall delays measured in the test may be up to  $2 \times TTI_{DCCH}$  higher than the measurement reporting delays above because of TTI insertion uncertainty of the measurement report in DCCH.

### A.7.6.2.5 SA event triggered reporting tests for FR2 without SSB time index detection when DRX is not used (PCell in FR1)

#### A.7.6.2.5.1 Test Purpose and Environment

The purpose of this test is to verify that the UE makes correct reporting of an event. This test will partly verify the SA inter-frequency NR cell search requirements in clause 9.3.4.

In this test, there are two cells: NR cell 1 as PCell in FR1 on NR RF channel 2 and NR cell 2 as neighbour cell in FR2 on NR RF channel 2. The test parameters and configurations are given in Tables A.7.6.2.5.1-1, A.7.6.2.5.1-2, and A.7.6.2.5.1-3.

In test 1 per-UE measurement gap pattern configuration # 0 as defined in Table A.7.6.2.5.1-2 is provided for a UE that does not support per-FR gap and in test 2 no gap pattern is configured as defined in Table A.7.6.2.5.1-2. If the UE supports per-FR gap, it is only required to pass test 2. Otherwise it is only required to pass test 1.

In the measurement control information, it is indicated to the UE that event-triggered reporting with Event A4 is used. The test consists of two successive time periods, with time duration of T1, and T2 respectively. During time duration T1, the UE shall not have any timing information of NR cell 2.

Supported test configurations are shown in table A.7.6.2.5.1-1.

**Table A.7.6.2.5.1-1 SA event triggered reporting tests without SSB index reading for FR1-FR2**

Config	Description of serving cell	Description of target cell
1	NR 15 kHz SSB SCS, 10 MHz bandwidth, FDD duplex mode	120 kHz SSB SCS, 100 MHz bandwidth, TDD duplex mode
2	NR 15 kHz SSB SCS, 10 MHz bandwidth, TDD duplex mode	
3	NR 30kHz SSB SCS, 40 MHz bandwidth, TDD duplex mode	

Note: The UE is only required to be tested in one of the supported test configurations

**Table A.7.6.2.5.1-2: General test parameters for SA inter-frequency event triggered reporting for FR2 without SSB time index detection**

Parameter	Unit	Test configuration	Value		Comment
			Test 1	Test 2	
NR RF Channel Number		Config 1,2,3	1, 2		One NR FR1 and one NR FR2 carrier frequency is used.
Active cell		Config 1,2,3	NR cell 1 (Pcell)		NR Cell 1 is on NR RF channel number 1.
Neighbour cell		Config 1,2,3	NR cell 2		NR cell 2 is on NR RF channel number 2.
Gap Pattern Id		Config 1,2,3	0	Gap not configured	As specified in clause 9.1.2-1.
Measurement gap offset		Config 1,2,3	39	N/A	
SMTC-SSB parameters on NR RF Channel 1		Config 1	SSB.1 FR1		As specified in clause A.3.10.1

		Config 2	SSB.1 FR1	As specified in clause A.3.10.1	
		Config 3	SSB.2 FR1	As specified in clause A.3.10.1	
CSI-RS for tracking parameters on NR RF Channel 1		Config 1	TRS.1.1 FDD		
		Config 2	TRS.1.1 TDD		
		Config 3	TRS.1.2 TDD		
SMTC-SSB parameters on NR RF Channel 2		Config 1,2,3	SSB.3 FR2	As specified in clause A.3.10.2	
offsetMO	dB	Config 1,2,3	6		
Hysteresis	dB	Config 1,2,3	0		
a4-Threshold	dBm	Config 1,2,3	-105		
CP length		Config 1,2,3	Normal		
TimeToTrigger	s	Config 1,2,3	0		
Filter coefficient		Config 1,2,3	0	L3 filtering is not used	
DRX		Config 1,2,3	OFF	DRX is not used	
Time offset between serving and neighbour cells		Config 1	3ms	Asynchronous cells. The timing of Cell 2 is 3ms later than the timing of Cell 1.	
		Config 2,3	3µs	Synchronous cells.	
T1	s	Config 1,2,3	5		
T2	s	Config 1,2,3	5.2 for PC1; 3.5 for other PC	3 for PC1; 2 for other PC	

**Table A.7.6.2.5.1-3: Cell specific test parameters for SA inter-frequency event triggered reporting for FR2 without SSB time index detection**

Parameter		Unit	Test configuration	Cell 1		Cell 2	
				T1	T2	T1	T2
AoA setup			Config 1,2,3	N/A		Setup 1 as specified in clause A.3.15	
Beam Assumption <sup>Note 7</sup>			Config 1,2,3	N/A		Rough	
NR RF Channel Number			Config 1,2,3	1		2	
Duplex mode			Config 1	FDD		TDD	
			Config 2,3	TDD		TDD	
TDD configuration			Config 1	Not Applicable		TDDConf.3.1	
			Config 2	TDDConf.1.1		TDDConf.3.1	
			Config 3	TDDConf.2.1		TDDConf.3.1	
BW <sub>channel</sub>		MHz	Config 1	10: N <sub>RB,c</sub> = 52		100: N <sub>RB,c</sub> = 66	
			Config 2	10: N <sub>RB,c</sub> = 52		100: N <sub>RB,c</sub> = 66	
			Config 3	40: N <sub>RB,c</sub> = 106		100: N <sub>RB,c</sub> = 66	
BWP BW		MHz	Config 1	10: N <sub>RB,c</sub> = 52		100: N <sub>RB,c</sub> = 66	
			Config 2	10: N <sub>RB,c</sub> = 52		100: N <sub>RB,c</sub> = 66	
			Config 3	40: N <sub>RB,c</sub> = 106		100: N <sub>RB,c</sub> = 66	
Data RBs allocated			Config 1	52		66	
			Config 2	52		66	
			Config 3	106		66	
BWP configuration	Initial DL BWP		Config 1,2,3	DLBWP.0.1		N/A	
	Initial UL BWP			ULBWP.0.1		N/A	
	Dedicated DL BWP			DLBWP.1.1		N/A	
	Dedicated UL BWP			ULBWP.1.1		N/A	
OCNG Patterns defined in A.3.2.1.1 (OP.1)			Config 1,2,3	OP.1		OP.1	
PDSCH Reference measurement channel			Config 1	SR.1.1 FDD		-	
			Config 2	SR.1.1 TDD			
			Config 3	SR2.1 TDD			
RMSI CORESET Reference Channel			Config 1	CR.1.1 FDD		-	
			Config 2	CR.1.1 TDD			

Dedicated CORESET RMC configuration		Config 3	CR2.1 TDD	-	
		Config 1	CCR.1.1 FDD		
		Config 2	CCR.1.1 TDD		
		Config 3	CCR.2.1 TDD		
SMTC configuration defined in A.3.11.1 and A.3.11.2		Config 1	SMTC.2	SMTC.2	
		Config 2,3	SMTC.1	SMTC.1	
PDSCH/PDCCH subcarrier spacing	kHz	Config 1,2	15	120	
		Config 3	30	120	
EPRE ratio of PSS to SSS		Config 1,2,3	0	0	
EPRE ratio of PBCH DMRS to SSS					
EPRE ratio of PBCH to PBCH DMRS					
EPRE ratio of PDCCH DMRS to SSS					
EPRE ratio of PDCCH to PDCCH DMRS					
EPRE ratio of PDSCH DMRS to SSS					
EPRE ratio of PDSCH to PDSCH					
EPRE ratio of OCNG DMRS to SSS(Note 1)					
EPRE ratio of OCNG to OCNG DMRS (Note 1)					
$\hat{E}_s$	dBm/S CS				
SSB_RP <sup>Note 3</sup>	dBm/S CS Note5	Config 1,2	-Infinity	-87	
		Config 3	-Infinity	-87	
$\hat{E}_s / I_{ot\_BB}$ <sup>Note 8</sup>	dB	Config 1,2,3	-Infinity	14.69	
$I_o$ <sup>Note3</sup>	dBm/95 .04 MHz Note5	Config 1,2,3	-Infinity	-58.01	
Propagation Condition		Config 1,2,3	AWGN	No external noise (Note 9)	
<p>Note 1: OCNG shall be used such that both cells are fully allocated and a constant total transmitted power spectral density is achieved for all OFDM symbols.</p> <p>Note 2: Void</p> <p>Note 3: SSB_RP, Es/lot and Io levels have been derived from other parameters for information purposes. They are not settable parameters themselves.</p> <p>Note 4: Void</p> <p>Note 5: Equivalent power received by an antenna with 0 dBi gain at the centre of the quiet zone</p> <p>Note 6: As observed with 0 dBi gain antenna at the centre of the quiet zone</p> <p>Note 7: Information about types of UE beam is given in B.2.1.3, and does not limit UE implementation or test system implementation</p> <p>Note 8: Calculation of Es/Iot<sub>BB</sub> includes the effect of UE internal noise up to the value assumed for the associated Refsens requirement in clause 7.3.2 of TS 38.101-2 [19], and an allowance of 1dB for UE multi-band relaxation factor ΔMB<sub>S</sub> from TS 38.101-2 [19] Table 6.2.1.3-4.</p> <p>Note 9: The downlink connection between the System Simulator and the UE is without Additive White Gaussian Noise, and has no fading or multipath effects as specified in TS 38.521-2 B.0 [37].</p>					

A.7.6.2.5.2 Test Requirements

In test 1 with per-UE gap and in test 2 with per-FR gap, the UE shall send one Event A4 triggered measurement report, with a measurement reporting delay less than X ms from the beginning of time period T2, where X is

- 5120 for UE supporting power class 1, or
- 3200 for UE supporting other power class.



In test 2, without the gap, the UE shall send one Event A4 triggered measurement report, with a measurement reporting delay less than X ms from the beginning of time period T2, where X is

2560 for UE supporting power class 1, or

1600 for UE supporting other power class.

In test 1 and 2 UE is not required to report SSB time index. The UE shall not send event triggered measurement reports, as long as the reporting criteria are not fulfilled. The rate of correct events observed during repeated tests shall be at least 90%.

NOTE: The actual overall delays measured in the test may be up to  $2 \times TTI_{DCCH}$  higher than the measurement reporting delays above because of TTI insertion uncertainty of the measurement report in DCCH.

### A.7.6.2.6 SA event triggered reporting tests for FR2 without SSB time index detection when DRX is used (PCell in FR1)

#### A.7.6.2.6.1 Test Purpose and Environment

The purpose of this test is to verify that the UE makes correct reporting of an event. This test will partly verify the SA inter-frequency NR cell search requirements in clause 9.3.4.

In this test, there are two cells: NR cell 1 as PCell in FR1 on NR RF channel 2 and NR cell 2 as neighbour cell in FR2 on NR RF channel 2. The test parameters and configurations are given in Tables A.7.6.2.6.1-1, A.7.6.2.6.1-2, and A.7.6.2.6.1-3.

In test 1&2 per-UE measurement gap pattern configuration # 0 as defined in Table A.7.6.2.6.1-2 is provided for a UE that does not support per-FR gap and in test 3&4 no gap pattern is configured as defined in Table A.7.6.2.6.1-2. If a UE supports per-FR gap it is only required to pass test 3&4. Otherwise it is only required to pass test 1&2.

In the measurement control information, it is indicated to the UE that event-triggered reporting with Event A4 is used. The test consists of two successive time periods, with time duration of T1, and T2 respectively. During time duration T1, the UE shall not have any timing information of NR cell 2.

Supported test configurations are shown in table A.7.6.2.6.1-1.

UE needs to be provided with new Timing Advance Command MAC control element at least once during each time alignment timer period to maintain uplink time alignment. Furthermore UE is allocated with PUSCH resource at every DRX cycle.

**Table A.7.6.2.6.1-1: SA event triggered reporting tests without SSB index reading for FR1-FR2**

Config	Description of serving cell	Description of target cell
1	NR 15 kHz SSB SCS, 10 MHz bandwidth, FDD duplex mode	120 kHz SSB SCS, 100 MHz bandwidth, TDD duplex mode
2	NR 15 kHz SSB SCS, 10 MHz bandwidth, TDD duplex mode	
3	NR 30 kHz SSB SCS, 40 MHz bandwidth, TDD duplex mode	
Note: The UE is only required to be tested in one of the supported test configurations		

**Table A.7.6.2.6.1-2: General test parameters for SA inter-frequency event triggered reporting for FR2 without SSB time index detection**

Parameter	Unit	Test configuration	Value				Comment
			Test 1	Test 2	Test 3	Test 4	
NR RF Channel Number		Config 1,2,3	1, 2				One NR FR1 and one NR FR2 carrier frequency is used.
Active cell		Config 1,2,3	NR cell 1 (Pcell)				NR Cell 1 is on NR RF channel number 1.
Neighbour cell		Config 1,2,3	NR cell 2				NR cell 2 is on NR RF channel number 2.

Gap Pattern Id		Config 1,2,3	0	Gap not configured				As specified in clause 9.1.2-1.
Measurement gap offset		Config 1,2,3	39	N/A				
SMTC-SSB parameters on NR RF Channel 1		Config 1	SSB.1 FR1				As specified in clause A.3.10.1	
		Config 2	SSB.1 FR1				As specified in clause A.3.10.1	
		Config 3	SSB.2 FR1				As specified in clause A.3.10.1	
SMTC-SSB parameters on NR RF Channel 2		Config 1,2,3	SSB.3 FR2				As specified in clause A.3.10.2	
CSI-RS for tracking parameters on NR RF Channel 1		Config 1	TRS.1.1 FDD					
		Config 2	TRS.1.1 TDD					
		Config 3	TRS.1.2 TDD					
offsetMO	dB	Config 1,2,3	6					
Hysteresis	dB	Config 1,2,3	0					
a4-Threshold	dBm	Config 1,2,3	-105					
CP length		Config 1,2,3	Normal					
TimeToTrigger	s	Config 1,2,3	0					
Filter coefficient		Config 1,2,3	0				L3 filtering is not used	
DRX		Config 1,2,3	DRX .1	DRX .7	DRX .1	DRX .7	As specified in clause A.3.3	
Time offset between serving and neighbour cells		Config 1	3ms				Asynchronous cells. The timing of Cell 2 is 3ms later than the timing of Cell 1.	
		Config 2,3	3µs				Synchronous cells.	
T1	s	Config 1,2,3	5					
T2	s	Config 1,2,3	8 for PC1; 5 for other PC	82 for PC1; 52 for other PC	8 for PC1; 5 for other PC	82 for PC1; 52 for other PC		

**Table A.7.6.2.6.1-3: Cell specific test parameters for SA inter-frequency event triggered reporting for FR2 without SSB time index detection**

Parameter		Unit	Test configuration	Cell 1		Cell 2	
				T1	T2	T1	T2
AoA setup			Config 1,2,3	NA		Setup 1 as specified in clause A.3.15	
NR RF Channel Number			Config 1,2,3	1		2	
Duplex mode			Config 1	FDD		TDD	
			Config 2,3	TDD		TDD	
TDD configuration			Config 1	Not Applicable		TDDConf.3.1	
			Config 2	TDDConf.1.1		TDDConf.3.1	
			Config 3	TDDConf.2.1		TDDConf.3.1	
BW <sub>channel</sub>		MHz	Config 1	10: N <sub>RB,c</sub> = 52		100: N <sub>RB,c</sub> = 66	
			Config 2	10: N <sub>RB,c</sub> = 52		100: N <sub>RB,c</sub> = 66	
			Config 3	40: N <sub>RB,c</sub> = 106		100: N <sub>RB,c</sub> = 66	
Data RBs allocated			Config 1	52		66	
			Config 2	52		66	
			Config 3	106		66	
BWP BW		MHz	Config 1	10: N <sub>RB,c</sub> = 52		100: N <sub>RB,c</sub> = 66	
			Config 2	10: N <sub>RB,c</sub> = 52		100: N <sub>RB,c</sub> = 66	
			Config 3	40: N <sub>RB,c</sub> = 106		100: N <sub>RB,c</sub> = 66	
BWP configuration	Initial DL BWP		Config 1,2,3	DLBWP.0.1		N/A	
	Initial UL BWP			ULBWP.0.1		N/A	
	Dedicated DL BWP			DLBWP.1.1		N/A	

	Dedicated UL BWP			ULBWP.1.1	N/A		
OCNG Patterns defined in A.3.2.1.1 (OP.1)			Config 1,2,3	OP.1	OP.1		
PDSCH Reference measurement channel			Config 1	SR.1.1 FDD	-		
			Config 2	SR.1.1 TDD			
			Config 3	SR2.1 TDD			
RMSI CORESET Reference Channel			Config 1	CR.1.1 FDD	-		
			Config 2	CR.1.1 TDD			
			Config 3	CR2.1 TDD			
Dedicated CORESET RMC configuration			Config 1	CCR.1.1 FDD	-		
			Config 2	CCR.1.1 TDD			
			Config 3	CCR.2.1 TDD			
SMTTC configuration defined in A.3.11.1 and A.3.11.2			Config 1	SMTTC.2	SMTTC.2		
			Config 2,3	SMTTC.1	SMTTC.1		
PDSCH/PDCCH subcarrier spacing		kHz	Config 1,2	15	120		
			Config 3	30	120		
EPRE ratio of PSS to SSS			Config 1,2,3	0	0		
EPRE ratio of PBCH DMRS to SSS							
EPRE ratio of PBCH to PBCH DMRS							
EPRE ratio of PDCCH DMRS to SSS							
EPRE ratio of PDCCH to PDCCH DMRS							
EPRE ratio of PDSCH DMRS to SSS							
EPRE ratio of PDSCH to PDSCH							
EPRE ratio of OCNG DMRS to SSS(Note 1)							
EPRE ratio of OCNG to OCNG DMRS (Note 1)							
$N_{oc}$ Note2	dBm/15 kHz Note5						Config 1,2
$N_{oc}$ Note2	dBm/S CS Note4		Config 3	-95.7			
SSB_RP Note3	dBm/S CS Note5	Config 1,2		-Infinity	-86.7		
		Config 3		-Infinity	-86.7		
$\hat{E}_s/I_{ot}$	dB		Config 1,2,3	-Infinity	9		
$\hat{E}_s/N_{oc}$	dB		Config 1,2,3	-Infinity	9		
$I_o$ Note3	dBm/9.36MHz		Config 1,2	-	-		
	dBm/38.16MHz		Config 3	-	-		
	dBm/95.04 MHz Note5		Config 1,2,3	-66.7	-57.2		
Propagation Condition			Config 1,2,3	AWGN			

Note 1:	OCNG shall be used such that both cells are fully allocated and a constant total transmitted power spectral density is achieved for all OFDM symbols.
Note 2:	Interference from other cells and noise sources not specified in the test is assumed to be constant over subcarriers and time and shall be modelled as AWGN of appropriate power for $N_{oc}$ to be fulfilled.
Note 3:	SSB_RP and $I_0$ levels have been derived from other parameters for information purposes. They are not settable parameters themselves.
Note 4:	SSB_RP minimum requirements are specified assuming independent interference and noise at each receiver antenna port.
Note 5:	Equivalent power received by an antenna with 0 dBi gain at the centre of the quiet zone
Note 6:	As observed with 0 dBi gain antenna at the centre of the quiet zone

#### A.7.6.2.6.2 Test Requirements

In test 1 with per-UE gap and in test 3 without the gap, the UE shall send one Event A4 triggered measurement report, with a measurement reporting delay less than  $X_1$  ms from the beginning of time period T2, where  $X_1$  is

- 7680 for UE supporting power class 1, or
- 4800 for UE supporting other power class.

In test 2 with per-UE gap and in test 4 without the gap, the UE shall send one Event A4 triggered measurement report, with a measurement reporting delay less than  $X_2$  ms from the beginning of time period T2, where  $X_2$  is

- 81920 for UE supporting power class 1, or
- 51200 for UE supporting other power class.

In test 1, 2, 3 and 4 UE is not required to report SSB time index. The UE shall not send event triggered measurement reports, as long as the reporting criteria are not fulfilled. The rate of correct events observed during repeated tests shall be at least 90%.

NOTE: The actual overall delays measured in the test may be up to  $2 \times TTI_{DCCH}$  higher than the measurement reporting delays above because of TTI insertion uncertainty of the measurement report in DCCH.

#### A.7.6.2.7 SA event triggered reporting tests for FR2 with SSB time index detection when DRX is not used (PCell in FR1)

##### A.7.6.2.7.1 Test Purpose and Environment

The purpose of this test is to verify that the UE makes correct reporting of an event. This test will partly verify the SA inter-frequency NR cell search requirements in clause 9.3.4.

In this test, there are two cells: NR cell 1 as PCell in FR1 on NR RF channel 2 and NR cell 2 as neighbour cell in FR2 on NR RF channel 2. The test parameters and configurations are given in Tables A.7.6.2.7.1-1, A.7.6.2.7.1-2, and A.7.6.2.7.1-3.

In test 1 per-UE measurement gap pattern configuration # 0 as defined in Table A.7.6.2.7.1-2 is provided for a UE that does not support per-FR gap and in test 2 measurement no gap pattern is configured as defined in Table A.7.6.2.7.1-2. If the UE supports per-FR gap, it is only required to pass test 2. Otherwise it is only required to pass test 1.

In the measurement control information, it is indicated to the UE that event-triggered reporting with Event A4 is used. The test consists of two successive time periods, with time duration of T1, and T2 respectively. During time duration T1, the UE shall not have any timing information of NR cell 2.

Supported test configurations are shown in table A.7.6.2.7.1-1.

**Table A.7.6.2.7.1-1: SA event triggered reporting tests with SSB index reading for FR1-FR2**

Config	Description of serving cell	Description of target cell
1	NR 15 kHz SSB SCS, 10 MHz bandwidth, FDD duplex mode	120 kHz SSB SCS,
2	NR 15 kHz SSB SCS, 10 MHz bandwidth, TDD duplex mode	100 MHz bandwidth, TDD
3	NR 30 kHz SSB SCS, 40 MHz bandwidth, TDD duplex mode	duplex mode
Note:	The UE is only required to be tested in one of the supported test configurations	

**Table A.7.6.2.7.1-2: General test parameters for SA inter-frequency event triggered reporting for FR2 with SSB time index detection**

Parameter	Unit	Test configuration	Value		Comment
			Test 1	Test 2	
NR RF Channel Number		Config 1,2,3	1, 2		One NR FR1 and one NR FR2 carrier frequency is used.
Active cell		Config 1,2,3	NR cell 1 (Pcell)		NR Cell 1 is on NR RF channel number 1.
Neighbour cell		Config 1,2,3	NR cell 2		NR cell 2 is on NR RF channel number 2.
Gap Pattern Id		Config 1,2,3	0	Gap not configured	As specified in clause 9.1.2-1.
Measurement gap offset		Config 1,2,3	39	N/A	
SMTC-SSB parameters on NR RF Channel 1		Config 1	SSB.1 FR1		As specified in clause A.3.10.1
		Config 2	SSB.1 FR1		As specified in clause A.3.10.1
		Config 3	SSB.2 FR1		As specified in clause A.3.10.1
CSI-RS for tracking parameters on NR RF Channel 1		Config 1	TRS.1.1 FDD		
		Config 2	TRS.1.1 TDD		
		Config 3	TRS.1.2 TDD		
SMTC-SSB parameters on NR RF Channel 2		Config 1,2,3	SSB.3 FR2		As specified in clause A.3.10.2
<i>offsetMO</i>	dB	Config 1,2,3	6		
Hysteresis	dB	Config 1,2,3	0		
<i>a4-Threshold</i>	dBm	Config 1,2,3,4,5,6	-105		
CP length		Config 1,2,3	Normal		
TimeToTrigger	s	Config 1,2,3	0		
Filter coefficient		Config 1,2,3	0		L3 filtering is not used
DRX		Config 1,2,3	OFF		DRX is not used
Time offset between serving and neighbour cells		Config 1	3ms		Asynchronous cells. The timing of Cell 2 is 3ms later than the timing of Cell 1.
		Config 2,3	3µs		Synchronous cells.
T1	s	Config 1,2,3	5		
T2	s	Config 1,2,3	7 for PC1; 4.5 for other PC	3.5 for PC1; 2.5 for other PC	

**Table A.7.6.2.7.1-3: Cell specific test parameters for SA inter-frequency event triggered reporting for FR2 with SSB time index detection**

Parameter	Unit	Test configuration	Cell 1		Cell 2	
			T1	T2	T1	T2
AoA setup		Config 1,2,3	NA		Setup 1 as specified in clause A.3.15	
Beam Assumption <sup>Note 7</sup>		Config 1,2,3	N/A		Rough	
NR RF Channel Number		Config 1,2,3	1		2	
Duplex mode		Config 1	FDD		TDD	
		Config 2,3	TDD		TDD	
TDD configuration		Config 1	Not Applicable		TDDConf.3.1	
		Config 2	TDDConf.1.1		TDDConf.3.1	
		Config 3	TDDConf.2.1		TDDConf.3.1	
BW <sub>channel</sub>	MHz	Config 1	10: N <sub>RB,c</sub> = 52		100: N <sub>RB,c</sub> = 66	
		Config 2	10: N <sub>RB,c</sub> = 52		100: N <sub>RB,c</sub> = 66	
		Config 3	40: N <sub>RB,c</sub> = 106		100: N <sub>RB,c</sub> = 66	

Data RBs allocated			Config 1	52	66	
			Config 2	52	66	
			Config 3	106	66	
BWP BW		MHz	Config 1	10: $N_{RB,c} = 52$	100: $N_{RB,c} = 66$	
			Config 2	10: $N_{RB,c} = 52$	100: $N_{RB,c} = 66$	
			Config 3	40: $N_{RB,c} = 106$	100: $N_{RB,c} = 66$	
BWP configuration	Initial DL BWP		Config 1,2,3	DLBWP.0.1	N/A	
	Initial UL BWP			ULBWP.0.1	N/A	
	Dedicated DL BWP			DLBWP.1.1	N/A	
	Dedicated UL BWP			ULBWP.1.1	N/A	
OCNG Patterns defined in A.3.2.1.1 (OP.1)			Config 1,2,3	OP.1	OP.1	
PDSCH Reference measurement channel			Config 1	SR.1.1 FDD	-	
			Config 2	SR.1.1 TDD		
			Config 3	SR2.1 TDD		
RMSI CORESET Reference Channel			Config 1	CR.1.1 FDD	-	
			Config 2	CR.1.1 TDD		
			Config 3	CR2.1 TDD		
Dedicated CORESET RMC configuration			Config 1	CCR.1.1 FDD	-	
			Config 2	CCR.1.1 TDD		
			Config 3	CCR.2.1 TDD		
SMTc configuration defined in A.3.11.1 and A.3.11.2			Config 1	SMTc.2	SMTc.2	
			Config 2,3	SMTc.1	SMTc.1	
PDSCH/PDCCH subcarrier spacing		kHz	Config 1,2	15	120	
			Config 3	30	120	
EPRE ratio of PSS to SSS			Config 1,2,3	0	0	
EPRE ratio of PBCH DMRS to SSS						
EPRE ratio of PBCH to PBCH DMRS						
EPRE ratio of PDCCH DMRS to SSS						
EPRE ratio of PDCCH to PDCCH DMRS						
EPRE ratio of PDSCH DMRS to SSS						
EPRE ratio of PDSCH to PDSCH						
EPRE ratio of OCNG DMRS to SSS(Note 1)						
EPRE ratio of OCNG to OCNG DMRS (Note 1)						
$\hat{E}_s$	dBm/SCS	Config 1,2, 3	NA Link only, see clause A.3.7A	-Infinity	-87	
SSB <sub>RP</sub> <sup>Note 3</sup>	dBm/SCS Note5	Config 1,2		-Infinity	-87	
		Config 3		-Infinity	-87	
$\hat{E}_s / I_{ot\_BB}$ <sup>Note 8</sup>	dB	Config 1,2,3		-Infinity	14.69	
$I_o$ <sup>Note3</sup>	dBm/95.04 MHz Note5	Config 1,2,3		Infinity	-58.01	
Propagation Condition			Config 1,2,3	No external noise (Note 9)		

Note 1:	OCNG shall be used such that both cells are fully allocated and a constant total transmitted power spectral density is achieved for all OFDM symbols.
Note 2:	Void
Note 3:	SSB_RP, Es/lot and Io levels have been derived from other parameters for information purposes. They are not settable parameters themselves.
Note 4:	Void
Note 5:	Equivalent power received by an antenna with 0 dBi gain at the centre of the quiet zone
Note 6:	As observed with 0 dBi gain antenna at the centre of the quiet zone
Note 7:	Information about types of UE beam is given in B.2.1.3, and does not limit UE implementation or test system implementation
Note 8:	Calculation of Es/Iot <sub>BB</sub> includes the effect of UE internal noise up to the value assumed for the associated Refsens requirement in clause 7.3.2 of TS 38.101-2 [19], and an allowance of 1dB for UE multi-band relaxation factor ΔMBs from TS 38.101-2 [19] Table 6.2.1.3-4.
Note 9:	The downlink connection between the System Simulator and the UE is without Additive White Gaussian Noise, and has no fading or multipath effects as specified in TS 38.521-2 B.0 [37].

#### A.7.6.2.7.2 Test Requirements

In test 1 with per-UE gap and in test 2 with per-FR gap, the UE shall send one Event A4 triggered measurement report, with a measurement reporting delay less than X ms from the beginning of time period T2, where X is

- 6720 for UE supporting power class 1, or
- 4160 for UE supporting other power class.

In test 2 without the gap, the UE shall send one Event A4 triggered measurement report, with a measurement reporting delay less than X ms from the beginning of time period T2, where X is

- 3360 for UE supporting power class 1, or
- 2080 for UE supporting other power class.

In test 1 and 2 UE is required to report SSB time index. The UE shall not send event triggered measurement reports, as long as the reporting criteria are not fulfilled. The rate of correct events observed during repeated tests shall be at least 90%.

NOTE: The actual overall delays measured in the test may be up to  $2 \times TTI_{DCC}$  higher than the measurement reporting delays above because of TTI insertion uncertainty of the measurement report in DCC.

#### A.7.6.2.8 SA event triggered reporting tests for FR2 with SSB time index detection when DRX is used (PCell in FR1)

##### A.7.6.2.8.1 Test Purpose and Environment

The purpose of this test is to verify that the UE makes correct reporting of an event. This test will partly verify the SA inter-frequency NR cell search requirements in clause 9.3.4.

In this test, there are two cells: NR cell 1 as PCell in FR1 on NR RF channel 2 and NR cell 2 as neighbour cell in FR2 on NR RF channel 2. The test parameters and configurations are given in Tables A.7.6.2.8.1-1, A.7.6.2.8.1-2, and A.7.6.2.8.1-3.

In test 1&2 per-UE measurement gap pattern configuration # 0 as defined in Table A.7.6.2.8.1-2 is provided for a UE that does not support per-FR gap and in test 3&4 measurement no gap pattern is configured as defined in Table A.7.6.2.8.1-2. If a UE supports per-FR gap, it is only required to pass test 3&4. Otherwise it is only required to pass test 1&2.

In the measurement control information, it is indicated to the UE that event-triggered reporting with Event A4 is used. The test consists of two successive time periods, with time duration of T1, and T2 respectively. During time duration T1, the UE shall not have any timing information of NR cell 2.

Supported test configurations are shown in table A.7.6.2.8.1-1.

UE needs to be provided with new Timing Advance Command MAC control element at least once during each time alignment timer period to maintain uplink time alignment. Furthermore UE is allocated with PUSCH resource at every DRX cycle.

**Table A.7.6.2.8.1-1: SA event triggered reporting tests with SSB index reading for FR1-FR2**

Config	Description of serving cell	Description of target cell
1	NR 15 kHz SSB SCS, 10 MHz bandwidth, FDD duplex mode	120 kHz SSB SCS, 100 MHz bandwidth, TDD duplex mode
2	NR 15 kHz SSB SCS, 10 MHz bandwidth, TDD duplex mode	
3	NR 30 kHz SSB SCS, 40 MHz bandwidth, TDD duplex mode	
Note: The UE is only required to be tested in one of the supported test configurations		

**Table A.7.6.2.8.1-2: General test parameters for SA inter-frequency event triggered reporting for FR2 with SSB time index detection**

Parameter	Unit	Test configuration	Value				Comment
			Test 1	Test 2	Test 3	Test 4	
NR RF Channel Number		Config 1,2,3	1, 2				One NR FR1 and one NR FR2 carrier frequency is used.
Active cell		Config 1,2,3	NR cell 1 (Pcell)				NR Cell 1 is on NR RF channel number 1.
Neighbour cell		Config 1,2,3	NR cell 2				NR cell 2 is on NR RF channel number 2.
Gap Pattern Id		Config 1,2,3	0	Gap not configured			As specified in clause 9.1.2-1.
Measurement gap offset		Config 1,2,3	39	N/A			
SMTC-SSB parameters on NR RF Channel 1		Config 1	SSB.1 FR1				As specified in clause A.3.10.1
		Config 2	SSB.1 FR1				As specified in clause A.3.10.1
		Config 3	SSB.2 FR1				As specified in clause A.3.10.1
CSI-RS for tracking parameters on NR RF Channel 1		Config 1	TRS.1.1 FDD				
		Config 2	TRS.1.1 TDD				
		Config 3	TRS.1.2 TDD				
SMTC-SSB parameters on NR RF Channel 2		Config 1,2,3	SSB.3 FR2				As specified in clause A.3.10.2
offsetMO	dB	Config 1,2,3	6				
Hysteresis	dB	Config 1,2,3	0				
a4-Threshold	dBm	Config 1,2,3	-105				
CP length		Config 1,2,3	Normal				
TimeToTrigger	s	Config 1,2,3	0				
Filter coefficient		Config 1,2,3	0				L3 filtering is not used
DRX		Config 1,2,3	DRX .1	DRX .7	DRX .1	DRX .7	As specified in clause A.3.3
Time offset between serving and neighbour cells		Config 1	3ms				Asynchronous cells. The timing of Cell 2 is 3ms later than the timing of Cell 1.
		Config 2,3	3µs				Synchronous cells.
T1	s	Config 1,2,3	5				
T2	s	Config 1,2,3	11 for PC1; 6.5 for other PCT BD	108 for PC1; 67 for other PCT BD	11 for PC1; 6.5 for other PCT BD	108 for PC1; 67 for other PCT BD	



**Table A.7.6.2.8.1-3: Cell specific test parameters for SA inter-frequency event triggered reporting for FR2 with SSB time index detection**

Parameter		Unit	Test configuration	Cell 1		Cell 2	
				T1	T2	T1	T2
AoA setup			Config 1,2,3	NA		Setup 1 as specified in clause A.3.15	
Beam Assumption <sup>Note 7</sup>			Config 1,2,3	N/A		Rough	
NR RF Channel Number			Config 1,2,3	1		2	
Duplex mode			Config 1	FDD		TDD	
			Config 2,3	TDD		TDD	
TDD configuration			Config 1	Not Applicable		TDDConf.3.1	
			Config 2	TDDConf.1.1		TDDConf.3.1	
			Config 3	TDDConf.2.1		TDDConf.3.1	
BW <sub>channel</sub>		MHz	Config 1	10: N <sub>RB,c</sub> = 52		100: N <sub>RB,c</sub> = 66	
			Config 2	10: N <sub>RB,c</sub> = 52		100: N <sub>RB,c</sub> = 66	
			Config 3	40: N <sub>RB,c</sub> = 106		100: N <sub>RB,c</sub> = 66	
Data RBs allocated			Config 1	52		66	
			Config 2	52		66	
			Config 3	106		66	
BWP BW		MHz	Config 1	10: N <sub>RB,c</sub> = 52		100: N <sub>RB,c</sub> = 66	
			Config 2	10: N <sub>RB,c</sub> = 52		100: N <sub>RB,c</sub> = 66	
			Config 3	40: N <sub>RB,c</sub> = 106		100: N <sub>RB,c</sub> = 66	
BWP configuration	Initial DL BWP		Config 1,2,3	DLBWP.0.1		N/A	
	Initial UL BWP			ULBWP.0.1		N/A	
	Dedicated DL BWP			DLBWP.1.1		N/A	
	Dedicated UL BWP			ULBWP.1.1		N/A	
OCNG Patterns defined in A.3.2.1.1 (OP.1)			Config 1,2,3	OP.1		OP.1	
PDSCH Reference measurement channel			Config 1	SR.1.1 FDD		-	
			Config 2	SR.1.1 TDD			
			Config 3	SR2.1 TDD			
RMSI CORESET Reference Channel			Config 1	CR.1.1 FDD		-	
			Config 2	CR.1.1 TDD			
			Config 3	CR2.1 TDD			
Dedicated CORESET RMC configuration			Config 1	CCR.1.1 FDD		-	
			Config 2	CCR.1.1 TDD			
			Config 3	CCR.2.1 TDD			
SMTC configuration defined in A.3.11.1 and A.3.11.2			Config 1	SMTC.2		SMTC.2	
			Config 2,3	SMTC.1		SMTC.1	
PDSCH/PDCCH subcarrier spacing		kHz	Config 1,2	15		120	
			Config 3	30		120	
EPRE ratio of PSS to SSS			Config 1,2,3	0	0		
EPRE ratio of PBCH DMRS to SSS							
EPRE ratio of PBCH to PBCH DMRS							
EPRE ratio of PDCCH DMRS to SSS							
EPRE ratio of PDCCH to PDCCH DMRS							
EPRE ratio of PDSCH DMRS to SSS							
EPRE ratio of PDSCH to PDSCH							

EPRE ratio of OCNG DMRS to SSS(Note 1)					
EPRE ratio of OCNG to OCNG DMRS (Note 1)					
$N_{oc}$ <sup>Note2</sup>	dBm/15 kHz Note5		NA Link only, see clause A.3.7A	-104.7	
$N_{oc}$ <sup>Note2</sup>	dBm/S CS Note4	Config 1,2		-95.7	
		Config 3		-95.7	
SSB_RP <sup>Note 3</sup>	dBm/S CS Note5	Config 1,2		-Infinity	-86.7
		Config 3		-Infinity	-86.7
$\hat{E}_s / I_{ot}$	dB	Config 1,2,3		-Infinity	9
$\hat{E}_s / N_{oc}$	dB	Config 1,2,3		-Infinity	9
$I_o$ <sup>Note3</sup>	dBm/9.36MHz	Config 1,2		-	-
	dBm/38.16MHz	Config 3		-	-
	dBm/95.04 MHz Note5	Config 1,2,3		-66.7	-57.2
Propagation Condition		Config 1,2,3		AWGN	
<p>Note 1: OCNG shall be used such that both cells are fully allocated and a constant total transmitted power spectral density is achieved for all OFDM symbols.</p> <p>Note 2: Interference from other cells and noise sources not specified in the test is assumed to be constant over subcarriers and time and shall be modelled as AWGN of appropriate power for <math>N_{oc}</math> to be fulfilled.</p> <p>Note 3: SSB_RP and <math>I_o</math> levels have been derived from other parameters for information purposes. They are not settable parameters themselves.</p> <p>Note 4: SSB_RP minimum requirements are specified assuming independent interference and noise at each receiver antenna port.</p> <p>Note 5: Equivalent power received by an antenna with 0 dBi gain at the centre of the quiet zone</p> <p>Note 6: As observed with 0 dBi gain antenna at the centre of the quiet zone</p> <p>Note 7: Information about types of UE beam is given in B.2.1.3, and does not limit UE implementation or test system implementation</p>					

A.7.6.2.8.2 Test Requirements

In test 1 with per-UE gap and in test 3 without the gap, the UE shall send one Event A4 triggered measurement report, with a measurement reporting delay less than X1 ms from the beginning of time period T2, where X1 is

- 10080 for UE supporting power class 1, or
- 6240 for UE supporting other power class.

In test 2 with per-UE gap and in test 4 without the gap, the UE shall send one Event A4 triggered measurement report, with a measurement reporting delay less than X2 ms from the beginning of time period T2, where X2 is

- 107520 for UE supporting power class 1, or
- 66560 for UE supporting other power class.

In test 1, 2, 3 and 4 UE is required to report SSB time index. The UE shall not send event triggered measurement reports, as long as the reporting criteria are not fulfilled. The rate of correct events observed during repeated tests shall be at least 90%.

NOTE: The actual overall delays measured in the test may be up to  $2 \times TTI_{DCCCH}$  higher than the measurement reporting delays above because of TTI insertion uncertainty of the measurement report in DCCCH.

### A.7.6.2.9 SA event triggered reporting tests For FR2 without SSB time index detection when DRX is not used (PCell in FR2) (rel16 additional mandatory gap pattern 17)

#### A.7.6.2.9.1 Test Purpose and Environment

The purpose of this test is to verify that the UE makes correct reporting of an event. This test will partly verify the SA inter-frequency NR cell search requirements in clause 9.3.4.

In this test, there are two cells: NR cell 1 as PCell in FR2 on NR RF channel 1 and NR cell 2 as neighbour cell in FR2 on NR RF channel 2. The test parameters and configurations are given in Tables A.7.6.2.9.1-1, A.7.6.2.9.1-2, and A.7.6.2.9.1-3.

In the measurement control information, it is indicated to the UE that event-triggered reporting with Event A3 is used. The test consists of two successive time periods, with time duration of T1, and T2 respectively. During time duration T1, the UE shall not have any timing information of NR cell 2.

Supported test configurations are shown in table A.7.6.2.9.1-1.

**Table A.7.6.2.9.1-1 SA event triggered reporting tests without SSB index reading for FR2-FR2**

Config	Description
1	120 kHz SSB SCS, 100 MHz bandwidth, TDD duplex mode
Note 1: Void.	

**Table A.7.6.2.9.1-2: General test parameters for SA inter-frequency event triggered reporting for FR2 without SSB time index detection (GP17)**

Parameter	Unit	Test configuration	Value	Comment
NR RF Channel Number		Config 1	1, 2	Two FR2 NR carrier frequencies is used.
Active cell		Config 1	NR cell 1 (Pcell)	NR Cell 1 is on NR RF channel number 1.
Neighbour cell		Config 1	NR cell 2	NR cell 2 is on NR RF channel number 2.
Gap Pattern Id		Config 1	17	As specified in clause 9.1.2-1.
Measurement gap offset		Config 1	39	
SMTTC-SSB parameters		Config 1	SSB.3 FR2	As specified in clause A.3.10.2
A3-Offset	dB	Config 1	-30	
Hysteresis	dB	Config 1	0	
CP length		Config 1	Normal	
TimeToTrigger	s	Config 1	0	
Filter coefficient		Config 1	0	L3 filtering is not used
DRX		Config 1	OFF	DRX is not used
Time offset between serving and neighbour cells		Config 1	3µs	Synchronous cells.
T1	s	Config 1	5	
T2	s	Config 1	6 (PC1) 4 (other PC)	

**Table A.7.6.2.9.1-3: Cell specific test parameters for SA inter-frequency event triggered reporting for FR2 without SSB time index detection (GP17)**

Parameter		Unit	Test configuration	Cell 1		Cell 1	
				T1	T2	T1	T2
AoA setup			Config 1	Setup 3 as specified in clause A.3.15			
				AoA1		AoA2	
Beam assumption <sup>Note 7</sup>			Config 1	Rough		Rough	
NR RF Channel Number			Config 1	1		2	
Duplex mode			Config 1	TDD		TDD	
TDD configuration			Config 1	TDDConf.3.1		TDDConf.3.1	
BW <sub>channel</sub>		MHz	Config 1	100: N <sub>RB,c</sub> = 66		100: N <sub>RB,c</sub> = 66	
BWP BW		MHz	Config 1	100: N <sub>RB,c</sub> = 66		100: N <sub>RB,c</sub> = 66	
BWP configuration	Initial DL BWP		Config 1	DLBWP.0.1		N/A	
	Initial UL BWP			ULBWP.0.1		N/A	
	Dedicated DL BWP			DLBWP.1.1		N/A	
	Dedicated UL BWP			ULBWP.1.1		N/A	
OCNG Patterns defined in A.3.2.1.1 (OP.1)			Config 1	OP.1		OP.1	
PDSCH Reference measurement channel			Config 1	SR.3.1 TDD		-	
CORESET Reference Channel			Config 1	CR.3.1 TDD		-	
SMTC configuration defined in A.3.11.1 and A.3.11.2			Config 1	SMTC.1		SMTC.1	
PDSCH/PDCCH subcarrier spacing		kHz	Config 1	120		120	
TRS configuration			Config 1	TRS.2.1 TDD		N/A	
TCI configuration			Config 1	CSI-RS.Config.0		N/A	
EPRE ratio of PSS to SSS			Config 1	0		0	
EPRE ratio of PBCH DMRS to SSS							
EPRE ratio of PBCH to PBCH DMRS							
EPRE ratio of PDCCH DMRS to SSS							
EPRE ratio of PDCCH to PDCCH DMRS							
EPRE ratio of PDSCH DMRS to SSS							
EPRE ratio of PDSCH to PDSCH							
EPRE ratio of OCNG DMRS to SSS(Note 1)							
EPRE ratio of OCNG to OCNG DMRS (Note 1)							
$N_{oc}$ <sup>Note2</sup>	dBm/15 kHz Note5		N/A		N/A		
$N_{oc}$ <sup>Note2</sup>	dBm/S CS Note4	Config 1	N/A		N/A		
SS-RSRP <sup>Note 3</sup>	dBm/S CS Note5	Config 1	-87	-87	-Infinity	-87	

$\hat{E}_s / I_{ot}$	dB	Config 1	N/A	N/A	-Infinity	N/A
$\hat{E}_s / N_{oc}$	dB	Config 1	N/A	N/A	-Infinity	N/A
$I_o$ <sup>Note3</sup>	dBm/95 .04 MHz Note5	Config 1	-58.01	-58.01	-Infinity	-58.01
Propagation Condition		Config 1	AWGN			
<p>Note 1: OCNG shall be used such that both cells are fully allocated and a constant total transmitted power spectral density is achieved for all OFDM symbols.</p> <p>Note 2: Interference from other cells and noise sources not specified in the test is assumed to be constant over subcarriers and time and shall be modelled as AWGN of appropriate power for <math>N_{oc}</math> to be fulfilled.</p> <p>Note 3: SS-RSRP and <math>I_o</math> levels have been derived from other parameters for information purposes. They are not settable parameters themselves.</p> <p>Note 4: SS-RSRP minimum requirements are specified assuming independent interference and noise at each receiver antenna port.</p> <p>Note 5: Equivalent power received by an antenna with 0 dBi gain at the centre of the quiet zone</p> <p>Note 6: As observed with 0 dBi gain antenna at the centre of the quiet zone</p> <p>Note 7: Information about types of UE beam is given in B.2.1.3, and does not limit UE implementation or test system implementation</p>						

#### A.7.6.2.9.2 Test Requirements

The UE shall send one Event A3 triggered measurement report, with a measurement reporting delay less than 5120ms (PC1) or 3200ms (other than PC1) from the beginning of time period T2.

The UE is not required to report SSB time index. The UE shall not send event triggered measurement reports, as long as the reporting criteria are not fulfilled. The rate of correct events observed during repeated tests shall be at least 90%.

NOTE: The actual overall delays measured in the test may be up to  $2 \times TTI_{DCCH}$  higher than the measurement reporting delays above because of TTI insertion uncertainty of the measurement report in DCCH.

#### A.7.6.2.10 SA event triggered reporting test without gap under non-DRX

##### A.7.6.2.10.1 Test Purpose and Environment

The purpose of this test is to verify that if UE supports *interFrequencyMeas-NoGap-r16* and the flag *interFrequencyConfig-NoGap-r16* is configured by the network, the UE makes correct reporting of an event. This test will partly verify the inter-frequency without gap cell search requirements in clause 9.3.9. Supported test configurations are shown in table A.7.6.2.10.1-1.

**Table A.7.6.2.10.1-1: supported test configurations**

Configuration	Description
1	120 kHz SSB SCS, 100 MHz bandwidth, TDD duplex mode

There are two cells in the test, NR cell 1 as PCell in FR2 on NR RF channel 1 and NR cell 2 as neighbour cell in FR2 on NR RF channel 2. The SSB of Cell 2 is completely within UE's active BWP BW. The RBs containing SSB from cell 1 and cell 2 should be different in frequency location within the cell bandwidth. The test parameters for the Cell 1 and Cell 2 are given in Table A.7.6.2.10.1-2, A.7.6.2.10.1-3 and A.7.6.2.10.1-4 below.

In the measurement control information, a measurement object is configured for the frequency of the PCell, and it is indicated to the UE that event-triggered reporting with Event A3 is used.

The test consists of two successive time periods, with time duration of T1, and T2 respectively. During time duration T1, the UE shall not have any timing information of Cell 2.

**Table A.7.6.2.10.1-2: General test parameters for intra-frequency event triggered reporting for SA with TDD PCell in FR2 without gap without DRX**

Parameter	Unit	Config	Value	Comment
Active cell		1	PCell (Cell 1)	NR Cell 1 is on NR RF channel number 1.
Neighbour cell		1	Cell 2	NR cell 2 is on NR RF channel number 2.
RF Channel Number		1	1, 2	Two FR2 NR carrier frequencies is used.
SMTC configuration		1	SMTC.1	
A3-Offset	dB	1	-6	
CP length		1	Normal	
Hysteresis	dB	1	0	
Time To Trigger	s	1	0	
Filter coefficient		1	0	L3 filtering is not used
DRX		1	OFF	
Time offset between Cell 1 and Cell 2		1	3 $\mu$ s	Synchronous cells
T1	s	1	5	
T2	s	1	5	

**Table A.7.6.2.10.1-3: NR Cell specific test parameters for intra-frequency event triggered reporting for SA with TDD PCell in FR2 without gap without DRX**

Parameter	Unit	Config	Cell 1		Cell 2	
			T1	T2	T1	T2
TDD configuration		1	TDDConf.3.1		TDDConf.3.1	
BW <sub>channel</sub>	MHz	1	100: N <sub>RB,c</sub> = 66		100: N <sub>RB,c</sub> = 66	
Initial BWP configuration		1	DLBWP.0.1 ULBWP.0.1		DLBWP.0.1 ULBWP.0.1	
Active DL BWP configuration		1	DLBWP.1.1		DLBWP.1.1	
Active UL BWP configuration		1	ULBWP.1.1		ULBWP.1.1	
RLM-RS		1	SSB		SSB	
PDSCH RMC configuration		1	SR.3.1 TDD		N/A	
RMSI CORESET RMC configuration		1	CR.3.1 TDD		CR.3.1 TDD	
Dedicated CORESET RMC configuration		1	CCR.3.1 TDD		CCR.3.1 TDD	
TRS configuration		1	TRS.2.1 TDD		N/A	
PDSCH/PDCCH TCI states		1	TCI.State.2		N/A	
OCNG Patterns		1	OP.1		OP.1	
SSB		1	SSB.3 FR2		SSB.3 FR2	
Propagation Condition		1	AWGN			

**Table A.7.6.2.10.1-4: NR OTA Cell specific test parameters for intra-frequency event triggered reporting for SA with TDD PCell in FR2 without gap without DRX**

Parameter	Unit	Config	Cell 1		Cell 2	
			T1	T2	T1	T2
AoA setup		1	Setup 1 defined in A.3.15.1			
Beam assumption <sup>Note 4</sup>		1	Rough		Rough	
$\hat{E}_s / I_{ot}$	dB	1	4	4	-Infinity	8
$N_{oc}$ <sup>Note 2</sup>	dBm/15 KHz	1	-102			
$N_{oc}$ <sup>Note 2</sup>	dBm/SCS	1	-93			

SS-RSRP	dBm/SCS	1	-89	-89	-Infinity	-85
$\hat{E}_s/N_{oc}$	dB	1	4	4	-Infinity	8
$I_o$	dBm/95.04MHz	1	-58.56		-55.38	
Note 1:	The resources for uplink transmission are assigned to the UE prior to the start of time period T2.					
Note 2:	Interference from other cells and noise sources not specified in the test is assumed to be constant over subcarriers and time and shall be modelled as AWGN of appropriate power for $N_{oc}$ to be fulfilled.					
Note 3:	SS-RSRP levels have been derived from other parameters for information purposes. They are not settable parameters themselves.					
Note 4:	Information about types of UE beam is given in B.2.1.3, and does not limit UE implementation or test system implementation					

### A.7.6.2.10.2 Test Requirements

In the test, the UE shall send one Event A3 triggered measurement report, with a measurement reporting delay less than X ms from the beginning of time period T2, where X is

- 2.4s for a UE supporting power class 1,
- 1.44s for a UE supporting power class 2, 3 and 4

The UE is not required to read the neighbour cell SSB index in this test.

The UE shall not send event triggered measurement reports, as long as the reporting criteria are not fulfilled.

The rate of correct events observed during repeated tests shall be at least 90%.

NOTE: The actual overall delays measured in the test may be up to  $2 \times TTI_{DCC}$  higher than the measurement reporting delays above because of TTI insertion uncertainty of the measurement report in DCC.

### A.7.6.2.11 SA event triggered reporting test without gap under DRX

#### A.7.6.2.11.1 Test Purpose and Environment

The purpose of this test is to verify that the UE makes correct reporting of an event. This test will partly verify the TDD inter-frequency cell search requirements in clause 9.2.5.1 and 9.2.5.2. Supported test configurations are shown in table A.7.6.2.11.1-1.

**Table A.7.6.2.11.1-1: supported test configurations**

Configuration	Description
1	120 kHz SSB SCS, 100 MHz bandwidth, TDD duplex mode
2	240 kHz SSB SCS, 100 MHz bandwidth, TDD duplex mode
Note:	The UE is only required to be tested in one of the supported test configurations.

There are two cells in the test: PCell (Cell 1) on NR RF channel 1 and a FR2 neighbour cell (Cell 2) on NR RF channel 2. The SSB of Cell 2 is completely within UE's active BWP BW. The RBs containing SSB from cell 1 and cell 2 should be different in frequency location within the cell bandwidth. The test parameters for the Cell 1 and Cell 2 are given in Table A.7.6.2.11.1-2 ~ 6.

In the measurement control information, a measurement object is configured for the frequency of the PCell, and it is indicated to the UE that event-triggered reporting with Event A3 is used.

The test consists of two successive time periods, with time duration of T1, and T2 respectively. During time duration T1, the UE shall not have any timing information of Cell 2.

UE needs to be provided with new Timing Advance Command MAC control element at least once during each time alignment timer period to maintain uplink time alignment. Furthermore UE is allocated with PUSCH resource at every DRX cycle.

**Table A.7.6.2.11.1-2: General test parameters for inter-frequency event triggered reporting for SA with TDD PCell in FR2 without gap with DRX**

Parameter	Unit	Config	Value	Comment
NR RF Channel Number		1, 2	1, 2	2 TDD carrier frequency are used for the NR cells.
Active cell		1, 2	PCell (Cell 1)	Cell 1 is on NR RF channel number 1.
Neighbour cell		1, 2	Cell 2	Cell to be identified. Cell 2 is on NR RF channel number 2.
SMTC configuration		1, 2	SMTC.1	
A3-Offset	dB	1, 2	-6	
CP length		1, 2	Normal	
Hysteresis	dB	1, 2	0	
Time To Trigger	s	1, 2	0	
Filter coefficient		1, 2	0	L3 filtering is not used
DRX		1, 2	DRX.7	
Time offset between Cell 1 and Cell 2		1, 2	3 $\mu$ s	Synchronous cells
T1	s	1, 2	5	
T2	s	1, 2	52	

**Table A.7.6.2.11.1-3: NR Cell specific test parameters for inter-frequency event triggered reporting for SA with TDD PCell in FR2 without gap with DRX**

Parameter	Unit	Config	Cell 1		Cell 2	
			T1	T2	T1	T2
NR RF Channel Number		1, 2	1		2	
TDD configuration		1, 2	TDDConf.3.1		TDDConf.3.1	
BW <sub>channel</sub>	MHz	1, 2	100: N <sub>RB,c</sub> = 66		100: N <sub>RB,c</sub> = 66	
Initial BWP configuration		1, 2	DLBWP.0.1 ULBWP.0.1		N/A	
Active DL BWP configuration		1, 2	DLBWP.1.1		N/A	
Active UL BWP configuration		1, 2	ULBWP.1.1		N/A	
RLM-RS		1, 2	SSB		N/A	
PDSCH RMC configuration		1, 2	SR.3.1 TDD		N/A	
RMSI CORESET RMC configuration		1, 2	CR.3.1 TDD		N/A	
Dedicated CORESET RMC configuration		1, 2	CCR.3.1 TDD		N/A	
TRS configuration		1, 2	TRS.2.1 TDD		N/A	
PDSCH/PDCCH TCI states		1, 2	TCI.State.2		N/A	
OCNG Patterns		1, 2	OP.1		OP.1	
SSB		1	SSB.3 FR2		SSB.3 FR2	
		2	SSB.4 FR2		SSB.4 FR2	
Propagation Condition		1, 2	AWGN			

**Table A.7.6.2.11.1-4: NR OTA Cell specific test parameters for inter-frequency event triggered reporting for SA with TDD PCell in FR2 without gap with DRX**

Parameter	Unit	Config	Cell 1		Cell 2	
			T1	T2	T1	T2
AoA setup		1, 2	Setup 1 defined in A.3.15.1			
Beam assumption <sup>Note 4</sup>		1,2	Rough		Rough	



$\hat{E}_s/I_{ot}$	dB	1, 2	4	-1.46	-Infinity	-1.46
$N_{oc}$ <small>Note 2</small>	dBm/15 KHz	1, 2	-98			
$N_{oc}$ <small>Note 2</small>	dBm/SCS	1	-89			
		2	-86			
SS-RSRP	dBm/SCS	1	-85	-85	-Infinity	-85
		2	-82	-82	-Infinity	-82
$\hat{E}_s/N_{oc}$	dB	1, 2	4	4	-Infinity	4
$I_o$	dBm/95.04MHz	1	-54.53	-52.18	-54.53	-52.18
<p>Note 1: The resources for uplink transmission are assigned to the UE prior to the start of time period T2.</p> <p>Note 2: Interference from other cells and noise sources not specified in the test is assumed to be constant over subcarriers and time and shall be modelled as AWGN of appropriate power for <math>N_{oc}</math> to be fulfilled.</p> <p>Note 3: SS-RSRP levels have been derived from other parameters for information purposes. They are not settable parameters themselves.</p> <p>Note 4: Information about types of UE beam is given in B.2.1.3, and does not limit UE implementation or test system implementation.</p>						

### A.7.6.2.11.2 Test Requirements

In test, the UE shall send one Event A3 triggered measurement report, with a measurement reporting delay less than X ms from the beginning of time period T2, where X is

- 51.2s for a UE supporting power class 1,
- 30.72s for a UE supporting power class 2, 3 and 4est

The UE is not required to read the neighbour cell SSB index in this test.

The UE shall not send event triggered measurement reports, as long as the reporting criteria are not fulfilled.

The rate of correct events observed during repeated tests shall be at least 90%.

NOTE: The actual overall delays measured in the test may be up to  $2 \times TTI_{DCCH}$  higher than the measurement reporting delays above because of TTI insertion uncertainty of the measurement report in DCCH.

## A.7.6.3 L1-RSRP measurement for beam reporting

### A.7.6.3.1 SSB based L1-RSRP measurement when DRX is not used

### A.7.6.3.1 SSB based L1-RSRP measurement when DRX is not used

#### A.7.6.3.1.1 Test Purpose and Environment

The purpose of this test is to verify that the UE makes correct reporting of L1-RSRP measurement. This test will partly verify the L1-RSRP measurement requirements in clause 9.5.4.1, with the testing configurations for NR cells in Table A.7.6.3.1.1-1.

The AoA setup for this test is Setup 1 as defined in clause A.3.15

**Table A.7.6.3.1.1-1: Applicable NR configurations for FR2 SSB based L1-RSRP test**

Config	Description
1	NR 120 kHz SSB SCS, 100 MHz bandwidth, TDD duplex mode
2	NR 240 kHz SSB SCS, 100 MHz bandwidth, TDD duplex mode
Note: The UE is only required to be tested in one of the supported test configurations	

### A.7.6.3.1.2 Test parameters

There is one cells in the test, the FR2 PCell (Cell 1). The test parameters for the Cell 1 are given in Table A.7.6.3.1.2-1 and Table A.7.6.3.1.2-2 below.

In CSI measurement configuration, UE is indicated to perform L1-RSRP measurement on the SSBs and report periodically. The test consists of two successive time periods, with time duration of T1 and T2 respectively. The test has higher layer parameter *timeRestrictionForChannelMeasurements* configured.

There is no measurement gap configured in the test. Before the test, UE is configured to perform RLM, BFD and L1-RSRP measurement based on the SSBs.

**Table A.7.6.3.1.2-1: General test parameters**

Parameter	Config	Unit	Value			
SSB GSCN	1~2		freq1			
Duplex mode	1~2		TDD			
TDD Configuration	1~2		TDDConf.3.1			
$BW_{channel}$	1~2	MHz	100: $N_{RB,c} = 66$			
Data RBs allocated	1~2		66			
PDSCH Reference measurement channel	1		SR.3.2 TDD			
	2		SR.3.3 TDD			
RMSI CORESET Reference Channel	1		CR.3.1 TDD			
	2		CR.3.2 TDD			
Dedicated CORESET Reference Channel	1		CCR.3.1 TDD			
	2		CCR.3.7 TDD			
SSB configuration	1		SSB.1 FR2			
	2		SSB.2 FR2			
OCNG Patterns	1~2		OP.1			
Initial BWP Configuration	1~2		DLBWP.0.1 ULBWP.0.1			
Dedicated BWP configuration	1~2		DLBWP.1.3 ULBWP.1.3			
SMTc configuration	1~2		SMTc.1			
TRS Configuration	1~2		TRS.2.1 TDD			
PDCCH/PDSCH TCI Configuration	1~2		TCI.State.2			
DRX configuration	1~2		Off			
reportConfigType	1~2		periodic			
reportQuantity	1~2		ssb-Index-RSRP			
Number of reported RS	1~2		2			
L1-RSRP reporting period	1~2	slot	320			
T1	1~2	s	5			
T2	1~2	s	2			
EPRE ratio of PSS to SSS	1~2	dB	0			
EPRE ratio of PBCH DMRS to SSS						
EPRE ratio of PBCH to PBCH DMRS						
EPRE ratio of PDCCH DMRS to SSS						
EPRE ratio of PDCCH to PDCCH DMRS						
EPRE ratio of PDSCH DMRS to SSS						
EPRE ratio of PDSCH to PDSCH DMRS						
EPRE ratio of OCNG DMRS to SSS <sup>Note 1</sup>						
EPRE ratio of OCNG to OCNG DMRS <sup>Note 1</sup>						
Propagation condition				1~2		AWGN

Note 1: OCNB shall be used such that the resources in Cell 1 are fully allocated and a constant total transmitted power spectral density is achieved for all OFDM symbols.

**Table A.7.6.3.1.2-2: SSB specific test parameters**

Parameter	Config	Unit	SSB#0		SSB#1	
			T1	T2	T1	T2
Angle of arrival configuration			Setup 1 according to A.3.15.1			
Beam Assumption <sup>Note 4</sup>	1-2		Rough			
$N_{oc}$ <sup>Note2</sup>	1~2	dBm/15kHz	-105			
$N_{oc}$ <sup>Note2</sup>	1	dBm/SSB SCS	-96			
	2		-93			
$\hat{E}_s / I_{ot}$	1~2	dB	0	0	-Infinity	9
SSB_RP <sup>Note3</sup>	1	dBm/SSB SCS	-96	-96	-Infinity	-87
	2		-93	-93	-Infinity	-84
I <sub>o</sub> <sup>Note3</sup>	1	dBm/95.04MHz	-63.97	-63.97	-66.98	-57.47
	2		-63.97	-63.97	-66.98	-57.47
$\hat{E}_s / N_{oc}$	1~2	dB	0	0	-Infinity	9
<p>Note 1: The resources for uplink transmission are assigned to the UE prior to the start of time period T2.</p> <p>Note 2: Interference from other cells and noise sources not specified in the test is assumed to be constant over subcarriers and time and shall be modelled as AWGN of appropriate power for <math>N_{oc}</math> to be fulfilled.</p> <p>Note 3: SSB_RP and I<sub>o</sub> levels have been derived from other parameters for information purposes. They are not settable parameters themselves.</p> <p>Note 4: Information about types of UE beam is given in B.2.1.3, and does not limit UE implementation or test system implementation</p>						

**A.7.6.3.1.3 Test Requirements**

The UE shall send L1-RSRP report every 320 slots. No later than X ms plus 320 slots from the beginning of time period T2, UE shall send L1-RSRP report including the results for both SSB#0 and SSB#1 while meeting the accuracy requirements defined in clause 10.1.20.1, where X is

- 1680 for UE supporting power class 1
- 1200 for UE supporting power class 2,3 or 4.

The reported L1-RSRP value shall include the Rx antenna gain in the range of -10 to +20 dB.

The rate of correct events observed during repeated tests shall be at least 90%.

**A.7.6.3.2 SSB based L1-RSRP measurement when DRX is used**

**A.7.6.3.2.1 Test Purpose and Environment**

The purpose of this test is to verify that the UE makes correct reporting of L1-RSRP measurement. This test will partly verify the L1-RSRP measurement requirements in clause 9.5.4.1, with the testing configurations for NR cells in Table A.7.6.3.2.1-1.

The AoA setup for this test is Setup 1 as defined in clause A.3.15

**Table A.7.6.3.2.1-1: Applicable NR configurations for FR2 SSB based L1-RSRP test**

Config	Description
--------	-------------

1	NR 120 kHz SSB SCS, 100 MHz bandwidth, TDD duplex mode
2	NR 240 kHz SSB SCS, 100 MHz bandwidth, TDD duplex mode
Note: The UE is only required to be tested in one of the supported test configurations	

### A.7.6.3.2.2 Test parameters

There is one cells in the test, the FR2 PCell (Cell 1). The test parameters for the Cell 1 are given in Table A.7.6.3.2.2-1 and Table A.7.6.3.2.2-2 below.

In CSI measurement configuration, UE is indicated to perform L1-RSRP measurement on the SSBs and report periodically. The test consists of two successive time periods, with time duration of T1 and T2 respectively. The test has higher layer parameter *timeRestrictionForChannelMeasurements* configured.

There is no measurement gap configured in the test. Before the test, UE is configured to perform RLM, BFD and L1-RSRP measurement based on the SSBs.

**Table A.7.6.3.2.2-1: General test parameters**

Parameter	Config	Unit	Value
SSB GSCN	1~2		freq1
Duplex mode	1~2		TDD
TDD Configuration	1~2		TDDConf.3.1
BW <sub>channel</sub>	1~2	MHz	100: N <sub>RB,c</sub> = 66
Data RBs allocated	1~2		66
PDSCH Reference measurement channel	1		SR.3.2 TDD
	2		SR.3.3 TDD
RMSI CORESET Reference Channel	1		CR.3.1 TDD
	2		CR.3.2 TDD
Dedicated CORESET Reference Channel	1		CCR.3.1 TDD
	2		CCR.3.7 TDD
SSB configuration	1		SSB.1 FR2
	2		SSB.2 FR2
OCNG Patterns	1~2		OP.1
Initial BWP Configuration	1~2		DLBWP.0.1 ULBWP.0.1
Dedicated BWP configuration	1~2		DLBWP.1.3 ULBWP.1.3
SMTc configuration	1~2		SMTc.1
TRS Configuration	1~2		TRS.2.1 TDD
PDCCH/PDSCH TCI Configuration	1~2		TCI.State.2
DRX configuration	1~2		DRX.3
reportConfigType	1~2		periodic
reportQuantity	1~2		ssb-Index-RSRP
Number of reported RS	1~2		2
L1-RSRP reporting period	1~2	slot	320
T1	1~2	s	5
T2	1~2	s	3
EPRE ratio of PSS to SSS	1~2	dB	0
EPRE ratio of PBCH DMRS to SSS			
EPRE ratio of PBCH to PBCH DMRS			
EPRE ratio of PDCCH DMRS to SSS			
EPRE ratio of PDCCH to PDCCH DMRS			
EPRE ratio of PDSCH DMRS to SSS			
EPRE ratio of PDSCH to PDSCH DMRS			
EPRE ratio of PDSCH to PDSCH DMRS			

EPRE ratio of OCNG DMRS to SSS <sup>Note 1</sup>			
EPRE ratio of OCNG to OCNG DMRS <sup>Note 1</sup>			
Propagation condition	1~2		AWGN
Note 1: OCNG shall be used such that the resources in Cell 1 are fully allocated and a constant total transmitted power spectral density is achieved for all OFDM symbols.			

**Table A.7.6.3.2.2-2: SSB specific test parameters**

Parameter	Config	Unit	SSB#0		SSB#1	
			T1	T2	T1	T2
Angle of arrival configuration			Setup 1 according to A.3.15.1			
Beam Assumption <sup>Note 4</sup>	1~2		Rough			
$N_{oc}$ <sup>Note 2</sup>	1~2	dBm/15kHz	-105			
$N_{oc}$ <sup>Note 2</sup>	1	dBm/SSB SCS	-96			
	2		-93			
$\hat{E}_s / I_{ot}$	1~2	dB	0	0	-Infinity	9
SSB_RP <sup>Note 3</sup>	1	dBm/SSB SCS	-96	-96	-Infinity	-87
	2		-93	-93	-Infinity	-84
I <sub>o</sub> <sup>Note 3</sup>	1	dBm/95.04MHz	-63.97	-63.97	-66.98	-57.47
	2		-63.97	-63.97	-66.98	-57.47
$\hat{E}_s / N_{oc}$	1~2	dB	0	0	-Infinity	9
<p>Note 1: The resources for uplink transmission are assigned to the UE prior to the start of time period T2.</p> <p>Note 2: Interference from other cells and noise sources not specified in the test is assumed to be constant over subcarriers and time and shall be modelled as AWGN of appropriate power for <math>N_{oc}</math> to be fulfilled.</p> <p>Note 3: SSB_RP and I<sub>o</sub> levels have been derived from other parameters for information purposes. They are not settable parameters themselves.</p> <p>Note 4: Information about types of UE beam is given in B.2.1.3, and does not limit UE implementation or test system implementation</p>						

**A.7.6.3.2.3 Test Requirements**

The UE shall send L1-RSRP report every 320 slots. No later than X ms plus 320 slots from the beginning of time period T2, UE shall send L1-RSRP report including the results for both SSB#0 and SSB#1 while meeting the accuracy requirements defined in clause 10.1.20.1, where X is

- 2880 for UE supporting power class 1
- 1920 for UE supporting power class 2,3 or 4.

The reported L1-RSRP value shall include the Rx antenna gain in the range of -10 to +20 dB.

The rate of correct events observed during repeated tests shall be at least 90%.

### A.7.6.3.3 CSI-RS based L1-RSRP measurement when DRX is not used

#### A.7.6.3.3.1 Test Purpose and Environment

The purpose of this test is to verify that the UE makes correct reporting of L1-RSRP measurement. This test will partly verify the L1-RSRP measurement requirements in clause 9.5.4.2, with the testing configurations for NR cells in Table A.7.6.3.3.1-1.

**Table A.7.6.3.3.1-1: Applicable NR configurations for FR2 CSI-RS based L1-RSRP test**

Config	Description
1	NR 120 kHz CSI-RS SCS, 100 MHz bandwidth, TDD duplex mode
Note: The UE is only required to be tested in one of the supported test configurations	

#### A.7.6.3.3.2 Test parameters

There is one cells in the test, the FR2 PCell (Cell 1). The test parameters for the Cell 1 are given in Table A.7.6.3.3.2-1 and Table A.7.6.3.3.2-2 below.

In CSI measurement configuration, UE is indicated to perform L1-RSRP measurement on the CSI-RS and report aperiodically. The test consists of a single time period T1, during which the UE is triggered via DCI to report L1-RSRP on aperiodic CSI-RS resources. UE is also configured to measure L1-RSRP based on SSB. After 480ms from the beginning of the test, the DCI trigger comes in slot 1 of a frame and UE provides the report back based on the reporting configuration as defined in Table A.7.6.3.3.2-1.

There is no measurement gap configured in the test. Before the test, UE is configured to perform RLM and BFD based on the SSBs.

**Table A.7.6.3.3.2-1: General test parameters**

Parameter	Config	Unit	Value
SSB GSCN	1		freq1
Duplex mode	1		TDD
TDD Configuration	1		TDDConf.3.1
BW <sub>channel</sub>	1	MHz	100: N <sub>RB,C</sub> = 66
PDSCH Reference measurement channel	1		SR.3.1 TDD
RMSI CORESET Reference Channel	1		CR.3.1 TDD
Dedicated CORESET Reference Channel	1		CCR.3.1 TDD
SSB configuration	1		SSB.1 FR2
CSI-RS configuration	1		CSI-RS.3.3 TDD
OCNG Patterns	1		OP.1
Initial BWP Configuration	1		DLBWP.0.1 ULBWP.0.1
Dedicated BWP configuration	1		DLBWP.1.1 ULBWP.1.1
SMTC configuration	1		SMTC.1
TRS Configuration	1		TRS.2.1 TDD
PDCCH/PDSCH TCI Configuration	1		TCI.State.2
DRX configuration	1		Off
reportConfigType	1		aperiodic
reportQuantity	1		cri-RSRP
Number of reported RS	1		2
qcl-Info	1		SSB#0 for resource#0 SSB#1 for resource#1
reportSlotOffsetList	1		8
Propagation condition	1		AWGN
T1	1	s	5
EPRE ratio of PSS to SSS	1	dB	0
EPRE ratio of PBCH DMRS to SSS			

EPRE ratio of PBCH to PBCH DMRS			
EPRE ratio of PDCCH DMRS to SSS			
EPRE ratio of PDCCH to PDCCH DMRS			
EPRE ratio of PDSCH DMRS to SSS			
EPRE ratio of PDSCH to PDSCH DMRS			
EPRE ratio of OCNG DMRS to SSS <sup>Note 1</sup>			
EPRE ratio of OCNG to OCNG DMRS <sup>Note 1</sup>			
Note 1: OCNG shall be used such that the resources in Cell 1 are fully allocated and a constant total transmitted power spectral density is achieved for all OFDM symbols.			

**Table A.7.6.3.3.2-1: CSI-RS specific test parameters**

Parameter	Config	Unit	CSI-RS#0	CSI-RS#1
Angle of arrival configuration	1		Setup 1 according to A.3.15.1	
Beam Assumption <sup>Note 4</sup>	1		Rough	Rough
$N_{oc}$ <sup>Note 1</sup>	1	dBm/15kHz	-105	
$N_{oc}$ <sup>Note 1</sup>	1	dBm/SSB SCS	-95.97	
$\hat{E}_s / I_{ot}$	1	dB	0	9
CSI-RS RSRP <sup>Note 2</sup>	1	dBm/SSB SCS	-95.97	-86.97
$I_o$ <sup>Note 2</sup>	1	dBm/95.04MHz	-63.97	-57.47
$\hat{E}_s / N_{oc}$	1	dB	0	9
<p>Note 2: Interference from other cells and noise sources not specified in the test is assumed to be constant over subcarriers and time and shall be modelled as AWGN of appropriate power for <math>N_{oc}</math> to be fulfilled.</p> <p>Note 3: CSI-RS RSRP and <math>I_o</math> levels have been derived from other parameters for information purposes. They are not settable parameters themselves.</p> <p>Note 4: Information about types of UE beam is given in B.2.1.3, and does not limit UE implementation or test system implementation</p>				

**A.7.6.3.3.3 Test Requirements**

After 480ms from the beginning of the test, the UE shall send L1-RSRP report at slot 8 from the reception of DCI triggering the L1-RSRP measurement. The L1-RSRP report shall include the results for both CSI-RS#0 and CSI-RS#1 while meeting the accuracy requirements defined in clause 10.1.20.1. The reported L1-RSRP value shall include the Rx antenna gain in the range of [-10 ~ +20] dB.

For absolute accuracy of CSI-RS0 and absolute accuracy of CSI-RS1, the UE is deemed to meet the requirement if the reported L1-RSRP is in the range shown in Table A.7.6.3.3.3-1.

For relative accuracy of CSI-RS0 compared with CSI-RS1, the UE is deemed to meet the requirement if the difference in reported L1-RSRP meets the requirements in Table 10.1.20.2.2-1.

**Table A.7.6.3.3.3-1: L1-RSRP absolute accuracy test requirement**

	Test requirement <sup>Notes 1,2,3</sup>
CSI-RS0	$CSI-RS\_RP0 - \delta + G_{min} \leq \text{Reported RSRP(dBm)} \leq CSI-RS\_RP0 + \delta + G_{max}$
CSI-RS1	$CSI-RS\_RP1 - \delta + G_{min} \leq \text{Reported RSRP(dBm)} \leq CSI-RS\_RP1 + \delta + G_{max}$
Note 1: CSI-RS_RPn is the equivalent power received by an antenna with 0dBi gain at the centre of the quiet zone configured in the test for the CSI-RS n under consideration	

Note 2:	$\delta$ is the RSRP absolute accuracy requirement from Table 10.1.20.2.1-1, selected according to the $I_o$ used in the test
Note 3:	$G_{min}$ and $G_{max}$ are the minimum and maximum UE gain values from Table B.2.1.5.1-1, selected according to the UE power class

#### A.7.6.3.4 CSI-RS based L1-RSRP measurement when DRX is used

##### A.7.6.3.4.1 Test Purpose and Environment

The purpose of this test is to verify that the UE makes correct reporting of L1-RSRP measurement. This test will partly verify the L1-RSRP measurement requirements in clause 9.5.4.2, with the testing configurations for NR cells in Table A.7.6.3.4.1-1.

**Table A.7.6.3.4.1-1: Applicable NR configurations for FR2 CSI-RS based L1-RSRP test**

Config	Description
1	NR 120 kHz CSI-RS SCS, 100 MHz bandwidth, TDD duplex mode
Note:	The UE is only required to be tested in one of the supported test configurations

##### A.7.6.3.4.2 Test parameters

There is one cells in the test, the FR2 PCell (Cell 1). The test parameters for the Cell 1 are given in Table A.7.6.3.4.2-1 and Table A.7.6.3.4.2-2 below.

In CSI measurement configuration, UE is indicated to perform L1-RSRP measurement on the CSI-RS and report aperiodically. The test consists of a single time period T1, during which the UE is triggered via DCI to report L1-RSRP on aperiodic CSI-RS resources. UE is also configured to measure L1-RSRP based on SSB. After 1440ms from the beginning of the test, the DCI trigger comes in slot 1 of a frame and UE provides the report back based on the reporting configuration as defined in Table A.7.6.3.4.2-1.

There is no measurement gap configured in the test. Before the test, UE is configured to perform RLM and BFD based on the SSBs.

**Table A.7.6.3.4.2-1: General test parameters**

Parameter	Config	Unit	Value
SSB GSCN	1		freq1
Duplex mode	1		TDD
TDD Configuration	1		TDDConf.3.1
$BW_{channel}$	1	MHz	100: $N_{RB,G} = 66$
PDSCH Reference measurement channel	1		SR.3.1 TDD
RMSI CORESET Reference Channel	1		CR.3.1 TDD
Dedicated CORESET Reference Channel	1		CCR.3.1 TDD
SSB configuration	1		SSB.1 FR2
CSI-RS configuration	1		CSI-RS.3.3 TDD
OCNG Patterns	1		OP.1
Initial BWP Configuration	1		DLBWP.0.1 ULBWP.0.1
Dedicated BWP configuration	1		DLBWP.1.1 ULBWP.1.1
SMTTC configuration	1		SMTTC.1
TRS Configuration	1		TRS.2.1 TDD
PDCCH/PDSCH TCI Configuration	1		TCI.State.2
DRX configuration	1		DRX.3
reportConfigType	1		aperiodic
reportQuantity	1		cri-RSRP
Number of reported RS	1		2
qcl-Info	1		SSB#0 for resource#0



			SSB#1 for resource#1
reportSlotOffsetList	1		8
Propagation condition	1		AWGN
T1	1	s	5
EPRE ratio of PSS to SSS	1	dB	0
EPRE ratio of PBCH DMRS to SSS			
EPRE ratio of PBCH to PBCH DMRS			
EPRE ratio of PDCCH DMRS to SSS			
EPRE ratio of PDCCH to PDCCH DMRS			
EPRE ratio of PDSCH DMRS to SSS			
EPRE ratio of PDSCH to PDSCH DMRS			
EPRE ratio of OCNG DMRS to SSS <sup>Note 1</sup>			
EPRE ratio of OCNG to OCNG DMRS <sup>Note 1</sup>			
Note 1: OCNG shall be used such that the resources in Cell 1 are fully allocated and a constant total transmitted power spectral density is achieved for all OFDM symbols.			

**Table A.7.6.3.4.2-1: CSI-RS specific test parameters**

Parameter	Config	Unit	CSI-RS#0	CSI-RS#1
Angle of arrival configuration	1		Setup 1 according to A.3.15.1	
Beam Assumption <sup>Note 4</sup>	1		Rough	Rough
$N_{oc}$ <sup>Note1</sup>	1	dBm/15kHz	-105	
$N_{oc}$ <sup>Note1</sup>	1	dBm/SSB SCS	-95.97	
$\hat{E}_s / I_{ot}$	1	dB	0	9
CSI-RS RSRP <sup>Note2</sup>	1	dBm/SSB SCS	-95.97	-86.97
$I_o$ <sup>Note2</sup>	1	dBm/95.04MHz	-63.97	-57.47
$\hat{E}_s / N_{oc}$	1	dB	0	9
<p>Note 2: Interference from other cells and noise sources not specified in the test is assumed to be constant over subcarriers and time and shall be modelled as AWGN of appropriate power for <math>N_{oc}</math> to be fulfilled.</p> <p>Note 3: CSI-RS RSRP and <math>I_o</math> levels have been derived from other parameters for information purposes. They are not settable parameters themselves.</p> <p>Note 4: Information about types of UE beam is given in B.2.1.3, and does not limit UE implementation or test system implementation</p>				

**A.7.6.3.3.3 Test Requirements**

After 1440ms from the beginning of the test, the UE shall send L1-RSRP report at slot 8 from the reception of DCI triggering the L1-RSRP measurement. The L1-RSRP report shall include the results for both CSI-RS#0 and CSI-RS#1 while meeting the accuracy requirements defined in clause 10.1.20.1. The reported L1-RSRP value shall include the Rx antenna gain in the range of [-10 ~ +20] dB.

For absolute accuracy of CSI-RS0 and absolute accuracy of CSI-RS1, the UE is deemed to meet the requirement if the reported L1-RSRP is in the range shown in Table A.7.6.3.4.3-1.

For relative accuracy of CSI-RS0 compared with CSI-RS1, the UE is deemed to meet the requirement if the difference in reported L1-RSRP meets the requirements in Table 10.1.20.2.2-1.

**Table A.7.6.3.4.3-1: L1-RSRP absolute accuracy test requirement**

	Test requirement <sup>Notes1,2,3</sup>
CSI-RS0	$CSI-RS\_RP0 - \delta + G_{min} \leq \text{Reported RSRP(dBm)} \leq CSI-RS\_RP0 + \delta + G_{max}$
CSI-RS1	$CSI-RS\_RP1 - \delta + G_{min} \leq \text{Reported RSRP(dBm)} \leq CSI-RS\_RP1 + \delta + G_{max}$
Note 1:	CSI-RS_RPn is the equivalent power received by an antenna with 0dBi gain at the centre of the quiet zone configured in the test for the CSI-RS n under consideration
Note 2:	$\delta$ is the RSRP absolute accuracy requirement from Table 10.1.20.2.1-1, selected according to the $I_o$ used in the test
Note 3:	$G_{min}$ and $G_{max}$ are the minimum and maximum UE gain values from Table B.2.1.5.1-1, selected according to the UE power class

## A.7.6.4 CLI measurements

### A.7.6.4.1 SRS-RSRP measurement with non-DRX

#### A.7.6.4.1.1 Test Purpose and Environment

The purpose of this test is to verify that the UE makes correct reporting of SRS-RSRP measurement. This test will verify the SRS-RSRP measurement requirements in clause 9.7.2.5 with the testing configurations for NR cells in Table A.7.6.4.1.1-1.

**Table A.7.6.4.1.1-1: Applicable NR configurations for FR2 SRS-RSRP test**

Configuration	Description
1	NR 120 kHz SRS SCS, 100 MHz bandwidth, TDD duplex mode

#### A.7.6.4.1.2 Test Parameters

One cell is deployed in the test, which is FR2 PCell (Cell 1). The test parameters for PCell is given in Table A.7.6.4.1.2-1 ~ A.7.6.4.1.2-3 below. In the measurement control information, a measurement object is configured for the frequency of the PCell, and it is indicated to the UE that event-triggered reporting with Event I1 is used. The test consists of two successive time periods, with time duration of T1 and T2, respectively.

During the test, the test system transmits SRS resource for measurement in the DL slot according to the SRS configuration in Table A.7.6.4.1.2-4 and the test parameters for the (virtual) neighbour cell UE in Table A. 7.6.4.1.2-3. During the test, the test system does not transmit PDCCH/PDSCH/OCNG on SRS symbol to be transmitted and on 2 data symbols before SRS to be transmitted.

**Table A.7.6.4.1.2-1: General test parameters for SRS-RSRP event triggered reporting for PCell in FR2**

Parameter	Unit	Test configuration	Value	Comment
Active cell		1	Cell 1	
RF Channel Number		1	1: Cell 1	
SSB configuration		1	SSB.1 FR2	
SMTC configuration		1	SMTC.1	
SRS configuration		1	SRSCnf.1	Table A.7.6.4.1.2-4
CP length		1	Normal	
i1-Threshold	dBm	1	-103	
Hysteresis	dB	1	0	
Time To Trigger	s	1	0	
Filter coefficient		1	0	L3 filtering is not used
DRX	ms	1	OFF	Non-DRX
Time offset between DL from serving cell and SRS from test system	$\mu$ s	1	10.67	
T1	s	1	5	
T2	s	1	1	

**Table A.7.6.4.1.2-2: NR Cell specific test parameters for SA SRS-RSRP event triggered reporting for PCell in FR2**

Parameter	Unit	Test configuration	Cell 1	
			T1	T2
TDD configuration		1	TDDConf.3.1	
PDSCH RMC configuration		1	SR.3.1 TDD	
RMSI CORESET RMC configuration		1	CR.3.1 TDD	
Dedicated CORESET RMC configuration		1	CCR.3.1 TDD	
OCNG Patterns		1	OP.1	
TRS configuration			TRS.2.1. TDD	
PDSCH/PDCCH TCI state		1	TCI.State.2	
Initial BWP configuration		1	DLBWP.0.1 ULBWP.0.1	
Active DL BWP configuration		1	DLBWP.1.1	
Active UL BWP configuration		1	ULBWP.1.1	
Propagation Condition		1	AWGN	

**Table A.7.6.4.1.2-3: NR OTA Cell specific test parameters for SA SRS-RSRP event triggered reporting for PCell and neighbour cell UE in FR2**

Parameter	Unit	Test configuration	Cell 1		Neighbour cell UE	
			T1	T2	T1	T2
AoA setup		1	Setup 1 defined in A.3.15.1			
Beam assumption Note 4		1	Fine			
$N_{oc}$ Note 2	dBm/15 kHz	1	-98		-98	
$N_{oc}$ Note 2	dBm/SCS	1	-89		-89	
$\hat{E}_s/I_{ot}$	dB	1	-	-	-infinity	4
$\hat{E}_s/N_{oc}$	dB	1	4	4	-infinity	4
SRS-RSRP Note 3	dBm/SCS kHz	1	-	-	-infinity	-94
$I_o$	dBm/95.04 MHz	1	-61.36	-55.91	-70.01	-68.82
Note 1:	The resources for uplink transmission are assigned to the UE prior to the start of time period T2.					
Note 2:	Interference from other cells and noise sources not specified in the test is assumed to be constant over subcarriers and time and shall be modelled as AWGN of appropriate power for $N_{oc}$ to be fulfilled.					
Note 3:	SRS-RSRP levels have been derived from other parameters for information purposes. They are not settable parameters themselves.					
Note 4:	Information about types of UE beam is given in B.2.1.3, and does not limit UE implementation or test system implementation.					
Note 5:	Cell 2 doesn't transmit during the SRS and the 2 previous symbols. $E_s/N_{oc}$ is not applied to those symbols.					

**Table A.7.6.4.1.2-4: SRS configuration for measurement reporting**

	Field	SRSCnf.1	Comments
SRS-ResourceSet	srs-ResourceSetId	0	
	srs-ResourceIdList	0	
	resourceType	Periodic	
	Usage	Codebook	
SRS-Resource	SRS-ResourceId	0	
	nrofSRS-Ports	Port1	

transmissionComb	n2	
combOffset-n2	0	
cyclicShift-n2	0	
resourceMapping startPosition	0	
resourceMapping nrofSymbols	n1	
resourceMapping repetitionFactor	n1	
freqDomainPosition	0	
freqDomainShift	0	
freqHopping c-SRS	12	
freqHopping b-SRS	0	
freqHopping b-hop	0	
groupOrSequenceHopping	Neither	
resourceType	Periodic	
periodicityAndOffset	sl40, 25	
sequenceId	0	Any 10 bit number

#### A.7.6.4.1.3 Test Requirements

The UE shall send one Event I1 triggered measurement report, with a measurement reporting delay less than 60 ms from the beginning of time period T2.

The UE shall not send event triggered measurement reports, as long as the reporting criteria are not fulfilled.

The rate of correct events observed during repeated tests shall be at least 90%.

NOTE: The actual overall delays measured in the test may be up to  $2xTTI_{DCCH}$  higher than the measurement reporting delays above because of TTI insertion uncertainty of the measurement report in DCCH.

#### A.7.6.4.2 CLI-RSSI measurement with non-DRX

##### A.7.6.4.2.1 Test Purpose and Environment

The purpose of this test is to verify that the UE makes correct reporting of CLI-RSSI measurement. This test will verify the CLI-RSSI measurement requirements in clause 9.7.3.5 with the testing configurations for NR cells in Table A.7.6.4.2.1-1.

**Table A.7.6.4.2.1-1: Applicable NR configurations for FR2 CLI-RSSI test**

Configuration	Description
1	NR 120 kHz SCS, 100 MHz bandwidth, TDD duplex mode

##### A.7.6.4.2.2 Test Parameters

One cell is deployed in the test, which is FR2 PCell (Cell 1). The test parameters for PCell is given in Table A.7.6.4.2.2-1 ~ A.7.6.4.2.2-3 below. In the measurement control information, a measurement object is configured for the frequency of the PCell, and it is indicated to the UE that event-triggered reporting with Event I1 is used. The test consists of two successive time periods, with time duration of T1 and T2, respectively.

During the test, the test system does not transmit PDCCH/PDSCH/OCNG on symbols for CLI-RSSI measurement resource and on 2 data symbols before. The CLI-RSSI measurement resource configuration is in Table A.7.6.4.2.2-4.

**Table A.7.6.4.2.2-1: General test parameters for CLI-RSSI event triggered reporting for PCell in FR2**

Parameter	Unit	Test configuration	Value	Comment
Active cell		1	NR Cell 1	
RF Channel Number		1	1: Cell 1	
SSB configuration		1	SSB.1 FR2	
SMTC configuration		1	SMTC.1	

CLI-RSSI configuration		1	CLI-RSSICnf.1	Table A.7.6.4.2.2-4
CP length		1	Normal	
i1-Threshold	dBm	1	-94.5	
Hysteresis	dB	1	0	
Time To Trigger	s	1	0	
Filter coefficient		1	0	L3 filtering is not used
DRX		1	OFF	Non-DRX
Time offset between DL from serving cell and OCNG from test system	$\mu$ s	1	10.67	
T1	s	1	5	
T2	s	1	1	

**Table A.7.6.4.2.2-2: NR Cell specific test parameters for CLI-RSSI event triggered reporting for PCell in FR2**

Parameter	Unit	Test configuration	Cell 1	
			T1	T2
TDD configuration		1	TDDConf.3.1	
PDSCH RMC configuration		1	SR.3.1 TDD	
PUSCH parameters		1	N/A	
RMSI CORESET RMC configuration		1	CR.3.1 TDD	
Dedicated CORESET RMC configuration		1	CCR.3.1 TDD	
OCNG Patterns <sup>Note 1</sup>		1	OP.1	
TRS configuration			TRS.2.1. TDD	
PDSCH/PDCCH TCI state		1	TCI.State.2	
Initial BWP configuration		1	DLBWP.0.1 ULBWP.0.1	
Active DL BWP configuration		1	DLBWP.1.1	
Active UL BWP configuration		1	ULBWP.1.1	
Propagation Condition		1	AWGN	
Note 1: OCNG is not transmitted in the CLI-RSSI measurement resources.				

**Table A.7.6.4.2.2-3: NR OTA Cell specific test parameters for CLI-RSSI event triggered reporting for PCell in FR2**

Parameter	Unit	Test configuration	Cell 1	
			T1	T2
AoA setup		1	Setup 1 defined in A.3.15.1	
Beam assumption <sup>Note 3</sup>		1	Fine	Fine
$N_{oc}$ on CLI-RSSI measurement resource <sup>Note 2</sup>	dBm/15 kHz	1	-119	-108
$N_{oc}$ on CLI-RSSI measurement resource <sup>Note 2</sup>	dBm/SCS	1	-110	-99
$l_o$ on CLI-RSSI measurement resource	dBm/95.04 MHz	1	-81.01	-70.01
$l_o$ on CLI-RSSI measurement resource	dBm/1.08 MHz	1	-100.46	-89.46
<p>Note 1: The resources for uplink transmission are assigned to the UE prior to the start of time period T2.</p> <p>Note 2: Interference from other cells and noise sources not specified in the test is assumed to be constant over subcarriers and time and shall be modelled as AWGN of appropriate power for <math>N_{oc}</math> to be fulfilled.</p> <p>Note 3: Information about types of UE beam is given in B.2.1.3, and does not limit UE implementation or test system implementation.</p>				

**Table A.7.6.4.2.2-4: CLI-RSSI measurement resource configuration for measurement reporting**

	Field	CLI-RSSICnf.1
RSSI-Resource	rssi-ResourceId	0
	rssi-SCS	120
	startPRB	0
	nrofPRBs	66
	startPosition	3
	nrofSymbols	11
	rssi-PeriodicityAndOffset	s140, 25

### A.7.6.4.2.3 Test Requirements

The UE shall send one Event I1 triggered measurement report, with a measurement reporting delay less than 5ms from the beginning of time period T2. The nominal RSSI used to evaluate the requirement shall be based on  $I_o$ .

The UE shall not send event triggered measurement reports, as long as the reporting criteria are not fulfilled.

The rate of correct events observed during repeated tests shall be at least 90%.

NOTE: The actual overall delays measured in the test may be up to  $2 \times TTI_{DCCH}$  higher than the measurement reporting delays above because of TTI insertion uncertainty of the measurement report in DCCH.

## A.7.6.5 NR Measurements with autonomous gaps

### A.7.6.5.1 SA interfrequency CGI reporting in autonomous gaps test (PCell in FR2)

#### A.7.6.5.1.1 Test Purpose and Environment

The purpose of this test is to verify that the UE makes correct reporting of an CGI. This test will partly verify the SA inter-frequency NR cell search requirements in clause 8.2.1.2.16 and 9.11

In this test, there are two cells: NR cell 1 as PCell in FR2 on NR RF channel 1 and NR cell 2 as neighbour cell in FR2 on NR RF channel 2. The test parameters and configurations are given in Tables A.7.6.5.1.1-1, A.7.6.5.1.1-2, and A.7.6.5.1.1-3.

Measurement gap patterns are configured. During T1 the UE shall report event A3 for cell 2. Within 3 seconds of the event report, the test equipment shall add a measurement reporting configuration using *ReportConfigNR* which contains a ReportCGI IE with cellForWhichToReportCGI set to the physical Cell ID of cell 2 and including the optional IE useAutonomousGaps-r16

In the measurement control information, it is indicated to the UE to decode the CGI of the neighbour cell using autonomous gaps. The test consists of two time phases, T1 and T2. Time period T2 begins 10ms after the test equipment has transmitted the RRC reconfiguration message containing the ReportCGI IE.

Supported test configurations are shown in table A.7.6.5.1.1-1.

**Table A.7.6.5.1.1-1 SA interfrequency CGI reporting test in autonomous gaps**

Config	Description
1	120 kHz SSB SCS, 100 MHz bandwidth, TDD duplex mode

**Table A.7.6.5.1.1-2: General test parameters for SA interfrequency CGI reporting in autonomous gaps**

Parameter	Unit	Test configuration	Value	Comment
NR RF Channel Number		Config 1	1, 2	Two FR2 NR carrier frequencies is used.

Active cell		Config 1	NR cell 1 (Pcell)	NR Cell 1 is on NR RF channel number 1.
Neighbour cell		Config 1	NR cell 2	NR cell 2 is on NR RF channel number 2.
Gap Pattern Id		Config 1	13	As specified in clause 9.1.2-1.
Measurement gap offset		Config 1	39	
SMTC-SSB parameters		Config 1	SSB.3 FR2	As specified in clause A.3.10.2
SI-RNTI scheduling rate	ms		40 ms	S-RNTI scheduled on four occasions per 160ms transmission period
A3-Offset	dB	Config 1	-30	
Hysteresis	dB	Config 1	0	
CP length		Config 1	Normal	
TimeToTrigger	s	Config 1	0	
Filter coefficient		Config 1	0	L3 filtering is not used
DRX		Config 1	OFF	DRX is not used
Time offset between serving and neighbour cells		Config 1	3µs	Synchronous cells.
T1	s	Config 1	<10	UE expected to report event A3 for cell 2 within 5,2s (PC1) or 3.5s (other PC) of the start of T1. Test equipment shall configure CGI reporting within 3s after receiving the event A3 report. T2 begins 10ms after test equipment has transmitted the RRC reconfiguration to configure CGI reporting.
T2	s	Config 1	1	

**Table A.7.6.5.1.1-3: Cell specific test parameters SA interfrequency CGI reporting in autonomous gaps**

Parameter		Unit	Test configuration	Cell 1		Cell 2	
				T1	T2	T1	T2
AoA setup			Config 1	Setup 3 as specified in clause A.3.15			
				AoA1		AoA2	
Beam Assumption <sup>Note 7</sup>			1,2	Rough			
NR RF Channel Number			Config 1	1		2	
Duplex mode			Config 1	TDD		TDD	
TDD configuration			Config 1	TDDConf.3.1		TDDConf.3.1	
BW <sub>channel</sub>		MHz	Config 1	100: N <sub>RB,c</sub> = 66		100: N <sub>RB,c</sub> = 66	
BWP BW		MHz	Config 1	100: N <sub>RB,c</sub> = 66		100: N <sub>RB,c</sub> = 66	
BWP configuration	Initial DL BWP		Config 1	DLBWP.0.1		N/A	
	Initial UL BWP			ULBWP.0.1		N/A	
	Dedicated DL BWP			DLBWP.1.1		N/A	
	Dedicated UL BWP			ULBWP.1.1		N/A	
OCNG Patterns defined in A.3.2.1.1 (OP.1)			Config 1	OP.1		Not sent	

PDSCH Reference measurement channel		Config 1	SR.3.1 TDD	-
CORESET Reference Channel		Config 1	CR.3.1 TDD	-
SMTC configuration defined in A.3.11.1 and A.3.11.2		Config 1	SMTC.1	SMTC.1
PDSCH/PDCCH subcarrier spacing	kHz	Config 1	120	120
TRS configuration		Config 1	TRS.2.1 TDD	N/A
TCI configuration		Config 1	CSI-RS.Config.0	N/A
EPRE ratio of PSS to SSS		Config 1	0	0
EPRE ratio of PBCH DMRS to SSS				
EPRE ratio of PBCH to PBCH DMRS				
EPRE ratio of PDCCH DMRS to SSS				
EPRE ratio of PDCCH to PDCCH DMRS				
EPRE ratio of PDSCH DMRS to SSS				
EPRE ratio of PDSCH to PDSCH				
EPRE ratio of OCNG DMRS to SSS(Note 1)				
EPRE ratio of OCNG to OCNG DMRS (Note 1)				
$N_{oc}$ Note2	dBm/15 kHz Note5			
$N_{oc}$ Note2	dBm/S CS Note4	Config 1	-90	-90
SS-RSRP Note 3	dBm/S CS Note5	Config 1	-87	-93
$\hat{E}_s / I_{ot}$	dB	Config 1	3	-3
$\hat{E}_s / N_{oc}$	dB	Config 1	3	-3
$I_o$ Note3	dBm/95 .04 MHz Note5	Config 1	-56.25	-59.25
Propagation Condition		Config 1	AWGN	
<p>Note 1: OCNG shall be used such that both cells are fully allocated and a constant total transmitted power spectral density is achieved for all OFDM symbols.</p> <p>Note 2: Interference from other cells and noise sources not specified in the test is assumed to be constant over subcarriers and time and shall be modelled as AWGN of appropriate power for <math>N_{oc}</math> to be fulfilled.</p> <p>Note 3: SS-RSRP and <math>I_o</math> levels have been derived from other parameters for information purposes. They are not settable parameters themselves.</p> <p>Note 4: SS-RSRP minimum requirements are specified assuming independent interference and noise at each receiver antenna port.</p> <p>Note 5: Equivalent power received by an antenna with 0 dBi gain at the centre of the quiet zone</p> <p>Note 6: As observed with 0 dBi gain antenna at the centre of the quiet zone</p> <p>Note 7: Information about types of UE beam is given in B.2.1.3, and does not limit UE implementation or test system implementation</p>				



### A.7.6.5.1.2 Test Requirements

The UE shall report the CGI of cell 2 within  $25 \cdot T_{\text{smc}} + 6 \cdot T_{\text{si-rnti}} + 20\text{ms} + 2\text{ms} = 762\text{ms}$  from the start of T2, allow 765ms. The rate of correct events observed during repeated tests shall be at least 90%.

The UE shall be scheduled continuously throughout the test, and from the start of T3 until 775 ms the number of interrupted slots shall not exceed the allowed number [as defined in clause 8.2.1.2.16 plus TBD].

The rate of correct events observed during repeated tests shall be at least 90%.

NOTE: The actual overall delays measured in the test may be up to  $2 \cdot T_{\text{TTI}_{\text{DCCH}}}$  higher than the measurement reporting delays above because of TTI insertion uncertainty of the measurement report in DCCH.

## A.7.6.6 L1-SINR measurement for beam reporting

### A.7.6.6.1 L1-SINR measurement with CSI-RS based CMR and no dedicated IMR configured when DRX is not used

#### A.7.6.6.1.1 Test Purpose and Environment

The purpose of this test is to verify that the UE makes correct reporting of L1-SINR measurement. This test will partly verify the L1-SINR measurement requirements in clause 9.8.4.1, with the testing configurations for NR cells in Table A.7.6.6.1.1-1.

**Table A.7.6.6.1.1-1: Applicable NR configurations for FR2 CSI-RS based L1-SINR test**

Config	Description
1	NR 120 kHz CSI-RS SCS, 100 MHz bandwidth, TDD duplex mode
Note:	The UE is only required to be tested in one of the supported test configurations

#### A.7.6.6.1.2 Test parameters

There is one cells in the test, the FR2 PCell (Cell 1). The test parameters for the Cell 1 are given in Table A.7.6.6.1.2-1 and Table A.7.6.6.1.2-2 below.

In CSI measurement configuration, UE is indicated to perform L1-SINR measurement on the CSI-RS and report aperiodically. The test consists of a single time period T1, during which the UE is triggered via DCI to report L1-SINR on aperiodic CSI-RS resources. After 160ms from the beginning of the test, the DCI trigger comes in slot 8 of a frame and UE provides the report back based on the reporting configuration as defined in Table A.7.6.6.1.2-1.

There is no measurement gap configured in the test. Before the test, UE is configured to perform RLM and BFD based on the SSBs.

**Table A.7.6.6.1.2-1: General test parameters**

Parameter	Config	Unit	Value
SSB GSCN	1		freq1
Duplex mode	1		TDD
TDD Configuration	1		TDDConf.3.1
$BW_{\text{channel}}$	1	MHz	100: $N_{\text{RB},c} = 66$
PDSCH Reference measurement channel	1		SR.3.1 TDD
RMSI CORESET Reference Channel	1		CR.3.1 TDD
Dedicated CORESET Reference Channel	1		CCR.3.1 TDD
SSB configuration	1		SSB.1 FR2
CSI-RS configuration	1		CSI-RS.3.3 TDD
OCNG Patterns	1		OP.1
Initial BWP Configuration	1		DLBWP.0.1 ULBWP.0.1
Dedicated BWP configuration	1		DLBWP.1.3 ULBWP.1.3

SMTC configuration	1		SMTC.1
TRS Configuration	1		TRS.2.1 TDD
PDCCH/PDSCH TCI Configuration	1		TCI.State.2
DRX configuration	1		Off
reportConfigType	1		aperiodic
reportQuantity	1		cri-SINR
reportQuantity-r16	1		cri-SINR-r16
Number of reported RS	1		2
qcl-Info	1		SSB#0 for resource#0 SSB#1 for resource#1
reportSlotOffsetList	1		26
Propagation condition	1		AWGN
T1	1	s	5
EPRE ratio of PSS to SSS	1	dB	0
EPRE ratio of PBCH DMRS to SSS			
EPRE ratio of PBCH to PBCH DMRS			
EPRE ratio of PDCCH DMRS to SSS			
EPRE ratio of PDCCH to PDCCH DMRS			
EPRE ratio of PDSCH DMRS to SSS			
EPRE ratio of PDSCH to PDSCH DMRS			
EPRE ratio of OCNG DMRS to SSS <sup>Note 1</sup>			
EPRE ratio of OCNG to OCNG DMRS <sup>Note 1</sup>			
Note 1: OCNG shall be used such that both cells are fully allocated and a constant total transmitted power spectral density is achieved for all OFDM symbols.			

Table A.7.6.6.1.2-2: CSI-RS specific test parameters

Parameter	Config	Unit	CSI-RS#0	CSI-RS#1
Angle of arrival configuration	1		Setup 1 according to A.3.15.1	
Beam assumption <sup>Note 3</sup>	1		Rough	
$N_{oc}$ <sup>Note 1</sup>	1	dBm/15kHz	-105	
$N_{oc}$ <sup>Note 1</sup>	1	dBm/SSB SCS	-95.97	
$\hat{E}_s / I_{ot}$	1	dB	0	9
CSI-RS RSRP <sup>Note 3</sup>	1	dBm/SSB SCS	-95.97	-86.97
$I_o$ <sup>Note 2</sup>	1	dBm/95.04MHz	-63.97	-57.47
$\hat{E}_s / N_{oc}$	1	dB	0	9
<p>Note 1: Interference from other cells and noise sources not specified in the test is assumed to be constant over subcarriers and time and shall be modelled as AWGN of appropriate power for <math>N_{oc}</math> to be fulfilled.</p> <p>Note 2: CSI-RS RSRP and <math>I_o</math> levels have been derived from other parameters for information purposes. They are not settable parameters themselves.</p> <p>Note 3: Information about types of UE beam is given in B.2.1.3, and does not limit UE implementation or test system implementation</p>				

### A.7.6.6.1.3 Test Requirements

After 160ms from the beginning of the test, the UE shall send L1-SINR report at slot 26 from the reception of DCI triggering the L1-SINR measurement. The L1-SINR report shall include the results for both CSI-RS#0 and CSI-RS#1 while meeting the accuracy requirements defined in clause 10.1.28.1.

The rate of correct events observed during repeated tests shall be at least 90%.

NOTE: The actual overall delays measured in the test may be up to  $2 \times TTI_{DCCH}$  higher than the measurement reporting delays above because of TTI insertion uncertainty of the measurement report in DCCH.

#### A.7.6.6.2 L1-SINR measurement with SSB based CMR and dedicated IMR when DRX is used

##### A.7.6.6.2.1 Test Purpose and Environment

The purpose of this test is to verify that the UE makes correct reporting of L1-SINR measurement. This test will partly verify the L1-SINR measurement requirements in clause 9.8.4.2, with the testing configurations for NR cells in Table A.7.6.6.2.1-1.

The AoA setup for this test is Setup 1 as defined in clause A.3.15

**Table A.7.6.6.2.1-1: Applicable NR configurations for FR2 L1-SINR measurement test with SSB based CMR and CSI-IM based IMR**

Config	Description
1	NR 120 kHz SSB SCS, 100 MHz bandwidth, TDD duplex mode
2	NR 240 kHz SSB SCS, 100 MHz bandwidth, TDD duplex mode
Note: The UE is only required to be tested in one of the supported test configurations	

##### A.7.6.6.2.2 Test parameters

There is one cells in the test, the FR2 PCell (Cell 1). The test parameters for the Cell 1 are given in Table A.7.6.6.2.2-1 and Table A.7.6.6.2.2-2 below.

In CSI measurement configuration, UE is indicated to perform L1-SINR measurement on the SSBs and the associated CSI-IM resources, and report periodically. The test consists of two successive time periods, with time duration of T1 and T2 respectively. The test has higher layer parameter *timeRestrictionForChannelMeasurements* configured.

There is no measurement gap configured in the test. Before the test, UE is configured to perform RLM and BFD measurements based on the SSBs, and UE is configured to perform L1-SINR measurement based on the SSBs as CMR and the CSI-IM resources as IMR.

**Table A.7.6.6.2.2-1: General test parameters**

Parameter	Config	Unit	Value
SSB GSCN	1~2		freq1
Duplex mode	1~2		TDD
TDD Configuration	1~2		TDDConf.3.1
$BW_{channel}$	1~2	MHz	$100: N_{RB,c} = 66$
PDSCH Reference measurement channel	1~2		SR.3.1 TDD
RMSI CORESET Reference Channel	1~2		CR.3.1 TDD
Dedicated CORESET Reference Channel	1~2		CCR.3.1 TDD
SSB configuration	1		SSB.1 FR2
	2		SSB.2 FR2
CSI-IM configuration	1~2		CSI-IM.3.1 TDD
OCNG Patterns	1~2		OP.1
Initial BWP Configuration	1~2		DLBWP.0.1
			ULBWP.0.1
Dedicated BWP configuration	1~2		DLBWP.1.3
			ULBWP.1.3
SMTTC configuration	1~2		SMTTC.1
TRS Configuration	1~2		TRS.2.1 TDD
PDCCH/PDSCH TCI Configuration	1~2		TCI.State.2

DRX configuration	1~2		DRX.3
reportConfigType	1~2		periodic
reportQuantity-r16	1~2		ssb-Index-SINR-r16
Number of reported RS	1~2		2
L1-SINR reporting period	1~2	slot	640
T1	1~2	s	5
T2	1~2	s	2
Propagation condition	1~2		AWGN
EPRE ratio of PSS to SSS	1~2	dB	0
EPRE ratio of PBCH DMRS to SSS			
EPRE ratio of PBCH to PBCH DMRS			
EPRE ratio of PDCCH DMRS to SSS			
EPRE ratio of PDCCH to PDCCH DMRS			
EPRE ratio of PDSCH DMRS to SSS			
EPRE ratio of PDSCH to PDSCH DMRS			
EPRE ratio of OCNG DMRS to SSS <sup>Note 1</sup>			
EPRE ratio of OCNG to OCNG DMRS <sup>Note 1</sup>			
Propagation condition			
Note 1: OCNG shall be used such that both cells are fully allocated and a constant total transmitted power spectral density is achieved for all OFDM symbols.			

**Table A.7.6.6.2.2-2: SSB specific test parameters**

Parameter	Config	Unit	SSB#0		SSB#1	
			T1	T2	T1	T2
Angle of arrival configuration	1~2		Setup 1 according to A.3.15.1			
Beam assumption <sup>Note 4</sup>	1~2		Rough			
$N_{oc}$ <sup>Note2</sup>	1~2	dBm/15kHz	-105			
$N_{oc}$ <sup>Note2</sup>	1	dBm/SSB SCS	-96			
	2		-93			
$\hat{E}_s / I_{ot}$	1~2	dB	0	0	-Infinity	9
SSB RSRP <sup>Note3</sup>	1	dBm/SSB SCS	-96	-96	-Infinity	-87
	2		-93	-93	-Infinity	-84
$I_o$ <sup>Note3</sup>	1	dBm/95.04MHz	-64	-64	-67	-57.5
	2		-64	-64	-67	-57.5
$\hat{E}_s / N_{oc}$	1~2	dB	0	0	-Infinity	9
<p>Note 1: The resources for uplink transmission are assigned to the UE prior to the start of time period T2.</p> <p>Note 2: Interference from other cells and noise sources not specified in the test is assumed to be constant over subcarriers and time and shall be modelled as AWGN of appropriate power for <math>N_{oc}</math> to be fulfilled.</p> <p>Note 3: SSB RSRP and <math>I_o</math> levels have been derived from other parameters for information purposes. They are not settable parameters themselves.</p> <p>Note 4: Information about types of UE beam is given in B.2.1.3, and does not limit UE implementation or test system implementation</p>						

**A.7.6.6.2.3 Test Requirements**

The UE shall send L1-SINR report every 640 slots. No later than X ms plus 640 slots from the beginning of time period T2, UE shall send L1-SINR report including the results for both SSB#0+CSI-IM#0 and SSB#1+CSI-IM#1 while meeting the accuracy requirements defined in clause 10.1.28.2, where X is

- 2880 for UE supporting power class 1
- 1920 for UE supporting power class 2,3 or 4.

The rate of correct events observed during repeated tests shall be at least 90%.

NOTE: The actual overall delays measured in the test may be up to  $2 \times TTI_{DCCCH}$  higher than the measurement reporting delays above because of TTI insertion uncertainty of the measurement report in DCCCH.

### A.7.6.6.3 L1-SINR measurement with CSI-RS based CMR and dedicated IMR configured when DRX is used

#### A.7.6.6.3.1 Test Purpose and Environment

The purpose of this test is to verify that the UE makes correct reporting of L1-SINR measurement. This test will partly verify the L1-SINR measurement requirements with CSI-RS based CMR and dedicated IMR configured in clause 9.8.4.3, with the testing configurations for NR cells in Table A.7.6.6.3.1-1.

**Table A.7.6.6.3.1-1: Applicable NR configurations for FR2 L1-SINR test with CMR and dedicated IMR**

Config	Description
1	LTE FDD, NR 120 kHz CSI-RS SCS, 100 MHz bandwidth, TDD duplex mode
Note: The UE is only required to be tested in one of the supported test configurations	

#### A.7.6.6.3.2 Test parameters

There is one cells in the test, the FR2 PCell (Cell 1). The test parameters for the Cell 1 are given in Table A.7.6.6.3.2-1 and Table A.7.6.6.3.2-2 below.

In CSI measurement configuration, UE is indicated to perform L1-SINR measurement on the configured CSI-RS as CMR and an associated CSI-RS as IMR, and report aperiodically. The test consists of a single time period T1, during which the UE is triggered via DCI to report L1-SINR on aperiodic CSI-RS resources and the associated IMR. UE is also configured to measure L1-SINR based on SSB. After 1440ms from the beginning of the test, the DCI trigger comes in slot 8 of a frame and UE provides the report back based on the reporting configuration as defined in Table A.7.6.6.3.2-1.

There is no measurement gap configured in the test. Before the test, UE is configured to perform RLM and BFD based on the SSBs, and UE is configured to perform L1-SINR measurement based on the CSI-RS as CMR and the CSI-RS as IMR.

**Table A.7.6.6.3.2-1: General test parameters**

Parameter	Config	Unit	Value
SSB GSCN	1		freq1
Duplex mode	1		TDD
TDD Configuration	1		TDDConf.3.1
$BW_{channel}$	1	MHz	100: $N_{RB,C} = 66$
PDSCH Reference measurement channel	1		SR.3.1 TDD
RMSI CORESET Reference Channel	1		CR.3.1 TDD
Dedicated CORESET Reference Channel	1		CCR.3.1 TDD
SSB configuration	1		SSB.1 FR2
CSI-RS as CMR configuration	1		CSI-RS.3.3 TDD
CSI-RS as IMR configuration	1		CSI-RS.3.2A TDD
OCNG Patterns	1		OP.1
Initial BWP Configuration	1		DLBWP.0.1 ULBWP.0.1
Dedicated BWP configuration	1		DLBWP.1.3 ULBWP.1.3

SMTC configuration	1		SMTC.1
TRS Configuration	1		TRS.2.1 TDD
PDCCH/PDSCH TCI Configuration	1		TCI.State.2
DRX configuration	1		DRX.3
reportConfigType	1		aperiodic
reportQuantity-r16	1		cri-SINR-r16
Number of reported RS	1		2
qcl-Info	1		SSB#0 for resource#0 SSB#1 for resource#1
reportSlotOffsetList	1		26
T1	1	s	5
EPRE ratio of PSS to SSS	1	dB	0
EPRE ratio of PBCH DMRS to SSS			
EPRE ratio of PBCH to PBCH DMRS			
EPRE ratio of PDCCH DMRS to SSS			
EPRE ratio of PDCCH to PDCCH DMRS			
EPRE ratio of PDSCH DMRS to SSS			
EPRE ratio of PDSCH to PDSCH DMRS			
EPRE ratio of OCNG DMRS to SSS <sup>Note 1</sup>			
EPRE ratio of OCNG to OCNG DMRS <sup>Note 1</sup>			
Propagation condition			
Note 1: OCNG shall be used such that both cells are fully allocated and a constant total transmitted power spectral density is achieved for all OFDM symbols.			

Table A.7.6.6.3.2-2: CSI-RS specific test parameters

Parameter	Config	Unit	CSI-RS#0	CSI-RS#1
Angle of arrival configuration	1~2		Setup 1 according to A.3.15.1	
Assumption for UE beams <sup>Note 3</sup>	1~2		Rough	
$N_{oc}$ <sup>Note1</sup>	1~2	dBm/15kHz	-105	
$N_{oc}$ <sup>Note1</sup>	1~2	dBm/SSB SCS	-95.97	
$\hat{E}_s / I_{ot}$	1~2	dB	0	9
CSI-RS RSRP <sup>Note2</sup>	1~2	dBm/SSB SCS	-95.97	-86.97
$I_o$ <sup>Note2</sup>	1~2	dBm/95.04MHz	-63.97	-57.47
$\hat{E}_s / N_{oc}$	1~2	dB	0	9
Note 1: Interference from other cells and noise sources not specified in the test is assumed to be constant over subcarriers and time and shall be modelled as AWGN of appropriate power for $N_{oc}$ to be fulfilled.				
Note 2: CSI-RS RSRP and $I_o$ levels have been derived from other parameters for information purposes. They are not settable parameters themselves.				
Note 3: Information about types of UE beam is given in B.2.1.3, and does not limit UE implementation or test system implementation				

### A.7.6.6.3.3 Test Requirements

After 1440ms from the beginning of the test, the UE shall send L1-SINR report at slot 26 from the reception of DCI triggering the L1-SINR measurement. The L1-SINR report shall include the results for both CSI-RS#0 as CMR + CSI-RS#0 as IMR and CSI-RS#1 as CMR + CSI-RS#1 as IMR while meeting the accuracy requirement in clause 10.1.28.3. The reported L1-SINR value shall consider the Rx antenna gain in the range of [-10 ~ +20] dB when calculated.

The rate of correct events observed during repeated tests shall be at least 90%.

NOTE: The actual overall delays measured in the test may be up to  $2 \times TTI_{DCCH}$  higher than the measurement reporting delays above because of TTI insertion uncertainty of the measurement report in DCCH.

## A.7.6.7 CSI-RS based intra-frequency Measurements

### A.7.6.7.1 SA event triggered reporting test without gap under DRX for CSI-RS based intra-frequency measurement

#### A.7.6.7.1.1 Test purpose and Environment

The purpose of this test is to verify that the UE makes correct reporting of an event. This test will partly verify the TDD intra-frequency measurement requirements in clause 9.10.2 and 9.10.3. Supported test configurations are shown in table A.7.6.7.1.1-1.

**Table A.7.6.7.1.1-1: supported test configurations**

Configuration	Description
1	120 kHz SSB and CSI-RS SCS, TDD duplex mode
Note: The UE is only required to be tested in one of the supported test configurations.	

There are two cells in the test, PCell (Cell 1) and a FR2 neighbour cell (Cell 2) on the same frequency as the PCell. The test parameters for the Cell 1 and Cell 2 are given in Table A.7.6.7.1.1-2 ~ 6.

In the measurement control information, a measurement object is configured for the frequency of the PCell, and it is indicated to the UE that event-triggered reporting with Event A3 is used.

The test consists of two successive time periods, with time duration of T1, and T2 respectively. During time duration T1, the UE shall not have any timing information of Cell 2.

UE needs to be provided at least once every 500ms with new Timing Advance Command MAC control element to restart the Time alignment timer to keep UE uplink time alignment. Furthermore UE is allocated with PUSCH resource at every DRX cycle.

**Table A.7.6.7.1.1-2: General test parameters for intra-frequency event triggered reporting for SA with TDD PCell in FR2 without gap with DRX**

Parameter	Unit	Config	Value	Comment
			Test 1	
Active cell		1	PCell (Cell 1)	
Neighbour cell		1	Cell 2	Cell to be identified.
RF Channel Number		1	1: Cell 1 and Cell 2	One TDD carrier frequency is used for the NR cells.
CSI-RS resource configuration		1	CSI-RS.RRM.FR2.1 TDD	
A3-Offset	dB	1	-6	
CP length		1	Normal	
Hysteresis	dB	1	0	
Time To Trigger	s	1	0	
Filter coefficient		1	0	L3 filtering is not used
DRX		1	DRX.1	DRX related parameters are defined in Table A.3.3
Time offset between Cell 1 and Cell 2	μs	1	0.58	
T1	s	1	5	

T2	s	1	10	
----	---	---	----	--



**Table A.7.6.7.1.1-3: NR Cell specific test parameters for intra-frequency event triggered reporting for SA with TDD PCell in FR2 without gap with DRX**

Parameter	Unit	Config	Cell 1		Cell 2	
			T1	T2	T1	T2
TDD configuration		1	TDDConf.3.1		TDDConf.3.1	
BW <sub>channel</sub>	MHz	1	100: N <sub>RB,c</sub> = 66		100: N <sub>RB,c</sub> = 66	
Initial BWP configuration		1	DLBWP.0.1 ULBWP.0.1		DLBWP.0.1 ULBWP.0.1	
Active DL BWP configuration		1	DLBWP.1.1		DLBWP.1.1	
Active UL BWP configuration		1	ULBWP.1.1		ULBWP.1.1	
RLM-RS		1	SSB		SSB	
PDSCH RMC configuration		1	SR.3.1 TDD		N/A	
RMSI CORESET RMC configuration		1	CR.3.1 TDD		CR.3.1 TDD	
Dedicated CORESET RMC configuration		1	CCR.3.1 TDD		CCR.3.1 TDD	
TRS configuration		1	TRS.2.1 TDD		N/A	
PDSCH/PDCCH TCI states		1	TCI.State.2		N/A	
OCNG Patterns		1	OP.1		OP.1	
SMTc		1	SMTc.1			
SSB		1	SSB.3 FR2		SSB.3 FR2	
CSI-RS		1	CSI-RS.RRM.FR2.1 TDD			
Propagation Condition		1	AWGN			

**Table A.7.6.7.1.1-4: NR OTA Cell specific test parameters for intra-frequency event triggered reporting for SA with TDD PCell in FR2 without gap with DRX**

Parameter	Unit	Config	Cell 1		Cell 2	
			T1	T2	T1	T2
AoA setup		1	Setup 1 defined in A.3.15.1			
Beam assumption <sup>Note 4</sup>		1	Fine		Fine	
$\hat{E}_s/I_{ot}$	dB	1	4	-1.46	-Infinity	-1.46
$N_{oc}$ <sup>Note 2</sup>	dBm/15 KHz	1	-98			
$N_{oc}$ <sup>Note 2</sup>	dBm/SCS	1	-86			
CSI-RSRP	dBm/SCS	1	-82	-82	-Infinity	-82
SS-RSRP	dBm/SCS	1	-82	-82	-Infinity	-82
$\hat{E}_s/N_{oc}$	dB	1	4	4	-Infinity	4
$I_o$	dBm/95.04MHz	1	-54.53	-52.18	-54.53	-52.18
Note 1:	The resources for uplink transmission are assigned to the UE prior to the start of time period T2.					
Note 2:	Interference from other cells and noise sources not specified in the test is assumed to be constant over subcarriers and time and shall be modelled as AWGN of appropriate power for $N_{oc}$ to be fulfilled.					
Note 3:	CSI-RSRP levels have been derived from other parameters for information purposes. They are not settable parameters themselves.					
Note 4:	Information about types of UE beam is given in B.2.1, and does not limit UE implementation or test system implementation.					

### A.7.6.7.1.2 Test Requirements

In this test, the UE shall send one Event A3 triggered measurement report, with a measurement reporting delay less than X1 ms from the beginning of time period T2, where X1 is

- 9.6s for a UE supporting power class 1,
- 5.76s for a UE supporting power class 2, 3 and 4

The UE is required to read the neighbour cell SSB index in this test.

The UE shall not send event triggered measurement reports, as long as the reporting criteria are not fulfilled.

The rate of correct events observed during repeated tests shall be at least 90%.

NOTE: The actual overall delays measured in the test may be up to  $2 \times TTI_{DCCH}$  higher than the measurement reporting delays above because of TTI insertion uncertainty of the measurement report in DCCH.

## A.7.6.8 CSI-RS based inter-frequency Measurements

### A.7.6.8.1 SA event triggered reporting tests for FR2 CSI-RS based measurement when non-DRX is used (PCell in FR2)

#### A.7.6.8.1.1 Test Purpose and Environment

The purpose of this test is to verify that the UE makes correct reporting of an event for CSI-RS based L3 measurement. This test will partly verify the SA inter-frequency NR cell search requirements in clause 9.10.3.5.

In this test, there are two cells: NR cell 1 as PCell in FR2 on NR RF channel 1 and NR cell 2 as neighbour cell in FR2 on NR RF channel 2. The test parameters and configurations are given in Tables A.7.6.8.1.1-1, A.7.6.8.1.1-2, and A.7.6.8.1.1-3.

In test 1&2 measurement gap pattern configuration # 13 as defined in Table A.7.6.8.1.1-2 is provided for UE that does not support per-FR gap and for UE that supports per-FR gap.

In the measurement control information, it is indicated to the UE that event-triggered reporting with Event A3 is used. The test consists of two successive time periods, with time duration of T1, and T2 respectively. During time duration T1, the UE shall not have any timing information of NR cell 2.

Supported test configurations are shown in table A.7.6.8.1.1-1.

UE needs to be provided at least once every 500ms with new Timing Advance Command MAC control element to restart the Time alignment timer to keep UE uplink time alignment. Furthermore UE is allocated with PUSCH resource at every DRX cycle.

**Table A.7.6.8.1.1-1: SA event triggered reporting tests for CSI-RS based L3 measurement for FR2-FR2**

Config	Description
1	120 kHz SSB and CSI-RS SCS, 100 MHz bandwidth, TDD duplex mode

**Table A.7.6.8.1.1-2: General test parameters for SA inter-frequency event triggered reporting for FR2 CSI-RS based L3 measurement**

Parameter	Unit	Test configuration	Value	Comment
NR RF Channel Number		Config 1	1, 2	Two FR2 NR carrier frequencies is used.
Active cell		Config 1	NR cell 1 (Pcell)	NR Cell 1 is on NR RF channel number 1.
Neighbour cell		Config 1	NR cell 2	NR cell 2 is on NR RF channel number 2.
Gap Pattern Id		Config 1	13	As specified in clause 9.1.2-1.

Measurement gap offset		Config 1	39	
SSB parameters		Config 1	SSB.3 FR2	As specified in clause A.3.10.2
SMTC configuration		Config 1	SMTC.1	As specified in clause A.3.11
A3-Offset	dB	Config 1	-6	
Hysteresis	dB	Config 1	0	
CP length		Config 1	Normal	
TimeToTrigger	s	Config 1	0	
Filter coefficient		Config 1	0	L3 filtering is not used
DRX		Config 1	OFF	DRX is not used
Time offset between serving and neighbour cells	μs	Config 1	0.58	Synchronous cells.
T1	s	Config 1	5	
T2	s	Config 1	7 for PC1; 4.5 for other PC	

**Table A.7.6.8.1.1-3: Cell specific test parameters for SA inter-frequency event triggered reporting for FR2 CSI-RS based L3 measurement**

Parameter		Unit	Test configuration	Cell 1		Cell 2	
				T1	T2	T1	T2
AoA setup			Config 1	Setup 1 as specified in clause A.3.15			
Beam Assumption <sup>Note 7</sup>			Config 1	Rough		Rough	
NR RF Channel Number			Config 1	1		2	
TDD configuration			Config 1	TDDConf.3.1		TDDConf.3.1	
Duplex mode			Config 1	TDD		TDD	
BW <sub>channel</sub>		MHz	Config 1	100: N <sub>RB,c</sub> = 66		100: N <sub>RB,c</sub> = 66	
BWP BW		MHz	Config 1	100: N <sub>RB,c</sub> = 66		100: N <sub>RB,c</sub> = 66	
BWP configuration	Initial DL BWP		Config 1	DLBWP.0.1		N/A	
	Initial UL BWP			ULBWP.0.1		N/A	
	Dedicated DL BWP			DLBWP.1.1		N/A	
	Dedicated UL BWP			ULBWP.1.1		N/A	
OCNG Patterns defined in A.3.2.1.1 (OP.1)			Config 1	OP.1		OP.1	
PDSCH Reference measurement channel			Config 1	SR.3.1 TDD		-	
CORESET Reference Channel			Config 1	CR.3.1 TDD		-	
SMTC configuration defined in A.3.11.1 and A.3.11.2			Config 1	SMTC.1		SMTC.1	
PDSCH/PDCCH subcarrier spacing		kHz	Config 1	120		120	
TRS configuration			Config 1	TRS.2.1 TDD		N/A	
TCI configuration			Config 1	CSI-RS.Config.0		N/A	
CSI-RS configuration for RRM				-		CSI-RS.RRM.FR2.1 TDD	
EPRE ratio of PSS to SSS			Config 1	0		0	
EPRE ratio of PBCH DMRS to SSS							
EPRE ratio of PBCH to PBCH DMRS							
EPRE ratio of PDCCH DMRS to SSS							
EPRE ratio of PDCCH to PDCCH DMRS							

EPRE ratio of PDSCH DMRS to SSS						
EPRE ratio of PDSCH to PDSCH						
EPRE ratio of OCNG DMRS to SSS(Note 1)						
EPRE ratio of OCNG to OCNG DMRS (Note 1)						
$N_{oc}$ <sup>Note2</sup>	dBm/15 kHz Note5		-104.7		-104.7	
$N_{oc}$ <sup>Note2</sup>	dBm/S CS Note4	Config 1	-95.7		-95.7	
CSI-RSRP <sup>Note 3</sup>	dBm/S CS Note5	Config 1	-89.7	-89.7	-Infinity	-86.7
SS-RSRP <sup>Note 3</sup>	dBm/S CS Note5	Config 1	-89.7	-89.7	-Infinity	-86.7
$\hat{E}_s/I_{ot}$	dB	Config 1	6	6	-Infinity	9
$\hat{E}_s/N_{oc}$	dB	Config 1	6	6	-Infinity	9
$I_o$ <sup>Note3</sup>	dBm/95 .04 MHz Note5	Config 1	-59.7	-59.7	-66.7	-57.2
Propagation Condition		Config 1	AWGN			
<p>Note 1: OCNG shall be used such that both cells are fully allocated and a constant total transmitted power spectral density is achieved for all OFDM symbols.</p> <p>Note 2: Interference from other cells and noise sources not specified in the test is assumed to be constant over subcarriers and time and shall be modelled as AWGN of appropriate power for <math>N_{oc}</math> to be fulfilled.</p> <p>Note 3: CSI-RSRP and <math>I_o</math> levels have been derived from other parameters for information purposes. They are not settable parameters themselves.</p> <p>Note 4: CSI-RSRP minimum requirements are specified assuming independent interference and noise at each receiver antenna port.</p> <p>Note 5: Equivalent power received by an antenna with 0 dBi gain at the centre of the quiet zone</p> <p>Note 6: As observed with 0 dBi gain antenna at the centre of the quiet zone</p> <p>Note 7: Information about types of UE beam is given in B.2.1.3, and does not limit UE implementation or test system implementation.</p>						

### A.7.6.2.2.2 Test Requirements

In the test the UE shall send one Event A3 triggered measurement report, with a measurement reporting delay less than  $X1$  ms from the beginning of time period  $T2$ , where  $X1$  is

6720 for UE supporting power class 1, or

4160 for UE supporting other power class

The UE shall not send event triggered measurement reports, as long as the reporting criteria are not fulfilled. The rate of correct events observed during repeated tests shall be at least 90%.

NOTE: The actual overall delays measured in the test may be up to  $2 \times TTI_{DCCCH}$  higher than the measurement reporting delays above because of TTI insertion uncertainty of the measurement report in DCCCH.

## A.7.6.9 RSTD measurements

### A.7.6.9.1 NR RSTD measurement reporting delay test case for single positioning frequency layer in FR2 SA

#### A.7.6.9.1.1 Test Purpose and Environment

The purpose of the test is to verify that the RSTD measurement meets the requirements specified in Clause 9.9.2 in an environment with AWGN propagation conditions in FR2 in standalone scenario when single positioning frequency layer is configured.

Supported test configurations are shown in table A.7.7.1.1-1. The test parameters are as given in Table 7.6.7.1.1-2, Table A.7.6.9.1.1-3 and Table A.7.6.9.1.1-4.

**Table A.7.6.9.1.1-1: Supported test configurations for NR RSTD**

Configuration	Description
1	120 kHz SSB SCS, 200 MHz bandwidth, TDD duplex mode

In the test there are three synchronous cells: Cell 1, Cell 2 and Cell 3. Cell 1 is the reference as well as the PCell. Cell 2 and Cell 3 are the neighbour cells. All cells are on the same RF channel distributed in single positioning frequency layers.

The test consists of two consecutive time intervals, with duration of  $T1$  and  $T2$ . During time duration  $T1$ , the UE shall not have any timing information of Cell 2 and Cell 3. All three cells transmit PRS during  $T2$ .

Note: The information on when PRS is muted is conveyed to the UE using PRS muting information.

The *NR-DL-TDOA-ProvideAssistanceData* and *nr-DL-TDOA-RequestLocationInformation* as defined in TS 37.355 [34, clause 6.5.12.1], shall be provided to the UE during  $T1$ . The last TTI containing the two messages shall be provided to the UE  $\Delta T$  ms before the start of  $T2$ , where  $\Delta T = 50$  ms is the maximum processing time of the *DL-TDOA assistance* data and location information request.

The beginning of the time interval  $T2$  shall be aligned with the beginning of the first MG instance containing the PRS resources.

The UE is configured with measurement gap pattern ID # 24 or #13 before  $T2$ .

**Table A.7.6.9.1.1-2: General test parameters for RSTD measurement reporting delay**

Parameter	Unit	Value	Comment
-----------	------	-------	---------

Reference cell			Cell 1	Reference cell is the cell in the DL-TDOA assistance data with respect to which the RSTD measurement is defined, as specified in TS 38.215 [4] and TS 37.355[34]. The reference cell is the PCell in this test case.
Neighbor cells			Cell 2 and Cell 3	Cell 2 and Cell 3 appear at the first and second places in the neighbour cell list in the DL-TDOA assistance data.
SSB configuration	Config 1		SSB.3 FR2	
SMTC configuration	Config 1		SMTC.1	
PDSCH RMC configuration	Config 1		SR.1.1 FDD	
RMSI CORESET RMC configuration	Config 1		CR.3.1 TDD	As specified in clause A.3.1.2.1
Dedicated CORESET RMC configuration	Config 1		CCR.1.1 FDD	
PRS Configuration	Config 1		PRS.1.1 FR2	As specified in clause A.3.31
Physical cell ID PCI			(PCI of Cell 1 – PCI of Cell 2)mod6=0 and (PCI of Cell 1 – PCI of Cell 3)mod6=0	The cell PCIs are selected such that the relative shifts of PRS patterns among cells are as given by the test parameters
CP length			Normal	
DRX			OFF	
Measurement gap			GP#24 or GP#13	GP#24 is configured if UE supports MG#24, otherwise GP#13 is configured
Radio frame receive time offset between the cells at the UE antenna connector		µs	Cell 2 to Cell 1: 0 Cell 3 to Cell 1: 3	PRS are transmitted from synchronous cells
Expected RSTD		µs	Cell 2: 3 Cell 3: 3 Other neighbour cells: randomly between -3 and 3	The expected RSTD is what is expected at the receiver. The corresponding parameter in the DL-TDOA assistance data specified in TS 37.355[34] is the expectedRSTD indicator
Expected RSTD uncertainty for all neighbour cells		µs	5	The corresponding parameter in the DL-TDOA assistance data specified in TS 37.355[34] is the expectedRSTD-Uncertainty index
Number of cells provided in DL-TDOA assistance data			4	Including the reference cell
PRS muting info			Cell 1: '10' Cell 2: '01' Cell 3: '10'	Corresponds to prs-MutingInfo defined in TS 37.355 [24]
PRS resource RE offset			Cell 1: 0 Cell 2: 0 Cell 3: 1	Cell 1 and Cell 3 are configured with different resource offsets

T1	s	3	The length of the time interval from the beginning of each test
T2	s	1.28	The length of the time interval that follows immediately after time interval T1
AoA setup		Setup 1	As defined in A.3.15.1
Beam assumption		Rough	Information about types of UE beam is given in B.2.1.3, and does not limit UE implementation or test system implementation

**Table A.7.6.9.1.1-3: Cell-specific test parameters for RSTD measurement reporting delay during T1**

Parameter	Unit	Cell 1	Cell 2	Cell 3
NR RF Channel Number		1	1	1
Positioning frequency layer		1	1	1
BW <sub>channel</sub>	MHz	200: N <sub>RB,c</sub> = 132	200: N <sub>RB,c</sub> = 132	200: N <sub>RB,c</sub> = 132
Correlation Matrix and Antenna Configuration		1x2 Low	1x2 Low	1x2 Low
OCNG patterns defined in A.3.2.1		OP.1	N/A	N/A
EPRE ratio of PSS to SSS	dB	0	0	0
EPRE ratio of PBCH DMRS to SSS				
EPRE ratio of PBCH to PBCH DMRS				
EPRE ratio of PDCCH DMRS to SSS				
EPRE ratio of PDCCH to PDCCH DMRS				
EPRE ratio of PDSCH DMRS to SSS				
EPRE ratio of PDSCH to PDSCH				
EPRE ratio of OCNG DMRS to SSS(Note 1)				
EPRE ratio of OCNG to OCNG DMRS (Note 1)				
$N_{oc}$ <sup>Note 3</sup>				
PRS $\hat{E}_s/N_{oc}$	dB	-Infinity	-Infinity	-Infinity
$I_o$ <sup>Note 4</sup>	Config 1	dBm/190.08MHz		
SSB <sub>RP</sub> <sup>Note4</sup>	Config 1	dBm/SCS		
SSB $\hat{E}_s/N_{oc}$	Config 1	dB		
Propagation Condition		AWGN		

Note 1: OCNG shall be used such that active cell (Cell 1) is fully allocated and a constant total transmitted power spectral density is achieved for all OFDM symbols other than those in the slots with transmitted PRS.

Note 2: The resources for uplink transmission are assigned to the UE prior to the start of time period T2.

Note 3: Interference from other cells and noise sources not specified in the test are assumed to be constant over subcarriers and time and shall be modelled as AWGN of appropriate power for  $N_{oc}$  to be fulfilled.

Note 4: SSB\_RP and  $I_o$  levels have been derived from other parameters and are given for information purpose. These are not settable test parameters.

**Table A.7.6.9.1.1-4: Cell-specific test parameters for RSTD measurement reporting delay during T2**

Parameter	Unit	Cell 1	Cell 2	Cell 3				
		T2	T2	T2				
RF Channel Number		1	1	1				
Positioning frequency layer		1	1	1				
$BW_{channel}$	MHz	200: $N_{RB,c} = 132$	200: $N_{RB,c} = 132$	200: $N_{RB,c} = 132$				
Correlation Matrix and Antenna Configuration		1x2 Low	1x2 Low	1x2 Low				
OCNG patterns defined in A.3.2.1		OP.1	OP.1	OP.1				
EPRE ratio of PSS to SSS	dB	0	0	0				
EPRE ratio of PBCH DMRS to SSS								
EPRE ratio of PBCH to PBCH DMRS								
EPRE ratio of PDCCH DMRS to SSS								
EPRE ratio of PDCCH to PDCCH DMRS								
EPRE ratio of PDSCH DMRS to SSS								
EPRE ratio of PDSCH to PDSCH								
EPRE ratio of OCNG DMRS to SSS(Note 1)								
EPRE ratio of OCNG to OCNG DMRS (Note 1)								
EPRE ratio of PRS to SSS								
PRACH configuration					FR2 PRACH configuration 1	FR2 PRACH configuration 1	FR2 PRACH configuration 1	
$N_{oc}$ Note 3					Config 1	-89	-89	-89
PRS $\hat{E}_s/N_{oc}$					Config 1	-5.45	-11.67	-11.67
$I_o$ Note 4					Config 1	-55.48	-55.48	-55.48
PRS $\hat{E}_s/I_{ot}$		-6	-13	-13				
PRP Note 4		-94.45	-100.67	-100.67				



Propagation Condition	AWGN
Note 1:	OCNG shall be used such that active cells are fully allocated and a constant total transmitted power spectral density is achieved for all OFDM symbols other than those in the slots with transmitted PRS.
Note 2:	The resources for uplink transmission are assigned to the UE prior to the start of time period T2.
Note 3:	Interference from other cells and noise sources not specified in the test are assumed to be constant over subcarriers and time and shall be modelled as AWGN of appropriate power for $N_{oc}$ to be fulfilled.
Note 4:	PRP and I <sub>o</sub> levels have been derived from other parameters and are given for information purpose. These are not settable test parameters. The I <sub>o</sub> is calculated based only on the symbols in which PRS is transmitted.
Note 5:	Calculation of E <sub>s</sub> /I <sub>o</sub> includes the effect of UE internal noise up to the value assumed for the associated Refsens requirement in clause 7.3.2 of TS 38.101-2 [19], and an allowance of 1dB for UE multi-band relaxation factor $\Delta MB_P$ from TS 38.101-2 [19] Table 6.2.1.3-4.

**Table A.7.6.9.1.-5: Void**

### A.7.6.9.1.2 Test Requirements

The RSTD measurement time fulfils the requirements specified in Clause 9.9.2.5.

The UE shall perform and report the RSTD measurements for Cell 2 and Cell 3 with respect to the reference cell in the DL-TDOA assistance data, Cell 1, within the time duration specified in section 9.9.2.5 starting from the beginning of time interval T2.

- NOTE: The actual overall delays measured in the test may be up to  $2 \times TTI_{DCCH}$  higher than the time duration above because of TTI insertion uncertainty of the measurement report in DCCH.

The rate of the correct events for each neighbour cell observed during repeated tests shall be at least 90%, where the reported RSTD measurement for each correct event shall be within the RSTD reporting range specified in Clause 10.1.23.3, i.e., between RSTD\_0000000 and RSTD\_1970049.

### A.7.6.9.2 NR RSTD measurement reporting delay test case for dual positioning frequency layers in FR2 SA

#### A.7.6.9.2.1 Test Purpose and Environment

The purpose of the test is to verify that the RSTD measurement meets the requirements specified in Clause 9.9.2 in an environment with AWGN propagation conditions in FR2 in standalone scenario when dual positioning frequency layer is configured.

Supported test configurations are shown in table A.7.6.9.2.1-1. The test parameters are as given in Table 7.6.7.2.1-2, Table A.7.6.9.2.1-3 and Table A.7.6.9.2.1-4.

**Table A.7.6.9.2.1-1: Supported test configurations for NR RSTD**

Configuration	Description
1	120 kHz SSB SCS, 200 MHz bandwidth, TDD duplex mode

In the test there are three synchronous cells: Cell 1, Cell 2 and Cell 3. Cell 1 is the reference as well as the PCell. Cell 2 and Cell 3 are the neighbour cells. All cells are on the 2 RF channels distributed in dual positioning frequency layers.

The test consists of two consecutive time intervals, with duration of T1 and T2. During time duration T1, the UE shall not have any timing information of Cell 2 and Cell 3. All three cells transmit PRS during T2. Note: The information on when PRS is muted is conveyed to the UE using PRS muting information.

The *NR-DL-TDOA-ProvideAssistanceData* and *nr-DL-TDOA-RequestLocationInformation* as defined in TS 37.355 [34, clause 6.5.12.1], shall be provided to the UE during T1. The last TTI containing the two messages shall be provided to

the UE  $\Delta T$  ms before the start of T2, where  $\Delta T = 50$  ms is the maximum processing time of the *DL-TDOA assistance* data and location information request.

The beginning of the time interval T2 shall be aligned with the beginning of the first MG instance containing the PRS resources.

The UE is configured with measurement gap pattern ID # 24 or #13 before T2.

**Table A.7.6.9.2.1-2: General test parameters for RSTD measurement reporting delay**

Parameter		Unit	Value	Comment
Reference cell			Cell 1	Reference cell is the cell in the DL-TDOA assistance data with respect to which the RSTD measurement is defined, as specified in TS 38.215 [4] and TS 37.355 [34]. The reference cell is the PCell in this test case.
Neighbor cells			Cell 2 and Cell 3	Cell 2 and Cell 3 appear at the first place in the respective neighbour cell list in the DL-TDOA assistance data for two positioning frequency layers
SSB configuration	Config 1		SSB.3 FR2	
SMTTC configuration	Config 1		SMTTC.1	
PDSCH RMC configuration	Config 1		SR.1.1 FDD	
RMSI CORESET RMC configuration	Config 1		CR.3.1 TDD	As specified in clause A.3.1.2.1
Dedicated CORESET RMC configuration	Config 1		CCR.1.1 FDD	
PRS Configuration	Config 1		PRS.1.1 FR2	As specified in clause A.3.31
Physical cell ID PCI			(PCI of Cell 1 – PCI of Cell 2) mod 6 = 0 and (PCI of Cell 1 – PCI of Cell 3) mod 6 = 0	The cell PCIs are selected such that the relative shifts of PRS patterns among cells are as given by the test parameters
CP length			Normal	
DRX			OFF	
Measurement gap			GP#24 or GP#13	GP#24 is configured if UE supports MG#24, otherwise GP#13 is configured
Radio frame receive time offset between the cells at the UE antenna connector		$\mu\text{s}$	Cell 2 to Cell 1: 0 Cell 3 to Cell 1: 3	PRS are transmitted from synchronous cells
Expected RSTD		$\mu\text{s}$	Cell 2: 3 Cell 3: 3 Other neighbour cells: randomly between -3 and 3	The expected RSTD is what is expected at the receiver. The corresponding parameter in the DL-TDOA assistance data specified in TS 37.355[34] is the expectedRSTD indicator

Expected RSTD uncertainty for all neighbour cells	μs	5	The corresponding parameter in the DL-TDOA assistance data specified in TS 37.355[34] is the expectedRSTD-Uncertainty index
Number of cells provided in DL-TDOA assistance data		4	Including the reference cell
PRS muting info		Cell 1: '10' Cell 2: '01' Cell 3: '10'	Correponds to prs-MutingInfo defined in TS 37.355 [24]
PRS resource RE offset		Cell 1: 0 Cell 2: 0 Cell 3: 1	Cell 1 and Cell 3 are configured with different resource offsets
T1	s	3	The length of the time interval from the beginning of each test
T2	s	1.28	The length of the time interval that follows immediately after time interval T1
AoA setup		Setup 1	As defined in A.3.15.1
Beam assumption		Rough	Information about types of UE beam is given in B.2.1.3, and does not limit UE implementation or test system implementation

**Table A.7.6.9.2.1-3: Cell-specific test parameters for RSTD measurement reporting delay during T1**

Parameter	Unit	Cell 1	Cell 2	Cell 3
NR RF Channel Number		1	1	2
Positioning frequency layer		1	1	2
BW <sub>channel</sub>	MHz	200: N <sub>RB,c</sub> = 132	200: N <sub>RB,c</sub> = 132	200: N <sub>RB,c</sub> = 132
Correlation Matrix and Antenna Configuration		1x2 Low	1x2 Low	1x2 Low
OCNG patterns defined in A.3.2.1		OP.1	N/A	N/A
EPRE ratio of PBCH DMRS to SSS				
EPRE ratio of PBCH to PBCH DMRS				
EPRE ratio of PDCCH DMRS to SSS				
EPRE ratio of PDCCH to PDCCH DMRS				
EPRE ratio of PDSCH DMRS to SSS				
EPRE ratio of PDSCH to PDSCH				
EPRE ratio of OCNG DMRS to SSS(Note 1)				
EPRE ratio of OCNG to OCNG DMRS (Note 1)				
$N_{oc}$ <sup>Note 3</sup>	Config 1	dBm/SCS -89		
PRS $\hat{E}_s/N_{oc}$	dB	-Infinity	-Infinity	-Infinity
$I_0$ <sup>Note 4</sup>	Config 1	dBm/190.08MHz -53.99	-53.99	-57.00
SSB <sub>RP</sub> <sup>Note4</sup>	Config 1	dBm/SCS -89	-Infinity	-Infinity
SSB $\hat{E}_s/N_{oc}$	dB	0	-Infinity	-Infinity
Propagation Condition		AWGN		

Note 1: OCNG shall be used such that active cell (Cell 1) is fully allocated and a constant total transmitted power spectral density is achieved for all OFDM symbols other than those in the slots with transmitted PRS.

Note 2: The resources for uplink transmission are assigned to the UE prior to the start of time period T2.

Note 3: Interference from other cells and noise sources not specified in the test are assumed to be constant over subcarriers and time and shall be modelled as AWGN of appropriate power for  $N_{oc}$  to be fulfilled.

Note 4: SSB\_RP and  $I_o$  levels have been derived from other parameters and are given for information purpose. These are not settable test parameters.

**Table A.7.6.9.2.1-4: Cell-specific test parameters for RSTD measurement reporting delay during T2**

Parameter	Unit	Cell 1	Cell 2	Cell 3	
		T2	T2	T2	
RF Channel Number		1	1	2	
Positioning frequency layer		1	1	2	
$BW_{channel}$	MHz	100: $N_{RB,c} = 66$	100: $N_{RB,c} = 66$	100: $N_{RB,c} = 66$	
Correlation Matrix and Antenna Configuration		1x2 Low	1x2 Low	1x2 Low	
OCNG patterns defined in A.3.2.1		OP.1	OP.1	OP.1	
EPRE ratio of PBCH DMRS to SSS	dB	0	0	0	
EPRE ratio of PBCH to PBCH DMRS					
EPRE ratio of PDCCH DMRS to SSS					
EPRE ratio of PDCCH to PDCCH DMRS					
EPRE ratio of PDSCH DMRS to SSS					
EPRE ratio of PDSCH to PDSCH					
EPRE ratio of OCNG DMRS to SSS(Note 1)					
EPRE ratio of OCNG to OCNG DMRS (Note 1)					
EPRE ratio of PRS to SSS					
PRACH configuration					
$N_{oc}$ Note 3	Config 1	dBm/SCS	-89	-89	-89
PRS $\hat{E}_s/N_{oc}$	Config 1	dB	-5.7	-11.9	-13
$I_o$ Note 4	Config 1	dBm/190.08MHz	-55.75	-55.75	-56.79
PRS $\hat{E}_s/I_{ot}$		dB	-6	-13	-13
PRP Note 4		dBm/SCS kHz	-94.7	-100.9	-102
Propagation Condition		AWGN			

Note 1:	OCNG shall be used such that active cells are fully allocated and a constant total transmitted power spectral density is achieved for all OFDM symbols other than those in the slots with transmitted PRS.
Note 2:	The resources for uplink transmission are assigned to the UE prior to the start of time period T2.
Note 3:	Interference from other cells and noise sources not specified in the test are assumed to be constant over subcarriers and time and shall be modelled as AWGN of appropriate power for $N_{oc}$ to be fulfilled.
Note 4:	PRP and I <sub>o</sub> levels have been derived from other parameters and are given for information purpose. These are not settable test parameters. The I <sub>o</sub> is calculated based only on the symbols in which PRS is transmitted.
Note 5:	Calculation of Es/I <sub>ot</sub> includes the effect of UE internal noise up to the value assumed for the associated Refsens requirement in clause 7.3.2 of TS 38.101-2 [19], and an allowance of 1dB for UE multi-band relaxation factor $\Delta MB_P$ from TS 38.101-2 [19] Table 6.2.1.3-4.

**Table A.7.6.9.2.1-5: Void**

### A.7.6.9.2.2 Test Requirements

The RSTD measurement time fulfils the requirements specified in Clause 9.9.2.5.

The UE shall perform and report the RSTD measurements for Cell 2 and Cell 3 with respect to the reference cell in the DL-TDOA assistance data, Cell 1, within the time duration specified in section 9.9.2.5 starting from the beginning of time interval T2.

- NOTE: The actual overall delays measured in the test may be up to  $2 \times TTI_{DCCH}$  higher than the time duration above because of TTI insertion uncertainty of the measurement report in DCCH.

The rate of the correct events for each neighbour cell observed during repeated tests shall be at least 90%, where the reported RSTD measurement for each correct event shall be within the RSTD reporting range specified in Clause 10.1.23.3, i.e., between RSTD\_000000 and RSTD\_1970049.

## A.7.6.10 PRS-RSRP measurements

### A.7.6.10.1 PRS-RSRP reporting delay test case for single positioning frequency layer

#### A.7.6.10.1.1 Test Purpose and Environment

The purpose of the test is to verify the PRS RSRP measurement requirements specified in Clause 9.9.3.5 for single positioning frequency layer under AWGN propagation conditions in standalone scenario. Supported test configurations are shown in table A.7.6.10.1.1-1

There are two cells in the test, PCell (Cell 1) and a FR2 neighbour cell (Cell 2) on the same frequency as the PCell.

The test consists of two successive time periods, with time duration of T1, and T2 respectively. During time duration T1, the UE shall not have any timing information of Cell 2. Both cells transmit PRS during T2.

The *NR-DL-AoD-RequestLocationInformation* message and *NR-DL-AoD-ProvideAssistanceData* message as defined in TS 37.355 shall be provided to the UE during T1. The last slot containing the two messages for the assistance data and location information request is denoted as #n.

The beginning of the time interval T2 shall be aligned with the beginning of the first MG instance containing the PRS resources that is  $\Delta T$  after slot #n, where  $\Delta T = 50$  ms is the maximum processing time of the assistance data and location information request.

The test parameters are as given in table A.7.6.10.1.1-2, and table A.7.6.10.1.1-3.

**Table A. 7.6.10.1.1-1: supported test configurations for PRS RSRP measurement for FR2-FR2**

Config	Description
1	120 kHz SSB SCS, 200 MHz bandwidth, TDD duplex mode

**Table A.7.6.10.1.1-2: General test parameters for PRS RSRP measurement reporting delay**

Parameter	Unit	Test configuration	Value	Comment
NR RF Channel Number		Config 1	1: Cell 1 and Cell 2	One TDD carrier frequency is used for the NR cells.
Active cell		Config 1	NR cell 1 (Pcell)	Cell 1 is the PCell and the DL-AoD reference cell in the positioning assistance data.
Neighbour cell		Config 1	NR cell 2	Cell 2 is a neighbour cell in the positioning assistance data.
Gap Pattern Id		Config 1	GP#13 or GP#24 <sup>Note1</sup>	As specified in clause 9.1.2-1.
Measurement gap offset		Config 1	39	
SMTC parameters		Config 1	SMTC.1	As specified in clause A.3.11
SSB parameters		Config 1	SSB.3 FR2	As specified in clause A.3.10.2
A3-Offset	dB	Config 1	-6	
Hysteresis	dB	Config 1	0	
CP length		Config 1	Normal	
TimeToTrigger	s	Config 1	0	
Filter coefficient		Config 1	0	L3 filtering is not used
DRX		Config 1	OFF	DRX is not used
Time offset between serving and neighbour cells		Config 1	3μs	Synchronous cells.
Expected RSTD	μs	Config 1	3	
Expected RSTD uncertainty	μs	Config 1	5	
T1	s	Config 1	5	
T2	s	Config 1	7	
Note 1: GP#24 is configured if UE supports MG#24, otherwise GP#13 is configured.				

**Table A.7.6.10.1.1-3: Cell-specific test parameters for PRS RSRP measurement reporting delay**

Parameter		Unit	Test configuration	Cell 1		Cell 2	
				T1	T2	T1	T2
AoA setup			Config 1	Setup 1 as specified in clause A.3.15			
Beam Assumption <sup>Note 7</sup>			Config 1	Rough		Rough	
TDD configuration			Config 1	TDDConf.3.1		TDDConf.3.1	
Duplex mode			Config 1	TDD		TDD	
BW <sub>channel</sub>		MHz	Config 1	200: N <sub>RB,c</sub> = 132		200: N <sub>RB,c</sub> = 132	
BWP configuration	Initial DL BWP		Config 1	DLBWP.0.1		N/A	
	Initial UL BWP			ULBWP.0.1		N/A	
	Dedicated DL BWP			DLBWP.1.1		N/A	
	Dedicated UL BWP			ULBWP.1.1		N/A	
OCNG Patterns defined in A.3.2.1.1 (OP.1)			Config 1	OP.1		OP.1	
PDSCH Reference measurement channel			Config 1	SR.3.1 TDD		-	

CORESET Reference Channel		Config 1	CR.3.1 TDD		-	
Dedicated CORESET RMC configuration		Config 1	CCR.3.1 TDD		-	
TRS configuration		Config 1	TRS.2.1 TDD		-	
PDSCH/PDCCH subcarrier spacing	kHz	Config 1	120		120	
PRS configuration		Config 1	PRS.1.1 FR2		PRS.1.1 FR2	
PRS muting configuration		Config 1	'10'		'01'	
EPRE ratio of PSS to SSS		Config 1	0		0	
EPRE ratio of PBCH DMRS to SSS						
EPRE ratio of PBCH to PBCH DMRS						
EPRE ratio of PDCCH DMRS to SSS						
EPRE ratio of PDCCH to PDCCH DMRS						
EPRE ratio of PDSCH DMRS to SSS						
EPRE ratio of PDSCH to PDSCH						
EPRE ratio of OCNG DMRS to SSS(Note 1)						
EPRE ratio of OCNG to OCNG DMRS (Note 1)						
$N_{oc}$ Note2	dBm/15 kHz Note5					
$N_{oc}$ Note2	dBm/S CS Note4	Config 1	-89		-89	
SSB_RP Note 3	dBm/S CS Note5	Config 1	-91	-91	-Infinity	-99
PRP Note 3	dBm/S CS Note5	Config 1	-Infinity	-91	-Infinity	-99
PRS $\hat{E}_s/I_{ot}$	dB	Config 1	-Infinity	-2.41	-Infinity	-12.12
PRS $\hat{E}_s/N_{oc}$	dB	Config 1	-Infinity	-2	-Infinity	-10
SSB $\hat{E}_s/N_{oc}$	dB	Config 1	-2	-2	-Infinity	-10
$I_o$ Note3	dBm/95 .04 MHz Note5	Config 1	-54.88	-54.62	-54.88	-54.62
Propagation Condition		Config 1	AWGN			
Note 1:	OCNG shall be used such that both cells are fully allocated and a constant total transmitted power spectral density is achieved for all OFDM symbols.					
Note 2:	Interference from other cells and noise sources not specified in the test is assumed to be constant over subcarriers and time and shall be modelled as AWGN of appropriate power for $N_{oc}$ to be fulfilled.					
Note 3:	SSB_RP/PRP and $I_o$ levels have been derived from other parameters for information purposes. They are not settable parameters themselves.					
Note 4:	PRS-RSRP minimum requirements are specified assuming independent interference and noise at each receiver antenna port.					
Note 5:	Equivalent power received by an antenna with 0 dBi gain at the centre of the quiet zone					
Note 6:	As observed with 0 dBi gain antenna at the centre of the quiet zone					
Note 7:	Information about types of UE beam is given in B.2.1.3, and does not limit UE implementation or test system implementation.					
Note 8:	Calculation of $E_s/I_{ot}$ includes the effect of UE internal noise up to the value assumed for the associated Refsens requirement in clause 7.3.2 of TS 38.101-2 [19], and an allowance of 1dB for UE multi-band relaxation factor $\Delta MB_P$ from TS 38.101-2 [19] Table 6.2.1.3-4.					

### A.7.6.10.1.2 Test Requirements

The PRS RSRP measurement time fulfils the requirements specified in Clause 9.9.3.5. The UE shall perform and report the PRS RSRP measurements for Cell 2 with respect to the reference cell in the DL-AoD assistance data, Cell 1, within the time duration specified in section 9.9.3.5 starting from the beginning of time interval T2.

- NOTE: The actual overall delays measured in the test may be up to  $2 \times TTI_{DCCH}$  higher than the time duration above because of TTI insertion uncertainty of the measurement report in DCCH.

The rate of the correct events for the neighbour cell observed during repeated tests shall be at least 90%, where the reported PRS RSRP measurement for each correct event shall be within the PRS RSRP reporting range specified in Clause 10.1.24.3, i.e., between PRS RSRP\_0 and PRS RSRP\_126.

### A.7.6.10.2 PRS-RSRP reporting delay test case for dual positioning frequency layer

#### A.7.6.10.2.1 Test Purpose and Environment

The purpose of the test is to verify the PRS RSRP measurement requirements specified in Clause 9.9.3.5 for dual positioning frequency layers under AWGN propagation conditions in standalone scenario. Supported test configurations are shown in table A.7.6.10.2.1-1

There are two cells in the test, PCell (Cell 1) and a FR2 neighbour cell (Cell 2) on the different frequency from the PCell.

The test consists of two successive time periods, with time duration of T1, and T2 respectively. During time duration T1, the UE shall not have any timing information of Cell 2. Both cells transmit PRS during T2.

The *NR-DL-AoD-RequestLocationInformation* message and *NR-DL-AoD-ProvideAssistanceData* message as defined in TS 37.355 shall be provided to the UE during T1. The last slot containing the two messages for the assistance data and location information request is denoted as #n.

The beginning of the time interval T2 shall be aligned with the beginning of the first MG instance containing the PRS resources that is  $\Delta T$  after slot #n, where  $\Delta T = 50$  ms is the maximum processing time of the assistance data and location information request.

The test parameters are as given in table A.7.6.10.2.1-2, and table A.7.6.10.2.1-3.

**Table A.7.6.10.2.1-1: supported test configurations for PRS RSRP measurement for FR2-FR2**

Config	Description
1	120 kHz SSB SCS, 200 MHz bandwidth, TDD duplex mode

**Table A.7.6.10.2.1-2: General test parameters for PRS RSRP measurement reporting delay**

Parameter	Unit	Test configuration	Value	Comment
Active cell		Config 1	NR cell 1 (Pcell)	Cell 1 is the PCell and the DL-AoD reference cell in the positioning assistance data.
Neighbour cell		Config 1	NR cell 2	Cell 2 is a neighbour cell in the positioning assistance data.
Gap Pattern Id		Config 1	GP#13 or GP#24 <sup>Note1</sup>	As specified in clause 9.1.2-1.
Measurement gap offset		Config 1	39	
SMTc parameters		Config 1	SMTc.1	As specified in clause A.3.11
SSB parameters		Config 1	SSB.3 FR2	As specified in clause A.3.10.2
A3-Offset	dB	Config 1	-6	



Hysteresis	dB	Config 1	0	
CP length		Config 1	Normal	
TimeToTrigger	s	Config 1	0	
Filter coefficient		Config 1	0	L3 filtering is not used
DRX		Config 1	OFF	DRX is not used
Time offset between serving and neighbour cells		Config 1	3 $\mu$ s	Synchronous cells.
Expected RSTD	$\mu$ s	Config 1	3	
Expected RSTD uncertainty	$\mu$ s	Config 1	5	
T1	s	Config 1	5	
T2	s	Config 1	7	
Note 1: GP#24 is configured if UE supports MG#24, otherwise GP#13 is configured.				

Table A.7.6.10.2.1-3: Cell-specific test parameters for PRS RSRP measurement reporting delay

Parameter		Unit	Test configuration	Cell 1		Cell 2	
				T1	T2	T1	T2
AoA setup			Config 1	Setup 1 as specified in clause A.3.15			
Beam Assumption <sup>Note 7</sup>			Config 1	Rough		Rough	
NR RF Channel Number			Config 1	1		2	
TDD configuration			Config 1	TDDConf.3.1		TDDConf.3.1	
Duplex mode			Config 1	TDD		TDD	
BW <sub>channel</sub>		MHz	Config 1	200: N <sub>RB,c</sub> = 132		200: N <sub>RB,c</sub> = 132	
BWP configuration	Initial DL BWP		Config 1	DLBWP.0.1		N/A	
	Initial UL BWP			ULBWP.0.1		N/A	
	Dedicated DL BWP			DLBWP.1.1		N/A	
	Dedicated UL BWP			ULBWP.1.1		N/A	
OCNG Patterns defined in A.3.2.1.1 (OP.1)			Config 1	OP.1		OP.1	
PDSCH Reference measurement channel			Config 1	SR.3.1 TDD		-	
CORESET Reference Channel			Config 1	CR.3.1 TDD		-	
Dedicated CORESET RMC configuration			Config 1	CCR.3.1 TDD		-	
TRS configuration			Config 1	TRS.2.1 TDD		-	
PDSCH/PDCCH subcarrier spacing		kHz	Config 1	120		120	
PRS configuration			Config 1	PRS.1.1 FR2		PRS.1.1 FR2	
PRS muting configuration			Config 1	'10'		'01'	
EPRE ratio of PSS to SSS			Config 1	0		0	
EPRE ratio of PBCH DMRS to SSS							
EPRE ratio of PBCH to PBCH DMRS							
EPRE ratio of PDCCH DMRS to SSS							
EPRE ratio of PDCCH to PDCCH DMRS							
EPRE ratio of PDSCH DMRS to SSS							
EPRE ratio of PDSCH to PDSCH							
EPRE ratio of OCNG DMRS to SSS(Note 1)							
EPRE ratio of OCNG to OCNG DMRS (Note 1)							

$N_{oc}$ <sup>Note2</sup>	dBm/15 kHz Note5		-98		-98	
$N_{oc}$ <sup>Note2</sup>	dBm/S CS Note4	Config 1	-89		-89	
SSB_RP <sup>Note3</sup>	dBm/S CS Note5	Config 1	-92	-92	-Infinity	-102
PRP <sup>Note3</sup>	dBm/S CS Note5	Config 1	-Infinity	-92	-Infinity	-102
PRS $\hat{E}_s/I_{ot}$	dB	Config 1	-Infinity	-3	-Infinity	-13
PRS $\hat{E}_s/N_{oc}$	dB	Config 1	-Infinity	-3	-Infinity	-13
SSB $\hat{E}_s/N_{oc}$	dB	Config 1	-3	-3	-Infinity	-13
$I_o$ <sup>Note3</sup>	dBm/19 0.08 MHz Note5	Config 1	-55.24	-55.24	-57.00	-56.79
Propagation Condition		Config 1	AWGN			
<p>Note 1: OCNG shall be used such that both cells are fully allocated and a constant total transmitted power spectral density is achieved for all OFDM symbols.</p> <p>Note 2: Interference from other cells and noise sources not specified in the test is assumed to be constant over subcarriers and time and shall be modelled as AWGN of appropriate power for <math>N_{oc}</math> to be fulfilled.</p> <p>Note 3: SSB_RP/PRP and <math>I_o</math> levels have been derived from other parameters for information purposes. They are not settable parameters themselves.</p> <p>Note 4: PRS-RSRP minimum requirements are specified assuming independent interference and noise at each receiver antenna port.</p> <p>Note 5: Equivalent power received by an antenna with 0 dBi gain at the centre of the quiet zone</p> <p>Note 6: As observed with 0 dBi gain antenna at the centre of the quiet zone</p> <p>Note 7: Information about types of UE beam is given in B.2.1.3, and does not limit UE implementation or test system implementation.</p> <p>Note 8: Calculation of <math>E_s/I_{ot}</math> includes the effect of UE internal noise up to the value assumed for the associated Refsens requirement in clause 7.3.2 of TS 38.101-2 [19], and an allowance of 1dB for UE multi-band relaxation factor <math>\Delta MB_P</math> from TS 38.101-2 [19] Table 6.2.1.3-4.</p>						

#### A.7.6.10.2.2 Test Requirements

The PRS RSRP measurement time fulfils the requirements specified in Clause 9.9.3.5. The UE shall perform and report the PRS RSRP measurements for Cell 2 with respect to the reference cell in the DL-AoD assistance data, Cell 1, within the time duration specified in section 9.9.3.5 starting from the beginning of time interval T2.

- NOTE: The actual overall delays measured in the test may be up to  $2 \times TTI_{DCCH}$  higher than the time duration above because of TTI insertion uncertainty of the measurement report in DCCH.

The rate of the correct events for the neighbour cell observed during repeated tests shall be at least 90%, where the reported PRS RSRP measurement for each correct event shall be within the PRS RSRP reporting range specified in Clause 10.1.24.3, i.e., between PRS RSRP\_0 and PRS RSRP\_126.

### A.7.6.11 UE Rx-Tx time difference measurements

#### A.7.6.11.1 UE Rx-Tx time difference measurements for single positioning frequency layer in FR2 SA

##### A.7.6.11.1.1 Test purpose and environment

The purpose of the test is to verify that the UE Rx-Tx measurement meets the requirements specified in clause 9.9.4.5 in AWGN propagation condition in FR2 in standalone scenario when single positioning frequency layer is configured.

The supported test configurations in listed in Table A.7.6.11.1.1-1.

**Table A.7.6.11.1.1-1: Supported test configurations**

Config	Description
1	120 kHz SSB and PRS SCS, 200 MHz bandwidth, TDD duplex mode

There are two cells in the test: PCell (Cell 1) and a neighbour cell (Cell 2). Both cells are on the same RF channel in FR2.

The test consists of two consecutive time intervals, with duration of T1 and T2. Cell 1 and Cell 2 mute PRS transmission during T1 and transmit PRS during T2.

The *NR-Multi-RTT-ProvideAssistanceData* and *nr-Multi-RTT-RequestLocationInformation* as defined in TS 37.355 [34, clause 6.5.12.1], shall be provided to the UE during T1. The last TTI containing the two messages shall be provided to the UE  $\Delta T$  ms before the start of T2, where  $\Delta T = 50$  ms is the maximum processing time of the multi-RTT assistance data and location information request.

The beginning of the time interval T2 shall be aligned with the beginning of the first MG instance containing the PRS resources.

The UE is configured with measurement gap pattern ID #13 or ID #24 before T2.

The UE is configured to transmit positioning SRS during T2.

The general test parameters and cell specific test parameters are as given in Table A.7.6.11.1.1-2 and Table A.7.6.11.1.1-3 respectively.

**Table A.7.6.11.1.1-2: General test parameters**

Parameter	Unit	Test configuration	Value	Comment
Active cell		1	Cell 1	Cell 1 is the PCell in <i>NR-Multi-RTT-ProvideAssistanceData</i> [34].
Neighbour cell		1	Cell 2	Cell 2 is a neighbour cell in <i>NR-Multi-RTT-ProvideAssistanceData</i> [34].
RF Channel Number		1	1	For both Cell 1 and Cell 2
BW <sub>channel</sub>	MHz	1	200: N <sub>RB,c</sub> = 132	
SSB configuration		1	SSB.2 FR2	
SMTC configuration		1	SMTC.1	
Measurement gap		1	GP#24 or GP#13 <sup>Note 1</sup>	
CP length		1	Normal	
DRX		1	OFF	
Time offset between serving and neighbour cells	μs	1	3	Synchronous cells
Expected RSTD	μs	1	3	
Expected RSTD uncertainty	μs	1	5	
T1	s	1	5	
T2	s	1	20	

NOTE 1: GP#24 is configured if UE supports MG#24, otherwise GP#13 is configured.

**Table A.7.6.11.1.1-3: Cell specific test parameters**

Parameter	Unit	Test configuration	Cell 1		Cell 2	
			T1	T2	T1	T2
AoA setup		1	Setup 1 as specified in clause A.3.15			
Beam Assumption <sup>Note 7</sup>		1	Rough		Rough	
TDD configuration		1	TDDConf.3.1		TDDConf.3.1	
PDSCH RMC configuration		1	SR.3.1 TDD		N/A	
RMSI CORESET RMC configuration		1	CR.3.1 TDD		N/A	
Dedicated CORESET RMC configuration		1	CCR.3.1 TDD		N/A	
OCNG Patterns		1	OP.1		OP.1	

EPRE ratio of PSS to SSS	dB	1	0	0		
EPRE ratio of PBCH DMRS to SSS						
EPRE ratio of PBCH to PBCH DMRS						
EPRE ratio of PDCCH DMRS to SSS						
EPRE ratio of PDCCH to PDCCH DMRS						
EPRE ratio of PDSCH DMRS to SSS						
EPRE ratio of PDSCH to PDSCH DMRS						
EPRE ratio of OCNG DMRS to SSS <sup>Note 1</sup>						
EPRE ratio of OCNG to OCNG DMRS <sup>Note 1</sup>						
EPRE ratio of PRS to SSS						
TRS Configuration		1	TRS.2.1 TDD			N/A
Initial BWP configuration		1	DLBWP.0.1 ULBWP.0.1			N/A
Active DL BWP configuration		1	DLBWP.1.1			N/A
Active UL BWP configuration		1	ULBWP.1.1			N/A
PRS configuration		1	PRS.1.1 FR2		PRS.1.1 FR2	
PRS muting info		1	'10'		'01'	
SRS configuration		1	POS-SRS.3		N/A	
$N_{oc}$ <sup>Note 2</sup>	dBm/SCS	1	-89			
$N_{oc}$ <sup>Note 2</sup>	dBm/15 kHz	1	-98			
PRS $\hat{E}_s/I_{ot}$	dB	1	-Infinity	-2.41	-Infinity	-12.12
PRS $\hat{E}_s/N_{oc}$	dB	1	-Infinity	-2	-Infinity	-10
PRP <sup>Note 3</sup>	dBm/SCS kHz	1	-Infinity	-91	-Infinity	-99
$I_o$	dBm/190.08 MHz	1	N/A	-54.62	N/A	-54.62
Propagation Condition		1	AWGN			
<p>Note 1: The resources for uplink transmission are assigned to the UE prior to the start of time period T2.</p> <p>Note 2: Interference from other cells and noise sources not specified in the test is assumed to be constant over subcarriers and time and shall be modelled as AWGN of appropriate power for <math>N_{oc}</math> to be fulfilled.</p> <p>Note 3: PRP and <math>I_o</math> levels have been derived from other parameters for information purposes. They are not settable parameters themselves.</p> <p>Note 4: PRS-RSRP minimum requirements are specified assuming independent interference and noise at each receiver antenna port.</p> <p>Note 5: Equivalent power received by an antenna with 0 dBi gain at the centre of the quiet zone</p> <p>Note 6: As observed with 0 dBi gain antenna at the centre of the quiet zone</p> <p>Note 7: Information about types of UE beam is given in B.2.1.3, and does not limit UE implementation or test system implementation.</p> <p>Note 8: Calculation of <math>E_s/I_{ot}</math> includes the effect of UE internal noise up to the value assumed for the associated Refsens requirement in clause 7.3.2 of TS 38.101-2 [19], and an allowance of 1dB for UE multi-band relaxation factor <math>\Delta MB_F</math> from TS 38.101-2 [19] Table 6.2.1.3-4.</p>						

**Table A.7.6.11.1.1-4: Void**

A.7.6.11.1.2 Test requirements

The UE Rx-Tx time difference measurement time fulfils the requirements specified in clause 9.9.4.5.

The UE shall perform and report the UE Rx-Tx time difference measurements for Cell 1 and Cell 2 within the specified UE Rx-Tx time difference measurement time starting from the beginning of time interval T2.

- NOTE: The actual overall delays measured in the test may be up to  $2 \times TTI_{DCCH}$  higher than the time duration above because of TTI insertion uncertainty of the measurement report in DCCH.

The rate of the correct events for each neighbour cell observed during repeated tests shall be at least 90%, where the reported UE Rx-Tx measurement for each correct event shall be within the UE Rx-Tx reporting range specified in clause 10.1.25.3.1.

### A.7.6.11.2 UE Rx-Tx time difference measurement period for dual positioning frequency layers in FR2 SA

#### A.7.6.11.2.1 Test purpose and environment

The purpose of the test is to verify that the UE Rx-Tx measurement meets the requirements specified in clause 9.9.4.5 in AWGN propagation condition in FR2 in standalone scenario when dual positioning frequency layers are configured.

The supported test configurations are listed in Table A.7.6.11.2.1-1.

**Table A.7.6.11.2.1-1: Supported test configurations**

Config	Description
1	120 kHz SSB and PRS SCS, 200 MHz bandwidth, TDD duplex mode

There are two cells in the test: PCell (Cell 1) and a neighbour cell (Cell 2). All cells are on different RF channels in FR2.

The test consists of two consecutive time intervals, with duration of T1 and T2. Cell 1 and Cell 2 mute PRS transmission during T1 and transmit PRS during T2.

The *NR-Multi-RTT-ProvideAssistanceData* and *nr-Multi-RTT-RequestLocationInformation* as defined in TS 37.355 [34, clause 6.5.12.1], shall be provided to the UE during T1. The last TTI containing the two messages shall be provided to the UE  $\Delta T$  ms before the start of T2, where  $\Delta T = 50$  ms is the maximum processing time of the multi-RTT assistance data and location information request.

The beginning of the time interval T2 shall be aligned with the beginning of the first MG instance containing the PRS resources.

The UE is configured with measurement gap pattern ID #13 or ID #24 before T2.

The UE is configured to transmit positioning SRS during T2.

The general test parameters and cell specific test parameters are as given in Table A.7.6.11.2.1-2 and Table A.7.6.11.2.1-3 respectively.

**Table A.7.6.11.2.1-2: General test parameters**

Parameter	Unit	Test configuration	Value	Comment
Active cell		1	Cell 1	Cell 1 is the PCell in <i>NR-Multi-RTT-ProvideAssistanceData</i> [34].
Neighbour cell		1	Cell 2	Cell 2 is a neighbour cell in <i>NR-Multi-RTT-ProvideAssistanceData</i> [34].
RF Channel Number		1	1	For Cell 1
RF Channel Number		1	2	For Cell 2
BW <sub>channel</sub>	MHz	1	200: N <sub>RB,c</sub> = 132	
SSB configuration		1	SSB.2 FR2	
SMTC configuration		1	SMTC.1	
Measurement gap		1	GP#24 or GP#13 Note 1	
CP length		1	Normal	
DRX		1	OFF	
Time offset between serving and neighbour cells	μs	1	3	Synchronous cells
Expected RSTD	μs	1	3	

Expected RSTD uncertainty	$\mu\text{s}$	1	5	
T1	s	1	5	
T2	s	1	20	
Note 1: GP#24 is configured if UE supports MG#24, otherwise GP#13 is configured.				

Table A.7.6.11.2.1-3: Cell specific test parameters

Parameter	Unit	Test configuration	Cell 1		Cell 2	
			T1	T2	T1	T2
AoA setup		1	Setup 1 as specified in clause A.3.15			
Beam Assumption <sup>Note 7</sup>		1	Rough		Rough	
TDD configuration		1	TDDConf.3.1		TDDConf.3.1	
PDSCH RMC configuration		1	SR.3.1 TDD		N/A	
RMSI CORESET RMC configuration		1	CR.3.1 TDD		N/A	
Dedicated CORESET RMC configuration		1	CCR.3.1 TDD		N/A	
OCNG Patterns		1	OP.1		OP.1	
EPRE ratio of PSS to SSS	dB	1	0		0	
EPRE ratio of PBCH DMRS to SSS						
EPRE ratio of PBCH to PBCH DMRS						
EPRE ratio of PDCCH DMRS to SSS						
EPRE ratio of PDCCH to PDCCH DMRS						
EPRE ratio of PDSCH DMRS to SSS						
EPRE ratio of PDSCH to PDSCH DMRS						
EPRE ratio of OCNG DMRS to SSS <sup>Note 1</sup>						
EPRE ratio of OCNG to OCNG DMRS <sup>Note 1</sup>						
EPRE ratio of PRS to SSS						
TRS Configuration		1	TRS.2.1 TDD		N/A	
Initial BWP configuration		1	DLBWP.0.1 ULBWP.0.1		N/A	
Active DL BWP configuration		1	DLBWP.1.1		N/A	
Active UL BWP configuration		1	ULBWP.1.1		N/A	
PRS configuration		1	PRS.1.1 FR2		PRS.1.1 FR2	
PRS muting info		1	'10'		'01'	
SRS configuration		1	POS-SRS.3		N/A	
$N_{oc}$ <sup>Note 2</sup>	dBm/SCS	1	-89			
$N_{oc}$ <sup>Note 2</sup>	dBm/15 kHz	1	-98			
PRS $\hat{E}_s/I_{ot}$	dB	1	-Infinity	-3	-Infinity	-13
PRS $\hat{E}_s/N_{oc}$	dB	1	-Infinity	-3	-Infinity	-13
PRP <sup>Note 3</sup>	dBm/SCS kHz	1	-Infinity	-92	-Infinity	-102
$I_o$	dBm/190.08 MHz	1	N/A	-55.24	N/A	-56.79
Propagation Condition		1	AWGN			

Note 1:	The resources for uplink transmission are assigned to the UE prior to the start of time period T2.
Note 2:	Interference from other cells and noise sources not specified in the test is assumed to be constant over subcarriers and time and shall be modelled as AWGN of appropriate power for $N_{oc}$ to be fulfilled.
Note 3:	PRP and Io levels have been derived from other parameters for information purposes. They are not settable parameters themselves.
Note 4:	PRS-RSRP minimum requirements are specified assuming independent interference and noise at each receiver antenna port.
Note 5:	Equivalent power received by an antenna with 0 dBi gain at the centre of the quiet zone
Note 6:	As observed with 0 dBi gain antenna at the centre of the quiet zone
Note 7:	Information about types of UE beam is given in B.2.1.3, and does not limit UE implementation or test system implementation.
Note 8:	Calculation of Es/Iot includes the effect of UE internal noise up to the value assumed for the associated Refsens requirement in clause 7.3.2 of TS 38.101-2 [19], and an allowance of 1dB for UE multi-band relaxation factor $\Delta MB_P$ from TS 38.101-2 [19] Table 6.2.1.3-4.

**Table A.7.6.11.1.1-4: Void**

### A.7.6.11.2.2 Test requirements

The UE Rx-Tx time difference measurement time fulfils the requirements specified in clause 9.9.4.5.

The UE shall perform and report the UE Rx-Tx time difference measurements for Cell 1 and Cell 2 within the specified UE Rx-Tx time difference measurement time starting from the beginning of time interval T2.

- NOTE: The actual overall delays measured in the test may be up to  $2 \times TTI_{DCCH}$  higher than the time duration above because of TTI insertion uncertainty of the measurement report in DCCH.

The rate of the correct events for each neighbour cell observed during repeated tests shall be at least 90%, where the reported UE Rx-Tx measurement for each correct event shall be within the UE Rx-Tx reporting range specified in clause 10.1.25.3.1.

## A.7.7 Measurement Performance requirements

Unless explicitly stated otherwise:

- Reported measurements shall be within defined range of accuracy limits defined in Clause 10 for at least 90 % of the reported cases. If multiple measurement performance requirements are verified in the same test, the reported measurements for each requirement shall be within defined range of accuracy limits of the corresponding requirement defined in Clause 10 for at least 90% of the reported cases.
- Measurements are performed in RRC\_CONNECTED state.
- The reference channels assume transmission of PDSCH with a maximum number of 5 HARQ transmissions unless otherwise specified.

### A.7.7.1 SS-RSRP

#### A.7.7.1.1 SA intra-frequency case measurement accuracy with FR2 serving cell and FR2 target cell

##### A.7.7.1.1.1 Test Purpose and Environment

The purpose of this test is to verify that the SS-RSRP measurement accuracy is within the specified limits. This test will verify the requirements in clauses 10.1.3.1.1 and 10.1.3.1.2 for intra-frequency measurements.

## A.7.7.1.1.2 Test parameters

In this set of test cases all cells are on the same carrier frequency. Supported test configurations are shown in Table A.7.7.1.1.2-1. Both absolute and relative accuracy of SS-RSRP intra-frequency measurements are tested by using the parameters in Table A.7.7.1.1.2-2 and A.7.7.1.1.2-3. In all test cases, Cell 1 is the PCell and Cell 2 the target cell. The TCI status for Cell 1 is defined in Table A.3.16.2-1 and TRS configuration for Cell 1 is defined in Table A.3.17.2.1-1. The test consists of two time phases T1 and T2.

Table A.7.7.1.1.2-1: SS-RSRP Intra frequency SS-RSRP supported test configurations

Configuration	Description
1	120 kHz SSB SCS, 100 MHz bandwidth, TDD duplex mode

Table A.7.7.1.1.2-2: SS-RSRP Intra frequency general test parameters

Parameter	Unit	T1		T2	
		Cell 1	Cell 2	Cell 1	Cell 2
Cell ID		489	0	489	0
SSB ARFCN		freq1		freq1	
Duplex mode		TDD		TDD	
TDD configuration		TDDConf.3.1		TDDConf.3.1	
BW <sub>channel</sub>	MHz	100: N <sub>RB,c</sub> = 66		100: N <sub>RB,c</sub> = 66	
Data RBs allocated		24		24	
Downlink initial BWP configuration		DLB WP.0. 1	-	DLB WP.0. 1	-
Downlink dedicated BWP configuration		DLB WP.1. 1	-	DLB WP.1. 1	-
Uplink initial BWP configuration		ULB WP.0. 1	-	ULB WP.0. 1	-
Uplink dedicated BWP configuration		ULB WP.1. 1	-	ULB WP.1. 1	-
DRX cycle configuration		Not applicable	-	Not applicable	-
TRS configuration		TRS.2 .1 TDD	-	TRS.2 .1 TDD	-
TCI state		TCI.St ate.0	-	TCI.St ate.0	-
PDSCH Reference measurement channel		SR.3. 2 TDD	-	SR.3. 2 TDD	-
RMSI CORESET Reference Channel		CR.3. 1 TDD	-	CR.3. 1 TDD	-
Dedicated CORESET Reference channel		CCR. 3.1 TDD	-	CCR. 3.1 TDD	-
OCNG Patterns		OP.3	OP.3	OP.3	OP.3
SSB configuration		SSB.3 FR2	SSB.3 FR2	SSB.3 FR2	SSB.3 FR2
SMTc configuration		SMTc .1	SMTc .1	SMTc .1	SMTc .1
Time offset with Cell 1	μs	-	3	-	3
PDSCH/PDCCH subcarrier spacing	kHz	120	120	120	120
EPRE ratio of PSS to SSS	dB	0	0	0	0
EPRE ratio of PBCH_DMRS to SSS					



EPRE ratio of PBCH to PBCH_DMRS					
EPRE ratio of PDCCH_DMRS to SSS					
EPRE ratio of PDCCH to PDCCH_DMRS					
EPRE ratio of PDSCH_DMRS to SSS					
EPRE ratio of PDSCH to PDSCH_DMRS					
EPRE ratio of OCNG DMRS to SSS <sup>Note 1</sup>					
EPRE ratio of OCNG to OCNG DMRS <sup>Note 1</sup>					
Propagation conditions		AWG N	AWG N	AWG N	AWG N
Antenna configuration		1x2	1x2	1x2	1x2
<p>Note 1: OCNG shall be used such that both cells are fully allocated and a constant total transmitted power spectral density is achieved for all OFDM symbols.</p> <p>Note 2: Void</p> <p>Note 3: Void</p> <p>Note 4: Void</p> <p>Note 5: Void</p>					

**Table A.7.7.1.1.2-3: SS-RSRP Intra frequency OTA related test parameters**

Parameter	Unit	T1		T2	
		Cell 1	Cell 2	Cell 1	Cell 2
Angle of arrival configuration		Setup 1 according to clause A.3.15.1			
Assumption for UE beams <sup>Note 7</sup>		Rough		Rough	
$N_{oc}$ <sup>Note1</sup>	dBm/15kHz $z$ <sup>Note4</sup>	-91.6		N/A	
$N_{oc}$ <sup>Note1</sup>	dBm/SCS <sup>Note4</sup>	-82.6		N/A	
$\hat{E}_s / N_{oc}$	dB	6.0	1.0	N/A	N/A
$E_s$	dBm/SCS <sup>Note4</sup>			(Table B.2.2-2 Rx Beam Peak +2.1dB)	(Table B.2.2-2 Rx Beam Peak +2.1dB)
SSB_RP <sup>Note2</sup>	dBm/SCS	-76.6	-81.6	(Table B.2.2-2 Rx Beam Peak +2.1dB)	(Table B.2.2-2 Rx Beam Peak +2.1dB)
$\hat{E}_s / I_{ot_{BB}}$ <sup>Note6</sup>	dB	2.44	-5.98	-5.98	-5.98
$I_o$ <sup>Note2</sup>	dBm/95.04 MHz <sup>Note4</sup>	-50.05		(Table B.2.2-2 Rx Beam Peak +29.70dB)	
<p>Note 1: Where used, interference from other cells and noise sources not specified in the test is assumed to be constant over subcarriers and time and shall be modelled as AWGN of appropriate power for <math>N_{oc}</math> to be fulfilled.</p> <p>Note 2: SSB_RP, <math>E_s/I_{ot}</math> and <math>I_o</math> levels have been derived from other parameters for information purposes. They are not settable parameters themselves.</p> <p>Note 3: Void</p> <p>Note 4: Equivalent power received by an antenna with 0 dBi gain at the centre of the quiet zone</p> <p>Note 5: Void</p> <p>Note 6: Calculation of <math>E_s/I_{ot_{BB}}</math> includes the effect of UE internal noise up to the value assumed for the associated Refsens requirement in clause 7.3.2</p>					

of TS 38.101-2 [19], and an allowance of 1dB for UE multi-band relaxation factor  $\Delta MB_P$  from TS 38.101-2 [19] Table 6.2.1.3-4.  
 Note 7: Information about types of UE beam is given in B.2.1.3, and does not limit UE implementation or test system implementation

### A.7.7.1.1.3 Test Requirements

The SS-RSRP measurement accuracy shall fulfil the absolute accuracy requirements in clauses 10.1.3.1.1 and relative accuracy requirements in clause 10.1.3.1.2. The following requirements are to be verified:

During T1:

Absolute accuracy of Cell 1 and absolute accuracy of Cell 2. The UE is deemed to meet the requirement if the reported SS-RSRP is in the range shown in table A.7.7.1.1.3-1.

Relative accuracy of Cell 2 compared with Cell 1. The UE is deemed to meet the requirement if the difference in reported SS-RSRP meets the requirements in Table 10.1.3.1.2-1.

During T2:

Absolute accuracy of Cell 1 and absolute accuracy of Cell 2. The UE is deemed to meet the requirement if the reported SS-RSRP is in the range shown in table A.7.7.1.1.3-1.

Relative accuracy of Cell 2 compared with Cell 1. The UE is deemed to meet the requirement if the difference in reported SS-RSRP meets the requirements in Table 10.1.3.1.2-1.

During T1 and T2:

Relative accuracy of Cell 1 during T2 compared with Cell 1 during T1. The UE is deemed to meet the requirement if the difference in reported SS-RSRP meets the requirements in Table 10.1.3.1.2-1

Relative accuracy of Cell 2 during T2 compared with Cell 2 during T1. The UE is deemed to meet the requirement if the difference in reported SS-RSRP meets the requirements in Table 10.1.3.1.2-1.

**Table A.7.7.1.1.3-1: SS-RSRP absolute accuracy test requirement**

	Test requirement <sup>Notes1,2,3</sup>
Cell 1	$SSB\_RP1 - \delta + G_{min} \leq \text{Reported RSRP(dBm)} \leq SSB\_RP1 + \delta + G_{max}$
Cell 2	$SSB\_RP2 - \delta + G_{min} \leq \text{Reported RSRP(dBm)} \leq SSB\_RP2 + \delta + G_{max}$
Note 1:	SSB_RPn is the equivalent power received by an antenna with 0dBi gain at the centre of the quiet zone configured in the test for the cell n under consideration
Note 2:	$\delta$ is the RSRP absolute accuracy requirement from Table 10.1.3.1.1-1, selected according to the $\delta$ used in the test
Note 3:	$G_{min}$ and $G_{max}$ are the minimum and maximum UE gain values from Table B.2.1.5.1-1, selected according to the UE power class

### A.7.7.1.2 SA inter-frequency case measurement accuracy with FR2 serving cell and FR2 target cell

#### A.7.7.1.2.1 Test Purpose and Environment

The purpose of this test is to verify that the SS-RSRP measurement accuracy is within the specified limits. This test will verify the requirements in clauses 10.1.5.1.1 and 10.1.5.1.2 for intrer-frequency measurements with the testing configurations for NR cells in Table A.7.7.1.2.1-1.

**Table A.7.7.1.2.1-1: Applicable NR configurations for FR2 inter-frequency SS-RSRP accuracy test**

Configuration	Description
1	120 kHz SSB SCS, 100 MHz bandwidth, TDD duplex mode
2	240 kHz SSB SCS, 100 MHz bandwidth, TDD duplex mode

A.7.7.1.2.2 Test parameters

In this set of test cases there are two cells in the test, PCell (Cell 1) and a FR2 neighbour cell (Cell 2) on a different frequency than the PCell. The test parameters and applicability for Cell 1 are defined in A.3.7.2. The test parameters for the Cell 1 and Cell 2 are given in Table A.7.7.1.2.2-1 and Table A.7.7.1.2.2-2 below. Both absolute and relative accuracy of RSRP inter-frequency measurements are tested by using the parameters in Table A.7.7.1.2.2-1 and Table A.7.7.1.2.2-1. The inter-frequency measurements are supported by a measurement gap.

**Table A.7.7.1.2.2-1: SS-RSRP inter-frequency test parameters**

Parameter	Config	Unit	Test 1		Test 2	
			Cell 1	Cell 2	Cell 1	Cell 2
SSB ARFCN	1~2		freq1	freq2	freq1	freq2
BW <sub>channel</sub>	1~2		100: N <sub>RB,c</sub> = 66		100: N <sub>RB,c</sub> = 66	
Data RBs allocated	1		24		24	
	2		48		48	
Gap pattern ID			0		0	
Duplex mode	1~2		TDD		TDD	
TDD configuration	1~2		TDDConf.3.1		TDDConf.3.1	
PDSCH Reference measurement channel	1		SR.3.2 TDD	-	SR.3.2 TDD	-
	2		SR.3.3 TDD		SR.3.3 TDD	
RMSI CORESET Reference Channel	1		CR.3.1 TDD	-	CR.3.1 TDD	-
	2		CR.3.2 TDD		CR.3.2 TDD	
Dedicated CORESET Reference Channel	1		CCR.3.1 TDD	-	CCR.3.1 TDD	-
	2		CCR.3.7 TDD		CCR.3.7 TDD	
SSB configuration	1		SSB.3 FR2		SSB.3 FR2	
	2		SSB.4 FR2		SSB.4 FR2	
PDSCH/PDCCH subcarrier spacing	1~2	kHz	120		120	
OCNG Patterns	1~2		OP.3		OP.3	
Initial BWP Configuration	1~2		DLBWP.0.1 ULBWP.0.1		DLBWP.0.1 ULBWP.0.1	
Dedicated BWP configuration	1~2		DLBWP.1.3 ULBWP.1.3		DLBWP.1.3 ULBWP.1.3	
TRS Configuration	1~2		TRS.2.1 TDD		TRS.2.1 TDD	
PDCCH/PDSCH TCI Configuration	1~2		TCI.State.2		TCI.State.2	
SMTc configuration	1~2		SMTc.1		SMTc.1	
Time offset between Cell 2 and Cell 1	1~2	µs	3		3	
EPRE ratio of PSS to SSS	1~2	dB	0	0	0	0
EPRE ratio of PBCH DMRS to SSS						
EPRE ratio of PBCH to PBCH DMRS						
EPRE ratio of PDCCH DMRS to SSS						
EPRE ratio of PDCCH to PDCCH DMRS						
EPRE ratio of PDSCH DMRS to SSS						
EPRE ratio of PDSCH to PDSCH DMRS						
EPRE ratio of OCNG DMRS to SSS <sup>Note 1</sup>						
EPRE ratio of OCNG to OCNG DMRS <sup>Note 1</sup>						
Propagation condition	1~2	-	AWGN	AWGN	AWGN	AWGN
Antenna configuration	1~2	-	1x2	1x2	1x2	AWGN
Note 1: OCNG shall be used such that a constant total transmitted power spectral density is achieved for all OFDM symbols.						
Note 2: Void.						

**Table A.7.7.1.2.2-2: SS-RSRP inter frequency OTA related test parameters**

Parameter	Config	Unit	Test 1	Test 2
-----------	--------	------	--------	--------

			Cell 1	Cell 2	Cell 1	Cell 2
Angle of arrival configuration	1~2		Setup 4b according to clause A.3.15.4.2		Setup 4b according to clause A.3.15.4.2	
			AoA1 Spherical coverage	AoA2 Rx Beam Peak	AoA1 Spherical coverage	AoA2 Rx Beam Peak
Assumption for UE beams <sup>Note 7</sup>	1~2		Rough		Rough	
$N_{oc}$ <sup>Note1</sup>	1	dBm/15kHz <sup>Note4</sup>	-90.6	-90.6	(Table B.2.3-2 Rx Beam Peak <sup>Note 8</sup> +1.97dB)	(Table B.2.3-2 Rx Beam Peak <sup>Note 8</sup> -3.03dB)
	2		-93.7	-93.7		
$N_{oc}$ <sup>Note1</sup>	1	dBm/SCS <sup>Note4</sup>	-81.6	-81.6	(Table B.2.3-2 Rx Beam Peak <sup>Note 8</sup> +11.0dB)	(Table B.2.3-2 Rx Beam Peak <sup>Note 8</sup> +6.0dB)
	2		-81.7	-81.7	(Table B.2.3-2 Rx Beam Peak <sup>Note 8</sup> +14.0dB)	(Table B.2.3-2 Rx Beam Peak <sup>Note 8</sup> +9.0dB)
$\hat{E}_s / N_{oc}$	1~2	dB	6.0	6.0	17.0	-1.0
SSB_RP <sup>Note2</sup>	1	dBm/SCS	-75.6	-75.6	(Table B.2.3-2 Rx Beam Peak <sup>Note 8</sup> +28.0dB)	(Table B.2.3-2 Rx Beam Peak <sup>Note 8</sup> +5.0dB)
	2		-75.7	-75.7	(Table B.2.3-2 Rx Beam Peak <sup>Note 8</sup> +31.0dB)	(Table B.2.3-2 Rx Beam Peak <sup>Note 8</sup> +8.0dB)
(SSB_RP <sub>Cell 1</sub> – SSB_RP <sub>Cell 2</sub> )	1~2	dB	0		23.00	
$\hat{E}_s / I_{ot\ BB}$ <sup>Note6</sup>	1	dB	5.26	5.96	9.53	-3.46
	2		4.61	5.91		
$I_o$ <sup>Note2</sup>	1	dBm/95.04 MHz <sup>Note4</sup>	-50.00	-50.00	(Table B.2.3-2 Rx Beam Peak <sup>Note 8</sup> +52.68dB)	(Table B.2.3-2 Rx Beam Peak <sup>Note 8</sup> +33.13dB)
	2		-50.09	-50.09	(Table B.2.3-2 Rx Beam Peak <sup>Note 8</sup> +55.69dB)	(Table B.2.3-2 Rx Beam Peak <sup>Note 8</sup> +36.14dB)
( $I_{ofreq 1} - I_{ofreq 2}$ )	1~2	dB	0		19.55	
<p>Note 1: Where used, interference from other cells and noise sources not specified in the test is assumed to be constant over subcarriers and time and shall be modelled as AWGN of appropriate power for <math>N_{oc}</math> to be fulfilled.</p> <p>Note 2: SSB_RP, <math>E_s/I_{ot}</math>, <math>I_o</math>, (SSB_RP<sub>Cell 2</sub> – SSB_RP<sub>Cell 1</sub>) and (<math>I_{ofreq 2} - I_{ofreq 1}</math>) levels have been derived from other parameters for information purposes. They are not settable parameters themselves.</p> <p>Note 3: Void</p> <p>Note 4: Equivalent power received by an antenna with 0 dBi gain at the centre of the quiet zone</p> <p>Note 5: Void</p> <p>Note 6: Calculation of <math>E_s/I_{ot\ BB}</math> includes the effect of UE internal noise up to the value assumed for the associated Refsens requirement in clause 7.3.2 of TS 36.101-2 [19], and an allowance of 1dB for UE multi-band relaxation factor <math>\Delta MB_P</math> or <math>\Delta MB_S</math> from TS 38.101-2 [19] Table 6.2.1.3-4.</p> <p>Note 7: Information about types of UE beam is given in B.2.1.3, and does not limit UE implementation or test system implementation</p>						

Note 8: The value in Table B.2.3-2 is the Minimum SSB\_RP for  $SCS_{SSB} = 120$  kHz, selected according to the operating band of Cell 2 and UE power class, without  $\Delta MB_{P,n}$  adjustment.

**A.7.7.1.2.3 Test Requirements**

The SS-RSRP measurement accuracy for Cell 1 and Cell 2 shall fulfil the absolute requirements in clause 10.1.5.1.1 and the relative requirements in clause 10.1.5.1.2.

Test 1:

Absolute accuracy of Cell 1 and absolute accuracy of Cell 2. The UE is deemed to meet the requirement if the reported SS-RSRP is in the range shown in Table A.7.7.1.2.3-1.

Relative accuracy of Cell 2 compared with Cell 1. The UE is deemed to meet the requirement if the difference in reported SS-RSRP meets the requirements in A.7.7.1.2.3-2.

Test 2:

Absolute accuracy of Cell 1 and absolute accuracy of Cell 2. The UE is deemed to meet the requirement if the reported SS-RSRP is in the range shown in Table A.7.7.1.2.3-1.

Relative accuracy of Cell 2 compared with Cell 1. The UE is deemed to meet the requirement if the difference in reported SS-RSRP meets the requirements in A.7.7.1.2.3-2.

**Table A.7.7.1.2.3-1: SS-RSRP absolute accuracy test requirement**

	<b>Test requirement</b> <small>Notes1,2,3,4</small>
Cell 1	$SSB\_RP1 - \delta + G_{min} + X \leq \text{Reported RSRP(dBm)} \leq SSB\_RP1 + \delta + G_{max}$
Cell 2	$SSB\_RP2 - \delta + G_{min} \leq \text{Reported RSRP(dBm)} \leq SSB\_RP2 + \delta + G_{max}$
Note 1:	SSB_RPn is the equivalent power received by an antenna with 0dBi gain at the centre of the quiet zone configured in the test for the cell n under consideration
Note 2:	$\delta$ is the RSRP absolute accuracy requirement from Table 10.1.5.1.1-1, selected according to the $I_o$ used in the test
Note 3:	$G_{min}$ and $G_{max}$ are the minimum and maximum UE gain values from Table B.2.1.5.1-1, selected according to the UE power class
Note 4:	X is the Spherical coverage gain difference in dB, derived as (UE Refsens - UE Spherical coverage) from TS 38.101-2 [19] clauses 7.3.2 and 7.3.4, selected according to the UE power class and operating band. X is always a negative value.

**Table A.7.7.1.2.3-2: SS-RSRP relative accuracy test requirement**

	<b>Test requirement</b> <small>Notes1,2,3,4, 5, 6, 7</small>
Cell 2 – Cell 1	$SSB\_RP2 - SSB\_RP1 - \delta - D - G_{inter} \leq \text{Reported RSRP(dB)} \leq SSB\_RP2 - SSB\_RP1 + \delta + G_{inter} - (X) + E$
Note 1:	SSB_RPn is the equivalent power received by an antenna with 0dBi gain at the centre of the quiet zone configured in the test for the cell n under consideration
Note 2:	$\delta$ is the RSRP relative accuracy requirement from Table 10.1.5.1.2-1
Note 3:	Void
Note 4:	X is the Spherical coverage gain difference in dB, derived as (UE Refsens - UE Spherical coverage) from TS 38.101-2 [19] clauses 7.3.2 and 7.3.4, selected according to the UE power class and operating band. X is always a negative value.
Note 5:	D is the margin due to mis-alignment between fine beam and rough beam. D is the Rough Beam gain reduction in Rx beam peak direction from Table B.2.1.5.3-1, selected according to the UE power class. D is always a positive value.
Note 6:	$G_{inter}$ is the margin due to different antenna gain caused by frequency separation. $G_{inter}$ is from Table B.2.1.5.2-1, selected according to the UE power class, and is always a positive value.
Note 7:	E = 3 (dB) is an additional margin to account for the actual gain difference between peak direction and spherical coverage using rough beams.

### A.7.7.1.3 SA inter-frequency measurement accuracy with FR1 serving cell and FR2 target cell

#### A.7.7.1.3.1 Test Purpose and Environment

The purpose of this test is to verify that the SS-RSRP measurement accuracy is within the specified limits. This test will verify the requirements in clauses 10.1.5.1.1 for inter-frequency measurements with the testing configurations in Table A.7.7.1.3.1-1.

**Table A.7.7.1.3.1-1: Applicable NR configurations for FR2 inter-frequency SS-RSRP accuracy test**

Config	Description of serving cell	Description of target cell
1	NR 15 kHz SSB SCS, 10 MHz bandwidth, FDD duplex mode	120 kHz SSB SCS, 100 MHz bandwidth, TDD duplex mode
2	NR 15 kHz SSB SCS, 10 MHz bandwidth, TDD duplex mode	
3	NR 30 kHz SSB SCS, 40 MHz bandwidth, TDD duplex mode	

#### A.7.7.1.3.2 Test parameters

In this set of test cases there are two cells in the test, PCell (Cell 1) in FR1 and Cell 2 in FR2. The test parameters for the Cell 1 and Cell 2 are given in Table A.7.7.1.3.2-1 and Table A.7.7.1.3.2-2 below. Absolute accuracy of RSRP inter-frequency measurements are tested by using the parameters in Table A.7.7.1.3.2-1 and Table A.7.7.1.3.2-2. The inter-frequency measurements are supported by a measurement gap.

**Table A.7.7.1.3.2-1: SS-RSRP inter-frequency test parameters**

Parameter	Config	Unit	Test 1		Test 2	
			Cell 1	Cell 2	Cell 1	Cell 2
SSB ARFCN	1~3		freq1	freq2	freq1	freq2
BW <sub>channel</sub>	1	MHz	10: N <sub>RB,c</sub> = 52	100: N <sub>RB,c</sub> = 66	10: N <sub>RB,c</sub> = 52	100: N <sub>RB,c</sub> = 66
	2		10: N <sub>RB,c</sub> = 52		10: N <sub>RB,c</sub> = 52	
	3		40: N <sub>RB,c</sub> = 106		40: N <sub>RB,c</sub> = 106	
Data RBs allocated	1,2		52	24	52	66
	3		106		106	
Duplex mode	1		FDD	TDD	FDD	TDD
	2		TDD		TDD	
	3		TDD		TDD	
TDD configuration	1		N/A	TDDConf. 3.1	N/A	TDDConf. 3.1
	2		TDDConf. 1.1		TDDConf. 1.1	
	3		TDDConf. 2.1		TDDConf. 2.1	
PDSCH Reference measurement channel	1		SR.1.1 FDD	-	SR.1.1 FDD	-
	2		SR.1.1 TDD		SR.1.1 TDD	
	3		SR.2.1 FDD		SR.2.1 FDD	
RMSI CORESET Reference Channel	1		CR.1.1 FDD	-	CR.1.1 FDD	-
	2		CR.1.1 TDD		CR.1.1 TDD	
	3		CR.2.1 FDD		CR.2.1 FDD	
Dedicated CORESET Reference Channel	1		CCR.1.1 FDD	-	CCR.1.1 FDD	-
	2		CCR.1.1 TDD		CCR.1.1 TDD	
	3		CCR.2.1 TDD		CCR.2.1 TDD	
SSB configuration	1		SSB.1 FR1	SSB.3 FR2	SSB.1 FR1	SSB.3 FR2
	2		SSB.1 FR1		SSB.1 FR1	

	3		SSB.2 FR1		SSB.2 FR1	
OCNG Patterns	1~3		OP.1	OP.3	OP.1	OP.1
Initial BWP Configuration	1~3		DLBWP.0.1 ULBWP.0.1		DLBWP.0.1 ULBWP.0.1	
Dedicated BWP configuration	1~3		DLBWP.1.3 ULBWP.1.3		DLBWP.1.3 ULBWP.1.3	
TRS Configuration	1~3		TRS.2.1 TDD		TRS.2.1 TDD	
PDCCH/PDSCH TCI Configuration	1~3		TCI.State.2		TCI.State.2	
SMTC configuration	1~3		SMTC.1		SMTC.1	
Time offset between Cell 2 and Cell 1	1~3	µs	3		3	
EPRE ratio of PSS to SSS	1~3	dB	0	0	0	0
EPRE ratio of PBCH DMRS to SSS						
EPRE ratio of PBCH to PBCH DMRS						
EPRE ratio of PDCCH DMRS to SSS						
EPRE ratio of PDCCH to PDCCH DMRS						
EPRE ratio of PDSCH DMRS to SSS						
EPRE ratio of PDSCH to PDSCH DMRS						
EPRE ratio of OCNG DMRS to SSS <sup>Note 1</sup>						
EPRE ratio of OCNG to OCNG DMRS <sup>Note 1</sup>						
Propagation condition	1~3	-	NA Link only, see clause A.3.7A	AWGN	NA Link only, see clause A.3.7A	AWGN
Antenna configuration	1~3	-		1x2		1x2
Note 1: OCNG shall be used such that both cells are fully allocated and a constant total transmitted power spectral density is achieved for all OFDM symbols.						
Note 2: Void						

**Table A.7.7.1.3.2-2: SS-RSRP inter-frequency OTA related test parameters**

Parameter	Config	Unit	Test 1		Test 2 <sup>NOTE 3</sup>	
			Cell 1	Cell 2	Cell 1	Cell 2
Angle of arrival configuration according to clause A.3.15			NA	Setup 2b	NA	Setup 2b
Assumption for UE beams <sup>Note 4</sup>			N/A	Rough	N/A	Rough
$N_{oc}$	1~3	dBm/15 kHz	Link only, see clause A.3.7A	-90	Link only, see clause A.3.7A	NA
$N_{oc}$	1~3	dBm/SS B SCS		-80.97		NA
$\hat{E}_s / N_{oc}$	1~3	dB		5		NA
$E_s$	1~3	dBm/SC S				(Table B.2.3-2 Spherical coverage +1dB)
SSB_RP <sup>Note1</sup>	1~3	dBm/SC S		-76.0		Table B.2.3-2 Spherical coverage +1dB)
$\hat{E}_s / I_{01, BB}$ <sup>Note6</sup>	1~3	dB		4.35		-3.81

$I_{o}^{Note1}$	1~3	dBm/ 95.04M Hz	50.18	SSB_RP +28.98
<p>Note 1: <math>E_s/I_{ot}</math>, SSB_RP and <math>I_o</math> levels have been derived from other parameters for information purposes. They are not settable parameters themselves.</p> <p>Note 2: Void</p> <p>Note 3: No additional noise is added by the test system in Test 2.</p> <p>Note 4: Information about types of UE beam is given in B.2.1.3, and does not limit UE implementation or test system implementation</p> <p>Note 5: Where used, interference from other cells and noise sources not specified in the test is assumed to be constant over subcarriers and time and shall be modelled as AWGN of appropriate power for <math>N_{oc}</math> to be fulfilled.</p> <p>Note 6: Calculation of <math>E_s/I_{otBB}</math> includes the effect of UE internal noise up to the value assumed for the associated Refsens requirement in clause 7.3.2 of TS 38.101-2 [19], and an allowance of 1dB for UE multi-band relaxation factor <math>\Delta MBs</math> from TS 38.101-2 [19] Table 6.2.1.3-4.</p>				

### A.7.7.1.3.3 Test Requirements

The SS-RSRP measurement accuracy for Cell 2 shall fulfil the Absolute requirement in clause 10.1.5.1.1.

Test 1:

Absolute accuracy of Cell 2. The UE is deemed to meet the requirement if the reported SS-RSRP is in the range shown in Table A.7.7.1.3.3.

Test 2:

Absolute accuracy of Cell 2. The UE is deemed to meet the requirement if the reported SS-RSRP is in the range shown in Table A.7.7.1.3.3.

**Table A.7.7.1.3.3: SS-RSRP absolute accuracy test requirement**

	Test requirement <sup>Notes1,2,3,4</sup>
Cell 2	$SSB\_RP1 - \delta + G_{min} + X \leq \text{Reported RSRP(dBm)} \leq SSB\_RP1 + \delta + G_{max}$
Note 1:	SSB_RPn is the equivalent power received by an antenna with 0dBi gain at the centre of the quiet zone configured in the test for the cell n under consideration
Note 2:	$\delta$ is the RSRP absolute accuracy requirement from Table 10.1.5.1.1-1, selected according to the $I_o$ used in the test
Note 3:	$G_{min}$ and $G_{max}$ are the minimum and maximum UE gain values from Table B.2.1.5.1-1, selected according to the UE power class
Note 4:	X is the Spherical coverage gain difference in dB, derived as (UE Refsens - UE Spherical coverage) from TS 38.101-2 [19] clauses 7.3.2 and 7.3.4, selected according to the UE power class and operating band. X is always a negative value.

## A.7.7.2 SS-RSRQ

### A.7.7.2.1 SA intra-frequency measurement accuracy with FR2 serving cell and FR2 target cell

#### A.7.7.2.1.1 Test Purpose and Environment

The purpose of this test is to verify that the SS-RSRQ measurement accuracy is within the specified limits. This test will verify the requirements in Clause 10.1.8.1.1.

#### A.7.7.2.1.2 Test Parameters

In this test case all cells are on the same carrier frequency. Supported test configurations are shown in Table A.7.7.2.1.2-1. The absolute accuracy of SS-RSRQ intra-frequency measurement is test by using the parameters in Table A.7.7.2.1.2-2 and Table A.7.7.2.1.2-3. In all test cases, Cell 1 is the PCell and Cell 2 the target cell.

**Table A.7.7.2.1.2-1: SS-RSRQ Intra frequency SS-RSRQ supported test configurations**

Configuration	Description
---------------	-------------



1	120 kHz SSB SCS, 100 MHz bandwidth, TDD duplex mode
---	---

**Table A.7.7.2.1.2-2: SS-RSRQ Intra frequency test parameters**

Parameter		Unit	Test 1		Test 2	
			Cell 1	Cell 2	Cell 1	Cell 2
Cell ID			489	0	489	0
SSB ARFCN			Freq1		Freq1	
Duplex mode			TDD		TDD	
TDD configuration			TDDConf.3.1		TDDConf.3.1	
BW <sub>channel</sub>		MHz	100: N <sub>RB,c</sub> = 66		100: N <sub>RB,c</sub> = 66	
Data RBs allocated			66		66	
BWP configuration	Initial DL BWP		DLBWP.0.1			
	Dedicated DL BWP		DLBWP.1.1			
	Initial UL BWP		ULBWP.0.1			
	Dedicated UL BWP		ULBWP.1.1			
TRS configuration			TRS.2.1 TDD		TRS.2.1 TDD	
TCI state			TCI.State. 0		TCI.Stat e.0	
PDSCH Reference measurement channel			SR.3.1 TDD		SR.3.1 TDD	
RMSI CORESET Reference Channel			CR.3.1 TDD	-	CR.3.1 TDD	
Control channel RMC			CCR.3.1 TDD	-	CCR.3.1 TDD	-
OCNG Patterns			OP.1	OP.1	OP.1	OP.1
SMTC configuration			SMTC.1			
SSB configuration			SSB.1 FR2	SSB.1 FR2	SSB.1 FR2	SSB.1 FR2
PDSCH/PDCCH subcarrier spacing		kHz	120	120	120	120
SS-RSSI-Measurement			Not Applicable			
EPRE ratio of PSS to SSS		dB	0	0	0	0
EPRE ratio of PBCH_DMRS to SSS						
EPRE ratio of PBCH to PBCH_DMRS						
EPRE ratio of PDCCH_DMRS to SSS						
EPRE ratio of PDCCH to PDCCH_DMRS						
EPRE ratio of PDSCH_DMRS to SSS						
EPRE ratio of PDSCH to PDSCH_DMRS						
EPRE ratio of OCNG DMRS to SSS <sup>Note 1</sup>						
EPRE ratio of OCNG to OCNG DMRS <sup>Note 1</sup>						
Propagation condition						
Antenna configuration			1x2	1x2	1x2	1x2
Note 1: OCNG shall be used such that both cells are fully allocated and a constant total transmitted power spectral density is achieved for all OFDM symbols. Note 2: Void Note 3: Void Note 4: Void Note 5: Void						

**Table A.7.7.2.1.2-3: SS-RSRQ Intra frequency OTA related test parameters**

	Unit	Test 1		Test 2	
		Cell 1	Cell 2	Cell 1	Cell 2
Angle of arrival configuration		Setup 1 according to clause A.3.15.1		Setup 1 according to clause A.3.15.1	
Assumption for UE beams <sup>Note 9</sup>		Rough			
$N_{oc}$ <sup>Note1</sup>	dBm/15kHz <sup>Note4</sup>	-95		-95	
$N_{oc}$ <sup>Note1</sup>	dBm/SCS <sup>Note3</sup>	-86		-86	
$\hat{E}_s / N_{oc}$	dB	3	3	-3	-3
SSB_RP <sup>Note2</sup>	dBm/SCS <sup>Note4</sup>	-83	-83	-89	-89

SS-RSRQ <sup>Note2</sup>	dB	-14.77	-14.77	-16.81	-16.81
$\hat{E}_s / I_{ot}$	dB	-1.76	-1.76	-4.76	-4.76
$I_o$ <sup>Note2</sup>	dBm/95.04 MHz <sup>Note4</sup>	-50		-54	
<p>Note 1: Interference from other cells and noise sources not specified in the test is assumed to be constant over subcarriers and time and shall be modelled as AWGN of appropriate power for <math>N_{oc}</math> to be fulfilled.</p> <p>Note 2: SS-RSRQ, SSB_RP, and <math>I_o</math> levels have been derived from other parameters for information purposes. They are not settable parameters themselves.</p> <p>Note 3: SS-RSRQ and SS-RSRP minimum requirements are specified assuming independent interference and noise at each receiver antenna port.</p> <p>Note 4: Equivalent power received by an antenna with 0dBi gain at the centre of the quiet zone</p> <p>Note 5: As observed with 0dBi gain antenna at the centre of the quiet zone</p> <p>Note 6: Void</p> <p>Note 7: Void</p> <p>Note 8: Void</p> <p>Note 9: Information about types of UE beam is given in B.2.1.3, and does not limit UE implementation or test system implementation</p>					

### A.7.7.2.1.3 Test Requirements

The SS-RSRQ absolute measurement accuracy in test 1 shall be within the range Nominal SS-RSRQ+2.5dB to Nominal SS-RSRQ-2.5dB and the SS-RSRQ measurement accuracy in test 2 shall be within the range Nominal RSRQ+3.5dB to Nominal RSRQ-3.5dB according to the requirements in clause 10.1.8.1.1. Nominal RSRQ is the value shown in table A.7.7.2.1.2-3.

### A.7.7.2.2 SA Inter-frequency measurement accuracy with FR2 serving cell and FR2 TDD target cell

#### A.7.7.2.2.1 Test Purpose and Environment

The purpose of this test is to verify that the SS-RSRQ measurement accuracy is within the specified limits. This test will verify the requirements in clause 10.1.9.1.1 and 10.1.9.1.2 for inter-frequency measurement.

#### A.7.7.2.2.2 Test Parameters

In this test case the two cells (i.e., Cell 1 and Cell 2) are on different carrier frequencies and measurement gaps are provided. Supported test configurations are shown in Table A.7.7.2.2.2-1. Both absolute accuracy and relative accuracy requirements of SS-RSRQ inter-frequency measurement are tested by using test parameters in Table A.7.7.2.2.2-2 and Table A.7.7.2.2.2-3. In all test cases, Cell 1 is the PCell and Cell 2 is target cell.

**Table A. 7.7.2.2.2-1: SS-RSRQ Inter frequency SS-RSRQ supported test configurations**

Configuration	Description
1	120 kHz SSB SCS, 100 MHz bandwidth, TDD duplex mode

**Table A.7.7.2.2.2-2: SS-RSRQ Inter frequency general test parameters**

Parameter	Unit	Test 1		Test 2	
		Cell 1	Cell 2	Cell 1	Cell 2
SSB ARFCN		Freq1	freq2	freq1	Freq2
SSB Configuration		SSB.1 FR2	SSB.1 FR2	SSB.1 FR2	SSB.1 FR2
CSI-RS for tracking		TRS.2. 1 TDD	-	TRS.2. 1 TDD	-
Duplex mode		TDD		TDD	
TDD configuration		TDDConf.3.1		TDDConf.3.1	
BW <sub>channel</sub>	MHz	100: N <sub>RB,c</sub> = 66		100: N <sub>RB,c</sub> = 66	
Data RBs allocated		66		66	
BWP configuration	Initial DL BWP	DLBWP.0.1			
	Dedicated DL BWP	DLBWP.1.1			

	Initial UL BWP	ULBWP.0.1			
	Dedicated UL BWP	ULBWP.1.1			
TRS configuration		TRS.2.1 TDD	-	TRS.2.1 TDD	-
TCI state		TCI.State.0	-	TCI.State.0	-
PDSCH Reference measurement channel		SR.3.1 TDD	-	SR.3.1 TDD	-
RMSI CORESET Reference Channel		CR.3.1 TDD	-	CR.3.1 TDD	-
OCNG Patterns		OP.1	OP.1	OP.1	OP.1
SMTC configuration		SMTC.1 FR2	SMTC.1 FR2	SMTC.1 FR2	SMTC.1 FR2
PDSCH/PDCCH subcarrier spacing	kHz	120	120	120	120
EPRE ratio of PSS to SSS	dB	0	0	0	0
EPRE ratio of PBCH_DMRS to SSS					
EPRE ratio of PBCH to PBCH_DMRS					
EPRE ratio of PDCCH_DMRS to SSS					
EPRE ratio of PDCCH to PDCCH_DMRS					
EPRE ratio of PDSCH_DMRS to SSS					
EPRE ratio of PDSCH to PDSCH_DMRS					
EPRE ratio of OCNG DMRS to SSS <sup>Note 1</sup>					
EPRE ratio of OCNG to OCNG DMRS <sup>Note 1</sup>					
Propagation conditions			AWGN	AWGN	AWGN
Antenna configuration		1x2	1x2	1x2	1x2
Note 1: OCNG shall be used such that both cells are fully allocated and a constant total transmitted power spectral density is achieved for all OFDM symbols. Note 2: Void Note 3: Void Note 4: Void					

**Table A.7.7.2.2-3: SS-RSRQ Inter frequency OTA related test parameters**

Parameter	Unit	Test 1		Test 2	
		Cell 1	Cell 2	Cell 1	Cell 2
AoA setup		Setup 1 in clause A.3.15.		Setup 1 in clause A.3.15.	
Assumption for UE beams <sup>Note 8</sup>		Rough		Rough	
$N_{oc}$ <sup>Note1</sup>	dBm/15kHz <sup>Note4</sup>	-94.03	-94.03	-94.03	-94.03
$N_{oc}$ <sup>Note1</sup>	dBm/SCS <sup>Note3</sup>	-85.0	-85.0	-85.0	-85.0
$\hat{E}_s / N_{oc}$	dB	-1.75	-1.75	-3	-1.75
SSB_RP <sup>Note2</sup>	dBm/SCS <sup>Note4</sup>	-86.75	-86.75	-88	-88
SS-RSRQ <sup>Note2</sup>	dB	-14.75	-14.75	-15.56	-15.56
$\hat{E}_s / I_{ot}$	dB	-1.75	-1.75	-3	-3
$I_o$ <sup>Note2</sup>	dBm/95.04 MHz <sup>Note4</sup>	-53.8	-53.8	-54.25	-54.25
Note 1: Interference from other cells and noise sources not specified in the test is assumed to be constant over subcarriers and time and shall be modelled as AWGN of appropriate power for $N_{oc}$ to be fulfilled. Note 2: SS-RSRQ, SSB_RP, and $I_o$ levels have been derived from other parameters for information purposes. They are not settable parameters themselves. Note 3: SS-RSRQ and SS-RSRP minimum requirements are specified assuming independent interference and noise at each receiver antenna port. Note 4: Equivalent power received by an antenna with 0dBi gain at the centre of the quiet zone Note 5: As observed with 0dBi gain antenna at the centre of the quiet zone Note 6: Void Note 7: Void Note 8: Information about types of UE beam is given in B.2.1.3, and does not limit UE implementation or test system implementation					

### A.7.7.2.2.3 Test Requirements

The SS-RSRQ absolute measurement accuracy in test 1 shall be within the range Nominal SS-RSRQ+2.5dB to Nominal SS-RSRQ -2.5dB and the SS-RSRQ measurement accuracy in test 2 shall be within the range Nominal SS-RSRQ +3.5dB to Nominal SS-RSRQ -3.5dB according to the requirements in clause 10.1.10.1.1.

The SS-RSRQ relative measurement accuracy shall fulfil the requirements in clause 10.1.10.1.2.

## A.7.7.3 SS-SINR

### A.7.7.3.1 SA intra-frequency case measurement accuracy with FR2 serving cell and FR2 target cell

#### A.7.7.3.1.1 Test Purpose and Environment

The purpose of this test is to verify that the SS-SINR measurement accuracy is within the specified limits. This test will verify the requirements in Clause 10.1.13.1.1.

#### A.7.7.3.1.2 Test Parameters

In this test case all cells are on the same carrier frequency. Supported test configurations are shown in Table A.7.7.3.1.2-1. The absolute accuracy of SS-SINR intra-frequency measurement is test by using the parameters in Table A.7.7.3.1.2-2 and Table A.7.7.3.1.2-3. In all test cases, Cell 1 is the PCell and Cell 2 the target cell. The TCI status for Cell 1 is defined in Table A.3.16.2-1 and TRS configuration for Cell 1 is defined in Table A.3.17.2.1-1.

**Table A.7.7.3.1.2-1: SS-SINR Intra frequency SS-SINR supported test configurations**

Configuration	Description
1	120 kHz SSB SCS, 100 MHz bandwidth, TDD duplex mode

**Table A.7.7.3.1.2-2: SS-SINR Intra frequency test parameters**

Parameter	Unit	Test 1		Test 2	
		Cell 1	Cell 2	Cell 1	Cell 2
Cell ID		489	0	489	0
SSB ARFCN		Freq2		Freq2	
Duplex mode		TDD		TDD	
TDD configuration		TDDConf.3.1		TDDConf.3.1	
BW <sub>channel</sub>	MHz	100: N <sub>RB,c</sub> = 66		100: N <sub>RB,c</sub> = 66	
Data RBs allocated		66		66	
Downlink initial BWP configuration		DLBWP.0.1			
Downlink dedicated BWP configuration		DLBWP.1.1			
Uplink initial BWP configuration		ULBWP.0.1			
Uplink dedicated BWP configuration		ULBWP.1.1			
DRX cycle configuration	ms	Not applicable			
TRS configuration		TRS.2.1 TDD			
TCI state		TCI.State.0			
PDSCH Reference measurement channel		SR.3.1 TDD		SR.3.1 TDD	
RMSI CORESET Reference Channel		CR.3.1 TDD	-	CR.3.1 TDD	
Dedicated RMSI CORESET Reference Channel		CCR.3. 1 TDD	-	CCR.3. 1 TDD	-
OCNG Patterns		OP.1	OP.1	OP.1	OP.1
SMTTC configuration		SMTTC.1			
SSB configuration		SSB.1 FR2	SSB.1 FR2	SSB.1 FR2	SSB.1 FR2
PDSCH/PDCCH subcarrier spacing	kHz	120	120	120	120
SS-RSSI-Measurement		Not Applicable			
EPRE ratio of PSS to SSS	dB	0	0	0	0
EPRE ratio of PBCH_DMRS to SSS					
EPRE ratio of PBCH to PBCH_DMRS					
EPRE ratio of PDCCH_DMRS to SSS					
EPRE ratio of PDCCH to PDCCH_DMRS					
EPRE ratio of PDSCH_DMRS to SSS					

EPRE ratio of PDSCH to PDSCH_DMRS				
EPRE ratio of OCNG DMRS to SSS <sup>Note 1</sup>				
EPRE ratio of OCNG to OCNG DMRS <sup>Note 1</sup>				
Propagation conditions		AWGN		
Note 1: OCNG shall be used such that both cells are fully allocated and a constant total transmitted power spectral density is achieved for all OFDM symbols.				
Note 2: Void				
Note 3: Void.				
Note 4: Void				

**Table A.7.7.3.1.2-3: SS-SINR Intra frequency OTA related test parameters**

Parameter	Unit	Test 1		Test 3	
		Cell 1	Cell 2	Cell 1	Cell 2
Angle of arrival configuration		Setup 1 according to clause A.3.15.1		Setup 1 according to clause A.3.15.1	
Assumption for UE beams <sup>Note 9</sup>		Rough		Rough	
$N_{oc}$ <sup>Note1</sup>	dBm/15kHz <sup>Note4</sup>	-105		-105	
$N_{oc}$ <sup>Note1</sup>	dBm/SCS <sup>Note3</sup>	-96		-96	
$\hat{E}_s / N_{oc}$	dB	4.54	2.66	-3	-3
SSB_RP <sup>Note2</sup>	dBm/SCS <sup>Note4</sup>	-91.46	-93.34	-99	-99
SS-SINR <sup>Note2</sup>	dB	0	-3.2	-4.76	-4.76
$\hat{E}_s / I_{ot}$	dB	0	-3.2	-4.76	-4.76
$I_o$ <sup>Note2</sup>	dBm/95.04 MHz <sup>Note4</sup>	-59.2		-64	
<p>Note 1: Interference from other cells and noise sources not specified in the test is assumed to be constant over subcarriers and time and shall be modelled as AWGN of appropriate power for <math>N_{oc}</math> to be fulfilled.</p> <p>Note 2: SS-SINR, SSB_RP, and <math>I_o</math> levels have been derived from other parameters for information purposes. They are not settable parameters themselves.</p> <p>Note 3: SS-SINR and SS-RSRP minimum requirements are specified assuming independent interference and noise at each receiver antenna port.</p> <p>Note 4: Equivalent power received by an antenna with 0 dBi gain at the centre of the quiet zone</p> <p>Note 5: As observed with 0 dBi gain antenna at the centre of the quiet zone</p> <p>Note 6: Void</p> <p>Note 7: Void</p> <p>Note 8: Void</p> <p>Note 9: Information about types of UE beam is given in B.2.1.3, and does not limit UE implementation or test system implementation</p>					

**A.7.7.3.1.3 Test Requirements**

The SS-SINR absolute measurement accuracy in test 1 shall be within the range Nominal SS-SINR+3B to Nominal SS-SINR -3dB and the SS-SINR measurement accuracy in test 2 shall be within the range Nominal SS-SINR +3.5dB to Nominal SS-SINR -3.5dB according to the requirements in clause 10.1.10.13.1.

**A.7.7.3.2 SA Inter-frequency measurement accuracy with FR2 serving cell and FR2 TDD target cell**

**A.7.7.3.2.1 Test Purpose and Environment**

The purpose of this test is to verify that the SS-SINR measurement accuracy is within the specified limits. This test will verify the requirements in Clause 10.1.15.1.1 and 10.1.15.1.2 for inter-frequency measurement.

A.7.7.3.2.2 Test Parameters

In this test case the two cells (i.e., Cell 1 and Cell 2) are on different carrier frequencies and measurement gaps are provided. Supported test configurations are shown in Table A.7.7.3.2.2-1. Both absolute accuracy and relative accuracy requirements of SS-SINR inter-frequency measurement are tested by using test parameters in Table A.7.7.3.2.2-2 and Table A.7.7.3.2.2-3. In all test cases, Cell 1 is the PCell and Cell 2 is target cell. The TCI status for Cell 1 is defined in Table A.3.16.2-1 and TRS configuration for Cell 1 is defined in Table A.3.17.2.1-1.

**Table A.7.7.3.2.2-1: SS-SINR Inter frequency SS-SINR supported test configurations**

Configuration	Description
1	120 kHz SSB SCS, 100 MHz bandwidth, TDD duplex mode

**Table A.7.7.3.2.2-2: SS-SINR Inter frequency general test parameters**

Parameter	Unit	Test 1		Test 2		Test 3	
		Cell 1	Cell 2	Cell 1	Cell 2	Cell 1	Cell 2
SSB ARFCN		freq1	freq2	freq1	freq2	freq1	freq2
Duplex mode		TDD		TDD		TDD	
TDD configuration		TDDConf.3.1		TDDConf.3.1		TDDConf.3.1	
BW <sub>channel</sub>	MHz	100: N <sub>RB,c</sub> = 66		100: N <sub>RB,c</sub> = 66		100: N <sub>RB,c</sub> = 66	
Data RBs allocated		66		66		66	
Downlink initial BWP configuration		DLBWP.0.1					
Downlink dedicated BWP configuration		DLBWP.1.1					
Uplink initial BWP configuration		ULBWP.0.1					
Uplink dedicated BWP configuration		ULBWP.1.1					
DRX cycle configuration	ms	Not applicable					
TRS configuration		TRS.2.1 TDD					
TCI state		TCI.State.0					
PDSCH Reference measurement channel		SR.3.1 TDD	-	SR.3.1 TDD	-	SR.3.1 TDD	-
RMSI CORESET Reference Channel		CR.3.1 TDD	-	CR.3.1 TDD	-	CR.3.1 TDD	-
OCNG Patterns		OP.1	OP.1	OP.1	OP.1	OP.1	OP.1
SMTC configuration		SMTC. 1 FR2	SMTC. 1 FR2	SMTC. 1 FR2	SMTC. 1 FR2	SMTC. 1 FR2	SMTC. 1 FR2
SSB configuration		SSB.3 FR2	SSB.3 FR2	SSB.3 FR2	SSB.3 FR2	SSB.3 FR2	SSB.3 FR2
PDSCH/PDCCH subcarrier spacing	kHz	120	120	120	120	120	120
EPRE ratio of PSS to SSS	dB	0	0	0	0	0	0
EPRE ratio of PBCH_DMRS to SSS							
EPRE ratio of PBCH to PBCH_DMRS							
EPRE ratio of PDCCH_DMRS to SSS							
EPRE ratio of PDCCH to PDCCH_DMRS							
EPRE ratio of PDSCH_DMRS to SSS							
EPRE ratio of PDSCH to PDSCH_DMRS							
EPRE ratio of OCNG DMRS to SSS <sup>Note 1</sup>							
EPRE ratio of OCNG to OCNG DMRS <sup>Note 1</sup>							
Propagation conditions		AWGN	AWGN	AWGN	AWGN	AWGN	AWGN
Antenna configuration		1x2	1x2	1x2	1x2	1x2	1x2
Note 1: OCNG shall be used such that both cells are fully allocated and a constant total transmitted power spectral density is achieved for all OFDM symbols. Note 2: Void Note 3: Void Note 4: Void							

**Table A.7.7.3.2.2-3: SS-SINR Inter frequency OTA related test parameters**

Parameter	Unit	Test 1		Test 2		Test 3	
		Cell 1	Cell 2	Cell 1	Cell 2	Cell 1	Cell 2
Angle of arrival configuration	degrees	Setup 1 according to A.3.15.1		Setup 1 according to A.3.15.1		Setup 1 according to A.3.15.1	

Assumption for UE beams <sup>Note 10</sup>		Rough		Rough		Rough	
$N_{oc}$ <sup>Note1</sup>	dBm/15kHz <sup>Note4</sup>	-105	-105	-105	-105	-105	-105
$N_{oc}$ <sup>Note1</sup>	dBm/SCS <sup>Note3</sup>	-96	-96	-96	-96	-96	-96
$\hat{E}_s / N_{oc}$	dB	-0.5	-0.5	11.0	11.0	-3.0	-3.0
SSB_RP <sup>Note2</sup>	dBm/SCS <sup>Note4</sup>	-96.5	-96.5	-85	-85	-99	-99
SS-SINR <sup>Note2</sup>	dB	-0.5	-0.5	11	11	-3.0	-3.0
$\hat{E}_s / I_{ot}$	dB	-0.5	-0.5	11	11	-3.0	-3.0
$I_o$ <sup>Note2</sup>	dBm/95.04 MHz <sup>Note4</sup>	-69.3	-69.3	-55.4	-55.4	-65.24	-65.24
<p>Note 1: Interference from other cells and noise sources not specified in the test is assumed to be constant over subcarriers and time and shall be modelled as AWGN of appropriate power for <math>N_{oc}</math> to be fulfilled.</p> <p>Note 2: SS-SINR, SSB_RP, and <math>I_o</math> levels have been derived from other parameters for information purposes. They are not settable parameters themselves.</p> <p>Note 3: SS-SINR and SS-RSRP minimum requirements are specified assuming independent interference and noise at each receiver antenna port.</p> <p>Note 4: Equivalent power received by an antenna with 0 dBi gain at the centre of the quiet zone</p> <p>Note 5: As observed with 0 dBi gain antenna at the centre of the quiet zone</p> <p>Note 6: Void</p> <p>Note 7: Void</p> <p>Note 8: Void</p> <p>Note 9: Void</p> <p>Note 10: Information about types of UE beam is given in B.2.1.3, and does not limit UE implementation or test system implementation</p>							

### A.7.7.3.2.3 Test Requirements

The SS-SINR absolute measurement accuracy in test 1 shall be within the range Nominal SS-SINR +3dB to Nominal SS-SINR -3dB and the SS-SINR measurement accuracy in test 2 shall be within the range Nominal SS-SINR +3.5dB to Nominal SS-SINR -3.5dB according to the requirements in clause 10.1.15.1.1.

The SS-SINR relative measurement accuracy shall fulfil the requirements in clause 10.1.15.1.2.

## A.7.7.4 L1-RSRP measurement for beam reporting

### A.7.7.4.1 SSB based L1-RSRP measurement

#### A.7.7.4.1.1 Test Purpose and Environment

The purpose of this test is to verify that the L1-RSRP measurement accuracy is within the specified limits. This test will verify the requirements in clauses 9.5.2 and clause 10.1.20.1 for L1-RSRP measurements based on SSB with the testing configurations for NR cells in Table A.7.7.4.1.1-1.

The AoA setup for this test is Setup 1 as defined in clause A.3.15.

**Table A.7.7.4.1.1-1: Applicable NR configurations for FR2 SSB based L1-RSRP test**

Config	Description
1	NR 120 kHz SSB SCS, 100 MHz bandwidth, TDD duplex mode
2	NR 240 kHz SSB SCS, 100 MHz bandwidth, TDD duplex mode
Note:	The UE is only required to be tested in one of the supported test configurations in each supported band

#### A.7.7.4.1.2 Test parameters

In this set of test cases there are two cells in the test, PCell (Cell 1). The test parameters for the Cell 1 are given in Table A.7.7.4.1.2-1 and Table A.7.7.4.1.2-2 below. The absolute and relative accuracy of L1-RSRP measurements are tested by using the parameters in Table A.7.7.4.1.2-1 and Table A.7.7.4.1.2-2.

Here is no measurement gap configured in the test. Before the test, UE is configured one SSB resource set with two SSB resources. UE is configured to perform RLM, BFD and L1-RSRP measurement based on the SSB resources 0 and 1.

**Table A.7.7.4.1.2-1: FR2 SSB based L1-RSRP general test parameters**

Parameter	Config	Unit	Test 1	Test 2
SSB GSCN	1~2		freq1	freq1
Duplex mode	1~2		TDD	TDD
TDD Configuration	1~2		TDDConf.3.1	TDDConf.3.1
BW <sub>channel</sub>	1~2	MHz	100: N <sub>RB,c</sub> = 66	100: N <sub>RB,c</sub> = 66
Data RBs allocated	1~2		66	66
PDSCH Reference measurement channel	1		SR.3.2 TDD	SR.3.2 TDD
	2		SR.3.3 TDD	SR.3.3 TDD
RMSI CORESET Reference Channel	1		CR.3.1 TDD	CR.3.1 TDD
	2		CR.3.2 TDD	CR.3.2 TDD
Dedicated CORESET Reference Channel	1		CCR.3.1 TDD	CCR.3.1 TDD
	2		CCR.3.7 TDD	CCR.3.7 TDD
SSB configuration	1		SSB.1 FR2	SSB.1 FR2
	2		SSB.2 FR2	SSB.2 FR2
OCNG Patterns	1~2		OP.1	OP.1
Initial BWP Configuration	1~2		DLBWP.0.1 ULBWP.0.1	DLBWP.0.1 ULBWP.0.1
Dedicated BWP configuration	1~2		DLBWP.1.3 ULBWP.1.3	DLBWP.1.3 ULBWP.1.3
TRS Configuration	1~2		TRS.2.1 TDD	TRS.2.1 TDD
PDCCH/PDSCH TCI Configuration	1~2		TCI.State.2	TCI.State.2
SMTc configuration	1~2		SMTc.1	SMTc.1
reportConfigType	1~2		periodic	periodic
reportQuantity	1~2		ssb-Index-RSRP	ssb-Index-RSRP
Number of reported RS	1~2		2	2
L1-RSRP reporting period	1~2		slot320	slot320
Propagation condition	1~2		AWGN	AWGN
Antenna configuration	1~2		1x2	1x2
EPRE ratio of PSS to SSS	1~2	dB	0	0
EPRE ratio of PBCH DMRS to SSS				
EPRE ratio of PBCH to PBCH DMRS				
EPRE ratio of PDCCH DMRS to SSS				
EPRE ratio of PDCCH to PDCCH DMRS				
EPRE ratio of PDSCH DMRS to SSS				
EPRE ratio of PDSCH to PDSCH DMRS				
EPRE ratio of OCNG DMRS to SSS <sup>Note 1</sup>				
EPRE ratio of OCNG to OCNG DMRS <sup>Note 1</sup>				
<p>Note 1: OCNG shall be used such that both cells are fully allocated and a constant total transmitted power spectral density is achieved for all OFDM symbols.</p> <p>Note 2: Interference from other cells and noise sources not specified in the test is assumed to be constant over subcarriers and time and shall be modelled as AWGN of appropriate power for <math>N_{oc}</math> to be fulfilled.</p>				

**Table A.7.7.4.1.2-2: FR2 SSB based L1-RSRP OTA related test parameters**

Parameter	Config	Unit	Test 1		Test 2 <sup>NOTE 3</sup>	
			SSB0	SSB1	SSB0	SSB1



Angle of arrival configuration			Setup 1 according to A.3.15.1		Setup 1 according to A.3.15.1
Assumption for UE beams <sup>Note 4</sup>			Rough		Rough
$N_{oc}$	1~2	dBm/15 kHz	-100		n.a.
$N_{oc}$	1	dBm/SSB SCS	-91		n.a.
	2		-88		n.a.
$\hat{E}_s/I_{ot}$	1~2	dB	10	-2	n.a.
SSB_RP <sup>Note1</sup>	1	dBm/SCS	-81	-93	As in Table B.2.4-2
	2		-78	-90	As in Table B.2.4-2
$I_o$ <sup>Note1</sup>	1~2	dBm/95.04M Hz	-51.57		SSB_RP+28.98
$\hat{E}_s/N_{oc}$	1~2	dB	10	-2	n.a.
<p>Note 1: SSB_RP and <math>I_o</math> levels have been derived from other parameters for information purposes. They are not settable parameters themselves.</p> <p>Note 2: Void.</p> <p>Note 3: No additional noise is added by the test system in Test 2.</p> <p>Note 4: Information about types of UE beam is given in B.2.1.3, and does not limit UE implementation or test system implementation</p>					

#### A.7.7.4.1.3 Test Requirements

After 320ms from the beginning of the test, the L1-RSRP measurement accuracy for SSB#0 and SSB#1 of Cell 2 shall fulfil the requirements in clauses 10.1.20.1. The following requirements are to be verified:

For Test 1:

Absolute accuracy of SSB0. The UE is deemed to meet the requirement if the reported L1-RSRP is in the range shown in Table A.7.7.4.1.3-1.

Relative accuracy of SSB0 compared with SSB1. The UE is deemed to meet the requirement if the difference in reported L1-RSRP meets the requirements in Table 10.1.20.1.2-1.

For Test 2:

Absolute accuracy of SSB resource reported by UE in L1-RSRP report (SSB0 or SSB1). The UE is deemed to meet the requirement if the reported L1-RSRP is in the range shown in Table A.7.7.4.1.3-1.

Relative accuracy of SSB0 compared with SSB1. The UE is deemed to meet the requirement if the difference in reported L1-RSRP meets the requirements in Table 10.1.20.1.2-1.

**Table A.7.7.4.1.3-1: L1-RSRP absolute accuracy test requirement**

	Test requirement <sup>Notes1,2,3</sup>
SSB0	$SSB\_RP0 - \delta + G_{min} \leq \text{Reported RSRP(dBm)} \leq SSB\_RP0 + \delta + G_{max}$
SSB1	$SSB\_RP1 - \delta + G_{min} \leq \text{Reported RSRP(dBm)} \leq SSB\_RP1 + \delta + G_{max}$
<p>Note 1: SSB_RPn is the equivalent power received by an antenna with 0dBi gain at the centre of the quiet zone configured in the test for the SSB n under consideration</p> <p>Note 2: <math>\delta</math> is the RSRP absolute accuracy requirement from Table 10.1.20.1.1-1, selected according to the <math>I_o</math> used in the test</p> <p>Note 3: <math>G_{min}</math> and <math>G_{max}</math> are the minimum and maximum UE gain values from Table B.2.1.5.1-1, selected according to the UE power class</p>	

## A.7.7.4.2 CSI-RS based L1-RSRP measurement on resource set with repetition off

### A.7.7.4.2.1 Test Purpose and Environment

The purpose of this test is to verify that the L1-RSRP measurement accuracy is within the specified limits. This test will verify the requirements in clauses 9.5.3 and clause 10.1.20.2 for L1-RSRP measurements based on CSI-RS with the testing configurations for NR cells in Table A.7.7.4.2.1-1.

The AoA setup for this test is Setup 1 as defined in clause A.3.15.

**Table A.7.7.4.2.1-1: Applicable NR configurations for FR1 CSI-RS based L1-RSRP test**

Config	Description
1	NR 120 kHz CSI-RS SCS, 100 MHz bandwidth, TDD duplex mode

### A.7.7.4.2.2 Test parameters

In this set of test cases there are one cell in the test, PCell (Cell 1). The test parameters for the Cell 1 are given in Table A.7.7.4.2.2-1 and Table A.7.7.4.2.2-2 below. The absolute and relative accuracy of L1-RSRP measurements are tested by using the parameters in Table A.7.7.4.2.2-1 and Table A.7.7.4.2.2-2.

There is no measurement gap configured in the test. Before the test, UE is configured one CSI-RS resource set with two CSI-RS resources. UE is configured to perform RLM and BFD based on SSB 0 and 1. CSI-RS is not transmitted in the same OFDM symbols as SSB.

**Table A.7.7.4.2.2-1: FR2 CSI-RS based L1-RSRP general test parameters**

Parameter	Config	Unit	Test 1	Test 2
SSB GSCN	1		freq1	freq1
Duplex mode	1		TDD	TDD
TDD Configuration	1		TDDConf.3.1	TDDConf.3.1
BW <sub>channel</sub>	1	MHz	100: N <sub>RB,c</sub> = 66	100: N <sub>RB,c</sub> = 66
PDSCH Reference measurement channel	1		SR.3.1 TDD	SR.3.1 TDD
RMSI CORESET Reference Channel	1		CR.3.1 TDD	CR.3.1 TDD
Dedicated CORESET Reference Channel	1		CCR.3.1 TDD	CCR.3.1 TDD
SSB configuration	1		SSB.1 FR2	SSB.1 FR2
OCNG Patterns	1		OP.1	OP.1
Initial BWP Configuration	1		DLBWP.0.1 ULBWP.0.1	DLBWP.0.1 ULBWP.0.1
Dedicated BWP configuration	1		DLBWP.1.1 ULBWP.1.1	DLBWP.1.1 ULBWP.1.1
TRS Configuration	1		TRS.2.1 TDD	TRS.2.1 TDD
PDCCH/PDSCH TCI Configuration	1		TCI.State.2	TCI.State.2
SMTc configuration	1		SMTc.1	SMTc.1
CSI-RS	1		CSI-RS.3.2 TDD	CSI-RS.3.2 TDD
reportConfigType	1		periodic	periodic
reportQuantity	1		cri-RSRP	cri-RSRP
Number of reported RS	1		2	2
L1-RSRP reporting period	1		slot80	slot80
Propagation condition	1		AWGN	AWGN
Antenna configuration	1		1x2	1x2
EPRE ratio of PSS to SSS	1	dB	0	0
EPRE ratio of PBCH DMRS to SSS				
EPRE ratio of PBCH to PBCH DMRS				
EPRE ratio of PDCCH DMRS to SSS				
EPRE ratio of PDCCH to PDCCH DMRS				

EPRE ratio of PDSCH DMRS to SSS			
EPRE ratio of PDSCH to PDSCH DMRS			
EPRE ratio of OCNG DMRS to SSS <sup>Note 1</sup>			
EPRE ratio of OCNG to OCNG DMRS <sup>Note 1</sup>			
<p>Note 1: OCNG shall be used such that both cells are fully allocated and a constant total transmitted power spectral density is achieved for all OFDM symbols.</p> <p>Note 2: Interference from other cells and noise sources not specified in the test is assumed to be constant over subcarriers and time and shall be modelled as AWGN of appropriate power for <math>N_{oc}</math> to be fulfilled.</p>			

**Table A.7.7.4.2.2-2: FR2 CSI-RS based L1-RSRP OTA related test parameters**

Parameter	Config	Unit	Test 1		Test 2 <sup>NOTE 3</sup>	
			CSI-RS0	CSI-RS1	CSI-RS0	CSI-RS1
Angle of arrival configuration			Setup 1 according to A.3.15.1		Setup 1 according to A.3.15.1	
Assumption for UE beams <sup>Note 4</sup>			Rough		Rough	
$N_{oc}$	1~2	dBm/15 kHz	-100		n.a.	
$N_{oc}$	1~2	dBm/SS B SCS	-91		n.a. n.a.	
$\hat{E}_s / I_{at}$	1~2	dB	10	-2	n.a.	
CSI-RS-RSRP <sup>Note1</sup>	1~2	dBm/SC S	-81	-93	As in Table B.2.4-2	
$I_o$ <sup>Note1</sup>	1~2	dBm/95.04M Hz	-59.86		SS-RSRP+28.98	
$\hat{E}_s / N_{oc}$	1~2	dB	-51.57	-2	n.a.	
<p>Note 1: RSRP and <math>I_o</math> levels have been derived from other parameters for information purposes. They are not settable parameters themselves.</p> <p>Note 2: RSRP minimum requirements are specified assuming independent interference and noise at each receiver antenna port.</p> <p>Note 3: No additional noise is added by the test system in Test 2.</p> <p>Note 4: Information about types of UE beam is given in B.2.1.3, and does not limit UE implementation or test system implementation</p>						

**A.7.7.4.2.3 Test Requirements**

After 640ms from the beginning of the test, the L1-RSRP measurement accuracy for CSI-RS#0 and CSI-RS#1 of Cell 1 shall fulfil the requirements in clause 10.1.20.2. The following requirements are to be verified:

For Test 1:

Absolute accuracy of CSI-RS0. The UE is deemed to meet the requirement if the reported L1-RSRP is in the range shown in Table A.7.7.4.2.3-1.

Relative accuracy of CSI-RS0 compared with CSI-RS1. The UE is deemed to meet the requirement if the difference in reported L1-RSRP meets the requirements in Table 10.1.20.2.2-1.

For Test 2:

Absolute accuracy of CSI-RS resource reported by UE in L1-RSRP report (CSI-RS0 or CSI-RS1). The UE is deemed to meet the requirement if the reported L1-RSRP is in the range shown in Table A.7.7.4.2.3-1.

Relative accuracy of CSI-RS0 compared with CSI-RS1. The UE is deemed to meet the requirement if the difference in reported L1-RSRP meets the requirements in Table 10.1.20.2.2-1.

**Table A.7.7.4.2.3-1: L1-RSRP absolute accuracy test requirement**

	Test requirement <sup>Notes1,2,3</sup>
CSI-RS0	$CSI-RS\_RP0 - \delta + G_{min} \leq \text{Reported RSRP(dBm)} \leq CSI-RS\_RP0 + \delta + G_{max}$
CSI-RS1	$CSI-RS\_RP1 - \delta + G_{min} \leq \text{Reported RSRP(dBm)} \leq CSI-RS\_RP1 + \delta + G_{max}$
Note 1:	CSI-RS_RPn is the equivalent power received by an antenna with 0dBi gain at the centre of the quiet zone configured in the test for the CSI-RS n under consideration
Note 2:	$\delta$ is the RSRP absolute accuracy requirement from Table 10.1.20.2.1-1, selected according to the $I_o$ used in the test
Note 3:	$G_{min}$ and $G_{max}$ are the minimum and maximum UE gain values from Table B.2.1.5.1-1, selected according to the UE power class

## A.7.7.5 CLI measurements

### A.7.7.5.1 SA SRS-RSRP measurement accuracy with FR2 serving cell

#### A.7.7.5.1.1 Test Purpose and Environment

The purpose of this test is to verify that the SRS-RSRP measurement accuracy is within the specified limits. This test will verify the requirements in Clauses 10.1.22.1.1 with the testing configurations for NR cells in Table A.7.7.5.1.1-1.

**Table A.7.7.5.1.1-1: Applicable NR configurations for FR2 SRS-RSRP accuracy test**

Config	Description
1	120 kHz SRS SCS, 100 MHz bandwidth, TDD duplex mode
Note:	The UE is only required to be tested in one of the supported test configurations in each supported band

#### A.7.7.5.1.2 Test parameters

In this set of test cases there is one cell in the test, FR2 PCell (Cell 1). The test parameters for the Cell 1 are given in Table A.7.7.5.1.2-1 and A.7.7.5.1.2-2 below. The test parameter for the (virtual) neighbor cell UE transmitting SRS are given in Table A.7.7.5.1.2-2.

Before the test UE is configured to perform SRS-RSRP measurement. During the test, the test system transmits SRS resources for measurement in the DL slots according to the SRS configuration in Table A.7.7.5.1.2-3. There is no measurement gap configured in the test. During the test, the test system does not transmit PDCCH/PDSCH/OCNG on SRS symbol to be transmitted and on 2 data symbols before SRS to be transmitted.

**Table A.7.7.5.1.2-1: FR2 test parameters for SRS-RSRP accuracy**

Parameter	Config	Unit	Test 1	Test 2
SSB GSCN	1		freq1	freq1
Duplex mode	1		TDD	TDD
TDD configuration	1		TDDConf.3.1	TDDConf.3.1
BW <sub>channel</sub>	1	MHz	100: N <sub>RB,c</sub> = 66	100: N <sub>RB,c</sub> = 66
PDSCH Reference measurement channel	1		SR.3.1 TDD	SR.3.1 TDD
RMSI CORESET Reference Channel	1		CR.3.1 TDD	CR.3.1 TDD
Dedicated CORESET Reference Channel	1		CCR.3.1 TDD	CCR.3.1 TDD
SSB configuration	1		SSB.3 FR2	SSB.3 FR2
OCNG Patterns	1		OP.1	OP.1
TRS configuration	1		TRS.2.1 TDD	TRS.2.1 TDD
Initial BWP Configuration	1		DLBWP.0.1 ULBWP.0.1	DLBWP.0.1 ULBWP.0.1
Dedicated BWP configuration	1		DLBWP.1.3 ULBWP.1.3	DLBWP.1.3 ULBWP.1.3
SMTc configuration	1		SMTc.1	SMTc.1
Time offset between DL from serving cell and SRS from test system	1	μs	10.76	10.67
EPRE ratio of PSS to SSS	1	dB	0	0
EPRE ratio of PBCH DMRS to SSS				

EPRE ratio of PBCH to PBCH DMRS				
EPRE ratio of PDCCH DMRS to SSS				
EPRE ratio of PDCCH to PDCCH DMRS				
EPRE ratio of PDSCH DMRS to SSS				
EPRE ratio of PDSCH to PDSCH DMRS				
EPRE ratio of OCNG DMRS to SSS <sup>Note 1</sup>				
EPRE ratio of OCNG to OCNG DMRS <sup>Note 1</sup>				
Propagation condition	1		AWGN	AWGN
Antenna configuration	1		1x2	1x2
Note 1: OCNG shall be used such that a constant total transmitted power spectral density is achieved for all OFDM symbols.				

**Table A.7.7.5.1.2-2: SRS-RSRP accuracy OTA related test parameters for PCell and Neighbour cell UE in FR2**

Parameter	Unit	T1	T2
Angle of arrival configuration		Setup 1 defined A.3.15.1	Setup 1 defined A.3.15.1
Beam assumption <sup>Note 5</sup>		Fine	Fine
$N_{oc}$ <sup>Note1</sup>	dBm/15kHz <sub>z</sub> <sup>Note3</sup>	-100	N/A
$N_{oc}$ <sup>Note1</sup>	dBm/SCS <sup>Note3</sup>	-91	N/A
$\hat{E}_s / N_{oc}$	dB	2	N/A
$E_s$	dBm/SCS <sup>Note3</sup>		(Table B.2.7-2 Rx Beam Peak)
SRS_RP <sup>Note2</sup>	dBm/SCS	-89	(Table B.2.7-2 Rx Beam Peak)
$\hat{E}_s / I_{ot\_BB}$ <sup>Note4</sup>	dB	>1	1
$I_o$ <sup>Note2</sup>	dBm/95.04 MHz <sup>Note3</sup>	-57.89	(Table B.2.7-2 Rx Beam Peak +50.79dB)
<p>Note 1: Where used, interference from other cells and noise sources not specified in the test is assumed to be constant over subcarriers and time and shall be modelled as AWGN of appropriate power for <math>N_{oc}</math> to be fulfilled.</p> <p>Note 2: SRS_RP, <math>E_s/I_{ot}</math> and <math>I_o</math> levels have been derived from other parameters for information purposes. They are not settable parameters themselves.</p> <p>Note 3: Equivalent power received by an antenna with 0 dBi gain at the centre of the quiet zone</p> <p>Note 4: Calculation of <math>E_s/I_{ot\_BB}</math> includes the effect of UE internal noise up to the value assumed for the associated Refsens requirement in clause 7.3.2 of TS 36.101-2 [19], and an allowance of 2dB for UE multi-band relaxation factor <math>\sum MB_P</math> from TS 38.101-2 [19] Table 6.2.1.3-4.</p> <p>Note 5: Information about types of UE beam is given in B.2.1.3, and does not limit UE implementation or test system implementation.</p>			

**Table A.7.7.5.1.2-3: SRS configuration parameters for FR2 SRS-RSRP accuracy**

	Field	SRSCnf.1
SRS-ResourceSet	srs-ResourceSetId	0
	srs-ResourceIdList	0
	resourceType	Periodic
	Usage	Codebook

SRS-Resource	SRS-ResourceId	0
	nrofSRS-Ports	Port1
	transmissionComb	n2
	combOffset-n2	0
	cyclicShift-n2	0
	resourceMapping startPosition	0
	resourceMapping nrofSymbols	n1
	resourceMapping repetitionFactor	n1
	freqDomainPosition	0
	freqDomainShift	0
	freqHopping c-SRS	12
	freqHopping b-SRS	0
	freqHopping b-hop	0
	groupOrSequenceHopping	Neither
	resourceType	Periodic
	periodicityAndOffset-p	s160,25
sequenceId	0	

A.7.7.5.1.3 Test Requirements

The SRS-RSRP measurement accuracy shall fulfil the absolute accuracy requirements in clauses 10.1.22.1.1. The following requirements are to be verified:

During T1:

The UE is deemed to meet the requirement if the reported SRS-RSRP is in the range shown in table A.7.7.5.1.3-1.

During T2:

The UE is deemed to meet the requirement if the reported SRS-RSRP is in the range shown in table A.7.7.5.1.3-1.

**Table A.7.7.5.1.3-1: SRS-RSRP absolute accuracy test requirement**

SRS	Test requirement <sup>Notes1,2,3</sup>
	$SRS\_RP - \delta + G_{min} \leq \text{Reported SRS-RSRP(dBm)} \leq SRS\_RP + \delta + G_{max}$
Note 1:	SRS_RP is the equivalent power received by an antenna with 0dBm gain at the centre of the quiet zone configured in the test
Note 2:	$\delta$ is the RSRP absolute accuracy requirement from Table 10.1.22.1.1-2, selected according to the $I_o$ used in the test
Note 3:	$G_{min}$ and $G_{max}$ are the minimum and maximum UE gain values from Table B.2.1.5.1-1, selected according to the UE power class

A.7.7.5.2 SA CLI-RSSI measurement accuracy with FR2 serving cell

A.7.7.5.2.1 Test Purpose and Environment

The purpose of this test is to verify that the CLI-RSSI measurement accuracy is within the specified limits. This test will verify the requirements in Clauses 10.1.22.2.1 with the testing configurations for NR cells in Table A.7.7.5.2.1-1.

**Table A.7.7.5.2.1-1: Applicable NR configurations for FR2 CLI-RSSI accuracy test**

Config	Description
1	120 kHz SRS SCS, 100 MHz bandwidth, TDD duplex mode
Note:	The UE is only required to be tested in one of the supported test configurations in each supported band

## A.7.7.5.2.2 Test parameters

In this set of test cases there is one cell in the test, FR2 PCell (Cell 1). The test parameters for the Cell 1 are given in Table A.7.7.5.2.2-1 and A.7.7.5.2.2-2 below.

Before the test UE is configured to perform CLI-RSSI measurement. There is no measurement gap configured in the test. During the test, the test system does not transmit PDCCH/PDSCH/OCNG on symbols for CLI-RSSI resource and on 2 data symbol before. The CLI-RSSI measurement resource configuration is in Table A.7.7.5.2.2-3.

**Table A.7.7.5.2.2-1: FR2 test parameters for CLI-RSSI accuracy**

Parameter	Config	Unit	Test 1	Test 2
SSB GSCN	1		freq1	freq1
Duplex mode	1		TDD	TDD
TDD configuration	1		TDDConf.3.1	TDDConf.3.1
BW <sub>channel</sub>	1	MHz	100: N <sub>RB,c</sub> = 66	100: N <sub>RB,c</sub> = 66
PDSCH Reference measurement channel	1		SR.3.1 TDD	SR.3.1 TDD
RMSI CORESET Reference Channel	1		CR.3.1 TDD	CR.3.1 TDD
Dedicated CORESET Reference Channel	1		CCR.3.1 TDD	CCR.3.1 TDD
SSB configuration	1		SSB.3 FR2	SSB.3 FR2
OCNG Patterns <sup>Note2</sup>	1		OP.1	OP.1
TRS configuration	1		TRS.2.1 TDD	TRS.2.1 TDD
Initial BWP Configuration	1		DLBWP.0.1 ULBWP.0.1	DLBWP.0.1 ULBWP.0.1
Dedicated BWP configuration	1		DLBWP.1.3 ULBWP.1.3	DLBWP.1.3 ULBWP.1.3
SMTc configuration	1		SMTc.1	SMTc.1
Time offset between DL from serving cell and OCNG from test system	1	µs	10.67	10.67
EPRE ratio of PSS to SSS	1	dB	0	0
EPRE ratio of PBCH DMRS to SSS				
EPRE ratio of PBCH to PBCH DMRS				
EPRE ratio of PDCCH DMRS to SSS				
EPRE ratio of PDCCH to PDCCH DMRS				
EPRE ratio of PDSCH DMRS to SSS				
EPRE ratio of PDSCH to PDSCH DMRS				
EPRE ratio of OCNG DMRS to SSS <sup>Note 1</sup>				
EPRE ratio of OCNG to OCNG DMRS <sup>Note 1</sup>				
Propagation condition	1		AWGN	AWGN
Antenna configuration	1		1x2	1x2
Note 1: OCNG shall be used such that a constant total transmitted power spectral density is achieved for all OFDM symbols.				
Note 2: OCNG is not transmitted in the CLI-RSSI measurement resources.				

**Table A.7.7.5.2.2-2: CLI-RSSI accuracy OTA related test parameters**

Parameter	Unit	T1	T2
Angle of arrival configuration		Setup 1 defined A.3.15.1	
Beam assumption <sup>Note 5</sup>		Fine	
$N_{oc}$ on CLI-RSSI measurement resource <sup>Note1</sup>	dBm/15kHz $z$ <sup>Note3</sup>	-100	

$N_{oc}$ on CLI-RSSI measurement resource <sup>Note1</sup>	dBm/SCS <sup>Note3</sup>	-91
$\hat{E}_s/N_{oc}$ on CLI-RSSI measurement resource	dB	-Infinity
RSRP on CLI-RSSI measurement resource <sup>Note2</sup>	dBm/SCS	-Infinity
$\hat{E}_s/I_{ot\ BB}$ on CLI-RSSI measurement resource <sup>Note4</sup>	dB	-Infinity
Io on CLI-RSSI measurement resource <sup>Note2</sup>	dBm/95.04 MHz <sup>Note3</sup>	-62.01
Io on CLI-RSSI measurement resource <sup>Note2</sup>	dBm/1.08 MHz	-81.46
<p>Note 1: Where used, interference from other cells and noise sources not specified in the test is assumed to be constant over subcarriers and time and shall be modelled as AWGN of appropriate power for <math>N_{oc}</math> to be fulfilled.</p> <p>Note 2: SRS<sub>RP</sub>, Es/Iot and Io levels have been derived from other parameters for information purposes. They are not settable parameters themselves.</p> <p>Note 3: Equivalent power received by an antenna with 0 dBi gain at the centre of the quiet zone</p> <p>Note 4: Calculation of Es/Iot<sub>BB</sub> includes the effect of UE internal noise up to the value assumed for the associated Refsens requirement in clause 7.3.2 of TS 36.101-2 [19], and an allowance of 2dB for UE multi-band relaxation factor <math>\Sigma MB_P</math> from TS 38.101-2 [19] Table 6.2.1.3-4.</p> <p>Note 5: Information about types of UE beam is given in B.2.1.3, and does not limit UE implementation or test system implementation.</p>		

**Table A.7.7.5.2.2-3: CLI-RSSI measurement resource configuration for FR2 CLI-RSSI accuracy**

	Field	SRSCConf.1
CLI-RSSI measurement resource	rsi-ResourceId	0
	rsi-SCS	120kHz
	startPRB	0
	nrofPRBs	66
	startPosition	3
	nrofSymbols	11
	rsi-PeriodicityAndOffset	sl160, 25

**A.7.7.5.2.3 Test Requirements**

The CLI-RSSI measurement accuracy shall fulfil the absolute accuracy requirements in clauses 10.1.22.2.1. The following requirements are to be verified:

During T1:

The UE is deemed to meet the requirement if the reported CLI-RSSI is in the range shown in table A.7.7.5.2.3-1.

During T2:

The UE is deemed to meet the requirement if the reported CLI-RSSI is in the range shown in table A.7.7.5.2.3-1.

**Table A.7.7.5.2.3-1: CLI-RSSI absolute accuracy test requirement**

	Test requirement <sup>Notes1,2,3</sup>
	$Io - \delta + G_{min} \leq \text{Reported CLI-RSSI(dBm)} \leq Io + \delta + G_{max}$
Note 1:	Io is the equivalent power received by an antenna with 0dBi gain at the centre of the quiet zone configured in the test for 1.08MHz
Note 2:	δ is the RSRP absolute accuracy requirement from Table 10.1.22.1.1-2, selected according to the Io used in the test



Note 3: $G_{min}$ and $G_{max}$ are the minimum and maximum UE gain values from Table B.2.1.5.1-1, selected according to the UE power class
---

## A.7.7.6 L1-SINR measurement for beam reporting

### A.7.7.6.1 L1-SINR measurement with CSI-RS based CMR and no dedicated IMR configured and CSI-RS resource set with repetition off

#### A.7.7.6.1.1 Test Purpose and Environment

The purpose of this test is to verify that the L1-SINR measurement accuracy is within the specified limits. This test will verify the requirements in clauses 9.8.4.1 and clause 10.1.28.1 for L1-SINR measurements based on CSI-RS with the testing configurations for NR cells in Table A.7.7.6.1.1-1.

The AoA setup for this test is Setup 1 as defined in clause A.3.15.

**Table A.7.7.6.1.1-1: Applicable NR configurations for FR2 L1-SINR test with CSI-RS based CMR and no dedicated IMR configured**

Config	Description
1	NR 120 kHz CSI-RS SCS, 100 MHz bandwidth, TDD duplex mode

#### A.7.7.6.1.2 Test parameters

In this set of test cases there are one cell in the test, PCell (Cell 1). The test parameters for the Cell 1 are given in Table A.7.7.6.1.2-1 and Table A.7.7.6.1.2-2 below. The absolute and relative accuracy of L1-SINR measurements are tested by using the parameters in Table A.7.7.6.1.2-1 and Table A.7.7.6.1.2-2.

There is no measurement gap configured in the test. Before the test, UE is configured one CSI-RS resource set with two CSI-RS resources. UE is configured to perform RLM and BFD based on SSB 0 and 1. CSI-RS is not transmitted in the same OFDM symbols as SSB.

**Table A.7.7.6.1.2-1: FR2 CSI-RS based L1-SINR general test parameters**

Parameter	Config	Unit	Test 1
SSB GSCN	1		freq1
Duplex mode	1		TDD
TDD Configuration	1		TDDConf.3.1
$BW_{channel}$	1	MHz	100: $N_{RB,c} = 66$
PDSCH Reference measurement channel	1		SR.3.1 TDD
RMSI CORESET Reference Channel	1		CR.3.1 TDD
Dedicated CORESET Reference Channel	1		CCR.3.1 TDD
SSB configuration	1		SSB.1 FR2
OCNG Patterns	1		OP.1
Initial BWP Configuration	1		DLBWP.0.1 ULBWP.0.1
Dedicated BWP configuration	1		DLBWP.1.3 ULBWP.1.3
TRS Configuration	1		TRS.2.1 TDD
PDCCH/PDSCH TCI Configuration	1		TCI.State.2
SMTc configuration	1		SMTc.1
CSI-RS	1		CSI-RS.3.2 TDD
reportConfigType	1		periodic
reportQuantity	1		cri-SINR-r16
nrofReportedRS	1		2
L1-SINR reporting period	1		slot80
Propagation condition	1		AWGN

Antenna configuration	1		1x2
EPRE ratio of PSS to SSS	1	dB	0
EPRE ratio of PBCH DMRS to SSS			
EPRE ratio of PBCH to PBCH DMRS			
EPRE ratio of PDCCH DMRS to SSS			
EPRE ratio of PDCCH to PDCCH DMRS			
EPRE ratio of PDSCH DMRS to SSS			
EPRE ratio of PDSCH to PDSCH DMRS			
EPRE ratio of OCNG DMRS to SSS <sup>Note 1</sup>			
EPRE ratio of OCNG to OCNG DMRS <sup>Note 1</sup>			
<p>Note 1: OCNG shall be used such that both cells are fully allocated and a constant total transmitted power spectral density is achieved for all OFDM symbols.</p> <p>Note 2: Interference from other cells and noise sources not specified in the test is assumed to be constant over subcarriers and time and shall be modelled as AWGN of appropriate power for <math>N_{oc}</math> to be fulfilled.</p>			

Table A.7.7.6.1.2-2: FR2 CSI-RS based L1-SINR OTA related test parameters

Parameter	Config	Unit	Test 1	
			CSI-RS0	CSI-RS1
Angle of arrival configuration			Setup 1 according to A.3.15.1	
Assumption for UE beams <sup>Note 4</sup>			Rough	
$N_{oc}$	1~2	dBm/15 kHz	-100	
$N_{oc}$	1~2	dBm/SSB SCS	-91	
$\hat{E}_s / I_{ot}$	1~2	dB	10	-2
CSI-RS-RSRP <sup>Note1</sup>	1~2	dBm/SCS	-81	-93
$I_o$ <sup>Note1</sup>	1~2	dBm/95.04M Hz	-51.57	-59.86
$\hat{E}_s / N_{oc}$	1~2	dB	10	-2
<p>Note 1: RSRP and <math>I_o</math> levels have been derived from other parameters for information purposes. They are not settable parameters themselves.</p> <p>Note 2: RSRP minimum requirements are specified assuming independent interference and noise at each receiver antenna port.</p> <p>Note 3: Void.</p> <p>Note 4: Information about types of UE beam is given in B.2.1.3, and does not limit UE implementation or test system implementation</p>				

### A.7.7.6.1.3 Test Requirements

After 640ms from the beginning of the test, the L1-SINR measurement accuracy for CSI-RS#0 and CSI-RS#1 of Cell 1 shall fulfil the requirements in clauses 10.1.28.1. The following requirements are to be verified:

For Test 1:

Absolute accuracy of CSI-RS0. The UE is deemed to meet the requirement if the reported L1-SINR is in the range shown in Table A.7.7.6.1.3-1.

Relative accuracy of CSI-RS0 compared with CSI-RS1. The UE is deemed to meet the requirement if the reported differential L1-SINR is in the range shown in Table A.7.7.6.1.3-1.

**Table A.7.7.6.1.3-1: L1-SINR absolute accuracy test requirement**

	Test requirement <sup>Notes1,2</sup>
CSI-RS0	$L1-SINR0 - \delta \leq \text{Reported SINR (dB)} \leq L1-SINR0 + \delta$
Note 1:	L1-SINR0 is the equivalent SINR received by an antenna with 0dBi gain at the centre of the quiet zone configured in the test for the CSI-RS 0 under consideration
Note 2:	$\delta$ is the SINR absolute accuracy requirement from Table 10.1.28.2.1-1, selected according to the $l_0$ used in the test

**Table A.5.7.6.1.3-2: L1-SINR relative accuracy test requirement**

	Test requirement <sup>Notes1,2</sup>
CSI-RS0 - CSI-RS1	$L1-SINR0 - L1-SINR1 - \sigma \leq \text{Reported DIFFSINR (dB)} \leq L1-SINR0 - L1-SINR1 + \sigma$
Note 1:	L1-SINRn is the equivalent SINR received by an antenna with 0dBi gain at the centre of the quiet zone configured in the test for the CSI-RS n under consideration
Note 2:	$\sigma$ is the SINR relative requirement from Table 10.1.28.1.2-1, selected according to the $l_0$ used in the test

## A.7.7.6.2 L1-SINR measurement with SSB based CMR and dedicated IMR

### A.7.7.6.2.1 Test Purpose and Environment

The purpose of this test is to verify that the L1-SINR measurement accuracy is within the specified limits. This test will verify the requirements in clauses 9.8.4.2 and clause 10.1.28.2 for L1-SINR measurements with SSB based CMR and CSI-IM based IMR, with the testing configurations for NR cells in Table A.7.7.6.2.1-1.

The AoA setup for this test is Setup 1 as defined in clause A.3.15.

**Table A.7.7.6.2.1-1: Applicable NR configurations for FR2 L1-SINR measurement test with SSB based CMR and CSI-IM based IMR**

Config	Description
1	LTE FDD, NR 120 kHz SSB SCS, 100 MHz bandwidth, TDD duplex mode
2	LTE FDD, NR 240 kHz SSB SCS, 100 MHz bandwidth, TDD duplex mode
Note:	The UE is only required to be tested in one of the supported test configurations in each supported band

### A.7.7.6.2.2 Test parameters

In this set of test cases there are two cells in the test, PCell (Cell 1). The test parameters for the Cell 1 are given in Table A.7.7.6.2.2-1 and Table A.7.7.6.2.2-2 below. The absolute and relative accuracy of L1-SINR measurements are tested by using the parameters in Table A.7.7.6.2.2-1 and Table A.7.7.6.2.2-2.

Here is no measurement gap configured in the test. Before the test, UE is configured one SSB resource set with two SSB resources and one CSI-IM resource set with two CSI-IM resource. UE is configured to perform RLM and BFD measurement based on the SSB resources 0 and 1. UE is configured to perform L1-SINR measurement based on the SSBs as CMR and the CSI-IM resources as IMR.

**Table A.7.7.6.2.2-1: FR2 L1-SINR general test parameters with SSB based CMR and CSI-IM based IMR**

Parameter	Config	Unit	Test 1
SSB GSCN	1~2		freq1
Duplex mode	1~2		TDD
TDD Configuration	1~2		TDDConf.3.1
BW <sub>channel</sub>	1~2	MHz	100: N <sub>RB,c</sub> = 66
PDSCH Reference measurement channel	1~2		SR.3.1 TDD
RMSI CORESET Reference Channel	1~2		CR.3.1 TDD

Dedicated CORESET Reference Channel	1~2		CCR.3.1 TDD
SSB configuration	1		SSB.1 FR2
	2		SSB.2 FR2
CSI-IM configuration	1~2		CSI-IM 3.1 TDD
OCNG Patterns	1~2		OP.1
Initial BWP Configuration	1~2		DLBWP.0.1 ULBWP.0.1
Dedicated BWP configuration	1~2		DLBWP.1.3 ULBWP.1.3
TRS Configuration	1~2		TRS.2.1 TDD
PDCCH/PDSCH TCI Configuration	1~2		TCI.State.2
SMTc configuration	1~2		SMTc.1
reportConfigType	1~2		periodic
reportQuantity-r16	1~2		ssb-Index-SINR-r16
Number of reported RS	1~2		2
L1-SINR reporting period	1~2		slot640
Propagation condition	1~2		AWGN
Antenna configuration	1~2		1x2
EPRE ratio of PSS to SSS	1~2	dB	0
EPRE ratio of PBCH DMRS to SSS			
EPRE ratio of PBCH to PBCH DMRS			
EPRE ratio of PDCCH DMRS to SSS			
EPRE ratio of PDCCH to PDCCH DMRS			
EPRE ratio of PDSCH DMRS to SSS			
EPRE ratio of PDSCH to PDSCH DMRS			
EPRE ratio of OCNG DMRS to SSS <sup>Note 1</sup>			
EPRE ratio of OCNG to OCNG DMRS <sup>Note 1</sup>			
<p>Note 1: OCNG shall be used such that both cells are fully allocated and a constant total transmitted power spectral density is achieved for all OFDM symbols.</p> <p>Note 2: Interference from other cells and noise sources not specified in the test is assumed to be constant over subcarriers and time and shall be modelled as AWGN of appropriate power for <math>N_{oc}</math> to be fulfilled.</p>			

Table A.7.7.6.2.2-2: FR2 L1-SINR SSB specific test parameters

Parameter	Config	Unit	Test 1	
			SSB0	SSB1
Angle of arrival configuration			Setup 1 according to A.3.15.1	
Assumption for UE beams <sup>Note 4</sup>			Rough	
$N_{oc}$	1~2	dBm/15kHz	-100	
$N_{oc}$	1	dBm/SSB	-91	
	2	SCS	-88	
$\hat{E}_s / I_{ot}$	1~2	dB	10	-2
SS-RSRP <sup>Note1</sup>	1	dBm/SCS	-81	-93
	2		-78	-90
$I_o$ <sup>Note1</sup>	1~2	dBm/95.04 MHz	-51.57	-59.86
$\hat{E}_s / N_{oc}$	1~2	dB	10	-2
<p>Note 1: RSRP and <math>I_o</math> levels have been derived from other parameters for information purposes. They are not settable parameters themselves.</p> <p>Note 2: RSRP minimum requirements are specified assuming independent interference and noise at each receiver antenna port.</p>				

Note 3: Information about types of UE beam is given in B.2.1.3, and does not limit UE implementation or test system implementation

### A.7.7.6.2.3 Test Requirements

After 640ms from the beginning of the test, the L1-SINR measurement accuracy for SSB#0+CSI-IM#0 and SSB#1+CSI-IM#1 of Cell 1 shall fulfil the requirements in clauses 10.1.28.2. The following requirements are to be verified:

For Test 1:

Absolute accuracy of SSB#0+CSI-IM#0. The UE is deemed to meet the requirement if the reported L1-SINR is in the range shown in Table A.7.7.6.2.3-1.

Relative accuracy of SSB#0+CSI-IM#0 compared with SSB#1+CSI-IM#1. The UE is deemed to meet the requirement if the reported differential L1-SINR is in the range shown in Table A.7.7.6.2.3-2.

**Table A.7.7.6.2.3-1: L1-SINR absolute accuracy test requirement**

Test requirement <sup>Notes1,2</sup>	
SSB#0+CSI-IM#0	$L1\_SINR0 - \delta \leq \text{Reported SINR(dB)} \leq L1\_SINR0 + \delta$
Note 1:	L1_SINR0 is the equivalent SINR received by an antenna with 0dBi gain at the centre of the quiet zone configured in the test for the SSB#0+CSI-IM#0 under consideration
Note 2:	$\delta$ is the SINR absolute accuracy requirement from Table 10.1.28.2.1-2, selected according to the $I_0$ used in the test

**Table A.7.7.6.2.3-2: L1-SINR relative accuracy test requirement**

Test requirement <sup>Notes1,2</sup>	
SSB#0+CSI-IM#0 - SSB#1+CSI-IM#1	$L1\_SINR0 - L1\_SINR1 - \sigma \leq \text{Reported DIFFSINR (dB)} \leq L1\_SINR0 - L1\_SINR1 + \sigma$
Note 1:	L1-SINRn is the equivalent SINR received by an antenna with 0dBi gain at the centre of the quiet zone configured in the test for the SSB#n+CSI-IM#n under consideration
Note 2:	$\sigma$ is the SINR relative requirement from Table 10.1.28.2.2-1, selected according to the $I_0$ used in the test

## A.7.7.6.3 L1-SINR measurement with CSI-RS based CMR and dedicated IMR

### A.7.7.6.3.1 Test Purpose and Environment

The purpose of this test is to verify that the L1-SINR measurement accuracy is within the specified limits. This test will partly verify the requirements in Clauses 9.8.4.3 and clause 10.1.28.3 for L1-SINR measurements based on CSI-RS as both CMR and IMR with the testing configurations for NR cell in Table A.7.7.6.3.1-1.

The AoA setup for this test is Setup 1 as defined in clause A.3.15.

**Table A.7.7.6.3.1-1: Applicable NR configurations for FR2 L1-SINR measurement test with CSI-RS based both CMR based IMR**

Config	Description
1	NR 120 kHz CSI-RS SCS, 100 MHz bandwidth, TDD duplex mode

### A.7.7.6.3.2 Test parameters

In this set of test cases there are one cell in the test, PCell (Cell 1). The test parameters for the Cell 1 are given in Table A.7.7.6.3.2-1 and Table A.7.7.6.3.2-2 below. The absolute and relative accuracy of L1-SINR measurements are tested by using the parameters in Table A.7.7.6.3.2-1 and Table A.7.7.6.3.2-2.

There is no measurement gap configured in the test. Before the test, UE is configured two CSI-RS resource sets with two CSI-RS resources for each set. UE is configured to perform RLM and BFD based on SSB 0 and 1. CSI-RS is not transmitted in the same OFDM symbols as SSB. UE is configured to perform L1-SINR measurement based on the configured CSI-RS as both CMR and IMR.

**Table A.7.7.6.3.2-1: FR2 L1-SINR measurement test with CSI-RS based both CMR and IMR**

Parameter	Config	Unit	Test 1
SSB GSCN	1		freq1
Duplex mode	1		TDD
TDD Configuration	1		TDDConf.3.1
BW <sub>channel</sub>	1	MHz	100: N <sub>RB,c</sub> = 66
PDSCH Reference measurement channel	1		SR.3.1 TDD
RMSI CORESET Reference Channel	1		CR.3.1 TDD
Dedicated CORESET Reference Channel	1		CCR.3.1 TDD
SSB configuration	1		SSB.1 FR2
OCNG Patterns	1		OP.1
Initial BWP Configuration	1		DLBWP.0.1 ULBWP.0.1
Dedicated BWP configuration	1		DLBWP.1.1 ULBWP.1.1
TRS Configuration	1		TRS.2.1 TDD
PDCCH/PDSCH TCI Configuration	1		TCI.State.2
SMTC configuration	1		SMTC.1
CSI-RS configuration as CMR	1		CSI-RS.3.2 TDD
CSI-RS configuration as IMR	1		CSI-RS.3.3A TDD
reportConfigType	1		periodic
reportQuantity-r16	1		cri-SINR-r16
nrofReportedRS	1		2
L1-RSRP reporting period	1		slot80
Propagation condition	1		AWGN
Antenna configuration	1		1x2
EPRE ratio of PSS to SSS	1	dB	0
EPRE ratio of PBCH DMRS to SSS			
EPRE ratio of PBCH to PBCH DMRS			
EPRE ratio of PDCCH DMRS to SSS			
EPRE ratio of PDCCH to PDCCH DMRS			
EPRE ratio of PDSCH DMRS to SSS			
EPRE ratio of PDSCH to PDSCH DMRS			
EPRE ratio of OCNG DMRS to SSS <sup>Note 1</sup>			
EPRE ratio of OCNG to OCNG DMRS <sup>Note 1</sup>			
<p>Note 1: OCNG shall be used such that both cells are fully allocated and a constant total transmitted power spectral density is achieved for all OFDM symbols.</p> <p>Note 2: Interference from other cells and noise sources not specified in the test is assumed to be constant over subcarriers and time and shall be modelled as AWGN of appropriate power for <math>N_{oc}</math> to be fulfilled.</p>			

**Table A.7.7.6.3.2-2: FR2 CSI-RS based L1-SINR measurement OTA related test parameters**

Parameter	Config	Unit	Test 1	
			CSI-RS0	CSI-RS1
Angle of arrival configuration			Setup 1 according to A.3.15.1	
Assumption for UE beams <sup>Note 4</sup>			Rough	
$N_{oc}$	1~2	dBm/15 kHz	-100	
$N_{oc}$	1~2	dBm/SS B SCS	-91	

$\hat{E}_s / I_{ot}$	1~2	dB	10	0
CSI-RS-RSRP <sup>Note1</sup>	1~2	dBm/SC S	-81	-91
$I_o$ <sup>Note1</sup>	1~2	dBm/ 95.04M Hz	-51.57	-59.86
$\hat{E}_s / N_{oc}$	1~2	dB	10	0
<p>Note 1: RSRP and <math>I_o</math> levels have been derived from other parameters for information purposes. They are not settable parameters themselves.</p> <p>Note 2: RSRP minimum requirements are specified assuming independent interference and noise at each receiver antenna port.</p> <p>Note 3: No additional noise is added by the test system in Test 2.</p> <p>Note 4: Information about types of UE beam is given in B.2.1.3, and does not limit UE implementation or test system implementation</p>				

### A.7.7.6.3.3 Test Requirements

After 640ms from the beginning of the test, the L1-SINR measurement accuracy for CSI-RS#0 for CMR +CSI-RS#0 for IMR and CSI-RS#1 for CMR +CSI-RS#0 for IMR of Cell 1 shall fulfil the requirements in clause 10.1.28.3. The following requirements are to be verified:

Absolute accuracy of CSI-RS#0 for CMR + CSI-RS#0 for IMR. The UE is deemed to meet the requirement if the reported L1-SINR is in the range shown in Table A.7.7.6.3.3-1.

Relative accuracy of CSI-RS#0 for CMR + CSI-RS#0 for IMR compared with CSI-RS#1 for CMR + CSI-RS#1 for IMR. The UE is deemed to meet the requirement if the reported differential L1-SINR is in the range shown in Table A.7.7.6.3.3-2.

**Table A.7.7.6.3.3-1: L1-SINR absolute accuracy test requirement**

	Test requirement <sup>Notes1,2</sup>
CSI-RS#0 for CMR + CSI-RS#0 for IMR	$L1-SINR_0 - \delta \leq \text{Reported SINR (dBm)} \leq L1-SINR_0 + \delta$
<p>Note 1: <math>L1-SINR_n</math> is the equivalent SINR received by an antenna with 0dBi gain at the centre of the quiet zone configured in the test for the CSI-RS#n under consideration</p> <p>Note 2: <math>\delta</math> is the SINR absolute accuracy requirement from Table 10.1.28.3.1-1.</p>	

**Table A.7.7.6.3.3-2: L1-SINR relative accuracy test requirement**

	Test requirement <sup>Notes1,2</sup>
(CSI-RS#0 for CMR + CSI-RS#0 for IMR) – (CSI-RS#1 for CMR + CSI-RS#1 for IMR)	$L1-SINR_0 - L1-SINR_1 - \sigma \leq \text{Reported DIFFSINR (dB)} \leq L1-SINR_0 - L1-SINR_1 + \sigma$
<p>Note 1: <math>L1-SINR_n</math> is the equivalent SINR received by an antenna with 0dBi gain at the centre of the quiet zone configured in the test for the (CSI-RS#n for CMR + CSI-RS#n for IMR) under consideration</p> <p>Note 2: <math>\sigma</math> is the SINR relative requirement from Table 10.1.28.3.2-1, selected according to the <math>I_o</math> used in the test</p>	

## A.7.7.7 CSI-RSRP

### A.7.7.7.1 SA intra-frequency case measurement accuracy with FR2 serving cell and FR2 target cell

#### A.7.7.7.1.1 Test Purpose and Environment

The purpose of this test is to verify that the CSI-RSRP measurement accuracy is within the specified limits. This test will verify the requirements in clauses 10.1.3.2.1 and 10.1.3.2.2 for intra-frequency measurements.

## A.7.7.7.1.2 Test parameters

In this set of test cases all cells are on the same carrier frequency. Supported test configurations are shown in Table A.7.7.7.1.2-1. Both absolute and relative accuracy of CSI-RSRP intra-frequency measurements are tested by using the parameters in Table A.7.7.7.1.2-2 and A.7.7.7.1.2-3. In all test cases, Cell 1 is the PCell and Cell 2 the target cell. The TCI status for Cell 1 is defined in Table A.3.16.2-1 and TRS configuration for Cell 1 is defined in Table A.3.17.2.1-1. The test consists of two time phases T1 and T2.

**Table A.7.7.7.1.2-1: CSI-RSRP Intra frequency CSI-RSRP supported test configurations**

Configuration	Description
1	120 kHz SSB and CSI-RS SCS, 100 MHz bandwidth, TDD duplex mode

**Table A.7.7.7.1.2-2: CSI-RSRP Intra frequency general test parameters**

Parameter	Unit	T1		T2	
		Cell 1	Cell 2	Cell 1	Cell 2
Duplex mode		TDD		TDD	
TDD configuration		TDDConf.3.1		TDDConf.3.1	
BW <sub>channel</sub>	MHz	100: N <sub>RB,C</sub> = 24		100: N <sub>RB,C</sub> = 24	
Downlink initial BWP configuration		DLB WP.0. 1	-	DLB WP.0. 1	-
Downlink dedicated BWP configuration		DLB WP.1. 1	-	DLB WP.1. 1	-
Uplink initial BWP configuration		ULB WP.0. 1	-	ULB WP.0. 1	-
Uplink dedicated BWP configuration		ULB WP.1. 1	-	ULB WP.1. 1	-
DRX cycle configuration		Not applicable	-	Not applicable	-
TRS configuration		TRS.2 .1 TDD	-	TRS.2 .1 TDD	-
TCI state		TCI.St ate.0	-	TCI.St ate.0	-
PDSCH Reference measurement channel		SR.3. 1 TDD	-	SR.3. 1 TDD	-
RMSI CORESET Reference Channel		CR.3. 1 TDD	-	CR.3. 1 TDD	-
Control channel RMC		CCR. 3.1 TDD	-	CCR. 3.1 TDD	-
OCNG Patterns		OP.3	OP.3	OP.3	OP.3
SMTC configuration		SMTC.1		SMTC.1	
SSB configuration		SSB.3 FR2	SSB.3 FR2	SSB.3 FR2	SSB.3 FR2
CSI-RS configuration for RRM		CSI-RS.RRM.FR2.1 TDD			
Time offset with Cell 1	μs	-	0.58	-	0.58
PDSCH/PDCCH subcarrier spacing	kHz	120	120	120	120
EPRE ratio of PSS to SSS	dB	0	0	0	0
EPRE ratio of PBCH_DMRS to SSS					
EPRE ratio of PBCH to PBCH_DMRS					
EPRE ratio of PDCCH_DMRS to SSS					



EPRE ratio of PDCCH to PDCCH_DMRS					
EPRE ratio of PDSCH_DMRS to SSS					
EPRE ratio of PDSCH to PDSCH_DMRS					
EPRE ratio of OCNG DMRS to SSS <sup>Note 1</sup>					
EPRE ratio of OCNG to OCNG DMRS <sup>Note 1</sup>					
Propagation conditions		AWG N	AWG N	AWG N	AWG N
Antenna configuration		1x2	1x2	1x2	1x2
Note 1: OCNG shall be used such that both cells are fully allocated and a constant total transmitted power spectral density is achieved for all OFDM symbols.					

Table A.7.7.1.2-3: CSI-RSRP Intra frequency OTA related test parameters

Parameter	Unit	T1		T2	
		Cell 1	Cell 2	Cell 1	Cell 2
Angle of arrival configuration		Setup 1 according to clause A.3.15.1			
Assumption for UE beams <sup>Note 7</sup>		Rough		Assumption for UE beams <sup>Note 7</sup>	
$N_{oc}$ <sup>Note1</sup>	dBm/15kHz <sup>Note4</sup>	-91.6		N/A	
$N_{oc}$ <sup>Note1</sup>	dBm/SCS <sup>Note4</sup>	-82.6		N/A	
$\hat{E}_s/N_{oc}$	dB	6.0	1.0	N/A	N/A
$E_s$	dBm/SCS <sup>Note4</sup>			(Table B.2.2.2-2 Rx Beam Peak +2.1dB)	(Table B.2.2.2-2 Rx Beam Peak +2.1dB)
CSI-RS_RP <sup>Note2</sup>	dBm/SCS	-76.6	-81.6	(Table B.2.2.2-2 Rx Beam Peak +2.1dB)	(Table B.2.2.2-2 Rx Beam Peak +2.1dB)
$\hat{E}_s/I_{ot\_BB}$ <sup>Note6</sup>	dB	2.44	-5.98	-5.98	-5.98
$I_o$ <sup>Note2</sup>	dBm/95.04 MHz <sup>Note4</sup>	-50.05		(Table B.2.2.2-2 Rx Beam Peak +29.70dB)	
<p>Note 1: Where used, interference from other cells and noise sources not specified in the test is assumed to be constant over subcarriers and time and shall be modelled as AWGN of appropriate power for <math>N_{oc}</math> to be fulfilled.</p> <p>Note 2: CSI-RS_RP, <math>E_s/I_{ot}</math> and <math>I_o</math> levels have been derived from other parameters for information purposes. They are not settable parameters themselves.</p> <p>Note 3: Void</p> <p>Note 4: Equivalent power received by an antenna with 0 dBi gain at the centre of the quiet zone</p> <p>Note 5: Void</p> <p>Note 6: Calculation of <math>E_s/I_{ot\_BB}</math> includes the effect of UE internal noise up to the value assumed for the associated Refsens requirement in clause 7.3.2 of TS 36.101-2 [19], and an allowance of 1dB for UE multi-band relaxation factor <math>\Delta MB_P</math> from TS 38.101-2 [19] Table 6.2.1.3-4.</p> <p>Note 7: Information about types of UE beam is given in B.2.1.3, and does not limit UE implementation or test system implementation</p>					

### A.7.7.7.1.3 Test Requirements

The CSI-RSRP measurement accuracy shall fulfil the absolute accuracy requirements in clauses 10.1.3.2.1 and relative accuracy requirements in clause 10.1.3.2.2. The following requirements are to be verified:

During T1:

Absolute accuracy of Cell 1 and absolute accuracy of Cell 2. The UE is deemed to meet the requirement if the reported CSI-RSRP is in the range shown in table A.7.7.7.1.3-1.

Relative accuracy of Cell 2 compared with Cell 1. The UE is deemed to meet the requirement if the difference in reported CSI-RSRP meets the requirements in Table 10.1.3.2.2-1.

During T2:

Absolute accuracy of Cell 1 and absolute accuracy of Cell 2. The UE is deemed to meet the requirement if the reported CSI-RSRP is in the range shown in table A.7.7.7.1.3-1.

Relative accuracy of Cell 2 compared with Cell 1. The UE is deemed to meet the requirement if the difference in reported CSI-RSRP meets the requirements in Table 10.1.3.2.2-1.

During T1 and T2:

Relative accuracy of Cell 1 during T2 compared with Cell 1 during T1. The UE is deemed to meet the requirement if the difference in reported CSI-RSRP meets the requirements in Table 10.1.3.2.2-1

Relative accuracy of Cell 2 during T2 compared with Cell 2 during T1. The UE is deemed to meet the requirement if the difference in reported CSI-RSRP meets the requirements in Table 10.1.3.2.2-1.

**Table A.7.7.7.1.3-1: CSI-RSRP absolute accuracy test requirement**

	Test requirement <sup>Notes1,2,3</sup>
Cell 1	$CSI-RS\_RP1 - \delta + G_{min} \leq \text{Reported RSRP(dBm)} \leq CSI-RS\_RP1 + \delta + G_{max}$
Cell 2	$CSI-RS\_RP2 - \delta + G_{min} \leq \text{Reported RSRP(dBm)} \leq CSI-RS\_RP2 + \delta + G_{max}$
Note 1:	CSI-RS_RPn is the equivalent power received by an antenna with 0dBi gain at the centre of the quiet zone configured in the test for the cell n under consideration
Note 2:	$\delta$ is the RSRP absolute accuracy requirement from Table 10.1.3.2.1-1, selected according to the $\delta$ used in the test
Note 3:	$G_{min}$ and $G_{max}$ are the minimum and maximum UE gain values from Table B.2.1.5.1-1, selected according to the UE power class

### A.7.7.7.2 SA inter-frequency case measurement accuracy with FR2 serving cell and FR2 target cell

#### A.7.7.7.2.1 Test Purpose and Environment

The purpose of this test is to verify that the CSI-RSRP measurement accuracy is within the specified limits. This test will verify the requirements in clauses 10.1.5.2.1 and 10.1.5.2.2 for inter-frequency measurements with the testing configurations for NR cells in Table A.7.7.7.2.1-1.

**Table A.7.7.7.2.1-1: Applicable NR configurations for FR2 inter-frequency CSI-RSRP accuracy test**

Configuration	Description
1	120 kHz SSB and CSI-RS SCS, 100 MHz bandwidth, TDD duplex mode

#### A.7.7.7.2.2 Test parameters

In this set of test cases there are two cells in the test, PCell (Cell 1) and a FR2 neighbour cell (Cell 2) on a different frequency than the PCell. The test parameters and applicability for Cell 1 are defined in A.3.7.2. The test parameters for the Cell 1 and Cell 2 are given in Table A.7.7.7.2.2-1 and Table A.7.7.7.2.2-2 below. Both absolute and relative accuracy of RSRP inter-frequency measurements are tested by using the parameters in Table A.7.7.7.2.2-1 and Table A.7.7.7.2.2-1. The inter-frequency measurements are supported by a measurement gap.

Table A.7.7.2.2-1: CSI-RSRP inter-frequency test parameters

Parameter	Unit	Test 1		Test 2	
		Cell 1	Cell 2	Cell 1	Cell 2
$BW_{channel}$		100: $N_{RB,c} = 24$		100: $N_{RB,c} = 24$	
Gap pattern ID		0		0	
Duplex mode		TDD	TDD	TDD	TDD
TDD configuration		TDDConf.3.1		TDDConf.3.1	
PDSCH Reference measurement channel		SR.3.1 TDD	-	SR.3.1 TDD	-
RMSI CORESET Reference Channel		CR.3.1 TDD	-	CR.3.1 TDD	-
Dedicated CORESET Reference Channel		CCR.3.1 TDD	-	CCR.3.1 TDD	-
SSB configuration		SSB.3 FR2		SSB.3 FR2	
SMTTC configuration		SMTTC.1		SMTTC.1	
OCNG Patterns		OP.3		OP.3	
Initial BWP Configuration		DLBWP.0.1 ULBWP.0.1		DLBWP.0.1 ULBWP.0.1	
Dedicated BWP configuration		DLBWP.1.3 ULBWP.1.3		DLBWP.1.3 ULBWP.1.3	
TRS Configuration		TRS.2.1 TDD		TRS.2.1 TDD	
PDCCH/PDSCH TCI Configuration		TCI.State.2		TCI.State.2	
CSI-RS configuration for RRM		CSI-RS.RRM.FR2.1 TDD		CSI-RS.RRM.FR2.1 TDD	
Time offset between Cell 2 and Cell 3	$\mu s$	0.58		0.58	
EPRE ratio of PSS to SSS	dB	0	0	0	0
EPRE ratio of PBCH DMRS to SSS					
EPRE ratio of PBCH to PBCH DMRS					
EPRE ratio of PDCCH DMRS to SSS					
EPRE ratio of PDCCH to PDCCH DMRS					
EPRE ratio of PDSCH DMRS to SSS					
EPRE ratio of PDSCH to PDSCH DMRS					
EPRE ratio of OCNG DMRS to SSS <sup>Note 1</sup>					
EPRE ratio of OCNG to OCNG DMRS <sup>Note 1</sup>					
Propagation condition	-	AWGN	AWGN	AWGN	AWGN
Antenna configuration	-	1x2	1x2	1x2	1x2

Note 1: OCNG shall be used such that both cells are fully allocated and a constant total transmitted power spectral density is achieved for all OFDM symbols.

Table A.7.7.2.2-2: SS-RSRP inter frequency OTA related test parameters

Parameter	Unit	Test 1		Test 2	
		Cell 1	Cell 2	Cell 1	Cell 2
Angle of arrival configuration		Setup 4b according to clause A.3.15.4.2		Setup 4b according to clause A.3.15.4.2	
		AoA1 Spherical coverage	AoA2 Rx Beam Peak	AoA1 Spherical coverage	AoA2 Rx Beam Peak
$N_{oc}$ <sup>Note1</sup>	$dBm/15kHz$ $z$ <sup>Note4</sup>	-90.6	-90.6	(Table B.2.3.2-2 Rx Beam)	(Table B.2.3.2-2 Rx Beam)

				Peak +1.97dB)	Peak - 3.03dB)
Assumption for UE beams <sup>Note 7</sup>		Rough		Rough	
$N_{oc}$ <sup>Note1</sup>	dBm/SCS <sup>Note4</sup>	-81.6	-81.6	(Table B.2.3.2-2 Rx Beam Peak +11.0dB)	(Table B.2.3.2-2 Rx Beam Peak +6.0dB)
$\hat{E}_s/N_{oc}$	dB	6.0	6.0	17.0	-1.0
CSI-RS_RP <sup>Note2</sup>	dBm/SCS	-75.60	-75.60	(Table B.2.3.2-2 Rx Beam Peak +28.0dB)	(Table B.2.3.2-2 Rx Beam Peak +5.0dB)
(CSI-RS_RP <sub>Cell 1</sub> – CSI-RS_RP <sub>Cell 2</sub> )	dB	0		23.00	
$\hat{E}_s/I_{otBB}$ <sup>Note6</sup>	dB	5.29	5.96	8.86	-3.92
$I_o$ <sup>Note2</sup>	dBm/95.04 MHz <sup>Note4</sup>	-50.03	-50.03	(Table B.2.3.2-2 Rx Beam Peak +52.68dB)	(Table B.2.3.2-2 Rx Beam Peak +33.13dB)
( $I_{ofreq 1} - I_{ofreq 2}$ )	dB	0		19.55	
Note 1:	Where used, interference from other cells and noise sources not specified in the test is assumed to be constant over subcarriers and time and shall be modelled as AWGN of appropriate power for $N_{oc}$ to be fulfilled.				
Note 2:	CSI-RS_RP, $E_s/I_{ot}$ , $I_o$ , (CSI-RS_RP <sub>Cell 2</sub> – CSI-RS_RP <sub>Cell 1</sub> ) and ( $I_{ofreq 2} - I_{ofreq 1}$ ) levels have been derived from other parameters for information purposes. They are not settable parameters themselves.				
Note 3:	Void				
Note 4:	Equivalent power received by an antenna with 0 dBi gain at the centre of the quiet zone				
Note 5:	Void				
Note 6:	Calculation of $E_s/I_{otBB}$ includes the effect of UE internal noise up to the value assumed for the associated Refsens requirement in clause 7.3.2 of TS 36.101-2 [19], and an allowance of 1dB for UE multi-band relaxation factor $\Delta MB_P$ or $\Delta MB_S$ from TS 38.101-2 [19] Table 6.2.1.3-4.				
Note 7:	Information about types of UE beam is given in B.2.1.3, and does not limit UE implementation or test system implementation				

### A.7.7.7.2.3 Test Requirements

The CSI-RSRP measurement accuracy for Cell 1 and Cell 2 shall fulfil the absolute requirements in clause 10.1.5.2.1 and the relative requirements in clause 10.1.5.2.2.

Test 1:

Absolute accuracy of Cell 1 and absolute accuracy of Cell 2. The UE is deemed to meet the requirement if the reported CSI-RSRP is in the range shown in Table A.7.7.7.2.3-1.

Relative accuracy of Cell 2 compared with Cell 1. The UE is deemed to meet the requirement if the difference in reported CSI-RSRP meets the requirements in A.7.7.7.2.3-2.

Test 2:

Absolute accuracy of Cell 1 and absolute accuracy of Cell 2. The UE is deemed to meet the requirement if the reported CSI-RSRP is in the range shown in Table A.7.7.7.2.3-1.

Relative accuracy of Cell 2 compared with Cell 1. The UE is deemed to meet the requirement if the difference in reported CSI-RSRP meets the requirements in A.7.7.7.2.3-2.

**Table A.7.7.7.2.3-1: CSI-RSRP absolute accuracy test requirement**

	Test requirement <sup>Notes1,2,3,4</sup>
Cell 1	$\text{CSI-RS\_RP1} - \delta + G_{\min} + X \leq \text{Reported RSRP(dBm)} \leq \text{CSI-RS\_RP1} + \delta + G_{\max}$
Cell 2	$\text{CSI-RS\_RP2} - \delta + G_{\min} \leq \text{Reported RSRP(dBm)} \leq \text{CSI-RS\_RP2} + \delta + G_{\max}$
Note 1:	CSI-RS_RPn is the equivalent power received by an antenna with 0dBi gain at the centre of the quiet zone configured in the test for the cell n under consideration
Note 2:	$\delta$ is the RSRP absolute accuracy requirement from Table 10.1.5.2.1-1, selected according to the $I_0$ used in the test
Note 3:	$G_{\min}$ and $G_{\max}$ are the minimum and maximum UE gain values from Table B.2.1.5.1-1, selected according to the UE power class
Note 4:	X is the Spherical coverage gain difference in dB, derived as (UE Refsens - UE Spherical coverage) from TS 38.101-2 [19] clauses 7.3.2 and 7.3.4, selected according to the UE power class and operating band. X is always a negative value.

**Table A.7.7.7.2.3-2: CSI-RSRP relative accuracy test requirement**

	Test requirement <sup>Notes1,2,3,4</sup>
Cell 2 – Cell 1	$\text{CSI-RS\_RP2} - \text{CSI-RS\_RP1} - \delta - D - G_{\text{inter}} \leq \text{Reported RSRP(dB)} \leq \text{CSI-RS\_RP2} - \text{CSI-RS\_RP1} + \delta + G_{\text{inter}} - (X) + E$
Note 1:	CSI-RS_RPn is the equivalent power received by an antenna with 0dBi gain at the centre of the quiet zone configured in the test for the cell n under consideration
Note 2:	$\delta$ is the RSRP relative accuracy requirement from Table 10.1.5.2.2-1
Note 3:	Void
Note 4:	X is the Spherical coverage gain difference in dB, derived as (UE Refsens - UE Spherical coverage) from TS 38.101-2 [19] clauses 7.3.2 and 7.3.4, selected according to the UE power class and operating band. X is always a negative value.
Note 5:	D is the margin due to mis-alignment between fine beam and rough beam. D is the Rough Beam gain reduction in Rx beam peak direction from Table B.2.1.5.3-1, selected according to the UE power class. D is always a positive value.
Note 6:	$G_{\text{inter}}$ is the margin due to different antenna gain caused by frequency separation. $G_{\text{inter}}$ is from Table B.2.1.5.2-1, selected according to the UE power class, and is always a positive value.
Note 7:	E = 3 (dB) is an additional margin to account for the actual gain difference between peak direction and spherical coverage using rough beams.

## A.7.7.8 CSI-RSRQ

### A.7.7.8.1 SA intra-frequency measurement accuracy with FR2 serving cell and FR2 target cell

#### A.7.7.8.1.1 Test Purpose and Environment

The purpose of this test is to verify that the CSI-RSRQ measurement accuracy is within the specified limits. This test will verify the requirements in Clause 10.1.8.2.1.

#### A.7.7.8.1.2 Test Parameters

In this test case all cells are on the same carrier frequency. Supported test configurations are shown in Table A.7.7.8.1.2-1. The absolute accuracy of CSI-RSRQ intra-frequency measurement is tested by using the parameters in Table A.7.7.8.1.2-2 and Table A.7.7.8.1.2-3. In all test cases, Cell 1 is the PCell and Cell 2 the target cell.

**Table A.7.7.8.1.2-1: CSI-RSRQ Intra frequency CSI-RSRQ supported test configurations**

Configuration	Description
1	120 kHz SSB and CSI-RS SCS, 100 MHz bandwidth, TDD duplex mode

**Table A.7.7.8.1.2-2: CSI-RSRQ Intra frequency test parameters**

Parameter	Unit	Test 1		Test 2	
		Cell 1	Cell 2	Cell 1	Cell 2

SSB ARFCN			Freq1		Freq1	
Duplex mode			TDD		TDD	
TDD configuration			TDDConf.3.1		TDDConf.3.1	
BW <sub>channel</sub>		MHz	100: N <sub>RB,c</sub> = 66		100: N <sub>RB,c</sub> = 66	
BWP configuration	Initial DL BWP		DLBWP.0.1			
	Dedicated DL BWP		DLBWP.1.1			
	Initial UL BWP		ULBWP.0.1			
	Dedicated UL BWP		ULBWP.1.1			
TRS configuration			TRS.2.1 TDD		TRS.2.1 TDD	
TCI state			TCI.State.0		TCI.State.0	
PDSCH Reference measurement channel			SR.3.1 TDD		SR.3.1 TDD	
RMSI CORESET Reference Channel			CR.3.1 TDD	-	CR.3.1 TDD	
Control channel RMC			CCR.3.1 TDD	-	CCR.3.1 TDD	-
OCNG Patterns			OP.1	OP.1	OP.1	OP.1
Time offset with Cell 1		µs	-	0.58	-	0.58
SMTC configuration			SMTC.1			
SSB configuration			SSB.1 FR2	SSB.1 FR2	SSB.1 FR2	SSB.1 FR2
PDSCH/PDCCH subcarrier spacing		kHz	120	120	120	120
CSI-RS configuration for RRM			CSI-RS.RRM.FR2.1 TDD			
EPRE ratio of CSI-RS to SSS						
EPRE ratio of PSS to SSS						
EPRE ratio of PBCH_DMRS to SSS						
EPRE ratio of PBCH to PBCH_DMRS						
EPRE ratio of PDCCH_DMRS to SSS						
EPRE ratio of PDCCH to PDCCH_DMRS		dB	0	0	0	0
EPRE ratio of PDSCH_DMRS to SSS						
EPRE ratio of PDSCH to PDSCH_DMRS						
EPRE ratio of OCNG DMRS to SSS <sup>Note 1</sup>						
EPRE ratio of OCNG to OCNG DMRS <sup>Note 1</sup>						
$\hat{E}_s / N_{oc}$		dB	3	3	-3	-3
Propagation condition			AWGN		AWGN	
Antenna configuration			1x2		1x2	
<p>Note 1: OCNG shall be used such that both cells are fully allocated and a constant total transmitted power spectral density is achieved for all OFDM symbols.</p> <p>Note 2: Interference from other cells and noise sources not specified in the test is assumed to be constant over subcarriers and time and shall be modelled as AWGN of appropriate power for <math>N_{oc}</math> to be fulfilled.</p>						

Table A.7.7.8.1.2-3: CSI-RSRQ Intra frequency OTA related test parameters

	Unit	Test 1		Test 2	
		Cell 1	Cell 2	Cell 1	Cell 2
Angle of arrival configuration		Setup 1 according to clause A.3.15.1		Setup 1 according to clause A.3.15.1	
Assumption for UE beams <sup>Note 9</sup>		Rough			
$N_{OC}$ <sup>Note1</sup>	dBm/15kHz <sup>Note4</sup>	-95		-95	
$N_{OC}$ <sup>Note1</sup>	dBm/SCS <sup>Note3</sup>	-86		-86	
CSI-RSRP <sup>Note2</sup>	dBm/SCS <sup>Note4</sup>	-83	-83	-89	-89
CSI-RSRQ <sup>Note2</sup>	dB	-14.77	-14.77	-16.81	-16.81
$\hat{E}_s / I_{ot}$	dB	-1.76	-1.76	-4.76	-4.76
$I_o$ <sup>Note2</sup>	dBm/95.04 MHz <sup>Note4</sup>	-50		-54	-54

Note 1:	Interference from other cells and noise sources not specified in the test is assumed to be constant over subcarriers and time and shall be modelled as AWGN of appropriate power for $N_{oc}$ to be fulfilled.
Note 2:	CSI-RSRQ, CSI-RSRP, and $I_0$ levels have been derived from other parameters for information purposes. They are not settable parameters themselves.
Note 3:	CSI-RSRQ and CSI-RSRP minimum requirements are specified assuming independent interference and noise at each receiver antenna port.
Note 4:	Equivalent power received by an antenna with 0dBi gain at the centre of the quiet zone
Note 5:	As observed with 0dBi gain antenna at the centre of the quiet zone
Note 6:	NR operating band groups are as defined in Clause 3.5.2.
Note 7:	Information about types of UE beam is given in B.2.1.3, and does not limit UE implementation or test system implementation

### A.7.7.8.1.3 Test Requirements

The CSI-RSRQ absolute measurement accuracy in test 1 shall be within the range Nominal CSI-RSRQ+2.5 dB to Nominal CSI-RSRQ-3.5 dB and the CSI-RSRQ measurement accuracy in test 2 shall be within the range Nominal CSI-RSRQ+3.5 dB to Nominal CSI-RSRQ-4.5 dB according to the requirements in clause 10.1.8.2.1 with an additional -1 dB margin reflecting the possible impact of UE self noise in the test. Nominal RSRQ is the value shown in table A.7.7.8.1.2-3.

### A.7.7.8.2 SA Inter-frequency measurement accuracy with FR2 serving cell and FR2 TDD target cell

#### A.7.7.8.2.1 Test Purpose and Environment

The purpose of this test is to verify that the CSI-RSRQ measurement accuracy is within the specified limits. This test will verify the requirements in clause 10.1.10.2.1 and 10.1.10.2.2 for inter-frequency measurement.

#### A.7.7.8.2.2 Test Parameters

In this test case the two cells (i.e., Cell 1 and Cell 2) are on different carrier frequencies and measurement gaps are provided. Supported test configurations are shown in Table A.7.7.8.2.2-1. Both absolute accuracy and relative accuracy requirements of CSI-RSRQ inter-frequency measurement are tested by using test parameters in Table A.7.7.8.2.2-2 and Table A.7.7.8.2.2-3. In all test cases, Cell 1 is the PCell and Cell 2 is target cell.

**Table A. 7.7.8.2.2-1: CSI-RSRQ Inter frequency supported test configurations**

Configuration	Description
1	120 kHz SSB and CSI-RS SCS, 100 MHz bandwidth, TDD duplex mode

**Table A.7.7.8.2.2-2: CSI-RSRQ Inter frequency general test parameters**

Parameter	Unit	Test 1		Test 2	
		Cell 1	Cell 2	Cell 1	Cell 2
SSB ARFCN		Freq1	freq2	freq1	Freq2
Duplex mode		TDD		TDD	
TDD configuration		TDDConf.3.1		TDDConf.3.1	
BW <sub>channel</sub>	MHz	100: N <sub>RB,c</sub> = 66		100: N <sub>RB,c</sub> = 66	
PDSCH Reference measurement channel		SR.3.1 TDD	-	SR.3.1 TDD	-
RMSI CORESET Reference Channel		CR.3.1 TDD	-	CR.3.1 TDD	-
OCNG Patterns		OP.1	OP.1	OP.1	OP.1
Time offset with Cell 1	μs	-	0.58	-	0.58
SMTc configuration		SMTc. 1 FR2	SMTc. 1 FR2	SMTc. 1 FR2	SMTc. 1 FR2
CSI-RS configuration for RRM		CSI-RS.RRM.FR2.1 TDD			
PDSCH/PDCCH subcarrier spacing	kHz	120	120	120	120
EPRE ratio of PSS to SSS	dB	0	0	0	0
EPRE ratio of PBCH_DMRS to SSS					

EPRE ratio of PBCH to PBCH_DMRS					
EPRE ratio of PDCCH_DMRS to SSS					
EPRE ratio of PDCCH to PDCCH_DMRS					
EPRE ratio of PDSCH_DMRS to SSS					
EPRE ratio of PDSCH to PDSCH_DMRS					
EPRE ratio of OCNG DMRS to SSS <sup>Note 1</sup>					
EPRE ratio of CSI-RS to SSS					
$\hat{E}_s / N_{oc}$	dB	-1.75	-1.75	-3	-1.75
<p>Note 1: OCNG shall be used such that both cells are fully allocated and a constant total transmitted power spectral density is achieved for all OFDM symbols.</p> <p>Note 2: Interference from other cells and noise sources not specified in the test is assumed to be constant over subcarriers and time and shall be modelled as AWGN of appropriate power for <math>N_{oc}</math> to be fulfilled.</p>					

**Table A.7.7.8.2.2-3: CSI-RSRQ Inter frequency OTA related test parameters**

Parameter	Unit	Test 1		Test 2	
		Cell 1	Cell 2	Cell 1	Cell 2
AoA setup		Setup 1 in clause A.3.15.		Setup 1 in clause A.3.15.	
Assumption for UE beams <sup>Note 8</sup>		Rough		Rough	
$N_{oc}$ <sup>Note1</sup>	dBm/15kHz <sup>Note4</sup>	-94.03		-94.03	
$N_{oc}$ <sup>Note1</sup>	dBm/SCS <sup>Note3</sup>	-85.0		-85.0	
CSI-RSRP <sup>Note2</sup>	dBm/SCS <sup>Note4</sup>	-86.75	-86.75	-88	-88
CSI-RSRQ <sup>Note2</sup>	dB	-14.75	-14.75	-15.56	-15.56
$\hat{E}_s / I_{ot}$	dB	-1.75	-1.75	-3	-3
$I_o$ <sup>Note2</sup>	dBm/95.04 MHz <sup>Note4</sup>	-53.8	-53.8	-54.25	-54.25
<p>Note 1: Interference from other cells and noise sources not specified in the test is assumed to be constant over subcarriers and time and shall be modelled as AWGN of appropriate power for <math>N_{oc}</math> to be fulfilled.</p> <p>Note 2: CSI-RSRQ, CSI-RSRP, and <math>I_o</math> levels have been derived from other parameters for information purposes. They are not settable parameters themselves.</p> <p>Note 3: CSI-RSRQ and CSI-RSRP minimum requirements are specified assuming independent interference and noise at each receiver antenna port.</p> <p>Note 4: Equivalent power received by an antenna with 0dBi gain at the centre of the quiet zone</p> <p>Note 5: As observed with 0dBi gain antenna at the centre of the quiet zone</p> <p>Note 6: Information about types of UE beam is given in B.2.1.3, and does not limit UE implementation or test system implementation</p>					

### A.7.7.8.2.3 Test Requirements

The CSI-RSRQ absolute measurement accuracy in test 1 shall be within the range Nominal CSI-RSRQ+2.5dB to Nominal CSI-RSRQ -3.5dB and the CSI-RSRQ measurement accuracy in test 2 shall be within the range Nominal CSI-RSRQ +3.5dB to Nominal CSI-RSRQ -4.5dB according to the requirements in clause 10.1.10.2.1 with an additional -1dB margin reflecting the possible impact of UE self noise in the test.

The CSI-RSRQ relative measurement accuracy shall fulfil the requirements in clause 10.1.10.2.2.



## A.7.7.9 CSI-SINR

### A.7.7.9.1 SA intra-frequency case measurement accuracy with FR2 serving cell and FR2 target cell

#### A.7.7.9.1.1 Test Purpose and Environment

The purpose of this test is to verify that the CSI-SINR measurement accuracy is within the specified limits. This test will verify the requirements in Clause 10.1.13.2.1.

#### A.7.7.9.1.2 Test Parameters

In this test case all cells are on the same carrier frequency. Supported test configurations are shown in Table A.7.7.9.1.2-1. The absolute accuracy of CSI-SINR intra-frequency measurement is test by using the parameters in Table A.7.7.9.1.2-2 and Table A.7.7.9.1.2-3. In all test cases, Cell 1 is the PCell and Cell 2 the target cell. The TCI status for Cell 1 is defined in Table A.3.16.2-1 and TRS configuration for Cell 1 is defined in Table A.3.17.2.1-1.

**Table A.7.7.9.1.2-1: CSI-SINR Intra frequency CSI-SINR supported test configurations**

Configuration	Description
1	120 kHz SSB and CSI-RS SCS, 100 MHz bandwidth, TDD duplex mode

**Table A.7.7.9.1.2-2: CSI-SINR Intra frequency test parameters**

Parameter	Unit	Test 1		Test 2	
		Cell 1	Cell 2	Cell 1	Cell 2
SSB ARFCN		Freq2		Freq2	
Duplex mode		TDD		TDD	
TDD configuration		TDDConf.3.1		TDDConf.3.1	
BW <sub>channel</sub>	MHz	100: N <sub>RB,c</sub> = 66		100: N <sub>RB,c</sub> = 66	
Downlink initial BWP configuration		DLBWP.0.1			
Downlink dedicated BWP configuration		DLBWP.1.1			
Uplink initial BWP configuration		ULBWP.0.1			
Uplink dedicated BWP configuration		ULBWP.1.1			
DRX cycle configuration	ms	Not applicable			
TRS configuration		TRS.2.1 TDD			
TCI state		TCI.State.0			
PDSCH Reference measurement channel		SR.3.1 TDD		SR.3.1 TDD	
RMSI CORESET Reference Channel		CR.3.1 TDD	-	CR.3.1 TDD	
Dedicated RMSI CORESET Reference Channel		CCR.3 .1 TDD	-	CCR.3. 1 TDD	-
Time offset with Cell 1	μs	-	0.29	-	0.29
OCNG Patterns		OP.1	OP.1	OP.1	OP.1
SMTC configuration		SMTC.1			
SSB configuration		SSB.1 FR2	SSB.1 FR2	SSB.1 FR2	SSB.1 FR2
CSI-RS configuration for RRM		CSI-RS.RRM.FR2.1 TDD			
PDSCH/PDCCH subcarrier spacing	kHz	120	120	120	120
SS-RSSI-Measurement		Not Applicable			
EPRE ratio of PSS to SSS	dB	0	0	0	0
EPRE ratio of PBCH_DMRS to SSS					
EPRE ratio of PBCH to PBCH_DMRS					
EPRE ratio of PDCCH_DMRS to SSS					
EPRE ratio of PDCCH to PDCCH_DMRS					
EPRE ratio of PDSCH_DMRS to SSS					
EPRE ratio of PDSCH to PDSCH_DMRS					
EPRE ratio of CSI-RS to SSS					
EPRE ratio of OCNG to SSS <sup>Note 1</sup>					
$\hat{E}_s / N_{oc}$	dB	4.54	2.66	-3	-3
Propagation conditions		AWGN			

Antenna configuration		1x2
Note 1:	OCNG shall be used such that both cells are fully allocated and a constant total transmitted power spectral density is achieved for all OFDM symbols.	
Note 2:	Interference from other cells and noise sources not specified in the test is assumed to be constant over subcarriers and time and shall be modelled as AWGN of appropriate power for $N_{oc}$ to be fulfilled.	
Note 3:	CSI-SINR, CSI-RSRP, and $I_o$ levels have been derived from other parameters for information purposes. They are not settable parameters themselves.	
Note 4:	CSI-SINR and CSI-RSRP minimum requirements are specified assuming independent interference and noise at each receiver antenna port.	

**Table A.7.7.9.1.2-3: CSI-SINR Intra frequency OTA related test parameters**

Parameter	Unit	Test 1		Test 3	
		Cell 1	Cell 2	Cell 1	Cell 2
Angle of arrival configuration		Setup 1 according to clause A.3.15.1		Setup 1 according to clause A.3.15.1	
Assumption for UE beams <sup>Note 9</sup>		Rough		Rough	
$N_{oc}$ <sup>Note1</sup>	dBm/15kHz <sup>Note4</sup>	-105		-105	
$N_{oc}$ <sup>Note1</sup>	dBm/SCS <sup>Note3</sup>	-96		-96	
CSI-RSRP <sup>Note2</sup>	dBm/SCS <sup>Note4</sup>	-91.46	-93.34	-99	-99
CSI-SINR <sup>Note2</sup>	dB	0	-3.2	-4.76	-4.76
$\hat{E}_s / I_{ot}$	dB	0	-3.2	-4.76	-4.76
$I_o$ <sup>Note2</sup>	dBm/95.04 MHz <sup>Note4</sup>	-59.2		-64	
Note 1:	Interference from other cells and noise sources not specified in the test is assumed to be constant over subcarriers and time and shall be modelled as AWGN of appropriate power for $N_{oc}$ to be fulfilled.				
Note 2:	CSI-SINR, CSI-RSRP, and $I_o$ levels have been derived from other parameters for information purposes. They are not settable parameters themselves.				
Note 3:	CSI-SINR and CSI-RSRP minimum requirements are specified assuming independent interference and noise at each receiver antenna port.				
Note 4:	Equivalent power received by an antenna with 0 dBi gain at the centre of the quiet zone				
Note 5:	As observed with 0 dBi gain antenna at the centre of the quiet zone				
Note 6:	NR operating band groups are as defined in clause 3.5.2.				
Note 7:	Void				
Note 8:	Void				
Note 9:	Information about types of UE beam is given in B.2.1.3, and does not limit UE implementation or test system implementation				

**A.7.7.9.1.3 Test Requirements**

The CSI-SINR absolute measurement accuracy in test 1 shall be within the range Nominal CSI-SINR+XdB to Nominal CSI-SINR -X-1dB and the CSI-SINR measurement accuracy in test 2 shall be within the range Nominal CSI-SINR +YdB to Nominal CSI-SINR -Y-1dB according to the requirements in clause 10.1.13.2.1 with an additional -1dB margin reflecting the possible impact of UE self noise in the test. The relative CSI-SINR measurement accuracy shall fulfil the requirements in clause 10.1.13.2.1.

Editor’s note: The values of X and Y are pending on the accuracy requirement discussion

**A.7.7.9.2 SA Inter-frequency measurement accuracy with FR2 serving cell and FR2 TDD target cell**

**A.7.7.9.2.1 Test Purpose and Environment**

The purpose of this test is to verify that the CSI-SINR measurement accuracy is within the specified limits. This test will verify the requirements in Clause 10.1.15.2.1 and 10.1.15.2.2 for inter-frequency measurement.

A.7.7.9.2.2 Test Parameters

In this test case the two cells (i.e., Cell 1 and Cell 2) are on different carrier frequencies and measurement gaps are provided. Supported test configurations are shown in Table A.7.7.9.2.2-1. Both absolute accuracy and relative accuracy requirements of CSI-SINR inter-frequency measurement are tested by using test parameters in Table A.7.7.9.2.2-2 and Table A.7.7.9.2.2-3. In all test cases, Cell 1 is the PCell and Cell 2 is target cell. The TCI status for Cell 1 is defined in Table A.3.16.2-1 and TRS configuration for Cell 1 is defined in Table A.3.17.2.1-1.

**Table A.7.7.9.2.2-1: CSI-SINR Inter frequency CSI-SINR supported test configurations**

Configuration	Description
1	120 kHz SSB and CSI-RS SCS, 100 MHz bandwidth, TDD duplex mode

**Table A.7.7.9.2.2-2: CSI-SINR Inter frequency general test parameters**

Parameter	Unit	Test 1		Test 2		Test 3	
		Cell 1	Cell 2	Cell 1	Cell 2	Cell 1	Cell 2
SSB ARFCN		freq1	freq2	freq1	freq2	freq1	freq2
Duplex mode		TDD		TDD		TDD	
TDD configuration		TDDConf.3.1		TDDConf.3.1		TDDConf.3.1	
BW <sub>channel</sub>	MHz	100: N <sub>RB,c</sub> = 66		100: N <sub>RB,c</sub> = 66		100: N <sub>RB,c</sub> = 66	
Downlink initial BWP configuration		DLBWP.0.1					
Downlink dedicated BWP configuration		DLBWP.1.1					
Uplink initial BWP configuration		ULBWP.0.1					
Uplink dedicated BWP configuration		ULBWP.1.1					
DRX cycle configuration	ms	Not applicable					
TRS configuration		TRS.2.1 TDD					
TCI state		TCI.State.0					
PDSCH Reference measurement channel		SR.3.1 TDD	-	SR.3.1 TDD	-	SR.3.1 TDD	-
RMSI CORESET Reference Channel		CR.3.1 TDD	-	CR.3.1 TDD	-	CR.3.1 TDD	-
Time offset with Cell 1	μs	-	0.29	-	0.29	-	0.29
OCNG Patterns		OP.1	OP.1	OP.1	OP.1	OP.1	OP.1
SMTc configuration		SMTc. 1 FR2	SMTc. 1 FR2	SMTc. 1 FR2	SMTc. 1 FR2	SMTc. 1 FR2	SMTc. 1 FR2
CSI-RS configuration for RRM		CSI-RS.RRM.FR2.1 TDD					
PDSCH/PDCCH subcarrier spacing	kHz	120	120	120	120	120	120
EPRE ratio of PSS to SSS	dB	0	0	0	0	0	0
EPRE ratio of PBCH_DMRS to SSS							
EPRE ratio of PBCH to PBCH_DMRS							
EPRE ratio of PDCCH_DMRS to SSS							
EPRE ratio of PDCCH to PDCCH_DMRS							
EPRE ratio of PDSCH_DMRS to SSS							
EPRE ratio of PDSCH to PDSCH_DMRS							
EPRE ratio of OCNG to SSS <sup>Note 1</sup>		-0.5	-0.5	11.0	11.0	-3.0	-3.0
Propagation conditions		AWGN					
Antenna configuration		1x2					
Note 1:	OCNG shall be used such that both cells are fully allocated and a constant total transmitted power spectral density is achieved for all OFDM symbols.						
Note 2:	Interference from other cells and noise sources not specified in the test is assumed to be constant over subcarriers and time and shall be modelled as AWGN of appropriate power for $N_{oc}$ to be fulfilled.						
Note 3:	CSI-SINR, CSI-RSRP and $I_0$ levels have been derived from other parameters for information purposes. They are not settable parameters themselves.						
Note 4:	CSI-SINR and CSI-RSRP minimum requirements are specified assuming independent interference and noise at each receiver antenna port.						

**Table A.7.7.9.2.2-3: CSI-SINR Inter frequency OTA related test parameters**

Parameter	Unit	Test 1	Test 2	Test 3
-----------	------	--------	--------	--------

		Cell 1	Cell 2	Cell 1	Cell 2	Cell 1	Cell 2
Angle of arrival configuration	degrees	Setup 1 according to A.3.15.1		Setup 1 according to A.3.15.1		Setup 1 according to A.3.15.1	
Assumption for UE beams <sup>Note 10</sup>		Rough		Rough		Rough	
$N_{oc}$ <sup>Note1</sup>	dBm/15kHz <sup>Note4</sup>	-105		-105		-105	
$N_{oc}$ <sup>Note1</sup>	dBm/SCS <sup>Note3</sup>	-96		-96		-96	
CSI-RSRP <sup>Note2</sup>	dBm/SCS <sup>Note4</sup>	-96.5	-96.5	-85	-85	-99	-99
CSI-SINR <sup>Note2</sup>	dB	-0.5	-0.5	11	11	-3.0	-3.0
$\hat{E}_s / I_{ot}$	dB	-0.5	-0.5	11	11	-3.0	-3.0
$I_o$ <sup>Note2</sup>	dBm/95.04 MHz <sup>Note4</sup>	-69.3		-55.4		-65.24	
<p>Note 1: Interference from other cells and noise sources not specified in the test is assumed to be constant over subcarriers and time and shall be modelled as AWGN of appropriate power for <math>N_{oc}</math> to be fulfilled.</p> <p>Note 2: CSI-SINR, CSI-RSRP, and <math>I_o</math> levels have been derived from other parameters for information purposes. They are not settable parameters themselves.</p> <p>Note 3: CSI-SINR and CSI-RSRP minimum requirements are specified assuming independent interference and noise at each receiver antenna port.</p> <p>Note 4: Equivalent power received by an antenna with 0 dBi gain at the centre of the quiet zone</p> <p>Note 5: As observed with 0 dBi gain antenna at the centre of the quiet zone</p> <p>Note 6: NR operating band groups are as defined in clause 3.5.2.</p> <p>Note 7: Void</p> <p>Note 8: Void</p> <p>Note 9: Void</p> <p>Note 10: Information about types of UE beam is given in B.2.1.3, and does not limit UE implementation or test system implementation</p>							

### A.7.7.9.2.3 Test Requirements

The CSI-SINR absolute measurement accuracy in test 1 shall be within the range Nominal CSI-SINR +XdB to Nominal CSI-SINR -X-dB and the CSI-SINR measurement accuracy in test 2 shall be within the range Nominal CSI-SINR +YdB to Nominal CSI-SINR -Y-dB according to the requirements in clause 10.1.15.2.1 with an additional -1dB margin reflecting the possible impact of UE self noise in the test.

The CSI-SINR relative measurement accuracy shall fulfil the requirements in clause 10.1.15.2.2.

## A.7.7.10 RSTD measurements

### A.7.7.10.1 RSTD measurement accuracy test case for single positioning frequency layer

#### A.7.7.10.1.1 Test purpose and Environment

The purpose of the test is to verify that the RSTD measurement meets the accuracy requirements specified in clause 10.1.23.2 in an environment with AWGN propagation conditions.

The supported test configurations are specified in Table A.7.7.10.1.1-1.

**Table A.7.7.10.1.1-1: Supported test configurations**

Configuration	Description
1	120 kHz SSB SCS, 200 MHz bandwidth, TDD duplex mode

In the test there are two synchronous cells: Cell 1 and Cell 2. Cell 1 is the reference as well as the PCell. Cell 2 is a neighbour cells. Both cells are on the same NR RF channel in FR2. GP#24 is configured if UE supports GP#24, otherwise, GP#13 is configured for the test. The *NR-TDOA-ProvideAssistanceData* and *NR-TDOA-*

*RequestLocationInformation* message as defined in TS 37.355 shall be provided to the UE before the start of the test. The test duration should be larger than the UE measurement period as defined in clause 9.9.2.

**Table A.7.7.10.1.1-2: RSTD accuracy test parameters**

Parameter	Unit	Test 1		Test 2	
		Cell 1	Cell 2	Cell 1	Cell 2
PRS ARFCN		freq1		freq1	
Duplex mode		TDD		TDD	
TDD configuration		TDDConf.3.1		TDDConf.3.1	
BW <sub>channel</sub>	MHz	200: N <sub>RB,c</sub> = 132		200: N <sub>RB,c</sub> = 132	
Measurement gap		GP#24 or GP#13		GP#24 or GP#13	
Downlink initial BWP configuration		DLBWP.0.1	-	DLBWP.0.1	-
Downlink dedicated BWP configuration		DLBWP.1.1	-	DLBWP.1.1	-
Uplink initial BWP configuration		ULBWP.0.1	-	ULBWP.0.1	-
Uplink dedicated BWP configuration		ULBWP.1.1	-	ULBWP.1.1	-
DRX cycle configuration		Not applicable	-	Not applicable	-
TRS configuration		TRS.2.1 TDD	-	TRS.2.1 TDD	-
TCI state		TCI.State.0	-	TCI.State.0	-
PDSCH Reference measurement channel		SR.3.1 TDD	-	SR.3.1 TDD	-
RMSI CORESET Reference Channel		CR.3.1 TDD	-	CR.3.1 TDD	-
Control channel RMC		CCR.3.1 TDD	-	CCR.3.1 TDD	-
OCNG Patterns		OP.1	OP.1	OP.1	OP.1
SSB configuration		SSB.3 FR2	SSB.3 FR2	SSB.3 FR2	SSB.3 FR2
SMTc configuration		SMTc.1	SMTc.1	SMTc.1	SMTc.1
PRS configuration		PRS.1.1 FR2	PRS.1.1 FR2	PRS.1.2 FR2	PRS.1.2 FR2
PRS Resource slot offset	slot	0	4	0	4
Expected RSTD	μs	N/A	3	N/A	3
Expected RSTD uncertainty	μs	N/A	5	N/A	5
Time offset with Cell 1	μs	-	3	-	3
PDSCH/PDCCH subcarrier spacing	kHz	120	120	120	120
EPRE ratio of PSS to SSS	dB	0	0	0	0
EPRE ratio of PBCH_DMRS to SSS					
EPRE ratio of PBCH to PBCH_DMRS					
EPRE ratio of PDCCH_DMRS to SSS					
EPRE ratio of PDCCH to PDCCH_DMRS					
EPRE ratio of PDSCH_DMRS to SSS					
EPRE ratio of PDSCH to PDSCH_DMRS					
EPRE ratio of OCNG DMRS to SSS <sup>Note 1</sup>					
EPRE ratio of OCNG to OCNG DMRS <sup>Note 1</sup>					
EPRE ratio of PRS to SSS					
Propagation conditions		AWGN	AWGN	AWGN	AWGN
Antenna configuration		1x2	1x2	1x2	1x2
Note 1: OCNG shall be used such that both cells are fully allocated and a constant total transmitted power spectral density is achieved for all OFDM symbols other than those in the slots with transmitted PRS.					

**Table A.7.7.10.1.1-3: RSTD accuracy OTA related test parameters**

Parameter	Unit	Test 1		Test 2	
		Cell 1	Cell 2	Cell 1	Cell 2
Angle of arrival configuration		Setup 1 according to clause A.3.15.1			

Assumption for UE beams <sup>Note 5</sup>		Rough		Rough	
$N_{oc}$ <sup>Note1</sup>	dBm/SCS <sup>Note3</sup>	-89		-89	
PRS $\hat{E}_s/N_{oc}$	dB	-5.7	-11.9	-5.7	-11.9
PRP <sup>Note2</sup>	dBm/SCS	-94.7	-100.9	-94.7	-100.9
PRS $\hat{E}_s/I_{ot}$	dB	-6	-13	-6	-13
$I_o$ <sup>Note2</sup>	dBm/190.0 8 MHz <sup>Note3</sup>	-55.75	-55.75	-55.75	-55.75
<p>Note 1: Where used, interference from other cells and noise sources not specified in the test is assumed to be constant over subcarriers and time and shall be modelled as AWGN of appropriate power for <math>N_{oc}</math> to be fulfilled.</p> <p>Note 2: PRP, <math>E_s/I_{ot}</math> and <math>I_o</math> levels have been derived from other parameters for information purposes. They are not settable parameters themselves. The <math>I_o</math> is calculated based only on the symbols in which PRS is transmitted.</p> <p>Note 3: Equivalent power received by an antenna with 0 dBi gain at the centre of the quiet zone</p> <p>Note 4: Calculation of <math>E_s/I_{ot}</math> includes the effect of UE internal noise up to the value assumed for the associated Refsens requirement in clause 7.3.2 of TS 38.101-2 [19], and an allowance of 1dB for UE multi-band relaxation factor <math>\Delta MB_P</math> from TS 38.101-2 [19] Table 6.2.1.3-4.</p> <p>Note 5: Information about types of UE beam is given in B.2.1.3, and does not limit UE implementation or test system implementation</p>					

A.7.7.10.1.2 Test Requirements

The RSTD measurement accuracy for Cell 2 shall fulfil the absolute requirement in clause 10.1.23.2.

A.7.7.10.2 RSTD measurement accuracy test case for dual positioning frequency layer

A.7.7.10.2.1 Test purpose and Environment

The purpose of the test is to verify that the RSTD measurement meets the accuracy requirements specified in clause 10.1.23.2 in an environment with AWGN propagation conditions. The *NR-TDOA-ProvideAssistanceData* and *NR-TDOA-RequestLocationInformation* message as defined in TS 37.355 shall be provided to the UE before the start of the test. The test duration should be larger than the UE measurement period as defined in clause 9.9.2.

The supported test configurations are specified in Table A.7.7.10.2.1-1.

**Table A.7.7.10.2.1-1: Supported test configurations**

Configuration	Description
1	120 kHz SSB SCS, 200MHz bandwidth, TDD duplex mode

In the test there are two synchronous cells: Cell 1 and Cell 2. Cell 1 is the reference as well as the PCell on NR RF channel #1 in FR2. Cell 2 is a neighbour cell on a different NR RF channel #2 in FR2. GP#24 is configured if UE supports GP#24, otherwise, GP#13 is configured for the test.

**Table A.7.7.10.2.1-2: RSTD accuracy test parameters**

Parameter	Unit	Test 1		Test 2	
		Cell 1	Cell 2	Cell 1	Cell 2
PRS ARFCN		freq1	freq2	freq1	freq2
Duplex mode		TDD		TDD	
TDD configuration		TDDConf.3.1		TDDConf.3.1	
BW <sub>channel</sub>	MHz	200: N <sub>RB,c</sub> = 132		200: N <sub>RB,c</sub> = 132	
Measurement gap		GP#24 or GP#13		GP#24 or GP#13	

Downlink initial BWP configuration		DLBWP.0.1	-	DLBWP.0.1	-
Downlink dedicated BWP configuration		DLBWP.1.1	-	DLBWP.1.1	-
Uplink initial BWP configuration		ULBWP.0.1	-	ULBWP.0.1	-
Uplink dedicated BWP configuration		ULBWP.1.1	-	ULBWP.1.1	-
DRX cycle configuration		Not applicable	-	Not applicable	-
TRS configuration		TRS.2.1 TDD	-	TRS.2.1 TDD	-
TCI state		TCI.State.0	-	TCI.State.0	-
PDSCH Reference measurement channel		SR.3.1 TDD	-	SR.3.1 TDD	-
RMSI CORESET Reference Channel		CR.3.1 TDD	-	CR.3.1 TDD	-
Control channel RMC		CCR.3.1 TDD	-	CCR.3.1 TDD	-
OCNG Patterns		OP.1	OP.1	OP.1	OP.1
SSB configuration		SSB.3 FR2	SSB.3 FR2	SSB.3 FR2	SSB.3 FR2
SMTC configuration		SMTC.1	SMTC.1	SMTC.1	SMTC.1
PRS configuration		PRS.1.1 FR2	PRS.1.1 FR2	PRS.1.2 FR2	PRS.1.2 FR2
PRS Resource slot offset	slot	0	4	0	4
Expected RSTD	$\mu$ s	N/A	3	N/A	3
Expected RSTD uncertainty	$\mu$ s	N/A	5	N/A	5
Time offset with Cell 1	$\mu$ s	-	3	-	3
PDSCH/PDCCH subcarrier spacing	kHz	120	120	120	120
EPRE ratio of PSS to SSS	dB	0	0	0	0
EPRE ratio of PBCH_DMRS to SSS					
EPRE ratio of PBCH to PBCH_DMRS					
EPRE ratio of PDCCH_DMRS to SSS					
EPRE ratio of PDCCH to PDCCH_DMRS					
EPRE ratio of PDSCH_DMRS to SSS					
EPRE ratio of PDSCH to PDSCH_DMRS					
EPRE ratio of OCNG DMRS to SSS <sup>Note 1</sup>					
EPRE ratio of OCNG to OCNG DMRS <sup>Note 1</sup>					
EPRE ratio of PRS to SSS					
Propagation conditions		AWGN	AWGN	AWGN	AWGN
Antenna configuration		1x2	1x2	1x2	1x2
Note 1: OCNG shall be used such that both cells are fully allocated and a constant total transmitted power spectral density is achieved for all OFDM symbols other than those in the slots with transmitted PRS.					

Table A.7.7.10.2.1-3: RSTD accuracy OTA related test parameters

Parameter	Unit	Test 1		Test 2	
		Cell 1	Cell 2	Cell 1	Cell 2
Angle of arrival configuration		Setup 1 according to clause A.3.15.1			
Assumption for UE beams <sup>Note 5</sup>		Rough		Rough	
$N_{oc}$ <sup>Note 1</sup>	dB/SCS <sup>Note 3</sup>	-89		-89	
PRS $\hat{E}_s/N_{oc}$	dB	-6	-13	-6	-13
PRP <sup>Note 2</sup>	dB/SCS	-95	-102	-95	-102
PRS $\hat{E}_s/I_{ot}$	dB	-6	-13	-6	-13
$I_o$ <sup>Note 2</sup>	dBm/190.0 8 MHz <sup>Note 3</sup>	-56.03	-56.79	-56.03	-56.79
Note 1: Where used, interference from other cells and noise sources not specified in the test is assumed to be constant over subcarriers and time					

and shall be modelled as AWGN of appropriate power for  $N_{oc}$  to be fulfilled.

Note 2: PRP, Es/lot and lo levels have been derived from other parameters for information purposes. They are not settable parameters themselves. The lo is calculated based only on the symbols in which PRS is transmitted.

Note 3: Equivalent power received by an antenna with 0 dBi gain at the centre of the quiet zone

Note 4: Calculation of Es/lot includes the effect of UE internal noise up to the value assumed for the associated Refsens requirement in clause 7.3.2 of TS 38.101-2 [19], and an allowance of 1dB for UE multi-band relaxation factor  $\Delta MB_P$  from TS 38.101-2 [19] Table 6.2.1.3-4.

Note 5: Information about types of UE beam is given in B.2.1.3, and does not limit UE implementation or test system implementation

### A.7.7.10.2.2 Test Requirements

The RSTD measurement accuracy for Cell 2 shall fulfil the absolute requirement in clause 10.1.23.2.

## A.7.7.11 PRS-RSRP measurements

### A.7.7.11.1 SA measurement accuracy with PRS in FR2

#### A.7.7.11.1.1 Test Purpose and Environment

The purpose of this test is to verify that the PRS-RSRP measurement accuracy is within the specified limits. This test will verify the requirements in clauses 10.1.24.2.1 and 10.1.24.2.2.

#### A.7.7.11.1.2 Test parameters

In this set of test cases all cells are on the same carrier frequency. Supported test configurations are shown in Table A.7.7.11.1.2-1. Both absolute and relative accuracy of PRS-RSRP measurements are tested by using the parameters in Table A.7.7.11.1.2-2 and A.7.7.11.1.2-3. In all test cases, Cell 1 is the PCell. The TCI status for Cell 1 is defined in Table A.3.16.2-1 and TRS configuration for Cell 1 is defined in Table A.3.17.2.1-1.

**Table A.7.7.11.1.2-1: PRS-RSRP supported test configurations**

Configuration	Description
1	120 kHz SSB SCS, 200 MHz bandwidth, TDD duplex mode

**Table A.7.7.11.1.2-2: PRS-RSRP general test parameters**

Parameter	Unit	Test 1		Test 2	
		Cell 1	Cell 2	Cell 1	Cell 2
Cell ID		489	0	489	0
SSB ARFCN		freq1		freq1	
Duplex mode		TDD		TDD	
TDD configuration		TDDConf.3.1		TDDConf.3.1	
BW <sub>channel</sub>	MHz	200; N <sub>RB,c</sub> = 132		200; N <sub>RB,c</sub> = 132	
Downlink initial BWP configuration		DLBWP.0.1	-	DLBWP.0.1	-
Downlink dedicated BWP configuration		DLBWP.1.1	-	DLBWP.1.1	-
Uplink initial BWP configuration		ULBWP.0.1	-	ULBWP.0.1	-
Uplink dedicated BWP configuration		ULBWP.1.1	-	ULBWP.1.1	-
DRX cycle configuration		Not applicable	-	Not applicable	-
Measurement gap		GP#13 or GP#24 <sup>Note2</sup>			
TRS configuration		TRS.2.1 TDD	-	TRS.2.1 TDD	-
TCI state		TCI.State.0	-	TCI.State.0	-



PDSCH Reference measurement channel		SR.3.1 TDD	-	SR.3.1 TDD	-
RMSI CORESET Reference Channel		CR.3.1 TDD	-	CR.3.1 TDD	-
Control channel RMC		CCR.3.1 TDD	-	CCR.3.1 TDD	-
OCNG Patterns		OP.1	OP.1	OP.1	OP.1
SSB configuration		SSB.3 FR2	SSB.3 FR2	SSB.3 FR2	SSB.3 FR2
SMTC configuration		SMTC.1	SMTC.1	SMTC.1	SMTC.1
Time offset with Cell 1	μs	-	3	-	3
Expected RSTD	μs	3			
Expected RSTD uncertainty	μs	5			
PRS configuration		PRS.1.3 FR2	PRS.1.3 FR2	PRS.1.4 FR2	PRS.1.4 FR2
PRS Resource slot offset	slot	0	4	0	4
PDSCH/PDCCH subcarrier spacing	kHz	120	120	120	120
EPRE ratio of PSS to SSS	dB	0	0	0	0
EPRE ratio of PBCH_DMRS to SSS					
EPRE ratio of PBCH to PBCH_DMRS					
EPRE ratio of PDCCH_DMRS to SSS					
EPRE ratio of PDCCH to PDCCH_DMRS					
EPRE ratio of PDSCH_DMRS to SSS					
EPRE ratio of PDSCH to PDSCH_DMRS					
EPRE ratio of OCNG DMRS to SSS <sup>Note 1</sup>					
EPRE ratio of OCNG to OCNG DMRS <sup>Note 1</sup>					
EPRE ratio of PRS to SSS					
Propagation conditions		AWGN	AWGN	AWGN	AWGN
Antenna configuration		1x2	1x2	1x2	1x2
<p>Note 1: OCNG shall be used such that both cells are fully allocated and a constant total transmitted power spectral density is achieved for all OFDM symbols.</p> <p>Note 2: GP#24 is configured if UE supports MG#24, otherwise GP#13 is configured.</p>					

**Table A.7.7.11.1.2-3: PRS-RSRP OTA related test parameters**

Parameter	Unit	Test 1		Test 2	
		Cell 1	Cell 2	Cell 1	Cell 2
Angle of arrival configuration		Setup 1 according to clause A.3.15.1			
Assumption for UE beams <sup>Note 7</sup>		Rough		Rough	
$N_{oc}$ <sup>Note1</sup>	dBm/15kHz <sup>Note4</sup>	-98		-98	
$N_{oc}$ <sup>Note1</sup>	dBm/SCS <sup>Note4</sup>	-89		-89	
PRS $\hat{E}_s / N_{oc}$	dB	-2	-10	-2	-10
PRP <sup>Note2</sup>	dBm/SCS	-91	-99	-91	-99
PRS $\hat{E}_s / I_{ot}$	dB	-2.41	-12.12	-2.41	-12.12
$I_0$ <sup>Note2</sup>	dBm/190.08 MHz <sup>Note4</sup>	-54.62		-54.62	

Note 1:	Where used, interference from other cells and noise sources not specified in the test is assumed to be constant over subcarriers and time and shall be modelled as AWGN of appropriate power for $N_{oc}$ to be fulfilled.
Note 2:	PRP, Es/lot and lo levels have been derived from other parameters for information purposes. They are not settable parameters themselves.
Note 3:	Void
Note 4:	Equivalent power received by an antenna with 0 dBi gain at the centre of the quiet zone
Note 5:	Void
Note 6:	Calculation of Es/lot includes the effect of UE internal noise up to the value assumed for the associated Refsens requirement in clause 7.3.2 of TS 38.101-2 [19], and an allowance of 1dB for UE multi-band relaxation factor $\Delta MB_P$ from TS 38.101-2 [19] Table 6.2.1.3-4.
Note 7:	Information about types of UE beam is given in B.2.1.3, and does not limit UE implementation or test system implementation

### A.7.7.11.1.3 Test Requirements

In each test, the absolute PRS-RSRP measurement for each cell shall fulfil the absolute accuracy requirement in clause 10.1.24.2.1 if the reported PRS-RSRP is in the range shown in table A.7.7.11.1.3-1. The relative PRS-RSRP measurement between the two PRS resources within the same cell shall fulfil the relative accuracy requirement in clause 10.1.24.2.2.

**Table A.7.7.11.1.3-1: PRS-RSRP absolute accuracy test requirement**

	Test requirement <sup>Notes1,2,3</sup>
Cell 1	$PRS\_RP1 - \delta + G_{min} \leq \text{Reported RSRP(dBm)} \leq PRS\_RP1 + \delta + G_{max}$
Cell 2	$PRS\_RP2 - \delta + G_{min} \leq \text{Reported RSRP(dBm)} \leq PRS\_RP2 + \delta + G_{max}$
Note 1:	PRS_RPn is the equivalent power received by an antenna with 0dBi gain at the centre of the quiet zone configured in the test for the cell n under consideration.
Note 2:	$\delta$ is the RSRP absolute accuracy requirement from Table 10.1.24.2.1-2, selected according to the lo used in the test.
Note 3:	$G_{min}$ and $G_{max}$ are the minimum and maximum UE gain values from Table B.2.1.6.1-1, selected according to the UE power class

## A.7.7.12 UE Rx-Tx time difference measurements

### A.7.7.12.1 UE Rx-Tx time difference measurement accuracy for single positioning frequency layer in FR2 SA

#### A.7.7.12.1.1 Test purpose and environment

The purpose of the test is to verify that the UE Rx-Tx time difference measurement accuracy is within the specified limits. This test will verify the requirements in clause 10.1.25.2. The test is conducted in AWGN propagation condition in FR2 in standalone scenario when single positioning frequency layer is configured.

The supported test configuration is listed in Table A.7.7.12.1.1-1.

**Table A.7.7.12.1.1-1: Supported test configurations**

Config	Description
1	120 kHz SSB and PRS SCS, 200 MHz bandwidth, TDD duplex mode

There are two cells in the test: PCell (Cell 1) and a neighbour cell (Cell 2). Both cells are on the same RF channel in FR2.

The *NR-Multi-RTT-ProvideAssistanceData* and *nr-Multi-RTT-RequestLocationInformation* as defined in TS 37.355 [34, clause 6.5.12.1], shall be provided to the UE before the start of the test.

The UE is configured with measurement gap pattern ID #13 or ID #24 before the test.

The UE is configured to transmit positioning SRS on Cell 1 during the test.

The test equipment measures the transmit timing of the UE using the transmitted SRS and measures the receive timing using the PRS. The test equipment then compares the difference of these two timings to the UE Rx-Tx measurement reported by the UE for each cell.

#### A.7.7.12.1.2 Test parameters

The UE Rx-Tx time difference accuracy test parameters are given in Table A.7.7.12.1.2-1.

**Table A.7.7.12.1.2-1: UE Rx-Tx time difference measurement accuracy test parameters**

Parameter	Unit	Test configuration	Test 1		Test 2	
			Cell 1	Cell 2	Cell 1	Cell 2
AoA setup		1	Setup 1 as specified in clause A.3.15		Setup 1 as specified in clause A.3.15	
Beam Assumption <sup>Note 7</sup>		1	Rough	Rough	Rough	Rough
Measurement gap		1	GP#24 or GP#13 <sup>Note 8</sup>		GP#24 or GP#13 <sup>Note 8</sup>	
DRX		1	OFF		OFF	
Time offset with Cell 1	μs	1	N/A	3	N/A	3
TDD configuration		1	TDDConf.3.1	TDDConf.3.1	TDDConf.3.1	TDDConf.3.1
PDSCH RMC configuration		1	SR.3.1 TDD	N/A	SR.3.1 TDD	N/A
RMSI CORESET RMC configuration		1	CR.3.1 TDD	N/A	CR.3.1 TDD	N/A
Dedicated CORESET RMC configuration		1	CCR.3.1 TDD	N/A	CCR.3.1 TDD	N/A
OCNG Patterns		1	OP.1	OP.1	OP.1	OP.1
EPRE ratio of PSS to SSS	dB	1	0	0	0	0
EPRE ratio of PBCH DMRS to SSS						
EPRE ratio of PBCH to PBCH DMRS						
EPRE ratio of PDCCH DMRS to SSS						
EPRE ratio of PDCCH to PDCCH DMRS						
EPRE ratio of PDSCH DMRS to SSS						
EPRE ratio of PDSCH to PDSCH DMRS						
EPRE ratio of OCNG DMRS to SSS <sup>Note 1</sup>						
EPRE ratio of OCNG to OCNG DMRS <sup>Note 1</sup>						
EPRE ratio of PRS to SSS						
TRS Configuration		1	TRS.2.1 TDD	N/A	TRS.2.1 TDD	N/A

Initial BWP configuration		1	DLBWP.0.1 ULBWP.0.1	N/A	DLBWP.0.1 ULBWP.0.1	N/A
Active DL BWP configuration		1	DLBWP.1.1	N/A	DLBWP.1.1	N/A
Active UL BWP configuration		1	ULBWP.1.1	N/A	ULBWP.1.1	N/A
PRS configuration		1	PRS.1.1 FR2	PRS.1.1 FR2	PRS.1.2 FR2	PRS.1.2 FR2
PRS Resource slot offset	slot	1	0	4	0	4
SRS configuration		1	POS-SRS.3	N/A	POS-SRS.3	N/A
$N_{oc}$ <small>Note 2</small>	dBm/SCS	1	-89		-89	
$N_{oc}$ <small>Note 2</small>	dBm/15 kHz	1	-98		-98	
PRS $\hat{E}_s/I_{ot}$	dB	1	-2.41	-12.12	-2.41	-12.12
PRS $\hat{E}_s/N_{oc}$	dB	1	-2	-10	-2	-10
PRP <small>Note 3</small>	dBm/SCS kHz	1	-91	-99	-91	-99
$I_o$	dBm/190.08 MHz	1	-54.62	-54.62	-54.62	-54.62
Propagation Condition		1	AWGN		AWGN	
<p>Note 1: Void.</p> <p>Note 2: Interference from other cells and noise sources not specified in the test is assumed to be constant over subcarriers and time and shall be modelled as AWGN of appropriate power for <math>N_{oc}</math> to be fulfilled.</p> <p>Note 3: PRP and <math>I_o</math> levels have been derived from other parameters for information purposes. They are not settable parameters themselves.</p> <p>Note 4: PRS-RSRP minimum requirements are specified assuming independent interference and noise at each receiver antenna port.</p> <p>Note 5: Equivalent power received by an antenna with 0 dBi gain at the centre of the quiet zone</p> <p>Note 6: As observed with 0 dBi gain antenna at the centre of the quiet zone</p> <p>Note 7: Information about types of UE beam is given in B.2.1.3, and does not limit UE implementation or test system implementation</p> <p>Note 8: GP#24 is configured if UE supports MG#24, otherwise GP#13 is configured.</p> <p>Note 9: Calculation of <math>E_s/I_{ot}</math> includes the effect of UE internal noise up to the value assumed for the associated Refsens requirement in clause 7.3.2 of TS 38.101-2 [19], and an allowance of 1dB for UE multi-band relaxation factor <math>\Delta MB_P</math> from TS 38.101-2 [19] Table 6.2.1.3-4.</p>						

Table A.7.7.12.1.2-2: Void

### A.7.7.12.1.3 Test requirements

The UE Rx-Tx time difference measurement time fulfils the UE Rx-Tx measurement accuracy requirements specified in clause 10.1.25.2 for both Cell 1 and Cell 2.

## A.8 E-UTRA standalone tests for NR RRM

*Editor notes: All NR RRM tests under E-UTRA standalone operations are included in this Annex. All EN-DC related NR RRM tests are in A.4 and A.5.*

## A.8.1 Void

## A.8.2 RRC\_IDLE state mobility

### A.8.2.1 Inter-RAT NR Cell re-selection

#### A.8.2.1.1 E-UTRA Cell reselection to higher priority NR target Cell in FR1

##### A.8.2.1.1.1 Test Purpose and Environment

This test is to verify the requirement for the E-UTRAN to NR inter-RAT cell reselection requirements specified in clause 4.2.2.5.6 in TS 36.133 [15].

The test scenario comprises of 1 E-UTRA cell and 1 NR cell as given in tables A.8.2.1.1.1-1, A.8.2.1.1.1-2, A.8.2.1.1.1-3 and A.8.2.1.1.1-4. The test consists of three successive time periods, with time duration of T1, T2, and T3 respectively. E-UTRA cell 1 is already identified by the UE prior to the start of the test. Cell 2 is of higher priority than cell 1.

**Table A.8.2.1.1.1-1: Supported test configurations**

Configuration	Description
1	LTE FDD, NR 15 kHz SSB SCS, 10 MHz bandwidth, FDD duplex mode
2	LTE FDD, NR 15 kHz SSB SCS, 10 MHz bandwidth, TDD duplex mode
3	LTE FDD, NR 30 kHz SSB SCS, 40 MHz bandwidth, TDD duplex mode
4	LTE TDD, NR 15 kHz SSB SCS, 10 MHz bandwidth, FDD duplex mode
5	LTE TDD, NR 15 kHz SSB SCS, 10 MHz bandwidth, TDD duplex mode
6	LTE TDD, NR 30 kHz SSB SCS, 40 MHz bandwidth, TDD duplex mode
Note:	The UE is only required to be tested in one of the supported test configurations

**Table A.8.2.1.1.1-2: General test parameters for E-UTRA cell re-selection FR1 NR cell test case**

Parameter		Unit	Test configuration	Value	Comment
Initial condition	Active cell		1, 2, 3, 4, 5, 6	Cell2	The UE camps on cell 2 in the initial phase
	Neighbour cell		1, 2, 3, 4, 5, 6	Cell1	
T1 end condition	Active cell			Cell1	During T1 period the UE reselects to cell 1
	Neighbour cell			Cell2	
T3 end condition	Active cell		1, 2, 3, 4, 5, 6	Cell2	The UE shall perform reselection to cell 2 during T3
	Neighbour cell		1, 2, 3, 4, 5, 6	Cell1	
RF Channel Number			1, 2, 3, 4, 5, 6	1, 2	E-UTRAN radio channel (1) and NR radio channel (2) are used for this test
Time offset between cells			1, 4	3 ms	Asynchronous cells
			2, 5	3 $\mu$ s	Synchronous cells
			3, 6	3 $\mu$ s	Synchronous cells
Access Barring Information		-	1, 2, 3, 4, 5, 6	Not Sent	No additional delays in random access procedure.
DRX cycle length		s	1, 2, 3, 4, 5, 6	1.28	The value shall be used for all cells in the test.
NR PRACH configuration index			1, 2, 3, 4, 5, 6	102	The detailed configuration is specified in TS 38.211 clause 6.3.3.2
T1		s	1, 2, 3, 4, 5, 6	15	T1 needs to be defined so that cell re-selection reaction time is taken into account.
T2		s	1, 2, 3, 4, 5, 6	>7	During T2, cell 2 shall be powered off, and during the off time the physical cell identity shall be changed. The intention is to ensure that cell 2 has not been detected by the UE prior to the start of period T3.

T3	s	1, 2, 3, 4, 5, 6	75	T3 needs to be defined so that cell re-selection reaction time is taken into account.
----	---	------------------	----	---

Table A.8.2.1.1-3: Cell specific test parameters for NR cell 2

Parameter	Unit	Test configuration	Cell 2		
			T1	T2	T3
TDD configuration		1, 4	N/A		
		2, 5	TDDConf.1.1		
		3, 6	TDDConf.2.1		
PDSCH Reference measurement channel		1, 4	SR.1.1 FDD		
		2, 5	SR.1.1 TDD		
		3, 6	SR.2.1 TDD		
RMSI CORESET Reference Channel		1, 4	CR.1.1 FDD		
		2, 5	CR.1.1 TDD		
		3, 6	CR.2.1 TDD		
RMC CORESET Reference Channel		1, 4	CCR.1.1 FDD		
		2, 5	CCR.1.1 TDD		
		3, 6	CCR.2.1 TDD		
OCNG Patterns		1, 2, 3, 4, 5, 6	OP.1		
SMTC configuration		1, 2, 3, 4, 5, 6	SMTC.1		
SSB configuration		1, 4	SSB.1 FR1		
		2, 5	SSB.1 FR1		
		3, 6	SSB.2 FR1		
Initial DL BWP configuration		1, 2, 3, 4, 5, 6	DLBWP.0.1		
Initial UL BWP configuration		1, 2, 3, 4, 5, 6	ULBWP.0.1		
RLM-RS		1, 2, 3, 4, 5, 6	SSB		
Qrxlevmin	dBm/SCS	1, 2, 4, 5	-140		
		3, 6	-137		
Pcompensation	dB	1, 2, 3, 4, 5, 6	0		
Qhysts	dB	1, 2, 3, 4, 5, 6	0		
Qoffsets <sub>s,n</sub>	dB	1, 2, 3, 4, 5, 6	0		
Cell_selection_and_reselection_quality_measurement		1, 2, 3, 4, 5, 6	SS-RSRP		
$\hat{E}_s / I_{\text{ot}}$	dB	1, 4	-4	-infinity	12
		2, 5			
		3, 6			
$N_{\text{oc}}$ <small>Note2</small>	dBm/SCS	1, 4	-98		
		2, 5	-98		
		3, 6	-95		
$N_{\text{oc}}$ <small>Note2</small>	dBm/15 kHz	1, 4	-98		
		2, 5			
		3, 6			
$\hat{E}_s / N_{\text{oc}}$	dB	1, 4	-4	-infinity	12
		2, 5			
		3, 6			
SS-RSRP <small>Note3</small>	dBm/SCS	1, 4	-102	-infinity	-86
		2, 5	-102	-infinity	-86
		3, 6	-99	-infinity	-83
I <sub>o</sub>	dBm/9.36 MHz	1, 4	-68.60	-70.05	-57.78
	dBm/9.36 MHz	2, 5	-68.60	-70.05	-57.78
	dBm/38.16 MHz	3, 6	-62.50	-63.95	-51.69
Treselection	s	1, 2, 3, 4, 5, 6	0	0	0
SnonintrasearchP	dB	1, 2, 3, 4, 5, 6	50		

Thresh <sub>x, highP</sub>	dB	1, 2, 3, 4, 5, 6	48
Thresh <sub>servicing, lowP</sub>	dB	1, 2, 3, 4, 5, 6	44
Thresh <sub>x, lowP</sub>	dB	1, 2, 3, 4, 5, 6	50
Propagation Condition		1, 2, 3, 4, 5, 6	AWGN
Note 1:	OCNG shall be used such that both cells are fully allocated and a constant total transmitted power spectral density is achieved for all OFDM symbols.		
Note 2:	Interference from other cells and noise sources not specified in the test is assumed to be constant over subcarriers and time and shall be modelled as AWGN of appropriate power for $N_{oc}$ to be fulfilled.		
Note 3:	SS-RSRP levels have been derived from other parameters for information purposes. They are not settable parameters themselves.		

Table A.8.2.1.1.1-4: Cell specific test parameters for E-UTRA cell 1

Parameter	Unit	Cell 1		
		T1	T2	T3
E-UTRA RF Channel number		1		
$BW_{channel}$	MHz	10		
OCNG Patterns defined in TS 36.133 [15] clause A.3.2		OP.2 TDD for test configuration 1, 2, 3; OP.2 FDD for test configuration 4, 5, 6		
PBCH_RA	dB	0		
PBCH_RB	dB			
PSS_RA	dB			
SSS_RA	dB			
PCFICH_RB	dB			
PHICH_RA	dB			
PHICH_RB	dB			
PDCCH_RA	dB			
PDCCH_RB	dB			
PDSCH_RA	dB			
PDSCH_RB	dB			
OCNG_RA <sup>Note 1</sup>	dB			
OCNG_RB <sup>Note 1</sup>	dB			
Qrxlevmin	dBm	-140		
$N_{oc}$ <sup>Note 2</sup>	dBm/15 kHz	-98		
RSRP <sup>Note 3</sup>	dBm/15 KHz	-84	-84	-84
$\hat{E}_s/I_{ot}$	dB	14	14	14
$\hat{E}_s/N_{oc}$	dB	14	14	14
Treselection <sub>EUTRAN</sub>	S	0		
SnonintrasearchP	dB	50		
Thresh <sub>x, highP</sub>	dB	48		
Thresh <sub>-serving, lowP</sub>	dB	44		
Thresh <sub>x, lowP</sub>	dB	50		
Propagation Condition		AWGN		
<p>Note 1: OCNG shall be used such that both cells are fully allocated and a constant total transmitted power spectral density is achieved for all OFDM symbols.</p> <p>Note 2: Interference from other cells and noise sources not specified in the test is assumed to be constant over subcarriers and time and shall be modelled as AWGN of appropriate power for <math>N_{oc}</math> to be fulfilled.</p> <p>Note 3: RSRP levels have been derived from other parameters for information purposes. They are not settable parameters themselves.</p>				

### A.8.2.1.1.2 Test Requirements

The cell reselection delay to a higher priority NR cell is defined as the time from the beginning of time period T3, to the moment when the UE camps on cell 2, and starts to send preambles on the PRACH for sending the *RRCSetupRequest* message to perform a Registration procedure for mobility and periodic registration update on cell 2.

The cell re-selection delay to a higher priority cell shall be less than 68 s.

The rate of correct cell reselections observed during repeated tests shall be at least 90%.

NOTE: The cell re-selection delay to a higher priority cell can be expressed as:  $T_{higher\_priority\_search} + T_{evaluate, NR} + T_{SI-NR}$ , and to a lower priority cell can be expressed as:  $T_{evaluate, EUTRAN} + T_{SI-EUTRA}$ .

Where:

$T_{higher\_priority\_search}$  See clause 4.2.2 in TS 36.133 [15]

$T_{evaluate, NR}$  See Table 4.2.2.5.6-1 in clause 4.2.2.5.6 in TS 36.133 [15]

$T_{SI-NR}$  Maximum repetition period of relevant system info blocks that needs to be received by the UE to camp on a cell; 1280 ms is assumed in this test case.



$T_{\text{evaluate, EUTRAN}}$  See Table 4.2.2.5-1 in clause 4.2.2.5

$T_{\text{SI-EUTRA}}$  Maximum repetition period of relevant system info blocks that needs to be received by the UE to camp on a cell; 1280 ms is assumed in this test case.

This gives a total of 67.68 s, allow 68 s for the cell re-selection delay to a higher priority NR cell and 7.68 s for the cell re-selection delay to a lower priority cell in the test case, which we allow 8 s.

### A.8.2.1.2 E-UTRA Cell reselection to lower priority NR target Cell in FR1 for UE configured with highSpeedInterRAT-NR-r16

#### A.8.2.1.2.1 Test Purpose and Environment

This test is to verify the requirement for the E-UTRAN to NR inter-RAT cell reselection requirements specified in clause 4.2.2.5.6 in 36.133 [15].

The test scenario comprises of 1 E-UTRA cell and 1 NR cell as given in tables A.8.2.1.2.1-1, A.8.2.1.2.1-2, A.8.2.1.2.1-3 and A.8.2.1.2.1-4. In SIB of the E-UTRA cell, highSpeedInterRAT-NR-r16 is configured and the carrier of NR cell is configured with highSpeedCarrierNR-r16. The test consists of two time periods, with time duration of T1 and T2 respectively. Both E-UTRA cell 1 and NR cell 2 are already identified by the UE prior to the start of the test. NR cell 2 is of lower priority than E-UTRA cell 1.

**Table A.8.2.1.2.1-1: Supported test configurations for UE configured with highSpeedInterRAT-NR-r16**

Configuration	Description
1	LTE FDD, NR 15 kHz SSB SCS, 10MHz bandwidth, FDD duplex mode
2	LTE FDD, NR 15 kHz SSB SCS, 10MHz bandwidth, TDD duplex mode
3	LTE FDD, NR 30kHz SSB SCS, 40MHz bandwidth, TDD duplex mode
4	LTE TDD, NR 15 kHz SSB SCS, 10MHz bandwidth, FDD duplex mode
5	LTE TDD, NR 15 kHz SSB SCS, 10MHz bandwidth, TDD duplex mode
6	LTE TDD, NR 30kHz SSB SCS, 40MHz bandwidth, TDD duplex mode
Note: The UE is only required to be tested in one of the supported test configurations	

**Table A.8.2.1.2.1-2: General test parameters in E-UTRA cell re-selection FR1 NR cell test case for UE configured with highSpeedInterRAT-NR-r16**

Parameter		Unit	Test configuration	Value	Comment
Initial condition	Active cell		1, 2, 3, 4, 5, 6	Cell1	The UE camps on cell 1 in the initial phase
T1 end condition	Active cell		1, 2, 3, 4, 5, 6	Cell2	The UE shall perform reselection to cell 2 during T1
	Neighbour cells		1, 2, 3, 4, 5, 6	Cell1	
T2 end condition	Active cell		1, 2, 3, 4, 5, 6	Cell1	The UE shall perform reselection to cell 1 during T2 for iteration of the tests.
	Neighbour cells		1, 2, 3, 4, 5, 6	Cell2	
RF Channel Number			1, 2, 3, 4, 5, 6	1, 2	E-UTRAN radio channel (1) and NR radio channel (2) are used for this test
Time offset between cells			1, 4	3 ms	Asynchronous cells
			2, 5	3 $\mu$ s	Synchronous cells
			3, 6	3 $\mu$ s	Synchronous cells
Access Barring Information		-	1, 2, 3, 4, 5, 6	Not Sent	No additional delays in random access procedure.
DRX cycle length		s	1, 2, 3, 4, 5, 6	0.32	The value shall be used for all cells in the test.
NR PRACH configuration index			1, 2, 3, 4, 5, 6	102	The detailed configuration is specified in TS 38.211 clause 6.3.3.2
T1		s	1, 2, 3, 4, 5, 6	15	T1 needs to be defined so that cell re-selection reaction time is taken into account.
T2		s	1, 2, 3, 4, 5, 6	75	T2 needs to be defined so that cell re-selection reaction time is taken into account.

**Table A.8.2.1.2.1-3: Cell specific test parameters for NR cell 2 in E-UTRA cell re-selection FR1 NR cell test case for UE configured with highSpeedInterRAT-NR-r16**

Parameter	Unit	Test configuration	Cell 2	
			T1	T2
TDD configuration		1, 4	N/A	
		2, 5	TDDConf.1.1	
		3, 6	TDDConf.2.1	
PDSCH Reference measurement channel		1, 4	SR.1.1 FDD	
		2, 5	SR.1.1 TDD	
		3, 6	SR.2.1 TDD	
RMSI CORESET Reference Channel		1, 4	CR.1.1 FDD	
		2, 5	CR.1.1 TDD	
		3, 6	CR.2.1 TDD	
RMC CORESET Reference Channel		1, 4	CCR.1.1 FDD	
		2, 5	CCR.1.1 TDD	
		3, 6	CCR.2.1 TDD	
OCNG Patterns		1, 2, 3, 4, 5, 6	OP.1	
SMTC configuration		1, 2, 3, 4, 5, 6	SMTC.1	
SSB configuration		1, 4	SSB.1 FR1	
		2, 5	SSB.1 FR1	
		3, 6	SSB.2 FR1	
Initial DL BWP configuration		1, 2, 3, 4, 5, 6	DLBWP.0.1	
Initial UL BWP configuration		1, 2, 3, 4, 5, 6	ULBWP.0.1	
RLM-RS		1, 2, 3, 4, 5, 6	SSB	
Qrxlevmin	dBm/SCS	1, 2, 4, 5	-140	
		3, 6	-137	
Pcompensation	dB	1, 2, 3, 4, 5, 6	0	
Qhyst <sub>s</sub>	dB	1, 2, 3, 4, 5, 6	0	
Qoffset <sub>s, n</sub>	dB	1, 2, 3, 4, 5, 6	0	
Cell_selection_and_reselection_quality_measurement		1, 2, 3, 4, 5, 6	SS-RSRP	
$\hat{E}_s/I_{ot}$	dB	1, 4	14	14
		2, 5		
		3, 6		
$N_{oc}$ <sup>Note2</sup>	dBm/SCS	1, 4	-98	
		2, 5	-98	
		3, 6	-95	
$N_{oc}$ <sup>Note2</sup>	dBm/15 kHz	1, 4	-98	
		2, 5		
		3, 6		
$\hat{E}_s/N_{oc}$	dB	1, 4	14	14
		2, 5		
		3, 6		
SS-RSRP <sup>Note3</sup>	dBm/SCS	1, 4	-84	-84
		2, 5	-84	-84
		3, 6	-81	-81
I <sub>o</sub>	dBm/9.36 MHz	1, 4	-55.88	-55.88
	dBm/9.36 MHz	2, 5	-55.88	-55.88
	dBm/38.16 MHz	3, 6	-47.79	-47.79
Treselection	s	1, 2, 3, 4, 5, 6	0	
Snonintrasearch	dB	1, 2, 3, 4, 5, 6	Not sent	
Thresh <sub>x, high</sub>	dB	1, 2, 3, 4, 5, 6	48	
Thresh <sub>serv, low</sub>	dB	1, 2, 3, 4, 5, 6	44	
Thresh <sub>x, low</sub>	dB	1, 2, 3, 4, 5, 6	50	
Propagation Condition		1, 2, 4, 5	AWGN 1944Hz <sup>Note 4</sup>	

		3,6	AWGN 3334Hz <sup>Note 5</sup>
Note 1:	OCNG shall be used such that both cells are fully allocated and a constant total transmitted power spectral density is achieved for all OFDM symbols.		
Note 2:	Interference from other cells and noise sources not specified in the test is assumed to be constant over subcarriers and time and shall be modelled as AWGN of appropriate power for $N_{oc}$ to be fulfilled.		
Note 3:	SS-RSRP levels have been derived from other parameters for information purposes. They are not settable parameters themselves.		
Note 4:	The AWGN 1944 Hz condition is a non fading propagation channel with one tap. Doppler shift is a constant 1944 Hz.		
Note 5:	The AWGN 3334 Hz condition is a non fading propagation channel with one tap. Doppler shift is a constant 3334 Hz.		

**Table A.8.2.1.2.1-4: Cell specific test parameters for E-UTRA cell 1 in E-UTRA cell re-selection FR1 NR cell test case for UE configured with highSpeedInterRAT-NR-r16**

Parameter	Unit	Cell 1	
		T1	T2
E-UTRA RF Channel number		1	
$BW_{channel}$	MHz	10	
OCNG Patterns defined in TS 36.133 clause A.3.2		OP.2 TDD for test configuration 1, 2, 3; OP.2 FDD for test configuration 4, 5, 6	
PBCH_RA	dB	0	
PBCH_RB	dB		
PSS_RA	dB		
SSS_RA	dB		
PCFICH_RB	dB		
PHICH_RA	dB		
PHICH_RB	dB		
PDCCH_RA	dB		
PDCCH_RB	dB		
PDSCH_RA	dB		
PDSCH_RB	dB		
OCNG_RA <sup>Note 1</sup>	dB		
OCNG_RB <sup>Note 1</sup>	dB		
Qrxlevmin	dBm	-140	
$N_{oc}$ <sup>Note 2</sup>	dBm/15 kHz	-98	
RSRP <sup>Note 3</sup>	dBm/15 KHz	-102	-86
$\hat{E}_s/I_{ot}$	dB	-4	12
$\hat{E}_s/N_{oc}$	dB	-4	12
Treselection <sub>EUTRAN</sub>	S	0	
Snonintrasearch	dB	50	
Thresh <sub>x, high</sub>	dB	48	
Thresh <sub>-serving, low</sub>	dB	44	
Thresh <sub>x, low</sub>	dB	50	
Propagation Condition		AWGN	
Note 1:	OCNG shall be used such that both cells are fully allocated and a constant total transmitted power spectral density is achieved for all OFDM symbols.		
Note 2:	Interference from other cells and noise sources not specified in the test is assumed to be constant over subcarriers and time and shall be modelled as AWGN of appropriate power for $N_{oc}$ to be fulfilled.		
Note 3:	RSRP levels have been derived from other parameters for information purposes. They are not settable parameters themselves.		
Note 4:	Void.		

### A.8.2.1.2.2 Test Requirements

The cell reselection delay to a lower priority NR cell is defined as the time from the beginning of time period T1, to the moment when the UE camps on cell 2, and starts to send preambles on the PRACH for sending the RRC CONNECTION REQUEST message to perform a Tracking Area Update procedure on cell 2.

The cell re-selection delay to a lower priority cell shall be less than 3 s.

The rate of correct cell reselections observed during repeated tests shall be at least 90%.

NOTE: The cell re-selection delay to a lower priority cell can be expressed as:  $T_{\text{evaluate, NR\_HST}} + T_{\text{SI-NR}}$ .

Where:

$T_{\text{evaluate, NR\_HST}}$  See Table 4.2.2.5.6-2 in clause 4.2.2.5.6 in [15]

$T_{\text{SI-NR}}$  Maximum repetition period of relevant system info blocks that needs to be received by the UE to camp on a cell; 1280 ms is assumed in this test case.

This gives a total of 2.24 s, allow 3 s for the cell re-selection delay to a lower priority NR cell.

## A.8.2.2 E-UTRA – NR Inter-RAT Early Measurement Reporting

### A.8.2.2.1 E-UTRA – NR Early Measurement Reporting for NR in FR1

#### A.8.2.2.1.1 Test Purpose and Environment

This test is to verify the requirement for the E-UTRAN to NR inter-RAT Idle mode DC measurement requirements specified in clause 4.9.2.4 in TS 36.133 [15]. This test is also to verify the accuracy requirement for the E-UTRAN to NR inter-RAT Idle mode DC measurement requirements specified in clause 9.11.1A and 9.11.2A in TS 36.133 [15]. Supported test configurations are shown in Table A.8.2.2.1.1-1.

**Table A.8.2.2.1.1-1: Supported test configurations**

Configuration	Description
1	LTE FDD, NR 15 kHz SSB SCS, 10 MHz bandwidth, FDD duplex mode
2	LTE FDD, NR 15 kHz SSB SCS, 10 MHz bandwidth, TDD duplex mode
3	LTE FDD, NR 30 kHz SSB SCS, 40 MHz bandwidth, TDD duplex mode
4	LTE TDD, NR 15 kHz SSB SCS, 10 MHz bandwidth, FDD duplex mode
5	LTE TDD, NR 15 kHz SSB SCS, 10 MHz bandwidth, TDD duplex mode
6	LTE TDD, NR 30 kHz SSB SCS, 40 MHz bandwidth, TDD duplex mode
Note:	The UE is only required to be tested in one of the supported test configurations

The test scenario comprises of 1 E-UTRA cell (Cell 1) and 1 NR cell (Cell 2). The the test parameters and applicability for the E-UTRAN cell are defined in Table A.8.2.2.1.1-4. The general test parameters and the cell specific test parameters for the NR cell are specified in Table A.8.2.2.1.1-2 and Table A.8.2.2.1.1-3, respectively.

The test consists of three successive time periods, with time duration of T1, T2, and T3 respectively. Prior to the start of the time duration T1, the UE shall be connected to Cell 1. During T1, Cell 2 shall be powered off. At the end of T1, the RRC connection to Cell 1 is released and UE is configured Idle mode DC measurement on the carrier frequency of Cell 2. Time duration T2 starts when the RRC connection is released, and during the T2 UE is in Idle mode. Cell 2 shall be powered on from the beginning of T2. At beginning of T3 the UE is paged for connection setup and requested by the network to send idle mode measurements.

**Table A.8.2.2.1.1-2: General test parameters**

Parameter	Unit	Test configuration	Value	Comment
Active cell		1, 2, 3, 4, 5, 6	E-UTRAN Cell 1	

Neighbour cell		1, 2, 3, 4, 5, 6	NR Cell 2	Cell 2 is of higher priority.
RF Channel Number		1, 2, 3, 4, 5, 6	1: Cell 1 2: Cell 2	
DRX cycle length	s	1, 2, 3, 4, 5, 6	1.28	
Time offset between Cell 1 and Cell 2		1, 2, 3, 4, 5, 6	3 μs	
T1	s	1, 2, 3, 4, 5, 6	0.5	
T2	s	1, 2, 3, 4, 5, 6	71	
T3	s	1, 2, 3, 4, 5, 6	2	
T331	s	1, 2, 3, 4, 5, 6	300	

Table A.8.2.2.1.1-3: Cell specific test parameters for NR cell 2

Parameter	Unit	Test configuration	Cell 2		
			T1	T2	T3
TDD configuration		1, 4	N/A		
		2, 5	TDDConf.1.1		
		3, 6	TDDConf.2.1		
PDSCH Reference measurement channel		1, 4	SR.1.1 FDD		
		2, 5	SR.1.1 TDD		
		3, 6	SR.2.1 TDD		
RMSI CORESET Reference Channel		1, 4	CR.1.1 FDD		
		2, 5	CR.1.1 TDD		
		3, 6	CR.2.1 TDD		
RMC CORESET Reference Channel		1, 4	CCR.1.1 FDD		
		2, 5	CCR.1.1 TDD		
		3, 6	CCR.2.1 TDD		
OCNG Patterns		1, 2, 3, 4, 5, 6	OP.1		
SMTC configuration		1, 2, 3, 4, 5, 6	SMTC.1		
SSB configuration		1, 4	SSB.1 FR1		
		2, 5	SSB.1 FR1		
		3, 6	SSB.2 FR1		
Initial DL BWP configuration		1, 2, 3, 4, 5, 6	DLBWP.0.1		
Initial UL BWP configuration		1, 2, 3, 4, 5, 6	ULBWP.0.1		
Qrxlevmin	dBm/SCS	1, 2, 4, 5	-140		
		3, 6	-137		
Pcompensation	dB	1, 2, 3, 4, 5, 6	0		
Qhysts	dB	1, 2, 3, 4, 5, 6	0		
Qoffsets, n	dB	1, 2, 3, 4, 5, 6	0		
Cell_selection_and_reselection_quality_measurement		1, 2, 3, 4, 5, 6	SS-RSRP		
$N_{oc}$ <small>Note2</small>	dBm/SCS	1, 4	-98		
		2, 5	-98		
		3, 6	-95		
$N_{oc}$ <small>Note2</small>	dBm/15 kHz	1, 4	-98		
		2, 5			
		3, 6			
$\hat{E}_s / N_{oc}$	dB	1, 2, 3, 4, 5, 6	-infinity	-4	-4
$\hat{E}_s / I_{ot}$	dB	1, 2, 3, 4, 5, 6	-infinity	-4	-4
SS-RSRP <small>Note3</small>	dBm/SCS	1, 4	-infinity	-102	-102
		2, 5	-infinity	-102	-102
		3, 6	-infinity	-99	-99
SS-RSRQ <small>Note3</small>	dB	1, 4	-infinity	-16.25	-16.25
		2, 5	-infinity	-16.25	-16.25
		3, 6	-infinity	-16.25	-16.25

Io	dBm/9.36 MHz	1, 4	-70.05	-68.60	-68.60
	dBm/9.36 MHz	2, 5	-70.05	-68.60	-68.60
	dBm/38.16 MHz	3, 6	-63.96	-62.50	-62.50
Propagation Condition		1, 2, 3, 4, 5, 6	AWGN		
Note 1:	OCNG shall be used such that both cells are fully allocated and a constant total transmitted power spectral density is achieved for all OFDM symbols.				
Note 2:	Interference from other cells and noise sources not specified in the test is assumed to be constant over subcarriers and time and shall be modelled as AWGN of appropriate power for $N_{oc}$ to be fulfilled.				
Note 3:	SS-RSRP levels have been derived from other parameters for information purposes. They are not settable parameters themselves.				

**Table A.8.2.2.1.1-4: Cell specific test parameters for E-UTRA cell 1**

Parameter	Unit	Cell 1		
		T1	T2	T3
E-UTRA RF Channel number		1		
BW <sub>channel</sub>	MHz	10		
OCNG Patterns defined in TS 36.133 [15] clause A.3.2		OP.2 TDD for test configuration 1, 2, 3; OP.2 FDD for test configuration 4, 5, 6		
PBCH_RA	dB	0		
PBCH_RB	dB			
PSS_RA	dB			
SSS_RA	dB			
PCFICH_RB	dB			
PHICH_RA	dB			
PHICH_RB	dB			
PDCCH_RA	dB			
PDCCH_RB	dB			
PDSCH_RA	dB			
PDSCH_RB	dB			
OCNG_RA <sup>Note 1</sup>	dB			
OCNG_RB <sup>Note 1</sup>	dB			
Qrxlevmin	dBm			
$N_{oc}$ <sup>Note 2</sup>	dBm/15 kHz	-98		
RSRP <sup>Note 3</sup>	dBm/15 KHz	-84	-84	-84
RSRQ <sup>Note 3</sup>	dB	-10.96	-10.96	-10.96
$\hat{E}_s/I_{ot}$	dB	14	14	14
$\hat{E}_s/N_{oc}$	dB	14	14	14
Treselection <sub>EUTRAN</sub>	S	0		
SnonintrasearchP	dB	50		
Thresh <sub>x, highP</sub>	dB	48		
Thresh <sub>serv, lowP</sub>	dB	44		
Thresh <sub>x, lowP</sub>	dB	50		
beamMeasConfigIdle		True		
Propagation Condition		AWGN		
Note 1:	OCNG shall be used such that both cells are fully allocated and a constant total transmitted power spectral density is achieved for all OFDM symbols.			
Note 2:	Interference from other cells and noise sources not specified in the test is assumed to be constant over subcarriers and time and shall be modelled as AWGN of appropriate power for $N_{oc}$ to be fulfilled.			
Note 3:	RSRP levels have been derived from other parameters for information purposes. They are not settable parameters themselves.			

### A.8.2.2.1.2 Test Requirements

At the beginning of the time-period T2 the connection is released, and UE enters idle mode. During the time period T2 the UE is in Idle mode and Cell 2 is active. The UE shall not perform reselection. The UE shall perform Idle Mode DC measurement according to clause 4.9.2.4 in TS 36.133 [15]. UE shall be able to detect, acquire the SSB index and measure the SS-RSRP and SS-RSRQ from Cell 2 for Idle mode DC measurement during T2.

NOTE: The Idle mode DC measurement period for the test setup can be expressed as:  $T_{\text{higher\_priority\_search}} + T_{\text{SSB\_index,NR}} + T_{\text{evaluate, NR}}$ .

Where:

$T_{\text{higher\_priority\_search}}$  See clause 4.2.2 in TS 36.133 [15]

$T_{\text{SSB\_index,NR}}$  See Table 4.9.2.4-1 in clause 4.9.2.4 in TS 36.133 [15]

$T_{\text{evaluate, NR}}$  See Table 4.2.2.5.6-1 in clause 4.2.2.5.6 in TS 36.133 [15]

This gives a total of 70.24 s, allow 71 s for the T2.

At the start of T3 the UE is paged for connection setup. During the connection setup the UE is requested to transmit early measurement report. The UE shall send early measurement report to the PCell.

After receiving the requested early measurement report, the test equipment verifies the accuracy of measurement reported for serving Cell 1 and Cell 2 meets the requirements in Section 9.1.2B in TS 36.133 [15] and Section 9.1.3B, respectively and test ends.

The rate of correct events observed during repeated tests shall be at least 90%.

## A.8.2.2.2 E-UTRA – NR Early Measurement Reporting for NR in FR2

### A.8.2.2.2.1 Test Purpose and Environment

This test is to verify the requirement for the E-UTRAN to NR inter-RAT Idle mode DC measurement requirements specified in clause 4.9.2.4 in TS 36.133 [15]. This test is also to verify the accuracy requirement for the E-UTRAN to NR inter-RAT Idle mode DC measurement requirements specified in clause 9.11.1A and 9.11.2A in TS 36.133 [15]. Supported test configurations are shown in Table A.8.2.2.2-1.

**Table A.8.2.2.2.1-1: Supported test configurations**

Configuration	Description
1	LTE FDD, NR 120 kHz SSB SCS, 100 MHz bandwidth, TDD duplex mode
2	LTE TDD, NR 120 kHz SSB SCS, 100 MHz bandwidth, TDD duplex mode
Note:	The UE is only required to be tested in one of the supported test configurations

The test scenario comprises of 1 E-UTRA cell (Cell 1) and 1 NR cell (Cell 2). The the test parameters and applicability for the E-UTRAN cell are defined in Table A.8.2.2.2.1-4. The general test parameters and the cell specific test parameters for the NR cell are specified in Table A.8.2.2.2.1-2 and Table A.8.2.2.2.1-3, respectively.

The test consists of three successive time periods, with time duration of T1, T2, and T3 respectively. Prior to the start of the time duration T1, the UE shall be connected to Cell 1. During T1, Cell 2 shall be powered off. At the end of T1, the RRC connection to Cell 1 is released and UE is configured Idle mode DC measurement on the carrier frequency of Cell 2. Time duration T2 starts when the RRC connection is released, and during the T2 UE is in Idle mode. Cell 2 shall be powered on from the beginning of T2. At beginning of T3 the UE is paged for connection setup and requested by the network to send idle mode measurements.

**Table A.8.2.2.2.1-2: General test parameters**

Parameter	Unit	Test	Value	Comment
-----------	------	------	-------	---------

		configuration		
Active cell		1, 2	E-UTRAN Cell 1	E-UTRA cell 1 is on E-UTRA RF channel number 1 as defined in clause A.3.7.2.2.
Neighbour cell		1, 2	NR Cell 2	Cell 2 is of higher priority.
E-UTRA RF Channel Number		1, 2	1	One E-UTRA carrier frequency is used.
NR RF Channel Number		1, 2	1	One FR2 NR carrier frequency is used.
DRX cycle length	s	1, 2	1.28	
Time offset between Cell 1 and Cell 2		1, 2	3 $\mu$ s	
T1	s	1, 2	0.5	
T2	s	1, 2	128	
T3	s	1, 2	2	
T331	s	1, 2	300	

Table A.8.2.2.1-3: Cell specific test parameters for NR cell 2

Parameter	Unit	Test configuration	Cell 2		
			T1	T2	T3
TDD configuration		1, 2	TDDConf.3.1		
PDSCH Reference measurement channel		1, 2	SR.3.1 TDD		
RMSI CORESET Reference Channel		1, 2	CR.3.1 TDD		
RMC CORESET Reference Channel		1, 2	CCR.3.1 TDD		
OCNG Patterns		1, 2	OP.1		
$BW_{channel}$	MHz	1, 2	100		
Data RBs allocated		1, 2	66		
SMTC configuration		1, 2	SMTC.1		
SSB configuration		1, 2	SSB.1 FR2		
Initial DL BWP configuration		1, 2	DLBWP.0.1		
Initial UL BWP configuration		1, 2	ULBWP.0.1		
RLM-RS			SSB		
Qrxlevmin			-140		
Pcompensation			0		
Qhysts			0		
Qoffsets, n			0		
Cell_selection_and_reselection_quality_measurement			SS-RSRP		
AoA setup			Setup 1 defined in A.3.15.1		
Beam assumption <sup>Note 4</sup>			Rough		
$\hat{E}_s / I_{ot} \hat{E}_s / I_{ot BB}$ <sup>Note 5</sup>	dB	1, 2	-infinity	-4.18	-4.18
$N_{oc}$ <sup>Note2</sup>	dBm/SCS	1, 2	-98		
$N_{oc}$ <sup>Note2</sup>	dBm/15kHz	1, 2	-107		
$\hat{E}_s / N_{oc}$	dB	1, 2	-infinity	-4	-4
SS-RSRP <sup>Note3</sup>	dBm/SCS	1, 2	-infinity	-102	-102
SS-RSRQ <sup>Note3</sup>	dB	1, 2	-infinity	-16.25	-16.25
Io	dBm/95.04MHz	1, 2	-69.01	-67.56	-67.56
Propagation Condition		1, 2	AWGN		



Note 1:	OCNG shall be used such that both cells are fully allocated and a constant total transmitted power spectral density is achieved for all OFDM symbols.
Note 2:	Interference from other cells and noise sources not specified in the test is assumed to be constant over subcarriers and time and shall be modelled as AWGN of appropriate power for $N_{oc}$ to be fulfilled.
Note 3:	SS-RSRP levels have been derived from other parameters for information purposes. They are not settable parameters themselves.
Note 4:	Information about types of UE beam is given in B.2.1.3, and does not limit UE implementation or test system implementation
Note 5:	Calculation of $E_s/I_{otBB}$ includes the effect of UE internal noise up to the value assumed for the associated Refsens requirement in clause 7.3.2 of TS 38.101-2 [19], and an allowance of 1dB for UE multi-band relaxation factor $\Delta MBP$ from TS 38.101-2 [19] Table 6.2.1.3-4.

**Table A.8.2.2.1-4: Cell specific test parameters for E-UTRA cell 1**

Parameter	Unit	Cell 1		
		T1	T2	T3
E-UTRA RF Channel number		1		
$BW_{channel}$	MHz	10		
OCNG Patterns defined in TS 36.133 [15] clause A.3.2		OP.2 TDD for test configuration 1, 2, 3; OP.2 FDD for test configuration 4, 5, 6		
PBCH_RA	dB	0		
PBCH_RB	dB			
PSS_RA	dB			
SSS_RA	dB			
PCFICH_RB	dB			
PHICH_RA	dB			
PHICH_RB	dB			
PDCCH_RA	dB			
PDCCH_RB	dB			
PDSCH_RA	dB			
PDSCH_RB	dB			
OCNG_RA <sup>Note 1</sup>	dB			
OCNG_RB <sup>Note 1</sup>	dB			
$Q_{rxlevmin}$	dBm	-140		
$N_{oc}$ <sup>Note 2</sup>	dBm/15 kHz	-98		
RSRP <sup>Note 3</sup>	dBm/15 KHz	-84	-84	-84
RSRQ <sup>Note 3</sup>	dB	-10.96	-10.96	-10.96
$\hat{E}_s/I_{ot}$	dB	14	14	14
$\hat{E}_s/N_{oc}$	dB	14	14	14
Treselection <sub>EUTRAN</sub>	S	0		
SnonintrasearchP	dB	N/A		
Thresh <sub>x, highP</sub>	dB	48		
Thresh <sub>servicing, lowP</sub>	dB	44		
Thresh <sub>x, lowP</sub>	dB	50		
beamMeasConfigIdle		False		
Propagation Condition		AWGN		
Note 1:	OCNG shall be used such that both cells are fully allocated and a constant total transmitted power spectral density is achieved for all OFDM symbols.			
Note 2:	Interference from other cells and noise sources not specified in the test is assumed to be constant over subcarriers and time and shall be modelled as AWGN of appropriate power for $N_{oc}$ to be fulfilled.			
Note 3:	RSRP levels have been derived from other parameters for information purposes. They are not settable parameters themselves.			

### A.8.2.2.2.2 Test Requirements

At the beginning of the time-period T2 the connection is released, and UE enters idle mode. During the time period T2 the UE is in Idle mode and Cell 2 is active. The UE shall not perform reselection. The UE shall perform Idle Mode DC measurement according to clause 4.9.2.4 in TS 36.133 [15]. UE shall be able to detect, acquire the SSB index and measure the SS-RSRP and SS-RSRQ from Cell 2 for Idle mode DC measurement during T2.

NOTE: The Idle mode DC measurement period for the test setup can be expressed as:  $T_{\text{detect, NR}}$ .

Where:

$T_{\text{detect, NR}}$  See Table 4.2.2.5.6-1 in clause 4.2.2.5.6 in TS 36.133 [15]

This gives a total of 128 s, allow 128 s for the T2.

At the start of T3 the UE is paged for connection setup. During the connection setup the UE is requested to transmit early measurement report. The UE shall send early measurement report to the PCell.

After receiving the requested early measurement report, the test equipment verifies the accuracy of measurement reported for serving Cell 1 and Cell 2 meets the requirements in Section 9.1.2B in TS 36.133 [15] and Section 9.1.3B, respectively and test ends.

The rate of correct events observed during repeated tests shall be at least 90%.

## A.8.3 RRC\_CONNECTED state mobility

### A.8.3.1 Handover

#### A.8.3.1.1 E-UTRAN - NR handover in FR1

##### A.8.3.1.1.1 Test Purpose and Environment

This test shall verify the E-UTRAN to NR FR1 handover requirements as specified in clause 6.1.2.1 specified in clause 5.3.4 in TS 36.133 [15].

The test comprises of one E-UTRA carrier and one NR carrier. There are two cells and one cell on each carrier. Cell 1 is the E-UTRAN and Cell 2 is an inter-RAT NR neighbour cell. The test consists of three successive time periods, with time durations of T1, T2 and T3 respectively. At the start of time duration T1, the UE does not have any timing information of Cell 2. Starting T2, Cell 2 becomes detectable and the UE is expected to detect and send a measurement report. Gap pattern configuration with id #0 as specified in Table 8.1.2.1-1 of TS 36.133 [15] is configured before T2 begins to enable inter-RAT frequency monitoring.

A RRC message implying handover shall be sent to the UE during period T2 after the UE has reported Event B2. The start of T3 is the instant when the last TTI containing the RRC message implying handover is sent to the UE. The handover message shall contain Cell 2 as the target cell.

Supported test configurations are shown in table A.8.3.1.1-1. General test parameters are provided in Table A.8.3.1.1-2. Cell specific test parameters for Cell 1 and Cell 2 are provided in Tables A.8.3.1.1-3 and A.8.3.1.1-4 respectively.

**Table A.8.3.1.1-1: Supported test configurations for E-UTRAN inter-RAT NR handover**

Configuration	Description
1	LTE FDD, NR 15 kHz SSB SCS, 10 MHz bandwidth, FDD duplex mode
2	LTE FDD, NR 15 kHz SSB SCS, 10 MHz bandwidth, TDD duplex mode
3	LTE FDD, NR 30 kHz SSB SCS, 40 MHz bandwidth, TDD duplex mode
4	LTE TDD, NR 15 kHz SSB SCS, 10 MHz bandwidth, FDD duplex mode
5	LTE TDD, NR 15 kHz SSB SCS, 10 MHz bandwidth, TDD duplex mode
6	LTE TDD, NR 30 kHz SSB SCS, 40 MHz bandwidth, TDD duplex mode
Note:	The UE is only required to be tested in one of the supported test configurations

**Table A.8.3.1.1-2: General test parameters for E-UTRAN inter-RAT NR handover**

Parameter		Unit	Value	Comment
NR RF Channel Number			1	1 NR carrier frequency is used in the test
LTE RF Channel Number			2	1 E-UTRAN carrier frequency is used in the test
Initial conditions	Active cell		Cell 1	E-UTRAN cell
	Neighbouring cell		Cell 2	NR cell
Final condition	Active cell		Cell 2	
NR measurement quantity			SS-RSRP	
E-UTRAN measurement quantity			RSRP	
b2-Threshold1		dBm	-83	Absolute E-UTRAN RSRP threshold for event B2
b2-Threshold2NR		dBm	As specified in Table A.8.3.1.1-4	Absolute NR SS-RSRP threshold for event B2
Hysteresis		dB	0	
TimeToTrigger		s	0	
Filter coefficient			0	L3 filtering is not used
DRX			OFF	Non-DRX test
Access Barring Information		-	Not sent	No additional delays in random access procedure
Time offset between cells			3 ms	Asynchronous cells
Gap pattern configuration Id			0	As specified in Table 8.1.2.1-1 started before T2 starts [15]
T1		s	5	
T2		s	≤5	
T3		s	1	

**Table A.8.3.1.1-3: Cell specific test parameters for E-UTRAN inter-RAT NR handover (Cell 1)**

Parameter	Unit	Configuration	Cell 1		
			T1	T2	T3
RF channel number		1, 2, 3, 4, 5, 6	2		
Duplex mode		1, 2, 3	FDD		
		4, 5, 6	TDD		
TDD special subframe configuration <sup>Note1</sup>		4, 5, 6	6		
TDD uplink-downlink configuration <sup>Note1</sup>		4, 5, 6	1		
BW <sub>channel</sub>	MHz	1, 2, 3, 4, 5, 6	5 MHz: N <sub>RB,c</sub> = 25 10 MHz: N <sub>RB,c</sub> = 50 20 MHz: N <sub>RB,c</sub> = 100		
PRACH Configuration <sup>Note2</sup>		1, 2, 3	4		
		4, 5, 6	53		
PDSCH parameters: DL Reference Measurement Channel <sup>Note3</sup>		1, 2, 3	5 MHz: R.7 FDD 10 MHz: R.3 FDD 20 MHz: R.6 FDD		
		4, 5, 6	5 MHz: R.4 TDD 10 MHz: R.0 TDD 20 MHz: R.3 TDD		
PCFICH/PDCCH/PHICH parameters: DL Reference Measurement Channel <sup>Note3</sup>		1, 2, 3	5 MHz: R.11 FDD 10 MHz: R.6 FDD 20 MHz: R.10 FDD		
		4, 5, 6	5 MHz: R.11 TDD 10 MHz: R.6 TDD 20 MHz: R.10 TDD		
OCNG Patterns <sup>Note3</sup>		1, 2, 3	5 MHz: OP.20 FDD 10 MHz: OP.10 FDD 20 MHz: OP.17 FDD		
		4, 5, 6	5 MHz: OP.9 TDD 10 MHz: OP.1 TDD 20 MHz: OP.7 TDD		
PBCH_RA	dB	1, 2, 3, 4, 5, 6	0		
PBCH_RB					

PSS_RA					
SSS_RA					
PCFICH_RB					
PHICH_RA					
PHICH_RB					
PDCCH_RA					
PDCCH_RB					
PDSCH_RA					
PDSCH_RB					
OCNG_RA <sup>Note4</sup>					
OCNG_RB <sup>Note4</sup>					
N <sub>oc</sub> <sup>Note5</sup>	dBm/15kHz	1, 2, 3, 4, 5, 6	-98		
$\bar{E}_s/N_{oc}$	dB	1, 2, 3, 4, 5, 6	7	7	7
$\bar{E}_s/I_{ot}$ <sup>Note6</sup>	dB	1, 2, 3, 4, 5, 6	7	7	7
RSRP <sup>Note6</sup>	dBm/15kHz	1, 2, 3, 4, 5, 6	-91	-91	-91
SCH_RP <sup>Note6</sup>	dBm/15kHz	1, 2, 3, 4, 5, 6	-91	-91	-91
I <sub>o</sub> <sup>Note6</sup>	dBm/9MHz	1, 2, 3, 4, 5, 6	-62.43	-62.43	-62.43
Propagation Condition		1, 2, 3, 4, 5, 6	AWGN		
Antenna Configuration and Correlation Matrix <sup>Note7</sup>		1, 2, 3, 4, 5, 6	1x2 Low		
<p>Note 1: Special subframe and uplink-downlink configurations are specified in table 4.2-1 in TS 36.211 [23].</p> <p>Note 2: PRACH configurations are specified in table 5.7.1-2 and table 5.7.1-3 in TS 36.211 [23].</p> <p>Note 3: DL RMCs and OCNG patterns are specified in clauses A 3.1 and A 3.2 of TS 36.133 [15] respectively.</p> <p>Note 4: OCNG shall be used such that all cells are fully allocated and a constant total transmitted power spectral density is achieved for all OFDM symbols.</p> <p>Note 5: Interference from other cells and noise sources not specified in the test is assumed to be constant over subcarriers and time and shall be modelled as AWGN of appropriate power for N<sub>oc</sub> to be fulfilled.</p> <p>Note 6: <math>\bar{E}_s/I_{ot}</math>, RSRP, SCH_RP and I<sub>o</sub> levels have been derived from other parameters for information purposes. They are not settable parameters themselves.</p> <p>Note 7: Propagation condition and correlation matrix are defined in clause B.2 in TS 36.101 [25].</p>					

**Table A.8.3.1.1-4: Cell specific test parameters E-UTRAN inter-RAT NR handover (Cell 2)**

Parameter	Unit	Configuration	Cell 2		
			T1	T2	T3
RF channel number		1, 2, 3, 4, 5, 6	1		
Duplex mode		1, 4	FDD		
		2, 3, 5, 6	TDD		
TDD Configuration		2, 5	TDDConf.1.1		
		3, 6	TDDConf.2.1		
BW <sub>channel</sub>	MHz	1, 4	10: N <sub>RB,c</sub> = 52 (FDD)		
		2, 5	10: N <sub>RB,c</sub> = 52 (TDD)		
		3, 6	40: N <sub>RB,c</sub> = 106 (TDD)		
PDSCH reference measurement channel		1, 4	SR.1.1 FDD		
		2, 5	SR.1.1 TDD		
		3, 6	SR.2.1 TDD		
CORSET reference channel		1, 4	CR.1.1 FDD		
		2, 5	CR.1.1 TDD		
		3, 6	CR.2.1 TDD		
PRACH configuration			FR1 PRACH configuration 1		
OCNG pattern <sup>Note1</sup>		1, 2, 3, 4, 5, 6	OP.1		
BWP	Initial DL BWP Dedicated DL BWP Initial UL BWP Dedicated UL BWP	1, 2, 3, 4, 5, 6	DLBWP.0.1		
			DLBWP.1.1		
			ULBWP.0.1		
			ULBWP.1.1		
SMTc configuration		1, 2, 3, 4, 5, 6	SMTc.1		
SSB configuration		1, 2, 4, 5	SSB.1 FR1		
		3, 6	SSB.2 FR1		
b2-Threshold2NR	dBm	1, 2, 4, 5	-106		
		3, 6	-103		
EPRE ratio of PSS to SSS	dB	1, 2, 3, 4, 5, 6	0		
EPRE ratio of PBCH_DMRS to SSS					

EPRE ratio of PBCH to PBCH_DMRS					
EPRE ratio of PDCCH_DMRS to SSS					
EPRE ratio of PDCCH to PDCCH_DMRS					
EPRE ratio of PDSCH_DMRS to SSS					
EPRE ratio of PDSCH to PDSCH_DMRS					
EPRE ratio of OCNG DMRS to SSS					
EPRE ratio of OCNG to OCNG DMRS					
$N_{oc}^{Note2}$	dBm/15 KHz	1, 2, 3, 4, 5, 6			-98
$N_{oc}^{Note2}$	dBm/SCS	1, 2, 4, 5			-98
		3, 6			-95
$\hat{E}_s/N_{oc}$	dB	1, 2, 3, 4, 5, 6	-infinity	0	0
$\hat{E}_s/I_{ot}^{Note3}$	dB	1, 2, 3, 4, 5, 6	-infinity	0	0
SS-RSRP <sup>Note3</sup>	dBm/SCS	1, 2, 4, 5	-infinity	-98	-98
		3, 6	-infinity	-95	-95
$I_o^{Note3}$	dBm/9.36 MHz	1, 2, 4, 5	-70.05	-67.04	-67.04
	dBm/38.16 MHz	3, 6	-63.96	-60.94	-60.94
Propagation condition		1, 2, 3, 4, 5, 6		AWGN	
Antenna Configuration and Correlation Matrix		1, 2, 3, 4, 5, 6		1x2 Low	
<p>Note 1: OCNG shall be used such that both cells are fully allocated and a constant total transmitted power spectral density is achieved for all OFDM symbols.</p> <p>Note 2: Interference from other cells and noise sources not specified in the test is assumed to be constant over subcarriers and time and shall be modelled as AWGN of appropriate power for <math>N_{oc}</math> to be fulfilled.</p> <p>Note 3: <math>\hat{E}_s/I_{ot}</math>, SS-RSRP, and <math>I_o</math> levels have been derived from other parameters for information purposes. They are not settable parameters themselves.</p>					

### A.8.3.1.1.2 Test Requirements

The UE shall start to transmit the PRACH to Cell 2 less than 112 ms from the beginning of time period T3.

The rate of correct handovers observed during repeated tests shall be at least 90%.

NOTE: The handover delay can be expressed as: RRC procedure delay +  $T_{interrupt}$ , where:

RRC procedure delay = 50 ms and is specified in TS36.133.

$T_{interrupt}$  = 62 ms in the test;  $T_{interrupt}$  is defined in TS36.133 clause 5.3.4.3.

This gives a total of 112 ms.

## A.8.4 Measurement procedure

### A.8.4.1 E-UTRA – NR Inter-RAT SFTD Measurement Delay

#### A.8.4.1.1 E-UTRA – NR Inter-RAT SFTD Measurement Delay in non-DRX

##### A.8.4.1.1.1 Test Purpose and Environment

The purpose of this test is to partly verify that measurement reporting delay for SFTD between E-UTRA PCell and inter-RAT NR neighbour cell in FR1 is within the requirements stated in clauses 8.1.2.4.25 and 8.1.2.4.26 of TS 36.133 [15] for E-UTRA FDD and TDD, respectively, when no measurement gaps are provided and no DRX is configured.

The tests consist of a single time period of duration T1. Two carriers are used in the tests: one E-UTRA carrier with the PCell (Cell 1), and one NR carrier with the NR neighbour cell (Cell 2).

Prior to the start of time duration T1, the UE is connected to Cell 1 and configured to carry out intra-frequency measurements only. The point in time at which the UE receives, at the UE antenna connector(s), a RRC message containing a measurement configuration for SFTD measurements on RF channel 1 defines the start of time duration T1. Following the start of T1 the UE shall detect Cell 2, determine the SFN and frame time difference of Cell 2 relative to Cell 1, and send a measurement report.

The supported test configurations are listed in Table A.8.4.1.1.1-1 below. Test parameters and cell-specific parameters for the NR cell are provided in Tables A.8.4.1.1.1-2 and A.8.4.1.1.1-3 below, respectively. Cell-specific parameters for the E-UTRA cell are provided in Table A.3.7.2.1-1 in clause A.3.7.2.1.

**Table A.8.4.1.1.1-1: Applicable E-UTRA and NR configurations for inter-RAT SFTD measurement delay test**

Config	Description
1	LTE FDD, NR 15 kHz SSB SCS, 10 MHz bandwidth, FDD duplex mode
2	LTE FDD, NR 15 kHz SSB SCS, 10 MHz bandwidth, TDD duplex mode
3	LTE FDD, NR 30 kHz SSB SCS, 40 MHz bandwidth, TDD duplex mode
4	LTE TDD, NR 15 kHz SSB SCS, 10 MHz bandwidth, FDD duplex mode
5	LTE TDD, NR 15 kHz SSB SCS, 10 MHz bandwidth, TDD duplex mode
6	LTE TDD, NR 30 kHz SSB SCS, 40 MHz bandwidth, TDD duplex mode

Note: The UE is only required to be tested in one of the supported test configurations

**Table A.8.4.1.1.1-2: Applicable E-UTRA and NR configurations for inter-RAT SFTD measurement delay test**

Parameter	Unit	Test configuration	Value		Comment
			Test 1	Test 2	
E-UTRA RF Channel Number		Config 1,2,3,4,5,6	1		One E-UTRAN carrier frequencies is used.
NR RF Channel Number		Config 1,2,3,4,5,6	1		One NR FR1 carrier frequencies is used.
Active cell		Config 1,2,3,4,5,6	Cell 1		Cell 1 is on E-UTRA RF channel number 1.
Neighbour cell		Config 1,2,3,4,5,6	Cell 2		Cell 2 is on NR RF channel number 1.
SSB configuration		Config 1,4	SSB.1 FR1		As specified in clause A.3.10.1
		Config 2,5	SSB.1 FR1		As specified in clause A.3.10.1
		Config 3,6	SSB.2 FR1		As specified in clause A.3.10.1
CP length		Config 1,2,3,4,5,6	Normal		Applicable to both cells.
DRX		Config 1,2,3,4,5,6	OFF		DRX is not used
Frame time offset between serving and neighbour cells	ms	Config 1,2,3,4	3	7	Asynchronous cells. The timing of Cell 2 relative to the timing of Cell 1.
	µs	Config 5,6	3		Synchronous cells.
SFN offset between serving and neighbour cells		Config 1,2,3,4,5,6	0	1	SFN of Cell 2 relative to SFN of Cell 1.
T1	s	Config 1,2,3,4,5,6	1		

**Table A.8.4.1.1.1-3: Cell specific test parameters for Cell 2 in inter-RAT SFTD measurement delay test**

Parameter	Unit	Test configuration	Cell 2
NR RF Channel Number		Config 1,2,3,4,5,6	1
Duplex mode		Config 1,4	FDD
		Config 2,3,5,6	TDD
BW <sub>channel</sub>	MHz	Config 1,4	10: N <sub>RB,c</sub> = 52
		Config 2,5	10: N <sub>RB,c</sub> = 52

		Config 3,6	40: $N_{RB,c} = 106$
TDD configuration		Config 2,5	TDDConf.1.1
		Config 3,6	TDDConf.2.1
OCNG Pattern defined in A.3.2.1.1		Config 1,2,3,4,5,6	OP.1
SMTC configuration		Config 1,2,3,4,5,6	SMTC.1
PDSCH/PDCCH subcarrier spacing	kHz	Config 1,2,4,5	15
		Config 3,6	30
EPRE ratio of PSS to SSS	dB	Config 1,2,3,4,5,6	0
EPRE ratio of PBCH DMRS to SSS	dB		
EPRE ratio of PBCH to PBCH DMRS	dB		
EPRE ratio of OCNG DMRS to SSS <sup>Note 1</sup>	dB		
EPRE ratio of OCNG to OCNG DMRS <sup>Note 1</sup>	dB		
$N_{oc}$ <sup>Note 2</sup>	dBm/15kHz		-98
$N_{oc}$ <sup>Note 2</sup>	dBm/SCS	Config 1,2,4,5	-98
		Config 3,6	-95
SS-RSRP <sup>Note 3, 4</sup>	dBm/SCS	Config 1,2,4,5	-94
		Config 3,6	-91
$\bar{E}_s/I_{ot}$	dB	Config 1,2,3,4,5,6	4
$\bar{E}_s/N_{oc}$	dB	Config 1,2,3,4,5,6	4
$I_o$ <sup>Note 3</sup>	dBm/9.36MHz	Config 1,2,4,5	-64.59
	dBm/38.16MHz	Config 3,6	-58.50
Propagation Condition		Config 1,2,3,4,5,6	AWGN
<p>Note 1: OCNG shall be used such that the cell is fully allocated and a constant total transmitted power spectral density is achieved for all OFDM symbols.</p> <p>Note 2: Interference from other cells and noise sources not specified in the test is assumed to be constant over subcarriers and time and shall be modelled as AWGN of appropriate power for <math>N_{oc}</math> to be fulfilled.</p> <p>Note 3: SS-RSRP and <math>I_o</math> levels have been derived from other parameters for information purposes. They are not settable parameters themselves.</p> <p>Note 4: SS-RSRP minimum requirements are specified assuming independent interference and noise at each receiver antenna port.</p>			

#### A.8.4.1.1.2 Test Requirements

Following the start of T1, the UE shall detect Cell 2 and determine the relative time difference between Cell 1 and Cell 2. At latest at  $T_{RRC\_procedure\_delay} + T_{measure\_SFTD1}$  after the beginning of time duration T1, the UE shall send a measurement report on SFTD between Cell 1 and Cell 2.

The observed rate of successful SFTD reports in repeated tests shall be at least 90%.

NOTE: The actual overall delays measured in the test may be up to  $2 \times TTI_{DCCH}$  longer than the measurement reporting delays above due to TTI insertion uncertainty of the measurement report in DCCH.

#### A.8.4.1.2 E-UTRA – NR Inter-RAT SFTD Measurement Delay in DRX

##### A.8.4.1.2.1 Test Purpose and Environment

The purpose of this test is to partly verify that measurement reporting delay for SFTD between E-UTRA PCell and inter-RAT NR neighbour cell in FR1 is within the requirements stated in clauses 8.1.2.4.25 and 8.1.2.4.26 of TS 36.133 [15] for E-UTRA FDD and TDD, respectively, when no measurement gaps are provided and DRX is configured.

The tests consist of a single time period of duration T1. Two carriers are used in the tests: one E-UTRA carrier with the PCell (Cell 1), and one NR carrier with the NR neighbour cell (Cell 2).

Prior to the start of time duration T1, the UE is connected to Cell 1 and configured to carry out intra-frequency measurements only. The point in time at which the UE receives, at the UE antenna connector(s), a RRC message containing a measurement configuration for SFTD measurements on RF channel 1 defines the start of time duration T1.

Following the start of T1 the UE shall detect Cell 2, determine the SFN and frame time difference of Cell 2 relative to Cell 1, and send a measurement report.

The supported test configurations are listed in Table A.8.4.1.2.1-1 below. Test parameters are provided in Tables A.8.4.1.2.1-2 below. Cell-specific parameters for the E-UTRA and NR cells are provided in Table A.3.7.2.1-1 in clause A.3.7.2.1, and Table A.8.4.1.1.1-3 in clause A.8.4.1.1.1, respectively.

**Table A.8.4.1.2.1-1: Applicable E-UTRA and NR configurations for inter-RAT SFTD measurement delay test in DRX**

Config	Description
1	LTE FDD, NR 15 kHz SSB SCS, 10 MHz bandwidth, FDD duplex mode
2	LTE FDD, NR 15 kHz SSB SCS, 10 MHz bandwidth, TDD duplex mode
3	LTE FDD, NR 30 kHz SSB SCS, 40 MHz bandwidth, TDD duplex mode
4	LTE TDD, NR 15 kHz SSB SCS, 10 MHz bandwidth, FDD duplex mode
5	LTE TDD, NR 15 kHz SSB SCS, 10 MHz bandwidth, TDD duplex mode
6	LTE TDD, NR 30 kHz SSB SCS, 40 MHz bandwidth, TDD duplex mode

Note: The UE is only required to be tested in one of the supported test configurations

**Table A.8.4.1.2.1-2: Applicable E-UTRA and NR configurations for inter-RAT SFTD measurement delay test in DRX**

Parameter	Unit	Test configuration	Value		Comment
			Test 1	Test 2	
E-UTRA RF Channel Number		Config 1,2,3,4,5,6	1		One E-UTRAN carrier frequencies is used.
NR RF Channel Number		Config 1,2,3,4,5,6	1		One NR FR1 carrier frequencies is used.
Active cell		Config 1,2,3,4,5,6	Cell 1		Cell 1 is on E-UTRA RF channel number 1.
Neighbour cell		Config 1,2,3,4,5,6	Cell 2		Cell 2 is on NR RF channel number 1.
SSB configuration		Config 1,4	SSB.1 FR1		As specified in clause A.3.10.1
		Config 2,5	SSB.1 FR1		As specified in clause A.3.10.1
		Config 3,6	SSB.2 FR1		As specified in clause A.3.10.1
CP length		Config 1,2,3,4,5,6	Normal		Applicable to both cells.
DRX		Config 1,2,3,4,5,6	DRX.4		DRX configuration as specified in clause A.3.3.4
Frame time offset between serving and neighbour cells	ms	Config 1,2,4,5	3	7	Asynchronous cells. The timing of Cell 2 relative to the timing of Cell 1.
	µs	Config 3,6	3		Synchronous cells.
SFN offset between serving and neighbour cells		Config 1,2,3,4,5,6	0	1	SFN of Cell 2 relative to SFN of Cell 1.
T1	s	Config 1,2,3,4,5,6	1		

#### A.8.4.1.2.2 Test Requirements

Following the start of T1, the UE shall detect Cell 2 and determine the relative time difference between Cell 1 and Cell 2. At latest at the earliest DRX activity time following upon  $T_{RRC\_procedure\_delay} + T_{measure\_SFTD1}$  from the beginning of time duration T1, the UE shall send a measurement report on SFTD between Cell 1 and Cell 2.

The observed rate of successful SFTD reports in repeated tests shall be at least 90%.

NOTE: The actual overall delays measured in the test may be up to  $2 \times TTI_{DCCH}$  longer than the measurement reporting delays above due to TTI insertion uncertainty of the measurement report in DCCH.



## A.8.4.2 E-UTRA – NR Inter-RAT Measurements

### A.8.4.2.1 NR Inter-RAT event triggered reporting tests for FR1 without SSB time index detection when DRX is not used

#### A.8.4.2.1.1 Test Purpose and Environment

The purpose of this test is to verify that the UE makes correct reporting of an event. This test will partly verify the NR inter-RAT cell search requirements in clause 8.1.2.4.21 of TS 36.133 [15] for E-UTRAN FDD-NR measurements and clause 8.1.2.4.22 of TS 36.133 [15] for E-UTRAN TDD-NR measurements.

In this test, there are two cells: E-UTRA cell 1 as PCell on E-UTRA RF channel 1 and NR cell 2 as neighbour cell in FR1 on NR RF channel 1. The test parameters are given in Tables A.8.4.2.1.1-1, A.8.4.2.1.1-2, A.8.4.2.1.1-3 and A.8.4.2.1.1-4.

In test 1 measurement gap pattern configuration # 0 as defined in Table A.8.4.2.1.1-2 is provided for UE that does not support per-FR gap and in test 2 measurement gap pattern configuration #4 as defined in Table A.8.4.2.1.1-2 is provided for UE that supports per-FR gap.

In the measurement control information, it is indicated to the UE that event-triggered reporting with Event B2 (PCell becomes worse than threshold1 and inter RAT neighbour becomes better than threshold2) [16] is used. The test consists of two successive time periods, with time duration of T1, and T2 respectively. During time duration T1, the UE shall not have any timing information of NR cell 2.

**Table A.8.4.2.1.1-1: NR inter-RAT event triggered reporting tests without SSB index reading for FR1**

Configuration	Description
1	LTE FDD, NR 15 kHz SSB SCS, 10 MHz bandwidth, FDD duplex mode
2	LTE FDD, NR 15 kHz SSB SCS, 10 MHz bandwidth, TDD duplex mode
3	LTE FDD, NR 30 kHz SSB SCS, 40 MHz bandwidth, TDD duplex mode
4	LTE TDD, NR 15 kHz SSB SCS, 10 MHz bandwidth, FDD duplex mode
5	LTE TDD, NR 15 kHz SSB SCS, 10 MHz bandwidth, TDD duplex mode
6	LTE TDD, NR 30 kHz SSB SCS, 40 MHz bandwidth, TDD duplex mode

Note 1: The UE is only required to be tested in one of the supported test configurations.

**Table A.8.4.2.1.1-2: General test parameters for NR inter-RAT event triggered reporting for FR1 without SSB time index detection**

Parameter	Unit	Test configuration	Value		Comment
			Test 1	Test 2	
E-UTRA RF Channel Number		1, 2, 3, 4, 5, 6	1		One E-UTRA carrier frequency is used.
NR RF Channel Number		1, 2, 3, 4, 5, 6	1		One FR1 NR carrier frequency is used.
Active cell		1, 2, 3, 4, 5, 6	E-UTRA cell 1 (PCell)		E-UTRA cell 1 is on E-UTRA RF channel number 1.
Neighbour cell		1, 2, 3, 4, 5, 6	NR cell 2		NR cell 2 is on NR RF channel number 1.
Gap Pattern Id		1, 2, 3, 4, 5, 6	0	4	As specified in clause Table 8.1.2.1-1 of TS 36.133 [15].
Measurement gap offset		1, 2, 3, 4, 5, 6	39	19	As specified in TS 36.331 [16].
b2-Threshold1	dBm	1, 2, 3, 4, 5, 6	Note 1		E-UTRA RSRP threshold for E-UTRA RSRP measurement on cell 1 for event B2 [16]
b2-Threshold2NR	dBm	1, 2, 3, 4, 5, 6	Note 2		SS-RSRP threshold for SS-RSRP measurement on cell 2 for event B2 [16]
Hysteresis	dB	1, 2, 3, 4, 5, 6	0		
CP length		1, 2, 3, 4, 5, 6	Normal		

TimeToTrigger	s	1, 2, 3, 4, 5, 6	0	
Filter coefficient		1, 2, 3, 4, 5, 6	0	L3 filtering is not used
DRX		1, 2, 3, 4, 5, 6	OFF	DRX is not used
Time offset between serving and neighbour cells		1, 4	3ms	Asynchronous cells. The timing of Cell 2 is 3ms later than the timing of Cell 1.
		2, 3, 5, 6	3μs	Synchronous cells.
T1	s	1, 2, 3, 4, 5, 6	5	
T2	s	1, 2, 3, 4, 5, 6	1	1
Note 1: The value of b2-Threshold1 is defined in Table A.8.4.2.1.1-3				
Note 2: The value of b2-Threshold2NR is defined in Table A.8.4.2.1.1-4				

**Table A.8.4.2.1.1-3: E-UTRAN PCell specific test parameters for NR inter-RAT event triggered reporting in non-DRX with NR neighbour cell in FR1 without SSB time index detection**

Parameter	Unit	Configuration	Cell 1					
			T1	T2				
RF channel number		1, 2, 3, 4, 5, 6	1					
Duplex mode		1, 2, 3	FDD					
		4, 5, 6	TDD					
TDD special subframe configuration <sup>Note1</sup>		4, 5, 6	6					
TDD uplink-downlink configuration <sup>Note1</sup>		4, 5, 6	1					
BW <sub>channel</sub>	MHz	1, 2, 3, 4, 5, 6	5 MHz: N <sub>RB,c</sub> = 25 10 MHz: N <sub>RB,c</sub> = 50 20 MHz: N <sub>RB,c</sub> = 100					
PDSCH parameters: DL Reference Measurement Channel <sup>Note2</sup>		1, 2, 3	5 MHz: R.7 FDD 10 MHz: R.3 FDD 20 MHz: R.6 FDD					
		4, 5, 6	5 MHz: R.4 TDD 10 MHz: R.0 TDD 20 MHz: R.3 TDD					
PCFICH/PDCCH/PHICH parameters: DL Reference Measurement Channel <sup>Note2</sup>		1, 2, 3	5 MHz: R.11 FDD 10 MHz: R.6 FDD 20 MHz: R.10 FDD					
		4, 5, 6	5 MHz: R.11 TDD 10 MHz: R.6 TDD 20 MHz: R.10 TDD					
OCNG Patterns <sup>Note2</sup>		1, 2, 3	5 MHz: OP.20 FDD 10 MHz: OP.10 FDD 20 MHz: OP.17 FDD					
		4, 5, 6	5 MHz: OP.9 TDD 10 MHz: OP.1 TDD 20 MHz: OP.7 TDD					
b2-Threshold1	dBm	1, 2, 3, 4, 5, 6	-77					
PBCH_RA	dB	1, 2, 3, 4, 5, 6	0					
PBCH_RB								
PSS_RA								
SSS_RA								
PCFICH_RB								
PHICH_RA								
PHICH_RB								
PDCCH_RA								
PDCCH_RB								
PDSCH_RA								
PDSCH_RB								
OCNG_RA <sup>Note3</sup>								
OCNG_RB <sup>Note3</sup>								
N <sub>oc</sub> <sup>Note4</sup>					dBm/15kHz	1, 2, 3, 4, 5, 6	-104	

$\hat{E}_s/N_{oc}$	dB	1, 2, 3, 4, 5, 6	17	17
$\hat{E}_s/I_{ot}$ <sup>Note5</sup>	dB	1, 2, 3, 4, 5, 6	17	17
RSRP <sup>Note5</sup>	dBm/15kHz	1, 2, 3, 4, 5, 6	-87	-87
SCH_RP <sup>Note5</sup>	dBm/15kHz	1, 2, 3, 4, 5, 6	-87	-87
$I_o$ <sup>Note5</sup>	dBm/9MHz	1, 2, 3, 4, 5, 6	$-59.13+10\log(N_{RB,c}/50)$	$-59.13+10\log(N_{RB,c}/50)$
Propagation Condition <sup>Note6</sup>		1, 2, 3, 4, 5, 6	AWGN	
Antenna Configuration and Correlation Matrix <sup>Note6</sup>		1, 2, 3, 4, 5, 6	1x2	
<p>Note 1: Special subframe and uplink-downlink configurations are specified in table 4.2-1 in TS 36.211 [23].</p> <p>Note 2: DL RMCs and OCNG patterns are specified in clauses A 3.1 and A 3.2 of TS 36.133 [15] respectively.</p> <p>Note 3: OCNG shall be used such that all cells are fully allocated and a constant total transmitted power spectral density is achieved for all OFDM symbols.</p> <p>Note 4: Interference from other cells and noise sources not specified in the test is assumed to be constant over subcarriers and time and shall be modelled as AWGN of appropriate power for <math>N_{oc}</math> to be fulfilled.</p> <p>Note 5: <math>\hat{E}_s/I_{ot}</math>, RSRP, SCH_RP and <math>I_o</math> levels have been derived from other parameters for information purposes. They are not settable parameters themselves.</p> <p>Note 6: Propagation condition and correlation matrix are defined in clause B.2 in TS 36.101 [25].</p>				

**Table A.8.4.2.1.1-4: NR neighbour cell specific test parameters for NR inter-RAT event triggered reporting for FR1 without SSB time index detection**

Parameter	Unit	Test configuration	Cell 2	
			T1	T2
NR RF Channel Number		1, 2, 3, 4, 5, 6	1	
Duplex mode		1, 4	FDD	
		2, 3, 5, 6	TDD	
TDD configuration		2, 5	TDDConf.1.1	
		3, 6	TDDConf.2.1	
$BW_{channel}$	MHz	1, 2, 4, 5	10: $N_{RB,c} = 52$	
		3, 6	40: $N_{RB,c} = 106$	
OCNG Patterns defined in A.3.2.1.1 (OP.1)		1, 2, 3, 4, 5, 6	OP.1	
SMTC configuration defined in A.3.11.1 and A.3.11.2		1, 4	SMTC.2	
		2, 3, 5, 6	SMTC.1	
PDSCH/PDCCH subcarrier spacing	kHz	1, 2, 4, 5	15	
		3, 6	30	
b2-Threshold2NR	dBm/SCS	1, 2, 4, 5	-101	
		3, 6	-98	
EPRE ratio of PSS to SSS		1, 2, 3, 4, 5, 6	0	
EPRE ratio of PBCH DMRS to SSS				
EPRE ratio of PBCH to PBCH DMRS				
EPRE ratio of PDCCH DMRS to SSS				
EPRE ratio of PDCCH to PDCCH DMRS				
EPRE ratio of PDSCH DMRS to SSS				
EPRE ratio of PDSCH to PDSCH				
EPRE ratio of OCNG DMRS to SSS (Note 1)				
EPRE ratio of OCNG to OCNG DMRS (Note 1)				
<sup>Note2</sup> $\hat{E}_s/I_{ot}$	dBm/15kHz			
<sup>Note2</sup> $\hat{E}_s/N_{oc}$	dBm/SCS	1, 2, 4, 5	-98	
		3, 6	-95	
SS-RSRP <sup>Note 3</sup>	dBm/SCS	1, 2, 4, 5	-Infinity	-91
		3, 6	-Infinity	-88
$\hat{E}_s/I_{ot}$	dB	1, 2, 3, 4, 5, 6	-Infinity	7
$\hat{E}_s/N_{oc}$	dB	1, 2, 3, 4, 5, 6	-Infinity	7
$I_o$ <sup>Note3</sup>	dBm/9.36MHz	1, 2, 4, 5	-70.05	-62.26
	dBm/38.16MHz	3, 6	-63.95	-56.16
Propagation Condition		1, 2, 3, 4, 5, 6	AWGN	

Antenna Configuration and Correlation Matrix		1, 2, 3, 4, 5, 6	1x2
Note 1:	OCNG shall be used such that the cell is fully allocated and a constant total transmitted power spectral density is achieved for all OFDM symbols.		
Note 2:	Interference from other cells and noise sources not specified in the test is assumed to be constant over subcarriers and time and shall be modelled as AWGN of appropriate power for $\gamma_{\text{min}}$ to be fulfilled.		
Note 3:	SS-RSRP and $I_0$ levels have been derived from other parameters for information purposes. They are not settable parameters themselves.		
Note 4:	SS-RSRP minimum requirements are specified assuming independent interference and noise at each receiver antenna port.		

#### A.8.4.2.1.2 Test Requirements

In test 1 with per-UE gap, the UE shall send one Event B2 triggered measurement report, with a measurement reporting delay less than 920 ms from the beginning of time period T2. The UE shall not send event triggered measurement reports, as long as the reporting criteria are not fulfilled. The rate of correct events observed during repeated tests shall be at least 90%.

In test 2 with per-FR gap, the UE shall send one Event B2 triggered measurement report, with a measurement reporting delay less than 800 ms from the beginning of time period T2. The UE shall not send event triggered measurement reports, as long as the reporting criteria are not fulfilled. The rate of correct events observed during repeated tests shall be at least 90%.

In test 1 and test 2, the UE is not required to report SSB time index.

NOTE: The actual overall delays measured in the test may be up to  $2 \times \text{TTI}_{\text{DCCH}}$  higher than the measurement reporting delays above because of TTI insertion uncertainty of the measurement report in DCCH.

#### A.8.4.2.2 NR Inter-RAT event triggered reporting tests for FR1 without SSB time index detection when DRX is used

##### A.8.4.2.2.1 Test Purpose and Environment

The purpose of this test is to verify that the UE makes correct reporting of an event. This test will partly verify the NR inter-RAT cell search requirements in clause 8.1.2.4.21 of TS 36.133 [15] for E-UTRAN FDD-NR measurements and clause 8.1.2.4.22 of TS 36.133 [15] for E-UTRAN TDD-NR measurements.

In this test, there are two cells: E-UTRA cell 1 as PCell on E-UTRA RF channel 1 and NR cell 2 as neighbour cell in FR1 on NR RF channel 1. The test parameters are given in Tables A.8.4.2.2.1-1, A.8.4.2.2.1-2, A.8.4.2.2.1-3 and A.8.4.2.2.1-4.

In tests 1 and 2, measurement gap pattern configuration # 0 as defined in Table A.8.4.2.2.1-2 is provided for UE that does not support per-FR gap and in tests 3 and 4, measurement gap pattern configuration #4 as defined in Table A.8.4.2.2.1-2 is provided for UE that supports per-FR gap.

In the measurement control information, it is indicated to the UE that event-triggered reporting with Event B2 (PCell becomes worse than threshold1 and inter RAT neighbour becomes better than threshold2) [16] is used. The test consists of two successive time periods, with time duration of T1, and T2 respectively. During time duration T1, the UE shall not have any timing information of NR cell 2.

**Table A.8.4.2.2.1-1: NR inter-RAT event triggered reporting tests without SSB index reading for FR1**

Configuration	Description
1	LTE FDD, NR 15 kHz SSB SCS, 10 MHz bandwidth, FDD duplex mode
2	LTE FDD, NR 15 kHz SSB SCS, 10 MHz bandwidth, TDD duplex mode
3	LTE FDD, NR 30 kHz SSB SCS, 40 MHz bandwidth, TDD duplex mode
4	LTE TDD, NR 15 kHz SSB SCS, 10 MHz bandwidth, FDD duplex mode
5	LTE TDD, NR 15 kHz SSB SCS, 10 MHz bandwidth, TDD duplex mode
6	LTE TDD, NR 30 kHz SSB SCS, 40 MHz bandwidth, TDD duplex mode
Note 1:	The UE is only required to be tested in one of the supported test configurations.

**Table A.8.4.2.2.1-2: General test parameters for NR inter-RAT event triggered reporting for FR1 without SSB time index detection**

Parameter	Unit	Test configuration	Value				Comment
			Test 1	Test 2	Test 3	Test 4	
E-UTRA RF Channel Number		1, 2, 3, 4, 5, 6	1				One E-UTRA carrier frequency is used.
NR RF Channel Number		1, 2, 3, 4, 5, 6	1				One FR1 NR carrier frequency is used.
Active cell		1, 2, 3, 4, 5, 6	E-UTRA cell 1 (PCell)				E-UTRA cell 1 is on E-UTRA RF channel number 1.
Neighbour cell		1, 2, 3, 4, 5, 6	NR cell 2				NR cell 2 is on NR RF channel number 1.
Gap Pattern Id		1, 2, 3, 4, 5, 6	0		4		As specified in clause Table 8.1.2.1-1 of TS 36.133 [15].
Measurement gap offset		1, 2, 3, 4, 5, 6	39		19		As specified in TS 36.331 [16].
b2-Threshold1	dBm	1, 2, 3, 4, 5, 6	Note 1				E-UTRA RSRP threshold for E-UTRA RSRP measurement on cell 1 for event B2 [16]
b2-Threshold2NR	dBm	1, 2, 3, 4, 5, 6	Note 2				SS-RSRP threshold for SS-RSRP measurement on cell 2 for event B2 [16]
Hysteresis	dB	1, 2, 3, 4, 5, 6	0				
CP length		1, 2, 3, 4, 5, 6	Normal				
TimeToTrigger	s	1, 2, 3, 4, 5, 6	0				
Filter coefficient		1, 2, 3, 4, 5, 6	0				L3 filtering is not used
DRX		1, 2, 3, 4, 5, 6	DRX.9	DRX.12	DRX.9	DRX.12	As specified in clause A.3.3
Time offset between serving and neighbour cells		1, 4	3ms				Asynchronous cells. The timing of Cell 2 is 3ms later than the timing of Cell 1.
		2, 3, 5, 6	3μs				Synchronous cells.
T1	s	1, 2, 3, 4, 5, 6	5				
T2	s	1, 2, 3, 4, 5, 6	2	11	2	11	
Note 1: The value of b2-Threshold1 is defined in Table A.8.4.2.2.1-3							
Note 2: The value of b2-Threshold2NR is defined in Table A.8.4.2.2.1-4							

**Table A.8.4.2.2.1-3: E-UTRAN PCell specific test parameters for NR inter-RAT event triggered reporting in non-DRX with NR neighbour cell in FR1 without SSB time index detection**

Parameter	Unit	Configuration	Cell 1	
			T1	T2
RF channel number		1, 2, 3, 4, 5, 6	1	
Duplex mode		1, 2, 3	FDD	
		4, 5, 6	TDD	
TDD special subframe configuration <sup>Note1</sup>		4, 5, 6	6	
TDD uplink-downlink configuration <sup>Note1</sup>		4, 5, 6	1	
BW <sub>channel</sub>	MHz	1, 2, 3, 4, 5, 6	5 MHz: N <sub>RB,c</sub> = 25 10 MHz: N <sub>RB,c</sub> = 50 20 MHz: N <sub>RB,c</sub> = 100	
PDSCH parameters: DL Reference Measurement Channel <sup>Note2</sup>		1, 2, 3	5 MHz: R.7 FDD 10 MHz: R.3 FDD 20 MHz: R.6 FDD	

		4, 5, 6	5 MHz: R.4 TDD 10 MHz: R.0 TDD 20 MHz: R.3 TDD	
PCFICH/PDCCH/PHICH parameters: DL Reference Measurement Channel <sup>Note2</sup>		1, 2, 3	5 MHz: R.11 FDD 10 MHz: R.6 FDD 20 MHz: R.10 FDD	
		4, 5, 6	5 MHz: R.11 TDD 10 MHz: R.6 TDD 20 MHz: R.10 TDD	
OCNG Patterns <sup>Note2</sup>		1, 2, 3	5 MHz: OP.20 FDD 10 MHz: OP.10 FDD 20 MHz: OP.17 FDD	
		4, 5, 6	5 MHz: OP.9 TDD 10 MHz: OP.1 TDD 20 MHz: OP.7 TDD	
b2-Threshold1	dBm	1, 2, 3, 4, 5, 6	-77	
PBCH_RA	dB	1, 2, 3, 4, 5, 6	0	
PBCH_RB				
PSS_RA				
SSS_RA				
PCFICH_RB				
PHICH_RA				
PHICH_RB				
PDCCH_RA				
PDCCH_RB				
PDSCH_RA				
PDSCH_RB				
OCNG_RA <sup>Note3</sup>				
OCNG_RB <sup>Note3</sup>				
N <sub>oc</sub> <sup>Note4</sup>				
$\bar{E}_s/N_{oc}$	dB	1, 2, 3, 4, 5, 6	17	17
$\bar{E}_s/I_{ot}$ <sup>Note5</sup>	dB	1, 2, 3, 4, 5, 6	17	17
RSRP <sup>Note5</sup>	dBm/15kHz	1, 2, 3, 4, 5, 6	-87	-87
SCH_RP <sup>Note5</sup>	dBm/15kHz	1, 2, 3, 4, 5, 6	-87	-87
I <sub>o</sub> <sup>Note5</sup>	dBm/9MHz	1, 2, 3, 4, 5, 6	-59.13+10log(N <sub>RB,c</sub> /50)	-59.13+10log(N <sub>RB,c</sub> /50)
Propagation Condition <sup>Note6</sup>		1, 2, 3, 4, 5, 6	AWGN	
Antenna Configuration and Correlation Matrix <sup>Note6</sup>		1, 2, 3, 4, 5, 6	1x2	
<p>Note 1: Special subframe and uplink-downlink configurations are specified in table 4.2-1 in TS 36.211 [23].</p> <p>Note 2: DL RMCs and OCNG patterns are specified in clauses A 3.1 and A 3.2 of TS 36.133 [15] respectively.</p> <p>Note 3: OCNG shall be used such that all cells are fully allocated and a constant total transmitted power spectral density is achieved for all OFDM symbols.</p> <p>Note 4: Interference from other cells and noise sources not specified in the test is assumed to be constant over subcarriers and time and shall be modelled as AWGN of appropriate power for N<sub>oc</sub> to be fulfilled.</p> <p>Note 5: <math>\bar{E}_s/I_{ot}</math>, RSRP, SCH_RP and I<sub>o</sub> levels have been derived from other parameters for information purposes. They are not settable parameters themselves.</p> <p>Note 6: Propagation condition and correlation matrix are defined in clause B.2 in TS 36.101 [25].</p>				

**Table A.8.4.2.2.1-4: NR neighbour cell specific test parameters for NR inter-RAT event triggered reporting for FR1 without SSB time index detection**

Parameter	Unit	Test configuration	Cell 2	
			T1	T2
NR RF Channel Number		1, 2, 3, 4, 5, 6	1	
Duplex mode		1, 4	FDD	
		2, 3, 5, 6	TDD	
TDD configuration		2, 5	TDDConf.1.1	
		3, 6	TDDConf.2.1	
BW <sub>channel</sub>	MHz	1, 2, 4, 5	10: N <sub>RB,c</sub> = 52	
		3, 6	40: N <sub>RB,c</sub> = 106	
OCNG Patterns defined in A.3.2.1.1 (OP.1)		1, 2, 3, 4, 5, 6	OP.1	

SMTC configuration defined in A.3.11.1 and A.3.11.2		1, 4	SMTC.2	
		2, 3, 5, 6	SMTC.1	
PDSCH/PDCCH subcarrier spacing	kHz	1, 2, 4, 5	15	
		3, 6	30	
b2-Threshold2NR	dBm/SCS	1, 2, 4, 5	-101	
		3, 6	-98	
EPRE ratio of PSS to SSS		1, 2, 3, 4, 5, 6	0	
EPRE ratio of PBCH DMRS to SSS				
EPRE ratio of PBCH to PBCH DMRS				
EPRE ratio of PDCCH DMRS to SSS				
EPRE ratio of PDCCH to PDCCH DMRS				
EPRE ratio of PDSCH DMRS to SSS				
EPRE ratio of PDSCH to PDSCH				
EPRE ratio of OCNG DMRS to SSS (Note 1)				
EPRE ratio of OCNG to OCNG DMRS (Note 1)				
Note2	dBm/15kHz	1, 2, 3, 4, 5, 6	-98	
Note2	dBm/SCS	1, 2, 4, 5	-98	
		3, 6	-95	
SS-RSRP Note 3	dBm/SCS	1, 2, 4, 5	-Infinity	-91
		3, 6	-Infinity	-88
$\hat{E}_s/I_{ot}$	dB	1, 2, 3, 4, 5, 6	-Infinity	7
$\hat{E}_s/N_{oc}$	dB	1, 2, 3, 4, 5, 6	-Infinity	7
$I_o$ Note3	dBm/9.36MHz	1, 2, 4, 5	-70.05	-62.26
	dBm/38.16MHz	3, 6	-63.95	-56.16
Propagation Condition		1, 2, 3, 4, 5, 6	AWGN	
Antenna Configuration and Correlation Matrix		1, 2, 3, 4, 5, 6	1x2	
<p>Note 1: OCNG shall be used such that the cell is fully allocated and a constant total transmitted power spectral density is achieved for all OFDM symbols.</p> <p>Note 2: Interference from other cells and noise sources not specified in the test is assumed to be constant over subcarriers and time and shall be modelled as AWGN of appropriate power for <math>\hat{E}_s/I_{ot}</math> to be fulfilled.</p> <p>Note 3: SS-RSRP and <math>I_o</math> levels have been derived from other parameters for information purposes. They are not settable parameters themselves.</p> <p>Note 4: SS-RSRP minimum requirements are specified assuming independent interference and noise at each receiver antenna port.</p>				

#### A.8.4.2.2.2 Test Requirements

In test 1 with per-UE gap, the UE shall send one Event B2 triggered measurement report, with a measurement reporting delay less than 1080 ms from the beginning of time period T2. The UE shall not send event triggered measurement reports, as long as the reporting criteria are not fulfilled. The rate of correct events observed during repeated tests shall be at least 90%.

In test 2 with per-UE gap, the UE shall send one Event B2 triggered measurement report, with a measurement reporting delay less than 10240 ms from the beginning of time period T2. The UE shall not send event triggered measurement reports, as long as the reporting criteria are not fulfilled. The rate of correct events observed during repeated tests shall be at least 90%.

In test 3 with per-FR gap, the UE shall send one Event B2 triggered measurement report, with a measurement reporting delay less than 1080 ms from the beginning of time period T2. The UE shall not send event triggered measurement reports, as long as the reporting criteria are not fulfilled. The rate of correct events observed during repeated tests shall be at least 90%.

In test 4 with per-FR gap, the UE shall send one Event B2 triggered measurement report, with a measurement reporting delay less than 10240 ms from the beginning of time period T2. The UE shall not send event triggered measurement reports, as long as the reporting criteria are not fulfilled. The rate of correct events observed during repeated tests shall be at least 90%.

In tests 1, 2, 3 and 4, the UE is not required to report SSB time index.

NOTE: The actual overall delays measured in the test may be up to  $2 \times TTI_{DCCH}$  higher than the measurement reporting delays above because of TTI insertion uncertainty of the measurement report in DCCH.

### A.8.4.2.3 NR Inter-RAT event triggered reporting tests for FR1 with SSB time index detection when DRX is not used

#### A.8.4.2.3.1 Test Purpose and Environment

The purpose of this test is to verify that the UE makes correct reporting of an event. This test will partly verify the NR inter-RAT cell search requirements in clause 8.1.2.4.21 of TS 36.133 [15] for E-UTRAN FDD-NR measurements and clause 8.1.2.4.22 of TS 36.133 [15] for E-UTRAN TDD-NR measurements.

In this test, there are two cells: E-UTRA cell 1 as PCell on E-UTRA RF channel 1 and NR cell 2 as neighbour cell in FR1 on NR RF channel 1. The test parameters are given in Tables A.8.4.2.3.1-1, A.8.4.2.3.1-2, A.8.4.2.3.1-3 and A.8.4.2.3.1-4.

In test 1 measurement gap pattern configuration # 0 as defined in Table A.8.4.2.3.1-2 is provided for UE that does not support per-FR gap and in test 2 measurement gap pattern configuration #4 as defined in Table A.8.4.2.3.1-2 is provided for UE that supports per-FR gap.

In the measurement control information, it is indicated to the UE that event-triggered reporting with Event B2 (PCell becomes worse than threshold1 and inter RAT neighbour becomes better than threshold2) [16] is used. In the measurement configuration the UE shall be indicated to report the SSB index of the identified NR cell. The test consists of two successive time periods, with time duration of T1, and T2 respectively. During time duration T1, the UE shall not have any timing information of NR cell 2.

**Table A.8.4.2.3.1-1: NR inter-RAT event triggered reporting tests without SSB index reading for FR1**

Configuration	Description
1	LTE FDD, NR 15 kHz SSB SCS, 10 MHz bandwidth, FDD duplex mode
2	LTE FDD, NR 15 kHz SSB SCS, 10 MHz bandwidth, TDD duplex mode
3	LTE FDD, NR 30 kHz SSB SCS, 40 MHz bandwidth, TDD duplex mode
4	LTE TDD, NR 15 kHz SSB SCS, 10 MHz bandwidth, FDD duplex mode
5	LTE TDD, NR 15 kHz SSB SCS, 10 MHz bandwidth, TDD duplex mode
6	LTE TDD, NR 30 kHz SSB SCS, 40 MHz bandwidth, TDD duplex mode

Note 1: The UE is only required to be tested in one of the supported test configurations.

**Table A.8.4.2.3.1-2: General test parameters for NR inter-RAT event triggered reporting for FR1 without SSB time index detection**

Parameter	Unit	Test configuration	Value		Comment
			Test 1	Test 2	
E-UTRA RF Channel Number		1, 2, 3, 4, 5, 6	1		One E-UTRA carrier frequency is used.
NR RF Channel Number		1, 2, 3, 4, 5, 6	1		One FR1 NR carrier frequency is used.
Active cell		1, 2, 3, 4, 5, 6	E-UTRA cell 1 (PCell)		E-UTRA cell 1 is on E-UTRA RF channel number 1.
Neighbour cell		1, 2, 3, 4, 5, 6	NR cell 2		NR cell 2 is on NR RF channel number 1.
Gap Pattern Id		1, 2, 3, 4, 5, 6	0	4	As specified in clause Table 8.1.2.1-1 of TS 36.133 [15].
Measurement gap offset		1, 2, 3, 4, 5, 6	39	19	As specified in TS 36.331 [16].
b2-Threshold1	dBm	1, 2, 3, 4, 5, 6	Note 1		E-UTRA RSRP threshold for E-UTRA RSRP measurement on cell 1 for event B2 [16]
b2-Threshold2NR	dBm	1, 2, 3, 4, 5, 6	Note 2		SS-RSRP threshold for SS-RSRP measurement on cell 2 for event B2 [16]



Hysteresis	dB	1, 2, 3, 4, 5, 6	0	
CP length		1, 2, 3, 4, 5, 6	Normal	
TimeToTrigger	s	1, 2, 3, 4, 5, 6	0	
Filter coefficient		1, 2, 3, 4, 5, 6	0	L3 filtering is not used
DRX		1, 2, 3, 4, 5, 6	OFF	DRX is not used
Time offset between serving and neighbour cells		1, 4	3ms	Asynchronous cells. The timing of Cell 2 is 3 ms later than the timing of Cell 1.
		2, 3, 5, 6	3μs	Synchronous cells.
T1	s	1, 2, 3, 4, 5, 6	5	
T2	s	1, 2, 3, 4, 5, 6	2	1
Note 1: The value of b2-Threshold1 is defined in Table A.8.4.2.3.1-3				
Note 2: The value of b2-Threshold2NR is defined in Table A.8.4.2.3.1-4				

**Table A.8.4.2.3.1-3: E-UTRAN PCell specific test parameters for NR inter-RAT event triggered reporting in non-DRX with NR neighbour cell in FR1 without SSB time index detection**

Parameter	Unit	Configuration	Cell 1	
			T1	T2
RF channel number		1, 2, 3, 4, 5, 6	1	
Duplex mode		1, 2, 3	FDD	
		4, 5, 6	TDD	
TDD special subframe configuration <sup>Note1</sup>		4, 5, 6	6	
TDD uplink-downlink configuration <sup>Note1</sup>		4, 5, 6	1	
BW <sub>channel</sub>	MHz	1, 2, 3, 4, 5, 6	5 MHz: N <sub>RB,c</sub> = 25 10 MHz: N <sub>RB,c</sub> = 50 20 MHz: N <sub>RB,c</sub> = 100	
PDSCH parameters: DL Reference Measurement Channel <sup>Note2</sup>		1, 2, 3	5 MHz: R.7 FDD 10 MHz: R.3 FDD 20 MHz: R.6 FDD	
		4, 5, 6	5 MHz: R.4 TDD 10 MHz: R.0 TDD 20 MHz: R.3 TDD	
PCFICH/PDCCH/PHICH parameters: DL Reference Measurement Channel <sup>Note2</sup>		1, 2, 3	5 MHz: R.11 FDD 10 MHz: R.6 FDD 20 MHz: R.10 FDD	
		4, 5, 6	5 MHz: R.11 TDD 10 MHz: R.6 TDD 20 MHz: R.10 TDD	
OCNG Patterns <sup>Note2</sup>		1, 2, 3	5 MHz: OP.20 FDD 10 MHz: OP.10 FDD 20 MHz: OP.17 FDD	
		4, 5, 6	5 MHz: OP.9 TDD 10 MHz: OP.1 TDD 20 MHz: OP.7 TDD	
b2-Threshold1	dBm	1, 2, 3, 4, 5, 6	-77	
PBCH_RA	dB	1, 2, 3, 4, 5, 6	0	
PBCH_RB				
PSS_RA				
SSS_RA				
PCFICH_RB				
PHICH_RA				
PHICH_RB				
PDCCH_RA				
PDCCH_RB				
PDSCH_RA				

PDSCH_RB				
OCNG_RA <sup>Note3</sup>				
OCNG_RB <sup>Note3</sup>				
N <sub>oc</sub> <sup>Note4</sup>	dBm/15kHz	1, 2, 3, 4, 5, 6	-104	
$\hat{E}_s/N_{oc}$	dB	1, 2, 3, 4, 5, 6	17	17
$\hat{E}_s/I_{ot}$ <sup>Note5</sup>	dB	1, 2, 3, 4, 5, 6	17	17
RSRP <sup>Note5</sup>	dBm/15kHz	1, 2, 3, 4, 5, 6	-87	-87
SCH_RP <sup>Note5</sup>	dBm/15kHz	1, 2, 3, 4, 5, 6	-87	-87
I <sub>o</sub> <sup>Note5</sup>	dBm/9MHz	1, 2, 3, 4, 5, 6	-59.13+10log(N <sub>RB,c</sub> /50)	-59.13+10log(N <sub>RB,c</sub> /50)
Propagation Condition <sup>Note6</sup>		1, 2, 3, 4, 5, 6	AWGN	
Antenna Configuration and Correlation Matrix <sup>Note6</sup>		1, 2, 3, 4, 5, 6	1x2	
<p>Note 1: Special subframe and uplink-downlink configurations are specified in table 4.2-1 in TS 36.211 [23].</p> <p>Note 2: DL RMCs and OCNG patterns are specified in clauses A 3.1 and A 3.2 of TS 36.133 [15] respectively.</p> <p>Note 3: OCNG shall be used such that all cells are fully allocated and a constant total transmitted power spectral density is achieved for all OFDM symbols.</p> <p>Note 4: Interference from other cells and noise sources not specified in the test is assumed to be constant over subcarriers and time and shall be modelled as AWGN of appropriate power for N<sub>oc</sub> to be fulfilled.</p> <p>Note 5: <math>\hat{E}_s/I_{ot}</math>, RSRP, SCH_RP and I<sub>o</sub> levels have been derived from other parameters for information purposes. They are not settable parameters themselves.</p> <p>Note 6: Propagation condition and correlation matrix are defined in clause B.2 in TS 36.101 [25].</p>				

**Table A.8.4.2.3.1-4: NR neighbour cell specific test parameters for NR inter-RAT event triggered reporting for FR1 without SSB time index detection**

Parameter	Unit	Test configuration	Cell 2	
			T1	T2
NR RF Channel Number		1, 2, 3, 4, 5, 6	1	
Duplex mode		1, 4	FDD	
		2, 3, 5, 6	TDD	
TDD configuration		2, 5	TDDConf.1.1	
		3, 6	TDDConf.2.1	
BW <sub>channel</sub>	MHz	1, 2, 4, 5	10: N <sub>RB,c</sub> = 52	
		3, 6	40: N <sub>RB,c</sub> = 106	
OCNG Patterns defined in A.3.2.1.1 (OP.1)		1, 2, 3, 4, 5, 6	OP.1	
SMTC configuration defined in A.3.11.1 and A.3.11.2		1, 4	SMTC.2	
		2, 3, 5, 6	SMTC.1	
PDSCH/PDCCH subcarrier spacing	kHz	1, 2, 4, 5	15	
		3, 6	30	
b2-Threshold2NR	dBm/SCS	1, 2, 4, 5	-101	
		3, 6	-98	
EPRE ratio of PSS to SSS		1, 2, 3, 4, 5, 6	0	
EPRE ratio of PBCH DMRS to SSS				
EPRE ratio of PBCH to PBCH DMRS				
EPRE ratio of PDCCH DMRS to SSS				
EPRE ratio of PDCCH to PDCCH DMRS				
EPRE ratio of PDSCH DMRS to SSS				
EPRE ratio of PDSCH to PDSCH				
EPRE ratio of OCNG DMRS to SSS (Note 1)				
EPRE ratio of OCNG to OCNG DMRS (Note 1)				
<sup>Note2</sup>	dBm/15kHz	1, 2, 3, 4, 5, 6	-98	
<sup>Note2</sup>	dBm/SCS	1, 2, 4, 5	-98	
		3, 6	-95	
SS-RSRP <sup>Note 3</sup>	dBm/SCS	1, 2, 4, 5	-Infinity	-91
		3, 6	-Infinity	-88
$\hat{E}_s/I_{ot}$	dB	1, 2, 3, 4, 5, 6	-Infinity	7
$\hat{E}_s/N_{oc}$	dB	1, 2, 3, 4, 5, 6	-Infinity	7
I <sub>o</sub> <sup>Note3</sup>	dBm/9.36MHz	1, 2, 4, 5	-70.05	-62.26

	dBm/38.16MHz z	3, 6	-63.95	-56.16
Propagation Condition		1, 2, 3, 4, 5, 6	AWGN	
Antenna Configuration and Correlation Matrix		1, 2, 3, 4, 5, 6	1x2	
Note 1:	OCNG shall be used such that the cell is fully allocated and a constant total transmitted power spectral density is achieved for all OFDM symbols.			
Note 2:	Interference from other cells and noise sources not specified in the test is assumed to be constant over subcarriers and time and shall be modelled as AWGN of appropriate power for $\sigma^2$ to be fulfilled.			
Note 3:	SS-RSRP and $I_0$ levels have been derived from other parameters for information purposes. They are not settable parameters themselves.			
Note 4:	SS-RSRP minimum requirements are specified assuming independent interference and noise at each receiver antenna port.			

#### A.8.4.2.3.2 Test Requirements

In test 1 with per-UE gap, the UE shall send one Event B2 triggered measurement report, with a measurement reporting delay less than 1040 ms from the beginning of time period T2. The UE shall not send event triggered measurement reports, as long as the reporting criteria are not fulfilled. The rate of correct events observed during repeated tests shall be at least 90%.

In test 2 with per-FR gap, the UE shall send one Event B2 triggered measurement report, with a measurement reporting delay less than 920 ms from the beginning of time period T2. The UE shall not send event triggered measurement reports, as long as the reporting criteria are not fulfilled. The rate of correct events observed during repeated tests shall be at least 90%.

In test 1 and test 2, the UE is required to report SSB time index.

NOTE: The actual overall delays measured in the test may be up to  $2 \times TTI_{DCCH}$  higher than the measurement reporting delays above because of TTI insertion uncertainty of the measurement report in DCCH.

#### A.8.4.2.4 NR Inter-RAT event triggered reporting tests for FR1 with SSB time index detection when DRX is used

##### A.8.4.2.4.1 Test Purpose and Environment

The purpose of this test is to verify that the UE makes correct reporting of an event. This test will partly verify the NR inter-RAT cell search requirements in clause 8.1.2.4.21 of TS 36.133 [15] for E-UTRAN FDD-NR measurements and clause 8.1.2.4.22 of TS 36.133 [15] for E-UTRAN TDD-NR measurements.

In this test, there are two cells: E-UTRA cell 1 as PCell on E-UTRA RF channel 1 and NR cell 2 as neighbour cell in FR1 on NR RF channel 1. The test parameters are given in Tables A.8.4.2.4.1-1, A.8.4.2.4.1-2, A.8.4.2.4.1-3 and A.8.4.2.4.1-4.

In tests 1 and 2, measurement gap pattern configuration # 0 as defined in Table A.8.4.2.4.1-2 is provided for UE that does not support per-FR gap and in tests 3 and 4, measurement gap pattern configuration #4 as defined in Table A.8.4.2.4.1-2 is provided for UE that supports per-FR gap.

In the measurement control information, it is indicated to the UE that event-triggered reporting with Event B2 (PCell becomes worse than threshold1 and inter RAT neighbour becomes better than threshold2) [16] is used. In the measurement configuration the UE shall be indicated to report the SSB index of the identified NR cell. The test consists of two successive time periods, with time duration of T1, and T2 respectively. During time duration T1, the UE shall not have any timing information of NR cell 2.

**Table A.8.4.2.4.1-1: NR inter-RAT event triggered reporting tests without SSB index reading for FR1**

Configuration	Description
1	LTE FDD, NR 15 kHz SSB SCS, 10 MHz bandwidth, FDD duplex mode
2	LTE FDD, NR 15 kHz SSB SCS, 10 MHz bandwidth, TDD duplex mode
3	LTE FDD, NR 30 kHz SSB SCS, 40 MHz bandwidth, TDD duplex mode
4	LTE TDD, NR 15 kHz SSB SCS, 10 MHz bandwidth, FDD duplex mode
5	LTE TDD, NR 15 kHz SSB SCS, 10 MHz bandwidth, TDD duplex mode
6	LTE TDD, NR 30 kHz SSB SCS, 40 MHz bandwidth, TDD duplex mode

Note 1: The UE is only required to be tested in one of the supported test configurations.

**Table A.8.4.2.4.1-2: General test parameters for NR inter-RAT event triggered reporting for FR1 without SSB time index detection**

Parameter	Unit	Test configuration	Value				Comment
			Test 1	Test 2	Test 3	Test 4	
E-UTRA RF Channel Number		1, 2, 3, 4, 5, 6	1				One E-UTRA carrier frequency is used.
NR RF Channel Number		1, 2, 3, 4, 5, 6	1				One FR1 NR carrier frequency is used.
Active cell		1, 2, 3, 4, 5, 6	E-UTRA cell 1 (PCell)				E-UTRA cell 1 is on E-UTRA RF channel number 1.
Neighbour cell		1, 2, 3, 4, 5, 6	NR cell 2				NR cell 2 is on NR RF channel number 1.
Gap Pattern Id		1, 2, 3, 4, 5, 6	0	4			As specified in clause Table 8.1.2.1-1 of TS 36.133 [15].
Measurement gap offset		1, 2, 3, 4, 5, 6	39	19			As specified in TS 36.331 [16].
b2-Threshold1	dBm	1, 2, 3, 4, 5, 6	Note 1				E-UTRA RSRP threshold for E-UTRA RSRP measurement on cell 1 for event B2 [16]
b2-Threshold2NR	dBm	1, 2, 3, 4, 5, 6	Note 2				SS-RSRP threshold for SS-RSRP measurement on cell 2 for event B2 [16]
Hysteresis	dB	1, 2, 3, 4, 5, 6	0				
CP length		1, 2, 3, 4, 5, 6	Normal				
TimeToTrigger	s	1, 2, 3, 4, 5, 6	0				
Filter coefficient		1, 2, 3, 4, 5, 6	0				L3 filtering is not used
DRX		1, 2, 3, 4, 5, 6	DRX.9	DRX.12	DRX.9	DRX.12	As specified in clause A.3.3
Time offset between serving and neighbour cells		1, 4	3ms				Asynchronous cells. The timing of Cell 2 is 3ms later than the timing of Cell 1.
		2, 3, 5, 6	3μs				Synchronous cells.
T1	s	1, 2, 3, 4, 5, 6	5				
T2	s	1, 2, 3, 4, 5, 6	2	13	2	13	
Note 1: The value of b2-Threshold1 is defined in Table A.8.4.2.4.1-3							
Note 2: The value of b2-Threshold2NR is defined in Table A.8.4.2.4.1-4							

**Table A.8.4.2.4.1-3: E-UTRAN PCell specific test parameters for NR inter-RAT event triggered reporting in non-DRX with NR neighbour cell in FR1 without SSB time index detection**

Parameter	Unit	Configuration	Cell 1	
			T1	T2
RF channel number		1, 2, 3, 4, 5, 6	1	
Duplex mode		1, 2, 3	FDD	
		4, 5, 6	TDD	
TDD special subframe configuration <sup>Note1</sup>		4, 5, 6	6	
TDD uplink-downlink configuration <sup>Note1</sup>		4, 5, 6	1	
BW <sub>channel</sub>	MHz	1, 2, 3, 4, 5, 6	5 MHz: N <sub>RB,c</sub> = 25 10 MHz: N <sub>RB,c</sub> = 50 20 MHz: N <sub>RB,c</sub> = 100	

PDSCH parameters: DL Reference Measurement Channel <sup>Note2</sup>		1, 2, 3	5 MHz: R.7 FDD 10 MHz: R.3 FDD 20 MHz: R.6 FDD	
		4, 5, 6	5 MHz: R.4 TDD 10 MHz: R.0 TDD 20 MHz: R.3 TDD	
PCFICH/PDCCH/PHICH parameters: DL Reference Measurement Channel <sup>Note2</sup>		1, 2, 3	5 MHz: R.11 FDD 10 MHz: R.6 FDD 20 MHz: R.10 FDD	
		4, 5, 6	5 MHz: R.11 TDD 10 MHz: R.6 TDD 20 MHz: R.10 TDD	
OCNG Patterns <sup>Note2</sup>		1, 2, 3	5 MHz: OP.20 FDD 10 MHz: OP.10 FDD 20 MHz: OP.17 FDD	
		4, 5, 6	5 MHz: OP.9 TDD 10 MHz: OP.1 TDD 20 MHz: OP.7 TDD	
b2-Threshold1	dBm	1, 2, 3, 4, 5, 6	-77	
PBCH_RA	dB	1, 2, 3, 4, 5, 6	0	
PBCH_RB				
PSS_RA				
SSS_RA				
PCFICH_RB				
PHICH_RA				
PHICH_RB				
PDCCH_RA				
PDCCH_RB				
PDSCH_RA				
PDSCH_RB				
OCNG_RA <sup>Note3</sup>				
OCNG_RB <sup>Note3</sup>				
N <sub>oc</sub> <sup>Note4</sup>				
$\hat{E}_s/N_{oc}$	dB	1, 2, 3, 4, 5, 6	17	17
$\hat{E}_s/I_{ot}$ <sup>Note5</sup>	dB	1, 2, 3, 4, 5, 6	17	17
RSRP <sup>Note5</sup>	dBm/15kHz	1, 2, 3, 4, 5, 6	-87	-87
SCH_RP <sup>Note5</sup>	dBm/15kHz	1, 2, 3, 4, 5, 6	-87	-87
I <sub>o</sub> <sup>Note5</sup>	dBm/9MHz	1, 2, 3, 4, 5, 6	$-59.13+10\log(N_{RB,c}/50)$	$-59.13+10\log(N_{RB,c}/50)$
Propagation Condition <sup>Note6</sup>		1, 2, 3, 4, 5, 6	AWGN	
Antenna Configuration and Correlation Matrix <sup>Note6</sup>		1, 2, 3, 4, 5, 6	1x2	
<p>Note 1: Special subframe and uplink-downlink configurations are specified in table 4.2-1 in TS 36.211 [23].</p> <p>Note 2: DL RMCs and OCNG patterns are specified in clauses A 3.1 and A 3.2 of TS 36.133 [15] respectively.</p> <p>Note 3: OCNG shall be used such that all cells are fully allocated and a constant total transmitted power spectral density is achieved for all OFDM symbols.</p> <p>Note 4: Interference from other cells and noise sources not specified in the test is assumed to be constant over subcarriers and time and shall be modelled as AWGN of appropriate power for N<sub>oc</sub> to be fulfilled.</p> <p>Note 5: <math>\hat{E}_s/I_{ot}</math>, RSRP, SCH_RP and I<sub>o</sub> levels have been derived from other parameters for information purposes. They are not settable parameters themselves.</p> <p>Note 6: Propagation condition and correlation matrix are defined in clause B.2 in TS 36.101 [25].</p>				

**Table A.8.4.2.4.1-4: NR neighbour cell specific test parameters for NR inter-RAT event triggered reporting for FR1 without SSB time index detection**

Parameter	Unit	Test configuration	Cell 2	
			T1	T2
NR RF Channel Number		1, 2, 3, 4, 5, 6	1	
Duplex mode		1, 4	FDD	
		2, 3, 5, 6	TDD	
TDD configuration		2, 5	TDDConf.1.1	
		3, 6	TDDConf.2.1	
BW <sub>channel</sub>	MHz	1, 2, 4, 5	10: N <sub>RB,c</sub> = 52	
		3, 6	40: N <sub>RB,c</sub> = 106	

OCNG Patterns defined in A.3.2.1.1 (OP.1)		1, 2, 3, 4, 5, 6	OP.1	
SMTC configuration defined in A.3.11.1 and A.3.11.2		1, 4	SMTC.2	
		2, 3, 5, 6	SMTC.1	
PDSCH/PDCCH subcarrier spacing	kHz	1, 2, 4, 5	15	
		3, 6	30	
b2-Threshold2NR	dBm/SCS	1, 2, 4, 5	-101	
		3, 6	-98	
EPRE ratio of PSS to SSS		1, 2, 3, 4, 5, 6	0	
EPRE ratio of PBCH DMRS to SSS				
EPRE ratio of PBCH to PBCH DMRS				
EPRE ratio of PDCCH DMRS to SSS				
EPRE ratio of PDCCH to PDCCH DMRS				
EPRE ratio of PDSCH DMRS to SSS				
EPRE ratio of PDSCH to PDSCH				
EPRE ratio of OCNG DMRS to SSS (Note 1)				
EPRE ratio of OCNG to OCNG DMRS (Note 1)				
Note2	dBm/15kHz	1, 2, 3, 4, 5, 6	-98	
Note2	dBm/SCS	1, 2, 4, 5	-98	
		3, 6	-95	
SS-RSRP Note 3	dBm/SCS	1, 2, 4, 5	-Infinity	-91
		3, 6	-Infinity	-88
$\hat{E}_s/I_{ot}$	dB	1, 2, 3, 4, 5, 6	-Infinity	7
$\hat{E}_s/N_{oc}$	dB	1, 2, 3, 4, 5, 6	-Infinity	7
$I_o$ Note3	dBm/9.36MHz	1, 2, 4, 5	-70.05	-62.26
	dBm/38.16MHz	3, 6	-63.95	-56.16
Propagation Condition		1, 2, 3, 4, 5, 6	AWGN	
Antenna Configuration and Correlation Matrix		1, 2, 3, 4, 5, 6	1x2	
<p>Note 1: OCNG shall be used such that the cell is fully allocated and a constant total transmitted power spectral density is achieved for all OFDM symbols.</p> <p>Note 2: Interference from other cells and noise sources not specified in the test is assumed to be constant over subcarriers and time and shall be modelled as AWGN of appropriate power for <math>\hat{E}_s/I_{ot}</math> to be fulfilled.</p> <p>Note 3: SS-RSRP and <math>I_o</math> levels have been derived from other parameters for information purposes. They are not settable parameters themselves.</p> <p>Note 4: SS-RSRP minimum requirements are specified assuming independent interference and noise at each receiver antenna port.</p>				

#### A.8.4.2.4.2 Test Requirements

In test 1 with per-UE gap, the UE shall send one Event B2 triggered measurement report, with a measurement reporting delay less than 1280 ms from the beginning of time period T2. The UE shall not send event triggered measurement reports, as long as the reporting criteria are not fulfilled. The rate of correct events observed during repeated tests shall be at least 90%.

In test 2 with per-UE gap, the UE shall send one Event B2 triggered measurement report, with a measurement reporting delay less than 12160 ms from the beginning of time period T2. The UE shall not send event triggered measurement reports, as long as the reporting criteria are not fulfilled. The rate of correct events observed during repeated tests shall be at least 90%.

In test 3 with per-FR gap, the UE shall send one Event B2 triggered measurement report, with a measurement reporting delay less than 1280 ms from the beginning of time period T2. The UE shall not send event triggered measurement reports, as long as the reporting criteria are not fulfilled. The rate of correct events observed during repeated tests shall be at least 90%.

In test 4 with per-FR gap, the UE shall send one Event B2 triggered measurement report, with a measurement reporting delay less than 12160 ms from the beginning of time period T2. The UE shall not send event triggered measurement

reports, as long as the reporting criteria are not fulfilled. The rate of correct events observed during repeated tests shall be at least 90%.

In tests 1, 2, 3 and 4, the UE is required to report SSB time index.

NOTE: The actual overall delays measured in the test may be up to  $2 \times TTI_{DCCH}$  higher than the measurement reporting delays above because of TTI insertion uncertainty of the measurement report in DCCH.

#### A.8.4.2.5 NR Inter-RAT event triggered reporting tests for FR2 without SSB time index detection when DRX is not used

##### A.8.4.2.5.1 Test Purpose and Environment

The purpose of this test is to verify that the UE makes correct reporting of an event. This test will partly verify the NR inter-RAT cell search requirements in clause 8.1.2.4.21 of TS 36.133 [15] for E-UTRAN FDD-NR measurements and clause 8.1.2.4.22 of TS 36.133 [15] for E-UTRAN TDD-NR measurements.

In this test, there are two cells: E-UTRA cell 1 as PCell on E-UTRA RF channel 1 and NR cell 2 as neighbour cell in FR2 on NR RF channel 1. The test parameters are given in Tables A.8.4.2.5.1-1, A.8.4.2.5.1-2 and A.8.4.2.5.1-3.

The cell specific test parameters for E-UTRA cell1 as PCell are defined in clause A.3.7.2.2.

In test 1 measurement gap pattern configuration # 0 as defined in Table A.8.4.2.5.1-2 is provided for UE that does not support per-FR gap and in test 2 measurement gap pattern configuration #4 as defined in Table A.8.4.2.5.1-2 is provided for UE that supports per-FR gap.

In the measurement control information, it is indicated to the UE that event-triggered reporting with Event B1 (Inter RAT neighbour becomes better than threshold) [16] is used. The test consists of two successive time periods, with time duration of T1, and T2 respectively. During time duration T1, the UE shall not have timing information of NR cell 2.

**Table A.8.4.2.5.1-1: NR inter-RAT event triggered reporting tests without SSB index reading for FR2 in non-DRX**

Configuration	Description
1	LTE FDD, NR 120 kHz SSB SCS, 100 MHz bandwidth, TDD duplex mode
2	LTE TDD, NR 120 kHz SSB SCS, 100 MHz bandwidth, TDD duplex mode

Note 1: The UE is only required to be tested in one of the supported test configurations.

**Table A.8.4.2.5.1-2: General test parameters for NR inter-RAT event triggered reporting for FR2 without SSB time index detection in non-DRX**

Parameter	Unit	Test configuration	Value		Comment
			Test 1	Test 2	
E-UTRA RF Channel Number		1, 2	1		One E-UTRA carrier frequency is used.
NR RF Channel Number		1, 2	1		One FR2 NR carrier frequency is used.
Active cell		1, 2	E-UTRA cell 1 (PCell)		E-UTRA cell 1 is on E-UTRA RF channel number 1 as defined in clause A.3.7.2.2.
Neighbour cell		1, 2	NR cell 2		NR cell 2 is on NR RF channel number 1.
Gap Pattern Id		1, 2	0	4	As specified in clause Table 8.1.2.1-1 of TS 36.133 [15].
Measurement gap offset		1, 2	39	19	As specified in TS 36.331 [16].
b1-ThresholdNR	dBm	1, 2	Note 1		SS-RSRP threshold for SS-RSRP measurement on cell 2 for event B1 [16]
Hysteresis	dB	1, 2	0		
CP length		1, 2	Normal		
TimeToTrigger	s	1, 2	0		
Filter coefficient		1, 2	0		L3 filtering is not used
DRX		1, 2	OFF		DRX is not used

Time offset between serving and neighbour cells		1	3ms		Asynchronous cells. The timing of Cell 2 is 3ms later than the timing of Cell 1.
		2	3μs		Synchronous cells.
T1	s	1, 2	10		
T2	s	1, 2	6	3	
Note 1: The value of b1-ThresholdNR is defined in Table A.8.4.2.5.1-3					

**Table A.8.4.2.5.1-3: NR neighbour cell specific test parameters for NR inter-RAT event triggered reporting for FR2 without SSB time index detection in non-DRX**

Parameter	Unit	Test configuration	Cell 2	
			T1	T2
AoA setup defined in A.3.15.2.1		1, 2	Setup 2a	
Assumption for UE beams <sup>Note 5</sup>		1, 2	Rough	
NR RF Channel Number		1, 2	1	
Duplex mode		1, 2	TDD	
TDD configuration		1, 2	TDDConf.3.1	
BW <sub>channel</sub>	MHz	1, 2	100: N <sub>RB,c</sub> = 24	
OCNG patterns defined in A.3.2.1.1		1, 2	OP.3	
SMTC configuration defined in A.3.11.1 and A.3.11.2		1	SMTC.2	
		2	SMTC.1	
PDSCH/PDCCH subcarrier spacing	kHz	1, 2	120	
b1-ThresholdNR	UE power class 3 dBm/SCS	1, 2	-112	
EPRE ratio of PSS to SSS		1, 2	0	
EPRE ratio of PBCH DMRS to SSS				
EPRE ratio of PBCH to PBCH DMRS				
EPRE ratio of PDCCH DMRS to SSS				
EPRE ratio of PDCCH to PDCCH DMRS				
EPRE ratio of PDSCH DMRS to SSS				
EPRE ratio of PDSCH to PDSCH				
EPRE ratio of OCNG DMRS to SSS (Note 1)				
EPRE ratio of OCNG to OCNG DMRS (Note 1)				
$\hat{E}_s$	dBm/SCS			
SSB_RP <sup>Note 3</sup>	dBm/SCS	1, 2	-Infinity	-80.6
$\hat{E}_s/I_{ot\_BB}$ <sup>Note 6</sup>	dB	1, 2	-Infinity	8.3
$I_o$ <sup>Note3</sup>	dBm/95.04MHz	1, 2	-Infinity	-56.0
Propagation Condition		1, 2	AWGN	
<p>Note 1: OCNG shall be used such that a constant total transmitted power spectral density is achieved for all OFDM symbols.</p> <p>Note 2: Void</p> <p>Note 3: SSB_RP and <math>I_o</math> levels have been derived from other parameters for information purposes. They are not settable parameters themselves.</p> <p>Note 4: Void</p> <p>Note 5: Information about types of UE beam is given in B.2.1.3, and does not limit UE implementation or test system implementation</p> <p>Note 6: Calculation of <math>\hat{E}_s/I_{ot\_BB}</math> includes the effect of UE internal noise up to the value assumed for the associated Refsens requirement in clause 7.3.2 of TS 38.101-2 [19], and an allowance of 1dB for UE multi-band relaxation factor <math>\Delta MB_P</math> from TS 38.101-2 [19] Table 6.2.1.3-4.</p>				

#### A.8.4.2.5.2 Test Requirements

In test 1 with per-UE gap, the UE shall send one Event B1 triggered measurement report, with a measurement reporting delay less than D1 ms from the beginning of time period T2. The UE shall not send event triggered measurement reports, as long as the reporting criteria are not fulfilled. The rate of correct events observed during repeated tests shall be at least 90%.



In test 2 with per-FR gap, the UE shall send one Event B1 triggered measurement report, with a measurement reporting delay less than D2 ms from the beginning of time period T2. The UE shall not send event triggered measurement reports, as long as the reporting criteria are not fulfilled. The rate of correct events observed during repeated tests shall be at least 90%.

In test 1 and test 2, the UE is not required to report SSB time index.

**Table A.8.4.2.5.2-1: Test requirements for NR inter-RAT event triggered reporting for FR2 without SSB time index detection in non-DRX**

Test case	Measurement reporting delay (ms)	
	Test 1: D1 ms	Test 2: D2 ms
UE power class 3	3200	1600

NOTE: The actual overall delays measured in the test may be up to  $2 \times TTI_{DCCCH}$  higher than the measurement reporting delays above because of TTI insertion uncertainty of the measurement report in DCCCH.

### A.8.4.2.6 NR Inter-RAT event triggered reporting tests for FR2 without SSB time index detection when DRX is used

#### A.8.4.2.6.1 Test Purpose and Environment

The purpose of this test is to verify that the UE makes correct reporting of an event. This test will partly verify the NR inter-RAT cell search requirements in clause 8.1.2.4.21 of TS 36.133 [15] for E-UTRAN FDD-NR measurements and clause 8.1.2.4.22 of TS 36.133 [15] for E-UTRAN TDD-NR measurements.

In this test, there are two cells: E-UTRA cell 1 as PCell on E-UTRA RF channel 1 and NR cell 2 as neighbour cell in FR2 on NR RF channel 1. The test parameters are given in Tables A.8.4.2.6.1-1, A.8.4.2.6.1-2 and A.8.4.2.6.1-3.

The cell specific test parameters for E-UTRA cell1 as PCell are defined in clause A.3.7.2.2.

In tests 1 and 2, measurement gap pattern configuration # 0 as defined in Table A.8.4.2.6.1-2 is provided for UE that does not support per-FR gap and in tests 3 and 4, measurement gap pattern configuration #4 as defined in Table A.8.4.2.6.1-2 is provided for UE that supports per-FR gap.

In the measurement control information, it is indicated to the UE that event-triggered reporting with Event B1 (Inter RAT neighbour becomes better than threshold) [16] is used. The test consists of two successive time periods, with time duration of T1, and T2 respectively. During time duration T1, the UE shall not have timing information of NR cell 2.

**Table A.8.4.2.6.1-1: NR inter-RAT event triggered reporting tests without SSB index reading for FR2 in DRX**

Configuration	Description
1	LTE FDD, NR 120 kHz SSB SCS, 100 MHz bandwidth, TDD duplex mode
2	LTE TDD, NR 120 kHz SSB SCS, 100 MHz bandwidth, TDD duplex mode
Note 1: The UE is only required to be tested in one of the supported test configurations.	

**Table A.8.4.2.6.1-2: General test parameters for NR inter-RAT event triggered reporting for FR2 without SSB time index detection in DRX**

Parameter	Unit	Test configuration	Value				Comment
			Test 1	Test 2	Test 3	Test 4	
E-UTRA RF Channel Number		1, 2	1				One E-UTRA carrier frequency is used.
NR RF Channel Number		1, 2	1				One FR2 NR carrier frequency is used.
Active cell		1, 2, 3, 4, 5, 6	E-UTRA cell 1 (PCell)				E-UTRA cell 1 is on E-UTRA RF channel number 1 as defined in clause A.3.7.2.2.
Neighbour cell		1, 2, 3, 4, 5, 6	NR cell 2				NR cell 2 is on NR RF channel number 1.

Gap Pattern Id		1, 2, 3, 4, 5, 6	0	4	As specified in clause Table 8.1.2.1-1 of TS 36.133 [15].		
Measurement gap offset		1, 2, 3, 4, 5, 6	39	19	As specified in TS 36.331 [16].		
b1-ThresholdNR	dBm	1, 2	Note 1		SS-RSRP threshold for SS-RSRP measurement on cell 2 for event B1 [16]		
Hysteresis	dB	1, 2, 3, 4, 5, 6	0				
CP length		1, 2, 3, 4, 5, 6	Normal				
TimeToTrigger	s	1, 2, 3, 4, 5, 6	0				
Filter coefficient		1, 2, 3, 4, 5, 6	0		L3 filtering is not used		
DRX		1, 2, 3, 4, 5, 6	DRX.9	DRX.12	DRX.9	DRX.12	As specified in clause A.3.3
Time offset between serving and neighbour cells		1	3ms			Asynchronous cells. The timing of Cell 2 is 3ms later than the timing of Cell 1.	
		2	3μs			Synchronous cells.	
T1	s	1, 2, 3, 4, 5, 6	5				
T2	s	1, 2, 3, 4, 5, 6	6	83	6	83	

Note 1: The value of b1-ThresholdNR is defined in Table A.8.4.2.6.1-3

**Table A.8.4.2.6.1-3: NR neighbour cell specific test parameters for NR inter-RAT event triggered reporting for FR2 without SSB time index detection in DRX**

Parameter	Unit	Test configuration	Cell 2	
			T1	T2
AoA setup defined in A.3.15.1		1, 2	Setup 1	
Assumption for UE beams <sup>Note 5</sup>		1, 2	Rough	
NR RF Channel Number		1, 2	1	
Duplex mode		1, 2	TDD	
TDD configuration		1, 2	TDDConf.3.1	
BW <sub>channel</sub>	MHz	1, 2	100: N <sub>RB,c</sub> = 66	
OCNG patterns defined in A.3.2.1.1		1, 2	OP.1	
SMTC configuration defined in A.3.11.1 and A.3.11.2		1	SMTC.2	
		2	SMTC.1	
PDSCH/PDCCH subcarrier spacing	kHz	1, 2	120	
b1-ThresholdNR   UE power class 3	dBm/SCS	1, 2	-106	
EPRE ratio of PSS to SSS		1, 2	0	
EPRE ratio of PBCH DMRS to SSS				
EPRE ratio of PBCH to PBCH DMRS				
EPRE ratio of PDCCH DMRS to SSS				
EPRE ratio of PDCCH to PDCCH DMRS				
EPRE ratio of PDSCH DMRS to SSS				
EPRE ratio of PDSCH to PDSCH				
EPRE ratio of OCNG DMRS to SSS (Note 1)				
EPRE ratio of OCNG to OCNG DMRS (Note 1)				
N <sub>oc</sub> <sup>Note 2</sup>	dBm/15kHz	1, 2	-104.7	
N <sub>oc</sub> <sup>Note 2</sup>	dBm/SCS	1, 2	-95.7	
SSN_RP <sup>Note 3</sup>	dBm/SCS	1, 2	-Infinity	-87.7
$\hat{E}_s/I_{ot}$	dB	1, 2	-Infinity	8
$\hat{E}_s/N_{oc}$	dB	1, 2	-Infinity	8

$I_0$ <sup>Note3</sup>	dBm/95.04MHz z	1, 2	-66.7	-58.0
Propagation Condition		1, 2	AWGN	
Note 1:	OCNG shall be used such that the cell is fully allocated and a constant total transmitted power spectral density is achieved for all OFDM symbols.			
Note 2:	Interference from other cells and noise sources not specified in the test is assumed to be constant over subcarriers and time and shall be modelled as AWGN of appropriate power for $N_{oc}$ to be fulfilled.			
Note 3:	SS-RSRP and $I_0$ levels have been derived from other parameters for information purposes. They are not settable parameters themselves.			
Note 4:	SS-RSRP minimum requirements are specified assuming independent interference and noise at each receiver antenna port.			
Note 5:	Information about types of UE beam is given in B.2.1.3, and does not limit UE implementation or test system implementation			

#### A.8.4.2.6.2 Test Requirements

In test 1 with per-UE gap, the UE shall send one Event B1 triggered measurement report, with a measurement reporting delay less than D1 ms from the beginning of time period T2. The UE shall not send event triggered measurement reports, as long as the reporting criteria are not fulfilled. The rate of correct events observed during repeated tests shall be at least 90%.

In test 2 with per-UE gap, the UE shall send one Event B1 triggered measurement report, with a measurement reporting delay less than D2 ms from the beginning of time period T2. The UE shall not send event triggered measurement reports, as long as the reporting criteria are not fulfilled. The rate of correct events observed during repeated tests shall be at least 90%.

In test 3 with per-FR gap, the UE shall send one Event B1 triggered measurement report, with a measurement reporting delay less than D3 ms from the beginning of time period T2. The UE shall not send event triggered measurement reports, as long as the reporting criteria are not fulfilled. The rate of correct events observed during repeated tests shall be at least 90%.

In test 4 with per-FR gap, the UE shall send one Event B1 triggered measurement report, with a measurement reporting delay less than D4 ms from the beginning of time period T2. The UE shall not send event triggered measurement reports, as long as the reporting criteria are not fulfilled. The rate of correct events observed during repeated tests shall be at least 90%.

In tests 1, 2, 3 and 4, the UE is not required to report SSB time index.

**Table A.8.4.2.6.2-1: Test requirements for NR inter-RAT event triggered reporting for FR2 without SSB time index detection in DRX**

Test case	Measurement reporting delay (ms)			
	Test 1: D1 ms	Test 2: D2 ms	Test 3: D3 ms	Test 4: D4 ms
UE power class 3	4800	51200	4800	51200

NOTE: The actual overall delays measured in the test may be up to  $2 \times TTI_{DCCH}$  higher than the measurement reporting delays above because of TTI insertion uncertainty of the measurement report in DCCH.

#### A.8.4.2.7 NR Inter-RAT event triggered reporting tests for FR2 with SSB time index detection when DRX is not used

##### A.8.4.2.7.1 Test Purpose and Environment

The purpose of this test is to verify that the UE makes correct reporting of an event. This test will partly verify the NR inter-RAT cell search requirements in clause 8.1.2.4.21 of TS 36.133 [15] for E-UTRAN FDD-NR measurements and clause 8.1.2.4.22 of TS 36.133 [15] for E-UTRAN TDD-NR measurements.

In this test, there are two cells: E-UTRA cell 1 as PCell on E-UTRA RF channel 1 and NR cell 2 as neighbour cell in FR2 on NR RF channel 1. The test parameters are given in Tables A.8.4.2.7.1-1, A.8.4.2.7.1-2 and A.8.4.2.7.1-3.

The cell specific test parameters for E-UTRA cell1 as PCell are defined in clause A.3.7.2.2.

In test 1 measurement gap pattern configuration # 0 as defined in Table A.8.4.2.7.1-2 is provided for UE that does not support per-FR gap and in test 2 measurement gap pattern configuration #4 as defined in Table A.8.4.2.7.1-2 is provided for UE that supports per-FR gap.

In the measurement control information, it is indicated to the UE that event-triggered reporting with Event B1 (Inter RAT neighbour becomes better than threshold) [16] is used. In the measurement configuration the UE shall be indicated to report the SSB index of the identified NR cell. The test consists of two successive time periods, with time duration of T1, and T2 respectively. During time duration T1, the UE shall not have any timing information of NR cell 2.

**Table A.8.4.2.7.1-1: NR inter-RAT event triggered reporting tests with SSB index reading for FR2 in non-DRX**

Configuration	Description
1	LTE FDD, NR 120 kHz SSB SCS, 100 MHz bandwidth, TDD duplex mode
2	LTE TDD, NR 120 kHz SSB SCS, 100 MHz bandwidth, TDD duplex mode
Note 1: The UE is only required to be tested in one of the supported test configurations.	

**Table A.8.4.2.7.1-2: General test parameters for NR inter-RAT event triggered reporting for FR2 with SSB time index detection in non-DRX**

Parameter	Unit	Test configuration	Value		Comment
			Test 1	Test 2	
E-UTRA RF Channel Numbers		1, 2	1		One E-UTRA carrier frequency is used.
NR RF Channel Numbers		1, 2	1		One FR2 NR carrier frequency is used.
Active cell		1, 2	E-UTRA cell 1 (PCell)		E-UTRA cell 1 is on E-UTRA RF channel number 1 as defined in clause A.3.7.2.2.
Neighbour cell		1, 2	NR cell 2		NR cell 2 is on NR RF channel number 1.
Gap Pattern Id		1, 2	0	4	As specified in clause Table 8.1.2.1-1 of TS 36.133 [15].
Measurement gap offset		1, 2	39	19	As specified in TS 36.331 [16].
b1-ThresholdNR	dBm	1, 2	Note 1		SS-RSRP threshold for SS-RSRP measurement on cell 2 for event B1 [16]
Hysteresis	dB	1, 2	0		
CP length		1, 2	Normal		
TimeToTrigger	s	1, 2	0		
Filter coefficient		1, 2	0		L3 filtering is not used
DRX		1, 2	OFF		DRX is not used
Time offset between serving and neighbour cells		1	3ms		Asynchronous cells. The timing of Cell 2 is 3ms later than the timing of Cell 1.
		2	3μs		Synchronous cells.
T1	s	1, 2	5		
T2	s	1, 2	5	3	
Note 1: The value of b1-ThresholdNR is defined in Table A.8.4.2.5.1-3					

**Table A.8.4.2.7.1-3: NR neighbour cell specific test parameters for NR inter-RAT event triggered reporting for FR2 with SSB time index detection in non-DRX**

Parameter	Unit	Test configuration	Cell 2	
			T1	T2
AoA setup defined in A.3.15.1		1, 2	Setup 1	
Assumption for UE beams <sup>Note 5</sup>		1, 2	Rough	
NR RF Channel Number		1, 2	1	
Duplex mode		1, 2	TDD	
TDD configuration		1, 2	TDDConf.3.1	
BW <sub>channel</sub>	MHz	1, 2	100: N <sub>RB,c</sub> = 66	
OCNG patterns defined in A.3.2.1.1		1, 2	OP.1	

SMTC configuration defined in A.3.11.1 and A.3.11.2			1	SMTC.2	
			2	SMTC.1	
PDSCH/PDCCH subcarrier spacing		kHz	1, 2	120	
b1-ThresholdNR	UE power class 3	dBm/SCS	1, 2	-106	
EPRE ratio of PSS to SSS			1, 2	0	
EPRE ratio of PBCH DMRS to SSS					
EPRE ratio of PBCH to PBCH DMRS					
EPRE ratio of PDCCH DMRS to SSS					
EPRE ratio of PDCCH to PDCCH DMRS					
EPRE ratio of PDSCH DMRS to SSS					
EPRE ratio of PDSCH to PDSCH					
EPRE ratio of OCNG DMRS to SSS (Note 1)					
EPRE ratio of OCNG to OCNG DMRS (Note 1)					
Note2		dBm/15kHz	1, 2	-104.7	
$N_{oc}$	Note2	dBm/SCS	1, 2	-95.7	
SS-RSRP Note 3		dBm/SCS	1, 2	-Infinity	-87.7
$\hat{E}_s/I_{ot}$		dB	1, 2	-Infinity	8
$\hat{E}_s/N_{oc}$		dB	1, 2	-Infinity	8
$I_o$ Note3		dBm/95.04MHz	1, 2	-66.7	-58.0
Propagation Condition			1, 2	AWGN	
<p>Note 1: OCNG shall be used such that the cell is fully allocated and a constant total transmitted power spectral density is achieved for all OFDM symbols.</p> <p>Note 2: Interference from other cells and noise sources not specified in the test is assumed to be constant over subcarriers and time and shall be modelled as AWGN of appropriate power for <math>N_{oc}</math> to be fulfilled.</p> <p>Note 3: SS-RSRP and <math>I_o</math> levels have been derived from other parameters for information purposes. They are not settable parameters themselves.</p> <p>Note 4: SS-RSRP minimum requirements are specified assuming independent interference and noise at each receiver antenna port.</p> <p>Note 5: Information about types of UE beam is given in B.2.1.3, and does not limit UE implementation or test system implementation</p>					

A.8.4.2.7.2 Test Requirements

In test 1 with per-UE gap, the UE shall send one Event B1 triggered measurement report, with a measurement reporting delay less than D1 ms from the beginning of time period T2. The UE shall not send event triggered measurement reports, as long as the reporting criteria are not fulfilled. The rate of correct events observed during repeated tests shall be at least 90%.

In test 2 with per-FR gap, the UE shall send one Event B1 triggered measurement report, with a measurement reporting delay less than D2 ms from the beginning of time period T2. The UE shall not send event triggered measurement reports, as long as the reporting criteria are not fulfilled. The rate of correct events observed during repeated tests shall be at least 90%.

In test 1 and test 2, the UE is required to report SSB time index.

NOTE: The actual overall delays measured in the test may be up to  $2 \times TTI_{DCCH}$  higher than the measurement reporting delays above because of TTI insertion uncertainty of the measurement report in DCCH.

**Table A.8.4.2.7.2-1: Test requirements for NR inter-RAT event triggered reporting for FR2 with SSB time index detection in non-DRX**

Test case	Measurement reporting delay (ms)	
	Test 1: D1 ms	Test 2: D2 ms
UE power class 3	4160	2080

## A.8.4.2.8 NR Inter-RAT event triggered reporting tests for FR2 with SSB time index detection when DRX is used

### A.8.4.2.8.1 Test Purpose and Environment

The purpose of this test is to verify that the UE makes correct reporting of an event. This test will partly verify the NR inter-RAT cell search requirements in clause 8.1.2.4.21 of TS 36.133 [15] for E-UTRAN FDD-NR measurements and clause 8.1.2.4.22 of TS 36.133 [15] for E-UTRAN TDD-NR measurements.

In this test, there are two cells: E-UTRA cell 1 as PCell on E-UTRA RF channel 1 and NR cell 2 as neighbour cell in FR2 on NR RF channel 1. The test parameters are given in Tables A.8.4.2.8.1-1, A.8.4.2.8.1-2 and A.8.4.2.8.1-3.

The cell specific test parameters for E-UTRA cell1 as PCell are defined in clause A.3.7.2.2.

In tests 1 and 2, measurement gap pattern configuration # 0 as defined in Table A.8.4.2.8.1-2 is provided for UE that does not support per-FR gap and in tests 3 and 4, measurement gap pattern configuration #4 as defined in Table A.8.4.2.8.1-2 is provided for UE that supports per-FR gap.

In the measurement control information, it is indicated to the UE that event-triggered reporting with Event B1 (Inter RAT neighbour becomes better than threshold) [16] is used. In the measurement configuration the UE shall be indicated to report the SSB index of the identified NR cell. The test consists of two successive time periods, with time duration of T1, and T2 respectively. During time duration T1, the UE shall not have any timing information of NR cell 2.

**Table A.8.4.2.8.1-1: NR inter-RAT event triggered reporting tests with SSB index reading for FR2 in DRX**

Configuration	Description
1	LTE FDD, NR 120 kHz SSB SCS, 100 MHz bandwidth, TDD duplex mode
2	LTE TDD, NR 120 kHz SSB SCS, 100 MHz bandwidth, TDD duplex mode

Note 1: The UE is only required to be tested in one of the supported test configurations.

**Table A.8.4.2.8.1-2: General test parameters for NR inter-RAT event triggered reporting for FR2 with SSB time index detection in DRX**

Parameter	Unit	Test configuration	Value				Comment
			Test 1	Test 2	Test 3	Test 4	
E-UTRA RF Channel Number		1, 2	1				One E-UTRA carrier frequency is used.
NR RF Channel Number		1, 2	1				One FR2 NR carrier frequency is used.
Active cell		1, 2	E-UTRA cell 1 (PCell)				E-UTRA cell 1 is on E-UTRA RF channel number 1 as defined in clause A.3.7.2.2.
Neighbour cell		1, 2	NR cell 2				NR cell 2 is on NR RF channel number 1.
Gap Pattern Id		1, 2	0		4		As specified in clause Table 8.1.2.1-1 of TS 36.133 [15].
Measurement gap offset		1, 2	39		19		As specified in TS 36.331 [16].
b1-ThresholdNR	dBm	1, 2	Note 1				SS-RSRP threshold for SS-RSRP measurement on cell 2 for event B1 [16]
Hysteresis	dB	1, 2	0				
CP length		1, 2	Normal				
TimeToTrigger	s	1, 2	0				
Filter coefficient		1, 2	0				L3 filtering is not used
DRX			DRX.9	DRX.12	DRX.9	DRX.12	As specified in clause A.3.3
Time offset between serving and neighbour cells		1	3ms				Asynchronous cells. The timing of Cell 2 is 3ms later than the timing of Cell 1.
		2	3µs				Synchronous cells.
T1	s	1, 2	5				

T2	s	1, 2	7	70	7	70	
Note 1: The value of b1-ThresholdNR is defined in Table A.8.4.2.8.1-3							

**Table A.8.4.2.8.1-3: NR neighbour cell specific test parameters for NR inter-RAT event triggered reporting for FR2 with SSB time index detection**

Parameter	Unit	Test configuration	Cell 2	
			T1	T2
AoA setup defined in A.3.15.1		1, 2	Setup 1	
Assumption for UE beams <sup>Note 5</sup>		1, 2	Rough	
NR RF Channel Number		1, 2	1	
Duplex mode		1, 2	TDD	
TDD configuration		1, 2	TDDConf.3.1	
BW <sub>channel</sub>	MHz	1, 2	100: N <sub>RB,c</sub> = 66	
OCNG patterns defined in A.3.2.1.1		1, 2	OP.1	
SMTC configuration defined in A.3.11.1 and A.3.11.2		1	SMTC.2	
		2	SMTC.1	
PDSCH/PDCCH subcarrier spacing	kHz	1, 2	120	
b1-ThresholdNR   UE power class 3	dBm/SCS	1, 2	-106	
EPRE ratio of PSS to SSS		1, 2	0	
EPRE ratio of PBCH DMRS to SSS				
EPRE ratio of PBCH to PBCH DMRS				
EPRE ratio of PDCCH DMRS to SSS				
EPRE ratio of PDCCH to PDCCH DMRS				
EPRE ratio of PDSCH DMRS to SSS				
EPRE ratio of PDSCH to PDSCH				
EPRE ratio of OCNG DMRS to SSS (Note 1)				
EPRE ratio of OCNG to OCNG DMRS (Note 1)				
N <sub>oc</sub> <sup>Note2</sup>	dBm/15kHz			
N <sub>oc</sub> <sup>Note2</sup>	dBm/SCS	1, 2	-95.7	
SS-RSRP <sup>Note 3</sup>	dBm/SCS	1, 2	-Infinity	-87.7
$\hat{E}_s/I_{ot}$	dB	1, 2	-Infinity	8
$\hat{E}_s/N_{oc}$	dB	1, 2	-Infinity	8
I <sub>o</sub> <sup>Note3</sup>	dBm/95.04MHz	1, 2	-66.7	-58.08
Propagation Condition		1, 2	AWGN	
<p>Note 1: OCNG shall be used such that the cell is fully allocated and a constant total transmitted power spectral density is achieved for all OFDM symbols.</p> <p>Note 2: Interference from other cells and noise sources not specified in the test is assumed to be constant over subcarriers and time and shall be modelled as AWGN of appropriate power for N<sub>oc</sub> to be fulfilled.</p> <p>Note 3: SS-RSRP and I<sub>o</sub> levels have been derived from other parameters for information purposes. They are not settable parameters themselves.</p> <p>Note 4: SS-RSRP minimum requirements are specified assuming independent interference and noise at each receiver antenna port.</p> <p>Note 5: Information about types of UE beam is given in B.2.1.3, and does not limit UE implementation or test system implementation</p>				

#### A.8.4.2.8.2 Test Requirements

In test 1 with per-UE gap, the UE shall send one Event B1 triggered measurement report, with a measurement reporting delay less than D1 ms from the beginning of time period T2. The UE shall not send event triggered measurement reports, as long as the reporting criteria are not fulfilled. The rate of correct events observed during repeated tests shall be at least 90%.

In test 2 with per-UE gap, the UE shall send one Event B1 triggered measurement report, with a measurement reporting delay less than D2 ms from the beginning of time period T2. The UE shall not send event triggered measurement reports, as long as the reporting criteria are not fulfilled. The rate of correct events observed during repeated tests shall be at least 90%.



In test 3 with per-FR gap, the UE shall send one Event B1 triggered measurement report, with a measurement reporting delay less than D3 ms from the beginning of time period T2. The UE shall not send event triggered measurement reports, as long as the reporting criteria are not fulfilled. The rate of correct events observed during repeated tests shall be at least 90%.

In test 4 with per-FR gap, the UE shall send one Event B1 triggered measurement report, with a measurement reporting delay less than D4 ms from the beginning of time period T2. The UE shall not send event triggered measurement reports, as long as the reporting criteria are not fulfilled. The rate of correct events observed during repeated tests shall be at least 90%.

In tests 1, 2, 3 and 4, the UE is required to report SSB time index.

**Table A.8.4.2.8.2-1: Test requirements for NR inter-RAT event triggered reporting for FR2 with SSB time index detection in DRX**

Test case	Measurement reporting delay (ms)			
	Test 1: D1 ms	Test 2: D2 ms	Test 3: D3 ms	Test 4: D4 ms
UE power class 3	6240	66560	6240	66560

NOTE: The actual overall delays measured in the test may be up to  $2 \times TTI_{DCCCH}$  higher than the measurement reporting delays above because of TTI insertion uncertainty of the measurement report in DCCCH.

#### A.8.4.2.9 NR Inter-RAT event triggered reporting tests for FR1 with SSB time index detection in DRX for UE configured with highSpeedInterRAT-NR-r16

##### A.8.4.2.9.1 Test Purpose and Environment

The purpose of this test is to verify that the UE makes correct reporting of an event. This test will partly verify the NR inter-RAT cell search requirements in clause 8.1.2.4.21 of TS 36.133 [15] for E-UTRAN FDD-NR measurements and clause 8.1.2.4.22 of TS 36.133 [15] for E-UTRAN TDD-NR measurements when UE is configured with *highSpeedInterRAT-NR-r16*.

In this test, there are two cells: E-UTRA cell 1 as PCell on E-UTRA RF channel 1 and NR cell 2 as neighbour cell in FR1 on NR RF channel 1. The test parameters are given in Tables A.8.4.2.9.1-1, A.8.4.2.9.1-2, A.8.4.2.9.1-3 and A.8.4.2.9.1-4.

In the measurement control information, it is indicated to the UE that event-triggered reporting with Event B2 (PCell becomes worse than threshold1 and inter RAT neighbour becomes better than threshold2) [16] is used. In the measurement configuration the UE shall be indicated to report the SSB index of the identified NR cell. The test consists of two successive time periods, with time duration of T1, and T2 respectively. During time duration T1, the UE shall not have any timing information of NR cell 2.

**Table A.8.4.2.9.1-1: NR inter-RAT event triggered reporting tests with SSB index reading for FR1 for UE configured with highSpeedInterRAT-NR-r16**

Configuration	Description
1	LTE FDD, NR 15 kHz SSB SCS, 10 MHz bandwidth, FDD duplex mode
2	LTE FDD, NR 15 kHz SSB SCS, 10 MHz bandwidth, TDD duplex mode
3	LTE FDD, NR 30 kHz SSB SCS, 40 MHz bandwidth, TDD duplex mode
4	LTE TDD, NR 15 kHz SSB SCS, 10 MHz bandwidth, FDD duplex mode
5	LTE TDD, NR 15 kHz SSB SCS, 10 MHz bandwidth, TDD duplex mode
6	LTE TDD, NR 30 kHz SSB SCS, 40 MHz bandwidth, TDD duplex mode

Note 1: The UE is only required to be tested in one of the supported test configurations.

**Table A.8.4.2.9.1-2: General test parameters for NR inter-RAT event triggered reporting for FR1 with SSB time index detection for UE configured with highSpeedInterRAT-NR-r16**

Parameter	Unit	Test configuration	Value	Comment
E-UTRA RF Channel Number		1, 2, 3, 4, 5, 6	1	One E-UTRA carrier frequency is used.

NR RF Channel Number		1, 2, 3, 4, 5, 6	1	One FR1 NR carrier frequency is used.
Active cell		1, 2, 3, 4, 5, 6	E-UTRA cell 1 (PCell)	E-UTRA cell 1 is on E-UTRA RF channel number 1.
Neighbour cell		1, 2, 3, 4, 5, 6	NR cell 2	NR cell 2 is on NR RF channel number 1.
Gap Pattern Id		1, 2, 3, 4, 5, 6	0	As specified in clause Table 8.1.2.1-1 of TS 36.133 [15].
Measurement gap offset		1, 2, 3, 4, 5, 6	39	As specified in TS 36.331 [16].
b2-Threshold1	dBm	1, 2, 3, 4, 5, 6	Note 1	E-UTRA RSRP threshold for E-UTRA RSRP measurement on cell 1 for event B2 [16]
b2-Threshold2NR	dBm	1, 2, 3, 4, 5, 6	Note 2	SS-RSRP threshold for SS-RSRP measurement on cell 2 for event B2 [16]
Hysteresis	dB	1, 2, 3, 4, 5, 6	0	
CP length		1, 2, 3, 4, 5, 6	Normal	
TimeToTrigger	s	1, 2, 3, 4, 5, 6	0	
Filter coefficient		1, 2, 3, 4, 5, 6	0	L3 filtering is not used
DRX		1, 2, 3, 4, 5, 6	DRX.5	As specified in clause A.3.3
Time offset between serving and neighbour cells		1, 4	3ms	Asynchronous cells. The timing of Cell 2 is 3ms later than the timing of Cell 1.
		2, 3, 5, 6	3µs	Synchronous cells.
T1	s	1, 2, 3, 4, 5, 6	5	
T2	s	1, 2, 3, 4, 5, 6	5	
Note 1: The value of b2-Threshold1 is defined in Table A.8.4.2.9.1-3				
Note 2: The value of b2-Threshold2NR is defined in Table A.8.4.2.9.1-4				

**Table A.8.4.2.9.1-3: E-UTRAN PCell specific test parameters for NR inter-RAT event triggered reporting with NR neighbour cell in FR1 with SSB time index detection for UE configured with highSpeedInterRAT-NR-r16**

Parameter	Unit	Configuration	Cell 1	
			T1	T2
RF channel number		1, 2, 3, 4, 5, 6	1	
Duplex mode		1, 2, 3	FDD	
		4, 5, 6	TDD	
TDD special subframe configuration <sup>Note1</sup>		4, 5, 6	6	
TDD uplink-downlink configuration <sup>Note1</sup>		4, 5, 6	1	
BW <sub>channel</sub>	MHz	1, 2, 3, 4, 5, 6	5 MHz: N <sub>RB,c</sub> = 25 10 MHz: N <sub>RB,c</sub> = 50 20 MHz: N <sub>RB,c</sub> = 100	
PDSCH parameters: DL Reference Measurement Channel <sup>Note2</sup>		1, 2, 3	5 MHz: R.7 FDD 10 MHz: R.3 FDD 20 MHz: R.6 FDD	
		4, 5, 6	5 MHz: R.4 TDD 10 MHz: R.0 TDD 20 MHz: R.3 TDD	
PCFICH/PDCCH/PHICH parameters: DL Reference Measurement Channel <sup>Note2</sup>		1, 2, 3	5 MHz: R.11 FDD 10 MHz: R.6 FDD 20 MHz: R.10 FDD	
		4, 5, 6	5 MHz: R.11 TDD 10 MHz: R.6 TDD	

OCNG Patterns <sup>Note2</sup>		1, 2, 3	20 MHz: R.10 TDD	
		4, 5, 6	5 MHz: OP.20 FDD 10 MHz: OP.10 FDD 20 MHz: OP.17 FDD	
b2-Threshold1	dBm	1, 2, 3, 4, 5, 6	-77	
PBCH_RA	dB	1, 2, 3, 4, 5, 6	0	
PBCH_RB				
PSS_RA				
SSS_RA				
PCFICH_RB				
PHICH_RA				
PHICH_RB				
PDCCH_RA				
PDCCH_RB				
PDSCH_RA				
PDSCH_RB				
OCNG_RA <sup>Note3</sup>				
OCNG_RB <sup>Note3</sup>				
N <sub>oc</sub> <sup>Note4</sup>				
$\hat{E}_s/N_{oc}$	dB	1, 2, 3, 4, 5, 6	17	17
$\hat{E}_s/I_{ot}$ <sup>Note5</sup>	dB	1, 2, 3, 4, 5, 6	17	17
RSRP <sup>Note5</sup>	dBm/15kHz	1, 2, 3, 4, 5, 6	-87	-87
SCH_RP <sup>Note5</sup>	dBm/15kHz	1, 2, 3, 4, 5, 6	-87	-87
I <sub>o</sub> <sup>Note5</sup>	dBm/9MHz	1, 2, 3, 4, 5, 6	$-59.13+10\log(N_{RB,c}/50)$	$-59.13+10\log(N_{RB,c}/50)$
Propagation Condition <sup>Note6</sup>		1, 2, 3, 4, 5, 6	AWGN	
Antenna Configuration and Correlation Matrix <sup>Note6</sup>		1, 2, 3, 4, 5, 6	1x2 Low	
<p>Note 1: Special subframe and uplink-downlink configurations are specified in table 4.2-1 in TS 36.211 [23].</p> <p>Note 2: DL RMCs and OCNG patterns are specified in clauses A 3.1 and A 3.2 of TS 36.133 [15] respectively.</p> <p>Note 3: OCNG shall be used such that all cells are fully allocated and a constant total transmitted power spectral density is achieved for all OFDM symbols.</p> <p>Note 4: Interference from other cells and noise sources not specified in the test is assumed to be constant over subcarriers and time and shall be modelled as AWGN of appropriate power for N<sub>oc</sub> to be fulfilled.</p> <p>Note 5: <math>\hat{E}_s/I_{ot}</math>, RSRP, SCH_RP and I<sub>o</sub> levels have been derived from other parameters for information purposes. They are not settable parameters themselves.</p> <p>Note 6: Propagation condition and correlation matrix are defined in clause B.2 in TS 36.101 [25].</p>				

**Table A.8.4.2.9.1-4: NR neighbour cell specific test parameters for NR inter-RAT event triggered reporting for FR1 with SSB time index detection for UE configured with highSpeedInterRAT-NR-r16**

Parameter	Unit	Test configuration	Cell 2	
			T1	T2
NR RF Channel Number		1, 2, 3, 4, 5, 6	1	
Duplex mode		1, 4	FDD	
		2, 3, 5, 6	TDD	
TDD configuration		2, 5	TDDConf.1.1	
		3, 6	TDDConf.2.1	
BW <sub>channel</sub>	MHz	1, 2, 4, 5	10: N <sub>RB,c</sub> = 52	
		3, 6	40: N <sub>RB,c</sub> = 106	
OCNG Patterns defined in A.3.2.1.1 (OP.1)		1, 2, 3, 4, 5, 6	OP.1	
SMTc configuration defined in A.3.11.1 and A.3.11.2		1, 4	SMTc.2	
		2, 3, 5, 6	SMTc.1	
PDSCH/PDCCH subcarrier spacing	kHz	1, 2, 4, 5	15	
		3, 6	30	
b2-Threshold2NR	dBm/SCS	1, 2, 4, 5	-101	
		3, 6	-98	
EPRE ratio of PSS to SSS		1, 2, 3, 4, 5, 6	0	
EPRE ratio of PBCH DMRS to SSS				
EPRE ratio of PBCH to PBCH DMRS				
EPRE ratio of PDCCH DMRS to SSS				

EPRE ratio of PDCCH to PDCCH DMRS				
EPRE ratio of PDSCH DMRS to SSS				
EPRE ratio of PDSCH to PDSCH				
EPRE ratio of OCNG DMRS to SSS (Note 1)				
EPRE ratio of OCNG to OCNG DMRS (Note 1)				
$N_{oc}$ <sup>Note2</sup>	dBm/15kHz	1, 2, 3, 4, 5, 6	-98	
$N_{oc}$ <sup>Note2</sup>	dBm/SCS	1, 2, 4, 5	-98	
		3, 6	-95	
SS-RSRP <sup>Note 3</sup>	dBm/SCS	1, 2, 4, 5	-Infinity	-91
		3, 6	-Infinity	-88
$\hat{E}_s/I_{no}$	dB	1, 2, 3, 4, 5, 6	-Infinity	7
$\hat{E}_s/N_{oc}$	dB	1, 2, 3, 4, 5, 6	-Infinity	7
$I_o$ <sup>Note3</sup>	dBm/9.36MHz	1, 2, 4, 5	-70.05	-62.26
	dBm/38.16MHz z	3, 6	-63.95	-56.16
Propagation Condition		1, 2, 4, 5	AWGN1944	
		3,6	AWGN3334	
Antenna Configuration and Correlation Matrix		1, 2, 3, 4, 5, 6	1x2 Low	
<p>Note 1: OCNG shall be used such that the cell is fully allocated and a constant total transmitted power spectral density is achieved for all OFDM symbols.</p> <p>Note 2: Interference from other cells and noise sources not specified in the test is assumed to be constant over subcarriers and time and shall be modelled as AWGN of appropriate power for <math>N_{oc}</math> to be fulfilled.</p> <p>Note 3: SS-RSRP and <math>I_o</math> levels have been derived from other parameters for information purposes. They are not settable parameters themselves.</p> <p>Note 4: SS-RSRP minimum requirements are specified assuming independent interference and noise at each receiver antenna port.</p>				

A.8.4.2.9.2 Test Requirements

The UE shall send one Event B2 triggered measurement report, with a measurement reporting delay less than 4.8s from the beginning of time period T2. The UE is required to read the neighbour cell SSB index and report the acquired SSB index in this test.

NOTE: The actual overall delays measured in the test may be up to  $2xTTI_{DCCH}$  higher than the measurement reporting delays above because of TTI insertion uncertainty of the measurement report in DCCH.

A.8.5 Measurement performance

A.8.5.1 SFTD accuracy

A.8.5.1.1 SFTD accuracy

A.8.5.1.1.1 Test Purpose

The purpose of this set of tests is to verify that the SFTD measurement accuracy is within the specified limits. This test will verify the requirements as specified in clause 9.1.27 in TS 36.133 [15] for inter-RAT FR1 SFTD measurements.

A.8.5.1.1.2 Test Environment

Supported test configurations are shown in Table A.8.5.1.1.2-1. In this set of test cases there are two cells on different carriers. Cell 1 is E-UTRAN PCell and Cell 2 is inter-RAT NR FR1 target cell. The test parameters of cell 1 are given in clause A.8.5.1.1.2-2. The test parameters of cell 2 are given in Table A.8.5.1.1.2-3. The SFTD between PCell and target cell shall be set by the test equipment to one of the time differences in Table A.8.5.1.1.2-4.

Table A.8.5.1.1.2-1: Supported test configurations for SFTD accuracy

Configuration	Description
1	NR 15 kHz SSB SCS, 10 MHz bandwidth, FDD duplex mode, LTE FDD
2	NR 15 kHz SSB SCS, 10 MHz bandwidth, TDD duplex mode, LTE FDD
3	NR 30 kHz SSB SCS, 40 MHz bandwidth, TDD duplex mode, LTE FDD

4	NR 15 kHz SSB SCS, 10 MHz bandwidth, FDD duplex mode, LTE TDD
5	NR 15 kHz SSB SCS, 10 MHz bandwidth, TDD duplex mode, LTE TDD
6	NR 30kHz SSB SCS, 40 MHz bandwidth, TDD duplex mode, LTE TDD
Note: The UE is only required to be tested in one of the supported test configurations	

**Table A.8.5.1.1.2-2: Test parameters for SFTD accuracy (Cell 1)**

Parameter	Unit	Test 1
E-UTRA RF Channel Number		1
Duplex mode		FDD or TDD
TDD special subframe configuration <sup>Note1</sup>		6
TDD uplink-downlink configuration <sup>Note1</sup>		1
BW <sub>channel</sub>		5 MHz: N <sub>RB,c</sub> = 25 10 MHz: N <sub>RB,c</sub> = 50 20 MHz: N <sub>RB,c</sub> = 100
PDSCH parameters: DL Reference Measurement Channel <sup>Note2</sup>		5 MHz: R.7 FDD 10 MHz: R.3 FDD 20 MHz: R.6 FDD 5 MHz: R.4 TDD 10 MHz: R.0 TDD 20 MHz: R.3 TDD
PCFICH/PDCCH/PHICH parameters: DL Reference Measurement Channel <sup>Note2</sup>		5 MHz: R.11 FDD 10 MHz: R.6 FDD 20 MHz: R.10 FDD 5 MHz: R.11 TDD 10 MHz: R.6 TDD 20 MHz: R.10 TDD
OCNG Patterns <sup>Note2</sup>		5 MHz: OP.20 FDD 10 MHz: OP.10 FDD 20 MHz: OP.17 FDD 5 MHz: OP.9 TDD 10 MHz: OP.1 TDD 20 MHz: OP.7 TDD
PBCH_RA	dB	0
PBCH_RB	dB	
PSS_RA	dB	
SSS_RA	dB	
PCFICH_RB	dB	
PHICH_RA	dB	
PHICH_RB	dB	
PDCCH_RA	dB	
PDCCH_RB	dB	
PDSCH_RA	dB	
PDSCH_RB	dB	
OCNG_RA <sup>Note3</sup>	dB	
OCNG_RB <sup>Note3</sup>	dB	
N <sub>oc</sub> <sup>Note4</sup>	dBm/15 kHz	
$\bar{E}_s/N_{oc}$	dB	-3
$\bar{E}_s/I_{ot}$	dB	-3
RSRP <sup>Note5</sup>	dBm/15 kHz	-107
SCH_RP <sup>Note5</sup>	dBm/15 kHz	-107
I <sub>o</sub> <sup>Note5</sup>	dBm/Ch BW	-74.45 +10log (N <sub>RB,c</sub> /50)
Propagation Condition		AWGN
Antenna Configuration		1x2
<p>Note 1: Special subframe and uplink-downlink configurations are specified in table 4.2-1 in TS 36.211 [23].</p> <p>Note 2: DL RMCs and OCNG patterns are specified in clauses A 3.1 and A 3.2 of TS 36.133 [15] respectively.</p> <p>Note 3: OCNG shall be used such that all cells are fully allocated and a constant total transmitted power spectral density is achieved for all OFDM symbols.</p> <p>Note 4: Interference from other cells and noise sources not specified in the test is assumed to be constant over subcarriers and time and shall be modelled as AWGN of appropriate power for N<sub>oc</sub> to be fulfilled.</p> <p>Note 5: E<sub>s</sub>/I<sub>ot</sub>, RSRP, SCH_RP and I<sub>o</sub> levels have been derived from other parameters for information purposes. They are not settable parameters themselves.</p>		

**Table A.8.5.1.1.2-3: Test parameters for SFTD accuracy (Cell 2)**

Parameter		Config	Unit	Test 1
SSB GSCN		1~6		freq1
Duplex mode		1,4		FDD
		2,5		TDD
		3,6		TDD
TDD Configuration		1,4		N/A
		2,5		TDDConf.1.1
		3,6		TDDConf.2.1
BW <sub>channel</sub>		1,4	MHz	10: N <sub>RB,c</sub> = 52
		2,5		10: N <sub>RB,c</sub> = 52
		3,6		40: N <sub>RB,c</sub> = 106
PDSCH Reference measurement channel		1,4		SR.1.1 FDD
		2,5		SR.1.1 TDD
		3,6		SR.2.1 TDD
RMSI CORESET Reference Channel		1,4		CR.1.1 FDD
		2,5		CR.1.1 TDD
		3,6		CR.2.1 TDD
RMC CORESET Reference Channel		1,4		CCR.1.1 FDD
		2,5		CCR.1.1 TDD
		3,6		CCR.2.1 TDD
SSB configuration		1,4		SSB.1 FR1
		2,5		SSB.1 FR1
		3,6		SSB.2 FR1
SMTc configuration		1~6		SMTc.1
DL BWP configuration		1~6		DLBWP.1.1
UL BWP configuration		1~6		ULBWP.1.1
OCNG Patterns		1~6		OP.1
EPRE ratio of PSS to SSS		1~6	dB	0
EPRE ratio of PBCH DMRS to SSS				
EPRE ratio of PBCH to PBCH DMRS				
EPRE ratio of PDCCH DMRS to SSS				
EPRE ratio of PDCCH to PDCCH DMRS				
EPRE ratio of PDSCH DMRS to SSS				
EPRE ratio of PDSCH to PDSCH DMRS				
EPRE ratio of OCNG DMRS to SSS <sup>Note 1</sup>				
EPRE ratio of OCNG to OCNG DMRS <sup>Note 1</sup>				
$N_{oc}$ <sup>Note2</sup>	NR_FDD_FR1_A, NR_TDD_FR1_A <sup>NOTE 5</sup>			
	NR_FDD_FR1_B			
	NR_TDD_FR1_C			
	NR_FDD_FR1_D, NR_TDD_FR1_D			
	NR_FDD_FR1_E, NR_TDD_FR1_E			
	NR_FDD_FR1_F			
	NR_FDD_FR1_G			
	NR_FDD_FR1_H			
$N_{oc}$ <sup>Note2</sup>	NR_FDD_FR1_A, NR_TDD_FR1_A <sup>NOTE 5</sup>	1,2,4,5	dBm/SSB SCS	-104
	NR_FDD_FR1_B			
	NR_TDD_FR1_C			
	NR_FDD_FR1_D, NR_TDD_FR1_D			
	NR_FDD_FR1_E, NR_TDD_FR1_E			
	NR_FDD_FR1_F			
	NR_FDD_FR1_G			

	NR_FDD_FR1_H			
	NR_FDD_FR1_A, NR_TDD_FR1_A <sup>NOTE 5</sup>	3,6		-101
	NR_FDD_FR1_B			
	NR_TDD_FR1_C			
	NR_FDD_FR1_D, NR_TDD_FR1_D			
	NR_FDD_FR1_E, NR_TDD_FR1_E			
	NR_FDD_FR1_F			
	NR_FDD_FR1_G			
	NR_FDD_FR1_H			
	$\hat{E}_s / I_{ot}$	1~6	dB	-3
	$\hat{E}_s / N_{oc}$	1~6	dB	-3
SS-RSRP <sup>Note3</sup>	NR_FDD_FR1_A, NR_TDD_FR1_A <sup>NOTE 5</sup>	1,2,4,5	dBm/SCS	-107
	NR_FDD_FR1_B			
	NR_TDD_FR1_C			
	NR_FDD_FR1_D, NR_TDD_FR1_D			
	NR_FDD_FR1_E, NR_TDD_FR1_E			
	NR_FDD_FR1_F			
	NR_FDD_FR1_G			
	NR_FDD_FR1_H			
	NR_FDD_FR1_A, NR_TDD_FR1_A <sup>NOTE 5</sup>	3,6		-104
	NR_FDD_FR1_B			
	NR_TDD_FR1_C			
	NR_FDD_FR1_D, NR_TDD_FR1_D			
	NR_FDD_FR1_E, NR_TDD_FR1_E			
	NR_FDD_FR1_F			
	NR_FDD_FR1_G			
	NR_FDD_FR1_H			
I <sub>O</sub> <sup>Note3</sup>	NR_FDD_FR1_A, NR_TDD_FR1_A <sup>NOTE 5</sup>	1,2,4,5	dBm/9.36 MHz	-74.28
	NR_FDD_FR1_B			
	NR_TDD_FR1_C			
	NR_FDD_FR1_D, NR_TDD_FR1_D			
	NR_FDD_FR1_E, NR_TDD_FR1_E			
	NR_FDD_FR1_F			
	NR_FDD_FR1_G			
	NR_FDD_FR1_H			
	NR_FDD_FR1_A, NR_TDD_FR1_A <sup>NOTE 5</sup>	3,6	dBm/38.16 MHz	-68.18
	NR_FDD_FR1_B			
	NR_TDD_FR1_C			
	NR_FDD_FR1_D, NR_TDD_FR1_D			
	NR_FDD_FR1_E, NR_TDD_FR1_E			
	NR_FDD_FR1_F			
	NR_FDD_FR1_G			
	NR_FDD_FR1_H			
Propagation condition		1~6		AWGN
Antenna configuration		1~6		1x2
<p>Note 1: OCNG shall be used such that both cells are fully allocated and a constant total transmitted power spectral density is achieved for all OFDM symbols.</p> <p>Note 2: Interference from other cells and noise sources not specified in the test is assumed to be constant over subcarriers and time and shall be modelled as AWGN of appropriate power for <math>N_{oc}</math> to be fulfilled.</p>				

Note 3:	SS-RSRP and Io levels have been derived from other parameters for information purposes. They are not settable parameters themselves.
Note 4:	SS-RSRP minimum requirements are specified assuming independent interference and noise at each receiver antenna port.
Note 5:	The test configuration excludes support for band n51 and it is not required to run this test on band n51 in this release of the specification

**Table A.8.5.1.1.2-4: Timing offsets for SFTD accuracy test**

Condition	SFN offset between PCell and PSCell	Frame boundary offset between PCell and PSCell (Ts)
1	100	-122000
2	300	-60540
3	500	1000
4	700	62540
5	900	124000

### A.8.5.1.1.3 Test Requirements

The SFTD reported by the UE consists of 2 elements, SFN offset and frame boundary offset between PCell and inter-RAT NR target cell. The reported SFTD accuracy shall fulfil the requirement in clause 9.1.27 in TS 36.133 [15].

## A.8.5.2 E-UTRA – NR Inter-RAT Measurement Performance requirements

### A.8.5.2.1 SS-RSRP

#### A.8.5.2.1.1 E-UTRAN – NR inter-RAT measurements with FR1 target cell

##### A.8.5.2.1.1.1 Test Purpose and Environment

The purpose of this test is to verify that the SS-RSRP measurement accuracy is within the specified limits. This test will verify the requirements in clause 9.11.1 in TS 36.133 [15] for inter-RAT FR1 SS-RSRP measurements.

##### A.8.5.2.1.1.2 Test Parameters

Supported test configurations are shown in Table A.8.5.2.1.1.2-1. In this test case there are two cells on different carriers. Cell 1 is the E-UTRA cell which specific test parameters for this test case are specified in Table A.3.7.2.1-1. Cell 2 is the inter-RAT NR FR1 target cell. The absolute accuracy requirements of SS-RSRP inter-RAT measurement is tested by using test parameters in Table A.8.5.2.1.1.2-2.

**Table A.8.5.2.1.1.2-1: SS-RSRP Inter-RAT SS-RSRP supported test configurations**

Config	Description
1	LTE FDD, NR 15 kHz SSB SCS, 10 MHz bandwidth, FDD duplex mode
2	LTE FDD, NR 15 kHz SSB SCS, 10 MHz bandwidth, TDD duplex mode
3	LTE FDD, NR 30 kHz SSB SCS, 40 MHz bandwidth, TDD duplex mode
4	LTE TDD, NR 15 kHz SSB SCS, 10 MHz bandwidth, FDD duplex mode
5	LTE TDD, NR 15 kHz SSB SCS, 10 MHz bandwidth, TDD duplex mode
6	LTE TDD, NR 30 kHz SSB SCS, 40 MHz bandwidth, TDD duplex mode

Note: The UE is only required to be tested in one of the supported test configurations



Table A.8.5.2.1.1.2-2: SS-RSRP inter-RAT test parameters

Parameter		Unit	Test 1		Test 2				
			Cell 2		Cell 2				
SSB ARFCN			freq1		freq1				
Duplex mode	Config 1,4		FDD						
	Config 2,3,5,6		TDD						
TDD configuration	Config 1,4		Not Applicable						
	Config 2,5		TDDConf.1.1						
	Config 3,6		TDDConf.2.1						
Downlink initial BWP configuration			DLBWP.0.1						
Uplink initial BWP configuration			ULBWP.0.1						
DRX Cycle configuration		ms	Not Applicable						
PDSCH Reference measurement channel	Config 1,4		-		-				
	Config 2,5								
	Config 3,6								
RMSI CORESET Reference Channel	Config 1,4		-		-				
	Config 2,5								
	Config 3,6								
Dedicated CORESET Reference Channel	Config 1,4		-		-				
	Config 2,5								
	Config 3,6								
OCNG Patterns			OP.1						
SS-RSSI-Measurement			Not Applicable						
SMTC configuration			SMTC.1						
SSB configuration	Config 1,2,4,5		SSB.1 FR1						
	Config 3,6		SSB.2 FR1						
PDSCH/PDCCH subcarrier spacing	Config 1,2,4,5	kHz	15						
	Config 3,6		30						
EPRE ratio of PSS to SSS		dB	0	0	0	0			
EPRE ratio of PBCH DMRS to SSS									
EPRE ratio of PBCH to PBCH DMRS									
EPRE ratio of PDCCH DMRS to SSS									
EPRE ratio of PDCCH to PDCCH DMRS									
EPRE ratio of PDSCH DMRS to SSS									
EPRE ratio of PDSCH to PDSCH									
EPRE ratio of OCNG DMRS to SSS(Note 1)									
EPRE ratio of OCNG to OCNG DMRS (Note 1)									
$N_{oc}$ <sup>Note2</sup>	Config 1,2,3,4,5,6	NR_FDD_FR1_A	dBm/15k Hz	-94.65		-117			
		NR_TDD_FR1_A <sup>NOTE 6</sup>							
		NR_FDD_FR1_B						-116.5	
		NR_TDD_FR1_C						-116	
		NR_FDD_FR1_D						-115.5	
		NR_TDD_FR1_D							
		NR_FDD_FR1_E						-115	
		NR_TDD_FR1_E						-114.5	
NR_FDD_FR1_F	-114								
NR_TDD_FR1_F	-113.5								
$N_{oc}$ <sup>Note2</sup>	Config 1,2,4,5			-94.65		Same as Noc for 15kHz			
	Config 3,6	NR_FDD_FR1_A	dBm/SC S	-91.65		-114			
		NR_TDD_FR1_A <sup>NOTE 6</sup>							
		NR_FDD_FR1_B						-113.5	
		NR_TDD_FR1_C						-113	
		NR_FDD_FR1_D						-112.5	
		NR_TDD_FR1_D							
NR_FDD_FR1_E	-112								
NR_TDD_FR1_E	-111.5								
NR_FDD_FR1_F									

		NR_FDD_FR1_G			-111	
		NR_FDD_FR1_H			-110.5	
$\hat{E}_s / I_{ot}$			dB	10	-4	
$\hat{E}_s / N_{oc}$			dB	10	-4	
SS-RSRP <sup>Not e3</sup>	Config 1,2,4,5	NR_FDD_FR1_A	dBm/SC S	-84.65	-121	
		NR_TDD_FR1_A NOTE 6				
		NR_FDD_FR1_B				-120.5
		NR_TDD_FR1_C				-120
		NR_FDD_FR1_D				-119.5
		NR_TDD_FR1_D				
		NR_FDD_FR1_E				-119
		NR_TDD_FR1_E				
		NR_FDD_FR1_F				-118.5
	NR_FDD_FR1_G	-118				
	NR_FDD_FR1_H	-117.5				
	Config 3,6	NR_FDD_FR1_A	dBm/SC S	-81.65	-118	
		NR_TDD_FR1_A NOTE 6				
		NR_FDD_FR1_B				-117.5
		NR_TDD_FR1_C				-117
		NR_FDD_FR1_D				-116.5
		NR_TDD_FR1_D				
		NR_FDD_FR1_E				-116
NR_TDD_FR1_E						
NR_FDD_FR1_F		-115.5				
NR_FDD_FR1_G	-115					
NR_FDD_FR1_H	-114.5					
I <sub>o</sub> <sup>Note3</sup>	Config 1,2,4,5	NR_FDD_FR1_A	dBm/ 9.36MHz	-56.28	-87.76	
		NR_TDD_FR1_A NOTE 6				
		NR_FDD_FR1_B				-87.26
		NR_TDD_FR1_C				-86.76
		NR_FDD_FR1_D				-86.26
		NR_TDD_FR1_D				
		NR_FDD_FR1_E				-85.76
		NR_TDD_FR1_E				
		NR_FDD_FR1_F				-85.26
	NR_FDD_FR1_G	-84.76				
	NR_FDD_FR1_H	-84.26				
	Config 3,6	NR_FDD_FR1_A	dBm/ 38.16MH z	-50.19	-84.76	
		NR_TDD_FR1_A NOTE 6				
		NR_FDD_FR1_B				-84.26
		NR_TDD_FR1_C				-83.76
		NR_FDD_FR1_D				-83.26
		NR_TDD_FR1_D				
		NR_FDD_FR1_E				-82.76
NR_TDD_FR1_E						
NR_FDD_FR1_F		-82.26				
NR_FDD_FR1_G	-81.76					
NR_FDD_FR1_H	-81.26					
Propagation condition			-	AWGN		
Antenna configuration			-	1x2		
<p>Note 1: OCNB shall be used such that both cells are fully allocated and a constant total transmitted power spectral density is achieved for all OFDM symbols.</p> <p>Note 2: Interference from other cells and noise sources not specified in the test is assumed to be constant over subcarriers and time and shall be modelled as AWGN of appropriate power for <math>N_{oc}</math> to be fulfilled.</p> <p>Note 3: SS-RSRP, and I<sub>o</sub> levels have been derived from other parameters for information purposes. They are not settable parameters themselves.</p> <p>Note 4: SS-RSRP minimum requirements are specified assuming independent interference and noise at each receiver antenna port.</p> <p>Note 5: NR operating band groups are as defined in clause 3.5.2.</p>						

Note 6: The test configuration excludes support for band n51 and it is not required to run this test on band n51 in this release of the specification.

### A.8.5.2.1.1.3 Test Requirements

The SS-RSRP measurement accuracy for Cell 2 shall fulfil the requirement in clause 9.11.1 in TS 36.133 [15].

### A.8.5.2.1.2 E-UTRAN – NR inter-RAT measurements with FR2 target cell

#### A.8.5.2.1.2.1 Test Purpose and Environment

The purpose of this test is to verify that the SS-RSRP measurement accuracy is within the specified limits. This test will verify the requirements in clause 9.11.1 in TS 36.133 [15] for inter-RAT FR2 SS-RSRP measurements.

#### A.8.5.2.1.2.2 Test Parameters

Supported test configurations are shown in Table A.8.5.2.1.2.2-1. In this test case there are two cells on different carriers. Absolute accuracy requirements of SS-RSRP inter-RAT measurement are tested by using test setup in Table A.8.5.2.1.2.2-2 and Table A.8.5.2.1.2.2-3. In all test cases, Cell 2 is target cell. Cell 1 is the E-UTRA cell which specific test parameters for this test case are specified in Table A.3.7.2.1-1.

**Table A.8.5.2.1.2.2-1: SS-RSRP Inter-RAT SS-RSRP supported test configurations**

Configuration	Description
1	LTE FDD, NR 120 kHz SSB SCS, 100 MHz bandwidth, TDD duplex mode
2	LTE TDD, NR 120 kHz SSB SCS, 100 MHz bandwidth, TDD duplex mode

**Table A.8.5.2.1.2.2-2: SS-RSRP Inter-RAT general test parameters**

Parameter	Unit	Test 1	Test 2
		Cell 2	Cell 2
SSB ARFCN		Freq1	freq1
Duplex mode		TDD	TDD
TDD configuration		TDDConf.3.1	TDDConf.3.1
BW <sub>channel</sub>	MHz	100: N <sub>RB,c</sub> = 66	100: N <sub>RB,c</sub> = 66
Downlink initial BWP configuration		DLBWP.0.1	
Uplink initial BWP configuration		ULBWP.0.1	
DRX cycle configuration	ms	Not applicable	
PDSCH Reference measurement channel		-	-
RMSI CORESET Reference Channel		-	-
OCNG Patterns		OP.1	OP.1
SMTTC configuration		SMTTC.1	SMTTC.1
SSB configuration		SSB.3 FR2	SSB.3 FR2
PDSCH/PDCCH subcarrier spacing	kHz	120	120
EPRE ratio of PSS to SSS	dB	0	0
EPRE ratio of PBCH_DMRS to SSS			
EPRE ratio of PBCH to PBCH_DMRS			
EPRE ratio of PDCCH_DMRS to SSS			
EPRE ratio of PDCCH to PDCCH_DMRS			
EPRE ratio of PDSCH_DMRS to SSS			
EPRE ratio of PDSCH to PDSCH_DMRS			
EPRE ratio of OCNG DMRS to SSS <sup>Note 1</sup>			
Note 1: OCNG shall be used such that both cells are fully allocated and a constant total transmitted power spectral density is achieved for all OFDM symbols.			
Note 2: Void			
Note 3: Void			
Note 4: Void			

**Table A.8.5.2.1.2.2-3: SS-RSRP Inter-RAT OTA related test parameters**

Parameter	Unit	Test 1	Test 2
		Cell 2	Cell 2

Angle of arrival configuration		Setup 1 according to A.3.15.1	Setup 1 according to A.3.15.1
Assumption for UE beams <sup>Note 10</sup>		Rough	Rough
$N_{oc}$ <sup>Note1</sup>	dBm/15kHz <sup>Note4</sup>	-105	N/A
$N_{oc}$ <sup>Note1</sup>	dBm/SCS <sup>Note4</sup>	-96	N/A
$E_s$	dBm/SCS <sup>Note4</sup>		(Table B.2.3-2 Rx Beam Peak +1dB) (Note 7)
$\hat{E}_s / N_{oc}$	dB	11	N/A
SSB_RP <sup>Note2</sup>	dBm/SCS <sup>Note4</sup>	-85	(Table B.2.3-2 Rx Beam Peak +1dB) (Note 7)
$\hat{E}_s / I_{ot\_BB}$ <sup>Note 2, Note 9</sup>	dB	9.97	-3.81
$I_o$ <sup>Note2</sup>	dBm/95.04 MHz <sup>Note4</sup>	-55.65	(Table B.2.3-2 Rx Beam Peak +30dB) (Note 8)
<p>Note 1: Where used, interference from other cells and noise sources not specified in the test is assumed to be constant over subcarriers and time and shall be modelled as AWGN of appropriate power for <math>N_{oc}</math> to be fulfilled.</p> <p>Note 2: SSB_RP, <math>E_s/I_{ot}</math> and <math>I_o</math> levels have been derived from other parameters for information purposes. They are not settable parameters themselves.</p> <p>Note 3: Void</p> <p>Note 4: Equivalent power received by an antenna with 0dBi gain at the centre of the quiet zone.</p> <p>Note 5: Void</p> <p>Note 6: Void</p> <p>Note 7: SSB_RP is applied at 1dB above the minimum level specified in Table B.2.3-2 for beam peak.</p> <p>Note 8: <math>I_o</math> is applied at <math>10\log_{10}(792)</math>dB+1dB above the minimum level specified in Table B.2.3-2 for beam peak.</p> <p>Note 9: Calculation of <math>E_s/I_{ot\_BB}</math> includes the effect of UE internal noise up to the value assumed for the associated Refsens requirement in clause 7.3.2 of TS 36.101-2 [19], and an allowance of 1dB for UE multi-band relaxation factor <math>\Delta MB_P</math> from TS 38.101-2 [19] Table 6.2.1.3-4.</p> <p>Note 10: Information about types of UE beam is given in B.2.1.3, and does not limit UE implementation or test system implementation.</p>			

#### A.8.5.2.1.2.3 Test Requirements

The SS-RSRP measurement accuracy for Cell 2 shall fulfil the requirement in clause 9.11.1 in TS 36.133 [15].

#### A.8.5.2.2 SS-RSRQ

##### A.8.5.2.2.1 E-UTRAN – NR inter-RAT measurements with FR1 target cell

###### A.8.5.2.2.1.1 Test Purpose and Environment

The purpose of this test is to verify that the SS-RSRQ measurement accuracy is within the specified limits. This test will verify the requirements in clause 9.11.2 in TS 36.133 [15] for inter-RAT FR1 SS-RSRQ measurements.

###### A.8.5.2.2.1.2 Test Parameters

Supported test configurations are shown in Table A.8.5.2.2.1.2-1. In this test case there are two cells on different carriers. Cell 1 is the E-UTRA cell which specific test parameters for this test case are specified in Table A.3.7.2.1-1. Cell 2 is the inter-RAT NR FR1 target cell. The absolute accuracy requirements of SS-RSRP inter-RAT measurement is tested by using test parameters in Table A.8.5.2.2.1.2-2.

**Table A.8.5.2.2.1.2-1: SS-RSRQ Inter-RAT SS-RSRQ supported test configurations**

<b>Config</b>	<b>Description</b>
1	LTE FDD, NR 15 kHz SSB SCS, 10 MHz bandwidth, FDD duplex mode
2	LTE FDD, NR 15 kHz SSB SCS, 10 MHz bandwidth, TDD duplex mode
3	LTE FDD, NR 30kHz SSB SCS, 40 MHz bandwidth, TDD duplex mode
4	LTE TDD, NR 15 kHz SSB SCS, 10 MHz bandwidth, FDD duplex mode
5	LTE TDD, NR 15 kHz SSB SCS, 10 MHz bandwidth, TDD duplex mode
6	LTE TDD, NR 30kHz SSB SCS, 40 MHz bandwidth, TDD duplex mode
Note:	The UE is only required to be tested in one of the supported test configurations

Table A.8.5.2.2.1.2-2: SS-RSRQ inter-RAT test parameters

Parameter			Unit	Test 1		Test 2		Test 3			
				Cell 2		Cell 2		Cell 2			
SSB ARFCN				freq1		freq1		freq1			
Duplex mode	Config 1,4			FDD							
	Config 2,3,5,6			TDD							
TDD configuration	Config 1,4			Not Applicable							
	Config 2,5			TDDConf.1.1							
	Config 3,6			TDDConf.2.1							
Downlink initial BWP configuration				DLBWP.0.1							
Uplink initial BWP configuration				ULBWP.0.1							
DRX Cycle configuration			ms	Not Applicable							
PDSCH Reference measurement channel	Config 1,4			-	-	-	-	-	-		
	Config 2,5										
	Config 3,6										
RMSI CORESET Reference Channel	Config 1,4			-	-	-	-	-	-		
	Config 2,5										
	Config 3,6										
Dedicated CORESET Reference Channel	Config 1,4			-	-	-	-	-	-		
	Config 2,5										
	Config 3,6										
OCNG Patterns				OP.1							
SS-RSSI-Measurement				Not Applicable							
SMTC configuration				SMTC.1							
SSB configuration	Config 1,2,4,5			SSB.1 FR1							
	Config 3,6			SSB.2 FR1							
PDSCH/PDCCH subcarrier spacing	Config 1,2,4,5		kHz	15							
	Config 3,6			30							
EPRE ratio of PSS to SSS			dB	0	0	0	0	0	0		
EPRE ratio of PBCH DMRS to SSS											
EPRE ratio of PBCH to PBCH DMRS											
EPRE ratio of PDCCH DMRS to SSS											
EPRE ratio of PDCCH to PDCCH DMRS											
EPRE ratio of PDSCH DMRS to SSS											
EPRE ratio of PDSCH to PDSCH											
EPRE ratio of OCNG DMRS to SSS(Note 1)											
EPRE ratio of OCNG to OCNG DMRS (Note 1)											
$N_{oc}$ Note2	Config 1,2,4,5	NR_FDD_FR1_A		dBm/15k Hz	-80.18		-106		-116		
		NR_TDD_FR1_A									
		NOTE 6									
		NR_FDD_FR1_B	-115.5								
		NR_TDD_FR1_C	-115								
		NR_FDD_FR1_D	-114.5								
		NR_TDD_FR1_D									
		NR_FDD_FR1_E	-114								
		NR_TDD_FR1_E									
	NR_FDD_FR1_F	-113.5									
NR_FDD_FR1_G	-113										
NR_FDD_FR1_H	-112.5										
Config 3,6			-86.27		-113	Same as Noc for Config 1,2,4,5					
$N_{oc}$ Note2	Config 1,2,4,5		dBm/SC S	-80.18		-106		Same as Noc for 15kHz			
	Config 3,6										
	Config 3,6	NR_FDD_FR1_A		NOTE 6	-83.27		-110		-113		
		NR_TDD_FR1_A									
		NR_FDD_FR1_B									-112.5
		NR_TDD_FR1_C									-112
NR_FDD_FR1_D	-111.5										
NR_TDD_FR1_D											

		NR_FDD_FR1_E				-111
		NR_TDD_FR1_E				-110.5
		NR_FDD_FR1_F				-110
		NR_FDD_FR1_G				-109.5
		NR_FDD_FR1_H				-109.5
$\hat{E}_s / I_{ot}$			dB	-1.75	-1.75	-1.75
$\hat{E}_s / N_{oc}$			dB	-1.75	-1.75	-1.75
SS-RSRP <sup>Not e3</sup>	Config 1,2,4,5	NR_FDD_FR1_A	dBm/SC S	-81.93	-107.75	-117.75
		NR_TDD_FR1_A				-117.25
		NR_FDD_FR1_B				-116.75
		NR_TDD_FR1_C				-116.25
		NR_FDD_FR1_D				-115.75
		NR_TDD_FR1_D				-115.25
		NR_FDD_FR1_E				-114.75
		NR_TDD_FR1_E				-114.25
		NR_FDD_FR1_F				-114.25
	Config 3,6	NR_TDD_FR1_G		-85.02	-111.75	-114.75
		NR_FDD_FR1_H		-114.25		
		NR_TDD_FR1_A		-114.25		
		NR_TDD_FR1_A		-113.75		
		NR_FDD_FR1_B		-113.25		
		NR_TDD_FR1_C		-112.75		
		NR_FDD_FR1_D		-112.25		
		NR_TDD_FR1_D		-111.75		
		NR_FDD_FR1_E		-111.25		
NR_TDD_FR1_E	-111.25					
NR_FDD_FR1_F	-111.25					
NR_TDD_FR1_F	-111.25					
NR_FDD_FR1_G	-111.25					
NR_TDD_FR1_G	-111.25					
NR_FDD_FR1_H	-111.25					
NR_TDD_FR1_H	-111.25					
SS-RSRQ <sup>Note3</sup>		NR_FDD_FR1_A	dB	-14.77	-40.59	-14.76
		NR_TDD_FR1_A				
		NR_FDD_FR1_B				
		NR_TDD_FR1_C				
		NR_FDD_FR1_D				
		NR_TDD_FR1_D				
		NR_FDD_FR1_E				
		NR_TDD_FR1_E				
		NR_FDD_FR1_F				
		NR_TDD_FR1_F				
		NR_FDD_FR1_G				
		NR_TDD_FR1_G				
		NR_FDD_FR1_H				
		NR_TDD_FR1_H				
I <sub>o</sub> <sup>Note3</sup>	Config 1,2,4,5	NR_FDD_FR1_A	dBm/ 9.36MHz	-50	-75.83	-85.83
		NR_TDD_FR1_A				-85.33
		NR_FDD_FR1_B				-84.83
		NR_TDD_FR1_C				-84.33
		NR_FDD_FR1_D				-83.83
		NR_TDD_FR1_D				-83.33
		NR_FDD_FR1_E				-82.83
		NR_TDD_FR1_E				-82.33
		NR_FDD_FR1_F				-82.33
	Config 3,6	NR_TDD_FR1_G		-50	-76.73	-79.73
		NR_FDD_FR1_H		-79.23		
		NR_TDD_FR1_A		-78.73		
		NR_TDD_FR1_A		-78.23		
		NR_FDD_FR1_B		-77.73		
		NR_TDD_FR1_C		-77.23		
		NR_FDD_FR1_D		-77.23		
		NR_TDD_FR1_D		-76.73		
		NR_FDD_FR1_E		-76.73		
NR_TDD_FR1_E	-76.73					
NR_FDD_FR1_F	-76.73					
NR_TDD_FR1_F	-76.73					
NR_FDD_FR1_G	-76.73					
NR_TDD_FR1_G	-76.73					

	NR_FDD_FR1_H		-76.53
Propagation condition	-	AWGN	
Antenna configuration	-	1x2	
Note 1:	OCNG shall be used such that both cells are fully allocated and a constant total transmitted power spectral density is achieved for all OFDM symbols.		
Note 2:	Interference from other cells and noise sources not specified in the test is assumed to be constant over subcarriers and time and shall be modelled as AWGN of appropriate power for $N_{oc}$ to be fulfilled.		
Note 3:	SS-RSRQ, SS-RSRP, and $I_o$ levels have been derived from other parameters for information purposes. They are not settable parameters themselves.		
Note 4:	SS-RSRQ minimum requirements are specified assuming independent interference and noise at each receiver antenna port.		
Note 5:	NR operating band groups are as defined in clause 3.5.2.		
Note 6:	The test configuration excludes support for band n51 and it is not required to run this test on band n51 in this release of the specification.		

A.8.5.2.2.1.3 Test Requirements

The SS-RSRQ measurement accuracy for Cell 2 shall fulfil the requirement in clause 9.11.2 in TS 36.133 [15].

A.8.5.2.2.2 E-UTRAN – NR inter-RAT measurements with FR2 target cell

A.8.5.2.2.2.1 Test Purpose and Environment

The purpose of this test is to verify that the SS-RSRQ measurement accuracy is within the specified limits. This test will verify the requirements in clause 9.11.2 in TS 36.133 [15] for inter-RAT FR2 SS-RSRQ measurements.

A.8.5.2.2.2.2 Test Parameters

Supported test configurations are shown in Table A.8.5.2.2.2.2-1. In this test case there are two cells on different carriers. Absolute accuracy requirements of SS-RSRQ inter-RAT measurement are tested by using test setup in Table A.8.5.2.2.2.2-2 and Table A.8.5.2.2.2.2-3. In all test cases, Cell 2 is target cell. Cell 1 is the E-UTRA cell which specific test parameters for this test case are specified in Table A.3.7.2.1-1.

**Table A.8.5.2.2.2.2-1: SS-RSRQ Inter-RAT SS-RSRQ supported test configurations**

Configuration	Description
1	LTE FDD, NR 120 kHz SSB SCS, 100 MHz bandwidth, TDD duplex mode
2	LTE TDD, NR 120 kHz SSB SCS, 100 MHz bandwidth, TDD duplex mode

**Table A.8.5.2.2.2.2-2: SS-RSRQ Inter-RAT general test parameters**

Parameter	Unit	Test 1	Test 2
		Cell 2	Cell 2
SSB ARFCN		Freq1	freq1
Duplex mode		TDD	TDD
TDD configuration		TDDConf.3.1	TDDConf.3.1
BW <sub>channel</sub>	MHz	100: N <sub>RB,c</sub> = 66	100: N <sub>RB,c</sub> = 66
Downlink initial BWP configuration		DLBWP.0.1	
Uplink initial BWP configuration		ULBWP.0.1	
DRX cycle configuration	ms	Not applicable	
PDSCH Reference measurement channel		-	-
RMSI CORESET Reference Channel		-	-
OCNG Patterns		OP.1	OP.1
SMTC configuration		SMTC.1	SMTC.1
SSB configuration		SSB.3 FR2	SSB.3 FR2
PDSCH/PDCCH subcarrier spacing	kHz	120	120
EPRE ratio of PSS to SSS	dB	0	0
EPRE ratio of PBCH_DMRS to SSS			
EPRE ratio of PBCH to PBCH_DMRS			
EPRE ratio of PDCCH_DMRS to SSS			
EPRE ratio of PDCCH to PDCCH_DMRS			
EPRE ratio of PDSCH_DMRS to SSS			
EPRE ratio of PDSCH to PDSCH_DMRS			
EPRE ratio of OCNG DMRS to SSS <sup>Note 1</sup>			



Note 1: OCNG shall be used such that both cells are fully allocated and a constant total transmitted power spectral density is achieved for all OFDM symbols.  
 Note 2: Void  
 Note 3: Void  
 Note 4: Void

**Table A.8.5.2.2.2-3: SS-RSRQ Inter-RAT OTA related test parameters**

Parameter	Unit	Test 1	Test 2
		Cell 2	Cell 2
Angle of arrival configuration		Setup 1 according to A.3.15.1	Setup 1 according to A.3.15.1
Assumption for UE beams <sup>Note 10</sup>		Rough	Rough
$N_{oc}$ <sup>Note1</sup>	dBm/15kHz <sup>Note4</sup>	-104.7	(Table B.2.3-2 Rx Beam Peak -5dB) (Note 7)
$N_{oc}$ <sup>Note1</sup>	dBm/SCS <sup>Note4</sup>	-95.7	(Table B.2.3-2 Rx Beam Peak +4dB) (Note 7)
$\hat{E}_s / N_{oc}$	dB	-0.5	-1.75
SSB_RP <sup>Note2</sup>	dBm/SCS <sup>Note4</sup>	-96.2	(Table B.2.3-2 Rx Beam Peak +2.25dB) (Note 8)
SS-RSRQ <sup>Note2</sup>	dB	-3.27	-14.82
$\hat{E}_s / I_{ot}$ <sup>Note2</sup>	dB	-0.5	-1.75
$I_o$ <sup>Note2</sup>	dBm/95.04 MHz <sup>Note4</sup>	-63.95	(Table B.2.3-2 Rx Beam Peak +35.22dB) (Note 9)
<p>Note 1: Interference from other cells and noise sources not specified in the test is assumed to be constant over subcarriers and time and shall be modelled as AWGN of appropriate power for <math>N_{oc}</math> to be fulfilled.</p> <p>Note 2: SSB_RP, SS-RSRQ, <math>E_s/I_{ot}</math> and <math>I_o</math> levels have been derived from other parameters for information purposes. They are not settable parameters themselves.</p> <p>Note 3: Void</p> <p>Note 4: Equivalent power received by an antenna with 0dBi gain at the centre of the quiet zone.</p> <p>Note 5: Void</p> <p>Note 6: Void</p> <p>Note 7: <math>N_{oc}</math> for SCS 15kHz is applied at <math>-10\log_{10}(8)+4</math>dB above the minimum level specified in Table B.2.3-2 for beam peak. <math>N_{oc}</math> for SCS 120kHz is applied at 4dB above the minimum level specified in Table B.2.3-2 for beam peak.</p> <p>Note 8: SSB_RP is applied at 2.25dB above the minimum level specified in Table B.2.3-2 for beam peak.</p> <p>Note 9: <math>I_o</math> is applied at <math>10\log_{10}(792)+6.22</math>dB above the minimum level specified in Table B.2.3-2 for beam peak.</p> <p>Note 10: Information about types of UE beam is given in B.2.1.3, and does not limit UE implementation or test system implementation.</p>			

### A.8.5.2.2.2.3 Test Requirements

The SS-RSRQ measurement accuracy for Cell 2 shall fulfil the requirement in clause 9.11.2 in TS 36.133 [15].

In this test case there are two cells on different carriers and measurement gaps are provided

A.8.5.2.3 SS-SINR

A.8.5.2.3.1 E-UTRAN – NR inter-RAT measurements with FR1 target cell

A.8.5.2.3.1.1 Test Purpose and Environment

The purpose of this test is to verify that the SS- SINR measurement accuracy is within the specified limits. This test will verify the requirements in clause 9.11.3 in TS 36.133 [15] for inter-RAT FR1 SS-SINR measurements.

A.8.5.2.3.1.2 Test Parameters

Supported test configurations are shown in Table A.8.5.2.3.1.2-1. In this test case there are two cells on different carriers. Cell 1 is the E-UTRA cell which specific test parameters for this test case are specified in Table A.3.7.2.1-1. Cell 2 is the inter-RAT NR FR1 target cell. The absolute accuracy requirements of SS-RSRP inter-RAT measurement is tested by using test parameters in Table A.8.5.2.3.1.2-2.

**Table A.8.5.2.3.1.2-1: SS- SINR Inter-RAT SS- SINR supported test configurations**

Config	Description
1	LTE FDD, NR 15 kHz SSB SCS, 10 MHz bandwidth, FDD duplex mode
2	LTE FDD, NR 15 kHz SSB SCS, 10 MHz bandwidth, TDD duplex mode
3	LTE FDD, NR 30kHz SSB SCS, 40 MHz bandwidth, TDD duplex mode
4	LTE TDD, NR 15 kHz SSB SCS, 10 MHz bandwidth, FDD duplex mode
5	LTE TDD, NR 15 kHz SSB SCS, 10 MHz bandwidth, TDD duplex mode
6	LTE TDD, NR 30kHz SSB SCS, 40 MHz bandwidth, TDD duplex mode

Note: The UE is only required to be tested in one of the supported test configurations

**Table A.8.5.2.3.1.2-2: SS-SINR inter-RAT test parameters**

Parameter		Unit	Test 1		Test 2		Test 3	
			Cell 2		Cell 2		Cell 2	
SSB ARFCN			freq1		freq1		freq1	
Duplex mode	Config 1,4		FDD					
	Config 2,3,5,6		TDD					
TDD configuration	Config 1,4		Not Applicable					
	Config 2,5		TDDConf.1.1					
	Config 3,6		TDDConf.2.1					
Downlink initial BWP configuration			DLBWP.0.1					
Uplink initial BWP configuration			ULBWP.0.1					
DRX Cycle configuration		ms	Not Applicable					
PDSCH Reference measurement channel	Config 1,4		-	-	-	-	-	-
	Config 2,5		-	-	-	-	-	
	Config 3,6		-	-	-	-	-	
RMSI CORESET Reference Channel	Config 1,4		-	-	-	-	-	
	Config 2,5		-	-	-	-	-	
	Config 3,6		-	-	-	-	-	
Dedicated CORESET Reference Channel	Config 1,4		-	-	-	-	-	
	Config 2,5		-	-	-	-	-	
	Config 3,6		-	-	-	-	-	
OCNG Patterns			OP.1					
SS-RSSI-Measurement			Not Applicable					
SMTC configuration			SMTC.1					
SSB configuration	Config 1,2,4,5		SSB.1 FR1					
	Config 3,6		SSB.2 FR1					
PDSCH/PDCCH subcarrier spacing	Config 1,2,4,5	kHz	15					
	Config 3,6		30					
EPRE ratio of PSS to SSS		dB	0	0	0	0	0	0
EPRE ratio of PBCH DMRS to SSS								
EPRE ratio of PBCH to PBCH DMRS								
EPRE ratio of PDCCH DMRS to SSS								
EPRE ratio of PDCCH to PDCCH DMRS								

EPRE ratio of PDSCH DMRS to SSS						
EPRE ratio of PDSCH to PDSCH						
EPRE ratio of OCNG DMRS to SSS <sup>(Note 1)</sup>						
EPRE ratio of OCNG to OCNG DMRS <sup>(Note 1)</sup>						
$N_{oc}$ Note2	Config 1,2,4,5	NR_FDD_FR1_A	dBm/15k Hz	-880	-108.5	-119.5
		NR_TDD_FR1_A NOTE 6				
		NR_FDD_FR1_B				-119
		NR_TDD_FR1_C				-118.5
		NR_FDD_FR1_D				-118
		NR_TDD_FR1_D				
		NR_FDD_FR1_E				-117.5
		NR_TDD_FR1_E				-117
		NR_FDD_FR1_F				-116.5
NR_TDD_FR1_F	-116					
$N_{oc}$ Note2	Config 1,2,4,5		dBm/SC S	[-80]	-88	-108.5
	Config 3,6	NR_FDD_FR1_A		-85	-105.5	-116.5
		NR_TDD_FR1_A NOTE 6				
		NR_FDD_FR1_B				-116
		NR_TDD_FR1_C				-115.5
		NR_FDD_FR1_D				-115
		NR_TDD_FR1_D				
		NR_FDD_FR1_E				-114.5
NR_TDD_FR1_E		-114				
NR_FDD_FR1_F	-114.5					
NR_TDD_FR1_F	-113					
$\hat{E}_s / I_{ot}$			dB	-1.75	20	-4.0
$\hat{E}_s / N_{oc}$			dB	-1.75	20	-4.0
SS-RSRP <sup>Not e3</sup>	Config 1,2,4,5	NR_FDD_FR1_A	dBm/SC S	-89.75	-88.5	-123.5
		NR_TDD_FR1_A NOTE 6				
		NR_FDD_FR1_B				-123
		NR_TDD_FR1_C				-122.5
		NR_FDD_FR1_D				-122
		NR_TDD_FR1_D				
		NR_FDD_FR1_E				-121.5
		NR_TDD_FR1_E				-121
		NR_FDD_FR1_F				-120.5
	NR_TDD_FR1_F	-120				
	Config 3,6	NR_FDD_FR1_A		-86.75	-85.5	-120.5
		NR_TDD_FR1_A NOTE 6				
		NR_FDD_FR1_B				-120
		NR_TDD_FR1_C				-119.5
		NR_FDD_FR1_D				-119
		NR_TDD_FR1_D				
		NR_FDD_FR1_E				-118.5
		NR_TDD_FR1_E				-118
		NR_FDD_FR1_F				-117.5
NR_TDD_FR1_F		-117				
SS-SINR <sup>Note3</sup>			dB	-1.75	20	-4.0
NR_FDD_FR1_A						
NR_TDD_FR1_A NOTE 6						
NR_FDD_FR1_B						
NR_TDD_FR1_C						
NR_FDD_FR1_D						
NR_TDD_FR1_D						
NR_FDD_FR1_E						
NR_TDD_FR1_E						

		NR_FDD_FR1_F					
		NR_FDD_FR1_G					
		NR_FDD_FR1_H					
I <sub>o</sub> <sup>Note3</sup>	Config 1,2,4,5	NR_FDD_FR1_A	dBm/ 9.36MHz	-57.83	-60.5	-90.09	
		NR_TDD_FR1_A					
		NOTE 6					
		NR_FDD_FR1_B					-89.59
		NR_TDD_FR1_C					-89.09
		NR_FDD_FR1_D					-88.59
		NR_TDD_FR1_D					
		NR_FDD_FR1_E					-88.09
		NR_TDD_FR1_E					
	NR_FDD_FR1_F	-87.59					
	NR_FDD_FR1_G	-87.09					
	NR_FDD_FR1_H	-86.59					
	Config 3,6	NR_FDD_FR1_A	dBm/ 38.16MHz	-51.73	-54.41	-84	
		NR_TDD_FR1_A					
		NOTE 6					
		NR_FDD_FR1_B					-83.5
		NR_TDD_FR1_C					-83
		NR_FDD_FR1_D					-82.5
NR_TDD_FR1_D							
NR_FDD_FR1_E		-82					
NR_TDD_FR1_E							
NR_FDD_FR1_F	-81.5						
NR_FDD_FR1_G	-81						
NR_FDD_FR1_H	-80.5						
Propagation condition			-	AWGN			
Antenna configuration			-	1x2			
<p>Note 1: OCNG shall be used such that both cells are fully allocated and a constant total transmitted power spectral density is achieved for all OFDM symbols.</p> <p>Note 2: Interference from other cells and noise sources not specified in the test is assumed to be constant over subcarriers and time and shall be modelled as AWGN of appropriate power for <math>N_{oc}</math> to be fulfilled.</p> <p>Note 3: SS-SINR, SS-RSRP, and I<sub>o</sub> levels have been derived from other parameters for information purposes. They are not settable parameters themselves.</p> <p>Note 4: SS-SINR, SS-RSRP minimum requirements are specified assuming independent interference and noise at each receiver antenna port.</p> <p>Note 5: NR operating band groups are as defined in clause 3.5.2.</p> <p>Note 6: The test configuration excludes support for band n51 and it is not required to run this test on band n51 in this release of the specification.</p>							

A.8.5.2.3.1.3 Test Requirements

The SS-SINR measurement accuracy for Cell 2 shall fulfil the requirement in clause 9.11.3 in TS 36.133 [15].

A.8.5.2.3.2 E-UTRAN – NR inter-RAT measurements with FR2 target cell

A.8.5.2.3.2.1 Test Purpose and Environment

The purpose of this test is to verify that the SS-SINR measurement accuracy is within the specified limits. This test will verify the requirements in clause 9.11.3 in TS 36.133 [15] for inter-RAT FR2 SS-SINR measurements.

A.8.5.2.3.2.2 Test Parameters

Supported test configurations are shown in Table A.8.5.2.3.2.2-1. In this test case there are two cells on different carriers. Absolute accuracy requirements of SS-SINR inter-RAT measurement are tested by using test setup in Table A.8.5.2.3.2.2-2 and A.8.5.2.3.2.2-3. In all test cases, Cell 2 is target cell. Cell 1 is the E-UTRA cell which specific test parameters for this test case are specified in Table A.3.7.2.1-1.

**Table A.8.5.2.3.2.2-1: SS-SINR Inter-RAT SS-SINR supported test configurations**

Configuration	Description
1	LTE FDD, NR 120 kHz SSB SCS, 100 MHz bandwidth, TDD duplex mode
2	LTE TDD, NR 120 kHz SSB SCS, 100 MHz bandwidth, TDD duplex mode

Table A.8.5.2.3.2.2-2: SS-SINR Inter-RAT general test parameters

Parameter	Unit	Test 1	Test 2	Test 3
		Cell 2	Cell 2	Cell 2
SSB ARFCN		Freq1	freq1	freq1
Duplex mode		TDD	TDD	TDD
TDD configuration		TDDConf.3.1	TDDConf.3.1	TDDConf.3.1
$BW_{\text{channel}}$	MHz	100: $N_{RB,c} = 66$	100: $N_{RB,c} = 66$	100: $N_{RB,c} = 66$
Downlink initial BWP configuration		DLBWP.0.1		
Uplink initial BWP configuration		ULBWP.0.1		
DRX cycle configuration	ms	Not applicable		
PDSCH Reference measurement channel		-	-	-
RMSI CORESET Reference Channel		-	-	-
OCNG Patterns		OP.1	OP.1	OP.1
SMTTC configuration		SMTTC.1	SMTTC.1	SMTTC.1
SSB configuration		SSB.3 FR2	SSB.3 FR2	SSB.3 FR2
PDSCH/PDCCH subcarrier spacing	kHz	120	120	120
EPRE ratio of PSS to SSS	dB	0	0	0
EPRE ratio of PBCH_DMRS to SSS				
EPRE ratio of PBCH to PBCH_DMRS				
EPRE ratio of PDCCH_DMRS to SSS				
EPRE ratio of PDCCH to PDCCH_DMRS				
EPRE ratio of PDSCH_DMRS to SSS				
EPRE ratio of PDSCH to PDSCH_DMRS				
EPRE ratio of OCNG DMRS to SSS <sup>Note 1</sup>				
Note 1: OCNG shall be used such that both cells are fully allocated and a constant total transmitted power spectral density is achieved for all OFDM symbols.				
Note 2: Void				
Note 3: Void				
Note 4: Void				

Table A.8.5.2.3.2.2-3: SS-SINR Inter-RAT OTA related test parameters

Parameter	Unit	Test 1	Test 2	Test 3
		Cell 2	Cell 2	Cell 2
Angle of arrival configuration		Setup 1 according to A.3.15.1	Setup 1 according to A.3.15.1	Setup 1 according to A.3.15.1
Assumption for UE beams <sup>Note 10</sup>		Rough	Rough	Rough
$N_{oc}$ <sup>Note1</sup>	dBm/15kHz <sup>Note4</sup>	-104.7	-104.7	(Table B.2.3-2 Rx Beam Peak -5dB) (Note 7)
$N_{oc}$ <sup>Note1</sup>	dBm/SCS <sup>Note4</sup>	-95.7	-95.7	(Table B.2.3-2 Rx Beam Peak +4dB) (Note 7)
$\hat{E}_s / N_{oc}$	dB	-0.5	11	-1.0
SSB_RP <sup>Note2</sup>	dBm/SCS <sup>Note4</sup>	-96.2	-84.7	(Table B.2.3-2 Rx Beam Peak +3dB) (Note 8)
SS-SINR <sup>Note2</sup>	dB	-0.5	11	-1.0
$\hat{E}_s / I_{ot}$ <sup>Note2</sup>	dB	-0.5	11	-1.0
$I_o$ <sup>Note2</sup>	dBm/95.04 MHz <sup>Note4</sup>	-63.95	-55.38	(Table B.2.3-2 Rx Beam Peak +35.54dB) (Note 9)
Note 1: Interference from other cells and noise sources not specified in the test is assumed to be constant over subcarriers and time and shall be modelled as AWGN of appropriate power for $N_{oc}$ to be fulfilled.				
Note 2: SSB_RP, SS-SINR, $E_s/I_{ot}$ and $I_o$ levels have been derived from other parameters for information purposes. They are not settable parameters themselves.				
Note 3: Void				
Note 4: Equivalent power received by an antenna with 0 dBi gain at the centre of the quiet zone.				

Note 5:	Void
Note 6:	Void
Note 7:	$N_{oc}$ for SCS 15kHz is applied at $-10\log_{10}(8)+4\text{dB}$ above the minimum level specified in Table B.2.3-2 for beam peak. $N_{oc}$ for SCS 120kHz is applied at 4dB above the minimum level specified in Table B.2.3-2 for beam peak.
Note 8:	SSB_RP is applied at 3dB above the minimum level specified in Table B.2.3-2 for beam peak.
Note 9:	$l_o$ is applied at level $10\log_{10}(792)+6.54\text{dB}$ above the minimum level specified in Table B.2.3-2 for beam peak.
Note 10:	Information about types of UE beam is given in B.2.1.3, and does not limit UE implementation or test system implementation.

#### A.8.5.2.3.2.3 Test Requirements

The SS-SINR measurement accuracy for Cell 2 shall fulfil the requirement in clause 9.11.3 in TS 36.133 [15].

## A.9 V2X Tests

### A.9.1 V2X Tests in FR1

#### A.9.1.1 Test for V2X UE Transmit Timing

##### A.9.1.1.1 Test for GNSS as Synchronization Reference Source

###### A.9.1.1.1.1 Test Purpose and Environment

The purpose of this test is to verify the UE timing requirements as specified in clause 12.2.2, when the GNSS is used as timing reference. For this test, the UE is triggered by the test loop function to transmit for V2X sidelink communication.

Table A.9.1.1.1.1-1 defines test parameters for UE transmit timing accuracy tests for V2X. There is one GNSS based synchronization source during the test. The test system can emulate and send the GNSS signal to the test UE. The test parameters for GNSS signals are defined in B.4.1.

**Table A.9.1.1.1.1-1: V2X Sidelink Test Parameters for UE Transmit Timing Tests for GNSS as Timing Reference**

Parameter	Unit	Value	Comment
RF Channel Number		1	HD carrier in Band n47 or n38
Channel Bandwidth ( $BW_{channel}$ ) <sup>Note 1</sup>	MHz	20 ( $N_{RB,c} = 50$ ) or 40 ( $N_{RB,c} = 100$ )	
SCS	kHz	30	
Active cell		None	
Active SyncRef UE		None	
V2X sidelink communication preconfiguration		As specified in section A.3.21.2	IE values unless specified otherwise in this test.
PSCCH Reference Measurement Channel		CC.1A HD	As specified in Table A.3.21.3-1
PSSCH Reference Measurement Channel		CD.1A HD	As specified in Table A.3.21.3-2
Propagation condition		AWGN	
Note 1: The UE is only required to be tested in one of the supported test configurations.			

###### A.9.1.1.1.2 Test requirements

For parameters specified in Tables A.9.1.1.1-1, the timing accuracy for V2X sidelink transmission shall be within the limits defined in clause 12.2.2. The timing accuracy is verified by using PSSCH transmissions.

## A.9.1.1.2 Test for SyncRef UE as Synchronization Reference Source

### A.9.1.1.2.1 Test Purpose and Environment

The purpose of this test is to verify the timing requirements for V2X sidelink transmissions specified in clause 12.2.5, when SyncRef UE is used as timing reference. For this test, the UE is triggered by the test loop function to transmit for V2X sidelink communication.

Table A.9.1.1.2.1-1 defines test parameters for UE transmit timing accuracy tests for V2X sidelink Communication. There is one active SyncRef UE in this test without either serving cell and or GNSS signals. Before the test starts, the UE has been synchronized to the SyncRef UE. The transmit timing accuracy is verified by using the transmission timing of PSSCH transmissions.

**Table A.9.1.1.2.1-1: General Test Parameters for V2X UE Transmit Timing Test for SyncRef UE as Timing Reference**

Parameter		Unit	Value	Comment
RF Channel Number			1	HD carrier in Band n47 or n38
Channel Bandwidth ( $BW_{\text{channel}}$ ) <sup>Note 3</sup>		MHz	20 ( $N_{RB,c} = 50$ ) or 40 ( $N_{RB,c} = 100$ )	
SCS		kHz	30	
Active cell			None	
Active SyncRef UE			SyncRef UE 1	Transmitting S-SSB on RF channel number 1
V2X sidelink communication preconfiguration			As specified in section A.3.21.2	IE values unless specified otherwise in this test.
PSCCH Reference Measurement Channel			CC.1A HD	As specified in Table A.3.21.3-1
PSSCH Reference Measurement Channel			CD.1A HD	As specified in Table A.3.21.3-2
$N_{oc}$ <sup>Note1,2</sup>		dBm/30kHz	-95	
SyncRef UE 1	sl-SSB-TimeAllocation		sl-SSB-TimeAllocation1	
	slssid		30	
	inCoverage		TRUE	In MIB-SL
	networkControlledSyncTx		ON	
	V2X sidelink communication configuration		As specified in section A.3.21.2	IE values unless specified otherwise in this test.
	$\hat{E}_s/N_{oc}$		3	
	PSBCH-RSRP <sup>Note1, Note 2</sup>	dBm/30kHz	-92	
Propagation condition			AWGN	
Note 1: PSBCH-RSRP levels have been derived from other parameters for information purposes. They are not settable parameters themselves.				
Note 2: S-PSS $E_s/N_{oc}$ and S-SSS $E_s/N_{oc}$ are set the same as PSBCH $E_s/N_{oc}$ .				
Note 3: The UE is only required to be tested in one of the supported test configurations.				

### A.9.1.1.2.2 Test requirements

For parameters specified in Tables A.9.1.1.2.1-1, the timing accuracy for V2X sidelink transmission shall be within the limits defined in clause 12.2.5. The timing accuracy is verified by using PSSCH transmissions.

## A.9.1.1.3 Test for FR1 NR Cell as Synchronization Reference Source

### A.9.1.1.3.1 Test Purpose and Environment

The purpose of this test is to verify the timing requirements for V2X sidelink transmissions specified in clause 12.2.3, when the downlink timing of the serving cell (RRC\_IDLE) or PCell (RRC\_CONNECTED) on a non-V2X sidelink carrier is used as timing reference. For this test, the UE is triggered by the test loop function or the upper layers to transmit for V2X sidelink communication.

This test is applicable for V2X sidelink communication capable UEs that support NR Uu and sidelink operation.

Table A.9.1.1.3.1-1, A.9.1.1.3.1-2 and A.9.1.1.3.1-3 define test parameters for UE transmit timing accuracy tests for V2X sidelink Communication. There is one active cell (PCell) in this test. The transmit timing accuracy is verified by using the transmission timing of PSSCH transmissions.

**Table A.9.1.1.3.1-1: Supported test configurations for FR1 PCell**

Configuration	Description
1	NR Uu: FDD, SSB SCS 15 kHz, data SCS 15 kHz, BW 10 MHz
2	NR Uu: TDD, SSB SCS 15 kHz, data SCS 15 kHz, BW 10 MHz
3	NR Uu: TDD, SSB SCS 30 kHz, data SCS 30 kHz, BW 40 MHz
Note:	The UE is only required to pass in one of the supported test configurations in FR1

**Table A.9.1.1.3.1-2: V2X Sidelink Test Parameters for V2X UE Transmit Timing Accuracy Test for gNB as Timing Reference**

Parameter	Unit	Value	Comment
RF Channel Number		1	HD carrier in Band n47 or n38
Channel Bandwidth ( $BW_{\text{channel}}$ ) <sup>Note 1</sup>	MHz	20 ( $N_{RB,c} = 50$ ) or 40 ( $N_{RB,c} = 100$ )	
SCS	kHz	30	
Active cell		Cell 1	
Active SyncRef UE		None	
V2X sidelink communication configuration		As specified in section A.3.21.2	IE values unless specified otherwise in this test.
PSSCH Reference Measurement Channel		CC.1A HD	As specified in Table A.3.21.3-1
PSSCH Reference Measurement Channel		CD.1A HD	As specified in Table A.3.21.3-2
Note 1: The UE is only required to be tested in one of the supported test configurations.			

**Table A.9.1.1.3.1-3: Cell Test Parameters for V2X UE Transmit Timing Accuracy Test for gNB as Timing Reference**

Parameter	Unit	Cell 1
RF Channel Number		2
Duplex Mode	Config 1	FDD
	Config 2,3	TDD
TDD configuration	Config 1	Not Applicable
	Config 2	TDDConf.1.1
	Config 3	TDDConf.2.1
Channel Bandwidth ( $BW_{\text{channel}}$ )	Config 1,2	10: $N_{RB,c} = 52$
	Config 3	40: $N_{RB,c} = 106$
Initial BWP Configuration		DLBWP.0.1 ULBWP.0.1
Dedicated BWP Configuration		DLBWP.1.1 ULBWP.1.1
DRX Cycle		N/A
PDSCH Reference measurement channel	Config 1	SR.1.1 FDD
	Config 2	SR.1.1 TDD
	Config 3	SR.2.1 TDD
CORESET Reference Channel	Config 1	CR.1.1 FDD
	Config 2	CR.1.1 TDD
	Config 3	CR.2.1 TDD
Dedicated CORESET Reference Channel	Config 1	CCR.1.1 FDD
	Config 2	CCR.1.1 TDD
	Config 3	CCR.2.1 TDD
SSB configuration	Config 1,2	SSB.1 FR1
	Config 3	SSB.2 FR1
SMTTC Configuration		SMTTC.2



OCNG Patterns			OP.1
EPRE ratio of PSS to SSS		dB	0
EPRE ratio of PBCH DMRS to SSS			
EPRE ratio of PBCH to PBCH DMRS			
EPRE ratio of PDCCH DMRS to SSS			
EPRE ratio of PDCCH to PDCCH DMRS			
EPRE ratio of PDSCH DMRS to SSS			
EPRE ratio of PDSCH to PDSCH			
EPRE ratio of OCNG DMRS to SSS(Note 1)			
EPRE ratio of OCNG to OCNG DMRS (Note 1)			
$N_{oc}$ <sup>Note2</sup>	Config 1,2,3	dBm/15 kHz	-98
$N_{oc}$ <sup>Note2</sup>	Config 1,2	dBm/SCS	-98
	Config 3		-95
$\hat{E}_s / N_{oc}$		dB	3
SS-RSRP <sup>Note3</sup>	Config 1,2	dBm/SCS	-95
	Config 3		-92
$I_o$ <sup>Note 3</sup>	Config 1,2	dBm/9.36 MHz	-65.2
	Config 3	dBm/38.1 MHz	-59.2
Propagation Condition			AWGN
<p>Note 1: OCNG shall be used such that cell is fully allocated and a constant total transmitted power spectral density is achieved for all OFDM symbols.</p> <p>Note 2: Interference from other cells and noise sources not specified in the test is assumed to be constant over subcarriers and time and shall be modelled as AWGN of appropriate power for <math>N_{oc}</math> to be fulfilled.</p> <p>Note 3: SS-RSRP levels have been derived from other parameters for information purposes. They are not settable parameters themselves.</p>			

### A.9.1.1.3.2 Test requirements

For parameters specified in Tables A.9.1.1.3.1-1 A.9.1.1.3.1-2 and A.9.1.1.3.1-3, the timing accuracy for V2X sidelink transmission shall be within the limits defined in clause 12.2.3. The timing accuracy is verified by using PSSCH transmissions.

## A.9.1.2 Test for Initiation/Cease of S-SSB Transmission with V2X Sidelink Communication

### A.9.1.2.1 Test for FR1 NR Cell as synchronization reference source without gap under non-DRX

#### A.9.1.2.1.1 Test Purpose and Environment

The purpose of this test is to verify that the V2X UE meets the requirements related to the maximum evaluation time allowed to initiate and cease S-SSB transmissions defined in clause 12.3.1.1, when the reference timing used for sidelink transmissions is a NR serving cell in FR1 on a non-V2X sidelink carrier.

This test is applicable for V2X sidelink communication capable UEs that support NR Uu and sidelink operation.

Supported test configurations for FR1 NR cell are shown in Table A.9.1.2.1.1-1.

**Table A.9.1.2.1.1-1: Supported Test Configurations for FR1 NR cell as synchronization reference source**

Configuration	Description
1	NR Uu: FDD, SSB SCS 15 kHz, data SCS 15 kHz, BW 10 MHz
2	NR Uu: TDD, SSB SCS 15 kHz, data SCS 15 kHz, BW 10 MHz
3	NR Uu: TDD, SSB SCS 30 kHz, data SCS 30 kHz, BW 40 MHz
<p>Note 1: The UE is only required to pass in one of the supported test configurations in FR1.</p> <p>Note 2: For NR SL, SL BW is one between 20MHz and 40MHz, and SL SCS is 30kHz.</p>	

The test parameters are given in Table A.9.1.2.1.1-2 and Table A.9.1.2.1.1-3 below. There is one active cell in this test. The test consists of three successive time periods, with time duration of T1, T2 and T3 respectively.

During T1, the SS-RSRP of the PCell is above *syncTxThreshIC* and the UE is not expected to be transmitting S-SSB.

During T2, the SS-RSRP of the PCell is lowered below *syncTxThreshIC* and the UE is expected to initiate S-SSB transmissions.

During T3, the SS-RSRP of the PCell is increased back to be above *syncTxThreshIC* and the UE is expected to cease S-SSB transmissions.

**Table A.9.1.2.1.1-2: Test Parameters for Initiation/Cease of SLSS Transmission Test for FR1 NR cell as synchronization reference source**

Parameter	Unit	Value	Comment
SCS	kHz	30	
Active cell		Cell 1	Serving cell on RF channel number 1
Active SyncRef UE		None	
Active V2X UE		V2X UE	Transmitting S-SSB on RF channel number 2 (HD carrier in Band n47 or n38)
V2X sidelink communication configuration		As specified in Table A.3.21.2-2	IE values unless specified otherwise in this test
networkControlledSyncTx		Not configured	
syncTxThreshIC	dBm/SCS	-110	In SIB12
DRX		OFF	
T1	s	3	
T2	s	5.24	
T3	s	5.24	

**Table A.9.1.2.1.1-3: FR1 NR Cell Specific Test Parameters for Initiation/Cease of S-SSB Transmission Test for FR1 NR cell as synchronization reference source**

Parameter		Unit	Cell1		
			T1	T2	T3
NR RF Channel Number			1		
Duplex Mode	Config 1		FDD		
	Config 2,3		TDD		
TDD configuration	Config 1		Not applicable		
	Config 2		TDDConf.1.1		
	Config 3		TDDConf.2.1		
Channel Bandwidth (BW <sub>channel</sub> )	Config 1,2	MHz	10:NR <sub>RB,c</sub> = 52		
	Config 3		40:NR <sub>RB,c</sub> = 106		
Initial BWP Configuration			DLBWP.0.1 ULBWP.0.1		
Dedicated BWP Configuration			DLBWP.1.1 ULBWP.1.1		
DRx Cycle		ms	N/A		
PDSCH Reference measurement channel	Config 1		SR.1.1 FDD		
	Config 2		SR.1.1 TDD		
	Config 3		SR.2.1 TDD		
CORESET Reference Channel	Config 1		CR.1.1 FDD		
	Config 2		CR.1.1 TDD		
	Config 3		CR.2.1 TDD		
Dedicated CORESET Reference Channel	Config 1		CCR.1.1 FDD		
	Config 2		CCR.1.1 TDD		
	Config 3		CCR.2.1 TDD		
SSB configuration	Config 1,2		SSB.1 FR1		
	Config 3		SSB.2 FR1		
SMTc Configuration	Config 1		SMTc.2		
	Config 2,3		SMTc.1		
TRS configuration			TRS.1.1 FDD		

	Config 2		TRS.1.1 TDD		
	Config 3		TRS.1.2 TDD		
OCNG Patterns			OP.1		
EPRE ratio of PSS to SSS		dB	0		
EPRE ratio of PBCH DMRS to SSS					
EPRE ratio of PBCH to PBCH DMRS					
EPRE ratio of PDCCH DMRS to SSS					
EPRE ratio of PDCCH to PDCCH DMRS					
EPRE ratio of PDSCH DMRS to SSS					
EPRE ratio of PDSCH to PDSCH					
EPRE ratio of OCNG DMRS to SSS <sup>Note 1</sup>					
EPRE ratio of OCNG to OCNG DMRS <sup>Note 1</sup>					
$N_{oc}$ <sup>Note2</sup>	Config 1,2,3	dBm/15 kHz	-110		
	Config 1,2	dBm /SCS	-110		
	Config 3		-107		
$\hat{E}_s / N_{oc}$		dB	4.5	-4.5	4.5
$\hat{E}_s / I_{oa}$		dB	4.5	-4.5	4.5
SS-RSRP <sup>Note3</sup>	Config 1,2	dBm /SCS	-105.5	-114.5	-105.5
	Config 3		-102.5	-111.5	-102.5
$I_o$ <sup>Note3</sup>	Config 1,2	dBm /9.36MHz	-76.2	-80.7	-76.2
	Config 3	dBm/ 38.16MHz	-70.1	-74.6	-70.1
Propagation condition			AWGN		
<p>Note 1: OCNG shall be used such that both cells are fully allocated and a constant total transmitted power spectral density is achieved for all OFDM symbols.</p> <p>Note 2: Interference from other cells and noise sources not specified in the test is assumed to be constant over subcarriers and time and shall be modelled as AWGN of appropriate power for <math>N_{oc}</math> to be fulfilled.</p> <p>Note 3: SS-RSRP and <math>I_o</math> levels have been derived from other parameters for information purposes. They are not settable parameters themselves.</p> <p>Note 4: SS-RSRP minimum requirements are specified assuming independent interference and noise at each receiver antenna port.</p>					

### A.9.1.2.1.2 Test Requirements

The S-SSB transmission initiation delay is defined as the time from the beginning of time period T2 up to the moment when the UE initiates the S-SSB transmission.

The S-SSB transmission initiation delay shall be less than 0.56 s.

The S-SSB transmission cease delay is defined as the time from the beginning of time period T3 up to the moment when the UE ceases the S-SSB transmission.

The S-SSB transmission cease delay shall be less than 0.56 s.

The rate of correct initiation/cease delay of S-SSB transmissions observed during repeated tests shall be at least 90%.

NOTE: The initiation/cease delay of S-SSB transmissions can be expressed as:  $T_{evaluate,SLSS} + S\text{-SSB period}$ ,

Where:

$T_{evaluate,SLSS} = 0.4$  sec (as specified in clause 12.3.1.1);

S-SSB period = 160ms.

### A.9.1.2.2 Test for SyncRef UE as synchronization reference source

#### A.9.1.2.2.1 Test Purpose and Environment

The purpose of this test is to verify the requirements related to the evaluation time allowed to initiate and cease S-SSB transmissions defined in clause 12.3.1.4, when the reference timing used for sidelink transmissions is a SyncRef UE.

The test parameters are given in Table A.9.1.2.2.1-1 and Table A.9.1.2.2.1-2 below. There are neither active cells nor GNSS signals in this test. There is one active SyncRef UE (SyncRef UE 1) in this test. The test system shall emulate SyncRef UE 1 to transmit S-SSB every synchronization period.

Prior to start of test, test system is required to ensure that the V2X UE is synchronized to the SyncRef UE 1 and is transmitting S-SSB as derived from the S-SSB of SyncRef UE 1 as per clause 5.8.5.3 of TS 38.331[2]. For the test configuration, the SLSSID used by the V2X UE shall be 30 with *inCoverage* IE in MIB-SL set as FALSE. The test consists of three successive time periods, with time duration of T1, T2 and T3 respectively.

During T1, the PSBCH-RSRP of SyncRef UE 1 is above *syncTxThreshOOC* and the UE is not expected to be transmitting S-SSB.

During T2, the PSBCH-RSRP of SyncRef UE 1 is lowered below *syncTxThreshOOC* and the UE is expected to initiate S-SSB transmissions.

During T3, the PSBCH-RSRP of SyncRef UE 1 is increased back to be above *syncTxThreshOOC* and the UE is expected to cease S-SSB transmissions.

**Table A.9.1.2.2.1-1: Test Parameters for Initiation/Cease of S-SSB Transmission Test for SyncRef UE as synchronization reference source**

Parameter	Unit	Value	Comment
SCS	kHz	30	
Active cell		None	
Active SyncRef UE		SyncRef UE 1	Transmitting S-SSB on RF channel number 1 (HD carrier in Band n47 or n38)
Active V2X UE		V2X UE	Transmitting S-SSB on RF channel number 1 (HD carrier in Band n47 or n38)
V2X sidelink communication preconfiguration		As specified in Table A.3.21.2-2	IE values unless specified otherwise in this test
networkControlledSyncTx		Not configured	
syncTxThreshOoC	dBm/30kHz	-100	
T1	s	3	
T2	s	5.24	
T3	s	5.24	

**Table A.9.1.2.2.1-2: SyncRef UE Specific Test Parameters for Initiation/Cease of S-SSB Transmission Test for SyncRef UE as synchronization reference source**

Parameter	Unit	SyncRef UE 1		
		T1	T2	T3
NR RF Channel Number		1		
V2X SL communication resource pool configuration		As specified in Table A.3.21.2-2		
Channel Bandwidth ( $BW_{channel}$ ) <sup>Note3</sup>	MHz	20( $N_{RB,c} = 50$ ) or 40( $N_{RB,c} = 100$ )		
SLSSID		30		
<i>inCoverage</i>		TRUE		
networkControlledSyncTx		ON		
$N_{oc}$ <sup>Note1</sup>	dBm/30 kHz	-98		
$\hat{E}_s / I_{\alpha}$	dB	5.5	-3.5	5.5
PSBCH $\hat{E}_s / N_{oc}$	dB	5.5	-3.5	5.5
PSBCH-RSRP <sup>Note2</sup>	dBm/30 kHz	-92.5	-101.5	-92.5
$I_0$ <sup>Note2</sup>	dBm /18MHz	-70.2	-75.2	-70.2
	dBm/36MHz	-70.2	-75.2	-70.2
Propagation condition		AWGN		
<p>Note 1: Interference from other UEs and noise sources not specified in the test is assumed to be constant over subcarriers and time and shall be modelled as AWGN of appropriate power for <math>N_{oc}</math> to be fulfilled.</p> <p>Note 2: PSBCH-RSRP and <math>I_0</math> levels have been derived from other parameters for information purposes. They are not settable parameters themselves. <math>I_0</math> level is based on the allocated RBs for S-PSS/S-SSS/PSBCH symbols.</p>				

Note 3: The UE is only required to be tested in one of the supported test configurations.  
 Note 4: S-PSS Es/Noc and S-SSS Es/Noc are set the same as PSBCH Es/Noc.

#### A.9.1.2.2.2 Test Requirements

The S-SSB transmission initiation delay is defined as the time from the beginning of time period T2 up to the moment when the UE initiates the S-SSB transmission.

The S-SSB transmission initiation delay shall be less than 0.8 s.

The S-SSB transmission cease delay is defined as the time from the beginning of time period T3 up to the moment when the UE ceases the S-SSB transmission.

The S-SSB transmission cease delay shall be less than 0.8 s.

The rate of correct initiation/cease delay of S-SSB transmissions observed during repeated tests shall be at least 90%.

NOTE: The initiation/cease delay of S-SSB transmissions can be expressed as:  $T_{\text{evaluate,SLSS}} + \text{S-SSB period}$ ,

Where:

- $T_{\text{evaluate,SLSS}} = 0.64 \text{ sec}$  (as specified in clause 12.3.1.4);
- S-SSB period = 160ms.

### A.9.1.3 Test for V2X Synchronization Reference Selection/Reselection

#### A.9.1.3.1 Test for GNSS configured as the highest priority

##### A.9.1.3.1.1 Test Purpose and Environment

The purpose of this test is to verify the requirements related to SyncRef UE selection / reselection defined in clause 12.4, when GNSS is configured as the highest priority. For this test, the UE is triggered by the test loop function or the upper layers to transmit for V2X Sidelink Communication.

The test parameters are given in Table A.9.1.3.1.1-1 and A.9.1.3.1.1-2 below. There are no GNSS signals in this test. There are three active SyncRef UEs (SyncRef UE 1, SyncRef UE 2 and SyncRef UE 3) in this test. The test system shall emulate SyncRef UE 1, SyncRef UE 2 and SyncRef UE 3 to transmit S-SSB every S-SSB period.

The test system can verify the selection / reselection of SyncRef UE by monitoring the SLSS ID used by the V2X UE for its S-SSB transmissions. When the V2X UE is not synchronized to any SyncRef UE, then the V2X UE shall use the SLSS ID belonging to set id\_oon. When the V2X UE is synchronized to a SyncRef UE, the V2X UE shall derive its SLSS ID from the SLSS ID of the SyncRef UE as per clause 5.8.5.3 of TS 38.331[2].

The test consists of three successive time periods, with time duration of T1, T2 and T3 respectively. SyncRef UE 1, SyncRef UE 2 and SyncRef UE 3 are all powered off before starting the test. During T1, SyncRef UE 1 is powered ON and the V2X UE will select SyncRef UE 1 as synchronization source. During T2, SyncRef UE 2 is powered ON and the V2X UE will select SyncRef UE 2 as the synchronization source. During T3, SyncRef UE 3 is powered ON and the V2X UE will reselect to SyncRef UE 3 as the synchronization source.

**Table A.9.1.3.1.1-1: Test Parameters for V2X Synchronization Reference Selection/Reselection Tests for GNSS configured as the highest priority**

Parameter		Unit	Value	Comment
SCS		kHz	30	
Initial condition	Active synchronization source		Sync Ref UE 1	DUT transmits for V2X Sidelink Communication and S-SSB with SLSS ID = 30 and in-coverage set as FALSE in MIB-SL.
T2 end condition	Active synchronization source		Sync Ref UE 2	DUT transmits for V2X Sidelink Communication and S-SSB with SLSS ID = 336 and in-coverage set as FALSE in MIB-SL.
Final condition	Active synchronization source		Sync Ref UE 3	UE transmits for V2X Sidelink Communication and S-SSB with

				SLSS ID = 0 and in-coverage set as FALSE in MIB-SL.
Active SyncRef UEs			SyncRef UE 1 SyncRef UE 2 SyncRef UE 3	Transmitting S-SSB on RF channel number 1 (HD carrier in Band n47 or n38)
Timing offset among SyncRef UEs	$\mu$ s		CP/2	Synchronous
Frequency offset of SyncRef UE 1,2,3	ppm		0	
V2X sidelink Communication configuration			As specified in Table A. 3.21.2-2	IE values unless specified otherwise in this test.
sl-SyncPriority			gnss	
syncTxThreshOoC			+infinity	
T1	s		24	
T2	s		16	
T3	s		3.2	

**Table A.9.1.3.1.1-2: SyncRef UE Specific Test Parameters for V2X Synchronization Reference Selection/Reselection Tests for GNSS configured as the highest priority**

Parameter	Unit	SyncRef UE 1			SyncRef UE 2			SyncRef UE 3		
		T1	T2	T3	T1	T2	T3	T1	T2	T3
NR RF Channel Number		1(HD carrier in Band n47 or n38)								
Channel Bandwidth (BW <sub>channel</sub> ) <sup>Note 4</sup>	MHz	20 (N <sub>RB,c</sub> = 50) or 40 (N <sub>RB,c</sub> = 100)								
V2X Sidelink Communication resource pool configuration		As specified in Table A.3.21.2-2								
networkControlledSyncTx		ON			N/A			ON		
syncTxThreshOoC	dBm/15 kHz	N/A			+infinity			N/A		
SLSSID		30			0			0		
inCoverage (in MIB-SL)		TRUE			FALSE			TRUE		
$N_{oc}$ <sup>Note1</sup>	dBm/30 kHz	-95								
$\hat{E}_s / N_{oc}$	dB	0	0	0	-infinity	0	0	-infinity	-infinity	3
$\hat{E}_s / I_{ot}$ <sup>Note2</sup>	dB	0	0	-4.76	-infinity	0	0	-infinity	-infinity	0
PSBCH-RSRP <sup>Note2, Note 3</sup>	dBm/30 kHz	-95	-95	-95	-infinity	-95	-95	-infinity	-infinity	-92
$I_o$ <sup>Note2</sup>	dBm/18 MHz	-70.78	-70.78	-67.78	-73.79	-70.78	-70.78	-70.78	-70.78	-67.78
	dBm/36 MHz	-70.78	-70.78	-67.78	-73.79	-70.78	-70.78	-70.78	-70.78	-67.78
Propagation Condition		AWGN								

- Note 1: Interference from other cells and noise sources not specified in the test is assumed to be constant over subcarriers and time and shall be modelled as AWGN of appropriate power for  $N_{oc}$  to be fulfilled.
- Note 2:  $E_s/I_{ot}$ ,  $I_o$ , PSBCH-RSRP levels have been derived from other parameters for information purposes. They are not settable parameters themselves.
- Note 3: S-PSS  $E_s/I_{ot}$  and S-SSS  $E_s/I_{ot}$  are set the same as PSBCH  $E_s/I_{ot}$ .
- Note 4: The UE is only required to be tested in one of the supported test configurations.

### A.9.1.3.1.2 Test Requirements

During T1, SyncRef UE selection delay is defined as the time from the beginning of T1 to the time UE is synchronized to SyncRef UE 1, and changes its S-SSB transmissions timing and SLSS ID to follow SyncRef UE 1 as the synchronization source. For the test configuration, the SLSS ID will be changed to 30 (with in-coverage IE in MIB-SL set to FALSE) after SyncRef UE selection delay from start of T1.

The SyncRef UE selection delay shall be less than 8.8sec. The SyncRef UE selection delay can be expressed as:

$$\text{SyncRef UE selection delay} = T_{\text{detect,SyncRef UE}} + T_{\text{evaluate,SLSS}} + \text{S-SSB period}$$

Where

- $T_{\text{detect,SyncRef UE}} = 8\text{sec}$  (as specified in sub-clause 12.4)
- $T_{\text{evaluate,SLSS}} = 0.64 \text{ sec}$  (as specified in sub-clause 12.3)
- S-SSB period = 160ms

This gives a total of 8.8 seconds.

2) During T2, SyncRef UE reselection delay is defined as the time from the beginning of T2 to the time UE changes its synchronization source from SyncRef UE 1 to SyncRef UE 2 and changes its S-SSB transmissions timing and SLSS ID to follow SyncRef UE 2 as the synchronization source. For the test configuration, the SLSS ID will be changed to 336 (with in-coverage IE in MIB-SL set to FALSE) after SyncRef UE reselection delay from start of T2.

The SyncRef UE reselection delay shall be less than 8.8sec. The SyncRef UE reselection delay can be expressed as:

$$\text{SyncRef UE reselection delay} = T_{\text{detect,SyncRef UE}} + T_{\text{evaluate,SLSS}} + \text{S-SSB period}$$

Where

- $T_{\text{detect,SyncRef UE}} = 8\text{sec}$  (as specified in sub-clause 12.4)
- $T_{\text{evaluate,SLSS}} = 0.64$  (as specified in sub-clause 12.3)
- S-SSB period = 160ms

This gives a total of 8.8 seconds.

3) During T3, SyncRef UE reselection delay is defined as the time from the beginning of T3 to the time UE changes its synchronization source from SyncRef UE 2 to SyncRef UE 3, and changes its S-SSB transmissions timing and SLSS ID to follow SyncRef UE 3 as the synchronization source. For the test configuration, the SLSS ID will still be 0 (with in-coverage IE in MIB-SL set to FALSE) after SyncRef UE reselection delay from start of T3.

The SyncRef UE reselection delay shall be less than 2.4sec. The SyncRef UE reselection delay can be expressed as:

$$\text{SyncRef UE reselection delay} = T_{\text{detect,SyncRef UE}} + T_{\text{evaluate,SLSS}} + \text{S-SSB period}$$

Where

- $T_{\text{detect,SyncRef UE}} = 1.6\text{sec}$  (as specified in sub-clause 12.4)
- $T_{\text{evaluate,SLSS}} = 0.64$  (as specified in sub-clause 12.3)
- S-SSB period = 160 ms

This gives a total of 2.4 seconds.

The test system will verify that the V2X UE does not drop or delay more than 6% of its V2X data and S-SSB transmissions during the duration of T2, and does not drop or delay more than 30% of its S-SSB transmissions during the duration of T3.

The rate of correct SyncRef UE selection / reselection observed during repeated tests shall be at least 90%.

### A.9.1.3.2 Test for FR1 NR Cell configured as the highest priority

#### A.9.1.3.2.1 Test Purpose and Environment

The purpose of this test is to verify the requirements related to SyncRef UE selection / reselection defined in clause 12.4, when gNB is configured as the highest priority. For this test, the UE is triggered by the test loop function or the upper layers to transmit for V2X Sidelink Communication.

This test is applicable for V2X sidelink communication capable UEs that support gNB as synchronization source and sidelink operation.

**Table A.9.1.3.2.1-1: Void**

The test parameters are given in Table A.9.1.3.2.1-2 and A.9.1.3.2.1-3 below. There are no active cells and GNSS is reliable during the whole test. The test system can emulate and send the GNSS signal to the test UE. The test parameters for GNSS signals are defined in B.4.1. There are two active SyncRef UEs (SyncRef UE 1 and SyncRef UE 2) in this test. The test system shall emulate SyncRef UE 1 and SyncRef UE 2 to transmit S-SSB every S-SSB period.

The test system can verify the selection / reselection of SyncRef UE by monitoring the SLSS ID used by the V2X UE for its S-SSB transmissions. When the V2X UE is synchronized to a SyncRef UE, the V2X UE shall derive its SLSS ID from the SLSS ID of the SyncRef UE as per clause 5.8.5.3 of TS 38.331[2].

The test consists of three successive time periods, with time duration of T1, T2 and T3 respectively. During T1, both SyncRef UE 1 and SyncRef UE 2 are powered off and the V2X UE will select GNSS as synchronization source. During T2, SyncRef UE 1 is powered ON and the V2X UE will select SyncRef UE 1 as the synchronization source. During T3, a higher priority SyncRef UE 2 is additionally powered ON and the V2X UE will reselect to the higher priority SyncRef UE 2 as the synchronization source.

**Table A.9.1.3.2.1-2: Test Parameters for V2X Synchronization Reference Selection/Reselection Tests for FR1 NR Cell configured as the highest priority**

Parameter		Unit	Value	Comment
SCS		kHz	30	
Initial condition	Active synchronization source		GNSS	DUT transmits for V2X Sidelink Communication and S-SSB with SLSS ID = 0 and in-coverage set as TRUE in MIB-SL.
T2 end condition	Active synchronization source		Sync Ref UE 1	DUT transmits for V2X Sidelink Communication and S-SSB with SLSS ID = 336+59 and in-coverage set as FALSE in MIB-SL.
Final condition	Active synchronization source		Sync Ref UE 2	UE transmits for V2X Sidelink Communication and S-SSB with SLSS ID = 30 and in-coverage set as FALSE in MIB-SL.
Active cell			None	
Active SyncRef UEs			SyncRef UE 1 SyncRef UE 2	Transmitting S-SSB on RF channel number 1
Timing offset between SyncRef UE 1 and SyncRef UE 2		ms	3	Asynchronous
Frequency offset of SyncRef UE 1,2		ppm	0	
V2X sidelink Communication preconfiguration			As specified in Table A.3.21.2-2	IE values unless specified otherwise in this test.
syncPriority			<i>gnb</i>	
syncTxThreshOoC			13 (+infinity)	
T1		s	24	
T2		s	16	
T3		s	16	

**Table A.9.1.3.2.1-3: SyncRef UE Specific Test Parameters for V2X Synchronization Reference Selection/Reselection Tests for FR1 NR Cell configured as the highest priority**

Parameter	Unit	SyncRef UE 1	SyncRef UE 2
-----------	------	--------------	--------------



		T1	T2	T3	T1	T2	T3
NR RF Channel Number		1(HD carrier in Band n47 or n38)					
Channel Bandwidth ( $BW_{\text{channel}}$ ) <sup>Note 4</sup>	MHz	20( $N_{RB,c} = 50$ ) or 40( $N_{RB,c} = 100$ )					
V2X Sidelink Communication resource pool configuration		As specified in Table A.3.21.2-2			As specified in Table A.3.21.2-2		
networkControlledSyncTx		N/A			ON		
syncTxThreshOoC	dBm/15 kHz	+infinity			N/A		
SLSSID		59			30		
inCoverage (in MIB-SL)		FALSE			TRUE		
$N_{oc}$ <sup>Note1</sup>	dBm/30 kHz	-95					
$\hat{E}_s / N_{oc}$	dB	-infinity	0	0	-infinity	-infinity	3
$\hat{E}_s / I_{ot}$ <sup>Note2,</sup>	dB	-infinity	0	-4.76	-infinity	-infinity	0
$I_o$ <sup>Note2,</sup>	dBm/18MHz	-73.79	-70.78	-70.78	-73.79	-73.79	-70.78
	dBm/36MHz	-73.79	-70.78	-70.78	-73.79	-73.79	-70.78
PSBCH-RSRP <sup>Note2, Note 3</sup>	dBm/30 kHz	-infinity	-95	-95	-infinity	-infinity	-92
Propagation Condition		AWGN					
<p>Note 1: Interference from other cells and noise sources not specified in the test is assumed to be constant over subcarriers and time and shall be modelled as AWGN of appropriate power for <math>N_{oc}</math> to be fulfilled.</p> <p>Note 2: <math>E_s/I_{ot}</math>, <math>I_o</math>, PSBCH-RSRP levels have been derived from other parameters for information purposes. They are not settable parameters themselves.</p> <p>Note 3: S-PSS <math>E_s/I_{ot}</math> and S-SSS <math>E_s/I_{ot}</math> are set the same as PSBCH <math>E_s/I_{ot}</math>.</p> <p>Note 4: The UE is only required to be tested in one of the supported test configurations.</p>							

### A.9.1.3.2.2 Test Requirements

1) During T2, SyncRef UE selection delay is defined as the time from the beginning of T2 to the time UE is synchronized to SyncRef UE 1 and changes its S-SSB transmissions timing and SLSS ID to follow SyncRef UE 1 as the synchronization source. For the test configuration, the SLSS ID will be changed to 336+59 (with in-coverage IE in MIB-SL set to FALSE) after SyncRef UE selection delay from start of T2.

The SyncRef UE selection delay shall be less than 8.8sec. The SyncRef UE selection/reselection delay can be expressed as:

$$\text{SyncRef UE selection/reselection delay} = T_{\text{detect, SyncRef UE}} + T_{\text{evaluate, SLSS}} + \text{S-SSB period}$$

Where

- $T_{\text{detect, SyncRef UE}} = 8\text{sec}$  (as specified in sub-clause 12.4)
- $T_{\text{evaluate, SLSS}} = 0.64\text{sec}$  (as specified in sub-clause 12.3)
- S-SSB period = 160ms

This gives a total of 8.8 seconds.

2) During T3, SyncRef UE reselection delay is defined as the time from the beginning of T3 to the time UE changes its synchronization source from SyncRef UE 1 to SyncRef UE 2, and changes its S-SSB transmissions timing and SLSS ID to follow SyncRef UE 2 as the synchronization source. For the test configuration, the SLSS ID will be changed to 30 (with in-coverage IE in MIB-SL set to FALSE) after SyncRef UE selection delay from start of T3.

The SyncRef UE reselection delay shall be less than 8.8sec. The SyncRef UE selection/reselection delay can be expressed as:

$$\text{SyncRef UE selection/reselection delay} = T_{\text{detect, SyncRef UE}} + T_{\text{evaluate, SLSS}} + \text{S-SSB period}$$

Where

- $T_{\text{detect, SyncRef UE}} = 8\text{sec}$  (as specified in sub-clause 12.4)

- $T_{\text{evaluate,SLSS}} = 0.64$  sec (as specified in sub-clause 12.3)
- S-SSB period = 160ms

This gives a total of 8.8 seconds.

The test system will verify that the V2X UE does not drop or delay more than 6% of its V2X data and S-SSB transmissions during the duration of T2 and T3.

## A.9.1.4 Test for L1 SL-RSRP Measurement

### A.9.1.4.1 Test for V2X UE Autonomous Resource Selection/Reselection

#### A.9.1.4.1.1 Test Purpose and Environment

The purpose of this test is to verify the requirements related to autonomous resource selection / reselection for V2X UE in mode 2 defined in clause 12.5. For this test, the UE is triggered by the test loop function or the upper layers to transmit for V2X Sidelink Communication.

The test parameters are given in Table A.9.1.4.1.1-1 and A.9.1.4.1.1-2 below. There are 50 active V2X sidelink UEs (UE0~UE49) in this test. Both the UE under test and active V2X sidelink UEs select GNSS as synchronization reference source. The test system can emulate and send the GNSS signal to the test UE and active V2X sidelink UEs. The test parameters for GNSS signals are defined in B.4.1. The test system shall emulate the active V2X sidelink UEs to transmit PSCCH/PSSCH every 5ms. At the beginning of whole test, the test equipment shall send one AT command to trigger the UE under test continuously transmits PSCCH/PSSCH.

The test consists of two duration T1 and T2. During T1, the signal from Test Equipment are configured such that

- the measured PSSCH-RSRP for 20 active V2X sidelink UEs(UE10~UE29) is above the measurement threshold, and the resource occupied by the 20 active V2X sidelink UEs is expected to be excluded in the resource selection procedure and,
- the measured PSSCH-RSRP for other 30 active V2X sidelink UEs(UE0~UE9, UE30~UE49) is low the measurement threshold, and the resource occupied by the 30 active V2X sidelink UEs is expected to be included in the resource selection procedure.

During T2, the signal from Test Equipment are configured such that

- the measured PSSCH-RSRP for the 20 active V2X sidelink UEs(UE10~UE29) is below the measurement threshold, and the resource occupied by the 20 active V2X sidelink UEs is expected to be included in the resource selection procedure and,
- the measured PSSCH-RSRP for other 30 active V2X sidelink UEs(UE0~UE9, UE30~UE49) is above the measurement threshold, and the resource occupied by the 30 active V2X sidelink UEs is expected to be excluded in the resource selection procedure.

**Table A.9.1.4.1.1-1: Test Parameters for V2X UE Autonomous Resource Selection/Reselection Tests for PSSCH-RSRP measurements**

Parameter	Unit	Value	Comment
NR RF Channel Number		1	HD carrier in Band n47 or n38
Channel Bandwidth ( $BW_{\text{channel}}$ ) <sup>Note 2</sup>	MHz	20 ( $N_{RB,c} = 50$ ) or 40 ( $N_{RB,c} = 100$ )	
SCS	kHz	30	
V2X sidelink communication pre-configuration		As specified in Table A.3.21.2-1 and A.3.21.2-3	IE values unless specified otherwise in this test.
sl-TimeResource-r16 included in SL-ResourcePool		1111111111	Indicates the bitmap of the TX and Rx resource pool, which is defined by repeating the bitmap within a SFN cycle (see TS 38.213[3])
sl-NumSubchannel-r16 included in SL-ResourcePool		5	Indicates the number of sub-channels for TX resource pool

sl-SubchannelSize-r16 included in SL-ResourcePool			10	Indicates the minimum granularity in frequency domain for the sensing for PSSCH resource selection in the unit of PRB
Number of Active Sidelink UEs			50	Active Sidelink UE $i = 0, \dots, 49$
SL-Thres-RSRP			12	Corresponding -106 dBm as defined in Section 6.3.5 in TS38.331[2] Same for all priority level pairs.
Active Sidelink UEs (UE $i = 0, \dots, 49$ )	V2X sidelink Communication preconfiguration		As specified in Table A.3.21.2-1 And A.3.21.2-3	IE values unless specified otherwise in this test.
	sl-TimeResource-r16 included in SL-ResourcePool		{1}_i Note1	Indicates the bitmap of the TX and Rx resource pool, which is defined by repeating the bitmap within a SFN cycle (see TS 38.213[3])
	sl-NumSubchannel-r16 included in SL-ResourcePool		1	Indicates the number of sub-channels for TX resource pool
	sl-StartRB-Subchannel-r16 included in SL-ResourcePool		$\text{floor}(i/10) \times 10$	Indicates the lowest RB index of the subchannel with the lowest index. UE 0~9 start RB=0; UE 10~19 start RB=10; UE 20~29 start RB=20; UE 30~39 start RB=30; UE 40~49 start RB=40;
	sl-SubchannelSize-r16 included in SL-ResourcePool		10	Indicates the minimum granularity in frequency domain for the sensing for PSSCH resource selection in the unit of PRB
	sl-ResourceReservePeriod2-r16	ms	5	
Timing offset among Active Sidelink UEs		$\mu\text{s}$	CP/2	Synchronous
Note 1: {1}_i is a sequence of nine 0's with one 1 in $(\text{mod}(i,10)+1)$ 'th position.				
Note 2: The UE is only required to be tested in one of the supported test configurations.				

**Table A.9.1.4.1.1-2: Active Sidelink UE Specific Test Parameters for V2X UE Autonomous Resource Selection/Reselection Tests for PSSCH-RSRP measurements**

Parameter	Unit	Active Sidelink UE $i$ ( $i = 0, \dots, 49$ )	
		T1	T2
NR RF Channel Number	-	1	
Channel Bandwidth ( $BW_{\text{channel}}$ ) Note 5	MHz	20 ( $N_{RB,c} = 50$ ) or 40 ( $N_{RB,c} = 100$ )	
PSSCH RMC (defined in A.3.21.3)	-	CC.1A HD	
PSSCH RMC (defined in A.3.21.3)	-	CD.1A HD	
$N_{oc}$ Note1	dBm/30 kHz	-111	-121
$\hat{E}_s/N_{oc}$ Note3	dB	10	
$\hat{E}_s/I_{ot}$ Note2,3	dB	10	

$\hat{E}_s/N_{oc}$ <sup>Note4</sup>	dB	0	20
$\hat{E}_s/I_{ot}$ <sup>Note2,4</sup>	dB	0	20
PSSCH-RSRP <sub>1</sub> <sup>Note 2,3</sup>	dBm/SC S	-101	-111
PSSCH-RSRP <sub>2</sub> <sup>Note 2,4</sup>	dBm/SC S	-111	-101
$I_o$ <sup>Note 2</sup>	dBm/18 MHz	-77.42	-74.03
	dBm/36 MHz	-77.42	-74.03
Antenna Configuration	-	1x2	
Propagation Condition	-	AWGN	
<p>Note 1: Interference from other UEs and noise sources not specified in the test is assumed to be constant over subcarriers and time and shall be modelled as AWGN of appropriate power for <math>N_{oc}</math> to be fulfilled.</p> <p>Note 2: <math>E_s/I_{ot}</math>, PSSCH-RSRP and <math>I_o</math> levels have been derived from other parameters for information purposes. They are not settable parameters themselves.</p> <p>Note 3: For UE 20 to 29, occupying subchannel #2</p> <p>Note 4: For UE 0 to 19 and 30 to 49, occupying subchannel #0/1/3/4</p> <p>Note 5: The UE is only required to be tested in one of the supported test configurations.</p>			

#### A.9.1.4.1.2 Test Requirements

The test time T1 and T2 should be long enough. The rate of PSSCH transmissions on the resources on subchannel #1 or #2 shall be less than 10% during T1. The rate of PSSCH transmissions on the resources on subchannel #1 or #2 shall be more than 90% during T2.

#### A.9.1.4.2 Test for V2X UE Resource Pre-emption

##### A.9.1.4.2.1 Test Purpose and Environment

The purpose of this test is to verify the requirements related to autonomous resource pre-emption for V2X UE in mode 2 defined in clause 12.5. For this test, the UE is triggered by the test loop function or the upper layers to transmit for V2X Sidelink Communication.

The test parameters are given in Table A. 9.1.4.2.1-1 and A.12. 9.1.4.1-2 below. There is one active V2X sidelink UE in this test. Both the UE under test and the active V2X sidelink UE select GNSS as synchronization reference source. The test system can emulate and send the GNSS signal to the test UE and active V2X sidelink UEs. The test parameters for GNSS signals are defined in B.4.1. At the beginning of whole test, the test equipment shall send one message with a SL-SCH MAC PDU as specified in Clause 6.1.6 in TS 38.321[7], in order to make sure that the UE under test needs continuously transmit PSSCH/PSSCH.

The test consists of two duration T1 and T2. During T1, the signal from Test Equipment are configured such that the active V2X sidelink UE is not transmitting. The UE under test shall transmit SL data and reserve future resources. The resource reservation is decoded by the active V2X sidelink UE. The point in time at which resource reservation from the UE under test is decoded by the active V2X sidelink UE defines the start of time period T2. During T2, the active V2X sidelink UE reserves the same resource as the UE under test with high priority data no later than slot  $n - T_{pre-empt}$ .

**Table A. 9.1.4.2.1-1: Test Parameters for V2X UE Resource Pre-emption Tests for PSSCH-RSRP measurements**

Parameter	Unit	Value	Comment
NR RF Channel Number		1	HD carrier in Band n47 and n38
Channel Bandwidth ( $BW_{channel}$ ) <sup>Note 1</sup>	MHz	20 ( $N_{RB,c} = 50$ ) or 40 ( $N_{RB,c} = 100$ )	
SCS	kHz	30	
V2X sidelink communication pre-configuration		As specified in Table A.3.21.2-1 and A.3.21.2-3	IE values unless specified otherwise in this test.

sl-TimeResource-r16 included in SL-ResourcePool in SL-ResourcePool in sl-TxPoolSelectedNormal-r16			10000000000000000000	Indicates the time resource of resource pool within <i>sl-Period</i> . (see TS 38.213 [3]) Note that this is for Tx pool.
sl-TimeResource-r16 included in SL-ResourcePool in sl-RxPool-r16			11111111111111111111	Indicates the time resource of resource pool within <i>sl-Period</i> . (see TS 38.213 [3]) Note that this is for Rx pool.
sl-NumSubchannel-r16 included in SL-ResourcePool			1	Indicates the number of subchannels in the corresponding resource pool, which consists of contiguous PRBs only
sl-SubchannelSize-r16 included in SL-ResourcePool			10	Indicates the minimum granularity in frequency domain for the sensing for PSSCH resource selection in the unit of PRB
sl-StartRB-Subchannel-r16 included in SL-ResourcePool			10	Indicates the lowest RB index of the subchannel with the lowest index.
Number of Active Sidelink UEs			1	
<i>SL-Thres-RSRP</i>			12	Corresponding -106 dBm as defined in Section 6.3.8 in TS38.331[2]
Active Sidelink UEs	V2X sidelink Communication preconfiguration		As specified in Table A.3.21.2-1 and A.3.21.2-3	IE values unless specified otherwise in this test.
	sl-TimeResource-r16 included in SL-ResourcePool		11111111111111111111	Indicates the bitmap of the TX and Rx resource pool, which is defined by repeating the bitmap within a SFN cycle (see TS 38.213[3])
	sl-NumSubchannel-r16 included in SL-ResourcePool		1	Indicates the number of sub-channels for TX resource pool
	sl-StartRB-Subchannel-r16 included in SL-ResourcePool		10	Indicates the lowest RB index of the subchannel with the lowest index.
	SI-SubchannelSize-r16 included in SL-ResourcePool		10	Indicates the minimum granularity in frequency domain for the sensing for PSSCH resource selection in the unit of PRB
Timing offset among Active Sidelink Ues		μs	CP/2	Synchronous
Note 1: The UE is only required to be tested in one of the supported test configurations.				

**Table A.9.1.4.2.1-2: Active Sidelink UE Specific Test Parameters for V2X UE Resource Pre-emption Tests for PSSCH-RSRP measurements**

Parameter	Unit	Active Sidelink UE	
		T1	T2
NR RF Channel Number	-	1	
Channel Bandwidth ( $BW_{channel}$ ) <sup>Note 3</sup>	MHz	20 ( $N_{RB,c} = 50$ ) or 40 ( $N_{RB,c} = 100$ )	
PSSCH RMC (defined in A.3.21.3)	-	CC.1A HD	
PSSCH RMC (defined in A.3.21.3)	-	CD.1A HD	
$N_{oc}$ <sup>Note1</sup>	dBm/30 kHz	N/A	-100
PSSCH $\hat{E}_s/N_{oc}$	dB		5
PSSCH $\hat{E}_s/N_{oc}$	dB		5
PSSCH $\hat{E}_s/I_{ot}$ <sup>Note2</sup>	dB		5

PSSCH $\hat{E}_s / I_{ot}$ <sup>Note2</sup>	dB		5
PSSCH-RSRP <sup>Note 2</sup>	dBm/30kHz		-95
$I_o$ <sup>Note 2</sup>	dBm/18MHz		-73.01
	dBm/36MHz		-73.01
Antenna Configuration	-	1x2	
Propagation Condition	-	AWGN	
<p>Note 1: Interference from other Ues and noise sources not specified in the test is assumed to be constant over subcarriers and time and shall be modelled as AWGN of appropriate power for <math>N_{oc}</math> to be fulfilled.</p> <p>Note 2: <math>E_s/I_{ot}</math>, PSSCH-RSRP and <math>I_o</math> have been derived from other parameters for information purposes. They are not settable parameters themselves.</p> <p>Note 3: The UE is only required to be tested in one of the supported test configurations.</p>			

#### A.9.1.4.2.2 Test Requirements

The test time T1 and T2 should be long enough. The UE under test is required to trigger resource reselection and not to transmit on the reserved resource at slot n when the high priority reservation is transmitted by the active V2X sidelink UE before  $n - T_{pre-empt}$ , where

$$T_{pre-empt} = T_3 + T_{proc,0}$$

$$T_3 = 5 \text{ slots and } T_{proc,0} = 1 \text{ slot for FR1.}$$

The rate of PSSCH transmissions on the resources at slot n shall be less than 10% during repeated tests.

#### A.9.1.4.3 Test for V2X UE Resource Re-evaluation

##### A.9.1.4.3.1 Test Purpose and Environment

The purpose of this test is to verify the requirements related to autonomous resource re-evaluation for V2X UE in mode 2 defined in clause 12.5. For this test, the UE is triggered by the test loop function or the upper layers to transmit for V2X Sidelink Communication.

The test parameters are given in Table A.9.1.4.3.1-1, A.9.1.4.3.1-2 and A.9.1.4.3.1-3 below. There are 130 active V2X sidelink UEs in this test. The first 100 active V2X sidelink UEs are scheduled with 50ms periodicity. The last 30 active V2X sidelink Ues are aperiodic service UE with retransmission reservation period equaling 15ms.

Both the UE under test and active V2X sidelink Ues select GNSS as synchronization reference source. The test system can emulate and send the GNSS signal to the test UE and active V2X sidelink Ues. The test parameters for GNSS signals are defined in B.4.1.

The test consists of three duration T0, T1, T2.

During T0, the signal from Test Equipment are configured. The resource occupied by the active V2X sidelink UEs is expected to be excluded in the resource selection procedure such that the measured PSSCH-RSRP is above the measurement threshold. The test equipment shall just configure the resource pool for the test UE without the MAC PDU for transmission channel configuration.

During T1, the signal from Test Equipment are configured. Some of the resource occupied by the active V2X sidelink Ues is expected to be excluded in the resource selection procedure such that the measured PSSCH-RSRP is above the measurement threshold and some of the resource occupied by the active V2X sidelink Ues is expected to be included in the resource selection procedure such that the measured PSSCH-RSRP is below the measurement threshold. The test system shall emulate the active V2X sidelink Ues to transmit PSCCH/PSSCH every 50ms according to the RSRP level specified in the Table A. 9.1.4.3.1-2, but UE #0~29 will be silent during T2

At the end of T1, where slot index mod 100 = 99, the test equipment shall send one message with a SL-SCH MAC PDU as specified in Clause 6.1.6 in TS 38.321[7], in order to make sure that the UE under test shall be scheduled to periodically transmit PSCCH/PSSCH.

During T2, the additional aperiodic active V2X sidelink UEs from Test Equipment are configured in the beginning 30 slots, and the resource occupied by these active V2X sidelink UEs is expected to be excluded in the resource re-evaluation procedure such that the measured PSSCH-RSRP is above the measurement threshold shown in Table A.

9.1.4.3.1-2. The test system shall emulate the active V2X sidelink UEs to transmit PSCCH/PSSCH with the maximum number of reserved PSCCH/PSSCH resources equalling  $n2$  and time resource assignment interval as 15ms.

During T2, the test UE is expected to reselect the resources and transmit the PSCCH/PSSCH in the newly re-evaluated resources.

**Table A.9.1.4.3.1-1: Test Parameters for V2X UE Resource Selection Tests for Re-evaluation**

Parameter		Unit	Value	Comment
NR RF Channel Number			1	HD carrier in Band n47 and n38
Channel Bandwidth ( $BW_{\text{channel}}$ ) <sup>Note 2</sup>		MHz	20 ( $N_{RB,c} = 50$ ) or 40 ( $N_{RB,c} = 100$ )	
SCS		kHz	30	
V2X sidelink communication pre-configuration			As specified in Table A.3.21.2-2	IE values unless specified otherwise in this test.
sl-TimeResource-r16 included in SL-ResourcePool			11111111111111111111 11111111111111111111 11111111111111111111 11111111111111111111 11111111111111111111	Indicates the bitmap of the TX and Rx resource pool, which is defined by repeating the bitmap within a SFN cycle (see TS 38.213[3])
sl-NumSubchannel-r16 included in SL-ResourcePool			1	Indicates the number of sub-channels for TX resource pool
sl-SubchannelSize-r16 included in SL-ResourcePool			10	
sl-StartRB-Subchannel-r16			0	
Number of Active Sidelink UEs			130	Active Sidelink UE $i = 0, \dots, 129$
SL-Thres-RSRP-r16			17	Corresponding -96 dBm as defined in Section 6.3.5 in TS38.331[2]
Active Sidelink UEs(UE $i=0-99$ )	V2X sidelink Communication preconfiguration		As specified in Table A.3.21.2-2	IE values unless specified otherwise in this test.
	sl-TimeResource-r16 included in SL-ResourcePool		{1 <sub>i</sub> } <sup>Note1</sup>	Indicates the bitmap of the TX resource pool, which is defined by repeating the bitmap within a SFN cycle (see TS 38.213 [3])
	sl-NumSubchannel-r16 included in SL-ResourcePool		1	Indicates the number of sub-channels for TX resource pool
	sl-SubchannelSize-r16 included in SL-ResourcePool		10	Indicates the size of sub-channels for TX resource pool
	sl-ResourceReservePeriod 2-r16	ms	50	
Active Sidelink UEs(UE $i=100-129$ )	V2X sidelink Communication preconfiguration		As specified in Table A.3.21.2-2	IE values unless specified otherwise in this test.
	sl-TimeResource-r16 included in SL-ResourcePool		{1 <sub>i</sub> } <sup>Note1</sup>	Indicates the bitmap of the TX resource pool, which is defined by repeating the bitmap within a SFN cycle (see TS 38.213 [3])
	sl-NumSubchannel-r16 included in SL-ResourcePool		1	Indicates the number of sub-channels for TX resource pool
	sl-SubchannelSize included in SL-ResourcePool		10	Indicates the size of sub-channels for TX resource pool
	sl-MultiReserveResource-r16		enabled	
	sl-MaxNumPerReserve-r16		$n2$	
	sl-ResourceReservePeriod 2-r16		0	Unit:ms

Timing offset among Active Sidelink UEs	$\mu\text{s}$	CP/2	Synchronous
T0	s	1	
T1	ms	50	
T2	ms	50	
Note 1: $\{1_i\}$ is a sequence of ninety-nine 0's with one 1 in $(\text{mod}(i,100)+1)$ 'th position. Note 2: The UE is only required to be tested in one of the supported test configurations.			

**Table A.9.1.4.3.1-2: Active Sidelink UE Specific Test Parameters for V2X UE Resource Selection Tests for Re-evaluation (UE #0...99)**

Parameter	Unit	Active Sidelink UE $i$ ( $i = 0, \dots, 99$ )	
		T1	T2
NR RF Channel Number	-	1	
Channel Bandwidth ( $BW_{\text{channel}}$ ) <sup>Note 7</sup>	MHz	20 ( $N_{RB,c} = 50$ ) or 40 ( $N_{RB,c} = 100$ )	
PSCCH RMC (defined in A.3.21.3)	-	CC.1A HD	
PSSCH RMC (defined in A.3.21.3)	-	CD.1A HD	
$N_{oc}$ <sup>Note1</sup>	dBm/SCS	-103	
PSSCH1 $\hat{E}_s/N_{oc}$ <sup>Note 3</sup>	dB	25.5	25.5
PSSCH2 $\hat{E}_s/N_{oc}$ <sup>Note 4</sup>	dB	2	2
PSSCH3 $\hat{E}_s/N_{oc}$ <sup>Note 5</sup>	dB	12	-infinity
PSSCH4 $\hat{E}_s/N_{oc}$ <sup>Note 6</sup>	dB	12	12
PSSCH1 $\hat{E}_s/I_{ot}$ <sup>Note2,3,10</sup>	dB	25.5	-0.01
PSSCH1 $\hat{E}_s/I_{ot}$ <sup>Note2,3,11</sup>	dB	25.5	25.5
PSSCH2 $\hat{E}_s/I_{ot}$ <sup>Note2,4</sup>	dB	2	-23.51
PSSCH3 $\hat{E}_s/I_{ot}$ <sup>Note2,5</sup>	dB	12	-infinity
PSSCH4 $\hat{E}_s/I_{ot}$ <sup>Note2,6</sup>	dB	12	12
PSSCH -RSRP1 <sup>Note 2, 3</sup>	dBm/SCS	-77.5	-77.5
PSSCH -RSRP2 <sup>Note 2, 4</sup>	dBm/SCS	-101	-101
PSSCH -RSRP3 <sup>Note 2, 5</sup>	dBm/SCS	-91	-infinity
PSSCH -RSRP4 <sup>Note 2, 6</sup>	dBm/SCS	-91	-91
$Io$ <sup>Note 2, 8</sup>	dBm/18 MHz	-69.94	-56.70
	dBm/36 MHz	-69.94	-56.70
$Io$ <sup>Note 2, 9</sup>	dBm/18 MHz	-78.08	-56.68
	dBm/36 MHz	-78.08	-56.68
$Io$ <sup>Note 2, 10</sup>	dBm/18 MHz	-56.70	-53.69
	dBm/36 MHz	-56.70	-53.69
$Io$ <sup>Note 2, 11</sup>	dBm/18 MHz	-56.70	-56.70
	dBm/36 MHz	-56.70	-56.70
$Io$ <sup>Note 2, 12</sup>	dBm/18 MHz	-69.94	-69.94
	dBm/36 MHz	-69.94	-69.94
Antenna Configuration	-	1x2	
Propagation Condition	-	AWGN	



Note 1:	Interference from other UEs and noise sources not specified in the test is assumed to be constant over subcarriers and time and shall be modelled as AWGN of appropriate power for $N_{oc}$ to be fulfilled.
Note 2:	$\hat{E}_s/I_{ot}$ , PSSCH-RSRP and $I_o$ levels have been derived from other parameters for information purposes. They are not settable parameters themselves.
Note 3:	UE #50~64 and UE #85~99 will periodically occupy the subchannels on the slot with “#slot index mod 100” = #50-64 and #85-99.
Note 4:	UE #30~49 will periodically occupy the subchannels on the slot with “#slot index mod 100” = #30-49.
Note 5:	UE #0~29 will periodically occupy the subchannels on the slot with “#slot index mod 100” = #0-29.
Note 6:	UE #65~84 will periodically occupy the subchannels on the slot with “#slot index mod 100” = #65-84.
Note 7:	The UE is only required to be tested in one of the supported configurations.
Note 8:	Calculated on slot with “#slot index mod 100” = #0~29.
Note 9:	Calculated on slot with “#slot index mod 100” = #30~49.
Note 10:	Calculated on slot with “#slot index mod 100” = #50~59.
Note 11:	Calculated on slot with “#slot index mod 100” = #60~64 and #85~99.
Note 12:	Calculated on slot with “#slot index mod 100” = #65~84.

**Table A.9.1.4.3.1-3: Active Sidelink UE Specific Test Parameters for V2X UE Resource Selection Tests for Re-evaluation (UE #100...129)**

Parameter	Unit	Active Sidelink UE i (i = 100, ..., 129)	
		T1	T2
NR RF Channel Number	-	1	
Channel Bandwidth ( $BW_{channel}$ ) <sup>Note 4</sup>	MHz	20 ( $N_{RB,c} = 50$ ) or 40 ( $N_{RB,c} = 100$ )	
PSSCH RMC (defined in A.3.21.3)	-	CC.1A HD	
PSSCH RMC (defined in A.3.21.3)	-	CD.1 A HD	
$N_{oc}$ <sup>Note1</sup>	dBm/SCS	-103	
PSSCH $\hat{E}_s/N_{oc}$	dB	-infinity	25.5
PSSCH $\hat{E}_s/I_{ot}$ <sup>Note2,5</sup>	dB	-infinity	25.5
PSSCH $\hat{E}_s/I_{ot}$ <sup>Note2,6</sup>		-infinity	21.38
PSSCH $\hat{E}_s/I_{ot}$ <sup>Note2,7</sup>		-infinity	-0.11
PSSCH-RSRP <sup>Note 2, Note 3</sup>	dBm/SCS	-infinity	-77.5
$I_o$ <sup>Note 2, 5</sup>	dBm/18 MHz	-69.94	-56.70
	dBm/36 MHz	-69.94	-56.70
$I_o$ <sup>Note 2, 6</sup>	dBm/18 MHz	-78.08	-56.68
	dBm/36 MHz	-78.08	-56.68
$I_o$ <sup>Note 2, 7</sup>	dBm/18 MHz	-56.70	-53.69
	dBm/36 MHz	-56.70	-53.69
Antenna Configuration	-	1x2	
Propagation Condition	-	AWGN	
Note 1:	Interference from other UEs and noise sources not specified in the test is assumed to be constant over subcarriers and time and shall be modelled as AWGN of appropriate power for $N_{oc}$ to be fulfilled.		
Note 2:	$E_s/I_{ot}$ , PSSCH-RSRP and $I_o$ levels have been derived from other parameters for information purposes. They are not settable parameters themselves.		
Note 3:	UE #100~129 will occupy the subchannels on the slots with “#slot index mod 100”= #0-29 during T2.		
Note 4:	The UE is only required to be tested in one of the supported configurations.		
Note 5:	Calculated on slot with “#slot index mod 100” = #0~29.		
Note 6:	Calculated on slot with “#slot index mod 100” = #30~49.		
Note 7:	Calculated on slot with “#slot index mod 100” = #50~59.		

**A.9.1.4.3.2 Test Requirements**

The rate of PSSCH transmissions on the resources of the subchannels which are occupied by UE #65-84 shall be more than 90% during T2.

## A.9.1.5 Test for Congestion Control Measurement

### A.9.1.5.1 Test Purpose and Environment

The purpose of this test is to verify the congestion control measurement requirements in section 12.6. For UE supporting NR Uu and sidelink operation, this test will also verify that V2X UE makes correct reporting of an event.

The test parameters are given in Table A.9.1.5.1-1, Table A.9.1.5.1-2, A.9.1.5.1-3 and A.9.1.5.1-4 below. There are 4 active V2X sidelink UEs in this test. The test system shall emulate the active sidelink UE to transmit PSCCH/PSSCH every 50ms. Additionally, For UE supporting NR Uu and sidelink operation, there is an active Cell (Cell 1) in this test. For UE only supporting NR sidelink, There are no active cell and GNSS is reliable during the whole test. The test system can emulate and send the GNSS signal to the test UE. The test parameters for GNSS signals are defined in B.4.1.

The test consists of two successive time periods, with time duration of T1, and T2 respectively. During T1, all of active V2X sidelink UEs are configured to transmit PSCCH/PSSCH with lower transmission power every 50ms. During T2, all of active V2X sidelink UEs are configured to transmit PSCCH/PSSCH with higher transmission power every 50ms.

For UE supporting NR Uu and sidelink operation, the UE under test and all active sidelink UEs select PCell as synchronization source. In the measurement control information it is indicated to the V2X UE that event-triggered reporting with Event C1 is used.

For UE only supporting NR sidelink, the UE under test and all active sidelink UEs select GNSS as synchronization source. The UE is triggered by the test loop function or the upper layers to transmit for V2X Sidelink Communication.

For UE supporting NR Uu and sidelink operation, Supported test configurations for FR1 NR cell are shown in Table A.9.1.5.1.1-1.

**Table A.9.1.5.1.1-1: Supported Test Configurations for FR1 NR cell (only for UE supporting both NR Uu and sidelink operation)**

Configuration	Description
1	NR Uu: FDD, SSB SCS 15 kHz, data SCS 15 kHz, BW 10 MHz
2	NR Uu: TDD, SSB SCS 15 kHz, data SCS 15 kHz, BW 10 MHz
3	NR Uu: TDD, SSB SCS 30 kHz, data SCS 30 kHz, BW 40 MHz
Note:	The UE is only required to pass in one of the supported test configurations in FR1

**Table A.9.1.5.1-2: General test parameters for Congestion Control Measurement Test for V2X UE**

Parameter	Unit	Value	Comment
NR RF Channel Number		1	HD carrier in Band n47 or n38
Channel Bandwidth ( $BW_{\text{channel}}$ ) <sup>Note 2</sup>	MHz	20 ( $N_{RB,c} = 50$ ) or 40 ( $N_{RB,c} = 100$ )	
SCS	kHz	30	
V2X sidelink communication configuration		As specified in Table A.3.21.2-1 and A.3.21.2-3	IE values unless specified otherwise in this test.
sl-TimeResource-r16 included in SL-ResourcePool		11111111111111111111 11111111111111111111 11111111111111111111 11111111111111111111 11111111111111111111	Indicates the bitmap of the TX and Rx resource pool, which is defined by repeating the bitmap within a SFN cycle (see TS 38.213[3])
sl-NumSubchannel-r16 included in SL-ResourcePool		1	ENUMERATED {n1}
sl-SubchannelSize included in SL-ResourcePool		10	ENUMERATED {n10}
sl-StartRB-Subchannel-r16		0	
<i>threshS-RSSI-CBR</i>		19	Corresponding -74dBm as defined in Section 6.3.8 in TS38.331[2]
Active Cell <sup>Note 3</sup>		Cell 1	
Number of Active Sidelink UEs every 50ms		4	Active Sidelink UE $i$ , where $i = 0, 1, 2, 3$

Active Sidelink UEs ( $i = 0, 1, 2, 3$ )	V2X sidelink Communication configuration		As specified in Table A.3.21.2-1 and A.3.21.2-3	IE values unless specified otherwise in this test.
	sl-TimeResource-r16 included in SL-ResourcePool		{1 <sub>i</sub> } <sup>Note 1</sup>	Indicates the bitmap of the TX and Rx resource pool, which is defined by repeating the bitmap within a SFN cycle (see TS 38.213[3])
	sl-NumSubchannel-r16 included in SL-ResourcePool		1	
	sl-SubchannelSize included in SL-ResourcePool		10	
Timing offset between V2X UE and Active Sidelink UEs		$\mu\text{s}$	CP/2	Synchronous
c1-Threshold-r16 <sup>Note 3</sup>			2	Corresponding 0.02 as defined in Section 6.3.2 in TS38.331[2]
sl-CBR-RangeConfigList-r16 <sup>Note 4</sup>			[2 100]	Two ranges are defined by this list: 0 to 0.02 and 0.02 to 1
sl-CR-Limit-r16 <sup>Note 4</sup>			10000 and 10	Corresponding to the two CBR ranges: if CBR > 0.02, CR $\leq$ 0.001, otherwise CR > 0.001
sl-Thres-RSRP-r16 <sup>Note 4</sup>			12	Configure threshold < -98.64dBm/30kHz to ensure not blocking transmission
Hysteresis			0	
Time To Trigger		s	0	
Filter coefficient			0	L3 filtering is not used
T1		s	5	
T2		s	5	
Note 1: {1 <sub>i</sub> } is a sequence of ninety nine 0's with one 1 in i+1'th position.				
Note 2: The UE is only required to be tested in one of the channel bandwidths.				
Note 3: Only for UE supporting both Uu and sidelink operation.				
Note 4: Only for UE supporting sidelink operation but not supporting Uu.				

**Table A.9.1.5.1-3: Active sidelink UE specific test parameters for Congestion Control Measurement Test for V2X UE**

Parameter	Unit	Active Sidelink UE $i$ ( $i = 0, 1, 2, 3$ )	
		T1	T2
NR RF Channel Number		1	
Channel Bandwidth ( $BW_{\text{channel}}$ ) <sup>Note 7</sup>	MHz	20 ( $N_{RB,c} = 50$ ) or 40 ( $N_{RB,c} = 100$ )	
PSCCH RMC (defined in A.3.21.3)		CC.1A HD	
PSSCH RMC (defined in A.3.21.3)		CD.1A HD	
$N_{oc}$ <sup>Note 1</sup>	dBm/30 kHz	-103	
$\hat{E}_s/N_{oc}$	dB	4.35	10.32
SL-RSSI1 <sup>Note 2,3</sup>	dBm/3.6 MHz	-76.5	-71.5
SL-RSSI2 <sup>Note 2,4</sup>	dBm/3.6 MHz	-82.21	-82.21
Io1 <sup>Note 2,5</sup>	dBm/18 MHz	-76.5	-71.5
	dBm/36 MHz	-76.5	-71.5
Io2 <sup>Note 2,6</sup>	dBm/18 MHz	-82.21	-82.21
	dBm/36 MHz	-82.21	-82.21
Propagation Condition	-	AWGN	

Note 1:	Interference from other UEs and noise sources not specified in the test is assumed to be constant over subcarriers and time and shall be modelled as AWGN of appropriate power for $N_{oc}$ to be fulfilled.
Note 2:	SL-RSSI1, SL-RSSI2, lo1 and lo2 levels have been derived from other parameters for information purposes. They are not settable parameters themselves.
Note 3:	SL-RSSI1 is the SL-RSSI level measured on the slot# 0 - 3 with "SFN mod 5 = 0".
Note 4:	SL-RSSI2 is the SL-RSSI level measured on the slot# 4-9 with "SFN mod 5 = 0" and the slot# 0-9 with "SFN mod 5 = 1,..., 4".
Note 5:	lo1 is the lo level measured on the slot# 0 - 3 with "SFN mod 5 = 0".
Note 6:	lo2 is the lo level measured on the slot# 4-9 with "SFN mod 5 = 0" and the slot# 0-9 with "SFN mod 5 = 1,..., 4".
Note 7:	The UE is only required to be tested in one of the supported test configurations.

**Table A.9.1.5.1-4: Cell Test Parameters for Congestion Control Measurement Test for V2X UE (only for UE supporting both NR Uu and sidelink operation)**

Parameter		Unit	Cell 1
RF Channel Number			2
Duplex Mode	Config 1		FDD
	Config 2,3		TDD
TDD configuration	Config 1		Not Applicable
	Config 2		TDDConf.1.1
	Config 3		TDDConf.2.1
Channel Bandwidth ( $BW_{channel}$ )	Config 1,2	MHz	10: $N_{RB,c} = 52$
	Config 3		40: $N_{RB,c} = 106$
Initial BWP Configuration			DLBWP.0.1 ULBWP.0.1
Dedicated BWP Configuration			DLBWP.1.1 ULBWP.1.1
DRX Cycle			N/A
PDSCH Reference measurement channel	Config 1		SR.1.1 FDD
	Config 2		SR.1.1 TDD
	Config 3		SR.2.1 TDD
CORESET Reference Channel	Config 1		CR.1.1 FDD
	Config 2		CR.1.1 TDD
	Config 3		CR.2.1 TDD
Dedicated CORESET Reference Channel	Config 1		CCR.1.1 FDD
	Config 2		CCR.1.1 TDD
	Config 3		CCR.2.1 TDD
SSB configuration	Config 1,2		SSB.1 FR1
	Config 3		SSB.2 FR1
SMTc Configuration			SMTc.2
OCNG Patterns			OP.1
EPRE ratio of PSS to SSS		dB	0
EPRE ratio of PBCH DMRS to SSS			
EPRE ratio of PBCH to PBCH DMRS			
EPRE ratio of PDCCH DMRS to SSS			
EPRE ratio of PDCCH to PDCCH DMRS			
EPRE ratio of PDSCH DMRS to SSS			
EPRE ratio of PDSCH to PDSCH			
EPRE ratio of OCNG DMRS to SSS(Note 1)			
EPRE ratio of OCNG to OCNG DMRS (Note 1)			
$N_{oc}$ Note2	Config 1,2,3		
$N_{oc}$ Note2	Config 1,2	dBm/SCS	-98
	Config 3		-95
$\hat{E}_s / N_{oc}$		dB	3
SS-RSRP Note3	Config 1,2	dBm/SCS	-95
	Config 3		-92
lo Note 3	Config 1,2	dBm/9.36 MHz	-65.2
	Config 3	dBm/38.1 MHz	-59.2
Propagation Condition			AWGN

Note 1:	OCNG shall be used such that cell is fully allocated and a constant total transmitted power spectral density is achieved for all OFDM symbols.
Note 2:	Interference from other cells and noise sources not specified in the test is assumed to be constant over subcarriers and time and shall be modelled as AWGN of appropriate power for $N_{oc}$ to be fulfilled.
Note 3:	SS-RSRP levels have been derived from other parameters for information purposes. They are not settable parameters themselves.

### A.9.1.5.2 Test Requirements

For UEs that support NR Uu and sidelink operation, the UEs shall not send event C1 triggered measurement reports during T1 and shall send event C1 triggered measurement reports during T2.

For UEs that support sidelink operation only, the UE channel occupancy ratio shall be larger than 0.001 during T1, and the UE channel occupancy ratio shall be no larger than 0.001 during T2.

The rate of correct events observed during repeated tests shall be at least 98%.

### A.9.1.6 Test for Interruption

#### A.9.1.6.1 Test for Interruption to WAN due to V2X Sidelink Communication

##### A.9.1.6.1.1 Test Purpose and Environment

The purpose of this test is to verify the requirements related to interruptions due to V2X sidelink communication defined in clause 12.7.1 under the following additional conditions:

- The UE is out of coverage on the V2X sidelink carrier and is associated with a serving cell on a non-V2X sidelink carrier

This test is applicable for V2X sidelink communication capable UEs that support inter-band concurrent V2X sidelink operation.

For this test, the UE is triggered by the test loop function or the upper layers to monitor V2X sidelink communication.

The test parameters are given in Table A.9.1.6.1.1-1, Table A.9.1.6.1.1-2, Table A.9.1.6.1.1-3 and Table A.9.1.6.1.1-4. The test consists of one active cell (PCell) on the serving RF channel 1, and there are no active cells on RF channel 2. On RF channel 2, the test consists of 8 active Sidelink UEs in this test transmitting V2X sidelink communication. The UE under test and all active sidelink UEs select the active cell as synchronization source.

The test consists of three successive time periods, with time duration of T1, T2 and T3 respectively.

During T1, the UE is in RRC\_IDLE and monitoring the V2X sidelink communication transmission from other active Sidelink UEs on the V2X sidelink communication resources.

During T2, the test system establishes a RRC connection with the UE. No PDSCH traffic is scheduled for UE, and the UE is expected to transmit *SidelinkUEInformationNR* indicating *sl-RxInterestedFreqList*. On reception of *SidelinkUEInformationNR*, the test system shall send RRC reconfiguration message to the UE and wait for the UE to respond with RRC reconfiguration complete message before transitioning to T3. If the UE does not transmit *SidelinkUEInformationNR* for up to 2 second, the test system shall transition to T3.

During T3, the UE is scheduled with PDSCH traffic on PCell downlink. The test system will count the missed ACK/NACKs during T3 to verify the allowed interruptions during V2X sidelink communication.

**Table A.9.1.6.1.1-1: Supported test configurations for FR1 PCell**

Configuration	Description
1	NR Uu: FDD, SSB SCS 15 kHz, data SCS 15 kHz, BW 10 MHz
2	NR Uu: TDD, SSB SCS 15 kHz, data SCS 15 kHz, BW 10 MHz
3	NR Uu: TDD, SSB SCS 30 kHz, data SCS 30 kHz, BW 40 MHz
Note:	The UE is only required to pass in one of the supported test configurations in FR1

**Table A.9.1.6.1.1-2: Test Parameters for Interruptions due to V2X Sidelink Communication**

Parameter	Unit	Value	Comment
RF Channel Number	-	1, 2	RF channel 1 is non-V2X sidelink carrier RF channel 2 is V2X sidelink carrier
SCS	kHz	30	
Active cell	-	Cell 1	PCell on RF channel number 1
CP length of Cell 1	-	Normal	
T1	s	5.12	
T2	s	Up to receiving RRC reconfiguration setup complete from the UE, or up to 2 second if UE does not transmit <i>SidelinkUEInformationNR</i> during this period.	
T3	s	10	

**Table A.9.1.6.1.1-3: Slidelink Communication Configuration for Interruptions due to V2X Sidelink Communication**

Parameter	Unit	Value	Comment	
RF Channel Number	-	2	HD carrier in Band n47 or n38	
Channel Bandwidth ( $BW_{channel}$ ) <sup>Note 1</sup>	MHz	20 ( $N_{RB,c} = 50$ ) or 40 ( $N_{RB,c} = 100$ )		
V2X sidelink Communication configuration	-	As specified in section A.3.21.2	IE values unless specified otherwise in this test.	
Number of Active Sidelink UEs	-	8	Active Sidelink UE $i = 0, \dots, 7$	
Active Sidelink UEs (UE $i = 0, \dots, 7$ )	V2X sidelink Communication configuration	-	As specified in section A.3.21.2	IE values unless specified otherwise in this test.
	PSCCH Reference Measurement Channel	-	CC.1A HD	As specified in Table A.3.21.3-1
	PSSCH Reference Measurement Channel	-	CD.1A HD	As specified in Table A.3.21.3-2
	sl-NumSubchannel-r16 included in SL-ResourcePool	-	1	Indicates the number of sub-channels for TX resource pool
	sl-StartRB-Subchannel-r16 included in SL-ResourcePool	-	$i$	Indicates the lowest RB index of the subchannel with the lowest index for active Sidelink UE $i = 0, \dots, 7$ .
	PSBCH-RSRP	dBm/30kHz	-95	

Note 1: The UE is only required to be tested in one of the supported test configurations.

**Table A.9.1.6.1.1-4: Cell specific test parameters for interruptions due to V2X sidelink communication**

Parameter	Unit	Cell 1		
		T1	T2	T3
RF Channel Number		1		
UE RRC state		IDLE	CONNECTED	
Duplex Mode	Config 1	FDD		
	Config 2,3	TDD		
TDD configuration	Config 1	Not Applicable		
	Config 2	TDDConf.1.1		
	Config 3	TDDConf.2.1		
Channel Bandwidth ( $BW_{channel}$ )	Config 1,2	MHz	10: $N_{RB,c} = 52$	
	Config 3		40: $N_{RB,c} = 106$	
Initial BWP Configuration		DLBWP.0.1 ULBWP.0.1		

Dedicated BWP Configuration			DLBWP.1.1 ULBWP.1.1
DRX Cycle			N/A
PDSCH Reference measurement channel	Config 1		N/A
	Config 2		None
	Config 3		SR.1.1 FDD SR.1.1 TDD SR.2.1 TDD
CORESET Reference Channel	Config 1		CR.1.1 FDD
	Config 2		CR.1.1 TDD
	Config 3		CR.2.1 TDD
Dedicated CORESET Reference Channel	Config 1		CCR.1.1 FDD
	Config 2		CCR.1.1 TDD
	Config 3		CCR.2.1 TDD
SSB configuration	Config 1,2		SSB.1 FR1
	Config 3		SSB.2 FR1
SMTTC Configuration			SMTTC.2
OCNG Patterns			OP.1
EPRE ratio of PSS to SSS		dB	0
EPRE ratio of PBCH DMRS to SSS			
EPRE ratio of PBCH to PBCH DMRS			
EPRE ratio of PDCCH DMRS to SSS			
EPRE ratio of PDCCH to PDCCH DMRS			
EPRE ratio of PDSCH DMRS to SSS			
EPRE ratio of PDSCH to PDSCH			
EPRE ratio of OCNG DMRS to SSS(Note 1)			
EPRE ratio of OCNG to OCNG DMRS (Note 1)			
$N_{oc}$ <sup>Note2</sup>	Config 1,2,3		
$N_{oc}$ <sup>Note2</sup>	Config 1,2	dBm/SCS	-98
	Config 3		-95
$\hat{E}_s / N_{oc}$		dB	3
SS-RSRP <sup>Note3</sup>	Config 1,2	dBm/SCS	-95
	Config 3		-92
$I_o$ <sup>Note 3</sup>	Config 1,2	dBm/9.36 MHz	-65.3
	Config 3	dBm/38.1 MHz	-59.2
Antenna Configuration			1x2
Propagation Condition			AWGN
<p>Note 1: OCNG shall be used such that cell is fully allocated and a constant total transmitted power spectral density is achieved for all OFDM symbols.</p> <p>Note 2: Interference from other cells and noise sources not specified in the test is assumed to be constant over subcarriers and time and shall be modelled as AWGN of appropriate power for <math>N_{oc}</math> to be fulfilled.</p> <p>Note 3: SS-RSRP levels have been derived from other parameters for information purposes. They are not settable parameters themselves.</p>			

#### A.9.1.6.1.2 Test Requirements

The UE shall be continuously scheduled on PCell on RF channel 1 during T3. During T3, the interruption on PCell shall not be more than the values specified in clause 12.7.1..

## A.10 EN-DC Tests with NR PSCell under CCA and Other NR Cells in FR1

*Editor's note: Test cases for EN-DC with NR PSCell under CCA and SCell under CCA are also included here.*

## A.10.1 RRC\_CONNECTED state mobility

### A.10.1.1 RRC connection mobility control

#### A.10.1.1.1 Random Access

##### A.10.1.1.1.1 4-step RA type contention-based random access for NR PSCell with CCA

###### A.10.1.1.1.1.1 Test Purpose and Environment

The purpose of this test is to verify that the behavior of the random access procedure is according to the requirements and that the PRACH power settings and timing are within specified limits when subject to CCA. This test will verify the requirements in clause 6.2.2A.2 and clause 7.1.2 in an AWGN model.

For this test two cells are used, with the configuration of Cell 1 (E-UTRA PCell) specified in clause A.3.7A.2.1 and Cell 2 configured as PSCell in FR1. Cell 1 is on a licensed band and cell 2 is subjected to CCA. Supported test parameters are shown in Table A.10.1.1.1.1-1. UE capable of EN-DC with PSCell in FR1 needs to be tested by using the parameters in Table A.10.1.1.1.1-2.

**Table A.10.1.1.1.1-1: Supported test configurations for contention based random access test in FR1 for PSCell with CCA**

Config	Description
1	LTE FDD, NR 30 kHz SSB SCS, 40 MHz bandwidth, TDD duplex mode
2	LTE TDD, NR 30 kHz SSB SCS, 40 MHz bandwidth, TDD duplex mode
Note: The UE is only required to be tested in one of the supported test configurations depending on UE capability	

**Table A.10.1.1.1.1-2: General test parameters for contention based random access test in FR1 for PSCell with CCA**

Parameter		Unit	Test-1	Comments	
SSB Configuration	Note 4, 6	Config 1,2	SSB.1 CCA	As defined in A.3.10A	
	Note 5, 6	Config 1,2	SSB.2 CCA	As defined in A.3.10A	
DBT Window Configuration		Config 1,2	DBT.1	As specified in A.3.28.1	
DL CCA model		Config 1,2	As specified in A.3.26.2.1		
UL CCA model		Config 1,2	As specified in A.3.26.2.2		
Duplex Mode for Cell 2		Config 1,2	TDD		
TDD Configuration		Config 1,2	TDDConf.1.1 CCA		
OCNG Pattern <sup>Note 1</sup>			OCNG pattern 1	As defined in A.3.2.1.	
PDSCH parameters <sup>Note 3</sup>		Config 1,2	SR.1.1 CCA	As defined in A.3.1A.1.	
NR RF Channel Number			1		
EPRE ratio of PSS to SSS		dB	0		
EPRE ratio of PBCH_DMRS to SSS		dB			
EPRE ratio of PBCH to PBCH_DMRS		dB			
EPRE ratio of PDCCH_DMRS to SSS		dB			
EPRE ratio of PDCCH to PDCCH_DMRS		dB			
EPRE ratio of PDSCH_DMRS to SSS		dB			
EPRE ratio of PDSCH to PDSCH_DMRS		dB			
SSB with index 0	$\hat{E}_s / I_{ot}$		dB	3	Power of SSB with index 0 is set to be above configured <i>rsrp-ThresholdSSB</i>
	$N_{oc}$	Config 1,2	dBm/15kHz	-101	
	$\hat{E}_s / N_{oc}$		dB	3	
	SS-RSRP		dBm/ SCS	-95	
SSB with index 1	$\hat{E}_s / I_{ot}$		dB	-17	Power of SSB with index 1 is set to be below



				configured <i>rsrp-ThresholdSSB</i>
	$N_{oc}$	Config 1,2	dBm/15kHz	-101
	$\hat{E}_s/N_{oc}$		dB	-17
	SS-RSRP		dBm/ SCS	-115
$I_o$ <small>Note 2</small>		Config 1,2	dBm	-62.2/38.16MHz
ss-PBCH-BlockPower			dBm/ SCS	-5
Configured UE transmitted power ( $P_{CMAX, f, c}$ )			dBm	23
PRACH Configuration				FR1 PRACH configuration 1 under CCA
DL CCA probability	Note 4, 6			0.9375
$P_{CCA\_DL}$	Note 5, 6			0.75 / 0.75
$L_{CCA\_DL}$ <small>Note 7</small>				4
$W_{CCA\_DL}$ <small>Note 8</small>				Inf
UL CCA probability	Note 4, 6			0.87
$P_{CCA\_UL}$	Note 5, 6			0.75
$L_{CCA\_UL}$ <small>Note 7</small>				5
$W_{CCA\_UL}$ <small>Note 8</small>				Inf
Semi-static channel access config period <small>Note 4, 6</small>			ms	2
Propagation Condition			-	AWGN
<p>Note 1: OCNG shall be used such that the cell is fully allocated and a constant total transmitted power spectral density is achieved for all OFDM symbols. The OCNG pattern is chosen during the test according to the presence of a DL reference measurement channel.</p> <p>Note 2: SS-RSRP, <math>E_s/I_{ot}</math> and <math>I_o</math> levels have been derived from other parameters for information purpose. They are not settable parameters.</p> <p>Note 3: The DL PDSCH reference measurement channel is used in the test only when a downlink transmission dedicated to the UE under test is required.</p> <p>Note 4: For UE supporting semi-static channel access and network configuring semi-static channel occupancy.</p> <p>Note 5: For UE supporting dynamic channel access and network configuring dynamic channel occupancy. The first value corresponds <math>P_{CCA\_DL1}</math> and the second value corresponds to the <math>P_{CCA\_DL2}</math>.</p> <p>Note 6: For UE supporting both semi-static and dynamic channel access, the UE must be tested under both dynamic channel occupancy and semi-static channel occupancy configuration.</p> <p>Note 7: <math>L_{CCA\_DL}</math> and <math>L_{CCA\_UL}</math> are chosen such that <math>preambleTransMax &gt; 5 + L_{CCA\_DL} + L_{CCA\_UL}</math>.</p> <p>Note 8: A window <math>W_{CCA\_DL}=W_{CCA\_UL}=Inf</math> is used to indicate that <math>L_{CCA\_DL}</math> and <math>L_{CCA\_UL}</math> are considered during the entire duration of a test run.</p>				

#### A.10.1.1.1.1.2 Test Requirements

Contention based random access is triggered by *not* explicitly assigning a random access preamble via dedicated signalling in the downlink.

##### A.10.1.1.1.1.2.1 Random Access Preamble Transmission

To test the UE behavior specified in Clause 6.2.2A.2.1.1 the System Simulator shall receive the Random Access Preamble which belongs to one of the Random Access Preambles associated with the SSB with index 0, which has SS-RSRP above the configured *rsrp-ThresholdSSB*, if the UL CCA is successful.

The three requirements below are relevant for all cases of PRACH transmissions described within the whole clause A.10.1.1.1.1.2:

- The System Simulator shall implement the UL CCA model of A.3.26.2 for the RACH occasions where PRACH transmissions are expected. The System Simulator shall monitor the RACH occasions to detect if the UE is transmitting PRACH preambles. If a PRACH transmission is detected on a RACH occasion that is expected to have UL CCA failure, the test is considered as failed.
- In case of CCA DL failure, the test equipment should verify that the UE does not transmit PRACH for semi-static channel access mode; for dynamic channel access mode it is assumed that RACH occasions are always scheduled within a UE-initiated COT.

- In case of UL CCA failure, The UE shall again perform the Random Access Resource selection procedure specified in clause 5.1.2 in TS38.321 [7], and transmit with the calculated PRACH transmission power.

In addition, the power applied to all preambles shall be in accordance with what is specified in Clause 6.2.2A.2. The power of the first preamble shall be -16 dBm with an accuracy specified in clause 6.3.4.2 of TS 38.101-1 [18]. The relative power applied to additional preambles shall have an accuracy specified in clause 6.3.4.3 of TS 38.101-1 [18].

The transmit timing of all PRACH transmissions shall be within the accuracy specified in Clause 7.1.2.

#### A.10.1.1.1.2.2 Random Access Response Reception

To test the UE behavior specified in Clause 6.2.2A.2.1.2 the System Simulator shall transmit a Random Access Response containing a Random Access Preamble identifier corresponding to the transmitted Random Access Preamble after 5 preambles have been received by the System Simulator. In response to the first 4 preambles, the System Simulator shall transmit a Random Access Response *not* corresponding to the transmitted Random Access Preamble. In case of CCA DL failure, the test equipment should delay the transmission of Random Access Response.

The UE may stop monitoring for Random Access Response(s) and shall transmit the msg3 if the Random Access Response contains a Random Access Preamble identifier corresponding to the transmitted Random Access Preamble if UL CCA is successful. The System Simulator shall monitor if the UE is transmitting msg3 when CCA UL failure. If a msg3 transmission is detected on a grant expected to have UL CCA failure, the test is considered as failed.

The UE shall again perform the Random Access Resource selection procedure specified in clause 5.1.2 in TS38.321 [7], and transmit with the calculated PRACH transmission power when the backoff time expires if all received Random Access Responses contain Random Access Preamble identifiers that do not match the transmitted Random Access Preamble.

In addition, the power applied to all preambles shall be in accordance with what is specified in Clause 6.2.2A.2. The power of the first preamble shall be -16 dBm with an accuracy specified in clause 6.3.4.2 of TS 38.101-1 [18]. The relative power applied to additional preambles shall have an accuracy specified in clause 6.3.4.3 of TS 38.101-1 [18].

The transmit timing of all PRACH transmissions shall be within the accuracy specified in Clause 7.1.2.

#### A.10.1.1.1.2.3 No Random Access Response Reception

To test the UE behavior specified in clause 6.2.2A.2.1.3 the System Simulator shall transmit a Random Access Response containing a Random Access Preamble identifier corresponding to the transmitted Random Access Preamble after 5 preambles have been received by the System Simulator. The System Simulator shall *not* respond to the first 4 preambles. In case of CCA DL failure, the test equipment should delay the transmission of Random Access Response.

The UE shall again perform the Random Access Resource selection procedure specified in clause 5.1.2 in TS38.321 [7], and transmit with the calculated PRACH transmission power when the backoff time expires if no Random Access Response is received within the RA Response window.

In addition, the power applied to all preambles shall be in accordance with what is specified in Clause 6.2.2A.2. The power of the first preamble shall be -16 dBm with an accuracy specified in clause 6.3.4.2 of TS 38.101-1 [18]. The relative power applied to additional preambles shall have an accuracy specified in clause 6.3.4.3 of TS 38.101-1 [18].

The transmit timing of all PRACH transmissions shall be within the accuracy specified in Clause 7.1.2.

#### A.10.1.1.1.2.4 Receiving an UL grant for msg3 retransmission

To test the UE behavior specified in clause 6.2.2A.2.1.4, the System Simulator shall provide an UL grant for msg3 retransmission following a successful Random Access Response if UL CCA is successful. The System Simulator shall monitor if the UE is transmitting msg3 when CCA UL failure. If a msg3 is detected on a grant expected to have UL CCA failure, the test is considered as failed.

The UE shall re-transmit the msg3 upon the reception of an UL grant for msg3 retransmission.

#### A.10.1.1.1.2.5 Contention Resolution Timer expiry

To test the UE behavior specified in Clause 6.2.2A.2.1.6 the System Simulator shall *not* send a response to a msg3.

The UE shall again perform the Random Access Resource selection procedure specified in clause 5.1.2 in TS38.321 [7], and transmit with the calculated PRACH transmission power when the backoff time expires if the Contention Resolution Timer expires.

A.10.1.1.1.2 4-step RA type non-contention based random access for NR PSCell with CCA

A.10.1.1.1.2.1 Test Purpose and Environment

The purpose of this test is to verify that the behavior of the random access procedure is according to the requirements and that the PRACH power settings and timing are within specified limits when subject to CCA. This test will verify the requirements in clause 6.2.2A.2 and clause 7.1.2 in an AWGN model.

For this test two cells are used, with the configuration of Cell 1 (E-UTRA PCell) specified in clause A.3.7A.2.1 and Cell 2 configured as PSCell in FR1. Cell 1 is on a licensed band and cell 2 is subjected to CCA. Supported test parameters are shown in Table A.10.1.1.1.2.1-1. UE capable of EN-DC with PSCell in FR1 needs to be tested by using the parameters in Table A.10.1.1.1.2.1-2.

**Table A.10.1.1.1.2.1-1: Supported test configurations for non-contention based random access test in FR1 for PSCell with CCA**

Config	Description
1	LTE FDD, NR 30 kHz SSB SCS, 40 MHz bandwidth, TDD duplex mode
2	LTE TDD, NR 30 kHz SSB SCS, 40 MHz bandwidth, TDD duplex mode
Note: The UE is only required to be tested in one of the supported test configurations depending on UE capability	

**Table A.10.1.1.1.2.1-2: General test parameters for non-contention based random access test in FR1 for PSCell with CCA**

Parameter		Unit	Test-1	Comments	
SSB Configuration	Note 4, 6	Config 1,2	SSB.1 CCA	As defined in A.3.10A	
	Note 5, 6	Config 1,2	SSB.2 CCA	As defined in A.3.10A	
DBT Window Configuration		Config 1,2	DBT.1	As specified in A.3.28.1	
DL CCA model		Config 1,2	As specified in A.3.26.2.1		
UL CCA model		Config 1,2	As specified in A.3.26.2.2		
Duplex Mode for Cell 2		Config 1,2	TDD		
TDD Configuration		Config 1,2	TDDConf.1.1 CCA		
OCNG Pattern <sup>Note 1</sup>			OCNG pattern 1	As defined in A.3.2.1.	
PDSCH parameters <sup>Note 3</sup>		Config 1,2	SR.1.1 CCA	As defined in A.3.1A.1.	
NR RF Channel Number			1		
EPRE ratio of PSS to SSS			0		
EPRE ratio of PBCH_DMRS to SSS					
EPRE ratio of PBCH to PBCH_DMRS					
EPRE ratio of PDCCH_DMRS to SSS					
EPRE ratio of PDCCH to PDCCH_DMRS					
EPRE ratio of PDSCH_DMRS to SSS					
EPRE ratio of PDSCH to PDSCH_DMRS					
SSB with index 0	$\hat{E}_s / I_{ot}$		dB	3	Power of SSB with index 0 is set to be above configured <i>rsrp-ThresholdSSB</i>
	$N_{oc}$	Config 1,2	dBm/15kHz	-101	
	$\hat{E}_s / N_{oc}$		dB	3	
	SS-RSRP		dBm/ SCS	-95	
SSB with index 1	$\hat{E}_s / I_{ot}$		dB	-17	Power of SSB with index 1 is set to be below configured <i>rsrp-ThresholdSSB</i>

	$N_{oc}$	Config 1,2	dBm/15kHz	-101	
	$\hat{E}_s/N_{oc}$		dB	-17	
	SS-RSRP		dBm/ SCS	-115	
$I_o$ <sup>Note 2</sup>		Config 1,2	dBm	-62.2/38.16MHz	For symbols without SSB index 1
ss-PBCH-BlockPower			dBm/ SCS	-5	As defined in clause 6.3.2 in TS 38.331 [2].
Configured UE transmitted power ( $P_{CMAX, f, c}$ )			dBm	23	As defined in clause 6.2.4 in TS 38.101-1.
PRACH Configuration				FR1 PRACH configuration 2 under CCA	As defined in A.3.8A.2.
DL CCA probability	Note 4, 6			0.9375	
$P_{CCA\_DL}$	Note 5, 6			0.75 / 0.75	
$L_{CCA\_DL}$ <sup>Note 7</sup>				4	
$W_{CCA\_DL}$ <sup>Note 8</sup>				Inf	
UL CCA probability	Note 4, 6			0.87	
$P_{CCA\_UL}$	Note 5, 6			0.75	
$L_{CCA\_UL}$ <sup>Note 7</sup>				5	
$W_{CCA\_UL}$ <sup>Note 8</sup>				Inf	
Semi-static channel access config period <sup>Note 4, 6</sup>			ms	2	
Propagation Condition			-	AWGN	
<p>Note 1: OCNG shall be used such that the cell is fully allocated and a constant total transmitted power spectral density is achieved for all OFDM symbols. The OCNG pattern is chosen during the test according to the presence of a DL reference measurement channel.</p> <p>Note 2: SS-RSRP, <math>E_s/I_o</math> and <math>I_o</math> levels have been derived from other parameters for information purpose. They are not settable parameters.</p> <p>Note 3: The DL PDSCH reference measurement channel is used in the test only when a downlink transmission dedicated to the UE under test is required.</p> <p>Note 4: For UE supporting semi-static channel access and network configuring semi-static channel occupancy.</p> <p>Note 5: For UE supporting dynamic channel access and network configuring dynamic channel occupancy. The first value corresponds <math>P_{CCA\_DL1}</math> and the second value corresponds to the <math>P_{CCA\_DL2}</math>.</p> <p>Note 6: For UE supporting both semi-static and dynamic channel access, the UE must be tested under both dynamic channel occupancy and semi-static channel occupancy configuration.</p> <p>Note 7: <math>L_{CCA\_DL}</math> and <math>L_{CCA\_UL}</math> are chosen such that <math>preambleTransMax &gt; 5 + L_{CCA\_DL} + L_{CCA\_UL}</math>.</p> <p>Note 8: A window <math>W_{CCA\_DL}=W_{CCA\_UL}=Inf</math> is used to indicate that <math>L_{CCA\_DL}</math> and <math>L_{CCA\_UL}</math> are considered during the entire duration of a test run.</p>					

#### A.10.1.1.1.2.2 Test Requirements

Non-Contention based random access is triggered by explicitly assigning a random access preamble via dedicated signalling in the downlink. In the test, the non-contention based random access procedure is not initialized for Other SI requested from UE or beam failure recovery.

##### A.10.1.1.1.2.2.1 SSB-based Random Access Preamble Transmission

In Test-1, to test the UE behavior specified in Clause 6.2.2A.2.2.1 for SSB-based Random Access Preamble transmission, with the contention-free Random Access Resources and the contention-free PRACH occasions associated with SSBs configured, the System Simulator shall receive the Random Access Preamble which has the Preamble Index associated with the SSB with index 0.

The three requirements below are relevant for all cases of PRACH transmissions described within the whole clause A.10.1.1.1.2.2:

- The System Simulator shall implement the UL CCA model of A.3.26.2 for the RACH occasions where PRACH transmissions are expected. The System Simulator shall monitor the RACH occasions to detect if the UE is transmitting PRACH preambles. If a PRACH transmission is detected on a RACH occasion that is expected to have UL CCA failure, the test is considered as failed.

- In case of CCA DL failure, the test equipment should verify that the UE does not transmit PRACH for semi-static channel access mode; for dynamic channel access mode it is assumed that RACH occasions are always scheduled within a UE-initiated COT.
- In case of UL CCA failure, The UE shall again perform the Random Access Resource selection procedure specified in clause 5.1.2 in TS38.321 [7], and transmit with the calculated PRACH transmission power.

In addition, the System Simulator shall receive the Random Access Preamble on the PRACH occasion which belongs to the PRACH occasions corresponding to the SSB with index 0, and the selected PRACH occasion shall belong to the PRACH occasions permitted by the restrictions given by the *ra-ssb-OccasionMaskIndex*.

In addition, the power applied to all preambles shall be in accordance with what is specified in Clause 6.2.2A.2. The power of the first preamble shall be -16 dBm with an accuracy specified in clause 6.3.4.2 of TS 38.101-1 [18]. The relative power applied to additional preambles shall have an accuracy specified in clause 6.3.4.3 of TS 38.101-1 [18].

The transmit timing of all PRACH transmissions shall be within the accuracy specified in Clause 7.1.2.

#### A.10.1.1.1.2.2.2 Random Access Response Reception

To test the UE behavior specified in Clause 6.2.2A.2.2.2 the System Simulator shall transmit a Random Access Response containing a Random Access Preamble identifier corresponding to the transmitted Random Access Preamble after 5 preambles have been received by the System Simulator. In response to the first 4 preambles, the System Simulator shall transmit a Random Access Response *not* corresponding to the transmitted Random Access Preamble. In case of CCA DL failure, the test equipment should delay the transmission of Random Access Response.

The UE may stop monitoring for Random Access Response(s) if the Random Access Response contains a Random Access Preamble identifier corresponding to the transmitted Random Access Preamble if UL CCA is successful. The System Simulator shall monitor if the UE is transmitting msg3 when CCA UL failure. If a msg3 is detected on a grant expected to have UL CCA failure, the test is considered as failed.

The UE shall again perform the Random Access Resource selection procedure specified in clause 5.1.2 in TS38.321 [7], and transmit with the calculated PRACH transmission power if all received Random Access Responses contain Random Access Preamble identifiers that do not match the transmitted Random Access Preamble.

In addition, the power applied to all preambles shall be in accordance with what is specified in Clause 6.2.2A.2. The power of the first preamble shall be -16 dBm with an accuracy specified in clause 6.3.4.2 of TS 38.101-1 [18]. The relative power applied to additional preambles shall have an accuracy specified in clause 6.3.4.3 of TS 38.101-1 [18].

The transmit timing of all PRACH transmissions shall be within the accuracy specified in Clause 7.1.2.

#### A.10.1.1.1.2.2.3 No Random Access Response Reception

To test the UE behavior specified in clause 6.2.2A.2.2.3 the System Simulator shall transmit a Random Access Response containing a Random Access Preamble identifier corresponding to the transmitted Random Access Preamble after 5 preambles have been received by the System Simulator. The System Simulator shall *not* respond to the first 4 preambles. In case of CCA DL failure, the test equipment should delay the transmission of Random Access Response.

The UE shall again perform the Random Access Resource selection procedure specified in clause 5.1.2 in TS38.321 [7], and transmit with the calculated PRACH transmission power when the backoff time expires if no Random Access Response is received within the RA Response window configured in *RACH-ConfigCommon*.

In addition, the power applied to all preambles shall be in accordance with what is specified in Clause 6.2.2A.2. The power of the first preamble shall be -16 dBm with an accuracy specified in clause 6.3.4.2 of TS 38.101-1 [18]. The relative power applied to additional preambles shall have an accuracy specified in clause 6.3.4.3 of TS 38.101-1 [18].

The transmit timing of all PRACH transmissions shall be within the accuracy specified in Clause 7.1.2.

#### A.10.1.1.1.3 2-step RA type contention-based random access for NR PSCell with CCA

##### A.10.1.1.1.3.1 Test Purpose and Environment

The purpose of this test is to verify that the behaviour of the random access procedure is according to the requirements and that the MsgA PRACH, MsgA PUSCH power settings and timing are within specified limits when subject to CCA. This test will verify the requirements in clause 6.2.2A.3 and clause 7.1.2 in an AWGN model.

For this test two cells are used, with the configuration of Cell 1 (E-UTRA PCell) specified in clause A.3.7A.2.1 and Cell 2 configured as PSCell in FR1. Cell 1 is on a licensed band and cell 2 is subjected to CCA. Supported test parameters are shown in Table A.10.1.1.3.1-1. UE capable of EN-DC with PSCell in FR1 needs to be tested by using the parameters in Table A.10.1.1.3.1-2.

**Table A.10.1.1.3.1-1: Supported test configurations for 2-step RA type contention based random access test in FR1 for PSCell with CCA**

Config	Description
1	LTE FDD, NR 30 kHz SSB SCS, 40 MHz bandwidth, TDD duplex mode
2	LTE TDD, NR 30 kHz SSB SCS, 40 MHz bandwidth, TDD duplex mode

Note: The UE is only required to be tested in one of the supported test configurations depending on UE capability

**Table A.10.1.1.3.1-2: General test parameters for 2-step RA type contention based random access test in FR1 for PSCell with CCA**

Parameter		Unit	Test-1	Comments	
SSB Configuration	Note 4, 6	Config 1,2	SSB.1 CCA	As defined in A.3.10A	
	Note 5, 6	Config 1,2	SSB.2 CCA	As defined in A.3.10A	
DBT Window Configuration		Config 1,2	DBT.1	As specified in A.3.28.1	
DL CCA model		Config 1,2	As specified in A.3.26.2.1		
UL CCA model		Config 1,2	As specified in A.3.26.2.2		
Duplex Mode for Cell 2		Config 1,2	TDD		
TDD Configuration		Config 3,4	TDDConf.1.1 CCA		
OCNG Pattern <sup>Note 1</sup>			OCNG pattern 1	As defined in A.3.2.1.	
PDSCH parameters <sup>Note 3</sup>		Config 1,2	SR.1.1 CCA	As defined in A.3.1A.1.	
NR RF Channel Number			1		
EPRE ratio of PSS to SSS		dB	0		
EPRE ratio of PBCH_DMRS to SSS		dB			
EPRE ratio of PBCH to PBCH_DMRS		dB			
EPRE ratio of PDCCH_DMRS to SSS		dB			
EPRE ratio of PDCCH to PDCCH_DMRS		dB			
EPRE ratio of PDSCH_DMRS to SSS		dB			
EPRE ratio of PDSCH to PDSCH_DMRS		dB			
SSB with index 0	$\hat{E}_s / I_{ot}$	dB	3	Power of SSB with index 0 is set to be above configured <i>msgA-RSRP-ThresholdSSB</i>	
	$N_{oc}$	Config 1,2	-101		
	$\hat{E}_s / N_{oc}$		3		
	SS-RSRP <sup>Note 2</sup>		-95		
SSB with index 1	$\hat{E}_s / I_{ot}$	dB	-17	Power of SSB with index 1 is set to be below configured <i>msgA-RSRP-ThresholdSSB</i>	
	$N_{oc}$	Config 1,2	-101		
	$\hat{E}_s / N_{oc}$		-17		
	SS-RSRP <sup>Note 2</sup>		-115		
Io		Config 1,2	dBm	-62.2/38.16MHz	For symbols without SSB index 1
ss-PBCH-BlockPower			dBm/ SCS	-5	As defined in clause 6.3.2 in TS 38.331 [2].
Configured UE transmitted power ( $P_{CMAX, f,c}$ )			dBm	23	As defined in clause 6.2.4 in TS 38.101-1.
MsgA Configuration				FR1 MsgA configuration 1 under CCA	As defined in A.3.20A.2.

<i>msgA-RSRP-ThresholdSSB</i>		dBm	RSRP_51	The actual value of the threshold is -105dBm, as defined in TS 38.331 [2].
DL CCA probability	Note 4, 6		0.9375	
$P_{CCA\_DL}$	Note 5, 6		0.75 / 0.75	
$L_{CCA\_DL}$	Note 7		4	
$W_{CCA\_DL}$	Note 8		Inf	
UL CCA probability	Note 4, 6		0.87	
$P_{CCA\_UL}$	Note 5, 6		0.75	
$L_{CCA\_UL}$	Note 7		5	
$W_{CCA\_UL}$	Note 8		Inf	
Semi-static channel access config period	Note 4, 6	ms	2	
Propagation Condition		-	AWGN	
<p>Note 1: OCNG shall be used such that the cell is fully allocated and a constant total transmitted power spectral density is achieved for all OFDM symbols. The OCNG pattern is chosen during the test according to the presence of a DL reference measurement channel.</p> <p>Note 2: SS-RSRP, Es/lot and Io levels have been derived from other parameters for information purpose. They are not settable parameters.</p> <p>Note 3: The DL PDSCH reference measurement channel is used in the test only when a downlink transmission dedicated to the UE under test is required.</p> <p>Note 4: For UE supporting semi-static channel access and network configuring semi-static channel occupancy.</p> <p>Note 5: For UE supporting dynamic channel access and network configuring dynamic channel occupancy. The first value corresponds <math>P_{CCA\_DL1}</math> and the second value corresponds to the <math>P_{CCA\_DL2}</math>.</p> <p>Note 6: For UE supporting both semi-static and dynamic channel access, the UE must be tested under both dynamic channel occupancy and semi-static channel occupancy configuration.</p> <p>Note 7: <math>L_{CCA\_DL}</math> and <math>L_{CCA\_UL}</math> are chosen such that <math>preambleTransMax &gt; 5 + L_{CCA\_DL} + L_{CCA\_UL}</math>.</p> <p>Note 8: A window <math>W_{CCA\_DL}=W_{CCA\_UL}=Inf</math> is used to indicate that <math>L_{CCA\_DL}</math> and <math>L_{CCA\_UL}</math> are considered during the entire duration of a test run.</p>				

#### A.10.1.1.1.3.2 Test Requirements

Contention based random access is triggered by *not* explicitly assigning a random access preamble via dedicated signalling in the downlink.

##### A.10.1.1.1.3.2.1 MsgA Transmission

To test the UE behaviour specified in Clause 6.2.2A.3.1.1 the System Simulator shall receive the MsgA with a preamble which belongs to one of the Random Access Preambles associated with the SSB with index 0, which has SS-RSRP above the configured *msgA-RSRP-ThresholdSSB*, if the UL CCA is successful.

below are relevant for all cases of MsgA transmissions described within the clause A.10.1.1.1.3.2:

- The System Simulator shall implement the UL CCA model for the MsgA occasions (i.e. both MsgA PRACH and MsgA PUSCH occasions) where MsgA transmissions are expected. The System Simulator shall monitor the MsgA occasions to detect if the UE is transmitting MsgA. If a MsgA transmission is detected on MsgA occasions that are expected to have UL CCA failure, the test is considered as failed.
- In case of CCA DL failure, the test equipment should verify that the UE does not transmit MsgA for semi-static channel access mode; for dynamic channel access mode it is assumed that MsgA occasions are always scheduled within a UE-initiated COT.
- The UE shall again perform the Random Access Resource selection procedure specified in clause 5.1.2a in TS38.321 [7], and transmit with the calculated PRACH transmission power in case of UL CCA failure.

The UE shall again perform the Random Access Resource selection procedure specified in clause 5.1.2a in TS38.321 [7], and transmit with the calculated PRACH transmission power in case of UL CCA failure. In addition, the power applied to all MsgA transmission shall be in accordance with what is specified in Clause 6.2.2A.2. The power of the first MsgA preamble shall be -16 dBm with an accuracy specified in clause 6.3.4.2 of TS 38.101-1 [18]. The power of the first MsgA PUSCH transmission shall be  $0.6 + 3(\mu + 2)$  dBm with an accuracy specified in clause 6.3.4.2 of TS 38.101-1 [18], where  $\mu$  indicates the MsgA PUSCH numerology. The relative power applied to additional MsgA transmissions shall have an accuracy specified in clause 6.3.4.3 of TS 38.101-1 [18].

The transmit timing of all MsgA transmissions shall be within the accuracy specified in Clause 7.1.2.

#### A.10.1.1.1.3.2.2 MsgB Reception

To test the UE behaviour specified in Clause 6.2.2A.3.1.2 the System Simulator shall transmit a MsgB with fallbackRAR containing a Random Access Preamble identifier corresponding to the transmitted Random Access Preamble after 5 preambles have been received by the System Simulator. In response to the first 4 preambles, the System Simulator shall transmit a MsgB *not* corresponding to the transmitted Random Access Preamble. In case of CCA DL failure, the test equipment should delay the transmission of MsgB.

The UE may stop monitoring for MsgB(s) and shall transmit the msg3 if the MsgB with a fallbackRAR contains a Random Access Preamble identifier corresponding to the transmitted Random Access Preamble if UL CCA is successful. The System Simulator shall monitor if the UE is transmitting msg3 when CCA UL failure. If a msg3 is detected on a grant expected to have UL CCA failure, the test is considered as failed.

The UE shall again perform the Random Access Resource selection procedure specified in clause 5.1.2a in TS 38.321 [7], and transmit with the calculated MsgA PRACH and MsgA PUSCH transmission power when the backoff time expires if all received MsgB's contain Random Access Preamble identifiers that do not match the transmitted Random Access Preamble .

In addition, the power applied to all MsgA transmission shall be in accordance with what is specified in Clause 6.2.2A.2. The power of the first MsgA preamble shall be -16 dBm with an accuracy specified in clause 6.3.4.2 of TS 38.101-1 [18]. The power of the first MsgA PUSCH transmission shall be  $0.6 + 3(\mu + 2)$  dBm with an accuracy specified in clause 6.3.4.2 of TS 38.101-1 [18], where  $\mu$  indicates the MsgA PUSCH numerology. The relative power applied to additional MsgA transmissions shall have an accuracy specified in clause 6.3.4.3 of TS 38.101-1 [18].

The transmit timing of all MsgA transmissions shall be within the accuracy specified in Clause 7.1.2.

#### A.10.1.1.1.3.2.3 No MsgB Reception

To test the UE behavior specified in clause 6.2.2A.3.1.3 the System Simulator shall transmit a MsgB with fallbackRAR containing a successRAR message and a Random Access Preamble identifier corresponding to the transmitted Random Access Preamble after 5 preambles have been received by the System Simulator. The System Simulator shall *not* respond to the first 4 preambles. In case of CCA DL failure, the test equipment should delay the transmission of MsgB.

The UE shall again perform the Random Access Resource selection procedure specified in clause 5.1.2a in TS 38.321 [7], and transmit with the calculated MsgA PRACH and MsgA PUSCH transmission power when the backoff time expires if no MsgB is received within the MsgB Response window.

In addition, the power applied to all MsgA transmission shall be in accordance with what is specified in Clause 6.2.2A.2. The power of the first MsgA preamble shall be -16 dBm with an accuracy specified in clause 6.3.4.2 of TS 38.101-1 [18]. The power of the first MsgA PUSCH transmission shall be  $0.6 + 3(\mu + 2)$  dBm with an accuracy specified in clause 6.3.4.2 of TS 38.101-1 [18], where  $\mu$  indicates the MsgA PUSCH numerology. The relative power applied to additional MsgA transmissions shall have an accuracy specified in clause 6.3.4.3 of TS 38.101-1 [18].

The transmit timing of all MsgA transmissions shall be within the accuracy specified in Clause 7.1.2.

### A.10.1.1.1.4 2-step RA type non-contention based random access for NR PSCell with CCA

#### A.10.1.1.1.4.1 Test Purpose and Environment

The purpose of this test is to verify that the behavior of the random access procedure is according to the requirements and that the MsgA PRACH, MsgA PUSCH power settings and timing are within specified limits when subject to CCA. This test will verify the requirements in clause 6.2.2A.3 and clause 7.1.2 in an AWGN model.

For this test two cells are used, with the configuration of Cell 1 (E-UTRA PCell) specified in clause A.3.7.2.1 and Cell 2 configured as PSCell in FR1. Cell 1 is on a licensed band and cell 2 is subjected to CCA. Supported test parameters are shown in Table A.10.1.1.1.4.1-1. UE capable of EN-DC with PSCell in FR1 needs to be tested by using the parameters in Table A.10.1.1.1.4.1-2.



**Table A.10.1.1.4.1-1: Supported test configurations for non-contention based random access test for 2-step RA type in FR1 for PSCell with CCA**

Config	Description
1	LTE FDD, NR 30 kHz SSB SCS, 40 MHz bandwidth, TDD duplex mode
2	LTE TDD, NR 30 kHz SSB SCS, 40 MHz bandwidth, TDD duplex mode

Note: The UE is only required to be tested in one of the supported test configurations depending on UE capability

**Table A.10.1.1.4.1-2: General test parameters for non-contention based random access test for 2-step RA type in FR1 for PSCell with CCA**

Parameter		Unit	Test-1	Comments	
SSB Configuration	Note 4, 6	Config 1,2	SSB.1 CCA	As defined in A.3.10A	
	Note 5, 6	Config 1,2	SSB.2 CCA	As defined in A.3.10A	
DBT Window Configuration		Config 1,2	DBT.1	As specified in A.3.28.1	
DL CCA model		Config 1,2	As specified in A.3.26.2.1		
UL CCA model		Config 1,2	As specified in A.3.26.2.2		
Duplex Mode for Cell 2		Config 1,2	TDD		
TDD Configuration		Config 1,2	TDDConf.1.1 CCA		
OCNG Pattern <sup>Note 1</sup>			OCNG pattern 1	As defined in A.3.2.1.	
PDSCH parameters <sup>Note 3</sup>		Config 1,2	SR.1.1 CCA	As defined in A.3.1A.1.	
NR RF Channel Number			1		
EPRE ratio of PSS to SSS		dB	0		
EPRE ratio of PBCH_DMRS to SSS		dB			
EPRE ratio of PBCH to PBCH_DMRS		dB			
EPRE ratio of PDCCH_DMRS to SSS		dB			
EPRE ratio of PDCCH to PDCCH_DMRS		dB			
EPRE ratio of PDSCH_DMRS to SSS		dB			
EPRE ratio of PDSCH to PDSCH_DMRS		dB			
SSB with index 0	$\hat{E}_s / I_{ot}$	dB	3	Power of SSB with index 0 is set to be above configured <i>msgA-RSRP-ThresholdSSB</i>	
	$N_{oc}$	Config 1,2	dBm/15kHz z		-101
	$\hat{E}_s / N_{oc}$	dB	3		
	SS-RSRP	dBm/ SCS	-95		
SSB with index 1	$\hat{E}_s / I_{ot}$	dB	-17	Power of SSB with index 1 is set to be below configured <i>msgA-RSRP-ThresholdSSB</i>	
	$N_{oc}$	Config 1,2	dBm/15kHz z		-101
	$\hat{E}_s / N_{oc}$	dB	-17		
	SS-RSRP	dBm/ SCS	-115		
$I_0$ <sup>Note 2</sup>		Config 1,2	dBm	-62.2/38.16MHz	For symbols without SSB index 1
ss-PBCH-BlockPower		dBm/ SCS	-5	As defined in clause 6.3.2 in TS 38.331 [2].	
Configured UE transmitted power ( $P_{CMAX,f,c}$ )		dBm	23	As defined in clause 6.2.4 in TS 38.101-1.	
MsgA Configuration			FR1 MsgA configuration 2 under CCA	As defined in A.3.20A.2.	

<i>msgA-RSRP-ThresholdSSB</i>		dBm	RSRP_51	The actual value of the threshold is -105dBm, as defined in TS 38.331 [2].
DL CCA probability	Note 4, 6		0.9375	
$P_{CCA\_DL}$	Note 5, 6		0.75 / 0.75	
$L_{CCA\_DL}$ <sup>Note 7</sup>			4	
$W_{CCA\_DL}$ <sup>Note 8</sup>			Inf	
UL CCA probability	Note 4, 6		0.87	
$P_{CCA\_UL}$	Note 5, 6		0.75	
$L_{CCA\_UL}$ <sup>Note 7</sup>			5	
$W_{CCA\_UL}$ <sup>Note 8</sup>			Inf	
Semi-static channel access config period <sup>Note 4, 6</sup>		ms	2	
Propagation Condition		-	AWGN	
<p>Note 1: OCNG shall be used such that the cell is fully allocated and a constant total transmitted power spectral density is achieved for all OFDM symbols. The OCNG pattern is chosen during the test according to the presence of a DL reference measurement channel.</p> <p>Note 2: SS-RSRP, Es/Iot and Io levels have been derived from other parameters for information purpose. They are not settable parameters.</p> <p>Note 3: The DL PDSCH reference measurement channel is used in the test only when a downlink transmission dedicated to the UE under test is required.</p> <p>Note 4: For UE supporting semi-static channel access and network configuring semi-static channel occupancy.</p> <p>Note 5: For UE supporting dynamic channel access and network configuring dynamic channel occupancy. The first value corresponds <math>P_{CCA\_DL1}</math> and the second value corresponds to the <math>P_{CCA\_DL2}</math>.</p> <p>Note 6: For UE supporting both semi-static and dynamic channel access, the UE must be tested under both dynamic channel occupancy and semi-static channel occupancy configuration.</p> <p>Note 7: <math>L_{CCA\_DL}</math> and <math>L_{CCA\_UL}</math> are chosen such that <math>preambleTransMax &gt; 5 + L_{CCA\_DL} + L_{CCA\_UL}</math>.</p> <p>Note 8: A window <math>W_{CCA\_DL}=W_{CCA\_UL}=Inf</math> is used to indicate that <math>L_{CCA\_DL}</math> and <math>L_{CCA\_UL}</math> are considered during the entire duration of a test run.</p>				

#### A.10.1.1.1.4.2 Test Requirements

Non-Contention based random access is triggered by explicitly assigning a random access preamble via dedicated signalling in the downlink. In the test, the non-contention based random access procedure is not initialized for Other SI requested from UE or beam failure recovery.

##### A.10.1.1.1.4.2.1 MsgA Transmission

In Test-1, to test the UE behavior specified in Clause 6.2.2A.3.2.1 for MsgA transmission, with the contention-free Random Access Resources and the contention-free PRACH occasions associated with SSBs configured, the System Simulator shall receive the MsgA which has the Preamble Index associated with the SSB with index 0.

In addition, the System Simulator shall receive the MsgA on the PRACH occasion which belongs to the PRACH occasions corresponding to the SSB with index 0, and the selected PRACH occasion shall belong to the PRACH occasions permitted by the restrictions given first by the *msgA-SSB-SharedRO-MaskIndex* if configured, or next by the *ra-ssb-OccasionMaskIndex* if configured.

The three requirements below are relevant for all cases of MsgA transmissions described within the clause A.10.1.1.1.4.2:

- The System Simulator shall implement the UL CCA model for the MsgA occasions (i.e. both MsgA PRACH and MsgA PUSCH occasions) where MsgA transmissions are expected. The System Simulator shall monitor the MsgA occasions to detect if the UE is transmitting MsgA. If a MsgA transmission is detected on MsgA occasions that are expected to have UL CCA failure, the test is considered as failed.
- In case of CCA DL failure, the test equipment should verify that the UE does not transmit MsgA for semi-static channel access mode; for dynamic channel access mode it is assumed that MsgA occasions are always scheduled within a UE-initiated COT.
- The UE shall again perform the Random Access Resource selection procedure specified in clause 5.1.2a in TS38.321 [7], and transmit with the calculated PRACH transmission power in case of UL CCA failure.

In addition, the power applied to all MsgA transmission shall be in accordance with what is specified in Clause 6.2.2A.2. The power of the first MsgA preamble shall be -16 dBm with an accuracy specified in clause 6.3.4.2 of TS 38.101-1 [18]. The power of the first MsgA PUSCH transmission shall be  $0.6 + 3(\mu + 2)$  dBm with an accuracy specified in clause 6.3.4.2 of TS 38.101-1 [18], where  $\mu$  indicates the MsgA PUSCH numerology. The relative power applied to additional MsgA transmissions shall have an accuracy specified in clause 6.3.4.3 of TS 38.101-1 [18].

The transmit timing of all MsgA transmissions shall be within the accuracy specified in Clause 7.1.2.

#### A.10.1.1.1.4.2.2 MsgB Reception

To test the UE behavior specified in Clause 6.2.2A.3.2.2 the System Simulator shall transmit a MsgB containing a successRAR MAC subPDU corresponding to the transmitted Random Access Preamble after 5 MsgA transmissions have been received by the System Simulator. In response to the first 4 preambles, the System Simulator shall transmit a MsgB *not* corresponding to the transmitted Random Access Preamble. In case of CCA DL failure, the test equipment should delay the transmission of MsgB.

The UE may stop monitoring for MsgB if the MsgB contains a successRAR MAC subPDU corresponding to the transmitted Random Access Preamble.

The UE shall again perform the Random Access Resource selection procedure specified in clause 5.1.2a in TS38.321 [7], and transmit with the calculated MsgA transmission power if Random Access Responses Reception has not been considered as successful.

In addition, the power applied to all MsgA transmissions shall be in accordance with what is specified in Clause 6.2.2A.3. The power of the first MsgA preamble shall be -16 dBm with an accuracy specified in clause 6.3.4.2 of TS 38.101-1 [18]. The power of the first MsgA PUSCH transmission shall be  $0.6 + 3(\mu + 2)$  dBm with an accuracy specified in clause 6.3.4.2 of TS 38.101-1 [18], where  $\mu$  indicates the MsgA PUSCH numerology. The relative power applied to additional MsgA transmissions shall have an accuracy specified in clause 6.3.4.3 of TS 38.101-1 [18].

The transmit timing of all MsgA transmissions shall be within the accuracy specified in Clause 7.1.2.

#### A.10.1.1.1.4.2.3 No MsgB Reception

To test the UE behavior specified in clause 6.2.2A.3.2.3 the System Simulator shall transmit a MsgB corresponding to the transmitted Random Access Preamble after 5 preambles have been received by the System Simulator. The System Simulator shall *not* respond to the first 4 preambles. In case of CCA DL failure, the test equipment should delay the transmission of MsgB.

The UE shall again perform the Random Access Resource selection procedure specified in clause 5.1.2a in TS38.321 [7], and transmit with the calculated MsgA transmission power when the backoff time expires if no MsgB is received within the MsgB Response window configured in *RACH-ConfigGenericTwoStepRA*.

In addition, the power applied to all MsgA transmissions shall be in accordance with what is specified in Clause 6.2.2A.3. The power of the first MsgA preamble shall be -16 dBm with an accuracy specified in clause 6.3.4.2 of TS 38.101-1 [18]. The power of the first MsgA PUSCH transmission shall be  $0.6 + 3(\mu + 2)$  dBm with an accuracy specified in clause 6.3.4.2 of TS 38.101-1 [18], where  $\mu$  indicates the MsgA PUSCH numerology. The relative power applied to additional MsgA transmissions shall have an accuracy specified in clause 6.3.4.3 of TS 38.101-1 [18].

The transmit timing of all MsgA transmissions shall be within the accuracy specified in Clause 7.1.2.

## A.10.2 Timing

### A.10.2.1 UE transmit timing

#### A.10.2.1.1 UE Transmit Timing Test with PSCell under DL CCA

##### A.10.2.1.1.1 Test Purpose and environment

The purpose of this test is to verify that the UE can follow frame timing change of the connected gNodeB when PSCell is subject to DL CCA and that the UE initial transmit timing accuracy, maximum amount of timing change in one adjustment, minimum and maximum adjustment rate are within the specified limits. This test will verify the requirements in clause 7.1.2. Supported test configurations are shown in Table 10.2.1.1.1-1.

**Table A.10.2.1.1.1-1: Supported test configurations for UE transmit timing test**

Config	Description
1	LTE FDD, With CCA: NR TDD, SSB SCS 30 kHz, data SCS 30 kHz, BW 40 MHz
2	LTE TDD, With CCA: NR TDD, SSB SCS 30 kHz, data SCS 30 kHz, BW 40 MHz

Note 1: The UE is only required to be tested in one of the supported test configurations.

The test consists of E-UTRA PCell and NR PSCell, which is subject to DL CCA. The configuration for E-UTRA is given in A.3.7.2.1. Table A.10.2.1.1.1-2 defines the parameters to be configured and strength of the transmitted signals. The transmit timing is verified by the UE transmitting SRS using the configuration defined in Table A.10.2.1.1.1-3.

**Table A.10.2.1.1.1-2: Cell Specific Test Parameters for UE Transmit Timing test**

Parameter		Unit	Config	Test1	Test2
SSB ARFCN			1,2	Freq1	Freq1
TDD configuration			1,2	TDDConf.1.1 CCA	
BW <sub>channel</sub>		MHz	1,2	40: N <sub>RB,c</sub> = 106	
Initial BWP Configuration			1,2	DLBWP.0.1 ULBWP.0.1	
Dedicated BWP Configuration			1,2	DLBWP.1.1 ULBWP.1.1	
DRX Cycle		ms	1,2	N/A	DRX.8 <sup>Note5</sup>
DL CCA model			1,2	As specified in clause A.3.26.2.1	
UL CCA model			1,2	As specified in clause A.3.26.2.2	
PDSCH Reference			1,2	SR.1.1 CCA	
CORESET Reference			1,2	CR.1.1 CCA	
OCNG Patterns			1,2	OCNG pattern 1	
SSB configuration	Semi- static channel acces		1,2	SSB.1 CCA	
	Dynamic channel acces		1,2	SSB.2 CCA	
SMTC configuration			1,2	SMTC.1 FR1	
TRS configuration			1,2	TRS.1.2 TDD	
DL CCA probability for semi-static channel access (P <sub>CCA_DL</sub> )			1,2	0.9375	0.9375
DL CCA model probability for dynamic static channel access (P <sub>CCA_DL_1</sub> )			1,2	0.75	0.75
DL CCA model probability for dynamic static channel access (P <sub>CCA_DL_2</sub> )			1,2	0.75	0.75
UL CCA probability (P <sub>CCA_UL</sub> )			1,2	1	1
EPRE ratio of PSS to SSS		dB	1,2	0	0
EPRE ratio of PBCH DMRS to SSS					
EPRE ratio of PBCH to PBCH DMRS					
EPRE ratio of PDCCH DMRS to SSS					
EPRE ratio of PDCCH to PDCCH DMRS					
EPRE ratio of PDSCH DMRS to SSS					
EPRE ratio of PDSCH to PDSCH					
EPRE ratio of OCNG DMRS to SSS (Note 1)					
EPRE ratio of OCNG to OCNG DMRS (Note 1)					
N <sub>oc</sub> <sup>Note2</sup>					
$\hat{E}_s / I_{ot}$			1,2	3	3
$\hat{E}_s / N_{oc}$			1,2	3	3
SS-RSRP <sup>Note3</sup>		dBm/30 kHz	1,2	-92	-92
I <sub>o</sub> <sup>Note3</sup>		dBm/38.1MHz	1,2	-59.2	-59.2
Propagation condition			1,2	AWGN	
SRS Config			1,2	SRSCConf.1 <sup>Note6</sup>	SRSCConf.2 <sup>Note6</sup>

Note 1:	OCNG shall be used such that both cells are fully allocated and a constant total transmitted power spectral density is achieved for all OFDM symbols.
Note 2:	Interference from other cells and noise sources not specified in the test is assumed to be constant over subcarriers and time and shall be modelled as AWGN of appropriate power for $N_{oc}$ to be fulfilled.
Note 3:	SS-RSRP and $I_o$ levels have been derived from other parameters for information purposes. They are not settable parameters themselves.
Note 4:	SS-RSRP minimum requirements are specified assuming independent interference and noise at each receiver antenna port.
Note 5:	DRX related parameters are given in Table A.3.3.8-1
Note 6:	SRS configs are given in Table A.10.2.1.1.1-3.
Note 7:	Parameters $P_{CCA\_DL}$ , $P_{CCA\_DL\_1}$ , $P_{CCA\_DL\_2}$ and $P_{CCA\_UL}$ are defined in clause A.3.26.2.
Note 8:	For UE supporting both semi-static and dynamic channel access, the UE must be tested under both dynamic and semi-static channel occupancy configurations.

**Table A.10.2.1.1.1-3: SRS Configuration for UE transmit timing**

	Field	SRSCnf.1	SRSCnf.2	Comments
SRS-ResourceSet	srs-ResourceSetId	0	0	
	srs-ResourceIdList	0	0	
	resourceType	Periodic	Periodic	
	Usage	Codebook	Codebook	
SRS-Resource	SRS-ResourceId	0	0	
	nrofSRS-Ports	Port1	Port1	
	transmissionComb	n2	n2	
	combOffset-n2	0	0	
	cyclicShift-n2	0	0	
	resourceMapping startPosition	0	0	
	resourceMapping nrofSymbols	n1	n1	
	resourceMapping repetitionFactor	n1	n1	
	freqDomainPosition	0	0	
	freqDomainShift	0	0	
	freqHopping c-SRS	14 for test configuration 1,2 25 for test configuration 3	25	Matches $N_{RB,c}$
	freqHopping b-SRS	0	0	
	freqHopping b-hop	0	0	
	groupOrSequenceHopping	Neither	Neither	
resourceType	Periodic	Periodic		
periodicityAndOffset-p	sl1, 0	sl640, 0	Offset to align with DRx periodicity	
sequencId	0	0	Any 10 bit number	

### A.10.2.1.1.2 Test requirements

The test sequence shall be carried out in RRC\_CONNECTED for every test case.

Following will be the test sequence for this test

- 1) Set up E-UTRA PCell according to parameters given in Table A.3.7.2.1-1 and setup NR PCell according to parameters given in Table A.10.2.1.1.1-1.
- 2) After connection set up with the cell, the test equipment will verify that the timing of the NR cell is within  $(N_{TA} + N_{TA\_offset}) \times T_c \pm T_e$  of the first detected path of DL SSB.
  - a. The  $N_{TA}$  offset value (in  $T_c$  units) is 25600
  - b. The  $T_e$  values depend on the DL and UL SCS for which the test is being run and are given in Table 7.1.2-1
- 3) The test system shall adjust the timing of the DL path by values given in Table A.10.2.1.1.2-1

**Table A.10.2.1.1.2-1: Adjustment Value for DL Timing**

SCS of SSB signals (kHz)	Adjustment Value	
	Test1	Test2
30	+32*64T <sub>c</sub>	+16*64T <sub>c</sub>

- 4) The test system shall verify that the adjustment step size and the adjustment rate shall be according to requirements specified in Clause 7.1.2 Table 7.1.2.1-1 until the UE transmit timing offset is within  $(N_{TA} + N_{TA\_offset}) \times T_c \pm T_e$  respective to the first detected path (in time) of DL SSB. Skip this step for test 2 with DRX configured.
- 5) The test system shall verify that the UE transmit timing offset stays within  $(N_{TA} + N_{TA\_offset}) \times T_c \pm T_e$  of the first detected path of DL SSB. For Test 2 the UE transmit timing offset shall be verified for the first transmission in the DRX cycle immediately after DL timing adjustment.

## A.10.2.2 UE timing advance

### A.10.2.2.1 UE Timing Advance Adjustment Accuracy with PSCell under DL CCA

#### A.10.2.2.1.1 Test Purpose and Environment

The purpose of the test is to verify UE Timing Advance adjustment delay and accuracy requirement defined in clause 7.3.

#### A.10.2.2.1.2 Test Parameters

Supported test configurations are shown in table A.10.2.2.1.2-1. Both timing advance adjustment delay and accuracy are tested by using the parameters in table A.10.2.2.1.2-2, A.10.2.2.1.2-3 and A.10.2.2.1.2-4. The configuration of Cell 1 (LTE PCell) is specified in clause A.3.7.2.1.

In all test cases, two cells are used. Cell 1 is the PCell in the primary Timing Advance Group (pTAG) and cell 2 is the PSCell which is subject to DL CCA is in the secondary Timing Advance Group (sTAG). Each test consists of two successive time periods, with time duration of T1 and T2 respectively. In each time period, timing advance commands for sTAG are sent to the UE and Sounding Reference Signals (SRS), as specified in table A.10.2.2.1.2-3, are sent from the UE and received by the test equipment. By measuring the reception of the SRS, the transmit timing, and hence the timing advance adjustment accuracy, can be measured for PSCell in sTAG.

During time period T1, the test equipment shall send one message with a Timing Advance Command MAC Control Element for sTAG, as specified in clause 6.1.3.4 in TS 38.321 [7]. The Timing Advance Command value shall be set to 31, which according to clause 4.2 in TS 38.213 [3] results in zero adjustment of the Timing Advance. In this way, a reference value for the timing advance for sTAG used by the UE is established.

During time period T2, the test equipment shall send a sequence of messages with Timing Advance Command MAC Control Elements for sTAG, with Timing Advance Command value specified in table A.10.2.2.1.2-2. This value shall result in changes of the timing advance for sTAG used by the UE, and the accuracy of the change shall then be measured, using the SRS sent from the UE.

As specified in clause 7.3.2.1, the UE adjusts its uplink timing at slot  $n+k$  for a timing advance command received in slot  $n$ . This delay must be taken into account when measuring the timing advance adjustment accuracy, via the SRS sent from the UE.

The UE Time Alignment Timer, described in clause 5.2 in TS 38.321, shall be configured so that it does not expire in the duration of the test.

**Table A.10.2.2.1.2-1: Supported test configurations for timing advance test**

Config	Description
1	LTE FDD, With CCA: NR TDD, SSB SCS 30 kHz, data SCS 30 kHz, BW 40 MHz
2	LTE TDD, With CCA: NR TDD, SSB SCS 30 kHz, data SCS 30 kHz, BW 40 MHz

Note 1: The UE is only required to be tested in one of the supported test configurations.

Note 2: The UE supporting EN-DC only on NR band(s) with shared spectrum access is required to be tested

**Table A.10.2.2.1.2-2: General test parameters for timing advance test**

Parameter	Unit	Value	Comment
RF channel number		Cell 1: 1 Cell 2: 2	1 for E-UTRAN PCell 2 for NR PSCell
Initial DL BWP		DLBWP.0.1	As specified in Table A.3.9.2.1-1
Dedicated DL BWP		DLBWP.1.1	As specified in Table A.3.9.2.2-1
Initial UL BWP		ULBWP.0.1	As specified in Table A.3.9.3.1-1
Dedicated UL BWP		ULBWP.1.1	As specified in Table A.3.9.3.2-1
Timing Advance Command ( $T_A$ ) value during T1		31	$N_{TA\_new} = N_{TA\_old}$ for the purpose of establishing a reference value from which the timing advance adjustment accuracy can be measured during T2
Timing Advance Command ( $T_A$ ) value during T2		39	For 30 kHz SCS $N_{TA\_new} = N_{TA\_old} + 4096 \cdot T_c$ (based on equation in clause 4.2 of TS 38.213 [3])
T1	s	5	
T2	s	5	

**Table A.10.2.2.1.2-3: Cell specific test parameters for timing advance test**

Parameter		Unit	Test1	
			T1	T2
TDD configuration	Config 1,2		TDDConf.1.1 CCA	
BW <sub>channel</sub>	Config 1,2	MHz	40: N <sub>RB,c</sub> = 106	
BWP BW	Config 1,2	MHz	40: N <sub>RB,c</sub> = 106	
DRX Cycle	Config 1,2	ms	Not Applicable	
DL CCA model	Config 1,2		As specified in clause A.3.26.2.1	
UL CCA model	Config 1,2		As specified in clause A.3.26.2.2	
PDSCH Reference	Config 1,2		SR.1.1 CCA	
CORESET Reference	Config 1,2		CR.1.1 CCA	
TRS configuration	Config 1,2		TRS.1.2 TDD	
OCNG Patterns	Config 1,2		OCNG pattern 1	
SSB Configuration	Semi-static channel access	Config 1,2	SSB.1 CCA	
	Dynamic channel access	Config 1,2	SSB.2 CCA	
SMTC configuration	Config 1,2		SMTC.1 FR1	
DL CCA probability for semi-static channel access ( $P_{CCA\_DL}$ )	Config 1,2		1	
DL CCA model probability for dynamic static channel access ( $P_{CCA\_DL\_1}$ )	Config 1,2		1	
DL CCA model probability for dynamic static channel access ( $P_{CCA\_DL\_2}$ )	Config 1,2		1	
UL CCA probability $P_{CCA}$	Config 1,2		1	
EPRE ratio of PSS to SSS		dB	0	
EPRE ratio of PBCH DMRS to SSS				
EPRE ratio of PBCH to PBCH DMRS				
EPRE ratio of PDCCH DMRS to SSS				
EPRE ratio of PDCCH to PDCCH DMRS				
EPRE ratio of PDSCH DMRS to SSS				

EPRE ratio of PDSCH to PDSCH			
EPRE ratio of OCNG DMRS to SSS(Note 1)			
EPRE ratio of OCNG to OCNG DMRS (Note 1)			
$N_{oc}$ Note2	Config 1,2	dBm/30 kHz	-95
	Config 3,6		-95
$\hat{E}_s / I_{ot}$		dB	3
$\hat{E}_s / N_{oc}$		dB	3
$I_o$ Note3	Config 1,2	dBm/38.16M Hz	-62.58
Propagation condition		-	AWGN
Note 1: OCNG shall be used such that both cells are fully allocated and a constant total transmitted power spectral density is achieved for all OFDM symbols.			
Note 2: Interference from other cells and noise sources not specified in the test is assumed to be constant over subcarriers and time and shall be modelled as AWGN of appropriate power for $N_{oc}$ to be fulfilled.			
Note 3: $I_o$ levels have been derived from other parameters for information purposes. They are not settable parameters themselves.			
Note 4: Parameters $P_{CCA\_DL}$ , $P_{CCA\_DL\_1}$ , $P_{CCA\_DL\_2}$ and $P_{CCA\_UL}$ are defined in clause A.3.26.2.			
Note 5: For UE supporting both semi-static and dynamic channel access, the UE must be tested under both dynamic and semi-static channel occupancy configurations.			

**Table A.10.2.2.1.2-4: Sounding Reference Symbol Configuration for timing advance test**

Field		Value	Comment
c-SRS	Config 1,2	24	Frequency hopping is disabled
b-SRS		0	
b-hop		0	
freqDomainPosition		0	Frequency domain position of SRS
freqDomainShift		0	
groupOrSequenceHopping		neither	No group or sequence hopping
SRS-PeriodicityAndOffset		sl5=4 for SCS 30kHz	Once every 5 slots
pathlossReferenceRS		ssb-Index=0	SSB #0 is used for SRS path loss estimation
usage		Codebook	Codebook based UL transmission
startPosition		0	resourceMapping setting: SRS on last symbol of slot, and 1symbols for SRS without repetition.
nrofSymbols		n1	transmissionComb setting
repetitionFactor		n1	
combOffset-n2		0	
cyclicShift-n2		0	
nrofSRS-Ports		port1	Number of antenna ports used for SRS transmission
Note: For further information see clause 6.3.2 in TS 38.331 [2].			

### A.10.2.2.1.3 Test Requirements

The UE shall apply the signalled Timing Advance value for PSCell in sTAG to the transmission timing at the designated activation time i.e.  $k+1$  slots after the reception of the timing advance command, where  $k=5$ .

The Timing Advance adjustment accuracy for PSCell in sTAG shall be within the limits specified in clause 7.3.2.2.

The rate of correct Timing Advance adjustments observed during repeated tests shall be at least 90%.



## A.10.3 Signalling characteristics

### A.10.3.1 Radio link monitoring

#### A.10.3.1.1 Introduction

In the test cases specified in clause A.10.3.1, any uplink signal transmitted by the UE is used for detecting the in-/out-of-sync state of the UE. In terms of measurement, the uplink signal is verified based on the UE output power:

- UE output power higher than Transmit OFF power -50 dBm (as defined in TS 38.101-3 [20]) means uplink signal
- UE output power equal to or less than Transmit OFF power -50 dBm (as defined in TS 38.101-3 [20]) means no uplink signal.

For intra-band contiguous carrier aggregation, transmit OFF power is measured as the mean power per component carrier.

For UE with multiple transmit antennas, transmit OFF power is measured as the mean power at each transmit connector.

#### A.10.3.1.2 Radio link monitoring out-of-sync test for PSCell configured with SSB-based RLM RS in non-DRX mode

##### A.10.3.1.2.1 Test purpose and environment

The purpose of this test is to verify that the UE properly detects the out-of-sync and in-sync for the purpose of monitoring downlink radio link quality of the PSCell. This test will partly verify the FR1 PSCell radio link monitoring requirements in clause 8.1A.

In the test, UE is configured to perform RLM based on SSB, with *detectionResource* included in *RadioLinkMonitoringRS* set to SSB#0 and SSB#1, and *purpose* set to 'rlf'. Supported test configurations are shown in table A.10.3.1.2.1-1. The test parameters are given in Tables A.10.3.1.2.1-2, A.10.3.1.2.1-3, and A.10.3.1.2.1-4 below. There are two cells in the test: Cell 1 is the E-UTRAN PCell, and Cell 2 is the FR1 PSCell which operates on a carrier frequency with CCA and transmits SSBs in DBT windows according to DL CCA model. The E-UTRAN PCell setting refers to Table A.3.7.2.1-1.

The test consists of three successive time periods, with time duration of T1, T2 and T3, respectively. Figure A.10.3.1.2.1-1 shows the variation of the downlink SNR in the active Cell 2 to emulate out-of-sync and in-sync states. Prior to the start of the time duration T1, the UE shall be fully synchronized to Cell 1 and Cell 2. The UE shall be configured for periodic CSI reporting with a reporting periodicity of 5 ms. The UE transmits according to UL CCA model. The UE is configured to perform inter-frequency measurements using Gap Pattern ID #0 (40 ms) in the test.

**Table A.10.3.1.2.1-1: Supported test configurations.**

Configuration	Description
1	LTE FDD; NR: TDD, SSB SCS 30 kHz, data SCS 30 kHz, BW 40 MHz
2	LTE TDD; NR: TDD, SSB SCS 30 kHz, data SCS 30 kHz, BW 40 MHz
NOTE: The UE is only required to pass in one of the supported test configurations above.	

**Table A.10.3.1.2.1-2: General test parameters for PSCell out-of-sync testing in non-DRX mode.**

Parameter		Unit	Value
			Test 1
Active E-UTRA PCell			Cell 1
E-UTRA RF Channel Number			1
Active PSCell			Cell 2
RF Channel Number			2
DL CCA model			As specified in clause A.3.26.2.1
UL CCA model			As specified in clause A.3.26.2.2
Duplex mode	Config 1,2		TDD
BW <sub>channel</sub>	Config 1,2	MHz	40: N <sub>RB,c</sub> = 106

DL initial BWP configuration	Config 1,2		DLBWP.0.1
DL dedicated BWP configuration	Config 1,2		DLBWP.1.1
UL initial BWP configuration	Config 1,2		ULBWP.0.1
UL dedicated BWP configuration	Config 1,2		ULBWP.1.1
TDD configuration	Config 1,2		TDDConf.1.1 CCA
CORESET Reference Channel	Config 1,2		CR.1.1 CCA
SSB configuration for semi-static channel access <sup>Note 4, 6</sup>	Config 1,2		SSB.1 CCA
SSB configuration for dynamic channel access <sup>Note 5, 6</sup>	Config 1,2		SSB.2 CCA
DBT window configuration	Config 1,2		DBT.1
PDSCH/PDCCH subcarrier spacing	Config 1,2		30 kHz
PRACH Configuration	Config 1,2		FR1 PRACH configuration 1 under CCA
SSB index assigned as RLM RS			0
OCNG parameters			OP.1
CP length			Normal
Correlation Matrix and Antenna Configuration			2x2 Low
Out of sync transmission parameters	DCI format		1-0
	Number of Control OFDM symbols		2
	Aggregation level	CCE	8
	Ratio of hypothetical PDCCH RE energy to average SSS RE energy	dB	4
	Ratio of hypothetical PDCCH DMRS energy to average SSS RE energy	dB	4
	DMRS precoder granularity		REG bundle size
REG bundle size			6
DRX			OFF
Gap pattern ID			gp0
Layer 3 filtering			Enabled
T310 timer		ms	0
T311 timer		ms	1000
N310			1
N311			1
CSI-RS configuration for CSI reporting	Config 1,2		CSI-RS.2.1 TDD
CSI-RS for tracking	Config 1,2		TRS.1.2 TDD
T1		s	0.2
T2		s	1.04
T3		s	1.04
D1		s	1
<p>NOTE 1: All configurations are assigned to the UE prior to the start of time period T1.</p> <p>NOTE 2: UE-specific PDCCH is not transmitted after T1 starts.</p> <p>NOTE 3: E-UTRAN is in non-DRX mode under test.</p> <p>Note 4: For UE supporting semi-static channel access and network configuring semi-static channel occupancy.</p> <p>Note 5: For UE supporting dynamic channel access and network configuring dynamic channel occupancy.</p> <p>Note 6: For a UE supporting both semi-static and dynamic channel access, the UE can be tested under dynamic channel occupancy only.</p>			

**Table A.10.3.1.2.1-3: Cell-specific test parameters for PSCell out-of-sync testing in non-DRX mode.**

Parameter		Unit	Test 1		
			T1	T2	T3
DL CCA probability $P_{CCA\_DL}$	Note 6,8		$P_{CCA\_DL}=0.9375$		
	Note 7,8		$P_{CCA\_DL\_1}=0.75$ $P_{CCA\_DL\_2}=0.75$		
UL CCA probability $P_{CCA\_UL}$			1		
EPRE ratio of PDCCH DMRS to SSS		dB	4		
EPRE ratio of PDCCH to PDCCH DMRS		dB	0		
EPRE ratio of PBCH DMRS to SSS		dB	0		
EPRE ratio of PBCH to PBCH DMRS		dB			
EPRE ratio of PSS to SSS		dB			
EPRE ratio of PDSCH DMRS to SSS		dB			
EPRE ratio of PDSCH to PDSCH DMRS		dB			
EPRE ratio of OCNG DMRS to SSS		dB			
EPRE ratio of OCNG to OCNG DMRS		dB			
SNR <sup>Note 3,4</sup> on RLM-RS	Config 1,2	dB	1	-7	-15
SNR on other channels and signals	Config 1,2	dB	1		
$N_{oc}$	Config 1,2	dBm/SCS	-95		
Propagation condition			TDL-C 300 ns 100 Hz		
<p>NOTE 1: OCNG shall be used such that the resources in Cell 1 are fully allocated and a constant total transmitted power spectral density is achieved for all OFDM symbols. For cells with CCA model, OCNG is transmitted only in slots with RMC burst transmission and is not transmitted during muted slots or during DBT windows.</p> <p>NOTE 2: The signal contains PDCCH for UEs other than the device under test as part of OCNG.</p> <p>NOTE 3: SNR levels correspond to the signal to noise ratio over the transmitted SSS REs during DBT windows.</p> <p>NOTE 4: The SNR in time periods T1, T2 and T3 is denoted as SNR1, SNR2 and SNR3, respectively, in Figure A.10.3.1.2.1-1.</p> <p>NOTE 5: The SNR values are specified for testing a UE which supports 2 RX on at least one band. For testing of a UE which supports 4 RX on all bands, the SNR during T3 is A.3.6.</p> <p>NOTE 6: For UE supporting semi-static channel access and network configuring semi-static channel occupancy.</p> <p>NOTE 7: For UE supporting dynamic channel access and network configuring dynamic channel occupancy.</p> <p>NOTE 8: For UE supporting both semi-static and dynamic channel access, the UE can be tested under dynamic channel occupancy only.</p>					

**Table A.10.3.1.2.1-4: Measurement gap configuration for PSCell out-of-sync testing in non-DRX mode.**

Field	Test 1	
	Value	
<i>gapOffset</i>	0	
NOTE 1: E-UTRAN PCell and PSCell are SFN-synchronous and frame boundary aligned.		
NOTE 2: Ensure that RLM RS is partially overlapped with measurement gap.		

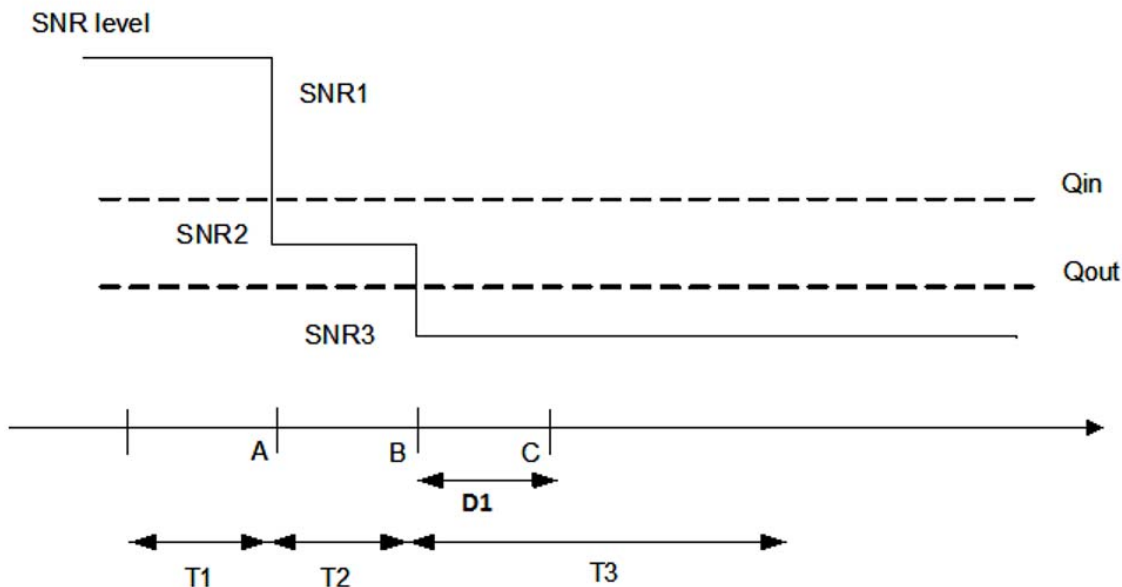

Figure A.10.3.1.2.1-1: SNR variation for out-of-sync testing.

A.10.3.1.2.2 Test requirements

The UE behaviour in each test during time durations T1, T2 and T3 shall be as follows:

- During the period from time point A to time point B the UE shall transmit uplink signal at least in all uplink slots configured for CSI transmission according to the configured periodic CSI reporting.
- The UE shall stop transmitting uplink signal no later than time point C (D1 second after the start of the time duration T3).

The rate of correct events observed during repeated tests shall be at least 90%

A.10.3.1.3 Radio link monitoring in-sync test for PSCell configured with SSB-based RLM RS in non-DRX mode

A.10.3.1.3.1 Test purpose and environment

The purpose of this test is to verify that the UE properly detects the out of sync and in sync for the purpose of monitoring downlink radio link quality of the PSCell. This test will partly verify the FR1 PSCell radio link monitoring requirements in clause 8.1A.

In the test, UE is configured to perform RLM on SSB, with *detectionResource* included in *RadioLinkMonitoringRS* set to SSB#0 and SSB#1, and *purpose* set to 'rlf'. Supported test configurations are shown in table A.10.3.1.3.1-1. The test parameters are given in Tables A.10.3.1.3.1-2, and A.10.3.1.3.1-3 below. There are two cells in the test: Cell 1 is the E-UTRAN PCell, and Cell 2 is the FR1 PSCell which operates on a carrier frequency with CCA and transmits SSBs in DBT windows according to DL CCA model. The E-UTRAN PCell setting refers to Table A.3.7.2.1-1.

The test consists of five successive time periods, with time duration of T1, T2, T3, T4 and T5 respectively. Figure A.10.3.1.3.1-1 shows the variation of the downlink SNR in the active cell to emulate out-of-sync and in-sync states. Prior to the start of the time duration T1, the UE shall be fully synchronized to Cell 1. The UE shall be configured for periodic CSI reporting with a reporting periodicity of 5 ms. The UE transmits according to UL CCA model.

Table A.10.3.1.3.1-1: Supported test configurations.

Configuration	Description
1	LTE FDD; NR: TDD, SSB SCS 30 kHz, data SCS 30 kHz, BW 40 MHz

2	LTE TDD; NR: TDD, SSB SCS 30 kHz, data SCS 30 kHz, BW 40 MHz
NOTE: The UE is only required to pass in one of the supported test configurations above.	

Table A.10.3.1.3.1-2: General test parameters for PSCell in-sync testing in non-DRX mode.

Parameter		Unit	Value
			Test 1
Active E-UTRA PCell			Cell 1
E-UTRA RF Channel Number			1
Active PSCell			Cell 2
RF Channel Number			2
DL CCA model			As specified in clause A.3.26.2.1
UL CCA model			As specified in clause A.3.26.2.2
Duplex mode	Config 1,2		TDD
BW <sub>channel</sub>	Config 1,2	MHz	40: N <sub>RB,c</sub> = 106
DL initial BWP configuration	Config 1,2		DLBWP.0.1
DL dedicated BWP configuration	Config 1,2		DLBWP.1.1
UL initial BWP configuration	Config 1,2		ULBWP.0.1
UL dedicated BWP configuration	Config 1,2		ULBWP.1.1
TDD Configuration	Config 1,2		TDDConf.1.1 CCA
CORESET Reference Channel	Config 1,2		CR.1.1 CCA
SSB configuration for semi-static channel access <sup>Note 3, 5</sup>	Config 1,2		SSB.1 CCA
SSB configuration for dynamic channel access <sup>Note 4,5</sup>	Config 1,2		SSB.2 CCA
DBT window configuration	Config 1,2		DBT.1
PDSCH/PDCCH subcarrier spacing	Config 1,2		30 kHz
PRACH Configuration	Config 1,2		FR1 PRACH configuration 1 under CCA
SSB index assigned as RLM RS			0
OCNG parameters			OP.1
CP length			Normal
Correlation Matrix and Antenna Configuration			2x2 Low
In sync transmission parameters	DCI format		1-0
	Number of Control OFDM symbols		2
	Aggregation level	CCE	4
	Ratio of hypothetical PDCCH RE energy to average SSS RE energy	dB	0
	Ratio of hypothetical PDCCH DMRS energy to average SSS RE energy	dB	0
	DMRS precoder granularity		REG bundle size
	REG bundle size		6
Out of sync transmission parameters	DCI format		1-0
	Number of Control OFDM symbols		2

	Aggregation level	CCE	8
	Ratio of hypothetical PDCCH RE energy to average SSS RE energy	dB	4
	Ratio of hypothetical PDCCH DMRS energy to average SSS RE energy	dB	4
	DMRS precoder granularity		REG bundle size
	REG bundle size		6
DRX			OFF
Gap pattern ID			N/A
Layer 3 filtering			Enabled
T310 timer		ms	2000
T311 timer		ms	1000
N310			1
N311			1
CSI-RS configuration for CSI reporting	Config 1,2		CSI-RS.2.1 TDD
CSI-RS for tracking	Config 1,2		TRS.1.2 TDD
T1		s	0.2
T2		s	0.2
T3		s	0.52
T4		s	0.2
T5		s	2.04
D1		s	2
NOTE 1: All configurations are assigned to the UE prior to the start of time period T1.			
NOTE 2: UE-specific PDCCH is not transmitted after T1 starts.			
NOTE 3: For UE supporting semi-static channel access and network configuring semi-static channel occupancy.			
NOTE 4: For UE supporting dynamic channel access and network configuring dynamic channel occupancy.			
NOTE 5: For a UE supporting both semi-static and dynamic channel access, the UE can be tested under dynamic channel occupancy only.			

Table A.10.3.1.3.1-3: Cell-specific test parameters for PSCell in-sync testing in non-DRX mode.

Parameter		Unit	Test 1				
			T1	T2	T3	T4	T5
DL CCA probability $P_{CCA\_DL}$	Note 6,8		$P_{CCA\_DL}=0.9375$				
	Note 7,8		$P_{CCA\_DL\_1}=0.75$ $P_{CCA\_DL\_2}=0.75$				
UL CCA probability $P_{CCA\_UL}$			1				
$L_{CCA\_DL}$			7				
$W_{CCA\_DL}$		ms	$T_{Evaluate\_in\_SSB\_CCA}$ NOTE 9				
EPRE ratio of PDCCH DMRS to SSS		dB	4				
EPRE ratio of PDCCH to PDCCH DMRS		dB	0				
EPRE ratio of PBCH DMRS to SSS		dB	0				
EPRE ratio of PBCH to PBCH DMRS		dB					
EPRE ratio of PSS to SSS		dB					
EPRE ratio of PDSCH DMRS to SSS		dB					
EPRE ratio of PDSCH to PDSCH DMRS		dB					
EPRE ratio of OCNG DMRS to SSS		dB					
EPRE ratio of OCNG to OCNG DMRS		dB					
SNR on RLM-RS	Config 1,2	dB	1	-7	-15	-4.5	1

SNR on other channels and signals	Config 1,2	dB	1
$N_{oc}$	Config 1,2	dBm/SCS	-95
Propagation condition		TDL-C 300ns 100Hz	
<p>NOTE 1: OCNG shall be used such that the resources in Cell 1 are fully allocated and a constant total transmitted power spectral density is achieved for all OFDM symbols. For cells with CCA model, OCNG is transmitted only in slots with RMC burst transmission and is not transmitted during muted slots or during DBT windows.</p> <p>NOTE 2: The signal contains PDCCH for UEs other than the device under test as part of OCNG.</p> <p>NOTE 3: SNR levels correspond to the signal to noise ratio over the transmitted SSS REs during DBT windows.</p> <p>NOTE 4: The SNR in time periods T1, T2, T3, T4 and T5 is denoted as SNR1, SNR2, SNR3, SNR4 and SNR5 respectively in Figure A.10.3.1.2.1-1.</p> <p>Note 5: The SNR values are specified for testing a UE which supports 2RX on at least one band. For testing of a UE which supports 4 RX on all bands, the SNR during T3 and T4 is modified as specified in clause A.3.6.</p> <p>NOTE 6: For UE supporting semi-static channel access and network configuring semi-static channel occupancy.</p> <p>NOTE 7: For UE supporting dynamic channel access and network configuring dynamic channel occupancy.</p> <p>NOTE 8: For UE supporting both semi-static and dynamic channel access, the UE can be tested under dynamic channel occupancy only.</p> <p>NOTE 9: As defined in Table 8.1A.2.2-1.</p>			

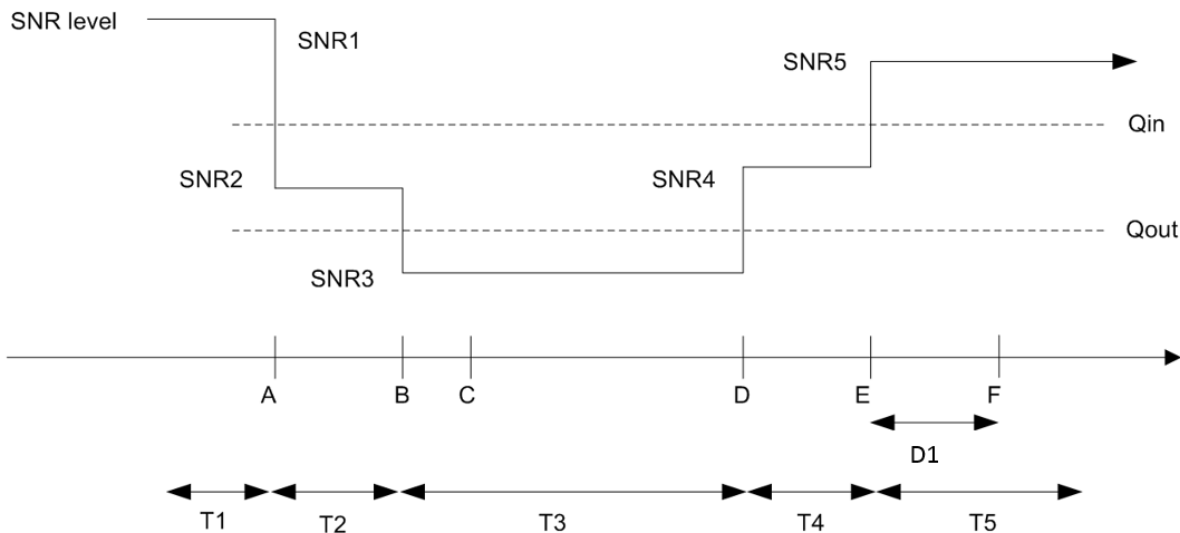

Figure A.10.3.1.2.1-1: SNR variation for in-sync testing.

A.10.3.1.3.2 Test requirements

The UE behaviour in each test during time durations T1, T2, T3, T4 and T5 shall be as follows:

During the period from time point A to time point F (D1 second after the start of time duration T5) the UE shall transmit uplink signal at least in all uplink slots configured for CSI transmission according to the configured periodic CSI reporting.

The rate of correct events observed during repeated tests shall be at least 90%.

A.10.3.1.4 Void

A.10.3.1.4.1 Void

A.10.3.1.4.2 Void

A.10.3.1.5 Void

A.10.3.1.5.1 Void

A.10.3.1.5.2 Void

## A.10.3.2 Interruption

### A.10.3.2.1 E-UTRAN – NR interruptions during SCell operations with CCA

#### A.10.3.2.1.1 Test Purpose and Environment

The purpose of this test is to verify E-UTRAN PCell and NR PSCell interruptions during SCell operations on an NR SCC with CCA, This test will verify the interruption requirements for E-UTRAN PCell and NR PSCell in EN-DC specified in TS 38.133 clause 8.2.1 and 8.3A. Supported test configurations are shown in table A.10.3.2.1.1-1.

The general test parameters and NR cell specific test parameters are given in Table A.10.3.2.1.1-2 and A.10.3.2.1.1-3 below. The E-UTRAN cell specific test parameters are provided in Table A.3.7.2.1-1. In the test there are three cells: Cell1, Cell2 and Cell3. Cell1 is LTE PCell, Cell2 and Cell3 is NR PSCell and NR SCell. Both of cell 2 and cell 3 are subject to CCA. The test consists of five time periods, with duration of T1, T2, T3, T4 and T5. Prior to the start of the time duration T1, the UE is connected to Cell1 and Cell2. Throughout the test, the LTE PCell and NR PSCell are continuously scheduled in DL. The power of signals on cell 1,2 and 3 is not modified during the test.

Prior to T1, a connection is started with cell 2 as the PSCell, and measurements of cell 3 are configured with gap pattern 0, such that cell 3 is reported. This ensures that cell 3 is known at the start of time period T1 and is not itself part of the tested requirement.

The point in time at which the RRC message implying SCell addition is received at the UE antenna connector, defines the start of time period T1. Measurement gap pattern 0 shall be stopped when the SCell is configured.

The point in time at which the RRC message implying SCell addition is received at the UE antenna connector, defines the start of time period T1.

The point in time at which the MAC-CE message implying SCell activation is received at the UE antenna connector, defines the start of time period T2.

The point in time at which the MAC-CE message implying SCell deactivation is received at the UE antenna connector, defines the start of time period T3.

The point in time at which deactivation delay requirement in section 8.3A are satisfied defines the start of time period T4

The point in time at which the RRC message implying SCell release is received at the UE antenna connector, defines the start of time period T5.

**Table A.10.3.2.1.1-1: Interruptions during measurements on deactivated NR SCC supported test configurations**

Config	Description
1	LTE FDD NR without CCA: 30 kHz SSB SCS, 40 MHz bandwidth, TDD duplex mode NR with CCA: 30 kHz SSB SCS, 40 MHz bandwidth, TDD duplex mode
2	LTE TDD NR without CCA: 30 kHz SSB SCS, 40 MHz bandwidth, TDD duplex mode NR with CCA: 30 kHz SSB SCS, 40 MHz bandwidth, TDD duplex mode



Note: The UE is only required to be tested in one of the supported test configurations
--

**Table A.10.3.2.1.1-2: General test parameters for Interruptions during measurements on deactivated NR SCC**

Parameter	Unit	Value	Comment
RF Channel Number		1, 2, 3	One is E-UTRAN RF channel and the other two are NR RF channels
Active PCell		Cell1	PCell on E-UTRAN RF channel number 1.
Configured PSCell		Cell2	PSCell on NR RF channel number 2.
Configured deactivated SCell		Cell3	Deactivated SCell on NR RF channel number 3.
CP length		Normal	Applicable to Cell1, Cell2 and Cell3
DRX		OFF	
Measurement gap pattern Id		OFF	
SCell measurement cycle (measCycleSCell)	ms	160	
T1	s	<10	
T2	s	<10	
T3	s	<10	
T4	s	<10	
T5	s	<10	

**Table A.10.3.2.1.1-3: NR cell specific test parameters for Interruptions during measurements on deactivated NR SCC**

Parameter	Unit	Cell2					Cell3									
		T1	T2	T3	T4	T5	T1	T2	T3	T4	T5					
TDD configuration	Config 1,2															
BW <sub>channel</sub>	Config 1,2	MHz					40: N <sub>RB,c</sub> = 106					40: N <sub>RB,c</sub> = 106				
DL CCA model	Config 1,2						As specified in clause A.3.20.2.1					As specified in clause A.3.20.2.1				
DL CCA probability for semi-static channel access <sup>Note6,8</sup>	P <sub>CCA_DL</sub>						0.9375					0.9375				
DL CCA probability for dynamic channel access <sup>Note7,8</sup>	P <sub>CCA_DL_1</sub>						0.75					0.75				
	P <sub>CCA_DL_2</sub>						0.75					0.75				
UL CCA model	Config 1,2						As specified in clause A.3.20.2.2					---				
UL CCA probability for semi-static channel access	P <sub>CCA_UL</sub>						0.87					---				
UL CCA probability for dynamic channel access	P <sub>CCA_UL</sub>						0.75					---				
Initial BWP Configuration	Config 1,2						DLBWP.0.1					DLBWP.0.1				
Dedicated DL BWP Configuration	Config 1,2						DLBWP.1.1					DLBWP.1.1				
Initial UL BWP Configuration	Config 1,2						ULBWP.0.1					ULBWP.0.1				
Dedicated UL BWP Configuration	Config 1,2						ULBWP.1.1					ULBWP.1.1				
PDSCH reference measurement channel	Config 1,2						SR.1.1 CCA					-				
RMSI CORESET Parameters	Config 1,2						CR.1.1 CCA					CR.1.1 CCA				
PDCCH CORESET Parameters	Config 1,2						CCR.1.1 CCA					CCR.1.1 CCA				
TRS configuration	Config 1,2						TRS.1.2 TDD					TRS.1.2 TDD				
OCNG Patterns							OP.1					OP.1				
SSB configuration for semi-static channel access <sup>Note6,8</sup>	Config 1,2						SSB.1 CCA					SSB.1 CCA				
SSB configuration for dynamic channel access <sup>Note7,8</sup>	Config 1,2						SSB.2 CCA					SSB.2 CCA				

SMTC Configuration	Config 1,2		SMTC.1	SMTC.1
DBT window configuration	Config 1,2		DBT.1	DBT.1
TCI state			TCI.State.0	TCI.State.0
Correlation Matrix and Antenna Configuration			1x2 Low	1x2 Low
EPRE ratio of PSS to SSS		dB	0	0
EPRE ratio of PBCH DMRS to SSS				
EPRE ratio of PBCH to PBCH DMRS				
EPRE ratio of PDCCH DMRS to SSS				
EPRE ratio of PDCCH to PDCCH DMRS				
EPRE ratio of PDSCH DMRS to SSS				
EPRE ratio of PDSCH to PDSCH				
EPRE ratio of OCNG DMRS to SSS(Note 1)				
EPRE ratio of OCNG to OCNG DMRS (Note 1)				
$N_{oc}$ <sup>Note 2</sup>				
SS-RSRP <sup>Note 3</sup>		dBm/15 kHz	-87	-87
$\bar{E}_s/I_{ot}$		dB	17	17
$\bar{E}_s/N_{oc}$		dB	17	17
$I_o$ <sup>Note3</sup>	Config 1,2	dBm/38.16MHz	-52.86	-52.86
Time offset to Cell1 <sup>Note 4</sup>		ms	3	3
Time offset to Cell2 <sup>Note 5</sup>		$\mu$ s	-	3
Propagation Condition			AWGN	AWGN
<p>Note 1: OCNG shall be used such that both cells are fully allocated and a constant total transmitted power spectral density is achieved for all OFDM symbols in slots with downlink transmission bursts. OCNG is not transmitted during muted slots or during DBT windows.</p> <p>Note 2: Interference from other cells and noise sources not specified in the test is assumed to be constant over subcarriers and time and shall be modeled as AWGN of appropriate power for <math>N_{oc}</math> to be fulfilled.</p> <p>Note 3: SS-RSRP and <math>I_o</math> levels have been derived from other parameters for information purposes. They are not settable parameters themselves.</p> <p>Note 4: Receive time difference of signals received between subframe timing boundary of E-UTRA PCell and slot timing boundary of PSCell at the UE antenna connector including time alignment error between the two cells</p> <p>Note 5: Receive time difference between slot boundaries of signals received from the two cells at the UE antenna connector including time alignment error between the two cells.</p> <p>Note 6: For UE supporting semi-static channel access and network configuring semi-static channel occupancy.</p> <p>Note 7: For UE supporting dynamic channel access and network configuring dynamic channel occupancy.</p> <p>Note 8: For UE supporting both semi-static and dynamic channel access, the UE must be tested under both dynamic and semi-static channel occupancy configurations.</p>				

#### A.10.3.2.1.2 Test Requirements

The UE shall meet the interruption requirements for SCell addition on both the victim PSCC in clause 8.2.1 and the victim LTE PCell in clause 7.32 of [15] during time T1

The UE shall meet the interruption requirements for SCell activation on both the victim PSCell in clause 8.2.1 and the victim LTE PCell in clause 7.32 of [15] during time T2. There shall be a single interruption with time window as specified in clause 8.3A.2

The UE shall meet the interruption requirements for SCell deactivation on both the victim PSCell in clause 8.2.1 and the victim LTE PCell in clause 7.32 of [15] during time T3. There shall be a single interruption with time window as specified in clause 8.3A,3

The UE shall meet the interruption requirements for deactivated SCell measurements on both the victim PSCell in clause 8.2.1 and the victim LTE PCell in clause 7.32 of [15] during time T4,3. The interruptions shall be within the time window as specified in clause 8.3A,3

The UE shall meet the interruption requirements for SCell release on both the victim PSCell in clause 8.2.1 and the victim LTE PCell in clause 7.32 of [15] during time T5.

The rate of correct events observed during repeated tests shall be at least 90%.

### A.10.3.3 SCell activation and deactivation delay

#### A.10.3.3.1 SCell Activation and Deactivation of known NR SCell with NR PSCell and NR SCell under CCA, 160 ms SCell measurement cycle

##### A.10.3.3.1.1 Test Purpose and Environment

The purpose of this test is to verify that SCell activation and deactivation delays for NR SCell, with NR PSCell and NR SCell both under CCA, are within the requirements stated in clause 8.3A, when the SCell is known by the UE at the time of activation and the configured SCell measurement cycle is 160 ms.

The supported test configurations are shown in Table A.10.3.3.1.1-1.

The test parameters are given in Table A.10.3.3.1.1-2 and cell-specific parameters for NR cells are provided in Table A.10.3.3.1.1-3 below. Cell-specific parameters for EUTRA PCell are provided in clause A.3.7.2.1.

The test consists of three successive time periods, with duration of T1, T2 and T3, respectively. There are three carriers, each with one cell: Cell 1 (PCell) on radio channel 1 (PCC) in E-UTRA, Cell 2 (PSCell) on radio channel 2 (PSCC) in NR, and Cell3 (SCell) on radio channel 3 (SCC) in NR. Before the test starts the UE is connected to Cell 1 and Cell 2, but is not aware of Cell 3, as the UE is only monitoring PCC and PSCC. The UE shall be continuously scheduled in the PCell and PSCell throughout the whole test.

At the beginning of T1 the UE receives an RRC message by which the SCell (Cell 3) becomes configured on radio channel 2. The UE now starts monitoring the SCC. At the end of T1, the test equipment sends a MAC message for activation of the SCell.

The point in time at which the MAC message is received at the UE antenna connector, in a slot # denoted  $m$ , defines the start of time period T2. The UE shall be able to report a valid CSI in PSCell for the activated SCell at latest in slot  $m + (T_{\text{HARQ}} + T_{\text{activation\_time\_withCCA}} + T_{\text{CSI\_Reporting\_withCCA}}) / \text{NR\_slot\_length}$ , as defined in clause 8.3A.2. The UE shall start reporting CSI in PSCell in first available uplink resource for CSI reporting after at least one CSI-RS transmission occasion for channel measurement and reporting following slot  $m + \frac{T_{\text{HARQ}} + 3\text{ms}}{\text{NR slot length}}$  and shall report CQI index 0 (out-of-range) until the SCell activation has been completed. Any PSCell interruption shall fall within the time window specified in clause 8.3A.2.

The point in time at which the MAC message is received by at the UE antenna connector, in a slot # denoted  $n$ , defines the start of time period T3. The UE shall complete the activation at latest in slot  $n + \frac{T_{\text{HARQ}} + 3\text{ms}}{\text{NR slot length}}$ . Any PSCell interruption shall fall within the time window specified in clause 8.3A.3.

The test equipment verifies that potential interruption is carried out in the correct time span by monitoring ACK/NACK sent in PSCell during activation and deactivation of SCell, respectively.

The test equipment verifies the activation time by counting the slots from the time when the SCell activation command is sent until a CSI report with other than CQI index 0 is received, while taking into account CCA failures on SCC.

The test equipment verifies the deactivation time by counting the slots from the time when the SCell deactivation command is sent until CQI reporting for SCell is discontinued.

**Table A.10.3.3.1.1-1: Supported test configurations for SCell Activation and Deactivation of known NR SCell with NR PSCell and SCell under CCA, 160 ms SCell measurement cycle**

Configuration	Description
1	PCC: LTE FDD duplex mode; With CCA: 30 kHz SSB SCS, 40 MHz bandwidth, TDD duplex mode; With CCA: 30 kHz SSB SCS, 40 MHz bandwidth, TDD duplex mode
2	PCC: LTE TDD duplex mode; With CCA: 30 kHz SSB SCS, 40 MHz bandwidth, TDD duplex mode; With CCA: 30 kHz SSB SCS, 40 MHz bandwidth, TDD duplex mode
Note:	The UE is only required to be tested in one of the supported test configurations

**Table A.10.3.3.1.1-2: General test parameters for known SCell activation case with NR PSCell and SCell under CCA, 160 ms SCell measurement cycle**

Parameter	Unit	Value	Comment
-----------	------	-------	---------

RF Channel Number		1,2,3	Three radio channels (1, 2, 3) are used for this test
Active PCell		Cell 1	Primary cell on E-UTRAN RF channel number 1.
Active PSCell		Cell 2	Primary secondary cell on NR RF channel number 2.
Configured deactivated SCell		Cell 3	Configured deactivated secondary cell on NR RF channel number 3
CP length		Normal	
DRX		OFF	Continuous monitoring of primary cell
CQI/PMI periodicity and offset configuration index		0	CQI reporting for SCell every second subframe
SCell measurement cycle (measCycleSCell)	ms	160	
Cell 3 timing offset to Cell 2	$\mu$ s	0	
Time alignment error between Cell 3 and Cell 2	$\mu$ s	$\leq$ TAE as specified in TS 38.104 [13] clause 6.5.3.1.	The value of time alignment error depends upon the type of carrier aggregation.
T1	s	7	During this time PCell and PSCell shall be known and the SCell configured and detected.
T2	s	1	During this time the UE shall activate the SCell.
T3	s	1	During this time the UE shall deactivate the SCell.
T <sub>HARQ</sub>	ms	$k_1 \times \text{NR slot length}$	$k_1$ is a number of slots and is indicated by the PDSCH-to-HARQ-timing-indicator field in the DCI format, if present, or provided by <i>dl-DataToUL-ACK</i> , the value of $k$ should be the minimum value defined in TS 38.213 [3] depends on UE's capability
T <sub>CSI_Reporting</sub>	ms	$10 + 5 \cdot 2^{\mu_{DL}}$	The delay (in ms) including uncertainty in acquiring the first available downlink CSI reference resource, UE processing time for CSI reporting (clause 5.2.2.5 in TS 38.214) and uncertainty in acquiring the first available CSI reporting resources as specified in TS 38.331 [2] $\mu_{DL}$ is the subcarrier spacing configuration for DL

**Table A.10.3.3.1.1-3: Cell specific test parameters for known SCell activation case with NR PSCell and SCell under CCA, 160 ms SCell measurement cycle**

Parameter		Unit	Cell 2			Cell 3		
			T1	T2	T3	T1	T2	T3
Duplex mode	Config 1,2		TDD			TDD		
TDD configuration	Config 1,2		TDDConf.1.1 CCA			TDDConf.1.1 CCA		
BW <sub>channel</sub>	Config 1,2	MHz	40: N <sub>RB,c</sub> = 106			40: N <sub>RB,c</sub> = 106		
DL CCA model			As specified in clause A.3.26.2.1			As specified in clause A.3.26.2.1		
UL CCA model			As specified in clause A.3.26.2.2			As specified in clause A.3.26.2.2		
DL CCA probability for semi-static channel access <sup>Note5,7</sup>	P <sub>CCA_DL</sub>		0.9375			0.9375		
DL CCA probability for dynamic channel access <sup>Note6,7</sup>	P <sub>CCA_DL_1</sub>		0.75			0.75		
	P <sub>CCA_DL_2</sub>		0.75			0.75		
UL CCA probability for semi-static channel access	P <sub>CCA_UL</sub>		0.87			0.87		
UL CCA probability for dynamic channel access	P <sub>CCA_UL</sub>		0.75			0.75		
L <sub>CCA_DL</sub> <sup>Note 8</sup>			2			2		
W <sub>CCA_DL</sub> <sup>Note 8</sup>			T <sub>activation_time_withCCA</sub>			T <sub>activation_time_withCCA</sub>		

Initial downlink BWP configuration			DLBWP.0.2	DLBWP.0.2
Initial uplink BWP configuration			ULBWP.0.1	ULBWP.0.1
Dedicated downlink BWP configuration			DLBWP.0.2	DLBWP.0.2
Dedicated uplink BWP configuration			ULBWP.0.1	ULBWP.0.1
TCI state			TCI.State.0	TCI.State.0
TRS Configuration	Config 1,2		TRS.1.2 TDD	TRS.1.2 TDD
PDSCH Reference measurement channel	Config 1,2		SR.1.1 CCA	SR.1.1 CCA
Dedicated CORESET parameters	Config 1,2		CCR.1.3 CCA	CCR.1.3 CCA
RMSI CORESET parameters	Config 1,2		CR.1.1 CCA	CR.1.1 CCA
OCNG Patterns <sup>Note1</sup>			OP.1	OP.1
SSB Configuration for semi-static channel access <sup>Note5,7</sup>	Config 1,2		SSB.1 CCA	SSB.1 CCA
SSB Configuration for dynamic channel access <sup>Note6,7</sup>	Config 1,2		SSB.2 CCA	SSB.2 CCA
SMTC configuration			SMTC.1	SMTC.1
DBT window configuration			DBT.1	DBT.1
EPRE ratio of PSS to SSS		dB	0	0
EPRE ratio of PBCH DMRS to SSS				
EPRE ratio of PBCH to PBCH DMRS				
EPRE ratio of PDCCH DMRS to SSS				
EPRE ratio of PDCCH to PDCCH DMRS				
EPRE ratio of PDSCH DMRS to SSS				
EPRE ratio of PDSCH to PDSCH				
EPRE ratio of OCNG DMRS to SSS <sup>Note1</sup>				
EPRE ratio of OCNG to OCNG DMRS <sup>Note1</sup>				
$N_{oc}$ <sup>Note2</sup>	Config 1,2	dBm/15kHz	-104	-104
$N_{oc}$ <sup>Note2</sup>	Config 1,2	dBm/SCS	-101	-101
$\bar{E}_s/I_{ot}$		dB	17	17
$\bar{E}_s/N_{oc}$		dB	17	17
SS-RSRP <sup>Note3</sup>	Config 1,2	dBm/SCS	-84	-84
$I_o$ <sup>Note3</sup>	Config 1,2	dBm/38.16MHz	-52.87	-52.87
Propagation condition		-	AWGN	
<p>Note 1: OCNG shall be used such that resources in the cells are fully allocated and a constant total transmitted power spectral density is achieved for all OFDM symbols in slots with downlink transmission bursts. OCNG is not transmitted during muted slots or during DBT windows.</p> <p>Note 2: Interference from other cells and noise sources not specified in the test is assumed to be constant over subcarriers and time and shall be modelled as AWGN of appropriate power for <math>N_{oc}</math> to be fulfilled.</p> <p>Note 3: SS-RSRP, SCH_RP and <math>I_o</math> levels have been derived from other parameters for information purposes. They are not settable parameters themselves.</p> <p>Note 4: The uplink resources for CSI reporting are assigned to the UE prior to the start of time period T2.</p> <p>Note 5: For UE supporting semi-static channel access and network configuring semi-static channel occupancy.</p> <p>Note 6: For UE supporting dynamic channel access and network configuring dynamic channel occupancy.</p> <p>Note 7: For UE supporting both semi-static and dynamic channel access, the UE must be tested under both dynamic and semi-static channel occupancy configurations.</p> <p>Note 8: As specified in clause 8.3A for <math>L_{1,max}</math>, <math>L_{2,1,max}</math>, <math>L_{2,2,max}</math>, <math>L_{3,1,max}</math>, and <math>L_{3,2,max}</math></p>				

### A.10.3.3.1.2 Test Requirements

During T2, starting after at least one CSI-RS transmission occasion for channel measurement and reporting from the slot specified in clause 4.3 of TS 38.213 [3] and until the UE has completed the SCell activation, the UE shall report out of range if the UE has available uplink resources to report CQI for the SCell.

During T2, the UE shall send the first valid CSI report (non-zero CQI) for the SCell in first available uplink resource for CSI reporting no later than slot  $m + (T_{HARQ} + T_{activation\_time\_withCCA} + T_{CSI\_Reporting\_withCCA})/NR\_slot\_length$ , where  $T_{activation\_time\_withCCA} = T_{FirstSSB} + L_1 * T_{TS} + 5ms$ , as specified in clause 8.3A.2.

During T3, the UE shall stop sending CSI reports for SCell at latest in slot  $n + \frac{T_{HARQ} + 3ms}{NR\_slot\_length}$ , as defined in clause 8.3A.3.

During T2, interruption on PSCell shall not occur outside slot  $m + 1 + \frac{T_{HARQ}}{NR\_slot\_length}$  to slot  $m + 1 + \frac{T_{HARQ} + 3 + T_X}{NR\_slot\_length}$  with  $T_X = T_{FirstSSB}$ .

During T3, interruption on PSCell shall not occur outside slot  $n + 1 + T_{HARQ}/NR\_slot\_length$  to slot  $n + 1 + (T_{HARQ} + 3ms)/NR\_slot\_length$ .

The interruption on PSCell shall not be more than specified for EN-DC in clause 8.2.1.2.4.

The rate of correctly observed SCell activation delays and SCell deactivation delays shall for repeated tests be at least 90%.

### A.10.3.3.2 SCell Activation and Deactivation of known NR SCell with NR PSCell and NR SCell under CCA, 640 ms SCell measurement cycle

#### A.10.3.3.2.1 Test Purpose and Environment

The purpose of this test is to verify that SCell activation and deactivation delays for NR SCell, with NR PSCell and NR SCell both under CCA, are within the requirements stated in clause 8.3A, when the SCell is known by the UE at the time of activation and the configured SCell measurement cycle is 640 ms.

The supported test configurations are same as in Table A.10.3.3.1.1-1 above.

The test parameters are same as in Table A.10.3.3.1.1-2 above, except for parameters listed below in Table A.10.3.3.2.1-1. The cell-specific parameters are same as in Table A.10.3.3.1.1-3 above.

The test execution is the same as described in clause A.10.3.3.1 above.

**Table A.10.3.3.2.1-1: General test parameters for known NR SCell activation with NR PSCell and SCell under CCA, 640 ms SCell measurement cycle**

Parameter	Unit	Value	Comment
SCell measurement cycle (measCycleSCell)	ms	640	

#### A.10.3.3.2.2 Test Requirements

During T2, starting after at least one CSI-RS transmission occasion for channel measurement and reporting from the slot specified in clause 4.3 of TS 38.213 [3] and until the UE has completed the SCell activation, the UE shall report out of range if the UE has available uplink resources to report CQI for the SCell.

During T2, the UE shall send the first valid CSI report (non-zero CQI) for the SCell in first available uplink resource for CSI reporting no later than slot  $m + (T_{HARQ} + T_{activation\_time\_withCCA} + T_{CSI\_reporting\_withCCA})/NR\_slot\_length$ , where  $T_{activation\_time\_withCCA} = T_{FirstSSB\_MAX} + L_{2,1} * T_{SMTC\_MAX} + (1 + L_{2,2}) * T_{rs} + 5ms$ , as specified in clause 8.3A.2.

During T3, the UE shall stop sending CSI reports for SCell at latest in slot  $n + \frac{T_{HARQ} + 3ms}{NR\_slot\_length}$ , as defined in clause 8.3A.3.

During T2, interruption on PSCell shall not occur outside slot  $m + 1 + \frac{T_{HARQ}}{NR\_slot\_length}$  to slot  $m + 1 + \frac{T_{HARQ} + 3 + T_X}{NR\_slot\_length}$  with  $T_X = T_{FirstSSB\_MAX} + L_{2,1} * T_{SMTC\_MAX}$ .

During T3, interruption on PSCell shall not occur outside slot  $n + 1 + T_{HARQ}/NR\_slot\_length$  to slot  $n + 1 + (T_{HARQ} + 3ms)/NR\_slot\_length$ .

The interruption on PSCell shall not be more than specified for EN-DC in clause 8.2.1.2.4.

The rate of correctly observed SCell activation delays and SCell deactivation delays shall for repeated tests be at least 90%.

### A.10.3.3.3 SCell Activation and Deactivation of unknown NR SCell with NR PSCell and NR SCell under CCA

#### A.10.3.3.3.1 Test Purpose and Environment

The purpose of this test is to verify that SCell activation and deactivation delays for NR SCell, with NR PSCell and NR SCell both under CCA, are within the requirements stated in clause 8.3A, when the SCell is unknown to the UE at the time of activation.

The supported test configurations are same as in Table A.10.3.3.1.1-1 above.

The test parameters are same as in Table A.10.3.3.1.1-2 above, except for parameters listed below in Table A.10.3.3.3.1-1. The cell-specific parameters are same as in Table A.10.3.3.1.1-3 above.

The test execution is the same as described in clause A.10.3.3.1 above.

**Table A.10.3.3.3.1-1: General test parameters for unknown NR SCell activation with NR PSCell and SCell under CCA**

Parameter	Unit	Value	Comment
T1	s	0.1	During this time period PCell and PSCell shall be known and the SCell configured, but not detected.

#### A.10.3.3.3.2 Test Requirements

During T2, starting after at least one CSI-RS transmission occasion for channel measurement and reporting from the slot specified in clause 4.3 of TS 38.213 [3] and until the UE has completed the SCell activation, the UE shall report out of range if the UE has available uplink resources to report CQI for the SCell.

During T2, the UE shall send the first valid CSI report (non-zero CQI) for the SCell in first available uplink resource for CSI reporting no later than slot  $m + (T_{\text{HARQ}} + T_{\text{activation\_time\_withCCA}} + T_{\text{CSI\_reporting\_withCCA}}) / \text{NR\_slot\_length}$ , where  $T_{\text{activation\_time\_withCCA}} = T_{\text{FirstSSB\_MAX}} + (1 + L_{3,1}) * T_{\text{SMTc\_MAX}} + (2 + L_{3,2}) * T_{\text{rs}} + 5\text{ms}$ , as specified in clause 8.3A.2.

During T3, the UE shall stop sending CSI reports for SCell at latest in slot  $n + \frac{T_{\text{HARQ}} + 3\text{ms}}{\text{NR\_slot\_length}}$ , as defined in clause 8.3A.3.

During T2, interruption on PSCell shall not occur outside slot  $m + 1 + \frac{T_{\text{HARQ}}}{\text{NR\_slot\_length}}$  to slot  $m + 1 + \frac{T_{\text{HARQ}} + 3 + T_{\text{X}}}{\text{NR\_slot\_length}}$  with  $T_{\text{X}} = T_{\text{FirstSSB\_MAX}} + L_{3,1} * T_{\text{SMTc\_MAX}}$ .

During T3, interruption on PSCell shall not occur outside slot  $n + 1 + T_{\text{HARQ}} / \text{NR\_slot\_length}$  to slot  $n + 1 + (T_{\text{HARQ}} + 3\text{ms}) / \text{NR\_slot\_length}$ .

The interruption on PSCell shall not be more than specified for EN-DC in clause 8.2.1.2.4.

The rate of correctly observed SCell activation delays and SCell deactivation delays shall for repeated tests be at least 90%.

### A.10.3.4 Beam failure detection and link recovery procedures

#### A.10.3.4.1 EN-DC Beam Failure Detection and Link Recovery Test for FR1 PSCell configured with SSB-based BFD and LR in non-DRX mode

##### A.10.3.4.1.1 Test Purpose and Environment

The purpose of this test is to verify that the UE properly detects SSB-based beam failure in the set  $q_0$  configured for a serving PSCell and that the UE performs correct SSB-based link recovery based on beam candidate set  $q_1$ . The purpose is to test the downlink monitoring for beam failure detection within the UEs active DL BWP of the PSCell, during the evaluation period, and link recovery, when no DRX is used. This test will partly verify the SSB based beam failure detection and link recovery for an FR1 serving cell requirements in clause 8.5A.

The test parameters are given in Tables A.10.3.4.1.1-1, A.10.3.4.1.1-2, and A.10.3.4.1.1-3 below. There are two cells, cell 1 is the E-UTRAN PCell, and cell 2 is the PSCell which operates on a carrier frequency with CCA and transmits SSBs in DBT windows according to DL CCA model. The test consists of five successive time periods, with time duration of T1, T2, T3, T4 and T5 respectively. Figure A.10.3.4.1.1-1 shows the variation of the downlink SNR of the PCell and the SNR of the SSB in set  $q_0$  in the active PSCell to emulate SSB based beam failure. Figure A.10.3.4.1.1-1 additionally shows the variation of the downlink L1-RSRP of the SSB in set  $q_1$  of the candidate beam used for link recovery. Prior to the start of the time duration T1, the UE shall be fully synchronized to cell 1 and cell 2. The UE shall be configured for periodic CSI reporting with a reporting periodicity of 2 ms. The UE transmits the reporting according to UL CCA model. In the test, DRX configuration is not enabled. The UE is configured to perform inter-frequency measurements using GP ID #0 (40 ms) in test 1.

**Table A.10.3.4.1.1-1: Supported test configurations for FR1 PSCell with CCA**

Configuration	Description
1	LTE FDD, NR 30 kHz SSB SCS, 40 MHz bandwidth, TDD duplex mode
2	LTE TDD, NR 30 kHz SSB SCS, 40 MHz bandwidth, TDD duplex mode
Note:	The UE is only required to pass in one of the supported test configurations in FR1

**Table A.10.3.4.1.1-2: General test parameters for FR1 PSCell for SSB-based beam failure detection and link recovery testing in non-DRX mode**

Parameter		Unit	Value	Comment
			Test 1	
Active E-UTRA PCell			Cell 1	
E-UTRA RF Channel Number			1	
Active PSCell			Cell 2	
RF Channel Number			2	
DL CCA model			As specified in A.3.26.2.1	
UL CCA model			As specified in A.3.26.2.2	
Duplex mode	Config 1, 2		TDD	
BWchannel	Config 1, 2	MHz	40: NRB,c = 106	
DL initial BWP configuration	Config 1, 2		DLBWP.0.1	
DL dedicated BWP configuration	Config 1, 2		DLBWP.1.1	
UL initial BWP configuration	Config 1, 2		ULBWP.0.1	
UL dedicated BWP configuration	Config 1, 2		ULBWP.1.1	
TDD configuration	Config 1, 2		TDDConf.1.1 CCA	
CORESET Reference Channel	Config 1, 2		CR.1.1 CCA	
SSB Configuration	Config 1, 2		SSB.3 CCA for semi-static channel access SSB.4 CCA for dynamic channel access	
DBT Window Configuration	Config 1, 2		DBT.1	
PDSCH/PDCCH subcarrier spacing	Config 1, 2		30 KHz	
PRACH Configuration	Config 1, 2		Table A.3.8.2.2-1	



SSB Index assigned as BFD RS ( $q_0$ )			0	
SSB Index assigned as CBD RS ( $q_1$ )			1	
OCNG parameters			OP.1	
CP length			Normal	
Correlation Matrix and Antenna Configuration			2x2 Low	
Beam failure detection transmission parameters	DCI format		1-0	
	Number of Control OFDM symbols		2	
	Aggregation level	CCE	8	
	Ratio of hypothetical PDCCH RE energy to average SSS RE energy	dB	0	
	Ratio of hypothetical PDCCH DMRS energy to average SSS RE energy	dB	0	
	DMRS precoder granularity		REG bundle size	
	REG bundle size		6	
DRX			OFF	
Gap pattern ID			gp0	
gapOffset			0	
rimInSyncOutOfSyncThreshold			absent	When the field is absent, the UE applies the value 0. (Table 8.1.1-1).
rsrp-ThresholdSSB	Config 1, 2	dBm/SCS kHz	-95	Threshold used for $Q_{in\_LR\_SSB}$
powerControlOffsetSS			db0	Used for deriving rsrp-ThresholdCSI-RS
beamFailureInstanceMaxCount			n1	see TS 38.321 [7], clause 5.17
beamFailureDetectionTimer			pbfd4	see TS 38.321 [7], clause 5.17
CSI-RS configuration for CSI reporting	Config 1, 2		CSI-RS.2.1 TDD	
CSI-RS for tracking	Config 1, 2		TRS.1.2 TDD	
SSB Index assigned as RLM RS			0,1	
T310 timer		ms	1000	
N310			2	
T1		s	0.2	During this time the the UE shall be fully synchronized to cell 1
T2		s	0.93	
T3		s	0.52	
T4		s	0	
T5		s	0.45	
D1		s	0.41	

Note 1: All configurations are assigned to the UE prior to the start of time period T1.  
 Note 2: UE-specific PDCCH is not transmitted after T1 starts.  
 Note 3: E-UTRAN is in non-DRX mode under test.

**Table A.10.3.4.1.1-3: Cell specific test parameters for FR1 PSCell for SSB-based beam failure detection and link recovery testing in non-DRX mode**

Parameter		Unit	Test 1				
			T1	T2	T3	T4	T5
DL CCA probability $P_{CCA,DL}$	Note 10, 12		1.0	0.9375	0.9375	0.9375	0.9375
	Note 11, 12		1.0/1.0	0.75/0.75	0.75/0.75	0.75/0.75	0.75/0.75
UL CCA probability $P_{CCA,UL}$			1.0	1.0	1.0	1.0	1.0
$L_{CCA,DL}$			N/A	7			
$W_{CCA,DL}$		ms	N/A	$T_{Evaluate\_CBD\_SSB\_CCA}$ Note 13			
EPRE ratio of PDCCH DMRS to SSS		dB	0				
EPRE ratio of PDCCH to PDCCH DMRS		dB					
EPRE ratio of PBCH DMRS to SSS		dB					
EPRE ratio of PBCH to PBCH DMRS		dB					
EPRE ratio of PSS to SSS		dB					
EPRE ratio of PDSCH DMRS to SSS		dB					
EPRE ratio of PDSCH to PDSCH DMRS		dB					
EPRE ratio of OCNG DMRS to SSS		dB					
EPRE ratio of OCNG to OCNG DMRS		dB					
SNR_SSB of set $q_0$	Config 1, 2	dB	5	-3	-12	-12	-12
SNR_SSB of set $q_1$	Config 1, 2	dB	-10	-10	10	10	10
SSB_RP of set $q_1$	Config 1, 2	dBm/SCS kHz	-105	-105	-85	-85	-85
$N_{oc}$	Config 1, 2	dBm/15 KHz	-98				
Propagation condition			TDL-C 300ns 100Hz				
<p>Note 1: OCNG shall be used such that the resources in Cell 1 are fully allocated and a constant total transmitted power spectral density is achieved for all OFDM symbols. For cells with CCA model, OCNG is transmitted only in the slots with downlink transmission burst and is not transmitted during the muted slots or during DBT window.</p> <p>Note 2: The uplink resources for CSI reporting are assigned to the UE prior to the start of time period T1.</p> <p>Note 3: NZP CSI-RS resource set configuration for CSI reporting are assigned to the UE prior to the start of time period T1.</p> <p>Note 4: Measurement gap configuration is assigned to the UE prior to the start of time period T1.</p> <p>Note 5: The timers and layer 3 filtering related parameters are configured prior to the start of time period T1.</p> <p>Note 6: The signal contains PDCCH for UEs other than the device under test as part of OCNG.</p> <p>Note 7: SNR levels correspond to the signal to noise ratio over the transmitted SSS REs during DBT window.</p> <p>Note 8: The SNR in time periods T1, T2, T3, T4 and T5 is denoted as SNR1, SNR2 and SNR3 respectively in figure A.4.5.5.1.1-1.</p> <p>Note 9: The SNR values are specified for testing a UE which supports 2RX on at least one band. For testing of a UE which supports 4RX on all bands, the SNR during T3 is modified as specified in clause A.3.6A.</p> <p>Note 10: For UE supporting semi-static channel access and network configuring semi-static channel occupancy.</p> <p>Note 11: For UE supporting dynamic channel access and network configuring dynamic channel occupancy. The first value corresponds <math>P_{CCA,DL1}</math> and the second value corresponds to the <math>P_{CCA,DL2}</math>.</p> <p>Note 12: For UE supporting both semi-static and dynamic channel access, the UE can be tested under dynamic channel occupancy only.</p> <p>Note 13: As defined in Table 8.5A.5.2-1.</p>							

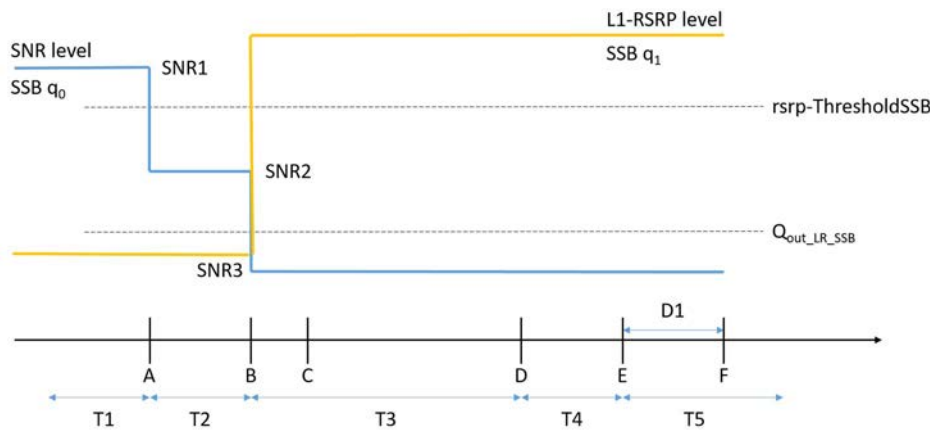

**Figure A.10.3.4.1.1-1: SNR and L1-RSRP variation SSB for SSB-based beam failure detection and link recovery testing in non-DRX mode**

#### A.10.3.4.1.2 Test Requirements

The UE behaviour during time durations T1, T2, T3, T4 and T5 shall be as follows:

During the time duration T1 and T2, the UE shall transmit uplink signal at least in all subframes configured for CSI transmission on Cell 1.

During the period from time point A to time point B the UE shall transmit uplink signal in Cell 1 in all uplink slots configured for CSI transmission according to the configured periodic CSI reporting for Cell 1.

During T3 the UE shall detect beam failure and initiate link recovery. During T4 and T5 the UE measures and evaluate beam candidate from beam candidate set  $q_1$ .

No later than time point F occurring no later than  $D1 = 410$  ms after the start of T5, the UE shall transmit preamble on a beam associated with the candidate beam set  $q_1$ . The UE shall not transmit preamble on a beam associated with the candidate beam set  $q_1$  earlier than time point B.

Test is concluded once the test equipment has received the initial preamble transmission from the UE. The rate of correct events observed during repeated tests shall be at least 90%.

#### A.10.3.4.2 EN-DC Beam Failure Detection and Link Recovery Test for FR1 PSCell configured with SSB-based BFD and LR in DRX mode

##### A.10.3.4.2.1 Test Purpose and Environment

The purpose of this test is to verify that the UE properly detects SSB-based beam failure in the set  $q_0$  configured for a serving PSCell and that the UE performs correct SSB-based link recovery based on beam candidate set  $q_1$ . The purpose is to test the downlink monitoring for beam failure detection within the UEs active DL BWP of the PSCell, during the evaluation period, and link recovery, when DRX is used. This test will partly verify the SSB based beam failure detection and link recovery for an FR1 serving cell requirements in clause 8.5A.

The test parameters are given in Tables A.10.3.4.2.1-1, A.10.3.4.2.1-2, and A.4.5.5.2.1-3 below. There are two cells, cell 1 is the E-UTRAN PCell, and cell 2 is the PSCell which operates on a carrier frequency with CCA and transmits SSBs in DBT windows according to DL CCA model, in the test. The test consists of five successive time periods, with time duration of T1, T2, T3, T4 and T5 respectively. Figure A.10.3.4.2.1-1 shows the variation of the downlink SNR of the PCell and the SNR of the SSB in set  $q_0$  in the active PSCell to emulate SSB based beam failure. Figure A.10.3.4.2.1-1 additionally shows the variation of the downlink L1-RSRP of the SSB in set  $q_1$  of the candidate beam used for link recovery. Prior to the start of the time duration T1, the UE shall be fully synchronized to cell 1 and cell 2. The UE shall be configured for periodic CSI reporting with a reporting periodicity of 2 ms. The UE transmits the reporting according to UL CCA model. In the test, DRX configuration is enabled in PSCell and DRX inactivity timer has already been expired, i.e. UE tries to decode PDCCH and to send periodic CQI during the period when On-duration timer is running. Time alignment timers shall be set to “infinity” so that UL timing alignment is maintained during the test.

**Table A.10.3.4.2.1-1: Supported test configurations for FR1 PSCell with CCA**

Configuration	Description
1	LTE FDD, NR 30 kHz SSB SCS, 40 MHz bandwidth, TDD duplex mode
2	LTE TDD, NR 30 kHz SSB SCS, 40 MHz bandwidth, TDD duplex mode
Note:	The UE is only required to pass in one of the supported test configurations in FR1

**Table A.10.3.4.2.1-2: General test parameters for FR1 PSCell for SSB-based beam failure detection and link recovery testing in DRX mode**

Parameter		Unit	Value	Comment
			Test 1	
Active E-UTRA PCell			Cell 1	
E-UTRA RF Channel Number			1	
Active PSCell			Cell 2	
RF Channel Number			2	
DL CCA model			As specified in A.3.26.2.1	
UL CCA model			As specified in A.3.26.2.2	
Duplex mode	Config 1, 2		TDD	
BWchannel	Config 1, 2	MHz	40: NRB,c = 106	
DL initial BWP configuration	Config 1, 2		DLBWP.0.1	
DL dedicated BWP configuration	Config 1, 2		DLBWP.1.1	
UL initial BWP configuration	Config 1, 2		ULBWP.0.1	
UL dedicated BWP configuration	Config 1, 2		ULBWP.1.1	
TDD configuration	Config 1, 2		TDDConf.1.1 CCA	
CORESET Reference Channel	Config 1, 2		CR.1.1 CCA	
SSB Configuration	Config 1, 2		SSB.3 CCA for semi-static channel access SSB.4 CCA for dynamic channel access	
DBT Window Configuration	Config 1, 2		DBT.1	
PDSCH/PDCCH subcarrier spacing	Config 1, 2		30 KHz	
PRACH Configuration	Config 1, 2		Table A.3.8.2.2-1	
SSB Index assigned as BFD RS ( $q_0$ )			0	
SSB Index assigned as CBD RS ( $q_1$ )			1	
OCNG parameters			OP.1	
CP length			Normal	
Correlation Matrix and Antenna Configuration			2x2 Low	
Beam failure	DCI format		1-0	

detection transmission parameters	Number of Control OFDM symbols		2	
	Aggregation level	CCE	8	
	Ratio of hypothetical PDCCH RE energy to average SSS RE energy	dB	0	
	Ratio of hypothetical PDCCH DMRS energy to average SSS RE energy	dB	0	
	DMRS precoder granularity		REG bundle size	
	REG bundle size		6	
DRX			DRX.7	A.3.3.7
Gap pattern ID			N.A.	
rimInSyncOutOfSyncThreshold			absent	When the field is absent, the UE applies the value 0. (Table 8.1.1-1).
rsrp-ThresholdSSB	Config 1, 2	dBm/SCS kHz	-95	Threshold used for $Q_{in\_LR\_SSB}$
powerControlOffsetSS			db0	Used for deriving rsrp-ThresholdCSI-RS
beamFailureInstanceMaxCount			n1	see TS 38.321 [7], clause 5.17
beamFailureDetectionTimer			pbfd4	see TS 38.321 [7], clause 5.17
CSI-RS configuration for CSI reporting	Config 1, 2		CSI-RS.2.1 TDD	
CSI-RS for tracking	Config 1, 2		TRS.1.2 TDD	
SSB Index assigned as RLM RS			0,1	
T310 timer		ms	1000	
N310			2	
T1		s	1	During this time the the UE shall be fully synchronized to cell 1
T2		s	9.01	
T3		s	5.16	
T4		s	0	
T5		s	3.89	
D1		s	3.85	
Note 1: All configurations are assigned to the UE prior to the start of time period T1.				
Note 2: UE-specific PDCCH is not transmitted after T1 starts.				
Note 3: E-UTRAN is in non-DRX mode under test.				

**Table A.10.3.4.2.1-3: Cell specific test parameters for FR1 PSCell for SSB-based beam failure detection and link recovery testing in DRX mode**

Parameter	Unit	Test 1				
		T1	T2	T3	T4	T5

DL CCA probability $P_{CCA\_DL}$	Semi-static channel access $P_{CCA\_DL}$ <sup>Note 10, 12</sup>		1.0	0.9375	0.9375	0.9375	0.9375
	Dynamic channel access, $P_{CCA\_DL\_1}/P_{CCA\_DL\_2}$ <sup>Note 11, 12</sup>		1.0/1.0	0.75/0.75	0.75/0.75	0.75/0.75	0.75/0.75
UL CCA probability $P_{CCA\_UL}$			1.0	1.0	1.0	1.0	1.0
$L_{CCA\_DL}$			N/A	3			
$W_{CCA\_DL}$		ms	N/A	$T_{Evaluate\_CBD\_SSB\_CCA}$ <sup>Note 13</sup>			
EPRE ratio of PDCCH DMRS to SSS		dB	0				
EPRE ratio of PDCCH to PDCCH DMRS		dB					
EPRE ratio of PBCH DMRS to SSS		dB					
EPRE ratio of PBCH to PBCH DMRS		dB					
EPRE ratio of PSS to SSS		dB					
EPRE ratio of PDSCH DMRS to SSS		dB					
EPRE ratio of PDSCH to PDSCH DMRS		dB					
EPRE ratio of OCNG DMRS to SSS		dB					
EPRE ratio of OCNG to OCNG DMRS		dB					
SNR_SSB of set $q_0$	Config 1, 2	dB					
SNR_SSB of set $q_1$	Config 1, 2	dB	-10	-10	10	10	10
SSB_RP of set $q_1$	Config 1, 2	dBm/SCS kHz	-105	-105	-85	-85	-85
$N_{oc}$	Config 1, 2	dBm/15 KHz	-98				
Propagation condition			TDL-C 300ns 100Hz				
<p>Note 1: OCNG shall be used such that the resources in Cell 1 are fully allocated and a constant total transmitted power spectral density is achieved for all OFDM symbols. For cells with CCA model, OCNG is transmitted only in the slots with downlink transmission burst and is not transmitted during the muted slots or during DBT window.</p> <p>Note 2: The uplink resources for CSI reporting are assigned to the UE prior to the start of time period T1.</p> <p>Note 3: NZP CSI-RS resource set configuration for CSI reporting are assigned to the UE prior to the start of time period T1.</p> <p>Note 4: Measurement gap configuration is assigned to the UE prior to the start of time period T1.</p> <p>Note 5: The timers and layer 3 filtering related parameters are configured prior to the start of time period T1.</p> <p>Note 6: The signal contains PDCCH for UEs other than the device under test as part of OCNG.</p> <p>Note 7: SNR levels correspond to the signal to noise ratio over the transmitted SSS REs during DBT window.</p> <p>Note 8: The SNR in time periods T1, T2, T3, T4 and T5 is denoted as SNR1, SNR2 and SNR3 respectively in figure A.4.5.5.1.1-1.</p> <p>Note 9: The SNR values are specified for testing a UE which supports 2RX on at least one band. For testing of a UE which supports 4RX on all bands, the SNR during T3 is modified as specified in clause A.3.6A.</p> <p>Note 10: For UE supporting semi-static channel access and network configuring semi-static channel occupancy.</p> <p>Note 11: For UE supporting dynamic channel access and network configuring dynamic channel occupancy. The first value corresponds <math>P_{CCA\_DL1}</math> and the second value corresponds to the <math>P_{CCA\_DL2}</math>.</p> <p>Note 12: For UE supporting both semi-static and dynamic channel access, the UE can be tested under dynamic channel occupancy only.</p> <p>Note 13: As defined in Table 8.5A.5.2-1, where <math>L_{CBD,max}=3</math> for <math>T_{DRX} &gt; 320</math>.</p>							

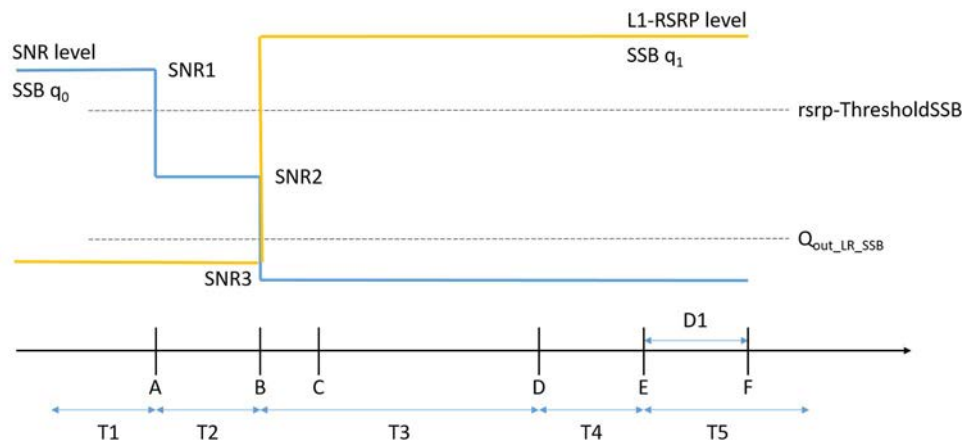

**Figure A.10.3.4.2.1-1: SNR and L1-RSRP variation for SSB-based beam failure detection and link recovery testing in DRX mode**

#### A.10.3.4.2.2 Test Requirements

The UE behaviour during time durations T1, T2, T3, T4 and T5 shall be as follows:

During the time duration T1 and T2, the UE shall transmit uplink signal at least in all subframes configured for CSI transmission on Cell 1.

During the period from time point A to time point B the UE shall transmit uplink signal in Cell 1 in all uplink slots configured for CSI transmission according to the configured periodic CSI reporting for Cell 1.

During T3 the UE shall detect beam failure and initiate link recovery. During T4 and T5 the UE measures and evaluate beam candidate from beam candidate set  $q_1$ .

No later than time point F occurring no later than  $D1 = 3850$  ms after the start of T5, the UE shall transmit preamble on a beam associated with the candidate beam set  $q_1$ . The UE shall not transmit preamble on a beam associated with the candidate beam set  $q_1$  earlier than time point B.

Test is concluded once the test equipment has received the initial preamble transmission from the UE. The rate of correct events observed during repeated tests shall be at least 90%.

### A.10.3.5 Active BWP switching

#### A.10.3.5.1 UL active BWP switch delay with consistent UL LBT failure on PSCell subject to UL CCA in EN-DC

##### A.10.3.5.1.1 Test Purpose and Environment

The purpose of this test is to verify the UL BWP switch delay requirement defined in clause 8.6.4.

The supported test configurations are shown in Table A.10.3.5.1.1-1.

The test scenario comprises of one E-UTRA PCell (Cell 1), and one NR PSCell (Cell 2) as given in A.10.3.5.1.1-2. Cell-specific parameters of E-UTRA PCell are specified in Table A.3.7.2.1-1 and Cell-specific parameters of NR PSCell is specified in Table A.10.3.5.1.1-2. SRS configuration used in the test is specified in Table A.10.3.5.1.1-4.

The UE shall be configured with PRACH configuration on UL BWP on which the UE shall switch after the consistent UL LBT failure detection.

Before the test starts,

- UE is connected to Cell 1 on radio channel 1 and Cell 2 on radio channel 2.

- UE is configured with 2 different UE-specific downlink and uplink bandwidth parts on Cell 2: DL BWP-1, DL BWP-2, UL BWP-1 and UL BWP-2 before starting the test. DL BWP-1 and DL BWP-2 always include bandwidth of the initial DL BWP and SSB. UL BWP-1 and UL BWP-2 always include bandwidth of the SRS.
- UE is indicated in *firstActiveDownlinkBWP-Id* that the active DL BWP is DL BWP-1.
- UE is indicated in *firstActiveUplinkBWP-Id* that the active UL BWP is UL BWP-1.
- UE is configured with *LBT-FailureRecoveryConfig* parameters for Cell 2.

The cell has constant signal levels throughout the test. The test consists of 2 successive time periods, with durations of T1 and T2, respectively.

During T1,

- Time period T1 starts when the UE has received the SRS configuration for periodic SRS transmission on active UL BWP-1.
- The UE shall perform UL CCA before SRS transmission.
- The parameter UL CCA probability  $P_{CCA}$  is set to 0 during T1. This requires the test system to set energy level above the detection level during portion of the UL slot where the UE performs UL CCA. This in turn forces the UE to fail the UL CCA. The UE consistently fails UL CCA during T1 and is therefore unable to transmit SRS.

During T2,

- T2 starts when the UE detects consistent UL LBT failures i.e. when total number of UL LBT failures in Cell 2 on active UL BWP-1 exceeds *lbt-FailureInstanceMaxCount* during *lbt-FailureDetectionTimer*.
- The UE upon detected consistent UL LBT failure starts the LBT recovery mechanism, which requires the UE to switch to active UL BWP-2 in Cell 2 and to send PRACH in the active UL BWP-2.
- Starting from T2, the UE shall be able to send PRACH in the active UL BWP-2 within the delay specified in clause 8.6.4.

**Table A.10.3.5.1.1-1: Supported test configurations for UL BWP switch test in EN-DC**

Config	Description
1	LTE FDD, With CCA: NR TDD, SSB SCS 30 kHz, data SCS 30 kHz, BW 40 MHz
2	LTE TDD, With CCA: NR TDD, SSB SCS 30 kHz, data SCS 30 kHz, BW 40 MHz

Note 1: The UE is only required to be tested in one of the supported test configurations.

**Table A.10.3.5.1.1-2: General test parameters for UL BWP switch in EN-DC**

Parameter	Unit	Value	Comment
E-UTRA RF Channel Number		1	One E-UTRA radio channel is used for this test
NR RF Channel Number		2	One NR radio channel is used for this test
Active PCell		Cell 1	PCell on RF channel number 1.
Active PSCell		Cell 2	PSCell on RF channel number 2.
CP length		Normal	
DRX		OFF	
<i>lbt-FailureDetectionTimer</i> [2]	ms	80	Parameter configured by IE: <i>LBT-FailureRecoveryConfig</i> [1]
<i>lbt-FailureInstanceMaxCount</i> [2]		4	Parameter configured by IE: <i>LBT-FailureRecoveryConfig</i> [1]
T1	s	0.1	During T1 consistent LBT failure is detected on active UL BWP-1
T2	s	0.1	During T2 UE sends PRACH on active UL BWP-2

**Table A.10.3.5.1.1-3: NR Cell specific test parameters for UL BWP switch test in EN-DC**

Parameter	Unit	Cell 2	
		T1	T2
TDD configuration	Config 1, 2	TDDConf.1.1 CCA	
$BW_{channel}$	Config 1, 2	40 MHz: $N_{RB,c} = 106$	



DL CCA model		Config 1, 2	As specified in clause A.3.20.2.1	
UL CCA model		Config 1, 2	As specified in clause A.3.20.2.2	
Active BWP ID		Config 1, 2	1, 2	
Initial DL BWP Configuration		Config 1, 2	DLBWP.0.2 <sup>Note 4</sup>	
Active DL BWP-1 Configuration		Config 1, 2	DLBWP.1.1 <sup>Note 4</sup>	
Active DL BWP-2 Configuration		Config 1, 2	DLBWP.1.3 <sup>Note 4</sup>	
Initial UL BWP Configuration		Config 1, 2	ULBWP.0.2 <sup>Note 4</sup>	
Active UL BWP-1 Configuration		Config 1, 2	ULBWP.1.1 <sup>Note 4</sup>	
Active UL BWP-2 Configuration		Config 1, 2	ULBWP.1.3 <sup>Note 4</sup>	
PDSCH Reference measurement channel		Config 1, 2	SR.1.1 CCA	
RMSI CORESET parameters		Config 1, 2	CR.1.1 CCA	
Dedicated CORESET parameters		Config 1, 2	CCR.1.1 CCA	
OCNG Patterns		Config 1, 2	OP.1	
SSB Configuration	Semi- static channel acces	Config 1, 2	SSB.1 CCA	
	Dymamic channel acces	Config 1, 2	SSB.2 CCA	
SMTc Configuration		Config 1, 2	SMTc.1 FR1	
Correlation Matrix and Antenna Configuration		Config 1, 2	1x2 Low	
TRS Configuration		Config 1, 2	TRS.1.2 TDD	
DL CCA probability for semi-static channel access ( $P_{CCA\_DL}$ )		Config 1, 2	1	1
DL CCA model probability for dynamic static channel access ( $P_{CCA\_DL\_1}$ )		Config 1, 2	1	1
DL CCA model probability for dynamic static channel access ( $P_{CCA\_DL\_2}$ )		Config 1, 2	1	1
UL CCA probability ( $P_{CCA\_UL}$ )		Config 1, 2	0	1
PRACH configuration		Config 1, 2	N/A	Configuration #1 in Table A.3.8.2.1-1
EPRE ratio of PSS to SSS			dB	0
EPRE ratio of PBCH DMRS to SSS				
EPRE ratio of PBCH to PBCH DMRS				
EPRE ratio of PDCCH DMRS to SSS				
EPRE ratio of PDCCH to PDCCH DMRS				
EPRE ratio of PDSCH DMRS to SSS				
EPRE ratio of PDSCH to PDSCH				
EPRE ratio of OCNG DMRS to SSS(Note 1)				
EPRE ratio of OCNG to OCNG DMRS (Note 1)				
$N_{oc}$ <sup>Note 2</sup>		Config 1, 2	dBm/SCS	-101
SS-RSRP <sup>Note 3</sup>		Config 1, 2	dBm/SCS	-84
$\bar{E}_s/I_{ot}$		Config 1, 2	dB	17
$\bar{E}_s/N_{oc}$		Config 1, 2	dB	17
$I_o$ <sup>Note 3</sup>		Config 1, 2	dBm/38.16MHz	-52.86
Propagation Condition			AWGN	
<p>Note 1: OCNG shall be used such that the resources in Cell 1 are fully allocated and a constant total transmitted power spectral density is achieved for all OFDM symbols.</p> <p>Note 2: Interference from other cells and noise sources not specified in the test is assumed to be constant over subcarriers and time and shall be modelled as AWGN of appropriate power for <math>N_{oc}</math> to be fulfilled.</p> <p>Note 3: SS-RSRP and <math>I_o</math> levels have been derived from other parameters for information purposes. They are not settable parameters themselves.</p> <p>Note 4: For unpaired spectrum, a DL BWP is linked with an UL BWP. DLBWP.0.2 is linked with ULBWP.0.2; DLBWP.1.1 is linked with ULBWP.1.1; DLBWP.1.3 is linked with ULBWP.1.3 defined in clause 12 of TS 38.213 [3].</p> <p>Note 5: Parameters <math>P_{CCA\_DL}</math>, <math>P_{CCA\_DL\_1}</math>, <math>P_{CCA\_DL\_2}</math> and <math>P_{CCA\_UL}</math> are defined in clause A.3.20.2.</p> <p>Note 6: For UE supporting both semi-static and dynamic channel access, the UE must be tested under both dynamic and semi-static channel occupancy configurations.</p>				

**Table A.10.3.5.1.1-4: Sounding Reference Symbol Configuration for UL BWP Switch Test in EN-DC**

Field	Value	Comment
c-SRS	24	Frequency hopping is disabled
b-SRS	0	
b-hop	0	
freqDomainPosition	0	Frequency domain position of SRS
freqDomainShift	0	
groupOrSequenceHopping	neither	No group or sequence hopping
SRS-PeriodicityAndOffset	sl5=4 for SCS 30kHz	Once every 5 slots
pathlossReferenceRS	ssb-Index=0	SSB #0 is used for SRS path loss estimation
usage	Codebook	Codebook based UL transmission
startPosition	0	resourceMapping setting: SRS on last symbol of slot, and 1 symbols for SRS without repetition.
nrofSymbols	n1	
repetitionFactor	n1	
combOffset-n2	0	transmissionComb setting
cyclicShift-n2	0	
nrofSRS-Ports	port1	Number of antenna ports used for SRS transmission
Note:	For further information see clause 6.3.2 in TS 38.331 [2].	

#### A.10.3.5.1.2 Test Requirements

The UE capable of *bwp-SwitchingDelay type1* [2] shall start to transmit the PRACH on active UL BWP-2 of Cell 2 (PSCell) less than 21.5 ms from the beginning of time period T1.

The UE capable of *bwp-SwitchingDelay type2* [2] shall start to transmit the PRACH on active UL BWP-2 of Cell 2 (PSCell) less than 23 ms from the beginning of time period T1.

The rate of correct events observed during repeated tests shall be at least 90%.

NOTE: The above delay is calculated as follows:’

The active UL BWP switch delay from UL BWP-1 to UL BWP-2 can be expressed as:

$$T_{\text{BWPswitchDelay}} * T_{\text{slot}} + 1 * T_{\text{slot}} + (1 + L_3) * T_{\text{SSB,RO}} + 10 \text{ ms}$$

Where:

$T_{\text{BWPswitchDelay}} = 1 \text{ ms}$  (2 slots) and  $2.5 \text{ ms}$  (5 slots) for *bwp-SwitchingDelay* [2] *type1* and *type2* UE capabilities according to clause 8.6.4.

$T_{\text{slot}}$  = It is the slot length. It is 0.5 ms for 30 kHz.

$L_3$  = It is the number of consecutive SSB to PRACH occasion association periods during which no PRACH occasion is available for PRACH transmission due to UL CCA failure.  $L_3 = 0$  during T2 since  $P_{\text{CCA}} = 1$ .

$T_{\text{SSB,RO}} = 10 \text{ ms}$  according to FR1 PRACH configuration 1.

This gives a total of 21.5 ms and 23 ms for *type1* and *type2* UE respectively.

## A.10.3.5.2 DCI-based and Timer-based Active BWP Switch

### A.10.3.5.2.1 E-UTRAN – NR PSCell FR1 DL active BWP switch in non-DRX in synchronous EN-DC

#### A.10.3.5.2.1.1 Test Purpose and Environment

The purpose of this test is to verify the DL BWP switch delay requirement defined in TS38.133 clause 8.6, and interruption requirement for E-UTRA victim cell defined in TS36.133 clause 7.32.2.7. Supported test configurations are shown in Table A.10.3.5.2.1.1-1.

The test scenario comprises of one E-UTRA PCell (Cell 1), and one NR PSCell (Cell 2) as given in Table A.10.3.5.2.1.1-2. Cell-specific parameters of E-UTRA PCell are specified in Table A.3.7.2.1-1 and Cell-specific parameters of NR PSCell is specified in Table A.10.3.5.2.1.1-3 below.

PDCCHs indicating new transmissions shall be sent continuously on PCell (Cell 1) to ensure that the UE will have ACK/NACK sending.

PDCCHs indicating new transmissions shall be sent continuously on PSCell (Cell 2) to ensure that the UE would have ACK/NACK sending except for the time duration when BWP is switching on Cell 2 and the time duration of T2.

Before the test starts,

- UE is connected to Cell 1 (PCell) on radio channel 1 (PCC), and Cell 2 (PSCell) on radio channel 2 (PSCC).
- UE is configured with 2 different UE-specific downlink bandwidth parts for PSCell, BWP-1 and BWP-2, in Cell 2 before starting the test. BWP-1 and BWP-2 always include bandwidth of the initial DL BWP and SSB.
- UE is indicated in *firstActiveDownlinkBWP-Id* that the active DL BWP is BWP-1 in PSCell.
- UE is configured with a *bwp-InactivityTimer* timer value for PSCell.

All cells have constant signal levels throughout the test.

The test consists of 3 successive time periods, with durations of T1, T2, and T3, respectively.

During T1,

Time period T1 starts when a DCI format 1\_1 command for PSCell DL BWP switch, sent from the test equipment to the UE, is received at the UE side in PSCell's slot # denoted  $i$ . The UE shall switch its bandwidth part from BWP-1 to BWP-2.

The UE shall be able to receive PDSCH at the beginning of the DL slot right after PSCell's DL slot ( $i+T_{BWPswitchDelay}$ ) as defined in clause 8.6 and starts to report valid ACK/NACK for the PSCell no later than at the beginning of the DL slot right after DL slot ( $i+T_{BWPswitchDelay}+kI$ ). The UE shall be continuously scheduled on PSCell's BWP-2 starting from the beginning of the DL slot right after DL slot ( $i+T_{BWPswitchDelay}$ ).

The starting time of PCell(Cell 1) interruption due to BWP switch on PSCell shall occur within the BWP switch delay.

During T2, the test equipment won't transmit DCI format for PDSCH reception on PSCell(Cell 2).

During T3,

The time period T3 starts from the slot # $j$ , where  $j$  is the beginning slot of the DL subframe immediately after the *bwp-InactivityTimer* timer expires. The UE shall switch its bandwidth part from BWP-2 back to the default bandwidth part – BWP-1.

The UE shall be able to receive PDSCH at the beginning of the DL slot right after PSCell's DL slot ( $j+T_{BWPswitchDelay}$ ) as defined in clause 8.6 and starts to report valid ACK/NACK for the PSCell at latest at the beginning of the DL slot right after DL slot ( $j+T_{BWPswitchDelay}+kI$ ). The UE shall be continuously scheduled on PSCell's BWP-1 starting from the beginning of the DL slot right after DL slot ( $j+T_{BWPswitchDelay}$ ).

The starting time of PCell(Cell 1) interruption due to BWP switch of PSCell shall occur within the BWP switch delay.

The test equipment verifies the DL BWP switch time in PSCell by counting the slots from the time when the BWP switch command is received or *bwp-InactivityTimer* timer expires till an ACK is received.

The test equipment verifies that potential interruption to E-UTRA PCell is carried out in the correct time span by monitoring ACK/NACK sent in PCell during BWP switch of PSCell, respectively.

**Table A.10.3.5.2.1.1-1: DL BWP switch supported test configurations**

Config	Description
1	LTE FDD, With CCA: NR TDD, SSB SCS 30 kHz, data SCS 30 kHz, BW 40 MHz
2	LTE TDD, With CCA: NR TDD, SSB SCS 30 kHz, data SCS 30 kHz, BW 40 MHz
Note 1: The UE is only required to be tested in one of the supported test configurations.	
Note 2: A UE which fulfils the requirements in test case A.10.3.5.2.2 can skip the test cases in A.10.3.5.2.1.	
Note 3: The UE supporting EN-DC with only NR band(s) with shared spectrum access is required to be test.	

**Table A.10.3.5.2.1.1-2: General test parameters for DL BWP switch in synchronous EN-DC**

Parameter	Unit	Value	Comment
E-UTRA RF Channel Number		1	One E-UTRA radio channel is used for this test
NR RF Channel Number		2	One NR radio channel is used for this test
Active PCell		Cell 1	PCell on RF channel number 1.
Active PSCell		Cell 2	PSCell on RF channel number 2.
CP length		Normal	
DRX		OFF	For both PCell and PSCell
DL CCA model		As specified in clause A.3.26.2.1	
UL CCA model		As specified in clause A.3.26.2.2	
<i>bwp-InactivityTimer</i>	ms	200	
Cell-individual offset for cells on RF channel number 1	dB	0	Individual offset for cells on PCC.
Cell-individual offset for cells on RF channel number 2	dB	0	Individual offset for cells on PSCC.
Cell2 timing offset to cell1	μs	3	Synchronous EN-DC
T1	s	0.2	
T2	s	0.2	
T3	s	0.2	

**Table A.10.3.5.2.1.1-3.: NR Cell specific test parameters for DL BWP switch in synchronous EN-DC**

Parameter		Unit	Cell 2
Frequency Range			FR1
Duplex mode		Config 1,2	TDD
TDD configuration		Config 1,2	TDDConf.1.1 CCA
BW <sub>channel</sub>		Config 1,2	40 MHz: N <sub>RB,c</sub> = 106
Active BWP ID			1, 2
Initial DL BWP Configuration		Config 1,2	DLBWP.0.2 <sup>Note 4</sup>
Active DL BWP-1 Configuration		Config 1,2	DLBWP.1.1 <sup>Note 4</sup>
Active DL BWP-2 Configuration		Config 1,2	DLBWP.1.3 <sup>Note 4</sup>
Initial UL BWP Configuration		Config 1,2	ULBWP.0.2 <sup>Note 4</sup>
Active UL BWP-1 Configuration		Config 1,2	ULBWP.1.1 <sup>Note 4</sup>
Active UL BWP-2 Configuration		Config 1,2	ULBWP.1.3 <sup>Note 4</sup>
PDSCH Reference measurement channel		Config 1,2	SR.1.1 CCA
RMSI CORESET parameters		Config 1,2	CR.1.1 CCA
Dedicated CORESET parameters		Config 1,2	CCR.1.1 CCA
OCNG Patterns		Config 1,2	OP.1
SSB Configuration	Semi- static channel acces	Config 1,2	SSB.1 CCA
	Dymamic channel acces	Config 1,2	SSB.2 CCA
SMTc Configuration		Config 1,2	SMTc.1
TRS Configuration		Config 1,2	TRS.1.2 TDD
DL CCA probability for semi-static channel access (P <sub>CCA_DL</sub> )		Config 1,2	1

DL CCA model probability for dynamic static channel access ( $P_{CCA\_DL\_1}$ )	Config 1,2		1
DL CCA model probability for dynamic static channel access ( $P_{CCA\_DL\_2}$ )	Config 1,2		1
DL CCA probability for semi-static channel access ( $P_{CCA\_DL}$ )	Config 1,2		1
Correlation Matrix and Antenna Configuration			1x2 Low
EPRE ratio of PSS to SSS		dB	0
EPRE ratio of PBCH DMRS to SSS			
EPRE ratio of PBCH to PBCH DMRS			
EPRE ratio of PDCCH DMRS to SSS			
EPRE ratio of PDCCH to PDCCH DMRS			
EPRE ratio of PDSCH DMRS to SSS			
EPRE ratio of PDSCH to PDSCH			
EPRE ratio of OCNG DMRS to SSS (Note 1)			
EPRE ratio of OCNG to OCNG DMRS (Note 1)			
$N_{oc}$ <sup>Note 2</sup>	Config 1,2	dBm/SCS	-101
SS-RSRP <sup>Note 3</sup>	Config 1,2	dBm/SCS	-84
$\bar{E}_s/I_{ot}$	Config 1,2	dB	17
$\bar{E}_s/N_{oc}$	Config 1,2	dB	17
$I_o$ <sup>Note3</sup>	Config 1,2	dBm/38.16MHz	-59
Propagation Condition			AWGN
<p>Note 1: OCNG shall be used such that both cells are fully allocated and a constant total transmitted power spectral density is achieved for all OFDM symbols.</p> <p>Note 2: Interference from other cells and noise sources not specified in the test is assumed to be constant over subcarriers and time and shall be modelled as AWGN of appropriate power for <math>N_{oc}</math> to be fulfilled.</p> <p>Note 3: SS-RSRP and <math>I_o</math> levels have been derived from other parameters for information purposes. They are not settable parameters themselves.</p> <p>Note 4: For unpaired spectrum, a DL BWP is linked with an UL BWP. DLBWP.0.2 is linked with ULBWP.0.2; DLBWP.1.1 is linked with ULBWP.1.1; DLBWP.1.3 is linked with ULBWP.1.3 defined in clause 12 of TS 38.213 [3].</p> <p>Note 5: Parameters <math>P_{CCA\_DL}</math>, <math>P_{CCA\_DL\_1}</math>, <math>P_{CCA\_DL\_2}</math> and <math>P_{CCA\_UL}</math> are defined in clause A.3.26.2.</p> <p>Note 6: For UE supporting both semi-static and dynamic channel access, the UE must be tested under both dynamic and semi-static channel occupancy configurations.</p>			

#### A.10.3.5.2.1.2 Test Requirements

During T1, the UE shall start to send the ACK for PSCell from the first UL slot that occurs after the beginning of DL slot  $(i + T_{BWPswitchDelay} + kI)$ .

During T3, the UE shall start to send the ACK for PSCell from the first UL slot that occurs after the beginning of DL slot  $(j + T_{BWPswitchDelay} + kI)$ .

Where,  $kI$  is the timing between DL data receiving and acknowledgement as specified in [7].

Depending on UE capability *bwp-SwitchingDelay* [2], UE shall finish BWP switch within the time duration  $T_{BWPswitchDelay}$  defined in Table 8.6.2-1.

All of the above test requirements shall be fulfilled in order for the observed PSCell active BWP switch delay to be counted as correct.

The rate of correct events observed during repeated tests shall be at least 90%.

During T1, the start time of PCell interruption during PSCell active BWP switch shall not happen outside the BWP switch delay.

During T3, the start time of PCell interruption of during PSCell active BWP switch shall not happen outside the BWP switch delay.

The interruption of PCell shall not be longer than the interruption duration specified for active BWP switch in TS36.133 Clause 7.32.2.7.

All of the above test requirements shall be fulfilled in order for the observed PCell active BWP switch interruption to be counted as correct.

The rate of correct events observed during repeated tests shall be at least 90%.

NOTE: During T1, T3 if there are no uplink resources for reporting the ACK in the DL slot right after DL slot  $(i+T_{BWPswitchDelay+kI})$ ,  $(j+T_{BWPswitchDelay+kI})$ , then the UE shall use the next available uplink resource for reporting the corresponding ACK.

### A.10.3.5.2.2 E-UTRAN – NR PSCell FR1 DL active BWP switch with FR1 SCell in non-DRX in synchronous EN-DC

#### A.10.3.5.2.2.1 Test Purpose and Environment

The purpose of this test is to verify the DL BWP switch delay requirement defined in clause 8.6, and interruption requirements for NR victim cell defined in clause 8.2.1.2.7 and interruption requirement for E-UTRA victim cell defined in clause 7.32.2.7 of TS 36.133 [15]. Supported test configurations are shown in Table A.10.3.5.2.2.1-1.

The test scenario comprises of one E-UTRA PCell (Cell 1), one NR PSCell (Cell 2) and one NR SCell (Cell 3) as given in Table A.10.3.5.2.2.1-2. Cell-specific parameters of E-UTRA PCell are specified in Table A.3.7.2.1-1 and Cell-specific parameters of NR PSCell and SCell are specified in Table A.10.3.5.2.2.1-3 below.

PDCCHs indicating new transmissions shall be sent continuously on PCell (Cell 1) and SCell (Cell 3) to ensure that the UE will have ACK/NACK sending.

PDCCHs indicating new transmissions shall be sent continuously on PSCell (Cell 2) to ensure that the UE would have ACK/NACK sending except for the time duration when BWP is switching on Cell 2 and the time duration of T2.

Before the test starts,

- UE is connected to Cell 1 (PCell) on radio channel 1 (PCC), Cell 2 (PSCell) on radio channel 2 (PSCC) and Cell 3 (SCell) on radio channel 3 (SCC).
- UE is configured with 2 different UE-specific downlink bandwidth parts for PSCell, BWP-1 and BWP-2, in Cell 2 before starting the test. BWP-1 and BWP-2 always include bandwidth of the initial DL BWP and SSB.
- UE is configured with 1 UE-specific downlink bandwidth parts the same as initial BWP for SCell, BWP-0 in Cell 3 before starting the test.
- UE is indicated in *firstActiveDownlinkBWP-Id* that the active DL BWP is BWP-1 in PSCell.
- UE is indicated in *firstActiveDownlinkBWP-Id* that the active DL BWP is BWP-0 in SCell.
- UE is configured with a *bwp-InactivityTimer* timer value for PSCell.

All cells have constant signal levels throughout the test.

The test consists of 3 successive time periods, with durations of T1, T2, and T3, respectively.

During T1,

Time period T1 starts when a DCI format 1\_1 command for PSCell DL BWP switch, sent from the test equipment to the UE, is received at the UE side in PSCell's slot # denoted  $i$ . The UE shall switch its bandwidth part from BWP-1 to BWP-2.

The UE shall be able to receive PDSCH at the beginning of the DL slot right after PSCell's DL slot  $(i+T_{BWPswitchDelay})$  as defined in clause 8.6 and starts to report valid ACK/NACK for the PSCell no later than at the beginning of the DL slot right after slot  $(i+T_{BWPswitchDelay+kI})$ . The UE shall be continuously scheduled on PSCell's BWP-2 starting from the beginning of the DL slot right after slot  $(i+T_{BWPswitchDelay})$ .

PCell(Cell 1) interruption due to BWP switch on PSCell shall occur within the BWP switch delay.

SCell(Cell 3) interruption due to BWP switch on PSCell shall occur within the BWP switch delay.

During T2, the test equipment won't transmit DCI format for PDSCH reception on PSCell(Cell 2).

During T3,

The time period T3 starts from the slot # $j$ , where  $j$  is the beginning slot of the DL subframe immediately after the slot wherein *bwp-InactivityTimer* timer expires. The UE shall switch its bandwidth part from BWP-2 back to the default bandwidth part – BWP-1.

The UE shall be able to receive PDSCH at the beginning of the DL slot right after PSCell's DL slot ( $j+T_{BWPswitchDelay}$ ) as defined in clause 8.6 and starts to report valid ACK/NACK for the PSCell at latest at the beginning of the DL slot right after slot ( $j+T_{BWPswitchDelay}+kI$ ). The UE shall be continuously scheduled on PSCell's BWP-1 starting from the beginning of the DL slot right after slot ( $j+T_{BWPswitchDelay}$ ).

PCell(Cell 1) interruption due to BWP switch of PSCell shall occur within the BWP switch delay.

SCell(Cell 3) interruption due to BWP switch of PSCell shall occur within the BWP switch delay.

The test equipment verifies the DL BWP switch time in PSCell by counting the slots from the time when the BWP switch command is received or *bwp-InactivityTimer* timer expires till an ACK is received.

The test equipment verifies that potential interruption to E-UTRA PCell and NR SCell is carried out in the correct time span by monitoring ACK/NACK sent in PCell and SCell during BWP switch of PSCell, respectively.

**Table A.10.3.5.2.2.1-1: DL BWP switch supported test configurations**

Config	Description
1	LTE FDD, With CCA: NR TDD, SSB SCS 30 kHz, data SCS 30 kHz, BW 40 MHz
2	LTE TDD, With CCA: NR TDD, SSB SCS 30 kHz, data SCS 30 kHz, BW 40 MHz
Note 1:	The UE is only required to be tested in one of the supported test configurations
Note 2:	A UE which fulfils the requirements in test case A.10.3.5.2.2 can skip the test cases in A.10.3.5.2.1.
Note 3:	NR configuration is the same for PSCell and SCells.
Note 4:	The UE supporting EN-DC with only NR band(s) with shared spectrum access is required to be tested.

**Table A.10.3.5.2.2.1-2: General test parameters for DL BWP switch in synchronous EN-DC**

Parameter	Unit	Value	Comment
E-UTRA RF Channel Number		1	One E-UTRA radio channel is used for this test
NR RF Channel Number		2, 3	Two NR radio channel is used for this test
Active PCell		Cell 1	PCell on RF channel number 1.
Active PSCell		Cell 2	PSCell on RF channel number 2.
Active SCell		Cell 3	SCell on RF channel number 3.
CP length		Normal	
DRX		OFF	
DL CCA model		As specified in clause A.3.26.2.1	
UL CCA model		As specified in clause A.3.26.2.2	
Cell-individual offset for cells on RF channel number 2	dB	0	Individual offset for cells on PSCC.
Cell-individual offset for cells on RF channel number 3	dB	0	Individual offset for cells on SCC.
Cell2 timing offset to cell1	μs	3	Synchronous EN-DC
Cell3 timing offset to cell2	μs	3	Synchronous cells
T1	s	0.2	
T2	s	0.2	
T3	s	0.2	

**Table A.10.3.5.2.2.1-3: NR Cell specific test parameters for DL BWP switch in synchronous EN-DC**

Parameter	Unit	Cell 2	Cell 3
Frequency Range		FR1	
Duplex mode	Config 1,2	TDD	
TDD configuration	Config 1,2	TDDConf.1.1 CCA	
BW <sub>channel</sub>	Config 1,2	40 MHz; N <sub>RB,c</sub> = 106	
Active BWP ID		1, 2	0
Initial BWP Configuration	Config 1,2	DLBWP.0.2	DLBWP.0.2
Active BWP-0 Configuration	Config 1,2	NA	DLBWP.0.2
Active BWP-1 Configuration	Config 1,2	DLBWP.1.3	NA
Active BWP-2 Configuration	Config 1,2	DLBWP.1.1	NA
PDSCH Reference measurement channel	Config 1,2	SR.1.1 CCA	
RMSI CORESET parameters	Config 1,2	CR.1.1 CCA	

Dedicated CORESET parameters		Config 1,2		CCR.1.1 CCA	
OCNG Patterns		Config 1,2		OP.1	
SSB Configuration	Semi- static channel acces	Config 1,2		SSB.1 CCA	
	Dymamic channel acces	Config 1,2		SSB.2 CCA	
SMTC Configuration		Config 1,2		SMTC.1	
TRS Configuration		Config 1,2		TRS.1.2 TDD	
DL CCA probability for semi-static channel access ( $P_{CCA\_DL}$ )		Config 1,2		1	1
DL CCA model probability for dynamic static channel access ( $P_{CCA\_DL\_1}$ )		Config 1,2		1	1
DL CCA model probability for dynamic static channel access ( $P_{CCA\_DL\_2}$ )		Config 1,2		1	1
DL CCA probability for semi-static channel access ( $P_{CCA\_DL}$ )		Config 1,2		1	1
Correlation Matrix and Antenna Configuration				1x2	
Propagation Condition				AWGN	
EPRE ratio of PSS to SSS			dB	0	0
EPRE ratio of PBCH DMRS to SSS					
EPRE ratio of PBCH to PBCH DMRS					
EPRE ratio of PDCCH DMRS to SSS					
EPRE ratio of PDCCH to PDCCH DMRS					
EPRE ratio of PDSCH DMRS to SSS					
EPRE ratio of PDSCH to PDSCH					
EPRE ratio of OCNG DMRS to SSS <sup>Note 1</sup>					
EPRE ratio of OCNG to OCNG DMRS <sup>Note 1</sup>					
$N_{oc}$ <sup>Note 2</sup>	Config 1,2	dBm/SCS kHz		-101	-101
SS-RSRP <sup>Note 3</sup>	Config 1,2	dBm/SCS kHz		-84	-84
$\bar{E}_s/I_{ot}$	Config 1,2	dB		17	17
$\bar{E}_s/N_{oc}$	Config 1,2	dB		17	17
$I_o$ <sup>Note 3</sup>	Config 1,2	dBm/38.16M Hz		-59	-59
<p>Note 1: OCNG shall be used such that both cells are fully allocated and a constant total transmitted power spectral density is achieved for all OFDM symbols.</p> <p>Note 2: Interference from other cells and noise sources not specified in the test is assumed to be constant over subcarriers and time and shall be modelled as AWGN of appropriate power for <math>N_{oc}</math> to be fulfilled.</p> <p>Note 3: SS-RSRP and <math>I_o</math> levels have been derived from other parameters for information purposes. They are not settable parameters themselves.</p> <p>Note 4: For unpaired spectrum, a DL BWP is linked with an UL BWP. DLBWP.0.2 is linked with ULBWP.0.2; DLBWP.1.1 is linked with ULBWP.1.1; DLBWP.1.3 is linked with ULBWP.1.3 defined in clause 12 of TS 38.213 [3].</p> <p>Note 5: Parameters <math>P_{CCA\_DL}</math>, <math>P_{CCA\_DL\_1}</math>, <math>P_{CCA\_DL\_2}</math> and <math>P_{CCA\_UL}</math> are defined in clause A.3.26.2.</p> <p>Note 6: For UE supporting both semi-static and dynamic cannel access, the UE must be tested under both dynamic and semi-static channel occupancy configurations.</p>					

#### A.10.3.5.2.2.2 Test Requirements

During T1, the UE shall start to send the ACK for PSCell from the first UL slot that occurs after the beginning of DL slot ( $i+T_{BWPswitchDelay}+kI$ ).

During T3, the UE shall start to send the ACK for PSCell from the first UL slot that occurs after the beginning of DL slot ( $j+T_{BWPswitchDelay}+kI$ ).

All of the above test requirements shall be fulfilled in order for the observed PSCell active BWP switch delay to be counted as correct.

The rate of correct events observed during repeated tests shall be at least 90%.

During T1, the start of the interruption of PCell during PSCell active BWP switch shall not happen outside the BWP switch delay.

During T3, the start of the interruption of PCell during PSCell active BWP switch shall not happen outside the BWP switch delay.



The interruption of PCell shall not be longer than the interruption duration specified for active BWP switch in clause 7.32.2.7 of TS 36.133 [15].

During T1, the start of the interruption of SCell during PSCell active BWP switch shall not happen outside the BWP switch delay.

During T3, the start of the interruption of SCell during PSCell active BWP switch shall not happen outside the BWP switch delay.

The interruption of SCell shall not be longer than the interruption duration specified for active BWP switch in clause 8.6.2.

All of the above test requirements shall be fulfilled in order for the observed PCell active BWP switch interruption to be counted as correct.

The rate of correct events observed during repeated tests shall be at least 90%.

NOTE: During T1, T3 if there are no uplink resources for reporting the ACK in the DL slot right after slot  $(i+T_{BWPswitchDelay}+kI)$ ,  $(j+T_{BWPswitchDelay}+kI)$ , then the UE shall use the next available uplink resource for reporting the corresponding ACK.

*Editor's note: FFS value of  $kI$  for type 1 and type 2 UE.*

### A.10.3.5.3 RRC-based Active BWP Switch

A.10.3.5.3.1 E-UTRAN – NR PSCell FR1 DL active BWP switch in non-DRX in synchronous EN-DC

A.10.3.5.3.1.1 Test Purpose and Environment

The purpose of this test is to verify the DL BWP switch delay requirement for RRC-based BWP switch defined in clause 8.6.3. Supported test configurations are shown in Table A.10.3.5.3.1.1-1.

The test scenario comprises of one E-UTRA PCell (Cell 1) and one NR PSCell (Cell 2) as given in Table A.10.3.5.3.1.1-2. Cell-specific parameters of E-UTRA PCell are specified in Table A.3.7.2.1-1 and Cell-specific parameters of NR PSCell are specified in Table A.10.3.5.3.1.1-3 below.

PDCCHs indicating new transmissions shall be sent continuously on PCell (Cell 1) to ensure that the UE will have ACK/NACK sending.

Before the test starts,

- UE is connected to Cell 1 (PCell) on radio channel 1 (PCC) and to Cell 2 (PSCell) on radio channel 2 (PSCC).
- UE has bandwidth part BWP-1 in its RRC-configuration for Cell 1 (PSCell).
- UE is indicated in *firstActiveDownlinkBWP-Id* that the active DL BWP is BWP-1 of initial condition in PSCell.

All cells have constant signal levels throughout the test.

The test consists of 1 time period, with duration of T1.

During T1,

Time period T1 starts when a *RRCReconfiguration* with updated bandwidth part configuration, sent from the test equipment to the UE, is completely received at the UE side in PSCell's slot # denoted  $i$ . The UE shall reconfigure its bandwidth part with the updated bandwidth part BWP-1 of final condition.

The UE shall be able to receive PDSCH at the beginning of the DL slot right after PSCell's DL slot  $(i+T_{RRCprocessingDelay}+T_{BWPswitchDelayRRC})$  as defined in clause 8.6.3 and be ready for the reception of uplink grant for the PSCell no later than at the beginning of the DL slot right after slot  $(i+T_{RRCprocessingDelay}+T_{BWPswitchDelayRRC})$ . The UE shall be continuously scheduled on PSCell's BWP-1 starting from the beginning of the DL slot right after slot  $(i+T_{RRCprocessingDelay}+T_{BWPswitchDelayRRC})$ .

$T_{RRCprocessingDelay}$  and  $T_{BWPswitchDelayRRC}$  are defined in clause 8.6.3.

The test equipment verifies the DL BWP switch time in PSCell by counting the time from the time when the RRC Reconfiguration message including updated BWP configuration is sent till the time when RRC Reconfiguration Complete message is received.

**Table A.10.3.5.3.1.1-1: DL BWP switch supported test configurations**

Config	Description
1	LTE FDD, With CCA: NR TDD, SSB SCS 30 kHz, data SCS 30 kHz, BW 40 MHz
2	LTE TDD, With CCA: NR TDD, SSB SCS 30 kHz, data SCS 30 kHz, BW 40 MHz
Note 1: The UE is only required to be tested in one of the supported test configurations.	
Note 2: The UE supporting EN-DC with only NR band(s) with shared spectrum access is required to be tested.	

**Table A.10.3.5.3.1.1-2: General test parameters for DL BWP switch in synchronous EN-DC**

Parameter	Unit	Value	Comment
E-UTRA RF Channel Number		1	One E-UTRA radio channel is used for this test
NR RF Channel Number		2	One NR radio channel is used for this test
Active PCell		Cell 1	PCell on RF channel number 1.
Active PSCell		Cell 2	PSCell on RF channel number 2.
CP length		Normal	
DRX		OFF	
DL CCA model		As specified in clause A.3.26.2.1	
UL CCA model		As specified in clause A.3.26.2.2	
Cell-individual offset for cells on RF channel number 1	dB	0	Individual offset for cells on PCC.
Cell-individual offset for cells on RF channel number 2	dB	0	Individual offset for cells on PSCC.
Cell2 timing offset to cell1	μs	3	Synchronous EN-DC
T1	s	0.2	

**Table A.10.3.5.3.1.1-3: NR Cell specific test parameters for DL BWP switch in synchronous EN-DC**

Parameter		Unit	Cell 2
Frequency Range			FR1
Duplex mode	Config 1,2		TDD
TDD configuration	Config 1,2		TDDConf.1.1 CCA
BW <sub>channel</sub>	Config 1,2		40 MHz: N <sub>RB,c</sub> = 106
Active DL BWP ID			1, 2
Initial DL BWP Configuration	Config 1,2		DLBWP.0.2
Initial UL BWP Configuration	Config 1,2		ULBWP.0.2
Initial Condition	Active DL BWP-1 Configuration	Config 1,2	DLBWP.1.3
Final Condition	Active DL BWP-1 Configuration	Config 1,2	DLBWP.1.1
Initial UL BWP Configuration	Config 1,2		ULBWP.0.2
Active UL BWP-1 Configuration	Config 1,2		ULBWP.1.3
Active UL BWP-2 Configuration	Config 1,2		ULBWP.1.1
PDSCH Reference measurement channel	Config 1,2		SR.1.1 CCA
RMSI CORESET parameters	Config 1,2		CR.1.1 CCA
Dedicated CORESET parameters	Config 1,2		CCR.1.1 CCA
OCNG Patterns	Config 1,2		OP.1
SSB Configuration	Semi- static channel acces	Config 1,2	SSB.1 CCA
	Dymamic channel acces	Config 1,2	SSB.2 CCA
SMTc Configuration	Config 1,2		SMTc.1
TRS Configuration	Config 1,2		TRS.1.2 TDD
DL CCA probability for semi-static channel access (P <sub>CCA_DL</sub> )	Config 1,2		1
DL CCA model probability for dynamic static channel access (P <sub>CCA_DL_1</sub> )	Config 1,2		1
DL CCA model probability for dynamic static channel access (P <sub>CCA_DL_2</sub> )	Config 1,2		1

DL CCA probability for semi-static channel access ( $P_{CCA\_DL}$ )	Config 1,2		1
Antenna Configuration			1x2
Propagation Condition			AWGN
EPRE ratio of PSS to SSS		dB	0
EPRE ratio of PBCH DMRS to SSS			
EPRE ratio of PBCH to PBCH DMRS			
EPRE ratio of PDCCH DMRS to SSS			
EPRE ratio of PDCCH to PDCCH DMRS			
EPRE ratio of PDSCH DMRS to SSS			
EPRE ratio of PDSCH to PDSCH			
EPRE ratio of OCNG DMRS to SSS(Note 1)			
EPRE ratio of OCNG to OCNG DMRS (Note 1)			
$N_{oc}$ <sup>Note 2</sup>	Config 1,2		
SS-RSRP <sup>Note 3</sup>	Config 1,2	dBm/SCS kHz	-84]
$\bar{E}_s/I_{ot}$	Config 1,2	dB	17
$\bar{E}_s/N_{oc}$	Config 1,2	dB	17
$I_o$ <sup>Note3</sup>	Config 1,2	dBm/38.16MHz	-59
<p>Note 1: OCNG shall be used such that both cells are fully allocated and a constant total transmitted power spectral density is achieved for all OFDM symbols.</p> <p>Note 2: Interference from other cells and noise sources not specified in the test is assumed to be constant over subcarriers and time and shall be modelled as AWGN of appropriate power for <math>N_{oc}</math> to be fulfilled.</p> <p>Note 3: SS-RSRP and <math>I_o</math> levels have been derived from other parameters for information purposes. They are not settable parameters themselves.</p> <p>Note 4: For unpaired spectrum, a DL BWP is linked with an UL BWP. DLBWP.0.2 is linked with ULBWP.0.2; DLBWP.1.1 is linked with ULBWP.1.1; DLBWP.1.3 is linked with ULBWP.1.3 defined in clause 12 of TS 38.213 [3].</p> <p>Note 5: Parameters <math>P_{CCA\_DL}</math>, <math>P_{CCA\_DL\_1}</math>, <math>P_{CCA\_DL\_2}</math> and <math>P_{CCA\_UL}</math> are defined in clause A.3.26.2.</p> <p>Note 6: For UE supporting both semi-static and dynamic channel access, the UE must be tested under both dynamic and semi-static channel occupancy configurations.</p>			

#### A.10.3.5.3.1.2 Test Requirements

During T1, the UE shall be ready for the reception of uplink grant for PSCell in the beginning of the DL slot right after slot ( $i + T_{RRCprocessingDelay} + T_{BWPswitchDelayRRC}$ ).

All of the above test requirements shall be fulfilled in order for the observed PSCell active BWP switch delay to be counted as correct.

The rate of correct events observed during repeated tests shall be at least 90%.

### A.10.3.6 PSCell addition and release delay

#### A.10.3.6.1 Addition and Release Delay of known NR PSCell on the carrier under CCA

##### A.10.3.6.1.1 Test purpose and environment

The purpose of this test is to verify that the NR PSCell addition and release delays on the carrier under CCA under EN-DC are within the requirements stated in clause 7.31A.2 [15] for the case when the PSCell is known by the UE at the time of addition.

Supported test configurations are shown in A.10.3.6.1.1-1. The test parameters for the E-UTRA cell are given in Table A.3.7.2.1-1. The E-UTRA cell once set up is not changed across time.

The test parameters for NR cell are given in Tables A.10.3.6.1.1-2 and cell-specific parameters in A.10.3.6.1.1-3 below. The test consists of five successive time periods with duration of T1, T2, T3, T4 and T5 respectively. There are two carriers each with one cell. Before the test starts the UE is connected to Cell 1 (E-UTRA PCell) on radio channel 1 (PCC) but is not aware of Cell 2 (NR PSCell) on radio channel 2. The UE is only monitoring the PCC. During T1 only Cell1 is known to the UE.

Before the start of T2, the UE in the measurement control information that event-triggered reporting with Event B1 is configured for neighbour cell (Cell2). Before the start of T2 the UE is configured with the measurement gaps (gap pattern Id # 0). The Cell2 becomes known to the UE during T2. Therefore, during T2 the UE shall report Event B1. The

point in time at which the RRC message to release measurement gap is transmitted from the test system defines the start of period T3. During T3, after measurement gap is released, the test system transmits the RRC message to the UE to add PSCell on radio channel 2.

The RRC message (to add PSCell) also includes a request for the UE to start periodic CSI reporting for the PSCell after the PSCell has been successfully added. The point in time at which the RRC message to add PSCell (Cell2) is received at the UE antenna connector defines the start of period T4.

The test system shall observe the periodic reporting of CSI for PSCell during T5. The point in time at which the UE has sent PRACH to the PSCell (Cell 2) defines the start of period T5.

The test system shall send a RRC message to the UE to release PSCell (Cell 2) on radio channel 2. The RRC message to release PSCell (Cell2) shall be sent to the UE during period T5, after the UE has sent at least one CQI report with non-zero CQI index for PSCell (Cell 2). The point in time at which the RRC message to release PSCell (Cell2) is received at the UE antenna connector defines the start of period T6.

**Table A.10.3.6.1.1-1: Supported test configurations for FR1 PSCell**

Configuration	Description
1	LTE FDD, NR SCS 30 kHz, BW 40 MHz, TDD
2	LTE TDD, NR SCS 30 kHz, BW 40 MHz, TDD
Note:	The UE is only required to pass in one of the supported test configurations in FR1

**Table A.10.3.6.1.1-2: General Test Parameters for PSCell Addition and Release**

Parameter		Unit	Value	Comment
RF Channel Number			1, 2	Two radio channels are used for this test. One for E-UTRA cell and second for NR Cell on the carrier under CCA
Initial	Active PCell		Cell1	PCell on RF channel number 1.
	Neighbour cell		Cell2	Neighbour cell on RF channel number 2.
Final Condition	Active PCell		Cell1	PCell on RF channel number 1.
	Neighbour Cell		Cell2	PSCell released on RF channel number 2.
B1	Hysteresis	dB	0	Hysteresis for evaluation of event B1.
	Threshold RSRP	dBm	-93	Actual RSRP threshold for event B1. Needs to take absolute accuracy tolerance in clause 9.1.11.1 into account plus margin.
	Time to Trigger	S	0	
DRX			OFF	Continuous monitoring of primary cell
DL CCA model	Dynamic channel access <sup>Note 1, 3</sup>			As specified in clause A.3.20.2.1
	Semi-static channel access <sup>Note 2, 3</sup>			
UL CCA model	Dynamic channel access <sup>Note 1, 3</sup>			As specified in clause A.3.20.2.2
	Semi-static channel access <sup>Note 2,3</sup>			
Measurement gap pattern Id			0	Gaps are configured before T2 and released before T3.
PRACH configuration on cell2			FR1 PRACH configuration 2	Captured in A.3.8.2.1
CQI/PMI periodicity and offset configuration index on cell2			2ms	CQI reporting for PSCell every uplink subframe
Cell-individual offset for cells on RF channel number 1		dB	0	Individual offset for cells on primary component carrier.

Cell-individual offset for cells on RF channel number 2	dB	0	Individual offset for cells on carrier frequency of cell2.
T304	ms	500	
L <sub>CCA_DL</sub>		5	
T1	s	1	During this time the PCell shall be known and cell2 shall be unknown.
T2	s	$\geq T_{\text{identify\_irat\_cca\_without\_index}}$	$T_{\text{identify\_irat\_cca\_without\_index}}$ is defined in clause 8.1.2.4.21A and 8.1.2.4.22A in TS 36.133 During this time the UE shall identify neighbour cell (cell2) and report event B1.
T3	s	3	During this time the test system transmit the RRC messages to release measurement gap and add the PSCell
T4	s	$\geq T_{\text{config\_PSCell\_withCCA}}$	During this time the UE adds the PSCell. $T_{\text{config\_PSCell\_withCCA}}$ is defined in clause 7.31A.2
T5	s	0.5	During this time the UE sends CSI reports for PSCell.
T6	s	0.5	During this time the UE releases the PSCell.
<p>NOTE 1: For a UE supporting dynamic channel access and network configuring dynamic channel occupancy.</p> <p>NOTE 2: For a UE supporting semi-static channel access and network configuring semi-static channel occupancy.</p> <p>NOTE 3: For a UE supporting both semi-static and dynamic channel access, the UE can be tested under dynamic channel occupancy only.</p>			

**Table A.10.3.6.1.1-3: Cell Specific Parameters for PSCell Addition and Release**

Parameter	Unit	Config	Test				
			T1	T2	T3	T4	T5
P <sub>CCA_DL</sub> for dynamic channel access <small>Note 5,7</small>	-	P <sub>CCA_DL_1</sub> =0.75 P <sub>CCA_DL_2</sub> =0.75	P <sub>CCA_DL_1</sub> =0.75 P <sub>CCA_DL_2</sub> =0.75				
P <sub>CCA_DL</sub> for semi-static channel access <small>Note 6,7</small>	-	P <sub>CCA_DL</sub> =0.9375	P <sub>CCA_DL</sub> =0.9375				
P <sub>CCA_UL</sub> for dynamic channel access <small>Note 5,7</small>	-	1	1				
P <sub>CCA_UL</sub> for semi-static channel access <small>Note 6,7</small>	-	1	1				
E-UTRA RF Channel Number		1,2	1				
NR RF Channel Number		1,2	2				
TDD configuration		1,2	TDDConf.1.1 CCA				
BW <sub>channel</sub>		1,2	40: N <sub>RB,c</sub> = 106				
Initial BWP Configuration		1,2	DLBWP.0.1 ULBWP.0.1				
Dedicated BWP Configuration		1,2	DLBWP.1.1 ULBWP.1.1				
PDSCH Reference		1,2	SR1.1 CCA				
RMSI CORESET Reference		1,2	CR1.1 CCA				
Dedicated CORESET Reference		1,2	CCR1.1 CCA				
OCNG Patterns		1,2	OP.1				
DBT window configuration		1, 2	DBT.1				
SSB configuration for semi-static channel access		1, 2	SSB.1 CCA				
SSB configuration for dynamic channel access		1, 2	SSB.2 CCA				
SMTc configuration		1,2	SMTc.1				
TRS Configuration		1,2	TRS.1.2 TDD				

EPRE ratio of PSS to SSS	dB	1,2	0	
EPRE ratio of PBCH DMRS to SSS				
EPRE ratio of PBCH to PBCH DMRS				
EPRE ratio of PDCCH DMRS to SSS				
EPRE ratio of PDCCH to PDCCH DMRS				
EPRE ratio of PDSCH DMRS to SSS				
EPRE ratio of PDSCH to PDSCH				
EPRE ratio of OCNG DMRS to SSS(Note 1)				
EPRE ratio of OCNG to OCNG DMRS (Note 1)				
$N_{oc}$ <sup>Note2</sup>	dBm/15 kHz	1,2	N/A	-85
$N_{oc}$ <sup>Note2</sup>	dBm/SCS	1,2	N/A	-82
$\hat{E}_s / I_{ot}$		1,2	-infinity	0
$\hat{E}_s / N_{oc}$		1,2	-infinity	0
SS-RSRP <sup>Note3</sup>	dBm/SCS	1,2	-infinity	-82
$I_o$ <sup>Note3</sup>	dBm/38.1MHz	1,2	N/A	-51
Propagation condition		1,2	AWGN	
<p>Note 1: OCNG shall be used such that both cells are fully allocated and a constant total transmitted power spectral density is achieved for all OFDM symbols. For cells with CCA model, OCNG is transmitted only in slots with RMC burst transmission and is not transmitted during muted slots or during DBT windows.</p> <p>Note 2: Interference from other cells and noise sources not specified in the test is assumed to be constant over subcarriers and time and shall be modelled as AWGN of appropriate power for <math>N_{oc}</math> to be fulfilled.</p> <p>Note 3: SS-RSRP and <math>I_o</math> levels have been derived from other parameters for information purposes. They are not settable parameters themselves.</p> <p>Note 4: SS-RSRP minimum requirements are specified assuming independent interference and noise at each receiver antenna port.</p> <p>Note 5: For UE supporting semi-static channel access and network configuring semi-static channel occupancy.</p> <p>Note 6: For UE supporting dynamic channel access and network configuring dynamic channel occupancy.</p> <p>Note 7: For a UE supporting both semi-static and dynamic channel access, the UE can be tested under dynamic channel occupancy only.</p>				

#### A.10.3.6.1.2 Test Requirements

The UE shall transmit the PRACH to PSCell at latest  $T_{\text{config\_PSCell\_withCCA}}$  <sup>Note1</sup> into T4.

The UE shall send at least one CSI report for PSCell with non-zero CQI index during T5.

The UE shall periodically send CSI reports for PSCell after the UE has sent first CQI report with non-zero CQI index during T5

The UE shall stop sending CSI reports for PSCell in at latest 20 ms into T6.

All the above test requirements shall be fulfilled in order for the observed PSCell addition delay and PSCell release delay to be counted as correct. The rate of correct observed PSCell addition delay and PSCell release delay during repeated tests shall be at least 90%.

Note1: The PSCell addition delay can be expressed as follows as specified in clause 7.31A.2 [15]:

$$T_{\text{config\_PSCell\_withCCA}} = T_{\text{RRC\_delay}} + T_{\text{processing}} + T_{\text{search\_withCCA}} + T_{\Delta\_withCCA} + T_{\text{PSCell\_DU\_withCCA}} + 2 \text{ ms}$$

Where:

$$T_{\text{RRC\_delay}} = 20 \text{ ms}$$

$$T_{\text{processing}} = 20 \text{ ms}$$

$$T_{\text{search\_withCCA}} = 0$$

$$T_{A\_withCCA} = (1 + L_2) * 20 \text{ ms}$$

$$T_{\text{PSCell\_DU\_withCCA}} = 20 \text{ ms.}$$

$L_2$  is the number of SMTC occasions not available at the UE for fine time tracking and acquiring full timing information, where  $L_2 \leq L_{\text{CCA\_DL}}$ .

### A.10.3.7 Void

## A.10.4 Measurement procedure

### A.10.4.1 Intra-frequency measurements

#### A.10.4.1.1 Event-triggered reporting tests on PSCC without gaps under non-DRX

##### A.10.4.1.1.1 Test purpose and environment

The purpose of this test is to verify that the UE makes correct reporting of an event. This test will partly verify the intra-frequency cell search requirements in clauses 9.2A.5.1 and 9.2A.5.2.

##### A.10.4.1.1.2 Test parameters

Three cells are deployed in the test, which are E-UTRAN PCell (Cell 1) and two cells on the same carrier frequency with CCA transmitting SSBs in DBT windows according to DL CCA model: PSCell (Cell 2) and a neighbour cell (Cell 3). The test parameters for the three cells are given in Table A.10.4.1.1.2-1 and A.10.4.1.1.2-2 below. In the measurement control information, a measurement object is configured for the frequency of the PSCell, and it is indicated to the UE that event-triggered reporting with Event A3 is used. The test consists of two successive time periods, with time duration of T1 and T2, respectively. During time duration T1, the UE shall not have any timing information of Cell 3.

**Table A.10.4.1.1.2-1: Supported test configurations**

Configuration	Description
1	LTE FDD; NR: 30 kHz SSB SCS, 40 MHz bandwidth, TDD duplex mode
2	LTE TDD; NR: 30 kHz SSB SCS, 40 MHz bandwidth, TDD duplex mode

NOTE: The UE is only required to be tested in one of the supported test configurations.

**Table A.10.4.1.1.2-2: General test parameters for intra-frequency event triggered reporting without gaps**

Parameter	Unit	Test configuration	Value		Comment
			Test 1	Test 2	
E-UTRA RF Channel Number		Config 1,2	1		
NR RF Channel Number		Config 1,2	1, 2		
Active cell		Config 1,2	LTE Cell 1 (PCell) and NR cell 2 with CCA (PScell)		LTE Cell 1 is on E-UTRA RF channel number 1. NR Cell 2 is on NR RF channel number 2 with CCA.
Neighbour cell		Config 1,2	NR cell 3		NR cell 3 is on NR RF channel number 2 with CCA.
DL CCA model		Config 1,2	As specified in clause A.3.26.2.1		
UL CCA model		Config 1,2	As specified in clause A.3.26.2.2		
A3-Offset	dB	Config 1,2	-6		
Hysteresis	dB	Config 1,2	0		
CP length		Config 1,2	Normal		

TimeToTrigger	s	Config 1,2	0	
Filter coefficient		Config 1,2	0	L3 filtering is not used
DRX		Config 1,2	OFF	DRX is not used
Time offset between PCell and PSCell		Config 1,2	3 $\mu$ s	Synchronous EN-DC
Time offset between serving and neighbour cells		Config 1,2	3 $\mu$ s	Synchronous cells.
T1	s	Config 1,2	5	
T2	s	Config 1,2	5	

**Table A.10.4.1.1.2-3: Cell-specific test parameters for intra-frequency event-triggered reporting without gaps**

Parameter		Unit	Test configuration	Cell 2		Cell 3	
				T1	T2	T1	T2
NR RF Channel Number			Config 1,2	2		2	
Duplex mode			Config 1,2	TDD			
BW <sub>channel</sub>		MHz	Config 1,2	40: N <sub>RB,c</sub> = 106			
BWP BW		MHz	Config 1,2	40: N <sub>RB,c</sub> = 106			
TDD configuration			Config 1,2	TDDConf.1.1 CCA		TDDConf.1.1 CCA	
Initial DL BWP			Config 1,2	DLBWP.0.1		NA	
Initial UL BWP			Config 1,2	ULBWP.0.1		NA	
Dedicated DL BWP			Config 1,2	DLBWP.1.1		NA	
Dedicated UL BWP			Config 1,2	ULBWP.1.1		NA	
TRS configuration			Config 1,2	TRS.1.2 TDD		NA	
OCNG Patterns defined in A.3.2.1.1 (OP.1)			Config 1,2	OP.1		OP.1	
PDSCH Reference measurement channel			Config 1,2	SR.1.1 CCA		-	
CORESET Reference Channel			Config 1,2	CR.1.1 CCA		-	
SSB parameters	Semi-static channel access <sup>Note 5,7</sup>		Config 1,2	SSB.1 CCA		SSB.1 CCA	
	Dynamic channel access <sup>Note 6,7</sup>		Config 1,2	SSB.2 CCA		SSB.2 CCA	
DBT window configuration			Config 1,2	As defined in A.3.28.1		As defined in A.3.28.1	
SMTC configuration			Config 1,2	SMTC.1		SMTC.4	
PDSCH/PDCCH		kHz	Config 1,2	30		30	
DL CCA probability P <sub>CCA_DL</sub>	Semi-static channel access <sup>Note 5,7</sup>		Config 1,2	P <sub>CCA_DL</sub> =0.9375		P <sub>CCA_DL</sub> =0.9375	
	Dynamic channel access <sup>Note 6,7</sup>		Config 1,2	P <sub>CCA_DL_1</sub> =0.75 P <sub>CCA_DL_2</sub> =0.75		P <sub>CCA_DL_1</sub> =0.75 P <sub>CCA_DL_2</sub> =0.75	
UL CCA probability P <sub>CCA_UL</sub>	Semi-static channel access <sup>Note 5,7</sup>		Config 1,2	P <sub>CCA_UL</sub> =1		P <sub>CCA_UL</sub> =1	
	Dynamic channel access <sup>Note 6,7</sup>		Config 1,2	P <sub>CCA_UL</sub> =1		P <sub>CCA_UL</sub> =1	
L <sub>CCA_DL</sub>			Config 1,2	12		12	
W <sub>CCA_DL</sub>		ms	Config 1,2	T <sub>PSS/SSS_sync_intra_cca</sub>		T <sub>PSS/SSS_sync_intra_cca</sub>	
EPRE ratio of PSS to SSS							
EPRE ratio of PBCH DMRS to SSS							



EPRE ratio of PBCH to PBCH DMRS		Config 1,2	0	0		
EPRE ratio of PDCCH DMRS to SSS						
EPRE ratio of PDCCH to PDCCH DMRS						
EPRE ratio of PDSCH DMRS to SSS						
EPRE ratio of PDSCH to PDSCH						
EPRE ratio of OCNG DMRS to SSS(Note 1)						
EPRE ratio of OCNG to OCNG DMRS (Note 1)						
$N_{oc}^{Note2}$	dBm/15k Hz	Config 1,2	-104	-104		
$N_{oc}^{Note2}$	dBm/SC S	Config 1,2	-101	-101		
SS-RSRP <sup>Note 3</sup>	dBm/SC S	Config 1,2	-91	-91	-Infinity	-88
$\hat{E}_s / I_{ot}$	dB	Config 1,2	4	4	-Infinity	7
$\hat{E}_s / N_{oc}$	dB	Config 1,2	4	4	-Infinity	7
$I_o^{Note3}$	dBm/38.1 6MHz	Config 1,2	-58.49	-58.49	-63.94	-56.15
Propagation Condition		Config 1,2	AWGN			
<p>Note 1: OCNG shall be used such that both cells are fully allocated and a constant total transmitted power spectral density is achieved for all OFDM symbols.</p> <p>Note 2: Interference from other cells and noise sources not specified in the test is assumed to be constant over subcarriers and time and shall be modelled as AWGN of appropriate power for <math>N_{oc}</math> to be fulfilled.</p> <p>Note 3: SS-RSRP and <math>I_o</math> levels have been derived from other parameters for information purposes. They are not settable parameters themselves.</p> <p>Note 4: SS-RSRP minimum requirements are specified assuming independent interference and noise at each receiver antenna port.</p> <p>Note 5: For UE supporting semi-static channel access and network configuring semi-static channel occupancy.</p> <p>Note 6: For UE supporting dynamic channel access and network configuring dynamic channel occupancy.</p> <p>Note 7: For UE supporting both semi-static and dynamic channel access, the UE must be tested under dynamic channel access configuration.</p>						

### A.10.4.1.1.3 Test Requirements

The UE shall send one Event A3 triggered measurement report, with a measurement reporting delay less than  $T_{identify\_intra\_without\_index\_CCA}$  ms from the beginning of time period T2. The UE is not required to read the neighbour cell SSB index in this test. The UE shall not send event triggered measurement reports, as long as the reporting criteria are not fulfilled. The rate of correct events observed during repeated tests shall be at least 90%.

$T_{identify\_intra\_cca\_without\_index} = (T_{PSS/SSS\_sync\_intra\_cca} + T_{SSB\_measurement\_period\_intra\_cca})$  ms, where

$T_{PSS/SSS\_sync\_intra\_cca}$ : it is the time period used in PSS/SSS detection given in table 9.2A.5.1-1.

$T_{SSB\_measurement\_period\_intra\_cca}$ : equal to a measurement period of SSB based measurement given in table 9.2A.5.2-1.

NOTE: The actual overall delays measured in the test may be up to  $2 \times TTI_{DCCH}$  higher than the measurement reporting delays above because of TTI insertion uncertainty of the measurement report in DCCH.

### A.10.4.1.2 Void

## A.10.4.1.3 Void

## A.10.4.1.4 Event-triggered reporting tests on PSCC with per-UE gaps under DRX

## A.10.4.1.4.1 Test purpose and environment

The purpose of this test is to verify that the UE makes correct reporting of an event. This test will partly verify the intra-frequency cell search requirements in clauses 9.2A.6.1 and 9.2A.6.2.

## A.10.4.1.4.2 Test parameters

Three cells are deployed in the test, which are E-UTRAN PCell (Cell 1) and two cells on the same carrier frequency with CCA transmitting SSBs in DBT windows according to DL CCA model: PSCell (Cell 2) and a neighbour cell (Cell 3). The test parameters for the three cells are given in Table A.10.4.1.4.2-1, A.10.4.1.4.2-2 and A.10.4.1.4.2-3 below. In the measurement control information, a measurement object is configured for the frequency of the PSCell, and it is indicated to the UE that event-triggered reporting with Event A3 is used. The test consists of two successive time periods, with time duration of T1 and T2, respectively. During time duration T1, the UE shall not have any timing information of Cell 3.

There are two BWPs configured in Cell 2, BWP1 which contains the cell defining SSB, and BWP2 which does not contain any SSB of Cell 2. During the whole test, BWP2 is always scheduled as the active BWP for the UE.

UE needs to be provided with new Timing Advance Command MAC control element at least once during each time alignment timer period to maintain uplink time alignment. Furthermore UE is allocated with PUSCH resource at every DRX cycle.

**Table A.10.4.1.4.2-1: Supported test configurations**

Configuration	Description
1	LTE FDD; NR: 30 kHz SSB SCS, 40 MHz bandwidth, TDD duplex mode
2	LTE TDD; NR: 30 kHz SSB SCS, 40 MHz bandwidth, TDD duplex mode
NOTE: The UE is only required to be tested in one of the supported test configurations.	

**Table A.10.4.1.1.2-2: General test parameters for intra-frequency event triggered reporting without gaps**

Parameter	Unit	Test configuration	Value		Comment
			Test 1	Test 2	
E-UTRA RF Channel Number		Config 1,2	1		
NR RF Channel Number		Config 1,2	1, 2		
Active cell		Config 1,2	LTE Cell 1 (PCell) and NR cell 2 with CCA (PSCell)		LTE Cell 1 is on E-UTRA RF channel number 1. NR Cell 2 is on NR RF channel number 2 with CCA.
Neighbour cell		Config 1,2	NR cell 3		NR cell 3 is on NR RF channel number 2 with CCA.
DL CCA model		Config 1,2	As specified in clause A.3.26.2.1		
UL CCA model		Config 1,2	As specified in clause A.3.26.2.2		
Measurement gap type		Config 1,2	Per-UE gaps		
Measurement gap repetition periodicity	ms	Config 1,2	40		
Measurement gap length	ms	Config 1,2	6		
Measurement gap offset	ms	Config 1,2	39		
A3-Offset	dB	Config 1,2	-6		
Hysteresis	dB	Config 1,2	0		
CP length		Config 1,2	Normal		
TimeToTrigger	s	Config 1,2	0		

Filter coefficient		Config 1,2	0	L3 filtering is not used
DRX		Config 1,2	DRX.1	
Time offset between PCell and PSCell		Config 1,2	3 $\mu$ s	Synchronous EN-DC
Time offset between serving and neighbour cells		Config 1,2	3 $\mu$ s	Synchronous cells.
T1	s	Config 1,2	5	
T2	s	Config 1,2	5	

**Table A.10.4.1.1.2-3: Cell-specific test parameters for intra-frequency event-triggered reporting without gaps**

Parameter		Unit	Test configuration	Cell 2		Cell 3	
				T1	T2	T1	T2
NR RF Channel Number			Config 1,2	2		2	
Duplex mode			Config 1,2	TDD			
BW <sub>channel</sub>		MHz	Config 1,2	40: N <sub>RB,c</sub> = 106			
BWP BW		MHz	Config 1,2	40: N <sub>RB,c</sub> = 106			
TDD configuration			Config 1,2	TDDConf.1.1 CCA		TDDConf.1.1 CCA	
Initial DL BWP			Config 1,2	DLBWP.0.1		NA	
Initial UL BWP			Config 1,2	ULBWP.0.1		NA	
Dedicated DL BWP			Config 1,2	DLBWP.1.1		NA	
Dedicated UL BWP			Config 1,2	ULBWP.1.1		NA	
TRS configuration			Config 1,2	TRS.1.2 TDD		NA	
OCNG Patterns defined in A.3.2.1.1 (OP.1)			Config 1,2	OP.1		OP.1	
PDSCH Reference measurement channel			Config 1,2	SR.1.1 CCA		-	
CORESET Reference Channel			Config 1,2	CR.1.1 CCA		-	
SSB parameters	Semi-static channel access <sup>Note 5,7</sup>		Config 1,2	SSB.1 CCA		SSB.1 CCA	
	Dynamic channel access <sup>Note 6,7</sup>		Config 1,2	SSB.2 CCA		SSB.2 CCA	
DBT window configuration			Config 1,2	As defined in A.3.28.1		As defined in A.3.28.1	
SMTC configuration			Config 1,2	SMTC.1		SMTC.4	
PDSCH/PDCCH		kHz	Config 1,2	30		30	
DL CCA probability P <sub>CCA_DL</sub>	Semi-static channel access <sup>Note 5,7</sup>		Config 1,2	P <sub>CCA_DL</sub> =0.9375		P <sub>CCA_DL</sub> =0.9375	
	Dynamic channel access <sup>Note 6,7</sup>		Config 1,2	P <sub>CCA_DL_1</sub> =0.75 P <sub>CCA_DL_2</sub> =0.75		P <sub>CCA_DL_1</sub> =0.75 P <sub>CCA_DL_2</sub> =0.75	
UL CCA probability P <sub>CCA_UL</sub>	Semi-static channel access <sup>Note 5,7</sup>		Config 1,2	P <sub>CCA_UL</sub> =1		P <sub>CCA_UL</sub> =1	
	Dynamic channel access <sup>Note 6,7</sup>		Config 1,2	P <sub>CCA_UL</sub> =1		P <sub>CCA_UL</sub> =1	
L <sub>CCA_DL</sub>			Config 1,2	12		12	
W <sub>CCA_DL</sub>		ms	Config 1,2	T <sub>PSS/SSS_sync_intra_cca</sub>		T <sub>PSS/SSS_sync_intra_cca</sub>	
EPRE ratio of PSS to SSS							
EPRE ratio of PBCH DMRS to SSS							
EPRE ratio of PBCH to PBCH DMRS							

EPRE ratio of PDCCH DMRS to SSS		Config 1,2	0	0		
EPRE ratio of PDCCH to PDCCH DMRS						
EPRE ratio of PDSCH DMRS to SSS						
EPRE ratio of PDSCH to PDSCH						
EPRE ratio of OCNG DMRS to SSS(Note 1)						
EPRE ratio of OCNG to OCNG DMRS (Note 1)						
$N_{oc}^{Note2}$	dBm/15k Hz	Config 1,2	-104			-104
$N_{oc}^{Note2}$	dBm/SC S	Config 1,2	-101			-101
SS-RSRP <sup>Note 3</sup>	dBm/SC S	Config 1,2	-91	-91	-Infinity	-88
$\hat{E}_s / I_{ot}$	dB	Config 1,2	4	4	-Infinity	7
$\hat{E}_s / N_{oc}$	dB	Config 1,2	4	4	-Infinity	7
$I_o^{Note3}$	dBm/38.1 6MHz	Config 1,2	-58.49	-58.49	-63.94	-56.15
Propagation Condition		Config 1,2	AWGN			
<p>Note 1: OCNG shall be used such that both cells are fully allocated and a constant total transmitted power spectral density is achieved for all OFDM symbols.</p> <p>Note 2: Interference from other cells and noise sources not specified in the test is assumed to be constant over subcarriers and time and shall be modelled as AWGN of appropriate power for <math>N_{oc}</math> to be fulfilled.</p> <p>Note 3: SS-RSRP and <math>I_o</math> levels have been derived from other parameters for information purposes. They are not settable parameters themselves.</p> <p>Note 4: SS-RSRP minimum requirements are specified assuming independent interference and noise at each receiver antenna port.</p> <p>Note 5: For UE supporting semi-static channel access and network configuring semi-static channel occupancy.</p> <p>Note 6: For UE supporting dynamic channel access and network configuring dynamic channel occupancy.</p> <p>Note 7: For UE supporting both semi-static and dynamic channel access, the UE must be tested under dynamic channel access configuration.</p>						

#### A.10.4.1.4.3 Test Requirements

The UE shall send one Event A3 triggered measurement report, with a measurement reporting delay less than  $T_{identify\_intra\_without\_index\_CCA}$  ms from the beginning of time period T2. The UE is not required to read the neighbour cell SSB index in this test. The UE shall not send event triggered measurement reports, as long as the reporting criteria are not fulfilled. The rate of correct events observed during repeated tests shall be at least 90%.

$T_{identify\_intra\_cca\_without\_index} = (T_{PSS/SSS\_sync\_intra\_cca} + T_{SSB\_measurement\_period\_intra\_cca})$  ms, where

$T_{PSS/SSS\_sync\_intra\_cca}$ : it is the time period used in PSS/SSS detection given in table 9.2A.6.1-1.

$T_{SSB\_measurement\_period\_intra\_cca}$ : equal to a measurement period of SSB based measurement given in table 9.2A.6.2-1.

NOTE: The actual overall delays measured in the test may be up to  $2 \times TTI_{DCCH}$  higher than the measurement reporting delays above because of TTI insertion uncertainty of the measurement report in DCCH.

A.10.4.1.5 Void

A.10.4.1.6 Void

A.10.4.1.7 Void

A.10.4.1.8 Void

A.10.4.1.9 RSSI measurement reporting on PSCC

A.10.4.1.9.1 Test purpose and environment

The purpose of this test is to verify that the UE correctly reports RSSI measurements. This test will partly verify the intra-frequency RSSI measurement reporting requirements in Section 9.2A.7.1.

A.10.4.1.9.2 Test parameters

In the test, the UE is configured to perform intra-frequency RSSI measurements on a carrier frequency under CCA.

Supported test configurations are shown in Table A.10.4.1.9.2-1. There are two cells in the test: Cell 1 is E-UTRAN PCell on a licensed band, and Cell 2 is PSCell operating on a carrier frequency under CCA. Prior to the start of the time duration T1, the UE is connected to Cell 1 and Cell 2. The E-UTRAN PCell setting refers to Table A.3.7.2.1-1.

**Table A.10.4.1.9.2-1: Supported test configurations.**

Configuration	Description
1	LTE FDD; NR: TDD, SSB SCS 30 kHz, data SCS 30 kHz, BW 40 MHz
2	LTE TDD; NR: TDD, SSB SCS 30 kHz, data SCS 30 kHz, BW 40 MHz
NOTE: The UE is only required to pass in one of the supported test configurations above.	

**Table A.10.4.1.9.2-2: General test parameters.**

Editor's note: Table TBD

A.10.4.1.10 Channel occupancy measurement reporting on PSCC

A.10.4.1.10.1 Test purpose and environment

The purpose of this test is to verify that the UE correctly reports channel occupancy measurements. This test will partly verify the intra-frequency channel occupancy measurement reporting requirements in Section 9.2A.7.2.

A.10.4.1.10.2 Test parameters

In the test, the UE is configured to perform intra-frequency channel occupancy measurements on a carrier frequency under CCA.

Supported test configurations are shown in Table A.10.4.1.10.2-1. There are two cells in the test: Cell 1 is E-UTRAN PCell on a licensed band, and Cell 2 is PSCell operating on a carrier frequency under CCA. Prior to the start of the time duration T1, the UE is connected to Cell 1 and Cell 2. The E-UTRAN PCell setting refers to Table A.3.7.2.1-1.

**Table A.10.4.1.10.2-1: Supported test configurations.**

Configuration	Description
1	LTE FDD; NR: TDD, SSB SCS 30 kHz, data SCS 30 kHz, BW 40 MHz
2	LTE TDD; NR: TDD, SSB SCS 30 kHz, data SCS 30 kHz, BW 40 MHz
NOTE: The UE is only required to pass in one of the supported test configurations above.	

**Table A.10.4.1.10.2-2: General test parameters.**

Editor's note: Table is TBD

**A.10.4.1.11 RSSI measurement reporting on SCC****A.10.4.1.11.1 Test purpose and environment**

The purpose of this test is to verify that the UE correctly reports RSSI measurements. This test will partly verify the intra-frequency RSSI measurement reporting requirements in Section 9.2A.7.1.

**A.10.4.1.11.2 Test parameters**

In the test, the UE is configured to perform intra-frequency RSSI measurements on a carrier frequency under CCA.

Supported test configurations are shown in Table A.10.4.1.11.2-1. There are three cells in the test: Cell 1 is E-UTRAN PCell on a licensed band, Cell 2 is PSCell operating on a carrier frequency under CCA, Cell 3 is SCell on a carrier frequency under CCA. Prior to the start of the time duration T1, the UE is connected to Cell 1, Cell 2, and Cell 3. The E-UTRAN PCell setting refers to Table A.3.7.2.1-1.

**Table A.10.4.1.11.2-1: Supported test configurations.**

Configuration	Description
1	LTE FDD; NR: TDD, SSB SCS 30 kHz, data SCS 30 kHz, BW 40 MHz
2	LTE TDD; NR: TDD, SSB SCS 30 kHz, data SCS 30 kHz, BW 40 MHz
NOTE: The UE is only required to pass in one of the supported test configurations above.	

**Table A.10.4.1.11.2-2: General test parameters.**

Editor's note: Table TBD

**A.10.4.1.12 Channel occupancy measurement reporting on SCC****A.10.4.1.12.1 Test purpose and environment**

The purpose of this test is to verify that the UE correctly reports channel occupancy measurements. This test will partly verify the intra-frequency channel occupancy measurement reporting requirements in Section 9.2A.7.2.

**A.10.4.1.12.2 Test parameters**

In the test, the UE is configured to perform intra-frequency channel occupancy measurements on a carrier frequency under CCA.

Supported test configurations are shown in Table A.10.4.1.12.2-1. There are three cells in the test: Cell 1 is E-UTRAN PCell on a licensed band, Cell 2 is PSCell operating on a carrier frequency under CCA, and Cell 3 is SCell operating on a carrier frequency under CCA. Prior to the start of the time duration T1, the UE is connected to Cell 1, Cell 2, Cell 3. The E-UTRAN PCell setting refers to Table A.3.7.2.1-1.

**Table A.10.4.1.12.2-1: Supported test configurations.**

Configuration	Description
1	LTE FDD; NR: TDD, SSB SCS 30 kHz, data SCS 30 kHz, BW 40 MHz
2	LTE TDD; NR: TDD, SSB SCS 30 kHz, data SCS 30 kHz, BW 40 MHz
NOTE: The UE is only required to pass in one of the supported test configurations above.	

**Table A.10.4.1.12.2-2: General test parameters.**

Editor's note: Table is TBD

## A.10.4.2 Inter-frequency measurements

### A.10.4.2.1 RSSI measurement reporting

#### A.10.4.2.1.1 Test purpose and environment

The purpose of this test is to verify that the UE correctly reports RSSI measurements. This test will partly verify the inter-frequency RSSI measurement reporting requirements in Section 9.3A.8.

#### A.10.4.2.1.2 Test parameters

In the test, the UE is configured to perform inter-frequency RSSI measurements on a carrier frequency under CCA.

Supported test configurations are shown in Table A.10.4.2.1.2-1. There are two cells in the test: Cell 1 is E-UTRAN PCell on a licensed band, and Cell 2 is PSCell operating on a carrier frequency under CCA. Prior to the start of the time duration T1, the UE is connected to Cell 1 and Cell 2. The RSSI measurement is performed on an inter-frequency under CCA. The E-UTRAN PCell setting refers to Table A.3.7.2.1-1.

**Table A.10.4.2.1.2-1: Supported test configurations.**

Configuration	Description
1	LTE FDD; NR: TDD, SSB SCS 30 kHz, data SCS 30 kHz, BW 40 MHz
2	LTE TDD; NR: TDD, SSB SCS 30 kHz, data SCS 30 kHz, BW 40 MHz
NOTE: The UE is only required to pass in one of the supported test configurations above.	

**Table A.10.4.2.1.2-2: General test parameters.**

Editor's note: Table TBD

### A.10.4.2.2 Channel occupancy measurement reporting

#### A.10.4.2.2.1 Test purpose and environment

The purpose of this test is to verify that the UE correctly reports channel occupancy measurements. This test will partly verify the inter-frequency channel occupancy measurement reporting requirements in Section 9.3A.9.

#### A.10.4.2.2.2 Test parameters

In the test, the UE is configured to perform inter-frequency channel occupancy measurements on a carrier frequency under CCA.

Supported test configurations are shown in Table A.10.4.2.2.2-1. There are two cells in the test: Cell 1 is E-UTRAN PCell on a licensed band, and Cell 2 is PSCell operating on a carrier frequency under CCA. Prior to the start of the time duration T1, the UE is connected to Cell 1 and Cell 2. The channel occupancy measurement is performed on an inter-frequency under CCA. The E-UTRAN PCell setting refers to Table A.3.7.2.1-1.

**Table A.10.4.2.2.2-1: Supported test configurations.**

Configuration	Description
1	LTE FDD; NR: TDD, SSB SCS 30 kHz, data SCS 30 kHz, BW 40 MHz
2	LTE TDD; NR: TDD, SSB SCS 30 kHz, data SCS 30 kHz, BW 40 MHz
NOTE: The UE is only required to pass in one of the supported test configurations above.	

**Table A.10.4.2.2.2-2: General test parameters.**

Editor's note: Table is TBD

**A.10.4.2.3 EN-DC event triggered reporting tests for FR1 with CCA cell without SSB time index detection when DRX is not used****A.10.4.2.3.1 Test Purpose and Environment**

The purpose of this test is to verify that the UE makes correct reporting of an event. This test will partly verify the EN-DC inter-frequency NR cell search requirements in clause 9.3A.4 and 9.3A.5.

In this test, there are three cells: LTE cell 1 as PCell on E-UTRA RF channel 1, NR cell 2 as PSCell in FR1 with CCA on NR RF channel 1 and NR cell 3 as neighbour cell in FR1 with CCA on NR RF channel 2. The test parameters and configurations are given in Tables A.10.4.2.3.1-1, A.10.4.2.3.1-2, and A.10.4.2.3.1-3.

In test 1 measurement gap pattern configuration # 0 as defined in Table A.10.4.2.3.1-2 is provided for a UE that does not support per-FR gap and in test 2 measurement gap pattern configuration #4 as defined in Table A.10.4.2.3.1-2 is provided for UE that support per-FR gap. If a UE supports per-FR gap and gap pattern configuration #4, it is only required to pass test 2. Otherwise it is only required to pass test 1.

In the measurement control information, it is indicated to the UE that event-triggered reporting with Event A3 is used. The test consists of two successive time periods, with time duration of T1, and T2 respectively. During time duration T1, the UE shall not have any timing information of NR cell 3.

The configuration of LTE cell 1 is defined in table A.3.7.2.1-1. Supported test configurations are shown in table A.10.4.2.3.1-1.

**Table A.10.4.2.3.1-1: EN-DC event triggered reporting tests without SSB index reading for FR1-FR1**

Config	Description
1	E-UTRAN cell: LTE FDD NR cell with CCA: 30 kHz SSB SCS, 40 MHz bandwidth, TDD duplex mode
2	E-UTRAN cell: LTE TDD NR cell with CCA: 30 kHz SSB SCS, 40 MHz bandwidth, TDD duplex mode
Note 1: The UE is only required to be tested in one of the supported test configurations	

**Table A.10.4.2.3.1-2: General test parameters for EN-DC inter-frequency event triggered reporting without SSB time index detection**

Parameter	Unit	Test configuration	Value		Comment
			Test 1	Test 2	
E-UTRA RF Channel Number		Config 1,2	1		One E-UTRAN carrier frequency is used.
NR RF Channel Number		Config 1,2	1, 2		Two FR1 NR carrier frequencies are used. Channels 1 and 2 are with CCA.
Active cell		Config 1,2	LTE Cell 1 (PCell) and NR cell 2 with CCA (PSCell)		LTE Cell 1 is on E-UTRA RF channel number 1. NR Cell 2 with CCA is on NR RF channel number 1.
Neighbour cell		Config 1,2	NR cell 3		NR cell 3 is on NR RF channel number 2 with CCA.
DL CCA model		Config 1,2	As specified in clause A.3.26.2.1		
UL CCA model		Config 1,2	As specified in clause A.3.26.2.2		
Gap Pattern Id		Config 1,2	0	4	As specified in clause 9.1.2-1.
Measurement gap offset		Config 1,2	9	9	
A3-Offset	dB	Config 1,2	-6		



Hysteresis	dB	Config 1,2	0		
CP length		Config 1,2	Normal		
TimeToTrigger	s	Config 1,2	0		
Filter coefficient		Config 1,2	0		L3 filtering is not used
DRX		Config 1,2	OFF		DRX is not used
Time offset between PCell and PSCell		Config 1,2	3 $\mu$ s		Synchronous EN-DC
Time offset between serving and neighbour cells		Config 1,2	3 $\mu$ s		Synchronous cells.
T1	s	Config 1,2	5		
T2	s	Config 1,2	1.7	1.7	

**Table A.10.4.2.3.1-3: Cell specific test parameters for EN-DC inter-frequency event triggered reporting without SSB time index detection**

Parameter		Unit	Test configuration	Cell 2		Cell 3	
				T1	T2	T1	T2
NR RF Channel Number			Config 1,2	1		2	
Duplex mode			Config 1,2	TDD			
BW <sub>channel</sub>		MHz	Config 1,2	40: N <sub>RB,c</sub> = 106			
BWP BW		MHz	Config 1,2	40: N <sub>RB,c</sub> = 106			
TDD configuration			Config 1,2	TDDConf.1.1 CCA		TDDConf.1.1 CCA	
Initial DL BWP			Config 1,2	DLBWP.0.1		NA	
Initial UL BWP			Config 1,2	ULBWP.0.1		NA	
Dedicated DL BWP			Config 1,2	DLBWP.1.1		NA	
Dedicated UL BWP			Config 1,2	ULBWP.1.1		NA	
TRS configuration			Config 1,2	TRS.1.2 TDD		NA	
OCNG Patterns defined in A.3.2.1.1 (OP.1)			Config 1,2	OP.1		OP.1	
PDSCH Reference measurement channel			Config 1,2	SR.1.1 CCA		-	
CORESET Reference Channel			Config 1,2	CR.1.1 CCA		-	
SSB parameters	Semi-static channel access <sup>Note 5,7</sup>		Config 1,2	SSB.1 CCA		SSB.1 CCA	
	Dynamic channel access <sup>Note 6,7</sup>		Config 1,2	SSB.2 CCA		SSB.2 CCA	
DBT window configuration			Config 1,2	As defined in A.3.28.1		As defined in A.3.28.1	
SMTC configuration			Config 1,2	SMTC.1		SMTC.4	
PDSCH/PDCCH		kHz	Config 1,2	30		30	
DL CCA probability P <sub>CCA_DL</sub>	Semi-static channel access <sup>Note 5,7</sup>		Config 1,2	P <sub>CCA_DL</sub> =0.9375		P <sub>CCA_DL</sub> =0.9375	
	Dynamic channel access <sup>Note 6,7</sup>		Config 1,2	P <sub>CCA_DL_1</sub> =0.75 P <sub>CCA_DL_2</sub> =0.75		P <sub>CCA_DL_1</sub> =0.75 P <sub>CCA_DL_2</sub> =0.75	
UL CCA probability P <sub>CCA_UL</sub>	Semi-static channel access <sup>Note 5,7</sup>		Config 1,2	P <sub>CCA_UL</sub> =1		P <sub>CCA_UL</sub> =1	
	Dynamic channel access <sup>Note 6,7</sup>		Config 1,2	P <sub>CCA_UL</sub> =1		P <sub>CCA_UL</sub> =1	
L <sub>CCA_DL</sub>			Config 1,2	12		12	
W <sub>CCA_DL</sub>		ms	Config 1,2	T <sub>PSS/SSS_sync_inter_cca</sub>		T <sub>PSS/SSS_sync_inter_cca</sub>	
EPRE ratio of PSS to SSS							

EPRE ratio of PBCH DMRS to SSS		Config 1,2	0	0		
EPRE ratio of PBCH to PBCH DMRS						
EPRE ratio of PDCCH DMRS to SSS						
EPRE ratio of PDCCH to PDCCH DMRS						
EPRE ratio of PDSCH DMRS to SSS						
EPRE ratio of PDSCH to PDSCH						
EPRE ratio of OCNG DMRS to SSS(Note 1)						
EPRE ratio of OCNG to OCNG DMRS (Note 1)						
$N_{oc}^{Note2}$	dBm/15k Hz	Config 1,2	-104		-104	
$N_{oc}^{Note2}$	dBm/SC S	Config 1,2	-101		-101	
SS-RSRP <sup>Note 3</sup>	dBm/SC S	Config 1,2	-91	-91	-Infinity	-88
$\hat{E}_s / I_{ot}$	dB	Config 1,2	4	4	-Infinity	7
$\hat{E}_s / N_{oc}$	dB	Config 1,2	4	4	-Infinity	7
$I_o^{Note3}$	dBm/38.1 6MHz	Config 1,2	-58.49	-58.49	-63.94	-56.15
Propagation Condition		Config 1,2	AWGN			
<p>Note 1: OCNG shall be used such that both cells are fully allocated and a constant total transmitted power spectral density is achieved for all OFDM symbols.</p> <p>Note 2: Interference from other cells and noise sources not specified in the test is assumed to be constant over subcarriers and time and shall be modelled as AWGN of appropriate power for <math>N_{oc}</math> to be fulfilled.</p> <p>Note 3: SS-RSRP and <math>I_o</math> levels have been derived from other parameters for information purposes. They are not settable parameters themselves.</p> <p>Note 4: SS-RSRP minimum requirements are specified assuming independent interference and noise at each receiver antenna port.</p> <p>Note 5: For UE supporting semi-static channel access and network configuring semi-static channel occupancy.</p> <p>Note 6: For UE supporting dynamic channel access and network configuring dynamic channel occupancy.</p> <p>Note 7: For UE supporting both semi-static and dynamic channel access, the UE must be tested under dynamic channel access configuration.</p>						

A.10.4.2.3.2 Test Requirements

In test 1 with per-UE gap, the UE shall send one Event A3 triggered measurement report, with a measurement reporting delay less than  $T_{identify\_inter\_cca\_without\_index}$  from the beginning of time period T2. The UE shall not send event triggered measurement reports, as long as the reporting criteria are not fulfilled. The rate of correct events observed during repeated tests shall be at least 90%.

In test 2 with per-FR gap, the UE shall send one Event A3 triggered measurement report, with a measurement reporting delay less than  $T_{identify\_inter\_cca\_without\_index}$  from the beginning of time period T2. The UE shall not send event triggered measurement reports, as long as the reporting criteria are not fulfilled. The rate of correct events observed during repeated tests shall be at least 90%.

In test 1 and 2 UE is not required to report SSB time index.

$T_{identify\_inter\_cca\_without\_index} = (T_{PSS/SSS\_sync\_inter\_cca} + T_{SSB\_measurement\_period\_inter\_cca})$  ms, where

$T_{PSS/SSS\_sync\_inter\_cca}$ : it is the time period used in PSS/SSS detection given in table 9.3A.4-1.

$T_{SSB\_measurement\_period\_inter\_cca}$ : equal to a measurement period of SSB based measurement given in table 9.3A.5-1.

For test 1, MGRP = 40 ms and for test 2 MGRP = 20 ms.

SMTC period = 20 ms.

NOTE: The actual overall delays measured in the test may be up to  $2 \times TTI_{DCCH}$  higher than the measurement reporting delays above because of TTI insertion uncertainty of the measurement report in DCCH.

#### A.10.4.2.4 EN-DC event triggered reporting tests for FR1 cell with CCA without SSB time index detection when DRX is used

##### A.10.4.2.4.1 Test Purpose and Environment

The purpose of this test is to verify that the UE makes correct reporting of an event. This test will partly verify the EN-DC inter-frequency NR cell search requirements in clause 9.3A.4 and 9.3A.5.

In this test, there are three cells: LTE cell 1 as PCell on E-UTRA RF channel 1, NR cell 2 as PSCell in FR1 with CCA on NR RF channel 1 and NR cell 3 as neighbour cell in FR1 with CCA on NR RF channel 2. The test parameters and configurations are given in Tables A.10.4.2.4.1-1, A.10.4.2.4.1-2, and A.10.4.2.4.1-3.

In test 1&2 measurement gap pattern configuration # 0 as defined in Table A.10.4.2.4.1-2 is provided for a UE that does not support per-FR gap and in test 3&4 measurement gap pattern configuration #4 as defined in Table A.10.4.2.4.1-2 is provided for UE that support per-FR gap. If a UE supports per-FR gap and gap pattern configuration #4, it is only required to pass test 3&4. Otherwise it is only required to pass test 1&2.

In the measurement control information, it is indicated to the UE that event-triggered reporting with Event A3 is used. The test consists of two successive time periods, with time duration of T1, and T2 respectively. During time duration T1, the UE shall not have any timing information of NR cell 3.

The configuration of LTE cell 1 is defined in table A.3.7.2.1-1. Supported test configurations are shown in table A.10.4.2.4.1-1.

UE needs to be provided at least once every 500ms with new Timing Advance Command MAC control element to restart the Time alignment timer to keep UE uplink time alignment. Furthermore, UE is allocated with PUSCH resource at every DRX cycle.

**Table A.10.4.2.4.1-1: EN-DC event triggered reporting tests without SSB index reading for FR1-FR1**

Config	Description
1	E-UTRAN cell: LTE FDD NR cell with CCA: 30 kHz SSB SCS, 40 MHz bandwidth, TDD duplex mode
2	E-UTRAN cell: LTE TDD NR cell with CCA: 30 kHz SSB SCS, 40 MHz bandwidth, TDD duplex mode
Note 1: The UE is only required to be tested in one of the supported test configurations	

**Table A.10.4.2.4.1-2: General test parameters for EN-DC inter-frequency event triggered reporting without SSB time index detection**

Parameter	Unit	Test configuration	Value				Comment
			Test 1	Test 2	Test 3	Test 4	
E-UTRA RF Channel Number		Config 1,2	1				One E-UTRAN carrier frequency is used.
NR RF Channel Number		Config 1,2	1, 2				Two FR1 NR carrier frequencies are used. Channels 1 and 2 are with CCA.
Active cell		Config 1,2	LTE Cell 1 (PCell) and NR cell 2 with CCA (PScell)				LTE Cell 1 is on E-UTRA RF channel number 1. NR Cell 2 with CCA is on NR RF channel number 1.
Neighbour cell		Config 1,2	NR cell 3				NR cell 3 is on NR RF channel number 2 with CCA.
DL CCA model		Config 1,2	As specified in clause A.3.26.2.1				
UL CCA model		Config 1,2	As specified in clause A.3.26.2.2				

Gap Pattern Id		Config 1,2	0	4	As specified in clause 9.1.2-1.		
Measurement gap offset		Config 1,2	9	9			
A3-Offset	dB	Config 1,2	-6				
Hysteresis	dB	Config 1,2	0				
CP length		Config 1,2	Normal				
TimeToTrigger	s	Config 1,2	0				
Filter coefficient		Config 1,2	0		L3 filtering is not used		
DRX		Config 1,2	DRX .1	DRX .2	DRX .1	DRX .2	As specified in clause A.3.3
Time offset between PCell and PSCell		Config 1,2	3 $\mu$ s		Synchronous EN-DC		
Time offset between serving and neighbour cells		Config 1,2	3 $\mu$ s		Synchronous cells.		
T1	s	Config 1,2	5				
T2	s	Config 1,2	2.5	17	2.5	17	

**Table A.10.4.2.4.1-3: Cell specific test parameters for EN-DC inter-frequency event triggered reporting without SSB time index detection**

Parameter		Unit	Test configuration	Cell 2				Cell 3			
				T1	T2	T3	T4	T1	T2	T3	T4
NR RF Channel Number			Config 1,2	1				2			
Duplex mode			Config 1,2	TDD							
BW <sub>channel</sub>		MHz	Config 1,2	40: N <sub>RB,c</sub> = 106							
BWP BW		MHz	Config 1,2	40: N <sub>RB,c</sub> = 106							
TDD configuration			Config 1,2	TDDConf.1.1 CCA				TDDConf.1.1 CCA			
Initial DL BWP			Config 1,2	DLBWP.0.1				NA			
Initial UL BWP			Config 1,2	ULBWP.0.1				NA			
Dedicated DL BWP			Config 1,2	DLBWP.1.1				NA			
Dedicated UL BWP			Config 1,2	ULBWP.1.1				NA			
TRS configuration			Config 1,2	TRS.1.2 TDD				NA			
OCNG Patterns defined in A.3.2.1.1 (OP.1)			Config 1,2	OP.1				OP.1			
PDSCH Reference			Config 1,2	SR.1.1 CCA				-			
CORESET Reference Channel			Config 1,2	CR.1.1 CCA				-			
SSB parameters	Semi-static channel access <sup>Note 5,7</sup>		Config 1,2	SSB.1 CCA				SSB.1 CCA			
	Dynamic channel access <sup>Note 6,7</sup>		Config 1,2	SSB.2 CCA				SSB.2 CCA			
DBT window configuration			Config 1,2	As defined in A.3.28.1				As defined in A.3.28.1			
SMTC configuration			Config 1,2	SMTC.1				SMTC.4			
PDSCH/PDCCH		kHz	Config 1,2	30				30			
DL CCA probability P <sub>CCA_DL</sub>	Semi-static channel access <sup>Note 5,7</sup>		Config 1,2	P <sub>CCA_DL</sub> =0.9375				P <sub>CCA_DL</sub> =0.9375			
	Dynamic channel access <sup>Note 6,7</sup>		Config 1,2	P <sub>CCA_DL_1</sub> =0.75 P <sub>CCA_DL_2</sub> =0.75				P <sub>CCA_DL_1</sub> =0.75 P <sub>CCA_DL_2</sub> =0.75			
UL CCA probability P <sub>CCA_UL</sub>	Semi-static channel access <sup>Note 5,7</sup>		Config 1,2	P <sub>CCA_UL</sub> =1				P <sub>CCA_UL</sub> =1			

	Dynamic channel access <sup>Note 6,7</sup>		Config 1,2	P <sub>CCA_UL</sub> =1		P <sub>CCA_UL</sub> =1	
L <sub>CCA_DL</sub>			Config 1,2	5		5	
W <sub>CCA_DL</sub>	ms		Config 1,2	T <sub>PSS/SSS_sync_inter_cca</sub>		T <sub>PSS/SSS_sync_inter_cca</sub>	
EPRE ratio of PSS to SSS		Config 1,2	0	0	0	0	0
EPRE ratio of PBCH DMRS to SSS							
EPRE ratio of PBCH to PBCH DMRS							
EPRE ratio of PDCCH DMRS to SSS							
EPRE ratio of PDCCH to PDCCH DMRS							
EPRE ratio of PDSCH DMRS to SSS							
EPRE ratio of PDSCH to PDSCH							
EPRE ratio of OCNG DMRS to SSS(Note 1)							
EPRE ratio of OCNG to OCNG DMRS (Note 1)							
N <sub>oc</sub> <sup>Note2</sup>	dBm/15k Hz	Config 1,2	-104		-104		
N <sub>oc</sub> <sup>Note2</sup>	dBm/SC S	Config 1,2	-101		-101		
SS-RSRP <sup>Note 3</sup>	dBm/SC S	Config 1,2	-91	-91	-Infinity	-88	
$\hat{E}_s / I_{ot}$	dB	Config 1,2	4	4	-Infinity	7	
$\hat{E}_s / N_{oc}$	dB	Config 1,2	4	4	-Infinity	7	
I <sub>o</sub> <sup>Note3</sup>	dBm/38.1 6MHz	Config 1,2	-58.49	-58.49	-63.94	-56.15	
Propagation Condition		Config 1,2	AWGN				
<p>Note 1: OCNG shall be used such that both cells are fully allocated and a constant total transmitted power spectral density is achieved for all OFDM symbols.</p> <p>Note 2: Interference from other cells and noise sources not specified in the test is assumed to be constant over subcarriers and time and shall be modelled as AWGN of appropriate power for N<sub>oc</sub> to be fulfilled.</p> <p>Note 3: SS-RSRP and I<sub>o</sub> levels have been derived from other parameters for information purposes. They are not settable parameters themselves.</p> <p>Note 4: SS-RSRP minimum requirements are specified assuming independent interference and noise at each receiver antenna port.</p> <p>Note 5: For UE supporting semi-static channel access and network configuring semi-static channel occupancy.</p> <p>Note 6: For UE supporting dynamic channel access and network configuring dynamic channel occupancy.</p> <p>Note 7: For UE supporting both semi-static and dynamic channel access, the UE must be tested under dynamic channel access configuration.</p>							

**Table A.10.4.2.4.1-4: DRX-Configuration for SA inter-frequency event triggered reporting without SSB time index detection**

Field	Test1&3	Test2&4	Comment
	Value	Value	
drx-onDurationTimer	ms1	ms1	As specified in clause 6.3.2 in TS 38.331 [2]
drx-InactivityTimer	ms1	ms1	
drx-RetransmissionTimerDL	sl1	sl1	
drx-RetransmissionTimerUL	sl1	sl1	
drx-LongCycleStartOffset	ms40	Ms640	
shortDRX	disable	disable	

**Table A.10.4.2.4.1-5: TimeAlignmentTimer -Configuration SA inter-frequency event triggered reporting without SSB time index detection**

Field	Value	Comment
TimeAlignmentTimer	ms500	As specified in clause 6.3.2 in TS 38.331 [2]

#### A.10.4.2.4.2 Test Requirements

In test 1 with per-UE gap, the UE shall send one Event A3 triggered measurement report, with a measurement reporting delay less than  $T_{\text{identify\_inter\_cca\_without\_index}}$  from the beginning of time period T2. The UE shall not send event triggered measurement reports, as long as the reporting criteria are not fulfilled. The rate of correct events observed during repeated tests shall be at least 90%.

In test 2 with per-FR gap, the UE shall send one Event A3 triggered measurement report, with a measurement reporting delay less than  $T_{\text{identify\_inter\_cca\_without\_index}}$  from the beginning of time period T2. The UE shall not send event triggered measurement reports, as long as the reporting criteria are not fulfilled. The rate of correct events observed during repeated tests shall be at least 90%.

In test 3 with per-UE gap, the UE shall send one Event A3 triggered measurement report, with a measurement reporting delay less than  $T_{\text{identify\_inter\_cca\_without\_index}}$  from the beginning of time period T2. The UE shall not send event triggered measurement reports, as long as the reporting criteria are not fulfilled. The rate of correct events observed during repeated tests shall be at least 90%.

In test 4 with per-FR gap, the UE shall send one Event A3 triggered measurement report, with a measurement reporting delay less than  $T_{\text{identify\_inter\_cca\_without\_index}}$  from the beginning of time period T2. The UE shall not send event triggered measurement reports, as long as the reporting criteria are not fulfilled. The rate of correct events observed during repeated tests shall be at least 90%.

In test 1, 2, 3 and 4 UE is not required to report SSB time index.

$T_{\text{identify\_inter\_cca\_without\_index}} = (T_{\text{PSS/SSS\_sync\_inter\_cca}} + T_{\text{SSB\_measurement\_period\_inter\_cca}})$  ms, where

$T_{\text{PSS/SSS\_sync\_inter\_cca}}$ : it is the time period used in PSS/SSS detection given in table 9.3A.4-1.

$T_{\text{SSB\_measurement\_period\_inter\_cca}}$ : equal to a measurement period of SSB based measurement given in table 9.3A.5-1.

For tests 1 and 2, MGRP = 40 ms and for tests 3 and 4 MGRP = 20 ms.

For tests 1 and 3, DRX cycle = 40 ms and for tests 2 and 4 DRX cycle = 640 ms.

SMTC period = 20 ms.

NOTE: The actual overall delays measured in the test may be up to  $2 \times T_{\text{TTI}_{\text{DCCH}}}$  higher than the measurement reporting delays above because of TTI insertion uncertainty of the measurement report in DCCH.

#### A.10.4.2.5 EN-DC event triggered reporting tests for FR1 cell with CCA with SSB time index detection when DRX is not used

##### A.10.4.2.5.1 Test Purpose and Environment

The purpose of this test is to verify that the UE makes correct reporting of an event. This test will partly verify the EN-DC inter-frequency NR cell search requirements in clause 9.3A.4 and 9.3A.5.

In this test, there are three cells: LTE cell 1 as PCell on E-UTRA RF channel 1, NR cell 2 as PSCell in FR1 with CCA on NR RF channel 1 and NR cell 3 as neighbour cell in FR1 with CCA on NR RF channel 2. The test parameters and configurations are given in Tables A.10.4.2.5.1-1, A.10.4.2.5.1-2, and A.10.4.2.5.1-3.

In test 1 measurement gap pattern configuration # 0 as defined in Table A.10.4.2.5.1-2 is provided for a UE that does not support per-FR gap and in test 2 measurement gap pattern configuration #4 as defined in Table A.10.4.2.5.1-2 is provided for UE that support per-FR gap. If a UE supports per-FR gap and gap pattern configuration #4, it is only required to pass test 2. Otherwise it is only required to pass test 1.

In the measurement control information, it is indicated to the UE that event-triggered reporting with Event A3 is used. The test consists of two successive time periods, with time duration of T1, and T2 respectively. During time duration T1, the UE shall not have any timing information of NR cell 3.

The configuration of LTE cell 1 is defined in table A.3.7.2.1-1. Supported test configurations are shown in table A.10.4.2.5.1-1.

**Table A.10.4.2.5.1-1: EN-DC event triggered reporting tests without SSB index reading for FR1-FR1**

Config	Description
1	E-UTRAN cell: LTE FDD NR cell with CCA: 30 kHz SSB SCS, 40 MHz bandwidth, TDD duplex mode
2	E-UTRAN cell: LTE TDD NR cell with CCA: 30 kHz SSB SCS, 40 MHz bandwidth, TDD duplex mode
Note 1: The UE is only required to be tested in one of the supported test configurations	

**Table A.10.4.2.5.1-2: General test parameters for EN-DC inter-frequency event triggered reporting with SSB time index detection**

Parameter	Unit	Test configuration	Value		Comment
			Test 1	Test 2	
E-UTRA RF Channel Number		Config 1,2	1		One E-UTRAN carrier frequency is used.
NR RF Channel Number		Config 1,2	1, 2		Two FR1 NR carrier frequencies are used. Channels 1 and 2 are with CCA.
Active cell		Config 1,2	LTE Cell 1 (PCell) and NR cell 2 with CCA (PScell)		LTE Cell 1 is on E-UTRA RF channel number 1. NR Cell 2 with CCA is on NR RF channel number 1.
Neighbour cell		Config 1,2	NR cell 3		NR cell 3 is on NR RF channel number 2 with CCA.
DL CCA model		Config 1,2	As specified in clause A.3.26.2.1		
UL CCA model		Config 1,2	As specified in clause A.3.26.2.2		
Gap Pattern Id		Config 1,2	0	4	As specified in clause 9.1.2-1.
Measurement gap offset		Config 1,2	9	9	
A3-Offset	dB	Config 1,2	-6		
Hysteresis	dB	Config 1,2	0		
CP length		Config 1,2	Normal		
TimeToTrigger	s	Config 1,2	0		
Filter coefficient		Config 1,2	0		L3 filtering is not used
DRX		Config 1,2	OFF		DRX is not used
Time offset between PCell and PScell		Config 1,2	3 $\mu$ s		Synchronous EN-DC
Time offset between serving and neighbour cells		Config 1,2	3 $\mu$ s		Synchronous cells.
T1	s	Config 1,2	5		
T2	s	Config 1,2	2	2	

**Table A.10.4.2.5.1-3: Cell specific test parameters for EN-DC inter-frequency event triggered reporting with SSB time index detection**

Parameter	Unit	Test configuration	Cell 2		Cell 3	
			T1	T2	T1	T2
NR RF Channel Number		Config 1,2	1		2	
Duplex mode		Config 1,2	TDD			
BW <sub>channel</sub>	MHz	Config 1,2	40: N <sub>RB,c</sub> = 106			
BWP BW	MHz	Config 1,2	40: N <sub>RB,c</sub> = 106			

TDD configuration			Config 1,2	TDDConf.1.1 CCA		TDDConf.1.1 CCA	
Initial DL BWP			Config 1,2	DLBWP.0.1		NA	
Initial UL BWP			Config 1,2	ULBWP.0.1		NA	
Dedicated DL BWP			Config 1,2	DLBWP.1.1		NA	
Dedicated UL BWP			Config 1,2	ULBWP.1.1		NA	
TRS configuration			Config 1,2	TRS.1.2 TDD		NA	
OCNG Patterns defined in A.3.2.1.1 (OP.1)			Config 1,2	OP.1		OP.1	
PDSCH Reference			Config 1,2	SR.1.1 CCA		-	
CORESET Reference Channel			Config 1,2	CR.1.1 CCA		-	
SSB parameters	Semi-static channel access <sup>Note 5,7</sup>		Config 1,2	SSB.1 CCA		SSB.1 CCA	
	Dynamic channel access <sup>Note 6,7</sup>		Config 1,2	SSB.2 CCA		SSB.2 CCA	
DBT window configuration			Config 1,2	As defined in A.3.28.1		As defined in A.3.28.1	
SMTC configuration			Config 1,2	SMTC.1		SMTC.4	
PDSCH/PDCCH		kHz	Config 1,2	30		30	
DL CCA probability $P_{CCA\_DL}$	Semi-static channel access <sup>Note 5,7</sup>		Config 1,2	$P_{CCA\_DL}=0.9375$		$P_{CCA\_DL}=0.9375$	
	Dynamic channel access <sup>Note 6,7</sup>		Config 1,2	$P_{CCA\_DL\_1}=0.75$ $P_{CCA\_DL\_2}=0.75$		$P_{CCA\_DL\_1}=0.75$ $P_{CCA\_DL\_2}=0.75$	
UL CCA probability $P_{CCA\_UL}$	Semi-static channel access <sup>Note 5,7</sup>		Config 1,2	$P_{CCA\_UL}=1$		$P_{CCA\_UL}=1$	
	Dynamic channel access <sup>Note 6,7</sup>		Config 1,2	$P_{CCA\_UL}=1$		$P_{CCA\_UL}=1$	
$L_{CCA\_DL}$			Config 1,2	5		5	
$W_{CCA\_DL}$		ms	Config 1,2	$T_{PSS/SSS\_sync\_inter\_cca}$		$T_{PSS/SSS\_sync\_inter\_cca}$	
EPRE ratio of PSS to SSS			Config 1,2	0		0	
EPRE ratio of PBCH DMRS to SSS							
EPRE ratio of PBCH to PBCH DMRS							
EPRE ratio of PDCCH DMRS to SSS							
EPRE ratio of PDCCH to PDCCH DMRS							
EPRE ratio of PDSCH DMRS to SSS							
EPRE ratio of PDSCH to PDSCH							
EPRE ratio of OCNG DMRS to SSS(Note 1)							
EPRE ratio of OCNG to OCNG DMRS (Note 1)							
$N_{oc}$ <sup>Note2</sup>		dBm/15k Hz					
$N_{oc}$ <sup>Note2</sup>		dBm/SC S	Config 1,2	-101		-101	
SS-RSRP <sup>Note 3</sup>		dBm/SC S	Config 1,2	-91	-91	-Infinity	-88
$\hat{E}_s / I_{ot}$		dB	Config 1,2	4	4	-Infinity	7
$\hat{E}_s / N_{oc}$		dB	Config 1,2	4	4	-Infinity	7



$I_0$ <sup>Note3</sup>	dBm/38.1 6MHz	Config 1,2	-58.49	-58.49	-63.94	-56.15
Propagation Condition		Config 1,2	AWGN			
Note 1:	OCNG shall be used such that both cells are fully allocated and a constant total transmitted power spectral density is achieved for all OFDM symbols.					
Note 2:	Interference from other cells and noise sources not specified in the test is assumed to be constant over subcarriers and time and shall be modelled as AWGN of appropriate power for $N_{oc}$ to be fulfilled.					
Note 3:	SS-RSRP and $I_0$ levels have been derived from other parameters for information purposes. They are not settable parameters themselves.					
Note 4:	SS-RSRP minimum requirements are specified assuming independent interference and noise at each receiver antenna port.					
Note 5:	For UE supporting semi-static channel access and network configuring semi-static channel occupancy.					
Note 6:	For UE supporting dynamic channel access and network configuring dynamic channel occupancy.					
Note 7:	For UE supporting both semi-static and dynamic channel access, the UE must be tested under dynamic channel access configuration.					

#### A.10.4.2.5.2 Test Requirements

In test 1 with per-UE gap, the UE shall send one Event A3 triggered measurement report, with a measurement reporting delay less than  $T_{\text{identify\_inter\_cca\_with\_index}}$  from the beginning of time period T2. The UE shall not send event triggered measurement reports, as long as the reporting criteria are not fulfilled. The rate of correct events observed during repeated tests shall be at least 90%.

In test 2 with per-FR gap, the UE shall send one Event A3 triggered measurement report, with a measurement reporting delay less than  $T_{\text{identify\_inter\_cca\_with\_index}}$  from the beginning of time period T2. The UE shall not send event triggered measurement reports, as long as the reporting criteria are not fulfilled. The rate of correct events observed during repeated tests shall be at least 90%.

In test 1 and 2 UE is required to report SSB time index.

$T_{\text{identify\_inter\_cca\_with\_index}} = (T_{\text{PSS/SSS\_sync\_inter\_cca}} + T_{\text{SSB\_measurement\_period\_inter\_cca}} + T_{\text{SSB\_time\_index\_inter\_cca}})$  ms, where

$T_{\text{PSS/SSS\_sync\_inter\_cca}}$ : it is the time period used in PSS/SSS detection given in table 9.3A.4-1.

$T_{\text{SSB\_time\_index\_inter\_cca}}$ : it is the time period used to acquire the index of the SSB being measured given in table 9.3A.4-2.

$T_{\text{SSB\_measurement\_period\_inter\_cca}}$ : equal to a measurement period of SSB based measurement given in table 9.3A.5-1.

For test 1, MGRP = 40 ms and for test 2 MGRP = 20 ms.

SMTC period = 20 ms.

NOTE: The actual overall delays measured in the test may be up to  $2xTTI_{\text{DCCH}}$  higher than the measurement reporting delays above because of TTI insertion uncertainty of the measurement report in DCCH.

#### A.10.4.2.6 EN-DC event triggered reporting tests for FR1 cell with CCA with SSB time index detection when DRX is used

##### A.10.4.2.6.1 Test Purpose and Environment

The purpose of this test is to verify that the UE makes correct reporting of an event. This test will partly verify the EN-DC inter-frequency NR cell search requirements in clause 9.3A.4 and 9.3A.5.

In this test, there are three cells: LTE cell 1 as PCell on E-UTRA RF channel 1, NR cell 2 as PSCell in FR1 with CCA on NR RF channel 1 and NR cell 3 as neighbour cell in FR1 with CCA on NR RF channel 2. The test parameters and configurations are given in Tables A.10.4.2.6.1-1, A.10.4.2.6.1-2, and A.10.4.2.6.1-3.

In test 1&2 measurement gap pattern configuration # 0 as defined in Table A.10.4.2.6.1-2 is provided for a UE that does not support per-FR gap and in test 3&4 measurement gap pattern configuration #4 as defined in Table A.10.4.2.6.1-2 is provided for UE that support per-FR gap. If a UE supports per-FR gap and gap pattern configuration #4, it is only required to pass test 3&4. Otherwise it is only required to pass test 1&2.

In the measurement control information, it is indicated to the UE that event-triggered reporting with Event A3 is used. The test consists of two successive time periods, with time duration of T1, and T2 respectively. During time duration T1, the UE shall not have any timing information of NR cell 3.

The configuration of LTE cell 1 is defined in table A.3.7.2.1-1. Supported test configurations are shown in table A.10.4.2.6.1-1.

UE needs to be provided at least once every 500ms with new Timing Advance Command MAC control element to restart the Time alignment timer to keep UE uplink time alignment. Furthermore, UE is allocated with PUSCH resource at every DRX cycle.

**Table A.10.4.2.6.1-1: EN-DC event triggered reporting tests without SSB index reading for FR1-FR1**

Config	Description
1	E-UTRAN cell: LTE FDD NR cell with CCA: 30 kHz SSB SCS, 40 MHz bandwidth, TDD duplex mode
2	E-UTRAN cell: LTE TDD NR cell with CCA: 30 kHz SSB SCS, 40 MHz bandwidth, TDD duplex mode
Note 1: The UE is only required to be tested in one of the supported test configurations	

**Table A.10.4.2.6.1-2: General test parameters for EN-DC inter-frequency event triggered reporting with SSB time index detection**

Parameter	Unit	Test configuration	Value				Comment
			Test 1	Test 2	Test 3	Test 4	
E-UTRA RF Channel Number		Config 1,2	1				One E-UTRAN carrier frequency is used.
NR RF Channel Number		Config 1,2	1, 2				Two FR1 NR carrier frequencies are used. Channels 1 and 2 are with CCA.
Active cell		Config 1,2	LTE Cell 1 (PCell) and NR cell 2 with CCA (PScell)				LTE Cell 1 is on E-UTRA RF channel number 1. NR Cell 2 with CCA is on NR RF channel number 1.
Neighbour cell		Config 1,2	NR cell 3				NR cell 3 is on NR RF channel number 2 with CCA.
DL CCA model		Config 1,2	As specified in clause A.3.26.2.1				
UL CCA model		Config 1,2	As specified in clause A.3.26.2.2				
Gap Pattern Id		Config 1,2	0		4		As specified in clause 9.1.2-1.
Measurement gap offset		Config 1,2	9		9		
A3-Offset	dB	Config 1,2	-6				
Hysteresis	dB	Config 1,2	0				
CP length		Config 1,2	Normal				
TimeToTrigger	s	Config 1,2	0				
Filter coefficient		Config 1,2	0				L3 filtering is not used
DRX		Config 1,2	DRX .1	DRX .2	DRX .1	DRX .2	As specified in clause A.3.3 DRX is not used
Time offset between PCell and PScell		Config 1,2	3 $\mu$ s				Synchronous EN-DC
Time offset between serving and neighbour cells		Config 1,2	3 $\mu$ s				Synchronous cells.
T1	s	Config 1,2	5				
T2	s	Config 1,2	3	20	3	20	

**Table A.10.4.2.6.1-3: Cell specific test parameters for EN-DC inter-frequency event triggered reporting with SSB time index detection**

Parameter		Unit	Test configuration	Cell 2				Cell 3			
				T1	T2	T3	T4	T1	T2	T3	T4
NR RF Channel Number			Config 1,2	1				2			
Duplex mode			Config 1,2	TDD							
BW <sub>channel</sub>		MHz	Config 1,2	40: N <sub>RB,c</sub> = 106							
BWP BW		MHz	Config 1,2	40: N <sub>RB,c</sub> = 106							
TDD configuration			Config 1,2	TDDConf.1.1 CCA				TDDConf.1.1 CCA			
Initial DL BWP			Config 1,2	DLBWP.0.1				NA			
Initial UL BWP			Config 1,2	ULBWP.0.1				NA			
Dedicated DL BWP			Config 1,2	DLBWP.1.1				NA			
Dedicated UL BWP			Config 1,2	ULBWP.1.1				NA			
TRS configuration			Config 1,2	TRS.1.2 TDD				NA			
OCNG Patterns defined in A.3.2.1.1 (OP.1)			Config 1,2	OP.1				OP.1			
PDSCH Reference			Config 1,2	SR.1.1 CCA				-			
CORESET Reference Channel			Config 1,2	CR.1.1 CCA				-			
SSB parameters	Semi-static channel access <sup>Note 5,7</sup>		Config 1,2	SSB.1 CCA				SSB.1 CCA			
	Dynamic channel access <sup>Note 6,7</sup>		Config 1,2	SSB.2 CCA				SSB.2 CCA			
DBT window configuration			Config 1,2	As defined in A.3.28.1				As defined in A.3.28.1			
SMTC configuration			Config 1,2	SMTC.1				SMTC.4			
PDSCH/PDCCH		kHz	Config 1,2	30				30			
DL CCA probability P <sub>CCA_DL</sub>	Semi-static channel access <sup>Note 5,7</sup>		Config 1,2	P <sub>CCA_DL</sub> =0.9375				P <sub>CCA_DL</sub> =0.9375			
	Dynamic channel access <sup>Note 6,7</sup>		Config 1,2	P <sub>CCA_DL_1</sub> =0.75 P <sub>CCA_DL_2</sub> =0.75				P <sub>CCA_DL_1</sub> =0.75 P <sub>CCA_DL_2</sub> =0.75			
UL CCA probability P <sub>CCA_UL</sub>	Semi-static channel access <sup>Note 5,7</sup>		Config 1,2	P <sub>CCA_UL</sub> =1				P <sub>CCA_UL</sub> =1			
	Dynamic channel access <sup>Note 6,7</sup>		Config 1,2	P <sub>CCA_UL</sub> =1				P <sub>CCA_UL</sub> =1			
L <sub>CCA_DL</sub>			Config 1,2	2				2			
W <sub>CCA_DL</sub>		ms	Config 1,2	T <sub>PSS/SSS_sync_inter_cca</sub>				T <sub>PSS/SSS_sync_inter_cca</sub>			
EPRE ratio of PSS to SSS			Config 1,2	0				0			
EPRE ratio of PBCH DMRS to SSS											
EPRE ratio of PBCH to PBCH DMRS											
EPRE ratio of PDCCH DMRS to SSS											
EPRE ratio of PDCCH to PDCCH DMRS											
EPRE ratio of PDSCH DMRS to SSS											
EPRE ratio of PDSCH to PDSCH											
EPRE ratio of OCNG DMRS to SSS(Note 1)											

EPRE ratio of OCNG to OCNG DMRS (Note 1)						
$N_{oc}^{Note2}$	dBm/15k Hz	Config 1,2	-104		-104	
$N_{oc}^{Note2}$	dBm/SC S	Config 1,2	-101		-101	
SS-RSRP <sup>Note 3</sup>	dBm/SC S	Config 1,2	-91	-91	-Infinity	-88
$\hat{E}_s / I_{ot}$	dB	Config 1,2	4	4	-Infinity	7
$\hat{E}_s / N_{oc}$	dB	Config 1,2	4	4	-Infinity	7
$I_o^{Note3}$	dBm/38.1 6MHz	Config 1,2	-58.49	-58.49	-63.94	-56.15
Propagation Condition		Config 1,2	AWGN			
<p>Note 1: OCNG shall be used such that both cells are fully allocated and a constant total transmitted power spectral density is achieved for all OFDM symbols.</p> <p>Note 2: Interference from other cells and noise sources not specified in the test is assumed to be constant over subcarriers and time and shall be modelled as AWGN of appropriate power for <math>N_{oc}</math> to be fulfilled.</p> <p>Note 3: SS-RSRP and <math>I_o</math> levels have been derived from other parameters for information purposes. They are not settable parameters themselves.</p> <p>Note 4: SS-RSRP minimum requirements are specified assuming independent interference and noise at each receiver antenna port.</p> <p>Note 5: For UE supporting semi-static channel access and network configuring semi-static channel occupancy.</p> <p>Note 6: For UE supporting dynamic channel access and network configuring dynamic channel occupancy.</p> <p>Note 7: For UE supporting both semi-static and dynamic channel access, the UE must be tested under dynamic channel access configuration.</p>						

**Table A.10.4.2.6.1-4: DRX-Configuration for SA inter-frequency event triggered reporting without SSB time index detection**

Field	Test1&3	Test2&4	Comment
	Value	Value	
drx-onDurationTimer	ms1	ms1	As specified in clause 6.3.2 in TS 38.331 [2]
drx-InactivityTimer	ms1	ms1	
drx-RetransmissionTimerDL	sl1	sl1	
drx-RetransmissionTimerUL	sl1	sl1	
drx-LongCycleStartOffset	ms40	Ms640	
shortDRX	disable	disable	

**Table A.10.4.2.6.1-5: TimeAlignmentTimer -Configuration SA inter-frequency event triggered reporting without SSB time index detection**

Field	Value	Comment
TimeAlignmentTimer	ms500	As specified in clause 6.3.2 in TS 38.331 [2]

**A.10.4.2.6.2 Test Requirements**

In test 1 with per-UE gap, the UE shall send one Event A3 triggered measurement report, with a measurement reporting delay less than  $T_{identify\_inter\_cca\_with\_}$  from the beginning of time period T2. The UE shall not send event triggered measurement reports, as long as the reporting criteria are not fulfilled. The rate of correct events observed during repeated tests shall be at least 90%.

In test 2 with per-FR gap, the UE shall send one Event A3 triggered measurement report, with a measurement reporting delay less than  $T_{identify\_inter\_cca\_with\_}$  from the beginning of time period T2. The UE shall not send event triggered measurement reports, as long as the reporting criteria are not fulfilled. The rate of correct events observed during repeated tests shall be at least 90%.

In test 3 with per-UE gap, the UE shall send one Event A3 triggered measurement report, with a measurement reporting delay less than  $T_{identify\_inter\_cca\_with\_}$  from the beginning of time period T2. The UE shall not send event triggered

measurement reports, as long as the reporting criteria are not fulfilled. The rate of correct events observed during repeated tests shall be at least 90%.

In test 4 with per-FR gap, the UE shall send one Event A3 triggered measurement report, with a measurement reporting delay less than  $T_{\text{identify\_inter\_cca\_with}}$  from the beginning of time period T2. The UE shall not send event triggered measurement reports, as long as the reporting criteria are not fulfilled. The rate of correct events observed during repeated tests shall be at least 90%.

In test 1, 2, 3 and 4 UE is required to report SSB time index.

$T_{\text{identify\_inter\_cca\_with\_index}} = (T_{\text{PSS/SSS\_sync\_inter\_cca}} + T_{\text{SSB\_measurement\_period\_inter\_cca}} + T_{\text{SSB\_time\_index\_inter\_cca}})$  ms, where

$T_{\text{PSS/SSS\_sync\_inter\_cca}}$ : it is the time period used in PSS/SSS detection given in table 9.3A.4-1.

$T_{\text{SSB\_time\_index\_inter\_cca}}$ : it is the time period used to acquire the index of the SSB being measured given in table 9.3A.4-2.

$T_{\text{SSB\_measurement\_period\_inter\_cca}}$ : equal to a measurement period of SSB based measurement given in table 9.3A.5-1.

For tests 1 and 2, MGRP = 40 ms and for tests 3 and 4 MGRP = 20 ms.

For tests 1 and 3, DRX cycle = 40 ms and for tests 2 and 4 DRX cycle = 640 ms.

SMTC period = 20 ms.

NOTE: The actual overall delays measured in the test may be up to  $2xTTI_{\text{DCCH}}$  higher than the measurement reporting delays above because of TTI insertion uncertainty of the measurement report in DCCH.

#### A.10.4.2.7 EN-DC event triggered reporting tests for FR1 cell without SSB time index detection when DRX is not used

##### A.10.4.2.7.1 Test Purpose and Environment

The purpose of this test is to verify that the UE makes correct reporting of an event. This test will partly verify the EN-DC inter-frequency NR cell search requirements in clause 9.3A.4 and 9.3A.5.

In this test, there are three cells: LTE cell 1 as PCell on E-UTRA RF channel 1, NR cell 2 as PSCell in FR1 with CCA on NR RF channel 1 and NR cell 3 as neighbour cell in FR1 on NR RF channel 2. The test parameters and configurations are given in Tables A.10.4.2.7.1-1, A.10.4.2.7.1-2, and A.10.4.2.7.1-3.

In test 1 measurement gap pattern configuration # 0 as defined in Table A.10.4.2.7.1-2 is provided for a UE that does not support per-FR gap and in test 2 measurement gap pattern configuration #4 as defined in Table A.10.4.2.7.1-2 is provided for UE that support per-FR gap. If a UE supports per-FR gap and gap pattern configuration #4, it is only required to pass test 2. Otherwise it is only required to pass test 1.

In the measurement control information, it is indicated to the UE that event-triggered reporting with Event A3 is used. The test consists of two successive time periods, with time duration of T1, and T2 respectively. During time duration T1, the UE shall not have any timing information of NR cell 3.

The configuration of LTE cell 1 is defined in table A.3.7.2.1-1. Supported test configurations are shown in table A.10.4.2.7.1-1.

**Table A.10.4.2.7.1-1: EN-DC event triggered reporting tests without SSB index reading for FR1-FR1**

Config	Description
1	E-UTRAN cell: LTE FDD NR cell without CCA: 15 kHz SSB SCS, 10 MHz bandwidth, FDD duplex mode NR cell with CCA: 30 kHz SSB SCS, 40 MHz bandwidth, TDD duplex mode
2	E-UTRAN cell: LTE FDD NR cell without CCA: 15 kHz SSB SCS, 10 MHz bandwidth, TDD duplex mode NR cell with CCA: 30 kHz SSB SCS, 40 MHz bandwidth, TDD duplex mode
3	E-UTRAN cell: LTE FDD NR cell without CCA: 30 kHz SSB SCS, 40 MHz bandwidth, TDD duplex mode NR cell with CCA: 30 kHz SSB SCS, 40 MHz bandwidth, TDD duplex mode

4	E-UTRAN cell: LTE TDD NR cell without CCA: 15 kHz SSB SCS, 10 MHz bandwidth, FDD duplex mode NR cell with CCA: 30 kHz SSB SCS, 40 MHz bandwidth, TDD duplex mode
5	E-UTRAN cell: LTE TDD NR cell without CCA: 15 kHz SSB SCS, 10 MHz bandwidth, TDD duplex mode, NR cell with CCA: 30 kHz SSB SCS, 40 MHz bandwidth, TDD duplex mode
6	E-UTRAN cell: LTE TDD NR cell without CCA: 30 kHz SSB SCS, 40 MHz bandwidth, TDD duplex mode NR cell with CCA: 30 kHz SSB SCS, 40 MHz bandwidth, TDD duplex mode
Note 1: The UE is only required to be tested in one of the supported test configurations	

**Table A.10.4.2.7.1-2: General test parameters for EN-DC inter-frequency event triggered reporting without SSB time index detection**

Parameter	Unit	Test configuration	Value		Comment
			Test 1	Test 2	
E-UTRA RF Channel Number		Config 1,2,3,4,5,6	1		One E-UTRAN carrier frequency is used.
NR RF Channel Number		Config 1,2,3,4,5,6	1, 2		Two FR1 NR carrier frequencies are used. NR RF channel 1 is with CCA.
Active cell		Config 1,2,3,4,5,6	LTE Cell 1 (PCell) and NR cell 2 (PScell)		LTE Cell 1 is on E-UTRA RF channel number 1. NR Cell 2 is on NR RF channel number 1 with CCA.
Neighbour cell		Config 1,2,3,4,5,6	NR cell 3		NR cell 3 is on NR RF channel number 2.
DL CCA model		Config 1,2,3,4,5,6	As specified in clause A.3.26.2.1		
UL CCA model		Config 1,2,3,4,5,6	As specified in clause A.3.26.2.2		
Gap Pattern Id		Config 1,2,3,4,5,6	0	4	As specified in clause 9.1.2-1.
Measurement gap offset		Config 1,2,3,4,5,6	9	9	
A3-Offset	dB	Config 1,2,3,4,5,6	-6		
Hysteresis	dB	Config 1,2,3,4,5,6	0		
CP length		Config 1,2,3,4,5,6	Normal		
TimeToTrigger	s	Config 1,2,3,4,5,6	0		
Filter coefficient		Config 1,2,3,4,5,6	0		L3 filtering is not used
DRX		Config 1,2,3,4,5,6	OFF		DRX is not used
Time offset between PCell and PScell		Config 1,2,3,4,5,6	3 $\mu$ s		Synchronous EN-DC
Time offset between serving and neighbour cells		Config 1,2,3,4,5,6	3 ms		Asynchronous cells. The timing of Cell 3 is 3ms later than the timing of Cell 2.
		Config 1,2,3,4,5,6	3 $\mu$ s		Synchronous cells.
T1	s	Config 1,2,3,4,5,6	5		
T2	s	Config 1,2,3,4,5,6	1.7	1.7	

**Table A.10.4.2.7.1-3: Cell specific test parameters for EN-DC inter-frequency event triggered reporting without SSB time index detection**

Parameter	Unit	Test	Cell 2	Cell 3
-----------	------	------	--------	--------

		configuration	T1	T2	T1	T2	
NR RF Channel Number		Config 1,2,3,4,5,6	1		2		
Duplex mode		Config 1,4	TDD		FDD		
		Config 2,3,5,6	TDD		TDD		
BW <sub>channel</sub>	MHz	Config 1,2,4,5	40: N <sub>RB,c</sub> = 106		10: N <sub>RB,c</sub> = 52		
		Config 3,6	40: N <sub>RB,c</sub> = 106		40: N <sub>RB,c</sub> = 106		
BWP BW	MHz	Config 1,2,4,5	40: N <sub>RB,c</sub> = 106		10: N <sub>RB,c</sub> = 52		
		Config 3,6	40: N <sub>RB,c</sub> = 106		40: N <sub>RB,c</sub> = 106		
TDD configuration		Config 1,4	TDDConf.1.1 CCA		NA		
		Config 2,5	TDDConf.1.1 CCA		TDDConf.1.1		
		Config 3,6	TDDConf.1.1 CCA		TDDConf.2.1		
Initial DL BWP		Config 1,2,3,4,5,6	DLBWP.0.1		NA		
Initial UL BWP		Config 1,2,3,4,5,6	ULBWP.0.1		NA		
Dedicated DL BWP		Config 1,2,3,4,5,6	DLBWP.1.1		NA		
Dedicated UL BWP		Config 1,2,3,4,5,6	ULBWP.1.1		NA		
TRS configuration		Config 1,2,3,4,5,6	TRS.1.2 TDD		NA		
OCNG Patterns defined in A.3.2.1.1 (OP.1)		Config 1,2,3,4,5,6	OP.1		OP.1		
PDSCH Reference measurement channel		Config 1,4	SR.1.1 CCA		SR.1.1 FDD		
		Config 2,5	SR.1.1 CCA		SR.1.1 TDD		
		Config 3,6	SR.1.1 CCA		SR.2.1 TDD		
CORESET Reference Channel		Config 1,4	CR.1.1 CCA		CR.1.1 FDD		
		Config 2,5	CR.1.1 CCA		CR.1.1 TDD		
		Config 3,6	CR.1.1 CCA		CR.2.1 TDD		
SSB parameters	Semi-static channel access <sup>Note 5,7</sup>	Config 1,4	SSB.1 CCA		SSB.1 FR1		
		Config 2,5	SSB.1 CCA		SSB.1 FR1		
		Config 3,6	SSB.1 CCA		SSB.2 FR1		
	Dynamic channel access <sup>Note 6,7</sup>	Config 1,4	SSB.2 CCA		SSB.1 FR1		
		Config 2,5	SSB.2 CCA		SSB.1 FR1		
		Config 3,6	SSB.2 CCA		SSB.2 FR1		
DBT window configuration		Config 1,2,3,4,5,6	As defined in A.3.28.1		Not applicable		
SMTTC configuration defined in A.3.11		Config 1,4	SMTTC.2		SMTTC.5		
		Config 2,3,5,6	SMTTC.1		SMTTC.4		
PDSCH/PDCCH subcarrier spacing		kHz	Config 1,2,4,5	30		15	
			Config 3,6	30		30	
DL CCA probability P <sub>CCA_DL</sub>	Semi-static channel access <sup>Note 5,7</sup>	Config 1,2,3,4,5,6	P <sub>CCA_DL</sub> =0.9375		Not applicable		
	Dynamic channel access <sup>Note 6,7</sup>	Config 1,2,3,4,5,6	P <sub>CCA_DL_1</sub> =0.75 P <sub>CCA_DL_2</sub> =0.75		Not applicable		
UL CCA probability P <sub>CCA_UL</sub>	Semi-static channel access <sup>Note 5,7</sup>	Config 1,2,3,4,5,6	P <sub>CCA_UL</sub> =1		Not applicable		
	Dynamic channel access <sup>Note 6,7</sup>	Config 1,2,3,4,5,6	P <sub>CCA_UL</sub> =1		Not applicable		
L <sub>CCA_DL</sub>		Config 1,2,3,4,5,6	12		12		
W <sub>CCA_DL</sub>		ms	Config 1,2,3,4,5,6	T <sub>PSS/SSS_sync_inter_cca</sub>		T <sub>PSS/SSS_sync_inter_cca</sub>	
EPRE ratio of PSS to SSS							

EPRE ratio of PBCH DMRS to SSS		Config 1,2,3,4,5,6	0	0		
EPRE ratio of PBCH to PBCH DMRS						
EPRE ratio of PDCCH DMRS to SSS						
EPRE ratio of PDCCH to PDCCH DMRS						
EPRE ratio of PDSCH DMRS to SSS						
EPRE ratio of PDSCH to PDSCH						
EPRE ratio of OCNG DMRS to SSS(Note 1)						
EPRE ratio of OCNG to OCNG DMRS (Note 1)						
$N_{oc}$ <sup>Note2</sup>	dBm/15k Hz	Config 1,2,3,4,5,6	-104	-98		
$N_{oc}$ <sup>Note2</sup>	dBm/SC S	Config 1,2,4,5	-101	-98		
		Config 3,6	-101	-95		
SS-RSRP <sup>Note 3</sup>	dBm/SC S	Config 1,2,4,5	-94	-94	-Infinity	-91
		Config 3,6	-91	-91	-Infinity	-88
$\hat{E}_s / I_{ot}$	dB	Config 1,2,3,4,5,6	4	4	-Infinity	7
$\hat{E}_s / N_{oc}$	dB	Config 1,2,3,4,5,6	4	4	-Infinity	7
$I_o$ <sup>Note3</sup>	dBm/9.36 MHz	NR Config 1,2,4,5	-58.49	-58.49	-70.05	-62.26
	dBm/38.1 6MHz	NR Config 3,6	-58.49	-58.49	-63.94	-56.15
Propagation Condition		Config 1,2,3,4,5,6	AWGN			
Note 1:	OCNG shall be used such that both cells are fully allocated and a constant total transmitted power spectral density is achieved for all OFDM symbols.					
Note 2:	Interference from other cells and noise sources not specified in the test is assumed to be constant over subcarriers and time and shall be modelled as AWGN of appropriate power for $N_{oc}$ to be fulfilled.					
Note 3:	SS-RSRP and $I_o$ levels have been derived from other parameters for information purposes. They are not settable parameters themselves.					
Note 4:	SS-RSRP minimum requirements are specified assuming independent interference and noise at each receiver antenna port.					
Note 5:	For UE supporting semi-static channel access and network configuring semi-static channel occupancy.					
Note 6:	For UE supporting dynamic channel access and network configuring dynamic channel occupancy.					
Note 7:	For UE supporting both semi-static and dynamic channel access, the UE must be tested under dynamic channel access configuration.					

#### A.10.4.2.7.2 Test Requirements

In test 1 with per-UE gap, the UE shall send one Event A3 triggered measurement report, with a measurement reporting delay less than  $T_{\text{identify\_inter\_cca\_without\_index}}$  from the beginning of time period T2. The UE shall not send event triggered measurement reports, as long as the reporting criteria are not fulfilled. The rate of correct events observed during repeated tests shall be at least 90%.

In test 2 with per-FR gap, the UE shall send one Event A3 triggered measurement report, with a measurement reporting delay less than  $T_{\text{identify\_inter\_cca\_without\_index}}$  from the beginning of time period T2. The UE shall not send event triggered measurement reports, as long as the reporting criteria are not fulfilled. The rate of correct events observed during repeated tests shall be at least 90%.

In test 1 and 2 UE is not required to report SSB time index.

$T_{\text{identify\_inter\_cca\_without\_index}} = (T_{\text{PSS/SSS\_sync\_inter\_cca}} + T_{\text{SSB\_measurement\_period\_inter\_cca}})$  ms, where

$T_{\text{PSS/SSS\_sync\_inter\_cca}}$ : it is the time period used in PSS/SSS detection given in table 9.3A.4-1.



$T_{SSB\_measurement\_period\_inter\_cca}$ : equal to a measurement period of SSB based measurement given in table 9.3A.5-1.

For test 1, MGRP = 40 ms and for test 2 MGRP = 20 ms.

SMTC period = 20 ms.

NOTE: The actual overall delays measured in the test may be up to  $2 \times TTI_{DCCH}$  higher than the measurement reporting delays above because of TTI insertion uncertainty of the measurement report in DCCH.

### A.10.4.2.8 EN-DC event triggered reporting tests for FR1 cell without SSB time index detection when DRX is used

#### A.10.4.2.8.1 Test Purpose and Environment

The purpose of this test is to verify that the UE makes correct reporting of an event. This test will partly verify the EN-DC inter-frequency NR cell search requirements in clause 9.3A.4 and 9.3A.5.

In this test, there are three cells: LTE cell 1 as PCell on E-UTRA RF channel 1, NR cell 2 as PCell in FR1 on NR RF channel 1 and NR cell 3 as neighbour cell in FR1 on NR RF channel 2. The test parameters and configurations are given in Tables A.10.4.2.8.1-1, A.10.4.2.8.1-2, and A.10.4.2.8.1-3.

In test 1&2 measurement gap pattern configuration # 0 as defined in Table A.10.4.2.8.1-2 is provided for a UE that does not support per-FR gap and in test 3&4 measurement gap pattern configuration #4 as defined in Table A.10.4.2.8.1-2 is provided for UE that support per-FR gap. If a UE supports per-FR gap and gap pattern configuration #4, it is only required to pass test 3&4. Otherwise it is only required to pass test 1&2.

In the measurement control information, it is indicated to the UE that event-triggered reporting with Event A3 is used. The test consists of two successive time periods, with time duration of T1, and T2 respectively. During time duration T1, the UE shall not have any timing information of NR cell 3.

The configuration of LTE cell 1 is defined in table A.3.7.2.1-1. Supported test configurations are shown in table A.10.4.2.8.1-1.

UE needs to be provided at least once every 500ms with new Timing Advance Command MAC control element to restart the Time alignment timer to keep UE uplink time alignment. Furthermore, UE is allocated with PUSCH resource at every DRX cycle.

**Table A.10.4.2.8.1-1: EN-DC event triggered reporting tests without SSB index reading for FR1-FR1**

Config	Description
1	E-UTRAN cell: LTE FDD NR cell without CCA: 15 kHz SSB SCS, 10 MHz bandwidth, FDD duplex mode NR cell with CCA: 30 kHz SSB SCS, 40 MHz bandwidth, TDD duplex mode
2	E-UTRAN cell: LTE FDD NR cell without CCA: 15 kHz SSB SCS, 10 MHz bandwidth, TDD duplex mode NR cell with CCA: 30 kHz SSB SCS, 40 MHz bandwidth, TDD duplex mode
3	E-UTRAN cell: LTE FDD NR cell without CCA: 30 kHz SSB SCS, 40 MHz bandwidth, TDD duplex mode NR cell with CCA: 30 kHz SSB SCS, 40 MHz bandwidth, TDD duplex mode
4	E-UTRAN cell: LTE TDD NR cell without CCA: 15 kHz SSB SCS, 10 MHz bandwidth, FDD duplex mode NR cell with CCA: 30 kHz SSB SCS, 40 MHz bandwidth, TDD duplex mode
5	E-UTRAN cell: LTE TDD NR cell without CCA: 15 kHz SSB SCS, 10 MHz bandwidth, TDD duplex mode, NR cell with CCA: 30 kHz SSB SCS, 40 MHz bandwidth, TDD duplex mod
6	E-UTRAN cell: LTE TDD NR cell without CCA: 30 kHz SSB SCS, 40 MHz bandwidth, TDD duplex mode NR cell with CCA: 30 kHz SSB SCS, 40 MHz bandwidth, TDD duplex mode
Note 1: The UE is only required to be tested in one of the supported test configurations	

**Table A.10.4.2.8.1-2: General test parameters for EN-DC inter-frequency event triggered reporting without SSB time index detection**

Parameter	Unit	Test	Value	Comment
-----------	------	------	-------	---------

		configuration	Test 1	Test 2	Test 3	Test 4	
E-UTRA RF Channel Number		Config 1,2,3,4,5,6	1				One E-UTRAN carrier frequency is used.
NR RF Channel Number		Config 1,2,3,4,5,6	1, 2				Two FR1 NR carrier frequencies are used. NR RF channel 1 is with CCA.
Active cell		Config 1,2,3,4,5,6	LTE Cell 1 (PCell) and NR cell 2 (PScell)				LTE Cell 1 is on E-UTRA RF channel number 1. NR Cell 2 is on NR RF channel number 1 with CCA.
Neighbour cell		Config 1,2,3,4,5,6	NR cell 3				NR cell 3 is on NR RF channel number 2.
DL CCA model		Config 1,2,3,4,5,6	As specified in clause A.3.26.2.1				
UL CCA model		Config 1,2,3,4,5,6	As specified in clause A.3.26.2.2				
Gap Pattern Id		Config 1,2,3,4,5,6	0		4		As specified in clause 9.1.2-1.
Measurement gap offset		Config 1,2,3,4,5,6	9		9		
A3-Offset	dB	Config 1,2,3,4,5,6	-6				
Hysteresis	dB	Config 1,2,3,4,5,6	0				
CP length		Config 1,2,3,4,5,6	Normal				
TimeToTrigger	s	Config 1,2,3,4,5,6	0				
Filter coefficient		Config 1,2,3,4,5,6	0				L3 filtering is not used
DRX		Config 1,2,3,4,5,6	DRX .1	DRX .2	DRX .1	DRX .2	As specified in clause A.3.3
Time offset between PCell and PSCell		Config 1,2,3,4,5,6	3 μs				Synchronous EN-DC
Time offset between serving and neighbour cells		Config 1,2,3,4,5,6	3 ms				Asynchronous cells. The timing of Cell 3 is 3ms later than the timing of Cell 2.
		Config 1,2,3,4,5,6	3 μs				Synchronous cells.
T1	s	Config 1,2,3,4,5,6	5				
T2	s	Config 1,2,3,4,5,6	2.5	17	2.5	17	

**Table A.10.4.2.8.1-3: Cell specific test parameters for EN-DC inter-frequency event triggered reporting without SSB time index detection**

Parameter	Unit	Test configuration	Cell 2				Cell 3			
			T1	T2	T3	T4	T1	T2	T3	T4
NR RF Channel Number		Config 1,2,3,4,5,6	1				2			
Duplex mode		Config 1,4	TDD				FDD			
		Config 2,3,5,6	TDD				TDD			
BW <sub>channel</sub>	MHz	Config 1,2,4,5	40: N <sub>RB,c</sub> = 106				10: N <sub>RB,c</sub> = 52			
		Config 3,6	40: N <sub>RB,c</sub> = 106				40: N <sub>RB,c</sub> = 106			
BWP BW	MHz	Config 1,2,4,5	40: N <sub>RB,c</sub> = 106				10: N <sub>RB,c</sub> = 52			
		Config 3,6	40: N <sub>RB,c</sub> = 106				40: N <sub>RB,c</sub> = 106			
TDD configuration		Config 1,4	TDDConf.1.1 CCA				NA			
		Config 2,5	TDDConf.1.1 CCA				TDDConf.1.1			
		Config 3,6	TDDConf.1.1 CCA				TDDConf.2.1			
Initial DL BWP		Config 1,2,3,4,5,6	DLBWP.0.1				NA			
Initial UL BWP		Config 1,2,3,4,5,6	ULBWP.0.1				NA			

Dedicated DL BWP			Config 1,2,3,4,5,6	DLBWP.1.1	NA
Dedicated UL BWP			Config 1,2,3,4,5,6	ULBWP.1.1	NA
TRS configuration			Config 1,2,3,4,5,6	TRS.1.2 TDD	NA
OCNG Patterns defined in A.3.2.1.1 (OP.1)			Config 1,2,3,4,5,6	OP.1	OP.1
PDSCH Reference measurement channel			Config 1,4	SR.1.1 CCA	SR.1.1 FDD
			Config 2,5	SR.1.1 CCA	SR.1.1 TDD
			Config 3,6	SR.1.1 CCA	SR.2.1 TDD
CORESET Reference Channel			Config 1,4	CR.1.1 CCA	CR.1.1 FDD
			Config 2,5	CR.1.1 CCA	CR.1.1 TDD
			Config 3,6	CR.1.1 CCA	CR.2.1 TDD
SSB parameters	Semi-static channel access <sup>Note 5,7</sup>		Config 1,4	SSB.1 CCA	SSB.1 FR1
			Config 2,5	SSB.1 CCA	SSB.1 FR1
			Config 3,6	SSB.1 CCA	SSB.2 FR1
	Dynamic channel access <sup>Note 6,7</sup>		Config 1,4	SSB.2 CCA	SSB.1 FR1
			Config 2,5	SSB.2 CCA	SSB.1 FR1
			Config 3,6	SSB.2 CCA	SSB.2 FR1
DBT window configuration			Config 1,2,3,4,5,6	As defined in A.3.28.1	Not applicable
SMTC configuration defined in A.3.11			Config 1,4	SMTC.2	SMTC.5
			Config 2,3,5,6	SMTC.1	SMTC.4
PDSCH/PDCCH subcarrier spacing		kHz	Config 1,2,4,5	30	15
			Config 3,6	30	30
DL CCA probability $P_{CCA\_DL}$	Semi-static channel access <sup>Note 5,7</sup>		Config 1,2,3,4,5,6	$P_{CCA\_DL}=0.9375$	Not applicable
	Dynamic channel access <sup>Note 6,7</sup>		Config 1,2,3,4,5,6	$P_{CCA\_DL\_1}=0.75$ $P_{CCA\_DL\_2}=0.75$	Not applicable
UL CCA probability $P_{CCA\_UL}$	Semi-static channel access <sup>Note 5,7</sup>		Config 1,2,3,4,5,6	$P_{CCA\_UL}=1$	Not applicable
	Dynamic channel access <sup>Note 6,7</sup>		Config 1,2,3,4,5,6	$P_{CCA\_UL}=1$	Not applicable
LCCA_DL			Config 1,2,3,4,5,6	5	5
WCCA_DL		ms	Config 1,2,3,4,5,6	$T_{PSS/SSS\_sync\_inter\_cca}$	$T_{PSS/SSS\_sync\_inter\_cca}$
EPRE ratio of PSS to SSS			Config 1,2,3,4,5,6	0	0
EPRE ratio of PBCH DMRS to SSS					
EPRE ratio of PBCH to PBCH DMRS					
EPRE ratio of PDCCH DMRS to SSS					
EPRE ratio of PDCCH to PDCCH DMRS					
EPRE ratio of PDSCH DMRS to SSS					
EPRE ratio of PDSCH to PDSCH					

EPRE ratio of OCNG DMRS to SSS(Note 1)						
EPRE ratio of OCNG to OCNG DMRS (Note 1)						
$N_{oc}^{Note2}$	dBm/15k Hz	Config 1,2,3,4,5,6	-104			-98
$N_{oc}^{Note2}$	dBm/SC S	Config 1,2,4,5	-101			-98
		Config 3,6	-101			-95
SS-RSRP <sup>Note 3</sup>	dBm/SC S	Config 1,2,4,5	-94	-94	-Infinity	-91
		Config 3,6	-91	-91	-Infinity	-88
$\hat{E}_s / I_{ot}$	dB	Config 1,2,3,4,5,6	4	4	-Infinity	7
$\hat{E}_s / N_{oc}$	dB	Config 1,2,3,4,5,6	4	4	-Infinity	7
$I_o^{Note3}$	dBm/9.36 MHz	NR Config 1,2,4,5	-58.49	-58.49	-70.05	-62.26
	dBm/38.1 6MHz	NR Config 3,6	-58.49	-58.49	-63.94	-56.15
Propagation Condition		Config 1,2,3,4,5,6	AWGN			
<p>Note 1: OCNG shall be used such that both cells are fully allocated and a constant total transmitted power spectral density is achieved for all OFDM symbols.</p> <p>Note 2: Interference from other cells and noise sources not specified in the test is assumed to be constant over subcarriers and time and shall be modelled as AWGN of appropriate power for <math>N_{oc}</math> to be fulfilled.</p> <p>Note 3: SS-RSRP and <math>I_o</math> levels have been derived from other parameters for information purposes. They are not settable parameters themselves.</p> <p>Note 4: SS-RSRP minimum requirements are specified assuming independent interference and noise at each receiver antenna port.</p> <p>Note 5: For UE supporting semi-static channel access and network configuring semi-static channel occupancy.</p> <p>Note 6: For UE supporting dynamic channel access and network configuring dynamic channel occupancy.</p> <p>Note 7: For UE supporting both semi-static and dynamic channel access, the UE must be tested under dynamic channel access configuration.</p>						

**Table A.10.4.2.8.1-4: DRX-Configuration for SA inter-frequency event triggered reporting without SSB time index detection**

Field	Test1&3	Test2&4	Comment
	Value	Value	
drx-onDurationTimer	ms1	ms1	As specified in clause 6.3.2 in TS 38.331 [2]
drx-InactivityTimer	ms1	ms1	
drx-RetransmissionTimerDL	sl1	sl1	
drx-RetransmissionTimerUL	sl1	sl1	
drx-LongCycleStartOffset	ms40	Ms640	
shortDRX	disable	disable	

**Table A.10.4.2.8.1-5: TimeAlignmentTimer-Configuration SA inter-frequency event triggered reporting without SSB time index detection**

Field	Value	Comment
TimeAlignmentTimer	ms500	As specified in clause 6.3.2 in TS 38.331 [2]

**A.10.4.2.8.2 Test Requirements**

In test 1 with per-UE gap, the UE shall send one Event A3 triggered measurement report, with a measurement reporting delay less than  $T_{identify\_inter\_cca\_without\_index}$  from the beginning of time period T2. The UE shall not send event triggered measurement reports, as long as the reporting criteria are not fulfilled. The rate of correct events observed during repeated tests shall be at least 90%.

In test 2 with per-FR gap, the UE shall send one Event A3 triggered measurement report, with a measurement reporting delay less than  $T_{\text{identify\_inter\_cca\_without\_index}}$  from the beginning of time period T2. The UE shall not send event triggered measurement reports, as long as the reporting criteria are not fulfilled. The rate of correct events observed during repeated tests shall be at least 90%.

In test 3 with per-UE gap, the UE shall send one Event A3 triggered measurement report, with a measurement reporting delay less than  $T_{\text{identify\_inter\_cca\_without\_index}}$  from the beginning of time period T2. The UE shall not send event triggered measurement reports, as long as the reporting criteria are not fulfilled. The rate of correct events observed during repeated tests shall be at least 90%.

In test 4 with per-FR gap, the UE shall send one Event A3 triggered measurement report, with a measurement reporting delay less than  $T_{\text{identify\_inter\_cca\_without\_index}}$  from the beginning of time period T2. The UE shall not send event triggered measurement reports, as long as the reporting criteria are not fulfilled. The rate of correct events observed during repeated tests shall be at least 90%.

In test 1, 2, 3 and 4 UE is not required to report SSB time index.

$T_{\text{identify\_inter\_cca\_without\_index}} = (T_{\text{PSS/SSS\_sync\_inter\_cca}} + T_{\text{SSB\_measurement\_period\_inter\_cca}})$  ms, where

$T_{\text{PSS/SSS\_sync\_inter\_cca}}$ : it is the time period used in PSS/SSS detection given in table 9.3A.4-1.

$T_{\text{SSB\_measurement\_period\_inter\_cca}}$ : equal to a measurement period of SSB based measurement given in table 9.3A.5-1.

For tests 1 and 2, MGRP = 40 ms and for tests 3 and 4 MGRP = 20 ms.

For tests 1 and 3, DRX cycle = 40 ms and for tests 2 and 4 DRX cycle = 640 ms.

SMTC period = 20 ms.

NOTE: The actual overall delays measured in the test may be up to  $2 \times T_{\text{TTI}_{\text{DCCH}}}$  higher than the measurement reporting delays above because of TTI insertion uncertainty of the measurement report in DCCH.

#### A.10.4.2.9 EN-DC event triggered reporting tests for FR1 cell with SSB time index detection when DRX is not used

##### A.10.4.2.9.1 Test Purpose and Environment

The purpose of this test is to verify that the UE makes correct reporting of an event. This test will partly verify the EN-DC inter-frequency NR cell search requirements in clause 9.3A.4 and 9.3A.5.

In this test, there are three cells: LTE cell 1 as PCell on E-UTRA RF channel 1, NR cell 2 as PSCell in FR1 on NR RF channel 1 and NR cell 3 as neighbour cell in FR1 on NR RF channel 2. The test parameters and configurations are given in Tables A.10.4.2.9.1-1, A.10.4.2.9.1-2, and A.10.4.2.9.1-3.

In test 1 measurement gap pattern configuration # 0 as defined in Table A.10.4.2.9.1-2 is provided for a UE that does not support per-FR gap and in test 2 measurement gap pattern configuration #4 as defined in Table A.10.4.2.9.1-2 is provided for UE that support per-FR gap. If a UE supports per-FR gap and gap pattern configuration #4, it is only required to pass test 2. Otherwise it is only required to pass test 1.

In the measurement control information, it is indicated to the UE that event-triggered reporting with Event A3 is used. The test consists of two successive time periods, with time duration of T1, and T2 respectively. During time duration T1, the UE shall not have any timing information of NR cell 3.

The configuration of LTE cell 1 is defined in table A.3.7.2.1-1. Supported test configurations are shown in table A.10.4.2.9.1-1.

**Table A.10.4.2.9.1-1: EN-DC event triggered reporting tests without SSB index reading for FR1-FR1**

Config	Description
1	E-UTRAN cell: LTE FDD NR cell without CCA: 15 kHz SSB SCS, 10 MHz bandwidth, FDD duplex mode NR cell with CCA: 30 kHz SSB SCS, 40 MHz bandwidth, TDD duplex mode
2	E-UTRAN cell: LTE FDD NR cell without CCA: 15 kHz SSB SCS, 10 MHz bandwidth, TDD duplex mode NR cell with CCA: 30 kHz SSB SCS, 40 MHz bandwidth, TDD duplex mode

3	E-UTRAN cell: LTE FDD NR cell without CCA: 30 kHz SSB SCS, 40 MHz bandwidth, TDD duplex mode NR cell with CCA: 30 kHz SSB SCS, 40 MHz bandwidth, TDD duplex mode
4	E-UTRAN cell: LTE TDD NR cell without CCA: 15 kHz SSB SCS, 10 MHz bandwidth, FDD duplex mode NR cell with CCA: 30 kHz SSB SCS, 40 MHz bandwidth, TDD duplex mode
5	E-UTRAN cell: LTE TDD NR cell without CCA: 15 kHz SSB SCS, 10 MHz bandwidth, TDD duplex mode, NR cell with CCA: 30 kHz SSB SCS, 40 MHz bandwidth, TDD duplex mod
6	E-UTRAN cell: LTE TDD NR cell without CCA: 30 kHz SSB SCS, 40 MHz bandwidth, TDD duplex mode NR cell with CCA: 30 kHz SSB SCS, 40 MHz bandwidth, TDD duplex mode
Note 1: The UE is only required to be tested in one of the supported test configurations	

**Table A.10.4.2.9.1-2: General test parameters for EN-DC inter-frequency event triggered reporting with SSB time index detection**

Parameter	Unit	Test configuration	Value		Comment
			Test 1	Test 2	
E-UTRA RF Channel Number		Config 1,2,3,4,5,6	1		One E-UTRAN carrier frequency is used.
NR RF Channel Number		Config 1,2,3,4,5,6	1, 2		Two FR1 NR carrier frequencies are used. NR RF channel 1 is with CCA.
Active cell		Config 1,2,3,4,5,6	LTE Cell 1 (PCell) and NR cell 2 (PScell)		LTE Cell 1 is on E-UTRA RF channel number 1. NR Cell 2 is on NR RF channel number 1 with CCA.
Neighbour cell		Config 1,2,3,4,5,6	NR cell 3		NR cell 3 is on NR RF channel number 2.
DL CCA model		Config 1,2,3,4,5,6	As specified in clause A.3.26.2.1		
UL CCA model		Config 1,2,3,4,5,6	As specified in clause A.3.26.2.2		
Gap Pattern Id		Config 1,2,3,4,5,6	0	4	As specified in clause 9.1.2-1.
Measurement gap offset		Config 1,2,3,4,5,6	9	9	
A3-Offset	dB	Config 1,2,3,4,5,6	-6		
Hysteresis	dB	Config 1,2,3,4,5,6	0		
CP length		Config 1,2,3,4,5,6	Normal		
TimeToTrigger	s	Config 1,2,3,4,5,6	0		
Filter coefficient		Config 1,2,3,4,5,6	0		L3 filtering is not used
DRX		Config 1,2,3,4,5,6	OFF		DRX is not used
Time offset between PCell and PScell		Config 1,2,3,4,5,6	3 $\mu$ s		Synchronous EN-DC
Time offset between serving and neighbour cells		Config 1,2,3,4,5,6	3 ms		Asynchronous cells. The timing of Cell 3 is 3ms later than the timing of Cell 2.
		Config 1,2,3,4,5,6	3 $\mu$ s		Synchronous cells.
T1	s	Config 1,2,3,4,5,6	5		
T2	s	Config 1,2,3,4,5,6	2	2	

**Table A.10.4.2.9.1-3: Cell specific test parameters for EN-DC inter-frequency event triggered reporting with SSB time index detection**

Parameter		Unit	Test configuration	Cell 2		Cell 3	
				T1	T2	T1	T2
NR RF Channel Number			Config 1,2,3,4,5,6	1		2	
Duplex mode			Config 1,4	TDD		FDD	
			Config 2,3,5,6	TDD		TDD	
BW <sub>channel</sub>		MHz	Config 1,2,4,5	40: N <sub>RB,c</sub> = 106		10: N <sub>RB,c</sub> = 52	
			Config 3,6	40: N <sub>RB,c</sub> = 106		40: N <sub>RB,c</sub> = 106	
BWP BW		MHz	Config 1,2,4,5	40: N <sub>RB,c</sub> = 106		10: N <sub>RB,c</sub> = 52	
			Config 3,6	40: N <sub>RB,c</sub> = 106		40: N <sub>RB,c</sub> = 106	
TDD configuration			Config 1,4	TDDConf.1.1 CCA		NA	
			Config 2,5	TDDConf.1.1 CCA		TDDConf.1.1	
			Config 3,6	TDDConf.1.1 CCA		TDDConf.2.1	
Initial DL BWP			Config 1,2,3,4,5,6	DLBWP.0.1		NA	
Initial UL BWP			Config 1,2,3,4,5,6	ULBWP.0.1		NA	
Dedicated DL BWP			Config 1,2,3,4,5,6	DLBWP.1.1		NA	
Dedicated UL BWP			Config 1,2,3,4,5,6	ULBWP.1.1		NA	
TRS configuration			Config 1,2,3,4,5,6	TRS.1.2 TDD		NA	
OCNG Patterns defined in A.3.2.1.1 (OP.1)			Config 1,2,3,4,5,6	OP.1		OP.1	
PDSCH Reference measurement channel			Config 1,4	SR.1.1 CCA		SR.1.1 FDD	
			Config 2,5	SR.1.1 CCA		SR.1.1 TDD	
			Config 3,6	SR.1.1 CCA		SR.2.1 TDD	
CORESET Reference Channel			Config 1,4	CR.1.1 CCA		CR.1.1 FDD	
			Config 2,5	CR.1.1 CCA		CR.1.1 TDD	
			Config 3,6	CR.1.1 CCA		CR.2.1 TDD	
SSB parameters		Semi-static channel access <sup>Note 5,7</sup>	Config 1,4	SSB.1 CCA		SSB.1 FR1	
			Config 2,5	SSB.1 CCA		SSB.1 FR1	
			Config 3,6	SSB.1 CCA		SSB.2 FR1	
		Dynamic channel access <sup>Note 6,7</sup>	Config 1,4	SSB.2 CCA		SSB.1 FR1	
			Config 2,5	SSB.2 CCA		SSB.1 FR1	
			Config 3,6	SSB.2 CCA		SSB.2 FR1	
DBT window configuration			Config 1,2,3,4,5,6	As defined in A.3.28.1		Not applicable	
SMTC configuration defined in A.3.11			Config 1,4	SMTC.2		SMTC.5	
			Config 2,3,5,6	SMTC.1		SMTC.4	
PDSCH/PDCCH subcarrier spacing		kHz	Config 1,2,4,5	30		15	
			Config 3,6	30		30	
DL CCA probability P <sub>CCA_DL</sub>		Semi-static channel access <sup>Note 5,7</sup>	Config 1,2,3,4,5,6	P <sub>CCA_DL</sub> =0.9375		Not applicable	
			Config 1,2,3,4,5,6	P <sub>CCA_DL_1</sub> =0.75 P <sub>CCA_DL_2</sub> =0.75		Not applicable	
UL CCA probability P <sub>CCA_UL</sub>		Semi-static channel access <sup>Note 5,7</sup>	Config 1,2,3,4,5,6	P <sub>CCA_UL</sub> =1		Not applicable	

	Dynamic channel access <sup>Note 6,7</sup>		Config 1,2,3,4,5,6	P <sub>CCA_UL</sub> =1	Not applicable	
L <sub>CCA_DL</sub>			Config 1,2,3,4,5,6	5	5	
W <sub>CCA_DL</sub>	ms		Config 1,2,3,4,5,6	T <sub>PSS/SSS_sync_inter_cca</sub>	T <sub>PSS/SSS_sync_inter_cca</sub>	
EPRE ratio of PSS to SSS		Config 1,2,3,4,5,6		0	0	
EPRE ratio of PBCH DMRS to SSS						
EPRE ratio of PBCH to PBCH DMRS						
EPRE ratio of PDCCH DMRS to SSS						
EPRE ratio of PDCCH to PDCCH DMRS						
EPRE ratio of PDSCH DMRS to SSS						
EPRE ratio of PDSCH to PDSCH						
EPRE ratio of OCNG DMRS to SSS(Note 1)						
EPRE ratio of OCNG to OCNG DMRS (Note 1)						
$N_{oc}$ <sup>Note2</sup>	dBm/15k Hz	Config 1,2,3,4,5,6	-104	-98		
$N_{oc}$ <sup>Note2</sup>	dBm/SC S	Config 1,2,4,5	-101	-98		
		Config 3,6	-101	-95		
SS-RSRP <sup>Note 3</sup>	dBm/SC S	Config 1,2,4,5	-94	-94	-Infinity	-91
		Config 3,6	-91	-91	-Infinity	-88
$\hat{E}_s / I_{ot}$	dB	Config 1,2,3,4,5,6	4	4	-Infinity	7
$\hat{E}_s / N_{oc}$	dB	Config 1,2,3,4,5,6	4	4	-Infinity	7
I <sub>o</sub> <sup>Note3</sup>	dBm/9.36 MHz	NR Config 1,2,4,5	-58.49	-58.49	-70.05	-62.26
	dBm/38.1 6MHz	NR Config 3,6	-58.49	-58.49	-63.94	-56.15
Propagation Condition		Config 1,2,3,4,5,6	AWGN			
<p>Note 1: OCNG shall be used such that both cells are fully allocated and a constant total transmitted power spectral density is achieved for all OFDM symbols.</p> <p>Note 2: Interference from other cells and noise sources not specified in the test is assumed to be constant over subcarriers and time and shall be modelled as AWGN of appropriate power for <math>N_{oc}</math> to be fulfilled.</p> <p>Note 3: SS-RSRP and I<sub>o</sub> levels have been derived from other parameters for information purposes. They are not settable parameters themselves.</p> <p>Note 4: SS-RSRP minimum requirements are specified assuming independent interference and noise at each receiver antenna port.</p> <p>Note 5: For UE supporting semi-static channel access and network configuring semi-static channel occupancy.</p> <p>Note 6: For UE supporting dynamic channel access and network configuring dynamic channel occupancy.</p> <p>Note 7: For UE supporting both semi-static and dynamic channel access, the UE must be tested under dynamic channel access configuration.</p>						

A.10.4.2.9.2 Test Requirements

In test 1 with per-UE gap, the UE shall send one Event A3 triggered measurement report, with a measurement reporting delay less than T<sub>identify\_inter\_cca\_with\_index</sub> from the beginning of time period T2. The UE shall not send event triggered measurement reports, as long as the reporting criteria are not fulfilled. The rate of correct events observed during repeated tests shall be at least 90%.



In test 2 with per-FR gap, the UE shall send one Event A3 triggered measurement report, with a measurement reporting delay less than  $T_{\text{identify\_inter\_cca\_with\_index}}$  from the beginning of time period T2. The UE shall not send event triggered measurement reports, as long as the reporting criteria are not fulfilled. The rate of correct events observed during repeated tests shall be at least 90%.

In test 1 and 2 UE is required to report SSB time index.

$T_{\text{identify\_inter\_cca\_with\_index}} = (T_{\text{PSS/SSS\_sync\_inter\_cca}} + T_{\text{SSB\_measurement\_period\_inter\_cca}} + T_{\text{SSB\_time\_index\_inter\_cca}})$  ms, where

$T_{\text{PSS/SSS\_sync\_inter\_cca}}$ : it is the time period used in PSS/SSS detection given in table 9.3A.4-1.

$T_{\text{SSB\_time\_index\_inter\_cca}}$ : it is the time period used to acquire the index of the SSB being measured given in table 9.3A.4-2.

$T_{\text{SSB\_measurement\_period\_inter\_cca}}$ : equal to a measurement period of SSB based measurement given in table 9.3A.5-1.

For test 1, MGRP = 40 ms and for test 2 MGRP = 20 ms.

SMTC period = 20 ms.

NOTE: The actual overall delays measured in the test may be up to  $2 \times T_{\text{TTI}_{\text{DCCH}}}$  higher than the measurement reporting delays above because of TTI insertion uncertainty of the measurement report in DCCH.

#### A.10.4.2.10 EN-DC event triggered reporting tests for FR1 cell with SSB time index detection when DRX is used

##### A.10.4.2.10.1 Test Purpose and Environment

The purpose of this test is to verify that the UE makes correct reporting of an event. This test will partly verify the EN-DC inter-frequency NR cell search requirements in clause 9.3A.4 and 9.3A.5.

In this test, there are three cells: LTE cell 1 as PCell on E-UTRA RF channel 1, NR cell 2 as PSCell in FR1 on NR RF channel 1 and NR cell 3 as neighbour cell in FR1 on NR RF channel 2. The test parameters and configurations are given in Tables A.10.4.2.10.1-1, A.10.4.2.10.1-2, and A.10.4.2.10.1-3.

In test 1&2 measurement gap pattern configuration # 0 as defined in Table A.10.4.2.10.1-2 is provided for a UE that does not support per-FR gap and in test 3&4 measurement gap pattern configuration #4 as defined in Table A.10.4.2.10.1-2 is provided for UE that support per-FR gap. If a UE supports per-FR gap and gap pattern configuration #4, it is only required to pass test 3&4. Otherwise it is only required to pass test 1&2.

In the measurement control information, it is indicated to the UE that event-triggered reporting with Event A3 is used. The test consists of two successive time periods, with time duration of T1, and T2 respectively. During time duration T1, the UE shall not have any timing information of NR cell 3.

The configuration of LTE cell 1 is defined in table A.3.7.2.1-1. Supported test configurations are shown in table A.10.4.2.10.1-1.

UE needs to be provided at least once every 500ms with new Timing Advance Command MAC control element to restart the Time alignment timer to keep UE uplink time alignment. Furthermore, UE is allocated with PUSCH resource at every DRX cycle.

**Table A.10.4.2.10.1-1: EN-DC event triggered reporting tests without SSB index reading for FR1-FR1**

Config	Description
1	E-UTRAN cell: LTE FDD NR cell without CCA: 15 kHz SSB SCS, 10 MHz bandwidth, FDD duplex mode NR cell with CCA: 30 kHz SSB SCS, 40 MHz bandwidth, TDD duplex mode
2	E-UTRAN cell: LTE FDD NR cell without CCA: 15 kHz SSB SCS, 10 MHz bandwidth, TDD duplex mode NR cell with CCA: 30 kHz SSB SCS, 40 MHz bandwidth, TDD duplex mode
3	E-UTRAN cell: LTE FDD NR cell without CCA: 30 kHz SSB SCS, 40 MHz bandwidth, TDD duplex mode NR cell with CCA: 30 kHz SSB SCS, 40 MHz bandwidth, TDD duplex mode
4	E-UTRAN cell: LTE TDD NR cell without CCA: 15 kHz SSB SCS, 10 MHz bandwidth, FDD duplex mode

	NR cell with CCA: 30 kHz SSB SCS, 40 MHz bandwidth, TDD duplex mode
5	E-UTRAN cell: LTE TDD NR cell without CCA: 15 kHz SSB SCS, 10 MHz bandwidth, TDD duplex mode, NR cell with CCA: 30 kHz SSB SCS, 40 MHz bandwidth, TDD duplex mod
6	E-UTRAN cell: LTE TDD NR cell without CCA: 30 kHz SSB SCS, 40 MHz bandwidth, TDD duplex mode NR cell with CCA: 30 kHz SSB SCS, 40 MHz bandwidth, TDD duplex mode
Note 1: The UE is only required to be tested in one of the supported test configurations	

**Table A.10.4.2.10.1-2: General test parameters for EN-DC inter-frequency event triggered reporting with SSB time index detection**

Parameter	Unit	Test configuration	Value				Comment
			Test 1	Test 2	Test 3	Test 4	
E-UTRA RF Channel Number		Config 1,2,3,4,5,6	1				One E-UTRAN carrier frequency is used.
NR RF Channel Number		Config 1,2,3,4,5,6	1, 2				Two FR1 NR carrier frequencies are used. NR RF channel 1 is with CCA.
Active cell		Config 1,2,3,4,5,6	LTE Cell 1 (PCell) and NR cell 2 (PScell)				LTE Cell 1 is on E-UTRA RF channel number 1. NR Cell 2 is on NR RF channel number 1 with CCA.
Neighbour cell		Config 1,2,3,4,5,6	NR cell 3				NR cell 3 is on NR RF channel number 2.
DL CCA model		Config 1,2,3,4,5,6	As specified in clause A.3.26.2.1				
UL CCA model		Config 1,2,3,4,5,6	As specified in clause A.3.26.2.2				
Gap Pattern Id		Config 1,2,3,4,5,6	0		4		As specified in clause 9.1.2-1.
Measurement gap offset		Config 1,2,3,4,5,6	9		9		
A3-Offset	dB	Config 1,2,3,4,5,6	-6				
Hysteresis	dB	Config 1,2,3,4,5,6	0				
CP length		Config 1,2,3,4,5,6	Normal				
TimeToTrigger	s	Config 1,2,3,4,5,6	0				
Filter coefficient		Config 1,2,3,4,5,6	0				L3 filtering is not used
DRX		Config 1,2,3,4,5,6	DRX .1	DRX .2	DRX .1	DRX .2	As specified in clause A.3.3
Time offset between PCell and PScell		Config 1,2,3,4,5,6	3 μs				Synchronous EN-DC
Time offset between serving and neighbour cells		Config 1,2,3,4,5,6	3 ms				Asynchronous cells. The timing of Cell 3 is 3ms later than the timing of Cell 2.
		Config 1,2,3,4,5,6	3 μs				Synchronous cells.
T1	s	Config 1,2,3,4,5,6	5				
T2	s	Config 1,2,3,4,5,6	3	20	3	20	

**Table A.10.4.2.10.1-3: Cell specific test parameters for EN-DC inter-frequency event triggered reporting with SSB time index detection**

Parameter	Unit	Test configuration	Cell 2				Cell 3			
			T1	T2	T3	T4	T1	T2	T3	T4

NR RF Channel Number			Config 1,2,3,4,5,6	1	2
Duplex mode			Config 1,4	TDD	FDD
			Config 2,3,5,6	TDD	TDD
BW <sub>channel</sub>	MHz		Config 1,2,4,5	40: N <sub>RB,c</sub> = 106	10: N <sub>RB,c</sub> = 52
			Config 3,6	40: N <sub>RB,c</sub> = 106	40: N <sub>RB,c</sub> = 106
BWP BW	MHz		Config 1,2,4,5	40: N <sub>RB,c</sub> = 106	10: N <sub>RB,c</sub> = 52
			Config 3,6	40: N <sub>RB,c</sub> = 106	40: N <sub>RB,c</sub> = 106
TDD configuration			Config 1,4	TDDConf.1.1 CCA	NA
			Config 2,5	TDDConf.1.1 CCA	TDDConf.1.1
			Config 3,6	TDDConf.1.1 CCA	TDDConf.2.1
Initial DL BWP			Config 1,2,3,4,5,6	DLBWP.0.1	NA
Initial UL BWP			Config 1,2,3,4,5,6	ULBWP.0.1	NA
Dedicated DL BWP			Config 1,2,3,4,5,6	DLBWP.1.1	NA
Dedicated UL BWP			Config 1,2,3,4,5,6	ULBWP.1.1	NA
TRS configuration			Config 1,2,3,4,5,6	TRS.1.2 TDD	NA
OCNG Patterns defined in A.3.2.1.1 (OP.1)			Config 1,2,3,4,5,6	OP.1	OP.1
PDSCH Reference measurement channel			Config 1,4	SR.1.1 CCA	SR.1.1 FDD
			Config 2,5	SR.1.1 CCA	SR.1.1 TDD
			Config 3,6	SR.1.1 CCA	SR.2.1 TDD
CORESET Reference Channel			Config 1,4	CR.1.1 CCA	CR.1.1 FDD
			Config 2,5	CR.1.1 CCA	CR.1.1 TDD
			Config 3,6	CR.1.1 CCA	CR.2.1 TDD
SSB parameters	Semi-static channel access <sup>Note 5,7</sup>		Config 1,4	SSB.1 CCA	SSB.1 FR1
			Config 2,5	SSB.1 CCA	SSB.1 FR1
			Config 3,6	SSB.1 CCA	SSB.2 FR1
	Dynamic channel access <sup>Note 6,7</sup>		Config 1,4	SSB.2 CCA	SSB.1 FR1
			Config 2,5	SSB.2 CCA	SSB.1 FR1
			Config 3,6	SSB.2 CCA	SSB.2 FR1
DBT window configuration			Config 1,2,3,4,5,6	As defined in A.3.28.1	Not applicable
SMTC configuration defined in A.3.11			Config 1,4	SMTC.2	SMTC.5
			Config 2,3,5,6	SMTC.1	SMTC.4
PDSCH/PDCCH subcarrier spacing		kHz	Config 1,2,4,5	30	15
			Config 3,6	30	30
DL CCA probability P <sub>CCA_DL</sub>	Semi-static channel access <sup>Note 5,7</sup>		Config 1,2,3,4,5,6	P <sub>CCA_DL</sub> =0.9375	Not applicable
	Dynamic channel access <sup>Note 6,7</sup>		Config 1,2,3,4,5,6	P <sub>CCA_DL_1</sub> =0.75 P <sub>CCA_DL_2</sub> =0.75	Not applicable
UL CCA probability P <sub>CCA_UL</sub>	Semi-static channel access <sup>Note 5,7</sup>		Config 1,2,3,4,5,6	P <sub>CCA_UL</sub> =1	Not applicable
	Dynamic channel access <sup>Note 6,7</sup>		Config 1,2,3,4,5,6	P <sub>CCA_UL</sub> =1	Not applicable
LCCA_DL			Config 1,2,3,4,5,6	2	2

$W_{CCA\_DL}$	ms	Config 1,2,3,4,5,6	$T_{PSS/SSS\_sync\_inter\_cca}$		$T_{PSS/SSS\_sync\_inter\_cca}$	
EPRE ratio of PSS to SSS		Config 1,2,3,4,5,6	0		0	
EPRE ratio of PBCH DMRS to SSS						
EPRE ratio of PBCH to PBCH DMRS						
EPRE ratio of PDCCH DMRS to SSS						
EPRE ratio of PDCCH to PDCCH DMRS						
EPRE ratio of PDSCH DMRS to SSS						
EPRE ratio of PDSCH to PDSCH						
EPRE ratio of OCNG DMRS to SSS(Note 1)						
EPRE ratio of OCNG to OCNG DMRS (Note 1)						
$N_{oc}^{Note2}$	dBm/15k Hz	Config 1,2,3,4,5,6	-104		-98	
$N_{oc}^{Note2}$	dBm/SC S	Config 1,2,4,5	-101		-98	
		Config 3,6	-101		-95	
SS-RSRP <sup>Note 3</sup>	dBm/SC S	Config 1,2,4,5	-94	-94	-Infinity	-91
		Config 3,6	-91	-91	-Infinity	-88
$\hat{E}_s / I_{ot}$	dB	Config 1,2,3,4,5,6	4	4	-Infinity	7
$\hat{E}_s / N_{oc}$	dB	Config 1,2,3,4,5,6	4	4	-Infinity	7
$I_o^{Note3}$	dBm/9.36 MHz	NR Config 1,2,4,5	-58.49	-58.49	-70.05	-62.26
	dBm/38.1 6MHz	NR Config 3,6	-58.49	-58.49	-63.94	-56.15
Propagation Condition		Config 1,2,3,4,5,6	AWGN			
<p>Note 1: OCNG shall be used such that both cells are fully allocated and a constant total transmitted power spectral density is achieved for all OFDM symbols.</p> <p>Note 2: Interference from other cells and noise sources not specified in the test is assumed to be constant over subcarriers and time and shall be modelled as AWGN of appropriate power for <math>N_{oc}</math> to be fulfilled.</p> <p>Note 3: SS-RSRP and <math>I_o</math> levels have been derived from other parameters for information purposes. They are not settable parameters themselves.</p> <p>Note 4: SS-RSRP minimum requirements are specified assuming independent interference and noise at each receiver antenna port.</p> <p>Note 5: For UE supporting semi-static channel access and network configuring semi-static channel occupancy.</p> <p>Note 6: For UE supporting dynamic channel access and network configuring dynamic channel occupancy.</p> <p>Note 7: For UE supporting both semi-static and dynamic channel access, the UE must be tested under dynamic channel access configuration.</p>						

**Table A.10.4.2.10.1-4: DRX-Configuration for SA inter-frequency event triggered reporting without SSB time index detection**

Field	Test1&3	Test2&4	Comment
	Value	Value	
drx-onDurationTimer	ms1	ms1	As specified in clause 6.3.2 in TS 38.331 [2]
drx-InactivityTimer	ms1	ms1	
drx-RetransmissionTimerDL	sl1	sl1	
drx-RetransmissionTimerUL	sl1	sl1	
drx-LongCycleStartOffset	ms40	Ms640	
shortDRX	disable	disable	

**Table A.10.4.2.10.1-5: TimeAlignmentTimer -Configuration SA inter-frequency event triggered reporting without SSB time index detection**

Field	Value	Comment
TimeAlignmentTimer	ms500	As specified in clause 6.3.2 in TS 38.331 [2]

#### A.10.4.2.10.2 Test Requirements

In test 1 with per-UE gap, the UE shall send one Event A3 triggered measurement report, with a measurement reporting delay less than  $T_{\text{identify\_inter\_cca\_with\_}}$  from the beginning of time period T2. The UE shall not send event triggered measurement reports, as long as the reporting criteria are not fulfilled. The rate of correct events observed during repeated tests shall be at least 90%.

In test 2 with per-FR gap, the UE shall send one Event A3 triggered measurement report, with a measurement reporting delay less than  $T_{\text{identify\_inter\_cca\_with\_}}$  from the beginning of time period T2. The UE shall not send event triggered measurement reports, as long as the reporting criteria are not fulfilled. The rate of correct events observed during repeated tests shall be at least 90%.

In test 3 with per-UE gap, the UE shall send one Event A3 triggered measurement report, with a measurement reporting delay less than  $T_{\text{identify\_inter\_cca\_with\_}}$  from the beginning of time period T2. The UE shall not send event triggered measurement reports, as long as the reporting criteria are not fulfilled. The rate of correct events observed during repeated tests shall be at least 90%.

In test 4 with per-FR gap, the UE shall send one Event A3 triggered measurement report, with a measurement reporting delay less than  $T_{\text{identify\_inter\_cca\_with\_}}$  from the beginning of time period T2. The UE shall not send event triggered measurement reports, as long as the reporting criteria are not fulfilled. The rate of correct events observed during repeated tests shall be at least 90%.

In test 1, 2, 3 and 4 UE is required to report SSB time index.

$T_{\text{identify\_inter\_cca\_with\_index}} = (T_{\text{PSS/SSS\_sync\_inter\_cca}} + T_{\text{SSB\_measurement\_period\_inter\_cca}} + T_{\text{SSB\_time\_index\_inter\_cca}})$  ms, where

$T_{\text{PSS/SSS\_sync\_inter\_cca}}$ : it is the time period used in PSS/SSS detection given in table 9.3A.4-1.

$T_{\text{SSB\_time\_index\_inter\_cca}}$ : it is the time period used to acquire the index of the SSB being measured given in table 9.3A.4-2.

$T_{\text{SSB\_measurement\_period\_inter\_cca}}$ : equal to a measurement period of SSB based measurement given in table 9.3A.5-1.

For tests 1 and 2, MGRP = 40 ms and for tests 3 and 4 MGRP = 20 ms.

For tests 1 and 3, DRX cycle = 40 ms and for tests 2 and 4 DRX cycle = 640 ms.

SMTC period = 20 ms.

NOTE: The actual overall delays measured in the test may be up to  $2 \times T_{\text{TTI}_{\text{DCCH}}}$  higher than the measurement reporting delays above because of TTI insertion uncertainty of the measurement report in DCCH.

### A.10.4.3 L1-RSRP measurements for beam reporting

#### A.10.4.3.1 SSB based L1-RSRP measurement on PSCC when DRX is not used

##### A.10.4.3.1.1 Test Purpose and Environment

The purpose of this test is to verify that the UE makes correct reporting of L1-RSRP measurement. This test will partly verify the L1-RSRP measurement requirements in clause 9.5A.4.1, with the testing configurations for NR cells in Table A.10.4.3.1.1-1.

**Table A.10.4.3.1.1-1: Applicable NR configurations for FR1 SSB based L1-RSRP test**

Config	Description
--------	-------------

1	LTE FDD With CCA: NR 30 kHz SSB SCS, 40 MHz bandwidth, TDD duplex mode
2	LTE TDD With CCA: NR 30 kHz SSB SCS, 40 MHz bandwidth, TDD duplex mode
Note: The UE is only required to be tested in one of the supported test configurations	

#### A.10.4.3.1.2 Test parameters

There are two cells in the test, E-UTRAN Pcell (Cell 1) and FR1 PSCell (Cell 2) which operates on a carrier frequency with CCA and transmits SSBs in DBT window according to DL CCA model. The test parameters and applicability for Cell 1 are defined in A.3.7A.2. The test parameters for the Cell 2 are given in Table A.10.4.3.1.2-1 and Table A.10.4.3.1.2-2 below.

In CSI measurement configuration, UE is indicated to perform L1-RSRP measurement on the SSBs and report periodically. The UE transmits the reporting according to UL CCA model. The test consists of two successive time periods, with time duration of T1 and T2 respectively. The test has higher layer parameter *timeRestrictionForChannelMeasurements* configured.

The same test is applicable for UE supporting any one or both semi-static channel access or dynamic channel access and for network configuring any of semi-static channel occupancy or dynamic channel occupancy.

There is no measurement gap configured in the test. Before the test, UE is configured to perform RLM, BFD and L1-RSRP measurement based on the SSBs.

**Table A.10.4.3.1.2-1: General test parameters**

Parameter	Config	Unit	Value
SSB GSCN	1,2		freq1
DL CCA model	1,2		As specified in A.3.20.2.1
UL CCA model	1,2		As specified in A.3.20.2.2
Duplex mode	1,2		TDD
TDD Configuration	1,2		TDDConf.1.1 CCA
BW <sub>channel</sub>	1,2	MHz	40: N <sub>RB,c</sub> = 106
PDSCH Reference measurement channel	1,2		SR.1.1 CCA
RMSI CORESET Reference Channel	1,2		CR.1.1 CCA
Dedicated CORESET Reference Channel	1,2		CCR.1.1 CCA
SSB configuration	1,2		SSB.3 CCA for semi-static channel access SSB.4 CCA for dynamic channel access
OCNG Patterns	1,2		OP.1
Initial BWP Configuration	1,2		DLBWP.0.1 ULBWP.0.1
Dedicated BWP configuration	1,2		DLBWP.1.1 ULBWP.1.1
DBT Window Configuration	1,2		DBT.1
TRS Configuration	1,2		TRS.1.2 TDD
DRX configuration	1,2		Off
reportConfigType	1,2		periodic
reportQuantity	1,2		ssb-Index-RSRP
Number of reported RS	1,2		2
L1-RSRP reporting period	1,2	slot	80
T1	1,2	s	5
T2	1,2	s	1
EPRE ratio of PSS to SSS			
EPRE ratio of PBCH DMRS to SSS			

EPRE ratio of PBCH to PBCH DMRS	1,2	dB	0
EPRE ratio of PDCCH DMRS to SSS			
EPRE ratio of PDCCH to PDCCH DMRS			
EPRE ratio of PDSCH DMRS to SSS			
EPRE ratio of PDSCH to PDSCH DMRS			
EPRE ratio of OCNG DMRS to SSS <sup>Note 1</sup>			
EPRE ratio of OCNG to OCNG DMRS <sup>Note 1</sup>			
Propagation condition	1,2		AWGN
<p>Note 1: OCNG shall be used such that both cells are fully allocated and a constant total transmitted power spectral density is achieved for all OFDM symbols. For cells with CCA model, OCNG is transmitted only in the slots with downlink transmission burst and is not transmitted during the muted slots or during DBT window.</p>			

**Table A.10.4.3.1.2-2: SSB specific test parameters**

Parameter	Config	Unit	SSB#0		SSB#1	
			T1	T2	T1	T2
DL CCA Probability $P_{CCA\_DL}$ <sup>Note 4,6</sup>	1,2		0.9375	0.9375	0.9375	0.9375
DL CCA Probability $P_{CCA\_DL}$ <sup>Note 4.7</sup>	1,2		0.75/0.75	0.75/0.75	0.75/0.75	0.75/0.75
UL CCA probability $P_{CCA\_UL}$	1,2		1.0	1.0	1.0	1.0
$N_{oc}$ <sup>Note2</sup>	1,2	dBm/15kHz	-94.65			
$N_{oc}$ <sup>Note2</sup>	1,2	dBm/SSB SCS	-91.65			
$\hat{E}_s / I_{ot}$	1,2	dB	0	0	-Infinity	3
SSB RSRP <sup>Note3</sup>	1,2	dBm/SSB SCS	-91.65	-91.65	-Infinity	-88.65
$I_o$ <sup>Note3</sup>	1,2	dBm/38.16 MHz	-57.59	-57.59	-60.61	-55.84
$\hat{E}_s / N_{oc}$	1,2	dB	0	0	-Infinity	3
<p>Note 1: The resources for uplink transmission are assigned to the UE prior to the start of time period T2.</p> <p>Note 2: Interference from other cells and noise sources not specified in the test is assumed to be constant over subcarriers and time and shall be modelled as AWGN of appropriate power for <math>N_{oc}</math> to be fulfilled.</p> <p>Note 3: SS-RSRP and <math>I_o</math> levels have been derived from other parameters for information purposes. They are not settable parameters themselves.</p> <p>Note 4: DL and UL CCA probabilities apply for UE supporting any one or both semi-static channel access or dynamic channel access and for network configuring any of semi-static channel occupancy or dynamic channel occupancy.</p> <p>Note 5: The signal levels apply for SSS Res when the discovery burst is transmitted during DBT windows.</p> <p>Note 6: For UE supporting semi-static channel access and network configuring semi-static channel occupancy.</p> <p>Note 7: For UE supporting dynamic channel access and network configuring dynamic channel occupancy. The first value corresponds <math>P_{CCA\_DL1}</math> and the second value corresponds to the <math>P_{CCA\_DL2}</math>.</p>						

### A.10.4.3.1.3 Test Requirements

The UE shall send L1-RSRP report every 80 slots. No later than 640 ms plus 80 slots from the beginning of time period T2, UE shall send L1-RSRP report including results of both SSB0 and SSB1 while meeting the absolute accuracy requirement in clause 10.1.19.1.1 and relative accuracy requirement in clause 10.1.19.1.2. The rate of correct events observed during repeated tests shall be at least 90%.

The UE shall send L1-RSRP report of both SSB0 and SSB1 in Cell 2.

NOTE: The actual overall delays measured in the test may be up to  $2 \times TTI_{DCCCH}$  higher than the measurement reporting delays above because of TTI insertion uncertainty of the measurement report in DCCCH.

### A.10.4.3.2 SSB based L1-RSRP measurement on PSCC when DRX is used

#### A.10.4.3.2.1 Test Purpose and Environment

The purpose of this test is to verify that the UE makes correct reporting of L1-RSRP measurement. This test will partly verify the L1-RSRP measurement requirements in clause 9.5A.4.1, with the testing configurations for NR cells in Table A.10.4.3.1.1-1.

**Table A.10.4.3.2.1-1: Applicable NR configurations for FR1 SSB based L1-RSRP test**

Config	Description
1	LTE FDD With CCA: NR 30 kHz SSB SCS, 40 MHz bandwidth, TDD duplex mode
2	LTE TDD With CCA: NR 30 kHz SSB SCS, 40 MHz bandwidth, TDD duplex mode

Note: The UE is only required to be tested in one of the supported test configurations

#### A.10.4.3.2.2 Test parameters

There are two cells in the test, E-UTRAN Pcell (Cell 1) and FR1 PSCell (Cell 2) which operates on a carrier frequency with CCA and transmits SSBs in DBT window according to DL CCA model. The test parameters and applicability for Cell 1 are defined in A.3.7A.2. The test parameters for the Cell 2 are given in Table A.10.4.3.2.2-1 and Table A.10.4.3.2.2-2 below.

In CSI measurement configuration, UE is indicated to perform L1-RSRP measurement on the SSBs and report periodically. The UE transmits the reporting according to UL CCA model. The test consists of two successive time periods, with time duration of T1 and T2 respectively. The test has higher layer parameter *timeRestrictionForChannelMeasurements* configured.

The same test is applicable for UE supporting any one or both semi-static channel access or dynamic channel access and for network configuring any of semi-static channel occupancy or dynamic channel occupancy.

There is no measurement gap configured in the test. Before the test, UE is configured to perform RLM, BFD and L1-RSRP measurement based on the SSBs.

**Table A.10.4.3.2.2-1: General test parameters**

Parameter	Config	Unit	Value
SSB GSCN	1,2		freq1
DL CCA model	1,2		As specified in A.3.20.2.1
UL CCA model	1,2		As specified in A.3.20.2.2
Duplex mode	1,2		TDD
TDD Configuration	1,2		TDDConf.1.1 CCA
BW <sub>channel</sub>	1,2	MHz	40: N <sub>RB,c</sub> = 106
PDSCH Reference measurement channel	1,2		SR.1.1 CCA
RMSI CORESET Reference Channel	1,2		CR.1.1 CCA
Dedicated CORESET Reference Channel	1,2		CCR.1.1 CCA



SSB configuration	1,2		SSB.3 CCA for semi-static channel access SSB.4 CCA for dynamic channel access
OCNG Patterns	1,2		OP.1
Initial BWP Configuration	1,2		DLBWP.0.1 ULBWP.0.1
Dedicated BWP configuration	1,2		DLBWP.1.1 ULBWP.1.1
DBT Window Configuration	1,2		DBT.1
TRS Configuration	1,2		TRS.1.2 TDD
DRX configuration	1,2		DRX.3
reportConfigType	1,2		periodic
reportQuantity	1,2		ssb-Index-RSRP
Number of reported RS	1,2		2
L1-RSRP reporting period	1,2	slot	80
T1	1,2	s	5
T2	1,2	s	1
EPRE ratio of PSS to SSS	1,2	dB	0
EPRE ratio of PBCH DMRS to SSS			
EPRE ratio of PBCH to PBCH DMRS			
EPRE ratio of PDCCH DMRS to SSS			
EPRE ratio of PDCCH to PDCCH DMRS			
EPRE ratio of PDSCH DMRS to SSS			
EPRE ratio of PDSCH to PDSCH DMRS			
EPRE ratio of OCNG DMRS to SSS <sup>Note 1</sup>			
EPRE ratio of OCNG to OCNG DMRS <sup>Note 1</sup>			
Propagation condition	1,2		AWGN
<p>Note 1: OCNG shall be used such that both cells are fully allocated and a constant total transmitted power spectral density is achieved for all OFDM symbols. For cells with CCA model, OCNG is transmitted only in the slots with downlink transmission burst and is not transmitted during the muted slots or during DBT window.</p>			

Table A.10.4.3.2.2-2: SSB specific test parameters

Parameter	Config	Unit	SSB#0		SSB#1	
			T1	T2	T1	T2
DL CCA Probability $P_{CCA\_DL}$ <sup>Note 4,6</sup>	1,2		0.9375	0.9375	0.9375	0.9375
DL CCA Probability $P_{CCA\_DL}$ <sup>Note 4,7</sup>	1,2		0.75/0.75	0.75/0.75	0.75/0.75	0.75/0.75
UL CCA probability $P_{CCA\_UL}$	1,2		1.0	1.0	1.0	1.0
$N_{oc}$ <sup>Note2</sup>	1,2	dBm/15kHz	-94.65			
$N_{oc}$ <sup>Note2</sup>	1,2	dBm/SSB SCS	-91.65			
$\hat{E}_s / I_{ot}$	1,2	dB	0	0	-Infinity	3
SSB RSRP <sup>Note3</sup>	1,2	dBm/SSB SCS	-91.65	-91.65	-Infinity	-88.65
$I_o$ <sup>Note3</sup>	1,2	dBm/38.16 MHz	-57.59	-57.59	-60.61	-55.84

$\hat{E}_s / N_{oc}$	1,2	dB	0	0	-Infinity	3
Note 1:	The resources for uplink transmission are assigned to the UE prior to the start of time period T2.					
Note 2:	Interference from other cells and noise sources not specified in the test is assumed to be constant over subcarriers and time and shall be modelled as AWGN of appropriate power for $N_{oc}$ to be fulfilled.					
Note 3:	SS-RSRP and $I_o$ levels have been derived from other parameters for information purposes. They are not settable parameters themselves.					
Note 4:	DL and UL CCA probabilities apply for UE supporting any one or both semi-static channel access or dynamic channel access and for network configuring any of semi-static channel occupancy or dynamic channel occupancy.					
Note 5:	The signal levels apply for SSS REs when the discovery burst is transmitted during DBT windows.					
Note 6:	For UE supporting semi-static channel access and network configuring semi-static channel occupancy.					
Note 7:	For UE supporting dynamic channel access and network configuring dynamic channel occupancy. The first value corresponds $P_{CCA\_DL1}$ and the second value corresponds to the $P_{CCA\_DL2}$ .					

### A.10.4.3.2.3 Test Requirements

The UE shall send L1-RSRP report every 80 slots. No later than 640 ms plus 80 slots from the beginning of time period T2, UE shall send L1-RSRP report including results of both SSB0 and SSB1 while meeting the absolute accuracy requirement in clause 10.1.19.1.1 and relative accuracy requirement in clause 10.1.19.1.2. The rate of correct events observed during repeated tests shall be at least 90%.

The UE shall send L1-RSRP report of both SSB0 and SSB1 in Cell 2.

NOTE: The actual overall delays measured in the test may be up to  $2xTTI_{DCC}$  higher than the measurement reporting delays above because of TTI insertion uncertainty of the measurement report in DCC.

### A.10.4.3.3 SSB based L1-RSRP measurement on SCC when DRX is not used

#### A.10.4.3.3.1 Test Purpose and Environment

The purpose of this test is to verify that the UE makes correct reporting of L1-RSRP measurement. This test will partly verify the L1-RSRP measurement requirements in clause 9.5A.4.1, with the testing configurations for NR cells in Table A.10.4.3.1.1-1.

**Table A.10.4.3.3.1-1: Applicable NR configurations for FR1 SSB based L1-RSRP test**

Config	Description
1	LTE FDD With CCA: NR 30 kHz SSB SCS, 40 MHz bandwidth, TDD duplex mode
2	LTE TDD With CCA: NR 30 kHz SSB SCS, 40 MHz bandwidth, TDD duplex mode
Note:	The UE is only required to be tested in one of the supported test configurations

#### A.10.4.3.3.2 Test parameters

There are three cells in the test, E-UTRAN PCell (Cell 1), FR1 PSCell (Cell 2), and FR1 SCell (Cell 3). Cell 2 and Cell 3 operate on a carrier frequency with CCA and transmits SSBs in DBT window according to DL CCA model. The test parameters and applicability for Cell 1 are defined in A.3.7A.2. The test parameters for the Cell 2 and Cell 3 are given in Table A.10.4.3.3.2-1 and Table A.10.4.3.3.2-2 below.

In CSI measurement configuration, UE is indicated to perform L1-RSRP measurement on the SSBs and report periodically. The UE transmits the reporting according to UL CCA model. The test consists of two successive time

periods, with time duration of T1 and T2 respectively. The test has higher layer parameter *timeRestrictionForChannelMeasurements* configured.

The same test is applicable for UE supporting any one or both semi-static channel access or dynamic channel access and for network configuring any of semi-static channel occupancy or dynamic channel occupancy.

There is no measurement gap configured in the test. Before the test, UE is configured to perform RLM, BFD and L1-RSRP measurement based on the SSBs.

**Table A.10.4.3.3.2-1: General test parameters**

Parameter	Config	Unit	Value
Active PScell	1,2		Cell 2
Active Scell	1,2		Cell 3
RF Channel Number	1,2		1: Cell 2 2: Cell 3
DL CCA model	1,2		As specified in A.3.20.2.1
UL CCA model	1,2		As specified in A.3.20.2.2
Duplex mode	1,2		TDD
TDD Configuration	1,2		TDDConf.1.1 CCA
BW <sub>channel</sub>	1,2	MHz	40: N <sub>RB,c</sub> = 106
PDSCH Reference measurement channel	1,2		SR.1.1 CCA
RMSI CORESET Reference Channel	1,2		CR.1.1 CCA
Dedicated CORESET Reference Channel	1,2		CCR.1.1 CCA
SSB configuration	1,2		SSB.3 CCA for semi-static channel access SSB.4 CCA for dynamic channel access
OCNG Patterns	1,2		OP.1
Initial BWP Configuration	1,2		DLBWP.0.1 ULBWP.0.1
Dedicated BWP configuration	1,2		DLBWP.1.1 ULBWP.1.1
DBT Window Configuration	1,2		DBT.1
TRS Configuration	1,2		TRS.1.2 TDD
DRX configuration	1,2		Off
reportConfigType	1,2		periodic
reportQuantity	1,2		ssb-Index-RSRP
Number of reported RS	1,2		2
L1-RSRP reporting period	1,2	slot	80
T1	1,2	s	5
T2	1,2	s	1
EPRE ratio of PSS to SSS	1,2	dB	0
EPRE ratio of PBCH DMRS to SSS			
EPRE ratio of PBCH to PBCH DMRS			
EPRE ratio of PDCCH DMRS to SSS			
EPRE ratio of PDCCH to PDCCH DMRS			
EPRE ratio of PDSCH DMRS to SSS			
EPRE ratio of PDSCH to PDSCH DMRS			
EPRE ratio of OCNG DMRS to SSS <sup>Note 1</sup>			
EPRE ratio of OCNG to OCNG DMRS <sup>Note 1</sup>			
Propagation condition	1,2		AWGN

Note 1: OCNG shall be used such that both cells are fully allocated and a constant total transmitted power spectral density is achieved for all OFDM symbols. For cells with CCA model, OCNG is transmitted only in the slots with downlink transmission burst and is not transmitted during the muted slots or during DBT window.

**Table A.10.4.3.3-2: SSB specific test parameters**

Parameter	Config	Unit	SSB#0		SSB#1	
			T1	T2	T1	T2
DL CCA Probability $P_{CCA\_DL}$ Note 4,6	1, 2		0.9375	0.9375	0.9375	0.9375
DL CCA Probability $P_{CCA\_DL}$ Note 4.7	1, 2		0.75/0.7 5	0.75/0.7 5	0.75/0.7 5	0.75/0.7 5
UL CCA probability $P_{CCA\_UL}$	1, 2		1.0	1.0	1.0	1.0
$N_{oc}$ Note2	1, 2	dBm/15kHz	-94.65			
$N_{oc}$ Note2	1, 2	dBm/SSB SCS	-91.65			
$\hat{E}_s / I_{ot}$	1, 2	dB	0	0	-Infinity	3
SSB RSRP Note3	1, 2	dBm/SSB SCS	-91.65	-91.65	-Infinity	-88.65
$I_o$ Note3	1, 2	dBm/38.16 MHz	-57.59	-57.59	-60.61	-55.84
$\hat{E}_s / N_{oc}$	1, 2	dB	0	0	-Infinity	3
<p>Note 1: The resources for uplink transmission are assigned to the UE prior to the start of time period T2.</p> <p>Note 2: Interference from other cells and noise sources not specified in the test is assumed to be constant over subcarriers and time and shall be modelled as AWGN of appropriate power for <math>N_{oc}</math> to be fulfilled.</p> <p>Note 3: SS-RSRP and <math>I_o</math> levels have been derived from other parameters for information purposes. They are not settable parameters themselves.</p> <p>Note 4: DL and UL CCA probabilities apply for UE supporting any one or both semi-static channel access or dynamic channel access and for network configuring any of semi-static channel occupancy or dynamic channel occupancy.</p> <p>Note 5: The signal levels apply for SSS REs when the discovery burst is transmitted during DBT windows.</p> <p>Note 6: For UE supporting semi-static channel access and network configuring semi-static channel occupancy.</p> <p>Note 7: For UE supporting dynamic channel access and network configuring dynamic channel occupancy. The first value corresponds <math>P_{CCA\_DL1}</math> and the second value corresponds to the <math>P_{CCA\_DL2}</math>.</p>						

### A.10.4.3.3.3 Test Requirements

The UE shall send L1-RSRP report every 80 slots. No later than 640 ms plus 80 slots from the beginning of time period T2, UE shall send L1-RSRP report including results of both SSB0 and SSB1 while meeting the absolute accuracy requirement in clause 10.1.19.1.1 and relative accuracy requirement in clause 10.1.19.1.2. The rate of correct events observed during repeated tests shall be at least 90%.

The UE shall send L1-RSRP report of both SSB0 and SSB1 in Cell 3.

NOTE: The actual overall delays measured in the test may be up to  $2xTTI_{DCC}$  higher than the measurement reporting delays above because of TTI insertion uncertainty of the measurement report in DCC.

### A.10.4.3.4 SSB based L1-RSRP measurement on SCC when DRX is used

#### A.10.4.3.4.1 Test Purpose and Environment

The purpose of this test is to verify that the UE makes correct reporting of L1-RSRP measurement. This test will partly verify the L1-RSRP measurement requirements in clause 9.5A.4.1, with the testing configurations for NR cells in Table A.10.4.3.4.1-1.

**Table A.10.4.3.4.1-1: Applicable NR configurations for FR1 SSB based L1-RSRP test**

Config	Description
1	LTE FDD With CCA: NR 30 kHz SSB SCS, 40 MHz bandwidth, TDD duplex mode
2	LTE TDD With CCA: NR 30 kHz SSB SCS, 40 MHz bandwidth, TDD duplex mode
Note: The UE is only required to be tested in one of the supported test configurations	

#### A.10.4.3.4.2 Test parameters

There are three cells in the test, E-UTRAN PCell (Cell 1), FR1 PSCell (Cell 2), and FR1 SCell (Cell 3). Cell 2 and Cell 3 operate on a carrier frequency with CCA and transmits SSBs in DBT window according to DL CCA model. The test parameters and applicability for Cell 1 are defined in A.3.7A.2. The test parameters for the Cell 2 and Cell 3 are given in Table A.10.4.3.4.2-1 and Table A.10.4.3.4.2-2 below.

In CSI measurement configuration, UE is indicated to perform L1-RSRP measurement on the SSBs and report periodically. The UE transmits the reporting according to UL CCA model. The test consists of two successive time periods, with time duration of T1 and T2 respectively. The test has higher layer parameter *timeRestrictionForChannelMeasurements* configured.

The same test is applicable for UE supporting any one or both semi-static channel access or dynamic channel access and for network configuring any of semi-static channel occupancy or dynamic channel occupancy.

There is no measurement gap configured in the test. Before the test, UE is configured to perform RLM, BFD and L1-RSRP measurement based on the SSBs.

**Table A.10.4.3.4.2-1: General test parameters**

Parameter	Config	Unit	Value
Active PScell	1,2		Cell 2
Active Scell	1,2		Cell 3
RF Channel Number	1,2		1: Cell 2 2: Cell 3
DL CCA model	1,2		As specified in A.3.20.2.1
UL CCA model	1,2		As specified in A.3.20.2.2
Duplex mode	1,2		TDD
TDD Configuration	1,2		TDDConf.1.1 CCA
BW <sub>channel</sub>	1,2	MHz	40: N <sub>RB,c</sub> = 106
PDSCH Reference measurement channel	1,2		SR.1.1 CCA
RMSI CORESET Reference Channel	1,2		CR.1.1 CCA
Dedicated CORESET Reference Channel	1,2		CCR.1.1 CCA
SSB configuration	1,2		SSB.3 CCA for semi-static channel access SSB.4 CCA for dynamic channel access
OCNG Patterns	1,2		OP.1

Initial BWP Configuration	1,2		DLBWP.0.1 ULBWP.0.1
Dedicated BWP configuration	1,2		DLBWP.1.1 ULBWP.1.1
DBT Window Configuration	1,2		DBT.1
TRS Configuration	1,2		TRS.1.2 TDD
DRX configuration	1,2		DRX.3
reportConfigType	1,2		periodic
reportQuantity	1,2		ssb-Index-RSRP
Number of reported RS	1,2		2
L1-RSRP reporting period	1,2	slot	80
T1	1,2	s	5
T2	1,2	s	1
EPRE ratio of PSS to SSS	1,2	dB	0
EPRE ratio of PBCH DMRS to SSS			
EPRE ratio of PBCH to PBCH DMRS			
EPRE ratio of PDCCH DMRS to SSS			
EPRE ratio of PDCCH to PDCCH DMRS			
EPRE ratio of PDSCH DMRS to SSS			
EPRE ratio of PDSCH to PDSCH DMRS			
EPRE ratio of OCNG DMRS to SSS <sup>Note 1</sup>			
EPRE ratio of OCNG to OCNG DMRS <sup>Note 1</sup>			
Propagation condition	1,2		AWGN
<p>Note 1: OCNG shall be used such that both cells are fully allocated and a constant total transmitted power spectral density is achieved for all OFDM symbols. For cells with CCA model, OCNG is transmitted only in the slots with downlink transmission burst and is not transmitted during the muted slots or during DBT window.</p>			

Table A.10.4.3.4.2-2: SSB specific test parameters

Parameter	Config	Unit	SSB#0		SSB#1	
			T1	T2	T1	T2
DL CCA Probability $P_{CCA\_DL}$ <sup>Note 4,6</sup>	1, 2		0.9375	0.9375	0.9375	0.9375
DL CCA Probability $P_{CCA\_DL}$ <sup>Note 4.7</sup>	1, 2		0.75/0.7 5	0.75/0.7 5	0.75/0.7 5	0.75/0.7 5
UL CCA probability $P_{CCA\_UL}$	1, 2		1.0	1.0	1.0	1.0
$N_{oc}$ <sup>Note2</sup>	1, 2	dBm/15kHz	-94.65			
$N_{oc}$ <sup>Note2</sup>	1, 2	dBm/SSB SCS	-91.65			
$\hat{E}_s / I_{ot}$	1, 2	dB	0	0	-Infinity	3
SSB RSRP <sup>Note3</sup>	1, 2	dBm/SSB SCS	-91.65	-91.65	-Infinity	-88.65
$I_o$ <sup>Note3</sup>	1, 2	dBm/38.16 MHz	-57.59	-57.59	-60.61	-55.84
$\hat{E}_s / N_{oc}$	1, 2	dB	0	0	-Infinity	3
<p>Note 1: The resources for uplink transmission are assigned to the UE prior to the start of time period T2.</p> <p>Note 2: Interference from other cells and noise sources not specified in the test is assumed to be constant over subcarriers and time and shall be modelled as AWGN of appropriate power for <math>N_{oc}</math> to be fulfilled.</p>						

Note 3:	SS-RSRP and Io levels have been derived from other parameters for information purposes. They are not settable parameters themselves.
Note 4:	DL and UL CCA probabilities apply for UE supporting any one or both semi-static channel access or dynamic channel access and for network configuring any of semi-static channel occupancy or dynamic channel occupancy.
Note 5:	The signal levels apply for SSS REs when the discovery burst is transmitted during DBT windows.
Note 6:	For UE supporting semi-static channel access and network configuring semi-static channel occupancy.
Note 7:	For UE supporting dynamic channel access and network configuring dynamic channel occupancy. The first value corresponds $P_{CCA\_DL1}$ and the second value corresponds to the $P_{CCA\_DL2}$ .

#### A.10.4.3.4.3 Test Requirements

The UE shall send L1-RSRP report every 80 slots. No later than 640 ms plus 80 slots from the beginning of time period T2, UE shall send L1-RSRP report including results of both SSB0 and SSB1 while meeting the absolute accuracy requirement in clause 10.1.19.1.1 and relative accuracy requirement in clause 10.1.19.1.2. The rate of correct events observed during repeated tests shall be at least 90%.

The UE shall send L1-RSRP report of both SSB0 and SSB1 in Cell 3.

NOTE: The actual overall delays measured in the test may be up to  $2 \times TTI_{DCCH}$  higher than the measurement reporting delays above because of TTI insertion uncertainty of the measurement report in DCCH.

### A.10.4.4 E-UTRAN–NR inter-RAT measurements on NR carrier frequency under CCA

#### A.10.4.4.1 E-UTRA-NR inter-RAT event triggered reporting tests for FR1 without SSB time index detection when DRX is not used

##### A.10.4.4.1.1 Test Purpose and Environment

The purpose of this test is to verify that the UE makes correct reporting of an event. This test will partly verify the NR inter-RAT cell search requirements in clause 8.1.2.4.21A of TS 36.133 [15] for E-UTRAN FDD-NR measurements under CCA and clause 8.1.2.4.22A of TS 36.133 [15] for E-UTRAN TDD-NR measurements under CCA.

In this test, there are three cells: LTE cell 1 as PCell on E-UTRA RF channel 1, NR cell 2 as PCell in FR1 with CCA on NR RF channel 1 and NR cell 3 as neighbour cell in FR1 with CCA on NR RF channel 2. The test parameters are given in Tables A.10.4.4.1.1-1, A.10.4.4.1.1-2, A.10.4.4.1.1-3 and A.10.4.4.1.1-4. Cell transmits SSBs in DBT windows according to DL CCA model.

In test 1 measurement gap pattern configuration # 0 as defined in Table A.10.4.4.1.1-2 is provided for UE that does not support per-FR gap and in test 2 measurement gap pattern configuration #4 as defined in Table A.10.4.4.1.1-2 is provided for UE that supports per-FR gap.

In the measurement control information, it is indicated to the UE that event-triggered reporting with Event B2 (PCell becomes worse than threshold1 and inter RAT neighbour becomes better than threshold2) [16] is used. The UE is tested when MeasTriggerQuantity is configured as RSRP, RSRQ and SINR for each test. The test consists of two successive time periods, with time duration of T1, and T2 respectively. During time duration T1, the UE shall not have any timing information of NR cell 3.

**Table A.10.4.4.1.1-1: NR inter-RAT event triggered reporting tests without SSB index reading for FR1**

Configuration	Description
1	LTE FDD; NR with CCA: SCS 30 kHz, BW 40 MHz, TDD
2	LTE TDD; NR with CCA: SCS 30 kHz, BW 40 MHz, TDD
NOTE:	The UE is only required to pass in one of the supported test configurations in FR1

**Table A.10.4.4.1.1-2: General test parameters for NR inter-RAT event triggered reporting for FR1 without SSB time index detection**

Parameter		Unit	Test configuration	Value		Comment
				Test 1	Test 2	
E-UTRA RF Channel Number			1, 2	1		One E-UTRA carrier frequency is used.
NR RF Channel Number			1, 2	1,2		Two FR1 NR carrier frequency under CCA is used.
DL CCA model	Dynamic channel access <sup>Note 3, 5</sup>			As specified in clause A.3.26.2.1		
	Semi-static channel access <sup>Note 4, 5</sup>					
UL CCA model	Dynamic channel access <sup>Note 3, 5</sup>			As specified in clause A.3.26.2.2		
	Semi-static channel access <sup>Note 4, 5</sup>					
Active cell			1, 2	E-UTRA cell 1 (PCell) and NR cell 2 with CCA (PSCell)		E-UTRA cell 1 is on E-UTRA RF channel number 1.
Neighbour cell			1, 2	NR cell 3		NR cell 3 is on NR RF channel number 2.
Gap Pattern Id			1, 2	0	4	As specified in clause Table 8.1.2.1-1 of TS 36.133 [15].
Measurement gap offset			1, 2	39	19	As specified in TS 36.331 [16].
b2-Threshold1		dBm	1, 2	Note 1		E-UTRA RSRP/RSRQ/SINR threshold for E-UTRA RSRP measurement on cell 1 for event B2 [16]
b2-Threshold2NR		dBm	1, 2	Note 2		SS-RSRP/ SS-RSRQ/ SS-SINR threshold measurement on cell 3 for event B2 [16]
Hysteresis		dB	1, 2	0		
CP length			1, 2	Normal		
TimeToTrigger		s	1, 2	0		
Filter coefficient			1, 2	0		L3 filtering is not used
DRX			1, 2	OFF		DRX is not used
Time offset between serving and neighbour cells			1, 2	3µs		Synchronous cells.
T1		s	1, 2	5		
T2		s	1, 2	$\geq T_{identify\_irat\_cca\_without\_index}$	$\geq T_{identify\_irat\_cca\_without\_index}$	$T_{identify\_irat\_cca\_without\_index}$ is defined in clause 8.1.2.4.21A.1 and 8.1.2.4.22A.1 in TS 36.133
<p>NOTE 1: The value of b2-Threshold1 is defined in Table A.10.4.4.1.1-3</p> <p>NOTE 2: The value of b2-Threshold2NR is defined in Table A.10.4.4.1.1-4</p> <p>NOTE 3: For a UE supporting dynamic channel access and network configuring dynamic channel occupancy.</p> <p>NOTE 4: For a UE supporting semi-static channel access and network configuring semi-static channel occupancy.</p> <p>NOTE 5: For a UE supporting both semi-static and dynamic channel access, the UE can be tested under dynamic channel occupancy only.</p>						

**Table A.10.4.4.1.1-3: E-UTRAN PCell specific test parameters for NR inter-RAT event triggered reporting in non-DRX with NR neighbour cell in FR1 without SSB time index detection**

Parameter	Unit	Configuration	Cell 1
-----------	------	---------------	--------



			T1	T2				
RF channel number		1, 2	1					
Duplex mode		1	FDD					
		2	TDD					
TDD special subframe configuration <sup>Note1</sup>		2	6					
TDD uplink-downlink configuration <sup>Note1</sup>		2	1					
BW <sub>channel</sub>	MHz	1, 2	5 MHz: N <sub>RB,c</sub> = 25 10 MHz: N <sub>RB,c</sub> = 50 20 MHz: N <sub>RB,c</sub> = 100					
PDSCH parameters: DL Reference Measurement Channel <sup>Note2</sup>		1	5 MHz: R.7 FDD 10 MHz: R.3 FDD 20 MHz: R.6 FDD					
		2	5 MHz: R.4 TDD 10 MHz: R.0 TDD 20 MHz: R.3 TDD					
PCFICH/PDCCH/PHICH parameters: DL Reference Measurement Channel <sup>Note2</sup>		1	5 MHz: R.11 FDD 10 MHz: R.6 FDD 20 MHz: R.10 FDD					
		2	5 MHz: R.11 TDD 10 MHz: R.6 TDD 20 MHz: R.10 TDD					
OCNG Patterns <sup>Note2</sup>		1	5 MHz: OP.20 FDD 10 MHz: OP.10 FDD 20 MHz: OP.17 FDD					
		2	5 MHz: OP.9 TDD 10 MHz: OP.1 TDD 20 MHz: OP.7 TDD					
b2-Threshold1	dBm	1, 2	-77 for RSRP					
		1, 2	77 for RSRQ					
		1, 2	90 for SINR					
PBCH_RA	dB	1, 2	0					
PBCH_RB								
PSS_RA								
SSS_RA								
PCFICH_RB								
PHICH_RA								
PHICH_RB								
PDCCH_RA								
PDCCH_RB								
PDSCH_RA								
PDSCH_RB								
OCNG_RA <sup>Note3</sup>								
OCNG_RB <sup>Note3</sup>								
N <sub>oc</sub> <sup>Note4</sup>					dBm/15kHz	1, 2	-104	
$\hat{E}_s/N_{oc}$					dB	1, 2	17	17
$\hat{E}_s/I_{ot}$ <sup>Note5</sup>	dB	1, 2	17	17				
RSRP <sup>Note5</sup>	dBm/15kHz	1, 2	-87	-87				
SCH_RP <sup>Note5</sup>	dBm/15kHz	1, 2	-87	-87				
I <sub>o</sub> <sup>Note5</sup>	dBm/9MHz	1, 2	-59.13+10log (N <sub>RB,c</sub> /50)	-59.13+10log (N <sub>RB,c</sub> /50)				
Propagation Condition <sup>Note6</sup>		1, 2	AWGN					
Antenna Configuration and Correlation Matrix <sup>Note6</sup>		1, 2	1x2 Low					

Note 1: Special subframe and uplink-downlink configurations are specified in table 4.2-1 in TS 36.211 [23].  
 Note 2: DL RMCs and OCNG patterns are specified in clauses A 3.1 and A 3.2 of TS 36.133 [15] respectively.  
 Note 3: OCNG shall be used such that all cells are fully allocated and a constant total transmitted power spectral density is achieved for all OFDM symbols.  
 Note 4: Interference from other cells and noise sources not specified in the test is assumed to be constant over subcarriers and time and shall be modelled as AWGN of appropriate power for N<sub>oc</sub> to be fulfilled.  
 Note 5:  $\hat{E}_s/I_{ot}$ , RSRP, SCH\_RP and I<sub>o</sub> levels have been derived from other parameters for information purposes. They are not settable parameters themselves.  
 Note 6: Propagation condition and correlation matrix are defined in clause B.2 in TS 36.101 [25].

**Table A.10.4.4.1.1-4: NR neighbour cell specific test parameters for NR inter-RAT event triggered reporting for FR1 without SSB time index detection**

Parameter	Unit	Test configuration	Cell 2		Cell 3	
			T1	T2	T2	T2
NR RF Channel Number		1, 2	2		3	
TDD configuration		1, 2	TDDConf.1.1 CCA		TDDConf.1.1 CCA	
$BW_{\text{channel}}$	MHz	1, 2	40: $N_{RB,c} = 106$		40: $N_{RB,c} = 106$	
$P_{CCA\_DL}$ for dynamic channel access <small>Note 6,8</small>		1, 2	$P_{CCA\_DL\_1}=0.75$ $P_{CCA\_DL\_2}=0.75$		$P_{CCA\_DL\_1}=0.75$ $P_{CCA\_DL\_2}=0.75$	
$P_{CCA\_DL}$ for semi-static channel access <small>Note 7,8</small>		1, 2	$P_{CCA\_DL}=0.9375$		$P_{CCA\_DL}=0.9375$	
$P_{CCA\_UL}$ for dynamic channel access <small>Note 6,8</small>		1, 2	1		1	
$P_{CCA\_UL}$ for semi-static channel access <small>Note 7,8</small>		1, 2	1		1	
OCNG Patterns defined in A.3.2.1.1 (OP.1)		1, 2	OP.1		OP.1	
SMTTC configuration defined in A.3.11.1 and A.3.11.2		1, 2	SMTTC.1		SMTTC.1	
DBT window configuration		1, 2	DBT.1		DBT.1	
SSB configuration for semi-static channel access		1, 2	SSB.1 CCA		SSB.1 CCA	
SSB configuration for dynamic channel access		1, 2	SSB.2 CCA		SSB.2 CCA	
PDSCH/PDCCH subcarrier spacing	kHz	1, 2	30		30	
b2-Threshold2NR	dBm	1, 2	NA		-98 for SS-RSRP	
	dB	1, 2	NA		55 for SS-RSRQ	
		1, 2	NA		50 for SS-SINR	
EPRE ratio of PSS to SSS		1, 2	0		0	
EPRE ratio of PBCH DMRS to SSS						
EPRE ratio of PBCH to PBCH DMRS						
EPRE ratio of PDCCH DMRS to SSS						
EPRE ratio of PDCCH to PDCCH DMRS						
EPRE ratio of PDSCH DMRS to SSS						
EPRE ratio of PDSCH to PDSCH						
EPRE ratio of OCNG DMRS to SSS (Note 1)						
EPRE ratio of OCNG to OCNG DMRS (Note 1)						
$N_{oc}$ <small>Note2</small>	dBm/15kHz	1, 2	-98		-98	
$N_{oc}$ <small>Note2</small>	dBm/SCS	1, 2	-95		-95	
SS-RSRP <small>Note 3,5</small>	dBm/SCS	1, 2	-91	-91	-Infinity	-88
$\hat{E}_s/I_{ot}$ <small>Note 5</small>	dB	1, 2	4	4	-Infinity	7
$\hat{E}_s/N_{oc}$ <small>Note 5</small>	dB	1, 2	4	4	-Infinity	7
$I_o$ <small>Note3</small>	dBm/38.16MHz	1, 2	-58.49	-58.49	-63.95	-56.16
Propagation Condition		1, 2	AWGN		AWGN	
Antenna Configuration and Correlation Matrix		1, 2,	1x2 Low		1x2 Low	

- NOTE 1: OCNG shall be used such that the cell is fully allocated and a constant total transmitted power spectral density is achieved for all OFDM symbols.
- NOTE 2: Interference from other cells and noise sources not specified in the test is assumed to be constant over subcarriers and time and shall be modelled as AWGN of appropriate power for  $N_{ac}$  to be fulfilled.
- NOTE 3: SS-RSRP and  $I_0$  levels have been derived from other parameters for information purposes. They are not settable parameters themselves.
- NOTE 4: SS-RSRP minimum requirements are specified assuming independent interference and noise at each receiver antenna port.
- NOTE 5: The signal levels apply for SSS REs when the discovery burst is transmitted during DBT windows.
- NOTE 6: For UE supporting semi-static channel access and network configuring semi-static channel occupancy.
- NOTE 7: For UE supporting dynamic channel access and network configuring dynamic channel occupancy.
- NOTE 8: For a UE supporting both semi-static and dynamic channel access, the UE can be tested under dynamic channel occupancy only.

#### A.10.4.4.1.2 Test Requirements

In test 1 with per-UE gap, the UE shall send one Event B2 triggered measurement report, with a measurement reporting delay less than  $T_{\text{identify\_irat\_cca\_without\_index}}$  ms from the beginning of time period T2. The UE shall not send event triggered measurement reports, as long as the reporting criteria are not fulfilled. The rate of correct events observed during repeated tests shall be at least 90%.

In test 2 with per-FR gap, the UE shall send one Event B2 triggered measurement report, with a measurement reporting delay less than  $T_{\text{identify\_irat\_cca\_without\_index}}$  from the beginning of time period T2. The UE shall not send event triggered measurement reports, as long as the reporting criteria are not fulfilled. The rate of correct events observed during repeated tests shall be at least 90%.

In test 1 and test 2, the UE is not required to report SSB time index.  $T_{\text{identify\_irat\_cca\_without\_index}}$  is defined in defined in clause 8.1.2.4.21A.1 and 8.1.2.4.22A.1 in TS 36.133.

NOTE: The actual overall delays measured in the test may be up to  $2 \times TTI_{\text{DCCH}}$  higher than the measurement reporting delays above because of TTI insertion uncertainty of the measurement report in DCCH.

#### A.10.4.4.2 E-UTRA-NR inter-RAT event triggered reporting tests for FR1 without SSB time index detection when DRX is used

##### A.10.4.4.2.1 Test Purpose and Environment

The purpose of this test is to verify that the UE makes correct reporting of an event. This test will partly verify the NR inter-RAT cell search requirements in clause 8.1.2.4.21 of TS 36.133 [15] for E-UTRAN FDD-NR measurements and clause 8.1.2.4.22 of TS 36.133 [15] for E-UTRAN TDD-NR measurements.

In this test, there are three cells: LTE cell 1 as PCell on E-UTRA RF channel 1, NR cell 2 as PSCell in FR1 with CCA on NR RF channel 1 and NR cell 3 as neighbour cell in FR1 with CCA on NR RF channel 2. The test parameters are given in Tables A.10.4.4.2.1-1, A.10.4.4.2.1-2, A.10.4.4.2.1-3 and A.10.4.4.2.1-4. Cell transmits SSBs in DBT windows according to DL CCA model.

In tests 1 and 2, measurement gap pattern configuration # 0 as defined in Table A.10.4.4.2.1-2 is provided for UE that does not support per-FR gap and in tests 3 and 4, measurement gap pattern configuration #4 as defined in Table A.10.4.4.2.1-2 is provided for UE that supports per-FR gap.

In the measurement control information, it is indicated to the UE that event-triggered reporting with Event B2 (PCell becomes worse than threshold1 and inter RAT neighbour becomes better than threshold2) [16] is used. The UE is tested when MeasTriggerQuantity is configured as RSRP, RSRQ and SINR for each test. The test consists of two successive time periods, with time duration of T1, and T2 respectively. During time duration T1, the UE shall not have any timing information of NR cell 3.

**Table A.10.4.4.2.1-1: NR inter-RAT event triggered reporting tests without SSB index reading for FR1**

Configuration	Description
1	LTE FDD; NR with CCA: SCS 30 kHz, BW 40 MHz, TDD
2	LTE TDD; NR with CCA: SCS 30 kHz, BW 40 MHz, TDD

NOTE: The UE is only required to pass in one of the supported test configurations in FR1

**Table A.10.4.4.2.1-2: General test parameters for NR inter-RAT event triggered reporting for FR1 without SSB time index detection**

Parameter		Unit	Test configuration	Value				Comment
				Test 1	Test 2	Test 3	Test 4	
E-UTRA RF Channel Number			1, 2	1				One E-UTRA carrier frequency is used.
NR RF Channel Number			1, 2	1,2				Two FR1 NR carrier frequency under CCA is used.
Active cell			1, 2	E-UTRA cell 1 (PCell) and NR cell 2 with CCA (PSCell)				E-UTRA cell 1 is on E-UTRA RF channel number 1.
DL CCA model	Dynamic channel access <sup>Note 3, 5</sup>			As specified in clause A.3.26.2.1				
	Semi-static channel access <sup>Note 4, 5</sup>							
UL CCA model	Dynamic channel access <sup>Note 3, 5</sup>			As specified in clause A.3.26.2.2				
	Semi-static channel access <sup>Note 4, 5</sup>							
Neighbour cell			1, 2	NR cell 3				NR cell 3 is on NR RF channel number 2.
Gap Pattern Id			1, 2	0	4			As specified in clause Table 8.1.2.1-1 of TS 36.133 [15].
Measurement gap offset			1, 2	39	19			As specified in TS 36.331 [16].
b2-Threshold1		dBm	1, 2	Note 1				E-UTRA RSRP/RSRQ/SINR threshold for E-UTRA RSRP measurement on cell 1 for event B2 [16]
b2-Threshold2NR		dBm	1, 2	Note 2				SS-RSRP/ SS-RSRQ/ SS-SINR threshold measurement on cell 3 for event B2 [16]
Hysteresis		dB	1, 2	0				
CP length			1, 2	Normal				
TimeToTrigger		s	1, 2	0				
Filter coefficient			1, 2	0				L3 filtering is not used
DRX			1, 2	DR X.9	DR X.1 2	DR X.9	DR X.1 2	As specified in clause A.3.3
Time offset between serving and neighbour cells			1, 2	3 $\mu$ s				Synchronous cells.
T1		s	1, 2	5				
T2		s	1, 2	$\geq T_{\text{identify\_irat\_cca\_without\_index}}$				$T_{\text{identify\_irat\_cca\_without\_index}}$ is defined in clause 8.1.2.4.21A.1 and 8.1.2.4.22A.1 in TS 36.133

NOTE 1: The value of b2-Threshold1 is defined in Table A.10.4.4.1.1-3  
 NOTE 2: The value of b2-Threshold2NR is defined in Table A.10.4.4.1.1-4  
 NOTE 3: For a UE supporting dynamic channel access and network configuring dynamic channel occupancy.  
 NOTE 4: For a UE supporting semi-static channel access and network configuring semi-static channel occupancy.  
 NOTE 5: For a UE supporting both semi-static and dynamic channel access, the UE can be tested under dynamic channel occupancy only.

**Table A.10.4.4.2.1-3: E-UTRAN PCell specific test parameters for NR inter-RAT event triggered reporting in non-DRX with NR neighbour cell in FR1 without SSB time index detection**

Parameter	Unit	Configuration	Cell 1	
			T1	T2
RF channel number		1, 2	1	
Duplex mode		1	FDD	
		2	TDD	
TDD special subframe configuration <sup>Note1</sup>		2	6	
TDD uplink-downlink configuration <sup>Note1</sup>		2	1	
BW <sub>channel</sub>	MHz	1, 2	5 MHz: N <sub>RB,c</sub> = 25 10 MHz: N <sub>RB,c</sub> = 50 20 MHz: N <sub>RB,c</sub> = 100	
PDSCH parameters: DL Reference Measurement Channel <sup>Note2</sup>		1	5 MHz: R.7 FDD 10 MHz: R.3 FDD 20 MHz: R.6 FDD	
		2	5 MHz: R.4 TDD 10 MHz: R.0 TDD 20 MHz: R.3 TDD	
PCFICH/PDCCH/PHICH parameters: DL Reference Measurement Channel <sup>Note2</sup>		1	5 MHz: R.11 FDD 10 MHz: R.6 FDD 20 MHz: R.10 FDD	
		2	5 MHz: R.11 TDD 10 MHz: R.6 TDD 20 MHz: R.10 TDD	
OCNG Patterns <sup>Note2</sup>		1	5 MHz: OP.20 FDD 10 MHz: OP.10 FDD 20 MHz: OP.17 FDD	
		2	5 MHz: OP.9 TDD 10 MHz: OP.1 TDD 20 MHz: OP.7 TDD	
b2-Threshold1	dBm	1, 2	-77 for RSRP	
	dB	1, 2	77 for RSRQ	
	dB	1, 2	90 for SINR	
PBCH_RA	dB	1, 2	0	
PBCH_RB				
PSS_RA				
SSS_RA				
PCFICH_RB				
PHICH_RA				
PHICH_RB				
PDCCH_RA				
PDCCH_RB				
PDSCH_RA				
PDSCH_RB				
OCNG_RA <sup>Note3</sup>				
OCNG_RB <sup>Note3</sup>				
N <sub>oc</sub> <sup>Note4</sup>				
E <sub>s</sub> /N <sub>oc</sub>	dB	1, 2	17	17
E <sub>s</sub> /I <sub>ot</sub> <sup>Note5</sup>	dB	1, 2	17	17
RSRP <sup>Note5</sup>	dBm/15kHz	1, 2	-87	-87
SCH_RP <sup>Note5</sup>	dBm/15kHz	1, 2	-87	-87
I <sub>o</sub> <sup>Note5</sup>	dBm/9MHz	1, 2	-59.13+10log(N <sub>RB,c</sub> /50)	-59.13+10log(N <sub>RB,c</sub> /50)
Propagation Condition <sup>Note6</sup>		1, 2	AWGN	

Antenna Configuration and Correlation Matrix <sup>Note6</sup>		1, 2	1x2 Low
Note 1:	Special subframe and uplink-downlink configurations are specified in table 4.2-1 in TS 36.211 [23].		
Note 2:	DL RMCs and OCNG patterns are specified in clauses A 3.1 and A 3.2 of TS 36.133 [15] respectively.		
Note 3:	OCNG shall be used such that all cells are fully allocated and a constant total transmitted power spectral density is achieved for all OFDM symbols.		
Note 4:	Interference from other cells and noise sources not specified in the test is assumed to be constant over subcarriers and time and shall be modelled as AWGN of appropriate power for $N_{oc}$ to be fulfilled.		
Note 5:	$\hat{E}_s/I_{ot}$ , RSRP, SCH_RP and $I_o$ levels have been derived from other parameters for information purposes. They are not settable parameters themselves.		
Note 6:	Propagation condition and correlation matrix are defined in clause B.2 in TS 36.101 [25].		

**Table A.10.4.4.2.1-4: NR neighbour cell specific test parameters for NR inter-RAT event triggered reporting for FR1 without SSB time index detection**

Parameter	Unit	Test configuration	Cell 2		Cell 3	
			T1	T2	T2	T2
NR RF Channel Number		1, 2	2		3	
TDD configuration		1, 2	TDDConf. 1.1 CCA		TDDConf. 1.1 CCA	
BW <sub>channel</sub>	MHz	1, 2	40: $N_{RB,C} = 106$		40: $N_{RB,C} = 106$	
P <sub>CCA_DL</sub> for dynamic channel access <sup>Note 6,8</sup>		1, 2	P <sub>CCA_DL_1</sub> =0.75 P <sub>CCA_DL_2</sub> =0.75		P <sub>CCA_DL_1</sub> =0.75 P <sub>CCA_DL_2</sub> =0.75	
P <sub>CCA_DL</sub> for semi-static channel access <sup>Note 7,8</sup>		1, 2	P <sub>CCA_DL</sub> =0.9375		P <sub>CCA_DL</sub> =0.9375	
P <sub>CCA_UL</sub> for dynamic channel access <sup>Note 6,8</sup>		1, 2	1		1	
P <sub>CCA_UL</sub> for semi-static channel access <sup>Note 7,8</sup>		1, 2	1		1	
OCNG Patterns defined in A.3.2.1.1 (OP.1)		1, 2	OP.1		OP.1	
SMTC configuration defined in A.3.11.1 and A.3.11.2		1, 2	SMTC.1		SMTC.1	
DBT window configuration		1, 2	DBT.1		DBT.1	
SSB configuration for semi-static channel access		1, 2	SSB.1 CCA		SSB.1 CCA	
SSB configuration for dynamic channel access		1, 2	SSB.2 CCA		SSB.2 CCA	
PDSCH/PDCCH subcarrier spacing	kHz	1, 2	30		30	
b2-Threshold2NR	dBm	1, 2	NA		-98 for SS-RSRP	
	dB	1, 2	NA		55 for SS-RSRQ	
		1, 2	NA		50 for SS-SINR	
EPRE ratio of PSS to SSS		1, 2	0		0	
EPRE ratio of PBCH DMRS to SSS						
EPRE ratio of PBCH to PBCH DMRS						
EPRE ratio of PDCCH DMRS to SSS						
EPRE ratio of PDCCH to PDCCH DMRS						
EPRE ratio of PDSCH DMRS to SSS						
EPRE ratio of PDSCH to PDSCH						
EPRE ratio of OCNG DMRS to SSS (Note 1)						
EPRE ratio of OCNG to OCNG DMRS (Note 1)						
$N_{oc}$ <sup>Note2</sup>	dBm/15kHz					
$N_{oc}$ <sup>Note2</sup>	dBm/SCS	1, 2	-95		-95	
SS-RSRP <sup>Note 3,5</sup>	dBm/SCS	1, 2	-91	-91	-Infinity	-88
$\hat{E}_s/I_{ot}$ <sup>Note 5</sup>	dB	1, 2	4	4	-Infinity	7

$\hat{E}_s / N_{oc}$ <sup>Note 5</sup>	dB	1, 2	4	4	-Infinity	7
$I_o$ <sup>Note 3</sup>	dBm/38.16MHz	1, 2	-58.49	-58.49	-63.95	-56.16
Propagation Condition		1, 2	AWGN		AWGN	
Antenna Configuration and Correlation Matrix		1, 2,	1x2 Low		1x2 Low	
<p>NOTE 1: OCNG shall be used such that the cell is fully allocated and a constant total transmitted power spectral density is achieved for all OFDM symbols.</p> <p>NOTE 2: Interference from other cells and noise sources not specified in the test is assumed to be constant over subcarriers and time and shall be modelled as AWGN of appropriate power for <math>N_{oc}</math> to be fulfilled.</p> <p>NOTE 3: SS-RSRP and <math>I_o</math> levels have been derived from other parameters for information purposes. They are not settable parameters themselves.</p> <p>NOTE 4: SS-RSRP minimum requirements are specified assuming independent interference and noise at each receiver antenna port.</p> <p>NOTE 5: The signal levels apply for SSS REs when the discovery burst is transmitted during DBT windows.</p> <p>NOTE 6: For UE supporting semi-static channel access and network configuring semi-static channel occupancy.</p> <p>NOTE 7: For UE supporting dynamic channel access and network configuring dynamic channel occupancy.</p> <p>NOTE 8: For a UE supporting both semi-static and dynamic channel access, the UE can be tested under dynamic channel occupancy only.</p>						

#### A.10.4.4.2 Test Requirements

In test 1 with per-UE gap, the UE shall send one Event B2 triggered measurement report, with a measurement reporting delay less than  $T_{\text{identify\_irat\_cca\_without\_index}}$  ms from the beginning of time period T2. The UE shall not send event triggered measurement reports, as long as the reporting criteria are not fulfilled. The rate of correct events observed during repeated tests shall be at least 90%.

In test 2 with per-UE gap, the UE shall send one Event B2 triggered measurement report, with a measurement reporting delay less than  $T_{\text{identify\_irat\_cca\_without\_index}}$  ms from the beginning of time period T2. The UE shall not send event triggered measurement reports, as long as the reporting criteria are not fulfilled. The rate of correct events observed during repeated tests shall be at least 90%.

In test 3 with per-FR gap, the UE shall send one Event B2 triggered measurement report, with a measurement reporting delay less than  $T_{\text{identify\_irat\_cca\_without\_index}}$  ms from the beginning of time period T2. The UE shall not send event triggered measurement reports, as long as the reporting criteria are not fulfilled. The rate of correct events observed during repeated tests shall be at least 90%.

In test 4 with per-FR gap, the UE shall send one Event B2 triggered measurement report, with a measurement reporting delay less than  $T_{\text{identify\_irat\_cca\_without\_index}}$  ms from the beginning of time period T2. The UE shall not send event triggered measurement reports, as long as the reporting criteria are not fulfilled. The rate of correct events observed during repeated tests shall be at least 90%.

In tests 1, 2, 3 and 4, the UE is not required to report SSB time index.

NOTE: The actual overall delays measured in the test may be up to  $2xTTI_{\text{DCCH}}$  higher than the measurement reporting delays above because of TTI insertion uncertainty of the measurement report in DCCH.

#### A.10.4.4.3 NR Inter-RAT event triggered reporting tests for FR1 with SSB time index detection when DRX is not used

##### A.10.4.4.3.1 Test Purpose and Environment

The purpose of this test is to verify that the UE makes correct reporting of an event. This test will partly verify the NR inter-RAT cell search requirements in clause 8.1.2.4.21 of TS 36.133 [15] for E-UTRAN FDD-NR measurements and clause 8.1.2.4.22 of TS 36.133 [15] for E-UTRAN TDD-NR measurements.

In this test, there are three cells: LTE cell 1 as PCell on E-UTRA RF channel 1, NR cell 2 as PCell in FR1 with CCA on NR RF channel 1 and NR cell 3 as neighbour cell in FR1 with CCA on NR RF channel 2. The test parameters are given in Tables A.10.4.4.3.1-1, A.10.4.4.3.1-2, A.10.4.4.3.1-3 and A.10.4.4.3.1-4. Cell transmits SSBs in DBT windows according to DL CCA model.

In test 1 measurement gap pattern configuration # 0 as defined in Table A.10.4.4.3.1-2 is provided for UE that does not support per-FR gap and in test 2 measurement gap pattern configuration #4 as defined in Table A.10.4.4.3.1-2 is provided for UE that supports per-FR gap.

In the measurement control information, it is indicated to the UE that event-triggered reporting with Event B2 (PCell becomes worse than threshold1 and inter RAT neighbour becomes better than threshold2) [16] is used. The UE is tested when MeasTriggerQuantity is configured as RSRP, RSRQ and SINR for each test. In the measurement configuration the UE shall be indicated to report the SSB index of the identified NR cell. The test consists of two successive time periods, with time duration of T1, and T2 respectively. During time duration T1, the UE shall not have any timing information of NR cell 3.

**Table A.10.4.4.3.1-1: NR inter-RAT event triggered reporting tests with SSB index reading for FR1**

Configuration	Description
1	LTE FDD; NR with CCA: SCS 30 kHz, BW 40 MHz, TDD
2	LTE TDD; NR with CCA: SCS 30 kHz, BW 40 MHz, TDD
NOTE: The UE is only required to pass in one of the supported test configurations in FR1	

**Table A.10.4.4.3.1-2: General test parameters for NR inter-RAT event triggered reporting for FR1 with SSB time index detection**

Parameter		Unit	Test configuration	Value		Comment
				Test 1	Test 2	
E-UTRA RF Channel Number			1, 2	1		One E-UTRA carrier frequency is used.
NR RF Channel Number			1, 2	1,2		Two FR1 NR carrier frequency under CCA is used.
DL CCA model	Dynamic channel access <sup>Note 3, 5</sup>			As specified in clause A.3.26.2.1		
	Semi-static channel access <sup>Note 4, 5</sup>					
UL CCA model	Dynamic channel access <sup>Note 3, 5</sup>			As specified in clause A.3.26.2.2		
	Semi-static channel access <sup>Note 4, 5</sup>					
Active cell			1, 2	E-UTRA cell 1 (PCell) and NR cell 2 with CCA (PSCell)		E-UTRA cell 1 is on E-UTRA RF channel number 1.
Neighbour cell			1, 2	NR cell 3		NR cell 3 is on NR RF channel number 2.
Gap Pattern Id			1, 2	0	4	As specified in clause Table 8.1.2.1-1 of TS 36.133 [15].
Measurement gap offset			1, 2	39	19	As specified in TS 36.331 [16].
b2-Threshold1		dBm	1, 2	Note 1		E-UTRA RSRP/RSRQ/SINR threshold for E-UTRA RSRP measurement on cell 1 for event B2 [16]
b2-Threshold2NR		dBm	1, 2	Note 2		SS-RSRP/ SS-RSRQ/ SS-SINR threshold measurement on cell 3 for event B2 [16]
Hysteresis		dB	1, 2	0		
CP length			1, 2	Normal		
TimeToTrigger		s	1, 2	0		



Filter coefficient		1, 2	0	L3 filtering is not used
DRX		1, 2	OFF	DRX is not used
Time offset between serving and neighbour cells		1, 2	3µs	Synchronous cells.
T1	s	1, 2	5	
T2	s	1, 2	$\geq T_{\text{identify\_irat\_cc a\_with\_index}}$ $\geq T_{\text{identify\_irat\_cc a\_with\_index}}$	$T_{\text{identify\_irat\_cca\_with\_index}}$ is defined in clause 8.1.2.4.21A.1 and 8.1.2.4.22A.1 in TS 36.133
<p>NOTE 1: The value of b2-Threshold1 is defined in Table A.10.4.4.3.1-3</p> <p>NOTE 2: The value of b2-Threshold2NR is defined in Table A.10.4.4.3.1-4</p> <p>NOTE 3: For a UE supporting dynamic channel access and network configuring dynamic channel occupancy.</p> <p>NOTE 4: For a UE supporting semi-static channel access and network configuring semi-static channel occupancy.</p> <p>NOTE 5: For a UE supporting both semi-static and dynamic channel access, the UE can be tested under dynamic channel occupancy only.</p>				

**Table A.10.4.4.3.1-3: E-UTRAN PCell specific test parameters for NR inter-RAT event triggered reporting in non-DRX with NR neighbour cell in FR1 with SSB time index detection**

Parameter	Unit	Configuration	Cell 1	
			T1	T2
RF channel number		1, 2	1	
Duplex mode		1	FDD	
		2	TDD	
TDD special subframe configuration <sup>Note1</sup>		2	6	
TDD uplink-downlink configuration <sup>Note1</sup>		2	1	
BW <sub>channel</sub>	MHz	1, 2	5 MHz: N <sub>RB,c</sub> = 25 10 MHz: N <sub>RB,c</sub> = 50 20 MHz: N <sub>RB,c</sub> = 100	
PDSCH parameters: DL Reference Measurement Channel <sup>Note2</sup>		1	5 MHz: R.7 FDD 10 MHz: R.3 FDD 20 MHz: R.6 FDD	
		2	5 MHz: R.4 TDD 10 MHz: R.0 TDD 20 MHz: R.3 TDD	
PCFICH/PDCCH/PHICH parameters: DL Reference Measurement Channel <sup>Note2</sup>		1	5 MHz: R.11 FDD 10 MHz: R.6 FDD 20 MHz: R.10 FDD	
		2	5 MHz: R.11 TDD 10 MHz: R.6 TDD 20 MHz: R.10 TDD	
OCNG Patterns <sup>Note2</sup>		1	5 MHz: OP.20 FDD 10 MHz: OP.10 FDD 20 MHz: OP.17 FDD	
		2	5 MHz: OP.9 TDD 10 MHz: OP.1 TDD 20 MHz: OP.7 TDD	
b2-Threshold1	dBm	1, 2	-77 for RSRP	
		1, 2	77 for RSRQ	
		1, 2	90 for SINR	
PBCH_RA	dB	1, 2	0	
PBCH_RB				
PSS_RA				
SSS_RA				
PCFICH_RB				
PHICH_RA				
PHICH_RB				
PDCCH_RA				
PDCCH_RB				
PDSCH_RA				
PDSCH_RB				
OCNG_RA <sup>Note3</sup>				
OCNG_RB <sup>Note3</sup>				

$N_{oc}$ <sup>Note4</sup>	dBm/15kHz	1, 2	-104	
$\bar{E}_s/N_{oc}$	dB	1, 2	17	17
$\bar{E}_s/I_{ot}$ <sup>Note5</sup>	dB	1, 2	17	17
RSRP <sup>Note5</sup>	dBm/15kHz	1, 2	-87	-87
SCH_RP <sup>Note5</sup>	dBm/15kHz	1, 2	-87	-87
$I_o$ <sup>Note5</sup>	dBm/9MHz	1, 2	$-59.13+10\log(N_{RB,c}/50)$	$-59.13+10\log(N_{RB,c}/50)$
Propagation Condition <sup>Note6</sup>		1, 2	AWGN	
Antenna Configuration and Correlation Matrix <sup>Note6</sup>		1, 2	1x2 Low	
<p>Note 1: Special subframe and uplink-downlink configurations are specified in table 4.2-1 in TS 36.211 [23].</p> <p>Note 2: DL RMCs and OCNG patterns are specified in clauses A 3.1 and A 3.2 of TS 36.133 [15] respectively.</p> <p>Note 3: OCNG shall be used such that all cells are fully allocated and a constant total transmitted power spectral density is achieved for all OFDM symbols.</p> <p>Note 4: Interference from other cells and noise sources not specified in the test is assumed to be constant over subcarriers and time and shall be modelled as AWGN of appropriate power for <math>N_{oc}</math> to be fulfilled.</p> <p>Note 5: <math>\bar{E}_s/I_{ot}</math>, RSRP, SCH_RP and <math>I_o</math> levels have been derived from other parameters for information purposes. They are not settable parameters themselves.</p> <p>Note 6: Propagation condition and correlation matrix are defined in clause B.2 in TS 36.101 [25].</p>				

**Table A.10.4.4.3.1-4: NR neighbour cell specific test parameters for NR inter-RAT event triggered reporting for FR1 with SSB time index detection**

Parameter	Unit	Test configuration	Cell 2		Cell 3	
			T1	T2	T2	T2
NR RF Channel Number		1, 2	2		3	
TDD configuration		1, 2	TDDConf.1.1 CCA		TDDConf.1.1 CCA	
BW <sub>channel</sub>	MHz	1, 2	40: $N_{RB,c} = 106$		40: $N_{RB,c} = 106$	
$P_{CCA\_DL}$ for dynamic channel access <sup>Note 6,8</sup>		1, 2	$P_{CCA\_DL\_1}=0.75$ $P_{CCA\_DL\_2}=0.75$		$P_{CCA\_DL\_1}=0.75$ $P_{CCA\_DL\_2}=0.75$	
$P_{CCA\_DL}$ for semi-static channel access <sup>Note 7,8</sup>		1, 2	$P_{CCA\_DL}=0.9375$		$P_{CCA\_DL}=0.9375$	
$P_{CCA\_UL}$ for dynamic channel access <sup>Note 6,8</sup>		1, 2	1		1	
$P_{CCA\_UL}$ for semi-static channel access <sup>Note 7,8</sup>		1, 2	1		1	
OCNG Patterns defined in A.3.2.1.1 (OP.1)		1, 2	OP.1		OP.1	
SMTTC configuration defined in A.3.11.1 and A.3.11.2		1, 2	SMTTC.1		SMTTC.1	
DBT window configuration		1, 2	DBT.1		DBT.1	
SSB configuration for semi-static channel access		1, 2	SSB.1 CCA		SSB.1 CCA	
SSB configuration for dynamic channel access		1, 2	SSB.2 CCA		SSB.2 CCA	
PDSCH/PDCCH subcarrier spacing	kHz	1, 2	30		30	
b2-Threshold2NR	dBm	1, 2	NA		-98 for SS-RSRP	
	dB	1, 2	NA		55 for SS-RSRQ	
		1, 2	NA		50 for SS-SINR	
EPRE ratio of PSS to SSS		1, 2	0		0	
EPRE ratio of PBCH DMRS to SSS						
EPRE ratio of PBCH to PBCH DMRS						
EPRE ratio of PDCCH DMRS to SSS						
EPRE ratio of PDCCH to PDCCH DMRS						
EPRE ratio of PDSCH DMRS to SSS						
EPRE ratio of PDSCH to PDSCH						
EPRE ratio of OCNG DMRS to SSS (Note 1)						

EPRE ratio of OCNG to OCNG DMRS (Note 1)						
$N_{oc}$ <sup>Note 2</sup>	dBm/15kHz	1, 2		-98		-98
$N_{oc}$ <sup>Note 2</sup>	dBm/SCS	1, 2		-95		-95
SS-RSRP <sup>Note 3,5</sup>	dBm/SCS	1, 2	-91	-91	-Infinity	-88
$\hat{E}_s/I_{ot}$ <sup>Note 5</sup>	dB	1, 2	4	4	-Infinity	7
$\hat{E}_s/N_{oc}$ <sup>Note 5</sup>	dB	1, 2	4	4	-Infinity	7
$I_o$ <sup>Note 3</sup>	dBm/38.16MHz	1, 2	-58.49	-58.49	-63.95	-56.16
Propagation Condition		1, 2	AWGN		AWGN	
Antenna Configuration and Correlation Matrix		1, 2,	1x2 Low		1x2 Low	
<p>NOTE 1: OCNG shall be used such that the cell is fully allocated and a constant total transmitted power spectral density is achieved for all OFDM symbols.</p> <p>NOTE 2: Interference from other cells and noise sources not specified in the test is assumed to be constant over subcarriers and time and shall be modelled as AWGN of appropriate power for <math>N_{oc}</math> to be fulfilled.</p> <p>NOTE 3: SS-RSRP and <math>I_o</math> levels have been derived from other parameters for information purposes. They are not settable parameters themselves.</p> <p>NOTE 4: SS-RSRP minimum requirements are specified assuming independent interference and noise at each receiver antenna port.</p> <p>NOTE 5: The signal levels apply for SSS REs when the discovery burst is transmitted during DBT windows.</p> <p>NOTE 6: For UE supporting semi-static channel access and network configuring semi-static channel occupancy.</p> <p>NOTE 7: For UE supporting dynamic channel access and network configuring dynamic channel occupancy.</p> <p>NOTE 8: For a UE supporting both semi-static and dynamic channel access, the UE can be tested under dynamic channel occupancy only.</p>						

#### A.10.4.4.3.2 Test Requirements

In test 1 with per-UE gap, the UE shall send one Event B2 triggered measurement report, with a measurement reporting delay less than  $T_{\text{identify\_irat\_cca\_with\_index}}$  ms from the beginning of time period T2. The UE shall not send event triggered measurement reports, as long as the reporting criteria are not fulfilled. The rate of correct events observed during repeated tests shall be at least 90%.

In test 2 with per-FR gap, the UE shall send one Event B2 triggered measurement report, with a measurement reporting delay less than  $T_{\text{identify\_irat\_cca\_with\_index}}$  ms from the beginning of time period T2. The UE shall not send event triggered measurement reports, as long as the reporting criteria are not fulfilled. The rate of correct events observed during repeated tests shall be at least 90%.

In test 1 and test 2, the UE is required to report SSB time index.

NOTE: The actual overall delays measured in the test may be up to  $2 \times TTI_{DCC}$  higher than the measurement reporting delays above because of TTI insertion uncertainty of the measurement report in DCC.

#### A.10.4.4.4 NR Inter-RAT event triggered reporting tests for FR1 with SSB time index detection when DRX is used

##### A.10.4.4.4.1 Test Purpose and Environment

The purpose of this test is to verify that the UE makes correct reporting of an event. This test will partly verify the NR inter-RAT cell search requirements in clause 8.1.2.4.21 of TS 36.133 [15] for E-UTRAN FDD-NR measurements and clause 8.1.2.4.22 of TS 36.133 [15] for E-UTRAN TDD-NR measurements.

In this test, there are three cells: LTE cell 1 as PCell on E-UTRA RF channel 1, NR cell 2 as PCell in FR1 with CCA on NR RF channel 1 and NR cell 3 as neighbour cell in FR1 with CCA on NR RF channel 2. The test parameters are given in Tables A.10.4.4.4.1-1, A.10.4.4.4.1-2, A.10.4.4.4.1-3 and A.10.4.4.4.1-4. Cell transmits SSBs in DBT windows according to DL CCA model.

In tests 1 and 2, measurement gap pattern configuration # 0 as defined in Table A.10.4.4.4.1-2 is provided for UE that does not support per-FR gap and in tests 3 and 4, measurement gap pattern configuration #4 as defined in Table A.10.4.4.4.1-2 is provided for UE that supports per-FR gap.

In the measurement control information, it is indicated to the UE that event-triggered reporting with Event B2 (PCell becomes worse than threshold1 and inter RAT neighbour becomes better than threshold2) [16] is used. In the measurement configuration the UE shall be indicated to report the SSB index of the identified NR cell. The test consists of two successive time periods, with time duration of T1, and T2 respectively. During time duration T1, the UE shall not have any timing information of NR cell 3.

**Table A.10.4.4.1-1: NR inter-RAT event triggered reporting tests with SSB index reading for FR1**

Configuration	Description
1	LTE FDD; NR with CCA: SCS 30 kHz, BW 40 MHz, TDD
2	LTE TDD; NR with CCA: SCS 30 kHz, BW 40 MHz, TDD
NOTE: The UE is only required to pass in one of the supported test configurations in FR1	

**Table A.10.4.4.1-2: General test parameters for NR inter-RAT event triggered reporting for FR1 with SSB time index detection**

Parameter		Unit	Test configuration	Value				Comment
				Test 1	Test 2	Test 3	Test 4	
E-UTRA RF Channel Number			1, 2	1				One E-UTRA carrier frequency is used.
NR RF Channel Number			1, 2	1,2				Two FR1 NR carrier frequency under CCA is used.
DL CCA model	Dynamic channel access <sup>Note 3, 5</sup>			As specified in clause A.3.26.2.1				
	Semi-static channel access <sup>Note 4, 5</sup>							
UL CCA model	Dynamic channel access <sup>Note 3, 5</sup>			As specified in clause A.3.26.2.2				
	Semi-static channel access <sup>Note 4, 5</sup>							
Active cell			1, 2	E-UTRA cell 1 (PCell) and NR cell 2 with CCA (PSCell)				E-UTRA cell 1 is on E-UTRA RF channel number 1.
Neighbour cell			1, 2	NR cell 3				NR cell 3 is on NR RF channel number 2.
Gap Pattern Id			1, 2	0	4			As specified in clause Table 8.1.2.1-1 of TS 36.133 [15].
Measurement gap offset			1, 2	39	19			As specified in TS 36.331 [16].
b2-Threshold1		dBm	1, 2	Note 1				E-UTRA RSRP/RSRQ/SINR threshold for E-UTRA RSRP measurement on cell 1 for event B2 [16]
b2-Threshold2NR		dBm	1, 2	Note 2				SS-RSRP/ SS-RSRQ/ SS-SINR threshold measurement on cell 3 for event B2 [16]
Hysteresis		dB	1, 2	0				
CP length			1, 2	Normal				
TimeToTrigger		s	1, 2	0				
Filter coefficient			1, 2	0				L3 filtering is not used
DRX			1, 2	DRX. 9	DRX. 12	DRX. 9	DRX. 12	As specified in clause A.3.3

Time offset between serving and neighbour cells		1, 2	3µs	Synchronous cells.
T1	s	1, 2	5	
T2	s	1, 2	$\geq T_{\text{identify\_irat\_cca\_with\_index}}$	$T_{\text{identify\_irat\_cca\_with\_index}}$ is defined in clause 8.1.2.4.21A.1 and 8.1.2.4.22A.1 in TS 36.133
<p>NOTE 1: The value of b2-Threshold1 is defined in Table A.10.4.4.4.1-3</p> <p>NOTE 2: The value of b2-Threshold2NR is defined in Table A.10.4.4.4.1-4</p> <p>NOTE 3: For a UE supporting dynamic channel access and network configuring dynamic channel occupancy.</p> <p>NOTE 4: For a UE supporting semi-static channel access and network configuring semi-static channel occupancy.</p> <p>NOTE 5: For a UE supporting both semi-static and dynamic channel access, the UE can be tested under dynamic channel occupancy only.</p>				

**Table A.10.4.4.1-3: E-UTRAN PCell specific test parameters for NR inter-RAT event triggered reporting in non-DRX with NR neighbour cell in FR1 with SSB time index detection**

Parameter	Unit	Configuration	Cell 1	
			T1	T2
RF channel number		1, 2	1	
Duplex mode		1	FDD	
		2	TDD	
TDD special subframe configuration <sup>Note1</sup>		2	6	
TDD uplink-downlink configuration <sup>Note1</sup>		2	1	
BW <sub>channel</sub>	MHz	1, 2	5 MHz: N <sub>RB,c</sub> = 25 10 MHz: N <sub>RB,c</sub> = 50 20 MHz: N <sub>RB,c</sub> = 100	
PDSCH parameters: DL Reference Measurement Channel <sup>Note2</sup>		1	5 MHz: R.7 FDD 10 MHz: R.3 FDD 20 MHz: R.6 FDD	
		2	5 MHz: R.4 TDD 10 MHz: R.0 TDD 20 MHz: R.3 TDD	
PCFICH/PDCCH/PHICH parameters: DL Reference Measurement Channel <sup>Note2</sup>		1	5 MHz: R.11 FDD 10 MHz: R.6 FDD 20 MHz: R.10 FDD	
		2	5 MHz: R.11 TDD 10 MHz: R.6 TDD 20 MHz: R.10 TDD	
OCNG Patterns <sup>Note2</sup>		1	5 MHz: OP.20 FDD 10 MHz: OP.10 FDD 20 MHz: OP.17 FDD	
		2	5 MHz: OP.9 TDD 10 MHz: OP.1 TDD 20 MHz: OP.7 TDD	
b2-Threshold1	dBm	1, 2	-77 for RSRP	
	dB	1, 2	77 for RSRQ	
	dB	1, 2	90 for SINR	
PBCH_RA	dB	1, 2	0	
PBCH_RB				
PSS_RA				
SSS_RA				
PCFICH_RB				
PHICH_RA				
PHICH_RB				
PDCCH_RA				
PDCCH_RB				
PDSCH_RA				
PDSCH_RB				
OCNG_RA <sup>Note3</sup>				
OCNG_RB <sup>Note3</sup>				
N <sub>oc</sub> <sup>Note4</sup>				
$\bar{E}_s/N_{oc}$	dB	1, 2	17	17

$\bar{E}_s/I_{ot}$ <sup>Note5</sup>	dB	1, 2	17	17
RSRP <sup>Note5</sup>	dBm/15kHz	1, 2	-87	-87
SCH_RP <sup>Note5</sup>	dBm/15kHz	1, 2	-87	-87
$I_o$ <sup>Note5</sup>	dBm/9MHz	1, 2	$-59.13+10\log(N_{RB,c}/50)$	$-59.13+10\log(N_{RB,c}/50)$
Propagation Condition <sup>Note6</sup>		1, 2	AWGN	
Antenna Configuration and Correlation Matrix <sup>Note6</sup>		1, 2	1x2 Low	
<p>Note 1: Special subframe and uplink-downlink configurations are specified in table 4.2-1 in TS 36.211 [23].</p> <p>Note 2: DL RMCs and OCNG patterns are specified in clauses A 3.1 and A 3.2 of TS 36.133 [15] respectively.</p> <p>Note 3: OCNG shall be used such that all cells are fully allocated and a constant total transmitted power spectral density is achieved for all OFDM symbols.</p> <p>Note 4: Interference from other cells and noise sources not specified in the test is assumed to be constant over subcarriers and time and shall be modelled as AWGN of appropriate power for <math>N_{oc}</math> to be fulfilled.</p> <p>Note 5: <math>\bar{E}_s/I_{ot}</math>, RSRP, SCH_RP and <math>I_o</math> levels have been derived from other parameters for information purposes. They are not settable parameters themselves.</p> <p>Note 6: Propagation condition and correlation matrix are defined in clause B.2 in TS 36.101 [25].</p>				

**Table A.10.4.4.1-4: NR neighbour cell specific test parameters for NR inter-RAT event triggered reporting for FR1 with SSB time index detection**

Parameter	Unit	Test configuration	Cell 2		Cell 3	
			T1	T2	T2	T2
NR RF Channel Number		1, 2	2		3	
TDD configuration		1, 2	TDDConf.1.1 CCA		TDDConf.1.1 CCA	
BW <sub>channel</sub>	MHz	1, 2	40: $N_{RB,c} = 106$		40: $N_{RB,c} = 106$	
$P_{CCA\_DL}$ for dynamic channel access <sup>Note 6,8</sup>		1, 2	$P_{CCA\_DL\_1}=0.75$ $P_{CCA\_DL\_2}=0.75$		$P_{CCA\_DL\_1}=0.75$ $P_{CCA\_DL\_2}=0.75$	
$P_{CCA\_DL}$ for semi-static channel access <sup>Note 7,8</sup>		1, 2	$P_{CCA\_DL}=0.9375$		$P_{CCA\_DL}=0.9375$	
$P_{CCA\_UL}$ for dynamic channel access <sup>Note 6,8</sup>		1, 2	1		1	
$P_{CCA\_UL}$ for semi-static channel access <sup>Note 7,8</sup>		1, 2	1		1	
OCNG Patterns defined in A.3.2.1.1 (OP.1)		1, 2	OP.1		OP.1	
SMTc configuration defined in A.3.11.1 and A.3.11.2		1, 2	SMTc.1		SMTc.1	
DBT window configuration		1, 2	DBT.1		DBT.1	
SSB configuration for semi-static channel access		1, 2	SSB.1 CCA		SSB.1 CCA	
SSB configuration for dynamic channel access		1, 2	SSB.2 CCA		SSB.2 CCA	
PDSCH/PDCCH subcarrier spacing	kHz	1, 2	30		30	
b2-Threshold2NR	dBm	1, 2	NA		-98 for SS-RSRP	
	dB	1, 2	NA		55 for SS-RSRQ	
		1, 2	NA		50 for SS-SINR	
EPRE ratio of PSS to SSS		1, 2	0		0	
EPRE ratio of PBCH DMRS to SSS						
EPRE ratio of PBCH to PBCH DMRS						
EPRE ratio of PDCCH DMRS to SSS						
EPRE ratio of PDCCH to PDCCH DMRS						
EPRE ratio of PDSCH DMRS to SSS						
EPRE ratio of PDSCH to PDSCH						
EPRE ratio of OCNG DMRS to SSS (Note 1)						
EPRE ratio of OCNG to OCNG DMRS (Note 1)						

$N_{oc}$ <sup>Note2</sup>	dBm/15kHz	1, 2	-98		-98	
$N_{oc}$ <sup>Note2</sup>	dBm/SCS	1, 2	-95		-95	
SS-RSRP <sup>Note 3,5</sup>	dBm/SCS	1, 2	-91	-91	-Infinity	-88
$\hat{E}_s/I_{ot}$ <sup>Note 5</sup>	dB	1, 2	4	4	-Infinity	7
$\hat{E}_s/N_{oc}$ <sup>Note 5</sup>	dB	1, 2	4	4	-Infinity	7
$I_o$ <sup>Note3</sup>	dBm/38.16MHz	1, 2	-58.49	-58.49	-63.95	-56.16
Propagation Condition		1, 2	AWGN		AWGN	
Antenna Configuration and Correlation Matrix		1, 2,	1x2 Low		1x2 Low	
<p>NOTE 1: OCNG shall be used such that the cell is fully allocated and a constant total transmitted power spectral density is achieved for all OFDM symbols.</p> <p>NOTE 2: Interference from other cells and noise sources not specified in the test is assumed to be constant over subcarriers and time and shall be modelled as AWGN of appropriate power for <math>N_{oc}</math> to be fulfilled.</p> <p>NOTE 3: SS-RSRP and <math>I_o</math> levels have been derived from other parameters for information purposes. They are not settable parameters themselves.</p> <p>NOTE 4: SS-RSRP minimum requirements are specified assuming independent interference and noise at each receiver antenna port.</p> <p>NOTE 5: The signal levels apply for SSS REs when the discovery burst is transmitted during DBT windows.</p>						

#### A.10.4.4.4.2 Test Requirements

In test 1 with per-UE gap, the UE shall send one Event B2 triggered measurement report, with a measurement reporting delay less than  $T_{\text{identify\_irat\_cca\_with\_index}}$  ms from the beginning of time period T2. The UE shall not send event triggered measurement reports, as long as the reporting criteria are not fulfilled. The rate of correct events observed during repeated tests shall be at least 90%.

In test 2 with per-UE gap, the UE shall send one Event B2 triggered measurement report, with a measurement reporting delay less than  $T_{\text{identify\_irat\_cca\_with\_index}}$  ms from the beginning of time period T2. The UE shall not send event triggered measurement reports, as long as the reporting criteria are not fulfilled. The rate of correct events observed during repeated tests shall be at least 90%.

In test 3 with per-FR gap, the UE shall send one Event B2 triggered measurement report, with a measurement reporting delay less than  $T_{\text{identify\_irat\_cca\_with\_index}}$  ms from the beginning of time period T2. The UE shall not send event triggered measurement reports, as long as the reporting criteria are not fulfilled. The rate of correct events observed during repeated tests shall be at least 90%.

In test 4 with per-FR gap, the UE shall send one Event B2 triggered measurement report, with a measurement reporting delay less than  $T_{\text{identify\_irat\_cca\_with\_index}}$  ms from the beginning of time period T2. The UE shall not send event triggered measurement reports, as long as the reporting criteria are not fulfilled. The rate of correct events observed during repeated tests shall be at least 90%.

In tests 1, 2, 3 and 4, the UE is required to report SSB time index.

NOTE: The actual overall delays measured in the test may be up to  $2 \times TTI_{\text{DCCH}}$  higher than the measurement reporting delays above because of TTI insertion uncertainty of the measurement report in DCCH.

## A.10.5 Measurement performance

### A.10.5.1 SS-RSRP

#### A.10.5.1.1 Intra-frequency measurement accuracy on a CCA serving cell

##### A.10.5.1.1.1 Test Purpose and Environment

The purpose of this test is to verify that the SS-RSRP measurement accuracy is within the specified limits. This test will verify the requirements in clause 10.1.36.1.1 and 10.1.36.1.2 when the serving cell is subject to CCA.

A.10.5.1.1.2 Test parameters

In this set of test cases there are two cells in the test, E-UTRAN PCell (Cell 1), FR1 PSCell under CCA (Cell 2). Cell 2 operates on a carrier frequency with CCA and transmits SSBs in DBT window according to DL CCA model. Supported test configurations are shown in Table A.10.5.1.1.1-1. Both absolute and relative accuracy of SS-RSRP intra-frequency measurements are tested by using the parameters in Table A.10.5.1.1.1-2. The configuration of cell 1 (E-UTRA PCell) is specified in clause A.3.7A.2.1. In all test cases, Cell 2 is the PSCell, and Cell 3 is the target cell.

**Table A.10.5.1.1.2-1: SS-RSRP Intra frequency SS-RSRP supported test configurations**

Config	Description
1	LTE FDD, NR 30kHz SSB SCS, 40 MHz bandwidth, TDD duplex mode
2	LTE TDD, NR 30kHz SSB SCS, 40 MHz bandwidth, TDD duplex mode

Note: The UE is only required to be tested in one of the supported test configurations for each supported band

**Table A.10.5.1.1.2-2: SS-RSRP Intra frequency test parameters**

Parameter		Unit	Test 1		Test 2		
			Cell 2	Cell 3	Cell 2	Cell 3	
Physical cell ID			489	0	489	0	
SSB ARFCN			freq1				
Duplex mode		Config 1, 2	TDD				
TDD configuration		Config 1, 2	TDDConf.1.1 CCA				
BW <sub>channel</sub>		Config 1, 2	40: N <sub>RB,c</sub> = 106				
Downlink initial BWP configuration			DLBWP.0.1				
Downlink dedicated BWP configuration			DLBWP.1.1				
Uplink initial BWP configuration			ULBWP.0.1				
Uplink dedicated BWP configuration			ULBWP.1.1				
TRS configuration		Config 1, 2	TRS.1.2 TDD	NA	TRS.1.2 TDD	NA	
DRX Cycle		ms	Not Applicable				
PDSCH Reference measurement channel		Config 1, 2	SR.1.1 CCA		SR.1.1 CCA		
RMSI CORESET Reference Channel		Config 1, 2	CR.1.1 CCA		CR.1.1 CCA		
Control Channel RMC		Config 1, 2	CCR.1.1 CCA		CCR.1.1 CCA		
DL CCA model			As specified in clause A.3.26.2.1				
UL CCA model			As specified in clause A.3.26.2.2				
P <sub>CCA,DL</sub> for dynamic channel access <sup>Note 7,8</sup>		Config 1, 2	P <sub>CCA,DL1</sub> =0.75 P <sub>CCA,DL2</sub> =0.75	P <sub>CCA,DL1</sub> =0.75 P <sub>CCA,DL2</sub> =0.75	P <sub>CCA,DL1</sub> =0.75 P <sub>CCA,DL2</sub> =0.75	P <sub>CCA,DL1</sub> =0.75 P <sub>CCA,DL2</sub> =0.75	
P <sub>CCA,DL</sub> for semi-static channel access <sup>Note 6.8</sup>		Config 1, 2	P <sub>CCA,DL</sub> =0.937 5	P <sub>CCA,DL</sub> =0.937 5	P <sub>CCA,DL</sub> =0.937 5	P <sub>CCA,DL</sub> =0.937 5	
P <sub>CCA,UL</sub>		Config 1, 2	1	1	1	1	
SSB configuration	Semi-static channel access	Config 1, 2	SSB.1 CCA (As defined in A.3.10A)	SSB.1 CCA (As defined in A.3.10A)	SSB.1 CCA (As defined in A.3.10A)	SSB.1 CCA (As defined in A.3.10A)	
	Dynamic channel access		SSB.2 CCA (As defined in A.3.10A)	SSB.2 CCA (As defined in A.3.10A)	SSB.2 CCA (As defined in A.3.10A)	SSB.2 CCA (As defined in A.3.10A)	
Time offset with Cell 2		Config 1, 2	μs	-	3	-	3
SMTC configuration		Config 1, 2	SMTC.1				
DBT Window Configuration		Config 1, 2	As defined in A.3.28.1				
DL CCA model		Config 1, 2	As specified in clause A.3.26.2.1				
UL CCA model		Config 1, 2	As specified in clause A.3.26.2.2				
OCNG Patterns			OP.1				
PDSCH/PDCCH subcarrier spacing		Config 1, 2	kHz				30kHz
EPRE ratio of PSS to SSS		dB	0	0	0	0	
EPRE ratio of PBCH DMRS to SSS							
EPRE ratio of PBCH to PBCH DMRS							
EPRE ratio of PDCCH DMRS to SSS							
EPRE ratio of PDCCH to PDCCH DMRS							
EPRE ratio of PDSCH DMRS to SSS							
EPRE ratio of PDSCH to PDSCH							
EPRE ratio of OCNG DMRS to SSS(Note 1)							



EPRE ratio of OCNG to OCNG DMRS (Note 1)							
$N_{oc}$ <small>Note2</small>	Config 1, 2	NR_CCA_FR1_I	dBm/15Kh Z	-94		-110	
		NR_CCA_FR1_J				-109.5	
$N_{oc}$ <small>Note2</small>	Config 1, 2	NR_CCA_FR1_I	dBm/SCS	-91		-107.0	
		NR_CCA_FR1_J				-106.5	
$\hat{E}_s/I_{ot}$			dB	2.46	-5.97	-2.01	-3.54
$\hat{E}_s/N_{oc}$			dB	6	1	1	0
SS-RSRP <small>Note3</small>	Config 1, 2	NR_CCA_FR1_I	dBm/SCS	-85	-90	-106.00	-107.00
		NR_CCA_FR1_J				-105.50	-106.50
$I_o$ <small>Note3</small>	Config 1, 2	NR_CCA_FR1_I	dBm/38.16MHz	-51.99		-70.82	
		NR_CCA_FR1_J				-70.32	
Propagation condition			-	AWGN			
Antenna configuration				1x2			
<p>Note 1: OCNG shall be used such that both cells are fully allocated and a constant total transmitted power spectral density is achieved for all OFDM symbols.</p> <p>Note 2: Interference from other cells and noise sources not specified in the test is assumed to be constant over subcarriers and time and shall be modelled as AWGN of appropriate power for <math>N_{oc}</math> to be fulfilled.</p> <p>Note 3: SS-RSRP and <math>I_o</math> levels have been derived from other parameters for information purposes. They are not settable parameters themselves.</p> <p>Note 4: SS-RSRP minimum requirements are specified assuming independent interference and noise at each receiver antenna port.</p> <p>Note 5: For UE supporting both semi-static and dynamic channel access, the UE must be tested under both dynamic and semi-static channel occupancy configurations.</p> <p>Note 6: For UE supporting semi-static channel access and network configuring semi-static channel occupancy.</p> <p>Note 7: For UE supporting dynamic channel access and network configuring dynamic channel occupancy.</p> <p>Note 8: For a UE supporting both semi-static and dynamic channel access, the UE can be tested under dynamic channel occupancy only.</p>							

A.10.5.1.1.3 Test Requirements

The SS-RSRP measurement accuracy for cell 2 and cell 3 shall fulfil absolute requirement in clause 10.1.2.1.1 and relative requirement in clause 10.1.36.1.1 and 10.1.36.1.2.

## A.10.5.1.2 Inter-frequency measurement accuracy with FR1 CCA serving cell and FR1 CCA target cell

### A.10.5.1.2.1 Test Purpose and Environment

The purpose of this test is to verify that the SS-RSRP measurement accuracy is within the specified limits. This test will verify the requirements in clauses 10.1.37.1.1 and 10.1.37.1.2 for inter-frequency measurements with the testing configurations in Table A.10.5.1.2.1-1.

**Table A.10.5.1.2.1-1: Applicable NR configurations for FR1 inter-frequency SS-RSRP accuracy test**

Config	Description
1	LTE FDD, NR 30 kHz SSB SCS, 40 MHz bandwidth, TDD duplex mode
2	LTE TDD, NR 30 kHz SSB SCS, 40 MHz bandwidth, TDD duplex mode
Note:	The UE is only required to be tested in one of the supported test configurations on each supported band

### A.10.5.1.2.2 Test parameters

In this set of test cases there are three cells in the test, E-UTRAN PCell (Cell 1), FR1 PSCell (Cell 2) and a FR1 neighbour cell (Cell 3) on a different frequency than the PSCell. The test parameters and applicability for Cell 1 are defined in A.3.7A.2.1. The test parameters for the Cell 2 and Cell 3 are given in Table A.10.5.1.2.2-1 below. Both absolute and relative accuracy of RSRP inter-frequency measurements are tested by using the parameters in Table A.10.5.1.2.2-1. The inter-frequency measurements are supported by a measurement gap.

**Table A.10.5.1.2.2-1: SS-RSRP inter-frequency test parameters**

Parameter		Config	Unit	Test 1		Test 2	
				Cell 2	Cell 3	Cell 2	Cell 3
SSB ARFCN		1, 2		freq1	freq2	freq1	freq2
BW <sub>channel</sub>		1, 2	MHz	40: N <sub>RB,c</sub> = 106		40: N <sub>RB,c</sub> = 106	
Gap pattern ID				0		0	
Duplex mode		1, 2		TDD		TDD	
TDD configuration		1, 2		TDDConf.1.1 CCA		TDDConf.1.1 CCA	
PDSCH Reference measurement channel		1, 2		SR.1.1 CCA		SR.1.1 CCA	
RMSI CORESET Reference Channel		1, 2		CR.1.1 CCA	-	CR.1.1 CCA	-
Dedicated CORESET Reference Channel		1, 2		CCR.1.1 CCA	-	CCR.1.1 CCA	-
SSB configuration	Semi-static channel access	1, 2		SSB.1 CCA (As defined in A.3.10A)		SSB.1 CCA (As defined in A.3.10A)	
	Dynamic channel access			SSB.2 CCA (As defined in A.3.10A)		SSB.2 CCA (As defined in A.3.10A)	
OCNG Patterns		1, 2		OP.1		OP.1	
TRS configuration		1, 2		TRS.1.2 TDD		TRS.1.2 TDD	
Initial BWP Configuration		1, 2		DLBWP.0.1 ULBWP.0.1		DLBWP.0.1 ULBWP.0.1	
Dedicated BWP configuration		1, 2		DLBWP.1.1 ULBWP.1.1		DLBWP.1.1 ULBWP.1.1	
Time offset with Cell 2		1, 2	μs	-	3	-	3
SMTC configuration		1, 2		TBD		TBD	
DBT Window Configuration		1, 2		As defined in A.3.28.1		As defined in A.3.28.1	
DL CCA model				As specified in clause A.3.20.2.1			
UL CCA model				As specified in clause A.3.20.2.2			
EPRE ratio of PSS to SSS		1, 2	dB	0	0	0	0
EPRE ratio of PBCH DMRS to SSS							
EPRE ratio of PBCH to PBCH DMRS							
EPRE ratio of PDCCH DMRS to SSS							
EPRE ratio of PDCCH to PDCCH DMRS							

EPRE ratio of PDSCH DMRS to SSS							
EPRE ratio of PDSCH to PDSCH DMRS							
EPRE ratio of OCNG DMRS to SSS <sup>Note 1</sup>							
EPRE ratio of OCNG to OCNG DMRS <sup>Note 1</sup>							
$N_{oc}$ <sup>Note2</sup>	NR_CCA_FR1_I	1, 2	dBm/15kHz	-94.65		$(N_{oc}$ for Cell 3 +8dB)	-111
	NR_CCA_FR1_J						-110.5
$N_{oc}$ <sup>Note2</sup>	NR_CCA_FR1_I	1, 2	dBm/SSB SCS	-91.65		$(N_{oc}$ for C 3 +8dB)	-109.00
	NR_CCA_FR1_J						-108.50
$\hat{E}_s / I_{ot}$		1, 2	dB	10	10	13	-3
SS-RSRP <sup>Note3</sup>	NR_CCA_FR1_I	1, 2	dBm/SCS	-81.65		(RSRP for Cell 3 +25dB)	-111.00
	NR_CCA_FR1_J						-110.50
$I_o$ <sup>Note3</sup>	R_CCA_FR1_I	1, 2	dBm/ 38.16MHz	-50.19		$(I_o$ for Channel 3 +19.75dB)	-75.19
	NR_CCA_FR1_J						-74.69
$\hat{E}_s / N_{oc}$		1, 2	dB	10	10	13	-3
Propagation condition		1, 2	-	AWGN		AWGN	
Antenna configuration				1x2		1x2	
<p>Note 1: OCNG shall be used such that both cells are fully allocated and a constant total transmitted power spectral density is achieved for all OFDM symbols.</p> <p>Note 2: Interference from other cells and noise sources not specified in the test is assumed to be constant over subcarriers and time and shall be modelled as AWGN of appropriate power for <math>N_{oc}</math> to be fulfilled.</p> <p>Note 3: RSRP and <math>I_o</math> levels have been derived from other parameters for information purposes. They are not settable parameters themselves.</p> <p>Note 4: RSRP minimum requirements are specified assuming independent interference and noise at each receiver antenna port.</p> <p>Note 5: For UE supporting both semi-static and dynamic channel access, the UE must be tested under both dynamic and semi-static channel occupancy configurations.</p>							

A.10.5.1.2.3 Test Requirements

The SS-RSRP measurement accuracy for Cell 2 and Cell 3 shall fulfil the Absolute requirement in clause 10.1.4.1.1 and Relative requirement in clause 10.1.37.1.1 and 10.1.37.1.2.

## A.10.5.2 SS-RSRQ

### A.10.5.2.1 Intra-frequency measurement accuracy with FR1 CCA serving cell and FR1 CCA target cell

#### A.10.5.2.1.1 Test Purpose and Environment

The purpose of this test is to verify that the SS-RSRQ measurement accuracy is within the specified limits. This test will verify the requirements in clause 10.1.29.1.1.

#### A.10.5.2.1.2 Test Parameters

In this test case all cells are on the same carrier frequency. Supported test configuration are shown in Table A.10.5.2.1.2-1. The absolute accuracy of SS-RSRQ intra-frequency measurement is test by using the parameters in Table A.10.5.2.1.2-2. The configuration of cell 1 (E-UTRA PCell) is specified in clause A.3.7A.2.1. In all test cases, Cell 2 is the PSCell and Cell 3 is the target cell.

**Table A.10.5.2.1.2-1: SS-RSRQ Intra frequency SS-RSRQ supported test configurations**

Config	Description
1	LTE FDD, NR 30kHz SSB SCS, 40MHz bandwidth, TDD duplex mode
2	LTE TDD, NR 30kHz SSB SCS, 40MHz bandwidth, TDD duplex mode

Note: The UE is only required to be tested in one of the supported test configurations in each supported band

**Table A.10.5.2.1.2-2: SS-RSRQ Intra frequency test parameters**

Parameter		Unit	Test 1		Test 3	
			Cell 2	Cell 3	Cell 2	Cell 3
SSB ARFCN			freq1			
Duplex mode	Config 1, 2		TDD			
TDD configuration	Config 1, 2		TDDConf.1.1 CCA			
BW <sub>channel</sub>	Config 1, 2	MHz	40: N <sub>RB,c</sub> = 106			
BWP configuration	Initial DL BWP		DLBWP.0.1			
	Dedicated DL BWP		DLBWP.1.1			
	Initial UL BWP		ULBWP.0.1			
	Dedicated UL BWP		ULBWP.1.1			
DRX Cycle		ms	Not Applicable			
PDSCH Reference measurement channel	Config 1, 2		SR.1.1 CCA		SR.1.1 CCA	
RMSI CORESET Reference Channel	Config 1, 2		CR.1.1 CCA		CR.1.1 CCA	
Control Channel RMC	Config 1, 2		CCR.1.1 CCA		CCR.1.1 CCA	
TRS configuration	Config 1, 2		TRS.1.2 TDD		TRS.1.2 TDD	
OCNG Patterns			OP. 1			
SS-RSSI-Measurement			Not Applicable			
Time offset with Cell 2	Config 1, 2	µs	-	3	-	3
SMTC configuration	Config 1, 2		SMTC.1			
SSB configuration	Semi-static channel access	Config 1, 2	SSB.1 CCA (As defined in A.3.10A)			
	Dynamic channel access		SSB.2 CCA (As defined in A.3.10A)			
PDSCH/PDCCH subcarrier spacing	Config 1, 2	kHz	30kHz			
DBT Window Configuration	Config 1, 2		DBT.1 (As defined in A.3.28.1)			
DL CCA model	Config 1, 2		As specified in clause A.3.26.2.1			
UL CCA model	Config 1, 2		As specified in clause A.3.26.2.2			
EPRE ratio of PSS to SSS		dB	0	0	0	0
EPRE ratio of PBCH DMRS to SSS						
EPRE ratio of PBCH to PBCH DMRS						
EPRE ratio of PDCCH DMRS to SSS						
EPRE ratio of PDCCH to PDCCH DMRS						

EPRE ratio of PDSCH DMRS to SSS							
EPRE ratio of PDSCH to PDSCH							
EPRE ratio of OCNG DMRS to SSS(Note 1)							
EPRE ratio of OCNG to OCNG DMRS (Note 1)							
$N_{oc}$ <sup>Note2</sup>	Config1, 2	NR_CCA_FR1_I	Bm/15kHz	-91		-110	
		NR_CCA_FR1_J					
$N_{oc}$ <sup>Note2</sup>	Config 1, 2	NR_CCA_FR1_I	dBm/SC S	-88		-107	
		NR_CCA_FR1_J					
$\hat{E}_s/I_{ot}$			dB	-1.76		-5.46	-5.46
$\hat{E}_s/N_{oc}$			dB	3	3	-4	-4
SS-RSRP <sup>Note3</sup>	Config 1, 2	NR_CCA_FR1_I	dBm/SCS	-85	-85	-111	-111
		NR_CCA_FR1_J					
SS-RSRQ <sup>Note3</sup>		NR_CCA_FR1_I	dB	-14.77	-14.77	-17.34	-17.34
		NR_CCA_FR1_J					
$I_o$ <sup>Note3</sup>	Config 1, 2	NR_CCA_FR1_I	dBm/ 38.16MHz	-50			
		NR_CCA_FR1_J					
Propagation condition			-	AWGN	AWGN	AWGN	AWGN
Antenna configuration				1x2	1x2	1x2	1x2
<p>Note 1: OCNG shall be used such that both cells are fully allocated and a constant total transmitted power spectral density is achieved for all OFDM symbols.</p> <p>Note 2: Interference from other cells and noise sources not specified in the test is assumed to be constant over subcarriers and time and shall be modelled as AWGN of appropriate power for <math>N_{oc}</math> to be fulfilled.</p> <p>Note 3: SS-RSRQ, SS-RSRP, and <math>I_o</math> levels have been derived from other parameters for information purposes. They are not settable parameters themselves.</p> <p>Note 4: SS-RSRQ, SS-RSRP minimum requirements are specified assuming independent interference and noise at each receiver antenna port.</p> <p>Note 5: NR operating band groups are as defined in Clause 3.5.2.</p> <p>Note 6: For UE supporting both semi-static and dynamic channel access, the UE must be tested under both dynamic and semi-static channel occupancy configurations.</p>							

### A.10.5.2.1.3 Test Requirements

The SS-RSRQ measurement accuracy shall fulfil the requirements in clause 10.1.29.1.1.

### A.10.5.2.2 Inter-frequency measurement accuracy with FR1 CCA serving cell and FR1 CCA target cell

#### A.10.5.2.2.1 Test Purpose and Environment

The purpose of this test is to verify that the SS-RSRQ measurement accuracy is within the specified limits. This test will verify the requirements in clause 10.1.30.1.1 and 10.1.30.1.2 for inter-frequency measurements with the testing configurations in Table A.10.5.2.2.2-1.

#### A.10.5.2.2.2 Test Parameters

In this set of test cases there are three cells in the test, E-UTRAN PCell (Cell 1), FR1 PCell (Cell 2) and a FR1 neighbour cell (Cell 3) on a different frequency than the PCell. The test parameters and applicability for Cell 1 are defined in A.3.7.2. The test parameters for the Cell 2 and Cell 3 are given in Table A.4.7.1.2.2-1 below. Both absolute and relative accuracy of RSRP inter-frequency measurements are tested by using the parameters in Table A.10.5.2.2.2-2. The inter-frequency measurements are supported by a measurement gap.

**Table A.10.5.2.2-1: SS-RSRQ Inter frequency SS-RSRQ supported test configurations**

Config	Description
1	LTE FDD, NR 30kHz SSB SCS, 40MHz bandwidth, TDD duplex mode
2	LTE TDD, NR 30kHz SSB SCS, 40MHz bandwidth, TDD duplex mode
Note: The UE is only required to be tested in one of the supported test configurations in each supported band	

**Table A.10.5.2.2-2: SS-RSRQ Inter frequency test parameters**

Parameter		Unit	Test 1		Test 2		Test 3		
			Cell 2	Cell 3	Cell 2	Cell 3	Cell 2	Cell 3	
SSB ARFCN			freq1	freq2	freq1	freq2	freq1	freq2	
Duplex mode		Config 1, 2	TDD						
TDD configuration		Config 1, 2	TDDConf.1.1 CCA						
BW <sub>channel</sub>		Config 1, 2	40: N <sub>RB,c</sub> = 106						
BWP BW		Config 1, 2	40: N <sub>RB,c</sub> = 106						
Gap pattern ID			0						
DRX Cycle		ms	Not Applicable						
PDSCH Reference measurement channel		Config 1, 2	SR.1.1 CCA		SR.1.1 CCA		SR.1.1 CCA		
RMSI CORESET Reference Channel		Config 1, 2	CR.1.1 CCA		CR.1.1 CCA		CR.1.1 CCA		
Dedicated CORESET Reference Channel		Config 1, 2	CCR.1.1 CCA		CCR.1.1 CCA		CCR.1.1 CCA		
TRS configuration		Config 1, 2	TRS.1.2 TDD		TRS.1.2 TDD		TRS.1.2 TDD		
OCNG Patterns			OCNG pattern 1						
Time offset with Cell 2		Config 1, 2	μs	-	3	-	3	-	3
SMTC configuration		Config 1, 2	SMTC.1						
SSB configuration	Semi-static channel access	Config 1, 2	SSB.1 CCA (As defined in A.3.10A)						
	Dynamic channel access		SSB.2 CCA (As defined in A.3.10A)						
DBT Window Configuration		Config 1, 2	DBT.1 (As defined in A.3.28.1)						
DL CCA model		Config 1, 2	As specified in clause A.3.26.2.1						
UL CCA model		Config 1, 2	As specified in clause A.3.26.2.2						
PDSCH/PDCCH subcarrier spacing		Config 1, 2	30 kHz						
EPRE ratio of PSS to SSS			dB		0	0	0	0	0
EPRE ratio of PBCH DMRS to SSS									
EPRE ratio of PBCH to PBCH DMRS									
EPRE ratio of PDCCH DMRS to SSS									
EPRE ratio of PDCCH to PDCCH DMRS									
EPRE ratio of PDSCH DMRS to SSS									
EPRE ratio of PDSCH to PDSCH									
EPRE ratio of OCNG DMRS to SSS(Note 1)									
EPRE ratio of OCNG to OCNG DMRS (Note 1)									
$N_{oc}^{Note2}$	Config 1, 2	NR_CCA_FR1_I	dBm/15kHz	-86.27	-86.27	-113	-113	-112	-112
		NR_CCA_FR1_J						-111.5	-111.5
$N_{oc}^{Note2}$	Config 1, 2	NR_CCA_FR1_I	dBm/SCS	-83.27	-83.27	-110	-110	-109	-109
		NR_CCA_FR1_J						-108.5	-108.5
$\hat{E}_s / I_{ot}$			dB	-1.75	-1.75	-1.75	-1.75	3	-1.75
$\hat{E}_s / N_{oc}$			dB	-1.75	-1.75	-1.75	-1.75	3	-1.75
SS-RSRP <sup>Note3</sup>	Config 1, 2	NR_CCA_FR1_I	dBm/SCS	-85.02	-85.02	-111.75	-111.75	-106	-110.75
		NR_CCA_FR1_J						-105.5	-110.25

SS-RSRQ <sup>Note3</sup>		NR_CCA_FR1_I	dB	-14.77	-14.77	-40.59	-40.59	-12.56	-14.76
		NR_CCA_FR1_J							
I <sub>o</sub> <sup>Note3</sup>	Config 1, 2	NR_CCA_FR1_I	dBm/ 38.16MHz	-50	-50	-76.73	-76.73	-73.19	-75.23
		NR_CCA_FR1_J						-72.69	-74.73
Propagation condition				AWGN	AWGN	AWGN	AWGN	AWGN	AWGN
Note 1: OCNG shall be used such that both cells are fully allocated and a constant total transmitted power spectral density is achieved for all OFDM symbols.									
Note 2: Interference from other cells and noise sources not specified in the test is assumed to be constant over subcarriers and time and shall be modelled as AWGN of appropriate power for $N_{oc}$ to be fulfilled.									
Note 3: SS-RSRQ, SS-RSRP, and I <sub>o</sub> levels have been derived from other parameters for information purposes. They are not settable parameters themselves.									
Note 4: SS-RSRQ, SS-RSRP minimum requirements are specified assuming independent interference and noise at each receiver antenna port.									
Note 5: NR operating band groups are as defined in Section 3.5.2.									
Note 6: For UE supporting both semi-static and dynamic channel access, the UE must be tested under both dynamic and semi-static channel occupancy configurations.									

### A.10.5.2.2.3 Test Requirements

The SS-RSRQ measurement accuracy shall fulfil the requirements in clause 10.1.30.1.1 and 10.1.30.1.2.

## A.10.5.3 SS-SINR

### A.10.5.3.1 Intra-frequency measurement accuracy on PSSC

#### A.10.5.3.1.1 Test Purpose and Environment

The purpose of this test is to verify that the SS-SINR measurement accuracy is within the specified limits. This test will verify the requirements in clause 10.1.31.1.

#### A.10.5.3.1.2 Test Parameters

In this test case all cells are on the same carrier frequency. Supported test configuration are shown in Table A.10.5.3.1.2-1. The absolute accuracy of SS-SINR intra-frequency measurement is tested by using the parameters in Table A.10.5.3.1.2-2. The configuration of cell 1 (E-UTRA PCell) is specified in clause A.3.7A.2.1. In all test cases, Cell 2 is the PCell with CCA and Cell 3 is the target cell with CCA. Two sub-tests (Test 1 and Test 2) are provided different  $N_{oc}$  on Cells 2 and 3.

**Table A.10.5.3.1.2-1: SS-SINR Intra frequency SS-SINR supported test configurations**

Config	Description
1	LTE FDD NR 30 kHz SSB SCS, 40 MHz bandwidth, TDD duplex mode
2	LTE TDD NR 30 kHz SSB SCS, 40 MHz bandwidth, TDD duplex mode

Note: The UE is only required to be tested in one of the supported test configurations

**Table A.10.5.3.1.2-2: SS-SINR Intra frequency test parameters**

Parameter		Unit	Test 1		Test 2	
			Cell 2	Cell 3	Cell 2	Cell 3
SSB ARFCN			freq1		freq1	
DL CCA model	Config 1,2		As specified in clause A.3.26.2.1			
UL CCA model	Config 1,2		As specified in clause A.3.26.2.2			
UL CCA probability	$P_{CCA\_UL}$		1.0	-	1.0	-
DL CCA probability for semi-static channel access <sup>Note 7, 8</sup>	$P_{CCA\_DL}$		0.9375	-	0.9375	-
DL CCA probability for	$P_{CCA\_DL\_1}$		0.75	-	0.75	-

dynamic channel access <small>Note 8, 9</small>						
	P <sub>CCA_DL_2</sub>		0.75	-	0.75	-
Duplex mode	Config 1,2		TDD			
TDD configuration	Config 1,2		TDDConf.1.1 CCA			
Downlink initial BWP configuration			DLBWP.0.1			
Downlink dedicated BWP configuration			DLBWP.1.1			
Uplink initial BWP configuration			ULBWP.0.1			
Uplink dedicated BWP configuration			ULBWP.1.1			
DRX Cycle configuration		ms	Not Applicable			
TRS Configuration	Config 1,2		TRS.1.2 TDD		TRS.1.2 TDD	
PDSCH Reference measurement channel	Config 1,2		SR.1.1 CCA		SR.1.1 CCA	
RMSI CORESET Reference Channel	Config 1,2		CR.1.1 CCA		CR.1.1 CCA	
Dedicated CORESET Reference Channel	Config 1,2		CCR.1.1 CCA		CCR.1.1 CCA	
OCNG Patterns			OP.1			
SS-RSSI-Measurement			Not Applicable			
Time offset with Cell 2	Config 1,2	µs	-	3	-	3
DBT Window Configuration	Config 1,2		DBT.1			
SSB configuration	Config 1,2		SSB.1 CCA for semi-static channel access SSB.2 CCA for dynamic channel access			
SMTC configuration	Config 1,2		SMTC.1			
PDSCH/PDCCH subcarrier spacing	Config 1,2	kHz	30			
EPRE ratio of PSS to SSS		dB	0	0	0	0
EPRE ratio of PBCH DMRS to SSS						
EPRE ratio of PBCH to PBCH DMRS						
EPRE ratio of PDCCH DMRS to SSS						
EPRE ratio of PDCCH to PDCCH DMRS						
EPRE ratio of PDSCH DMRS to SSS						
EPRE ratio of PDSCH to PDSCH						
EPRE ratio of OCNG DMRS to SSS(Note 1)						
EPRE ratio of OCNG to OCNG DMRS (Note 1)						
$N_{oc}$ <small>Note2</small>		dBm/15kHz z	-93		-112	
	NR_CCA_FR1_I					
	NR_CCA_FR1_J				-111.5	
$N_{oc}$ <small>Note2</small>	Config 1,2	dBm/SCS	-90		-109	
	NR_CCA_FR1_I					
	NR_CCA_FR1_J				-108.5	
$\hat{E}_s / I_{ot}$		dB	0	-3.19	-5.46	-5.46
$\hat{E}_s / N_{oc}$		dB	4.54	2.66	-4	-4
SS-RSRP <small>Note3</small>	Config 1,2	dBm/SCS	-85.46	-87.34	-113	-113
	NR_CCA_FR1_I					
	NR_CCA_FR1_J				-112.5	-112.5
SS-SINR <small>Note3</small>		dB	0	-3.19	-5.46	-5.46
	NR_CCA_FR1_I					
	NR_CCA_FR1_J					
$I_o$ <small>Note3</small>	Config 1,2	dBm/ 38.16MHz	-51.41		-75.41	
	NR_CCA_FR1_I					
	NR_CCA_FR1_J				-74.91	
Propagation condition		-	AWGN			
Antenna configuration		-	1x2			
<p>Note 1: OCNG shall be used such that both cells are fully allocated and a constant total transmitted power spectral density is achieved for all OFDM symbols.</p> <p>Note 2: Interference from other cells and noise sources not specified in the test is assumed to be constant over subcarriers and time and shall be modelled as AWGN of appropriate power for <math>N_{oc}</math> to be fulfilled.</p> <p>Note 3: SS-SINR, SS-RSRP, and <math>I_o</math> levels have been derived from other parameters for information purposes. They are not settable parameters themselves.</p>						



Note 4:	SS-SINR, SS-RSRP minimum requirements are specified assuming independent interference and noise at each receiver antenna port.
Note 5:	NR operating band groups are as defined in Clause 3.5.2.
Note 6:	For UE supporting both semi-static and dynamic channel access, the UE must be tested under both dynamic and semi-static channel occupancy configuration.
Note 7:	For UE supporting semi-static channel access and network configuring semi-static channel occupancy.
Note 8:	For UE supporting dynamic channel access and network configuring dynamic channel occupancy.
Note 9:	For UE supporting both semi-static and dynamic channel access, the UE must be tested under both dynamic and semi-static channel occupancy configurations.

### A.10.5.3.1.3 Test Requirements

The SS-SINR measurement accuracy shall fulfil the requirements in clause 10.1.31.1.1.

### A.10.5.3.2 Inter-frequency measurement accuracy on PSCC

#### A.10.5.3.2.1 Test Purpose and Environment

The purpose of this test is to verify that the SS-SINR measurement accuracy is within the specified limits. This test will verify the requirements in clause 10.1.32.1.1 and 10.1.32.1.2 for inter-frequency measurement.

#### A.10.5.3.2.2 Test Parameters

In this test case the two NR cells (i.e., Cell 2 and Cell 3) are on different carrier frequencies and measurement gaps are provided. Supported test configurations are shown in Table A.10.5.3.2.2-1. Both absolute accuracy and relative accuracy requirements of SS-SINR inter-frequency measurement are tested by using test parameters in Table A.10.5.3.2.2-2. In all test cases, Cell 2 is the PSCell with CCA and Cell 3 is target cell with CCA. Cell 1 is the E-UTRA cell of which specific test parameters for this test case are specified in Table A.3.7A.2.1-1. Three sub-tests (Test 1, Test 2 and Test 3) are provided different  $N_{oc}$  on Cells 2 and 3.

**Table A.10.5.3.2.2-1: SS-SINR Inter frequency SS-SINR supported test configurations**

Config	Description
1	LTE FDD NR 30 kHz SSB SCS, 40 MHz bandwidth, TDD duplex mode
2	LTE TDD NR 30 kHz SSB SCS, 40 MHz bandwidth, TDD duplex mode
Note:	The UE is only required to be tested in one of the supported test configurations

**Table A.10.5.3.2.2-2: SS-SINR Inter frequency test parameters**

Parameter	Unit	Test 1		Test 2		Test 3	
		Cell 2	Cell 3	Cell 2	Cell 3	Cell 2	Cell 3
SSB ARFCN		freq1	freq2	freq1	freq2	freq1	freq2
DL CCA model	Config 1,2	As specified in clause A.3.26.2.1					
UL CCA model	Config 1,2	As specified in clause A.3.26.2.2					
UL CCA probability	$P_{CCA\_UL}$	1.0	-	1.0	-	1.0	-
DL CCA probability for semi-static channel access <small>Note 7, 8</small>	$P_{CCA\_DL}$	0.9375	-	0.9375	-	0.9375	-
DL CCA probability for dynamic channel access <small>Note 8, 9</small>	$P_{CCA\_DL\_1}$	0.75	-	0.75	-	0.75	-
	$P_{CCA\_DL\_2}$	0.75	-	0.75	-	0.75	-
Duplex mode	Config 1,2	TDD					
TDD configuration	Config 1,2	TDDConf.1.1 CCA					
Downlink initial BWP configuration		DLBWP.0.1					
Downlink dedicated BWP configuration		DLBWP.1.1					
Uplink initial BWP configuration		ULBWP.0.1					

Uplink dedicated BWP configuration			ULBWP.1.1					
DRX Cycle configuration		ms	Not Applicable					
Gap pattern ID			0	-	0	-	0	-
TRS configuration	Config 1,2		TRS.1.2 TDD		TRS.1.2 TDD		TRS.1.2 TDD	
PDSCH Reference measurement channel	Config 1,2		SR.1.1 CCA		SR.1.1 CCA		SR.1.1 CCA	
RMSI CORESET Reference Channel	Config 1,2		CR.1.1 CCA		CR.1.1 CCA		CR.1.1 CCA	
Dedicated CORESET Reference Channel	Config 1,2		CCR.1. 1 CCA		CCR.1. 1 CCA		CCR.1. 1 CCA	
OCNG Patterns			OP.1					
SS-RSSI-Measurement			Not Applicable					
Time offset with Cell 2	Config 1,2	μs	-	3	-	3	-	3
DBT Window configuration	Config 1,2		DBT.1					
SSB configuration	Config 1,2		SSB.1 CCA for semi-static channel access SSB.2 CCA for dynamic channel access					
SMTC configuration	Config 1,2		SMTC.1					
PDSCH/PDCCH subcarrier spacing	Config 1,2	kHz	30					
EPRE ratio of PSS to SSS		dB	0	0	0	0	0	0
EPRE ratio of PBCH DMRS to SSS								
EPRE ratio of PBCH to PBCH DMRS								
EPRE ratio of PDCCH DMRS to SSS								
EPRE ratio of PDCCH to PDCCH DMRS								
EPRE ratio of PDSCH DMRS to SSS								
EPRE ratio of PDSCH to PDSCH								
EPRE ratio of OCNG DMRS to SSS(Note 1)								
EPRE ratio of OCNG to OCNG DMRS (Note 1)								
$N_{oc}$ <sup>Note2</sup>		NR_CCA_FR1_I	dBm/15k Hz	-88	-108.5	-115.5		
		NR_CCA_FR1_J				-116		
$N_{oc}$ <sup>Note2</sup>	Config 1,2	NR_CCA_FR1_I	dBm/SC S	-85	-105.5	-112.5		
		NR_CCA_FR1_J				-113		
$\hat{E}_s / I_{ot}$		dB	-1.75	20	-4.0			
$\hat{E}_s / N_{oc}$		dB	-1.75	20	-4.0			
SS-RSRP <sup>Not e3</sup>	Config 1,2	NR_CCA_FR1_I		-86.75	-85.5	-116.5		
		NR_CCA_FR1_J				-116		
SS-SINR <sup>Note3</sup>		dB	-1.75	20	-4.0			
$I_o$ <sup>Note3</sup>	Config 1,2	NR_CCA_FR1_I	dBm/ 38.16MH z	-51.73	-54.41	-80		
		NR_CCA_FR1_J				-79.5		
Propagation condition		-	AWGN					
Antenna configuration		-	1x2					
<p>Note 1: OCNG shall be used such that both cells are fully allocated and a constant total transmitted power spectral density is achieved for all OFDM symbols.</p> <p>Note 2: Interference from other cells and noise sources not specified in the test is assumed to be constant over subcarriers and time and shall be modelled as AWGN of appropriate power for <math>N_{oc}</math> to be fulfilled.</p> <p>Note 3: SS-SINR, SS-RSRP, and <math>I_o</math> levels have been derived from other parameters for information purposes. They are not settable parameters themselves.</p> <p>Note 4: SS-SINR, SS-RSRP minimum requirements are specified assuming independent interference and noise at each receiver antenna port.</p> <p>Note 5: NR operating band groups are as defined in Clause 3.5.2.</p> <p>Note 6: For UE supporting both semi-static and dynamic channel access, the UE must be tested under both dynamic and semi-static channel occupancy configuration</p> <p>Note 7: For UE supporting semi-static channel access and network configuring semi-static channel occupancy.</p> <p>Note 8: For UE supporting dynamic channel access and network configuring dynamic channel occupancy.</p>								

Note 9: For UE supporting both semi-static and dynamic channel access, the UE must be tested under both dynamic and semi-static channel occupancy configurations.

### A.10.5.3.2.3 Test Requirements

The SS-SINR measurement accuracy shall fulfil the requirements in clause 10.1.32.1.1 and 10.1.32.1.2.

### A.10.5.3.3 Intra-frequency measurement accuracy on SCC

#### A.10.5.3.3.1 Test Purpose and Environment

The purpose of this test is to verify that the SS-SINR measurement accuracy is within the specified limits. This test will verify the requirements in clause 10.1.31.1.

#### A.10.5.3.3.2 Test Parameters

In this test case, Cell2 (PSCell) is on frequency 1 while Cell 3 (SCell) and Cell 4 (target cell) which are intra-frequency neighbors, are on frequency 2. Supported test configuration are shown in Table A.10.5.3.3.2-1. The absolute accuracy of SS-SINR intra-frequency measurement is tested by using the parameters in Table A.10.5.3.3.2-2. The configuration of cell 1 (E-UTRA PCell) is specified in clause A.3.7A.2.1. In all test cases, Cell 2 is the PSCell with CCA, Cell 3 is the SCell with CCA, and Cell 4 is the target cell with CCA. Two sub-tests (Test 1 and Test 2) are provided different  $N_{oc}$  on Cells 2, 3 and 4.

**Table A.10.5.3.3.2-1: SS-SINR Intra frequency SS-SINR supported test configurations**

Config	Description
1	LTE FDD NR 30 kHz SSB SCS, 40 MHz bandwidth, TDD duplex mode
2	LTE TDD NR 30 kHz SSB SCS, 40 MHz bandwidth, TDD duplex mode

Note: The UE is only required to be tested in one of the supported test configurations

**Table A.10.5.3.3.2-2: SS-SINR Intra frequency test parameters**

Parameter	Unit	Test 1		Test 2	
		Cell 2 / Cell 3	Cell 4	Cell 2 / Cell 3	Cell 4
SSB ARFCN		freq1 for Cell 2 freq2 for Cell 3	freq2	freq1 for Cell 2 freq2 for Cell 3	freq2
DL CCA model	Config 1,2	As specified in clause A.3.26.2.1			
UL CCA model	Config 1,2	As specified in clause A.3.26.2.2			
UL CCA probability	$P_{CCA\_UL}$	1.0	-	1.0	-
DL CCA probability for semi-static channel access <small>Note 7, 8</small>	$P_{CCA\_DL}$	0.9375	-	0.9375	-
DL CCA probability for dynamic channel access <small>Note 8, 9</small>	$P_{CCA\_DL\_1}$	0.75	-	0.75	-
	$P_{CCA\_DL\_2}$	0.75	-	0.75	-
Duplex mode	Config 1,2	TDD			
TDD configuration	Config 1,2	TDDConf.1.1 CCA			
Downlink initial BWP configuration		DLBWP.0.1			
Downlink dedicated BWP configuration		DLBWP.1.1			
Uplink initial BWP configuration		ULBWP.0.1			
Uplink dedicated BWP configuration		ULBWP.1.1			
DRX Cycle configuration		Not Applicable			
TRS Configuration	Config 1,2	TRS.1.2 TDD		TRS.1.2 TDD	

PDSCH Reference measurement channel	Config 1,2		SR.1.1 CCA		SR1.1 CCA	
RMSI CORESET Reference Channel	Config 1,2		CR.1.1 CCA		CR.1.1 CCA	
Dedicated CORESET Reference Channel	Config 1,2		CCR.1.1 CCA		CCR.1.1 CCA	
OCNG Patterns			OP.1			
SS-RSSI-Measurement			Not Applicable			
Time offset with Cell 2	Config 1,2	µs	3 (for Cell 3)	3	3 (for Cell 3)	3
DBT Window Configuration	Config 1,2		DBT.1			
SSB configuration	Config 1,2		SSB.1 CCA for semi-static channel access SSB.2 CCA for dynamic channel access			
SMTTC configuration	Config 1,2		SMTTC.1			
PDSCH/PDCCH subcarrier spacing	Config 1,2	kHz	30			
EPRE ratio of PSS to SSS		dB	0	0	0	0
EPRE ratio of PBCH DMRS to SSS						
EPRE ratio of PBCH to PBCH DMRS						
EPRE ratio of PDCCH DMRS to SSS						
EPRE ratio of PDCCH to PDCCH DMRS						
EPRE ratio of PDSCH DMRS to SSS						
EPRE ratio of PDSCH to PDSCH						
EPRE ratio of OCNG DMRS to SSS(Note 1)						
EPRE ratio of OCNG to OCNG DMRS (Note 1)						
$N_{oc}$ <sup>Note2</sup>	Config 1,2	NR_CCA_FR1_I	dBm/15kHz	-93	-112	
		NR_CCA_FR1_J			-111.5	
$N_{oc}$ <sup>Note2</sup>	Config 1,2	NR_CCA_FR1_I	dBm/SCS	-90	-109	
		NR_CCA_FR1_J			-108.5	
$\hat{E}_s / I_{ot}$		dB	0	-3.19	-5.46	-5.46
$\hat{E}_s / N_{oc}$		dB	4.54	2.66	-4	-4
SS-RSRP <sup>Note3</sup>	Config 1,2	NR_CCA_FR1_I	dBm/SCS	-85.46	-87.34	-113
		NR_CCA_FR1_J				-112.5
SS-SINR <sup>Note3</sup>	Config 1,2	NR_CCA_FR1_I	dB	0	-3.19	-5.46
		NR_CCA_FR1_J				-5.46
$I_o$ <sup>Note3</sup>	Config 1,2	NR_CCA_FR1_I	dBm/38.16MHz	-51.41	-75.41	
		NR_CCA_FR1_J			-74.91	
Propagation condition			- AWGN			
Antenna configuration			- 1x2			
<p>Note 1: OCNG shall be used such that both cells are fully allocated and a constant total transmitted power spectral density is achieved for all OFDM symbols.</p> <p>Note 2: Interference from other cells and noise sources not specified in the test is assumed to be constant over subcarriers and time and shall be modelled as AWGN of appropriate power for <math>N_{oc}</math> to be fulfilled.</p> <p>Note 3: SS-SINR, SS-RSRP, and <math>I_o</math> levels have been derived from other parameters for information purposes. They are not settable parameters themselves.</p> <p>Note 4: SS-SINR, SS-RSRP minimum requirements are specified assuming independent interference and noise at each receiver antenna port.</p> <p>Note 5: NR operating band groups are as defined in Clause 3.5.2.</p> <p>Note 6: For UE supporting both semi-static and dynamic channel access, the UE must be tested under both dynamic and semi-static channel occupancy configuration</p> <p>Note 7: For UE supporting semi-static channel access and network configuring semi-static channel occupancy.</p> <p>Note 8: For UE supporting dynamic channel access and network configuring dynamic channel occupancy.</p> <p>Note 9: For UE supporting both semi-static and dynamic channel access, the UE must be tested under both dynamic and semi-static channel occupancy configurations.</p>						

### A.10.5.3.3.3 Test Requirements

The SS-SINR measurement accuracy shall fulfil the requirements in clause 10.1.31.1.1.

## A.10.5.4 L1-RSRP measurement for beam reporting with CCA serving cell

### A.10.5.4.1 SSB based L1-RSRP measurement

#### A.10.5.4.1.1 Test Purpose and Environment

The purpose of this test is to verify that the L1-RSRP measurement accuracy is within the specified limits. This test will verify the requirements in clause 10.1.33.1 for L1-RSRP measurements based on SSB with the testing configurations for NR cells in Table A.10.5.4.1.1-1.

**Table A.10.5.4.1.1-1: Applicable NR configurations for FR1 SSB based L1-RSRP test**

Config	Description
1	LTE FDD, NR 30kHz SSB SCS, 40 MHz bandwidth, TDD duplex mode
2	LTE TDD, NR 30kHz SSB SCS, 40 MHz bandwidth, TDD duplex mode
Note: The UE is only required to pass in one of the supported test configurations	

#### A.10.5.4.1.2 Test parameters

In this set of test cases there are two cells in the test, E-UTRAN PCell (Cell 1), FR1 PSCell under CCA (Cell 2). Cell 2 operates on a carrier frequency with CCA and transmits SSBs in DBT window according to DL CCA model.

Two sub-tests (Test 1 and Test 2) are provided with different  $N_{oc}$  on Cell 2. The test parameters and applicability for Cell 1 are defined in A.3.7A.2. The test parameters for the Cell 2 are given in Table A.10.5.4.1.2-1 below. The absolute and relative accuracy of L1-RSRP measurements are tested by using the parameters in Table A.10.5.4.1.2-1.

The same test is applicable for UE supporting any one or both semi-static channel access or dynamic channel access and for network configuring any of semi-static channel occupancy or dynamic channel occupancy.

There is no measurement gap configured in the test. Before the test, UE is configured one SSB resource set with two SSB resources. UE is configured to perform RLM, BFD and L1-RSRP measurement based on the SSB resources 0 and 1.

**Table A.10.5.4.1.2-1: FR1 SSB based L1-RSRP test parameters**

Parameter	Config	Unit	Test 1	Test 2
SSB GSCN	1,2		freq1	freq1
DL CCA model	1,2		As specified in A.3.26.2.1	As specified in A.3.26.2.1
UL CCA model	1,2		As specified in A.3.26.2.2	As specified in A.3.26.2.2
Duplex mode	1,2		TDD	TDD
TDD Configuration	1,2		TDDConf.1.1 CCA	TDDConf.1.1 CCA
$BW_{channel}$	1,2	MHz	40: $N_{RB,c} = 106$	40: $N_{RB,c} = 106$
Duplex mode	1,2		TDD	TDD
TDD configuration	1,2		TDDConf.1.1 CCA	TDDConf.1.1 CCA
PDSCH Reference measurement channel	1,2		SR.1.1 CCA	SR.1.1 CCA
RMSI CORESET Reference Channel	1,2		CR.1.1 CCA	CR.1.1 CCA
Dedicated CORESET Reference Channel	1,2		CCR.1.1 CCA	CCR.1.1 CCA

SSB configuration for Semi-static channel access	1,2		SSB.3 CCA	SSB.3 CCA	
SSB configuration for Dynamic channel access	1,2		SSB.4 CCA	SSB.4 CCA	
OCNG Patterns	1,2		OP.1	OP.1	
TRS configuration	1,2		TRS.1.2 TDD	TRS.1.2 TDD	
Initial BWP Configuration	1,2		DLBWP.0.1 ULBWP.0.1	DLBWP.0.1 ULBWP.0.1	
Dedicated BWP configuration	1,2		DLBWP.1.1 ULBWP.1.1	DLBWP.1.1 ULBWP.1.1	
DBT Window Configuration	1,2		DBT.1	DBT.1	
reportConfigType	1,2		periodic	periodic	
reportQuantity	1,2		ssb-Index-RSRP	ssb-Index-RSRP	
Number of reported RS	1,2		2	2	
L1-RSRP reporting period	1,2		slot80	slot80	
EPRE ratio of PSS to SSS	1,2	dB	0	0	
EPRE ratio of PBCH DMRS to SSS	1,2				
EPRE ratio of PBCH to PBCH DMRS					
EPRE ratio of PDCCH DMRS to SSS					
EPRE ratio of PDCCH to PDCCH DMRS					
EPRE ratio of PDSCH DMRS to SSS					
EPRE ratio of PDSCH to PDSCH DMRS					
EPRE ratio of OCNG DMRS to SSS <sup>Note 1</sup>					
EPRE ratio of OCNG to OCNG DMRS <sup>Note 1</sup>					
$N_{oc}$ <sup>Note2</sup>	NR_TDD_FR1_I	1,2	dBm/15kHz	-94.65	-113
$N_{oc}$ <sup>Note2</sup>	NR_TDD_FR1_I	1,2	dBm/SCS	-91.65	-110
$\hat{E}_s / I_{ot}$		1,2	dB	10	-3
SS-RSRP <sup>Note3</sup>	NR_TDD_FR1_I	1,2	dBm/SCS	-81.65	-113
$I_o$ <sup>Note3</sup>	NR_TDD_FR1_I	1,2	dBm/ 38.16MHz	-50.19	-77.19
$\hat{E}_s / N_{oc}$		1,2	dB	10	-3
Propagation condition	1,2		AWGN	AWGN	
Antenna configuration	1,2		1x2	1x2	
<p>Note 1: OCNG shall be used such that both cells are fully allocated and a constant total transmitted power spectral density is achieved for all OFDM symbols.</p> <p>Note 2: Interference from other cells and noise sources not specified in the test is assumed to be constant over subcarriers and time and shall be modelled as AWGN of appropriate power for <math>N_{oc}</math> to be fulfilled.</p> <p>Note 3: RSRP and <math>I_o</math> levels have been derived from other parameters for information purposes. They are not settable parameters themselves.</p> <p>Note 4: RSRP minimum requirements are specified assuming independent interference and noise at each receiver antenna port.</p> <p>Note 5: The test configuration excludes support for band n51 and it is not required to run this test on band n51 in this release of the specification</p>					

### A.10.5.4.1.3 Test Requirements

In both Test 1 and Test 2, the L1-RSRP measurement accuracy for SSB#0 and SSB#1 of Cell 2 shall fulfil the requirements in clauses 10.1.33.1.

## A.10.5.5 RSSI

### A.10.5.5.1 RSSI measurement accuracy on PSCC with CCA

#### A.10.5.5.1.1 Test Purpose and Environment

The purpose of this test is to verify that the RSSI measurement accuracy is within the specified limits. This test will partially verify the RSSI measurement accuracy requirements in Section 10.1.34.1.

#### A.10.5.5.1.2 Test parameters

In all test cases, Cell 1 is E-UTRAN PCell on a licensed band, and Cell 2 is PSCell operating on a carrier frequency under CCA. RSSI is measured on channel number 1. Supported test configurations are shown in table A.10.5.5.1.2-1. The accuracy of RSSI intra-frequency measurements is tested by using the parameters in A.10.5.5.1.2-2 and A.10.5.5.1.2-3. The E-UTRAN PCell setting refers to Table A.3.7.2.1-1.

**Table A.10.5.5.1.2-1: RSSI supported test configurations**

Configuration	Description
1	LTE FDD; NR: TDD, SSB SCS 30 kHz, data SCS 30 kHz, BW 40 MHz
2	LTE TDD; NR: TDD, SSB SCS 30 kHz, data SCS 30 kHz, BW 40 MHz
NOTE: The UE is only required to pass in one of the supported test configurations above.	

**Table A.10.5.5.1.2-2: RSSI test parameters**

Parameter		Configurations	Unit	Test 1 Cell 2
RF Channel Number				1
BW <sub>channel</sub>			MHz	40
SSB configuration	Semi-static channel access <small>Note 1, 3</small>	1,2		SSB.1 CCA
	Dynamic channel access <small>Note 2, 3</small>	1,2		SSB.2 CCA
P <sub>CCA_DL</sub>				0.9375 (Note 1, 3) 0.75 / 0.75 (Note 2, 3)
P <sub>CCA_UL</sub>				0.87 (Note 1, 3) 0.75 (Note 2, 3)
DL CCA model				As specified in A.3.26.2.1
UL CCA model				As specified in A.3.26.2.2
Measurement bandwidth			$n_{PRE}$	Same as channel access bandwidth
Channel access bandwidth			MHz	20
DRX Cycle configuration			ms	Not Applicable
PDSCH Reference measurement channel				SR.1.1 CCA
RMSI CORESET Reference Channel				CR.1.1 CCA
Dedicated CORESET Reference Channel				CCR.1.1 CCA
OCNG Patterns				OP.1
EPRE ratio of PSS to SSS			dB	0
EPRE ratio of PBCH DMRS to SSS				
EPRE ratio of PBCH to PBCH DMRS				
EPRE ratio of PDCCH DMRS to SSS				
EPRE ratio of PDCCH to PDCCH DMRS				
EPRE ratio of PDSCH DMRS to SSS				
EPRE ratio of PDSCH to PDSCH				
EPRE ratio of OCNG DMRS to SSS (Note 1)				
EPRE ratio of OCNG to OCNG DMRS (Note 1)				

$N_{oc}$ in slots not corresponding to RSSI measurement time configuration (RMTC)		dBm/SCS	-106
$N_{oc}$ in slots corresponding to RSSI measurement time configuration (RMTC)		dBm/SCS	-87
$\hat{E}_s/I_{ot}$ in slots not corresponding to RSSI measurement time configuration (RMTC)		dB	2.5
$\hat{E}_s/I_{ot}$ in slots corresponding to RSSI measurement time configuration (RMTC)		dB	-Infinity
SS-RSRP in slots not corresponding to RSSI measurement time configuration (RMTC)		dBm/SCS	-103.5
SS-RSRP in slots corresponding to RSSI measurement time configuration (RMTC)			-Infinity
$I_o$ within measurement bandwidth in slots not corresponding to RSSI measurement time configuration (RMTC)		dBm/BW	-101.6
$I_o$ within measurement bandwidth in slots corresponding to RSSI measurement time configuration (RMTC)		dBm/BW	-87
Propagation condition		-	AWGN
Note 1: For UE supporting semi-static channel access and network configuring semi-static channel occupancy. Note 2: For UE supporting dynamic channel access and network configuring dynamic channel occupancy. Note 3: For a UE supporting both semi-static and dynamic channel access, the UE can be tested under dynamic channel occupancy only.			

**Table A.10.5.5.1.2-3: RSSI RMTC parameters**

measDurationSymbols-r16	sym14or12
rmtc-Periodicity-r16	ms40
rmtc-SubframeOffset-r16	20
ref-SCS-CP-r16	kHz15
ReportInterval	ms120

### A.10.5.5.1.3 Test Requirements

The average RSSI measurement accuracy shall fulfil the requirements in sections 10.1.34.1. The nominal RSSI used to evaluate the requirement shall be based on  $I_o$  in slots corresponding to RSSI measurement time configuration (RMTC).

## A.10.5.5.2 RSSI measurement accuracy on SCC with CCA

### A.10.5.5.2.1 Test Purpose and Environment

The purpose of this test is to verify that the RSSI measurement accuracy is within the specified limits. This test will partially verify the RSSI measurement accuracy requirements in Section 10.1.34.1.

### A.10.5.5.2.2 Test parameters

In all test cases, Cell 1 is E-UTRAN PCell on a licensed band, Cell 2 is PSCell operating on a carrier frequency under CCA, Cell 3 is SCell on a carrier frequency under CCA. RSSI is measured on channel number 2. Supported test configurations are shown in table A.10.5.5.2.2-1. The accuracy of RSSI intra-frequency measurements is tested by using the parameters in A.10.5.5.2.2-2 and A.10.5.5.2.2-3. The E-UTRAN PCell setting refers to Table A.3.7.2.1-1.

**Table A.10.5.5.2.2-1: RSSI supported test configurations**

Configuration	Description
1	LTE FDD; NR: TDD, SSB SCS 30 kHz, data SCS 30 kHz, BW 40 MHz



2	LTE TDD; NR: TDD, SSB SCS 30 kHz, data SCS 30 kHz, BW 40 MHz
NOTE: The UE is only required to pass in one of the supported test configurations above.	

**Table A.10.5.5.2.2-2: RSSI test parameters**

Parameter		Configurations	Unit	Test 1	
				Cell 2	Cell 3
RF Channel Number				1	2
BW <sub>channel</sub>			MHz	40	40
SSB configuration	Semi-static channel access Note 1, 3	1,2		SSB.1 CCA	SSB.1 CCA
	Dynamic channel access Note 2, 3	1,2		SSB.2 CCA	SSB.2 CCA
P <sub>CCA_DL</sub>				1	0.9375 (Note 1, 3) 0.75 / 0.75 (Note 2, 3)
P <sub>CCA_UL</sub>				1	0.87 (Note 1, 3) 0.75 (Note 2, 3)
DL CCA model				N/A	As specified in A.3.26.2.1
UL CCA model				N/A	As specified in A.3.26.2.2
Measurement bandwidth			$n_{PRE}$	Same as channel access bandwidth	
Channel access bandwidth			MHz	20	
DRX Cycle configuration			ms	Not Applicable	
PDSCH Reference measurement channel				SR.1.1 CCA	SR.1.1 CCA
RMSI CORESET Reference Channel				CR.1.1 CCA	CR.1.1 CCA
Dedicated CORESET Reference Channel				CCR.1.1 CCA	CCR.1.1 CCA
OCNG Patterns				OP.1	OP.1
EPRE ratio of PSS to SSS			dB	0	0
EPRE ratio of PBCH DMRS to SSS					
EPRE ratio of PBCH to PBCH DMRS					
EPRE ratio of PDCCH DMRS to SSS					
EPRE ratio of PDCCH to PDCCH DMRS					
EPRE ratio of PDSCH DMRS to SSS					
EPRE ratio of PDSCH to PDSCH					
EPRE ratio of OCNG DMRS to SSS(Note 1)					
EPRE ratio of OCNG to OCNG DMRS (Note 1)					
$N_{oc}$ in slots not corresponding to RSSI measurement time configuration (RMTC)			dBm/SCS	-106	-106
$N_{oc}$ in slots corresponding to RSSI measurement time configuration (RMTC)			dBm/SCS	-106	-87
$\hat{E}_s/I_{ot}$ in slots not corresponding to RSSI measurement time configuration (RMTC)			dB	2.5	2.5

$\hat{E}_s / I_{ot}$ in slots corresponding to RSSI measurement time configuration (RMTC)		dB	2.5	-Infinity
SS-RSRP in slots not corresponding to RSSI measurement time configuration (RMTC)		dBm/SCS	-103.5	-103.5
SS-RSRP in slots corresponding to RSSI measurement time configuration (RMTC)			-103.5	-Infinity
Io within measurement bandwidth in slots not corresponding to RSSI measurement time configuration (RMTC)		dBm/BW	-101.6	-101.6
Io within measurement bandwidth in slots corresponding to RSSI measurement time configuration (RMTC)		dBm/BW	-101.6	-87
Propagation condition		-	AWGN	
<p>Note 1: For UE supporting semi-static channel access and network configuring semi-static channel occupancy.</p> <p>Note 2: For UE supporting dynamic channel access and network configuring dynamic channel occupancy.</p> <p>Note 3: For a UE supporting both semi-static and dynamic channel access, the UE can be tested under dynamic channel occupancy only.</p>				

**Table A.10.5.5.2.2-3: RSSI RMTC parameters**

measDurationSymbols-r16	sym14or12
rmtc-Periodicity-r16	ms40
rmtc-SubframeOffset-r16	20
ref-SCS-CP-r16	kHz15
ReportInterval	ms120

### A.10.5.5.2.3 Test Requirements

The average RSSI measurement accuracy shall fulfil the requirements in sections 10.1.34.1. The nominal RSSI used to evaluate the requirement shall be based on Io in slots corresponding to RSSI measurement time configuration (RMTC).

## A.10.5.5.3 Inter-frequency RSSI measurement accuracy on a carrier with CCA

### A.10.5.5.3.1 Test Purpose and Environment

The purpose of this test is to verify that the RSSI measurement accuracy is within the specified limits. This test will partially verify the RSSI measurement accuracy requirements in Section 10.1.34.2.

### A.10.5.5.3.2 Test parameters

In all test cases, Cell 1 is E-UTRAN PCell on a licensed band, Cell 2 is PSCell operating on a carrier frequency under CCA, and Cell 3 is the neighbour with CCA. RSSI is measured on channel number 2. Supported test configurations are shown in table A.10.5.5.3.2-1. The accuracy of RSSI inter-frequency measurements is tested by using the parameters in A.10.5.5.3.2-2 and A.10.5.5.3.2-3. The E-UTRAN PCell setting refers to Table A.3.7.2.1-1.

**Table A.10.5.5.3.2-1: RSSI supported test configurations**

Configuration	Description
1	LTE FDD; NR: TDD, SSB SCS 30 kHz, data SCS 30 kHz, BW 40 MHz
2	LTE TDD; NR: TDD, SSB SCS 30 kHz, data SCS 30 kHz, BW 40 MHz
NOTE: The UE is only required to pass in one of the supported test configurations above.	

Table A.10.5.3.2-2: RSSI test parameters

Parameter		Configurations	Unit	Test 1	
				Cell 2	Cell 3
RF Channel Number				1	2
$BW_{channel}$			MHz	40	40
SSB configuration	Semi-static channel access Note 1, 3	1,2		SSB.1 CCA	SSB.1 CCA
	Dynamic channel access Note 2, 3	1,2		SSB.2 CCA	SSB.2 CCA
$P_{CCA\_DL}$				1	0.9375 (Note 1, 3) 0.75 / 0.75 (Note 2, 3)
$P_{CCA\_UL}$				1	0.87 (Note 1, 3) 0.75 (Note 2, 3)
DL CCA model				N/A	As specified in A.3.26.2.1
UL CCA model				N/A	As specified in A.3.26.2.2
Measurement bandwidth			$n_{PRE}$	Same as channel access bandwidth	
Channel access bandwidth			MHz	20	
DRX Cycle configuration			ms	Not Applicable	
PDSCH Reference measurement channel				SR.1.1 TDD	NA
RMSI CORESET Reference Channel				CR.1.1 TDD	NA
Dedicated CORESET Reference Channel				CCR.1.1 TDD	NA
OCNG Patterns				OP.1	NA
EPRE ratio of PSS to SSS			dB	0	NA
EPRE ratio of PBCH DMRS to SSS					
EPRE ratio of PBCH to PBCH DMRS					
EPRE ratio of PDCCH DMRS to SSS					
EPRE ratio of PDCCH to PDCCH DMRS					
EPRE ratio of PDSCH DMRS to SSS					
EPRE ratio of PDSCH to PDSCH					
EPRE ratio of OCNG DMRS to SSS(Note 1)					
EPRE ratio of OCNG to OCNG DMRS (Note 1)					
$N_{oc}$ in slots not corresponding to RSSI measurement time configuration (RMTC)			dBm/SCS	-106	-106
$N_{oc}$ in slots corresponding to RSSI measurement time configuration (RMTC)			dBm/SCS	-106	-87
$\hat{E}_s/I_{ot}$ in slots not corresponding to RSSI measurement time configuration (RMTC)			dB	2.5	2.5
$\hat{E}_s/I_{ot}$ in slots corresponding to RSSI measurement time configuration (RMTC)			dB	2.5	-Infinity

SS-RSRP in slots not corresponding to RSSI measurement time configuration (RMTC)		dBm/SCS	-103.5	-103.5
SS-RSRP in slots corresponding to RSSI measurement time configuration (RMTC)			-103.5	-Infinity
Io within measurement bandwidth in slots not corresponding to RSSI measurement time configuration (RMTC)		dBm/BW	-101.6	-101.6
Io within measurement bandwidth in slots corresponding to RSSI measurement time configuration (RMTC)		dBm/BW	-101.6	-87
Propagation condition		-	AWGN	
Note 1: For UE supporting semi-static channel access and network configuring semi-static channel occupancy. Note 2: For UE supporting dynamic channel access and network configuring dynamic channel occupancy. Note 3: For a UE supporting both semi-static and dynamic channel access, the UE can be tested under dynamic channel occupancy only.				

**Table A.10.5.5.3.2-3: RSSI RMTC parameters**

measDurationSymbols-r16	sym14or12
rmtc-Periodicity-r16	ms40
rmtc-SubframeOffset-r16	20
ref-SCS-CP-r16	kHz15
ReportInterval	ms120

### A.10.5.5.3.3 Test Requirements

The average RSSI measurement accuracy shall fulfil the requirements in sections 10.1.34.2. The nominal RSSI used to evaluate the requirement shall be based on Io in slots corresponding to RSSI measurement time configuration (RMTC).

## A.10.5.6 Channel occupancy

### A.10.5.6.1 Channel occupancy measurement accuracy on PSSC with CCA

#### A.10.5.6.1.1 Test Purpose and Environment

The purpose of this test is to verify that the channel occupancy measurement accuracy is within the specified limits. This test will partially verify the channel occupancy measurement accuracy requirements in Section 10.1.35.1.

#### A.10.5.6.1.2 Test parameters

In all test cases, Cell 1 is E-UTRAN PCell on a licensed band, and Cell 2 is PSCell operating on a carrier frequency under CCA. Channel occupancy is measured on channel number 1. Supported test configurations are shown in table A.10.5.6.1.2-1. The accuracy of channel occupancy intra-frequency measurements is tested by using the parameters in A.10.5.6.1.2-2 and A.10.5.6.1.2-3. The E-UTRAN PCell setting refers to Table A.3.7.2.1-1.

**Table A.10.5.6.1.2-1: CO supported test configurations**

Configuration	Description
1	LTE FDD; NR: TDD, SSB SCS 30 kHz, data SCS 30 kHz, BW 40 MHz
2	LTE TDD; NR: TDD, SSB SCS 30 kHz, data SCS 30 kHz, BW 40 MHz
NOTE: The UE is only required to pass in one of the supported test configurations above.	

Table A.10.5.6.1.2-2: CO test parameters

Parameter		Configurations	Unit	Test 1
				Cell 2
RF Channel Number				1
$BW_{channel}$			MHz	40
SSB configuration	Semi-static channel access <small>Note 1, 3</small>	1,2		SSB.1 CCA
	Dynamic channel access <small>Note 2, 3</small>	1,2		SSB.2 CCA
$P_{CCA\_DL}$				0.9375 (Note 1, 3) 0.75 / 0.75 (Note 2, 3)
$P_{CCA\_UL}$				0.87 (Note 1, 3) 0.75 (Note 2, 3)
DL CCA model				As specified in A.3.26.2.1
UL CCA model				As specified in A.3.26.2.2
Measurement bandwidth			$n_{PRE}$	Same as channel access bandwidth
Channel access bandwidth			MHz	20
DRX Cycle configuration			ms	Not Applicable
PDSCH Reference measurement channel				SR.1.1 CCA
RMSI CORESET Reference Channel				CR.1.1 CCA
Dedicated CORESET Reference Channel				CCR.1.1 CCA
OCNG Patterns				OP.1
EPRE ratio of PSS to SSS			dB	0
EPRE ratio of PBCH DMRS to SSS				
EPRE ratio of PBCH to PBCH DMRS				
EPRE ratio of PDCCH DMRS to SSS				
EPRE ratio of PDCCH to PDCCH DMRS				
EPRE ratio of PDSCH DMRS to SSS				
EPRE ratio of PDSCH to PDSCH				
EPRE ratio of OCNG DMRS to SSS (Note 1)				
EPRE ratio of OCNG to OCNG DMRS (Note 1)				
$N_{oc}$ in slots not corresponding to RSSI measurement time configuration (RMTC)			dBm/SCS	-106
$N_{oc}$ in slots corresponding to RSSI measurement time configuration (RMTC)			dBm/SCS	-87
$\hat{E}_s / I_{ot}$ in slots not corresponding to RSSI measurement time configuration (RMTC)			dB	2.5
$\hat{E}_s / I_{ot}$ in slots corresponding to RSSI measurement time configuration (RMTC)			dB	-Infinity
SS-RSRP in slots not corresponding to RSSI measurement time configuration (RMTC)			dBm/SCS	-103.5
SS-RSRP in slots corresponding to RSSI measurement time configuration (RMTC)				-Infinity
Io within measurement bandwidth in slots not corresponding to RSSI measurement time configuration (RMTC)			dBm/BW	-101.6
Io within measurement bandwidth in slots corresponding to RSSI measurement time configuration (RMTC)			dBm/BW	-87
Propagation condition			-	AWGN
channelOccupancyThreshold			dBm	-83
Note 1: For UE supporting semi-static channel access and network configuring semi-static channel occupancy.				
Note 2: For UE supporting dynamic channel access and network configuring dynamic channel occupancy.				
Note 3: For a UE supporting both semi-static and dynamic channel access, the UE can be tested under dynamic channel occupancy only.				

**Table A.10.5.6.1.2-3: CO RMTC parameters**

measDurationSymbols-r16	sym14or12
rmtc-Periodicity-r16	ms40
rmtc-SubframeOffset-r16	20
ref-SCS-CP-r16	kHz15
ReportInterval	ms120

### A.10.5.6.1.3 Test Requirements

The nominal reported *channelOccupancy* shall be TBD. At least 90% of channel occupancy reports made by the UE shall indicate this value.

## A.10.5.6.2 Channel occupancy measurement accuracy on SCC with CCA

### A.10.5.6.2.1 Test Purpose and Environment

The purpose of this test is to verify that the channel occupancy measurement accuracy is within the specified limits. This test will partially verify the channel occupancy measurement accuracy requirements in Section 10.1.35.1.

### A.10.5.6.2.2 Test parameters

In all test cases, Cell 1 is E-UTRAN PCell on a licensed band, Cell 2 is PSCell operating on a carrier frequency under CCA, Cell 3 is SCell on a carrier frequency under CCA. Channel occupancy is measured on channel number 2. Supported test configurations are shown in table A.10.5.6.2.2-1. The accuracy of channel occupancy intra-frequency measurements is tested by using the parameters in A.10.5.6.2.2-2 and A.10.5.6.2.2-3. The E-UTRAN PCell setting refers to Table A.3.7.2.1-1.

**Table A.10.5.6.2.2-1: CO supported test configurations**

Configuration	Description
1	LTE FDD; NR: TDD, SSB SCS 30 kHz, data SCS 30 kHz, BW 40 MHz
2	LTE TDD; NR: TDD, SSB SCS 30 kHz, data SCS 30 kHz, BW 40 MHz
NOTE: The UE is only required to pass in one of the supported test configurations above.	

**Table A.10.5.6.2.2-2: CO test parameters**

Parameter	Configurations	Unit	Test 1	
			Cell 2	Cell 3
RF Channel Number			1	2
BW <sub>channel</sub>		MHz	40	40
SSB configuration	Semi-static channel access Note 1, 3	1,2	SSB.1 CCA	SSB.1 CCA
	Dynamic channel access Note 2, 3	1,2	SSB.2 CCA	SSB.2 CCA
P <sub>CCA_DL</sub>			1	0.9375 (Note 1, 3) 0.75 / 0.75 (Note 2, 3)
P <sub>CCA_UL</sub>			1	0.87 (Note 1, 3) 0.75 (Note 2, 3)

DL CCA model			N/A	As specified in A.3.26.2.1
UL CCA model			N/A	As specified in A.3.26.2.2
Measurement bandwidth		$n_{PRE}$	Same as channel access bandwidth	
Channel access bandwidth		MHz	20	
DRX Cycle configuration		ms	Not Applicable	
PDSCH Reference measurement channel			SR.1.1 CCA	SR.1.1 CCA
RMSI CORESET Reference Channel			CR.1.1 CCA	CR.1.1 CCA
Dedicated CORESET Reference Channel			CCR.1.1 CCA	CCR.1.1 CCA
OCNG Patterns			OP.1	OP.1
EPRE ratio of PSS to SSS		dB	0	0
EPRE ratio of PBCH DMRS to SSS				
EPRE ratio of PBCH to PBCH DMRS				
EPRE ratio of PDCCH DMRS to SSS				
EPRE ratio of PDCCH to PDCCH DMRS				
EPRE ratio of PDSCH DMRS to SSS				
EPRE ratio of PDSCH to PDSCH				
EPRE ratio of OCNG DMRS to SSS(Note 1)				
EPRE ratio of OCNG to OCNG DMRS (Note 1)				
$N_{oc}$ in slots not corresponding to RSSI measurement time configuration (RMTC)		dBm/SCS	-106	-106
$N_{oc}$ in slots corresponding to RSSI measurement time configuration (RMTC)		dBm/SCS	-106	-87
$\hat{E}_s/I_{ot}$ in slots not corresponding to RSSI measurement time configuration (RMTC)		dB	2.5	2.5
$\hat{E}_s/I_{ot}$ in slots corresponding to RSSI measurement time configuration (RMTC)		dB	2.5	-Infinity
SS-RSRP in slots not corresponding to RSSI measurement time configuration (RMTC)		dBm/SCS	-103.5	-103.5
SS-RSRP in slots corresponding to RSSI measurement time configuration (RMTC)			-103.5	-Infinity
$I_o$ within measurement bandwidth in slots not corresponding to RSSI measurement time configuration (RMTC)		dBm/BW	-101.6	-101.6
$I_o$ within measurement bandwidth in slots corresponding to RSSI measurement time configuration (RMTC)		dBm/BW	-101.6	-87
Propagation condition		-	AWGN	
channelOccupancyThreshold		dBm	-83	
Note 1: For UE supporting semi-static channel access and network configuring semi-static channel occupancy.				
Note 2: For UE supporting dynamic channel access and network configuring dynamic channel occupancy.				
Note 3: For a UE supporting both semi-static and dynamic channel access, the UE can be tested under dynamic channel occupancy only.				

**Table A.10.5.6.2.2-3: CO RMTC parameters**

measDurationSymbols-r16	sym14or12
rmtc-Periodicity-r16	ms40
rmtc-SubframeOffset-r16	20
ref-SCS-CP-r16	kHz15
ReportInterval	ms120

### A.10.5.6.2.3 Test Requirements

The nominal reported *channelOccupancy* shall be TBD. At least 90% of channel occupancy reports made by the UE shall indicate this value.

## A.10.5.6.3 Inter-frequency channel occupancy measurement accuracy on a carrier with CCA

### A.10.5.6.3.1 Test Purpose and Environment

The purpose of this test is to verify that the channel occupancy measurement accuracy is within the specified limits. This test will partially verify the channel occupancy measurement accuracy requirements in Section 10.1.35.2.

### A.10.5.6.3.2 Test parameters

In all test cases, Cell 1 is E-UTRAN PCell on a licensed band, Cell 2 is PSCell operating on a carrier frequency under CCA, and Cell 3 is the neighbour with CCA. Channel occupancy is measured on channel number 2. Supported test configurations are shown in table A.10.5.6.3.2-1. The accuracy of channel occupancy inter-frequency measurements is tested by using the parameters in A.10.5.6.3.2-2 and A.10.5.6.3.2-3. The E-UTRAN PCell setting refers to Table A.3.7.2.1-1.

**Table A.10.5.6.3.2-1: CO supported test configurations**

Configuration	Description
1	LTE FDD; NR: TDD, SSB SCS 30 kHz, data SCS 30 kHz, BW 40 MHz
2	LTE TDD; NR: TDD, SSB SCS 30 kHz, data SCS 30 kHz, BW 40 MHz
NOTE: The UE is only required to pass in one of the supported test configurations above.	

**Table A.10.5.5.3.2-2: CO test parameters**

Parameter	Configurations	Unit	Test 1	
			Cell 2	Cell 3
RF Channel Number			1	2
BW <sub>channel</sub>		MHz	40	40
SSB configuration	Semi-static channel access Note 1, 3	1,2	SSB.1 CCA	SSB.1 CCA
	Dynamic channel access Note 2, 3	1,2	SSB.2 CCA	SSB.2 CCA
P <sub>CCA_DL</sub>			1	0.9375 (Note 1, 3) 0.75 / 0.75 (Note 2, 3)TBD
P <sub>CCA_UL</sub>			1	0.87 (Note 1, 3) 0.75 (Note 2, 3)TBD
DL CCA model			N/A	As specified in A.3.20.2.1A.3.26.2.1



UL CCA model			N/A	As specified in A.3.20.2.2A.3.26.2.2
Measurement bandwidth		$n_{PRE}$	Same as channel access bandwidth	
Channel access bandwidth		MHz	20	
DRX Cycle configuration		ms	Not Applicable	
PDSCH Reference measurement channel			SR.1.1 TDD	NA
RMSI CORESET Reference Channel			CR.1.1 TDD	NA
Dedicated CORESET Reference Channel			CCR.1.1 TDD	NA
OCNG Patterns			OP.1	NA
EPRE ratio of PSS to SSS		dB	0	NA
EPRE ratio of PBCH DMRS to SSS				
EPRE ratio of PBCH to PBCH DMRS				
EPRE ratio of PDCCH DMRS to SSS				
EPRE ratio of PDCCH to PDCCH DMRS				
EPRE ratio of PDSCH DMRS to SSS				
EPRE ratio of PDSCH to PDSCH				
EPRE ratio of OCNG DMRS to SSS(Note 1)				
EPRE ratio of OCNG to OCNG DMRS (Note 1)				
$N_{oc}$ in slots not corresponding to RSSI measurement time configuration (RMTC)				
$N_{oc}$ in slots corresponding to RSSI measurement time configuration (RMTC)		dBm/SCS	-106	-87
$\hat{E}_s/I_{ot}$ in slots not corresponding to RSSI measurement time configuration (RMTC)		dB	2.5	2.5
$\hat{E}_s/I_{ot}$ in slots corresponding to RSSI measurement time configuration (RMTC)		dB	2.5	-Infinity
SS-RSRP in slots not corresponding to RSSI measurement time configuration (RMTC)		dBm/SCS	-103.5	-103.5
SS-RSRP in slots corresponding to RSSI measurement time configuration (RMTC)			-103.5	-Infinity
Io within measurement bandwidth in slots not corresponding to RSSI measurement time configuration (RMTC)		dBm/BW	-101.6	-101.6
Io within measurement bandwidth in slots corresponding to RSSI measurement time configuration (RMTC)		dBm/BW	-101.6	-87
Propagation condition		-	AWGN	
channelOccupancyThreshold		dBm	-83	
Note 1: For UE supporting semi-static channel access and network configuring semi-static channel occupancy.				
Note 2: For UE supporting dynamic channel access and network configuring dynamic channel occupancy.				
Note 3: For a UE supporting both semi-static and dynamic channel access, the UE can be tested under dynamic channel occupancy only.				

**Table A.10.5.6.3.2-3: CO RMTC parameters**

measDurationSymbols-r16	sym14or12
rmtc-Periodicity-r16	ms40
rmtc-SubframeOffset-r16	20
ref-SCS-CP-r16	kHz15
ReportInterval	ms120

### A.10.5.6.3.3 Test Requirements

The nominal reported *channelOccupancy* shall be TBD. At least 90% of channel occupancy reports made by the UE shall indicate this value.

## A.11 NR Standalone Tests with NR PCell under CCA and Other NR Cells in FR1

*Editor's note: Test cases for NR SA with NR PCell under CCA and SCell under CCA are also included here.*

### A.11.1 RRC\_IDLE state mobility

#### A.11.1.1 Cell re-selection with both source and target NR carrier frequencies under CCA

##### A.11.1.1.1 Cell reselection to FR1 intra-frequency NR cells when subject to CCA on the serving and target cell

###### A.11.1.1.1.1 Test Purpose and Environment

This test is to verify the requirement for the intra frequency NR cell reselection requirements subject to CCA specified in clause 4.2A.2.3. Supported test configurations are shown in table A. 11.1.1.1.2-1.

###### A.11.1.1.1.2 Test Parameters

The test scenario comprises of 1 NR carrier that is subject to CCA and 2 cells as given in tables A.11.1.1.1.2-1, A.11.1.1.1.2-2 and A.11.1.1.1.2-3. The test consists of three successive time periods, with time duration of T1, T2, and T3 respectively. Only cell 1 is already identified by the UE prior to the start of the test. Cell 1 and cell 2 belong to different tracking areas. Furthermore, UE has not registered with network for the tracking area containing cell 2.

**Table A.11.1.1.1.2-1: Supported test configurations**

Configuration	Description
1	With CCA: 30 kHz SSB SCS, 40 MHz bandwidth, TDD duplex mode

**Table A.11.1.1.1.2-2: General test parameters for intra frequency NR cell re-selection test case when subject to CCA**

Parameter	Unit	Test configuration	Value	Comment
Initial condition	Active cell	1	Cell1	
	Neighbour cells	1	Cell2	
T2 end condition	Active cell	1	Cell2	
	Neighbour cells	1	Cell1	
Final condition	Active cell	1	Cell1	
RF Channel Number		1	1	

Time offset between cells			1	3 $\mu$ s	Synchronous cells
Access Barring Information		-	1	Not Sent	No additional delays in random access procedure.
SSB configuration	Semi-static channel access		1	SSB.1 CCA	(As defined in A.3.10A )
	Dynamic channel access			SSB.2 CCA	
DBT Window Configuration			1	DBT.1	As specified in clause A.3.28.1.
SMTC configuration				SMTC.1	
DL CCA model			1	As specified in clause A.3.26.2.1	
UL CCA model			1	As specified in clause A.3.26.2.2	
DRX cycle length		s	1	1.28	The value shall be used for all cells in the test.
PRACH configuration index			1	102	The detailed configuration is specified in TS 38.211 clause 6.3.3.2
rangeToBestCell			1	Not configured	
T1		s	1	>7	During T1, Cell 2 shall be powered off, and during the off time the physical cell identity shall be changed, The intention is to ensure that Cell 2 has not been detected by the UE prior to the start of period T2
T2		s	1	40	T2 needs to be defined so that cell re-selection reaction time is taken into account.
T3		s	1	15	T3 needs to be defined so that cell re-selection reaction time is taken into account.

**Table A.11.1.1.1.2-3: Cell specific test parameters for intra frequency NR cell re-selection test case in AWGN when subject to CCA**

Parameter	Unit	Test configuration	Cell 1			Cell 2		
			T1	T2	T3	T1	T2	T3
TDD configuration		1	TDDConf.1.1 CCA			TDDConf.1.1 CCA		
DL CCA probability for semi-static channel access ( $P_{CCA\_DL}$ )		1	0.9			0.9		
DL CCA probability for for dynamic static channel access ( $P_{CCA\_DL\_1}$ )		1	0.75			0.75		
DL CCA probability for for dynamic static channel access ( $P_{CCA\_DL\_2}$ )		1	0.5			0.5		
UL CCA probability $P_{CCA\_UL}$		1	1			1		
$M_{d,max}$		1	16			16		
$M_{m,max}$		1	4			4		
$M_{e,max}$		1	8			8		
PDSCH RMC		1	SR.1.1 CCA			SR.1.1 CCA		
RMSI CORESET		1	CR.1.1 CCA			CR.1.1 CCA		
Dedicated CORESET		1	CCR.1.1 CCA			CCR.1.1 CCA		
OCNG Pattern		1	OP.1 defined in A.3.2.1			OP.1 defined in A.3.2.1		
Initial DL BWP configuration		1	DLBWP.0.1			DLBWP.0.1		
Initial UL BWP configuration		1	ULBWP.0.1			ULBWP.0.1		
RLM-RS		1	SSB			SSB		
$Q_{rxlevmin}$	dB/SCS	1	-127			-127		
$P_{compensation}$	dB	1	0			0		
$Q_{hyst_s}$	dB	1	0			0		
$Q_{offset_s, n}$	dB	1	0			0		

Cell_selection_and_reselection_quality_measurement		1	SS-RSRP			SS-RSRP		
$\hat{E}_s / I_{\alpha}$	dB	1	16	-3.11	2.79	-infinity	2.79	-3.11
$N_{oc}$ Note2	dBm/SCS	1	-95					
$N_{oc}$ Note2	dBm/15 kHz	1	-98					
$\hat{E}_s / N_{oc}$	dB	1	16	13	16	-infinity	16	13
SS-RSRP Note3	dBm/SCS	1	-79	-82	-79	-infinity	-79	-82
Io	dBm/38.16 MHz	1	-47.85	-46.12	-46.12	Same as parameters specified in Cell 1 columns-		
Treselection	s	1	0	0	0	0	0	0
SintrasearchP	dB	1	50			50		
Propagation Condition		1	AWGN					
<p>Note 1: OCNG shall be used such that both cells are fully allocated and a constant total transmitted power spectral density is achieved for all OFDM symbols.</p> <p>Note 2: Interference from other cells and noise sources not specified in the test is assumed to be constant over subcarriers and time and shall be modelled as AWGN of appropriate power for <math>N_{oc}</math> to be fulfilled.</p> <p>Note 3: SS-RSRP levels have been derived from other parameters for information purposes. They are not settable parameters themselves.</p> <p>Note 4: For UE supporting both semi-static and dynamic channel access, the UE must be tested under both dynamic and semi-static channel occupancy configurations.</p>								

#### A.11.1.1.1.3 Test Requirements

The cell reselection delay to a newly detectable cell is defined as the time from the beginning of time period T2, to the moment when the UE camps on Cell 2, and starts to send preambles on the PRACH for sending the *RRCSetupRequest* message to perform a Tracking Area Update procedure on Cell 2.

The cell re-selection delay to a newly detectable cell shall be less than  $(25 + M_d) \cdot 1.28 + T_{SI\_CCA}$  s.  $M_d$  is the number of DRX cycles with at least one SMTC where there are no SSBs available during the  $T_{\text{detect, NR\_Intra\_CCA}}$ . If  $M_d > M_{d, \text{max}}$  the UE is required to restart the detection of Cell 2.

The cell reselection delay to an already detected cell is defined as the time from the beginning of time period T3, to the moment when the UE camps on cell 1, and starts to send preambles on the PRACH for sending the *RRCSetupRequest* message to perform a Tracking Area Update procedure on cell 1.

The cell re-selection delay to an already detected cell shall be less than  $(5 + M_e) \cdot 1.28 + T_{SI\_CCA}$  s.  $M_e$  is the number of DRX cycles with at least one SMTC where there are no SSBs available during the  $T_{\text{evaluate, NR\_Intra\_CCA}}$ . If  $M_e > M_{e, \text{max}}$  the UE is required to restart the evaluation of Cell 2.

The rate of correct cell reselections observed during repeated tests shall be at least 90%.

NOTE: The cell re-selection delay to a newly detectable cell can be expressed as:  $T_{\text{detect, NR\_Intra\_CCA}} + T_{SI\_CCA}$ , and to an already detected cell can be expressed as:  $T_{\text{evaluate, NR\_intra\_CCA}} + T_{SI\_CCA}$ ,

Where:

$T_{\text{detect, NR\_Intra\_CCA}}$  See Table 4.2A.2.3-1 in clause 4.2A.2.3

$T_{\text{evaluate, NR\_intra\_CCA}}$  See Table 4.2A.2.3-1 in clause 4.2A.2.3

$T_{SI\_CCA}$  Maximum repetition period of relevant system info blocks that needs to be received by the UE to camp on a cell.

This gives a total of  $(25 + M_d) \cdot 1.28 + T_{SL\_CCA}$  s for the cell re-selection delay to a newly detectable cell and  $(5 + M_e) \cdot 1.28 + T_{SL\_CCA}$  s for the cell re-selection delay to an already detected cell in the test case.

### A.11.1.1.2 Cell reselection to FR1 inter-frequency NR case when subject to CCA on the serving and target cell

#### A.11.1.1.2.1 Test Purpose and Environment

This test is to verify the requirement for the inter frequency NR cell reselection requirements subject to CCA specified in clause 4.2A.2.4. Supported test configurations are shown in table A.11.1.1.2.2-1.

#### A.11.1.1.2.2 Test Parameters

The test scenario comprises of 2 cells on 2 different NR carriers that are subject to CCA respectively as given in tables A.11.1.1.2.2-1, A.11.1.1.2.2-2 and A.11.1.1.2.2-3. The test consists of three successive time periods, with time duration of T1, T2, and T3 respectively. Both cell 1 and cell 2 are already identified by the UE prior to the start of the test. Cell 1 and cell 2 belong to different tracking areas and cell 2 is of higher priority than cell 1.

**Table A.11.1.1.2.2-1: Supported test configurations**

Configuration	Description of cell 1 with CCA	Description of cell 2 with CCA
1	30 kHz SSB SCS, 40 MHz bandwidth, TDD duplex mode	30 kHz SSB SCS, 40 MHz bandwidth, TDD duplex mode

**Table A.11.1.1.2.2-2: General test parameters for FR1 inter frequency NR cell re-selection test case when subject to CCA**

Parameter		Unit	Test configuration	Value	Comment
Initial condition	Active cell		1	Cell2	The UE camps on cell 2 in the initial phase and during T1 period the UE reselects to cell 1
T1 end condition	Active cell		1	Cell1	The UE shall perform reselection to cell 1 during T1
	Neighbour cells		1	Cell2	
T3 end condition	Active cell		1	Cell2	The UE shall perform reselection to cell 2 with higher priority during T3
RF Channel Number			1	1, 2	
Time offset between cells			1	3 $\mu$ s	Synchronous cells
Access Barring Information		-	1	Not Sent	No additional delays in random access procedure.
SSB configuration	Semi-static channel access		1	SSB.1 CCA (As defined in A.3.10A)	
	Dynamic channel access			SSB.2 CCA (As defined in A.3.10A)	
DBT Window Configuration			1	DBT.1	As specified in clause A.3.28.1.
SMTC configuration			1	SMTC.1	
DL CCA model			1	As specified in clause A.3.26.2.1	
UL CCA model			1	As specified in clause A.3.26.2.2	
DRX cycle length		s	1	1.28	The value shall be used for all cells in the test.
PRACH configuration index			1	102	The detailed configuration is specified in TS 38.211 clause 6.3.3.2
rangeToBestCell			1	Not configured	
T1		s	1	15	T1 needs to be defined so that cell re-selection reaction time is taken into account.

T2	s	1	>7	During T2, cell 2 shall be powered off, and during the off time the physical cell identity shall be changed. The intention is to ensure that cell 2 has not been detected by the UE prior to the start of period T3.
T3	s	1	75	T3 needs to be defined so that cell re-selection reaction time is taken into account.

**Table A.11.1.1.2.2-3: Cell specific test parameters for FR1 inter frequency NR cell re-selection test case in AWGN**

Parameter	Unit	Test configuration	Cell 1			Cell 2		
			T1	T2	T3	T1	T2	T3
TDD configuration		1	TDDConf.1.1 CCA			TDDConf.1.1 CCA		
DL CCA probability for semi-static channel access ( $P_{CCA\_DL}$ )		1	0.9			0.9		
DL CCA probability for for dynamic static channel access ( $P_{CCA\_DL\_1}$ )		1	0.75			0.75		
DL CCA probability for for dynamic static channel access ( $P_{CCA\_DL\_2}$ )		2	0.5			0.5		
UL CCA probability $P_{CCA\_UL}$		1	1			1		
$M_{d,max}$		1	16			16		
$M_{m,max}$		1	4			4		
$M_{e,max}$		1	8			8		
PDSCH RMC		1	SR.1.1 CCA			SR.1.1 CCA		
RMSI CORESET		1	CR.1.1 CCA			CR.1.1 CCA		
Dedicated CORESET		1	CCR.1.1 CCA			CCR.1.1 CCA		
OCNG Pattern		1	OP.1 defined in A.3.2.1			OP.1 defined in A.3.2.1		
Initial DL BWP configuration		1	DLBWP.0.1			DLBWP.0.1		
Initial UL BWP configuration		1	ULBWP.0.1			ULBWP.0.1		
RLM-RS		1	SSB			SSB		
Qrxlevmin	dBm/SCS	1	-137			-137		
Pcompensation	dB	1	0			0		
Qhyst <sub>s</sub>	dB	1	0			0		
Qoffset <sub>s, n</sub>	dB	1	0			0		
Cell_selection_and_reselection_quality_measurement		1	SS-RSRP			SS-RSRP		
$\hat{E}_s / I_{oc}$	dB	1	14	14	14	-4	-infinity	12
$N_{oc}$ <sup>Note2</sup>	dBm/SCS	1	-95					
$N_{oc}$ <sup>Note2</sup>	dBm/15 kHz	1	-98					
$\hat{E}_s / N_{oc}$	dB	1	14	14	14	-4	-infinity	12
SS-RSRP <sup>Note3</sup>	dBm/SCS	1	-81	-81	-81	-99	-infinity	-83
Io	dBm/38.16 MHz	1	-49.79	-49.79	-49.79	-62.50	-infinity	-51.69
Treselection	s	1	0	0	0	0	0	0
SnonintrasearchP	dB	1	50			50		

Thresh <sub>x, high</sub>	dB	1	48	48
Thresh <sub>serv, low</sub>	dB	1	44	44
Thresh <sub>x, low</sub>	dB	1	50	50
Propagation Condition		1	AWGN	
Note 1:	OCNG shall be used such that both cells are fully allocated and a constant total transmitted power spectral density is achieved for all OFDM symbols.			
Note 2:	Interference from other cells and noise sources not specified in the test is assumed to be constant over subcarriers and time and shall be modelled as AWGN of appropriate power for $N_{oc}$ to be fulfilled.			
Note 3:	SS-RSRP levels have been derived from other parameters for information purposes. They are not settable parameters themselves.			
Note 4:	For UE supporting both semi-static and dynamic channel access, the UE must be tested under both dynamic and semi-static channel occupancy configurations.			

### A.11.1.1.2.3 Test Requirements

The cell reselection delay to a higher priority cell is defined as the time from the beginning of time period T3, to the moment when the UE camps again on cell 2, and starts to send preambles on the PRACH for sending the *RRCSetupRequest* message to perform a Tracking Area Update procedure on cell 2.

The cell re-selection delay to a higher priority cell shall be less than  $60 + 1.28 \times (5 + M_e) + T_{SI\_CCA}$  s.  $M_e$  is the number of DRX cycles with at least one SMTC where there are no SSBs available during the  $T_{evaluate, NR\_Intra\_CCA}$ . If  $M_e > M_{e, max}$  the UE is required to restart the evaluation of cell 2.

The cell reselection delay to a lower priority cell is defined as the time from the beginning of time period T1, to the moment when the UE camps on cell 1, and starts to send preambles on the PRACH for sending the *RRCSetupRequest* message to perform a Tracking Area Update procedure on cell 1.

The cell re-selection delay to a lower priority cell shall be less than  $1.28 \times (5 + M_e) + T_{SI\_CCA}$  s.  $M_e$  is the number of DRX cycles with at least one SMTC where there are no SSBs available during the  $T_{evaluate, NR\_Intra\_CCA}$ . If  $M_e > M_{e, max}$  the UE is required to restart the evaluation of cell 2.

The rate of correct cell reselections observed during repeated tests shall be at least 90%.

NOTE: The cell re-selection delay to a higher priority cell can be expressed as:  $T_{higher\_priority\_search} + T_{evaluate, NR\_inter\_CCA} + T_{SI\_CCA}$ , and to a lower priority cell can be expressed as:  $T_{evaluate, NR\_inter\_CCA} + T_{SI\_CCA}$ .

Where:

$T_{higher\_priority\_search}$  See clause 4.2.2.7

$T_{evaluate, NR\_inter\_CCA}$  See Table 4.2A.2.4-1 in clause 4.2A.2.4

$T_{SI\_CCA}$  Maximum repetition period of relevant system info blocks that needs to be received by the UE to camp on a cell.

This gives a total of  $60 + 1.28 \times (5 + M_e) + T_{SI\_CCA}$  s for the cell re-selection delay to a higher priority cell and  $1.28 \times (5 + M_e) + T_{SI\_CCA}$  s for the cell re-selection delay to a lower priority cell in the test case.

## A.11.1.2 Cell re-selection to NR with source NR carrier frequency under CCA

### A.11.1.2.1 Cell reselection to FR1 inter-frequency NR case when serving cell is subject to CCA

#### A.11.1.2.1.1 Test Purpose and Environment

This test is to verify the requirement for the inter frequency NR cell reselection requirements specified in clause 4.2.2.4 when the serving cell is subject to CCA. Supported test configurations are shown in table A.11.1.2.1.2-1.

#### A.11.1.2.1.2 Test Parameters

The test scenario comprises of 2 cells on 2 different NR carriers where the first carrier is subject to CCA as given in tables A.11.1.2.1.2-1, A.11.1.2.1.2-2 and A.11.1.2.1.2-3. The test consists of three successive time periods, with time

duration of T1, T2, and T3 respectively. Both cell 1 and cell 2 are already identified by the UE prior to the start of the test. Cell 1 and cell 2 belong to different tracking areas and cell 2 is of higher priority than cell 1.

**Table A.11.1.2.1.2-1: Supported test configurations**

Configuration	Description of a cell with CCA	Description of a cell without CCA
1	30 kHz SSB SCS, 40 MHz bandwidth, TDD duplex mode	15 kHz SSB SCS, 10 MHz bandwidth, FDD duplex mode
2	30 kHz SSB SCS, 40 MHz bandwidth, TDD duplex mode	15 kHz SSB SCS, 10 MHz bandwidth, TDD duplex mode
3	30 kHz SSB SCS, 40 MHz bandwidth, TDD duplex mode	30 kHz SSB SCS, 40 MHz bandwidth, TDD duplex mode

Note: The UE is only required to be tested in one of the supported test configurations.

**Table A.11.1.2.1.2-2: General test parameters for FR1 inter frequency NR cell re-selection test case when serving cell is subject to CCA**

Parameter	Unit	Test configuration	Value	Comment
Initial condition	Active cell	1, 2, 3	Cell2	The UE camps on cell 2 which is subject to CCA in the initial phase and during T1 period the UE reselects to cell 1 which is an inter-frequency NR cell
T1 end condition	Active cell	1, 2, 3	Cell1	The UE shall perform reselection to cell 1 during T1
	Neighbour cells	1, 2, 3	Cell2	
T3 end condition	Active cell	1, 2, 3	Cell2	The UE shall perform reselection to cell 2 with higher priority during T3
RF Channel Number		1, 2, 3	1, 2	
Time offset between cells		1	3 ms	Asynchronous cells
		2	3 $\mu$ s	Synchronous cells
		3	3 $\mu$ s	Synchronous cells
Access Barring Information	-	1, 2, 3	Not Sent	No additional delays in random access procedure.
SSB configuration		1	Cell 1: SSB.1 FR1 Cell 2: SSB.1 CCA for semi-static channel access; Cell 2: SSB.2 CCA for dynamic channel access	
		2	Cell 1: SSB.1 FR1 Cell 2: SSB.1 CCA for semi-static channel access; Cell 2: SSB.2 CCA for dynamic channel access	
		3	Cell 1: SSB.2 FR1 Cell 2: SSB.1 CCA for semi-static channel access; Cell 2: SSB.2 CCA for dynamic channel access	
SMTC configuration		1	Cell 1: SMTC pattern 2 Cell 2: N/A	
		2	Cell 1: SMTC pattern 1 Cell 2: N/A	
		3	Cell 1: SMTC pattern 1 Cell 2: N/A	
DBT Window Configuration		1, 2, 3	Cell 1: N/A Cell 2: DBT.1	As specified in clause A.3.28.1.
DL CCA model		1, 2, 3	Cell 1: N/A Cell 2: As specified in clause A.3.26.2.1	
UL CCA model		1, 2, 3	Cell 1: N/A Cell 2: As specified in clause A.3.26.2.2	



DRX cycle length	s	1, 2, 3	1.28	The value shall be used for all cells in the test.
PRACH configuration index		1, 2, 3	102	The detailed configuration is specified in TS 38.211 clause 6.3.3.2
rangeToBestCell		1, 2, 3	Not configured	
T1	s	1, 2, 3	15	T1 needs to be defined so that cell re-selection reaction time is taken into account.
T2	s	1, 2, 3	>7	During T2, cell 2 shall be powered off, and during the off time the physical cell identity shall be changed. The intention is to ensure that cell 2 has not been detected by the UE prior to the start of period T3.
T3	s	1, 2, 3	75	T3 needs to be defined so that cell re-selection reaction time is taken into account.

**Table A.11.1.2.1.2-3: Cell specific test parameters for FR1 inter frequency NR cell re-selection test case in AWGN when serving cell is subject to CCA**

Parameter	Unit	Test configuration	Cell 1			Cell 2		
			T1	T2	T3	T1	T2	T3
TDD configuration		1	N/A			TDDConf.1.1.CCA		
		2	TDDConf.1.1			TDDConf.1.1.CCA		
		3	TDDConf.2.1			TDDConf.1.1.CCA		
DL CCA probability for semi-static channel access ( $P_{CCA\_DL}$ )		1, 2, 3	N/A			0.9		
DL CCA probability for dynamic static channel access ( $P_{CCA\_DL\_1}$ )		1, 2, 3	N/A			0.75		
DL CCA probability for dynamic static channel access ( $P_{CCA\_DL\_2}$ )		1, 2, 3	N/A			0.5		
UL CCA probability $P_{CCA\_UL}$		1, 2, 3	N/A			1		
$M_{d,max}$		1, 2, 3	N/A			16		
$M_{m,max}$		1, 2, 3	N/A			4		
$M_{e,max}$		1, 2, 3	N/A			8		
PDSCH RMC configuration		1	SR.1.1 FDD			SR.1.1 CCA		
		2	SR.1.1 TDD			SR.1.1 CCA		
		3	SR.2.1 TDD			SR.1.1 CCA		
RMSI CORESET RMC configuration		1	CR.1.1 FDD			CR.1.1 CCA		
		2	CR.1.1 TDD			CR.1.1 CCA		
		3	CR.2.1 TDD			CR.1.1 CCA		
Dedicated CORESET RMC configuration		1	CCR.1.1 FDD			CCR.1.1 CCA		
		2	CCR.1.1 TDD			CCR.1.1 CCA		
		3	CCR.2.1 TDD			CCR.1.1 CCA		
OCNG Pattern		1, 2, 3	OP.1 defined in A.3.2.1			OP.1 defined in A.3.2.1		
Initial DL BWP configuration		1, 2, 3	DLBWP.0.1			DLBWP.0.1		
Initial UL BWP configuration		1, 2, 3	ULBWP.0.1			ULBWP.0.1		
RLM-RS		1, 2, 3	SSB			SSB		
Qrxlevmin	dBm/SCS	1, 2	-140			-137		
		3	-137			-137		
Pcompensation	dB	1, 2, 3	0			0		

Cell_selection_and_reselection_quality_measurement		1, 2, 3	SS-RSRP			SS-RSRP		
$\hat{E}_s/I_{ot}$	dB	1	14	14	14	-4	-infinity	12
		2						
		3						
$N_{oc}$ Note2	dBm/SCS	1	-98			-95		
		2	-98			-95		
		3	-95					
$N_{oc}$ Note2	dBm/15 kHz	1	-98					
		2						
		3						
$\hat{E}_s/N_{oc}$	dB	1	14	14	14	-4	-infinity	12
		2						
		3						
SS-RSRP Note3	dBm/SCS	1	-84	-84	-84	-102	-infinity	-83
		2	-84	-84	-84	-102	-infinity	-83
		3	-81	-81	-81	-99	-infinity	-83
Io	dBm/9.36 MHz	1	-55.88	-55.88	-55.88	-68.60	--	--
	dBm/9.36 MHz	2	-55.88	-55.88	-55.88	-68.60	--	--
	dBm/38.16 MHz	3	-49.79	-49.79	-49.79	-62.50	-63.96	-51.69
Treselection	s	1, 2, 3	0	0	0	0	0	0
SnonintraSearchP	dB	1, 2, 3	50			50		
Thresh <sub>x, highP</sub>	dB	1, 2, 3	48			48		
Thresh <sub>serv, lowP</sub>	dB	1, 2, 3	44			44		
Thresh <sub>x, lowP</sub>	dB	1, 2, 3	50			50		
Propagation Condition		1, 2, 3	AWGN					
Note 1:	OCNG shall be used such that both cells are fully allocated and a constant total transmitted power spectral density is achieved for all OFDM symbols.							
Note 2:	Interference from other cells and noise sources not specified in the test is assumed to be constant over subcarriers and time and shall be modelled as AWGN of appropriate power for $N_{oc}$ to be fulfilled.							
Note 3:	SS-RSRP levels have been derived from other parameters for information purposes. They are not settable parameters themselves.							
Note 4:	For UE supporting both semi-static and dynamic channel access, the UE must be tested under both dynamic and semi-static channel occupancy configurations.							

### A.11.1.2.1.3 Test Requirements

The cell reselection delay to a higher priority cell is defined as the time from the beginning of time period T3, to the moment when the UE camps again on cell 2, and starts to send preambles on the PRACH for sending the *RRCSetupRequest* message to perform a Tracking Area Update procedure on cell 2.

The cell re-selection delay to a higher priority cell shall be less than  $60 + 1.28 \times (5 + M_e) + T_{SI\_CCA}$  s.  $M_e$  is the number of DRX cycles with at least one SMTC where there are no SSBs available during the  $T_{evaluate\_NR\_Intra\_CCA}$ . If  $M_e > M_{e,max}$  the UE is required to restart the evaluation of cell 2.

The cell reselection delay to a lower priority cell is defined as the time from the beginning of time period T1, to the moment when the UE camps on cell 1, and starts to send preambles on the PRACH for sending the *RRCSetupRequest* message to perform a Tracking Area Update procedure on cell 1.

The cell re-selection delay to a lower priority cell shall be less than 8 s.

The rate of correct cell reselections observed during repeated tests shall be at least 90%.

NOTE: The cell re-selection delay to a higher priority cell can be expressed as:  $T_{higher\_priority\_search} + T_{evaluate\_NR\_inter\_CCA} + T_{SI\_CCA}$ , and to a lower priority cell can be expressed as:  $T_{evaluate\_NR\_inter} + T_{SI\_NR}$ .

Where:

$T_{higher\_priority\_search}$  See clause 4.2.2.7

$T_{\text{evaluate, NR\_inter\_CCA}}$  See Table 4.2A.2.4-1 in clause 4.2A.2.4

$T_{\text{SL\_CCA}}$  Maximum repetition period of relevant system info blocks that needs to be received by the UE to camp on a cell.

$T_{\text{evaluate, NR\_inter}}$  See Table 4.2.2.4-1 in clause 4.2.2.4

$T_{\text{SL-NR}}$  Maximum repetition period of relevant system info blocks that needs to be received by the UE to camp on a cell; 1280 ms is assumed in this test cases.

This gives a total of  $60 + 1.28 \times (5 + M_e) + T_{\text{SL\_CCA}}$  s for the cell re-selection delay to a higher priority cell and 7.68 s for the cell re-selection delay to a lower priority cell in the test case, which we allow 8 s.

### A.11.1.3 Cell re-selection from NR carrier with target NR carrier frequency under CCA

#### A.11.1.3.1 Cell reselection to FR1 inter-frequency NR case when target cell is subject to CCA

##### A.11.1.3.1.1 Test Purpose and Environment

This test is to verify the requirement for the inter frequency NR cell reselection requirements specified in clause 4.2A.2.4 when the target cell is subject to CCA. Supported test configurations are shown in table A. 11.1.3.1.2-1.

##### A.11.1.3.1.2 Test Parameters

The test scenario comprises of 2 cells on 2 different NR carriers where the second carrier is subject to CCA as given in tables A.11.1.3.1.2-1, A.11.1.3.1.2-2 and A.11.1.3.1.2-3. The test consists of three successive time periods, with time duration of T1, T2, and T3 respectively. Both cell 1 and cell 2 are already identified by the UE prior to the start of the test. Cell 1 and cell 2 belong to different tracking areas and cell 2 is of higher priority than cell 1.

**Table A.11.1.3.1.2-1: Supported test configurations**

Configuration	Description of a cell without CCA	Description of a cell with CCA
1	15 kHz SSB SCS, 10 MHz bandwidth, FDD duplex mode	30 kHz SSB SCS, 40 MHz bandwidth, TDD duplex mode
2	15 kHz SSB SCS, 10 MHz bandwidth, TDD duplex mode	30 kHz SSB SCS, 40 MHz bandwidth, TDD duplex mode
3	30 kHz SSB SCS, 40 MHz bandwidth, TDD duplex mode	30 kHz SSB SCS, 40 MHz bandwidth, TDD duplex mode

The UE is only required to be tested in one of the supported test configurations.

**Table A.11.1.3.1.2-2: General test parameters for FR1 inter frequency NR cell re-selection test case when target cell is subject to CCA**

Parameter		Unit	Test configuration	Value	Comment
Initial condition	Active cell		1, 2, 3	Cell2	The UE camps on cell 2 which is an inter-frequency NR cell in the initial phase and during T1 period the UE reselects to cell 1 which is cell subject to CCA
	Neighbour cell		1, 2, 3	Cell 1	
T1 end condition	Active cell		1, 2, 3	Cell1	The UE shall perform reselection to cell 1 during T1
	Neighbour cells		1, 2, 3	Cell2	
T3 end condition	Active cell		1, 2, 3	Cell2	The UE shall perform reselection to cell 2 with higher priority during T3

	Neighbour cell	1, 2, 3	Cell 1	
RF Channel Number		1, 2, 3	1, 2	
Time offset between cells		1	3 ms	Asynchronous cells
		2	3 $\mu$ s	Synchronous cells
		3	3 $\mu$ s	Synchronous cells
Access Barring Information	-	1, 2, 3	Not Sent	No additional delays in random access procedure.
SSB configuration		1	Cell 1: SSB.1 CCA for semi-static channel access; Cell 1: SSB.2 CCA for dynamic channel access; Cell 2: SSB.1 FR1	
		2	Cell 1: SSB.1 CCA for semi-static channel access; Cell 1: SSB.2 CCA for dynamic channel access; Cell 2: SSB.1 FR1	
		3	Cell 1: SSB.1 CCA for semi-static channel access; Cell 1: SSB.2 CCA for dynamic channel access; Cell 2: SSB.2 FR1	
SMTC configuration		1	Cell 1: SMTC.1 Cell 2: SMTC.2	
		2	Cell 1: SMTC.1 Cell 2: SMTC.1	
		3	Cell 1: SMTC.1 Cell 2: SMTC.1	
DBT Window Configuration		1, 2, 3	Cell 1: DBT.1 Cell 2: N/A	As specified in clause A.3.28.1.
DL CCA model		1, 2, 3	Cell 1: As specified in clause A.3.26.2.1 Cell 2: N/A	
UL CCA model		1, 2, 3	Cell 1: As specified in clause A.3.26.2.2 Cell 2: N/A	
DRX cycle length	s	1, 2, 3	1.28	The value shall be used for all cells in the test.
PRACH configuration index		1, 2, 3	102	The detailed configuration is specified in TS 38.211 clause 6.3.3.2
rangeToBestCell		1, 2, 3	Not configured	
T1	s	1, 2, 3	15	T1 needs to be defined so that cell re-selection reaction time is taken into account.
T2	s	1, 2, 3	>7	During T2, cell 2 shall be powered off, and during the off time the physical cell identity shall be changed. The intention is to ensure that cell 2 has not been detected by the UE prior to the start of period T3.
T3	s	1, 2, 3	75	T3 needs to be defined so that cell re-selection reaction time is taken into account.

**Table A.11.1.3.1.2-3: Cell specific test parameters for FR1 inter frequency NR cell re-selection test case in AWGN when target cell is subject to CCA**

Parameter	Unit	Test configuration	Cell 1			Cell 2		
			T1	T2	T3	T1	T2	T3
TDD configuration		1	TDDConf.1.1.CCA			N/A		
		2	TDDConf.1.1.CCA			TDDConf.1.1		
		3	TDDConf.1.1.CCA			TDDConf.2.1		
DL CCA probability for semi-static channel access ( $P_{CCA\_DL}$ )		1, 2, 3	0.9			N/A		
DL CCA probability for for dynamic static channel access ( $P_{CCA\_DL\_1}$ )		1, 2, 3	0.75			N/A		
DL CCA probability for for dynamic static channel access ( $P_{CCA\_DL\_2}$ )		1, 2, 3	0.5			N/A		
UL CCA probability $P_{CCA\_UL}$		1, 2, 3	1			N/A		
$M_{d,max}$		1, 2, 3	16			N/A		
$M_{m,max}$		1, 2, 3	4			N/A		
$M_{e,max}$		1, 2, 3	8			N/A		
PDSCH RMC configuration		1	SR.1.1 CCA			SR.1.1 FDD		
		2	SR.1.1 CCA			SR.1.1 TDD		
		3	SR.1.1 CCA			SR.2.1 TDD		
RMSI CORESET RMC configuration		1	CR.1.1 CCA			CR.1.1 FDD		
		2	CR.1.1 CCA			CR.1.1 TDD		
		3	CR.1.1 CCA			CR.2.1 TDD		
Dedicated CORESET RMC configuration		1	CCR.1.1 CCA			CCR.1.1 FDD		
		2	CCR.1.1 CCA			CCR.1.1 TDD		
		3	CCR.1.1 CCA			CCR.2.1 TDD		
OCNG Pattern		1, 2, 3	OP.1 defined in A.3.2.1			OP.1 defined in A.3.2.1		
Initial DL BWP configuration		1, 2, 3	DLBWP.0.1			DLBWP.0.1		
Initial UL BWP configuration		1, 2, 3	ULBWP.0.1			ULBWP.0.1		
RLM-RS		1, 2, 3	SSB			SSB		
Qrxlevmin	dBm/SCS	1, 2	-137			-140		
		3	-137			-137		
Pcompensation	dB	1, 2, 3	0			0		
Cell_selection_and_reselection_quality_measurement		1, 2, 3	SS-RSRP			SS-RSRP		
$\hat{E}_s/I_{ot}$	dB	1	14	14	14	-4	-infinity	12
		2						
		3						
$N_{oc}$ <sup>Note2</sup>	dBm/SCS	1	-95			-98		
		2	-95			-98		
		3	-95			-98		
$N_{oc}$ <sup>Note2</sup>	dBm/15 kHz	1	-98					
		2						
		3						
$\hat{E}_s/N_{oc}$	dB	1	14	14	14	-4	-infinity	12
		2						
		3						
SS-RSRP <sup>Note3</sup>	dBm/SCS	1	-81	-81	-81	-102	-infinity	-86
		2	-81	-81	-81	-102	-infinity	-86

		3	-81	-81	-81	-99	-infinity	-83
Io	dBm/9.36 MHz	1	--	--	--	-68.60	-70.05	-57.78
	dBm/9.36 MHz	2	--	--	--	-68.60	-70.05	-57.78
	dBm/38.16 MHz	3	-49.79	-49.79	-49.79	-62.50	-63.96	-51.69
Treselection	s	1, 2, 3	0	0	0	0	0	0
SnonintrasearchP	dB	1, 2, 3	50			50		
Thresh <sub>x, highP</sub>	dB	1, 2, 3	48			48		
Thresh <sub>serv, lowP</sub>	dB	1, 2, 3	44			44		
Thresh <sub>x, lowP</sub>	dB	1, 2, 3	50			50		
Propagation Condition		1, 2, 3	AWGN					
Note 1:	OCNG shall be used such that both cells are fully allocated and a constant total transmitted power spectral density is achieved for all OFDM symbols.							
Note 2:	Interference from other cells and noise sources not specified in the test is assumed to be constant over subcarriers and time and shall be modelled as AWGN of appropriate power for $N_{oc}$ to be fulfilled.							
Note 3:	SS-RSRP levels have been derived from other parameters for information purposes. They are not settable parameters themselves.							
Note 4:	For UE supporting both semi-static and dynamic channel access, the UE must be tested under both dynamic and semi-static channel occupancy configurations.							

### A.11.1.3.1.3 Test Requirements

The cell reselection delay to a higher priority cell is defined as the time from the beginning of time period T3, to the moment when the UE camps again on cell 2, and starts to send preambles on the PRACH for sending the *RRCSetupRequest* message to perform a Tracking Area Update procedure on cell 2.

The cell re-selection delay to a higher priority cell shall be less than 68 s.

The cell reselection delay to a lower priority cell is defined as the time from the beginning of time period T1, to the moment when the UE camps on cell 1, and starts to send preambles on the PRACH for sending the *RRCSetupRequest* message to perform a Tracking Area Update procedure on cell 1.

$1.28 \times (5 + M_e) + T_{SI\_CCA}$  s.  $M_e$  is the number of DRX cycles with at least one SMTC where there are no SSBs available during the  $T_{evaluate\_NR\_Intra\_CCA}$ . If  $M_e > M_{e,max}$  the UE is required to restart the evaluation of cell 2.

The rate of correct cell reselections observed during repeated tests shall be at least 90%.

NOTE: The cell re-selection delay to a higher priority cell can be expressed as:  $T_{higher\_priority\_search} + T_{evaluate\_NR\_inter} + T_{SI-NR}$ , and to a lower priority cell can be expressed as:  $T_{evaluate\_NR\_inter} + T_{SI-NR}$ .

Where:

$T_{higher\_priority\_search}$  See clause 4.2.2.7

$T_{evaluate\_NR\_inter\_CCA}$  See Table 4.2A.2.4-1 in clause 4.2A.2.4

$T_{SI\_CCA}$  Maximum repetition period of relevant system info blocks that needs to be received by the UE to camp on a cell.

$T_{evaluate\_NR\_inter}$  See Table 4.2.2.4-1 in clause 4.2.2.4

$T_{SI-NR}$  Maximum repetition period of relevant system info blocks that needs to be received by the UE to camp on a cell; 1280 ms is assumed in this test case.

This gives a total of 67.68 s, allow 68 s for the cell re-selection delay to a higher priority cell and  $1.28 \times (5 + M_e) + T_{SI\_CCA}$  s for the cell re-selection delay to a lower priority cell in the test case.

## A.11.1.4 Inter-RAT cell re-selection to E-UTRAN with source NR carrier frequency under CCA

### A.11.1.4.1 Cell reselection to higher priority E-UTRAN when serving cell is subject to CCA

#### A.11.1.4.1.1 Test Purpose and Environment

This test is to verify the requirement for the NR cell subject to CCA to E-UTRAN inter-RAT cell reselection requirements specified in clause 4.2A.2.5 when the E-UTRAN cell is of higher priority.

#### A.11.1.4.1.2 Test Parameters

The test scenario comprises of one NR cell which is subject to CCA and one E-UTRAN cell as given in tables A.11.1.4.1.2-1, A.11.1.4.1.2-2, A.11.1.4.1.2-3 and A.11.1.4.1.2-4. The test consists of three successive time periods, with time duration of T1, T2, and T3 respectively. NR cell 1 is already identified by the UE prior to the start of the test. E-UTRAN cell 2 is of higher priority than cell 1.

**Table A.11.1.4.1.2-1: Supported test configurations**

Configuration	Description of a cell with CCA	Description of a cell without CCA
1	NR 30 kHz SSB SCS, 40 MHz bandwidth, TDD duplex mode	LTE 10 MHz bandwidth, TDD duplex mode
2	NR 30 kHz SSB SCS, 40 MHz bandwidth, TDD duplex mode	LTE 10 MHz bandwidth, FDD duplex mode

Note: The UE is only required to be tested in one of the supported test configurations.

**Table A.11.1.4.1.2-2: General test parameters for NR cell subject to CCA to E-UTRAN cell re-selection test case**

Parameter		Unit	Test configuration	Value	Comment
Initial condition	Active cell		1, 2	Cell1	The UE camps on cell 1 in the initial phase and during T2 period the UE reselects to cell 2.
T2 end condition	Active cell		1, 2	Cell2	The UE shall perform reselection to cell 2 during T2.
	Neighbour cells		1, 2	Cell1	
T3 end condition	Active cell		1, 2	Cell1	The UE shall perform reselection to cell 1 during T3 for iteration of the tests.
	Neighbour cells		1, 2	Cell2	
Access Barring Information		-	1, 2	Not Sent	No additional delays in random access procedure.
SMTC configuration			1, 2	SMTC.1	
DBT Window Configuration			1, 2	DBT.1	As specified in clause A.3.28.1.
SSB configuration				Cell 1: SSB.1 CCA for semi-static channel access; Cell 1: SSB.2 CCA for dynamic channel access;	
DL CCA model			1, 2	As specified in clause A.3.26.2.1	
UL CCA model			1, 2	As specified in clause A.3.26.2.2	
DRX cycle length		s	1, 2	1.28	The value shall be used for all cells in the test.
NR PRACH configuration index			1, 2	102	The detailed configuration is specified in TS 38.211 clause 6.3.3.2

E-UTRAN PRACH configuration index		1	53	As specified in table 5.7.1-2 in TS 36.211 [23]
		2	4	
E-UTRAN PRACH configuration index		1	53	As specified in table 5.7.1-2 in TS 36.211 [23]
		2	4	
T1	s	1, 2	>7	During T1, cell 2 shall be powered off, and during the off time the physical cell identity shall be changed. The intention is to ensure that cell 2 has not been detected by the UE prior to the start of period T2.
T2	s	1, 2	75	T2 needs to be defined so that cell re-selection reaction time is taken into account.
T3	s	1, 2	15	T3 needs to be defined so that cell re-selection reaction time is taken into account.

Table A.11.1.4.1.2-3: Cell specific test parameters for NR cell 1 subject to CCA

Parameter	Unit	Test configuration	Cell 1		
			T1	T2	T3
TDD configuration		1, 2	TDDConf.1.1.CCA		
DL CCA probability for semi-static channel access ( $P_{CCA\_DL}$ )		1, 2	0.9		
DL CCA probability for for dynamic static channel access ( $P_{CCA\_DL\_1}$ )		1, 2	0.75		
DL CCA probability for for dynamic static channel access ( $P_{CCA\_DL\_2}$ )		1, 2	0.5		
UL CCA probability $P_{CCA\_UL}$		1, 2	1		
$M_{d,max}$		1, 2	16		
$M_{m,max}$		1, 2	4		
$M_{e,max}$		1, 2	8		
PDSCH parameters		1, 2	SR.1.1 CCA		
RMSI CORESET parameters		1, 2	CR.1.1 CCA		
Dedicated CORESET parameters		1, 2	CCR.1.1 CCA		
SSB parameters		1, 2	SSB.1 CCA for semi-static channel access; SSB.2 CCA for dynamic channel access		
NR SMTTC parameters		1, 2	SMTTC.1		
OCNG Pattern		1, 2	OP.1 defined in A.3.2.1		
Initial DL BWP configuration		1, 2	DLBWP.0		
Initial UL BWP configuration		1, 2	ULBWP.0		
RLM-RS		1, 2	SSB		
$Q_{rxlevmin}$	dBm/SCS	1, 2	-137		
$N_{\alpha}$	dBm/SCS	1, 2	-95		
$N_{\alpha}$	dBm/15 kHz	1, 2	-98		
SS-RSRP		1, 2	-81	-81	-81
$\hat{E}_s / I_{ot}$	dB	1, 2	14	14	14
$\hat{E}_s / N_{oc}$	dB	1, 2	14	14	14
$I_o$	dBm/38.16 MHz	1, 2	-49.79	-49.79	-49.79
Treselection	S	1, 2	0		
Snonintrasearch	dB	1, 2	50		
Thresh <sub>x, high</sub> (Note 2)	dB	1, 2	48		
Thresh <sub>serv, low</sub>	dB	1, 2	44		
Thresh <sub>x, low</sub>	dB	1, 2	50		
Propagation Condition		1, 2	AWGN		
Note 1: OCNG shall be used such that both cells are fully allocated and a constant total transmitted power spectral density is achieved for all OFDM symbols.					
Note 2: This refers to the value of Thresh <sub>x, high</sub> which is included in NR system information, and is a threshold for the E-UTRA target cell					
Note 4: For UE supporting both semi-static and dynamic channel access, the UE must be tested under both dynamic and semi-static channel occupancy configurations.					



Table A.11.1.4.1.2-4: Cell specific test parameters for E-UTRA cell 2

Parameter	Unit	Cell 2		
		T1	T2	T3
E-UTRA RF Channel number		1		
$BW_{channel}$	MHz	10		
OCNG Patterns defined in TS 36.133 [15] clause A.3.2		OP.2 TDD for test configuration 1, 2, 3; OP.2 FDD for test configuration 4, 5, 6		
PBCH_RA	dB	0		
PBCH_RB	dB			
PSS_RA	dB			
SSS_RA	dB			
PCFICH_RB	dB			
PHICH_RA	dB			
PHICH_RB	dB			
PDCCH_RA	dB			
PDCCH_RB	dB			
PDSCH_RA	dB			
PDSCH_RB	dB			
OCNG_RA <sup>Note 1</sup>	dB			
OCNG_RB <sup>Note 1</sup>	dB			
$Q_{rxlevmin}$	dBm			
$N_{oi}$	dBm/15 kHz	-98		
RSRP	dBm/15 KHz	-infinity	-86	-102
$\hat{E}_s / I_{ot}$	dB	-infinity	12	-4
$\hat{E}_s / N_{oc}$	dB	-infinity	12	-4
$T_{reselection_{EUTRAN}}$	S	0		
$S_{nonintrasearch}$	dB	50		
$Thresh_{x, high}$ (Note 2)	dB	48		
$Thresh_{serving, low}$	dB	44		
$Thresh_{x, low}$	dB	50		
Propagation Condition		AWGN		
Note 1: OCNG shall be used such that both cells are fully allocated and a constant total transmitted power spectral density is achieved for all OFDM symbols. Note 2: This refers to the value of $Thresh_{x, high}$ which is included in E-UTRA system information, and is a threshold for the NR target cell				

### A.11.1.4.1.3 Test Requirements

The cell reselection delay to a higher priority E-UTRAN cell is defined as the time from the beginning of time period T2, to the moment when the UE camps on cell 2, and starts to send preambles on the PRACH for sending the *RRCSetupRequest* message to perform a Tracking Area Update procedure on cell 2.

The cell re-selection delay to a higher priority cell shall be less than 68 s.

The rate of correct cell reselections observed during repeated tests shall be at least 90%.

NOTE: The cell re-selection delay to a higher priority cell can be expressed as:  $T_{higher\_priority\_search} + T_{evaluate, E-UTRAN} + T_{SI-E-UTRA}$ ,

Where:

$T_{higher\_priority\_search}$  See clause 4.2.2.7

$T_{evaluate, E-UTRAN}$  See Table 4.2.2.5-1 in clause 4.2.2.5

$T_{SI-E-UTRA}$  Maximum repetition period of relevant system info blocks that needs to be received by the UE to camp on a cell; 1280 ms is assumed in this test case.

This gives a total of 67.68 s, allow 68 s for the cell re-selection delay to a higher priority E-UTRAN cell.

## A.11.1.4.2 Cell reselection to lower priority E-UTRAN when serving cell is subject to CCA

### A.11.1.4.2.1 Test Purpose and Environment

This test is to verify the requirement for the NR cell subject to CCA to E-UTRAN inter-RAT cell reselection requirements specified in clause 4.2A.2.5 when the E-UTRAN cell is of lower priority.

The test scenario comprises of one NR cell and one E-UTRAN cell as given in tables A.11.1.4.2.1-1, A.11.1.4.2.1-2, A.11.1.4.2.1-3 and A.11.1.4.2.1-4. The test consists of three successive time periods, with time duration of T1 and T2 respectively. Both NR cell 1 and E-UTRAN cell 2 are already identified by the UE prior to the start of the test. E-UTRAN cell 2 is of lower priority than cell 1.

**Table A.11.1.4.2.1-1: Supported test configurations**

Configuration	Description of a cell with CCA	Description of a cell without CCA
1	NR 30 kHz SSB SCS, 40 MHz bandwidth, TDD duplex mode	LTE 10 MHz bandwidth, TDD duplex mode
2	NR 30 kHz SSB SCS, 40 MHz bandwidth, TDD duplex mode	LTE 10 MHz bandwidth, FDD duplex mode

Note: The UE is only required to be tested in one of the supported test configurations.

**Table A.11.1.4.2.1-2: General test parameters for NR cell subject to CCA to E-UTRAN cell re-selection test case**

Parameter	Unit	Test configuration	Value	Comment
Initial condition	Active cell	1, 2	Cell1	The UE camps on cell 1 in the initial phase.
T1 end condition	Active cell	1, 2	Cell2	The UE shall perform reselection to cell 2 during T1.
	Neighbour cells	1, 2	Cell1	
T2 end condition	Active cell	1, 2	Cell1	The UE shall perform reselection to cell 1 during T2 for iteration of the tests.
	Neighbour cells	1, 2	Cell2	
Access Barring Information	-	1, 2	Not Sent	No additional delays in random access procedure.
SMTC configuration		1, 2	SMTC.1	
DBT Window Configuration		1, 2	DBT.1	As specified in clause A.3.28.1.
DL CCA model		1, 2	As specified in clause A.3.26.2.1	
UL CCA model		1, 2	As specified in clause A.3.26.2.1	
DRX cycle length	s	1, 2	1.28	The value shall be used for all cells in the test.
NR PRACH configuration index		1, 2	102	The detailed configuration is specified in TS 38.211 clause 6.3.3.2
E-UTRAN PRACH configuration index		1	53	As specified in table 5.7.1-2 in TS 36.211 [23]
		2	4	
T1	s	1, 2	15	T1 needs to be defined so that cell reselection reaction time is taken into account.
T2	s	1, 2	75	T2 needs to be defined so that cell reselection reaction time is taken into account.

**Table A.11.1.4.2.1-3: Cell specific test parameters for NR cell 1 subject to CCA**

Parameter	Unit	Test configuration	Cell 1	
			T1	T2
TDD configuration		1, 2	TDDConf.1.1.CCA	
DL CCA probability for semi-static channel access ( $P_{CCA\_DL}$ )		1, 2	0.9	

DL CCA probability for for dynamic static channel access ( $P_{CCA\_DL\_1}$ )		1, 2	0.75	
DL CCA probability for for dynamic static channel access ( $P_{CCA\_DL\_2}$ )		1, 2	0.5	
UL CCA probability $P_{CCA\_UL}$		1, 2	1	
$M_{d,max}$		1, 2	16	
$M_{m,max}$		1, 2	4	
$M_{e,max}$		1, 2	8	
PDSCH RMC configuration		1, 2	SR.1.1 CCA	
RMSI CORESET RMC Configuration		1, 2	CR.1.1 CCA	
Dedicated CORESET RMC Configuration		1, 2	CCR.1.1 CCA	
SSB configuration		1, 2	SSB.1 CCA for semi-static channel access; SSB.2 CCA for dynamic channel access	
SMTC configuration		1, 2	SMTC.1	
OCNG Pattern		1, 2	OP.1 defined in A.3.2.1	
Initial DL BWP configuration		1, 2	DLBWP.0	
Initial UL BWP configuration		1, 2	ULBWP.0	
RLM-RS		1, 2	SSB	
$Q_{rxlevmin}$	dBm/SCS	1, 2	-137	
$N_{oc}$	dBm/SCS	1, 2	-95	
$N_{oc}$	dBm/15 kHz	1, 2	-98	
SS-RSRP	dBm/SCS	1, 2	-99	-83
$\hat{E}_s / I_{ot}$	dB	1, 2	-4	12
$\hat{E}_s / N_{oc}$	dB	1, 2	-4	12
$l_o$	dBm/38.16 MHz	1, 2	-62.50	-51.69
Treselection	S	1, 2	0	
$S_{nonintrasearch}$	dB	1, 2	50	
$Thresh_{x, high}$ (Note 2)	dB	1, 2	48	
$Thresh_{serving, low}$	dB	1, 2	44	
$Thresh_{x, low}$	dB	1, 2	50	
Propagation Condition		1, 2	AWGN	
<p>Note 1: OCNG shall be used such that both cells are fully allocated and a constant total transmitted power spectral density is achieved for all OFDM symbols.</p> <p>Note 2: This refers to the value of <math>Thresh_{x, high}</math> which is included in NR system information, and is a threshold for the E-UTRA target cell</p> <p>Note 4: For UE supporting both semi-static and dynamic channel access, the UE must be tested under both dynamic and semi-static channel occupancy configurations.</p>				

Table A.11.1.4.2.1-4: Cell specific test parameters for E-UTRA cell 2

Parameter	Unit	Cell 2	
		T1	T2
E-UTRA RF Channel number		1	
$BW_{channel}$	MHz	10	
OCNG Patterns defined in TS 36.133 [15] clause A.3.2		OP.2 TDD for test configuration 1, 2, 3; OP.2 FDD for test configuration 4, 5, 6	
PBCH_RA	dB	0	
PBCH_RB	dB		

PSS_RA	dB		
SSS_RA	dB		
PCFICH_RB	dB		
PHICH_RA	dB		
PHICH_RB	dB		
PDCCH_RA	dB		
PDCCH_RB	dB		
PDSCH_RA	dB		
PDSCH_RB	dB		
OCNG_RA <sup>Note 1</sup>	dB		
OCNG_RB <sup>Note 1</sup>	dB		
Qrxlevmin	dBm	-140	
$N_{oc}$	dBm/15 kHz	-98	
RSRP	dBm/15 KHz	-84	-84
$\hat{E}_s / I_{ot}$	dB	14	14
$\hat{E}_s / N_{oc}$	dB	14	14
Treselection <sub>EUTRAN</sub>	S	0	
Snointrasearch	dB	50	
Thresh <sub>x, high</sub> (Note 2)	dB	48	
Thresh <sub>serv, low</sub>	dB	44	
Thresh <sub>x, low</sub>	dB	50	
Propagation Condition		AWGN	
Note 1: OCNG shall be used such that both cells are fully allocated and a constant total transmitted power spectral density is achieved for all OFDM symbols.			
Note 2: This refers to the value of Thresh <sub>x, high</sub> which is included in E-UTRA system information, and is a threshold for the NR target cell			

#### A.11.1.4.2.2 Test Requirements

The cell reselection delay to a lower priority E-UTRAN cell is defined as the time from the beginning of time period T1, to the moment when the UE camps on cell 2, and starts to send preambles on the PRACH for sending the *RRCSetupRequest* message to perform a Tracking Area Update procedure on cell 2.

The cell re-selection delay to a lower priority cell shall be less than 8 s.

The rate of correct cell reselections observed during repeated tests shall be at least 90%.

NOTE: The cell re-selection delay to a lower priority cell can be expressed as:  $T_{\text{evaluate, E-UTRAN}} + T_{\text{SI-E-UTRA}}$ ,

Where:

$T_{\text{evaluate, E-UTRAN}}$  See Table 4.2.2.5-1 in clause 4.2.2.5

$T_{\text{SI-E-UTRA}}$  Maximum repetition period of relevant system info blocks that needs to be received by the UE to camp on a cell; 1280 ms is assumed in this test case.

This gives a total of 7.68 s, allow 8 s for the cell re-selection delay to a lower priority E-UTRAN cell.

## A.11.2 RRC\_CONNECTED state mobility

### A.11.2.1 Handover

#### A.11.2.1.1 Intra-frequency handover from FR1 carrier under CCA to FR1 carrier under CCA; known target cell

##### A.11.2.1.1.1 Test Purpose and Environment

This test is to verify the requirement for the NR intra frequency handover requirements from FR1 carrier under CCA to FR1 carrier under CCA specified in clause 6.1B.1.2.

##### A.11.2.1.1.2 Test Parameters

Supported test configurations are shown in table A.11.2.1.1.2-1. Both handover delay and interruption length are tested by using the parameters in table A.11.2.1.1.2-2, and A.11.2.1.1.2-3.

The test consists of three successive time periods, with time durations of T1, T2 and T3 respectively. At the start of time duration T1, the UE may not have any timing information of cell 2.

NR shall send a RRC message implying handover to cell 2. The RRC message implying handover shall be sent to the UE during period T2, after the UE has reported Event A3. T3 is defined as the end of the last TTI containing the RRC message implying handover.

**Table A.11.2.1.1.2-1: Intra-frequency handover from FR1 carrier under CCA to FR1 carrier under CCA test configurations**

Config	Description
1	Source cell: NR 30 kHz SSB SCS, 40 MHz bandwidth, TDD duplex mode Target cell: NR 30 kHz SSB SCS, 40 MHz bandwidth, TDD duplex mode

**Table A.11.2.1.1.2-2: General test parameters Intra-frequency handover from FR1 carrier under CCA to FR1 carrier under CCA**

Parameter		Unit	Value	Comment
Initial conditions	Active cell		Cell 1	On the carrier under CCA
	Neighbouring cell		Cell 2	On the carrier under CCA
Final condition	Active cell		Cell 2	On the carrier under CCA
DL CCA model	Dynamic channel access <sup>Note 1, 3</sup>		As specified in clause A.3.20.2.1	
	Semi-static channel access <sup>Note 2, 3</sup>			
UL CCA model	Dynamic channel access <sup>Note 1, 3</sup>		As specified in clause A.3.20.2.2	
	Semi-static channel access <sup>Note 2,3</sup>			
A3-Offset		dB	0	
Hysteresis		dB	0	
Time To Trigger		s	0	
Filter coefficient			0	L3 filtering is not used
Access Barring Information		-	Not Sent	No additional delays in random access procedure.
Time offset between cells			3 $\mu$ s	Synchronous cells
T304		ms	500	
LCCA_DL			5	
WCCA_DL		ms	T304	
LCCA_UL			5	
WCCA_UL		ms	T304	
T1		s	5	
T2		s	$\leq 5$	
T3		s	$\geq T_{\text{interrupt}}$	$T_{\text{interrupt}}$ is defined in clause 6.1B.1.2

NOTE 1: For a UE supporting dynamic channel access and network configuring dynamic channel occupancy.  
 NOTE 2: For a UE supporting semi-static channel access and network configuring semi-static channel occupancy.  
 NOTE 3: For a UE supporting both semi-static and dynamic channel access, the UE can be tested under dynamic channel occupancy only.

**Table A.11.2.1.1.2-3: Cell specific test parameters for NR FR1-FR1 Intra frequency handover test case**

Parameter		Unit	Cell 1			Cell 2		
			T1	T2	T3	T1	T2	T3
NR RF Channel Number			1			1		
P <sub>CCA_DL</sub> for dynamic channel access <sup>Note 4,6</sup>		-	P <sub>CCA_DL_1</sub> =0.75 P <sub>CCA_DL_2</sub> =0.75			P <sub>CCA_DL_1</sub> =0.75 P <sub>CCA_DL_2</sub> =0.75		
P <sub>CCA_DL</sub> for semi-static channel access <sup>Note 5,6</sup>		-	P <sub>CCA_DL</sub> =0.9375			P <sub>CCA_DL</sub> =0.9375		
P <sub>CCA_UL</sub> for dynamic channel access <sup>Note 4,6</sup>		-	0.75			0.75		
P <sub>CCA_UL</sub> for semi-static channel access <sup>Note 5,6</sup>		-	0.87			0.87		
TDD configuration	Config 1		TDDConf.1.1 CCA					
BW <sub>channel</sub>	Config 1		40: N <sub>RB,c</sub> = 106					
BWP BW	Config 1		40: N <sub>RB,c</sub> = 106					
DRX Cycle		ms	Not Applicable					
PDSCH Reference	Config 1		SR.1.1 CCA					
CORESET Reference Channel	Config 1		CR.1.1 CCA					
Dedicated CORESET RMC configuration	Config 1		CCR.1.1 CCA					
TRS configuration	Config 1		TRS.1.1 TDD					
OCNG Patterns			OP.1					
SMTC Configuration			SMTC.1					
DBT window configuration	Config 1		DBT.1					
SSB configuration for semi-static channel access <sup>Note 4, 6</sup>	Config 1		SSB.1 CCA					
SSB configuration for dynamic channel access <sup>Note 5, 6</sup>	Config 1		SSB.2 CCA					
ssb-PositionQCL	Config 1		[1]					
PDSCH/PDCCH subcarrier spacing	Config 1	kHz	30 kHz					
PUCCH/PUSCH subcarrier spacing	Config 1	kHz	30 kHz					
PRACH configuration			FR1 PRACH configuration 1 under CCA					
BWP configuration	Initial DL BWP		DLBWP.0.1					
	Dedicated DL BWP		DLBWP.1.1					
	Initial UL BWP		ULBWP.0.1					
	Dedicated UL BWP		ULBWP.1.1					
EPRE ratio of PSS to SSS		dB	0					
EPRE ratio of PBCH DMRS to SSS								
EPRE ratio of PBCH to PBCH DMRS								
EPRE ratio of PDCCH DMRS to SSS								
EPRE ratio of PDCCH to PDCCH DMRS								
EPRE ratio of PDSCH DMRS to SSS								
EPRE ratio of PDSCH to PDSCH								
EPRE ratio of OCNG DMRS to SSS(Note 1)								
EPRE ratio of OCNG to OCNG DMRS (Note 1)								
N <sub>oc</sub> <sup>Note2</sup>		dBm/15kHz	-98					
N <sub>oc</sub> <sup>Note2</sup>		dBm/SCS	-95					
Ê <sub>s</sub> / I <sub>ot</sub>		dB	8	-3.3	-3.3	- Infinity	2.36	2.36

$\hat{E}_s / N_{oc}$		dB	8	8	8	- Infinity	11	11
SSB_RP	Config 1	dBm/SCS	-87	-87	-87	- Infinity	-84	-84
$I_o$ <sup>Note3</sup>	Config 1	dBm/ 38.16MHz	-55.31	-50.96	-50.96	-55.31	-50.96	-50.96
Propagation condition		-	AWGN			AWGN		
<p>Note 1: OCNG shall be used such that both cells are fully allocated and a constant total transmitted power spectral density is achieved for all OFDM symbols.</p> <p>Note 2: Interference from other cells and noise sources not specified in the test is assumed to be constant over subcarriers and time and shall be modelled as AWGN of appropriate power for <math>N_{oc}</math> to be fulfilled.</p> <p>Note 3: <math>I_o</math> levels have been derived from other parameters for information purposes. They are not settable parameters themselves.</p> <p>Note 4: For UE supporting semi-static channel access and network configuring semi-static channel occupancy.</p> <p>Note 5: For UE supporting dynamic channel access and network configuring dynamic channel occupancy.</p> <p>Note 6: For a UE supporting both semi-static and dynamic channel access, the UE can be tested under dynamic channel occupancy only.</p>								

### A.11.2.1.1.3 Test Requirements

The UE shall start to transmit the PRACH to Cell 2 less than  $T_{interrupt}$  from the beginning of time period T3, where  $T_{interrupt}$  is defined in clause 6.1B.1.2

The rate of correct handovers observed during repeated tests shall be at least 90%.

NOTE: The handover delay can be expressed as: RRC procedure delay +  $T_{interrupt}$ , where:

$$T_{interrupt} = T_{search} + T_{IU} + T_{processing} + T_{\Delta} + T_{margin}$$

$$T_{search} = 0.$$

$$T_{processing} = 20 \text{ ms.}$$

$$T_{margin} = 2 \text{ ms.}$$

$$T_{\Delta} = (1 + L_2) * 20 \text{ ms.}$$

$$T_{IU} = (1 + L_3) * 10 + 10 \text{ ms}$$

RRC procedure delay = 10 ms and is specified in clause 12 in TS 38.331 [2],  $L_2$  is the number of SMTC occasions not available at the UE during the time tracking period where  $L_2 \leq L_{CCA\_DL}$ , and  $L_3$  is the number of consecutive SSB to PRACH occasion association periods during which no PRACH occasion is available for PRACH transmission due to UL CCA failure, where  $L_3 \leq L_{CCA\_UL}$ .  $L_3 = 0$  for Type 2C UL channel access procedure as defined in TS 37.213 [33]. The interruption time considering the potential extensions caused by  $L_1, L_2, L_3$  and by the UL CCA failure detection/recovery mechanism is limited by the T304 timer. The UE behaviour at the T304 timer expiry is detailed in TS 38.331 [2]. Test equipment should make sure that  $L_{CCA\_DL}$  and  $L_{CCA\_UL}$  are not exceeded during a test by monitoring the number of CCA failures and preventing additional CCA failures from happening after  $L_{CCA\_DL}$  or  $L_{CCA\_UL}$  is reached.

### A.11.2.1.2 Intra-frequency handover from FR1 carrier under CCA to FR1 carrier under CCA; unknown target cell

#### A.11.2.1.2.1 Test Purpose and Environment

This test is to verify the requirement intra frequency handover requirements from FR1 carrier under CCA to FR1 carrier under CCA specified in clause 6.1B.1.2.

#### A.11.2.1.2.2 Test Parameters

Supported test configurations are shown in table A.11.2.1.2.2-1. Both handover delay and interruption length are tested by using the parameters in table A.11.2.1.2.2-2, and A.11.2.1.2.2-3.

The test scenario comprises of two carriers and one cell on each carrier. No gap patterns are configured in the test case. The test consists of two successive time periods, with time durations of T1, T2 respectively. At the start of time duration T1, the UE does not have any timing information of cell 2. Starting T2, cell 2 becomes detectable and the UE receives a RRC handover command from the network. The start of T2 is the instant when the last TTI containing the RRC message implying handover is sent to the UE.

**Table A.11.2.1.2.2-1: Intra-frequency handover from FR1 carrier under CCA to FR1 carrier under CCA test configurations**

Config	Description
1	Source cell: NR 30 kHz SSB SCS, 40 MHz bandwidth, TDD duplex mode Target cell: NR 30 kHz SSB SCS, 40 MHz bandwidth, TDD duplex mode

**Table A.11.2.1.2.2-2: General test parameters Intra-frequency handover from FR1 carrier under CCA to FR1 carrier under CCA**

Parameter		Unit	Value	Comment
Initial conditions	Active cell		Cell 1	On the carrier under CCA
	Neighbouring cell		Cell 2	On the carrier under CCA
Final condition	Active cell		Cell 2	On the carrier under CCA
DL CCA model	Dynamic channel access <sup>Note 1, 3</sup>		As specified in clause A.3.20.2.1	
	Semi-static channel access <sup>Note 2, 3</sup>			
UL CCA model	Dynamic channel access <sup>Note 1, 3</sup>		As specified in clause A.3.20.2.2	
	Semi-static channel access <sup>Note 2,3</sup>			
Access Barring Information		-	Not Sent	No additional delays in random access procedure.
Time offset between cells			3 $\mu$ s	Synchronous cells
T304		ms	500	
L <sub>CCA_DL</sub>			5	
W <sub>CCA_DL</sub>		ms	T304	
L <sub>CCA_UL</sub>			5	
W <sub>CCA_UL</sub>		ms	T304	
T1		s	5	
T2		s	$\geq T_{\text{interrupt}}$	$T_{\text{interrupt}}$ is defined in clause 6.1B.1.2
NOTE 1: For a UE supporting dynamic channel access and network configuring dynamic channel occupancy.				
NOTE 2: For a UE supporting semi-static channel access and network configuring semi-static channel occupancy.				
NOTE 3: For a UE supporting both semi-static and dynamic channel access, the UE can be tested under dynamic channel occupancy only.				

**Table A.11.2.1.2.2-3: Cell specific test parameters for NR FR1-FR1 Intra frequency handover test case**

Parameter		Unit	Cell 1		Cell 2	
			T1	T2	T1	T2
NR RF Channel Number			1		1	
P <sub>CCA_DL</sub> for dynamic channel access <sup>Note 4,6</sup>		-	P <sub>CCA_DL_1</sub> =0.75 P <sub>CCA_DL_2</sub> =0.75		P <sub>CCA_DL_1</sub> =0.75 P <sub>CCA_DL_2</sub> =0.75	
P <sub>CCA_DL</sub> for semi-static channel access <sup>Note 5,6</sup>		-	P <sub>CCA_DL</sub> =0.9375		P <sub>CCA_DL</sub> =0.9375	
P <sub>CCA_UL</sub> for dynamic channel access <sup>Note 4,6</sup>		-	0.75		0.75	
P <sub>CCA_UL</sub> for semi-static channel access <sup>Note 5,6</sup>		-	0.87		0.87	
TDD configuration	Config 1		TDDConf.1.1 CCA			
BW <sub>channel</sub>	Config 1		40: N <sub>RB,c</sub> = 106			
BWP BW	Config 1		40: N <sub>RB,c</sub> = 106			
DRX Cycle		ms	Not Applicable			
PDSCH Reference	Config 1		SR.1.1 CCA			
CORESET Reference Channel	Config 1		CR.1.1 CCA			



Dedicated CORESET RMC configuration	Config 1		CCR.1.1 CCA			
TRS configuration	Config 1		TRS.1.2 TDD			
OCNG Patterns			OP.1			
SMTC Configuration			SMTC.1			
DBT window configuration	Config 1		DBT.1			
SSB configuration for semi-static channel access <sup>Note 4, 6</sup>	Config 1		SSB.1 CCA			
SSB configuration for dynamic channel access <sup>Note 5, 6</sup>	Config 1		SSB.2 CCA			
ssb-PositionQCL	Config 1		[1]			
PDSCH/PDCCH subcarrier spacing	Config 1	kHz	30 kHz			
PUCCH/PUSCH subcarrier spacing	Config 1	kHz	30 kHz			
PRACH configuration			FR1 PRACH configuration 1 under CCA			
BWP configuration	Initial DL BWP		DLBWP.0.1			
	Dedicated DL BWP		DLBWP.1.1			
	Initial UL BWP		ULBWP.0.1			
	Dedicated UL BWP		ULBWP.1.1			
EPRE ratio of PSS to SSS		dB	0			
EPRE ratio of PBCH DMRS to SSS						
EPRE ratio of PBCH to PBCH DMRS						
EPRE ratio of PDCCH DMRS to SSS						
EPRE ratio of PDCCH to PDCCH DMRS						
EPRE ratio of PDSCH DMRS to SSS						
EPRE ratio of PDSCH to PDSCH						
EPRE ratio of OCNG DMRS to SSS(Note 1)						
EPRE ratio of OCNG to OCNG DMRS (Note 1)						
$N_{oc}$ <sup>Note2</sup>		dBm/15kHz	-98			
$N_{oc}$ <sup>Note2</sup>	Config 1	dBm/SCS	-95			
$\hat{E}_s / I_{\alpha}$		dB	8	-0.64	-Infinity	-0.64
$\hat{E}_s / N_{oc}$		dB	8	8	-Infinity	8
SSB_RP	Config 1	dBm/SCS	-87	-87	-Infinity	-87
$I_o$ <sup>Note3</sup>	Config 1	dBm/38.16MHz	-55.31	-52.60	-55.31	-52.60
Propagation condition		-	AWGN		AWGN	
<p>Note 1: OCNG shall be used such that both cells are fully allocated and a constant total transmitted power spectral density is achieved for all OFDM symbols.</p> <p>Note 2: Interference from other cells and noise sources not specified in the test is assumed to be constant over subcarriers and time and shall be modelled as AWGN of appropriate power for <math>N_{oc}</math> to be fulfilled.</p> <p>Note 3: <math>I_o</math> levels have been derived from other parameters for information purposes. They are not settable parameters themselves.</p> <p>Note 4: For UE supporting semi-static channel access and network configuring semi-static channel occupancy.</p> <p>Note 5: For UE supporting dynamic channel access and network configuring dynamic channel occupancy.</p> <p>Note 6: For a UE supporting both semi-static and dynamic channel access, the UE can be tested under dynamic channel occupancy only.</p>						

A.11.2.1.2.3 Test Requirements

The UE shall start to transmit the PRACH to Cell 2 less than  $T_{interrupt}$  from the beginning of time period T3, where  $T_{interrupt}$  is defined in clause 6.1B.1.2

The rate of correct handovers observed during repeated tests shall be at least 90%.

NOTE: The handover delay can be expressed as: RRC procedure delay +  $T_{interrupt}$ , where:

$$T_{\text{interrupt}} = T_{\text{search}} + T_{\text{IU}} + T_{\text{processing}} + T_{\Delta} + T_{\text{margin}}$$

$$T_{\text{search}} = (1+L_1) * 20 \text{ ms.}$$

$$T_{\text{processing}} = 20 \text{ ms.}$$

$$T_{\text{margin}} = 2 \text{ ms.}$$

$$T_{\Delta} = (1+L_2) * 20 \text{ ms.}$$

$$T_{\text{IU}} = (1+L_3) * 10 + 10 \text{ ms}$$

RRC procedure delay = 10 ms and is specified in clause 12 in TS 38.331 [2],  $L_1$  is the number of SMTC occasions not available at the UE during the intra-frequency detection period,  $L_2$  is the number of SMTC occasions not available at the UE during the time tracking period, where  $L_1 + L_2 \leq L_{\text{CCA\_DL}}$ , and  $L_3$  is the number of consecutive SSB to PRACH occasion association periods during which no PRACH occasion is available for PRACH transmission due to UL CCA failure, where  $L_3 \leq L_{\text{CCA\_UL}}$ .  $L_3 = 0$  for Type 2C UL channel access procedure as defined in TS 37.213 [33]. The interruption time considering the potential extensions caused by  $L_1, L_2, L_3$  and by the UL CCA failure detection/recovery mechanism is limited by the T304 timer.

### A.11.2.1.3 Inter-frequency handover from FR1 carrier under CCA to FR1 carrier under CCA; unknown target cell

#### A.11.2.1.3.1 Test Purpose and Environment

This test is to verify the requirement for inter frequency handover requirements from FR1 carrier under CCA to FR1 carrier under CCA specified in clause 6.1B.1.2.

#### A.11.2.1.3.2 Test Parameters

Supported test configurations are shown in table A.11.2.1.3.2-1. Both handover delay and interruption length are tested by using the parameters in table A.11.2.1.3.2-2, and A.11.2.1.3.2-3.

The test scenario comprises of two carriers and one cell on each carrier. No gap patterns are configured in the test case. The test consists of two successive time periods, with time durations of T1, T2 respectively. At the start of time duration T1, the UE does not have any timing information of cell 2. Starting T2, cell 2 becomes detectable and the UE receives a RRC handover command from the network. The start of T2 is the instant when the last TTI containing the RRC message implying handover is sent to the UE.

**Table A.11.2.1.3.2-1: Inter-frequency handover from FR1 carrier under CCA to FR1 carrier under CCA test configurations**

Config	Description
1	Source cell: NR 30 kHz SSB SCS, 40 MHz bandwidth, TDD duplex mode Target cell: NR 30 kHz SSB SCS, 40 MHz bandwidth, TDD duplex mode

**Table A.11.2.1.3.2-2: General test parameters Inter-frequency handover from FR1 carrier under CCA to FR1 carrier under CCA**

Parameter	Unit	Value	Comment
Initial conditions	Active cell	Cell 1	On the carrier under CCA
	Neighbouring cell	Cell 2	On the carrier under CCA
Final condition	Active cell	Cell 2	On the carrier under CCA
DL CCA model	Dynamic channel access <sup>Note 1, 3</sup>	As specified in clause A.3.20.2.1	
	Semi-static channel access <sup>Note 2, 3</sup>		
UL CCA model	Dynamic channel access <sup>Note 1, 3</sup>	As specified in clause A.3.20.2.2	
	Semi-static channel access <sup>Note 2,3</sup>		
Access Barring Information	-	Not Sent	No additional delays in random access procedure.
T304	ms	500	
$L_{\text{CCA\_DL}}$		5	

$W_{CCA\_DL}$	ms	T304	
$L_{CCA\_UL}$		5	
$W_{CCA\_UL}$	ms	T304	
T1	s	5	
T2	s	$\leq T_{interrupt}$	$T_{interrupt}$ is defined in clause 6.1B.1.2

NOTE 1: For a UE supporting dynamic channel access and network configuring dynamic channel occupancy.  
 NOTE 2: For a UE supporting semi-static channel access and network configuring semi-static channel occupancy.  
 NOTE 3: For a UE supporting both semi-static and dynamic channel access, the UE can be tested under dynamic channel occupancy only.

**Table A.11.2.1.3.2-3: Cell specific test parameters for NR FR1-FR1 Inter frequency handover test case**

Parameter		Unit	Cell 1		Cell 2	
			T1	T2	T1	T2
NR RF Channel Number			1		2	
$P_{CCA\_DL}$ for dynamic channel access <small>Note 4,6</small>		-	$P_{CCA\_DL\_1}=0.75$ $P_{CCA\_DL\_2}=0.75$		$P_{CCA\_DL\_1}=0.75$ $P_{CCA\_DL\_2}=0.75$	
$P_{CCA\_DL}$ for semi-static channel access <small>Note 5,6</small>		-	$P_{CCA\_DL}=0.9375$		$P_{CCA\_DL}=0.9375$	
$P_{CCA\_UL}$ for dynamic channel access <small>Note 4,6</small>		-	0.75		0.75	
$P_{CCA\_UL}$ for semi-static channel access <small>Note 5,6</small>		-	0.87		0.87	
TDD configuration	Config 1		TDDConf.1.1 CCA			
$BW_{channel}$	Config 1		40: $N_{RB,c} = 106$			
BWP BW	Config 1		40: $N_{RB,c} = 106$			
DRX Cycle		ms	Not Applicable			
PDSCH Reference	Config 1		SR.1.1 CCA			
CORESET Reference Channel	Config 1		CR1.1 CCA			
Dedicated CORESET RMC configuration	Config 1		CCR.1.1 CCA			
TRS configuration	Config 1		TRS.1.2 TDD			
OCNG Patterns			OP.1			
SMTC Configuration			SMTC.1			
DBT window configuration	Config 1		DBT.1			
SSB configuration for semi-static channel access <small>Note 4, 6</small>	Config 1		SSB.1 CCA			
SSB configuration for dynamic channel access <small>Note 5, 6</small>	Config 1		SSB.2 CCA			
ssb-PositionQCL	Config 1		[1]			
PDSCH/PDCCH subcarrier spacing	Config 1	kHz	30 kHz			
PUCCH/PUSCH subcarrier spacing	Config 1	kHz	30 kHz			
PRACH configuration			FR1 PRACH configuration 1 under CCA			
BWP configuration	Initial DL BWP		DLBWP.0.1			
	Dedicated DL BWP		DLBWP.1.1			
	Initial UL BWP		ULBWP.0.1			
	Dedicated UL BWP		ULBWP.1.1			
EPRE ratio of PSS to SSS		dB	0			
EPRE ratio of PBCH DMRS to SSS						
EPRE ratio of PBCH to PBCH DMRS						
EPRE ratio of PDCCH DMRS to SSS						
EPRE ratio of PDCCH to PDCCH DMRS						
EPRE ratio of PDSCH DMRS to SSS						
EPRE ratio of PDSCH to PDSCH						
EPRE ratio of OCNG DMRS to SSS(Note 1)						
EPRE ratio of OCNG to OCNG DMRS (Note 1)						

$N_{oc}$ <sup>Note2</sup>		dBm/15kHz z	-98			
$N_{oc}$ <sup>Note2</sup>	Config 1	dBm/SCS	-95			
$\hat{E}_s / I_{ot}$		dB	4	4	-Infinity	5
$\hat{E}_s / N_{oc}$		dB	4	4	-Infinity	5
SSB_RP	Config 1	dBm/SCS	-91	-91	-Infinity	-90
$I_o$ <sup>Note3</sup>	Config 1	dBm/ 38.16MHz	-58.49	-58.49	-63.94	-57.75
Propagation condition		-	AWGN		AWGN	
<p>Note 1: OCNG shall be used such that both cells are fully allocated and a constant total transmitted power spectral density is achieved for all OFDM symbols.</p> <p>Note 2: Interference from other cells and noise sources not specified in the test is assumed to be constant over subcarriers and time and shall be modelled as AWGN of appropriate power for <math>N_{oc}</math> to be fulfilled.</p> <p>Note 3: <math>I_o</math> levels have been derived from other parameters for information purposes. They are not settable parameters themselves.</p> <p>Note 4: For UE supporting semi-static channel access and network configuring semi-static channel occupancy.</p> <p>Note 5: For UE supporting dynamic channel access and network configuring dynamic channel occupancy.</p> <p>Note 6: For a UE supporting both semi-static and dynamic channel access, the UE can be tested under dynamic channel occupancy only.</p>						

### A.11.2.1.3.3 Test Requirements

The UE shall start to transmit the PRACH to Cell 2 less than  $T_{interrupt}$  from the beginning of time period T3, where  $T_{interrupt}$  is defined in clause 6.1B.1.2

The rate of correct handovers observed during repeated tests shall be at least 90%.

NOTE: The handover delay can be expressed as: RRC procedure delay +  $T_{interrupt}$ , where:

$$T_{interrupt} = T_{search} + T_{IU} + T_{processing} + T_{\Delta} + T_{margin}$$

$$T_{search} = (3+L_1') * 20 \text{ ms.}$$

$$T_{processing} = 20 \text{ ms.}$$

$$T_{margin} = 2 \text{ ms.}$$

$$T_{\Delta} = (1+L_2) * 20 \text{ ms.}$$

$$T_{IU} = (1+L_3) * 10 + 10 \text{ ms}$$

RRC procedure delay = 10 ms and is specified in clause 12 in TS 38.331 [2],  $L_1'$  is the number of SMTC occasions not available at the UE during the inter-frequency detection period,  $L_2$  is the number of SMTC occasions not available at the UE during the time tracking period, where  $L_1' + L_2 \leq L_{CCA\_DL}$ , and  $L_3$  is the number of consecutive SSB to PRACH occasion association periods during which no PRACH occasion is available for PRACH transmission due to UL CCA failure, where  $L_3 \leq L_{CCA\_UL}$ .  $L_3 = 0$  for Type 2C UL channel access procedure as defined in TS 37.213 [33]. The interruption time considering the potential extensions caused by  $L_1', L_2, L_3$  and by the UL CCA failure detection/recovery mechanism is limited by the T304 timer.

### A.11.2.1.4 Inter-frequency handover from FR1 carrier under CCA to FR1; known target cell

#### A.11.2.1.4.1 Test Purpose and Environment

This test is to verify the requirement for the NR with CCA FR1-NR FR1 handover requirements specified in clause 6.1.1.2.

#### A.11.2.1.4.2 Test Parameters

Supported test configurations are shown in table A.11.2.1.4.2-1. Both handover delay and interruption length are tested by using the parameters in table A.11.2.1.4.2-2, and A.11.2.1.4.2-3.

The test consists of three successive time periods, with time durations of T1 T2 and T3 respectively. At the start of time duration T1, the UE may not have any timing information of cell 2.

NR with CCA shall send a RRC message implying handover to cell 2. The RRC message implying handover shall be sent to the UE during period T2, after the UE has reported Event A3. T3 is defined as the end of the last TTI containing the RRC message implying handover.

**Table A.11.2.1.4.2-1: Handover from NR with CCA FR1 to NR FR1 test configuration**

Config	Description
1	Source cell: NR with CCA 30 kHz SSB SCS, 40 MHz bandwidth, TDD duplex mode Target cell: NR 15 kHz SSB SCS, 10 MHz bandwidth, FDD duplex mode
2	Source cell: NR with CCA 30 kHz SSB SCS, 40 MHz bandwidth, TDD duplex mode Target cell: NR 15 kHz SSB SCS, 10 MHz bandwidth, TDD duplex mode
3	Source cell: NR with CCA 30 kHz SSB SCS, 40 MHz bandwidth, TDD duplex mode Target cell: NR 30 kHz SSB SCS, 40 MHz bandwidth, TDD duplex mode
Note: The UE is only required to be tested in one of the supported test configurations	

**Table A.11.2.1.4.2-2: General test parameters handover from NR with CCA FR1 to NR FR1**

Parameter	Unit	Value	Comment
Initial conditions	Active cell	Cell 1	NR cell with CCA
	Neighbouring cell	Cell 2	NR cell
Final condition	Active cell	Cell 2	
DL CCA model		As specified in clause A.3.20.2.1	
UL CCA model		As specified in clause A.3.20.2.2	
A3-Offset	dB	0	
Hysteresis	dB	0	
Time To Trigger	s	0	
Filter coefficient		0	L3 filtering is not used
Access Barring Information	-	Not Sent	No additional delays in random access procedure.
Time offset between cells		3 $\mu$ s	Synchronous cells
T1	s	5	
T2	s	$\leq 5$	
T3	s	1	

**Table A.11.2.1.4.2-3: Cell specific test parameters for NR with CCA FR1 – NR FR1 handover test case**

Parameter	Unit	Test configuration	Cell 1			Cell 2		
			T1	T2	T3	T1	T2	T3
NR RF Channel Number		1,2,3	1			2		
Duplex mode		1	TDD			FDD		
		2	TDD			TDD		
		3	TDD			TDD		
TDD configuration		1	TDDConf.1.1 CCA			Not Applicable		
		2	TDDConf.1.1 CCA			TDDConf.1.1		
		3	TDDConf.1.1 CCA			TDDConf.2.1		
BW <sub>channel</sub>	MHz	1	40: N <sub>RB,c</sub> = 106			10: N <sub>RB,c</sub> = 52		
		2	40: N <sub>RB,c</sub> = 106			10: N <sub>RB,c</sub> = 52		
		3	40: N <sub>RB,c</sub> = 106			40: N <sub>RB,c</sub> = 106		
BWP BW	MHz	1	40: N <sub>RB,c</sub> = 106			10: N <sub>RB,c</sub> = 52		
		2	40: N <sub>RB,c</sub> = 106			10: N <sub>RB,c</sub> = 52		
		3	40: N <sub>RB,c</sub> = 106			40: N <sub>RB,c</sub> = 106		
DRX Cycle	ms	1,2,3	Not Applicable					
PDSCH Reference measurement channel		1	SR.1.1 CCA			SR.1.1 FDD		
		2	SR.1.1 CCA			SR.1.1 TDD		
		3	SR.1.1 CCA			SR2.1 TDD		
CORESET Reference Channel		1	CR1.1 CCA			CR.1.1 FDD		
		2	CR1.1 CCA			CR.1.1 TDD		
		3	CR1.1 CCA			CR2.1 TDD		
Dedicated CORESET RMC configuration		1	CCR.1.1 CCA			CCR.1.1 FDD		

			2	CCR.1.1 CCA			CCR.1.1 TDD		
			3	CCR.1.1 CCA			CCR.2.1 TDD		
DL CCA probability for semi-static channel access ( $P_{CCA\_DL}$ )DL CCA probability $P_{CCA\_DL}$			1,2,3	0.9375			N/A		
DL CCA probability for dynamic channel access ( $P_{CCA\_DL\_1}$ )			1,2,3	0.75			N/A		
DL CCA probability for dynamic channel access ( $P_{CCA\_DL\_2}$ )			1,2,3	0.75			N/A		
UL CCA probability for semi-static channel access $P_{CCA\_UL}$			1,2,3	0.75			N/A		
UL CCA probability for dynamic static channel access $P_{CCA\_UL}$			1,2,3	0.87					
TRS configuration			1	TRS.1.2 TDD			TRS.1.1 FDD		
			2	TRS.1.2 TDD			TRS.1.1 TDD		
			3	TRS.1.2 TDD			TRS.1.2 TDD		
OCNG Patterns				OP.1					
SMTC Configuration				SMTC.1					
SSB Configuration	Semi-static channel access		1,2	SSB.1 CCA (As defined in A.3.10A )			SSB.1 FR1		
	Dynamic channel access			SSB.2 CCA (As defined in A.3.10A )					
	Semi-static channel access		3	SSB.1 CCA (As defined in A.3.10A )			SSB.2 FR1		
	Dynamic channel access			SSB.2 CCA (As defined in A.3.10A )					
DBT window configuration				As defined in A.3.28.1			Not applicable		
PDSCH/PDCCH subcarrier spacing		kHz	1,2	30 kHz			15 kHz		
			3	30 kHz			30 kHz		
PUCCH/PUSCH subcarrier spacing		kHz	1,2	30 kHz			15 kHz		
			3	30 kHz			30 kHz		
PRACH configuration				FR1 PRACH configuration 1 under CCA			FR1 PRACH configuration 1		
BWP configuration	Initial DL BWP		1,2,3	DLBWP.0.1					
	Dedicated DL BWP		1,2,3	DLBWP.1.1					
	Initial UL BWP		1,2,3	ULBWP.0.1					
	Dedicated UL BWP		1,2,3	ULBWP.1.1					
EPRE ratio of PSS to SSS		dB	1,2,3	0					
EPRE ratio of PBCH DMRS to SSS			1,2,3						
EPRE ratio of PBCH to PBCH DMRS			1,2,3						
EPRE ratio of PDCCH DMRS to SSS			1,2,3						
EPRE ratio of PDCCH to PDCCH DMRS			1,2,3						
EPRE ratio of PDSCH DMRS to SSS			1,2,3						
EPRE ratio of PDSCH to PDSCH			1,2,3						
EPRE ratio of OCNG DMRS to SSS <sup>Note1</sup>			1,2,3						
EPRE ratio of OCNG to OCNG DMRS <sup>Note1</sup>			1,2,3						
$N_{oc}$ <sup>Note2</sup>		dBm/S CS	1,2	[-101]			-98		
			3	[-101]			-95		
$\hat{E}_s / I_{ot}$		dB	1,2,3	8	-3.3	-3.3	-Infinity	2.36	2.36
$\hat{E}_s / N_{oc}$		dB	1,2,3	8	8	8	-Infinity	11	11
SSB <sub>RP</sub>	Config 1	dBm/S CS	1,2,3	-90	-90	-90	-Infinity	-87	-87
$I_o$ <sup>Note3</sup>	Config 1	dBm/9.36MHz	1,2,3	-61.41	-57.06	-57.06	-61.41	-57.06	-57.06
Propagation condition		-	1,2,3	AWGN			AWGN		
Note 1: OCNG shall be used such that both cells are fully allocated and a constant total transmitted power spectral density is achieved for all OFDM symbols.									

Note 2:	Interference from other cells and noise sources not specified in the test is assumed to be constant over subcarriers and time and shall be modelled as AWGN of appropriate power for $N_{oc}$ to be fulfilled.
Note 3:	Io levels have been derived from other parameters for information purposes. They are not settable parameters themselves.
Note 4:	For UE supporting both semi-static and dynamic channel access, the UE must be tested under both dynamic and semi-static channel occupancy configurations.

#### A.11.2.1.4.3 Test Requirements

The UE shall start to transmit the PRACH to Cell 2 less than 112 ms from the beginning of time period T3. The rate of correct handovers observed during repeated tests shall be at least 90%.

NOTE: The handover delay can be expressed as: RRC procedure delay +  $T_{interrupt}$ , where:

RRC procedure delay = 10 ms and is specified in clause 12 in TS 38.331 [2].

$T_{interrupt}$  = 102 ms in the test.  $T_{interrupt}$  is defined in clause 6.1.1.2.2.

This gives a total of 112 ms.

#### A.11.2.1.5 Inter-frequency handover from FR1 carrier under CCA to FR1; unknown target cell

##### A.11.2.1.5.1 Test Purpose and Environment

This test is to verify the requirement for the NR with CCA FR1-NR FR1 handover requirements specified in clause 6.1.1.2.

##### A.11.2.1.5.2 Test Parameters

Supported test configurations are shown in table A.11.2.1.5.2-1. Both handover delay and interruption length are tested by using the parameters in table A.11.2.1.5.2-2, and A.12.2.1.7.2-3.

The test scenario comprises of two carriers and one cell on each carrier. Cell 1 is the NR with CCA cell and Cell 2 is an NR neighbour cell. No gap patterns are configured in the test case. The test consists of two successive time periods, with time durations of T1 and T2 respectively. At the start of time duration T1, the UE does not have any timing information of cell 2.

Starting T2, cell 2 becomes detectable and the UE receives a RRC handover command from the network. The start of T2 is the instant when the last TTI containing the RRC message implying handover is sent to the UE.

**Table A.11.2.1.5.2-1: Handover from NR with CCA FR1 to NR FR1 test configuration**

Config	Description
1	Source cell: NR with CCA 30 kHz SSB SCS, 40 MHz bandwidth, TDD duplex mode Target cell: NR 15 kHz SSB SCS, 10 MHz bandwidth, FDD duplex mode
2	Source cell: NR with CCA 30 kHz SSB SCS, 40 MHz bandwidth, TDD duplex mode Target cell: NR 15 kHz SSB SCS, 10 MHz bandwidth, TDD duplex mode
3	Source cell: NR with CCA 30 kHz SSB SCS, 40 MHz bandwidth, TDD duplex mode Target cell: NR 30 kHz SSB SCS, 40 MHz bandwidth, TDD duplex mode
Note:	The UE is only required to be tested in one of the supported test configurations

**Table A.11.2.1.5.2-2: General test parameters handover from NR with CCA FR1 to NR FR1**

Parameter	Unit	Value	Comment
Initial conditions	Active cell	Cell 1	NR cell with CCA
	Neighbouring cell	Cell 2	NR cell
Final condition	Active cell	Cell 2	
DL CCA model		As specified in clause A.3.20.2.1	
UL CCA model		As specified in clause A.3.20.2.2	

Access Barring Information	-	Not Sent	No additional delays in random access procedure.
Time offset between cells		3 $\mu$ s	Synchronous cells
T1	s	5	
T2	s	$\leq 5$	

**Table A.11.2.1.5.2-3: Cell specific test parameters for NR with CCA FR1 – NR FR1 handover test case**

Parameter	Unit	Configuration	Cell 1		Cell 2	
			T1	T2	T1	T2
NR RF Channel Number		1, 2, 3	1		2	
Duplex mode		1	TDD		FDD	
		2	TDD		TDD	
		3	TDD		TDD	
DL CCA model		1, 2, 3	As specified in clause A.3.26.2.1		N/A	
UL CCA model		1, 2, 3	As specified in clause A.3.26.2.2			
TDD configuration		1	TDDConf.1.1 CCA		Not Applicable	
		2	TDDConf.1.1 CCA		TDDConf.1.1	
		3	TDDConf.1.1 CCA		TDDConf.2.1	
BW <sub>channel</sub>	MHz	1	40: N <sub>RB,c</sub> = 106		10: N <sub>RB,c</sub> = 52	
		2	40: N <sub>RB,c</sub> = 106		10: N <sub>RB,c</sub> = 52	
		3	40: N <sub>RB,c</sub> = 106		40: N <sub>RB,c</sub> = 106	
BWP BW	MHz	1	40: N <sub>RB,c</sub> = 106		10: N <sub>RB,c</sub> = 52	
		2	40: N <sub>RB,c</sub> = 106		10: N <sub>RB,c</sub> = 52	
		3	40: N <sub>RB,c</sub> = 106		40: N <sub>RB,c</sub> = 106	
DRX Cycle	ms		Not Applicable			
PDSCH Reference measurement channel		1	SR.1.1 CCA		SR.1.1 FDD	
		2	SR.1.1 CCA		SR.1.1 TDD	
		3	SR.1.1 CCA		SR.2.1 TDD	
CORESET Reference Channel		1	CR2.1 TDD		CR.1.1 FDD	
		2	CR2.1 TDD		CR.1.1 TDD	
		3	CR2.1 TDD		CR.2.1 TDD	
Dedicated CORESET RMC configuration		1	CCR.1.1 CCA		CCR.1.1 FDD	
		2	CCR.1.1 CCA		CCR.1.1 TDD	
		3	CCR.1.1 CCA		CCR.2.1 TDD	
TRS configuration		1	TRS.1.2 TDD		TRS.1.1 FDD	
		2	TRS.1.2 TDD		TRS.1.1 TDD	
		3	TRS.1.2 TDD		TRS.1.2 TDD	
DL CCA probability for semi-static channel access (P <sub>CCA_DL</sub> )DL CCA probability P <sub>CCA_DL</sub>		1, 2, 3	0.9375		N/A	
DL CCA probability for dynamic channel access (P <sub>CCA_DL_1</sub> )		1, 2, 3	0.75		N/A	
DL CCA probability for dynamic channel access (P <sub>CCA_DL_2</sub> )		1, 2, 3	0.75		N/A	
UL CCA probability for semi-static channel access P <sub>CCA_UL</sub>		1, 2, 3	0.75		N/A	
UL CCA probability for dynamic static channel access P <sub>CCA_UL</sub>		1, 2, 3	0.87		N/A	
OCNG Patterns		1, 2, 3	OP.1			
SMTC Configuration		1, 2, 3	SMTC.1			
DBT window configuration		1, 2, 3	As defined in A.3.28.1		N/A	
SSB configuration	Semi-static channel access	1,2	SSB.1 CCA (As defined in A.3.10A)		SSB.1 FR1	
	Dynamic channel access		SSB.2 CCA (As defined in A.3.10A)			
	Semi-static channel access	3	SSB.1 CCA (As defined in A.3.10A)		SSB.2 FR1	



	Dynamic channel access		SSB.2 CCA (As defined in A.3.10A )			
ssb-PositionQCL			[1]		N/A	
PDSCH/PDCCH subcarrier spacing	kHz	1	30 kHz		15 kHz	
		2	30 kHz		15 kHz	
		3	30 kHz		30 kHz	
PUCCH/PUSCH subcarrier spacing	kHz	1	30 kHz		15 kHz	
		2	30 kHz		15 kHz	
		3	30 kHz		30 kHz	
PRACH configuration		1,2,3	FR1 PRACH configuration 1		FR1 PRACH configuration 1 under CCA	
BWP configuration	Initial DL BWP	1,2,3	DLBWP.0.1			
	Dedicated DL BWP	1,2,3	DLBWP.1.1			
	Initial UL BWP	1,2,3	ULBWP.0.1			
	Dedicated UL BWP	1,2,3	ULBWP.1.1			
EPRE ratio of PSS to SSS	dB	1,2,3	0			
EPRE ratio of PBCH DMRS to SSS		1,2,3				
EPRE ratio of PBCH to PBCH DMRS		1,2,3				
EPRE ratio of PDCCH DMRS to SSS		1,2,3				
EPRE ratio of PDCCH to PDCCH DMRS		1,2,3				
EPRE ratio of PDSCH DMRS to SSS		1,2,3				
EPRE ratio of PDSCH to PDSCH		1,2,3				
EPRE ratio of OCNG DMRS to SSS <sup>Note1</sup>		1,2,3				
EPRE ratio of OCNG to OCNG DMRS <sup>Note1</sup>		1,2,3				
$N_{oc}$ <sup>Note2</sup>		dBm/SCS				
			[-101]		-95	
$\hat{E}_s / I_{ot}$	dB	1,2,3	-Infinity	5	4	4
$\hat{E}_s / N_{oc}$	dB	1,2,3	-Infinity	5	4	4
SSB_RP	dBm/SCS	1,2,3	-Infinity	-93	-94	-94
			-Infinity	-90	-91	-91
$I_o$ <sup>Note3</sup>	dBm/ 9.36MHz	1,2,3	-70.05	-63.85	-	-
	dBm/ 38.16MHz	1,2,3	-63.94	-57.75	64.59	64.59
					58.49	58.49
Propagation condition	-	1,2,3	AWGN		AWGN	
<p>Note 1: OCNG shall be used such that both cells are fully allocated and a constant total transmitted power spectral density is achieved for all OFDM symbols.</p> <p>Note 2: Interference from other cells and noise sources not specified in the test is assumed to be constant over subcarriers and time and shall be modelled as AWGN of appropriate power for <math>N_{oc}</math> to be fulfilled.</p> <p>Note 3: <math>I_o</math> levels have been derived from other parameters for information purposes. They are not settable parameters themselves.</p> <p>Note 4: For UE supporting both semi-static and dynamic channel access, the UE must be tested under both dynamic and semi-static channel occupancy configurations.</p>						

### A.11.2.1.5.3 Test Requirements

The UE shall start to transmit the PRACH to Cell 2 less than 132 ms from the beginning of time period T2. The rate of correct handovers observed during repeated tests shall be at least 90%.

NOTE: The handover delay can be expressed as: RRC procedure delay +  $T_{interrupt}$ , where:

RRC procedure delay = 10 ms and is specified in clause 12 in TS 38.331 [2].

$T_{interrupt}$  = 122 ms in the test.  $T_{interrupt}$  is defined in clause 6.1.1.2.2.

This gives a total of 132 ms.

### A.11.2.1.6 Inter-frequency handover from FR1 to FR1 carrier under CCA; unknown target cell

#### A.11.2.1.6.1 Test Purpose and Environment

This test is to verify the requirement for inter frequency handover requirements from FR1 to FR1 carrier under CCA specified in clause 6.1B.1.2.

#### A.11.2.1.6.2 Test Parameters

Supported test configurations are shown in table A.11.2.1.6.2-1. Both handover delay and interruption length are tested by using the parameters in table A.11.2.1.6.2-2, and A.11.2.1.6.2-3.

The test scenario comprises of two carriers and one cell on each carrier. No gap patterns are configured in the test case. The test consists of two successive time periods, with time durations of T1, T2 respectively. At the start of time duration T1, the UE does not have any timing information of cell 2. Starting T2, cell 2 becomes detectable and the UE receives a RRC handover command from the network. The start of T2 is the instant when the last TTI containing the RRC message implying handover is sent to the UE.

**Table A.11.2.1.6.2-1: Inter-frequency handover from FR1 to FR1 carrier under CCA test configurations**

Configuration	Description of a cell with CCA	Description of a cell without CCA
1	30 kHz SSB SCS, 40 MHz bandwidth, TDD duplex mode	15 kHz SSB SCS, 10 MHz bandwidth, FDD duplex mode
2	30 kHz SSB SCS, 40 MHz bandwidth, TDD duplex mode	15 kHz SSB SCS, 10 MHz bandwidth, TDD duplex mode
3	30 kHz SSB SCS, 40 MHz bandwidth, TDD duplex mode	30 kHz SSB SCS, 40 MHz bandwidth, TDD duplex mode

Note: The UE is only required to be tested in one of the supported test configurations

**Table A.11.2.1.6.2-2: General test parameters Inter-frequency handover from FR1 to FR1 carrier under CCA**

Parameter	Unit	Value	Comment
Initial conditions	Active cell	Cell 1	
	Neighbouring cell	Cell 2	On the carrier under CCA
Final condition	Active cell	Cell 2	On the carrier under CCA
DL CCA model		As specified in clause A.3.20.2.1	
UL CCA model		As specified in clause A.3.20.2.2	
Access Barring Information	-	Not Sent	No additional delays in random access procedure.
T1	s	5	
T2	s	$\leq T_{\text{interrupt}}$	$T_{\text{interrupt}}$ is defined in clause 6.1B.1.2

**Table A.11.2.1.6.2-3: Cell specific test parameters for NR FR1-FR1 Inter frequency handover test case**

Parameter	Unit	Configuration	Cell 1		Cell 2	
			T1	T2	T1	T2
NR RF Channel Number		1, 2, 3	1		2	
DL CCA probability for semi-static channel access ( $P_{\text{CCA\_DL}}$ )DL CCA probability $P_{\text{CCA\_DL}}$		1, 2, 3	N/A		0.9375	
DL CCA probability for dynamic channel access ( $P_{\text{CCA\_DL\_1}}$ )		1, 2, 3	N/A		0.75	
DL CCA probability for dynamic channel access ( $P_{\text{CCA\_DL\_2}}$ )		1, 2, 3	N/A		0.75	
UL CCA probability for semi-static channel access $P_{\text{CCA\_UL}}$		1, 2, 3	N/A		0.75	
UL CCA probability for dynamic static channel access $P_{\text{CCA\_UL}}$		1, 2, 3	N/A		0.87	
TDD configuration		1	N/A		TDDConf.1.1.CCA	

		2	TDDConf.1.1	TDDConf.1.1.CCA
		3	TDDConf.1.2	TDDConf.1.1.CCA
BW <sub>channel</sub>		1	10: N <sub>RB,c</sub> = 52	40: N <sub>RB,c</sub> = 106
		2	10: N <sub>RB,c</sub> = 52	40: N <sub>RB,c</sub> = 106
		3	40: N <sub>RB,c</sub> = 106	40: N <sub>RB,c</sub> = 106
BWP BW		1	10: N <sub>RB,c</sub> = 52	40: N <sub>RB,c</sub> = 106
		2	10: N <sub>RB,c</sub> = 52	40: N <sub>RB,c</sub> = 106
		3	40: N <sub>RB,c</sub> = 106	40: N <sub>RB,c</sub> = 106
DRX Cycle	ms		Not Applicable	
PDSCH Reference		1	SR.1.1 FDD	SR.1.1 CCA
		2	SR.1.1 TDD	SR.1.1 CCA
		3	SR.2.1 TDD	SR.1.1 CCA
CORESET Reference Channel		1	CR.1.1 FDD	CR.1.1 CCA
		2	CR.1.1 TDD	CR.1.1 CCA
		3	CR.2.1 TDD	CR.1.1 CCA
Dedicated CORESET RMC configuration		1	CCR.1.1 FDD	CCR.1.1 CCA
		2	CCR.1.1 TDD	CCR.1.1 CCA
		3	CCR.2.1 TDD	CCR.1.1 CCA
TRS configuration		1	TRS.1.1 FDD	TRS.1.2 TDD
		2	TRS.1.1 TDD	TRS.1.2 TDD
		3	TRS.1.2 TDD	TRS.1.2 TDD
OCNG Patterns		1, 2, 3	OP.1	
SMTC Configuration		1, 2, 3	SMTC.1	
DBT window configuration		1, 2, 3	N/A	As defined in A.3.28.1
SSB configuration		1, 2	SSB.1 FR1	SSB.1 CCA for semi-static channel access; SSB.2 CCA for dynamic channel access;
		3	SSB.2 FR1	SSB.1 CCA for semi-static channel access; SSB.2 CCA for dynamic channel access;
ssb-PositionQCL			N/A	[1]
PDSCH/PDCCH subcarrier spacing	kHz	1	15 kHz	30 kHz
		2	15 kHz	30 kHz
		3	30 kHz	30 kHz
PUCCH/PUSCH subcarrier spacing	kHz	1	15 kHz	30 kHz
		2	15 kHz	30 kHz
		3	30 kHz	30 kHz
PRACH configuration			FR1 PRACH configuration 1	FR1 PRACH configuration 1 CCA
BWP configuration	Initial DL BWP		1, 2, 3	DLBWP.0.1
	Dedicated DL BWP		1, 2, 3	DLBWP.1.1
	Initial UL BWP		1, 2, 3	ULBWP.0.1
	Dedicated UL BWP		1, 2, 3	ULBWP.1.1
EPRE ratio of PSS to SSS	dB			0
EPRE ratio of PBCH DMRS to SSS				
EPRE ratio of PBCH to PBCH DMRS				
EPRE ratio of PDCCH DMRS to SSS				
EPRE ratio of PDCCH to PDCCH DMRS				
EPRE ratio of PDSCH DMRS to SSS				
EPRE ratio of PDSCH to PDSCH				
EPRE ratio of OCNG DMRS to SSS(Note 1)				
EPRE ratio of OCNG to OCNG DMRS (Note 1)				

$N_{oc}$ <sup>Note2</sup>		dBm/15kHz		-98			
$N_{oc}$ <sup>Note2</sup>	Config 1	dBm/SCS	1, 2	-98			
			3	-95			
$\hat{E}_s / I_{ot}$		dB		4	4	-Infinity	5
$\hat{E}_s / N_{oc}$		dB		4	4	-Infinity	5
SSB_RP	Config 1	dBm/SCS	1, 2	-94	-94	-Infinity	-93
			3	-91	-91	-Infinity	-90
$I_o$ <sup>Note3</sup>	Config 1	dBm/ 9.36MHz	1, 2	-	-	-70.05	-63.85
		dBm/ 38.16MHz	3	64.59	64.59	-63.94	-57.75
Propagation condition		-		AWGN		AWGN	
<p>Note 1: OCNG shall be used such that both cells are fully allocated and a constant total transmitted power spectral density is achieved for all OFDM symbols.</p> <p>Note 2: Interference from other cells and noise sources not specified in the test is assumed to be constant over subcarriers and time and shall be modelled as AWGN of appropriate power for <math>N_{oc}</math> to be fulfilled.</p> <p>Note 3: <math>I_o</math> levels have been derived from other parameters for information purposes. They are not settable parameters themselves.</p> <p>Note 4: For UE supporting both semi-static and dynamic channel access, the UE must be tested under both dynamic and semi-static channel occupancy configurations.</p>							

### A.11.2.1.6.3 Test Requirements

The UE shall start to transmit the PRACH to Cell 2 less than  $T_{interrupt}$  from the beginning of time period T3, where  $T_{interrupt}$  is defined in clause 6.1B.1.2

The rate of correct handovers observed during repeated tests shall be at least 90%.

NOTE: The handover delay can be expressed as: RRC procedure delay +  $T_{interrupt}$ , where:

RRC procedure delay = 10 ms and is specified in clause 12 in TS 38.331 [2],  $L_1'$  is the number of SMTC occasions not available at the UE during the inter-frequency detection period,  $L_2$  is the number of SMTC occasions not available at the UE during the time tracking period, and  $L_3$  is the number of consecutive SSB to PRACH occasion association periods during which no PRACH occasion is available for PRACH transmission due to UL CCA failure.  $L_3 = 0$  for Type 2C UL channel access procedure as defined in TS 37.213 [33]. The interruption time considering the potential extensions caused by  $L_1, L_1', L_2, L_3$  and by the UL CCA failure detection/recovery mechanism is limited by the T304 timer. The UE behaviour at the T304 timer expiry is detailed in TS 38.331 [2].

## A.11.2.1.7 SA NR FR1 carrier under CCA - E-UTRAN handover with known target cell

### A.11.2.1.7.1 Test Purpose and Environment

The purpose of this set of tests is to verify that the UE can make correct inter-RAT E-UTRAN handover when operating in standalone (SA) operation with PCell in FR1 carrier under CCA. This test shall verify the NR to E-UTRAN handover requirements as specified in clause 6.1.2.1.

The test comprises of one NR carrier under CCA and one E-UTRA carrier. There are two cells and one cell on each carrier. Cell 1 is the NR PCell and Cell 2 is an inter-RAT E-UTRAN neighbour cell. The test consists of three successive time periods, with time durations of T1, T2 and T3 respectively. At the start of time duration T1, the UE does not have any timing information of Cell 2. Starting T2, Cell 2 becomes detectable and the UE is expected to detect and send a measurement report. Gap pattern configuration with id #0 as specified in Table 9.1.2-1 is configured before T2 begins to enable inter-RAT frequency monitoring.

A RRC message implying handover shall be sent to the UE during period T2 after the UE has reported Event B2. The start of T3 is the next instant after the last TTI containing the RRC message implying handover is sent to the UE. The handover message shall contain Cell 2 as the target cell.

Supported test configurations are shown in table A.11.2.1.7-1. General test parameters are provided in Table A.11.2.1.7-2. Cell specific test parameters for Cell 1 and Cell 2 are provided in Tables A.11.2.1.7-3 and A.11.2.1.7-4 respectively.

**Table A.11.2.1.7-1: Supported test configurations for SA inter-RAT E-UTRAN handover tests**

Configuration	Description of a cell with CCA	Description of a cell without CCA
1	NR 30 kHz SSB SCS, 40 MHz bandwidth, TDD duplex mode	LTE 10 MHz bandwidth, TDD duplex mode
2	NR 30 kHz SSB SCS, 40 MHz bandwidth, TDD duplex mode	LTE 10 MHz bandwidth, FDD duplex mode
Note 1: The UE is only required to be tested in one of the supported test configurations.		
Note 2: The UE supporting SA operation only on NR band(s) with shared spectrum access is required to be tested.		

**Table A.11.2.1.7-2: General test parameters for SA inter-RAT E-UTRAN handover**

Parameter	Unit	Value	Comment
NR RF Channel Number		1	1 NR carrier frequency is used in the test
LTE RF Channel Number		2	1 E-UTRAN carrier frequency is used in the test
Initial conditions	Active cell	Cell 1	NR cell on a carrier under CCA
	Neighbouring cell	Cell 2	E-UTRAN cell
Final condition	Active cell	Cell 2	
DL CCA model		As specified in clause A.3.20.2.1	
UL CCA model		As specified in clause A.3.20.2.2	
NR measurement quantity		SS-RSRP	
E-UTRAN measurement quantity		RSRP	
b2-Threshold1	dBm	As specified in Table A.11.2.1.7-3	Absolute NR SS-RSRP threshold for event B2
b2-Threshold2EUTRAN	dBm	-98	Absolute E-UTRAN RSRP threshold for event B2
Hysteresis	dB	0	
TimeToTrigger	s	0	
Filter coefficient		0	L3 filtering is not used
DRX		OFF	Non-DRX test
Access Barring Information	-	Not sent	No additional delays in random access procedure
Time offset between cells		3 ms	Asynchronous cells
Gap pattern configuration Id		0	As specified in Table 9.1.2-1 started before T2 starts
T1	s	5	
T2	s	≤5	
T3	s	1	

**Table A.11.2.1.7-3: Cell specific test parameters for SA inter-RAT E-UTRA handover (Cell 1)**

Parameter	Unit	Configuration	Cell 1		
			T1	T2	T3
RF channel number		1, 2	1		
TDD Configuration		1, 2	TDDConf.1.1.CCA		
DL CCA probability for semi-static channel access ( $P_{CCA\_DL}$ )DL CCA probability $P_{CCA\_DL}$		1, 2	0.9375		
DL CCA probability for for dynamic static channel access ( $P_{CCA\_DL\_1}$ )		1, 2	0.75		
DL CCA probability for for dynamic static channel access ( $P_{CCA\_DL\_2}$ )		1, 2	0.75		
UL CCA probability for semi-static channel access $P_{CCA\_UL}$		1, 2	0.75		
UL CCA probability for dynamic static channel access $P_{CCA\_UL}$		1, 2	0.87		
$BW_{channel}$		1, 2	40: $N_{RB,c} = 106$ (TDD)		

PDSCH reference measurement channel		1, 2	SR.1.1 CCA		
CORESET reference channel		1, 2	CR.1.1 CCA		
Dedicated CORESET RMC configuration		1, 2	CCR.1.1 CCA		
TRS configuration		1, 2	TRS.1.2 TDD		
OCNG pattern <sup>Note1</sup>		1, 2	OP.1		
BWP	Initial DL BWP	1, 2	DLBWP.0.1		
	Dedicated DL BWP		DLBWP.1.1		
	Initial UL BWP		ULBWP.0.1		
	Dedicated UL BWP		ULBWP.1.1		
SMTC configuration		1, 2	SMTC.1		
DBT window configuration		1, 2	As defined in A.3.28.1		
SSB configuration		1, 2	SSB.1 CCA for semi-static channel access; SSB.2 CCA for dynamic channel access;		
b2-Threshold1	dBm	1, 2	-93		
EPRE ratio of PSS to SSS	dB	1, 2	0		
EPRE ratio of PBCH_DMRS to SSS					
EPRE ratio of PBCH to PBCH_DMRS					
EPRE ratio of PDCCH_DMRS to SSS					
EPRE ratio of PDCCH to PDCCH_DMRS					
EPRE ratio of PDSCH_DMRS to SSS					
EPRE ratio of PDSCH to PDSCH_DMRS					
EPRE ratio of OCNG DMRS to SSS					
EPRE ratio of OCNG to OCNG DMRS					
$N_{oc}$ <sup>Note2</sup>					
$N_{oc}$ <sup>Note2</sup>	dBm/SCS	1, 2	-97	-101	-97
$\hat{E}_s/N_{oc}$	dB	1, 2	12	0	0
$\hat{E}_s/I_{ot}$ <sup>Note3</sup>	dB	1, 2	12	0	0
SS-RSRP <sup>Note3</sup>	dBm/SCS	1, 2	-85	-101	-97
$I_o$ <sup>Note3</sup>	dBm/38.16 MHz	1, 2	-53.68	-66.93	-62.93
Propagation condition		1, 2	AWGN		
Antenna Configuration and Correlation Matrix		1, 2	1x2 Low		
<p>Note 1: OCNG shall be used such that both cells are fully allocated and a constant total transmitted power spectral density is achieved for all OFDM symbols.</p> <p>Note 2: Interference from other cells and noise sources not specified in the test is assumed to be constant over subcarriers and time and shall be modelled as AWGN of appropriate power for <math>N_{oc}</math> to be fulfilled.</p> <p>Note 3: <math>\hat{E}_s/I_{ot}</math>, SS-RSRP, and <math>I_o</math> levels have been derived from other parameters for information purposes. They are not settable parameters themselves.</p> <p>Note 4: For UE supporting both semi-static and dynamic channel access, the UE must be tested under both dynamic and semi-static channel occupancy configurations.</p>					

Table A.11.2.1.7-4: Cell specific test parameters for SA inter-RAT E-UTRA handover (Cell 2)

Parameter	Unit	Configuration	Cell 2		
			T1	T2	T3
RF channel number		1, 2	2		

Duplex mode		1	FDD		
		2	TDD		
TDD special subframe configuration <sup>Note1</sup>		2	6		
TDD uplink-downlink configuration <sup>Note1</sup>		2	1		
BW <sub>channel</sub>	MHz	1, 2	10 MHz: N <sub>RB,c</sub> = 50		
PRACH Configuration <sup>Note2</sup>		1	4		
		2	53		
PDSCH parameters: DL Reference Measurement Channel <sup>Note3</sup>		1	10 MHz: R.3 FDD		
		2	10 MHz: R.0 TDD		
PCFICH/PDCCH/PHICH parameters: DL Reference Measurement Channel <sup>Note3</sup>		1	10 MHz: R.6 FDD		
		2	10 MHz: R.6 TDD		
OCNG Patterns <sup>Note3</sup>		1	10 MHz: OP.10 FDD		
		2	10 MHz: OP.1 TDD		
PBCH_RA	dB	1, 2	0		
PBCH_RB					
PSS_RA					
SSS_RA					
PCFICH_RB					
PHICH_RA					
PHICH_RB					
PDCCH_RA					
PDCCH_RB					
PDSCH_RA					
PDSCH_RB					
OCNG_RA <sup>Note4</sup>					
OCNG_RB <sup>Note4</sup>					
N <sub>oc</sub> <sup>Note5</sup>					
E <sub>s</sub> /N <sub>oc</sub>	dB	1, 2	-Infinity	8	78
E <sub>s</sub> /I <sub>ot</sub> <sup>Note6</sup>	dB	1, 2	-Infinity	8	78
RSRP <sup>Note6</sup>	dBm/15kHz	1, 2	-Infinity	-90	-90
SCH_RP <sup>Note6</sup>	dBm/15kHz	1, 2	-Infinity	-90	-90
I <sub>o</sub> <sup>Note6</sup>	dBm/9MHz	1, 2	-67.21 +10log(N <sub>RB,c</sub> /100)	-58.57 +10log(N <sub>RB,c</sub> /100)	-58.57 +10log(N <sub>RB,c</sub> /100)
Propagation Condition		1, 2	AWGN		
Antenna Configuration and Correlation Matrix <sup>Note7</sup>		1, 2	1x2 Low		

- Note 1: Special subframe and uplink-downlink configurations are specified in table 4.2-1 in TS 36.211 [23].
- Note 2: PRACH configurations are specified in table 5.7.1-2 and table 5.7.1-3 in TS 36.211 [23].
- Note 3: DL RMCs and OCNG patterns are specified in clauses A 3.1 and A 3.2 of TS 36.133 [15] respectively.
- Note 4: OCNG shall be used such that all cells are fully allocated and a constant total transmitted power spectral density is achieved for all OFDM symbols.
- Note 5: Interference from other cells and noise sources not specified in the test is assumed to be constant over subcarriers and time and shall be modelled as AWGN of appropriate power for N<sub>oc</sub> to be fulfilled.
- Note 6: E<sub>s</sub>/I<sub>ot</sub>, RSRP, SCH\_RP and I<sub>o</sub> levels have been derived from other parameters for information purposes. They are not settable parameters themselves.
- Note 7: Propagation condition and correlation matrix are defined in clause B.2 in TS 36.101 [25].

### A.11.2.1.7.2 Test Requirements

The UE shall start to transmit the PRACH to Cell 2 less than 85 ms from the beginning of time period T3.

The rate of correct handovers observed during repeated tests shall be at least 90%.

NOTE: The handover delay can be expressed as: RRC procedure delay +  $T_{\text{interrupt}}$ , where:

RRC procedure delay = 50 ms and is specified in clause 6.1.2.1.

$T_{\text{interrupt}}$  = 35 ms in the test;  $T_{\text{interrupt}}$  is defined in clause 6.1.2.1.

This gives a total of 85 ms.

### A.11.2.1.8 SA NR FR1 carrier under CCA - E-UTRAN handover with unknown target cell

#### A.11.2.1.8.1 Test Purpose and Environment

The purpose of this set of tests is to verify that the UE can make correct inter-RAT E-UTRAN handover when operating in standalone (SA) operation with PCell in FR1 carrier under CCA. This test shall verify the NR to E-UTRAN handover requirements for the case when the target E-UTRAN cell is unknown as specified in clause 6.1.2.1.

The test comprises of one NR carrier under CCA and one E-UTRA carrier. There are two cells and one cell on each carrier. Cell 1 is the NR PCell and Cell 2 is an inter-RAT E-UTRAN neighbour cell. The test consists of two successive time periods, with time durations of T1 and T2 respectively. At the start of time duration T1, the UE does not have any timing information of Cell 2. Starting T2, Cell 2 becomes detectable. No Gap pattern shall be configured.

A RRC message implying handover shall be sent to the UE during period T1. The start of T2 is the next instant after the last TTI containing the RRC message implying handover is sent to the UE. The handover message shall contain Cell 2 as the target cell.

Supported test configurations are shown in table A.11.2.1.8-1. General test parameters are provided in Table A.11.2.1.8-2. Cell specific test parameters for Cell 1 and Cell 2 are provided in Tables A.11.2.1.8-3 and A.11.2.1.8-4 respectively.

**Table A.11.2.1.8-1: Supported test configurations for SA inter-RAT E-UTRAN handover tests**

Configuration	Description of a cell with CCA	Description of a cell without CCA
1	NR 30 kHz SSB SCS, 40 MHz bandwidth, TDD duplex mode	LTE 10 MHz bandwidth, TDD duplex mode
2	NR 30 kHz SSB SCS, 40 MHz bandwidth, TDD duplex mode	LTE 10 MHz bandwidth, FDD duplex mode

Note 1: The UE is only required to be tested in one of the supported test configurations.  
Note 2: The UE supporting SA operation only on NR band(s) with shared spectrum access is required to be tested.

**Table A.11.2.1.8-2: General test parameters for SA inter-RAT E-UTRAN handover**

Parameter	Unit	Value	Comment
NR RF Channel Number		1	1 NR carrier frequency is used in the test
LTE RF Channel Number		2	1 E-UTRAN carrier frequency is used in the test
Initial conditions	Active cell	Cell 1	NR cell on a carrier under CCA E-UTRAN cell
	Neighbouring cell	Cell 2	
Final condition	Active cell	Cell 2	
DL CCA model		As specified in clause A.3.20.2.1	
UL CCA model		As specified in clause A.3.20.2.2	
NR measurement quantity		SS-RSRP	
DRX		OFF	Non-DRX test
Access Barring Information	-	Not sent	No additional delays in random access procedure



Time offset between cells		3 ms	Asynchronous cells
T1	s	≤5	
T2	s	1	

**Table A.11.2.1.8-3: Cell specific test parameters for SA inter-RAT E-UTRA handover (Cell 1)**

Parameter	Unit	Configuration	Cell 1	
			T1	T2
RF channel number		1, 2	1	
DL CCA probability for semi-static channel access ( $P_{CCA\_DL}$ )DL CCA probability $P_{CCA\_DL}$		1, 2	0.9375	
DL CCA probability for dynamic channel access ( $P_{CCA\_DL\_1}$ )		1, 2	0.75	
DL CCA probability for dynamic channel access ( $P_{CCA\_DL\_2}$ )		1, 2	0.75	
UL CCA probability for semi-static channel access $P_{CCA\_UL}$		1, 2	0.75	
UL CCA probability for dynamic static channel access $P_{CCA\_UL}$		1, 2	0.87	
TDD Configuration		1, 2	TDDConf.1.1.CCA	
$BW_{channel}$	MHz	1, 2	40: $N_{RB,c} = 106$ (TDD)	
PDSCH reference measurement channel		1, 2	SR.1.1 CCA	
CORESET reference channel		1, 2	CR.1.1 CCA	
Dedicated CORESET RMC configuration		1, 2	CCR.1.1 CCA	
TRS configuration		1, 2	TRS.1.2 TDD	
OCNG pattern <sup>Note1</sup>		1, 2	OP.1	
BWP	Initial DL BWP	1, 2	DLBWP.0.1	
	Dedicated DL BWP		DLBWP.1.1	
	Initial UL BWP		ULBWP.0.1	
	Dedicated UL BWP		ULBWP.1.1	
SMTC configuration		1, 2	SMTC.1	
DBT window configuration		1, 2	As defined in A.3.28.1	
SSB configuration		1, 2	SSB.1 CCA for semi-static channel access; SSB.2 CCA for dynamic channel access;	
EPRE ratio of PSS to SSS	dB	1, 2	0	
EPRE ratio of PBCH_DMRS to SSS				
EPRE ratio of PBCH to PBCH_DMRS				
EPRE ratio of PDCCH_DMRS to SSS				
EPRE ratio of PDCCH to PDCCH_DMRS				
EPRE ratio of PDSCH_DMRS to SSS				
EPRE ratio of PDSCH to PDSCH_DMRS				
EPRE ratio of OCNG DMRS to SSS				

EPRE ratio of OCNG to OCNG DMRS				
$N_{oc}$ <sup>Note2</sup>	dBm/15 KHz	1, 2	-98	
$N_{oc}$ <sup>Note2</sup>	dBm/SCS	1, 2	-95	
$\bar{E}_s/N_{oc}$	dB	1, 2	0	0
$\bar{E}_s/I_{ot}$ <sup>Note3</sup>	dB	1, 2	0	0
SS-RSRP <sup>Note3</sup>	dBm/SCS	1, 2	-95	-95
$I_o$ <sup>Note3</sup>	dBm/38.16 MHz	1, 2	-60.94	-60.94
Propagation condition		1, 2	AWGN	
Antenna Configuration and Correlation Matrix		1, 2	1x2 Low	
<p>Note 1: OCNG shall be used such that both cells are fully allocated and a constant total transmitted power spectral density is achieved for all OFDM symbols.</p> <p>Note 2: Interference from other cells and noise sources not specified in the test is assumed to be constant over subcarriers and time and shall be modelled as AWGN of appropriate power for <math>N_{oc}</math> to be fulfilled.</p> <p>Note 3: <math>\bar{E}_s/I_{ot}</math>, SS-RSRP, and <math>I_o</math> levels have been derived from other parameters for information purposes. They are not settable parameters themselves.</p> <p>Note 4: For UE supporting both semi-static and dynamic channel access, the UE must be tested under both dynamic and semi-static channel occupancy configurations.</p>				

**Table A.11.2.1.8-4: Cell specific test parameters for SA inter-RAT E-UTRA handover (Cell 2)**

Parameter	Unit	Configuration	Cell 2	
			T1	T2
RF channel number		1, 2	2	
Duplex mode		1	FDD	
		2	TDD	
TDD special subframe configuration <sup>Note1</sup>		2	6	
TDD uplink-downlink configuration <sup>Note1</sup>		2	1	
BW <sub>channel</sub>	MHz	1, 2	10 MHz: $N_{RB,c} = 50$	
PRACH Configuration <sup>Note2</sup>		1	4	
		2	53	
PDSCH parameters: DL Reference Measurement Channel <sup>Note3</sup>		1	10 MHz: R.3 FDD	
		2	10 MHz: R.0 TDD	
PCFICH/PDCCH/PHICH parameters: DL Reference Measurement Channel <sup>Note3</sup>		1	10 MHz: R.6 FDD	
		2	10 MHz: R.6 TDD	
OCNG Patterns <sup>Note3</sup>		1	10 MHz: OP.10 FDD	
		2	10 MHz: OP.1 TDD	
PBCH_RA	dB	1, 2	0	
PBCH_RB				
PSS_RA				
SSS_RA				
PCFICH_RB				
PHICH_RA				
PHICH_RB				
PDCCH_RA				
PDCCH_RB				
PDSCH_RA				
PDSCH_RB				
OCNG_RA <sup>Note4</sup>				
OCNG_RB <sup>Note4</sup>				
$N_{oc}$ <sup>Note5</sup>	dBm/15kHz	1, 2	-98	
$\bar{E}_s/N_{oc}$	dB	1, 2	-Infinity	7
$\bar{E}_s/I_{ot}$ <sup>Note6</sup>	dB	1, 2	-Infinity	7
RSRP <sup>Note6</sup>	dBm/15kHz	1, 2	-Infinity	-91
SCH_RP <sup>Note6</sup>	dBm/15kHz	1, 2	-Infinity	-91

$I_0$ <sup>Note6</sup>	dBm/9MHz	1, 2	-70.22	-62.43
Propagation Condition		1, 2	AWGN	
Antenna Configuration and Correlation Matrix <sup>Note7</sup>		1, 2	1x2 Low	
<p>Note 1: Special subframe and uplink-downlink configurations are specified in table 4.2-1 in TS 36.211 [23].</p> <p>Note 2: PRACH configurations are specified in table 5.7.1-2 and table 5.7.1-3 in TS 36.211 [23].</p> <p>Note 3: DL RMCs and OCNG patterns are specified in clauses A 3.1 and A 3.2 of TS 36.133 [15] respectively.</p> <p>Note 4: OCNG shall be used such that all cells are fully allocated and a constant total transmitted power spectral density is achieved for all OFDM symbols.</p> <p>Note 5: Interference from other cells and noise sources not specified in the test is assumed to be constant over subcarriers and time and shall be modelled as AWGN of appropriate power for <math>N_{oc}</math> to be fulfilled.</p> <p>Note 6: <math>\hat{E}_s/I_{ot}</math>, RSRP, SCH_RP and <math>I_0</math> levels have been derived from other parameters for information purposes. They are not settable parameters themselves.</p> <p>Note 7: Propagation condition and correlation matrix are defined in clause B.2 in TS 36.101 [25].</p>				

### A.11.2.1.8.2 Test Requirements

The UE shall start to transmit the PRACH to Cell 2 less than 165 ms from the beginning of time period T2.

The rate of correct handovers observed during repeated tests shall be at least 90%.

NOTE: The handover delay can be expressed as: RRC procedure delay +  $T_{interrupt}$ , where:

RRC procedure delay = 50 ms and is specified in clause 6.1.2.1.

$T_{interrupt}$  = 115 ms in the test;  $T_{interrupt}$  is defined in clause 6.1.2.1.

This gives a total of 165 ms.

## A.11.2.2 RRC connection mobility control

### A.11.2.2.1 RRC re-establishment

#### A.11.2.2.1.1 Intra-frequency RRC Re-establishment with CCA in FR1

##### A.11.2.2.1.1.1 Test Purpose and Environment

The purpose is to verify that the NR intra-frequency RRC re-establishment delay with CCA in FR1 with known target cell is within the specified limits. These tests will verify the requirements in clause 6.2.1A.

The test parameters are given in table A.11.2.2.1.1.1-1, table A.11.2.2.1.1.1-2 and table A.11.2.2.1.1.1-3 below. The test consists of 3 successive time periods, with time duration of T1, T2 and T3 respectively. At the start of time period T2, cell 1, which is the active cell with CCA, is deactivated. The time period T3 starts after the occurrence of the radio link failure.

**Table A.11.2.2.1.1.1-1: Supported test configurations**

Configuration	Description
1	30 kHz SSB SCS, 40 MHz bandwidth, TDD duplex mode

**Table A.11.2.2.1.1.1-2: General test parameters for NR intra-frequency RRC Re-establishment test case with CCA**

Parameter	Unit	Value	Comment	
Initial Condition	Active cell	-	Cell1	Cell 1 is with CCA.
	Neighbour cells	-	Cell2	Cell 2 is with CCA.
Final condition	Active cell	-	Cell2	
RF Channel Number	-	1		
DL CCA model	Dynamic channel access <sup>Note 1, 3</sup>	-	As specified in clause A.3.26.2.1	

	Semi-static channel access <sup>Note 2, 3</sup>	-		
UL CCA model	Dynamic channel access <sup>Note 1, 3</sup>	-	As specified in clause A.3.26.2.2	
	Semi-static channel access <sup>Note 2, 3</sup>	-		
Time offset between cells		-	3 $\mu$ s	Synchronous cells
N310		-	1	Maximum consecutive out-of-sync indications from lower layers
N311		-	1	Minimum consecutive in-sync indications from lower layers
T310		ms	0	Radio link failure timer; T310 is disabled
T311		ms	3000	RRC re-establishment timer
Access Barring Information		-	Not Sent	No additional delays in random access procedure.
SSB configuration	Dynamic channel access <sup>Note 1, 3</sup>	-	SSB.2 CCA	Table A.3.10A.1.2-1
	Semi-static channel access <sup>Note 2, 3</sup>	-	SSB.1 CCA	Table A.3.10A.1.1-1
DBT window configuration		-	DBT.1	Table A.3.28.1-1
SMTC configuration		-	SMTC pattern 1	
DRX cycle length		s	OFF	
PRACH configuration		-	FR1 PRACH configuration 1 under CCA	Table A.3.8A.2.1-1
T1		s	5	
T2		ms	480	Time for the UE to detect RLF
T3		s	2	
NOTE 1: For a UE supporting dynamic channel access and network configuring dynamic channel occupancy.				
NOTE 2: For a UE supporting semi-static channel access and network configuring semi-static channel occupancy.				
NOTE 3: For a UE supporting both semi-static and dynamic channel access, the UE can be tested under dynamic channel occupancy only.				

**Table A.11.2.2.1.1-3: Cell specific test parameters for NR intra-frequency RRC Re-establishment test case with CCA**

Parameter	Unit	Cell 1			Cell 2		
		T1	T2	T3	T1	T2	T3
TDD configuration	-	TDDConf.1.1 CCA			TDDConf.1.1 CCA		
DL CCA probability $P_{CCA\_DL}$ for dynamic channel access <sup>Note 4,6</sup>	-	$P_{CCA\_DL\_1}=0.75$ $P_{CCA\_DL\_2}=0.75$			$P_{CCA\_DL\_1}=0.75$ $P_{CCA\_DL\_2}=0.75$		
DL CCA probability $P_{CCA\_DL}$ for semi-static channel access <sup>Note 5,6</sup>	-	$P_{CCA\_DL}=0.9375$			$P_{CCA\_DL}=0.9375$		
UL CCA probability $P_{CCA\_UL}$	-	1			1		
PDSCH RMC configuration		SR.1.1 CCA			SR.1.1 CCA		
RMSI CORESET RMC configuration		CR.1.1 CCA			CR.1.1 CCA		
Dedicated CORESET RMC configuration		CCR.1.1 CCA			CCR.1.1 CCA		
OCNG Pattern		OP.1 defined in A.3.2.1			OP.1 defined in A.3.2.1		
TRS configuration		TRS.1.2 TDD			N/A		
Initial DL BWP configuration		DLBWP.0.1			DLBWP.0.1		
Initial UL BWP configuration		ULBWP.0.1			ULBWP.0.1		
Active DL BWP configuration		DLBWP.1.1	N/A	N/A	N/A	N/A	DLBW P.1.1

Active UL BWP configuration		ULBWP. 1.1	N/A	N/A	N/A	N/A	ULBW P.1.1
RLM-RS		SSB			SSB		
$\hat{E}_s/I_{\alpha}$	dB	1.54	-infinity	-infinity	-3.79	4	4
$N_{oc}$ Note2	dBm/SCS	-95					
$N_{oc}$ Note2	dBm/15 kHz	-98					
$\hat{E}_s/N_{oc}$	dB	7	-infinity	-infinity	4	4	4
SS-RSRP Note3	dBm/SCS	-88	-infinity	-infinity	-91	-91	-91
Io	dBm/38.16 MHz	-54.65	-58.50	-58.50	-54.65	-58.50	-58.50
Propagation Condition		AWGN					
NOTE 1: OCNG shall be used such that both cells are fully allocated and a constant total transmitted power spectral density is achieved for all OFDM symbols.							
NOTE 2: Interference from other cells and noise sources not specified in the test is assumed to be constant over subcarriers and time and shall be modelled as AWGN of appropriate power for $N_{oc}$ to be fulfilled.							
NOTE 3: SS-RSRP levels have been derived from other parameters for information purposes. They are not settable parameters themselves.							
NOTE 4: For a UE supporting dynamic channel access and network configuring dynamic channel occupancy.							
NOTE 5: For a UE supporting semi-static channel access and network configuring semi-static channel occupancy.							
NOTE 6: For a UE supporting both semi-static and dynamic channel access, the UE can be tested under dynamic channel occupancy only.							

#### A.11.2.2.1.1.2 Test Requirements

The RRC re-establishment delay is defined as the time from the start of time period T3, to the moment when the UE starts to send PRACH preambles to cell 2 for sending the *RRCReestablishmentRequest* message to cell 2.

The RRC re-establishment delay to a known NR intra frequency cell with CCA shall be less than  $1350 + \text{MAX}(200, (5+K_1) \times 20)$  ms.

The rate of correct RRC re-establishments observed during repeated tests shall be at least 90%.

NOTE: The RRC re-establishment delay in the test is derived from the following expression:

$$T_{re-establish\_delay\_CCA} = T_{UE\_re-establish\_delay\_CCA} + T_{UL\_grant}$$

Where:

$T_{UL\_grant}$  = It is the time required to acquire and process uplink grant from the target cell. The PRACH reception at the system simulator is used as a trigger for the completion of the test; hence  $T_{UL\_grant}$  is not used.

$$\begin{aligned} T_{UE\_re-establish\_delay\_CCA} &= 50 \text{ ms} + T_{identify\_intra\_NR\_CCA} + \sum_{i=1}^{N_{freq}-1} T_{identify\_inter\_NR\_CCA,i} + T_{SI-NR\_CCA} \\ &+ T_{PRACH\_CCA} \end{aligned}$$

Where

$$N_{freq} = 1$$

$$T_{identify\_intra\_NR\_CCA} = \text{MAX}(200 \text{ ms}, (5+K_1) \times T_{SMTC}), \text{ where}$$

$K_1$  is the number of SMTC occasions not available at the UE due to DL CCA failures during RRC re-establishment period on the carrier with CCA.

$T_{SMTC} = 20 \text{ ms}$  is the SMTC periodicity.

$$T_{identify\_inter\_NR\_CCA} = 0 \text{ ms}$$

$T_{\text{SL-NR\_CCA}} = 1280$  ms; it is the time required for receiving all the relevant system information as defined in TS 38.331 for the target intra-frequency NR cell.

$T_{\text{PRACH\_CCA}} = T_{\text{SSB,RO}} + 10$  ms, where:

- $T_{\text{SSB,RO}}$  is the SSB to PRACH occasion association period as defined in Table 8.1-1 of TS 38.213 [39], which is  $T_{\text{SSB,RO}} = 10$  ms for FR1 PRACH configuration 1 under CCA.

This gives a total of  $1350 + \text{MAX}(200, (5+K_1) \times 20)$  ms.

### A.11.2.2.1.2 Inter-frequency RRC Re-establishment with CCA in FR1

#### A.11.2.2.1.2.1 Test Purpose and Environment

The purpose is to verify that the NR inter-frequency RRC re-establishment delay with CCA in FR1 without known target cell is within the specified limits. These tests will verify the requirements in clause 6.2.1A.

The test parameters are given in table A.11.2.2.1.2.1-1, table A.11.2.2.1.2.1-2 and table A.11.2.2.1.2.1-3 below. The test consists of 3 successive time periods, with time duration of T1, T2 and T3 respectively. At the start of time period T2, cell 1, which is the active cell with CCA, becomes inactive. The time period T3 starts after the occurrence of the radio link failure. During T1, the UE shall be configured with the carrier frequency of cell 2 (with RF Channel Number #2) to ensure that the UE has the context of the carrier frequency of cell 2 by the end of T1.

**Table A.11.2.2.1.2.1-1: Supported test configurations**

Configuration	Description
1	30 kHz SSB SCS, 40 MHz bandwidth, TDD duplex mode

**Table A.11.2.2.1.2.1-2: General test parameters for NR inter-frequency RRC Re-establishment test case in FR1**

Parameter		Unit	Value	Comment
Initial Condition	Active cell	-	Cell1	Cell 1 is with CCA.
	Neighbour cells	-	Cell2	Cell 2 is with CCA.
Final condition	Active cell	-	Cell2	
RF Channel Number		-	1	
DL CCA model	Dynamic channel access <sup>Note 1, 3</sup>	-	As specified in clause A.3.26.2.1	
	Semi-static channel access <sup>Note 2, 3</sup>	-		
UL CCA model	Dynamic channel access <sup>Note 1, 3</sup>	-	As specified in clause A.3.26.2.2	
	Semi-static channel access <sup>Note 2, 3</sup>	-		
Time offset between cells		-	3 $\mu$ s	Synchronous cells
N310		-	1	Maximum consecutive out-of-sync indications from lower layers
N311		-	1	Minimum consecutive in-sync indications from lower layers
T310		ms	0	Radio link failure timer; T310 is disabled
T311		ms	3000	RRC re-establishment timer
Access Barring Information		-	Not Sent	No additional delays in random access procedure.
SSB configuration	Dynamic channel access <sup>Note 1, 3</sup>	-	SSB.2 CCA	Table A.3.10A.1.2-1
	Semi-static channel access <sup>Note 2, 3</sup>	-	SSB.1 CCA	Table A.3.10A.1.1-1
DBT window configuration		-	DBT.1	Table A.3.28.1-1
SMTC configuration		-	SMTC pattern 1	
DRX cycle length		s	OFF	
PRACH configuration		-	FR1 PRACH configuration 1 under CCA	Table A.3.8A.2.1-1

T1	s	5	
T2	ms	200	Time for the UE to detect RLF
T3	s	2	
NOTE 1: For a UE supporting dynamic channel access and network configuring dynamic channel occupancy.			
NOTE 2: For a UE supporting semi-static channel access and network configuring semi-static channel occupancy.			
NOTE 3: For a UE supporting both semi-static and dynamic channel access, the UE can be tested under dynamic channel occupancy only.			

**Table A.11.2.1.2.1-3: Cell specific test parameters for NR inter-frequency RRC Re-establishment test case in FR1**

Parameter	Unit	Cell 1			Cell 2		
		T1	T2	T3	T1	T2	T3
TDD configuration		TDDConf.1.1 CCA			TDDConf.1.1 CCA		
DL CCA probability $P_{CCA\_DL}$ for dynamic channel access <sup>Note</sup> 4,6	-	$P_{CCA\_DL\_1}=0.75$ $P_{CCA\_DL\_2}=0.75$			$P_{CCA\_DL\_1}=0.75$ $P_{CCA\_DL\_2}=0.75$		
DL CCA probability $P_{CCA\_DL}$ for semi- static channel access <sup>Note</sup> 5,6	-	$P_{CCA\_DL}=0.9375$			$P_{CCA\_DL}=0.9375$		
UL CCA probability $P_{CCA\_UL}$	-	1			1		
PDSCH RMC configuration		SR.1.1 CCA			SR.1.1 CCA		
RMSI CORESET RMC configuration		CR.1.1 CCA			CR.1.1 CCA		
Dedicated CORESET RMC configuration		CCR.1.1 CCA			CCR.1.1 CCA		
OCNG Pattern		OP.1 defined in A.3.2.1			OP.1 defined in A.3.2.1		
TRS configuration		TRS.1.2 TDD			N/A		
Initial DL BWP configuration		DLBWP.0.1			DLBWP.0.1		
Initial UL BWP configuration		ULBWP.0.1			ULBWP.0.1		
Active DL BWP configuration		DLBWP. 1.1	N/A	N/A	N/A	N/A	DLBW P.1.1
Active UL BWP configuration		ULBWP. 1.1	N/A	N/A	N/A	N/A	ULBW P.1.1
RLM-RS		SSB			SSB		
$\hat{E}_s / I_{ot}$	dB	1.54	-infinity	-infinity	-3.79	4	4
$N_{oc}$ <sup>Note2</sup>	dBm/SCS	-101					
$N_{oc}$ <sup>Note2</sup>	dBm/15 kHz	-104					
$\hat{E}_s / N_{oc}$	dB	7	-infinity	-infinity	4	4	4
SS-RSRP <sup>Note3</sup>	dBm/SCS	-88	-infinity	-infinity	-91	-91	-91
$l_o$	dBm/9.36 MHz	-54.65	-58.50	-58.50	-54.65	-58.50	-58.50
Propagation Condition		AWGN					

NOTE 1: OCNB shall be used such that both cells are fully allocated and a constant total transmitted power spectral density is achieved for all OFDM symbols.

NOTE 2: Interference from other cells and noise sources not specified in the test is assumed to be constant over subcarriers and time and shall be modelled as AWGN of appropriate power for  $N_{oc}$  to be fulfilled.

NOTE 3: SS-RSRP levels have been derived from other parameters for information purposes. They are not settable parameters themselves.

NOTE 4: For a UE supporting dynamic channel access and network configuring dynamic channel occupancy.

NOTE 5: For a UE supporting semi-static channel access and network configuring semi-static channel occupancy.

NOTE 6: For a UE supporting both semi-static and dynamic channel access, the UE can be tested under dynamic channel occupancy only.

#### A.11.2.2.1.2.2 Test Requirements

The RRC re-establishment delay is defined as the time from the start of time period T3, to the moment when the UE starts to send PRACH preambles to cell 2 for sending the *RRCReestablishmentRequest* message to cell 2.

The RRC re-establishment delay to an unknown NR inter frequency cell shall be less than TBD s.

The rate of correct RRC re-establishments observed during repeated tests shall be at least 90%.

NOTE: The RRC re-establishment delay in the test is derived from the following expression:

$$T_{re-establish_{delay_{CCA}}} = T_{UE_{re-establish_{delay_{CCA}}} + T_{UL_{grant}}$$

Where:

$T_{UL_{grant}}$  = It is the time required to acquire and process uplink grant from the target cell. The PRACH reception at the system simulator is used as a trigger for the completion of the test; hence  $T_{UL_{grant}}$  is not used.

$$T_{UE_{re-establish_{delay_{CCA}}} = 50 \text{ ms} + T_{identify\_intra\_NR\_CCA} + \sum_{i=1}^{N_{freq}-1} T_{identify\_inter\_NR\_CCA,i} + T_{SI-NR\_CCA} + T_{PRACH\_CCA}$$

Where

$T_{identify\_intra\_NR\_CCA}$ : 0 ms

$T_{identify\_inter\_NR\_CCA,i}$ : MAX (200 ms, ([6]+K2,i) x TSMTC, i),

where

K2,i is the number of SMTC not available at the UE during RRC re-establishment period on the “i” th carrier with CCA

$T_{SMTC,i}$ : It is the periodicity of the SMTC occasion configured for the inter-frequency carrier *i*.

$N_{freq} = 2$

$T_{SI-NR\_CCA} = 1280$  ms; it is the time required for receiving all the relevant system information as defined in TS 38.331 for the target inter-frequency NR cell.

$T_{PRACH\_CCA} = (1 + K_3) * T_{SSB,RO} + 10$  ms, where:

- $T_{SSB,RO}$  is the SSB to PRACH occasion association period as defined in Table 8.1-1 of TS 38.213 [3].
- $K_3$  is the number of consecutive SSB to PRACH occasion association periods during which no PRACH occasion is available for PRACH transmission due to UL CCA failure.  $K_3 = 0$  for Type 2C UL channel access procedure as defined in TS 37.213 [57].



This gives a total of  $T_{re-establishment_{delay_{CCA}}} = 50 + \text{MAX}(200 \text{ ms}, (6+K_2, 1) \times \text{TSMTC}, 1) + 1280 + (1+K_3) \times T_{SSB,RO} + 10 \text{ ms.}$

### A.11.2.2.1.3 Intra-frequency RRC Re-establishment with CCA in FR1 without serving cell timing

#### A.11.2.2.1.3.1 Test Purpose and Environment

The purpose is to verify that the NR intra-frequency RRC re-establishment delay with CCA in FR1 without serving cell timing is within the specified limits. These tests will verify the requirements in clause 6.2.1A.

The test parameters are given in table A.11.2.2.1.3.1-1, table A.11.2.2.1.3.1-2 and table A.11.2.2.1.3.1-3 below. The test consists of 3 successive time periods, with time duration of T1, T2 and T3 respectively. At the start of time period T2, cell 1, which is the active cell with CCA, is deactivated. The time period T3 starts after the occurrence of the radio link failure.

**Table A.11.2.2.1.3.1-1: Supported test configurations**

Configuration	Description
1	30 kHz SSB SCS, 40 MHz bandwidth, TDD duplex mode

**Table A.11.2.2.1.3.1-2: General test parameters for NR intra-frequency RRC Re-establishment test case in FR1**

Parameter		Unit	Value	Comment
Initial Condition	Active cell	-	Cell1	Cell 1 is with CCA.
	Neighbour cells	-	Cell2	Cell 2 is with CCA.
Final condition	Active cell	-	Cell2	
RF Channel Number		-	1	
DL CCA model	Dynamic channel access <sup>Note 1,3</sup>	-	As specified in clause A.3.26.2.1	
	Semi-static channel access <sup>Note 2,3</sup>	-		
UL CCA model	Dynamic channel access <sup>Note 1,3</sup>	-	As specified in clause A.3.26.2.2	
	Semi-static channel access <sup>Note 2,3</sup>	-		
Time offset between cells		-	3 $\mu$ s	Synchronous cells
N310		-	1	Maximum consecutive out-of-sync indications from lower layers
N311		-	1	Minimum consecutive in-sync indications from lower layers
T310		ms	0	Radio link failure timer; T310 is disabled
T311		ms	3000	RRC re-establishment timer
Access Barring Information		-	Not Sent	No additional delays in random access procedure.
SSB configuration	Dynamic channel access <sup>Note 1, 3</sup>	-	SSB.2 CCA	Table A.3.10A.1.2-1
	Semi-static channel access <sup>Note 2, 3</sup>	-	SSB.1 CCA	Table A.3.10A.1.1-1
DBT window configuration		-	DBT.1	Table A.3.28.1-1
SMTC configuration		-	SMTC pattern 1	
DRX cycle length		s	OFF	
PRACH configuration		-	FR1 PRACH configuration 1	Table A.3.8A.2.1-1
T1		s	5	
T2		ms	6	Time for the UE to detect RLF
T3		s	3	
NOTE 1: For a UE supporting dynamic channel access and network configuring dynamic channel occupancy.				
NOTE 2: For a UE supporting semi-static channel access and network configuring semi-static channel occupancy.				
NOTE 3: For a UE supporting both semi-static and dynamic channel access, the UE can be tested under dynamic channel occupancy only.				

**Table A.11.2.2.1.3.1-3: Cell specific test parameters for NR intra-frequency RRC Re-establishment test case in FR1**

Parameter	Unit	Cell 1			Cell 2		
		T1	T2	T3	T1	T2	T3
TDD configuration		TDDConf.1.1 CCA			TDDConf.1.1 CCA		
DL CCA probability $P_{CCA\_DL}$ for dynamic channel access <sup>Note</sup> 4,6	-	$P_{CCA\_DL\_1}=0.75$ $P_{CCA\_DL\_2}=0.75$			$P_{CCA\_DL\_1}=0.75$ $P_{CCA\_DL\_2}=0.75$		
DL CCA probability $P_{CCA\_DL}$ for semi- static channel access <sup>Note</sup> 5,6	-	$P_{CCA\_DL}=0.9375$			$P_{CCA\_DL}=0.9375$		
UL CCA probability $P_{CCA\_UL}$	-	1			1		
PDSCH RMC configuration		SR.1.1 CCA			SR.1.1 CCA		
RMSI CORESET RMC configuration		CR.1.1 CCA			CR.1.1 CCA		
Dedicated CORESET RMC configuration		CCR.1.1 CCA			CCR.1.1 CCA		
OCNG Pattern		OP.1 defined in A.3.2.1			OP.1 defined in A.3.2.1		
TRS configuration		TRS.1.2 TDD			N/A		
Initial DL BWP configuration		DLBWP.0.1			DLBWP.0.1		
Initial UL BWP configuration		ULBWP.0.1			ULBWP.0.1		
Active DL BWP configuration		DLBWP. 1.1	N/A	N/A	N/A	N/A	DLBW P.1.1
Active UL BWP configuration		ULBWP. 1.1	N/A	N/A	N/A	N/A	ULBW P.1.1
RLM-RS		SSB			SSB		
$\hat{E}_s / I_{ot}$	dB	4	-infinity	-infinity	-infinity	-infinity	4
$N_{oc}$ <sup>Note2</sup>	dBm/SCS	-95					
$N_{oc}$ <sup>Note2</sup>	dBm/15 kHz	-98					
$\hat{E}_s / N_{oc}$	dB	7	-infinity	-infinity	-infinity	-infinity	4
SS-RSRP <sup>Note3</sup>	dBm/SCS	-91	-infinity	-infinity	-infinity	-infinity	-91
$I_o$	dBm/38.16 MHz	-58.50	-63.94	-63.94	-63.94	-63.94	-58.50
Propagation Condition		AWGN					
NOTE 1: OCNG shall be used such that both cells are fully allocated and a constant total transmitted power spectral density is achieved for all OFDM symbols.							
NOTE 2: Interference from other cells and noise sources not specified in the test is assumed to be constant over subcarriers and time and shall be modelled as AWGN of appropriate power for $N_{oc}$ to be fulfilled.							
NOTE 3: SS-RSRP levels have been derived from other parameters for information purposes. They are not settable parameters themselves.							
NOTE 4: For a UE supporting dynamic channel access and network configuring dynamic channel occupancy.							
NOTE 5: For a UE supporting semi-static channel access and network configuring semi-static channel occupancy.							
NOTE 6: For a UE supporting both semi-static and dynamic channel access, the UE can be tested under dynamic channel occupancy only.							

**A.11.2.2.1.3.2 Test Requirements**

The RRC re-establishment delay is defined as the time from the start of time period T3, to the moment when the UE starts to send PRACH preambles to cell 2 for sending the *RRCReestablishmentRequest* message to cell 2.

The RRC re-establishment delay to an unknown NR intra frequency cell without serving cell timing shall be less than  $1350 + \text{MAX}(800 \text{ ms}, (10+ K_1) \times 20) \text{ ms}$ .

The rate of correct RRC re-establishments observed during repeated tests shall be at least 90%.

NOTE: The RRC re-establishment delay in the test is derived from the following expression:

$$T_{re-establish\_delay\_CCA} = T_{UE\_re-establish\_delay\_CCA} + T_{UL\_grant}$$

Where:

$T_{UL\_grant}$  = It is the time required to acquire and process uplink grant from the target cell. The PRACH reception at the system simulator is used as a trigger for the completion of the test; hence  $T_{UL\_grant}$  is not used.

$$\begin{aligned} T_{UE\_re-establish\_delay\_CCA} &= 50 \text{ ms} + T_{identify\_intra\_NR\_CCA} + \sum_{i=1}^{N_{freq}-1} T_{identify\_inter\_NR\_CCA,i} + T_{SI-NR\_CCA} \\ &+ T_{PRACH\_CCA} \end{aligned}$$

Where,

$$N_{freq} = 1$$

$$T_{identify\_intra\_NR} = \text{MAX}(800 \text{ ms}, (10+ K_1) \times T_{SMTc}), \text{ where}$$

$K_1$  is the number of SMTc occasions not available at the UE due to DL CCA failures during RRC re-establishment period on the carrier with CCA.

$T_{SMTc}$  is the SMTc periodicity which is 20 ms.

$$T_{identify\_inter\_NR\_CCA} = 0 \text{ ms}$$

$T_{SI-NR\_CCA} = 1280 \text{ ms}$ ; it is the time required for receiving all the relevant system information as defined in TS 38.331 [2] for the target intra-frequency NR cell.

$$T_{PRACH\_CCA} = (1+ K_3) \times T_{SSB,RO} + 10 \text{ ms}, \text{ where:}$$

- $T_{SSB,RO}$  is the SSB to PRACH occasion association period as defined in Table 8.1-1 of TS 38.213 [39]. It is 10 ms for FR1 PRACH configuration 1 under CCA.
- $K_3 = 0$ .

This gives total  $T_{UE\_re-establish\_delay\_CCA} = 1350 + \text{MAX}(800 \text{ ms}, (10+ K_1) \times 20) \text{ ms}$ .

#### A.11.2.2.1.4 Inter-frequency RRC Re-establishment from NR FR1 carrier without CCA to NR FR1 carrier under CCA

##### A.11.2.2.1.4.1 Test Purpose and Environment

The purpose is to verify that the NR inter-frequency RRC re-establishment delay requirement for RRC re-establishment from NR FR1 carrier without CCA to NR FR1 inter-frequency carrier under CCA with unknown target cell. These tests will verify the requirements in clause 6.2.1A.

The test parameters are given in table A.11.2.2.1.4.1-1, table A.11.2.2.1.4.1-2 and table A.11.2.2.1.4.1-3 below. The test consists of 3 successive time periods, with time duration of T1, T2 and T3 respectively. At the start of time period T2, cell 1, which is the active cell, becomes inactive. The time period T3 starts after the occurrence of the radio link failure. During T1, the UE shall be configured with the carrier frequency of cell 2 (with RF Channel Number #2) to ensure that the UE has the context of the carrier frequency of cell 2 by the end of T1.

**Table A.11.2.2.1.4.1-1: Supported test configurations inter-frequency RRC re-establishment from NR FR1 without under CCA to NR FR1 inter-frequency carrier under CCA**

Configuration	Source cell without CCA	Target cell with CCA
1	15 kHz SSB SCS, 10 MHz bandwidth, FDD	30 kHz SSB SCS, 40 MHz bandwidth, TDD
2	15 kHz SSB SCS, 10 MHz bandwidth, TDD	30 kHz SSB SCS, 40 MHz bandwidth, TDD

3	30 kHz SSB SCS, 40 MHz bandwidth, TDD	30 kHz SSB SCS, 40 MHz bandwidth, TDD
Note: The UE is only required to be tested in one of the supported test configurations		

**Table A.11.2.2.1.4.1-2: General test parameters for NR inter-frequency RRC Re-establishment test case from NR FR1 carrier without CCA to NR FR1 intrer-frequency carrier under CCA**

Parameter		Unit	Value	Comment
Initial condition	Active cell		Cell1	
	Neighbour cells		Cell2	
Final condition	Active cell		Cell2	
RF Channel Number			1, 2	
Time offset between cells			3 μs	Synchronous cells
DL CCA model	Dynamic channel access <sup>Note 1,3</sup>	-	As specified in clause A.3.26.2.1	
	Semi-static channel access <sup>Note 2,3</sup>	-		
UL CCA model	Dynamic channel access <sup>Note 1,3</sup>	-	As specified in clause A.3.26.2.2	
	Semi-static channel access <sup>Note 2,3</sup>	-		
N310		-	1	Maximum consecutive out-of-sync indications from lower layers
N311		-	1	Minimum consecutive in-sync indications from lower layers
T310		ms	0	Radio link failure timer; T310 is disabled
T311		ms	5000	RRC re-establishment timer
Access Barring Information		-	Not Sent	No additional delays in random access procedure.
DRX cycle length		s	OFF	
PRACH configuration			FR1 PRACH configuration 1	Table A.3.8A.2.1-1
T1		s	5	
T2		ms	480	Time for the UE to detect RLF
T3		s	≥ T <sub>UE_re-establish_delay_CCA</sub>	As defined in clause 6.2.1A
NOTE 1: For a UE supporting dynamic channel access and network configuring dynamic channel occupancy.				
NOTE 2: For a UE supporting semi-static channel access and network configuring semi-static channel occupancy.				
NOTE 3: For a UE supporting both semi-static and dynamic channel access, the UE can be tested under dynamic channel occupancy only.				

**Table A.11.2.2.1.4.1-3: Cell specific test parameters for NR inter-frequency RRC Re-establishment test case from NR FR1 carrier without CCA to NR FR1 intrer-frequency carrier under CCA**

Parameter	Test config	Unit	Cell 1			Cell 2		
			T1	T2	T3	T1	T2	T3
TDD configuration	1		N/A			TDDConf.1.1.CCA		
	2		TDDConf.1.1			TDDConf.1.1.CCA		
	3		TDDConf.2.1			TDDConf.1.1.CCA		
PDSCH RMC configuration	1		SR.1.1 FDD			SR.1.1 CCA		
	2		SR.1.1 TDD			SR.1.1 CCA		
	3		SR.2.1 TDD			SR.1.1 CCA		
RMSI CORESET RMC configuration	1		CR.1.1 FDD			CR.1.1 CCA		
	2		CR.1.1 TDD			CR.1.1 CCA		
	3		CR.2.1 TDD			CR.1.1 CCA		
Dedicated CORESET RMC configuration	1		CCR.1.1 FDD			CCR.1.1 CCA		
	2		CCR.1.1 TDD			CCR.1.1 CCA		
	3		CCR.2.1 TDD			CCR.1.1 CCA		
OCNG Pattern	1		OP.1 defined in A.3.2.1			OP.1 defined in A.3.2.1		
TRS configuration	1		TRS.1.1 FDD			TRS.1.2 TDD		
	2		TRS.1.1 TDD			TRS.1.2 TDD		
	3		TRS.1.2 TDD			TRS.1.2 TDD		

SMTC configuration	1,2,3		SMTC.1			SMTC.1			
SSB configuration	Semi- static channel acces	1,2		SSB.1 FR1			SSB.1 CCA		
	Semi- static channel acces	3		SSB.2 FR1			SSB.1 CCA		
	Dymamic channel acces	1,2		SSB.1 FR1			SSB.2 CCA		
	Dymamic channel acces	3		SSB.2 FR1			SSB.2 CCA		
Initial DL BWP configuration	1,2,3		DLBWP.0.1			DLBWP.0.1			
Initial UL BWP configuration	1,2,3		ULBWP.0.1			ULBWP.0.1			
Active DL BWP configuration	1,2,3		DLBWP.1.1	N/A	N/A	N/A	N/A	DLBW P.1.1	
Active UL BWP configuration	1,2,3		ULBWP.1.1	N/A	N/A	N/A	N/A	ULBW P.1.1	
DL CCA probability for semi-static channel access ( $P_{CCA\_DL}$ )	1,2,3		N/A	N/A	N/A	1	1	0.9375	
DL CCA probability for for dynamic static channel access ( $P_{CCA\_DL\_1}$ )	1,2,3		N/A	N/A	N/A	1	1	0.75	
DL CCA probability for for dynamic static channel access ( $P_{CCA\_DL\_2}$ )	1,2,3		N/A	N/A	N/A	1	1	0.75	
UL CCA probability ( $P_{CCA\_UL}$ )	1,2,3		N/A	N/A	N/A	1	1	1	
RLM-RS	1,2,3		SSB			SSB			
$\hat{E}_s / I_{ot}$	1,2,3	dB	4	-infinity	-infinity	-infinity	-infinity	7	
$N_{oc}$ Note2	1,2,3	dBm/15 KHz	-98						
$N_{oc}$ Note2	1,2	dBm/SCS	-98						
	3		-95						
$\hat{E}_s / N_{oc}$	1,2,3	dB	4	-infinity	-infinity	-infinity	-infinity	7	
SS-RSRP Note3	1, 2	dBm/SCS	-94	-infinity	-infinity	-infinity	-infinity	-91	
	3		-91	-infinity	-infinity	-infinity	-infinity	-88	
Io	1,2	dBm/9.36 MHz	-64.59	-70.05	-70.05	-70.05	-70.05	-62.26	
	3	dBm/38.16 MHz	-58.50	-63.94	-63.94	-63.94	-63.94	-56.15	
Propagation Condition	1,2,3		AWGN						
Note 1:	OCNG shall be used such that both cells are fully allocated and a constant total transmitted power spectral density is achieved for all OFDM symbols.								
Note 2:	Interference from other cells and noise sources not specified in the test is assumed to be constant over subcarriers and time and shall be modelled as AWGN of appropriate power for $N_{oc}$ to be fulfilled.								
Note 3:	SS-RSRP levels have been derived from other parameters for information purposes. They are not settable parameters themselves.								
Note 4:	Parameters $P_{CCA\_DL}$ , $P_{CCA\_DL\_1}$ , $P_{CCA\_DL\_2}$ and $P_{CCA\_UL}$ are defined in clause A.3.20.2.								
Note 5:	For UE supporting both semi-static and dynamic channel access, the UE must be tested under both dynamic and semi-static channel occupancy configurations.								

A.11.2.2.1.4.2 Test Requirements

The RRC re-establishment delay is defined as the time from the start of time period T3, to the moment when the UE starts to send PRACH preambles to cell 2 for sending the *RRCReestablishmentRequest* message to cell 2.

The RRC re-establishment delay to an unknown NR inter frequency cell shall be less  $T_{UE\_re-establish\_delay\_CCA}$ .

The rate of correct RRC re-establishments observed during repeated tests shall be at least 90%.

NOTE: The RRC re-establishment delay in the test is derived from the following expression:

$$T_{re-establish\_delay\_CCA} = T_{UE\_re-establish\_delay\_CCA} + T_{UL\_grant}$$

Where:

$T_{UL\_grant}$  = It is the time required to acquire and process uplink grant from the target cell. The PRACH reception at the system simulator is used as a trigger for the completion of the test; hence  $T_{UL\_grant}$  is not used.

$$T_{UE\_re-establish\_delay\_CCA} = 50 \text{ ms} + T_{identify\_intra\_NR\_CCA} + \sum_{i=1}^{N_{freq}-1} T_{identify\_inter\_NR\_CCA,i} + T_{SI-NR\_CCA} + T_{PRACH\_CCA}$$

$$N_{\text{freq}} = 2$$

$$T_{\text{identify\_intra\_NR\_CCA}} = \text{MAX} (800 \text{ ms}, (10+ K_1) \times 20) \text{ ms}$$

$$T_{\text{identify\_inter\_NR\_CCA}} = \text{MAX} (800 \text{ ms}, ([13]+K_{2,2}) \times 20) \text{ ms}$$

$T_{\text{SI}} = 1280 \text{ ms}$ ; it is the time required for receiving all the relevant system information as defined in TS 38.331 for the target inter-frequency NR cell.

$T_{\text{PRACH\_CCA}}$  = It is the delay uncertainty in acquiring the first available PRACH occasion in the target NR cell.  
 $T_{\text{PRACH\_CCA}} = (1+ K_3) \times T_{\text{SSB,RO}} + 10 \text{ ms}$ ; where  $K_3=0$  and  $T_{\text{SSB,RO}}=10 \text{ ms}$  for FR1 PRACH configuration 1 under CCA.

$K_1$  is the number of SMTC occasions not available at the UE due during RRC re-establishment period on the carrier with CCA and with RF channel number # 1.

$K_{2,2}$  is the number of SMTC occasions not available at the UE during RRC re-establishment period on the carrier with CCA and with RF channel number # 2.

This gives total  $T_{\text{UE\_re-establish\_delay\_CCA}} = 1350 + \text{MAX} (800 \text{ ms}, (10+ K_1) \times 20) \text{ ms} + \text{MAX} (800 \text{ ms}, ([13]+K_{2,2}) \times 20) \text{ ms}$ .

### A.11.2.2.2 Random Access

#### A.11.2.2.2.1 4-step RA type contention-based random access for NR PCell with CCA

##### A.11.2.2.2.1.1 Test Purpose and Environment

The purpose of this test is to verify that the behavior of the random access procedure is according to the requirements and that the PRACH power settings and timing are within specified limits when subject to CCA. This test will verify the requirements in Clause 6.2.2A.2 and Clause 7.1.2 in an AWGN model.

For this test one cell is used and configured as PCell in FR1, which operates on a carrier frequency with CCA. Supported test parameters are shown in Table A.11.2.2.2.1.1-1. UE capable of SA with PCell in FR1 needs to be tested by using the parameters in Table A.11.2.2.2.1.1-2.

**Table A.11.2.2.2.1.1-1: Supported test configurations for contention based random access test for FR1 PCell with CCA**

Config	Description
1	NR 30 kHz SSB SCS, 40 MHz bandwidth, TDD duplex mode
Note:	Void

**Table A.11.2.2.2.1.1-2: General test parameters for contention based random access test for FR1 PCell with CCA**

Parameter		Unit	Test-1	Comments
SSB Configuration	Note 4, 6	Config 1	SSB.3 CCA	As defined in A.3.10A
	Note 5, 6	Config 1	SSB.4 CCA	As defined in A.3.10A
DBT Window Configuration		Config 1	DBT.1	As specified in A.3.28.1
DL CCA model		Config 1	As specified in A.3.26.2.1	
UL CCA model		Config 1	As specified in A.3.26.2.2	
Duplex Mode for Cell 2		Config 1	TDD	
TDD Configuration		Config 1	TDDConf.1.1 CCA	
OCNG Pattern <sup>Note 1</sup>			OCNG pattern 1	As defined in A.3.2.1.
PDSCH parameters <sup>Note 3</sup>		Config 1	SR.1.1 CCA	As defined in A.3.1A.1.
NR RF Channel Number			1	
EPRE ratio of PSS to SSS		dB	0	
EPRE ratio of PBCH_DMRS to SSS		dB		

EPRE ratio of PBCH to PBCH_DMRS			dB		
EPRE ratio of PDCCH_DMRS to SSS			dB		
EPRE ratio of PDCCH to PDCCH_DMRS			dB		
EPRE ratio of PDSCH_DMRS to SSS			dB		
EPRE ratio of PDSCH to PDSCH_DMRS			dB		
SSB with index 0	$\hat{E}_s / I_{ot}$		dB	3	Power of SSB with index 0 is set to be above configured <i>rsrp-ThresholdSSB</i>
	$N_{oc}$	Config 1	dBm/15kHz	-101	
	$\hat{E}_s / N_{oc}$		dB	3	
	SS-RSRP		dBm/ SCS	-95	
SSB with index 1	$\hat{E}_s / I_{ot}$		dB	-17	Power of SSB with index 1 is set to be below configured <i>rsrp-ThresholdSSB</i>
	$N_{oc}$	Config 1	dBm/15kHz	-101	
	$\hat{E}_s / N_{oc}$		dB	-17	
	SS-RSRP		dBm/ SCS	-115	
I <sub>o</sub> <sup>Note 2</sup>		Config 1	dBm	-62.2/38.16MHz	For symbols without SSB index 1
ss-PBCH-BlockPower			dBm/ SCS	-5	As defined in clause 6.3.2 in TS 38.331 [2].
Configured UE transmitted power (P <sub>CMAX,f,c</sub> )			dBm	23	As defined in clause 6.2.4 in TS 38.101-1.
PRACH Configuration				FR1 PRACH configuration 1 under CCA	As defined in A.3.8A.2.
DL CCA probability	Note 4, 6			0.9375	
P <sub>CCA_DL</sub>	Note 5, 6			0.75 / 0.75	
L <sub>CCA_DL</sub> <sup>Note 7</sup>				4	
W <sub>CCA_DL</sub> <sup>Note 8</sup>				Inf	
UL CCA probability	Note 4, 6			0.87	
P <sub>CCA_UL</sub>	Note 5, 6			0.75	
L <sub>CCA_UL</sub> <sup>Note 7</sup>				5	
W <sub>CCA_UL</sub> <sup>Note 8</sup>				Inf	
Semi-static channel access config period <sup>Note 4, 6</sup>			ms	2	
Propagation Condition			-	AWGN	
<p>Note 1: OCNG shall be used such that the cell is fully allocated and a constant total transmitted power spectral density is achieved for all OFDM symbols. The OCNG pattern is chosen during the test according to the presence of a DL reference measurement channel.</p> <p>Note 2: SS-RSRP, Es/Iot and Io levels have been derived from other parameters for information purpose. They are not settable parameters.</p> <p>Note 3: The DL PDSCH reference measurement channel is used in the test only when a downlink transmission dedicated to the UE under test is required.</p> <p>Note 4: For UE supporting semi-static channel access and network configuring semi-static channel occupancy.</p> <p>Note 5: For UE supporting dynamic channel access and network configuring dynamic channel occupancy. The first value corresponds P<sub>CCA_DL1</sub> and the second value corresponds to the P<sub>CCA_DL2</sub>.</p> <p>Note 6: For UE supporting both semi-static and dynamic channel access, the UE must be tested under both dynamic channel occupancy and semi-static channel occupancy configuration.</p> <p>Note 7: L<sub>CCA_DL</sub> and L<sub>CCA_UL</sub> are chosen such that preambleTransMax &gt; 5 + L<sub>CCA_DL</sub> + L<sub>CCA_UL</sub>.</p> <p>Note 8: A window W<sub>CCA_DL</sub>=W<sub>CCA_UL</sub>=Inf is used to indicate that L<sub>CCA_DL</sub> and L<sub>CCA_UL</sub> are considered during the entire duration of a test run.</p>					

#### A.11.2.2.2.1.2 Test Requirements

Contention based random access is triggered by *not* explicitly assigning a random access preamble via dedicated signalling in the downlink.

#### A.11.2.2.2.1.2.1 Random Access Preamble Transmission

To test the UE behavior specified in Clause 6.2.2A.2.1.1 the System Simulator shall receive the Random Access Preamble which belongs to one of the Random Access Preambles associated with the SSB with index 0, which has SS-RSRP above the configured *rsrp-ThresholdSSB*, if the UL CCA is successful.

The three requirements below are relevant for all cases of PRACH transmissions described within the whole clause A.11.2.2.2.1.2:

- The System Simulator shall implement the UL CCA model of A.3.26.2 for the RACH occasions where PRACH transmissions are expected. The System Simulator shall monitor the RACH occasions to detect if the UE is transmitting PRACH preambles. If a PRACH transmission is detected on a RACH occasion that is expected to have UL CCA failure, the test is considered as failed.
- In case of CCA DL failure, the test equipment should verify that the UE does not transmit PRACH for semi-static channel access mode; for dynamic channel access mode it is assumed that RACH occasions are always scheduled within a UE-initiated COT.
- In case of UL CCA failure, The UE shall again perform the Random Access Resource selection procedure specified in clause 5.1.2 in TS38.321 [7], and transmit with the calculated PRACH transmission power.

In addition, the power applied to all preambles shall be in accordance with what is specified in Clause 6.2.2A.2. The power of the first preamble shall be -16 dBm with an accuracy specified in clause 6.3.4.2 of TS 38.101-1 [18]. The relative power applied to additional preambles shall have an accuracy specified in clause 6.3.4.3 of TS 38.101-1 [18].

The transmit timing of all PRACH transmissions shall be within the accuracy specified in Clause 7.1.2.

#### A.11.2.2.2.1.2.2 Random Access Response Reception

To test the UE behavior specified in Clause 6.2.2A.2.1.2 the System Simulator shall transmit a Random Access Response containing a Random Access Preamble identifier corresponding to the transmitted Random Access Preamble after 5 preambles have been received by the System Simulator. In response to the first 4 preambles, the System Simulator shall transmit a Random Access Response *not* corresponding to the transmitted Random Access Preamble. In case of CCA DL failure, the test equipment should delay the transmission of Random Access Response.

The UE may stop monitoring for Random Access Response(s) and shall transmit the msg3 if the Random Access Response contains a Random Access Preamble identifier corresponding to the transmitted Random Access Preamble if UL CCA is successful. The System Simulator shall monitor if the UE is transmitting msg3 when CCA UL failure. If a msg3 transmission is detected on a grant expected to have UL CCA failure, the test is considered as failed.

The UE shall again perform the Random Access Resource selection procedure specified in clause 5.1.2 in TS 38.321 [7], and transmit with the calculated PRACH transmission power when the backoff time expires if all received Random Access Responses contain Random Access Preamble identifiers that do not match the transmitted Random Access Preamble.

In addition, the power applied to all preambles shall be in accordance with what is specified in Clause 6.2.2A.2. The power of the first preamble shall be -16 dBm with an accuracy specified in clause 6.3.4.2 of TS 38.101-1 [18]. The relative power applied to additional preambles shall have an accuracy specified in clause 6.3.4.3 of TS 38.101-1 [18].

The transmit timing of all PRACH transmissions shall be within the accuracy specified in Clause 7.1.2.

#### A.11.2.2.2.1.2.3 No Random Access Response Reception

To test the UE behavior specified in clause 6.2.2A.2.1.3 the System Simulator shall transmit a Random Access Response containing a Random Access Preamble identifier corresponding to the transmitted Random Access Preamble after 5 preambles have been received by the System Simulator. The System Simulator shall *not* respond to the first 4 preambles. In case of CCA DL failure, the test equipment should delay the transmission of Random Access Response.

The UE shall again perform the Random Access Resource selection procedure specified in clause 5.1.2 in TS 38.321 [7], and transmit with the calculated PRACH transmission power when the backoff time expires if no Random Access Response is received within the RA Response window.

In addition, the power applied to all preambles shall be in accordance with what is specified in Clause 6.2.2A.2. The power of the first preamble shall be -16 dBm with an accuracy specified in clause 6.3.4.2 of TS 38.101-1 [18]. The relative power applied to additional preambles shall have an accuracy specified in clause 6.3.4.3 of TS 38.101-1 [18].



The transmit timing of all PRACH transmissions shall be within the accuracy specified in Clause 7.1.2.

A.11.2.2.2.1.2.4 Receiving an UL grant for msg3 retransmission

To test the UE behavior specified in clause 6.2.2A.2.1.4 the System Simulator shall provide an UL grant for msg3 retransmission following a successful Random Access Response if UL CCA is successful. The System Simulator shall monitor if the UE is transmitting msg3 when CCA UL failure. If a msg3 is detected on a grant expected to have UL CCA failure, the test is considered as failed.

The UE shall re-transmit the msg3 upon the reception of an UL grant for msg3 retransmission.

A.11.2.2.2.1.2.5 Reception of an Incorrect Message over Temporary C-RNTI

To test the UE behavior specified in Clause 6.2.2A.2.1.5 the System Simulator shall send a message addressed to the temporary C-RNTI with a UE Contention Resolution Identity included in the MAC control element *not* matching the CCCH SDU transmitted in msg3 uplink message.

The UE shall again perform the Random Access Resource selection procedure specified in clause 5.1.2 in TS 38.321 [7], and transmit with the calculated PRACH transmission power when the backoff time expires unless the received message includes a UE Contention Resolution Identity MAC control element and the UE Contention Resolution Identity included in the MAC control element matches the CCCH SDU transmitted in the uplink message.

A.11.2.2.2.1.2.6 Reception of a Correct Message over Temporary C-RNTI

To test the UE behavior specified in Clause 6.2.2A.2.1.5 the System Simulator shall send a message addressed to the temporary C-RNTI with a UE Contention Resolution Identity included in the MAC control element matching the CCCH SDU transmitted in the msg3 uplink message.

The UE shall send ACK if the Contention Resolution is successful.

A.11.2.2.2.1.2.7 Contention Resolution Timer expiry

To test the UE behavior specified in Clause 6.2.2A.2.1.6 the System Simulator shall *not* send a response to a msg3.

The UE shall again perform the Random Access Resource selection procedure specified in clause 5.1.2 in TS 38.321 [7], and transmit with the calculated PRACH transmission power when the backoff time expires if the Contention Resolution Timer expires.

A.11.2.2.2.2 4-step RA type non-contention based random access for NR PSCell with CCA

A.11.2.2.2.2.1 Test Purpose and Environment

The purpose of this test is to verify that the behavior of the random access procedure is according to the requirements and that the PRACH power settings and timing are within specified limits when subject to CCA. This test will verify the requirements in Clause 6.2.2A.2 and Clause 7.1.2 in an AWGN model.

For this test one cell is used and configured as PCell in FR1, which operates on a carrier frequency with CCA. Supported test parameters are shown in Table A.11.2.2.2.2.1-1. UE capable of SA with PCell in FR1 needs to be tested by using the parameters in Table A.11.2.2.2.2.1-2.

**Table A.11.2.2.2.2.1-1: Supported test configurations for non-contention based random access test for FR1 PCell with CCA**

Config	Description
1	NR 30 kHz SSB SCS, 40 MHz bandwidth, TDD duplex mode
Note:	Void.

**Table A.11.2.2.2.2.1-2: General test parameters for non-contention based random access test for FR1 PCell with CCA**

Parameter	Unit	Test-1	Comments
SSB Configuration	Config 1	SSB.3 CCA	As defined in A.3.10A

	Note 5, 6	Config 1		SSB.4 CCA	As defined in A.3.10A
DBT Window Configuration		Config 1		DBT.1	As specified in A.3.28.1
DL CCA model		Config 1		As specified in A.3.26.2.1	
UL CCA model		Config 1		As specified in A.3.26.2.2	
Duplex Mode for Cell 2		Config 1		TDD	
TDD Configuration		Config 1		TDDConf.1.1 CCA	
OCNG Pattern	Note 1			OCNG pattern 1	As defined in A.3.2.1.
PDSCH parameters	Note 3	Config 1		SR.1.1 CCA	As defined in A.3.1A.1.
NR RF Channel Number				1	
EPRE ratio of PSS to SSS			dB	0	
EPRE ratio of PBCH_DMRS to SSS			dB		
EPRE ratio of PBCH to PBCH_DMRS			dB		
EPRE ratio of PDCCH_DMRS to SSS			dB		
EPRE ratio of PDCCH to PDCCH_DMRS			dB		
EPRE ratio of PDSCH_DMRS to SSS			dB		
EPRE ratio of PDSCH to PDSCH_DMRS			dB		
SSB with index 0	$\hat{E}_s / I_{ot}$		dB	3	Power of SSB with index 0 is set to be above configured <i>rsrp-ThresholdSSB</i>
	$N_{oc}$	Config 1	dBm/15kHz	-101	
	$\hat{E}_s / N_{oc}$		dB	3	
	SS-RSRP		dBm/ SCS	-95	
SSB with index 1	$\hat{E}_s / I_{ot}$		dB	-17	Power of SSB with index 1 is set to be below configured <i>rsrp-ThresholdSSB</i>
	$N_{oc}$	Config 1	dBm/15kHz	-101	
	$\hat{E}_s / N_{oc}$		dB	-17	
	SS-RSRP		dBm/ SCS	-115	
$I_o$	Note 2	Config 1	dBm	-62.2/38.16MHz	For symbols without SSB index 1
ss-PBCH-BlockPower			dBm/ SCS	-5	As defined in clause 6.3.2 in TS 38.331 [2].
Configured UE transmitted power ( $P_{C_{MAX, f, c}}$ )			dBm	23	As defined in clause 6.2.4 in TS 38.101-1.
PRACH Configuration				FR1 PRACH configuration 2 under CCA	As defined in A.3.8A.2.
DL CCA probability $P_{CCA\_DL}$	Note 4, 6			0.9375	
	Note 5, 6			0.75 / 0.75	
$L_{CCA\_DL}$			Note 7	4	
$W_{CCA\_DL}$			Note 8	Inf	
UL CCA probability $P_{CCA\_UL}$	Note 4, 6			0.87	
	Note 5, 6			0.75	
$L_{CCA\_UL}$			Note 7	5	
$W_{CCA\_UL}$			Note 8	Inf	
Semi-static channel access config period			Note 4, 6	ms	2
Propagation Condition				-	AWGN
<p>Note 1: OCNG shall be used such that the cell is fully allocated and a constant total transmitted power spectral density is achieved for all OFDM symbols. The OCNG pattern is chosen during the test according to the presence of a DL reference measurement channel.</p> <p>Note 2: SS-RSRP, <math>E_s/I_{ot}</math> and <math>I_o</math> levels have been derived from other parameters for information purpose. They are not settable parameters.</p>					

Note 3:	The DL PDSCH reference measurement channel is used in the test only when a downlink transmission dedicated to the UE under test is required.
Note 4:	For UE supporting semi-static channel access and network configuring semi-static channel occupancy.
Note 5:	For UE supporting dynamic channel access and network configuring dynamic channel occupancy. The first value corresponds $P_{CCA\_DL1}$ and the second value corresponds to the $P_{CCA\_DL2}$ .
Note 6:	For UE supporting both semi-static and dynamic channel access, the UE must be tested under both dynamic channel occupancy and semi-static channel occupancy configuration.
Note 7:	$L_{CCA\_DL}$ and $L_{CCA\_UL}$ are chosen such that $preambleTransMax > 5 + L_{CCA\_DL} + L_{CCA\_UL}$ .
Note 8:	A window $W_{CCA\_DL}=W_{CCA\_UL}=Inf$ is used to indicate that $L_{CCA\_DL}$ and $L_{CCA\_UL}$ are considered during the entire duration of a test run.

#### A.11.2.2.2.2.2 Test Requirements

Non-Contention based random access is triggered by explicitly assigning a random access preamble via dedicated signalling in the downlink. In the test, the non-contention based random access procedure is not initialized for Other SI requested from UE or beam failure recovery.

##### A.11.2.2.2.2.1 SSB-based Random Access Preamble Transmission

In Test-1, to test the UE behavior specified in Clause 6.2.2A.2.2.1 for SSB-based Random Access Preamble transmission, with the contention-free Random Access Resources and the contention-free PRACH occasions associated with SSBs configured, the System Simulator shall receive the Random Access Preamble which has the Preamble Index associated with the SSB with index 0.

The three requirements below are relevant for all cases of PRACH transmissions described within the clause A.11.2.2.2.2.2:

- The System Simulator shall implement the UL CCA model of A.3.26.2 for the RACH occasions where PRACH transmissions are expected. The System Simulator shall monitor the RACH occasions to detect if the UE is transmitting PRACH preambles. If a PRACH transmission is detected on a RACH occasion that is expected to have UL CCA failure, the test is considered as failed.
- In case of CCA DL failure, the test equipment should verify that the UE does not transmit PRACH for semi-static channel access mode; for dynamic channel access mode it is assumed that RACH occasions are always scheduled within a UE-initiated COT.
- In case of UL CCA failure The UE shall again perform the Random Access Resource selection procedure specified in clause 5.1.2 in TS38.321 [7], and transmit with the calculated PRACH transmission power.

In addition, the System Simulator shall receive the Random Access Preamble on the PRACH occasion which belongs to the PRACH occasions corresponding to the SSB with index 0, and the selected PRACH occasion shall belong to the PRACH occasions permitted by the restrictions given by the *ra-ssb-OccasionMaskIndex*.

In addition, the power applied to all preambles shall be in accordance with what is specified in Clause 6.2.2A.2. The power of the first preamble shall be -16 dBm with an accuracy specified in clause 6.3.4.2 of TS 38.101-1 [18]. The relative power applied to additional preambles shall have an accuracy specified in clause 6.3.4.3 of TS 38.101-1 [18].

The transmit timing of all PRACH transmissions shall be within the accuracy specified in Clause 7.1.2.

##### A.11.2.2.2.2.2 Random Access Response Reception

To test the UE behavior specified in Clause 6.2.2A.2.2.2 the System Simulator shall transmit a Random Access Response containing a Random Access Preamble identifier corresponding to the transmitted Random Access Preamble after 5 preambles have been received by the System Simulator. In response to the first 4 preambles, the System Simulator shall transmit a Random Access Response *not* corresponding to the transmitted Random Access Preamble. In case of CCA DL failure, the test equipment should delay the transmission of Random Access Response.

The UE may stop monitoring for Random Access Response(s) if the Random Access Response contains a Random Access Preamble identifier corresponding to the transmitted Random Access Preamble if UL CCA is successful. The System Simulator shall monitor if the UE is transmitting msg3 when CCA UL failure. If a msg3 is detected on a grant expected to have UL CCA failure, the test is considered as failed.

The UE shall again perform the Random Access Resource selection procedure specified in clause 5.1.2 in TS 38.321 [7], and transmit with the calculated PRACH transmission power if all received Random Access Responses contain Random Access Preamble identifiers that do not match the transmitted Random Access Preamble.

In addition, the power applied to all preambles shall be in accordance with what is specified in Clause 6.2.2A.2. The power of the first preamble shall be -16 dBm with an accuracy specified in clause 6.3.4.2 of TS 38.101-1 [18]. The relative power applied to additional preambles shall have an accuracy specified in clause 6.3.4.3 of TS 38.101-1 [18].

The transmit timing of all PRACH transmissions shall be within the accuracy specified in Clause 7.1.2.

#### A.11.2.2.2.2.3 No Random Access Response Reception

To test the UE behavior specified in clause 6.2.2A.2.2.3 the System Simulator shall transmit a Random Access Response containing a Random Access Preamble identifier corresponding to the transmitted Random Access Preamble after 5 preambles have been received by the System Simulator. The System Simulator shall *not* respond to the first 4 preambles. In case of CCA DL failure, the test equipment should delay the transmission of Random Access Response.

The UE shall again perform the Random Access Resource selection procedure specified in clause 5.1.2 in TS 38.321 [7], and transmit with the calculated PRACH transmission power when the backoff time expires if no Random Access Response is received within the RA Response window configured in *RACH-ConfigCommon*.

In addition, the power applied to all preambles shall be in accordance with what is specified in Clause 6.2.2A.2. The power of the first preamble shall be -16 dBm with an accuracy specified in clause 6.3.4.2 of TS 38.101-1 [18]. The relative power applied to additional preambles shall have an accuracy specified in clause 6.3.4.3 of TS 38.101-1 [18].

The transmit timing of all PRACH transmissions shall be within the accuracy specified in Clause 7.1.2.

#### A.11.2.2.2.3 2-step RA type contention-based random access for NR PCell with CCA

##### A.11.2.2.2.3.1 Test Purpose and Environment

The purpose of this test is to verify that the behavior of the 2-step RA type random access procedure is according to the requirements and that the MsgA PRACH, MsgA PUSCH power settings and timing are within specified limits when subject to CCA. This test will verify the requirements in Clause 6.2.2A.3 and Clause 7.1.2 in an AWGN model.

For this test one cell is used and configured as PCell in FR1, which operates on a carrier frequency with CCA. Supported test parameters are shown in Table A.11.2.2.2.3.1-1. UE capable of SA with PCell in FR1 needs to be tested by using the parameters in Table A.11.2.2.2.3.1-2.

**Table A.11.2.2.2.3.1-1: Supported test configurations for 2-step RA type contention based random access with successRAR test for FR1 PCell with CCA**

Config	Description
1	NR 30 kHz SSB SCS, 40 MHz bandwidth, TDD duplex mode
Note:	Void.

**Table A.11.2.2.2.3.1-2: General test parameters for 2-step RA type contention based random access with successRAR test for FR1 PCell with CCA**

Parameter		Unit	Test-1	Comments
SSB Configuration	Note 4, 6	Config 1	SSB.3 CCA	As defined in A.3.10A
	Note 5, 6	Config 1	SSB.4 CCA	As defined in A.3.10A
DBT Window Configuration	Config 1		DBT.1	As specified in A.3.28.1
DL CCA model	Config 1		As specified in A.3.26.2.1	
UL CCA model	Config 1		As specified in A.3.26.2.2	
Duplex Mode for Cell 2	Config 1		TDD	
TDD Configuration	Config 2		TDDConf.1.1 CCA	
OCNG Pattern <sup>Note 1</sup>			OCNG pattern 1	As defined in A.3.2.1.
PDSCH parameters <sup>Note 3</sup>	Config 1		SR.1.1 CCA	As defined in A.3.1A.1.
NR RF Channel Number			1	

EPRE ratio of PSS to SSS		dB	0		
EPRE ratio of PBCH_DMRS to SSS		dB			
EPRE ratio of PBCH to PBCH_DMRS		dB			
EPRE ratio of PDCCH_DMRS to SSS		dB			
EPRE ratio of PDCCH to PDCCH_DMRS		dB			
EPRE ratio of PDSCH_DMRS to SSS		dB			
EPRE ratio of PDSCH to PDSCH_DMRS		dB			
SSB with index 0	$\hat{E}_s / I_{ot}$		dB	3	Power of SSB with index 0 is set to be above configured <i>msgA-RSRP-ThresholdSSB</i>
	$N_{oc}$	Config 1	dBm/15kHz	-101	
	$\hat{E}_s / N_{oc}$		dB	3	
	SS-RSRP		dBm/ SCS	-95	
SSB with index 1	$\hat{E}_s / I_{ot}$		dB	-17	Power of SSB with index 1 is set to be below configured <i>msgA-RSRP-ThresholdSSB</i>
	$N_{oc}$	Config 1	dBm/15kHz	-101	
	$\hat{E}_s / N_{oc}$		dB	-17	
	SS-RSRP		dBm/ SCS	-115	
I <sub>o</sub> <sup>Note 2</sup>		Config 1	dBm	-62.2/38.16MHz	For symbols without SSB index 1
ss-PBCH-BlockPower		dBm/ SCS		-5	As defined in clause 6.3.2 in TS 38.331 [2].
Configured UE transmitted power (P <sub>C<sub>MAX,f,c</sub></sub> )		dBm		23	As defined in clause 6.2.4 in TS 38.101-1.
MsgA Configuration				FR1 MsgA configuration 1 under CCA	As defined in A.3.20A.2.
<i>msgA-RSRP-ThresholdSSB</i>		dBm		RSRP_51	The actual value of the threshold is -105dBm, as defined in TS 38.331 [2].
DL CCA probability	Note 4, 6			0.9375	
P <sub>CCA_DL</sub>	Note 5, 6			0.75 / 0.75	
L <sub>CCA_DL</sub> <sup>Note 7</sup>				4	
W <sub>CCA_DL</sub> <sup>Note 8</sup>				Inf	
UL CCA probability	Note 4, 6			0.87	
P <sub>CCA_UL</sub>	Note 5, 6			0.75	
L <sub>CCA_UL</sub> <sup>Note 7</sup>				5	
W <sub>CCA_UL</sub> <sup>Note 8</sup>				Inf	
Semi-static channel access config period <sup>Note 4, 6</sup>		ms		2	
Propagation Condition		-		AWGN	
<p>Note 1: OCNG shall be used such that the cell is fully allocated and a constant total transmitted power spectral density is achieved for all OFDM symbols. The OCNG pattern is chosen during the test according to the presence of a DL reference measurement channel.</p> <p>Note 2: SS-RSRP, Es/I<sub>ot</sub> and I<sub>o</sub> levels have been derived from other parameters for information purpose. They are not settable parameters.</p> <p>Note 3: The DL PDSCH reference measurement channel is used in the test only when a downlink transmission dedicated to the UE under test is required.</p> <p>Note 4: For UE supporting semi-static channel access and network configuring semi-static channel occupancy.</p> <p>Note 5: For UE supporting dynamic channel access and network configuring dynamic channel occupancy. The first value corresponds P<sub>CCA_DL1</sub> and the second value corresponds to the P<sub>CCA_DL2</sub>.</p> <p>Note 6: For UE supporting both semi-static and dynamic channel access, the UE must be tested under both dynamic channel occupancy and semi-static channel occupancy configuration.</p> <p>Note 7: L<sub>CCA_DL</sub> and L<sub>CCA_UL</sub> are chosen such that preambleTransMax &gt; 5 + L<sub>CCA_DL</sub> + L<sub>CCA_UL</sub>.</p> <p>Note 8: A window W<sub>CCA_DL</sub>=W<sub>CCA_UL</sub>=Inf is used to indicate that L<sub>CCA_DL</sub> and L<sub>CCA_UL</sub> are considered during the entire duration of a test run.</p>					

#### A.11.2.2.3.2 Test Requirements

Contention based random access is triggered by *not* explicitly assigning a random access preamble via dedicated signalling in the downlink.

#### A.11.2.2.2.3.2.1 MsgA Transmission

To test the UE behavior specified in Clause 6.2.2A.3.1.1 the System Simulator shall receive the MsgA with a preamble which belongs to one of the Random Access Preambles associated with the SSB with index 0, which has SS-RSRP above the configured *msgA-RSRP-ThresholdSSB*, if the UL CCA is successful.

The three requirements below are relevant for all cases of MsgA transmissions described within the clause A.11.2.2.2.3.2:

- The System Simulator shall implement the UL CCA model for the MsgA occasions (i.e. both MsgA PRACH and MsgA PUSCH occasions) where MsgA transmissions are expected. The System Simulator shall monitor the MsgA occasions to detect if the UE is transmitting MsgA. If a MsgA transmission is detected on MsgA occasions that are expected to have UL CCA failure, the test is considered as failed.
- In case of CCA DL failure, the test equipment should verify that the UE does not transmit MsgA for semi-static channel access mode; for dynamic channel access mode it is assumed that MsgA occasions are always scheduled within a UE-initiated COT.
- The UE shall again perform the Random Access Resource selection procedure specified in clause 5.1.2a in TS38.321 [7], and transmit with the calculated PRACH transmission power in case of UL CCA failure.

The UE shall again perform the Random Access Resource selection procedure specified in clause 5.1.2a in TS38.321 [7], and transmit with the calculated PRACH transmission power in case of UL CCA failure.

In addition, the power applied to all MsgA transmissions shall be in accordance with what is specified in Clause 6.2.2A.3. The power of the first MsgA preamble transmission shall be -16 dBm with an accuracy specified in clause 6.3.4.2 of TS 38.101-1 [18]. The power of the first MsgA PUSCH transmission shall be  $0.6 + 3(\mu + 2)$  dBm with an accuracy specified in clause 6.3.4.2 of TS 38.101-1 [18], where  $\mu$  indicates the MsgA PUSCH numerology. The relative power applied to additional MsgA transmissions shall have an accuracy specified in clause 6.3.4.3 of TS 38.101-1 [18].

The transmit timing of all MsgA transmissions shall be within the accuracy specified in Clause 7.1.2.

#### A.11.2.2.2.3.2.2 MsgB Reception

To test the UE behavior specified in Clause 6.2.2A.3.1.2 the System Simulator shall transmit a MsgB containing a Random Access Preamble identifier corresponding to the transmitted Random Access Preamble after 5 preambles have been received by the System Simulator. In response to the first 4 preambles, the System Simulator shall transmit a MsgB *not* corresponding to the transmitted Random Access Preamble. In case of CCA DL failure, the test equipment should delay the transmission of MsgB.

The UE may stop monitoring for MsgB(s) and shall transmit an ACK if the MsgB with a successRAR contains a Random Access Preamble identifier corresponding to the transmitted Random Access Preamble and if the Contention Resolution is successful and if UL CCA is successful. The System Simulator shall monitor if the UE is transmitting ACK in the case of CCA UL failure. If ACK transmission is detected on a grant expected to have UL CCA failure, the test is considered as failed.

The UE may stop monitoring for MsgB(s) and shall transmit the msg3 if the MsgB with a fallbackRAR contains a Random Access Preamble identifier corresponding to the transmitted Random Access Preamble if UL CCA is successful. The System Simulator shall monitor if the UE is transmitting msg3 when CCA UL failure. If a msg3 is detected on a grant expected to have UL CCA failure, the test is considered as failed.

The UE shall again perform the Random Access Resource selection procedure specified in clause 5.1.2a in TS 38.321 [7], and transmit with the calculated MsgA PRACH and MsgA PUSCH transmission power when the backoff time expires if all received MsgB(s) contain Random Access Preamble identifiers that do not match the transmitted Random Access Preamble.

In addition, the power applied to all MsgA transmissions shall be in accordance with what is specified in Clause 6.2.2A.3. The power of the first MsgA preamble shall be -16 dBm with an accuracy specified in clause 6.3.4.2 of TS 38.101-1 [18]. The power of the first MsgA PUSCH transmission shall be  $0.6 + 3(\mu + 2)$  dBm with an accuracy specified in clause 6.3.4.2 of TS 38.101-1 [18], where  $\mu$  indicates the MsgA PUSCH numerology. The relative power applied to additional MsgA transmissions shall have an accuracy specified in clause 6.3.4.3 of TS 38.101-1 [18].

The transmit timing of all MsgA transmissions shall be within the accuracy specified in Clause 7.1.2.

## A.11.2.2.2.3.2.3 No MsgB Reception

To test the UE behavior specified in clause 6.2.2A.3.1.3 the System Simulator shall transmit a MsgB containing a successRAR message and a Random Access Preamble identifier corresponding to the transmitted Random Access Preamble after 5 preambles have been received by the System Simulator. The System Simulator shall *not* respond to the first 4 preambles. In case of CCA DL failure, the test equipment should delay the transmission of MsgB.

The UE shall again perform the Random Access Resource selection procedure specified in clause 5.1.2a in TS 38.321 [7], and transmit with the calculated MsgA PRACH and MsgA PUSCH transmission power when the backoff time expires if no MsgB is received within the MsgB Response window.

In addition, the power applied to all MsgA transmissions shall be in accordance with what is specified in Clause 6.2.2A.3. The power of the first MsgA preamble shall be -16 dBm with an accuracy specified in clause 6.3.4.2 of TS 38.101-1 [18]. The power of the first MsgA PUSCH transmission shall be  $0.6 + 3(\mu + 2)$  dBm with an accuracy specified in clause 6.3.4.2 of TS 38.101-1 [18], where  $\mu$  indicates the MsgA PUSCH numerology. The relative power applied to additional MsgA transmissions shall have an accuracy specified in clause 6.3.4.3 of TS 38.101-1 [18].

The transmit timing of all MsgA transmissions shall be within the accuracy specified in Clause 7.1.2.

## A.11.2.2.2.4 2-step RA type non-contention-based random access for NR PCell with CCA

## A.11.2.2.2.4.1 Test Purpose and Environment

The purpose of this test is to verify that the behavior of the random access procedure is according to the requirements and that the MsgA PRACH, MsgA PUSCH power settings and timing are within specified limits when subject to CCA. This test will verify the requirements in Clause 6.2.2A.3 and Clause 7.1.2 in an AWGN model.

For this test one cell is used and configured as PCell in FR1, which operates on a carrier frequency with CCA. Supported test parameters are shown in Table A.11.2.2.2.4.1-1. UE capable of SA with PCell in FR1 needs to be tested by using the parameters in Table A.11.2.2.2.4.1-2.

**Table A.11.2.2.2.4.1-1: Supported test configurations for non-contention based random access test for FR1 PCell with CCA**

Config	Description
1	NR 30 kHz SSB SCS, 40 MHz bandwidth, TDD duplex mode
Note:	Void.

**Table A.11.2.2.2.4.1-2: General test parameters for non-contention based random access test for FR1 PCell with CCA**

Parameter		Unit	Test-1	Comments
SSB Configuration	Note 4, 6	Config 1	SSB.3 CCA	As defined in A.3.10A
	Note 5, 6	Config 1	SSB.4 CCA	As defined in A.3.10A
DBT Window Configuration		Config 1	DBT.1	As specified in A.3.28.1
DL CCA model		Config 1	As specified in A.3.26.2.1	
UL CCA model		Config 1	As specified in A.3.26.2.2	
Duplex Mode for Cell 1		Config 1	TDD	
TDD Configuration		Config 1	TDDConf.1.1 CCA	
OCNG Pattern <sup>Note 1</sup>			OCNG pattern 1	As defined in A.3.2.1.
PDSCH parameters <sup>Note 3</sup>		Config 1	SR.1.1 CCA	As defined in A.3.1A.1.
NR RF Channel Number			1	
EPRE ratio of PSS to SSS		dB	0	
EPRE ratio of PBCH_DMRS to SSS		dB		

EPRE ratio of PBCH to PBCH_DMRS		dB			
EPRE ratio of PDCCH_DMRS to SSS		dB			
EPRE ratio of PDCCH to PDCCH_DMRS		dB			
EPRE ratio of PDSCH_DMRS to SSS		dB			
EPRE ratio of PDSCH to PDSCH_DMRS		dB			
msgA-RSRP-ThresholdSSB		dBm	RSRP_51	The actual value of the threshold is -105dBm, as defined in TS 38.331 [2].	
SSB with index 0	$\hat{E}_s / I_{ot}$		dB	3	Power of SSB with index 0 is set to be above configured msgA-RSRP-ThresholdSSB
	$N_{oc}$	Config 1	dBm/15kHz	-101	
	$\hat{E}_s / N_{oc}$		dB	3	
	SS-RSRP		dBm/ SCS	-95	
SSB with index 1	$\hat{E}_s / I_{ot}$		dB	-17	Power of SSB with index 1 is set to be below configured msgA-RSRP-ThresholdSSB
	$N_{oc}$	Config 1	dBm/15kHz	-101	
	$\hat{E}_s / N_{oc}$		dB	-17	
	SS-RSRP		dBm/ SCS	-115	
Io <sup>Note 2</sup>		Config 1	dBm	-62.2/38.16MHz	For symbols without SSB index 1
ss-PBCH-BlockPower		dBm/ SCS		-5	As defined in clause 6.3.2 in TS 38.331 [2].
Configured UE transmitted power ( $P_{CMAX, f, c}$ )		dBm		23	As defined in clause 6.2.4 in TS 38.101-1.
MsgA Configuration				FR1 MsgA configuration 2 under CCA	As defined in A.3.20A.2.
DL CCA probability	Note 4, 6			0.9375	
$P_{CCA\_DL}$	Note 5, 6			0.75 / 0.75	
$L_{CCA\_DL}$ <sup>Note 7</sup>				4	
$W_{CCA\_DL}$ <sup>Note 8</sup>				Inf	
UL CCA probability	Note 4, 6			0.87	
$P_{CCA\_UL}$	Note 5, 6			0.75	
$L_{CCA\_UL}$ <sup>Note 7</sup>				5	
$W_{CCA\_UL}$ <sup>Note 8</sup>				Inf	
Semi-static channel access config period <sup>Note 4, 6</sup>		ms		2	
Propagation Condition		-		AWGN	
<p>Note 1: OCNG shall be used such that the cell is fully allocated and a constant total transmitted power spectral density is achieved for all OFDM symbols. The OCNG pattern is chosen during the test according to the presence of a DL reference measurement channel.</p> <p>Note 2: SS-RSRP, <math>E_s/I_{ot}</math> and <math>I_o</math> levels have been derived from other parameters for information purpose. They are not settable parameters.</p> <p>Note 3: The DL PDSCH reference measurement channel is used in the test only when a downlink transmission dedicated to the UE under test is required.</p> <p>Note 4: For UE supporting semi-static channel access and network configuring semi-static channel occupancy.</p> <p>Note 5: For UE supporting dynamic channel access and network configuring dynamic channel occupancy. The first value corresponds <math>P_{CCA\_DL1}</math> and the second value corresponds to the <math>P_{CCA\_DL2}</math>.</p> <p>Note 6: For UE supporting both semi-static and dynamic channel access, the UE must be tested under both dynamic channel occupancy and semi-static channel occupancy configuration.</p> <p>Note 7: <math>L_{CCA\_DL}</math> and <math>L_{CCA\_UL}</math> are chosen such that <math>preambleTransMax &gt; 5 + L_{CCA\_DL} + L_{CCA\_UL}</math>.</p> <p>Note 8: A window <math>W_{CCA\_DL}=W_{CCA\_UL}=Inf</math> is used to indicate that <math>L_{CCA\_DL}</math> and <math>L_{CCA\_UL}</math> are considered during the entire duration of a test run.</p>					



#### A.11.2.2.2.4.2 Test Requirements

Non-Contention based random access is triggered by explicitly assigning a random access preamble via dedicated signalling in the downlink. In the test, the non-contention based random access procedure is not initialized for Other SI requested from UE or beam failure recovery.

##### A.11.2.2.2.4.2.1 MsgA Transmission

To test the UE behavior specified in Clause 6.2.2A.3.2.1, with the contention-free Random Access Resources and the contention-free PRACH occasions associated with SSBs configured, the System Simulator shall receive the MsgA with a preamble which belongs to one of the Random Access Preambles associated with the SSB with index 0.

In addition, the System Simulator shall receive the MsgA PRACH on the PRACH occasion which belongs to the PRACH occasions corresponding to the SSB with index 0, and the selected PRACH occasion shall belong to the PRACH occasions permitted by the restrictions given first by the *msgA-SSB-SharedRO-MaskIndex* if configured, or next by the *ra-ssb-OccasionMaskIndex* if configured.

The three requirements below are relevant for all cases of MsgA transmissions described within the clause A.11.2.2.2.4.2:

- The System Simulator shall implement the UL CCA model for the MsgA occasions (i.e. both MsgA PRACH and MsgA PUSCH occasions) where MsgA transmissions are expected. The System Simulator shall monitor the MsgA occasions to detect if the UE is transmitting MsgA. If a MsgA transmission is detected on MsgA occasions that are expected to have UL CCA failure, the test is considered as failed.
- In case of CCA DL failure, the test equipment should verify that the UE does not transmit MsgA for semi-static channel access mode; for dynamic channel access mode it is assumed that MsgA occasions are always scheduled within a UE-initiated COT.
- The UE shall again perform the Random Access Resource selection procedure specified in clause 5.1.2a in TS38.321 [7], and transmit with the calculated PRACH transmission power in case of UL CCA failure.

In addition, the power applied to all preambles shall be in accordance with what is specified in Clause 6.2.2A.3. The power of the first MsgA preamble shall be -16 dBm with an accuracy specified in clause 6.3.4.2 of TS 38.101-1 [18]. The power of the first MsgA PUSCH transmission shall be  $0.6 + 3(\mu + 2)$  dBm with an accuracy specified in clause 6.3.4.2 of TS 38.101-1 [18], where  $\mu$  indicates the MsgA PUSCH numerology. The relative power applied to additional MsgA transmissions shall have an accuracy specified in clause 6.3.4.3 of TS 38.101-1 [18].

The transmit timing of all MsgA transmissions shall be within the accuracy specified in Clause 7.1.2.

##### A.11.2.2.2.4.2.2 MsgB Reception

To test the UE behavior specified in Clause 6.2.2A.3.2.2 the System Simulator shall transmit a MsgB containing a fallbackRAR containing a Random Access Preamble identifier corresponding to the transmitted Random Access Preamble after 5 preambles have been received by the System Simulator. In response to the first 4 preambles, the System Simulator shall transmit a MsgB *not* corresponding to the transmitted Random Access Preamble. In case of CCA DL failure, the test equipment should delay the transmission of MsgB.

The UE may stop monitoring for MsgB(s) and shall transmit the msg3 containing the payload of MsgA PUSCH if the MsgB with a fallbackRAR contains a Random Access Preamble identifier corresponding to the transmitted Random Access Preamble if UL CCA is successful. The System Simulator shall monitor if the UE is transmitting msg3 when CCA UL failure. If a msg3 is detected on a grant expected to have UL CCA failure, the test is considered as failed. The UE shall monitor contention resolution as described in clause 8.2A in TS 38.213 [3].

The UE shall again perform the Random Access Resource selection procedure specified in clause 5.1.2a in TS 38.321 [7], and transmit with the calculated MsgA PRACH and MsgA PUSCH transmission power when the backoff time expires if all received MsgB's contain Random Access Preamble identifiers that do not match the transmitted Random Access Preamble.

The system simulator shall implement the UL CCA model of A.3.26.2 for the MsgA occasions where MsgA System Simulator transmissions are expected. The System Simulator shall monitor the MsgA occasions to detect if the UE is transmitting MsgA. If a MsgA transmission is detected on a MsgA occasion that is expected to have UL CCA failure, the test is considered as failed.

In case of CCA DL failure, the test equipment should verify that the UE does not transmit MsgA for semi-static channel access mode.

The UE shall again perform the Random Access Resource selection procedure specified in clause 5.1.2a in TS38.321 [7], and transmit with the calculated MsgA transmission power in case UL CCA failure.

In addition, the power applied to all preambles shall be in accordance with what is specified in Clause 6.2.2A.3. The power of the first MsgA preamble shall be -16 dBm with an accuracy specified in clause 6.3.4.2 of TS 38.101-1 [18]. The power of the first MsgA PUSCH transmission shall be  $0.6 + 3(\mu + 2)$  dBm with an accuracy specified in clause 6.3.4.2 of TS 38.101-1 [18], where  $\mu$  indicates the MsgA PUSCH numerology. The relative power applied to additional preambles shall have an accuracy specified in clause 6.3.4.3 of TS 38.101-1 [18].

The transmit timing of all MsgA and msg3 transmissions shall be within the accuracy specified in Clause 7.1.2.

#### A.11.2.2.4.2.3 No MsgB Reception

To test the UE behavior specified in clause 6.2.2A.3.2.3 the System Simulator shall transmit a MsgB containing a successRAR message and a Random Access Preamble identifier corresponding to the transmitted Random Access Preamble after 5 preambles have been received by the System Simulator. The System Simulator shall *not* respond to the first 4 preambles. In case of CCA DL failure, the test equipment should delay the transmission of MsgB.

The UE shall again perform the Random Access Resource selection procedure specified in clause 5.1.2a in TS 38.321 [7], and transmit with the calculated MsgA transmission power when the backoff time expires if no MsgB is received within the MsgB Response window.

The System Simulator shall implement the UL CCA model of A.3.26.2 for the MsgA occasions where MsgA transmissions are expected. The System Simulator shall monitor the MsgA occasions to detect if the UE is transmitting MsgA. If a MsgA transmission is detected on a MsgA occasion that is expected to have UL CCA failure, the test is considered as failed.

In case of CCA DL failure, the test equipment should verify that the UE does not transmit MsgA for semi-static channel access mode.

The UE shall again perform the Random Access Resource selection procedure specified in clause 5.1.2a in TS38.321 [7], and transmit with the calculated MsgA transmission power in case UL CCA failure.

In addition, the power applied to all MsgA transmissions shall be in accordance with what is specified in Clause 6.2.2A.3. The power of the first MsgA preamble shall be -16 dBm with an accuracy specified in clause 6.3.4.2 of TS 38.101-1 [18]. The power of the first MsgA PUSCH transmission shall be  $0.6 + 3(\mu + 2)$  dBm with an accuracy specified in clause 6.3.4.2 of TS 38.101-1 [18], where  $\mu$  indicates the MsgA PUSCH numerology. The relative power applied to additional MsgA transmissions shall have an accuracy specified in clause 6.3.4.3 of TS 38.101-1 [18].

The transmit timing of all MsgA transmissions shall be within the accuracy specified in Clause 7.1.2.

### A.11.2.2.3 RRC connection release with redirection

#### A.11.2.2.3.1 Redirection from NR FR1 carrier under CCA to NR FR1 carrier under CCA

##### A.11.2.2.3.1.1 Test Purpose and Environment

This test is to verify RRC connection release with redirection from NR FR1 carrier under CCA to NR FR1 carrier under CCA specified in clause 6.2.3.2.3.

##### A.11.2.2.3.1.2 Test Parameters

Supported test configurations are shown in table A.11.2.2.3.1.2-1. The time delay is tested by using the parameters in table A.11.2.2.3.1.2-2, and A.11.2.2.3.1.2-3.

The test consists of two successive time periods, with time duration of T1, and T2 respectively. The *RRCRelease* message shall be sent to the UE during period T1 and the start of T2 is the instant when the last TTI containing the RRC message is sent to the UE. Prior to time duration T2, the UE shall not have any timing information of Cell 2. Cell 2 is powered up at the beginning of the T2.

**Table A.11.2.2.3.1.2-1: Redirection from NR to NR test configurations**

Config	Description
1	Source cell: NR 30 kHz SSB SCS, 40 MHz bandwidth, TDD duplex mode Target cell: NR 30 kHz SSB SCS, 40 MHz bandwidth, TDD duplex mode

**Table A.11.2.2.3.1.2-2: General test parameters for Redirection from NR to NR test case**

Parameter		Unit	Value	Comment
Initial conditions	Active cell		Cell 1	On the carrier under CCA
	Neighbouring cell		Cell 2	On the carrier under CCA
Final condition	Active cell		Cell 2	On the carrier under CCA
Filter coefficient			0	L3 filtering is not used
Access Barring Information		-	Not Sent	No additional delays in random access procedure.
Time offset between cells			3 $\mu$ s	Synchronous cells
DL CCA model	Dynamic channel access <sup>Note 1, 3</sup>		As specified in clause A.3.26.2.1	
	Semi-static channel access <sup>Note 2, 3</sup>			
UL CCA model	Dynamic channel access <sup>Note 1, 3</sup>		As specified in clause A.3.26.2.2	
	Semi-static channel access <sup>Note 2,3</sup>			
T1		s	5	
T2		s	$\geq T_{\text{connection\_release\_redirect\_NR\_CCA}}$	$T_{\text{connection\_release\_redirect\_NR\_CCA}}$ is defined in clause 6.2.3.2.3

NOTE 1: For a UE supporting dynamic channel access and network configuring dynamic channel occupancy.  
 NOTE 2: For a UE supporting semi-static channel access and network configuring semi-static channel occupancy.  
 NOTE 3: For a UE supporting both semi-static and dynamic channel access, the UE can be tested under dynamic channel occupancy only.

**Table A.11.2.2.3.1.2-3: Cell specific test parameters for Redirection from NR to NR test case**

Parameter		Unit	Cell 1		Cell 2	
			T1	T2	T1	T2
NR RF Channel Number			1		2	
$P_{\text{CCA\_DL}}$ for dynamic channel access <sup>Note 4,6</sup>		-	$P_{\text{CCA\_DL\_1}}=0.75$ $P_{\text{CCA\_DL\_2}}=0.75$		$P_{\text{CCA\_DL\_1}}=0.75$ $P_{\text{CCA\_DL\_2}}=0.75$	
$P_{\text{CCA\_DL}}$ for semi-static channel access <sup>Note 5,6</sup>		-	$P_{\text{CCA\_DL}}=0.9375$		$P_{\text{CCA\_DL}}=0.9375$	
$P_{\text{CCA\_UL}}$ for dynamic channel access <sup>Note 4,6</sup>		-	1		1	
$P_{\text{CCA\_UL}}$ for semi-static channel access <sup>Note 5,6</sup>		-	1		1	
$L_{\text{CCA\_DL}}$ <sup>Note 7</sup>			N/A		8	
$W_{\text{CCA\_DL}}$ <sup>Note 7</sup>		ms	N/A		$T_{\text{identify-NR\_CCA}}$	
TDD configuration	Config 1		TDDConf.1.1 CCA			
$BW_{\text{channel}}$	Config 1		40: $N_{\text{RB,c}} = 106$			
BWP BW	Config 1		40: $N_{\text{RB,c}} = 106$			
DRX Cycle		ms	Not Applicable			
PDSCH Reference	Config 1		SR.1.1 CCA			
RMSI CORESET Reference Channel	Config 1		CR.1.1 CCA			
Dedicated CORESET RMC configuration	Config 1		CCR.1.1 CCA			
TRS configuration	Config 1		TRS.1.2 TDD			
OCNG Patterns			OP.1			
SMTTC Configuration			SMTTC.1			
DBT configuration			DBT.1			
SSB configuration for semi-static channel access <sup>Note 4, 6</sup>	Config 1		SSB.1 CCA			
SSB configuration for dynamic channel access <sup>Note 5, 6</sup>	Config 1		SSB.2 CCA			
ssb-PositionQCL	Config 1		[1]			

PDSCH/PDCCH subcarrier spacing	Config 1	kHz	30 kHz			
PUCCH/PUSCH subcarrier spacing	Config 1	kHz	30 kHz			
PRACH configuration			FR1 PRACH configuration 1 under CCA			
BWP configuration	Initial DL BWP		DLBWP.0.1			
	Dedicated DL BWP		DLBWP.1.1			
	Initial UL BWP		ULBWP.0.1			
	Dedicated UL BWP		ULBWP.1.1			
EPRE ratio of PSS to SSS		dB	0			
EPRE ratio of PBCH DMRS to SSS						
EPRE ratio of PBCH to PBCH DMRS						
EPRE ratio of PDCCH DMRS to SSS						
EPRE ratio of PDCCH to PDCCH DMRS						
EPRE ratio of PDSCH DMRS to SSS						
EPRE ratio of PDSCH to PDSCH						
EPRE ratio of OCNG DMRS to SSS(Note 1)						
EPRE ratio of OCNG to OCNG DMRS (Note 1)						
$N_{oc}$ Note2						
$N_{oc}$ Note2	Config 1	dBm/SCS	-95			
$\hat{E}_s / I_{ot}$		dB	4	4	-infinity	4
$\hat{E}_s / N_{oc}$		dB	4	4	-infinity	4
$I_o$ Note3	Config 1	dBm/38.16MHz	-58.49	-58.49	-63.94	-58.49
Propagation condition		-	AWGN		AWGN	
<p>Note 1: OCNG shall be used such that both cells are fully allocated and a constant total transmitted power spectral density is achieved for all OFDM symbols.</p> <p>Note 2: Interference from other cells and noise sources not specified in the test is assumed to be constant over subcarriers and time and shall be modelled as AWGN of appropriate power for <math>N_{oc}</math> to be fulfilled.</p> <p>Note 3: <math>I_o</math> levels have been derived from other parameters for information purposes. They are not settable parameters themselves.</p> <p>Note 4: For UE supporting semi-static channel access and network configuring semi-static channel occupancy.</p> <p>Note 5: For UE supporting dynamic channel access and network configuring dynamic channel occupancy.</p> <p>Note 6: For a UE supporting both semi-static and dynamic channel access, the UE can be tested under dynamic channel occupancy only.</p> <p>Note 7: As defined in clause 6.2.3.2.3 for <math>T_{rs} \leq 40</math> ms.</p>						

A.11.2.2.3.1.3 Test Requirements

The UE shall start to transmit the PRACH to Cell 2 less than  $T_{connection\_release\_redirect\_NR\_CCA}$  ms from the beginning of time period T2, where  $T_{connection\_release\_redirect\_NR\_CCA}$  is defined in clause 6.2.3.2.3.

The rate of correct RRC connection release redirection to NR observed during repeated tests shall be at least 90%.

NOTE: The redirection delay can be expressed as:

$$T_{connection\_release\_redirect\_NR\_CCA} = T_{RRC\_procedure\_delay} + T_{identify\_NR\_CCA} + T_{SI\_NR\_CCA} + T_{RACH\_CCA},$$

where:

$T_{RRC\_procedure\_delay} = 110$  ms in the test.

$T_{identify\_NR\_CCA} = \text{MAX}(680 \text{ ms}, (L_1+11) \times 20 \text{ ms})$  in the test.

$T_{SI\_NR} = 1280$  ms, it is the time required for receiving all the relevant system information as defined in TS 38.331 for the target NR cell.

$T_{RACH\_CCA}$  is the delay uncertainty in acquiring the first available PRACH occasion in the target NR cell.

$L_1$  is the number of SMTC occasions not available at the UE due to DL CCA failures. The test equipment ensure that number of  $L_1$  in target cell does not exceed  $L_{1,max}$  using the configured  $L_{CCA\_DL}$  as in clause A.3.26.2.1;

A.11.2.2.3.2 Redirection from NR FR1 carrier without CCA to NR FR1 carrier with CCA

A.11.2.2.3.2.1 Test Purpose and Environment

This test is to verify RRC connection release with redirection from NR FR1 carrier without CCA to NR FR1 carrier with CCA specified in clause 6.2.3.2.3.

A.11.2.2.3.2.2 Test Parameters

Supported test configurations are shown in table A.11.2.2.3.2.2-1. The time delay is tested by using the parameters in table A.11.2.2.3.2.2-2, and A.11.2.2.3.2.2-3.

The test consists of two successive time periods, with time duration of T1, and T2 respectively. The *RRCRelease* message shall be sent to the UE during period T1 and the start of T2 is the instant when the last TTI containing the RRC message is sent to the UE. Prior to time duration T2, the UE shall not have any timing information of Cell 2. Cell 2 is powered up at the beginning of the T2.

**Table A.11.2.2.3.2.2-1: Redirection from NR to NR test configurations**

Configuration	Source cell without CCA	Target cell with CCA
1	15 kHz SSB SCS, 10 MHz bandwidth, FDD	30 kHz SSB SCS, 40 MHz bandwidth, TDD
2	15 kHz SSB SCS, 10 MHz bandwidth, TDD	30 kHz SSB SCS, 40 MHz bandwidth, TDD
3	30 kHz SSB SCS, 40 MHz bandwidth, TDD	30 kHz SSB SCS, 40 MHz bandwidth, TDD

Note: The UE is only required to be tested in one of the supported test configurations

**Table A.11.2.2.3.2.2-2: General test parameters for Redirection from NR to NR test case**

Parameter		Unit	Value	Comment
Initial conditions	Active cell		Cell 1	On the carrier without CCA
	Neighbouring cell		Cell 2	On the carrier under CCA
Final condition	Active cell		Cell 2	On the carrier under CCA
Filter coefficient			0	L3 filtering is not used
Access Barring Information		-	Not Sent	No additional delays in random access procedure.
Time offset between cells			3 $\mu$ s	Synchronous cells
DL CCA model	Dynamic channel access <sup>Note 1, 3</sup>		As specified in clause A.3.26.2.1	
	Semi-static channel access <sup>Note 2, 3</sup>			
UL CCA model	Dynamic channel access <sup>Note 1, 3</sup>		As specified in clause A.3.26.2.2	
	Semi-static channel access <sup>Note 2, 3</sup>			
T1		s	5	
T2		s	$\geq T_{connection\_release\_redirect\_NR\_CCA}$	$T_{connection\_release\_redirect\_NR\_CCA}$ is defined in clause 6.2.3.2.3

NOTE 1: For a UE supporting dynamic channel access and network configuring dynamic channel occupancy.  
 NOTE 2: For a UE supporting semi-static channel access and network configuring semi-static channel occupancy.  
 NOTE 3: For a UE supporting both semi-static and dynamic channel access, the UE can be tested under dynamic channel occupancy only.

**Table A.11.2.2.3.2.2-3: Cell specific test parameters for Redirection from NR to NR test case**

Parameter	Unit	Cell 1		Cell 2	
		T1	T2	T1	T2
NR RF Channel Number		1		2	

P <sub>CCA_DL</sub> for dynamic channel access <sup>Note 4,6</sup>			N/A	P <sub>CCA_DL1</sub> =0.75 P <sub>CCA_DL2</sub> =0.75
P <sub>CCA_DL</sub> for semi-static channel access <sup>Note 5,6</sup>			N/A	P <sub>CCA_DL</sub> =0.9375
P <sub>CCA_UL</sub> for dynamic channel access <sup>Note 4,6</sup>			N/A	1
P <sub>CCA_UL</sub> for semi-static channel access <sup>Note 5,6</sup>			N/A	1
L <sub>CCA_DL</sub> <sup>Note 7</sup>			N/A	8
W <sub>CCA_DL</sub> <sup>Note 7</sup>			N/A	T <sub>identify-NR_CCA</sub>
Duplex mode	Config 1		FDD	TDD
	Config 2,3		TDD	
TDD configuration	Config 1		Not Applicable	TDDConf.1.1 CCA
	Config 2		TDDConf.1.1	TDDConf.1.1 CCA
	Config 3		TDDConf.2.1	TDDConf.1.1 CCA
BW <sub>channel</sub>	Config 1	MHz	10: N <sub>RB,c</sub> = 52	40: N <sub>RB,c</sub> = 106
	Config 2		10: N <sub>RB,c</sub> = 52	40: N <sub>RB,c</sub> = 106
	Config 3		40: N <sub>RB,c</sub> = 106	
BWP BW	Config 1	MHz	10: N <sub>RB,c</sub> = 52	40: N <sub>RB,c</sub> = 106
	Config 2		10: N <sub>RB,c</sub> = 52	40: N <sub>RB,c</sub> = 106
	Config 3		40: N <sub>RB,c</sub> = 106	
DRX Cycle		ms	Not Applicable	
PDSCH Reference measurement channel	Config 1		SR.1.1 FDD	SR.1.1 CCA
	Config 2		SR.1.1 TDD	SR.1.1 CCA
	Config 3		SR2.1 TDD	SR.1.1 CCA
RMSI CORESET RMC configuration	Config 1		CR.1.1 FDD	CR.1.1 CCA
	Config 2		CR.1.1 TDD	CR.1.1 CCA
	Config 3		CR2.1 TDD	CR.1.1 CCA
Dedicated CORESET RMC configuration	Config 1		CCR.1.1 FDD	CCR.1.1 CCA
	Config 2		CCR.1.1 TDD	CCR.1.1 CCA
	Config 3		CCR.2.1 TDD	CCR.1.1 CCA
OCNG Patterns			OCNG pattern 1	
SSB Configuration	Semi-static channel access	Config 1,2	SSB.1 FR1	SSB.1 CCA
	Dynamic channel access	Config 3	SSB.2 FR1	SSB.2 CCA
	Semi-static channel access	Config 1,2	SSB.1 FR1	SSB.1 CCA
	Dynamic channel access	Config 3	SSB.2 FR1	SSB.2 CCA
SMTc configuration	Config 1,2		SMTc.1 FR1	SMTc.2 FR1
	Config 3		SMTc.2 FR1	
PDSCH/PDCCH subcarrier spacing	Config 1,2	kHz	15 kHz	30 kHz
	Config 3		30 kHz	
PUCCH/PUSCH subcarrier spacing	Config 1,2	kHz	15 kHz	30 kHz
	Config 3		30 kHz	
PRACH configuration			FR1 PRACH configuration 1 under CCA in Table A.3.8A.2.1-1	
BWP configuration	Initial DL BWP		DLBWP.0.1	
	Dedicated DL BWP		DLBWP.1.1	
	Initial UL BWP		ULBWP.0.1	
	Dedicated UL BWP		ULBWP.1.1	
EPRE ratio of PSS to SSS		dB	0	
EPRE ratio of PBCH DMRS to SSS				
EPRE ratio of PBCH to PBCH DMRS				
EPRE ratio of PDCCH DMRS to SSS				
EPRE ratio of PDCCH to PDCCH DMRS				
EPRE ratio of PDSCH DMRS to SSS				
EPRE ratio of PDSCH to PDSCH				

EPRE ratio of OCNG DMRS to SSS (Note 1)						
EPRE ratio of OCNG to OCNG DMRS (Note 1)						
$N_{oc}$ <sup>Note2</sup>		dBm/15kHz Z	-98			
$N_{oc}$ <sup>Note2</sup>	Config 1,2	dBm/SCS	-98		-95	
	Config 3		-95			
$\hat{E}_s/I_{ot}$		dB	4	4	-infinity	4
$\hat{E}_s/N_{oc}$		dB	4	4	-infinity	4
$I_o$ <sup>Note3</sup>	Config 1,2	dBm/9.36 MHz	-64.59	-64.59	N/A	N/A
	Config 3	dBm/38.16 MHz	-58.49	-58.49	-63.94	-58.49
Propagation condition		-	AWGN			
<p>Note 1: OCNG shall be used such that both cells are fully allocated and a constant total transmitted power spectral density is achieved for all OFDM symbols.</p> <p>Note 2: Interference from other cells and noise sources not specified in the test is assumed to be constant over subcarriers and time and shall be modelled as AWGN of appropriate power for <math>N_{oc}</math> to be fulfilled.</p> <p>Note 3: <math>I_o</math> levels have been derived from other parameters for information purposes. They are not settable parameters themselves.</p> <p>Note 4: For UE supporting semi-static channel access and network configuring semi-static channel occupancy.</p> <p>Note 5: For UE supporting dynamic channel access and network configuring dynamic channel occupancy.</p> <p>Note 6: For a UE supporting both semi-static and dynamic channel access, the UE can be tested under dynamic channel occupancy only.</p> <p>Note 7: As defined in clause 6.2.3.2.3 for <math>T_{rs} \leq 40</math> ms.</p>						

#### A.11.2.2.3.2.3 Test Requirements

The UE shall start to transmit the PRACH to Cell 2 less than  $T_{\text{connection\_release\_redirect\_NR\_CCA}}$  ms from the beginning of time period T2, where  $T_{\text{connection\_release\_redirect\_NR\_CCA}}$  is defined in clause 6.2.3.2.3.

The rate of correct RRC connection release redirection to NR observed during repeated tests shall be at least 90%.

NOTE: The redirection delay can be expressed as:

$$T_{\text{connection\_release\_redirect\_NR\_CCA}} = T_{\text{RRC\_procedure\_delay}} + T_{\text{identify-NR\_CCA}} + T_{\text{SI-NR\_CCA}} + T_{\text{RACH\_CCA}},$$

where:

$T_{\text{RRC\_procedure\_delay}} = 110$  ms in the test.

$T_{\text{identify-NR\_CCA}} = \text{MAX}(680 \text{ ms}, (L_1+11) \times 20 \text{ ms})$  in the test.

$T_{\text{SI-NR\_CCA}} = 1280$  ms, it is the time required for receiving all the relevant system information as defined in TS 38.331 for the target NR cell.

$T_{\text{RACH\_CCA}}$  is the delay uncertainty in acquiring the first available PRACH occasion in the target NR cell.

$T_{\text{RACH\_CCA}} = (1+L_2) \times T_{\text{SSB,RO}} + 10$  ms; where  $T_{\text{SSB,RO}} = 10$  ms for FR1 PRACH configuration 1.

$L_1$  is the number of SMTC occasions not available at the UE due to DL CCA failures. The test equipment shall ensure that  $L_1$  does not exceed  $L_{1,\text{max}}$ . In the test  $L_{1,\text{max}} = L_{\text{CCA\_DL}}$  which is defined in clause A.3.26.2.1.

$L_2$  is the consecutive number of SSB to PRACH occasion association periods during which no PRACH occasion is available for PRACH transmission due to UL CCA failures.  $L_2 = 0$  in the test.

The total delay,  $T_{\text{connection\_release\_redirect\_NR\_CCA}}$ , shall be less than  $1410 + \text{MAX}(680, (L_1+11) \times 20)$  ms.

## A.11.3 Timing

### A.11.3.1 UE transmit timing

#### A.11.3.1.1 UE Transmit Timing Test with PCell under DL CCA

##### A.11.3.1.1.1 Test Purpose and environment

The purpose of this test is to verify that the UE can follow frame timing change of the connected gNodeB when PCell is subject to DL CCA and that the UE initial transmit timing accuracy, maximum amount of timing change in one adjustment, minimum and maximum adjustment rate are within the specified limits. This test will verify the requirements in clause 7.1.2.

Supported test configurations are shown in Table 11.3.1.1.1-1

**Table A.11.3.1.1.1-1: Supported test configuration for UE transmit timing test**

Configuration	Description
1	NR TDD, SSB SCS 30 kHz, data SCS 30 kHz, BW 40 MHz

For this test a single NR cell is used. Table A.11.3.1.1.1-2 defines the parameters to be configured and strength of the transmitted signals. The transmit timing is verified by the UE transmitting SRS using the configuration defined in Table A.11.3.1.1.1-3.

**Table A.11.3.1.1.1-2: Cell Specific Test Parameters for UE transmit timing test**

Parameter		Unit	Configuration	Test1	Test2
SSB ARFCN			1	1	1
TDD configuration			1	TDDConf.1.1 CCA	
BW <sub>channel</sub>		MHz	1	40: N <sub>RB,c</sub> = 106	
Initial BWP Configuration			1	DLBWP.0.1 ULBWP.0.1	
Dedicated BWP Configuration			1	DLBWP.1.1 ULBWP.1.1	
DRX Cycle		ms	1	N/A	DRX.8 <sup>Note5</sup>
DL CCA model			1	As specified in clause A.3.26.2.1	
UL CCA model			1	As specified in clause A.3.26.2.2	
PDSCH Reference measurement channel			1	SR.1.1 CCA	
RMSI CORESET Reference Channel			1	CR.1.1 CCA	
Dedicated CORESET Reference Channel			1	CCR.1.1 CCA	
OCNG Patterns			1	OP.1	
SSB configuration	Semi- static channel acces		1	SSB.1 CCA	
	Dynamic channel acces		1	SSB.2 CCA	
SMTTC Configuration			1	SMTTC.1 FR1	
TRS configuration			1	TRS.1.2 TDD	
DL CCA probability for semi-static channel access ( $P_{CCA\_DL}$ )			1	0.9375	0.9375
DL CCA model probability for dynamic static channel access ( $P_{CCA\_DL\_1}$ )			1	0.75	0.75
DL CCA model probability for dynamic static channel access ( $P_{CCA\_DL\_2}$ )			1	0.75	0.75
UL CCA probability ( $P_{CCA\_UL}$ )			1	1	1
EPRE ratio of PSS to SSS		dB	1	0	0
EPRE ratio of PBCH DMRS to SSS					
EPRE ratio of PBCH to PBCH DMRS					
EPRE ratio of PDCCH DMRS to SSS					
EPRE ratio of PDCCH to PDCCH DMRS					
EPRE ratio of PDSCH DMRS to SSS					
EPRE ratio of PDSCH to PDSCH					



EPRE ratio of OCNG DMRS to SSS (Note 1)				
EPRE ratio of OCNG to OCNG DMRS (Note 1)				
$N_{oc}$ <sup>Note2</sup>	dBm/30 KHz	1	-95	-95
$\hat{E}_s / I_{ot}$		1	3	3
$\hat{E}_s / N_{oc}$		1	3	3
SS-RSRP <sup>Note3</sup>	dBm/30 kHz	1	-92	-92
$I_o$ <sup>Note3</sup>	dBm/38.1MHz	1	-59.2	-59.2
Propagation condition		1	AWGN	
SRS Config		1	SRSCConf.1 <sup>Note6</sup>	SRSCConf.2 <sup>Note6</sup>
<p>Note 1: OCNG shall be used such that both cells are fully allocated and a constant total transmitted power spectral density is achieved for all OFDM symbols.</p> <p>Note 2: Interference from other cells and noise sources not specified in the test is assumed to be constant over subcarriers and time and shall be modelled as AWGN of appropriate power for <math>N_{oc}</math> to be fulfilled.</p> <p>Note 3: SS-RSRP and <math>I_o</math> levels have been derived from other parameters for information purposes. They are not settable parameters themselves.</p> <p>Note 4: SS-RSRP minimum requirements are specified assuming independent interference and noise at each receiver antenna port.</p> <p>Note 5: DRX related parameters are given in Table A.3.3.8-1</p> <p>Note 6: SRS configs are given in Table A.11.3.1.1.1-3</p> <p>Note 7: Parameters <math>P_{CCA\_DL}</math>, <math>P_{CCA\_DL\_1}</math>, <math>P_{CCA\_DL\_2}</math> and <math>P_{CCA\_UL}</math> are defined in clause A.3.26.2.</p> <p>Note 8: For UE supporting both semi-static and dynamic channel access, the UE must be tested under both dynamic and semi-static channel occupancy configurations.</p>				

**Table A.11.3.1.1.1-3: SRS Configuration for UE transmit timing test**

	Field	SRSCConf.1	SRSCConf.2	Comments
SRS-ResourceSet	srs-ResourceSetId	0	0	
	srs-ResourceSetList	0	0	
	resourceType	Periodic	Periodic	
	Usage	Codebook	Codebook	
SRS-Resource	SRS-ResourceId	0	0	
	nrofSRS-Ports	Port1	Port1	
	transmissionComb	n2	n2	
	combOffset-n2	0	0	
	cyclicShift-n2	0	0	
	resourceMapping startPosition	0	0	
	resourceMapping nrofSymbols	n1	n1	
	resourceMapping repetitionFactor	n1	n1	
	freqDomainPosition	0	0	
	freqDomainShift	0	0	
	freqHopping c-SRS	14 for test configuration 1,2 25 for test configuration 3	25	Matches $N_{RB,c}$
	freqHopping b-SRS	0	0	
	freqHopping b-hop	0	0	
	groupOrSequenceHopping	Neither	Neither	
	resourceType	Periodic	Periodic	
periodicityAndOffset-p	sl1, 0	sl640, 0	Offset to align with DRX periodicity	
sequenceId	0	0	Any 10 bit number	

**A.11.3.1.1.2 Test requirements**

The test sequence shall be carried out in RRC\_CONNECTED for every test case.

Following will be the test sequence for this test

- 1) Setup NR PCell according to parameters given in Table A.11.3.1.1.1-1.
- 2) After connection set up with the cell, the test equipment will verify that the timing of the NR cell is within  $(N_{TA} + N_{TA\_offset}) \times T_c \pm T_e$  of the first detected path of DL SSB.
  - a. The  $N_{TA}$  offset value (in  $T_c$  units) is 25600
  - b. The  $T_e$  values depend on the DL and UL SCS for which the test is being run and are given in Table 7.1.2-1
- 3) The test system shall adjust the timing of the DL path by values given in Table A.11.3.1.1.2-1

**Table A.11.3.1.1.2-1: Adjustment Value for DL Timing**

SCS of SSB signals (KHz)	Adjustment Value	
	Test1	Test2
30	+32*64T <sub>c</sub>	+16*64T <sub>c</sub>

- 4) The test system shall verify that the adjustment step size and the adjustment rate shall be according to requirements specified in clause 7.1.2 Table 7.1.2.1-1 until the UE transmit timing offset is within  $(N_{TA} + N_{TA\_offset}) \times T_c \pm T_e$  respective to the first detected path (in time) of DL SSB. Skip this step for test 2 with DRX configured.
- 5) The test system shall verify that the UE transmit timing offset stays within  $(N_{TA} + N_{TA\_offset}) \times T_c \pm T_e$  of the first detected path of DL SSB. For Test 2 the UE transmit timing offset shall be verified for the first transmission in the DRX cycle immediately after DL timing adjustment

## A.11.3.2 UE timing advance

### A.11.3.2.1 UE Timing Advance Adjustment Accuracy with PCell under DL CCA

#### A.11.3.2.1.1 Test Purpose and Environment

The purpose of the test is to verify UE Timing Advance adjustment delay and accuracy requirement defined in clause 7.3.

#### A.11.3.2.1.2 Test Parameters

Supported test configurations are shown in table A.11.3.2.1.2-1. Both timing advance adjustment delay and accuracy are tested by using the parameters in table A.11.3.2.1.2-2, A.11.3.2.1.2-3 and A.11.3.2.1.2-4.

In all test cases, single cell is used. Each test consists of two successive time periods, with time duration of T1 and T2 respectively. In each time period, timing advance commands are sent to the UE and Sounding Reference Signals (SRS), as specified in table A.11.3.2.1.2-3, are sent from the UE and received by the test equipment. By measuring the reception of the SRS, the transmit timing, and hence the timing advance adjustment accuracy, can be measured.

During time period T1, the test equipment shall send one message with a Timing Advance Command MAC Control Element, as specified in Clause 6.1.3.4 in TS 38.321 [7]. The Timing Advance Command value shall be set to 31, which according to Clause 4.2 in TS 38.213 [3] results in zero adjustment of the Timing Advance. In this way, a reference value for the timing advance used by the UE is established.

During time period T2, the test equipment shall send a sequence of messages with Timing Advance Command MAC Control Elements, with Timing Advance Command value specified in table A.11.3.2.1.2-2. This value shall result in changes of the timing advance used by the UE, and the accuracy of the change shall then be measured, using the SRS sent from the UE.

As specified in Clause 7.3.2.1, the UE adjusts its uplink timing at slot n+k for a timing advance command received in slot n. This delay must be taken into account when measuring the timing advance adjustment accuracy, via the SRS sent from the UE.

The UE Time Alignment Timer, described in Clause 5.2 in TS 38.321 [7], shall be configured so that it does not expire in the duration of the test.

**Table A.11.3.2.1.2-1: Supported test configuration for timing advance test**

Config	Description
1	NR 30 kHz SSB SCS, 40 MHz bandwidth, TDD duplex mode
Note: The UE supporting SA operation only on NR band(s) with shared spectrum access is required to be tested	

**Table A.11.3.2.1.2-2: General test parameters for timing advance test**

Parameter	Unit	Value	Comment
RF channel number		1	
Initial DL BWP		DLBWP.0.1	As specified in Table A.3.9.2.1-1
Dedicated DL BWP		DLBWP.1.1	As specified in Table A.3.9.2.2-1
Initial UL BWP		ULBWP.0.1	As specified in Table A.3.9.3.1-1
Dedicated UL BWP		ULBWP.1.1	As specified in Table A.3.9.3.2-1
Timing Advance Command ( $T_A$ ) value during T1		31	$N_{TA\_new} = N_{TA\_old}$ for the purpose of establishing a reference value from which the timing advance adjustment accuracy can be measured during T2
Timing Advance Command ( $T_A$ ) value during T2		39	For 30 kHz SCS $N_{TA\_new} = N_{TA\_old} + 4096 * T_c$ (based on equation in clause 4.2 of TS 38.213 [3])
T1	s	5	
T2	s	5	

**Table A.11.3.2.1.2-3: Cell specific test parameters for timing advance test**

Parameter		Unit	Test1	
			T1	T2
TDD configuration	Config 1		TDDConf.1.1 CCA	
$BW_{channel}$	Config 1	MHz	40: $N_{RB,c} = 106$	
BWP BW	Config 1	MHz	40: $N_{RB,c} = 106$	
DRX Cycle	Config 1	ms	Not Applicable	
DL CCA model	Config 1		As specified in clause A.3.26.2.1	
UL CCA model	Config 1		As specified in clause A.3.26.2.2	
PDSCH Reference measurement channel	Config 1		SR.1.1 CCA	
CORESET Reference Channel	Config 1		CR.1.1 CCA	
TRS configuration	Config 1		TRS.1.2 TDD	
OCNG Patterns	Config 1		OCNG pattern 1	
SMTC configuration	Config 1		SMTC.1 FR1	
SSB configuration	Semi-static channel access	Config 1	SSB.1 CCA	
	Dynamic channel access	Config 1	SSB.2 CCA	
DL CCA probability for semi-static channel access ( $P_{CCA\_DL}$ )	Config 1		1	
DL CCA model probability for dynamic static channel access ( $P_{CCA\_DL\_1}$ )	Config 1		1	
DL CCA model probability for dynamic static channel access ( $P_{CCA\_DL\_2}$ )	Config 1		1	

UL CCA probability $P_{CCA}$	Config 1		1
EPRE ratio of PSS to SSS		dB	0
EPRE ratio of PBCH DMRS to SSS			
EPRE ratio of PBCH to PBCH DMRS			
EPRE ratio of PDCCH DMRS to SSS			
EPRE ratio of PDCCH to PDCCH DMRS			
EPRE ratio of PDSCH DMRS to SSS			
EPRE ratio of PDSCH to PDSCH			
EPRE ratio of OCNG DMRS to SSS(Note 1)			
EPRE ratio of OCNG to OCNG DMRS (Note 1)			
$N_{oc}$ <sup>Note2</sup>	Config 1		
$\hat{E}_s / I_{ot}$		dB	3
$\hat{E}_s / N_{oc}$		dB	3
$I_o$ <sup>Note3</sup>	Config 1	dBm/38.16MHz	-62.58
Propagation condition		-	AWGN
<p>Note 1: OCNG shall be used such that both cells are fully allocated and a constant total transmitted power spectral density is achieved for all OFDM symbols.</p> <p>Note 2: Interference from other cells and noise sources not specified in the test is assumed to be constant over subcarriers and time and shall be modelled as AWGN of appropriate power for <math>N_{oc}</math> to be fulfilled.</p> <p>Note 3: <math>I_o</math> levels have been derived from other parameters for information purposes. They are not settable parameters themselves.</p> <p>Note 4: Parameters <math>P_{CCA\_DL}</math>, <math>P_{CCA\_DL\_1}</math>, <math>P_{CCA\_DL\_2}</math> and <math>P_{CCA\_UL}</math> are defined in clause A.3.26.2.</p> <p>Note 5: For UE supporting both semi-static and dynamic channel access, the UE must be tested under both dynamic and semi-static channel occupancy configurations.</p>			

**Table A.11.3.2.1.2-4: Sounding Reference Symbol Configuration for Timing Advance Accuracy Test**

Field	Value	Comment
c-SRS	24	Frequency hopping is disabled
b-SRS	0	
b-hop	0	
freqDomainPosition	0	Frequency domain position of SRS
freqDomainShift	0	
groupOrSequenceHopping	neither	No group or sequence hopping
SRS-PeriodicityAndOffset	sl5=4 for SCS 30kHz	Once every 5 slots
pathlossReferenceRS	ssb-Index=0	SSB #0 is used for SRS path loss estimation
usage	Codebook	Codebook based UL transmission
startPosition	0	resourceMapping setting: SRS on last symbol of slot, and 1 symbols for SRS without repetition.
nrofSymbols	n1	
repetitionFactor	n1	
combOffset-n2	0	transmissionComb setting
cyclicShift-n2	0	
nrofSRS-Ports	port1	Number of antenna ports used for SRS transmission
Note: For further information see clause 6.3.2 in TS 38.331 [2].		

### A.11.3.2.1.3 Test Requirements

The UE shall apply the signalled Timing Advance value to the transmission timing at the designated activation time i.e.  $k+1$  slots after the reception of the timing advance command, where  $k=5$ .

The Timing Advance adjustment accuracy shall be within the limits specified in clause 7.3.2.2.

The rate of correct Timing Advance adjustments observed during repeated tests shall be at least 90%.

## A.11.4 Signalling characteristics

### A.11.4.1 Radio link monitoring

#### A.11.4.1.1 Introduction

In the test cases specified in clause A.11.4.1, any uplink signal transmitted by the UE is used for detecting the in-/out-of-sync state of the UE. In terms of measurement, the uplink signal is verified based on the UE output power:

- UE output power higher than Transmit OFF power -50 dBm (as defined in TS 38.101-1 [18]) means uplink signal
- UE output power equal to or less than Transmit OFF power -50 dBm (as defined in TS 38.101-1 [18]) means no uplink signal.

For intra-band contiguous carrier aggregation, transmit OFF power is measured as the mean power per component carrier.

For UE with multiple transmit antennas, transmit OFF power is measured as the mean power at each transmit connector.

#### A.11.4.1.2 Radio link monitoring out-of-sync test for PCell configured with SSB-based RLM RS in non-DRX mode

##### A.11.4.1.2.1 Test purpose and environment

The purpose of this test is to verify that the UE properly detects the out-of-sync and in-sync for the purpose of monitoring downlink radio link quality of the PCell. This test will partly verify the FR1 PCell radio link monitoring requirements in clause 8.1A.

In the test, UE is configured to perform RLM based on SSB, with *detectionResource* included in *RadioLinkMonitoringRS* set to SSB#0 and SSB#1, and *purpose* set to 'rlf'. Supported test configurations are shown in table A.11.4.1.2.1-1. The test parameters are given in Tables A.11.4.1.2.1-2, A.11.4.1.2.1-3, and A.11.4.1.2.1-4 below. There is one cell (Cell 1), which is the active NR cell in FR1, in the test. Cell 1 operates on a carrier frequency with CCA and transmits SSBs in DBT windows according to DL CCA model.

The test consists of three successive time periods, with time duration of T1, T2 and T3, respectively. Figure A.11.4.1.2.1-1 shows the variation of the downlink SNR in the active cell to emulate out-of-sync and in-sync states. Prior to the start of the time duration T1, the UE shall be fully synchronized to Cell 1. The UE shall be configured for periodic CSI reporting with a reporting periodicity of 5 ms. The UE transmits according to UL CCA model. The UE is configured to perform inter-frequency measurements using Gap Pattern ID #0 (40 ms) in the test.

**Table A.11.4.1.2.1-1: Supported test configurations.**

Configuration	Description
1	TDD, SSB SCS 30 kHz, data SCS 30 kHz, bandwidth 40 MHz

**Table A.11.4.1.2.1-2: General test parameters for PCell out-of-sync testing in non-DRX mode.**

Parameter		Unit	Value
			Test 1
Active PCell			Cell 1
RF Channel Number			1
DL CCA model			As specified in clause A.3.26.2.1
UL CCA model			As specified in clause A.3.26.2.2
Duplex mode	Config 1		TDD
BW <sub>channel</sub>	Config 1	MHz	40: N <sub>RB,c</sub> = 106
DL initial BWP configuration	Config 1		DLBWP.0.1
DL dedicated BWP configuration	Config 1		DLBWP.1.1
UL initial BWP configuration	Config 1		ULBWP.0.1

UL dedicated BWP configuration	Config 1		ULBWP.1.1
TDD configuration	Config 1		TDDConf.1.1 CCA
CORESET Reference Channel	Config 1		CR.1.1 CCA
SSB configuration for semi-static channel access <sup>Note 3, 5</sup>	Config 1		SSB.1 CCA
SSB configuration for dynamic channel access <sup>Note 4, 5</sup>	Config 1		SSB.2 CCA
DBT window configuration	Config 1		DBT.1
PDSCH/PDCCH subcarrier spacing	Config 1		30 kHz
PRACH Configuration	Config 1		FR1 PRACH configuration 1 under CCA
SSB index assigned as RLM RS			0
OCNG parameters			OP.1
CP length			Normal
Correlation Matrix and Antenna Configuration			2x2 Low
Out of sync transmission parameters	DCI format		1-0
	Number of Control OFDM symbols		2
	Aggregation level	CCE	8
	Ratio of hypothetical PDCCH RE energy to average SSS RE energy	dB	4
	Ratio of hypothetical PDCCH DMRS energy to average SSS RE energy	dB	4
	DMRS precoder granularity		REG bundle size
	REG bundle size		6
DRX			OFF
Gap pattern ID			gp0
Layer 3 filtering			Enabled
T310 timer		ms	0
T311 timer		ms	1000
N310			1
N311			1
CSI-RS configuration for CSI reporting	Config 1		CSI-RS.2.1 TDD
CSI-RS for tracking	Config 1		TRS.1.2 TDD
T1		s	0.2
T2		s	1.04
T3		s	1.04
D1		s	1
<p>NOTE 1: All configurations are assigned to the UE prior to the start of time period T1.</p> <p>NOTE 2: UE-specific PDCCH is not transmitted after T1 starts.</p> <p>Note 4: For UE supporting semi-static channel access and network configuring semi-static channel occupancy.</p> <p>Note 5: For UE supporting dynamic channel access and network configuring dynamic channel occupancy.</p> <p>Note 6: For a UE supporting both semi-static and dynamic channel access, the UE can be tested under dynamic channel occupancy only.</p>			

**Table A.11.4.1.2.1-3: Cell-specific test parameters for PCell out-of-sync testing in non-DRX mode.**

Parameter	Unit	Test 1		
		T1	T2	T3
Note 6,8		P <sub>CCA_DL</sub> =0.9375		

DL CCA probability $P_{CCA\_DL}$	Note 7,8		$P_{CCA\_DL\_1}=0.75$ $P_{CCA\_DL\_2}=0.75$					
UL CCA probability $P_{CCA\_UL}$			1					
EPRE ratio of PDCCH DMRS to SSS		dB	4					
EPRE ratio of PDCCH to PDCCH DMRS		dB	0					
EPRE ratio of PBCH DMRS to SSS		dB	0					
EPRE ratio of PBCH to PBCH DMRS		dB						
EPRE ratio of PSS to SSS		dB						
EPRE ratio of PDSCH DMRS to SSS		dB						
EPRE ratio of PDSCH to PDSCH DMRS		dB						
EPRE ratio of OCNG DMRS to SSS		dB						
EPRE ratio of OCNG to OCNG DMRS		dB						
SNR <sup>Note 3,4</sup> on RLM-RS	Config 1	dB	1	-7	-15			
SNR on other channels and signals	Config 1	dB	1					
$N_{oc}$	Config 1	dBm/SCS	-95					
Propagation condition			TDL-C 300 ns 100 Hz					
<p>NOTE 1: OCNG shall be used such that the resources in Cell 1 are fully allocated and a constant total transmitted power spectral density is achieved for all OFDM symbols. For cells with CCA model, OCNG is transmitted only in slots with RMC burst transmission and is not transmitted during muted slots or during DBT windows.</p> <p>NOTE 2: The signal contains PDCCH for UEs other than the device under test as part of OCNG.</p> <p>NOTE 3: SNR levels correspond to the signal to noise ratio over the transmitted SSS REs during DBT windows.</p> <p>NOTE 4: The SNR in time periods T1, T2 and T3 is denoted as SNR1, SNR2 and SNR3, respectively, in Figure A.10.4.1.2.1-1.</p> <p>NOTE 5: The SNR values are specified for testing a UE which supports 2 RX on at least one band. For testing of a UE which supports 4 RX on all bands, the SNR during T3 is A.3.6.</p> <p>NOTE 6: For UE supporting semi-static channel access and network configuring semi-static channel occupancy.</p> <p>NOTE 7: For UE supporting dynamic channel access and network configuring dynamic channel occupancy.</p> <p>NOTE 8: For UE supporting both semi-static and dynamic channel access, the UE can be tested under dynamic channel occupancy only.</p>								

**Table A.11.4.1.2.1-4: Measurement gap configuration for PCell out-of-sync testing in non-DRX mode.**

Field	Test 1	
	Value	
<i>gapOffset</i>	0	
NOTE: Ensure that RLM RS is partially overlapped with measurement gap0		

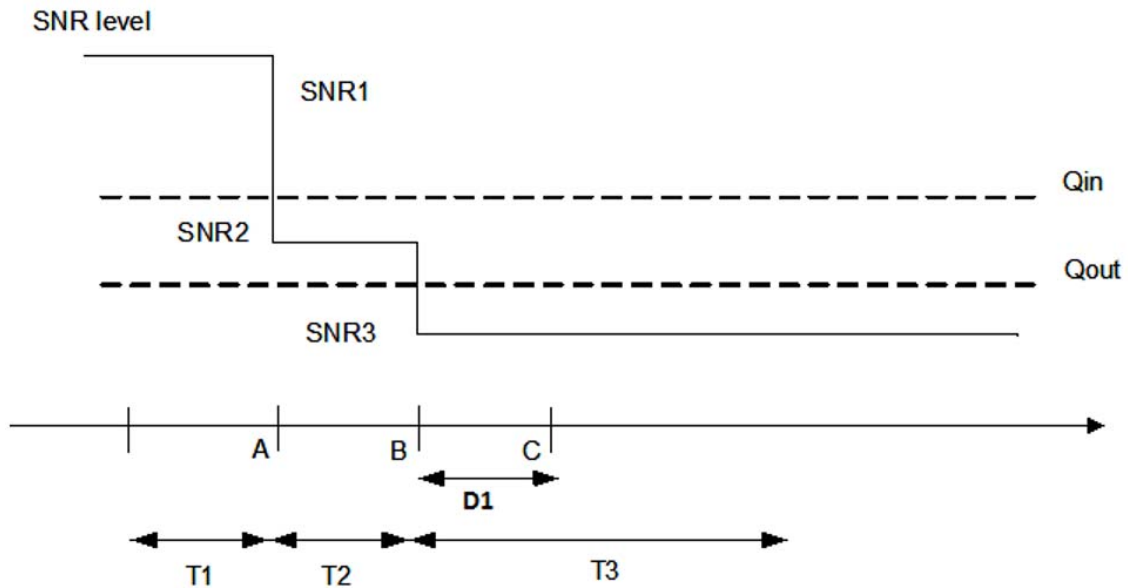

Figure A.11.4.1.2.1-1: SNR variation for out-of-sync testing.

A.11.4.1.2.2 Test requirements

The UE behaviour in each test during time durations T1, T2 and T3 shall be as follows:

- During the period from time point A to time point B the UE shall transmit uplink signal at least in all uplink slots configured for CSI transmission according to the configured periodic CSI reporting.
- The UE shall stop transmitting uplink signal no later than time point C (D1 second after the start of the time duration T3).

The rate of correct events observed during repeated tests shall be at least 90%.

A.11.4.1.3 Radio link monitoring in-sync test for PCell configured with SSB-based RLM RS in non-DRX mode

A.11.4.1.3.1 Test purpose and environment

The purpose of this test is to verify that the UE properly detects the out-of-sync and in-sync for the purpose of monitoring downlink radio link quality of the PCell. This test will partly verify the FR1 PCell radio link monitoring requirements in clause 8.1A.

In the test, UE is configured to perform RLM based on SSB, with *detectionResource* included in *RadioLinkMonitoringRS* set to SSB#0 and SSB#1, and *purpose* set to 'rlf'. Supported test configurations are shown in table A.11.4.1.3.1-1. The test parameters are given in Tables A.11.4.1.3.1-2, and A.11.4.1.3.1-3 below. There is one cell (Cell 1), which is the active NR cell in FR1, in the test. Cell 1 operates on a carrier frequency with CCA and transmits SSBs in DBT windows according to DL CCA model.

The test consists of five successive time periods, with time duration of T1, T2, T3, T4 and T5, respectively. Figure A.11.4.1.3.1-1 shows the variation of the downlink SNR in the active cell to emulate out-of-sync and in-sync states. Prior to the start of the time duration T1, the UE shall be fully synchronized to Cell 1. The UE shall be configured for periodic CSI reporting with a reporting periodicity of 5 ms. The UE transmits according to UL CCA model.

Table A.11.4.1.3.1-1: Supported test configurations.

Configuration	Description
1	NR TDD, SSB SCS 30 kHz, data SCS 30 kHz, BW 40 MHz



Table A.11.4.1.3.1-2: General test parameters for PCell in-sync testing in non-DRX mode.

Parameter		Unit	Value
			Test 1
Active PCell			Cell 1
RF Channel Number			1
DL CCA model			As specified in clause A.3.26.2.1
UL CCA model			As specified in clause A.3.26.2.2
Duplex mode	Config 1		TDD
BW <sub>channel</sub>	Config 1	MHz	40: N <sub>RB,c</sub> = 106
DL initial BWP configuration	Config 1		DLBWP.0.1
DL dedicated BWP configuration	Config 1		DLBWP.1.1
UL initial BWP configuration	Config 1		ULBWP.0.1
UL dedicated BWP configuration	Config 1		ULBWP.1.1
TDD Configuration	Config 1		TDDConf.1.1 CCA
CORESET Reference Channel	Config 1		CR.1.1 CCA
SSB configuration for semi-static channel access <sup>Note 3, 5</sup>	Config 1		SSB.1 CCA
SSB configuration for dynamic channel access <sup>Note 4,5</sup>	Config 1		SSB.2 CCA
DBT window configuration	Config 1		DBT.1
PDSCH/PDCCH subcarrier spacing	Config 1		30 kHz
PRACH Configuration	Config 1		FR1 PRACH configuration 1 under CCA
SSB index assigned as RLM RS			0
OCNG parameters			OP.1
CP length			Normal
Correlation Matrix and Antenna Configuration			2x2 Low
In sync transmission parameters	DCI format		1-0
	Number of Control OFDM symbols		2
	Aggregation level	CCE	4
	Ratio of hypothetical PDCCH RE energy to average SSS RE energy	dB	0
	Ratio of hypothetical PDCCH DMRS energy to average SSS RE energy	dB	0
	DMRS precoder granularity		REG bundle size
	REG bundle size		6
Out of sync transmission parameters	DCI format		1-0
	Number of Control OFDM symbols		2
	Aggregation level	CCE	8
	Ratio of hypothetical PDCCH RE energy to average SSS RE energy	dB	4
	Ratio of hypothetical PDCCH DMRS	dB	4

	energy to average SSS RE energy		
	DMRS precoder granularity		REG bundle size
	REG bundle size		6
DRX			OFF
Gap pattern ID			N/A
Layer 3 filtering			Enabled
T310 timer	ms		2000
T311 timer	ms		1000
N310			1
N311			1
CSI-RS configuration for CSI reporting	Config 1		CSI-RS.2.1 TDD
CSI-RS for tracking	Config 1		TRS.1.2 TDD
T1		s	0.2
T2		s	0.2
T3		s	0.52
T4		s	0.2
T5		s	2.04
D1		s	2
<p>NOTE 1: All configurations are assigned to the UE prior to the start of time period T1.</p> <p>NOTE 2: UE-specific PDCCH is not transmitted after T1 starts.</p> <p>NOTE 4: For UE supporting semi-static channel access and network configuring semi-static channel occupancy.</p> <p>NOTE 5: For UE supporting dynamic channel access and network configuring dynamic channel occupancy.</p> <p>NOTE 6: For a UE supporting both semi-static and dynamic channel access, the UE can be tested under dynamic channel occupancy only.</p>			

**Table A.11.4.1.3.1-3: Cell-specific test parameters for PCell in-sync testing in non-DRX mode.**

Parameter		Unit	Test 1				
			T1	T2	T3	T4	T5
DL CCA probability $P_{CCA\_DL}$	Note 6,8		$P_{CCA\_DL}=0.9375$				
	Note 7,8		$P_{CCA\_DL\_1}=0.75$ $P_{CCA\_DL\_2}=0.75$				
UL CCA probability $P_{CCA\_UL}$			1				
$L_{CCA\_DL}$			7				
$W_{CCA\_DL}$		ms	$T_{Evaluate\_in\_SSB\_CCA}$ NOTE 9				
EPRE ratio of PDCCH DMRS to SSS		dB	4				
EPRE ratio of PDCCH to PDCCH DMRS		dB	0				
EPRE ratio of PBCH DMRS to SSS		dB	0				
EPRE ratio of PBCH to PBCH DMRS		dB					
EPRE ratio of PSS to SSS		dB					
EPRE ratio of PDSCH DMRS to SSS		dB					
EPRE ratio of PDSCH to PDSCH DMRS		dB					
EPRE ratio of OCNG DMRS to SSS		dB					
EPRE ratio of OCNG to OCNG DMRS		dB					
SNR on RLM-RS	Config 1	dB	1	-7	-15	-4.5	1
SNR on other channels and signals	Config 1	dB	1				
$N_{oc}$	Config 1	dBm/SCS	-95				
Propagation condition			TDL-C 300ns 100Hz				

- NOTE 1: OCNG shall be used such that the resources in Cell 1 are fully allocated and a constant total transmitted power spectral density is achieved for all OFDM symbols. For cells with CCA model, OCNG is transmitted only in slots with RMC burst transmission and is not transmitted during muted slots or during DBT windows.
- NOTE 2: The signal contains PDCCH for UEs other than the device under test as part of OCNG.
- NOTE 3: SNR levels correspond to the signal to noise ratio over the transmitted SSS REs during DBT windows.
- NOTE 4: The SNR in time periods T1, T2, T3, T4 and T5 is denoted as SNR1, SNR2, SNR3, SNR4 and SNR5 respectively in Figure A.11.4.1.3.1-1.
- NOTE 5: The SNR values are specified for testing a UE which supports 2RX on at least one band. For testing of a UE which supports 4 RX on all bands, the SNR during T3 and T4 is modified as specified in clause A.3.6.
- NOTE 6: For UE supporting semi-static channel access and network configuring semi-static channel occupancy.
- NOTE 7: For UE supporting dynamic channel access and network configuring dynamic channel occupancy.
- NOTE 8: For UE supporting both semi-static and dynamic channel access, the UE can be tested under dynamic channel occupancy only.
- NOTE 9: As defined in Table 8.1A.2.2-1.

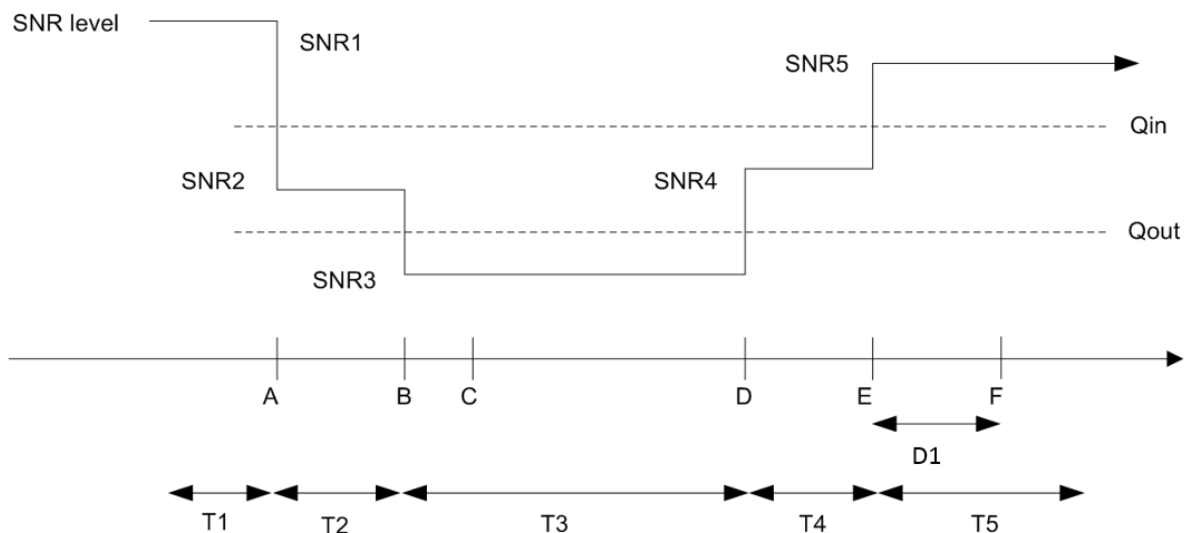

**Figure A.11.4.1.3.1-1: SNR variation for in-sync testing.**

#### A.11.4.1.3.2 Test requirements

The UE behaviour in each test during time durations T1, T2, T3, T4 and T5 shall be as follows:

- During the period from time point A to time point F (D1 second after the start of time duration T5) the UE shall transmit uplink signal at least in all uplink slots configured for CSI transmission according to the configured periodic CSI reporting.

The rate of correct events observed during repeated tests shall be at least 90%.

#### A.11.4.1.4 Void

##### A.11.4.1.4.1 Void

##### A.11.4.1.4.2 Void

A.11.4.1.5 Void

A.11.4.1.5.1 Void

A.11.4.1.5.2 Void

## A.11.4.2 Interruption

### A.11.4.2.1 NR interruptions during Scell operations with CCA on PCell and SCell

#### A.11.4.2.1.1 Test Purpose and Environment

The purpose of this test is to verify NR PCell interruptions during Scell operations on an NR SCC with CCA. This test will verify the interruption requirements for NR PCell in NR SA specified in TS 38.133 clause 8.2.2 and 8.3A. Supported test configurations are shown in table A.11.4.2.1.1-1.

The general test parameters and NR cell specific test parameters are given in Table A.11.4.2.1.1-2 and A.11.4.2.1.1-3 below. In the test there are two cells: Cell1 and Cell2. Cell1 and Cell2 are PCell and SCell. Both of cell 1 and cell 2 are subject to CCA. The test consists of five time periods, with duration of T1, T2, T3, T4 and T5. Prior to the start of the time duration T1, the UE is connected to Cell1 and Cell2. Throughout the test, the PCell are continuously scheduled in DL. The power of signals on cell 1 and 2 is not modified during the test.

Prior to T1, a connection is started with cell 1 as the PCell, and measurements of cell 2 are configured with gap pattern 0, such that cell 2 is reported. This ensures that cell 2 is known at the start of time period T1 and is not itself part of the tested requirement.

The point in time at which the RRC message implying Scell addition is received at the UE antenna connector, defines the start of time period T1. Measurement gap pattern 0 shall be stopped when the Scell is configured.

The point in time at which the MAC-CE message implying Scell activation is received at the UE antenna connector, defines the start of time period T2.

The point in time at which the MAC-CE message implying Scell deactivation is received at the UE antenna connector, defines the start of time period T3.

The point in time at which deactivation delay requirement in section 8.3A are satisfied defines the start of time period T4

The point in time at which the RRC message implying Scell release is received at the UE antenna connector, defines the start of time period T5.

**Table A.11.4.2.1.1-1: Interruptions during measurements on deactivated NR SCC supported test configurations**

Config	Description
1	With CCA: NR 30 kHz SSB SCS, 40 MHz bandwidth, TDD duplex mode With CCA: NR 30 kHz SSB SCS, 40 MHz bandwidth, TDD duplex mode

**Table A.11.4.2.1.1-2: General test parameters for Interruptions during measurements on deactivated NR SCC**

Parameter	Unit	Value	Comment
RF Channel Number		1, 2	
Active PCell		Cell1	PCell on RF channel number 1.
Configured SCell		Cell2	Deactivated SCell on NR RF channel number 2.
CP length		Normal	Applicable to Cell1, Cell2
DRX		OFF	
Measurement gap pattern Id		OFF	

SCell measurement cycle (measCycleSCell)	ms	160	
T1	s	<10	
T2	s	<10	
T3	s	<10	
T4	s	<10	
T5	s	<10	

**Table A.11.4.2.1.1-3: NR cell specific test parameters for Interruptions during measurements on deactivated NR SCC**

Parameter		Unit	Cell1					Cell2				
			T1	T2	T3	T4	T5	T1	T2	T3	T4	T5
TDD configuration	Config 1		TDDConf.1.1 CCA					TDDConf.1.1 CCA				
BW <sub>channel</sub>	Config 1	MHz	40: N <sub>RB,c</sub> = 106					40: N <sub>RB,c</sub> = 106				
DL CCA model	Config 1		As specified in clause A.3.20.2.1					As specified in clause A.3.20.2.1				
DL CCA probability for semi-static channel access <sup>Note6,8</sup>	P <sub>CCA_DL</sub>		0.9375					0.9375				
DL CCA probability for dynamic channel access <sup>Note7,8</sup>	P <sub>CCA_DL_1</sub>		0.75					0.75				
	P <sub>CCA_DL_2</sub>		0.75					0.75				
UL CCA model	Config 1		As specified in clause A.3.20.2.2					---				
UL CCA probability for semi-static channel access	P <sub>CCA_UL</sub>		0.87					---				
UL CCA probability for dynamic channel access	P <sub>CCA_UL</sub>		0.75					---				
Initial BWP Configuration	Config 1		DLBWP.0.1					DLBWP.0.1				
Dedicated DL BWP Configuration	Config 1		DLBWP.1.1					DLBWP.1.1				
Initial UL BWP Configuration	Config 1		ULBWP.0.1					ULBWP.0.1				
Dedicated UL BWP Configuration	Config 1		ULBWP.1.1					ULBWP.1.1				
PDSCH reference measurement channel	Config 1		SR.1.1 CCA					---				
RMSI CORESET parameters	Config 1		CR.1.1 CCA					CR.1.1 CCA				
PDCCH CORESET parameters	Config 1		CCR.1.1 CCA					CCR.1.1 CCA				
TRS configuration	Config 1		TRS.1.2 TDD					TRS.1.2 TDD				
OCNG Patterns			OP.1					OP.1				
SSB configuration for semi-static channel access <sup>Note6,8</sup>	Config 1		SSB.1 CCA					SSB.1 CCA				
SSB configuration for dynamic channel access <sup>Note7,8</sup>	Config 1		SSB.2 CCA					SSB.2 CCA				
SMTC Configuration	Config 1		SMTC.1					SMTC.1				
DBT window configuration	Config 1		DBT.1					DBT.1				
TCI state			TCI.State.0					TCI.State.0				
Correlation Matrix and Antenna Configuration			1x2 Low					1x2 Low				
EPRE ratio of PSS to SSS		dB	0					0				
EPRE ratio of PBCH DMRS to SSS												
EPRE ratio of PBCH to PBCH DMRS												
EPRE ratio of PDCCH DMRS to SSS												
EPRE ratio of PDCCH to PDCCH DMRS												
EPRE ratio of PDSCH DMRS to SSS												
EPRE ratio of PDSCH to PDSCH												
EPRE ratio of OCNG DMRS to SSS(Note 1)												
EPRE ratio of OCNG to OCNG DMRS (Note 1)												
N <sub>oc</sub> <sup>Note 2</sup>		dBm/15 kHz	-104					-104				
SS-RSRP <sup>Note 3</sup>		dBm/15 kHz	-87					-87				
$\hat{E}_s/I_{ot}$		dB	17					17				

$\bar{E}_s/N_{oc}$		dB	17	17
$I_o$ <sup>Note3</sup>	Config 1	dBm/38.16MHz	-52.86	-52.86
Time offset to Cell1 <sup>Note 4</sup>		ms	3	3
Time offset to Cell2 <sup>Note 5</sup>		$\mu$ s	-	3
Propagation Condition			AWGN	AWGN
Note 1:	OCNG shall be used such that resources in the cells are fully allocated and a constant total transmitted power spectral density is achieved for all OFDM symbols in slots with downlink transmission bursts. OCNG is not transmitted during muted slots or during DBT windows.			
Note 2:	Interference from other cells and noise sources not specified in the test is assumed to be constant over subcarriers and time and shall be modeled as AWGN of appropriate power for $N_{oc}$ to be fulfilled.			
Note 3:	SS-RSRP and $I_o$ levels have been derived from other parameters for information purposes. They are not settable parameters themselves.			
Note 4:	Receive time difference of signals received between subframe timing boundary of E-UTRA PCell and slot timing boundary of PSCell at the UE antenna connector including time alignment error between the two cells			
Note 5:	Receive time difference between slot boundaries of signals received from the two cells at the UE antenna connector including time alignment error between the two cells.			
Note 6:	For UE supporting semi-static channel access and network configuring semi-static channel occupancy.			
Note 7:	For UE supporting dynamic channel access and network configuring dynamic channel occupancy.			
Note 8:	For UE supporting both semi-static and dynamic channel access, the UE must be tested under both dynamic and semi-static channel occupancy configurations.			

#### A.11.4.2.1.2 Test Requirements

The UE shall meet the interruption requirements for SCell addition on the victim Pcell in clause 8.2.1 during time T1

The UE shall meet the interruption requirements for SCell activation on the victim Pcell in clause 8.2.1 during time T2. There shall be a single interruption with time window as specified in clause 8.3A.2

The UE shall meet the interruption requirements for SCell deactivation on the victim PCell in clause 8.2.1 during time T3. There shall be a single interruption with time window as specified in clause 8.3A.3

The UE shall meet the interruption requirements for deactivated SCell measurements on the victim PCell in clause 8.2.1 during time T4. The interruptions shall be within the time window as specified in clause 8.3A.3

The UE shall meet the interruption requirements for SCell release on the victim PCell in clause 8.2.1 during time T5.

The rate of correct events observed during repeated tests shall be at least 90%.

### A.11.4.3 SCell activation and deactivation delay

#### A.11.4.3.1 SCell Activation and Deactivation of known SCell with PCell and SCell under CCA, 160 ms SCell measurement cycle

##### A.11.4.3.1.1 Test Purpose and Environment

The purpose of this test is to verify that SCell activation and deactivation delays for SCell, with PCell and SCell both under CCA, are within the requirements stated in clause 8.3A, when the SCell is known by the UE at the time of activation and the configured SCell measurement cycle is 160 ms.

The supported test configurations are shown in Table A.11.4.3.1.1-1.

The test parameters are given in Table A.11.4.3.1.1-2 and cell-specific parameters in Table A.11.4.3.1.1-3 below. The test consists of three successive time periods, with duration of T1, T2 and T3, respectively. There are two carriers, each with one cell: Cell 1 (PCell) on radio channel 1 (PCC) in NR with CCA, and Cell2 (SCell) on radio channel 2 (SCC) in NR with CCA. Before the test starts the UE is connected to Cell 1, but is not aware of Cell 2, as the UE is only monitoring the PCC. The UE shall be continuously scheduled in the PCell throughout the whole test.

At the beginning of T1 the UE receives an RRC message by which the SCell (Cell 2) becomes configured on radio channel 2. The UE now starts monitoring the SCC. At the end of T1, the test equipment sends a MAC message for activation of the SCell.

The point in time at which the MAC message is received at the UE antenna connector, in a slot # denoted  $m$ , defines the start of time period T2. The UE shall be able to report a valid CSI in PCell for the activated SCell at latest in slot  $m + (T_{\text{HARQ}} + T_{\text{activation\_time\_withCCA}} + T_{\text{CSL\_Reporting\_withCCA}}) / \text{NR\_slot\_length}$ , as defined in clause 8.3A.2. The UE shall start reporting CSI in PCell in first available uplink resource for CSI reporting after at least one CSI-RS transmission occasion for channel measurement and reporting following slot  $m + \frac{T_{\text{HARQ}} + 3\text{ms}}{\text{NR slot length}}$  and shall report CQI index 0 (out-of-range) until the SCell activation has been completed. Any PCell interruption shall fall within the time window specified in clause 8.3.2.

The point in time at which the MAC message is received by at the UE antenna connector, in a slot # denoted  $n$ , defines the start of time period T3. The UE shall complete the activation at latest in slot  $n + \frac{T_{\text{HARQ}} + 3\text{ms}}{\text{NR slot length}}$ . Any PCell interruption shall fall within the time window specified in clause 8.3A.3.

The test equipment verifies that potential interruption is carried out in the correct time span by monitoring ACK/NACK sent in PCell during activation and deactivation of SCell, respectively.

The test equipment verifies the activation time by counting the slots from the time when the SCell activation command is sent until a CSI report with other than CQI index 0 is received, while taking into account CCA failures on SCC.

The test equipment verifies the deactivation time by counting the slots from the time when the SCell deactivation command is sent until CQI reporting for SCell is discontinued.

**Table A.11.4.3.1.1-1: Supported test configurations for SCell Activation and Deactivation of known SCell with PCell and SCell under CCA, 160 ms SCell measurement cycle**

Configuration	Description
1	With CCA: 30 kHz SSB SCS, 40 MHz bandwidth, TDD duplex mode; With CCA: 30 kHz SSB SCS, 40 MHz bandwidth, TDD duplex mode

**Table A.11.4.3.1.1-2: General test parameters for known SCell activation with PCell and SCell under CCA, 160 ms SCell measurement cycle**

Parameter	Unit	Value	Comment
RF Channel Number		1,2	Two radio channels (1, 2) are used for this test
Active PCell		Cell 1	Primary cell on NR RF channel number 1.
Configured deactivated SCell		Cell 2	Configured deactivated secondary cell on NR RF channel number 2
CP length		Normal	
DRX		OFF	Continuous monitoring of primary cell
CQI/PMI periodicity and offset configuration index		0	CQI reporting for SCell every second subframe
SCell measurement cycle (measCycleSCell)	ms	160	
Cell2 timing offset to cell1	μs	0	
Time alignment error between cell2 and cell1	μs	≤ TAE as specified in TS 38.104 [13] clause 6.5.3.1.	The value of time alignment error depends upon the type of carrier aggregation.
T1	s	7	During this time the PCell shall be known and the SCell configured and detected.
T2	s	1	During this time the UE shall activate the SCell.
T3	s	1	During this time the UE shall deactivate the SCell.
$T_{\text{HARQ}}$	ms	$k_1 \times \text{NR slot length}$	$k_1$ is a number of slots and is indicated by the PDSCH-to-HARQ-timing-indicator field in the DCI format, if present, or provided by <i>dl-DataToUL-ACK</i> , the value of $k$ should be the minimum value defined in TS 38.213 [3] depends on UE's capability

$T_{CSI\_Reporting}$	ms	$10 + 5 \cdot 2^{\mu_{DL}}$	The delay (in ms) including uncertainty in acquiring the first available downlink CSI reference resource, UE processing time for CSI reporting (clause 5.2.2.5 in TS 38.214) and uncertainty in acquiring the first available CSI reporting resources as specified in TS 38.331 [2] $\mu_{DL}$ is the subcarrier spacing configuration for DL
----------------------	----	-----------------------------	--

**Table A.11.4.3.1.1-3: Cell specific test parameters for known SCell activation case with PCell and SCell under CCA, 160 ms SCell measurement cycle**

Parameter		Unit	Cell 1			Cell 2		
			T1	T2	T3	T1	T2	T3
Duplex mode	Config 1		TDD			TDD		
TDD configuration	Config 1		TDDConf.1.1 CCA			TDDConf.1.1 CCA		
BW <sub>channel</sub>	Config 1	MHz	40: N <sub>RB,c</sub> = 106			40: N <sub>RB,c</sub> = 106		
DL CCA model			As specified in clause A.3.26.2.1			As specified in clause A.3.26.2.1		
UL CCA model			As specified in clause A.3.26.2.2			As specified in clause A.3.26.2.2		
DL CCA probability for semi-static channel access <sup>Note5,7</sup>	P <sub>CCA_DL</sub>		0.9375			0.9375		
DL CCA probability for dynamic channel access <sup>Note6,7</sup>	P <sub>CCA_DL_1</sub>		0.75			0.75		
	P <sub>CCA_DL_2</sub>		0.75			0.75		
UL CCA probability for semi-static channel access	P <sub>CCA_UL</sub>		0.87			0.87		
UL CCA probability for dynamic channel access	P <sub>CCA_UL</sub>		0.75			0.75		
L <sub>CCA_DL</sub> <sup>Note 8</sup>			2			2		
W <sub>CCA_DL</sub> <sup>Note 8</sup>		ms	T <sub>activation_time_withCCA</sub>			T <sub>activation_time_withCCA</sub>		
Initial downlink BWP configuration			DLBWP.0.2			DLBWP.0.2		
Initial uplink BWP configuration			ULBWP.0.1			ULBWP.0.1		
Dedicated downlink BWP configuration			DLBWP.0.2			DLBWP.0.2		
Dedicated uplink BWP configuration			ULBWP.0.1			ULBWP.0.1		
TCI state			TCI.State.0			TCI.State.0		
TRS Configuration	Config 1		TRS.1.2 TDD			TRS.1.2 TDD		
PDSCH Reference measurement channel	Config 1		SR.1.1 CCA			SR.1.1 CCA		
Dedicated CORESET parameters	Config 1		CCR.1.3 CCA			CCR.1.3 CCA		
RMSI CORESET parameters	Config 1		CR.1.1 CCA			CR.1.1 CCA		
OCNG Patterns <sup>Note1</sup>			OP.1			OP.1		
SSB Configuration for semi-static channel access <sup>Note5,7</sup>	Config 1		SSB.1 CCA			SSB.1 CCA		
SSB Configuration for dynamic channel access <sup>Note6,7</sup>	Config 1		SSB.2 CCA			SSB.2 CCA		
SMTC configuration			SMTC.1			SMTC.1		
EPRE ratio of PSS to SSS		dB	0			0		
EPRE ratio of PBCH DMRS to SSS								
EPRE ratio of PBCH to PBCH DMRS								
EPRE ratio of PDCCH DMRS to SSS								
EPRE ratio of PDCCH to PDCCH DMRS								
EPRE ratio of PDSCH DMRS to SSS								
EPRE ratio of PDSCH to PDSCH								
EPRE ratio of OCNG DMRS to SSS <sup>Note1</sup>								
EPRE ratio of OCNG to OCNG DMRS <sup>Note1</sup>								
N <sub>oc</sub> <sup>Note2</sup>	Config 1	dBm/15kHz	-104			-104		
N <sub>oc</sub> <sup>Note2</sup>	Config 1	dBm/SCS	-101			-101		



$\bar{E}_s/I_{ot}$		dB	17	17
$\bar{E}_s/N_{oc}$		dB	17	17
SS-RSRP <sup>Note3</sup>	Config 1	dBm/SCS	-84	-84
$I_o$ <sup>Note3</sup>	Config 1	dBm/ 38.16MHz	-52.87	-52.87
Propagation condition		-	AWGN	
<p>Note 1: OCNG shall be used such that resources in the cells are fully allocated and a constant total transmitted power spectral density is achieved for all OFDM symbols in slots with downlink transmission bursts. OCNG is not transmitted during muted slots or during DBT windows.</p> <p>Note 2: Interference from other cells and noise sources not specified in the test is assumed to be constant over subcarriers and time and shall be modelled as AWGN of appropriate power for <math>N_{oc}</math> to be fulfilled.</p> <p>Note 3: SS-RSRP, SCH_RP and <math>I_o</math> levels have been derived from other parameters for information purposes. They are not settable parameters themselves.</p> <p>Note 4: The uplink resources for CSI reporting are assigned to the UE prior to the start of time period T2.</p> <p>Note 5: For UE supporting semi-static channel access and network configuring semi-static channel occupancy.</p> <p>Note 6: For UE supporting dynamic channel access and network configuring dynamic channel occupancy.</p> <p>Note 7: For UE supporting both semi-static and dynamic channel access, the UE must be tested under both dynamic and semi-static channel occupancy configurations.</p> <p>Note 8: As specified in clause 8.3A for <math>L_{1,max}</math>, <math>L_{2,1,max}</math>, <math>L_{2,2,max}</math>, <math>L_{3,1,max}</math>, and <math>L_{3,2,max}</math></p>				

#### A.11.4.3.1.2 Test Requirements

During T2, starting after at least one CSI-RS transmission occasion for channel measurement and reporting from the slot specified in clause 4.3 of TS 38.213 [3] and until the UE has completed the SCell activation, the UE shall report out of range if the UE has available uplink resources to report CQI for the SCell.

During T2, the UE shall send the first valid CSI report (non-zero CQI) for the SCell in first available uplink resource for CSI reporting no later than slot  $m + (T_{HARQ} + T_{activation\_time\_withCCA} + T_{CSI\_Reporting\_withCCA}) / NR\_slot\_length$ , where  $T_{activation\_time\_withCCA} = T_{FirstSSB} + L_1 * T_{rs} + 5ms$ , as specified in clause 8.3A.2.

During T3, the UE shall stop sending CSI reports for SCell at latest in slot  $n + \frac{T_{HARQ} + 3ms}{NR\_slot\_length}$ , as defined in clause 8.3A.3.

During T2, interruption on PCell shall not occur outside slot  $m + 1 + \frac{T_{HARQ}}{NR\_slot\_length}$  to slot  $m + 1 + \frac{T_{HARQ} + 3 + T_X}{NR\_slot\_length}$  with  $T_X = T_{FirstSSB}$ .

During T3, interruption on PCell shall not occur outside slot  $n + 1 + T_{HARQ} / NR\_slot\_length$  to slot  $n + 1 + (T_{HARQ} + 3ms) / NR\_slot\_length$ .

The interruption on PCell shall not be more than specified for SA in clause 8.2.2.2.2.

The rate of correctly observed SCell activation delays and SCell deactivation delays shall for repeated tests be at least 90%.

#### A.11.4.3.2 SCell Activation and Deactivation of known SCell with PCell and SCell under CCA, 640 ms SCell measurement cycle

##### A.11.4.3.2.1 Test Purpose and Environment

The purpose of this test is to verify that SCell activation and deactivation delays for SCell, with PCell and SCell under CCA, are within the requirements stated in clause 8.3A, when the SCell is known by the UE at the time of activation and the configured SCell measurement cycle is 640 ms.

The supported test configurations are same as in Table A.11.4.3.1.1-1 above.

The test parameters are same as in Table A.11.4.3.1.1-2 above, except for parameters listed below in Table A.11.4.3.2.1-1. The cell-specific parameters are same as in Table A.11.4.3.1.1-3 above.

The test execution is the same as described in clause A.11.4.3.1 above.

**Table A.11.4.3.2.1-1: General test parameters for known SCell activation with PCell and SCell under CCA, 640 ms SCell measurement cycle**

Parameter	Unit	Value	Comment
-----------	------	-------	---------

SCell measurement cycle (measCycleSCell)	ms	640	
--	----	-----	--

#### A.11.4.3.2.2 Test Requirements

During T2, starting after at least one CSI-RS transmission occasion for channel measurement and reporting from the slot specified in clause 4.3 of TS 38.213 [3] and until the UE has completed the SCell activation, the UE shall report out of range if the UE has available uplink resources to report CQI for the SCell.

During T2, the UE shall send the first valid CSI report (non-zero CQI) for the SCell in first available uplink resource for CSI reporting no later than slot  $m + (T_{\text{HARQ}} + T_{\text{activation\_time\_withCCA}} + T_{\text{CSI\_Reporting\_withCCA}}) / \text{NR\_slot\_length}$ , where  $T_{\text{activation\_time\_withCCA}} = T_{\text{FirstSSB\_MAX}} + L_{2,1} * T_{\text{SMTc\_MAX}} + (1 + L_{2,2}) * T_{\text{rs}} + 5\text{ms}$ , as specified in clause 8.3A.2.

During T3, the UE shall stop sending CSI reports for SCell at latest in slot  $n + \frac{T_{\text{HARQ}} + 3\text{ms}}{\text{NR\_slot\_length}}$ , as defined in clause 8.3A.3.

During T2, interruption on PCell shall not occur outside slot  $m + 1 + \frac{T_{\text{HARQ}}}{\text{NR\_slot\_length}}$  to slot  $m + 1 + \frac{T_{\text{HARQ}} + 3 + T_{\text{X}}}{\text{NR\_slot\_length}}$  with  $T_{\text{X}} = T_{\text{FirstSSB\_MAX}} + L_{2,1} * T_{\text{SMTc\_MAX}}$ .

During T3, interruption on PCell shall not occur outside slot  $n + 1 + T_{\text{HARQ}} / \text{NR\_slot\_length}$  to slot  $n + 1 + (T_{\text{HARQ}} + 3\text{ms}) / \text{NR\_slot\_length}$ .

The interruption on PCell shall not be more than specified for SA in clause 8.2.2.2.2.

The rate of correctly observed SCell activation delays and SCell deactivation delays shall for repeated tests be at least 90%.

#### A.11.4.3.3 SCell Activation and Deactivation of unknown SCell with PCell and SCell under CCA

##### A.11.4.3.3.1 Test Purpose and Environment

The purpose of this test is to verify that SCell activation and deactivation delays for SCell, with PCell and SCell under CCA, are within the requirements stated in clause 8.3A, when the SCell is unknown to the UE at the time of activation.

The supported test configurations are same as in Table A.11.4.3.1.1-1 above.

The test parameters are same as in Table A.11.4.3.1.1-2 above, except for parameters listed below in Table A.11.4.3.3.1-1. The cell-specific parameters are same as in Table A.11.4.3.1.1-3 above.

The test execution is the same as described in clause A.11.4.3.1 above.

**Table A.11.4.3.3.1-1: General test parameters for unknown SCell activation with PCell and SCell under CCA**

Parameter	Unit	Value	Comment
T1	s	0.1	During this time period the PCell shall be known and the SCell configured, but not detected.

##### A.11.4.3.3.2 Test Requirements

During T2, starting after at least one CSI-RS transmission occasion for channel measurement and reporting from the slot specified in clause 4.3 of TS 38.213 [3] and until the UE has completed the SCell activation, the UE shall report out of range if the UE has available uplink resources to report CQI for the SCell.

During T2, the UE shall send the first valid CSI report (non-zero CQI) for the SCell in first available uplink resource for CSI reporting no later than slot  $m + (T_{\text{HARQ}} + T_{\text{activation\_time\_withCCA}} + T_{\text{CSI\_Reporting\_withCCA}}) / \text{NR\_slot\_length}$ , where  $T_{\text{activation\_time\_withCCA}} = T_{\text{FirstSSB\_MAX}} + (1 + L_{3,1}) * T_{\text{SMTc\_MAX}} + (2 + L_{3,2}) * T_{\text{rs}} + 5\text{ms}$ , as specified in clause 8.3A.2.

During T3, the UE shall stop sending CSI reports for SCell at latest in slot  $n + \frac{T_{\text{HARQ}} + 3\text{ms}}{\text{NR\_slot\_length}}$ , as defined in clause 8.3A.3.

During T2, interruption on PCell shall not occur outside slot  $m+1+\frac{T_{HARQ}}{NR\_slot\_length}$  to slot  $m+1+\frac{T_{HARQ}+3+T_X}{NR\_slot\_length}$  with  $T_X = T_{FirstSSB\_MAX} + L_{3,1} * T_{SMTc\_MAX}$ .

During T3, interruption on PCell shall not occur outside slot  $n+1+T_{HARQ}/NR\_slot\_length$  to slot  $n+1+(T_{HARQ}+3ms)/NR\_slot\_length$ .

The interruption on PCell shall not be more than specified for SA in clause 8.2.2.2.2.

The rate of correctly observed SCell activation delays and SCell deactivation delays shall for repeated tests be at least 90%.

## A.11.4.4 Beam failure detection and link recovery procedures

### A.11.4.4.1 Beam Failure Detection and Link Recovery Test for FR1 PCell configured with SSB-based BFD and LR in non-DRX mode

#### A.11.4.4.1.1 Test Purpose and Environment

The purpose of this test is to verify that the UE properly detects SSB-based beam failure in the set  $q_0$  configured for a serving cell and that the UE performs correct SSB-based link recovery based on beam candidate set  $q_1$ . The purpose is to test the downlink monitoring for beam failure detection within the UEs active DL BWP, during the evaluation period, and link recovery, when no DRX is used. This test will partly verify the SSB based beam failure detection and link recovery for an FR1 serving cell requirements in clause 8.5A.

The test parameters are given in Tables A.11.4.4.1.1-1, A.11.4.4.1.1-2, A.11.4.4.1.1-3 and A.11.4.4.1.1-4 below. There is one cell, cell 1 which is the active cell, in the test. Cell 1 operates on a carrier frequency with CCA and transmits SSBs in DBT windows according to DL CCA model. The test consists of five successive time periods, with time duration of T1, T2, T3, T4 and T5 respectively. Figure A.11.4.4.1.1-1 shows the variation of the downlink SNR of the SSB in set  $q_0$  in the active cell to emulate SSB based beam failure. Figure A.11.4.4.1.1-1 additionally shows the variation of the downlink L1-RSRP of the SSB in set  $q_1$  of the candidate beam used for link recovery. Prior to the start of the time duration T1, the UE shall be fully synchronized to cell 1. The UE shall be configured for periodic CSI reporting with a reporting periodicity of 2 ms. The UE transmits the reporting according to UL CCA mode. In the test, DRX configuration is not enabled. The UE is configured to perform inter-frequency measurements using GP ID #0 (40 ms) in test 1.

**Table A.11.4.4.1.1-1: Supported test configurations for FR1 PCell with CCA**

Configuration	Description
1	TDD duplex mode, 30 kHz SSB SCS, 40 MHz bandwidth

**Table A.11.4.4.1.1-2: General test parameters for FR1 PCell for SSB-based beam failure detection and link recovery testing in non-DRX mode**

Parameter	Unit	Value		Comment
		Test 1		
Active PSCell		Cell 1		
RF Channel Number		1		
DL CCA model		As specified in A.3.26.2.1		
UL CCA model		As specified in A.3.26.2.2		
Duplex mode	Config 1	TDD		
BWchannel	Config 1	MHz	40: NR <sub>B,c</sub> = 106	
DL initial BWP configuration	Config 1		DLBWP.0.1	
DL dedicated BWP configuration	Config 1		DLBWP.1.1	
UL initial BWP configuration	Config 1		ULBWP.0.1	
UL dedicated BWP configuration	Config 1		ULBWP.1.1	

TDD Configuration		Config 1		TDDConf.1.1 CCA	
CORESET Reference Channel		Config 1		CR.1.1 CCA	
SSB Configuration		Config 1		SSB.3 CCA for semi-static channel access SSB.4 CCA for dynamic channel access	
DBT Window Configuration		Config 1		DBT.1	
PDSCH/PDCCH subcarrier spacing		Config 1		30 KHz	
PRACH Configuration		Config 1		Table A.3.8A.2.2-1	
SSB Index assigned as BFD RS ( $q_0$ )				0	
SSB Index assigned as CBD RS ( $q_1$ )				1	
OCNG parameters				OP.1	
CP length				Normal	
Correlation Matrix and Antenna Configuration				2x2 Low	
Beam failure detection transmission parameters	DCI format			1-0	
	Number of Control OFDM symbols			2	
	Aggregation level	CCE		8	
	Ratio of hypothetical PDCCH RE energy to average SSS RE energy	dB		0	
	Ratio of hypothetical PDCCH DMRS energy to average SSS RE energy	dB		0	
	DMRS precoder granularity			REG bundle size	
	REG bundle size			6	
DRX				OFF	
Gap pattern ID				gp0	
gapOffset				0	
rlmInSyncOutOfSyncThreshold				absent	When the field is absent, the UE applies the value 0. (Table 8.1.1-1).
rsrp-ThresholdSSB	Config 1	dBm/SCS kHz		-95	Threshold used for $Q_{in\_LR\_SSB}$
powerControlOffsetSS				db0	Used for deriving rsrp-ThresholdCSI-RS
beamFailureInstanceMaxCount				n1	see clause 5.17 of TS 38.321 [7]

beamFailureDetectionTimer			pbfd4		see clause 5.17 of TS 38.321 [7]
CSI-RS configuration for CSI reporting	Config 1		CSI-RS.2.1 TDD		
CSI-RS for tracking	Config 1		TRS.1.2 TDD		
SSB Index assigned as RLM RS			0, 1		
T310 Timer		ms	1000		
N310			2		
T1		s	0.2		During this time the the UE shall be fully synchronized to cell 1
T2		s	0.93		
T3		s	0.52		
T4		s	0		
T5		s	0.45		
D1		s	0.41		
Note 1: All configurations are assigned to the UE prior to the start of time period T1.					
Note 2: UE-specific PDCCH is not transmitted after T1 starts.					

**Table A.11.4.4.1.1-3: Cell specific test parameters for FR1 PCell for SSB-based beam failure detection and link recovery testing in non-DRX mode**

Parameter		Unit	Test 1				
			T1	T2	T3	T4	T5
DL CCA probability $P_{CCA,DL}$	Note 10, 12		1.0	0.9375	0.9375	0.9375	0.9375
	Note 11, 12		1.0/1.0	0.75/0.75	0.75/0.75	0.75/0.75	0.75/0.75
UL CCA probability $P_{CCA,UL}$			1.0	1.0	1.0	1.0	1.0
$L_{CCA,DL}$			N/A	7			
$W_{CCA,DL}$		ms	N/A	$T_{Evaluate\_CBD\_SSB\_CCA}$ Note 13			
EPRE ratio of PDCCH DMRS to SSS		dB	0				
EPRE ratio of PDCCH to PDCCH DMRS		dB	0				
EPRE ratio of PBCH DMRS to SSS		dB	0				
EPRE ratio of PBCH to PBCH DMRS		dB	0				
EPRE ratio of PSS to SSS		dB	0				
EPRE ratio of PDSCH DMRS to SSS		dB	0				
EPRE ratio of PDSCH to PDSCH DMRS		dB	0				
EPRE ratio of OCNG DMRS to SSS		dB	0				
EPRE ratio of OCNG to OCNG DMRS		dB	0				
SNR_SSB of set $q_0$	Config 1	dB	5	-3	-12	-12	-12
SNR_SSB of set $q_1$	Config 1	dB	-10	-10	10	10	10
SSB_RP of set $q_1$	Config 1	dBm/S CS kHz	-105	-105	-85	-85	-85
$N_{oc}$	Config 1	dBm/15 KHz	-98				
Propagation condition			TDL-C 300ns 100Hz				

- Note 1: OCNG shall be used such that the resources in Cell 1 are fully allocated and a constant total transmitted power spectral density is achieved for all OFDM symbols. For cells with CCA model, OCNG is transmitted only in the slots with downlink transmission burst and is not transmitted during the muted slots or during DBT window.
- Note 2: The uplink resources for CSI reporting are assigned to the UE prior to the start of time period T1.
- Note 3: NZP CSI-RS resource set configuration for CSI reporting are assigned to the UE prior to the start of time period T1.
- Note 4: Measurement gap configuration is assigned to the UE prior to the start of time period T1.
- Note 5: The timers and layer 3 filtering related parameters are configured prior to the start of time period T1.
- Note 6: The signal contains PDCCH for UEs other than the device under test as part of OCNG.
- Note 7: SNR levels correspond to the signal to noise ratio the transmitted SSS REs during DBT window.
- Note 8: The SNR in time periods T1, T2, T3, T4 and T5 is denoted as SNR1, SNR2 and SNR3 respectively in figure A.4.5.5.1.1-1.
- Note 9: The SNR values are specified for testing a UE which supports 2RX on at least one band. For testing of a UE which supports 4RX on all bands, the SNR during T3 is modified as specified in clause A.3.6A.
- Note 10: For UE supporting semi-static channel access and network configuring semi-static channel occupancy.
- Note 11: For UE supporting dynamic channel access and network configuring dynamic channel occupancy. The first value corresponds  $P_{CCA\_DL1}$  and the second value corresponds to the  $P_{CCA\_DL2}$ .
- Note 12: For UE supporting both semi-static and dynamic channel access, the UE can be tested under dynamic channel occupancy only.
- Note 13: As defined in Table 8.5A.5.2-1.

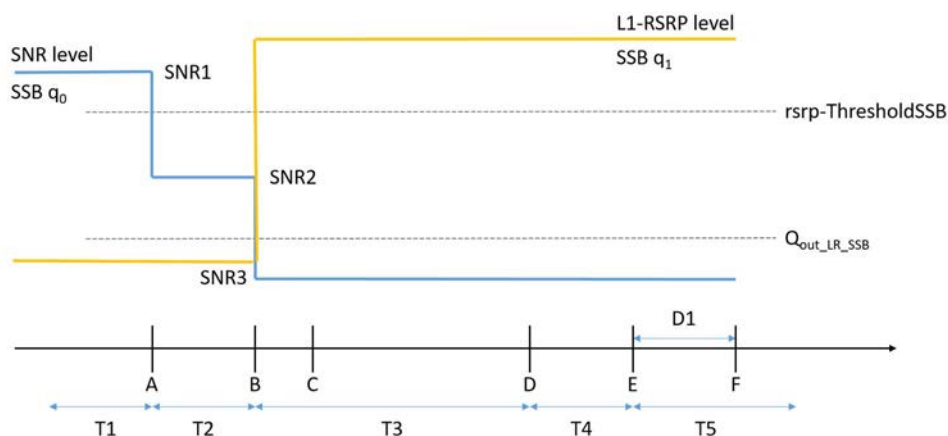

**Figure A.11.4.4.1.1-1: SNR and L1-RSRP variation SSB for SSB-based beam failure detection and link recovery testing in non-DRX mode**

#### A.11.4.4.1.2 Test Requirements

The UE behaviour during time durations T1, T2, T3, T4 and T5 shall be as follows:

During the time duration T1 and T2, the UE shall transmit uplink signal at least in all subframes configured for CSI transmission on Cell 1.

During the period from time point A to time point B the UE shall transmit uplink signal in Cell 1 in all uplink slots configured for CSI transmission according to the configured periodic CSI reporting for Cell 1.

During T3 the UE shall detect beam failure and initiate link recovery. During T4 and T5 the UE measures and evaluate beam candidate from beam candidate set  $q_1$ .

No later than time point F occurring no later than  $D1 = 410$  ms after the start of T5, the UE shall transmit preamble on a beam associated with the candidate beam set  $q_1$ . The UE shall not transmit preamble on a beam associated with the candidate beam set  $q_1$  earlier than time point B.

Test is concluded once the test equipment has received the initial preamble transmission from the UE. The rate of correct events observed during repeated tests shall be at least 90%.

## A.11.4.4.2 Beam Failure Detection and Link Recovery Test for FR1 PCell configured with SSB-based BFD and LR in DRX mode

### A.11.4.4.2.1 Test Purpose and Environment

The purpose of this test is to verify that the UE properly detects SSB-based beam failure in the set  $q_0$  configured for a serving cell and that the UE performs correct SSB-based link recovery based on beam candidate set  $q_1$ . The purpose is to test the downlink monitoring for beam failure detection within the UEs active DL BWP, during the evaluation period, and link recovery, when DRX is used. This test will partly verify the SSB based beam failure detection and link recovery for an FR1 serving cell requirements in clause 8.5A.

The test parameters are given in Tables A.11.4.4.2.1-1, A.11.4.4.2.1-2, and A.11.4.4.2.1-3 below. There is one cell, cell 1 which is the active cell, in the test. Cell 1 operates on a carrier frequency with CCA and transmits SSBs in DBT windows according to DL CCA model. The test consists of five successive time periods, with time duration of T1, T2, T3, T4 and T5 respectively. Figure A.11.4.4.2.1-1 shows the variation of the downlink SNR of the SSB in set  $q_0$  in the active cell to emulate SSB based beam failure. Figure A.11.4.4.2.1-1 additionally shows the variation of the downlink L1-RSRP of the SSB in set  $q_1$  of the candidate beam used for link recovery. Prior to the start of the time duration T1, the UE shall be fully synchronized to cell 1. The UE shall be configured for periodic CSI reporting with a reporting periodicity of 2 ms. The UE transmits the reporting according to UL CCA mode. In the test, DRX configuration is enabled in PCell and DRX inactivity timer has already been expired, i.e. UE tries to decode PDCCH and to send periodic CQI during the period when On-duration timer is running. Time alignment timers shall be set to “infinity” so that UL timing alignment is maintained during the test.

**Table A.11.4.4.2.1-1: Supported test configurations for FR1 PCell with CCA**

Configuration	Description
1	TDD duplex mode, 30 kHz SSB SCS, 40 MHz bandwidth

**Table A.11.4.4.2.1-2: General test parameters for FR1 PCell for SSB-based beam failure detection and link recovery testing in DRX mode**

Parameter	Unit	Value		Comment
		Test 1		
Active PSCell		Cell 1		
RF Channel Number		1		
DL CCA model		As specified in A.3.26.2.1		
UL CCA model		As specified in A.3.26.2.2		
Duplex mode	Config 1	TDD		
BWchannel	Config 1	MHz	40: NRB,c = 106	
DL initial BWP configuration	Config 1		DLBWP.0.1	
DL dedicated BWP configuration	Config 1		DLBWP.1.1	
UL initial BWP configuration	Config 1		ULBWP.0.1	
UL dedicated BWP configuration	Config 1		ULBWP.1.1	
TDD Configuration	Config 1		TDDConf.1.1 CCA	
CORESET Reference Channel	Config 1		CR.1.1 CCA	
SSB Configuration	Config 1		SSB.3 CCA for semi-static channel access SSB.4 CCA for dynamic channel access	
DBT Window Configuration	Config 1		DBT.1	
PDSCH/PDCCH subcarrier spacing	Config 1		30 KHz	
PRACH Configuration	Config 1		Table A.3.8A.2.2-1	
SSB Index assigned as BFD RS ( $q_0$ )			0	

SSB Index assigned as CBD RS ( $q_1$ )			1		
OCNG parameters			OP.1		
CP length			Normal		
Correlation Matrix and Antenna Configuration			2x2 Low		
Beam failure detection transmission parameters	DCI format		1-0		
	Number of Control OFDM symbols		2		
	Aggregation level	CCE	8		
	Ratio of hypothetical PDCCH RE energy to average SSS RE energy	dB	0		
	Ratio of hypothetical PDCCH DMRS energy to average SSS RE energy	dB	0		
	DMRS precoder granularity		REG bundle size		
	REG bundle size		6		
DRX			DRX.7		A.3.3.7
Gap pattern ID			N.A.		
rlmInSyncOutOfSyncThreshold			absent		When the field is absent, the UE applies the value 0. (Table 8.1.1-1).
rsrp-ThresholdSSB	Config 1	dBm/SCS kHz	-95		Threshold used for $Q_{in\_LR\_SSB}$
powerControlOffsetSS			db0		Used for deriving rsrp-ThresholdCSI-RS
beamFailureInstanceMaxCount			n1		see clause 5.17 of TS 38.321 [7]
beamFailureDetectionTimer			pbfd4		see clause 5.17 of TS 38.321 [7]
CSI-RS configuration for CSI reporting	Config 1		CSI-RS.2.1 TDD		
CSI-RS for tracking	Config 1		TRS.1.2 TDD		
SSB Index assigned as RLM RS			0, 1		
T310 Timer		ms	1000		
N310			2		
T1		s	1		During this time the the UE shall be fully synchronized to cell 1



T2	s	9.01		
T3	s	5.16		
T4	s	0		
T5	s	3.89		
D1	s	3.85		
Note 1: All configurations are assigned to the UE prior to the start of time period T1.				
Note 2: UE-specific PDCCH is not transmitted after T1 starts.				

**Table A.11.4.4.2.1-3: Cell specific test parameters for FR1 PCell for SSB-based beam failure detection and link recovery testing in DRX mode**

Parameter		Unit	Test 1				
			T1	T2	T3	T4	T5
DL CCA probability $P_{CCA}$	Note 10, 12		1.0	0.9375	0.9375	0.9375	0.9375
	Note 11, 12		1.0/1.0	0.75/0.7	0.75/0.7	0.75/0.7	0.75/0.7
UL CCA probability $P_{CCA}$			1.0	1.0	1.0	1.0	1.0
EPRE ratio of PDCCH DMRS to SSS		dB	0				
EPRE ratio of PDCCH to PDCCH DMRS		dB	0				
EPRE ratio of PBCH DMRS to SSS		dB	0				
EPRE ratio of PBCH to PBCH DMRS		dB	0				
EPRE ratio of PSS to SSS		dB	0				
EPRE ratio of PDSCH DMRS to SSS		dB	0				
EPRE ratio of PDSCH to PDSCH DMRS		dB	0				
EPRE ratio of OCNG DMRS to SSS		dB	0				
EPRE ratio of OCNG to OCNG DMRS		dB	0				
SNR_SSB of set $q_0$	Config 1	dB	5	-3	-12	-12	-12
SNR_SSB of set $q_1$	Config 1	dB	-10	-10	10	10	10
SSB_RP of set $q_1$	Config 1	dBm/S CS kHz	-105	-105	-85	-85	-85
$N_{oc}$	Config 1	dBm/15 KHz	-98				
Propagation condition			TDL-C 300ns 100Hz				
<p>Note 1: OCNG shall be used such that the resources in Cell 1 are fully allocated and a constant total transmitted power spectral density is achieved for all OFDM symbols. For cells with CCA model, OCNG is transmitted only in the slots with downlink transmission burst and is not transmitted during the muted slots or during DBT window.</p> <p>Note 2: The uplink resources for CSI reporting are assigned to the UE prior to the start of time period T1.</p> <p>Note 3: NZP CSI-RS resource set configuration for CSI reporting are assigned to the UE prior to the start of time period T1.</p> <p>Note 4: Measurement gap configuration is assigned to the UE prior to the start of time period T1.</p> <p>Note 5: The timers and layer 3 filtering related parameters are configured prior to the start of time period T1.</p> <p>Note 6: The signal contains PDCCH for UEs other than the device under test as part of OCNG.</p> <p>Note 7: SNR levels correspond to the signal to noise ratio the transmitted SSS REs during DBT window.</p> <p>Note 8: The SNR in time periods T1, T2, T3, T4 and T5 is denoted as SNR1, SNR2 and SNR3 respectively in figure A.4.5.5.1.1-1.</p> <p>Note 9: The SNR values are specified for testing a UE which supports 2RX on at least one band. For testing of a UE which supports 4RX on all bands, the SNR during T3 is modified as specified in clause A.3.6A.</p> <p>Note 10: For UE supporting semi-static channel access and network configuring semi-static channel occupancy.</p> <p>Note 11: For UE supporting dynamic channel access and network configuring dynamic channel occupancy. The first value corresponds to <math>P_{CCA\_DL1}</math> and the second value corresponds to the <math>P_{CCA\_DL2}</math>.</p> <p>Note 12: For UE supporting both semi-static and dynamic channel access, the UE can be tested under dynamic channel occupancy only.</p>							

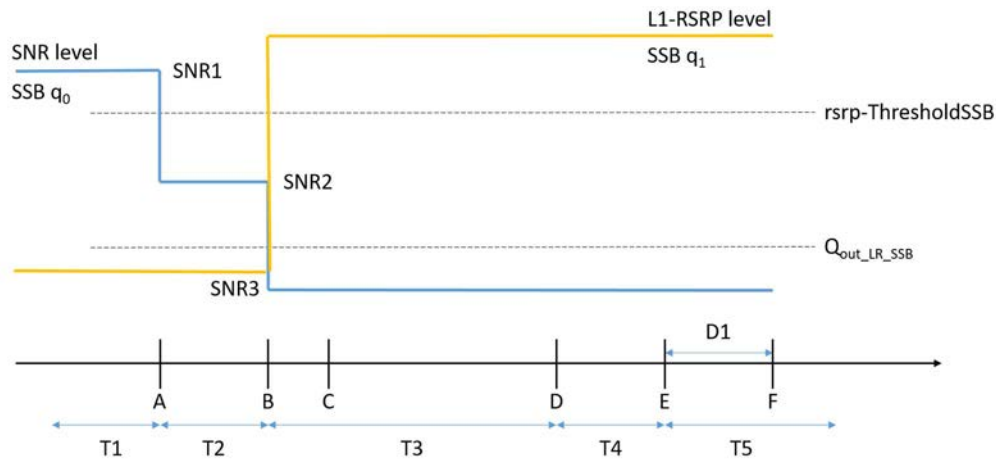

**Figure A.11.4.4.2.1-1: SNR and L1-RSRP variation for SSB-based beam failure detection and link recovery testing in non-DRX mode**

#### A.11.4.4.2.2 Test Requirements

The UE behaviour during time durations T1, T2, T3, T4 and T5 shall be as follows:

During the time duration T1 and T2, the UE shall transmit uplink signal at least in all subframes configured for CSI transmission on Cell 1.

During the period from time point A to time point B the UE shall transmit uplink signal in Cell 1 in all uplink slots configured for CSI transmission according to the configured periodic CSI reporting for Cell 1.

During T3 the UE shall detect beam failure and initiate link recovery. During T4 and T5 the UE measures and evaluate beam candidate from beam candidate set  $q_1$ .

No later than time point F occurring no later than  $D1 = 3850$  ms after the start of T5, the UE shall transmit preamble on a beam associated with the candidate beam set  $q_1$ . The UE shall not transmit preamble on a beam associated with the candidate beam set  $q_1$  earlier than time point B.

Test is concluded once the test equipment has received the initial preamble transmission from the UE. The rate of correct events observed during repeated tests shall be at least 90%.

### A.11.4.5 Active BWP switching

#### A.11.4.5.1 UL active BWP switch delay with consistent UL LBT failure on PCell subject to UL CCA

##### A.11.4.5.1.1 Test Purpose and Environment

The purpose of this test is to verify the UL BWP switch delay requirement defined in clause 8.6.4.

The supported test configurations are shown in Table A.11.4.5.1.1-1. The test scenario comprises of one cell (Cell 1), which is Pcell as given in Table A.11.4.5.1.1-2. Cell-specific parameters of the cell are specified in Table A.11.4.5.1.1-3 below. SRS configuration used in the test is specified in Table A.11.4.5.1.1-4.

Before the test starts,

- UE is connected to Cell 1 on radio channel 1.
- UE is configured with 2 different UE-specific downlink and uplink bandwidth parts: DL BWP-1, DL BWP-2, UL BWP-1 and UL BWP-2 before starting the test. DL BWP-1 and DL BWP-2 always include bandwidth of the initial DL BWP and SSB. UL BWP-1 and UL BWP-2 always include bandwidth of the SRS.
- UE is indicated in *firstActiveDownlinkBWP-Id* that the active DL BWP is DL BWP-1.
- UE is indicated in *firstActiveUplinkBWP-Id* that the active UL BWP is UL BWP-1.

- UE is configured with *LBT-FailureRecoveryConfig* parameters for Cell 1.

The cell has constant signal levels throughout the test. The test consists of 2 successive time periods, with durations of T1 and T2, respectively.

During T1,

- Time period T1 starts when the UE has received the SRS configuration for periodic SRS transmission on active UL BWP-1.
- The UE shall perform UL CCA before SRS transmission.
- The parameter UL CCA probability  $P_{CCA}$  is set to 0 during T1. This requires the test system to set energy level above the detection level during portion of the UL slot where the UE performs UL CCA. This in turn forces the UE to fail the UL CCA. The UE consistently fails UL CCA during T1 and is therefore unable to transmit SRS.

During T2,

- T2 starts when the UE detects consistent UL LBT failures i.e. when total number of UL LBT failures in cell1 on active UL BWP-1 exceeds *lbt-FailureInstanceMaxCount* during *lbt-FailureDetectionTimer*.
- The UE upon detected consistent UL LBT failure starts the LBT recovery mechanism, which requires the UE to switch to active UL BWP-2 in Cell 1 and to send PRACH in the active UL BWP-2.
- Starting from T2, the UE shall be able to send PRACH in the active UL BWP-2 within the delay specified in clause 8.6.4.

**Table A.11.4.5.1.1-1: Supported test configurations for UL BWP switch test in SA**

Config	Description
1	With CCA: NR 30 kHz SSB SCS, 40 MHz bandwidth, TDD duplex mode
Note 1:	void

**Table A.11.4.5.1.1-2: General test parameters for UL BWP switch test in SA**

Parameter	Unit	Value	Comment
NR RF Channel Number		1	One NR radio channel is used for this test
Active Cell		Cell 1	Cell1 on RF channel number 1.
CP length		Normal	
DRX		OFF	
<i>lbt-FailureDetectionTimer</i> [2]	ms	80	Parameter configured by IE: <i>LBT-FailureRecoveryConfig</i> [1]
<i>lbt-FailureInstanceMaxCount</i> [2]		4	Parameter configured by IE: <i>LBT-FailureRecoveryConfig</i> [1]
T1	s	0.1	During T1 consistent LBT failure is detected on active UL BWP-1
T2	s	0.1	During T2 UE sends PRACH on active UL BWP-2

**Table A.11.4.5.1.1-3: NR Cell specific test parameters for UL BWP switch test in SA**

Parameter	Unit	Cell 1	
		T1	T2
TDD configuration	Config 1	TDDConf.1.1 CCA	
BW <sub>channel</sub>	Config 1	40 MHz: N <sub>RB,c</sub> = 106	
DL CCA model	Config 1	As specified in clause A.3.26.2.1	
UL CCA model	Config 1	As specified in clause A.3.26.2.2	
Active BWP ID	Config 1	1, 2	
Initial DL BWP Configuration	Config 1	DLBWP.0.2 <sup>Note 4</sup>	
Active DL BWP-1 Configuration	Config 1	DLBWP.1.1 <sup>Note 4</sup>	
Active DL BWP-2 Configuration	Config 1	DLBWP.1.3 <sup>Note 4</sup>	
Initial UL BWP Configuration	Config 1	ULBWP.0.2 <sup>Note 4</sup>	
Active UL BWP-1 Configuration	Config 1	ULBWP.1.1 <sup>Note 4</sup>	
Active UL BWP-2 Configuration	Config 1	ULBWP.1.3 <sup>Note 4</sup>	
PDSCH Reference measurement channel	Config 1	SR.1.1 CCA	
RMSI CORESET parameters	Config 1	CR.1.1 CCA	

Dedicated CORESET parameters		Config 1		CCR.1.3 CCA	
OCNG Patterns		Config 1		OP.1	
SSB Configuration	Semi- static channel acces	Config 1		SSB.1 CCA	
	Dymamic channel acces	Config 1		SSB.2 CCA	
SMTC Configuration		Config 1		SMTC.1 FR1	
Correlation Matrix and Antenna Configuration		Config 1		1x2 Low	
TRS Configuration		Config 1		TRS.1.2 TDD	
DL CCA probability for semi-static channel access ( $P_{CCA\_DL}$ )		Config 1		1	1
DL CCA model probability for dynamic static channel access ( $P_{CCA\_DL\_1}$ )		Config 1		1	1
DL CCA model probability for dynamic static channel access ( $P_{CCA\_DL\_2}$ )		Config 1		1	1
UL CCA probability ( $P_{CCA\_UL}$ )		Config 1		0	1
PRACH configuration		Config 1		N/A	Configuration #1 in Table A.3.8.2.1-1
EPRE ratio of PSS to SSS			dB	0	
EPRE ratio of PBCH DMRS to SSS					
EPRE ratio of PBCH to PBCH DMRS					
EPRE ratio of PDCCH DMRS to SSS					
EPRE ratio of PDCCH to PDCCH DMRS					
EPRE ratio of PDSCH DMRS to SSS					
EPRE ratio of PDSCH to PDSCH					
EPRE ratio of OCNG DMRS to SSS(Note 1)					
EPRE ratio of OCNG to OCNG DMRS (Note 1)					
$N_{oc}$ <sup>Note 2</sup>	Config 1		dBm/SCS	-101	
SS-RSRP <sup>Note 3</sup>	Config 1		dBm/SCS	-84	
$\bar{E}_s/I_{ot}$	Config 1		dB	17	
$\bar{E}_s/N_{oc}$	Config 1		dB	17	
$I_o$ <sup>Note3</sup>	Config 1		dBm/38.16MHz	-52.86	
Propagation Condition				AWGN	
<p>Note 1: OCNG shall be used such that the resources in Cell 1 are fully allocated and a constant total transmitted power spectral density is achieved for all OFDM symbols.</p> <p>Note 2: Interference from other cells and noise sources not specified in the test is assumed to be constant over subcarriers and time and shall be modelled as AWGN of appropriate power for <math>N_{oc}</math> to be fulfilled.</p> <p>Note 3: SS-RSRP and <math>I_o</math> levels have been derived from other parameters for information purposes. They are not settable parameters themselves.</p> <p>Note 4: For unpaired spectrum, a DL BWP is linked with an UL BWP. DLBWP.0.2 is linked with ULBWP.0.2; DLBWP.1.1 is linked with ULBWP.1.1; DLBWP.1.3 is linked with ULBWP.1.3 defined in clause 12 of TS 38.213 [3].</p> <p>Note 5: Parameters <math>P_{CCA\_DL}</math>, <math>P_{CCA\_DL\_1}</math>, <math>P_{CCA\_DL\_2}</math> and <math>P_{CCA\_UL}</math> are defined in clause A.3.26.2.</p> <p>Note 6: For UE supporting both semi-static and dynamic cannel access, the UE must be tested under both dynamic and semi-static channel occupancy configurations.</p>					

**Table A.11.4.5.1.1-4: Sounding Reference Symbol Configuration for UL BWP Switch Test**

Field	Value	Comment
c-SRS	24	Frequency hopping is disabled
b-SRS	0	
b-hop	0	
freqDomainPosition	0	Frequency domain position of SRS
freqDomainShift	0	
groupOrSequenceHopping	neither	No group or sequence hopping
SRS-PeriodicityAndOffset	sl5=4 for SCS 30kHz	Once every 5 slots
pathlossReferenceRS	ssb-Index=0	SSB #0 is used for SRS path loss estimation
usage	Codebook	Codebook based UL transmission

startPosition	0	resourceMapping setting: SRS on last symbol of slot, and 1 symbols for SRS without repetition.
nrofSymbols	n1	
repetitionFactor	n1	
combOffset-n2	0	transmissionComb setting
cyclicShift-n2	0	
nrofSRS-Ports	port1	Number of antenna ports used for SRS transmission
Note:	For further information see clause 6.3.2 in TS 38.331 [2].	

#### A.11.4.5.1.2 Test Requirements

The UE capable of *bwp-SwitchingDelay type1* [2] shall start to transmit the PRACH on active UL BWP-2 of Cell 1 (PCell) less than 21.5 ms from the beginning of time period T1.

The UE capable of *bwp-SwitchingDelay type2* [2] shall start to transmit the PRACH on active UL BWP-2 of Cell 1 (PCell) less than 23 ms from the beginning of time period T1.

The rate of correct events observed during repeated tests shall be at least 90%.

NOTE: The above delay is calculated as follows:’

The active UL BWP switch delay from UL BWP-1 to UL BWP-2 can be expressed as:

$$T_{\text{BWPswitchDelay}} * T_{\text{slot}} + 1 * T_{\text{slot}} + (1 + L_3) * T_{\text{SSB,RO}} + 10 \text{ ms}$$

Where:

- $T_{\text{BWPswitchDelay}} = 1 \text{ ms}$  (2 slots) and  $2.5 \text{ ms}$  (5 slots) for *bwp-SwitchingDelay* [2] *type1* and *type2* UE capabilities according to clause 8.6.4.
- $T_{\text{slot}} =$  It is the slot length. It is  $0.5 \text{ ms}$  for  $30 \text{ kHz}$ .
- $L_3 =$  It is the number of consecutive SSB to PRACH occasion association periods during which no PRACH occasion is available for PRACH transmission due to UL CCA failure.  $L_3 = 0$  during T2 since  $P_{\text{CCA}} = 1$ .
- $T_{\text{SSB,RO}} = 10 \text{ ms}$  according to FR1 PRACH configuration 1.

This gives a total of 21.5 ms and 23 ms for *type1* and *type2* UE respectively.

#### A.11.4.5.2 DCI-based and Timer-based Active BWP Switch

##### A.11.4.5.2.1 NR FR1- NR FR1 DL active BWP switch of PCell with non-DRX in SA

###### A.11.4.5.2.1.1 Test Purpose and Environment

The purpose of this test is to verify the DL BWP switch delay requirement defined in clause 8.6, and interruption requirement on other active serving cell defined in clause 8.2.2.2.5.

The supported test configurations are shown in Table A.11.4.5.2.1.1-1 below. The test scenario comprises of one PCell (Cell 1) and one SCell (Cell 2) as given in Table A.11.4.5.2.1.1-2. NR Cell-specific parameters are specified in Table A.11.4.5.2.1.1-3 below.

PDCCHs indicating new transmissions shall be sent continuously on PCell (Cell 1) to ensure that the UE would have ACK/NACK sending except for the time duration when BWP is switching on Cell 1 and the time duration of T2.

PDCCHs indicating new transmissions shall be sent continuously on SCell (Cell 2) to ensure that the UE will have ACK/NACK sending.

Before the test starts,

- UE is connected to Cell 1 (PCell) on radio channel 1 (PCC), and Cell 2 (SCell) on radio channel 2 (SCC).

- UE is configured with 2 different UE-specific downlink bandwidth parts for PCell, BWP-1 and BWP-2, in Cell 1 before starting the test. BWP-1 and BWP-2 always include bandwidth of the initial DL BWP and SSB.
- UE is configured with 1 UE-specific downlink bandwidth parts the same as initial BWP for SCell, BWP-0 in Cell 2 before starting the test.
- UE is indicated in *firstActiveDownlinkBWP-Id* that the active DL BWP is BWP-1 in PCell.
- UE is indicated in *firstActiveDownlinkBWP-Id* that the active DL BWP is BWP-0 in SCell.
- UE is configured with a *bwp-InactivityTimer* timer value for PCell.

All cells have constant signal levels throughout the test.

The test consists of 3 successive time periods, with durations of T1, T2, and T3, respectively.

During T1,

Time period T1 starts when a DCI format 1\_1 command for PCell DL BWP switch, sent from the test equipment to the UE, is received at the UE side in PCell's slot # denoted  $i$ . The UE shall switch its bandwidth part from BWP-1 to BWP-2.

The UE shall be able to receive PDSCH no later than the first DL slot that occurs after the beginning of PCell's DL slot ( $i+T_{BWPswitchDelay}$ ) as defined in clause 8.6 and starts to report valid ACK/NACK for the PCell no later than the first UL slot that occurs after the beginning of slot ( $i+T_{BWPswitchDelay}+kI$ ). The UE shall be continuously scheduled on PCell's BWP-2 no later than the first DL slot that occurs after the beginning of slot ( $i+T_{BWPswitchDelay}$ ).

The starting time of SCell (Cell 2) interruption due to BWP switch on PCell shall occur within the BWP switch delay.

During T2, the test equipment won't transmit DCI format for PDSCH reception on PCell (Cell 1).

During T3,

The time period T3 starts from the slot # $j$ , where  $j$  is the first slot of the subframe immediately after *bwp-InactivityTimer* timer expires. The UE should switch its bandwidth part from BWP-2 back to the default bandwidth part – BWP-1.

The UE shall be able to receive PDSCH no later than the first DL slot that occurs after the beginning of PCell's slot ( $j+T_{BWPswitchDelay}$ ) as defined in clause 8.6 and starts to report valid ACK/NACK for the SCell at latest on the first UL slot that occurs after the beginning of slot ( $j+T_{BWPswitchDelay}+kI$ ). The UE shall be continuously scheduled on PCell's BWP-1 no later than the first DL slot that occurs after the beginning of slot ( $j+T_{BWPswitchDelay}$ ).

The starting time of SCell (Cell 2) interruption due to BWP switch of PCell shall occur within the BWP switch delay.

The test equipment verifies the DL BWP switch time in PCell by counting the slots from the time when the BWP switch command is received or *bwp-InactivityTimer* timer expires till an ACK/NACK is received.

The test equipment verifies that potential interruption to SCell is carried out in the correct time span by monitoring ACK/NACK sent in SCell during BWP switch of PCell, respectively.

**Table A.11.4.5.2.1.1-1: DL BWP switch supported test configurations**

Config	Description
1	With CCA: NR 30 kHz SSB SCS, 40 MHz bandwidth, TDD duplex mode
Note 1:	Void
Note 2:	The UE supporting SA operation with only NR band(s) with shared spectrum access is required to be tested.

**Table A.11.4.5.2.1.1-2: General test parameters for DL BWP switch in SA**

Parameter	Unit	Value	Comment
NR RF Channel Number		1, 2	Two NR radio channels are used in this test
Active PCell		Cell 1	PCell on RF channel number 1.
Active SCell		Cell 2	SCell on RF channel number 2.

CP length		Normal	
DRX		OFF	For both PCell and SCell
DL CCA model		As specified in clause A.3.26.2.1	
UL CCA model		As specified in clause A.3.26.2.2	
<i>bwp-InactivityTimer</i>	ms	200	
Cell-individual offset for cells on RF channel number 1	dB	0	Individual offset for cells on PCC.
Cell-individual offset for cells on RF channel number 2	dB	0	Individual offset for cells on SCC.
Cell2 timing offset to cell1	$\mu$ s	3	Time alignment error as specified in TS 38.104 [13] clause 6.5.3.1.
T1	s	0.2	
T2	s	0.2	
T3	s	0.2	

Table A.11.4.5.2.1.1-3: NR Cell specific test parameters for DL BWP switch in SA

Parameter		Unit	Cell 1	Cell2
Frequency Range			FR1	
Duplex mode	Config 1		TDD	
TDD configuration	Config 1		TDDConf.1.1 CCA	
BW <sub>channel</sub>	Config 1		40 MHz: N <sub>RB,c</sub> = 106	
Active BWP ID			1, 2	0
Initial DL BWP Configuration			DLBWP.0.2 <sup>Note4</sup>	
Initial UL BWP Configuration			ULBWP.0.2 <sup>Note4</sup>	
Active DL BWP-0 Configuration			N.A.	DLBWP.0.2 <sup>Note4</sup>
Active DL BWP-1 Configuration			DLBWP.1.1 <sup>Note4</sup>	N.A.
Active DL BWP-2 Configuration			DLBWP.1.3 <sup>Note4</sup>	N.A.
Active UL BWP-0 Configuration			N.A.	ULBWP.0.2 <sup>Note4</sup>
Active UL BWP-1 Configuration			ULBWP.1.1 <sup>Note4</sup>	N.A.
Active UL BWP-2 Configuration			ULBWP.1.3 <sup>Note4</sup>	N.A.
PDSCH Reference measurement channel	Config 1		SR.1.1 CCA	
RMSI CORESET parameters	Config 1		CR.1.1 CCA	
Dedicated CORESET parameters	Config 1		CCR.1.3 CCA	
OCNG Patterns			OP.1	
SSB Configuration	Semi- static channel acces	Config 1	SSB.1 CCA	
	Dynamic channel acces	Config 1	SSB.2 CCA	
SMTTC Configuration		Config 1	SMTTC.1	
DL CCA probability (P <sub>CCA_DL</sub> )	Config 1		1	1
UL CCA probability (P <sub>CCA_UL</sub> )	Config 1		1	1
Correlation Matrix and Antenna Configuration			1x2 Low	
EPRE ratio of PSS to SSS		dB	0	0
EPRE ratio of PBCH DMRS to SSS				
EPRE ratio of PBCH to PBCH DMRS				
EPRE ratio of PDCCH DMRS to SSS				
EPRE ratio of PDCCH to PDCCH DMRS				
EPRE ratio of PDSCH DMRS to SSS				
EPRE ratio of PDSCH to PDSCH				
EPRE ratio of OCNG DMRS to SSS(Note 1)				
EPRE ratio of OCNG to OCNG DMRS (Note 1)				
N <sub>oc</sub> <sup>Note 2</sup>	Config 1	dBm/SCS	-101	-101
SS-RSRP <sup>Note 3</sup>	Config 1	dBm/SCS	-84	-84
$\tilde{E}_s/I_{ot}$	Config 1	dB	17	17
$\tilde{E}_s/N_{oc}$	Config 1	dB	17	17
I <sub>o</sub> <sup>Note3</sup>	Config 1	dBm/38.16MHz	-52.86	-52.86
Propagation Condition			AWGN	AWGN
Note 1: OCNG shall be used such that both cells are fully allocated and a constant total transmitted power spectral density is achieved for all OFDM symbols.				
Note 2: Interference from other cells and noise sources not specified in the test is assumed to be constant over subcarriers and time and shall be modelled as AWGN of appropriate power for N <sub>oc</sub> to be fulfilled.				
Note 3: SS-RSRP and I <sub>o</sub> levels have been derived from other parameters for information purposes. They are not settable parameters themselves.				
Note 4: For unpaired spectrum, a DL BWP is linked with an UL BWP. DLBWP.0.2 is linked with ULBWP.0.2; DLBWP.1.1 is linked with ULBWP.1.1; DLBWP.1.3 is linked with ULBWP.1.3 defined in clause 12 of TS 38.213 [3].				

#### A.11.4.5.2.1.2 Test Requirements

During T1, the UE shall start to send the ACK/NACK for PCell from the first UL slot that occurs after the beginning of DL slot  $(i+T_{BWPswitchDelay}+kI)$ .

During T3, the UE shall start to send the ACK/NACK for PCell from the first UL slot that occurs after the beginning of DL slot  $(j+T_{BWPswitchDelay}+kI)$ .

Where,  $kI$  is the timing between DL data receiving and acknowledgement as specified in [7].

Depending on UE capability *bwp-SwitchingDelay* [2], UE shall finish BWP switch within the time duration  $T_{BWPswitchDelay}$  defined in Table 8.6.2-1.

All of the above test requirements shall be fulfilled in order for the observed PCell active BWP switch delay to be counted as correct.

The rate of correct events observed during repeated tests shall be at least 90%.

During T1 and T3, the start time of SCell interruption during PCell active BWP switch shall not happen outside the BWP switch delay.

The interruption of SCell shall not be longer than the interruption duration specified for active BWP switch in clause 8.2.2.2.5.

All of the above test requirements shall be fulfilled in order for the observed PCell active BWP switch interruption to be counted as correct.

The rate of correct events observed during repeated tests shall be at least 90%.

NOTE: During T1, T3 if there are no uplink resources for reporting the ACK/NACK in the first DL slot that occurs after the beginning of DL slot  $(i+T_{BWPswitchDelay}+kI)$ ,  $(j+T_{BWPswitchDelay}+kI)$ , then the UE shall use the next available uplink resource for reporting the corresponding ACK/NACK.

#### A.11.4.5.2.2 NR FR1 DL active BWP switch with non-DRX in SA

##### A.11.4.5.2.2.1 Test Purpose and Environment

The purpose of this test is to verify the DL BWP switch delay requirement defined in clause 8.6.

The supported test configurations are shown in Table A.11.4.5.2.2.1-1. The test scenario comprises of one cell (Cell 1) as given in Table A.11.4.5.2.2.1-2. Cell-specific parameters of the cell are specified in Table A.11.4.5.2.2.1-3 below.

PDCCHs indicating new transmissions shall be sent continuously on Cell 1 to ensure that the UE will have ACK/NACK sending.

Before the test starts,

- UE is connected to Cell 1 on radio channel 1.
- UE is configured with 2 different UE-specific downlink bandwidth parts, BWP-1 and BWP-2 before starting the test. BWP-1 and BWP-2 always include bandwidth of the initial DL BWP and SSB.
- UE is indicated in *firstActiveDownlinkBWP-Id* that the active DL BWP is BWP-1.
- UE is configured with a *bwp-InactivityTimer* timer value for Cell1.

The cell has constant signal levels throughout the test.

The test consists of 3 successive time periods, with durations of T1, T2, and T3, respectively.

During T1,

Time period T1 starts when a DCI format 1\_1 command for DL BWP switch, sent from the test equipment to the UE, is received at the UE side in Cell1's slot # denoted  $i$ . The UE shall switch its bandwidth part from BWP-1 to BWP-2.



The UE shall be able to receive PDSCH on the first DL slot that occurs after the beginning of Cell1's DL slot ( $i+T_{BWPswitchDelay}$ ) as defined in clause 8.6 and starts to report valid ACK/NACK for the Cell1 no later than the first UL slot that occurs after the beginning of slot ( $i+T_{BWPswitchDelay}+kI$ ). The UE shall be continuously scheduled on Cell1's BWP-2 starting from the first DL slot that occurs after the beginning of slot ( $i+T_{BWPswitchDelay}$ ).

During T2, the test equipment won't transmit DCI format for PDSCH reception on Cell1.

During T3,

The time period T3 starts from the slot # $j$ , where  $j$  is the first slot of the subframe immediately after *bwp-InactivityTimer* timer expires. The UE shall switch its bandwidth part from BWP-2 back to the default bandwidth part – BWP-1.

The UE shall be able to receive PDSCH on the first DL slot that occurs after the beginning of Cell1's slot ( $j+T_{BWPswitchDelay}$ ) as defined in clause 8.6 and starts to report valid ACK/NACK for the Cell1 at latest on the first UL slot that occurs after the beginning of slot ( $j+T_{BWPswitchDelay}+kI$ ). The UE shall be continuously scheduled on Cell1's BWP-1 starting from the first DL slot that occurs after the beginning of slot ( $j+T_{BWPswitchDelay}$ ).

The test equipment verifies the DL BWP switch time by counting the slots from the time when the BWP switch command is received or *bwp-InactivityTimer* timer expires till an ACK/NACK is received.

**Table A.11.4.5.2.2.1-1: DL BWP switch supported test configurations**

Config	Description
1	With CCA: NR 30 kHz SSB SCS, 40 MHz bandwidth, TDD duplex mode
Note 1:	The UE is only required to be tested in one of the supported test configurations.
Note 2:	A UE which fulfils the requirements in test case A.11.4.5.2.1 can skip the test cases in A.11.4.5.2.2.
Note 3:	The UE supporting SA operation with only NR band(s) with shared spectrum access is required to be tested.

**Table A.11.4.5.2.2.1-2: General test parameters for DL BWP switch in SA**

Parameter	Unit	Value	Comment
NR RF Channel Number		1	One NR radio channel is used for this test
Active Cell		Cell 1	Cell1 on RF channel number 1.
CP length		Normal	
DRX		OFF	
DL CCA model		As specified in clause A.3.26.2.1	
UL CCA model		As specified in clause A.3.26.2.2	
<i>bwp-InactivityTimer</i>	ms	200	
T1	s	0.2	
T2	s	0.2	
T3	s	0.2	

**Table A.11.4.5.2.2.1-3: NR Cell specific test parameters for DL BWP switch in SA**

Parameter		Unit	Cell 1
Frequency Range			FR1
Duplex mode		Config 1	TDD
TDD configuration		Config 1	TDDConf.1.1 CCA
$BW_{channel}$		Config 1	40 MHz: $N_{RB,c} = 106$
Active BWP ID			1, 2
Initial DL BWP Configuration		Config 1	DLBWP.0.2 <sup>Note 4</sup>
Active DL BWP-1 Configuration		Config 1	DLBWP.1.1 <sup>Note 4</sup>
Active DL BWP-2 Configuration		Config 1	DLBWP.1.3 <sup>Note 4</sup>
Initial UL BWP Configuration		Config 1	ULBWP.0.2 <sup>Note 4</sup>
Active UL BWP-1 Configuration		Config 1	ULBWP.1.1 <sup>Note 4</sup>
Active UL BWP-2 Configuration		Config 1	ULBWP.1.3 <sup>Note 4</sup>
PDSCH Reference measurement channel		Config 1	SR.1.1 CCA
RMSI CORESET parameters		Config 1	CR.1.1 CCA
Dedicated CORESET parameters		Config 1	CCR.1.3 CCA
OCNG Patterns			OP.1
SSB Configuration	Semi- static channel acces	Config 1	SSB.1 CCA
	Dymamic channel acces	Config 1	SSB.2 CCA
SMTc Configuration		Config 1	SMTc.1

Correlation Matrix and Antenna Configuration			1x2 Low
TRS Configuration	Config 1		TRS.1.2 TDD
DL CCA probability ( $P_{CCA\_DL}$ )	Config 1		1
UL CCA probability ( $P_{CCA\_UL}$ )	Config 1		1
EPRE ratio of PSS to SSS		dB	0
EPRE ratio of PBCH DMRS to SSS			
EPRE ratio of PBCH to PBCH DMRS			
EPRE ratio of PDCCH DMRS to SSS			
EPRE ratio of PDCCH to PDCCH DMRS			
EPRE ratio of PDSCH DMRS to SSS			
EPRE ratio of PDSCH to PDSCH			
EPRE ratio of OCNB DMRS to SSS (Note 1)			
EPRE ratio of OCNB to OCNB DMRS (Note 1)			
$N_{oc}$ <sup>Note 2</sup>	Config 1		
SS-RSRP <sup>Note 3</sup>	Config 1	dBm/SCS	-84
$\bar{E}_s/I_{ot}$	Config 1	dB	17
$\bar{E}_s/N_{oc}$	Config 1	dB	17
$I_o$ <sup>Note3</sup>	Config 1	dBm/38.16 MHz	-52.86
Propagation Condition			AWGN
<p>Note 1: OCNB shall be used such that the resources in Cell 1 are fully allocated and a constant total transmitted power spectral density is achieved for all OFDM symbols.</p> <p>Note 2: Interference from other cells and noise sources not specified in the test is assumed to be constant over subcarriers and time and shall be modelled as AWGN of appropriate power for <math>N_{oc}</math> to be fulfilled.</p> <p>Note 3: SS-RSRP and <math>I_o</math> levels have been derived from other parameters for information purposes. They are not settable parameters themselves.</p> <p>Note 4: For unpaired spectrum, a DL BWP is linked with an UL BWP. DLBWP.0.2 is linked with ULBWP.0.2; DLBWP.1.1 is linked with ULBWP.1.1; DLBWP.1.3 is linked with ULBWP.1.3 defined in clause 12 of TS 38.213 [3].</p>			

#### A.11.4.5.2.2 Test Requirements

During T1, the UE shall start to send the ACK/NACK for PCell from the first UL slot that occurs after the beginning of DL slot ( $i+T_{BWPswitchDelay}+kI$ ).

During T3, the UE shall start to send the ACK/NACK for PCell from the first UL slot that occurs after the beginning of DL slot ( $j+T_{BWPswitchDelay}+kI$ ).

Where,  $kI$  is the timing between DL data receiving and acknowledgement as specified in [7].

Depending on UE capability *bwp-SwitchingDelay* [2], UE shall finish BWP switch within the time duration  $T_{BWPswitchDelay}$  defined in Table 8.6.2-1.

All of the above test requirements shall be fulfilled in order for the observed Cell1 active BWP switch delay to be counted as correct.

The rate of correct events observed during repeated tests shall be at least 90%.

NOTE: During T1, T3 if there are no uplink resources for reporting the ACK/NACK in the first UL slot that occurs after beginning of DL slot ( $i+T_{BWPswitchDelay}+kI$ ), ( $j+T_{BWPswitchDelay}+kI$ ), then the UE shall use the next available uplink resource for reporting the corresponding ACK/NACK.

#### A.11.4.5.3 RRC-based Active BWP Switch

##### A.11.4.5.3.1 NR FR1 DL active BWP switch of Cell with non-DRX in SA

###### A.11.4.5.3.1.1 Test Purpose and Environment

The purpose of this test is to verify the DL BWP switch delay requirement for RRC-based BWP switch defined in clause 8.6.

The supported test configurations are shown in Table A.11.4.5.3.1.1-1. The test scenario comprises of one Cell (Cell 1) as given in Table A.11.4.5.3.1.1-2. Cell-specific parameters of Cell are specified in Table A.11.4.5.3.1.1-3 below.

PDCCHs indicating new transmissions shall be sent continuously on Cell 1 to ensure that the UE will have ACK/NACK sending.

Before the test starts,

- UE is connected to Cell 1 on radio channel 1.
- UE has bandwidth part BWP-1 in its RRC-configuration for Cell 1.
- UE is indicated in *firstActiveDownlinkBWP-Id* that the active DL BWP is BWP-1 of initial condition in Cell 1.

All cells have constant signal levels throughout the test.

The test consists of 1 time period, with duration of T1.

During T1,

Time period T1 starts when a *RRCReconfiguration* with updated bandwidth part configuration, sent from the test equipment to the UE, is completely received at the UE side in PCell’s slot # denoted *i*. The UE shall reconfigure its bandwidth part with the updated bandwidth part BWP-1 of final condition.

The UE shall be able to receive PDSCH on PCell from the first DL slot that occurs after the beginning of DL slot  $i + \frac{T_{RRCprocessingDelay} + T_{BWPswitchDelayRRC}}{NR\ Slot\ length}$  as defined in clause 8.6.3 and starts to report valid ACK/NACK for the PCell from the first UL slot that occurs after the beginning of DL slot  $i + \frac{T_{RRCprocessingDelay} + T_{BWPswitchDelayRRC}}{NR\ Slot\ length} + k1$  on BWP-1 of final condition. The UE shall be continuously scheduled on PCell’s BWP-1 of final condition starting from the first DL slot right after slot  $i + \frac{T_{RRCprocessingDelay} + T_{BWPswitchDelayRRC}}{NR\ Slot\ length}$ .

$T_{RRCprocessingDelay}$  and  $T_{BWPswitchDelayRRC}$  are defined in clause 8.6.3.

The test equipment verifies the DL BWP switch time in Cell by counting the time from the time when the RRC Reconfiguration message including updated BWP configuration is sent till the time when a valid ACK/NACK is received is received.

**Table A.11.4.5.3.1.1-1: DL BWP switch supported test configurations in SA scenario**

Config	Description
1	With CCA: NR 30 kHz SSB SCS, 40 MHz bandwidth, TDD duplex mode
Note 1:	Void
Note 2:	The UE supporting SA operation with only NR band(s) with shared spectrum access is required to be tested.

**Table A.11.4.5.3.1.1-2: General test parameters for DL BWP switch in SA scenario**

Parameter	Unit	Value	Comment
NR RF Channel Number		1	One NR radio channel is used for this test
Active Cell		Cell 1	Cell on RF channel number 1.
CP length		Normal	
DL CCA model		As specified in clause A.3.26.2.1	
UL CCA model		As specified in clause A.3.26.2.2	
DRX		OFF	
T1	s	0.2	

**Table A.11.4.5.3.1.1-3: NR Cell specific test parameters for DL BWP switch in SA scenario**

Parameter	Unit	Cell 1
Frequency Range		FR1
Duplex mode	Config 1	TDD
TDD configuration	Config 1	TDDConf.1.1 CCA
BW <sub>channel</sub>	Config 1	40 MHz: N <sub>RB,c</sub> = 106
Active BWP ID		1
Initial DL BWP Configuration	Config 1	DLBWP.0.2
Initial UL BWP Configuration	Config 1	ULBWP.0.2

Initial Condition	Active DL BWP-1 Configuration	Config 1		DLBWP.1.3
	Active UL BWP-1 Configuration	Config 1		ULBWP.1.3
Final Condition	Active DL BWP-1 Configuration	Config 1		DLBWP.1.1
	Active UL BWP-1 Configuration	Config 1		ULBWP.1.1
PDSCH Reference measurement channel		Config 1		SR.1.1 CCA
RMSI CORESET parameters		Config 1		CR.1.1 CCA
Dedicated CORESET parameters		Config 1		CCR.1.3 CCA
OCNG Patterns				OP.1
SSB Configuration	Semi-static channel acces	Config 1		SSB.1 CCA
	Dymamic channel acces	Config 1		SSB.2 CCA
SMTC Configuration				SMTC.1
TRS Configuration		Config 1		TRS.1.2 TDD
DL CCA probability ( $P_{CCA\_DL}$ )		Config 1		1
UL CCA probability ( $P_{CCA\_UL}$ )		Config 1		1
Propagation Condition				AWGN
EPRE ratio of PSS to SSS			dB	0
EPRE ratio of PBCH DMRS to SSS				
EPRE ratio of PBCH to PBCH DMRS				
EPRE ratio of PDCCH DMRS to SSS				
EPRE ratio of PDCCH to PDCCH DMRS				
EPRE ratio of PDSCH DMRS to SSS				
EPRE ratio of PDSCH to PDSCH				
EPRE ratio of OCNG DMRS to SSS (Note 1)				
EPRE ratio of OCNG to OCNG DMRS (Note 1)				
$N_{oc}$ Note 2		Config 1		
SS-RSRP Note 3		Config 1	dBm/SCS	-84
$\tilde{E}_s/I_{ot}$		Config 1	dB	17
$\tilde{E}_s/N_{oc}$		Config 1	dB	17
$I_0$ Note 3		Config 1	dBm/38.16MHz	-52.86
<p>Note 1: OCNG shall be used such that both cells are fully allocated and a constant total transmitted power spectral density is achieved for all OFDM symbols.</p> <p>Note 2: Interference from other cells and noise sources not specified in the test is assumed to be constant over subcarriers and time and shall be modelled as AWGN of appropriate power for <math>N_{oc}</math> to be fulfilled.</p> <p>Note 3: SS-RSRP and <math>I_0</math> levels have been derived from other parameters for information purposes. They are not settable parameters themselves.</p> <p>Note 4: For unpaired spectrum, a DL BWP is linked with an UL BWP. DLBWP.0.2 is linked with ULBWP.0.2; DLBWP.1.1 is linked with ULBWP.1.1; DLBWP.1.3 is linked with ULBWP.1.3 defined in clause 12 of TS 38.213 [3].</p>				

#### A.11.4.5.3.1.2 Test Requirements

During T1, the UE shall be ready for the reception of uplink grant for the Cell from the first DL slot that occurs right after the beginning of slot  $i + \frac{T_{RRCprocessingDelay} + T_{BWPswitchDelayRRC}}{NR\ Slot\ length}$  and starts to report valid ACK/NACK for PCell from the first UL slot that occurs after the beginning of DL slot  $i + \frac{T_{RRCprocessingDelay} + T_{BWPswitchDelayRRC}}{NR\ Slot\ length} + k1$ .

Where,  $k1$  is the timing between DL data receiving and acknowledgement as specified in [7].

All of the above test requirements shall be fulfilled in order for the observed Cell active BWP switch delay to be counted as correct.

The rate of correct events observed during repeated tests shall be at least 90%.

## A.11.4.6 Void

## A.11.5 Measurement procedure

### A.11.5.1 Intra-frequency measurements

#### A.11.5.1.1 Event-triggered reporting tests on PCC without gaps under non-DRX

##### A.11.5.1.1.1 Test purpose and environment

The purpose of this test is to verify that the UE makes correct reporting of an event. This test will partly verify the intra-frequency cell search requirements in clauses 9.2A.5.1 and 9.2A.5.2.

##### A.11.5.1.1.2 Test parameters

Two cells are deployed in the test, which are PCell (Cell 1) and a neighbour cell (Cell 2) on the same carrier frequency with CCA transmitting SSBs in DBT windows according to DL CCA model. The test parameters for the two cells are given in Table A.11.5.1.1.2-1 and A.11.5.1.1.2-2 below. In the measurement control information, a measurement object is configured for the frequency of the PCell, and it is indicated to the UE that event-triggered reporting with Event A3 is used. The test consists of two successive time periods, with time duration of T1 and T2, respectively. During time duration T1, the UE shall not have any timing information of Cell 2.

The same test is applicable for UE supporting any one or both semi-static channel access or dynamic channel access and for network configuring any of semi-static channel occupancy or dynamic channel occupancy.

The test is conducted for SS-RSRP, SS-RSRQ, and SS-SINR:

- In the first test (Test 1), the UE is configured with SS-RSRP as Event A3 measurement quantity.
- In the second test (Test 2), the UE is configured with SS-RSRQ as Event A3 measurement quantity.
- In the third test (Test 3), the UE is configured with SS-SINR as Event A3 measurement quantity.

**Table A.11.5.1.1.2-1: Supported test configurations**

Configuration	Description
1	30 kHz SSB SCS, 40 MHz bandwidth, TDD duplex mode

**Table A.11.5.1.1.2-2: General test parameters for intra-frequency event triggered reporting without gaps**

Parameter	Unit	Test configuration	Value	Comment
Active cell		1	Cell 1	
Neighbour cell		1	Cell 2	Cell to be identified.
RF Channel Number		1	1: Cell 1 and Cell 2	
DL CCA model		1	As specified in clause A.3.26.2.1	
UL CCA model		1	As specified in clause A.3.26.2.2	
SSB configuration	Semi-static channel access <sup>Note 1,3</sup>	1	SSB.1 CCA	
	Dynamic channel access <sup>Note 2,3</sup>	1	SSB.2 CCA	
SMTc configuration		1	SMTc.1	
A3-Offset	dB	1	-4.5	
CP length		1	Normal	
Hysteresis	dB	1	0	
Time To Trigger	s	1	0	
Filter coefficient		1	0	L3 filtering is not used
DRX		1	OFF	DRX is not used

Time offset between serving and neighbour cells		1	3 $\mu$ s	Synchronous cells
T1	s	1	5	
T2	s	1	5	
Note 1: For UE supporting semi-static channel access and network configuring semi-static channel occupancy. Note 2: For UE supporting dynamic channel access and network configuring dynamic channel occupancy. Note 3: For UE supporting both semi-static and dynamic channel access, the UE must be tested under dynamic channel access configuration.				

**Table A.11.5.1.1.2-3: Cell-specific test parameters for intra-frequency event-triggered reporting without gaps**

Parameter	Unit	Test configuration	Cell 1		Cell 2	
			T1	T2	T1	T2
TDD configuration		1	TDDConf.1.1 CCA		TDDConf.1.1 CCA	
DL CCA probability for semi-static channel access ( $P_{CCA\_DL}$ )		1	$P_{CCA\_DL}=0.9375$		$P_{CCA\_DL}=0.9375$	
DL CCA probability for for dynamic static channel access ( $P_{CCA\_DL\_1}$ )		1	$P_{CCA\_DL\_1}=0.75$		$P_{CCA\_DL\_1}=0.75$	
DL CCA probability for for dynamic static channel access ( $P_{CCA\_DL\_2}$ )		1	$P_{CCA\_DL\_2}=0.75$		$P_{CCA\_DL\_2}=0.75$	
UL CCA probability $P_{CCA\_UL}$		1	$P_{CCA\_UL}=1$		$P_{CCA\_UL}=1$	
$L_{CCA\_DL}$		1	7		7	
$W_{CCA\_DL}$	ms	1	600		600	
PDSCH RMC configuration		1	SR.1.1 CCA		N/A	
RMSI CORESET RMC configuration		1	CR.1.1 CCA		N/A	
Dedicated CORESET RMC configuration		1	CCR.1.1 CCA		N/A	
OCNG Patterns		1, 2, 3	OP.1		OP.1	
TRS Configuration		1	TRS.1.2 TDD		N/A	
Initial BWP configuration		1	DLBWP.0.1 ULBWP.0.1		DLBWP.0.1 ULBWP.0.1	
Active DL BWP configuration		1	DLBWP.1.1		DLBWP.1.1	
Active UL BWP configuration		1	ULBWP.1.1		ULBWP.1.1	
RLM-RS		1	SSB		SSB	
$N_{oc}$ Note 2	dBm/SCS	1	[-95]			
$N_{oc}$ Note 2	dBm/15 kHz	1	[-98]			
$\hat{E}_s/I_{ot}$	dB	1	[4]	[-1.46]	-Infinity	[-1.46]
		2				
		3				
$\hat{E}_s/N_{oc}$	dB	1	[4]	[4]	-Infinity	[4]
SS-RSRP Note 3	dBm/SCS kHz	1	[-91]	[-91]	-Infinity	[-91]
$I_o$	dBm/38.16 MHz	1	[-58.50]	[-56.16]	[-58.50]	[-56.16]

Propagation Condition		1	AWGN
Note 1:	The resources for uplink transmission are assigned to the UE prior to the start of time period T2.		
Note 2:	Interference from other cells and noise sources not specified in the test is assumed to be constant over subcarriers and time and shall be modelled as AWGN of appropriate power for $N_{oc}$ to be fulfilled.		
Note 3:	SS-RSRP levels have been derived from other parameters for information purposes. They are not settable parameters themselves.		

### A.11.5.1.1.3 Test Requirements

The UE shall send one Event A3 triggered measurement report (SS-RSRP in Test 1, SS-RSRQ in Test 2, SS-SINR in Test 3), with a measurement reporting delay less than 840 ms from the beginning of time period T2.

The UE is not required to read the neighbour cell SSB index in this test.

The UE shall not send event triggered measurement reports, as long as the reporting criteria are not fulfilled.

The rate of correct events observed during repeated tests shall be at least 90%.

FFS: NOTE: The actual overall delays measured in the test may be up to  $2 \times TTI_{DCCH}$  higher than the measurement reporting delays above because of TTI insertion uncertainty of the measurement report in DCCH.

### A.11.5.1.2 Event-triggered reporting tests on PCC without gaps under DRX

#### A.11.5.1.2.1 Test purpose and environment

The purpose of this test is to verify that the UE makes correct reporting of an event. This test will partly verify the intra-frequency cell search requirements in clauses 9.2A.5.1 and 9.2A.5.2.

#### A.11.5.1.2.2 Test parameters

Two cells are deployed in the test, which are PCell (Cell 1) and a neighbour cell (Cell 2) on the same carrier frequency with CCA transmitting SSBs in DBT windows according to DL CCA model. The test parameters for the two cells are given in Table A.11.5.1.2.2-1 and A.11.5.1.2.2-2 below. In the measurement control information, a measurement object is configured for the frequency of the PCell, and it is indicated to the UE that event-triggered reporting with Event A3 is used. The test consists of two successive time periods, with time duration of T1 and T2, respectively. During time duration T1, the UE shall not have any timing information of Cell 2.

UE needs to be provided with new Timing Advance Command MAC control element at least once during each time alignment timer period to maintain uplink time alignment. Furthermore, the UE is allocated with PUSCH resource at every DRX cycle.

The same test is applicable for UE supporting any one or both semi-static channel access or dynamic channel access and for network configuring any of semi-static channel occupancy or dynamic channel occupancy.

**Table A.11.5.1.2.2-1: Supported test configurations**

Configuration	Description
1	30 kHz SSB SCS, 40 MHz bandwidth, TDD duplex mode

**Table A.11.5.1.2.2-2: General test parameters for intra-frequency event triggered reporting without gaps**

Parameter	Unit	Test configuration	Value		Comment
			Test 1	Test 2	
Active cell		1	Cell 1		
Neighbour cell		1	Cell 2		Cell to be identified.
RF Channel Number		1	1: Cell 1 and Cell 2		

DL CCA model			1	As specified in clause A.3.26.2.1	
UL CCA model			1	As specified in clause A.3.26.2.2	
SSB configuration	Semi-static channel access <sup>Note 1,3</sup>		1	SSB.1 CCA	
	Dynamic channel access <sup>Note 2,3</sup>		1	SSB.2 CCA	
SMTc configuration			1	SMTc.1	
A3-Offset	dB		1	-4.5	
CP length			1	Normal	
Hysteresis	dB		1	0	
Time To Trigger	s		1	0	
Filter coefficient			1	0	
DRX			1	DRX.1	DRX.7
Time offset between serving and neighbour cells			1	3 μs	
T1	s		1	5	
T2	s		1	5	15
<p>Note 1: For UE supporting semi-static channel access and network configuring semi-static channel occupancy.</p> <p>Note 2: For UE supporting dynamic channel access and network configuring dynamic channel occupancy.</p> <p>Note 3: For UE supporting both semi-static and dynamic channel access, the UE must be tested under dynamic channel access configuration.</p>					

**Table A.11.5.1.2.2-3: Cell-specific test parameters for intra-frequency event-triggered reporting without gaps**

Parameter	Unit	Test configuration	Cell 1		Cell 2	
			T1	T2	T1	T2
TDD configuration		1	TDDConf.1.1 CCA		TDDConf.1.1 CCA	
DL CCA probability for semi-static channel access ( $P_{CCA\_DL}$ )		1	$P_{CCA\_DL}=0.9375$		$P_{CCA\_DL}=0.9375$	
DL CCA probability for for dynamic static channel access ( $P_{CCA\_DL\_1}$ )		1	$P_{CCA\_DL\_1}=0.75$		$P_{CCA\_DL\_1}=0.75$	
DL CCA probability for for dynamic static channel access ( $P_{CCA\_DL\_2}$ )		1	$P_{CCA\_DL\_2}=0.75$		$P_{CCA\_DL\_2}=0.75$	
UL CCA probability $P_{CCA\_UL}$		1	$P_{CCA\_UL}=1$		$P_{CCA\_UL}=1$	
$L_{CCA\_DL}$		1	Test 1: $L_{CCA\_DL} = 5$ Test 2: $L_{CCA\_DL} = 3$		Test 1: $L_{CCA\_DL} = 5$ Test 2: $L_{CCA\_DL} = 3$	
$W_{CCA\_DL}$	ms	1	Test 1: $W_{CCA\_DL} = 600$ Test 2: $W_{CCA\_DL} = 5120$		Test 1: $W_{CCA\_DL} = 600$ Test 2: $W_{CCA\_DL} = 5120$	
PDSCH RMC configuration		1	SR.1.1 CCA		N/A	
RMSI CORESET RMC configuration		1	CR.1.1 CCA		N/A	



Dedicated CORESET RMC configuration		1	CCR.1.1 CCA	N/A		
OCNG Patterns		1, 2, 3	OP.1	OP.1		
TRS Configuration		1	TRS.1.2 TDD	N/A		
Initial BWP configuration		1	DLBWP.0.1 ULBWP.0.1	DLBWP.0.1 ULBWP.0.1		
Active DL BWP configuration		1	DLBWP.1.1	DLBWP.1.1		
Active UL BWP configuration		1	ULBWP.1.1	ULBWP.1.1		
RLM-RS		1	SSB	SSB		
$N_{oc}$ <sup>Note 2</sup>	dBm/SCS	1	[-95]			
$N_{oc}$ <sup>Note 2</sup>	dBm/15 kHz	1	[-98]			
$\hat{E}_s/I_{ot}$	dB	1	[4]	[-1.46]	-Infinity	[-1.46]
		2				
		3				
$\hat{E}_s/N_{oc}$	dB	1	[4]	[4]	-Infinity	[4]
SS-RSRP <sup>Note 3</sup>	dBm/SCS kHz	1	[-91]	[-91]	-Infinity	[-91]
Io	dBm/38.16 MHz	1	[-58.50]	[-56.16]	[-58.50]	[-56.16]
Propagation Condition		1	AWGN			
<p>Note 1: The resources for uplink transmission are assigned to the UE prior to the start of time period T2.</p> <p>Note 2: Interference from other cells and noise sources not specified in the test is assumed to be constant over subcarriers and time and shall be modelled as AWGN of appropriate power for <math>N_{oc}</math> to be fulfilled.</p> <p>Note 3: SS-RSRP levels have been derived from other parameters for information purposes. They are not settable parameters themselves.</p>						

### A.11.5.1.2.3 Test Requirements

In test 1, the UE shall send one Event A3 triggered measurement report with a measurement reporting delay less than 1200 ms from the beginning of time period T2.

In test 2, the UE shall send one Event A3 triggered measurement report with a measurement reporting delay less than 10240 ms from the beginning of time period T2.

The UE is not required to read the neighbour cell SSB index in this test.

The UE shall not send event triggered measurement reports, as long as the reporting criteria are not fulfilled.

The rate of correct events observed during repeated tests shall be at least 90%.

NOTE: The actual overall delays measured in the test may be up to  $2 \times TTI_{DCC}$  higher than the measurement reporting delays above because of TTI insertion uncertainty of the measurement report in DCC.

### A.11.5.1.3 Event-triggered reporting tests on PCC with per-UE gaps under non-DRX

#### A.11.5.1.3.1 Test purpose and environment

The purpose of this test is to verify that the UE makes correct reporting of an event. This test will partly verify the intra-frequency cell search requirements in clauses 9.2A.6.1 and 9.2A.6.2.

#### A.11.5.1.3.2 Test parameters

#### A.11.5.1.3.3 Test Requirements

The UE shall send one Event A3 triggered measurement report (SS-RSRP in Test 1, SS-RSRQ in Test 2, SS-SINR in Test 3), with a measurement reporting delay less than  $D1$  ms from the beginning of time period T2.

*Editor's note:  $D1=TBD$ .*

The UE is not required to read the neighbour cell SSB index in this test.

The UE shall not send event triggered measurement reports, as long as the reporting criteria are not fulfilled.

The rate of correct events observed during repeated tests shall be at least 90%.

FFS: NOTE: The actual overall delays measured in the test may be up to  $2xTTI_{DCCH}$  higher than the measurement reporting delays above because of TTI insertion uncertainty of the measurement report in DCCH.

#### A.11.5.1.4 Event-triggered reporting tests on PCC with per-UE gaps under DRX

##### A.11.5.1.4.1 Test purpose and environment

The purpose of this test is to verify that the UE makes correct reporting of an event. This test will partly verify the intra-frequency cell search requirements in clauses 9.2A.6.1 and 9.2A.6.2.

##### A.11.5.1.4.2 Test parameters

##### A.11.5.1.4.3 Test Requirements

The UE shall send one Event A3 triggered measurement report (SS-RSRP in Test 1 and Test 2, SS-RSRQ in Test 3 and Test 4, SS-SINR in Test 5 and Test 6), with a measurement reporting delay less than  $D1$  ms from the beginning of time period T2.

*Editor's note:  $D1=TBD$  ( $D1$  is different for different DRX configurations).*

The UE is not required to read the neighbour cell SSB index in this test.

The UE shall not send event triggered measurement reports, as long as the reporting criteria are not fulfilled.

The rate of correct events observed during repeated tests shall be at least 90%.

FFS: NOTE: The actual overall delays measured in the test may be up to  $2xTTI_{DCCH}$  higher than the measurement reporting delays above because of TTI insertion uncertainty of the measurement report in DCCH.

#### A.11.5.1.5 Event-triggered reporting tests on SCC without gaps under non-DRX

##### A.11.5.1.5.1 Test purpose and environment

The purpose of this test is to verify that the UE makes correct reporting of an event. This test will partly verify the intra-frequency cell search requirements in clauses 9.2A.5.1 and 9.2A.5.2.

##### A.11.5.1.5.2 Test parameters

The UE shall send one Event A3 triggered measurement report (SS-RSRP in Test 1, SS-RSRQ in Test 2, SS-SINR in Test 3), with a measurement reporting delay less than  $D1$  ms from the beginning of time period T2.

*Editor's note:  $D1=TBD$ .*

The UE is not required to read the neighbour cell SSB index in this test.

The UE shall not send event triggered measurement reports, as long as the reporting criteria are not fulfilled.

The rate of correct events observed during repeated tests shall be at least 90%.

FFS: NOTE: The actual overall delays measured in the test may be up to  $2xTTI_{DCCH}$  higher than the measurement reporting delays above because of TTI insertion uncertainty of the measurement report in DCCH.

### A.11.5.1.6 Event-triggered reporting tests on SCC without gaps under DRX

#### A.11.5.1.6.1 Test purpose and environment

The purpose of this test is to verify that the UE makes correct reporting of an event. This test will partly verify the intra-frequency cell search requirements in clauses 9.2A.5.1 and 9.2A.5.2.

#### A.11.5.1.6.2 Test parameters

#### A.11.5.1.6.3 Test Requirements

The UE shall send one Event A3 triggered measurement report (SS-RSRP in Test 1 and Test 2, SS-RSRQ in Test 3 and Test 4, SS-SINR in Test 5 and Test 6), with a measurement reporting delay less than  $D1$  ms from the beginning of time period T2.

*Editor's note:  $D1=TBD$  ( $D1$  is different for different DRX configurations).*

The UE is not required to read the neighbour cell SSB index in this test.

The UE shall not send event triggered measurement reports, as long as the reporting criteria are not fulfilled.

The rate of correct events observed during repeated tests shall be at least 90%.

FFS: NOTE: The actual overall delays measured in the test may be up to  $2xTTI_{DCCH}$  higher than the measurement reporting delays above because of TTI insertion uncertainty of the measurement report in DCCH.

### A.11.5.1.7 Event-triggered reporting tests on SCC with per-UE gaps under non-DRX

#### A.11.5.1.7.1 Test purpose and environment

The purpose of this test is to verify that the UE makes correct reporting of an event. This test will partly verify the intra-frequency cell search requirements in clauses 9.2A.6.1 and 9.2A.6.2.

#### A.11.5.1.7.2 Test parameters

#### A.11.5.1.7.3 Test Requirements

The UE shall send one Event A3 triggered measurement report (SS-RSRP in Test 1, SS-RSRQ in Test 2, SS-SINR in Test 3), with a measurement reporting delay less than  $D1$  ms from the beginning of time period T2.

*Editor's note:  $D1=TBD$ .*

The UE is not required to read the neighbour cell SSB index in this test.

The UE shall not send event triggered measurement reports, as long as the reporting criteria are not fulfilled.

The rate of correct events observed during repeated tests shall be at least 90%.

FFS: NOTE: The actual overall delays measured in the test may be up to  $2xTTI_{DCCH}$  higher than the measurement reporting delays above because of TTI insertion uncertainty of the measurement report in DCCH.

### A.11.5.1.8 Event-triggered reporting tests on SCC with per-UE gaps under DRX

#### A.11.5.1.8.1 Test purpose and environment

The purpose of this test is to verify that the UE makes correct reporting of an event. This test will partly verify the intra-frequency cell search requirements in clauses 9.2A.6.1 and 9.2A.6.2.

## A.11.5.1.8.2 Test parameters

## A.11.5.1.8.3 Test Requirements

The UE shall send one Event A3 triggered measurement report (SS-RSRP in Test 1 and Test 2, SS-RSRQ in Test 3 and Test 4, SS-SINR in Test 5 and Test 6), with a measurement reporting delay less than  $D1$  ms from the beginning of time period T2.

*Editor's note:  $D1=TBD$  ( $D1$  is different for different DRX configurations).*

The UE is not required to read the neighbour cell SSB index in this test.

The UE shall not send event triggered measurement reports, as long as the reporting criteria are not fulfilled.

The rate of correct events observed during repeated tests shall be at least 90%.

FFS: NOTE: The actual overall delays measured in the test may be up to  $2 \times TTI_{DCCH}$  higher than the measurement reporting delays above because of TTI insertion uncertainty of the measurement report in DCCH.

## A.11.5.1.9 RSSI measurement reporting on PCC

## A.11.5.1.9.1 Test purpose and environment

The purpose of this test is to verify that the UE correctly reports RSSI measurements. This test will partly verify the intra-frequency RSSI measurement reporting requirements in Section 9.2A.7.1.

## A.11.5.1.9.2 Test parameters

In the test, the UE is configured to perform intra-frequency RSSI measurements on a carrier frequency under CCA.

Supported test configurations are shown in Table A.11.5.1.9.2-1. There is one cell in the test: Cell 1 which is PCell operating on a carrier frequency under CCA. Prior to the start of the time duration T1, the UE is connected to Cell 1.

**Table A.11.5.1.9.2-1: Supported test configurations.**

Configuration	Description
1	NR TDD, SSB SCS 30 kHz, data SCS 30 kHz, bandwidth 40 MHz

**Table A.11.5.1.9.2-2: General test parameters.**

Editor's note: Table TBD

## A.11.5.1.10 Channel occupancy measurement reporting on PCC

## A.11.5.1.10.1 Test purpose and environment

The purpose of this test is to verify that the UE correctly reports channel occupancy measurements. This test will partly verify the intra-frequency channel occupancy measurement reporting requirements in Section 9.2A.7.2.

## A.11.5.1.10.2 Test parameters

In the test, the UE is configured to perform intra-frequency channel occupancy measurements on a carrier frequency under CCA.

Supported test configurations are shown in Table A.11.5.1.10.2-1. There is one cell in the test: Cell 1 which is PCell operating on a carrier frequency under CCA. Prior to the start of the time duration T1, the UE is connected to Cell 1.

**Table A.11.5.1.10.2-1: Supported test configurations.**

Configuration	Description
1	NR TDD, SSB SCS 30 kHz, data SCS 30 kHz, bandwidth 40 MHz

**Table A.11.5.1.10.2-2: General test parameters.**

Editor's note: Table is TBD

### A.11.5.1.11 RSSI measurement reporting on SCC

#### A.11.5.1.11.1 Test purpose and environment

The purpose of this test is to verify that the UE correctly reports RSSI measurements. This test will partly verify the intra-frequency RSSI measurement reporting requirements in Section 9.2A.7.1.

#### A.11.5.1.11.2 Test parameters

In the test, the UE is configured to perform intra-frequency RSSI measurements on a carrier frequency under CCA.

Supported test configurations are shown in Table A.11.5.1.11.2-1. There are two cells in the test: Cell 1 which is PCell operating on a carrier frequency under CCA, and Cell 2 which is SCell operating on a carrier frequency under CCA. Prior to the start of the time duration T1, the UE is connected to Cell 1 and Cell 2.

**Table A.11.5.1.11.2-1: Supported test configurations.**

Configuration	Description
1	NR TDD, SSB SCS 30 kHz, data SCS 30 kHz, bandwidth 40 MHz

**Table A.11.5.1.11.2-2: General test parameters.**

Editor's note: Tabs TBD

### A.11.5.1.12 Channel occupancy measurement reporting on SCC

#### A.11.5.1.12.1 Test purpose and environment

The purpose of this test is to verify that the UE correctly reports channel occupancy measurements. This test will partly verify the intra-frequency channel occupancy measurement reporting requirements in Section 9.2A.7.2.

#### A.11.5.1.12.2 Test parameters

In the test, the UE is configured to perform intra-frequency channel occupancy measurements on a carrier frequency under CCA.

Supported test configurations are shown in Table A.11.5.1.12.2-1. There are two cells in the test: Cell 1 which is PCell operating on a carrier frequency under CCA, and Cell 2 which is SCell operating on a carrier frequency under CCA. Prior to the start of the time duration T1, the UE is connected to Cell 1 and Cell 2.

**Table A.11.5.1.12.2-1: Supported test configurations.**

Configuration	Description
1	NR TDD, SSB SCS 30 kHz, data SCS 30 kHz, bandwidth 40 MHz

**Table A.11.5.1.12.2-2: General test parameters.**

Editor's note: Table is TBD

## A.11.5.2 Inter-frequency measurements

### A.11.5.2.1 RSSI measurement reporting

#### A.11.5.2.1.1 Test purpose and environment

The purpose of this test is to verify that the UE correctly reports RSSI measurements. This test will partly verify the inter-frequency RSSI measurement reporting requirements in Section 9.3A.8.

#### A.11.5.2.1.2 Test parameters

In the test, the UE is configured to perform inter-frequency RSSI measurements on a carrier frequency under CCA.

Supported test configurations are shown in Table A.11.5.2.1.2-1. There is one cell in the test: Cell 1 which is PCell operating on a carrier frequency under CCA. Prior to the start of the time duration T1, the UE is connected to Cell 1. The RSSI measurement is performed on an inter-frequency under CCA.

**Table A.11.5.2.1.2-1: Supported test configurations.**

Configuration	Description
1	NR TDD, SSB SCS 30 kHz, data SCS 30 kHz, bandwidth 40 MHz

**Table A.11.5.2.1.2-2: General test parameters.**

Editor's note: Table TBD

### A.11.5.2.2 Channel occupancy measurement reporting

#### A.11.5.2.2.1 Test purpose and environment

The purpose of this test is to verify that the UE correctly reports channel occupancy measurements. This test will partly verify the inter-frequency channel occupancy measurement reporting requirements in Section 9.3A.9.

#### A.11.5.2.2.2 Test parameters

In the test, the UE is configured to perform inter-frequency channel occupancy measurements on a carrier frequency under CCA.

Supported test configurations are shown in Table A.11.5.2.2.2-1. There is one cell in the test: Cell 1 which is PCell operating on a carrier frequency under CCA. Prior to the start of the time duration T1, the UE is connected to Cell 1. The channel occupancy measurement is performed on an inter-frequency under CCA.

**Table A.11.5.2.2.2-1: Supported test configurations.**

Configuration	Description
1	NR TDD, SSB SCS 30 kHz, data SCS 30 kHz, bandwidth 40 MHz

**Table A.11.5.2.2.2-2: General test parameters.**

Editor's note: Table is TBD

### A.11.5.2.3 Event triggered reporting tests for FR1 with CCA without SSB time index detection when DRX is not used

#### A.11.5.2.3.1 Test Purpose and Environment

The purpose of this test is to verify that the UE makes correct reporting of an event. This test will partly verify the SA inter-frequency NR cell search requirements for NR cell with CCA in clause 9.3A.4 and 9.3A.5.

In this test, there are two cells: NR cell 1 with CCA as PCell in FR1 on NR RF channel 1 and NR cell 2 as neighbour cell in FR1 with CCA on NR RF channel 2. The test parameters are given in Tables A.11.5.2.3.1-1, A.11.5.2.3.1-2 and A.11.5.2.3.1-3.

In test 1, measurement gap pattern configuration # 0 as defined in Table A.11.5.2.3.1-2 is provided for UE that does not support per-FR gap. In test 2, measurement gap pattern configuration #4 as defined in Table A.11.5.2.3.1-2 is provided for UE that supports per-FR gap. If a UE supports per-FR gap and gap pattern configuration #4, it is only required to pass test 2. Otherwise it is only required to pass test 1.

In the measurement control information, it is indicated to the UE that event-triggered reporting with Event A3 is used. The test consists of two successive time periods, with time duration of T1, and T2 respectively. During time duration T1, the UE shall not have any timing information of NR cell 3.

**Table A.11.5.2.3.1-1: SA event triggered reporting tests without SSB index reading for FR1-FR1 with CCA**

Config	Description
1	NR cell with CCA: 30 kHz SSB SCS, 40 MHz bandwidth, TDD duplex mode
Note 1: The UE is only required to be tested in one of the supported test configurations	

**Table A.11.5.2.3.1-2: General test parameters for SA inter-frequency event triggered reporting for FR1 with CCA without SSB time index detection**

Parameter	Unit	Test configuration	Value		Comment
			Test 1	Test 2	
NR RF Channel Number		Config 1	1, 2		Two FR1 NR carrier frequencies are used. Channels 1 and 2 are with CCA.
Active cells		Config 1	NR cell 1 with CCA (PCell)		NR cell 1 is on NR RF channel number 1 with CCA.
Neighbour cell		Config 1	NR cell 2 with CCA		NR cell 2 is on NR RF channel number 2 with CCA.
DL CCA model		Config 1	As specified in clause A.3.26.2.1		
UL CCA model		Config 1	As specified in clause A.3.26.2.2		
Gap Pattern Id		Config 1	0	4	As specified in clause 9.1.2-1.
Measurement gap offset		Config 1	9	9	
A3-Offset	dB	Config 1	-6		
Hysteresis	dB	Config 1	0		
CP length		Config 1	Normal		
TimeToTrigger	s	Config 1	0		
Filter coefficient		Config 1	0		L3 filtering is not used
DRX		Config 1	OFF		DRX is not used
Time offset between serving and neighbour cells		Config 1	3μs		Synchronous cells.
T1	s	Config 1	5		
T2	s	Config 1	1.7	1.7	

**Table A.11.5.2.3.1-3: Cell specific test parameters for SA inter-frequency event triggered reporting for FR1 with CCA without SSB time index detection**

Parameter	Unit	Test configuration	Cell 1		Cell 2	
			T1	T2	T1	T2
NR RF Channel Number		Config 1	1		2	
Duplex mode		Config 1	TDD			
TDD configuration		Config 1	TDDConf.1.1 CCA			
BW <sub>channel</sub>	MHz	Config 1	40: N <sub>RB,c</sub> = 106			
BWP BW	MHz	Config 1	40: N <sub>RB,c</sub> = 106			

BWP configuration	Initial DL BWP	Config 1	Config 1	DLBWP.0.1	NA		
	Initial UL BWP	Config 1		ULBWP.0.1	NA		
	Dedicated DL BWP	Config 1		DLBWP.1.1	NA		
	Dedicated UL BWP	Config 1		ULBWP.1.1	NA		
TRS configuration			Config 1	TRS.1.2 TDD	NA		
OCNG Patterns defined in A.3.2.1.1 (OP.1)			Config 1	OP.1	OP.1		
PDSCH Reference measurement channel			Config 1	SR.1.1 CCA			
CORESET Reference Channel			Config 1	CR.1.1 CCA			
SSB parameters	Semi-static channel access <sup>Note 5,7</sup>		Config 1	SSB.1 CCA	SSB.1 CCA		
	Dynamic channel access <sup>Note 6,7</sup>		Config 1	SSB.2 CCA	SSB.2 CCA		
DBT window configuration			Config 1	As defined in A.3.28.1	As defined in A.3.28.1		
SMTC configuration defined in A.3.11			Config 1	SMTC.1	SMTC.4		
DL CCA probability $P_{CCA\_DL}$	Semi-static channel access <sup>Note 5,7</sup>		Config 1	$P_{CCA\_DL}=0.9375$	$P_{CCA\_DL}=0.9375$		
	Dynamic channel access <sup>Note 6,7</sup>		Config 1	$P_{CCA\_DL\_1}=0.75$ $P_{CCA\_DL\_2}=0.75$	$P_{CCA\_DL\_1}=0.75$ $P_{CCA\_DL\_2}=0.75$		
UL CCA probability $P_{CCA\_UL}$	Semi-static channel access <sup>Note 5,7</sup>		Config 1	$P_{CCA\_UL}=1$	$P_{CCA\_UL}=1$		
	Dynamic channel access <sup>Note 6,7</sup>		Config 1	$P_{CCA\_UL}=1$	$P_{CCA\_UL}=1$		
$L_{CCA\_DL}$			Config 1	12	12		
$W_{CCA\_DL}$		ms	Config 1	$T_{PSS/SSS\_sync\_inter\_cca}$	$T_{PSS/SSS\_sync\_inter\_cca}$		
PDSCH/PDCCH subcarrier spacing		kHz	Config 1	30			
EPRE ratio of PSS to SSS			Config 1	0			
EPRE ratio of PBCH DMRS to SSS							
EPRE ratio of PBCH to PBCH DMRS							
EPRE ratio of PDCCH DMRS to SSS							
EPRE ratio of PDCCH to PDCCH DMRS							
EPRE ratio of PDSCH DMRS to SSS							
EPRE ratio of PDSCH to PDSCH							
EPRE ratio of OCNG DMRS to SSS(Note 1)							
EPRE ratio of OCNG to OCNG DMRS (Note 1)							
$N_{oc}$ <sup>Note2</sup>		dBm/15 kHz	Config 1	-104	-104		
$N_{oc}$ <sup>Note2</sup>		dBm/S CS	Config 1	-101	-101		
SS-RSRP <sup>Note 3</sup>		dBm/S CS	Config 1	-91	-91	-Infinity	-88
$\hat{E}_s/I_{ot}$		dB	Config 1	4	4	-Infinity	7



$\hat{E}_s/N_{oc}$	dB	Config 1	4	4	-Infinity	7
$I_o$ <sup>Note3</sup>	dBm/9.36MHz	Config 1	-58.49	-58.49	-63.94	-56.15
Propagation Condition		Config 1	AWGN		AWGN	
Note 1:	OCNG shall be used such that both cells are fully allocated and a constant total transmitted power spectral density is achieved for all OFDM symbols.					
Note 2:	Interference from other cells and noise sources not specified in the test is assumed to be constant over subcarriers and time and shall be modelled as AWGN of appropriate power for $N_{oc}$ to be fulfilled.					
Note 3:	SS-RSRP and $I_o$ levels have been derived from other parameters for information purposes. They are not settable parameters themselves.					
Note 4:	SS-RSRP minimum requirements are specified assuming independent interference and noise at each receiver antenna port.					
Note 5:	For UE supporting semi-static channel access and network configuring semi-static channel occupancy.					
Note 6:	For UE supporting dynamic channel access and network configuring dynamic channel occupancy.					
Note 7:	For UE supporting both semi-static and dynamic channel access, the UE must be tested under dynamic channel access configuration.					

### A.11.5.2.3.2 Test Requirements

In test 1 with per-UE gap, the UE shall send one Event A3 triggered measurement report, with a measurement reporting delay less than  $T_{\text{identify\_inter\_cca\_without\_index}}$  from the beginning of time period T2. The UE shall not send event triggered measurement reports, as long as the reporting criteria are not fulfilled. The rate of correct events observed during repeated tests shall be at least 90%. In test 2 with per-FR gap, the UE shall send one Event A3 triggered measurement report, with a measurement reporting delay less than  $T_{\text{identify\_inter\_cca\_without\_index}}$  from the beginning of time period T2. The UE shall not send event triggered measurement reports, as long as the reporting criteria are not fulfilled. The rate of correct events observed during repeated tests shall be at least 90%.

In test 1 and 2 UE is not required to report SSB time index.

$T_{\text{identify\_inter\_cca\_without\_index}} = (T_{\text{PSS/SSS\_sync\_inter\_cca}} + T_{\text{SSB\_measurement\_period\_inter\_cca}})$  ms, where

$T_{\text{PSS/SSS\_sync\_inter\_cca}}$ : it is the time period used in PSS/SSS detection given in table 9.3A.4-1.

$T_{\text{SSB\_measurement\_period\_inter\_cca}}$ : equal to a measurement period of SSB based measurement given in table 9.3A.5-1.

For test 1, MGRP = 40 ms and for test 2 MGRP = 20 ms.

SMTC period = 20 ms.

NOTE: The actual overall delays measured in the test may be up to  $2xTTI_{\text{DCCH}}$  higher than the measurement reporting delays above because of TTI insertion uncertainty of the measurement report in DCCH.

### A.11.5.2.4 Event triggered reporting tests for FR1 with CCA without SSB time index detection when DRX is used

#### A.11.5.2.4.1 Test Purpose and Environment

The purpose of this test is to verify that the UE makes correct reporting of an event. This test will partly verify the SA inter-frequency NR cell search requirements in clause 9.3A.4 and 9.3A.5.

In this test, there are two cells: NR cell 1 as PCell in FR1 with CCA on NR RF channel 1 and NR cell 2 as neighbour cell in FR1 with CCA on NR RF channel 2. The test parameters are given in Tables A.11.5.2.4.1-1, A.11.5.2.4.1-2 and A.11.5.2.4.1-3.

In test 1&2 measurement gap pattern configuration # 0 as defined in Table A.11.5.2.4.1-2 is provided for UE that does not support per-FR gap and in test 3&4 measurement gap pattern configuration #4 as defined in Table A.11.5.2.4.1-2 is provided for UE that supports per-FR gap. If a UE supports per-FR gap and gap pattern configuration #4, it is only required to pass test 3&4. Otherwise it is only required to pass test 1&2.

In the measurement control information, it is indicated to the UE that event-triggered reporting with Event A3 is used. The test consists of two successive time periods, with time duration of T1, and T2 respectively. During time duration T1, the UE shall not have any timing information of NR cell 3.

UE needs to be provided at least once every 500ms with new Timing Advance Command MAC control element to restart the Time alignment timer to keep UE uplink time alignment. Furthermore, UE is allocated with PUSCH resource at every DRX cycle.

**Table A.11.5.2.4.1-1: SA event triggered reporting tests without SSB index reading for FR1-FR1 with CCA**

Config	Description
1	NR cell with CCA: 30 kHz SSB SCS, 40 MHz bandwidth, TDD duplex mode
Note 1: The UE is only required to be tested in one of the supported test configurations	

**Table A.11.5.2.4.1-2: General test parameters for SA inter-frequency event triggered reporting for FR1 with CCA without SSB time index detection**

Parameter	Unit	Test configuration	Value				Comment
			Test 1	Test 2	Test 3	Test 4	
NR RF Channel Number		Config 1	1, 2				Two FR1 NR carrier frequencies are used. Channels 1 and 2 are with CCA.
Active cells		Config 1	NR cell 1 with CCA (PCell)				NR cell 1 is on NR RF channel number 1 with CCA.
Neighbour cell		Config 1	NR cell 2 with CCA				NR cell 2 is on NR RF channel number 2 with CCA.
DL CCA model		Config 1	As specified in clause A.3.26.2.1				
UL CCA model		Config 1	As specified in clause A.3.26.2.2				
Gap Pattern Id		Config 1	0		4		As specified in clause 9.1.2-1.
Measurement gap offset		Config 1	9		9		
A3-Offset	dB	Config 1	-6				
Hysteresis	dB	Config 1	0				
CP length		Config 1	Normal				
TimeToTrigger	s	Config 1	0				
Filter coefficient		Config 1	0				L3 filtering is not used
DRX		Config 1	DRX .1	DRX .2	DRX .1	DRX .2	As specified in clause A.3.3
Time offset between serving and neighbour cells		Config 1	3μs				Synchronous cells.
T1	s	Config 1	5				
T2	s	Config 1	2.5	17	2.5	17	

**Table A.11.5.2.4.1-3: Cell specific test parameters for SA inter-frequency event triggered reporting for FR1 with CCA without SSB time index detection**

Parameter	Unit	Test configuration	Cell 1				Cell 2			
			T1	T2	T3	T4	T1	T2	T3	T4
NR RF Channel Number		Config 1	1				2			
Duplex mode		Config 1	TDD							
TDD configuration		Config 1	TDDConf.1.1 CCA							
BW <sub>channel</sub>	MHz	Config 1	40: N <sub>RB,c</sub> = 106							

BWP BW		MHz	Config 1	40: $N_{RB,c} = 106$			
BWP configuration	Initial DL BWP	Config 1	Config 1	DLBWP.0.1		NA	
	Initial UL BWP	Config 1		ULBWP.0.1		NA	
	Dedicated DL BWP	Config 1		DLBWP.1.1		NA	
	Dedicated UL BWP	Config 1		ULBWP.1.1		NA	
TRS configuration			Config 1	TRS.1.2 TDD		NA	
OCNG Patterns defined in A.3.2.1.1 (OP.1)			Config 1	OP.1		OP.1	
PDSCH Reference measurement channel			Config 1	SR.1.1 CCA			
CORESET Reference Channel			Config 1	CR.1.1 CCA			
SSB parameters	Semi-static channel access <sup>Note 5,7</sup>		Config 1	SSB.1 CCA		SSB.1 CCA	
	Dynamic channel access <sup>Note 6,7</sup>		Config 1	SSB.2 CCA		SSB.2 CCA	
DBT window configuration			Config 1	As defined in A.3.28.1		As defined in A.3.28.1	
SMTC configuration defined in A.3.11			Config 1	SMTC.1		SMTC.4	
DL CCA probability $P_{CCA\_DL}$	Semi-static channel access <sup>Note 5,7</sup>		Config 1	$P_{CCA\_DL}=0.9375$		$P_{CCA\_DL}=0.9375$	
	Dynamic channel access <sup>Note 6,7</sup>		Config 1	$P_{CCA\_DL\_1}=0.75$ $P_{CCA\_DL\_2}=0.75$		$P_{CCA\_DL\_1}=0.75$ $P_{CCA\_DL\_2}=0.75$	
UL CCA probability $P_{CCA\_UL}$	Semi-static channel access <sup>Note 5,7</sup>		Config 1	$P_{CCA\_UL}=1$		$P_{CCA\_UL}=1$	
	Dynamic channel access <sup>Note 6,7</sup>		Config 1	$P_{CCA\_UL}=1$		$P_{CCA\_UL}=1$	
PDSCH/PDCCH subcarrier spacing		kHz	Config 1	30			
EPRE ratio of PSS to SSS			Config 1	0		0	
EPRE ratio of PBCH DMRS to SSS							
EPRE ratio of PBCH to PBCH DMRS							
EPRE ratio of PDCCH DMRS to SSS							
EPRE ratio of PDCCH to PDCCH DMRS							
EPRE ratio of PDSCH DMRS to SSS							
EPRE ratio of PDSCH to PDSCH							
EPRE ratio of OCNG DMRS to SSS(Note 1)							
EPRE ratio of OCNG to OCNG DMRS (Note 1)							
$N_{oc}$ <sup>Note2</sup>		dBm/15 kHz					
$N_{oc}$ <sup>Note2</sup>		dBm/S CS	Config 1	-101		-101	
SS-RSRP <sup>Note 3</sup>		dBm/S CS	Config 1	-91	-91	-Infinity	-88
$\hat{E}_s/I_{ot}$		dB	Config 1	4	4	-Infinity	7

$\hat{E}_s/N_{oc}$	dB	Config 1	4	4	-Infinity	7
$I_o$ <sup>Note3</sup>	dBm/9.36MHz	Config 1	-58.49	-58.49	-63.94	-56.15
Propagation Condition		Config 1	AWGN		AWGN	
Note 1:	OCNG shall be used such that both cells are fully allocated and a constant total transmitted power spectral density is achieved for all OFDM symbols.					
Note 2:	Interference from other cells and noise sources not specified in the test is assumed to be constant over subcarriers and time and shall be modelled as AWGN of appropriate power for $N_{oc}$ to be fulfilled.					
Note 3:	SS-RSRP and $I_o$ levels have been derived from other parameters for information purposes. They are not settable parameters themselves.					
Note 4:	SS-RSRP minimum requirements are specified assuming independent interference and noise at each receiver antenna port.					
Note 5:	For UE supporting semi-static channel access and network configuring semi-static channel occupancy.					
Note 6:	For UE supporting dynamic channel access and network configuring dynamic channel occupancy.					
Note 7:	For UE supporting both semi-static and dynamic channel access, the UE must be tested under dynamic channel access configuration.					

**Table A.11.5.2.4.1-4: DRX-Configuration for SA inter-frequency event triggered reporting without SSB time index detection**

Field	Test1&3	Test2&4	Comment
	Value	Value	
drx-onDurationTimer	ms1	ms1	As specified in clause 6.3.2 in TS 38.331 [2]
drx-InactivityTimer	ms1	ms1	
drx-RetransmissionTimerDL	sl1	sl1	
drx-RetransmissionTimerUL	sl1	sl1	
drx-LongCycleStartOffset	ms40	Ms640	
shortDRX	disable	disable	

**Table A.11.5.2.4.1-5: *TimeAlignmentTimer* -Configuration SA inter-frequency event triggered reporting without SSB time index detection**

Field	Value	Comment
TimeAlignmentTimer	ms500	As specified in clause 6.3.2 in TS 38.331 [2]

#### A.11.5.2.4.2 Test Requirements

In test 1 with per-UE gap, the UE shall send one Event A3 triggered measurement report, with a measurement reporting delay less than  $T_{\text{identify\_inter\_cca\_without\_index}}$  from the beginning of time period T2. The UE shall not send event triggered measurement reports, as long as the reporting criteria are not fulfilled. The rate of correct events observed during repeated tests shall be at least 90%.

In test 2 with per-FR gap, the UE shall send one Event A3 triggered measurement report, with a measurement reporting delay less than  $T_{\text{identify\_inter\_cca\_without\_index}}$  from the beginning of time period T2. The UE shall not send event triggered measurement reports, as long as the reporting criteria are not fulfilled. The rate of correct events observed during repeated tests shall be at least 90%.

In test 3 with per-UE gap, the UE shall send one Event A3 triggered measurement report, with a measurement reporting delay less than  $T_{\text{identify\_inter\_cca\_without\_index}}$  from the beginning of time period T2. The UE shall not send event triggered measurement reports, as long as the reporting criteria are not fulfilled. The rate of correct events observed during repeated tests shall be at least 90%.

In test 4 with per-FR gap, the UE shall send one Event A3 triggered measurement report, with a measurement reporting delay less than  $T_{\text{identify\_inter\_cca\_without\_index}}$  from the beginning of time period T2. The UE shall not send event triggered measurement reports, as long as the reporting criteria are not fulfilled. The rate of correct events observed during repeated tests shall be at least 90%.

In test 1, 2, 3 and 4 UE is not required to report SSB time index.

$T_{\text{identify\_inter\_cca\_without\_index}} = (T_{\text{PSS/SSS\_sync\_inter\_cca}} + T_{\text{SSB\_measurement\_period\_inter\_cca}})$  ms, where

$T_{\text{PSS/SSS\_sync\_inter\_cca}}$ : it is the time period used in PSS/SSS detection given in table 9.3A.4-1.

$T_{\text{SSB\_measurement\_period\_inter\_cca}}$ : equal to a measurement period of SSB based measurement given in table 9.3A.5-1.

For tests 1 and 2, MGRP = 40 ms and for tests 3 and 4 MGRP = 20 ms.

For tests 1 and 3, DRX cycle = 40 ms and for tests 2 and 4 DRX cycle = 640 ms.

SMTC period = 20 ms.

NOTE: The actual overall delays measured in the test may be up to  $2 \times TTI_{\text{DCCCH}}$  higher than the measurement reporting delays above because of TTI insertion uncertainty of the measurement report in DCCCH.

### A.11.5.2.5 Event triggered reporting tests for FR1 with CCA with SSB time index detection when DRX is not used

#### A.11.5.2.5.1 Test Purpose and Environment

The purpose of this test is to verify that the UE makes correct reporting of an event. This test will partly verify the SA inter-frequency NR cell search requirements in clause 9.3A.4 and 9.3A.5.

In this test, there are two cells: NR cell 1 as PCell in FR1 with CCA on NR RF channel 1 and NR cell 2 as neighbour cell in FR1 with CCA on NR RF channel 2. The test parameters are given in Tables A.11.5.2.5.1-1, A.11.5.2.5.1-2 and A.11.5.2.5.1-3.

In test 1 measurement gap pattern configuration # 0 as defined in Table A.11.5.2.5.1-2 is provided for UE that does not support per-FR gap and in test 2 measurement gap pattern configuration #4 as defined in Table A.11.5.2.5.1-2 is provided for UE that supports per-FR gap. If a UE supports per-FR gap and gap pattern configuration #4, it is only required to pass test 2. Otherwise it is only required to pass test 1.

In the measurement control information, it is indicated to the UE that event-triggered reporting with Event A3 is used. The test consists of two successive time periods, with time duration of T1, and T2 respectively. During time duration T1, the UE shall not have any timing information of NR cell 3.

**Table A.11.5.2.5.1-1: SA event triggered reporting tests with SSB index reading for FR1-FR1 with CCA**

Config	Description
1	NR cell with CCA: 30 kHz SSB SCS, 40 MHz bandwidth, TDD duplex mode
Note 1: The UE is only required to be tested in one of the supported test configurations	

**Table A.11.5.2.5.1-2: General test parameters for SA inter-frequency event triggered reporting for FR1 with CCA with SSB time index detection**

Parameter	Unit	Test configuration	Value		Comment
			Test 1	Test 2	
NR RF Channel Number		Config 1	1, 2		Two FR1 NR carrier frequencies are used. Channels 1 and 2 are with CCA.
Active cells		Config 1	NR cell 1 with CCA (PCell)		NR cell 1 is on NR RF channel number 1 with CCA.
Neighbour cell		Config 1	NR cell 2 with CCA		NR cell 2 is on NR RF channel number 2 with CCA.
DL CCA model		Config 1	As specified in clause A.3.26.2.1		
UL CCA model		Config 1	As specified in clause A.3.26.2.2		
Gap Pattern Id		Config 1	0	4	As specified in clause 9.1.2-1.

Measurement gap offset		Config 1	9	9	
A3-Offset	dB	Config 1	-6		
Hysteresis	dB	Config 1	0		
CP length		Config 1	Normal		
TimeToTrigger	s	Config 1	0		
Filter coefficient		Config 1	0		L3 filtering is not used
DRX		Config 1	OFF		DRX is not used
Time offset between serving and neighbour cells		Config 1	3µs		Synchronous cells.
T1	s	Config 1	5		
T2	s	Config 1	2	2	

**Table A.11.5.2.5.1-3: Cell specific test parameters for SA inter-frequency event triggered reporting for FR1 with CCA with SSB time index detection**

Parameter		Unit	Test configuration	Cell 1		Cell 2	
				T1	T2	T1	T2
NR RF Channel Number			Config 1	1		2	
Duplex mode			Config 1	TDD			
TDD configuration			Config 1	TDDConf.1.1 CCA			
BW <sub>channel</sub>		MHz	Config 1	40: N <sub>RB,c</sub> = 106			
BWP BW		MHz	Config 1	40: N <sub>RB,c</sub> = 106			
BWP configuration	Initial DL BWP	Config 1	Config 1	DLBWP.0.1		NA	
	Initial UL BWP	Config 1		ULBWP.0.1		NA	
	Dedicated DL BWP	Config 1		DLBWP.1.1		NA	
	Dedicated UL BWP	Config 1		ULBWP.1.1		NA	
TRS configuration			Config 1	TRS.1.2 TDD		NA	
OCNG Patterns defined in A.3.2.1.1 (OP.1)			Config 1	OP.1		OP.1	
PDSCH Reference measurement channel			Config 1	SR.1.1 CCA			
CORESET Reference Channel			Config 1	CR.1.1 CCA			
SSB parameters	Semi-static channel access <sup>Note 5,7</sup>		Config 1	SSB.1 CCA		SSB.1 CCA	
	Semi-static channel access <sup>Note 5,7</sup>		Config 1	SSB.2 CCA		SSB.2 CCA	
DBT window configuration			Config 1	As defined in A.3.28.1		As defined in A.3.28.1	
SMTC configuration defined in A.3.11			Config 1	SMTC.1		SMTC.4	
DL CCA probability P <sub>CCA_DL</sub>	Semi-static channel access <sup>Note 5,7</sup>		Config 1	P <sub>CCA_DL</sub> =0.9375		P <sub>CCA_DL</sub> =0.9375	
	Dynamic channel access <sup>Note 6,7</sup>		Config 1	P <sub>CCA_DL_1</sub> =0.75 P <sub>CCA_DL_2</sub> =0.75		P <sub>CCA_DL_1</sub> =0.75 P <sub>CCA_DL_2</sub> =0.75	
UL CCA probability P <sub>CCA_UL</sub>	Semi-static channel access <sup>Note 5,7</sup>		Config 1	P <sub>CCA_UL</sub> =1		P <sub>CCA_UL</sub> =1	
	Dynamic channel access <sup>Note 6,7</sup>		Config 1	P <sub>CCA_UL</sub> =1		P <sub>CCA_UL</sub> =1	

LCCA_DL		Config 1	5		5	
WCCA_DL	ms	Config 1	T <sub>PSS/SSS_sync_inter_cca</sub>		T <sub>PSS/SSS_sync_inter_cca</sub>	
PDSCH/PDCCH subcarrier spacing	kHz	Config 1	30			
EPRE ratio of PSS to SSS		Config 1	0			
EPRE ratio of PBCH DMRS to SSS						
EPRE ratio of PBCH to PBCH DMRS						
EPRE ratio of PDCCH DMRS to SSS						
EPRE ratio of PDCCH to PDCCH DMRS						
EPRE ratio of PDSCH DMRS to SSS						
EPRE ratio of PDSCH to PDSCH						
EPRE ratio of OCNG DMRS to SSS(Note 1)						
EPRE ratio of OCNG to OCNG DMRS (Note 1)			0		0	
$N_{oc}$ <sup>Note2</sup>	dBm/15 kHz	Config 1	-104		-104	
$N_{oc}$ <sup>Note2</sup>	dBm/S CS	Config 1	-101		-101	
SS-RSRP <sup>Note 3</sup>	dBm/S CS	Config 1	-91	-91	-Infinity	-88
$\hat{E}_s/I_{ot}$	dB	Config 1	4	4	-Infinity	7
$\hat{E}_s/N_{oc}$	dB	Config 1	4	4	-Infinity	7
$I_o$ <sup>Note3</sup>	dBm/9.36MHz	Config 1	-58.49	-58.49	-63.94	-56.15
Propagation Condition		Config 1	AWGN		AWGN	
<p>Note 1: OCNG shall be used such that both cells are fully allocated and a constant total transmitted power spectral density is achieved for all OFDM symbols.</p> <p>Note 2: Interference from other cells and noise sources not specified in the test is assumed to be constant over subcarriers and time and shall be modelled as AWGN of appropriate power for <math>N_{oc}</math> to be fulfilled.</p> <p>Note 3: SS-RSRP and <math>I_o</math> levels have been derived from other parameters for information purposes. They are not settable parameters themselves.</p> <p>Note 4: SS-RSRP minimum requirements are specified assuming independent interference and noise at each receiver antenna port.</p> <p>Note 5: For UE supporting semi-static channel access and network configuring semi-static channel occupancy.</p> <p>Note 6: For UE supporting dynamic channel access and network configuring dynamic channel occupancy.</p> <p>Note 7: For UE supporting both semi-static and dynamic channel access, the UE must be tested under dynamic channel access configuration.</p>						

#### A.11.5.2.5.2 Test Requirements

In test 1 with per-UE gap, the UE shall send one Event A3 triggered measurement report, with a measurement reporting delay less than  $T_{\text{identify\_inter\_cca\_with\_index}}$  from the beginning of time period T2. The UE shall not send event triggered measurement reports, as long as the reporting criteria are not fulfilled. The rate of correct events observed during repeated tests shall be at least 90%.

In test 2 with per-FR gap, the UE shall send one Event A3 triggered measurement report, with a measurement reporting delay less than  $T_{\text{identify\_inter\_cca\_with\_index}}$  from the beginning of time period T2. The UE shall not send event triggered measurement reports, as long as the reporting criteria are not fulfilled. The rate of correct events observed during repeated tests shall be at least 90%.

In test 1 and 2 UE is required to report SSB time index.

$T_{\text{identify\_inter\_cca\_with\_index}} = (T_{\text{PSS/SSS\_sync\_inter\_cca}} + T_{\text{SSB\_measurement\_period\_inter\_cca}} + T_{\text{SSB\_time\_index\_inter\_cca}})$  ms, where

$T_{PSS/SSS\_sync\_inter\_cca}$ : it is the time period used in PSS/SSS detection given in table 9.3A.4-1.

$T_{SSB\_time\_index\_inter\_cca}$ : it is the time period used to acquire the index of the SSB being measured given in table 9.3A.4-2.

$T_{SSB\_measurement\_period\_inter\_cca}$ : equal to a measurement period of SSB based measurement given in table 9.3A.5-1.

For test 1, MGRP = 40 ms and for test 2 MGRP = 20 ms.

SMTC period = 20 ms.

NOTE: The actual overall delays measured in the test may be up to  $2 \times TTI_{DCCH}$  higher than the measurement reporting delays above because of TTI insertion uncertainty of the measurement report in DCCH.

### A.11.5.2.6 Event triggered reporting tests for FR1 with CCA with SSB time index detection when DRX is used

#### A.11.5.2.6.1 Test Purpose and Environment

The purpose of this test is to verify that the UE makes correct reporting of an event. This test will partly verify the SA inter-frequency NR cell search requirements in clause 9.3A.4 and 9.3A.5.

In this test, there are two cells: NR cell 1 as PCell in FR1 with CCA on NR RF channel 1 and NR cell 2 as neighbour cell in FR1 with CCA on NR RF channel 2. The test parameters are given in Tables A.11.5.2.6.1-1, A.11.5.2.6.1-2 and A.11.5.2.6.1-3.

In test 1&2 measurement gap pattern configuration # 0 as defined in Table A.11.5.2.6.1-2 is provided for UE that does not support per-FR gap and in test 3&4 measurement gap pattern configuration #4 as defined in Table A.11.5.2.6.1-2 is provided for UE that supports per-FR gap. If a UE supports per-FR gap and gap pattern configuration #4, it is only required to pass test 3&4. Otherwise it is only required to pass test 1&2.

In the measurement control information, it is indicated to the UE that event-triggered reporting with Event A3 is used. The test consists of two successive time periods, with time duration of T1, and T2 respectively. During time duration T1, the UE shall not have any timing information of NR cell 3.

UE needs to be provided at least once every 500 ms with new Timing Advance Command MAC control element to restart the Time alignment timer to keep UE uplink time alignment. Furthermore, UE is allocated with PUSCH resource at every DRX cycle.

**Table A.11.5.2.6.1-1: SA event triggered reporting tests with SSB index reading for FR1-FR1 with CCA**

Config	Description
1	NR cell with CCA: 30 kHz SSB SCS, 40 MHz bandwidth, TDD duplex mode
Note 1: The UE is only required to be tested in one of the supported test configurations	

**Table A.11.5.2.6.1-2: General test parameters for SA inter-frequency event triggered reporting for FR1 with CCA with SSB time index detection**

Parameter	Unit	Test configuration	Value				Comment
			Test 1	Test 2	Test 3	Test 4	
NR RF Channel Number		Config 1	1, 2				Two FR1 NR carrier frequencies are used. Channels 1 and 2 are with CCA.
Active cells		Config 1	NR cell 1 with CCA (PCell)				NR cell 1 is on NR RF channel number 1 with CCA.
Neighbour cell		Config 1	NR cell 2 with CCA				NR cell 2 is on NR RF channel number 2 with CCA.
DL CCA model		Config 1	As specified in clause A.3.26.2.1				
UL CCA model		Config 1	As specified in clause A.3.26.2.2				



Gap Pattern Id		Config 1	0	4	As specified in clause 9.1.2-1.	
Measurement gap offset		Config 1	9	9		
A3-Offset	dB	Config 1	-6			
Hysteresis	dB	Config 1	0			
CP length		Config 1	Normal			
TimeToTrigger	s	Config 1	0			
Filter coefficient		Config 1	0		L3 filtering is not used	
DRX		Config 1	DRX .1	DRX .2	DRX .1	DRX .2
Time offset between serving and neighbour cells		Config 1	3μs		Synchronous cells.	
T1	s	Config 1	5			
T2	s	Config 1	3	20	3	20

**Table A.11.5.2.6.1-3: Cell specific test parameters for SA inter-frequency event triggered reporting for FR1 with CCA with SSB time index detection**

Parameter		Unit	Test configuration	Cell 1				Cell 2			
				T1	T2	T3	T4	T1	T2	T3	T4
NR RF Channel Number			Config 1	1				2			
Duplex mode			Config 1	TDD							
TDD configuration			Config 1	TDDConf.1.1 CCA							
BW <sub>channel</sub>		MHz	Config 1	40: N <sub>RB,c</sub> = 106							
BWP BW		MHz	Config 1	40: N <sub>RB,c</sub> = 106							
BWP configuration	Initial DL BWP	Config 1	Config 1	DLBWP.0.1				NA			
	Initial UL BWP	Config 1		ULBWP.0.1				NA			
	Dedicated DL BWP	Config 1		DLBWP.1.1				NA			
	Dedicated UL BWP	Config 1		ULBWP.1.1				NA			
TRS configuration			Config 1	TRS.1.2 TDD				NA			
OCNG Patterns defined in A.3.2.1.1 (OP.1)			Config 1	OP.1				OP.1			
PDSCH Reference measurement channel			Config 1	SR.1.1 CCA							
CORESET Reference Channel			Config 1	CR.1.1 CCA							
SSB parameters	Semi-static channel access <sup>Note 5,7</sup>		Config 1	SSB.1 CCA				SSB.1 CCA			
	Semi-static channel access <sup>Note 5,7</sup>		Config 1	SSB.2 CCA				SSB.2 CCA			
DBT window configuration			Config 1	As defined in A.3.28.1				As defined in A.3.28.1			
SMTC configuration defined in A.3.11			Config 1	SMTC.1				SMTC.4			
DL CCA probability P <sub>CCA_DL</sub>	Semi-static channel access <sup>Note 5,7</sup>		Config 1	P <sub>CCA_DL</sub> =0.9375				P <sub>CCA_DL</sub> =0.9375			
	Dynamic channel access <sup>Note 6,7</sup>		Config 1	P <sub>CCA_DL_1</sub> =0.75 P <sub>CCA_DL_2</sub> =0.75				P <sub>CCA_DL_1</sub> =0.75 P <sub>CCA_DL_2</sub> =0.75			
UL CCA probability P <sub>CCA_UL</sub>	Semi-static channel access <sup>Note 5,7</sup>		Config 1	P <sub>CCA_UL</sub> =1				P <sub>CCA_UL</sub> =1			

	Dynamic channel access <small>Note 6,7</small>		Config 1	PCCA_UL=1		PCCA_UL=1	
LCCA_DL			Config 1	2		2	
WCCA_DL	ms		Config 1	TPSS/SSS_sync_inter_cca		TPSS/SSS_sync_inter_cca	
PDSCH/PDCCH subcarrier spacing	kHz		Config 1	30			
EPRE ratio of PSS to SSS		Config 1		0	0		
EPRE ratio of PBCH DMRS to SSS							
EPRE ratio of PBCH to PBCH DMRS							
EPRE ratio of PDCCH DMRS to SSS							
EPRE ratio of PDCCH to PDCCH DMRS							
EPRE ratio of PDSCH DMRS to SSS							
EPRE ratio of PDSCH to PDSCH							
EPRE ratio of OCNG DMRS to SSS(Note 1)							
EPRE ratio of OCNG to OCNG DMRS (Note 1)							
$N_{oc}$ <small>Note2</small>	dBm/15 kHz	Config 1		-104		-104	
$N_{oc}$ <small>Note2</small>	dBm/S CS	Config 1		-101		-101	
SS-RSRP <small>Note 3</small>	dBm/S CS	Config 1	-91	-91	-Infinity	-88	
$\hat{E}_s/I_{ot}$	dB	Config 1	4	4	-Infinity	7	
$\hat{E}_s/N_{oc}$	dB	Config 1	4	4	-Infinity	7	
$I_o$ <small>Note3</small>	dBm/9.36MHz	Config 1	-58.49	-58.49	-63.94	-56.15	
Propagation Condition		Config 1	AWGN		AWGN		
<p>Note 1: OCNG shall be used such that both cells are fully allocated and a constant total transmitted power spectral density is achieved for all OFDM symbols.</p> <p>Note 2: Interference from other cells and noise sources not specified in the test is assumed to be constant over subcarriers and time and shall be modelled as AWGN of appropriate power for <math>N_{oc}</math> to be fulfilled.</p> <p>Note 3: SS-RSRP and <math>I_o</math> levels have been derived from other parameters for information purposes. They are not settable parameters themselves.</p> <p>Note 4: SS-RSRP minimum requirements are specified assuming independent interference and noise at each receiver antenna port.</p> <p>Note 5: For UE supporting semi-static channel access and network configuring semi-static channel occupancy.</p> <p>Note 6: For UE supporting dynamic channel access and network configuring dynamic channel occupancy.</p> <p>Note 7: For UE supporting both semi-static and dynamic channel access, the UE must be tested under dynamic channel access configuration.</p>							

**Table A.11.5.2.6.1-4: DRX-Configuration for SA inter-frequency event triggered reporting without SSB time index detection**

Field	Test1&3	Test2&4	Comment
	Value	Value	
drx-onDurationTimer	ms1	ms1	As specified in clause 6.3.2 in TS 38.331 [2]
drx-InactivityTimer	ms1	ms1	
drx-RetransmissionTimerDL	sl1	sl1	
drx-RetransmissionTimerUL	sl1	sl1	
drx-LongCycleStartOffset	ms40	Ms640	
shortDRX	disable	disable	

**Table A.11.5.2.6.1-5: TimeAlignmentTimer -Configuration SA inter-frequency event triggered reporting without SSB time index detection**

Field	Value	Comment
TimeAlignmentTimer	ms500	As specified in clause 6.3.2 in TS 38.331 [2]

### A.11.5.2.6.2 Test Requirements

In test 1 with per-UE gap, the UE shall send one Event A3 triggered measurement report, with a measurement reporting delay less than  $T_{\text{identify\_inter\_cca\_with\_index}}$  from the beginning of time period T2. The UE shall not send event triggered measurement reports, as long as the reporting criteria are not fulfilled. The rate of correct events observed during repeated tests shall be at least 90%. In test 2 with per-FR gap, the UE shall send one Event A3 triggered measurement report, with a measurement reporting delay less than  $T_{\text{identify\_inter\_cca\_with\_index}}$  from the beginning of time period T2. The UE shall not send event triggered measurement reports, as long as the reporting criteria are not fulfilled. The rate of correct events observed during repeated tests shall be at least 90%.

In test 3 with per-UE gap, the UE shall send one Event A3 triggered measurement report, with a measurement reporting delay less than  $T_{\text{identify\_inter\_cca\_with\_index}}$  from the beginning of time period T2. The UE shall not send event triggered measurement reports, as long as the reporting criteria are not fulfilled. The rate of correct events observed during repeated tests shall be at least 90%.

In test 4 with per-FR gap, the UE shall send one Event A3 triggered measurement report, with a measurement reporting delay less than  $T_{\text{identify\_inter\_cca\_with\_index}}$  from the beginning of time period T2. The UE shall not send event triggered measurement reports, as long as the reporting criteria are not fulfilled. The rate of correct events observed during repeated tests shall be at least 90%.

In test 1, 2, 3 and 4 UE is required to report SSB time index.

$T_{\text{identify\_inter\_cca\_with\_index}} = (T_{\text{PSS/SSS\_sync\_inter\_cca}} + T_{\text{SSB\_measurement\_period\_inter\_cca}} + T_{\text{SSB\_time\_index\_inter\_cca}})$  ms, where

$T_{\text{PSS/SSS\_sync\_inter\_cca}}$ : it is the time period used in PSS/SSS detection given in table 9.3A.4-1.

$T_{\text{SSB\_time\_index\_inter\_cca}}$ : it is the time period used to acquire the index of the SSB being measured given in table 9.3A.4-2.

$T_{\text{SSB\_measurement\_period\_inter\_cca}}$ : equal to a measurement period of SSB based measurement given in table 9.3A.5-1.

For tests 1 and 2, MGRP = 40 ms and for tests 3 and 4 MGRP = 20 ms.

For tests 1 and 3, DRX cycle = 40 ms and for tests 2 and 4 DRX cycle = 640 ms.

SMTC period = 20 ms.

NOTE: The actual overall delays measured in the test may be up to  $2 \times TTI_{\text{DCCH}}$  higher than the measurement reporting delays above because of TTI insertion uncertainty of

## A.11.5.2.7 Event triggered reporting tests for FR1 without SSB time index detection when DRX is not used

### A.11.5.2.7.1 Test Purpose and Environment

The purpose of this test is to verify that the UE makes correct reporting of an event. This test will partly verify the SA inter-frequency NR cell search requirements for NR cell with CCA in clause 9.3A.4 and 9.3A.5.

In this test, there are two cells: NR cell 1 with CCA as PCell in FR1 on NR RF channel 1 and NR cell 2 as neighbour cell in FR1 on NR RF channel 2. The test parameters are given in Tables A.11.5.2.7.1-1, A.11.5.2.7.1-2 and A.11.5.2.7.1-3.

In test 1, measurement gap pattern configuration # 0 as defined in Table A.11.5.2.7.1-2 is provided for UE that does not support per-FR gap. In test 2, measurement gap pattern configuration #4 as defined in Table A.11.5.2.7.1-2 is provided

for UE that supports per-FR gap. If a UE supports per-FR gap and gap pattern configuration #4, it is only required to pass test 2. Otherwise it is only required to pass test 1.

In the measurement control information, it is indicated to the UE that event-triggered reporting with Event A3 is used. The test consists of two successive time periods, with time duration of T1, and T2 respectively. During time duration T1, the UE shall not have any timing information of NR cell 3.

**Table A.11.5.2.7.1-1: SA event triggered reporting tests without SSB index reading for FR1-FR1 with CCA**

Config	Description
1	NR cell with CCA: 30 kHz SSB SCS, 40 MHz bandwidth, TDD duplex mode NR cell without CCA: 15 kHz SSB SCS, 10 MHz bandwidth, FDD duplex mode
2	NR cell with CCA: 30 kHz SSB SCS, 40 MHz bandwidth, TDD duplex mode NR cell without CCA: 15 kHz SSB SCS, 10 MHz bandwidth, TDD duplex mode
3	NR cell with CCA: 30 kHz SSB SCS, 40 MHz bandwidth, TDD duplex mode NR cell without CCA: 30 kHz SSB SCS, 40 MHz bandwidth, TDD duplex mode
Note 1: The UE is only required to be tested in one of the supported test configurations	

**Table A.11.5.2.7.1-2: General test parameters for SA inter-frequency event triggered reporting for FR1 without SSB time index detection**

Parameter	Unit	Test configuration	Value		Comment
			Test 1	Test 2	
NR RF Channel Number		Config 1,2,3	1, 2		Two FR1 NR carrier frequencies are used. NR channel 1 is with CCA.
Active cell		Config 1,2,3	NR cell 1 (PCell)		NR cell 1 is on NR RF channel number 1 with CCA.
Neighbour cell		Config 1,2,3	NR cell 2		NR cell 2 is on NR RF channel number 2.
DL CCA model		Config 1,2,3	As specified in clause A.3.26.2.1		
UL CCA model		Config 1,2,3	As specified in clause A.3.26.2.2		
Gap Pattern Id		Config 1,2,3	0	4	As specified in clause 9.1.2-1.
Measurement gap offset		Config 1,2,3	9	9	
A3-Offset	dB	Config 1,2,3	-6		
Hysteresis	dB	Config 1,2,3	0		
CP length		Config 1,2,3	Normal		
TimeToTrigger	s	Config 1,2,3	0		
Filter coefficient		Config 1,2,3	0		L3 filtering is not used
DRX		Config 1,2,3	OFF		DRX is not used
Time offset between serving and neighbour cells		Config 1,2,3	3ms		Asynchronous cells. The timing of Cell 2 is 3ms later than the timing of Cell 1.
		Config 1,2,3	3μs		Synchronous cells.
T1	s	Config 1,2,3	5		
T2	s	Config 1,2,3	1.7	1.7	

**Table A.11.5.2.7.1-3: Cell specific test parameters for SA inter-frequency event triggered reporting for FR1 without SSB time index detection**

Parameter	Unit	Test configuration	Cell 1		Cell 2	
			T1	T2	T1	T2

NR RF Channel Number			Config 1,2,3	1	2
Duplex mode			Config 1	TDD	FDD
			Config 2,3	TDD	TDD
TDD configuration			Config 1	TDDConf.1.1 CCA	Not Applicable
			Config 2	TDDConf.1.1 CCA	TDDConf.1.1
			Config 3	TDDConf.1.1 CCA	TDDConf.2.1
BW <sub>channel</sub>		MHz	Config 1,2	40: N <sub>RB,c</sub> = 106	10: N <sub>RB,c</sub> = 52
			Config 3	40: N <sub>RB,c</sub> = 106	40: N <sub>RB,c</sub> = 106
BWP BW		MHz	Config 1,2	40: N <sub>RB,c</sub> = 106	10: N <sub>RB,c</sub> = 52
			Config 3	40: N <sub>RB,c</sub> = 106	40: N <sub>RB,c</sub> = 106
BWP configuration	Initial DL BWP		Config 1,2,3	DLBWP.0.1	NA
	Initial UL BWP			ULBWP.0.1	NA
	Dedicated DL BWP			DLBWP.1.1	NA
	Dedicated UL BWP			ULBWP.1.1	NA
TRS configuration			Config 1,2,3	TRS.1.2 TDD	NA
OCNG Patterns defined in A.3.2.1.1 (OP.1)			Config 1,2,3	OP.1	OP.1
PDSCH Reference measurement channel			Config 1,2,3	SR.1.1 CCA	
CORESET Reference Channel			Config 1,2,3	CR.1.1 CCA	
SSB parameters	Semi-static channel access <small>Note 5,7</small>		Config 1,2	SSB.1 CCA	SSB.1 FR1
			Config 3	SSB.1 CCA	SSB.2 FR1
	Semi-static channel access <small>Note 5,7</small>		Config 1,2	SSB.2 CCA	SSB.1 FR1
			Config 3	SSB.2 CCA	SSB.2 FR1
DBT window configuration			Config 1,2,3	As defined in A.3.28.1	Not applicable
SMTC configuration defined in A.3.11			Config 1,2,3	SMTC.1	SMTC.4
PDSCH/PDCCH subcarrier spacing		kHz	Config 1,2	30	15
			Config 3	30	30
DL CCA probability P <sub>CCA_DL</sub>	Semi-static channel access <small>Note 5,7</small>		Config 1,2,3	P <sub>CCA_DL</sub> =0.9375	NA
	Dynamic channel access <small>Note 6,7</small>		Config 1,2,3	P <sub>CCA_DL_1</sub> =0.75 P <sub>CCA_DL_2</sub> =0.75	NA
UL CCA probability P <sub>CCA_UL</sub>	Semi-static channel access <small>Note 5,7</small>		Config 1,2,3	P <sub>CCA_UL</sub> =1	NA
	Dynamic channel access <small>Note 6,7</small>		Config 1,2,3	P <sub>CCA_UL</sub> =1	NA
L <sub>CCA_DL</sub>			Config 1,2,3	12	12
W <sub>CCA_DL</sub>		ms	Config 1,2,3	T <sub>PSS/SSS_sync_inter_cca</sub>	T <sub>PSS/SSS_sync_inter_cca</sub>
EPRE ratio of PSS to SSS			Config 1,2,3	0	0
EPRE ratio of PBCH DMRS to SSS					
EPRE ratio of PBCH to PBCH DMRS					
EPRE ratio of PDCCH DMRS to SSS					
EPRE ratio of PDCCH to PDCCH DMRS					
EPRE ratio of PDSCH DMRS to SSS					
EPRE ratio of PDSCH to PDSCH					
EPRE ratio of OCNG DMRS to SSS(Note 1)					

EPRE ratio of OCNG to OCNG DMRS (Note 1)						
$N_{oc}$ <sup>Note2</sup>	dBm/1 5kHz	Config 1,2,3	-104			-98
$N_{oc}$ <sup>Note2</sup>	dBm/S CS	Config 1,2	-101			-98
		Config 3	-101			-95
SS-RSRP <sup>Note 3</sup>	dBm/S CS	Config 1,2	-91	-91	-Infinity	-91
		Config 3	-91	-91	-Infinity	-88
$\hat{E}_s/I_{ot}$	dB	Config 1,2,3	4	4	-Infinity	7
$\hat{E}_s/N_{oc}$	dB	Config 1,2,3	4	4	-Infinity	7
$I_o$ <sup>Note3</sup>	dBm/9 .36MHz	Config 1,2	-58.49	-58.49	-70.05	-62.26
	dBm/3 8.16MHz	Config 3	-58.49	-58.49	-63.94	-56.15
Propagation Condition		Config 1,2,3	AWGN		AWGN	
<p>Note 1: OCNG shall be used such that both cells are fully allocated and a constant total transmitted power spectral density is achieved for all OFDM symbols.</p> <p>Note 2: Interference from other cells and noise sources not specified in the test is assumed to be constant over subcarriers and time and shall be modelled as AWGN of appropriate power for <math>N_{oc}</math> to be fulfilled.</p> <p>Note 3: SS-RSRP and <math>I_o</math> levels have been derived from other parameters for information purposes. They are not settable parameters themselves.</p> <p>Note 4: SS-RSRP minimum requirements are specified assuming independent interference and noise at each receiver antenna port.</p> <p>Note 5: For UE supporting semi-static channel access and network configuring semi-static channel occupancy.</p> <p>Note 6: For UE supporting dynamic channel access and network configuring dynamic channel occupancy.</p> <p>Note 7: For UE supporting both semi-static and dynamic channel access, the UE must be tested under dynamic channel access configuration.</p>						

### A.11.5.2.7.2 Test Requirements

In test 1 with per-UE gap, the UE shall send one Event A3 triggered measurement report, with a measurement reporting delay less than  $T_{\text{identify\_inter\_cca\_without\_index}}$  from the beginning of time period T2. The UE shall not send event triggered measurement reports, as long as the reporting criteria are not fulfilled. The rate of correct events observed during repeated tests shall be at least 90%. In test 2 with per-FR gap, the UE shall send one Event A3 triggered measurement report, with a measurement reporting delay less than  $T_{\text{identify\_inter\_cca\_without\_index}}$  from the beginning of time period T2. The UE shall not send event triggered measurement reports, as long as the reporting criteria are not fulfilled. The rate of correct events observed during repeated tests shall be at least 90%.

In test 1 and 2 UE is not required to report SSB time index.

$T_{\text{identify\_inter\_cca\_without\_index}} = (T_{\text{PSS/SSS\_sync\_inter\_cca}} + T_{\text{SSB\_measurement\_period\_inter\_cca}})$  ms, where

$T_{\text{PSS/SSS\_sync\_inter\_cca}}$ : it is the time period used in PSS/SSS detection given in table 9.3A.4-1.

$T_{\text{SSB\_measurement\_period\_inter\_cca}}$ : equal to a measurement period of SSB based measurement given in table 9.3A.5-1.

For test 1, MGRP = 40 ms and for test 2 MGRP = 20 ms.

SMTC period = 20 ms.

NOTE: The actual overall delays measured in the test may be up to  $2xTTI_{\text{DCCH}}$  higher than the measurement reporting delays above because of TTI insertion uncertainty of the measurement report in DCCH.

## A.11.5.2.8 Event triggered reporting tests for FR1 without SSB time index detection when DRX is used

### A.11.5.2.8.1 Test Purpose and Environment

The purpose of this test is to verify that the UE makes correct reporting of an event. This test will partly verify the SA inter-frequency NR cell search requirements in clause 9.3A.4 and 9.3A.5.

In this test, there are two cells: NR cell 1 with CCA as PCell in FR1 on NR RF channel 1 and NR cell 2 as neighbour cell in FR1 on NR RF channel 2. The test parameters are given in Tables A.11.5.2.8.1-1, A.11.5.2.8.1-2 and A.11.5.2.8.1-3.

In test 1&2 measurement gap pattern configuration # 0 as defined in Table A.11.5.2.8.1-2 is provided for UE that does not support per-FR gap and in test 3&4 measurement gap pattern configuration #4 as defined in Table A.11.5.2.8.1-2 is provided for UE that supports per-FR gap. If a UE supports per-FR gap and gap pattern configuration #4, it is only required to pass test 3&4. Otherwise it is only required to pass test 1&2.

In the measurement control information, it is indicated to the UE that event-triggered reporting with Event A3 is used. The test consists of two successive time periods, with time duration of T1, and T2 respectively. During time duration T1, the UE shall not have any timing information of NR cell 3.

UE needs to be provided at least once every 500ms with new Timing Advance Command MAC control element to restart the Time alignment timer to keep UE uplink time alignment. Furthermore, UE is allocated with PUSCH resource at every DRX cycle.

**Table A.11.5.2.8.1-1: SA event triggered reporting tests without SSB index reading for FR1-FR1 with CCA**

Config	Description
1	NR cell with CCA: 30 kHz SSB SCS, 40 MHz bandwidth, TDD duplex mode NR cell without CCA: 15 kHz SSB SCS, 10 MHz bandwidth, FDD duplex mode
2	NR cell with CCA: 30 kHz SSB SCS, 40 MHz bandwidth, TDD duplex mode NR cell without CCA: 15 kHz SSB SCS, 10 MHz bandwidth, TDD duplex mode
3	NR cell with CCA: 30 kHz SSB SCS, 40 MHz bandwidth, TDD duplex mode NR cell without CCA: 30 kHz SSB SCS, 40 MHz bandwidth, TDD duplex mode
Note 1: The UE is only required to be tested in one of the supported test configurations	

**Table A.11.5.2.8.1-2: General test parameters for SA inter-frequency event triggered reporting for FR1 with CCA without SSB time index detection**

Parameter	Unit	Test configuration	Value				Comment
			Test 1	Test 2	Test 3	Test 4	
NR RF Channel Number		Config 1,2,3	1, 2				Two FR1 NR carrier frequencies are used. NR channel 1 is with CCA.
Active cell		Config 1,2,3	NR cell 1 (PCell)				NR cell 1 is on NR RF channel number 1 with CCA.
Neighbour cell		Config 1,2,3	NR cell 2				NR cell 2 is on NR RF channel number 2.
DL CCA model		Config 1,2,3	As specified in clause A.3.26.2.1				
UL CCA model		Config 1,2,3	As specified in clause A.3.26.2.2				
Gap Pattern Id		Config 1,2,3	0		4		As specified in clause 9.1.2-1.
Measurement gap offset		Config 1,2,3	9		9		
A3-Offset	dB	Config 1,2,3	-6				
Hysteresis	dB	Config 1,2,3	0				
CP length		Config 1,2,3	Normal				
TimeToTrigger	s	Config 1,2,3	0				

Filter coefficient		Config 1,2,3	0				L3 filtering is not used
DRX		Config 1,2,3	DRX .1	DRX .2	DRX .1	DRX .2	As specified in clause A.3.3
Time offset between serving and neighbour cells		Config 1,2,3	3ms				Asynchronous cells. The timing of Cell 2 is 3ms later than the timing of Cell 1.
		Config 1,2,3	3µs				Synchronous cells.
T1	s	Config 1,2,3	5				
T2	s	Config 1,2,3	2.5	17	2.5	17	

**Table A.11.5.2.8.1-3: Cell specific test parameters for SA inter-frequency event triggered reporting for FR1 with CCA without SSB time index detection**

Parameter		Unit	Test configuration	Cell 1				Cell 2			
				T1	T2	T3	T4	T1	T2	T3	T4
NR RF Channel Number			Config 1,2,3	1				2			
Duplex mode			Config 1	TDD				FDD			
			Config 2,3	TDD				TDD			
TDD configuration			Config 1	TDDConf.1.1 CCA				Not Applicable			
			Config 2	TDDConf.1.1 CCA				TDDConf.1.1			
			Config 3	TDDConf.1.1 CCA				TDDConf.2.1			
BW <sub>channel</sub>		MHz	Config 1,2	40: N <sub>RB,c</sub> = 106				10: N <sub>RB,c</sub> = 52			
			Config 3	40: N <sub>RB,c</sub> = 106				40: N <sub>RB,c</sub> = 106			
BWP BW		MHz	Config 1,2	40: N <sub>RB,c</sub> = 106				10: N <sub>RB,c</sub> = 52			
			Config 3	40: N <sub>RB,c</sub> = 106				40: N <sub>RB,c</sub> = 106			
BWP configuration	Initial DL BWP		Config 1,2,3	DLBWP.0.1				NA			
	Initial UL BWP			ULBWP.0.1				NA			
	Dedicated DL BWP			DLBWP.1.1				NA			
	Dedicated UL BWP			ULBWP.1.1				NA			
TRS configuration			Config 1,2,3	TRS.1.2 TDD				NA			
OCNG Patterns defined in A.3.2.1.1 (OP.1)			Config 1,2,3	OP.1				OP.1			
PDSCH Reference measurement channel			Config 1,2,3	SR.1.1 CCA							
CORESET Reference Channel			Config 1,2,3	CR.1.1 CCA							
SSB parameters	Semi-static channel access <sup>Note 5,7</sup>		Config 1,2	SSB.1 CCA				SSB.1 FR1			
			Config 3	SSB.1 CCA				SSB.2 FR1			
	Semi-static channel access <sup>Note 5,7</sup>		Config 1,2	SSB.2 CCA				SSB.1 FR1			
			Config 3	SSB.2 CCA				SSB.2 FR1			
DBT window configuration			Config 1,2,3	As defined in A.3.28.1				Not applicable			
SMTC configuration defined in A.3.11			Config 1,2,3	SMTC.1				SMTC.4			
PDSCH/PDCCH subcarrier spacing		kHz	Config 1,2	30				15			
			Config 3	30				30			
DL CCA probability P <sub>CCA_DL</sub>	Semi-static channel access <sup>Note 5,7</sup>		Config 1,2,3	P <sub>CCA_DL</sub> =0.9375				NA			
	Dynamic channel access <sup>Note 6,7</sup>		Config 1,2,3	P <sub>CCA_DL_1</sub> =0.75 P <sub>CCA_DL_2</sub> =0.75				NA			
UL CCA probability P <sub>CCA_UL</sub>	Semi-static channel access <sup>Note 5,7</sup>		Config 1,2,3	P <sub>CCA_UL</sub> =1				NA			



	Dynamic channel access <sup>Note 6,7</sup>		Config 1,2,3	PCCA_UL=1		NA	
LCCA_DL			Config 1,2,3	5		5	
WCCA_DL	ms		Config 1,2,3	TPSS/SSS_sync_inter_cca		TPSS/SSS_sync_inter_cca	
EPRE ratio of PSS to SSS		Config 1,2,3		0	0		
EPRE ratio of PBCH DMRS to SSS							
EPRE ratio of PBCH to PBCH DMRS							
EPRE ratio of PDCCH DMRS to SSS							
EPRE ratio of PDCCH to PDCCH DMRS							
EPRE ratio of PDSCH DMRS to SSS							
EPRE ratio of PDSCH to PDSCH							
EPRE ratio of OCNG DMRS to SSS(Note 1)							
EPRE ratio of OCNG to OCNG DMRS (Note 1)							
$N_{oc}$ <sup>Note2</sup>	dBm/1 5kHz						
$N_{oc}$ <sup>Note2</sup>	dBm/S CS	Config 1,2		-101		-98	
		Config 3		-101		-95	
SS-RSRP <sup>Note 3</sup>	dBm/S CS	Config 1,2	-91	-91	-Infinity	-91	
		Config 3	-91	-91	-Infinity	-88	
$\hat{E}_s/I_{ot}$	dB	Config 1,2,3	4	4	-Infinity	7	
$\hat{E}_s/N_{oc}$	dB	Config 1,2,3	4	4	-Infinity	7	
$I_o$ <sup>Note3</sup>	dBm/9 .36MHz	Config 1,2	-58.49	-58.49	-70.05	-62.26	
	dBm/3 8.16MHz	Config 3	-58.49	-58.49	-63.94	-56.15	
Propagation Condition		Config 1,2,3	AWGN		AWGN		
<p>Note 1: OCNG shall be used such that both cells are fully allocated and a constant total transmitted power spectral density is achieved for all OFDM symbols.</p> <p>Note 2: Interference from other cells and noise sources not specified in the test is assumed to be constant over subcarriers and time and shall be modelled as AWGN of appropriate power for <math>N_{oc}</math> to be fulfilled.</p> <p>Note 3: SS-RSRP and <math>I_o</math> levels have been derived from other parameters for information purposes. They are not settable parameters themselves.</p> <p>Note 4: SS-RSRP minimum requirements are specified assuming independent interference and noise at each receiver antenna port.</p> <p>Note 5: For UE supporting semi-static channel access and network configuring semi-static channel occupancy.</p> <p>Note 6: For UE supporting dynamic channel access and network configuring dynamic channel occupancy.</p> <p>Note 7: For UE supporting both semi-static and dynamic channel access, the UE must be tested under dynamic channel access configuration.</p>							

**Table A.11.5.2.8.1-4: DRX-Configuration for SA inter-frequency event triggered reporting without SSB time index detection**

Field	Test1&3	Test2&4	Comment
	Value	Value	
drx-onDurationTimer	ms1	ms1	As specified in clause 6.3.2 in TS 38.331 [2]
drx-InactivityTimer	ms1	ms1	
drx-RetransmissionTimerDL	sl1	sl1	
drx-RetransmissionTimerUL	sl1	sl1	
drx-LongCycleStartOffset	ms40	Ms640	

shortDRX	disable	disable	
----------	---------	---------	--

**Table A.11.5.2.8.1-5: TimeAlignmentTimer-Configuration SA inter-frequency event triggered reporting without SSB time index detection**

Field	Value	Comment
TimeAlignmentTimer	ms500	As specified in clause 6.3.2 in TS 38.331 [2]

### A.11.5.2.8.2 Test Requirements

In test 1 with per-UE gap, the UE shall send one Event A3 triggered measurement report, with a measurement reporting delay less than  $T_{\text{identify\_inter\_cca\_without\_index}}$  from the beginning of time period T2. The UE shall not send event triggered measurement reports, as long as the reporting criteria are not fulfilled. The rate of correct events observed during repeated tests shall be at least 90%.

In test 2 with per-FR gap, the UE shall send one Event A3 triggered measurement report, with a measurement reporting delay less than  $T_{\text{identify\_inter\_cca\_without\_index}}$  from the beginning of time period T2. The UE shall not send event triggered measurement reports, as long as the reporting criteria are not fulfilled. The rate of correct events observed during repeated tests shall be at least 90%.

In test 3 with per-UE gap, the UE shall send one Event A3 triggered measurement report, with a measurement reporting delay less than  $T_{\text{identify\_inter\_cca\_without\_index}}$  from the beginning of time period T2. The UE shall not send event triggered measurement reports, as long as the reporting criteria are not fulfilled. The rate of correct events observed during repeated tests shall be at least 90%.

In test 4 with per-FR gap, the UE shall send one Event A3 triggered measurement report, with a measurement reporting delay less than  $T_{\text{identify\_inter\_cca\_without\_index}}$  from the beginning of time period T2. The UE shall not send event triggered measurement reports, as long as the reporting criteria are not fulfilled. The rate of correct events observed during repeated tests shall be at least 90%.

In test 1, 2, 3 and 4 UE is not required to report SSB time index.

$T_{\text{identify\_inter\_cca\_without\_index}} = (T_{\text{PSS/SSS\_sync\_inter\_cca}} + T_{\text{SSB\_measurement\_period\_inter\_cca}})$  ms, where

$T_{\text{PSS/SSS\_sync\_inter\_cca}}$ : it is the time period used in PSS/SSS detection given in table 9.3A.4-1.

$T_{\text{SSB\_measurement\_period\_inter\_cca}}$ : equal to a measurement period of SSB based measurement given in table 9.3A.5-1.

For tests 1 and 2, MGRP = 40 ms and for tests 3 and 4 MGRP = 20 ms.

For tests 1 and 3, DRX cycle = 40 ms and for tests 2 and 4 DRX cycle = 640 ms.

SMTC period = 20 ms.

NOTE: The actual overall delays measured in the test may be up to  $2 \times TTI_{\text{DCCCH}}$  higher than the measurement reporting delays above because of TTI insertion uncertainty of the measurement report in DCCCH.

### A.11.5.2.9 Event triggered reporting tests for FR1 with SSB time index detection when DRX is not used

#### A.11.5.2.9.1 Test Purpose and Environment

The purpose of this test is to verify that the UE makes correct reporting of an event. This test will partly verify the SA inter-frequency NR cell search requirements in clause 9.3A.4 and 9.3A.5.

In this test, there are two cells: NR cell 1 with CCA as PCell in FR1 on NR RF channel 1 and NR cell 2 as neighbour cell in FR1 on NR RF channel 2. The test parameters are given in Tables A.11.5.2.9.1-1, A.11.5.2.9.1-2 and A.11.5.2.9.1-3.

In test 1 measurement gap pattern configuration # 0 as defined in Table A.11.5.2.9.1-2 is provided for UE that does not support per-FR gap and in test 2 measurement gap pattern configuration #4 as defined in Table A.11.5.2.9.1-2 is

provided for UE that supports per-FR gap. If a UE supports per-FR gap and gap pattern configuration #4, it is only required to pass test 2. Otherwise it is only required to pass test 1.

In the measurement control information, it is indicated to the UE that event-triggered reporting with Event A3 is used. The test consists of two successive time periods, with time duration of T1, and T2 respectively. During time duration T1, the UE shall not have any timing information of NR cell 3.

**Table A.11.5.2.9.1-1: SA event triggered reporting tests with SSB index reading for FR1-FR1 with CCA**

Config	Description
1	NR cell with CCA: 30 kHz SSB SCS, 40 MHz bandwidth, TDD duplex mode NR cell without CCA: 15 kHz SSB SCS, 10 MHz bandwidth, FDD duplex mode
2	NR cell with CCA: 30 kHz SSB SCS, 40 MHz bandwidth, TDD duplex mode NR cell without CCA: 15 kHz SSB SCS, 10 MHz bandwidth, TDD duplex mode
3	NR cell with CCA: 30 kHz SSB SCS, 40 MHz bandwidth, TDD duplex mode NR cell without CCA: 30 kHz SSB SCS, 40 MHz bandwidth, TDD duplex mode
Note 1: The UE is only required to be tested in one of the supported test configurations	

**Table A.11.5.2.9.1-2: General test parameters for SA inter-frequency event triggered reporting for FR1 with CCA with SSB time index detection**

Parameter	Unit	Test configuration	Value		Comment
			Test 1	Test 2	
NR RF Channel Number		Config 1,2,3	1, 2		Two FR1 NR carrier frequencies are used. NR channel 1 is with CCA.
Active cell		Config 1,2,3	NR cell 1 (PCell)		NR cell 1 is on NR RF channel number 1 with CCA.
Neighbour cell		Config 1,2,3	NR cell 2		NR cell 2 is on NR RF channel number 2.
DL CCA model		Config 1,2,3	As specified in clause A.3.26.2.1		
UL CCA model		Config 1,2,3	As specified in clause A.3.26.2.2		
Gap Pattern Id		Config 1,2,3	0	4	As specified in clause 9.1.2-1.
Measurement gap offset		Config 1,2,3	9	9	
A3-Offset	dB	Config 1,2,3	-6		
Hysteresis	dB	Config 1,2,3	0		
CP length		Config 1,2,3	Normal		
TimeToTrigger	s	Config 1,2,3	0		
Filter coefficient		Config 1,2,3	0		L3 filtering is not used
DRX		Config 1,2,3	OFF		DRX is not used
Time offset between serving and neighbour cells		Config 1,2,3	3ms		Asynchronous cells. The timing of Cell 2 is 3ms later than the timing of Cell 1.
		Config 1,2,3	3μs		Synchronous cells.
T1	s	Config 1,2,3	5		
T2	s	Config 1,2,3	2	2	

**Table A.11.5.2.9.1-3: Cell specific test parameters for SA inter-frequency event triggered reporting for FR1 with CCA with SSB time index detection**

Parameter	Unit	Test configuration	Cell 1		Cell 2	
			T1	T2	T1	T2
NR RF Channel Number		Config 1,2,3	1		2	
Duplex mode		Config 1	TDD		FDD	

			Config 2,3	TDD	TDD
TDD configuration			Config 1	TDDConf.1.1 CCA	Not Applicable
			Config 2	TDDConf.1.1 CCA	TDDConf.1.1
			Config 3	TDDConf.1.1 CCA	TDDConf.2.1
BW <sub>channel</sub>		MHz	Config 1,2	40: N <sub>RB,c</sub> = 106	10: N <sub>RB,c</sub> = 52
			Config 3	40: N <sub>RB,c</sub> = 106	40: N <sub>RB,c</sub> = 106
BWP BW		MHz	Config 1,2	40: N <sub>RB,c</sub> = 106	10: N <sub>RB,c</sub> = 52
			Config 3	40: N <sub>RB,c</sub> = 106	40: N <sub>RB,c</sub> = 106
BWP configuration	Initial DL BWP		Config 1,2,3	DLBWP.0.1	NA
	Initial UL BWP			ULBWP.0.1	NA
	Dedicated DL BWP			DLBWP.1.1	NA
	Dedicated UL BWP			ULBWP.1.1	NA
TRS configuration			Config 1,2,3	TRS.1.2 TDD	NA
OCNG Patterns defined in A.3.2.1.1 (OP.1)			Config 1,2,3	OP.1	OP.1
PDSCH Reference measurement channel			Config 1,2,3	SR.1.1 CCA	
CORESET Reference Channel			Config 1,2,3	CR.1.1 CCA	
SSB parameters	Semi-static channel access <sup>Note 5,7</sup>		Config 1,2	SSB.1 CCA	SSB.1 FR1
			Config 3	SSB.1 CCA	SSB.2 FR1
	Semi-static channel access <sup>Note 5,7</sup>		Config 1,2	SSB.2 CCA	SSB.1 FR1
			Config 3	SSB.2 CCA	SSB.2 FR1
DBT window configuration			Config 1,2,3	As defined in A.3.28.1	Not applicable
SMTC configuration defined in A.3.11			Config 1,2,3	SMTC.1	SMTC.4
PDSCH/PDCCH subcarrier spacing		kHz	Config 1,2	30	15
			Config 3	30	30
DL CCA probability P <sub>CCA_DL</sub>	Semi-static channel access <sup>Note 5,7</sup>		Config 1,2,3	P <sub>CCA_DL</sub> =0.9375	NA
	Dynamic channel access <sup>Note 6,7</sup>		Config 1,2,3	P <sub>CCA_DL_1</sub> =0.75 P <sub>CCA_DL_2</sub> =0.75	NA
UL CCA probability P <sub>CCA_UL</sub>	Semi-static channel access <sup>Note 5,7</sup>		Config 1,2,3	P <sub>CCA_UL</sub> =1	NA
	Dynamic channel access <sup>Note 6,7</sup>		Config 1,2,3	P <sub>CCA_UL</sub> =1	NA
L <sub>CCA_DL</sub>			Config 1,2,3	5	5
W <sub>CCA_DL</sub>		ms	Config 1,2,3	T <sub>PSS/SSS_sync_inter_cca</sub>	T <sub>PSS/SSS_sync_inter_cca</sub>
EPRE ratio of PSS to SSS			Config 1,2,3	0	0
EPRE ratio of PBCH DMRS to SSS					
EPRE ratio of PBCH to PBCH DMRS					
EPRE ratio of PDCCH DMRS to SSS					
EPRE ratio of PDCCH to PDCCH DMRS					
EPRE ratio of PDSCH DMRS to SSS					
EPRE ratio of PDSCH to PDSCH					
EPRE ratio of OCNG DMRS to SSS(Note 1)					
EPRE ratio of OCNG to OCNG DMRS (Note 1)					

$N_{oc}$ <sup>Note2</sup>	dBm/1 5kHz	Config 1,2,3	-104		-98	
$N_{oc}$ <sup>Note2</sup>	dBm/S CS	Config 1,2	-101		-98	
		Config 3	-101		-95	
SS-RSRP <sup>Note 3</sup>	dBm/S CS	Config 1,2	-91	-91	-Infinity	-91
		Config 3	-91	-91	-Infinity	-88
$\hat{E}_s/I_{ot}$	dB	Config 1,2,3	4	4	-Infinity	7
$\hat{E}_s/N_{oc}$	dB	Config 1,2,3	4	4	-Infinity	7
$I_o$ <sup>Note3</sup>	dBm/9 .36MHz	Config 1,2	-58.49	-58.49	-70.05	-62.26
	dBm/3 8.16MHz	Config 3	-58.49	-58.49	-63.94	-56.15
Propagation Condition		Config 1,2,3	AWGN		AWGN	
<p>Note 1: OCNG shall be used such that both cells are fully allocated and a constant total transmitted power spectral density is achieved for all OFDM symbols.</p> <p>Note 2: Interference from other cells and noise sources not specified in the test is assumed to be constant over subcarriers and time and shall be modelled as AWGN of appropriate power for <math>N_{oc}</math> to be fulfilled.</p> <p>Note 3: SS-RSRP and <math>I_o</math> levels have been derived from other parameters for information purposes. They are not settable parameters themselves.</p> <p>Note 4: SS-RSRP minimum requirements are specified assuming independent interference and noise at each receiver antenna port.</p> <p>Note 5: For UE supporting semi-static channel access and network configuring semi-static channel occupancy.</p> <p>Note 6: For UE supporting dynamic channel access and network configuring dynamic channel occupancy.</p> <p>Note 7: For UE supporting both semi-static and dynamic channel access, the UE must be tested under dynamic channel access configuration.</p>						

#### A.11.5.2.9.2 Test Requirements

In test 1 with per-UE gap, the UE shall send one Event A3 triggered measurement report, with a measurement reporting delay less than  $T_{\text{identify\_inter\_cca\_with\_index}}$  from the beginning of time period T2. The UE shall not send event triggered measurement reports, as long as the reporting criteria are not fulfilled. The rate of correct events observed during repeated tests shall be at least 90%.

In test 2 with per-FR gap, the UE shall send one Event A3 triggered measurement report, with a measurement reporting delay less than  $T_{\text{identify\_inter\_cca\_with\_index}}$  from the beginning of time period T2. The UE shall not send event triggered measurement reports, as long as the reporting criteria are not fulfilled. The rate of correct events observed during repeated tests shall be at least 90%.

In test 1 and 2 UE is required to report SSB time index.

$T_{\text{identify\_inter\_cca\_with\_index}} = (T_{\text{PSS/SSS\_sync\_inter\_cca}} + T_{\text{SSB\_measurement\_period\_inter\_cca}} + T_{\text{SSB\_time\_index\_inter\_cca}})$  ms, where

$T_{\text{PSS/SSS\_sync\_inter\_cca}}$ : it is the time period used in PSS/SSS detection given in table 9.3A.4-1.

$T_{\text{SSB\_time\_index\_inter\_cca}}$ : it is the time period used to acquire the index of the SSB being measured given in table 9.3A.4-2.

$T_{\text{SSB\_measurement\_period\_inter\_cca}}$ : equal to a measurement period of SSB based measurement given in table 9.3A.5-1.

For test 1, MGRP = 40 ms and for test 2 MGRP = 20 ms.

SMTC period = 20 ms.

NOTE: The actual overall delays measured in the test may be up to  $2 \times TTI_{\text{DCCH}}$  higher than the measurement reporting delays above because of TTI insertion uncertainty of the measurement report in DCCH.

## A.11.5.2.10 Event triggered reporting tests for FR1 with SSB time index detection when DRX is used

### A.11.5.2.10.1 Test Purpose and Environment

The purpose of this test is to verify that the UE makes correct reporting of an event. This test will partly verify the SA inter-frequency NR cell search requirements in clause 9.3A.4 and 9.3A.5.

In this test, there are two cells: NR cell 1 with CCA as PCell in FR1 on NR RF channel 1 and NR cell 2 as neighbour cell in FR1 on NR RF channel 2. The test parameters are given in Tables A.11.5.2.10.1-1, A.11.5.2.10.1-2 and A.11.5.2.10.1-3.

In test 1&2 measurement gap pattern configuration # 0 as defined in Table A.11.5.2.10.1-2 is provided for UE that does not support per-FR gap and in test 3&4 measurement gap pattern configuration #4 as defined in Table A.11.5.2.10.1-2 is provided for UE that supports per-FR gap. If a UE supports per-FR gap and gap pattern configuration #4, it is only required to pass test 3&4. Otherwise it is only required to pass test 1&2.

In the measurement control information, it is indicated to the UE that event-triggered reporting with Event A3 is used. The test consists of two successive time periods, with time duration of T1, and T2 respectively. During time duration T1, the UE shall not have any timing information of NR cell 3.

UE needs to be provided at least once every 500 ms with new Timing Advance Command MAC control element to restart the Time alignment timer to keep UE uplink time alignment. Furthermore, UE is allocated with PUSCH resource at every DRX cycle.

**Table A.11.5.2.10.1-1: SA event triggered reporting tests with SSB index reading for FR1-FR1 with CCA**

Config	Description
1	NR cell with CCA: 30 kHz SSB SCS, 40 MHz bandwidth, TDD duplex mode NR cell without CCA: 15 kHz SSB SCS, 10 MHz bandwidth, FDD duplex mode
2	NR cell with CCA: 30 kHz SSB SCS, 40 MHz bandwidth, TDD duplex mode NR cell without CCA: 15 kHz SSB SCS, 10 MHz bandwidth, TDD duplex mode
3	NR cell with CCA: 30 kHz SSB SCS, 40 MHz bandwidth, TDD duplex mode NR cell without CCA: 30 kHz SSB SCS, 40 MHz bandwidth, TDD duplex mode
Note 1: The UE is only required to be tested in one of the supported test configurations	

**Table A.11.5.2.10.1-2: General test parameters for SA inter-frequency event triggered reporting for FR1 with CCA with SSB time index detection**

Parameter	Unit	Test configuration	Value				Comment
			Test 1	Test 2	Test 3	Test 4	
NR RF Channel Number		Config 1,2,3	1, 2				Two FR1 NR carrier frequencies are used. NR channel 1 is with CCA.
Active cell		Config 1,2,3	NR cell 1 (PCell)				NR cell 1 is on NR RF channel number 1 with CCA.
Neighbour cell		Config 1,2,3	NR cell 2				NR cell 2 is on NR RF channel number 2.
DL CCA model		Config 1,2,3	As specified in clause A.3.26.2.1				
UL CCA model		Config 1,2,3	As specified in clause A.3.26.2.2				
Gap Pattern Id		Config 1,2,3	0		4		As specified in clause 9.1.2-1.
Measurement gap offset		Config 1,2,3	9		9		
A3-Offset	dB	Config 1,2,3	-6				
Hysteresis	dB	Config 1,2,3	0				
CP length		Config 1,2,3	Normal				
TimeToTrigger	s	Config 1,2,3	0				

Filter coefficient		Config 1,2,3	0				L3 filtering is not used
DRX		Config 1,2,3	DRX .1	DRX .2	DRX .1	DRX .2	As specified in clause A.3.3
Time offset between serving and neighbour cells		Config 1,2,3	3ms				Asynchronous cells. The timing of Cell 2 is 3ms later than the timing of Cell 1.
		Config 1,2,3	3μs				Synchronous cells.
T1	s	Config 1,2,3	5				
T2	s	Config 1,2,3	3	20	3	20	

**Table A.11.5.2.10.1-3: Cell specific test parameters for SA inter-frequency event triggered reporting for FR1 with CCA with SSB time index detection**

Parameter		Unit	Test configuration	Cell 1				Cell 2			
				T1	T2	T3	T4	T1	T2	T3	T4
NR RF Channel Number			Config 1,2,3	1				2			
Duplex mode			Config 1	TDD				FDD			
			Config 2,3	TDD				TDD			
TDD configuration			Config 1	TDDConf.1.1 CCA				Not Applicable			
			Config 2	TDDConf.1.1 CCA				TDDConf.1.1			
			Config 3	TDDConf.1.1 CCA				TDDConf.2.1			
BW <sub>channel</sub>		MHz	Config 1,2	40: N <sub>RB,c</sub> = 106				10: N <sub>RB,c</sub> = 52			
BWP BW		MHz	Config 1,2	40: N <sub>RB,c</sub> = 106				10: N <sub>RB,c</sub> = 52			
			Config 3	40: N <sub>RB,c</sub> = 106				40: N <sub>RB,c</sub> = 106			
BWP configuration	Initial DL BWP		Config 1,2,3	DLBWP.0.1				NA			
	Initial UL BWP			ULBWP.0.1				NA			
	Dedicated DL BWP			DLBWP.1.1				NA			
	Dedicated UL BWP			ULBWP.1.1				NA			
TRS configuration			Config 1,2,3	TRS.1.2 TDD				NA			
OCNG Patterns defined in A.3.2.1.1 (OP.1)			Config 1,2,3	OP.1				OP.1			
PDSCH Reference measurement channel			Config 1,2,3	SR.1.1 CCA							
CORESET Reference Channel			Config 1,2,3	CR.1.1 CCA							
SSB parameters	Semi-static channel access <sup>Note 5,7</sup>		Config 1,2	SSB.1 CCA				SSB.1 FR1			
			Config 3	SSB.1 CCA				SSB.2 FR1			
	Semi-static channel access <sup>Note 5,7</sup>		Config 1,2	SSB.2 CCA				SSB.1 FR1			
			Config 3	SSB.2 CCA				SSB.2 FR1			
DBT window configuration			Config 1,2,3	As defined in A.3.28.1				Not applicable			
SMTC configuration defined in A.3.11			Config 1,2,3	SMTC.1				SMTC.4			
PDSCH/PDCCH subcarrier spacing		kHz	Config 1,2	30				15			
			Config 3	30				30			
DL CCA probability P <sub>CCA_DL</sub>	Semi-static channel access <sup>Note 5,7</sup>		Config 1,2,3	P <sub>CCA_DL</sub> =0.9375				NA			
	Dynamic channel access <sup>Note 6,7</sup>		Config 1,2,3	P <sub>CCA_DL_1</sub> =0.75 P <sub>CCA_DL_2</sub> =0.75				NA			
UL CCA probability P <sub>CCA_UL</sub>	Semi-static channel access <sup>Note 5,7</sup>		Config 1,2,3	P <sub>CCA_UL</sub> =1				NA			
	Dynamic channel access <sup>Note 6,7</sup>		Config 1,2,3	P <sub>CCA_UL</sub> =1				NA			
LCCA_DL			Config 1,2,3	2				2			

$W_{CCA\_DL}$	ms	Config 1,2,3	$T_{PSS/SSS\_sync\_inter\_cca}$		$T_{PSS/SSS\_sync\_inter\_cca}$	
EPRE ratio of PSS to SSS		Config 1,2,3	0		0	
EPRE ratio of PBCH DMRS to SSS						
EPRE ratio of PBCH to PBCH DMRS						
EPRE ratio of PDCCH DMRS to SSS						
EPRE ratio of PDCCH to PDCCH DMRS						
EPRE ratio of PDSCH DMRS to SSS						
EPRE ratio of PDSCH to PDSCH						
EPRE ratio of OCNG DMRS to SSS(Note 1)						
EPRE ratio of OCNG to OCNG DMRS (Note 1)						
$N_{oc}^{Note2}$	dBm/15kHz	Config 1,2,3	-104		-98	
$N_{oc}^{Note2}$	dBm/S CS	Config 1,2	-101		-98	
		Config 3	-101		-95	
SS-RSRP Note 3	dBm/S CS	Config 1,2	-91	-91	-Infinity	-91
		Config 3	-91	-91	-Infinity	-88
$\hat{E}_s/I_{ot}$	dB	Config 1,2,3	4	4	-Infinity	7
$\hat{E}_s/N_{oc}$	dB	Config 1,2,3	4	4	-Infinity	7
$I_o^{Note3}$	dBm/9.36MHz	Config 1,2	-58.49	-58.49	-70.05	-62.26
	dBm/38.16MHz	Config 3	-58.49	-58.49	-63.94	-56.15
Propagation Condition		Config 1,2,3	AWGN		AWGN	
<p>Note 1: OCNG shall be used such that both cells are fully allocated and a constant total transmitted power spectral density is achieved for all OFDM symbols.</p> <p>Note 2: Interference from other cells and noise sources not specified in the test is assumed to be constant over subcarriers and time and shall be modelled as AWGN of appropriate power for <math>N_{oc}</math> to be fulfilled.</p> <p>Note 3: SS-RSRP and <math>I_o</math> levels have been derived from other parameters for information purposes. They are not settable parameters themselves.</p> <p>Note 4: SS-RSRP minimum requirements are specified assuming independent interference and noise at each receiver antenna port.</p> <p>Note 5: For UE supporting semi-static channel access and network configuring semi-static channel occupancy.</p> <p>Note 6: For UE supporting dynamic channel access and network configuring dynamic channel occupancy.</p> <p>Note 7: For UE supporting both semi-static and dynamic channel access, the UE must be tested under dynamic channel access configuration.</p>						

**Table A.11.5.2.10.1-4: DRX-Configuration for SA inter-frequency event triggered reporting without SSB time index detection**

Field	Test1&3	Test2&4	Comment
	Value	Value	
drx-onDurationTimer	ms1	ms1	As specified in clause 6.3.2 in TS 38.331 [2]
drx-InactivityTimer	ms1	ms1	
drx-RetransmissionTimerDL	sl1	sl1	
drx-RetransmissionTimerUL	sl1	sl1	
drx-LongCycleStartOffset	ms40	Ms640	
shortDRX	disable	disable	



**Table A.11.5.2.10.1-5: *TimeAlignmentTimer* -Configuration SA inter-frequency event triggered reporting without SSB time index detection**

Field	Value	Comment
TimeAlignmentTimer	ms500	As specified in clause 6.3.2 in TS 38.331 [2]

### A.11.5.2.10.2 Test Requirements

In test 1 with per-UE gap, the UE shall send one Event A3 triggered measurement report, with a measurement reporting delay less than  $T_{\text{identify\_inter\_cca\_with\_index}}$  from the beginning of time period T2. The UE shall not send event triggered measurement reports, as long as the reporting criteria are not fulfilled. The rate of correct events observed during repeated tests shall be at least 90%. In test 2 with per-FR gap, the UE shall send one Event A3 triggered measurement report, with a measurement reporting delay less than  $T_{\text{identify\_inter\_cca\_with\_index}}$  from the beginning of time period T2. The UE shall not send event triggered measurement reports, as long as the reporting criteria are not fulfilled. The rate of correct events observed during repeated tests shall be at least 90%.

In test 3 with per-UE gap, the UE shall send one Event A3 triggered measurement report, with a measurement reporting delay less than  $T_{\text{identify\_inter\_cca\_with\_index}}$  from the beginning of time period T2. The UE shall not send event triggered measurement reports, as long as the reporting criteria are not fulfilled. The rate of correct events observed during repeated tests shall be at least 90%.

In test 4 with per-FR gap, the UE shall send one Event A3 triggered measurement report, with a measurement reporting delay less than  $T_{\text{identify\_inter\_cca\_with\_index}}$  from the beginning of time period T2. The UE shall not send event triggered measurement reports, as long as the reporting criteria are not fulfilled. The rate of correct events observed during repeated tests shall be at least 90%.

In test 1, 2, 3 and 4 UE is required to report SSB time index.

$T_{\text{identify\_inter\_cca\_with\_index}} = (T_{\text{PSS/SSS\_sync\_inter\_cca}} + T_{\text{SSB\_measurement\_period\_inter\_cca}} + T_{\text{SSB\_time\_index\_inter\_cca}})$  ms, where

$T_{\text{PSS/SSS\_sync\_inter\_cca}}$ : it is the time period used in PSS/SSS detection given in table 9.3A.4-1.

$T_{\text{SSB\_time\_index\_inter\_cca}}$ : it is the time period used to acquire the index of the SSB being measured given in table 9.3A.4-2.

$T_{\text{SSB\_measurement\_period\_inter\_cca}}$ : equal to a measurement period of SSB based measurement given in table 9.3A.5-1.

For tests 1 and 2, MGRP = 40 ms and for tests 3 and 4 MGRP = 20 ms.

For tests 1 and 3, DRX cycle = 40 ms and for tests 2 and 4 DRX cycle = 640 ms.

SMTC period = 20 ms.

NOTE: The actual overall delays measured in the test may be up to  $2 \times T_{\text{TTI}_{\text{DCCH}}}$  higher than the measurement reporting delays above because of TTI insertion uncertainty of the measurement report in DCCH.

## A.11.5.3 Inter-RAT E-UTRAN measurements

### A.11.5.3.1 SA NR - E-UTRAN event-triggered reporting in non-DRX in FR1

#### A.11.5.3.1.1 Test Purpose and Environment

The purpose of this set of tests is to verify that the UE makes correct event-triggered reporting of inter-RAT E-UTRAN measurements when operating in standalone (SA) operation with PCell in FR1. This test shall partly verify the cell search and measurement requirements in Clauses 9.4.2 and 9.4.3.

In each test there are two cells: Cell 1 and Cell 2. Cell 1 is the NR PCell on a frequency carrier with CCA and Cell 2 is an inter-RAT E-UTRAN inter-RAT neighbour cell. In the measurement control information from the PCell it is indicated to the UE that event-triggered reporting with Event B2 (PCell becomes worse than threshold1 and inter RAT neighbour becomes better than threshold2) is to be used. Each test consists of two consecutive time periods, with

durations T1 and T2, respectively. Prior to the start of time duration T1, the UE shall be fully synchronized to Cell 1. During T1, the UE shall not have any information on Cell 2.

Supported test configurations are shown in table A.11.5.3.1.1-1. General test parameters are provided in Table A.11.5.3.1.1-2 below. Test parameters for Cell 1 and Cell 2, valid for both time duration T1 and T2, are provided in Tables A.11.5.3.1.1-3 and A.11.5.3.1.1-4, respectively.

**Table A.11.5.3.1.1-1: Supported test configurations in SA inter-RAT E-UTRAN event triggered reporting in non-DRX with PCell in FR1**

Configuration	Description
1	NR with CCA 30 kHz SSB SCS, 40 MHz bandwidth, TDD duplex mode, LTE FDD
2	NR with CCA 30 kHz SSB SCS, 40 MHz bandwidth, TDD duplex mode, LTE TDD
Note: The UE is only required to be tested in one of the supported test configurations	

**Table A.11.5.3.1.1-2: General test parameters for SA inter-RAT E-UTRAN event triggered reporting in non-DRX with PCell in FR1**

Parameter	Unit	Value	Comment
NR RF Channel Number		1	1 NR carrier frequency is used in the test
LTE RF Channel Number		1	1 LTE carrier frequency is used in the test
Channel Bandwidth	MHz	As specified in Tables A.11.5.3.1.1-2 and A.11.5.3.1.1-3.	
Active cell		Cell 1	Cell 1 is on RF channel number 1
Neighbour cell		Cell 2	Cell 2 is on RF channel number 2
Gap Pattern Id		0	As specified in Clause Table 9.1.2-1. Per-UE gap pattern.
NR measurement quantity		SS-RSRP	Measurement quantity for Cell 1
Inter-RAT E-UTRAN measurement quantity		RSRP	Measurement quantity for Cell 2
b2-Threshold1	dBm	Note 1	SS-RSRP threshold for SS-RSRP measurement on cell1 for event B2
b2-Threshold2EUTRA	dBm	-95	E-UTRAN RSRP threshold for SS-RSRP measurement on cell1 for event B2
Hysteresis	dB	0	
TimeToTrigger	s	0	
Filter coefficient		0	L3 filtering is not used
DRX		OFF	OFF
T1	s	5	
T2	s	5	
Note 1: Values are defined in Table A.11.5.3.1.1-3			

**Table A.11.5.3.1.1-3: PCell specific test parameters for SA inter-RAT E-UTRA event triggered reporting in non-DRX with PCell in FR1**

Parameter	Unit	Test configuration	Cell 1	
			T1	T2
NR RF Channel Number		1, 2	1	
TDD configuration		1, 2	TDDConf.1.1 CCA	
BW <sub>channel</sub>	MHz	1, 2	40: N <sub>RB,c</sub> = 106	
P <sub>CCA_DL</sub> for dynamic channel access <sup>Note 6,8</sup>		1, 2	P <sub>CCA_DL_1</sub> =0.75 P <sub>CCA_DL_2</sub> =0.75	
P <sub>CCA_DL</sub> for semi-static channel access <sup>Note 7,8</sup>		1, 2	P <sub>CCA_DL</sub> =0.9375	
OCNG Patterns defined in A.3.2.1.1 (OP.1)		1, 2	OP.1	
SMTC configuration defined in A.3.11.1 and A.3.11.2		1, 2	SMTC.1	
DBT window configuration		1, 2	DBT.1	
SSB configuration for semi-static channel access		1, 2	SSB.1 CCA	
SSB configuration for dynamic channel access		1, 2	SSB.2 CCA	

PDSCH/PDCCH subcarrier spacing	kHz	1, 2	30	
EPRE ratio of PSS to SSS		1, 2	0	
EPRE ratio of PBCH DMRS to SSS				
EPRE ratio of PBCH to PBCH DMRS				
EPRE ratio of PDCCH DMRS to SSS				
EPRE ratio of PDCCH to PDCCH DMRS				
EPRE ratio of PDSCH DMRS to SSS				
EPRE ratio of PDSCH to PDSCH				
EPRE ratio of OCNG DMRS to SSS (Note 1)				
EPRE ratio of OCNG to OCNG DMRS (Note 1)				
$N_{oc}$ <sup>Note2</sup>	dBm/15kHz	1, 2	-106	
$N_{oc}$ <sup>Note2</sup>	dBm/SCS	1, 2	-103	
SS-RSRP <sup>Note 3,5</sup>	dBm/SCS	1, 2	-85	-105
$\hat{E}_s/I_{ot}$ <sup>Note 5</sup>	dB	1, 2	18	-2
$\hat{E}_s/N_{oc}$ <sup>Note 5</sup>	dB	1, 2	18	-2
$I_o$ <sup>Note3</sup>	dBm/38.16MHz	1, 2	-53.88	-69.82
Propagation Condition		1, 2	AWGN	
Antenna Configuration and Correlation Matrix		1, 2	1x2 Low	
<p>NOTE 1: OCNG shall be used such that the cell is fully allocated and a constant total transmitted power spectral density is achieved for all OFDM symbols.</p> <p>NOTE 2: Interference from other cells and noise sources not specified in the test is assumed to be constant over subcarriers and time and shall be modelled as AWGN of appropriate power for <math>N_{oc}</math> to be fulfilled.</p> <p>NOTE 3: SS-RSRP and <math>I_o</math> levels have been derived from other parameters for information purposes. They are not settable parameters themselves.</p> <p>NOTE 4: SS-RSRP minimum requirements are specified assuming independent interference and noise at each receiver antenna port.</p> <p>NOTE 5: The signal levels apply for SSS REs when the discovery burst is transmitted during DBT windows.</p> <p>NOTE 6: For UE supporting semi-static channel access and network configuring semi-static channel occupancy.</p> <p>NOTE 7: For UE supporting dynamic channel access and network configuring dynamic channel occupancy.</p> <p>NOTE 8: For a UE supporting both semi-static and dynamic channel access, the UE can be tested under dynamic channel occupancy only.</p>				

**Table A.11.5.3.1.1-4: E-UTRAN neighbour cell specific test parameters for SA inter-RAT E-UTRAN event triggered reporting in non-DRX with PCell in FR1**

Parameter	Unit	Configuration	Cell 2	
			T1	T2
RF channel number		1,2	1	
Duplex mode		1	FDD	
		2	TDD	
TDD special subframe configuration <sup>Note1</sup>		2	6	
TDD uplink-downlink configuration <sup>Note1</sup>		2	1	
BW <sub>channel</sub>	MHz	1,2	5 MHz: $N_{RB,c} = 25$ 10 MHz: $N_{RB,c} = 50$ 20 MHz: $N_{RB,c} = 100$	
PDSCH parameters: DL Reference Measurement Channel <sup>Note2</sup>		1	5 MHz: R.7 FDD 10 MHz: R.3 FDD 20 MHz: R.6 FDD	
		2	5 MHz: R.4 TDD 10 MHz: R.0 TDD 20 MHz: R.3 TDD	
PCFICH/PDCCH/PHICH parameters: DL Reference Measurement Channel <sup>Note2</sup>		1	5 MHz: R.11 FDD 10 MHz: R.6 FDD 20 MHz: R.10 FDD	

		2	5 MHz: R.11 TDD 10 MHz: R.6 TDD 20 MHz: R.10 TDD	
OCNG Patterns <sup>Note2</sup>		1	5 MHz: OP.20 FDD 10 MHz: OP.10 FDD 20 MHz: OP.17 FDD	
		2	5 MHz: OP.9 TDD 10 MHz: OP.1 TDD 20 MHz: OP.7 TDD	
PBCH_RA	dB	1, 2	0	
PBCH_RB				
PSS_RA				
SSS_RA				
PCFICH_RB				
PHICH_RA				
PHICH_RB				
PDCCH_RA				
PDCCH_RB				
PDSCH_RA				
PDSCH_RB				
OCNG_RA <sup>Note3</sup>				
OCNG_RB <sup>Note3</sup>				
$N_{oc}$ <sup>Note4</sup>				
$\hat{E}_s/N_{oc}$	dB	1, 2	-Infinity	17
$\hat{E}_s/I_{ot}$ <sup>Note5</sup>	dB	1, 2	-Infinity	17
RSRP <sup>Note5</sup>	dBm/15kHz	1, 2	-Infinity	-87
SCH_RP <sup>Note5</sup>	dBm/15kHz	1, 2	-Infinity	-87
$I_o$ <sup>Note5</sup>	dBm/9MHz	1, 2	$-73.21+10\log(N_{RB,c}/50)$	$-56.12+10\log(N_{RB,c}/50)$
Propagation Condition		1, 2	AWGN	
Antenna Configuration and Correlation Matrix		1, 2	1x2	
<p>Note 1: Special subframe and uplink-downlink configurations are specified in table 4.2-1 in TS 36.211 [23].</p> <p>Note 2: DL RMCs and OCNG patterns are specified in clauses A 3.1 and A 3.2 of TS 36.133 [15] respectively.</p> <p>Note 3: OCNG shall be used such that all cells are fully allocated and a constant total transmitted power spectral density is achieved for all OFDM symbols.</p> <p>Note 4: Interference from other cells and noise sources not specified in the test is assumed to be constant over subcarriers and time and shall be modelled as AWGN of appropriate power for <math>N_{oc}</math> to be fulfilled.</p> <p>Note 5: <math>\hat{E}_s/I_{ot}</math>, RSRP, SCH_RP and <math>I_o</math> levels have been derived from other parameters for information purposes. They are not settable parameters themselves.</p>				

A.11.5.3.1.2 Test Requirements

The UE shall send one Event B2 triggered measurement report for Cell 2 to the PCell, with a measurement reporting delay less than 3.84s from the start of period T2. The measurement reporting delay is defined as the time from the beginning of time period T2 to the moment when the UE sends the measurement report on PUSCH.

The UE shall not send event-triggered measurement reports as long as the reporting criteria is not fulfilled.

The rate of correct events observed during repeated tests shall be at least 90%.

A.11.5.3.2 SA NR - E-UTRAN event-triggered reporting in DRX in FR1

A.11.5.3.2.1 Test Purpose and Environment

The purpose of this set of tests is to verify that the UE makes correct event-triggered reporting of inter-RAT E-UTRAN measurements when operating in standalone (SA) operation with PCell in FR1 when DRX is used. This test shall partly verify the cell search and measurement requirements in Clauses 9.4.2 and 9.4.3. There are two test cases. In test 1 the UE shall be configured with DRX cycle of 40 ms. In test 2 the UE shall be configured with DRX cycle of 640 ms.

In each test there are two cells: Cell 1 and Cell 2. Cell 1 is the NR PCell with CCA and Cell 2 is an inter-RAT E-UTRAN inter-RAT neighbour cell. In the measurement control information from the PCell it is indicated to the UE that event-triggered reporting with Event B2 (PCell becomes worse than threshold1 and inter RAT neighbour becomes better than threshold2) is to be used. Each test consists of two consecutive time periods, with durations T1 and T2,

respectively. Prior to the start of time duration T1, the UE shall be fully synchronized to Cell 1. During T1, the UE shall not have any information on Cell 2.

In each test the UE shall be provided with new Timing Advance Command MAC control element at least once during each time alignment timer period to maintain uplink time alignment. Furthermore, the UE shall be allocated with PUSCH resource at every DRX cycle.

Supported test configurations are shown in table A.11.5.3.2.1-1. General test parameters are provided in Table A.11.5.3.2.1-2 below. Test parameters for Cell 1 and Cell 2, valid for both time duration T1 and T2, are provided in Tables A.11.5.3.2.1-3 and A.11.5.3.2.1-4, respectively.

**Table A.11.5.3.2.1-1: Supported test configurations in SA inter-RAT E-UTRAN event triggered reporting in DRX with PCell in FR1**

Configuration	Description
1	NR with CCA 30 kHz SSB SCS, 40 MHz bandwidth, TDD duplex mode, LTE FDD
2	NR with CCA 30 kHz SSB SCS, 40 MHz bandwidth, TDD duplex mode, LTE TDD
Note:	The UE is only required to be tested in one of the supported test configurations

**Table A.11.5.3.2.1-2: General test parameters for SA inter-RAT E-UTRAN event triggered reporting in DRX with PCell in FR1**

Parameter	Unit	Test 1	Test 2	Comment
		Value		
NR RF Channel Number		1		1 NR carrier frequency is used in the test
LTE RF Channel Number		2		1 LTE carrier frequency is used in the test
Channel Bandwidth	MHz	As specified in Tables A.11.5.3.2.1-2 and A.11.5.3.2.1-3.		
Active cell		Cell 1		Cell 1 is on RF channel number 1
Neighbour cell		Cell 2		Cell 2 is on RF channel number 2
Gap Pattern Id		0		As specified in Clause Table 9.1.2-1. Per-UE gap pattern.
NR measurement quantity		SS-RSRP		Measurement quantity for Cell 1
Inter-RAT E-UTRAN measurement quantity		RSRP		Measurement quantity for Cell 2
b2-Threshold1	dBm	Note 1		SS-RSRP threshold for SS-RSRP measurement on cell1 for event B2
b2-Threshold2EUTRA	dBm	-95		E-UTRAN RSRP threshold for SS-RSRP measurement on cell1 for event B2
Hysteresis	dB	0		
TimeToTrigger	s	0		
Filter coefficient		0		L3 filtering is not used
DRX		DRX.1	DRX.7	DRX cycle configurations DRX.1 and DRX.7 are defined in Table A.3.3.1-1 and Table A.3.3.7-1 respectively.
T1	s	5		
T2	s	5	15	
Note 1: Values are defined in Table A.11.5.3.2.1-3				

**Table A.11.5.3.2.1-3: PCell specific test parameters for SA inter-RAT E-UTRA event triggered reporting in DRX with PCell in FR1**

Parameter	Unit	Test configuration	Cell 1	
			T1	T2
NR RF Channel Number		1, 2	1	
TDD configuration		1, 2	TDDConf.1.1 CCA	
BW <sub>channel</sub>	MHz	1, 2	40: N <sub>RB,c</sub> = 106	
P <sub>CCA_DL</sub> for dynamic channel access <sup>Note 6,8</sup>		1, 2	P <sub>CCA_DL_1</sub> =0.75 P <sub>CCA_DL_2</sub> =0.75	
P <sub>CCA_DL</sub> for semi-static channel access <sup>Note 7,8</sup>		1, 2	P <sub>CCA_DL</sub> =0.9375	
OCNG Patterns defined in A.3.2.1.1 (OP.1)		1, 2	OP.1	

SMTC configuration defined in A.3.11.1 and A.3.11.2		1, 2	SMTC.1	
DBT window configuration		1, 2	DBT.1	
SSB configuration for semi-static channel access		1, 2	SSB.1 CCA	
SSB configuration for dynamic channel access		1, 2	SSB.2 CCA	
PDSCH/PDCCH subcarrier spacing	kHz	1, 2	30	
EPRE ratio of PSS to SSS		1, 2	0	
EPRE ratio of PBCH DMRS to SSS				
EPRE ratio of PBCH to PBCH DMRS				
EPRE ratio of PDCCH DMRS to SSS				
EPRE ratio of PDCCH to PDCCH DMRS				
EPRE ratio of PDSCH DMRS to SSS				
EPRE ratio of PDSCH to PDSCH				
EPRE ratio of OCNG DMRS to SSS (Note 1)				
EPRE ratio of OCNG to OCNG DMRS (Note 1)				
$N_{oc}$ <sup>Note2</sup>	dBm/15kHz	1, 2	-106	
$N_{oc}$ <sup>Note2</sup>	dBm/SCS	1, 2	-103	
SS-RSRP <sup>Note 3,5</sup>	dBm/SCS	1, 2	-85	-105
$\hat{E}_s/I_{ot}$ <sup>Note 5</sup>	dB	1, 2	18	-2
$\hat{E}_s/N_{oc}$ <sup>Note 5</sup>	dB	1, 2	18	-2
$I_o$ <sup>Note3</sup>	dBm/38.16MHz	1, 2	-53.88	-69.82
Propagation Condition		1, 2	AWGN	
Antenna Configuration and Correlation Matrix		1, 2	1x2 Low	
<p>NOTE 1: OCNG shall be used such that the cell is fully allocated and a constant total transmitted power spectral density is achieved for all OFDM symbols.</p> <p>NOTE 2: Interference from other cells and noise sources not specified in the test is assumed to be constant over subcarriers and time and shall be modelled as AWGN of appropriate power for <math>N_{oc}</math> to be fulfilled.</p> <p>NOTE 3: SS-RSRP and <math>I_o</math> levels have been derived from other parameters for information purposes. They are not settable parameters themselves.</p> <p>NOTE 4: SS-RSRP minimum requirements are specified assuming independent interference and noise at each receiver antenna port.</p> <p>NOTE 5: The signal levels apply for SSS REs when the discovery burst is transmitted during DBT windows.</p> <p>NOTE 6: For UE supporting semi-static channel access and network configuring semi-static channel occupancy.</p> <p>NOTE 7: For UE supporting dynamic channel access and network configuring dynamic channel occupancy.</p> <p>NOTE 8: For a UE supporting both semi-static and dynamic channel access, the UE can be tested under dynamic channel occupancy only.</p>				

**Table A.11.5.3.2.1-4: E-UTRAN neighbour cell specific test parameters for SA inter-RAT E-UTRAN event triggered reporting in DRX with PCell in FR1**

Parameter	Unit	Configuration	Cell 2	
			T1	T2
RF channel number		1,2	1	
Duplex mode		1	FDD	
		2	TDD	
TDD special subframe configuration <sup>Note1</sup>		2	6	
TDD uplink-downlink configuration <sup>Note1</sup>		2	1	
$BW_{channel}$	MHz	1,2	5 MHz: $N_{RB,c} = 25$ 10 MHz: $N_{RB,c} = 50$ 20 MHz: $N_{RB,c} = 100$	
PDSCH parameters: DL Reference Measurement Channel <sup>Note2</sup>		1	5 MHz: R.7 FDD 10 MHz: R.3 FDD 20 MHz: R.6 FDD	

		2	5 MHz: R.4 TDD 10 MHz: R.0 TDD 20 MHz: R.3 TDD	
PCFICH/PDCCH/PHICH parameters: DL Reference Measurement Channel <sup>Note2</sup>		1	5 MHz: R.11 FDD 10 MHz: R.6 FDD 20 MHz: R.10 FDD	
		2	5 MHz: R.11 TDD 10 MHz: R.6 TDD 20 MHz: R.10 TDD	
OCNG Patterns <sup>Note2</sup>		1	5 MHz: OP.20 FDD 10 MHz: OP.10 FDD 20 MHz: OP.17 FDD	
		2	5 MHz: OP.9 TDD 10 MHz: OP.1 TDD 20 MHz: OP.7 TDD	
PBCH_RA	dB	1, 2	0	
PBCH_RB				
PSS_RA				
SSS_RA				
PCFICH_RB				
PHICH_RA				
PHICH_RB				
PDCCH_RA				
PDCCH_RB				
PDSCH_RA				
PDSCH_RB				
OCNG_RA <sup>Note3</sup>				
OCNG_RB <sup>Note3</sup>				
N <sub>oc</sub> <sup>Note4</sup>				dBm/15kHz
$\hat{E}_s/N_{oc}$	dB	1, 2	-Infinity	17
$\hat{E}_s/I_{ot}$ <sup>Note5</sup>	dB	1, 2	-Infinity	17
RSRP <sup>Note5</sup>	dBm/15kHz	1, 2	-Infinity	-87
SCH_RP <sup>Note5</sup>	dBm/15kHz	1, 2	-Infinity	-87
I <sub>o</sub> <sup>Note5</sup>	dBm/9MHz	1, 2	$-73.21+10\log(N_{RB,c}/50)$	$-56.12+10\log(N_{RB,c}/50)$
Propagation Condition		1, 2	AWGN	
Antenna Configuration and Correlation Matrix		1, 2	1x2	
<p>Note 1: Special subframe and uplink-downlink configurations are specified in table 4.2-1 in TS 36.211 [23].</p> <p>Note 2: DL RMCs and OCNG patterns are specified in clauses A 3.1 and A 3.2 of TS 36.133 [15] respectively.</p> <p>Note 3: OCNG shall be used such that all cells are fully allocated and a constant total transmitted power spectral density is achieved for all OFDM symbols.</p> <p>Note 4: Interference from other cells and noise sources not specified in the test is assumed to be constant over subcarriers and time and shall be modelled as AWGN of appropriate power for N<sub>oc</sub> to be fulfilled.</p> <p>Note 5: <math>\hat{E}_s/I_{ot}</math>, RSRP, SCH_RP and I<sub>o</sub> levels have been derived from other parameters for information purposes. They are not settable parameters themselves.</p>				

A.11.5.3.2.2 Test Requirements

In test 1, the UE shall send one Event B2 triggered measurement report for Cell 2 to the PCell, with a measurement reporting delay less than 3.84s from the start of period T2. The measurement reporting delay is defined as the time from the beginning of time period T2 to the moment when the UE sends the measurement report on PUSCH.

In test 2, the UE shall send one Event B2 triggered measurement report for Cell 2 to the PCell, with a measurement reporting delay less than 12.8s from the start of period T2. The measurement reporting delay is defined as the time from the beginning of time period T2 to the moment when the UE sends the measurement report on PUSCH.

The UE shall not send event-triggered measurement reports as long as the reporting criteria is not fulfilled.

The rate of correct events observed during repeated tests shall be at least 90%.

## A.11.5.4 L1-RSRP measurements for beam reporting

### A.11.5.4.1 SSB based L1-RSRP measurement when DRX is not used

#### A.11.5.4.1.1 Test Purpose and Environment

The purpose of this test is to verify that the UE makes correct reporting of L1-RSRP measurement. This test will partly verify the L1-RSRP measurement requirements in clause 9.5A.4.1, with the testing configurations for NR cells in Table A.11.5.4.1.1-1.

**Table A.11.5.4.1.1-1: Applicable NR configurations for FR1 SSB based L1-RSRP test**

Config	Description
1	With CCA: NR 30 kHz SSB SCS, 40 MHz bandwidth, TDD duplex mode
Note:	The UE is only required to be tested in one of the supported test configurations

#### A.11.5.4.1.2 Test parameters

There is one cell in the test, the FR1 PCell (Cell 1). Cell 1 operates on a carrier frequency with CCA and transmits SSBs in DBT windows according to DL CCA model. The test parameters for the Cell 1 are given in Table A.11.5.4.1.2-1 and Table A.11.5.4.1.2-2 below.

In CSI measurement configuration, UE is indicated to perform L1-RSRP measurement on the SSBs and report periodically. The UE transmits the reporting according to UL CCA model. The test consists of two successive time periods, with time duration of T1 and T2 respectively. The test has higher layer parameter *timeRestrictionForChannelMeasurements* configured.

The same test is applicable for UE supporting any one or both semi-static channel access or dynamic channel access and for network configuring any of semi-static channel occupancy or dynamic channel occupancy.

There is no measurement gap configured in the test. Before the test, UE is configured to perform RLM, BFD and L1-RSRP measurement based on the SSBs.

**Table A.11.5.4.1.2-1: General test parameters**

Parameter	Config	Unit	Value
SSB GSCN	1		freq1
DL CCA model	1		As specified in A.3.20.2.1
UL CCA model	1		As specified in A.3.20.2.2
Duplex mode	1		TDD
TDD Configuration	1		TDDConf.1.1 CCA
BW <sub>channel</sub>	1	MHz	40: N <sub>RB,c</sub> = 106
PDSCH Reference measurement channel	1		SR.1.1 CCA
RMSI CORESET Reference Channel	1		CR.1.1 CCA
Dedicated CORESET Reference Channel	1		CCR.1.1 CCA
SSB configuration	1		SSB.3 CCA for semi-static channel access SSB.4 CCA for dynamic channel access
OCNG Patterns	1		OP.1
Initial BWP Configuration	1		DLBWP.0.1 ULBWP.0.1
Dedicated BWP configuration	1		DLBWP.1.1 ULBWP.1.1
DBT Window Configuration	1		DBT.1
TRS Configuration	1		TRS.1.2 TDD
DRX configuration	1		Off
reportConfigType	1		periodic



reportQuantity	1		ssb-Index-RSRP
Number of reported RS	1		2
L1-RSRP reporting period	1	slot	80
T1	1	s	5
T2	1	s	1
EPRE ratio of PSS to SSS	1	dB	0
EPRE ratio of PBCH DMRS to SSS			
EPRE ratio of PBCH to PBCH DMRS			
EPRE ratio of PDCCH DMRS to SSS			
EPRE ratio of PDCCH to PDCCH DMRS			
EPRE ratio of PDSCH DMRS to SSS			
EPRE ratio of PDSCH to PDSCH DMRS			
EPRE ratio of OCNG DMRS to SSS <sup>Note 1</sup>			
EPRE ratio of OCNG to OCNG DMRS <sup>Note 1</sup>			
Propagation condition	1		AWGN
<p>Note 1: OCNG shall be used such that the resources in Cell 1 are fully allocated and a constant total transmitted power spectral density is achieved for all OFDM symbols. For cells with CCA model, OCNG is transmitted only in the slots with downlink transmission burst and is not transmitted during the muted slots or during DBT window.</p>			

Table A.11.5.4.1.2-2: SSB specific test parameters

Parameter	Config	Unit	SSB#0		SSB#1	
			T1	T2	T1	T2
DL CCA Probability $P_{CCA\_DL}$ <sup>Note 4,6</sup>	1		0.9375	0.9375	0.9375	0.9375
DL CCA Probability $P_{CCA\_DL}$ <sup>Note 4.7</sup>	1		0.75/0.75	0.75/0.75	0.75/0.75	0.75/0.75
UL CCA probability $P_{CCA\_UL}$	1		1.0	1.0	1.0	1.0
$N_{oc}$ <sup>Note2</sup>	1	dBm/15kHz	-94.65			
$N_{oc}$ <sup>Note2</sup>	1	dBm/SSB SCS	-91.65			
$\hat{E}_s / I_{ot}$	1	dB	0	0	-Infinity	3
SSB RSRP <sup>Note3</sup>	1	dBm/SSB SCS	-91.65	-91.65	-Infinity	-88.65
$I_o$ <sup>Note3</sup>	1	dBm/38.16 MHz	-57.59	-57.59	-60.61	-55.84
$\hat{E}_s / N_{oc}$	1	dB	0	0	-Infinity	3
<p>Note 1: The resources for uplink transmission are assigned to the UE prior to the start of time period T2.</p> <p>Note 2: Interference from other cells and noise sources not specified in the test is assumed to be constant over subcarriers and time and shall be modelled as AWGN of appropriate power for <math>N_{oc}</math> to be fulfilled.</p> <p>Note 3: SS-RSRP and <math>I_o</math> levels have been derived from other parameters for information purposes. They are not settable parameters themselves.</p> <p>Note 4: DL and UL CCA probabilities apply for UE supporting any one or both semi-static channel access or dynamic channel access and for network configuring any of semi-static channel occupancy or dynamic channel occupancy.</p> <p>Note 5: The signal levels apply for SSS REs when the discovery burst is transmitted during DBT windows.</p> <p>Note 6: For UE supporting semi-static channel access and network configuring semi-static channel occupancy.</p>						

Note 7: For UE supporting dynamic channel access and network configuring dynamic channel occupancy. The first value corresponds  $P_{CCA\_DL1}$  and the second value corresponds to the  $P_{CCA\_DL2}$ .

### A.11.5.4.1.3 Test Requirements

The UE shall send L1-RSRP report every 80 slots. No later than 640 ms plus 80 slots from the beginning of time period T2, UE shall send L1-RSRP report including results of both SSB0 and SSB1 while meeting the absolute accuracy requirement in clause 10.1.19.1.1 and relative accuracy requirement in clause 10.1.19.1.2. The rate of correct events observed during repeated tests shall be at least 90%.

NOTE: The actual overall delays measured in the test may be up to  $2 \times TTI_{DCCH}$  higher than the measurement reporting delays above because of TTI insertion uncertainty of the measurement report in DCCH.

### A.11.5.4.2 SSB based L1-RSRP measurement when DRX is used

#### A.11.5.4.2.1 Test Purpose and Environment

The purpose of this test is to verify that the UE makes correct reporting of L1-RSRP measurement. This test will partly verify the L1-RSRP measurement requirements in clause 9.5A.4.1, with the testing configurations for NR cells in Table A.11.5.4.2.1-1.

**Table A.11.5.4.2.1-1: Applicable NR configurations for FR1 SSB based L1-RSRP test**

Config	Description
1	With CCA: NR 30 kHz SSB SCS, 40 MHz bandwidth, TDD duplex mode
Note: The UE is only required to be tested in one of the supported test configurations	

#### A.11.5.4.2.2 Test parameters

There is one cell in the test, the FR1 PCell (Cell 1). Cell 1 operates on a carrier frequency with CCA and transmits SSBs in DBT windows according to DL CCA model. The test parameters for the Cell 1 are given in Table A.11.5.4.2.2-1 and Table A.11.5.4.2.2-2 below.

In CSI measurement configuration, UE is indicated to perform L1-RSRP measurement on the SSBs and report periodically. The UE transmits the reporting according to UL CCA model. The test consists of two successive time periods, with time duration of T1 and T2 respectively. The test has higher layer parameter *timeRestrictionForChannelMeasurements* configured.

The same test is applicable for UE supporting any one or both semi-static channel access or dynamic channel access and for network configuring any of semi-static channel occupancy or dynamic channel occupancy.

There is no measurement gap configured in the test. Before the test, UE is configured to perform RLM, BFD and L1-RSRP measurement based on the SSBs.

**Table A.11.5.4.2.2-1: General test parameters**

Parameter	Config	Unit	Value
SSB GSCN	1		freq1
DL CCA model	1		As specified in A.3.20.2.1
UL CCA model	1		As specified in A.3.20.2.2
Duplex mode	1		TDD
TDD Configuration	1		TDDConf.1.1 CCA
$BW_{channel}$	1	MHz	40: $N_{RB,c} = 106$
PDSCH Reference measurement channel	1		SR.1.1 CCA
RMSI CORESET Reference Channel	1		CR.1.1 CCA
Dedicated CORESET Reference Channel	1		CCR.1.1 CCA

SSB configuration	1		SSB.3 CCA for semi-static channel access SSB.4 CCA for dynamic channel access
OCNG Patterns	1		OP.1
Initial BWP Configuration	1		DLBWP.0.1 ULBWP.0.1
Dedicated BWP configuration	1		DLBWP.1.1 ULBWP.1.1
DBT Window Configuration	1		DBT.1
TRS Configuration	1		TRS.1.2 TDD
DRX configuration	1		DRX.3
reportConfigType	1		periodic
reportQuantity	1		ssb-Index-RSRP
Number of reported RS	1		2
L1-RSRP reporting period	1	slot	80
T1	1	s	5
T2	1	s	1
EPRE ratio of PSS to SSS	1	dB	0
EPRE ratio of PBCH DMRS to SSS			
EPRE ratio of PBCH to PBCH DMRS			
EPRE ratio of PDCCH DMRS to SSS			
EPRE ratio of PDCCH to PDCCH DMRS			
EPRE ratio of PDSCH DMRS to SSS			
EPRE ratio of PDSCH to PDSCH DMRS			
EPRE ratio of OCNG DMRS to SSS <sup>Note 1</sup>			
EPRE ratio of OCNG to OCNG DMRS <sup>Note 1</sup>			
Propagation condition			
<p>Note 1: OCNG shall be used such that the resources in Cell 1 are fully allocated and a constant total transmitted power spectral density is achieved for all OFDM symbols. For cells with CCA model, OCNG is transmitted only in the slots with downlink transmission burst and is not transmitted during the muted slots or during DBT window.</p>			

Table A.11.5.4.2.2-2: SSB specific test parameters

Parameter	Config	Unit	SSB#0		SSB#1	
			T1	T2	T1	T2
DL CCA Probability $P_{CCA\_DL}$ <sup>Note 4,6</sup>	1		0.9375	0.9375	0.9375	0.9375
DL CCA Probability $P_{CCA\_DL}$ <sup>Note 4,7</sup>	1		0.75/0.75	0.75/0.75	0.75/0.75	0.75/0.75
UL CCA probability $P_{CCA\_UL}$	1		1.0	1.0	1.0	1.0
$N_{oc}$ <sup>Note2</sup>	1	dBm/15kHz	-94.65			
$N_{oc}$ <sup>Note2</sup>	1	dBm/SSB SCS	-91.65			
$\hat{E}_s / I_{ot}$	1	dB	0	0	-Infinity	3
SSB RSRP <sup>Note3</sup>	1	dBm/SSB SCS	-91.65	-91.65	-Infinity	-88.65
$I_o$ <sup>Note3</sup>	1	dBm/38.16 MHz	-57.59	-57.59	-60.61	-55.84
$\hat{E}_s / N_{oc}$	1	dB	0	0	-Infinity	3

Note 1:	The resources for uplink transmission are assigned to the UE prior to the start of time period T2.
Note 2:	Interference from other cells and noise sources not specified in the test is assumed to be constant over subcarriers and time and shall be modelled as AWGN of appropriate power for $N_{oc}$ to be fulfilled.
Note 3:	SS-RSRP and Io levels have been derived from other parameters for information purposes. They are not settable parameters themselves.
Note 4:	DL and UL CCA probabilities apply for UE supporting any one or both semi-static channel access or dynamic channel access and for network configuring any of semi-static channel occupancy or dynamic channel occupancy.
Note 5:	The signal levels apply for SSS REs when the discovery burst is transmitted during DBT windows.
Note 6:	For UE supporting semi-static channel access and network configuring semi-static channel occupancy.
Note 7:	For UE supporting dynamic channel access and network configuring dynamic channel occupancy. The first value corresponds $P_{CCA\_DL1}$ and the second value corresponds to the $P_{CCA\_DL2}$ .

### A.11.5.4.2.3 Test Requirements

The UE shall send L1-RSRP report every 80 slots. No later than 640 ms plus 80 slots from the beginning of time period T2, UE shall send L1-RSRP report including results of both SSB0 and SSB1 while meeting the absolute accuracy requirement in clause 10.1.19.1.1 and relative accuracy requirement in clause 10.1.19.1.2. The rate of correct events observed during repeated tests shall be at least 90%.

NOTE: The actual overall delays measured in the test may be up to  $2 \times TTI_{DCC}$  higher than the measurement reporting delays above because of TTI insertion uncertainty of the measurement report in DCC.

### A.11.5.4.3 SSB based L1-RSRP measurement on SCC when DRX is not used

#### A.11.5.4.3.1 Test Purpose and Environment

The purpose of this test is to verify that the UE makes correct reporting of L1-RSRP measurement. This test will partly verify the L1-RSRP measurement requirements in clause 9.5A.4.1, with the testing configurations for NR cells in Table A.11.5.4.3.1-1.

**Table A.11.5.4.3.1-1: Applicable NR configurations for FR1 SSB based L1-RSRP test**

Config	Description
1	With CCA: NR 30 kHz SSB SCS, 40 MHz bandwidth, TDD duplex mode
Note:	The UE is only required to be tested in one of the supported test configurations

#### A.11.5.4.3.2 Test parameters

There are two cells in the test, the FR1 PCell (Cell 1) and FR1 SCell (Cell 2). Both Cell 1 and Cell 2 operate on a carrier frequency with CCA and transmits SSBs in DBT windows according to DL CCA model. The test parameters for the Cell 1 are given in Table A.11.5.4.3.2-1 and Table A.11.5.4.3.2-2 below.

In CSI measurement configuration, UE is indicated to perform L1-RSRP measurement on the SSBs and report periodically. The UE transmits the reporting according to UL CCA model. The test consists of two successive time periods, with time duration of T1 and T2 respectively. The test has higher layer parameter *timeRestrictionForChannelMeasurements* configured.

The same test is applicable for UE supporting any one or both semi-static channel access or dynamic channel access and for network configuring any of semi-static channel occupancy or dynamic channel occupancy.

There is no measurement gap configured in the test. Before the test, UE is configured to perform RLM, BFD and L1-RSRP measurement based on the SSBs.

**Table A.11.5.4.3.2-1: General test parameters**

Parameter	Config	Unit	Value
Active PCell	1		Cell 1

Active SCell	1		Cell 2
RF Channel Number	1		1: Cell 1 2: Cell 2
DL CCA model	1		As specified in A.3.20.2.1
UL CCA model	1		As specified in A.3.20.2.2
Duplex mode	1		TDD
TDD Configuration	1		TDDConf.1.1 CCA
$BW_{channel}$	1	MHz	40: $N_{RB,c} = 106$
PDSCH Reference measurement channel	1		SR.1.1 CCA
RMSI CORESET Reference Channel	1		CR.1.1 CCA
Dedicated CORESET Reference Channel	1		CCR.1.1 CCA
SSB configuration	1		SSB.3 CCA for semi-static channel access SSB.4 CCA for dynamic channel access
OCNG Patterns	1		OP.1
Initial BWP Configuration	1		DLBWP.0.1 ULBWP.0.1
Dedicated BWP configuration	1		DLBWP.1.1 ULBWP.1.1
DBT Window Configuration	1		DBT.1
TRS Configuration	1		TRS.1.2 TDD
DRX configuration	1		Off
reportConfigType	1		periodic
reportQuantity	1		ssb-Index-RSRP
Number of reported RS	1		2
L1-RSRP reporting period	1	slot	80
T1	1	s	5
T2	1	s	1
EPRE ratio of PSS to SSS	1	dB	0
EPRE ratio of PBCH DMRS to SSS			
EPRE ratio of PBCH to PBCH DMRS			
EPRE ratio of PDCCH DMRS to SSS			
EPRE ratio of PDCCH to PDCCH DMRS			
EPRE ratio of PDSCH DMRS to SSS			
EPRE ratio of PDSCH to PDSCH DMRS			
EPRE ratio of OCNG DMRS to SSS <sup>Note 1</sup>			
EPRE ratio of OCNG to OCNG DMRS <sup>Note 1</sup>			
Propagation condition			
Note 1: OCNG shall be used such that the resources in Cell 1 are fully allocated and a constant total transmitted power spectral density is achieved for all OFDM symbols. For cells with CCA model, OCNG is transmitted only in the slots with downlink transmission burst and is not transmitted during the muted slots or during DBT window.			

Table A.11.5.4.3.2-2: SSB specific test parameters

Parameter	Config	Unit	SSB#0		SSB#1	
			T1	T2	T1	T2
DL CCA Probability $P_{CCA\_DL}$ <sup>Note 4,6</sup>	1		0.9375	0.9375	0.9375	0.9375

DL CCA Probability $P_{CCA\_DL}$ <sup>Note 4.7</sup>	1		0.75/0.75	0.75/0.75	0.75/0.75	0.75/0.75
UL CCA probability $P_{CCA\_UL}$	1		1.0	1.0	1.0	1.0
$N_{oc}$ <sup>Note2</sup>	1	dBm/15kHz	-94.65			
$N_{oc}$ <sup>Note2</sup>	1	dBm/SSB SCS	-91.65			
$\hat{E}_s / I_{ot}$	1	dB	0	0	-Infinity	3
SSB RSRP <sup>Note3</sup>	1	dBm/SSB SCS	-91.65	-91.65	-Infinity	-88.65
$I_o$ <sup>Note3</sup>	1	dBm/38.16 MHz	-57.59	-57.59	-60.61	-55.84
$\hat{E}_s / N_{oc}$	1	dB	0	0	-Infinity	3
<p>Note 1: The resources for uplink transmission are assigned to the UE prior to the start of time period T2.</p> <p>Note 2: Interference from other cells and noise sources not specified in the test is assumed to be constant over subcarriers and time and shall be modelled as AWGN of appropriate power for <math>N_{oc}</math> to be fulfilled.</p> <p>Note 3: SS-RSRP and <math>I_o</math> levels have been derived from other parameters for information purposes. They are not settable parameters themselves.</p> <p>Note 4: DL and UL CCA probabilities apply for UE supporting any one or both semi-static channel access or dynamic channel access and for network configuring any of semi-static channel occupancy or dynamic channel occupancy.</p> <p>Note 5: The signal levels apply for SSS REs when the discovery burst is transmitted during DBT windows.</p> <p>Note 6: For UE supporting semi-static channel access and network configuring semi-static channel occupancy.</p> <p>Note 7: For UE supporting dynamic channel access and network configuring dynamic channel occupancy. The first value corresponds <math>P_{CCA\_DL1}</math> and the second value corresponds to the <math>P_{CCA\_DL2}</math>.</p>						

### A.11.5.4.3.3 Test Requirements

The UE shall send L1-RSRP report every 80 slots. No later than 640 ms plus 80 slots from the beginning of time period T2, UE shall send L1-RSRP report including results of both SSB0 and SSB1 while meeting the absolute accuracy requirement in clause 10.1.19.1.1 and relative accuracy requirement in clause 10.1.19.1.2. The rate of correct events observed during repeated tests shall be at least 90%.

The UE shall send L1-RSRP report of both SSB0 and SSB1 in Cell 2.

NOTE: The actual overall delays measured in the test may be up to  $2 \times TTI_{DCC}$  higher than the measurement reporting delays above because of TTI insertion uncertainty of the measurement report in DCC.

### A.11.5.4.4 SSB based L1-RSRP measurement on SCC when DRX is used

#### A.11.5.4.4.1 Test Purpose and Environment

The purpose of this test is to verify that the UE makes correct reporting of L1-RSRP measurement. This test will partly verify the L1-RSRP measurement requirements in clause 9.5A.4.1, with the testing configurations for NR cells in Table A.11.5.4.4.1-1.

**Table A.11.5.4.4.1-1: Applicable NR configurations for FR1 SSB based L1-RSRP test**

Config	Description
1	With CCA: NR 30 kHz SSB SCS, 40 MHz bandwidth, TDD duplex mode
Note:	The UE is only required to be tested in one of the supported test configurations

#### A.11.5.4.4.2 Test parameters

There are two cells in the test, the FR1 PCell (Cell 1) and FR1 SCell (Cell 2). Both Cell 1 and Cell 2 operate on a carrier frequency with CCA and transmits SSBs in DBT windows according to DL CCA model. The test parameters for the Cell 1 are given in Table A.11.5.4.4.2-1 and Table A.11.5.4.4.2-2 below.

In CSI measurement configuration, UE is indicated to perform L1-RSRP measurement on the SSBs and report periodically. The UE transmits the reporting according to UL CCA model. The test consists of two successive time periods, with time duration of T1 and T2 respectively. The test has higher layer parameter *timeRestrictionForChannelMeasurements* configured.

The same test is applicable for UE supporting any one or both semi-static channel access or dynamic channel access and for network configuring any of semi-static channel occupancy or dynamic channel occupancy.

There is no measurement gap configured in the test. Before the test, UE is configured to perform RLM, BFD and L1-RSRP measurement based on the SSBs.

**Table A.11.5.4.4.2-1: General test parameters**

Parameter	Config	Unit	Value
Active PCell	1		Cell 1
Active SCell	1		Cell 2
RF Channel Number	1		1: Cell 1 2: Cell 2
DL CCA model	1		As specified in A.3.20.2.1
UL CCA model	1		As specified in A.3.20.2.2
Duplex mode	1		TDD
TDD Configuration	1		TDDConf.1.1 CCA
BW <sub>channel</sub>	1	MHz	40: N <sub>RB,c</sub> = 106
PDSCH Reference measurement channel	1		SR.1.1 CCA
RMSI CORESET Reference Channel	1		CR.1.1 CCA
Dedicated CORESET Reference Channel	1		CCR.1.1 CCA
SSB configuration	1		SSB.3 CCA for semi-static channel access SSB.4 CCA for dynamic channel access
OCNG Patterns	1		OP.1
Initial BWP Configuration	1		DLBWP.0.1 ULBWP.0.1
Dedicated BWP configuration	1		DLBWP.1.1 ULBWP.1.1
DBT Window Configuration	1		DBT.1
TRS Configuration	1		TRS.1.2 TDD
DRX configuration	1		DRX.3
reportConfigType	1		periodic
reportQuantity	1		ssb-Index-RSRP
Number of reported RS	1		2
L1-RSRP reporting period	1	slot	80
T1	1	s	5
T2	1	s	1
EPRE ratio of PSS to SSS	1	dB	0
EPRE ratio of PBCH DMRS to SSS			
EPRE ratio of PBCH to PBCH DMRS			
EPRE ratio of PDCCH DMRS to SSS			
EPRE ratio of PDCCH to PDCCH DMRS			

EPRE ratio of PDSCH DMRS to SSS			
EPRE ratio of PDSCH to PDSCH DMRS			
EPRE ratio of OCNG DMRS to SSS <sup>Note 1</sup>			
EPRE ratio of OCNG to OCNG DMRS <sup>Note 1</sup>			
Propagation condition	1		AWGN
Note 1: OCNG shall be used such that the resources in Cell 1 are fully allocated and a constant total transmitted power spectral density is achieved for all OFDM symbols. For cells with CCA model, OCNG is transmitted only in the slots with downlink transmission burst and is not transmitted during the muted slots or during DBT window.			

**Table A.11.5.4.4.2-2: SSB specific test parameters**

Parameter	Config	Unit	SSB#0		SSB#1	
			T1	T2	T1	T2
DL CCA Probability $P_{CCA\_DL}$ <sup>Note 4,6</sup>	1		0.9375	0.9375	0.9375	0.9375
DL CCA Probability $P_{CCA\_DL}$ <sup>Note 4,7</sup>	1		0.75/0.75	0.75/0.75	0.75/0.75	0.75/0.75
UL CCA probability $P_{CCA\_UL}$	1		1.0	1.0	1.0	1.0
$N_{oc}$ <sup>Note2</sup>	1	dBm/15kHz	-94.65			
$N_{oc}$ <sup>Note2</sup>	1	dBm/SSB SCS	-91.65			
$\hat{E}_s / I_{ot}$	1	dB	0	0	-Infinity	3
SSB RSRP <sup>Note3</sup>	1	dBm/SSB SCS	-91.65	-91.65	-Infinity	-88.65
$I_o$ <sup>Note3</sup>	1	dBm/38.16 MHz	-57.59	-57.59	-60.61	-55.84
$\hat{E}_s / N_{oc}$	1	dB	0	0	-Infinity	3
Note 1: The resources for uplink transmission are assigned to the UE prior to the start of time period T2. Note 2: Interference from other cells and noise sources not specified in the test is assumed to be constant over subcarriers and time and shall be modelled as AWGN of appropriate power for $N_{oc}$ to be fulfilled. Note 3: SS-RSRP and $I_o$ levels have been derived from other parameters for information purposes. They are not settable parameters themselves. Note 4: DL and UL CCA probabilities apply for UE supporting any one or both semi-static channel access or dynamic channel access and for network configuring any of semi-static channel occupancy or dynamic channel occupancy. Note 5: The signal levels apply for SSS REs when the discovery burst is transmitted during DBT windows. Note 6: For UE supporting semi-static channel access and network configuring semi-static channel occupancy. Note 7: For UE supporting dynamic channel access and network configuring dynamic channel occupancy. The first value corresponds $P_{CCA\_DL1}$ and the second value corresponds to the $P_{CCA\_DL2}$ .						

**A.11.5.4.4.3 Test Requirements**

The UE shall send L1-RSRP report every 80 slots. No later than 640 ms plus 80 slots from the beginning of time period T2, UE shall send L1-RSRP report including results of both SSB0 and SSB1 while meeting the absolute accuracy requirement in clause 10.1.19.1.1 and relative accuracy requirement in clause 10.1.19.1.2. The rate of correct events observed during repeated tests shall be at least 90%.

The UE shall send L1-RSRP report of both SSB0 and SSB1 in Cell 2.



NOTE: The actual overall delays measured in the test may be up to  $2 \times TTI_{DCC}$  higher than the measurement reporting delays above because of TTI insertion uncertainty of the measurement report in DCC.

## A.11.6 Measurement performance

### A.11.6.1 SS-RSRP

#### A.11.6.1.1 Intra-frequency measurement accuracy on a carrier frequency with CCA

##### A.11.6.1.1.1 Test Purpose and Environment

The purpose of this test is to verify that the SS-RSRP measurement accuracy on the carrier frequency with CCA is within the specified limits. This test will verify the requirements in clauses 10.1.36.1.1 and 10.1.36.1.2 for intra-frequency measurements under CCA.

##### A.11.6.1.1.2 Test parameters

In this set of test cases all cells are on the same carrier frequency with CCA and transmit SSBs in DBT windows according to DL CCA model. Supported test configurations are shown in table A.11.6.1.1.2-1. Both absolute and relative accuracy of SS-RSRP intra-frequency measurements are tested by using the parameters in A.11.6.1.1.2-2. In all test cases, Cell 1 is the PCell, and Cell 2 is the target cell.

**Table A.11.6.1.1.2-1: SS-RSRP Intra frequency SS-RSRP supported test configurations**

Config	Description
1	NR 30kHz SSB SCS, 40 MHz bandwidth, TDD duplex mode

**Table A.11.6.1.1.2-2: SS-RSRP Intra frequency test parameters**

Parameter		Unit	Test 1		Test 2		Test 3	
			Cell 1	Cell 2	Cell 1	Cell 2	Cell 1	Cell 2
Cell ID			489	0	489	0	489	0
SSB ARFCN			freq1		freq1		freq1	
TDD configuration	Config 1		TDDConf.1.1 CCA					
BW <sub>channel</sub>	Config 1	MHz	40: N <sub>RB,c</sub> = 106					
BWP BW	Config 1		40: N <sub>RB,c</sub> = 106					
DL CCA model			As specified in clause A.3.26.2.1					
UL CCA model			As specified in clause A.3.26.2.2					
P <sub>CCA,DL</sub> for dynamic channel access <sup>Note 7,9</sup>			P <sub>CCA,DL,1</sub> =0.75 P <sub>CCA,DL,2</sub> =0.75					
P <sub>CCA,DL</sub> for semi-static channel access <sup>Note 8,9</sup>			P <sub>CCA,DL</sub> =0.9375					
P <sub>CCA,UL</sub>			1					
Downlink initial BWP configuration			DLBWP.0.1					
Downlink dedicated BWP configuration			DLBWP.1.1					
Uplink initial BWP configuration			ULBWP.0.1					
Uplink dedicated BWP configuration			ULBWP.1.1					
TRS configuration	Config 1		TRS.1. 2 TDD	NA	TRS.1 .2 TDD	NA	TRS.1. 2 TDD	NA
DRX Cycle		ms	Not Applicable					
PDSCH Reference measurement channel	Config 1		SR.1.1 CCA	-	SR.1.1 CCA	-	SR.1.1 CCA	-
RMSI CORESET Reference Channel	Config 1		CR.1.1 CCA	-	CR.1.1 CCA	-	CR.1.1 CCA	-
Control channel RMC	Config 1		CR.1.1 CCA	-	CR.1.1 CCA	-	CR.1.1 CCA	-
SSB configuration for semi-static channel access	Config 1		SSB.1 CCA	SSB.1 CCA	SSB.1 CCA	SSB.1 CCA	SSB.1 CCA	SSB.1 CCA

SSB configuration for dynamic channel access	Config 1		SSB.2 CCA	SSB.2 CCA	SSB.2 CCA	SSB.2 CCA	SSB.2 CCA	SSB.2 CCA	
DBT window configuration	Config 1,2,3		DBT.1	DBT.1	DBT.1	DBT.1	DBT.1	DBT.1	
Time offset with Cell 1	Config 1	µs	-	3	-	3	-	3	
SMTC configuration	Config 1		SMTC.1						
OCNG Patterns			OCNG pattern 1						
PDSCH/PDCCH subcarrier spacing	Config 1	kHz	30 kHz						
EPRE ratio of PSS to SSS		dB	0	0	0	0	0	0	
EPRE ratio of PBCH DMRS to SSS									
EPRE ratio of PBCH to PBCH DMRS									
EPRE ratio of PDCCH DMRS to SSS									
EPRE ratio of PDCCH to PDCCH DMRS									
EPRE ratio of PDSCH DMRS to SSS									
EPRE ratio of PDSCH to PDSCH									
EPRE ratio of OCNG DMRS to SSS(Note 1)									
EPRE ratio of OCNG to OCNG DMRS (Note 1)									
$N_{oc}$ Note2	Config 1		NR_CCA_FR1_I	Not applicable <sup>Note 5</sup>		-94		-110	
		NR_CCA_FR1_J					-109.5		
$N_{oc}$ Note2	Config 1	NR_CCA_FR1_I	Not applicable <sup>Note 5</sup>		-91		-107.0		
		NR_CCA_FR1_J					-106.5		
$\hat{E}_s/I_{ot}$ Note6			dB	2.46	-5.97	2.46	-5.97	-2.01	-3.54
$\hat{E}_s/N_{oc}$ Note6			dB	6	1	6	1	1	0
SS-RSRP <sup>Not e3,6</sup>	Config 1	NR_CCA_FR1_I	dBm/SCS	Not applicable <sup>Note 5</sup>	Not applicable <sup>Note 5</sup>	-85	-90	-	-
		NR_CCA_FR1_J						106.00	107.00
								-	-
								105.50	106.50
$I_o$ Note3	Config 1	NR_CCA_FR1_I	dBm/38.16MHz	Not applicable <sup>Note 5</sup>		-51.99		-70.82	
		NR_CCA_FR1_J						-70.32	
Propagation condition			-	AWGN					
Antenna configuration				1x2					
<p>NOTE 1: OCNG shall be used such that both cells are fully allocated and a constant total transmitted power spectral density is achieved for all OFDM symbols.</p> <p>NOTE 2: Interference from other cells and noise sources not specified in the test is assumed to be constant over subcarriers and time and shall be modelled as AWGN of appropriate power for <math>N_{oc}</math> to be fulfilled.</p> <p>NOTE 3: SS-RSRP and <math>I_o</math> levels have been derived from other parameters for information purposes. They are not settable parameters themselves.</p> <p>NOTE 4: SS-RSRP minimum requirements are specified assuming independent interference and noise at each receiver antenna port.</p> <p>NOTE 5: Subtest 1 is not used when testing with 30kHz SSB SCS.</p> <p>NOTE 6: The signal levels apply for SSS REs when the discovery burst is transmitted during DBT windows.</p> <p>NOTE 7: For UE supporting semi-static channel access and network configuring semi-static channel occupancy.</p> <p>NOTE 8: For UE supporting dynamic channel access and network configuring dynamic channel occupancy.</p> <p>NOTE 9: For a UE supporting both semi-static and dynamic channel access, the UE can be tested under dynamic channel occupancy only.</p>									

A.11.6.1.1.3 Test Requirements

The SS-RSRP measurement accuracy for cell 1 and cell 2 shall fulfil absolute requirement in clause 10.1.36.1.1 and relative requirement in clause 10.1.36.1.2.

## A.11.6.1.2 Intra-frequency measurement accuracy on SCC on a carrier frequency with CCA

### A.11.6.1.2.1 Test Purpose and Environment

The purpose of this test is to verify that the SS-RSRP measurement accuracy on the carrier frequency with CCA is within the specified limits. This test will verify the requirements in clauses 10.1.36.1.1 and 10.1.36.1.2 for intra-frequency measurements under CCA.

### A.11.6.1.2.2 Test parameters

Three cells are deployed in the test, which are FR1 PCell (Cell 1) on the carrier frequency with CCA, and two cells on the same carrier frequency with CCA and transmit SSBs in DBT windows according to DL CCA model: SCell (Cell 2) and a neighbour cell (Cell 3). Supported test configurations are shown in table A.11.6.1.2.2-1. Both absolute and relative accuracy of SS-RSRP intra-frequency measurements are tested by using the parameters in A.11.6.1.2.2-2.

**Table A.11.6.1.2.2-1: SS-RSRP Intra frequency SS-RSRP supported test configurations**

Config	Description
1	NR 30kHz SSB SCS, 40 MHz bandwidth, TDD duplex mode

**Table A.11.6.1.2.2-2: SS-RSRP Intra frequency test parameters**

Parameter		Unit	Test 1		Test 2		Test 3	
			Cell 2	Cell 3	Cell 2	Cell 3	Cell 2	Cell 3
Cell ID			489	0	489	0	489	0
SSB ARFCN			freq1		freq1		freq1	
TDD configuration	Config 1		TDDConf.1.1 CCA					
BW <sub>channel</sub>	Config 1	MHz	40: N <sub>RB,c</sub> = 106					
BWP BW	Config 1		40: N <sub>RB,c</sub> = 106					
DL CCA model			As specified in clause A.3.26.2.1					
UL CCA model			As specified in clause A.3.26.2.2					
P <sub>CCA,DL</sub> for dynamic channel access <sup>Note 7,9</sup>			P <sub>CCA,DL_1</sub> =0.75 P <sub>CCA,DL_2</sub> =0.75					
P <sub>CCA,DL</sub> for semi-static channel access <sup>Note 8,9</sup>			P <sub>CCA,DL</sub> =0.9375					
P <sub>CCA,UL</sub>			1					
Downlink initial BWP configuration			DLBWP.0.1					
Downlink dedicated BWP configuration			DLBWP.1.1					
Uplink initial BWP configuration			ULBWP.0.1					
Uplink dedicated BWP configuration			ULBWP.1.1					
TRS configuration	Config 1		TRS.1. 2 TDD	NA	TRS.1 .2 TDD	NA	TRS.1. 2 TDD	NA
DRX Cycle		ms	Not Applicable					
PDSCH Reference measurement channel	Config 1		SR.1.1 CCA	-	SR.1.1 CCA	-	SR.1.1 CCA	-
RMSI CORESET Reference Channel	Config 1		CR.1.1 CCA	-	CR.1.1 CCA	-	CR.1.1 CCA	-
Control channel RMC	Config 1		CR.1.1 CCA	-	CR.1.1 CCA	-	CR.1.1 CCA	-
SSB configuration for semi-static channel access	Config 1		SSB.1 CCA	SSB.1 CCA	SSB.1 CCA	SSB.1 CCA	SSB.1 CCA	SSB.1 CCA
SSB configuration for dynamic channel access	Config 1		SSB.2 CCA	SSB.2 CCA	SSB.2 CCA	SSB.2 CCA	SSB.2 CCA	SSB.2 CCA
DBT window configuration	Config 1,2,3		DBT.1	DBT.1	DBT.1	DBT.1	DBT.1	DBT.1
Time offset with Cell 1	Config 1	μs	-	3	-	3	-	3
SMTC configuration	Config 1		SMTC.1					
OCNG Patterns			OCNG pattern 1					

PDSCH/PDCCH subcarrier spacing	Config 1		kHz	30 kHz					
EPRE ratio of PSS to SSS			dB	0	0	0	0	0	0
EPRE ratio of PBCH DMRS to SSS									
EPRE ratio of PBCH to PBCH DMRS									
EPRE ratio of PDCCH DMRS to SSS									
EPRE ratio of PDCCH to PDCCH DMRS									
EPRE ratio of PDSCH DMRS to SSS									
EPRE ratio of PDSCH to PDSCH									
EPRE ratio of OCNG DMRS to SSS(Note 1)									
EPRE ratio of OCNG to OCNG DMRS (Note 1)									
$N_{oc}$ <sup>Note2</sup>	Config 1	NR_CCA_FR1_I NR_CCA_FR1_J			Not applicable <sup>Note 5</sup>		-94		-110 -109.5
$N_{oc}$ <sup>Note2</sup>	Config 1	NR_CCA_FR1_I NR_CCA_FR1_J	dBm/SCS	Not applicable <sup>Note 5</sup>		-91		-107.0 -106.5	
$\hat{E}_s/I_{ot}$ <sup>Note6</sup>			dB	2.46	-5.97	2.46	-5.97	-2.01	-3.54
$\hat{E}_s/N_{oc}$ <sup>Note6</sup>			dB	6	1	6	1	1	0
SS-RSRP <sup>Not e3</sup>	Config 1	NR_CCA_FR1_I NR_CCA_FR1_J	dBm/SCS	Not applicable <sup>Note 5</sup>	Not applicable <sup>Note 5</sup>	-85	-90	- 106.00	- 107.00
								- 105.50	- 106.50
$I_o$ <sup>Note3</sup>	Config 1	NR_CCA_FR1_I NR_CCA_FR1_J	dBm/ 38.16MHz	Not applicable <sup>Note 5</sup>		-51.99		-70.82 -70.32	
Propagation condition			-	AWGN					
Antenna configuration				1x2					
<p>NOTE 1: OCNG shall be used such that both cells are fully allocated and a constant total transmitted power spectral density is achieved for all OFDM symbols.</p> <p>NOTE 2: Interference from other cells and noise sources not specified in the test is assumed to be constant over subcarriers and time and shall be modelled as AWGN of appropriate power for <math>N_{oc}</math> to be fulfilled.</p> <p>NOTE 3: SS-RSRP and <math>I_o</math> levels have been derived from other parameters for information purposes. They are not settable parameters themselves.</p> <p>NOTE 4: SS-RSRP minimum requirements are specified assuming independent interference and noise at each receiver antenna port.</p> <p>NOTE 5: Subtest 1 is not used when testing with 30kHz SSB SCS.</p> <p>NOTE 6: The signal levels apply for SSS REs when the discovery burst is transmitted during DBT windows.</p> <p>NOTE 7: For UE supporting semi-static channel access and network configuring semi-static channel occupancy.</p> <p>NOTE 8: For UE supporting dynamic channel access and network configuring dynamic channel occupancy.</p> <p>NOTE 9: For a UE supporting both semi-static and dynamic channel access, the UE can be tested under dynamic channel occupancy only.</p>									

### A.11.6.1.2.3 Test Requirements

The SS-RSRP measurement accuracy for cell 2 and cell 3 shall fulfil absolute requirement in clause 10.1.36.1.1 and relative requirement in clause 10.1.36.1.2.

## A.11.6.2 SS-RSRQ

### A.11.6.2.1 Intra-frequency measurement accuracy

#### A.11.6.2.1.1 Test Purpose and Environment

The purpose of this test is to verify that the SS-RSRQ measurement accuracy is within the specified limits. This test will verify the requirements in Clause 10.1.29.1.1.

#### A.11.6.2.1.2 Test Parameters

In this test case all cells are on the same carrier frequency. Supported test configuration are shown in Table A.11.6.2.1.2-1. The absolute accuracy of SS-RSRQ intra-frequency measurement is tested by using the parameters in

Table A.11.6.2.1.2-2. In all test cases, Cell 1 is the PCell with CCA and Cell 2 is the target cell with CCA. Three subtests (Test 1, Test 2, and Test 3) are provided different  $N_{oc}$  on Cells 1 and 2.

**Table A.11.6.2.1.2-1: SS-RSRQ Intra frequency SS-RSRQ supported test configurations**

Config	Description
1	With CCA: NR 30 kHz SSB SCS, 40 MHz bandwidth, TDD duplex mode
Note:	The UE is only required to be tested in one of the supported test configurations

**Table A.11.6.2.1.2-2: SS-RSRQ Intra frequency test parameters**

Parameter	Unit	Test 1		Test 2		Test 3		
		Cell 1	Cell 2	Cell 1	Cell 2	Cell 1	Cell 2	
SSB ARFCN		freq1		freq1		freq1		
DL CCA model	Config 1	As specified in clause A.3.26.2.1						
UL CCA model	Config 1	As specified in clause A.3.26.2.2						
UL CCA probability	$P_{CCA\_UL}$	1.0	-	1.0	-	1.0	-	
DL CCA probability for semi-static channel access <small>Note 7, 8</small>	$P_{CCA\_DL}$	0.9375	-	0.9375	-	0.9375	-	
DL CCA probability for dynamic channel access <small>Note 8, 9</small>	$P_{CCA\_DL\_1}$	0.75	-	0.75	-	0.75	-	
	$P_{CCA\_DL\_2}$	0.75	-	0.75	-	0.75	-	
Duplex mode	Config 1	TDD						
TDD configuration	Config 1	TDDConf.1.1 CCA						
$BW_{channel}$	Config 1	MHz 40: $N_{RB,c} = 106$						
Gap Pattern ID		0						
BWP configuration	Initial DL BWP	DLBWP.0.1						
	Dedicated DL BWP	DLBWP.1.1						
	Initial UL BWP	ULBWP.0.1						
	Dedicated UL BWP	ULBWP.1.1						
DRX Cycle	ms	Not Applicable						
PDSCH Reference measurement channel	Config 1	SR1.1 CCA		SR1.1 CCA		SR1.1 CCA		
RMSI CORESET Reference Channel	Config 1	CR.1.1 CCA		CR.1.1 CCA		CR.1.1 CCA		
Control Channel RMC	Config 1	CCR.1.1 CCA		CCR.1.1 CCA		CCR.1.1 CCA		
TRS Configuration	Config 1	TRS.1.2 TDD		TRS.1.2 TDD		TRS.1.2 TDD		
OCNG Patterns		OP. 1						
SS-RSSI-Measurement		Not Applicable						
Time offset with Cell 1	Config 1	$\mu s$	-	3	-	3	-	3
DBT Window configuration	Config 1	DBT.1						
SSB configuration	Config 1	SSB.1 CCA for semi-static channel access SSB.2 CCA for dynamic channel access						
SMTc configuration	Config 1	SMTc.1						
PDSCH/PDCCH subcarrier spacing	Config 1	kHz 30 kHz						
EPRE ratio of PSS to SSS	dB	0	0	0	0	0	0	
EPRE ratio of PBCH DMRS to SSS								
EPRE ratio of PBCH to PBCH DMRS								
EPRE ratio of PDCCH DMRS to SSS								
EPRE ratio of PDCCH to PDCCH DMRS								
EPRE ratio of PDSCH DMRS to SSS								
EPRE ratio of PDSCH to PDSCH								
EPRE ratio of OCNG DMRS to SSS (Note 1)								
EPRE ratio of OCNG to OCNG DMRS (Note 1)								
$N_{oc}$ <small>Note2</small>	NR_CCA_FR1_I	dBm/15kHz z	-91		-		-110	

$N_{oc}$ <sup>Note2</sup>	Config 1	NR_CCA_FR1_J	dBm/SCS	-88	-	-109.5			
		NR_CCA_FR1_I				-107			
		NR_CCA_FR1_J				-106.5			
$\hat{E}_s/I_{ot}$			dB	-1.76	-4.7	-5.46	-5.46		
$\hat{E}_s/N_{oc}$			dB	3	3	-2.9	-2.9	-4	-4
SS-RSRP <sup>Note3</sup>	Config 1	NR_CCA_FR1_I		-85	-85	-	-	-111	-111
		NR_CCA_FR1_J						-110.5	-110.5
SS-RSRQ <sup>Note3</sup>		NR_CCA_FR1_I	dB	-14.77	-14.77	-16.76	-16.76	-17.34	-17.34
		NR_CCA_FR1_J							
$I_o$ <sup>Note3</sup>	Config 1	NR_CCA_FR1_I	dBm/ 38.16MHz	-50	-	-73.4			
		NR_CCA_FR1_J				-72.9			
Propagation condition			-	AWGN	AWGN	AWGN	AWGN	AWGN	AWGN
Antenna configuration				1x2	1x2	1x2	1x2	1x2	1x2
<p>Note 1: OCNG shall be used such that both cells are fully allocated and a constant total transmitted power spectral density is achieved for all OFDM symbols.</p> <p>Note 2: Interference from other cells and noise sources not specified in the test is assumed to be constant over subcarriers and time and shall be modelled as AWGN of appropriate power for <math>N_{oc}</math> to be fulfilled.</p> <p>Note 3: SS-RSRQ, SS-RSRP, and <math>I_o</math> levels have been derived from other parameters for information purposes. They are not settable parameters themselves.</p> <p>Note 4: SS-RSRQ, SS-RSRP minimum requirements are specified assuming independent interference and noise at each receiver antenna port.</p> <p>Note 5: NR operating band groups are as defined in clause 3.5.2.</p> <p>Note 6: For UE supporting both semi-static and dynamic channel access, the UE must be tested under both dynamic and semi-static channel occupancy configuration</p> <p>Note 7: For UE supporting semi-static channel access and network configuring semi-static channel occupancy.</p> <p>Note 8: For UE supporting dynamic channel access and network configuring dynamic channel occupancy.</p> <p>Note 9: For UE supporting both semi-static and dynamic channel access, the UE must be tested under both dynamic and semi-static channel occupancy configurations.</p>									

A.11.6.2.1.3 Test Requirements

The SS-RSRQ measurement accuracy shall fulfil the requirements in clause 10.1.29.1.1.

A.11.6.2.2 Inter-frequency measurement accuracy

A.11.6.2.2.1 Test Purpose and Environment

The purpose of this test is to verify that the SS-RSRQ measurement accuracy is within the specified limits. This test will verify the requirements in Clause 10.1.30.1.1 and 10.1.30.1.2.

A.11.6.2.2.2 Test Parameters

In this test case the two cells (i.e., Cell 1 and Cell 2) are on different carrier frequencies and measurement gaps are provided. Supported test configurations are shown in Table A.11.6.2.2.2-1. Both absolute accuracy and relative accuracy requirements of SS-RSRQ inter-frequency measurement are tested by using test parameters in Table A.11.6.2.2.2-2. In all test cases, Cell 1 is the PCell with CCA and Cell 2 is target cell with CCA. Three sub-tests (Test 1, Test 2, and Test 3) are provided different  $N_{oc}$  on Cells 1 and 2.

**Table A.11.6.2.2-1: SS-RSRQ Inter frequency SS-RSRQ supported test configurations**

Config	Description
1	With CCA: NR 30kHz SSB SCS, 40 MHz bandwidth, TDD duplex mode
Note:	The UE is only required to be tested in one of the supported test configurations

**Table A.11.6.2.2-2: SS-RSRQ Inter frequency test parameters**

Parameter	Unit	Test 1		Test 2		Test 3	
		Cell 1	Cell 2	Cell 1	Cell 2	Cell 1	Cell 2

SSB ARFCN			freq1	freq2	freq1	freq2	freq1	freq2		
DL CCA model	Config 1		As specified in clause A.3.26.2.1							
UL CCA model	Config 1		As specified in clause A.3.26.2.2							
UL CCA probability	P <sub>CCA_UL</sub>		1.0	-	1.0	-	1.0	-		
DL CCA probability for semi-static channel access <small>Note 7, 8</small>	P <sub>CCA_DL</sub>		0.9375	-	0.9375	-	0.9375	-		
DL CCA probability for dynamic channel access <small>Note 8, 9</small>	P <sub>CCA_DL_1</sub>		0.75	-	0.75	-	0.75	-		
	P <sub>CCA_DL_2</sub>		0.75	-	0.75	-	0.75	-		
Duplex mode	Config 1		TDD							
TDD configuration	Config 1		TDDConf.1.1 CCA							
BW <sub>channel</sub>	Config 1	MHz	40: N <sub>RB,c</sub> = 106							
Gap pattern ID	Config 1		0							
BWP BW	Config 1		40: N <sub>RB,c</sub> = 106							
DRX Cycle		ms	Not Applicable							
PDSCH Reference measurement channel	Config 1		SR.1.1 CCA		SR.1.1 CCA		SR.1.1 CCA			
RMSI CORESET Reference Channel	Config 1		CR.1.1 CCA		CR.1.1 CCA		CR.1.1 CCA			
Dedicated CORESET Reference Channel	Config 1		CCR.1.1 CCA		CCR.1.1 CCA		CCR.1.1 CCA			
TRS Configuration	Config 1		TRS.1.2 TDD		TRS.1.2 TDD		TRS.1.2 TDD			
OCNG Patterns			OCNG pattern 1							
Time offset with Cell 1	Config 1	μs	-	3	-	3	-	3		
DBT Window configuration	Config 1		DBT.1							
SSB configuration	Config 1		SSB.1 CCA for semi-static channel access SSB.2 CCA for dynamic channel access							
SMTC configuration	Config 1		SMTC.1							
PDSCH/PDCCH subcarrier spacing	Config 1	kHz	30 kHz							
EPRE ratio of PSS to SSS		dB	0	0	0	0	0	0		
EPRE ratio of PBCH DMRS to SSS										
EPRE ratio of PBCH to PBCH DMRS										
EPRE ratio of PDCCH DMRS to SSS										
EPRE ratio of PDCCH to PDCCH DMRS										
EPRE ratio of PDSCH DMRS to SSS										
EPRE ratio of PDSCH to PDSCH										
EPRE ratio of OCNG DMRS to SSS (Note 1)										
EPRE ratio of OCNG to OCNG DMRS (Note 1)										
N <sub>oc</sub> <small>Note2</small>		NR_CCA_FR1_I	dBm/15kHz		-86.27		-113		-112	
		NR_CCA_FR1_J							-111.5	
N <sub>oc</sub> <small>Note2</small>	Config 1	NR_CCA_FR1_I	dBm/SCS		-83.27		-110		-109	
		NR_CCA_FR1_J							-108.5	
Ê <sub>s</sub> / I <sub>ot</sub>			dB	-1.75		-1.75		3	-1.75	
Ê <sub>s</sub> / N <sub>oc</sub>			dB	-1.75		-1.75		3	-1.75	
SS-RSRP <sup>Not e3</sup>	Config 1	NR_CCA_FR1_I	-85.02	-85.02	-	-	111.75	111.75	-106	-
		NR_CCA_FR1_J							-105.5	-
SS-RSRQ <sup>Note3</sup>			dB	-14.77	-14.77	-40.59	-40.59	12.56	14.76	
I <sub>o</sub> <sup>Note3</sup>	Config 1	NR_CCA_FR1_I	dBm/SCS		-50		-76.73		-73.19	-75.73
		NR_CCA_FR1_J							-72.69	-75.23
Propagation condition			-	AWGN	AWGN	AWGN	AWGN	AWGN	AWGN	
Antenna configuration				1x2	1x2	1x2	1x2	1x2	1x2	

Note 1:	OCNG shall be used such that both cells are fully allocated and a constant total transmitted power spectral density is achieved for all OFDM symbols.
Note 2:	Interference from other cells and noise sources not specified in the test is assumed to be constant over subcarriers and time and shall be modelled as AWGN of appropriate power for $N_{oc}$ to be fulfilled.
Note 3:	SS-RSRQ, SS-RSRP, and $I_0$ levels have been derived from other parameters for information purposes. They are not settable parameters themselves.
Note 4:	SS-RSRQ, SS-RSRP minimum requirements are specified assuming independent interference and noise at each receiver antenna port.
Note 5:	NR operating band groups are as defined in clause 3.5.2.
Note 6:	For UE supporting both semi-static and dynamic channel access, the UE must be tested under both dynamic and semi-static channel occupancy configuration.
Note 7:	For UE supporting semi-static channel access and network configuring semi-static channel occupancy.
Note 8:	For UE supporting dynamic channel access and network configuring dynamic channel occupancy.
Note 9:	For UE supporting both semi-static and dynamic channel access, the UE must be tested under both dynamic and semi-static channel occupancy configurations.

### A.11.6.2.2.3 Test Requirements

The SS-RSRQ measurement accuracy shall fulfil the requirements in clause 10.1.30.1.1 and 10.1.30.1.2.

## A.11.6.2.3 Intra-frequency measurement accuracy on SCC

### A.11.6.2.3.1 Test Purpose and Environment

The purpose of this test is to verify that the SS-RSRQ measurement accuracy is within the specified limits. This test will verify the requirements in Clause 10.1.29.1.1.

### A.11.6.2.3.2 Test Parameters

In this test case all cells are on the same carrier frequency. Supported test configuration are shown in Table A.11.6.2.3.2-1. The absolute accuracy of SS-RSRQ intra-frequency measurement is tested by using the parameters in Table A.11.6.2.3.2-2. In all test cases, Cell 1 is the PCell with CCA, Cell 2 is the SCell with CCA, and Cell 3 is the target cell with CCA. Three sub-tests (Test 1, Test 2, and Test 3) are provided different  $N_{oc}$  on Cells 1, 2, and 3.

**Table A.11.6.2.3.2-1: SS-RSRQ Intra frequency SS-RSRQ supported test configurations**

Config	Description
1	With CCA: NR 30 kHz SSB SCS, 40 MHz bandwidth, TDD duplex mode
Note:	The UE is only required to be tested in one of the supported test configurations

**Table A.11.6.2.3.2-2: SS-RSRQ Intra frequency test parameters**

Parameter	Unit	Test 1		Test 2		Test 3	
		Cell 1 / Cell 2	Cell 3	Cell 1 / Cell 2	Cell 3	Cell 1 / Cell 2	Cell 3
SSB ARFCN		freq1 for Cell 1 freq2 for Cell 2	freq2	freq1 for Cell 1 freq2 for Cell 2	freq2	freq1 for Cell 1 freq2 for Cell 2	freq2
DL CCA model	Config 1	As specified in clause A.3.26.2.1					
UL CCA model	Config 1	As specified in clause A.3.26.2.2					
UL CCA probability	$P_{CCA\_UL}$	1.0	-	1.0	-	1.0	-
DL CCA probability for semi-static channel access <small>Note 7, 8</small>	$P_{CCA\_DL}$	0.9375	-	0.9375	-	0.9375	-
DL CCA probability for dynamic channel access <small>Note 8, 9</small>	$P_{CCA\_DL\_1}$	0.75	-	0.75	-	0.75	-
	$P_{CCA\_DL\_2}$	0.75	-	0.75	-	0.75	-



Duplex mode	Config 1		TDD					
TDD configuration	Config 1		TDDConf.1.1 CCA					
BW <sub>channel</sub>	Config 1	MHz	40: N <sub>RB,c</sub> = 106					
Gap Pattern ID			0					
BWP configuration	Initial DL BWP		DLBWP.0.1					
	Dedicated DL BWP		DLBWP.1.1					
	Initial UL BWP		ULBWP.0.1					
	Dedicated UL BWP		ULBWP.1.1					
DRX Cycle		ms	Not Applicable					
PDSCH Reference measurement channel	Config 1		SR1.1 CCA		SR1.1 CCA		SR1.1 CCA	
RMSI CORESET Reference Channel	Config 1		CR.1.1 CCA		CR.1.1 CCA		CR.1.1 CCA	
Control Channel RMC	Config 1		CCR.1.1 CCA		CCR.1.1 CCA		CCR.1.1 CCA	
TRS Configuration	Config 1		TRS.1.2 TDD		TRS.1.2 TDD		TRS.1.2 TDD	
OCNG Patterns			OP. 1					
SS-RSSI-Measurement			Not Applicable					
Time offset with Cell 1	Config 1	μs	3 (for Cell 2)	3	3 (for Cell 2)	3	3 (for Cell 2)	3
DBT Window configuration	Config 1		DBT.1					
SSB configuration	Config 1		SSB.1 CCA for semi-static channel access SSB.2 CCA for dynamic channel access					
SMTC configuration	Config 1		SMTC.1					
CSI-RS for tracking	Config 1		TRS.1.2 TDD					
PDSCH/PDCCH subcarrier spacing	Config 1	kHz	30 kHz					
EPRE ratio of PSS to SSS		dB	0	0	0	0	0	0
EPRE ratio of PBCH DMRS to SSS								
EPRE ratio of PBCH to PBCH DMRS								
EPRE ratio of PDCCH DMRS to SSS								
EPRE ratio of PDCCH to PDCCH DMRS								
EPRE ratio of PDSCH DMRS to SSS								
EPRE ratio of PDSCH to PDSCH								
EPRE ratio of OCNG DMRS to SSS(Note 1)								
EPRE ratio of OCNG to OCNG DMRS (Note 1)								
N <sub>oc</sub> <sup>Note2</sup>		NR_CCA_FR1_I	dBm/15kHz	-91		-		-110
		NR_CCA_FR1_J						-109.5
N <sub>oc</sub> <sup>Note2</sup>	Config 1	NR_CCA_FR1_I	dBm/SCS	-88		-		-107
		NR_CCA_FR1_J						-106.5
E <sub>s</sub> /I <sub>ot</sub>			dB	-1.76		-4.7		-5.46 -5.46
E <sub>s</sub> /N <sub>oc</sub>			dB	3	3	-2.9	-2.9	-4 -4
SS-RSRP <sup>Note3</sup>	Config 1	NR_CCA_FR1_I		-85	-85	-	-	-111 -111
		NR_CCA_FR1_J						-110.5 -110.5
SS-RSRQ <sup>Note3</sup>		NR_CCA_FR1_I	dB	-14.77	-14.77	-16.76	-16.76	-17.34 -17.34
		NR_CCA_FR1_J						
I <sub>o</sub> <sup>Note3</sup>	Config 1	NR_CCA_FR1_I	dBm/38.16MHz	-50		-		-73.4
		NR_CCA_FR1_J						-72.9
Propagation condition			-	AWGN	AWGN	AWGN	AWGN	AWGN
Antenna configuration				1x2	1x2	1x2	1x2	1x2
<p>Note 1: OCNG shall be used such that both cells are fully allocated and a constant total transmitted power spectral density is achieved for all OFDM symbols.</p> <p>Note 2: Interference from other cells and noise sources not specified in the test is assumed to be constant over subcarriers and time and shall be modelled as AWGN of appropriate power for N<sub>oc</sub> to be fulfilled.</p>								

Note 3:	SS-RSRQ, SS-RSRP, and Io levels have been derived from other parameters for information purposes. They are not settable parameters themselves.
Note 4:	SS-RSRQ, SS-RSRP minimum requirements are specified assuming independent interference and noise at each receiver antenna port.
Note 5:	NR operating band groups are as defined in clause 3.5.2.
Note 6:	For UE supporting both semi-static and dynamic channel access, the UE must be tested under both dynamic and semi-static channel occupancy configuration.
Note 7:	For UE supporting semi-static channel access and network configuring semi-static channel occupancy.
Note 8:	For UE supporting dynamic channel access and network configuring dynamic channel occupancy.
Note 9:	For UE supporting both semi-static and dynamic channel access, the UE must be tested under both dynamic and semi-static channel occupancy configurations.

### A.11.6.2.3.3 Test Requirements

The SS-RSRQ measurement accuracy shall fulfil the requirements in clause 10.1.29.1.1.

### A.11.6.2.4 Inter-frequency measurement accuracy

#### A.11.6.2.4.1 Test Purpose and Environment

The purpose of this test is to verify that the SS-RSRQ measurement accuracy is within the specified limits. This test will verify the requirements in Clause 10.1.30.1.1 and 10.1.30.1.2.

#### A.11.6.2.4.2 Test Parameters

In this test case the two cells (i.e., Cell 1 and Cell 2) are on different carrier frequencies and measurement gaps are provided. Supported test configurations are shown in Table A.11.6.2.4.2-1. Both absolute accuracy and relative accuracy requirements of SS-RSRQ inter-frequency measurement are tested by using test parameters in Table A.11.6.2.4.2-2 and A.11.6.2.4.2-3. In all test cases, Cell 1 is the PCell and Cell 2 is target cell with CCA. Three sub-tests (Test 1, Test 2, and Test 3) are provided different  $N_{oc}$  on Cells 1 and 2.

**Table A.11.6.2.4.2-1: SS-RSRQ Inter frequency SS-RSRQ supported test configurations**

Config	Description
1	Without CCA: NR 15 kHz SSB SCS, 10 MHz bandwidth, FDD duplex mode With CCA: NR 30 kHz SSB SCS, 40 MHz bandwidth, TDD duplex mode
2	Without CCA: NR 15 kHz SSB SCS, 10 MHz bandwidth, TDD duplex mode With CCA: NR 30 kHz SSB SCS, 40 MHz bandwidth, TDD duplex mode
3	Without CCA: NR 30 kHz SSB SCS, 40 MHz bandwidth, TDD duplex mode With CCA: NR 30 kHz SSB SCS, 40 MHz bandwidth, TDD duplex mode
Note:	The UE is only required to be tested in one of the supported test configurations

**Table A.11.6.2.4.2-2: SS-RSRQ Inter frequency test parameters**

Parameter	Unit	Test 1	Test 2	Test 3
		Cell 2	Cell 2	Cell 2
SSB ARFCN		freq2	freq2	freq2
DL CCA model	Config 1, 2, 3	As specified in clause A.3.26.2.1		
UL CCA model	Config 1, 2, 3	As specified in clause A.3.26.2.2		
UL CCA probability	$P_{CCA\_UL}$	1.0		
DL CCA probability for semi-static channel access <small>Note 7, 8</small>	$P_{CCA\_DL}$	0.9375		
DL CCA probability for dynamic channel access <small>Note 8, 9</small>	$P_{CCA\_DL\_1}$	0.75		
	$P_{CCA\_DL\_2}$	0.75		
Duplex mode	Config 1, 2, 3	TDD		
TDD configuration	Config 1, 2, 3	TDDConf.1.1 CCA		
$BW_{channel}$	Config 1, 2, 3	MHz	40: $N_{RB,c} = 106$	
Gap pattern ID	Config 1, 2, 3	0		
BWP BW	Config 1, 2, 3	40: $N_{RB,c} = 106$		
DRX Cycle		ms	Not Applicable	
OCNG Patterns		OCNG pattern 1		

Time offset with Cell 1		Config 1, 2, 3	$\mu$ s	3		
DBT Window configuration		Config 1, 2, 3		DBT.1		
SSB configuration		Config 1, 2, 3		SSB.1 CCA for semi-static channel access SSB.2 CCA for dynamic channel access		
SMTC configuration		Config 1, 2, 3		SMTC.1		
PDSCH/PDCCH subcarrier spacing		Config 1, 2, 3	kHz	30 kHz		
EPRE ratio of PSS to SSS			dB	0	0	0
EPRE ratio of PBCH DMRS to SSS						
EPRE ratio of PBCH to PBCH DMRS						
EPRE ratio of PDCCH DMRS to SSS						
EPRE ratio of PDCCH to PDCCH DMRS						
EPRE ratio of PDSCH DMRS to SSS						
EPRE ratio of PDSCH to PDSCH						
EPRE ratio of OCNG DMRS to SSS(Note 1)						
EPRE ratio of OCNG to OCNG DMRS (Note 1)						
$N_{oc}$ <sup>Note2</sup>		NR_CCA_FR1_I				
		NR_CCA_FR1_J	-111.5			
$N_{oc}$ <sup>Note2</sup>	Config 1, 2, 3	NR_CCA_FR1_I	dBm/SCS	-83.27	-110	-109
		NR_CCA_FR1_J				-108.5
$\hat{E}_s / I_{ot}$			dB	-1.75	-1.75	-1.75
$\hat{E}_s / N_{oc}$			dB	-1.75		-1.75
SS-RSRP <sup>Note3</sup>	Config 1, 2, 3	NR_CCA_FR1_I		-85.02	-111.75	-110.75
		NR_CCA_FR1_J				-110.25
SS-RSRQ <sup>Note3</sup>		NR_CCA_FR1_I	dB	-14.77	-40.59	14.76
		NR_CCA_FR1_J				
$I_o$ <sup>Note3</sup>	Config 1, 2, 3	NR_CCA_FR1_I	dBm/SCS	-50	-76.73	-75.73
		NR_CCA_FR1_J				-75.23
Propagation condition			-	AWGN	AWGN	AWGN
Antenna configuration				1x2	1x2	1x2
<p>Note 1: OCNG shall be used such that both cells are fully allocated and a constant total transmitted power spectral density is achieved for all OFDM symbols.</p> <p>Note 2: Interference from other cells and noise sources not specified in the test is assumed to be constant over subcarriers and time and shall be modelled as AWGN of appropriate power for <math>N_{oc}</math> to be fulfilled.</p> <p>Note 3: SS-RSRQ, SS-RSRP, and <math>I_o</math> levels have been derived from other parameters for information purposes. They are not settable parameters themselves.</p> <p>Note 4: SS-RSRQ, SS-RSRP minimum requirements are specified assuming independent interference and noise at each receiver antenna port.</p> <p>Note 5: NR operating band groups are as defined in clause 3.5.2.</p> <p>Note 6: For UE supporting both semi-static and dynamic channel access, the UE must be tested under both dynamic and semi-static channel occupancy configuration.</p> <p>Note 7: For UE supporting semi-static channel access and network configuring semi-static channel occupancy.</p> <p>Note 8: For UE supporting dynamic channel access and network configuring dynamic channel occupancy.</p> <p>Note 9: For UE supporting both semi-static and dynamic channel access, the UE must be tested under both dynamic and semi-static channel occupancy configurations.</p>						

**Table A.11.6.2.4.2-3: SS-RSRQ Intra frequency test parameters for NR PCell**

Parameter		Unit	Test 1	Test 2	Test 3
			Cell 1	Cell 1	Cell 1
SSB ARFCN			freq1		
Duplex mode	Config 1		FDD		

		Config 2,3			TDD	
TDD configuration		Config 1			Not Applicable	
		Config 2			TDDConf.1.1	
		Config 3			TDDConf.2.1	
BW <sub>channel</sub>		Config 1	MHz		10: N <sub>RB,c</sub> = 52	
		Config 2			10: N <sub>RB,c</sub> = 52	
		Config 3			40: N <sub>RB,c</sub> = 106	
Gap Pattern ID					0	
BWP configuration		Initial DL BWP			DLBWP.0.1	
		Dedicated DL BWP			DLBWP.1.1	
		Initial UL BWP			ULBWP.0.1	
		Dedicated UL BWP			ULBWP.1.1	
DRX Cycle			ms		Not Applicable	
PDSCH Reference measurement channel		Config 1			SR.1.1 FDD	
		Config 2			SR.1.1 TDD	
		Config 3			SR2.1 TDD	
RMSI CORESET Reference Channel		Config 1			CR.1.1 FDD	
		Config 2			CR.1.1 TDD	
		Config 3			CR.2.1 TDD	
Control Channel RMC		Config 1			CCR.1.1 FDD	
		Config 2			CCR.1.1 TDD	
		Config 3			CCR.2.1 TDD	
TRS Configuration		Config 1			TRS.1.1 FDD	
		Config 2			TRS.1.1 TDD	
		Config 3			TRS.1.2 TDD	
OCNG Patterns					OP. 1	
SS-RSSI-Measurement					Not Applicable	
SMTC configuration		Config 1			SMTC.2	
		Config 2,3			SMTC.1	
SSB configuration		Config 1,2			SSB.1 FR1	
		Config 3			SSB.2 FR1	
CSI-RS for tracking		Config 1			TRS.1.1 FDD	
		Config 2			TRS.1.1 TDD	
		Config 3			TRS.1.2 TDD	
PDSCH/PDCCH subcarrier spacing		Config 1,2	kHz		15 kHz	
		Config 3			30 kHz	
EPRE ratio of PSS to SSS			dB		0	
EPRE ratio of PBCH DMRS to SSS						
EPRE ratio of PBCH to PBCH DMRS						
EPRE ratio of PDCCH DMRS to SSS						
EPRE ratio of PDCCH to PDCCH DMRS						
EPRE ratio of PDSCH DMRS to SSS						
EPRE ratio of PDSCH to PDSCH						
EPRE ratio of OCNG DMRS to SSS(Note 1)						
EPRE ratio of OCNG to OCNG DMRS (Note 1)						
N <sub>oc</sub> <sup>Note2</sup>	Config 1,2	NR_FDD_FR1_A, NR_TDD_FR1_A NOTE 6		dBm/15kHz z	-85	-101
		NR_FDD_FR1_B	-113.5			
		NR_TDD_FR1_C	-113			
		NR_FDD_FR1_D, NR_TDD_FR1_D	-112.5			

		NR_FDD_FR1_E, NR_TDD_FR1_E				-112
		NR_FDD_FR1_F				-111.5
		NR_FDD_FR1_G				-111
		NR_FDD_FR1_H				-110.5
	Config 3	NR_FDD_FR1_A, NR_TDD_FR1_A NOTE 6		-91	-	-114
		NR_FDD_FR1_B				-113.5
		NR_TDD_FR1_C				-113
		NR_FDD_FR1_D, NR_TDD_FR1_D				-112.5
		NR_FDD_FR1_E, NR_TDD_FR1_E				-112
		NR_FDD_FR1_F				-111.5
		NR_FDD_FR1_G				-111
		NR_FDD_FR1_H				-110.5
$N_{oc}$ Note2	Config 1,2	NR_FDD_FR1_A, NR_TDD_FR1_A NOTE 6	dBm/SCS	-85	-101	-114
		NR_FDD_FR1_B				-113.5
		NR_TDD_FR1_C				-113
		NR_FDD_FR1_D, NR_TDD_FR1_D				-112.5
		NR_FDD_FR1_E, NR_TDD_FR1_E				-112
		NR_FDD_FR1_F				-111.5
		NR_FDD_FR1_G				-111
		NR_FDD_FR1_H				-110.5
	Config 3	NR_FDD_FR1_A, NR_TDD_FR1_A NOTE 6		-88	-	-111
		NR_FDD_FR1_B				-110.5
		NR_TDD_FR1_C				-110
		NR_FDD_FR1_D, NR_TDD_FR1_D				-109.5
		NR_FDD_FR1_E, NR_TDD_FR1_E				-109
		NR_FDD_FR1_F				-108.5
		NR_FDD_FR1_G				-108
		NR_FDD_FR1_H				-107.5
$\hat{E}_s/I_{\alpha}$			dB	-1.76	-4.7	-5.46
$\hat{E}_s/N_{oc}$			dB	3	-2.9	-4
SS- RSRP <sup>Note 3</sup>	Config 1,2	NR_FDD_FR1_A, NR_TDD_FR1_A NOTE 6	dBm/SCS	-82	-103.9	-118
		NR_FDD_FR1_B				-117.5
		NR_TDD_FR1_C				-117
		NR_FDD_FR1_D, NR_TDD_FR1_D				-116.5
		NR_FDD_FR1_E, NR_TDD_FR1_E				-116
		NR_FDD_FR1_F				-115.5
		NR_FDD_FR1_G				-115
		NR_FDD_FR1_H				-114.5
	Config 3	NR_FDD_FR1_A, NR_TDD_FR1_A NOTE 6		-85	-	-115

		NR_FDD_FR1_B				-114.5			
		NR_TDD_FR1_C				-114			
		NR_FDD_FR1_D, NR_TDD_FR1_D				-113.5			
		NR_FDD_FR1_E, NR_TDD_FR1_E				-113			
		NR_FDD_FR1_F				-112.5			
		NR_FDD_FR1_G				-112			
		NR_FDD_FR1_H				-111.5			
SS-RSRQ	Note3	NR_FDD_FR1_A, NR_TDD_FR1_A NOTE 6	dB	-14.77	-16.76	-17.34			
		NR_FDD_FR1_B							
		NR_TDD_FR1_C							
		NR_FDD_FR1_D, NR_TDD_FR1_D							
		NR_FDD_FR1_E, NR_TDD_FR1_E							
		NR_FDD_FR1_F							
		NR_FDD_FR1_G							
		NR_FDD_FR1_H							
Io	Note3	Config 1,2	dBm/ 9.36MHz	-50	-70	-83.5			
		NR_FDD_FR1_A, NR_TDD_FR1_A NOTE 6							-83
		NR_FDD_FR1_B							-82.5
		NR_TDD_FR1_C							-82
		NR_FDD_FR1_D, NR_TDD_FR1_D							-81.5
		NR_FDD_FR1_E, NR_TDD_FR1_E							-81
		NR_FDD_FR1_F							-80.5
		NR_FDD_FR1_G							-80
		NR_FDD_FR1_H							
		Config 3	dBm/ 38.16MHz	-50	-	-77.4			
		NR_FDD_FR1_A, NR_TDD_FR1_A NOTE 6							-76.9
		NR_FDD_FR1_B							-76.4
		NR_TDD_FR1_C							-75.9
		NR_FDD_FR1_D, NR_TDD_FR1_D							-75.4
		NR_FDD_FR1_E, NR_TDD_FR1_E							-74.9
		NR_FDD_FR1_F							-74.4
		NR_FDD_FR1_G							-73.9
		NR_FDD_FR1_H							
Propagation condition			-	AWGN	AWGN	AWGN			
Antenna configuration				1x2	1x2	1x2			
<p>Note 1: OCNG shall be used such that both cells are fully allocated and a constant total transmitted power spectral density is achieved for all OFDM symbols.</p> <p>Note 2: Interference from other cells and noise sources not specified in the test is assumed to be constant over subcarriers and time and shall be modelled as AWGN of appropriate power for <math>N_{oc}</math> to be fulfilled.</p> <p>Note 3: SS-RSRQ, SS-RSRP, and Io levels have been derived from other parameters for information purposes. They are not settable parameters themselves.</p> <p>Note 4: SS-RSRQ, SS-RSRP minimum requirements are specified assuming independent interference and noise at each receiver antenna port.</p>									

Note 5: NR operating band groups are as defined in clause 3.5.2.

Note 6: The test configuration excludes support for band n51 and it is not required to run this test on band n51 in this release of the specification.

#### A.11.6.2.4.3 Test Requirements

The SS-RSRQ measurement accuracy shall fulfil the requirements in clause 10.1.30.1.1 and 10.1.30.1.2.

### A.11.6.3 SS-SINR

#### A.11.6.3.1 Intra-frequency measurement accuracy

##### A.11.6.3.1.1 Test Purpose and Environment

The purpose of this test is to verify that the SS-SINR measurement accuracy is within the specified limits. This test will verify the requirements in clause 10.1.31.1.1.

##### A.11.6.3.1.2 Test Parameters

In this test case all cells are on the same carrier frequency. Supported test configuration are shown in Table A.11.6.3.1.2-1. The absolute accuracy of SS-SINR intra-frequency measurement is tested by using the parameters in Table A.11.6.3.1.2-2. In all test cases, Cell 1 is the PCell with CCA and Cell 2 is the target cell with CCA. Two sub-tests (Test 1 and Test 2) are provided different  $N_{oc}$  on Cells 1 and 2.

**Table A.11.6.3.1.2-1: SS-SINR Intra frequency SS-SINR supported test configurations**

Config	Description
1	With CCA: NR 30 kHz SSB SCS, 40 MHz bandwidth, TDD duplex mode
Note:	The UE is only required to be tested in one of the supported test configurations

**Table A.11.6.3.1.2-2: SS-SINR Intra frequency test parameters**

Parameter		Unit	Test 1		Test 2	
			Cell 1	Cell 2	Cell 1	Cell 2
SSB ARFCN			freq1		freq1	
DL CCA model	Config 1		As specified in clause A.3.26.2.1			
UL CCA model	Config 1		As specified in clause A.3.26.2.2			
UL CCA probability	$P_{CCA\_UL}$		1.0	-	1.0	-
DL CCA probability for semi-static channel access <small>Note 7, 8</small>	$P_{CCA\_DL}$		0.9375	-	0.9375	-
DL CCA probability for dynamic channel access <small>Note 8, 9</small>	$P_{CCA\_DL\_1}$		0.75	-	0.75	-
	$P_{CCA\_DL\_2}$		0.75	-	0.75	-
Duplex mode	Config 1		TDD			
TDD configuration	Config 1		TDDConf.1.1 CCA			
Downlink initial BWP configuration			DLBWP.0.1			
Downlink dedicated BWP configuration			DLBWP.1.1			
Uplink initial BWP configuration			ULBWP.0.1			
Uplink dedicated BWP configuration			ULBWP.1.1			
DRX Cycle configuration		ms	Not Applicable			
TRS configuration	Config 1		TRS.1.2 TDD		TRS.1.2 TDD	
PDSCH Reference measurement channel	Config 1		SR.1.1 CCA		SR.1.1 CCA	
RMSI CORESET Reference Channel	Config 1		CR.1.1 CCA		CR.1.1 CCA	
Dedicated CORESET Reference Channel	Config 1		CCR.1.1 CCA		CCR.1.1 CCA	

OCNG Patterns				OP.1			
SS-RSSI-Measurement				Not Applicable			
DBT Window configuration	Config 1		DBT.1				
Time offset with Cell 1	Config 1	μs	-	3	-	3	
SSB configuration	Config 1		SSB.1 CCA for semi-static channel access SSB.2 CCA for dynamic channel access				
SMTTC configuration	Config 1		SMTTC.1				
PDSCH/PDCCH subcarrier spacing	Config 1	kHz	30				
EPRE ratio of PSS to SSS		dB	0	0	0	0	
EPRE ratio of PBCH DMRS to SSS							
EPRE ratio of PBCH to PBCH DMRS							
EPRE ratio of PDCCH DMRS to SSS							
EPRE ratio of PDCCH to PDCCH DMRS							
EPRE ratio of PDSCH DMRS to SSS							
EPRE ratio of PDSCH to PDSCH							
EPRE ratio of OCNG DMRS to SSS(Note 1)							
EPRE ratio of OCNG to OCNG DMRS (Note 1)							
$N_{oc}$ <sup>Note2</sup>		dBm/15kHz z	-93		-112		
	NR_CCA_FR1_I						
	NR_CCA_FR1_J				-111.5		
$N_{oc}$ <sup>Note2</sup>	Config 1	dBm/SCS	-90		-109		
	NR_CCA_FR1_I						
	NR_CCA_FR1_J				-108.5		
$\hat{E}_s / I_{oi}$		dB	0	-3.19	-5.46	-5.46	
$\hat{E}_s / N_{oc}$		dB	4.54	2.66	-4	-4	
SS-RSRP <sup>Note3</sup>	Config 1	dBm/SCS	-85.46	-87.34	-113	-113	
	NR_CCA_FR1_I						
	NR_CCA_FR1_J				-112.5	-112.5	
SS-SINR <sup>Note3</sup>		dB	0	-3.19	-5.46	-5.46	
	NR_CCA_FR1_I						
	NR_CCA_FR1_J						
$I_o$ <sup>Note3</sup>	Config 1	dBm/ 38.16MHz	-51.41		-75.41		
	NR_CCA_FR1_I						
	NR_CCA_FR1_J				-74.91		
Propagation condition			-	AWGN			
Antenna configuration			-	1x2			
<p>Note 1: OCNG shall be used such that both cells are fully allocated and a constant total transmitted power spectral density is achieved for all OFDM symbols.</p> <p>Note 2: Interference from other cells and noise sources not specified in the test is assumed to be constant over subcarriers and time and shall be modelled as AWGN of appropriate power for <math>N_{oc}</math> to be fulfilled.</p> <p>Note 3: SS-SINR, SS-RSRP, and <math>I_o</math> levels have been derived from other parameters for information purposes. They are not settable parameters themselves.</p> <p>Note 4: SS-SINR, SS-RSRP minimum requirements are specified assuming independent interference and noise at each receiver antenna port.</p> <p>Note 5: NR operating band groups are as defined in clause 3.5.2.</p> <p>Note 6: For UE supporting both semi-static and dynamic channel access, the UE must be tested under both dynamic and semi-static channel occupancy configuration.</p> <p>Note 7: For UE supporting semi-static channel access and network configuring semi-static channel occupancy.</p> <p>Note 8: For UE supporting dynamic channel access and network configuring dynamic channel occupancy.</p> <p>Note 9: For UE supporting both semi-static and dynamic channel access, the UE must be tested under both dynamic and semi-static channel occupancy configurations.</p>							

A.11.6.3.1.3 Test Requirements

The SS-SINR measurement accuracy shall fulfil the requirements in clause 10.1.31.1.1.



### A.11.6.3.2 Inter-frequency measurement accuracy

#### A.11.6.3.2.1 Test Purpose and Environment

The purpose of this test is to verify that the SS-SINR measurement accuracy is within the specified limits. This test will verify the requirements in clauses 10.1.32.1.1 and 10.1.32.1.2.

#### A.11.6.3.2.2 Test Parameters

In this test case the two cells (i.e., Cell 1 and Cell 2) are on different carrier frequencies and measurement gaps are provided. Supported test configurations are shown in Table A.11.6.3.2.2-1. Both absolute accuracy and relative accuracy requirements of SS-SINR inter-frequency measurement are tested by using test parameters in Table A.11.6.3.2.2-2. In all test cases, Cell 1 is the PCell with CCA and Cell 2 is target cell with CCA. Three sub-tests (Test 1, Test 2, and Test 3) are provided different  $N_{oc}$  on Cells 1 and 2.

**Table A.11.6.3.2.2-1: SS-SINR Inter frequency SS-SINR supported test configurations**

Config	Description
1	With CCA: NR 30 kHz SSB SCS, 40 MHz bandwidth, TDD duplex mode
Note:	The UE is only required to be tested in one of the supported test configurations

**Table A.11.6.3.2.2-2: SS-SINR Inter frequency test parameters**

Parameter		Unit	Test 1		Test 2		Test 3	
			Cell 1	Cell 2	Cell 1	Cell 2	Cell 1	Cell 2
SSB ARFCN			freq1	freq2	freq1	freq2	freq1	freq2
DL CCA model	Config 1		As specified in clause A.3.26.2.1					
UL CCA model	Config 1		As specified in clause A.3.26.2.2					
UL CCA probability	$P_{CCA\_UL}$		1.0	-	1.0	-	1.0	-
DL CCA probability for semi-static channel access <small>Note 7, 8</small>	$P_{CCA\_DL}$		0.9375	-	0.9375	-	0.9375	-
DL CCA probability for dynamic channel access <small>Note 8, 9</small>	$P_{CCA\_DL\_1}$		0.75	-	0.75	-	0.75	-
	$P_{CCA\_DL\_2}$		0.75	-	0.75	-	0.75	-
Duplex mode	Config 1		TDD					
TDD configuration	Config 1		TDDConf.1.1 CCA					
Downlink initial BWP configuration			DLBWP.0.1					
Downlink dedicated BWP configuration			DLBWP.1.1					
Uplink initial BWP configuration			ULBWP.0.1					
Uplink dedicated BWP configuration			ULBWP.1.1					
DRX Cycle configuration		ms	Not Applicable					
Gap pattern ID			0	-	0	-	0	-
TRS configuration	Config 1		TRS.1. 2 TDD		TRS.1. 2 TDD		TRS.1. 2 TDD	
PDSCH Reference measurement channel	Config 1		SR.1.1 CCA		SR.1.1 CCA		SR.1.1 CCA	
RMSI CORESET Reference Channel	Config 1		CR.1.1 CCA		CR.1.1 CCA		CR.1.1 CCA	
Dedicated CORESET Reference Channel	Config 1		CCR.1. 1 CCA		CCR.1. 1 CCA		CCR.1. 1 CCA	
OCNG Patterns			OP.1					
SS-RSSI-Measurement			Not Applicable					
Time offset with Cell 1	Config 1	$\mu$ s	-	3	-	3	-	3
DBT Window configuration	Config 1		DBT.1					
SSB configuration	Config 1		SSB.1 CCA for semi-static channel access SSB.2 CCA for dynamic channel access					
SMTTC configuration	Config 1		SMTTC.1					
PDSCH/PDCCH subcarrier spacing	Config 1	kHz	30					
EPRE ratio of PSS to SSS		dB	0	0	0	0	0	0
EPRE ratio of PBCH DMRS to SSS								
EPRE ratio of PBCH to PBCH DMRS								

EPRE ratio of PDCCH DMRS to SSS								
EPRE ratio of PDCCH to PDCCH DMRS								
EPRE ratio of PDSCH DMRS to SSS								
EPRE ratio of PDSCH to PDSCH								
EPRE ratio of OCNG DMRS to SSS(Note 1)								
EPRE ratio of OCNG to OCNG DMRS (Note 1)								
$N_{oc}$ <sup>Note2</sup>		NR_CCA_FR1_I	dBm/15kHz	-88	-108.5	-115.5		
		NR_CCA_FR1_J				-115		
$N_{oc}$ <sup>Note2</sup>	Config 1	NR_CCA_FR1_I	dBm/SCS	-85	-105.5	-112.5		
		NR_CCA_FR1_J				-112		
$\hat{E}_s / I_{ot}$			dB	-1.75	-1.75	20	20	-4.0 -4.0
$\hat{E}_s / N_{oc}$			dB	-1.75		20		-4.0
SS-RSRP <sup>Note3</sup>	Config 1	NR_CCA_FR1_I	dBm/SCS	-86.75	-85.5	-116.5		
		NR_CCA_FR1_J				-116		
SS-SINR <sup>Note3</sup>			dB	-1.75		20		-4.0
$I_o$ <sup>Note3</sup>	Config 1	NR_CCA_FR1_I	dBm/38.16MHz	-51.73	-54.41	-80		
		NR_CCA_FR1_J				-79.5		
Propagation condition			-	AWGN				
Antenna configuration			-	1x2				
<p>Note 1: OCNG shall be used such that both cells are fully allocated and a constant total transmitted power spectral density is achieved for all OFDM symbols.</p> <p>Note 2: Interference from other cells and noise sources not specified in the test is assumed to be constant over subcarriers and time and shall be modelled as AWGN of appropriate power for <math>N_{oc}</math> to be fulfilled.</p> <p>Note 3: SS-SINR, SS-RSRP, and <math>I_o</math> levels have been derived from other parameters for information purposes. They are not settable parameters themselves.</p> <p>Note 4: SS-SINR, SS-RSRP minimum requirements are specified assuming independent interference and noise at each receiver antenna port.</p> <p>Note 5: NR operating band groups are as defined in clause 3.5.2.</p> <p>Note 6: For UE supporting both semi-static and dynamic channel access, the UE must be tested under both dynamic and semi-static channel occupancy configuration.</p> <p>Note 7: For UE supporting semi-static channel access and network configuring semi-static channel occupancy.</p> <p>Note 8: For UE supporting dynamic channel access and network configuring dynamic channel occupancy.</p> <p>Note 9: For UE supporting both semi-static and dynamic channel access, the UE must be tested under both dynamic and semi-static channel occupancy configurations.</p>								

A.11.6.3.2.3 Test Requirements

The SS-SINR measurement accuracy shall fulfil the requirements in clause 10.1.32.1.1 and 10.1.32.1.2.

A.11.6.3.3 Intra-frequency measurement accuracy on SCC

A.11.6.3.3.1 Test Purpose and Environment

The purpose of this test is to verify that the SS-SINR measurement accuracy is within the specified limits. This test will verify the requirements in clause 10.1.31.1.1.

A.11.6.3.3.2 Test Parameters

In this test case all cells are on the same carrier frequency. Supported test configuration are shown in Table A.11.6.3.3.2-1. The absolute accuracy of SS-SINR intra-frequency measurement is tested by using the parameters in Table A.11.6.3.3.2-2. In all test cases, Cell 1 is the PCell with CCA, Cell 2 is the SCell with CCA, and Cell 3 is the target cell with CCA. Two sub-tests (Test 1 and Test 2) are provided different  $N_{oc}$  on Cells 1, 2, and 3.

**Table A.11.6.3.3.2-1: SS-SINR Intra frequency SS-SINR supported test configurations**

Config	Description
1	With CCA: NR 30 kHz SSB SCS, 40 MHz bandwidth, TDD duplex mode
Note: The UE is only required to be tested in one of the supported test configurations	

**Table A.11.6.3.3.2-2: SS-SINR Intra frequency test parameters**

Parameter		Unit	Test 1		Test 2	
			Cell 1 / Cell 2	Cell 3	Cell 1 / Cell 2	Cell 3
SSB ARFCN			freq1 for Cell 1 freq2 for Cell 2	freq2	freq1 for Cell 1 freq2 for Cell 2	freq2
DL CCA model	Config 1		As specified in clause A.3.26.2.1			
UL CCA model	Config 1		As specified in clause A.3.26.2.2			
UL CCA probability	P <sub>CCA_UL</sub>		1.0	-	1.0	-
DL CCA probability for semi-static channel access <small>Note 7, 8</small>	P <sub>CCA_DL</sub>		0.9375	-	0.9375	-
DL CCA probability for dynamic channel access <small>Note 8, 9</small>	P <sub>CCA_DL_1</sub>		0.75	-	0.75	-
	P <sub>CCA_DL_2</sub>		0.75	-	0.75	-
Duplex mode	Config 1		TDD			
TDD configuration	Config 1		TDDConf.1.1 CCA			
Downlink initial BWP configuration			DLBWP.0.1			
Downlink dedicated BWP configuration			DLBWP.1.1			
Uplink initial BWP configuration			ULBWP.0.1			
Uplink dedicated BWP configuration			ULBWP.1.1			
DRX Cycle configuration		ms	Not Applicable			
TRS configuration	Config 1		TRS.1.2 TDD		TRS.1.2 TDD	
PDSCH Reference measurement channel	Config 1		SR.1.1 CCA		SR.1.1 CCA	
RMSI CORESET Reference Channel	Config 1		CR.1.1 CCA		CR.1.1 CCA	
Dedicated CORESET Reference Channel	Config 1		CCR.1.1 CCA		CCR.1.1 CCA	
OCNG Patterns			OP.1			
SS-RSSI-Measurement			Not Applicable			
DBT Window configuration	Config 1		DBT.1			
Time offset with Cell 1	Config 1	µs	3 (for Cell 2)	3	3 (for Cell 2)	3
SSB configuration	Config 1		SSB.1 CCA for semi-static channel access SSB.2 CCA for dynamic channel access			
SMTC configuration	Config 1		SMTC.1			
PDSCH/PDCCH subcarrier spacing	Config 1	kHz	30			
EPRE ratio of PSS to SSS		dB	0	0	0	0
EPRE ratio of PBCH DMRS to SSS						
EPRE ratio of PBCH to PBCH DMRS						
EPRE ratio of PDCCH DMRS to SSS						
EPRE ratio of PDCCH to PDCCH DMRS						
EPRE ratio of PDSCH DMRS to SSS						
EPRE ratio of PDSCH to PDSCH						
EPRE ratio of OCNG DMRS to SSS(Note 1)						
EPRE ratio of OCNG to OCNG DMRS (Note 1)						

$N_{oc}$ <sup>Note2</sup>		NR_CCA_FR1_I	dBm/15kHz z	-93		-112	
		NR_CCA_FR1_J				-111.5	
$N_{oc}$ <sup>Note2</sup>	Config 1	NR_CCA_FR1_I	dBm/SCS	-90		-109	
		NR_CCA_FR1_J				-108.5	
$\hat{E}_s / I_{ot}$			dB	0	-3.19	-5.46	-5.46
$\hat{E}_s / N_{oc}$			dB	4.54	2.66	-4	-4
SS-RSRP <sup>Note3</sup>	Config 1	NR_CCA_FR1_I	dBm/SCS	-85.46	-87.34	-113	
		NR_CCA_FR1_J				-112.5	
SS-SINR <sup>Note3</sup>		NR_CCA_FR1_I	dB	0	-3.19	-5.46	
		NR_CCA_FR1_J				-5.46	
$I_o$ <sup>Note3</sup>	Config 1	NR_CCA_FR1_I	dBm/ 38.16MHz	-51.41		-75.41	
		NR_CCA_FR1_J				-74.91	
Propagation condition			-	AWGN			
Antenna configuration			-	1x2			
<p>Note 1: OCNB shall be used such that both cells are fully allocated and a constant total transmitted power spectral density is achieved for all OFDM symbols.</p> <p>Note 2: Interference from other cells and noise sources not specified in the test is assumed to be constant over subcarriers and time and shall be modelled as AWGN of appropriate power for <math>N_{oc}</math> to be fulfilled.</p> <p>Note 3: SS-SINR, SS-RSRP, and <math>I_o</math> levels have been derived from other parameters for information purposes. They are not settable parameters themselves.</p> <p>Note 4: SS-SINR, SS-RSRP minimum requirements are specified assuming independent interference and noise at each receiver antenna port.</p> <p>Note 5: NR operating band groups are as defined in clause 3.5.2.</p> <p>Note 6: For UE supporting both semi-static and dynamic channel access, the UE must be tested under both dynamic and semi-static channel occupancy configuration.</p> <p>Note 7: For UE supporting semi-static channel access and network configuring semi-static channel occupancy.</p> <p>Note 8: For UE supporting dynamic channel access and network configuring dynamic channel occupancy.</p> <p>Note 9: For UE supporting both semi-static and dynamic channel access, the UE must be tested under both dynamic and semi-static channel occupancy configurations.</p>							

A.11.6.3.3.3 Test Requirements

The SS-SINR measurement accuracy shall fulfil the requirements in clause 10.1.31.1.1.

A.11.6.3.4 Inter-frequency measurement accuracy

A.11.6.3.4.1 Test Purpose and Environment

The purpose of this test is to verify that the SS-SINR measurement accuracy is within the specified limits. This test will verify the requirements in clauses 10.1.32.1.1 and 10.1.32.1.2.

A.11.6.3.4.2 Test Parameters

In this test case the two cells (i.e., Cell 1 and Cell 2) are on different carrier frequencies and measurement gaps are provided. Supported test configurations are shown in Table A.11.6.3.4.2-1. Both absolute accuracy and relative accuracy requirements of SS-SINR inter-frequency measurement are tested by using test parameters in Table A.11.6.3.4.2-2 and Table A.11.6.3.4.2-3. In all test cases, Cell 1 is the PCell and Cell 2 is target cell with CCA. Three sub-tests (Test 1, Test 2, and Test 3) are provided different  $N_{oc}$  on Cells 1 and 2.

**Table A.11.6.3.4.2-1: SS-SINR Inter frequency SS-SINR supported test configurations**

Config	Description
1	Without CCA: NR 15 kHz SSB SCS, 10 MHz bandwidth, FDD duplex mode With CCA: NR 30 kHz SSB SCS, 40 MHz bandwidth, TDD duplex mode
2	Without CCA: NR 15 kHz SSB SCS, 10 MHz bandwidth, TDD duplex mode With CCA: NR 30 kHz SSB SCS, 40 MHz bandwidth, TDD duplex mode
3	Without CCA: NR 30 kHz SSB SCS, 40 MHz bandwidth, TDD duplex mode

	With CCA: NR 30 kHz SSB SCS, 40 MHz bandwidth, TDD duplex mode
Note:	The UE is only required to be tested in one of the supported test configurations

**Table A.11.6.3.4.2-2: SS-SINR Inter frequency test parameters**

Parameter		Unit	Test 1	Test 2	Test 3
			Cell 2	Cell 2	Cell 2
SSB ARFCN			freq2	freq2	freq2
DL CCA model	Config 1		As specified in clause A.3.26.2.1		
UL CCA model	Config 1		As specified in clause A.3.26.2.2		
UL CCA probability	P <sub>CCA_UL</sub>		1.0		
DL CCA probability for semi-static channel access <small>Note 7, 8</small>	P <sub>CCA_DL</sub>		0.9375		
DL CCA probability for dynamic channel access <small>Note 8, 9</small>	P <sub>CCA_DL_1</sub>		0.75		
	P <sub>CCA_DL_2</sub>		0.75		
Duplex mode	Config 1		TDD		
TDD configuration	Config 1		TDDConf.1.1 CCA		
Downlink initial BWP configuration			DLBWP.0.1		
Downlink dedicated BWP configuration			DLBWP.1.1		
Uplink initial BWP configuration			ULBWP.0.1		
Uplink dedicated BWP configuration			ULBWP.1.1		
DRX Cycle configuration		ms	Not Applicable		
Gap pattern ID			-		
OCNG Patterns			OP.1		
SS-RSSI-Measurement			Not Applicable		
Time offset with Cell 1	Config 1	µs	3		
DBT Window configuration	Config 1		DBT.1		
SSB configuration	Config 1		SSB.1 CCA for semi-static channel access SSB.2 CCA for dynamic channel access		
SMTC configuration	Config 1		SMTC.1		
PDSCH/PDCCH subcarrier spacing	Config 1	kHz	30		
EPRE ratio of PSS to SSS		dB	0	0	0
EPRE ratio of PBCH DMRS to SSS					
EPRE ratio of PBCH to PBCH DMRS					
EPRE ratio of PDCCH DMRS to SSS					
EPRE ratio of PDCCH to PDCCH DMRS					
EPRE ratio of PDSCH DMRS to SSS					
EPRE ratio of PDSCH to PDSCH					
EPRE ratio of OCNG DMRS to SSS(Note 1)					
EPRE ratio of OCNG to OCNG DMRS (Note 1)					
N <sub>oc</sub> <small>Note2</small>		dBm/15kHz	-88	-108.5	-115.5
					-115
N <sub>oc</sub> <small>Note2</small>	Config 1	dBm/SCS	-85	-105.5	-112.5
$\hat{E}_s / I_{ot}$		dB	-1.75	20	-4.0
$\hat{E}_s / N_{oc}$					
SS-RSRP <small>Note3</small>	Config 1	NR_CCA_FR1_I	dBm/SCS	-86.75	-85.5
		NR_CCA_FR1_J			
SS-SINR <small>Note3</small>		NR_CCA_FR1_I	dB	-1.75	20
		NR_CCA_FR1_J			
I <sub>o</sub> <small>Note3</small>	Config 1	NR_CCA_FR1_I	dBm/ 38.16MHz	-51.73	-54.41
		NR_CCA_FR1_J			
					-79.5

Propagation condition	-	AWGN
Antenna configuration	-	1x2
Note 1:	OCNG shall be used such that both cells are fully allocated and a constant total transmitted power spectral density is achieved for all OFDM symbols.	
Note 2:	Interference from other cells and noise sources not specified in the test is assumed to be constant over subcarriers and time and shall be modelled as AWGN of appropriate power for $N_{oc}$ to be fulfilled.	
Note 3:	SS-SINR, SS-RSRP, and Io levels have been derived from other parameters for information purposes. They are not settable parameters themselves.	
Note 4:	SS-SINR, SS-RSRP minimum requirements are specified assuming independent interference and noise at each receiver antenna port.	
Note 5:	NR operating band groups are as defined in clause 3.5.2.	
Note 6:	For UE supporting both semi-static and dynamic channel access, the UE must be tested under both dynamic and semi-static channel occupancy configuration.	
Note 7:	For UE supporting semi-static channel access and network configuring semi-static channel occupancy.	
Note 8:	For UE supporting dynamic channel access and network configuring dynamic channel occupancy.	
Note 9:	For UE supporting both semi-static and dynamic channel access, the UE must be tested under both dynamic and semi-static channel occupancy configurations.	

**Table A.11.6.3.4.2-3: SS-SINR Inter frequency test parameters for NR PCell**

Parameter		Unit	Test 1	Test 2	Test 3
			Cell 1	Cell 1	Cell 1
SSB ARFCN			freq1	freq1	freq1
Duplex mode	Config 1		FDD		
	Config 2,3		TDD		
TDD configuration	Config 1		Not Applicable		
	Config 2		TDDConf.1.1		
	Config 3		TDDConf.2.1		
Downlink initial BWP configuration			DLBWP.0.1		
Downlink dedicated BWP configuration			DLBWP.1.1		
Uplink initial BWP configuration			ULBWP.0.1		
Uplink dedicated BWP configuration			ULBWP.1.1		
DRX Cycle configuration		ms	Not Applicable		
Gap pattern ID			0		
TRS configuration	Config 1		TRS.1.1 FDD		
	Config 2		TRS.1.1 TDD		
	Config 3		TRS.1.2 TDD		
PDSCH Reference measurement channel	Config 1		SR.1.1 FDD		
	Config 2		SR.1.1 TDD		
	Config 3		SR2.1 TDD		
RMSI CORESET Reference Channel	Config 1		CR.1.1 FDD		
	Config 2		CR.1.1 TDD		
	Config 3		CR2.1 TDD		
Dedicated CORESET Reference Channel	Config 1		CCR.1.1 FDD		
	Config 2		CCR.1.1 TDD		
	Config 3		CCR2.1 TDD		
OCNG Patterns			OP.1		
SS-RSSI-Measurement			Not Applicable		
SMTC configuration	Config 1		SMTC pattern 2		
	Config 2,3		SMTC pattern 1		

SSB configuration		Config 1,2		SSB.1 FR1					
		Config 3		SSB.2 FR1					
PDSCH/PDCCH subcarrier spacing		Config 1,2	kHz	15					
		Config 3		30					
EPRE ratio of PSS to SSS			dB	0	0	0			
EPRE ratio of PBCH DMRS to SSS									
EPRE ratio of PBCH to PBCH DMRS									
EPRE ratio of PDCCH DMRS to SSS									
EPRE ratio of PDCCH to PDCCH DMRS									
EPRE ratio of PDSCH DMRS to SSS									
EPRE ratio of PDSCH to PDSCH									
EPRE ratio of OCNG DMRS to SSS(Note 1)									
EPRE ratio of OCNG to OCNG DMRS (Note 1)									
$N_{oc}$ <sup>Note2</sup>	Config 1,2	NR_FDD_FR1_A NR_TDD_FR1_A <sup>NOTE 6</sup>	dBm/15 kHz	-88	-108.5	-119.5			
		NR_FDD_FR1_B				-119			
		NR_TDD_FR1_C				-118.5			
		NR_FDD_FR1_D NR_TDD_FR1_D				-118			
		NR_FDD_FR1_E NR_TDD_FR1_E				-117.5			
		NR_FDD_FR1_F				-117			
		NR_FDD_FR1_G				-116.5			
		NR_FDD_FR1_H				-116			
		$N_{oc}$ <sup>Note2</sup>				Config 1,2		dBm/S CS	-88
Config 3	NR_FDD_FR1_A NR_TDD_FR1_A <sup>NOTE 6</sup>		-116.5						
			NR_FDD_FR1_B	-116					
			NR_TDD_FR1_C	-115.5					
			NR_FDD_FR1_D NR_TDD_FR1_D	-115					
			NR_FDD_FR1_E NR_TDD_FR1_E	-114.5					
NR_FDD_FR1_F	-114								
NR_FDD_FR1_G	-114.5								
NR_FDD_FR1_H	-113								
$\hat{E}_s / I_{ot}$			dB	-1.75	20	-4.0			
$\hat{E}_s / N_{oc}$			dB	-1.75	20	-4.0			
SS-RSRP <sup>Note3</sup>	Config 1,2	NR_FDD_FR1_A NR_TDD_FR1_A <sup>NOTE 6</sup>	dBm/S CS	-89.75	-88.5	-123.5			
		NR_FDD_FR1_B				-123			
		NR_TDD_FR1_C				-122.5			
		NR_FDD_FR1_D NR_TDD_FR1_D				-122			
		NR_FDD_FR1_E NR_TDD_FR1_E				-121.5			
		NR_FDD_FR1_F				-121			
		NR_FDD_FR1_G				-120.5			
		NR_FDD_FR1_H				-120			
	Config 3	NR_FDD_FR1_A NR_TDD_FR1_A <sup>NOTE 6</sup>		-120.5					
				NR_FDD_FR1_B	-120				
				NR_TDD_FR1_C	-119.5				
				NR_FDD_FR1_D NR_TDD_FR1_D	-119				
				NR_FDD_FR1_E	-118.5				

		NR_FDD_FR1_F				-118						
		NR_FDD_FR1_G				-117.5						
		NR_FDD_FR1_H				-117						
SS-SINR <sup>Note3</sup>		NR_FDD_FR1_A NR_TDD_FR1_A <sup>NOTE 6</sup>	dB	-1.75	20	-4.0						
		NR_FDD_FR1_B										
		NR_TDD_FR1_C										
		NR_FDD_FR1_D NR_TDD_FR1_D										
		NR_FDD_FR1_E NR_TDD_FR1_E										
		NR_FDD_FR1_F										
		NR_FDD_FR1_G										
		NR_FDD_FR1_H										
		Io <sup>Note3</sup>					Config 1,2	NR_FDD_FR1_A NR_TDD_FR1_A <sup>NOTE 6</sup>	dBm/ 9.36MHz	-57.83	-60.5	-90.09
								NR_FDD_FR1_B				
NR_TDD_FR1_C	-89.09											
NR_FDD_FR1_D NR_TDD_FR1_D	-88.59											
NR_FDD_FR1_E NR_TDD_FR1_E	-88.09											
NR_FDD_FR1_F	-87.59											
NR_FDD_FR1_G	-87.09											
NR_FDD_FR1_H	-86.59											
Config 3	NR_FDD_FR1_A NR_TDD_FR1_A <sup>NOTE 6</sup>		dBm/ 38.16M Hz	-51.73	-54.41	-84						
	NR_FDD_FR1_B						-83.5					
	NR_TDD_FR1_C						-83					
	NR_FDD_FR1_D NR_TDD_FR1_D						-82.5					
	NR_FDD_FR1_E NR_TDD_FR1_E						-82					
	NR_FDD_FR1_F						-81.5					
	NR_FDD_FR1_G						-81					
	NR_FDD_FR1_H						-80.5					
	Propagation condition						-	AWGN				
Antenna configuration			-	1x2								
<p>Note 1: OCNG shall be used such that both cells are fully allocated and a constant total transmitted power spectral density is achieved for all OFDM symbols.</p> <p>Note 2: Interference from other cells and noise sources not specified in the test is assumed to be constant over subcarriers and time and shall be modelled as AWGN of appropriate power for <math>N_{oc}</math> to be fulfilled.</p> <p>Note 3: SS-SINR, SS-RSRP, and Io levels have been derived from other parameters for information purposes. They are not settable parameters themselves.</p> <p>Note 4: SS-SINR, SS-RSRP minimum requirements are specified assuming independent interference and noise at each receiver antenna port.</p> <p>Note 5: NR operating band groups are as defined in clause 3.5.2.</p> <p>Note 6: The test configuration excludes support for band n51 and it is not required to run this test on band n51 in this release of the specification.</p>												

A.11.6.3.4.3 Test Requirements

The SS-SINR measurement accuracy shall fulfil the requirements in clause 10.1.32.1.1 and 10.1.32.1.2.



## A.11.6.4 L1-RSRP measurement for beam reporting with CCA serving cell

### A.11.6.4.1 SSB based L1-RSRP measurement

#### A.11.6.4.1.1 Test Purpose and Environment

The purpose of this test is to verify that the L1-RSRP measurement accuracy is within the specified limits. This test will verify the requirements in clause 10.1.33.1 for L1-RSRP measurements based on SSB with the testing configurations for NR cells in Table A.11.6.4.1.1-1.

**Table A.11.6.4.1.1-1: Applicable NR configurations for FR1 SSB based L1-RSRP test**

Config	Description
1	NR 30kHz SSB SCS, 40 MHz bandwidth, TDD duplex mode
Note: The UE is only required to be tested in one of the supported test configurations in each supported band	

#### A.11.6.4.1.2 Test parameters

In this set of test cases there one cell in the test, PCell under CCA (Cell 1). Cell 1 operates on a carrier frequency with CCA and transmits SSBs in DBT window according to DL CCA model.

Two sub-tests (Test 1 and Test 2) are provided with different  $N_{oc}$  on Cell 1. The test parameters for the Cell 1 are given in Table A.11.6.4.1.2-1 below. The absolute and relative accuracy of L1-RSRP measurements are tested by using the parameters in Table A.11.6.4.1.2-1.

The same test is applicable for UE supporting any one or both semi-static channel access or dynamic channel access and for network configuring any of semi-static channel occupancy or dynamic channel occupancy.

There is no measurement gap configured in the test. Before the test, UE is configured one SSB resource set with two SSB resources. UE is configured to perform RLM, BFD and L1-RSRP measurement based on the SSB resources 0 and 1.

**Table A.11.6.4.1.2-1: FR1 SSB based L1-RSRP test parameters**

Parameter	Config	Unit	Test 1	Test 2
SSB GSCN	1		freq1	freq1
DL CCA model	1		As specified in A.3.20.2.1	As specified in A.3.20.2.1
UL CCA model	1		As specified in A.3.20.2.2	As specified in A.3.20.2.2
Duplex mode	1		TDD	TDD
TDD configuration	1		TDDConf.1.1 CCA	TDDConf.1.1 CCA
BW <sub>channel</sub>	1	MHz	40: $N_{RB,c} = 106$	40: $N_{RB,c} = 106$
PDSCH Reference measurement channel	1		SR.1.1 CCA	SR.1.1 CCA
RMSI CORESET Reference Channel	1		CR.1.1 CCA	CR.1.1 CCA
Dedicated CORESET Reference Channel	1		CCR.1.1 CCA	CCR.1.1 CCA
SSB configuration Semi-static channel access	1		SSB.3 CCA	SSB.3 CCA
SSB configuration for Dynamic channel access	1		SSB.4 CCA	SSB.4 CCA
OCNG Patterns	1		OP.1	OP.1
Initial BWP Configuration	1		DLBWP.0.1 ULBWP.0.1	DLBWP.0.1 ULBWP.0.1
TRS configuration	1		TRS.1.2 TDD	TRS.1.2 TDD
Dedicated BWP configuration	1		DLBWP.1.1 ULBWP.1.1	DLBWP.1.1 ULBWP.1.1
DBT Window Configuration	1		DBT.1	DBT.1
reportConfigType	1		periodic	periodic
reportQuantity	1		ssb-Index-RSRP	ssb-Index-RSRP
Number of reported RS	1		2	2
L1-RSRP reporting period	1		slot80	slot80
EPRE ratio of PSS to SSS				

EPRE ratio of PBCH DMRS to SSS		1	dB	0	0
EPRE ratio of PBCH to PBCH DMRS					
EPRE ratio of PDCCH DMRS to SSS					
EPRE ratio of PDCCH to PDCCH DMRS					
EPRE ratio of PDSCH DMRS to SSS					
EPRE ratio of PDSCH to PDSCH DMRS					
EPRE ratio of OCNG DMRS to SSS <sup>Note 1</sup>					
EPRE ratio of OCNG to OCNG DMRS <sup>Note 1</sup>					
$N_{oc}$ <sup>Note2</sup>	NR_TDD_FR1_I	1	dBm/15kHz	-94.65	[-113]
$N_{oc}$ <sup>Note2</sup>	NR_TDD_FR1_I	1	dBm/SCS	-91.65	[-110]
$\hat{E}_s/I_{ot}$		1	dB	10	-3
SS-RSRP <sup>Note3</sup>	NR_TDD_FR1_I	1	dBm/SCS	-81.65	[-113]
$I_o$ <sup>Note3</sup>	NR_TDD_FR1_I	1	dBm/38.16MHz	-50.19	[-77.19]
$\hat{E}_s/N_{oc}$		1	dB	10	-3
Propagation condition		1		AWGN	AWGN
Antenna configuration		1		1x2	1x2
<p>Note 1: OCNG shall be used such that both cells are fully allocated and a constant total transmitted power spectral density is achieved for all OFDM symbols.</p> <p>Note 2: Interference from other cells and noise sources not specified in the test is assumed to be constant over subcarriers and time and shall be modelled as AWGN of appropriate power for <math>N_{oc}</math> to be fulfilled.</p> <p>Note 3: RSRP and <math>I_o</math> levels have been derived from other parameters for information purposes. They are not settable parameters themselves.</p> <p>Note 4: RSRP minimum requirements are specified assuming independent interference and noise at each receiver antenna port.</p> <p>Note 5: The test configuration excludes support for band n51 and it is not required to run this test on band n51 in this release of the specification.</p>					

#### A.11.6.4.1.3 Test Requirements

In both Test 1 and Test 2, the L1-RSRP measurement accuracy for SSB#0 and SSB#1 of Cell 1 shall fulfil the requirements in clauses 10.1.33.1.

### A.11.6.5 RSSI

#### A.11.6.5.1 Intra-frequency RSSI measurement accuracy on PCC with CCA

##### A.11.6.5.1.1 Test Purpose and Environment

The purpose of this test is to verify that the RSSI measurement accuracy is within the specified limits. This test will partially verify the RSSI measurement accuracy requirements in Section 10.1.34.1.

##### A.11.6.5.1.2 Test parameters

In all test cases, Cell 1 is the PCell with CCA. RSSI is measured on channel number 1. Supported test configurations are shown in table A.11.6.5.1.2-1. The accuracy of RSSI intra-frequency measurements is tested by using the parameters in A.11.6.5.1.2-2 and A.11.6.5.1.2-3.

**Table A.11.6.5.1.2-1: Intra frequency RSSI supported test configurations**

Configuration	Description
1	NR TDD, SSB SCS 30 kHz, data SCS 30 kHz, bandwidth 40 MHz

Table A.11.6.5.1.2-2: RSSI Intra frequency test parameters

Parameter		Configurations	Unit	Test 1
				Cell 1
RF Channel Number				1
$BW_{channel}$			MHz	40
SSB configuration	Semi-static channel access <small>Note 1, 3</small>	1		SSB.1 CCA
	Dynamic channel access <small>Note 2, 3</small>	1		SSB.2 CCA
$P_{CCA\_DL}$				TBD
$P_{CCA\_UL}$				TBD
DL CCA model				As specified in A.3.20.2.1
UL CCA model				As specified in A.3.20.2.2
Measurement bandwidth			$n_{PRE}$	Same as channel access bandwidth
Channel access bandwidth			MHz	20
DRX Cycle configuration			ms	Not Applicable
PDSCH Reference measurement channel				SR.1.1 CCA
RMSI CORESET Reference Channel				CR.1.1 CCA
Dedicated CORESET Reference Channel				CCR.1.1 CCA
OCNG Patterns				OP.1
EPRE ratio of PSS to SSS			dB	0
EPRE ratio of PBCH DMRS to SSS				
EPRE ratio of PBCH to PBCH DMRS				
EPRE ratio of PDCCH DMRS to SSS				
EPRE ratio of PDCCH to PDCCH DMRS				
EPRE ratio of PDSCH DMRS to SSS				
EPRE ratio of PDSCH to PDSCH				
EPRE ratio of OCNG DMRS to SSS (Note 1)				
EPRE ratio of OCNG to OCNG DMRS (Note 1)				
$N_{oc}$ in slots not corresponding to RSSI measurement time configuration (RMTC)			dBm/SCS	-106
$N_{oc}$ in slots corresponding to RSSI measurement time configuration (RMTC)			dBm/SCS	-87
$\hat{E}_s/I_{ot}$ in slots not corresponding to RSSI measurement time configuration (RMTC)			dB	2.5
$\hat{E}_s/I_{ot}$ in slots corresponding to RSSI measurement time configuration (RMTC)			dB	-Infinity
SS-RSRP in slots not corresponding to RSSI measurement time configuration (RMTC)			dBm/SCS	-103.5
SS-RSRP in slots corresponding to RSSI measurement time configuration (RMTC)				-Infinity
Io within measurement bandwidth in slots not corresponding to RSSI measurement time configuration (RMTC)			dBm/BW	-101.6
Io within measurement bandwidth in slots corresponding to RSSI measurement time configuration (RMTC)			dBm/BW	-87
Propagation condition			-	AWGN
Note 1: For UE supporting semi-static channel access and network configuring semi-static channel occupancy.				
Note 2: For UE supporting dynamic channel access and network configuring dynamic channel occupancy.				
Note 3: For a UE supporting both semi-static and dynamic channel access, the UE can be tested under dynamic channel occupancy only.				

**Table A.11.6.5.1.2-3: RSSI RMTC parameters**

measDurationSymbols-r16	sym14or12
rmtc-Periodicity-r16	ms40
rmtc-SubframeOffset-r16	20
ref-SCS-CP-r16	kHz15
ReportInterval	ms120

### A.11.6.5.1.3 Test Requirements

The average RSSI measurement accuracy shall fulfil the requirements in sections 10.1.34.1. The nominal RSSI used to evaluate the requirement shall be based on  $I_0$  in slots corresponding to RSSI measurement time configuration (RMTC).

## A.11.6.5.2 Intra-frequency RSSI measurement accuracy on SCC with CCA

### A.11.6.5.2.1 Test Purpose and Environment

The purpose of this test is to verify that the RSSI measurement accuracy is within the specified limits. This test will partially verify the RSSI measurement accuracy requirements in Section 10.1.34.1.

### A.11.6.5.2.2 Test parameters

In all test cases, Cell 1 which is PCell operating on a carrier frequency under CCA, and Cell 2 which is SCell operating on a carrier frequency under CCA. RSSI is measured on channel number 2. Supported test configurations are shown in table A.11.6.5.2.2-1. The accuracy of RSSI intra-frequency measurements is tested by using the parameters in A.11.6.5.2.2-2 and A.11.6.5.2.2-3.

**Table A.11.6.5.2.2-1: Intra frequency RSSI supported test configurations**

Configuration	Description
1	NR TDD, SSB SCS 30 kHz, data SCS 30 kHz, bandwidth 40 MHz

**Table A.11.6.5.2.2-2: RSSI Intra frequency test parameters**

Parameter		Configurations	Unit	Test 1	
				Cell 1	Cell 2
RF Channel Number				1	2
$BW_{\text{channel}}$			MHz	40	40
SSB configuration	Semi-static channel access Note 1, 3	1		SSB.1 CCA	SSB.1 CCA
	Dynamic channel access Note 2, 3	1		SSB.2 CCA	SSB.2 CCA
$P_{\text{CCA\_DL}}$				1	TBD
$P_{\text{CCA\_UL}}$				1	TBD
DL CCA model				N/A	As specified in A.3.20.2.1
UL CCA model				N/A	As specified in A.3.20.2.2
Measurement bandwidth			$n_{\text{PRE}}$	Same as channel access bandwidth	
Channel access bandwidth			MHz	20	
DRX Cycle configuration			ms	Not Applicable	
PDSCH Reference measurement channel				SR.1.1 CCA	SR.1.1 CCA
RMSI CORESET Reference Channel				CR.1.1 CCA	CR.1.1 CCA

Dedicated CORESET Reference Channel			CCR.1.1 CCA	CCR.1.1 CCA
OCNG Patterns			OP.1	OP.1
EPRE ratio of PSS to SSS		dB	0	0
EPRE ratio of PBCH DMRS to SSS				
EPRE ratio of PBCH to PBCH DMRS				
EPRE ratio of PDCCH DMRS to SSS				
EPRE ratio of PDCCH to PDCCH DMRS				
EPRE ratio of PDSCH DMRS to SSS				
EPRE ratio of PDSCH to PDSCH				
EPRE ratio of OCNG DMRS to SSS(Note 1)				
EPRE ratio of OCNG to OCNG DMRS (Note 1)				
$N_{oc}$ in slots not corresponding to RSSI measurement time configuration (RMTC)		dBm/SCS	-106	-106
$N_{oc}$ in slots corresponding to RSSI measurement time configuration (RMTC)		dBm/SCS	-106	-87
$\hat{E}_s/I_{ot}$ in slots not corresponding to RSSI measurement time configuration (RMTC)		dB	2.5	2.5
$\hat{E}_s/I_{ot}$ in slots corresponding to RSSI measurement time configuration (RMTC)		dB	2.5	-Infinity
SS-RSRP in slots not corresponding to RSSI measurement time configuration (RMTC)		dBm/SCS	-103.5	-103.5
SS-RSRP in slots corresponding to RSSI measurement time configuration (RMTC)			-103.5	-Infinity
Io within measurement bandwidth in slots not corresponding to RSSI measurement time configuration (RMTC)		dBm/BW	-101.6	-101.6
Io within measurement bandwidth in slots corresponding to RSSI measurement time configuration (RMTC)		dBm/BW	-101.6	-87
Propagation condition		-	AWGN	
<p>Note 1: For UE supporting semi-static channel access and network configuring semi-static channel occupancy.</p> <p>Note 2: For UE supporting dynamic channel access and network configuring dynamic channel occupancy.</p> <p>Note 3: For a UE supporting both semi-static and dynamic channel access, the UE can be tested under dynamic channel occupancy only.</p>				

**Table A.11.6.5.2.2-3: RSSI RMTC parameters**

measDurationSymbols-r16	sym14or12
rmtc-Periodicity-r16	ms40
rmtc-SubframeOffset-r16	20
ref-SCS-CP-r16	kHz15
ReportInterval	ms120

### A.11.6.5.2.3 Test Requirements

The average RSSI measurement accuracy shall fulfil the requirements in sections 10.1.34.1. The nominal RSSI used to evaluate the requirement shall be based on  $I_0$  in slots corresponding to RSSI measurement time configuration (RMTC).

## A.11.6.5.3 Inter-frequency RSSI measurement accuracy on a carrier with CCA

### A.11.6.5.3.1 Test Purpose and Environment

The purpose of this test is to verify that the RSSI measurement accuracy is within the specified limits. This test will partially verify the RSSI measurement accuracy requirements in Section 10.1.34.2.

### A.11.6.5.3.2 Test parameters

In all test cases, Cell 1 which is PCell operating on a carrier frequency under CCA, and Cell 2 which is neighbor cell operating on a carrier frequency under CCA. RSSI is measured on channel number 2. Supported test configurations are shown in table A.11.6.5.3.2-1. The accuracy of RSSI intra-frequency measurements is tested by using the parameters in A.11.6.5.3.2-2 and A.11.6.5.3.2-3.

**Table A.11.6.5.3.2-1: Inter frequency RSSI supported test configurations**

Configuration	Description
1	NR TDD, SSB SCS 30 kHz, data SCS 30 kHz, bandwidth 40 MHz

**Table A.11.6.5.3.2-2: RSSI Inter frequency test parameters**

Parameter		Configurations	Unit	Test 1	
				Cell 1	Cell 2
RF Channel Number				1	2
$BW_{channel}$			MHz	40	40
SSB configuration	Semi-static channel access Note 1, 3	1		SSB.1 CCA	SSB.1 CCA
	Dynamic channel access Note 2, 3	1		SSB.2 CCA	SSB.2 CCA
$P_{CCA\_DL}$				1	TBD
$P_{CCA\_UL}$				1	TBD
DL CCA model				N/A	As specified in A.3.20.2.1
UL CCA model				N/A	As specified in A.3.20.2.2
Measurement bandwidth			$n_{PRE}$	Same as channel access bandwidth	
Channel access bandwidth			MHz	20	
DRX Cycle configuration			ms	Not Applicable	
PDSCH Reference measurement channel				SR.1.1 CCA	SR.1.1 CCA
RMSI CORESET Reference Channel				CR.1.1 CCA	CR.1.1 CCA
Dedicated CORESET Reference Channel				CCR.1.1 CCA	CCR.1.1 CCA
OCNG Patterns				OP.1	OP.1
EPRE ratio of PSS to SSS			dB	0	0
EPRE ratio of PBCH DMRS to SSS					
EPRE ratio of PBCH to PBCH DMRS					
EPRE ratio of PDCCH DMRS to SSS					

EPRE ratio of PDCCH to PDCCH DMRS				
EPRE ratio of PDSCH DMRS to SSS				
EPRE ratio of PDSCH to PDSCH				
EPRE ratio of OCNG DMRS to SSS(Note 1)				
EPRE ratio of OCNG to OCNG DMRS (Note 1)				
$N_{oc}$ in slots not corresponding to RSSI measurement time configuration (RMTC)		dBm/SCS	-106	-106
$N_{oc}$ in slots corresponding to RSSI measurement time configuration (RMTC)		dBm/SCS	-106	-87
$\hat{E}_s/I_{ot}$ in slots not corresponding to RSSI measurement time configuration (RMTC)		dB	2.5	2.5
$\hat{E}_s/I_{ot}$ in slots corresponding to RSSI measurement time configuration (RMTC)		dB	2.5	-Infinity
SS-RSRP in slots not corresponding to RSSI measurement time configuration (RMTC)		dBm/SCS	-103.5	-103.5
SS-RSRP in slots corresponding to RSSI measurement time configuration (RMTC)			-103.5	-Infinity
Io within measurement bandwidth in slots not corresponding to RSSI measurement time configuration (RMTC)		dBm/BW	-101.6	-101.6
Io within measurement bandwidth in slots corresponding to RSSI measurement time configuration (RMTC)		dBm/BW	-101.6	-87
Propagation condition		-	AWGN	
Note 1: For UE supporting semi-static channel access and network configuring semi-static channel occupancy. Note 2: For UE supporting dynamic channel access and network configuring dynamic channel occupancy. Note 3: For a UE supporting both semi-static and dynamic channel access, the UE can be tested under dynamic channel occupancy only.				

**Table A.11.6.5.3.2-3: RSSI RMTC parameters**

measDurationSymbols-r16	sym14or12
rmtc-Periodicity-r16	ms40
rmtc-SubframeOffset-r16	20
ref-SCS-CP-r16	kHz15
ReportInterval	ms120

**A.11.6.5.3.3 Test Requirements**

The average RSSI measurement accuracy shall fulfil the requirements in sections 10.1.34.2. The nominal RSSI used to evaluate the requirement shall be based on Io in slots corresponding to RSSI measurement time configuration (RMTC).

## A.11.6.6 Channel occupancy

### A.11.6.6.1 Intra-frequency channel occupancy measurement accuracy on PCC with CCA

#### A.11.6.6.1.1 Test Purpose and Environment

The purpose of this test is to verify that the channel occupancy measurement accuracy is within the specified limits. This test will partially verify the channel occupancy measurement accuracy requirements in Section 10.1.35.1.

#### A.11.6.6.1.2 Test parameters

In all test cases, Cell 1 is the PCell with CCA. channel occupancy is measured on channel number 1. Supported test configurations are shown in table A.11.6.6.1.2-1. The accuracy of channel occupancy intra-frequency measurements is tested by using the parameters in A.11.6.6.1.2-2 and A.11.6.6.1.2-3.

**Table A.11.6.6.1.2-1: Intra frequency CO supported test configurations**

Configuration	Description
1	NR TDD, SSB SCS 30 kHz, data SCS 30 kHz, bandwidth 40 MHz

**Table A.11.6.6.1.2-2: CO Intra frequency test parameters**

Parameter		Configurations	Unit	Test 1 Cell 1
RF Channel Number				1
BW <sub>channel</sub>			MHz	40
SSB configuration	Semi-static channel access <small>Note 1, 3</small>	1		SSB.1 CCA
	Dynamic channel access <small>Note 2, 3</small>	1		SSB.2 CCA
P <sub>CCA_DL</sub>				TBD
P <sub>CCA_UL</sub>				TBD
DL CCA model				As specified in A.3.20.2.1
UL CCA model				As specified in A.3.20.2.2
Measurement bandwidth			$n_{PRE}$	Same as channel access bandwidth
Channel access bandwidth			MHz	20
DRX Cycle configuration			ms	Not Applicable
PDSCH Reference measurement channel				SR.1.1 CCA
RMSI CORESET Reference Channel				CR.1.1 CCA
Dedicated CORESET Reference Channel				CCR.1.1 CCA
OCNG Patterns				OP.1
EPRE ratio of PSS to SSS			dB	0
EPRE ratio of PBCH DMRS to SSS				
EPRE ratio of PBCH to PBCH DMRS				
EPRE ratio of PDCCH DMRS to SSS				
EPRE ratio of PDCCH to PDCCH DMRS				
EPRE ratio of PDSCH DMRS to SSS				
EPRE ratio of PDSCH to PDSCH				
EPRE ratio of OCNG DMRS to SSS(Note 1)				
EPRE ratio of OCNG to OCNG DMRS (Note 1)				
$N_{oc}$ in slots not corresponding to RSSI measurement time configuration (RMTc)			dBm/SCS	-106
$N_{oc}$ in slots corresponding to RSSI measurement time configuration (RMTc)			dBm/SCS	-87



$\hat{E}_s/I_{ot}$ in slots not corresponding to RSSI measurement time configuration (RMTC)		dB	2.5
$\hat{E}_s/I_{ot}$ in slots corresponding to RSSI measurement time configuration (RMTC)		dB	-Infinity
SS-RSRP in slots not corresponding to RSSI measurement time configuration (RMTC)		dBm/SCS	-103.5
SS-RSRP in slots corresponding to RSSI measurement time configuration (RMTC)			-Infinity
Io within measurement bandwidth in slots not corresponding to RSSI measurement time configuration (RMTC)		dBm/BW	-101.6
Io within measurement bandwidth in slots corresponding to RSSI measurement time configuration (RMTC)		dBm/BW	-87
Propagation condition		-	AWGN
channelOccupancyThreshold		dBm	-83
<p>Note 1: For UE supporting semi-static channel access and network configuring semi-static channel occupancy.</p> <p>Note 2: For UE supporting dynamic channel access and network configuring dynamic channel occupancy.</p> <p>Note 3: For a UE supporting both semi-static and dynamic channel access, the UE can be tested under dynamic channel occupancy only.</p>			

**Table A.11.6.6.1.2-3: CO RMTC parameters**

measDurationSymbols-r16	sym14or12
rmtc-Periodicity-r16	ms40
rmtc-SubframeOffset-r16	20
ref-SCS-CP-r16	kHz15
ReportInterval	ms120

### A.11.6.6.1.3 Test Requirements

The nominal reported *channelOccupancy* shall be TBD. At least 90% of channel occupancy reports made by the UE shall indicate this value.

## A.11.6.6.2 Intra-frequency channel occupancy measurement accuracy on SCC with CCA

### A.11.6.6.2.1 Test Purpose and Environment

The purpose of this test is to verify that the channel occupancy measurement accuracy is within the specified limits. This test will partially verify the channel occupancy measurement accuracy requirements in Section 10.1.35.1.

### A.11.6.6.2.2 Test parameters

In all test cases, Cell 1 which is PCell operating on a carrier frequency under CCA, and Cell 2 which is SCell operating on a carrier frequency under CCA. Channel occupancy is measured on channel number 2. Supported test configurations are shown in table A.11.6.6.2.2-1. The accuracy of channel occupancy intra-frequency measurements is tested by using the parameters in A.11.6.6.2.2-2 and A.11.6.6.2.2-3.

**Table A.11.6.6.2.2-1: Intra frequency CO supported test configurations**

Configuration	Description
1	NR TDD, SSB SCS 30 kHz, data SCS 30 kHz, bandwidth 40 MHz

Table A.11.6.6.2.2-2: CO Intra frequency test parameters

Parameter		Configurations	Unit	Test 1	
				Cell 1	Cell 2
RF Channel Number				1	2
$BW_{channel}$			MHz	40	40
SSB configuration	Semi-static channel access Note 1, 3	1		SSB.1 CCA	SSB.1 CCA
	Dynamic channel access Note 2, 3	1		SSB.2 CCA	SSB.2 CCA
$P_{CCA\_DL}$				1	TBD
$P_{CCA\_UL}$				1	TBD
DL CCA model				N/A	As specified in A.3.20.2.1
UL CCA model				N/A	As specified in A.3.20.2.2
Measurement bandwidth			$n_{PRE}$	Same as channel access bandwidth	
Channel access bandwidth			MHz	20	
DRX Cycle configuration			ms	Not Applicable	
PDSCH Reference measurement channel				SR.1.1 CCA	SR.1.1 CCA
RMSI CORESET Reference Channel				CR.1.1 CCA	CR.1.1 CCA
Dedicated CORESET Reference Channel				CCR.1.1 CCA	CCR.1.1 CCA
OCNG Patterns				OP.1	OP.1
EPRE ratio of PSS to SSS			dB	0	0
EPRE ratio of PBCH DMRS to SSS					
EPRE ratio of PBCH to PBCH DMRS					
EPRE ratio of PDCCH DMRS to SSS					
EPRE ratio of PDCCH to PDCCH DMRS					
EPRE ratio of PDSCH DMRS to SSS					
EPRE ratio of PDSCH to PDSCH					
EPRE ratio of OCNG DMRS to SSS(Note 1)					
EPRE ratio of OCNG to OCNG DMRS (Note 1)					
$N_{oc}$ in slots not corresponding to RSSI measurement time configuration (RMTC)			dBm/SCS	-106	-106
$N_{oc}$ in slots corresponding to RSSI measurement time configuration (RMTC)			dBm/SCS	-106	-87
$\hat{E}_s/I_{ot}$ in slots not corresponding to RSSI measurement time configuration (RMTC)			dB	2.5	2.5
$\hat{E}_s/I_{ot}$ in slots corresponding to RSSI measurement time configuration (RMTC)			dB	2.5	-Infinity
SS-RSRP in slots not corresponding to RSSI measurement time configuration (RMTC)			dBm/SCS	-103.5	-103.5
SS-RSRP in slots corresponding to RSSI measurement time configuration (RMTC)				-103.5	-Infinity
Io within measurement bandwidth in slots not corresponding to RSSI			dBm/BW	-101.6	-101.6

measurement time configuration (RMTC)				
Io within measurement bandwidth in slots corresponding to RSSI measurement time configuration (RMTC)		dBm/BW	-101.6	-87
Propagation condition		-	AWGN	
channelOccupancyThreshold		dBm	-83	
Note 1:	For UE supporting semi-static channel access and network configuring semi-static channel occupancy.			
Note 2:	For UE supporting dynamic channel access and network configuring dynamic channel occupancy.			
Note 3:	For a UE supporting both semi-static and dynamic channel access, the UE can be tested under dynamic channel occupancy only.			

**Table A.11.6.6.2-3: CO RMTC parameters**

measDurationSymbols-r16	sym14or12
rmtc-Periodicity-r16	ms40
rmtc-SubframeOffset-r16	20
ref-SCS-CP-r16	kHz15
ReportInterval	ms120

### A.11.6.6.2.3 Test Requirements

The nominal reported *channelOccupancy* shall be TBD. At least 90% of channel occupancy reports made by the UE shall indicate this value.

## A.11.6.6.3 Inter-frequency channel occupancy measurement accuracy on a carrier with CCA

### A.11.6.6.3.1 Test Purpose and Environment

The purpose of this test is to verify that the channel occupancy measurement accuracy is within the specified limits. This test will partially verify the channel occupancy measurement accuracy requirements in Section 10.1.34.2.

### A.11.6.6.3.2 Test parameters

In all test cases, Cell 1 which is PCell operating on a carrier frequency under CCA, and Cell 2 which is neighbor cell operating on a carrier frequency under CCA. Channel occupancy is measured on channel number 2. Supported test configurations are shown in table A.11.6.6.3.2-1. The accuracy of channel occupancy intra-frequency measurements is tested by using the parameters in A.11.6.6.3.2-2 and A.11.6.6.3.2-3.

**Table A.11.6.6.3.2-1: Inter frequency CO supported test configurations**

Configuration	Description
1	NR TDD, SSB SCS 30 kHz, data SCS 30 kHz, bandwidth 40 MHz

**Table A.11.6.6.3.2-2: CO Inter frequency test parameters**

Parameter		Configurations	Unit	Test 1	
				Cell 1	Cell 2
RF Channel Number				1	2
BW <sub>channel</sub>			MHz	40	40
SSB configuration	Semi-static channel access Note 1, 3	1		SSB.1 CCA	SSB.1 CCA

	Dynamic channel access Note 2, 3	1		SSB.2 CCA	SSB.2 CCA
P <sub>CCA_DL</sub>				1	TBD
P <sub>CCA_UL</sub>				1	TBD
DL CCA model				N/A	As specified in A.3.20.2.1
UL CCA model				N/A	As specified in A.3.20.2.2
Measurement bandwidth			$n_{PRE}$	Same as channel access bandwidth	
Channel access bandwidth			MHz	20	
DRX Cycle configuration			ms	Not Applicable	
PDSCH Reference measurement channel				SR.1.1 CCA	SR.1.1 CCA
RMSI CORESET Reference Channel				CR.1.1 CCA	CR.1.1 CCA
Dedicated CORESET Reference Channel				CCR.1.1 CCA	CCR.1.1 CCA
OCNG Patterns				OP.1	OP.1
EPRE ratio of PSS to SSS			dB	0	0
EPRE ratio of PBCH DMRS to SSS					
EPRE ratio of PBCH to PBCH DMRS					
EPRE ratio of PDCCH DMRS to SSS					
EPRE ratio of PDCCH to PDCCH DMRS					
EPRE ratio of PDSCH DMRS to SSS					
EPRE ratio of PDSCH to PDSCH					
EPRE ratio of OCNG DMRS to SSS(Note 1)					
EPRE ratio of OCNG to OCNG DMRS (Note 1)					
$N_{oc}$ in slots not corresponding to RSSI measurement time configuration (RMTC)					
$N_{oc}$ in slots corresponding to RSSI measurement time configuration (RMTC)			dBm/SCS	-106	-87
$\hat{E}_s/I_{ot}$ in slots not corresponding to RSSI measurement time configuration (RMTC)			dB	2.5	2.5
$\hat{E}_s/I_{ot}$ in slots corresponding to RSSI measurement time configuration (RMTC)			dB	2.5	-Infinity
SS-RSRP in slots not corresponding to RSSI measurement time configuration (RMTC)			dBm/SCS	-103.5	-103.5
SS-RSRP in slots corresponding to RSSI measurement time configuration (RMTC)				-103.5	-Infinity
I <sub>o</sub> within measurement bandwidth in slots not corresponding to RSSI measurement time configuration (RMTC)			dBm/BW	-101.6	-101.6
I <sub>o</sub> within measurement bandwidth in slots corresponding to RSSI measurement time configuration (RMTC)			dBm/BW	-101.6	-87
Propagation condition			-	AWGN	
channelOccupancyThreshold			dBm	-83	
Note 1: For UE supporting semi-static channel access and network configuring semi-static channel occupancy.					

Note 2: For UE supporting dynamic channel access and network configuring dynamic channel occupancy.  
 Note 3: For a UE supporting both semi-static and dynamic channel access, the UE can be tested under dynamic channel occupancy only.

**Table A.11.6.6.3.2-3: CO RMTC parameters**

measDurationSymbols-r16	sym14or12
rmtc-Periodicity-r16	ms40
rmtc-SubframeOffset-r16	20
ref-SCS-CP-r16	kHz15
ReportInterval	ms120

### A.11.6.6.3.3 Test Requirements

The nominal reported *channelOccupancy* shall be TBD. At least 90% of channel occupancy reports made by the UE shall indicate this value.

### A.11.6.7 E-UTRAN RSRP

### A.11.6.8 E-UTRAN RSRQ

### A.11.6.9 E-UTRAN SINR

## A.12 E-UTRA Standalone Tests with at Least One NR Cell under CCA

### A.12.1 RRC\_IDLE state mobility

#### A.12.1.1 Inter-RAT cell re-selection to NR on a carrier frequency with CCA

##### A.12.1.1.1 E-UTRA Cell reselection to higher priority NR target Cell in FR1 when target cell is subject to CCA

###### A.12.1.1.1.1 Test Purpose and Environment

This test is to verify the requirement for the E-UTRAN to NR inter-RAT cell subject to CCA reselection requirements specified in clause 4.2.2.5.7 in TS 36.133 [15].

The test scenario comprises of 1 E-UTRA cell and 1 NR cell subject to CCA as given in tables A.12.1.1.1.1-1, A.8.2.1.1.1-2, A.8.2.1.1.1-3 and A.8.2.1.1.1-4. The test consists of three successive time periods, with time duration of T1, T2, and T3 respectively. E-UTRA cell 1 is already identified by the UE prior to the start of the test. Cell 2 is of higher priority than cell 1.

**Table A.12.1.1.1.1-1: Supported test configurations**

Configuration	Description of a cell without CCA	Description of a cell with CCA
1	LTE FDD	NR 30 kHz SSB SCS, 40 MHz bandwidth, TDD duplex mode
2	LTE TDD	NR 30 kHz SSB SCS, 40 MHz bandwidth, TDD duplex mode

Note: The UE is only required to be tested in one of the supported test configurations

**Table A.12.1.1.1.1-2: General test parameters for E-UTRA cell re-selection FR1 NR cell subject to CCA test case**

Parameter	Unit	Test configuration	Value	Comment
Initial condition	Active cell	1, 2	Cell2	The UE camps on cell 2 in the initial phase

	Neighbour cell		1, 2	Cell1	
T1 end condition	Active cell			Cell1	During T1 period the UE reselects to cell 1
	Neighbour cell			Cell2	
T3 end condition	Active cell		1, 2	Cell2	The UE shall perform reselection to cell 2 during T3
	Neighbour cell		1, 2	Cell1	
RF Channel Number			1, 2	1, 2	E-UTRAN radio channel (1) and NR radio channel (2) are used for this test
Time offset between cells			1, 2	3 $\mu$ s	Synchronous cells
Access Barring Information		-	1, 2	Not Sent	No additional delays in random access procedure.
DBT Window Configuration			1, 2	TBD	As specified in clause A.3.28.1.
DL CCA model			1, 2	As specified in clause A.3.20.2.1	DL CCA model
UL CCA model			1, 2	As specified in clause A.3.20.2.2	UL CCA model
DRX cycle length		s	1, 2	1.28	The value shall be used for all cells in the test.
NR PRACH configuration index			1, 2	102	The detailed configuration is specified in TS 38.211 clause 6.3.3.2
T1		s	1, 2	TBD	T1 needs to be defined so that cell re-selection reaction time is taken into account.
T2		s	1, 2	TBD	During T2, cell 2 shall be powered off, and during the off time the physical cell identity shall be changed. The intention is to ensure that cell 2 has not been detected by the UE prior to the start of period T3.
T3		s	1, 2	TBD	T3 needs to be defined so that cell re-selection reaction time is taken into account.

Table A.12.1.1.1-3: Cell specific test parameters for NR cell 2 subject to CCA

Parameter	Unit	Test configuration	Cell 2		
			T1	T2	T3
TDD configuration		1, 2	TBD		
DL CCA probability $P_{CCA\_DL}$		1, 2	TBD		
UL CCA probability $P_{CCA\_UL}$		1, 2	TBD		
$M_{d,max}$		1, 2	16		
$M_{m,max}$		1, 2	4		
$M_{e,max}$		1, 2	8		
PDSCH Reference measurement channel		1, 2	TBD		
RMSI CORESET Reference Channel		1, 2	TBD		
RMC CORESET Reference Channel		1, 2	TBD		
OCNG Patterns		1, 2	OP.1		
SSB configuration		1, 2	TBD		
Initial DL BWP configuration		1, 2	DLBWP.0.1		
Initial UL BWP configuration		1, 2	ULBWP.0.1		
RLM-RS		1, 2	SSB		
$Q_{rxlevmin}$	dBm/SCS	1, 2	-137		
$P_{compensation}$	dB	1, 2	0		
$Q_{hyst_s}$	dB	1, 2	0		

Qoffset <sub>s, n</sub>	dB	1, 2	0		
Cell_selection_and_reselection_quality_measurement		1, 2	SS-RSRP		
$\hat{E}_s / I_{ot}$	dB	1, 2	-4	-infinity	12
$N_{oc}$ <sup>Note2</sup>	dBm/SCS	1, 2	-95		
$N_{oc}$ <sup>Note2</sup>	dBm/15 kHz	1, 2	-98		
$\hat{E}_s / N_{oc}$	dB	1, 2	-4	-infinity	12
SS-RSRP <sup>Note3</sup>	dBm/SCS	1, 2	-99	-infinity	-83
Io	dBm/38.16 MHz	1, 2	-62.50	-63.95	-51.69
Treselection	s	1, 2	0	0	0
SnonintrasearchP	dB	1, 2	50		
Thresh <sub>x, highP</sub>	dB	1, 2	48		
Thresh <sub>serv, lowP</sub>	dB	1, 2	44		
Thresh <sub>x, lowP</sub>	dB	1, 2	50		
Propagation Condition		1, 2	AWGN		
Note 1:	OCNG shall be used such that both cells are fully allocated and a constant total transmitted power spectral density is achieved for all OFDM symbols.				
Note 2:	Interference from other cells and noise sources not specified in the test is assumed to be constant over subcarriers and time and shall be modelled as AWGN of appropriate power for $N_{oc}$ to be fulfilled.				
Note 3:	SS-RSRP levels have been derived from other parameters for information purposes. They are not settable parameters themselves.				

Table A.12.1.1.1-4: Cell specific test parameters for E-UTRA cell 1

Parameter	Unit	Cell 1		
		T1	T2	T3
E-UTRA RF Channel number		1		
$BW_{channel}$	MHz	10		
OCNG Patterns defined in TS 36.133 [15] clause A.3.2		OP.2 TDD for test configuration 1, 2, 3; OP.2 FDD for test configuration 4, 5, 6		
PBCH_RA	dB	0		
PBCH_RB	dB			
PSS_RA	dB			
SSS_RA	dB			
PCFICH_RB	dB			
PHICH_RA	dB			
PHICH_RB	dB			
PDCCH_RA	dB			
PDCCH_RB	dB			
PDSCH_RA	dB			
PDSCH_RB	dB			
OCNG_RA <sup>Note 1</sup>	dB			
OCNG_RB <sup>Note 1</sup>	dB			
Qrxlevmin	dBm	-140		
$N_{oc}$ <sup>Note 2</sup>	dBm/15 kHz	-98		
RSRP <sup>Note 3</sup>	dBm/15 KHz	-84	-84	-84
$\hat{E}_s/I_{ot}$	dB	14	14	14
$\hat{E}_s/N_{oc}$	dB	14	14	14
Treselection <sub>EUTRAN</sub>	S	0		
SnonintrasearchP	dB	50		
Thresh <sub>x, highP</sub>	dB	48		
Thresh <sub>-serving, lowP</sub>	dB	44		
Thresh <sub>x, lowP</sub>	dB	50		
Propagation Condition		AWGN		
<p>Note 1: OCNG shall be used such that both cells are fully allocated and a constant total transmitted power spectral density is achieved for all OFDM symbols.</p> <p>Note 2: Interference from other cells and noise sources not specified in the test is assumed to be constant over subcarriers and time and shall be modelled as AWGN of appropriate power for <math>N_{oc}</math> to be fulfilled.</p> <p>Note 3: RSRP levels have been derived from other parameters for information purposes. They are not settable parameters themselves.</p>				

#### A.12.1.1.1.2 Test Requirements

The cell reselection delay to a higher priority NR cell subject to CCA is defined as the time from the beginning of time period T3, to the moment when the UE camps on cell 2, and starts to send preambles on the PRACH for sending the *RRCSetupRequest* message to perform a Registration procedure for mobility and periodic registration update on cell 2.

The cell re-selection delay to a higher priority cell shall be less than  $60 + 1.28 \times (5 + M_e) + T_{SI\_CCA}$  s.  $M_e$  is the number of DRX cycles with at least one SMTC where there are no SSBs available during the  $T_{evaluate, NR\_Intra\_CCA}$ . If  $M_e > M_{e, max}$  the UE is required to restart the evaluation of cell 2.

The rate of correct cell reselections observed during repeated tests shall be at least 90%.

NOTE: The cell re-selection delay to a higher priority cell can be expressed as:  $T_{higher\_priority\_search} + T_{evaluate, NR\_inter\_CCA} + T_{SI\_CCA}$ , and to a lower priority cell can be expressed as:  $T_{evaluate, NR} + T_{SI\_NR}$ .

Where:

$T_{higher\_priority\_search}$  See clause 4.2.2 in TS 36.133 [15]

$T_{evaluate, NR\_inter\_CCA}$  See Table 4.2.2.5.7-1 in clause 4.2.2.5.7



$T_{SI\_CCA}$  Maximum repetition period of relevant system info blocks that needs to be received by the UE to camp on a cell.

$T_{evaluate, NR}$  See Table 4.2.2.5.6-1 in clause 4.2.2.5.6 in TS 36.133 [15]

$T_{SI\_NR}$  Maximum repetition period of relevant system info blocks that needs to be received by the UE to camp on a cell; 1280 ms is assumed in this test case.

This gives a total of 67.68 s, allow 68 s for the cell re-selection delay to a higher priority NR cell and 7.68 s for the cell re-selection delay to a lower priority cell in the test case, which we allow 8 s.

## A.12.2 RRC\_CONNECTED state mobility

### A.12.2.1 Handover

#### A.12.2.1.1 E-UTRAN - NR with CCA handover

##### A.12.2.1.1.1 Test Purpose and Environment

This test shall verify the E-UTRAN to NR FR1 handover requirements specified in clause 5.3.4A in TS 36.133 [15].

The test comprises of one E-UTRA carrier and one NR carrier with CCA. There are two cells and one cell on each carrier. Cell 1 is the E-UTRAN cell and Cell 2 is an inter-RAT NR neighbour cell with CCA.

The test consists of three successive time periods, with time durations of T1, T2 and T3 respectively. At the start of time duration T1, the UE does not have any timing information of Cell 2. Starting T2, Cell 2 becomes detectable and the UE is expected to detect and send a measurement report. Gap pattern configuration with id #0 as specified in Table 8.1.2.1-1 of TS 36.133 [15] is configured before T2 begins to enable inter-RAT frequency monitoring. A RRC message implying handover shall be sent to the UE during period T2 after the UE has reported Event B2. The start of T3 is the instant when the last TTI containing the RRC message implying handover is sent to the UE. The handover message shall contain Cell 2 as the target cell.

Supported test configurations are shown in table A.12.2.1.1-1. General test parameters are provided in Table A.12.2.1.1-2. Cell specific test parameters for Cell 1 and Cell 2 are provided in Tables A.12.2.1.1-3 and A.12.2.1.1-4 respectively.

**Table A.12.2.1.1-1: Supported test configurations for E-UTRAN inter-RAT NR handover**

Configuration	Description
1	LTE FDD, NR with CCA 30 kHz SSB SCS, 40 MHz bandwidth, TDD duplex mode
2	LTE TDD, NR with CCA 30 kHz SSB SCS, 40 MHz bandwidth, TDD duplex mode
NOTE: The UE is only required to be tested in one of the supported test configurations.	

**Table A.12.2.1.1-2: General test parameters for E-UTRAN inter-RAT NR handover**

Parameter	Unit	Value	Comment
NR RF Channel Number		1	1 NR carrier frequency with CCA is used in the test
LTE RF Channel Number		2	1 E-UTRAN carrier frequency is used in the test
Initial conditions	Active cell	Cell 1	E-UTRAN cell
	Neighbouring cell	Cell 2	NR cell with CCA
Final condition	Active cell	Cell 2	
DL CCA model		As specified in clause A.3.26.2.1	
UL CCA model		As specified in clause A.3.26.2.2	
NR measurement quantity		SS-RSRP	
E-UTRAN measurement quantity		RSRP	
b2-Threshold1	dBm	-84	Absolute E-UTRAN RSRP threshold for event B2
b2-Threshold2NR	dBm	As specified in Table A.12.2.1.1-4	Absolute NR SS-RSRP threshold for event B2

Hysteresis	dB	0	
TimeToTrigger	s	0	
Filter coefficient		0	L3 filtering is not used
DRX		OFF	Non-DRX test
Access Barring Information	-	Not sent	No additional delays in random access procedure
Time offset between cells		3 ms	Asynchronous cells
Gap pattern configuration Id		0	As specified in Table 8.1.2.1-1 started before T2 starts [15]
T1	s	[5]	
T2	s	[≤5]	
T3	s	[1]	

**Table A.12.2.1.1-3: Cell specific test parameters for E-UTRAN inter-RAT NR handover with CCA (Cell 1)**

Parameter	Unit	Configuration	Cell 1		
			T1	T2	T3
RF channel number		1, 2	2		
Duplex mode		1	FDD		
		2	TDD		
TDD special subframe configuration <sup>Note1</sup>		1, 2	6		
TDD uplink-downlink configuration <sup>Note1</sup>		1, 2	1		
BW <sub>channel</sub>	MHz	1, 2	5 MHz: N <sub>RB,C</sub> = 25 10 MHz: N <sub>RB,C</sub> = 50 20 MHz: N <sub>RB,C</sub> = 100		
PRACH Configuration <sup>Note2</sup>		1	4		
		2	53		
PDSCH parameters: DL Reference Measurement Channel <sup>Note3</sup>		1	5 MHz: R.7 FDD 10 MHz: R.3 FDD 20 MHz: R.6 FDD		
		2	5 MHz: R.4 TDD 10 MHz: R.0 TDD 20 MHz: R.3 TDD		
PCFICH/PDCCH/PHICH parameters: DL Reference Measurement Channel <sup>Note3</sup>		1	5 MHz: R.11 FDD 10 MHz: R.6 FDD 20 MHz: R.10 FDD		
		2	5 MHz: R.11 TDD 10 MHz: R.6 TDD 20 MHz: R.10 TDD		
OCNG Patterns <sup>Note3</sup>		1	5 MHz: OP.20 FDD 10 MHz: OP.10 FDD 20 MHz: OP.17 FDD		
		2	5 MHz: OP.9 TDD 10 MHz: OP.1 TDD 20 MHz: OP.7 TDD		
PBCH_RA	dB	1, 2	0		
PBCH_RB					
PSS_RA					
SSS_RA					
PCFICH_RB					
PHICH_RA					
PHICH_RB					
PDCCH_RA					
PDCCH_RB					
PDSCH_RA					
PDSCH_RB					
OCNG_RA <sup>Note4</sup>					
OCNG_RB <sup>Note4</sup>					
N <sub>oc</sub> <sup>Note5</sup>					
E <sub>s</sub> /N <sub>oc</sub>	dB	1, 2	7	7	7
E <sub>s</sub> /I <sub>ot</sub> <sup>Note6</sup>	dB	1, 2	7	7	7

RSRP <sup>Note6</sup>	dBm/15kHz	1, 2	-91	-91	-91
SCH_RP <sup>Note6</sup>	dBm/15kHz	1, 2	-91	-91	-91
Io <sup>Note6</sup>	dBm/9MHz	1, 2	-62.43	-62.43	-62.43
Propagation Condition		1, 2	AWGN		
Antenna Configuration and Correlation Matrix <sup>Note7</sup>		1, 2	1x2 Low		
<p>Note 1: Special subframe and uplink-downlink configurations are specified in table 4.2-1 in TS 36.211 [23].</p> <p>Note 2: PRACH configurations are specified in table 5.7.1-2 and table 5.7.1-3 in TS 36.211 [23].</p> <p>Note 3: DL RMCs and OCNG patterns are specified in clauses A 3.1 and A 3.2 of TS 36.133 [15] respectively.</p> <p>Note 4: OCNG shall be used such that all cells are fully allocated and a constant total transmitted power spectral density is achieved for all OFDM symbols.</p> <p>Note 5: Interference from other cells and noise sources not specified in the test is assumed to be constant over subcarriers and time and shall be modelled as AWGN of appropriate power for <math>N_{oc}</math> to be fulfilled.</p> <p>Note 6: <math>\hat{E}_{s/lot}</math>, RSRP, SCH_RP and Io levels have been derived from other parameters for information purposes. They are not settable parameters themselves.</p> <p>Note 7: Propagation condition and correlation matrix are defined in clause B.2 in TS 36.101 [25].</p>					

Table A.12.2.1.1-4: Cell specific test parameters E-UTRAN inter-RAT NR with CCA handover (Cell 2)

Parameter		Unit	Configuration	Cell 2		
				T1	T2	T3
RF channel number			1, 2	1		
DL CCA probability $P_{CCA\_DL}$	Semi-static channel access <sup>Note 4, 6</sup>		1, 2	$P_{CCA\_DL}=0.9375$		
	Dynamic channel access <sup>Note 5, 6</sup>		1, 2	$P_{CCA\_DL\_1}=0.75$ $P_{CCA\_DL\_2}=0.75$		
UL CCA probability $P_{CCA\_UL}$	Semi-static channel access <sup>Note 4, 6</sup>		1, 2	$P_{CCA\_UL}=0.87$		
	Dynamic channel access <sup>Note 5, 6</sup>		1, 2	$P_{CCA\_UL}=0.75$		
$L_{CCA\_DL}$		-	1, 2	5		
$W_{CCA\_DL}$		ms	1, 2	T304		
$L_{CCA\_UL}$		-	1, 2	5		
$W_{CCA\_UL}$		ms	1, 2	T304		
T304		ms	1, 2	500		
Duplex mode			1, 2	TDD		
TDD Configuration			1, 2	TDDConf.1.1 CCA		
$BW_{channel}$		MHz	1, 2	40: $N_{RB,C} = 106$ (TDD)		
PDSCH reference measurement channel			1, 2	SR.1.1 CCA		
CORESET reference channel			1, 2	CR.1.1 CCA		
PRACH configuration			1, 2	FR1 PRACH configuration 1 under CCA		
OCNG pattern <sup>Note1</sup>			1, 2	OP.1		
BWP	Initial DL BWP		1, 2	DLBWP.0.1		
	Dedicated DL BWP			DLBWP.1.1		
	Initial UL BWP			ULBWP.0.1		
	Dedicated UL BWP			ULBWP.1.1		
SMTc configuration			1, 2	SMTc.1		
SSB configuration	Semi-static channel access <sup>Note 4, 6</sup>		1, 2	SSB.1 CCA		
	Dynamic channel access <sup>Note 5, 6</sup>		1, 2	SSB.2 CCA		
DBT window configuration				As defined in A.3.28.1		
b2-Threshold2NR		dBm	1	-105		
			2	-103		
EPRE ratio of PSS to SSS		dB	1, 2	0		

EPRE ratio of PBCH_DMRS to SSS					
EPRE ratio of PBCH to PBCH_DMRS					
EPRE ratio of PDCCH_DMRS to SSS					
EPRE ratio of PDCCH to PDCCH_DMRS					
EPRE ratio of PDSCH_DMRS to SSS					
EPRE ratio of PDSCH to PDSCH_DMRS					
EPRE ratio of OCNG DMRS to SSS					
EPRE ratio of OCNG to OCNG DMRS					
$N_{oc}$ <sup>Note2</sup>	dBm/15 KHz	1, 2	-98		
$N_{oc}$ <sup>Note2</sup>	dBm/SCS	1, 2	-95		
$\bar{E}_s/N_{oc}$	dB	1, 2	-inifinit	0	0
$\bar{E}_s/I_{ot}$ <sup>Note3</sup>	dB	1, 2	-inifinit	0	0
SS-RSRP <sup>Note3</sup>	dBm/SCS	1, 2	-inifinit	-95	-95
$I_o$ <sup>Note3</sup>	dBm/38.16 MHz	1, 2	-63.96	-60.94	-60.94
Propagation condition		1, 2	AWGN		
Antenna Configuration and Correlation Matrix		1, 2	1x2 Low		
<p>Note 1: OCNG shall be used such that both cells are fully allocated and a constant total transmitted power spectral density is achieved for all OFDM symbols.</p> <p>Note 2: Interference from other cells and noise sources not specified in the test is assumed to be constant over subcarriers and time and shall be modelled as AWGN of appropriate power for <math>N_{oc}</math> to be fulfilled.</p> <p>Note 3: <math>\bar{E}_s/I_{ot}</math>, SS-RSRP, and <math>I_o</math> levels have been derived from other parameters for information purposes. They are not settable parameters themselves.</p> <p>Note 4: For UE supporting semi-static channel access and network configuring semi-static channel occupancy.</p> <p>Note 5: For UE supporting dynamic channel access and network configuring dynamic channel occupancy.</p> <p>Note 6: For UE supporting both semi-static and dynamic channel access, the UE must be tested under both dynamic and semi-static channel occupancy configurations.</p>					

A.12.2.1.1.2 Test Requirements

The UE shall start to transmit the PRACH to Cell 2 less than  $112 + (L_1' + L_3) * 20$  ms from the beginning of time period T3.

The rate of correct handovers observed during repeated tests shall be at least 90%.

NOTE: The handover delay can be expressed as: RRC procedure delay +  $T_{interrupt}$ , where:

RRC procedure delay = 50 ms and is specified in TS36.331.

$T_{interrupt} = 62 + (L_1' + L_3) * T_{SMTC}$ ;  $T_{interrupt}$  is defined in TS36.133 clause 5.3.4A.3 where

$L_1'$  is the number of SMTC occasions not available at the UE during the inter-RAT detection period.

$L_3$  is the number of consecutive SSB to PRACH occasion association periods during which no PRACH occasion is available for PRACH transmission due to UL CCA failure.  $L_3 = 0$  for Type 2C UL channel access procedure as defined in TS 37.213 [33].

$T_{SMTC} = 20$  ms is the SMTC periodicity ms in the test.

This gives a total of  $112 + (L_1' + L_3) * 20$  ms.

## A.12.3 Signalling characteristics

### A.12.3.1 Interruptions

## A.12.4 Measurement procedure

### A.12.4.1 E-UTRAN–NR inter-RAT SFTD measurements

#### A.12.4.1.1 E-UTRA – NR Inter-RAT SFTD Measurement Delay with NR under CCA in non-DRX

##### A.12.4.1.1.1 Test Purpose and Environment

The purpose of this test is to partly verify that measurement reporting delay for SFTD between E-UTRA PCell and inter-RAT NR neighbour cell under CCA is within the requirements stated in clauses 8.1.2.4.25 and 8.1.2.4.26 of TS 36.133 [15] for E-UTRA FDD and TDD, respectively, when no measurement gaps are provided and no DRX is configured.

The tests consist of a single time period of duration T1. Two carriers are used in the tests: one E-UTRA carrier with the PCell (Cell 1), and one NR carrier under CCA with the NR neighbour cell (Cell 2).

Prior to the start of time duration T1, the UE is connected to Cell 1 and configured to carry out intra-frequency measurements only. The point in time at which the UE receives, at the UE antenna connector(s), a RRC message containing a measurement configuration for SFTD measurements on RF channel 2 defines the start of time duration T1. Following the start of T1 the UE shall detect Cell 2, determine the SFN and frame time difference of Cell 2 relative to Cell 1, and send a measurement report.

The supported test configurations are listed in Table A.12.4.1.1.1-1 below. General test parameters and cell-specific parameters for the NR cell are provided in Tables A.12.4.1.1.1-2 and A.12.4.1.1.1-3 below, respectively. Cell-specific parameters for the E-UTRA cell are provided in clause A.3.7.2.1.

**Table A.12.4.1.1.1-1: Applicable test configurations for inter-RAT SFTD measurement delay test with NR under CCA**

Config	Description
1	LTE FDD; NR: 30 kHz SSB SCS, 40 MHz bandwidth, TDD duplex mode
2	LTE TDD; NR: 30 kHz SSB SCS, 40 MHz bandwidth, TDD duplex mode
Note: The UE is only required to be tested in one of the supported test configurations	

**Table A.12.4.1.1.1-2: General test parameters for inter-RAT SFTD measurement delay test with NR under CCA**

Parameter	Unit	Test configuration	Value		Comment
			Test 1	Test 2	
E-UTRA RF Channel Number		Config 1,2	1		One E-UTRAN carrier frequencies is used.
NR RF Channel Number		Config 1,2	1		One NR carrier frequencies is used.
Active cell		Config 1,2	Cell 1		Cell 1 is on E-UTRA RF channel number 1.
Neighbour cell		Config 1,2	Cell 2		Cell 2 is on NR RF channel number 1.
CP length		Config 1,2	Normal		Applicable to both cells.
DRX		Config 1,2	OFF		DRX is not used
Frame time offset between serving and neighbour cells	ms	Config 1	3	7	Asynchronous cells. The timing of Cell 2 relative to the timing of Cell 1.
	μs	Config 2	3		Synchronous cells.
SFN offset between serving and neighbour cells		Config 1,2	0	1	SFN of Cell 2 relative to SFN of Cell 1.
SS-RSRP reporting		Config 1,2	No		Only SFTD is reported.

T1	s	Config 1,2	2	T1 shall exceed $T_{\text{measure\_SFTD\_LBT\_max}} = 56 \times \text{SMTC}$
----	---	------------	---	--

**Table A.12.4.1.1.1-3: Cell specific test parameters for Cell 2 in inter-RAT SFTD measurement delay test with NR under CCA**

Parameter		Unit	Cell 2
NR RF Channel Number			1
Duplex mode			TDD
BW <sub>channel</sub>		MHz	40: N <sub>RB,c</sub> = 106
TDD configuration			TDDConf.1.1 CCA
DL CCA model			As specified in clause A.3.20.2.1
DL CCA probability for semi-static channel access <sup>Note5,7</sup>	P <sub>CCA_DL</sub>		0.9375
DL CCA probability for dynamic channel access <sup>Note6,7</sup>	P <sub>CCA_DL_1</sub>		0.75
	P <sub>CCA_DL_2</sub>		0.75
OCNG Pattern defined in A.3.2.1.1 <sup>Note 1</sup>			OP.1
SMTC configuration defined in A.3.2.11.1 and A.3.2.11.2			SMTC.2
SSB configuration for semi-static channel access <sup>Note5,7</sup>			SSB.1 CCA
SSB configuration for dynamic channel access <sup>Note6,7</sup>			SSB.2 CCA
DBT window configuration			DBT.1
PDSCH/PDCCH subcarrier spacing		kHz	30
EPRE ratio of PSS to SSS		dB	0
EPRE ratio of PBCH DMRS to SSS		dB	
EPRE ratio of PBCH to PBCH DMRS		dB	
EPRE ratio of OCNG DMRS to SSS <sup>Note 1</sup>		dB	
EPRE ratio of OCNG to OCNG DMRS <sup>Note 1</sup>		dB	
N <sub>oc</sub> <sup>Note2</sup>		dBm/15 kHz	-98
N <sub>oc</sub> <sup>Note2</sup>		dBm/SCS	-95
SS-RSRP <sup>Note 3, 4</sup>		dBm/SCS	-91
$\bar{E}_s/I_{ot}$		dB	4
$\bar{E}_s/N_{oc}$		dB	4
I <sub>o</sub> <sup>Note 3</sup>		dBm/38.16 MHz	-58.50
Propagation Condition			AWGN

Note 1:	OCNG shall be used such that the cell is fully allocated and a constant total transmitted power spectral density is achieved for all OFDM symbols in slots with downlink transmission bursts.
Note 2:	Interference from other cells and noise sources not specified in the test is assumed to be constant over subcarriers and time and shall be modelled as AWGN of appropriate power for $N_{oc}$ to be fulfilled.
Note 3:	SS-RSRP and $I_0$ levels have been derived from other parameters for information purposes. They are not settable parameters themselves.
Note 4:	SS-RSRP minimum requirements are specified assuming independent interference and noise at each receiver antenna port.
Note 5:	For UE supporting semi-static channel access and network configuring semi-static channel occupancy.
Note 6:	For UE supporting dynamic channel access and network configuring dynamic channel occupancy.
Note 7:	For UE supporting both semi-static and dynamic channel access, the UE can be tested under dynamic channel access only..

#### A.12.4.1.1.2 Test Requirements

Following the start of T1, the UE shall detect Cell 2 and determine the relative time difference between Cell 1 and Cell 2. At latest at  $T_{RRC\_procedure\_delay} + T_{measure\_SFTD\_LBT\_max}$  after the beginning of time duration T1, the UE shall send a measurement report on SFTD between Cell 1 and Cell 2.

The observed rate of successful SFTD reports in repeated tests shall be at least 90%.

NOTE: The actual overall delays measured in the test may be up to  $2 \times TTI_{DCC}$  longer than the measurement reporting delays above due to TTI insertion uncertainty of the measurement report in DCCH.

### A.12.4.2 E-UTRAN–NR inter-RAT measurements on NR carrier frequency under CCA

#### A.12.4.2.1 E-UTRA-NR inter-RAT event triggered reporting tests for FR1 without SSB time index detection when DRX is not used

##### A.12.4.2.1.1 Test Purpose and Environment

The purpose of this test is to verify that the UE makes correct reporting of an event. This test will partly verify the NR inter-RAT cell search requirements in clause 8.1.2.4.21A of TS 36.133 [15] for E-UTRAN FDD-NR measurements under CCA and clause 8.1.2.4.22A of TS 36.133 [15] for E-UTRAN TDD-NR measurements under CCA.

In this test, there are two cells: E-UTRA cell 1 as PCell on E-UTRA RF channel 1 and NR cell 2 as neighbour cell in FR1 on NR RF channel 1 on a carrier frequency with CCA. The test parameters are given in Tables A.12.4.2.1.1-1, A.12.4.2.1.1-2, A.12.4.2.1.1-3 and A.12.4.2.1.1-4. Cell transmits SSBs in DBT windows according to DL CCA model.

In test 1 measurement gap pattern configuration # 0 as defined in Table A.12.4.2.1.1-2 is provided for UE that does not support per-FR gap and in test 2 measurement gap pattern configuration #4 as defined in Table A.12.4.2.1.1-2 is provided for UE that supports per-FR gap.

In the measurement control information, it is indicated to the UE that event-triggered reporting with Event B2 (PCell becomes worse than threshold1 and inter RAT neighbour becomes better than threshold2) [16] is used. The UE is tested when MeasTriggerQuantity is configured as RSRP, RSRQ and SINR for each test. The test consists of two successive time periods, with time duration of T1, and T2 respectively. During time duration T1, the UE shall not have any timing information of NR cell 2.

**Table A.12.4.2.1.1-1: NR inter-RAT event triggered reporting tests without SSB index reading for FR1**

Configuration	Description
1	LTE FDD; NR with CCA: SCS 30 kHz, BW 40 MHz, TDD
2	LTE TDD; NR with CCA: SCS 30 kHz, BW 40 MHz, TDD
NOTE:	The UE is only required to pass in one of the supported test configurations in FR1

**Table A.12.4.2.1.1-2: General test parameters for NR inter-RAT event triggered reporting for FR1 without SSB time index detection**

Parameter	Unit	Test configuration	Value		Comment
			Test 1	Test 2	
E-UTRA RF Channel Number		1, 2	1		One E-UTRA carrier frequency is used.
NR RF Channel Number		1, 2	1		One FR1 NR carrier frequency under CCA is used.
DL CCA model			As specified in clause A.3.26.2.1		
UL CCA model			As specified in clause A.3.26.2.2		
Active cell		1, 2	E-UTRA cell 1 (PCell)		E-UTRA cell 1 is on E-UTRA RF channel number 1.
Neighbour cell		1, 2	NR cell 2		NR cell 2 is on NR RF channel number 1.
Gap Pattern Id		1, 2	0	4	As specified in clause Table 8.1.2.1-1 of TS 36.133 [15].
Measurement gap offset		1, 2	39	19	As specified in TS 36.331 [16].
b2-Threshold1	dBm	1, 2	Note 1		E-UTRA RSRP/RSRQ/SINR threshold for E-UTRA RSRP measurement on cell 1 for event B2 [16]
b2-Threshold2NR	dBm	1, 2	Note 2		SS-RSRP/ SS-RSRQ/ SS-SINR threshold measurement on cell 2 for event B2 [16]
Hysteresis	dB	1, 2	0		
CP length		1, 2	Normal		
TimeToTrigger	s	1, 2	0		
Filter coefficient		1, 2	0		L3 filtering is not used
DRX		1, 2	OFF		DRX is not used
Time offset between serving and neighbour cells		1, 2	3µs		Synchronous cells.
T1	s	1, 2	5		
T2	s	1, 2	$\geq T_{\text{identify\_irat\_cca\_without\_index}}$	$\geq T_{\text{identify\_irat\_cca\_without\_index}}$	$T_{\text{identify\_irat\_cca\_without\_index}}$ is defined in clause 8.1.2.4.21A.1 and 8.1.2.4.22A.1 in TS 36.133
Note 1: The value of b2-Threshold1 is defined in Table A.12.4.2.1.1-3					
Note 2: The value of b2-Threshold2NR is defined in Table A.12.4.2.1.1-4					

**Table A.12.4.2.1.1-3: E-UTRAN PCell specific test parameters for NR inter-RAT event triggered reporting in non-DRX with NR neighbour cell in FR1 without SSB time index detection**

Parameter	Unit	Configuration	Cell 1	
			T1	T2
RF channel number		1, 2	1	
Duplex mode		1	FDD	
		2	TDD	
TDD special subframe configuration <sup>Note1</sup>		2	6	
TDD uplink-downlink configuration <sup>Note1</sup>		2	1	
BW <sub>channel</sub>	MHz	1, 2	5 MHz: N <sub>RB,c</sub> = 25 10 MHz: N <sub>RB,c</sub> = 50 20 MHz: N <sub>RB,c</sub> = 100	
PDSCH parameters: DL Reference Measurement Channel <sup>Note2</sup>		1	5 MHz: R.7 FDD 10 MHz: R.3 FDD 20 MHz: R.6 FDD	
		2	5 MHz: R.4 TDD	



			10 MHz: R.0 TDD 20 MHz: R.3 TDD
PCFICH/PDCCH/PHICH parameters: DL Reference Measurement Channel <sup>Note2</sup>		1	5 MHz: R.11 FDD 10 MHz: R.6 FDD 20 MHz: R.10 FDD
		2	5 MHz: R.11 TDD 10 MHz: R.6 TDD 20 MHz: R.10 TDD
OCNG Patterns <sup>Note2</sup>		1	5 MHz: OP.20 FDD 10 MHz: OP.10 FDD 20 MHz: OP.17 FDD
		2	5 MHz: OP.9 TDD 10 MHz: OP.1 TDD 20 MHz: OP.7 TDD
b2-Threshold1	dBm	1, 2	-77 for RSRP
	dB	1, 2	77 for RSRQ
	dB	1, 2	90 for SINR
PBCH_RA	dB	1, 2	0
PBCH_RB			
PSS_RA			
SSS_RA			
PCFICH_RB			
PHICH_RA			
PHICH_RB			
PDCCH_RA			
PDCCH_RB			
PDSCH_RA			
PDSCH_RB			
OCNG_RA <sup>Note3</sup>			
OCNG_RB <sup>Note3</sup>			
N <sub>oc</sub> <sup>Note4</sup>	dBm/15kHz	1, 2	-104
$\bar{E}_s/N_{oc}$	dB	1, 2	17
$\bar{E}_s/I_{ot}$ <sup>Note5</sup>	dB	1, 2	17
RSRP <sup>Note5</sup>	dBm/15kHz	1, 2	-87
SCH_RP <sup>Note5</sup>	dBm/15kHz	1, 2	-87
I <sub>o</sub> <sup>Note5</sup>	dBm/9MHz	1, 2	-59.13+10log(N <sub>RB,c</sub> /50)
Propagation Condition <sup>Note6</sup>		1, 2	ETU70
Antenna Configuration and Correlation Matrix <sup>Note6</sup>		1, 2	1x2 Low
<p>Note 1: Special subframe and uplink-downlink configurations are specified in table 4.2-1 in TS 36.211 [23].</p> <p>Note 2: DL RMCs and OCNG patterns are specified in clauses A 3.1 and A 3.2 of TS 36.133 [15] respectively.</p> <p>Note 3: OCNG shall be used such that all cells are fully allocated and a constant total transmitted power spectral density is achieved for all OFDM symbols.</p> <p>Note 4: Interference from other cells and noise sources not specified in the test is assumed to be constant over subcarriers and time and shall be modelled as AWGN of appropriate power for N<sub>oc</sub> to be fulfilled.</p> <p>Note 5: <math>\bar{E}_s/I_{ot}</math>, RSRP, SCH_RP and I<sub>o</sub> levels have been derived from other parameters for information purposes. They are not settable parameters themselves.</p> <p>Note 6: Propagation condition and correlation matrix are defined in clause B.2 in TS 36.101 [25].</p>			

**Table A.12.4.2.1.1-4: NR neighbour cell specific test parameters for NR inter-RAT event triggered reporting for FR1 without SSB time index detection**

Parameter	Unit	Test configuration	Cell 2	
			T1	T2
NR RF Channel Number		1, 2	2	
TDD configuration		1, 2	TDDConf.1.1 CCA	
BW <sub>channel</sub>	MHz	1, 2	40: N <sub>RB,c</sub> = 106	
P <sub>CCA_DL</sub> for dynamic channel access <sup>Note 6,8</sup>		1, 2	P <sub>CCA_DL_1</sub> =0.75 P <sub>CCA_DL_2</sub> =0.75	
P <sub>CCA_DL</sub> for semi-static channel access <sup>Note 7,8</sup>		1, 2	P <sub>CCA_DL</sub> =0.9375	

OCNG Patterns defined in A.3.2.1.1 (OP.1)		1, 2	OP.1	
SMTC configuration defined in A.3.11.1 and A.3.11.2		1, 2	SMTC.1	
DBT window configuration		1, 2	DBT.1	
SSB configuration for semi-static channel access		1, 2	SSB.1 CCA	
SSB configuration for dynamic channel access		1, 2	SSB.2 CCA	
PDSCH/PDCCH subcarrier spacing	kHz	1, 2	30	
b2-Threshold2NR	dBm	1, 2	-98 for SS-RSRP	
	dB	1, 2	55 for SS-RSRQ	
		1, 2	50 for SS-RSRQ	
EPRE ratio of PSS to SSS		1, 2	0	
EPRE ratio of PBCH DMRS to SSS				
EPRE ratio of PBCH to PBCH DMRS				
EPRE ratio of PDCCH DMRS to SSS				
EPRE ratio of PDCCH to PDCCH DMRS				
EPRE ratio of PDSCH DMRS to SSS				
EPRE ratio of PDSCH to PDSCH				
EPRE ratio of OCNG DMRS to SSS (Note 1)				
EPRE ratio of OCNG to OCNG DMRS (Note 1)				
$N_{oc}$ Note2	dBm/15kHz	1, 2	-98	
$N_{oc}$ Note2	dBm/SCS	1, 2	-95	
SS-RSRP Note 3,5	dBm/SCS	1, 2	-Infinity	-88
$\hat{E}_s/I_{ot}$ Note 5	dB	1, 2	-Infinity	7
$\hat{E}_s/N_{oc}$ Note 5	dB	1, 2	-Infinity	7
$I_o$ Note3	dBm/38.16MHz	1, 2	-63.95	-56.16
Propagation Condition		1, 2	ETU70	
Antenna Configuration and Correlation Matrix		1, 2	1x2 Low	
<p>NOTE 1: OCNG shall be used such that the cell is fully allocated and a constant total transmitted power spectral density is achieved for all OFDM symbols.</p> <p>NOTE 2: Interference from other cells and noise sources not specified in the test is assumed to be constant over subcarriers and time and shall be modelled as AWGN of appropriate power for <math>N_{oc}</math> to be fulfilled.</p> <p>NOTE 3: SS-RSRP and <math>I_o</math> levels have been derived from other parameters for information purposes. They are not settable parameters themselves.</p> <p>NOTE 4: SS-RSRP minimum requirements are specified assuming independent interference and noise at each receiver antenna port.</p> <p>NOTE 5: The signal levels apply for SSS REs when the discovery burst is transmitted during DBT windows.</p> <p>NOTE 6: For UE supporting semi-static channel access and network configuring semi-static channel occupancy.</p> <p>NOTE 7: For UE supporting dynamic channel access and network configuring dynamic channel occupancy.</p> <p>NOTE 8: For a UE supporting both semi-static and dynamic channel access, the UE can be tested under dynamic channel occupancy only.</p>				

#### A.12.4.2.1.2 Test Requirements

In test 1 with per-UE gap, the UE shall send one Event B2 triggered measurement report, with a measurement reporting delay less than  $T_{\text{identify\_irat\_cca\_without\_index}}$  ms from the beginning of time period T2. The UE shall not send event triggered measurement reports, as long as the reporting criteria are not fulfilled. The rate of correct events observed during repeated tests shall be at least 90%.

In test 2 with per-FR gap, the UE shall send one Event B2 triggered measurement report, with a measurement reporting delay less than  $T_{\text{identify\_irat\_cca\_without\_index}}$  from the beginning of time period T2. The UE shall not send event triggered measurement reports, as long as the reporting criteria are not fulfilled. The rate of correct events observed during repeated tests shall be at least 90%.

In test 1 and test 2, the UE is not required to report SSB time index.  $T_{\text{identify\_irat\_cca\_without\_index}}$  is defined in defined in clause 8.1.2.4.21A.1 and 8.1.2.4.22A.1 in TS 36.133.

NOTE: The actual overall delays measured in the test may be up to  $2 \times TTI_{\text{DCCH}}$  higher than the measurement reporting delays above because of TTI insertion uncertainty of the measurement report in DCCH.

## A.12.4.2.2 E-UTRA-NR inter-RAT event triggered reporting tests for FR1 without SSB time index detection when DRX is used

### A.12.4.2.2.1 Test Purpose and Environment

The purpose of this test is to verify that the UE makes correct reporting of an event. This test will partly verify the NR inter-RAT cell search requirements in clause 8.1.2.4.21A of TS 36.133 [15] for E-UTRAN FDD-NR measurements and clause 8.1.2.4.22A of TS 36.133 [15] for E-UTRAN TDD-NR measurements.

In this test, there are two cells: E-UTRA cell 1 as PCell on E-UTRA RF channel 1 and NR cell 2 as neighbour cell in FR1 on NR RF channel 1 on a carrier frequency with CCA. The test parameters are given in Tables A.12.4.2.2.1-1, A.12.4.2.2.1-2, A.12.4.2.2.1-3 and A.12.4.2.2.1-4. Cell transmits SSBs in DBT windows according to DL CCA model.

In tests 1 and 2, measurement gap pattern configuration # 0 as defined in Table A.12.4.2.2.1-2 is provided for UE that does not support per-FR gap and in tests 3 and 4, measurement gap pattern configuration #4 as defined in Table A.12.4.2.2.1-2 is provided for UE that supports per-FR gap.

In the measurement control information, it is indicated to the UE that event-triggered reporting with Event B2 (PCell becomes worse than threshold1 and inter RAT neighbour becomes better than threshold2) [16] is used. The UE is tested when MeasTriggerQuantity is configured as RSRP, RSRQ and SINR for each test. The test consists of two successive time periods, with time duration of T1, and T2 respectively. During time duration T1, the UE shall not have any timing information of NR cell 2.

**Table A.12.4.2.2.1-1: NR inter-RAT event triggered reporting tests without SSB index reading for FR1**

Configuration	Description
1	LTE FDD; NR with CCA: SCS 30 kHz, BW 40 MHz, TDD
2	LTE TDD; NR with CCA: SCS 30 kHz, BW 40 MHz, TDD
NOTE: The UE is only required to pass in one of the supported test configurations in FR1	

**Table A.12.4.2.2.1-2: General test parameters for NR inter-RAT event triggered reporting for FR1 without SSB time index detection**

Parameter	Unit	Test configuration	Value				Comment
			Test 1	Test 2	Test 3	Test 4	
E-UTRA RF Channel Number		1, 2	1				One E-UTRA carrier frequency is used.
NR RF Channel Number		1, 2	1				One FR1 NR carrier frequency under CCA is used.
Active cell		1, 2	E-UTRA cell 1 (PCell)				E-UTRA cell 1 is on E-UTRA RF channel number 1.
DL CCA model			As specified in clause A.3.26.2.1				
UL CCA model			As specified in clause A.3.26.2.2				
Neighbour cell		1, 2	NR cell 2				NR cell 2 is on NR RF channel number 1.
Gap Pattern Id		1, 2	0	4			As specified in clause Table 8.1.2.1-1 of TS 36.133 [15].
Measurement gap offset		1, 2	39	19			As specified in TS 36.331 [16].
b2-Threshold1	dBm	1, 2	Note 1				E-UTRA RSRP/RSRQ/SINR threshold for E-UTRA RSRP measurement on cell 1 for event B2 [16]

b2-Threshold2NR	dBm	1, 2	Note 2				SS-RSRP/ SS-RSRQ/ SS-SINR threshold measurement on cell 2 for event B2 [16]
Hysteresis	dB	1, 2	0				
CP length		1, 2	Normal				
TimeToTrigger	s	1, 2	0				
Filter coefficient		1, 2	0				L3 filtering is not used
DRX		1, 2	DR X.9	DR X.1 2	DR X.9	DR X.1 2	As specified in clause A.3.3
Time offset between serving and neighbour cells		1, 2	3µs				Synchronous cells.
T1	s	1, 2	5				
T2	s	1, 2	≥T <sub>identify_irat_cca_without_index</sub>				T <sub>identify_irat_cca_without_index</sub> is defined in clause 8.1.2.4.21A.1 and 8.1.2.4.22A.1 in TS 36.133
Note 1: The value of b2-Threshold1 is defined in Table A.12.4.2.1.1-3							
Note 2: The value of b2-Threshold2NR is defined in Table A.12.4.2.1.1-4							

**Table A.12.4.2.1-3: E-UTRAN PCell specific test parameters for NR inter-RAT event triggered reporting in non-DRX with NR neighbour cell in FR1 without SSB time index detection**

Parameter	Unit	Configuration	Cell 1	
			T1	T2
RF channel number		1, 2	1	
Duplex mode		1	FDD	
		2	TDD	
TDD special subframe configuration <sup>Note1</sup>		2	6	
TDD uplink-downlink configuration <sup>Note1</sup>		2	1	
BW <sub>channel</sub>	MHz	1, 2	5 MHz: N <sub>RB,c</sub> = 25 10 MHz: N <sub>RB,c</sub> = 50 20 MHz: N <sub>RB,c</sub> = 100	
PDSCH parameters: DL Reference Measurement Channel <sup>Note2</sup>		1	5 MHz: R.7 FDD 10 MHz: R.3 FDD 20 MHz: R.6 FDD	
		2	5 MHz: R.4 TDD 10 MHz: R.0 TDD 20 MHz: R.3 TDD	
PCFICH/PDCCH/PHICH parameters: DL Reference Measurement Channel <sup>Note2</sup>		1	5 MHz: R.11 FDD 10 MHz: R.6 FDD 20 MHz: R.10 FDD	
		2	5 MHz: R.11 TDD 10 MHz: R.6 TDD 20 MHz: R.10 TDD	
OCNG Patterns <sup>Note2</sup>		1	5 MHz: OP.20 FDD 10 MHz: OP.10 FDD 20 MHz: OP.17 FDD	
		2	5 MHz: OP.9 TDD 10 MHz: OP.1 TDD 20 MHz: OP.7 TDD	
b2-Threshold1	dBm	1, 2	-77 for RSRP	
	dB	1, 2	77 for RSRQ	
	dB	1, 2	90 for SINR	
PBCH_RA	dB	1, 2	0	
PBCH_RB				
PSS_RA				
SSS_RA				
PCFICH_RB				
PHICH_RA				
PHICH_RB				
PDCCH_RA				
PDCCH_RB				

PDSCH_RA				
PDSCH_RB				
OCNG_RA <sup>Note3</sup>				
OCNG_RB <sup>Note3</sup>				
$N_{oc}$ <sup>Note4</sup>	dBm/15kHz	1, 2	-104	
$\bar{E}_s/N_{oc}$	dB	1, 2	17	17
$\bar{E}_s/I_{ot}$ <sup>Note5</sup>	dB	1, 2	17	17
RSRP <sup>Note5</sup>	dBm/15kHz	1, 2	-87	-87
SCH_RP <sup>Note5</sup>	dBm/15kHz	1, 2	-87	-87
$I_o$ <sup>Note5</sup>	dBm/9MHz	1, 2	$-59.13+10\log(N_{RB,c}/50)$	$-59.13+10\log(N_{RB,c}/50)$
Propagation Condition <sup>Note6</sup>		1, 2	ETU70	
Antenna Configuration and Correlation Matrix <sup>Note6</sup>		1, 2	1x2 Low	
<p>Note 1: Special subframe and uplink-downlink configurations are specified in table 4.2-1 in TS 36.211 [23].</p> <p>Note 2: DL RMCs and OCNG patterns are specified in clauses A 3.1 and A 3.2 of TS 36.133 [15] respectively.</p> <p>Note 3: OCNG shall be used such that all cells are fully allocated and a constant total transmitted power spectral density is achieved for all OFDM symbols.</p> <p>Note 4: Interference from other cells and noise sources not specified in the test is assumed to be constant over subcarriers and time and shall be modelled as AWGN of appropriate power for <math>N_{oc}</math> to be fulfilled.</p> <p>Note 5: <math>\bar{E}_s/I_{ot}</math>, RSRP, SCH_RP and <math>I_o</math> levels have been derived from other parameters for information purposes. They are not settable parameters themselves.</p> <p>Note 6: Propagation condition and correlation matrix are defined in clause B.2 in TS 36.101 [25].</p>				

**Table A.12.4.2.2.1-4: NR neighbour cell specific test parameters for NR inter-RAT event triggered reporting for FR1 without SSB time index detection**

Parameter	Unit	Test configuration	Cell 2	
			T1	T2
NR RF Channel Number		1, 2	1	
TDD configuration		1, 2	TDDConf.1.1 CCA	
$BW_{channel}$	MHz	1, 2	40: $N_{RB,c} = 106$	
$P_{CCA\_DL}$ for dynamic channel access <sup>Note 6,8</sup>		1, 2	$P_{CCA\_DL\_1}=0.75$ $P_{CCA\_DL\_2}=0.75$	
$P_{CCA\_DL}$ for semi-static channel access <sup>Note 7,8</sup>		1, 2	$P_{CCA\_DL}=0.9375$	
OCNG Patterns defined in A.3.2.1.1 (OP.1)		1, 2	OP.1	
SMTC configuration defined in A.3.11.1 and A.3.11.2		1, 2	SMTC.1	
DBT window configuration		1, 2	DBT.1	
SSB configuration for semi-static channel access		1, 2	SSB.1 CCA	
SSB configuration for dynamic channel access		1, 2	SSB.2 CCA	
PDSCH/PDCCH subcarrier spacing	kHz	1, 2	30	
b2-Threshold2NR	dBm	1, 2	-98 for SS-RSRP	
	dB	1, 2	55 for SS-RSRQ	
		1, 2	50 for SS-SINR	
EPRE ratio of PSS to SSS		1, 2	0	
EPRE ratio of PBCH DMRS to SSS				
EPRE ratio of PBCH to PBCH DMRS				
EPRE ratio of PDCCH DMRS to SSS				
EPRE ratio of PDCCH to PDCCH DMRS				
EPRE ratio of PDSCH DMRS to SSS				
EPRE ratio of PDSCH to PDSCH				
EPRE ratio of OCNG DMRS to SSS (Note 1)				
EPRE ratio of OCNG to OCNG DMRS (Note 1)				
$N_{oc}$ <sup>Note2</sup>	dBm/15kHz	1, 2	-98	
$N_{oc}$ <sup>Note2</sup>	dBm/SCS	1, 2	-95	
SS-RSRP <sup>Note 3,5</sup>	dBm/SCS	1, 2	-Infinity	-88

$\hat{E}_s/I_{ot}$ Note 5	dB	1, 2	-Infinity	7
$\hat{E}_s/N_{oc}$ Note 5	dB	1, 2	-Infinity	7
$I_o$ Note 3	dBm/38.16MHz	1, 2	-63.95	-56.16
Propagation Condition		1, 2	ETU70	
Antenna Configuration and Correlation Matrix		1, 2,	1x2 Low	
<p>NOTE 1: OCNG shall be used such that the cell is fully allocated and a constant total transmitted power spectral density is achieved for all OFDM symbols.</p> <p>NOTE 2: Interference from other cells and noise sources not specified in the test is assumed to be constant over subcarriers and time and shall be modelled as AWGN of appropriate power for <math>\hat{E}_s/I_{ot}</math> to be fulfilled.</p> <p>NOTE 3: SS-RSRP and <math>I_o</math> levels have been derived from other parameters for information purposes. They are not settable parameters themselves.</p> <p>NOTE 4: SS-RSRP minimum requirements are specified assuming independent interference and noise at each receiver antenna port.</p> <p>NOTE 5: The signal levels apply for SSS REs when the discovery burst is transmitted during DBT windows.</p> <p>NOTE 6: For UE supporting semi-static channel access and network configuring semi-static channel occupancy.</p> <p>NOTE 7: For UE supporting dynamic channel access and network configuring dynamic channel occupancy.</p> <p>NOTE 8: For a UE supporting both semi-static and dynamic channel access, the UE can be tested under dynamic channel occupancy only.</p>				

#### A.12.4.2.2.2 Test Requirements

In test 1 with per-UE gap, the UE shall send one Event B2 triggered measurement report, with a measurement reporting delay less than  $T_{\text{identify\_irat\_cca\_without\_index}}$  ms from the beginning of time period T2. The UE shall not send event triggered measurement reports, as long as the reporting criteria are not fulfilled. The rate of correct events observed during repeated tests shall be at least 90%.

In test 2 with per-UE gap, the UE shall send one Event B2 triggered measurement report, with a measurement reporting delay less than  $T_{\text{identify\_irat\_cca\_without\_index}}$  ms from the beginning of time period T2. The UE shall not send event triggered measurement reports, as long as the reporting criteria are not fulfilled. The rate of correct events observed during repeated tests shall be at least 90%.

In test 3 with per-FR gap, the UE shall send one Event B2 triggered measurement report, with a measurement reporting delay less than  $T_{\text{identify\_irat\_cca\_without\_index}}$  ms from the beginning of time period T2. The UE shall not send event triggered measurement reports, as long as the reporting criteria are not fulfilled. The rate of correct events observed during repeated tests shall be at least 90%.

In test 4 with per-FR gap, the UE shall send one Event B2 triggered measurement report, with a measurement reporting delay less than  $T_{\text{identify\_irat\_cca\_without\_index}}$  ms from the beginning of time period T2. The UE shall not send event triggered measurement reports, as long as the reporting criteria are not fulfilled. The rate of correct events observed during repeated tests shall be at least 90%.

In tests 1, 2, 3 and 4, the UE is not required to report SSB time index.

NOTE: The actual overall delays measured in the test may be up to  $2 \times TTI_{DCC}$  higher than the measurement reporting delays above because of TTI insertion uncertainty of the measurement report in DCC.

#### A.12.4.2.3 NR Inter-RAT event triggered reporting tests for FR1 with SSB time index detection when DRX is not used

##### A.12.4.2.3.1 Test Purpose and Environment

The purpose of this test is to verify that the UE makes correct reporting of an event. This test will partly verify the NR inter-RAT cell search requirements in clause 8.1.2.4.21A of TS 36.133 [15] for E-UTRAN FDD-NR measurements and clause 8.1.2.4.22A of TS 36.133 [15] for E-UTRAN TDD-NR measurements.

In this test, there are two cells: E-UTRA cell 1 as PCell on E-UTRA RF channel 1 and NR cell 2 as neighbour cell in FR1 on NR RF channel 1 on a carrier frequency with CCA. The test parameters are given in Tables A.12.4.2.3.1-1, A.12.4.2.3.1-2, A.12.4.2.3.1-3 and A.12.4.2.3.1-4. Cell transmits SSBs in DBT windows according to DL CCA model.

In test 1 measurement gap pattern configuration # 0 as defined in Table A.12.4.2.3.1-2 is provided for UE that does not support per-FR gap and in test 2 measurement gap pattern configuration #4 as defined in Table A.12.4.2.3.1-2 is provided for UE that supports per-FR gap.

In the measurement control information, it is indicated to the UE that event-triggered reporting with Event B2 (PCell becomes worse than threshold1 and inter RAT neighbour becomes better than threshold2) [16] is used. The UE is tested when MeasTriggerQuantity is configured as RSRP, RSRQ and SINR for each test. In the measurement configuration the UE shall be indicated to report the SSB index of the identified NR cell. The test consists of two successive time periods, with time duration of T1, and T2 respectively. During time duration T1, the UE shall not have any timing information of NR cell 2.

**Table A.12.4.2.3.1-1: NR inter-RAT event triggered reporting tests with SSB index reading for FR1**

Configuration	Description
1	LTE FDD; NR with CCA: SCS 30 kHz, BW 40 MHz, TDD
2	LTE TDD; NR with CCA: SCS 30 kHz, BW 40 MHz, TDD
NOTE: The UE is only required to pass in one of the supported test configurations in FR1	

**Table A.12.4.2.3.1-2: General test parameters for NR inter-RAT event triggered reporting for FR1 with SSB time index detection**

Parameter	Unit	Test configuration	Value		Comment
			Test 1	Test 2	
E-UTRA RF Channel Number		1, 2	1		One E-UTRA carrier frequency is used.
NR RF Channel Number		1, 2	1		One FR1 NR carrier frequency under CCA is used.
DL CCA model			As specified in clause A.3.26.2.1		
UL CCA model			As specified in clause A.3.26.2.2		
Active cell		1, 2	E-UTRA cell 1 (PCell)		E-UTRA cell 1 is on E-UTRA RF channel number 1.
Neighbour cell		1, 2	NR cell 2		NR cell 2 is on NR RF channel number 1.
Gap Pattern Id		1, 2	0	4	As specified in clause Table 8.1.2.1-1 of TS 36.133 [15].
Measurement gap offset		1, 2	39	19	As specified in TS 36.331 [16].
b2-Threshold1	dBm	1, 2	Note 1		E-UTRA RSRP/RSRQ/SINR threshold for E-UTRA RSRP measurement on cell 1 for event B2 [16]
b2-Threshold2NR	dBm	1, 2	Note 2		SS-RSRP/ SS-RSRQ/ SS-SINR threshold measurement on cell 2 for event B2 [16]
Hysteresis	dB	1, 2	0		
CP length		1, 2	Normal		
TimeToTrigger	s	1, 2	0		
Filter coefficient		1, 2	0		L3 filtering is not used
DRX		1, 2	OFF		DRX is not used
Time offset between serving and neighbour cells		1, 2	3µs		Synchronous cells.
T1	s	1, 2	5		
T2	s	1, 2	$\geq T_{\text{identify\_irat\_cca\_with\_index}}$	$\geq T_{\text{identify\_irat\_cca\_with\_index}}$	$T_{\text{identify\_irat\_cca\_with\_index}}$ is defined in clause 8.1.2.4.21A.1 and 8.1.2.4.22A.1 in TS 36.133
Note 1: The value of b2-Threshold1 is defined in Table A.12.4.2.3.1-3					
Note 2: The value of b2-Threshold2NR is defined in Table A.12.4.2.3.1-4					

**Table A.12.4.2.3.1-3: E-UTRAN PCell specific test parameters for NR inter-RAT event triggered reporting in non-DRX with NR neighbour cell in FR1 with SSB time index detection**

Parameter	Unit	Configuration	Cell 1	
			T1	T2
RF channel number		1, 2	1	
Duplex mode		1	FDD	
		2	TDD	
TDD special subframe configuration <sup>Note1</sup>		2	6	
TDD uplink-downlink configuration <sup>Note1</sup>		2	1	
BW <sub>channel</sub>	MHz	1, 2	5 MHz: N <sub>RB,c</sub> = 25 10 MHz: N <sub>RB,c</sub> = 50 20 MHz: N <sub>RB,c</sub> = 100	
PDSCH parameters: DL Reference Measurement Channel <sup>Note2</sup>		1	5 MHz: R.7 FDD 10 MHz: R.3 FDD 20 MHz: R.6 FDD	
		2	5 MHz: R.4 TDD 10 MHz: R.0 TDD 20 MHz: R.3 TDD	
PCFICH/PDCCH/PHICH parameters: DL Reference Measurement Channel <sup>Note2</sup>		1	5 MHz: R.11 FDD 10 MHz: R.6 FDD 20 MHz: R.10 FDD	
		2	5 MHz: R.11 TDD 10 MHz: R.6 TDD 20 MHz: R.10 TDD	
OCNG Patterns <sup>Note2</sup>		1	5 MHz: OP.20 FDD 10 MHz: OP.10 FDD 20 MHz: OP.17 FDD	
		2	5 MHz: OP.9 TDD 10 MHz: OP.1 TDD 20 MHz: OP.7 TDD	
b2-Threshold1	dBm	1, 2	-77 for RSRP	
	dB	1, 2	77 for RSRQ	
	dB	1, 2	90 for SINR	
PBCH_RA	dB	1, 2	0	
PBCH_RB				
PSS_RA				
SSS_RA				
PCFICH_RB				
PHICH_RA				
PHICH_RB				
PDCCH_RA				
PDCCH_RB				
PDSCH_RA				
PDSCH_RB				
OCNG_RA <sup>Note3</sup>				
OCNG_RB <sup>Note3</sup>				
N <sub>oc</sub> <sup>Note4</sup>				
E <sub>s</sub> /N <sub>oc</sub>	dB	1, 2	17	17
E <sub>s</sub> /I <sub>ot</sub> <sup>Note5</sup>	dB	1, 2	17	17
RSRP <sup>Note5</sup>	dBm/15kHz	1, 2	-87	-87
SCH_RP <sup>Note5</sup>	dBm/15kHz	1, 2	-87	-87
I <sub>o</sub> <sup>Note5</sup>	dBm/9MHz	1, 2	-59.13+10log (N <sub>RB,c</sub> /50)	-59.13+10log (N <sub>RB,c</sub> /50)
Propagation Condition <sup>Note6</sup>		1, 2	ETU70	
Antenna Configuration and Correlation Matrix <sup>Note6</sup>		1, 2	1x2 Low	
<p>Note 1: Special subframe and uplink-downlink configurations are specified in table 4.2-1 in TS 36.211 [23].</p> <p>Note 2: DL RMCs and OCNG patterns are specified in clauses A 3.1 and A 3.2 of TS 36.133 [15] respectively.</p> <p>Note 3: OCNG shall be used such that all cells are fully allocated and a constant total transmitted power spectral density is achieved for all OFDM symbols.</p> <p>Note 4: Interference from other cells and noise sources not specified in the test is assumed to be constant over subcarriers and time and shall be modelled as AWGN of appropriate power for N<sub>oc</sub> to be fulfilled.</p>				



Note 5:  $\hat{E}_s/I_{ot}$ , RSRP, SCH\_RP and  $I_o$  levels have been derived from other parameters for information purposes. They are not settable parameters themselves.  
 Note 6: Propagation condition and correlation matrix are defined in clause B.2 in TS 36.101 [25].

**Table A.12.4.2.3.1-4: NR neighbour cell specific test parameters for NR inter-RAT event triggered reporting for FR1 with SSB time index detection**

Parameter	Unit	Test configuration	Cell 2	
			T1	T2
NR RF Channel Number		1, 2	1	
TDD configuration		1, 2	TDDConf.1.1 CCA	
BW <sub>channel</sub>	MHz	1, 2	40: N <sub>RB,c</sub> = 106	
P <sub>CCA_DL</sub> for dynamic channel access <sup>Note 6,8</sup>		1, 2	P <sub>CCA_DL_1</sub> =0.75 P <sub>CCA_DL_2</sub> =0.75	
P <sub>CCA_DL</sub> for semi-static channel access <sup>Note 7,8</sup>		1, 2	P <sub>CCA_DL</sub> =0.9375	
OCNG Patterns defined in A.3.2.1.1 (OP.1)		1, 2	OP.1	
SMTC configuration defined in A.3.11.1 and A.3.11.2		1, 2	SMTC.1	
DBT window configuration		1, 2	DBT.1	
SSB configuration for semi-static channel access		1, 2	SSB.1 CCA	
SSB configuration for dynamic channel access		1, 2	SSB.2 CCA	
PDSCH/PDCCH subcarrier spacing	kHz	1, 2	30	
b2-Threshold2NR	dBm	1, 2	-98 for SS-RSRP	
	dB	1, 2	55 for SS-RSRQ	
		1, 2	50 for SS-SINR	
EPRE ratio of PSS to SSS		1, 2	0	
EPRE ratio of PBCH DMRS to SSS				
EPRE ratio of PBCH to PBCH DMRS				
EPRE ratio of PDCCH DMRS to SSS				
EPRE ratio of PDCCH to PDCCH DMRS				
EPRE ratio of PDSCH DMRS to SSS				
EPRE ratio of PDSCH to PDSCH				
EPRE ratio of OCNG DMRS to SSS (Note 1)				
EPRE ratio of OCNG to OCNG DMRS (Note 1)				
N <sub>oc</sub> <sup>Note2</sup>	dBm/15kHz	1, 2	-98	
N <sub>oc</sub> <sup>Note2</sup>	dBm/SCS	1, 2	-95	
SS-RSRP <sup>Note 3,5</sup>	dBm/SCS	1, 2	-Infinity	-88
$\hat{E}_s/I_{ot}$ <sup>Note 5</sup>	dB	1, 2	-Infinity	7
$\hat{E}_s/N_{oc}$ <sup>Note 5</sup>	dB	1, 2	-Infinity	7
I <sub>o</sub> <sup>Note3</sup>	dBm/38.16MHz	1, 2	-63.95	-56.16
Propagation Condition		1, 2	ETU70	
Antenna Configuration and Correlation Matrix		1, 2,	1x2 Low	

NOTE 1:	OCNG shall be used such that the cell is fully allocated and a constant total transmitted power spectral density is achieved for all OFDM symbols.
NOTE 2:	Interference from other cells and noise sources not specified in the test is assumed to be constant over subcarriers and time and shall be modelled as AWGN of appropriate power for $N$ to be fulfilled.
NOTE 3:	SS-RSRP and $I_0$ levels have been derived from other parameters for information purposes. They are not settable parameters themselves.
NOTE 4:	SS-RSRP minimum requirements are specified assuming independent interference and noise at each receiver antenna port.
NOTE 5:	The signal levels apply for SSS REs when the discovery burst is transmitted during DBT windows.
NOTE 6:	For UE supporting semi-static channel access and network configuring semi-static channel occupancy.
NOTE 7:	For UE supporting dynamic channel access and network configuring dynamic channel occupancy.
NOTE 8:	For a UE supporting both semi-static and dynamic channel access, the UE can be tested under dynamic channel occupancy only.

### A.12.4.2.3.2 Test Requirements

In test 1 with per-UE gap, the UE shall send one Event B2 triggered measurement report, with a measurement reporting delay less than  $T_{\text{identify\_irat\_cca\_with\_index}}$  ms from the beginning of time period T2. The UE shall not send event triggered measurement reports, as long as the reporting criteria are not fulfilled. The rate of correct events observed during repeated tests shall be at least 90%.

In test 2 with per-FR gap, the UE shall send one Event B2 triggered measurement report, with a measurement reporting delay less than  $T_{\text{identify\_irat\_cca\_with\_index}}$  ms from the beginning of time period T2. The UE shall not send event triggered measurement reports, as long as the reporting criteria are not fulfilled. The rate of correct events observed during repeated tests shall be at least 90%.

In test 1 and test 2, the UE is required to report SSB time index.

NOTE: The actual overall delays measured in the test may be up to  $2xTTI_{\text{DCCH}}$  higher than the measurement reporting delays above because of TTI insertion uncertainty of the measurement report in DCCH.

### A.12.4.2.4 NR Inter-RAT event triggered reporting tests for FR1 with SSB time index detection when DRX is used

#### A.12.4.2.4.1 Test Purpose and Environment

The purpose of this test is to verify that the UE makes correct reporting of an event. This test will partly verify the NR inter-RAT cell search requirements in clause 8.1.2.4.21A of TS 36.133 [15] for E-UTRAN FDD-NR measurements and clause 8.1.2.4.22A of TS 36.133 [15] for E-UTRAN TDD-NR measurements.

In this test, there are two cells: E-UTRA cell 1 as PCell on E-UTRA RF channel 1 and NR cell 2 as neighbour cell in FR1 on NR RF channel 1 on a carrier frequency with CCA. The test parameters are given in Tables A.12.4.2.4.1-1, A.12.4.2.4.1-2, A.12.4.2.4.1-3 and A.12.4.2.4.1-4. Cell transmits SSBs in DBT windows according to DL CCA model.

In tests 1 and 2, measurement gap pattern configuration # 0 as defined in Table A.12.4.2.4.1-2 is provided for UE that does not support per-FR gap and in tests 3 and 4, measurement gap pattern configuration #4 as defined in Table A.12.4.2.4.1-2 is provided for UE that supports per-FR gap.

In the measurement control information, it is indicated to the UE that event-triggered reporting with Event B2 (PCell becomes worse than threshold1 and inter RAT neighbour becomes better than threshold2) [16] is used. In the measurement configuration the UE shall be indicated to report the SSB index of the identified NR cell. The test consists of two successive time periods, with time duration of T1, and T2 respectively. During time duration T1, the UE shall not have any timing information of NR cell 2.

**Table A.12.4.2.4.1-1: NR inter-RAT event triggered reporting tests with SSB index reading for FR1**

Configuration	Description
1	LTE FDD; NR with CCA: SCS 30 kHz, BW 40 MHz, TDD
2	LTE TDD; NR with CCA: SCS 30 kHz, BW 40 MHz, TDD
NOTE:	The UE is only required to pass in one of the supported test configurations in FR1

**Table A.12.4.2.4.1-2: General test parameters for NR inter-RAT event triggered reporting for FR1 with SSB time index detection**

Parameter	Unit	Test configuration	Value				Comment
			Test 1	Test 2	Test 3	Test 4	
E-UTRA RF Channel Number		1, 2	1				One E-UTRA carrier frequency is used.
NR RF Channel Number		1, 2	1				One FR1 NR carrier frequency under CCA is used.
DL CCA model			As specified in clause A.3.26.2.1				
UL CCA model			As specified in clause A.3.26.2.2				
Active cell		1, 2	E-UTRA cell 1 (PCell)				E-UTRA cell 1 is on E-UTRA RF channel number 1.
Neighbour cell		1, 2	NR cell 2				NR cell 2 is on NR RF channel number 1.
Gap Pattern Id		1, 2	0	4			As specified in clause Table 8.1.2.1-1 of TS 36.133 [15].
Measurement gap offset		1, 2	39	19			As specified in TS 36.331 [16].
b2-Threshold1	dBm	1, 2	Note 1				E-UTRA RSRP/RSRQ/SINR threshold for E-UTRA RSRP measurement on cell 1 for event B2 [16]
b2-Threshold2NR	dBm	1, 2	Note 2				SS-RSRP/ SS-RSRQ/ SS-SINR threshold measurement on cell 2 for event B2 [16]
Hysteresis	dB	1, 2	0				
CP length		1, 2	Normal				
TimeToTrigger	s	1, 2	0				
Filter coefficient		1, 2	0				L3 filtering is not used
DRX		1, 2	DR X.9	DR X.1	DR X.9	DR X.1	As specified in clause A.3.3
Time offset between serving and neighbour cells		1, 2	3μs				Synchronous cells.
T1	s	1, 2	5				
T2	s	1, 2	$\geq T_{\text{identify\_irat\_cca\_with\_index}}$				$T_{\text{identify\_irat\_cca\_with\_index}}$ is defined in clause 8.1.2.4.21A.1 and 8.1.2.4.22A.1 in TS 36.133
Note 1: The value of b2-Threshold1 is defined in Table A.12.4.2.4.1-3							
Note 2: The value of b2-Threshold2NR is defined in Table A.12.4.2.4.1-4							

**Table A.12.4.2.4.1-3: E-UTRAN PCell specific test parameters for NR inter-RAT event triggered reporting in non-DRX with NR neighbour cell in FR1 with SSB time index detection**

Parameter	Unit	Configuration	Cell 1	
			T1	T2
RF channel number		1, 2	1	
Duplex mode		1	FDD	
		2	TDD	
TDD special subframe configuration <sup>Note1</sup>		2	6	
TDD uplink-downlink configuration <sup>Note1</sup>		2	1	
BW <sub>channel</sub>	MHz	1, 2	5 MHz: N <sub>RB,c</sub> = 25 10 MHz: N <sub>RB,c</sub> = 50 20 MHz: N <sub>RB,c</sub> = 100	
PDSCH parameters:		1	5 MHz: R.7 FDD	

DL Reference Measurement Channel <sup>Note2</sup>			10 MHz: R.3 FDD 20 MHz: R.6 FDD
		2	5 MHz: R.4 TDD 10 MHz: R.0 TDD 20 MHz: R.3 TDD
PCFICH/PDCCH/PHICH parameters: DL Reference Measurement Channel <sup>Note2</sup>		1	5 MHz: R.11 FDD 10 MHz: R.6 FDD 20 MHz: R.10 FDD
		2	5 MHz: R.11 TDD 10 MHz: R.6 TDD 20 MHz: R.10 TDD
OCNG Patterns <sup>Note2</sup>		1	5 MHz: OP.20 FDD 10 MHz: OP.10 FDD 20 MHz: OP.17 FDD
		2	5 MHz: OP.9 TDD 10 MHz: OP.1 TDD 20 MHz: OP.7 TDD
b2-Threshold1	dBm	1, 2	-77 for RSRP
	dB	1, 2	77 for RSRQ
	dB	1, 2	90 for SINR
PBCH_RA	dB	1, 2	0
PBCH_RB			
PSS_RA			
SSS_RA			
PCFICH_RB			
PHICH_RA			
PHICH_RB			
PDCCH_RA			
PDCCH_RB			
PDSCH_RA			
PDSCH_RB			
OCNG_RA <sup>Note3</sup>			
OCNG_RB <sup>Note3</sup>			
N <sub>oc</sub> <sup>Note4</sup>			
$\bar{E}_s/N_{oc}$	dB	1, 2	17
$\bar{E}_s/I_{ot}$ <sup>Note5</sup>	dB	1, 2	17
RSRP <sup>Note5</sup>	dBm/15kHz	1, 2	-87
SCH_RP <sup>Note5</sup>	dBm/15kHz	1, 2	-87
I <sub>o</sub> <sup>Note5</sup>	dBm/9MHz	1, 2	-59.13+10log (N <sub>RB,c</sub> /50)
Propagation Condition <sup>Note6</sup>		1, 2	ETU70
Antenna Configuration and Correlation Matrix <sup>Note6</sup>		1, 2	1x2 Low
<p>Note 1: Special subframe and uplink-downlink configurations are specified in table 4.2-1 in TS 36.211 [23].</p> <p>Note 2: DL RMCs and OCNG patterns are specified in clauses A 3.1 and A 3.2 of TS 36.133 [15] respectively.</p> <p>Note 3: OCNG shall be used such that all cells are fully allocated and a constant total transmitted power spectral density is achieved for all OFDM symbols.</p> <p>Note 4: Interference from other cells and noise sources not specified in the test is assumed to be constant over subcarriers and time and shall be modelled as AWGN of appropriate power for N<sub>oc</sub> to be fulfilled.</p> <p>Note 5: <math>\bar{E}_s/I_{ot}</math>, RSRP, SCH_RP and I<sub>o</sub> levels have been derived from other parameters for information purposes. They are not settable parameters themselves.</p> <p>Note 6: Propagation condition and correlation matrix are defined in clause B.2 in TS 36.101 [25].</p>			

**Table A.12.4.2.4.1-4: NR neighbour cell specific test parameters for NR inter-RAT event triggered reporting for FR1 with SSB time index detection**

Parameter	Unit	Test configuration	Cell 2	
			T1	T2
NR RF Channel Number		1, 2	1	
TDD configuration		1, 2	TDDConf.1.1 CCA	
BW <sub>channel</sub>	MHz	1, 2	40: N <sub>RB,c</sub> = 106	
P <sub>CCA_DL</sub> for dynamic channel access <sup>Note 6,8</sup>		1, 2	P <sub>CCA_DL_1</sub> =0.75 P <sub>CCA_DL_2</sub> =0.75	

$P_{CCA\_DL}$ for semi-static channel access <sup>Note 7,8</sup>		1, 2	$P_{CCA\_DL}=0.9375$	
OCNG Patterns defined in A.3.2.1.1 (OP.1)		1, 2	OP.1	
SMTC configuration defined in A.3.11.1 and A.3.11.2		1, 2	SMTC.1	
DBT window configuration		1, 2	DBT.1	
SSB configuration for semi-static channel access		1, 2	SSB.1 CCA	
SSB configuration for dynamic channel access		1, 2	SSB.2 CCA	
PDSCH/PDCCH subcarrier spacing	kHz	1, 2	30	
b2-Threshold2NR	dBm/SCS	1, 2	-98 for SS-RSRP	
	dB	1, 2	55 for SS-RSRQ	
		1, 2	50 for SS-SINR	
EPRE ratio of PSS to SSS		1, 2	0	
EPRE ratio of PBCH DMRS to SSS				
EPRE ratio of PBCH to PBCH DMRS				
EPRE ratio of PDCCH DMRS to SSS				
EPRE ratio of PDCCH to PDCCH DMRS				
EPRE ratio of PDSCH DMRS to SSS				
EPRE ratio of PDSCH to PDSCH				
EPRE ratio of OCNG DMRS to SSS (Note 1)				
EPRE ratio of OCNG to OCNG DMRS (Note 1)				
$N_{oc}$ <sup>Note2</sup>	dBm/15kHz			
$N_{oc}$ <sup>Note2</sup>	dBm/SCS	1, 2	-95	
SS-RSRP <sup>Note 3,5</sup>	dBm/SCS	1, 2	-Infinity	-88
$\hat{E}_s/I_{ot}$ <sup>Note 5</sup>	dB	1, 2	-Infinity	7
$\hat{E}_s/N_{oc}$ <sup>Note 5</sup>	dB	1, 2	-Infinity	7
$I_o$ <sup>Note3</sup>	dBm/38.16MHz	1, 2	-63.95	-56.16
Propagation Condition		1, 2	ETU70	
Antenna Configuration and Correlation Matrix		1, 2,	1x2 Low	
<p>NOTE 1: OCNG shall be used such that the cell is fully allocated and a constant total transmitted power spectral density is achieved for all OFDM symbols.</p> <p>NOTE 2: Interference from other cells and noise sources not specified in the test is assumed to be constant over subcarriers and time and shall be modelled as AWGN of appropriate power for <math>N_{oc}</math> to be fulfilled.</p> <p>NOTE 3: SS-RSRP and <math>I_o</math> levels have been derived from other parameters for information purposes. They are not settable parameters themselves.</p> <p>NOTE 4: SS-RSRP minimum requirements are specified assuming independent interference and noise at each receiver antenna port.</p> <p>NOTE 5: The signal levels apply for SSS REs when the discovery burst is transmitted during DBT windows.</p> <p>NOTE 6: For UE supporting semi-static channel access and network configuring semi-static channel occupancy.</p> <p>NOTE 7: For UE supporting dynamic channel access and network configuring dynamic channel occupancy.</p> <p>NOTE 8: For a UE supporting both semi-static and dynamic channel access, the UE can be tested under dynamic channel occupancy only.</p>				

#### A.12.4.2.4.2 Test Requirements

In test 1 with per-UE gap, the UE shall send one Event B2 triggered measurement report, with a measurement reporting delay less than  $T_{identify\_irat\_cca\_with\_index}$  ms from the beginning of time period T2. The UE shall not send event triggered measurement reports, as long as the reporting criteria are not fulfilled. The rate of correct events observed during repeated tests shall be at least 90%.

In test 2 with per-UE gap, the UE shall send one Event B2 triggered measurement report, with a measurement reporting delay less than  $T_{identify\_irat\_cca\_with\_index}$  ms from the beginning of time period T2. The UE shall not send event triggered measurement reports, as long as the reporting criteria are not fulfilled. The rate of correct events observed during repeated tests shall be at least 90%.

In test 3 with per-FR gap, the UE shall send one Event B2 triggered measurement report, with a measurement reporting delay less than  $T_{\text{identify\_irat\_cca\_with\_index}}$  ms from the beginning of time period T2. The UE shall not send event triggered measurement reports, as long as the reporting criteria are not fulfilled. The rate of correct events observed during repeated tests shall be at least 90%.

In test 4 with per-FR gap, the UE shall send one Event B2 triggered measurement report, with a measurement reporting delay less than  $T_{\text{identify\_irat\_cca\_with\_index}}$  ms from the beginning of time period T2. The UE shall not send event triggered measurement reports, as long as the reporting criteria are not fulfilled. The rate of correct events observed during repeated tests shall be at least 90%.

In tests 1, 2, 3 and 4, the UE is required to report SSB time index.

NOTE: The actual overall delays measured in the test may be up to  $2xTTI_{\text{DCCH}}$  higher than the measurement reporting delays above because of TTI insertion uncertainty of the measurement report in DCCH.

## A.12.4.2.5 RSSI measurement reporting

### A.12.4.2.5.1 Test purpose and environment

The purpose of this test is to verify that the UE correctly reports RSSI measurements. This test will partly verify the inter-RAT RSSI measurement reporting requirements in TS 36.133 [15, Section 8.1.2.4.21A.1.5].

### A.12.4.2.5.2 Test parameters

In the test, the UE is configured to perform inter-RAT RSSI measurements on a carrier frequency under CCA.

Supported test configurations are shown in Table A.12.4.2.5.2-1. There are two cells in the test: Cell 1 is E-UTRAN PCell on a licensed band. Prior to the start of the time duration T1, the UE is connected to Cell 1. Cell 2 is NR Cell on an unlicensed band under CCA. The RSSI measurement is performed on an inter-RAT carrier frequency under CCA. The E-UTRAN PCell setting refers to Table A.3.7.2.1-1. The Inter-RAT RSSI measurement test parameters are defined in table A.12.4.2.5.2-2 and A.12.4.2.5.2-3.

**Table A.12.4.2.5.2-1: Supported test configurations.**

Configuration	Description
1	LTE FDD; NR: TDD, SSB SCS 30 kHz, data SCS 30 kHz, BW 40 MHz
2	LTE TDD; NR: TDD, SSB SCS 30 kHz, data SCS 30 kHz, BW 40 MHz
NOTE: The UE is only required to pass in one of the supported test configurations above.	

**Table A.12.4.2.5.2-2: Inter-RAT RSSI test parameters**

Parameter		Configurations	Unit	Test 1
				Cell 2
RF Channel Number				2
BW <sub>channel</sub>			MHz	40
SSB configuration	Semi-static channel access Note 1, 3	1, 2		SSB.1 CCA
	Dynamic channel access Note 2, 3	1, 2		SSB.2 CCA
P <sub>CCA_DL</sub> for dynamic channel access Note 1,3		1, 2		P <sub>CCA_DL_1</sub> =0.75 P <sub>CCA_DL_2</sub> =0.75
P <sub>CCA_DL</sub> for semi-static channel access Note 2,3		1, 2		P <sub>CCA_DL</sub> =0.9375
P <sub>CCA_UL</sub>		1, 2		1
Gap Pattern Id		1, 2		0
Measurement gap offset		1, 2		19
DL CCA model		1, 2		As specified in A.3.26.2.1
UL CCA model		1, 2		As specified in A.3.26.2.2

PDSCH Reference measurement channel	1, 2		NA		
RMSI CORESET Reference Channel	1, 2		NA		
Dedicated CORESET Reference Channel	1, 2		NA		
OCNG Patterns	1, 2		NA		
EPRE ratio of PSS to SSS	1, 2	dB	NA		
EPRE ratio of PBCH DMRS to SSS	1, 2				
EPRE ratio of PBCH to PBCH DMRS	1, 2				
EPRE ratio of PDCCH DMRS to SSS	1, 2				
EPRE ratio of PDCCH to PDCCH DMRS	1, 2				
EPRE ratio of PDSCH DMRS to SSS	1, 2				
EPRE ratio of PDSCH to PDSCH	1, 2				
EPRE ratio of OCNG DMRS to SSS(Note 1)	1, 2				
EPRE ratio of OCNG to OCNG DMRS (Note 1)	1, 2				
$N_{oc}$ in slots not corresponding to RSSI measurement time configuration (RMTC)	1, 2			dBm/SCS	-106
$N_{oc}$ in slots corresponding to RSSI measurement time configuration (RMTC)	1, 2			dBm/SCS	-87
$\hat{E}_s/I_{ot}$ in slots not corresponding to RSSI measurement time configuration (RMTC)	1, 2			dB	2.5
$\hat{E}_s/I_{ot}$ in slots corresponding to RSSI measurement time configuration (RMTC)	1, 2	dB	-Infinity		
SS-RSRP in slots not corresponding to RSSI measurement time configuration (RMTC)	1, 2	dBm/SCS	-103.5		
SS-RSRP in slots corresponding to RSSI measurement time configuration (RMTC)	1, 2		-Infinity		
$I_o$ within measurement bandwidth in slots not corresponding to RSSI measurement time configuration (RMTC)	1, 2	dBm/SCS	-101.6		
$I_o$ within measurement bandwidth in slots corresponding to RSSI measurement time configuration (RMTC)	1, 2	dBm/SCS	-87		
Time offset between Cell 1 and Cell 2	1, 2	$\mu$ s	3		
Propagation condition	1, 2		AWGN		
<p>Note 1: For UE supporting semi-static channel access and network configuring semi-static channel occupancy.</p> <p>Note 2: For UE supporting dynamic channel access and network configuring dynamic channel occupancy.</p> <p>Note 3: For a UE supporting both semi-static and dynamic channel access, the UE can be tested under dynamic channel occupancy only.</p>					

Table A.12.4.2.5.2-3: RSSI RMTC parameters

measDurationSymbols-r16	sym14or12
rmtc-Periodicity-r16	ms40
rmtc-SubframeOffset-r16	20
ref-SCS-CP-r16	kHz15

ReportInterval	ms120
----------------	-------

### A.12.4.2.5.3 Test Requirements

In the test the UE shall send RSSI measurement report, with a measurement reporting delay less than  $T_{\text{RSSI\_measurement\_period\_NR\_cca}}$  ms from the beginning of time period T1. The rate of correct events observed during repeated tests shall be at least 90%.

### A.12.4.2.6 Channel occupancy measurement reporting

#### A.12.4.2.6.1 Test purpose and environment

The purpose of this test is to verify that the UE correctly reports channel occupancy measurements. This test will partly verify the inter-RAT channel occupancy measurement reporting requirements in TS 36.133 [15, Section 8.1.2.4.21A.1.6].

#### A.12.4.2.6.2 Test parameters

In the test, the UE is configured to perform inter-frequency channel occupancy measurements on a carrier frequency under CCA.

Supported test configurations are shown in Table A.12.4.2.6.2-1. There are two cells in the test: Cell 1 which is E-UTRAN PCell on a licensed band. Prior to the start of the time duration T1, the UE is connected to Cell 1. Cell 2 is NR Cell on an unlicensed band under CCA. The channel occupancy measurement is performed on an inter-RAT carrier frequency under CCA. The E-UTRAN PCell setting refers to Table A.3.7.2.1-1. The Inter-RAT CO measurement test parameters are defined in table A.12.4.2.6.2-2 and A.12.4.2.6.2-3.

**Table A.12.4.2.6.2-1: Supported test configurations.**

Configuration	Description
1	LTE FDD; NR: TDD, SSB SCS 30 kHz, data SCS 30 kHz, BW 40 MHz
2	LTE TDD; NR: TDD, SSB SCS 30 kHz, data SCS 30 kHz, BW 40 MHz
NOTE: The UE is only required to pass in one of the supported test configurations above.	

**Table A.12.4.2.6.2-2: Inter-RAT CO test parameters**

Parameter		Configurations	Unit	Test 1
				Cell 2
RF Channel Number				2
BW <sub>channel</sub>			MHz	40
SSB configuration	Semi-static channel access Note 1, 3	1, 2		SSB.1 CCA
	Dynamic channel access Note 2, 3	1, 2		SSB.2 CCA
P <sub>CCA_DL</sub> for dynamic channel access Note 1,3		1, 2		P <sub>CCA_DL_1</sub> =0.75 P <sub>CCA_DL_2</sub> =0.75
P <sub>CCA_DL</sub> for semi-static channel access Note 2,3		1, 2		P <sub>CCA_DL</sub> =0.9375
P <sub>CCA_UL</sub>		1, 2		1
Gap Pattern Id		1, 2		0
Measurement gap offset		1, 2		19
DL CCA model		1, 2		As specified in A.3.26.2.1
UL CCA model		1, 2		As specified in A.3.26.2.2
PDSCH Reference measurement channel		1, 2		NA



RMSI CORESET Reference Channel	1, 2		NA		
Dedicated CORESET Reference Channel	1, 2		NA		
OCNG Patterns	1, 2		NA		
EPRE ratio of PSS to SSS	1, 2	dB	NA		
EPRE ratio of PBCH DMRS to SSS	1, 2				
EPRE ratio of PBCH to PBCH DMRS	1, 2				
EPRE ratio of PDCCH DMRS to SSS	1, 2				
EPRE ratio of PDCCH to PDCCH DMRS	1, 2				
EPRE ratio of PDSCH DMRS to SSS	1, 2				
EPRE ratio of PDSCH to PDSCH	1, 2				
EPRE ratio of OCNG DMRS to SSS(Note 1)	1, 2				
EPRE ratio of OCNG to OCNG DMRS (Note 1)	1, 2				
$N_{oc}$ in slots not corresponding to RSSI measurement time configuration (RMTC)	1, 2			dBm/SCS	-106
$N_{oc}$ in slots corresponding to RSSI measurement time configuration (RMTC)	1, 2				
$\hat{E}_s/I_{ot}$ in slots not corresponding to RSSI measurement time configuration (RMTC)	1, 2	dB	2.5		
$\hat{E}_s/I_{ot}$ in slots corresponding to RSSI measurement time configuration (RMTC)	1, 2				
SS-RSRP in slots not corresponding to RSSI measurement time configuration (RMTC)	1, 2	dBm/SCS	-103.5		
SS-RSRP in slots corresponding to RSSI measurement time configuration (RMTC)	1, 2				
Io within measurement bandwidth in slots not corresponding to RSSI measurement time configuration (RMTC)	1, 2	dBm/SCS	-101.6		
Io within measurement bandwidth in slots corresponding to RSSI measurement time configuration (RMTC)	1, 2				
Time offset between Cell 1 and Cell 2	1, 2	$\mu$ s	3		
Propagation condition	1, 2		AWGN		
channelOccupancyThreshold		dBm	-83		
<p>Note 1: For UE supporting semi-static channel access and network configuring semi-static channel occupancy.</p> <p>Note 2: For UE supporting dynamic channel access and network configuring dynamic channel occupancy.</p> <p>Note 3: For a UE supporting both semi-static and dynamic channel access, the UE can be tested under dynamic channel occupancy only.</p>					

Table A.12.4.2.6.2-3: CO RMTC parameters

measDurationSymbols-r16	sym14or12
rmc-Periodicity-r16	ms40
rmc-SubframeOffset-r16	20
ref-SCS-CP-r16	kHz15
ReportInterval	ms120

### A.12.4.2.6.3 Test Requirements

In the test the UE shall send CO measurement report, with a measurement reporting delay less than  $T_{CO\_measurement\_period\_NR\_cca}$  ms from the beginning of time period T1. The rate of correct events observed during repeated tests shall be at least 90%.

## A.12.5 Measurement performance

### A.12.5.1 E-UTRAN–NR SFTD

#### A.12.5.1.1 Inter-RAT SFTD accuracy with NR target cell under CCA

##### A.12.5.1.1.1 Test Purpose

The purpose of this set of tests is to verify that the SFTD measurement accuracy is within the specified limits. This test will verify the requirements as specified in clause 9.1.27 in TS 36.133 [15] for inter-RAT SFTD measurements between E-UTRA PCell and NR target cell under CCA.

##### A.12.5.1.1.2 Test Environment

Supported test configurations are shown in Table A.12.5.1.1.2-1. In this set of test cases there are two cells on different carriers. Cell 1 is E-UTRAN PCell and Cell 2 is inter-RAT NR target cell under CCA. The test parameters of Cell 1 are given in clause A.12.5.1.1.2-2. The test parameters of Cell 2 are given in Table A.12.5.1.1.2-3. The SFTD between PCell and NR target cell shall be set by the test equipment to one of the time differences in Table A.12.5.1.1.2-4.

**Table A.12.5.1.1.2-1: Supported test configurations for SFTD accuracy with NR target cell under CCA**

Config	Description
1	LTE FDD NR with CCA: 30 kHz SSB SCS, 40 MHz bandwidth, TDD duplex mode
2	LTE TDD NR with CCA: 30 kHz SSB SCS, 40 MHz bandwidth, TDD duplex mode
Note: The UE is only required to be tested in one of the supported test configurations	

**Table A.12.5.1.1.2-2: Test parameters for inter-RAT SFTD accuracy with NR target cell under CCA (Cell 1)**

Parameter	Unit	Test 1
E-UTRA RF Channel Number		1
Duplex mode		FDD or TDD
TDD special subframe configuration <sup>Note1</sup>		6
TDD uplink-downlink configuration <sup>Note1</sup>		1
BW <sub>channel</sub>		5 MHz: $N_{RB,c} = 25$ 10 MHz: $N_{RB,c} = 50$ 20 MHz: $N_{RB,c} = 100$
PDSCH parameters: DL Reference Measurement Channel <sup>Note2</sup>		5 MHz: R.7 FDD 10 MHz: R.3 FDD 20 MHz: R.6 FDD 5 MHz: R.4 TDD 10 MHz: R.0 TDD 20 MHz: R.3 TDD
PCFICH/PDCCH/PHICH parameters: DL Reference Measurement Channel <sup>Note2</sup>		5 MHz: R.11 FDD 10 MHz: R.6 FDD 20 MHz: R.10 FDD 5 MHz: R.11 TDD 10 MHz: R.6 TDD 20 MHz: R.10 TDD

OCNG Patterns <sup>Note2</sup>		5 MHz: OP.20 FDD 10 MHz: OP.10 FDD 20 MHz: OP.17 FDD 5 MHz: OP.9 TDD 10 MHz: OP.1 TDD 20 MHz: OP.7 TDD
PBCH_RA	dB	0
PBCH_RB	dB	
PSS_RA	dB	
SSS_RA	dB	
PCFICH_RB	dB	
PHICH_RA	dB	
PHICH_RB	dB	
PDCCH_RA	dB	
PDCCH_RB	dB	
PDSCH_RA	dB	
PDSCH_RB	dB	
OCNG_RA <sup>Note3</sup>	dB	
OCNG_RB <sup>Note3</sup>	dB	
N <sub>oc</sub> <sup>Note4</sup>	dBm/15 kHz	-104
$\bar{E}_s/N_{oc}$	dB	-3
$\bar{E}_s/I_{ot}$	dB	-3
RSRP <sup>Note5</sup>	dBm/15 kHz	-107
SCH_RP <sup>Note5</sup>	dBm/15 kHz	-107
I <sub>o</sub> <sup>Note5</sup>	dBm/Ch BW	-74.45 +10log (N <sub>RB,c</sub> /50)
Propagation Condition		AWGN
Antenna Configuration		1x2
<p>Note 1: Special subframe and uplink-downlink configurations are specified in table 4.2-1 in TS 36.211 [23].</p> <p>Note 2: DL RMCs and OCNG patterns are specified in clauses A 3.1 and A 3.2 of TS 36.133 [15] respectively.</p> <p>Note 3: OCNG shall be used such that all cells are fully allocated and a constant total transmitted power spectral density is achieved for all OFDM symbols.</p> <p>Note 4: Interference from other cells and noise sources not specified in the test is assumed to be constant over subcarriers and time and shall be modelled as AWGN of appropriate power for N<sub>oc</sub> to be fulfilled.</p> <p>Note 5: E<sub>s</sub>/I<sub>ot</sub>, RSRP, SCH_RP and I<sub>o</sub> levels have been derived from other parameters for information purposes. They are not settable parameters themselves.</p>		

**Table A.12.5.1.1.2-3: Test parameters for inter-RAT SFTD accuracy with NR target cell under CCA (Cell 2)**

Parameter		Unit	Test 1
Duplex mode			TDD
TDD Configuration			TDDConf.1.1 CCA
BW <sub>channel</sub>		MHz	40: N <sub>RB,c</sub> = 106
DL CCA model			As specified in clause A.3.20.2.1
DL CCA probability for semi-static channel access <sup>Note6,8</sup>	P <sub>CCA</sub>		[0.75]
DL CCA probability for dynamic channel access <sup>Note7,8</sup>	P <sub>CCA_DL_1</sub>		[0.75]
	P <sub>CCA_DL_2</sub>		[0.75]
SSB configuration for semi-static channel access <sup>Note6,8</sup>			SSB.1 CCA
SSB configuration for dynamic channel access <sup>Note7,8</sup>			SSB.2 CCA
SMTC configuration			SMTC.1
DBT window configuration			DBT.1
OCNG Patterns			OP.1
EPRE ratio of PSS to SSS		dB	0
EPRE ratio of PBCH DMRS to SSS			
EPRE ratio of PBCH to PBCH DMRS			

EPRE ratio of PDCCH DMRS to SSS		
EPRE ratio of PDCCH to PDCCH DMRS		
EPRE ratio of PDSCH DMRS to SSS		
EPRE ratio of PDSCH to PDSCH DMRS		
EPRE ratio of OCNG DMRS to SSS <sup>Note 1</sup>		
EPRE ratio of OCNG to OCNG DMRS <sup>Note 1</sup>		
$N_{oc}$ <sup>Note2</sup>	dBm/15kHz	-104
$N_{oc}$ <sup>Note2</sup>	dBm/SSB SCS	-101
$\bar{E}_s/I_{ot}$	dB	-3
$\bar{E}_s/N_{oc}$	dB	-3
SS-RSRP <sup>Note3</sup>	dBm/SCS	-104
$I_o$ <sup>Note3</sup>	dBm/38.16 MHz	-68.18
Propagation condition		AWGN
Antenna configuration		1x2
<p>Note 1: OCNG shall be used such that the cell is fully allocated and a constant total transmitted power spectral density is achieved for all OFDM symbols in slots with downlink transmission bursts.</p> <p>Note 2: Interference from other cells and noise sources not specified in the test is assumed to be constant over subcarriers and time and shall be modelled as AWGN of appropriate power for <math>N_{oc}</math> to be fulfilled.</p> <p>Note 3: SS-RSRP and <math>I_o</math> levels have been derived from other parameters for information purposes. They are not settable parameters themselves.</p> <p>Note 4: SS-RSRP minimum requirements are specified assuming independent interference and noise at each receiver antenna port.</p> <p>Note 5: The test configuration excludes support for band n51 and it is not required to run this test on band n51 in this release of the specification</p> <p>Note 6: For UE supporting semi-static channel access and network configuring semi-static channel occupancy.</p> <p>Note 7: For UE supporting dynamic channel access and network configuring dynamic channel occupancy.</p> <p>Note 8: For UE supporting both semi-static and dynamic channel access, the UE must be tested under both dynamic and semi-static channel occupancy configurations.</p>		

**Table A.12.5.1.1.2-4: Timing offsets for inter-RAT SFTD accuracy test with NR target cell under CCA**

Configuration	SFN offset between PCell and NR neighbor cell	Frame boundary offset between PCell and NR neighbour cell (Ts)
1	100	-122000
2	300	-60540
3	500	1000
4	700	62540
5	900	124000

**A.12.5.1.1.3 Test Requirements**

The SFTD reported by the UE consists of 2 elements, SFN offset and frame boundary offset between PCell and inter-RAT NR target cell. The reported SFTD accuracy shall fulfil the requirement in clause 9.1.27 in TS 36.133 [15].

A.12.5.2 E-UTRAN–NR SS-RSRP

A.12.5.3 E-UTRAN–NR SS-RSRQ

A.12.5.4 E-UTRAN–NR SS-SINR

A.12.5.5 E-UTRAN–NR RSSI

A.12.5.6 E-UTRAN–NR channel occupancy

---

## A.13 NR Standalone Tests with NR SCell under CCA and All Other NR Cells in FR1

### A.13.1 Timing

#### A.13.1.1 UE transmit timing

#### A.13.1.2 Timing advance

### A.13.2 Signalling characteristics

#### A.13.2.1 Interruption

##### A.13.2.1.1 NR interruptions during SCell operations with CCA on SCell

###### A.13.2.1.1.1 Test Purpose and Environment

The purpose of this test is to verify NR PCell interruptions during SCell operations on an NR SCC with CCA, This test will verify the interruption requirements for NR PCell in NR SA specified in TS 38.133 clause 8.2.2 and 8.3A. Supported test configurations are shown in table A.13.2.1.1.1-1.

The general test parameters and NR cell specific test parameters are given in Table A.13.2.1.1.1-2 and A.13.2.1.1.1-3 below. In the test there are two cells: Cell1 and Cell2. Cell1 and Cell2 are PCell and SCell. Cell 1 is on a licenced band and cell 2 is subject to CCA. The test consists of five time periods, with duration of T1, T2, T3, T4 and T5. Prior to the start of the time duration T1, the UE is connected to Cell1 and Cell2. Throughout the test, the PCell are continuously scheduled in DL. The power of signals on cell 1 and 2 is not modified during the test.

Prior to T1, a connection is started with cell 1 as the PCell, and measurements of cell 2 are configured with gap pattern 0, such that cell 2 is reported. This ensures that cell 2 is known at the start of time period T1 and is not itself part of the tested requirement.

The point in time at which the RRC message implying Scell addition is received at the UE antenna connector, defines the start of time period T1. Measurement gap pattern 0 shall be stopped when the Scell is configured.

The point in time at which the MAC-CE message implying Scell activation is received at the UE antenna connector, defines the start of time period T2.

The point in time at which the MAC-CE message implying Scell deactivation is received at the UE antenna connector, defines the start of time period T3.

The point in time at which deactivation delay requirement in section 8.3A are satisfied defines the start of time period T4

The point in time at which the RRC message implying Scell release is received at the UE antenna connector, defines the start of time period T5.

**Table A.13.2.1.1.1-1: Interruptions during measurements on deactivated NR SCC supported test configurations**

Configuration	Description
1	Without CCA: 15 kHz SSB SCS, 10 MHz bandwidth, FDD duplex mode; With CCA: 30 kHz SSB SCS, 40 MHz bandwidth, TDD duplex mode
2	Without CCA: 15 kHz SSB SCS, 10 MHz bandwidth, TDD duplex mode; With CCA: 30 kHz SSB SCS, 40 MHz bandwidth, TDD duplex mode
3	Without CCA: 30 kHz SSB SCS, 40 MHz bandwidth, TDD duplex mode; With CCA: 30 kHz SSB SCS, 40 MHz bandwidth, TDD duplex mode
Note: The UE is only required to be tested in one of the supported test configurations	

**Table A.13.2.1.1.1-2: General test parameters for Interruptions during measurements on deactivated NR SCC**

Parameter	Unit	Value	Comment
RF Channel Number		1, 2	
Active PCell		Cell1	PCell on NR RF channel number 1.
Configured dSCell		Cell2	SCell on NR RF channel number 2
CP length		Normal	Applicable to Cell1, Cell2
DRX		OFF	
Measurement gap pattern Id		OFF	
SCell measurement cycle (measCycleSCell)	ms	160	
T1	s	<10	
T2	s	<10	
T3	s	<10	
T4	s	<10	
T5	s	<10	

**Table A.13.2.1.1.1-3: NR cell specific test parameters for Interruptions during measurements on deactivated NR SCC**

Parameter	Unit	Cell1					Cell2				
		T1	T2	T3	T4	T5	T1	T2	T3	T4	T5
TDD configuration	Config 1	---					TDDConf.1.1 CCA				
	Config 2	TDDConf.1.1									
	Config 3	TDDConf.2.1									
BW <sub>channel</sub>	Config 1,2	MHz					10: N <sub>RB,c</sub> = 52				
	Config 3						40: N <sub>RB,c</sub> = 106				
DL CCA model	Config 1,2,3	---					As specified in clause A.3.20.2.1				
DL CCA probability for semi-static channel access <sup>Note6,8</sup>	P <sub>CCA_DL</sub>	---					0.9375				
DL CCA probability for dynamic channel access <sup>Note7,8</sup>	P <sub>CCA_DL_1</sub>	---					0.75				
	P <sub>CCA_DL_2</sub>	---					0.75				
Initial BWP Configuration	Config 1,2,3	DLBWP.0.1					DLBWP.0.1				
Dedicated DL BWP Configuration	Config 1,2,3	DLBWP.1.1					DLBWP.1.1				
Initial UL BWP Configuration	Config 1,2,3	ULBWP.0.1					ULBWP.0.1				
Dedicated UL BWP Configuration	Config 1,2,3	ULBWP.1.1					ULBWP.1.1				
PDSCH reference measurement channel	Config 1	SR.1.1 FDD					---				
	Config 2	SR.1.1 TDD									
	Config 3	SR.2.1 TDD									
RMSI CORESET Parameters	Config 1	CR.1.1 FDD					---				
	Config 2	CR.1.1 TDD									
	Config 3	CR.2.1 TDD									
PDCCH CORESET Parameters	Config 1	CCR.1.1 FDD					---				
	Config 2	CCR.1.1 TDD									

	Config 3		CCR.2.1 TDD	
TRS configuration	Config 1		TRS.1.1 FDD	---
	Config 2		TRS.1.1 TDD	
	Config 3		TRS.1.2 TDD	
OCNG Pattern			OP.1	OP.1
SSB configuration for semi-static channel access <sup>Note6,8</sup>	Config 1,2		SSB.1 FR1	SSB.1 CCA
	Config 3		SSB.2 FR1	
SSB configuration for dynamic channel access <sup>Note7,8</sup>	Config 1,2		SSB.1 FR1	SSB.2 CCA
	Config 3		SSB.2 FR1	
SMTTC Configuration	Config 1,2,3		SMTTC.1	SMTTC.1
DBT window configuration	Config 1,2,3		---	DBT.1
TCI state			TCI.State.0	---
Correlation Matrix and Antenna Configuration			1x2 Low	1x2 Low
EPRE ratio of PSS to SSS		dB	0	0
EPRE ratio of PBCH DMRS to SSS				
EPRE ratio of PBCH to PBCH DMRS				
EPRE ratio of PDCCH DMRS to SSS				
EPRE ratio of PDCCH to PDCCH DMRS				
EPRE ratio of PDSCH DMRS to SSS				
EPRE ratio of PDSCH to PDSCH				
EPRE ratio of OCNG DMRS to SSS(Note 1)				
EPRE ratio of OCNG to OCNG DMRS (Note 1)				
$N_{oc}$ <sup>Note 2</sup>	Config 1,2,3			
$N_{oc}$ <sup>Note 2</sup>	Config 1,2	dBm/SCS	-104	-101
	Config 3		-101	
SS-RSRP <sup>Note 3</sup>	Config 1,2,3	dBm/15 kHz	-87	-87
$\bar{E}_s/I_{ot}$		dB	17	17
$\bar{E}_s/N_{oc}$		dB	17	17
Propagation Condition			AWGN	AWGN
<p>Note 1: OCNG shall be used such that both cells are fully allocated and a constant total transmitted power spectral density is achieved for all OFDM symbols. For Cell 2 with CCA model, OCNG is transmitted only in slots with downlink transmission bursts and is not transmitted during muted slots or during DBT windows.</p> <p>Note 2: Interference from other cells and noise sources not specified in the test is assumed to be constant over subcarriers and time and shall be modeled as AWGN of appropriate power for <math>N_{oc}</math> to be fulfilled.</p> <p>Note 3: SS-RSRP and <math>I_o</math> levels have been derived from other parameters for information purposes. They are not settable parameters themselves.</p> <p>Note 4: Receive time difference of signals received between subframe timing boundary of E-UTRA PCell and slot timing boundary of PSCell at the UE antenna connector including time alignment error between the two cells</p> <p>Note 5: Receive time difference between slot boundaries of signals received from the two cells at the UE antenna connector including time alignment error between the two cells.</p> <p>Note 6: For UE supporting semi-static channel access and network configuring semi-static channel occupancy.</p> <p>Note 7: For UE supporting dynamic channel access and network configuring dynamic channel occupancy.</p> <p>Note 8: For UE supporting both semi-static and dynamic channel access, the UE must be tested under both dynamic and semi-static channel occupancy configurations.</p>				

### A.13.2.1.1.2 Test Requirements

The UE shall meet the interruption requirements for SCell addition on the victim Pcell in clause 8.2.1 during time T1

The UE shall meet the interruption requirements for SCell activation on the victim Pcell in clause 8.2.1 during time T2. There shall be a single interruption with time window as specified in clause 8.3A.2

The UE shall meet the interruption requirements for SCell deactivation on the victim PCell in clause 8.2.1 during time T3. There shall be a single interruption with time window as specified in clause 8.3A.3

The UE shall meet the interruption requirements for deactivated SCell measurements on the victim PCell in clause 8.2.1 during time T4. The interruptions shall be within the time window as specified in clause 8.3A.3

The UE shall meet the interruption requirements for SCell release on the victim PCell in clause 8.2.1 during time T5.

The rate of correct events observed during repeated tests shall be at least 90%.

## A.13.2.2 SCell activation and deactivation delay

### A.13.2.2.1 SCell Activation and Deactivation of known SCell under CCA, 160 ms SCell measurement cycle

#### A.13.2.2.1.1 Test Purpose and Environment

The purpose of this test is to verify that SCell activation and deactivation delays for SCell on NR-U SCC with CCA are within the requirements stated in clause 8.3A, when the SCell is known by the UE at the time of activation and the configured SCell measurement cycle is 160 ms.

The supported test configurations are shown in Table A.13.2.2.1.1-1.

The test parameters are given in Table A.13.2.2.1.1-2 and cell-specific parameters in Table A.13.2.2.1.1-3 below. The test consists of three successive time periods, with duration of T1, T2 and T3, respectively. There are two carriers, each with one cell: Cell 1 (PCell) on radio channel 1 (PCC) in NR FR1, and Cell2 (SCell) on radio channel 2 (SCC) in NR with CCA. Before the test starts the UE is connected to Cell 1, but is not aware of Cell 2, as the UE is only monitoring the PCC. The UE shall be continuously scheduled in the PCell throughout the whole test.

At the beginning of T1 the UE receives an RRC message by which the SCell (Cell 2) becomes configured on radio channel 2. The UE now starts monitoring the SCC. At the end of T1, the test equipment sends a MAC message for activation of the SCell.

The point in time at which the MAC message is received at the UE antenna connector, in a slot # denoted  $m$ , defines the start of time period T2. The UE shall be able to report a valid CSI in PCell for the activated SCell at latest in slot  $m + \frac{T_{\text{HARQ}} + T_{\text{activation\_time\_withCCA}} + T_{\text{CSI\_Reporting\_withCCA}}}{\text{NR slot length}}$ , as defined in clause 8.3A.2. The UE shall start reporting CSI in PCell after at least one CSI-RS transmission occasion for channel measurement and reporting after slot  $m + \frac{T_{\text{HARQ}} + 3\text{ms}}{\text{NR slot length}}$  and shall report CQI index 0 (out-of-range) until the SCell activation has been completed.

Any PCell interruption shall fall within the time window specified in clause 8.3A.2. At the end of T2 the test equipment sends a MAC message for deactivation of the SCell.

The point in time at which the MAC message is received by at the UE antenna connector, in a slot # denoted  $n$ , defines the start of time period T3. The UE shall complete the activation at latest in slot  $n + \frac{T_{\text{HARQ}} + 3\text{ms}}{\text{NR slot length}}$ . Any PCell interruption shall fall within the time window specified in clause 8.3A.3.

The test equipment verifies that potential interruption is carried out in the correct time span by monitoring ACK/NACK sent in PCell during activation and deactivation of SCell, respectively.

The test equipment verifies the activation time by counting the slots from the time when the SCell activation command is sent until a CSI report with other than CQI index 0 is received, while taking into account CCA failures on SCC.

The test equipment verifies the deactivation time by counting the slots from the time when the SCell deactivation command is sent until CQI reporting for SCell is discontinued.

**Table A.13.2.2.1.1-1: Supported test configurations for SCell Activation and Deactivation of known SCell under CCA, 160 ms SCell measurement cycle**

Configuration	Description
1	Without CCA: 15 kHz SSB SCS, 10 MHz bandwidth, FDD duplex mode; With CCA: 30 kHz SSB SCS, 40 MHz bandwidth, TDD duplex mode
2	Without CCA: 15 kHz SSB SCS, 10 MHz bandwidth, TDD duplex mode; With CCA: 30 kHz SSB SCS, 40 MHz bandwidth, TDD duplex mode
3	Without CCA: 30 kHz SSB SCS, 40 MHz bandwidth, TDD duplex mode; With CCA: 30 kHz SSB SCS, 40 MHz bandwidth, TDD duplex mode
Note:	The UE is only required to be tested in one of the supported test configurations

**Table A.13.2.2.1.1-2: General test parameters for known SCell activation with SCell under CCA, 160 ms SCell measurement cycle**

Parameter	Unit	Value	Comment
-----------	------	-------	---------



RF Channel Number		1,2	Two radio channels (1, 2) are used for this test
Active PCell		Cell 1	Primary cell on NR RF channel number 1.
Configured deactivated SCell		Cell 2	Configured deactivated secondary cell on NR RF channel number 2
CP length		Normal	
DRX		OFF	Continuous monitoring of primary cell
CQI/PMI periodicity and offset configuration index		0	CQI reporting for SCell every fourth slot
SCell measurement cycle (measCycleSCell)	ms	160	
Cell2 timing offset to cell1	μs	0	
Time alignment error between cell2 and cell1	μs	≤ TAE as specified in TS 38.104 [13] clause 6.5.3.1.	The value of time alignment error depends upon the type of carrier aggregation.
T1	s	7	During this time the PCell shall be known and the SCell configured and detected.
T2	s	1	During this time the UE shall activate the SCell.
T3	s	1	During this time the UE shall deactivate the SCell.
T <sub>HARQ</sub>	ms	k <sub>1</sub> × NR slot length	k <sub>1</sub> is a number of slots and is indicated by the PDSCH-to-HARQ-timing-indicator field in the DCI format, if present, or provided by <i>dl-DataToUL-ACK</i> , the value of k should be the minimum value defined in TS 38.213 [3] depends on UE's capability
T <sub>CSI_Reporting</sub>	ms	10 + 5 · 2 <sup>μ<sub>DL</sub></sup>	the delay (in ms) including uncertainty in acquiring the first available downlink CSI reference resource, UE processing time for CSI reporting (clause 5.2.2.5 in TS 38.214) and uncertainty in acquiring the first available CSI reporting resources as specified in TS 38.331 [2] μ <sub>DL</sub> is the subcarrier spacing configuration for DL

**Table A.13.2.2.1.1-3: Cell specific test parameters for known FR1 SCell activation case with SCell under CCA, 160 ms SCell measurement cycle**

Parameter		Unit	Cell 1			Cell 2		
			T1	T2	T3	T1	T2	T3
Duplex mode	Config 1		FDD			TDD		
	Config 2,3		TDD					
TDD configuration	Config 1		---			TDDConf.1.1 CCA		
	Config 2		TDDConf.1.1					
	Config 3		TDDConf.2.1					
BW <sub>channel</sub>	Config 1,2	MHz	10: N <sub>RB,c</sub> = 52			40: N <sub>RB,c</sub> = 106		
	Config 3		40: N <sub>RB,c</sub> = 106					
DL CCA model			---			As specified in clause A.3.26.2.1		
DL CCA probability for semi-static channel access <sup>Note5,7</sup>	P <sub>CCA_DL</sub>		---			0.9375		
DL CCA probability for dynamic channel access <sup>Note6,7</sup>	P <sub>CCA_DL_1</sub>		---			0.75		
	P <sub>CCA_DL_2</sub>		---			0.75		
P <sub>CCA_UL</sub>						1		
L <sub>CCA_DL</sub> <sup>Note 8</sup>						2		
W <sub>CCA_DL</sub> <sup>Note 8</sup>		ms				T <sub>activation_time_withCCA</sub>		
Initial downlink BWP configuration			DLBWP.0.2			DLBWP.0.2		
Initial uplink BWP configuration			ULBWP.0.1			ULBWP.0.1		
Dedicated downlink BWP configuration			DLBWP.0.2			DLBWP.0.2		
Dedicated uplink BWP configuration			ULBWP.0.1			ULBWP.0.1		
TCI state			TCI.State.0			TCI.State.0		

TRS Configuration	Config 1		TRS.1.1 FDD	TRS.1.2 TDD
	Config 2		TRS.1.1 TDD	
	Config 3		TRS.1.2 TDD	
PDSCH Reference measurement channel	Config 1		SR.1.1 FDD	SR.1.1 CCA
	Config 2		SR.1.1 TDD	
	Config 3		SR.2.1 TDD	
Dedicated CORESET parameters	Config 1		CCR.1.1 FDD	CCR.1.3 CCA
	Config 2		CCR.1.1 TDD	
	Config 3		CCR.2.1 TDD	
RMSI CORESET parameters	Config 1		CR.1.1 FDD	CR.1.1 CCA
	Config 2		CR.1.1 TDD	
	Config 3		CR.2.1 TDD	
OCNG Patterns <sup>Note1</sup>			OP.1	OP.1
SSB Configuration for semi-static channel access <sup>Note5,7</sup>	Config 1,2		SSB.1 FR1	SSB.1 CCA
	Config 3		SSB.2 FR1	
SSB Configuration for dynamic channel access <sup>Note6,7</sup>	Config 1,2		SSB.1 FR1	SSB.2 CCA
	Config 3		SSB.2 FR1	
SMTC configuration			SMTC.1	SMTC.1
DBT window configuration			---	DBT.1
EPRE ratio of PSS to SSS		dB	0	0
EPRE ratio of PBCH DMRS to SSS				
EPRE ratio of PBCH to PBCH DMRS				
EPRE ratio of PDCCH DMRS to SSS				
EPRE ratio of PDCCH to PDCCH DMRS				
EPRE ratio of PDSCH DMRS to SSS				
EPRE ratio of PDSCH to PDSCH				
EPRE ratio of OCNG DMRS to SSS <sup>Note1</sup>				
EPRE ratio of OCNG to OCNG DMRS <sup>Note1</sup>				
$N_{oc}$ <sup>Note2</sup>	Config 1,2			
	Config 3			
$N_{oc}$ <sup>Note2</sup>	Config 1,2	dBm/SCS	-104	-101
	Config 3		-101	
$\bar{E}_s/I_{ot}$		dB	17	17
$\bar{E}_s/N_{oc}$		dB	17	17
SS-RSRP <sup>Note3</sup>	Config 1,2	dBm/SCS	-87	-84
	Config 3		-84	-84
$I_o$ <sup>Note3</sup>	Config 1,2		-58.96	-52.87
	Config 3		-52.87	-52.87
Propagation condition		-	AWGN	
<p>Note 1: OCNG shall be used such that resources in Cell 1 are fully allocated and a constant total transmitted power spectral density is achieved for all OFDM symbols. For Cell 2 with CCA model, OCNG is transmitted only in slots with downlink transmission bursts and is not transmitted during muted slots or during DBT windows.</p> <p>Note 2: Interference from other cells and noise sources not specified in the test is assumed to be constant over subcarriers and time and shall be modelled as AWGN of appropriate power for <math>N_{oc}</math> to be fulfilled.</p> <p>Note 3: SS-RSRP, SCH_RP and <math>I_o</math> levels have been derived from other parameters for information purposes. They are not settable parameters themselves.</p> <p>Note 4: The uplink resources for CSI reporting are assigned to the UE prior to the start of time period T2.</p> <p>Note 5: For UE supporting semi-static channel access and network configuring semi-static channel occupancy.</p> <p>Note 6: For UE supporting dynamic channel access and network configuring dynamic channel occupancy.</p> <p>Note 7: For UE supporting both semi-static and dynamic channel access, the UE must be tested under both dynamic and semi-static channel occupancy configurations.</p> <p>Note 8: As specified in clause 8.3A for <math>L_{1,max}</math>, <math>L_{2,1,max}</math>, <math>L_{2,2,max}</math>, <math>L_{3,1,max}</math>, and <math>L_{3,2,max}</math></p>				

A.13.2.2.1.2 Test Requirements

During T2, the UE shall send the first CSI report for SCell after at least one CSI-RS transmission occasion for channel measurement and reporting after slot  $m+1 + \frac{T_{HARQ}+3ms}{NR\ slot\ length}$ .

During T2, conditioned on that downlink CCA failures  $L_1$  and  $L_{2,2}$  experienced in the SCell fulfill  $L_1 \leq L_{1,max}$  and  $L_{2,2} \leq L_{2,2,max}$  with  $L_{1,max} = 2$  and  $L_{2,2,max} = 2$ , respectively, the UE shall send the first valid CSI report (non-zero CQI) for the SCell no later than slot  $m + (T_{HARQ}+T_{activation\_time\_withCCA} + T_{CSI\_Reporting\_withCCA})/NR\_slot\_length$ , where

$T_{\text{activation\_time\_withCCA}} = T_{\text{FirstSSB}} + L_1 * T_{\text{rs}} + 5\text{ms}$  and  $T_{\text{CSI\_reporting\_withCCA}} = T_{\text{CSI\_reporting}} + L_{2,2} * T_{\text{CSI-RS}} + T_{\text{CSI\_ReportingDelay}}$ , as specified in clause 8.3A.2.

During T3, the UE shall stop sending CSI reports for SCell at latest in slot  $n + \frac{T_{\text{HARQ}} + 3\text{ms}}{\text{NR\_slot\_length}}$ , as defined in clause 8.3A.3.

During T2, interruption on PCell shall not occur outside slot  $m + 1 + \frac{T_{\text{HARQ}}}{\text{NR\_slot\_length}}$  to slot  $m + 1 + \frac{T_{\text{HARQ}} + 3 + T_X}{\text{NR\_slot\_length}}$  with  $T_X = T_{\text{FirstSSB}}$ .

During T3, interruption on PCell shall not occur outside slot  $n + 1 + T_{\text{HARQ}}/\text{NR\_slot\_length}$  to slot  $n + 1 + (T_{\text{HARQ}} + 3\text{ms})/\text{NR\_slot\_length}$ .

The interruption on PCell shall not be more than specified for SA in clause 8.2.2.2.2.

The rate of correctly observed SCell activation delays and SCell deactivation delays shall for repeated tests be at least 90%.

### A.13.2.2.2 SCell Activation and Deactivation of known SCell under CCA, 640 ms SCell measurement cycle

#### A.13.2.2.2.1 Test Purpose and Environment

The purpose of this test is to verify that SCell activation and deactivation delays for SCell on NR-U SCC with CCA are within the requirements stated in clause 8.3A, when the SCell is known by the UE at the time of activation and the configured SCell measurement cycle is 640 ms.

The supported test configurations are same as in Table A.13.2.2.1.1-1 above.

The test parameters are same as in Table A.13.2.2.1.1-2 above, except for parameters listed below in Table A.13.2.2.2.1-1. The cell-specific parameters are same as in Table A.13.2.2.1.1-3 above.

The test execution is the same as described in clause A.13.2.2.1 above, except that downlink CCA failures  $L_{2,1}$  and  $L_{2,2}$  with limits  $L_{2,1} \leq L_{2,1,\text{max}}$  and  $L_{2,2} \leq L_{2,2,\text{max}}$  replace  $L_1$  as described in clause 8.3A.2 for activation of known SCell with a measurement cycle larger than 160 ms.

**Table A.13.2.2.2.1-1: General test parameters for known SCell activation with SCell under CCA, 640 ms SCell measurement cycle**

Parameter	Unit	Value	Comment
SCell measurement cycle (measCycleSCell)	ms	640	

#### A.13.2.2.2.2 Test Requirements

During T2, the UE shall send the first CSI report for SCell after at least one CSI-RS transmission occasion for channel measurement and reporting after slot  $m + 1 + \frac{T_{\text{HARQ}} + 3\text{ms}}{\text{NR\_slot\_length}}$ .

During T2, conditioned on that downlink CCA failures  $L_{2,1}$  and  $L_{2,2}$  experienced in the SCell fulfill  $L_{2,1} \leq L_{2,1,\text{max}}$  and  $L_{2,2} \leq L_{2,2,\text{max}}$  with  $L_{2,1,\text{max}} = 2$  and  $L_{2,2,\text{max}} = 2$ , respectively, the UE shall send the first valid CSI report (non-zero CQI) for the SCell no later than slot  $m + (T_{\text{HARQ}} + T_{\text{activation\_time\_withCCA}} + T_{\text{CSI\_Reporting\_withCCA}})/\text{NR\_slot\_length}$ , where  $T_{\text{activation\_time\_withCCA}} = T_{\text{FirstSSB\_MAX}} + L_{2,1} * T_{\text{SMTc\_MAX}} + (1 + L_{2,2}) * T_{\text{rs}} + 5\text{ms}$  and  $T_{\text{CSI\_reporting\_withCCA}} = T_{\text{CSI\_reporting}} + T_{\text{CSI\_ReportingDelay}}$ , as specified in clause 8.3A.2.

During T3, the UE shall stop sending CSI reports for SCell at latest in slot  $n + \frac{T_{\text{HARQ}} + 3\text{ms}}{\text{NR\_slot\_length}}$ , as defined in clause 8.3A.3.

During T2, interruption on PCell shall not occur outside slot  $m + 1 + \frac{T_{\text{HARQ}}}{\text{NR\_slot\_length}}$  to slot  $m + 1 + \frac{T_{\text{HARQ}} + 3 + T_X}{\text{NR\_slot\_length}}$  with  $T_X = T_{\text{FirstSSB}}$ .

During T3, interruption on PCell shall not occur outside slot  $n + 1 + T_{\text{HARQ}}/\text{NR\_slot\_length}$  to slot  $n + 1 + (T_{\text{HARQ}} + 3\text{ms})/\text{NR\_slot\_length}$ .

The interruption on PCell shall not be more than specified for SA in clause 8.2.2.2.2.

The rate of correctly observed SCell activation delays and SCell deactivation delays shall for repeated tests be at least 90%.

### A.13.2.2.3 SCell Activation and Deactivation of unknown SCell under CCA

#### A.13.2.2.3.1 Test Purpose and Environment

The purpose of this test is to verify that SCell activation and deactivation delays for SCell on NR-U SCC with CCA are within the requirements stated in clause 8.3A, when the SCell is unknown to the UE at the time of activation.

The supported test configurations are same as in Table A.13.2.2.1.1-1 above.

The test parameters are same as in Table A.13.2.2.1.1-2 above, except for parameters listed below in Table A.13.2.2.3.1-1. The cell-specific parameters are same as in Table A.13.2.2.1.1-3 above.

The test execution is the same as described in clause A.13.2.2.1 above, except that downlink CCA failures  $L_{3,1}$  and  $L_{3,2}$  with limits  $L_{3,1} \leq L_{3,1,max}$  and  $L_{3,2} \leq L_{3,2,max}$  replace  $L_1$  as described in clause 8.3A.2 for activation of unknown SCell.

**Table A.13.2.2.3.1-1: General test parameters for unknown SCell activation with SCell under CCA**

Parameter	Unit	Value	Comment
T1	s	0.1	During this time period the PCell shall be known and the SCell configured, but not detected.

#### A.13.2.2.3.2 Test Requirements

During T2, the UE shall send the first CSI report for SCell after at least one CSI-RS transmission occasion for channel measurement and reporting after slot  $m+1 + \frac{T_{HARQ}+3ms}{NR\ slot\ length}$ .

During T2, conditioned on that downlink CCA failures  $L_{3,1}$  and  $L_{3,2}$  experienced in the SCell fulfill  $L_{3,1} \leq L_{3,1,max}$  and  $L_{3,2} \leq L_{3,2,max}$  with  $L_{3,1,max} = 2$  and  $L_{3,2,max} = 2$ , respectively, the UE shall send the first valid CSI report (non-zero CQI) for the SCell no later than slot  $m + (T_{HARQ} + T_{activation\_time\_withCCA} + T_{CSI\_Reporting\_withCCA}) / NR\_slot\_length$ , where  $T_{activation\_time\_withCCA} = T_{FirstSSB\_MAX} + (1 + L_{3,1}) * T_{SMTc\_MAX} + (2 + L_{3,2}) * T_{rs} + 5ms$  and  $T_{CSI\_reporting\_withCCA} = T_{CSI\_reporting} + T_{CSI\_ReportingDelay}$ , as specified in clause 8.3A.2.

During T3, the UE shall stop sending CSI reports for SCell at latest in slot  $n + \frac{T_{HARQ}+3ms}{NR\ slot\ length}$ , as defined in clause 8.3A.3.

During T2, interruption on PCell shall not occur outside slot  $m+1 + \frac{T_{HARQ}}{NR\ slot\ length}$  to slot  $m+1 + \frac{T_{HARQ}+3+T_X}{NR\ slot\ length}$  with  $T_X = T_{FirstSSB}$ .

During T3, interruption on PCell shall not occur outside slot  $n+1 + T_{HARQ}/NR\_slot\_length$  to slot  $n+1 + (T_{HARQ} + 3ms)/NR\_slot\_length$ .

The interruption on PCell shall not be more than specified for SA in clause 8.2.2.2.2.

The rate of correctly observed SCell activation delays and SCell deactivation delays shall for repeated tests be at least 90%.

### A.13.2.3 Void

## A.13.3 Measurement procedure

### A.13.3.1 Intra-frequency measurements

#### A.13.3.1.1 Event-triggered reporting tests on SCC without gaps under non-DRX

##### A.13.3.1.1.1 Test purpose and environment

The purpose of this test is to verify that the UE makes correct reporting of an event. This test will partly verify the intra-frequency cell search requirements in clauses 9.2A.5.1 and 9.2A.5.2.

##### A.13.3.1.1.2 Test parameters

Three cells are deployed in the test, which are FR1 PCell (Cell 1), and two cells on the same carrier frequency with CCA and transmit SSBs in DBT windows according to DL CCA model: SCell (Cell 2) and a neighbour cell (Cell 3). The test parameters for the three cells are given in Table A.13.3.1.1.2-1 and A.13.3.1.1.2-2 below. In the measurement control information, a measurement object is configured for the frequency of the SCell, and it is indicated to the UE that event-triggered reporting with Event A3 is used. The test consists of two successive time periods, with time duration of T1 and T2, respectively. During time duration T1, the UE shall not have any timing information of Cell 3.

FFS: The same test is applicable for UE supporting any one or both semi-static channel access or dynamic channel access and for network configuring any of semi-static channel occupancy or dynamic channel occupancy.

The test is conducted for SS-RSRP, SS-RSRQ, and SS-SINR:

- In the first test (Test 1), the UE is configured with SS-RSRP as Event A3 measurement quantity.
- In the second test (Test 2), the UE is configured with SS-RSRQ as Event A3 measurement quantity.
- In the third test (Test 3), the UE is configured with SS-SINR as Event A3 measurement quantity.

**Table A.13.3.1.1.2-1: Supported test configurations**

Configuration	Description
1	Without CCA: 15 kHz SSB SCS, 10 MHz bandwidth, FDD duplex mode With CCA: 30 kHz SSB SCS, 40 MHz bandwidth, TDD duplex mode
2	Without CCA: 15 kHz SSB SCS, 10 MHz bandwidth, TDD duplex mode With CCA: 30 kHz SSB SCS, 40 MHz bandwidth, TDD duplex mode
3	Without CCA: 30 kHz SSB SCS, 40 MHz bandwidth, TDD duplex mode With CCA: 30 kHz SSB SCS, 40 MHz bandwidth, TDD duplex mode

NOTE: The UE is only required to be tested in one of the supported test configurations.

**Table A.13.3.1.1.2-2: General test parameters for intra-frequency event triggered reporting without gaps**

Parameter	Unit	Test configuration	Value			Comment
			Test 1	Test 2	Test 3	
Active PCell		1, 2, 3	Cell 1			
Active SCell		1, 2, 3	Cell 2			
Neighbour cell		1, 2, 3	Cell 3			Cell to be identified.
RF Channel Number		1, 2, 3	1: Cell 1 2: Cell 2 and Cell 3			
DL CCA model			As specified in clause A.3.20.2.1			
UL CCA model			As specified in clause A.3.20.2.2			
SSB configuration		1	Cell 1: SSB.1 FR1 Cell 2,3: TBD			
		2	Cell 1: SSB.1 FR1 Cell 2,3: TBD			
		3	Cell 1: SSB.2 FR1 Cell 2,3: TBD			

SMTC configuration		1	Cell 1: SMTC.2 Cell 2,3: N/A			
		2	Cell 1: SMTC.1 Cell 2,3: N/A			
		3	Cell 1: SMTC.1 Cell 2,3: N/A			
DBT window configuration		1, 2, 3	Cell 1: N/A Cell 2,3: TBD			
A3-Offset	dB	1, 2, 3	-4.5			
Event A3 measurement quantity			SS-RSRP	SS-RSRQ	SS-SINR	
CP length		1, 2, 3	Normal			
Hysteresis	dB	1, 2, 3	0			
Time To Trigger	s	1, 2, 3	0			
Filter coefficient		1, 2, 3	0			L3 filtering is not used
DRX		1, 2, 3				OFF
Time offset between Cell 2 and Cell 3		1	3 ms			Asynchronous cells. The timing of Cell 3 is 3ms later than the timing of Cell 2.
		2	3 $\mu$ s			Synchronous cells
		3	3 $\mu$ s			Synchronous cells
<i>deriveSSB-IndexFromCell</i>		1	False			
		2	True			
		3	True			
T1	s	1, 2, 3	TBD			
T2	s	1, 2, 3	TBD			

**Table A.13.3.1.1.2-3: Cell-specific test parameters for intra-frequency event-triggered reporting without gaps**

Parameter	Unit	Test configuration	Cell 1		Cell 2		Cell 3	
			T1	T2	T1	T2	T1	T2
DL CCA probability $P_{CCA\_DL}$		1, 2, 3	N/A		TBD	TBD	TBD	TBD
UL CCA probability $P_{CCA\_UL}$		1, 2, 3	N/A		TBD	TBD	TBD	TBD
TDD configuration		1	N/A		TBD		TBD	
		2	TDDConf.1.1		TBD		TBD	
		3	TDDConf.2.1		TBD		TBD	
PDSCH RMC configuration		1	SR.1.1 FDD		TBD		TBD	
		2	SR.1.1 TDD					
		3	SR.2.1 TDD					
RMSI CORESET RMC configuration		1	CR.1.1 FDD		TBD		TBD	
		2	CR.1.1 TDD		TBD		TBD	
		3	CR.2.1 TDD		TBD		TBD	
Dedicated CORESET RMC configuration		1	CCR.1.1 FDD		TBD		TBD	
		2	CCR.1.1 TDD		TBD		TBD	
		3	CCR.2.1 TDD		TBD		TBD	
OCNG Patterns		1, 2, 3	OP.1		TBD		TBD	
TRS Configuration		1	TRS.1.1 FDD		TBD		TBD	
		2	TRS.1.1 TDD		TBD		TBD	
		3	TRS.1.2 TDD		TBD		TBD	
Initial BWP configuration		1, 2, 3	DLBWP.0.1 ULBWP.0.1		DLBWP.0.1 ULBWP.0.1		DLBWP.0.1 ULBWP.0.1	
Active DL BWP configuration		1, 2, 3	DLBWP.1.1		DLBWP.1.1		DLBWP.1.1	

Active UL BWP configuration		1, 2, 3	ULBWP.1.1		ULBWP.1.1		ULBWP.1.1	
RLM-RS		1, 2, 3	SSB		SSB		SSB	
$N_{oc}$ Note 2	dBm/SCS	1	-98		TBD		TBD	
		2	-98		TBD		TBD	
		3	-95		TBD		TBD	
$N_{oc}$ Note 2	dBm/15 kHz	1	-98		TBD		TBD	
		2	-98		TBD		TBD	
		3	-95		TBD		TBD	
$\hat{E}_s/I_{ot}$ Note 5	dB	1	4	-1.46	TBD	TBD	-Infinity	TBD
		2			TBD	TBD	-Infinity	TBD
		3			TBD	TBD	-Infinity	TBD
$\hat{E}_s/N_{oc}$ Note 5	dB	1	4	4	TBD	TBD	-Infinity	TBD
		2			TBD	TBD	-Infinity	TBD
		3			TBD	TBD	-Infinity	TBD
SS-RSRP Note 3,5	dBm/SCS kHz	1	-94	-94	TBD	TBD	-Infinity	TBD
		2	-94	-94	TBD	TBD	-Infinity	TBD
		3	-91	-91	TBD	TBD	-Infinity	TBD
I <sub>o</sub>	dBm/9.36 MHz	1	-64.60	-62.25	TBD	TBD	TBD	TBD
	dBm/9.36 MHz	2	-64.60	-62.25	TBD	TBD	TBD	TBD
	dBm/38.16 MHz	3	-58.50	-56.16	TBD	TBD	TBD	TBD
Propagation Condition		1, 2, 3	AWGN					

NOTE 1: The resources for uplink transmission are assigned to the UE prior to the start of time period T2.

NOTE 2: Interference from other cells and noise sources not specified in the test is assumed to be constant over subcarriers and time and shall be modelled as AWGN of appropriate power for  $N_{oc}$  to be fulfilled.

NOTE 3: SS-RSRP levels have been derived from other parameters for information purposes. They are not settable parameters themselves.

NOTE 4: DL and UL CCA probabilities apply for UE supporting any one or both semi-static channel access or dynamic channel access and for network configuring any of semi-static channel occupancy or dynamic channel occupancy.

NOTE 5: The signal levels apply for SSS REs when the discovery burst is transmitted during DBT windows.

### A.13.3.1.1.3 Test Requirements

The UE shall send one Event A3 triggered measurement report (SS-RSRP in Test 1, SS-RSRQ in Test 2, SS-SINR in Test 3), with a measurement reporting delay less than D1 ms from the beginning of time period T2.

*Editor's note: D1=TBD.*

The UE is not required to read the neighbour cell SSB index in this test.

The UE shall not send event triggered measurement reports, as long as the reporting criteria are not fulfilled.

The rate of correct events observed during repeated tests shall be at least 90%.

FFS: NOTE: The actual overall delays measured in the test may be up to  $2 \times TTI_{DCCH}$  higher than the measurement reporting delays above because of TTI insertion uncertainty of the measurement report in DCCH.

### A.13.3.1.2 Event-triggered reporting tests on SCC without gaps under DRX

#### A.13.3.1.2.1 Test purpose and environment

The purpose of this test is to verify that the UE makes correct reporting of an event. This test will partly verify the intra-frequency cell search requirements in clauses 9.2A.5.1 and 9.2A.5.2.

#### A.13.3.1.2.2 Test parameters

Three cells are deployed in the test, which are FR1 PCell (Cell 1), and two cells on the same carrier frequency with CCA and transmit SSBs in DBT windows according to DL CCA model: SCell (Cell 2) and a neighbour cell (Cell 3). The test parameters for the three cells are given in Table A.13.3.1.2.2-1 and A.13.3.1.2.2-2 below. In the measurement control information, a measurement object is configured for the frequency of the SCell, and it is indicated to the UE that

event-triggered reporting with Event A3 is used. The test consists of two successive time periods, with time duration of T1 and T2, respectively. During time duration T1, the UE shall not have any timing information of Cell 3.

FFS: The same test is applicable for UE supporting any one or both semi-static channel access or dynamic channel access and for network configuring any of semi-static channel occupancy or dynamic channel occupancy.

UE needs to be provided at least once every 500ms with new Timing Advance Command MAC control element to restart the Time alignment timer to keep UE uplink time alignment. Furthermore UE is allocated with PUSCH resource at every DRX cycle.

The test is conducted for SS-RSRP, SS-RSRQ, and SS-SINR:

- In Test 1 and Test 2, the UE is configured with SS-RSRP as Event A3 measurement quantity.
- In Test 3 and Test 4, the UE is configured with SS-RSRQ as Event A3 measurement quantity.
- In Test 5 and Test 6, the UE is configured with SS-SINR as Event A3 measurement quantity.

**Table A.13.3.1.2.2-1: Supported test configurations**

Configuration	Description
1	Without CCA: 15 kHz SSB SCS, 10 MHz bandwidth, FDD duplex mode With CCA: 30 kHz SSB SCS, 40 MHz bandwidth, TDD duplex mode
2	Without CCA: 15 kHz SSB SCS, 10 MHz bandwidth, TDD duplex mode With CCA: 30 kHz SSB SCS, 40 MHz bandwidth, TDD duplex mode
3	Without CCA: 30 kHz SSB SCS, 40 MHz bandwidth, TDD duplex mode With CCA: 30 kHz SSB SCS, 40 MHz bandwidth, TDD duplex mode
NOTE: The UE is only required to be tested in one of the supported test configurations.	

**Table A.13.3.1.2.2-2: General test parameters for intra-frequency event triggered reporting without gaps with DRX**

Parameter	Unit	Test configuration	Value						Comment
			Test 1	Test 2	Test 3	Test 4	Test 5	Test 6	
Active PCell		1, 2, 3	Cell 1						
Active SCell		1, 2, 3	Cell 2						
Neighbour cell		1, 2, 3	Cell 3						Cell to be identified.
RF Channel Number		1, 2, 3	1: Cell 1 2: Cell 2 and Cell 3						
DL CCA model			As specified in clause A.3.20.2.1						
UL CCA model			As specified in clause A.3.20.2.2						
SSB configuration		1	Cell 1: SSB.1 FR1 Cell 2,3: TBD						
		2	Cell 1: SSB.1 FR1 Cell 2,3: TBD						
		3	Cell 1: SSB.2 FR1 Cell 2,3: TBD						
SMTC configuration		1	Cell 1: SMTC.2 Cell 2,3: N/A						
		2	Cell 1: SMTC.1 Cell 2,3: N/A						
		3	Cell 1: SMTC.1 Cell 2,3: N/A						
DBT window configuration		1, 2, 3	Cell 1: N/A Cell 2,3: TBD						
A3-Offset	dB	1, 2, 3	-4.5						
Event A3 measurement quantity			SS-RSRP	SS-RSRQ	SS-SINR				
CP length		1, 2, 3	Normal						
Hysteresis	dB	1, 2, 3	0						
Time To Trigger	s	1, 2, 3	0						
Filter coefficient		1, 2, 3	0						L3 filtering is not used
DRX		1, 2, 3	DRX.1	DRX.2	DRX.1	DRX.2	DRX.1	DRX.2	



Time offset between Cell 2 and Cell 3		1	3 ms					Asynchronous cells. The timing of Cell 3 is 3ms later than the timing of Cell 2.	
		2	3 μs					Synchronous cells	
		3	3 μs					Synchronous cells	
	<i>deriveSSB-IndexFromCell</i>		1	<i>False</i>					
			2	<i>True</i>					
			3	<i>True</i>					
T1	s	1, 2, 3	TBD						
T2	s	1, 2, 3	TBD	TBD	TBD	TBD	TBD	TBD	

**Table A.13.3.1.2.2-3: Cell-specific test parameters for intra-frequency event-triggered reporting without gaps**

Parameter	Unit	Test configuration	Cell 1		Cell 2		Cell 3	
			T1	T2	T1	T2	T1	T2
DL CCA probability $P_{CCA\_DL}$		1, 2, 3	N/A		TBD	TBD	TBD	TBD
UL CCA probability $P_{CCA\_UL}$		1, 2, 3	N/A		TBD	TBD	TBD	TBD
TDD configuration		1	N/A		TBD		TBD	
		2	TDDConf.1.1		TBD		TBD	
		3	TDDConf.2.1		TBD		TBD	
PDSCH RMC configuration		1	SR.1.1 FDD		TBD		TBD	
		2	SR.1.1 TDD					
		3	SR.2.1 TDD					
RMSI CORESET RMC configuration		1	CR.1.1 FDD		TBD		TBD	
		2	CR.1.1 TDD		TBD		TBD	
		3	CR.2.1 TDD		TBD		TBD	
Dedicated CORESET RMC configuration		1	CCR.1.1 FDD		TBD		TBD	
		2	CCR.1.1 TDD		TBD		TBD	
		3	CCR.2.1 TDD		TBD		TBD	
OCNG Patterns		1, 2, 3	OP.1		TBD		TBD	
TRS Configuration		1	TRS.1.1 FDD		TBD		TBD	
		2	TRS.1.1 TDD		TBD		TBD	
		3	TRS.1.2 TDD		TBD		TBD	
Initial BWP configuration		1, 2, 3	DLBWP.0.1 ULBWP.0.1		DLBWP.0.1 ULBWP.0.1		DLBWP.0.1 ULBWP.0.1	
Active DL BWP configuration		1, 2, 3	DLBWP.1.1		DLBWP.1.1		DLBWP.1.1	
Active UL BWP configuration		1, 2, 3	ULBWP.1.1		ULBWP.1.1		ULBWP.1.1	
RLM-RS		1, 2, 3	SSB		SSB		SSB	
$N_{oc}$ <small>Note 2</small>	dBm/SCS	1	-98		TBD		TBD	
		2	-98		TBD		TBD	
		3	-95		TBD		TBD	
$N_{oc}$ <small>Note 2</small>	dBm/15 kHz	1	-98		TBD		TBD	
		2	-98		TBD		TBD	
		3	-95		TBD		TBD	
$\hat{E}_s/I_{ot}$ <small>Note 5</small>	dB	1	4	-1.46	TBD	TBD	-Infinity	TBD
		2			TBD	TBD	-Infinity	TBD
		3			TBD	TBD	-Infinity	TBD

$\hat{E}_s/N_{oc}$ <small>Note 5</small>	dB	1	4	4	TBD	TBD	-Infinity	TBD
		2			TBD	TBD	-Infinity	TBD
		3			TBD	TBD	-Infinity	TBD
SS-RSRP <small>Note 3,5</small>	dBm/SCS kHz	1	-94	-94	TBD	TBD	-Infinity	TBD
		2	-94	-94	TBD	TBD	-Infinity	TBD
		3	-91	-91	TBD	TBD	-Infinity	TBD
Io	dBm/9.36 MHz	1	-64.60	-62.25	TBD	TBD	TBD	TBD
	dBm/9.36 MHz	2	-64.60	-62.25	TBD	TBD	TBD	TBD
	dBm/38.16 MHz	3	-58.50	-56.16	TBD	TBD	TBD	TBD
Propagation Condition		1, 2, 3	AWGN					

NOTE 1: The resources for uplink transmission are assigned to the UE prior to the start of time period T2.

NOTE 2: Interference from other cells and noise sources not specified in the test is assumed to be constant over subcarriers and time and shall be modelled as AWGN of appropriate power for  $N_{oc}$  to be fulfilled.

NOTE 3: SS-RSRP levels have been derived from other parameters for information purposes. They are not settable parameters themselves.

NOTE 4: DL and UL CCA probabilities apply for UE supporting any one or both semi-static channel access or dynamic channel access and for network configuring any of semi-static channel occupancy or dynamic channel occupancy.

NOTE 5: The signal levels apply for SSS REs when the discovery burst is transmitted during DBT windows.

### A.13.3.1.2.3 Test Requirements

The UE shall send one Event A3 triggered measurement report (SS-RSRP in Test 1 and Test 2, SS-RSRQ in Test 3 and Test 4, SS-SINR in Test 5 and Test 6), with a measurement reporting delay less than D1 ms from the beginning of time period T2.

*Editor's note: D1=TBD (D1 is different for different DRX configurations).*

The UE is not required to read the neighbour cell SSB index in this test.

The UE shall not send event triggered measurement reports, as long as the reporting criteria are not fulfilled.

The rate of correct events observed during repeated tests shall be at least 90%.

FFS: NOTE: The actual overall delays measured in the test may be up to  $2 \times TTI_{DCCH}$  higher than the measurement reporting delays above because of TTI insertion uncertainty of the measurement report in DCCH.

### A.13.3.1.3 Event-triggered reporting tests on SCC with per-UE gaps under non-DRX

#### A.13.3.1.3.1 Test purpose and environment

The purpose of this test is to verify that the UE makes correct reporting of an event. This test will partly verify the intra-frequency cell search requirements in clauses 9.2A.6.1 and 9.2A.6.2.

#### A.13.3.1.3.2 Test parameters

Three cells are deployed in the test, which are FR1 PCell (Cell 1), and two cells on the same carrier frequency with CCA and transmit SSBs in DBT windows according to DL CCA model: SCell (Cell 2) and a neighbour cell (Cell 3). The test parameters for the three cells are given in Table A.13.3.1.3.2-1 and A.13.3.1.3.2-2 below. In the measurement control information, a measurement object is configured for the frequency of the SCell, and it is indicated to the UE that event-triggered reporting with Event A3 is used. The test consists of two successive time periods, with time duration of T1 and T2, respectively. During time duration T1, the UE shall not have any timing information of Cell 3.

FFS: The same test is applicable for UE supporting any one or both semi-static channel access or dynamic channel access and for network configuring any of semi-static channel occupancy or dynamic channel occupancy.

There are two BWPs configured in Cell 1, BWP1 which contains the cell defining SSB, and BWP2 which does not contain any SSB of Cell 1. During the whole test, BWP2 is always scheduled as the active BWP for the UE.

The test is conducted for SS-RSRP, SS-RSRQ, and SS-SINR:

- In the first test (Test 1), the UE is configured with SS-RSRP as Event A3 measurement quantity.

- In the second test (Test 2), the UE is configured with SS-RSRQ as Event A3 measurement quantity.
- In the third test (Test 3), the UE is configured with SS-SINR as Event A3 measurement quantity.

**Table A.13.3.1.3.2-1: Supported test configurations**

Configuration	Description
1	Without CCA: 15 kHz SSB SCS, 10 MHz bandwidth, FDD duplex mode With CCA: 30 kHz SSB SCS, 40 MHz bandwidth, TDD duplex mode
2	Without CCA: 15 kHz SSB SCS, 10 MHz bandwidth, TDD duplex mode With CCA: 30 kHz SSB SCS, 40 MHz bandwidth, TDD duplex mode
3	Without CCA: 30 kHz SSB SCS, 40 MHz bandwidth, TDD duplex mode With CCA: 30 kHz SSB SCS, 40 MHz bandwidth, TDD duplex mode
NOTE: The UE is only required to be tested in one of the supported test configurations.	

**Table A.13.3.1.3.2-2: General test parameters for intra-frequency event triggered reporting with per-UE gaps**

Parameter	Unit	Test configuration	Value			Comment
			Test 1	Test 2	Test 3	
Active PCell		1, 2, 3	Cell 1			
Active SCell		1, 2, 3	Cell 2			
Neighbour cell		1, 2, 3	Cell 3			Cell to be identified.
RF Channel Number		1, 2, 3	1: Cell 1 2: Cell 2 and Cell 3			
Measurement gap type		1, 2, 3	Per-UE gaps			
Measurement gap repetition periodicity	ms	1, 2, 3	40			
Measurement gap length	ms	1, 2, 3	[6]			
Measurement gap offset	ms	1, 2, 3	[39]			
DL CCA model			As specified in clause A.3.20.2.1			
UL CCA model			As specified in clause A.3.20.2.2			
SSB configuration		1	Cell 1: SSB.1 FR1 Cell 2,3: TBD			
		2	Cell 1: SSB.1 FR1 Cell 2,3: TBD			
		3	Cell 1: SSB.2 FR1 Cell 2,3: TBD			
SMTTC configuration		1	Cell 1: SMTTC.2 Cell 2,3: N/A			
		2	Cell 1: SMTTC.1 Cell 2,3: N/A			
		3	Cell 1: SMTTC.1 Cell 2,3: N/A			
DBT window configuration		1, 2, 3	Cell 1: N/A Cell 2,3: TBD			
CSI-RS parameters in Cell 1		1	CSI-RS.1.2 FDD resource #0			
		2	CSI-RS.1.2 TDD resource #0			
		3	CSI-RS.2.2 TDD resource #0			
A3-Offset	dB	1, 2, 3	-4.5			
Event A3 measurement quantity			SS-RSRP	SS-RSRQ	SS-SINR	
CP length		1, 2, 3	Normal			
Hysteresis	dB	1, 2, 3	0			
Time To Trigger	s	1, 2, 3	0			
Filter coefficient		1, 2, 3	0			L3 filtering is not used
DRX		1, 2, 3				OFF
Time offset between Cell 2 and Cell 3		1	3 ms			Asynchronous cells. The timing of Cell 3 is 3ms later than the timing of Cell 2.
		2	3 μs			Synchronous cells
		3	3 μs			Synchronous cells
deriveSSB-IndexFromCell		1	False			
		2	True			
		3	True			

T1	s	1, 2, 3	TBD	
T2	s	1, 2, 3	TBD	

**Table A.13.3.1.3.2-3: Cell-specific test parameters for intra-frequency event-triggered reporting without gap**

Parameter	Unit	Test configuration	Cell 1		Cell 2		Cell 3	
			T1	T2	T1	T2	T1	T2
DL CCA probability $P_{CCA\_DL}$		1, 2, 3	N/A		TBD	TBD	TBD	TBD
UL CCA probability $P_{CCA\_UL}$		1, 2, 3	N/A		TBD	TBD	TBD	TBD
TDD configuration		1	N/A		TBD		TBD	
		2	TDDConf.1.1		TBD		TBD	
		3	TDDConf.2.1		TBD		TBD	
PDSCH RMC configuration		1	SR.1.1 FDD		TBD		TBD	
		2	SR.1.1 TDD					
		3	SR.2.1 TDD					
RMSI CORESET RMC configuration		1	CR.1.1 FDD		TBD		TBD	
		2	CR.1.1 TDD		TBD		TBD	
		3	CR.2.1 TDD		TBD		TBD	
Dedicated CORESET RMC configuration		1	CCR.1.1 FDD		TBD		TBD	
		2	CCR.1.1 TDD		TBD		TBD	
		3	CCR.2.1 TDD		TBD		TBD	
OCNG Patterns		1, 2, 3	OP.1		TBD		TBD	
TRS Configuration		1	TRS.1.1 FDD		TBD		TBD	
		2	TRS.1.1 TDD		TBD		TBD	
		3	TRS.1.2 TDD		TBD		TBD	
Initial BWP configuration		1, 2, 3	DLBWP.0.1 ULBWP.0.1		DLBWP.0.1 ULBWP.0.1		DLBWP.0.1 ULBWP.0.1	
Active DL BWP configuration		1, 2, 3	DLBWP.1.1		DLBWP.1.2		DLBWP.1.1	
Active UL BWP configuration		1, 2, 3	ULBWP.1.1		DLBWP.1.2		ULBWP.1.1	
RLM-RS		1, 2, 3	SSB		SSB		SSB	
$N_{oc}$ Note 2	dBm/SCS	1	-98		TBD		TBD	
		2	-98		TBD		TBD	
		3	-95		TBD		TBD	
$N_{oc}$ Note 2	dBm/15 kHz	1	-98		TBD		TBD	
		2	-98		TBD		TBD	
		3	-95		TBD		TBD	
$\hat{E}_s/I_{ot}$ Note 5	dB	1	4	-1.46	TBD	TBD	-Infinity	TBD
		2			TBD	TBD	-Infinity	TBD
		3			TBD	TBD	-Infinity	TBD
$\hat{E}_s/N_{oc}$ Note 5	dB	1	4	4	TBD	TBD	-Infinity	TBD
		2			TBD	TBD	-Infinity	TBD
		3			TBD	TBD	-Infinity	TBD
SS-RSRP Note 3,5	dBm/SCS kHz	1	-94	-94	TBD	TBD	-Infinity	TBD
		2	-94	-94	TBD	TBD	-Infinity	TBD
		3	-91	-91	TBD	TBD	-Infinity	TBD
$I_o$	dBm/9.36 MHz	1	-64.60	-62.25	TBD	TBD	TBD	TBD
	dBm/9.36 MHz	2	-64.60	-62.25	TBD	TBD	TBD	TBD
	dBm/38.16 MHz	3	-58.50	-56.16	TBD	TBD	TBD	TBD

Propagation Condition		1, 2, 3	AWGN
NOTE 1: The resources for uplink transmission are assigned to the UE prior to the start of time period T2.			
NOTE 2: Interference from other cells and noise sources not specified in the test is assumed to be constant over subcarriers and time and shall be modelled as AWGN of appropriate power for $N_{oc}$ to be fulfilled.			
NOTE 3: SS-RSRP levels have been derived from other parameters for information purposes. They are not settable parameters themselves.			
NOTE 4: DL and UL CCA probabilities apply for UE supporting any one or both semi-static channel access or dynamic channel access and for network configuring any of semi-static channel occupancy or dynamic channel occupancy.			
NOTE 5: The signal levels apply for SSS REs when the discovery burst is transmitted during DBT windows.			

### A.13.3.1.3.3 Test Requirements

The UE shall send one Event A3 triggered measurement report (SS-RSRP in Test 1, SS-RSRQ in Test 2, SS-SINR in Test 3), with a measurement reporting delay less than D1 ms from the beginning of time period T2.

*Editor's note: D1=TBD.*

The UE is not required to read the neighbour cell SSB index in this test.

The UE shall not send event triggered measurement reports, as long as the reporting criteria are not fulfilled.

The rate of correct events observed during repeated tests shall be at least 90%.

FFS: NOTE: The actual overall delays measured in the test may be up to  $2 \times TTI_{DCCH}$  higher than the measurement reporting delays above because of TTI insertion uncertainty of the measurement report in DCCH.

### A.13.3.1.4 Event-triggered reporting tests on SCC with per-UE gaps under DRX

#### A.13.3.1.4.1 Test purpose and environment

The purpose of this test is to verify that the UE makes correct reporting of an event. This test will partly verify the intra-frequency cell search requirements in clauses 9.2A.6.1 and 9.2A.6.2.

#### A.13.3.1.4.2 Test parameters

Three cells are deployed in the test, which are FR1 PCell (Cell 1), and two cells on the same carrier frequency with CCA and transmit SSBs in DBT windows according to DL CCA model: SCell (Cell 2) and a neighbour cell (Cell 3). The test parameters for the three cells are given in Table A.13.3.1.4.2-1 and A.13.3.1.4.2-2 below. In the measurement control information, a measurement object is configured for the frequency of the SCell, and it is indicated to the UE that event-triggered reporting with Event A3 is used. The test consists of two successive time periods, with time duration of T1 and T2, respectively. During time duration T1, the UE shall not have any timing information of Cell 3.

FFS: The same test is applicable for UE supporting any one or both semi-static channel access or dynamic channel access and for network configuring any of semi-static channel occupancy or dynamic channel occupancy.

There are two BWPs configured in Cell 1, BWP1 which contains the cell defining SSB, and BWP2 which does not contain any SSB of Cell 1. During the whole test, BWP2 is always scheduled as the active BWP for the UE.

UE needs to be provided at least once every 500ms with new Timing Advance Command MAC control element to restart the Time alignment timer to keep UE uplink time alignment. Furthermore UE is allocated with PUSCH resource at every DRX cycle.

The test is conducted for SS-RSRP, SS-RSRQ, and SS-SINR:

- In Test 1 and Test 2, the UE is configured with SS-RSRP as Event A3 measurement quantity.
- In Test 3 and Test 4, the UE is configured with SS-RSRQ as Event A3 measurement quantity.
- In Test 5 and Test 6, the UE is configured with SS-SINR as Event A3 measurement quantity.

**Table A.13.3.1.4.2-1: Supported test configurations**

Configuration	Description
1	Without CCA: 15 kHz SSB SCS, 10 MHz bandwidth, FDD duplex mode With CCA: 30 kHz SSB SCS, 40 MHz bandwidth, TDD duplex mode
2	Without CCA: 15 kHz SSB SCS, 10 MHz bandwidth, TDD duplex mode

	With CCA: 30 kHz SSB SCS, 40 MHz bandwidth, TDD duplex mode
3	Without CCA: 30 kHz SSB SCS, 40 MHz bandwidth, TDD duplex mode With CCA: 30 kHz SSB SCS, 40 MHz bandwidth, TDD duplex mode
NOTE: The UE is only required to be tested in one of the supported test configurations.	

**Table A.13.3.1.4.2-2: General test parameters for intra-frequency event triggered reporting without gap with DRX**

Parameter	Unit	Test configuration	Value						Comment
			Test 1	Test 2	Test 3	Test 4	Test 5	Test 6	
Active PCell		1, 2, 3	Cell 1						
Active SCell		1, 2, 3	Cell 2						
Neighbour cell		1, 2, 3	Cell 3						Cell to be identified.
RF Channel Number		1, 2, 3	1: Cell 1 2: Cell 2 and Cell 3						
Measurement gap type		1, 2, 3	Per-UE gaps						
Measurement gap repetition periodicity	ms	1, 2, 3	40						
Measurement gap length	ms	1, 2, 3	[6]						
Measurement gap offset	ms	1, 2, 3	[39]						
DL CCA model			As specified in clause A.3.20.2.1						
UL CCA model			As specified in clause A.3.20.2.2						
SSB configuration		1	Cell 1: SSB.1 FR1 Cell 2,3: TBD						
		2	Cell 1: SSB.1 FR1 Cell 2,3: TBD						
		3	Cell 1: SSB.2 FR1 Cell 2,3: TBD						
SMTC configuration		1	Cell 1: SMTC.2 Cell 2,3: N/A						
		2	Cell 1: SMTC.1 Cell 2,3: N/A						
		3	Cell 1: SMTC.1 Cell 2,3: N/A						
DBT window configuration		1, 2, 3	Cell 1: N/A Cell 2,3: TBD						
CSI-RS parameters in Cell 1		1	CSI-RS.1.2 FDD resource #0						
		2	CSI-RS.1.2 TDD resource #0						
		3	CSI-RS.2.2 TDD resource #0						
A3-Offset	dB	1, 2, 3	-4.5						
Event A3 measurement quantity			SS-RSRP	SS-RSRQ	SS-SINR				
CP length		1, 2, 3	Normal						
Hysteresis	dB	1, 2, 3	0						
Time To Trigger	s	1, 2, 3	0						
Filter coefficient		1, 2, 3	0						L3 filtering is not used
DRX		1, 2, 3	DRX.1	DRX.2	DRX.1	DRX.2	DRX.1	DRX.2	
Time offset between Cell 2 and Cell 3		1	3 ms						Asynchronous cells. The timing of Cell 3 is 3ms later than the timing of Cell 2.
		2	3 μs						Synchronous cells
		3	3 μs						Synchronous cells
deriveSSB-IndexFromCell		1	False						
		2	True						
		3	True						
T1	s	1, 2, 3	TBD						
T2	s	1, 2, 3	TBD	TBD	TBD	TBD	TBD	TBD	

**Table A.13.3.1.4.2-3: Cell-specific test parameters for intra-frequency event-triggered reporting without gap**

Parameter	Unit	Test configuration	Cell 1		Cell 2		Cell 3	
			T1	T2	T1	T2	T1	T2
DL CCA probability $P_{CCA\_DL}$		1, 2, 3	N/A		TBD	TBD	TBD	TBD
UL CCA probability $P_{CCA\_UL}$		1, 2, 3	N/A		TBD	TBD	TBD	TBD
TDD configuration		1	N/A		TBD		TBD	
		2	TDDConf.1.1		TBD		TBD	
		3	TDDConf.2.1		TBD		TBD	
PDSCH RMC configuration		1	SR.1.1 FDD		TBD		TBD	
		2	SR.1.1 TDD					
		3	SR.2.1 TDD					
RMSI CORESET RMC configuration		1	CR.1.1 FDD		TBD		TBD	
		2	CR.1.1 TDD		TBD		TBD	
		3	CR.2.1 TDD		TBD		TBD	
Dedicated CORESET RMC configuration		1	CCR.1.1 FDD		TBD		TBD	
		2	CCR.1.1 TDD		TBD		TBD	
		3	CCR.2.1 TDD		TBD		TBD	
OCNG Patterns		1, 2, 3	OP.1		TBD		TBD	
TRS Configuration		1	TRS.1.1 FDD		TBD		TBD	
		2	TRS.1.1 TDD		TBD		TBD	
		3	TRS.1.2 TDD		TBD		TBD	
Initial BWP configuration		1, 2, 3	DLBWP.0.1 ULBWP.0.1		DLBWP.0.1 ULBWP.0.1		DLBWP.0.1 ULBWP.0.1	
Active DL BWP configuration		1, 2, 3	DLBWP.1.1		DLBWP.1.2		DLBWP.1.1	
Active UL BWP configuration		1, 2, 3	ULBWP.1.1		DLBWP.1.2		ULBWP.1.1	
RLM-RS		1, 2, 3	SSB		SSB		SSB	
$N_{oc}$ Note 2	dBm/SCS	1	-98		TBD		TBD	
		2	-98		TBD		TBD	
		3	-95		TBD		TBD	
$N_{oc}$ Note 2	dBm/15 kHz	1	-98		TBD		TBD	
		2	-98		TBD		TBD	
		3	-95		TBD		TBD	
$\hat{E}_s/I_{ot}$ Note 5	dB	1	4	-1.46	TBD	TBD	-Infinity	TBD
		2			TBD	TBD	-Infinity	TBD
		3			TBD	TBD	-Infinity	TBD
$\hat{E}_s/N_{oc}$ Note 5	dB	1	4	4	TBD	TBD	-Infinity	TBD
		2			TBD	TBD	-Infinity	TBD
		3			TBD	TBD	-Infinity	TBD
SS-RSRP Note 3,5	dBm/SCS kHz	1	-94	-94	TBD	TBD	-Infinity	TBD
		2	-94	-94	TBD	TBD	-Infinity	TBD
		3	-91	-91	TBD	TBD	-Infinity	TBD
I <sub>o</sub>	dBm/9.36 MHz	1	-64.60	-62.25	TBD	TBD	TBD	TBD
	dBm/9.36 MHz	2	-64.60	-62.25	TBD	TBD	TBD	TBD
	dBm/38.16 MHz	3	-58.50	-56.16	TBD	TBD	TBD	TBD
Propagation Condition		1, 2, 3	AWGN					

NOTE 1:	The resources for uplink transmission are assigned to the UE prior to the start of time period T2.
NOTE 2:	Interference from other cells and noise sources not specified in the test is assumed to be constant over subcarriers and time and shall be modelled as AWGN of appropriate power for $N_{oc}$ to be fulfilled.
NOTE 3:	SS-RSRP levels have been derived from other parameters for information purposes. They are not settable parameters themselves.
NOTE 4:	DL and UL CCA probabilities apply for UE supporting any one or both semi-static channel access or dynamic channel access and for network configuring any of semi-static channel occupancy or dynamic channel occupancy.
NOTE 5:	The signal levels apply for SSS REs when the discovery burst is transmitted during DBT windows.

#### A.13.3.1.4.3 Test Requirements

The UE shall send one Event A3 triggered measurement report (SS-RSRP in Test 1 and Test 2, SS-RSRQ in Test 3 and Test 4, SS-SINR in Test 5 and Test 6), with a measurement reporting delay less than D1 ms from the beginning of time period T2.

*Editor's note: D1=TBD (D1 is different for different DRX configurations).*

The UE is not required to read the neighbour cell SSB index in this test.

The UE shall not send event triggered measurement reports, as long as the reporting criteria are not fulfilled.

The rate of correct events observed during repeated tests shall be at least 90%.

FFS: NOTE: The actual overall delays measured in the test may be up to  $2 \times TTI_{DCCH}$  higher than the measurement reporting delays above because of TTI insertion uncertainty of the measurement report in DCCH.

#### A.13.3.1.5 RSSI measurement reporting on SCC

##### A.13.3.1.5.1 Test purpose and environment

The purpose of this test is to verify that the UE correctly reports RSSI measurements. This test will partly verify the intra-frequency RSSI measurement reporting requirements in Section 9.2A.7.1.

##### A.13.3.1.5.2 Test parameters

In the test, the UE is configured to perform intra-frequency RSSI measurements on a carrier frequency under CCA.

Supported test configurations are shown in Table A.13.3.1.5.2-1. There are two cells in the test: Cell 1 is PCell on a licensed FR1 band, and Cell 2 is SCell operating on a carrier frequency under CCA. Prior to the start of the time duration T1, the UE is connected to Cell 1 and Cell 2.

**Table A.13.3.1.5.2-1: Supported test configurations.**

Configuration	Description
1	Without CCA: 15 kHz SSB SCS, 10 MHz bandwidth, FDD duplex mode With CCA: 30 kHz SSB SCS, 40 MHz bandwidth, TDD duplex mode
2	Without CCA: 15 kHz SSB SCS, 10 MHz bandwidth, TDD duplex mode With CCA: 30 kHz SSB SCS, 40 MHz bandwidth, TDD duplex mode
3	Without CCA: 30 kHz SSB SCS, 40 MHz bandwidth, TDD duplex mode With CCA: 30 kHz SSB SCS, 40 MHz bandwidth, TDD duplex mode
NOTE: The UE is only required to be tested in one of the supported test configurations.	

**Table A.13.3.1.5.2-2: General test parameters.**

Parameter	Configurations	Unit	Test 1	
			Cell 1	Cell 2
RF Channel Number			1	2
$BW_{channel}$		MHz	40	40
DL CCA model			N/A	$P_{CCA\_DL}=1.0$
UL CCA model			N/A	$P_{CCA\_UL}=1.0$
Measurement bandwidth		$n_{PRE}$	Same as channel access bandwidth	
Channel access bandwidth		$n_{PRE}$	TBD	



PDSCH Reference measurement channel defined in TBD			TBD	TBD
PDCCH/PCFICH/PHICH Reference measurement channel defined in TBD			TBD	TBD
OCNG Patterns defined in TBD			TBD	TBD
Other general configuration parameters: TBD			TBD	TBD
$N_{oc}$ in slots not corresponding to RSSI measurement time configuration (RMTC)		dBm/SCS	TBD	TBD
$N_{oc}$ in slots corresponding to RSSI measurement time configuration (RMTC)		dBm/SCS	TBD	TBD
$\hat{E}_s/I_{ot}$ in slots not corresponding to RSSI measurement time configuration (RMTC)		dB	TBD	TBD
$\hat{E}_s/I_{ot}$ in slots corresponding to RSSI measurement time configuration (RMTC)		dB	TBD	TBD
SS-RSRP in slots not corresponding to RSSI measurement time configuration (RMTC)		dBm/SCS	TBD	TBD
SS-RSRP in slots corresponding to RSSI measurement time configuration (RMTC)			TBD	TBD
$I_o$ within measurement bandwidth in slots corresponding to RSSI measurement time configuration (RMTC)		dBm/BW	TBD	TBD
$I_o$ within measurement bandwidth in slots not corresponding to RSSI measurement time configuration (RMTC)		dBm/BW	TBD	TBD
Propagation condition		-	AWGN	

### A.13.3.1.6 Channel occupancy measurement reporting on SCC

#### A.13.3.1.6.1 Test purpose and environment

The purpose of this test is to verify that the UE correctly reports channel occupancy measurements. This test will partly verify the intra-frequency channel occupancy measurement reporting requirements in Section 9.2A.7.2.

#### A.13.3.1.6.2 Test parameters

In the test, the UE is configured to perform intra-frequency channel occupancy measurements on a carrier frequency under CCA.

Supported test configurations are shown in Table A.13.3.1.6.2-1. There are two cells in the test: Cell 1 is PCell on a licensed FR1 band, and Cell 2 is SCell operating on a carrier frequency under CCA. Prior to the start of the time duration T1, the UE is connected to Cell 1 and Cell 2.

**Table A.13.3.1.6.2-1: Supported test configurations.**

Configuration	Description
1	Without CCA: 15 kHz SSB SCS, 10 MHz bandwidth, FDD duplex mode With CCA: 30 kHz SSB SCS, 40 MHz bandwidth, TDD duplex mode
2	Without CCA: 15 kHz SSB SCS, 10 MHz bandwidth, TDD duplex mode With CCA: 30 kHz SSB SCS, 40 MHz bandwidth, TDD duplex mode
3	Without CCA: 30 kHz SSB SCS, 40 MHz bandwidth, TDD duplex mode With CCA: 30 kHz SSB SCS, 40 MHz bandwidth, TDD duplex mode

NOTE: The UE is only required to be tested in one of the supported test configurations.

**Table A.13.3.1.6.2-2: General test parameters.**

Editor's note: Table is TBD

## A.13.3.2 Inter-frequency measurements

### A.13.3.2.1 RSSI measurement reporting

#### A.13.3.2.1.1 Test purpose and environment

The purpose of this test is to verify that the UE correctly reports RSSI measurements. This test will partly verify the inter-frequency RSSI measurement reporting requirements in Section 9.3A.8.

#### A.13.3.2.1.2 Test parameters

In the test, the UE is configured to perform inter-frequency RSSI measurements on a carrier frequency under CCA.

Supported test configurations are shown in Table A.13.3.2.1.2-1. There are two cells in the test: Cell 1 is PCell on a licensed FR1 band, and Cell 2 is SCell operating on a carrier frequency under CCA. Prior to the start of the time duration T1, the UE is connected to Cell 1 and Cell 2. The RSSI measurement is performed on an inter-frequency under CCA.

**Table A.13.3.2.1.2-1: Supported test configurations.**

Configuration	Description
1	Without CCA: 15 kHz SSB SCS, 10 MHz bandwidth, FDD duplex mode With CCA: 30 kHz SSB SCS, 40 MHz bandwidth, TDD duplex mode
2	Without CCA: 15 kHz SSB SCS, 10 MHz bandwidth, TDD duplex mode With CCA: 30 kHz SSB SCS, 40 MHz bandwidth, TDD duplex mode
3	Without CCA: 30 kHz SSB SCS, 40 MHz bandwidth, TDD duplex mode With CCA: 30 kHz SSB SCS, 40 MHz bandwidth, TDD duplex mode
NOTE: The UE is only required to be tested in one of the supported test configurations.	

**Table A.13.3.2.1.2-2: General test parameters.**

Editor's note: Table TBD

### A.13.3.2.2 Channel occupancy measurement reporting

#### A.13.3.2.2.1 Test purpose and environment

The purpose of this test is to verify that the UE correctly reports channel occupancy measurements. This test will partly verify the inter-frequency channel occupancy measurement reporting requirements in Section 9.3A.13.

#### A.13.3.2.2.2 Test parameters

In the test, the UE is configured to perform inter-frequency channel occupancy measurements on a carrier frequency under CCA.

Supported test configurations are shown in Table A.13.3.2.2-1. There are two cells in the test: Cell 1 is PCell on a licensed FR1 band, and Cell 2 is SCell operating on a carrier frequency under CCA. Prior to the start of the time duration T1, the UE is connected to Cell 1 and Cell 2. The channel occupancy measurement is performed on an inter-frequency under CCA.

**Table A.13.3.2.2-1: Supported test configurations.**

Configuration	Description
1	Without CCA: 15 kHz SSB SCS, 10 MHz bandwidth, FDD duplex mode With CCA: 30 kHz SSB SCS, 40 MHz bandwidth, TDD duplex mode
2	Without CCA: 15 kHz SSB SCS, 10 MHz bandwidth, TDD duplex mode With CCA: 30 kHz SSB SCS, 40 MHz bandwidth, TDD duplex mode

3	Without CCA: 30 kHz SSB SCS, 40 MHz bandwidth, TDD duplex mode With CCA: 30 kHz SSB SCS, 40 MHz bandwidth, TDD duplex mode
NOTE: The UE is only required to be tested in one of the supported test configurations.	

**Table A.13.3.2.2-2: General test parameters.**

Editor's note: Table is TBD

**A.13.3.2.3 Event triggered reporting tests for FR1 with CCA without SSB time index detection when DRX is not used****A.13.3.2.3.1 Test Purpose and Environment**

The purpose of this test is to verify that the UE makes correct reporting of an event. This test will partly verify the SA inter-frequency NR cell search requirements for NR cell with CCA in clause 9.3A.4 and 9.3A.5.

In this test, there are three cells: NR cell 1 as PCell in FR1 on NR RF channel 1, NR cell 2 as SCell in FR1 with CCA on NR RF channel 2 and NR cell 3 as neighbour cell in FR1 with CCA on NR RF channel 3. The test parameters are given in Tables A.13.3.2.3.1-1, A.13.3.2.3.1-2 and A.13.3.2.3.1-3.

In test 1, measurement gap pattern configuration # 0 as defined in Table A.13.3.2.3.1-2 is provided for UE that does not support per-FR gap. In test 2, measurement gap pattern configuration #4 as defined in Table A.13.3.2.3.1-2 is provided for UE that supports per-FR gap. If a UE supports per-FR gap and gap pattern configuration #4, it is only required to pass test 2. Otherwise it is only required to pass test 1.

In the measurement control information, it is indicated to the UE that event-triggered reporting with Event A3 is used. The test consists of two successive time periods, with time duration of T1, and T2 respectively. During time duration T1, the UE shall not have any timing information of NR cell 3.

**Table A.13.3.2.3.1-1: SA event triggered reporting tests without SSB index reading for FR1-FR1 with CCA**

Config	Description
1	NR cell with CCA: 30 kHz SSB SCS, 40 MHz bandwidth, TDD duplex mode NR cell without CCA: 15 kHz SSB SCS, 10 MHz bandwidth, FDD duplex mode
2	NR cell with CCA: 30 kHz SSB SCS, 40 MHz bandwidth, TDD duplex mode NR cell without CCA: 15 kHz SSB SCS, 10 MHz bandwidth, TDD duplex mode
3	NR cell with CCA: 30 kHz SSB SCS, 40 MHz bandwidth, TDD duplex mode, NR cell without CCA: NR 30 kHz SSB SCS, 40 MHz bandwidth, TDD duplex mode
Note 1: The UE is only required to be tested in one of the supported test configurations	

**Table A.13.3.2.3.1-2: General test parameters for SA inter-frequency event triggered reporting for FR1 with CCA without SSB time index detection**

Parameter	Unit	Test configuration	Value		Comment
			Test 1	Test 2	
NR RF Channel Number		Config 1,2,3	1, 2, 3		Three FR1 NR carrier frequencies are used. Channels 2 and 3 are with CCA.
Active cells		Config 1,2,3	NR cell 1 (PCell), NR cell 2 with CCA (SCell)		NR cell 1 is on NR RF channel number 1. NR cell 2 is on NR RF channel number 2 with CCA.
Neighbour cell		Config 1,2,3	NR cell 3 with CCA		NR cell 3 is on NR RF channel number 3 with CCA.
DL CCA model		Config 1,2,3	As specified in clause A.3.26.2.1		
UL CCA model		Config 1,2,3	As specified in clause A.3.26.2.2		
Gap Pattern Id		Config 1,2,3	0	4	As specified in clause 9.1.2-1.

Measurement gap offset		Config 1,2,3	9	9	
A3-Offset	dB	Config 1,2,3	-6		
Hysteresis	dB	Config 1,2,3	0		
CP length		Config 1,2,3	Normal		
TimeToTrigger	s	Config 1,2,3	0		
Filter coefficient		Config 1,2,3	0		L3 filtering is not used
DRX		Config 1,2,3	OFF		DRX is not used
Time offset between serving and neighbour cells		Config 1,2,3	3µs		Synchronous cells.
T1	s	Config 1,2,3	5		
T2	s	Config 1,2,3	1.7	1.7	

**Table A.13.3.2.3.1-3: Cell specific test parameters for SA inter-frequency event triggered reporting for FR1 with CCA without SSB time index detection**

Parameter		Unit	Test configuration	Cell 1		Cell 2		Cell 3	
				T1	T2	T1	T2	T1	T2
NR RF Channel Number			Config 1,2,3	1		2		3	
Duplex mode			Config 1	FDD		TDD		TDD	
			Config 2,3	TDD		TDD		TDD	
TDD configuration			Config 1	Not Applicable		TDDConf.1.1 CCA		TDDConf.1.1 CCA	
			Config 2	TDDConf.1.1		TDDConf.1.1 CCA		TDDConf.1.1 CCA	
			Config 3	TDDConf.2.1		TDDConf.1.1 CCA		TDDConf.1.1 CCA	
DL CCA probability P <sub>CCA_DL</sub>	Semi-static channel access Note 5,7		Config 1,2,3	Not Applicable		P <sub>CCA_DL</sub> =0.9375		P <sub>CCA_DL</sub> =0.9375	
	Dynami c channel access Note 6,7		Config 1,2,3	Not Applicable		P <sub>CCA_DL_1</sub> =0.75 P <sub>CCA_DL_2</sub> =0.75		P <sub>CCA_DL_1</sub> =0.75 P <sub>CCA_DL_2</sub> =0.75	
UL CCA probability P <sub>CCA_UL</sub>	Semi-static channel access Note 5,7		Config 1,2,3	Not Applicable		P <sub>CCA_UL</sub> =1		P <sub>CCA_UL</sub> =1	
	Dynami c channel access Note 6,7		Config 1,2,3	Not Applicable		P <sub>CCA_UL</sub> =1		P <sub>CCA_UL</sub> =1	
L <sub>CCA_DL</sub>			Config 1,2,3	Not Applicable		12		12	
W <sub>CCA_DL</sub>		ms	Config 1,2,3	Not Applicable		T <sub>PSS/SSS_sync_inter_cca</sub>		T <sub>PSS/SSS_sync_inter_cca</sub>	
BW <sub>channel</sub>		MH z	Config 1,2	10: N <sub>RB,c</sub> = 52		40: N <sub>RB,c</sub> = 106		40: N <sub>RB,c</sub> = 106	
			Config 3	40: N <sub>RB,c</sub> = 106		40: N <sub>RB,c</sub> = 106		40: N <sub>RB,c</sub> = 106	
BWP BW		MH z	Config 1,2	10: N <sub>RB,c</sub> = 52		40: N <sub>RB,c</sub> = 106		40: N <sub>RB,c</sub> = 106	
			Config 3	40: N <sub>RB,c</sub> = 106		40: N <sub>RB,c</sub> = 106		40: N <sub>RB,c</sub> = 106	
BWP configuration	Initial DL BWP		Config 1,2,3	DLBWP.0.1		DLBWP.0.1			
	Initial UL BWP			ULBWP.0.1		ULBWP.0.1			
	Dedicated DL BWP			DLBWP.1.1		DLBWP.1.1			
	Dedicated UL BWP			ULBWP.1.1		ULBWP.1.1			
TRS configuration			Config 1	TRS.1.1 FDD		TRS.1.2 TDD			
			Config 2	TRS.1.1 TDD		TRS.1.2 TDD			

			Config 3	TRS.1.2 TDD	TRS.1.2 TDD			
OCNG Patterns defined in A.3.2.1.1 (OP.1)			Config 1,2,3	OP.1	OP.1	OP.1		
PDSCH Reference measurement channel			Config 1	SR.1.1 FDD	SR.1.1 CCA			
			Config 2	SR.1.1 TDD	SR.1.1 CCA			
			Config 3	SR2.1 TDD	SR.1.1 CCA			
CORESET Reference Channel			Config 1	CR.1.1 FDD	CR.1.1 CCA			
			Config 2	CR.1.1 TDD	CR.1.1 CCA			
			Config 3	CR2.1 TDD	CR.1.1 CCA			
SSB parameters	Semi-static channel Note 5,7		Config 1	SSB.1 FR1	SSB.1 CCA	SSB.1 CCA		
			Config 2	SSB.1 FR1	SSB.1 CCA	SSB.1 CCA		
			Config 3	SSB.2 FR1	SSB.1 CCA	SSB.1 CCA		
	Dynamic channel Access Note 6,7		Config 1	SSB.1 FR1	SSB.2 CCA	SSB.2 CCA		
			Config 2	SSB.1 FR1	SSB.2 CCA	SSB.2 CCA		
			Config 3	SSB.2 FR1	SSB.2 CCA	SSB.2 CCA		
DBT window configuration			Config 1,2,3	Not Applicable	As defined in A.3.28.1	As defined in A.3.28.1		
SMTTC configuration defined in A.3.11			Config 1,2,3	SMTTC.1	SMTTC.1	SMTTC.4		
PDSCH/PDCCH subcarrier spacing		kHz	Config 1	15	30	30		
			Config 2	15	30	30		
			Config 3	30	30	30		
EPRE ratio of PSS to SSS			Config 1,2,3	0	0	0		
EPRE ratio of PBCH DMRS to SSS								
EPRE ratio of PBCH to PBCH DMRS								
EPRE ratio of PDCCH DMRS to SSS								
EPRE ratio of PDCCH to PDCCH DMRS								
EPRE ratio of PDSCH DMRS to SSS								
EPRE ratio of PDSCH to PDSCH								
EPRE ratio of OCNG DMRS to SSS(Note 1)								
EPRE ratio of OCNG to OCNG DMRS (Note 1)								
$N_{oc}$ <sup>Note2</sup>	dB m/15kHz	Config 1,2,3	-98	-104	-104			
$N_{oc}$ <sup>Note2</sup>	dB m/S CS	Config 1,2	-98	-101	-101			
		Config 3	-95	-101	-101			
SS-RSRP <sup>Note 3</sup>	dB m/S CS	Config 1,2	-94	-94	-91	-91	-Infinity	-88
		Config 3	-91	-91	-91	-91	-Infinity	-88
$\hat{E}_s/I_{ot}$	dB	Config 1,2	4	4	4	4	-Infinity	7
$\hat{E}_s/N_{oc}$	dB	Config 1,2	4	4	4	4	-Infinity	7

I <sub>o</sub> <sup>Note3</sup>	dB m/9. 36M Hz	Config 1,2	-64.59	-64.59	-58.49	-58.49	-63.94	-56.15
	dB m/3 8.16 MH z	Config 3	-58.49	-58.49	-58.49	-58.49	-63.94	-56.15
Propagation Condition		Config 1,2,3	AWGN		AWGN		AWGN	
<p>Note 1: OCNG shall be used such that both cells are fully allocated and a constant total transmitted power spectral density is achieved for all OFDM symbols.</p> <p>Note 2: Interference from other cells and noise sources not specified in the test is assumed to be constant over subcarriers and time and shall be modelled as AWGN of appropriate power for <math>N_{oc}</math> to be fulfilled.</p> <p>Note 3: SS-RSRP and I<sub>o</sub> levels have been derived from other parameters for information purposes. They are not settable parameters themselves.</p> <p>Note 4: SS-RSRP minimum requirements are specified assuming independent interference and noise at each receiver antenna port.</p> <p>Note 5: For UE supporting semi-static channel access and network configuring semi-static channel occupancy.</p> <p>Note 6: For UE supporting dynamic channel access and network configuring dynamic channel occupancy.</p> <p>Note 7: For UE supporting both semi-static and dynamic channel access, the UE must be tested under dynamic channel access configuration.</p>								

### A.13.3.2.3.2 Test Requirements

In test 1 with per-UE gap, the UE shall send one Event A3 triggered measurement report, with a measurement reporting delay less than  $T_{\text{identify\_inter\_cca\_without\_index}}$  from the beginning of time period T2. The UE shall not send event triggered measurement reports, as long as the reporting criteria are not fulfilled. The rate of correct events observed during repeated tests shall be at least 90%. In test 2 with per-FR gap, the UE shall send one Event A3 triggered measurement report, with a measurement reporting delay less than  $T_{\text{identify\_inter\_cca\_without\_index}}$  from the beginning of time period T2. The UE shall not send event triggered measurement reports, as long as the reporting criteria are not fulfilled. The rate of correct events observed during repeated tests shall be at least 90%.

In test 1 and 2 UE is not required to report SSB time index.

$T_{\text{identify\_inter\_cca\_without\_index}} = (T_{\text{PSS/SSS\_sync\_inter\_cca}} + T_{\text{SSB\_measurement\_period\_inter\_cca}})$  ms, where

$T_{\text{PSS/SSS\_sync\_inter\_cca}}$ : it is the time period used in PSS/SSS detection given in table 9.3A.4-1.

$T_{\text{SSB\_measurement\_period\_inter\_cca}}$ : equal to a measurement period of SSB based measurement given in table 9.3A.5-1.

For test 1, MGRP = 40 ms and for test 2 MGRP = 20 ms.

SMTC period = 20 ms.

NOTE: The actual overall delays measured in the test may be up to  $2 \times T_{\text{TTI}_{\text{DCCH}}}$  higher than the measurement reporting delays above because of TTI insertion uncertainty of the measurement report in DCCH.

### A.13.3.2.4 Event triggered reporting tests for FR1 with CCA without SSB time index detection when DRX is used

#### A.13.3.2.4.1 Test Purpose and Environment

The purpose of this test is to verify that the UE makes correct reporting of an event. This test will partly verify the SA inter-frequency NR cell search requirements in clause 9.3A.4 and 9.3A.5.

In this test, there are three cells: NR cell 1 as PCell in FR1 on NR RF channel 1, NR cell 2 as SCell in FR1 with CCA on NR RF channel 2 and NR cell 3 as neighbour cell in FR1 with CCA on NR RF channel 3. The test parameters are given in Tables A.13.3.2.4.1-1, A.13.3.2.4.1-2 and A.13.3.2.4.1-3.

In test 1&2 measurement gap pattern configuration # 0 as defined in Table A.13.3.2.4.1-2 is provided for UE that does not support per-FR gap and in test 3&4 measurement gap pattern configuration #4 as defined in Table A.13.3.2.4.1-2 is

provided for UE that supports per-FR gap. If a UE supports per-FR gap and gap pattern configuration #4, it is only required to pass test 3&4. Otherwise it is only required to pass test 1&2.

In the measurement control information, it is indicated to the UE that event-triggered reporting with Event A3 is used. The test consists of two successive time periods, with time duration of T1, and T2 respectively. During time duration T1, the UE shall not have any timing information of NR cell 3.

UE needs to be provided at least once every 500ms with new Timing Advance Command MAC control element to restart the Time alignment timer to keep UE uplink time alignment. Furthermore, UE is allocated with PUSCH resource at every DRX cycle.

**Table A.13.3.2.4.1-1: SA event triggered reporting tests without SSB index reading for FR1-FR1 with CCA**

Config	Description
1	NR cell with CCA: 30 kHz SSB SCS, 40 MHz bandwidth, TDD duplex mode NR cell without CCA: 15 kHz SSB SCS, 10 MHz bandwidth, FDD duplex mode
2	NR cell with CCA: 30 kHz SSB SCS, 40 MHz bandwidth, TDD duplex mode NR cell without CCA: 15 kHz SSB SCS, 10 MHz bandwidth, TDD duplex mode
3	NR cell with CCA: 30 kHz SSB SCS, 40 MHz bandwidth, TDD duplex mode, NR cell without CCA: NR 30 kHz SSB SCS, 40 MHz bandwidth, TDD duplex mode
Note 1: The UE is only required to be tested in one of the supported test configurations	

**Table A.13.3.2.4.1-2: General test parameters for SA inter-frequency event triggered reporting for FR1 with CCA without SSB time index detection**

Parameter	Unit	Test configuration	Value				Comment
			Test 1	Test 2	Test 3	Test 4	
NR RF Channel Number		Config 1,2,3	1, 2, 3				Three FR1 NR carrier frequencies are used. Channels 2 and 3 are with CCA.
Active cells		Config 1,2,3	NR cell 1 (PCell), NR cell 2 with CCA (SCell)				NR cell 1 is on NR RF channel number 1. NR cell 2 is on NR RF channel number 2 with CCA.
Neighbour cell		Config 1,2,3	NR cell 3 with CCA				NR cell 3 is on NR RF channel number 3 with CCA.
DL CCA model		Config 1,2,3	As specified in clause A.3.26.2.1				
UL CCA model		Config 1,2,3	As specified in clause A.3.26.2.2				
Gap Pattern Id		Config 1,2,3	0		4		As specified in clause 9.1.2-1.
Measurement gap offset		Config 1,2,3	9		9		
A3-Offset	dB	Config 1,2,3	-6				
Hysteresis	dB	Config 1,2,3	0				
CP length		Config 1,2,3	Normal				
TimeToTrigger	s	Config 1,2,3	0				
Filter coefficient		Config 1,2,3	0				L3 filtering is not used
DRX		Config 1,2,3	DRX .1	DRX .2	DRX .1	DRX .2	As specified in clause A.3.3
Time offset between serving and neighbour cells		Config 1,2,3	3μs				Synchronous cells.
T1	s	Config 1,2,3	5				
T2	s	Config 1,2,3	2.5	17	2.5	17	

**Table A.13.3.2.4.1-3: Cell specific test parameters for SA inter-frequency event triggered reporting for FR1 with CCA without SSB time index detection**

Parameter	Unit	Cell 1	Cell 2	Cell 3
-----------	------	--------	--------	--------

		Test configuration	T1	T2	T1	T2	T1	T2
NR RF Channel Number		Config 1,2,3	1		2		3	
Duplex mode		Config 1	FDD		TDD		TDD	
		Config 2,3	TDD		TDD		TDD	
TDD configuration		Config 1	Not Applicable		TDDConf.1.1 CCA		TDDConf.1.1 CCA	
		Config 2	TDDConf.1.1		TDDConf.1.1 CCA		TDDConf.1.1 CCA	
		Config 3	TDDConf.2.1		TDDConf.1.1 CCA		TDDConf.1.1 CCA	
DL CCA probability $P_{CCA\_DL}$ Note 5,7	Semi-static channel access Note 5,7	Config 1,2,3	Not Applicable		$P_{CCA\_DL}=0.9375$		$P_{CCA\_DL}=0.9375$	
	Dynamic channel access Note 6,7	Config 1,2,3	Not Applicable		$P_{CCA\_DL\_1}=0.75$ $P_{CCA\_DL\_2}=0.75$		$P_{CCA\_DL\_1}=0.75$ $P_{CCA\_DL\_2}=0.75$	
UL CCA probability $P_{CCA\_UL}$	Semi-static channel access Note 5,7	Config 1,2,3	Not Applicable		$P_{CCA\_UL}=1$		$P_{CCA\_UL}=1$	
	Dynamic channel access Note 6,7	Config 1,2,3	Not Applicable		$P_{CCA\_UL}=1$		$P_{CCA\_UL}=1$	
BW <sub>channel</sub>		MHz	Config 1,2	10: $N_{RB,c} = 52$	40: $N_{RB,c} = 106$		40: $N_{RB,c} = 106$	
			Config 3	40: $N_{RB,c} = 106$	40: $N_{RB,c} = 106$		40: $N_{RB,c} = 106$	
BWP BW		MHz	Config 1,2	10: $N_{RB,c} = 52$	40: $N_{RB,c} = 106$		40: $N_{RB,c} = 106$	
			Config 3	40: $N_{RB,c} = 106$	40: $N_{RB,c} = 106$		40: $N_{RB,c} = 106$	
BWP configuration	Initial DL BWP	Config 1,2,3	DLBWP.0.1		DLBWP.0.1			
	Initial UL BWP		ULBWP.0.1		ULBWP.0.1			
	Dedicated DL BWP		DLBWP.1.1		DLBWP.1.1			
	Dedicated UL BWP		ULBWP.1.1		ULBWP.1.1			
TRS configuration		Config 1	TRS.1.1 FDD		TRS.1.2 TDD			
		Config 2	TRS.1.1 TDD		TRS.1.2 TDD			
		Config 3	TRS.1.2 TDD		TRS.1.2 TDD			
OCNG Patterns defined in A.3.2.1.1 (OP.1)		Config 1,2,3	OP.1		OP.1		OP.1	
PDSCH Reference measurement channel		Config 1	SR.1.1 FDD		SR.1.1 CCA			
		Config 2	SR.1.1 TDD		SR.1.1 CCA			
		Config 3	SR2.1 TDD		SR.1.1 CCA			
CORESET Reference Channel		Config 1	CR.1.1 FDD		CR.1.1 CCA			
		Config 2	CR.1.1 TDD		CR.1.1 CCA			
		Config 3	CR2.1 TDD		CR.1.1 CCA			
SSB parameters	Semi-static channel access Note 5,7	Config 1	SSB.1 FR1		SSB.1 CCA		SSB.1 CCA	
		Config 2	SSB.1 FR1		SSB.1 CCA		SSB.1 CCA	
		Config 3	SSB.2 FR1		SSB.1 CCA		SSB.1 CCA	
	Dynamic channel	Config 1	SSB.1 FR1		SSB.2 CCA		SSB.2 CCA	
		Config 2	SSB.1 FR1		SSB.2 CCA		SSB.2 CCA	



	Access Note 6,7		Config 3	SSB.2 FR1	SSB.2 CCA	SSB.2 CCA	SSB.2 CCA	
DBT window configuration			Config 1,2,3	Not Applicable	As defined in A.3.28.1	As defined in A.3.28.1		
SMTTC configuration defined in A.3.11			Config 1,2,3	SMTTC.1	SMTTC.1	SMTTC.4		
PDSCH/PDCCH subcarrier spacing	kHz		Config 1	15	30	30		
			Config 2	15	30	30		
			Config 3	30	30	30		
EPRE ratio of PSS to SSS		Config 1,2,3	0	0	0			
EPRE ratio of PBCH DMRS to SSS								
EPRE ratio of PBCH to PBCH DMRS								
EPRE ratio of PDCCH DMRS to SSS								
EPRE ratio of PDCCH to PDCCH DMRS								
EPRE ratio of PDSCH DMRS to SSS								
EPRE ratio of PDSCH to PDSCH								
EPRE ratio of OCNG DMRS to SSS(Note 1)								
EPRE ratio of OCNG to OCNG DMRS (Note 1)								
$N_{oc}^{Note2}$	dBm/15kHz	Config 1,2,3	-98	-104	-104			
$N_{oc}^{Note2}$	dBm/SCS	Config 1,2	-98	-101	-101			
		Config 3	-95	-101	-101			
SS-RSRP Note 3	dBm/SCS	Config 1,2	-94	-94	-91	-91	-Infinity	-88
		Config 3	-91	-91	-91	-91	-Infinity	-88
$\hat{E}_s/I_{ot}$	dB	Config 1,2	4	4	4	4	-Infinity	7
$\hat{E}_s/N_{oc}$	dB	Config 1,2	4	4	4	4	-Infinity	7
$I_o^{Note3}$	dBm/9.36 MHz	Config 1,2	-64.59	-64.59	-58.49	-58.49	-63.94	-56.15
	dBm/38.16 MHz	Config 3	-58.49	-58.49	-58.49	-58.49	-63.94	-56.15
Propagation Condition		Config 1,2,3	AWGN	AWGN	AWGN	AWGN		
<p>Note 1: OCNG shall be used such that both cells are fully allocated and a constant total transmitted power spectral density is achieved for all OFDM symbols.</p> <p>Note 2: Interference from other cells and noise sources not specified in the test is assumed to be constant over subcarriers and time and shall be modelled as AWGN of appropriate power for <math>N_{oc}</math> to be fulfilled.</p> <p>Note 3: SS-RSRP and <math>I_o</math> levels have been derived from other parameters for information purposes. They are not settable parameters themselves.</p> <p>Note 4: SS-RSRP minimum requirements are specified assuming independent interference and noise at each receiver antenna port.</p> <p>Note 5: For UE supporting semi-static channel access and network configuring semi-static channel occupancy.</p> <p>Note 6: For UE supporting dynamic channel access and network configuring dynamic channel occupancy.</p> <p>Note 7: For UE supporting both semi-static and dynamic channel access, the UE must be tested under dynamic channel access configuration.</p>								

**Table A.13.3.2.4.1-4: DRX-Configuration for SA inter-frequency event triggered reporting without SSB time index detection**

Field	Test1&3	Test2&4	Comment
	Value	Value	
drx-onDurationTimer	ms1	ms1	As specified in clause 6.3.2 in TS 38.331 [2]
drx-InactivityTimer	ms1	ms1	
drx-RetransmissionTimerDL	sl1	sl1	
drx-RetransmissionTimerUL	sl1	sl1	
drx-LongCycleStartOffset	ms40	Ms640	
shortDRX	disable	disable	

**Table A.13.3.2.4.1-5: TimeAlignmentTimer-Configuration SA inter-frequency event triggered reporting without SSB time index detection**

Field	Value	Comment
TimeAlignmentTimer	ms500	As specified in clause 6.3.2 in TS 38.331 [2]

#### A.13.3.2.4.2 Test Requirements

In test 1 with per-UE gap, the UE shall send one Event A3 triggered measurement report, with a measurement reporting delay less than  $T_{\text{identify\_inter\_cca\_without\_index}}$  from the beginning of time period T2. The UE shall not send event triggered measurement reports, as long as the reporting criteria are not fulfilled. The rate of correct events observed during repeated tests shall be at least 90%.

In test 2 with per-FR gap, the UE shall send one Event A3 triggered measurement report, with a measurement reporting delay less than  $T_{\text{identify\_inter\_cca\_without\_index}}$  from the beginning of time period T2. The UE shall not send event triggered measurement reports, as long as the reporting criteria are not fulfilled. The rate of correct events observed during repeated tests shall be at least 90%.

In test 3 with per-UE gap, the UE shall send one Event A3 triggered measurement report, with a measurement reporting delay less than  $T_{\text{identify\_inter\_cca\_without\_index}}$  from the beginning of time period T2. The UE shall not send event triggered measurement reports, as long as the reporting criteria are not fulfilled. The rate of correct events observed during repeated tests shall be at least 90%.

In test 4 with per-FR gap, the UE shall send one Event A3 triggered measurement report, with a measurement reporting delay less than  $T_{\text{identify\_inter\_cca\_without\_index}}$  from the beginning of time period T2. The UE shall not send event triggered measurement reports, as long as the reporting criteria are not fulfilled. The rate of correct events observed during repeated tests shall be at least 90%.

In test 1, 2, 3 and 4 UE is not required to report SSB time index.

$T_{\text{identify\_inter\_cca\_without\_index}} = (T_{\text{PSS/SSS\_sync\_inter\_cca}} + T_{\text{SSB\_measurement\_period\_inter\_cca}})$  ms, where

$T_{\text{PSS/SSS\_sync\_inter\_cca}}$ : it is the time period used in PSS/SSS detection given in table 9.3A.4-1.

$T_{\text{SSB\_measurement\_period\_inter\_cca}}$ : equal to a measurement period of SSB based measurement given in table 9.3A.5-1.

For tests 1 and 2, MGRP = 40 ms and for tests 3 and 4 MGRP = 20 ms.

For tests 1 and 3, DRX cycle = 40 ms and for tests 2 and 4 DRX cycle = 640 ms.

SMTC period = 20 ms.

NOTE: The actual overall delays measured in the test may be up to  $2 \times TTI_{\text{DCCH}}$  higher than the measurement reporting delays above because of TTI insertion uncertainty of the measurement report in DCCH.

### A.13.3.2.5 Event triggered reporting tests for FR1 with CCA with SSB time index detection when DRX is not used

#### A.13.3.2.5.1 Test Purpose and Environment

The purpose of this test is to verify that the UE makes correct reporting of an event. This test will partly verify the SA inter-frequency NR cell search requirements in clause 9.3A.4 and 9.3A.5.

In this test, there are three cells: NR cell 1 as PCell in FR1 on NR RF channel 1, NR cell 2 as SCell in FR1 with CCA on NR RF channel 2 and NR cell 3 as neighbour cell in FR1 with CCA on NR RF channel 3. The test parameters are given in Tables A.13.3.2.5.1-1, A.13.3.2.5.1-2 and A.13.3.2.5.1-3.

In test 1 measurement gap pattern configuration # 0 as defined in Table A.13.3.2.5.1-2 is provided for UE that does not support per-FR gap and in test 2 measurement gap pattern configuration #4 as defined in Table A.13.3.2.5.1-2 is provided for UE that supports per-FR gap. If a UE supports per-FR gap and gap pattern configuration #4, it is only required to pass test 2. Otherwise it is only required to pass test 1.

In the measurement control information, it is indicated to the UE that event-triggered reporting with Event A3 is used. The test consists of two successive time periods, with time duration of T1, and T2 respectively. During time duration T1, the UE shall not have any timing information of NR cell 3.

**Table A.13.3.2.5.1-1: SA event triggered reporting tests with SSB index reading for FR1-FR1 with CCA**

Config	Description
1	NR cell with CCA: 30 kHz SSB SCS, 40 MHz bandwidth, TDD duplex mode NR cell without CCA: 15 kHz SSB SCS, 10 MHz bandwidth, FDD duplex mode
2	NR cell with CCA: 30 kHz SSB SCS, 40 MHz bandwidth, TDD duplex mode NR cell without CCA: 15 kHz SSB SCS, 10 MHz bandwidth, TDD duplex mode
3	NR cell with CCA: 30 kHz SSB SCS, 40 MHz bandwidth, TDD duplex mode, NR cell without CCA: NR 30 kHz SSB SCS, 40 MHz bandwidth, TDD duplex mode
Note 1: The UE is only required to be tested in one of the supported test configurations	

**Table A.13.3.2.5.1-2: General test parameters for SA inter-frequency event triggered reporting for FR1 with CCA with SSB time index detection**

Parameter	Unit	Test configuration	Value		Comment
			Test 1	Test 2	
NR RF Channel Number		Config 1,2,3	1, 2, 3		Three FR1 NR carrier frequencies are used. Channels 2 and 3 are with CCA.
Active cells		Config 1,2,3	NR cell 1 (PCell), NR cell 2 with CCA (SCell)		NR cell 1 is on NR RF channel number 1. NR cell 2 is on NR RF channel number 2 with CCA.
Neighbour cell		Config 1,2,3	NR cell 3 with CCA		NR cell 3 is on NR RF channel number 3 with CCA.
DL CCA model		Config 1,2,3	As specified in clause A.3.26.2.1		
UL CCA model		Config 1,2,3	As specified in clause A.3.26.2.2		
Gap Pattern Id		Config 1,2,3	0	4	As specified in clause 9.1.2-1.
Measurement gap offset		Config 1,2,3	9	9	
A3-Offset	dB	Config 1,2,3	-6		
Hysteresis	dB	Config 1,2,3	0		
CP length		Config 1,2,3	Normal		
TimeToTrigger	s	Config 1,2,3	0		
Filter coefficient		Config 1,2,3	0		L3 filtering is not used
DRX		Config 1,2,3	OFF		DRX is not used
Time offset between serving and neighbour cells		Config 1,2,3	3µs		Synchronous cells.

T1	s	Config 1,2,3	5		
T2	s	Config 1,2,3	2	2	

**Table A.13.3.2.5.1-3: Cell specific test parameters for SA inter-frequency event triggered reporting for FR1 with CCA with SSB time index detection**

Parameter		Unit	Test configuration	Cell 1		Cell 2		Cell 3	
				T1	T2	T1	T2	T1	T2
NR RF Channel Number			Config 1,2,3	1		2		3	
Duplex mode			Config 1	FDD		TDD		TDD	
			Config 2,3	TDD		TDD		TDD	
TDD configuration			Config 1	Not Applicable		TDDConf.1.1 CCA		TDDConf.1.1 CCA	
			Config 2	TDDConf.1.1		TDDConf.1.1 CCA		TDDConf.1.1 CCA	
			Config 3	TDDConf.2.1		TDDConf.1.1 CCA		TDDConf.1.1 CCA	
DL CCA probability P <sub>CCA_DL</sub>	Semi-static channel access Note 5,7		Config 1,2,3	Not Applicable		P <sub>CCA_DL</sub> =0.9375		P <sub>CCA_DL</sub> =0.9375	
	Dynamic channel access Note 6,7		Config 1,2,3	Not Applicable		P <sub>CCA_DL_1</sub> =0.75 P <sub>CCA_DL_2</sub> =0.75		P <sub>CCA_DL_1</sub> =0.75 P <sub>CCA_DL_2</sub> =0.75	
UL CCA probability P <sub>CCA_UL</sub>	Semi-static channel access Note 5,7		Config 1,2,3	Not Applicable		P <sub>CCA_UL</sub> =1		P <sub>CCA_UL</sub> =1	
	Dynamic channel access Note 6,7		Config 1,2,3	Not Applicable		P <sub>CCA_UL</sub> =1		P <sub>CCA_UL</sub> =1	
L <sub>CCA_DL</sub>			Config 1,2,3	Not Applicable		5		5	
W <sub>CCA_DL</sub>		ms	Config 1,2,3	Not Applicable		T <sub>PSS/SSS_sync_inter_cca</sub>		T <sub>PSS/SSS_sync_inter_cca</sub>	
BW <sub>channel</sub>		MHz	Config 1,2	10: N <sub>RB,c</sub> = 52		40: N <sub>RB,c</sub> = 106		40: N <sub>RB,c</sub> = 106	
			Config 3	40: N <sub>RB,c</sub> = 106		40: N <sub>RB,c</sub> = 106		40: N <sub>RB,c</sub> = 106	
BWP BW		MHz	Config 1,2	10: N <sub>RB,c</sub> = 52		40: N <sub>RB,c</sub> = 106		40: N <sub>RB,c</sub> = 106	
			Config 3	40: N <sub>RB,c</sub> = 106		40: N <sub>RB,c</sub> = 106		40: N <sub>RB,c</sub> = 106	
BWP configuration	Initial DL BWP		Config 1,2,3	DLBWP.0.1		DLBWP.0.1			
	Initial UL BWP			ULBWP.0.1		ULBWP.0.1			
	Dedicated DL BWP			DLBWP.1.1		DLBWP.1.1			
	Dedicated UL BWP			ULBWP.1.1		ULBWP.1.1			
TRS configuration			Config 1	TRS.1.1 FDD		TRS.1.2 TDD			
			Config 2	TRS.1.1 TDD		TRS.1.2 TDD			
			Config 3	TRS.1.2 TDD		TRS.1.2 TDD			
OCNG Patterns defined in A.3.2.1.1 (OP.1)			Config 1,2,3	OP.1		OP.1		OP.1	
PDSCH Reference measurement channel			Config 1	SR.1.1 FDD		SR.1.1 CCA			
			Config 2	SR.1.1 TDD		SR.1.1 CCA			
			Config 3	SR2.1 TDD		SR.1.1 CCA			

CORESET Reference Channel			Config 1	CR.1.1 FDD	CR.1.1 CCA			
			Config 2	CR.1.1 TDD	CR.1.1 CCA			
			Config 3	CR2.1 TDD	CR.1.1 CCA			
SSB parameters	Semi-static channel Note 5,7		Config 1	SSB.1 FR1	SSB.1 CCA		SSB.1 CCA	
			Config 2	SSB.1 FR1	SSB.1 CCA		SSB.1 CCA	
			Config 3	SSB.2 FR1	SSB.1 CCA		SSB.1 CCA	
	Dynamic channel Access Note 6,7		Config 1	SSB.1 FR1	SSB.2 CCA		SSB.2 CCA	
			Config 2	SSB.1 FR1	SSB.2 CCA		SSB.2 CCA	
			Config 3	SSB.2 FR1	SSB.2 CCA		SSB.2 CCA	
DBT window configuration			Config 1,2,3	Not Applicable	As defined in A.3.28.1		As defined in A.3.28.1	
SMTC configuration defined in A.3.11			Config 1,2,3	SMTC.1	SMTC.1		SMTC.4	
PDSCH/PDCCH subcarrier spacing		kHz	Config 1	15	30		30	
			Config 2	15	30		30	
			Config 3	30	30		30	
EPRE ratio of PSS to SSS		Config 1,2,3		0	0		0	
EPRE ratio of PBCH DMRS to SSS								
EPRE ratio of PBCH to PBCH DMRS								
EPRE ratio of PDCCH DMRS to SSS								
EPRE ratio of PDCCH to PDCCH DMRS								
EPRE ratio of PDSCH DMRS to SSS								
EPRE ratio of PDSCH to PDSCH								
EPRE ratio of OCNG DMRS to SSS(Note 1)								
EPRE ratio of OCNG to OCNG DMRS (Note 1)								
$N_{oc}$ <sup>Note2</sup>	dBm/15kHz							
$N_{oc}$ <sup>Note2</sup>	dBm/SCS	Config 1,2	-98	-101		-101		
		Config 3	-95	-101		-101		
SS-RSRP <sup>Note 3</sup>	dBm/SCS	Config 1,2	-94	-94	-91	-91	-Infinity	-88
		Config 3	-91	-91	-91	-91	-Infinity	-88
$\hat{E}_s/I_{ot}$	dB	Config 1,2	4	4	4	4	-Infinity	7
$\hat{E}_s/N_{oc}$	dB	Config 1,2	4	4	4	4	-Infinity	7
$I_o$ <sup>Note3</sup>	dBm/9.36 MHz	Config 1,2	-64.59	-64.59	-58.49	-58.49	-63.94	-56.15
	dBm/38.16 MHz	Config 3	-58.49	-58.49	-58.49	-58.49	-63.94	-56.15
Propagation Condition			Config 1,2,3	AWGN		AWGN		AWGN

Note 1:	OCNG shall be used such that both cells are fully allocated and a constant total transmitted power spectral density is achieved for all OFDM symbols.
Note 2:	Interference from other cells and noise sources not specified in the test is assumed to be constant over subcarriers and time and shall be modelled as AWGN of appropriate power for $N_{ac}$ to be fulfilled.
Note 3:	SS-RSRP and $I_0$ levels have been derived from other parameters for information purposes. They are not settable parameters themselves.
Note 4:	SS-RSRP minimum requirements are specified assuming independent interference and noise at each receiver antenna port.
Note 5:	For UE supporting semi-static channel access and network configuring semi-static channel occupancy.
Note 6:	For UE supporting dynamic channel access and network configuring dynamic channel occupancy.
Note 7:	For UE supporting both semi-static and dynamic channel access, the UE must be tested under dynamic channel access configuration

### A.13.3.2.5.2 Test Requirements

In test 1 with per-UE gap, the UE shall send one Event A3 triggered measurement report, with a measurement reporting delay less than  $T_{\text{identify\_inter\_cca\_with\_index}}$  from the beginning of time period T2. The UE shall not send event triggered measurement reports, as long as the reporting criteria are not fulfilled. The rate of correct events observed during repeated tests shall be at least 90%.

In test 2 with per-FR gap, the UE shall send one Event A3 triggered measurement report, with a measurement reporting delay less than  $T_{\text{identify\_inter\_cca\_with\_index}}$  from the beginning of time period T2. The UE shall not send event triggered measurement reports, as long as the reporting criteria are not fulfilled. The rate of correct events observed during repeated tests shall be at least 90%.

In test 1 and 2 UE is required to report SSB time index.

$T_{\text{identify\_inter\_cca\_with\_index}} = (T_{\text{PSS/SSS\_sync\_inter\_cca}} + T_{\text{SSB\_measurement\_period\_inter\_cca}} + T_{\text{SSB\_time\_index\_inter\_cca}})$  ms, where

$T_{\text{PSS/SSS\_sync\_inter\_cca}}$ : it is the time period used in PSS/SSS detection given in table 9.3A.4-1.

$T_{\text{SSB\_time\_index\_inter\_cca}}$ : it is the time period used to acquire the index of the SSB being measured given in table 9.3A.4-2.

$T_{\text{SSB\_measurement\_period\_inter\_cca}}$ : equal to a measurement period of SSB based measurement given in table 9.3A.5-1.

For test 1, MGRP = 40 ms and for test 2 MGRP = 20 ms.

SMTC period = 20 ms.

NOTE: The actual overall delays measured in the test may be up to  $2 \times TTI_{\text{DCCH}}$  higher than the measurement reporting delays above because of TTI insertion uncertainty of the measurement report in DCCH.

### A.13.3.2.6 Event triggered reporting tests for FR1 with CCA with SSB time index detection when DRX is used

#### A.13.3.2.6.1 Test Purpose and Environment

The purpose of this test is to verify that the UE makes correct reporting of an event. This test will partly verify the SA inter-frequency NR cell search requirements in clause 9.3A.4 and 9.3A.5.

In this test, there are three cells: NR cell 1 as PCell in FR1 on NR RF channel 1, NR cell 2 as SCell in FR1 with CCA on NR RF channel 2 and NR cell 3 as neighbour cell in FR1 with CCA on NR RF channel 3. The test parameters are given in Tables A.13.3.2.6.1-1, A.13.3.2.6.1-2 and A.13.3.2.6.1-3.

In test 1&2 measurement gap pattern configuration # 0 as defined in Table A.13.3.2.6.1-2 is provided for UE that does not support per-FR gap and in test 3&4 measurement gap pattern configuration #4 as defined in Table A.13.3.2.6.1-2 is provided for UE that supports per-FR gap. If a UE supports per-FR gap and gap pattern configuration #4, it is only required to pass test 3&4. Otherwise it is only required to pass test 1&2.

In the measurement control information, it is indicated to the UE that event-triggered reporting with Event A3 is used. The test consists of two successive time periods, with time duration of T1, and T2 respectively. During time duration T1, the UE shall not have any timing information of NR cell 3.

UE needs to be provided at least once every 500 ms with new Timing Advance Command MAC control element to restart the Time alignment timer to keep UE uplink time alignment. Furthermore, UE is allocated with PUSCH resource at every DRX cycle.

**Table A.13.3.2.6.1-1: SA event triggered reporting tests with SSB index reading for FR1-FR1 with CCA**

Config	Description
1	NR cell with CCA: 30 kHz SSB SCS, 40 MHz bandwidth, TDD duplex mode NR cell without CCA: 15 kHz SSB SCS, 10 MHz bandwidth, FDD duplex mode
2	NR cell with CCA: 30 kHz SSB SCS, 40 MHz bandwidth, TDD duplex mode NR cell without CCA: 15 kHz SSB SCS, 10 MHz bandwidth, TDD duplex mode
3	NR cell with CCA: 30 kHz SSB SCS, 40 MHz bandwidth, TDD duplex mode, NR cell without CCA: NR 30 kHz SSB SCS, 40 MHz bandwidth, TDD duplex mode
Note 1: The UE is only required to be tested in one of the supported test configurations	

**Table A.13.3.2.6.1-2: General test parameters for SA inter-frequency event triggered reporting for FR1 with CCA with SSB time index detection**

Parameter	Unit	Test configuration	Value				Comment
			Test 1	Test 2	Test 3	Test 4	
NR RF Channel Number		Config 1,2,3	1, 2, 3				Three FR1 NR carrier frequencies are used. Channels 2 and 3 are with CCA.
Active cells		Config 1,2,3	NR cell 1 (PCell), NR cell 2 with CCA (SCell)				NR cell 1 is on NR RF channel number 1. NR cell 2 is on NR RF channel number 2 with CCA.
Neighbour cell		Config 1,2,3	NR cell 3 with CCA				NR cell 3 is on NR RF channel number 3 with CCA.
DL CCA model		Config 1,2,3	As specified in clause A.3.26.2.1				
UL CCA model		Config 1,2,3	As specified in clause A.3.26.2.2				
Gap Pattern Id		Config 1,2,3	0		4		As specified in clause 9.1.2-1.
Measurement gap offset		Config 1,2,3	9		9		
A3-Offset	dB	Config 1,2,3	-6				
Hysteresis	dB	Config 1,2,3	0				
CP length		Config 1,2,3	Normal				
TimeToTrigger	s	Config 1,2,3	0				
Filter coefficient		Config 1,2,3	0				L3 filtering is not used
DRX		Config 1,2,3	DRX .1	DRX .2	DRX .1	DRX .2	As specified in clause A.3.3
Time offset between serving and neighbour cells		Config 1,2,3	3µs				Synchronous cells.
T1	s	Config 1,2,3	5				
T2	s	Config 1,2,3	3	20	3	20	

**Table A.13.3.2.6.1-3: Cell specific test parameters for SA inter-frequency event triggered reporting for FR1 with CCA with SSB time index detection**

Parameter	Unit	Test configuration	Cell 1		Cell 2		Cell 3	
			T1	T2	T1	T2	T1	T2
NR RF Channel Number		Config 1,2,3	1		2		3	
Duplex mode		Config 1	FDD		TDD		TDD	
		Config 2,3	TDD		TDD		TDD	
TDD configuration		Config 1	Not Applicable		TDDConf.1.1 CCA		TDDConf.1.1 CCA	
		Config 2	TDDConf.1.1		TDDConf.1.1 CCA		TDDConf.1.1 CCA	
		Config 3	TDDConf.2.1		TDDConf.1.1 CCA		TDDConf.1.1 CCA	

DL CCA probability $P_{CCA\_DL}$ Note 5,7	Semi-static channel access		Config 1,2,3	Not Applicable	$P_{CCA\_DL}=0.9375$	$P_{CCA\_DL}=0.9375$
	Dynamic channel access		Config 1,2,3	Not Applicable	$P_{CCA\_DL\_1}=0.75$ $P_{CCA\_DL\_2}=0.75$	$P_{CCA\_DL\_1}=0.75$ $P_{CCA\_DL\_2}=0.75$
UL CCA probability $P_{CCA\_UL}$ Note 5,7	Semi-static channel access		Config 1,2,3	Not Applicable	$P_{CCA\_UL}=1$	$P_{CCA\_UL}=1$
	Dynamic channel access		Config 1,2,3	Not Applicable	$P_{CCA\_UL}=1$	$P_{CCA\_UL}=1$
BW <sub>channel</sub>		MHz	Config 1,2 Config 3	10: $N_{RB,c} = 52$ 40: $N_{RB,c} = 106$	40: $N_{RB,c} = 106$ 40: $N_{RB,c} = 106$	40: $N_{RB,c} = 106$ 40: $N_{RB,c} = 106$
BWP BW		MHz	Config 1,2 Config 3	10: $N_{RB,c} = 52$ 40: $N_{RB,c} = 106$	40: $N_{RB,c} = 106$ 40: $N_{RB,c} = 106$	40: $N_{RB,c} = 106$ 40: $N_{RB,c} = 106$
BWP configuration	Initial DL BWP		Config 1,2,3	DLBWP.0.1	DLBWP.0.1	
	Initial UL BWP			ULBWP.0.1	ULBWP.0.1	
	Dedicated DL BWP			DLBWP.1.1	DLBWP.1.1	
	Dedicated UL BWP			ULBWP.1.1	ULBWP.1.1	
TRS configuration			Config 1 Config 2 Config 3	TRS.1.1 FDD TRS.1.1 TDD TRS.1.2 TDD	TRS.1.2 TDD TRS.1.2 TDD TRS.1.2 TDD	
OCNG Patterns defined in A.3.2.1.1 (OP.1)			Config 1,2,3	OP.1	OP.1	OP.1
PDSCH Reference measurement channel			Config 1 Config 2 Config 3	SR.1.1 FDD SR.1.1 TDD SR2.1 TDD	SR.1.1 CCA SR.1.1 CCA SR.1.1 CCA	
CORESET Reference Channel			Config 1 Config 2 Config 3	CR.1.1 FDD CR.1.1 TDD CR2.1 TDD	CR.1.1 CCA CR.1.1 CCA CR.1.1 CCA	
SSB parameters	Semi-static channel access		Config 1	SSB.1 FR1	SSB.1 CCA	SSB.1 CCA
			Config 2	SSB.1 FR1	SSB.1 CCA	SSB.1 CCA
			Config 3	SSB.2 FR1	SSB.1 CCA	SSB.1 CCA
	Dynamic channel Access		Config 1	SSB.1 FR1	SSB.2 CCA	SSB.2 CCA
			Config 2	SSB.1 FR1	SSB.2 CCA	SSB.2 CCA
			Config 3	SSB.2 FR1	SSB.2 CCA	SSB.2 CCA
DBT window configuration			Config 1,2,3	Not Applicable	As defined in A.3.28.1	As defined in A.3.28.1
SMTTC configuration defined in A.3.11			Config 1,2,3	SMTTC.1	SMTTC.1	SMTTC.4
PDSCH/PDCCH subcarrier spacing		kHz	Config 1 Config 2 Config 3	15 15 30	30 30 30	30 30 30



EPRE ratio of PSS to SSS		Config 1,2,3	0	0	0	0	0	
EPRE ratio of PBCH DMRS to SSS								
EPRE ratio of PBCH to PBCH DMRS								
EPRE ratio of PDCCH DMRS to SSS								
EPRE ratio of PDCCH to PDCCH DMRS								
EPRE ratio of PDSCH DMRS to SSS								
EPRE ratio of PDSCH to PDSCH								
EPRE ratio of OCNG DMRS to SSS(Note 1)								
EPRE ratio of OCNG to OCNG DMRS (Note 1)								
$N_{oc}^{Note2}$	dBm/15kHz	Config 1,2,3	-98	-104	-104			
$N_{oc}^{Note2}$	dBm/SCS	Config 1,2	-98	-101	-101			
		Config 3	-95	-101	-101			
SS-RSRP <sup>Note 3</sup>	dBm/SCS	Config 1,2	-94	-94	-91	-91	-Infinity	-88
		Config 3	-91	-91	-91	-91	-Infinity	-88
$\hat{E}_s/I_{ot}$	dB	Config 1,2	4	4	4	4	-Infinity	7
$\hat{E}_s/N_{oc}$	dB	Config 1,2	4	4	4	4	-Infinity	7
$I_o^{Note3}$	dBm/9.36 MHz	Config 1,2	-64.59	-64.59	-58.49	-58.49	-63.94	-56.15
	dBm/38.16 MHz	Config 3	-58.49	-58.49	-58.49	-58.49	-63.94	-56.15
Propagation Condition		Config 1,2,3	AWGN		AWGN		AWGN	
<p>Note 1: OCNG shall be used such that both cells are fully allocated and a constant total transmitted power spectral density is achieved for all OFDM symbols.</p> <p>Note 2: Interference from other cells and noise sources not specified in the test is assumed to be constant over subcarriers and time and shall be modelled as AWGN of appropriate power for <math>N_{oc}</math> to be fulfilled.</p> <p>Note 3: SS-RSRP and <math>I_o</math> levels have been derived from other parameters for information purposes. They are not settable parameters themselves.</p> <p>Note 4: SS-RSRP minimum requirements are specified assuming independent interference and noise at each receiver antenna port.</p> <p>Note 5: For UE supporting semi-static channel access and network configuring semi-static channel occupancy.</p> <p>Note 6: For UE supporting dynamic channel access and network configuring dynamic channel occupancy.</p> <p>Note 7: For UE supporting both semi-static and dynamic channel access, the UE must be tested under dynamic channel access configuration.</p>								

**Table A.13.3.2.6.1-4: DRX-Configuration for SA inter-frequency event triggered reporting without SSB time index detection**

Field	Test1&3	Test2&4	Comment
	Value	Value	
drx-onDurationTimer	ms1	ms1	As specified in clause 6.3.2 in TS 38.331 [2]
drx-InactivityTimer	ms1	ms1	
drx-RetransmissionTimerDL	sl1	sl1	

drx-RetransmissionTimerUL	sl1	sl1	
drx-LongCycleStartOffset	ms40	Ms640	
shortDRX	disable	disable	

**Table A.13.3.2.6.1-5: TimeAlignmentTimer -Configuration SA inter-frequency event triggered reporting without SSB time index detection**

Field	Value	Comment
TimeAlignmentTimer	ms500	As specified in clause 6.3.2 in TS 38.331 [2]

### A.13.3.2.6.2 Test Requirements

In test 1 with per-UE gap, the UE shall send one Event A3 triggered measurement report, with a measurement reporting delay less than  $T_{\text{identify\_inter\_cca\_with\_index}}$  from the beginning of time period T2. The UE shall not send event triggered measurement reports, as long as the reporting criteria are not fulfilled. The rate of correct events observed during repeated tests shall be at least 90%. In test 2 with per-FR gap, the UE shall send one Event A3 triggered measurement report, with a measurement reporting delay less than  $T_{\text{identify\_inter\_cca\_with\_index}}$  from the beginning of time period T2. The UE shall not send event triggered measurement reports, as long as the reporting criteria are not fulfilled. The rate of correct events observed during repeated tests shall be at least 90%.

In test 3 with per-UE gap, the UE shall send one Event A3 triggered measurement report, with a measurement reporting delay less than  $T_{\text{identify\_inter\_cca\_with\_index}}$  from the beginning of time period T2. The UE shall not send event triggered measurement reports, as long as the reporting criteria are not fulfilled. The rate of correct events observed during repeated tests shall be at least 90%.

In test 4 with per-FR gap, the UE shall send one Event A3 triggered measurement report, with a measurement reporting delay less than  $T_{\text{identify\_inter\_cca\_with\_index}}$  from the beginning of time period T2. The UE shall not send event triggered measurement reports, as long as the reporting criteria are not fulfilled. The rate of correct events observed during repeated tests shall be at least 90%.

In test 1, 2, 3 and 4 UE is required to report SSB time index.

$T_{\text{identify\_inter\_cca\_with\_index}} = (T_{\text{PSS/SSS\_sync\_inter\_cca}} + T_{\text{SSB\_measurement\_period\_inter\_cca}} + T_{\text{SSB\_time\_index\_inter\_cca}})$  ms, where

$T_{\text{PSS/SSS\_sync\_inter\_cca}}$ : it is the time period used in PSS/SSS detection given in table 9.3A.4-1.

$T_{\text{SSB\_time\_index\_inter\_cca}}$ : it is the time period used to acquire the index of the SSB being measured given in table 9.3A.4-2.

$T_{\text{SSB\_measurement\_period\_inter\_cca}}$ : equal to a measurement period of SSB based measurement given in table 9.3A.5-1.

For tests 1 and 2, MGRP = 40 ms and for tests 3 and 4 MGRP = 20 ms.

For tests 1 and 3, DRX cycle = 40 ms and for tests 2 and 4 DRX cycle = 640 ms.

SMTC period = 20 ms.

NOTE: The actual overall delays measured in the test may be up to  $2 \times TTI_{\text{DCCH}}$  higher than the measurement reporting delays above because of TTI insertion uncertainty of the measurement report in DCCH.

## A.13.3.3 L1-RSRP measurements for beam reporting

### A.13.3.3.1 SSB based L1-RSRP measurement when DRX is not used

#### A.13.3.3.1.1 Test Purpose and Environment

The purpose of this test is to verify that the UE makes correct reporting of L1-RSRP measurement. This test will partly verify the L1-RSRP measurement requirements in clause 9.5A.4.1, with the testing configurations for NR cells in Table A.13.3.3.1.1-1.

**Table A.13.3.3.1.1-1: Applicable NR configurations for FR1 SSB based L1-RSRP test**

Config	Description
1	Without CCA: 15 kHz SSB SCS, 10 MHz bandwidth, FDD duplex mode With CCA: 30 kHz SSB SCS, 40 MHz bandwidth, TDD duplex mode
2	Without CCA: 15 kHz SSB SCS, 10 MHz bandwidth, TDD duplex mode With CCA: 30 kHz SSB SCS, 40 MHz bandwidth, TDD duplex mode
3	Without CCA: 30 kHz SSB SCS, 40 MHz bandwidth, TDD duplex mode With CCA: 30 kHz SSB SCS, 40 MHz bandwidth, TDD duplex mode
Note:	The UE is only required to be tested in one of the supported test configurations

### A.13.3.3.1.2 Test parameters

There are two cells in the tests, FR1 PCell (Cell 1) and FR1 SCell (Cell 2). Cell 2 operates on a carrier frequency with CCA and transmits SSBs in DBT window according to DL CCA model. The test parameters and applicability for Cell 1 and Cell 2 are given in Table A.13.3.3.1.2-1 and Table A.13.3.3.1.2-2 below.

In CSI measurement configuration, UE is indicated to perform L1-RSRP measurement on the SSBs and report periodically. The UE transmits the reporting according to UL CCA model. The test consists of two successive time periods, with time duration of T1 and T2 respectively. The test has higher layer parameter *timeRestrictionForChannelMeasurements* configured.

The same test is applicable for UE supporting any one or both semi-static channel access or dynamic channel access and for network configuring any of semi-static channel occupancy or dynamic channel occupancy.

There is no measurement gap configured in the test. Before the test, UE is configured to perform RLM, BFD and L1-RSRP measurement based on the SSBs.

**Table A.13.3.3.1.2-1: General test parameters**

Parameter	Config	Unit	Value	
			Cell 1	Cell 2
Active PCell/SCell Configuration			PCell	SCell
RF Channel Number			1	2
DL CCA model	1~3		N/A	As specified in A.3.20.2.1
UL CCA model	1~3		N/A	As specified in A.3.20.2.2
Duplex mode	1		FDD	TDD
	2		TDD	
	3		TDD	
TDD Configuration	1		N/A	TDDConf.1.1 CCA
	2		TDDConf.1.1	
	3		TDDConf.2.1	
BW <sub>channel</sub>	1	MHz	10: N <sub>RB,c</sub> = 52	40: N <sub>RB,c</sub> = 106
	2		10: N <sub>RB,c</sub> = 52	
	3		40: N <sub>RB,c</sub> = 106	
PDSCH Reference measurement channel	1		SR.1.1 FDD	SR.1.1 CCA
	2		SR.1.1 TDD	
	3		SR.2.1 TDD	
RMSI CORESET Reference Channel	1		CR.1.1 FDD	CR.1.1 CCA
	2		CR.1.1 TDD	
	3		CR.2.1 TDD	
Dedicated CORESET Reference Channel	1		CCR.1.1 FDD	CCR.1.1 CCA
	2		CCR.1.1 TDD	
	3		CCR.2.1 TDD	
SSB configuration	1		SSB.3 FR1	SSB.3 CCA for semi-static channel access SSB.4 CCA for dynamic channel access
	2		SSB.3 FR1	

	3		SSB.4 FR1					
OCNG Patterns	1~3		OP.1	OP.1				
Initial BWP Configuration	1~3		DLBWP.0.1 ULBWP.0.1	DLBWP.0.1 ULBWP.0.1				
Dedicated BWP configuration	1~3		DLBWP.1.1 ULBWP.1.1	DLBWP.1.1 ULBWP.1.1				
SMTC configuration	1~3		SMTC.1	N/A				
DBT Window Configuration	1~3		N/A	DBT.1				
TRS Configuration	1		TRS.1.1 FDD	TRS.1.2 TDD				
	2		TRS.1.1 TDD					
	3		TRS.1.2 TDD					
DRX configuration	1~3		Off	Off				
reportConfigType	1~3		periodic	periodic				
reportQuantity	1~3		ssb-Index-RSRP	ssb-Index-RSRP				
Number of reported RS	1~3		2	2				
L1-RSRP reporting period	1~3	slot	80	80				
T1	1~3	s	5	5				
T2	1~3	s	1	1				
EPRE ratio of PSS to SSS	1~3	dB	0	0				
EPRE ratio of PBCH DMRS to SSS								
EPRE ratio of PBCH to PBCH DMRS								
EPRE ratio of PDCCH DMRS to SSS								
EPRE ratio of PDCCH to PDCCH DMRS								
EPRE ratio of PDSCH DMRS to SSS								
EPRE ratio of PDSCH to PDSCH DMRS								
EPRE ratio of OCNG DMRS to SSS <sup>Note 1</sup>								
EPRE ratio of OCNG to OCNG DMRS <sup>Note 1</sup>								
Propagation condition					1~3		AWGN	AWGN
<p>Note 1: OCNG shall be used such that the resources in Cell 1 are fully allocated and a constant total transmitted power spectral density is achieved for all OFDM symbols. For cells with CCA model, OCNG is transmitted only in the slots with downlink transmission burst and is not transmitted during the muted slots or during DBT window.</p>								

Table A.13.3.3.1.2-2: SSB specific test parameters

Parameter	Config	Unit	SSB#0		SSB#1	
			T1	T2	T1	T2
DL CCA Probability $P_{CCA\_DL}$ <sup>Note 4,6</sup>	1,2,3		[0.9375]	[0.9375]	[0.9375]	[0.9375]
DL CCA Probability $P_{CCA\_DL}$ <sup>Note 4.7</sup>	1,2,3		[0.75]/[0.75]	[0.75]/[0.75]	[0.75]/[0.75]	[0.75]/[0.75]
UL CCA probability $P_{CCA\_UL}$	1,2,3		[1.0]	[1.0]	[1.0]	[1.0]
$N_{oc}$ <sup>Note2</sup>	1,2,3	dBm/15kHz	-94.65			
$N_{oc}$ <sup>Note2</sup>	1,2,3	dBm/SSB SCS	-91.65			
$\hat{E}_s / I_{ot}$	1,2,3	dB	0	0	-Infinity	3
SSB RSRP <sup>Note3</sup>	1,2,3	dBm/SSB SCS	-91.65	-91.65	-Infinity	-88.65
$I_o$ <sup>Note3</sup>	1,2,3	dBm/38.16 MHz	-57.59	-57.59	-60.61	-55.84
$\hat{E}_s / N_{oc}$	1,2,3	dB	0	0	-Infinity	3

Note 1:	The resources for uplink transmission are assigned to the UE prior to the start of time period T2.
Note 2:	Interference from other cells and noise sources not specified in the test is assumed to be constant over subcarriers and time and shall be modelled as AWGN of appropriate power for $N_{oc}$ to be fulfilled.
Note 3:	SS-RSRP and $I_o$ levels have been derived from other parameters for information purposes. They are not settable parameters themselves.
Note 4:	DL and UL CCA probabilities apply for UE supporting any one or both semi-static channel access or dynamic channel access and for network configuring any of semi-static channel occupancy or dynamic channel occupancy.
Note 5:	The signal levels apply for SSS Res when the discovery burst is transmitted during DBT windows.
Note 6:	For UE supporting semi-static channel access and network configuring semi-static channel occupancy.
Note 7:	For UE supporting dynamic channel access and network configuring dynamic channel occupancy. The first value corresponds $P_{CCA\_DL1}$ and the second value corresponds to the $P_{CCA\_DL2}$ .

### A.13.3.3.1.3 Test Requirements

The UE shall send L1-RSRP report every 80 slots. No later than 640 ms plus 80 slots from the beginning of time period T2, UE shall send L1-RSRP report including results of both SSB0 and SSB1 while meeting the absolute accuracy requirement in clause 10.1.19.1.1 and relative accuracy requirement in clause 10.1.19.1.2. The rate of correct events observed during repeated tests shall be at least 90%.

The UE shall send L1-RSRP report of both SSB0 and SSB1 in Cell 2.

NOTE: The actual overall delays measured in the test may be up to  $2 \times TTI$  DCCH higher than the measurement reporting delays above because of TTI insertion uncertainty of the measurement report in DCCH.

### A.13.3.3.2 SSB based L1-RSRP measurement when DRX is used

#### A.13.3.3.2.1 Test Purpose and Environment

The purpose of this test is to verify that the UE makes correct reporting of L1-RSRP measurement. This test will partly verify the L1-RSRP measurement requirements in clause 9.5A.4.1, with the testing configurations for NR cells in Table A.13.3.3.1.1-1.

**Table A.13.3.3.2.1-1: Applicable NR configurations for FR1 SSB based L1-RSRP test**

Config	Description
1	Without CCA: 15 kHz SSB SCS, 10 MHz bandwidth, FDD duplex mode With CCA: 30 kHz SSB SCS, 40 MHz bandwidth, TDD duplex mode
2	Without CCA: 15 kHz SSB SCS, 10 MHz bandwidth, TDD duplex mode With CCA: 30 kHz SSB SCS, 40 MHz bandwidth, TDD duplex mode
3	Without CCA 30 kHz SSB SCS, 40 MHz bandwidth, TDD duplex mode With CCA: 30 kHz SSB SCS, 40 MHz bandwidth, TDD duplex mode
Note:	The UE is only required to be tested in one of the supported test configurations

#### A.13.3.3.2.2 Test parameters

There are two cells in the tests, FR1 Pcell (Cell 1) and FR1 Scell (Cell 2). Cell 2 operates on a carrier frequency with CCA and transmits SSBs in DBT window according to DL CCA model. The test parameters and applicability for Cell 1 and Cell 2 are given in Table A.13.3.3.2.2-1 and Table A.13.3.3.2.2-2 below.

In CSI measurement configuration, UE is indicated to perform L1-RSRP measurement on the SSBs and report periodically. The UE transmits the reporting according to UL CCA model. The test consists of two successive time periods, with time duration of T1 and T2 respectively. The test has higher layer parameter *timeRestrictionForChannelMeasurements* configured.

The same test is applicable for UE supporting any one or both semi-static channel access or dynamic channel access and for network configuring any of semi-static channel occupancy or dynamic channel occupancy.

There is no measurement gap configured in the test. Before the test, UE is configured to perform RLM, BFD and L1-RSRP measurement based on the SSBs.

**Table A.13.3.3.2-1: General test parameters**

Parameter	Config	Unit	Value	
			Cell 1	Cell 2
Active Pcell/Scell Configuration			Pcell	Scell
RF Channel Number			1	2
DL CCA model	1~3		N/A	As specified in A.3.20.2.1
UL CCA model	1~3		N/A	As specified in A.3.20.2.2
Duplex mode	1		FDD	TDD
	2		TDD	
	3		TDD	
TDD Configuration	1		N/A	TDDConf.1.1 CCA
	2		TDDConf.1.1	
	3		TDDConf.2.1	
BW <sub>channel</sub>	1	MHz	10: N <sub>RB,c</sub> = 52	40: N <sub>RB,c</sub> = 106
	2		10: N <sub>RB,c</sub> = 52	
	3		40: N <sub>RB,c</sub> = 106	
PDSCH Reference measurement channel	1		SR.1.1 FDD	SR.1.1 CCA
	2		SR.1.1 TDD	
	3		SR.2.1 TDD	
RMSI CORESET Reference Channel	1		CR.1.1 FDD	CR.1.1 CCA
	2		CR.1.1 TDD	
	3		CR.2.1 TDD	
Dedicated CORESET Reference Channel	1		CCR.1.1 FDD	CCR.1.1 CCA
	2		CCR.1.1 TDD	
	3		CCR.2.1 TDD	
SSB configuration	1		SSB.3 FR1	SSB.3 CCA for semi-static channel access SSB.4 CCA for dynamic channel access
	2		SSB.3 FR1	
	3		SSB.4 FR1	
OCNG Patterns	1~3		OP.1	OP.1
Initial BWP Configuration	1~3		DLBWP.0.1 ULBWP.0.1	DLBWP.0.1 ULBWP.0.1
Dedicated BWP configuration	1~3		DLBWP.1.1 ULBWP.1.1	DLBWP.1.1 ULBWP.1.1
SMTc configuration	1~3		SMTc.1	N/A
DBT Window Configuration	1~3		N/A	DBT.1
TRS Configuration	1		TRS.1.1 FDD	TRS.1.2 TDD
	2		TRS.1.1 TDD	
	3		TRS.1.2 TDD	
DRX configuration	1~3		DRX.3	DRX.3
reportConfigType	1~3		periodic	periodic
reportQuantity	1~3		ssb-Index-RSRP	ssb-Index-RSRP
Number of reported RS	1~3		2	2
L1-RSRP reporting period	1~3	slot	80	80
T1	1~3	s	5	5
T2	1~3	s	1	1
EPRE ratio of PSS to SSS	1~3	dB	0	0
EPRE ratio of PBCH DMRS to SSS				
EPRE ratio of PBCH to PBCH DMRS				

EPRE ratio of PDCCH DMRS to SSS				
EPRE ratio of PDCCH to PDCCH DMRS				
EPRE ratio of PDSCH DMRS to SSS				
EPRE ratio of PDSCH to PDSCH DMRS				
EPRE ratio of OCNG DMRS to SSS <sup>Note 1</sup>				
EPRE ratio of OCNG to OCNG DMRS <sup>Note 1</sup>				
Propagation condition	1~3		AWGN	AWGN
<p>Note 1: OCNG shall be used such that the resources in Cell 1 are fully allocated and a constant total transmitted power spectral density is achieved for all OFDM symbols. For cells with CCA model, OCNG is transmitted only in the slots with downlink transmission burst and is not transmitted during the muted slots or during DBT window.</p>				

**Table A.13.3.3.2.2-2: SSB specific test parameters**

Parameter	Config	Unit	SSB#0		SSB#1	
			T1	T2	T1	T2
DL CCA Probability $P_{CCA\_DL}$ <sup>Note 4,6</sup>	1,2,3		[0.9375]	[0.9375]	[0.9375]	[0.9375]
DL CCA Probability $P_{CCA\_DL}$ <sup>Note 4.7</sup>	1,2,3		[0.75]/[0.75]	[0.75]/[0.75]	[0.75]/[0.75]	[0.75]/[0.75]
UL CCA probability $P_{CCA\_UL}$	1,2,3		[1.0]	[1.0]	[1.0]	[1.0]
$N_{oc}$ <sup>Note2</sup>	1,2,3	dBm/15kHz	-94.65			
$N_{oc}$ <sup>Note2</sup>	1,2,3	dBm/SSB SCS	-91.65			
$\hat{E}_s / I_{ot}$	1,2,3	dB	0	0	-Infinity	3
SSB RSRP <sup>Note3</sup>	1,2,3	dBm/SSB SCS	-91.65	-91.65	-Infinity	-88.65
$I_o$ <sup>Note3</sup>	1,2,3	dBm/38.16 MHz	-57.59	-57.59	-60.61	-55.84
$\hat{E}_s / N_{oc}$	1,2,3	dB	0	0	-Infinity	3
<p>Note 1: The resources for uplink transmission are assigned to the UE prior to the start of time period T2.</p> <p>Note 2: Interference from other cells and noise sources not specified in the test is assumed to be constant over subcarriers and time and shall be modelled as AWGN of appropriate power for <math>N_{oc}</math> to be fulfilled.</p> <p>Note 3: SS-RSRP and <math>I_o</math> levels have been derived from other parameters for information purposes. They are not settable parameters themselves.</p> <p>Note 4: DL and UL CCA probabilities apply for UE supporting any one or both semi-static channel access or dynamic channel access and for network configuring any of semi-static channel occupancy or dynamic channel occupancy.</p> <p>Note 5: The signal levels apply for SSS Res when the discovery burst is transmitted during DBT windows.</p> <p>Note 6: For UE supporting semi-static channel access and network configuring semi-static channel occupancy.</p> <p>Note 7: For UE supporting dynamic channel access and network configuring dynamic channel occupancy. The first value corresponds <math>P_{CCA\_DL1}</math> and the second value corresponds to the <math>P_{CCA\_DL2}</math>.</p>						

### A.13.3.3.2.3 Test Requirements

The UE shall send L1-RSRP report every 80 slots. No later than 640 ms plus 80 slots from the beginning of time period T2, UE shall send L1-RSRP report including results of both SSB0 and SSB1 while meeting the absolute accuracy requirement in clause 10.1.19.1.1 and relative accuracy requirement in clause 10.1.19.1.2. The rate of correct events observed during repeated tests shall be at least 90%.

The UE shall send L1-RSRP report of both SSB0 and SSB1 in Cell 2.

NOTE: The actual overall delays measured in the test may be up to 2xTTI DCCH higher than the measurement reporting delays above because of TTI insertion uncertainty of the measurement report in DCCH.

## A.13.4 Measurement performance

### A.13.4.1 SS-RSRP

#### A.13.4.1.1 Intra-frequency measurement accuracy on a carrier frequency with CCA

##### A.13.4.1.1.1 Test Purpose and Environment

The purpose of this test is to verify that the SS-RSRP measurement accuracy on the carrier frequency with CCA is within the specified limits. This test will verify the requirements in clauses 10.1.36.1.1 and 10.1.36.1.2 for intra-frequency measurements under CCA.

##### A.13.4.1.1.2 Test parameters

Three cells are deployed in the test, which are FR1 PCell (Cell 1), and two cells on the same carrier frequency with CCA and transmit SSBs in DBT windows according to DL CCA model: SCell (Cell 2) and a neighbour cell (Cell 3). Supported test configurations are shown in table A.13.4.1.1.2-1. Both absolute and relative accuracy of SS-RSRP intra-frequency measurements are tested by using the parameters in A.13.4.1.1.2-2.

**Table A.13.4.1.1.2-1: SS-RSRP Intra frequency SS-RSRP supported test configurations**

Config	Description
1	NR carrier with CCA: 30 kHz SSB SCS, 40 MHz bandwidth, TDD duplex mode NR carrier without CCA: 15 kHz SSB SCS, 10 MHz bandwidth, FDD duplex mode
2	NR carrier with CCA: 30 kHz SSB SCS, 40 MHz bandwidth, TDD duplex mode NR carrier without CCA: 15 kHz SSB SCS, 10 MHz bandwidth, TDD duplex mode
3	NR carrier with CCA: 30 kHz SSB SCS, 40 MHz bandwidth, TDD duplex mode NR carrier without CCA: 30 kHz SSB SCS, 40 MHz bandwidth, TDD duplex mode
Note:	The UE is only required to be tested in one of the supported test configurations for each supported band

**Table A.13.4.1.1.2-2: SS-RSRP Intra frequency test parameters**

Parameter	Unit	Test 1		Test 2		Test 3	
		Cell 2	Cell 3	Cell 2	Cell 3	Cell 2	Cell 3
Cell ID		489	0	489	0	489	0
SSB ARFCN		freq1		freq1		freq1	
DL CCA model		As specified in clause A.3.26.2.1					
UL CCA model		As specified in clause A.3.26.2.2					
P <sub>CCA,DL</sub> for dynamic channel access <sup>Note 7,9</sup>		P <sub>CCA,DL,1</sub> =0.75 P <sub>CCA,DL,2</sub> =0.75					
P <sub>CCA,DL</sub> for semi-static channel access <sup>Note 8,9</sup>		P <sub>CCA,DL</sub> =0.9375					
P <sub>CCA,UL</sub>		1					
TDD configuration	Config 1,2,3	TDDConf.1.1 CCA					
BW <sub>channel</sub>	Config 1,2,3	MHz					
BWP BW	Config 1,2,3	40: N <sub>RB,c</sub> = 106					
CCA model	Config 1,2,3	TBD					
Downlink initial BWP configuration		DLBWP.0.1					
Downlink dedicated BWP configuration		DLBWP.1.1					
Uplink initial BWP configuration		ULBWP.0.1					



Uplink dedicated BWP configuration			ULBWP.1.1					
TRS configuration	Config 1,2,3		TRS.1.2 TDD	NA	TRS.1.2 TDD	NA	TRS.1.2 TDD	NA
DRX Cycle		ms	Not Applicable					
PDSCH Reference measurement channel	Config 1,2,3		SR.1.1 CCA	-	SR.1.1 CCA	-	SR.1.1 CCA	-
RMSI CORESET Reference Channel	Config 1,2,3		CR.1.1 CCA	-	CR.1.1 CCA	-	CR.1.1 CCA	-
Control channel RMC	Config 1,2,3		CR.1.1 CCA	-	CR.1.1 CCA	-	CR.1.1 CCA	-
SSB configuration for semi-static channel access	Config 1,2,3		SSB.1 CCA	SSB.1 CCA	SSB.1 CCA	SSB.1 CCA	SSB.1 CCA	SSB.1 CCA
SSB configuration for dynamic channel access	Config 1,2,3		SSB.2 CCA	SSB.2 CCA	SSB.2 CCA	SSB.2 CCA	SSB.2 CCA	SSB.2 CCA
DBT window configuration	Config 1,2,3		DBT.1	DBT.1	DBT.1	DBT.1	DBT.1	DBT.1
Time offset with Cell 1	Config 1,2,3	μs	-	3	-	3	-	3
SMTC configuration	Config 1,2,3		SMTC.1					
OCNG Patterns			OCNG pattern 1					
PDSCH/PDCCH subcarrier spacing	Config 1,2,3	kHz	30 kHz					
EPRE ratio of PSS to SSS		dB	0	0	0	0	0	0
EPRE ratio of PBCH DMRS to SSS								
EPRE ratio of PBCH to PBCH DMRS								
EPRE ratio of PDCCH DMRS to SSS								
EPRE ratio of PDCCH to PDCCH DMRS								
EPRE ratio of PDSCH DMRS to SSS								
EPRE ratio of PDSCH to PDSCH								
EPRE ratio of OCNG DMRS to SSS(Note 1)								
EPRE ratio of OCNG to OCNG DMRS (Note 1)								
$N_{oc}$ Note2	Config 1,2,3	NR_CCA_FR1_I	Not applicable <sup>Note 5</sup>		-94		-110	
		NR_CCA_FR1_J					-109.5	
$N_{oc}$ Note2	Config 1,2,3	NR_CCA_FR1_I	Not applicable <sup>Note 5</sup>		-91		-107.0	
		NR_CCA_FR1_J					-106.5	
$\hat{E}_s/I_{ot}$ Note6			2.46	-5.97	2.46	-5.97	-2.01	-3.54
$\hat{E}_s/N_{oc}$ Note6			6	1	6	1	1	0
SS-RSRP <sup>Not e3,6</sup>	Config 1,2,3	NR_CCA_FR1_I	Not applicable <sup>Note 5</sup>	Not applicable <sup>Note 5</sup>	-85	-90	-	-
		NR_CCA_FR1_J					106.00	107.00
							-	-
							105.50	106.50
$I_o$ <sup>Note3</sup>	Config 1,2,3	NR_CCA_FR1_I	Not applicable <sup>Note 5</sup>		-51.99		-70.82	
		NR_CCA_FR1_J					-70.32	
Propagation condition			AWGN					
Antenna configuration			1x2					
NOTE 1: OCNG shall be used such that both cells are fully allocated and a constant total transmitted power spectral density is achieved for all OFDM symbols.								
NOTE 2: Interference from other cells and noise sources not specified in the test is assumed to be constant over subcarriers and time and shall be modelled as AWGN of appropriate power for $N_{oc}$ to be fulfilled.								
NOTE 3: SS-RSRP and $I_o$ levels have been derived from other parameters for information purposes. They are not settable parameters themselves.								
NOTE 4: SS-RSRP minimum requirements are specified assuming independent interference and noise at each receiver antenna port.								
NOTE 5: Subtest 1 is not used when testing with 30kHz SSB SCS.								
NOTE 6: The signal levels apply for SSS REs when the discovery burst is transmitted during DBT windows.								

NOTE 7: For UE supporting semi-static channel access and network configuring semi-static channel occupancy.  
 NOTE 8: For UE supporting dynamic channel access and network configuring dynamic channel occupancy.  
 NOTE 9: For a UE supporting both semi-static and dynamic channel access, the UE can be tested under dynamic channel occupancy only.

### A.13.4.1.1.3 Test Requirements

The SS-RSRP measurement accuracy for cell 2 and cell 3 shall fulfil absolute requirement in clause 10.1.36.1.1 and relative requirement in clause 10.1.36.1.2.

## A.13.4.2 SS-RSRQ

### A.13.4.2.1 Intra-frequency measurement accuracy on SCC

#### A.13.4.2.1.1 Test Purpose and Environment

The purpose of this test is to verify that the SS-RSRQ measurement accuracy is within the specified limits. This test will verify the requirements in Clause 10.1.29.1.1.

#### A.13.4.2.1.2 Test Parameters

In this test case all cells are on the same carrier frequency. Supported test configuration are shown in Table A.13.4.2.1.2-1. The absolute accuracy of SS-RSRQ intra-frequency measurement is tested by using the parameters in Table A.13.4.2.1.2-2 and Table A.13.4.2.1.2-3. In all test cases, Cell 1 is the PCell, Cell 2 is the SCell with CCA, and Cell 3 is the target cell with CCA. Three sub-tests (Test 1, Test 2, and Test 3) are provided different  $N_{oc}$  on Cells 1, 2, and 3.

**Table A.13.4.2.1.2-1: SS-RSRQ Intra frequency SS-RSRQ supported test configurations**

Config	Description
1	Without CCA: NR 15 kHz SSB SCS, 10 MHz bandwidth, FDD duplex mode With CCA: NR 30 kHz SSB SCS, 40 MHz bandwidth, TDD duplex mode
2	Without CCA: NR 15 kHz SSB SCS, 10 MHz bandwidth, TDD duplex mode With CCA: NR 30 kHz SSB SCS, 40 MHz bandwidth, TDD duplex mode
3	Without CCA: NR 30 kHz SSB SCS, 40 MHz bandwidth, TDD duplex mode With CCA: NR 30 kHz SSB SCS, 40 MHz bandwidth, TDD duplex mode
Note:	The UE is only required to be tested in one of the supported test configurations

**Table A.13.4.2.1.2-2: SS-RSRQ Intra frequency test parameters**

Parameter	Unit	Test 1		Test 2		Test 3	
		Cell 2	Cell 3	Cell 2	Cell 3	Cell 2	Cell 3
SSB ARFCN		freq2	freq2	freq2	freq2	freq2	freq2
DL CCA model	Config 1, 2, 3	As specified in clause A.3.26.2.1					
UL CCA model	Config 1, 2, 3	As specified in clause A.3.26.2.2					
UL CCA probability	$P_{CCA\_UL}$	1.0	-	1.0	-	1.0	-
DL CCA probability for semi-static channel access <small>Note 7, 8</small>	$P_{CCA\_DL}$	0.9375	-	0.9375	-	0.9375	-
DL CCA probability for dynamic channel access <small>Note 8, 9</small>	$P_{CCA\_DL\_1}$	0.75	-	0.75	-	0.75	-
	$P_{CCA\_DL\_2}$	0.75	-	0.75	-	0.75	-
Duplex mode	Config 1, 2, 3	TDD					
TDD configuration	Config 1, 2, 3	TDDConf.1.1 CCA					
$BW_{channel}$	Config 1, 2, 3	MHz					
Gap Pattern ID		40: $N_{RB,c} = 106$					
BWP configuration	Initial DL BWP	0					
		DLBWP.0.1					

	Dedicated DL BWP		DLBWP.1.1					
	Initial UL BWP		ULBWP.0.1					
	Dedicated UL BWP		ULBWP.1.1					
DRX Cycle		ms	Not Applicable					
PDSCH Reference measurement channel	Config 1, 2, 3		SR1.1 CCA		SR1.1 CCA		SR1.1 CCA	
RMSI CORESET Reference Channel	Config 1, 2, 3		CR.1.1 CCA		CR.1.1 CCA		CR.1.1 CCA	
Control Channel RMC	Config 1, 2, 3		CCR.1.1 CCA		CCR.1.1 CCA		CCR.1.1 CCA	
TRS Configuration	Config 1, 2, 3		TRS.1.2 TDD		TRS.1.2 TDD		TRS.1.2 TDD	
OCNG Patterns			OP. 1					
SS-RSSI-Measurement			Not Applicable					
Time offset with Cell 1	Config 1, 2, 3	μs	3	3	3	3	3	3
DBT Window configuration	Config 1, 2, 3		DBT.1					
SSB configuration	Config 1, 2, 3		SSB.1 CCA for semi-static channel access SSB.2 CCA for dynamic channel access					
SMTC configuration	Config 1, 2, 3		SMTC.1					
CSI-RS for tracking	Config 1, 2, 3		TRS.1.2 TDD					
PDSCH/PDCCH subcarrier spacing	Config 1, 2, 3	kHz	30 kHz					
EPRE ratio of PSS to SSS		dB	0	0	0	0	0	0
EPRE ratio of PBCH DMRS to SSS								
EPRE ratio of PBCH to PBCH DMRS								
EPRE ratio of PDCCH DMRS to SSS								
EPRE ratio of PDCCH to PDCCH DMRS								
EPRE ratio of PDSCH DMRS to SSS								
EPRE ratio of PDSCH to PDSCH								
EPRE ratio of OCNG DMRS to SSS(Note 1)								
EPRE ratio of OCNG to OCNG DMRS (Note 1)								
$N_{oc}$ <sup>Note2</sup>	NR_CCA_FR1_I	dBm/15kHz z	-91		-		-110	
	NR_CCA_FR1_J						-109.5	
$N_{oc}$ <sup>Note2</sup>	Config 1, 2, 3		-88		-		-107	
	NR_CCA_FR1_J						-106.5	
$\hat{E}_s/I_{ot}$		dB	-1.76		-4.7		-5.46	
$\hat{E}_s/N_{oc}$		dB	3	3	-2.9	-2.9	-4	-4
SS-RSRP <sup>Note3</sup>	Config 1, 2, 3		-85	-85	-	-	-111	-111
	NR_CCA_FR1_J						-110.5	-110.5
SS-RSRQ <sup>Note3</sup>	NR_CCA_FR1_I	dB	-14.77	-14.77	-16.76	-16.76	-17.34	-17.34
	NR_CCA_FR1_J							
$I_o$ <sup>Note3</sup>	Config 1, 2, 3	dBm/ 38.16MHz	-50		-		-73.4	
	NR_CCA_FR1_J						-72.9	
Propagation condition		-	AWGN	AWGN	AWGN	AWGN	AWGN	AWGN
Antenna configuration			1x2	1x2	1x2	1x2	1x2	1x2
<p>Note 1: OCNG shall be used such that both cells are fully allocated and a constant total transmitted power spectral density is achieved for all OFDM symbols.</p> <p>Note 2: Interference from other cells and noise sources not specified in the test is assumed to be constant over subcarriers and time and shall be modelled as AWGN of appropriate power for <math>N_{oc}</math> to be fulfilled.</p> <p>Note 3: SS-RSRQ, SS-RSRP, and <math>I_o</math> levels have been derived from other parameters for information purposes. They are not settable parameters themselves.</p> <p>Note 4: SS-RSRQ, SS-RSRP minimum requirements are specified assuming independent interference and noise at each receiver antenna port.</p> <p>Note 5: NR operating band groups are as defined in clause 3.5.2.</p>								

Note 6: For UE supporting both semi-static and dynamic channel access, the UE must be tested under both dynamic and semi-static channel occupancy configuration.  
 Note 7: For UE supporting semi-static channel access and network configuring semi-static channel occupancy.  
 Note 8: For UE supporting dynamic channel access and network configuring dynamic channel occupancy.  
 Note 9: For UE supporting both semi-static and dynamic channel access, the UE must be tested under both dynamic and semi-static channel occupancy configurations.

**Table A.13.4.2.1.2-3: SS-RSRQ Intra frequency test parameters for NR PCell**

Parameter		Unit	Test 1	Test 2	Test 3
			Cell 1	Cell 1	Cell 1
SSB ARFCN			freq1		
Duplex mode	Config 1		FDD		
	Config 2,3		TDD		
TDD configuration	Config 1		Not Applicable		
	Config 2		TDDConf.1.1		
	Config 3		TDDConf.2.1		
BW <sub>channel</sub>	Config 1	MHz	10: N <sub>RB,c</sub> = 52		
	Config 2		10: N <sub>RB,c</sub> = 52		
	Config 3		40: N <sub>RB,c</sub> = 106		
Gap Pattern ID			0		
BWP configuration	Initial DL BWP		DLBWP.0.1		
	Dedicated DL BWP		DLBWP.1.1		
	Initial UL BWP		ULBWP.0.1		
	Dedicated UL BWP		ULBWP.1.1		
DRX Cycle		ms	Not Applicable		
PDSCH Reference measurement channel	Config 1		SR.1.1 FDD		
	Config 2		SR.1.1 TDD		
	Config 3		SR2.1 TDD		
RMSI CORESET Reference Channel	Config 1		CR.1.1 FDD		
	Config 2		CR.1.1 TDD		
	Config 3		CR.2.1 TDD		
Control Channel RMC	Config 1		CCR.1.1 FDD		
	Config 2		CCR.1.1 TDD		
	Config 3		CCR.2.1 TDD		
TRS Configuration	Config 1		TRS.1.1 FDD		
	Config 2		TRS.1.1 TDD		
	Config 3		TRS.1.2 TDD		
OCNG Patterns			OP. 1		
SS-RSSI-Measurement			Not Applicable		
SMTC configuration	Config 1		SMTC.2		
	Config 2,3		SMTC.1		
SSB configuration	Config 1,2		SSB.1 FR1		
	Config 3		SSB.2 FR1		
CSI-RS for tracking	Config 1		TRS.1.1 FDD		
	Config 2		TRS.1.1 TDD		
	Config 3		TRS.1.2 TDD		
PDSCH/PDCCH subcarrier spacing	Config 1,2	kHz	15 kHz		
	Config 3		30 kHz		
EPRE ratio of PSS to SSS		dB	0		
EPRE ratio of PBCH DMRS to SSS					
EPRE ratio of PBCH to PBCH DMRS					
EPRE ratio of PDCCH DMRS to SSS					
EPRE ratio of PDCCH to PDCCH DMRS					
EPRE ratio of PDSCH DMRS to SSS					

EPRE ratio of PDSCH to PDSCH						
EPRE ratio of OCNG DMRS to SSS(Note 1)						
EPRE ratio of OCNG to OCNG DMRS (Note 1)						
N <sub>oc</sub> <sup>Note2</sup>	Config 1,2	NR_FDD_FR1_A, NR_TDD_FR1_A NOTE 6	dBm/15kHz z	-85	-101	-114
		NR_FDD_FR1_B				-113.5
		NR_TDD_FR1_C				-113
		NR_FDD_FR1_D, NR_TDD_FR1_D				-112.5
		NR_FDD_FR1_E, NR_TDD_FR1_E				-112
		NR_FDD_FR1_F				-111.5
		NR_FDD_FR1_G				-111
		NR_FDD_FR1_H				-110.5
	Config 3	NR_FDD_FR1_A, NR_TDD_FR1_A NOTE 6		-91	-	-114
		NR_FDD_FR1_B				-113.5
		NR_TDD_FR1_C				-113
		NR_FDD_FR1_D, NR_TDD_FR1_D				-112.5
		NR_FDD_FR1_E, NR_TDD_FR1_E				-112
		NR_FDD_FR1_F				-111.5
		NR_FDD_FR1_G				-111
		NR_FDD_FR1_H				-110.5
N <sub>oc</sub> <sup>Note2</sup>	Config 1,2	NR_FDD_FR1_A, NR_TDD_FR1_A NOTE 6	dBm/SCS	-85	-101	-114
		NR_FDD_FR1_B				-113.5
		NR_TDD_FR1_C				-113
		NR_FDD_FR1_D, NR_TDD_FR1_D				-112.5
		NR_FDD_FR1_E, NR_TDD_FR1_E				-112
		NR_FDD_FR1_F				-111.5
		NR_FDD_FR1_G				-111
		NR_FDD_FR1_H				-110.5
	Config 3	NR_FDD_FR1_A, NR_TDD_FR1_A NOTE 6		-88	-	-111
		NR_FDD_FR1_B				-110.5
		NR_TDD_FR1_C				-110
		NR_FDD_FR1_D, NR_TDD_FR1_D				-109.5
		NR_FDD_FR1_E, NR_TDD_FR1_E				-109
		NR_FDD_FR1_F				-108.5
		NR_FDD_FR1_G				-108
		NR_FDD_FR1_H				-107.5
$\hat{E}_s/I_{ot}$			dB	-1.76	-4.7	-5.46
$\hat{E}_s/N_{oc}$			dB	3	-2.9	-4
SS-RSRP <sup>Note 3</sup>	Config 1,2	NR_FDD_FR1_A, NR_TDD_FR1_A NOTE 6	dBm/SCS	-82	-103.9	-118
		NR_FDD_FR1_B				-117.5

		NR_TDD_FR1_C				-117
		NR_FDD_FR1_D, NR_TDD_FR1_D				-116.5
		NR_FDD_FR1_E, NR_TDD_FR1_E				-116
		NR_FDD_FR1_F				-115.5
		NR_FDD_FR1_G				-115
		NR_FDD_FR1_H				-114.5
	Config 3	NR_FDD_FR1_A, NR_TDD_FR1_A NOTE 6		-85	-	-115
		NR_FDD_FR1_B				-114.5
		NR_TDD_FR1_C				-114
		NR_FDD_FR1_D, NR_TDD_FR1_D				-113.5
		NR_FDD_FR1_E, NR_TDD_FR1_E				-113
		NR_FDD_FR1_F				-112.5
		NR_FDD_FR1_G				-112
		NR_FDD_FR1_H				-111.5
SS-RSRQ <sup>Note3</sup>		NR_FDD_FR1_A, NR_TDD_FR1_A NOTE 6	dB	-14.77	-16.76	-17.34
		NR_FDD_FR1_B				
		NR_TDD_FR1_C				
		NR_FDD_FR1_D, NR_TDD_FR1_D				
		NR_FDD_FR1_E, NR_TDD_FR1_E				
		NR_FDD_FR1_F				
		NR_FDD_FR1_G				
		NR_FDD_FR1_H				
Io <sup>Note3</sup>	Config 1,2	NR_FDD_FR1_A, NR_TDD_FR1_A NOTE 6	dBm/ 9.36MHz	-50	-70	-83.5
		NR_FDD_FR1_B				-83
		NR_TDD_FR1_C				-82.5
		NR_FDD_FR1_D, NR_TDD_FR1_D				-82
		NR_FDD_FR1_E, NR_TDD_FR1_E				-81.5
		NR_FDD_FR1_F				-81
		NR_FDD_FR1_G				-80.5
		NR_FDD_FR1_H				-80
	Config 3	NR_FDD_FR1_A, NR_TDD_FR1_A NOTE 6	dBm/ 38.16MHz	-50	-	-77.4
		NR_FDD_FR1_B				-76.9
		NR_TDD_FR1_C				-76.4
		NR_FDD_FR1_D, NR_TDD_FR1_D				-75.9
		NR_FDD_FR1_E, NR_TDD_FR1_E				-75.4
		NR_FDD_FR1_F				-74.9
		NR_FDD_FR1_G				-74.4
		NR_FDD_FR1_H				-73.9

Propagation condition	-	AWGN	AWGN	AWGN
Antenna configuration		1x2	1x2	1x2
Note 1:	OCNG shall be used such that both cells are fully allocated and a constant total transmitted power spectral density is achieved for all OFDM symbols.			
Note 2:	Interference from other cells and noise sources not specified in the test is assumed to be constant over subcarriers and time and shall be modelled as AWGN of appropriate power for $N_{oc}$ to be fulfilled.			
Note 3:	SS-RSRQ, SS-RSRP, and $I_0$ levels have been derived from other parameters for information purposes. They are not settable parameters themselves.			
Note 4:	SS-RSRQ, SS-RSRP minimum requirements are specified assuming independent interference and noise at each receiver antenna port.			
Note 5:	NR operating band groups are as defined in clause 3.5.2.			
Note 6:	The test configuration excludes support for band n51 and it is not required to run this test on band n51 in this release of the specification.			

### A.13.4.2.1.3 Test Requirements

The SS-RSRQ measurement accuracy shall fulfil the requirements in clause 10.1.29.1.1.

## A.13.4.3 SS-SINR

### A.13.4.3.1 Intra-frequency measurement accuracy on SCC

#### A.13.4.3.1.1 Test Purpose and Environment

The purpose of this test is to verify that the SS-SINR measurement accuracy is within the specified limits. This test will verify the requirements in clause 10.1.31.1.1.

#### A.13.4.3.1.2 Test Parameters

In this test case all cells are on the same carrier frequency. Supported test configuration are shown in Table A.13.4.3.1.2-1. The absolute accuracy of SS-SINR intra-frequency measurement is tested by using the parameters in Table A.13.4.3.1.2-2 and Table A.13.4.3.1.2-3. In all test cases, Cell 1 is the PCell, Cell 2 is the SCell with CCA, and Cell 3 is the target cell with CCA. Two sub-tests (Test 1 and Test 2) are provided different  $N_{oc}$  on Cells 1, 2, and 3.

**Table A.13.4.3.1.2-1: SS-SINR Intra frequency SS-SINR supported test configurations**

Config	Description
1	Without CCA: NR 15 kHz SSB SCS, 10 MHz bandwidth, FDD duplex mode With CCA: NR 30 kHz SSB SCS, 40 MHz bandwidth, TDD duplex mode
2	Without CCA: NR 15 kHz SSB SCS, 10 MHz bandwidth, TDD duplex mode With CCA: NR 30 kHz SSB SCS, 40 MHz bandwidth, TDD duplex mode
3	Without CCA: NR 30 kHz SSB SCS, 40 MHz bandwidth, TDD duplex mode With CCA: NR 30 kHz SSB SCS, 40 MHz bandwidth, TDD duplex mode
Note:	The UE is only required to be tested in one of the supported test configurations

**A.13.4.3.1.2-2: SS-SINR Intra frequency test parameters**

Parameter	Unit	Test 1		Test 2	
		Cell 2	Cell 3	Cell 2	Cell 3
SSB ARFCN		freq2	freq2	freq2	freq2
DL CCA model	Config 1, 2, 3	As specified in clause A.3.26.2.1			
UL CCA model	Config 1, 2, 3	As specified in clause A.3.26.2.2			
UL CCA probability	$P_{CCA\_UL}$	1.0	-	1.0	-
DL CCA probability for semi-static channel access <small>Note 7, 8</small>	$P_{CCA\_DL}$	0.9375	-	0.9375	-
DL CCA probability for	$P_{CCA\_DL\_1}$	0.75	-	0.75	-

dynamic channel access <small>Note 8, 9</small>							
		P <sub>CCA_DL_2</sub>		0.75	-	0.75	-
Duplex mode	Config 1, 2, 3		TDD				
TDD configuration	Config 1, 2, 3		TDDConf.1.1 CCA				
Downlink initial BWP configuration			DLBWP.0.1				
Downlink dedicated BWP configuration			DLBWP.1.1				
Uplink initial BWP configuration			ULBWP.0.1				
Uplink dedicated BWP configuration			ULBWP.1.1				
DRX Cycle configuration			ms Not Applicable				
TRS configuration	Config 1, 2, 3		TRS.1.2 TDD		TRS.1.2 TDD		
PDSCH Reference measurement channel	Config 1, 2, 3		SR.1.1 CCA		SR.1.1 CCA		
RMSI CORESET Reference Channel	Config 1, 2, 3		CR.1.1 CCA		CR.1.1 CCA		
Dedicated CORESET Reference Channel	Config 1, 2, 3		CCR.1.1 CCA		CCR.1.1 CCA		
OCNG Patterns			OP.1				
SS-RSSI-Measurement			Not Applicable				
DBT Window configuration	Config 1, 2, 3		DBT.1				
Time offset with Cell 1	Config 1, 2, 3		μs	3 (for Cell 2)	3	3 (for Cell 2)	3
SSB configuration	Config 1, 2, 3		SSB.1 CCA for semi-static channel access SSB.2 CCA for dynamic channel access				
SMTc configuration	Config 1, 2, 3		SMTc.1				
PDSCH/PDCCH subcarrier spacing	Config 1, 2, 3		kHz 30				
EPRE ratio of PSS to SSS			dB				
EPRE ratio of PBCH DMRS to SSS			0				
EPRE ratio of PBCH to PBCH DMRS			0				
EPRE ratio of PDCCH DMRS to SSS			0				
EPRE ratio of PDCCH to PDCCH DMRS			0				
EPRE ratio of PDSCH DMRS to SSS			0				
EPRE ratio of PDSCH to PDSCH			0				
EPRE ratio of OCNG DMRS to SSS(Note 1)			0				
EPRE ratio of OCNG to OCNG DMRS (Note 1)			0				
$N_{oc}$ <small>Note2</small>	NR_CCA_FR1_I		dBm/15kHz z	-93		-112	
	NR_CCA_FR1_J					-111.5	
$N_{oc}$ <small>Note2</small>	Config 1, 2, 3	NR_CCA_FR1_I	dBm/SCS	-90		-109	
		NR_CCA_FR1_J				-108.5	
$\hat{E}_s / I_{ot}$			dB	0	-3.19	-5.46	-5.46
$\hat{E}_s / N_{oc}$			dB	4.54	2.66	-4	-4
SS-RSRP <small>Note3</small>	Config 1, 2, 3	NR_CCA_FR1_I	dBm/SCS	-85.46	-87.34	-113	-113
		NR_CCA_FR1_J					-112.5
SS-SINR <small>Note3</small>	Config 1, 2, 3	NR_CCA_FR1_I	dB	0	-3.19	-5.46	-5.46
		NR_CCA_FR1_J					-5.46
I <sub>o</sub> <small>Note3</small>	Config 1, 2, 3	NR_CCA_FR1_I	dBm/ 38.16MHz	-51.41		-75.41	
		NR_CCA_FR1_J				-74.91	
Propagation condition				- AWGN			
Antenna configuration				- 1x2			
<p>Note 1: OCNG shall be used such that both cells are fully allocated and a constant total transmitted power spectral density is achieved for all OFDM symbols.</p> <p>Note 2: Interference from other cells and noise sources not specified in the test is assumed to be constant over subcarriers and time and shall be modelled as AWGN of appropriate power for <math>N_{oc}</math> to be fulfilled.</p>							



- Note 3: SS-SINR, SS-RSRP, and lo levels have been derived from other parameters for information purposes. They are not settable parameters themselves.
- Note 4: SS-SINR, SS-RSRP minimum requirements are specified assuming independent interference and noise at each receiver antenna port.
- Note 5: NR operating band groups are as defined in clause 3.5.2.
- Note 6: For UE supporting both semi-static and dynamic channel access, the UE must be tested under both dynamic and semi-static channel occupancy configuration.
- Note 7: For UE supporting semi-static channel access and network configuring semi-static channel occupancy.
- Note 8: For UE supporting dynamic channel access and network configuring dynamic channel occupancy.
- Note 9: For UE supporting both semi-static and dynamic channel access, the UE must be tested under both dynamic and semi-static channel occupancy configurations.

**A.13.4.3.1.2-3: SS-SINR Intra frequency test parameters for NR PCell**

Parameter		Unit	Test 1	Test 2
			Cell 1	Cell 1
SSB ARFCN			freq1	freq1
Duplex mode	Config 1		FDD	FDD
	Config 2,3		TDD	TDD
TDD configuration	Config 1		Not Applicable	Not Applicable
	Config 2		TDDConf.1.1	TDDConf.1.1
	Config 3		TDDConf.2.1	TDDConf.2.1
Downlink initial BWP configuration			DLBWP.0.1	DLBWP.0.1
Downlink dedicated BWP configuration			DLBWP.1.1	DLBWP.1.1
Uplink initial BWP configuration			ULBWP.0.1	ULBWP.0.1
Uplink dedicated BWP configuration			ULBWP.1.1	ULBWP.1.1
DRX Cycle configuration		ms	Not Applicable	Not Applicable
TRS configuration	Config 1		TRS.1.1 FDD	TRS.1.1 FDD
	Config 2		TRS.1.1 TDD	TRS.1.1 TDD
	Config 3		TRS.1.2 TDD	TRS.1.2 TDD
PDSCH Reference measurement channel	Config 1		SR.1.1 FDD	SR.1.1 FDD
	Config 2		SR.1.1 TDD	SR.1.1 TDD
	Config 3		SR.2.1 TDD	SR.2.1 TDD
RMSI CORESET Reference Channel	Config 1		CR.1.1 FDD	CR.1.1 FDD
	Config 2		CR.1.1 TDD	CR.1.1 TDD
	Config 3		CR.2.1 TDD	CR.2.1 TDD
Dedicated CORESET Reference Channel	Config 1		CCR.1.1 FDD	CCR.1.1 FDD
	Config 2		CCR.1.1 TDD	CCR.1.1 TDD
	Config 3		CCR.2.1 TDD	CCR.2.1 TDD
OCNG Patterns			OP.1	OP.1
SS-RSSI-Measurement			Not Applicable	Not Applicable
SMTC configuration	Config 1		SMTC.2	SMTC.2
	Config 2,3		SMTC.1	SMTC.1
SSB configuration	Config 1,2		SSB.1 FR1	SSB.1 FR1
	Config 3		SSB.2 FR1	SSB.2 FR1
PDSCH/PDCCH subcarrier spacing	Config 1,2	kHz	15	15
	Config 3		30	30
EPRE ratio of PSS to SSS		dB	0	0
EPRE ratio of PBCH DMRS to SSS				
EPRE ratio of PBCH to PBCH DMRS				
EPRE ratio of PDCCH DMRS to SSS				

EPRE ratio of PDCCH to PDCCH DMRS					
EPRE ratio of PDSCH DMRS to SSS					
EPRE ratio of PDSCH to PDSCH					
EPRE ratio of OCNG DMRS to SSS(Note 1)					
EPRE ratio of OCNG to OCNG DMRS (Note 1)					
$N_{oc}$ <sup>Note2</sup>		NR_FDD_FR1_A, NR_TDD_FR1_A NOTE 6	dBm/15kHz z	-93	-116
		NR_FDD_FR1_B			-115.5
		NR_TDD_FR1_C			-115
		NR_FDD_FR1_D, NR_TDD_FR1_D			-114.5
		NR_FDD_FR1_E, NR_TDD_FR1_E			-114
		NR_FDD_FR1_F			-113.5
		NR_FDD_FR1_G			-113
		NR_FDD_FR1_H			-112.5
$N_{oc}$ <sup>Note2</sup>	Config 1,2		dBm/SCS	-93	Same as $N_{oc}$ for 15 kHz
		Config 3			NR_FDD_FR1_A, NR_TDD_FR1_A NOTE 6
	NR_FDD_FR1_B				-112.5
	NR_TDD_FR1_C				-112
	NR_FDD_FR1_D, NR_TDD_FR1_D				-111.5
	NR_FDD_FR1_E, NR_TDD_FR1_E				-111
	NR_FDD_FR1_F				-110.5
	NR_FDD_FR1_G				-110
	NR_FDD_FR1_H				-109.5
	$\hat{E}_s / I_{ot}$			dB	0
$\hat{E}_s / N_{oc}$			dB	4.54	-4
SS- RSRP <sup>Note 3</sup>	Config 1,2	NR_FDD_FR1_A, NR_TDD_FR1_A NOTE 6	dBm/SCS	-88.46	-120
		NR_FDD_FR1_B			-119.5
		NR_TDD_FR1_C			-119
		NR_FDD_FR1_D, NR_TDD_FR1_D			-118.5
		NR_FDD_FR1_E, NR_TDD_FR1_E			-118
		NR_FDD_FR1_F			-117.5
		NR_FDD_FR1_G			-117
		NR_FDD_FR1_H			-116.5
	Config 3	NR_FDD_FR1_A, NR_TDD_FR1_A NOTE 6		-85.46	-117
		NR_FDD_FR1_B			-116.5
		NR_TDD_FR1_C			-116
		NR_FDD_FR1_D, NR_TDD_FR1_D			-115.5
		NR_FDD_FR1_E, NR_TDD_FR1_E			-115
		NR_FDD_FR1_F			-114.5

		NR_FDD_FR1_G			-114	
		NR_FDD_FR1_H			-113.5	
SS-SINR <sup>Note3</sup>		NR_FDD_FR1_A, NR_TDD_FR1_A NOTE 6	dB	0	-5.46	
		NR_FDD_FR1_B				
		NR_TDD_FR1_C				
		NR_FDD_FR1_D, NR_TDD_FR1_D				
		NR_FDD_FR1_E, NR_TDD_FR1_E				
		NR_FDD_FR1_F				
		NR_FDD_FR1_G				
		NR_FDD_FR1_H				
		Io <sup>Note3</sup>	Config 1,2	NR_FDD_FR1_A, NR_TDD_FR1_A NOTE 6	dBm/ 9.36MHz	-57.5
NR_FDD_FR1_B	-85.01					
NR_TDD_FR1_C	-84.51					
NR_FDD_FR1_D, NR_TDD_FR1_D	-84.01					
NR_FDD_FR1_E, NR_TDD_FR1_E	-83.51					
NR_FDD_FR1_F	-83.01					
NR_FDD_FR1_G	-82.51					
NR_FDD_FR1_H	-82.01					
Config 3	NR_FDD_FR1_A, NR_TDD_FR1_A NOTE 6			dBm/ 38.16MHz		
	NR_FDD_FR1_B		-78.91			
	NR_TDD_FR1_C		-78.41			
	NR_FDD_FR1_D, NR_TDD_FR1_D		-77.91			
	NR_FDD_FR1_E, NR_TDD_FR1_E		-77.41			
	NR_FDD_FR1_F		-76.91			
	NR_FDD_FR1_G		-76.41			
	NR_FDD_FR1_H		-75.91			
	Propagation condition				-	AWGN
Antenna configuration			-	1x2	1x2	
<p>Note 1: OCNG shall be used such that both cells are fully allocated and a constant total transmitted power spectral density is achieved for all OFDM symbols.</p> <p>Note 2: Interference from other cells and noise sources not specified in the test is assumed to be constant over subcarriers and time and shall be modelled as AWGN of appropriate power for <math>N_{oc}</math> to be fulfilled.</p> <p>Note 3: SS-SINR, SS-RSRP, and Io levels have been derived from other parameters for information purposes. They are not settable parameters themselves.</p> <p>Note 4: SS-SINR, SS-RSRP minimum requirements are specified assuming independent interference and noise at each receiver antenna port.</p> <p>Note 5: NR operating band groups are as defined in clause 3.5.2.</p> <p>Note 6: The test configuration excludes support for band n51 and it is not required to run this test on band n51 in this release of the specification.</p>						

A.13.4.3.1.3 Test Requirements

The SS-SINR measurement accuracy shall fulfil the requirements in clause 10.1.31.1.1.

## A.13.4.4 L1-RSRP measurement for beam reporting with CCA serving cell

### A.13.4.4.1 SSB based L1-RSRP measurement

#### A.13.4.4.1.1 Test Purpose and Environment

The purpose of this test is to verify that the L1-RSRP measurement accuracy is within the specified limits. This test will verify the requirements in clause 10.1.33.1 for L1-RSRP measurements based on SSB with the testing configurations for NR cells in Table A.13.4.4.1.1-1.

**Table A.13.4.4.1.1-1: Applicable NR configurations for FR1 SSB based L1-RSRP test**

Config	Description
1	Without CCA: 15 kHz SSB SCS, 10 MHz bandwidth, FDD duplex mode With CCA: 30 kHz SSB SCS, 40 MHz bandwidth, TDD duplex mode
2	Without CCA: 15 kHz SSB SCS, 10 MHz bandwidth, TDD duplex mode With CCA: 30 kHz SSB SCS, 40 MHz bandwidth, TDD duplex mode
3	Without CCA: 30 kHz SSB SCS, 40 MHz bandwidth, TDD duplex mode With CCA: 30 kHz SSB SCS, 40 MHz bandwidth, TDD duplex mode
Note:	The UE is only required to be tested in one of the supported test configurations

#### A.13.4.4.1.2 Test parameters

In this set of test cases there are two cells in the test, PCell (Cell 1) and a SCell under CCA (Cell2). Cell 2 operates on a carrier frequency with CCA and transmits SSBs in DBT window according to DL CCA model.

Two sub-tests (Test 1 and Test 2) are provided with different  $N_{oc}$  on Cell 2. The test parameters for the Cell 1 and Cell 2 are given in Table A.13.4.4.1.2-1 below. The absolute and relative accuracy of L1-RSRP measurements are tested by using the parameters in Table A.13.4.4.1.2-1.

The same test is applicable for UE supporting any one or both semi-static channel access or dynamic channel access and for network configuring any of semi-static channel occupancy or dynamic channel occupancy.

There is no measurement gap configured in the test. Before the test, UE is configured one SSB resource set with two SSB resources. On Cell 2, UE is configured to perform L1-RSRP measurement based on the SSB resources 0 and 1.

**Table A.13.4.4.1.2-1: FR1 SSB based L1-RSRP test parameters**

Parameter	Config	Unit	Test 1		Test 2	
			Cell 1	Cell 2	Cell 1	Cell 2
Active PCell/SCell Configuration	1~3		PCell	SCell	PCell	SCell
SSB GSCN	1~3		freq1	freq2	freq1	freq2
DL CCA model	1~3		N/A	As specified in A.3.20.2.1	N/A	As specified in A.3.20.2.1
UL CCA model	1~3		N/A	As specified in A.3.20.2.2	N/A	As specified in A.3.20.2.2
Duplex mode	1		FDD	TDD	FDD	TDD
	2,3		TDD		TDD	
TDD configuration	1		N/A	TDDConf.1.1 CCA	N/A	TDDConf.1.1 CCA
	2		TDDConf.1.1		TDDConf.1.1	
	3		TDDConf.2.1		TDDConf.2.1	
BW <sub>channel</sub>	1	MHz	10: $N_{RB,c} = 52$	40: $N_{RB,c} = 106$	10: $N_{RB,c} = 52$	40: $N_{RB,c} = 106$
	2		10: $N_{RB,c} = 52$		10: $N_{RB,c} = 52$	
	3		40: $N_{RB,c} = 106$		40: $N_{RB,c} = 106$	
PDSCH Reference measurement channel	1		SR.1.1 FDD	SR.1.1 CCA	SR.1.1 FDD	SR.1.1 CCA
	2		SR.1.1 TDD		SR.1.1 TDD	
	3		SR.2.1 TDD		SR.2.1 TDD	

RMSI CORESET Reference Channel	1		CR.1.1 FDD	CR.1.1 CCA	CR.1.1 FDD	CR.1.1 CCA
	2		CR.1.1 TDD		CR.1.1 TDD	
	3		CR.2.1 TDD		CR.2.1 TDD	
Dedicated CORESET Reference Channel	1		CCR.1.1 FDD	CCR.1.1 CCA	CCR.1.1 FDD	CCR.1.1 CCA
	2		CCR.1.1 TDD		CCR.1.1 TDD	
	3		CCR.2.1 TDD		CCR.2.1 TDD	
SSB configuration for Semi-static channel access	1		SSB.3 FR1	SSB.3 CCA	SSB.3 FR1	SSB.3 CCA
	2		SSB.3 FR1		SSB.3 FR1	
	3		SSB.4 FR1		SSB.4 FR1	
SSB configuration for Dynamic channel access	1		SSB.3 FR1	SSB.4 CCA	SSB.3 FR1	SSB.4 CCA
	2		SSB.3 FR1		SSB.3 FR1	
	3		SSB.4 FR1		SSB.4 FR1	
TRS configuration	1		TRS.1.1 FDD	TRS.1.2 TDD	TRS.1.1 FDD	TRS.1.2 TDD
	2		TRS.1.1 TDD		TRS.1.1 TDD	
	3		TRS.1.2 TDD		TRS.1.2 TDD	
OCNG Patterns	1~3		OP.1		OP.1	
Initial BWP Configuration	1~3		DLBWP.0.1 ULBWP.0.1		DLBWP.0.1 ULBWP.0.1	
Dedicated BWP configuration	1~3		DLBWP.1.1 ULBWP.1.1		DLBWP.1.1 ULBWP.1.1	
SMTC configuration	1~3		SMTC.1	N/A	SMTC.1	N/A
DBT Window Configuration	1~3		N/A	DBT.1	N/A	DBT.1
reportConfigType	1~3		periodic		periodic	
reportQuantity	1~3		ssb-Index-RSRP		ssb-Index-RSRP	
Number of reported RS	1~3		2		2	
L1-RSRP reporting period	1~3		slot80		slot80	
EPRE ratio of PSS to SSS	1~3	dB	0	0	0	0
EPRE ratio of PBCH DMRS to SSS						
EPRE ratio of PBCH to PBCH DMRS						
EPRE ratio of PDCCH DMRS to SSS						
EPRE ratio of PDCCH to PDCCH DMRS						
EPRE ratio of PDSCH DMRS to SSS						
EPRE ratio of PDSCH to PDSCH DMRS						
EPRE ratio of OCNG DMRS to SSS <sup>Note 1</sup>						
EPRE ratio of OCNG to OCNG DMRS <sup>Note 1</sup>						
$N_{oc}$ Note2						
	NR_FDD_FR1_B	-				
	NR_TDD_FR1_C	-				
	NR_FDD_FR1_D, NR_TDD_FR1_D	-				
	NR_FDD_FR1_E, NR_TDD_FR1_E	-				
	NR_FDD_FR1_F	-				
	NR_FDD_FR1_G	-				
	NR_FDD_FR1_H	-				
	NR_TDD_FR1_I	-	-113			
$N_{oc}$ Note2	NR_FDD_FR1_A, NR_TDD_FR1_A NOTE 5	1~3	dBm/S SB SCS	-91.65	-91.65	-
	NR_FDD_FR1_B					-
	NR_TDD_FR1_C					-

	NR_FDD_FR1_D, NR_TDD_FR1_D					-
	NR_FDD_FR1_E, NR_TDD_FR1_E					-
	NR_FDD_FR1_F					-
	NR_FDD_FR1_G					-
	NR_FDD_FR1_H					-
	NR_TDD_FR1_I				-	-110
	$\hat{E}_s/I_{ot}$	1~3	dB	10	10	-3
SS- RSRP <sup>Note3</sup>	NR_FDD_FR1_A, NR_TDD_FR1_A NOTE 5	1~3	dBm/S CS	-81.65	-81.65	-
	NR_FDD_FR1_B					-
	NR_TDD_FR1_C					-
	NR_FDD_FR1_D, NR_TDD_FR1_D					-
	NR_FDD_FR1_E, NR_TDD_FR1_E					-
	NR_FDD_FR1_F					-
	NR_FDD_FR1_G					-
	NR_FDD_FR1_H NR_TDD_FR1_I					-
I <sub>o</sub> <sup>Note3</sup>	NR_FDD_FR1_A, NR_TDD_FR1_A NOTE 5	1~3	dBm/ 38.16M Hz	-50.19	-50.19	-
	NR_FDD_FR1_B					-
	NR_TDD_FR1_C					-
	NR_FDD_FR1_D, NR_TDD_FR1_D					-
	NR_FDD_FR1_E, NR_TDD_FR1_E					-
	NR_FDD_FR1_F					-
	NR_FDD_FR1_G					-
	NR_FDD_FR1_H NR_TDD_FR1_I					-
	$\hat{E}_s/N_{oc}$	1~3	dB	10	10	-3
	Propagation condition	1~3		AWGN		AWGN
	Antenna configuration	1~3		1x2		1x2
<p>Note 1: OCNG shall be used such that both cells are fully allocated and a constant total transmitted power spectral density is achieved for all OFDM symbols.</p> <p>Note 2: Interference from other cells and noise sources not specified in the test is assumed to be constant over subcarriers and time and shall be modelled as AWGN of appropriate power for <math>N_{oc}</math> to be fulfilled.</p> <p>Note 3: RSRP and I<sub>o</sub> levels have been derived from other parameters for information purposes. They are not settable parameters themselves.</p> <p>Note 4: RSRP minimum requirements are specified assuming independent interference and noise at each receiver antenna port.</p> <p>Note 5: The test configuration excludes support for band n51 and it is not required to run this test on band n51 in this release of the specification.</p>						

### A.13.4.4.1.3 Test Requirements

In both Test 1 and Test 2, the L1-RSRP measurement accuracy for SSB#0 and SSB#1 of Cell 2 shall fulfil the requirements in clauses 10.1.33.1.

## A.13.4.5 RSSI

### A.13.4.5.1 Intra-frequency RSSI measurement accuracy on a carrier with CCA

#### A.13.4.5.1.1 Test Purpose and Environment

The purpose of this test is to verify that the RSSI measurement accuracy is within the specified limits. This test will partially verify the RSSI measurement accuracy requirements in Section 10.1.34.1.

#### A.13.4.5.1.2 Test parameters

In all test cases, Cell 1 is the PCell on a licensed FR1 band and Cell 2 is the SCell with CCA. RSSI is measured on channel number 2. Supported test configurations are shown in table A.13.4.5.1.2-1. The accuracy of RSSI intra-frequency measurements is tested by using the parameters in A.13.4.5.1.2-2 and A.13.4.5.1.2-3.

**Table A.13.4.5.1.2-1: Intra frequency RSSI supported test configurations**

Configuration	Description
1	Without CCA: 15 kHz SSB SCS, 10 MHz bandwidth, FDD duplex mode With CCA: 30 kHz SSB SCS, 40 MHz bandwidth, TDD duplex mode
2	Without CCA: 15 kHz SSB SCS, 10 MHz bandwidth, TDD duplex mode With CCA: 30 kHz SSB SCS, 40 MHz bandwidth, TDD duplex mode
3	Without CCA: 30 kHz SSB SCS, 40 MHz bandwidth, TDD duplex mode With CCA: 30 kHz SSB SCS, 40 MHz bandwidth, TDD duplex mode
NOTE: The UE is only required to be tested in one of the supported test configurations.	

**Table A.13.4.5.1.2-2: RSSI Intra frequency test parameters**

Parameter		Configurations	Unit	Test 1	
				Cell 1	Cell 2
RF Channel Number				1	2
BW <sub>channel</sub>			MHz	40	40
SSB configuration	Semi-static channel access Note 1, 3	1,2,3		Configuration 1,2: SSB.1 FR1 Configuration 3: SSB.2 FR1	SSB.1 CCA
	Dynamic channel access Note 2, 3	1,2,3		Configuration 1,2: SSB.1 FR1 Configuration 3: SSB.2 FR1	SSB.2 CCA
P <sub>CCA_DL</sub>				1	TBD
P <sub>CCA_UL</sub>				1	TBD
DL CCA model				N/A	As specified in A.3.20.2.1
UL CCA model				N/A	As specified in A.3.20.2.2
Measurement bandwidth			$n_{PRB}$	Same as channel access bandwidth	
Channel access bandwidth			MHz	20	
DRX Cycle configuration			ms	Not Applicable	
PDSCH Reference measurement channel	1			SR.1.1 FDD	SR.1.1 CCA
	2,3			SR.1.1 TDD	
RMSI CORESET Reference Channel	1			CR.1.1 FDD	CR.1.1 CCA
	2,3			CR.1.1 TDD	
Dedicated CORESET Reference Channel	1			CCR.1.1 FDD	CCR.1.1 CCA
	2,3			CCR.1.1 TDD	
OCNG Patterns				OP.1	OP.1
EPRE ratio of PSS to SSS			dB	0	0
EPRE ratio of PBCH DMRS to SSS					
EPRE ratio of PBCH to PBCH DMRS					
EPRE ratio of PDCCH DMRS to SSS					

EPRE ratio of PDCCH to PDCCH DMRS				
EPRE ratio of PDSCH DMRS to SSS				
EPRE ratio of PDSCH to PDSCH				
EPRE ratio of OCNG DMRS to SSS(Note 1)				
EPRE ratio of OCNG to OCNG DMRS (Note 1)				
$N_{oc}$ in slots not corresponding to RSSI measurement time configuration (RMTC)		dBm/SCS	-106	-106
$N_{oc}$ in slots corresponding to RSSI measurement time configuration (RMTC)		dBm/SCS	-106	-87
$\hat{E}_s/I_{ot}$ in slots not corresponding to RSSI measurement time configuration (RMTC)		dB	2.5	2.5
$\hat{E}_s/I_{ot}$ in slots corresponding to RSSI measurement time configuration (RMTC)		dB	2.5	-Infinity
SS-RSRP in slots not corresponding to RSSI measurement time configuration (RMTC)		dBm/SCS	-103.5	-103.5
SS-RSRP in slots corresponding to RSSI measurement time configuration (RMTC)			-103.5	-Infinity
$I_o$ within measurement bandwidth in slots not corresponding to RSSI measurement time configuration (RMTC)		dBm/SCS	-101.6	-101.6
$I_o$ within measurement bandwidth in slots corresponding to RSSI measurement time configuration (RMTC)		dBm/SCS	-101.6	-87
Propagation condition		-	AWGN	
Note 1: For UE supporting semi-static channel access and network configuring semi-static channel occupancy.				
Note 2: For UE supporting dynamic channel access and network configuring dynamic channel occupancy.				
Note 3: For a UE supporting both semi-static and dynamic channel access, the UE can be tested under dynamic channel occupancy only.				

**Table A.13.4.5.1.2-3: RSSI RMTC parameters**

measDurationSymbols-r16	sym14or12
rmtc-Periodicity-r16	ms40
rmtc-SubframeOffset-r16	20
ref-SCS-CP-r16	kHz15
ReportInterval	ms120

### A.13.4.5.1.3 Test Requirements

The average RSSI measurement accuracy shall fulfil the requirements in sections 10.1.34.1. The nominal RSSI used to evaluate the requirement shall be based on  $I_o$  in slots corresponding to RSSI measurement time configuration (RMTC).



## A.13.4.5.2 Inter-frequency RSSI measurement accuracy on a carrier with CCA

### A.13.4.5.2.1 Test Purpose and Environment

The purpose of this test is to verify that the RSSI measurement accuracy is within the specified limits. This test will partially verify the RSSI measurement accuracy requirements in Section 10.1.34.2.

### A.13.4.5.2.2 Test parameters

In all test cases, Cell 1 is the PCell on a licensed FR1 band and Cell 2 is the neighbour with CCA. RSSI is measured on channel number 2. Supported test configurations are shown in table A.13.4.5.2.2-1. The accuracy of RSSI inter-frequency measurements is tested by using the parameters in A.13.4.5.2.2-2 and A.13.4.5.2.3.

**Table A.13.4.5.2.2-1: Inter frequency RSSI supported test configurations**

Configuration	Description
1	Without CCA: 15 kHz SSB SCS, 10 MHz bandwidth, FDD duplex mode With CCA: 30 kHz SSB SCS, 40 MHz bandwidth, TDD duplex mode
2	Without CCA: 15 kHz SSB SCS, 10 MHz bandwidth, TDD duplex mode With CCA: 30 kHz SSB SCS, 40 MHz bandwidth, TDD duplex mode
3	Without CCA: 30 kHz SSB SCS, 40 MHz bandwidth, TDD duplex mode With CCA: 30 kHz SSB SCS, 40 MHz bandwidth, TDD duplex mode

NOTE: The UE is only required to be tested in one of the supported test configurations.

**Table A.13.4.5.2.2-2: RSSI Inter frequency test parameters**

Parameter		Configurations	Unit	Test 1	
				Cell 1	Cell 2
RF Channel Number				1	2
$BW_{channel}$			MHz	40	40
SSB configuration	Semi-static channel access Note 1, 3	1,2,3		Configuration 1,2: SSB.1 FR1 Configuration 3: SSB.2 FR1	SSB.1 CCA
	Dynamic channel access Note 2, 3	1,2,3		Configuration 1,2: SSB.1 FR1 Configuration 3: SSB.2 FR1	SSB.2 CCA
$P_{CCA\_DL}$				1	TBD
$P_{CCA\_UL}$				1	TBD
DL CCA model				N/A	As specified in A.3.20.2.1
UL CCA model				N/A	As specified in A.3.20.2.2
Measurement bandwidth			$n_{PRL}$	Same as channel access bandwidth	
Channel access bandwidth			MHz	20	
DRX Cycle configuration			ms	Not Applicable	
PDSCH Reference measurement channel	1			SR.1.1 FDD	NA
	2,3			SR.1.1 TDD	
RMSI CORESET Reference Channel	1			CR.1.1 FDD	NA
	2,3			CR.1.1 TDD	
Dedicated CORESET Reference Channel	1			CCR.1.1 FDD	NA
	2,3			CCR.1.1 TDD	
OCNG Patterns				OP.1	NA
EPRE ratio of PSS to SSS			dB	0	NA
EPRE ratio of PBCH DMRS to SSS					
EPRE ratio of PBCH to PBCH DMRS					
EPRE ratio of PDCCH DMRS to SSS					
EPRE ratio of PDCCH to PDCCH DMRS					

EPRE ratio of PDSCH DMRS to SSS				
EPRE ratio of PDSCH to PDSCH				
EPRE ratio of OCNG DMRS to SSS(Note 1)				
EPRE ratio of OCNG to OCNG DMRS (Note 1)				
$N_{oc}$ in slots not corresponding to RSSI measurement time configuration (RMTC)		dBm/SCS	-106	-106
$N_{oc}$ in slots corresponding to RSSI measurement time configuration (RMTC)		dBm/SCS	-106	-87
$\hat{E}_s/I_{ot}$ in slots not corresponding to RSSI measurement time configuration (RMTC)		dB	2.5	2.5
$\hat{E}_s/I_{ot}$ in slots corresponding to RSSI measurement time configuration (RMTC)		dB	2.5	-Infinity
SS-RSRP in slots not corresponding to RSSI measurement time configuration (RMTC)		dBm/SCS	-103.5	-103.5
SS-RSRP in slots corresponding to RSSI measurement time configuration (RMTC)			-103.5	-Infinity
$I_o$ within measurement bandwidth in slots not corresponding to RSSI measurement time configuration (RMTC)		dBm/SCS	-101.6	-101.6
$I_o$ within measurement bandwidth in slots corresponding to RSSI measurement time configuration (RMTC)		dBm/SCS	-101.6	-87
Propagation condition		-	AWGN	
Note 1: For UE supporting semi-static channel access and network configuring semi-static channel occupancy. Note 2: For UE supporting dynamic channel access and network configuring dynamic channel occupancy. Note 3: For a UE supporting both semi-static and dynamic channel access, the UE can be tested under dynamic channel occupancy only.				

**Table A.13.4.5.2.2-3: RSSI RMTC parameters**

measDurationSymbols-r16	sym14or12
rmtc-Periodicity-r16	ms40
rmtc-SubframeOffset-r16	20
ref-SCS-CP-r16	kHz15
ReportInterval	ms120

**A.13.4.5.2.3 Test Requirements**

The average RSSI measurement accuracy shall fulfil the requirements in sections 10.1.34.2. The nominal RSSI used to evaluate the requirement shall be based on  $I_o$  in slots corresponding to RSSI measurement time configuration (RMTC).

## A.13.4.6 Channel occupancy

### A.13.4.6.1 Intra-frequency channel occupancy measurement accuracy on SCC with CCA

#### A.13.4.6.1.1 Test Purpose and Environment

The purpose of this test is to verify that the channel occupancy measurement accuracy is within the specified limits. This test will partially verify the channel occupancy measurement accuracy requirements in Section 10.1.35.1.

#### A.13.4.6.1.2 Test parameters

In all test cases, Cell 1 is the PCell on a licensed FR1 band and Cell 2 is the SCell with CCA. Channel occupancy is measured on channel number 2. Supported test configurations are shown in table A.13.4.6.1.2-1. The accuracy of channel occupancy intra-frequency measurements is tested by using the parameters in A.13.4.6.1.2-2 and A.13.4.6.1.2-3.

**Table A.13.4.6.1.2-1: Intra frequency CO supported test configurations**

Configuration	Description
1	Without CCA: 15 kHz SSB SCS, 10 MHz bandwidth, FDD duplex mode With CCA: 30 kHz SSB SCS, 40 MHz bandwidth, TDD duplex mode
2	Without CCA: 15 kHz SSB SCS, 10 MHz bandwidth, TDD duplex mode With CCA: 30 kHz SSB SCS, 40 MHz bandwidth, TDD duplex mode
3	Without CCA: 30 kHz SSB SCS, 40 MHz bandwidth, TDD duplex mode With CCA: 30 kHz SSB SCS, 40 MHz bandwidth, TDD duplex mode

NOTE: The UE is only required to be tested in one of the supported test configurations.

**Table A.13.4.6.1.2-2: CO Intra frequency test parameters**

Parameter		Configurations	Unit	Test 1	
				Cell 1	Cell 2
RF Channel Number				1	2
BW <sub>channel</sub>			MHz	40	40
SSB configuration	Semi-static channel access Note 1, 3	1,2,3		Configuration 1,2: SSB.1 FR1 Configuration 3: SSB.2 FR1	SSB.1 CCA
	Dynamic channel access Note 2, 3	1,2,3		Configuration 1,2: SSB.1 FR1 Configuration 3: SSB.2 FR1	SSB.2 CCA
P <sub>CCA_DL</sub>				1	TBD
P <sub>CCA_UL</sub>				1	TBD
DL CCA model				N/A	As specified in A.3.20.2.1
UL CCA model				N/A	As specified in A.3.20.2.2
Measurement bandwidth			$n_{PRL}$	Same as channel access bandwidth	
Channel access bandwidth			MHz	20	
DRX Cycle configuration			ms	Not Applicable	
PDSCH Reference measurement channel	1			SR.1.1 FDD	SR.1.1 CCA
	2,3			SR.1.1 TDD	
RMSI CORESET Reference Channel	1			CR.1.1 FDD	CR.1.1 CCA
	2,3			CR.1.1 TDD	
Dedicated CORESET Reference Channel	1			CCR.1.1 FDD	CCR.1.1 CCA
	2,3			CCR.1.1 TDD	
OCNG Patterns				OP.1	OP.1
EPRE ratio of PSS to SSS			dB	0	0
EPRE ratio of PBCH DMRS to SSS					
EPRE ratio of PBCH to PBCH DMRS					

EPRE ratio of PDCCH DMRS to SSS				
EPRE ratio of PDCCH to PDCCH DMRS				
EPRE ratio of PDSCH DMRS to SSS				
EPRE ratio of PDSCH to PDSCH				
EPRE ratio of OCNG DMRS to SSS(Note 1)				
EPRE ratio of OCNG to OCNG DMRS (Note 1)				
$N_{oc}$ in slots not corresponding to RSSI measurement time configuration (RMTC)		dBm/SCS	-106	-106
$N_{oc}$ in slots corresponding to RSSI measurement time configuration (RMTC)		dBm/SCS	-106	-87
$\hat{E}_s/I_{ot}$ in slots not corresponding to RSSI measurement time configuration (RMTC)		dB	2.5	2.5
$\hat{E}_s/I_{ot}$ in slots corresponding to RSSI measurement time configuration (RMTC)		dB	2.5	-Infinity
SS-RSRP in slots not corresponding to RSSI measurement time configuration (RMTC)		dBm/SCS	-103.5	-103.5
SS-RSRP in slots corresponding to RSSI measurement time configuration (RMTC)			-103.5	-Infinity
Io within measurement bandwidth in slots not corresponding to RSSI measurement time configuration (RMTC)		dBm/BW	-101.6	-101.6
Io within measurement bandwidth in slots corresponding to RSSI measurement time configuration (RMTC)		dBm/BW	-101.6	-87
Propagation condition		-	AWGN	
channelOccupancyThreshold		dBm	-83	
Note 1: For UE supporting semi-static channel access and network configuring semi-static channel occupancy. Note 2: For UE supporting dynamic channel access and network configuring dynamic channel occupancy. Note 3: For a UE supporting both semi-static and dynamic channel access, the UE can be tested under dynamic channel occupancy only.				

**Table A.13.4.6.1.2-3: CO RMTC parameters**

measDurationSymbols-r16	sym14or12
rmtc-Periodicity-r16	ms40
rmtc-SubframeOffset-r16	20
ref-SCS-CP-r16	kHz15
ReportInterval	ms120

### A.13.4.6.1.3 Test Requirements

The nominal reported *channelOccupancy* shall be TBD. At least 90% of channel occupancy reports made by the UE shall indicate this value.

## A.13.4.6.2 Inter-frequency channel occupancy measurement accuracy on a carrier with CCA

### A.13.4.6.2.1 Test Purpose and Environment

The purpose of this test is to verify that the channel occupancy measurement accuracy is within the specified limits. This test will partially verify the channel occupancy measurement accuracy requirements in Section 10.1.35.2.

### A.13.4.6.2.2 Test parameters

In all test cases, Cell 1 is the PCell on a licensed FR1 band and Cell 2 is the neighbour with CCA. Channel occupancy is measured on channel number 2. Supported test configurations are shown in table A.13.4.6.2.2-1. The accuracy of channel occupancy inter-frequency measurements is tested by using the parameters in A.13.4.6.2.2-2 and A.13.4.6.2.3.

**Table A.13.4.6.2.2-1: Inter frequency CO supported test configurations**

Configuration	Description
1	Without CCA: 15 kHz SSB SCS, 10 MHz bandwidth, FDD duplex mode With CCA: 30 kHz SSB SCS, 40 MHz bandwidth, TDD duplex mode
2	Without CCA: 15 kHz SSB SCS, 10 MHz bandwidth, TDD duplex mode With CCA: 30 kHz SSB SCS, 40 MHz bandwidth, TDD duplex mode
3	Without CCA: 30 kHz SSB SCS, 40 MHz bandwidth, TDD duplex mode With CCA: 30 kHz SSB SCS, 40 MHz bandwidth, TDD duplex mode

NOTE: The UE is only required to be tested in one of the supported test configurations.

**Table A.13.4.6.2.2-2: CO Inter frequency test parameters**

Parameter		Configurations	Unit	Test 1	
				Cell 1	Cell 2
RF Channel Number				1	2
$BW_{channel}$			MHz	40	40
SSB configuration	Semi-static channel access Note 1, 3	1,2,3		Configuration 1,2: SSB.1 FR1 Configuration 3: SSB.2 FR1	SSB.1 CCA
	Dynamic channel access Note 2, 3	1,2,3		Configuration 1,2: SSB.1 FR1 Configuration 3: SSB.2 FR1	SSB.2 CCA
$P_{CCA\_DL}$				1	TBD
$P_{CCA\_UL}$				1	TBD
DL CCA model				N/A	As specified in A.3.20.2.1
UL CCA model				N/A	As specified in A.3.20.2.2
Measurement bandwidth			$n_{PRL}$	Same as channel access bandwidth	
Channel access bandwidth			MHz	20	
DRX Cycle configuration			ms	Not Applicable	
PDSCH Reference measurement channel	1			SR.1.1 FDD	NA
	2,3			SR.1.1 TDD	
RMSI CORESET Reference Channel	1			CR.1.1 FDD	NA
	2,3			CR.1.1 TDD	
Dedicated CORESET Reference Channel	1			CCR.1.1 FDD	NA
	2,3			CCR.1.1 TDD	
OCNG Patterns				OP.1	NA
EPRE ratio of PSS to SSS			dB	0	NA
EPRE ratio of PBCH DMRS to SSS					
EPRE ratio of PBCH to PBCH DMRS					
EPRE ratio of PDCCH DMRS to SSS					
EPRE ratio of PDCCH to PDCCH DMRS					

EPRE ratio of PDSCH DMRS to SSS				
EPRE ratio of PDSCH to PDSCH				
EPRE ratio of OCNG DMRS to SSS(Note 1)				
EPRE ratio of OCNG to OCNG DMRS (Note 1)				
$N_{oc}$ in slots not corresponding to RSSI measurement time configuration (RMTC)		dBm/SCS	-106	-106
$N_{oc}$ in slots corresponding to RSSI measurement time configuration (RMTC)		dBm/SCS	-106	-87
$\hat{E}_s/I_{ot}$ in slots not corresponding to RSSI measurement time configuration (RMTC)		dB	2.5	2.5
$\hat{E}_s/I_{ot}$ in slots corresponding to RSSI measurement time configuration (RMTC)		dB	2.5	-Infinity
SS-RSRP in slots not corresponding to RSSI measurement time configuration (RMTC)		dBm/SCS	-103.5	-103.5
SS-RSRP in slots corresponding to RSSI measurement time configuration (RMTC)			-103.5	-Infinity
Io within measurement bandwidth in slots not corresponding to RSSI measurement time configuration (RMTC)		dBm/BW	-101.6	-101.6
Io within measurement bandwidth in slots corresponding to RSSI measurement time configuration (RMTC)		dBm/BW	-101.6	-87
Propagation condition		-	AWGN	
channelOccupancyThreshold		dBm	-83	
Note 1: For UE supporting semi-static channel access and network configuring semi-static channel occupancy.				
Note 2: For UE supporting dynamic channel access and network configuring dynamic channel occupancy.				
Note 3: For a UE supporting both semi-static and dynamic channel access, the UE can be tested under dynamic channel occupancy only.				

**Table A.13.4.6.2.2-3: CO RMTC parameters**

measDurationSymbols-r16	sym14or12
rmtc-Periodicity-r16	ms40
rmtc-SubframeOffset-r16	20
ref-SCS-CP-r16	kHz15
ReportInterval	ms120

### A.13.4.6.2.3 Test Requirements

The nominal reported *channelOccupancy* shall be TBD. At least 90% of channel occupancy reports made by the UE shall indicate this value.

# Annex B (normative): Conditions for RRM requirements applicability for operating bands

## B.1 Conditions for NR RRC\_IDLE state mobility

### B.1.1 Introduction

In Annex B.1, the following conditions are specified:

- UE conditions which shall apply for UE intra-frequency measurements procedures and requirements in clause 4,
- UE conditions which shall apply for UE inter-frequency measurements procedures and requirements in clause 4.

### B.1.2 Conditions for measurements on NR intra-frequency cells for cell re-selection

This clause defines the following conditions for NR intra-frequency measurements performed based on SSBs for cell re-selection: SSB<sub>RP</sub> and SSB  $\dot{E}_s/\text{lot}$ , applicable for a corresponding operating band.

The conditions are defined in Table B.1.2-1 for FR1 NR cells.

The conditions are defined in Table B.1.2-2 for FR2 NR cells.

**Table B.1.2-1: Conditions for intra-frequency cell re-selection in FR1**

Parameter	NR operating band groups <sup>Note1</sup>	Minimum SSB <sub>RP</sub>		SSB $\dot{E}_s/\text{lot}$
		dBm / SCS <sub>SSB</sub>		dB
		SCS <sub>SSB</sub> = 15 kHz	SCS <sub>SSB</sub> = 30 kHz	
Conditions	NR_FDD_FR1_A, NR_TDD_FR1_A	-124	-121	≥ -4
	NR_FDD_FR1_B	-123.5	-120.5	
	NR_TDD_FR1_C	-123	-120	
	NR_FDD_FR1_D, NR_TDD_FR1_D	-122.5	-119.5	
	NR_FDD_FR1_E, NR_TDD_FR1_E	-122	-119	
	NR_FDD_FR1_F	-121.5	-118.5	
	NR_FDD_FR1_G	-121	-118	
	NR_FDD_FR1_H	-120.5	-117.5	

NOTE 1: NR operating band groups are defined in clause 3.5.2.

**Table B.1.2-2: Conditions for intra-frequency cell re-selection in FR2**

Parameter	Angle of arrival	NR operating bands	Minimum SSB <sub>RP</sub> <sup>Note 2, Note 3</sup>				SSB $\dot{E}_s/\text{lot}$	
			dBm / SCS <sub>SSB</sub>				dB	
			SCS <sub>SSB</sub> = 120 kHz			SCS <sub>SSB</sub> = 240 kHz		
			UE Power class			UE Power class		
			1	2	3	4	1, 2, 3, 4	
Conditions	Rx Beam Peak	n257	-125.3+Y <sub>1</sub>	-110.8	-109.1	-124.8+Y <sub>4</sub>	(Value for SCS <sub>SSB</sub> = 120 kHz) +3dB	≥ -4
		n258	-125.3+Y <sub>1</sub>	-110.8	-109.1	-124.8+Y <sub>4</sub>		
		n259			-105.5			
		n260	-122.3+Y <sub>1</sub>		-106.5	-122.8+Y <sub>4</sub>		

		n261	- 125.3+Y <sub>1</sub>	-110.8	-109.1	- 124.8+Y <sub>4</sub>		
	Spherical coverage Note 1	n257	- 117.3+Z <sub>1</sub>	-99.8	-98.2	- 115.8+Z <sub>4</sub>	(Value for SCS <sub>SSB</sub> = 120 kHz) +3dB	≥-4
		n258	- 117.3+Z <sub>1</sub>	-99.8	-98.2	- 115.8+Z <sub>4</sub>		
		n259			-92.7			
		n260	- 114.3+Z <sub>1</sub>		-93.9	- 110.8+Z <sub>4</sub>		
		n261	- 117.3+Z <sub>1</sub>	-99.8	-98.2	- 115.8+Z <sub>4</sub>		
<p>NOTE 1: Values based on EIS spherical coverage as defined in clause 7.3.4 of TS 38.101-2 [19]. Side condition applies for directions in which EIS spherical coverage requirement is met.</p> <p>NOTE 2: Values specified at the Reference point to give minimum SSB <math>\hat{E}_s/I_{ot}</math>, with no applied noise.</p> <p>NOTE 3: For UEs that support multiple FR2 bands, Rx Beam Peak values are increased by <math>\Delta MB_{P,n}</math> and Spherical coverage values are increased by <math>\Delta MB_{S,n}</math>, the UE multi-band relaxation factor in dB specified in clause 6.2.1 of TS 38.101-2 [19].</p>								

Editor's notes for Table B.1.2-2:

- The value of Y for Power classes 1 and 4 is FFS, where Y<sub>1</sub> and Y<sub>4</sub> are the rough/fine beam gain differences in Rx beam peak direction for Power classes 1 and 4 respectively
- The value of Z for Power classes 1 and 4 is FFS, where Z<sub>1</sub> and Z<sub>4</sub> are the rough/fine beam gain differences in spherical coverage directions for Power classes 1 and 4 respectively

## B.1.3 Conditions for measurements on NR inter-frequency cells for cell re-selection

This clause defines the following conditions for NR inter-frequency measurements performed based on SSBs for cell re-selection: SSB<sub>RP</sub> and SSB  $\hat{E}_s/I_{ot}$ , applicable for a corresponding operating band.

The conditions defined in Table B.1.2-1 for FR1 NR intra-frequency cell re-selection shall also apply for FR1 NR inter-frequency cells in this clause.

The conditions defined in Table B.1.2-2 for FR2 NR intra-frequency cell re-selection shall also apply for FR2 NR inter-frequency cells in this clause.

## B.2 Conditions for UE measurements procedures and performance requirements in RRC\_CONNECTED state

### B.2.1 Introduction

#### B.2.1.1 General

In Annex B.2, the following conditions are specified:

- The conditions for RRC connection release with redirection to NR requirements in clause 6.2.3.2.1,
- The conditions for UE transmit timing adjustment in clause 7.1
- UE conditions which shall apply for UE intra-frequency measurements procedures and requirements in clause 9, UE conditions which shall apply for UE inter-frequency measurements procedures and requirements in clause 9,
- UE conditions which shall apply for UE intra-frequency measurements performance requirements in clause 10,
- UE conditions which shall apply for UE inter-frequency measurements performance requirements in clause 10.



## B.2.1.2 Derivation of Minimum SSB\_RP values for FR1

[FFS]

## B.2.1.3 Derivation of Minimum SSB\_RP values for FR2

*Editor's note:*

- The Assumption for UE beams (fine or rough) in Annex A RRM test cases is defined based on power class 3, and unless otherwise stated also applies for other UE power classes

### B.2.1.3.1 Minimum SSB\_RP values for Rx Beam Peak angle of arrival

Minimum SSB\_RP values in Tables B.2.2-2 and B.2.3-2 are based on Reference sensitivity for the Operating band and for the UE power class, taking a baseline of UE Power class 3 in Band n260 with 50 MHz channel bandwidth.

Minimum SSB\_RP = Reference sensitivity<sub>PC3, n260, 50MHz</sub> + Y - 10Log<sub>10</sub>(PRB<sub>Refsens</sub> x 12) - SNR<sub>Refsens</sub> + SSB Ês/Iot + ΔMB<sub>P,n</sub>

where:

Reference sensitivity<sub>PC3, n260, 50MHz</sub> is the reference sensitivity value in dBm specified for power class 3 in Band n260 for 50 MHz Channel bandwidth in Table 7.3.2.3-1 of TS 38.101-2 [19];

Y is the gain difference between fine and rough beams, which is defined in Table B.2.1.3.1-1;

**Table B.2.1.3.1-1: Gain difference Y between fine and rough beams, Rx beam peak direction**

Value "Y" in dB, for each UE power class			
1	2	3	4
FFS	9.0	7.0	FFS

PRB<sub>Refsens</sub> is N<sub>RB</sub> associated with subcarrier spacing 120 kHz for 50MHz in TS 38.101-2 [19] Table 5.3.2-1, and is 32;

12 is the number of subcarriers in a PRB;

SNR<sub>Refsens</sub> is the SNR used for simulation of Refsens and EIS spherical coverage, and is -1 dB;

SSB Ês/Iot is the minimum value required by the UE to perform measurements, and is -6 dB for intra-frequency measurements and -4 dB for inter-frequency measurements. The only contribution to Iot is the UE internal noise;

ΔMB<sub>P,n</sub> is the UE multi-band relaxation factor value in dB specified in TS 38.101-2 [19] clause 6.2.1.

The calculated Minimum SSB\_RP value for the baseline of UE power class 3 in Band n260 is (-109.5+ΔMB<sub>P,n</sub>) dBm/120kHz for intra-frequency measurements and (-107.5+ΔMB<sub>P,n</sub>) dBm/120kHz for inter-frequency measurements.

The following methodology to define the Minimum SSB\_RP level for power class X (PC\_X) and operating band Y (Band\_Y) is used:

For Intra-frequency: Minimum SSB\_RP (PC\_X, Band\_Y) = -109.5 dBm/120kHz + Refsens<sub>PC\_X, Band\_Y, 50MHz</sub> - Refsens<sub>PC3, n260, 50MHz</sub> + Y<sub>PC\_X</sub> - Y<sub>PC3</sub> + ΔMB<sub>P,n</sub>,

For Inter-frequency: Minimum SSB\_RP (PC\_X, Band\_Y) = -107.5 dBm/120kHz + Refsens<sub>PC\_X, Band\_Y, 50MHz</sub> - Refsens<sub>PC3, n260, 50MHz</sub> + Y<sub>PC\_X</sub> - Y<sub>PC3</sub> + ΔMB<sub>P,n</sub>.

### B.2.1.3.2 Minimum SSB\_RP values for angle of arrival within Spherical coverage

Minimum SSB\_RP values in Tables B.2.2-2 and B.2.3-2 are based on EIS spherical coverage for the Operating band and for the UE power class, taking a baseline of UE power class 3 in Band n260 with 50 MHz channel bandwidth.

Minimum SSB\_RP = EIS spherical coverage<sub>PC3, n260, 50MHz</sub> + Z - 10Log<sub>10</sub>(PRB<sub>Refsens</sub> x 12) - SNR<sub>Refsens</sub> + SSB Ês/Iot + ΔMB<sub>S,n</sub>

where:

EIS spherical coverage  $_{PC3, n260, 50MHz}$  is the EIS spherical coverage value in dBm specified for power class 3 in Band n260 for 50MHz Channel bandwidth in TS 38.101-2 [19] Table 7.3.4.3-1;

Z is the gain difference between fine and rough beams, and is defined in Table B.2.1.3.2-1;

**Table B.2.1.3.2-1: Gain difference Z between fine and rough beams, Spherical coverage directions**

Value "Z" in dB, for each UE power class			
1	2	3	4
FFS	9.0	7.0	FFS

$PRB_{Refsens}$  is  $N_{RB}$  associated with subcarrier spacing 120 kHz for 50MHz in TS 38.101-2 [19] Table 5.3.2-1, and is 32;

12 is the number of subcarriers in a PRB;

$SNR_{Refsens}$  is the SNR used for simulation of Refsens and EIS spherical coverage, and is -1 dB;

$SSB \hat{E}_s/I_{ot}$  is the minimum value required by the UE to perform measurements, and is -6 dB for intra-frequency measurements and -4 dB for inter-frequency measurements. The only contribution to  $I_{ot}$  is the UE internal noise;

$\Delta MB_{S,n}$  is the UE multi-band relaxation factor value in dB specified in TS 38.101-2 [19] clause 6.2.1.

The calculated Minimum SSB\_RP value for the baseline of UE power class 3 in Band n260 is (-96.9+ $\Delta MB_{S,n}$ ) dBm/120kHz for intra-frequency measurements and is (-94.9+ $\Delta MB_{S,n}$ ) dBm/120kHz for inter-frequency measurements.

The following methodology to define the Minimum SSB\_RP level for power class X ( $PC_X$ ) and operating band Y ( $Band_Y$ ) is used:

For Intra-frequency: Minimum SSB\_RP ( $PC_X, Band_Y$ ) = -96.9 dBm/120kHz + EIS spherical coverage  $_{PC_X, Band_Y, 50MHz}$  – EIS spherical coverage  $_{PC3, n260, 50MHz}$  +  $Z_{PC_X} - Z_{PC3} + \Delta MB_{S,n}$

For Inter-frequency: Minimum SSB\_RP ( $PC_X, Band_Y$ ) = -94.9 dBm/120kHz + EIS spherical coverage  $_{PC_X, Band_Y, 50MHz}$  – EIS spherical coverage  $_{PC3, n260, 50MHz}$  +  $Z_{PC_X} - Z_{PC3} + \Delta MB_{S,n}$

## B.2.1.4 Gain to SS-RSRP and CSI-RSRP measurement point for FR1

In FR1 conducted requirements are specified at the UE antenna connector, which is also the SS-RSRP and CSI-RSRP measurement point.

## B.2.1.5 Gain to SS-RSRP and CSI-RSRP measurement point for FR2

### B.2.1.5.1 Gain to SS-RSRP and CSI-RSRP measurement point for Rx Beam Peak angle of arrival

In clause 5.1.1 of TS 38.215 [4] SS-RSRP and CSI-RSRP is defined to be measured based on the combined signal from antenna elements corresponding to a given receiver branch. The reference point for requirement parameters from the UE perspective is the input of the UE antenna array. The gain "G" relates the combined signal from antenna elements corresponding to a given receiver branch to the reference point for requirement parameters.

The gain "G" affects absolute signal level values reported by the UE.

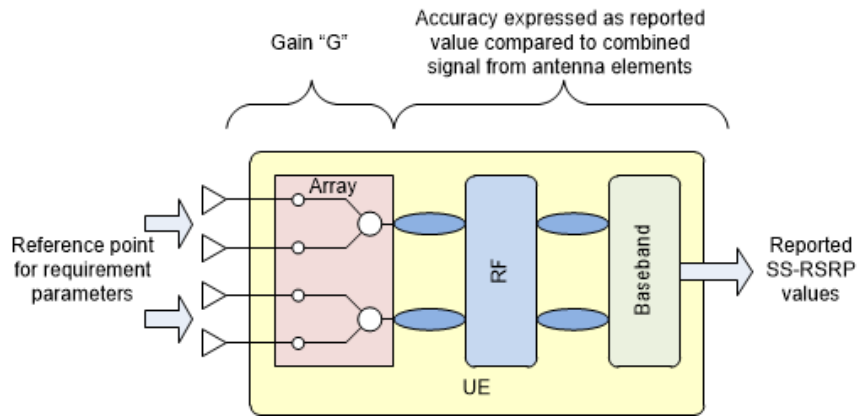

**Figure B.2.1.5.1-1: Gain and Reference point for requirement parameters**

The gain range for each power class is specified in Table B.2.1.5.1-1.

**Table B.2.1.5.1-1: UE gain G, Rx beam peak direction**

	UE Power class			
	1	2	3	4
Minimum, dBi	FFS	FFS	-10	FFS
Maximum, dBi	FFS	FFS	+20	FFS

Gain range in spherical coverage directions may be lower than in Rx beam peak direction, according to the difference between the EIS spherical coverage value specified in TS 38.101-2 [19] clause 7.3.4 and the Reference sensitivity level specified in TS 38.101-2 [19] clause 7.3.2.

**B.2.1.5.2 Gain to SS-RSRP measurement point for different frequency**

In any specific direction, the UE gain G may be different depending on frequencies. The gain “G<sub>inter</sub>” affects relative signal level values reported by the UE when measuring between different frequencies and is specified in Table B.2.1.5.2-1 for each power class.

**Table B.2.1.5.2-1: UE gain difference between inter-frequencies G<sub>inter</sub>**

	UE Power class			
	1	2	3	4
Maximum difference, dB	FFS	FFS	3	FFS

**B.2.1.5.3 Alignment of Rough beam to Rx beam Peak**

The definition of Rx Beam Peak in TS 38.101-2 [19] clause 7.3.2 is based on Throughput at Reference sensitivity power level, and assumes use of Fine beams. In many RRM scenarios the UE can use Rough beams, but the largest Rough beam gain direction may not be aligned to the Fine beam Peak direction.

When the Rx Beam Peak is selected and defined based on Fine Beams, the rough beam gain in that direction may be lower than the largest rough beam gain in another direction within Spherical Coverage. The term “D” is the maximum allowed rough beam gain reduction, and is specified in Table B.2.1.5.3-1 for each power class.

**Table B.2.1.5.3-1: Rough Beam gain reduction “D” in Rx Beam Peak direction**

	UE Power class			
	1	2	3	4
Maximum gain reduction, dB	FFS	FFS	5.5	FFS

## B.2.1.6 Gain to PRS-RSRP measurement point for FR2

### B.2.1.6.1 Gain to PRS-RSRP measurement point for Rx Beam Peak angle of arrival

In clause 5.1.28 of TS 38.215 [4] PRS-RSRP is defined to be measured based on the combined signal from antenna elements corresponding to a given receiver branch. The reference point for requirement parameters from the UE perspective is the input of the UE antenna array. The gain “G” relates the combined signal from antenna elements corresponding to a given receiver branch to the reference point for requirement parameters.

The gain “G” affects absolute signal level values reported by the UE.

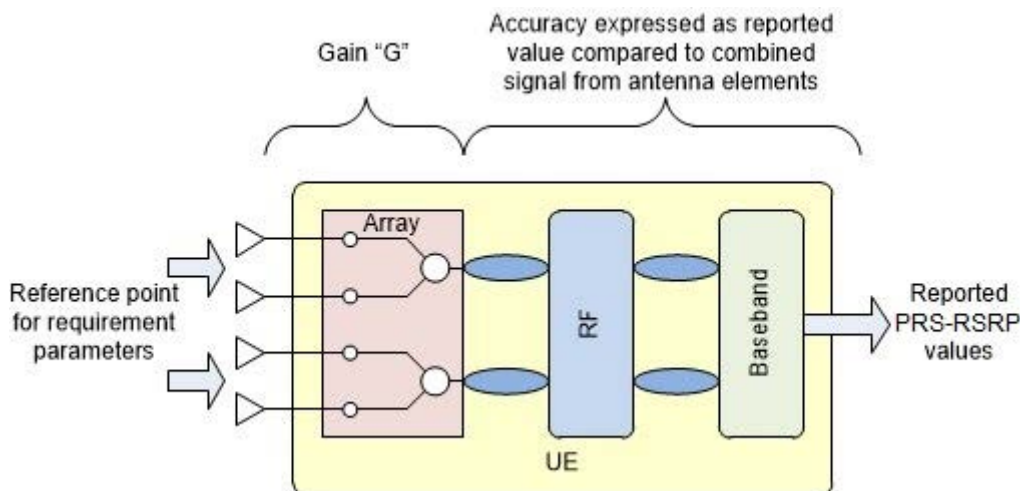

Figure B.2.1.6.1-1: Gain and Reference point for requirement parameters

The gain range for each power class is specified in Table B.2.1.61-1.

Table B.2.1.6.1-1: UE gain G, Rx beam peak direction

	UE Power class			
	1	2	3	4
Minimum, dBi	FFS	FFS	-10	FFS
Maximum, dBi	FFS	FFS	+20	FFS

Gain range in spherical coverage directions may be lower than in Rx beam peak direction, according to the difference between the EIS spherical coverage value specified in TS 38.101-2 [19] clause 7.3.4 and the Reference sensitivity level specified in TS 38.101-2 [19] clause 7.3.2.

## B.2.2 Conditions for NR intra-frequency measurements

This clause defines the following conditions for NR intra-frequency measurements and corresponding procedures performed based on SSBs: SSB<sub>RP</sub> and SSB  $\hat{E}_s/I_{ot}$ , applicable for a corresponding operating band.

The conditions are defined in Table B.2.2-1 for FR1 NR cells.

The conditions are defined in Table B.2.2-2 for FR2 NR cells.

Table B.2.2-1: Conditions for intra-frequency measurements in FR1

Parameter	NR operating band groups <sup>Note1</sup>	Minimum SSB <sub>RP</sub>		SSB $\hat{E}_s/I_{ot}$
		dBm / SCS <sub>SSB</sub>		dB
		SCS <sub>SSB</sub> = 15 kHz	SCS <sub>SSB</sub> = 30 kHz	
Conditions	NR_FDD_FR1_A, NR_TDD_FR1_A, NR_SDL_FR1_A	-127	-124	≥ -6

	NR_FDD_FR1_B	-126.5	-123.5
	NR_TDD_FR1_C	-126	-123
	NR_FDD_FR1_D, NR_TDD_FR1_D	-125.5	-122.5
	NR_FDD_FR1_E, NR_TDD_FR1_E	-125	-122
	NR_FDD_FR1_F	-124.5	-121.5
	NR_FDD_FR1_G	-124	-121
	NR_FDD_FR1_H	-123.5	-120.5

NOTE 1: NR operating band groups are defined in clause 3.5.2.

**Table B.2.2-2: Conditions for intra-frequency measurements in FR2**

Parameter	Angle of arrival	NR operating bands	Minimum SSB <sub>RP</sub> <sup>Note 2, Note 3</sup>				SSB $\hat{E}$ s/lot	
			dBm / SCS <sub>SSB</sub>				dB	
			SCS <sub>SSB</sub> = 120 kHz		SCS <sub>SSB</sub> = 240 kHz			
			UE power class					UE power class
		1	2	3	4	1, 2, 3, 4		
Conditions	Rx Beam Peak	n257	- 128.3+Y <sub>1</sub>	-113.8	-112.1	- 127.8+Y <sub>4</sub>	(Value for SCS <sub>SSB</sub> = 120 kHz) +3dB	≥-6
		n258	- 128.3+Y <sub>1</sub>	-113.8	-112.1	- 127.8+Y <sub>4</sub>		
		n259	-		-108.5	-		
		n260	- 125.3+Y <sub>1</sub>		-109.5	- 125.8+Y <sub>4</sub>		
		n261	- 128.3+Y <sub>1</sub>	-113.8	-112.1	- 127.8+Y <sub>4</sub>		
	Spherical coverage <sup>Note 1</sup>	n257	- 120.3+Z <sub>1</sub>	-102.8	-101.2	- 118.8+Z <sub>4</sub>	(Value for SCS <sub>SSB</sub> = 120 kHz) +3dB	≥-6
		n258	- 120.3+Z <sub>1</sub>	-102.8	-101.2	- 118.8+Z <sub>4</sub>		
		n259	-		-95.7	-		
		n260	- 117.3+Z <sub>1</sub>		-96.9	- 113.8+Z <sub>4</sub>		
		n261	- 120.3+Z <sub>1</sub>	-102.8	-101.2	- 118.8+Z <sub>4</sub>		

Note 1: Values based on EIS spherical coverage as defined in clause 7.3.4 of TS 38.101-2 [19]. Side condition applies for directions in which EIS spherical coverage requirement is met.

Note 2: Values specified at the Reference point to give minimum SSB  $\hat{E}$ s/lot, with no applied noise.

Note 3: For UEs that support multiple FR2 bands, Rx Beam Peak values are increased by  $\Delta MB_{P,n}$  and spherical coverage values are increased by  $\Delta MB_{S,n}$ , the UE multi-band relaxation factor in dB specified in clause 6.2.1 of TS 38.101-2 [19].

*Editor’s notes for Table B.2.2-2:*

- The value of Y for power classes 1 and 4 is FFS, where Y<sub>1</sub> and Y<sub>4</sub> are the rough/fine beam gain differences in Rx beam peak direction for power classes 1 and 4 respectively
- The value of Z for power classes 1 and 4 is FFS, where Z<sub>1</sub> and Z<sub>4</sub> are the rough/fine beam gain differences in spherical coverage directions for power classes 1 and 4 respectively

### B.2.3 Conditions for NR inter-frequency measurements

This clause defines the following conditions for NR inter-frequency measurements and corresponding procedures performed based on SSBs: SSB<sub>RP</sub> and SSB  $\hat{E}$ s/lot, applicable for a corresponding operating band.

The conditions are defined in Table B.2.3-1 for FR1 NR cells.

The conditions are defined in Table B.2.3-2 for FR2 NR cells.

**Table B.2.3-1: Conditions for inter-frequency measurements in FR1**

Parameter	NR operating band groups <sup>Note1</sup>	Minimum SSB <sub>RP</sub>		SSB $\hat{E}$ s/lot
		dBm / SCS <sub>SSB</sub>		
		SCS <sub>SSB</sub> = 15 kHz	SCS <sub>SSB</sub> = 30 kHz	dB
Conditions	NR_FDD_FR1_A, NR_TDD_FR1_A, NR_SDL_FR1_A	-125	-122	≥ -4
	NR_FDD_FR1_B	-124.5	-121.5	
	NR_TDD_FR1_C	-124	-121	
	NR_FDD_FR1_D, NR_TDD_FR1_D	-124.5	-120.5	
	NR_FDD_FR1_E, NR_TDD_FR1_E	-123	-120	
	NR_FDD_FR1_F	-122.5	-119.5	
	NR_FDD_FR1_G	-122	-119	
	NR_FDD_FR1_H	-121.5	-118.5	

NOTE 1: NR operating band groups are defined in clause 3.5.2.

**Table B.2.3-2: Conditions for inter-frequency measurements in FR2**

Parameter	Angle of arrival	NR operating bands	Minimum SSB <sub>RP</sub> <sup>Note 2, Note 3</sup>				SSB $\hat{E}$ s/lot	
			dBm / SCS <sub>SSB</sub>					
			SCS <sub>SSB</sub> = 120 kHz			SCS <sub>SSB</sub> = 240 kHz	dB	
			UE power class			UE power class		
			1	2	3	4		1, 2, 3, 4
Conditions	Rx Beam Peak	n257	-	-111.8	-110.1	-	(Value for SCS <sub>SSB</sub> = 120 kHz) +3dB	≥ -4
			126.3+Y <sub>1</sub>			125.8+Y <sub>4</sub>		
		n258	-	-111.8	-110.1	-		
			126.3+Y <sub>1</sub>			125.8+Y <sub>4</sub>		
		n259	-		-106.5	-		
	n260	-		-107.5	-	123.8+Y <sub>4</sub>		
		123.3+Y <sub>1</sub>			123.8+Y <sub>4</sub>			
	n261	-	-111.8	-110.1	-	125.8+Y <sub>4</sub>		
		126.3+Y <sub>1</sub>			125.8+Y <sub>4</sub>			
	n257	-	-100.8	-99.2	-	116.8+Z <sub>4</sub>	(Value for SCS <sub>SSB</sub> = 120 kHz) +3dB	≥ -4
	118.3+Z <sub>1</sub>			116.8+Z <sub>4</sub>				
n258	-	-100.8	-99.2	-				
	118.3+Z <sub>1</sub>			116.8+Z <sub>4</sub>				
n259	-		-93.7	-				
n260	-		-94.9	-	111.8+Z <sub>4</sub>			
	115.3+Z <sub>1</sub>			111.8+Z <sub>4</sub>				
n261	-	-100.8	-99.2	-	116.8+Z <sub>4</sub>			
	118.3+Z <sub>1</sub>			116.8+Z <sub>4</sub>				

NOTE 1: Values based on EIS spherical coverage as defined in clause 7.3.4 of TS 38.101-2 [19]. Side condition applies for directions in which EIS spherical coverage requirement is met.  
 NOTE 2: Values specified at the Reference point to give minimum SSB  $\hat{E}$ s/lot, with no applied noise.  
 NOTE 3: For UEs that support multiple FR2 bands, Rx Beam Peak values are increased by  $\Delta MB_{P,n}$  and Spherical coverage values are increased by  $\Delta MB_{S,n}$ , the UE multi-band relaxation factor in dB specified in clause 6.2.1 of TS 38.101-2 [19].

Editor’s notes for Table B.2.3-2:

- The value of Y for power classes 1 and 4 is FFS, where Y<sub>1</sub> and Y<sub>4</sub> are the rough/fine beam gain differences in Rx beam peak direction for power classes 1 and 4 respectively
- The value of Z for power classes 1 and 4 is FFS, where Z<sub>1</sub>, and Z<sub>4</sub> are the rough/fine beam gain differences in spherical coverage directions for power classes 1 and 4 respectively

## B.2.4 Conditions for NR L1-RSRP reporting

### B.2.4.1 Conditions for SSB based L1-RSRP reporting

This clause defines the following conditions for NR L1-RSRP measurement reporting and corresponding procedures performed based on SSBs: SSB<sub>RP</sub> and SSB  $\hat{E}$ s/lot, applicable for a corresponding operating band.

The conditions are defined in Table B.2.4.1-1 for FR1 NR cells.

The conditions are defined in Table B.2.4.1-2 for FR2 NR cells.

**Table B.2.4.1-1: Conditions for SSB based L1-RSRP measurements in FR1**

Parameter	NR operating band groups <sup>Note1</sup>	Minimum SSB <sub>RP</sub>		SSB $\hat{E}$ s/lot
		dBm / SCS <sub>SSB</sub>		dB
		SCS <sub>SSB</sub> = 15 kHz	SCS <sub>SSB</sub> = 30 kHz	
Conditions	NR_FDD_FR1_A, NR_TDD_FR1_A, NR_SDL_FR1_A	-124	-121	≥ -3
	NR_FDD_FR1_B	-123.5	-120.5	
	NR_TDD_FR1_C	-123	-120	
	NR_FDD_FR1_D, NR_TDD_FR1_D	-122.5	-119.5	
	NR_FDD_FR1_E, NR_TDD_FR1_E	-122	-119	
	NR_FDD_FR1_F	-121.5	-118.5	
	NR_FDD_FR1_G	-121	-118	
	NR_FDD_FR1_H	-120.5	-117.5	

NOTE 1: NR operating band groups are defined in clause 3.5.2.

**Table B.2.4.1-2: Conditions for SSB based L1-RSRP measurements in FR2**

Parameter	Angle of arrival	NR operating bands	Minimum SSB <sub>RP</sub> <sup>Note 2, Note 3</sup>				SSB $\hat{E}$ s/lot	
			dBm / SCS <sub>SSB</sub>				dB	
			SCS <sub>SSB</sub> = 120 kHz		SCS <sub>SSB</sub> = 240 kHz			
			UE power class		UE power class			
			1	2	3	4	1, 2, 3, 4	
Conditions	Rx Beam Peak	n257	-	-110.8	-109.1	-	(Value for SCS <sub>SSB</sub> = 120 kHz) +3dB	≥ -3
		n258	125.3+Y <sub>1</sub>	-110.8	-109.1	124.8+Y <sub>4</sub>		
		n259			-105.5			
		n260	122.3+Y <sub>1</sub>		-106.5	122.8+Y <sub>4</sub>		
		n261	125.3+Y <sub>1</sub>	-110.8	-109.1	124.8+Y <sub>4</sub>		
	Spherical coverage <sup>Note 1</sup>	n257	-	-99.8	-98.2	-	(Value for SCS <sub>SSB</sub> = 120 kHz) +3dB	≥ -3
		n258	117.3+Z <sub>1</sub>	-99.8	-98.2	115.8+Z <sub>4</sub>		
		n259			-92.7			
		n260	114.3+Z <sub>1</sub>		-93.9	110.8+Z <sub>4</sub>		
		n261	117.3+Z <sub>1</sub>	-99.8	-98.2	115.8+Z <sub>4</sub>		

NOTE 1: Values based on EIS spherical coverage as defined in clause 7.3.4 of TS 38.101-2 [19]. Side condition applies for directions in which EIS spherical coverage requirement is met.

NOTE 2: Values specified at the Reference point to give minimum SSB  $\hat{E}$ s/lot, with no applied noise.

NOTE 3: For UEs that support multiple FR2 bands, Rx Beam Peak values are increased by  $\Delta$ MB<sub>P,n</sub> and Spherical coverage values are increased by  $\Delta$ MB<sub>S,n</sub>, the UE multi-band relaxation factor in dB specified in clause 6.2.1 of TS 38.101-2 [19].

Editor's notes for Table B.2.4.1-2:

- The value of  $Y$  for power classes 1 and 4 is FFS, where  $Y_1$  and  $Y_4$  are the rough/fine beam gain differences in Rx beam peak direction for power classes 1 and 4 respectively

- The value of  $Z$  for power classes 1 and 4 is FFS, where  $Z_1$  and  $Z_4$  are the rough/fine beam gain differences in spherical coverage directions for power classes 1 and 4 respectively

### B.2.4.2 Conditions for CSI-RS based L1-RSRP reporting

This clause defines the following conditions for NR L1-RSRP measurement reporting and corresponding procedures performed based on CSI-RS: CSI-RS<sub>RP</sub> and CSI-RS  $\hat{E}$ s/lot, applicable for a corresponding operating band.

The conditions are defined in Table B.2.4.2-1 for FR1 NR cells.

The conditions are defined in Table B.2.4.2-2 for FR2 NR cells.

**Table B.2.4.2-1: Conditions for CSI-RS based L1-RSRP measurements in FR1**

Parameter	NR operating band groups <sup>Note 1</sup>	Minimum CSI-RS <sub>RP</sub>			CSI-RS $\hat{E}$ s/lot
		dBm / SCS <sub>CSI-RS</sub>			dB
		SCS <sub>CSI-RS</sub> = 15 kHz	SCS <sub>CSI-RS</sub> = 30 kHz	SCS <sub>CSI-RS</sub> = 60 kHz	
Conditions	NR_FDD_FR1_A, NR_TDD_FR1_A, NR_SDL_FR1_A	-124	-121	-118	≥ -3
	NR_FDD_FR1_B	-123.5	-120.5	-117.5	
	NR_TDD_FR1_C	-123	-120	-117	
	NR_FDD_FR1_D, NR_TDD_FR1_D	-122.5	-119.5	-116.5	
	NR_FDD_FR1_E, NR_TDD_FR1_E	-122	-119	-116	
	NR_FDD_FR1_F	-121.5	-118.5	-115.5	
	NR_FDD_FR1_G	-121	-118	-115	
	NR_FDD_FR1_H	-120.5	-117.5	-114.5	

NOTE 1: NR operating band groups are defined in clause 3.5.2.

**Table B.2.4.2-2: Conditions for CSI-RS based L1-RSRP measurements in FR2**

Parameter	Angle of arrival	NR operating bands	Minimum CSI-RS <sub>RP</sub> <sup>Note 2, Note 3</sup>				CSI-RS $\hat{E}$ s/lot	
			dBm / SCS <sub>CSI-RS</sub>				dB	
			SCS <sub>CSI-RS</sub> = 60 kHz			SCS <sub>CSI-RS</sub> = 120 kHz		
			UE power class			UE power class		
			1	2	3	4		1, 2, 3, 4
Conditions	Rx Beam Peak	n257	-	-113.8	-112.1	-	(Value for SCS <sub>CSI-RS</sub> = 60 kHz) +3dB	≥ -3
		n258	128.3+ $Y_1$	-	-	127.8+ $Y_4$		
		n259	-	-	-108.5	-		
		n260	125.3+ $Y_1$	-	-109.5	125.8+ $Y_4$		
		n261	128.3+ $Y_1$	-113.8	-112.1	127.8+ $Y_4$		
	Spherical coverage <sup>Note 1</sup>	n257	-	-102.8	-101.2	-	(Value for SCS <sub>CSI-RS</sub> = 60 kHz) +3dB	≥ -3
		n258	120.3+ $Z_1$	-	-	118.8+ $Z_4$		
		n259	-	-	-95.7	-		
		n260	117.3+ $Z_1$	-	-96.9	113.8+ $Z_4$		
		n261	120.3+ $Z_1$	-102.8	-101.2	118.8+ $Z_4$		

NOTE 1: Values based on EIS spherical coverage as defined in clause 7.3.4 of TS 38.101-2 [19]. Side condition applies for directions in which EIS spherical coverage requirement is met.

NOTE 2: Values specified at the Reference point to give minimum CSI-RS  $\hat{E}$ s/lot, with no applied noise.



NOTE 3: For UEs that support multiple FR2 bands, Rx Beam Peak values are increased by  $\Delta MB_{P,n}$  and Spherical coverage values are increased by  $\Delta MB_{S,n}$ , the UE multi-band relaxation factor in dB specified in clause 6.2.1 of TS 38.101-2 [19].

Editor’s notes for Table B.2.4.2-2:

- The value of Y for power classes 1 and 4 is FFS, where  $Y_1$  and  $Y_4$  are the rough/fine beam gain differences in Rx beam peak direction for power classes 1 and 4 respectively
- The value of Z for power classes 1 and 4 is FFS, where  $Z_1$  and  $Z_4$  are the rough/fine beam gain differences in spherical coverage directions for power classes 1 and 4 respectively

## B.2.5 Conditions for RRC connection release with redirection to NR

This clause defines the following conditions for RRC connection release with redirection to NR: SSB<sub>RP</sub> and SSB<sub>Es/lot</sub>, applicable for a corresponding operating band.

The conditions are defined in Table B.2.5-1 for FR1 NR cells.

The conditions are defined in Table B.2.5-2 for FR2 NR cells.

**Table B.2.5-1: Conditions for for RRC connection release with redirection to NR in FR1**

Parameter	NR operating band groups <sup>Note1</sup>	Minimum SSB <sub>RP</sub>		SSB $\hat{E}_s/\text{lot}$
		dBm / SCS <sub>SSB</sub>		
		SCS <sub>SSB</sub> = 15 kHz	SCS <sub>SSB</sub> = 30 kHz	dB
Conditions	NR_FDD_FR1_A, NR_TDD_FR1_A	-125	-122	≥ -4
	NR_FDD_FR1_B	-124.5	-121.5	
	NR_TDD_FR1_C	-124	-121	
	NR_FDD_FR1_D, NR_TDD_FR1_D	-124.5	-120.5	
	NR_FDD_FR1_E, NR_TDD_FR1_E	-123	-120	
	NR_FDD_FR1_F	-122.5	-119.5	
	NR_FDD_FR1_G	-122	-119	
	NR_FDD_FR1_H	-121.5	-118.5	

NOTE 1: NR operating band groups are defined in clause 3.5.2.

**Table B.2.5-2: Conditions for RRC connection release with redirection to NR in FR2**

Parameter	Angle of arrival	NR operating bands	Minimum SSB <sub>RP</sub> <sup>Note 2, Note 3</sup>				SSB $\hat{E}_s/\text{lot}$	
			dBm / SCS <sub>SSB</sub>					
			SCS <sub>SSB</sub> = 120 kHz			SCS <sub>SSB</sub> = 240 kHz	dB	
			UE power class			UE power class		
			1	2	3	4		1, 2, 3, 4
Conditions	Rx Beam Peak	n257	-	-111.8	-110.1	-	(Value for SCS <sub>SSB</sub> = 120 kHz) +3dB	≥ -4
		n258	126.3+Y <sub>1</sub>	-111.8	-110.1	125.8+Y <sub>4</sub>		
		n259			-106.5			
		n260	123.3+Y <sub>1</sub>		-107.5	123.8+Y <sub>4</sub>		
		n261	126.3+Y <sub>1</sub>	-111.8	-110.1	125.8+Y <sub>4</sub>		
	Spherical coverage <sup>Note 1</sup>	n257	-	-100.8	-99.2	-	(Value for SCS <sub>SSB</sub> = 120 kHz) +3dB	≥ -4
		n258	118.3+Z <sub>1</sub>	-100.8	-99.2	116.8+Z <sub>4</sub>		
		n259			-93.7			
n260		115.3+Z <sub>1</sub>		-94.9	111.8+Z <sub>4</sub>			

		n261	118.3+Z <sub>1</sub>	-100.8	-99.2	- 116.8+Z <sub>4</sub>		
<p>NOTE 1: Values based on EIS spherical coverage as defined in clause 7.3.4 of TS 38.101-2 [19]. Side condition applies for directions in which EIS spherical coverage requirement is met.</p> <p>NOTE 2: Values specified at the Reference point to give minimum SSB <math>\hat{E}_s/\text{lot}</math>, with no applied noise.</p> <p>NOTE 3: For UEs that support multiple FR2 bands, Rx Beam Peak values are increased by <math>\Delta\text{MB}_{P,n}</math> and spherical coverage values are increased by <math>\Delta\text{MB}_{S,n}</math>, the UE multi-band relaxation factor in dB specified in clause 6.2.1 of TS 38.101-2 [19].</p>								

Editor’s notes for Table B.2.5.2-2:

- The value of Y for power classes 1 and 4 is FFS, where Y<sub>1</sub> and Y<sub>4</sub> are the rough/fine beam gain differences in Rx beam peak direction for power classes 1 and 4 respectively

- The value of Z for power classes 1 and 4 is FFS, where Z<sub>1</sub> and Z<sub>4</sub> are the rough/fine

## B.2.6 Void

### B.2.6.1 Void

Table B.2.6.1-1: Void

Table B.2.6.1-2: Void

### B.2.6.2 Void

## B.2.7 Conditions for SRS-RSRP measurements

This clause defines the following conditions for SRS-RSRP measurement and corresponding procedures performed based on SRSs: SRS<sub>RP</sub> and SRS  $\hat{E}_s/\text{lot}$ , applicable for a corresponding operating band.

The conditions are defined in Table B.2.7-1 for FR1 NR cells.

The conditions are defined in Table B.2.7-2 for FR2 NR cells.

Table B.2.7-1: Conditions for SRS-RSRP measurements in FR1

Parameter	NR operating band groups <sup>Note1</sup>	Minimum SRS <sub>RP</sub>			SRS $\hat{E}_s/\text{lot}$
		dBm / SCS <sub>SRS</sub>			dB
		SCS <sub>SRS</sub> = 15 kHz	SCS <sub>SRS</sub> = 30 kHz	SCS <sub>SRS</sub> = 60 kHz	
Conditions	NR_TDD_FR1_A	-120	-117	-114	≥ 1
	NR_TDD_FR1_C	-119	-116	-113	
	NR_TDD_FR1_D	-118.5	-115.5	-112.5	
	NR_TDD_FR1_E	-118	-115	-112	

NOTE 1: NR operating band groups are defined in clause 3.5.2.

Table B.2.7-2: Conditions for SRS-RSRP measurements in FR2

Parameter	Angle of arrival	NR operating bands	Minimum SRS <sub>RP</sub> <sup>Note 2, Note 3</sup>				SRS $\hat{E}_s/\text{lot}$	
			dBm / SCS <sub>SRS</sub>				dB	
			SCS <sub>SRS</sub> = 60 kHz			SCS <sub>SRS</sub> = 120 kHz		
			UE Power class					UE Power class
			1	2	3	4		1, 2, 3, 4
Conditions	Rx Beam Peak	n257	-124.5	-119.0	-115.3	-124.0	≥ 1	
		n258	-124.5	-119.0	-115.3	-124.0		
		n260	-121.5		-112.7	-122.0		

(Value for SCS<sub>SRS</sub> = 60 kHz) +3dB

Spherical coverage Note 1	n261	-124.5	-119.0	-115.3	-124.0	(Value for SCS <sub>SRS</sub> = 60 kHz) +3dB	≥1
	n257	-116.5	-108.0	-104.4	-115.0		
	n258	-116.5	-108.0	-104.4	-115.0		
	n260	-113.5		-100.1	-110.0		
	n261	-116.5	-108.0	-104.4	-115.0		
NOTE 1: Values based on EIS spherical coverage as defined in clause 7.3.4 of TS 38.101-2 [19]. Side condition applies for directions in which EIS spherical coverage requirement is met.							
NOTE 2: Values specified at the Reference point to give minimum SRS Ês/lot, with no applied noise.							
NOTE 3: For UEs that support multiple FR2 bands, Rx Beam Peak values are increased by ΔMB <sub>P,n</sub> and Spherical coverage values are increased by ΔMB <sub>S,n</sub> , the UE multi-band relaxation factor in dB specified in clause 6.2.1 of TS 38.101-2 [19].							

## B.2.8 Conditions for NR L1-SINR reporting

### B.2.8.1 Conditions for L1-SINR reporting with CSI-RS based CMR and no dedicated IMR configured

This clause defines the following conditions for NR L1-SINR measurement reporting and corresponding procedures performed based on CSI-RSs: CSI-RS<sub>RP</sub> and CSI-RS Ês/lot, applicable for a corresponding operating band.

The conditions are defined in Tables B.2.8.1-1 for FR1 NR cells.

The conditions are defined in Tables B.2.8.1-2 for FR2 NR cells.

**Table B.2.8.1-1: Conditions for L1-SINR measurements with CSI-RS based CMR only in FR1**

Parameter	NR operating band groups Note1	Minimum CSI-RS <sub>RP</sub>			CSI-RS CMR Ês/lot
		dBm / SCS <sub>CSI-RS</sub>			dB
		SCS <sub>CSI-RS</sub> = 15 kHz	SCS <sub>CSI-RS</sub> = 30 kHz	SCS <sub>CSI-RS</sub> = 60 kHz	
Conditions	NR_FDD_FR1_A, NR_TDD_FR1_A, NR_SDL_FR1_A	-124	-121	-118	≥ -3
	NR_FDD_FR1_B	-123.5	-120.5	-117.5	
	NR_TDD_FR1_C	-123	-120	-117	
	NR_FDD_FR1_D, NR_TDD_FR1_D	-122.5	-119.5	-116.5	
	NR_FDD_FR1_E, NR_TDD_FR1_E	-122	-119	-116	
	NR_FDD_FR1_F	-121.5	-118.5	-115.5	
	NR_FDD_FR1_G	-121	-118	-115	
	NR_FDD_FR1_H	-120.5	-117.5	-114.5	
NOTE 1: NR operating band groups are defined in clause 3.5.2.					

**Table B.2.8.1-2: Conditions for L1-SINR measurements with CSI-RS based CMR only in FR2**

Parameter	Angle of arrival	NR operating bands	Minimum CSI-RS <sub>RP</sub> Note 2, Note 3				CSI-RS CMR Ês/lot	
			dBm / SCS <sub>CSI-RS</sub>				dB	
			SCS <sub>CSI-RS</sub> = 60 kHz			SCS <sub>CSI-RS</sub> = 120 kHz		
			UE power class					UE power class
			1	2	3	4		1, 2, 3, 4
Conditions	Rx Beam Peak	n257	-128.3+Y <sub>1</sub>	-113.8	-112.1	-127.8+Y <sub>4</sub>	(Value for SCS <sub>CSI-RS</sub> = 60 kHz) +3dB	
		n258	-128.3+Y <sub>1</sub>	-113.8	-112.1	-127.8+Y <sub>4</sub>		
		n259			-108.5			
		n260	-125.3+Y <sub>1</sub>		-109.5	-125.8+Y <sub>4</sub>		
		n261	-128.3+Y <sub>1</sub>	-113.8	-112.1	-127.8+Y <sub>4</sub>		
		n257	-120.3+Z <sub>1</sub>	-102.8	-101.2	-118.8+Z <sub>4</sub>		(Value for SCS <sub>CSI-RS</sub> =
n258	-120.3+Z <sub>1</sub>	-102.8	-101.2	-118.8+Z <sub>4</sub>	≥-3			

Spherical coverage Note 1	n259			-95.7		60 kHz) +3dB
	n260	-117.3+Z <sub>1</sub>		-96.9	-113.8+Z <sub>4</sub>	
	n261	-120.3+Z <sub>1</sub>	-102.8	-101.2	-118.8+Z <sub>4</sub>	

NOTE 1: Values based on EIS spherical coverage as defined in clause 7.3.4 of TS 38.101-2 [19]. Side condition applies for directions in which EIS spherical coverage requirement is met.  
 NOTE 2: Values specified at the Reference point to give minimum CSI-RS Ês/lot, with no applied noise.  
 NOTE 3: For UEs that support multiple FR2 bands, Rx Beam Peak values are increased by ΔMB<sub>P,n</sub> and Spherical coverage values are increased by ΔMB<sub>S,n</sub>, the UE multi-band relaxation factor in dB specified in clause 6.2.1 of TS 38.101-2 [19].

### B.2.8.2 Conditions for L1-SINR reporting with SSB based CMR and dedicated IMR configured

#### B.2.8.2.1 L1-SINR reporting with SSB based CMR and dedicated ZP-IMR configured

This clause defines the following conditions for NR L1-SINR measurement reporting and corresponding procedures performed based on SSBs and ZP-IMRs: SSB\_RP and SSB Ês/lot, applicable for a corresponding operating band.

The conditions are defined in Tables B.2.8.2.1-1 for FR1 NR cells.

The conditions are defined in Tables B.2.8.2.1-2 for FR2 NR cells.

**Table B.2.8.2.1-1: Conditions for L1-SINR measurements with SSB based CMR and ZP-IMR in FR1**

Parameter	NR operating band groups Note1	Minimum SSB_RP		SSB-CMR Ês/lot
		dBm / SCS <sub>SSB</sub>		
		SCS <sub>SSB</sub> = 15 kHz	SCS <sub>SSB</sub> = 30 kHz	dB
Conditions	NR_FDD_FR1_A, NR_TDD_FR1_A, NR_SDL_FR1_A	-124	-121	≥ -3
	NR_FDD_FR1_B	-123.5	-120.5	
	NR_TDD_FR1_C	-123	-120	
	NR_FDD_FR1_D, NR_TDD_FR1_D	-122.5	-119.5	
	NR_FDD_FR1_E, NR_TDD_FR1_E	-122	-119	
	NR_FDD_FR1_F	-121.5	-118.5	
	NR_FDD_FR1_G	-121	-118	
	NR_FDD_FR1_H	-120.5	-117.5	

NOTE 1: NR operating band groups are defined in clause 3.5.2.

**Table B.2.8.2.1-2: Conditions for L1-SINR measurements with SSB based CMR and ZP-IMR in FR2**

Parameter	Angle of arrival	NR operating bands	Minimum SSB_RP Note 2, Note 3				SSB-CMR Ês/lot	
			dBm / SCS <sub>SSB</sub>					
			SCS <sub>SSB</sub> = 120 kHz			SCS <sub>SSB</sub> = 240 kHz	dB	
			UE power class			UE power class		
			1	2	3	4		1, 2, 3, 4
Conditions	Rx Beam Peak	n257	-125.3+Y <sub>1</sub>	-110.8	-109.1	-124.8+Y <sub>4</sub>	(Value for SCS <sub>SSB</sub> = 120 kHz) +3dB	≥ -3
		n258	-125.3+Y <sub>1</sub>	-110.8	-109.1	-124.8+Y <sub>4</sub>		
		n259			-105.5			
		n260	-122.3+Y <sub>1</sub>		-106.5	-122.8+Y <sub>4</sub>		
		n261	-125.3+Y <sub>1</sub>	-110.8	-109.1	-124.8+Y <sub>4</sub>		
	Spherical coverage Note 1	n257	-117.3+Z <sub>1</sub>	-99.8	-98.2	-115.8+Z <sub>4</sub>	(Value for SCS <sub>SSB</sub> = 120 kHz) +3dB	≥ -3
		n258	-117.3+Z <sub>1</sub>	-99.8	-98.2	-115.8+Z <sub>4</sub>		
		n259			-92.7			
		n260	-114.3+Z <sub>1</sub>		-93.9	-110.8+Z <sub>4</sub>		
		n261	-117.3+Z <sub>1</sub>	-99.8	-98.2	-115.8+Z <sub>4</sub>		

NOTE 1: Values based on EIS spherical coverage as defined in clause 7.3.4 of TS 38.101-2 [19]. Side condition applies for directions in which EIS spherical coverage requirement is met.

NOTE 2: Values specified at the Reference point to give minimum SSB  $\hat{E}_s/\text{lot}$ , with no applied noise.  
 NOTE 3: For UEs that support multiple FR2 bands, Rx Beam Peak values are increased by  $\Delta\text{MB}_{P,n}$  and Spherical coverage values are increased by  $\Delta\text{MB}_{S,n}$ , the UE multi-band relaxation factor in dB specified in clause 6.2.1 of TS 38.101-2 [19].

**B.2.8.2.2 L1-SINR reporting with SSB based CMR and dedicated NZP-IMR configured**

This clause defines the following conditions for NR L1-SINR measurement reporting and corresponding procedures performed based on SSBs and NZP-IMRs: SSB<sub>RP</sub>, SSB  $\hat{E}_s/\text{lot}$  and NZP-IMR  $\hat{E}_s/\text{lot}$ , applicable for a corresponding operating band.

The conditions are defined in Tables B.2.8.2.2-1 for FR1 NR cells.

**The conditions are defined in Tables B.2.8.2.2-2 for FR2 NR cells. Table B.2.8.2.2-1: Conditions for L1-SINR measurements with SSB based CMR and NZP-IMR in FR1**

Parameter	NR operating band groups <sup>Note 1</sup>	Minimum SSB <sub>RP</sub>		SSB-CMR $\hat{E}_s/\text{lot}$	NZP-IMR $\hat{E}_s/\text{lot}$
		dBm / SCS <sub>SSB</sub>		dB	dB
		SCS <sub>SSB</sub> = 15 kHz	SCS <sub>SSB</sub> = 30 kHz		
Conditions	NR_FDD_FR1_A, NR_TDD_FR1_A, NR_SDL_FR1_A	-121	-118	≥ 0	≥ 0
	NR_FDD_FR1_B	-120.5	-117.5		
	NR_TDD_FR1_C	-120	-117		
	NR_FDD_FR1_D, NR_TDD_FR1_D	-119.5	-116.5		
	NR_FDD_FR1_E, NR_TDD_FR1_E	-119	-116		
	NR_FDD_FR1_F	-118.5	-115.5		
	NR_FDD_FR1_G	-118	-115		
	NR_FDD_FR1_H	-117.5	-114.5		

NOTE 1: NR operating band groups are defined in clause 3.5.2.

**Table B.2.8.2.2-2: Conditions for L1-SINR measurements with SSB based CMR and NZP-IMR in FR2**

Parameter	Angle of arrival	NR operating bands	Minimum SSB <sub>RP</sub> <sup>Note 2, Note 3</sup>				SSB-CMR $\hat{E}_s/\text{lot}$	NZP-IMR $\hat{E}_s/\text{lot}$	
			dBm / SCS <sub>SSB</sub>						dB
			SCS <sub>SSB</sub> = 120 kHz			SCS <sub>SSB</sub> = 240 kHz	dB	dB	
			UE power class			UE power class			
			1	2	3	4			1, 2, 3, 4
Conditions	Rx Beam Peak	n257	-122.3+Y <sub>1</sub>	-107.8	-106.1	-121.8+Y <sub>4</sub>	(Value for SCS <sub>SSB</sub> = 120 kHz) +3dB	≥ 0	≥ 0
		n258	-122.3+Y <sub>1</sub>	-107.8	-106.1	-121.8+Y <sub>4</sub>			
		n259			-102.5				
		n260	-119.3+Y <sub>1</sub>		-103.5	-119.8+Y <sub>4</sub>			
		n261	-122.3+Y <sub>1</sub>	-107.8	-106.1	-121.8+Y <sub>4</sub>			
	Spherical coverage <sup>Note 1</sup>	n257	-114.3+Z <sub>1</sub>	-96.8	-95.2	-112.8+Z <sub>4</sub>	(Value for SCS <sub>SSB</sub> = 120 kHz) +3dB	≥ 0	≥ 0
		n258	-114.3+Z <sub>1</sub>	-96.8	-95.2	-112.8+Z <sub>4</sub>			
		n259			-89.7				
		n260	-111.3+Z <sub>1</sub>		-90.9	-107.8+Z <sub>4</sub>			
		n261	-114.3+Z <sub>1</sub>	-96.8	-95.2	-112.8+Z <sub>4</sub>			

NOTE 1: Values based on EIS spherical coverage as defined in clause 7.3.4 of TS 38.101-2 [19]. Side condition applies for directions in which EIS spherical coverage requirement is met.  
 NOTE 2: Values specified at the Reference point to give minimum SSB  $\hat{E}_s/\text{lot}$ , with no applied noise.  
 NOTE 3: For UEs that support multiple FR2 bands, Rx Beam Peak values are increased by  $\Delta\text{MB}_{P,n}$  and Spherical coverage values are increased by  $\Delta\text{MB}_{S,n}$ , the UE multi-band relaxation factor in dB specified in clause 6.2.1 of TS 38.101-2 [19].

Editor's notes for Table B.2.8.2.2-1 and B.2.8.2.2-2:

- The value of Y for power classes 1 and 4 is FFS, where  $Y_1$  and  $Y_4$  are the rough/fine beam gain differences in Rx beam peak direction for power classes 1 and 4 respectively

- The value of Z for power classes 1 and 4 is FFS, where  $Z_1$  and  $Z_4$  are the rough/fine beam gain differences in spherical coverage directions for power classes 1 and 4 respectively

### B.2.8.3 Conditions for L1-SINR reporting with CSI-RS based CMR and dedicated IMR configured

#### B.2.8.3.1 L1-SINR reporting with CSI-RS based CMR and dedicated ZP-IMR configured

This clause defines the following conditions for NR L1-SINR measurement reporting and corresponding procedures performed based on CSI-RSs and ZP-IMRs: CSI-RS<sub>RP</sub> and CSI-RS  $\hat{E}_s/I_{ot}$ , applicable for a corresponding operating band.

The conditions defined in Table B.2.8.3.1-1 for FR1 NR cells.

The conditions defined in Table B.2.8.3.1-2 for FR2 NR cells.

**Table B.2.8.3.1-1: Conditions for L1-SINR measurements with CSI-RS based CMR and ZP-IMR in FR1**

Parameter	NR operating band groups <sup>Note1</sup>	Minimum CSI-RS <sub>RP</sub>			CSI-RS CMR $\hat{E}_s/I_{ot}$
		dBm / SCS <sub>CSI-RS</sub>			
		SCS <sub>CSI-RS</sub> = 15 kHz	SCS <sub>CSI-RS</sub> = 30 kHz	SCS <sub>CSI-RS</sub> = 60 kHz	dB
Conditions	NR_FDD_FR1_A, NR_TDD_FR1_A, NR_SDL_FR1_A	-124	-121	-118	≥ -3
	NR_FDD_FR1_B	-123.5	-120.5	-117.5	
	NR_TDD_FR1_C	-123	-120	-117	
	NR_FDD_FR1_D, NR_TDD_FR1_D	-122.5	-119.5	-116.5	
	NR_FDD_FR1_E, NR_TDD_FR1_E	-122	-119	-116	
	NR_FDD_FR1_F	-121.5	-118.5	-115.5	
	NR_FDD_FR1_G	-121	-118	-115	
	NR_FDD_FR1_H	-120.5	-117.5	-114.5	

NOTE 1: NR operating band groups are defined in clause 3.5.2.

**Table B.2.8.3.1-2: Conditions for L1-SINR measurements with CSI-RS based CMR and ZP-IMR in FR2**

Parameter	Angle of arrival	NR operating bands	Minimum CSI-RS <sub>RP</sub> <sup>Note 2, Note 3</sup>				CSI-RS CMR $\hat{E}_s/I_{ot}$	
			dBm / SCS <sub>CSI-RS</sub>					
			SCS <sub>CSI-RS</sub> = 60 kHz			SCS <sub>CSI-RS</sub> = 120 kHz	dB	
			UE power class					UE power class
			1	2	3	4		1, 2, 3, 4
Conditions	Rx Beam Peak	n257	-128.3+ $Y_1$	-113.8	-112.1	-127.8+ $Y_4$	≥ -3	
		n258	-128.3+ $Y_1$	-113.8	-112.1	-127.8+ $Y_4$		
		n259			-108.5			
		n260	-125.3+ $Y_1$		-109.5	-125.8+ $Y_4$		
		n261	-128.3+ $Y_1$	-113.8	-112.1	-127.8+ $Y_4$		
	Spherical coverage <sup>Note 1</sup>	n257	-120.3+ $Z_1$	-102.8	-101.2	-118.8+ $Z_4$	≥ -3	
		n258	-120.3+ $Z_1$	-102.8	-101.2	-118.8+ $Z_4$		
n259				-95.7				

		n260	-117.3+Z <sub>1</sub>		-96.9	-113.8+Z <sub>4</sub>	60 kHz)	
		n261	-120.3+Z <sub>1</sub>	-102.8	-101.2	-118.8+Z <sub>4</sub>	+3dB	

NOTE 1: Values based on EIS spherical coverage as defined in clause 7.3.4 of TS 38.101-2 [19]. Side condition applies for directions in which EIS spherical coverage requirement is met.  
 NOTE 2: Values specified at the Reference point to give minimum CSI-RS Ês/lot, with no applied noise.  
 NOTE 3: For UEs that support multiple FR2 bands, Rx Beam Peak values are increased by ΔMB<sub>P,n</sub> and Spherical coverage values are increased by ΔMB<sub>S,n</sub>, the UE multi-band relaxation factor in dB specified in clause 6.2.1 of TS 38.101-2 [19].

**B.2.8.3.2 L1-SINR reporting with CSI-RS based CMR and dedicated NZP-IMR configured**

This clause defines the following conditions for NR L1-SINR measurement reporting and corresponding procedures performed based on CSI-RSs and NZP-IMRs: CSI-RS<sub>RP</sub>, CSI-RS Ês/lot and NZP-IMR Ês/lot, applicable for a corresponding operating band.

The conditions are defined in Tables B.2.8.3.2-1 for FR1 NR cells. The conditions are defined in Tables B.2.8.3.2-2 for FR2 NR cells.

**Table B.2.8.3.2-1: Conditions for L1-SINR measurements with CSI-RS based CMR and NZP-IMR in FR1**

Parameter	NR operating band groups <sup>Note1</sup>	Minimum CSI-RS <sub>RP</sub>			CSI-RS CMR Ês/lot	NZP-IMR Ês/lot
		dBm / SCS <sub>CSI-RS</sub>				
		SCS <sub>CSI-RS</sub> = 15 kHz	SCS <sub>CSI-RS</sub> = 30 kHz	SCS <sub>CSI-RS</sub> = 60 kHz	dB	dB
Conditions	NR_FDD_FR1_A, NR_TDD_FR1_A, NR_SDL_FR1_A	-121	-118	-115	≥ 0	≥ 0
	NR_FDD_FR1_B	-120.5	-117.5	-114.5		
	NR_TDD_FR1_C	-120	-117	-114		
	NR_FDD_FR1_D, NR_TDD_FR1_D	-119.5	-116.5	-113.5		
	NR_FDD_FR1_E, NR_TDD_FR1_E	-119	-116	-113		
	NR_FDD_FR1_F	-118.5	-115.5	-112.5		
	NR_FDD_FR1_G	-118	-115	-112		
	NR_FDD_FR1_H	-117.5	-114.5	-111.5		

NOTE 1: NR operating band groups are defined in clause 3.5.2.

**Table B.2.8.3.2-2: Conditions for L1-SINR measurements with CSI-RS based CMR and NZP-IMR in FR2**

Parameter	Angle of arrival	NR operating bands	Minimum CSI-RS <sub>RP</sub> <sup>Note 2, Note 3</sup>				CSI-RS CMR Ês/lot	NZP-IMR Ês/lot
			dBm / SCS <sub>CSI-RS</sub>					
			SCS <sub>CSI-RS</sub> = 60 kHz			SCS <sub>CSI-RS</sub> = 120 kHz	dB	dB
			UE power class			UE power class		
1	2	3	4	1, 2, 3, 4				
Conditions	Rx Beam Peak	n257	-125.3+Y <sub>1</sub>	-110.8	-109.1	-124.8+Y <sub>4</sub>	≥ 0	≥ 0
		n258	-125.3+Y <sub>1</sub>	-110.8	-109.1	-124.8+Y <sub>4</sub>		
		n259			-105.5			
		n260	-122.3+Y <sub>1</sub>		-106.5	-122.8+Y <sub>4</sub>		
		n261	-125.3+Y <sub>1</sub>	-110.8	-109.1	-124.8+Y <sub>4</sub>		
	Spherica I	n257	-117.3+Z <sub>1</sub>	-99.8	-98.2	-115.8+Z <sub>4</sub>	≥ 0	≥ 0
		n258	-117.3+Z <sub>1</sub>	-99.8	-98.2	-115.8+Z <sub>4</sub>		
		n259			-92.7			

	coverag e <sup>Note 1</sup>	n260	-114.3+Z <sub>1</sub>		-93.9	-110.8+Z <sub>4</sub>	60 kHz)		
		n261	-117.3+Z <sub>1</sub>	-99.8	-98.2	-115.8+Z <sub>4</sub>	+3dB		

NOTE 1: Values based on EIS spherical coverage as defined in clause 7.3.4 of TS 38.101-2 [19]. Side condition applies for directions in which EIS spherical coverage requirement is met.

NOTE 2: Values specified at the Reference point to give minimum CSI-RS  $\hat{E}_s/\text{lot}$ , with no applied noise.

NOTE 3: For UEs that support multiple FR2 bands, Rx Beam Peak values are increased by  $\Delta\text{MB}_{P,n}$  and Spherical coverage values are increased by  $\Delta\text{MB}_{S,n}$ , the UE multi-band relaxation factor in dB specified in clause 6.2.1 of TS 38.101-2 [19].

Editor's notes for Tables B.2.8.3.2-1 and B.2.8.3.2-2:

- The value of  $Y$  for power classes 1 and 4 is FFS, where  $Y_1$  and  $Y_4$  are the rough/fine beam gain differences in Rx beam peak direction for power classes 1 and 4 respectively

- The value of  $Z$  for power classes 1 and 4 is FFS, where  $Z_1$  and  $Z_4$  are the rough/fine

## B.2.9 Conditions for NR intra-frequency measurements under CCA

This clause defines the following conditions for NR intra-frequency measurements under CCA and corresponding procedures performed based on SSBs: SSB<sub>RP</sub> and SSB  $\hat{E}_s/\text{lot}$ , applicable for a corresponding operating band.

The conditions are defined in Table B.2.9-1 for NR cells under CCA.

**Table B.2.9-1: Conditions for intra-frequency measurements under CCA**

Parameter	NR operating band groups <sup>Note1</sup>	Minimum SSB <sub>RP</sub>		SSB $\hat{E}_s/\text{lot}$
		dBm / SCS <sub>SSB</sub>		dB
		SCS <sub>SSB</sub> = 15 kHz	SCS <sub>SSB</sub> = 30 kHz	
Conditions	NR_CCA_FR1_I	-123	-120	≥ -6
	NR_CCA_FR1_J	-122.5	-119.5	

NOTE 1: NR operating band groups are as defined in clause 3.5.2.

## B.2.10 Conditions for NR inter-frequency measurements under CCA

This clause defines the following conditions for NR inter-frequency measurements and corresponding procedures performed based on SSBs: SSB<sub>RP</sub> and SSB  $\hat{E}_s/\text{lot}$ , applicable for a corresponding operating band.

The conditions are defined in Table B.2.10-1 for NR cells under CCA.

**Table B.2.10-1: Conditions for inter-frequency measurements under CCA**

Parameter	NR operating band groups <sup>Note1</sup>	Minimum SSB <sub>RP</sub>		SSB $\hat{E}_s/\text{lot}$
		dBm / SCS <sub>SSB</sub>		dB
		SCS <sub>SSB</sub> = 15 kHz	SCS <sub>SSB</sub> = 30 kHz	
Conditions	NR_CCA_FR1_I	-121	-118	≥ -4
	NR_CCA_FR1_J	-120.5	-117.5	

NOTE 1: NR operating band groups are as defined in clause 3.5.2.

## B.2.11 Conditions for NR L1-RSRP reporting under CCA

### B.2.11.1 Conditions for SSB based L1-RSRP reporting

This clause defines the following conditions for NR L1-RSRP measurement reporting and corresponding procedures performed based on SSBs under CCA: SSB<sub>RP</sub> and SSB  $\hat{E}_s/\text{lot}$ , applicable for a corresponding operating band.



The conditions are defined in Table B.2.11.1-1 for NR cells under CCA.

**Table B.2.11.1-1: Conditions for SSB based L1-RSRP measurements under CCA**

Parameter	NR operating band groups <sup>Note1</sup>	Minimum SSB_RP		SSB $\hat{E}_s/\text{lot}$
		dBm / SCS <sub>SSB</sub>		dB
		SCS <sub>SSB</sub> = 15 kHz	SCS <sub>SSB</sub> = 30 kHz	
Conditions	NR_CCA_FR1_I	-120	-117	≥ -3
	NR_CCA_FR1_J	-119.5	-116.5	

NOTE 1: NR operating band groups are defined in clause 3.5.2.

## B.2.12 Conditions for NR CSI-RS based intra-frequency measurements

This clause defines the following conditions for NR CSI-RS based intra-frequency measurements and corresponding procedures performed based on CSI-RS: CSI\_RP and CSI-RS  $\hat{E}_s/\text{lot}$ , applicable for a corresponding operating band.

The conditions are defined in Table B.2.12-1 for FR1 NR cells.

The conditions are defined in Table B.2.12-2 for FR2 NR cells.

**Table B.2.12-1: Conditions for CSI-RS based intra-frequency measurements in FR1**

Parameter	NR operating band groups <sup>Note1</sup>	Minimum CSI_RP			CSI-RS $\hat{E}_s/\text{lot}$
		dBm / SCS <sub>CSI-RS</sub>			dB
		SCS <sub>CSI-RS</sub> = 15 kHz	SCS <sub>CSI-RS</sub> = 30 kHz	SCS <sub>CSI-RS</sub> = 60 kHz	
Conditions	NR_FDD_FR1_A, NR_TDD_FR1_A, NR_SDL_FR1_A	-127	-124	-121	≥ -6
	NR_FDD_FR1_B	-126.5	-123.5	-120.5	
	NR_TDD_FR1_C	-126	-123	-120	
	NR_FDD_FR1_D, NR_TDD_FR1_D	-125.5	-122.5	-119.5	
	NR_FDD_FR1_E, NR_TDD_FR1_E	-125	-122	-119	
	NR_FDD_FR1_F	-124.5	-121.5	-118.5	
	NR_FDD_FR1_G	-124	-121	-118	
	NR_FDD_FR1_H	-123.5	-120.5	-117.5	

NOTE 1: NR operating band groups are defined in clause 3.5.2.

**Table B.2.12-2: Conditions for CSI-RS based intra-frequency measurements in FR2**

Parameter	Angle of arrival	NR operating bands	Minimum CSI_RP <sup>Note 2, Note 3</sup>				CSI-RS $\hat{E}_s/\text{lot}$
			dBm / SCS <sub>CSI-RS</sub>				dB
			SCS <sub>CSI-RS</sub> = 120 kHz			SCS <sub>CSI-RS</sub> = 60 kHz	
			UE power class			UE power class	
			1	2	3	4	
Conditions	Rx Beam Peak	n257	- 128.3+Y <sub>1</sub>	-113.8	-112.1	- 127.8+Y <sub>4</sub>	(Value for SCS <sub>CSI-RS</sub> = 120 kHz) - 3dB
		n258	- 128.3+Y <sub>1</sub>	-113.8	-112.1	- 127.8+Y <sub>4</sub>	
		n259	-	-	-108.5	-	
		n260	- 125.3+Y <sub>1</sub>	-	-109.5	- 125.8+Y <sub>4</sub>	
		n261	- 128.3+Y <sub>1</sub>	-113.8	-112.1	- 127.8+Y <sub>4</sub>	
		n257	- 120.3+Z <sub>1</sub>	-102.8	-101.2	- 118.8+Z <sub>4</sub>	≥ -6

Spherical coverage Note 1	n258	-	-102.8	-101.2	-	(Value for $SCS_{CSI-RS} = 120$ kHz) - 3dB
	n259	$120.3+Z_1$		-95.7		
	n260	-		-96.9	-	
	n261	$120.3+Z_1$	-102.8	-101.2	$118.8+Z_4$	

Note 1: Values based on EIS spherical coverage as defined in clause 7.3.4 of TS 38.101-2 [19]. Side condition applies for directions in which EIS spherical coverage requirement is met.  
 Note 2: Values specified at the Reference point to give minimum CSI-RS  $\hat{E}_s/I_{ot}$ , with no applied noise.  
 Note 3: For UEs that support multiple FR2 bands, Rx Beam Peak values are increased by  $\Delta MB_{P,n}$  and spherical coverage values are increased by  $\Delta MB_{S,n}$ , the UE multi-band relaxation factor in dB specified in clause 6.2.1 of TS 38.101-2 [19].

Editor’s notes for Table B.2.12-2:

- The value of Y for power classes 1 and 4 is FFS, where  $Y_1$  and  $Y_4$  are the rough/fine beam gain differences in Rx beam peak direction for power classes 1 and 4 respectively
- The value of Z for power classes 1 and 4 is FFS, where  $Z_1$  and  $Z_4$  are the rough/fine beam gain differences in spherical coverage directions for power classes 1 and 4 respectively

### B.2.13 Conditions for NR CSI-RS based inter-frequency measurements

This clause defines the following conditions for NR CSI-RS based inter-frequency measurements and corresponding procedures performed based on CSI-RS: CSI\_RP and CSI-RS  $\hat{E}_s/I_{ot}$ , applicable for a corresponding operating band.

The conditions are defined in Table B.2.13-1 for FR1 NR cells.

The conditions are defined in Table B.2.13-2 for FR2 NR cells.

**Table B.2.13-1: Conditions for CSI-RS based inter-frequency measurements in FR1**

Parameter	NR operating band groups Note1	Minimum CSI_RP			CSI-RS $\hat{E}_s/I_{ot}$
		dBm / $SCS_{CSI-RS}$			
		$SCS_{CSI-RS} = 15$ kHz	$SCS_{CSI-RS} = 30$ kHz	$SCS_{CSI-RS} = 60$ kHz	dB
Conditions	NR_FDD_FR1_A, NR_TDD_FR1_A, NR_SDL_FR1_A	-125	-122	-119	$\geq -6$
	NR_FDD_FR1_B	-124.5	-121.5	-118.5	
	NR_TDD_FR1_C	-124	-121	-118	
	NR_FDD_FR1_D, NR_TDD_FR1_D	-124.5	-120.5	-117.5	
	NR_FDD_FR1_E, NR_TDD_FR1_E	-123	-120	-117	
	NR_FDD_FR1_F	-122.5	-119.5	-116.5	
	NR_FDD_FR1_G	-122	-119	-116	
	NR_FDD_FR1_H	-121.5	-118.5	-115.5	

NOTE 1: NR operating band groups are defined in clause 3.5.2.

**Table B.2.13-2: Conditions for CSI-RS based inter-frequency measurements in FR2**

Parameter	Angle of arrival	NR operating bands	Minimum CSI_RP Note 2, Note 3				CSI-RS $\hat{E}_s/I_{ot}$
			dBm / $SCS_{CSI-RS}$				
			$SCS_{CSI-RS} = 120$ kHz			$SCS_{CSI-RS} = 60$ kHz	dB
			UE power class			UE power class	
			1	2	3	4	

Conditions	Rx Beam Peak	n257	-	-111.8	-110.1	-	(Value for $SCS_{CSI-RS} = 120 \text{ kHz}$ ) - 3dB	$\geq -4$
		n258	$126.3+Y_1$	-111.8	-110.1	$125.8+Y_4$		
		n259			-106.5			
		n260	-		-107.5	-		
		n261	$126.3+Y_1$	-111.8	-110.1	$125.8+Y_4$		
	Spherical coverage Note 1	n257	-	-100.8	-99.2	-	(Value for $SCS_{CSI-RS} = 120 \text{ kHz}$ ) - 3dB	$\geq -4$
		n258	$118.3+Z_1$	-100.8	-99.2	$116.8+Z_4$		
		n259			-93.7			
		n260	-		-94.9	-		
		n261	$118.3+Z_1$	-100.8	-99.2	$116.8+Z_4$		

NOTE 1: Values based on EIS spherical coverage as defined in clause 7.3.4 of TS 38.101-2 [19]. Side condition applies for directions in which EIS spherical coverage requirement is met.

NOTE 2: Values specified at the Reference point to give minimum CSI-RS  $\hat{E}_s/\text{lot}$ , with no applied noise.

NOTE 3: For UEs that support multiple FR2 bands, Rx Beam Peak values are increased by  $\Delta MB_{P,n}$  and Spherical coverage values are increased by  $\Delta MB_{S,n}$ , the UE multi-band relaxation factor in dB specified in clause 6.2.1 of TS 38.101-2 [19].

Editor's notes for Table B.2.13-2:

- The value of  $Y$  for power classes 1 and 4 is FFS, where  $Y_1$  and  $Y_4$  are the rough/fine beam gain differences in Rx beam peak direction for power classes 1 and 4 respectively

- The value of  $Z$  for power classes 1 and 4 is FFS, where  $Z_1$ , and  $Z_4$  are the rough/fine beam gain differences in spherical coverage directions for power classes 1 and 4 respectively.

## B.2.14 Conditions for NR PRS-based measurements

This clause defines the following conditions for NR PRS-based measurements and corresponding procedures performed based on PRS: PRP and PRS  $\hat{E}_s/\text{lot}$ , applicable for a corresponding operating band.

The conditions are defined in Table B.2.14-1 for FR1 NR cells.

The conditions are defined in Table B.2.14-2 for FR2 NR cells.

**Table B.2.14-1: Conditions for NR PRS-based measurements in FR1**

Parameter	NR operating band groups <sup>Note1</sup>	Minimum PRP <sub>1,2</sub>			PRS $\hat{E}_s/\text{lot}$
		dBm / $SCS_{PRS}$			
		$SCS_{PRS} = 15 \text{ kHz}$	$SCS_{PRS} = 30 \text{ kHz}$	$SCS_{PRS} = 60 \text{ kHz}$	dB
Conditions	NR_FDD_FR1_A, NR_TDD_FR1_A, NR_SDL_FR1_A	-127	-124	-121	$\geq -6$ Note2 $\geq -13$ Note3 $\geq -3$ Note4
	NR_FDD_FR1_B	-126.5	-123.5	-120.5	
	NR_TDD_FR1_C	-126	-123	-120	
	NR_FDD_FR1_D, NR_TDD_FR1_D	-125.5	-122.5	-119.5	
	NR_FDD_FR1_E, NR_TDD_FR1_E	-125	-122	-119	
	NR_FDD_FR1_F	-124.5	-121.5	-118.5	
	NR_FDD_FR1_G	-124	-121	-118	
	NR_FDD_FR1_H	-123.5	-120.5	-117.5	

NOTE 1: NR operating band groups are defined in clause 3.5.2.

NOTE 2: PRS  $\hat{E}_s/\text{lot}$  for RSTD measurement reference cell PRS resource.

NOTE 3: PRS  $\hat{E}_s/\text{lot}$  for RSTD measurement neighbor cell PRS resource, PRS-RSRP measurement and UE Rx-Tx time difference measurement.

NOTE 4: PRS  $\hat{E}_s/\text{lot}$  for PRS-RSRP measurement and UE Rx-Tx time difference measurement.

**Table B.2.14-2: Conditions for NR PRS-based measurements in FR2**

Parameter	Angle of arrival	NR operating bands	Minimum PRP <sub>1,2</sub> <small>Note 2, Note 3</small>				PRS $\hat{E}_s/\text{lot}$	
			dBm / SCS <sub>PRS</sub>					
			SCS <sub>PRS</sub> = 120 kHz		SCS <sub>PRS</sub> = 60 kHz			
			UE power class		UE power class			
			1	2	3	4		1, 2, 3, 4
Conditions	Rx Beam Peak	n257	- 128.3+Y <sub>1</sub>	-113.8	-112.1	- 127.8+Y <sub>4</sub>	(Value for SCS <sub>PRS</sub> = 120 kHz) - 3dB	≥ -6 <small>Note4</small> ≥ -13 <small>Note5</small> ≥ -3 <small>Note6</small>
		n258	- 128.3+Y <sub>1</sub>	-113.8	-112.1	- 127.8+Y <sub>4</sub>		
		n259			-108.5			
		n260	- 125.3+Y <sub>1</sub>		-109.5	- 125.8+Y <sub>4</sub>		
		n261	- 128.3+Y <sub>1</sub>	-113.8	-112.1	- 127.8+Y <sub>4</sub>		
	Spherical coverage <small>Note 1</small>	n257	- 120.3+Z <sub>1</sub>	-102.8	-101.2	- 118.8+Z <sub>4</sub>	(Value for SCS <sub>PRS</sub> = 120 kHz) - 3dB	≥ -6 <small>Note4</small> ≥ -13 <small>Note5</small> ≥ -3 <small>Note6</small>
		n258	- 120.3+Z <sub>1</sub>	-102.8	-101.2	- 118.8+Z <sub>4</sub>		
		n259			-95.7			
		n260	- 117.3+Z <sub>1</sub>		-96.9	- 113.8+Z <sub>4</sub>		
		n261	- 120.3+Z <sub>1</sub>	-102.8	-101.2	- 118.8+Z <sub>4</sub>		

NOTE 1: Values based on EIS spherical coverage as defined in clause 7.3.4 of TS 38.101-2 [19]. Side condition applies for directions in which EIS spherical coverage requirement is met.  
 NOTE 2: Values specified at the Reference point to give minimum PRS  $\hat{E}_s/\text{lot}$ , with no applied noise.  
 NOTE 3: For UEs that support multiple FR2 bands, Rx Beam Peak values are increased by  $\Delta\text{MB}_{P,n}$  and spherical coverage values are increased by  $\Delta\text{MB}_{S,n}$ , the UE multi-band relaxation factor in dB specified in clause 6.2.1 of TS 38.101-2 [19].  
 NOTE 4: PRS  $\hat{E}_s/\text{lot}$  for RSTD measurement reference cell PRS resource.  
 NOTE 5: PRS  $\hat{E}_s/\text{lot}$  for RSTD measurement neighbor cell PRS resource, PRS-RSRP measurement and UE Rx-Tx time difference measurement.  
 NOTE 6: PRS  $\hat{E}_s/\text{lot}$  for PRS-RSRP measurement and UE Rx-Tx time difference measurement.

*Editor's notes for Table B.2.14-2:*

- The value of Y for power classes 1 and 4 is FFS, where Y<sub>1</sub> and Y<sub>4</sub> are the rough/fine beam gain differences in Rx beam peak direction for power classes 1 and 4 respectively
- The value of Z for power classes 1 and 4 is FFS, where Z<sub>1</sub> and Z<sub>4</sub> are the rough/fine beam gain differences in spherical coverage directions for power classes 1 and 4 respectively

## B.3 RRM Requirements Exceptions

### B.3.1 Introduction

Annex B.3 covers exceptions for side conditions based on receiver sensitivity for CA, DC, and SUL.

## B.3.2 Receiver sensitivity relaxation for CA

### B.3.2.1 Receiver sensitivity relaxation for UE supporting CA in FR1

For a UE supporting inter-band carrier aggregation configuration with uplink in NR band, if there is a relaxation of receiver sensitivity  $\Delta R_{IB,c} > 0$  dB as defined in clause 7.3A.3 of TS 38.101-1 [18], the relevant side conditions specifying received power levels (SSB\_RP and Io) shall be increased by the amount  $\Delta = \Delta R_{IB,c}$  defined for the corresponding downlink NR bands.

For a UE supporting CA configuration in FR1, the requirement in this clause applies for both SC and CA operation.

### B.3.2.2 Receiver sensitivity relaxation for UE configured with CA in FR1

#### B.3.2.2.1 Inter-band carrier aggregation

For a UE configured with inter-band carrier aggregation with active uplink in NR band, if there is a relaxation of receiver sensitivity  $\Delta R_{IB,c} > 0$  dB as defined in clause 7.3A.3 of TS 38.101-1 [18], the relevant side conditions specifying received power levels (SSB\_RP and Io) shall be increased by the amount  $\Delta = \Delta R_{IB,c}$  defined for the corresponding downlink NR bands.

If the relaxation  $\Delta$  specified in this clause applies, then the relaxation specified in clause B.3.2.1 should not be applied.

#### B.3.2.2.2 Reference sensitivity exceptions due to UL harmonic interference for CA

In this clause, requirements exceptions are described for the UE configured with a band in FR1 when it is impacted by UL harmonic interference from another band in FR1 of the same CA configuration.

A relevant side condition (SSB\_RP and Io) in a requirement shall be increased by the amount  $\Delta = L2 - L1$ , where L1 is the reference sensitivity level specified in clause 7.3.2 of TS 38.101-1 [18], and L2 is the reference sensitivity level based on the requirements in clause 7.3A.4 of TS 38.101-1 [18], when the following conditions are fulfilled,

- corresponding downlink component carriers on different NR bands are configured with CA and active,
- the uplink is configured in the NR low operating band and is active,
- the uplink configuration is as specified in clause 7.3A.4 of TS 38.101-1 [18], and
- the exception requirements specified in clause 7.3A.4 of TS 38.101-1 [18] apply.

If the relaxation  $\Delta$  specified in this clause applies, then the relaxation specified in clause B.3.2.1 should not be applied.

#### B.3.2.2.3 Reference sensitivity exceptions due to intermodulation interference due to 2UL CA

In this clause, requirements exceptions are described for the UE with an inter-band carrier aggregation with uplink assigned to two NR bands.

A relevant side condition (SSB\_RP and Io) in a requirement shall be increased by the amount  $\Delta = L2 - L1$ , where L1 is the reference sensitivity level specified in clause 7.3.2 of TS 38.101-1 [18], and L2 is the reference sensitivity level based on the requirements in clause 7.3A.5 of TS 38.101-1 [18], when the following conditions are fulfilled,

- corresponding downlink component carriers on different bands are configured with CA and active,
- uplinks are assigned to two NR bands,
- the exception requirements specified in clause 7.3A.5 of TS 38.101-1 [18] apply.

If the relaxation  $\Delta$  specified in this clause applies, then the relaxation specified in clause B.3.2.1 should not be applied.

### B.3.2.3 Receiver sensitivity relaxation for UE supporting CA in FR2

### B.3.2.4 Receiver sensitivity relaxation for UE configured with CA in FR2

#### B.3.2.4.1 Intra-band contiguous carrier aggregation

For a UE configured with intra-band contiguous carrier aggregation in NR band in FR2, if there is a relaxation of receiver sensitivity  $\Delta R_{IB} > 0$  dB as defined in clause 7.3A.2.1 of TS 38.101-2 [19] depending on the aggregated channel bandwidth, the relevant side conditions specifying received power levels (SSB\_RP and  $I_o$ ) shall be increased by the amount  $\Delta = \Delta R_{IB}$  defined for the corresponding downlink NR bands.

#### B.3.2.4.2 Intra-band non-contiguous carrier aggregation

For a UE configured with intra-band non-contiguous carrier aggregation in NR band in FR2, if there is a relaxation of receiver sensitivity  $\Delta R_{IB} > 0$  dB as defined in clause 7.3A.2.1 of TS 38.101-2 [19] depending on the aggregated channel bandwidth, the relevant side conditions specifying received power levels (SSB\_RP and  $I_o$ ) shall be increased by the amount  $\Delta = \Delta R_{IB}$  defined for the corresponding downlink NR bands.

## B.3.3 Receiver sensitivity relaxation for DC

### B.3.3.1 Receiver sensitivity relaxation for EN-DC

Editor's note: TBD

### B.3.3.2 Receiver sensitivity relaxation for NE-DC

Editor's note: TBD

## B.3.4 Receiver sensitivity relaxation for SUL

### B.3.4.1 Receiver sensitivity relaxation for UE supporting SUL in FR1

For a UE supporting a SUL configuration in FR1, if there is a relaxation of receiver sensitivity  $\Delta R_{IB,c} > 0$  dB as defined in clause 7.3C.3 of TS 38.101-1 [18], the relevant side conditions specifying received power levels (SSB\_RP and  $I_o$ ) shall be increased by the amount  $\Delta = \Delta R_{IB,c}$  defined for the corresponding downlink NR bands.

For a UE supporting a SUL configuration in FR1, the requirement in this clause applies for both SC and SUL operation.

### B.3.4.2 Receiver sensitivity relaxation for UE configured with SUL in FR1

#### B.3.4.2.1 Reference sensitivity exceptions due to UL harmonic interference for SUL

In this clause, requirements exceptions are described for the UE with a band in FR1 when it is impacted by UL harmonic interference from another band in FR1 of the same SUL configuration.

A relevant side condition (SSB\_RP and  $I_o$ ) in a requirement shall be increased by the amount  $\Delta = L2 - L1$ , where  $L1$  is the reference sensitivity level specified in clause 7.3.2 of TS 38.101-1 [18], and  $L2$  is the reference sensitivity level based on the requirements in clause 7.3C.2 of TS 38.101-1 [18], when the following conditions are fulfilled,

- a downlink component carrier is configured in NR band and is active,
- the uplink is configured in the NR low operating band and is active,
- the uplink configuration is as specified in clause 7.3C.2 of TS 38.101-1 [18], and
- the exception requirements specified in clause 7.3C.2 of TS 38.101-1 [18] apply.

If the relaxation  $\Delta$  specified in this clause applies, then the relaxation specified in clause B.3.4.1 should not be applied.

## B.4 Conditions for V2X

### B.4.1 Test parameters for GNSS signals

This clause defines the reference signal power levels of generated satellites for a corresponding GNSS, which will be used in V2X test cases.

**Table B.4.1-1: GNSS Reference Signal Power Parameters**

System	Parameters	Unit	Value
	Number of generated satellites per system	-	6
GPS <sup>(1)</sup>	Reference signal power level for all satellites	dBm	-128.5
Galileo	Reference signal power level for all satellites	dBm	-127
GLONASS	Reference signal power level for all satellites	dBm	-131
BDS	Reference signal power level for all satellites	dBm	-133

NOTE 1: "GPS" here means GPS L1 C/A, Modernized GPS, or both, dependent on UE capabilities.  
 NOTE 2: The DUT UE does not need to support all systems. The DUT UE shall support at least one system and will be test for the supported systems.

### B.4.2 Conditions for PSBCH-RSRP Accuracy Requirements

This clause defines the following conditions for PSBCH-RSRP measurement accuracy requirements applicable for a corresponding operating band.

The conditions are defined in Table B.4.2-1 for FR1.

**Table B.4.2-1: Conditions for PSBCH-RSRP measurements in FR1**

Parameter	NR V2X operating band groups <sup>Note1</sup>	Minimum S-SSB <sub>RP</sub>			S-SSB $\hat{E}_s/I_{ot}$
		dBm/SCS <sub>S-SSB</sub>			dB
		SCS <sub>S-SSB</sub> = 15kHz	SCS <sub>S-SSB</sub> = 30kHz	SCS <sub>S-SSB</sub> = 60kHz	
	NR_TDD_FR1_B	-126.5	-123.5	-120.5	≥ -6
	NR_TDD_FR1_J	-122.5	-119.5	-116.5	

NOTE 1: NR V2X operating band groups are as defined in Section 3.5 for the corresponding NR operating bands.

### B.4.3 Conditions for Selection/Reselection to Intra-frequency SyncRef UE

This clause defines the S-SSB<sub>RP</sub> and S-SSB  $\hat{E}_s/I_{ot}$  applicable for a corresponding operating band.

The conditions for selection/reselection to intra-frequency SyncRef UE are defined in Table B.4.3-1 for FR1.

**Table B.4.3-1: V2X synchronization measurements in FR1**

Parameter	NR V2X operating band groups <sup>Note1</sup>	Minimum S-SSB <sub>RP</sub>			S-SSB $\hat{E}_s/I_{ot}$
		dBm/SCS <sub>S-SSB</sub>			dB
		SCS <sub>S-SSB</sub> = 15kHz	SCS <sub>S-SSB</sub> = 30kHz	SCS <sub>S-SSB</sub> = 60kHz	
	NR_TDD_FR1_B	-120.5	-117.5	-114.5	≥ 0
	NR_TDD_FR1_J	-116.5	-113.5	-110.5	≥ 0

NOTE 1: NR V2X operating band groups are as defined in Section 3.5 for the corresponding NR operating bands.  
 NOTE 2: The SyncRef UE transmission frequency shall be accurate to within ±5 PPM compared to the absolute frequency.

## B.4.4 Conditions for L1 SL-RSRP Accuracy Requirements

This clause defines the following conditions for L1 SL-RSRP measurement accuracy requirements applicable for a corresponding operating band.

The conditions are defined in Table B.4.4-1 for FR1.

**Table B.4.4-1: Conditions for L1 SL-RSRP measurements in FR1**

Parameter	NR V2X operating band groups <sup>Note1</sup>	Minimum L1 SL-RSRP			$\hat{E}s/lot$
		dBm/SCS			dB
		SCS= 15kHz	SCS= 30kHz	SCS = 60kHz	
	NR_TDD_FR1_B	-120.5	-117.5	-114.5	$\geq 0$
	NR_TDD_FR1_J	-116.5	-113.5	-110.5	

NOTE 1: NR V2X operating band groups are as defined in Section 3.5 for the corresponding NR operating bands.  
NOTE 2: The parameter  $\hat{E}s/lot$  is the  $\hat{E}s/lot$  of PSCCH-DMRS and/or PSSCH-DMRS.  
NOTE 3: The SCS is for PSCCH and/or PSSCH.



## Annex C (informative): Change history

Change history							
Date	Meeting	TDoc	CR	Rev	Cat	Subject/Comment	New version
2017-05	RAN4#83	R4-1706324				Specification skeleton	0.0.1
2017-09						Email approved	0.1.0
2017-09	RAN4-NR AH #3	R4-1709413				Capture TPs approved in the meeting	0.2.0
2017-10	RAN4#84 -Bis	R4-1711985				Capture TPs approved in the meeting	0.3.0
2017-12	RAN4#85	R4-1714546				Capture TPs approved in RAN4#85	0.4.0
2017-12	RAN#78	RP-172407				v1.0.0 submitted for plenary approval	1.0.0
2017-12	RAN#78					Approved by plenary – Rel-15 spec under change control	15.0.0
2018-03	RAN#79	RP-180264	0032		B	CR to TS38.133	15.1.0
2018-06	RAN#80	RP-181075	0037		B	CR to TS 38.133: Implementation of endorsed draft CRs from RAN4 #86bis and RAN4 #87	15.2.0
2018-09	RAN#81	RP-181896	0043		B	CR to TS 38.133: Implementation of endorsed draft CRs from RAN4-AH-1807 and RAN4 #88	15.3.0
2018-12	RAN#82	RP-182763	0057	3	B	CR to TS 38.133: Implementation of endorsed draft CRs from RAN4-88bis and RAN4-89	15.4.0
2019-03	RAN#83	RP-190569	0064	1	B	CR to TS 38.133: Implementation of endorsed draft CRs from RAN4#90	15.5.0
2019-06	RAN#84	RP-191240	0072	1	F	CR to TS 38.133: Implementation of endorsed draft CRs from RAN4#90bis and RAN4#91	15.6.0
2019-06	RAN#84	RP-191248	0066		B	Introduction of band n48	16.0.0
2019-06	RAN#84	RP-191242	0067		B	Introduction of band n14 - CR to TS 38.133	16.0.0
2019-06	RAN#84	RP-191246	0068		B	Introduction of band n30 - CR to TS 38.133	16.0.0
2019-06	RAN#84	RP-191244	0069		B	introduce n18 into TS38.133	16.0.0
2019-06	RAN#84	RP-191250	0070	1	B	n65 introduction to 38.133	16.0.0
2019-09	RAN#85	RP-192034	0077		B	n29 introduction to 38.133	16.1.0
2019-09	RAN#85	RP-192022	0085		A	CR to TS 38.133: Implementation of endorsed draft CRs from RAN4#92 (Rel-16) - Mirrors changes in R4-1910356 for Rel-15 TS 38.133	16.1.0
2019-12	RAN#86	RP-192997	0093		A	Specification of UE antenna gain range	16.2.0
2019-12	RAN#86	RP-192992	0095	1	A	Add RRM Test case setup for 1 AoA in Rx beam peak and 1 in non Rx beam peak	16.2.0
2019-12	RAN#86	RP-192997	0097		A	Update of Parameters, Test case A.7.7.1.1 FR2 Intra-frequency SS-RSRP accuracy	16.2.0
2019-12	RAN#86	RP-192997	0099		A	Update of Parameters, Test case A.5.7.1.1 FR2 Intra-frequency SS-RSRP accuracy	16.2.0
2019-12	RAN#86	RP-192997	0101		A	Update of Parameters, Test case A.7.7.1.2 FR2 Inter-frequency SS-RSRP accuracy	16.2.0
2019-12	RAN#86	RP-192997	0103		A	Update of Parameters, Test case A.5.7.1.2 FR2 Inter-frequency SS-RSRP accuracy	16.2.0
2019-12	RAN#86	RP-192992	0105		A	Correction to Random access test case in FR1 for PSCell in EN-DC	16.2.0
2019-12	RAN#86	RP-193040	0107		A	CR on handover 38.133 - R16	16.2.0
2019-12	RAN#86	RP-192994	0112	1	A	CR on the BWP switch test cases EN-DC FR1 (clause A.4.5.6)	16.2.0
2019-12	RAN#86	RP-192994	0113	1	A	CR on the BWP switch test cases EN-DC FR2 (clause A.5.5.6)	16.2.0
2019-12	RAN#86	RP-192994	0114	1	A	CR on the BWP switch test cases SA FR1 (clause A.6.5.6)	16.2.0
2019-12	RAN#86	RP-192994	0115	1	A	CR on the BWP switch test cases SA FR2 (clause A.7.5.6)	16.2.0
2019-12	RAN#86	RP-193042	0117		A	CR to TS38.133 on correction for BWP switching with SCS changing (Section 8.2.1.2.7, 8.2.2.2.5 and 8.6.2)	16.2.0
2019-12	RAN#86	RP-193040	0121		A	CR on handover RRM requirement (clause 6.1.1.5) (R16)	16.2.0
2019-12	RAN#86	RP-192994	0123		A	CR on test cases for EN-DC FR2 inter-frequency measurement (clause A.5.6.2) (R16)	16.2.0
2019-12	RAN#86	RP-192994	0127	1	A	CR on test cases for Redirection from NR in FR2 to NR in FR2 (clause A.7.3.2.3) (R16)	16.2.0
2019-12	RAN#86	RP-192994	0129	1	A	CR on test cases for FR2 handover (clause A.7.3.1) (R16)	16.2.0
2019-12	RAN#86	RP-193042	0131		A	CR to 38.133 on TCI state switching (Section 8.10) (R16)	16.2.0
2019-12	RAN#86	RP-193009	0133		F	CR on measurement gap applicability requirement for SRVCC	16.2.0
2019-12	RAN#86	RP-192994	0137		A	CR on TC with monitoring PDCCH not in first 3 OFDM symbols R16	16.2.0
2019-12	RAN#86	RP-193021	0139		F	CR to add n90 in the NR operating bands in FR1 (3.5.2)	16.2.0
2019-12	RAN#86	RP-193040	0148	1	A	CR on inter-RAT measurement in TS38.133 (clause 9.4.2, 9.4.3)	16.2.0
2019-12	RAN#86	RP-193042	0151		A	CR to 38.133 R16 Add the missing units to DRX cycle values (Cat A)	16.2.0

2019-12	RAN#86	RP-193005	0152	1	B	CR for Abbreviations for cross link interference (clause 3)	16.2.0
2019-12	RAN#86	RP-193005	0153	1	B	CR for cross link interference measurements (clause 9)	16.2.0
2019-12	RAN#86	RP-193041	0156		A	CR on NR MTTD and MRTD definition for R16	16.2.0
2019-12	RAN#86	RP-193042	0157	1	A	Editorial correction for SCell activation and deactivation delay	16.2.0
2019-12	RAN#86	RP-193039	0159		A	CR for SCell activation delay in FR2	16.2.0
2019-12	RAN#86	RP-193040	0161		A	CR for scheduling restriction due to L1-RSRP measurement	16.2.0
2019-12	RAN#86	RP-192993	0167		A	CR on SSB setting for new gap and SMTC setting (Section A.3.10)	16.2.0
2019-12	RAN#86	RP-192995	0169		A	CR on TS38.133 for EN-DC SS-SINR tests with PSCell in FR1 (Section A.4.7.3)	16.2.0
2019-12	RAN#86	RP-192995	0171		A	CR on TS38.133 for SA SS-SINR tests with PCell in FR1 (Section A.6.7.3)	16.2.0
2019-12	RAN#86	RP-192993	0185		A	CR on cell-reselection test cases for NR SA FR2 R16	16.2.0
2019-12	RAN#86	RP-192995	0187		A	endorsed CR on intra-frequency measurement and reporting for EN-DC FR2 R16	16.2.0
2019-12	RAN#86	RP-192996	0189		A	endorsed CR on intra-frequency measurement and reporting for NR SA FR2 R16	16.2.0
2019-12	RAN#86	RP-192996	0191		A	endorsed CR on RLM scheduling restrictions for EN-DC FR2 R16	16.2.0
2019-12	RAN#86	RP-192996	0193		A	endorsed CR on RLM scheduling restrictions for NR SA FR2 R16	16.2.0
2019-12	RAN#86	RP-192992	0201		A	Correction to PRACH configuration index in test cases_r16	16.2.0
2019-12	RAN#86	RP-193009	0205		B	CR on UMTS inter-RAT measurement requirements	16.2.0
2019-12	RAN#86	RP-193009	0206		B	CR on CSSF for SRVCC	16.2.0
2019-12	RAN#86	RP-193009	0207		B	CR on measurement capability for NR- UMTS for SRVCC	16.2.0
2019-12	RAN#86	RP-193039	0209		A	Correction on the TCI state switching (clause 8.10)	16.2.0
2019-12	RAN#86	RP-193039	0219		A	CR for 38133 editorial for clause 8.1,8.8,8.9,8.10,8.11 in Rel-16	16.2.0
2019-12	RAN#86	RP-193039	0220		A	CR for 38133 editorial for clause 8.5 in Rel-16	16.2.0
2019-12	RAN#86	RP-193039	0221		A	CR for 38133 editorial for clause 9.3 in Rel-16	16.2.0
2019-12	RAN#86	RP-193040	0222		A	CR on 38133 for removal the duplicated reference in clause 2	16.2.0
2019-12	RAN#86	RP-193040	0223		A	CR on 38133 for clause 11 in Rel-16	16.2.0
2019-12	RAN#86	RP-192994	0225	1	A	CR on TC of UE transmit timing (A.4.4.1.1, A.5.4.1.1, A.6.4.1.1, A.7.4.1.1) Rel-16	16.2.0
2019-12	RAN#86	RP-193042	0230		A	Update on requirements related to inter-band EN-DC and NE-DC synchronous requirements	16.2.0
2019-12	RAN#86	RP-193008	0231	1	B	MRTD and MTTD requirements for asynchronous NR-NR DC	16.2.0
2019-12	RAN#86	RP-192995	0233	1	A	Editorial corrections to measurement accuracy tests	16.2.0
2019-12	RAN#86	RP-192992	0235		A	Corrections to SS-RSRQ and SS-SINR OTA tests with SA	16.2.0
2019-12	RAN#86	RP-192992	0237	1	A	Corrections to SS-RSRQ and SS-SINR OTA tests with EN-DC	16.2.0
2019-12	RAN#86	RP-193042	0239	1	A	Editorial corrections to clause 9.2	16.2.0
2019-12	RAN#86	RP-193009	0240		B	Introduction of handover requirements for SRVCC in clause 6.1.2	16.2.0
2019-12	RAN#86	RP-192992	0242		A	Corrections to band applicability of measurement accuracy tests	16.2.0
2019-12	RAN#86	RP-192996	0244		A	Introduction of bandwidth limited OCNG for OTA testing	16.2.0
2019-12	RAN#86	RP-192992	0248		A	Corrections to test cases for SA FR2 inter-frequency measurement (clause A.7.6.2)	16.2.0
2019-12	RAN#86	RP-193041	0250		A	CR to 38.133 NR reporting criteria	16.2.0
2019-12	RAN#86	RP-192993	0264		A	CR on correcting CSI-RS based BFD and link recovery tests for EN-DC in FR1	16.2.0
2019-12	RAN#86	RP-192993	0266		A	CR on correcting CSI-RS based BFD and link recovery tests for SA in FR1	16.2.0
2019-12	RAN#86	RP-192993	0268		A	CR on correcting CSI-RS based BFD and link recovery tests for EN-DC in FR2	16.2.0
2019-12	RAN#86	RP-192993	0270		A	CR on correcting CSI-RS based BFD and link recovery tests for SA in FR2	16.2.0
2019-12	RAN#86	RP-193004	0274	1	B	CR on introducing L1-SINR mapping in TS38.133 R16	16.2.0
2019-12	RAN#86	RP-193040	0276		A	CR on delay uncertainty of RRC Release with redirection requirements in TS 38.133 (Cat A)	16.2.0
2019-12	RAN#86	RP-193040	0278		A	CR on known condition of PSCell addition requirement in NE-DC (Cat A)	16.2.0
2019-12	RAN#86	RP-193041	0280		A	CR on known condition of PSCell addition requirement in NR DC (Cat A)	16.2.0
2019-12	RAN#86	RP-193041	0282		A	CR on RRC Re-establishment requirements in TS 38.133 (Cat A)	16.2.0
2019-12	RAN#86	RP-193041	0284		A	CR on scope of interruption requirements of EN-DC in TS 38.133 (Cat A)	16.2.0
2019-12	RAN#86	RP-193041	0286		A	CR on scope of MTTD requirements in TS 38.133 (Cat A)	16.2.0
2019-12	RAN#86	RP-192994	0288		A	CR on SSB-based RLM test case for EN-DC FR1 (Cat A)	16.2.0
2019-12	RAN#86	RP-192994	0290		A	CR on SSB-based RLM test case for NR SA FR1 (Cat A)	16.2.0
2019-12	RAN#86	RP-193042	0292		A	Editorial CR on clause 8.2 (Cat A)	16.2.0
2019-12	RAN#86	RP-193041	0296		A	CR on NR inter-frequency identification (Cat A)	16.2.0
2019-12	RAN#86	RP-193041	0298		A	CR on NR intra-frequency measurements (Cat A)	16.2.0
2019-12	RAN#86	RP-193039	0312		A	Correction on CSSF within measurement gap (clause 9.1.5.2) (cat-A)	16.2.0
2019-12	RAN#86	RP-193041	0314		A	CR on RLM scheduling restriction (clause 8.1.7) (cat-A)	16.2.0
2019-12	RAN#86	RP-193041	0316		A	CR on SCell activation requirements (clause 8.3.2) (cat-A)	16.2.0
2019-12	RAN#86	RP-193042	0318		A	CR to add QCL definition (clause 3.6) (cat-A)	16.2.0
2019-12	RAN#86	RP-192993	0320		A	CR on power offset in TRS RMC (A.3.17) (cat-A)	16.2.0
2019-12	RAN#86	RP-192995	0322		A	CR to introduce new PDCCH RMC (A.3.1.3.2) (cat-A)	16.2.0

2019-12	RAN#86	RP-192997	0324		A	Maintenance CR for measurement accuracy (clause 10.1) (cat-A)	16.2.0
2019-12	RAN#86	RP-192996	0326		A	FR1 CSI-RS RLM test OOS/IS non-DRX for EN-DC (clause A.4.5.1) (cat-A)	16.2.0
2019-12	RAN#86	RP-192996	0328		A	FR2 CSI-RS RLM test OOS/IS non-DRX for EN-DC (clause A.4.5.1) (cat-A)	16.2.0
2019-12	RAN#86	RP-192996	0330		A	FR1 CSI-RS RLM test OOS/IS non-DRX for SA (clause A.6.5.1) (cat-A)	16.2.0
2019-12	RAN#86	RP-192996	0332		A	FR2 CSI-RS RLM test OOS/IS non-DRX for SA (clause A.6.5.1) (cat-A)	16.2.0
2019-12	RAN#86	RP-192997	0334		A	L1-RSRP delay test FR1 EN-DC (clause A.4.6.3) (cat-A)	16.2.0
2019-12	RAN#86	RP-192997	0336		A	L1-RSRP delay test FR2 EN-DC (clause A.5.6.3) (cat-A)	16.2.0
2019-12	RAN#86	RP-192997	0338		A	L1-RSRP delay test FR1 SA (clause A.6.6.4) (cat-A)	16.2.0
2019-12	RAN#86	RP-192997	0340		A	L1-RSRP delay test FR2 SA (clause A.7.6.3) (cat-A)	16.2.0
2019-12	RAN#86	RP-192996	0344		A	L1-RSRP accuracy test FR2 EN-DC (clause A.5.7.4) (cat-A)	16.2.0
2019-12	RAN#86	RP-192996	0346		A	L1-RSRP accuracy test FR2 SA (clause A.7.7.4) (cat-A)	16.2.0
2019-12	RAN#86	RP-193005	0347	1	B	CR to introduce CLI measurement accuracy requirements	16.2.0
2019-12	RAN#86	RP-193008	0348		B	CR on measurement gap interruption due to async NR-DC	16.2.0
2019-12	RAN#86	RP-193008	0349		B	CR on Interruptions at PSCell/SCell addition/release in async NR-DC	16.2.0
2019-12	RAN#86	RP-193008	0350		B	Introducing euCA related interruption requirements for EN-DC in 38.133 (clause 8.2.1)	16.2.0
2019-12	RAN#86	RP-193008	0351		B	Introducing euCA related interruption requirements for NE-DC in 38.133 (clause 8.2.3)	16.2.0
2019-12	RAN#86	RP-193008	0352	1	B	CR on direct SCell activation delay	16.2.0
2019-12	RAN#86	RP-193039	0358		A	CR 38.133 (8.3.2) Amendment of requirements depending on T_SMTTC_Max	16.2.0
2019-12	RAN#86	RP-193039	0360		A	CR 38.133 (8.3.3) Correction of SCell deactivation delay	16.2.0
2019-12	RAN#86	RP-192992	0362	1	A	CR 38.133 (A.7.5.7) TCs for PSCell addition and release delay	16.2.0
2019-12	RAN#86	RP-192995	0366		A	CR to TS 38.133: New common clause with OTA related definitions for FR2 testing (Rel-16)	16.2.0
2019-12	RAN#86	RP-192995	0368		A	CR to TS 38.133: Configuration of NR FR1 cell in NR FR1-FR2 tests (Rel-16)	16.2.0
2019-12	RAN#86	RP-192995	0370		A	CR to TS 38.133: Clarificatins to Antenna Configurations for FR2 (Rel-16)	16.2.0
2019-12	RAN#86	RP-192995	0372		A	CR to TS 38.133: Corrections to CORESET RMCs (Rel-16)	16.2.0
2019-12	RAN#86	RP-192995	0374		A	CR to TS 38.133: Corrections to FR2 test configurations (Rel-16)	16.2.0
2019-12	RAN#86	RP-193042	0376	1	A	Editorial updates (clause 9.4)	16.2.0
2019-12	RAN#86	RP-193039	0378		A	Correction in interruption requirements (clause 8.2)	16.2.0
2019-12	RAN#86	RP-193042	0380	1	A	Editorial updates (Annex B)	16.2.0
2019-12	RAN#86	RP-193040	0382		A	CR on 38133 for MRTD and MTTD in intra-band EN-DC	16.2.0
2019-12	RAN#86	RP-193039	0390		A	Correction to the starting point of the DRX cycle length interval	16.2.0
2019-12	RAN#86	RP-192992	0391		A	CR for MAC-CE based TCI State switch for ENDC (Section A.5.5.8)	16.2.0
2019-12	RAN#86	RP-192993	0392		A	CR for MAC-CE based TCI State switch for NR SA (Section A.7.5.7)	16.2.0
2019-12	RAN#86	RP-192993	0393		A	CR for RRC based TCI State switch for NR SA (Section A.7.5.7)	16.2.0
2019-12	RAN#86	RP-192993	0394		A	CR for RRC based TCI State switch for EN-DC (Section A.5.5.8)	16.2.0
2019-12	RAN#86	RP-192992	0395		A	CR for FR1 handover test cases (Section A.6.3.1.1, A.6.3.1.2, A.6.3.1.3)	16.2.0
2019-12	RAN#86	RP-193041	0396		A	CR on MTTD for intra-band EN-DC	16.2.0
2019-12	RAN#86	RP-193040	0398		A	CR on corrections on NR intra frequency measurement reporting requirements (Section 9.2.4)	16.2.0
2020-03	RAN#87	RP-200401	0405	1	A	[CR] handover requirements 38.133 R16 (Cat A)	16.3.0
2020-03	RAN#87	RP-200401	0412	1	A	[CR] SCell activation delay 38.133 R16 (Cat A)	16.3.0
2020-03	RAN#87	RP-200401	0417		A	Corrections to RRM Test case A.7.1.1.2	16.3.0
2020-03	RAN#87	RP-200401	0419		A	Correction to Active UL BWP for SA intra-frequency event triggered reporting with per-UE gaps	16.3.0
2020-03	RAN#87	RP-200401	0421		A	Correction to FR1-E-UTRA Inter-RAT cell re-selection test cases	16.3.0
2020-03	RAN#87	RP-200401	0423		A	Removal of Time offset between PCell and PSCell in SA RRM Test cases	16.3.0
2020-03	RAN#87	RP-200401	0425		A	Correction to SRS periodicity and Offset for UL transit timing with DRx config	16.3.0
2020-03	RAN#87	RP-200401	0427		A	Update of Test Requirements, FR2 Intra-frequency SS-RSRP accuracy Test cases	16.3.0
2020-03	RAN#87	RP-200401	0429		A	Update of Test requirements, FR2 Inter-frequency SS-RSRP accuracy Test cases	16.3.0
2020-03	RAN#87	RP-200401	0439	1	A	CR on test cases for SA FR2 inter-frequency measurement R16 (section A.7.6.2)	16.3.0
2020-03	RAN#87	RP-200401	0441		A	Editorial corrections for 38.133 Core Part R16 (Cat A)	16.3.0
2020-03	RAN#87	RP-200401	0445	1	A	Editorial corrections for 38.133 Perf Part R16 (Cat A)	16.3.0
2020-03	RAN#87	RP-200401	0454		A	Editorial correction for active TCI state switching delay	16.3.0
2020-03	RAN#87	RP-200401	0462	1	A	Corrections for BWP switch delay R16 (Cat A)	16.3.0
2020-03	RAN#87	RP-200401	0464		A	CR for reference correction on L1-RSRP measurement period (section 9.5.3)	16.3.0

2020-03	RAN#87	RP-200401	0466		A	CR for measurement restriction in FR2 across CCs (section 8.1.2.3, 8.1.3.3, 8.5.2.3, 8.5.3.3, 8.5.5.3, 8.5.6.3, 9.5.5.1, 9.5.5.2)	16.3.0
2020-03	RAN#87	RP-200401	0468		A	CR for SSB based candidate beam detection (section 8.5.5.2)	16.3.0
2020-03	RAN#87	RP-200401	0488		A	CR to TS 38.133: Corrections to FR1-FR2 event triggered test cases Annex A.5 (Rel-16)	16.3.0
2020-03	RAN#87	RP-200401	0490		A	CR to TS 38.133: Corrections to FR1-FR2 event triggered test cases Annex A.7 (Rel-16)	16.3.0
2020-03	RAN#87	RP-200401	0492		A	CR to TS 38.133: Clarifications to AoA setup and AoA cell assignment Annex A.5 (Rel-16)	16.3.0
2020-03	RAN#87	RP-200401	0494		A	CR to TS 38.133: Clarifications to AoA setup Annex A.8 (Rel-16)	16.3.0
2020-03	RAN#87	RP-200401	0496		A	CR to TS 38.133: Addition of TC A.4.7.2.2 (Rel-16)	16.3.0
2020-03	RAN#87	RP-200401	0500		A	Editorial correction of EN-DC FR1 L1-RSRP measurement for beam reporting	16.3.0
2020-03	RAN#87	RP-200401	0502		A	Editorial correction of NR SA FR1 L1-RSRP measurement for beam reporting	16.3.0
2020-03	RAN#87	RP-200401	0509		A	CR on removing one-shot timing adjustment requirements (Cat A)	16.3.0
2020-03	RAN#87	RP-200401	0516		A	Correction to BWP switching delay_r16	16.3.0
2020-03	RAN#87	RP-200401	0518		A	Correction to inter-RAT measurement on LTE serving carrier_r16	16.3.0
2020-03	RAN#87	RP-200401	0520		A	Correction to configurations for TRS_r16	16.3.0
2020-03	RAN#87	RP-200401	0522		A	Correction to FR1 SA inter-RAT measurement TCs_r16	16.3.0
					NOTE	The CR is not implemented because the corresponding Cat F CR is not implementable.	
2020-03	RAN#87	RP-200401	0524		A	Correction to interruption TCs_r16	16.3.0
					NOTE	The CR is not implemented because the corresponding Cat F CR is not implementable.	
2020-03	RAN#87	RP-200401	0528		A	Correction to RF channels configuration_r16	16.3.0
2020-03	RAN#87	RP-200401	0530		A	Correction to RRC release with redirection TCs_r16	16.3.0
2020-03	RAN#87	RP-200401	0532		A	Correction to UL reconfiguration delay TCs_r16	16.3.0
2020-03	RAN#87	RP-200401	0538		A	CR on SSB RLM test cases EN-DC R16	16.3.0
2020-03	RAN#87	RP-200401	0540		A	CR on SSB RLM test cases SA R16	16.3.0
2020-03	RAN#87	RP-200401	0542		A	CR on cell reselection test cases for FR2 SA R16	16.3.0
2020-03	RAN#87	RP-200401	0544		A	OCNG pattern for TDM-ed SSB R16	16.3.0
2020-03	RAN#87	RP-200401	0564		A	NR editorial correction	16.3.0
2020-03	RAN#87	RP-200401	0580		A	CR 38.133 (8.11) Corrections to PSCell change delay requirements	16.3.0
2020-03	RAN#87	RP-200401	0587		A	PRACH configurations in FR1 SSB based RLM tests	16.3.0
2020-03	RAN#87	RP-200401	0589		A	PRACH configurations in FR1 SSB based BFR tests	16.3.0
2020-03	RAN#87	RP-200375	0437	1	B	CR for Conditional PSCell addition/change RRM requirement	16.3.0
2020-03	RAN#87	RP-200381	0440		B	n26 introduction to 38.133	16.3.0
2020-03	RAN#87	RP-200374	0452	1	B	CR on interruption requirements for NR V2X	16.3.0
2020-03	RAN#87	RP-200372	0455		B	CR on RRM requirement for maximum MIMO layer adaptation	16.3.0
2020-03	RAN#87	RP-200389	0460	1	F	introduce n18 into TS38.133	16.3.0
2020-03	RAN#87	RP-200374	0473	1	B	CR of NR V2X RRM(introduction & reliability of GNSS signal)	16.3.0
2020-03	RAN#87	RP-200374	0476	2	B	CR on NR V2X initiation SLSS 38.133 -R16	16.3.0
2020-03	RAN#87	RP-200401	0479		F	CR to 38.133 NR reporting criteria	16.3.0
2020-03	RAN#87	RP-200382	0486		B	Introduction of n53 into 38.133	16.3.0
2020-03	RAN#87	RP-200371	0498		B	Updates to SA NR interruption requirements for NR-U	16.3.0
2020-03	RAN#87	RP-200401	0510		F	CR on inter-band EN-DC and NE-DC synchronous requirements	16.3.0
2020-03	RAN#87	RP-200375	0511	1	B	CR on DAPS handover requirements	16.3.0
2020-03	RAN#87	RP-200374	0512		B	CR on introducing UE sidelink timing requirements for NR V2X	16.3.0
2020-03	RAN#87	RP-200370	0545	1	F	CR on CLI measurement requirements	16.3.0
2020-03	RAN#87	RP-200370	0546	1	F	CR on CLI measurement accuracy requirements	16.3.0
2020-03	RAN#87	RP-200406	0547		B	CR on Interruptions at SCell activation/deactivation in async NR-DC	16.3.0
2020-03	RAN#87	RP-200406	0548	1	F	CR on direct SCell activation delay	16.3.0
2020-03	RAN#87	RP-200376	0551	1	F	Correction on handover requirements for SRVCC	16.3.0
2020-03	RAN#87	RP-200371	0558	1	B	CR to 38.133 to address NR-U inter-RAT measurements	16.3.0
2020-03	RAN#87	RP-200401	0578		F	CR 38.133 (8.3.2) Correction of error in Rel-16 SCell activation	16.3.0
2020-03	RAN#87	RP-200370	0582		B	CR for conditions for cross link interference measurements (section B)	16.3.0
2020-06	RAN#88	RP-200987	0595		A	[CR] Editorial corrections for 38.133 R16 Core Part - Cat A	16.4.0
2020-06	RAN#88	RP-200987	0596		F	[CR] Editorial corrections for 38.133 R16 Core Part - Cat F	16.4.0
2020-06	RAN#88	RP-200987	0598		A	[CR] Editorial corrections for 38.133 R16 Perf Part - Cat A	16.4.0
2020-06	RAN#88	RP-200966	0599		F	[CR] Delay requirements for direct SCell activation	16.4.0
2020-06	RAN#88	RP-200987	0600		F	[CR] Editorial corrections for 38.133 R16 Perf Part - Cat F	16.4.0
2020-06	RAN#88	RP-200987	0602		A	CR to Intra-frequency handover from FR1 to FR1	16.4.0
2020-06	RAN#88	RP-200987	0606		A	CR to A.6.1.2.1 Cell reselection to higher priority E-UTRAN	16.4.0
2020-06	RAN#88	RP-200987	0608		A	Correction to General test parameters in A.6.6.1.2	16.4.0
2020-06	RAN#88	RP-200987	0620		A	CR on CSSF correction for R16 TS38.133	16.4.0
2020-06	RAN#88	RP-201047	0625	1	B	CR on multiple SCell activation deactivation requirement for R16	16.4.0

2020-06	RAN#88	RP-201047	0626	1	B	CR on multiple SCell activation interruption requirement for R16	16.4.0
2020-06	RAN#88	RP-200987	0629		A	CR on Active TCI State Switching requirements - Rel16	16.4.0
2020-06	RAN#88	RP-201055	0632	2	F	Rapporteur CR for TS38.133	16.4.0
2020-06	RAN#88	RP-201048	0635	2	B	CR on minimum requirement at transition period for UE power saving	16.4.0
2020-06	RAN#88	RP-200958	0636	1	F	CR on interruption requirements for NR V2X	16.4.0
2020-06	RAN#88	RP-200975	0641	1	B	CR on cell identification requirements for NR HST	16.4.0
2020-06	RAN#88	RP-201044	0642	2	B	CR on PRS-RSRP measurement report mapping	16.4.0
2020-06	RAN#88	RP-201044	0645	1	B	CR on SRS RSRP measurement report mapping	16.4.0
2020-06	RAN#88	RP-200973	0646	2	B	CR to TS38.133 on introduction of L1-SINR Measurement Requirement (Section 3.3 and 9)	16.4.0
2020-06	RAN#88	RP-200973	0648	1	B	CR to TS38.133 on introduction of SCell BFRQ Procedure (Section 8.5)	16.4.0
2020-06	RAN#88	RP-200987	0651		A	Add UE Beam assumption for RRM Test cases in A.7.3, A.7.4, A.7.7	16.4.0
2020-06	RAN#88	RP-200987	0653		A	Add UE Beam assumption for RRM Test cases in A.5.3, A.5.4, A.5.7	16.4.0
2020-06	RAN#88	RP-200987	0655		A	Update of FR2 RLM Test cases with 2 Angles of Arrival	16.4.0
2020-06	RAN#88	RP-200987	0657		F	Update of Tx Timing Test cases	16.4.0
2020-06	RAN#88	RP-200987	0659		A	Update of FR2 RLM and BFD-LR Test cases	16.4.0
2020-06	RAN#88	RP-200987	0661		A	Update of FR2 SS-RSRP Test cases	16.4.0
2020-06	RAN#88	RP-200987	0663	1	A	CR on TCI state switch	16.4.0
2020-06	RAN#88	RP-200987	0665		A	CR on PDSCH RMC	16.4.0
2020-06	RAN#88	RP-201047	0668	1	B	CR on active spatial relation switch	16.4.0
2020-06	RAN#88	RP-200976	0671	1	B	CR to TS 38.133: CHO RRM requirement	16.4.0
2020-06	RAN#88	RP-201047	0672	1	B	CR to TS 38.133: RRM requirement for UE-specific CBW change delay	16.4.0
2020-06	RAN#88	RP-201047	0673		B	CR to TS 38.133: RRM requirement for interruption due to UE-specific CBW change	16.4.0
2020-06	RAN#88	RP-200969	0678	1	B	CR to TS 38.133: introducing 2-step RACH core requirements	16.4.0
2020-06	RAN#88	RP-200987	0680		A	Correction of CFRA RSRP threshold	16.4.0
2020-06	RAN#88	RP-200970	0682		B	CR for event triggered reporting tests for CLI	16.4.0
2020-06	RAN#88	RP-200958	0685		B	CR of NR V2X abbreviations	16.4.0
2020-06	RAN#88	RP-200958	0686	1	B	CR of interruption for switching between NR SL and LTE SL	16.4.0
2020-06	RAN#88	RP-200958	0687	2	F	CR of NR V2X editorial correction	16.4.0
2020-06	RAN#88	RP-200971	0689	1	B	38.133 CR on cell re-selection requirements for Rel-16 NR HST	16.4.0
2020-06	RAN#88	RP-201047	0690	1	B	CR on introducing inter-frequency measurements without measurement gap (9.1.5, 9.1.6, 9.3.1, 9.3.4, 9.3.5)	16.4.0
2020-06	RAN#88	RP-200987	0696		A	CR on SMTC period for beam management requirements	16.4.0
2020-06	RAN#88	RP-200987	0698		A	CR for CSI-RS based L1-RSRP measurement period	16.4.0
2020-06	RAN#88	RP-200987	0700		A	CR on RACH test cases with CSI-RS resource R16	16.4.0
2020-06	RAN#88	RP-200987	0704		A	CR on TS38.133 for modification of the layer 3 and layer 1 measurement sharing factor when both SSB and RSSI symbol to be measured are considered	16.4.0
2020-06	RAN#88	RP-200987	0706		A	CR on TS38.133 for modification on number of cells and number of SSB to be measured for FR2 intra-frequency measurement	16.4.0
2020-06	RAN#88	RP-200987	0708		A	[CR] TCI state switch delay 38.133 R16 Cat A	16.4.0
2020-06	RAN#88	RP-201047	0709	1	F	LTE CGI measurements with autonomous gaps for 38.133	16.4.0
2020-06	RAN#88	RP-201042	0710	3	B	Updates to general section for NR-U in 38.133	16.4.0
2020-06	RAN#88	RP-200976	0711	1	F	Correction to DAPS HO requirements in 38.133	16.4.0
2020-06	RAN#88	RP-201049	0712	2	F	SRVCC test case for event triggered reporting	16.4.0
2020-06	RAN#88	RP-201049	0713		F	Gap applicability errors corrected for SRVCC	16.4.0
2020-06	RAN#88	RP-200987	0715		A	Correction of NR SA FR2 inter-freq measurement reporting	16.4.0
2020-06	RAN#88	RP-200968	0717		F	NTA_offset setting for NR coexistence with NB-IoT	16.4.0
2020-06	RAN#88	RP-201042	0718	2	B	CR to TS 38.133: adding NR-U Handover.	16.4.0
2020-06	RAN#88	RP-200975	0723	1	B	CR on cell re-selection requirement for NR-EUTRAN measurement in TS38.133	16.4.0
2020-06	RAN#88	RP-201042	0725	1	B	CR: Introduction of L1-RSRP measurement requirements with CCA	16.4.0
2020-06	RAN#88	RP-200987	0727		A	CR: Correction of L1-RSRP measurement period	16.4.0
2020-06	RAN#88	RP-200987	0729		A	CR to TS 38.133: Correction to CSI-RS configurations in A.3.14 (Rel-16)	16.4.0
2020-06	RAN#88	RP-200987	0731		A	CR to TS 38.133: Correction to SMTC configuration in measurement accuracy tests (Rel-16)	16.4.0
2020-06	RAN#88	RP-200987	0733		A	CR to TS 38.133: Clarifications to AoA setup Annex A.5 (Rel-16)	16.4.0
2020-06	RAN#88	RP-200987	0735		A	CR to TS 38.133: Clarifications to AoA setup Annex A.7 (Rel-16)	16.4.0
2020-06	RAN#88	RP-201048	0736		F	CR for maximum MIMO layer adaptation	16.4.0
2020-06	RAN#88	RP-200987	0738	1	F	Applicability of QCL	16.4.0
2020-06	RAN#88	RP-201047	0741	1	B	CR to 38.133 on SRS carrier switching interruption requirements	16.4.0
2020-06	RAN#88	RP-201047	0742	1	B	CR to 38.133 on impact to measurement requirements due to LTE SRS carrier switching	16.4.0
2020-06	RAN#88	RP-200969	0743	1	B	CR to 38.133 on UE transmit timing requirements for 2-step RACH	16.4.0
2020-06	RAN#88	RP-200987	0744	1	F	CR to 38.133 on intra frequency measurements without gaps	16.4.0
2020-06	RAN#88	RP-200987	0748		A	CR on Psharingfactor_r16	16.4.0

2020-06	RAN#88	RP-200987	0750		A	CR on E-UTRAN Serving Cell Parameters_r16	16.4.0
2020-06	RAN#88	RP-200987	0752		A	CR on Modified parameters for BFD TCs with 4Rx antenna_r16	16.4.0
2020-06	RAN#88	RP-200987	0754		A	CR on BFD TCs_r16	16.4.0
2020-06	RAN#88	RP-200987	0756		A	CR on UL carrier RRC reconfiguration Delay TC_r16	16.4.0
2020-06	RAN#88	RP-200987	0758		A	CR to FR1 SCell activation delay test cases_r16	16.4.0
2020-06	RAN#88	RP-200987	0760		A	CR to inter-frequency measurement TCs_r16	16.4.0
2020-06	RAN#88	RP-200987	0762	1	F	CR to interruption TCs_r16	16.4.0
2020-06	RAN#88	RP-200987	0763	1	F	CR to FR1 SA inter-RAT measurement TCs_r16	16.4.0
2020-06	RAN#88	RP-201047	0764	1	B	CR on introduction of RRM requirements for BWP switching delay on multiple CCs	16.4.0
2020-06	RAN#88	RP-201042	0767	1	B	CR on introduction of Active TCI state switching delay with CCA Requirements for NR-U	16.4.0
2020-06	RAN#88	RP-201042	0768	2	B	CR on introduction of reporting criteria for NR-U	16.4.0
2020-06	RAN#88	RP-201042	0770	1	B	CR on introduction of RRC_INACTIVE state mobility requirements for NR-U	16.4.0
2020-06	RAN#88	RP-200987	0775		A	CR on interruption due to Active BWP switch (Cat A)	16.4.0
2020-06	RAN#88	RP-200987	0779		A	CR on UE transmit timing (Cat A)	16.4.0
2020-06	RAN#88	RP-200987	0781		A	Editorial CR on TS 38.133 Rel-16 (Cat A)	16.4.0
2020-06	RAN#88	RP-200987	0783		A	CR on RRC Connection Release with Redirection (Cat A)	16.4.0
2020-06	RAN#88	RP-200987	0785		A	CR on RRC Re-establishment test cases (Cat A)	16.4.0
2020-06	RAN#88	RP-200987	0787		A	CR on Timing advance test cases for EN-DC (Cat A)	16.4.0
2020-06	RAN#88	RP-200987	0789		A	CR on Timing test cases for NR SA (Cat A)	16.4.0
2020-06	RAN#88	RP-201045	0792	1	B	CR on DL interruption Tx switching between two uplink carriers	16.4.0
2020-06	RAN#88	RP-200975	0796	1	B	Cell identification in connected mode for NR-EUTRAN measurement in HST	16.4.0
2020-06	RAN#88	RP-200987	0799		A	Correction on TCI state switching R16	16.4.0
2020-06	RAN#88	RP-200987	0801		A	Accuracy of carrier aggregation in NR R16	16.4.0
2020-06	RAN#88	RP-201049	0802	1	B	Test case for NR to UTRA FDD Inter-RAT handover	16.4.0
2020-06	RAN#88	RP-200976	0804		F	CR on conditional PSCell change requirements	16.4.0
2020-06	RAN#88	RP-200973	0806	1	B	CR on SCell BFD and CBD requirements	16.4.0
2020-06	RAN#88	RP-201047	0808	1	B	CR on interruption requirements for FR2 inter-band CA	16.4.0
2020-06	RAN#88	RP-201047	0809		B	CR on scaling factor CSSFoutside_gap for FR2 inter-band CA	16.4.0
2020-06	RAN#88	RP-201047	0810	1	B	CR on scheduling availability requirements for FR2 inter-band CA	16.4.0
2020-06	RAN#88	RP-200987	0813		A	CR 38.133 (8.10.5) Corrections to RRC-based TCI state change	16.4.0
2020-06	RAN#88	RP-200966	0814		F	CR 38.133 (8.3.4-5) Corrections to Direct SCell activation	16.4.0
2020-06	RAN#88	RP-200987	0816		A	CR 38.133 (8.3.2) Corrections to SCell Activation delay requirements	16.4.0
2020-06	RAN#88	RP-200966	0817	1	F	CR 38.133 (8.3.4-5) Addition of interruption windows for Direct SCell Activation	16.4.0
2020-06	RAN#88	RP-200978	0818	1	B	CR to 38.133 for Introduction of band n259	16.4.0
2020-06	RAN#88	RP-201047	0819	1	B	CR on SCell activation requirements for FR2 inter-band CA	16.4.0
2020-06	RAN#88	RP-200987	0821		A	CR on FR2 measurement requirements outside gaps R16	16.4.0
2020-06	RAN#88	RP-200987	0823		A	CR on inter-RAT RSTD requirements for NE-DC in 38.133 R16	16.4.0
2020-06	RAN#88	RP-200987	0825		A	CR on SCell activation requirements R16	16.4.0
2020-06	RAN#88	RP-200987	0827		A	CR on SSB based L1-RSRP measurement R16	16.4.0
2020-06	RAN#88	RP-200987	0829		A	CR on L1-RSRP delay tests for FR2 R16	16.4.0
2020-06	RAN#88	RP-200987	0831		A	CR to L1-RSRP accuracy TC for FR2 EN-DC R16	16.4.0
2020-06	RAN#88	RP-200987	0833		A	CR to L1-RSRP accuracy TC for FR2 SA R16	16.4.0
2020-06	RAN#88	RP-200987	0835		A	CR to TCI state switch TC R16	16.4.0
2020-06	RAN#88	RP-200970	0836		F	CR on CLI measurement requirements	16.4.0
2020-06	RAN#88	RP-200970	0837	1	F	CR on CLI measurement performance requirements	16.4.0
2020-06	RAN#88	RP-200970	0838		B	CR on test cases for SRS-RSRP measurement accuracy in FR1	16.4.0
2020-06	RAN#88	RP-200970	0839	1	B	CR on test cases for SRS-RSRP measurement accuracy in FR2	16.4.0
2020-06	RAN#88	RP-200970	0840		B	CR on test cases for CLI-RSSI measurement accuracy in FR1	16.4.0
2020-06	RAN#88	RP-200970	0841	1	B	CR on test cases for CLI-RSSI measurement accuracy in FR2	16.4.0
2020-06	RAN#88	RP-200966	0843		B	CR on interruption requirements for direct SCell activation for 38.133	16.4.0
2020-06	RAN#88	RP-200966	0844	1	B	CR on delay requirements for SCell dormancy	16.4.0
2020-06	RAN#88	RP-200966	0845	1	B	CR on interruption requirements for SCell dormancy	16.4.0
2020-06	RAN#88	RP-201044	0847	1	B	CR for gNB Rx-Tx time difference and UL-RTOA report mapping	16.4.0
2020-06	RAN#88	RP-201044	0849	1	B	CR for AoA/ZoA report mapping	16.4.0
2020-06	RAN#88	RP-201048	0854	2	B	Measurement requirements for UEs under power saving mode	16.4.0
2020-06	RAN#88	RP-201044	0857	1	B	NR E-CID reporting criteria requirements	16.4.0
2020-06	RAN#88	RP-201044	0858	1	B	NR E-CID measurement requirements	16.4.0
2020-06	RAN#88	RP-201044	0862	1	B	Positioning measurement accuracy requirements structure in section 10	16.4.0
2020-06	RAN#88	RP-201044	0863	2	B	Reporting criteria for NR RSTD	16.4.0
2020-06	RAN#88	RP-200987	0867		A	Clarification on RLM	16.4.0
2020-06	RAN#88	RP-201042	0869		B	BWP switching interruption requirement due to consistent UL failure in 38.133	16.4.0
2020-06	RAN#88	RP-200969	0871	1	B	Applicability of 2-step RA and 4-step RA in RRM requirements in 38.133	16.4.0
2020-06	RAN#88	RP-200975	0874	1	B	CR to TS 38.133: NR HST beam management requirements	16.4.0

2020-06	RAN#88	RP-201047	0875	1	B	CR on 38133 interruption requirements for BWP switching on multiple CCs	16.4.0
2020-06	RAN#88	RP-200966	0879	1	B	Big CR Introduction of UE requirement for MR-DC early measurement reporting in 38.133	16.4.0
2020-06	RAN#88	RP-201042	0885		B	RRC release with redirection requirements in NR-U in 38.133	16.4.0
2020-06	RAN#88	RP-200988	0886	1	A	Rapporteur CR for TS38.133	16.4.0
2020-06	RAN#88	RP-201047	0887		B	CR: mandatory gap pattern	16.4.0
2020-09	RAN#88	RP-201512	0889		A	CR to Redirection from NR in FR1 to E-UTRAN	16.5.0
2020-09	RAN#88	RP-201512	0891		A	CR to timing advance adjustment accuracy in FR1	16.5.0
2020-09	RAN#88	RP-201512	0895		A	CR to SS-RSRQ Intra-Frequency and Inter-frequency FR1 measurement accuracy	16.5.0
2020-09	RAN#88	RP-201512	0897		A	Update to FR2 240kHz SSB Configurations	16.5.0
2020-09	RAN#88	RP-201512	0899		A	Update of FR2 Random Access Test cases	16.5.0
2020-09	RAN#88	RP-201512	0901		A	Update to FR2 event-triggered reporting RRM Test cases in A.5.6 and A.7.6	16.5.0
2020-09	RAN#88	RP-201512	0903		A	Update to FR2 SS-RSRP RRM Test cases in A.5.7 and A.7.7	16.5.0
2020-09	RAN#88	RP-201512	0905		A	CR to EN-DC timing advance adjustment accuracy in FR2	16.5.0
2020-09	RAN#88	RP-201512	0907		A	CR to configuration of CSI-RS for tracking	16.5.0
2020-09	RAN#88	RP-201512	0909		A	Update of RRC-based Active BWP Switch test cases	16.5.0
2020-09	RAN#88	RP-201512	0911		A	Update to FR2 Annex B RRM side conditions	16.5.0
2020-09	RAN#88	RP-201512	0913		A	Add UE Beam assumption for RRM Test cases in A.5.5	16.5.0
2020-09	RAN#88	RP-201496	0914	1	B	Introduction of the P-MPR 2 bits report mapping in 38.133	16.5.0
2020-09	RAN#88	RP-201512	0922		A	Add UE Beam assumption for RRM Test cases in A.7.5 Rel-16	16.5.0
2020-09	RAN#88	RP-201489	0924	1	F	Maintenance CR for 2-step RA	16.5.0
2020-09	RAN#88	RP-201491	0925	2	B	CR to TS 38.133: PRS RSTD requirements	16.5.0
2020-09	RAN#88	RP-201498	0928	1	F	CR on capabilities for support of event triggering and reporting criteria	16.5.0
2020-09	RAN#88	RP-201512	0931		F	CR for TS38.133 Rel-16, Correction for SCell activation delay requirement	16.5.0
2020-09	RAN#88	RP-201512	0933		A	CR for TS38.133 Rel-16, Correction for RRM core requirements	16.5.0
2020-09	RAN#88	RP-201512	0935		A	CR for TS38.133 Rel-16, Correction for test cases of BWP switching	16.5.0
2020-09	RAN#88	RP-201498	0937	1	B	CR on CSI-RS based intra-frequency measurement requirement (Introduction, requirement applicability and number of cell and beams)	16.5.0
2020-09	RAN#88	RP-201500	0939	1	B	CR on uplink spatial relation switch delay (section 8.12)	16.5.0
2020-09	RAN#88	RP-201506	0940	1	B	Introduction of SCell activation/deactivation delay requirements for SCells operating with CCA	16.5.0
2020-09	RAN#88	RP-201491	0941	2	B	Revision of CSSF within gap to include NR positioning measurements with gap sharing	16.5.0
2020-09	RAN#88	RP-201491	0942	3	B	Introduction of new MG patterns for NR positioning	16.5.0
2020-09	RAN#88	RP-201491	0943	2	B	Introduction of UE Rx-Tx time difference measurement requirements for NR positioning	16.5.0
2020-09	RAN#88	RP-201512	0946		A	CR on TS38.133 for handover test cases	16.5.0
2020-09	RAN#88	RP-201512	0948		A	CR on TS38.133 for introducing the PDSCH RMC configuration in cell re-selection test cases	16.5.0
2020-09	RAN#88	RP-201493	0950	2	F	CR on TS38.133 for dual active protocol stack handover (Section 6.1.3)	16.5.0
2020-09	RAN#88	RP-201507	0952		F	CR on TS38.133 for intra-frequency measurement definition (Section 9.2.1)	16.5.0
2020-09	RAN#88	RP-201512	0956		A	CR on FR2 measurement capability for R16	16.5.0
2020-09	RAN#88	RP-201506	0957		B	CR on UE measurement capability of NR-U for R16	16.5.0
2020-09	RAN#88	RP-201507	0958	1	B	CR on RRM requirement based on dual DRX for FR1+FR2 CA	16.5.0
2020-09	RAN#88	RP-201506	0959		F	Update NR Frequency Band Groups to include Band n30	16.5.0
2020-09	RAN#88	RP-201506	0960		F	Update NR Frequency Band Groups to include Band n14	16.5.0
2020-09	RAN#88	RP-201506	0961		F	CR for Table number mismatch for CLI performance tests	16.5.0
2020-09	RAN#88	RP-201512	0963		A	CR on Inter-RAT RSTD measurements (section 9.4.4)	16.5.0
2020-09	RAN#88	RP-201512	0965		A	CR on active BWP switch in R16	16.5.0
2020-09	RAN#88	RP-201500	0968	1	F	CR on multiple SCells activation (section 8.3.7)	16.5.0
2020-09	RAN#88	RP-201496	0969	1	F	CR on MRTD and MTTD for FR2 inter-band CA	16.5.0
2020-09	RAN#88	RP-201498	0970	1	B	CR on MRTD for FR2 inter-band CA	16.5.0
2020-09	RAN#88	RP-201498	0971	1	B	38.133 CR on UE measurement capability on the number of frequency layers to be monitored for CSI-RS measurement	16.5.0
2020-09	RAN#88	RP-201497	0972		F	38.133 CR on cell re-selection requirements for Rel-16 NR HST	16.5.0
2020-09	RAN#88	RP-201492	0973	1	F	CR of missed requirements based on the agreed CRs in RAN4#95-e	16.5.0
2020-09	RAN#88	RP-201492	0974	1	F	CR of interruption requirements	16.5.0
2020-09	RAN#88	RP-201500	0976	1	F	CR on definition of inter-frequency measurements without measurement gap (9.3.1)	16.5.0
2020-09	RAN#88	RP-201500	0984		F	CR on BWP switch on multiple CCs	16.5.0
2020-09	RAN#88	RP-201512	0986		A	CR for SCell activation delay in FR2 in R16	16.5.0
2020-09	RAN#88	RP-201512	0988		A	CR on TCI state switch delay in R16	16.5.0
2020-09	RAN#88	RP-201506	0991	1	B	CR for timing requirement for NR-U	16.5.0
2020-09	RAN#88	RP-201488	0992	1	B	CR for introduction of pathloss reference signal switching delay	16.5.0

2020-09	RAN#88	RP-201488	0993	1	F	CR for L1-SINR requirement	16.5.0
2020-09	RAN#88	RP-201498	0996	2	B	CR on introduction, applicability and capability for CSI-RS inter-frequency measurement requirements	16.5.0
2020-09	RAN#88	RP-201500	0999	1	B	Impact of CGI reading on L1 and L3 measurement	16.5.0
2020-09	RAN#88	RP-201498	1003	1	B	38.133 CR on introduction of CSI-RS based measurement	16.5.0
2020-09	RAN#88	RP-201488	1006		F	Correction of L1-SINR reporting requirements	16.5.0
2020-09	RAN#88	RP-201506	1007	2	B	CR: Beam management requirements with CCA	16.5.0
2020-09	RAN#88	RP-201507	1008		F	[CR] Corrections to DAPS Handover	16.5.0
2020-09	RAN#88	RP-201500	1010	2	F	CR for FR2 inter-band CA requirements	16.5.0
2020-09	RAN#88	RP-201506	1011	1	D	CR to TS 38.133 - Handover requirements in NR-U	16.5.0
2020-09	RAN#88	RP-201506	1012	2	B	CR to TS 38.133 to address NR-U inter-frequency measurements	16.5.0
2020-09	RAN#88	RP-201512	1015	1	F	CR 38.133 (8.3.2-3) Corrections to SCell activation delay requirements	16.5.0
2020-09	RAN#88	RP-201494	1016	1	B	CR 38.133 (8.3.9-8.3.11) Direct SCell activation delay for multiple downlink SCells	16.5.0
2020-09	RAN#88	RP-201494	1017	2	F	CR 38.133 SCell dormancy switching of multiple SCells	16.5.0
2020-09	RAN#88	RP-201494	1018		B	CR on delay requirements for SCell dormancy	16.5.0
2020-09	RAN#88	RP-201498	1020	1	B	CR on inter-frequency CSI-RS L3 measurement requirements	16.5.0
2020-09	RAN#88	RP-201512	1023		A	Clarification of SNR values in RLM Test cases	16.5.0
2020-09	RAN#88	RP-201512	1025		A	CR to TS 38.133: Corrections to CSI-RS configurations in A.3.14 (Rel-16)	16.5.0
2020-09	RAN#88	RP-201512	1027		A	CR to TS 38.133: Corrections to event triggered test cases (Rel-16)	16.5.0
2020-09	RAN#88	RP-201512	1029		A	CR to TS 38.133: Corrections to inter-RAT test cases (Rel-16)	16.5.0
2020-09	RAN#88	RP-201512	1031		A	CR to TS 38.133: Corrections to AoA setup information in some test cases (Rel-16)	16.5.0
2020-09	RAN#88	RP-201512	1033		A	CR on maintaining handover tests in Rel-16	16.5.0
2020-09	RAN#88	RP-201500	1039	1	F	CR on maintaining measurement restriction requirements for NR CA	16.5.0
2020-09	RAN#88	RP-201500	1041	3	F	CR on BWP switching delay on multiple CCs	16.5.0
2020-09	RAN#88	RP-201506	1042	2	F	CR on active TCI state switching for NR-U	16.5.0
2020-09	RAN#88	RP-201506	1043	2	B	CR on introduction of intra-frequency measurements requirements for NR-U	16.5.0
2020-09	RAN#88	RP-201506	1044	1	B	CR on introduction of Active BWP switching delay requirements for NR-U	16.5.0
2020-09	RAN#88	RP-201506	1045	1	B	CR on introduction of RRC_IDLE state mobility requirements for NR-U	16.5.0
2020-09	RAN#88	RP-201506	1046	1	B	Discussion on RRC re-establishment for NR-U	16.5.0
2020-09	RAN#88	RP-201512	1048		A	CR on reporting criteria for EN-DC in 38.133 R15	16.5.0
2020-09	RAN#88	RP-201512	1050		A	CR on test cases for Active TCI state switch delay R15	16.5.0
2020-09	RAN#88	RP-201512	1052		A	Addition of new default configurations for RMC scheduling_r16	16.5.0
2020-09	RAN#88	RP-201512	1054		A	Correction to beam failure detection and link recovery test cases_r16	16.5.0
2020-09	RAN#88	RP-201512	1056		A	Correction to BWP switching delay test cases_r16	16.5.0
2020-09	RAN#88	RP-201512	1058		A	Correction to FR1 intra-frequency measurement with gap test cases_r16	16.5.0
2020-09	RAN#88	RP-201512	1060		A	Correction to inter-RAT HO test cases_r16	16.5.0
2020-09	RAN#88	RP-201498	1064	2	B	CR on CSI-RS based intra-frequency measurement requirements	16.5.0
2020-09	RAN#88	RP-201500	1066	1	F	Correction on the interruption requirements due to SRS carrier switching	16.5.0
2020-09	RAN#88	RP-201500	1067	1	F	CSSF for inter-frequency measurement without gap in FR2 inter-band CA scenario	16.5.0
2020-09	RAN#88	RP-201512	1070		A	CR on correction to CSSF within gap R16	16.5.0
2020-09	RAN#88	RP-201512	1072		A	CR on SCell activation requirements R16	16.5.0
2020-09	RAN#88	RP-201512	1075		A	CR on UL BWP configuration for RRM test cases R16	16.5.0
2020-09	RAN#88	RP-201512	1077		A	CR to add UE beam assumption for TC in A.5.6 R16	16.5.0
2020-09	RAN#88	RP-201506	1078		F	CR on reporting criteria for CLI	16.5.0
2020-09	RAN#88	RP-201494	1080	1	B	CR on direct SCell activation	16.5.0
2020-09	RAN#88	RP-201494	1081	2	F	CR on requirements for SCell dormancy	16.5.0
2020-09	RAN#88	RP-201491	1082	1	B	CR for general applicability of PRS measurement requirements	16.5.0
2020-09	RAN#88	RP-201491	1083	2	B	CR for measurement requirements for PRS-RSRP	16.5.0
2020-09	RAN#88	RP-201491	1085	2	B	CR to add CSI-RS related reporting criteria for ECID	16.5.0
2020-09	RAN#88	RP-201490	1088	2	F	Correction CR to Rel-16 UE power saving requirements	16.5.0
2020-09	RAN#88	RP-201506	1090		F	Correction to RACH delay in RRC release requirements in NR-U in 38.133	16.5.0
2020-09	RAN#88	RP-201512	1097		A	CR to 38.133 correction to RRC based BWP switch delay requirements	16.5.0
2020-09	RAN#88	RP-201512	1099		A	CR to 38.133 correction to interruption requirements for per-FR gap in FR2	16.5.0
2020-09	RAN#88	RP-201500	1100		B	CR to 38.133 on CGI reading of NR cell	16.5.0
2020-09	RAN#88	RP-201497	1101		F	CR to TS 38.133: Corrections to Table 9.4.3.3-2 in subclause 9.4.3.3 (Requirements when DRX is used)	16.5.0
2020-09	RAN#88	RP-201506	1102	2	B	Introduction of RLM requirements for NR-U	16.5.0



2020-09	RAN#88	RP-201491	1103	2	B	Measurement report mapping and additional path reporting for UE Rx-Tx	16.5.0
2020-09	RAN#88	RP-201491	1104	2	B	Measurement report mapping and additional path reporting for RSTD	16.5.0
2020-09	RAN#88	RP-201491	1106	1	F	Reporting criteria for NR positioning measurements	16.5.0
2020-09	RAN#88	RP-201491	1107		F	General introduction of NR positioning measurements	16.5.0
2020-09	RAN#88	RP-201498	1108	1	B	CR on scheduling restriction for CSI-RS based intra-frequency measurement	16.5.0
2020-09	RAN#88	RP-201507	1111		F	[CR] Replacing x in references with correct numbers (Core R16 Cat F)	16.5.0
2020-09	RAN#88	RP-201512	1113		A	[CR] Replacing x in references with correct numbers (Core R16 Cat A)	16.5.0
2020-09	RAN#88	RP-201512	1114		A	[CR] Replacing x in references with correct numbers (Perf R16 Cat A)	16.5.0
2020-09	RAN#88	RP-201512	1116		A	Fine/rough beam assumption for idle mode and measurement procedure test case	16.5.0
2020-09	RAN#88	RP-201512	1117		A	CR on BWP switching delay requirements R16	16.5.0
2020-12	RAN#90	RP-202433	1108	4	B	CR on scheduling restriction for CSI-RS based intra-frequency measurement	16.6.0
2020-12	RAN#90	RP-202487	1119		A	RB allocation and Noc level in RLM Test cases	16.6.0
2020-12	RAN#90	RP-202487	1121		A	Update FR2 event-triggered reporting Test cases in A.5.6, A.7.6	16.6.0
2020-12	RAN#90	RP-202487	1123		A	240kHz SSB SCS Configuration for FR2 SS-RSRP Test cases	16.6.0
2020-12	RAN#90	RP-202487	1125		A	Correct UE beam assumption for Test Cases in A.5.6	16.6.0
2020-12	RAN#90	RP-202487	1127		A	Aggregation level of CORESET for RMC scheduling	16.6.0
2020-12	RAN#90	RP-202487	1129		A	Claiify FR1 NSA SS-SINR measurement TCs	16.6.0
2020-12	RAN#90	RP-202487	1131		A	FR1 Inter-frequency Event triggered Reporting tests in DRX	16.6.0
2020-12	RAN#90	RP-202487	1133		A	E-UTRAN	16.6.0
2020-12	RAN#90	RP-202419	1138		F	CR for DAPS HO test applicability	16.6.0
2020-12	RAN#90	RP-202487	1139		F	Maintenance CR on SA inter-frequency event triggered reporting tests for FR1	16.6.0
2020-12	RAN#90	RP-202433	1140	1	F	CR on CSSF with both CSI-RS and SSB	16.6.0
2020-12	RAN#90	RP-202444	1146		A	CR on CSI-RS BW condition for BFD/CBD R16	16.6.0
2020-12	RAN#90	RP-202444	1148		A	CR on AP-CSI-RS based L1-RSRP measurement R16	16.6.0
2020-12	RAN#90	RP-202427	1152	1	F	CR of NR V2X operating band group	16.6.0
2020-12	RAN#90	RP-202436	1155	1	F	CR on TS38.133 for dual active protocol stack handover	16.6.0
2020-12	RAN#90	RP-202430	1156	2	F	CR on TS38.133 interruption time for CA with non-aligned frame boundaries	16.6.0
2020-12	RAN#90	RP-202444	1158		F	CR on TS38.133 for inter-frequency measurement requirement without gap	16.6.0
2020-12	RAN#90	RP-202487	1160		A	CR on TS38.133 for cell activation and deactivation test case	16.6.0
2020-12	RAN#90	RP-202487	1162		A	CR on TS38.133 for cell reselection test case	16.6.0
2020-12	RAN#90	RP-202487	1164		A	CR on TS38.133 for active BWP switch test cases	16.6.0
2020-12	RAN#90	RP-202487	1165		F	CR on TS38.133 for E-UTRAN	16.6.0
2020-12	RAN#90	RP-202509	1166		F	CR on TS38.133 for SCell activation and deactivation delay test cases	16.6.0
2020-12	RAN#90	RP-202487	1168		A	CR for TS38.133 Rel-16, Correction for RRM core and test cases	16.6.0
2020-12	RAN#90	RP-202433	1171	1	F	CR on abbreviations about CSI-RS based measurement in 38.133.	16.6.0
2020-12	RAN#90	RP-202442	1184		F	CR to TS 38.133: Add information on the inter-band EN-DC and UL CA configurations with no DL interruption	16.6.0
2020-12	RAN#90	RP-202433	1186	1	F	CR on R16 CSI-RS based L3 measurements	16.6.0
2020-12	RAN#90	RP-202419	1187	2	B	Intra-band Inter-frequency sync DAPS handover test in SA for FR1	16.6.0
2020-12	RAN#90	RP-202427	1191	1	F	CR: Interruption requirement for NR V2X synchronization source chang	16.6.0
2020-12	RAN#90	RP-202432	1193		F	Fine/rough beam assumption for CLI performance test cases	16.6.0
2020-12	RAN#90	RP-202435	1194	1	F	38.133 CR on CSSFintra for measurement period for intra-frequency measurements in connected mode for Rel-16 NR HST	16.6.0
2020-12	RAN#90	RP-202486	1196		A	CR on carrier frequency range of PCell/PSCell for the maximum number of RLM-RS resources	16.6.0
2020-12	RAN#90	RP-202487	1209		A	Correction on beamFailureInstanceMaxCount for test cases of availability restriction during FR2 BFR in R16	16.6.0
2020-12	RAN#90	RP-202444	1212	1	F	Correction on unknown SCell activation in FR2.	16.6.0
2020-12	RAN#90	RP-202415	1213	1	B	Big CR on 2-step RA type RRM performance requirements	16.6.0
2020-12	RAN#90	RP-202431	1214	1	F	CR Maintenance 2-step RACH RRM requirements	16.6.0
2020-12	RAN#90	RP-202487	1216		A	Correction of RRM tests	16.6.0
2020-12	RAN#90	RP-202435	1217	1	F	CR on IDLE state cell re-selection requirements for HST in 38.133	16.6.0
2020-12	RAN#90	RP-202487	1225		A	Correction to types of requirements in annex A	16.6.0
2020-12	RAN#90	RP-202487	1227		A	Corrections to frequency range in interfrequency measurement procedures tests	16.6.0
2020-12	RAN#90	RP-202487	1230		A	Correction on TBD values in FR1+FR2 interfrequency RSRP accuracy tests	16.6.0
2020-12	RAN#90	RP-202486	1232		A	Addition of symbol definitions	16.6.0
2020-12	RAN#90	RP-202487	1236		A	Square bracket removal in 38.133 section A.1 to A.5	16.6.0
2020-12	RAN#90	RP-202487	1238		A	Square bracket removal in 38.133 section A.6 to A.8	16.6.0
2020-12	RAN#90	RP-202419	1240	1	B	Conditional handover test cases for NR	16.6.0

2020-12	RAN#90	RP-202414	1241		B	Updates to general section for NR-U in 38.133	16.6.0
2020-12	RAN#90	RP-202486	1250		A	CR on MO merge	16.6.0
2020-12	RAN#90	RP-202444	1252	1	F	CR to TS 38.133 on DCI based BWP switch requirements for cross carrier scheduling	16.6.0
2020-12	RAN#90	RP-202441	1254	1	B	CR on PRS-RSRP report mapping	16.6.0
2020-12	RAN#90	RP-202487	1259		A	Correction to CSI-RS RMC configuration R16	16.6.0
2020-12	RAN#90	RP-202487	1261		A	Correction to cell reselection test cases R16	16.6.0
2020-12	RAN#90	RP-202487	1263		A	Correction to inter-RAT handover test cases R16	16.6.0
2020-12	RAN#90	RP-202487	1265		A	Correction to NR measurement under LTE SA test cases R16	16.6.0
2020-12	RAN#90	RP-202487	1267		A	Correction to inter-RAT SFTD measurement test cases R16	16.6.0
2020-12	RAN#90	RP-202487	1271		A	CR on maintaining BFD/CBD measurements test cases in TS38.133 R16	16.6.0
2020-12	RAN#90	RP-202487	1273		F	CR on maintaining L1-RSRP measurements test cases R16	16.6.0
2020-12	RAN#90	RP-202446	1275	1	F	Correction CR to Rel-16 UE power saving requirements	16.6.0
2020-12	RAN#90	RP-202442	1276		F	Correction on DL interruption on Tx Switching between two uplink carriers	16.6.0
2020-12	RAN#90	RP-202433	1277	1	F	CR on CSI-RS based intra-frequency measurement requirements	16.6.0
2020-12	RAN#90	RP-202444	1281		F	Correction on RRC based spatial relation switch delay	16.6.0
2020-12	RAN#90	RP-202487	1282		F	Correction on SA inter-RAT measurement FR1 test case	16.6.0
2020-12	RAN#90	RP-202444	1283	1	F	CR on BWP switching delay on multiple CCs	16.6.0
2020-12	RAN#90	RP-202444	1284	1	F	CR on interruption due to active BWP switching on multiple CCs	16.6.0
2020-12	RAN#90	RP-202414	1288	1	F	CR on TCI state switching requirements for NR-U	16.6.0
2020-12	RAN#90	RP-202414	1291		F	CR on intra-frequency measurement requirements for NR-U	16.6.0
2020-12	RAN#90	RP-202486	1296		A	CR on RRC-based BWP switch requirements R16	16.6.0
2020-12	RAN#90	RP-202487	1298		A	CR on RRC-based active TCI state switch test case Rel-16	16.6.0
2020-12	RAN#90	RP-202425	1299		F	Update NR Frequency Band Groups to include Band n48	16.6.0
2020-12	RAN#90	RP-202439	1300		F	Update NR Frequency Band Groups to include Band n65	16.6.0
2020-12	RAN#90	RP-202446	1305		F	CR to 38.133: Correction to relaxed measurement requirements	16.6.0
2020-12	RAN#90	RP-202444	1306	1	F	CR to 38.133: Correction to relaxed measurement requirements	16.6.0
2020-12	RAN#90	RP-202444	1307	1	F	CR to 38.133: Correction to SRS carrier based switching requirements	16.6.0
2020-12	RAN#90	RP-202444	1308	1	F	CR to 38.133: Correction to mandatory gap pattern	16.6.0
2020-12	RAN#90	RP-202509	1309		F	[CR] NR Perf Maintenance R16 Cat F	16.6.0
2020-12	RAN#90	RP-202486	1311		A	[CR] Specify RRC processing delay in TCI state switching delay (Cat A)	16.6.0
2020-12	RAN#90	RP-202486	1317		A	CR on SCell activation requirements R16	16.6.0
2020-12	RAN#90	RP-202487	1319		A	CR on FR2 unknown SCell activation test cases R16	16.6.0
2020-12	RAN#90	RP-202487	1321		A	CR on BWP in L1-RSRP delay and accuracy test cases R16	16.6.0
2020-12	RAN#90	RP-202430	1322	1	F	CR on BWP switching and SCell dormancy	16.6.0
2020-12	RAN#90	RP-202441	1324	1	F	CR to update PRS-RSRP measurement requirements	16.6.0
2020-12	RAN#90	RP-202444	1328	1	F	CR on CGI reading requirements 38.133	16.6.0
2020-12	RAN#90	RP-202509	1330		F	[CR] Specify RRC processing delay in TCI state switching delay for R16 NR-U	16.6.0
2020-12	RAN#90	RP-202442	1331		F	Correction of CR0972 implementation	16.6.0
2020-12	RAN#90	RP-202487	1333		F	CR: Correction of CFRA test in FR2 SA	16.6.0
2020-12	RAN#90	RP-202434	1334	1	F	CR: Clarification of L1-SINR reporting with CSI-RS based CMR and dedicated IMR configured	16.6.0
2020-12	RAN#90	RP-202486	1336		A	Introducing reference to the source of the Lmax and NRLM.	16.6.0
2020-12	RAN#90	RP-202430	1338	2	F	CR on UE requirement for MR-DC early measurement reporting in 38.133	16.6.0
2020-12	RAN#90	RP-202444	1340		F	CR on measurement restrictions for FR2 inter-band CA	16.6.0
2020-12	RAN#90	RP-202487	1342		A	CR to TS 38.133: Corrections to inter-RAT FR1 test cases (Rel-16)	16.6.0
2020-12	RAN#90	RP-202487	1344		A	CR to TS 38.133: Corrections to inter-RAT FR2 test cases (Rel-16)	16.6.0
2020-12	RAN#90	RP-202436	1346		F	CR 38.133 Corrections to Conditional PCell Change delay requirement	16.6.0
2020-12	RAN#90	RP-202444	1347		F	CR 38.133 Removal of brackets for Multiple SCell activation	16.6.0
2020-12	RAN#90	RP-202430	1348	1	F	CR 38.133 Removal of brackets for SCell Dormancy and Direct SCell Activation	16.6.0
2020-12	RAN#90	RP-202487	1350		A	CR 38.133 Correction to test case for TCI state switching (Rel-16)	16.6.0
2020-12	RAN#90	RP-202418	1358	1	F	gNB timing positioning measurement report mapping update for k	16.6.0
2020-12	RAN#90	RP-202446	1360	1	F	Corrections to UE power saving requirements	16.6.0
2020-12	RAN#90	RP-202487	1364		A	Removal of annex B.2.6 on one shot timing adjustment in 38.133	16.6.0
2020-12	RAN#90	RP-202487	1366		F	Correction to NR FR1 DL active BWP switch of Cell with non-DRX in SA (A.6.5.6.2.1)	16.6.0
2020-12	RAN#90	RP-202444	1367	1	F	Correction to RRC based non-simultaneous multiple CC BWP	16.6.0
2020-12	RAN#90	RP-202414	1369		F	Requirements for known cell in RRC re-establishment with CCA	16.6.0
2020-12	RAN#90	RP-202435	1370		F	CR to TS 38.133: Corrections to Tables 9.5.4.1-1 and 9.5.4.2-1.	16.6.0
2020-12	RAN#90	RP-202486	1372	1	A	CR to 38.133 on Active BWP switch and Active TCI State Switching requirements - Rel16	16.6.0
2020-12	RAN#90	RP-202441	1375	2	F	UE positioning measurements: RSTD	16.6.0
2020-12	RAN#90	RP-202414	1384	1	F	Terminology updates for NR-U	16.6.0
2020-12	RAN#90	RP-202414	1387		F	Clause numbering correction	16.6.0
2020-12	RAN#90	RP-202414	1390	1	F	Measurement requirements for NR-U	16.6.0
2020-12	RAN#90	RP-202444	1391		F	Correction in NR SRS carrier-based switching requirements	16.6.0

2020-12	RAN#90	RP-202419	1393	1	B	Introduction of intra-frequency sync and async DAPS HO test cases in FR1	16.6.0
2020-12	RAN#90	RP-202430	1400	1	F	CR to Multi-SCell activation for FR1 intra-band contiguous CA	16.6.0
2020-12	RAN#90	RP-202430	1401		F	CR to Starting point of an Interruption window at Direct SCell activation	16.6.0
2020-12	RAN#90	RP-202414	1403	1	F	Interruption windows and applicability of Scell activation/deactivation requirements for SCells operating with CCA	16.6.0
2020-12	RAN#90	RP-202419	1406		B	CR on inter-band DAPS handover tests	16.6.0
2020-12	RAN#90	RP-202414	1407		F	Correction to timing requirements in NR-U	16.6.0
2020-12	RAN#90	RP-202417	1409		B	Big CR: Introduction of Rel-16 NR UE Power Saving RRM Performance requirements (TS 38.133)	16.6.0
2020-12	RAN#90	RP-202421	1410		B	Big CR: Introduction of Rel-16 NR FR1 RF WI RRM performance requirements	16.6.0
2020-12	RAN#90	RP-202422	1411		B	Big CR: NR HST RRM performance requirements	16.6.0
2020-12	RAN#90	RP-202487	1413		A	[CR] NR Perf Maintenance R16 Cat A	16.6.0
2021-03	RAN#91	RP-210116	1417		A	[CR] RRM test case maintenance R16 Cat A	16.7.0
2021-03	RAN#91	RP-210116	1423		A	Update FR2 Reference channels and OCNB for FR2 RRM Test cases	16.7.0
2021-03	RAN#91	RP-210116	1426		F	CR to FR1 SA SS-SINR measurement TCs	16.7.0
2021-03	RAN#91	RP-210116	1429		A	CR on E-UTRA carrier for EN-DC event triggered reporting tests	16.7.0
2021-03	RAN#91	RP-210116	1432		A	Add missing FR2 Test case setups and Beam assumptions	16.7.0
2021-03	RAN#91	RP-210091	1436		F	[CR] Core maintenance for 38.133	16.7.0
2021-03	RAN#91	RP-210071	1445		F	CR on maintenance for inter-band FR2 CA RRM R16	16.7.0
2021-03	RAN#91	RP-210071	1447	1	F	CR on UE behavior for UE specific CBW change R16	16.7.0
2021-03	RAN#91	RP-210091	1449	1	B	CR on IDLE/INACTIVE RRM requirement with SMTC2-LP R16	16.7.0
2021-03	RAN#91	RP-210070	1455	1	F	CR to 38.133 on Link Recovery requirements (R16)	16.7.0
2021-03	RAN#91	RP-210070	1457	1	F	CR to 38.133 on Pathloss activation delay requirements (R16)	16.7.0
2021-03	RAN#91	RP-210091	1464	1	F	Interruption requirements maintenance in NR-DC (R16)	16.7.0
2021-03	RAN#91	RP-210077	1466	1	F	CR on HST core part maintenance	16.7.0
2021-03	RAN#91	RP-210076	1470	1	F	CR on CSI-RS based L3 measurement	16.7.0
2021-03	RAN#91	RP-210081	1477	1	F	CR on PRS RSTD measurement requirements	16.7.0
2021-03	RAN#91	RP-210116	1495		A	Correction to cell reselection test case	16.7.0
2021-03	RAN#91	RP-210066	1497	1	F	Correction to cell reselection test case for UE Power saving	16.7.0
2021-03	RAN#91	RP-210073	1501		F	2-step RACH RRM performance requirements corrections	16.7.0
2021-03	RAN#91	RP-210116	1504		F	Update of DRX configuration in FR1 Event-triggered Test cases	16.7.0
2021-03	RAN#91	RP-210072	1506	1	B	Big CR-Introduction of NR V2X RRM performance requirements (Rel-16)	16.7.0
2021-03	RAN#91	RP-210070	1510		F	Correction on the measurement restriction for CSI-IM resource in R16	16.7.0
2021-03	RAN#91	RP-210116	1513		A	Correction on PRACH configuration for FR2 Non-Contention based Random Access in R16	16.7.0
2021-03	RAN#91	RP-210116	1516		A	Correction on PRACH configuration for Beam Failure Detection and Link Recovery Test in R16	16.7.0
2021-03	RAN#91	RP-210116	1519		A	Correction on PRACH RMC for FR1 CSI-RS based Non-Contention based Random Access for BFR in R16	16.7.0
2021-03	RAN#91	RP-210071	1521	1	F	Correction on scheduling availability and measurement restriction on FR2 inter-band CA in R16	16.7.0
2021-03	RAN#91	RP-210077	1526	1	F	CR on HST RRM requirements in connected mode	16.7.0
2021-03	RAN#91	RP-210070	1533	1	F	CR to TS38.133 on L1-SINR measurement requirement	16.7.0
2021-03	RAN#91	RP-210064	1535		B	Big CR: Introduction of Rel-16 NR eMIMO RRM performance requirements and test cases	16.7.0
2021-03	RAN#91	RP-210117	1538		A	CR on Scell activation delay maintenance (R16)	16.7.0
2021-03	RAN#91	RP-210116	1546		A	CR for test requirements correction of SA event triggered reporting tests for FR1 inter-frequency measurements with SSB time index detection when DRX is used	16.7.0
2021-03	RAN#91	RP-210117	1549		A	CR on R15 remaining issues	16.7.0
2021-03	RAN#91	RP-210072	1551	1	B	CR on V2X interruption	16.7.0
2021-03	RAN#91	RP-210091	1555	1	F	CR for measurement period requirements correction	16.7.0
2021-03	RAN#91	RP-210122	1559	1	F	Update on interruption test cases for Tx switching R16	16.7.0
2021-03	RAN#91	RP-210076	1561	1	F	Maintenance CR for CSI-RS based L3 measurement requirements R16	16.7.0
2021-03	RAN#91	RP-210116	1564		A	Correction on the power of the first preamble for random access in EN-DC and SA in R16	16.7.0
2021-03	RAN#91	RP-210116	1567		A	Correction on the time for Scell activation and CSI-report in R16	16.7.0
2021-03	RAN#91	RP-210116	1570		A	Correction on the Noc level in TS38.133 in R16	16.7.0
2021-03	RAN#91	RP-210079	1577	1	F	CR on TS38.133 for Pcell change	16.7.0
2021-03	RAN#91	RP-210071	1585	1	F	CR on TS38.133 for inter-frequency measurement requirement without gap	16.7.0
2021-03	RAN#91	RP-210076	1596	2	F	38.133 CR on the CSI-RS based measurement requirements	16.7.0
2021-03	RAN#91	RP-210122	1599	1	B	Big CR: Introduction of Rel-16 NR RRM enhancements WI performance requirements and test cases (Rel-16)	16.7.0
2021-03	RAN#91	RP-210084	1601	1	B	CR: Introduction of random access requirements with CCA	16.7.0
2021-03	RAN#91	RP-210084	1603	1	F	CR: Beam management requirements with CCA	16.7.0
2021-03	RAN#91	RP-210117	1606		A	CR on the filter for beam failure indications in 38.133	16.7.0

2021-03	RAN#91	RP-210081	1608	1	F	CR to TS 38.133 on UE Rx-Tx time difference measurements (section 9.9.4)	16.7.0
2021-03	RAN#91	RP-210091	1609	1	F	Maintenance CR on interruption at EUTRA SRS carrier switching in 38.133	16.7.0
2021-03	RAN#91	RP-210091	1610	1	F	Maintenance CR on SCell activation delay requirement in TS38.133	16.7.0
2021-03	RAN#91	RP-210116	1615		A	Correction to Aperiodic CSI-RS configurations R16	16.7.0
2021-03	RAN#91	RP-210116	1618		A	Correction to radio link monitoring test cases R16	16.7.0
2021-03	RAN#91	RP-210116	1621		A	Correction to beam failure recovery test cases R16	16.7.0
2021-03	RAN#91	RP-210116	1624		A	Correction to L1-RSRP reporting delay test cases R16	16.7.0
2021-03	RAN#91	RP-210084	1630		F	CR on measurement requirements for NR-U	16.7.0
2021-03	RAN#91	RP-210122	1635		A	CR on maintaining Antenna configurations in TS38.133 R16	16.7.0
2021-03	RAN#91	RP-210122	1638		A	CR on test requirements for measurement performance tests R16	16.7.0
2021-03	RAN#91	RP-210070	1642	1	F	CR on maintaining L1-SINR measurement requirements Rel-16	16.7.0
2021-03	RAN#91	RP-210071	1647		F	Correction on interruptions of SRS carrier switching	16.7.0
2021-03	RAN#91	RP-210071	1651	1	F	UL spatial relation switching to an unknown DL RS	16.7.0
2021-03	RAN#91	RP-210116	1654		A	Correction on test cases of inter-frequency Measurements R16	16.7.0
2021-03	RAN#91	RP-210122	1659	1	F	Correction on test cases of DL interruptions at switching between two uplink carriers	16.7.0
2021-03	RAN#91	RP-210081	1669	2	F	CR to 38.133 correction on CCSF for NR measurements for positioning	16.7.0
2021-03	RAN#91	RP-210072	1671		F	CR to 38.133 correction on reselection of V2X synchronization reference source requirements	16.7.0
2021-03	RAN#91	RP-210085	1673	1	F	Correction on inter-RAT E-UTRAN cells for UE configured with relaxed measurement criterion	16.7.0
2021-03	RAN#91	RP-210066	1674	1	F	Test case for cell reselection to FR2 intra-frequency NR case for UE configured with relaxed measurement	16.7.0
2021-03	RAN#91	RP-210076	1678		F	Correction on CSSFoutsidemap	16.7.0
2021-03	RAN#91	RP-210077	1682		F	Correction on inter-RAT measurement in high speed scenario	16.7.0
2021-03	RAN#91	RP-210084	1692		F	Maintenance CR for NR-U core requirements	16.7.0
2021-03	RAN#91	RP-210091	1696		F	Correction of band group notation for FR2	16.7.0
2021-03	RAN#91	RP-210087	1698		F	Correction to Idle Mode CA/DC Measurements for Inactive mode	16.7.0
2021-03	RAN#91	RP-210087	1700		F	CR clarifying the UE measurement requirements for an SCell with dormant BWP	16.7.0
2021-03	RAN#91	RP-210087	1702		F	Correction to simultaneous DCI based BWP switch delay on multiple CCs	16.7.0
2021-03	RAN#91	RP-210116	1713		A	CR to TS 38.133: Redundant and incorrect TCI state in tests with TRS (Rel-16)	16.7.0
2021-03	RAN#91	RP-210116	1716		A	CR to TS 38.133: Corrections to TC A.4.5.7.1 (Rel-16)	16.7.0
2021-03	RAN#91	RP-210071	1720	1	F	CR 38.133 (8.6.2A) Clarification on DCI-triggered BWP switch on multiple CCs	16.7.0
2021-03	RAN#91	RP-210084	1722	1	F	Updates in RLM requirements for NR-U	16.7.0
2021-03	RAN#91	RP-210084	1726	1	F	Terminology updates for NR-U in 38.133	16.7.0
2021-03	RAN#91	RP-210081	1732	2	F	PRS-RSRP measurement requirements	16.7.0
2021-03	RAN#91	RP-210084	1738		F	Applicability of RA with CCA on RRM requirements in NR-U in 38.133	16.7.0
2021-03	RAN#91	RP-210084	1743		F	CR on Active TCI state switching for NR-U	16.7.0
2021-03	RAN#91	RP-210071	1745		F	CR on maintenance on BWP switch requirements on multiple CCs	16.7.0
2021-03	RAN#91	RP-210116	1750		A	CR on test cases for inter-RAT measurement r16	16.7.0
2021-03	RAN#91	RP-210117	1753		A	CR on SCell activation delay, cell identification requirements on deactivated SCell and inter-RAT ECID requirements for NE-DC R16	16.7.0
2021-03	RAN#91	RP-210116	1756		A	CR on SCell activation TCs R16	16.7.0
2021-03	RAN#91	RP-210087	1758		F	CR on EMR requirement maintenance in 38.133	16.7.0
2021-03	RAN#91	RP-210087	1760	1	F	CR on SCell dormancy switching	16.7.0
2021-03	RAN#91	RP-210071	1770	1	F	CR on multiple SCell activation requirements	16.7.0
2021-03	RAN#91	RP-210071	1772	1	F	CR on CGI reading requirements 38.133	16.7.0
2021-03	RAN#91	RP-210116	1780		A	Cat-A CR to addition of TRS Configurations in Rel-16 Test Cases	16.7.0
2021-03	RAN#91	RP-210091	1787	1	F	Cat-F CR to addition of TRS Configurations in Rel-16 Test Case	16.7.0
2021-03	RAN#91	RP-210116	1789		A	CR on correcting SSB and RACH configuration in CSI-RS based beam failure detection and link recovery tests	16.7.0
2021-03	RAN#91	RP-210084	1791	1	F	CR on Interruptions during Scell activation in NR-U	16.7.0
2021-03	RAN#91	RP-210076	1795		F	CR on core requirement for CSI-RS L3 measurement	16.7.0
2021-06	RAN#92	RP-211083	1808		F	CR to A.3.14 CSI-RS configurations for nzp-CSI-RS-ResourceId values	16.8.0
2021-06	RAN#92	RP-211083	1811		A	CR to Interruptions during measurements on deactivated NR SCC	16.8.0
2021-06	RAN#92	RP-211083	1814		A	CR to CSI-RS based L1-RSRP measurement on resource set with repetition off TCs	16.8.0
2021-06	RAN#92	RP-211084	1817		A	CR to the notation of SMTC in the general test parameters of Re-establishment TCs	16.8.0
2021-06	RAN#92	RP-211084	1820		A	CR to BWP configuration for interruption test case.	16.8.0
2021-06	RAN#92	RP-211080	1826	1	F	Update of DRX configuration in Event-triggered Test cases	16.8.0
2021-06	RAN#92	RP-211084	1832		A	Update RRM Test cases where 66RBs gives insufficient dB range	16.8.0

2021-06	RAN#92	RP-211084	1835		A	Update Reference channels and OCNB for FR2 240kHz SSB SCS RRM Test cases	16.8.0
2021-06	RAN#92	RP-211084	1838		A	Cat-A CR to Cell Reselection Tests with Async Cells in Rel-16	16.8.0
2021-06	RAN#92	RP-211081	1840	1	F	Cat-F CR to Cell Reselection Tests with Async Cells in Rel-16	16.8.0
2021-06	RAN#92	RP-211085	1843		A	Cat-A CR to FR2 CORESET and Search Space RMC in Rel-16	16.8.0
2021-06	RAN#92	RP-211085	1846		A	Cat-A CR to PDSCH RMC in Rel-16	16.8.0
2021-06	RAN#92	RP-211085	1849		A	Cat-A CR to TRS Configuration in Rel-16 Test Case	16.8.0
2021-06	RAN#92	RP-211081	1851	1	F	FR1 Single SCell activation requirement with TCI activation [FR1_SCell_TCI_Act]	16.8.0
2021-06	RAN#92	RP-211085	1856		A	Maintenance CR for test cases - R16 Cat A	16.8.0
2021-06	RAN#92	RP-211102	1858	1	F	Correction to cell reselection test case for HST	16.8.0
2021-06	RAN#92	RP-211104	1860		F	Correction to cell reselection test case for UE Power saving	16.8.0
2021-06	RAN#92	RP-211085	1863		A	CR on BFD and link recovery test cases	16.8.0
2021-06	RAN#92	RP-211101	1865	1	F	CR on CSI-RS intra-frequency requirement and scheduling restriction	16.8.0
2021-06	RAN#92	RP-211101	1866	1	F	CR on CSI-RS based measurement requirements	16.8.0
2021-06	RAN#92	RP-211101	1869		B	Big CR: Introduction of Rel-16 CSI-RS based L3 measurement RRM performance requirements	16.8.0
2021-06	RAN#92	RP-211103	1870		F	CR on PRS RSTD measurement requirements	16.8.0
2021-06	RAN#92	RP-211101	1875		F	CR for clarification on frequency layer merging R16	16.8.0
2021-06	RAN#92	RP-211103	1877	1	F	CR on legacy Rel-16 HST NR UE measurement requirements (R16)	16.8.0
2021-06	RAN#92	RP-211097	1879	1	F	CR on RRC based BWP switching on multiple CCs of EN-DC for FR1 (R16)	16.8.0
2021-06	RAN#92	RP-211104	1881		F	Correction on the power of the first preamble for 2-step RACH	16.8.0
2021-06	RAN#92	RP-211086	1886		A	Maintenance on CSSF for EN-DC and deactivated SCell measurement R16	16.8.0
2021-06	RAN#92	RP-211095	1888	1	F	CR on reference cell availability for NR-U R16	16.8.0
2021-06	RAN#92	RP-211095	1890		F	CR on SCell activation requirement for NR-U R16	16.8.0
2021-06	RAN#92	RP-211097	1892	1	F	CR on interruption for SCell addition/release R16	16.8.0
2021-06	RAN#92	RP-211104	1901		F	CR to 38.133 on Link recovery requirements - R16	16.8.0
2021-06	RAN#92	RP-211097	1905	1	F	CR to 38.133 on Uplink Spatial relation switch for PUCCH - R16	16.8.0
2021-06	RAN#92	RP-211097	1906	2	F	CR to introduce test case for RRC based BWP switch on multiple CCs- SA in FR2 -R16	16.8.0
2021-06	RAN#92	RP-211095	1909		F	Terminology update for NR-U	16.8.0
2021-06	RAN#92	RP-211102	1913	1	F	CR on CSSFintra for HST measurement requirements	16.8.0
2021-06	RAN#92	RP-211101	1920		F	CR: RRM congestion control test cases for NR V2X	16.8.0
2021-06	RAN#92	RP-211097	1921	1	F	CR: CGI reading test	16.8.0
2021-06	RAN#92	RP-211097	1922	1	F	CR: UL spatial relation test	16.8.0
2021-06	RAN#92	RP-211097	1923	1	F	CR for test cases for simultaneous DCI and Timer based BWP switch on multiple CCs for NR SA	16.8.0
2021-06	RAN#92	RP-211081	1929	1	A	Correction on the SS-RSRP difference value for SS-RSRP measurement TC in R16	16.8.0
2021-06	RAN#92	RP-211081	1932	1	A	Correction on the CSI-reporting period for SCell activation delay in R16	16.8.0
2021-06	RAN#92	RP-211086	1939		A	CR on scheduling restriction of UE during intra-frequency measurements on FR2 in R16	16.8.0
2021-06	RAN#92	RP-211119	1941	1	F	CR on TS38.133 for direct SCell activation	16.8.0
2021-06	RAN#92	RP-211097	1943	1	D	CR on TS38.133 for typo modifications on intra frequency and inter frequency measurement requirement	16.8.0
2021-06	RAN#92	RP-211097	1945	1	F	CR to 38.133 correction on SRS carrier based switching core requirements	16.8.0
2021-06	RAN#92	RP-211097	1947	1	F	CR to 38.133 correction on SRS carrier based switching test cases	16.8.0
2021-06	RAN#92	RP-211103	1953	1	F	CR to 38.133 correction on CCSF for NR measurements for positioning	16.8.0
2021-06	RAN#92	RP-211096	1955		F	CR to 38.133 Introduction of Gain to PRS-RSRP measurement point for FR2 in Annex B	16.8.0
2021-06	RAN#92	RP-211097	1958	1	F	CR on TS38.133 inter-frequency without gap -r16 NOTE Part of the CR is not implemented because changes to clause 9.1.5.1 have no track marks.	16.8.0
2021-06	RAN#92	RP-211101	1959	1	F	CR to 38.133 Correction on core requirements for CSI-RS based measurement	16.8.0
2021-06	RAN#92	RP-211105	1969		F	CR to 38.133 Correction on the requirement of FR2 L1-SINR measurement accuracy (Rel-16)	16.8.0
2021-06	RAN#92	RP-211102	1976	1	F	CR on UE Rx-Tx time difference measurement period	16.8.0
2021-06	RAN#92	RP-211087	1982		A	CR to TS 38.133: Correction of TDD Configuration for several TCs (Rel-16)	16.8.0
2021-06	RAN#92	RP-211087	1985		A	CR to TS 38.133: Correction of OCNB pattern for several TCs (Rel-16)	16.8.0
2021-06	RAN#92	RP-211087	1988		A	CR to TS 38.133: Correction of IRAT TCs (Rel-16)	16.8.0
2021-06	RAN#92	RP-211087	1991		A	CR to TS 38.133: Corrections to SS-RSRP/RSRQ/SINR accuracy TCs (Rel 16)	16.8.0
2021-06	RAN#92	RP-211087	1994		A	CR to TS 38.133: Several corrections to TCs (Rel 16)	16.8.0

2021-06	RAN#92	RP-211087	1996		F	CR on maintaining condition requirements in TS38.133 R16	16.8.0
2021-06	RAN#92	RP-211102	1998	1	F	CR on maintaining L1-SINR measurement accuracy requirements R16	16.8.0
2021-06	RAN#92	RP-211106	2000		F	CR on maintaining L1-SINR measurement accuracy tests R16	16.8.0
2021-06	RAN#92	RP-211106	2002		F	CR on maintaining L1-SINR measurement requirements R16	16.8.0
2021-06	RAN#92	RP-211097	2004	1	F	CR on maintaining SCell activation and deactivation delay test for FR2 inter-band CA R16	16.8.0
2021-06	RAN#92	RP-211103	2006	1	F	CR on maintaining sync conditions for intra-band DAPS handover R16	16.8.0
2021-06	RAN#92	RP-211106	2008		F	CR on maintaining interruptions for intra-band DAPS handover R16	16.8.0
2021-06	RAN#92	RP-211095	2019		F	CR on Active TCI state switching for NR-U R16	16.8.0
2021-06	RAN#92	RP-211095	2021		F	CR on RLM requirements NR-U R16	16.8.0
2021-06	RAN#92	RP-211095	2023		F	CR on beam management requirements for NR-U R16	16.8.0
2021-06	RAN#92	RP-211095	2025		F	CR on measurement requirements for NR-U R16	16.8.0
2021-06	RAN#92	RP-211095	2027		F	CR on CSSF for NR-U R16	16.8.0
2021-06	RAN#92	RP-211098	2029		F	CR on maintenance of BWP Switch on multiple CCs 38133 R16	16.8.0
2021-06	RAN#92	RP-211087	2032		A	CR on measurement on deactivated SCell and interruption to NR serving cells for measurements on deactivated NR SCell	16.8.0
2021-06	RAN#92	RP-211101	2036	1	F	CR on time validity of the detected associatedSSB	16.8.0
2021-06	RAN#92	RP-211107	2040		F	Correction on test cases for inter-RAT cell identification in connected mode for HST	16.8.0
2021-06	RAN#92	RP-211101	2044		F	Adding intra-frequency CSI-RS measurement in CSSF	16.8.0
2021-06	RAN#92	RP-211097	2046	1	F	Correction on SRS carrier switching	16.8.0
2021-06	RAN#92	RP-211109	2054		F	Correction of test case of link recovery with link recovery requests	16.8.0
2021-06	RAN#92	RP-211088	2057		A	Correction to CSI-RS reference configuration_R16	16.8.0
2021-06	RAN#92	RP-211088	2061		A	Correction to reference configurations related to DLBWP.0.2_R16	16.8.0
2021-06	RAN#92	RP-211089	2064		A	Correction to TRS reference configuration_R16	16.8.0
2021-06	RAN#92	RP-211089	2067		A	Correction to FR1 test cases using DLBWP.0.2_R16	16.8.0
2021-06	RAN#92	RP-211089	2073		A	Correction to interruption during measurement on deactivated SCell test cases_R16	16.8.0
2021-06	RAN#92	RP-211089	2075		A	Correction of test parameters for SA inter-frequency event triggered reporting TCs	16.8.0
2021-06	RAN#92	RP-211089	2077		A	CR on Rel-15 SCell activation, SMTC determination and UL timing 38133 R16	16.8.0
2021-06	RAN#92	RP-211119	2079		F	CR on EMR requirements correction 38133	16.8.0
2021-06	RAN#92	RP-211119	2081		F	CR on direct SCell activation	16.8.0
2021-06	RAN#92	RP-211119	2083		F	CR on SCell dormancy requirements	16.8.0
2021-06	RAN#92	RP-211109	2085		F	CR on MG for PRS measurement 38.133 R16	16.8.0
2021-06	RAN#92	RP-211103	2093	1	F	CR on CSSF and measurement capability for PRS measurement 38.133	16.8.0
2021-06	RAN#92	RP-211097	2095	1	F	CR on SSB offset in multiple SCell activation	16.8.0
2021-06	RAN#92	RP-211097	2097	1	F	CR on SMTC alignment in multiple SCell activation	16.8.0
2021-06	RAN#92	RP-211101	2099	1	F	CR on CSI-RS measurement window	16.8.0
2021-06	RAN#92	RP-211119	2104	1	F	Big CR 38.133: Introduction of Rel-16 MR-DC Direct SCell activation and SCell dormancy RRM performance requirements NOTE Part of the CR is not implemented because CCR.2.3 TDD* are already exist	16.8.0
2021-06	RAN#92	RP-211090	2110		A	CR on NR-DC PSCell addition and release delay in Rel16 - Cat A	16.8.0
2021-06	RAN#92	RP-211090	2113		A	Maintenance CR for RRM test cases in Rel16 - Cat A	16.8.0
2021-06	RAN#92	RP-211097	2115	1	F	CR on RRC-based BWP switch on multiple CCs in Rel16 NOTE The CR is not implemented because the corresponding Cat A CR is not implementable.	16.8.0
2021-06	RAN#92	RP-211098	2116		A	CR on RRC-based BWP switch on multiple CCs in Rel17 - Cat A NOTE The CR is not implemented because the Cat A CR is not implementable.	16.8.0
2021-06	RAN#92	RP-211097	2117	1	F	CR on test case for RRC-based BWP switch on multiple CCs - TC3	16.8.0
2021-06	RAN#92	RP-211102	2122	1	F	Changes to cell reselection tests under power saving	16.8.0
2021-06	RAN#92	RP-211119	2126	1	F	CR for Direct SCell activation delay	16.8.0
2021-06	RAN#92	RP-211103	2128	1	F	CR to TS 38.133: Adding conditions for L1-SINR reporting (Annex B.2)	16.8.0
2021-06	RAN#92	RP-211119	2130	1	F	CR Correction of activation delay for Direct activated SCell	16.8.0
2021-06	RAN#92	RP-211091	2138		A	Correction to AoA setup in FR2	16.8.0
2021-06	RAN#92	RP-211081	2140	1	F	Correction to AoA setup and beam assumptions in FR2 tests in Rel-16	16.8.0
2021-06	RAN#92	RP-211102	2142	1	F	Correction to beam assumptions in L1-SINR FR2 tests	16.8.0
2021-06	RAN#92	RP-211097	2144	1	F	Correction to beam assumptions in FR2 tests on Rel-16 Mandatory gaps	16.8.0
2021-06	RAN#92	RP-211097	2146	1	F	Correction to beam assumptions in FR2 tests on UL spatial relation	16.8.0
2021-06	RAN#92	RP-211110	2148		F	Correction to HO tests in FR2 under mobility enhancements	16.8.0
2021-06	RAN#92	RP-211102	2152	1	F	PRS-RSRP measurement requirements	16.8.0

2021-06	RAN#92	RP-211095	2162	1	F	Interruption during Scell activation requirements for SCells operating with CCA	16.8.0
2021-06	RAN#92	RP-211095	2164	1	F	SI reading time in RRC mobility control	16.8.0
2021-06	RAN#92	RP-211095	2168		F	Updates in SCell activation in NR-U	16.8.0
2021-06	RAN#92	RP-211095	2170		F	NR-U bands	16.8.0
2021-06	RAN#92	RP-211095	2172	1	F	Big CR: Introduction of Rel-16 NR-U RRM performance	16.8.0
2021-06	RAN#92	RP-211119	2174		F	CR for core requirement maintenance on direct SCell activation R16	16.8.0
2021-06	RAN#92	RP-211119	2176		B	Big CR: Introduction of Rel-16 MR-DC EMR RRM performance requirements (TS 38.133) NOTE Part of the CR is not implemented because new clause have no reference point	16.8.0
2021-06	RAN#92	RP-211097	2178	1	F	CR on introducing RRC based Active BWP Switch on multiple CCs in EN-DC FR2	16.8.0
2021-06	RAN#92	RP-211081	2180		A	Core requirement maintenance on signal characteristics (R16)	16.8.0
2021-06	RAN#92	RP-211102	2181		F	Introduce the SCell beam failure recovery without the dedicated PUCCH resource in R16	16.8.0
2021-06	RAN#92	RP-211096	2183		B	Big CR: Introduction of Rel-16 NR Positioning RRM performance requirements and test cases	16.8.0
2021-09	RAN#93	RP-211922	2198		F	Big CR to TS 38.133: NR_newRAT-Core maintenance (Rel-16)	16.9.0
2021-09	RAN#93	RP-211925	2201		F	Big CR to TS 38.133: NR_newRAT-Perf maintenance Part 1 (Rel-16)	16.9.0
2021-09	RAN#93	RP-211925	2204		F	Big CR to TS 38.133: NR_newRAT-Perf maintenance Part 2 (Rel-16)	16.9.0
2021-09	RAN#93	RP-211925	2207		F	Big CR to TS 38.133: NR_newRAT-Perf maintenance Part 3 (Rel-16)	16.9.0
2021-09	RAN#93	RP-211890	2209		F	Big CR to TS 38.133: NR_unlic maintenance Part 1 (Rel-16)	16.9.0
2021-09	RAN#93	RP-211890	2211		F	Big CR to TS 38.133: NR_unlic maintenance Part 2 (Rel-16)	16.9.0
2021-09	RAN#93	RP-211893	2213		F	Big CR to TS 38.133: NR_pos maintenance (Rel-16)	16.9.0
2021-09	RAN#93	RP-211891	2215		F	Big CR to TS 38.133: Rel-16 WIs RRM maintenance Part 1 (Rel-16)	16.9.0
2021-09	RAN#93	RP-211893	2217		F	Big CR to TS 38.133: Rel-16 WIs RRM maintenance Part 2 (Rel-16)	16.9.0
2021-12	RAN#94	RP-212854	2238		A	Big CR to TS 38.133: NR_newRAT-Core maintenance (Rel-16)	16.10.0
2021-12	RAN#94	RP-212846	2241		F	Big CR to TS 38.133: NR_newRAT-Perf maintenance (Rel-16)	16.10.0
2021-12	RAN#94	RP-212847	2243		F	Big CR to TS 38.133: Rel-16 WIs RRM maintenance Part 1 (Rel-16)	16.10.0
2021-12	RAN#94	RP-212849	2245		F	Big CR to TS 38.133: Rel-16 WIs RRM maintenance Part 2 (Rel-16)	16.10.0
2021-12	RAN#94	RP-212847	2247		F	Big CR to TS 38.133: Rel-16 WIs RRM maintenance Part 3 (Rel-16)	16.10.0
2021-12	RAN#94	RP-212847	2249		F	Big CR to TS 38.133: Rel-16 WIs RRM maintenance Part 4 (Rel-16)	16.10.0
2022-03	RAN#95	RP-220337	2271		F	Big CR to TS 38.133: NR_newRAT-Core maintenance (Rel-16)	16.11.0
2022-03	RAN#95	RP-220337	2274	1	F	Big CR to TS 38.133: NR_newRAT-Perf maintenance (Rel-16)	16.11.0
2022-03	RAN#95	RP-220334	2276		F	Big CR to TS 38.133: Rel-16 WIs RRM maintenance Part 1 (Rel-16)	16.11.0
2022-03	RAN#95	RP-220339	2278		F	Big CR to TS 38.133: Rel-16 WIs RRM maintenance Part 2 (Rel-16)	16.11.0
2022-03	RAN#95	RP-220339	2280		F	Big CR to TS 38.133: Rel-16 WIs RRM maintenance Part 3 (Rel-16)	16.11.0
2022-06	RAN#96	RP-221655	2405		F	Big CR for TS 38.133 Core Maintenance Part-1 (Rel-16)	16.12.0
2022-06	RAN#96	RP-221655	2408		F	Big CR for TS 38.133 Core Maintenance Part-2 (Rel-16)	16.12.0
2022-06	RAN#96	RP-221660	2411		F	Big CR for TS 38.133 Perf Maintenance Part-1 (Rel-16)	16.12.0
2022-06	RAN#96	RP-221660	2414		F	Big CR for TS 38.133 Perf Maintenance Part-2 (Rel-16)	16.12.0
2022-09	RAN#97	RP-222023	2569		F	Big CR for 38.133 maintenance part1 (Rel-16)	16.13.0
2022-09	RAN#97	RP-222559	2571	1	F	Big CR for 38.133 maintenance part2 (Rel-16)	16.13.0
2022-12	RAN#98-e	RP-223297	2660	1	F	CR to TS 38.133: Corrections to NR positioning and high speed train test cases (Rel 16)	16.14.0
2022-12	RAN#98-e	RP-223290	2663		A	CR on NR RRM maintenance R16	16.14.0
2022-12	RAN#98-e	RP-223291	2670	1	D	Editorial CR on scheduling restrictions for L3 measurements in FR2 (Rel-16)	16.14.0
2022-12	RAN#98-e	RP-223293	2675	1	F	CR to CSI-RS, RLM and BWP switching in annex	16.14.0
2022-12	RAN#98-e	RP-223292	2678		A	Update on Scell activation and deactivation and Control Channel RMC for RLM FR2 (Rel-16)	16.14.0
2022-12	RAN#98-e	RP-223292	2681		A	Update to L1-RSRP test scenarios (Rel-16)	16.14.0
2022-12	RAN#98-e	RP-223297	2685	1	F	Modification on TS38.133 for Rel-16	16.14.0
2022-12	RAN#98-e	RP-223297	2690		F	CR on positioning measurement accuracy requirements in R16	16.14.0
2022-12	RAN#98-e	RP-223292	2694		A	R16 Cat-A CR testcase correction from R15 TS 38.133	16.14.0
2022-12	RAN#98-e	RP-223293	2696	1	F	R16 Cat-F CR testcase correction from R16 TS 38.133	16.14.0
2022-12	RAN#98-e	RP-223292	2701		A	CR on test case correction for timing advance	16.14.0
2022-12	RAN#98-e	RP-223296	2704		F	38133 CR on SRS configuration for SRS carrier based switching	16.14.0
2022-12	RAN#98-e	RP-223292	2710		A	CR on TC for known PSCell addition in R16	16.14.0

2022-12	RAN#98-e	RP-223292	2713		A	CR on TC for inter-RAT NR Cell reselection in R16	16.14.0
2022-12	RAN#98-e	RP-223296	2733	1	F	Correction of L1 L3 measurement measurement sharing factors for inter-frequency L3 measurement performed outside gaps in R16	16.14.0
2022-12	RAN#98-e	RP-223293	2748	2	F	Correction on Aperiodic CSI-RS RMCs and RLM in-sync test cases for R16	16.14.0
2022-12	RAN#98-e	RP-223297	2756	1	F	CR on positioning requirements R16	16.14.0
2022-12	RAN#98-e	RP-223296	2771	2	F	Correction to Idle Mode CA/DC Measurement Tests in TS 38.133	16.14.0
2022-12	RAN#98-e	RP-223297	2778	1	F	CR on Rel-16 measurements and UE specific CBW switch maintenance	16.14.0
2023-03	RAN#99	RP-230505	2696	3	F	R16 Cat-F CR CLI measurement testcase correction	16.15.0
2023-03	RAN#99	RP-230504	2794		A	CR on TC for FR2 inter-frequency relative accuracy in R16	16.15.0
2023-03	RAN#99	RP-230504	2798		A	CR on TC for known PSCell addition in R16	16.15.0
2023-03	RAN#99	RP-230504	2802		A	CR to SNR on RLM-RS2 for FR2 CSI-RS based RLM OOS/IS tests	16.15.0
2023-03	RAN#99	RP-230506	2806	1	F	CR to SNR of q0 level for BFD and LR in FR2	16.15.0
2023-03	RAN#99	RP-230504	2810		A	CR to ConfigNo of SSB Configuration and CSI-RS for tracking in redirection test	16.15.0
2023-03	RAN#99	RP-230505	2829		A	R16 Cat-A CR SA NR-LTE HO testcase correction	16.15.0
2023-03	RAN#99	RP-230506	2848	1	F	CR on positioning test case in R16	16.15.0
2023-03	RAN#99	RP-230499	2857		F	Sidelink R16 resource selection test configuration correction	16.15.0
2023-03	RAN#99	RP-230514	2864		F	FR1 HST L1-RSRP test configuration correction	16.15.0
2023-03	RAN#99	RP-230500	2876		F	Correction on test cases for direct SCell activation delay	16.15.0
2023-03	RAN#99	RP-230507	2909	1	F	CR on TC maintenance for NR-U R16	16.15.0
2023-03	RAN#99	RP-230506	2934		F	PRS measurement period for Deferred MT-LR with event "Periodic Location"	16.15.0
2023-03	RAN#99	RP-230503	2944		F	CR on measurement requirements with per-FR gap R16	16.15.0
2023-03	RAN#99	RP-230506	2950		F	CR on positioning test cases R16	16.15.0
2023-03	RAN#99	RP-230506	2953		F	CR on positioning accuracy requirements R16	16.15.0
2023-03	RAN#99	RP-230507	2976	1	F	Correction to CBW change TCs_R16	16.15.0
2023-03	RAN#99	RP-230513	2982	1	F	CR on correction of eMIMO test cases R16	16.15.0
2023-03	RAN#99	RP-230500	3049		F	Correction to Inter-RAT Idle Mode CA/DC Measurement Tests in TS 38.133	16.15.0
2023-03	RAN#99	RP-230507	3066	1	F	CR on RLM OOS and IS tests with no DRX in NR-U standalone mode	16.15.0
2023-03	RAN#99	RP-230507	3067	1	F	CR on BFD and LR tests in NR-U standalone mode	16.15.0
2023-03	RAN#99	RP-230505	3077		F	CR to TS 38.133: Corrections to NR RRM test cases (Rel 16)	16.15.0
2023-03	RAN#99	RP-230506	3080		F	CR to TS 38.133: Corrections to NR positioning requirements (Rel 16)	16.15.0
2023-03	RAN#99	RP-230506	3093		F	CR to TS38.133: Revise the Measured quantity value(ZoA)	16.15.0
2023-03	RAN#99	RP-230506	3095		F	CR to TS38.133:Revise the abbreviation of AoA, A-AoA and ZoA	16.15.0
2023-06	RAN#100	RP-231358	3110		F	CR on relationship between SNR, RSRP level and thresholds for FR1 BFD and LR	16.16.0
2023-06	RAN#100	RP-231357	3114		A	CR (CAT-A) on R15 NR Inter-RAT measurements testcase correction	16.16.0
2023-06	RAN#100	RP-231357	3122		A	CR to TS 38.133: Corrections to NR RRM test cases (Rel 16)	16.16.0
2023-06	RAN#100	RP-231354	3128	1	F	Corrections to RRM HST A.6.1.1.7 (Rel-16)	16.16.0
2023-06	RAN#100	RP-231340	3137	1	F	Update of RRM DCCA SCell activation and deactivation test cases	16.16.0
2023-06	RAN#100	RP-231354	3138	1	F	Update to RRM idle mode HST test cases	16.16.0
2023-06	RAN#100	RP-231357	3141		A	CR to FR2 RLM In-syn test cases (Cat-A Rel-16)	16.16.0
2023-06	RAN#100	RP-231355	3155		A	CR of known cell condition for HO on 38.133 R16	16.16.0
2023-06	RAN#100	RP-231341	3159	1	F	Clarification on MRTD/MTTD and interruption requirement for EN-DC in Rel-16	16.16.0
2023-06	RAN#100	RP-231357	3196		A	Correction to inter-RAT NR measurement TCs_R16	16.16.0
2023-06	RAN#100	RP-231357	3200		A	Correction to inter-frequency NR measurement TCs_R16	16.16.0
2023-09	RAN#101	RP-232487	3376		A	CR (CAT-A) on FR2 Active TCI state switch delay testcase correction	16.17.0
2023-09	RAN#101	RP-232488	3383		F	LTE_NR_DC_CA_enh-Perf Update of RRM DCCA SCell activation and deactivation test cases	16.17.0
2023-09	RAN#101	RP-232503	3397		A	[NR_newRAT-Perf] CR to BWP Switch Delay TCs	16.17.0
2023-09	RAN#101	RP-232500	3404		F	On NE-DC requirement (R16)	16.17.0
2023-09	RAN#101	RP-232502	3410		A	[NR_newRAT-Perf] CR for Active TCI State switch test requirements - Rel16	16.17.0
2023-09	RAN#101	RP-232499	3413		F	[NR_RRM_enh-Perf] Editorial CR for Spatial relation info switch test requirements - Rel16	16.17.0
2023-09	RAN#101	RP-232500	3418		F	CR on additional UE gain - R16	16.17.0
2023-09	RAN#101	RP-232495	3438		F	CR on R16 positioning performance requirements	16.17.0
2023-09	RAN#101	RP-232491	3444		F	NR_HST-Perf Clarification to RRM HST A.6.1.1.7 (Rel-16)	16.17.0
2023-09	RAN#101	RP-232501	3473		F	[NR_newRAT-Core] Correction to P factor for RLM BFD CBD and L1RSRP_R16	16.17.0



2023-09	RAN#101	RP-232496	3476		F	[NR_UE_pow_sav-Perf] Correction to relaxed idle measurement TCs_R16	16.17.0
2023-09	RAN#101	RP-232499	3479		F	[NR_RRM_Enh-Perf] Correction to simultaneous BWP switching TCs_R16	16.17.0
2023-09	RAN#101	RP-232499	3486		F	[NR_unlic-Perf] CR on TC maintenance for NR-U	16.17.0
2023-09	RAN#101	RP-232499	3515	1	F	[NR_RRM_Enh-Perf] CR: Correction of SRS configuration for SRS carrier based switching tests	16.17.0
2023-09	RAN#101	RP-232495	3518		F	[NR_pos-Perf] CR on Rx-Tx accuracy requirements	16.17.0
2023-09	RAN#101	RP-232487	3535		A	CR on maintaining SS-RSRQ/SS-SINR measurement accuracy tests R16	16.17.0
2023-09	RAN#101	RP-232500	3547		F	TEI16 Update MRTD/MTTD and interruption requirements for non-collocated inter-band EN-DC in Rel-16	16.17.0
2023-09	RAN#101	RP-232484	3589		B	NR_unlic CR correcting NR-U infra frequency RSRP test cases	16.17.0
2023-09	RAN#101	RP-232499	3592		F	NR_unlic CR correcting NR-U RRC re-establishment RSRP test cases	16.17.0
2023-09	RAN#101	RP-232503	3615		A	[NR_newRAT-Perf] Inter-frequency measurement for UE capable of independentGapConfig (Cat-A Rel-16)	16.17.0
2023-09	RAN#101	RP-232503	3629		A	2AoA Relative angular offset between active probes for PC1 devices (Rel-16)	16.17.0
2023-09	RAN#101	RP-232499	3636	1	F	[NR_unlic-Perf] CR to correct NR-U test cases	16.17.0
2023-12	RAN#102	RP-233342	3661		F	CR on R16 positioning test cases	16.18.0
2023-12	RAN#102	RP-233341	3669		F	[NR_RRM_Enh-Perf] Maintenance perf part CR on event triggered reporting tests with additional mandatory gap pattern R16	16.18.0
2023-12	RAN#102	RP-233330	3684		F	CR on RRM test cases with testability issues - R16	16.18.0
2023-12	RAN#102	RP-233330	3687		F	On MRTD/MTTD requirement for inter-band non-collocated EN-DC/NE-DC (R16)	16.18.0
2023-12	RAN#102	RP-233342	3723		F	Draft CR on CSSF in NR-U	16.18.0
2023-12	RAN#102	RP-233338	3726		F	Draft CR on inter-frequency measurement without gap in CHO	16.18.0
2023-12	RAN#102	RP-233333	3730		A	[NR_newRAT-Perf] CR of correction in TC A.6.5.5.4	16.18.0
2023-12	RAN#102	RP-233340	3735	1	F	Correction on measurements for UE configured with relaxed measurement criterion	16.18.0
2023-12	RAN#102	RP-233333	3744		F	[NR_newRAT-Perf] Correction to CORESET RMC and SS-RSRQ accuracy test cases_R16	16.18.0
2023-12	RAN#102	RP-233341	3819		F	[NR_RRM_Enh-Perf] CR on TCs for UE specific CBW change R16	16.18.0
2023-12	RAN#102	RP-233334	3824		A	NR_newRAT-Perf CR clarification on MAC-CE based TCI state switch delay	16.18.0
2023-12	RAN#102	RP-233341	3842	2	F	[NR_RRM_Enh-Core] CR on the SCell activation	16.18.0
2023-12	RAN#102	RP-233342	3868		A	[NR_unlic-Core]: Modify the condition for gradual timing adjustment.	16.18.0
2023-12	RAN#102	RP-233330	3896	1	F	Corrections to NR Measurements with Autonomous Gaps	16.18.0
2023-12	RAN#102	RP-233341	3899	1	F	Correction of measurement gap parameters for additional rel-16 mandatory gap patterns test case	16.18.0
2023-12	RAN#102	RP-233342	3930		F	[NR_unlic] EN-DC intra-frequency measurement test cases for NR-U – R16	16.18.0
2023-12	RAN#102	RP-233342	3944		F	[NR_unlic-Perf] HO test cases under CCA update	16.18.0
2024-03	RAN#103	RP-240555	4133		F	(LTE_NR_DC_CA_Enh-Core) CR to correct Inactive mode CA/DC measurement requirements	16.19.0
2024-03	RAN#103	RP-240559	4006	1	F	CR on combination of HST and RRM relaxation - R16	16.19.0
2024-03	RAN#103	RP-240562	4019		A	(NR_newRAT) CR on NR-E-UTRAN HO requirement maintenance R16	16.19.0
2024-03	RAN#103	RP-240563	4139		A	(NR_newRAT-Core) CR to correct and clarify Rel-15 TCI state switching delay requirements	16.19.0
2024-03	RAN#103	RP-240564	4218		A	(NR_newRAT-Core) CR on MG related requirements R16	16.19.0
2024-03	RAN#103	RP-240566	3981		A	(NR_newRAT-Perf) CR to A.6.3.2.1.3 Intra-freq RRC re-establishment	16.19.0
2024-03	RAN#103	RP-240566	3987		A	(NR_newRAT-Perf) CR to FR1 SA intra-frequency SS-RSRQ measurement accuracy	16.19.0
2024-03	RAN#103	RP-240566	3991		A	(NR_newRAT-Perf) CR to CORESET and PDSCH RMCs of A.5.6.1.3, A.5.3.1.4 SSB SCS 240kHz config	16.19.0
2024-03	RAN#103	RP-240567	4050		A	(NR_newRAT-Perf) 38.133 CR on corrections for SMTC configuration – R16	16.19.0
2024-03	RAN#103	RP-240567	4115		A	(NR_newRAT-Perf) Corrections to TCI states switching test cases R16	16.19.0
2024-03	RAN#103	RP-240568	4119		A	(NR_newRAT-Perf) Correcting propagation condition of test cases not configuring Noc Rel-16	16.19.0
2024-03	RAN#103	RP-240568	4191		A	(NR_newRAT-Perf)CR on test cases for SCell activation delay reduction in R16	16.19.0
2024-03	RAN#103	RP-240568	4259		A	(NR_newRAT-Perf) Inter-frequency measurement for UE capable of independentGapConfig (Cat-A Rel-15)	16.19.0
2024-03	RAN#103	RP-240571	3965		F	(NR_pos-Perf) CR on positioning test cases in R16	16.19.0
2024-03	RAN#103	RP-240575	4221		F	(NR_RRM_Enh-Core) CR on multiple SCell activation requirements	16.19.0
2024-03	RAN#103	RP-240575	4087	1	F	(NR_RRM_Enh-Perf) Maintenance perf part CR on event triggered reporting tests with additional mandatory gap pattern (Rel-16)	16.19.0

2024-03	RAN#103	RP-240575	4096	1	F	(NR_RRM_Enh-Perf) Correction to CGI measurement test cases_R16	16.19.0
2024-03	RAN#103	RP-240575	4144	1	F	(NR_RRM_enh-Perf) corrections for FR2 inter-band SCell activation TC – R16	16.19.0
2024-03	RAN#103	RP-240576	4046		F	(NR_unlic-Perf) Correction CR on UL CCA model (R16)	16.19.0
2024-03	RAN#103	RP-240576	4022	1	F	(NR_unlic-Core)CR on max function for cell dection in NR-U R16	16.19.0
2024-03	RAN#103	RP-240576	4270	1	F	(NR_unlic-Perf) CR for NR-U TC correction (R16)	16.19.0

# History

<b>Document history</b>		
V16.4.0	August 2020	Publication
V16.5.0	December 2020	Publication
V16.6.0	February 2021	Publication
V16.7.0	June 2021	Publication
V16.8.0	September 2021	Publication
V16.9.0	December 2021	Publication
V16.10.0	April 2022	Publication
V16.11.0	May 2022	Publication
V16.12.0	July 2022	Publication
V16.13.0	January 2023	Publication
V16.14.0	January 2023	Publication
V16.15.0	June 2023	Publication
V16.16.0	July 2023	Publication
V16.17.0	October 2023	Publication
V16.18.0	February 2024	Publication
V16.19.0	June 2024	Publication