

ETSI TS 138 151 V18.3.0 (2025-01)



**5G;  
NR;  
User Equipment (UE) Multiple Input Multiple Output (MIMO)  
Over-the-Air (OTA) performance requirements  
(3GPP TS 38.151 version 18.3.0 Release 18)**



---

**Reference**

RTS/TSGR-0438151 vi30

---

**Keywords**

5G

**ETSI**

---

650 Route des Lucioles  
F-06921 Sophia Antipolis Cedex - FRANCE

Tel.: +33 4 92 94 42 00 Fax: +33 4 93 65 47 16

Siret N° 348 623 562 00017 - APE 7112B  
Association à but non lucratif enregistrée à la  
Sous-Préfecture de Grasse (06) N° w061004871

---

**Important notice**

The present document can be downloaded from the  
[ETSI Search & Browse Standards application](#).

The present document may be made available in electronic versions and/or in print. The content of any electronic and/or print versions of the present document shall not be modified without the prior written authorization of ETSI. In case of any existing or perceived difference in contents between such versions and/or in print, the prevailing version of an ETSI deliverable is the one made publicly available in PDF format on [ETSI deliver repository](#).

Users should be aware that the present document may be revised or have its status changed, this information is available in the [Milestones listing](#).

If you find errors in the present document, please send your comments to the relevant service listed under [Committee Support Staff](#).

If you find a security vulnerability in the present document, please report it through our [Coordinated Vulnerability Disclosure \(CVD\)](#) program.

---

**Notice of disclaimer & limitation of liability**

The information provided in the present deliverable is directed solely to professionals who have the appropriate degree of experience to understand and interpret its content in accordance with generally accepted engineering or other professional standard and applicable regulations.

No recommendation as to products and services or vendors is made or should be implied.

No representation or warranty is made that this deliverable is technically accurate or sufficient or conforms to any law and/or governmental rule and/or regulation and further, no representation or warranty is made of merchantability or fitness for any particular purpose or against infringement of intellectual property rights.

In no event shall ETSI be held liable for loss of profits or any other incidental or consequential damages.

Any software contained in this deliverable is provided "AS IS" with no warranties, express or implied, including but not limited to, the warranties of merchantability, fitness for a particular purpose and non-infringement of intellectual property rights and ETSI shall not be held liable in any event for any damages whatsoever (including, without limitation, damages for loss of profits, business interruption, loss of information, or any other pecuniary loss) arising out of or related to the use of or inability to use the software.

---

**Copyright Notification**

No part may be reproduced or utilized in any form or by any means, electronic or mechanical, including photocopying and microfilm except as authorized by written permission of ETSI.

The content of the PDF version shall not be modified without the written authorization of ETSI.

The copyright and the foregoing restriction extend to reproduction in all media.

© ETSI 2025.  
All rights reserved.

---

# Intellectual Property Rights

## Essential patents

IPRs essential or potentially essential to normative deliverables may have been declared to ETSI. The declarations pertaining to these essential IPRs, if any, are publicly available for **ETSI members and non-members**, and can be found in ETSI SR 000 314: "*Intellectual Property Rights (IPRs); Essential, or potentially Essential, IPRs notified to ETSI in respect of ETSI standards*", which is available from the ETSI Secretariat. Latest updates are available on the [ETSI IPR online database](#).

Pursuant to the ETSI Directives including the ETSI IPR Policy, no investigation regarding the essentiality of IPRs, including IPR searches, has been carried out by ETSI. No guarantee can be given as to the existence of other IPRs not referenced in ETSI SR 000 314 (or the updates on the ETSI Web server) which are, or may be, or may become, essential to the present document.

## Trademarks

The present document may include trademarks and/or tradenames which are asserted and/or registered by their owners. ETSI claims no ownership of these except for any which are indicated as being the property of ETSI, and conveys no right to use or reproduce any trademark and/or tradename. Mention of those trademarks in the present document does not constitute an endorsement by ETSI of products, services or organizations associated with those trademarks.

**DECT™**, **PLUGTESTS™**, **UMTS™** and the ETSI logo are trademarks of ETSI registered for the benefit of its Members. **3GPP™**, **LTE™** and **5G™** logo are trademarks of ETSI registered for the benefit of its Members and of the 3GPP Organizational Partners. **oneM2M™** logo is a trademark of ETSI registered for the benefit of its Members and of the oneM2M Partners. **GSM®** and the GSM logo are trademarks registered and owned by the GSM Association.

---

# Legal Notice

This Technical Specification (TS) has been produced by ETSI 3rd Generation Partnership Project (3GPP).

The present document may refer to technical specifications or reports using their 3GPP identities. These shall be interpreted as being references to the corresponding ETSI deliverables.

The cross reference between 3GPP and ETSI identities can be found at [3GPP to ETSI numbering cross-referencing](#).

---

# Modal verbs terminology

In the present document "**shall**", "**shall not**", "**should**", "**should not**", "**may**", "**need not**", "**will**", "**will not**", "**can**" and "**cannot**" are to be interpreted as described in clause 3.2 of the [ETSI Drafting Rules](#) (Verbal forms for the expression of provisions).

"**must**" and "**must not**" are **NOT** allowed in ETSI deliverables except when used in direct citation.

# Contents

Intellectual Property Rights .....	2
Legal Notice .....	2
Modal verbs terminology.....	2
Foreword.....	5
1 Scope .....	7
2 References .....	7
3 Definitions of terms, symbols and abbreviations .....	8
3.1 Terms.....	8
3.2 Symbols.....	8
3.3 Abbreviations .....	8
4 General .....	9
4.1 Relationship between minimum requirements and test requirements .....	9
4.2 Applicability of minimum requirements .....	9
4.3 Applicability rules for testing of SA and NSA UEs.....	9
5 Frequency bands.....	10
5.1 General .....	10
5.2 Operating bands.....	10
6 FR1 MIMO OTA requirements.....	13
6.1 General .....	13
6.1.1 Definition of MIMO throughput.....	13
6.1.2 Total Radiated Multi-antenna Sensitivity (TRMS).....	13
6.2 Minimum requirement.....	14
7 FR2 MIMO OTA requirements.....	14
7.1 General .....	14
7.1.1 MIMO Average Spherical Coverage (MASC) .....	14
7.2 Minimum requirement.....	15
<b>Annex A (normative):      &lt;FR1 Test methodology&gt; .....</b>	<b>16</b>
A.1 General .....	16
A.2 Multi-Probe Anechoic Chamber (MPAC).....	16
A.2.1 System setup.....	16
A.2.2 Calibration procedure .....	17
A.2.3 Test procedure .....	17
A.2.4 Minimum Range Length .....	18
A.2.5 Preliminary MU budget of FR1 MPAC system .....	18
A.3 EUT positioning .....	19
<b>Annex B (normative):      &lt;FR2 Test methodology&gt; .....</b>	<b>22</b>
B.1 General .....	22
B.2 FR2 3D Multi-Probe Anechoic Chamber (3D-MPAC).....	22
B.2.1 System setup.....	22
B.2.2 Calibration procedure .....	24
B.2.3 Test procedure .....	24
B.2.4 Minimum Range Length .....	26
B.2.5 Preliminary MU of FR2 3D-MPAC system.....	27
B.2.6 Sample Device Orientations for Selected Test Points .....	28
B.3 EUT positioning .....	31

<b>Annex C (normative):</b>	<b>&lt;FR1 Channel models and Validation procedure&gt;</b>	<b>32</b>
C.1	FR1 Channel models	32
C.2	FR1 Base Station beam configuration	33
C.3	FR1 Channel model validation	34
C.3.1	General	34
C.3.2	Power Delay Profile (PDP)	35
C.3.3	Doppler/Temporal correlation	38
C.3.4	Spatial correlation	41
C.3.5	Cross-polarization	48
C.3.6	Power validation	51
C.4	Validation Pass/fail limit	52
C.4.1	General	52
C.4.2	Pass/Fail Criteria of PDP	52
C.4.3	Pass/Fail Criteria of Doppler/Temporal correlation	52
C.4.4	Pass/Fail Criteria of Spatial correlation	54
C.4.5	Pass/Fail Criteria of Cross-polarization	57
C.4.6	Pass/Fail Criteria of Power validation	57
<b>Annex D (normative):</b>	<b>&lt;FR2 Channel models and Validation procedure &gt;</b>	<b>58</b>
D.1	FR2 Channel models	58
D.2	FR2 Base Station beam configuration	58
D.3	FR2 Channel model validation	59
D.3.1	General	59
D.3.2	FR2 Power Delay Profile (PDP)	60
D.3.3	FR2 Doppler/Temporal correlation	61
D.3.4	FR2 PAS similarity percentage (PSP)	63
D.3.5	FR2 Cross-polarization	67
D.3.6	FR2 Power validation	68
D.4	Validation Pass/fail limit	69
D.4.1	General	69
D.4.2	Pass/Fail Criteria of PDP	69
D.4.3	Pass/Fail Criteria of Doppler/Temporal correlation	69
D.4.4	Pass/Fail Criteria of PSP	70
D.4.5	Pass/Fail Criteria of Cross-polarization	71
D.4.6	Pass/Fail Criteria of Power validation	71
<b>Annex E (normative):</b>	<b>&lt;gNB configurations&gt;</b>	<b>72</b>
E.1	FR1 gNB configurations	72
E.2	FR2 gNB configurations	76
<b>Annex F (normative):</b>	<b>&lt;Environmental requirements&gt;</b>	<b>81</b>
F.1	Scope	81
F.2	Ambient temperature	81
F.3	Operating voltage	81
<b>Annex G (informative):</b>	<b>Change history</b>	<b>82</b>
History		84

---

# Foreword

This Technical Specification has been produced by the 3rd Generation Partnership Project (3GPP).

The contents of the present document are subject to continuing work within the TSG and may change following formal TSG approval. Should the TSG modify the contents of the present document, it will be re-released by the TSG with an identifying change of release date and an increase in version number as follows:

Version x.y.z

where:

- x the first digit:
  - 1 presented to TSG for information;
  - 2 presented to TSG for approval;
  - 3 or greater indicates TSG approved document under change control.
- y the second digit is incremented for all changes of substance, i.e. technical enhancements, corrections, updates, etc.
- z the third digit is incremented when editorial only changes have been incorporated in the document.

In the present document, modal verbs have the following meanings:

- shall** indicates a mandatory requirement to do something
- shall not** indicates an interdiction (prohibition) to do something

The constructions "shall" and "shall not" are confined to the context of normative provisions, and do not appear in Technical Reports.

The constructions "must" and "must not" are not used as substitutes for "shall" and "shall not". Their use is avoided insofar as possible, and they are not used in a normative context except in a direct citation from an external, referenced, non-3GPP document, or so as to maintain continuity of style when extending or modifying the provisions of such a referenced document.

- should** indicates a recommendation to do something
- should not** indicates a recommendation not to do something
- may** indicates permission to do something
- need not** indicates permission not to do something

The construction "may not" is ambiguous and is not used in normative elements. The unambiguous constructions "might not" or "shall not" are used instead, depending upon the meaning intended.

- can** indicates that something is possible
- cannot** indicates that something is impossible

The constructions "can" and "cannot" are not substitutes for "may" and "need not".

- will** indicates that something is certain or expected to happen as a result of action taken by an agency the behaviour of which is outside the scope of the present document
- will not** indicates that something is certain or expected not to happen as a result of action taken by an agency the behaviour of which is outside the scope of the present document
- might** indicates a likelihood that something will happen as a result of action taken by some agency the behaviour of which is outside the scope of the present document

**might not** indicates a likelihood that something will not happen as a result of action taken by some agency the behaviour of which is outside the scope of the present document

In addition:

**is** (or any other verb in the indicative mood) indicates a statement of fact

**is not** (or any other negative verb in the indicative mood) indicates a statement of fact

The constructions "is" and "is not" do not indicate requirements.

---

# 1 Scope

The present document establishes the Multiple Input Multiple Output (MIMO) Over-the-Air (OTA) performance requirements for NR UEs operating on frequency Range 1 and frequency rang 2, for NR standalone (SA) and NR non-standalone (NSA) operation mode. The corresponding test methodologies are also presented in the Annex of this Technical Specification.

---

# 2 References

The following documents contain provisions which, through reference in this text, constitute provisions of the present document.

- References are either specific (identified by date of publication, edition number, version number, etc.) or non-specific.
- For a specific reference, subsequent revisions do not apply.
- For a non-specific reference, the latest version applies. In the case of a reference to a 3GPP document (including a GSM document), a non-specific reference implicitly refers to the latest version of that document *in the same Release as the present document*.

- [1] 3GPP TR 21.905: "Vocabulary for 3GPP Specifications".
- [2] 3GPP TR 38.827: "Study on radiated metrics and test methodology for the verification of multi-antenna reception performance of NR User Equipment (UE)".
- [3] 3GPP TS 38.101-1: "NR; User Equipment (UE) radio transmission and reception; Part 1: Range 1 Standalone"
- [4] 3GPP TS 38.101-2: "NR; User Equipment (UE) radio transmission and reception; Part 2: Range 2 Standalone"
- [5] 3GPP TS 38.101-3: "NR; User Equipment (UE) radio transmission and reception; Part 3: Range 1 and Range 2 Interworking operation with other radios"
- [6] 3GPP TS 36.101: "Evolved Universal Terrestrial Radio Access (E-UTRA); User Equipment (UE) radio transmission and reception"
- [7] 3GPP TS 38.508-1: "5GS; User Equipment (UE) conformance specification; Part 1: Common test environment"
- [8] 3GPP TR 38.901: "Study on channel model for frequencies from 0.5 to 100 GHz"
- [9] F. Zhang, L. Hentilä, P. Kyösti and W. Fan, "Millimeter-wave New Radio Test Zone Validation for MIMO Over-the-air Testing," in IEEE Transactions on Antennas and Propagation, doi: 10.1109/TAP.2021.3111326.
- [10] 3GPP TS 38.101-4: "NR; User Equipment (UE) radio transmission and reception; Part 4: Performance requirements"
- [11] 3GPP TS 38.551: "NR; User Equipment (UE) Multiple Input Multiple Output (MIMO) Over-the-Air (OTA) performance; Conformance testing"



## 3 Definitions of terms, symbols and abbreviations

### 3.1 Terms

For the purposes of the present document, the terms given in 3GPP TR 21.905 [1] and the following apply. A term defined in the present document takes precedence over the definition of the same term, if any, in 3GPP TR 21.905 [1].

**FS:** UE used in a free space configuration.

**Handheld UE:** A UE intended to be used in hand held scenario.

**MIMO Average Spherical Coverage:** An averaged sensitivity of best 18 FR2 MIMO OTA sensitivity values within the 3D sphere with constant-density points for PC3 device.

**Primary mechanical mode:** The mode that is most often used for a specific user scenario. Every terminal has at least one primary mechanical mode, if multiple modes are supported, different primary mechanical modes may be applicable for different user scenarios, e.g., different primary mechanical modes for Free Space and Hand phantom usage for the same UE.

**PSP (PAS Similarity Percentage):** The similarity of the PAS produced by the OTA system and the reference PAS, which is presented by the Total Variation Distance (TVD) of power angular spectrum (PAS). PSP is defined as  $(1 - \text{TVD}) * 100\%$ . PSP=100% denotes full similarity and PSP=0% denotes full dissimilarity.

### 3.2 Symbols

For the purposes of the present document, the following symbols apply:

$P_{RS-EPRE-MAX}$  Maximum downlink RS-EPRE

### 3.3 Abbreviations

For the purposes of the present document, the abbreviations given in 3GPP TR 21.905 [1] and the following apply. An abbreviation defined in the present document takes precedence over the definition of the same abbreviation, if any, in 3GPP TR 21.905 [1].

AOA	Azimuth angle Of Arrival
AOD	Azimuth angle Of Departure
BS	Base Station
CDL	Clustered Delay Line
CW	Continuous Wave
DML	Data Mode Landscape
DMP	Data Mode Portrait
DMSU	Data Mode Screen Up
DUT	Device Under Test
EUT	Equipment Under Test
FR1	Frequency Range 1
FR2	Frequency Range 2
FS	Free Space
MASC	MIMO Average Spherical Coverage
MIMO	Multiple Input Multiple Output
MPAC	Multi-Probe Anechoic Chamber
NR	New Radio
NSA	Non-Standalone, a mode of operation where operation of an other radio is assisted with an other radio
OTA	Over The Air
PAS	Power Angular Spectrum
PDP	Power Delay Profile

PSP	PAS Similarity Percentage
RS-EPRE	Reference Signal-Energy Per Resource Element
SS	System Simulator
SSS	Secondary Synchronization Signal
TRMS	Total Radiated Multi-antenna Sensitivity
UE	User Equipment
UMa	Urban Macro
UMi	Urban Micro
XPR	Cross-Polarization Ratio
ZOA	Zenith angle Of Arrival
ZOD	Zenith angle Of Departure
ZSA	Zenith angle Spread of Arrival
ZSD	Zenith angle Spread of Departure

---

## 4 General

### 4.1 Relationship between minimum requirements and test requirements

The Minimum Requirements given in this specification make no allowance for measurement uncertainty. The test specification in RAN5 will define test tolerances for FR1 and FR2 MIMO OTA. The test tolerances are used to relax the minimum requirements in this specification to create test requirements.

### 4.2 Applicability of minimum requirements

The MIMO OTA minimum requirements apply only to the primary mechanical mode of UE which is declared by the manufacturer if the UE can support multiple mechanical modes.

The minimum requirements apply only to the UE under normal environmental conditions specified in Annex F.

### 4.3 Applicability rules for testing of SA and NSA UEs

The applicability and test coverage rules for Non-Standalone (NSA) only capable UEs shall include the following:

- For FR1 NSA (EN-DC) only capable UEs, testing is not required.
- For FR2 NSA (EN-DC) only capable UEs, for each FR2 NR band supported by the device, test the UE in EN-DC mode using any one example configuration containing that NR band or configuration declaration decision tree as per recommended MIMO OTA test procedures in this specification.

The applicability and test coverage rules for Standalone (SA) and NSA (EN-DC) capable UEs shall include the following:

- For FR1 UEs, for each NR band in a device, test the UE in Standalone Mode as per the TRMS test procedures in this specification. This shall also fulfil coverage for all EN-DC minimum performance requirements for that NR band and need not be retested in EN-DC mode.
- For FR2 UEs, for each FR2 NR band supported by the device, test the UE in any of SA modes including FR2 only mode, FR1+FR2 NR-DC mode and FR1+FR2 NR-CA mode using any one example configuration containing that NR band. This shall fulfil coverage for FR2 MIMO OTA requirements for that NR band and need not be retested in EN-DC mode.

## 5 Frequency bands

### 5.1 General

NR MIMO OTA Requirements are defined separately for different frequency ranges (FR). The frequency ranges in which NR can operate according to this version of the specification are identified as described in Table 5.1-1.

**Table 5.1-1: Definition of frequency ranges**

Frequency range designation	Corresponding frequency range
FR1	410 MHz – 7125 MHz
FR2	24250 MHz – 52600 MHz

The present specification covers both FR1 and FR2 operating bands. For FR2, only FR2-1 bands are applicable.

### 5.2 Operating bands

NR is designed to operate in FR1 operating bands defined in TS 38.101-1 [3] and FR2 operating bands defined in TS 38.101-2 [4]. NSA band combinations are defined in TS 38.101-3 [5]. E-UTRA is designed to operate in operating bands defined in TS 36.101 [6].

For FR2 EN-DC capable UEs, principle of EN-DC band combinations selection for FR2 MIMO OTA testing is as following:

- 1) Focus on the performance of the NR carrier and do not consider multiple permutations between different LTE bands and NR band under test, i.e., for each NR band, only select one EN-DC band combination.
- 2) For UE supporting multiple EN-DC band combinations for the same NR band, consider only those EN-DC configurations which have no MSD impact on either LTE or NR.

**Table 5.2-1: Measurement parameters for example inter-band EN-DC band combinations (LTE + FR2, two bands)**

EN-DC configuration	E-UTRA configurations	NR FR2 configurations
DC_66A_n261A	Mid channel	Mid channel

**Table 5.2-2: Measurement parameters for example inter-band NR-DC band combinations (FR1 + FR2, two bands)**

NR-DC configuration	NR FR1 configurations	NR FR2 configurations
DC_n66A_n261A	Mid channel	Mid channel

**Table 5.2-3: Measurement parameters for example inter-band NR-CA band combinations (FR1 + FR2, two bands)**

NR-CA configuration	NR FR1 configurations	NR FR2 configurations
CA-n66A_n261A	Mid channel	Mid channel

With the above basic principle and example band combination, the selection logic for testing is defined by the decision trees shown in Figure 5.2-1 and Figure 5.2-2.

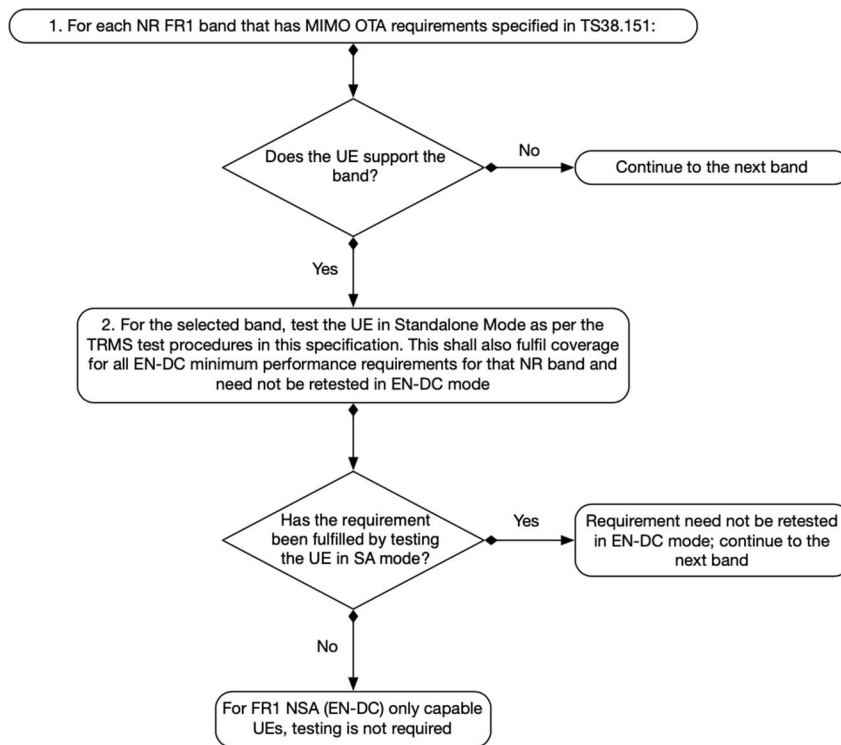

Figure 5.2-1: Decision tree for FR1 MIMO OTA testing

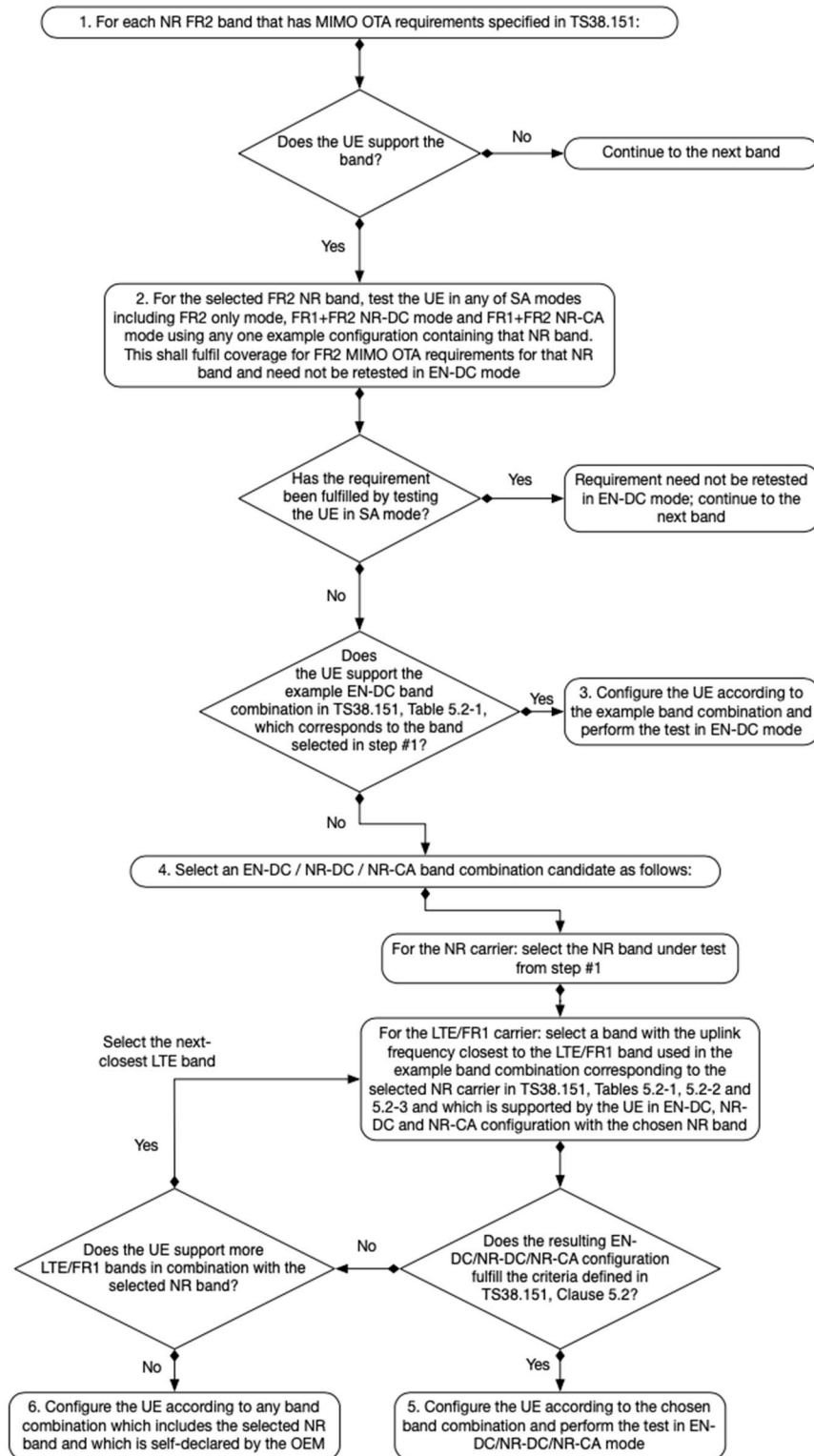

Figure 5.2-2: Decision tree for FR2 MIMO OTA testing

## 6 FR1 MIMO OTA requirements

### 6.1 General

#### 6.1.1 Definition of MIMO throughput

The MIMO throughput is defined here as the time-averaged number of correctly received transport blocks in a communication system running an application, where a Transport Block is defined in the reference measurement channel. From OTA perspective, this is also called MIMO OTA throughput. It will be used as the baseline figure of merit for FR1 and FR2 MIMO OTA testing.

The MIMO OTA throughput is measured at the top of physical layer of NR system under the use of FRC, the SS transmit fixed-size payload bits to the DUT. The DUT signals back either ACK or NACK to the SS. The SS then records the following:

- Number of ACKs,
- Number of NACKs, and
- Number of DTX slots

Hence the MIMO (OTA) throughput can be calculated as

$$\text{MIMO (OTA) Throughput} = \frac{\text{Transmitted TBS} \times \text{Num of ACKs}}{\text{MeasurementTime}}$$

Where Transmitted TBS is the Transport Block Size transmitted by the SS, which is fixed for an FRC during the measurement period. MeasurementTime is the total composed of successful slots (ACK), unsuccessful slots (NACK) and DTX-symbols.

The time-averaging is to be taken over a time period sufficiently long to average out the variations due to the fading channel. Therefore, this is also called the average MIMO OTA throughput. The throughput should be measured at a time when eventual start-up transients in the system have evanesced.

#### 6.1.2 Total Radiated Multi-antenna Sensitivity (TRMS)

The average TRMS of free space data mode portrait (FS DMP), free space data mode landscape (FS DML), and free space data mode screen up (FS DMSU), is defined as the FR1 MIMO OTA requirement. The averaging shall be done in linear scale for the TRMS results at these DUT positions, according to the formula:

$$\text{TRMS}_{\text{average},70} = 10 \log \left[ 3 / \left( \frac{1}{10^{S_{FS\_DMP,70}/10}} + \frac{1}{10^{S_{FS\_DML,70}/10}} + \frac{1}{10^{S_{FS\_DMSU,70}/10}} \right) \right]$$

where

$$S_{\text{MODE},70} = 10 \log \left[ 12 / \left( \frac{1}{10^{P_{\text{MODE},70,0}/10}} + \frac{1}{10^{P_{\text{MODE},70,1}/10}} + \dots + \frac{1}{10^{P_{\text{MODE},70,11}/10}} \right) \right]$$

Such that *MODE* is one of {*FS\_DMP*, *FS\_DML*, *FS\_DMSU*}, and {*P<sub>MODE,70,0</sub>*, ..., *P<sub>MODE,70,11</sub>*} are the measured sensitivity values at each azimuth position at the 70% throughput outage.

If 1 azimuth position does not result in a defined measured sensitivity at 70% throughput, *S<sub>MODE,70</sub>* is calculated using the 11 measured sensitivities and the maximum downlink RS-EPRE *P<sub>RS-EPRE-MAX</sub>* (substitution approach) for the one missing result. *P<sub>RS-EPRE-MAX</sub>* is the maximum downlink RS-EPRE supported by the test system. For bands > 1 GHz, *P<sub>RS-EPRE-MAX</sub>* is defined as -80dBm/15kHz (or equivalent -77dBm/30kHz) for FR1 MIMO OTA; for bands < 1 GHz, *P<sub>RS-EPRE-MAX</sub>* is defined as -78dBm/15kHz for FR1 MIMO OTA.

The TRMS shall be measured at the mid channel as specified in TS 38.508-1 subclause 4.3.1 [7]. The average TRMS shall be lower than the average TRMS requirements specified in Clause 6.2.

The additional criterion in azimuthal orientations shall be met:

- The EUT must meet 70% throughput in 11 of total 12 azimuthal orientations. If the EUT fails to meet this criterion even under maximum downlink power condition (i.e.  $P_{RS-EPRE-MAX}$ ), the EUT shall fail the FR1 MIMO OTA test.
- The EUT must meet 90% throughput in 10 of total 12 azimuthal orientations for bands > 1 GHz, and 8 of total 12 azimuthal orientations for bands < 1 GHz. If the EUT fails to meet this criterion even under maximum downlink power condition (i.e.  $P_{RS-EPRE-MAX}$ ), the EUT shall fail the FR1 MIMO OTA test.

## 6.2 Minimum requirement

FR1 TRMS minimum performance requirements for NR handheld UEs operating on SA mode in free space and the primary mechanical mode for 70% DL throughput with the corresponding measurement configurations (i.e., channel model and gNB configuration) specified in Annex C.1 and Annex E.1 are defined in Table 6.2-1.

**Table 6.2-1: FR1 TRMS minimum performance requirements for NR handheld UEs operating on SA mode in free space and the primary mechanical mode**

NR bands	Bandwidth [MHz]	MIMO layer	Channel model	Reference channel	TRMS <sub>average,70</sub>
n1	10	4x4	FR1 UMa CDL-C	R.PDSCH.1-2.4 FDD	-96.0 dBm/15kHz
n5	10	2x2	FR1 UMi CDL-C	R.PDSCH.1-3.1 FDD	-88.0 dBm/15kHz
n28	10	2x2	FR1 UMi CDL-C	R.PDSCH.1-3.1 FDD	-84.6 dBm/15kHz
n41	40	4x4	FR1 UMa CDL-C	R.PDSCH.2-2.4 TDD	-93.3 dBm/30kHz
n78	40	4x4	FR1 UMa CDL-C	R.PDSCH.2-2.4 TDD	-94.8 dBm/30kHz
n79	40	4x4	FR1 UMa CDL-C	R.PDSCH.2-2.4 TDD	

## 7 FR2 MIMO OTA requirements

### 7.1 General

#### 7.1.1 MIMO Average Spherical Coverage (MASC)

The MIMO Average Spherical Coverage (MASC) is the Figure of Merit of FR2 MIMO OTA requirement. FR2 MIMO OTA is measured with 36 constant-density points within the 3D sphere. The MASC is determined by the averaging of the best 18 sensitivity values for power class 3 UE. The averaging shall be done in linear scale for the MASC result according to the formula:

$$MASC_{70} = 10 \log \left[ \frac{18}{\left( \frac{1}{10^{-\frac{P_{70,1}}{10}}} + \frac{1}{10^{-\frac{P_{70,2}}{10}}} + \dots + \frac{1}{10^{-\frac{P_{70,18}}{10}}} \right)} \right]$$

Such that  $\{P_{70,1}, \dots, P_{70,18}\}$  are the best 18 sensitivity values from all the 36 constant density measurement points, as defined in Annex B.2.3.

The MASC is determined by the averaging of the best 5 sensitivity values for power class 1 UE. The averaging shall be done in linear scale for the MASC result according to the formula:

$$MASC_{70} = 10 \log \left[ \frac{5}{\left( \frac{1}{10^{-\frac{P_{70,1}}{10}}} + \frac{1}{10^{-\frac{P_{70,2}}{10}}} + \dots + \frac{1}{10^{-\frac{P_{70,5}}{10}}} \right)} \right]$$

Such that  $\{P_{70,1}, \dots, P_{70,5}\}$  are the best 5 sensitivity values from all the 36 constant density measurement points, as defined in Annex B.2.3.

The MASC shall be measured at the mid channel as specified in TS 38.508-1 subclause 4.3.1 [7]. The MASC shall be lower than the requirements specified in Clause 7.2.

For FR2 MIMO OTA,  $P_{RS-EPRE-MAX}$ , i.e., the maximum downlink RS-EPRE supported by the test system, is defined as -79.1dBm/120kHz.

For power class 3 UE, if the number of test points where the UE can meet 70% maximum throughput outage even under maximum downlink power condition (i.e., -79.1dBm/120kHz) is less than 18, then UE fails the test. For power class 1 UE, if the number of test points where the UE can meet 70% maximum throughput outage even under maximum downlink power condition (i.e., -79.1dBm/120kHz) is less than 5, then UE fails the test.

Other criteria for FR2 are FFS.

## 7.2 Minimum requirement

FR2 MASC minimum performance requirements for power class 3 NR handheld UEs in free space and the primary mechanical mode for averaging of the best 18 sensitivity values for 70% DL throughput with the corresponding measurement configurations (i.e., channel model and gNB configuration) specified in Annex D.1 and Annex E.2 are defined in Table 7.2-1.

**Table 7.2-1: FR2 MASC minimum performance requirements for NR handheld UEs in free space and the primary mechanical mode**

NR bands	Bandwidth [MHz]	MIMO layer	Channel model	Reference channel	MASC <sub>70</sub> [dBm/120kHz]
n257	100	2x2	FR2 UMi CDL-C	R.PDSCH.5-2.2 TDD	
n258	100	2x2	FR2 UMi CDL-C	R.PDSCH.5-2.2 TDD	
n260	100	2x2	FR2 UMi CDL-C	R.PDSCH.5-2.2 TDD	
n261	100	2x2	FR2 UMi CDL-C	R.PDSCH.5-2.2 TDD	-100.0



# Annex A (normative): <FR1 Test methodology>

## A.1 General

FR1 MIMO OTA requirement testing is based on UE-noise limited environmental condition, i.e., UE throughput characterized as a function of signal power incident to the DUT antennas.

The minimum test zone size for FR1 MIMO OTA test methods is 20cm. “Black-box” testing approach is adopted for NR MIMO OTA testing, the physical centre of the EUT shall be placed in the centre of the test zone, the EUT shall be completely contained within the minimum test zone size.

FR1 MIMO OTA requirement testing should be performed under primary mechanical mode. The primary mechanical mode for devices having multiple mechanical modes shall be declared by the manufacturers. Single primary mechanical mode for each device should be declared for MIMO OTA conformance testing.

## A.2 Multi-Probe Anechoic Chamber (MPAC)

### A.2.1 System setup

MPAC test method is the reference methodology for FR NR MIMO OTA testing. By arranging an array of antennas around the Equipment Under Test (EUT), a spatial distribution of angles of arrival in MPAC system may be simulated to expose the EUT to a near field environment that appears to have originated from a complex multipath far field environment.

As illustrated schematically in Figure A.2.1-1, signals propagate from the base station/communication tester to the EUT through a simulated multipath environment known as a spatial channel model, where appropriate channel impairments such as Doppler and fading are applied to each path prior to injecting all of the directional signals into the chamber simultaneously through the antenna array. The resulting field distribution in the test zone is then integrated by the EUT antenna(s) and processed by the receiver(s) just as it would do so in any non-simulated multipath environment. MPAC system with 16 uniformly-spaced dual-polarized probes is permitted for NR FR1 MIMO OTA testing.

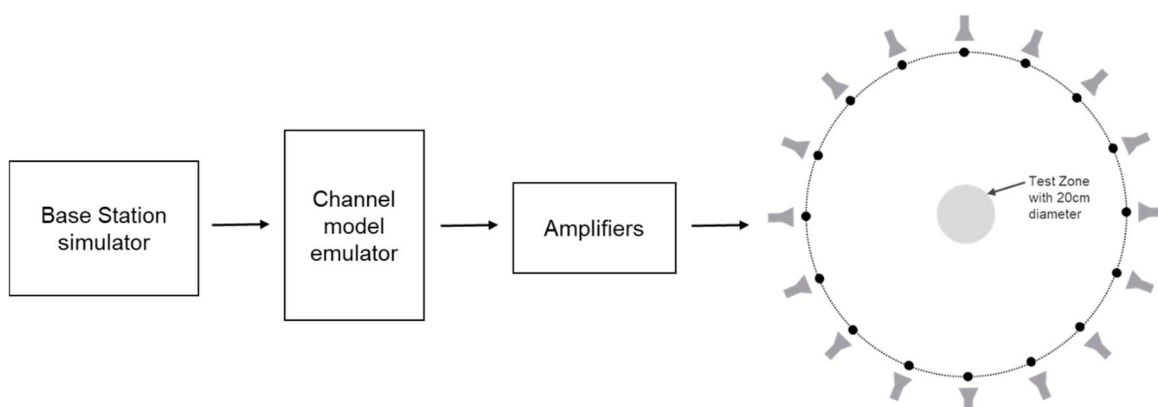

Figure A.2.1-1: MPAC system layout for NR FR1 MIMO OTA testing

## A.2.2 Calibration procedure

The system needs to be calibrated by using a reference calibration antenna with known gain values in order to ensure that the downlink signal power is correct. In non-standalone (NSA) mode, the LTE link antenna provides a stable LTE signal without precise path loss or polarization control.

Unlike traditional TRP/TRS testing where the path loss corrections can all be applied as a post processing step to the measured data, the path loss for each probe in the MPAC system must be balanced at test time in order to generate the desired channel model environment within the test zone of the chamber. The imbalance of each path during testing would result in an alteration of the angular dependence of the channel model (i.e. varied characteristics of generated channel model) within the test zone of the chamber.

1. Place a vertical reference dipole in the centre of the test zone, connected to a VNA port, with the other VNA port connected to the input of the channel emulator unit.
2. Configure the channel emulator for bypass mode.
3. Measure the response of each path from each vertical polarization probe to the reference antenna in the centre of test zone.
4. Adjust the power on all vertical polarization branches of the channel emulator so that the powers received at the centre are equal.
5. Repeat the steps 1 to 4 with the magnetic loop or horizontally polarized reference dipole instead, and adjust the horizontal polarization branches of the channel emulator.
6. The worst-case path loss becomes the reference path loss of the entire system, this loss is used to compute the power in the centre of the test zone relative to the output power of the Base Station simulator. Besides, based on the reference path loss, the relative offset of each path loss shall be corrected.

Note: Calibration based on other antennas, e.g., horn antennas is not precluded.

## A.2.3 Test procedure

Before throughput testing, the initial conditions shall be confirmed to reach the correct measurement state for each test case.

1. Ensure environmental requirements of Annex F are met.
2. Configure the test system according to Annex C, D and E for the applicable test case.
3. Verify the implementation of the channel model as specified in Annex C.3.
4. Position the UE in the chamber according to Annex A.3.
5. Power on the UE.
6. Set up the connection.

Note: For step 3, the verification of the channel model implementation is usually performed once for each channel model as part of the laboratory accreditation process, and will remain valid as long as the setup and instruments remain unchanged. Otherwise the channel model validation may need to be performed prior to starting each throughput test.

For throughput testing, the following steps shall be followed in order to evaluate NR MIMO OTA performance of the DUT:

1. Measure MIMO OTA throughput from one measurement point, the maximum downlink power  $P_{RS-EPRE-MAX}$  is defined in Clause 6.1.2. MIMO OTA throughput is the minimum downlink signal power resulting in a pre-defined throughput value, i.e., 70% and 90% of the maximum theoretical throughput. The downlink signal power step size shall be no more than 0.5 dB when RF power level is near the NR MIMO sensitivity level.
2. Rotate the UE around vertical axis of the test system by 30 degrees and repeat from step 1 until one complete rotation has been measured i.e. 12 different UE azimuth rotations.

3. Repeat the test from step 1 for each specified device orientation. A list of orientations is given in Annex A.3.
4. The postprocessing method to calculate the average MIMO Throughput is defined in Clause 6.

Note: For step 1 of throughput testing, the measurement is not needed to start from maximum downlink power each time. To save testing time, the starting downlink power can be set as a proper value (lower than maximum downlink power supported by test system) as long as all the throughput curve curves at 12 different UE azimuth rotations can reach at least 90% of the maximum theoretical throughput.

## A.2.4 Minimum Range Length

The minimum range length of FR1 MPAC system is defined as the distance from the centre of the test zone to the aperture of the measurement probes/antennas, as illustrated in Figure A.2.4-1.

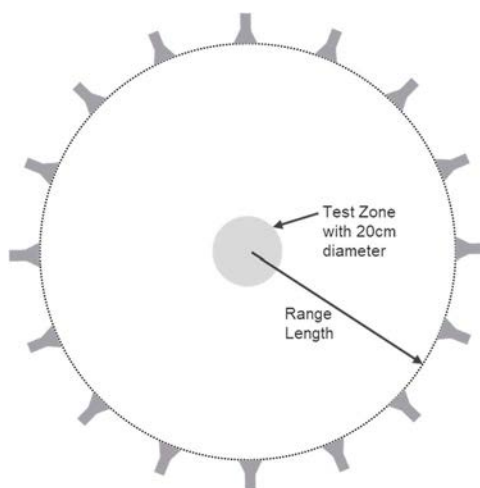

**Figure A.2.4-1: Illustration of range length definition of FR1 MPAC**

The minimum range length for NR FR1 MPAC OTA systems with 20cm test zone size is 1.2m. While for MPAC systems, the far-field requirements do not have to apply, it was shown that the spatial correlation can be impacted significantly for distances below 1.2m.

## A.2.5 Preliminary MU budget of FR1 MPAC system

This clause defines the measurement uncertainty (MU) budget for FR1 MPAC system, as shown in Table A.2.5-1.

Table A.2.5-1: Measurement uncertainty budget for FR1 MPAC system

UID	Description of uncertainty contribution	Example value (410 MHz < f ≤ 3 GHz) [dB]	Example value (3 GHz < f ≤ 7.125GHz) [dB]	Distribution of the probability	Std Uncertainty (410 MHz < f ≤ 3 GHz) [dB]	Std Uncertainty (3 GHz < f ≤ 7.125GHz) [dB]
<b>Stage 2: DUT measurement</b>						
1	Mismatch for measurement process	0	0	U-Shaped	0	0
2	Measure distance uncertainty	0	0	Normal	0	0
3	Quality of quiet zone	0.5	0.5	Actual	0.5	0.5
4	Base Station simulator	1.3	1.3	Normal	0.65	0.65
5	Channel Emulator - absolute output power - output signal stability - output stability with temperature	1.5 0.5 0.4	1.5 0.5 0.4	Actual (Normal - power; rect-stability)	0.84	0.84
6	Amplifier uncertainties	0.7	0.7	Rectangular	0.40	0.40
7	Random uncertainty	0.4	0.4	Normal	0.20	0.20
8	Throughput measurement: output level step resolution	0	0	Rectangular	0	0
9	Signal flatness	0	0	Normal	0	0
<b>Stage 1: Calibration measurement</b>						
10	Mismatch for calibration process - loopback cable path - system input path - reference antenna	0.2	0.2	U-Shaped	0.14	0.14
11	Reference antenna positioning misalignment	0	0	Normal	0	0
12	Quality of quiet zone	0.5	0.5	Rectangular	0.29	0.20
13	Total uncertainty of the Network Analyzer	0.2	0.5	Normal	0.10	0.25
14	Uncertainty of an absolute gain of the calibration antenna	0.58	0.58	Normal	0.29	0.29
15	Offset of the Phase Center of the Reference Antenna	0	0	Normal	0	0
<b>Total Expanded Uncertainty, U, with 95 % Confidence Interval</b>					<b>2.61</b>	<b>2.65</b>

The detailed descriptions of each measurement uncertainty contributor are defined in Annex B. 2 in [11].

## A.3 EUT positioning

This Clause defines the measurement coordinate system for the NR MIMO OTA.

There are three sets of coordinate systems used for FR1 MIMO OTA measurement. They are aligned with the following instructions to avoid misalignment and ambiguity.

The coordinate system for UE positioning is the guidance to specify the UE orientation in Annex A of 3GPP TR 38.827. The default position of DUT aligned to coordinate system is illustrated in Figure A.3-1. For convenience, name the coordinate axis of DUT coordinate system as  $x_{DUT}$ ,  $y_{DUT}$  and  $z_{DUT}$ .

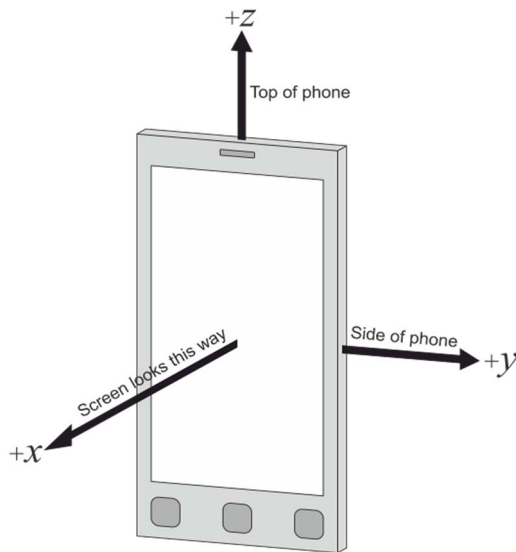

**Figure A.3-1: Illustration of DUT coordinate system**

The coordinate system for channel model, which is used to specify 2x2 and 4x4 channel models for FR1 MIMO OTA, is defined in Clause 7 of 3GPP TR 38.901. With similar approach, name the coordinate axis of channel model coordinate system as  $x_{CM}$ ,  $y_{CM}$  and  $z_{CM}$ . The channel model coordinate system is illustrated in Figure A.3-2.

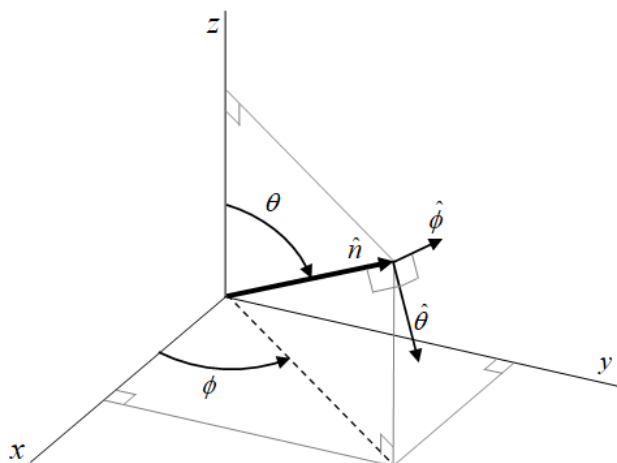

**Figure A.3-2: Illustration of channel model coordinate system**

The coordinate system of anechoic chamber is also applied where the 16 measurement probes are evenly located in the azimuth plane. Considering chamber implementation flexibility, there are two possible probe placements together with chamber coordinate system, shown in Figure A.3-3. Naming the coordinate axis of chamber coordinate system as  $x_{chamber}$  and  $y_{chamber}$ .

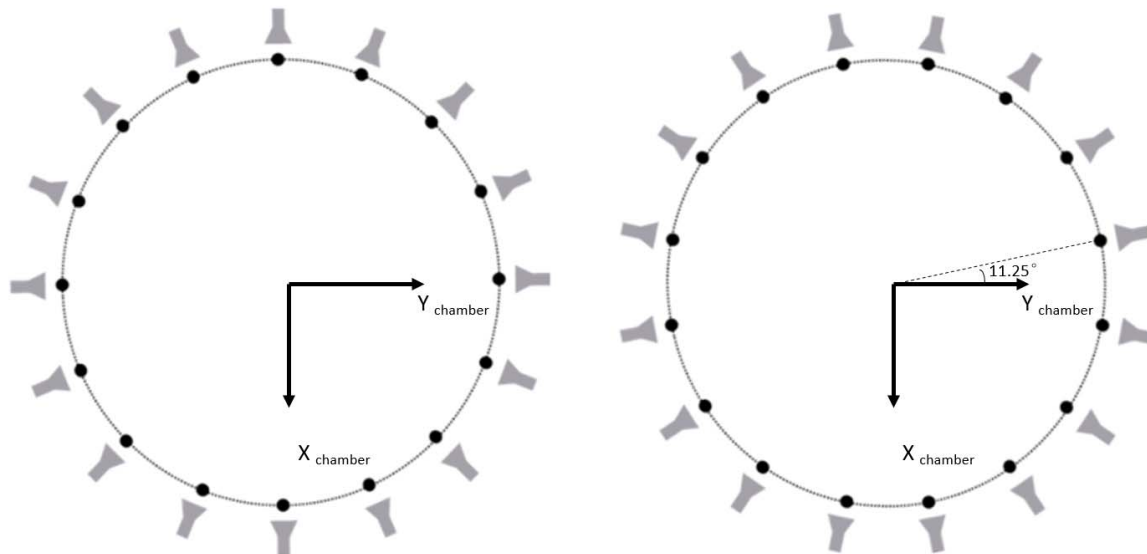

Figure A.3-3: Illustration of AC chamber coordinate system

In order to avoid misalignment and ambiguity for FR1 MIMO OTA measurement, the aligned coordinate system is defined. Align  $x_{DUT}$ ,  $x_{CM}$  and  $x_{chamber}$  together as  $x_{reference}$ , align  $y_{DUT}$ ,  $y_{CM}$  and  $y_{chamber}$  together as  $y_{reference}$  and align  $z_{DUT}$  and  $z_{CM}$  together as  $z_{reference}$ . The aligned coordinate system is illustrated in Figure A.3-4 where only one chamber implementation is shown below for instance.

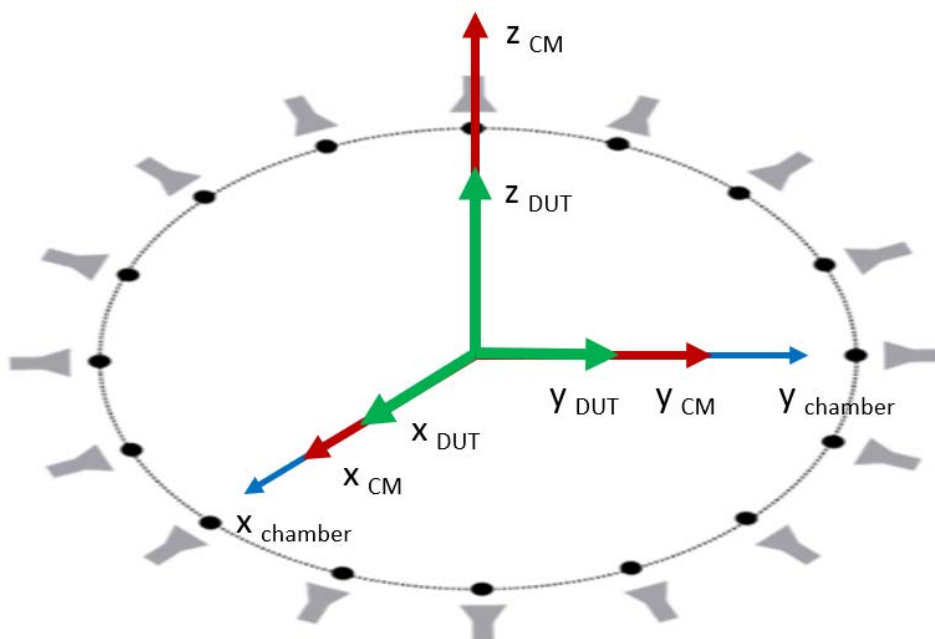

Figure A.3-4: Illustration of the aligned coordinate system

For FR1 MIMO OTA, the DUT shall be tested under Free Space Data Mode Portrait (FS DMP), Free Space Data Mode Landscape (FS DML), and Free Space Data Mode Screen Up (FS DMSU), the DUT azimuthal rotation shall be performed over 360 degrees per orientation in 30 degree steps (12 total positions).

## Annex B (normative): <FR2 Test methodology>

### B.1 General

FR2 MIMO OTA requirement testing is based on UE-noise limited environmental condition, i.e., UE throughput characterized as a function of signal power incident to the DUT antennas.

The minimum test zone size for FR2 MIMO OTA 3D-MPAC system is 20cm. “Black-box” testing approach is adopted for NR MIMO OTA testing, the physical centre of the EUT shall be placed in the centre of the test zone, the EUT shall be completely contained within the minimum test zone size.

FR2 MIMO OTA requirement testing should be performed under primary mechanical mode. The primary mechanical mode for devices having multiple mechanical modes shall be declared by the manufacturers. Single primary mechanical mode for each device should be declared for MIMO OTA conformance testing.

### B.2 FR2 3D Multi-Probe Anechoic Chamber (3D-MPAC)

#### B.2.1 System setup

The 3D MPAC test method is the reference methodology for FR2 NR MIMO OTA testing. By arranging an array of antennas around the Equipment Under Test (EUT), a spatial distribution of angles of arrival in the 3D MPAC system may be simulated to expose the EUT to a near field environment that appears to have originated from a complex multipath far field environment.

As illustrated schematically in Figure B.2.1-1, signals propagate from the base station/communication tester to the EUT through a simulated multipath environment known as a spatial channel model, where appropriate channel impairments such as Doppler and fading are applied to each path prior to injecting all of the directional signals into the chamber simultaneously through the probe array. The resulting field distribution in the test zone is then integrated by the EUT antenna(s) and processed by the receiver(s) just as it would do so in any non-simulated multipath environment. The 3D MPAC system with 6 dual-polarized probes (illustrated with black dots in Figure B.2.1-1) placed on a sector with minimum radius of 0.75m from the centre of the test zone is permitted for NR FR2 MIMO OTA testing.

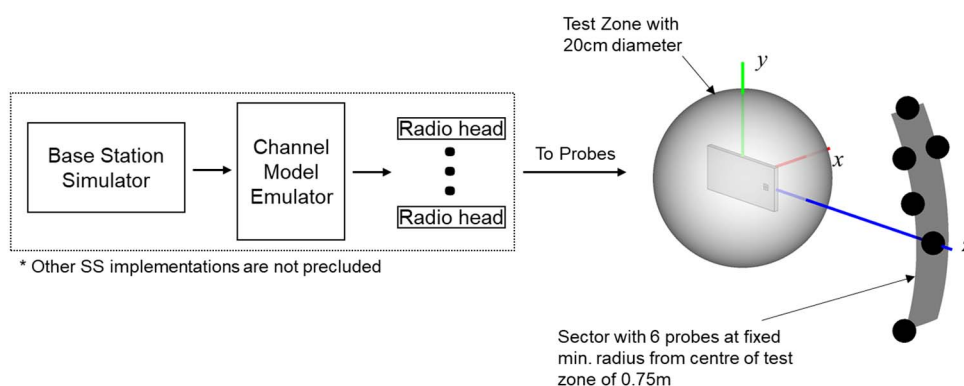

**Figure B.2.1-1: 3D MPAC system layout for NR FR2 MIMO OTA testing**

The exact probe locations with respect to the OTA test system coordinate system are tabulated in Table B.2.1-1.

**Table B.2.1-1. FR2 3D MPAC Probe Locations in OTA test system coordinate system**

Probe Number	Theta [deg]	Phi [deg]
1	0.0	0.0
2	11.2	116.7
3	20.6	-104.3
4	20.6	104.3
5	20.6	75.7
6	30.0	90.0

The 3D MPAC probes in Table B.2.1-1 can be implemented using conventional millimetre-wave probes as well as IFF-based probes as long as the same probe configuration and same number of probes is used.

The channel model parameters and probe locations for channel model implementation are defined in a channel model coordinate system, which is illustrated in figure B.2.1-2. The channel model coordinate axes  $x_{CM}$ ,  $y_{CM}$ , and  $z_{CM}$  correspond to the OTA test system coordinate axes  $z$ ,  $y$ , and  $-x$ , respectively.

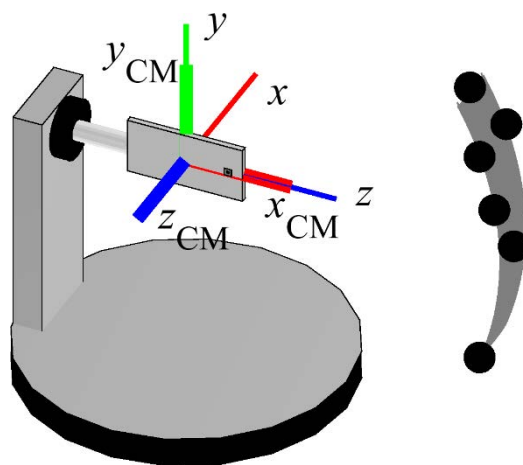

**Figure B.2.1-2: Channel Model Coordinate Axes in FR2 3D-MPAC system**

The probe locations with respect to channel model coordinate axes are tabulated in table B.2.1-2.

**Table B.2.1-2. FR2 3D MPAC Probe Locations in Channel Model Coordinate System**

Probe Number	Theta [deg]	Phi [deg]
1	90	0
2	85	10
3	85	-20
4	85	20
5	95	20
6	90	30

The channel model rotations assumed for this probe configuration are tabulated in Table B.2.1-3.

**Table B.2.1-3. Channel Model Rotations**

UMi CDL-C	
Phi [deg]	Theta [deg]
32	15.0

This channel model rotation assumes the relative orientations of BS and UE antennas displayed in Figure B.2.1-3, i.e., the DUT antenna is pointed towards the BS in channel model coordinate system.

In order to avoid positioning ambiguities, the turntable implementing the rotation in  $\theta$  shall match the intended DUT  $\theta$  for P0 Orientation 1 without the re-positioning approach, as defined in Annex A.3 in [2], applied. With the re-



positioning approach applied, the relative orientation between the DUT and the probes for P0 Orientation 2 shall be the same the relative orientation between DUT and probes as for P0 Orientation 1.

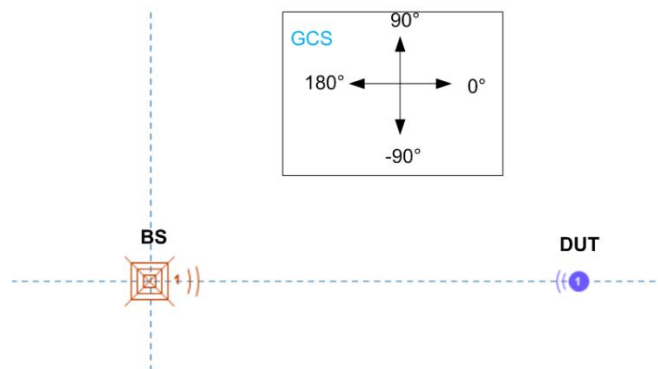

**Figure B.2.1-3: Relative orientations of BS and UE antennas.**

Since the test points are uniformly spaced in 3D already, Table B.2.3-1, there is no need to adjust/rotate the DUT rotations by the channel model rotations.

## B.2.2 Calibration procedure

The system needs to be calibrated by using a reference calibration antenna with known gain values in order to ensure that the downlink signal power is correct. In non-standalone (NSA) mode, the LTE link antenna provides a stable LTE signal without precise path loss or polarization control.

The path loss for each probe in the 3D MPAC system must be calibrated at test time in order to generate the desired channel model environment within the test zone of the chamber. The imbalance of each path during testing would result in an alteration of the angular dependence of the channel model (i.e. varied characteristics of generated channel model) within the test zone of the chamber.

For the calibration measurement, the reference antenna is placed in the centre of the quiet zone, connected to a VNA port, with the other VNA port connected to the input of the channel emulator unit as illustrated schematically in Figure D.3.2-1. For each probe antenna, the reference antenna needs to be aligned in polarization, i.e.,  $\theta$  or  $\phi$ , and direction with the probe antenna that corresponds to the respective path to be calibrated. For each calibration measurement, the channel emulator needs to be configured in bypass mode. The calibration process determines the composite loss,  $L_{\text{path,pol}}$ , of the entire receiver chain path gains (measurement antenna, amplification) and losses (switches, combiners, cables, path loss, etc.). The calibration measurement is repeated for each measurement path (two orthogonal polarizations and each signal path).

## B.2.3 Test procedure

Before throughput testing, the initial conditions shall be confirmed to reach the correct measurement state for each test case.

1. Ensure environmental requirements of Annex F are met.
2. Configure the test system according to Annex E.2 and Annex D.1 for the applicable test case.
3. Verify the implementation of the channel model as specified in Annex D.3.
4. Position the UE in the chamber according to Annex B.3.
5. Power on the UE.
6. Set up the connection.

Note: For step 3, the verification of the channel model implementation is usually performed once for each channel model as part of the laboratory accreditation process, and will remain valid as long as the setup and instruments remain unchanged. Otherwise the channel model validation may need to be performed prior to starting each throughput test.

For throughput testing, the following steps shall be followed in order to evaluate FR2 MIMO OTA performance of the DUT:

1. Position the DUT in the default P0 alignment option (Orientation 1), as defined in Annex A.3 in TR38.827 [2].
2. Measure MIMO OTA throughput, the maximum downlink power is TBD. MIMO OTA throughput is the minimum downlink signal power resulting in a pre-defined throughput value (70%) of the maximum theoretical throughput. The downlink signal power step size shall be no more than 0.5 dB when RF power level is near the NR MIMO sensitivity level.
3. Rotate the UE to the next test point. Table B.2.3-1 lists 36 evenly spaced test points determined using the charged particle approach and with test point #1 centred at (0,0).
4. Repeat the test from step 2 for each specified test point. If the re-positioning concept is applied, the device needs to be positioned in P0 Orientation 2 (either option 1 or option 2).
5. The postprocessing method and the performance metric are defined in Clause 7.1.

Note: For step 2 of throughput testing, the measurement is not needed to start from maximum downlink power each time. To save testing time, the starting downlink power can be set as a proper value (lower than maximum downlink power supported by test system) as long as the throughput curve can reach at least 70% of the maximum theoretical throughput.

**Table B.2.3-1. Evenly spaced FR2 test points with a constant density**

Test Point Number	Theta [deg]	Phi [deg]
1	0.0	0.0
2	33.5	139.7
3	33.9	49.7
4	35.5	-142.9
5	35.5	-76.9
6	37.6	-17.2
7	52.3	94.7
8	56.9	175.7
9	62.5	20.4
10	63.7	-99.8
11	67.1	-55.0
12	69.3	-139.5
13	69.5	130.1
14	70.3	60.8
15	72.1	-16.2
16	88.7	-167.5
17	88.7	98.5
18	89.3	157.0
19	93.9	-78.9
20	94.6	31.6
21	95.3	-115.6
22	99.6	-38.3
23	103.8	-1.1
24	104.4	66.3
25	110.1	127.5
26	115.1	-145.6
27	120.8	171.9
28	125.3	-60.7
29	128.2	-104.1
30	128.8	91.3
31	129.9	35.8
32	136.0	-13.4
33	145.8	138.1
34	150.2	-153.3
35	160.6	-67.4
36	161.7	59.1

## B.2.4 Minimum Range Length

The minimum range length of FR2 MPAC system is defined as the distance from the centre of the test zone to the aperture of the measurement probes/antennas, as illustrated in Figure B.2.4-1.

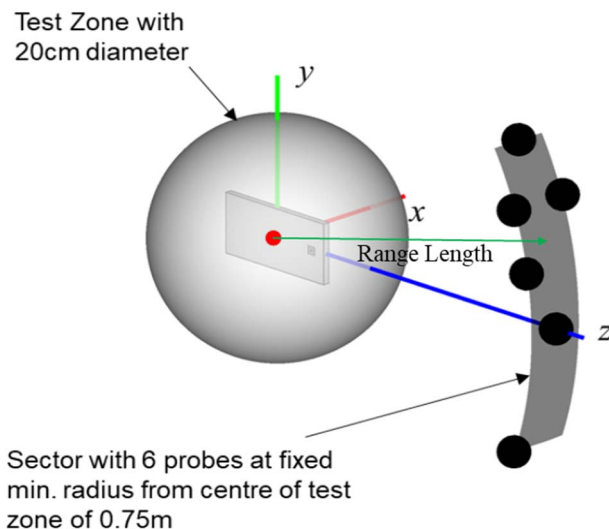

**Figure B.2.4-1: Illustration of range length definition of FR2 3D-MPAC**

The minimum range length for NR FR2 MPAC OTA systems with 20cm test zone size is 0.75m. It was shown that the PSP can be reduced significantly for distances below 0.75m.

## B.2.5 Preliminary MU of FR2 3D-MPAC system

This clause defines the Preliminary measurement uncertainty (MU) budget for FR2 3D-MPAC system, as shown in Table B.2.5-1.

**Table B.2.5-1: Preliminary measurement uncertainty budget for FR2 3D-MPAC system**

UID	Description of uncertainty contribution	Example value (26.5GHz≤f≤29.5GHz)	Example value (37GHz ≤f≤40GHz)	Distribution of the probability	Std Uncertainty (26.5GHz≤f≤29.5GHz) [dB]	Std Uncertainty (37GHz ≤f≤40GHz) [dB]
Stage 2: DUT measurement						
1	Mismatch for measurement process	1.30	TBD	Actual	1.30	TBD
2	Measure distance uncertainty	0.00	TBD	Rectangular	0.00	TBD
3	Quality of quiet zone	0.6	TBD	Actual	0.6	TBD
4	Base Station simulator	2.9	TBD	Normal	1.45	TBD
5	Channel Emulator -absolute value -stability -linearity	1.5dB 0.5dB 0.4dB	TBD	Actual (normal-power; rect-stability)	0.84	TBD
6	Amplifier uncertainties	2.10	TBD	Normal	1.05	TBD
7	Random uncertainty	0.50	TBD	Normal	0.25	TBD
8	Throughput measurement: output level step resolution	0.25	TBD	Rectangular	0.14	TBD
9	DUT sensitivity drift	0.2	0.2	Rectangular	0.12	TBD
10	Signal flatness	0.00	0.00	Normal	0.00	TBD
Stage 1: Calibration measurement						
11	Mismatch for calibration process - loopback cable path - system input path - reference antenna	0.00	TBD	U-Shaped	0.00	TBD
12	Reference antenna positioning misalignment	0.01	TBD	Rectangular	0.01	TBD
13	Quality of quiet zone	0.60	TBD	Actual	0.60	TBD
14	Total uncertainty of the Network Analyzer	0.73	TBD	Normal	0.37	TBD
15	Uncertainty of an absolute gain of the calibration antenna	0.60	TBD	Normal	0.30	TBD
16	Offset of the Phase Center of the Reference Antenna	0.00	TBD	Rectangular	0.00	TBD
<b>Total Expanded Uncertainty, U, with 95% Confidence Interval</b>					5.05	TBD

## B.2.6 Sample Device Orientations for Selected Test Points

Tables B.2.6-1 and B.2.6-2 include illustrations of device/positioner/probe configurations & orientations based on a sample MIMO OTA test system for various test points for  $\Theta < 90^\circ$  (Table B.2.6-1) and  $\Theta > 90^\circ$  (Table B.2.6-2), respectively.

**Table B.2.6-1. Visualization of DUT Orientation of test points with  $\Theta < 90^\circ$ .**

Test Point Number	Theta [deg]	Phi [deg]	Sample System/DUT Illustration with P0 – Orientation 1
1	0.0	0.0	
2	33.5	139.7	
3	33.9	49.7	
...			
18	89.3	157.0	

The illustrations in Table B.2.6-2 with  $\Theta > 90^\circ$  include the device and positioner orientations with the device placed in the P0 alignment option with Orientation 1 as well as Orientation 2 (Option 1 or Option 2) with the re-positioning approach as defined in Annex A.3 in [2].

**Table B.2.6-2. Visualization of DUT Orientation of test points with  $\Theta > 90^\circ$ .**

Test Point Number	Theta [deg]	Phi [deg]	Sample System/DUT Illustration with P0 – Orientation 1	Sample System/DUT Illustration with P0 – Orientation 2
19	93.9	-78.9		
...				
35	160.6	-67.4		
36	161.7	59.1		

---

## B.3 EUT positioning

This Clause defines the measurement coordinate system for the NR MIMO OTA.

For FR2 MIMO OTA, the DUT shall be tested using a 3D scan. With the DUT positioned in the default P0 alignment option, as defined in Annex A.3 in [2], measurements on 36 evenly spaced test points with a constant density shall be performed.



## Annex C (normative): <FR1 Channel models and Validation procedure>

### C.1 FR1 Channel models

The following channel models are required for FR1 MIMO OTA measurement.

The generic models are Table C.1-1 FR1 UMi CDL-C and Table C.1-2 FR1 UMa CDL-C, which do not include base station antenna filtering. UMi CDL-C and UMa CDL-C are selected to define 2x2 and 4x4 MIMO OTA requirements, respectively.

Therefore, in addition, the BS beam filtering effect defined in Annex C.2 also apply when emulating the channel models.

**Table C.1-1: Channel model parameters for UMi CDL-C**

Cluster #	Absolute Delay [ns]	Power in [dB]	AOD in [°]	AOA in [°]	ZOD in [°]	ZOA in [°]
1	0	-4.4215	-36.1891	-122.2815	98.9242	90
2	20.99	-1.25	-21.5937	125.831	99.1915	90
3	22.19	-3.4684	-21.5937	125.831	99.1915	90
4	23.29	-5.2294	-21.5937	125.831	99.1915	90
5	21.76	-2.5215	-32.5709	-143.6126	99.5732	90
6	63.66	0	-7.4275	166.4003	99.306	90
7	64.48	-2.2185	-7.4275	166.4003	99.306	90
8	65.6	-3.9794	-7.4275	166.4003	99.306	90
9	65.84	-7.4215	37.2175	73.8315	100.4513	90
10	79.35	-7.1215	-47.1664	82.7664	98.5616	90
11	82.13	-10.7215	41.5716	-79.6999	100.6231	90
12	93.36	-11.1215	-67.1585	66.9895	98.218	90
13	122.85	-5.1215	-41.5244	84.0543	100.165	90
14	130.83	-6.8215	-47.0437	-96.2818	100.2604	90
15	217.04	-8.7215	-55.7519	94.8406	98.1225	90
16	271.05	-13.2215	55.3698	53.9494	100.2604	90
17	425.89	-13.9215	53.2234	16.0364	98.4852	90
18	460.03	-13.9215	46.8456	32.2963	98.1416	90
19	549.02	-15.8215	-70.1021	18.2098	97.9698	90
20	560.77	-17.1215	48.9306	37.0455	100.7376	90
21	630.65	-16.0215	49.6052	33.7452	98.1225	90
22	663.74	-15.7215	57.7615	29.801	98.1034	90
23	704.27	-21.6215	65.6725	11.6092	100.4513	90
24	865.23	-22.8215	-83.5324	56.2837	100.9476	90
Per-Cluster Parameters						
Parameter	CASD in [°]	CASA in [°]	CZSD in [°]	CZSA in [°]	XPR in [dB]	
Value	1.2265	12.0742	0.5726	0	7	

Table C.1-2: Channel model parameters for UMa CDL-C

Cluster #	Absolute Delay [ns]	Power in [dB]	AOD in [°]	AOA in [°]	ZOD in [°]	ZOA in [°]
1	0	-4.4215	-37.4195	-96.4031	96.7645	90
2	76.6135	-1.25	-21.7362	118.7405	98.4506	90
3	80.9935	-3.4684	-21.7362	118.7405	98.4506	90
4	85.0085	-5.2294	-21.7362	118.7405	98.4506	90
5	79.424	-2.5215	-33.5316	-124.0196	100.8594	90
6	232.359	0	-6.5142	171.2639	99.1732	90
7	235.352	-2.2185	-6.5142	171.2639	99.1732	90
8	239.44	-3.9794	-6.5142	171.2639	99.1732	90
9	240.316	-7.4215	41.4581	51.4188	106.3995	90
10	289.6275	-7.1215	-49.2149	62.9864	94.4761	90
11	299.7745	-10.7215	46.1367	-41.2744	107.4834	90
12	340.764	-11.1215	-70.697	42.5606	92.3083	90
13	448.4025	-5.1215	-43.1524	64.6538	104.5929	90
14	477.5295	-6.8215	-49.0831	-62.7423	105.1951	90
15	792.196	-8.7215	-58.4403	78.6184	91.7061	90
16	989.3325	-13.2215	60.9633	25.6781	105.1951	90
17	1554.4985	-13.9215	58.6569	-23.4063	93.9944	90
18	1679.1095	-13.9215	51.8037	-2.3553	91.8265	90
19	2003.923	-15.8215	-73.86	-20.5926	90.7426	90
20	2046.8105	-17.1215	54.0442	3.7933	108.2061	90
21	2301.8725	-16.0215	54.7691	-0.4794	91.7061	90
22	2422.651	-15.7215	63.5332	-5.5859	91.5856	90
23	2570.5855	-21.6215	72.0338	-29.1381	106.3995	90
24	3158.0895	-22.8215	-88.2912	28.7003	109.5309	90
Per-Cluster Parameters						
Parameter	CASD in [°]	CASA in [°]	CZSD in [°]	CZSA in [°]	XPR in [dB]	
Value	1.3179	15.632	3.6131	0	7	

## C.2 FR1 Base Station beam configuration

The emulated BS beam configuration to be used for all emulation of channel models defined in Annex C.1 is specified in this clause.

The Base Station beam configuration includes basic antenna parameters and beamforming characteristic. The basic BS antenna parameters is defined in Table C.2-1.

Table C.2-1: BS Antenna Parameters

Parameter description	Symbol	Parameter value	
		FR1 ≤2.5GHz	FR1 >2.5GHz
Antenna panels in vertical dimension	$M_g$	1	1
Antenna panels in horizontal dimension	$N_g$	1	1
Elements per panel in vertical dimension	$M_e$	4	8
Elements per panel in horizontal dimension	$N_e$	8	8
Number of polarizations per panel	$P$	2	2
Element spacing in horizontal dimension ( $\lambda$ )	$d_H$	0.5	0.5
Element spacing in vertical dimension ( $\lambda$ )	$d_V$	0.5	0.5

Antenna element radiation patterns, including orientation of the element main polarization components as well as orientation of the antenna array are as in the example pattern in Table 7.3-1 of TR38.901. The antenna element has  $\pm 45^\circ$

polarization components and the radiation pattern parameters are  $\theta_{3\text{dB}} = 65^\circ$ ,  $\phi_{3\text{dB}} = 65^\circ$ ,  $A_{\text{max}} = 30\text{dB}$ ,  $\text{SLAV} = 30\text{dB}$ ,  $G_{E,\text{max}} = 8\text{ dBi}$ .

The beamforming characteristic of the FR1 BS pattern is defined as follow:

- A code book of 60 fixed beams is constructed to a grid of five elevation angles from  $-20^\circ$  to  $+20^\circ$  with  $10^\circ$  steps and 12 azimuth angles from  $-80^\circ$  to  $+80^\circ$  with  $\sim 15^\circ$  steps;
- For 4x4 MIMO OTA, two strongest transmitting beams are selected from the pre-defined beam grid based on their proximity to the strong clusters of each FR1 channel model. These beams should have different azimuth directions and can provide the highest receive power for UE.
- For 2x2 MIMO OTA, 1 strongest transmitting beam is selected from the pre-defined beam grid which provides the highest received power for UE based on the FR1 channel model.
- Beam directions for channels model given in Annex C.1 are:
  - For UMa CDL-C, the beam directions are:
    - Strongest beam: AoD:  $-7.27^\circ$ , ZoD:  $100^\circ$
    - 2<sup>nd</sup> strongest beam: AoD:  $-21.82^\circ$ , ZoD:  $100^\circ$
  - For UMi CDL-C, the strongest beam direction is: AoD:  $-7.27^\circ$ , ZoD:  $100^\circ$ .

## C.3 FR1 Channel model validation

### C.3.1 General

This clause describes the MIMO OTA validation measurements, in order to ensure that the channel models are correctly implemented and hence capable of generating the propagation environment, as described by the model, within the test zone.

The following measurements shall be done for FR1 channel model validation:

- Power Delay Profile (PDP)
- Doppler/Temporal correlation
- Spatial correlation
- Cross-polarization
- Power validation

Frequencies to be used to test for channel model validation:

**Table C.3.1-1: Frequencies for PDP, Doppler, Spatial correlation, and Cross-polarization validation**

NR FR1 Bands	Range	Test frequency (MHz)
n71	Low	617MHz
n12, n17, n29, n14, n28		722MHz
n5, n8, n18, n20		836.5MHz
n50, n51, n74	Mid	1575.42MHz
n3, n2, n25, n39		1880MHz
n1, n34, n65		2132.5MHz
n7, n30, n41, n40, n38, [n90]		2450MHz
n77, n78	High	3600MHz
n79		[4700MHz]

**Table C.3.1-2: Frequencies for Power validation**

NR FR1 Bands	Range	Test frequency (centre frequency of each band)
n71	Low	n71
n12, n17, n29, n14, n28		n28
n5, n8, n18, n20		n8
n50, n51, n74	Mid	n51
n3, n2, n25, n39		n3
n1, n34, n65		n1
n7, n30, n41, n40, n38, [n90]		n41
n77, n78	High	n78
n79		n79

### C.3.2 Power Delay Profile (PDP)

This measurement checks that the resulting power delay profile (PDP) is in-line with the PDP defined for the channel model. For PDP validation measurement, only Vertical validation is required.

The PDP measurement is performed with a Vector Network Analyser (VNA). An example setup for PDP measurement is shown in Figure C.3.2-1. VNA transmits frequency sweep signals through the NR MIMO OTA test system. A reference antenna (i.e dipole antenna), within the centre of the test zone, receives the signal and VNA analyses the frequency response of the system. A number of traces (frequency responses) are measured and recorded by VNA and analysed by a post processing SW, e.g., Matlab. Special care has to be taken into account to keep the fading conditions unchanged, i.e. frozen, during the short period of time of a single trace measurement. The fading may proceed only in between traces.

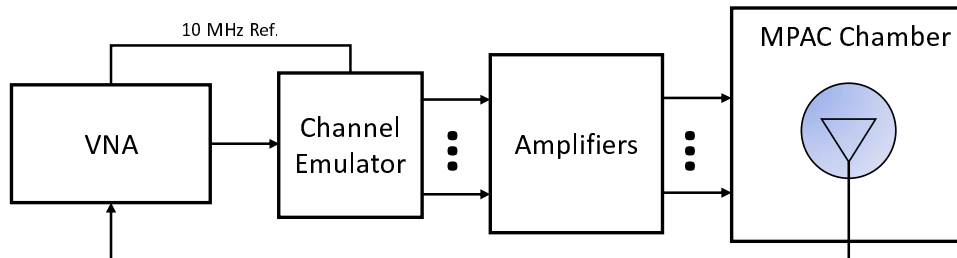

**Figure C.3.2-1: Setup for PDP measurements**

Step the emulation and store traces from VNA, i.e., run the emulation to CIR number 1, pause, measure VNA trace, run the emulation to CIR number 10, pause, measure VNA trace. Continue until 1000 VNA traces are measured.

VNA settings for PDP measurements are presented in Table C.3.2-1.

**Table C.3.2-1: VNA settings for PDP measurements**

Item	Unit	Value
Centre frequency	MHz	Downlink centre frequency in Table C.3.1-1
Span	MHz	200
Number of traces		1000
Number of points		1101
Averaging		1

Channel model specification for PDP measurements is presented in Table C.3.2-2.

**Table C.3.2-2: Channel model specification for PDP measurements**

Item	Unit	Value
Centre frequency	MHz	Downlink centre frequency in Table C.3.1-1
Distance between traces in channel model	wavelength (Note)	> 2
Channel model		As specified in Annex C.1
NOTE: Time [s] = distance [λ] / MS speed [λ/s] MS speed [λ/s] = MS speed [m/s] / Speed of light [m/s] * Centre frequency [Hz]		

**Method of measurement result analysis:**

Measured VNA traces (frequency responses H(t,f)) are saved into a hard drive. The data is read into, e.g., Matlab. The analysis is performed by taking the Fourier transform of each FR. The resulting impulse responses h(t,τ) are averaged in power over time:

$$P(\tau) = \frac{1}{T} \sum_{t=1}^T |h(t, \tau)|^2$$

Finally the resulting PDP is shifted in delay, such that the first tap is on delay zero.

**Beam-Specific Block Diagram**

It is assumed that the beams are mapped to the inputs of the channel emulator as follows:

- Beam 1: Input 1 and Input 2
- Beam 2: Input 3 and Input 4 (CDL-C UMa only)

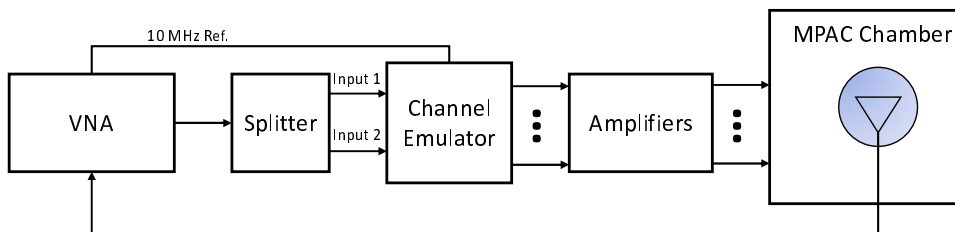

**Figure C.3.2-2: Setup for Beam-Specific PDP measurements (Beam 1)**

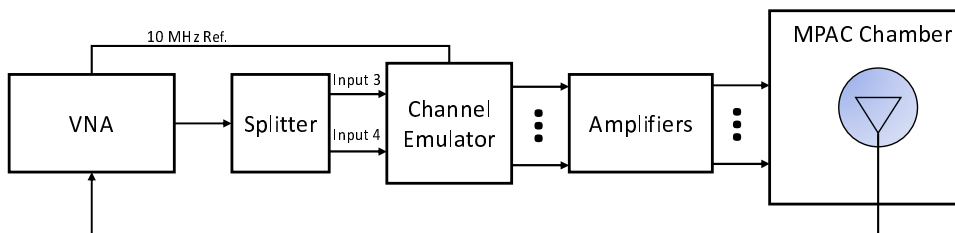

**Figure C.3.2-3: Setup for Beam-Specific PDP measurements (Beam 2 CDL-C UMa only)**

The detailed PDP reference value for CDL-C UMa and CDL-C UMi validation are defined in the following tables:

**Table C.3.2-3: PDP Targets for CDL-C UMa beam 1 at  $\leq 2.5$  GHz**

Combined Clusters index	Delay(ns)	Power(dB)
1	0	-34.3
2-5	80	-19.5
6-8	235	0.0
9-10	290	-33.0
11	450	-35.8
12	480	-34.0

**Table C.3.2-4: PDP Targets for CDL-C UMa beam 2 at  $\leq 2.5$  GHz**

Combined Clusters index	Delay(ns)	Power(dB)
1	0	-27.9
2-5	80	0.0
6-8	235	-18.4
9-10	290	-27.8
11	450	-27.9
12	480	-28.0

**Table C.3.2-5: PDP Targets for CDL-C UMa beam 1 at  $> 2.5$  GHz**

Combined Clusters index	Delay(ns)	Power(dB)
1	0	-34.2
2-5	80	-19.3
6-8	235	0.0
9	290	-34.7
10	450	-35.8
11	480	-34.7

**Table C.3.2-6: PDP Targets for CDL-C UMa beam 2 at  $> 2.5$  GHz**

Combined Clusters index	delay(ns)	power(dB)
1	0	-27.8
2-5	80	0.0
6-8	235	-18.3
9-10	290	-28.9
11	450	-28.1
12	480	-28.8

**Table C.3.2-7: PDP Targets for CDL-C UMi at  $\leq 2.5$  GHz and  $> 2.5$  GHz**

Combined Clusters index	Delay(ns)	Power(dB)
1	0	-30.7
2-5	20	-19.2
6-10	65	0
11-12	130	-31.4

### C.3.3 Doppler/Temporal correlation

This measurement checks the Doppler/temporal correlation. For Doppler/Temporal correlation validation measurement, only Vertical validation is required.

The Doppler spectrum is measured with a spectrum analyser as shown in Figure C.3.3-1. In this case a signal generator transmits CW signal through the NR MIMO OTA test system. The signal is received by a test antenna within the test area. Finally, the signal is analysed by a spectrum analyser and the measured spectrum is compared to the target spectrum. This setup can be used to measure Doppler Spectrum of the Channel models defined in Annex C.1.

**Method of measurement:**

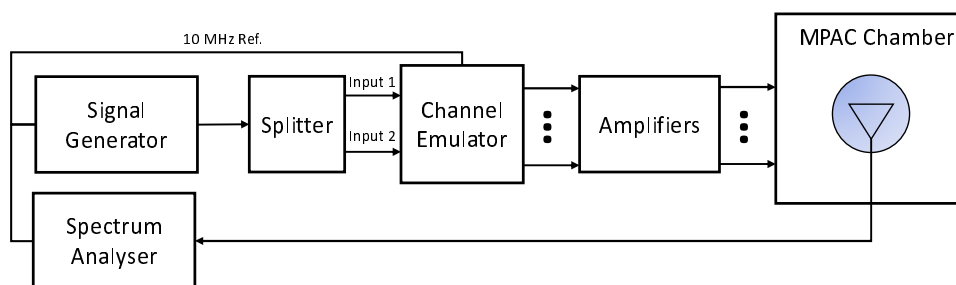

**Figure C.3.3-1: Setup for Doppler measurements**

Sine wave (CW, carrier wave) signal is transmitted from the signal generator. The signal is connected from the signal generator to fading emulator via cables. The fading emulator output signals are connected to power amplifier boxes via cables. The amplified signals are then transferred via cables to the probe antennas. The probe antennas radiate the signals over the air to the test antenna. The Doppler spectrum is measured by the spectrum analyser and the trace is saved.

Signal generator settings for Doppler/Temporal correlation measurements are presented in Table C.3.3-1.

**Table C.3.3-1: Signal generator settings for Doppler/Temporal correlation measurements**

Item	Unit	Value
Centre frequency	MHz	Downlink centre frequency in Table C.3.1-1
Modulation		OFF

Spectrum analyser settings for Doppler/Temporal correlation measurements are presented in Table C.3.3-2.

**Table C.3.3-2: Spectrum analyser settings for Doppler/Temporal correlation measurements**

Item	Unit	Value
Centre frequency	MHz	Downlink centre frequency in Table C.3.1-1
Minimum Span	Hz	4 kHz
RBW	Hz	1
VBW	Hz	1
Number of points		16001
Averaging		100

Channel model specification for Doppler/Temporal correlation measurements is presented in Table C.3.3-3.

**Table C.3.3-3: Channel model specification for Doppler/Temporal correlation measurements**

Item	Unit	Value
Centre frequency	MHz	Downlink centre frequency in Table C.3.1-1
Channel model		As specified in Annex C.1
Mobile speed	km/h	100

Method of measurement result analysis: Measurement data file (Doppler power spectrum) is saved into hard drive. The data is read into, e.g., Matlab. The analysis is performed by taking the Fourier transformation of the Doppler spectrum.

The resulting temporal correlation function  $R_r(\Delta t)$  is normalized such that  $\max(\text{abs}(R_r(\Delta t)))=1$ . Then the function values left from the maximum i.e., the negative lags are cut out. Further on the function values after five periods are cut out.

**Time Domain Alternate Method**

Time domain techniques can also be used to validate the tempoal correlation. The temporal correlation validation measurement setup is illustrated in Figure C.3.3-2. In this case a Signal generator transmits a CW signal through the MIMO test system. The signal is received by a test antenna within the test area. Finally, the signal is collected by a signal analyser and the measured signal is stored as IQ data format for postprocessing.

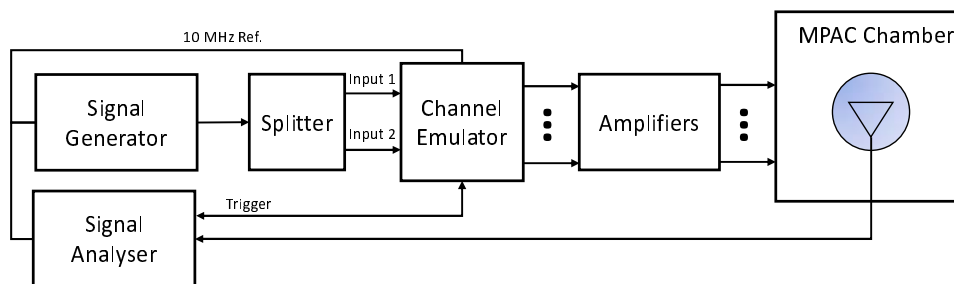

**Figure C.3.3-2: Setup for Doppler measurements based on time domain technique**

The time domain doppler spectrum is measured by the signal analyser (SAN) and the trace in IQ format is saved. Follow the same procedure to post process the data and calculate the temporal correlation curve. Data recording is synchronized with the channel emulator trigger. Depending on CE implementation, the trigger direction between SAN and CE needs to be adjusted, i.e., from SAN to CE or from CE to SAN.

The settings for the signal analyser are presented in Table C.3.3-4.



**Table C.3.3-4: Signal Analyser Settings**

Item	Unit	Value
Centre frequency	MHz	Downlink centre frequency in Table C.3.1-1
Sampling	Hz	At least 15 times bigger than the max Doppler spread ( $f_d=v/\lambda$ )
Observation time	s	At least 16s. Channel Model length should be the same or greater than the observation time.

**Beam-Specific Block Diagram**

It is assumed that the beams are mapped to the inputs of the channel emulator as follows:

- Beam 1: Input 1 and Input 2
- Beam 2: Input 3 and Input 4 (CDL-C UMa only)

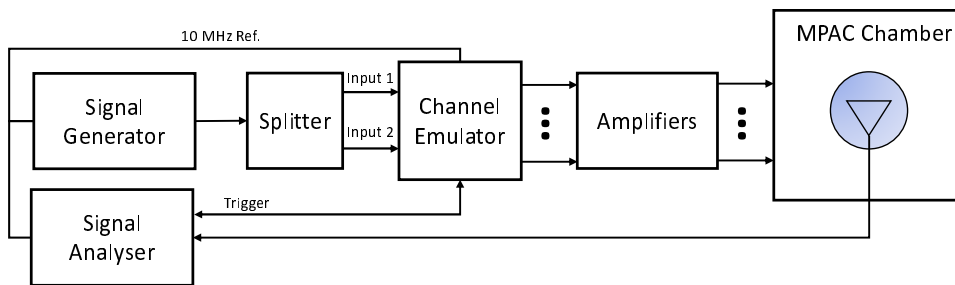

**Figure C.3.3-3: Setup for Beam-Specific Doppler measurements (Beam 1)**

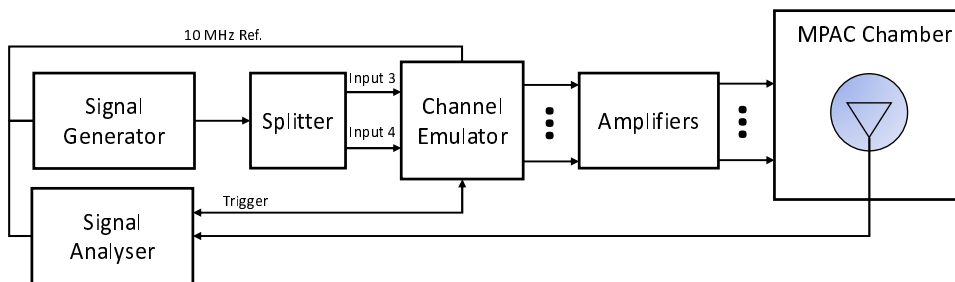

**Figure C.3.3-4: Setup for Beam-Specific Doppler measurements (Beam 2 CDL-C UMa only)**

The detailed Temporal correlation reference value for CDL-C UMa and CDL-C UMi channel model validation is defined in Table C.3.3-5.

**Table C.3.3-5: Autocorrelation Targets**

Lambda Separation	CDL-C UMa beam 1 at $\leq 2.5$ GHz	CDL-C UMa beam 2 at $\leq 2.5$ GHz	CDL-C UMa beam 1 at $> 2.5$ GHz	CDL-C UMa beam 2 at $> 2.5$ GHz	CDL-C UMi beam 1 at $\leq 2.5$ GHz	CDL-C UMi beam 1 at $> 2.5$ GHz
0.0	1.000	1.000	1.000	1.000	1.000	1.000
0.1	0.986	0.974	0.985	0.973	0.995	0.995
0.2	0.945	0.907	0.942	0.904	0.982	0.982
0.3	0.882	0.832	0.874	0.825	0.962	0.961
0.4	0.801	0.776	0.787	0.765	0.936	0.935
0.5	0.709	0.738	0.689	0.723	0.906	0.905
0.6	0.613	0.695	0.586	0.675	0.872	0.871
0.7	0.518	0.623	0.486	0.599	0.834	0.834
0.8	0.430	0.525	0.394	0.496	0.793	0.793
0.9	0.353	0.426	0.315	0.391	0.750	0.749
1.0	0.289	0.360	0.252	0.319	0.705	0.704
1.1	0.240	0.335	0.206	0.290	0.659	0.658
1.2	0.204	0.320	0.174	0.273	0.614	0.612

1.3	0.181	0.287	0.154	0.239	0.569	0.568
1.4	0.167	0.233	0.143	0.185	0.527	0.525
1.5	0.159	0.176	0.137	0.129	0.487	0.485
1.6	0.155	0.141	0.135	0.096	0.450	0.448
1.7	0.153	0.135	0.134	0.092	0.417	0.415
1.8	0.150	0.137	0.134	0.095	0.387	0.385
1.9	0.144	0.132	0.130	0.093	0.361	0.358
2.0	0.135	0.117	0.122	0.089	0.337	0.335
2.1	0.121	0.097	0.109	0.086	0.316	0.313
2.2	0.105	0.076	0.090	0.076	0.296	0.293
2.3	0.085	0.062	0.069	0.064	0.277	0.274
2.4	0.065	0.071	0.047	0.067	0.258	0.255
2.5	0.048	0.090	0.031	0.088	0.239	0.236
2.6	0.039	0.099	0.033	0.103	0.219	0.216
2.7	0.038	0.088	0.046	0.099	0.198	0.195
2.8	0.042	0.058	0.057	0.073	0.178	0.175
2.9	0.043	0.037	0.062	0.038	0.158	0.154
3.0	0.041	0.067	0.060	0.045	0.138	0.135
3.1	0.037	0.103	0.050	0.080	0.120	0.116
3.2	0.036	0.120	0.036	0.100	0.103	0.100
3.3	0.044	0.115	0.019	0.099	0.089	0.085
3.4	0.056	0.097	0.010	0.081	0.076	0.073
3.5	0.068	0.082	0.019	0.061	0.066	0.063
3.6	0.075	0.083	0.029	0.053	0.057	0.055
3.7	0.076	0.090	0.034	0.060	0.051	0.049
3.8	0.068	0.089	0.036	0.073	0.046	0.044
3.9	0.051	0.079	0.044	0.091	0.042	0.041
4.0	0.027	0.068	0.062	0.111	0.039	0.038
4.1	0.007	0.063	0.090	0.127	0.037	0.035
4.2	0.036	0.062	0.123	0.133	0.036	0.034
4.3	0.067	0.057	0.155	0.129	0.038	0.036
4.4	0.093	0.052	0.182	0.126	0.043	0.040
4.5	0.111	0.055	0.200	0.131	0.051	0.048
4.6	0.119	0.063	0.207	0.139	0.061	0.058
4.7	0.116	0.066	0.200	0.138	0.073	0.070
4.8	0.101	0.058	0.180	0.117	0.085	0.082
4.9	0.078	0.047	0.149	0.079	0.096	0.093
5.0	0.051	0.048	0.110	0.034	0.107	0.104

### C.3.4 Spatial correlation

This measurement checks whether the measured correlation curve follows the theoretical curve. For spatial correlation validation measurement, only Vertical validation measurement is required. Spatial correlation validation is only adopted for FR1 MIMO OTA.

The spatial correlation validation measurement setup is illustrated in Figure C.3.4-1. The network analyser transmits signals through the fading emulator and probes. The 16 probes radiate the signals within the anechoic chamber and a receiving test antenna is placed within the test zone. The test antenna is attached to a positioner that can move the antenna to pre-defined spatial locations on a fixed radius from the centre of the quiet zone. The received signal is measured with the network analyser.

The measurement and analysis procedure are as follows:

Set the target channel model to fading emulator.

1. For each position of the test antenna in the test zone, step & pause the emulator to different time instances. Measure the frequency responses  $H(f, t) = H(m\Delta f, n\Delta T)$ ,  $m = 0, \dots, M - 1$  for all stepped channel snapshots  $n = 0, \dots, N - 1$ , where the interval between frequency and time samples is  $\Delta f$  and  $\Delta T$ , respectively. The number of channel snapshots  $N$  and frequency samples  $M$  should be sufficiently high so that the matrix can be estimated reliably.

2. Move the measurement antenna with a positioner to another location  $k$  and repeat step 2 to record frequency responses  $H_k(m\Delta f, n\Delta T)$  of all stepped channel snapshots.
3. Repeat step 3 to record frequency responses at all  $k = 1, \dots, K$  spatial sample points.
4. Stack measured time and frequency samples to a vector and calculate correlation between the first spatial sample point (i.e.  $k = 1$ ) and other spatial points  $k = 1, \dots, K$
5.  $\rho_k = \text{corr}[\text{vec}(H_1(m\Delta f, n\Delta T)), \text{vec}(H_k(m\Delta f, n\Delta T))]$
6. Take the theoretical reference spatial correlation of the corresponding spatial sample points. Plot both the measured and theoretical curves.
7. Calculate the weighted RMS correlation error between the measured and the reference.

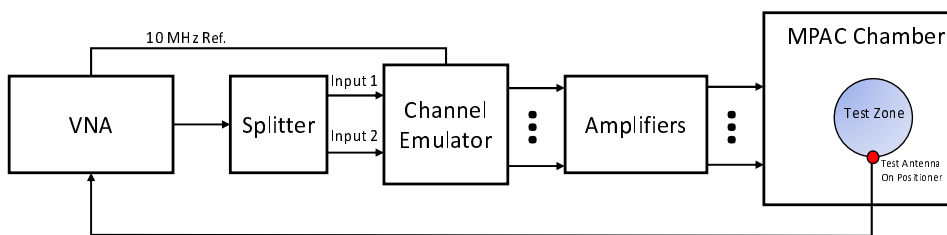

Figure C.3.4-1: Configuration for spatial correlation validation

**Beam-Specific Block Diagram**

It is assumed that the beams are mapped to the inputs of the channel emulator as follows:

- Beam 1: Input 1 and Input 2
- Beam 2: Input 3 and Input 4 (CDL-C UMa only)

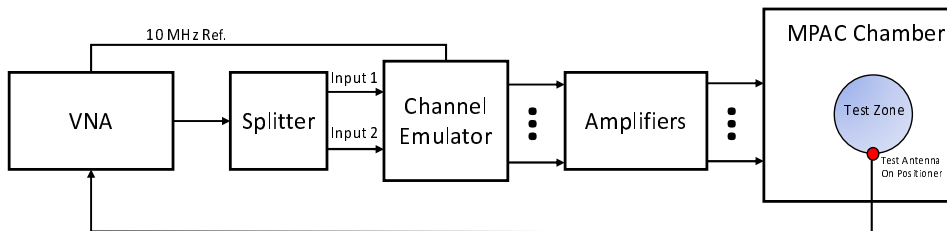

Figure C.3.4-2: Configuration for spatial correlation validation (CDL-C UMi)

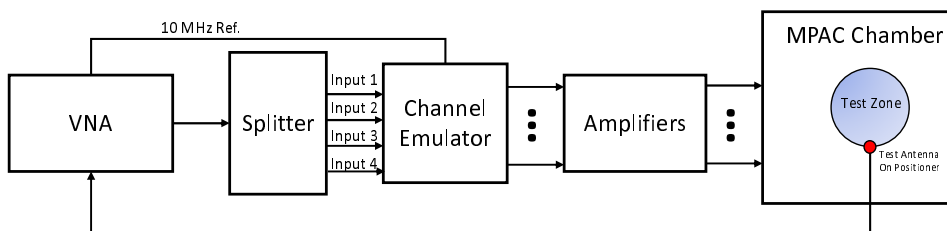

Figure C.3.4-3: Configuration for spatial correlation validation (CDL-C UMa)

**Time and frequency samples**

The number of temporal snapshots  $N$  and frequency samples  $M$  is shown in Table C.3.4-1. The channel model specification is presented in Table C.3.4-2.

**Table C.3.4-1: VNA settings for spatial correlation**

Item	Unit	Value
Centre frequency	MHz	Downlink centre frequency in Table C.3.1-1
Span	MHz	0 (Note 2)
RF output level	dBm	-15
Number of traces		1000
Distance between traces in channel model	Wavelength (Note 1)	> 2
Number of points		1 (or the smallest possible) (Note 2)
Averaging		1
NOTE1: Time in seconds = distance [ $\lambda$ ] / MS speed [ $\lambda/s$ ] MS speed [ $\lambda/s$ ] = MS speed [m /s] / Speed of light [m/s] * Center frequency [Hz]		
NOTE 2: Span and number of points may be increased to estimate reliably		

**Table C.3.4-2: Channel model specification**

Item	Unit	Value
Centre frequency	MHz	Downlink centre frequency in Table C.3.1-1
Channel model samples	Wavelength	> 2000
Channel model		As specified in Annex C.1
Mobile speed	km/h	30

### Spatial samples

The spatial samples for the correlation validation measurement are on the circumference of the quiet zone, as illustrated in Figure C.3.4-4. The test zone is a circle with 20 cm diameter in the horizontal plane. The reference point (denoted by a red marker) is in AoA 270°. The mean AoAs of the CDL-C UMi and CDL-C UMa models are slightly different, but the underlying geometry for the CDL model indicates that the mean AoA (or assumed LoS direction) of the model is 180°. The reference point orientation of the validation measurement is proposed to be with 90° offset to the channel model reference AoA to enable accurate sampling of the main lobe of the spatial correlation curve. The reference point orientation must be defined in the channel model coordinate system instead of the chamber/probe coordinate system to enable optimization of OTA model implementation to achieve better alignment with the cluster AoAs and probe directions. In order to have spatial samples that yield reasonable measurement times and adequately capture the main lobe of the correlation curve, a non-uniform sampling is used where the first quadrant i.e., 270°-180°, is sampled with dense sampling compared to the rest of the circle. The spacing of the spatial samples is summarized in Table C.3.4-3 for test frequencies less than 1800 MHz and equal to or greater than 1800 MHz.

**Table C.3.4-3: Spacing of Spatial Samples**

Test Frequencies [MHz]	First quadrant of test zone circumference (270°-180°)	Remaining quadrants
617, 722, 836.5, 1575.42	$\lambda/15$	$\lambda/4$
1800, 2132.50, 2450, 3600, 4700	$\lambda/10$	$\lambda/2$

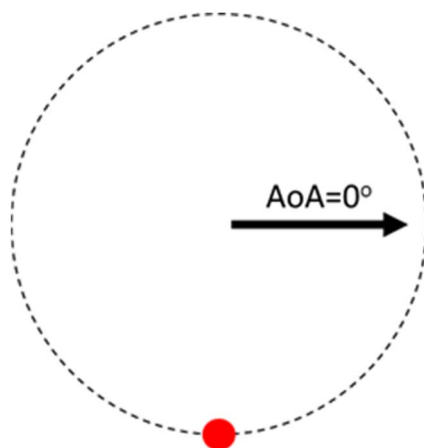

Figure C.3.4-4: Test zone interpretation with Angle of Arrival reference orientation

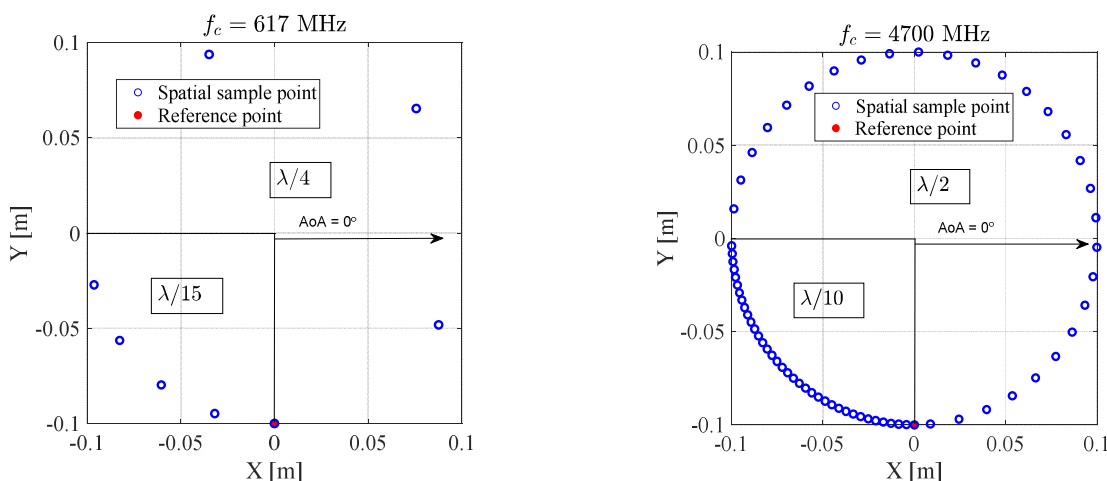

Figure C.3.4-5: Spatial sampling for spatial correlation validation measurement for test frequencies less than and equal to or greater than 1800 MHz: 617 MHz spatial sampling (left) and 4700 MHz spatial sampling (right).

Reference Spatial Correlation Curves

The spatial correlation validation reference curves are tabulated in tables C.3.4-4 and C.3.4-5 for CDL-C UMi and CDL-C UMa, respectively, for a vertically polarized MPAC OTA setup with 16 uniformly spaced probes.

Table C.3.4-4: Spatial correlation reference curves for CDL-C UMi model for a vertically polarized MPAC OTA setup with 16 uniformly spaced probes at FR1 test frequencies

Azim [°]	$ \rho $ beam 1	Azim [°]	$ \rho $ beam 1	Azim [°]	$ \rho $ beam 1	Azim [°]	$ \rho $ beam 1	Azim [°]	$ \rho $ beam 1
617 MHz		722 MHz		836.5 MHz		1575.42 MHz		1800 MHz	
270.0	1.00	270.0	1.00	270.0	1.00	270.0	1.00	270.0	1.00
251.4	1.00	254.1	1.00	256.3	1.00	262.7	1.00	260.9	1.00
232.9	1.00	238.3	1.00	242.6	1.00	255.5	1.00	251.7	1.00
214.3	0.99	222.4	1.00	228.9	1.00	248.2	1.00	242.6	0.99
195.8	0.99	206.6	0.99	215.2	0.99	240.9	0.99	233.5	0.99
110.4	0.87	190.7	0.98	201.6	0.98	233.7	0.99	224.3	0.98
40.8	0.87	120.5	0.84	187.9	0.96	226.4	0.99	215.2	0.97
331.2	0.98	61.1	0.80	128.7	0.82	219.1	0.98	206.0	0.95
		1.6	0.91	77.3	0.73	211.9	0.97	196.9	0.92
		302.1	0.99	26.0	0.81	204.6	0.96	187.8	0.87

				334.7	0.95	197.3	0.94	134.3	0.39
				283.3	1.00	190.0	0.91	88.6	0.15
						182.8	0.87	43.0	0.24
						152.7	0.66	357.3	0.62
						125.5	0.44	311.6	0.94
						98.2	0.30		
						71.0	0.28		
						43.7	0.37		
						16.5	0.54		
						349.2	0.75		
						321.9	0.91		
						294.7	0.99		

Azim [°]	$ \rho $ beam 1	Azim [°]	$ \rho $ beam 1	Azim [°]	$ \rho $ beam 1	Azim [°]	$ \rho $ beam 1
<b>2132.5 MHz</b>		<b>2450 MHz</b>		<b>3600 MHz</b>		<b>4700 MHz</b>	
270.0	1.00	270.0	1.00	270.0	1.00	270.0	1.00
261.9	1.00	263.0	1.00	265.2	1.00	266.3	1.00
253.9	1.00	256.0	1.00	260.5	1.00	262.7	1.00
245.8	0.99	249.0	0.99	255.7	0.99	259.0	0.99
237.8	0.99	242.0	0.99	250.9	0.99	255.4	0.99
229.7	0.98	234.9	0.99	246.1	0.99	251.7	0.99
221.7	0.97	227.9	0.98	241.4	0.98	248.1	0.98
213.6	0.96	220.9	0.97	236.6	0.98	244.4	0.98
205.6	0.93	213.9	0.95	231.8	0.97	240.8	0.98
197.5	0.89	206.9	0.92	227.1	0.97	237.1	0.97
189.5	0.84	199.9	0.88	222.3	0.95	233.5	0.97
181.4	0.77	192.9	0.83	217.5	0.93	229.8	0.96
139.7	0.27	185.9	0.76	212.7	0.90	226.1	0.95
99.5	0.14	144.9	0.19	208.0	0.86	222.5	0.93
59.2	0.14	109.9	0.26	203.2	0.81	218.8	0.91
18.9	0.26	74.8	0.37	198.4	0.75	215.2	0.87
338.6	0.71	39.8	0.19	193.7	0.68	211.5	0.83
298.4	0.97	4.7	0.29	188.9	0.59	207.9	0.78
		329.7	0.74	184.1	0.49	204.2	0.72
		294.6	0.97	156.1	0.23	200.6	0.64
				132.3	0.62	196.9	0.56
				108.4	0.85	193.3	0.47
				84.6	0.93	189.6	0.37
				60.7	0.92	185.9	0.27
				36.9	0.79	182.3	0.18
				13.0	0.42	161.7	0.51
				349.1	0.15	143.5	0.83
				325.3	0.60	125.2	0.95
				301.4	0.90	106.9	0.89
				277.6	1.00	88.6	0.80
						70.4	0.78
						52.1	0.88
						33.8	0.98
						15.5	0.91
						357.3	0.53
						339.0	0.09
						320.7	0.50
						302.4	0.82
						284.2	0.97

Table C.3.4-5: Spatial correlation reference curves for CDL-C UMa model for a vertically polarized MPAC OTA setup with 16 uniformly spaced probes at FR1 test frequencies

Azim [°]	$ \rho $ comb	Azim [°]	$ \rho $ comb	Azim [°]	$ \rho $ comb	Azim [°]	$ \rho $ comb	Azim [°]	$ \rho $ comb
<b>617 MHz</b>		<b>722 MHz</b>		<b>836.5 MHz</b>		<b>1575.42 MHz</b>		<b>1800 MHz</b>	

270.0	1.00	270.0	1.00	270.0	1.00	270.0	1.00	270.0	1.00
251.4	0.99	254.1	0.99	256.3	0.99	262.7	0.99	260.9	0.99
232.9	0.99	238.3	0.98	242.6	0.98	255.5	0.98	251.7	0.96
214.3	0.98	222.4	0.97	228.9	0.97	248.2	0.96	242.6	0.93
195.8	0.96	206.6	0.96	215.2	0.96	240.9	0.94	233.5	0.90
110.4	0.61	190.7	0.94	201.6	0.95	233.7	0.92	224.3	0.89
40.8	0.47	120.5	0.58	187.9	0.92	226.4	0.91	215.2	0.88
331.2	0.85	61.1	0.30	128.7	0.56	219.1	0.90	206.0	0.87
		1.6	0.56	77.3	0.19	211.9	0.89	196.9	0.84
		302.1	0.95	26.0	0.27	204.6	0.88	187.8	0.79
				334.7	0.70	197.3	0.87	134.3	0.16
				283.3	0.99	190.0	0.84	88.6	0.30
						182.8	0.79	43.0	0.22
						152.7	0.42	357.3	0.36
						125.5	0.13	311.6	0.57
						98.2	0.30		
						71.0	0.31		
						43.7	0.29		
						16.5	0.33		
						349.2	0.29		
						321.9	0.48		
						294.7	0.88		

Azim [°]	ρ  comb	Azim [°]	ρ  comb	Azim [°]	ρ  comb	Azim [°]	ρ  comb
2132.5 MHz		2450 MHz		3600 MHz		4700 MHz	
270.0	1.00	270.0	1.00	270.0	1.00	270.0	1.00
261.9	0.99	263.0	0.99	265.2	0.98	266.3	0.98
253.9	0.95	256.0	0.95	260.5	0.95	262.7	0.94
245.8	0.92	249.0	0.91	255.7	0.90	259.0	0.89
237.8	0.89	242.0	0.87	250.9	0.84	255.4	0.83
229.7	0.86	234.9	0.85	246.1	0.80	251.7	0.78
221.7	0.85	227.9	0.83	241.4	0.77	248.1	0.73
213.6	0.85	220.9	0.82	236.6	0.75	244.4	0.70
205.6	0.83	213.9	0.82	231.8	0.73	240.8	0.68
197.5	0.80	206.9	0.80	227.1	0.72	237.1	0.66
189.5	0.75	199.9	0.77	222.3	0.71	233.5	0.65
181.4	0.67	192.9	0.73	217.5	0.70	229.8	0.64
139.7	0.22	185.9	0.66	212.7	0.69	226.1	0.63
99.5	0.24	144.9	0.26	208.0	0.67	222.5	0.62
59.2	0.03	109.9	0.23	203.2	0.64	218.8	0.61
18.9	0.16	74.8	0.19	198.4	0.61	215.2	0.60
338.6	0.37	39.8	0.13	193.7	0.56	211.5	0.59
298.4	0.73	4.7	0.15	188.9	0.49	207.9	0.57
		329.7	0.38	184.1	0.41	204.2	0.55
		294.6	0.74	156.1	0.42	200.6	0.52
				132.3	0.19	196.9	0.48
				108.4	0.64	193.3	0.42
				84.6	0.47	189.6	0.35
				60.7	0.44	185.9	0.26
				36.9	0.28	182.3	0.18
				13.0	0.16	161.7	0.59
				349.1	0.16	143.5	0.26
				325.3	0.41	125.2	0.79
				301.4	0.40	106.9	0.43
				277.6	0.95	88.6	0.68
						70.4	0.63
						52.1	0.75
						33.8	0.87

						15.5	0.67
						357.3	0.09
						339.0	0.25
						320.7	0.32
						302.4	0.42
						284.2	0.73

**Time Domain Alternative Method:**

Time domain techniques can also be used to validate the spatial correlation. The spatial correlation validation measurement setup is illustrated in Figure C.3.4-6. In this case a Signal generator transmits a CW signal through the MIMO test system. The signal is received by a test antenna within the test area. Finally, the signal is collected by a signal analyser and the measured signal is stored for postprocessing.

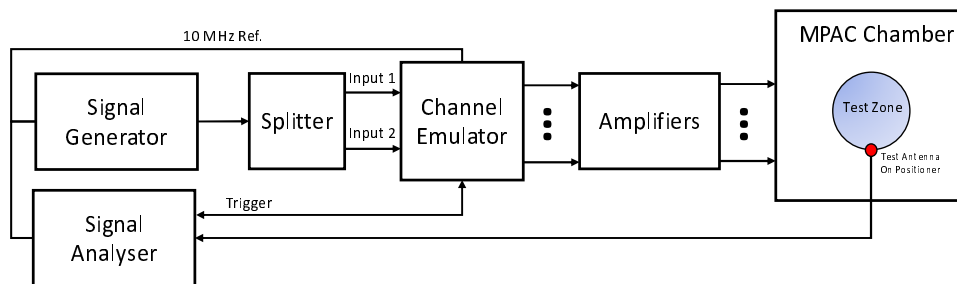

**Figure C.3.4-6: Configuration for spatial correlation validation based on time domain techniques**

For each spatial point, the channel emulator should issue a trigger signal each time fading is started. For each point collect a time domain trace with the signal analyser, when done, stop fading. Data recording is synchronized with the channel emulator trigger. Depending on CE implementation, the trigger direction between SAN and CE needs to be adjusted, i.e., from SAN to CE or from CE to SAN.

Follow the same procedure to postprocess the data and calculate the spatial correlation by setting  $m$  to 1. The settings for the Signal Generator and Signal Analyser are in Table C.3.4-6 and C.3.4-7 respectively.

**Table C.3.4-6: Signal Generator Settings**

Item	Unit	Value
Centre frequency	MHz	Downlink centre frequency in Table C.3.1-1
Output power	dBm	Function of the CE. Sufficiently above Noise Floor

**Table C.3.4-7: Signal Analyser Settings**

Item	Unit	Value
Centre frequency	MHz	Downlink centre frequency in Table C.3.1-1
Sampling	Hz	At least 15 times bigger than the max Doppler spread ( $f_d=v/\lambda$ )
Observation time	s	At least 16s. Channel Model length should be the same or greater than the observation time.

**Beam-Simultaneous Block Diagram**

It is assumed that the beams are mapped to the inputs of the channel emulator as follows:

- Beam 1: Input 1 and Input 2
- Beam 2: Input 3 and Input 4 (CDL-C UMa only)



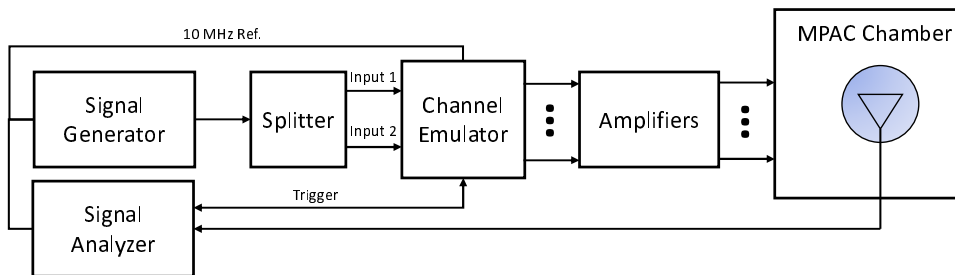

**Figure C.3.4-7: Configuration for spatial correlation validation based on time domain techniques (CDL-C UMi)**

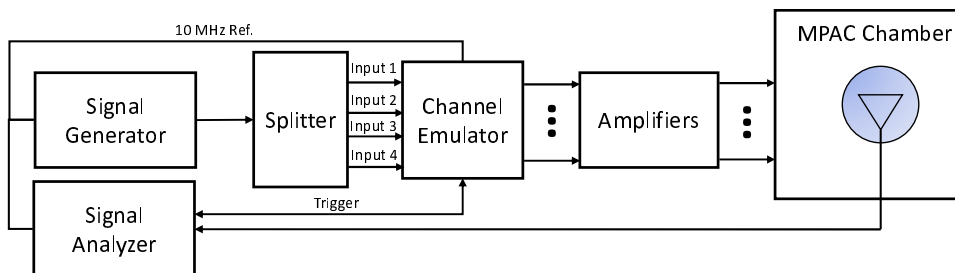

**Figure C.3.4-8: Configuration for spatial correlation validation based on time domain techniques (CDL-C UMa)**

### C.3.5 Cross-polarization

This measurement checks how well the measured vertically or horizontally polarized power levels follow expected values. The test setup for cross-polarization is the same as PDP validation in Figure C.3.2-1.

**Method of measurement:** Step the emulation and store traces from VNA.

VNA settings for cross-polarization measurements are presented in Table C.3.5-1.

**Table C.3.5-1: VNA settings for cross-polarization measurements**

Item	Unit	Value
Centre frequency	MHz	Downlink Centre Frequency in Table C.3.1-1
Span	MHz	40
Number of traces		1000
Number of points		802
Averaging		1

Channel model specification for cross-polarization measurements is presented in Table C.3.5-2.

**Table C.3.5-2: Channel model specification for cross-polarization measurements**

Item	Unit	Value
Centre frequency	MHz	Downlink centre frequency in Table C.3.1-1
Distance between traces in channel model	wavelength (Note)	> 2
Channel model		As specified in Annex C.1
Mobile speed (**)	km/h	30
NOTE: Time [s] = distance [ $\lambda$ ] / MS speed [ $\lambda/s$ ] MS speed [ $\lambda/s$ ] = MS speed [m /s] / Speed of light [m/s] * Centre frequency [Hz] (** The mobile speed is valid for the Time Domain Alternative method only		

**Measurement Procedure:**

Step the emulation and store traces from VNA. i.e., run the emulation to CIR number 1, pause, measure VNA trace, run the emulation to CIR number 10, pause, measure VNA trace. Continue until 1000 VNA traces are measured. Ensure that the phase relationship at the inputs of the channel emulator do not produce destructive interference.

- a. Use a vertically polarized sleeve dipole to measure the V component.
- b. Use a horizontally polarized (vertically oriented) magnetic loop dipole, or a horizontally polarized sleeve dipole measured in four orthogonal horizontal positions and summed to measure the H component.

**Method of measurement result analysis:**

Measured VNA traces (frequency responses  $H_V(t, f)$  and  $H_H(t, f)$ ) are saved into a hard drive. The data is read into, e.g., Matlab. The frequency responses are averaged in power over time and frequency and the V/H ratio calculated as follows:

$$P_V = \sum_t \sum_f |H_V(t, f)|^2$$

$$P_H = \sum_t \sum_f |H_H(t, f)|^2$$

$$P_{V/H}[dB] = 10 \log_{10} \left( \frac{P_V}{P_H} \right)$$

**Beam-Specific Block Diagram**

It is assumed that the beams are mapped to the inputs of the channel emulator as follows:

- Beam 1: Input 1 and Input 2
- Beam 2: Input 3 and Input 4 (CDL-C UMa only)

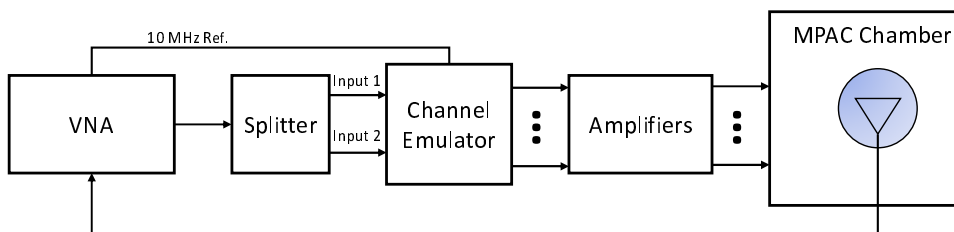

**Figure C.3.5-1: Setup for Beam-Specific V/H measurements (Beam 1)**

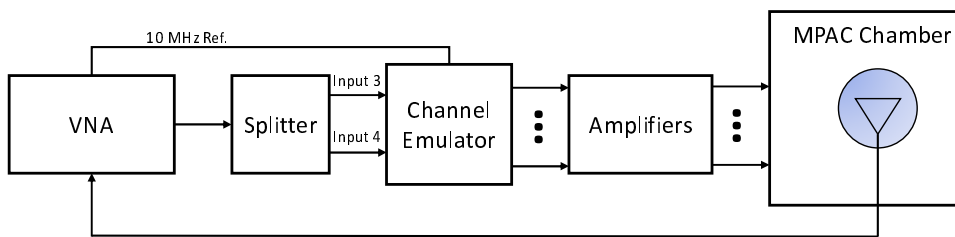

Figure C.3.5-2: Setup for Beam-Specific V/H measurements (Beam 2 CDL-C UMa only)

**Time Domain Alternative Method:**

The power in the Vertical and Horizontal polarizations can also be measured in time domain. The measurement setup for Beam-Specific are presented in Figures C.3.5-3, and C.3.5-4.

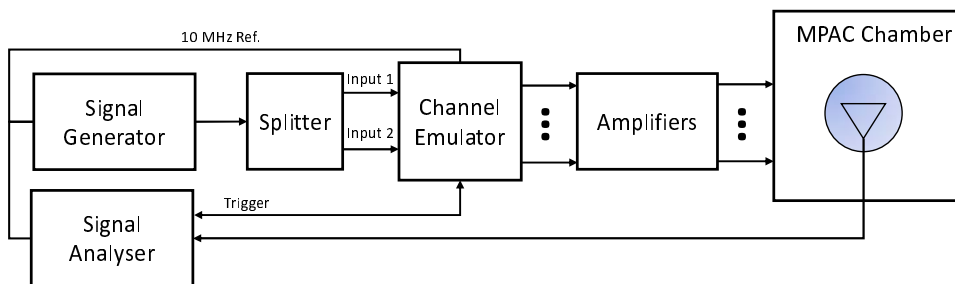

Figure C.3.5-3: Setup for Beam-Specific V/H measurements (Beam 1)

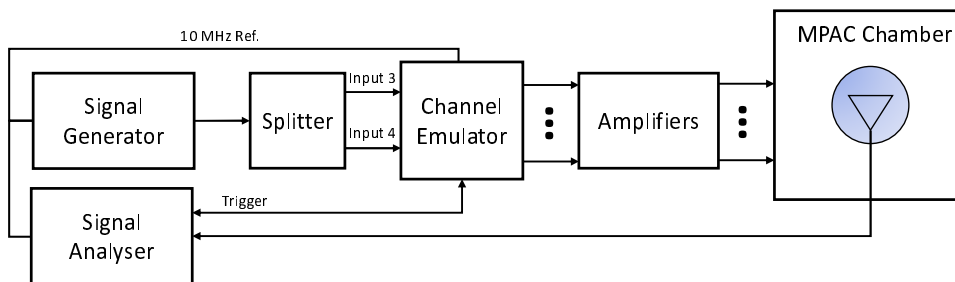

Figure C.3.5-4: Setup for Beam-Specific V/H measurements (Beam 2 CDL-C UMa only)

The instruments settings are the same as those in tables C.3.4-6 and C.3.4-7. The measurement analysis is the same as that of the frequency domain method setting the summation over  $f$  to a single point.

The reference V/H-ratios for CDL-C UMa and CDL-C UMi channel model validation are defined in tables C.3.5-3 and C.3.5-4, respectively.

**Table C.3.5-3: Reference V/H-ratios for CDL-C UMa**

UMa C, $f_c \leq 2.5$ GHz	Beam 1	Input 1+2: V/H = 0 dB
	Beam 2	Input 3+4: V/H = 0 dB
UMa C, $f_c > 2.5$ GHz	Beam 1	Input 1+2: V/H = 0 dB
	Beam 2	Input 3+4: V/H = 0 dB

**Table C.3.5-4: Reference V/H-ratios for CDL-C UMi**

UMi C, $f_c \leq 2.5$ GHz	Beam 1	Inputs 1+2: V/H = 0 dB
UMi C, $f_c > 2.5$ GHz	Beam 1	Inputs 1+2: V/H = 0 dB

### C.3.6 Power validation

This measurement checks the total power in the centre of the test zone. The power validation is measured with a spectrum analyser as shown in Figure C.3.6-1.

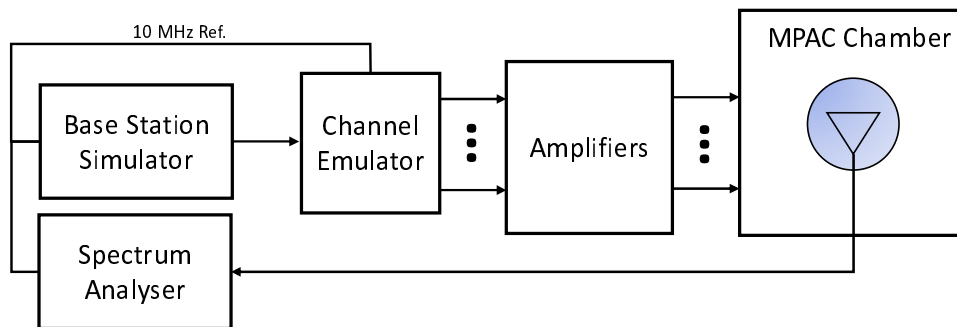

**Figure C.3.6-1: Setup for power validation measurements**

Spectrum analyser settings for power validation measurements are presented in Table C.3.6-1.

**Table C.3.6-1: Spectrum analyser settings for power validation measurements**

Item	Unit	Value
Centre frequency	MHz	Downlink centre frequency in Table C.3.1-2
Integrated Channel Span	Hz	40MHz
RBW	Hz	30 kHz
VBW	Hz	≥10MHz
Number of points		≥400
Averaging		≥100
Detector		RMS

**Measurement Procedure:**

1. Place a vertical reference dipole in the centre of the test zone connected to a spectrum analyser (or power meter) via a cable.
2. Record the cable and reference dipole gains.
3. Load the target channel model into the channel emulator and play the model.
4. Start the NR FR1 signalling in the base station emulator with the required parameter identical to the measurements conditions.
5. Average the power received by the spectrum analyser for a sufficient amount of time to account for the fading channel – one full channel simulation might be unnecessary. The possibility to use an equipment capable to decode the NR signal for EPRE Power Validation is not precluded.
6. Repeat steps 1 to 4 with a magnetic loop for the horizontal polarization, or a horizontally polarized sleeve dipole measured in at least four orthogonal horizontal positions and average the summed orientations to get the H component.
7. Calculate the total power received at the test area as the sum of the power in the two polarizations.

Note: in step 6, if horizontally polarized sleeve dipole is used, the reference gain correction should be the average of the theta gain pattern cut of the dipole. Besides, more horizontal positions for averaging will improve the measurement accuracy but increase the total measurement time.

The detailed power validation setup for CDL-C UMi and CDL-C UMa channel models are illustrated in Figure C.3.6-2 and Figure C.3.6-3.

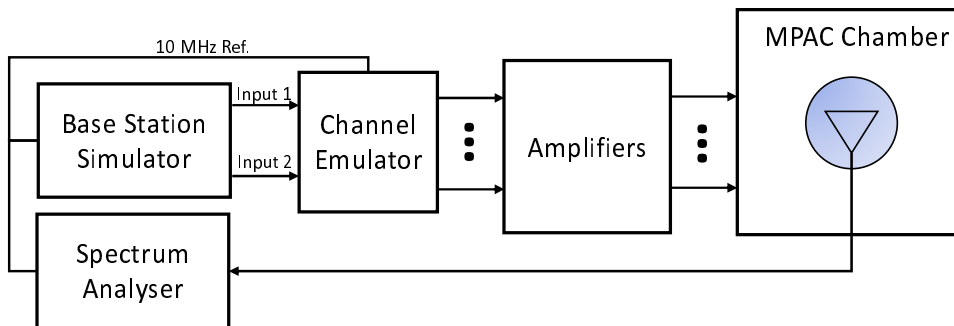

Figure C.3.6-2: Setup for power validation measurements for CDL-C UMi

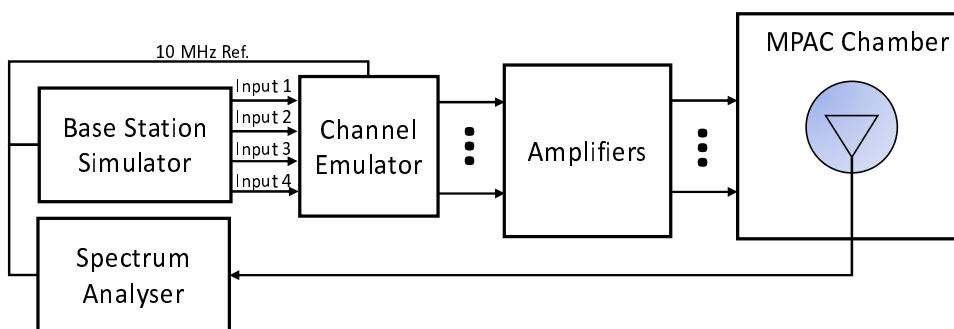

Figure C.3.6-3: Setup for power validation measurements for CDL-C UMa

## C.4 Validation Pass/fail limit

### C.4.1 General

This clause defines the pass/fail limit of FR1 MPAC system for FR1 channel model validation.

### C.4.2 Pass/Fail Criteria of PDP

This clause defines the pass/fail criteria of PDP, this pass/fail limits apply for all FR1 frequency bands, for both combined and individual beams.

The detailed pass/fail limits for each cluster of CDL-C UMa and CDL-C UMi are defined in Table C.4.2-1.

Table C.4.2-1: PDP pass/fail limits for CDL-C UMa and CDL-C UMi channel model validation

	Power Tolerance	Delay Tolerance
Paths from 0dB to 10dB	±1dB	±6ns
Paths from 10dB to 20dB	±2.5dB	±6ns
Paths from 20dB to 30dB	±5dB	±6ns
Paths from 30dB to 40dB	±10dB	±6ns

### C.4.3 Pass/Fail Criteria of Doppler/Temporal correlation

This clause defines the pass/fail criteria of doppler/temporal correlation, this pass/fail limits apply for all channel models in all FR1 frequency bands, for both combined and individual beams.



Based on the values defined in Table C.4.3-1, Figure C.4.3-1 shows the pass/fail and reference curve of temporal correlation.

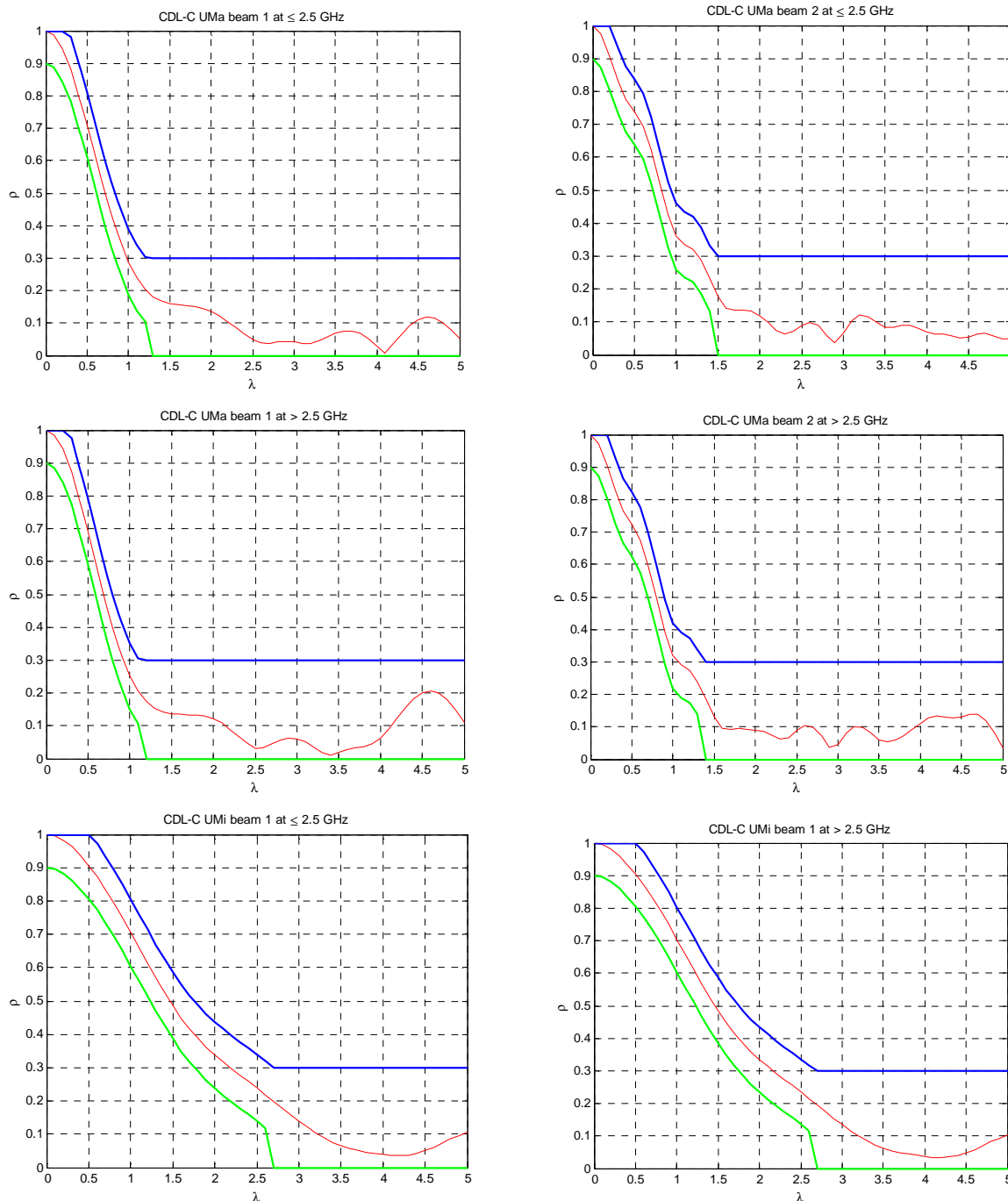

**Figure C.4.3-1: Pass/fail limits and targets of Temporal correlation for CDL-C UMa and CDL-C UMi channel model: red curve (reference), blue (upper limit) and green (lower limit)**

### C.4.4 Pass/Fail Criteria of Spatial correlation

This clause defines the pass/fail criteria of spatial correlation, this general pass/fail limits principle apply for all channel models in all FR1 frequency bands, for both combined and individual beams.

The pass/fail limits for spatial correlation are formed as bands of  $\pm 10\%$  of correlation capped at 100% for the upper limit for target correlation defined in clause C.3.4 of 35% (for CDL-C UMa @3600MHz, this value is 65%) and above. For target correlations below 35% (for CDL-C UMa @3600MHz, this value is 65%), the band is widened to  $\pm 20\%$  capped at 0%.

For the detailed pass/fail limits, the values are defined in the Table C.4.4-1 and Table C.4.4-2, for CDL-C UMi and CDL-C UMa channel model, respectively.

**Table C.4.4-1: Spatial correlation pass/fail limits for CDL-C UMi channel model**

Lower	Upper	Lower	Upper	Lower	Upper	Lower	Upper	Lower	Upper
617 MHz		722 MHz		836.5 MHz		1575.42 MHz		1880 MHz	
0.90	1.00	0.90	1.00	0.90	1.00	0.90	1.00	0.90	1.00
0.90	1.00	0.90	1.00	0.90	1.00	0.90	1.00	0.90	1.00
0.90	1.00	0.90	1.00	0.90	1.00	0.90	1.00	0.90	1.00
0.90	1.00	0.90	1.00	0.90	1.00	0.90	1.00	0.89	1.00
0.89	1.00	0.89	1.00	0.89	1.00	0.89	1.00	0.89	1.00
0.77	0.97	0.88	1.00	0.88	1.00	0.89	1.00	0.88	1.00
0.77	0.97	0.74	0.94	0.86	1.00	0.89	1.00	0.87	1.00
0.88	1	0.70	0.90	0.72	0.92	0.88	1.00	0.85	1.00
		0.81	1.00	0.63	0.83	0.87	1.00	0.82	1.00
		0.89	1.00	0.71	0.91	0.86	1.00	0.77	0.97
				0.85	1.00	0.84	1.00	0.29	0.49
				0.90	1.00	0.81	1.00	0.00	0.35
						0.77	0.97	0.04	0.44
						0.56	0.76	0.52	0.72
						0.34	0.54	0.84	1.00
						0.10	0.50		
						0.08	0.48		
						0.27	0.47		
						0.44	0.64		
						0.65	0.85		
						0.81	1.00		
						0.89	1.00		

Lower	Upper	Lower	Upper	Lower	Upper	Lower	Upper
2132.5 MHz		2450 MHz		3600 MHz		4700 MHz	
0.90	1.00	0.90	1.00	0.90	1.00	0.90	1.00
0.90	1.00	0.90	1.00	0.90	1.00	0.90	1.00
0.90	1.00	0.90	1.00	0.90	1.00	0.90	1.00
0.89	1.00	0.89	1.00	0.89	1.00	0.89	1.00
0.89	1.00	0.89	1.00	0.89	1.00	0.89	1.00
0.88	1.00	0.89	1.00	0.89	1.00	0.89	1.00
0.87	1.00	0.88	1.00	0.88	1.00	0.88	1.00
0.86	1.00	0.87	1.00	0.88	1.00	0.88	1.00
0.83	1.00	0.85	1.00	0.87	1.00	0.88	1.00
0.79	0.99	0.82	1.00	0.87	1.00	0.87	1.00
0.74	0.94	0.78	0.98	0.85	1.00	0.87	1.00
0.67	0.87	0.73	0.93	0.83	1.00	0.86	1.00
0.07	0.47	0.66	0.86	0.80	1.00	0.85	1.00
0	0.34	0.00	0.39	0.76	0.96	0.83	1.00
0	0.34	0.06	0.46	0.71	0.91	0.81	1.00
0.06	0.46	0.27	0.47	0.65	0.85	0.77	0.97
0.61	0.81	0.00	0.39	0.58	0.78	0.73	0.93
0.87	1.00	0.09	0.49	0.49	0.69	0.68	0.88
		0.64	0.84	0.39	0.59	0.62	0.82
		0.87	1.00	0.03	0.43	0.54	0.74
				0.52	0.72	0.46	0.66
				0.75	0.95	0.37	0.57
				0.83	1.00	0.27	0.47
				0.82	1.00	0.07	0.47
				0.69	0.89	0.00	0.38
				0.32	0.52	0.41	0.61
				0.00	0.35	0.73	0.93
				0.50	0.70	0.85	1.00
				0.80	1.00	0.79	0.99
				0.90	1.00	0.70	0.90
						0.68	0.88
						0.78	0.98



						0.88	1.00
						0.81	1.00
						0.43	0.63
						0.00	0.29
						0.40	0.60
						0.72	0.92
						0.87	1.00

**Table C.4.4-2:**  
Spatial correlation

**pass/fail limits for CDL-C UMa channel model**

Lower	Upper	Lower	Upper	Lower	Upper	Lower	Upper	Lower	Upper
617 MHz		722 MHz		836.5 MHz		1575.42 MHz		1800 MHz	
0.90	1.00	0.90	1.00	0.90	1.00	0.90	1.00	0.90	1.00
0.89	1.00	0.89	1.00	0.89	1.00	0.89	1.00	0.89	1.00
0.89	1.00	0.88	1.00	0.88	1.00	0.88	1.00	0.86	1.00
0.88	1.00	0.87	1.00	0.87	1.00	0.86	1.00	0.83	1.00
0.86	1.00	0.86	1.00	0.86	1.00	0.84	1.00	0.80	1.00
0.51	0.71	0.84	1.00	0.85	1.00	0.82	1.00	0.79	0.99
0.37	0.57	0.48	0.68	0.82	1.00	0.81	1.00	0.78	0.98
0.75	0.95	0.10	0.50	0.46	0.66	0.80	1.00	0.77	0.97
		0.46	0.66	0	0.39	0.79	0.99	0.74	0.94
		0.85	1.00	0.07	0.47	0.78	0.98	0.69	0.89
				0.60	0.80	0.77	0.97	0.00	0.36
				0.89	1.00	0.74	0.94	0.10	0.50
						0.69	0.89	0.02	0.42
						0.32	0.52	0.26	0.46
						0.00	0.33	0.47	0.67
						0.10	0.50		
						0.11	0.51		
						0.09	0.49		
						0.13	0.53		
						0.09	0.49		
						0.38	0.58		
						0.78	0.98		

Lower	Upper	Lower	Upper	Lower	Upper	Lower	Upper
2132.5 MHz		2450 MHz		3600 MHz		4700 MHz	
0.90	1.00	0.90	1.00	0.90	1.00	0.90	1.00
0.89	1.00	0.89	1.00	0.88	1.00	0.88	1.00
0.85	1.00	0.85	1.00	0.85	1.00	0.84	1.00
0.82	1.00	0.81	1.00	0.80	1.00	0.79	0.99
0.79	0.99	0.77	0.97	0.74	0.94	0.73	0.93
0.76	0.96	0.75	0.95	0.70	0.90	0.68	0.88
0.75	0.95	0.73	0.93	0.67	0.87	0.63	0.83
0.75	0.95	0.72	0.92	0.65	0.85	0.60	0.80
0.73	0.93	0.72	0.92	0.63	0.83	0.58	0.78
0.7	0.9	0.70	0.90	0.62	0.82	0.56	0.76
0.65	0.85	0.67	0.87	0.61	0.81	0.55	0.75
0.57	0.77	0.63	0.83	0.60	0.80	0.54	0.74
0.02	0.42	0.56	0.76	0.59	0.79	0.53	0.73
0.04	0.44	0.06	0.46	0.57	0.77	0.52	0.72
0	0.23	0.03	0.43	0.44	0.84	0.51	0.71
0	0.36	0.00	0.39	0.41	0.81	0.50	0.70
0.27	0.47	0.00	0.33	0.36	0.76	0.49	0.69
0.63	0.83	0.00	0.35	0.29	0.69	0.47	0.67
		0.28	0.48	0.21	0.61	0.45	0.65
		0.64	0.84	0.22	0.62	0.42	0.62
				0.00	0.39	0.38	0.58
				0.44	0.84	0.32	0.52
				0.27	0.67	0.15	0.55
				0.24	0.64	0.06	0.46
				0.08	0.48	0.00	0.38
				0.00	0.36	0.49	0.69
				0.00	0.36	0.06	0.46

				0.21	0.61	0.69	0.89
				0.20	0.60	0.33	0.53
				0.85	1.00	0.58	0.78
						0.53	0.73
						0.65	0.85
						0.77	0.97
						0.57	0.77
						0.00	0.29
						0.05	0.45
						0.12	0.52
						0.32	0.52
						0.63	0.83

## C.4.5

### Pass/Fail Criteria of Cross-polarization

This clause defines the pass/fail criteria of cross-polarization, this pass/fail limits apply for all channel models in all FR1 frequency bands, for both combined and individual beams.

The cross-polarization ratio pass/fail limit is specified as  $\pm 1$ dB.

### C.4.6 Pass/Fail Criteria of Power validation

This clause defines the pass/fail criteria of power validation, this pass/fail limit applies to all channel models in all FR1 frequency bands.

The power validation pass/fail limit is specified as  $\pm 1.5$  dB.

## Annex D (normative): <FR2 Channel models and Validation procedure >

### D.1 FR2 Channel models

The following channel model is required for FR2 MIMO OTA measurement.

The generic model is Table D.1-1 FR2 UMi CDL-C, which does not include base station antenna filtering. Therefore, in addition, the BS beam filtering effect defined in Annex D.2 also apply when emulating the channel models.

**Table D.1-1: Channel model parameters for UMi CDL-C at 28 GHz**

Cluster #	Absolute Delay [ns]	Power in [dB]	AOD in [°]	AOA in [°]	ZOD in [°]	ZOA in [°]
1	0	-4.4215	-30.4353	-134.4434	98.9242	83.3318
2	12.594	-1.25	-20.9269	129.1633	99.1915	72.5229
3	13.314	-3.4684	-20.9269	129.1633	99.1915	72.5229
4	13.974	-5.2294	-20.9269	129.1633	99.1915	72.5229
5	13.056	-2.5215	-28.0782	-152.8206	99.5732	71.1282
6	38.196	0	-11.6982	164.1145	99.306	74.7544
7	38.688	-2.2185	-11.6982	164.1145	99.306	74.7544
8	39.36	-3.9794	-11.6982	164.1145	99.306	74.7544
9	39.504	-7.4215	17.3861	84.3647	100.4513	69.2454
10	47.61	-7.1215	-37.5865	92.0623	98.5616	66.7349
11	49.278	-10.7215	20.2226	-97.7585	100.6231	72.0348
12	56.016	-11.1215	-50.6106	78.4702	98.218	64.4337
13	73.71	-5.1215	-33.911	93.1719	100.165	85.4238
14	78.498	-6.8215	-37.5066	-112.0441	100.2604	64.1548
15	130.224	-8.7215	-43.1797	102.4645	98.1225	64.7824
16	162.63	-13.2215	29.2116	67.2359	100.2604	92.467
17	255.534	-13.9215	27.8133	34.5731	98.4852	65.6889
18	276.018	-13.9215	23.6584	48.5813	98.1416	68.7572
19	329.412	-15.8215	-52.5282	36.4455	97.9698	59.1339
20	336.462	-17.1215	25.0168	52.6729	100.7376	65.3402
21	378.39	-16.0215	25.4562	49.8296	98.1225	58.4365
22	398.244	-15.7215	30.7697	46.4316	98.1034	65.2705
23	422.562	-21.6215	35.9234	30.759	100.4513	62.6903
24	519.138	-22.8215	-61.2775	69.2469	100.9476	61.993
Per-Cluster Parameters						
Parameter	CASD in [°]	CASA in [°]	CZSD in [°]	CZSA in [°]	XPR in [dB]	
Value	0.799	10.4021	0.5726	4.8814	7	

### D.2 FR2 Base Station beam configuration

The emulated BS beam configuration to be used for emulation of channel model defined in Annex D.1 is specified in this clause.

The Base Station beam configuration includes basic antenna parameters and beamforming characteristic. The basic BS antenna parameters is defined in Table D.2-1.

Table D.2-1: FR2 BS Antenna Parameters

Parameter description	Symbol	Parameter value
		FR2
Antenna panels in vertical dimension	$M_g$	1
Antenna panels in horizontal dimension	$N_g$	1
Elements per panel in vertical dimension	$M_e$	8
Elements per panel in horizontal dimension	$N_e$	16
Number of polarizations per panel	$P$	2
Element spacing in horizontal dimension ( $\lambda$ )	$d_H$	0.5
Element spacing in vertical dimension ( $\lambda$ )	$d_V$	0.5

Antenna element radiation patterns, including orientation of the element main polarization components as well as orientation of the antenna array are as in the example pattern in Table 7.3-1 of TR 38.901. The antenna element has  $\pm 45^\circ$  polarization components and the radiation pattern parameters are  $\theta_{3dB} = 65^\circ$ ,  $\phi_{3dB} = 65^\circ$ ,  $A_{max} = 30dB$ ,  $SLAV = 30dB$ ,  $G_{E,max} = 8$  dBi.

The beamforming characteristic of the FR2 BS pattern is defined as follow:

- A code book of 128 fixed beams is constructed to a grid of eight elevation angles from  $-25^\circ$  to  $+25^\circ$  with  $\sim 7.1^\circ$  step size and  $16^\circ$  azimuth angles from  $-60^\circ$  to  $+60^\circ$  with  $8^\circ$  step size;
- 1 strongest transmitting beam is generated from BS, the direction of this beam towards the strongest cluster of the FR2 channel model. Specifically, the direction in UMi CDL-C model is: AoD:  $-12^\circ$ , ZoD:  $100.71^\circ$ .

## D.3 FR2 Channel model validation

### D.3.1 General

This clause describes the FR2 MIMO OTA validation measurements, in order to ensure that the channel models are correctly implemented and hence capable of generating the propagation environment, as described by the model, within the test zone of the 3D-MPAC system.

The following measurements shall be done for FR2 channel model validation:

- Power Delay Profile (PDP)
- Doppler/Temporal correlation
- PAS similarity percentage (PSP)
- Cross-polarization
- Power validation

Frequencies to be used to test for FR2 channel model validation:

Table D.3.1-1: FR2 Channel model validation frequencies

NR FR2 Bands	Range	Test Frequency (MHz)
n257	Low	27750
n260	High	38500
n258	Low	25875
n261	Low	27925

### D.3.2 FR2 Power Delay Profile (PDP)

This measurement checks that the resulting power delay profile (PDP) is in-line with the PDP defined for the channel model. For PDP validation measurement, only Vertical validation is required.

The PDP measurement is performed with a Vector Network Analyser (VNA). An example setup for PDP measurement is shown in Figure D.3.2-1. VNA transmits frequency sweep signals through the NR MIMO OTA test system. A reference antenna, within the centre of the test zone, receives the signal and VNA analyses the frequency response of the system. A number of traces (frequency responses) are measured and recorded by VNA and analysed by a post processing SW, e.g., Matlab. Special care has to be taken into account to keep the fading conditions unchanged, i.e. frozen, during the short period of time of a single trace measurement. The fading may proceed only in between traces.

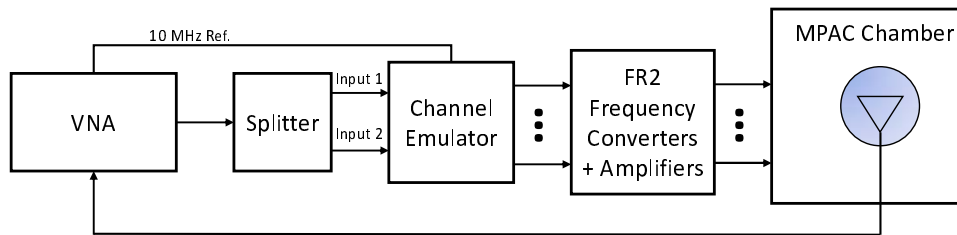

**Figure D.3.2-1: Setup for PDP measurements (FR2)**

Step the emulation and store traces from VNA. I.e. run the emulation to CIR number 1, pause, measure VNA trace, run the emulation to CIR number 10, pause, measure VNA trace. Continue until 1000 VNA traces are measured.

**VNA settings:**

**Table D.3.2-1: VNA settings for FR2 PDP measurements**

Item	Unit	Value
Centre frequency	MHz	Downlink centre frequency in Table D.3.1-1
Span	MHz	200
Number of traces		1000
Number of points		1101
Averaging		1

**Channel model specification:**

**Table D.3.2-2: Channel model specification for FR2 PDP measurements**

Item	Unit	Value
Centre frequency	MHz	Downlink centre frequency in Table D.3.1-1
Distance between traces in channel model	wavelength (Note)	> 2
Channel model		As specified in Annex D.1
NOTE: Time [s] = distance [λ] / MS speed [λ/s] MS speed [λ/s] = MS speed [m/s] / Speed of light [m/s] * Centre frequency [Hz]		

**Method of measurement result analysis:**

Measured VNA traces (frequency responses H(t,f)) are saved into a hard drive. The data is read into, e.g., Matlab. The analysis is performed by taking the Fourier transform of each trace. The resulting impulse responses h(t,τ) are averaged in power over time:

$$P(\tau) = \frac{1}{T} \sum_{t=1}^T |h(t, \tau)|^2$$

Finally, the resulting PDP is shifted in delay, such that the first tap is on delay zero.

The detailed PDP reference value for FR2 CDL-C UMi validation are defined in the following table:

**Table D.3.2-3: PDP Targets for FR2 CDL-C UMi**

Combined Clusters index	Delay(ns)	Power(dB)
1	0	-27.8
2-5	15	-18.3
6-11	40	0.0
13-14	75	-31.2

### D.3.3 FR2 Doppler/Temporal correlation

This measurement checks the Doppler/temporal correlation. For Doppler/Temporal correlation validation measurement, only Vertical validation is required.

The Doppler spectrum is measured with a spectrum analyser as shown in Figure D.3.3-1. In this case a signal generator transmits CW signal through the NR MIMO OTA test system. The signal is received by a test antenna within the test area. Finally, the signal is analysed by a spectrum analyser and the measured spectrum is compared to the target spectrum. This setup can be used to measure Doppler Spectrum of the Channel models defined in Annex D.2.

**Method of measurement:**

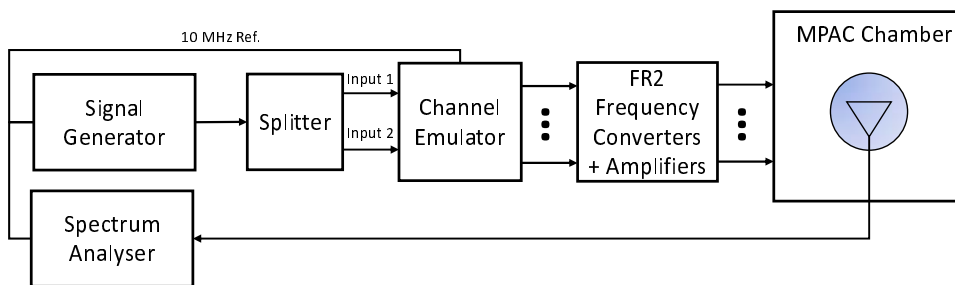

**Figure D.3.3-1: Setup for FR2 Doppler measurements**

Sine wave (CW, carrier wave) signal is transmitted from the signal generator. The signal is connected from the signal generator to fading emulator via cables. The fading emulator output signals are connected to frequency converter and power amplifier boxes via cables. The amplified signals are then transferred via cables to the probe antennas. The probe antennas radiate the signals over the air to the test antenna. The Doppler spectrum is measured by the spectrum analyser and the trace is saved.

**Signal generator settings:**

**Table D.3.3-1: Signal generator settings for FR2 Doppler/Temporal correlation measurements**

Item	Unit	Value
Centre frequency	MHz	Downlink centre frequency in Table D.3.1-1
Modulation		OFF

**Spectrum analyser settings:**

**Table D.3.3-2: Spectrum analyser settings for FR2 Doppler/Temporal correlation measurements**

Item	Unit	Value
Centre frequency	MHz	Downlink centre frequency in Table D.3.1-1
Minimum Span	Hz	4 kHz
RBW	Hz	1
VBW	Hz	1
Number of points		16002
Averaging		100

Channel model specification:

**Table D.3.3-3: Channel model specification for FR2 Doppler/Temporal correlation measurements**

Item	Unit	Value
Centre frequency	MHz	Downlink centre frequency in Table D.3.1-1
Channel model		As specified in Annex D.1
Mobile speed	km/h	12

Method of measurement result analysis: Measurement data file (Doppler power spectrum) is saved into hard drive. The data is read into, e.g., Matlab. The analysis is performed by taking the Fourier transformation of the Doppler spectrum.

The resulting temporal correlation function  $R_t(\Delta t)$  is normalized such that  $\max(\text{abs}(R_t(\Delta t)))=1$ . Then the function values left from the maximum is cut out. Further on the function values after, e.g. seven periods is cut out.

The detailed Temporal correlation reference value for FR2 CDL-C UMi channel model validation is defined in table D.3.3-4.

**Table D.3.3-4: Temporal correlation Targets**

Distance [ $\lambda$ ]	X2V Corr.	Distance [ $\lambda$ ]	X2V Corr.
0	1.0000	2.5	0.1769
0.1	0.9929	2.6	0.1717
0.2	0.9717	2.7	0.1649
0.3	0.9379	2.8	0.1564
0.4	0.8937	2.9	0.1456
0.5	0.8414	3	0.1327
0.6	0.7834	3.1	0.1177
0.7	0.7223	3.2	0.1011
0.8	0.6601	3.3	0.0829
0.9	0.5986	3.4	0.0638
1	0.5387	3.5	0.0449
1.1	0.4817	3.6	0.0272
1.2	0.4284	3.7	0.0121
1.3	0.3796	3.8	0.0023
1.4	0.3362	3.9	0.0079
1.5	0.2984	4	0.0104
1.6	0.2667	4.1	0.0083
1.7	0.2416	4.2	0.0026
1.8	0.2221	4.3	0.0095
1.9	0.2081	4.4	0.0235
2	0.1987	4.5	0.0397
2.1	0.1921	4.6	0.0572
2.2	0.1879	4.7	0.0738
2.3	0.1844	4.8	0.0890
2.4	0.1812	4.9	0.1018
		5	0.1109

**Time Domain Alternate Method**

Time domain techniques can also be used to validate the tempoal correlation. The temporal correlation validation measurement setup is illustrated in Figure D.3.3-2. In this case a Signal generator transmits a CW signal through the MIMO test system. The signal is received by a test antenna within the test area. Finally, the signal is collected by a signal analyser and the measured signal is stored as IQ data format for postprocessing. Depending on CE implementation, the trigger direction between spectrum analyser (SAN) and CE needs to be adjusted, i.e., from SAN to CE or from CE to SAN.

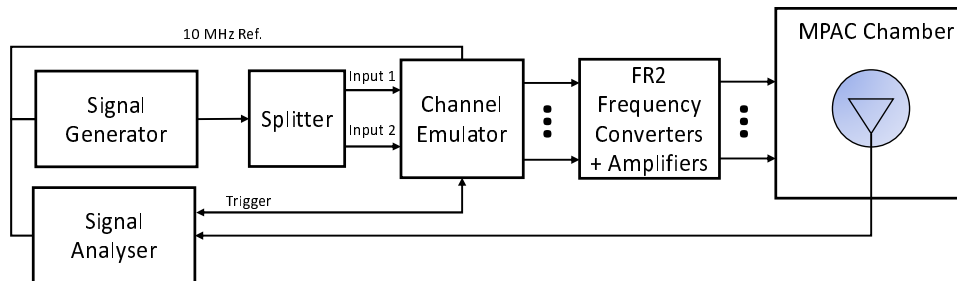

**Figure D.3.3-2: Setup for Doppler measurements based on time domain technique**

The time domain doppler spectrum is measured by the signal analyser and the trace in IQ format is saved. Follow the same procedure to post process the data and calculate the temporal correlation curve. Data recording is synchronized with the channel emulator trigger.

The settings for the signal analyser are in Table D.3.3-5:

**Table D.3.3-5: Signal Analyser Settings**

Item	Unit	Value
Centre frequency	MHz	Downlink centre frequency in Table D.3.1-1
Sampling	Hz	At least 15 times bigger than the max Doppler spread ( $f_d = v/\lambda$ )
Observation time	s	At least 16s. Channel Model length should be the same or greater than the observation time.

**D.3.4 FR2 PAS similarity percentage (PSP)**

The PSP validation measurements aim at evaluating PAS similarity percentage (PSP), which is one of the validation metrics for characterizing FR2 channel model under test in the quite zone of 3D-MPAC. For PSP validation measurement, only vertical polarization validation is required.

The measurement array is essentially a virtual array configuration realized in 3D-MPAC through a  $\phi$ - $\theta$  positioning system. The measurement array is a semi-circle and sectored array configuration illustrated in Figure D.3.4-1 where complex channel frequency response is measured at each antenna location  $0.5 \lambda$  apart using a vector network analyser (VNA) setup. The vertical sectors of the measurement array are limited to  $60^\circ (\pm 30^\circ)$  and the horizontal sector to  $180^\circ (\pm 90^\circ)$  with the broad side direction points towards the probes. Depending of the turntable architecture/implementation, the virtual array configuration for the PSP validation is composed of two alternative semi-circle arrangements (1 x horizontal and either 2 x crossed vertical or 2 x parallel vertical). The radius of the array element locations with respect to the centre of the test zone is 5 cm, which is equivalent to the half of the test zone radius at 28 GHz. For different frequency bands, the radius of the measurement array sectored semi-circles remains fixed at 5 cm while the spatial sampling of the array varies. This measurement validates the proper angular behaviour in the test zone.



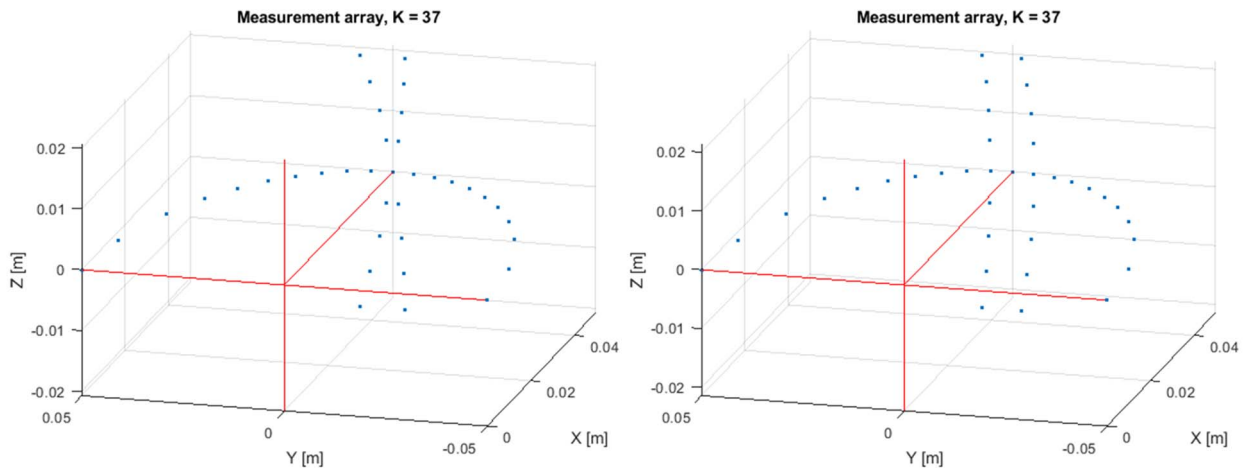

**Figure D.3.4-1: Semi-circle measurement array configurations with  $K = 37$  elements (at 28 GHz). On the left with two crossed vertical sectors, on the right with two parallel vertical sectors.**

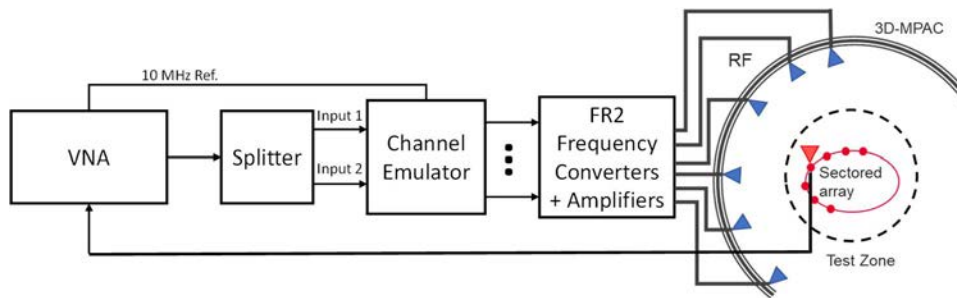

**Figure D.3.4-2: Setup for FR2 PSP validation measurements**

The PSP validation is measured with a vector network analyser as shown in Figure D.3.4-2 illustrating the PSP measurement setup. Port 1 of the VNA transmits signals through the fading emulator and radiate them through  $L$  probes within the anechoic chamber. The radiated signals are then received at the test antenna that is positioned inside the test zone. The test antenna is mounted on a  $\phi$ - $\theta$  positioner which is capable of moving the antenna to pre-defined spatial locations on a fixed radius from the centre of the quiet zone according the measurement array configuration. Finally, the signal is received at port 2 of the VNA. The most suitable approach for the PSP validation is based on an omnidirectional antenna (omnidirectional pattern in AZ and wide BW in EL) as the test can be automated easily. Alternatively, a directional antenna could be used but requires frequent re-positioning.

The measurement and analysis procedure are given as follows:

1. Set the target channel model in the Channel Emulator.
2. For each position of the test antenna on the measurement array configuration in the test zone, step & pause the emulator to different time instances. Measure the complex frequency responses  $H(f, t) = H(m\Delta f, n\Delta T)$ ,  $m = 0, \dots, M - 1$  for all stepped channel snapshots  $n = 0, \dots, N - 1$ , where the interval between frequency and time samples is  $\Delta f$  and  $\Delta T$ , respectively. The number of channel snapshots  $N$  and frequency samples  $M$ .
3. Move the measurement antenna with a positioner to another location  $k$  and repeat step 2 to record frequency responses  $H_k(m\Delta f, n\Delta T)$  of all stepped channel snapshots.
4. Repeat step 3 to record frequency responses at all  $k = 0, \dots, K$  spatial sample points.
5. Estimate the measured PAS through the following two- stage processing:
  - a. In the first stage, calculate the discrete azimuth and elevation angles (DoA) for the measurement array configuration by applying the MUSIC algorithm. Estimate the powers from the DoA and auto-covariance matrix of the received signal acquired through VNA complex frequency response data.

i) Compose an estimate of the covariance matrix  $\mathbf{R}_H \in \mathbb{C}^{K \times K}$ . The entry on the  $k$ th row and  $k'$ th column of  $\mathbf{R}_H$  is

$$R_H(k, k') = \sum_{n=1}^N \sum_{m=1}^M H_k(m\Delta f, n\Delta T) \overline{H_{k'}(m\Delta f, n\Delta T)},$$

where  $(\overline{\phantom{x}})$  is the complex conjugate operator.

ii) Compose pseudo-PAS of the chamber environment and channel model using the MUSIC algorithm. The intention of this step is to estimate DoAs of signals radiated by probes. Perform first the eigen decomposition of  $\mathbf{R}_H$  and pick the noise-subspace matrix  $\mathbf{V}$ . The matrix  $\mathbf{V}$  is obtained from the eigen decomposition by removing eigenvectors, i.e. columns, that correspond to  $X$  strongest eigenvalues, where  $X$  is the number of active probes in the MPAC setup. The pseudo-PAS is [9]

$$P_{\text{MUSIC}}(\beta) = \frac{1}{\boldsymbol{\omega}(\beta) \mathbf{V} \mathbf{V}^H \boldsymbol{\omega}^H(\beta)},$$

where  $(\phantom{x})^H$  is the matrix Hermitean operator and the near-field array factor of the virtual array composed by  $K$  spatial measurement antenna locations is

$$\boldsymbol{\omega}(\beta) = \frac{\lambda_0}{4\pi \|\vec{r}_k - R \vec{u}(\beta)\|} \exp\left(\frac{j2\pi \|\vec{r}_k - R \vec{u}(\beta)\|}{\lambda_0}\right),$$

where  $\lambda_0$  is the wavelength at the carrier centre frequency,  $\|\phantom{x}\|$  is the norm of a vector,  $\vec{r}_k$  is a location vector of the  $k$ th virtual array element,  $\vec{u}(\beta)$  is the unit vector to direction  $\beta$ , and  $R$  is the a priori known approximate range length [9]. Both vectors  $\vec{r}_k$  and  $\vec{u}(\beta)$  are defined with respect to same origin, which is the centre of the test zone.

iii) Find local maxima of  $P_{\text{MUSIC}}(\beta)$  and pick directions  $\beta_x, x = 1, \dots, X$  of the  $X$  highest peaks.

iv) Perform Bartlett beamforming as defined in step 6 with the steering vector  $\boldsymbol{\omega}(\beta_x)$  (instead of  $a(\beta)$ ) to the  $X$  directions identified in iii). The output is  $X$  power estimates  $P_{\text{est}}(\beta_x)$ .

b. In the second stage, use the angle and power estimates, i.e. the discrete PAS of  $X$  azimuth and elevation directions and power values in conjunction with a 4x4 DUT sampling array for beamforming with the conventional Bartlett beamformer to estimate the “measured PAS seen by DUT” for PSP calculation. This is

$$\hat{P}_o(\beta) = a^H(\beta) \left( \sum_{x=1}^X a(\beta_x) P_{\text{est}}(\beta_x) a^H(\beta_x) \right) a(\beta),$$

where  $a(\beta)$  is the array steering vector of the 4x4 DUT array.

6. Evaluate the reference OTA PAS for the 4x4 DUT array by applying the conventional Bartlett beamformer. The theoretical PAS as reference is calculated for the ideal channel model as

$$\hat{P}_r(\beta) = a^H(\beta) \oint a(\beta') P(\beta') a^H(\beta') d\beta' a(\beta),$$

where  $a(\beta)$  is the array steering vector of the 4x4 DUT array and  $P(\beta')$  is the PAS of the reference channel model.

7. Calculate total variation distance ( $D_p$ ) from the reference and measured PAS. Mathematically,

$$D_p = \frac{1}{2} \int \left| \frac{\hat{P}_r(\beta)}{\int \hat{P}_r(\beta') d\beta'} - \frac{\hat{P}_o(\beta)}{\int \hat{P}_o(\beta') d\beta'} \right| d\beta$$

8. Calculate PSP values as  $\text{PSP} = (1 - D_p) \times 100\%$ .

**VNA settings:**

**Table D.3.4-1: VNA settings for FR2 PSP measurements**

Item	Unit	Value
Centre frequency	MHz	Downlink centre frequency in Table D.3.1-1
Span	MHz	0, or the minimum (Note 1)
Number of traces		1000
Number of points		1 (Note 1)
NOTE 1: Span and number of points may be increased to estimate reliably.		

**Channel model specification:**

**Table D.3.4-2: Channel model specification for FR2 PSP measurements**

Item	Unit	Value
Centre frequency	MHz	Downlink centre frequency in Table D.3.1-1
Distance between traces in channel model	wavelength (Note)	> 2
Channel model		As specified in Annex D.1
NOTE: Time [s] = distance [ $\lambda$ ] / MS speed [ $\lambda$ /s] MS speed [ $\lambda$ /s] = MS speed [m/s] / Speed of light [m/s] * Centre frequency [Hz]		

**Time Domain Alternative Method:**

PSP validation can also be implemented using time-domain techniques using the testing setup presented in Figure D.3.4-3. The VNA is substituted by a signal generator, and a signal analyser. Depending on CE implementation, the trigger direction between SAN and CE needs to be adjusted, i.e., from SAN to CE or from CE to SAN.

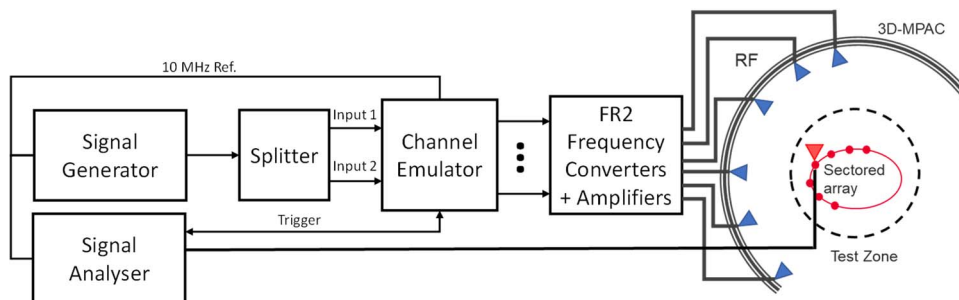

**Figure D.3.4-3: Setup for FR2 PSP validation measurements based on time domain**

**Table D.3.4-3: Signal Generator Settings for FR2 PSP measurements based on time domain**

Item	Unit	Value
Centre frequency	MHz	Downlink centre frequency in Table D.3.1-1
Output power	dBm	Function of the CE. Sufficiently above Noise Floor

**Table D.3.4-4: Signal Analyser Settings for FR2 PSP measurements based on time domain**

Item	Unit	Value
Centre frequency	MHz	Downlink centre frequency in Table D.3.1-1
Sampling	Hz	At least 10 times bigger than the max Doppler spread ( $f_d=v/\lambda$ )
Observation time	s	At least 32s

The measurement and analysis procedure are given as follows:

Follow the same procedure as before, but M is set to 1. The Channel Emulator is not stepped, but it is allowed to play in free run mode for each of the K spatial points.

## D.3.5 FR2 Cross-polarization

This measurement checks how well the measured vertically or horizontally polarized power levels follow expected values. The test setup for cross-polarization is the same as PDP validation in Figure D.3.2-1.

**Method of measurement:** Step the emulation and store traces from VNA.

**VNA settings:**

**Table D.3.5-1: VNA settings for FR2 cross-polarization**

Item	Unit	Value
Centre frequency	MHz	Downlink Centre Frequency in Table D.3.1-1
Span	MHz	40
Number of traces		1000
Number of points		802
Averaging		1

**Channel model specification:**

**Table D.3.5-2: Channel model specification for FR2 cross-polarization.**

Item	Unit	Value
Centre frequency	MHz	Downlink centre frequency in Table D.3.1-1
Distance between traces in channel model	wavelength (Note)	> 2
Channel model		As specified in Annex D.1
Mobile speed	km/h	30
NOTE: Time [s] = distance [ $\lambda$ ] / MS speed [ $\lambda$ /s] MS speed [ $\lambda$ /s] = MS speed [m /s] / Speed of light [m/s] * Centre frequency [Hz]		

### Measurement Procedure:

1. Play or step through the channel model listed in Annex D.1.
2. Measure the absolute power received at the centre of the test zone, averaged over a statistically significant number of fades.
  - a. Perform separate V-polarization and H-polarization measurements sequentially, e.g., by rotating a single-polarized horn antenna accordingly or with a use of a dual-polarized horn where the un-used polarization is terminated.
  - b. Measure input 1+2 first and then enable input at a time to measure input 1 and 2 separately
  - c. Disable all CE outputs and enable one output at a time. Get the VNA trace pointing the measurement horn antenna towards the active probe. Record frequency sweeps through the channel model. Repeat for all the probes.
3. Calculate the V/H ratio.
  - Measure VNA traces (frequency responses over time and probes  $H_V(t, f, k_V)$  and  $H_H(t, f, k_H)$ ) are saved into a hard drive. The data is read into, e.g., Matlab. The frequency responses are summed in power over time  $t$ , frequency  $f$  and probes  $k$  and the V/H ratio calculated as follows:

$$P_V = \sum_t \sum_f \sum_{k_V} |H_V(t, f, k_V)|^2$$

$$P_H = \sum_t \sum_f \sum_{k_H} |H_H(t, f, k_H)|^2$$

$$P_{V/H}[dB] = 10 \log_{10} \left( \frac{P_V}{P_H} \right)$$

4. Compare it with the theory value.

**Reference target for FR2 CDL-C UMi:**

- V/H FR2 CDL-C-UMi, X2+, fc=28 GHz
- Beam 1, Input 1: V/H = -0.45 dB
- Beam 1, Input 2: V/H = 0.49 dB
- Beam 1, Input 1+2: V/H = 0 dB

### D.3.6 FR2 Power validation

This measurement checks the total power in the centre of the test zone. The power validation is measured with a spectrum analyser as shown in Figure D.3.6-1.

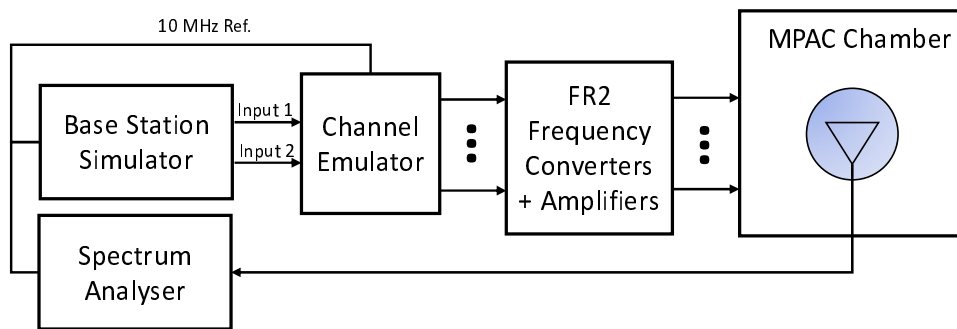

**Figure D.3.6-1: Setup for FR2 power validation measurements**

**Spectrum analyser settings:**

**Table D.3.6-1: Spectrum analyser settings for FR2 power validation measurements**

Item	Unit	Value
Centre frequency	MHz	Downlink centre frequency in Table D.3.1-1
Integrated Channel Span	Hz	20MHz
RBW	Hz	30 kHz
VBW	Hz	≥10MHz
Number of points		≥400
Averaging		≥100
Detector		RMS

**Measurement Procedure:**

1. Place a horn antenna in the centre of the test zone connected to a spectrum analyser (or power meter) via a cable. Point the horn to the first probe and initially select the V-polarization.

2. Record the cable and horn antenna gains.
3. Load the target channel model into the channel emulator.
4. Start the NR FR2 signalling in the base station emulator with the required parameter identical to the measurements conditions.
5. Disable all CE outputs and enable only the CE output that points towards the active probe with the polarization matching the polarization of the reference horn antenna.
6. Average the power received by the spectrum analyser to get  $\geq 100$  averages to account for the fading channel.
7. Repeat steps 5 to 6 for all six probe directions and perform separate V and H polarization measurements while matching the polarization of the horn antenna in the centre of the test zone with the polarization of the probe.
8. Calculate the total power received at the test area as the sum of the power over  $k = 6$  probes in the two polarizations as follows:

$$P_V = 10 \log_{10} \sum_{k_V} 10^{\left(\frac{P_{k_V}[dB]}{10}\right)}$$

$$P_H = 10 \log_{10} \sum_{k_H} 10^{\left(\frac{P_{k_H}[dB]}{10}\right)}$$

$$P_{total}[dB] = 10 \log_{10} \left[ \sum_{k_V} 10^{\left(\frac{P_{k_V}[dB]}{10}\right)} + \sum_{k_H} 10^{\left(\frac{P_{k_H}[dB]}{10}\right)} \right]$$

---

## D.4 Validation Pass/fail limit

### D.4.1 General

This clause defines the pass/fail limit of FR2 3D-MPAC system for FR2 channel model validation.

### D.4.2 Pass/Fail Criteria of PDP

This clause defines the pass/fail criteria of PDP, this pass/fail limits apply for all FR2 frequency bands.

The detailed pass/fail limits for each cluster of FR2 CDL-C UMi are defined in Table D.4.2-1.

**Table D.4.2-1: PDP pass/fail limits for FR2 CDL-C UMi channel model validation**

	<b>Power Tolerance</b>	<b>Delay Tolerance</b>
Paths from 0dB to 10dB	$\pm 1$ dB	$\pm 6$ ns
Paths from 10dB to 30dB	$\pm 5$ dB	$\pm 6$ ns
Paths from 30dB to 40dB	$\pm 10$ dB	$\pm 6$ ns

### D.4.3 Pass/Fail Criteria of Doppler/Temporal correlation

This clause defines the pass/fail criteria of doppler/temporal correlation validation, this pass/fail limits apply for all FR2 frequency bands.

The pass/fail limits for theoretical temporal correlation defined in Clause D.3.3 above 0.3 are formed as bands of  $\pm 0.1$  of correlation capped at 1 at the high end. Additionally, when the theoretical temporal correlation drops below 0.3, the limits are formed at bands of  $\pm 0.3$  of correlation capped at 0 at the low end.

Table D.4.3-1: pass/fail limits for temporal correlation

Distance [ $\lambda$ ]	X2V Corr.		Distance [ $\lambda$ ]	X2V Corr.	
	Lower	Upper		Lower	Upper
0	0.9000	1.0000	2.5	0.0000	0.3000
0.1	0.8929	1.0000	2.6	0.0000	0.3000
0.2	0.8717	1.0000	2.7	0.0000	0.3000
0.3	0.8379	1.0000	2.8	0.0000	0.3000
0.4	0.7937	0.9937	2.9	0.0000	0.3000
0.5	0.7414	0.9414	3	0.0000	0.3000
0.6	0.6834	0.8834	3.1	0.0000	0.3000
0.7	0.6223	0.8223	3.2	0.0000	0.3000
0.8	0.5601	0.7601	3.3	0.0000	0.3000
0.9	0.4986	0.6986	3.4	0.0000	0.3000
1	0.4387	0.6387	3.5	0.0000	0.3000
1.1	0.3817	0.5817	3.6	0.0000	0.3000
1.2	0.3284	0.5284	3.7	0.0000	0.3000
1.3	0.2796	0.4796	3.8	0.0000	0.3000
1.4	0.2362	0.4362	3.9	0.0000	0.3000
1.5	0.1984	0.3984	4	0.0000	0.3000
1.6	0.1667	0.3667	4.1	0.0000	0.3000
1.7	0.1416	0.3416	4.2	0.0000	0.3000
1.8	0.1221	0.3221	4.3	0.0000	0.3000
1.9	0.1081	0.3081	4.4	0.0000	0.3000
2	0.0000	0.3000	4.5	0.0000	0.3000
2.1	0.0000	0.3000	4.6	0.0000	0.3000
2.2	0.0000	0.3000	4.7	0.0000	0.3000
2.3	0.0000	0.3000	4.8	0.0000	0.3000
2.4	0.0000	0.3000	4.9	0.0000	0.3000
			5	0.0000	0.3000

Based on the value defined in Table D.4.3-1, Figure D.4.3-1 shows the pass/fail and reference curve of temporal correlation.

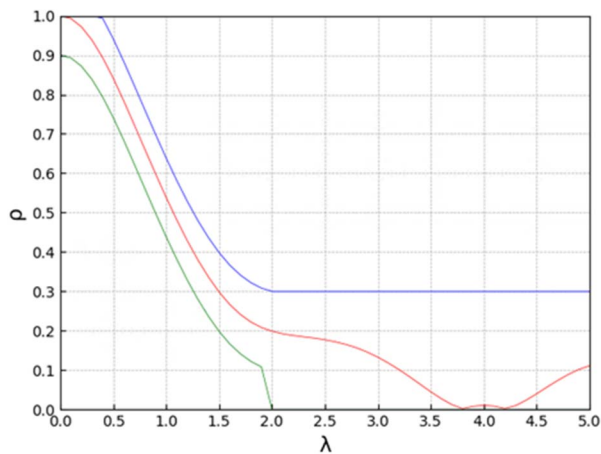

Figure D.4.3-1: Pass/fail limits and targets of Temporal correlation for CDL-C UMi channel model: red curve (reference), blue (upper limit) and green (lower limit)

### D.4.4 Pass/Fail Criteria of PSP

This clause defines the pass/fail criteria of PSP, this general pass/fail limits principle apply for all FR2 frequency bands.

The PSP pass/fail limit is specified as 84%.

## D.4.5 Pass/Fail Criteria of Cross-polarization

This clause defines the pass/fail criteria of cross-polarization, this pass/fail limits apply for all FR2 frequency bands.

The cross-polarization ratio pass/fail limit is specified as  $\pm 1.5$  dB.

## D.4.6 Pass/Fail Criteria of Power validation

This clause defines the pass/fail criteria of power validation, this pass/fail limits apply for all FR2 bands.

The power validation pass/fail limit is specified as 1.5 dB.



## Annex E (normative): <gNB configurations>

### E.1 FR1 gNB configurations

The gNodeB emulator parameters shall be set according to Table E.1-1 for FR1 common parameters, Table E.1-2 for FR1 FDD 2x2 test parameters, Table E.1-3 for FR1 TDD 2x2 test parameters, Table E.1-4 for FR1 FDD 4x4 test parameters, and Table E.1-5 for FR1 TDD 4x4 test parameters.

**Table E.1-1: FR1 Common test parameters**

Parameter		Unit	Value
PDSCH transmission scheme			Transmission scheme 1
Carrier configuration	Offset between Point A and the lowest usable subcarrier on this carrier (Note 2)	RBs	0
	Subcarrier spacing	kHz	15 or 30
DL BWP configuration #1	Cyclic prefix		Normal
	RB offset	RBs	0
	Number of contiguous PRB	PRBs	Maximum transmission bandwidth configuration as specified in clause 5.3.2 of TS 38.101-1 for tested channel bandwidth and subcarrier spacing
Common serving cell parameters	Physical Cell ID		0
	SSB position in burst		First SSB in Slot #0
	SSB periodicity	ms	20
	First DMRS position for Type A PDSCH mapping		2
PDCCH configuration	Slots for PDCCH monitoring		Each slot
	Symbols with PDCCH	Symbols	0, 1
	Number of PRBs in CORESET		Table 5.2-2 of TS 38.101-4 for tested channel bandwidth and subcarrier spacing
	Number of PDCCH candidates and aggregation levels		1/AL8
	CCE-to-REG mapping type		Non-interleaved
	DCI format		1_1
	TCI state		TCI state #1
Cross carrier scheduling			Not configured
CSI-RS for tracking	First subcarrier index in the PRB used for CSI-RS		$k_0=0$ for CSI-RS resource 1,2,3,4
	First OFDM symbol in the PRB used for CSI-RS		$l_0 = 6$ for CSI-RS resource 1 and 3 $l_0 = 10$ for CSI-RS resource 2 and 4
	Number of CSI-RS ports (X)		1 for CSI-RS resource 1,2,3,4
	CDM Type		'No CDM' for CSI-RS resource 1,2,3,4
	Density ( $\rho$ )		3 for CSI-RS resource 1,2,3,4
	CSI-RS periodicity	Slots	15 kHz SCS: 20 for CSI-RS resource 1,2,3,4 30 kHz SCS: 40 for CSI-RS resource 1,2,3,4
	CSI-RS offset	Slots	15 kHz SCS: 10 for CSI-RS resource 1 and 2 11 for CSI-RS resource 3 and 4  30 kHz SCS: 20 for CSI-RS resource 1 and 2 21 for CSI-RS resource 3 and 4
	Frequency Occupation		Start PRB 0 Number of PRB = BWP size
	QCL info		TCI state #0

N/ZP CSI-RS for CSI acquisition	First subcarrier index in the PRB used for CSI-RS		$k_0 = 0$
	First OFDM symbol in the PRB used for CSI-RS		$l_0 = 12$
	Number of CSI-RS ports ( $X$ )		Same as number of transmit antenna
	CDM Type		'FD-CDM2'
	Density ( $\rho$ )		1
	CSI-RS periodicity	Slots	15 kHz SCS: 20 30 kHz SCS: 40
	CSI-RS offset	Slots	0
	Frequency Occupation		Start PRB 0 Number of PRB = BWP size
	QCL info		TCI state #1
ZP CSI-RS for CSI acquisition	First subcarrier index in the PRB used for CSI-RS		$k_0 = 4$
	First OFDM symbol in the PRB used for CSI-RS		$l_0 = 12$
	Number of CSI-RS ports ( $X$ )		4
	CDM Type		'FD-CDM2'
	Density ( $\rho$ )		1
	CSI-RS periodicity	Slots	15 kHz SCS: 20 30 kHz SCS: 40
	CSI-RS offset	Slots	0
	Frequency Occupation		Start PRB 0 Number of PRB = BWP size
PDSCH DMRS configuration	Antenna ports indexes		{1000, 1001} for Rank 2 tests {1000-1003} for Rank 4 tests
	Number of PDSCH DMRS CDM group(s) without data		1 for Rank 2 tests 2 for Rank 4 tests
TCI state #0	Type 1 QCL information	SSB index	SSB #0
		QCL Type	Type C
	Type 2 QCL information	SSB index	N/A
		QCL Type	N/A
TCI state #1	Type 1 QCL information	CSI-RS resource	CSI-RS resource 1 from 'CSI-RS for tracking' configuration
		QCL Type	Type A
	Type 2 QCL information	CSI-RS resource	N/A
		QCL Type	N/A
PT-RS configuration			PT-RS is not configured
Maximum number of code block groups for ACK/NACK feedback			1
Maximum number of HARQ transmission			1
HARQ ACK/NACK bundling			Multiplexed
Redundancy version coding sequence			N.A
Precoding configuration			SP Type I, Random per slot with PRB bundling granularity
Symbols for all unused REs			OCNG Annex A.5 of TS 38.101-4
Minimum Number of Slots per Stream			20000 for 15kHz SCS 40000 for 30kHz SCS (Note 3)
Transmit Power Control		dBm	13
DL power level (RS EPRE of SSS)		dBm / SCS	Set at gNodeB simulator with correction from calibration
EPRE ratio of PDSCH to SSS		dB	0
<p>Note 1: UE assumes that the TCI state for the PDSCH is identical to the TCI state applied for the PDCCH transmission.</p> <p>Note 2: Point A coincides with minimum guard band as specified in Table 5.3.3-1 from TS 38.101-1 for tested channel bandwidth and subcarrier spacing.</p> <p>Note 3: For FR1 MIMO OTA test lab alignments and FR1 MIMO OTA UE performance requirements, the following values can be used:                      For FR1 bands &gt;1GHz: 20k for 30kHz SCS, 10k for 15kHz SCS;                      For FR1 bands &lt;1GHz: 10k for 15kHz SCS;</p>			

Table E.1-2: Test parameters for FR1 FDD 2x2

Parameter		Unit	Value
Duplex mode			FDD
Reference channel			R.PDSCH.1-3.1 FDD (Note 1)
Bandwidth		MHz	10
SCS		kHz	15
Modulation DL			64QAM
Modulation UL			QPSK
Active DL BWP index			1
PDSCH configuration	Mapping type		Type A
	k0		0
	Starting symbol (S)		2
	Length (L)		12
	PDSCH aggregation factor		1
	PRB bundling type		Static
	PRB bundling size		2
	Resource allocation type		Type 0
	RBG size		Config2
	VRB-to-PRB mapping type		Non-interleaved
VRB-to-PRB mapping interleaver bundle size		N/A	
PDSCH DMRS configuration	DMRS Type		Type 1
	Number of additional DMRS		1
	Maximum number of OFDM symbols for DL front loaded DMRS		1
CSI-RS for tracking	CSI-RS periodicity	Slots	20
	CSI-RS offset	Slots	Table 8.2-1.
Number of HARQ Processes			4
The number of slots between PDSCH and corresponding HARQ-ACK information			2
Note 1: "R.PDSCH.1-3.1 FDD" is defined in Table A.3.2.1.1-3 of TS 38.101-4			

Table E.1-3: Test parameters for FR1 TDD 2x2

Parameter		Unit	Value
Duplex mode			TDD
Reference channel			R.PDSCH.2-3.1 TDD (Note 1)
Bandwidth		MHz	40
SCS		kHz	30
Modulation DL			64QAM
Modulation UL			QPSK
Active DL BWP index			1
PDSCH configuration	Mapping type		Type A
	k0		0
	Starting symbol (S)		2
	Length (L)		Specific to each Reference channel
	PDSCH aggregation factor		1
	PRB bundling type		Static
	PRB bundling size		2
	Resource allocation type		Type 0
	RBG size		Config2
	VRB-to-PRB mapping type		Non-interleaved
VRB-to-PRB mapping interleaver bundle size		N/A	
PDSCH DMRS configuration	DMRS Type		Type 1
	Number of additional DMRS		1
	Maximum number of OFDM symbols for DL front loaded DMRS		1
CSI-RS for tracking	First OFDM symbol in the PRB used for CSI-RS		Table 8.2-1.
	CSI-RS periodicity	Slots	40
	CSI-RS offset	Slots	Table 8.2-1.
Number of HARQ Processes			8
TDD UL-DL pattern			FR1.30-1 (Note 2)

Note 1: "R.PDSCH.2-3.1 TDD" is defined in Table A.3.2.2.2-3 of TS 38.101-4  
 Note 2: "FR1.30-1" is defined in Annex A.1.2 of TS 38.101-4

Table E.1-4: Test parameters for FR1 FDD 4x4

Parameter		Unit	Value
Duplex mode			FDD
Reference channel			R.PDSCH.1-2.4 FDD (Note 1)
Bandwidth		MHz	10
SCS		kHz	15
Modulation DL			16QAM
Modulation UL			QPSK
Active DL BWP index			1
PDSCH configuration	Mapping type		Type A
	k0		0
	Starting symbol (S)		2
	Length (L)		12
	PDSCH aggregation factor		1
	PRB bundling type		Static
	PRB bundling size		2
	Resource allocation type		Type 0
	RBG size		Config2
	VRB-to-PRB mapping type		Non-interleaved
VRB-to-PRB mapping interleaver bundle size		N/A	
PDSCH DMRS configuration	DMRS Type		Type 1
	Number of additional DMRS		1
	Maximum number of OFDM symbols for DL front loaded DMRS		1
CSI-RS for tracking	CSI-RS periodicity	Slots	20
	CSI-RS offset	Slots	Table 8.2-1.
Number of HARQ Processes			4
The number of slots between PDSCH and corresponding HARQ-ACK information			2
Note 1: "R.PDSCH.1-2.4 FDD" is defined in Table A.3.2.1.1-2 of TS 38.101-4			

Table E.1-5: Test parameters for FR1 TDD 4x4

Parameter		Unit	Value
Duplex mode			TDD
Reference channel			R.PDSCH.2-2.4 TDD (Note 1)
Bandwidth		MHz	40
SCS		kHz	30
Modulation DL			16QAM
Modulation UL			QPSK
Active DL BWP index			1
PDSCH configuration	Mapping type		Type A
	k0		0
	Starting symbol (S)		2
	Length (L)		Specific to each Reference channel
	PDSCH aggregation factor		1
	PRB bundling type		Static
	PRB bundling size		2
	Resource allocation type		Type 0
	RBG size		Config2
	VRB-to-PRB mapping type		Non-interleaved
VRB-to-PRB mapping interleaver bundle size		N/A	
PDSCH DMRS configuration	DMRS Type		Type 1
	Number of additional DMRS		1
	Maximum number of OFDM symbols for DL front loaded DMRS		1

CSI-RS for tracking	First OFDM symbol in the PRB used for CSI-RS		Table 8.2-1.
	CSI-RS periodicity	Slots	40.
	CSI-RS offset	Slots	Table 8.2-1.
Number of HARQ Processes			8
TDD UL-DL pattern			FR1.30-1 (Note 2)
Note 1: "R.PDSCH.2-2.4 TDD" is defined in Table A.3.2.2.2-2 of TS 38.101-4			
Note 2: "FR1.30-1" is defined in Annex A.1.2 of TS 38.101-4			

---

## E.2 FR2 gNB configurations

The gNodeB emulator parameters for FR2 MIMO OTA testing shall be set according to Table E.2-1 for FR2 common parameters and Table E.2-2 for FR2 TDD 2x2 test parameters.

**Table E.2-1: FR2 Common test parameters**

Parameter		Unit	Value
PDSCH transmission scheme			Transmission scheme 1
PTRS <i>epre</i> -Ratio			0
Actual carrier configuration	Offset between Point A and the lowest usable subcarrier on this carrier (Note 2)	RBs	0
	Subcarrier spacing	kHz	120
DL BWP configuration #1	Cyclic prefix		Normal
	RB offset	RBs	0
	Number of contiguous PRB	PRBs	Maximum transmission bandwidth configuration as specified in clause 5.3.2 of TS 38.101-2 for tested channel bandwidth and subcarrier spacing
Common serving cell parameters	Physical Cell ID		0
	SSB position in burst		1
	SSB periodicity	ms	20
	First DMRS position for Type A PDSCH mapping		2
PDCCH configuration	Slots for PDCCH monitoring		Each slot
	Symbols with PDCCH		0
	Number of PRBs in CORESET		Table 7.2-2 of TS 38.101-4 for tested channel bandwidth and subcarrier spacing
	Number of PDCCH candidates and aggregation levels		1/AL8
	CCE-to-REG mapping type		Non-interleaved
	DCI format		1_1
	TCI state		TCI state #1
Cross carrier scheduling			Not configured
CSI-RS for tracking	First subcarrier index in the PRB used for CSI-RS ( $k_0$ )		0 for CSI-RS resource 1,2,3,4
	First OFDM symbol in the PRB used for CSI-RS ( $l_0$ )		6 for CSI-RS resource 1 and 3 10 for CSI-RS resource 2 and 4
	Number of CSI-RS ports ( $X$ )		1 for CSI-RS resource 1,2,3,4
	CDM Type		'No CDM' for CSI-RS resource 1,2,3,4
	Density ( $\rho$ )		3 for CSI-RS resource 1,2,3,4
	CSI-RS periodicity	Slots	120 kHz SCS: 160 for CSI-RS resource 1,2,3,4
	CSI-RS offset	Slots	120 kHz SCS: 80 for CSI-RS resource 1 and 2 81 for CSI-RS resource 3 and 4
	Frequency Occupation		Start PRB 0 Number of PRB = BWP size
	QCL info		TCI state #0
NZP CSI-RS for CSI acquisition	First subcarrier index in the PRB used for CSI-RS ( $k_0$ )		0
	First OFDM symbol in the PRB used for CSI-RS ( $l_0$ )		12
	Number of CSI-RS ports ( $X$ )		2
	CDM Type		FD-CDM2
	Density ( $\rho$ )		1
	CSI-RS periodicity	Slots	120 kHz SCS: 160
	CSI-RS offset		0
	Frequency Occupation		Start PRB 0 Number of PRB = BWP size
QCL info		TCI state #1	
ZP CSI-RS for CSI acquisition	First subcarrier index in the PRB used for CSI-RS ( $k_0$ )		4

	First OFDM symbol in the PRB used for CSI-RS ( $l_0$ )		12
	Number of CSI-RS ports ( $X$ )		4
	CDM Type		FD-CDM2
	Density ( $\rho$ )		1
	CSI-RS periodicity	Slots	120 kHz SCS: 160
	CSI-RS offset		0
	Frequency Occupation		Start PRB 0 Number of PRB = BWP size
CSI-RS for beam refinement	First subcarrier index in the PRB used for CSI-RS		$k_0=0$ for CSI-RS resource 1,2
	First OFDM symbol in the PRB used for CSI-RS		$l_0 = 8$ for CSI-RS resource 1 $l_0 = 9$ for CSI-RS resource 2
	Number of CSI-RS ports ( $X$ )		1 for CSI-RS resource 1,2
	CDM Type		'No CDM' for CSI-RS resource 1,2
	Density ( $\rho$ )		3 for CSI-RS resource 1,2
	CSI-RS periodicity	Slots	60 kHz SCS: 80 for CSI-RS resource 1,2 120 kHz SCS: 160 for CSI-RS resource 1,2
	CSI-RS offset	Slots	0 for CSI-RS resource 1,2
	QCL info		TCI state #1
PDSCH DMRS configuration	Antenna ports indexes		{1000} for Rank 1 tests {1000, 1001} for Rank 2 tests
	Number of PDSCH DMRS CDM group(s) without data		1
TCI state #0	Type 1 QCL information	SSB index	SSB #0
		QCL Type	Type C
	Type 2 QCL information	SSB index	SSB #0
		QCL Type	Type D
TCI state #1	Type 1 QCL information	CSI-RS resource	CSI-RS resource 1 from 'CSI-RS for tracking' configuration
		QCL Type	Type A
	Type 2 QCL information	CSI-RS resource	CSI-RS resource 1 from 'CSI-RS for tracking' configuration
		QCL Type	Type D
PTRS configuration	Frequency density ( $K_{PT-RS}$ )		2
	Time density ( $L_{PT-RS}$ )		1
Maximum number of code block groups for ACK/NACK feedback			1
Maximum number of HARQ transmission			1
HARQ ACK/NACK bundling			Multiplexed
Redundancy version coding sequence			{0,2,3,1}
Precoding configuration			SP Type I, Random per slot with PRB bundling granularity
Symbols for all unused Res			OCNG in Annex A.5 of TS 38.101-4
Minimum Number of Slots per Stream			20000 for FR2 UMi CDL-C
Transmit Power Control		dBm	13 dBm
Note 1:	UE assumes that the TCI state for the PDSCH is identical to the TCI state applied for the PDCCH transmission.		
Note 2:	Point A coincides with minimum guard band as specified in Table 5.3.3-1 from TS 38.101-2 for tested channel bandwidth and subcarrier spacing.		



Table E.2-2: Test parameters for FR2 TDD 2x2

Parameter		Unit	Value
Duplex mode			TDD
Reference channel			R.PDSCH.5-2.2 TDD (Note 1)
Bandwidth		MHz	100
SCS		kHz	120
Modulation DL			16QAM
Modulation UL			QPSK
Active DL BWP index			1
CSI-RS for tracking	First OFDM symbol in the PRB used for CSI-RS ( $l_0$ )		Table E.2-1
	CSI-RS offset	Slots	Table E.2-1
PDCCH configuration			Number of PDCCH candidates and aggregation levels 1/AL8
PDSCH configuration	Mapping type		Type A
	$k_0$		0
	Starting symbol (S)		1
	Length (L)		Specific to each Reference channel as defined in A.3.2.2 of TS 38.101-4
	PDSCH aggregation factor		1
	PRB bundling type		Static
	PRB bundling size		WB for Test 1-1, 2 for other tests
	Resource allocation type		Type 0
	RBG size		config2
	VRB-to-PRB mapping type		Non-interleaved
	VRB-to-PRB mapping interleaver bundle size		N/A
PDSCH DMRS configuration	DMRS Type		Type 1
	Number of additional DMRS		1
	Maximum number of OFDM symbols for DL front loaded DMRS		1
Number of HARQ Processes			8
TDD UL-DL pattern			FR2.120-1 (Note2)
Note 1: "R.PDSCH.5-2.2 TDD" is defined in Table A.3.2.2.5-2 of TS 38.101-4			
Note 2: "FR2.120-1" is defined in Annex A.1.3 of TS 38.101-4			

---

## Annex F (normative): <Environmental requirements>

---

---

### F.1 Scope

The requirements in this clause apply to all types of UE(s) in FR1 and FR2.

---

### F.2 Ambient temperature

All the MIMO OTA requirements are applicable in room temperature e.g. 25°C.

---

### F.3 Operating voltage

For FR1 MIMO OTA, all test cases shall be performed in the normal voltage condition with the DUT operated in stand-alone battery powered mode. No extreme voltage testing is required. It is recommended to start testing with a fully charged battery and conclude and/or pause testing before the battery has completely lost its charge.

For FR2 MIMO OTA, all test cases shall be performed in the normal voltage condition with the DUT operated in stand-alone battery powered mode or external power source. No extreme voltage testing is required. It shall be demonstrated that the impact of external power source to device performance is negligible comparing to stand-alone battery powered mode. It is recommended to start testing with a fully charged battery and conclude and/or pause testing before the battery has completely lost its charge.

## Annex G (informative): Change history

Change history							
Date	Meeting	TDoc	CR	Rev	Cat	Subject/Comment	New version
2020-08	RAN4#96-e	R4-2012709				Initial Skeleton	0.0.1
2020-11	RAN4#97-e	R4-2016216				R4-2016218, TP to TS 38.151 v0.0.1 on general part R4-2016222, TP to TS 38.151 v0.0.1 on FR1 test system for requirements R4-2017584, TP to TS 38.151 v0.0.1 on FR1 Channel model and RMC	0.1.0
2021-02	RAN4#98-e	R4-2101822				R4-2103969 TP to TS38.151 v0.1.0 on FR2 Channel model and RMC R4-2103970 TP to TS38.151 v0.1.0 on FR2 test system for requirements R4-2103971 TP to TS38.151 v0.1.0 on Performance metrics for NR MIMO OTA requirements	0.2.0
2021-04	RAN4#98-bis-e	R4-2104512				R4-2106094 TP to TS38.151 v0.2.0 on FR1 Channel model R4-2104511 TP to TS38.151 v0.2.0 on FR1 Calibration and Test procedure R4-2106093 TP to TS38.151: revision on MIMO Average Spherical Coverage	0.3.0
2021-05	RAN4#99-e	R4-2108094				R4-2108614 TP to TS38.151 v0.3.0 on FR1 TRMS R4-2109660 TP to TS38.151 v0.3.0 on CDL-C UMi channel model R4-2108615 TP to TS38.151 v0.3.0 on Power validation	0.4.0
2021-08	RAN4#100-e	R4-2112976				R4-2112977 Rapporteur input to TS38.151 R4-2112979 TP to TS38.151 on Minimum Number of Slots and Power Control R4-2115757 TP on Channel Model and DUT Positioning Clarifications R4-2115811 TP to TS38.151 on FR2 PAS similarity percentage	0.5.0
2021-11	RAN4#101-e	R4-2118299				R4-2118302 TP to TS 38.151 on updated structure R4-2119377 Clarification of NF Compensation for FR2 PSP	0.6.0
2022-01	RAN4#101-bis-e	R4-2200966				R4-2201920 Illustration of Device Orientations for Select Test Points R4-2200780 TP on TS 38.151 for test parameters of FR2 performance R4-2200967 TP to TS38.151 on FR2 maximum downlink power and test procedure R4-2203064 TP to TS38.151 on FR1 Spatial Channel Model Validation	0.7.0
2022-03	RAN4#102-e	R4-2204945				R4-2204572 TP to TS 38.151 on FR1 MIMO OTA test parameter R4-2207306 TP to TS38.151 on FR1 MPAC MU budget R4-2207307 TP to TS38.151 on channel model validation limits R4-2207308 TP to TS38.151 on FR1 Temporal Correlation Validation – Time domain technique	0.8.0
2022-03	RAN#95-e	RP-220793				For one-step approval in RAN Plenary	1.0.0

Change history							
Date	Meeting	TDoc	CR	Rev	Cat	Subject/Comment	New version
2022-03	RAN#95					Approved by plenary – Rel-17 spec under change control	17.0.0
2022-06	RAN#96	RP-221662	0001		F	BIG CR to 38.151	17.1.0
2022-09	RAN#97	RP-222039	0003		B	Big CR to 38.151: Introduction MIMO OTA performance requirements (Rel-17, CAT B)	17.2.0
2022-12	RAN#98-e	RP-223310	0004		F	CR to TS 38.151 on FR2 MU	17.3.0
2023-06	RAN#100	RP-231342	0005	1	F	CR to TS38.151 on FR1 power validation pass fail limit	17.4.0
2023-06	RAN#100	RP-231342	0006		F	CR to TS 38.151 on FR1 spatial correlation pass/fail limits	17.4.0
2023-06	RAN#100	RP-231342	0007		F	CR on TS 38.151 for clarifications on FR1 channel model parameters	17.4.0
2023-06	RAN#100	RP-231342	0008	1	F	Update on PDP Targets for FR2 CDL-C channel model	17.4.0
2023-06	RAN#100	RP-231342	0009	1	F	Update on TCF Test Methodology for FR2 CDL-C channel model	17.4.0
2023-06	RAN#100	RP-231342	0012	1	F	On TS 38.151 Annex C editorial updates	17.4.0
2023-09	RAN#101	RP-232517	0016	1	F	On Test Methodology for FR2 Channel Model Power Validation NOTE: This CR was not implemented. Author allocated it for Rel-18 in 3GU and not Rel-17.	17.5.0
2023-09	RAN#101	RP-232492	0017		F	CR to TS 38.151 on Definitions of terms	17.5.0
2023-09	RAN#101	RP-232517	0018	1	F	FR2 CM Validation Corrections	17.5.0
2023-12	RAN#102	RP-233365	0019	1	F	Updates to FR1 Channel model validation	17.6.0
2023-12	RAN#102	RP-233348	0020		F	CR to update preliminary FR2 MU	17.6.0
2023-12	RAN#102	RP-233348	0021	1	F	CR to TS 38.151 on test configurations	17.6.0
2023-12	RAN#102	RP-233348	0022	1	F	CR on introduction of applicability rules for MIMO OTA requirements	17.6.0
2023-12	RAN#102	RP-233348	0023		F	CR to TS 38.151 on FR2 channel model validation pass/fail limits	17.6.0
2024-03	RAN#103	RP-240561	0024	1	F	CR to TS 38.151 on FR1 MIMO OTA spatial correlation validation pass/fail limits	17.7.0
2024-03	RAN#103	RP-240608	0025	1	F	CR to 38.151 on FR1 MIMO OTA MU	17.7.0
2024-03	RAN#103	RP-240608	0027		F	Update to FR1 Channel model validation	17.7.0
2024-03	RAN#103	RP-240561	0029		F	(NR_MIMO_OTA-Core) Correction on the example inter-band band combination tables	17.7.0

Change history							
Date	Meeting	TDoc	CR	Rev	Cat	Subject/Comment	New version
2024-03	RAN#103					Update to Rel-18 version (MCC)	18.0.0
2024-06	RAN#104	RP-241486	0032		B	CR to 38.151 on FR2 MIMO OTA FoM	18.1.0
2024-06	RAN#104	RP-241440	0033	1	B	CR to 38.151 on MIMO OTA performance requirements	18.1.0
2024-06	RAN#104	RP-241486	0035		B	CR to TS 38.151 on introduction of FR2 PC1 MIMO OTA performance metric	18.1.0
2024-06	RAN#104	RP-241486	0040		F	Formal CR 38151 Clarification of UE positioning for FR1 MIMO OTA	18.1.0
2024-09	RAN#105	RP-242169	0042		A	Autocorrelation Channel Model Speed Correction	18.2.0
2024-09	RAN#105	RP-242169	0044		A	Clarification of voltage environmental requirement	18.2.0
2024-12	RAN#106	RP-243050	0045		A	Correction of FR2 CM Validation Setups	18.3.0
2024-12	RAN#106	RP-243050	0047		A	Correction of FR1 CM Validation Setups	18.3.0

---

# History

<b>Document history</b>		
V18.0.0	May 2024	Publication
V18.1.0	August 2024	Publication
V18.2.0	October 2024	Publication
V18.3.0	January 2025	Publication