

ETSI TS 138 161 V18.0.0 (2024-05)



**5G;
NR;
User Equipment (UE) TRP (Total Radiated Power)
and TRS (Total Radiated Sensitivity) requirements;
Range 1 Standalone and Range 1
Interworking operation with other radios
(3GPP TS 38.161 version 18.0.0 Release 18)**



Reference

RTS/TSGR-0438161 vi00

Keywords

5G

ETSI

650 Route des Lucioles
F-06921 Sophia Antipolis Cedex - FRANCE

Tel.: +33 4 92 94 42 00 Fax: +33 4 93 65 47 16

Siret N° 348 623 562 00017 - APE 7112B
Association à but non lucratif enregistrée à la
Sous-Préfecture de Grasse (06) N° w061004871

Important notice

The present document can be downloaded from:

<https://www.etsi.org/standards-search>

The present document may be made available in electronic versions and/or in print. The content of any electronic and/or print versions of the present document shall not be modified without the prior written authorization of ETSI. In case of any existing or perceived difference in contents between such versions and/or in print, the prevailing version of an ETSI deliverable is the one made publicly available in PDF format at www.etsi.org/deliver.

Users of the present document should be aware that the document may be subject to revision or change of status.

Information on the current status of this and other ETSI documents is available at

<https://portal.etsi.org/TB/ETSIDeliverableStatus.aspx>

If you find errors in the present document, please send your comment to one of the following services:

<https://portal.etsi.org/People/CommitteeSupportStaff.aspx>

If you find a security vulnerability in the present document, please report it through our
Coordinated Vulnerability Disclosure Program:

<https://www.etsi.org/standards/coordinated-vulnerability-disclosure>

Notice of disclaimer & limitation of liability

The information provided in the present deliverable is directed solely to professionals who have the appropriate degree of experience to understand and interpret its content in accordance with generally accepted engineering or other professional standard and applicable regulations.

No recommendation as to products and services or vendors is made or should be implied.

No representation or warranty is made that this deliverable is technically accurate or sufficient or conforms to any law and/or governmental rule and/or regulation and further, no representation or warranty is made of merchantability or fitness for any particular purpose or against infringement of intellectual property rights.

In no event shall ETSI be held liable for loss of profits or any other incidental or consequential damages.

Any software contained in this deliverable is provided "AS IS" with no warranties, express or implied, including but not limited to, the warranties of merchantability, fitness for a particular purpose and non-infringement of intellectual property rights and ETSI shall not be held liable in any event for any damages whatsoever (including, without limitation, damages for loss of profits, business interruption, loss of information, or any other pecuniary loss) arising out of or related to the use of or inability to use the software.

Copyright Notification

No part may be reproduced or utilized in any form or by any means, electronic or mechanical, including photocopying and microfilm except as authorized by written permission of ETSI.

The content of the PDF version shall not be modified without the written authorization of ETSI.

The copyright and the foregoing restriction extend to reproduction in all media.

© ETSI 2024.
All rights reserved.

Intellectual Property Rights

Essential patents

IPRs essential or potentially essential to normative deliverables may have been declared to ETSI. The declarations pertaining to these essential IPRs, if any, are publicly available for **ETSI members and non-members**, and can be found in ETSI SR 000 314: "*Intellectual Property Rights (IPRs); Essential, or potentially Essential, IPRs notified to ETSI in respect of ETSI standards*", which is available from the ETSI Secretariat. Latest updates are available on the ETSI Web server (<https://ipr.etsi.org/>).

Pursuant to the ETSI Directives including the ETSI IPR Policy, no investigation regarding the essentiality of IPRs, including IPR searches, has been carried out by ETSI. No guarantee can be given as to the existence of other IPRs not referenced in ETSI SR 000 314 (or the updates on the ETSI Web server) which are, or may be, or may become, essential to the present document.

Trademarks

The present document may include trademarks and/or tradenames which are asserted and/or registered by their owners. ETSI claims no ownership of these except for any which are indicated as being the property of ETSI, and conveys no right to use or reproduce any trademark and/or tradename. Mention of those trademarks in the present document does not constitute an endorsement by ETSI of products, services or organizations associated with those trademarks.

DECT™, **PLUGTESTS™**, **UMTS™** and the ETSI logo are trademarks of ETSI registered for the benefit of its Members. **3GPP™** and **LTE™** are trademarks of ETSI registered for the benefit of its Members and of the 3GPP Organizational Partners. **oneM2M™** logo is a trademark of ETSI registered for the benefit of its Members and of the oneM2M Partners. **GSM®** and the GSM logo are trademarks registered and owned by the GSM Association.

Legal Notice

This Technical Specification (TS) has been produced by ETSI 3rd Generation Partnership Project (3GPP).

The present document may refer to technical specifications or reports using their 3GPP identities. These shall be interpreted as being references to the corresponding ETSI deliverables.

The cross reference between 3GPP and ETSI identities can be found under <https://webapp.etsi.org/key/queryform.asp>.

Modal verbs terminology

In the present document "**shall**", "**shall not**", "**should**", "**should not**", "**may**", "**need not**", "**will**", "**will not**", "**can**" and "**cannot**" are to be interpreted as described in clause 3.2 of the [ETSI Drafting Rules](#) (Verbal forms for the expression of provisions).

"**must**" and "**must not**" are **NOT** allowed in ETSI deliverables except when used in direct citation.

Contents

Intellectual Property Rights	2
Legal Notice	2
Modal verbs terminology.....	2
Foreword.....	5
1 Scope	7
2 References	7
3 Definitions of terms, symbols and abbreviations	7
3.1 Terms.....	7
3.2 Symbols.....	8
3.3 Abbreviations	8
4 General	9
4.1 Relationship between minimum requirements and test requirements	9
4.2 Applicability of minimum requirements	9
4.2.1 General.....	9
4.2.1 UE mechanical modes	9
4.3 Applicability rules for testing of FR1 SA and NSA UEs	9
4.4 Applicability rules for testing of power class capability of UEs	9
5 Frequency bands.....	10
5.1 General	10
5.2 Operating bands.....	10
5.2.1 FR1 Standalone Operating bands.....	10
5.2.2 FR1 EN-DC band combinations.....	11
5.3 Test parameters for each band.....	13
6 FR1 TRP requirements.....	19
6.1 General	19
6.2 Minimum requirement.....	19
6.2.1 Minimum requirement for handheld UE.....	19
6.2.1.1 Hand phantom browsing mode	20
6.2.1.1.1 NR FR1.....	20
6.2.1.1.2 NR FR1 in EN-DC mode.....	20
6.2.1.2 Beside the head and hand phantom talk mode	21
6.2.1.2.1 NR FR1.....	21
6.2.1.2.2 NR FR1 in EN-DC mode.....	21
7 FR1 TRS requirements.....	22
7.1 General	22
7.2 Minimum requirement.....	22
7.2.1 Minimum requirement for handheld UE.....	22
7.2.1.1 Hand phantom browsing mode	22
7.2.1.1.1 NR FR1.....	22
7.2.1.1.2 NR FR1 in EN-DC mode.....	23
7.2.1.2 Beside the head and hand phantom position	23
7.2.1.2.1 NR FR1.....	23
7.2.1.2.2 NR FR1 in EN-DC mode.....	23
Annex A (normative): Test methodology	25
A.1 General	25
A.2 UE configuration	25
A.2.1 General	25
A.2.2 UE configuration for TRP test.....	25
A.2.3 UE configuration for TRS test.....	25

A.3	Test system of Anechoic Chamber method.....	26
A.3.1	System setup.....	26
A.3.2	Calibration procedure.....	26
A.3.3	Test procedure.....	27
A.3.3.1	General.....	27
A.3.3.2	TRP Test procedure.....	27
A.3.3.3	TRS Test procedure.....	28
A.3.4	Minimum Range Length.....	28
A.3.5	Definition of TRP and TRS for AC.....	30
A.3.5.1	Total Radiated Power (TRP).....	30
A.3.5.2	Total Radiated Sensitivity (TRS).....	30
A.4	Preliminary example MU budget.....	32
Annex B (normative): Phantoms definition and Positioning		43
B.1	General.....	43
B.2	Phantom Definition.....	43
B.2.1	Head Phantom.....	43
B.2.2	PDA Grip Hand Phantom.....	43
B.2.3	Wide Grip Hand Phantom.....	43
B.2.4	Forearm Phantom.....	44
B.3	UE positioning guidelines.....	44
B.3.1	Hand phantom only (Browsing mode).....	44
B.3.1.1	Wide Grip Hand.....	45
B.3.1.2	PDA Grip Hand.....	45
B.3.2	Head and Hand phantom (Talk Mode).....	47
B.3.2.1	General.....	47
B.3.2.2	Wide Grip Hand and Head.....	48
B.3.2.1	PDA Grip Hand and Head.....	48
B.3.3	Forearm phantom (Wrist-worn Mode).....	48
B.3.2.1	General.....	48
B.3.2.2	Forearm phantom positioning in the chamber.....	48
B.3.2.3	Wrist-Worn RedCap Device mounted on the Forearm Phantom.....	49
Annex C (normative): Environmental requirements		51
C.1	General.....	51
C.2	Environmental.....	51
C.2.1	Temperature.....	51
C.2.2	Voltage.....	51
Annex D (informative): Change history		52
History.....		53

Foreword

This Technical Specification has been produced by the 3rd Generation Partnership Project (3GPP).

The contents of the present document are subject to continuing work within the TSG and may change following formal TSG approval. Should the TSG modify the contents of the present document, it will be re-released by the TSG with an identifying change of release date and an increase in version number as follows:

Version x.y.z

where:

- x the first digit:
 - 1 presented to TSG for information;
 - 2 presented to TSG for approval;
 - 3 or greater indicates TSG approved document under change control.
- y the second digit is incremented for all changes of substance, i.e. technical enhancements, corrections, updates, etc.
- z the third digit is incremented when editorial only changes have been incorporated in the document.

In the present document, modal verbs have the following meanings:

- shall** indicates a mandatory requirement to do something
- shall not** indicates an interdiction (prohibition) to do something

The constructions "shall" and "shall not" are confined to the context of normative provisions, and do not appear in Technical Reports.

The constructions "must" and "must not" are not used as substitutes for "shall" and "shall not". Their use is avoided insofar as possible, and they are not used in a normative context except in a direct citation from an external, referenced, non-3GPP document, or so as to maintain continuity of style when extending or modifying the provisions of such a referenced document.

- should** indicates a recommendation to do something
- should not** indicates a recommendation not to do something
- may** indicates permission to do something
- need not** indicates permission not to do something

The construction "may not" is ambiguous and is not used in normative elements. The unambiguous constructions "might not" or "shall not" are used instead, depending upon the meaning intended.

- can** indicates that something is possible
- cannot** indicates that something is impossible

The constructions "can" and "cannot" are not substitutes for "may" and "need not".

- will** indicates that something is certain or expected to happen as a result of action taken by an agency the behaviour of which is outside the scope of the present document
- will not** indicates that something is certain or expected not to happen as a result of action taken by an agency the behaviour of which is outside the scope of the present document
- might** indicates a likelihood that something will happen as a result of action taken by some agency the behaviour of which is outside the scope of the present document

might not indicates a likelihood that something will not happen as a result of action taken by some agency the behaviour of which is outside the scope of the present document

In addition:

is (or any other verb in the indicative mood) indicates a statement of fact

is not (or any other negative verb in the indicative mood) indicates a statement of fact

The constructions "is" and "is not" do not indicate requirements.

1 Scope

The present document establishes the TRP (Total Radiated Power) and TRS (Total Radiated Sensitivity) requirements for NR UEs operating on Range 1 Standalone and Range 1 Interworking operation with other radios.

2 References

The following documents contain provisions which, through reference in this text, constitute provisions of the present document.

- References are either specific (identified by date of publication, edition number, version number, etc.) or non-specific.
- For a specific reference, subsequent revisions do not apply.
- For a non-specific reference, the latest version applies. In the case of a reference to a 3GPP document (including a GSM document), a non-specific reference implicitly refers to the latest version of that document *in the same Release as the present document*.

- [1] 3GPP TR 21.905: "Vocabulary for 3GPP Specifications".
- [2] 3GPP TR 38.834: "Measurements of User Equipment (UE) Over-the-Air (OTA) performance for NR FR1; Total Radiated Power (TRP) and Total Radiated Sensitivity (TRS) test methodology".
- [3] 3GPP TS 38.101-1: "NR; User Equipment (UE) radio transmission and reception; Part 1: Range 1 Standalone".
- [4] 3GPP TS 38.101-3: "NR; User Equipment (UE) radio transmission and reception; Part 3: Range 1 and Range 2 Interworking operation with other radios".
- [5] 3GPP TS 38.521-1: "NR; User Equipment (UE) conformance specification; Radio transmission and reception; Part 1: Range 1 Standalone".
- [6] 3GPP TS 38.521-3: "NR; User Equipment (UE) conformance specification; Radio transmission and reception; Part 3: Range 1 and Range 2 Interworking operation with other radios".
- [7] 3GPP TS 38.508-1: "5GS; User Equipment (UE) conformance specification; Part 1: Common test environment".
- [8] 3GPP TS 37.544: "Universal Terrestrial Radio Access (UTRA) and Evolved Universal Terrestrial Radio Access (E-UTRA); User Equipment (UE) Over The Air (OTA) performance; Conformance testing".
- [9] CTIA Certification™: "CTIA Certification Test Plan for Wireless Device Over-the-Air Performance, CTIA 01.71 Device Setup and Positioning Guidelines", latest active version available at: <https://ctiacertification.org/test-plans/>
- [10] CTIA Certification™: "CTIA Certification Test Plan for Wireless Device Over-the-Air Performance, CTIA 01.72: Near-Field Phantoms", latest active version available at: <https://ctiacertification.org/test-plans/>

3 Definitions of terms, symbols and abbreviations

3.1 Terms

For the purposes of the present document, the terms given in 3GPP TR 21.905 [1] and the following apply. A term defined in the present document takes precedence over the definition of the same term, if any, in 3GPP TR 21.905 [1].

Browsing mode usage: This mode corresponds to “data” mode, the device is tested via hand-only phantoms.

Primary mechanical mode: The mode that is most often used for a specific user scenario. Every terminal has at least one primary mechanical mode, if multiple modes are supported, different primary mechanical modes may be applicable for different user scenarios, e.g., different primary mechanical modes for Browsing mode usage and Talk mode usage for the same UE.

Talk mode usage: This mode corresponds to “talk” mode, the device is tested via head&hand phantoms.

Wrist-worn mode usage: This mode corresponds to wearable device for wrist-worn mode, the device is tested via forearm phantoms.

3.2 Symbols

For the purposes of the present document, the following symbols apply:

$TRP_{average}$	The average measured total radiated power of low, mid and high channel. When hand phantom is involved, the average is performed with low, mid and high channel from both hand left and hand right.
$TRS_{average}$	The average measured total radiated sensitivity of low, mid and high channel. When hand phantom is involved, the average is performed with low, mid and high channel from both hand left and hand right.

3.3 Abbreviations

For the purposes of the present document, the abbreviations given in 3GPP TR 21.905 [1] and the following apply. An abbreviation defined in the present document takes precedence over the definition of the same abbreviation, if any, in 3GPP TR 21.905 [1].

AC	Anechoic Chamber
BHHL	Beside Head and Hand Left Side (Head and Hand Phantom)
BHHR	Beside Head and Hand Right Side (Head and Hand Phantom)
CA	Carrier Aggregation
DUT	Device Under Test
E-UTRA	Evolved UTRA
EIRP	Effective Isotropic Radiated Power
EUT	Equipment Under Test
FR1	Frequency Range 1
FS	Free Space
HL	Hand Left (Hand Phantom Only)
HR	Hand Right (Hand Phantom Only)
MPR	Allowed maximum power reduction
NR	New Radio
NSA	Non-Standalone, a mode of operation where operation of an other radio is assisted with an other radio
OTA	Over The Air
QZ	Quiet Zone
RedCap	Reduced Capability
SA	Standalone
SS	System Simulator
TAA	Time-Averaging Algorithm
TAS	Tx Antenna Switching
TRP	Total Radiated Power
TRS	Total Radiated Sensitivity
TxD	Tx Diversity
UE	User Equipment
UL MIMO	Uplink Multiple Antenna transmission

4 General

4.1 Relationship between minimum requirements and test requirements

The Minimum Requirements given in this specification make no allowance for measurement uncertainty. The test specification in RAN5 will define final test tolerances for FR1 TRP TRS. The test tolerances are used to relax the minimum requirements in this specification to create test requirements.

4.2 Applicability of minimum requirements

4.2.1 General

The minimum requirements apply only to the corresponding primary mechanical mode of UE in the environmental conditions specified in Annex C.4.2.2.

4.2.1 UE mechanical modes

The mechanical modes of a device under test (DUT) are declared by the manufacturer. A DUT shall have at least one mechanical mode. If only one mode is supported, then this is defined as the primary. If multiple modes are supported, the manufacturer can declare different primary mechanical modes applicable for different user scenarios, e.g., different primary mechanical mode for Browsing mode usage and Talk mode usage for the same UE.

4.3 Applicability rules for testing of FR1 SA and NSA UEs

The applicability and test coverage rules for Non-Standalone (NSA) only capable devices shall include the following:

- For each NR band supported by the device, test the UE in EN-DC mode using any one example configuration containing that NR band or configuration declaration decision tree as per recommended TRP/TRS test procedures in this specification.

The applicability and test coverage rules for Standalone (SA) and NSA (EN-DC) capable devices shall include the following:

- For each NR band in a device, test the UE in Standalone Mode as per the TRP/TRS test procedures in this specification.
- This shall also fulfil coverage for all EN-DC FR1 minimum performance requirements for that NR band and need not be retested in EN-DC mode.

4.4 Applicability rules for testing of power class capability of UEs

The applicability and test coverage rules for PC2 and PC3 UEs shall include the following:

- For UEs that support PC2 in a given band: verify the requirement only with PC2 configuration
- For UEs that only support PC3 in a given band: verify the requirement with PC3 configuration

NOTE 1: The test procedure and requirements in this version of the specification apply only for handheld UEs based on 1 Tx configuration and are not applicable to UEs under TxD and UL MIMO configurations.

5 Frequency bands

5.1 General

The requirements defined in this specification for NR apply to the frequency bands defined in Clause 5.2.

5.2 Operating bands

5.2.1 FR1 Standalone Operating bands

The requirements defined in this specification for FR1 standalone apply to the operating bands defined in Table 5.2.1-1.

Table 5.2.1-1 NR operating bands in FR1 standalone

NR operating band	Uplink (UL) operating band BS receive / UE transmit	Downlink (DL) operating band BS transmit / UE receive	Duplex Mode
	F _{UL_low} – F _{UL_high}	F _{DL_low} – F _{DL_high}	
n1	1920 MHz – 1980 MHz	2110 MHz – 2170 MHz	FDD
n2	1850 MHz – 1910 MHz	1930 MHz – 1990 MHz	FDD
n3	1710 MHz – 1785 MHz	1805 MHz – 1880 MHz	FDD
n5	824 MHz – 849 MHz	869 MHz – 894 MHz	FDD
n7	2500 MHz – 2570 MHz	2620 MHz – 2690 MHz	FDD
n8	880 MHz – 915 MHz	925 MHz – 960 MHz	FDD
n12	699 MHz – 716 MHz	729 MHz – 746 MHz	FDD
n14	788 MHz – 798 MHz	758 MHz – 768 MHz	FDD
n20	832 MHz – 862 MHz	791 MHz – 821 MHz	FDD
n25	1850 MHz – 1915 MHz	1930 MHz – 1995 MHz	FDD
n26	814 MHz – 849 MHz	859 MHz – 894 MHz	FDD
n28	703 MHz – 748 MHz	758 MHz – 803 MHz	FDD
n30	2305 MHz – 2315 MHz	2350 MHz – 2360 MHz	FDD
n34	2010 MHz – 2025 MHz	2010 MHz – 2025 MHz	TDD
n38	2570 MHz – 2620 MHz	2570 MHz – 2620 MHz	TDD
n39	1880 MHz – 1920 MHz	1880 MHz – 1920 MHz	TDD
n40	2300 MHz – 2400 MHz	2300 MHz – 2400 MHz	TDD
n41	2496 MHz – 2690 MHz	2496 MHz – 2690 MHz	TDD
n48	3550 MHz – 3700 MHz	3550 MHz – 3700 MHz	TDD
n50	1432 MHz – 1517 MHz	1432 MHz – 1517 MHz	TDD ¹
n51	1427 MHz – 1432 MHz	1427 MHz – 1432 MHz	TDD
n53	2483.5 MHz – 2495 MHz	2483.5 MHz – 2495 MHz	TDD
n65	1920 MHz – 2010 MHz	2110 MHz – 2200 MHz	FDD ⁴
n66	1710 MHz – 1780 MHz	2110 MHz – 2200 MHz	FDD
n70	1695 MHz – 1710 MHz	1995 MHz – 2020 MHz	FDD
n71	663 MHz – 698 MHz	617 MHz – 652 MHz	FDD
n74	1427 MHz – 1470 MHz	1475 MHz – 1518 MHz	FDD
n75	N/A	1432 MHz – 1517 MHz	SDL
n76	N/A	1427 MHz – 1432 MHz	SDL
n77 ¹²	3300 MHz – 4200 MHz	3300 MHz – 4200 MHz	TDD
n78	3300 MHz – 3800 MHz	3300 MHz – 3800 MHz	TDD
n79	4400 MHz – 5000 MHz	4400 MHz – 5000 MHz	TDD
n80	1710 MHz – 1785 MHz	N/A	SUL
n81	880 MHz – 915 MHz	N/A	SUL
n82	832 MHz – 862 MHz	N/A	SUL
n83	703 MHz – 748 MHz	N/A	SUL
n84	1920 MHz – 1980 MHz	N/A	SUL
n86	1710 MHz – 1780 MHz	N/A	SUL
n95	2010 MHz – 2025 MHz	N/A	SUL

Other operating bands may be considered in future releases.

5.2.2 FR1 EN-DC band combinations

<Editor's note: Example EN-DC combinations can be further added. >

Principle of EN-DC band combinations selection for FR1 TRP TRS OTA testing:

- 1) Focus on the performance of the NR carrier and do not consider multiple permutations between different LTE bands and NR band under test, i.e., for each NR band, only select one EN-DC band combination.
- 2) For UE supporting multiple EN-DC band combinations for the same NR band, consider only those EN-DC configurations which have no MSD impact on either LTE or NR, i.e., the selected EN-DC combination should be no MSD issue identified in TS 38.101-3 Section 7.3B.2.3 (Inter-band EN-DC within FR1).

Table 5.2.2-1: Measurement parameters for example inter-band EN-DC band combinations (two bands)

EN-DC configuration	E-UTRA configurations	NR configurations
DC_3A_n28A	Note1	Note2
DC_2A_n41A	Note1	Note2
DC_1A_n78A	Note1	Note2
DC_1A_n79A	Note1	Note2
Note 1:	As per TS 37.544 [8], Clause 5.3 and 5.4 (Measurement frequencies for E-UTRA FDD and TDD).	
Note 2:	As per Table 5.3-1 and Table 5.3-2 in this specification. The measurement parameters for NR Low Mid High ranges correspond to E-UTRA Low Mid High ranges respectively.	

With the above basic principle and EN-DC example band combination, the selection logic for testing is defined by the decision tree below.

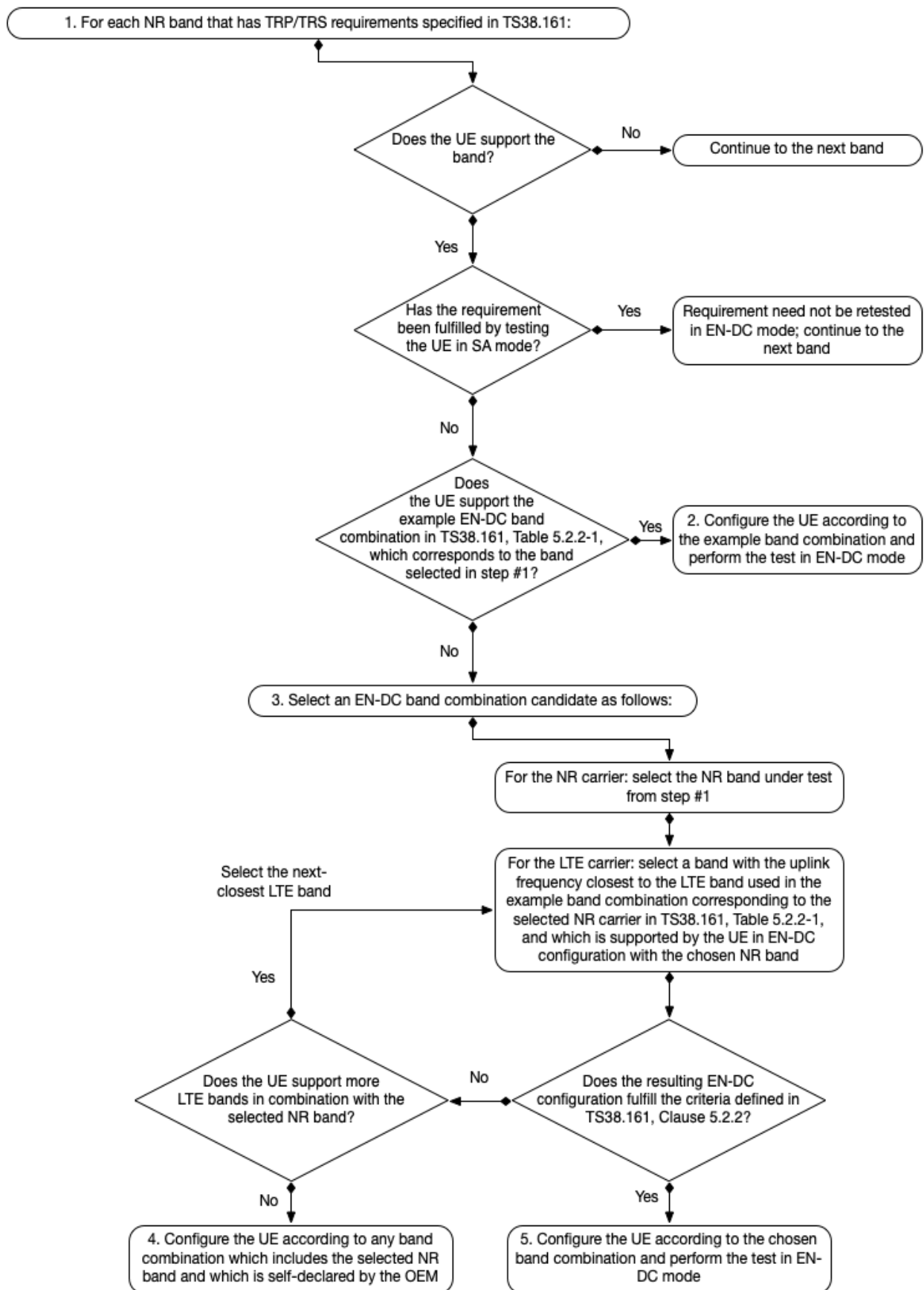

Figure 5.2.2-1: Decision tree to select the EN-DC band combination for TRP/TRS testing

5.3 Test parameters for each band

The detailed testing parameters for each band is defined in Table 5.3-1 and Table 5.3-2.

Table 5.3-1: NR FR1 TRP measurement parameters

NR Band	CBW [MHz]	SCS (kHz)	UL modulation	Range	UL Carrier centre [ARFCN]	UL Carrier Center (MHz)	DL Carrier centre [ARFCN]	DL Carrier Center (MHz)	UL RB Allocation (LCRB @ RB _{start})	DL configuration
n1	15	15	DFT-s-OFDM QPSK	Low	385500	1927.5	423500	2117.5	36@18	N/A
				Mid	390000	1950	428000	2140		
				High	394500	1972.5	432500	2162.5		
n2	15	15	DFT-s-OFDM QPSK	Low	371500	1857.5	387500	1937.5	36@18	N/A
				Mid	376000	1880	392000	1960		
				High	380500	1902.5	396500	1982.5		
n3	20	15	DFT-s-OFDM QPSK	Low	344000	1720	363000	1815	50@25	N/A
				Mid	349500	1747.5	368500	1842.5		
				High	355000	1775	374000	1870		
n5	15	15	DFT-s-OFDM QPSK	Low	166300	831.5	175300	876.5	36@18	N/A
				Mid	167300	836.5	176300	881.5		
				High	168300	841.5	177300	886.5		
n7	15	15	DFT-s-OFDM QPSK	Low	501500	2507.5	525500	2627.5	36@18	N/A
				Mid	507000	2535	531000	2655		
				High	512500	2562.5	536500	2682.5		
n8	15	15	DFT-s-OFDM QPSK	Low	177500	887.5	186500	932.5	36@18	N/A
				Mid	179500	897.5	188500	942.5		
				High	181500	907.5	190500	952.5		
n12	10	15	DFT-s-OFDM QPSK	Low	140800	704	146800	734	25@12	N/A
				Mid	141500	707.5	147500	737.5		
				High	142200	711	148200	741		
n14	10	15	DFT-s-OFDM QPSK	Low	158600	793	152600	763	25@12	N/A
				Mid						
				High						
n20	15	15	DFT-s-OFDM QPSK	Low	167900	839.5	159700	798.5	36@18	N/A
				Mid	169400	847	161200	806		
				High	170900	854.5	162700	813.5		
n25	15	15	DFT-s-OFDM QPSK	Low	371500	1857.5	387500	1937.5	36@18	N/A
				Mid	376500	1882.5	392500	1962.5		
				High	381500	1907.5	397500	1987.5		
n26	10	15	DFT-s-OFDM QPSK	Low	163800	819	172800	864	25@12	N/A
				Mid	166300	831.5	175300	876.5		
				High	168800	844	177800	889		
n28	20	15	DFT-s-OFDM QPSK	Low	142600	713	153600	768	50@25	N/A
				Mid	145600	728	156600	783		
				High	147600	738	158600	793		
n30	10	15	DFT-s-OFDM QPSK	Low	462000	2310	471000	2355	25@12	N/A
				Mid						
				High						
n34	10	15	DFT-s-OFDM QPSK	Low	403000	2015	403000	2015	25@12	N/A
				Mid	403500	2017.5	403500	2017.5		
				High	404000	2020	404000	2020		
n38	15	15	DFT-s-OFDM QPSK	Low	515500	2577.5	515500	2577.5	36@18	N/A
				Mid	519000	2595	519000	2595		
				High	522500	2612.5	522500	2612.5		
n39	20	15	DFT-s-OFDM QPSK	Low	378000	1890	378000	1890	50@25	N/A
				Mid	380000	1900	380000	1900		
				High	382000	1910	382000	1910		
n40	30	15	DFT-s-OFDM QPSK	Low	463000	2315	463000	2315	TBD	N/A
				Mid	470000	2350	470000	2350		
				High	477000	2385	477000	2385		
n41	100	30		Low	509202	2546.01	509202	2546.01	135@67	N/A

			DFT-s-OFDM QPSK	Mid	518598	2592.99	518598	2592.99		
				High	528000	2640	528000	2640		
n48	20	15	DFT-s-OFDM QPSK	Low	637334	3560.01	637334	3560.01	50@25	N/A
				Mid	641666	3624.99	641666	3624.99		
				High	646000	3690	646000	3690		
n50	20	15	DFT-s-OFDM QPSK	Low	288400	1442	288400	1442	50@25	N/A
				Mid	294900	1474.5	294900	1474.5		
				High	301400	1507	301400	1507		
n51	5	15	DFT-s-OFDM QPSK	Low	285900	1429.5	285900	1429.5	12@6	N/A
				Mid						
				High						
n53	10	15	DFT-s-OFDM QPSK	Low	497700	2488.5	497700	2488.5	25@12	N/A
				Mid	497860	2489.3	497860	2489.3		
				High	498000	2490	498000	2490		
n65	15	15	DFT-s-OFDM QPSK	Low	423500	2117.5	423500	2117.5	36@18	N/A
				Mid	431000	2155	431000	2155		
				High	438500	2192.5	438500	2192.5		
n66	20 (20+20)	15	DFT-s-OFDM QPSK	Low	344000	1720	424000	2120	50@25	N/A
				Mid	349000	1745	429000	2145		
				High	354000	1770	434000	2170		
n70	15 (15+15)	15	DFT-s-OFDM QPSK	Low	340500	1702.5	400500	2002.5	36@18	N/A
				Mid						
				High						
n71	10	15	DFT-s-OFDM QPSK	Low	133600	668	124400	622	25@12	N/A
				Mid	136100	680.5	126900	634.5		
				High	138600	693	129400	647		
n74	15	15	DFT-s-OFDM QPSK	Low	286900	1434.5	296500	1482.5	36@18	N/A
				Mid	289700	1448.5	299300	1496.5		
				High	292500	1462.5	302100	1510.5		
n77	100	30	DFT-s-OFDM QPSK	Low	623334	3350.01	623334	3350.01	135@67	N/A
				Mid	650000	3750	650000	3750		
				High	676666	4149.99	676666	4149.99		
n78	100	30	DFT-s-OFDM QPSK	Low	623334	3350.01	623334	3350.01	135@67	N/A
				Mid	636666	3549.99	636666	3549.99		
				High	650000	3750	650000	3750		
n79	100	30	DFT-s-OFDM QPSK	Low	696668	4450.02	696668	4450.02	135@67	N/A
				Mid	713334	4700.01	713334	4700.01		
				High	730000	4950	730000	4950		
n80	20	15	DFT-s-OFDM QPSK	Low	344000	1720	N/A	N/A	50@25	N/A
				Mid	349500	1747.5	N/A	N/A		
				High	355000	1775	N/A	N/A		
n81	15	15	DFT-s-OFDM QPSK	Low	177500	887.5	N/A	N/A	36@18	N/A
				Mid	179500	897.5	N/A	N/A		
				High	181500	907.5	N/A	N/A		
n82	15	15	DFT-s-OFDM QPSK	Low	167900	839.5	N/A	N/A	36@18	N/A
				Mid	169400	847	N/A	N/A		
				High	170900	854.5	N/A	N/A		
n83	15	15	DFT-s-OFDM QPSK	Low	142100	710.5	N/A	N/A	36@18	N/A
				Mid	145100	725.5	N/A	N/A		
				High	148100	740.5	N/A	N/A		
n84	15	15	DFT-s-OFDM QPSK	Low	385500	1927.5	N/A	N/A	36@18	N/A
				Mid	390000	1950	N/A	N/A		
				High	394500	1972.5	N/A	N/A		
n86	20	15	DFT-s-OFDM QPSK	Low	344000	1720	N/A	N/A	50@25	N/A
				Mid	349000	1745	N/A	N/A		
				High	354000	1770	N/A	N/A		
N95	10	15	DFT-s-OFDM QPSK	Low	403000	2015	N/A	N/A	50@25	N/A
				Mid	403500	2017.5	N/A	N/A		
				High	404000	2020	N/A	N/A		

Table 5.3-2: NR FR1 TRS measurement parameters

NR Band	CBW (MHz)	SCS (kHz)	DL modulation	UL modulation	Range	UL Carrier centre [ARFCN]	UL Carrier Center (MHz)	DL Carrier centre [ARFCN]	DL Carrier Center (MHz)	UL RB Allocation (LCRB @ RB _{start})	DL Configuration (FULL RB, LCRB @ RB _{start})
n1	15	15	CP-OFDM QPSK	DFT-s-OFDM QPSK	Low	385500	1927.5	423500	2117.5	75@4	79@0
					Mid	390000	1950	428000	2140		
					High	394500	1972.5	432500	2162.5		
n2	15	15	CP-OFDM QPSK	DFT-s-OFDM QPSK	Low	371500	1857.5	387500	1937.5	50@29	79@0
					Mid	376000	1880	392000	1960		
					High	380500	1902.5	396500	1982.5		
n3	20	15	CP-OFDM QPSK	DFT-s-OFDM QPSK	Low	344000	1720	363000	1815	50@56	106@0
					Mid	349500	1747.5	368500	1842.5		
					High	355000	1775	374000	1870		
n5	15	15	CP-OFDM QPSK	DFT-s-OFDM QPSK	Low	166300	831.5	175300	876.5	25@54	79@0
					Mid	167300	836.5	176300	881.5		
					High	168300	841.5	177300	886.5		
n7	15	15	CP-OFDM QPSK	DFT-s-OFDM QPSK	Low	501500	2507.5	525500	2627.5	75@4	79@0
					Mid	507000	2535	531000	2655		
					High	512500	2562.5	536500	2682.5		
n8	15	15	CP-OFDM QPSK	DFT-s-OFDM QPSK	Low	177500	887.5	186500	932.5	25@54	79@0
					Mid	179500	897.5	188500	942.5		
					High	181500	907.5	190500	952.5		
n12	10	15	CP-OFDM QPSK	DFT-s-OFDM QPSK	Low	140800	704	146800	734	20@32	52@0
					Mid	141500	707.5	147500	737.5		
					High	142200	711	148200	741		
n14	10	15	CP-OFDM QPSK	DFT-s-OFDM QPSK	Low	158600	793	152600	763	20@32	52@0
					Mid						
					High						
n20	15	15	CP-OFDM QPSK	DFT-s-OFDM QPSK	Low	167900	839.5	159700	798.5	20@11	79@0
					Mid	169400	847	161200	806		
					High	170900	854.5	162700	813.5		
n25	15	15	CP-OFDM QPSK	DFT-s-OFDM QPSK	Low	371500	1857.5	387500	1937.5	50@29	79@0
					Mid	376500	1882.5	392500	1962.5		
					High	381500	1907.5	397500	1987.5		
n26	10	15	CP-OFDM QPSK	DFT-s-OFDM QPSK	Low	163800	819	172800	864	25@27	52@0
					Mid	166300	831.5	175300	876.5		
					High	168800	844	177800	889		
n28	20	15	CP-OFDM QPSK	DFT-s-OFDM QPSK	Low	142600	713	153600	768	25@81	106@0
					Mid	145600	728	156600	783		
					High	147600	738	158600	793		
n30	10	15	CP-OFDM QPSK	DFT-s-OFDM QPSK	Low	462000	2310	471000	2355	20@32	52@0
					Mid						
					High						
n34	10	15	CP-OFDM QPSK	DFT-s-OFDM QPSK	Low	403000	2015	403000	2015	50@0	52@0
					Mid	403500	2017.5	403500	2017.5		
					High	404000	2020	404000	2020		
n38	15	15	CP-OFDM QPSK	DFT-s-OFDM QPSK	Low	515500	2577.5	515500	2577.5	75@0	79@0
					Mid	519000	2595	519000	2595		
					High	522500	2612.5	522500	2612.5		
n39	20	15	CP-OFDM QPSK	DFT-s-OFDM QPSK	Low	378000	1890	378000	1890	100@0	106@0
					Mid	380000	1900	380000	1900		
					High	382000	1910	382000	1910		
n40	30	15	CP-OFDM QPSK	DFT-s-OFDM QPSK	Low	463000	2315	463000	2315	160@0	160@0
					Mid	470000	2350	470000	2350		
					High	477000	2385	477000	2385		
n41	100	30	CP-OFDM QPSK	DFT-s-OFDM QPSK	Low	509202	2546.01	509202	2546.01	270@0	273@0
					Mid	518598	2592.99	518598	2592.99		
					High	528000	2640	528000	2640		
n48	20	15	CP-OFDM QPSK	DFT-s-OFDM QPSK	Low	637334	3560.01	637334	3560.01	100@0	106@0
					Mid	641666	3624.99	641666	3624.99		
					High	646000	3690	646000	3690		
n50	20	15			Low	288400	1442	288400	1442	100@0	106@0

			CP-OFDM QPSK	DFT-s-OFDM QPSK	Mid	294900	1474.5	294900	1474.5		
					High	301400	1507	301400	1507		
n51	5	15	CP-OFDM QPSK	DFT-s-OFDM QPSK	Low	285900	1429.5	285900	1429.5	25@0	25@0
				Mid							
				High							
n53	10	15	CP-OFDM QPSK	DFT-s-OFDM QPSK	Low	497700	2488.5	497700	2488.5	50@0	52@0
				Mid	497860	2489.3	497860	2489.3			
				High	498000	2490	498000	2490			
n65	15	15	CP-OFDM QPSK	DFT-s-OFDM QPSK	Low	423500	2117.5	423500	2117.5	75@4	79@0
				Mid	431000	2155	431000	2155			
				High	438500	2192.5	438500	2192.5			
n66	20 (20+20)	15	CP-OFDM QPSK	DFT-s-OFDM QPSK	Low	344000	1720	424000	2120	100@6	106@0
				Mid	349000	1745	429000	2145			
				High	354000	1770	434000	2170			
n70	15	15	CP-OFDM QPSK	DFT-s-OFDM QPSK	Low	340500	1702.5	400500	2002.5	75@4	79@0
				Mid							
				High							
n71	10	15	CP-OFDM QPSK	DFT-s-OFDM QPSK	Low	133600	668	124400	622	25@0	52@0
				Mid	136100	680.5	126900	634.5			
				High	138600	693	129400	647			
n74	15	15	CP-OFDM QPSK	DFT-s-OFDM QPSK	Low	286900	1434.5	296500	1482.5	25@54	79@0
				Mid	289700	1448.5	299300	1496.5			
				High	292500	1462.5	302100	1510.5			
n75 SDL	15	15	CP-OFDM QPSK	DFT-s-OFDM QPSK	Low	N/A	N/A	287900	1439.5	NA	79@0
				Mid	N/A	N/A	294900	1474.5			
				High	N/A	N/A	301900	1509.5			
n76 SDL	5	15	CP-OFDM QPSK	DFT-s-OFDM QPSK	Low	N/A	N/A	285900	1429.5	NA	25@0
				Mid							
				High							
n77	100	30	CP-OFDM QPSK	DFT-s-OFDM QPSK	Low	623334	3350.01	623334	3350.01	270@0	273@0
				Mid	650000	3750	650000	3750			
				High	676666	4149.99	676666	4149.99			
n78	100	30	CP-OFDM QPSK	DFT-s-OFDM QPSK	Low	623334	3350.01	623334	3350.01	270@0	273@0
				Mid	636666	3549.99	636666	3549.99			
				High	650000	3750	650000	3750			
n79	100	30	CP-OFDM QPSK	DFT-s-OFDM QPSK	Low	696668	4450.02	696668	4450.02	270@0	273@0
				Mid	713334	4700.01	713334	4700.01			
				High	730000	4950	730000	4950			

The detailed testing parameters for each band for RedCap UE is defined in Table 5.3-3 and Table 5.3-4.

Table 5.3-3: NR FR1 TRP measurement parameters for RedCap UE

NR Band	CBW [MHz]	SCS (kHz)	UL modulation	Range	UL Carrier centre [ARFCN]	UL Carrier Center (MHz)	DL Carrier centre [ARFCN]	DL Carrier Center (MHz)	UL RB Allocation (L _{CRB} @ RB _{start})	DL configuration
n1	15	15	DFT-s-OFDM QPSK	Low	385500	1927.5	423500	2117.5	36@18	N/A
				Mid	390000	1950	428000	2140		
				High	394500	1972.5	432500	2162.5		
n2	15	15	DFT-s-OFDM QPSK	Low	371500	1857.5	387500	1937.5	36@18	N/A
				Mid	376000	1880	392000	1960		
				High	380500	1902.5	396500	1982.5		
n3	15	15	DFT-s-OFDM QPSK	Low	343500	1717.5	362500	1812.5	36@18	N/A
				Mid	349500	1747.5	368500	1842.5		
				High	355500	1777.5	374500	1872.5		
n5	15	15	DFT-s-OFDM QPSK	Low	166300	831.5	175300	876.5	36@18	N/A
				Mid	167300	836.5	176300	881.5		
				High	168300	841.5	177300	886.5		
n7	15	15	DFT-s-OFDM QPSK	Low	501500	2507.5	525500	2627.5	36@18	N/A
				Mid	507000	2535	531000	2655		
				High	512500	2562.5	536500	2682.5		
n8	15	15		Low	177500	887.5	186500	932.5	36@18	N/A

			DFT-s-OFDM QPSK	Mid	179500	897.5	188500	942.5		
				High	181500	907.5	190500	952.5		
n12	10	15	DFT-s-OFDM QPSK	Low	140800	704	146800	734	25@12	N/A
				Mid	141500	707.5	147500	737.5		
				High	142200	711	148200	741		
n14	10	15	DFT-s-OFDM QPSK	Low	158600	793	152600	763	25@12	N/A
				Mid						
				High						
n20	15	15	DFT-s-OFDM QPSK	Low	167900	839.5	159700	798.5	36@18	N/A
				Mid	169400	847	161200	806		
				High	170900	854.5	162700	813.5		
n25	15	15	DFT-s-OFDM QPSK	Low	371500	1857.5	387500	1937.5	36@18	N/A
				Mid	376500	1882.5	392500	1962.5		
				High	381500	1907.5	397500	1987.5		
n26	15	15	DFT-s-OFDM QPSK	Low	164300	821.5	173300	866.5	36@18	N/A
				Mid	166300	831.5	175300	876.5		
				High	168300	841.5	177300	886.5		
n28	15	15	DFT-s-OFDM QPSK	Low	142100	710.5	153100	765.5	36@18	N/A
				Mid	145100	725.5	156100	780.5		
				High	148100	740.5	159100	795.5		
n30	10	15	DFT-s-OFDM QPSK	Low	462000	2310	471000	2355	25@12	N/A
				Mid						
				High						
n34	10	15	DFT-s-OFDM QPSK	Low	403000	2015	403000	2015	25@12	N/A
				Mid	403500	2017.5	403500	2017.5		
				High	404000	2020	404000	2020		
n38	15	15	DFT-s-OFDM QPSK	Low	515500	2577.5	515500	2577.5	36@18	N/A
				Mid	519000	2595	519000	2595		
				High	522500	2612.5	522500	2612.5		
n39	15	15	DFT-s-OFDM QPSK	Low	377500	1887.5	377500	1887.5	36@18	N/A
				Mid	380000	1900	380000	1900		
				High	382500	1912.5	382500	1912.5		
n40	15	15	DFT-s-OFDM QPSK	Low	461500	2307.5	461500	2307.5	36@18	N/A
				Mid	470000	2350	470000	2350		
				High	478500	2392.5	478500	2392.5		
n41	15	15	DFT-s-OFDM QPSK	Low	500700	2503.5	500700	2503.5	36@18	N/A
				Mid	518601	2593.005	518601	2593.005		
				High	536499	2682.495	536499	2682.495		
n48	15	15	DFT-s-OFDM QPSK	Low	637168	3557.52	637168	3557.52	36@18	N/A
				Mid	641666	3624.99	641666	3624.99		
				High	646166	3692.49	646166	3692.49		
n50	15	15	DFT-s-OFDM QPSK	Low	287900	1439.5	287900	1439.5	36@18	N/A
				Mid	294900	1474.5	294900	1474.5		
				High	301900	1509.5	301900	1509.5		
n51	5	15	DFT-s-OFDM QPSK	Low	285900	1429.5	285900	1429.5	12@6	N/A
				Mid						
				High						
n53	10	15	DFT-s-OFDM QPSK	Low	497700	2488.5	497700	2488.5	25@12	N/A
				Mid	497860	2489.3	497860	2489.3		
				High	498000	2490	498000	2490		
n65	15	15	DFT-s-OFDM QPSK	Low	423500	2117.5	423500	2117.5	36@18	N/A
				Mid	431000	2155	431000	2155		
				High	438500	2192.5	438500	2192.5		
n71	10	15	DFT-s-OFDM QPSK	Low	133600	668	124400	622	25@12	N/A
				Mid	136100	680.5	126900	634.5		
				High	138600	693	129400	647		
n74	15	15	DFT-s-OFDM QPSK	Low	286900	1434.5	296500	1482.5	36@18	N/A
				Mid	289700	1448.5	299300	1496.5		
				High	292500	1462.5	302100	1510.5		
n77	15	15	DFT-s-OFDM QPSK	Low	620500	3307.5	620500	3307.5	36@18	N/A
				Mid	650000	3750	650000	3750		
				High	679500	4192.5	679500	4192.5		
n78	15	15	DFT-s-OFDM	Low	620500	3307.5	620500	3307.5	36@18	N/A
				Mid	636666	3549.99	636666	3549.99		

			QPSK	High	652832	3792.48	652832	3792.48		
n79	20	15	DFT-s-OFDM QPSK	Low	694000	4410	694000	4410	50@25	N/A
				Mid	713333	4699.995	713333	4699.995		
				High	732667	4990.005	732667	4990.005		

Table 5.3-4: NR FR1 TRS measurement parameters for RedCap UE

NR Band	CBW (MHz)	SCS (kHz)	DL modulation	UL modulation	Range	UL Carrier centre [ARFCN]	UL Carrier Center (MHz)	DL Carrier centre [ARFCN]	DL Carrier Center (MHz)	UL RB Allocation (LCRB @ RB _{start})	DL Configuration (FULL RB, LCRB @ RB _{start})
n1	15	15	CP-OFDM QPSK	DFT-s-OFDM QPSK	Low	385500	1927.5	423500	2117.5	75@4	79@0
					Mid	390000	1950	428000	2140		
					High	394500	1972.5	432500	2162.5		
n2	15	15	CP-OFDM QPSK	DFT-s-OFDM QPSK	Low	371500	1857.5	387500	1937.5	50@29	79@0
					Mid	376000	1880	392000	1960		
					High	380500	1902.5	396500	1982.5		
n3	15	15	CP-OFDM QPSK	DFT-s-OFDM QPSK	Low	343500	1717.5	362500	1812.5	50@29	79@0
					Mid	349500	1747.5	368500	1842.5		
					High	355500	1777.5	374500	1872.5		
n5	15	15	CP-OFDM QPSK	DFT-s-OFDM QPSK	Low	166300	831.5	175300	876.5	25@54	79@0
					Mid	167300	836.5	176300	881.5		
					High	168300	841.5	177300	886.5		
n7	15	15	CP-OFDM QPSK	DFT-s-OFDM QPSK	Low	501500	2507.5	525500	2627.5	75@4	79@0
					Mid	507000	2535	531000	2655		
					High	512500	2562.5	536500	2682.5		
n8	15	15	CP-OFDM QPSK	DFT-s-OFDM QPSK	Low	177500	887.5	186500	932.5	25@54	79@0
					Mid	179500	897.5	188500	942.5		
					High	181500	907.5	190500	952.5		
n12	10	15	CP-OFDM QPSK	DFT-s-OFDM QPSK	Low	140800	704	146800	734	20@32	52@0
					Mid	141500	707.5	147500	737.5		
					High	142200	711	148200	741		
n14	10	15	CP-OFDM QPSK	DFT-s-OFDM QPSK	Low	158600	793	152600	763	20@32	52@0
					Mid						
					High						
n20	15	15	CP-OFDM QPSK	DFT-s-OFDM QPSK	Low	167900	839.5	159700	798.5	20@11	79@0
					Mid	169400	847	161200	806		
					High	170900	854.5	162700	813.5		
n25	15	15	CP-OFDM QPSK	DFT-s-OFDM QPSK	Low	371500	1857.5	387500	1937.5	50@29	79@0
					Mid	376500	1882.5	392500	1962.5		
					High	381500	1907.5	397500	1987.5		
n26	15	15	CP-OFDM QPSK	DFT-s-OFDM QPSK	Low	164300	821.5	173300	866.5	25@54	79@0
					Mid	166300	831.5	175300	876.5		
					High	168300	841.5	177300	886.5		
n28	15	15	CP-OFDM QPSK	DFT-s-OFDM QPSK	Low	142100	710.5	153100	765.5	25@54	79@0
					Mid	145100	725.5	156100	780.5		
					High	148100	740.5	159100	795.5		
n30	10	15	CP-OFDM QPSK	DFT-s-OFDM QPSK	Low	462000	2310	471000	2355	20@32	52@0
					Mid						
					High						
n34	10	15	CP-OFDM QPSK	DFT-s-OFDM QPSK	Low	403000	2015	403000	2015	50@0	52@0
					Mid	403500	2017.5	403500	2017.5		
					High	404000	2020	404000	2020		
n38	15	15	CP-OFDM QPSK	DFT-s-OFDM QPSK	Low	515500	2577.5	515500	2577.5	75@0	79@0
					Mid	519000	2595	519000	2595		
					High	522500	2612.5	522500	2612.5		
n39	15	15	CP-OFDM QPSK	DFT-s-OFDM QPSK	Low	377500	1887.5	377500	1887.5	75@0	79@0
					Mid	380000	1900	380000	1900		
					High	382500	1912.5	382500	1912.5		
n40	15	15	CP-OFDM QPSK	DFT-s-OFDM QPSK	Low	461500	2307.5	461500	2307.5	75@0	79@0
					Mid	470000	2350	470000	2350		
					High	478500	2392.5	478500	2392.5		
n41	15	15			Low	500700	2503.5	500700	2503.5	75@0	79@0

			CP-OFDM QPSK	DFT-s-OFDM QPSK	Mid	518601	2593.00 5	518601	2593.00 5		
					High	536499	2682.49 5	536499	2682.49 5		
n48	15	15	CP-OFDM QPSK	DFT-s-OFDM QPSK	Low	637168	3557.52	637168	3557.52	75@0	79@0
					Mid	641666	3624.99	641666	3624.99		
					High	646166	3692.49	646166	3692.49		
n50	15	15	CP-OFDM QPSK	DFT-s-OFDM QPSK	Low	287900	1439.5	287900	1439.5	75@0	79@0
					Mid	294900	1474.5	294900	1474.5		
					High	301900	1509.5	301900	1509.5		
n51	5	15	CP-OFDM QPSK	DFT-s-OFDM QPSK	Low	285900	1429.5	285900	1429.5	25@0	25@0
					Mid						
					High						
n53	10	15	CP-OFDM QPSK	DFT-s-OFDM QPSK	Low	497700	2488.5	497700	2488.5	50@0	52@0
					Mid	497860	2489.3	497860	2489.3		
					High	498000	2490	498000	2490		
n65	15	15	CP-OFDM QPSK	DFT-s-OFDM QPSK	Low	423500	2117.5	423500	2117.5	75@4	79@0
					Mid	431000	2155	431000	2155		
					High	438500	2192.5	438500	2192.5		
n70	15	15	CP-OFDM QPSK	DFT-s-OFDM QPSK	Low	340500	1702.5	400500	2002.5	75@4	79@0
					Mid						
					High						
n71	10	15	CP-OFDM QPSK	DFT-s-OFDM QPSK	Low	133600	668	124400	622	25@0	52@0
					Mid	136100	680.5	126900	634.5		
					High	138600	693	129400	647		
n74	15	15	CP-OFDM QPSK	DFT-s-OFDM QPSK	Low	286900	1434.5	296500	1482.5	25@54	79@0
					Mid	289700	1448.5	299300	1496.5		
					High	292500	1462.5	302100	1510.5		
n77	15	15	CP-OFDM QPSK	DFT-s-OFDM QPSK	Low	620500	3307.5	620500	3307.5	75@0	79@0
					Mid	650000	3750	650000	3750		
					High	679500	4192.5	679500	4192.5		
n78	15	15	CP-OFDM QPSK	DFT-s-OFDM QPSK	Low	620500	3307.5	620500	3307.5	75@0	79@0
					Mid	636666	3549.99	636666	3549.99		
					High	652832	3792.48	652832	3792.48		
n79	20	15	CP-OFDM QPSK	DFT-s-OFDM QPSK	Low	694000	4410	694000	4410	100@0	106@0
					Mid	713333	4699.99 5	713333	4699.99 5		
					High	732667	4990.00 5	732667	4990.00 5		

6 FR1 TRP requirements

6.1 General

The TRP requirements specified in Clause 6 apply to handheld UE with TAS off and power back-off functions disabled.

The TRP requirements defined in Clause 6.2 should be verified based on the detailed test parameters in Table 5.3-1.

6.2 Minimum requirement

6.2.1 Minimum requirement for handheld UE

The average measured total radiated power (TRP) of low, mid and high channel for handheld UE shall be higher than the average TRP requirement specified in subclauses 6.2.1.1 and 6.2.1.2. The averaging shall be done in linear scale for the TRP results of both right and left side of the phantom head in case of beside the head and hand phantom positions. For the hand phantom browsing mode position the averaging shall be done in linear scale for the TRP results of both right and left hand phantom measurements.

$$TRP_{average} = 10 \log \left[\frac{10^{P_{left_low}/10} + 10^{P_{left_mid}/10} + 10^{P_{left_high}/10} + 10^{P_{right_low}/10} + 10^{P_{right_mid}/10} + 10^{P_{right_high}/10}}{6} \right]$$

For UEs which do not support NR FR1 in stand-alone mode, EN-DC mode requirements apply. SA and EN-DC test case applicability is defined in Clause 4.3, and test case applicability based on power class capability is defined in Clause 4.4. The relevant test methodology is defined in Annexes A and B of this specification.

6.2.1.1 Hand phantom browsing mode

Hand phantom browsing mode positions are defined in Clause B.3.1.

6.2.1.1.1 NR FR1

Handheld UE TRP minimum performance requirement for NR FR1 bands in the hand phantom browsing position and the primary mechanical mode are defined in Tables 6.2.1.1.1-1 and 6.2.1.1.1-2.

Table 6.2.1.1.1-1: Handheld PC3 UE TRP minimum performance requirement for NR FR1 bands in the hand phantom browsing position and the primary mechanical mode

NR Band	Bandwidth (MHz)	Usage Scenario	Power Class 3	
			Average TRP (dBm)	
			UE width ≤ 72mm	UE width > 72mm
n28	20	HL and HR		
n41	100	HL and HR		
n78	100	HL and HR		
n79	100	HL and HR		

Table 6.2.1.1.2: Handheld PC2 UE TRP minimum performance requirement for NR FR1 bands in the hand phantom browsing position and the primary mechanical mode

NR Band	Bandwidth (MHz)	Usage Scenario	Power Class 2	
			Average TRP (dBm)	
			UE width ≤ 72mm	UE width > 72mm
n28	20	HL and HR		
n41	100	HL and HR		12.5
n78	100	HL and HR		13
n79	100	HL and HR		

6.2.1.1.2 NR FR1 in EN-DC mode

Handheld UE TRP minimum performance requirement for NR FR1 bands (in EN-DC mode) in the hand phantom browsing position and the primary mechanical mode are defined in Tables 6.2.1.1.2-1 and 6.2.1.1.2-2.

Table 6.2.1.1.2-1: Handheld PC3 UE TRP minimum performance requirement for NR FR1 bands (in EN-DC mode) in the hand phantom browsing position and the primary mechanical mode

NR Band	Bandwidth (MHz)	Usage Scenario	Power Class 3	
			Average TRP (dBm)	
			UE width ≤ 72mm	UE width > 72mm
n28	20	HL and HR		
n41	100	HL and HR		
n78	100	HL and HR		
n79	100	HL and HR		

Table 6.2.1.1.2-2: Handheld PC2 UE TRP minimum performance requirement for NR FR1 bands (in EN-DC mode) in the hand phantom browsing position and the primary mechanical mode

NR Band	Bandwidth (MHz)	Usage Scenario	Power Class 2	
			Average TRP (dBm)	
			UE width ≤ 72mm	UE width > 72mm
n28	20	HL and HR		
n41	100	HL and HR		
n78	100	HL and HR		
n79	100	HL and HR		

6.2.1.2 Beside the head and hand phantom talk mode

Beside the head and hand phantom mode positions are defined in Clause B.3.2 of this specification.

6.2.1.2.1 NR FR1

Handheld UE TRP minimum performance requirement for NR FR1 bands in the beside head and hand phantom talk position and the primary mechanical mode are defined in Tables 6.2.1.2.1-1 and 6.2.1.2.1-2.

Table 6.2.1.2.1-1: Handheld PC3 UE TRP minimum performance requirement for NR FR1 bands in the beside head and hand phantom talk position and the primary mechanical mode

NR Band	Bandwidth (MHz)	Usage Scenario	Power Class 3	
			Average TRP (dBm)	
			UE width ≤ 72mm	UE width > 72mm
n28	20	BHHL and BHHR		
n41	100	BHHL and BHHR		
n78	100	BHHL and BHHR		
n79	100	BHHL and BHHR		

Table 6.2.1.2.1-2: Handheld PC2 UE TRP minimum performance requirement for NR FR1 bands in the beside head and hand phantom talk position and the primary mechanical mode

NR Band	Bandwidth (MHz)	Usage Scenario	Power Class 2	
			Average TRP (dBm)	
			UE width ≤ 72mm	UE width > 72mm
n28	20	BHHL and BHHR		
n41	100	BHHL and BHHR		
n78	100	BHHL and BHHR		
n79	100	BHHL and BHHR		

6.2.1.2.2 NR FR1 in EN-DC mode

Handheld UE TRP minimum performance requirement for NR FR1 bands (in EN-DC mode) in the beside head and hand phantom talk position and the primary mechanical mode are defined in Tables 6.2.1.2.2-1 and 6.2.1.2.2-2.

Table 6.2.1.2.2-1: Handheld PC3 UE TRP minimum performance requirement for NR FR1 bands (in EN-DC mode) in the beside head and hand phantom talk position and the primary mechanical mode

NR Band	Bandwidth (MHz)	Usage Scenario	Power Class 3	
			Average TRP (dBm)	
			UE width ≤ 72mm	UE width > 72mm
n28	20	BHHL and BHHR		
n41	100	BHHL and BHHR		
n78	100	BHHL and BHHR		
n79	100	BHHL and BHHR		

Table 6.2.1.2.2-2: Handheld PC2 UE TRP minimum performance requirement for NR FR1 bands (in EN-DC mode) in the beside head and hand phantom talk position and the primary mechanical mode

NR Band	Bandwidth (MHz)	Usage Scenario	Power Class 2	
			Average TRP (dBm)	
			UE width ≤ 72mm	UE width > 72mm
n28	20	BHHL and BHHR		
n41	100	BHHL and BHHR		
n78	100	BHHL and BHHR		
n79	100	BHHL and BHHR		

7 FR1 TRS requirements

7.1 General

The TRS requirements specified in Clause 7 apply to handheld UE configured with maximum number of Rx antennas supported for each band, which is specified in TS 38.101-1 Clause 7.3 [3].

The TRS requirements defined in Clause 7.2 should be verified based on the detailed test parameters in Table 5.3-2.

7.2 Minimum requirement

7.2.1 Minimum requirement for handheld UE

The average measured total radiated sensitivity (TRS) of low, mid and high channel for handheld UE shall be lower than the average TRS requirement specified in subclauses 7.2.1.1 and 7.2.1.2. The averaging shall be done in linear scale for the TRS results of both right and left side of the phantom head in case of beside the head and hand phantom positions. For the hand phantom browsing mode position the averaging shall be done in linear scale for the TRP results of both right and left hand phantom measurements.

$$TRS_{average} = 10 \log \left[6 / \left(\frac{1}{10^{\frac{P_{left_low}}{10}}} + \frac{1}{10^{\frac{P_{left_mid}}{10}}} + \frac{1}{10^{\frac{P_{left_high}}{10}}} + \frac{1}{10^{\frac{P_{right_low}}{10}}} + \frac{1}{10^{\frac{P_{right_mid}}{10}}} + \frac{1}{10^{\frac{P_{right_high}}{10}}} \right) \right]$$

For UEs which do not support NR FR1 in stand-alone mode, EN-DC mode requirements apply. SA and EN-DC test case applicability is defined in Clause 4.3, and test case applicability based on power class capability is defined in Clause 4.4. The relevant test methodology is defined in Annexes A and B of this specification.

7.2.1.1 Hand phantom browsing mode

Hand phantom browsing mode positions are defined in Clause B.3.1.

7.2.1.1.1 NR FR1

Handheld UE TRS minimum performance requirement for NR FR1 bands in the hand phantom browsing position and the primary mechanical mode are defined in Tables 7.2.1.1.1-1 and 7.2.1.1.1-2.

Table 7.2.1.1.1-1: Handheld PC3 and PC2 UE TRS minimum performance requirement for NR FR1 bands in the hand phantom browsing position and the primary mechanical mode

NR Band	Bandwidth (MHz)	Usage Scenario	Power Class 3 and Power Class 2	
			Average TRS (dBm)	
			UE width \leq 72mm	UE width $>$ 72mm
n28	20	HL and HR		
n41	100	HL and HR		-80
n78	100	HL and HR		-81.2
n79	100	HL and HR		

7.2.1.1.2 NR FR1 in EN-DC mode

Handheld UE TRS minimum performance requirement for NR FR1 bands (in EN-DC mode) in the hand phantom browsing position and the primary mechanical mode are defined in Tables 6.2.1.1.2-1 and 6.2.1.1.2-2.

Table 7.2.1.1.2-1: Handheld PC3 and PC2 UE TRS minimum performance requirement for NR FR1 bands (in EN-DC mode) in the hand phantom browsing position and the primary mechanical mode

NR Band	Bandwidth (MHz)	Usage Scenario	Power Class 3 and Power Class 2	
			Average TRS (dBm)	
			UE width \leq 72mm	UE width $>$ 72mm
n28	20	HL and HR		
n41	100	HL and HR		
n78	100	HL and HR		
n79	100	HL and HR		

7.2.1.2 Beside the head and hand phantom position

Beside the head and hand phantom mode positions are defined in Clause B.3.2.

7.2.1.2.1 NR FR1

Handheld UE TRP minimum performance requirement for NR FR1 bands in the beside head and hand phantom position and the primary mechanical mode are defined in Tables 7.2.1.2.1-1 and 7.2.1.2.1-2.

Table 7.2.1.2.1-1: Handheld PC3 and PC2 UE TRS minimum performance requirement for NR FR1 bands in the beside head and hand phantom position and the primary mechanical mode

NR Band	Bandwidth (MHz)	Usage Scenario	Power Class 3 and Power Class 2	
			Average TRS (dBm)	
			UE width \leq 72mm	UE width $>$ 72mm
n28	20	BHHL and BHHR		
n41	100	BHHL and BHHR		
n78	100	BHHL and BHHR		
n79	100	BHHL and BHHR		

7.2.1.2.2 NR FR1 in EN-DC mode

Handheld UE TRS minimum performance requirement for NR FR1 bands (in EN-DC mode) in the beside head and hand phantom position and the primary mechanical mode are defined in Tables 6.2.1.2.2-1 and 6.2.1.2.2-2.

Table 7.2.1.2.2-1: Handheld PC3 and PC2 UE TRS minimum performance requirement for NR FR1 bands (in EN-DC mode) in the beside head and hand phantom position and the primary mechanical mode

NR Band	Bandwidth (MHz)	Usage Scenario	Power Class 3 and Power Class 2	
			Average TRS (dBm)	
			UE width \leq 72mm	UE width $>$ 72mm
n28	20	BHHL and BHHR		
n41	100	BHHL and BHHR		
n78	100	BHHL and BHHR		
n79	100	BHHL and BHHR		

Annex A (normative): Test methodology

A.1 General

TRP TRS minimum requirement specified in Clause 6 and Clause 7 should be measured with Anechoic Chamber method.

A.2 UE configuration

A.2.1 General

For FR1 TRP and TRS radiated conformance testing, P-MPRc shall be 0 dB.

FR1 TRP and TRS radiated conformance testing shall be performed with the UE consistently operating at maximum power level, e.g., Time-Averaged Algorithm (TAA) and other power back-off functions should be disabled. The above functions OFF should be based on manufacturer declaration, if declared, then the manufacturer is required to provide a mechanism for the test lab to enable/disable the function.

The NR SS should send continuous uplink power control “up” commands to the DUT to ensure the DUT’s transmitter is at maximum output power during the TRP and TRS test.

A.2.2 UE configuration for TRP test

For devices containing multiple Tx antennas, the Tx Antenna Switching (TAS) function should be OFF, and the TRP should be measured for each Tx antenna individually. The antenna with better TRP is identified as the primary antenna, and the corresponding TRP result will be used to determine the pass/fail compliance. Otherwise, the primary antenna should be selected based on manufacturer declaration. To ensure the TAS OFF testing, the manufacture should provide either software/guidance to lab to control which Tx antenna is used, or the pre-configured DUT locked at primary antenna.

For Standalone, the NR System Simulator (SS) and DUT shall be configured per TS 38.521-1 [5], section 6.2.1 (UE maximum output power) using the default settings specified in TS 38.521-1 [5] and TS 38.508-1 [7] as applicable. The measurement should be carried out based on the detailed test parameters for each band, as defined in Clause 5 Table 5.3-1.

For EN-DC, the SS and DUT shall be configured per TS 38.521-3 [6], Section 6.2B.1 (UE Maximum Output Power for EN-DC) using the default settings specified in TS 38.521-3 [6] and TS 38.508 [7] as applicable. The measurement should be carried out based on the detailed test parameters for each band, as defined in Clause 5 Table 5.3-1. The UL output power of LTE carrier should be set as a constant power of 10dBm, while measuring NR at maximum output power, i.e., with fixed p-MaxEUTRA-r15=10 dBm, and p-NR-FR1 not configured.

A.2.3 UE configuration for TRS test

For TRS measurement, no specific setting is needed for Rx antennas. By default, the maximum number of Rx antennas supported at each band should be enabled during the TRS test.

For Standalone, the NR System Simulator (SS) and DUT shall be configured per section 7.3.2 (Reference sensitivity power level) of TS 38.521-1 [5] using the defaults specified in TS 38.521-1 [5] and TS 38.508-1 [7] as applicable. The measurement should be carried out based on the detailed test parameters for each band, as defined in Clause 5 Table 5.3-2.

For EN-DC, the EN-DC SS and DUT shall be configured per section 7.3B.2 (Reference Sensitivity for EN-DC) of TS 38.521-3 [6], using the defaults specified in TS 38.521-3 [6] and TS 38.508 [7], as applicable. The measurement should be carried out based on the detailed test parameters for each band, as defined in Clause 5 Table 5.3-2. The UL power configuration for LTE and NR is 50%-50% power splitting, i.e.,

- For PC3, $p\text{-MaxEUTRA-r15}=20$ dBm, and $p\text{-NR-FR1}=20$ dBm;
- For PC2, $p\text{-MaxEUTRA-r15}=23$ dBm, and $p\text{-NR-FR1}=23$ dBm.

A.3 Test system of Anechoic Chamber method

A.3.1 System setup

For FR1 TRP TRS testing, both Single-antenna and multiple-antennas anechoic chambers can be applied. In Figure A.3.1-1, an example TRP TRS test system with combined axes system is presented.

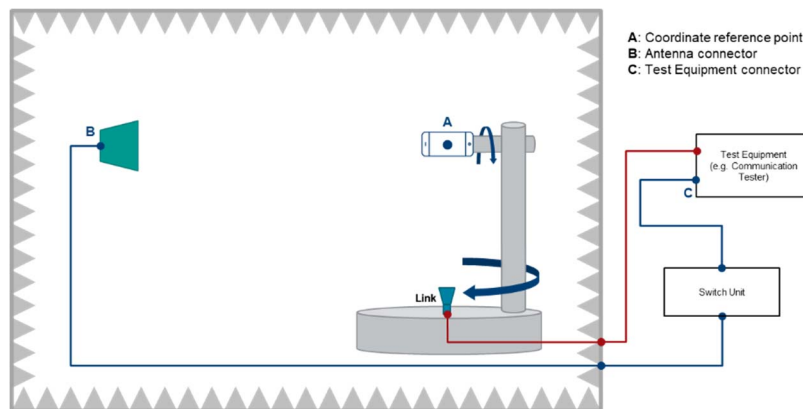

Figure A.3.1-1: Example of a FR1 TRP TRS OTA test system with combined axis

In Figure A.3.1-2, an example TRP TRS test system with distributed axes system is presented.

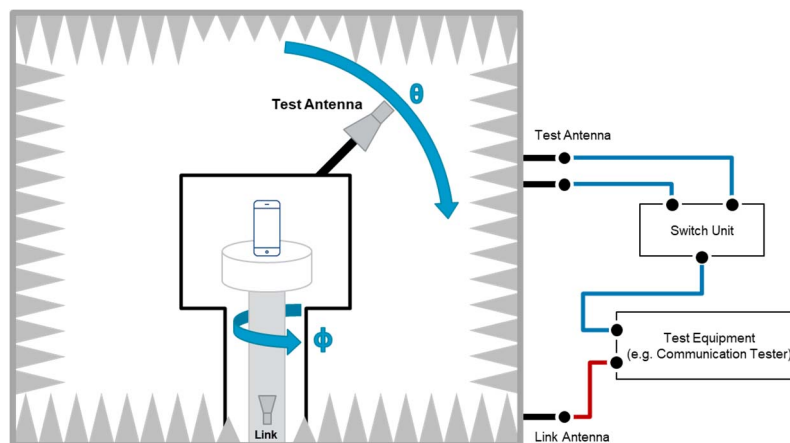

Figure A.3.1-2: Example of a FR1 TRP TRS OTA test system with distributed axis

A.3.2 Calibration procedure

The relative power values of the measurement points will be transformed to absolute radiated power values (in dBm) by performing a range path loss calibration measurement. The system needs to be calibrated by using a reference calibration antenna with known gain values. In the range path loss calibration measurement, the reference antenna is measured in the same place as the DUT, i.e. the center of the QZ, and the attenuation of the complete transmission path (L_{total}) from the DUT to the measurement receiver/BS simulator is calibrated out.

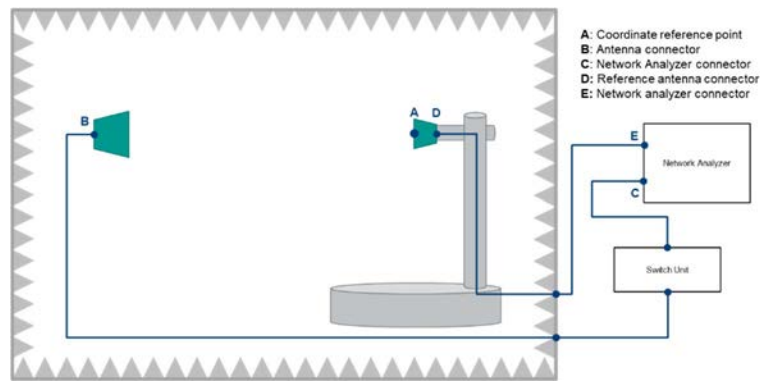

Figure A.3.2-1: Example FR1 TRP TRS calibration setup

The calibration measurement is repeated for each measurement path (two orthogonal polarizations and each signal path). The range path loss calibration measurement is performed in a two-step process including total path loss measurement and cable calibration.

Step 1: Cable calibration: the measurement of path loss L_{DE} , by connecting the cable from D to E to the two ports of VNA, and measure the cable path loss.

Step 2: Total path loss measurement: the measurement of total path loss L_{BC} ;

1. Place the reference calibration antenna (e.g. reference dipole) in the center of the test zone aligned with θ polarization of the measurement antenna, connected to a VNA port E, with the other VNA port C connected to the input of the Switch box – in Figure A.2.2-1.
2. Configure the proper output power of VNA.
3. Measure the response L_{CE} of each path from each θ polarization of the measurement antenna to the reference antenna in the center of QZ.
4. Repeat the steps 1 to 3 with the reference antenna aligned with the ϕ polarization of the measurement antenna.

Then, the $L_{total} = (L_{CE} - L_{DE} + G_{cal})$, Where L_{DE} is cable loss from D to E. G_{cal} is the gain or efficiency of the calibration antenna at the frequency of interest. In TRP and TRS measurements point C is connected to the calibrated input/output port of measurement receiver.

This range path loss calibration procedure is common to both SA and EN-DC measurements.

A.3.3 Test procedure

A.3.3.1 General

For TRP and TRS testing in SA or EN-DC mode, measurements should be only performed at NR carrier. The LTE link antenna in EN-DC mode is used to provide a stable LTE link to the DUT without precise path loss or polarization control.

A.3.3.2 TRP Test procedure

The TRP of the DUT is measured by sampling the radiated transmit power of the DUT with three-dimensional scan at various locations surrounding the device. The measurement is performed with a constant sampling step, e.g., 15 degrees or 30 degrees, in both theta (θ) and phi (ϕ) axes for TRP measurement. For some test system can not measure 180° EIRP, then the extrapolation approach can be adopted when generating the 3D antenna pattern. All of the measured power values will be integrated to TRP, as defined in Clause A.3.5.1.

For TRP measurement, the evaluations shall be performed at maximum transmit power.

The measurement procedure includes the following steps:

- 1) Place the DUT inside the QZ following the positioning guideline defined in Clause 6.
- 2) Connect the SS with the DUT through the link antenna following steps 1 and 2 in section 6.2.1.4.2 of TS 38.521-1 [5] and ensure the DUT transmits with its maximum power.
- 3) Measure the power at each measurement point, and calculate $EIRP(\theta, \phi)$ by adding the composite loss of the entire transmission path.

The TRP value is calculated using the TRP integration approaches outlined in Clause A.3.5.1.

This TRP test procedure is common to both SA and EN-DC measurements. The detailed UE configurations for TRP test in SA and EN-DC mode are specified in Clause A.2.

A.3.3.3 TRS Test procedure

The TRS of the DUT is measured by sampling effective isotropic sensitivity (EIS) of the DUT with three-dimensional scan at various locations surrounding the device. The measurement is performed with a constant sampling step, e.g., 30 degrees or 45 degree in both theta (θ) and phi (ϕ) axes for TRS measurement.

EIS, or receiver sensitivity measurements, is defined as the minimum downlink signal power received at the UE antenna input required to provide a data throughput rate greater than or equal to 95% of the maximum throughput of the reference measurement channel (RMC) (the maximum throughput is per Appendix A of TS 38.521-1 [5]).

For TRS measurement, the evaluations shall be performed at maximum transmit power.

The measurement procedure includes the following steps:

- 1) Place the DUT inside the QZ following the positioning guideline defined in Clause 6.
- 2) Connect the SS with the DUT through the measurement antenna.
- 3) Follow steps 1 through 4 in section 7.3.2.4.2 of TS 38.521-1 [5], with the following exception: determine each EIS, i.e., by adjusting the downlink signal level until the minimum power level at which the throughput exceeds or equal to 95% of the maximum throughput of the specified RMC, at each sampling point. The downlink power step size shall be no more than 0.5 dB when the RF power level is near the NR sensitivity level.

The TRS value is calculated using the equation and integration approaches outlined in Clause A.3.5.2.

This TRS test procedure is common to both SA and EN-DC measurements. The detailed UE configurations for TRS test in SA and EN-DC mode are specified in Clause A.2.

A.3.4 Minimum Range Length

This sub-section specifies the minimum range lengths for Anechoic-Chamber-based FR1 TRP-TRS OTA systems. The range length is defined as the distance from the centre of the quiet zone to the aperture of the measurement probes/antennas, as illustrated in Figure A.3.4-1.

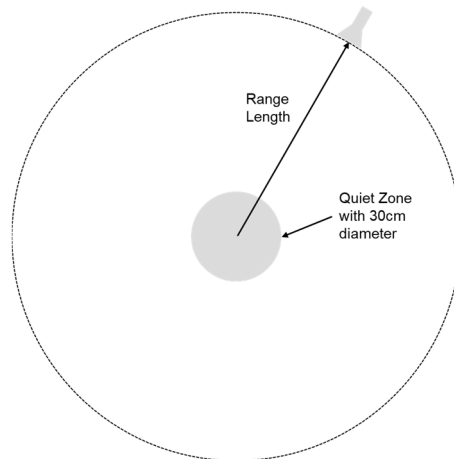

Figure A.3.4-1: Illustration of range length definition

The minimum range length shall be the maximum of the following three limits

- The phase uncertainty limit: $R_{QZ} + 2D_{rad}^2/\lambda$
- The amplitude uncertainty limit: $3D$
- The reactive Near-Field limit: $R_{QZ} + 2\lambda$

where R_{QZ} is defined as the radius of the quiet zone, i.e., $R_{QZ} = D/2$, and D_{rad} is the diameter of the effective radiating aperture. The minimum range length calculations for $D=30\text{cm}$ quiet zone size TRP-TRS OTA test systems shall assume that D_{rad} is 30cm below 1GHz and decrease linearly from 30cm to 5cm from 1GHz to 7.125GHz, respectively. The last column of Table A.3.4-1 shall be considered the minimum range length for NR FR1 TRP-TRS OTA systems with 30cm quiet zone size.

Table A.3.4-1: Minimum Range Length for NR FR1 TRP-TRS OTA systems with 30cm quiet zone size.

F [GHz]	D_{rad} [m]	$R_{QZ} + 2D_{rad}^2/\lambda$	$3D = 6R_{QZ}$	$R_{QZ} + 2\lambda$	$\max(R_{QZ} + 2\lambda, 3D, R_{QZ} + 2D_{rad}^2/\lambda)$
0.41	0.30	0.40	0.9	1.61	1.61
0.6	0.30	0.51	0.9	1.15	1.15
0.7	0.30	0.57	0.9	1.01	1.01
0.8	0.30	0.63	0.9	0.90	0.90
1	0.30	0.75	0.9	0.75	0.90
1.2	0.29	0.83	0.9	0.65	0.90
1.4	0.28	0.90	0.9	0.58	0.90
1.6	0.28	0.96	0.9	0.52	0.96
1.8	0.27	1.01	0.9	0.48	1.01
2	0.26	1.05	0.9	0.45	1.05
2.2	0.25	1.07	0.9	0.42	1.07
2.4	0.24	1.09	0.9	0.40	1.09
2.6	0.23	1.11	0.9	0.38	1.11
2.8	0.23	1.11	0.9	0.36	1.11
3	0.22	1.10	0.9	0.35	1.10
4	0.18	0.99	0.9	0.30	0.99
5	0.14	0.77	0.9	0.27	0.90
6	0.10	0.52	0.9	0.25	0.90
7	0.06	0.29	0.9	0.24	0.90
7.125	0.05	0.27	0.9	0.23	0.90

A.3.5 Definition of TRP and TRS for AC

A.3.5.1 Total Radiated Power (TRP)

This definition is used to calculate the Total Radiated Power (TRP) value. For Anechoic Chamber method, TRP is defined as:

$$TRP = \frac{1}{4\pi} \int_{\theta=0}^{\pi} \int_{\phi=0}^{2\pi} [EIRP_{\theta}(\theta, \phi) + EIRP_{\phi}(\theta, \phi)] \sin(\theta) d\phi d\theta$$

Where the effective isotropic radiated power (EIRP) is defined as

$$EIRP(\theta, \phi) = P_T G_T(\theta, \phi)$$

Where $P_T G_T$ is the product of the power delivered to the antenna and the antenna's power gain, and $EIRP_{\theta}$ and $EIRP_{\phi}$ are the EIRP in the corresponding θ and ϕ polarizations.

The summation form based on the $\sin\theta \cdot \Delta\theta$ weights of TRP with Anechoic Chamber method is defined as:

$$TRP \approx \frac{\pi}{2NM} \sum_{n=0}^{N-1} \sum_{m=0}^{M-1} [EIRP_{\theta}(\theta_n, \phi_m) + EIRP_{\phi}(\theta_n, \phi_m)] \sin \theta_n$$

Where N and M are the number of sampling intervals for θ and ϕ . θ_n and ϕ_m are the measurement angles.

The summation form based on the Clenshaw-Curtis quadrature integral approximation of TRP with Anechoic Chamber method is defined as:

$$TRP \approx \frac{1}{2M} \sum_{n=0}^N \sum_{m=0}^{M-1} [EIRP_{\theta}(\theta_n, \phi_m) + EIRP_{\phi}(\theta_n, \phi_m)] W(\theta_n)$$

Where the value of $W(\theta_n)$ can be calculated as follows:

$$W(\theta_n) = \frac{c_i}{N} \left[1 - \sum_{j=1}^{\text{int}(\frac{N}{2})} \frac{b_j}{4j^2-1} \cos(2j\theta_n) \right]$$

with

$$b_j = \begin{cases} 1, & 2j = N \\ 2, & \text{otherwise} \end{cases}$$

and

$$c_i = \begin{cases} 1, & i = 0 \text{ or } N \\ 2, & \text{otherwise} \end{cases}$$

The applicability of TRP quadratures, frequency ranges, and measurement grids is tabulated in Table A.3.5.1-1.

Table A.3.5.1-1: Applicability for TRP measurement grids

Frequency Range	Quadrature	$\Delta\theta=\Delta\phi$ [°]	N	M	Min. Number of Grid Points
FR1	sin(θ)	15	12	24	266
		30	6	12	62
	Clenshaw-Curtis	15	12	24	266
		30	6	12	62

A.3.5.2 Total Radiated Sensitivity (TRS)

This definition is used to calculate the Total Radiated Sensitivity (TRS) value. For Anechoic Chamber method, the TRS with is defined as:

$$TRS = \frac{4\pi}{\int_{\theta=0}^{\pi} \int_{\phi=0}^{2\pi} \left[\frac{1}{EIS_{\theta}(\theta,\phi)} + \frac{1}{EIS_{\phi}(\theta,\phi)} \right] \sin \theta d\phi d\theta}$$

Where the effective isotropic sensitivity (EIS) is defined as the minimum power level at which the throughput exceeds or equal to 95% of the maximum throughput of the specified RMC, at each sampling point, and EIS_{θ} and EIS_{ϕ} are the EIS in the corresponding θ and ϕ polarizations.

The summation form based on the $\sin\theta \cdot \Delta\theta$ weights of TRS with Anechoic Chamber method defined as:

$$TRS \approx \frac{2NM}{\pi \sum_{n=0}^{N-1} \sum_{m=0}^{M-1} \left[\frac{1}{EIS_{\theta}(\theta_n, \phi_m)} + \frac{1}{EIS_{\phi}(\theta_n, \phi_m)} \right]} \sin \theta_n$$

Where N and M are the number of sampling intervals for θ and ϕ . θ_n and ϕ_m are the measurement angles.

The summation form based on the Clenshaw-Curtis quadrature integral approximation of TRS with Anechoic Chamber method is defined as:

$$TRS \approx \frac{2M}{\sum_{n=0}^{N-1} \sum_{m=0}^{M-1} \left[\frac{1}{EIS_{\theta}(\theta_n, \phi_m)} + \frac{1}{EIS_{\phi}(\theta_n, \phi_m)} \right]} W(\theta_n)$$

Where the value of $W(\theta_n)$ can be calculated as follows (same equation as TRP):

$$W(\theta_n) = \frac{c_i}{N} \left[1 - \sum_{j=1}^{\text{int}\left(\frac{N}{2}\right)} \frac{b_j}{4j^2 - 1} \cos(2j\theta_n) \right]$$

with

$$b_j = \begin{cases} 1, & 2j = N \\ 2, & \text{otherwise} \end{cases}$$

and

$$c_i = \begin{cases} 1, & i = 0 \text{ or } N \\ 2, & \text{otherwise} \end{cases}$$

The applicability of TRS quadratures, frequency ranges, and measurement grids is tabulated in Table A.3.5.2-1.

Table A.3.5.2-1: Applicability for TRS measurement grids

Frequency Range	Quadrature	$\Delta\theta=\Delta\phi$ [°]	N	M	Min. Number of Grid Points
< 3GHz	$\sin(\theta)$	30	6	12	62
	Clenshaw-Curtis	30	6	12	62
		45	4	8	26
> 3GHz	$\sin(\theta)$	30	6	12	62
	Clenshaw-Curtis	30	6	12	62
		45	4	8	26 (Note 1)

Note 1: When the back pole at $\theta = 180^\circ$ cannot be measured due to obstruction and/or blocking, extrapolation is used to estimate EIS at $\theta = 180^\circ$ for measurement grids with $\Delta\theta=\Delta\phi=45^\circ$ by either a) using at least two points within 15° of the pole or b) averaging the last cut (i.e. $\theta = 135^\circ$)

A.4 Preliminary example MU budget

A.4.1 General

A.4.2 Test system of Anechoic Chamber method

The uncertainty contributions related to TRP are described in Annex B in [2]. The preliminary example uncertainty budget for TRP test case using Anechoic Chamber test system is presented in Table A.4.2-1 for Browsing mode and Table A.4.2-2 for Talk mode, respectively.

Table A.4.2-1 Preliminary example of uncertainty budget for TRP hand only (browsing mode) measurement for anechoic chamber method for NR FR1 bands

UID	Uncertainty Source	Comment	Uncertainty Value [dB]		Prob Distr	Div	ci	Standard Uncertainty [dB]	
			Below 3GHz	Above 3GHz				Below 3GHz	Above 3GHz
Stage 2: DUT measurement									
1	Mismatch of receiver chain	$\Gamma_{\text{receiver}} < 0.33$ $\Gamma_{\text{measurement antenna}} < 0.5$ Cable attenuation > 3dB	0.26	0.26	U-shaped	1.4	1	0.18	0.18
2	Insertion loss of receiver chain	Systematic with Stage 1 (\Rightarrow cancels)	0	0	Rectangular	1.7	1	0.00	0.00
3	Influence of the measurement antenna cable	Systematic with Stage 1 (\Rightarrow cancels)	0	0	Rectangular	1.7	1	0.00	0.00
4	Measurement Receiver: uncertainty of the absolute level	Spectrum Analyzer	0.42	0.54	Normal	2	1	0.21	0.27
5	Measurement distance	DUT is not offset for hand-only phantom testing	0	0	Rectangular	1.7	1	0.00	0.00
6	Quality of quiet zone	Surface standard deviation of power measurements in ripple test	0.5	0.5	Actual	1	1	0.50	0.50
7	DUT Tx-power drift	Drift	0.2	0.2	Rectangular	1.7	1	0.12	0.12
8	Uncertainty related to the use of phantoms	Material Dielectric Constant, Material Conductivity, Geometry/Shape (incl. spacer), Data Mode Fixture	0.64	0.64	Rectangular	1.7	1	0.37	0.37
9	Coarse sampling grid	Sampling grids per Table Table B.2.12-1	0	0.11	Actual	1	1	0.00	0.11
10	Random Uncertainty	Fixed MU to account for all the unknown, unquantifiable, etc. uncertainties	0.25	0.25	Normal	2	1	0.13	0.13
11	Frequency Response	Average path loss corrected	0	0	Rectangular	1.7	1	0.00	0.00
Stage 1: Calibration measurement, network analyzer method									

12	Uncertainty of network analyzer	From datasheet of VNA with assessed transmission coefficients	[0.2]	[0.5]	Normal	2	1	[0.10]	[0.25]
13	Mismatch of receiver chain	Taken into account in VNA uncertainty term	0	0	U-shaped	1.4	1	0.00	0.00
14	Insertion loss of receiver chain	Systematic with Stage 2 (=> cancels)	0	0	Rectangular	1.7	1	0.00	0.00
15	Mismatch in the connection of calibration antenna	Taken in to account in VNA setup uncertainty	0	0	U-shaped	1.4	1	0.00	0.00
16	Influence of the calibration antenna feed cable	Gain calibration with a dipole	0.3	0.3	Rectangular	1.7	1	0.17	0.17
17	Influence of the measurement antenna cable	Systematic with Stage 2 (=> cancels)	0	0	Rectangular	1.7	1	0.00	0.00
18	Uncertainty of the absolute gain/ radiation efficiency of the calibration antenna	Calibration report with traceability to a National Metrology Institute	[0.58]	[0.58]	Normal	2	1	[0.29]	[0.29]
19	Measurement distance	Dipole: aligned with phase center	0	0	Rectangular	1.7	1	0.00	0.00
20	Quality of the Quiet Zone	Peak-to-null ripple	0.5	0.5	Rectangular	1.7	1	0.29	0.29
Combined standard uncertainty [dB]								[0.84]	[0.89]
Expanded uncertainty [dB] (Confidence interval of 95 %)								[1.64]	[1.75]
21	Systematic Error related to TRP grids	mean error	0	0	Actual	1	1	0.00	0.00
Total Expanded uncertainty [dB] (Confidence interval of 95 %)								[1.64]	[1.75]

Table A.4.2-2 Preliminary example of uncertainty budget for TRP Beside Head and Hand (Talk mode) measurement for anechoic chamber method for NR FR1 bands

UID	Uncertainty Source	Comment	Uncertainty Value [dB]		Prob Distr	Div	ci	Standard Uncertainty [dB]	
			Below 3GHz	Above 3GHz				Below 3GHz	Above 3GHz
Stage 2: DUT measurement									
1	Mismatch of receiver chain	$\Gamma_{\text{receiver}} < 0.33$ $\Gamma_{\text{measurement antenna}} < 0.5$ Cable attenuation > 3dB	0.26	0.26	U-shaped	1.4	1	0.18	0.18
2	Insertion loss of receiver chain	Systematic with Stage 1 (=> cancels)	0	0	Rectangular	1.7	1	0.00	0.00
3	Influence of the measurement antenna cable	Systematic with Stage 1 (=> cancels)	0	0	Rectangular	1.7	1	0.00	0.00
4	Measurement Receiver: uncertainty of the absolute level	Spectrum Analyzer	0.42	0.54	Normal	2	1	0.21	0.27
5	Measurement distance	d=1.6m, $\Delta d=0.05\text{m}$	0.27	0.27	Rectangular	1.7	1	0.16	0.16
6	Quality of quiet zone	Surface standard deviation of power measurements in ripple test	0.5	0.5	Actual	1	1	0.50	0.50
7	DUT Tx-power drift	Drift	0.2	0.2	Rectangular	1.7	1	0.12	0.12
8	Uncertainty related to the use of phantoms	Material Dielectric Constant, Material Conductivity, Geometry/Shape (incl. spacer), Beside Head and Hand	0.99	0.99	Rectangular	1.7	1	0.57	0.57
9	Coarse sampling grid	Sampling grids per Table Table B.2.12-1	0	0.11	Actual	1	1	0.00	0.11
10	Random Uncertainty	Fixed MU to account for all the unknown, unquantifiable, etc. uncertainties	0.25	0.25	Normal	2	1	0.13	0.13
11	Frequency Response	Average path loss corrected	0	0	Rectangular	1.7	1	0.00	0.00
Stage 1: Calibration measurement, network analyzer method									
12	Uncertainty of network analyzer	From datasheet of VNA with assessed transmission coefficients	[0.2]	[0.5]	Normal	2	1	[0.10]	[0.25]
13	Mismatch of receiver chain	Taken into account in VNA uncertainty term	0	0	U-shaped	1.4	1	0.00	0.00
14	Insertion loss of receiver chain	Systematic with Stage 2 (=> cancels)	0	0	Rectangular	1.7	1	0.00	0.00
15	Mismatch in the connection of calibration antenna	Taken in to account in VNA setup uncertainty	0	0	U-shaped	1.4	1	0.00	0.00
16	Influence of the calibration antenna feed cable	Gain calibration with a dipole	0.3	0.3	Rectangular	1.7	1	0.17	0.17
17	Influence of the measurement antenna cable	Systematic with Stage 2 (=> cancels)	0	0	Rectangular	1.7	1	0.00	0.00

18	Uncertainty of the absolute gain/radiation efficiency of the calibration antenna	Calibration report with traceability to a National Metrology Institute	[0.58]	[0.58]	Normal	2	1	[0.29]	[0.29]
19	Measurement distance	Dipole: aligned with phase center	0	0	Rectangular	1.7	1	0.00	0.00
20	Quality of the Quiet Zone	Peak-to-null ripple	0.5	0.5	Rectangular	1.7	1	0.29	0.29
Combined standard uncertainty [dB]								[0.96]	[1.00]
Expanded uncertainty [dB] (Confidence interval of 95 %)								[1.87]	[1.97]
21	Systematic Error related to TRP grids	mean error	0	0	Actual	1	1	0.00	0.00
Total Expanded uncertainty [dB] (Confidence interval of 95 %)								[1.87]	[1.97]

The uncertainty contributions related to TRS are described in Annex B in [2]. T preliminary example uncertainty budget TRS test cases using Anechoic Chamber test system is presented in Table A.4.2-3 for Browsing mode and Table A.4.2-4 for Talk mode, respectively.

Table A.4.2-3: Preliminary example of uncertainty budget for TRS hand only (browsing mode) measurement for anechoic chamber method for NR FR1 bands

UID	Uncertainty Source	Comment	Uncertainty Value [dB]		Prob Distr	Div	ci	Standard Uncertainty [dB]	
			Below 3GHz	Above 3GHz				Below 3GHz	Above 3GHz
Stage 2: DUT measurement									
1	Mismatch of receiver chain	$\Gamma_{\text{comm tester}} < 0.29$ $\Gamma_{\text{measurement antenna}} < 0.5$ Cable attenuation > 3dB	0.22	0.22	U-shaped	1.4	1	0.16	0.16
2	Insertion loss of receiver chain	Systematic with Stage 1 (=> cancels)	0	0	Rectangular	1.7	1	0.00	0.00
3	Influence of the measurement antenna cable	Systematic with Stage 1 (=> cancels)	0	0	Rectangular	1.7	1	0.00	0.00
4	Communication Tester: uncertainty of the absolute output level	Manufacturer's data sheet	[1.16]	[1.16]	Normal	2	1	[0.58]	[0.58]
5	Sensitivity measurement: output level step resolution	Systematic error that can be corrected	0	0	Rectangular	1.73	1	0.00	0.00
6	Measurement distance	DUT is not offset for hand-only phantom testing	0	0	Rectangular	1.7	1	0.00	0.00
7	Quality of quiet zone	Surface standard deviation of power measurements in ripple test	0.5	0.5	Actual	1	1	0.50	0.50
8	DUT sensitivity drift	Drift	0.2	0.2	Rectangular	1.7	1	0.12	0.12
9	Uncertainty related to the use of phantoms	Material Dielectric Constant, Material Conductivity, Geometry/Shape (incl. spacer), Data Mode Fixture	0.64	0.64	Rectangular	1.7	1	0.37	0.37
10	Coarse sampling grid	Sampling grids per Table Table B.2.12-1	0.04	0.25	Actual	1	1	0.04	0.25
11	Random Uncertainty	Fixed MU to account for all the unknown, unquantifiable, etc. uncertainties including digital error rate	0.4	0.4	Normal	2	1	0.20	0.20
12	Frequency Response	Included in the output level step resolution	0	0	Rectangular	1.7	1	0.00	0.00
Stage 1: Calibration measurement, network analyzer method									
13	Uncertainty of network analyzer	From datasheet of VNA with assessed transmission coefficients	[0.2]	[0.5]	Normal	2	1	[0.10]	[0.25]
14	Mismatch of receiver chain	Taken into account in VNA uncertainty term	0	0	U-shaped	1.4	1	0.00	0.00
15	Insertion loss of receiver chain	Systematic with Stage 2 (=> cancels)	0	0	Rectangular	1.7	1	0.00	0.00
16	Mismatch in the connection of calibration antenna	Taken in to account in VNA setup uncertainty	0	0	U-shaped	1.4	1	0.00	0.00

17	Influence of the calibration antenna feed cable	Gain calibration with a dipole	0.3	0.3	Rectangular	1.7	1	0.17	0.17
18	Influence of the measurement antenna cable	Systematic with Stage 2 (=> cancels)	0	0	Rectangular	1.7	1	0.00	0.00
19	Uncertainty of the absolute gain/ radiation efficiency of the calibration antenna	Calibration report with traceability to a National Metrology Institute	[0.58]	[0.58]	Normal	2	1	[0.29]	[0.29]
20	Measurement distance	Dipole: aligned with phase center	0	0	Rectangular	1.7	1	0.00	0.00
21	Quality of the Quiet Zone	Peak-to-null ripple	0.5	0.5	Rectangular	1.7	1	0.29	0.29
Combined standard uncertainty [dB]								[1.00]	[1.06]
Expanded uncertainty [dB] (Confidence interval of 95 %)								[1.97]	[2.08]
22	Systematic Error related to TRP grids	mean error	0	0	Actual	1	1	0.00	0.08
Total Expanded uncertainty [dB] (Confidence interval of 95 %)								[1.97]	[2.16]

Table A.4.2-4: Preliminary example of uncertainty budget for TRS Beside Head and Hand (Talk mode) measurement for anechoic chamber method for NR FR1 bands

UID	Uncertainty Source	Comment	Uncertainty Value [dB]		Prob Distr	Div	ci	Standard Uncertainty [dB]	
			Below 3GHz	Above 3GHz				Below 3GHz	Above 3GHz
Stage 2: DUT measurement									
1	Mismatch of receiver chain	$\Gamma_{\text{comm tester}} < 0.29$ $\Gamma_{\text{measurement antenna}} < 0.5$ Cable attenuation > 3dB	0.22	0.22	U-shaped	1.4	1	0.16	0.16
2	Insertion loss of receiver chain	Systematic with Stage 1 (=> cancels)	0	0	Rectangular	1.7	1	0.00	0.00
3	Influence of the measurement antenna cable	Systematic with Stage 1 (=> cancels)	0	0	Rectangular	1.7	1	0.00	0.00
4	Communication Tester: uncertainty of the absolute output level	Manufacturer's data sheet	[1.16]	[1.16]	Normal	2	1	[0.58]	[0.58]
5	Sensitivity measurement: output level step resolution	Systematic error that can be corrected	0	0	Rectangular	1.73	1	0.00	0.00
6	Measurement distance	d=1.6m, $\Delta d=0.05\text{m}$	0.27	0.27	Rectangular	1.7	1	0.16	0.16
7	Quality of quiet zone	Surface standard deviation of power measurements in ripple test	0.5	0.5	Actual	1	1	0.50	0.50
8	DUT sensitivity drift	Drift	0.2	0.2	Rectangular	1.7	1	0.12	0.12
9	Uncertainty related to the use of phantoms	Material Dielectric Constant, Material Conductivity, Geometry/Shape (incl. spacer), Data Mode Fixture	0.99	0.99	Rectangular	1.7	1	0.57	0.57
10	Coarse sampling grid	Sampling grids per Table Table B.2.12-1	0.04	0.25	Actual	1	1	0.04	0.25
11	Random Uncertainty	Fixed MU to account for all the unknown, unquantifiable, etc. uncertainties including digital error rate	0.4	0.4	Normal	2	1	0.20	0.20
12	Frequency Response	Included in the output level step resolution	0	0	Rectangular	1.7	1	0.00	0.00
Stage 1: Calibration measurement, network analyzer method									
13	Uncertainty of network analyzer	From datasheet of VNA with assessed transmission coefficients	[0.2]	[0.5]	Normal	2	1	[0.10]	[0.25]
14	Mismatch of receiver chain	Taken into account in VNA uncertainty term	0	0	U-shaped	1.4	1	0.00	0.00
15	Insertion loss of receiver chain	Systematic with Stage 2 (=> cancels)	0	0	Rectangular	1.7	1	0.00	0.00
16	Mismatch in the connection of calibration antenna	Taken in to account in VNA setup uncertainty	0	0	U-shaped	1.4	1	0.00	0.00
17	Influence of the calibration antenna feed cable	Gain calibration with a dipole	0.3	0.3	Rectangular	1.7	1	0.17	0.17

18	Influence of the measurement antenna cable	Systematic with Stage 2 (=> cancels)	0	0	Rectangular	1.7	1	0.00	0.00
19	Uncertainty of the absolute gain/radiation efficiency of the calibration antenna	Calibration report with traceability to a National Metrology Institute	[0.58]	[0.58]	Normal	2	1	[0.29]	[0.29]
20	Measurement distance	Dipole: aligned with phase center	0	0	Rectangular	1.7	1	0.00	0.00
21	Quality of the Quiet Zone	Peak-to-null ripple	0.5	0.5	Rectangular	1.7	1	0.29	0.29
Combined standard uncertainty [dB]								[1.11]	[1.16]
Expanded uncertainty [dB] (Confidence interval of 95 %)								[2.17]	[2.27]
22	Systematic Error related to TRP grids	mean error	0	0	Actual	1	1	0.00	0.08
Total Expanded uncertainty [dB] (Confidence interval of 95 %)								[2.17]	[2.35]

Annex B (normative): Phantoms definition and Positioning

B.1 General

This Clause defines the phantom definition and positioning guidance for TRP TRS requirement measurement.

B.2 Phantom Definition

B.2.1 Head Phantom

The basic head phantom is based on the “SAM” head phantom in IEEE Std 1528-2003, which is also described in TS 37.544 Annex A.2 [8]. For TRP TRS test, the IEEE SAM head model has been extended to the neck region, which is specified in CTIA Certification OTA Test Plan 01.72 [10].

The Head phantom defined in CTIA Certification OTA Test Plan 01.72, section 2.1 [10], is used for FR1 TRP TRS requirement testing.

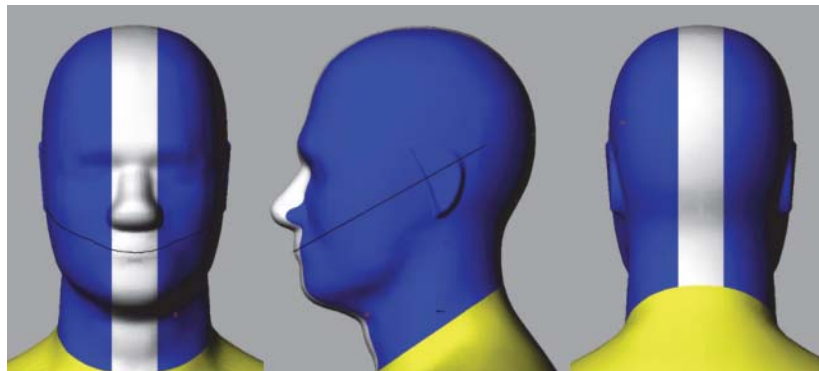

Figure B.2.1-1 Head Phantom (© 2001 – 2022 CTIA Certification. Reproduced with permission.), defined in the CTIA Certification OTA Test Plan

B.2.2 PDA Grip Hand Phantom

The PDA Grip Hand described in TS 37.544 Annex A.2.2 [8], which is identical to that defined in CTIA Certification OTA Test Plan 01.72, section 2.2.12 [10], is adopted for TRP TRS testing for the UE with width $\geq 56\text{mm}$ and $\leq 72\text{mm}$.

B.2.3 Wide Grip Hand Phantom

The Wide Grip hand defined in CTIA Certification OTA Test Plan 01.72, section 2.2.13 [10], is used for FR1 TRP TRS testing for UE with width $>72\text{mm}$ and $\leq 92\text{mm}$.



Figure B.2.3-1 Wide Grip hand (© 2001 – 2022 CTIA Certification. Reproduced with permission.), defined in the CTIA Certification OTA Test Plan

B.2.4 Forearm Phantom

The Forearm phantom defined in CTIA Certification OTA Test Plan 01.72 section 2.3 [10], is used for FR1 TRP TRS testing for wrist-worn RedCap UE in this technical report.

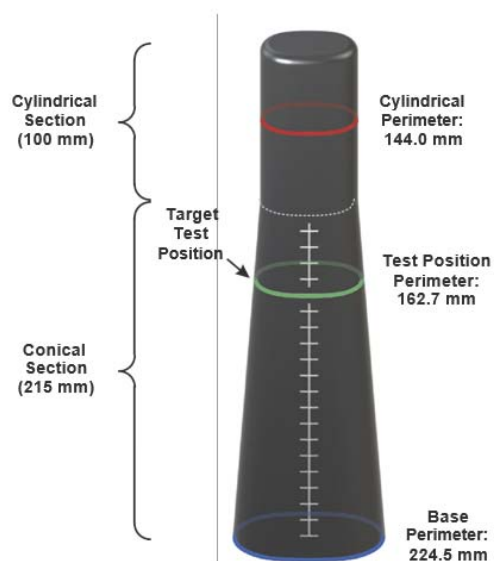

Figure B.2.4-1: Forearm Phantom with Target Test Position (© 2001 – 2022 CTIA Certification. Reproduced with permission.), defined in the CTIA Certification OTA Test Plan

B.3 UE positioning guidelines

B.3.1 Hand phantom only (Browsing mode)

The positioning specified in this clause is used for the test cases for Browsing Mode with Hand Phantom. The characteristics of the Hand Phantom are specified in Clause B.3.1. Browsing mode is used to simulate user cases where the DUT is held in hand, but not pressed against ear e.g. web browsing and navigation. The DUT should be set as

primary mechanical mode for browsing mode scenario, which is declared by manufacturer if the UE support multiple mechanical modes. Then, the DUT shall be mounted in a suitable hand phantom and oriented such that the DUT's main display is tilted 45 degrees from vertical:

- Wide Grip Hand for UE with Width $>72\text{mm}$ and $\leq 92\text{mm}$
- PDA Grip Hand for UE with Width $\geq 56\text{mm}$ and $\leq 72\text{mm}$

Note: the width is the UE width under primary mechanical mode for Browsing mode scenario.

B.3.1.1 Wide Grip Hand

This positioning guideline is suitable for DUTs with width $>72\text{mm}$ and $\leq 92\text{mm}$.

The positioning guideline for mounting a DUT in the Wide Grip Hand Phantom defined in CTIA Certification OTA Test Plan 01.71 section 2.2.7 [9], is used for FR1 TRP TRS testing for UE with width $>72\text{mm}$ and $\leq 92\text{mm}$.

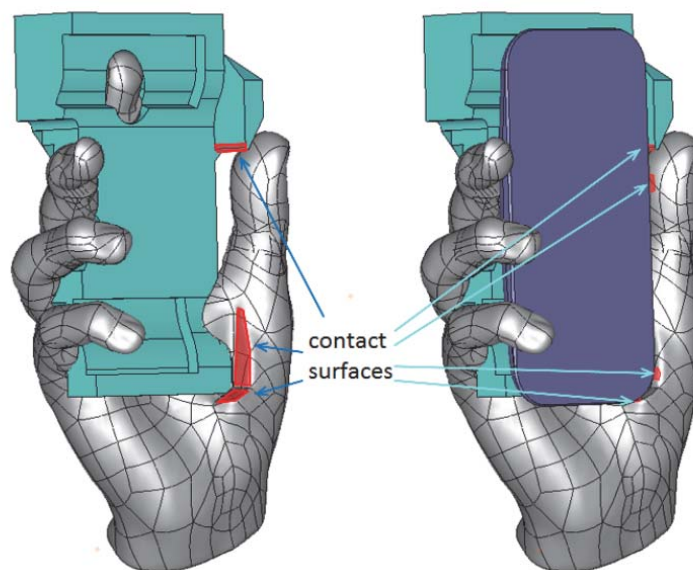

Figure B.3.1.1-1: Positioning guidance for Wide Grip Hand (© 2001 – 2022 CTIA Certification. Reproduced with permission.), defined in the CTIA Certification OTA Test Plan

B.3.1.2 PDA Grip Hand

This clause defines the positioning guideline for mounting a DUT in the PDA Grip Hand Phantom. This positioning guideline is suitable for DUTs with width $\geq 56\text{mm}$ and $\leq 72\text{mm}$.

To help achieve a consistent positioning, the DUT is aligned to a PDA palm spacer. No alignment tool is required. The PDA spacer features side and bottom walls to ensure consistent alignment of DUTs of various sizes.

1. Place the DUT on the PDA spacer between the fingers and align the DUT to the side wall of the PDA.
2. If the DUT is shorter than 135 mm, then align the top of the DUT with the top of the PDA spacer. Otherwise, align the bottom of the DUT with the bottom wall of the PDA spacer.



Figure 6.2.2-1: Right-handed PDA Grip hand phantom with a spacer

NOTE: Use left-handed (mirror-imaged) spacers with left-handed phantoms.

B.3.2 Head and Hand phantom (Talk Mode)

B.3.2.1 General

The positioning specified in this clause is used for the test cases for Talk Mode using Head & Hand Phantom. The characteristics of the Hand Phantom and Head Phantom are specified in Clause B.2.

Talk mode is used to simulate user cases where the DUT is placed into a hand phantom, which is holding the DUT against the SAM head phantom, presenting a realistic voice call operation of the DUT. The DUT should be set as primary mechanical mode for talk mode scenario, which is declared by manufacturer if the UE support multiple mechanical modes. Same as Browsing mode, the DUT for talk mode shall also be mounted in a suitable hand phantom:

- Wide Grip Hand for UE with Width $>72\text{mm}$ and $\leq 92\text{mm}$
- PDA Grip Hand for UE with Width $\geq 56\text{mm}$ and $\leq 72\text{mm}$

Note: the width is the UE width under primary mechanical mode for talk mode scenario.

In this section, the procedure provides the guideline on how to place the DUT+hand against the head phantom. The detailed DUT positioning into hand phantom for talk mode is defined in Clause B.3.1.

For talk mode, the DUT is attached to the head phantom in “cheek” position. The DUT performance is measured on both left and right side of the head. Three points as shown in Figure B.3.2.1-1 define the reference plane: centre of the right ear piece (RE), centre of the left ear piece (LE) and centre of mouth (M).

Definition of the ‘Cheek’ position:

1. Align the ear piece of the phone (see Figure B.3.2.1-1) at the line RE-LE. Then, position the DUT beside the phantom so that the vertical line (see Figure B.3.2.1-3) is parallel to the reference plane in Figure B.3.2.1-2 and is aligned with the line M-RE on the reference plane (see Figure B.3.2.1-3).
2. Position the DUT so that the ear piece of the DUT touches the ear piece of the phantom head on the line RE-LE. Tilt the DUT chassis towards the cheek of the phantom having the vertical line aligned with the reference plane until any point on the front side of the DUT is in contact with the cheek or until the contact with the ear is lost.

NOTE: A holder fixture made of e.g. plastic may be used to position the handset against the phantom.

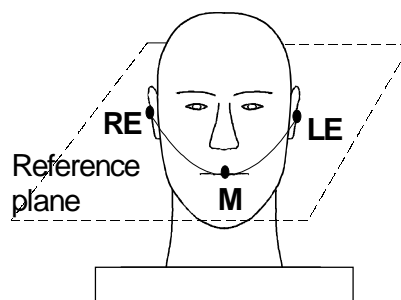

Figure B.3.2.1-1: Reference plane on head phantom, front view

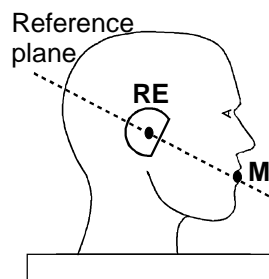

Figure B.3.2.1-2: Reference plane on head phantom, side view

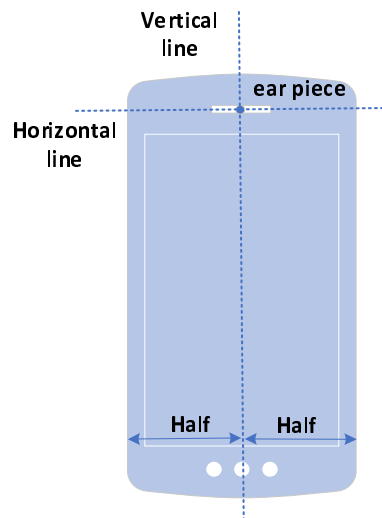

Figure B.3.2.1-3: Reference lines at a mobile handset.

In addition, 6° tilt angle from the cheek is being used instead of having direct contact between the cheek and DUT. A mask may be used to help configuration of cheek + 6° tilt angle. The mask is a 32 mm wide conformal strip, created by sweeping the surface of the head phantom through a 6° rotation about the ear. Direct DUT contact against the mask thus establishes the required 6° spacing away from the cheek, regardless of DUT form factor. The material for the head phantom mask spacer shall have dielectric constant of less than 1.3 and a loss tangent of less than 0.003. Material additions can be used to help fixing of the mask spacer onto the head phantom.

In summary, for head + hand phantom, keeping the DUT in the hand phantom in the position defined in clause B.3.1, while place the DUT and the hand phantom against the head phantom in such way that the DUT is in 6° tilt angle as described above.

B.3.2.2 Wide Grip Hand and Head

This procedure is suitable for talk mode use with DUTs of width $>72\text{mm}$ and $\leq 92\text{mm}$. The positioning of the DUT in the Wide Grip hand for talk mode is identical to that for browsing mode described in Clause B.3.1.1.

B.3.2.1 PDA Grip Hand and Head

This procedure is suitable for talk mode use with DUTs of width $\geq 56\text{mm}$ and $\leq 72\text{mm}$. The positioning of the DUT in the PDA Grip hand for talk mode is identical to that for browsing mode described in Clause B.3.1.2.

B.3.3 Forearm phantom (Wrist-worn Mode)

B.3.2.1 General

The positioning specified in this clause is used for the test cases for Wrist-worn Mode using Forearm Phantom. The characteristics of the Forearm phantom is specified in Clause B.2.4.

Talk mode is used to simulate user cases where the DUT is placed in Forearm phantom. The DUT should be set as primary mechanical mode for browsing mode scenario, which is declared by manufacturer if the UE support multiple mechanical modes.

B.3.2.2 Forearm phantom positioning in the chamber

The Forearm Phantom shall be mounted in the chamber coordinate system as shown in Figure B.3.2.2-1.

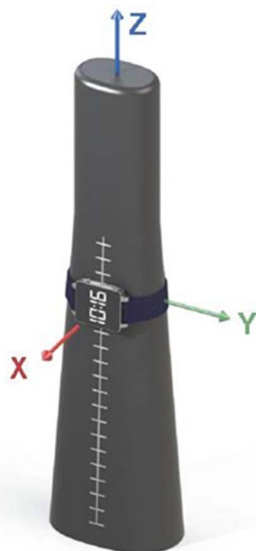

Figure B.3.2.2-1: Positioning guidance for Forearm Phantom in the chamber (© 2001 – 2022 CTIA Certification. Reproduced with permission.), defined in the CTIA Certification OTA Test Plan

B.3.2.3 Wrist-Worn RedCap Device mounted on the Forearm Phantom

This clause defines the positioning guideline for wrist-worn RedCap devices.

The positioning guideline defined in CTIA Certification OTA Test Plan 01.71, section 2.3 [9], is used for FR1 TRP TRS testing for wrist-worn RedCap devices in this technical specification.

The Wrist-worn Device should be fully aligned under some specific virtual Plane to make sure the Wrist-worn Device is properly mounted on the Forearm Phantom, as shown in B.3.2.3-1. Plane *J* cuts through the surface of the forearm phantom and passes through the target test position and is perpendicular to the *Y*-axis. Plane *J* is the *X-Z* plane. Plane *K* cuts through the forearm phantom at the target test position and is perpendicular to the *Z*-axis. Plane *K* is the *X-Y* plane. Plane *A* and Plane *B* are virtual planes on wrist-worn device. Plane *A* cuts through the center of wrist band and Plane *B* cuts through the center of the display.

Plane *B* shall be fully aligned with Plane *J* when the device is mounted on the forearm phantom.

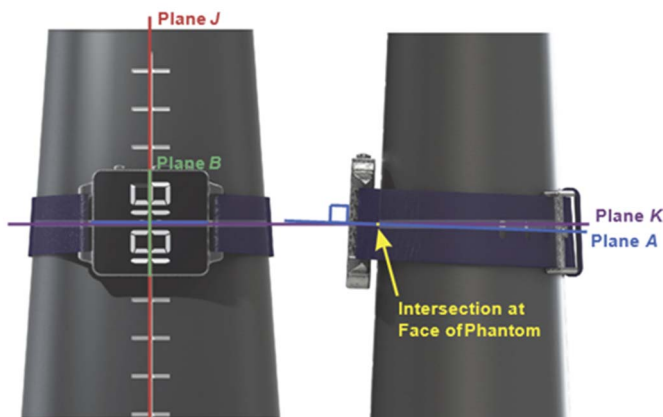

Figure B.3.2.3-1: Positioning guidance for Wrist-Worn Device mounted on the Forearm Phantom (© 2001 – 2022 CTIA Certification. Reproduced with permission.), defined in the CTIA Certification OTA Test Plan

DUTs shall be mounted with sufficiently snug band tightness so as to prevent the DUT from slipping off under the force of gravity when the phantom is inverted.

Similar to handheld UEs, there are also two Orientations for Wrist-worn RedCap Devices representing the Left and Right Wrist, as shown in Figure B.3.2.3-2.



Figure B.3.2.3-2: Left and Right positioning for Wrist-Worn Device on Forearm Phantom (© 2001 – 2022 CTIA Certification. Reproduced with permission.), defined in the CTIA Certification OTA Test Plan

Annex C (normative): Environmental requirements

C.1 General

This normative annex specifies the environmental requirements of the UE. Within these limits the requirements of the present documents shall be fulfilled.

C.2 Environmental

The requirements in this clause apply to all types of UE(s).

C.2.1 Temperature

All the test cases defined in this technical specification should be measured in room temperature e.g. 25°C.

C.2.2 Voltage

All test cases shall be performed with the DUT operated in stand-alone battery powered mode. It is preferable if the UE is fully charged in the beginning of the test.

Annex D (informative): Change history

Change history							
Date	Meeting	TDoc	CR	Rev	Cat	Subject/Comment	New version
2021-11	RAN4#101-e	R4-2120687				Initial Skeleton	0.0.1
2022-01	RAN4#101-bis-e	R4-2200971				R4-2200974 TP to TS 38.161 on requirement applicability	0.1.0
2022-03	RAN4#102-e	R4-2204952				R4-2205174 TP to 38.161 on general aspects R4-2207315 Text proposal on environmental requirements for 38.161 R4-2207323 TP to 38.161 on TRP aspects R4-2207316 TP to TS 38.161 on frequency bands R4-2207322 TP to TS 38.161 on Annex A: Test methodology	0.2.0
2022-05	RAN4#103-e	R4-2208626				R4-2208481 TP to TS 38.161 on primary mechanical mode R4-2210939 TP to 38.161 on EN-DC and PC2 test case applicability rules R4-2210940 TP to 38.161 on TRP aspects R4-2210942 TP to TS 38.161 on test method R4-2210944 TP to TS 38.161 on Phantoms	0.3.0
2022-08	RAN4#104-e	R4-2212810				R4-2214795 TP to TS 38.161 on general aspects R4-2214796 TP to TS 38.161 on TRP TRS requirements	0.4.0
2022-09	RAN#97-e	RP-222321				For one-step approval in RAN Plenary	1.0.0
2022-09	RAN#97-e	RP-222608				Editorial update from Rapporteur	1.1.0
2022-09	RAN#97-e					Under change control	17.0.0
2022-12	RAN#98-e	RP-223310	0001		F	CR to TS 38.161 on test parameters	17.1.0
2023-03	RAN#99	RP-230514	0002		F	CR to TS 38.161 on clarification of test parameters	17.2.0
2023-06	RAN#100	RP-231343	0003	1	F	CR to TS 38.161 on EN-DC decision tree	17.3.0
2023-06	RAN#100	RP-231343	0004	1	F	CR to TS 38.161 on measurement grids and editorial correction	17.3.0
2023-12	RAN#102	RP-233365	0007		B	CR to TS 38.161 on New test configurations for Rel-18 TRP TRS	18.0.0

History

Document history		
V18.0.0	May 2024	Publication